

AT9520 Series

Multilayer Chip Antenna

Features

- ❖ Monolithic SMD with small, low-profile and light-weight type.
- ❖ Wide bandwidth

Applications

- ❖ 2.4GHz WLAN, Home RF, Bluetooth Modules, etc.



Specifications

Part Number	Frequency Range (MHz)	Peak Gain (XZ-V)	Average Gain (XZ-V)	VSWR	Impedance
AT9520-B2R4HAA_	2400~2500	3.0 dBi typ.	1.0 dBi typ.	2 max.	50 Ω

Q'ty/Reel (pcs) : 1000pcs
 Operating Temperature Range : -40 ~ +85 °C
 Storage Temperature Range : -40 ~ +85 °C
 Power Capacity : 3W max.

Part Number

AT **9520** - **B** **2R4** **HAA** **□**
 ① ② ③ ④ ⑤ ⑥

① Type	AT : Antenna	② Dimensions (L x W)	9.5x 2.0 mm
③ Material Code	B	④ Frequency Range	2R4=2400MHz
⑤ Specification Code	HAA	⑥ Packaging	T: Tape & Reel B: Bulk

Terminal Configuration

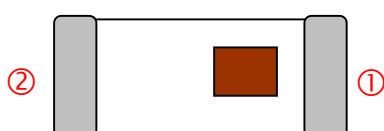

No.	Terminal Name	No.	Terminal Name
①	Feeding Point	②	NC

Dimensions and Recommended PC Board Pattern

Unit : mm

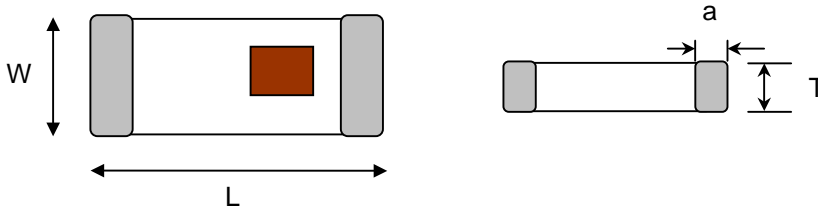

Mark	L	W	T	a
Dimensions	9.5±0.2	2.0±0.2	1.2+ 0.1/-0.2	0.5±0.3

(a) Without Matching Circuits (Moderate Bandwidth)

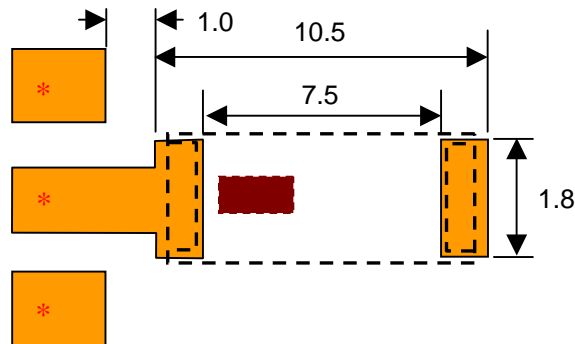

(b) With Matching Circuits (Wide Bandwidth)

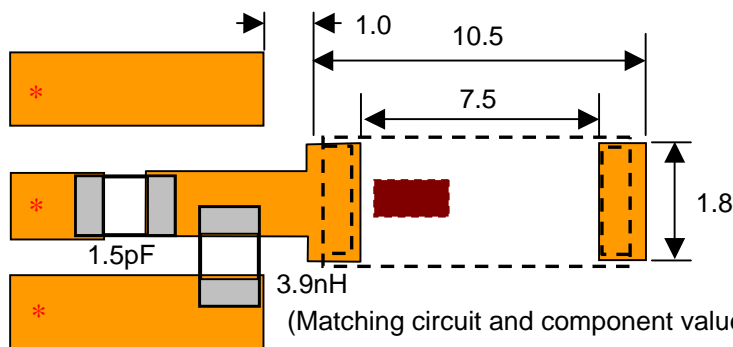

(Matching circuit and component values will be different, depending on PCB layout)

*Line width should be designed to match 50Ω characteristic impedance, depending on PCB material and thickness.

Typical Electrical Characteristics (T=25°C)

❖ Test Board

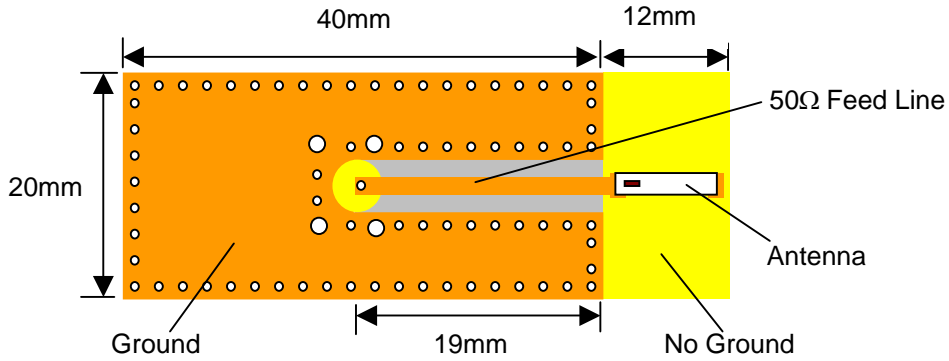

❖ Return Loss

(a) Without Matching Circuits

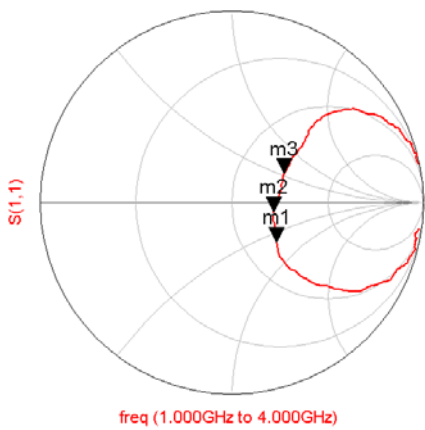
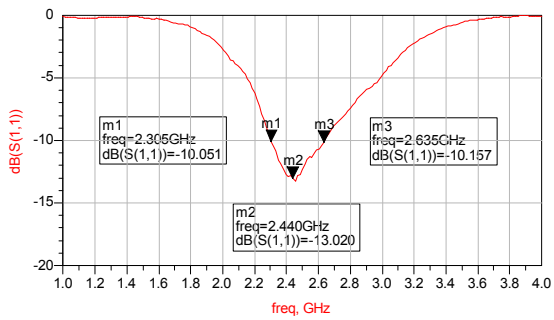

(b) With Matching Circuits

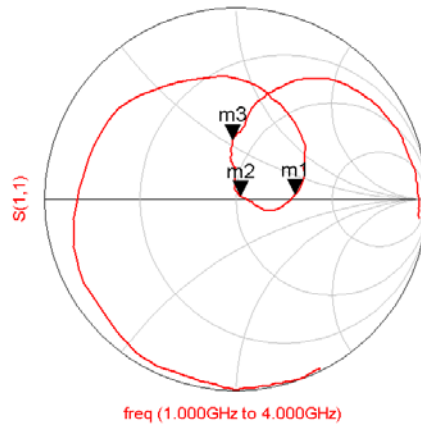
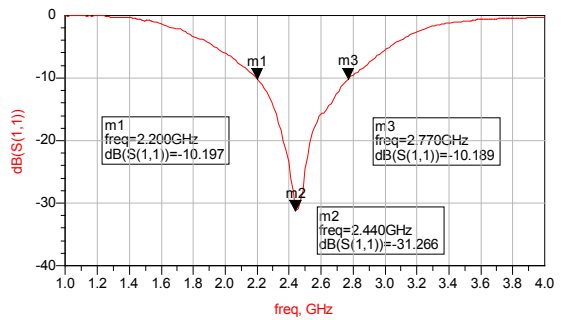

❖ Radiation Patterns

XY-V/XY-H

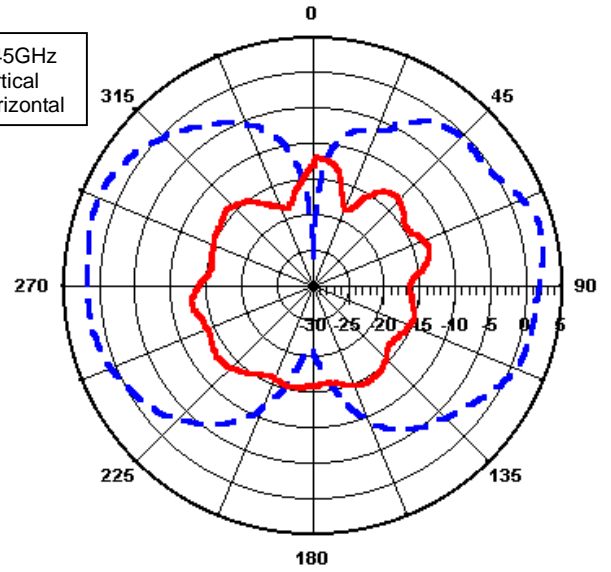
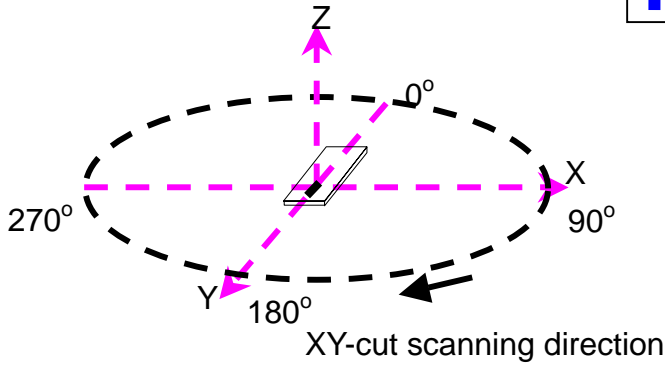

XZ-V/XZ-H

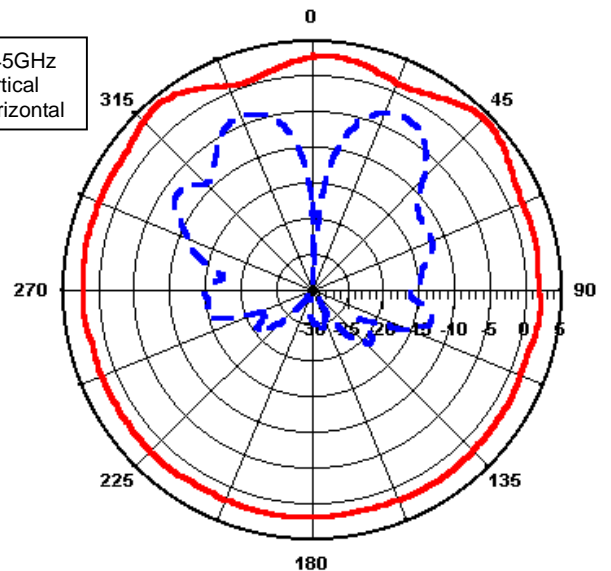
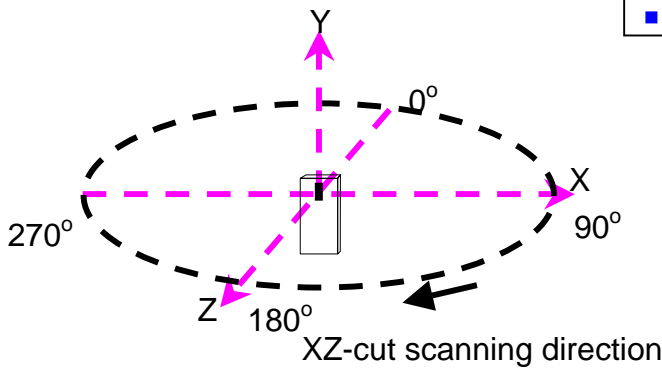

YZ-V/YZ-H

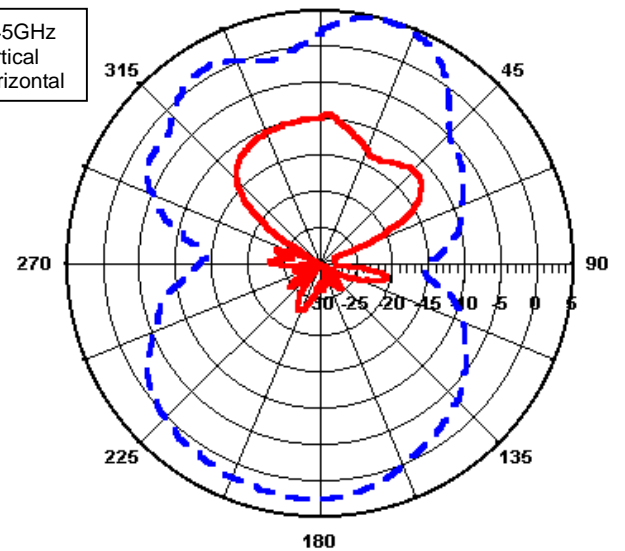
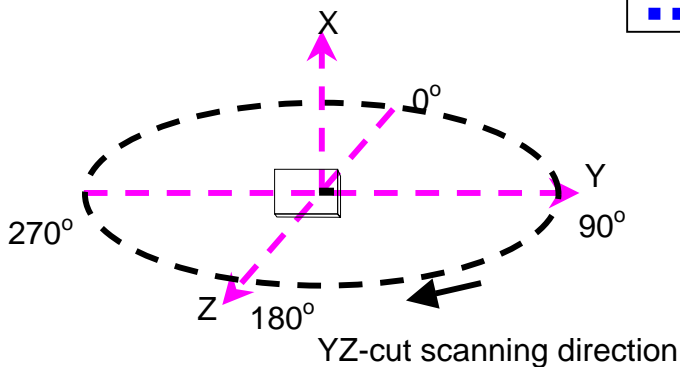

Advanced Ceramic X Corp.

16 Tzu Chiang Road, Hsinchu Industrial District Hsinchu Hsien 303, Taiwan

TEL:886-3-5987008 FAX:886-3-5987001

E-mail: acx@acxc.com.tw <http://www.acxc.com.tw>