

Test of AP0127730, AP0134760

To: FCC 47 CFR Part 15.407 & IC RSS-210

Test Report Serial No.: RDWN12-U2 Rev B



TEST REPORT

FROM



Test of AP0127730, AP0134760

to

To FCC 47 CFR Part 15.407 & IC RSS-210

Test Report Serial No.: RDWN12-U2 Rev B

This report supersedes None

Applicant: RADWIN Ltd
27 Habarzel Street
Tel Aviv, 69710
Israel

Product Function: 5 GHz 2x2 MIMO RF Module

Copy No: pdf Issue Date: 18th January 2013

This Test Report is Issued Under the Authority of:

MiCOM Labs, Inc.
440 Boulder Court, Suite 200
Pleasanton, CA 94566 USA
Phone: +1 (925) 462-0304
Fax: +1 (925) 462-0306
www.micomlabs.com



TEST CERTIFICATE #2381.01

MiCOM Labs is an ISO 17025 Accredited Testing Laboratory



Title: AP0127730, AP0134760
To: FCC 47 CFR Part 15.407 & IC RSS-210
Serial #: RDWN12-U2 Rev B
Issue Date: 18th January 2013
Page: 3 of 272

This page has been left intentionally blank

This test report may be reproduced in full only. The document may only be updated by MiCOM Labs personnel. Any changes will be noted in the Document History section of the report.



TABLE OF CONTENTS

ACCREDITATION, LISTINGS & RECOGNITION	5
TESTING ACCREDITATION	5
RECOGNITION.....	6
PRODUCT CERTIFICATION.....	7
1. TEST RESULT CERTIFICATE	9
2. REFERENCES AND MEASUREMENT UNCERTAINTY.....	10
2.1. Normative References	10
2.2. Test and Uncertainty Procedures	11
3. PRODUCT DETAILS AND TEST CONFIGURATIONS	12
3.1. Technical Details	12
3.2. Scope of Test Program.....	13
3.3. Equipment Model(s) and Serial Number(s).....	17
3.4. Antenna Details	18
3.5. Cabling and I/O Ports.....	19
3.6. Test Configurations.....	19
3.7. Equipment Modifications.....	20
3.8. Deviations from the Test Standard	20
3.9. Subcontracted Testing or Third Party Data.....	20
4. TESTING EQUIPMENT CONFIGURATION(S)	21
4.1. Conducted RF Emission Test Set-up.....	21
4.2. Radiated Spurious Emission Test Set-up > 1 GHz.....	22
4.3. Digital Emissions Test Set-up (0.03 – 1 GHz)	23
4.4. ac Wireline Emission Test Set-up.....	24
5. TEST SUMMARY	25
6. TEST RESULTS.....	27
6.1. Device Characteristics	27
6.1.1. <i>Conducted Testing</i>	27
6.1.2. <i>Radiated Emission Testing</i>	87
6.1.3. <i>Receiver Radiated Spurious Emissions (above 1 GHz)</i>	147
6.1.4. <i>Digital Emissions (30M-1 GHz)</i>	154
6.1.5. <i>AC Wireline Conducted Emissions (150 kHz – 30 MHz)</i>	157
7. PHOTOGRAPHS.....	159
7.1. Conducted Test Setup	159
7.2. Test Setup - Digital Emissions below 1 GHz	160
7.3. Radiated Emissions Test Setup >1 GHz	161
8. TEST EQUIPMENT DETAILS	162
APPENDIX.....	163
A. SUPPORTING INFORMATION.....	163
A.1. CONDUCTED TEST PLOTS	163
A.1.1. <i>26 dB & 99% Bandwidth</i>	164
A.1.2. <i>Peak Power Spectral Density</i>	200
A.1.3. <i>Peak Excursion Ratio</i>	236

This test report may be reproduced in full only. The document may only be updated by MiCOM Labs personnel. Any changes will be noted in the Document History section of the report.

ACCREDITATION, LISTINGS & RECOGNITION

TESTING ACCREDITATION

MiCOM Labs, Inc. is an accredited Electrical testing laboratory per the international standard EN ISO/IEC 17025. The company is accredited by the American Association for Laboratory Accreditation (A2LA) www.a2la.org test laboratory number 2381.01. MiCOM Labs test schedule is available at the following URL; <http://www.a2la.org/scopepdf/2381-01.pdf>



This test report may be reproduced in full only. The document may only be updated by MiCOM Labs personnel. Any changes will be noted in the Document History section of the report.



RECOGNITION

MiCOM Labs, Inc has widely recognized Electrical testing capabilities. Our international recognition includes Conformity Assessment Body designation by APEC MRA** countries. Our test reports are widely accepted for global type approvals.

Country	Recognition Body	Status	Phase	Identification No.
USA	Federal Communications Commission (FCC)	TCB	-	US0159 Listing #: 102167
Canada	Industry Canada (IC)	FCB	APEC MRA 2	US0159 Listing #: 4143A-2
Japan	MIC (Ministry of Internal Affairs and Communication)	CAB	APEC MRA 2	RCB 210
	VCCI	--	--	A-0012
Europe	European Commission	NB	EU MRA	NB 2280
Australia	Australian Communications and Media Authority (ACMA)	CAB	APEC MRA 1	US0159
Hong Kong	Office of the Telecommunication Authority (OFTA)	CAB	APEC MRA 1	
Korea	Ministry of Information and Communication Radio Research Laboratory (RRL)	CAB	APEC MRA 1	
Singapore	Infocomm Development Authority (IDA)	CAB	APEC MRA 1	
Taiwan	National Communications Commission (NCC) Bureau of Standards, Metrology and Inspection (BSMI)	CAB	APEC MRA 1	
Vietnam	Ministry of Communication (MIC)	CAB	APEC MRA 1	

**APEC MRA – Asia Pacific Economic Community Mutual Recognition Agreement.
Is a recognition agreement under which test lab is accredited to regulatory standards of the APEC member countries.

Phase I - recognition for product testing
Phase II – recognition for both product testing and certification
N/A – Not Applicable

**EU MRA – European Union Mutual Recognition Agreement.
Is a recognition agreement under which test lab is accredited to regulatory standards of the EU member countries.

**NB – Notified Body

This test report may be reproduced in full only. The document may only be updated by MiCOM Labs personnel. Any changes will be noted in the Document History section of the report.

PRODUCT CERTIFICATION

MiCOM Labs, Inc. is an accredited Product Certification Body per the international standard EN ISO/IEC Guide 65. The company is accredited by the American Association for Laboratory Accreditation (A2LA) www.a2la.org test laboratory number 2381.02. MiCOM Labs test schedule is available at the following URL; <http://www.a2la.org/scopepdf/2381-02.pdf>



USA Telecommunication Certification Body (TCB) - TCB Identifier – US0159

Industry Canada Certification Body - CAB Identifier – US0159

European Notified Body - Notified Body Identifier - 2280

Japan – Recognized Certification Body (RCB) - RCB Identifier - 210

This test report may be reproduced in full only. The document may only be updated by MiCOM Labs personnel. Any changes will be noted in the Document History section of the report.



Title: AP0127730, AP0134760
To: FCC 47 CFR Part 15.407 & IC RSS-210
Serial #: RDWN12-U2 Rev B
Issue Date: 18th January 2013
Page: 8 of 272

DOCUMENT HISTORY

Document History		
Revision	Date	Comments
Draft		
Rev A	29th November 2012	Initial release
Rev B	18th January 2013	Removed mention of 40 MHz from all sections of this report

This test report may be reproduced in full only. The document may only be updated by MiCOM Labs personnel. Any changes will be noted in the Document History section of the report.



Title: AP0127730, AP0134760
To: FCC 47 CFR Part 15.407 & IC RSS-210
Serial #: RDWN12-U2 Rev B
Issue Date: 18th January 2013
Page: 9 of 272

1. TEST RESULT CERTIFICATE

Applicant:	RADWIN Ltd 27 Habarzel Street Tel Aviv, 69710 Israel	Tested By:	MiCOM Labs, Inc. 440 Boulder Court Suite 200 Pleasanton California, 94566, USA
EUT:	RF Module operating in the 4.9 – 5.8 GHz bands.	Tel:	+1 925 462 0304
Model:	AP0127730, AP0134760	Fax:	+1 925 462 0306
S/N:	Prototype		
Test Date(s):	10th to 18th September '12	Website:	www.micomlabs.com

STANDARD(S)	TEST RESULTS
FCC 47 CFR Part 15.407 & IC RSS-210	EQUIPMENT COMPLIES

MiCOM Labs, Inc. tested the equipment mentioned in accordance with the requirements set forth in the above standards. Test results indicate that the equipment tested is capable of demonstrating compliance with the requirements as documented within this report.

Notes:

1. This document reports conditions under which testing was conducted and the results of testing performed.
2. Details of test methods used have been recorded and kept on file by the laboratory.
3. Test results apply only to the item(s) tested.

Approved & Released for MiCOM Labs, Inc. by:



TESTING CERTIFICATE #2381.01

Graeme Grieve
Quality Manager MiCOM Labs,

Gordon Hurst
President & CEO MiCOM Labs, Inc.

This test report may be reproduced in full only. The document may only be updated by MiCOM Labs personnel. Any changes will be noted in the Document History section of the report.

2. REFERENCES AND MEASUREMENT UNCERTAINTY

2.1. Normative References

Ref.	Publication	Year	Title
(i)	FCC 47 CFR Part 15.407	2012	Code of Federal Regulations
(ii)	FCC 06-96	June 2006	Memorandum Opinion and Order
(iii)	FCC OET KDB 662911	4 th April 2011	Emissions Testing of Transmitters with Multiple Outputs in the Same Band
(iv)	Industry Canada RSS-210	2010	Low Power License-Exempt Radiocommunication Devices (All Frequency Bands): Category 1 Equipment
(v)	Industry Canada RSS-Gen	2010	General Requirements and Information for the Certification of Radiocommunication Equipment
(vi)	ANSI C63.4	2009	American National Standards for Methods of Measurement of Radio-Noise Emissions from Low-Voltage Electrical and Electronic Equipment in the Range of 9 kHz to 40 GHz
(vii)	CISPR 22/ EN 55022	2008 2006+A1:2007	Limits and Methods of Measurements of Radio Disturbance Characteristics of Information Technology Equipment
(viii)	M 3003	Edition 1 Dec. 1997	Expression of Uncertainty and Confidence in Measurements
(ix)	LAB34	Edition 1 Aug 2002	The expression of uncertainty in EMC Testing
(x)	ETSI TR 100 028	2001	Parts 1 and 2 Electromagnetic compatibility and Radio Spectrum Matters (ERM); Uncertainties in the measurement of mobile radio equipment characteristics
(xi)	A2LA	July 2012	Reference to A2LA Accreditation Status – A2LA Advertising Policy
(xii)	FCC Public Notice – DA 02-2138	2002	Guidelines for Assessing Unlicensed National Information Infrastructure (U-NII) Devices

This test report may be reproduced in full only. The document may only be updated by MiCOM Labs personnel. Any changes will be noted in the Document History section of the report.



Title: AP0127730, AP0134760
To: FCC 47 CFR Part 15.407 & IC RSS-210
Serial #: RDWN12-U2 Rev B
Issue Date: 18th January 2013
Page: 11 of 272

2.2. Test and Uncertainty Procedures

Conducted and radiated emission measurements were conducted in accordance with American National Standards Institute ANSI C63.4, listed in the Normative References section of this report.

Measurement uncertainty figures are calculated in accordance with ETSI TR 100 028 Parts 1 and 2.

Measurement uncertainties stated are based on a standard uncertainty multiplied by a coverage factor $k = 2$, providing a level of confidence of approximately 95 % in accordance with UKAS document M 3003 listed in the Normative References section of this report.

This test report may be reproduced in full only. The document may only be updated by MiCOM Labs personnel. Any changes will be noted in the Document History section of the report.



Title: AP0127730, AP0134760
To: FCC 47 CFR Part 15.407 & IC RSS-210
Serial #: RDWN12-U2 Rev B
Issue Date: 18th January 2013
Page: 12 of 272

3. PRODUCT DETAILS AND TEST CONFIGURATIONS

3.1. Technical Details

Details	Description
Purpose:	Test of the AP0127730, AP0134760 in the frequency ranges 5,250 to 5,350 MHz and 5470 to 5725 MHz to FCC Part 15.407 and Industry Canada RSS-210 regulations.
Applicant:	RADWIN Ltd 27 Habarzel Street Tel Aviv, 69710, Israel
Manufacturer:	As applicant
Laboratory performing the tests:	MiCOM Labs, Inc. 440 Boulder Court, Suite 200 Pleasanton, California 94566 USA
Test report reference number:	RDWN12-U2 Rev B
Date EUT received:	10 th September 2012
Standard(s) applied:	FCC 47 CFR Part 15.407 & IC RSS-210
Dates of test (from - to):	10th to 18th September '12
No of Units Tested:	One
Type of Equipment:	5 GHz 2x2 MIMO RF module.
Applicants Trade Name:	RADWIN
Model(s):	AP0127730, AP0134760
Location for use:	Inside outdoor enclosure
Declared Frequency Range(s):	5,250 to 5,350 MHz and 5470 to 5725 MHz
Hardware Rev	Prototype
Software Rev	Prototype
Type of Modulation:	Per 802.11n – BPSK, QPSK, 16QAM, 64QAM, OFDM
Declared Nominal Output Power: (Average Power)	5 MHz: 18.03 dBm (5250-5350 MHz), 17.24 dBm (5470-5725 MHz) 10 MHz: 19.95 dBm (5250-5350 MHz), 20.03 dBm (5470-5725 MHz) 20 MHz: 23.36 dBm (5250-5350 MHz), 23.06 dBm (5470-5725 MHz)
EUT Modes of Operation:	5, 10, 20 MHz
Transmit/Receive Operation:	Time Division Duplex
System Beam Forming:	AP0127730, AP0134760 has no capability for beam forming
Rated Input Voltage and Current:	POE 55 Vdc 1 A
Operating Temperature Range:	Declared range -35° to +60°C
ITU Emission Designator:	5 MHz 5M00W7W 10 MHz 10M0W7W 20 MHz 20M0W7W
Equipment Dimensions:	1.9" x 2.0" x 0.3" inches
Weight:	0.042 lb (19 g)
Primary function of equipment:	5 GHz 2x2 MIMO RF module

This test report may be reproduced in full only. The document may only be updated by MiCOM Labs personnel. Any changes will be noted in the Document History section of the report.



Title: AP0127730, AP0134760
To: FCC 47 CFR Part 15.407 & IC RSS-210
Serial #: RDWN12-U2 Rev B
Issue Date: 18th January 2013
Page: 13 of 272

3.2. Scope of Test Program

AP0127730, AP0134760 RF Testing

The scope of the test program was to test the AP0127730, AP0134760 5 GHz 2x2 MIMO RF module configurations in the frequency range 5250 to 5350 MHz and 5470 to 5725 MHz for compliance against FCC 47 CFR Part 15.407 and Industry Canada RSS-210 specifications.

FCC OET KDB Implementation

This test program implements the following FCC KDB – 662911 4/4/2011;

Emissions Testing of Transmitters with Multiple Outputs in the Same Band

The KDB document provides guidance for measurements of conducted output emissions of devices that employ a single transmitter with multiple outputs in the same band, with the outputs occupying the same or overlapping frequency ranges. It applies to EMC compliance measurements on devices that transmit on multiple antennas simultaneously in the same or overlapping frequency ranges through a coordinated process. Examples include, but are not limited to, devices employing beam forming or multiple-input and multiple-output (MIMO.) This guidance applies to both licensed and unlicensed devices wherever the FCC rules call for conducted output measurements. Guidance is provided for in-band, out-of-band and spurious emission measurements.

This guidance does not apply to the multiple transmitters included in a composite device, such as a device that combines an 802.11 modem with a cell phone in one enclosure with each driving its own antenna.

This test report may be reproduced in full only. The document may only be updated by MiCOM Labs personnel. Any changes will be noted in the Document History section of the report.

AP0127730, AP0134760



This test report may be reproduced in full only. The document may only be updated by MiCOM Labs personnel. Any changes will be noted in the Document History section of the report.

AP0127730, AP0134760 (Rear)



This test report may be reproduced in full only. The document may only be updated by MiCOM Labs personnel. Any changes will be noted in the Document History section of the report.

AP0127730, AP0134760 Label





Title: AP0127730, AP0134760
To: FCC 47 CFR Part 15.407 & IC RSS-210
Serial #: RDWN12-U2 Rev B
Issue Date: 18th January 2013
Page: 17 of 272

3.3. Equipment Model(s) and Serial Number(s)

Equipment Type	Equipment Description (Including Brand Name)	Mfr	Model No.	Serial No.
EUT	RF module operating in the 4.9-5.8 GHz bands	RADWIN Ltd	AP0127730, AP0134760	None
Support	Laptop PC	DELL	LATITUDE D530	None

This test report may be reproduced in full only. The document may only be updated by MiCOM Labs personnel. Any changes will be noted in the Document History section of the report.

3.4. Antenna Details

Radiated emissions testing were performed in the mode with the highest spectral density to verify compliance. Radiated emissions were performed on the highest gain of each type of antenna as identified in the table below;-

Radiated Emission Results (Antenna #)	Antenna Type	Manufacturer	Model Number	Antenna Gain (dBi)	
				5250-5350 MHz	5470-5725 MHz
1	Sector Dual Pole Integrated 120 Deg	RADWIN Ltd.	MT0128930	11	11
	Sector Dual Pole 120 Deg	RADWIN Ltd.	RW-9061-5004	11	11
2	Sector Dual Pole Integrated 95 Deg	RADWIN Ltd.	AM0135060	12	12
	Sector Dual Pole 90 Deg	RADWIN Ltd.	RW-9061-5001	14	14
3	Sector Dual Pole 60 Deg	RADWIN Ltd.	RW-9061-5002	15.5	16.5
	Sector Dual Pole Integrated 90 Deg	RADWIN Ltd.	MT0125250	13	13
	Flat Panel Dual Pole Integrated	RADWIN Ltd.	AM0119960	16	16
4	Flat Panel Dual Pole Integrated	RADWIN Ltd.	AM0111760	16	16.5
	Flat Panel Dual Pole External	RADWIN Ltd.	RW-9612-5001	23	23
5	Flat Panel Dual Pole Integrated	RADWIN Ltd.	MT0070760	23.5	23.5
6	Flat Panel Dual Pole External	RADWIN Ltd.	RW-9622-5001	29	29
	Dual Pole Dish	RADWIN Ltd.	RW-9721-5158	28	29
7	Dual Pole Dish	RADWIN Ltd.	RW-9732-4958	32	32

This test report may be reproduced in full only. The document may only be updated by MiCOM Labs personnel. Any changes will be noted in the Document History section of the report.



3.5. Cabling and I/O Ports

Number and type of I/O ports

1. 1 x 10/100/1000 Ethernet (includes POE +55 Vdc)

3.6. Test Configurations

Testing was performed to determine the highest power level versus bit rate. The variant with the highest power was used to exercise the product.

Matrix of test configurations

Channel Bandwidth	Data Rates with Highest Power	Frequencies (MHz)
5 MHz	15 MCS	5255 / 5300 / 5345
10 MHz	15 MCS	5260 / 5300 / 5340
20 MHz	15 MCS	5265 / 5300 / 5335
5 MHz	15 MCS	5475 / 5595 / 5720
10 MHz	15 MCS	5475 / 5595 / 5720
20 MHz	15 MCS	5480 / 5590 / 5715

Antenna Test Configurations for Radiated Emissions and Band-Edge

The following measurements were performed on all antenna configurations identified in Section 3.4 Antenna Details.

Spurious Emission and Band-Edge Test Strategy

Bands 5,250 – 5,350 Hz ; 5470 – 5725 MHz

5 MHz
SE 5255
SE 5300
SE 5345
BE 5350
BE 5470
SE 5475
SE 5595
SE 5720

KEY:-

SE – Spurious Emissions

BE – Band-Edge



Title: AP0127730, AP0134760
To: FCC 47 CFR Part 15.407 & IC RSS-210
Serial #: RDWN12-U2 Rev B
Issue Date: 18th January 2013
Page: 20 of 272

3.7. Equipment Modifications

The following modifications were required to bring the equipment into compliance:

1. Band-Edge Power Reduction

The power settings required for each antenna to comply with the requirements are detailed in Section 6.1.1.2 "Maximum Conducted Output Power"

3.8. Deviations from the Test Standard

The following deviations from the test standard were required in order to complete the test program:

1. NONE

3.9. Subcontracted Testing or Third Party Data

NONE

This test report may be reproduced in full only. The document may only be updated by MiCOM Labs personnel. Any changes will be noted in the Document History section of the report.

4. TESTING EQUIPMENT CONFIGURATION(S)

4.1. Conducted RF Emission Test Set-up

The following tests were performed using the conducted test set-up shown in the diagram below.

1. Section 6.1.1.1. 26 dB and 99% Bandwidth
2. Section 6.1.1.2. Maximum Conducted Output Power
3. Section 6.1.1.3. Peak Power Spectral Density
4. Section 6.1.1.4. Peak Excursion Ratio

Conducted Test Set-Up Pictorial Representation

3 - Port Test Configuration

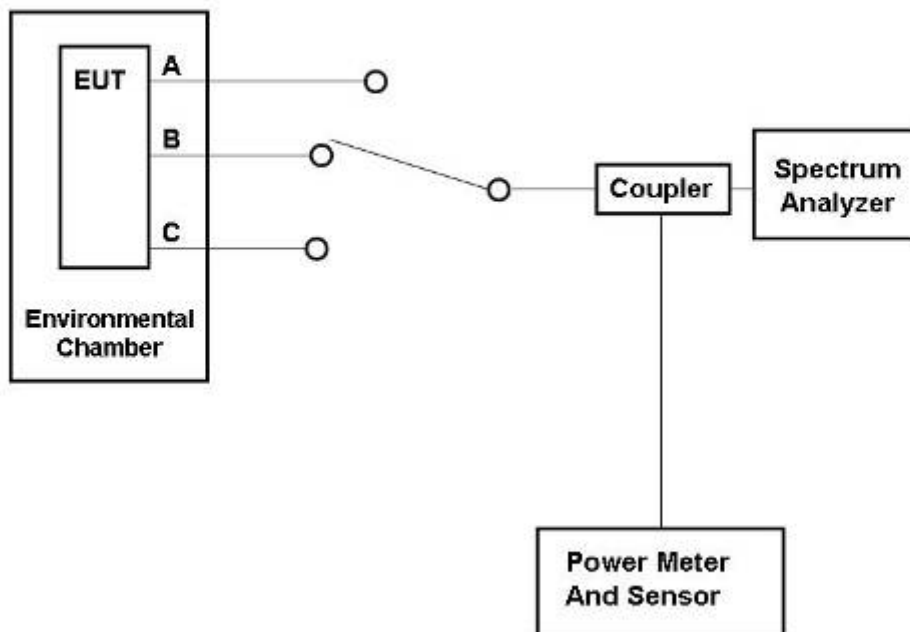

This test report may be reproduced in full only. The document may only be updated by MiCOM Labs personnel. Any changes will be noted in the Document History section of the report.

4.2. Radiated Spurious Emission Test Set-up > 1 GHz

The following tests were performed using the conducted test set-up shown in the diagram below.

1. Section 6.1.2.

Radiated Emission Measurement Setup – Above 1 GHz

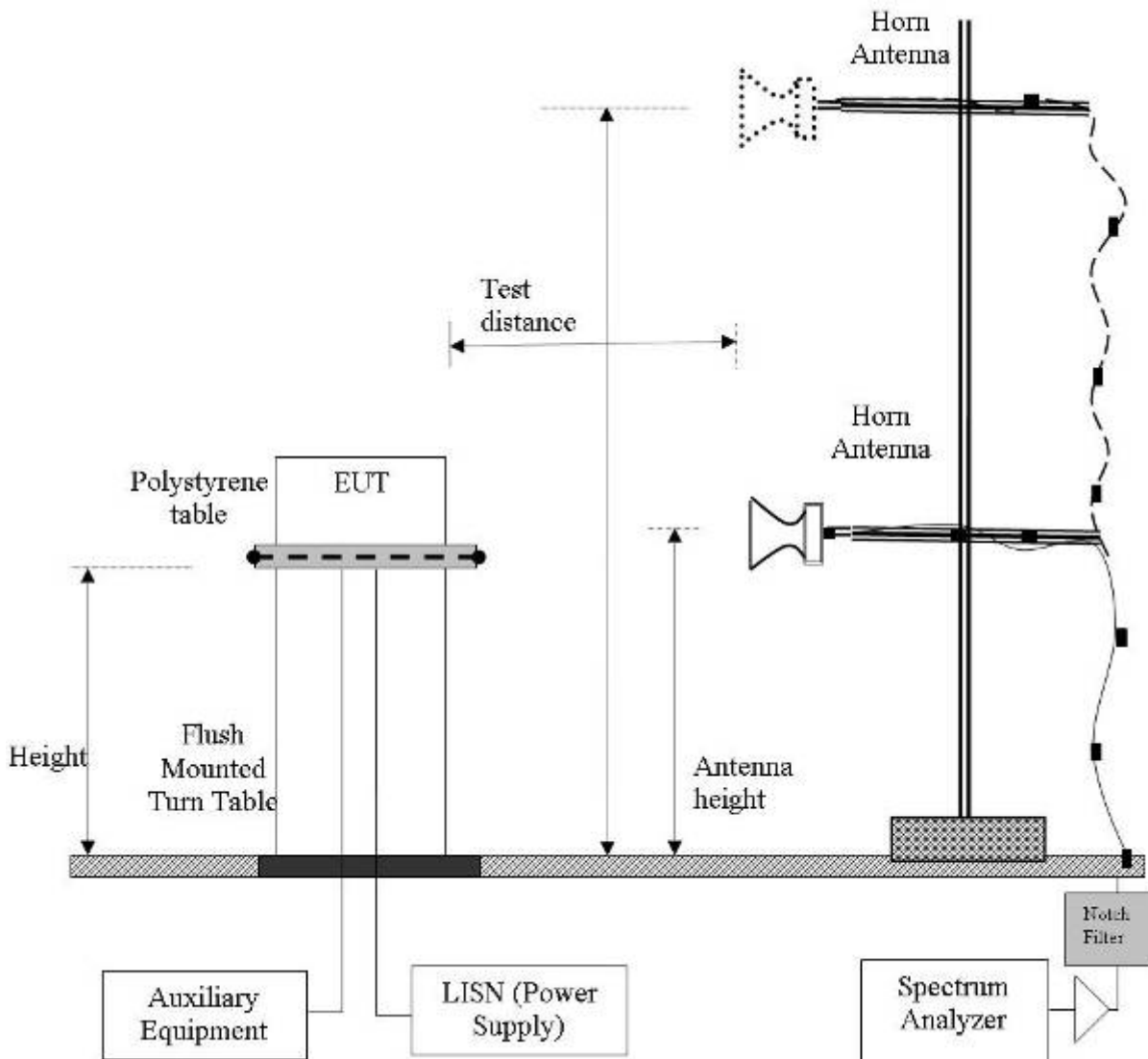

This test report may be reproduced in full only. The document may only be updated by MiCOM Labs personnel. Any changes will be noted in the Document History section of the report.

4.3. Digital Emissions Test Set-up (0.03 – 1 GHz)

The following tests were performed using the conducted test set-up shown in the diagram below.

1. Section 6.1.2.4. Digital Emissions

Digital Emission Measurement Setup – Below 1 GHz

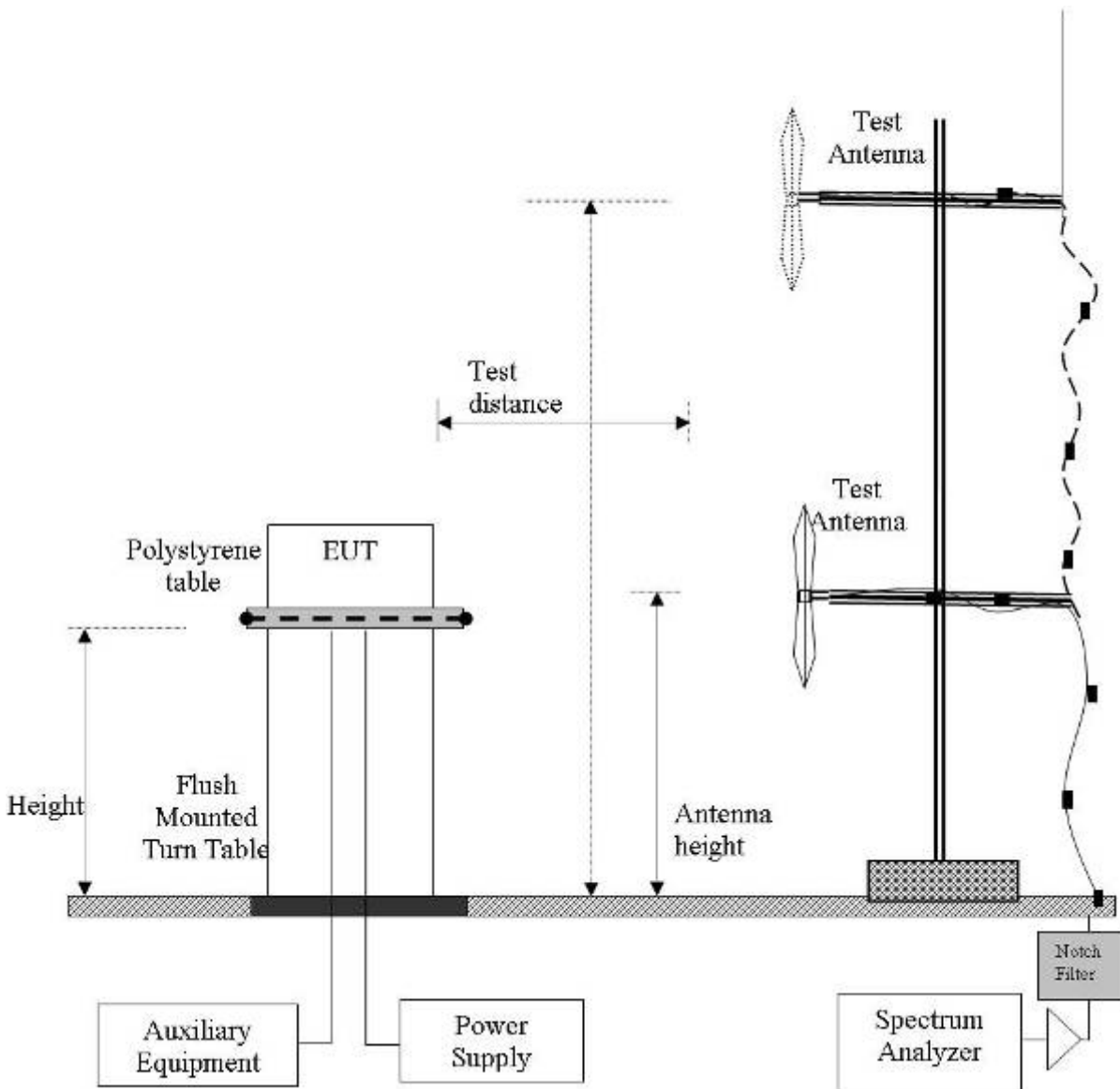

This test report may be reproduced in full only. The document may only be updated by MiCOM Labs personnel. Any changes will be noted in the Document History section of the report.

4.4. ac Wireline Emission Test Set-up

The following tests were performed using the conducted test set-up shown in the diagram below.

1. Section 6.1.3 ac Wireline Conducted Emissions

Conducted Test Set-Up Pictorial Representation

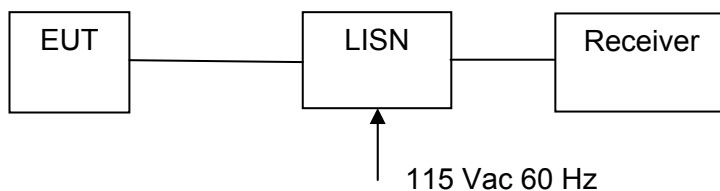

Measurement set up for ac Wireline Conducted Emissions Test

5. TEST SUMMARY

List of Measurements

The following table represents the list of measurements required under the **FCC CFR47 Part 15.407** and **Industry Canada RSS-210** and **Industry Canada RSS-Gen**.

Section(s)	Test Items	Description	Condition	Result	Test Report Section
15.407(a) A9.2(2) 4.4	26dB and 99% Emission BW	Emission bandwidth measurement	Conducted	Complies	6.1.1.1 A.1.1
15.407(a) A9.2(2) 4.6	Maximum Conducted Output Power	Power Measurement	Conducted	Complies	6.1.1.2
15.407(a) A9.2(2)	Peak Power Spectral Density	PPSD	Conducted	Complies	6.1.1.3 A.1.2
15.407(a)(6)	Peak Excursion Ratio	<13dB in any 1MHz bandwidth	Conducted	Complies	6.1.1.4 A.1.3
15.407(g) 15.31 2.1 4.5	Frequency Stability	Limits: contained within band of operation at all times.	Applicant declaration	Complies	6.1.1.5
15.407(f) 5.5	Radio Frequency Radiation Exposure	Exposure to radio frequency energy levels, Maximum Permissible Exposure (MPE)	Conducted	See included MPE exhibit	6.1.1.6

This test report may be reproduced in full only. The document may only be updated by MiCOM Labs personnel. Any changes will be noted in the Document History section of the report.

List of Measurements (continued)

The following table represents the list of measurements required under the **FCC CFR47 Part 15.407** and **Industry Canada RSS-210** and **Industry Canada RSS-Gen**.

Section(s)	Test Items	Description	Condition	Result	Test Report Section
15.407(b)(2) 15.205(a) 15.209(a) 2.2 2.6 A9.3(2) 4.7	Radiated Emissions		Radiated		6.1.2
	Transmitter Radiated Spurious Emissions	Emissions above 1 GHz		Complies	6.1.2
	Radiated Band Edge	Band edge results		Complies	6.1.2
4.10 6	Radiated Receiver Emissions			Complies	6.1.3
15.407(b)(6) 15.205(a) 15.209(a) 2.2	Digital Radiated Emissions	Emissions <1 GHz (30M-1 GHz)		Complies	6.1.4
15.407(b)(6) 15.207 7.2.2	AC Wireline Conducted Emissions 150 kHz–30 MHz	Conducted Emissions	Conducted	N/A EUT is POE powered - not shipped with equipment	6.1.5

Note 1: Test results reported in this document relate only to the items tested

Note 2: The required tests demonstrated compliance as per client declaration of test configuration, monitoring methodology and associated pass/fail criteria

Note 3: Section 3.7 Equipment Modifications highlights the equipment modifications that were required to bring the product into compliance with the above test matrix

This test report may be reproduced in full only. The document may only be updated by MiCOM Labs personnel. Any changes will be noted in the Document History section of the report.



Title: AP0127730, AP0134760
To: FCC 47 CFR Part 15.407 & IC RSS-210
Serial #: RDWN12-U2 Rev B
Issue Date: 18th January 2013
Page: 27 of 272

6. TEST RESULTS

6.1. Device Characteristics

6.1.1. Conducted Testing

6.1.1.1. 26 dB and 99 % Bandwidth

Conducted Test Conditions for 26 dB and 99% Bandwidth			
Standard:	FCC CFR 47:15.407	Ambient Temp. (°C):	24.0 - 27.5
Test Heading:	26 dB and 99 % Bandwidth	Rel. Humidity (%):	32 - 45
Standard Section(s):	15.407 (a)	Pressure (mBars):	999 - 1001
Reference Document(s):	KDB 789033 - D01 DTS General UNII Test Procedures v01		

Test Procedure for 26 dB and 99% Bandwidth Measurement

The bandwidth at 26 dB and 99 % is measured with a spectrum analyzer connected to the antenna terminal, while EUT is operating in transmission mode at the appropriate center frequency. KDB 789033 Section 5.1 Emission Bandwidth was used in order to prove compliance. The Resolution Bandwidth was set to approximately 1% of the emission bandwidth.

This test report may be reproduced in full only. The document may only be updated by MiCOM Labs personnel. Any changes will be noted in the Document History section of the report.



Title: AP0127730, AP0134760
To: FCC 47 CFR Part 15.407 & IC RSS-210
Serial #: RDWN12-U2 Rev B
Issue Date: 18th January 2013
Page: 28 of 272

Measurement Results for 26 dB and 99 % Operational Bandwidth(s)

5250 -5350 MHz

Equipment Configuration for 26 dB 99%
--

Variant: 5 MHz	Duty Cycle (%): 100
Data Rate: 15 MCS	Antenna Gain (dBi): Not Applicable
Modulation: OFDM	Beam Forming Gain (Y): Not Applicable
TPC: Maximum Power	
Engineering Test Notes:	

Test Measurement Results

Test Frequency	Measured 26 dB Bandwidth (MHz)				26 dB Bandwidth (MHz)			
	Port(s)				Highest	Lowest		
MHz	a	b	c	d				
5255.0	6.889	7.014			7.014	6.889		
5300.0	6.789	6.889			6.889	6.789		
5345.0	6.713	6.864			6.864	6.713		

Test Frequency	Measured 99% Bandwidth (MHz)				99% Bandwidth (MHz)			
	Port(s)				Highest	Lowest		
MHz	a	b	c	d				
5255.0	4.684	4.684			4.684	4.684		
5300.0	4.684	4.684			4.684	4.684		
5345.0	4.684	4.659			4.684	4.659		

Traceability to Industry Recognized Test Methodologies

Work Instruction:	WI-03 Measuring RF Spectrum Mask
Measurement Uncertainty:	±2.81 dB

[Click on the links above to see the plot](#)

This test report may be reproduced in full only. The document may only be updated by MiCOM Labs personnel. Any changes will be noted in the Document History section of the report.



Title: AP0127730, AP0134760
To: FCC 47 CFR Part 15.407 & IC RSS-210
Serial #: RDWN12-U2 Rev B
Issue Date: 18th January 2013
Page: 29 of 272

Equipment Configuration for 26 dB 99%

Variant:	10 MHz	Duty Cycle (%):	100
Data Rate:	15 MCS	Antenna Gain (dBi):	Not Applicable
Modulation:	OFDM	Beam Forming Gain (Y):	Not Applicable
TPC:	Maximum Power		
Engineering Test Notes:			

Test Measurement Results

Test Frequency	Measured 26 dB Bandwidth (MHz)				26 dB Bandwidth (MHz)			
	Port(s)				Highest	Lowest		
MHz	a	b	c	d				
5260.0	11.423	11.022			11.423	11.022		
5300.0	10.922	10.822			10.922	10.822		
5340.0	11.573	10.571			11.573	10.571		

Test Frequency	Measured 99% Bandwidth (MHz)				99% Bandwidth (MHz)			
	Port(s)				Highest	Lowest		
MHz	a	b	c	d				
5260.0	9.018	9.068			9.068	9.018		
5300.0	9.018	8.968			9.018	8.968		
5340.0	8.968	8.968			8.968	8.968		

Traceability to Industry Recognized Test Methodologies

Work Instruction:	WI-03 Measuring RF Spectrum Mask
Measurement Uncertainty:	±2.81 dB

[Click on the links above to see the plot](#)

This test report may be reproduced in full only. The document may only be updated by MiCOM Labs personnel. Any changes will be noted in the Document History section of the report.



Title: AP0127730, AP0134760
To: FCC 47 CFR Part 15.407 & IC RSS-210
Serial #: RDWN12-U2 Rev B
Issue Date: 18th January 2013
Page: 30 of 272

Equipment Configuration for 26 dB 99%

Variant:	20 MHz	Duty Cycle (%):	100
Data Rate:	15 MCS	Antenna Gain (dBi):	Not Applicable
Modulation:	OFDM	Beam Forming Gain (Y):	Not Applicable
TPC:	Maximum Power		
Engineering Test Notes:			

Test Measurement Results

Test Frequency	Measured 26 dB Bandwidth (MHz)				26 dB Bandwidth (MHz)			
	Port(s)				Highest	Lowest		
MHz	a	b	c	d				
5265.0	23.046	22.545			23.046	22.545		
5300.0	22.745	23.046			23.046	22.745		
5335.0	23.046	22.745			23.046	22.745		

Test Frequency	Measured 99% Bandwidth (MHz)				99% Bandwidth (MHz)			
	Port(s)				Highest	Lowest		
MHz	a	b	c	d				
5265.0	17.936	17.936			17.936	17.936		
5300.0	17.936	17.936			17.936	17.936		
5335.0	17.936	17.936			17.936	17.936		

Traceability to Industry Recognized Test Methodologies

Work Instruction:	WI-03 Measuring RF Spectrum Mask
Measurement Uncertainty:	±2.81 dB

[Click on the links above to see the plot](#)

This test report may be reproduced in full only. The document may only be updated by MiCOM Labs personnel. Any changes will be noted in the Document History section of the report.



Title: AP0127730, AP0134760
To: FCC 47 CFR Part 15.407 & IC RSS-210
Serial #: RDWN12-U2 Rev B
Issue Date: 18th January 2013
Page: 31 of 272

5470 -5725 MHz

Equipment Configuration for 26 dB 99%

Variant:	5 MHz	Duty Cycle (%):	100
Data Rate:	15 MCS	Antenna Gain (dBi):	Not Applicable
Modulation:	OFDM	Beam Forming Gain (Y):	Not Applicable
TPC:	Maximum Power		
Engineering Test Notes:			

Test Measurement Results

Test Frequency	Measured 26 dB Bandwidth (MHz)				26 dB Bandwidth (MHz)			
	Port(s)				Highest	Lowest		
MHz	a	b	c	d				
5475.0	6.488	6.613			6.613	6.488		
5595.0	6.688	6.638			6.688	6.638		
5720.0	6.288	6.588			6.588	6.288		

Test Frequency	Measured 99% Bandwidth (MHz)				99% Bandwidth (MHz)			
	Port(s)				Highest	Lowest		
MHz	a	b	c	d				
5475.0	4.684	4.684			4.684	4.684		
5595.0	4.659	4.684			4.684	4.659		
5720.0	4.659	4.684			4.684	4.659		

Traceability to Industry Recognized Test Methodologies

Work Instruction:	WI-03 Measuring RF Spectrum Mask
Measurement Uncertainty:	±2.81 dB

[Click on the links above to see the plot](#)

This test report may be reproduced in full only. The document may only be updated by MiCOM Labs personnel. Any changes will be noted in the Document History section of the report.



Title: AP0127730, AP0134760
To: FCC 47 CFR Part 15.407 & IC RSS-210
Serial #: RDWN12-U2 Rev B
Issue Date: 18th January 2013
Page: 32 of 272

Equipment Configuration for 26 dB 99%

Variant:	10 MHz	Duty Cycle (%):	100
Data Rate:	15 MCS	Antenna Gain (dBi):	Not Applicable
Modulation:	OFDM	Beam Forming Gain (Y):	Not Applicable
TPC:	Maximum Power		
Engineering Test Notes:			

Test Measurement Results

Test Frequency	Measured 26 dB Bandwidth (MHz)				26 dB Bandwidth (MHz)			
	Port(s)				Highest	Lowest		
MHz	a	b	c	d				
5475.0	11.022	10.371			11.022	10.371		
5595.0	10.972	10.721			10.972	10.721		
5720.0	11.373	11.473			11.473	11.373		

Test Frequency	Measured 99% Bandwidth (MHz)				99% Bandwidth (MHz)			
	Port(s)				Highest	Lowest		
MHz	a	b	c	d				
5475.0	9.018	9.018			9.018	9.018		
5595.0	9.018	8.968			9.018	8.968		
5720.0	9.018	9.018			9.018	9.018		

Traceability to Industry Recognized Test Methodologies

Work Instruction:	WI-03 Measuring RF Spectrum Mask
Measurement Uncertainty:	±2.81 dB

[Click on the links above to see the plot](#)

This test report may be reproduced in full only. The document may only be updated by MiCOM Labs personnel. Any changes will be noted in the Document History section of the report.



Title: AP0127730, AP0134760
To: FCC 47 CFR Part 15.407 & IC RSS-210
Serial #: RDWN12-U2 Rev B
Issue Date: 18th January 2013
Page: 33 of 272

Equipment Configuration for 26 dB 99%

Variant:	20 MHz	Duty Cycle (%):	100
Data Rate:	15 MCS	Antenna Gain (dBi):	Not Applicable
Modulation:	OFDM	Beam Forming Gain (Y):	Not Applicable
TPC:	Maximum Power		
Engineering Test Notes:			

Test Measurement Results

Test Frequency	Measured 26 dB Bandwidth (MHz)				26 dB Bandwidth (MHz)			
	Port(s)				Highest	Lowest		
MHz	a	b	c	d				
5480.0	23.246	22.745			23.246	22.745		
5590.0	22.745	23.046			23.046	22.745		
5715.0	23.347	23.146			23.347	23.146		

Test Frequency	Measured 99% Bandwidth (MHz)				99% Bandwidth (MHz)			
	Port(s)				Highest	Lowest		
MHz	a	b	c	d				
5480.0	17.936	17.936			17.936	17.936		
5590.0	17.936	17.936			17.936	17.936		
5715.0	17.936	17.936			17.936	17.936		

Traceability to Industry Recognized Test Methodologies

Work Instruction:	WI-03 Measuring RF Spectrum Mask
Measurement Uncertainty:	±2.81 dB

[Click on the links above to see the plot](#)

This test report may be reproduced in full only. The document may only be updated by MiCOM Labs personnel. Any changes will be noted in the Document History section of the report.



Title: AP0127730, AP0134760
To: FCC 47 CFR Part 15.407 & IC RSS-210
Serial #: RDWN12-U2 Rev B
Issue Date: 18th January 2013
Page: 34 of 272

Specification

Limits

FCC, Part 15 §15.407 (a)(1), (a)(2) and Industry Canada RSS-210 § A9.2(2)

(a)(1) For the band 5.15-5.25 GHz the maximum conducted output power over the frequency band of operation shall not exceed the lesser of 50 mW or +4 dBm + 10 log B, where B is the 26 dB emission bandwidth in megahertz. In addition, the peak power spectral density shall not exceed +4 dBm in any 1 megahertz band.

(a)(2) For the 5.25-5.35 GHz band the maximum conducted output power over the frequency band of operation shall not exceed the lesser of 250 mW or +11 dBm + 10 log B, where B is the 26 dB emission bandwidth in megahertz. In addition, the peak power spectral density shall not exceed +11 dBm in any 1 megahertz band.

Industry Canada RSS-Gen 4.4

When an occupied bandwidth value is not specified in the applicable RSS, the transmitted signal bandwidth to be reported is to be its 99% emission bandwidth, as calculated or measured.

Traceability

Test Equipment Used

0158, 0287, 0252, 0313, 0314, 0070, 0116, 0117

This test report may be reproduced in full only. The document may only be updated by MiCOM Labs personnel. Any changes will be noted in the Document History section of the report.



Title: AP0127730, AP0134760
To: FCC 47 CFR Part 15.407 & IC RSS-210
Serial #: RDWN12-U2 Rev B
Issue Date: 18th January 2013
Page: 35 of 272

6.1.1.2. Maximum Conducted Output Power

Conducted Test Conditions for Maximum Conducted Output Power			
Standard:	FCC CFR 47:15.407	Ambient Temp. (°C):	24.0 - 27.5
Test Heading:	Maximum Conducted Output Power	Rel. Humidity (%):	32 - 45
Standard Section(s):	15.407 (a)	Pressure (mBars):	999 - 1001
Reference Document(s):	KDB 789033 - D01 DTS General UNII Test Procedures v01		
Test Procedure for Maximum Conducted Output Power Measurement			
<p><u>Method PM (Measurement using an RF average power meter)</u>. Section C) 4) of KDB 789033 defines a methodology using an average wideband power meter. Measurements were made while the EUT was operating in a continuous transmission mode (100% duty cycle) at the appropriate center frequency. All cable losses and offsets were taken into consideration in the measured result. All operational modes and frequency bands were measured independently and the resultant \square calculated. For multiple outputs, the measurements were made simultaneously on each output port and summed in a linear fashion. This technique was used in order to prove compliance.</p>			

This test report may be reproduced in full only. The document may only be updated by MiCOM Labs personnel. Any changes will be noted in the Document History section of the report.



Title: AP0127730, AP0134760
To: FCC 47 CFR Part 15.407 & IC RSS-210
Serial #: RDWN12-U2 Rev B
Issue Date: 18th January 2013
Page: 36 of 272

Antenna Power Levels

15. 407 (a) (2) Operation with directional antenna gains greater than 6 dBi.

(2) For the 5.25-5.35 GHz and 5.47-5.725 GHz bands, the maximum conducted output power over the frequency bands of operation shall not exceed the lesser of 250 mW or 11 dBm + 10 log B, where B is the 26 dB emission bandwidth in megahertz. In addition, the peak power spectral density shall not exceed 11 dBm in any 1 megahertz band. If transmitting antennas of directional gain greater than 6 dBi are used, both the maximum conducted output power and the peak power spectral density shall be reduced by the amount in dB that the directional gain of the antenna exceeds 6 dBi.

If transmitting antennas of directional gain greater than 6 dBi are used, the conducted output power from the intentional radiator shall be reduced by the amount in dB that the directional gain of the antenna exceeds 6 dBi. Further FCC KDB 662911 D01 Multiple Transmitter Output v01 requires that the gain of antennas transmitting the same data (legacy 802.11a mode) must be increased by $10 * \text{Log}(N)$ when N is the number of antenna elements.

This test report may be reproduced in full only. The document may only be updated by MiCOM Labs personnel. Any changes will be noted in the Document History section of the report.



Operating Frequency Band 5250 - 5350 MHz and 5470 – 5725 MHz

Antenna	Gain	Max. Allowable Conducted Peak Power (dBm)		Maximum EIRP	
		Model Number	(dBi)		Max. Total Power
RW-9732-4958	31*		-1	-4.01	30
RW-9721-5158	27* (5250-5350 MHz)		3	-0.01	30
	28* (5470-5725 MHz)		2	-1.01	30
RW-9622-5001	28*		2	-1.01	30
RW-9612-5001	22*		8	4.99	30
MT0070760	23.5		6.5	3.49	30
AM0111760	16 (5250-5350 MHz)		14	10.99	30
	16.5 (5470-5725 MHz)		13.5	10.49	30
AM0119960	16		14	10.99	30
MT0125250	13		17	13.99	30
RW-9061-5002	14.5* (5250-5350 MHz)		15.5	12.49	30
	15.5* (5470-5725 MHz)		14.5	11.49	30
RW-9061-5001	13*		17	13.99	30
RW-9061-5004	10*		20	16.99	30
MT0128930	11		19	15.99	30
AM0135060	12		18	14.99	30

* The gain includes 1 dB feeder cable loss for external antennas

The AP0127730, AP0134760 has no beam-forming capability. The EUT operates in three different bandwidth modes;- 5 MHz; 10 MHz and 20 MHz. The 11 dBm + 10 log B limits are calculated for each mode along with the conducted power measurements for each antenna presented in this section of the test report.



Measurement Results for Maximum Conducted Output Power

Output Power 5250 – 5350 MHz

Test Conditions:	15.407 (a)(1)	Rel. Humidity (%):	35	to	42
Variant:	5 MHz	Ambient Temp. (°C):	19	to	22
TPC:	HIGH	Pressure (mBars):	998	to	1003
Modulation:	ON	Duty Cycle (x):	100		
Beam Forming Gain (Y):	N/A	dB	Antenna Gain: 0 dBi		
Applied Voltage:	55.0	Vdc			
Notes 1:					
Notes 2:					

Test Frequency	Measured Peak Power				Total Power (dBm)		26dB Limit	Margin
	RF Port (dBm)				Combined	Calculated		
MHz	a	b	c	d				
5255	14.08	14.27	--	--	N/A	17.19	19.27	-2.08
5300	14.09	13.68	--	--	N/A	16.90	19.27	-2.37
5345	15.23	14.80	--	--	N/A	18.03	19.27	-1.24

Measurement uncertainty:	±1.33 dB
---------------------------------	----------

Test Conditions:	15.407 (a)(1)	Rel. Humidity (%):	35	to	42
Variant:	10 MHz	Ambient Temp. (°C):	19	to	22
TPC:	HIGH	Pressure (mBars):	998	to	1003
Modulation:	ON	Duty Cycle (x):	100		
Beam Forming Gain (Y):	N/A	dB	Antenna Gain: 0 dBi		
Applied Voltage:	55.0	Vdc			
Notes 1:					
Notes 2:					

Test Frequency	Measured Peak Power				Total Power (dBm)		26dB Limit	Margin
	RF Port (dBm)				Combined	Calculated		
MHz	a	b	c	d				
5260	16.75	16.32	--	--	N/A	19.55	21.24	-1.69
5300	17.03	16.74	--	--	N/A	19.90	21.24	-1.34
5340	17.14	16.73	--	--	N/A	19.95	21.24	-1.29

Measurement uncertainty:	±1.33 dB
---------------------------------	----------

This test report may be reproduced in full only. The document may only be updated by MiCOM Labs personnel. Any changes will be noted in the Document History section of the report.



Title: AP0127730, AP0134760
To: FCC 47 CFR Part 15.407 & IC RSS-210
Serial #: RDWN12-U2 Rev B
Issue Date: 18th January 2013
Page: 39 of 272

Output Power 5250 – 5350 MHz

Test Conditions:	15.407 (a)(1)	Rel. Humidity (%):	35	to	42
Variant:	20 MHz	Ambient Temp. (°C):	19	to	22
TPC:	HIGH	Pressure (mBars):	998	to	1003
Modulation:	ON	Duty Cycle (x):	100		
Beam Forming Gain (Y):	N/A dB	Antenna Gain:	0 dBi		
Applied Voltage:	55.0 Vdc				
Notes 1:					
Notes 2:					

Test Frequency	Measured Peak Power				Total Power (dBm)		26dB Limit	Margin
	RF Port (dBm)				Combined	Calculated		
MHz	a	b	c	d				
5265	20.09	19.40	--	--	N/A	22.77	24.00	-1.23
5300	19.94	19.30	--	--	N/A	22.64	24.00	-1.36
5335	20.43	20.26	--	--	N/A	23.36	24.00	-0.64

Measurement uncertainty:	±1.33 dB
---------------------------------	----------

This test report may be reproduced in full only. The document may only be updated by MiCOM Labs personnel. Any changes will be noted in the Document History section of the report.



Title: AP0127730, AP0134760
To: FCC 47 CFR Part 15.407 & IC RSS-210
Serial #: RDWN12-U2 Rev B
Issue Date: 18th January 2013
Page: 40 of 272

Output Power 5470 – 5725 MHz

Test Conditions:	15.407 (a)(1)	Rel. Humidity (%):	35	to	42
Variant:	5 MHz	Ambient Temp. (°C):	19	to	22
TPC:	HIGH	Pressure (mBars):	998	to	1003
Modulation:	ON	Duty Cycle (x):	100		
Beam Forming Gain (Y):	N/A dB	Antenna Gain:	0 dBi		
Applied Voltage:	55.0 Vdc				
Notes 1:					
Notes 2:					

Test Frequency	Measured Peak Power				Total Power (dBm)		26 dB Limit	Margin
	RF Port (dBm)				Combined	Calculated		
MHz	a	b	c	d				
5475	14.46	12.70	--	--	N/A	16.68	19.27	-2.59
5595	14.64	13.49	--	--	N/A	17.11	19.27	-2.16
5720	14.57	13.86	--	--	N/A	17.24	19.27	-2.03

Measurement uncertainty:	±1.33 dB
---------------------------------	----------

Test Conditions:	15.407 (a)(1)	Rel. Humidity (%):	35	to	42
Variant:	10 MHz	Ambient Temp. (°C):	19	to	22
TPC:	HIGH	Pressure (mBars):	998	to	1003
Modulation:	ON	Duty Cycle (x):	100		
Beam Forming Gain (Y):	N/A dB	Antenna Gain:	0 dBi		
Applied Voltage:	55.0 Vdc				
Notes 1:					
Notes 2:					

Test Frequency	Measured Peak Power				Total Power (dBm)		26 dB Limit	Margin
	RF Port (dBm)				Combined	Calculated		
MHz	a	b	c	d				
5475	17.22	15.91	--	--	N/A	19.62	21.24	-1.62
5595	17.25	16.06	--	--	N/A	19.71	21.24	-1.53
5720	17.36	16.66	--	--	N/A	20.03	21.24	-1.21

Measurement uncertainty:	±1.33 dB
---------------------------------	----------

This test report may be reproduced in full only. The document may only be updated by MiCOM Labs personnel. Any changes will be noted in the Document History section of the report.



Title: AP0127730, AP0134760
To: FCC 47 CFR Part 15.407 & IC RSS-210
Serial #: RDWN12-U2 Rev B
Issue Date: 18th January 2013
Page: 41 of 272

Output Power 5470 – 5725 MHz

Test Conditions:	15.407 (a)(1)	Rel. Humidity (%):	35	to	42
Variant:	20 MHz	Ambient Temp. (°C):	19	to	22
TPC:	HIGH	Pressure (mBars):	998	to	1003
Modulation:	ON	Duty Cycle (x):	100		
Beam Forming Gain (Y):	N/A	Antenna Gain:	0 dBi		
Applied Voltage:	55.0	Vdc			
Notes 1:					
Notes 2:					

Test Frequency	Measured Peak Power				Total Power (dBm)		26 dB Limit	Margin
	RF Port (dBm)				Combined	Calculated		
MHz	a	b	c	d			dBm	dB
5480	20.49	19.55	--	--	N/A	23.06	24.00	-0.94
5590	20.58	19.28	--	--	N/A	22.99	24.00	-1.01
5715	19.96	19.41	--	--	N/A	22.70	24.00	-1.30

Measurement uncertainty:	±1.33 dB
---------------------------------	----------

This test report may be reproduced in full only. The document may only be updated by MiCOM Labs personnel. Any changes will be noted in the Document History section of the report.



Antenna #1; 11dBi Sector Antenna
Output Power 5250 – 5350 MHz

Test Conditions:	15.407 (a)(1)	Rel. Humidity (%):	35	to	42
Variant:	5 MHz	Ambient Temp. (°C):	19	to	22
TPC:	HIGH	Pressure (mBars):	998	to	1003
Modulation:	ON	Duty Cycle (x):	100		
Beam Forming	N/A dB	Antenna Gain:	11 dBi		
Applied Voltage:	55.0 Vdc		0		
Notes 1:	Bold = Reduced Power Levels to meet Band Edge requirements				
Notes 2:					

Test Frequency MHz	Measured Peak Power RF Port (dBm)				Total Power (dBm)		EIRP dBm	26 dB Limit dBm	EIRP Limit dBm	Power Limit dBm	Margin dB	Radwin PS
	a	b	c	d	Comb	Calculated	Calculated					
5255	11.08	11.27	--	--	N/A	14.19	25.19	19.27	25.27	14.27	-0.08	10
5300	11.09	10.68	--	--	N/A	13.90	24.90	19.27	25.27	14.27	-0.37	10
5345	5.16	6.57	--	--	N/A	8.93	19.93	19.27	25.27	14.27	-5.33	1

Measurement uncertainty:	±1.33 dB
---------------------------------	----------

Test Conditions:	15.407 (a)(1)	Rel. Humidity (%):	35	to	42
Variant:	10 MHz	Ambient Temp. (°C):	19	to	22
TPC:	HIGH	Pressure (mBars):	998	to	1003
Modulation:	ON	Duty Cycle (x):	100		
Beam Forming	N/A dB	Antenna Gain:	11 dBi		
Applied Voltage:	55.0 Vdc				
Notes 1:	Bold = Reduced Power Levels to meet Band Edge requirements				
Notes 2:					

Test Frequency MHz	Measured Peak Power RF Port (dBm)				Total Power (dBm)		EIRP dBm	26 dB Limit dBm	EIRP Limit dBm	Power Limit dBm	Margin dB	Radwin PS
	a	b	c	d	Comb	Calculated	Calculated					
5260	13.31	13.07	--	--	N/A	16.20	27.20	21.24	27.24	16.24	-0.04	15
5300	13.33	12.74	--	--	N/A	16.06	27.06	21.24	27.24	16.24	-0.19	15
5340	8.13	9.37	--	--	N/A	11.80	22.80	21.24	27.24	16.24	-4.44	7

This test report may be reproduced in full only. The document may only be updated by MiCOM Labs personnel. Any changes will be noted in the Document History section of the report.



Title: AP0127730, AP0134760
To: FCC 47 CFR Part 15.407 & IC RSS-210
Serial #: RDWN12-U2 Rev B
Issue Date: 18th January 2013
Page: 43 of 272

Antenna #1; 11dBi Sector Antenna
 Output Power 5250 – 5350 MHz

Test Conditions:	15.407 (a)(1)	Rel. Humidity (%):	35	to	42
Variant:	20 MHz	Ambient Temp. (°C):	19	to	22
TPC:	HIGH	Pressure (mBars):	998	to	1003
Modulation:	ON	Duty Cycle (x):	100		
Beam Forming	N/A	Antenna Gain:	11 dBi		
Applied Voltage:	55.0 Vdc				
Notes 1:	Bold = Reduced Power Levels to meet Band Edge requirements				
Notes 2:					

Test Frequency	Measured Peak Power				Total Power (dBm)		EIRP	26 dB Limit	EIRP Limit	Power Limit	Margin	Radwin
	RF Port (dBm)				Comb	Calculated	dBm					
MHz	a	b	c	d			Calculated	dBm	dBm	dBm	dB	PS
5265	16.03	15.85	--	--	N/A	18.95	29.95	24.00	30.00	19.00	-0.05	20
5300	16.04	15.80	--	--	N/A	18.93	29.93	24.00	30.00	19.00	-0.07	20
5335	9.34	9.34	--	--	N/A	12.35	23.35	24.00	30.00	19.00	-6.65	7

Measurement uncertainty:	±1.33 dB
---------------------------------	----------

This test report may be reproduced in full only. The document may only be updated by MiCOM Labs personnel. Any changes will be noted in the Document History section of the report.



Antenna #1; 11dBi Sector Antenna
Output Power 5470 – 5725 MHz

Test Conditions:	15.407 (a)(1)	Rel. Humidity (%):	35	to	42
Variant:	5 MHz	Ambient Temp. (°C):	19	to	22
TPC:	HIGH	Pressure (mBars):	998	to	1003
Modulation:	ON	Duty Cycle (x):	100		
Beam Forming	N/A dB	Antenna Gain:	11 dBi		
Applied Voltage:	55.0 Vdc				
Notes 1:					
Notes 2:					

Test Frequency	Measured Peak Power				Total Power (dBm)		EIRP	26 dB Limit	EIRP	Power Limit	Margin	Radwin
	RF Port (dBm)				Comb	Calculated	dBm		Limit			
MHz	a	b	c	d	Comb	Calculated	Calculated	dBm	dBm	dBm	dB	PS
5475	11.46	10.70	--	--	N/A	14.11	25.11	19.27	25.27	14.27	-0.16	10
5595	11.64	10.49	--	--	N/A	14.11	25.11	19.27	25.27	14.27	-0.15	10
5720	11.57	10.86	--	--	N/A	14.24	25.24	19.27	25.27	14.27	-0.03	10

Measurement uncertainty:	±1.33 dB
---------------------------------	----------

Test Conditions:	15.407 (a)(1)	Rel. Humidity (%):	35	to	42
Variant:	10 MHz	Ambient Temp. (°C):	19	to	22
TPC:	HIGH	Pressure (mBars):	998	to	1003
Modulation:	ON	Duty Cycle (x):	100		
Beam Forming	N/A dB	Antenna Gain:	11 dBi		
Applied Voltage:	55.0 Vdc				
Notes 1:	Bold = Reduced Power Levels to meet Band Edge requirements				
Notes 2:					

Test Frequency	Measured Peak Power				Total Power (dBm)		EIRP	26 dB Limit	EIRP	Power Limit	Margin	Radwin
	RF Port (dBm)				Comb	Calculated	dBm		Limit			
MHz	a	b	c	d	Comb	Calculated	Calculated	dBm	dBm	dBm	dB	PS
5475	12.62	12.66	--	--	N/A	15.65	26.65	21.24	27.24	16.24	-0.59	15
5595	13.25	12.06	--	--	N/A	15.71	26.71	21.24	27.24	16.24	-0.53	15
5720	13.36	12.66	--	--	N/A	16.03	27.03	21.24	27.24	16.24	-0.21	15

Measurement uncertainty:	±1.33 dB
---------------------------------	----------

This test report may be reproduced in full only. The document may only be updated by MiCOM Labs personnel. Any changes will be noted in the Document History section of the report.



Title: AP0127730, AP0134760
To: FCC 47 CFR Part 15.407 & IC RSS-210
Serial #: RDWN12-U2 Rev B
Issue Date: 18th January 2013
Page: 45 of 272

Antenna #1; 11dBi Sector Antenna
 Output Power 5470 – 5725 MHz

Test Conditions:	15.407 (a)(1)	Rel. Humidity (%):	35	to	42
Variants:	20 MHz	Ambient Temp. (°C):	19	to	22
TPC:	HIGH	Pressure (mBars):	998	to	1003
Modulation:	ON	Duty Cycle (x):	100		
Beam Forming	N/A dB	Antenna Gain:	11 dBi		
Applied Voltage:	55.0 Vdc				
Notes 1:	Bold = Reduced Power Levels to meet Band Edge requirements				
Notes 2:					

Test Frequency MHz	Measured Peak Power RF Port (dBm)				Total Power (dBm)		EIRP dBm	26 dB Limit dBm	EIRP Limit dBm	Power Limit dBm	Margin dB	Radwin PS
	a	b	c	d	Comb	Calculated	Calculated					
5480	12.64	12.43	--	--	N/A	15.55	26.55	24.00	30.00	19.00	-3.45	15
5590	16.58	15.28	--	--	N/A	18.99	29.99	24.00	30.00	19.00	-0.01	20
5715	15.96	15.41	--	--	N/A	18.70	29.70	24.00	30.00	19.00	-0.30	20

Measurement uncertainty:	±1.33 dB
---------------------------------	----------

This test report may be reproduced in full only. The document may only be updated by MiCOM Labs personnel. Any changes will be noted in the Document History section of the report.



Title: AP0127730, AP0134760
To: FCC 47 CFR Part 15.407 & IC RSS-210
Serial #: RDWN12-U2 Rev B
Issue Date: 18th January 2013
Page: 46 of 272

Antenna #2; 12dBi Sector Antenna
 Output Power 5250 – 5350 MHz

Test Conditions:	15.407 (a)(1)	Rel. Humidity (%):	35	to	42
Variant:	5 MHz	Ambient Temp. (°C):	19	to	22
TPC:	HIGH	Pressure (mBars):	998	to	1003
Modulation:	ON	Duty Cycle (x):	100		
Beam Forming Gain (Y):	N/A dB	Antenna Gain:	12 dBi		
Applied Voltage:	55.0 Vdc				
Notes 1:	Bold = Reduced Power Levels to meet Band Edge requirements				
Notes 2:					

Test Frequency MHz	Measured Peak Power RF Port (dBm)				Total Power (dBm)		EIRP dBm	26 dB Limit dBm	EIRP Limit dBm	Power Limit dBm	Margin dB	Radwin PS
	a	b	c	d	Comb	Calculated	Calculated					
5255	10.08	10.27	--	--	N/A	13.19	25.19	19.27	25.27	13.27	-0.08	9
5300	10.09	9.68	--	--	N/A	12.90	24.90	19.27	25.27	13.27	-0.37	9
5345	5.16	6.57	--	--	N/A	8.93	20.93	19.27	25.27	13.27	-4.33	1

Measurement uncertainty:	±1.33 dB
---------------------------------	----------

Test Conditions:	15.407 (a)(1)	Rel. Humidity (%):	35	to	42
Variant:	10 MHz	Ambient Temp. (°C):	19	to	22
TPC:	HIGH	Pressure (mBars):	998	to	1003
Modulation:	ON	Duty Cycle (x):	100		
Beam Forming Gain (Y):	N/A dB	Antenna Gain:	12 dBi		
Applied Voltage:	55.0 Vdc				
Notes 1:	Bold = Reduced Power Levels to meet Band Edge requirements				
Notes 2:					

Test Frequency MHz	Measured Peak Power RF Port (dBm)				Total Power (dBm)		EIRP dBm	26 dB Limit dBm	EIRP Limit dBm	Power Limit dBm	Margin dB	Radwin PS
	a	b	c	d	Comb	Calculated	Calculated					
5260	12.25	11.82	--	--	N/A	15.05	27.05	21.24	27.24	15.24	-0.19	13
5300	12.03	11.74	--	--	N/A	14.90	26.90	21.24	27.24	15.24	-0.34	13
5340	8.13	9.37	--	--	N/A	11.80	23.80	21.24	27.24	15.24	-3.44	7

Measurement uncertainty:	±1.33 dB
---------------------------------	----------

This test report may be reproduced in full only. The document may only be updated by MiCOM Labs personnel. Any changes will be noted in the Document History section of the report.



Title: AP0127730, AP0134760
To: FCC 47 CFR Part 15.407 & IC RSS-210
Serial #: RDWN12-U2 Rev B
Issue Date: 18th January 2013
Page: 47 of 272

Antenna #2; 12dBi Sector Antenna
Output Power 5250 – 5350 MHz

Test Conditions:	15.407 (a)(1)	Rel. Humidity (%):	35	to	42
Variant:	20 MHz	Ambient Temp. (°C):	19	to	22
TPC:	HIGH	Pressure (mBars):	998	to	1003
Modulation:	ON	Duty Cycle (x):	100		
Beam Forming Gain (Y):	N/A dB	Antenna Gain:	12 dBi		
Applied Voltage:	55.0 Vdc				
Notes 1:	Bold = Reduced Power Levels to meet Band Edge requirements				
Notes 2:					

Test Frequency MHz	Measured Peak Power RF Port (dBm)				Total Power (dBm)		EIRP dBm	26 dB Limit dBm	EIRP Limit dBm	Power Limit dBm	Margin dB	Radwin PS
	a	b	c	d	Comb	Calculated	Calculated					
5265	15.09	14.40	--	--	N/A	17.77	29.77	24.00	30.00	18.00	-0.23	17
5300	14.94	14.30	--	--	N/A	17.64	29.64	24.00	30.00	18.00	-0.36	17
5335	9.34	9.34	--	--	N/A	12.35	24.35	24.00	30.00	18.00	-5.65	7

Measurement uncertainty:	±1.33 dB
---------------------------------	----------

This test report may be reproduced in full only. The document may only be updated by MiCOM Labs personnel. Any changes will be noted in the Document History section of the report.



Antenna #2; 12dBi Sector Antenna
 Output Power 5470 – 5725 MHz

Test Conditions:	15.407 (a)(1)	Rel. Humidity (%):	35	to	42
Variant:	5 MHz	Ambient Temp. (°C):	19	to	22
TPC:	HIGH	Pressure (mBars):	998	to	1003
Modulation:	ON	Duty Cycle (x):	100		
Beam Forming Gain (Y):	N/A dB	Antenna Gain:	12 dBi		
Applied Voltage:	55.0 Vdc				
Notes 1:					
Notes 2:					

Test Frequency MHz	Measured Peak Power RF Port (dBm)				Total Power (dBm)		EIRP dBm	26 dB Limit dBm	EIRP Limit dBm	Power Limit dBm	Margin dB	Radwin PS
	a	b	c	d	Comb	Calculated	Calculated					
5475	10.46	8.70	--	--	N/A	12.68	24.68	19.27	25.27	13.27	-0.59	8
5595	10.64	9.49	--	--	N/A	13.11	25.11	19.27	25.27	13.27	-0.15	8
5720	10.57	9.86	--	--	N/A	13.24	25.24	19.27	25.27	13.27	-0.03	8

Measurement uncertainty:	±1.33 dB
---------------------------------	----------

Test Conditions:	15.407 (a)(1)	Rel. Humidity (%):	35	to	42
Variant:	10 MHz	Ambient Temp. (°C):	19	to	22
TPC:	HIGH	Pressure (mBars):	998	to	1003
Modulation:	ON	Duty Cycle (x):	100		
Beam Forming Gain (Y):	N/A dB	Antenna Gain:	12 dBi		
Applied Voltage:	55.0 Vdc				
Notes 1:	Bold = Reduced Power Levels to meet Band Edge requirements				
Notes 2:					

Test Frequency MHz	Measured Peak Power RF Port (dBm)				Total Power (dBm)		EIRP dBm	26 dB Limit dBm	EIRP Limit dBm	Power Limit dBm	Margin dB	Radwin PS
	a	b	c	d	Comb	Calculated	Calculated					
5475	12.27	11.90	--	--	N/A	15.10	27.10	21.24	27.24	15.24	-0.14	15
5595	12.75	11.56	--	--	N/A	15.21	27.21	21.24	27.24	15.24	-0.03	12
5720	12.50	11.90	--	--	N/A	15.22	27.22	21.24	27.24	15.24	-0.02	12

Measurement uncertainty:	±1.33 dB
---------------------------------	----------

This test report may be reproduced in full only. The document may only be updated by MiCOM Labs personnel. Any changes will be noted in the Document History section of the report.



Title: AP0127730, AP0134760
To: FCC 47 CFR Part 15.407 & IC RSS-210
Serial #: RDWN12-U2 Rev B
Issue Date: 18th January 2013
Page: 49 of 272

Antenna #2; 12dBi Sector Antenna
 Output Power 5470 – 5725 MHz

Test Conditions:	15.407 (a)(1)	Rel. Humidity (%):	35	to	42
Variant:	20 MHz	Ambient Temp. (°C):	19	to	22
TPC:	HIGH	Pressure (mBars):	998	to	1003
Modulation:	ON	Duty Cycle (x):	100		
Beam Forming Gain (Y):	N/A dB	Antenna Gain:	12 dBi		
Applied Voltage:	55.0 Vdc				
Notes 1:	Bold = Reduced Power Levels to meet Band Edge requirements				
Notes 2:	(Numbers in Parenthesis are original measured Power vs 30 dBm)				

Test Frequency MHz	Measured Peak Power RF Port (dBm)				Total Power (dBm)		EIRP dBm	26 dB Limit	EIRP Limit	Power Limit	Margin	Radwin
	a	b	c	d	Comb	Calculated	Calculated	dBm	dBm	dBm	dB	PS
5480	13.52	13.37	--	--	N/A	16.46	28.46	24.00	30.00	18.00	-1.54	17
5590	15.58	14.28	--	--	N/A	17.99	29.99	24.00	30.00	18.00	-0.01	18
5715	14.96	14.41	--	--	N/A	17.70	29.70	24.00	30.00	18.00	-0.30	18

Measurement uncertainty:	±1.33 dB
---------------------------------	----------

This test report may be reproduced in full only. The document may only be updated by MiCOM Labs personnel. Any changes will be noted in the Document History section of the report.



Antenna #3; 16.5 dBi Flat Panel Antenna
 Output Power 5250 – 5350 MHz

Test Conditions:	15.407 (a)(1)	Rel. Humidity (%):	35	to	42
Variant:	5 MHz	Ambient Temp. (°C):	19	to	22
TPC:	HIGH	Pressure (mBars):	998	to	1003
Modulation:	ON	Duty Cycle (x):	100		
Beam Forming Gain (Y):	N/A dB	Actual Ant Gain	16 dBi		
Applied Voltage:	55.0 Vdc				
Notes 1:	Bold = Reduced Power Levels to meet Band Edge requirements				
Notes 2:					

Test Frequency MHz	Measured Peak Power RF Port (dBm)				Total Power (dBm)		EIRP dBm	26 dB Limit dBm	EIRP Limit dBm	Power Limit dBm	Margin dB	Radwin PS
	a	b	c	d	Comb	Calculated	Calculate					
5255	6.08	6.27	--	--	N/A	9.19	25.19	19.27	25.27	9.27	-0.08	0
5300	6.09	5.68	--	--	N/A	8.90	24.90	19.27	25.27	9.27	-0.37	0
5345	2.24	4.20	--	--	N/A	6.34	22.34	19.27	25.27	9.27	-2.93	-3

Measurement uncertainty:	±1.33 dB
---------------------------------	----------

Test Conditions:	15.407 (a)(1)	Rel. Humidity (%):	35	to	42
Variant:	10 MHz	Ambient Temp. (°C):	19	to	22
TPC:	HIGH	Pressure (mBars):	998	to	1003
Modulation:	ON	Duty Cycle (x):	100		
Beam Forming Gain (Y):	N/A dB	Actual Ant Gain	16 dBi		
Applied Voltage:	55.0 Vdc				
Notes 1:	Bold = Reduced Power Levels to meet Band Edge requirements				
Notes 2:					

Test Frequency MHz	Measured Peak Power RF Port (dBm)				Total Power (dBm)		EIRP dBm	26 dB Limit dBm	EIRP Limit dBm	Power Limit dBm	Margin dB	Radwin PS
	a	b	c	d	Comb	Calculated	Calculated					
5255	7.21	8.54	--	--	N/A	10.94	26.94	21.24	27.24	11.24	-0.30	6
5300	7.22	8.73	--	--	N/A	11.05	27.05	21.24	27.24	11.24	-0.19	6
5345	6.76	8.08	--	--	N/A	10.48	26.48	21.24	27.24	11.24	-0.76	4

Measurement uncertainty:	±1.33 dB
---------------------------------	----------

This test report may be reproduced in full only. The document may only be updated by MiCOM Labs personnel. Any changes will be noted in the Document History section of the report.



Title: AP0127730, AP0134760
To: FCC 47 CFR Part 15.407 & IC RSS-210
Serial #: RDWN12-U2 Rev B
Issue Date: 18th January 2013
Page: 51 of 272

Antenna #3; 16.5 dBi Flat Panel Antenna
 Output Power 5250 – 5350 MHz

Test Conditions:	15.407 (a)(1)	Rel. Humidity (%):	35	to	42
Variant:	20 MHz	Ambient Temp. (°C):	19	to	22
TPC:	HIGH	Pressure (mBars):	998	to	1003
Modulation:	ON	Duty Cycle (x):	100		
Beam Forming Gain (Y):	N/A dB	Actual Ant Gain	16 dBi		
Applied Voltage:	55.0 Vdc				
Notes 1:	Bold = Reduced Power Levels to meet Band Edge requirements				
Notes 2:					

Test Frequency MHz	Measured Peak Power RF Port (dBm)				Total Power (dBm)		EIRP dBm	26 dB Limit dBm	EIRP Limit dBm	Power Limit dBm	Margin dB	Radwin PS
	a	b	c	d	Comb	Calculated	Calculated					
5265	10.17	11.43	--	--	N/A	13.86	29.86	24.00	30.00	14.00	-0.14	12
5300	10.22	11.63	--	--	N/A	13.99	29.99	24.00	30.00	14.00	-0.01	12
5335	5.80	6.85	--	--	N/A	9.37	25.37	24.00	30.00	14.00	-4.63	2

Measurement uncertainty:	±1.33 dB
---------------------------------	----------

This test report may be reproduced in full only. The document may only be updated by MiCOM Labs personnel. Any changes will be noted in the Document History section of the report.



Antenna #3; 16.5 dBi Flat Panel Antenna
 Output Power 5470 – 5725 MHz

Test Conditions:	15.407 (a)(1)	Rel. Humidity (%):	35	to	42
Variant:	5 MHz	Ambient Temp. (°C):	19	to	22
TPC:	HIGH	Pressure (mBars):	998	to	1003
Modulation:	ON	Duty Cycle (x):	100		
Beam Forming Gain (Y):	N/A dB	Actual Ant Gain	16.5 dBi		
Applied Voltage:	55.0 Vdc				
Notes 1:					
Notes 2:					

Test Frequency MHz	Measured Peak Power RF Port (dBm)				Total Power (dBm)		EIRP dBm	26 dB Limit dBm	EIRP Limit dBm	Power Limit dBm	Margin dB	Radwin PS
	a	b	c	d	Comb	Calculated	Calculated					
5475	6.46	4.70	--	--	N/A	8.68	25.18	19.27	25.27	8.77	-0.09	0
5595	6.14	5.00	--	--	N/A	8.62	25.12	19.27	25.27	8.77	-0.15	0
5720	6.07	5.36	--	--	N/A	8.74	25.24	19.27	25.27	8.77	-0.03	0

Measurement uncertainty:	±1.33 dB
---------------------------------	----------

Test Conditions:	15.407 (a)(1)	Rel. Humidity (%):	35	to	42
Variant:	10 MHz	Ambient Temp. (°C):	19	to	22
TPC:	HIGH	Pressure (mBars):	998	to	1003
Modulation:	ON	Duty Cycle (x):	100		
Beam Forming Gain (Y):	N/A dB	Actual Ant Gain	16.5 dBi		
Applied Voltage:	55.0 Vdc				
Notes 1:	Bold = Reduced Power Levels to meet Band Edge requirements				
Notes 2:					

Test Frequency MHz	Measured Peak Power RF Port (dBm)				Total Power (dBm)		EIRP dBm	26 dB Limit dBm	EIRP Limit dBm	Power Limit dBm	Margin dB	Radwin PS
	a	b	c	d	Comb	Calculated	Calculated					
5475	7.84	7.05	--	--	N/A	10.47	26.97	21.24	27.24	10.74	-0.27	5
5595	7.83	7.54	--	--	N/A	10.70	27.20	21.24	27.24	10.74	-0.04	6
5720	7.62	7.71	--	--	N/A	10.68	27.18	21.24	27.24	10.74	-0.07	5

Measurement uncertainty:	±1.33 dB
---------------------------------	----------

This test report may be reproduced in full only. The document may only be updated by MiCOM Labs personnel. Any changes will be noted in the Document History section of the report.



Title: AP0127730, AP0134760
To: FCC 47 CFR Part 15.407 & IC RSS-210
Serial #: RDWN12-U2 Rev B
Issue Date: 18th January 2013
Page: 53 of 272

Antenna #3; 16.5 dBi Flat Panel Antenna
 Output Power 5470 – 5725 MHz

Test Conditions:	15.407 (a)(1)	Rel. Humidity (%):	35	to	42
Variant:	20 MHz	Ambient Temp. (°C):	19	to	22
TPC:	HIGH	Pressure (mBars):	998	to	1003
Modulation:	ON	Duty Cycle (x):	100		
Beam Forming Gain (Y):	N/A dB	Actual Ant Gain	16.5 dBi		
Applied Voltage:	55.0 Vdc				
Notes 1:	Bold = Reduced Power Levels to meet Band Edge requirements				
Notes 2:					

Test Frequency	Measured Peak Power				Total Power (dBm)		EIRP	26 dB	EIRP	Power	Margin	Radwin
	RF Port (dBm)				Comb	Calculated	dBm	Limit	Limit	Limit		
MHz	a	b	c	d			Calculated	dBm	dBm	dBm	dB	PS
5480	10.76	10.11	--	--	N/A	13.46	29.96	24.00	30.00	13.50	-0.04	11
5590	10.56	10.07	--	--	N/A	13.33	29.83	24.00	30.00	13.50	-0.17	11
5715	10.30	10.42	--	--	N/A	13.37	29.87	24.00	30.00	13.50	-0.13	11

Measurement uncertainty:	±1.33 dB
---------------------------------	----------

This test report may be reproduced in full only. The document may only be updated by MiCOM Labs personnel. Any changes will be noted in the Document History section of the report.



Antenna #4; 16.5 dBi Flat Panel Sector Antenna
 Output Power 5250 – 5350 MHz

Test Conditions:	15.407 (a)(1)	Rel. Humidity (%):	35	to	42
Variant:	5 MHz	Ambient Temp. (°C):	19	to	22
TPC:	HIGH	Pressure (mBars):	998	to	1003
Modulation:	ON	Duty Cycle (x):	100		
Beam Forming Gain (Y):	N/A dB	Ant Gain - Feeder Loss:	14.5 dBi		
Applied Voltage:	55.0 Vdc				
Notes 1:	Bold = Reduced Power Levels to meet Band Edge requirements				
Notes 2:					

Test Frequency MHz	Measured Peak Power RF Port (dBm)				Total Power (dBm)		EIRP dBm	26 dB Limit dBm	EIRP Limit dBm	Power Limit dBm	Margin dB	Radwin PS
	a	b	c	d	Comb	Calculated	Calculated					
5255	7.58	7.77	--	--	N/A	10.69	25.19	19.27	25.27	10.77	-0.08	3
5300	7.97	7.50	--	--	N/A	10.75	25.25	19.27	25.27	10.77	-0.02	3
5345	0.96	2.46	--	--	N/A	4.78	19.28	19.27	25.27	10.77	-5.98	-6

Measurement uncertainty:	±1.33 dB
---------------------------------	----------

Test Conditions:	15.407 (a)(1)	Rel. Humidity (%):	35	to	42
Variant:	10 MHz	Ambient Temp. (°C):	19	to	22
TPC:	HIGH	Pressure (mBars):	998	to	1003
Modulation:	ON	Duty Cycle (x):	100		
Beam Forming Gain (Y):	N/A dB	Ant Gain - Feeder Loss:	14.5 dBi		
Applied Voltage:	55.0 Vdc				
Notes 1:	Bold = Reduced Power Levels to meet Band Edge requirements				
Notes 2:					

Test Frequency MHz	Measured Peak Power RF Port (dBm)				Total Power (dBm)		EIRP dBm	26 dB Limit dBm	EIRP Limit dBm	Power Limit dBm	Margin dB	Radwin PS
	a	b	c	d	Comb	Calculated	Calculated					
5260	8.71	10.04	--	--	N/A	12.44	26.94	21.24	27.24	12.74	-0.30	11
5300	8.72	10.13	--	--	N/A	12.49	26.99	21.24	27.24	12.74	-0.25	11
5340	4.23	5.43	--	--	N/A	7.88	22.38	21.24	27.24	12.74	-4.86	3

Measurement uncertainty:	±1.33 dB
---------------------------------	----------

This test report may be reproduced in full only. The document may only be updated by MiCOM Labs personnel. Any changes will be noted in the Document History section of the report.



Title: AP0127730, AP0134760
To: FCC 47 CFR Part 15.407 & IC RSS-210
Serial #: RDWN12-U2 Rev B
Issue Date: 18th January 2013
Page: 55 of 272

Antenna #4; 16.5 dBi Flat Panel Sector Antenna
 Output Power 5250 – 5350 MHz

Test Conditions:	15.407 (a)(1)	Rel. Humidity (%):	35	to	42
Variant:	20 MHz	Ambient Temp. (°C):	19	to	22
TPC:	HIGH	Pressure (mBars):	998	to	1003
Modulation:	ON	Duty Cycle (x):	100		
Beam Forming Gain	N/A dB	Ant Gain - Feeder	14.5 dBi		
Applied Voltage:	55.0 Vdc				
Notes 1:	Bold = Reduced Power Levels to meet Band Edge requirements				
Notes 2:					

Test Frequency	Measured Peak Power				Total Power (dBm)		EIRP	26 dB	EIRP	Power	Margin	Radwin
	RF Port (dBm)				Comb	Calculated	dBm	Limit	Limit	Limit		
MHz	a	b	c	d			Calculated	dBm	dBm	dBm	dB	PS
5265	11.67	12.93	--	--	N/A	15.36	29.86	24.00	30.00	15.50	-0.14	14
5300	11.72	13.13	--	--	N/A	15.49	29.99	24.00	30.00	15.50	-0.01	14
5335	2.59	4.26	--	--	N/A	6.52	21.02	24.00	30.00	15.50	-8.98	-3

Measurement uncertainty:	±1.33 dB
---------------------------------	----------

This test report may be reproduced in full only. The document may only be updated by MiCOM Labs personnel. Any changes will be noted in the Document History section of the report.



Antenna #4; 16.5 dBi Flat Panel Sector Antenna
 Output Power 5470 – 5725 MHz

Test Conditions:	15.407 (a)(1)	Rel. Humidity (%):	35	to	42
Variant:	5 MHz	Ambient Temp. (°C):	19	to	22
TPC:	HIGH	Pressure (mBars):	998	to	1003
Modulation:	ON	Duty Cycle (x):	100		
Beam Forming Gain (Y):	N/A dB	Ant Gain - Feeder Loss:	15.5 dBi		
Applied Voltage:	55.0 Vdc				
Notes 1:					
Notes 2:					

Test Frequency MHz	Measured Peak Power RF Port (dBm)				Total Power (dBm)		EIRP dBm	26 dB Limit dBm	EIRP Limit dBm	Power Limit dBm	Margin dB	Radwin PS
	a	b	c	d	Comb	Calculated	Calculated					
5475	7.46	5.70	--	--	N/A	9.68	25.18	19.27	25.27	9.77	-0.09	2
5595	7.14	6.00	--	--	N/A	9.62	25.12	19.27	25.27	9.77	-0.15	2
5720	7.10	6.33	--	--	N/A	9.74	25.24	19.27	25.27	9.77	-0.02	2

Measurement uncertainty:	±1.33 dB
---------------------------------	----------

Test Conditions:	15.407 (a)(1)	Rel. Humidity (%):	35	to	42
Variant:	10 MHz	Ambient Temp. (°C):	19	to	22
TPC:	HIGH	Pressure (mBars):	998	to	1003
Modulation:	ON	Duty Cycle (x):	100		
Beam Forming Gain (Y):	N/A dB	Ant Gain - Feeder Loss:	15.5 dBi		
Applied Voltage:	55.0 Vdc				
Notes 1:	Bold = Reduced Power Levels to meet Band Edge requirements				
Notes 2:					

Test Frequency MHz	Measured Peak Power RF Port (dBm)				Total Power (dBm)		EIRP dBm	26 dB Limit dBm	EIRP Limit dBm	Power Limit dBm	Margin dB	Radwin PS
	a	b	c	d	Comb	Calculated	Calculated					
5475	8.56	8.47	--	--	N/A	11.53	27.03	21.24	27.24	11.74	-0.22	7
5595	8.83	8.54	--	--	N/A	11.70	27.20	21.24	27.24	11.74	-0.04	8
5720	8.62	8.71	--	--	N/A	11.68	27.18	21.24	27.24	11.74	-0.07	7

Measurement uncertainty:	±1.33 dB
---------------------------------	----------

This test report may be reproduced in full only. The document may only be updated by MiCOM Labs personnel. Any changes will be noted in the Document History section of the report.



Title: AP0127730, AP0134760
To: FCC 47 CFR Part 15.407 & IC RSS-210
Serial #: RDWN12-U2 Rev B
Issue Date: 18th January 2013
Page: 57 of 272

Antenna #4; 16.5 dBi Flat Panel Sector Antenna
 Output Power 5470 – 5725 MHz

Test Conditions:	15.407 (a)(1)	Rel. Humidity (%):	35	to	42
Variant:	20 MHz	Ambient Temp. (°C):	19	to	22
TPC:	HIGH	Pressure (mBars):	998	to	1003
Modulation:	ON	Duty Cycle (x):	100		
Beam Forming Gain (Y):	N/A dB	Ant Gain - Feeder Loss:	15.5 dBi		
Applied Voltage:	55.0 Vdc				
Notes 1:	Bold = Reduced Power Levels to meet Band Edge requirements				
Notes 2:					

Test Frequency	Measured Peak Power				Total Power (dBm)		EIRP	26 dB	EIRP	Power	Margin	Radwin
	RF Port (dBm)				Comb	Calculated	dBm	Limit	Limit	Limit	dB	PS
MHz	a	b	c	d			Calculated	dBm	dBm	dBm		
5480	9.19	8.94	--	--	N/A	12.08	27.58	24.00	30.00	14.50	-2.42	8
5590	11.50	11.17	--	--	N/A	14.35	29.85	24.00	30.00	14.50	-0.15	13
5715	11.30	11.42	--	--	N/A	14.37	29.87	24.00	30.00	14.50	-0.13	12

Measurement uncertainty:	±1.33 dB
---------------------------------	----------

This test report may be reproduced in full only. The document may only be updated by MiCOM Labs personnel. Any changes will be noted in the Document History section of the report.



Antenna #5; 23.5 dBi Flat Panel Antenna
 Output Power 5250 – 5350 MHz

Test Conditions:	15.407 (a)(1)	Rel. Humidity (%):	35	to	42
Variant:	5 MHz	Ambient Temp. (°C):	19	to	22
TPC:	HIGH	Pressure (mBars):	998	to	1003
Modulation:	ON	Duty Cycle (x):	100		
Beam Forming Gain (Y):	N/A dB	Actual Antenna Gain	23.5 dBi		
Applied Voltage:	55.0 Vdc				
Notes 1:	Bold = Reduced Power Levels to meet Band Edge requirements				
Notes 2:					

Test Frequency MHz	Measured Peak Power RF Port (dBm)				Total Power (dBm)		EIRP dBm	26 dB Limit dBm	EIRP Limit dBm	Power Limit dBm	Margin dB	Radwin PS
	a	b	c	d	Comb	Calculated	Calculated					
5255	-1.52	-1.00	--	--	N/A	1.76	25.26	19.27	25.27	1.77	-0.01	-11
5300	-1.89	-0.80	--	--	N/A	1.70	25.20	19.27	25.27	1.77	-0.07	-11
5345	-7.64	-5.02	--	--	N/A	-3.13	20.37	19.27	25.27	1.77	-4.89	-23

Measurement uncertainty:	±1.33 dB
---------------------------------	----------

Test Conditions:	15.407 (a)(1)	Rel. Humidity (%):	35	to	42
Variant:	10 MHz	Ambient Temp. (°C):	19	to	22
TPC:	HIGH	Pressure (mBars):	998	to	1003
Modulation:	ON	Duty Cycle (x):	100		
Beam Forming Gain (Y):	N/A dB	Actual Antenna Gain	23.5 dBi		
Applied Voltage:	55.0 Vdc				
Notes 1:	Bold = Reduced Power Levels to meet Band Edge requirements				
Notes 2:					

Test Frequency MHz	Measured Peak Power RF Port (dBm)				Total Power (dBm)		EIRP dBm	26 dB Limit dBm	EIRP Limit dBm	Power Limit dBm	Margin dB	Radwin PS
	a	b	c	d	Comb	Calculated	Calculated					
5260	0.00	1.12	--	--	N/A	3.61	27.11	21.24	27.24	3.74	-0.13	-7
5300	-0.07	1.39	--	--	N/A	3.73	27.23	21.24	27.24	3.74	-0.01	-7
5340	-2.89	-0.84	--	--	N/A	1.27	24.77	21.24	27.24	3.74	-2.48	-14

Measurement uncertainty:	±1.33 dB
---------------------------------	----------

This test report may be reproduced in full only. The document may only be updated by MiCOM Labs personnel. Any changes will be noted in the Document History section of the report.



Title: AP0127730, AP0134760
To: FCC 47 CFR Part 15.407 & IC RSS-210
Serial #: RDWN12-U2 Rev B
Issue Date: 18th January 2013
Page: 59 of 272

Antenna #5; 23.5 dBi Flat Panel Antenna
 Output Power 5250 – 5350 MHz

Test Conditions:	15.407 (a)(1)	Rel. Humidity (%):	35	to	42
Variant:	20 MHz	Ambient Temp. (°C):	19	to	22
TPC:	HIGH	Pressure (mBars):	998	to	1003
Modulation:	ON	Duty Cycle (x):	100		
Beam Forming Gain (Y):	N/A dB	Actual Antenna Gain	23.5 dBi		
Applied Voltage:	55.0 Vdc				
Notes 1:	Bold = Reduced Power Levels to meet Band Edge requirements				
Notes 2:					

Test Frequency MHz	Measured Peak Power RF Port (dBm)				Total Power (dBm)		EIRP dBm	26 dB Limit dBm	EIRP Limit dBm	Power Limit dBm	Margin dB	Radwin PS
	a	b	c	d	Comb	Calculated	Calculated					
5265	2.77	3.71	--	--	N/A	6.28	29.78	24.00	30.00	6.50	-0.22	-2
5300	2.72	3.86	--	--	N/A	6.34	29.84	24.00	30.00	6.50	-0.16	-2
5335	-3.73	-1.87	--	--	N/A	0.31	23.81	24.00	30.00	6.50	-6.19	-16

Measurement uncertainty:	±1.33 dB
---------------------------------	----------

This test report may be reproduced in full only. The document may only be updated by MiCOM Labs personnel. Any changes will be noted in the Document History section of the report.



Antenna #5; 23.5 dBi Flat Panel Antenna
 Output Power 5470 – 5725 MHz

Test Conditions:	15.407 (a)(1)	Rel. Humidity (%):	35	to	42
Variant:	5 MHz	Ambient Temp. (°C):	19	to	22
TPC:	HIGH	Pressure (mBars):	998	to	1003
Modulation:	ON	Duty Cycle (x):	100		
Beam Forming Gain (Y):	N/A dB	Actual Antenna Gain	23.5 dBi		
Applied Voltage:	55.0 Vdc				
Notes 1:	Bold = Reduced Power Levels to meet Band Edge requirements				
Notes 2:					

Test Frequency MHz	Measured Peak Power RF Port (dBm)				Total Power (dBm)		EIRP dBm	26 dB Limit	EIRP Limit	Power Limit	Margin	Radwin
	a	b	c	d	Comb	Calculated	Calculated	dBm	dBm	dBm	dB	PS
5475	-1.58	-1.65	--	--	N/A	1.40	24.90	19.27	25.27	1.77	-0.37	-13
5595	-1.13	-1.55	--	--	N/A	1.68	25.18	19.27	25.27	1.77	-0.09	-12
5720	-0.76	-2.09	--	--	N/A	1.64	25.14	19.27	25.27	1.77	-0.13	-12

Measurement uncertainty:	±1.33 dB
--------------------------	----------

Test Conditions:	15.407 (a)(1)	Rel. Humidity (%):	35	to	42
Variant:	10 MHz	Ambient Temp. (°C):	19	to	22
TPC:	HIGH	Pressure (mBars):	998	to	1003
Modulation:	ON	Duty Cycle (x):	100		
Beam Forming Gain (Y):	N/A dB	Actual Antenna Gain	23.5 dBi		
Applied Voltage:	55.0 Vdc				
Notes 1:	Bold = Reduced Power Levels to meet Band Edge requirements				
Notes 2:					

Test Frequency MHz	Measured Peak Power RF Port (dBm)				Total Power (dBm)		EIRP dBm	26 dB Limit	EIRP Limit	Power Limit	Margin	Radwin
	a	b	c	d	Comb	Calculated	Calculated	dBm	dBm	dBm	dB	PS
5475	0.34	0.95	--	--	N/A	3.67	27.17	21.24	27.24	3.74	-0.07	-13
5595	0.68	0.56	--	--	N/A	3.63	27.13	21.24	27.24	3.74	-0.11	-12
5720	0.76	0.58	--	--	N/A	3.68	27.18	21.24	27.24	3.74	-0.06	-12

Measurement uncertainty:	±1.33 dB
--------------------------	----------

This test report may be reproduced in full only. The document may only be updated by MiCOM Labs personnel. Any changes will be noted in the Document History section of the report.



Title: AP0127730, AP0134760
To: FCC 47 CFR Part 15.407 & IC RSS-210
Serial #: RDWN12-U2 Rev B
Issue Date: 18th January 2013
Page: 61 of 272

Antenna #5; 23.5 dBi Flat Panel Antenna
 Output Power 5470 – 5725 MHz

Test Conditions:	15.407 (a)(1)	Rel. Humidity (%):	35	to	42
Variant:	20 MHz	Ambient Temp. (°C):	19	to	22
TPC:	HIGH	Pressure (mBars):	998	to	1003
Modulation:	ON	Duty Cycle (x):	100		
Beam Forming Gain (Y):	N/A dB	Actual Antenna Gain	23.5 dBi		
Applied Voltage:	55.0 Vdc				
Notes 1:	Bold = Reduced Power Levels to meet Band Edge requirements				
Notes 2:					

Test Frequency MHz	Measured Peak Power RF Port (dBm)				Total Power (dBm)		EIRP dBm	26 dB Limit dBm	EIRP Limit dBm	Power Limit dBm	Margin dB	Radwin PS
	a	b	c	d	Comb	Calculated	Calculated					
5480	1.59	1.95	--	--	N/A	4.78	28.28	24.00	30.00	6.50	-1.72	-6
5590	3.81	3.09	--	--	N/A	6.48	29.98	24.00	30.00	6.50	-0.02	-3
5715	3.55	2.83	--	--	N/A	6.22	29.72	24.00	30.00	6.50	-0.28	-3

Measurement uncertainty:	±1.33 dB
---------------------------------	----------

This test report may be reproduced in full only. The document may only be updated by MiCOM Labs personnel. Any changes will be noted in the Document History section of the report.



Antenna #6; 29 dBi Flat Panel Antenna
 Output Power 5250 – 5350 MHz

Test Conditions:	15.407 (a)(1)	Rel. Humidity (%):	35	to	42
Variant:	5 MHz	Ambient Temp. (°C):	19	to	22
TPC:	HIGH	Pressure (mBars):	998	to	1003
Modulation:	ON	Duty Cycle (x):	100		
Beam Forming Gain (Y):	N/A	dB	Ant Gain - Feeder Loss 28 dBi		
Applied Voltage:	55.0	Vdc			
Notes 1:					
Notes 2:					

Test Frequency MHz	Measured Peak Power RF Port (dBm)				Total Power (dBm)		EIRP dBm	26 dB Limit dBm	EIRP Limit dBm	Power Limit dBm	Margin dB	Radwin PS
	a	b	c	d	Comb	Calculated	Calculated					
5255	-6.40	-5.34	--	--	N/A	-2.83	25.17	19.27	25.27	-2.73	-0.09	-20
5300	-6.70	-5.16	--	--	N/A	-2.85	25.15	19.27	25.27	-2.73	-0.12	-20
5345	-6.70	-5.77	--	--	N/A	-3.20	24.80	19.27	25.27	-2.73	-0.47	-22

Measurement uncertainty: ±1.33 dB

Test Conditions:	15.407 (a)(1)	Rel. Humidity (%):	35	to	42
Variant:	10 MHz	Ambient Temp. (°C):	19	to	22
TPC:	HIGH	Pressure (mBars):	998	to	1003
Modulation:	ON	Duty Cycle (x):	100		
Beam Forming Gain (Y):	N/A	dB	Ant Gain - Feeder Loss 28 dBi		
Applied Voltage:	55.0	Vdc			
Notes 1:					
Notes 2:					

Test Frequency MHz	Measured Peak Power RF Port (dBm)				Total Power (dBm)		EIRP dBm	26 dB Limit dBm	EIRP Limit dBm	Power Limit dBm	Margin dB	Radwin PS
	a	b	c	d	Comb	Calculated	Calculated					
5260	-5.05	-3.48	--	--	N/A	-1.18	26.82	21.24	27.24	-0.76	-0.42	-18
5300	-4.85	-3.42	--	--	N/A	-1.07	26.93	21.24	27.24	-0.76	-0.31	-18
5340	-4.62	-3.39	--	--	N/A	-0.95	27.05	21.24	27.24	-0.76	-0.19	-20

Measurement uncertainty: ±1.33 dB

This test report may be reproduced in full only. The document may only be updated by MiCOM Labs personnel. Any changes will be noted in the Document History section of the report.



Title: AP0127730, AP0134760
To: FCC 47 CFR Part 15.407 & IC RSS-210
Serial #: RDWN12-U2 Rev B
Issue Date: 18th January 2013
Page: 63 of 272

Antenna #6; 29 dBi Flat Panel Antenna
 Output Power 5250 – 5350 MHz

Test Conditions:	15.407 (a)(1)	Rel. Humidity (%):	35	to	42
Variant:	20 MHz	Ambient Temp. (°C):	19	to	22
TPC:	HIGH	Pressure (mBars):	998	to	1003
Modulation:	ON	Duty Cycle (x):	100		
Beam Forming Gain (Y):	N/A	Ant Gain - Feeder Loss	28 dBi		
Applied Voltage:	55.0	Vdc			
Notes 1:					
Notes 2:					

Test Frequency MHz	Measured Peak Power RF Port (dBm)				Total Power (dBm)		EIRP dBm	26 dB Limit dBm	EIRP Limit dBm	Power Limit dBm	Margin dB	Radwin PS
	a	b	c	d	Comb	Calculated	Calculated					
5265	-2.08	-0.82	--	--	N/A	1.61	29.61	24.00	30.00	2.00	-0.39	-13
5300	-2.04	-0.88	--	--	N/A	1.59	29.59	24.00	30.00	2.00	-0.41	-13
5335	-2.00	-0.93	--	--	N/A	1.58	29.58	24.00	30.00	2.00	-0.42	-15

Measurement uncertainty:	±1.33 dB
---------------------------------	----------

This test report may be reproduced in full only. The document may only be updated by MiCOM Labs personnel. Any changes will be noted in the Document History section of the report.



Antenna #6; 29 dBi Flat Panel Antenna
 Output Power 5470 – 5725 MHz

Test Conditions:	15.407 (a)(1)	Rel. Humidity (%):	35	to	42
Variant:	5 MHz	Ambient Temp. (°C):	19	to	22
TPC:	HIGH	Pressure (mBars):	998	to	1003
Modulation:	ON	Duty Cycle (x):	100		
Beam Forming Gain (Y):	N/A dB	Ant Gain - Feeder Loss	28 dBi		
Applied Voltage:	55.0 Vdc				
Notes 1:					
Notes 2:					

Test Frequency MHz	Measured Peak Power RF Port (dBm)				Total Power (dBm)		EIRP dBm	26 dB Limit dBm	EIRP Limit dBm	Power Limit dBm	Margin dB	Radwin PS
	a	b	c	d	Comb	Calculated	Calculated					
5475	-6.54	-5.62	--	--	N/A	-3.05	24.95	19.27	25.27	-2.73	-0.31	-21
5595	-5.86	-5.69	--	--	N/A	-2.76	25.24	19.27	25.27	-2.73	-0.03	-20
5720	-6.43	-5.51	--	--	N/A	-2.94	25.06	19.27	25.27	-2.73	-0.20	-20

Measurement uncertainty:	±1.33 dB
---------------------------------	----------

Test Conditions:	15.407 (a)(1)	Rel. Humidity (%):	35	to	42
Variant:	10 MHz	Ambient Temp. (°C):	19	to	22
TPC:	HIGH	Pressure (mBars):	998	to	1003
Modulation:	ON	Duty Cycle (x):	100		
Beam Forming Gain (Y):	N/A dB	Ant Gain - Feeder Loss	28 dBi		
Applied Voltage:	55.0 Vdc				
Notes 1:					
Notes 2:					

Test Frequency MHz	Measured Peak Power RF Port (dBm)				Total Power (dBm)		EIRP dBm	26 dB Limit dBm	EIRP Limit dBm	Power Limit dBm	Margin dB	Radwin PS
	a	b	c	d	Comb	Calculated	Calculated					
5475	-4.06	-4.08	--	--	N/A	-1.06	26.94	21.24	27.24	-0.76	-0.30	-18
5595	-3.92	-4.20	--	--	N/A	-1.05	26.95	21.24	27.24	-0.76	-0.29	-17
5720	-3.99	-3.95	--	--	N/A	-0.96	27.04	21.24	27.24	-0.76	-0.20	-18

Measurement uncertainty:	±1.33 dB
---------------------------------	----------

This test report may be reproduced in full only. The document may only be updated by MiCOM Labs personnel. Any changes will be noted in the Document History section of the report.



Title: AP0127730, AP0134760
To: FCC 47 CFR Part 15.407 & IC RSS-210
Serial #: RDWN12-U2 Rev B
Issue Date: 18th January 2013
Page: 65 of 272

Antenna #6; 29 dBi Flat Panel Antenna
 Output Power 5470 – 5725 MHz

Test Conditions:	15.407 (a)(1)	Rel. Humidity (%):	35	to	42
Variant:	20 MHz	Ambient Temp. (°C):	19	to	22
TPC:	HIGH	Pressure (mBars):	998	to	1003
Modulation:	ON	Duty Cycle (x):	100		
Beam Forming Gain (Y):	N/A dB	Ant Gain - Feeder Loss	28 dBi		
Applied Voltage:	55.0 Vdc				
Notes 1:					
Notes 2:					

Test Frequency MHz	Measured Peak Power RF Port (dBm)				Total Power (dBm)		EIRP dBm	26 dB Limit dBm	EIRP Limit dBm	Power Limit dBm	Margin dB	Radwin PS
	a	b	c	d	Comb	Calculated	Calculated					
5480	-0.99	-1.74	--	--	N/A	1.66	29.66	24.00	30.00	2.00	-0.34	-13
5590	-1.27	-1.59	--	--	N/A	1.58	29.58	24.00	30.00	2.00	-0.42	-12
5715	-1.20	-1.36	--	--	N/A	1.73	29.73	24.00	30.00	2.00	-0.27	-13

Measurement uncertainty:	±1.33 dB
---------------------------------	----------

This test report may be reproduced in full only. The document may only be updated by MiCOM Labs personnel. Any changes will be noted in the Document History section of the report.



Antenna #7; 32 dBi Dish Antenna
 Output Power 5250 – 5350 MHz

Test Conditions:	15.407 (a)(1)	Rel. Humidity (%):	35	to	42
Variant:	5 MHz	Ambient Temp. (°C):	19	to	22
TPC:	HIGH	Pressure (mBars):	998	to	1003
Modulation:	ON	Duty Cycle (x):	100		
Beam Forming Gain (Y):	N/A dB	Ant Gain- Feeder Loss	31 dBi		
Applied Voltage:	55.0 Vdc				
Notes 1:	Bold = Reduced Power Levels to meet Band Edge requirements				
Notes 2:					

Test Frequency MHz	Measured Peak Power RF Port (dBm)				Total Power (dBm)		EIRP dBm	26 dB Limit dBm	EIRP Limit dBm	Power Limit dBm	Margin dB	Radwin PS
	a	b	c	d	Comb	Calculated	Calculated					
5255	-10.14	-8.32	--	--	N/A	-6.13	24.87	19.27	25.27	-5.73	-0.39	-26
5300	-10.43	-8.22	--	--	N/A	-6.18	24.82	19.27	25.27	-5.73	-0.44	-26
5345	-10.26	-8.22	--	--	N/A	-6.11	24.89	19.27	25.27	-5.73	-0.38	-26

Measurement uncertainty: ±1.33 dB

Test Conditions:	15.407 (a)(1)	Rel. Humidity (%):	35	to	42
Variant:	10 MHz	Ambient Temp. (°C):	19	to	22
TPC:	HIGH	Pressure (mBars):	998	to	1003
Modulation:	ON	Duty Cycle (x):	100		
Beam Forming Gain (Y):	N/A dB	Ant Gain- Feeder Loss	31 dBi		
Applied Voltage:	55.0 Vdc				
Notes 1:	Bold = Reduced Power Levels to meet Band Edge requirements				
Notes 2:					

Test Frequency MHz	Measured Peak Power RF Port (dBm)				Total Power (dBm)		EIRP dBm	26 dB Limit dBm	EIRP Limit dBm	Power Limit dBm	Margin dB	Radwin PS
	a	b	c	d	Comb	Calculated	Calculated					
5260	-8.99	-5.73	--	--	N/A	-4.05	26.95	21.24	27.24	-3.76	-0.29	-21
5300	-8.94	-5.77	--	--	N/A	-4.06	26.94	21.24	27.24	-3.76	-0.30	-21
5340	-7.56	-6.74	--	--	N/A	-4.12	26.88	21.24	27.24	-3.76	-0.36	-23

Measurement uncertainty: ±1.33 dB

This test report may be reproduced in full only. The document may only be updated by MiCOM Labs personnel. Any changes will be noted in the Document History section of the report.



Title: AP0127730, AP0134760
To: FCC 47 CFR Part 15.407 & IC RSS-210
Serial #: RDWN12-U2 Rev B
Issue Date: 18th January 2013
Page: 67 of 272

Antenna #7; 32 dBi Dish Antenna
 Output Power 5250 – 5350 MHz

Test Conditions:	15.407 (a)(1)	Rel. Humidity (%):	35	to	42
Variant:	20 MHz	Ambient Temp. (°C):	19	to	22
TPC:	HIGH	Pressure (mBars):	998	to	1003
Modulation:	ON	Duty Cycle (x):	100		
Beam Forming Gain (Y):	N/A dB	Ant Gain- Feeder Loss	31 dBi		
Applied Voltage:	55.0 Vdc				
Notes 1:	Bold = Reduced Power Levels to meet Band Edge requirements				
Notes 2:					

Test Frequency	Measured Peak Power				Total Power (dBm)		EIRP	26 dB	EIRP	Power	Margin	Radwin
	RF Port (dBm)				Comb	Calculated	dBm	Limit	Limit	Limit		
MHz	a	b	c	d					dBm	dBm	dBm	dB
5265	-5.31	-3.03	--	--	N/A	-1.01	29.99	24.00	30.00	-1.00	-0.01	-16
5300	-5.45	-3.26	--	--	N/A	-1.21	29.79	24.00	30.00	-1.00	-0.21	-17
5335	-5.35	-3.44	--	--	N/A	-1.28	29.72	24.00	30.00	-1.00	-0.28	-21

Measurement uncertainty:	±1.33 dB
---------------------------------	----------

This test report may be reproduced in full only. The document may only be updated by MiCOM Labs personnel. Any changes will be noted in the Document History section of the report.



Antenna #7; 32 dBi Dish Antenna
 Output Power 5470 – 5725 MHz

Test Conditions:	15.407 (a)(1)	Rel. Humidity (%):	35	to	42
Variant:	5 MHz	Ambient Temp. (°C):	19	to	22
TPC:	HIGH	Pressure (mBars):	998	to	1003
Modulation:	ON	Duty Cycle (x):	100		
Beam Forming Gain (Y):	N/A dB	Ant Gain- Feeder Loss	31 dBi		
Applied Voltage:	55.0 Vdc				
Notes 1:					
Notes 2:					

Test Frequency	Measured Peak Power				Total Power (dBm)		EIRP	26 dB	EIRP	Power	Margin	Radwin
	RF Port (dBm)				Comb	Calculated	dBm	Limit	Limit	Limit	dB	PS
MHz	a	b	c	d			Calculated	dBm	dBm	dBm		
5475	-10.18	-9.50	--	--	N/A	-6.82	24.18	19.27	25.27	-5.73	-1.08	-28
5595	-10.07	-9.58	--	--	N/A	-6.81	24.19	19.27	25.27	-5.73	-1.08	-29
5720	-10.15	-10.06	--	--	N/A	-7.09	23.91	19.27	25.27	-5.73	-1.36	-32

Measurement uncertainty:	±1.33 dB
---------------------------------	----------

Test Conditions:	15.407 (a)(1)	Rel. Humidity (%):	35	to	42
Variant:	10 MHz	Ambient Temp. (°C):	19	to	22
TPC:	HIGH	Pressure (mBars):	998	to	1003
Modulation:	ON	Duty Cycle (x):	100		
Beam Forming Gain (Y):	N/A dB	Ant Gain- Feeder Loss	31 dBi		
Applied Voltage:	55.0 Vdc				
Notes 1:					
Notes 2:					

Test Frequency	Measured Peak Power				Total Power (dBm)		EIRP	26 dB	EIRP	Power	Margin	Radwin
	RF Port (dBm)				Comb	Calculated	dBm	Limit	Limit	Limit	dB	PS
MHz	a	b	c	d			Calculated	dBm	dBm	dBm		
5475	-7.18	-6.44	--	--	N/A	-3.78	27.22	21.24	27.24	-3.76	-0.02	-28
5595	-7.18	-6.51	--	--	N/A	-3.82	27.18	21.24	27.24	-3.76	-0.06	-29
5720	-7.24	-7.10	--	--	N/A	-4.16	26.84	21.24	27.24	-3.76	-0.40	-32

Measurement uncertainty:	±1.33 dB
---------------------------------	----------

This test report may be reproduced in full only. The document may only be updated by MiCOM Labs personnel. Any changes will be noted in the Document History section of the report.



Title: AP0127730, AP0134760
To: FCC 47 CFR Part 15.407 & IC RSS-210
Serial #: RDWN12-U2 Rev B
Issue Date: 18th January 2013
Page: 69 of 272

Antenna #7; 32 dBi Dish Antenna
 Output Power 5470 – 5725 MHz

Test Conditions:	15.407 (a)(1)	Rel. Humidity (%):	35	to	42
Variant:	20 MHz	Ambient Temp. (°C):	19	to	22
TPC:	HIGH	Pressure (mBars):	998	to	1003
Modulation:	ON	Duty Cycle (x):	100		
Beam Forming Gain (Y):	N/A dB	Ant Gain- Feeder Loss	31 dBi		
Applied Voltage:	55.0 Vdc				
Notes 1:					
Notes 2:					

Test Frequency MHz	Measured Peak Power RF Port (dBm)				Total Power (dBm)		EIRP dBm	26 dB Limit	EIRP Limit	Power Limit	Margin	Radwin
	a	b	c	d	Comb	Calculated	Calculated	dBm	dBm	dBm	dB	PS
5480	-4.41	-3.73	--	--	N/A	-1.05	29.95	24.00	30.00	-1.00	-0.05	-18
5590	-4.62	-4.08	--	--	N/A	-1.33	29.67	24.00	30.00	-1.00	-0.33	-19
5715	-4.11	-4.09	--	--	N/A	-1.09	29.91	24.00	30.00	-1.00	-0.09	-20

Measurement uncertainty:	±1.33 dB
---------------------------------	----------

This test report may be reproduced in full only. The document may only be updated by MiCOM Labs personnel. Any changes will be noted in the Document History section of the report.



Specification Limits

FCC, Part 15 §15.407 (a)(1), (a)(2) and Industry Canada RSS-210 § A9.2(2)

(a)(1) For the band 5.15-5.25 GHz the maximum conducted output power over the frequency band of operation shall not exceed the lesser of 50 mW or $+4 \text{ dBm} + 10 \log B$, where B is the 26 dB emission bandwidth in megahertz. In addition, the peak power spectral density shall not exceed +4 dBm in any 1 megahertz band.

(a)(2) For the 5.25-5.35 and 5470-5725 MHz GHz band the maximum conducted output power over the frequency band of operation shall not exceed the lesser of 250 mW or $+11 \text{ dBm} + 10 \log B$, where B is the 26 dB emission bandwidth in megahertz. In addition, the peak power spectral density shall not exceed +11 dBm in any 1 megahertz band.

Industry Canada RSS-210 §A9.2(2)

For the band 5150-5250 MHz, the maximum equivalent isotropically radiated power (e.i.r.p.) shall not exceed 200 mW or $10 + 10 \log_{10} B$, dBm, whichever power is less. B is the 99% emission bandwidth in MHz. The e.i.r.p. spectral density shall not exceed 10 dBm in any 1.0 MHz band.

For the band 5250-5350 MHz and 5470-5725 MHz, the maximum conducted output power shall not exceed 250 mW or $11 + 10 \log_{10} B$, dBm, whichever power is less. The power spectral density shall not exceed 11 dBm in any 1.0 MHz band. The maximum e.i.r.p. shall not exceed 1.0 W or $17 + 10 \log_{10} B$, dBm, whichever power is less. B is the 99% emission bandwidth in MHz.

Industry Canada RSS-Gen 4.4

When an occupied bandwidth value is not specified in the applicable RSS, the transmitted signal bandwidth to be reported is to be its 99% emission bandwidth, as calculated or measured.

Traceability

Test Equipment Used

0158, 0287, 0252, 0313, 0314, 0070, 0116, 0117
--



Title: AP0127730, AP0134760
To: FCC 47 CFR Part 15.407 & IC RSS-210
Serial #: RDWN12-U2 Rev B
Issue Date: 18th January 2013
Page: 71 of 272

6.1.1.3. Peak Power Spectral Density

Conducted Test Conditions for Power Spectral Density			
Standard:	FCC CFR 47:15.407	Ambient Temp. (°C):	24.0 - 27.5
Test Heading:	Power Spectral Density	Rel. Humidity (%):	32 - 45
Standard Section(s):	15.247 (a)	Pressure (mBars):	999 - 1001
Reference Document(s):	KDB 789033 - D01 DTS General UNII Test Procedures v01		
Test Procedure for Power Spectral Density			
The In-Band power spectral density was measured using the measure and sum approach per FCC KDB 662911 (D01 Multiple Transmitter Output v01.)			
<u>Measure and sum the spectra across the outputs.</u> With this technique, spectra are measured at each output of the device at the required resolution bandwidth. The individual spectra are then summed mathematically in linear power units. Unlike in-band power measurements, in which the sum involves a single measured value (output power) from each output, measurements for compliance with PSD limits involve summing entire spectra across corresponding frequency bins on the various outputs. Consistency is maintained for any device with N transmitter outputs to be certain the individual outputs are all aligned with the same span and same number of points. In this instance, the linear power spectrum value within the first spectral bin of output 0 is summed with that in the first spectral bin of output 1, and the first spectral bin of output 2, and so on up to the Nth output to obtain the true value for the first frequency bin of the summed spectrum. The summed spectrum value for each frequency bin is computed in this fashion. These summed spectral values were calculated on a computer, and the results read back into the spectrum analyzer as a data file to produce a representative plot of total spectral power density.			
Calculated Power = A + 10 log (1/x) dBm			
A = Total Power Spectral Density [10 Log ₁₀ (10a/10 + 10 b/10 + 10c/10 + 10d/10)]			
x = Duty Cycle			

This test report may be reproduced in full only. The document may only be updated by MiCOM Labs personnel. Any changes will be noted in the Document History section of the report.



5250 – 5350 MHz

Equipment Configuration for power density

Variant:	5 MHz	Duty Cycle (%):	100
Data Rate:	15 MCS	Antenna Gain (dBi):	Not Applicable
Modulation:	OFDM	Beam Forming Gain (Y):	Not Applicable
TPC:	Maximum Power		
Engineering Test Notes:			

Test Measurement Results								
Test Frequency	Measured Power Spectral Density (dBm)				Calculated Total Power Spectral Density (dBm)		Limit	Margin
	Port(s)				S Port(s)	Conversion to 3 kHz RBW		
MHz	a	b	c	d				
5255.0	7.675	8.267			10.991	N/A	11	-0.01
5300.0	7.448	6.856			10.172	N/A	11	-0.83
5345.0	8.407	7.529			11.000	N/A	11	0.00

Traceability to Industry Recognized Test Methodologies	
Work Instruction:	WI-03 Measuring RF Spectrum Mask
Measurement Uncertainty:	±2.81 dB

Equipment Configuration for power density

Variant:	10 MHz	Duty Cycle (%):	100
Data Rate:	15 MCS	Antenna Gain (dBi):	Not Applicable
Modulation:	OFDM	Beam Forming Gain (Y):	Not Applicable
TPC:	Maximum Power		
Engineering Test Notes:			

Test Measurement Results								
Test Frequency	Measured Power Spectral Density (dBm)				Calculated Total Power Spectral Density (dBm)		Limit	Margin
	Port(s)				S Port(s)	Conversion to 3 kHz RBW		
MHz	a	b	c	d				
5260.0	8.006	7.578			10.808	N/A	11	-0.19
5300.0	8.003	7.642			10.837	N/A	11	-0.16
5340.0	7.990	7.575			10.798	N/A	11	-0.20

Traceability to Industry Recognized Test Methodologies	
Work Instruction:	WI-03 Measuring RF Spectrum Mask
Measurement Uncertainty:	±2.81 dB

[Click on the links above to see the plot](#)

This test report may be reproduced in full only. The document may only be updated by MiCOM Labs personnel. Any changes will be noted in the Document History section of the report.



Title: AP0127730, AP0134760
To: FCC 47 CFR Part 15.407 & IC RSS-210
Serial #: RDWN12-U2 Rev B
Issue Date: 18th January 2013
Page: 73 of 272

5250 – 5350 MHz

Equipment Configuration for power density

Variant:	20 MHz	Duty Cycle (%):	100
Data Rate:	15 MCS	Antenna Gain (dBi):	Not Applicable
Modulation:	OFDM	Beam Forming Gain (Y):	Not Applicable
TPC:	Maximum Power		
Engineering Test Notes:			

Test Measurement Results

Test Frequency	Measured Power Spectral Density (dBm)				Calculated Total Power Spectral Density (dBm)		Limit	Margin
	Port(s)				S Port(s)	Conversion to 3 kHz RBW		
MHz	a	b	c	d				
5265.0	8.147	7.468			10.831	N/A	11	-0.17
5300.0	8.086	7.478			10.803	N/A	11	-0.20
5335.0	8.289	8.045			10.952	N/A	11	-0.05

Traceability to Industry Recognized Test Methodologies

Work Instruction:	WI-03 Measuring RF Spectrum Mask
Measurement Uncertainty:	±2.81 dB

This test report may be reproduced in full only. The document may only be updated by MiCOM Labs personnel. Any changes will be noted in the Document History section of the report.



5470 – 5725 MHz

Equipment Configuration for power density

Variant:	5 MHz	Duty Cycle (%):	100
Data Rate:	15 MCS	Antenna Gain (dBi):	Not Applicable
Modulation:	OFDM	Beam Forming Gain (Y):	Not Applicable
TPC:	Maximum Power		
Engineering Test Notes:			

Test Measurement Results								
Test Frequency	Measured Power Spectral Density (dBm)				Calculated Total Power Spectral Density (dBm)		Limit	Margin
	Port(s)				S Port(s)	Conversion to 3 kHz RBW		
MHz	a	b	c	d				
5475.0	7.889	6.472			10.248	N/A	11	-0.75
5595.0	8.161	6.982			10.622	N/A	11	-0.38
5720.0	8.397	7.608			10.987	N/A	11	-0.01

Traceability to Industry Recognized Test Methodologies	
Work Instruction:	WI-03 Measuring RF Spectrum Mask
Measurement Uncertainty:	±2.81 dB

Equipment Configuration for power density

Variant:	10 MHz	Duty Cycle (%):	100
Data Rate:	15 MCS	Antenna Gain (dBi):	Not Applicable
Modulation:	OFDM	Beam Forming Gain (Y):	Not Applicable
TPC:	Maximum Power		
Engineering Test Notes:			

Test Measurement Results								
Test Frequency	Measured Power Spectral Density (dBm)				Calculated Total Power Spectral Density (dBm)		Limit	Margin
	Port(s)				S Port(s)	Conversion to 3 kHz RBW		
MHz	a	b	c	d				
5475.0	7.985	6.909			10.491	N/A	11	-0.51
5595.0	7.843	6.639			10.293	N/A	11	-0.71
5720.0	8.191	7.472			10.857	N/A	11	-0.14

Traceability to Industry Recognized Test Methodologies	
Work Instruction:	WI-03 Measuring RF Spectrum Mask
Measurement Uncertainty:	±2.81 dB

[Click on the links above to see the plot](#)

This test report may be reproduced in full only. The document may only be updated by MiCOM Labs personnel. Any changes will be noted in the Document History section of the report.



Title: AP0127730, AP0134760
To: FCC 47 CFR Part 15.407 & IC RSS-210
Serial #: RDWN12-U2 Rev B
Issue Date: 18th January 2013
Page: 75 of 272

5470 – 5725 MHz

Equipment Configuration for power density
--

Variant:	20 MHz	Duty Cycle (%):	100
Data Rate:	15 MCS	Antenna Gain (dBi):	Not Applicable
Modulation:	OFDM	Beam Forming Gain (Y):	Not Applicable
TPC:	Maximum Power		
Engineering Test Notes:			

Test Measurement Results								
---------------------------------	--	--	--	--	--	--	--	--

Test Frequency	Measured Power Spectral Density (dBm)				Calculated Total Power Spectral Density (dBm)		Limit	Margin
	Port(s)				S Port(s)	Conversion to 3 kHz RBW		
MHz	a	b	c	d				
5480.0	8.239	7.330			10.819	N/A	11	-0.18
5590.0	8.336	6.809			10.650	N/A	11	-0.35
5715.0	7.844	7.348			10.613	N/A	11	-0.39

Traceability to Industry Recognized Test Methodologies	
---	--

Work Instruction:	WI-03 Measuring RF Spectrum Mask
Measurement Uncertainty:	±2.81 dB

This test report may be reproduced in full only. The document may only be updated by MiCOM Labs personnel. Any changes will be noted in the Document History section of the report.



Specification

FCC, Part 15 §15.407 (a)(1), (a)(2)

5150 – 5250 MHz

(a)(1) The peak power spectral density shall not exceed +4 dBm in any 1 megahertz band.

5250 – 5350 MHz & 5470 – 5725 MHz

(a)(2) The peak power spectral density shall not exceed +11 dBm in any 1 megahertz band.

Industry Canada RSS-210 § A9.2(1), A9.2(2)

5150 – 5250 MHz

§ **A9.2(1)** The eirp spectral density shall not exceed +10 dBm in any 1 MHz band

5250 – 5350 MHz & 5470 – 5725 MHz

§ **A9.2(2)** The power spectral density shall not exceed +11 dBm in any 1 MHz band

Traceability

Test Equipment Used

0158, 0287, 0252, 0313, 0314, 0070, 0116, 0117
--



Title: AP0127730, AP0134760
To: FCC 47 CFR Part 15.407 & IC RSS-210
Serial #: RDWN12-U2 Rev B
Issue Date: 18th January 2013
Page: 77 of 272

6.1.1.4. Peak Excursion Ratio

Conducted Test Conditions for Peak Excursion Ratio			
Standard:	FCC CFR 47:15.407	Ambient Temp. (°C):	24.0 - 27.5
Test Heading:	Peak Excursion Ratio	Rel. Humidity (%):	32 - 45
Standard Section(s):	15.407 (a)(6)	Pressure (mBars):	999 - 1001
Reference Document(s):	KDB 789033 - D01 DTS General UNII Test Procedures v01		

Test Procedure for Peak Excursion Ratio

Compliance with the peak excursion requirement is demonstrated by confirming the ratio of the maximum of the peak-hold spectrum to the maximum of the average spectrum during continuous transmission. Section F) of KDB 789033 was used in order to prove compliance. This is a conducted measurement using a spectrum analyzer using dual traces. Peak Excursion Ratio is the difference in amplitude (dB) between both traces; The following identifies two spectrum traces on the same plot. Trace 1 is the max hold Peak detector, and Trace 2 is the recalled trace data from Peak Power Spectral Density measurements. Each frequency and operational mode is recalled in order to prove compliance.

This test report may be reproduced in full only. The document may only be updated by MiCOM Labs personnel. Any changes will be noted in the Document History section of the report.



Title: AP0127730, AP0134760
To: FCC 47 CFR Part 15.407 & IC RSS-210
Serial #: RDWN12-U2 Rev B
Issue Date: 18th January 2013
Page: 78 of 272

5250 – 5350 MHz

Equipment Configuration for peak excursion

Variant:	5 MHz	Duty Cycle (%):	100
Data Rate:	15 MCS	Antenna Gain (dBi):	Not Applicable
Modulation:	OFDM	Beam Forming Gain (Y):	Not Applicable
TPC:	Maximum Power		
Engineering Test Notes:			

Test Measurement Results

Test Frequency MHz	Measured Peak Excursion (dB) Port(s)				Ratio (dB)		Limit dB	Lowest Margin MHz
	a	b	c	d	Highest	Lowest		
5255.0	12.58	10.65			12.58	10.65	-13.0	-0.42
5300.0	12.63	11.62			12.63	11.62	-13.0	-0.37
5345.0	12.50	11.57			12.50	11.57	-13.0	-0.50

Traceability to Industry Recognized Test Methodologies

Work Instruction:	WI-03 Measuring RF Spectrum Mask
Measurement Uncertainty:	±2.81 dB

Equipment Configuration for peak excursion

Variant:	10 MHz	Duty Cycle (%):	100
Data Rate:	15 MCS	Antenna Gain (dBi):	Not Applicable
Modulation:	OFDM	Beam Forming Gain (Y):	Not Applicable
TPC:	Maximum Power		
Engineering Test Notes:			

Test Measurement Results

Test Frequency MHz	Measured Peak Excursion (dB) Port(s)				Ratio (dB)		Limit dB	Lowest Margin MHz
	a	b	c	d	Highest	Lowest		
5260.0	11.14	11.71			11.71	11.14	-13.0	-1.29
5300.0	11.80	11.83			11.83	11.80	-13.0	-1.17
5340.0	12.18	11.65			12.18	11.65	-13.0	-0.82

Traceability to Industry Recognized Test Methodologies

Work Instruction:	WI-03 Measuring RF Spectrum Mask
Measurement Uncertainty:	±2.81 dB

[Click on the links above to see the plot](#)

This test report may be reproduced in full only. The document may only be updated by MiCOM Labs personnel. Any changes will be noted in the Document History section of the report.



Title: AP0127730, AP0134760
To: FCC 47 CFR Part 15.407 & IC RSS-210
Serial #: RDWN12-U2 Rev B
Issue Date: 18th January 2013
Page: 79 of 272

5250 – 5350 MHz

Equipment Configuration for peak excursion

Variant:	20 MHz	Duty Cycle (%):	100
Data Rate:	15 MCS	Antenna Gain (dBi):	Not Applicable
Modulation:	OFDM	Beam Forming Gain (Y):	Not Applicable
TPC:	Maximum Power		
Engineering Test Notes:			

Test Measurement Results

Test Frequency MHz	Measured Peak Excursion (dB)				Ratio (dB)		Limit dB	Lowest Margin MHz
	Port(s)				Highest	Lowest		
	a	b	c	d				
5265.0	10.80	11.55			11.55	10.80	-13.0	-1.45
5300.0	10.81	10.94			10.94	10.81	-13.0	-2.06
5335.0	10.98	10.83			10.98	10.83	-13.0	-2.02

Traceability to Industry Recognized Test Methodologies

Work Instruction:	WI-03 Measuring RF Spectrum Mask
Measurement Uncertainty:	±2.81 dB

This test report may be reproduced in full only. The document may only be updated by MiCOM Labs personnel. Any changes will be noted in the Document History section of the report.



5470 – 5725 MHz

Equipment Configuration for peak excursion

Variant:	5 MHz	Duty Cycle (%):	100
Data Rate:	15 MCS	Antenna Gain (dBi):	Not Applicable
Modulation:	OFDM	Beam Forming Gain (Y):	Not Applicable
TPC:	Maximum Power		
Engineering Test Notes:			

Test Measurement Results

Test Frequency MHz	Measured Peak Excursion (dB)				Ratio (dB)		Limit dB	Lowest Margin MHz
	Port(s)				Highest	Lowest		
	a	b	c	d				
5475.0	11.93	11.61			11.93	11.61	-13.0	-1.07
5595.0	11.93	11.51			11.93	11.51	-13.0	-1.07
5720.0	11.34	11.60			11.60	11.34	-13.0	-1.40

Traceability to Industry Recognized Test Methodologies

Work Instruction:	WI-03 Measuring RF Spectrum Mask
Measurement Uncertainty:	±2.81 dB

Equipment Configuration for peak excursion

Variant:	10 MHz	Duty Cycle (%):	100
Data Rate:	15 MCS	Antenna Gain (dBi):	Not Applicable
Modulation:	OFDM	Beam Forming Gain (Y):	Not Applicable
TPC:	Maximum Power		
Engineering Test Notes:			

Test Measurement Results

Test Frequency MHz	Measured Peak Excursion (dB)				Ratio (dB)		Limit dB	Lowest Margin MHz
	Port(s)				Highest	Lowest		
	a	b	c	d				
5475.0	11.44	11.21			11.44	11.21	-13.0	-1.56
5595.0	11.71	11.69			11.71	11.69	-13.0	-1.29
5720.0	11.27	11.12			11.27	11.12	-13.0	-1.73

Traceability to Industry Recognized Test Methodologies

Work Instruction:	WI-03 Measuring RF Spectrum Mask
Measurement Uncertainty:	±2.81 dB

[Click on the links above to see the plot](#)

This test report may be reproduced in full only. The document may only be updated by MiCOM Labs personnel. Any changes will be noted in the Document History section of the report.



Title: AP0127730, AP0134760
To: FCC 47 CFR Part 15.407 & IC RSS-210
Serial #: RDWN12-U2 Rev B
Issue Date: 18th January 2013
Page: 81 of 272

5470 – 5725 MHz

Equipment Configuration for peak excursion

Variant:	20 MHz	Duty Cycle (%):	100
Data Rate:	15 MCS	Antenna Gain (dBi):	Not Applicable
Modulation:	OFDM	Beam Forming Gain (Y):	Not Applicable
TPC:	Maximum Power		
Engineering Test Notes:			

Test Measurement Results

Test Frequency MHz	Measured Peak Excursion (dB)				Ratio (dB)		Limit dB	Lowest Margin MHz
	Port(s)				Highest	Lowest		
	a	b	c	d				
5480.0	10.78	10.73			10.78	10.73	-13.0	-2.22
5590.0	10.99	10.85			10.99	10.85	-13.0	-2.01
5715.0	11.34	10.89			11.34	10.89	-13.0	-1.66

Traceability to Industry Recognized Test Methodologies

Work Instruction:	WI-03 Measuring RF Spectrum Mask
Measurement Uncertainty:	±2.81 dB

This test report may be reproduced in full only. The document may only be updated by MiCOM Labs personnel. Any changes will be noted in the Document History section of the report.



Title: AP0127730, AP0134760
To: FCC 47 CFR Part 15.407 & IC RSS-210
Serial #: RDWN12-U2 Rev B
Issue Date: 18th January 2013
Page: 82 of 272

Specification

Limits

§15.407 (a)(6) The ratio of the peak excursion of the modulation envelope (measured using a peak hold function) to the peak transmit power (measured as specified in this paragraph) shall not exceed 13dB across any 1MHz bandwidth or the emission bandwidth whichever is less

Traceability

Test Equipment Used

0158, 0287, 0252, 0313, 0314, 0070, 0116, 0117
--

This test report may be reproduced in full only. The document may only be updated by MiCOM Labs personnel. Any changes will be noted in the Document History section of the report.



Title: AP0127730, AP0134760
To: FCC 47 CFR Part 15.407 & IC RSS-210
Serial #: RDWN12-U2 Rev B
Issue Date: 18th January 2013
Page: 83 of 272

6.1.1.5. Frequency Stability

FCC, Part 15 Subpart C §15.407(g)
Industry Canada RSS-210 §2.1

Test Procedure

The manufacturer of the equipment is responsible for ensuring that the frequency stability is such that emissions are always maintained within the band of operation under all conditions.

Manufacturer Declaration

The frequency stability of the reference oscillator sets the frequency stability of the RF transceiver signals. Therefore all of the RF signals should have ± 20 ppm stability.

This stability accounts for room temp tolerance of the crystal oscillator circuit, frequency variation across temperature, and crystal ageing.

± 20 ppm at 5.250 GHz translates to a maximum frequency shift of ± 105 KHz. As the edge of the channels is at least one MHz from either of the band edges, ± 105 KHz is more than sufficient to guarantee that the intentional emission will remain in the band over the entire operating range of the EUT.

Specification

Limits

<p>§15.407 (g) Manufacturers of U-NII devices are responsible for ensuring frequency stability such that an emission is maintained within the band of operation under all conditions of normal operation as specified in the user's manual.</p>
--

This test report may be reproduced in full only. The document may only be updated by MiCOM Labs personnel. Any changes will be noted in the Document History section of the report.



6.1.1.6. Maximum Permissible Exposure

FCC, Part 15 Subpart C §15.407(f)
Industry Canada RSS-Gen §5.6

Calculations for Maximum Permissible Exposure Levels

$$\text{Power Density} = P_d \text{ (mW/cm}^2\text{)} = \text{EIRP}/(4\pi d^2)$$

$$\text{EIRP} = P * G$$

P = Peak output power (mW)

G = Antenna numeric gain (numeric)

d = Separation distance (cm)

$$\text{Numeric Gain} = 10 ^ (G \text{ (dBi)}/10)$$

Because the EUT belongs to the General Population/Uncontrolled Exposure the limit of power density is 1.0 mW/cm²

Note: for mobile or fixed location transmitters the minimum separation distance is 20cm, even if calculations indicate the MPE distance to be less.

Specification

Maximum Permissible Exposure Limits

FCC §1.1310 Limit = 1mW / cm² from 1.310 Table 1

RSS-Gen §5.6 Category I and Category II equipment shall comply with the applicable requirements of RSS-102.

Laboratory Measurement Uncertainty for Power Measurements

Measurement uncertainty

±1.33 dB

This test report may be reproduced in full only. The document may only be updated by MiCOM Labs personnel. Any changes will be noted in the Document History section of the report.



5250 – 5350 MHz

Antenna Model	Type	Ant Gain (dBi)	Numeric Gain (numeric)	Peak Output Power (dBm)	Peak Output Power (mW)	Calculated Safe Distance @ 1mW/cm ² Limit(cm)	Power Density @ 20cm (mW/cm ²)
MT0128930	Sector Dual Pole Integrated 120 Deg	11	13	18.99	79.25	8.91	0.20
RW-9061-5004	Sector Dual Pole 120 Deg	11	13	18.99	79.25	8.91	0.20
AM0135060	Sector Dual Pole Integrated 95 Deg	12	16	17.98	62.81	8.90	0.20
RW-9061-5001	Sector Dual Pole 90 Deg	14	25	15.49	35.40	8.41	0.18
RW-9061-5002	Sector Dual Pole 60 Deg	15.5	35	15.49	35.40	10.00	0.25
MT0125250	Sector Dual Pole Integrated 90 Deg	13	20	15.49	35.40	7.50	0.14
AM0119960	Flat Panel Dual Pole Integrated	16	40	13.99	25.06	8.91	0.20
AM0111760	Flat Panel Dual Pole Integrated	16	40	13.99	25.06	8.91	0.20
RW-9612-5001	Flat Panel Dual Pole External	23	200	6.45	4.42	8.37	0.18
MT0070760	Flat Panel Dual Pole Integrated	23.5	224	6.45	4.42	8.87	0.20
RW-9622-5001	Flat Panel Dual Pole External	29	794	1.73	1.49	9.70	0.24
RW-9721-5158	Dual Pole Dish	28	631	1.73	1.49	8.65	0.19
RW-9732-4958	Dual Pole Dish	32	1585	-1.01	0.79	10.00	0.25

This test report may be reproduced in full only. The document may only be updated by MiCOM Labs personnel. Any changes will be noted in the Document History section of the report.



5470 – 5725 MHz

Antenna Model	Type	Ant Gain (dBi)	Numeric Gain (numeric)	Peak Output Power (dBm)	Peak Output Power (mW)	Calculated Safe Distance @ 1mW/cm ² Limit(cm)	Power Density @ 20cm (mW/cm ²)
MT0128930	Sector Dual Pole Integrated 120 Deg	11	13	18.99	79.25	8.91	0.20
RW-9061-5004	Sector Dual Pole 120 Deg	11	13	18.99	79.25	8.91	0.20
AM0135060	Sector Dual Pole Integrated 95 Deg	12	16	17.99	62.95	8.91	0.20
RW-9061-5001	Sector Dual Pole 90 Deg	14	25	14.37	27.35	7.39	0.14
RW-9061-5002	Sector Dual Pole 60 Deg	16.5	45	14.37	27.35	9.86	0.24
MT0125250	Sector Dual Pole Integrated 90 Deg	13	20	14.37	27.35	6.59	0.11
AM0119960	Flat Panel Dual Pole Integrated	16	40	13.46	22.18	8.38	0.18
AM0111760	Flat Panel Dual Pole Integrated	16.5	45	13.46	22.18	8.88	0.20
RW-9612-5001	Flat Panel Dual Pole External	23	200	6.48	4.45	8.40	0.18
MT0070760	Flat Panel Dual Pole Integrated	23.5	224	6.48	4.45	8.90	0.20
RW-9622-5001	Flat Panel Dual Pole External	29	794	1.73	1.49	9.70	0.24
RW-9721-5158	Dual Pole Dish	29	794	1.73	1.49	9.70	0.24
RW-9732-4958	Dual Pole Dish	32	1585	-1.05	0.79	9.95	0.25

This test report may be reproduced in full only. The document may only be updated by MiCOM Labs personnel. Any changes will be noted in the Document History section of the report.



6.1.2. Radiated Emission Testing

FCC, Part 15 Subpart C §15.407(b)(2), §15.205(a)/15.209(a)
Industry Canada RSS-210 §A9.3(2); §2.2; §2.6; RSS-Gen §4.7

Test Procedure

Testing was performed in a 3-meter anechoic chamber. Preliminary radiated emissions were measured on every azimuth and with the receiving antenna in both horizontal and vertical polarizations. Preliminary emissions were recorded with in Spectrum Analyzer mode, using a maximum peak detector while in peak hold mode. Depending on the frequency band spanned a notch filter and/or waveguide filter was used to remove the fundamental frequency.

Emissions nearest the limits were chosen for maximization and formal measurement using a CISPR compliant receiver. Emissions above 1000 MHz are measured utilizing a CISPR compliant average detector with a tuned receiver, using a bandwidth of 1 MHz. Emissions from 30 MHz – 1000 MHz are measured utilizing a CISPR compliant quasi-peak detector with a tuned receiver, using a bandwidth of 120 kHz. Only the highest emissions relative to the limit are listed.

Field Strength Calculation

The field strength is calculated by adding the Antenna Factor and Cable Loss, and subtracting Amplifier Gain from the measured reading. All factors are included in the reported data.

$$FS = R + AF + CORR - FO$$

FS = Field Strength
R = Measured Spectrum analyzer Input Amplitude
AF = Antenna Factor

$$CORR = \text{Correction Factor} = CL - AG + NFL$$

CL = Cable Loss
AG = Amplifier Gain
FO = Distance Falloff Factor
NFL = Notch Filter Loss or Waveguide Loss

Field Strength Calculation Example:

Given receiver input reading of 51.5 dB μ V; Antenna Factor of 8.5 dB; Cable Loss of 1.3 dB; Falloff Factor of 0 dB, an Amplifier Gain of 26 dB and Notch Filter Loss of 1 dB. The Field Strength of the measured emission is:

$$FS = 51.5 + 8.5 + 1.3 - 26.0 + 1 = 36.3 \text{ dB}\mu\text{V/m}$$

Conversion between dB μ V/m (or dB μ V) and μ V/m (or μ V) are done as:

$$\text{Level (dB}\mu\text{V/m)} = 20 * \text{Log (level (\mu\text{V/m}))}$$

$$\begin{aligned} 40 \text{ dB}\mu\text{V/m} &= 100 \mu\text{V/m} \\ 48 \text{ dB}\mu\text{V/m} &= 250 \mu\text{V/m} \end{aligned}$$

This test report may be reproduced in full only. The document may only be updated by MiCOM Labs personnel. Any changes will be noted in the Document History section of the report.

The following formula is used to convert the equipment isotropic radiated power (eirp) to field strength (dB μ V/m);

$$E = 1000000 \times \sqrt{30P} / 3 \mu\text{V/m}$$

where P is the EIRP in Watts

Therefore: -27 dBm/MHz = 68.23 dB μ V/m

Note: The data in this Section identifies that the EUT is in compliance with the -27dBm/MHz EIRP limit (68.23 dB μ V/m) for out of band emissions. All out of band emissions are less than 68.23 dB μ V/m.

Specification

Radiated Spurious Emissions

15.407 (b)(2). All emissions outside of the 5,150-5,350MHz band shall not exceed an EIRP of -27dBm/MHz.

FCC §15.205 (a) Except as shown in paragraph (d) of 15.205 (a), only spurious emissions are permitted in any of the frequency bands listed.

FCC §15.205 (a) Except as shown in paragraphs (d) and (e) of this section, the field strength of emissions appearing within these frequency bands shall not exceed the limits shown in Section §15.209. At frequencies equal to or less than 1000 MHz, compliance with the limits in Section 15.209 shall be demonstrated using measurement instrumentation employing a CISPR quasi-peak detector. Above 1000 MHz, compliance with the emission limits in Section 15.209 shall be demonstrated based on the average value of the measured emissions. The provisions in Section 15.35 apply to these measurements.

FCC §15.209 (a) Except as provided elsewhere in this subpart, the emissions from an intentional radiator shall not exceed the field strength levels specified in the following table.

RSS-210 §A9.3(2) For transmitters operating in the 5250-5350 MHz band, all emissions outside the 5150-5350 MHz band shall not exceed -27 dBm/MHz e.i.r.p. Devices operating in the 5250-5350 MHz band that generate emissions in the 5150-5250 MHz band shall not exceed out of band emission limit of 27 dBm/MHz e.i.r.p. in the 5150-5250 MHz band in order to operate indoor/outdoor, or alternatively shall comply with the spectral power density for operation within the 5150-5250 MHz band and shall be labeled "for indoor use only".

RSS-Gen §4.10 the search for spurious emissions shall be from the lowest frequency internally generated or used in the receiver (e.g.. local oscillator, intermediate or carrier frequency), or 30 MHz, whichever is higher, to at least 3 times the highest tuneable or local oscillator frequency, whichever is higher, without exceeding 40 GHz.

For emissions below 1000 MHz, measurements shall be performed using a CISPR quasi-peak detector and the related measurement bandwidth. As an alternative to CISPR quasi-peak measurement, compliance with the emission limit can be demonstrated using measuring equipment employing a peak detector function properly adjusted for factors such as pulse desensitization as required, with an equal or greater measurement bandwidth relative to the applicable CISPR quasi-peak bandwidth.

Above 1000 MHz, measurements shall be performed using an average detector with a minimum resolution bandwidth of 1 MHz.



Title: AP0127730, AP0134760
To: FCC 47 CFR Part 15.407 & IC RSS-210
Serial #: RDWN12-U2 Rev B
Issue Date: 18th January 2013
Page: 90 of 272

Table 1: FCC 15.209 & RSS-Gen Spurious Emissions Limits

Frequency (MHz)	Field Strength ($\mu\text{V/m}$)	Field Strength ($\text{dB}\mu\text{V/m}$)	Measurement Distance (meters)
30-88	100	40.0	3
88-216	150	43.5	3
216-960	200	46.0	3
Above 960	500	54.0	3

Traceability:

Test Equipment Used
0088, 0158, 0134, 0304, 0311, 0315, 0310, 0312

This test report may be reproduced in full only. The document may only be updated by MiCOM Labs personnel. Any changes will be noted in the Document History section of the report.



Title: AP0127730, AP0134760
To: FCC 47 CFR Part 15.407 & IC RSS-210
Serial #: RDWN12-U2 Rev B
Issue Date: 18th January 2013
Page: 91 of 272

6.1.2.1. Antenna # 1

5250 -5350 MHz

LOW

Test Freq.	5255 MHz	Engineer	JMH
Variant	5 MHz	Temp (°C)	25
Freq. Range	1000 MHz - 18000 MHz	Rel. Hum.(%)	34
Power Setting	16	Press. (mBars)	1004
Antenna	11dBi Flat Panel Sector	Duty Cycle (%)	100
Test Notes 1			
Test Notes 2			

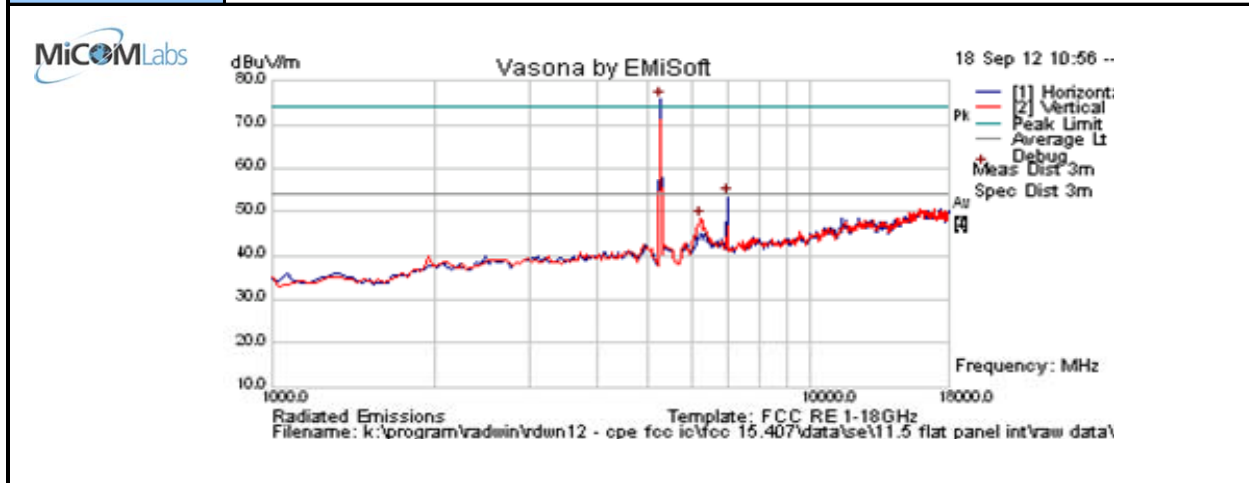

Formally measured emission peaks

Frequency MHz	Raw dBuV	Cable Loss	AF dB	Level dBuV/m	Measurement Type	Pol	Hgt cm	Azt Deg	Limit dBuV/m	Margin dB	Pass /Fail	Comments
5258.517	80.8	4.6	-9.7	75.7	Peak [Scan]	H	100	0				FUND
6995.991984	54.2	5.4	-6.4	53.2	Peak [Scan]	H	100	0				NRB
6246.493	50.9	5.0	-7.6	48.3	Peak [Scan]	V	100	0				NRB

Legend: TX = Transmitter Emissions; DIG = Digital Emissions; FUND = Fundamental; WB = Wideband Emission
 NRB = Non-Restricted Band. Limit = 68.23 dBuV/m; RB = Restricted Band. Limits per 15.205

This test report may be reproduced in full only. The document may only be updated by MiCOM Labs personnel. Any changes will be noted in the Document History section of the report.



Title: AP0127730, AP0134760
To: FCC 47 CFR Part 15.407 & IC RSS-210
Serial #: RDWN12-U2 Rev B
Issue Date: 18th January 2013
Page: 92 of 272

Mid

Test Freq.	5300 MHz	Engineer	JMH
Variant	5 MHz	Temp (°C)	25
Freq. Range	1000 MHz - 18000 MHz	Rel. Hum.(%)	34
Power Setting	16	Press. (mBars)	1004
Antenna	11dBi Flat Panel Sector	Duty Cycle (%)	100
Test Notes 1			
Test Notes 2			

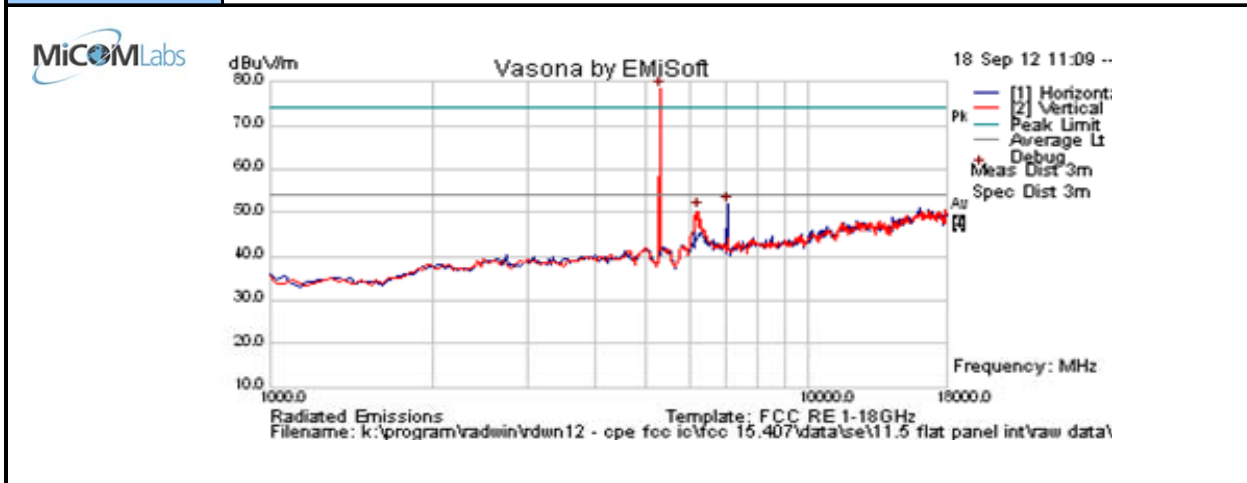

Formally measured emission peaks

Frequency MHz	Raw dBuV	Cable Loss	AF dB	Level dBuV/m	Measurement Type	Pol	Hgt cm	Azt Deg	Limit dBuV/m	Margin dB	Pass /Fail	Comments
5292.585	83.4	4.6	-9.6	78.4	Peak [Scan]	V	100	0				FUND
7064.128257	52.5	5.4	-6.1	51.8	Peak [Scan]	H	100	0				NRB
6246.493	52.9	5.0	-7.6	50.3	Peak [Scan]	V	100	0				NRB

Legend: TX = Transmitter Emissions; DIG = Digital Emissions; FUND = Fundamental; WB = Wideband Emission
 NRB = Non-Restricted Band. Limit = 68.23 dBuV/m; RB = Restricted Band. Limits per 15.205

This test report may be reproduced in full only. The document may only be updated by MiCOM Labs personnel. Any changes will be noted in the Document History section of the report.



Title: AP0127730, AP0134760
To: FCC 47 CFR Part 15.407 & IC RSS-210
Serial #: RDWN12-U2 Rev B
Issue Date: 18th January 2013
Page: 93 of 272

High

Test Freq.	5345 MHz	Engineer	JMH
Variant	5 MHz	Temp (°C)	25
Freq. Range	1000 MHz - 18000 MHz	Rel. Hum.(%)	34
Power Setting	16	Press. (mBars)	1004
Antenna	11dBi Flat Panel Sector	Duty Cycle (%)	100
Test Notes 1			
Test Notes 2			

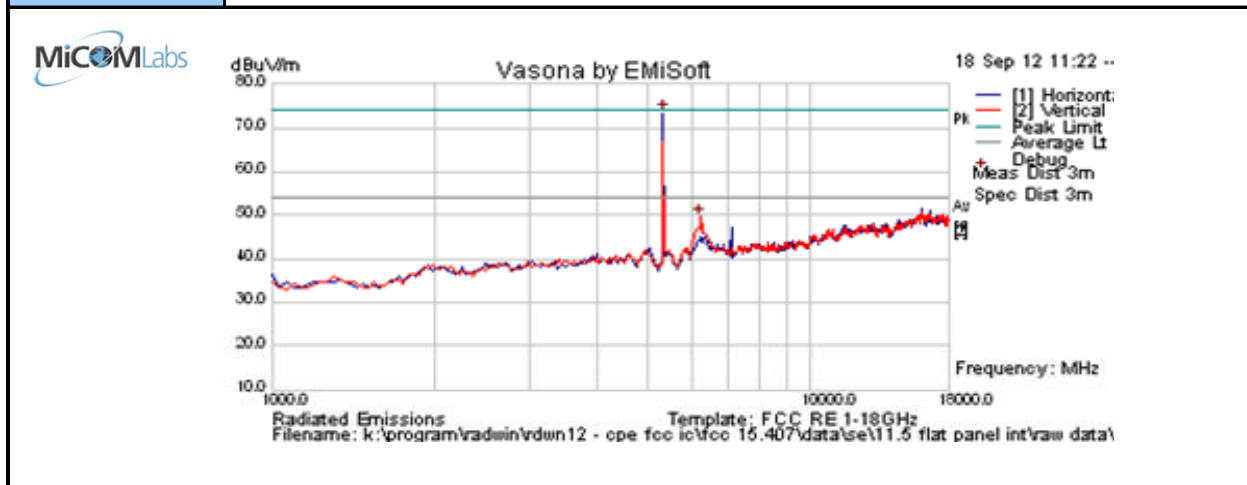

Formally measured emission peaks

Frequency MHz	Raw dBuV	Cable Loss	AF dB	Level dBuV/m	Measurement Type	Pol	Hgt cm	Azt Deg	Limit dBuV/m	Margin dB	Pass /Fail	Comments
5326.653	78.2	4.6	-9.5	73.3	Peak [Scan]	H	100	0				FUND
6246.492986	52.1	5.0	-7.6	49.6	Peak [Scan]	V	100	0				NRB

Legend: TX = Transmitter Emissions; DIG = Digital Emissions; FUND = Fundamental; WB = Wideband Emission
 NRB = Non-Restricted Band. Limit = 68.23 dBuV/m; RB = Restricted Band. Limits per 15.205

This test report may be reproduced in full only. The document may only be updated by MiCOM Labs personnel. Any changes will be noted in the Document History section of the report.



Title: AP0127730, AP0134760
To: FCC 47 CFR Part 15.407 & IC RSS-210
Serial #: RDWN12-U2 Rev B
Issue Date: 18th January 2013
Page: 94 of 272

5 MHz 5345 MHz 5350 – 5460 Restricted Band-edge Power Setting = 1

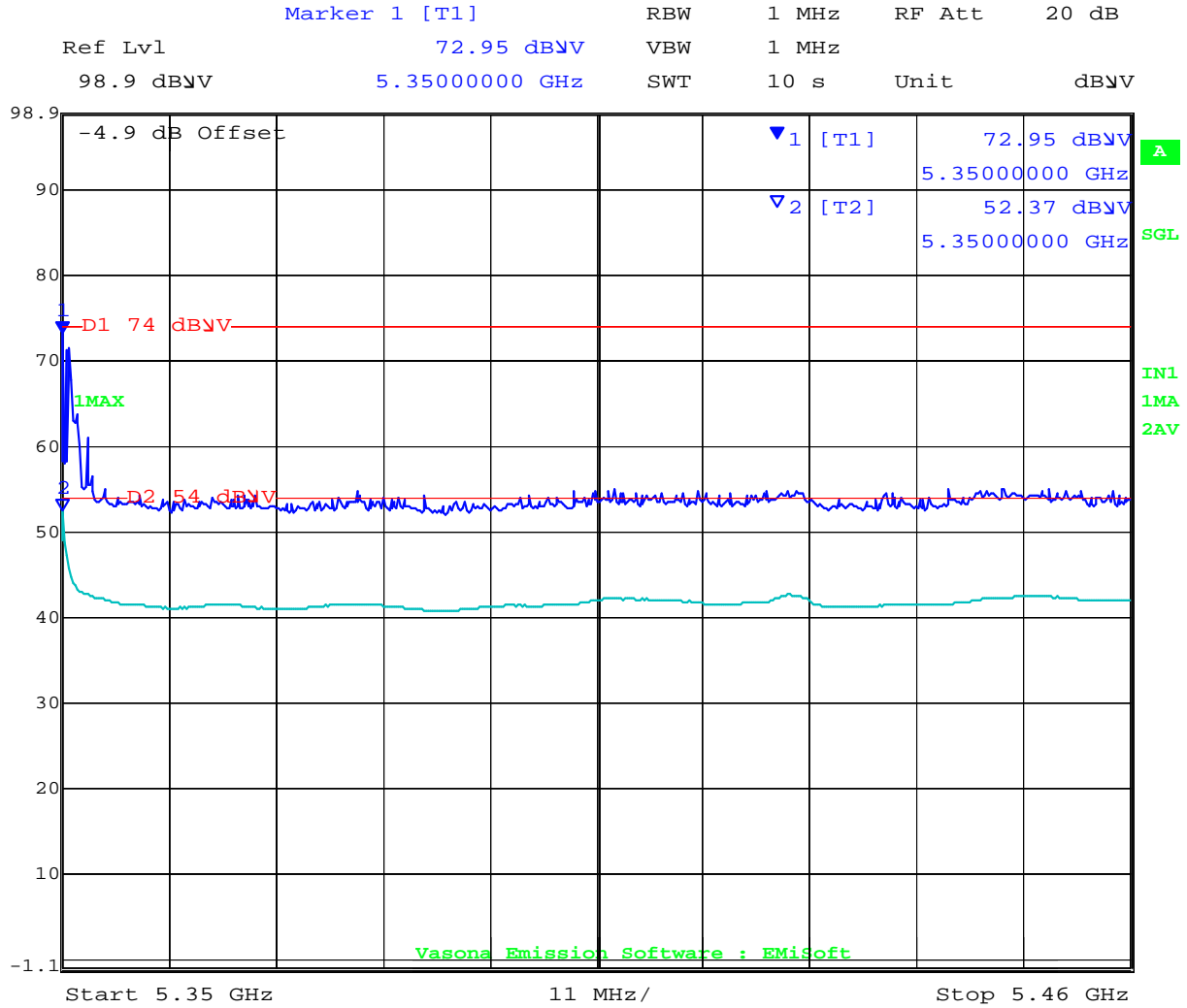

Date: 18.SEP.2012 15:31:26

This test report may be reproduced in full only. The document may only be updated by MiCOM Labs personnel. Any changes will be noted in the Document History section of the report.



5 MHz 5475 MHz 5350 – 5460 Restricted Band-edge Power Setting = 15

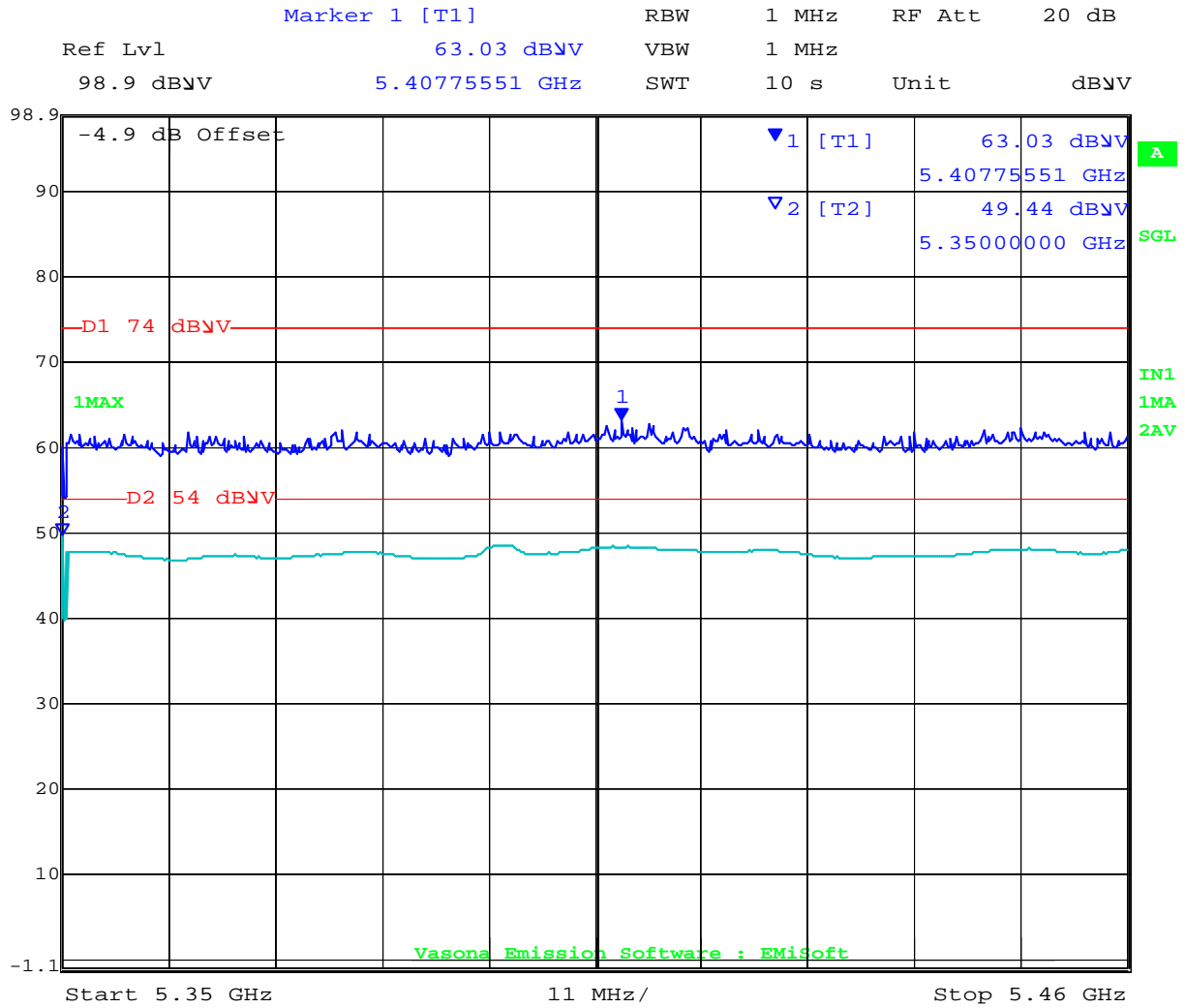

Date: 18.SEP.2012 15:54:23

This test report may be reproduced in full only. The document may only be updated by MiCOM Labs personnel. Any changes will be noted in the Document History section of the report.



Title: AP0127730, AP0134760
To: FCC 47 CFR Part 15.407 & IC RSS-210
Serial #: RDWN12-U2 Rev B
Issue Date: 18th January 2013
Page: 96 of 272

5470 -5725 MHz

LOW

Test Freq.	5475 MHz	Engineer	JMH
Variant	5 MHz	Temp (°C)	25
Freq. Range	1000 MHz - 18000 MHz	Rel. Hum.(%)	34
Power Setting	16	Press. (mBars)	1004
Antenna	11 dBi Flat Panel 120d Sector	Duty Cycle (%)	100
Test Notes 1			
Test Notes 2			

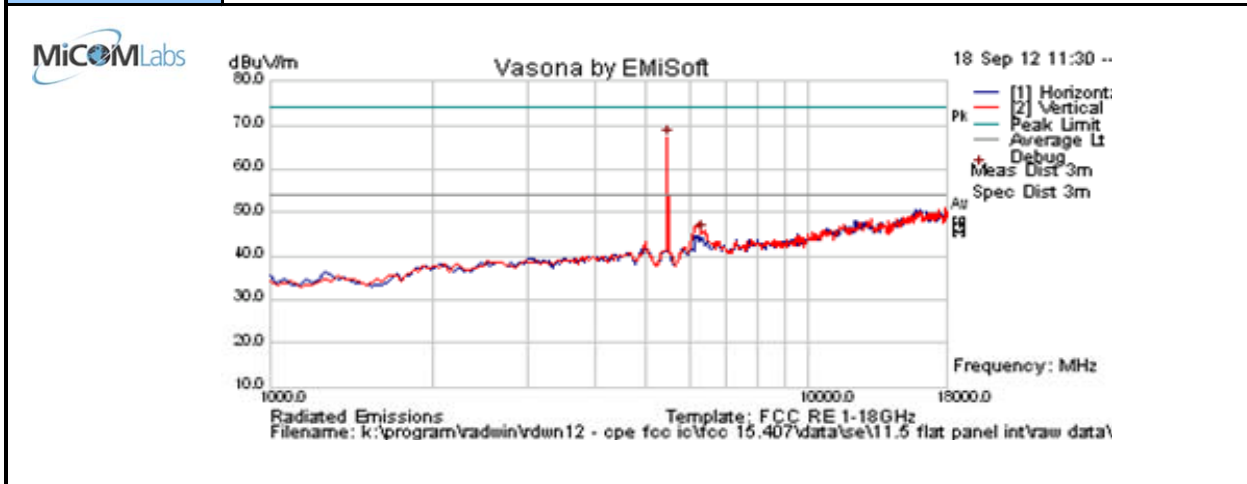

Formally measured emission peaks

Frequency MHz	Raw dBuV	Cable Loss	AF dB	Level dBuV/m	Measurement Type	Pol	Hgt cm	Azt Deg	Limit dBuV/m	Margin dB	Pass /Fail	Comments
5462.926	72.2	4.6	-9.7	67.2	Peak [Scan]	V	100	0				FUND
6349.606	47.6	5.1	-7.4	45.3	Peak [Scan]	V	98	0				NRB

Legend: TX = Transmitter Emissions; DIG = Digital Emissions; FUND = Fundamental; WB = Wideband Emission
 NRB = Non-Restricted Band. Limit = 68.23 dBuV/m; RB = Restricted Band. Limits per 15.205

This test report may be reproduced in full only. The document may only be updated by MiCOM Labs personnel. Any changes will be noted in the Document History section of the report.



Title: AP0127730, AP0134760
To: FCC 47 CFR Part 15.407 & IC RSS-210
Serial #: RDWN12-U2 Rev B
Issue Date: 18th January 2013
Page: 97 of 272

Mid

Test Freq.	5595 MHz	Engineer	JMH
Variant	5 MHz	Temp (°C)	25
Freq. Range	1000 MHz - 18000 MHz	Rel. Hum.(%)	34
Power Setting	16	Press. (mBars)	1004
Antenna	11 dBi Flat Panel 120d Sector	Duty Cycle (%)	100
Test Notes 1			
Test Notes 2			

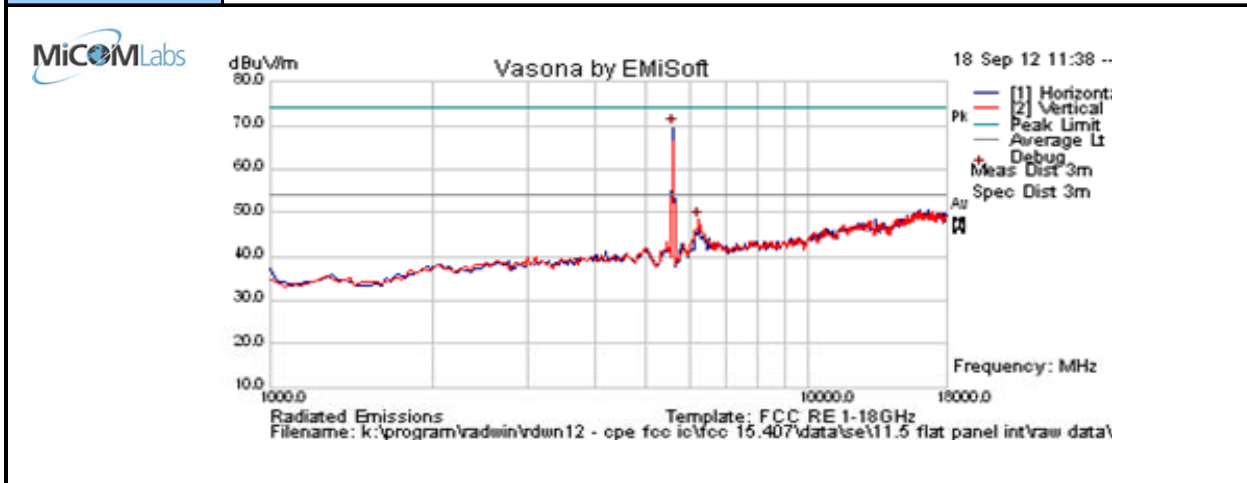

Formally measured emission peaks

Frequency MHz	Raw dBuV	Cable Loss	AF dB	Level dBuV/m	Measurement Type	Pol	Hgt cm	Azt Deg	Limit dBuV/m	Margin dB	Pass /Fail	Comments
5599.198	74.5	4.7	-9.7	69.5	Peak [Scan]	H	100	0				FUND
6246.492986	50.9	5.0	-7.6	48.3	Peak [Scan]	V	100	0				NRB

Legend: TX = Transmitter Emissions; DIG = Digital Emissions; FUND = Fundamental; WB = Wideband Emission
 NRB = Non-Restricted Band. Limit = 68.23 dBuV/m; RB = Restricted Band. Limits per 15.205

This test report may be reproduced in full only. The document may only be updated by MiCOM Labs personnel. Any changes will be noted in the Document History section of the report.



Title: AP0127730, AP0134760
To: FCC 47 CFR Part 15.407 & IC RSS-210
Serial #: RDWN12-U2 Rev B
Issue Date: 18th January 2013
Page: 98 of 272

High

Test Freq.	5720 MHz	Engineer	JMH
Variant	5 MHz	Temp (°C)	25
Freq. Range	1000 MHz - 18000 MHz	Rel. Hum.(%)	34
Power Setting	16	Press. (mBars)	1004
Antenna	11 dBi Flat Panel 120d Sector	Duty Cycle (%)	100
Test Notes 1			
Test Notes 2			

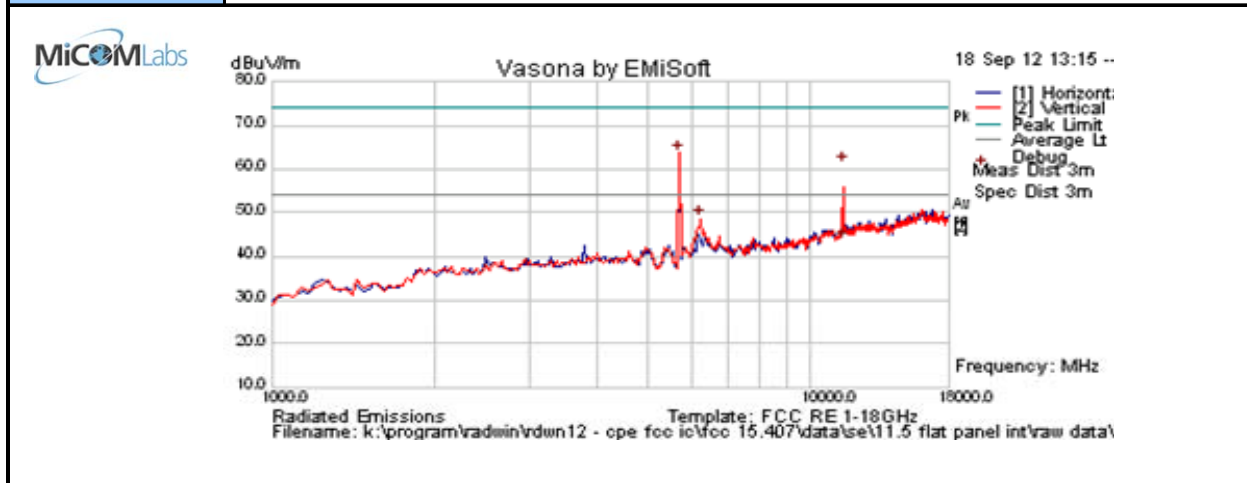

Formally measured emission peaks

Frequency MHz	Raw dBuV	Cable Loss	AF dB	Level dBuV/m	Measurement Type	Pol	Hgt cm	Azt Deg	Limit dBuV/m	Margin dB	Pass /Fail	Comments
5701.403	68.5	4.7	-9.6	63.7	Peak [Scan]	V	100	0				FUND
6246.492986	51.1	5.0	-7.6	48.5	Peak [Scan]	V	100	0				NRB
11440.251	56.6	6.8	-2.1	61.3	Peak Max	V	126	220	74	-12.8	Pass	RB
11440.251	39.0	6.8	-2.1	43.7	Average Max	V	126	220	54	-10.3	Pass	RB

Legend: TX = Transmitter Emissions; DIG = Digital Emissions; FUND = Fundamental; WB = Wideband Emission
 NRB = Non-Restricted Band. Limit = 68.23 dBuV/m; RB = Restricted Band. Limits per 15.205

This test report may be reproduced in full only. The document may only be updated by MiCOM Labs personnel. Any changes will be noted in the Document History section of the report.



6.1.2.2. Antenna # 2

5250 -5350 MHz

Low

Test Freq.	5255 MHz	Engineer	JMH
Variant	5 MHz	Temp (°C)	25
Freq. Range	1000 MHz - 18000 MHz	Rel. Hum.(%)	34
Power Setting	16	Press. (mBars)	1004
Antenna	12 dBi Flat Panel Sector	Duty Cycle (%)	100
Test Notes 1			
Test Notes 2			

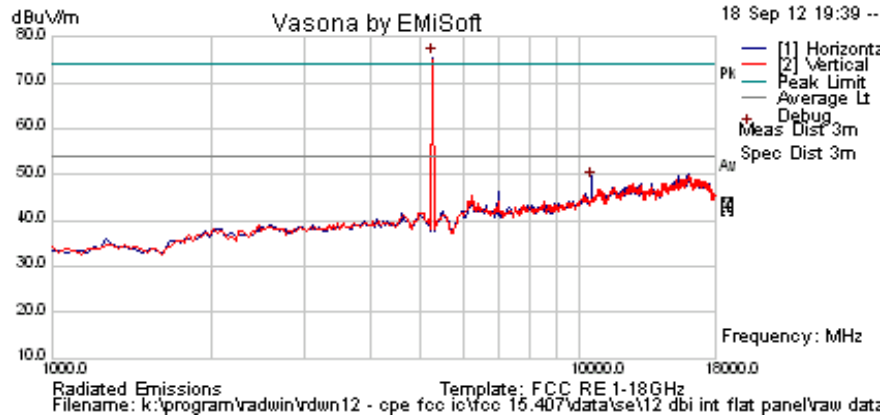

Formally measured emission peaks

Frequency MHz	Raw dBuV	Cable Loss	AF dB	Level dBuV/m	Measurement Type	Pol	Hgt cm	Azt Deg	Limit dBuV/m	Margin dB	Pass /Fail	Comments
5258.517	80.7	4.6	-9.7	75.6	Peak [Scan]	H	100	0				FUND
10510.329	44.3	6.8	-2.4	48.7	Peak [Scan]	V	98	0				NRB

Legend: TX = Transmitter Emissions; DIG = Digital Emissions; FUND = Fundamental; WB = Wideband Emission
 NRB = Non-Restricted Band. Limit = 68.23 dBuV/m; RB = Restricted Band. Limits per 15.205

This test report may be reproduced in full only. The document may only be updated by MiCOM Labs personnel. Any changes will be noted in the Document History section of the report.



Title: AP0127730, AP0134760
To: FCC 47 CFR Part 15.407 & IC RSS-210
Serial #: RDWN12-U2 Rev B
Issue Date: 18th January 2013
Page: 100 of 272

Mid

Test Freq.	5300 MHz	Engineer	JMH
Variant	5 MHz	Temp (°C)	25
Freq. Range	1000 MHz - 18000 MHz	Rel. Hum.(%)	34
Power Setting	16	Press. (mBars)	1004
Antenna	12 dBi Flat Panel Sector	Duty Cycle (%)	100
Test Notes 1			
Test Notes 2			

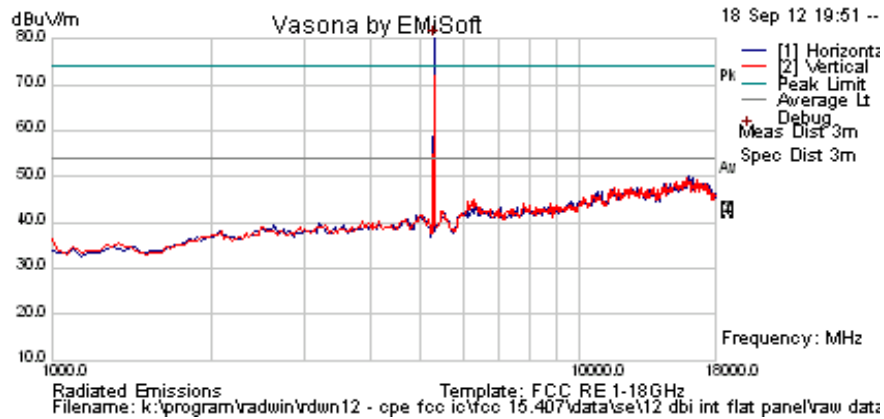

Formally measured emission peaks

Frequency MHz	Raw dBuV	Cable Loss	AF dB	Level dBuV/m	Measurement Type	Pol	Hgt cm	Azt Deg	Limit dBuV/m	Margin dB	Pass /Fail	Comments
5292.585	85.1	4.6	-9.6	80.1	Peak [Scan]	H	100	0				FUND

Legend: TX = Transmitter Emissions; DIG = Digital Emissions; FUND = Fundamental; WB = Wideband Emission
 NRB = Non-Restricted Band. Limit = 68.23 dBuV/m; RB = Restricted Band. Limits per 15.205

This test report may be reproduced in full only. The document may only be updated by MiCOM Labs personnel. Any changes will be noted in the Document History section of the report.



High

Test Freq.	5345 MHz	Engineer	JMH
Variant	5 MHz	Temp (°C)	25
Freq. Range	1000 MHz - 18000 MHz	Rel. Hum.(%)	34
Power Setting	16	Press. (mBars)	1004
Antenna	12 dBi Flat Panel Sector	Duty Cycle (%)	100
Test Notes 1			
Test Notes 2			

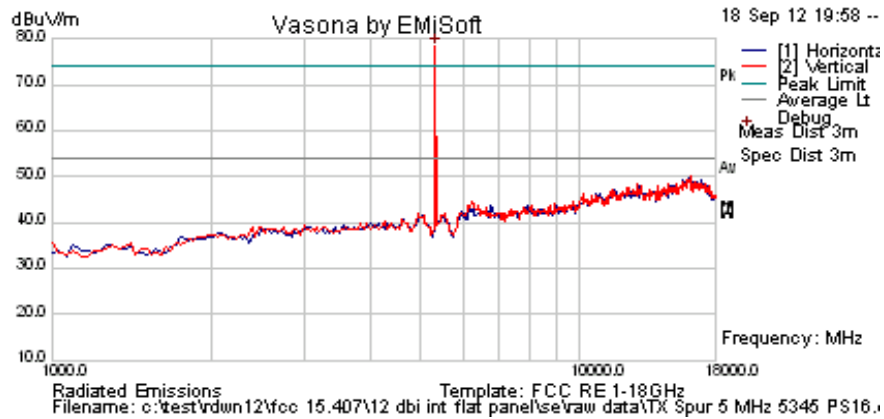

Formally measured emission peaks

Frequency MHz	Raw dBuV	Cable Loss	AF dB	Level dBuV/m	Measurement Type	Pol	Hgt cm	Azt Deg	Limit dBuV/m	Margin dB	Pass /Fail	Comments
5326.653	83.2	4.6	-9.5	78.3	Peak [Scan]	V	100	0				FUND

Legend: TX = Transmitter Emissions; DIG = Digital Emissions; FUND = Fundamental; WB = Wideband Emission
 NRB = Non-Restricted Band. Limit = 68.23 dBuV/m; RB = Restricted Band. Limits per 15.205

This test report may be reproduced in full only. The document may only be updated by MiCOM Labs personnel. Any changes will be noted in the Document History section of the report.



5 MHz 5345 MHz 5350 – 5460 Restricted Band-edge Power Setting = 1

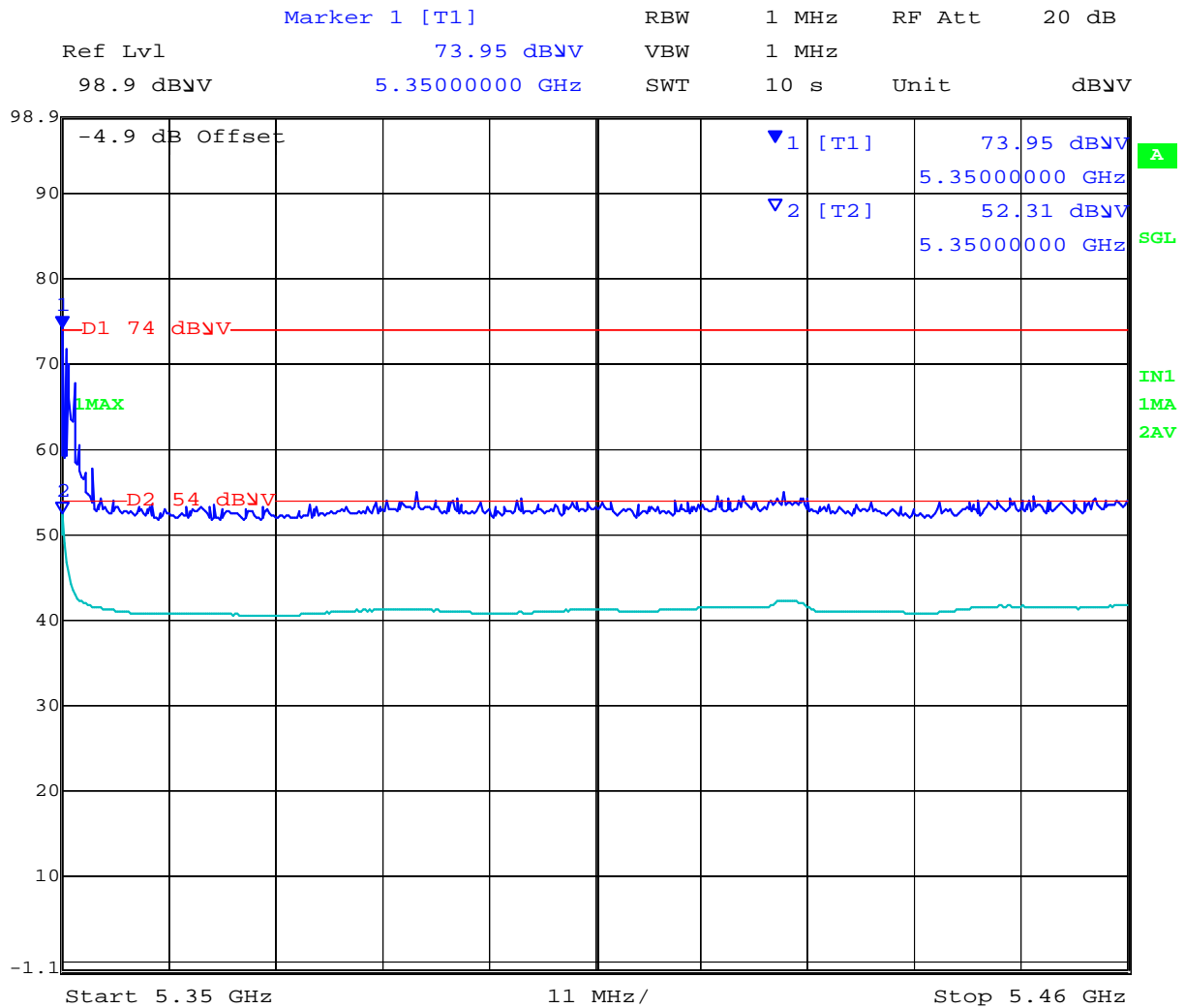

Date: 18.SEP.2012 19:18:35

This test report may be reproduced in full only. The document may only be updated by MiCOM Labs personnel. Any changes will be noted in the Document History section of the report.



5 MHz 5475 MHz 5350 – 5460 Restricted Band-edge Power Setting = 15

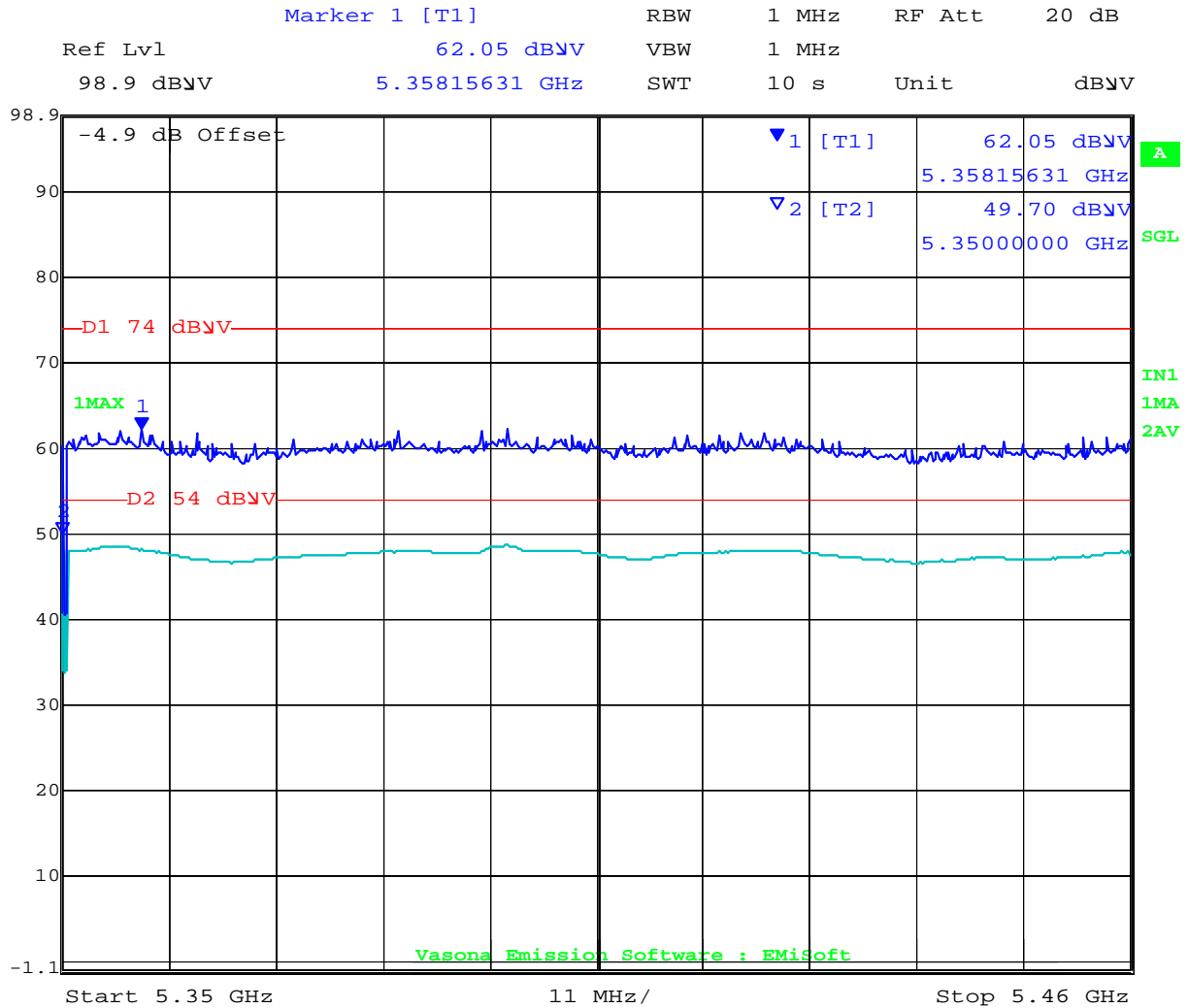

Date: 18.SEP.2012 17:33:20

This test report may be reproduced in full only. The document may only be updated by MiCOM Labs personnel. Any changes will be noted in the Document History section of the report.



5470 -5725 MHz

Low

Test Freq.	5475 MHz	Engineer	JMH
Variant	5 MHz	Temp (°C)	25
Freq. Range	1000 MHz - 18000 MHz	Rel. Hum.(%)	34
Power Setting	15	Press. (mBars)	1004
Antenna	12 dBi Flat Panel Sector	Duty Cycle (%)	100
Test Notes 1			
Test Notes 2			

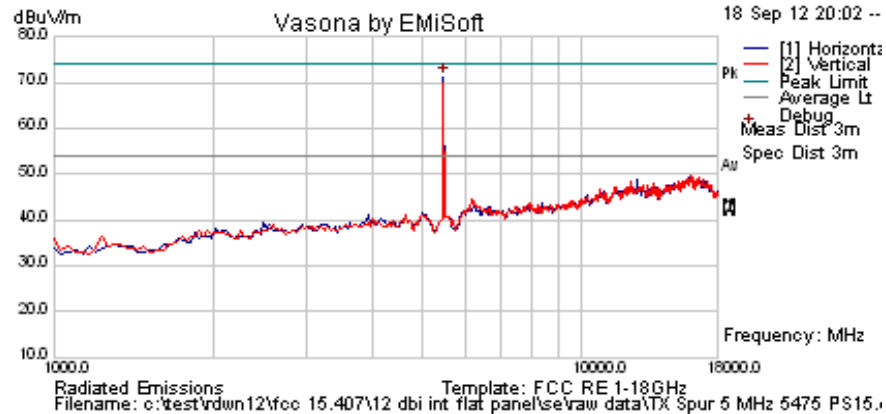

Formally measured emission peaks

Frequency MHz	Raw dBuV	Cable Loss	AF dB	Level dBuV/m	Measurement Type	Pol	Hgt cm	Azt Deg	Limit dBuV/m	Margin dB	Pass /Fail	Comments
5462.926	76.3	4.6	-9.7	71.3	Peak [Scan]	H	150	0				FUND
Legend: TX = Transmitter Emissions; DIG = Digital Emissions; FUND = Fundamental; WB = Wideband Emission NRB = Non-Restricted Band. Limit = 68.23 dBuV/m; RB = Restricted Band. Limits per 15.205												

This test report may be reproduced in full only. The document may only be updated by MiCOM Labs personnel. Any changes will be noted in the Document History section of the report.



Title: AP0127730, AP0134760
To: FCC 47 CFR Part 15.407 & IC RSS-210
Serial #: RDWN12-U2 Rev B
Issue Date: 18th January 2013
Page: 105 of 272

Mid

Test Freq.	5595 MHz	Engineer	JMH
Variant	5 MHz	Temp (°C)	25
Freq. Range	1000 MHz - 18000 MHz	Rel. Hum.(%)	34
Power Setting	16	Press. (mBars)	1004
Antenna	12 dBi Flat Panel Sector	Duty Cycle (%)	100
Test Notes 1			
Test Notes 2			

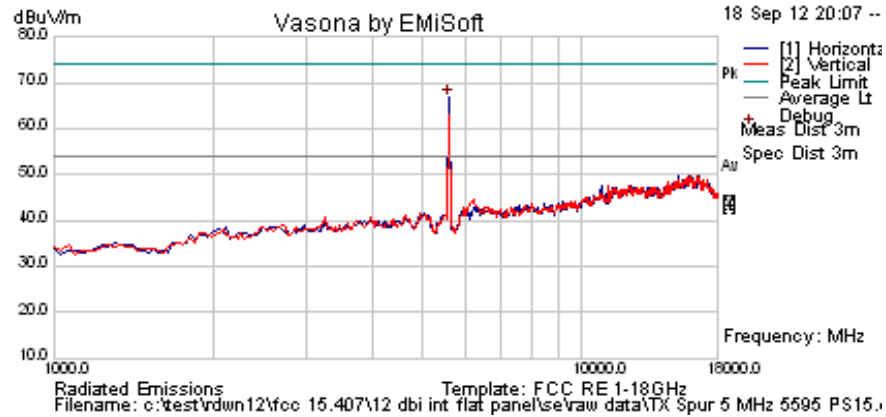

Formally measured emission peaks

Frequency MHz	Raw dBuV	Cable Loss	AF dB	Level dBuV/m	Measurement Type	Pol	Hgt cm	Azt Deg	Limit dBuV/m	Margin dB	Pass /Fail	Comments
5599.198	71.8	4.7	-9.7	66.7	Peak [Scan]	H	150	0				FUND

Legend: TX = Transmitter Emissions; DIG = Digital Emissions; FUND = Fundamental; WB = Wideband Emission
 NRB = Non-Restricted Band. Limit = 68.23 dBuV/m; RB = Restricted Band. Limits per 15.205

This test report may be reproduced in full only. The document may only be updated by MiCOM Labs personnel. Any changes will be noted in the Document History section of the report.



Title: AP0127730, AP0134760
To: FCC 47 CFR Part 15.407 & IC RSS-210
Serial #: RDWN12-U2 Rev B
Issue Date: 18th January 2013
Page: 106 of 272

High

Test Freq.	5720 MHz	Engineer	JMH
Variant	5 MHz	Temp (°C)	25
Freq. Range	1000 MHz - 18000 MHz	Rel. Hum.(%)	34
Power Setting	16	Press. (mBars)	1004
Antenna	12 dBi Flat Panel Sector	Duty Cycle (%)	100
Test Notes 1			
Test Notes 2			

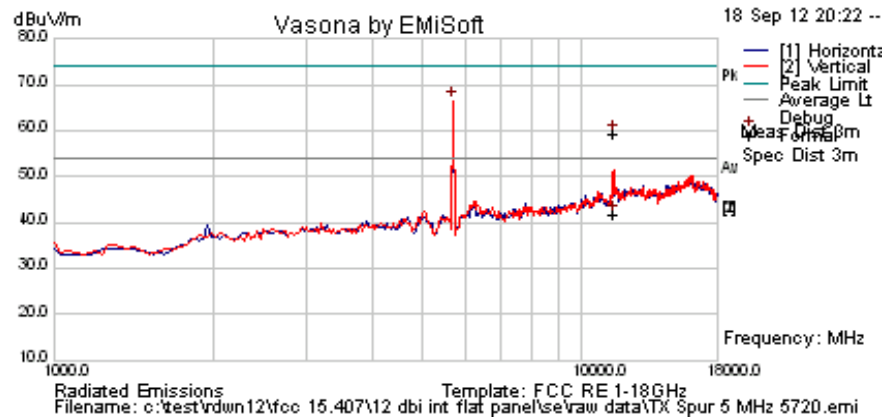

Formally measured emission peaks

Frequency MHz	Raw dBuV	Cable Loss	AF dB	Level dBuV/m	Measurement Type	Pol	Hgt cm	Azt Deg	Limit dBuV/m	Margin dB	Pass /Fail	Comments
5701.403	71.3	4.7	-9.6	66.5	Peak [Scan]	V	100	0				FUND
11440.04	54.6	6.8	-2.1	59.3	Peak Max	V	112	208	74.0	-14.7	Pass	RB
11440.040	37.2	6.8	-2.1	41.9	Average Max	V	112	208	54	-12.1	Pass	RB
Legend: TX = Transmitter Emissions; DIG = Digital Emissions; FUND = Fundamental; WB = Wideband Emission NRB = Non-Restricted Band. Limit = 68.23 dBuV/m; RB = Restricted Band. Limits per 15.205												

This test report may be reproduced in full only. The document may only be updated by MiCOM Labs personnel. Any changes will be noted in the Document History section of the report.



6.1.2.3. Antenna # 3

5250 -5350 MHz

Low

Test Freq.	5255 MHz	Engineer	SB
Variant	5 MHz	Temp (°C)	23
Freq. Range	1000 MHz - 18000 MHz	Rel. Hum.(%)	33
Power Setting	16	Press. (mBars)	1008
Antenna	16.5 dBi Flat Panel Sector	Duty Cycle (%)	100
Test Notes 1			
Test Notes 2			

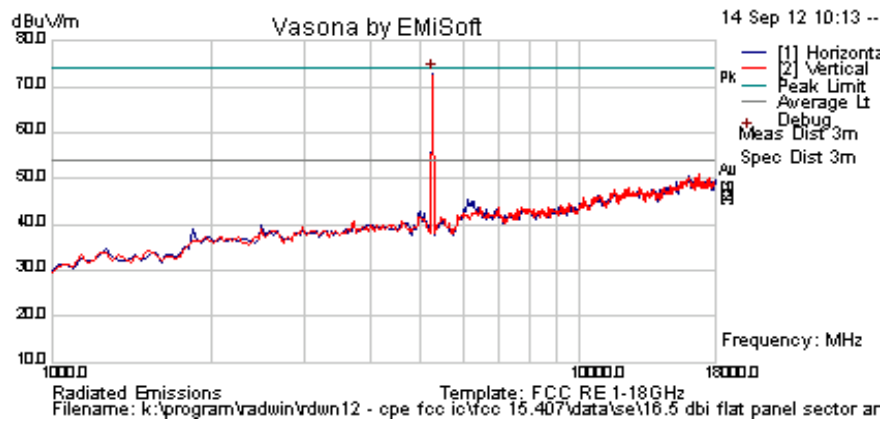

Formally measured emission peaks

Frequency MHz	Raw dBuV	Cable Loss	AF dB	Level dBuV/m	Measurement Type	Pol	Hgt cm	Azt Deg	Limit dBuV/m	Margin dB	Pass /Fail	Comments
5258.517	78.1	4.6	-9.7	73.0	Peak [Scan]	H	100	0				FUND
Legend: TX = Transmitter Emissions; DIG = Digital Emissions; FUND = Fundamental; WB = Wideband Emission NRB = Non-Restricted Band. Limit = 68.23 dBuV/m; RB = Restricted Band. Limits per 15.205												

This test report may be reproduced in full only. The document may only be updated by MiCOM Labs personnel. Any changes will be noted in the Document History section of the report.



Title: AP0127730, AP0134760
To: FCC 47 CFR Part 15.407 & IC RSS-210
Serial #: RDWN12-U2 Rev B
Issue Date: 18th January 2013
Page: 108 of 272

Mid

Test Freq.	5300 MHz	Engineer	SB
Variant	5 MHz	Temp (°C)	23
Freq. Range	1000 MHz - 18000 MHz	Rel. Hum.(%)	33
Power Setting	16	Press. (mBars)	1008
Antenna	16.5 dBi Flat Panel Sector	Duty Cycle (%)	100
Test Notes 1			
Test Notes 2			

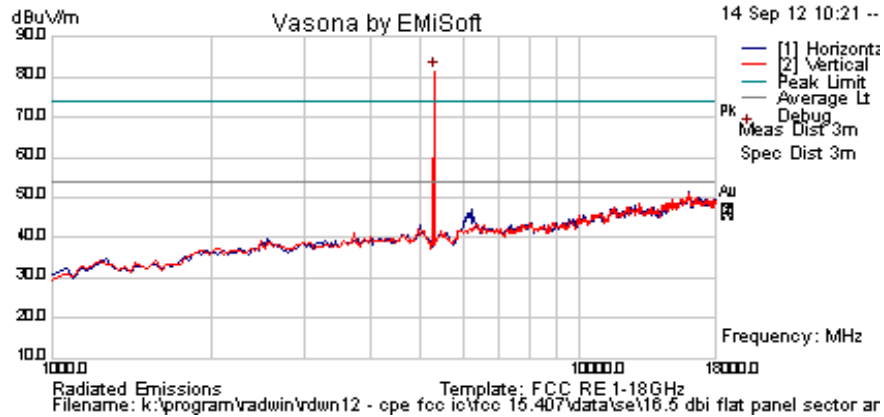

Formally measured emission peaks

Frequency MHz	Raw dBuV	Cable Loss	AF dB	Level dBuV/m	Measurement Type	Pol	Hgt cm	Azt Deg	Limit dBuV/m	Margin dB	Pass /Fail	Comments
5292.585	86.5	4.6	-9.6	81.5	Peak [Scan]	V	100	0				FUND

Legend: TX = Transmitter Emissions; DIG = Digital Emissions; FUND = Fundamental; WB = Wideband Emission
 NRB = Non-Restricted Band. Limit = 68.23 dBuV/m; RB = Restricted Band. Limits per 15.205

This test report may be reproduced in full only. The document may only be updated by MiCOM Labs personnel. Any changes will be noted in the Document History section of the report.



Title: AP0127730, AP0134760
To: FCC 47 CFR Part 15.407 & IC RSS-210
Serial #: RDWN12-U2 Rev B
Issue Date: 18th January 2013
Page: 109 of 272

High

Test Freq.	5345 MHz	Engineer	SB
Variant	5 MHz	Temp (°C)	23
Freq. Range	1000 MHz - 18000 MHz	Rel. Hum.(%)	33
Power Setting	16	Press. (mBars)	1008
Antenna	16.5 dBi Flat Panel Sector	Duty Cycle (%)	100
Test Notes 1			
Test Notes 2			

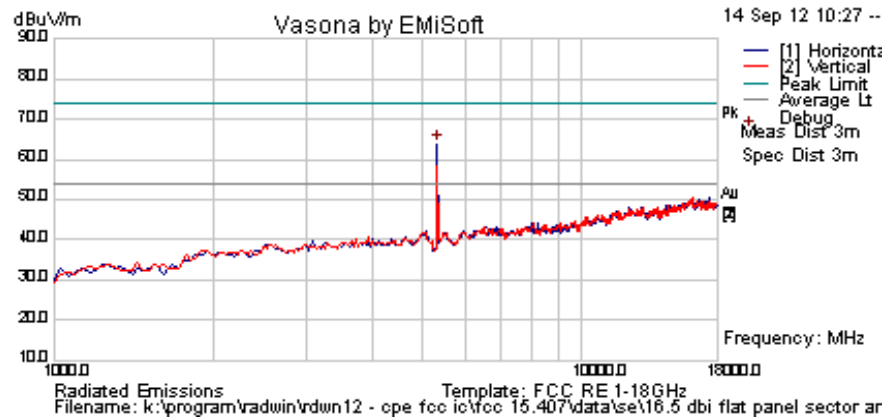

Formally measured emission peaks

Frequency MHz	Raw dBuV	Cable Loss	AF dB	Level dBuV/m	Measurement Type	Pol	Hgt cm	Azt Deg	Limit dBuV/m	Margin dB	Pass /Fail	Comments
5326.653	68.7	4.6	-9.5	63.8	Peak [Scan]	H	100	0				FUND

Legend: TX = Transmitter Emissions; DIG = Digital Emissions; FUND = Fundamental; WB = Wideband Emission
 NRB = Non-Restricted Band. Limit = 68.23 dBuV/m; RB = Restricted Band. Limits per 15.205

This test report may be reproduced in full only. The document may only be updated by MiCOM Labs personnel. Any changes will be noted in the Document History section of the report.



5 MHz 5345 MHz 5350 – 5460 Restricted Band-edge Power Setting = -6

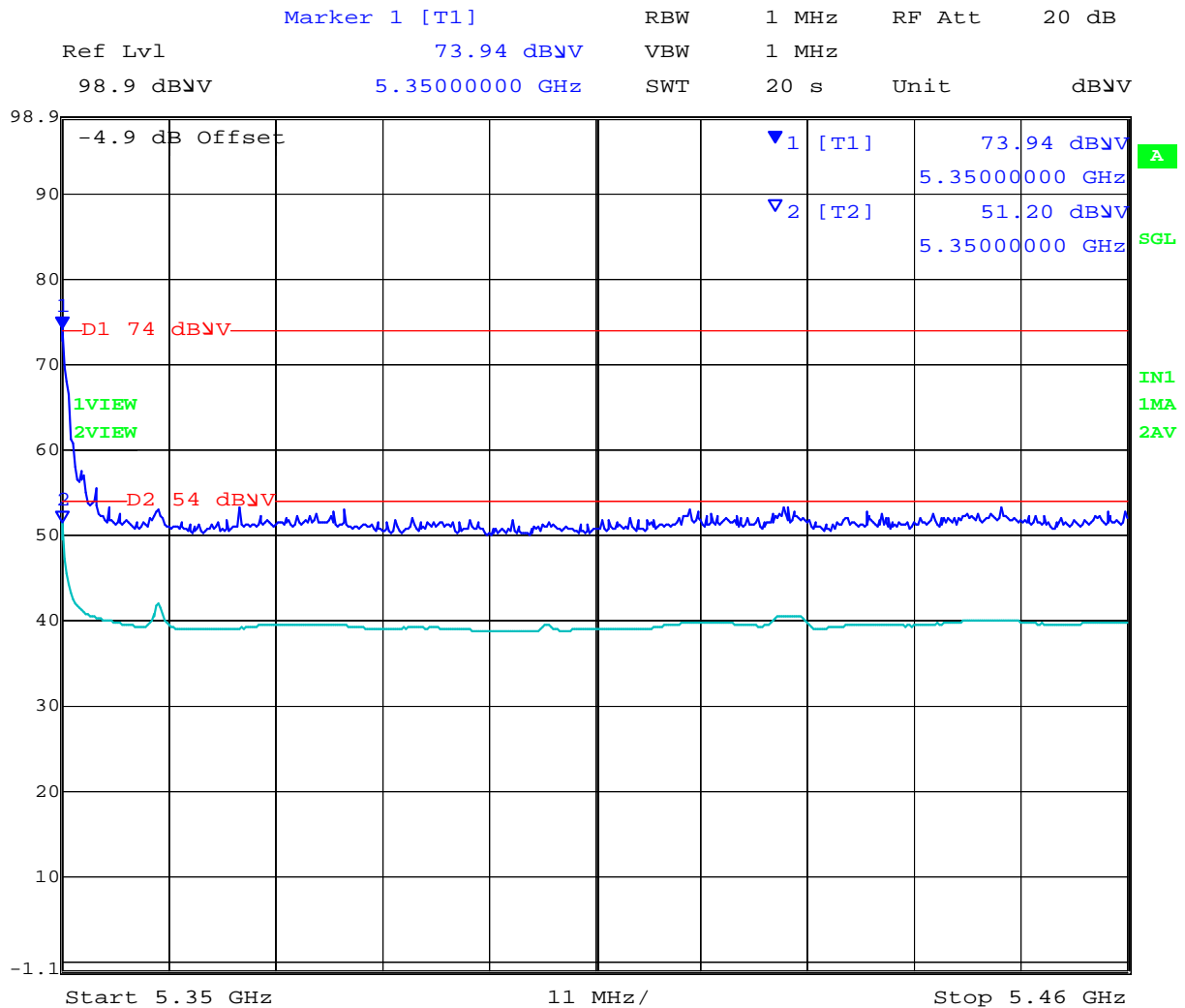

Date: 14.SEP.2012 09:24:26

This test report may be reproduced in full only. The document may only be updated by MiCOM Labs personnel. Any changes will be noted in the Document History section of the report.



5470 -5725 MHz

Low

Test Freq.	5475 MHz	Engineer	SB
Variant	5 MHz	Temp (°C)	23
Freq. Range	1000 MHz - 18000 MHz	Rel. Hum.(%)	33
Power Setting	16	Press. (mBars)	1008
Antenna	16.5 dBi Flat Panel Sector	Duty Cycle (%)	100
Test Notes 1			
Test Notes 2			

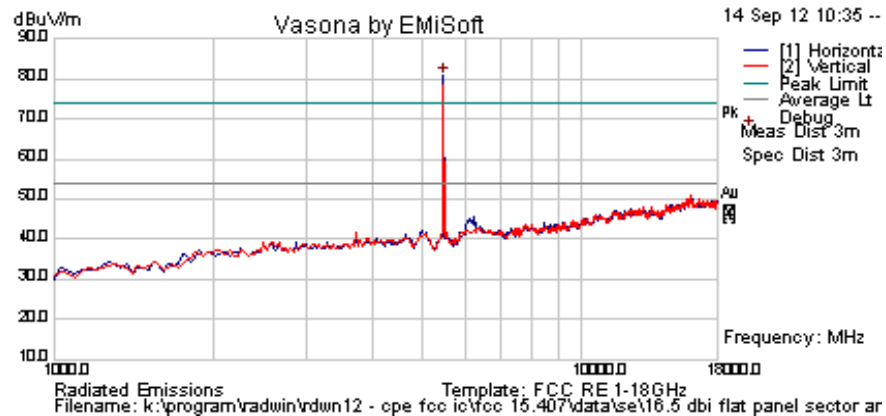

Formally measured emission peaks

Frequency MHz	Raw dBuV	Cable Loss	AF dB	Level dBuV/m	Measurement Type	Pol	Hgt cm	Azt Deg	Limit dBuV/m	Margin dB	Pass /Fail	Comments
5462.926	85.8	4.6	-9.7	80.7	Peak [Scan]	H	100	0				FUND
Legend: TX = Transmitter Emissions; DIG = Digital Emissions; FUND = Fundamental; WB = Wideband Emission NRB = Non-Restricted Band. Limit = 68.23 dBuV/m; RB = Restricted Band. Limits per 15.205												

This test report may be reproduced in full only. The document may only be updated by MiCOM Labs personnel. Any changes will be noted in the Document History section of the report.



Title: AP0127730, AP0134760
To: FCC 47 CFR Part 15.407 & IC RSS-210
Serial #: RDWN12-U2 Rev B
Issue Date: 18th January 2013
Page: 113 of 272

Mid

Test Freq.	5595 MHz	Engineer	SB
Variant	5 MHz	Temp (°C)	23
Freq. Range	1000 MHz - 18000 MHz	Rel. Hum.(%)	33
Power Setting	16	Press. (mBars)	1008
Antenna	16.5 dBi Flat Panel Sector	Duty Cycle (%)	100
Test Notes 1			
Test Notes 2			

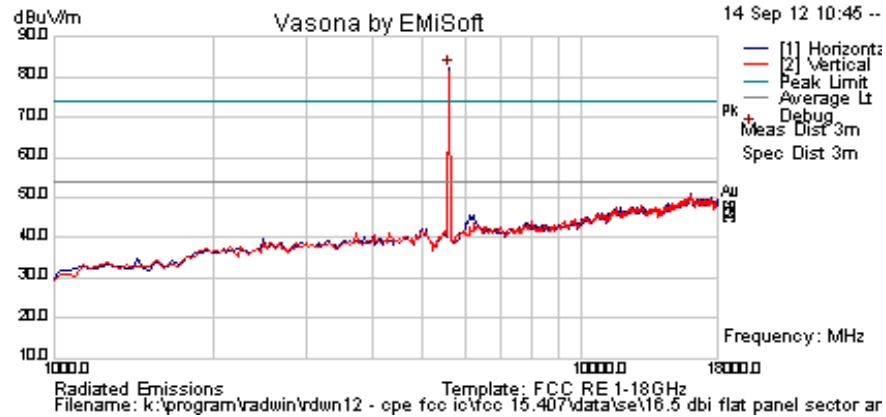

Formally measured emission peaks

Frequency MHz	Raw dBuV	Cable Loss	AF dB	Level dBuV/m	Measurement Type	Pol	Hgt cm	Azt Deg	Limit dBuV/m	Margin dB	Pass /Fail	Comments
5599.198	87.2	4.7	-9.7	82.1	Peak [Scan]	H	150	0				FUND

Legend: TX = Transmitter Emissions; DIG = Digital Emissions; FUND = Fundamental; WB = Wideband Emission
 NRB = Non-Restricted Band. Limit = 68.23 dBuV/m; RB = Restricted Band. Limits per 15.205

This test report may be reproduced in full only. The document may only be updated by MiCOM Labs personnel. Any changes will be noted in the Document History section of the report.



Title: AP0127730, AP0134760
To: FCC 47 CFR Part 15.407 & IC RSS-210
Serial #: RDWN12-U2 Rev B
Issue Date: 18th January 2013
Page: 114 of 272

High

Test Freq.	5720 MHz	Engineer	SB
Variant	5 MHz	Temp (°C)	23
Freq. Range	1000 MHz - 18000 MHz	Rel. Hum.(%)	33
Power Setting	16	Press. (mBars)	1008
Antenna	16.5 dBi Flat Panel Sector	Duty Cycle (%)	100
Test Notes 1			
Test Notes 2			

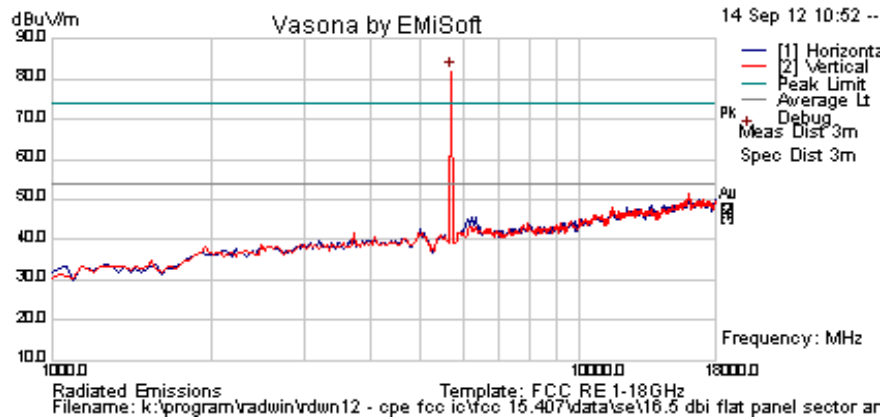

Formally measured emission peaks

Frequency MHz	Raw dBuV	Cable Loss	AF dB	Level dBuV/m	Measurement Type	Pol	Hgt cm	Azt Deg	Limit dBuV/m	Margin dB	Pass /Fail	Comments
5701.403	86.8	4.7	-9.6	81.9	Peak [Scan]	H	100	0				FUND

Legend: TX = Transmitter Emissions; DIG = Digital Emissions; FUND = Fundamental; WB = Wideband Emission
 NRB = Non-Restricted Band. Limit = 68.23 dBuV/m; RB = Restricted Band. Limits per 15.205

This test report may be reproduced in full only. The document may only be updated by MiCOM Labs personnel. Any changes will be noted in the Document History section of the report.



6.1.2.4. Antenna # 4

5250 -5350 MHz

Low

Test Freq.	5255 MHz	Engineer	jmh
Variant	5 MHz	Temp (°C)	25
Freq. Range	1000 MHz - 18000 MHz	Rel. Hum.(%)	31
Power Setting	16	Press. (mBars)	1006
Antenna	16.5 dBi INT Flat Panel	Duty Cycle (%)	100
Test Notes 1	Data rate MCS 15		
Test Notes 2			

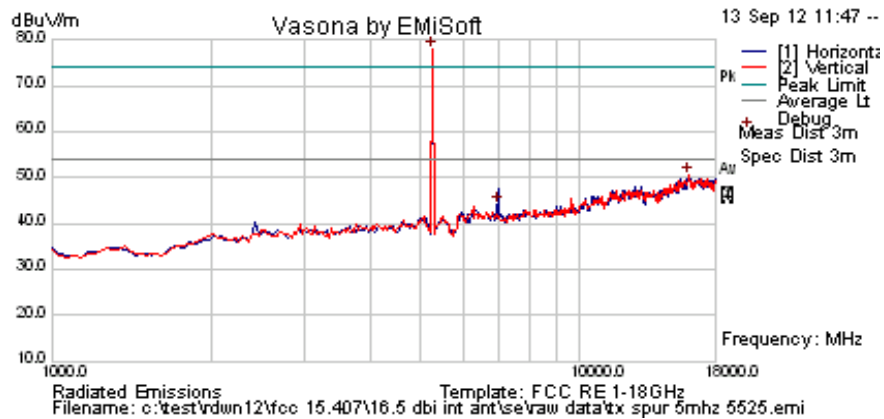

Formally measured emission peaks

Frequency MHz	Raw dBuV	Cable Loss	AF dB	Level dBuV/m	Measurement Type	Pol	Hgt cm	Azt Deg	Limit dBuV/m	Margin dB	Pass /Fail	Comments
5258.517	83.0	4.6	-9.7	77.9	Peak [Scan]	V						FUND
16058.116	41.1	9.0	0.3	50.4	Peak [Scan]	V	100	0	54.0	-3.6	Pass	Noise
7006.683	44.9	5.4	-6.3	44.0	Peak [Scan]	H	98	360	54.0	-10.0	Pass	NRB

Legend: TX = Transmitter Emissions; DIG = Digital Emissions; FUND = Fundamental; WB = Wideband Emission
 NRB = Non-Restricted Band. Limit = 68.23 dBuV/m; RB = Restricted Band. Limits per 15.205

This test report may be reproduced in full only. The document may only be updated by MiCOM Labs personnel. Any changes will be noted in the Document History section of the report.



Mid

Test Freq.	5300 MHz	Engineer	jmh
Variant	5 MHz	Temp (°C)	25
Freq. Range	1000 MHz - 18000 MHz	Rel. Hum.(%)	31
Power Setting	16	Press. (mBars)	1006
Antenna	16.5 dBi INT Flat Panel	Duty Cycle (%)	100
Test Notes 1	Data rate MCS 15		
Test Notes 2			

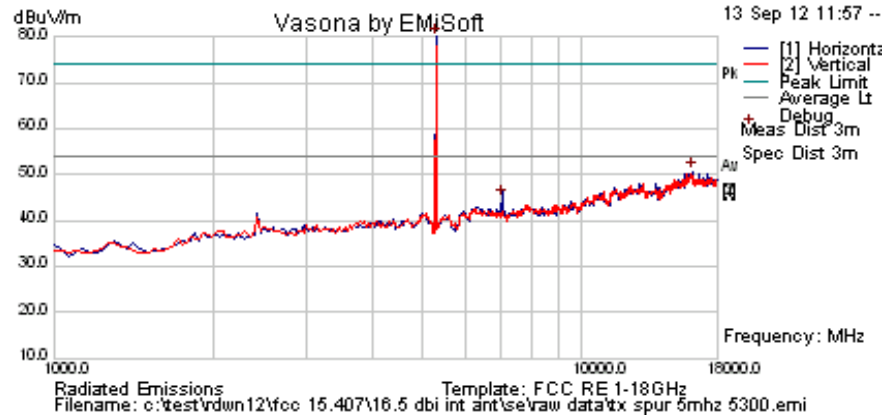

Formally measured emission peaks

Frequency MHz	Raw dBuV	Cable Loss	AF dB	Level dBuV/m	Measurement Type	Pol	Hgt cm	Azt Deg	Limit dBuV/m	Margin dB	Pass /Fail	Comments
5292.585	85.1	4.6	-9.6	80.2	Peak [Scan]	H						FUND
16228.457	41.5	8.9	0.1	50.6	Peak [Scan]	H						Noise
7076.516	45.4	5.4	-6.1	44.7	Peak [Scan]	V	98	0	54.0	-9.3	Pass	NRB
Legend: TX = Transmitter Emissions; DIG = Digital Emissions; FUND = Fundamental; WB = Wideband Emission NRB = Non-Restricted Band. Limit = 68.23 dBuV/m; RB = Restricted Band. Limits per 15.205												

This test report may be reproduced in full only. The document may only be updated by MiCOM Labs personnel. Any changes will be noted in the Document History section of the report.



Title: AP0127730, AP0134760
To: FCC 47 CFR Part 15.407 & IC RSS-210
Serial #: RDWN12-U2 Rev B
Issue Date: 18th January 2013
Page: 117 of 272

High

Test Freq.	5345 MHz	Engineer	jmh
Variant	5 MHz	Temp (°C)	25
Freq. Range	1000 MHz - 18000 MHz	Rel. Hum.(%)	31
Power Setting	16	Press. (mBars)	1006
Antenna	16.5 dBi INT Flat Panel	Duty Cycle (%)	100
Test Notes 1	Data rate MCS 15		
Test Notes 2			

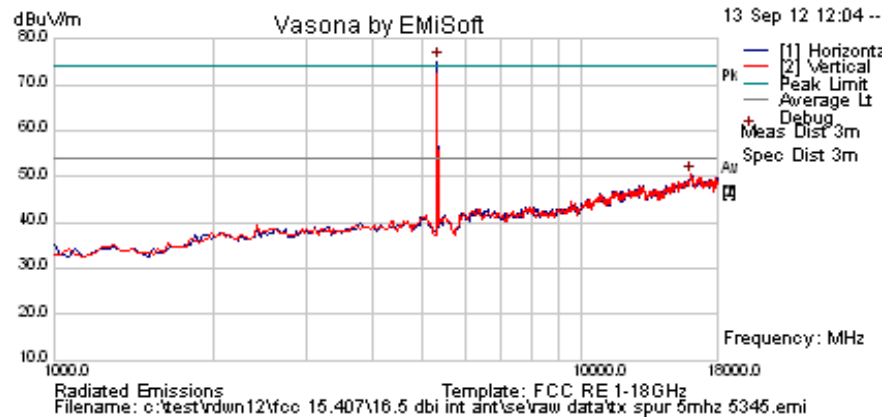

Formally measured emission peaks

Frequency MHz	Raw dBuV	Cable Loss	AF dB	Level dBuV/m	Measurement Type	Pol	Hgt cm	Azt Deg	Limit dBuV/m	Margin dB	Pass /Fail	Comments
5326.653	80.0	4.6	-9.5	75.1	Peak [Scan]	H						FUND
16058.116	41.2	9.0	0.3	50.4	Peak [Scan]	V	100	0	54.0	-3.6	Pass	Noise

Legend: TX = Transmitter Emissions; DIG = Digital Emissions; FUND = Fundamental; WB = Wideband Emission
 NRB = Non-Restricted Band. Limit = 68.23 dBuV/m; RB = Restricted Band. Limits per 15.205

This test report may be reproduced in full only. The document may only be updated by MiCOM Labs personnel. Any changes will be noted in the Document History section of the report.



5 MHz 5345 MHz 5350 – 5460 Restricted Band-edge Power Setting = -3

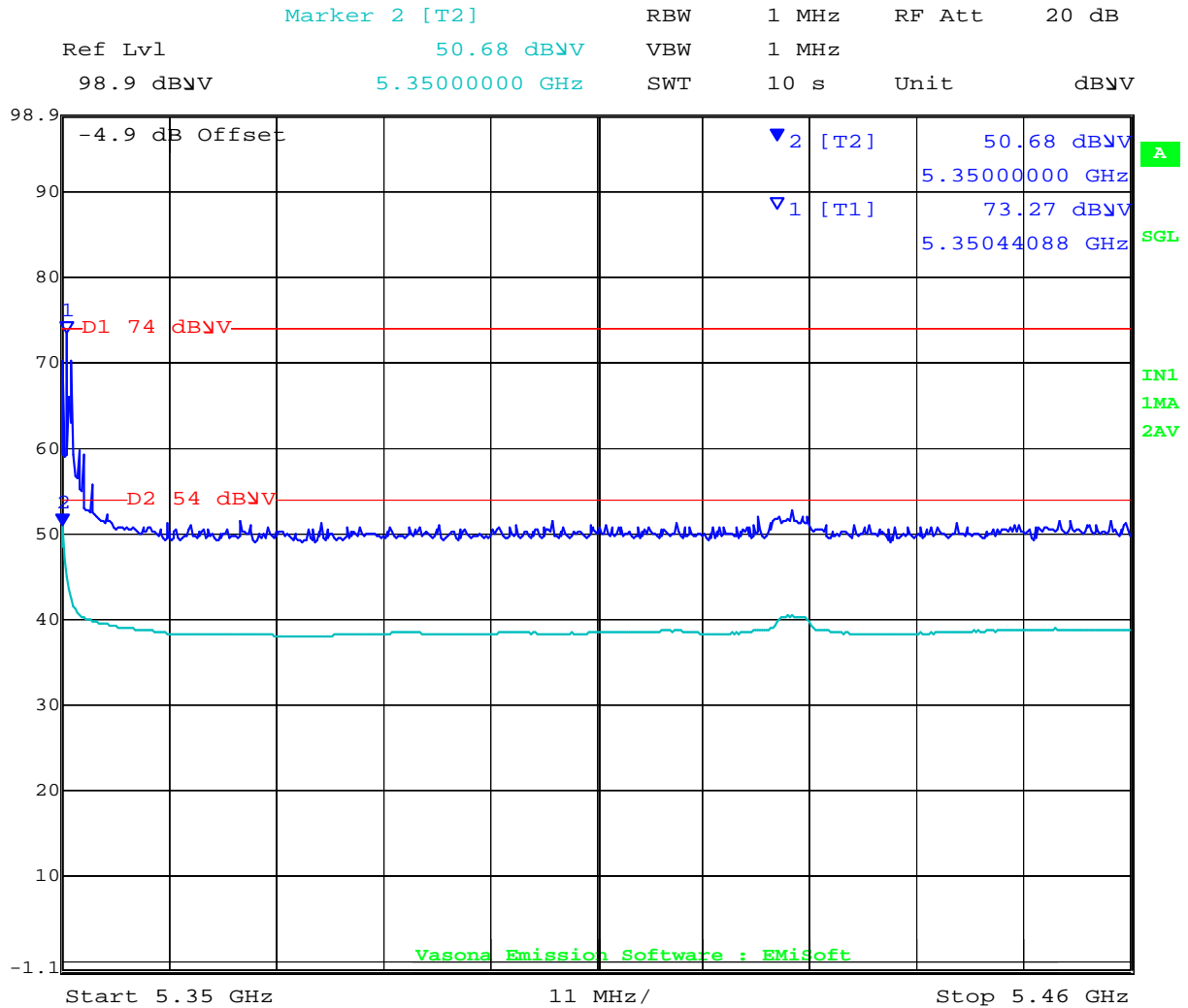

Date: 13.SEP.2012 12:44:24

This test report may be reproduced in full only. The document may only be updated by MiCOM Labs personnel. Any changes will be noted in the Document History section of the report.



Title: AP0127730, AP0134760
To: FCC 47 CFR Part 15.407 & IC RSS-210
Serial #: RDWN12-U2 Rev B
Issue Date: 18th January 2013
Page: 119 of 272

5 MHz 5475 MHz 5350 – 5460 Restricted Band-edge Power Setting = 15

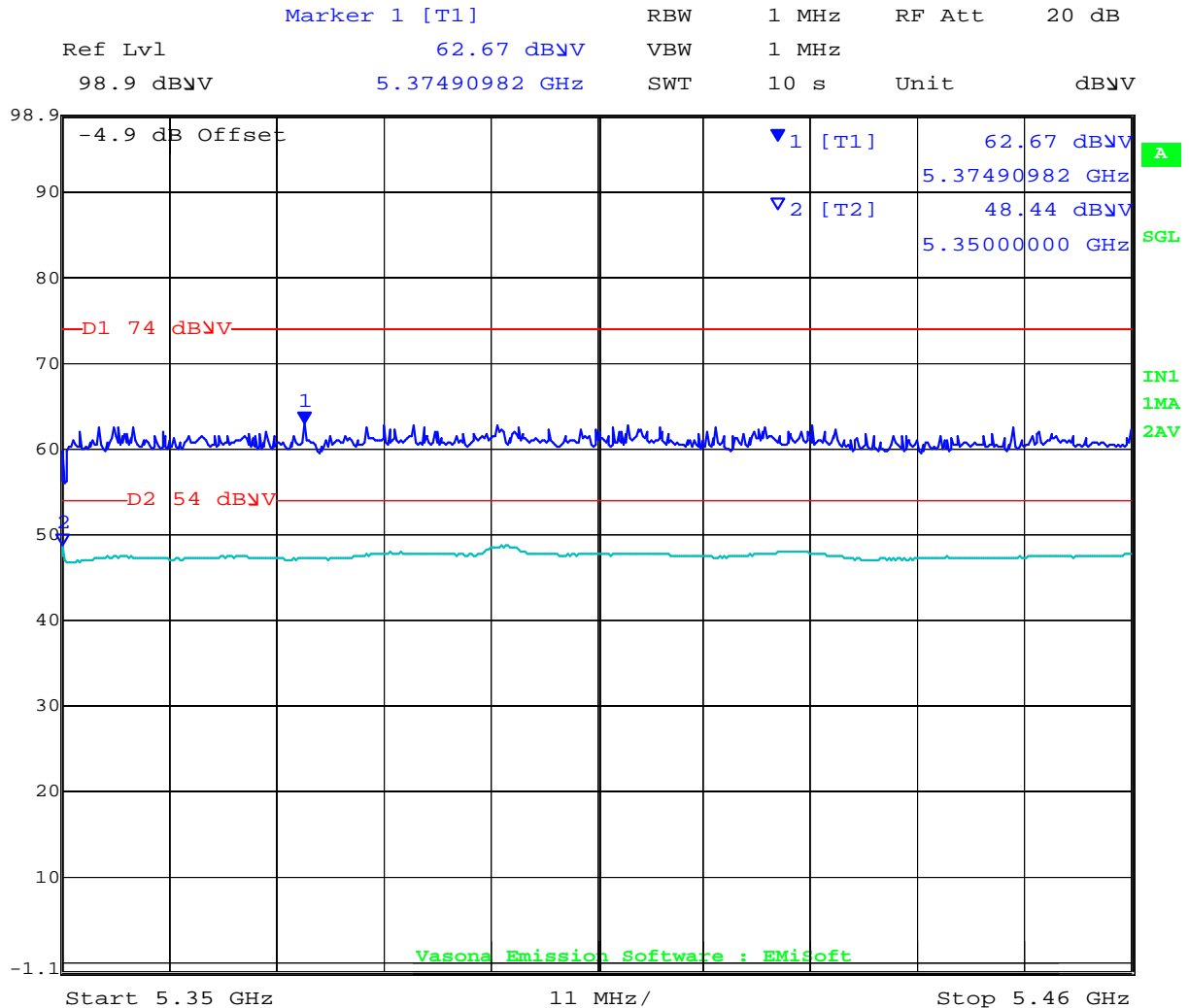

Date: 13.SEP.2012 13:17:10

This test report may be reproduced in full only. The document may only be updated by MiCOM Labs personnel. Any changes will be noted in the Document History section of the report.



Title: AP0127730, AP0134760
To: FCC 47 CFR Part 15.407 & IC RSS-210
Serial #: RDWN12-U2 Rev B
Issue Date: 18th January 2013
Page: 120 of 272

5470 -5725 MHz

Low

Test Freq.	5475 MHz	Engineer	JMH
Variant	5 MHz	Temp (°C)	24
Freq. Range	1000 MHz - 18000 MHz	Rel. Hum.(%)	33
Power Setting	15	Press. (mBars)	1005
Antenna	16.5 dBi Int Flat Panel	Duty Cycle (%)	100
Test Notes 1	Data Rate MCS 15		
Test Notes 2			

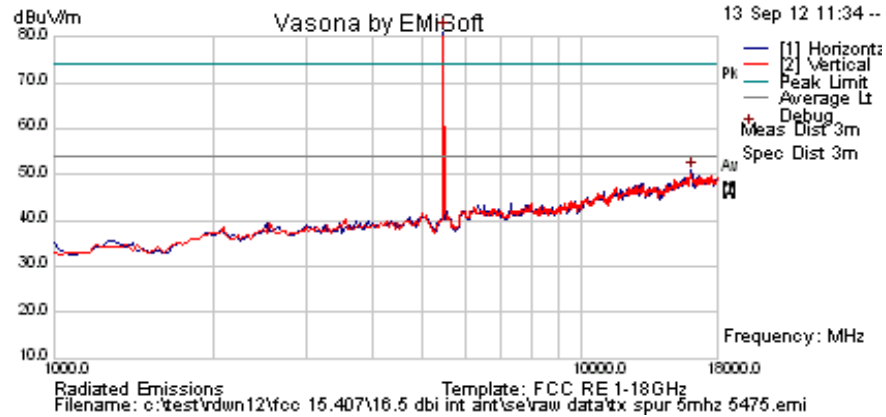

Formally measured emission peaks

Frequency MHz	Raw dBuV	Cable Loss	AF dB	Level dBuV/m	Measurement Type	Pol	Hgt cm	Azt Deg	Limit dBuV/m	Margin dB	Pass /Fail	Comments
5462.926	86.1	4.6	-9.7	81.1	Peak [Scan]	H						FUND
16092.184	41.7	9.0	0.3	50.9	Peak [Scan]	H						Noise
Legend: TX = Transmitter Emissions; DIG = Digital Emissions; FUND = Fundamental; WB = Wideband Emission NRB = Non-Restricted Band. Limit = 68.23 dBuV/m; RB = Restricted Band. Limits per 15.205												

This test report may be reproduced in full only. The document may only be updated by MiCOM Labs personnel. Any changes will be noted in the Document History section of the report.



Title: AP0127730, AP0134760
To: FCC 47 CFR Part 15.407 & IC RSS-210
Serial #: RDWN12-U2 Rev B
Issue Date: 18th January 2013
Page: 121 of 272

Mid

Test Freq.	5595 MHz	Engineer	JMH
Variant	5 MHz	Temp (°C)	24
Freq. Range	1000 MHz - 18000 MHz	Rel. Hum.(%)	33
Power Setting	15	Press. (mBars)	1005
Antenna	16.5 dBi Int Flat Panel	Duty Cycle (%)	100
Test Notes 1	Data Rate MCS 15		
Test Notes 2			

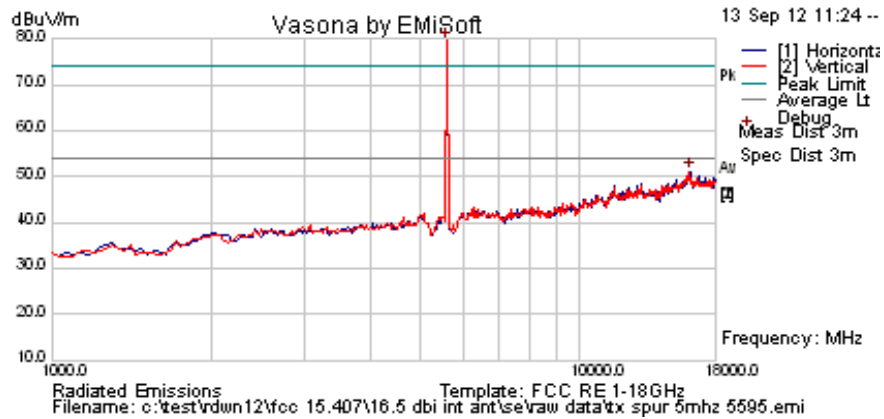

Formally measured emission peaks

Frequency MHz	Raw dBuV	Cable Loss	AF dB	Level dBuV/m	Measurement Type	Pol	Hgt cm	Azt Deg	Limit dBuV/m	Margin dB	Pass /Fail	Comments
5599.198	84.5	4.7	-9.7	79.5	Peak [Scan]	V						FUND
16092.184	41.9	9.0	0.3	51.1	Peak [Scan]	V						Noise

Legend: TX = Transmitter Emissions; DIG = Digital Emissions; FUND = Fundamental; WB = Wideband Emission
 NRB = Non-Restricted Band. Limit = 68.23 dBuV/m; RB = Restricted Band. Limits per 15.205

This test report may be reproduced in full only. The document may only be updated by MiCOM Labs personnel. Any changes will be noted in the Document History section of the report.



Title: AP0127730, AP0134760
To: FCC 47 CFR Part 15.407 & IC RSS-210
Serial #: RDWN12-U2 Rev B
Issue Date: 18th January 2013
Page: 122 of 272

High

Test Freq.	5720 MHz	Engineer	JMH
Variant	5 MHz	Temp (°C)	24
Freq. Range	1000 MHz - 18000 MHz	Rel. Hum.(%)	33
Power Setting	15	Press. (mBars)	1005
Antenna	16.5 dBi Int Flat Panel	Duty Cycle (%)	100
Test Notes 1	Data Rate MCS 15		
Test Notes 2			

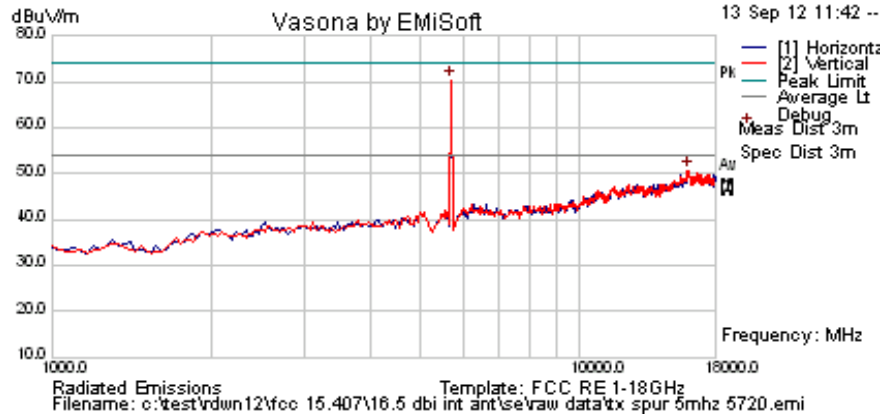

Formally measured emission peaks

Frequency MHz	Raw dBuV	Cable Loss	AF dB	Level dBuV/m	Measurement Type	PoI	Hgt cm	Azt Deg	Limit dBuV/m	Margin dB	Pass /Fail	Comments
5701.403	75.3	4.7	-9.6	70.4	Peak [Scan]	V						FUND
16058.116	41.3	9.0	0.3	50.6	Peak [Scan]	V						Noise

Legend: TX = Transmitter Emissions; DIG = Digital Emissions; FUND = Fundamental; WB = Wideband Emission
 NRB = Non-Restricted Band. Limit = 68.23 dBuV/m; RB = Restricted Band. Limits per 15.205

This test report may be reproduced in full only. The document may only be updated by MiCOM Labs personnel. Any changes will be noted in the Document History section of the report.



6.1.2.5. Antenna # 5

5250 -5350 MHz

Low

Test Freq.	5255 MHz	Engineer	jmh
Variant	5 MHz	Temp (°C)	25
Freq. Range	1000 MHz - 18000 MHz	Rel. Hum.(%)	31
Power Setting	16	Press. (mBars)	1006
Antenna	24 dBi INT Flat Panel	Duty Cycle (%)	100
Test Notes 1	Data rate MCS 15		
Test Notes 2			

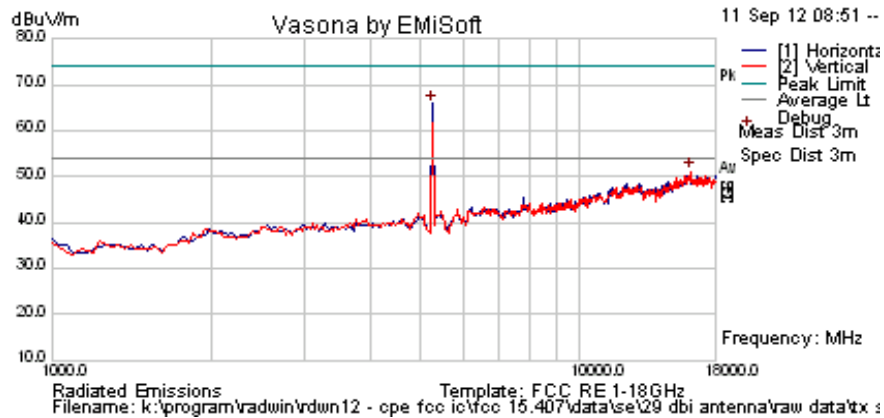

Formally measured emission peaks

Frequency MHz	Raw dBuV	Cable Loss	AF dB	Level dBuV/m	Measurement Type	Pol	Hgt cm	Azt Deg	Limit dBuV/m	Margin dB	Pass /Fail	Comments
5258.517	84.4	4.6	-9.7	79.3	Peak [Scan]	H						FUND
6212.42485	53.8	5.0	-7.8	51.0	Peak [Scan]	V						NRB
16092.184	41.2	9.0	0.3	50.4	Peak [Scan]	H	100	0	54.0	-3.6	Pass	Noise
6995.992	50.8	5.4	-6.4	49.8	Peak [Scan]	H						NRB
5000.414	50.2	4.6	-9.9	44.9	Peak [Scan]	V	98	0	54.0	-9.1	Pass	RB

Legend: TX = Transmitter Emissions; DIG = Digital Emissions; FUND = Fundamental; WB = Wideband Emission
 NRB = Non-Restricted Band. Limit = 68.23 dBuV/m; RB = Restricted Band. Limits per 15.205

This test report may be reproduced in full only. The document may only be updated by MiCOM Labs personnel. Any changes will be noted in the Document History section of the report.



Mid

Test Freq.	5300 MHz	Engineer	jmh
Variant	5 MHz	Temp (°C)	25
Freq. Range	1000 MHz - 18000 MHz	Rel. Hum.(%)	31
Power Setting	16	Press. (mBars)	1006
Antenna	24 dBi INT Flat Panel	Duty Cycle (%)	100
Test Notes 1	Data rate MCS 15		
Test Notes 2			

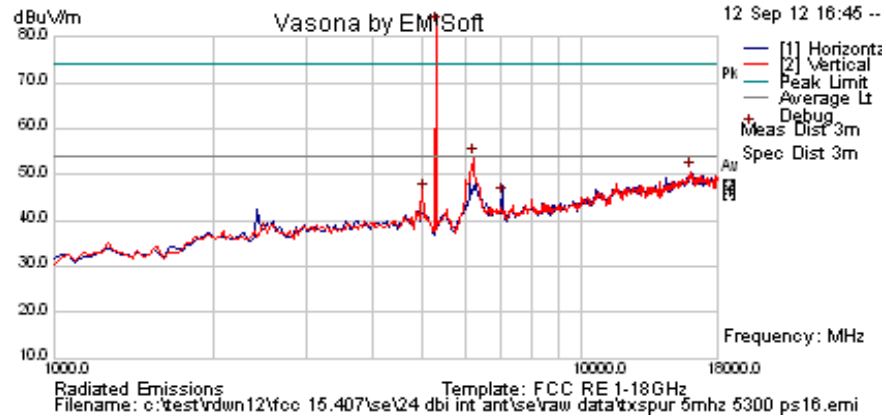

Formally measured emission peaks

Frequency MHz	Raw dBuV	Cable Loss	AF dB	Level dBuV/m	Measurement Type	Pol	Hgt cm	Azt Deg	Limit dBuV/m	Margin dB	Pass /Fail	Comments
5292.585	87.4	4.6	-9.6	82.4	Peak [Scan]	V						FUND
6212.42485	56.5	5.0	-7.8	53.7	Peak [Scan]	V						NRB
15989.980	41.6	9.0	0.1	50.7	Peak [Scan]	V	200	0	54.0	-3.3	Pass	Noise
7076.516	46.1	5.4	-6.1	45.4	Peak [Scan]	V						NRB
5000.254	51.4	4.6	-9.9	46.1	Peak [Scan]	V	98	0	54.0	-7.9	Pass	RB

Legend: TX = Transmitter Emissions; DIG = Digital Emissions; FUND = Fundamental; WB = Wideband Emission
 NRB = Non-Restricted Band. Limit = 68.23 dBuV/m; RB = Restricted Band. Limits per 15.205

This test report may be reproduced in full only. The document may only be updated by MiCOM Labs personnel. Any changes will be noted in the Document History section of the report.



High

Test Freq.	5345 MHz	Engineer	jmh
Variant	5 MHz	Temp (°C)	25
Freq. Range	1000 MHz - 18000 MHz	Rel. Hum.(%)	31
Power Setting	16	Press. (mBars)	1006
Antenna	24 dBi INT Flat Panel	Duty Cycle (%)	100
Test Notes 1	Data rate MCS 15		
Test Notes 2			

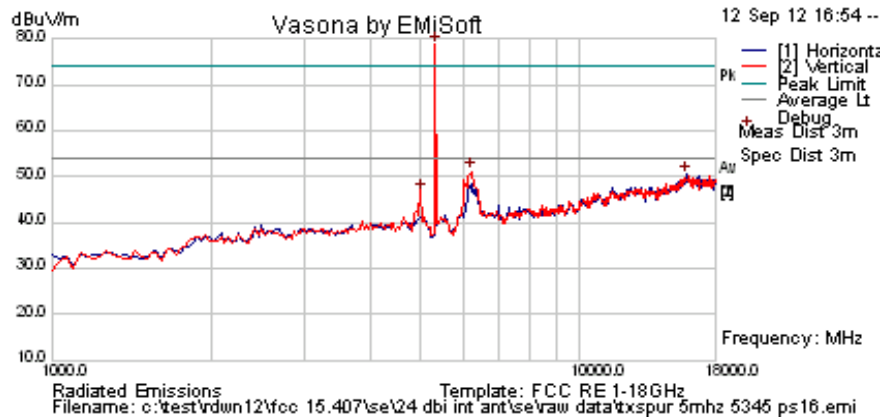

Formally measured emission peaks

Frequency MHz	Raw dBuV	Cable Loss	AF dB	Level dBuV/m	Measurement Type	Pol	Hgt cm	Azt Deg	Limit dBuV/m	Margin dB	Pass /Fail	Comments
5326.653	83.7	4.6	-9.5	78.8	Peak [Scan]	V						FUND
6212.42485	53.9	5.0	-7.8	51.1	Peak [Scan]	V						NRB
15921.844	41.7	8.9	-0.1	50.5	Peak [Scan]	H	200	0	54.0	-3.5	Pass	Noise
5000.013	51.7	4.6	-9.9	46.4	Peak [Scan]	V	98	0	54	-7.6	Pass	RB
Legend: TX = Transmitter Emissions; DIG = Digital Emissions; FUND = Fundamental; WB = Wideband Emission NRB = Non-Restricted Band. Limit = 68.23 dBuV/m; RB = Restricted Band. Limits per 15.205												

This test report may be reproduced in full only. The document may only be updated by MiCOM Labs personnel. Any changes will be noted in the Document History section of the report.



5 MHz 5345 MHz 5350 – 5460 Restricted Band-edge Power Setting = -23

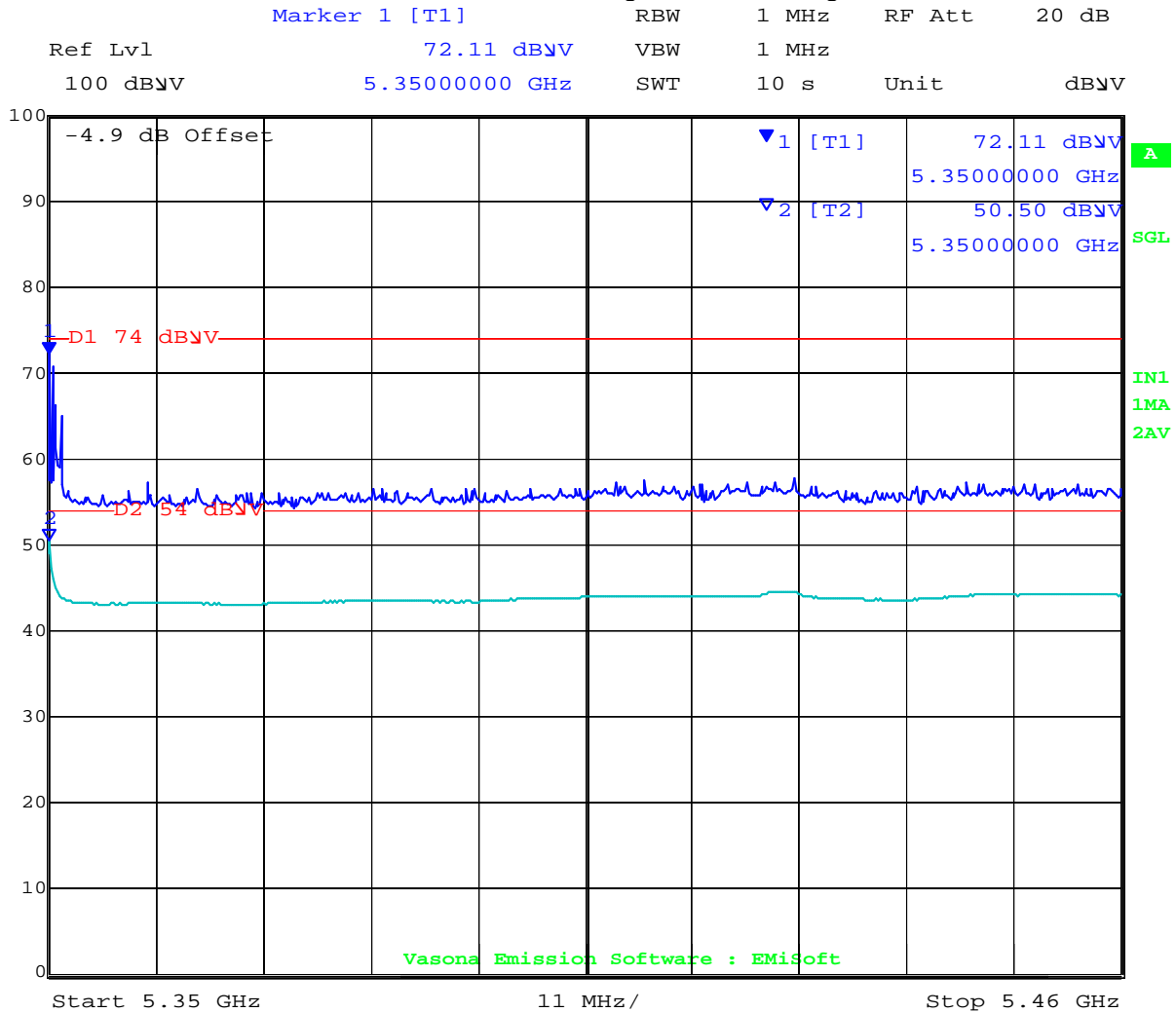

Date: 12.SEP.2012 18:17:28

This test report may be reproduced in full only. The document may only be updated by MiCOM Labs personnel. Any changes will be noted in the Document History section of the report.



5 MHz 5475 MHz 5350 – 5460 Restricted Band-edge Power Setting = 7

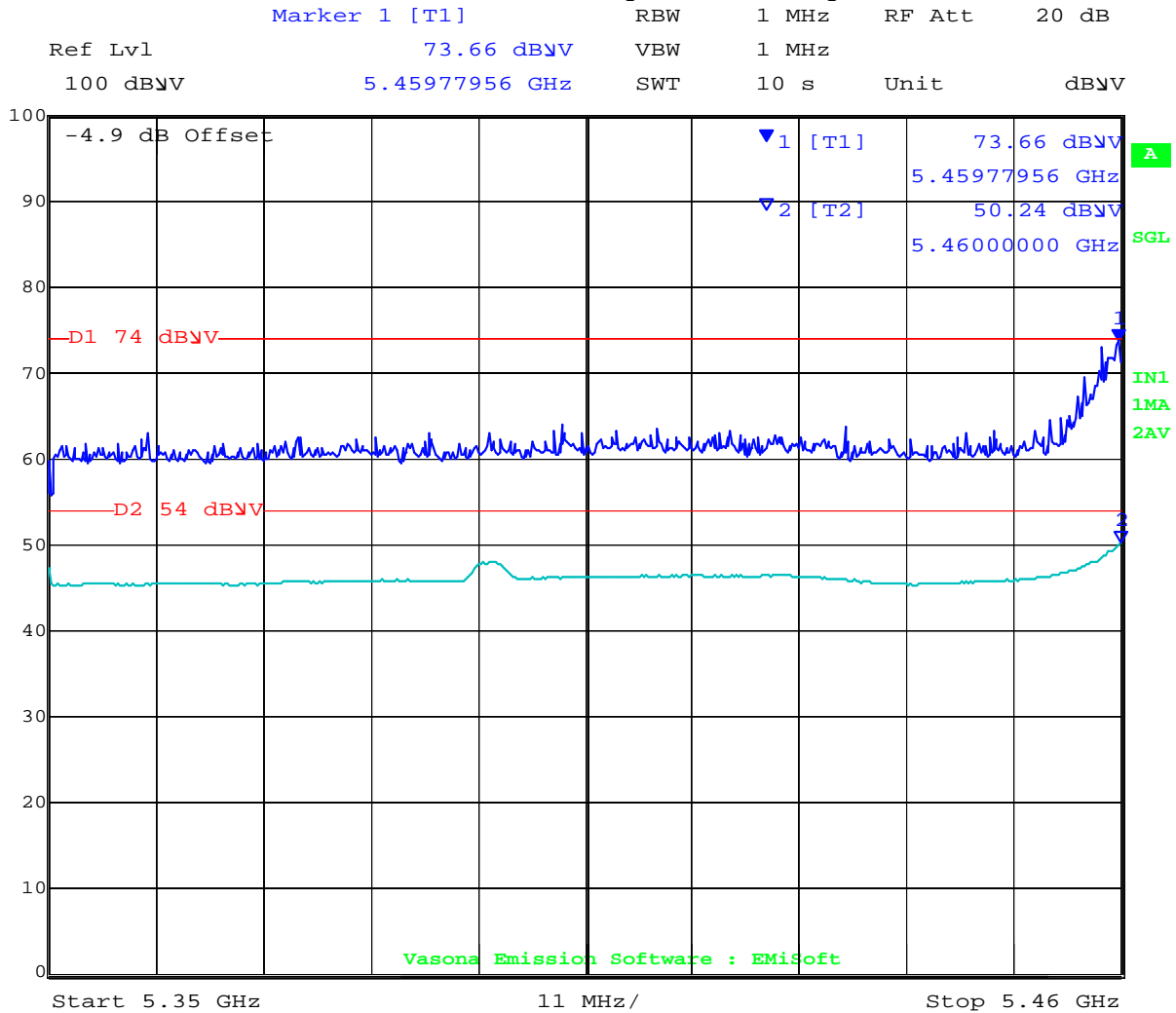

Date: 12.SEP.2012 18:49:54

This test report may be reproduced in full only. The document may only be updated by MiCOM Labs personnel. Any changes will be noted in the Document History section of the report.



5470 -5725 MHz

Low

Test Freq.	5475 MHz	Engineer	JMH
Variant	5 MHz	Temp (°C)	24
Freq. Range	1000 MHz - 18000 MHz	Rel. Hum.(%)	33
Power Setting	15	Press. (mBars)	1005
Antenna	24 dBi Int Flat Panel	Duty Cycle (%)	100
Test Notes 1	Data Rate MCS 15		
Test Notes 2			

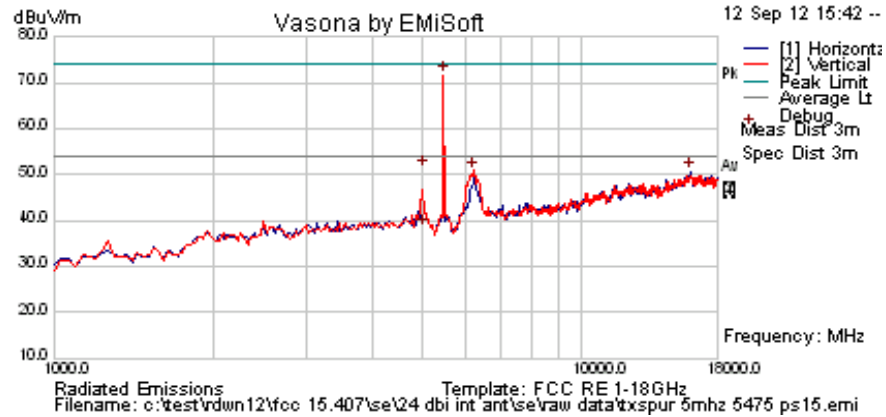

Formally measured emission peaks

Frequency MHz	Raw dBuV	Cable Loss	AF dB	Level dBuV/m	Measurement Type	Pol	Hgt cm	Azt Deg	Limit dBuV/m	Margin dB	Pass /Fail	Comments
5462.926	76.7	4.6	-9.7	71.7	Peak [Scan]	V						FUND
6212.42485	53.6	5.0	-7.8	50.8	Peak [Scan]	V						NRB
15989.980	41.5	9.0	0.1	50.6	Peak [Scan]	H	100	0	54	-3.4	Pass	Noise
5000.895	56.5	4.6	-9.9	51.2	Peak Max	V	99	9	74	-22.8	Pass	RB
5000.895	43.6	4.6	-9.9	38.4	Average Max	V	99	9	54	-15.6	Pass	RB

Legend: TX = Transmitter Emissions; DIG = Digital Emissions; FUND = Fundamental; WB = Wideband Emission
 NRB = Non-Restricted Band. Limit = 68.23 dBuV/m; RB = Restricted Band. Limits per 15.205

This test report may be reproduced in full only. The document may only be updated by MiCOM Labs personnel. Any changes will be noted in the Document History section of the report.



Mid

Test Freq.	5595 MHz	Engineer	JMH
Variant	5 MHz	Temp (°C)	24
Freq. Range	1000 MHz - 18000 MHz	Rel. Hum.(%)	33
Power Setting	15	Press. (mBars)	1005
Antenna	24 dBi Int Flat Panel	Duty Cycle (%)	100
Test Notes 1	Data Rate MCS 15		
Test Notes 2			

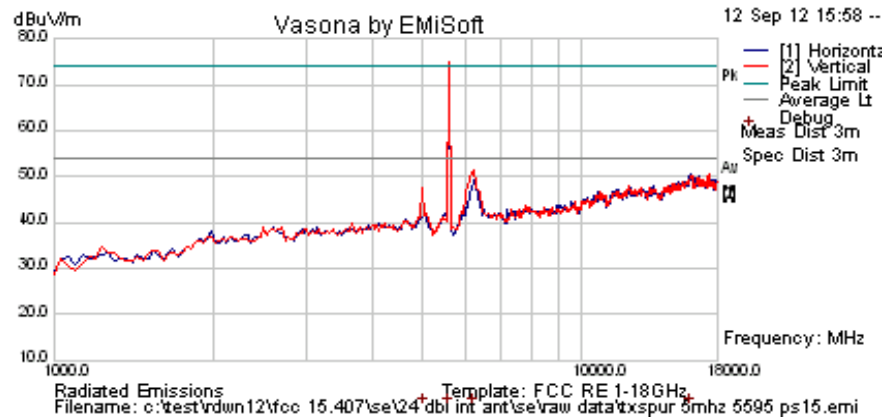

Formally measured emission peaks

Frequency MHz	Raw dBuV	Cable Loss	AF dB	Level dBuV/m	Measurement Type	Pol	Hgt cm	Azt Deg	Limit dBuV/m	Margin dB	Pass /Fail	Comments
5599.198	80.1	4.7	-9.7	75.1	Peak [Scan]	V						FUND
6246.492986	53.9	5.0	-7.6	51.3	Peak [Scan]	V						NRB
15989.980	41.5	9.0	0.1	50.6	Peak [Scan]	H	150	0	54	-3.4	Pass	Noise
5000.735	56.1	4.6	-9.9	50.8	Peak Max	V	98	8	74.0	-23.2	Pass	RB
5000.735	44.3	4.6	-9.9	39.0	Average Max	V	98	8	54	-15.0	Pass	RB

Legend: TX = Transmitter Emissions; DIG = Digital Emissions; FUND = Fundamental; WB = Wideband Emission
 NRB = Non-Restricted Band. Limit = 68.23 dBuV/m; RB = Restricted Band. Limits per 15.205

This test report may be reproduced in full only. The document may only be updated by MiCOM Labs personnel. Any changes will be noted in the Document History section of the report.



Title: AP0127730, AP0134760
To: FCC 47 CFR Part 15.407 & IC RSS-210
Serial #: RDWN12-U2 Rev B
Issue Date: 18th January 2013
Page: 130 of 272

High

Test Freq.	5720 MHz	Engineer	JMH
Variant	5 MHz	Temp (°C)	24
Freq. Range	1000 MHz - 18000 MHz	Rel. Hum.(%)	33
Power Setting	15	Press. (mBars)	1005
Antenna	24 dBi Int Flat Panel	Duty Cycle (%)	100
Test Notes 1	Data Rate MCS 15		
Test Notes 2			

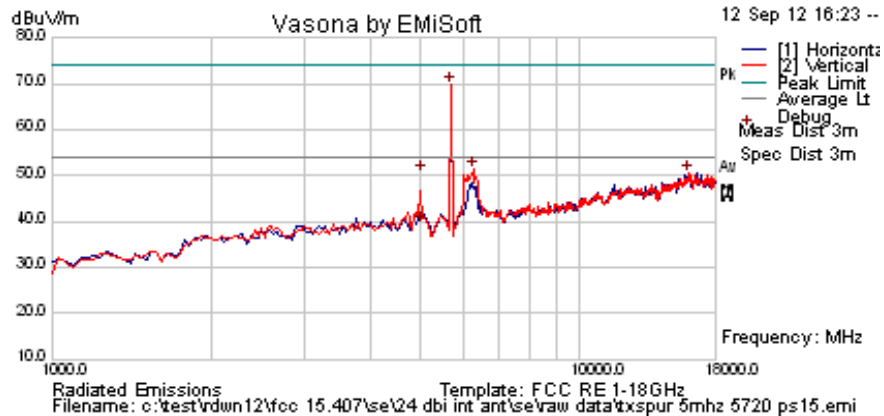

Formally measured emission peaks

Frequency MHz	Raw dBuV	Cable Loss	AF dB	Level dBuV/m	Measurement Type	PoI	Hgt cm	Azt Deg	Limit dBuV/m	Margin dB	Pass /Fail	Comments
5701.403	74.5	4.7	-9.6	69.7	Peak [Scan]	V						FUND
6280.561122	53.9	5.0	-7.5	51.4	Peak [Scan]	V						NRB
16058.116	41.3	9.0	0.3	50.6	Peak [Scan]	V	150	0	54	-3.4	Pass	Noise
5000.174	55.7	4.6	-9.9	50.5	Peak Max	V	98	9	74.0	-23.6	Pass	RB
5000.174	44.5	4.6	-9.9	39.3	Average Max	V	98	9	54	-14.7	Pass	RB

Legend: TX = Transmitter Emissions; DIG = Digital Emissions; FUND = Fundamental; WB = Wideband Emission
 NRB = Non-Restricted Band. Limit = 68.23 dBuV/m; RB = Restricted Band. Limits per 15.205

This test report may be reproduced in full only. The document may only be updated by MiCOM Labs personnel. Any changes will be noted in the Document History section of the report.



6.1.2.6. Antenna # 6

5250 -5350 MHz

Low

Test Freq.	5255 MHz	Engineer	jmh
Variant	5 MHz	Temp (°C)	25
Freq. Range	1000 MHz - 18000 MHz	Rel. Hum.(%)	31
Power Setting	20	Press. (mBars)	1006
Antenna	29 dBi Flat	Duty Cycle (%)	100
Test Notes 1	Data rate MCS 15		
Test Notes 2			

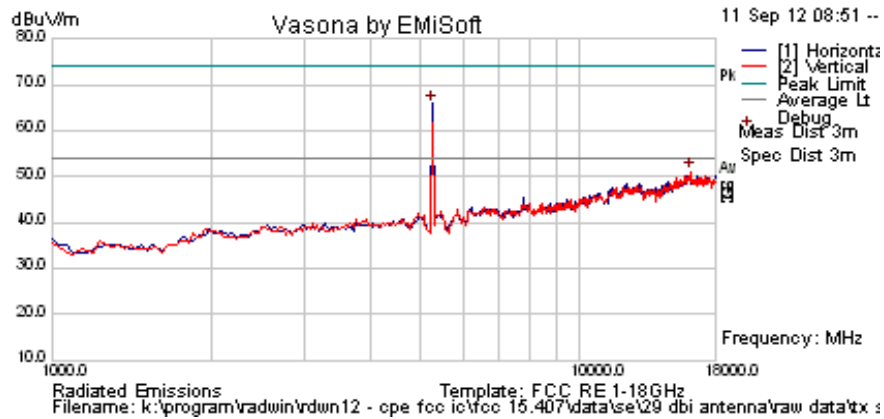

Formally measured emission peaks

Frequency MHz	Raw dBuV	Cable Loss	AF dB	Level dBuV/m	Measurement Type	Pol	Hgt cm	Azt Deg	Limit dBuV/m	Margin dB	Pass /Fail	Comments
5258.517	71.1	4.6	-9.7	66.0	Peak [Scan]	H						FUND
16126.253	41.9	9.0	0.2	51.1	Peak [Scan]	V					Pass	Noise
Legend: TX = Transmitter Emissions; DIG = Digital Emissions; FUND = Fundamental; WB = Wideband Emission NRB = Non-Restricted Band. Limit = 68.23 dBuV/m; RB = Restricted Band. Limits per 15.205												

This test report may be reproduced in full only. The document may only be updated by MiCOM Labs personnel. Any changes will be noted in the Document History section of the report.



Mid

Test Freq.	5300 MHz	Engineer	jmh
Variant	5 MHz	Temp (°C)	25
Freq. Range	1000 MHz - 18000 MHz	Rel. Hum.(%)	31
Power Setting	20	Press. (mBars)	1006
Antenna	29 dBi Flat	Duty Cycle (%)	100
Test Notes 1	Data rate MCS 15		
Test Notes 2			

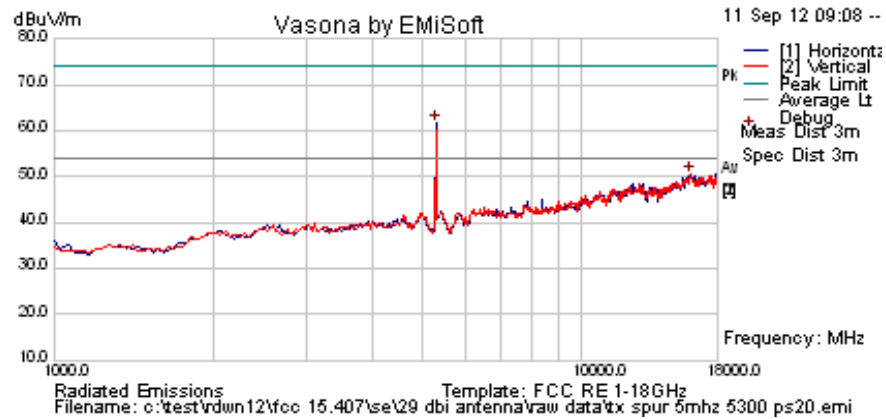

Formally measured emission peaks

Frequency MHz	Raw dBuV	Cable Loss	AF dB	Level dBuV/m	Measurement Type	Pol	Hgt cm	Azt Deg	Limit dBuV/m	Margin dB	Pass /Fail	Comments
5292.585	66.6	4.6	-9.6	61.6	Peak [Scan]	H						FUND
15989.98	41.3	9.0	0.1	50.5	Peak [Scan]	V					Pass	Noise

Legend: TX = Transmitter Emissions; DIG = Digital Emissions; FUND = Fundamental; WB = Wideband Emission
 NRB = Non-Restricted Band. Limit = 68.23 dBuV/m; RB = Restricted Band. Limits per 15.205

This test report may be reproduced in full only. The document may only be updated by MiCOM Labs personnel. Any changes will be noted in the Document History section of the report.



High

Test Freq.	5345 MHz	Engineer	jmh
Variant	5 MHz	Temp (°C)	25
Freq. Range	1000 MHz - 18000 MHz	Rel. Hum.(%)	31
Power Setting	20	Press. (mBars)	1006
Antenna	29 dBi Flat	Duty Cycle (%)	100
Test Notes 1	Data rate MCS 15		
Test Notes 2			

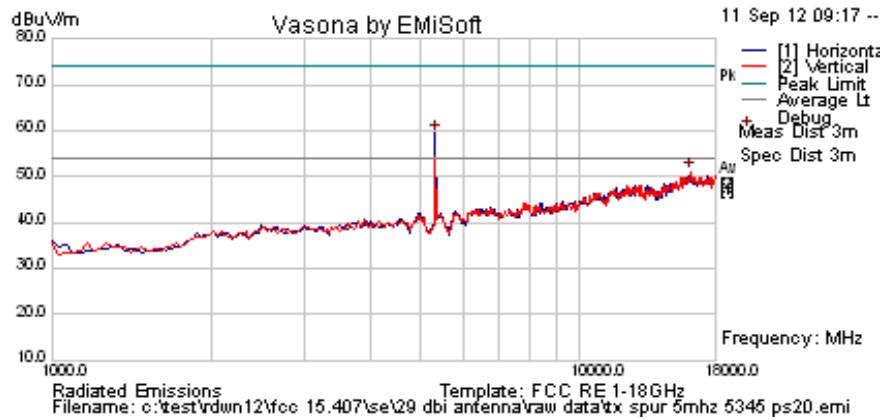

Formally measured emission peaks

Frequency MHz	Raw dBuV	Cable Loss	AF dB	Level dBuV/m	Measurement Type	Pol	Hgt cm	Azt Deg	Limit dBuV/m	Margin dB	Pass /Fail	Comments
5326.653	64.3	4.6	-9.5	59.4	Peak [Scan]	H						FUND
16194.389	42.0	8.9	0.2	51.1	Peak [Scan]	V					Pass	Noise

Legend: TX = Transmitter Emissions; DIG = Digital Emissions; FUND = Fundamental; WB = Wideband Emission
 NRB = Non-Restricted Band. Limit = 68.23 dBuV/m; RB = Restricted Band. Limits per 15.205

This test report may be reproduced in full only. The document may only be updated by MiCOM Labs personnel. Any changes will be noted in the Document History section of the report.



5 MHz 5345 MHz 5350 – 5460 Restricted Band-edge Power Setting = 20

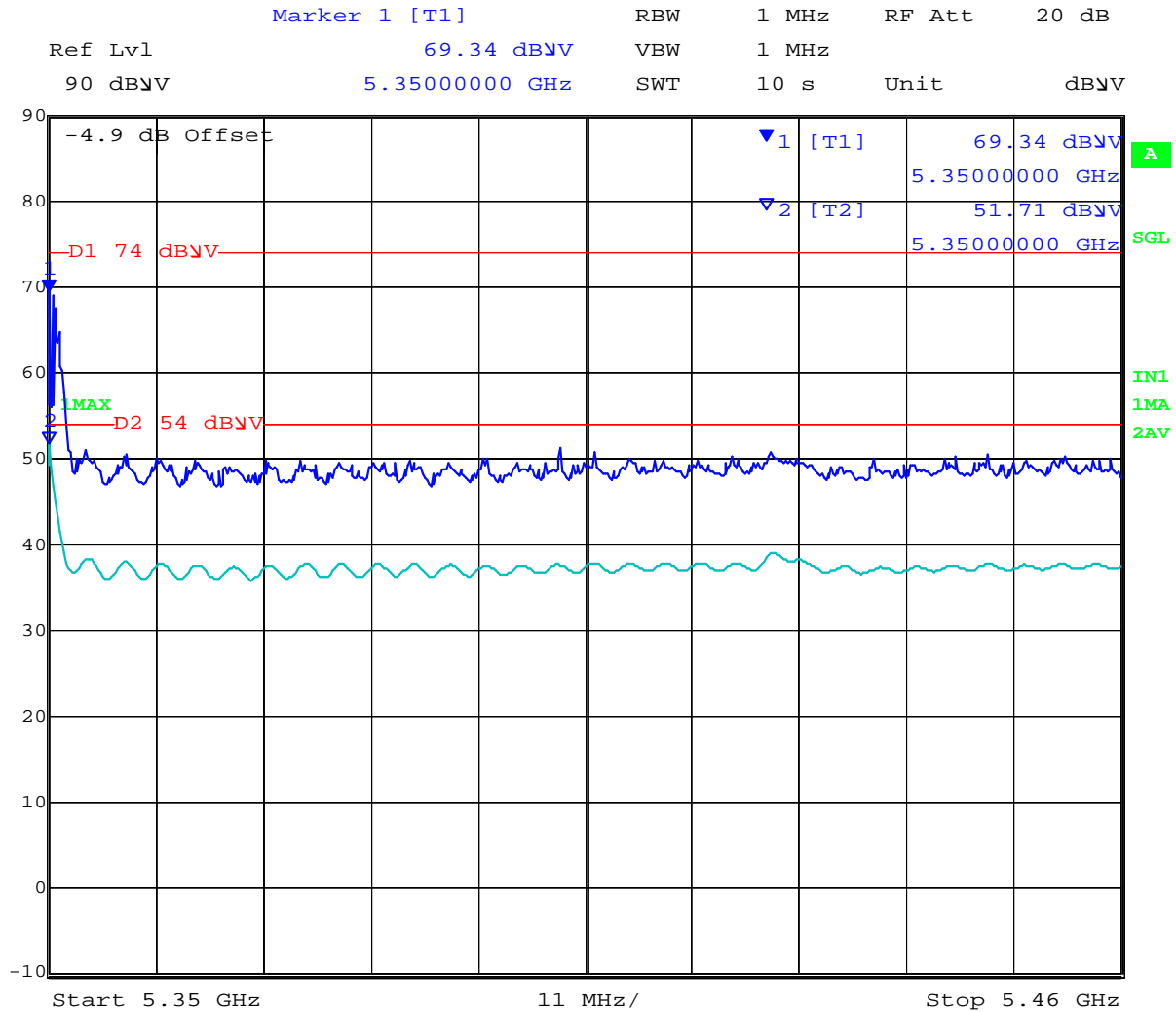

Date: 11.SEP.2012 10:32:41

This test report may be reproduced in full only. The document may only be updated by MiCOM Labs personnel. Any changes will be noted in the Document History section of the report.



5 MHz 5475 MHz 5350 – 5460 Restricted Band-edge Power Setting = 21

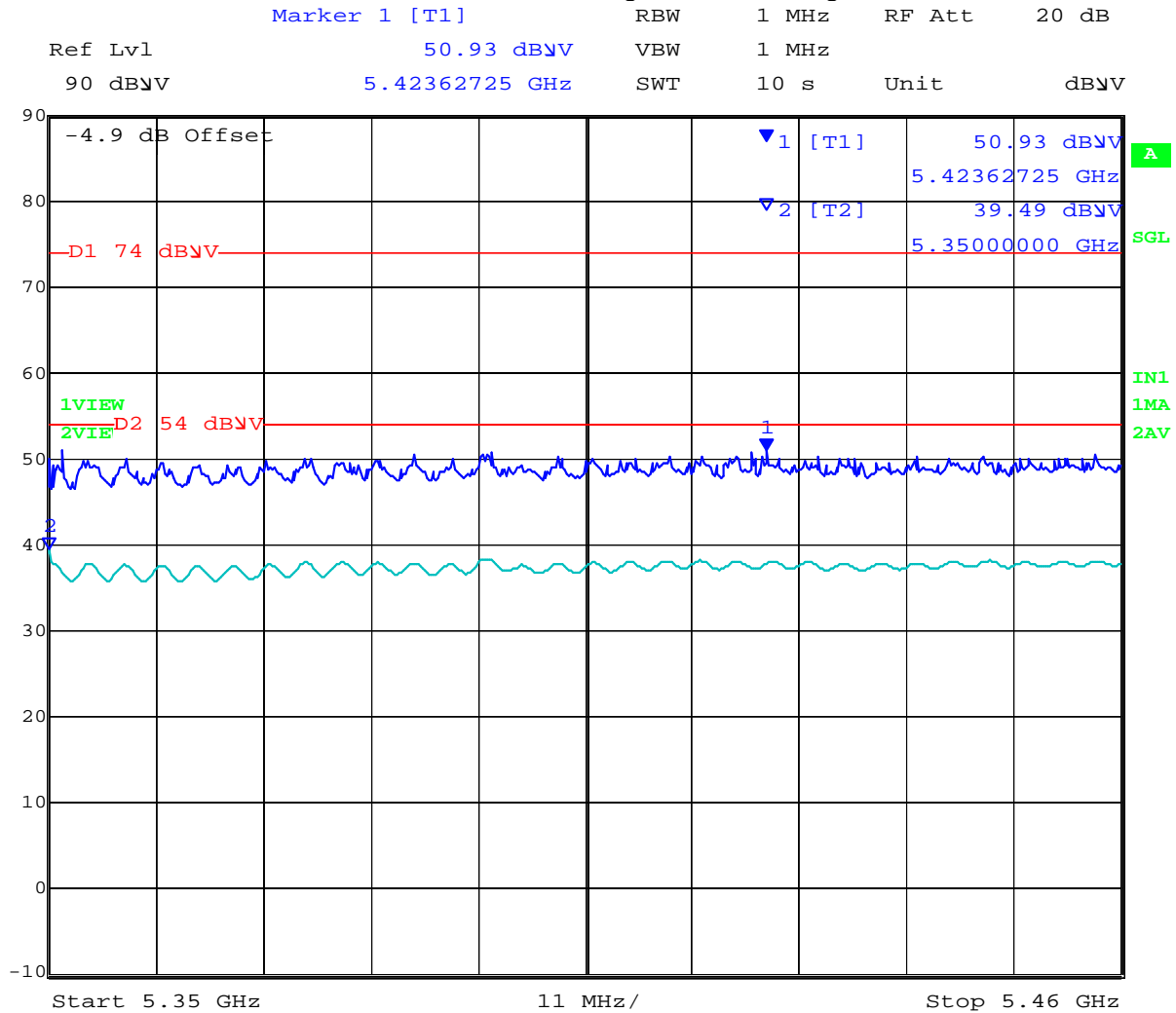

Date: 11.SEP.2012 10:41:29

This test report may be reproduced in full only. The document may only be updated by MiCOM Labs personnel. Any changes will be noted in the Document History section of the report.



Title: AP0127730, AP0134760
To: FCC 47 CFR Part 15.407 & IC RSS-210
Serial #: RDWN12-U2 Rev B
Issue Date: 18th January 2013
Page: 136 of 272

5470 -5725 MHz

Low

Test Freq.	5475 MHz	Engineer	JMH
Variant	5 MHz	Temp (°C)	24
Freq. Range	1000 MHz - 18000 MHz	Rel. Hum.(%)	33
Power Setting	21	Press. (mBars)	1005
Antenna	29 dBi Flat	Duty Cycle (%)	100
Test Notes 1	Data Rate MCS 15		
Test Notes 2			

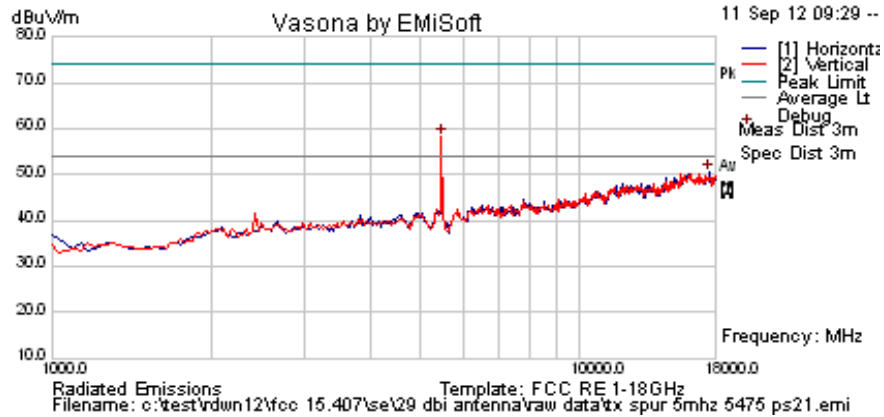

Formally measured emission peaks

Frequency MHz	Raw dBuV	Cable Loss	AF dB	Level dBuV/m	Measurement Type	Pol	Hgt cm	Azt Deg	Limit dBuV/m	Margin dB	Pass /Fail	Comments
5462.926	63.2	4.6	-9.7	58.1	Peak [Scan]	V						FUND
17557.114	40.8	8.8	0.8	50.4	Peak [Scan]	H					Pass	Noise
Legend: TX = Transmitter Emissions; DIG = Digital Emissions; FUND = Fundamental; WB = Wideband Emission NRB = Non-Restricted Band. Limit = 68.23 dBuV/m; RB = Restricted Band. Limits per 15.205												

This test report may be reproduced in full only. The document may only be updated by MiCOM Labs personnel. Any changes will be noted in the Document History section of the report.



Mid

Test Freq.	5595 MHz	Engineer	JMH
Variant	5 MHz	Temp (°C)	24
Freq. Range	1000 MHz - 18000 MHz	Rel. Hum.(%)	33
Power Setting	21	Press. (mBars)	1005
Antenna	29 dBi Flat	Duty Cycle (%)	100
Test Notes 1	Data Rate MCS 15		
Test Notes 2			

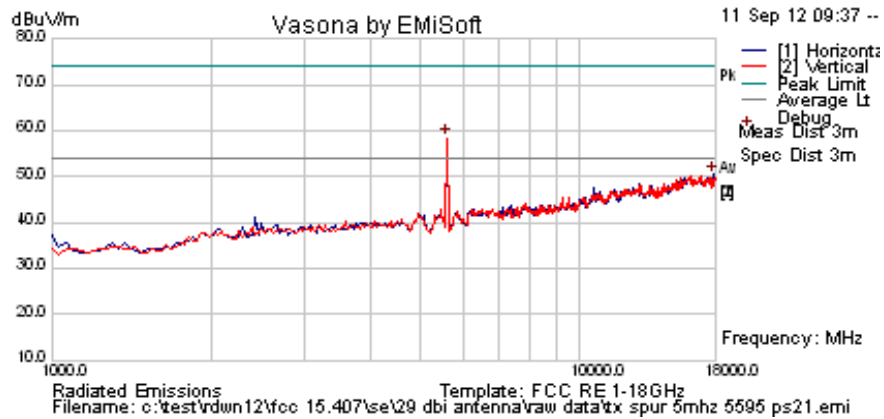

Formally measured emission peaks

Frequency MHz	Raw dBuV	Cable Loss	AF dB	Level dBuV/m	Measurement Type	Pol	Hgt cm	Azt Deg	Limit dBuV/m	Margin dB	Pass /Fail	Comments
5599.198	63.4	4.7	-9.7	58.4	Peak [Scan]	V						FUND
17863.727	41.4	8.8	0.3	50.5	Peak [Scan]	H					Pass	Noise

Legend: TX = Transmitter Emissions; DIG = Digital Emissions; FUND = Fundamental; WB = Wideband Emission
 NRB = Non-Restricted Band. Limit = 68.23 dBuV/m; RB = Restricted Band. Limits per 15.205

This test report may be reproduced in full only. The document may only be updated by MiCOM Labs personnel. Any changes will be noted in the Document History section of the report.



Title: AP0127730, AP0134760
To: FCC 47 CFR Part 15.407 & IC RSS-210
Serial #: RDWN12-U2 Rev B
Issue Date: 18th January 2013
Page: 138 of 272

High

Test Freq.	5720 MHz	Engineer	JMH
Variant	5 MHz	Temp (°C)	24
Freq. Range	1000 MHz - 18000 MHz	Rel. Hum.(%)	33
Power Setting	21	Press. (mBars)	1005
Antenna	29 dBi Flat	Duty Cycle (%)	100
Test Notes 1	Data Rate MCS 15		
Test Notes 2			

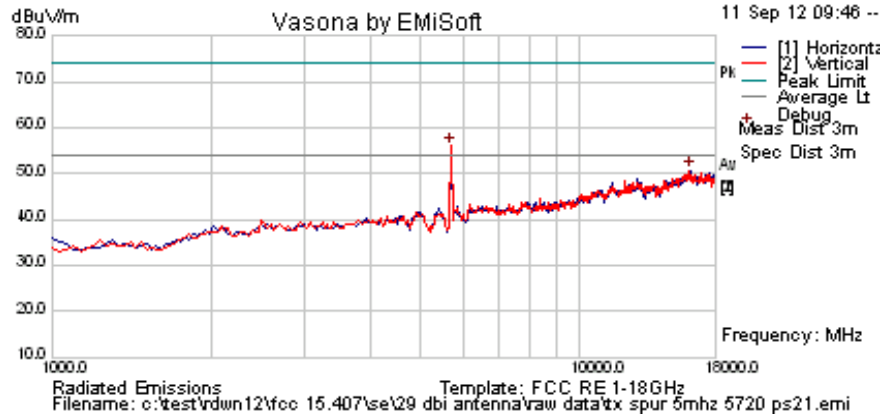

Formally measured emission peaks

Frequency MHz	Raw dBuV	Cable Loss	AF dB	Level dBuV/m	Measurement Type	PoI	Hgt cm	Azt Deg	Limit dBuV/m	Margin dB	Pass /Fail	Comments
5701.403	60.8	4.7	-9.6	56.0	Peak [Scan]	V						FUND
16126.253	41.5	9.0	0.2	50.6	Peak [Scan]	H					Pass	Noise

Legend: TX = Transmitter Emissions; DIG = Digital Emissions; FUND = Fundamental; WB = Wideband Emission
 NRB = Non-Restricted Band. Limit = 68.23 dBuV/m; RB = Restricted Band. Limits per 15.205

This test report may be reproduced in full only. The document may only be updated by MiCOM Labs personnel. Any changes will be noted in the Document History section of the report.



6.1.2.7. Antenna # 7

5250 -5350 MHz

Low

Test Freq.	5255 MHz	Engineer	jmh
Variant	5 MHz	Temp (°C)	25
Freq. Range	1000 MHz - 18000 MHz	Rel. Hum.(%)	31
Power Setting	16	Press. (mBars)	1006
Antenna	32 dBi Dish	Duty Cycle (%)	100
Test Notes 1	Data rate MCS 15		
Test Notes 2			

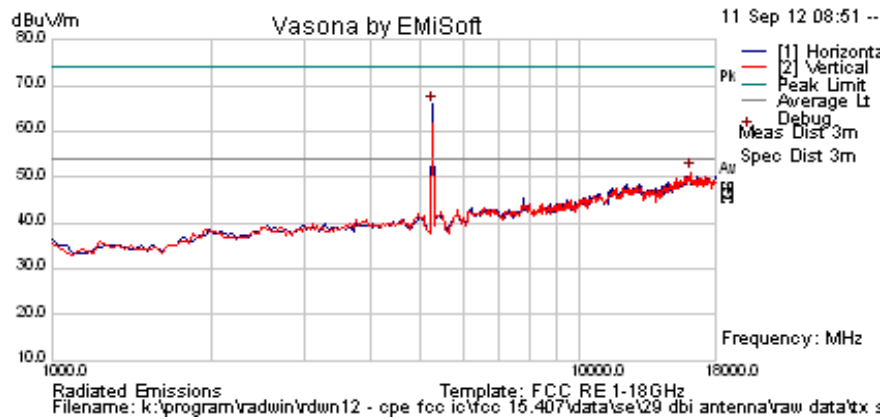

Formally measured emission peaks

Frequency MHz	Raw dBuV	Cable Loss	AF dB	Level dBuV/m	Measurement Type	Pol	Hgt cm	Azt Deg	Limit dBuV/m	Margin dB	Pass /Fail	Comments
5258.517	87.6	4.6	-9.7	82.5	Peak [Scan]	V						FUND
7006.613	64.2	5.4	-6.3	63.3	Peak [Scan]	V						NRB
6246.493	61.1	5.0	-7.6	58.5	Peak [Scan]	H						NRB
6348.697	56.7	5.1	-7.4	54.4	Peak [Scan]	H						NRB
16092.184	41.2	9.0	0.3	50.5	Peak [Scan]	H	150	0	54.0	-3.5	Pass	Noise
6553.106	50.3	5.2	-7.0	48.4	Peak [Scan]	V						NRB
4804.110	50.5	4.5	-9.7	45.3	Peak [Scan]	V	100	0	54.0	-4.7	Pass	RB
2446.284	53.6	3.0	-11.5	45.1	Peak [Scan]	H						NRB

Legend: TX = Transmitter Emissions; DIG = Digital Emissions; FUND = Fundamental; WB = Wideband Emission
 NRB = Non-Restricted Band. Limit = 68.23 dBuV/m; RB = Restricted Band. Limits per 15.205

This test report may be reproduced in full only. The document may only be updated by MiCOM Labs personnel. Any changes will be noted in the Document History section of the report.



Mid

Test Freq.	5300 MHz	Engineer	jmh
Variant	5 MHz	Temp (°C)	25
Freq. Range	1000 MHz - 18000 MHz	Rel. Hum.(%)	31
Power Setting	16	Press. (mBars)	1006
Antenna	32 dBi Dish	Duty Cycle (%)	100
Test Notes 1	Data rate MCS 15		
Test Notes 2			

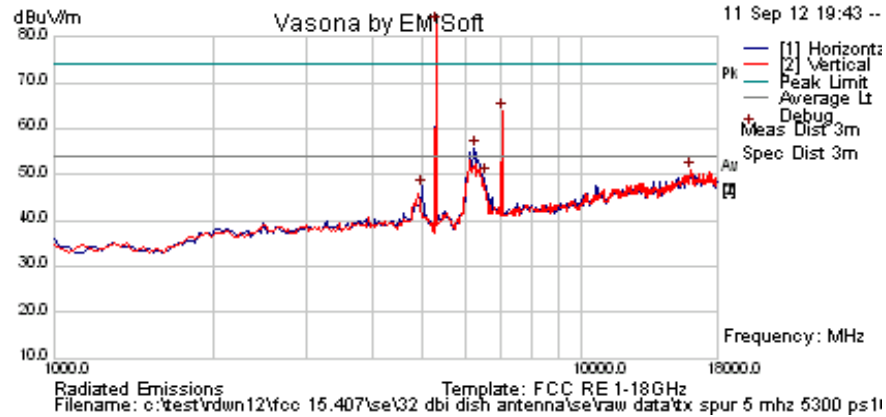

Formally measured emission peaks

Frequency MHz	Raw dBuV	Cable Loss	AF dB	Level dBuV/m	Measurement Type	Pol	Hgt cm	Azt Deg	Limit dBuV/m	Margin dB	Pass /Fail	Comments
5292.585	87.7	4.6	-9.6	82.7	Peak [Scan]	V						FUND
7066.743	64.6	5.4	-6.1	63.8	Peak [Scan]	V						NRB
6251.222	58.3	5.0	-7.6	55.7	Peak [Scan]	H						NRB
15989.980	41.7	9.0	0.1	50.8	Peak [Scan]	V						Noise
6553.106	51.2	5.2	-7.0	49.4	Peak [Scan]	H						NRB
4980.855	52.3	4.6	-9.9	47.0	Peak [Scan]	H	98	0	54	-7.0	Pass	RB

Legend: TX = Transmitter Emissions; DIG = Digital Emissions; FUND = Fundamental; WB = Wideband Emission
 NRB = Non-Restricted Band. Limit = 68.23 dBuV/m; RB = Restricted Band. Limits per 15.205

This test report may be reproduced in full only. The document may only be updated by MiCOM Labs personnel. Any changes will be noted in the Document History section of the report.



High

Test Freq.	5345 MHz	Engineer	jmh
Variant	5 MHz	Temp (°C)	25
Freq. Range	1000 MHz - 18000 MHz	Rel. Hum.(%)	31
Power Setting	16	Press. (mBars)	1006
Antenna	32 dBi Dish	Duty Cycle (%)	100
Test Notes 1	Data rate MCS 15		
Test Notes 2			

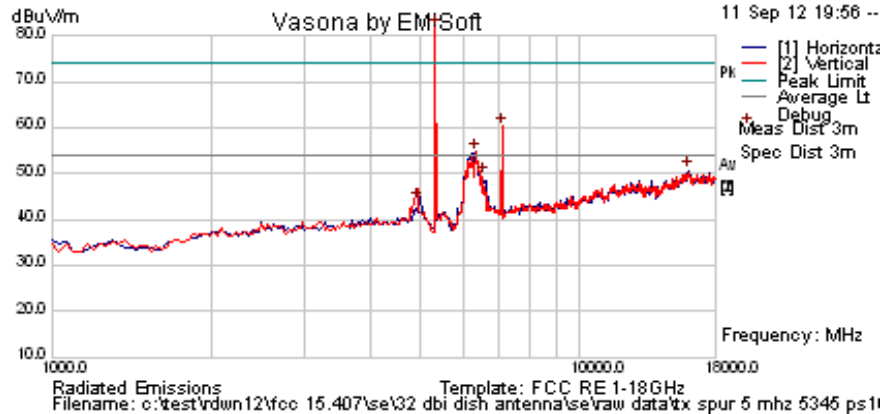

Formally measured emission peaks

Frequency MHz	Raw dBuV	Cable Loss	AF dB	Level dBuV/m	Measurement Type	PoI	Hgt cm	Azt Deg	Limit dBuV/m	Margin dB	Pass /Fail	Comments
5326.653	86.8	4.6	-9.5	81.9	Peak [Scan]	V						FUND
7126.633	60.9	5.4	-6.0	60.2	Peak [Scan]	V						NRB
6348.697	57.0	5.1	-7.4	54.7	Peak [Scan]	V						NRB
16058.116	41.4	9.0	0.3	50.7	Peak [Scan]	H	200	0	54	-3.4	Pass	Noise
6553.106	51.3	5.2	-7.0	49.5	Peak [Scan]	H						NRB
4937.852	49.4	4.6	-9.8	44.1	Peak [Scan]	V	98	0	54	-9.9	Pass	RB

Legend: TX = Transmitter Emissions; DIG = Digital Emissions; FUND = Fundamental; WB = Wideband Emission
 NRB = Non-Restricted Band. Limit = 68.23 dBuV/m; RB = Restricted Band. Limits per 15.205

This test report may be reproduced in full only. The document may only be updated by MiCOM Labs personnel. Any changes will be noted in the Document History section of the report.



5 MHz 5345 MHz 5350 – 5460 Restricted Band-edge Power Setting = -17

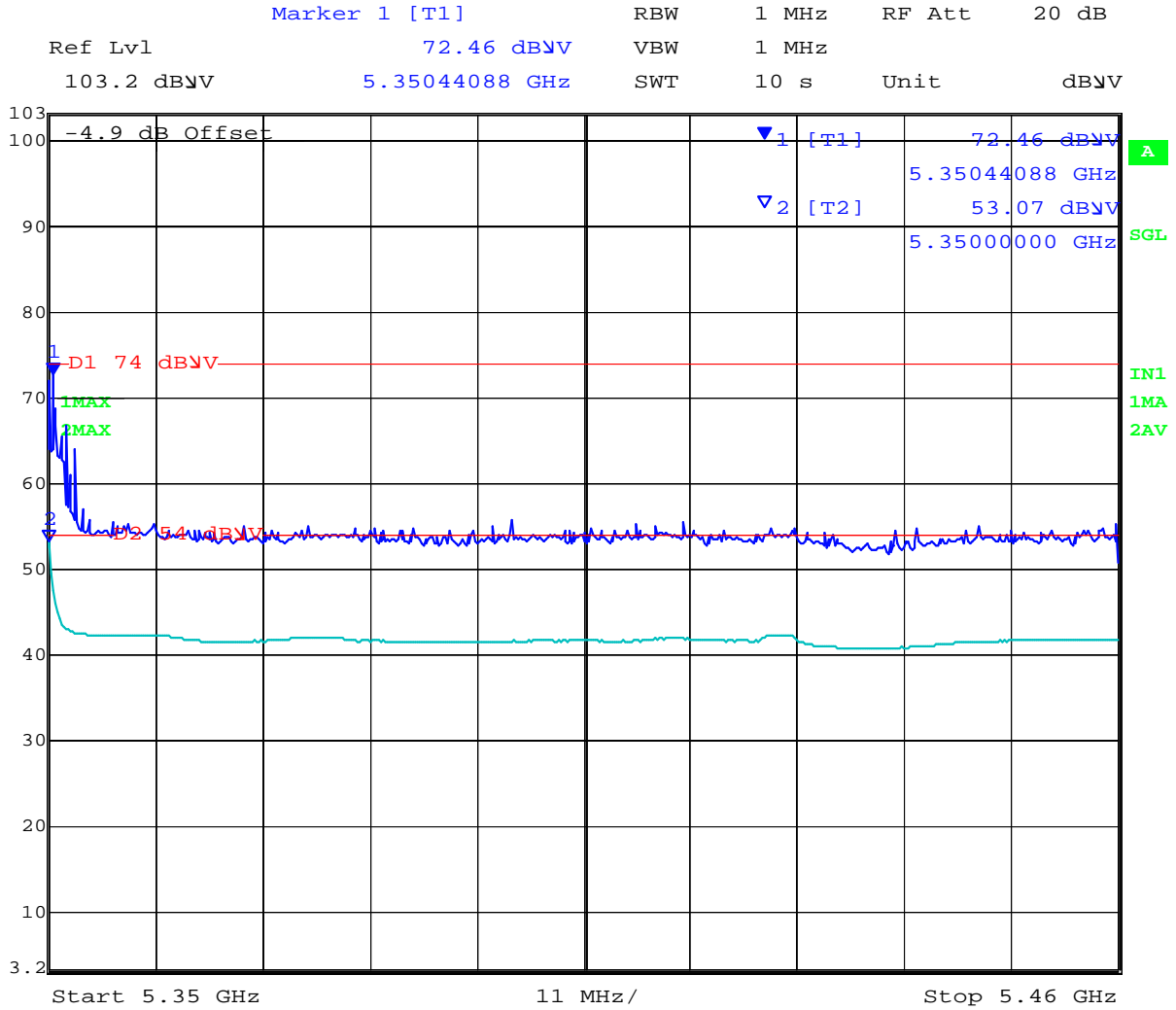

Date: 12.SEP.2012 09:40:45

This test report may be reproduced in full only. The document may only be updated by MiCOM Labs personnel. Any changes will be noted in the Document History section of the report.



5 MHz 5475 MHz 5350 – 5460 Restricted Band-edge Power Setting = 15

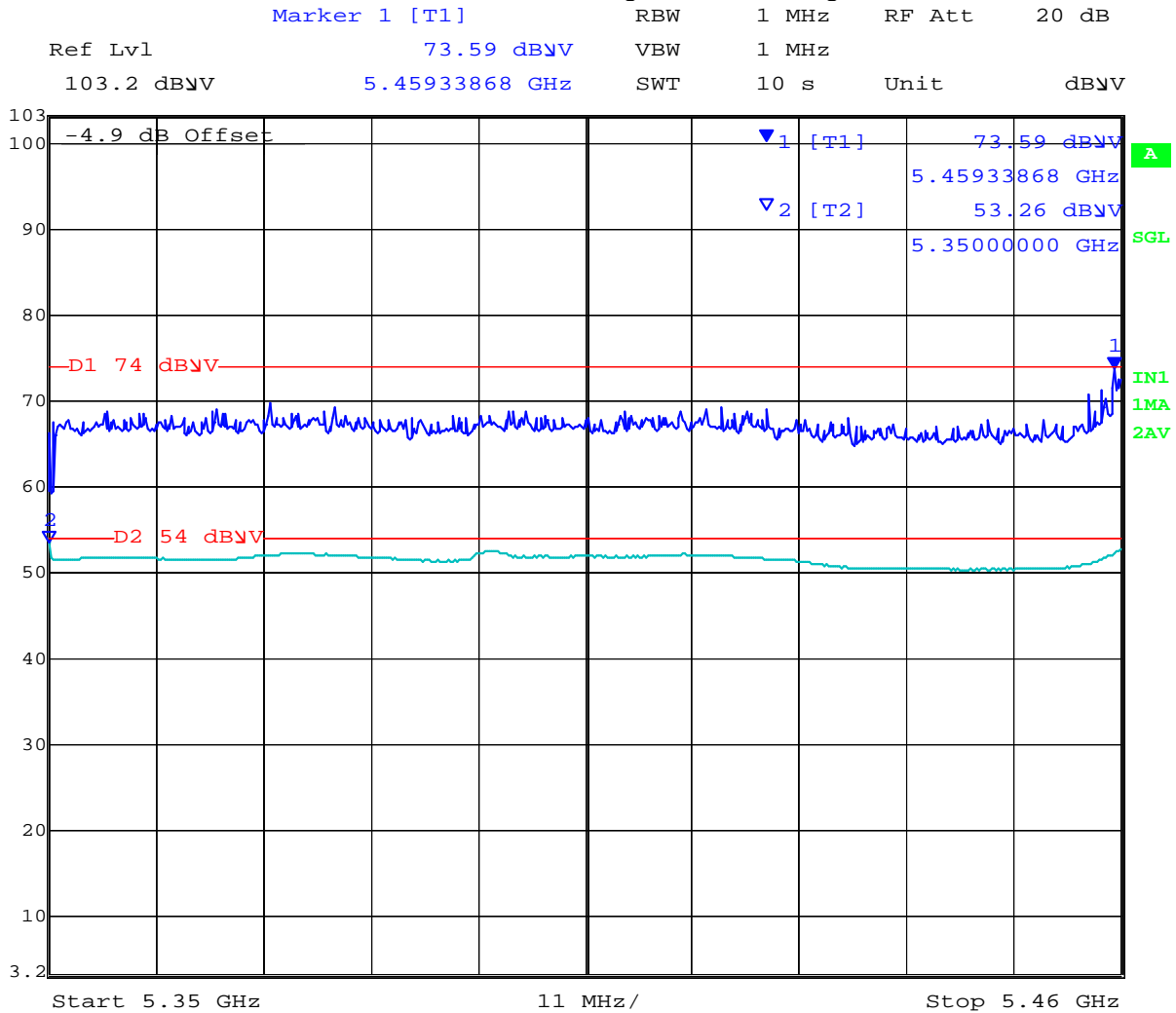

Date: 12.SEP.2012 10:26:17

This test report may be reproduced in full only. The document may only be updated by MiCOM Labs personnel. Any changes will be noted in the Document History section of the report.



5470 -5725 MHz

Low

Test Freq.	5475 MHz	Engineer	JMH
Variant	5 MHz	Temp (°C)	24
Freq. Range	1000 MHz - 18000 MHz	Rel. Hum.(%)	33
Power Setting	15	Press. (mBars)	1005
Antenna	32 dBi Dish	Duty Cycle (%)	100
Test Notes 1	Data Rate MCS 15		
Test Notes 2			

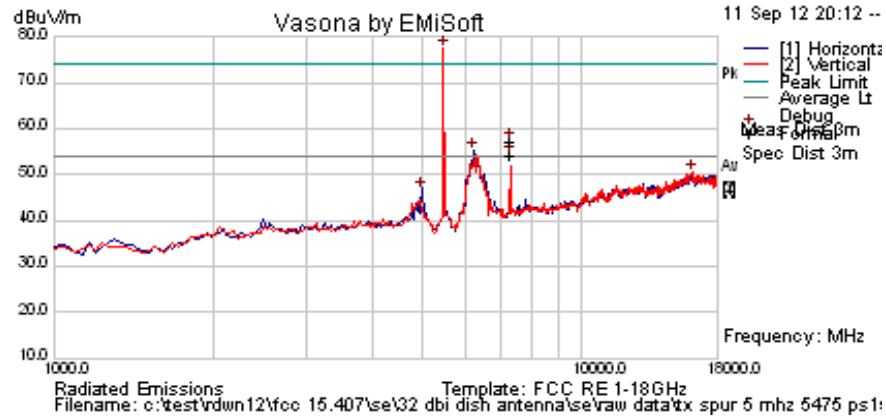

Formally measured emission peaks

Frequency MHz	Raw dBuV	Cable Loss	AF dB	Level dBuV/m	Measurement Type	Pol	Hgt cm	Azt Deg	Limit dBuV/m	Margin dB	Pass /Fail	Comments
5462.926	82.5	4.6	-9.7	77.5	Peak [Scan]	V						FUND
6246.492986	57.7	5.0	-7.6	55.1	Peak [Scan]	H						NRB
16126.253	41.4	9.0	0.2	50.6	Peak [Scan]	V	100	0	54	-3.4	Pass	Noise
4980.855	51.6	4.6	-9.9	46.4	Peak [Scan]	H	98	0	54	-7.6	Pass	RB
7300.140	57.4	5.4	-5.7	57.2	Peak Max	V	98	11	74	-16.9	Pass	RB
7300.140	54.3	5.4	-5.7	54.0	Average Max	V	98	11	54	0.0	Pass	RB

Legend: TX = Transmitter Emissions; DIG = Digital Emissions; FUND = Fundamental; WB = Wideband Emission
 NRB = Non-Restricted Band. Limit = 68.23 dBuV/m; RB = Restricted Band. Limits per 15.205

This test report may be reproduced in full only. The document may only be updated by MiCOM Labs personnel. Any changes will be noted in the Document History section of the report.



Title: AP0127730, AP0134760
To: FCC 47 CFR Part 15.407 & IC RSS-210
Serial #: RDWN12-U2 Rev B
Issue Date: 18th January 2013
Page: 145 of 272

Mid

Test Freq.	5595 MHz	Engineer	JMH
Variant	5 MHz	Temp (°C)	24
Freq. Range	1000 MHz - 18000 MHz	Rel. Hum.(%)	33
Power Setting	15	Press. (mBars)	1005
Antenna	32 dBi Dish	Duty Cycle (%)	100
Test Notes 1	Data Rate MCS 15		
Test Notes 2			

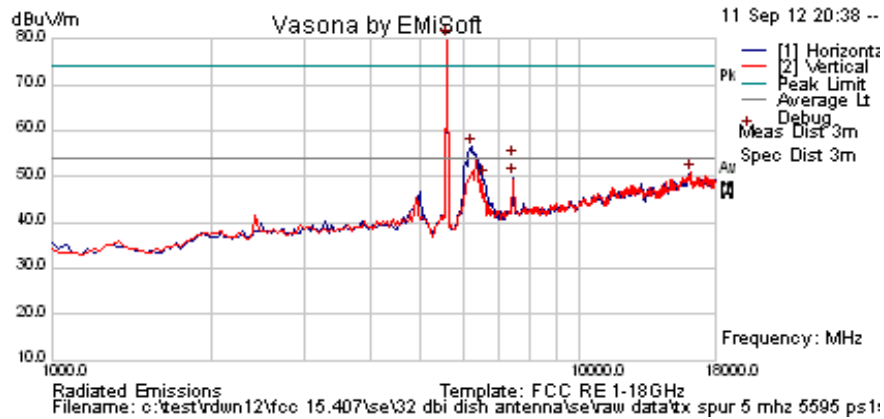

Formally measured emission peaks

Frequency MHz	Raw dBuV	Cable Loss	AF dB	Level dBuV/m	Measurement Type	Pol	Hgt cm	Azt Deg	Limit dBuV/m	Margin dB	Pass /Fail	Comments
5599.198	84.9	4.7	-9.7	79.9	Peak [Scan]	V						FUND
6246.492986	59.0	5.0	-7.6	56.4	Peak [Scan]	H						NRB
16194.389	41.8	8.9	0.2	50.9	Peak [Scan]	V	200	0	54	-3.1	Pass	Noise
6587.174	51.2	5.2	-7.0	49.4	Peak [Scan]	H						NRB
7459.880	53.8	5.5	-5.3	53.9	Peak Max	H	104	10	74	-20.1	Pass	RB
7459.880	49.7	5.5	-5.3	49.9	Average Max	H	104	10	54	-4.1	Pass	RB

Legend: TX = Transmitter Emissions; DIG = Digital Emissions; FUND = Fundamental; WB = Wideband Emission
 NRB = Non-Restricted Band. Limit = 68.23 dBuV/m; RB = Restricted Band. Limits per 15.205

This test report may be reproduced in full only. The document may only be updated by MiCOM Labs personnel. Any changes will be noted in the Document History section of the report.



High

Test Freq.	5720 MHz	Engineer	JMH
Variant	5 MHz	Temp (°C)	24
Freq. Range	1000 MHz - 18000 MHz	Rel. Hum.(%)	33
Power Setting	21	Press. (mBars)	1005
Antenna	32 dBi Dish	Duty Cycle (%)	100
Test Notes 1	Data Rate MCS 15		
Test Notes 2			

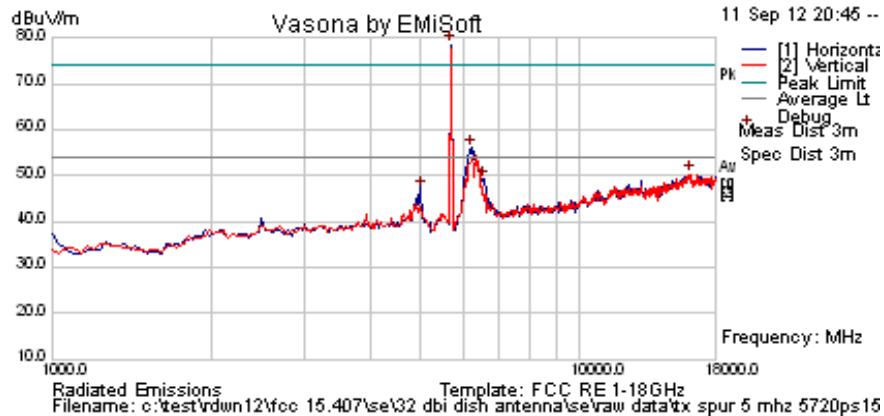

Formally measured emission peaks

Frequency MHz	Raw dBuV	Cable Loss	AF dB	Level dBuV/m	Measurement Type	PoI	Hgt cm	Azt Deg	Limit dBuV/m	Margin dB	Pass /Fail	Comments
5701.403	83.4	4.7	-9.6	78.5	Peak [Scan]	H						FUND
6212.42485	58.8	5.0	-7.8	56.0	Peak [Scan]	H						NRB
16126.253	41.1	9.0	0.2	50.3	Peak [Scan]	V	200	0	54	-3.7	Pass	Noise
6587.174	51.0	5.2	-7.0	49.3	Peak [Scan]	H						NRB
5001.296	52.3	4.6	-9.9	47.1	Peak [Scan]	H	98	0	54	-6.9	Pass	RB

Legend: TX = Transmitter Emissions; DIG = Digital Emissions; FUND = Fundamental; WB = Wideband Emission
 NRB = Non-Restricted Band. Limit = 68.23 dBuV/m; RB = Restricted Band. Limits per 15.205

This test report may be reproduced in full only. The document may only be updated by MiCOM Labs personnel. Any changes will be noted in the Document History section of the report.

6.1.3. Receiver Radiated Spurious Emissions (above 1 GHz)

Industry Canada RSS-Gen §4.10, §6

Test Procedure

Radiated emissions above 1 GHz are measured in the anechoic chamber at a 3-meter distance on every azimuth in both horizontal and vertical polarities. The emissions are recorded and maximized as a function of azimuth by rotation through 360° with a spectrum analyzer in peak hold mode. Depending on the frequency band spanned a notch filter and waveguide filter was used to remove the fundamental frequency. The highest emissions relative to the limit are listed for each frequency spanned.

All measurements on any frequency or frequencies over 1 MHz are based on the use of measurement instrumentation employing an average detector function. All measurements above 1 GHz were performed using a minimum resolution bandwidth of 1 MHz.

All Sectors of the EUT were tested simultaneously

Test Measurement Set up

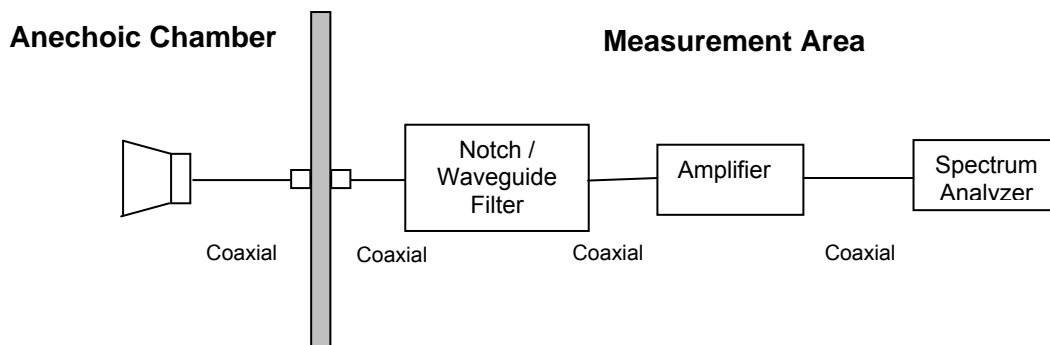

Measurement set up for Radiated Emission Test

Field Strength Calculation

The field strength is calculated by adding the Antenna Factor and Cable Loss, and subtracting Amplifier Gain from the measured reading. All factors are included in the reported data.

$$FS = R + AF + CORR - FO$$

where: FS = Field Strength

R = Measured Spectrum analyzer Input Amplitude

AF = Antenna Factor

CORR = Correction Factor = CL – AG + NFL

CL = Cable Loss

AG = Amplifier Gain

FO = Distance Falloff Factor

NFL = Notch Filter Loss or Waveguide Loss



Title: AP0127730, AP0134760
To: FCC 47 CFR Part 15.407 & IC RSS-210
Serial #: RDWN12-U2 Rev B
Issue Date: 18th January 2013
Page: 148 of 272

For example:

Given receiver input reading of 51.5 dB μ V; Antenna Factor of 8.5 dB; Cable Loss of 1.3 dB; Falloff Factor of 0 dB, an Amplifier Gain of 26 dB and Notch Filter Loss of 1 dB. The Field Strength of the measured emission is:

$$FS = 51.5 + 8.5 + 1.3 - 26.0 + 1 = 36.3 \text{ dB}\mu\text{V/m}$$

Conversion between dB μ V/m (or dB μ V) and μ V/m (or μ V) are done as:

$$\text{Level (dB}\mu\text{V/m)} = 20 * \text{Log (level (\mu\text{V/m}))}$$

$$40 \text{ dB}\mu\text{V/m} = 100 \mu\text{V/m}$$

$$48 \text{ dB}\mu\text{V/m} = 250 \mu\text{V/m}$$

This test report may be reproduced in full only. The document may only be updated by MiCOM Labs personnel. Any changes will be noted in the Document History section of the report.



Specification

Radiated Receiver Spurious Emissions

RSS-Gen §4.10 the search for spurious emissions shall be from the lowest frequency internally generated or used in the receiver (e.g.. local oscillator, intermediate or carrier frequency), or 30 MHz, whichever is higher, to at least 3 times the highest tunable or local oscillator frequency, whichever is higher, without exceeding 40 GHz.

For emissions below 1000 MHz, measurements shall be performed using a CISPR quasi-peak detector and the related measurement bandwidth. As an alternative to CISPR quasi-peak measurement, compliance with the emission limit can be demonstrated using measuring equipment employing a peak detector function properly adjusted for factors such as pulse desensitization as required, with an equal or greater measurement bandwidth relative to the applicable CISPR quasi-peak bandwidth.

Above 1000 MHz, measurements shall be performed using an average detector with a minimum resolution bandwidth of 1 MHz.

RSS-Gen §6 Receiver Spurious Radiated Limits

Spurious emissions from receivers shall not exceed the radiated limits shown in the table below:

RSS-Gen Spurious Emissions Limits

Frequency (MHz)	Field Strength ($\mu\text{V/m}$)	Field Strength ($\text{dB}\mu\text{V/m}$)	Measurement Distance (meters)
30-88	100	40.0	3
88-216	150	43.5	3
216-960	200	46.0	3
Above 960	500	54.0	3

Traceability:

Test Equipment Used

0088, 0158, 0134, 0304, 0311, 0315, 0310, 0312



Title: AP0127730, AP0134760
To: FCC 47 CFR Part 15.407 & IC RSS-210
Serial #: RDWN12-U2 Rev B
Issue Date: 18th January 2013
Page: 150 of 272

Receiver Radiated Spurious Emissions above 1 GHz

Radiated receiver testing was performed on antennas with the highest gains; 29 dBi Flat Panel and 32 dBi Dish antennas

Test Freq.	5300 MHz	Engineer	JMH
Variant	Receive in Test Utility	Temp (°C)	24
Freq. Range	1000 MHz - 18000 MHz	Rel. Hum.(%)	34
Power Setting	Not Applicable in Receive Mode	Press. (mBars)	1002
Antenna	29 dBi Flat Panel		
Test Notes 1			
Test Notes 2			

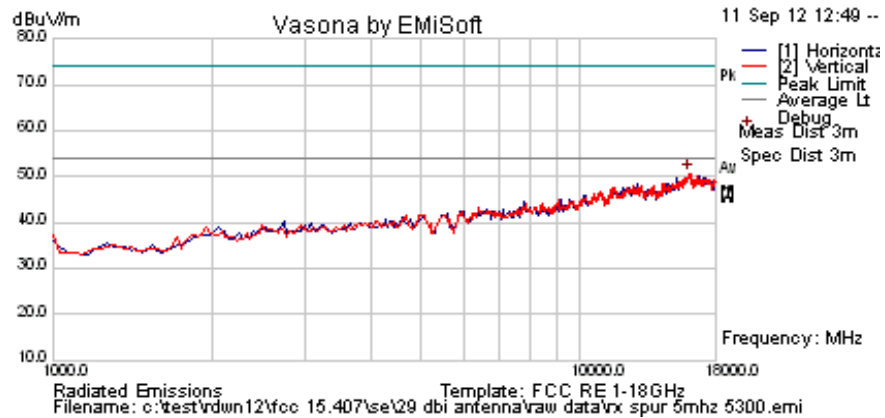

Formally measured emission peaks

Frequency MHz	Raw dBuV	Cable Loss	AF dB	Level dBuV/m	Measurement Type	Pol	Hgt cm	Azt Deg	Limit dBuV/m	Margin dB	Pass /Fail	Comments
16058.116	41.5	9.0	0.3	50.7	Peak [Scan]	V	200	0	54	-3.3	Pass	Noise
Legend: RB = Restricted Band; NRB = Non-Restricted Band; FUND = Fundamental Freq. BE = Emission in Restricted Band Nearest Transmission Band Edge;												

This test report may be reproduced in full only. The document may only be updated by MiCOM Labs personnel. Any changes will be noted in the Document History section of the report.



Title: AP0127730, AP0134760
To: FCC 47 CFR Part 15.407 & IC RSS-210
Serial #: RDWN12-U2 Rev B
Issue Date: 18th January 2013
Page: 151 of 272

Test Freq.	5595 MHz	Engineer	JMH
Variant	Receive in Test Utility	Temp (°C)	24
Freq. Range	1000 MHz - 18000 MHz	Rel. Hum.(%)	34
Power Setting	Not Applicable in Receive Mode	Press. (mBars)	1002
Antenna	29 dBi Flat Panel		
Test Notes 1			
Test Notes 2			

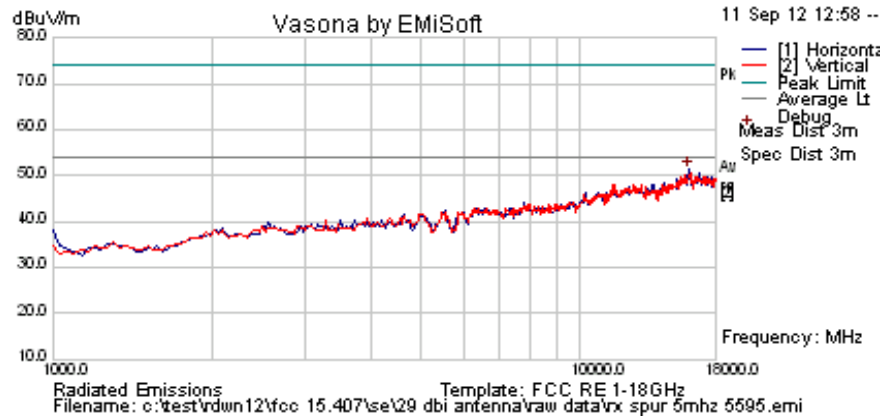

Formally measured emission peaks

Frequency MHz	Raw dBuV	Cable Loss	AF dB	Level dBuV/m	Measurement Type	Pol	Hgt cm	Azt Deg	Limit dBuV/m	Margin dB	Pass /Fail	Comments
15989.980	42.22	9	0.12	51.34	Peak [Scan]	H	100	0	54	-2.66	Pass	

Legend: RB = Restricted Band; NRB = Non-Restricted Band; FUND = Fundamental Freq.
 BE = Emission in Restricted Band Nearest Transmission Band Edge;

This test report may be reproduced in full only. The document may only be updated by MiCOM Labs personnel. Any changes will be noted in the Document History section of the report.



Title: AP0127730, AP0134760
To: FCC 47 CFR Part 15.407 & IC RSS-210
Serial #: RDWN12-U2 Rev B
Issue Date: 18th January 2013
Page: 152 of 272

32 dBi Dish antenna

Test Freq.	5300 MHz	Engineer	JMH
Variant	Receive in Test Utility	Temp (°C)	25
Freq. Range	1000 MHz - 18000 MHz	Rel. Hum.(%)	34
Power Setting	Not Applicable in Receive Mode	Press. (mBars)	1006
Antenna	32 dBi Dish		
Test Notes 1			
Test Notes 2			

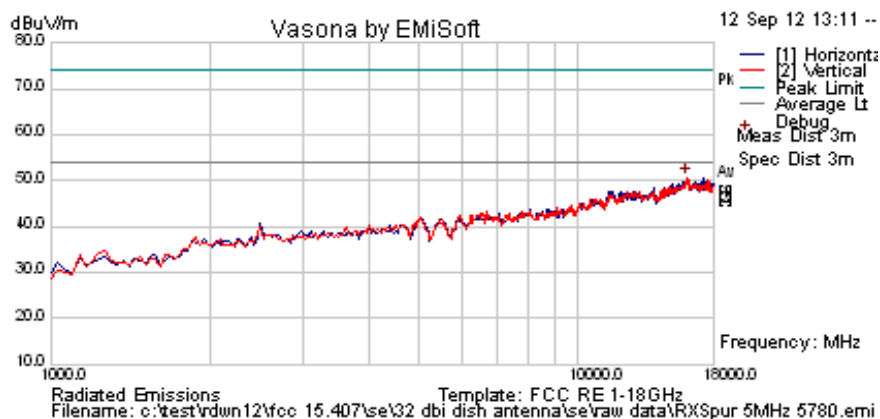

Formally measured emission peaks

Frequency MHz	Raw dBuV	Cable Loss	AF dB	Level dBuV/m	Measurement Type	Pol	Hgt cm	Azt Deg	Limit dBuV/m	Margin dB	Pass /Fail	Comments
16058.116	41.4	9.0	0.3	50.7	Peak [Scan]	V	150	0	54	-3.3	Pass	Noise

Legend: RB = Restricted Band; NRB = Non-Restricted Band; FUND = Fundamental Freq.
 BE = Emission in Restricted Band Nearest Transmission Band Edge;

This test report may be reproduced in full only. The document may only be updated by MiCOM Labs personnel. Any changes will be noted in the Document History section of the report.



Title: AP0127730, AP0134760
To: FCC 47 CFR Part 15.407 & IC RSS-210
Serial #: RDWN12-U2 Rev B
Issue Date: 18th January 2013
Page: 153 of 272

Test Freq.	5595 MHz	Engineer	JMH
Variant	Receive in Test Utility	Temp (°C)	25
Freq. Range	1000 MHz - 18000 MHz	Rel. Hum.(%)	34
Power Setting	Not Applicable in Receive Mode	Press. (mBars)	1006
Antenna	32 dBi Dish		
Test Notes 1			
Test Notes 2			

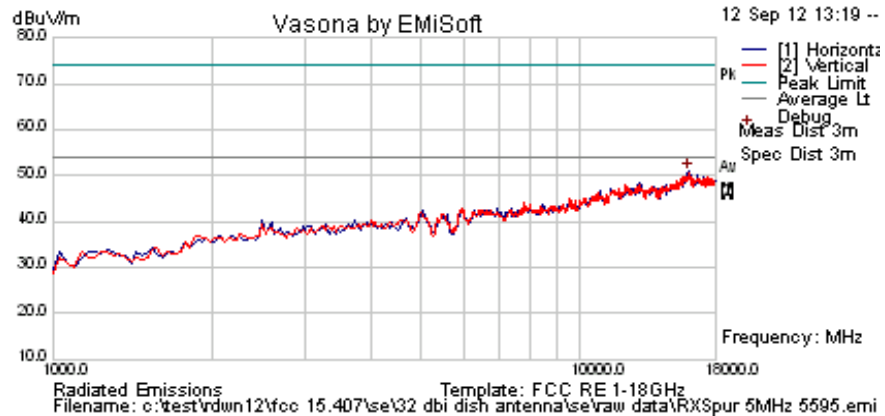

Formally measured emission peaks

Frequency MHz	Raw dBuV	Cable Loss	AF dB	Level dBuV/m	Measurement Type	Pol	Hgt cm	Azt Deg	Limit dBuV/m	Margin dB	Pass /Fail	Comments
15989.980	41.66	9	0.12	50.78	Peak [Scan]	H	100	0	54	-3.22	Pass	

Legend: RB = Restricted Band; NRB = Non-Restricted Band; FUND = Fundamental Freq.
 BE = Emission in Restricted Band Nearest Transmission Band Edge;

This test report may be reproduced in full only. The document may only be updated by MiCOM Labs personnel. Any changes will be noted in the Document History section of the report.



6.1.4. Digital Emissions (30M-1 GHz)

FCC, Part 15 Subpart C §15.205/ §15.209
Industry Canada RSS-210 §2.2

Test Procedure

Testing 30M-1 GHz was performed in a 3-meter anechoic chamber using a CISPR compliant receiver. Preliminary radiated emissions were measured on every azimuth and with the receiving antenna in both horizontal and vertical polarizations. To further maximize emissions the receive antenna was varied between 1 and 4 meters. The emissions are recorded with receiver in peak hold mode. Emissions closest to the limits are measured in the quasi-peak mode with the tuned receiver using a bandwidth of 120 kHz. Only the highest emissions relative to the limit are listed. The anechoic chamber test set-up is identified in Section 6 Test Set-Up Photographs.

The EUT had two methods of powering on ac/dc converter and Power over Ethernet (POE). Both modes were tested for emissions below 1GHz.

Field Strength Calculation

The field strength is calculated by adding the Antenna Factor and Cable Loss, and subtracting Amplifier Gain from the measured reading. In this test facility, the Antenna Factor, Cable Loss, and Amplifier Gains are loaded into the Rohde & Schwarz Receiver and the corrected field strength can be read directly on the receiver.

$$FS = R + AF + CORR$$

where:

FS = Field Strength
R = Measured Receiver Input Amplitude
AF = Antenna Factor
CORR = Correction Factor = CL – AG + NFL
CL = Cable Loss
AG = Amplifier Gain

For example:

Given a Receiver input reading of 51.5dB μ V; Antenna Factor of 8.5dB; Cable Loss of 1.3dB; Falloff Factor of 0dB, an Amplifier Gain of 26dB and Notch Filter Loss of 1dB. The Field Strength of the measured emission is:

$$FS = 51.5 + 8.5 + 1.3 - 26.0 + 1 = 36.3\text{dB}\mu\text{V/m}$$

Conversion between dB μ V/m (or dB μ V) and μ V/m (or μ V) are done as:

$$\text{Level (dB}\mu\text{V/m)} = 20 * \text{Log (level (\mu\text{V/m}))}$$

$$40 \text{ dB}\mu\text{V/m} = 100\mu\text{V/m}$$

$$48 \text{ dB}\mu\text{V/m} = 250\mu\text{V/m}$$

This test report may be reproduced in full only. The document may only be updated by MiCOM Labs personnel. Any changes will be noted in the Document History section of the report.



Title: AP0127730, AP0134760
To: FCC 47 CFR Part 15.407 & IC RSS-210
Serial #: RDWN12-U2 Rev B
Issue Date: 18th January 2013
Page: 155 of 272

Test Freq.	N/A	Engineer	SB
Variant	Digital Emissions	Temp (°C)	23
Freq. Range	30 MHz - 1000 MHz	Rel. Hum.(%)	33
Power Setting	25	Press. (mBars)	1008
Antenna	16.5 dBi Flat Panel Sector		
Test Notes 1			
Test Notes 2			

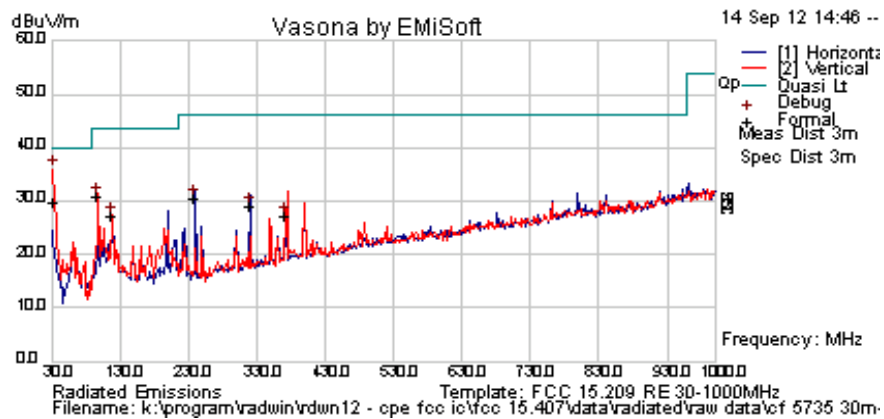

Formally measured emission peaks

Frequency MHz	Raw dBuV	Cable Loss	AF dB	Level dBuV/m	Measurement Type	Pol	Hgt cm	Azt Deg	Limit dBuV/m	Margin dB	Pass /Fail	Comments
33.058	38.4	3.5	-12.1	29.7	Quasi Max	V	104	261	40	-10.3	Pass	
240.136	44.7	4.8	-19.0	30.5	Peak [Scan]	H	104	261	46	-15.5	Pass	
319.958	40.5	5.2	-16.7	29.1	Peak [Scan]	H	104	261	46	-16.9	Pass	
97.912	48.8	4.1	-21.9	31.0	Peak [Scan]	V	104	261	43.5	-12.5	Pass	
119.199	40.7	4.2	-17.5	27.4	Peak [Scan]	V	104	261	43.5	-16.1	Pass	
372.410	37.1	5.4	-15.3	27.2	Peak [Scan]	V	104	261	46	-18.8	Pass	

Legend: DIG = Digital Device Emission; TX = Transmitter Emission; FUND = Fundamental Frequency
 NRB = Non-Restricted Band, Limit is 20 dB below Fundamental; RB = Restricted Band

This test report may be reproduced in full only. The document may only be updated by MiCOM Labs personnel. Any changes will be noted in the Document History section of the report.



Specification

Limits

§15.205 (a) Except as shown in paragraph (d) of 15.205 (a), only spurious emissions are permitted in any of the frequency bands listed.

§15.205 (a) Except as shown in paragraphs (d) and (e) of this section, the field strength of emissions appearing within these frequency bands shall not exceed the limits shown in Section §15.209. At frequencies equal to or less than 1000 MHz, compliance with the limits in Section 15.209 shall be demonstrated using measurement instrumentation employing a CISPR quasi-peak detector. Above 1000 MHz, compliance with the emission limits in Section 15.209 shall be demonstrated based on the average value of the measured emissions. The provisions in Section 15.35 apply to these measurements.

§15.209 (a) Except as provided elsewhere in this subpart, the emissions from an intentional radiator shall not exceed the field strength levels specified in the following table.

§15.209 (a) and RSS-Gen §2.2 Limit Matrix

Frequency(MHz)	Field Strength ($\mu\text{V/m}$)	Field Strength ($\text{dB}\mu\text{V/m}$)	Measurement Distance (meters)
30-88	100	40.0	3
88-216	150	43.5	3
216-960	200	46.0	3
Above 960	500	54.0	3

Laboratory Measurement Uncertainty for Radiated Emissions

Measurement uncertainty	+5.6/ -4.5 dB
-------------------------	---------------

Traceability

Method	Test Equipment Used
Measurements were made per work instruction WI-03 'Measurement of Radiated Emissions'	0088, 0158, 0134, 0304, 0311, 0315, 0310, 0312

This test report may be reproduced in full only. The document may only be updated by MiCOM Labs personnel. Any changes will be noted in the Document History section of the report.



Title: AP0127730, AP0134760
To: FCC 47 CFR Part 15.407 & IC RSS-210
Serial #: RDWN12-U2 Rev B
Issue Date: 18th January 2013
Page: 157 of 272

6.1.5. AC Wireline Conducted Emissions (150 kHz – 30 MHz)

FCC, Part 15 Subpart C §15.207
Industry Canada RSS-Gen §7.2.2

Test Procedure

The EUT is configured in accordance with ANSI C63.4. The conducted emissions are measured in a shielded room with a spectrum analyzer in peak hold in the first instance. Emissions closest to the limit are measured in the quasi-peak mode (QP) with the tuned receiver using a bandwidth of 9 kHz. The emissions are maximized further by cable manipulation. The highest emissions relative to the limit are listed.

Measurement Results for AC Wireline Conducted Emissions (150 kHz – 30 MHz)

Ambient conditions.

Temperature: 17 to 23 °C Relative humidity: 31 to 57 % Pressure: 999 to 1012 mbar

Not required - EUT is POE only.

This test report may be reproduced in full only. The document may only be updated by MiCOM Labs personnel. Any changes will be noted in the Document History section of the report.