

Hermon Laboratories Ltd.
Harakevet Industrial Zone, Binyamina 30500,
Israel
Tel. +972-4-6288001
Fax. +972-4-6288277
E-mail: mail@hermonlabs.com

TEST REPORT

ACCORDING TO: FCC 47CFR part 15 subpart C § 15.247 and RSS-210 issue 8

FOR:

RADWIN Ltd.

**Outdoor radio unit operating
in the 5.8 GHz band**

**Model: RADWIN 1000,
RADWIN 2000,
RADWIN 5000**

This report is in conformity with ISO/IEC 17025. The "A2LA Accredited" symbol endorsement applies only to the tests and calibrations that are listed in the scope of Hermon Laboratories accreditation. The test results relate only to the items tested. This test report shall not be reproduced in any form except in full with the written approval of Hermon Laboratories Ltd.



Table of contents

1	Applicant information	3
2	Equipment under test attributes	3
3	Manufacturer information	3
4	Test details	3
5	Tests summary	4
6	EUT description	5
6.1	General information	5
6.2	Ports and lines	5
6.3	Support and test equipment	5
6.4	Changes made in the EUT	5
6.5	Test configuration	6
6.6	Transmitter characteristics	7
7	Transmitter tests according to 47CFR part 15 subpart C requirements	8
7.1	Minimum 6 dB bandwidth	8
7.2	Peak output power	17
7.3	Spurious emissions at RF antenna connector	19
7.4	Field strength of spurious emissions	56
7.5	Peak spectral power density	164
7.6	Conducted emissions	184
7.7	Antenna requirements	187
8	APPENDIX A Test equipment and ancillaries used for tests	189
9	APPENDIX B Measurement uncertainties	191
10	APPENDIX C Test laboratory description	192
11	APPENDIX D Specification references	192
12	APPENDIX E Test equipment correction factors	193
13	APPENDIX F Abbreviations and acronyms	203
14	APPENDIX G RADWIN 1000/2000 Antenna List and Power Settings	204
15	APPENDIX H RADWIN 5000 Antenna List and Power Settings	205



HERMON LABORATORIES

1 Applicant information

Client name: RADWIN Ltd.
Address: 27 Habarzel str., Tel Aviv 69710, Israel
Telephone: +972 3766 2988
Fax: +972 3766 2902
E-mail: shlomo_weiss@radwin.com
Contact name: Mr. Shlomo Weiss

2 Equipment under test attributes

Product name: Outdoor radio unit operating in the 5.8 GHz band
Product type: Point to Point and Point to Multipoint transceiver
Model(s): RADWIN 1000, RADWIN 2000, RADWIN 5000
Receipt date 5/28/2008

3 Manufacturer information

Manufacturer name: RADWIN Ltd.
Address: 27 Habarzel str., Tel Aviv 69710, Israel
Telephone: +972 3766 2988
Fax: +972 3766 2902
E-Mail: shlomo_weiss@radwin.com
Contact name: Mr. Shlomo Weiss

4 Test details

Project ID: 18826
Location: Hermon Laboratories Ltd. Harakevet Industrial Zone, Binyamina 30500, Israel
Test started: 5/28/2008
Test completed: 11/14/2008
Test specification(s): FCC 47CFR part 15:2007, subpart C §§15.247; RSS-210 issue 8:2010, annex 8



5 Tests summary

Test	Status
Transmitter characteristics	
FCC section 15.247(a)(2), RSS-210 section A8.2(a), 6 dB bandwidth	Pass
FCC section 15.247(b)(3), RSS-210 section A8.4(4), Peak output power	Pass*
FCC section 15.247(i), RSS-Gen section 5.6, RF exposure	Pass, the exhibit to the application of certification is provided
FCC section 15.247(d), RSS-210 section A8.5, Conducted spurious emissions	Pass
FCC section 15.247(d), RSS-210 section A8.5, Radiated spurious emissions	Pass
FCC section 15.247(e), RSS-210 section A8.2(b), Peak power density	Pass
FCC section 15.207(a), RSS-Gen section 7.2.4, Conducted emission	Pass
FCC section 15.203, RSS-Gen section 7.1.2, Antenna requirement	Pass

Note: The EUT model RADWIN 2000 with power setting that produced Maximum Output Power with maximum Antenna Gain 23.5 and 28 dBi was tested as the worst case between all RADWIN 1000,2000,5000 models. The more detailed description of RADWIN 1000,2000,5000 is provided in section 6.1 of the test report.

* - All power measurements were performed under the nominal power voltage as all RF circuits are powered from voltage regulators, as provided in "RF_schematics_18826.pdf" at page 8.

Testing was completed against all relevant requirements of the test standard. The results obtained indicate that the product under test complies in full with the requirements tested.
 The test results relate only to the items tested. Pass/ fail decision was based on nominal values.

This test report replaces the previously issued test report identified by Doc ID:RDWRAD_FCC.18826_21882.

	Name and Title	Date	Signature
Tested by:	Mr. E. Plotnichenko, test engineer	November 14, 2008	
Reviewed by:	Ms. N. Averin, certification engineer	April 17, 2011	
Approved by:	Mr. M. Nikishin, EMC and Radio group manager	April 17, 2011	



6 EUT description

6.1 General information

The EUT, RADWIN 1000, RADWIN 2000, RADWIN 5000 is an outdoor unit (ODU). The power and Ethernet communication are supplied by an indoor unit (IDU) or PoE device. It has connectorized and integrated antenna configurations that can support dual pole antenna type. The RADWIN 1000 activates one RF port, RADWIN 2000 activates two RF ports for software configured Point to Point topology and RADWIN 5000 is identifier for software configured Point to Multipoint topology. For relevant output power setting versus each antenna type please refer to RADWIN 5000 Antenna List and Power Settings and RADWIN 1000/2000 Antenna List and Power Settings attached.

The EUT model RADWIN 2000 was tested as worst case representative.

6.2 Ports and lines

Port type	Port description	Connected		Connector type	Q-ty	Cable type	Cable length, m	Indoor / outdoor
		From	To					
Power	-48 VDC	AC/DC adapter	IDU	Terminal block	1	unshielded	1.5	Indoor
Power	AC power	mains	AC/DC adapter	IEC 60320	1	unshielded	1.5	Indoor
RF1	RF1 (Antenna 1)	EUT	antenna	N-type	1	shielded	1	Outdoor*
RF2	RF2 (Antenna 2)	EUT	antenna	N-type	1	shielded	1	Outdoor*
Signal	Ethernet	IDU	Laptop	RJ45	1	FTP	20	Indoor

* - for external antenna configuration only

6.3 Support and test equipment

Description	Manufacturer	Model number	Serial number
Laptop	Dell	Latitude/D530	NA
IDU (for configuration with ODU)	RadWin Ltd.	IDU-E	DE000201267
AC/DC	YCL	WMB480042-5G	S0714002271

6.4 Changes made in the EUT

No changes were implemented.

6.5 Test configuration

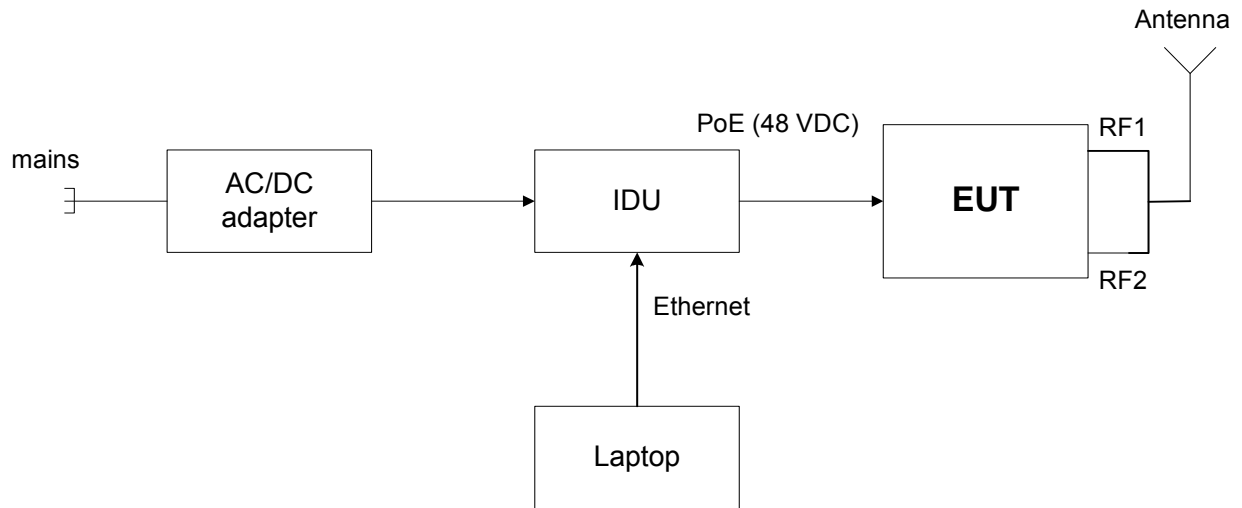



6.6 Transmitter characteristics

Type of equipment				
V	Stand-alone (Equipment with or without its own control provisions)			
	Combined equipment (Equipment where the radio part is fully integrated within another type of equipment)			
	Plug-in card (Equipment intended for a variety of host systems)			
Intended use		Condition of use		
V	Fixed	Always at a distance more than 2 m from all people		
	mobile	Always at a distance more than 20 cm from all people		
	portable	May operate at a distance closer than 20 cm to human body		
Assigned frequency range		5725 - 5850 MHz		
Operating frequency range		5730 - 5845 MHz, 5735 - 5840 MHz		
RF channel bandwidth		5 MHz, 20 MHz		
Maximum rated output power	Peak (conducted)	Antenna 24.0 dBi	29.95 dBm	
		Antenna 22.0 dBi		
		Antenna 27.9 dBi		
		Antenna 15.5 dBi		20.0 dBm
		Antenna 13.0 dBi		23.0 dBm
		Antenna 8.0 dBi	28.0 dBm	
Is transmitter output power variable?	V	No	continuous variable	
		Yes	stepped variable with stepsize	
			minimum RF power	
			maximum RF power	
Antenna connection				
unique coupling	V	standard connector	Integral	
			with temporary RF connector	
			without temporary RF connector	
Antenna/s technical characteristics				
Type	Manufacturer	Model number	Antenna assembly gain	
Dish – Dual polarized External	RADWIN Ltd.	RW-9721-5158	27.9 dBi (28.9 dBi with 1 dB feeder loss)	
Flat Panel – Dual polarized Integrated	RADWIN Ltd.	RW-9611-4958INT	Port H – 22.5 dBi, port V – 24 dBi (min)	
Flat Panel – Dual polarized external	RADWIN Ltd.	RW-9611-4958	23.0 dBi (22.0 dBi with 1 dB feeder loss)	
Flat Panel Dual Pole External	RADWIN Ltd.	RW-9061-5002	15.5 dBi (16.5 dBi with 1 dB feeder loss)	
Flat Panel Dual Pole External	RADWIN Ltd.	RW-9061-5001	13.0 dBi (14.0 dBi with 1 dB feeder loss)	
Flat Panel Dual Pole External	RADWIN Ltd.	RW-9061-5002	8.0 dBi (16.5 dBi with 8.5 dB feeder loss)	
Flat Panel Dual Pole External	RADWIN Ltd.	RW-9061-5001	8.0 dBi (14.0 dBi with 6.0 dB feeder loss)	
Transmitter 99% power bandwidth	Transmitter aggregate data rate/s, MBps		Type of modulation (OFDM)	
5 MHz	3.25		BPSK	
	32.5		64QAM	
20 MHz	13		BPSK	
	130		64QAM	
Modulating test signal (baseband)		OFDM		
Maximum transmitter duty cycle in normal use		50%		
Maximum transmitter duty cycle for test purposes		100%		
Transmitter power source				
	Nominal rated voltage	Battery type		
V	DC (PoE)	48 VDC from IDU unit powered by 120 VAC		
	AC mains	Nominal rated voltage	Frequency Hz	
Common power source for transmitter and receiver		V	yes no	

Test specification:		FCC section 15.247(a)(2), RSS-210 section A8.2(a), 6 dB bandwidth	
Test procedure:		FCC New Guidance on Measurements for DTS in section 15.247(a)(2)	
Test mode:	Compliance	Verdict:	PASS
Date & Time:	11/2/2008 5:34:11 PM		
Temperature: 21°C	Air Pressure: 1011 hPa	Relative Humidity: 45%	Power Supply: 48 VDC
Remarks:			

7 Transmitter tests according to 47CFR part 15 subpart C requirements

7.1 Minimum 6 dB bandwidth

7.1.1 General

This test was performed to measure 6 dB bandwidth of the EUT carrier frequency. Specification test limits are given in Table 7.1.1.

Table 7.1.1 The 6 dB bandwidth limits

Assigned frequency, MHz	Modulation envelope reference points*, dBc	Minimum bandwidth, kHz
902.0 – 928.0	6.0	500.0
2400.0 – 2483.5		
5725.0 – 5850.0		

* - Modulation envelope reference points provided in terms of attenuation below the peak of modulated carrier.

7.1.2 Test procedure

7.1.2.1 The EUT was set up as shown in Figure 7.1.1, energized and its proper operation was checked.

7.1.2.2 The EUT was set to transmit modulated carrier.

7.1.2.3 The transmitter minimum 6 dB bandwidth was measured with spectrum analyzer RBW=100 kHz as frequency delta between reference points on modulation envelope and provided in Table 7.1.2 and associated plots.

Figure 7.1.1 The 6 dB bandwidth test setup

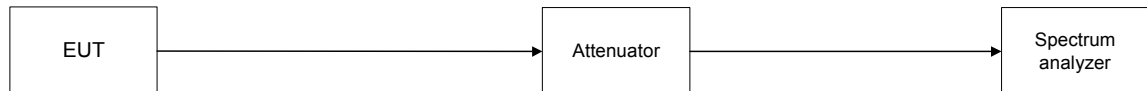



Test specification:	FCC section 15.247(a)(2), RSS-210 section A8.2(a), 6 dB bandwidth		
Test procedure:	FCC New Guidance on Measurements for DTS in section 15.247(a)(2)		
Test mode:	Compliance	Verdict:	PASS
Date & Time:	11/2/2008 5:34:11 PM		
Temperature: 21°C	Air Pressure: 1011 hPa	Relative Humidity: 45%	Power Supply: 48 VDC
Remarks:			

Table 7.1.2 The 6 dB bandwidth test results, 5 MHz channel bandwidth

ASSIGNED FREQUENCY BAND: 5725 – 5850 MHz
DETECTOR USED: Peak
SWEEP MODE: Single
RESOLUTION BANDWIDTH: 100 kHz
VIDEO BANDWIDTH: 300 kHz
MODULATION ENVELOPE REFERENCE POINTS: 6.0 dBc
MODULATION: BPSK / 64QAM
MODULATING SIGNAL: OFDM

Modulation	Bit rate, Mbps	6 dB bandwidth, kHz	Limit, kHz	Margin, kHz	Verdict
Low frequency, 5730 MHz					
BPSK	3.25	4459.0	500	-3959.0	Pass
64QAM	32.5	4462.5	500	-3962.5	Pass
Mid frequency, 5780 MHz					
BPSK	3.25	4474	500	-3974.0	Pass
64QAM	32.5	4449	500	-3949.0	Pass
High frequency, 5845 MHz					
BPSK	3.25	4464	500	-3964.0	Pass
64QAM	32.5	4444	500	-3944.0	Pass

Reference numbers of test equipment used

HL 2909	HL 3180	HL 3181	HL 3386				
---------	---------	---------	---------	--	--	--	--

Full description is given in Appendix A.



HERMON LABORATORIES

Test specification:	FCC section 15.247(a)(2), RSS-210 section A8.2(a), 6 dB bandwidth		
Test procedure:	FCC New Guidance on Measurements for DTS in section 15.247(a)(2)		
Test mode:	Compliance	Verdict:	PASS
Date & Time:	11/2/2008 5:34:11 PM		
Temperature: 21°C	Air Pressure: 1011 hPa	Relative Humidity: 45%	Power Supply: 48 VDC
Remarks:			

Plot 7.1.1 The 6 dB bandwidth test result at low frequency, BPSK modulation

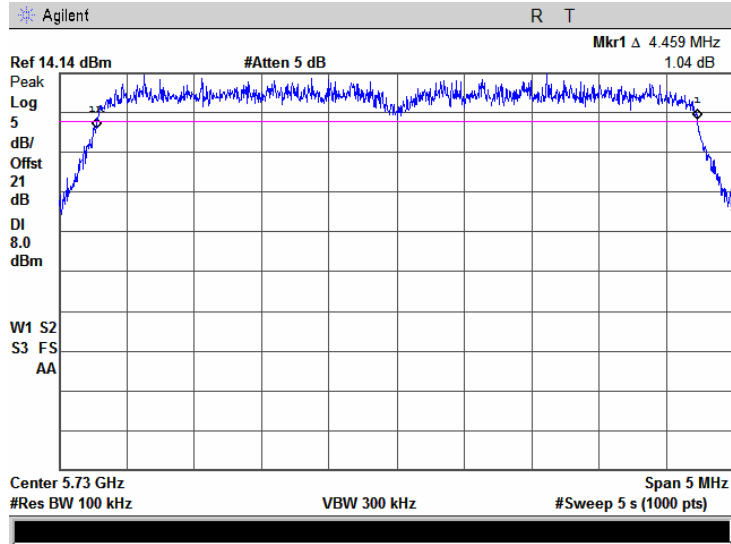

Plot 7.1.2 The 6 dB bandwidth test result at low frequency, 64QAM modulation

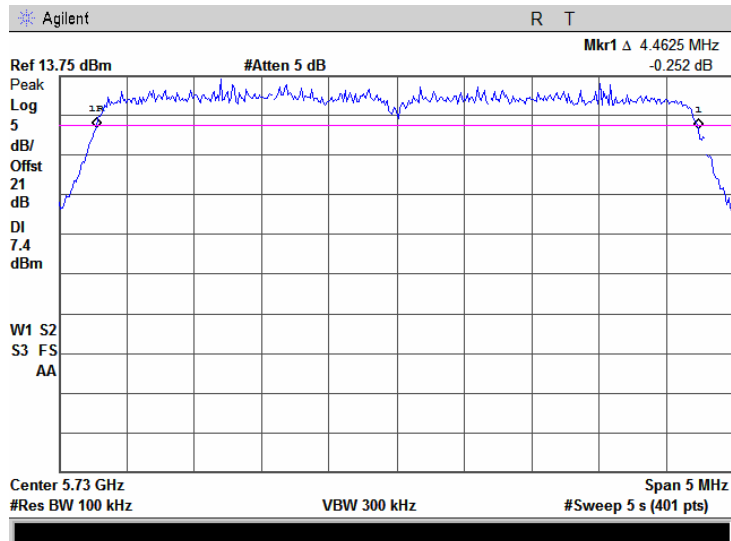



HERMON LABORATORIES

Test specification:	FCC section 15.247(a)(2), RSS-210 section A8.2(a), 6 dB bandwidth		
Test procedure:	FCC New Guidance on Measurements for DTS in section 15.247(a)(2)		
Test mode:	Compliance	Verdict:	PASS
Date & Time:	11/2/2008 5:34:11 PM		
Temperature: 21°C	Air Pressure: 1011 hPa	Relative Humidity: 45%	Power Supply: 48 VDC
Remarks:			

Plot 7.1.3 The 6 dB bandwidth test result at mid frequency, BPSK modulation

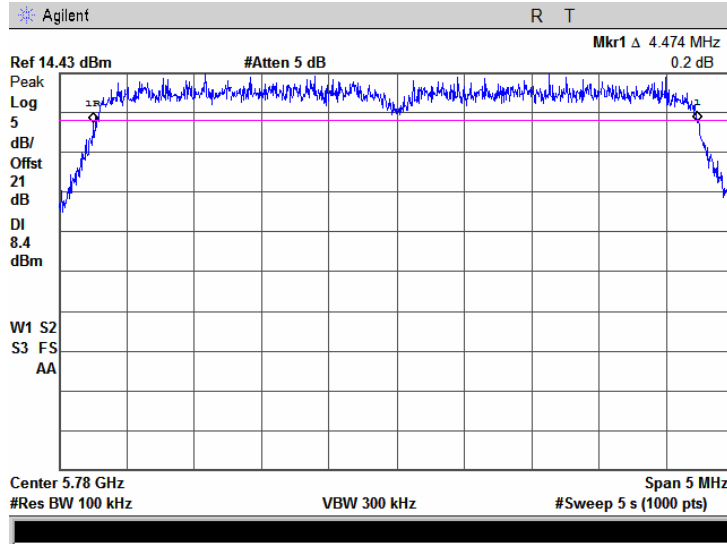

Plot 7.1.4 The 6 dB bandwidth test result at mid frequency, 64QAM modulation

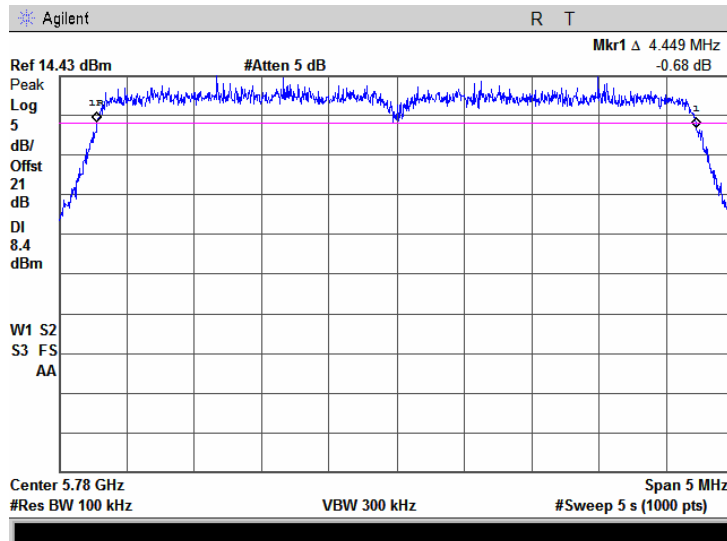



HERMON LABORATORIES

Test specification:	FCC section 15.247(a)(2), RSS-210 section A8.2(a), 6 dB bandwidth		
Test procedure:	FCC New Guidance on Measurements for DTS in section 15.247(a)(2)		
Test mode:	Compliance	Verdict:	PASS
Date & Time:	11/2/2008 5:34:11 PM		
Temperature: 21°C	Air Pressure: 1011 hPa	Relative Humidity: 45%	Power Supply: 48 VDC
Remarks:			

Plot 7.1.5 The 6 dB bandwidth test result at high frequency, BPSK modulation

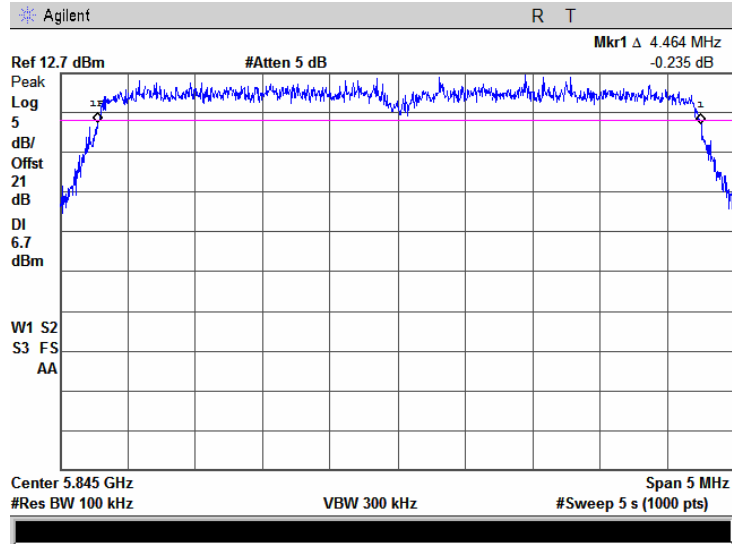

Plot 7.1.6 The 6 dB bandwidth test result at mid frequency, 64QAM modulation

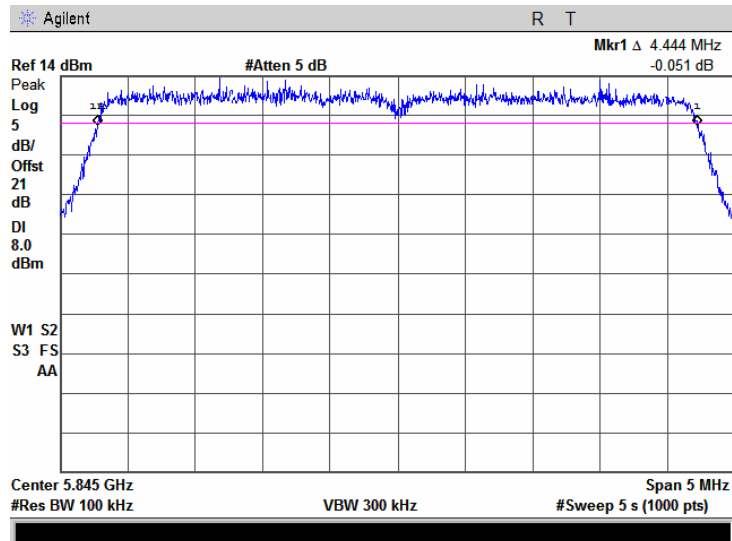



Test specification:	FCC section 15.247(a)(2), RSS-210 section A8.2(a), 6 dB bandwidth		
Test procedure:	FCC New Guidance on Measurements for DTS in section 15.247(a)(2)		
Test mode:	Compliance	Verdict:	PASS
Date & Time:	11/2/2008 5:34:11 PM		
Temperature: 21°C	Air Pressure: 1011 hPa	Relative Humidity: 45%	Power Supply: 48 VDC
Remarks:			

Table 7.1.3 The 6 dB bandwidth test results, 20 MHz channel bandwidth

ASSIGNED FREQUENCY BAND: 5725 – 5850 MHz
DETECTOR USED: Peak
SWEEP MODE: Single
RESOLUTION BANDWIDTH: 100 kHz
VIDEO BANDWIDTH: 300 kHz
MODULATION ENVELOPE REFERENCE POINTS: 6.0 dBc
MODULATION: BPSK / 64QAM
MODULATING SIGNAL: OFDM

Modulation	Bit rate, Mbps	6 dB bandwidth, kHz	Limit, kHz	Margin, kHz	Verdict
Low frequency, 5735 MHz					
BPSK	13	17718	500	-17218	Pass
64QAM	130	17758	500	-17258	Pass
Mid frequency, 5780 MHz					
BPSK	13	17738	500	-17238	Pass
64QAM	130	17738	500	-17238	Pass
High frequency, 5840 MHz					
BPSK	13	17718	500	-17218	Pass
64QAM	130	17778	500	-17278	Pass

Reference numbers of test equipment used

HL 2909	HL 3180	HL 3181	HL 3386				
---------	---------	---------	---------	--	--	--	--

Full description is given in Appendix A.



HERMON LABORATORIES

Test specification:	FCC section 15.247(a)(2), RSS-210 section A8.2(a), 6 dB bandwidth		
Test procedure:	FCC New Guidance on Measurements for DTS in section 15.247(a)(2)		
Test mode:	Compliance	Verdict:	PASS
Date & Time:	11/2/2008 5:34:11 PM		
Temperature: 21°C	Air Pressure: 1011 hPa	Relative Humidity: 45%	Power Supply: 48 VDC
Remarks:			

Plot 7.1.7 The 6 dB bandwidth test result at low frequency, BPSK modulation

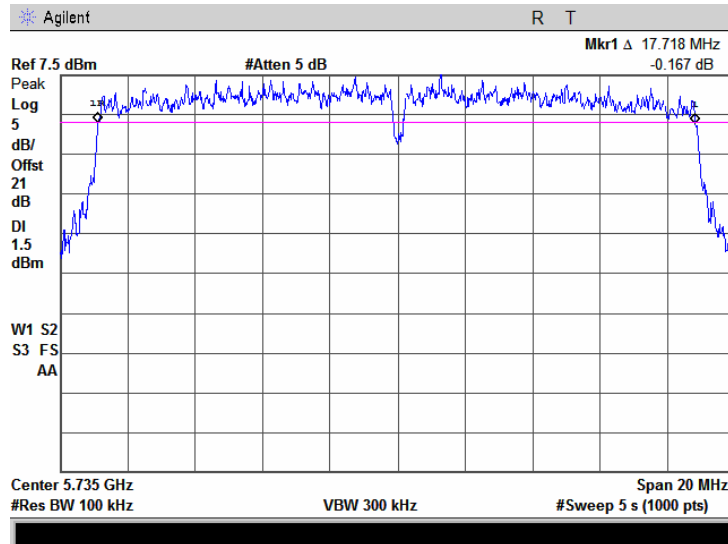

Plot 7.1.8 The 6 dB bandwidth test result at low frequency, 64QAM modulation

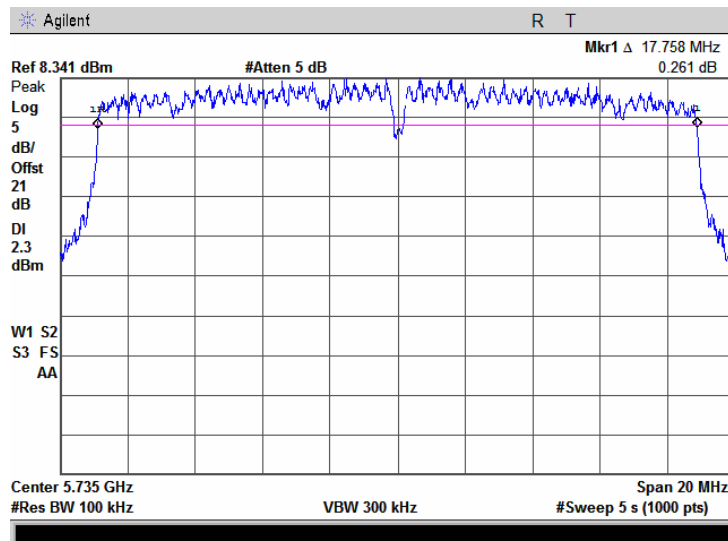



HERMON LABORATORIES

Test specification:	FCC section 15.247(a)(2), RSS-210 section A8.2(a), 6 dB bandwidth		
Test procedure:	FCC New Guidance on Measurements for DTS in section 15.247(a)(2)		
Test mode:	Compliance	Verdict:	PASS
Date & Time:	11/2/2008 5:34:11 PM		
Temperature: 21°C	Air Pressure: 1011 hPa	Relative Humidity: 45%	Power Supply: 48 VDC
Remarks:			

Plot 7.1.9 The 6 dB bandwidth test result at mid frequency, BPSK modulation

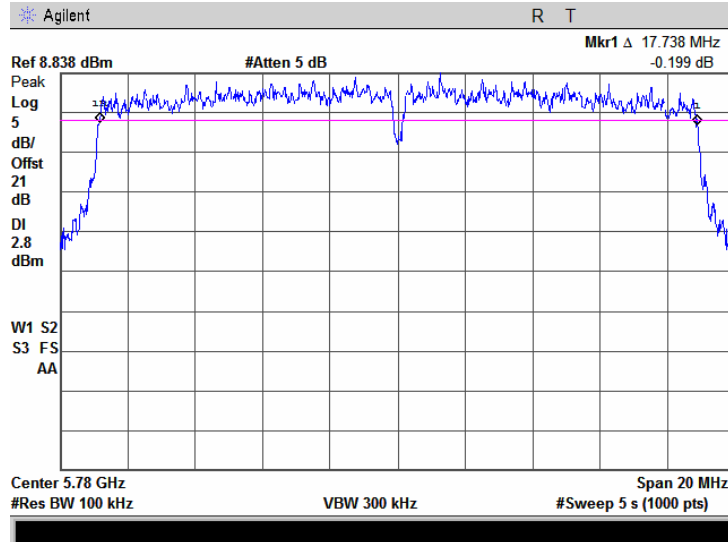

Plot 7.1.10 The 6 dB bandwidth test result at mid frequency, 64QAM modulation

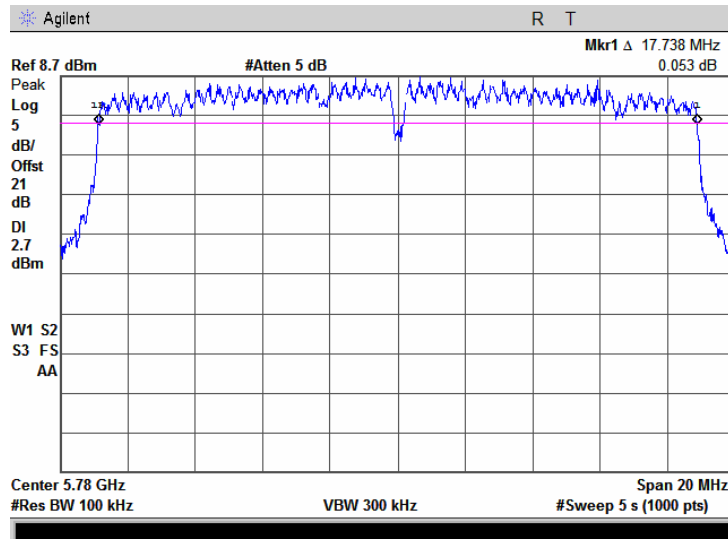



HERMON LABORATORIES

Test specification:	FCC section 15.247(a)(2), RSS-210 section A8.2(a), 6 dB bandwidth		
Test procedure:	FCC New Guidance on Measurements for DTS in section 15.247(a)(2)		
Test mode:	Compliance	Verdict:	PASS
Date & Time:	11/2/2008 5:34:11 PM		
Temperature: 21°C	Air Pressure: 1011 hPa	Relative Humidity: 45%	Power Supply: 48 VDC
Remarks:			

Plot 7.1.11 The 6 dB bandwidth test result at high frequency, BPSK modulation

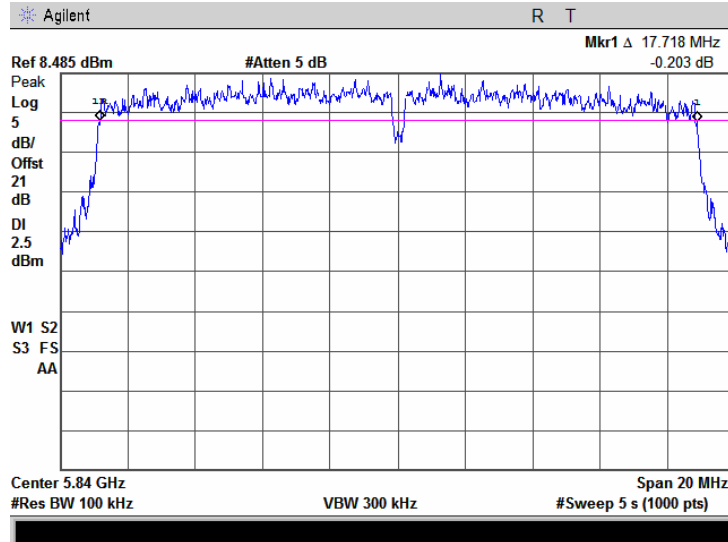

Plot 7.1.12 The 6 dB bandwidth test result at mid frequency, 64QAM modulation

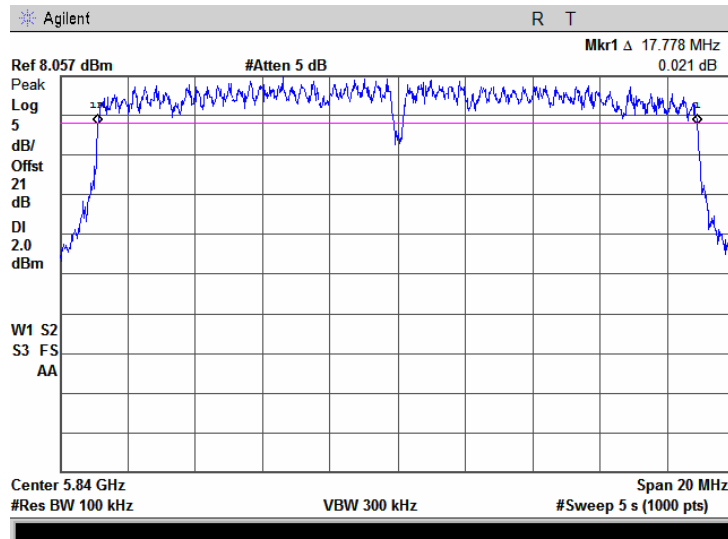



Test specification:	Section 15.247(b)(3), RSS-210 section A8.4(4), Peak output power		
Test procedure:	FCC New Guidance on Measurements for DTS in section 15.247(b), Option 2, Method #3		
Test mode:	Compliance	Verdict:	PASS
Date & Time:	10/29/2008 9:36:36 AM		
Temperature: 21°C	Air Pressure: 1010 hPa	Relative Humidity: 46%	Power Supply: 48 VDC
Remarks:			

7.2 Peak output power

7.2.1 General

This test was performed to measure the maximum peak output power at the transmitter RF antenna connector. Specification test limits are given in Table 7.2.1.

Table 7.2.1 Peak output power limits

Assigned frequency range, MHz	Maximum antenna gain, dBi	Peak output power*	
		W	dBm
902.0 – 928.0	6.0	1.0	30.0
2400.0 – 2483.5			
5725.0 – 5850.0			

*- If transmitting antennas of directional gain greater than 6 dBi are used, the peak output power limit shall be reduced below the stated value as follows:

- by 1 dB for every 3 dB that the directional gain of antenna exceeds 6 dBi for fixed point-to-point transmitters operate in 2400-2483.5 MHz band;
- without any corresponding reduction for fixed point-to-point transmitters operate in 5725-5850 MHz band;
- by the amount in dB that the directional gain of antenna exceeds 6 dBi for the rest of transmitters.

7.2.2 Test procedure

7.2.2.1 The EUT was set up as shown in Figure 7.2.1, energized and its proper operation was checked.

7.2.2.2 The EUT was adjusted to produce maximum available for end user RF output power.

7.2.2.3 The peak power meter was used and the maximum peak output power was measured as provided in Table 7.2.2.

Figure 7.2.1 Peak output power test setup

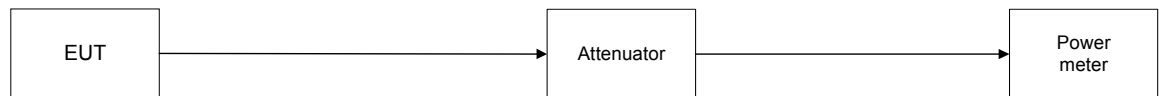



Test specification:	Section 15.247(b)(3), RSS-210 section A8.4(4), Peak output power		
Test procedure:	FCC New Guidance on Measurements for DTS in section 15.247(b), Option 2, Method #3		
Test mode:	Compliance	Verdict:	PASS
Date & Time:	10/29/2008 9:36:36 AM		
Temperature: 21°C	Air Pressure: 1010 hPa	Relative Humidity: 46%	Power Supply: 48 VDC
Remarks:			

Table 7.2.2 Peak output power test results

ASSIGNED FREQUENCY RANGE: 5725 – 5850 MHz
 MODULATION: BPSK / 64QAM
 MODULATING SIGNAL: PRBS
 TRANSMITTER OUTPUT POWER SETTINGS: Maximum
 DETECTOR USED: Peak

Modulation, Bit rate, Mbps	Power meter reading, mW		Total peak output power, mW**	Limit, mW	Margin*, mW	Verdict
	Antenna 1	Antenna 2				
5 MHz BW, Low channel (5730 MHz)						
BPSK, 3.25	477	466	943	1000	-57	Pass
64QAM, 32.5	475	474	949	1000	-51	Pass
5 MHz BW, Mid channel (5780 MHz)						
BPSK, 3.25	462	425	887	1000	-113	Pass
64QAM, 32.5	473	439	912	1000	-88	Pass
5 MHz BW, High channel (5845 MHz)						
BPSK, 3.25	423	424	847	1000	-153	Pass
64QAM, 32.5	432	406	838	1000	-162	Pass
20 MHz BW, Low channel (5735 MHz)						
BPSK, 13	497	491	988	1000	-12	Pass
64QAM, 130	490	489	979	1000	-21	Pass
20 MHz BW, Mid channel (5780 MHz)						
BPSK, 13	484	460	944	1000	-56	Pass
64QAM, 130	481	443	924	1000	-76	Pass
20 MHz BW, High channel (5840 MHz)						
BPSK, 13	429	434	863	1000	-137	Pass
64QAM, 130	444	439	883	1000	-117	Pass

* - Margin = Peak output power – specification limit.

** - The total peak output power is the sum of power, measured at 2 antenna outputs

Reference numbers of test equipment used

HL 3179	HL 3301	HL 3302					
---------	---------	---------	--	--	--	--	--

Full description is given in Appendix A.

Test specification:	Section 15.247(d), RSS-210 section A8.5, Conducted spurious emissions		
Test procedure:	FCC New Guidance on Measurements for DTS in section 15.247(c)		
Test mode:	Compliance	Verdict:	PASS
Date & Time:	11/12/2008 2:31:40 PM		
Temperature: 21°C	Air Pressure: 1010 hPa	Relative Humidity: 43%	Power Supply: 48 VDC
Remarks			

7.3 Spurious emissions at RF antenna connector

7.3.1 General

This test was performed to measure spurious emissions at RF antenna connector. Specification test limits are given in Table 7.3.1.

Table 7.3.1 Spurious emission limits

Frequency*, MHz	Attenuation below carrier*, dBc
0.009 – 10 ^m harmonic	20.0 (30.0)

* - The above limits applied from the lowest radio frequency generated in the device, without going below 9 kHz up to the tenth harmonic of the highest fundamental frequency.

** - Spurious emission limit is provided in terms of attenuation below the peak of modulated carrier measured with the same resolution bandwidth.

7.3.2 Test procedure for individual chain testing

7.3.2.1 The EUT was set up as shown in Figure 7.3.1, energized and its proper operation was checked.

7.3.2.2 The EUT was adjusted to produce maximum available to end user RF output power.

7.3.2.3 The highest emission level within the authorized band was measured.

7.3.2.4 The spurious emission was measured with spectrum analyzer as provided in Table 7.3.2, Plots 7.3.1 to 7.3.46 and referenced to the highest emission level measured within the authorized band.

7.3.3 Test procedure for combined chain testing

7.3.3.1 The EUT was set up as shown in Figure 7.3.1, energized and its proper operation was checked.

7.3.3.2 The EUT was adjusted to produce maximum available to end user RF output power.

7.3.3.3 The highest emission level within the authorized band was measured.

7.3.3.4 The spurious emission was measured with spectrum analyzer as provided in Table 7.3.3, Plots 7.3.47 to 7.3.68 and referenced to the highest emission level measured within the authorized band.

Figure 7.3.1 Spurious emission test setup - individual Tx chain

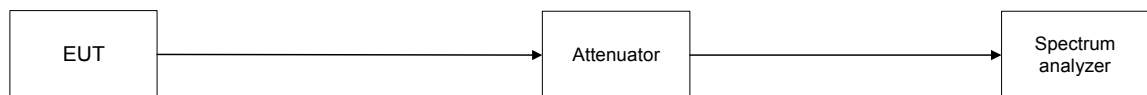
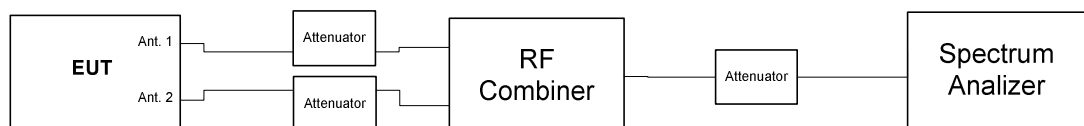

Figure 7.3.2 Spurious emission test setup – combined Tx chains





Test specification:	Section 15.247(d), RSS-210 section A8.5, Conducted spurious emissions		
Test procedure:	FCC New Guidance on Measurements for DTS in section 15.247(c)		
Test mode:	Compliance	Verdict:	PASS
Date & Time:	11/12/2008 2:31:40 PM		
Temperature: 21°C	Air Pressure: 1010 hPa	Relative Humidity: 43%	Power Supply: 48 VDC
Remarks Individual Tx chain testing			

Table 7.3.2 Spurious emission test results

ASSIGNED FREQUENCY RANGE: 5725 – 5850 MHz
 INVESTIGATED FREQUENCY RANGE: 0.009 – 40000 MHz
 DETECTOR USED: Peak
 RESOLUTION BANDWIDTH: 100 kHz
 VIDEO BANDWIDTH: 300 kHz
 MODULATION: BPSK / 64QAM
 TRANSMITTER OUTPUT POWER SETTINGS: Maximum

Frequency, MHz	Channel bandwidth, MHz	Spurious emission, dBm	Emission at carrier, dBm	Attenuation below carrier, dBc	Limit, dBc	Margin, dB*	Verdict
Low carrier frequency							
5725.0	5	-16.71	13.19	29.90	20.0	9.90	Pass
5725.0	20	-13.92	9.48	23.40		3.40	
Mid carrier frequency							
No emissions were found	5	No emissions were found	14.13	NA	20.0	NA	Pass
	20		8.92				
High carrier frequency							
5850.0	5	-19.32	13.73	33.05	20.0	13.05	Pass
5883.0	5	-42.75	13.73	56.48		36.48	
5887.1	5	-46.08	13.73	59.81		39.81	
5850.0	20	-13.67	9.02	22.69		2.69	

*- Margin = Attenuation below carrier – specification limit.

Reference numbers of test equipment used

HL 1424	HL 2254	HL 2909	HL 3175	HL 3180	HL 3386	HL 3455
---------	---------	---------	---------	---------	---------	---------

Full description is given in Appendix A.



HERMON LABORATORIES

Test specification:	Section 15.247(d), RSS-210 section A8.5, Conducted spurious emissions		
Test procedure:	FCC New Guidance on Measurements for DTS in section 15.247(c)		
Test mode:	Compliance	Verdict:	PASS
Date & Time:	11/12/2008 2:31:40 PM		
Temperature: 21°C	Air Pressure: 1010 hPa	Relative Humidity: 43%	Power Supply: 48 VDC
Remarks Individual Tx chain testing			

Plot 7.3.1 The highest emission level within the assigned band at low carrier frequency

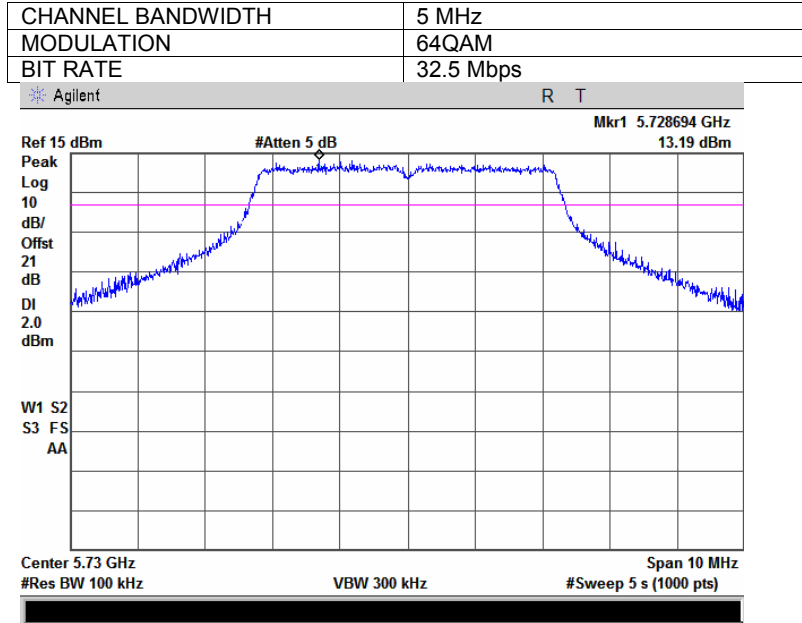

Plot 7.3.2 The highest emission level within the assigned band at mid carrier frequency

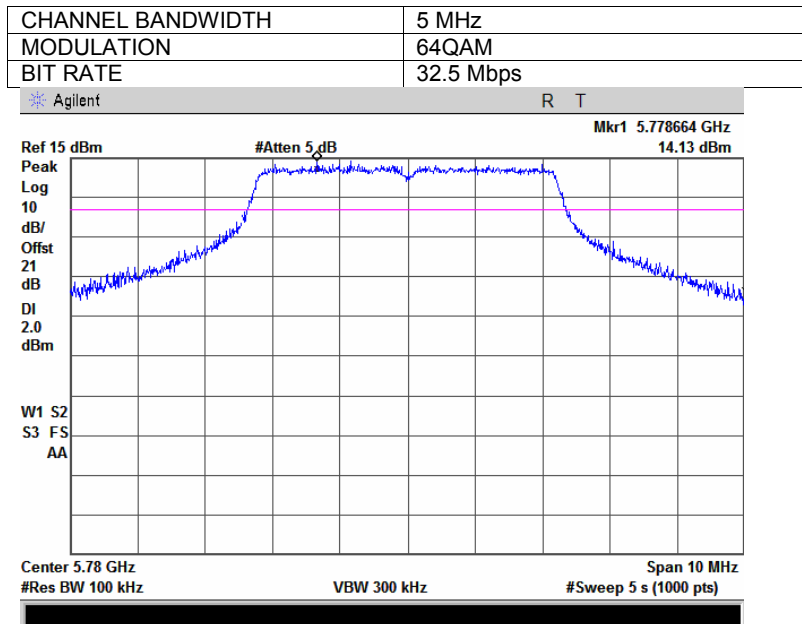



HERMON LABORATORIES

Test specification:	Section 15.247(d), RSS-210 section A8.5, Conducted spurious emissions		
Test procedure:	FCC New Guidance on Measurements for DTS in section 15.247(c)		
Test mode:	Compliance	Verdict:	PASS
Date & Time:	11/12/2008 2:31:40 PM		
Temperature: 21°C	Air Pressure: 1010 hPa	Relative Humidity: 43%	Power Supply: 48 VDC
Remarks Individual Tx chain testing			

Plot 7.3.3 The highest emission level within the assigned band at high carrier frequency

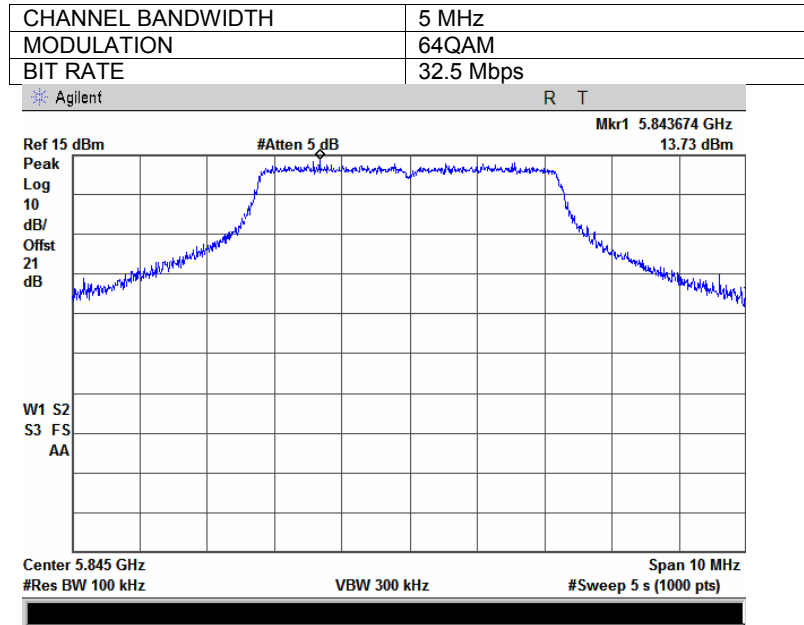

Plot 7.3.4 The highest emission level within the assigned band at low carrier frequency

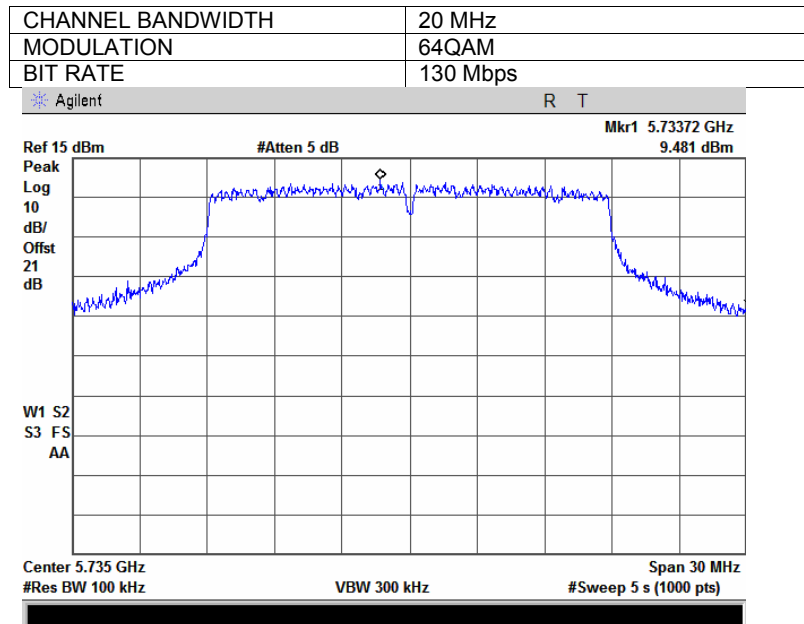



HERMON LABORATORIES

Test specification:	Section 15.247(d), RSS-210 section A8.5, Conducted spurious emissions		
Test procedure:	FCC New Guidance on Measurements for DTS in section 15.247(c)		
Test mode:	Compliance	Verdict:	PASS
Date & Time:	11/12/2008 2:31:40 PM		
Temperature: 21°C	Air Pressure: 1010 hPa	Relative Humidity: 43%	Power Supply: 48 VDC
Remarks Individual Tx chain testing			

Plot 7.3.5 The highest emission level within the assigned band at mid carrier frequency

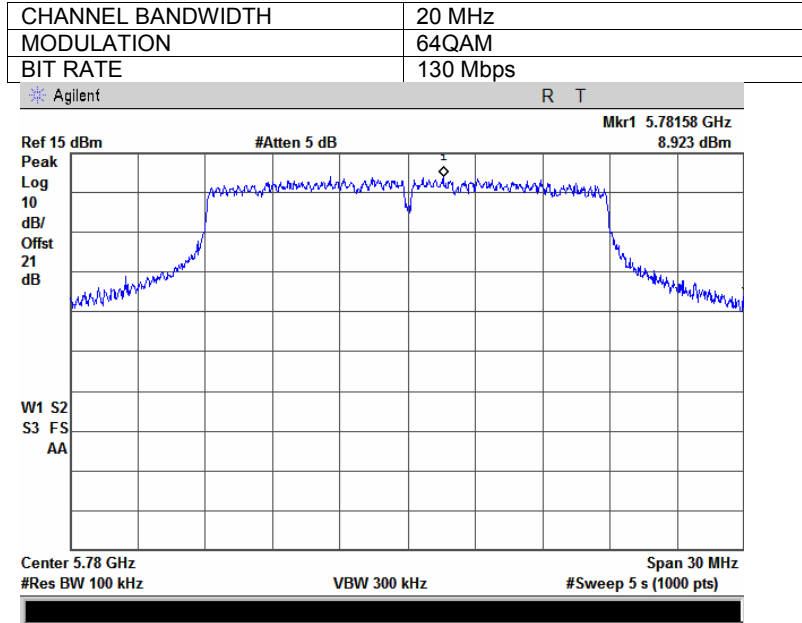

Plot 7.3.6 The highest emission level within the assigned band at high carrier frequency

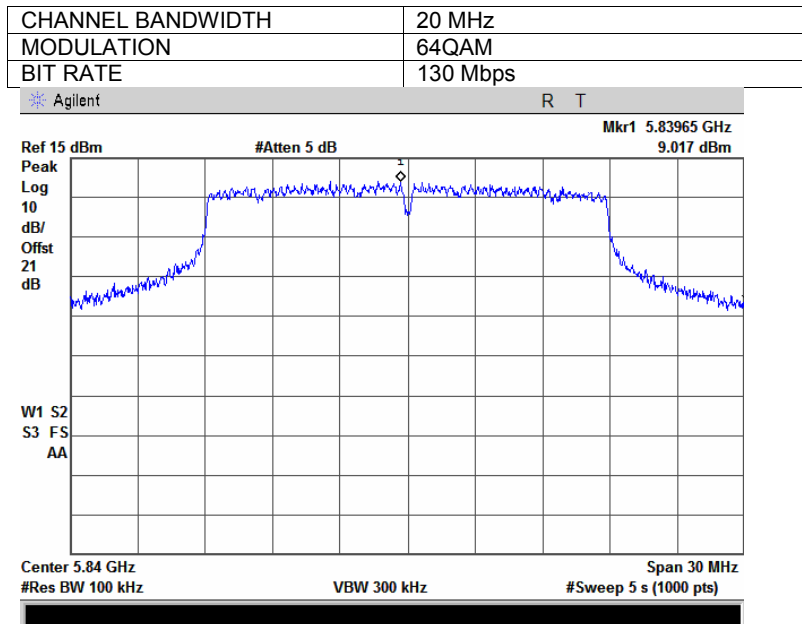



HERMON LABORATORIES

Test specification:	Section 15.247(d), RSS-210 section A8.5, Conducted spurious emissions		
Test procedure:	FCC New Guidance on Measurements for DTS in section 15.247(c)		
Test mode:	Compliance	Verdict:	PASS
Date & Time:	11/12/2008 2:31:40 PM		
Temperature: 21°C	Air Pressure: 1010 hPa	Relative Humidity: 43%	Power Supply: 48 VDC
Remarks Individual Tx chain testing			

Plot 7.3.7 Spurious emission measurements in 9 - 150 kHz range at low carrier frequency

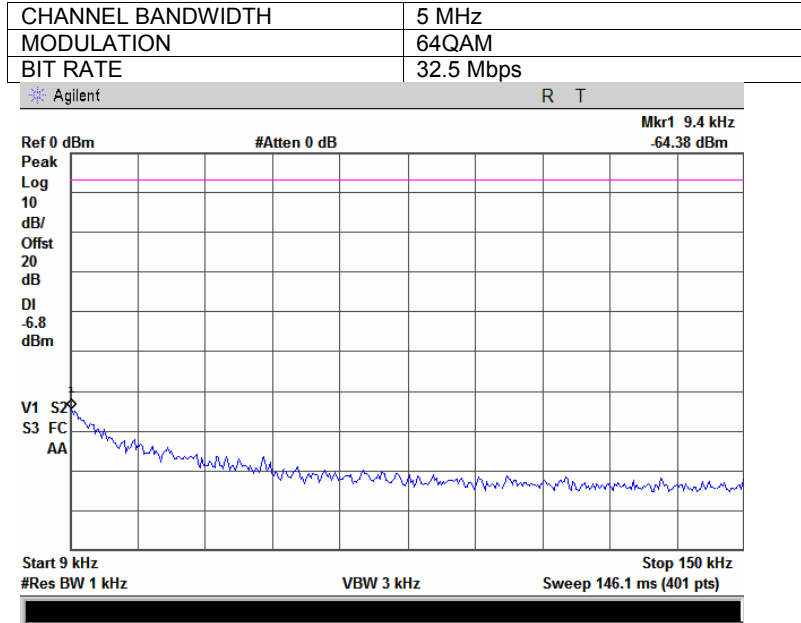

Plot 7.3.8 Spurious emission measurements in 9 - 150 kHz range at mid carrier frequency

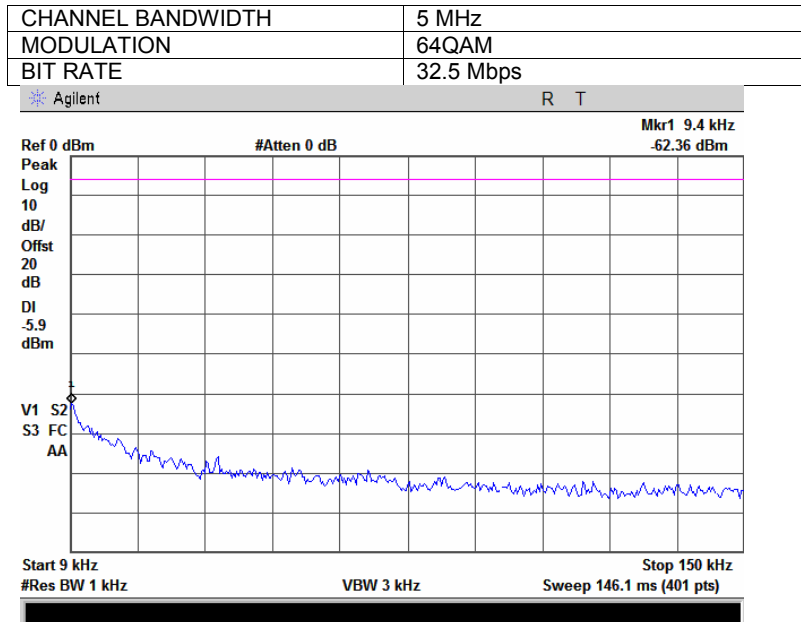



HERMON LABORATORIES

Test specification:	Section 15.247(d), RSS-210 section A8.5, Conducted spurious emissions		
Test procedure:	FCC New Guidance on Measurements for DTS in section 15.247(c)		
Test mode:	Compliance	Verdict:	PASS
Date & Time:	11/12/2008 2:31:40 PM		
Temperature: 21°C	Air Pressure: 1010 hPa	Relative Humidity: 43%	Power Supply: 48 VDC
Remarks Individual Tx chain testing			

Plot 7.3.9 Spurious emission measurements in 9 - 150 kHz range at high carrier frequency

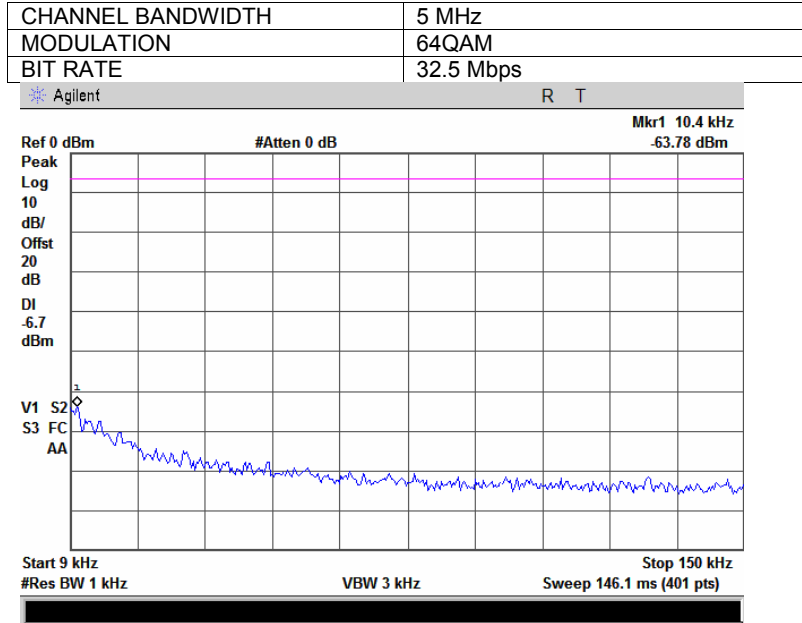

Plot 7.3.10 Spurious emission measurements in 9 - 150 kHz range at low carrier frequency

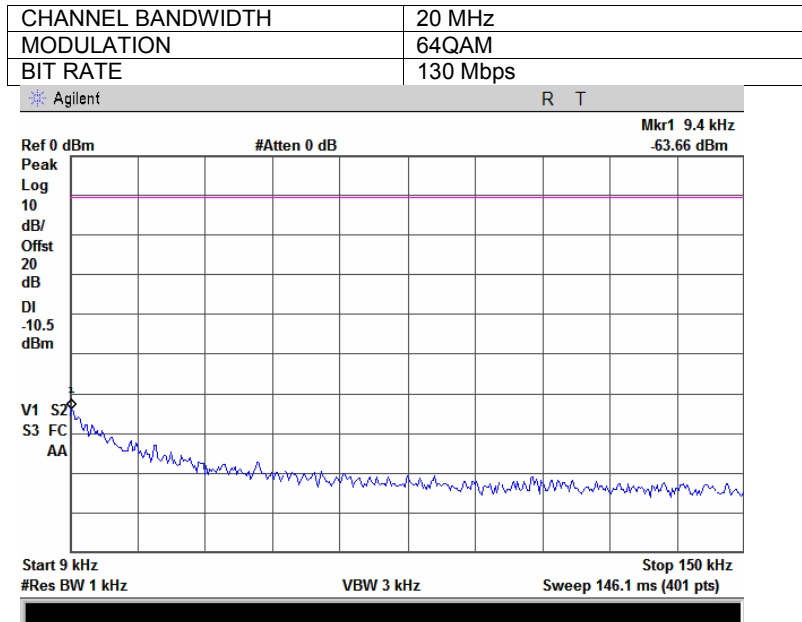



HERMON LABORATORIES

Test specification:	Section 15.247(d), RSS-210 section A8.5, Conducted spurious emissions		
Test procedure:	FCC New Guidance on Measurements for DTS in section 15.247(c)		
Test mode:	Compliance	Verdict:	PASS
Date & Time:	11/12/2008 2:31:40 PM		
Temperature: 21°C	Air Pressure: 1010 hPa	Relative Humidity: 43%	Power Supply: 48 VDC
Remarks Individual Tx chain testing			

Plot 7.3.11 Spurious emission measurements in 9 - 150 kHz range at mid carrier frequency

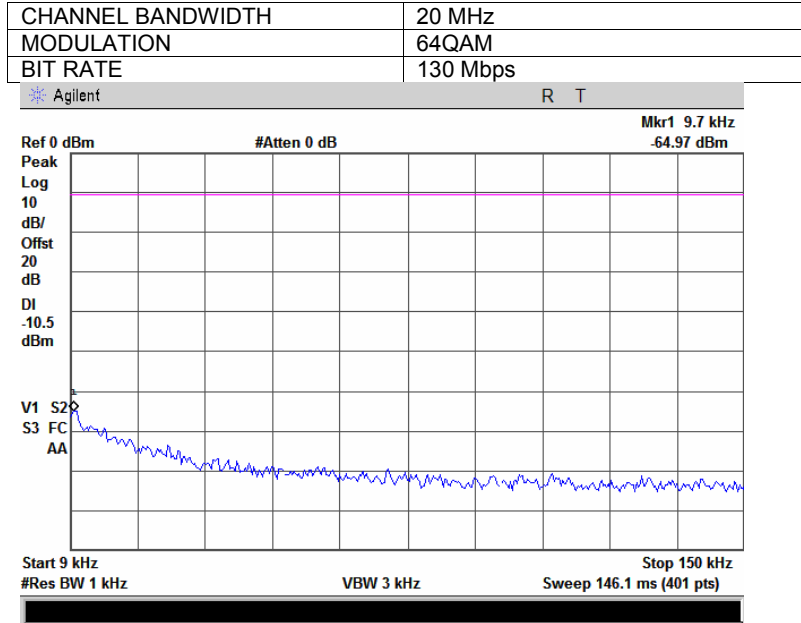

Plot 7.3.12 Spurious emission measurements in 9 - 150 kHz range at high carrier frequency

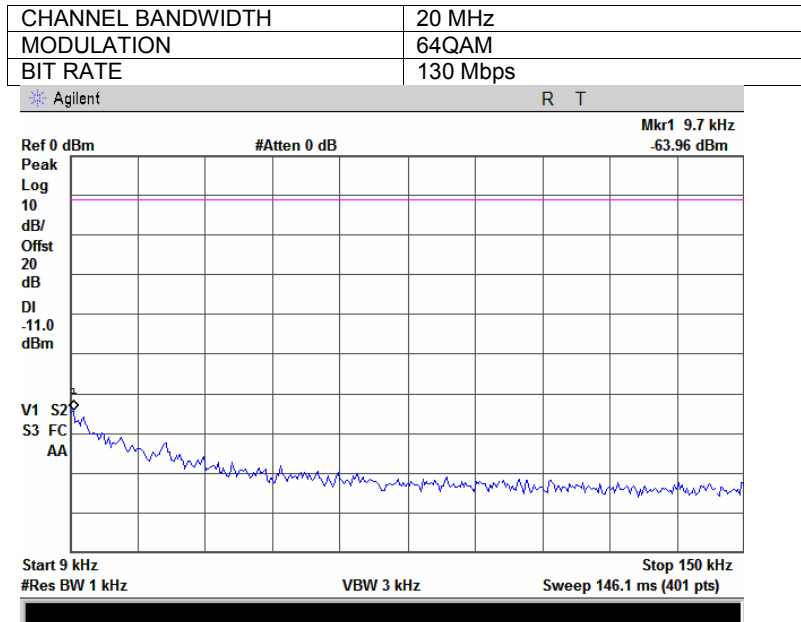



Test specification:	Section 15.247(d), RSS-210 section A8.5, Conducted spurious emissions		
Test procedure:	FCC New Guidance on Measurements for DTS in section 15.247(c)		
Test mode:	Compliance	Verdict:	PASS
Date & Time:	11/12/2008 2:31:40 PM		
Temperature: 21°C	Air Pressure: 1010 hPa	Relative Humidity: 43%	Power Supply: 48 VDC
Remarks Individual Tx chain testing			

Plot 7.3.13 Spurious emission measurements in 0.15 - 30 MHz range at low carrier frequency

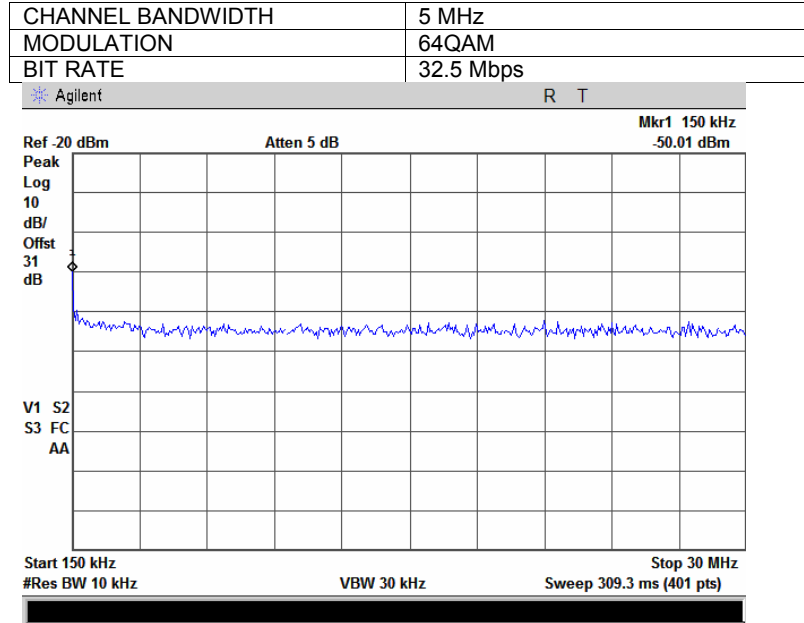

Plot 7.3.14 Spurious emission measurements in 0.15 - 30 MHz range at mid carrier frequency

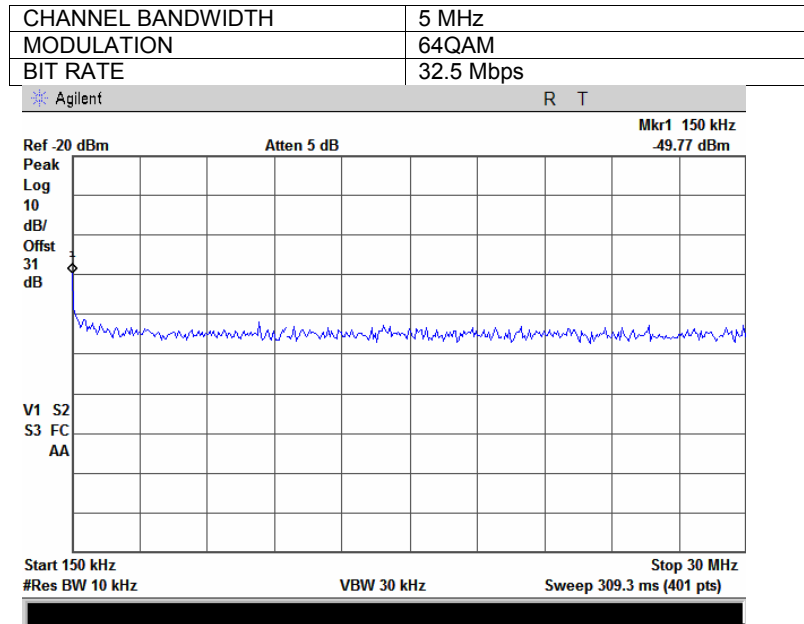



Test specification:	Section 15.247(d), RSS-210 section A8.5, Conducted spurious emissions		
Test procedure:	FCC New Guidance on Measurements for DTS in section 15.247(c)		
Test mode:	Compliance	Verdict:	PASS
Date & Time:	11/12/2008 2:31:40 PM		
Temperature: 21°C	Air Pressure: 1010 hPa	Relative Humidity: 43%	Power Supply: 48 VDC
Remarks Individual Tx chain testing			

Plot 7.3.15 Spurious emission measurements in 0.15 - 30 MHz range at high carrier frequency

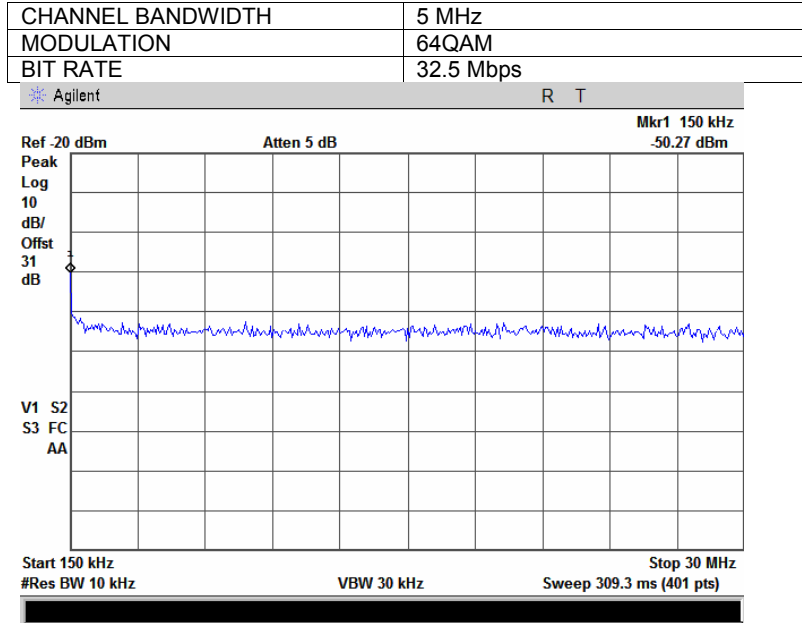

Plot 7.3.16 Spurious emission measurements in 0.15 - 30 MHz range at low carrier frequency

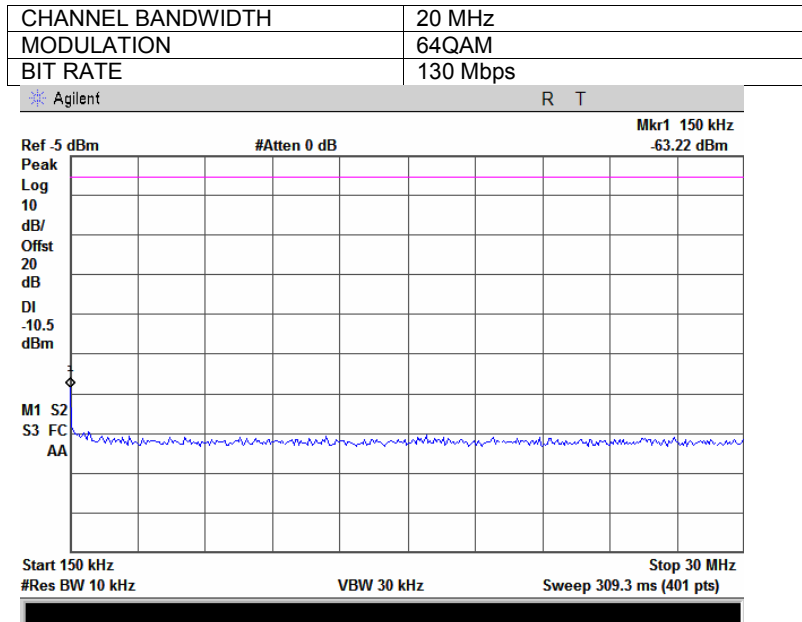



Test specification:	Section 15.247(d), RSS-210 section A8.5, Conducted spurious emissions		
Test procedure:	FCC New Guidance on Measurements for DTS in section 15.247(c)		
Test mode:	Compliance	Verdict:	PASS
Date & Time:	11/12/2008 2:31:40 PM		
Temperature: 21°C	Air Pressure: 1010 hPa	Relative Humidity: 43%	Power Supply: 48 VDC
Remarks Individual Tx chain testing			

Plot 7.3.17 Spurious emission measurements in 0.15 - 30 MHz range at mid carrier frequency

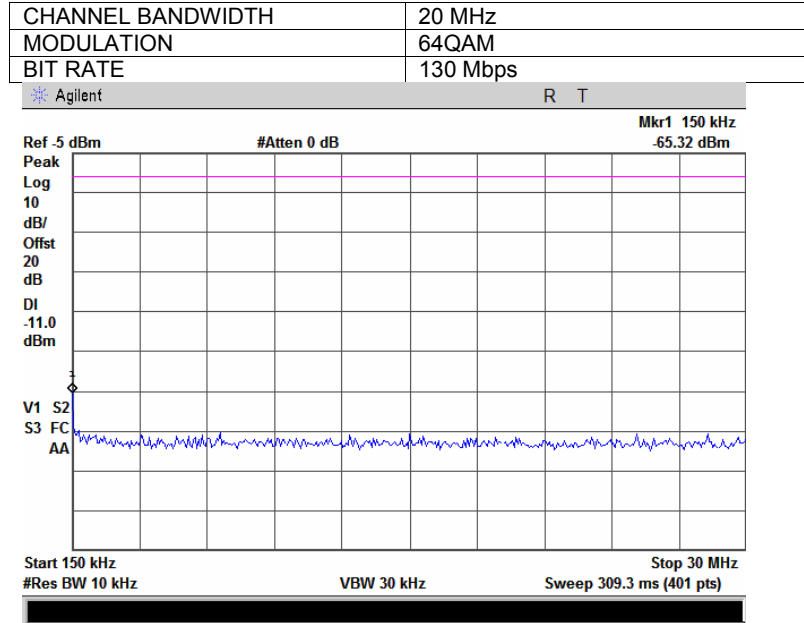

Plot 7.3.18 Spurious emission measurements in 0.15 - 30 MHz range at high carrier frequency

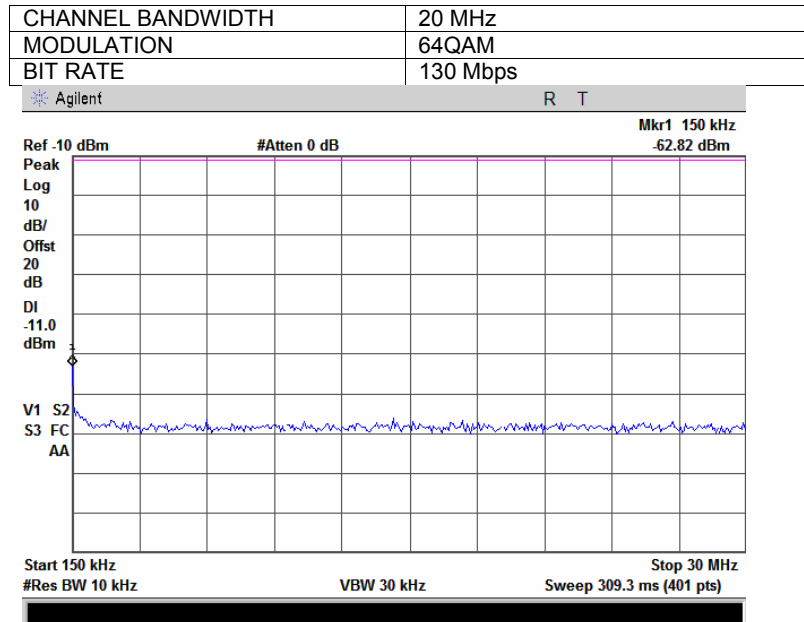



HERMON LABORATORIES

Test specification:	Section 15.247(d), RSS-210 section A8.5, Conducted spurious emissions		
Test procedure:	FCC New Guidance on Measurements for DTS in section 15.247(c)		
Test mode:	Compliance	Verdict:	PASS
Date & Time:	11/12/2008 2:31:40 PM		
Temperature: 21°C	Air Pressure: 1010 hPa	Relative Humidity: 43%	Power Supply: 48 VDC
Remarks Individual Tx chain testing			

Plot 7.3.19 Spurious emission measurements in 30 - 1000 MHz range at low carrier frequency

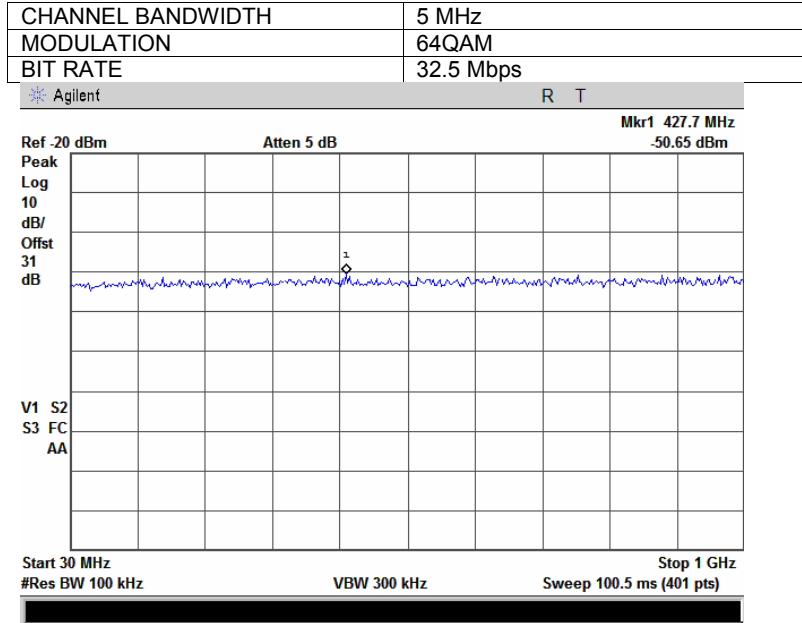

Plot 7.3.20 Spurious emission measurements in 30 - 1000 MHz range at mid carrier frequency

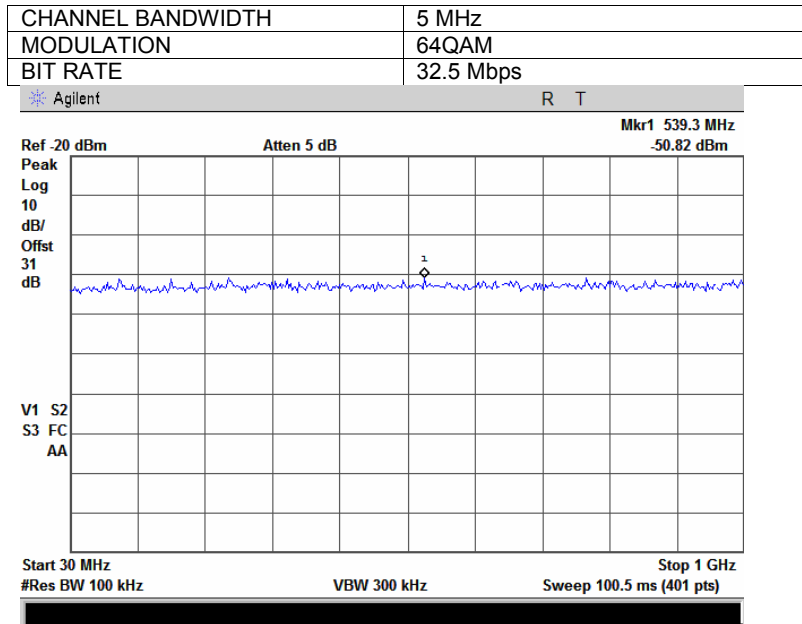



HERMON LABORATORIES

Test specification:	Section 15.247(d), RSS-210 section A8.5, Conducted spurious emissions		
Test procedure:	FCC New Guidance on Measurements for DTS in section 15.247(c)		
Test mode:	Compliance	Verdict:	PASS
Date & Time:	11/12/2008 2:31:40 PM		
Temperature: 21°C	Air Pressure: 1010 hPa	Relative Humidity: 43%	Power Supply: 48 VDC
Remarks Individual Tx chain testing			

Plot 7.3.21 Spurious emission measurements in 30 - 1000 MHz range at high carrier frequency

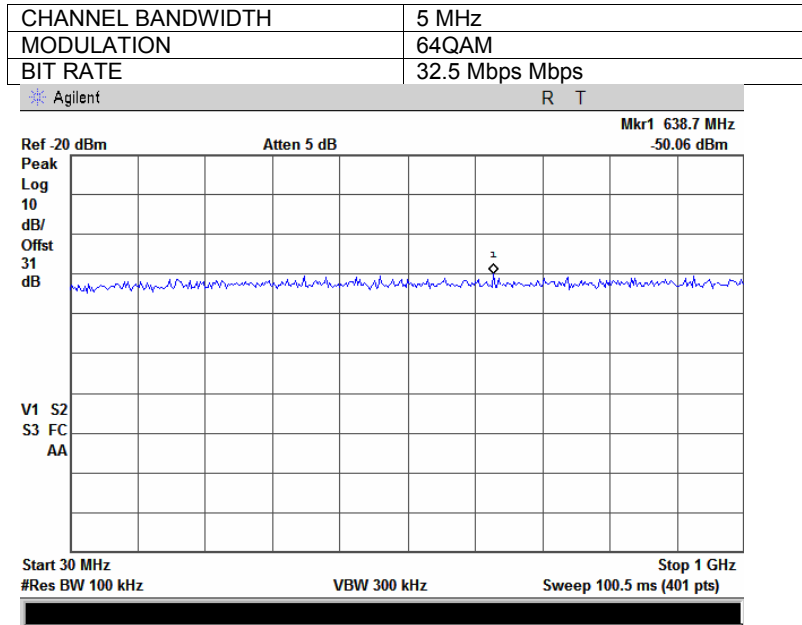

Plot 7.3.22 Spurious emission measurements in 30 - 1000 MHz range at low carrier frequency

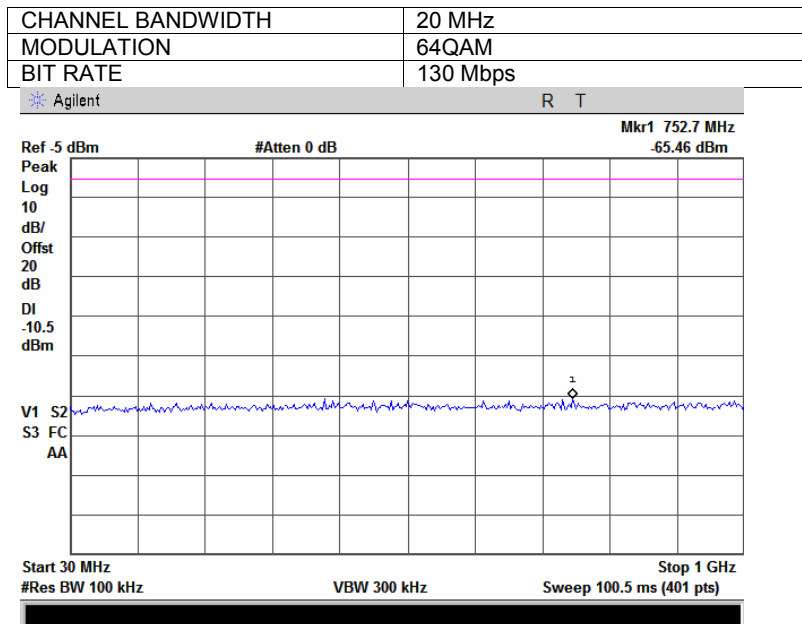



HERMON LABORATORIES

Test specification:	Section 15.247(d), RSS-210 section A8.5, Conducted spurious emissions		
Test procedure:	FCC New Guidance on Measurements for DTS in section 15.247(c)		
Test mode:	Compliance	Verdict:	PASS
Date & Time:	11/12/2008 2:31:40 PM		
Temperature: 21°C	Air Pressure: 1010 hPa	Relative Humidity: 43%	Power Supply: 48 VDC
Remarks Individual Tx chain testing			

Plot 7.3.23 Spurious emission measurements in 30 - 1000 MHz range at mid carrier frequency

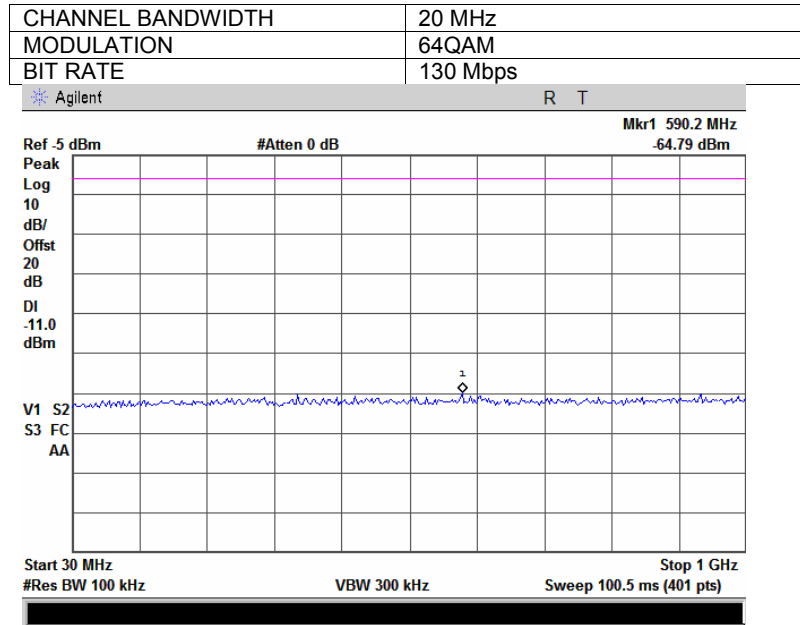

Plot 7.3.24 Spurious emission measurements in 30 - 1000 MHz range at high carrier frequency

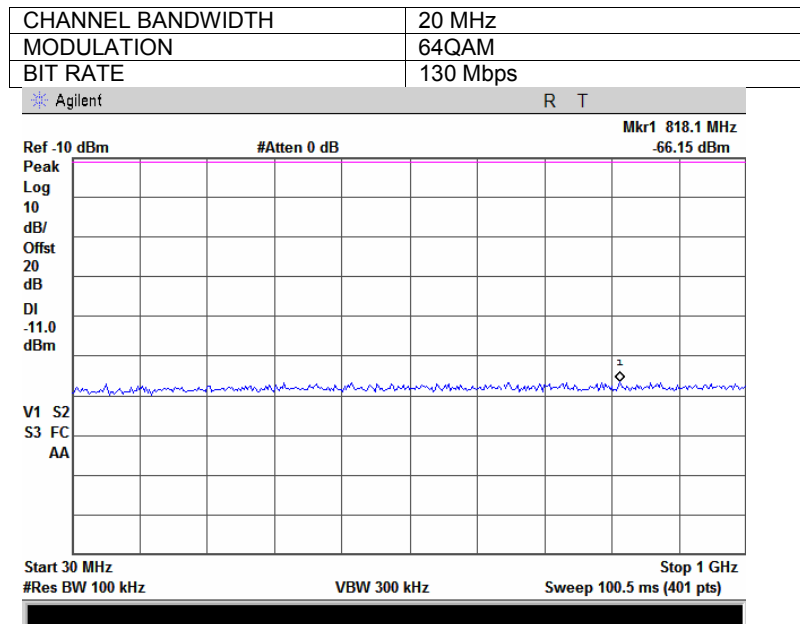



HERMON LABORATORIES

Test specification:	Section 15.247(d), RSS-210 section A8.5, Conducted spurious emissions		
Test procedure:	FCC New Guidance on Measurements for DTS in section 15.247(c)		
Test mode:	Compliance	Verdict:	PASS
Date & Time:	11/12/2008 2:31:40 PM		
Temperature: 21°C	Air Pressure: 1010 hPa	Relative Humidity: 43%	Power Supply: 48 VDC
Remarks Individual Tx chain testing			

Plot 7.3.25 Spurious emission measurements in 1000 – 5700 MHz range at low carrier frequency

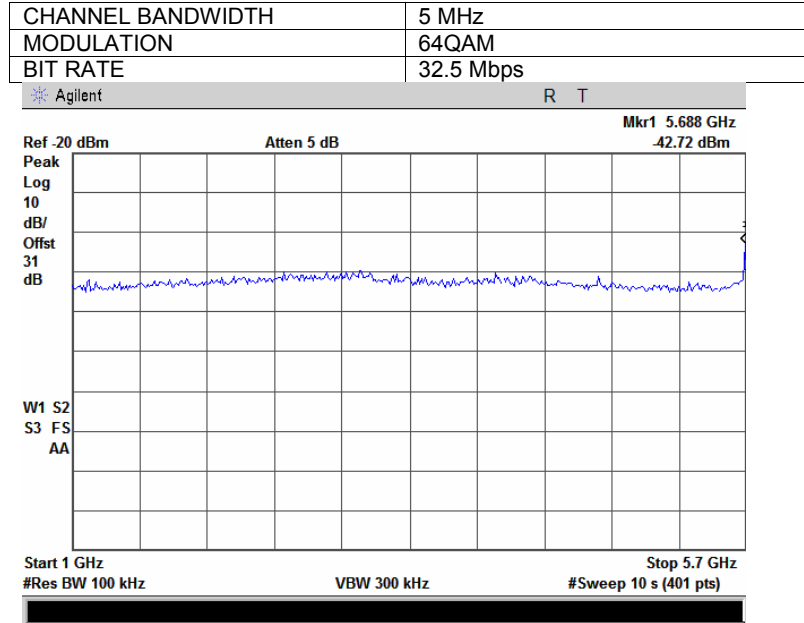

Plot 7.3.26 Spurious emission measurements in 1000 – 5725 MHz range at mid carrier frequency

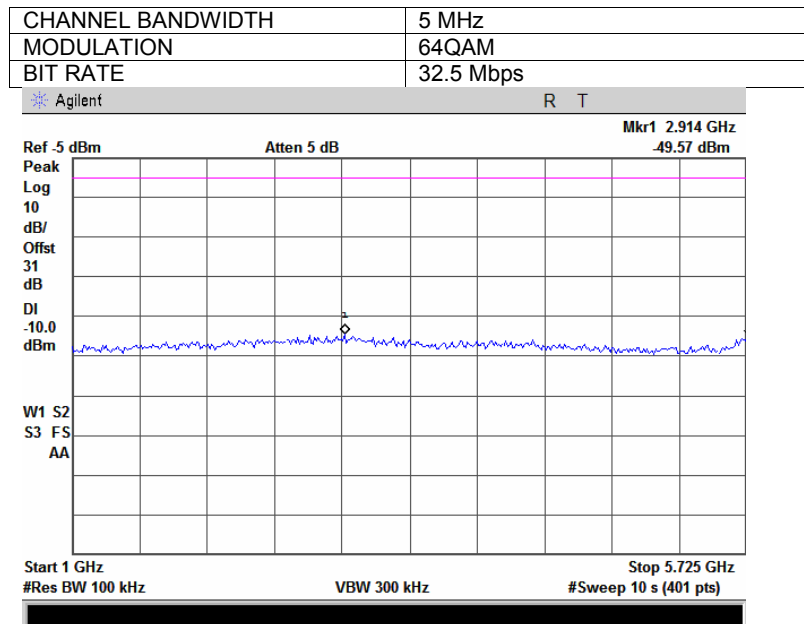



HERMON LABORATORIES

Test specification:	Section 15.247(d), RSS-210 section A8.5, Conducted spurious emissions		
Test procedure:	FCC New Guidance on Measurements for DTS in section 15.247(c)		
Test mode:	Compliance	Verdict:	PASS
Date & Time:	11/12/2008 2:31:40 PM		
Temperature: 21°C	Air Pressure: 1010 hPa	Relative Humidity: 43%	Power Supply: 48 VDC
Remarks Individual Tx chain testing			

Plot 7.3.27 Spurious emission measurements in 1000 – 5725 MHz range at high carrier frequency

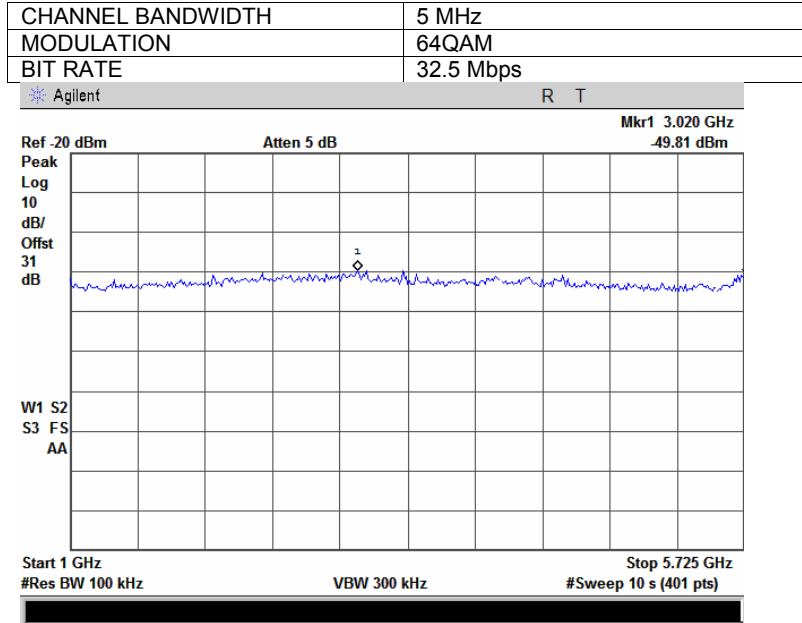

Plot 7.3.28 Spurious emission measurements in 1000 – 5700 MHz range at low carrier frequency

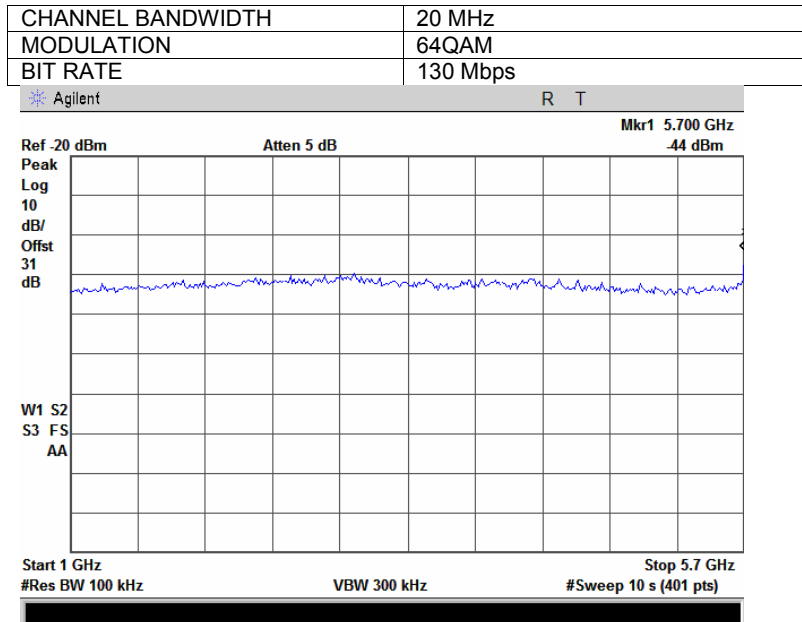



HERMON LABORATORIES

Test specification:	Section 15.247(d), RSS-210 section A8.5, Conducted spurious emissions		
Test procedure:	FCC New Guidance on Measurements for DTS in section 15.247(c)		
Test mode:	Compliance	Verdict:	PASS
Date & Time:	11/12/2008 2:31:40 PM		
Temperature: 21°C	Air Pressure: 1010 hPa	Relative Humidity: 43%	Power Supply: 48 VDC
Remarks Individual Tx chain testing			

Plot 7.3.29 Spurious emission measurements in 1000 – 5725 MHz range at mid carrier frequency

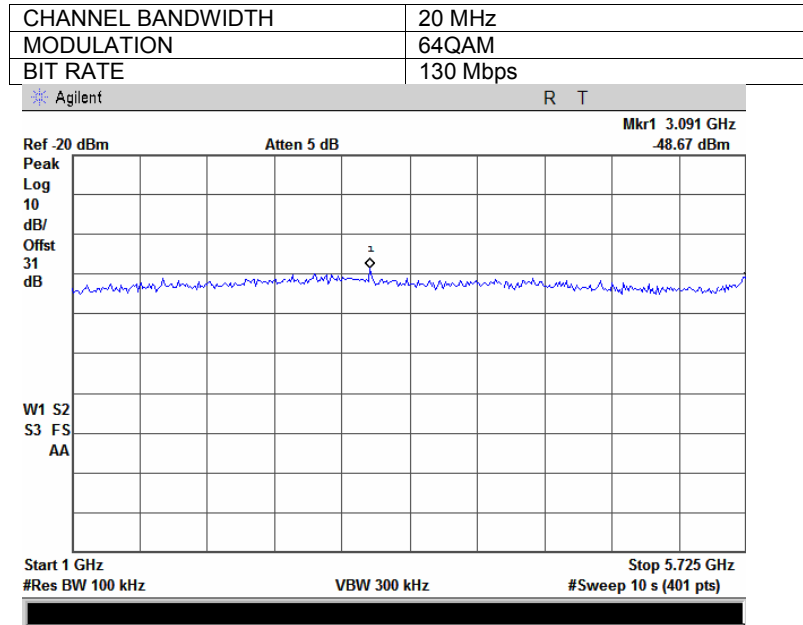

Plot 7.3.30 Spurious emission measurements in 1000 – 5725 MHz range at high carrier frequency

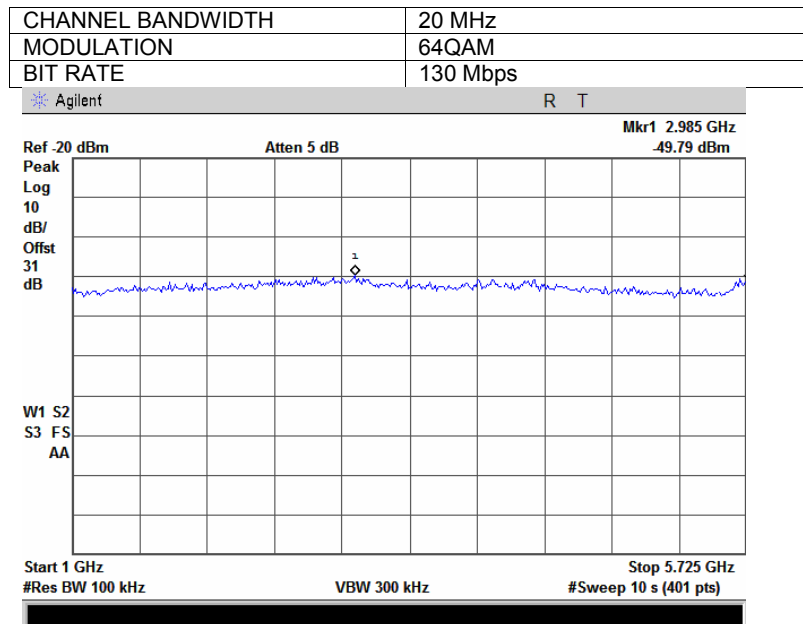



HERMON LABORATORIES

Test specification:	Section 15.247(d), RSS-210 section A8.5, Conducted spurious emissions		
Test procedure:	FCC New Guidance on Measurements for DTS in section 15.247(c)		
Test mode:	Compliance	Verdict:	PASS
Date & Time:	11/12/2008 2:31:40 PM		
Temperature: 21°C	Air Pressure: 1010 hPa	Relative Humidity: 43%	Power Supply: 48 VDC
Remarks Individual Tx chain testing			

Plot 7.3.31 Spurious emission measurements in 5700 – 5725 MHz range at low carrier frequency

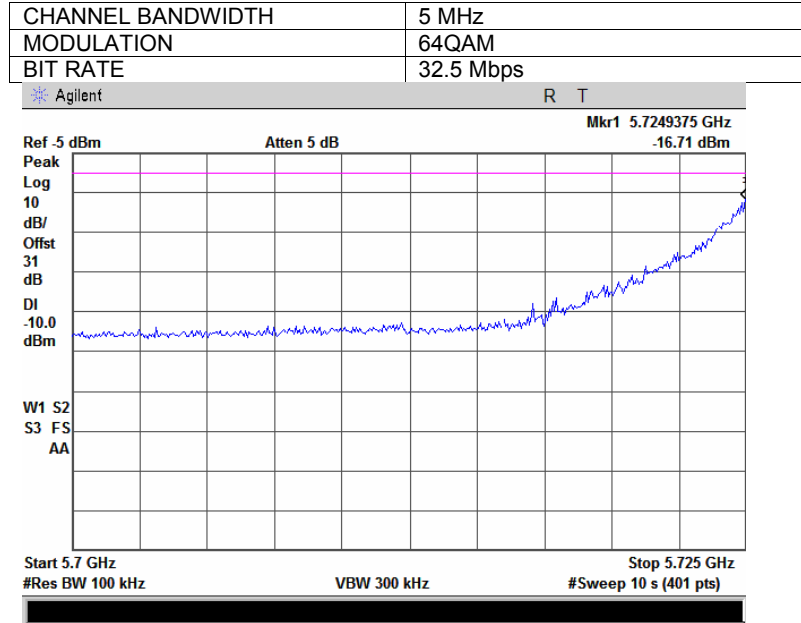

Plot 7.3.32 Spurious emission measurements in 5700 – 5725 MHz range at low carrier frequency

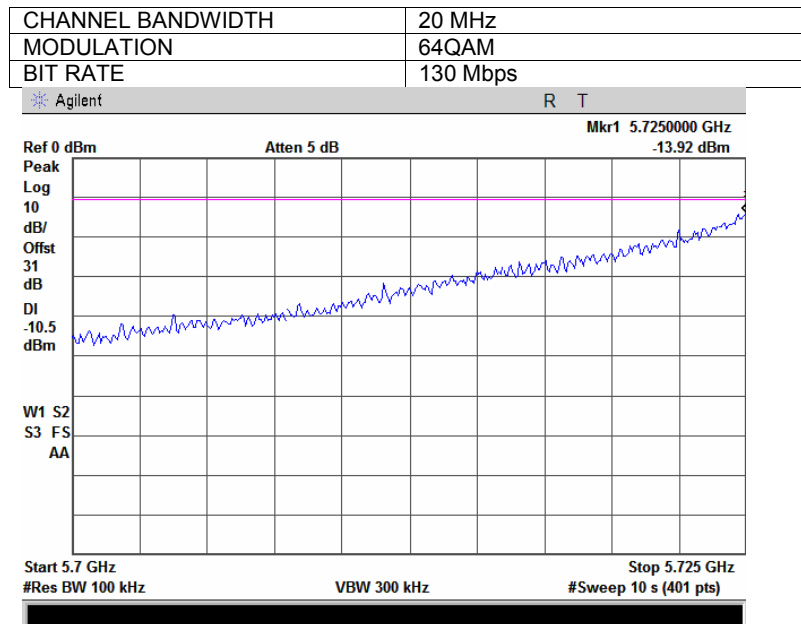



Test specification:	Section 15.247(d), RSS-210 section A8.5, Conducted spurious emissions		
Test procedure:	FCC New Guidance on Measurements for DTS in section 15.247(c)		
Test mode:	Compliance	Verdict:	PASS
Date & Time:	11/12/2008 2:31:40 PM		
Temperature: 21°C	Air Pressure: 1010 hPa	Relative Humidity: 43%	Power Supply: 48 VDC
Remarks Individual Tx chain testing			

Plot 7.3.33 Spurious emission measurements in 5850 – 6000 MHz range at high carrier frequency

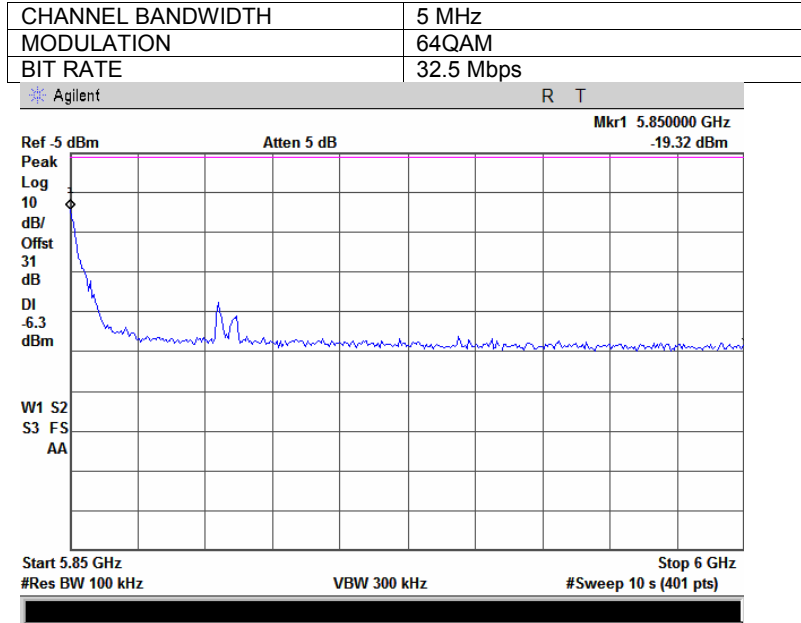

Plot 7.3.34 Spurious emission measurements in 5850 – 6000 MHz range at high carrier frequency

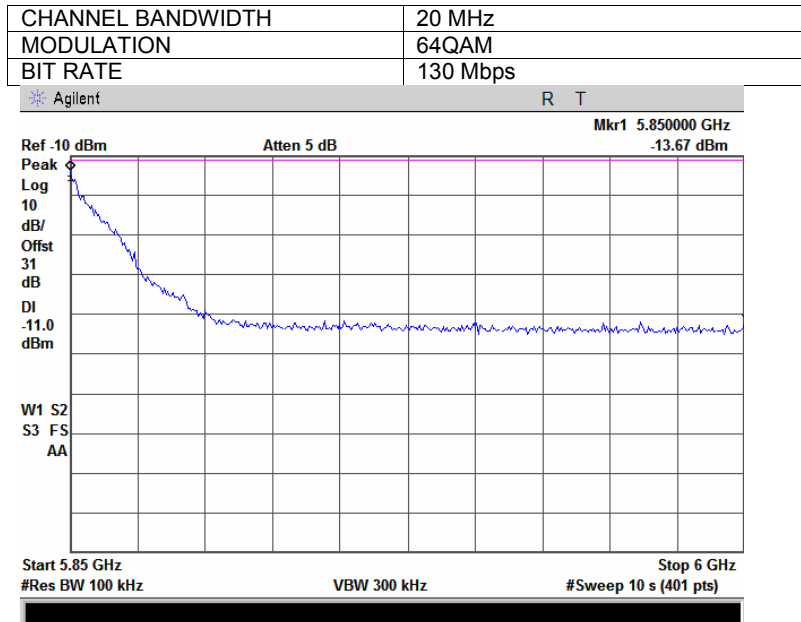



HERMON LABORATORIES

Test specification:	Section 15.247(d), RSS-210 section A8.5, Conducted spurious emissions		
Test procedure:	FCC New Guidance on Measurements for DTS in section 15.247(c)		
Test mode:	Compliance	Verdict:	PASS
Date & Time:	11/12/2008 2:31:40 PM		
Temperature: 21°C	Air Pressure: 1010 hPa	Relative Humidity: 43%	Power Supply: 48 VDC
Remarks Individual Tx chain testing			

Plot 7.3.35 Spurious emission measurements in 5850 – 18000 MHz range at low carrier frequency

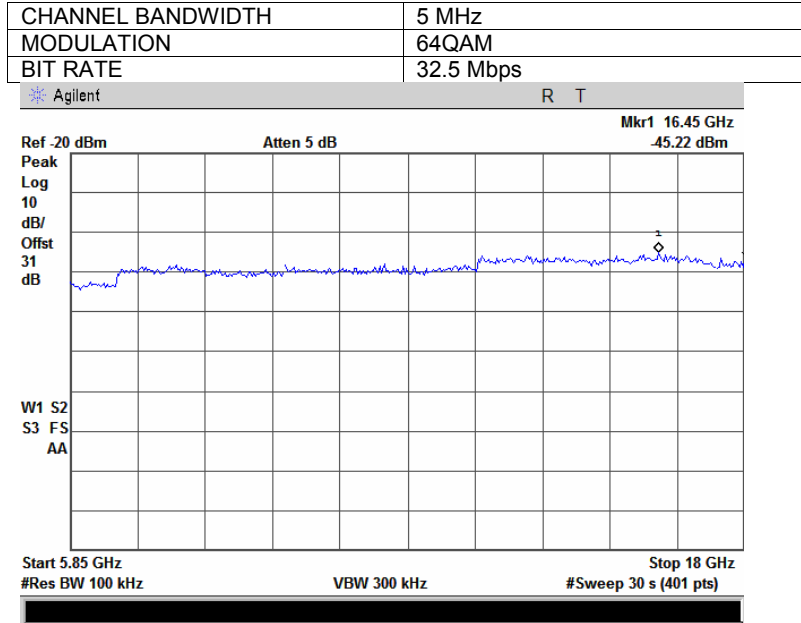

Plot 7.3.36 Spurious emission measurements in 5850 – 18000 MHz range at mid carrier frequency

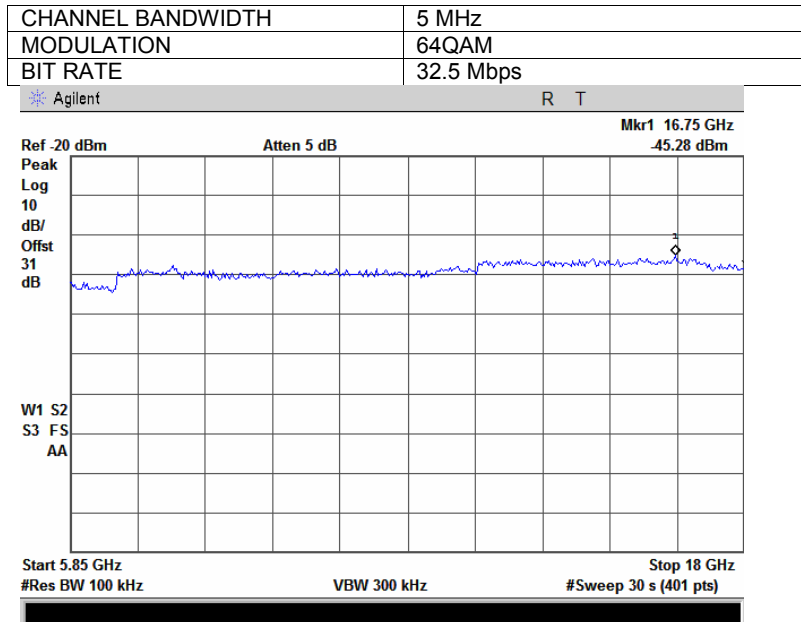



HERMON LABORATORIES

Test specification:	Section 15.247(d), RSS-210 section A8.5, Conducted spurious emissions		
Test procedure:	FCC New Guidance on Measurements for DTS in section 15.247(c)		
Test mode:	Compliance	Verdict:	PASS
Date & Time:	11/12/2008 2:31:40 PM		
Temperature: 21°C	Air Pressure: 1010 hPa	Relative Humidity: 43%	Power Supply: 48 VDC
Remarks Individual Tx chain testing			

Plot 7.3.37 Spurious emission measurements in 6000 – 18000 MHz range at high carrier frequency

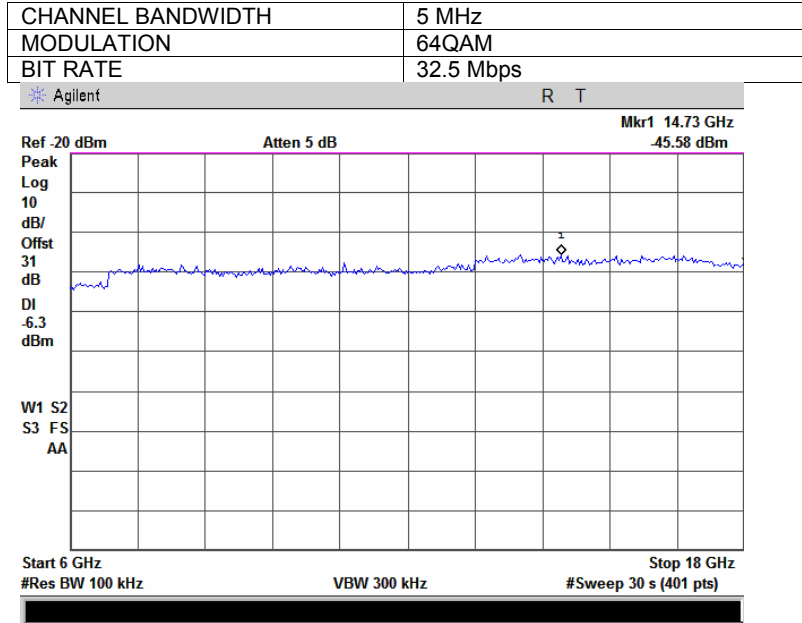

Plot 7.3.38 Spurious emission measurements in 5850 – 18000 MHz range at low carrier frequency

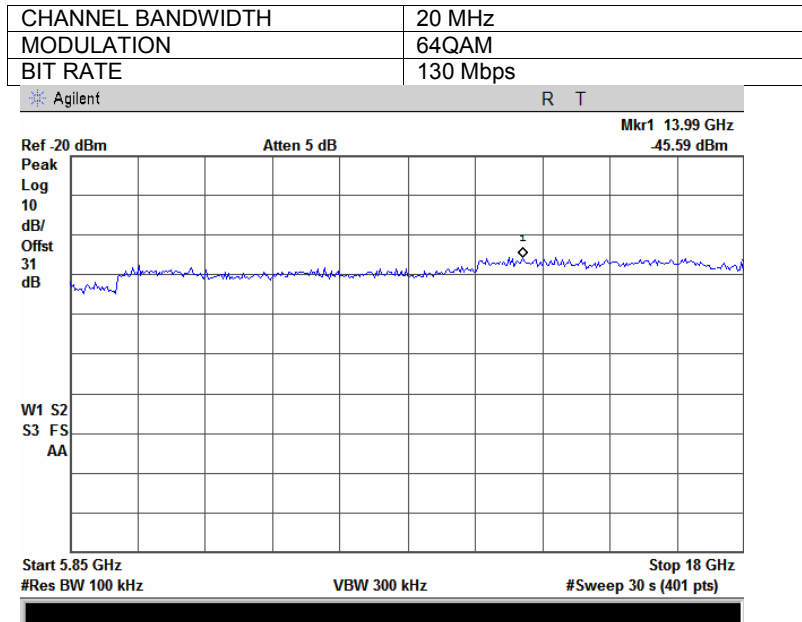



HERMON LABORATORIES

Test specification:	Section 15.247(d), RSS-210 section A8.5, Conducted spurious emissions		
Test procedure:	FCC New Guidance on Measurements for DTS in section 15.247(c)		
Test mode:	Compliance	Verdict:	PASS
Date & Time:	11/12/2008 2:31:40 PM		
Temperature: 21°C	Air Pressure: 1010 hPa	Relative Humidity: 43%	Power Supply: 48 VDC
Remarks Individual Tx chain testing			

Plot 7.3.39 Spurious emission measurements in 5850 – 18000 MHz range at mid carrier frequency

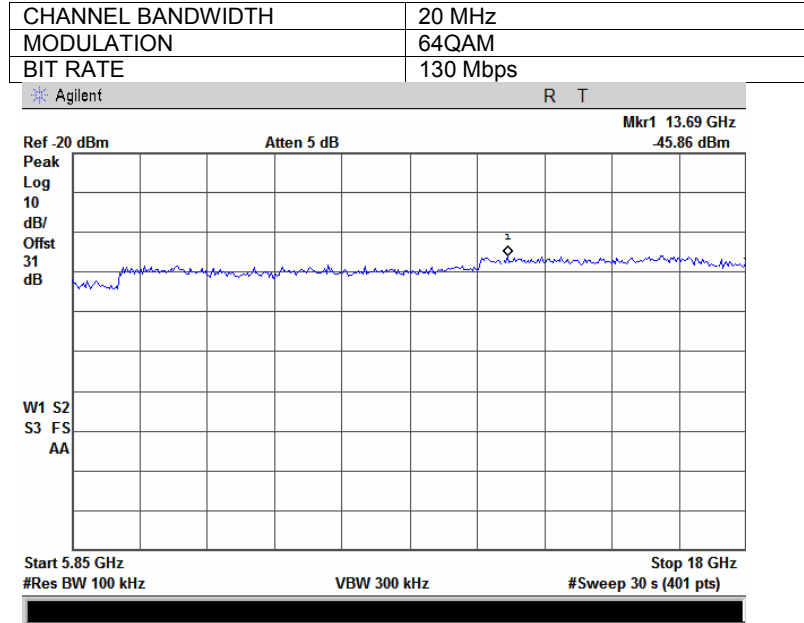

Plot 7.3.40 Spurious emission measurements in 6000 – 18000 MHz range at high carrier frequency

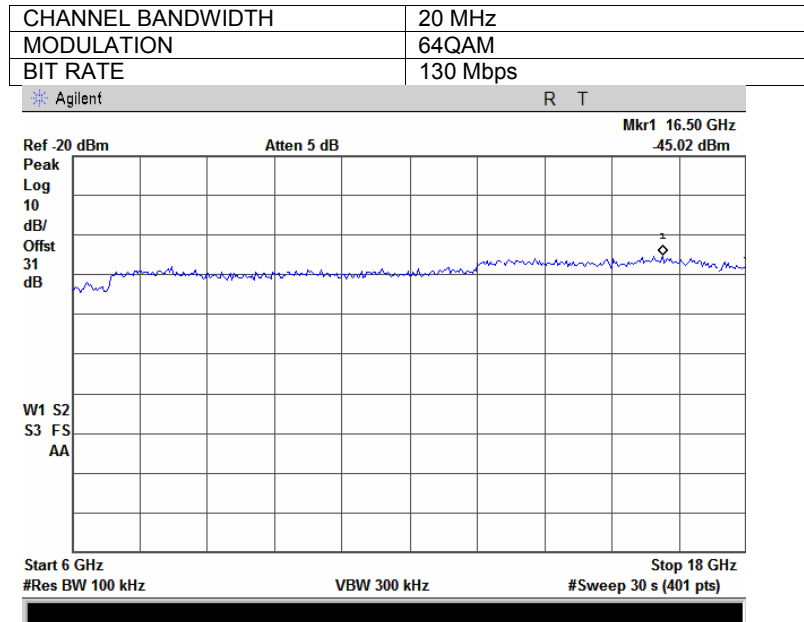



Test specification:	Section 15.247(d), RSS-210 section A8.5, Conducted spurious emissions		
Test procedure:	FCC New Guidance on Measurements for DTS in section 15.247(c)		
Test mode:	Compliance	Verdict:	PASS
Date & Time:	11/12/2008 2:31:40 PM		
Temperature: 21°C	Air Pressure: 1010 hPa	Relative Humidity: 43%	Power Supply: 48 VDC
Remarks Individual Tx chain testing			

Plot 7.3.41 Spurious emission measurements in 18000 – 40000 MHz range at low carrier frequency

CHANNEL BANDWIDTH	5 MHz
MODULATION	64QAM
BIT RATE	32.5 Mbps

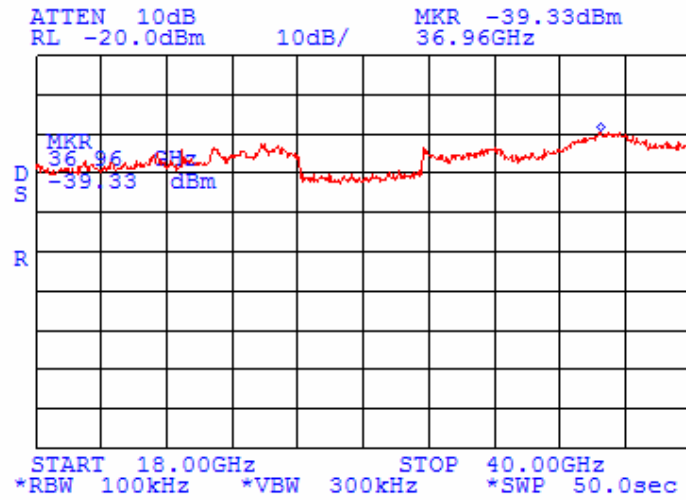

Plot 7.3.42 Spurious emission measurements in 18000 – 40000 MHz range at mid carrier frequency

CHANNEL BANDWIDTH	5 MHz
MODULATION	64QAM
BIT RATE	32.5 Mbps

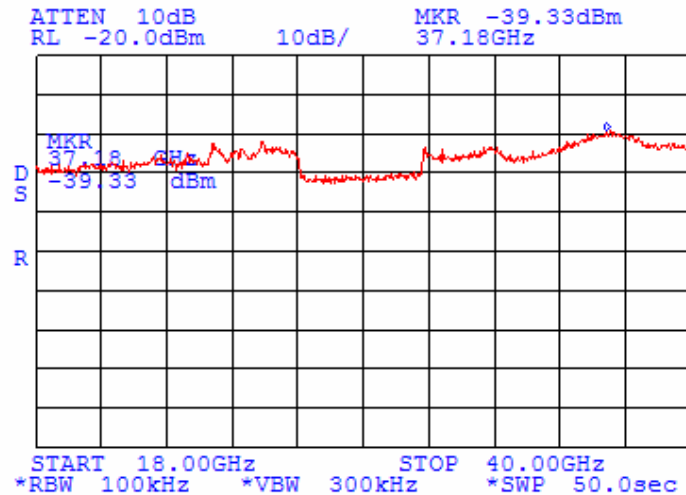



HERMON LABORATORIES

Test specification:	Section 15.247(d), RSS-210 section A8.5, Conducted spurious emissions		
Test procedure:	FCC New Guidance on Measurements for DTS in section 15.247(c)		
Test mode:	Compliance	Verdict:	PASS
Date & Time:	11/12/2008 2:31:40 PM		
Temperature: 21°C	Air Pressure: 1010 hPa	Relative Humidity: 43%	Power Supply: 48 VDC
Remarks Individual Tx chain testing			

Plot 7.3.43 Spurious emission measurements in 18000 – 40000 MHz range at high carrier frequency

CHANNEL BANDWIDTH	5 MHz
MODULATION	64QAM
BIT RATE	32.5 Mbps

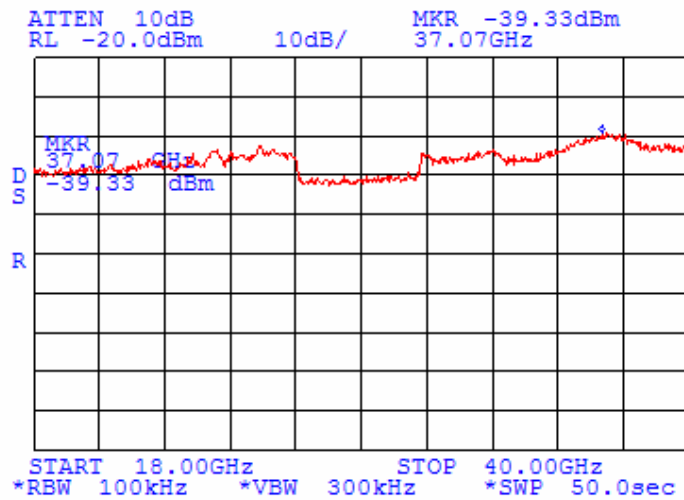

Plot 7.3.44 Spurious emission measurements in 18000 – 40000 MHz range at low carrier frequency

CHANNEL BANDWIDTH	20 MHz
MODULATION	64QAM
BIT RATE	130 Mbps

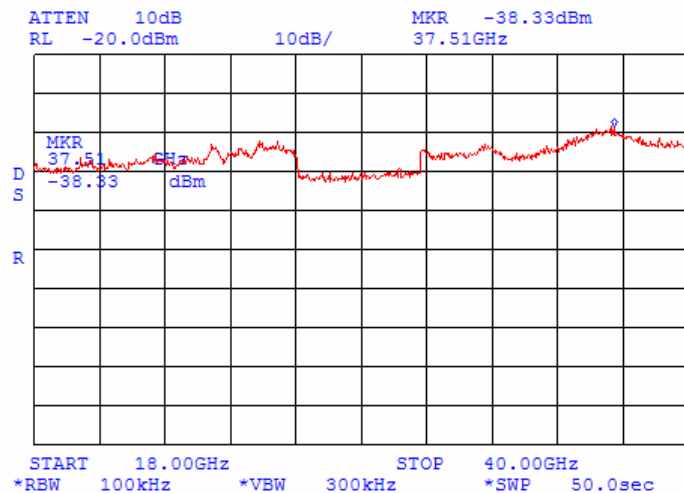



Test specification:	Section 15.247(d), RSS-210 section A8.5, Conducted spurious emissions		
Test procedure:	FCC New Guidance on Measurements for DTS in section 15.247(c)		
Test mode:	Compliance	Verdict:	PASS
Date & Time:	11/12/2008 2:31:40 PM		
Temperature: 21°C	Air Pressure: 1010 hPa	Relative Humidity: 43%	Power Supply: 48 VDC
Remarks Individual Tx chain testing			

Plot 7.3.45 Spurious emission measurements in 18000 – 40000 MHz range at mid carrier frequency

CHANNEL BANDWIDTH	20 MHz
MODULATION	64QAM
BIT RATE	130 Mbps

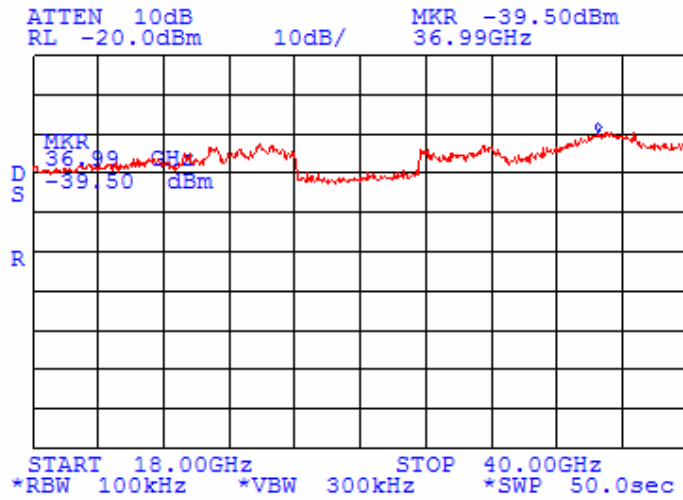

Plot 7.3.46 Spurious emission measurements in 18000 – 40000 MHz range at high carrier frequency

CHANNEL BANDWIDTH	20 MHz
MODULATION	64QAM
BIT RATE	130 Mbps

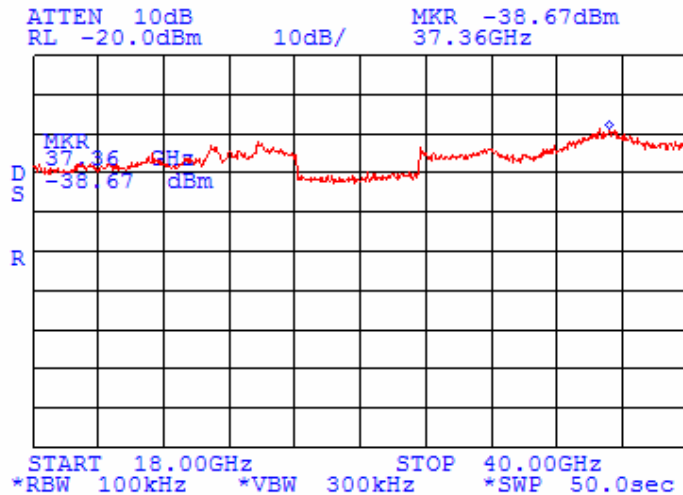



Test specification:	Section 15.247(d), RSS-210 section A8.5, Conducted spurious emissions		
Test procedure:	FCC New Guidance on Measurements for DTS in section 15.247(c)		
Test mode:	Compliance	Verdict: PASS	
Date & Time:	1/25/2009 12:10:20 PM		
Temperature: 21°C	Air Pressure: 1014 hPa	Relative Humidity: 38%	Power Supply: 48 VDC
Remarks Combined Tx chain testing			

Table 7.3.3 Spurious emission test results

ASSIGNED FREQUENCY RANGE: 5725 – 5850 MHz
 INVESTIGATED FREQUENCY RANGE: 0.5 – 18000 MHz
 DETECTOR USED: Peak
 RESOLUTION BANDWIDTH: 100 kHz
 VIDEO BANDWIDTH: 300 kHz
 MODULATION: BPSK / 64QAM
 TRANSMITTER OUTPUT POWER SETTINGS: Maximum

Frequency, MHz	Channel bandwidth, MHz	Spurious emission, dBm	Emission at carrier, dBm	Attenuation below carrier, dBc	Limit, dBc	Margin, dB*	Verdict
Low carrier frequency							
5725.0	5	-14.34	17.84	32.18	20.0	-12.18	Pass
5724.875	20	-10.29	12.82	23.11		-3.11	
Mid carrier frequency							
No emissions were found	5	No emissions were found	18.05	NA	20.0	NA	Pass
	20		13.16				
High carrier frequency							
5850.0	5	-13.56	18.44	32.00	20.0	-12.00	Pass
5883.0	5	-35.67	18.44	54.11		-34.11	
5887.1	5	-38.01	18.44	56.45		-36.45	
5850.0	20	-10.09	13.84	23.93		-3.93	

*- Margin = Attenuation below carrier – specification limit.

Reference numbers of test equipment used

HL 1906	HL 2909	HL 3179	HL 3180	HL 3181	HL 3472	HL 3473	HL 3474
---------	---------	---------	---------	---------	---------	---------	---------

Full description is given in Appendix A.



HERMON LABORATORIES

Test specification: Section 15.247(d), RSS-210 section A8.5, Conducted spurious emissions			
Test procedure: FCC New Guidance on Measurements for DTS in section 15.247(c)			
Test mode: Compliance	Verdict: PASS		
Date & Time: 1/25/2009 12:10:20 PM			
Temperature: 21°C	Air Pressure: 1014 hPa	Relative Humidity: 38%	Power Supply: 48 VDC
Remarks Combined Tx chain testing			

Plot 7.3.47 The highest emission level within the assigned band at low carrier frequency

CHANNEL BANDWIDTH	5 MHz
MODULATION	64QAM
BIT RATE	32.5 Mbps

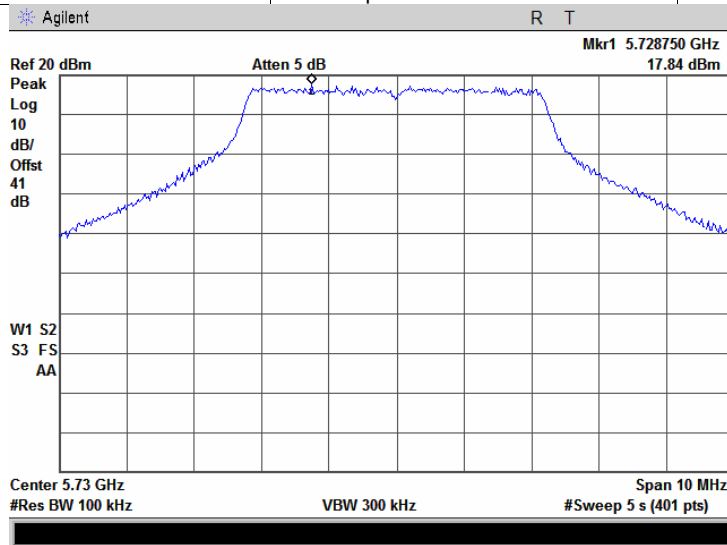

Plot 7.3.48 The highest emission level within the assigned band at mid carrier frequency

CHANNEL BANDWIDTH	5 MHz
MODULATION	64QAM
BIT RATE	32.5 Mbps

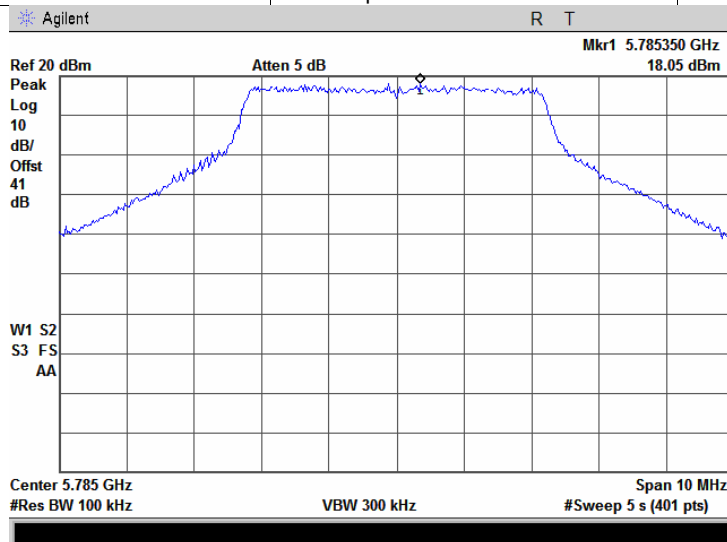



HERMON LABORATORIES

Test specification: Section 15.247(d), RSS-210 section A8.5, Conducted spurious emissions			
Test procedure: FCC New Guidance on Measurements for DTS in section 15.247(c)			
Test mode: Compliance	Verdict: PASS		
Date & Time: 1/25/2009 12:10:20 PM			
Temperature: 21°C	Air Pressure: 1014 hPa	Relative Humidity: 38%	Power Supply: 48 VDC
Remarks Combined Tx chain testing			

Plot 7.3.49 The highest emission level within the assigned band at high carrier frequency

CHANNEL BANDWIDTH	5 MHz
MODULATION	64QAM
BIT RATE	32.5 Mbps

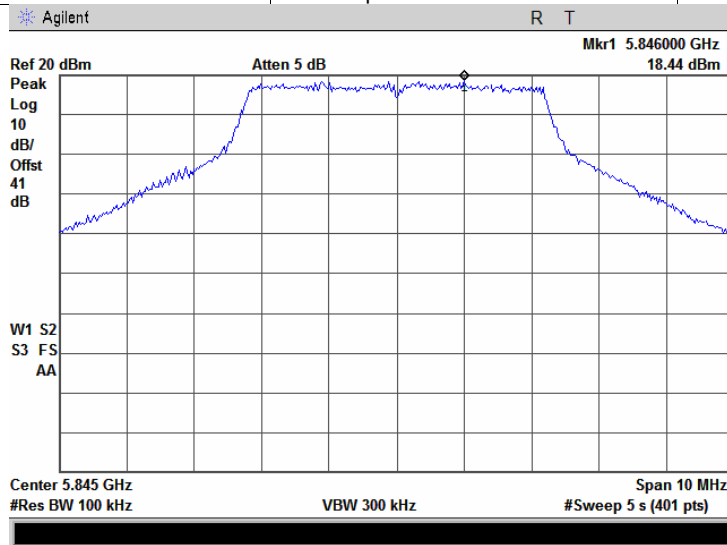

Plot 7.3.50 The highest emission level within the assigned band at low carrier frequency

CHANNEL BANDWIDTH	20 MHz
MODULATION	64QAM
BIT RATE	130 Mbps

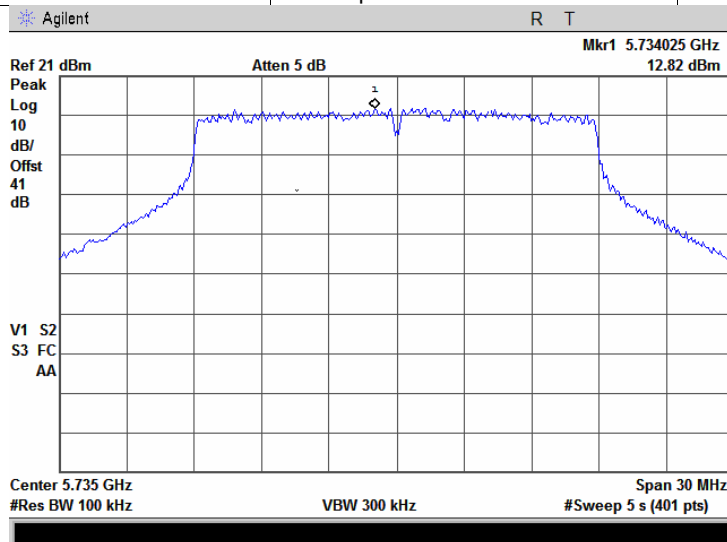



HERMON LABORATORIES

Test specification: Section 15.247(d), RSS-210 section A8.5, Conducted spurious emissions			
Test procedure: FCC New Guidance on Measurements for DTS in section 15.247(c)			
Test mode: Compliance	Verdict: PASS		
Date & Time: 1/25/2009 12:10:20 PM			
Temperature: 21°C	Air Pressure: 1014 hPa	Relative Humidity: 38%	Power Supply: 48 VDC
Remarks Combined Tx chain testing			

Plot 7.3.51 The highest emission level within the assigned band at mid carrier frequency

CHANNEL BANDWIDTH	20 MHz
MODULATION	64QAM
BIT RATE	130 Mbps

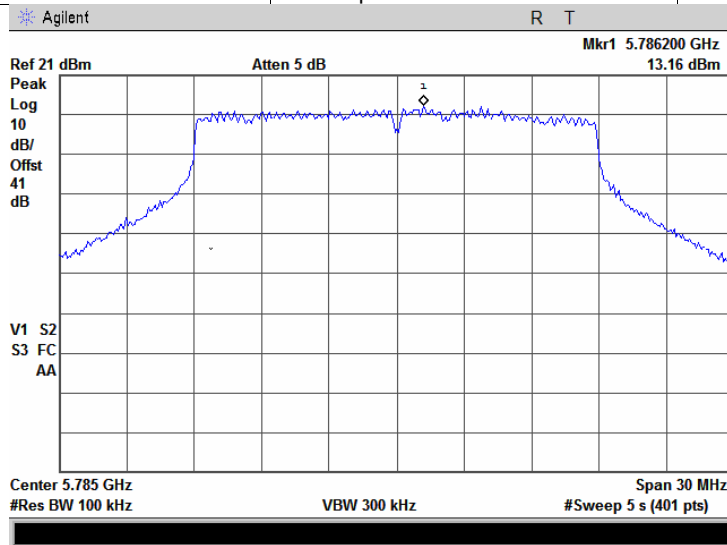

Plot 7.3.52 The highest emission level within the assigned band at high carrier frequency

CHANNEL BANDWIDTH	20 MHz
MODULATION	64QAM
BIT RATE	130 Mbps

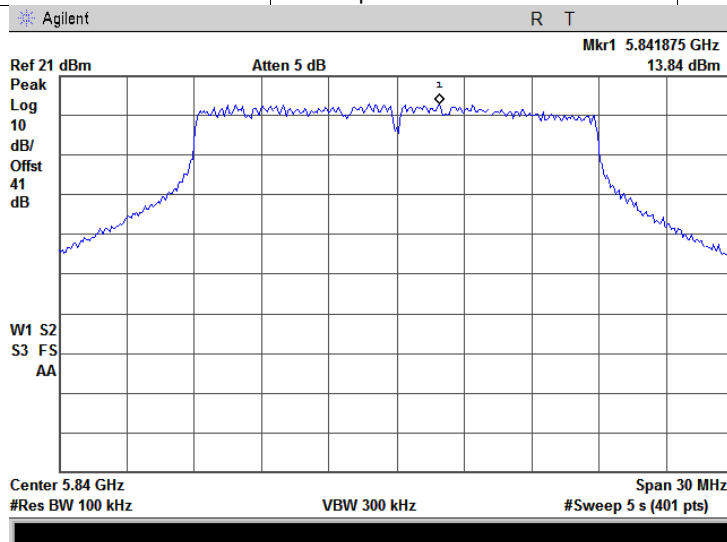



HERMON LABORATORIES

Test specification:	Section 15.247(d), RSS-210 section A8.5, Conducted spurious emissions		
Test procedure:	FCC New Guidance on Measurements for DTS in section 15.247(c)		
Test mode:	Compliance	Verdict:	PASS
Date & Time:	1/25/2009 12:10:20 PM		
Temperature: 21°C	Air Pressure: 1014 hPa	Relative Humidity: 38%	Power Supply: 48 VDC
Remarks Combined Tx chain testing			

Plot 7.3.53 Spurious emission measurements in 500 – 5700 MHz range at low carrier frequency

CHANNEL BANDWIDTH	5 MHz
MODULATION	64QAM
BIT RATE	32.5 Mbps

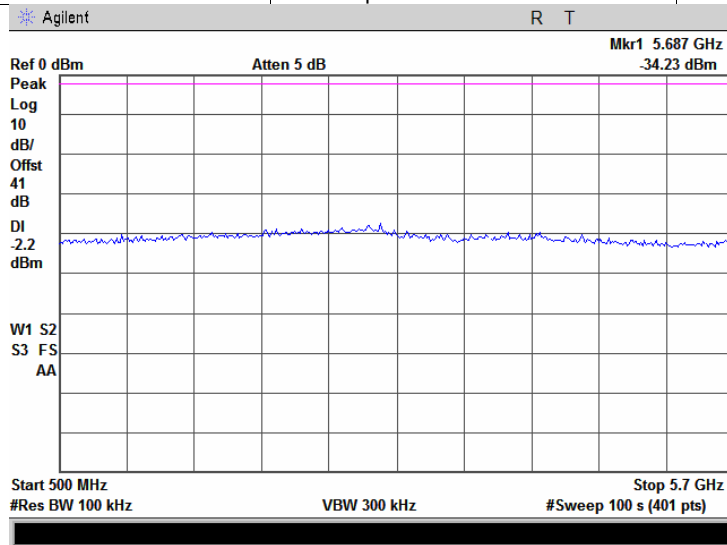

Plot 7.3.54 Spurious emission measurements in 500 – 5725 MHz range at mid carrier frequency

CHANNEL BANDWIDTH	5 MHz
MODULATION	64QAM
BIT RATE	32.5 Mbps

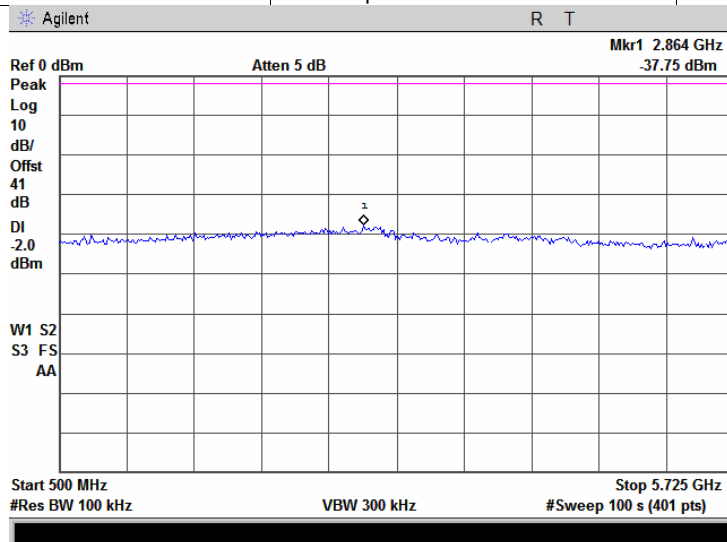



HERMON LABORATORIES

Test specification:	Section 15.247(d), RSS-210 section A8.5, Conducted spurious emissions		
Test procedure:	FCC New Guidance on Measurements for DTS in section 15.247(c)		
Test mode:	Compliance	Verdict:	PASS
Date & Time:	1/25/2009 12:10:20 PM		
Temperature: 21°C	Air Pressure: 1014 hPa	Relative Humidity: 38%	Power Supply: 48 VDC
Remarks Combined Tx chain testing			

Plot 7.3.55 Spurious emission measurements in 500 – 5725 MHz range at high carrier frequency

CHANNEL BANDWIDTH	5 MHz
MODULATION	64QAM
BIT RATE	32.5 Mbps

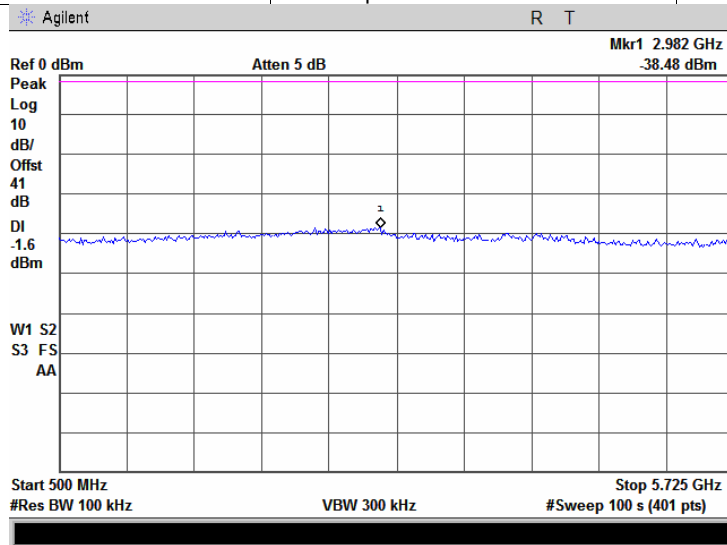

Plot 7.3.56 Spurious emission measurements in 500 – 5700 MHz range at low carrier frequency

CHANNEL BANDWIDTH	20 MHz
MODULATION	64QAM
BIT RATE	130 Mbps

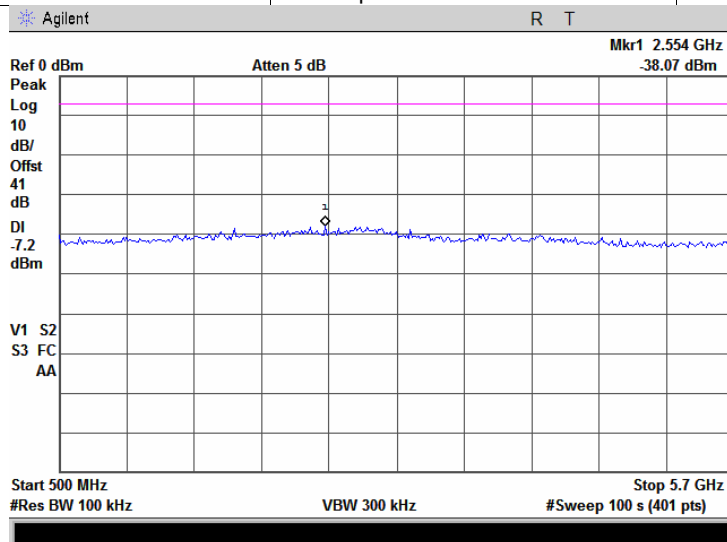



HERMON LABORATORIES

Test specification:	Section 15.247(d), RSS-210 section A8.5, Conducted spurious emissions		
Test procedure:	FCC New Guidance on Measurements for DTS in section 15.247(c)		
Test mode:	Compliance	Verdict:	PASS
Date & Time:	1/25/2009 12:10:20 PM		
Temperature: 21°C	Air Pressure: 1014 hPa	Relative Humidity: 38%	Power Supply: 48 VDC
Remarks Combined Tx chain testing			

Plot 7.3.57 Spurious emission measurements in 500 – 5725 MHz range at mid carrier frequency

CHANNEL BANDWIDTH	20 MHz
MODULATION	64QAM
BIT RATE	130 Mbps

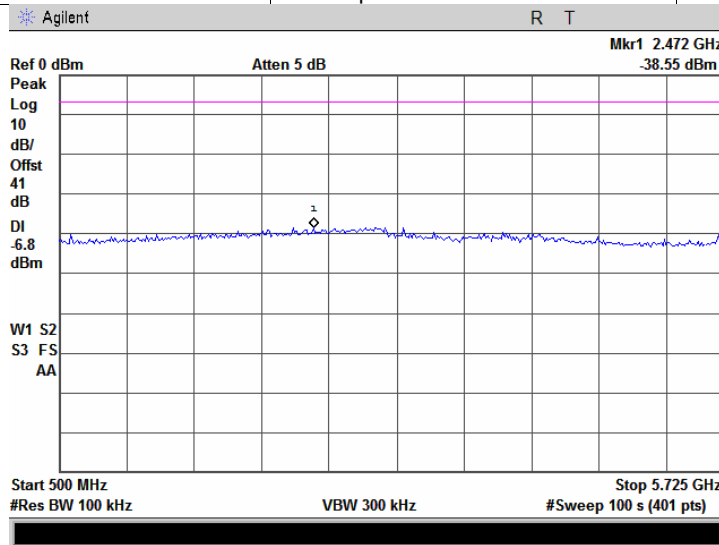

Plot 7.3.58 Spurious emission measurements in 500 – 5725 MHz range at high carrier frequency

CHANNEL BANDWIDTH	20 MHz
MODULATION	64QAM
BIT RATE	130 Mbps

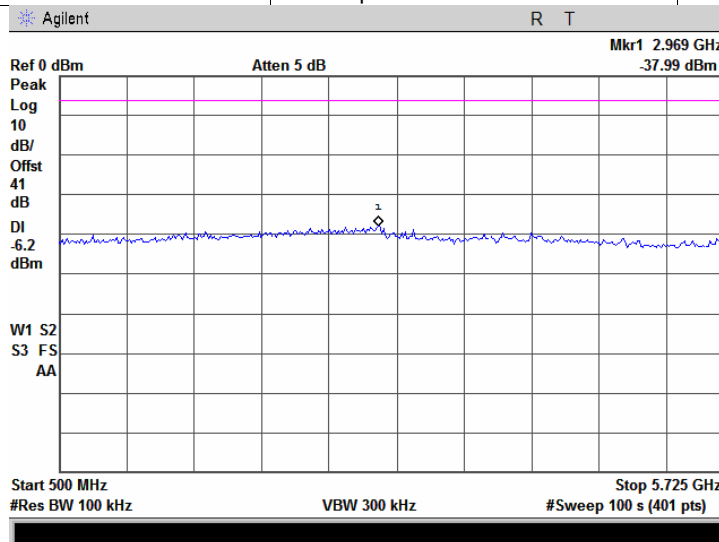



HERMON LABORATORIES

Test specification:	Section 15.247(d), RSS-210 section A8.5, Conducted spurious emissions		
Test procedure:	FCC New Guidance on Measurements for DTS in section 15.247(c)		
Test mode:	Compliance	Verdict:	PASS
Date & Time:	1/25/2009 12:10:20 PM		
Temperature: 21°C	Air Pressure: 1014 hPa	Relative Humidity: 38%	Power Supply: 48 VDC
Remarks Combined Tx chain testing			

Plot 7.3.59 Spurious emission measurements in 5700 – 5725 MHz range at low carrier frequency

CHANNEL BANDWIDTH	5 MHz
MODULATION	64QAM
BIT RATE	32.5 Mbps

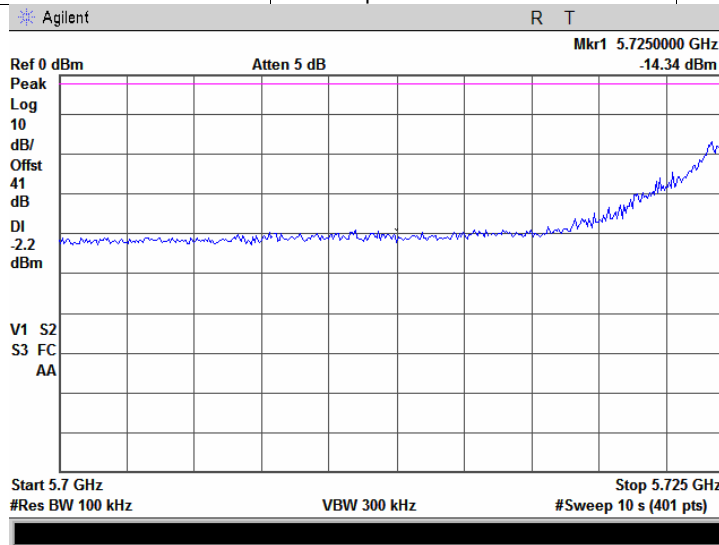

Plot 7.3.60 Spurious emission measurements in 5700 – 5725 MHz range at low carrier frequency

CHANNEL BANDWIDTH	20 MHz
MODULATION	64QAM
BIT RATE	130 Mbps

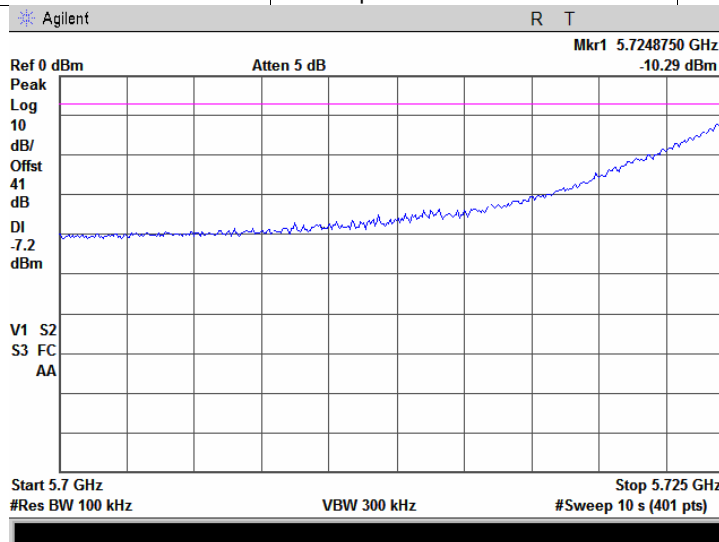



HERMON LABORATORIES

Test specification:	Section 15.247(d), RSS-210 section A8.5, Conducted spurious emissions		
Test procedure:	FCC New Guidance on Measurements for DTS in section 15.247(c)		
Test mode:	Compliance	Verdict:	PASS
Date & Time:	1/25/2009 12:10:20 PM		
Temperature: 21°C	Air Pressure: 1014 hPa	Relative Humidity: 38%	Power Supply: 48 VDC
Remarks Combined Tx chain testing			

Plot 7.3.61 Spurious emission measurements in 5850 – 6000 MHz range at high carrier frequency

CHANNEL BANDWIDTH	5 MHz
MODULATION	64QAM
BIT RATE	32.5 Mbps

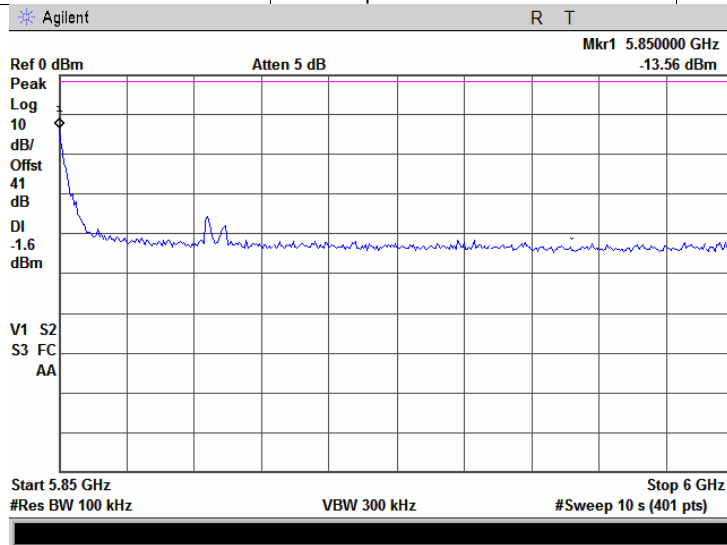

Plot 7.3.62 Spurious emission measurements in 5850 – 6000 MHz range at high carrier frequency

CHANNEL BANDWIDTH	20 MHz
MODULATION	64QAM
BIT RATE	130 Mbps

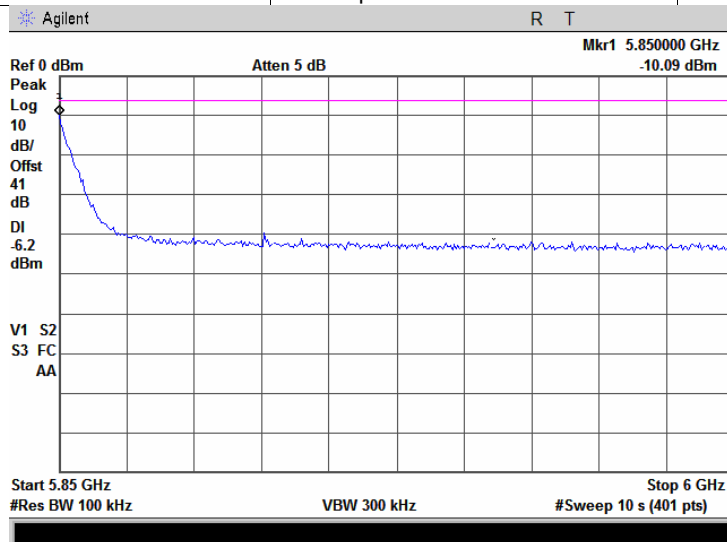



HERMON LABORATORIES

Test specification:	Section 15.247(d), RSS-210 section A8.5, Conducted spurious emissions		
Test procedure:	FCC New Guidance on Measurements for DTS in section 15.247(c)		
Test mode:	Compliance	Verdict:	PASS
Date & Time:	1/25/2009 12:10:20 PM		
Temperature: 21°C	Air Pressure: 1014 hPa	Relative Humidity: 38%	Power Supply: 48 VDC
Remarks Combined Tx chain testing			

Plot 7.3.63 Spurious emission measurements in 5850 – 18000 MHz range at low carrier frequency

CHANNEL BANDWIDTH	5 MHz
MODULATION	64QAM
BIT RATE	32.5 Mbps

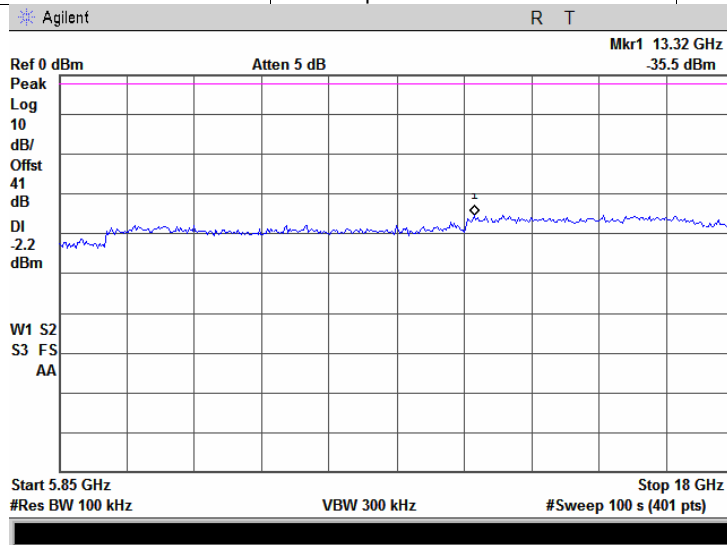

Plot 7.3.64 Spurious emission measurements in 5850 – 18000 MHz range at mid carrier frequency

CHANNEL BANDWIDTH	5 MHz
MODULATION	64QAM
BIT RATE	32.5 Mbps

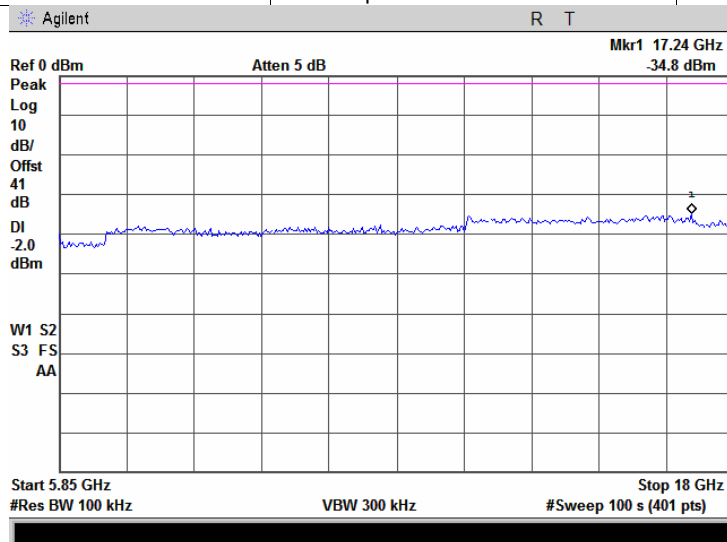



HERMON LABORATORIES

Test specification:	Section 15.247(d), RSS-210 section A8.5, Conducted spurious emissions		
Test procedure:	FCC New Guidance on Measurements for DTS in section 15.247(c)		
Test mode:	Compliance	Verdict:	PASS
Date & Time:	1/25/2009 12:10:20 PM		
Temperature: 21°C	Air Pressure: 1014 hPa	Relative Humidity: 38%	Power Supply: 48 VDC
Remarks Combined Tx chain testing			

Plot 7.3.65 Spurious emission measurements in 6000 – 18000 MHz range at high carrier frequency

CHANNEL BANDWIDTH	5 MHz
MODULATION	64QAM
BIT RATE	32.5 Mbps

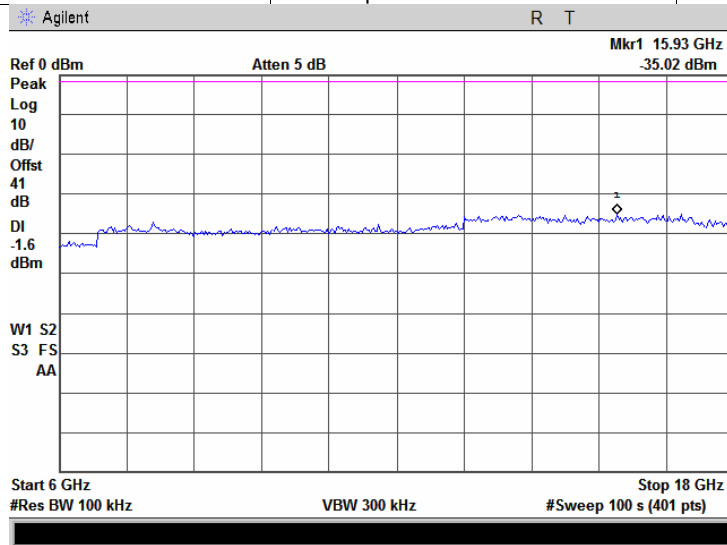

Plot 7.3.66 Spurious emission measurements in 5850 – 18000 MHz range at low carrier frequency

CHANNEL BANDWIDTH	20 MHz
MODULATION	64QAM
BIT RATE	130 Mbps

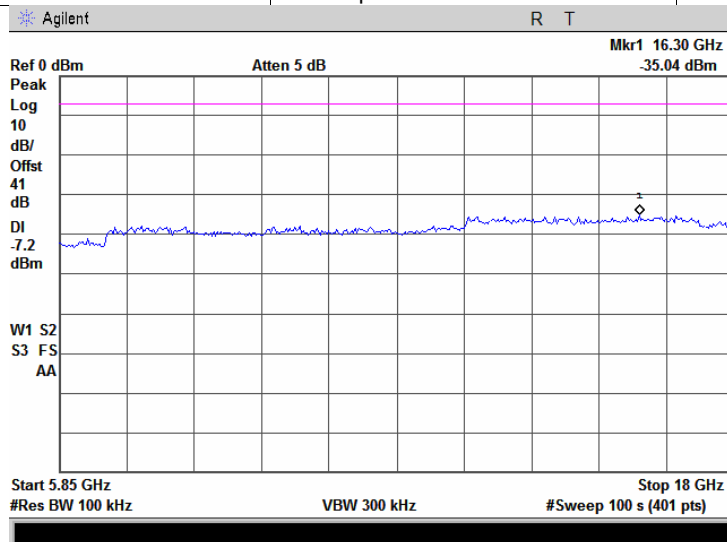



Test specification:	Section 15.247(d), RSS-210 section A8.5, Conducted spurious emissions		
Test procedure:	FCC New Guidance on Measurements for DTS in section 15.247(c)		
Test mode:	Compliance	Verdict:	PASS
Date & Time:	1/25/2009 12:10:20 PM		
Temperature: 21°C	Air Pressure: 1014 hPa	Relative Humidity: 38%	Power Supply: 48 VDC
Remarks Combined Tx chain testing			

Plot 7.3.67 Spurious emission measurements in 5850 – 18000 MHz range at mid carrier frequency

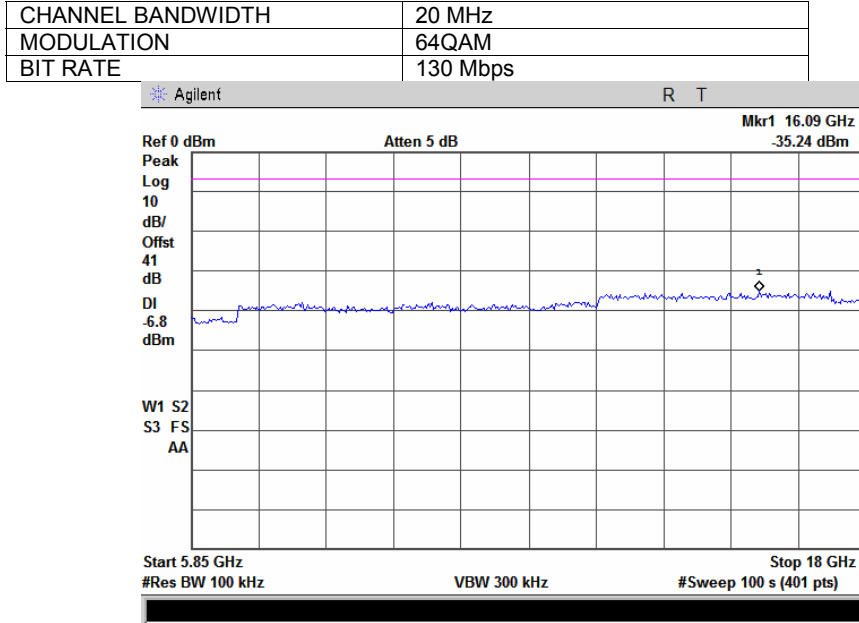

Plot 7.3.68 Spurious emission measurements in 6000 – 18000 MHz range at high carrier frequency

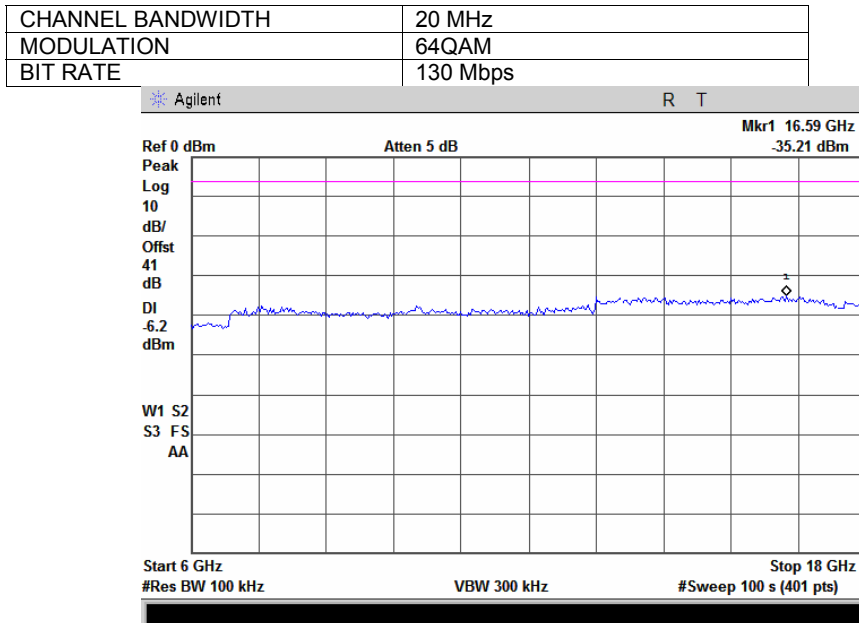



Test specification:	Section 15.247(d), RSS-210 section A8.5, Radiated spurious emissions		
Test procedure:	FCC New Guidance on Measurements for DTS in section 15.247(c)/ANSI C63.4, Section 13.1.4		
Test mode:	Compliance	Verdict:	PASS
Date & Time:	11/12/2008 2:52:30 PM		
Temperature: 21°C	Air Pressure: 1010 hPa	Relative Humidity: 43%	Power Supply: 48 VDC
Remarks:			

7.4 Field strength of spurious emissions

7.4.1 General

This test was performed to measure field strength of spurious emissions from the EUT. Specification test limits are given in Table 7.4.1.

Table 7.4.1 Radiated spurious emissions limits

Frequency, MHz	Field strength at 3 m within restricted bands, dB(μ V/m)*			Attenuation of field strength of spurious versus carrier outside restricted bands, dBc***
	Peak	Quasi Peak	Average	
0.009 – 0.090	148.5 – 128.5	NA	128.5 – 108.5**	20.0
0.090 – 0.110	NA	108.5 – 106.8**	NA	
0.110 – 0.490	126.8 – 113.8	NA	106.8 – 93.8**	
0.490 – 1.705	NA	73.8 – 63.0**	NA	
1.705 – 30.0*		69.5		
30 – 88		40.0		
88 – 216		43.5		
216 – 960		46.0		
960 – 1000		54.0		
1000 – 10 th harmonic	74.0	NA	54.0	

*- The limit for 3 m test distance was calculated using the inverse square distance extrapolation factor as follows:

$$\text{Lim}_{S_2} = \text{Lim}_{S_1} + 40 \log(S_1/S_2),$$

where S_1 and S_2 – standard defined and test distance respectively in meters.

** - The limit decreases linearly with the logarithm of frequency.

*** - The field strength limits applied from the lowest radio frequency generated in the device, without going below 9 kHz up to the tenth harmonic of the highest fundamental frequency.

7.4.2 Test procedure for spurious emission field strength measurements in 9 kHz to 30 MHz band

7.4.2.1 The EUT was set up as shown in Figure 7.4.1, energized and the performance check was conducted.

7.4.2.2 The specified frequency range was investigated with antenna connected to spectrum analyzer/ EMI receiver. To find maximum radiation the turntable was rotated 360° and the measuring antenna was rotated around its vertical axis.

7.4.2.3 The worst test results (the lowest margins) were recorded and shown in the associated plots.

7.4.3 Test procedure for spurious emission field strength measurements above 30 MHz

7.4.3.1 The EUT was set up as shown in Figure 7.4.2, energized and the performance check was conducted.

7.4.3.2 The specified frequency range was investigated with antenna connected to spectrum analyzer/ EMI receiver. To find maximum radiation the turntable was rotated 360°, the measuring antenna height was changed from 1 to 4 m, its polarization was switched from vertical to horizontal.

7.4.3.3 The worst test results (the lowest margins) were recorded and shown in the associated plots.



Test specification: Section 15.247(d), RSS-210 section A8.5, Radiated spurious emissions			
Test procedure: FCC New Guidance on Measurements for DTS in section 15.247(c)/ANSI C63.4, Section 13.1.4			
Test mode: Compliance	Verdict: PASS		
Date & Time: 11/12/2008 2:52:30 PM			
Temperature: 21°C	Air Pressure: 1010 hPa	Relative Humidity: 43%	Power Supply: 48 VDC
Remarks:			

Figure 7.4.1 Setup for spurious emission field strength measurements below 30 MHz

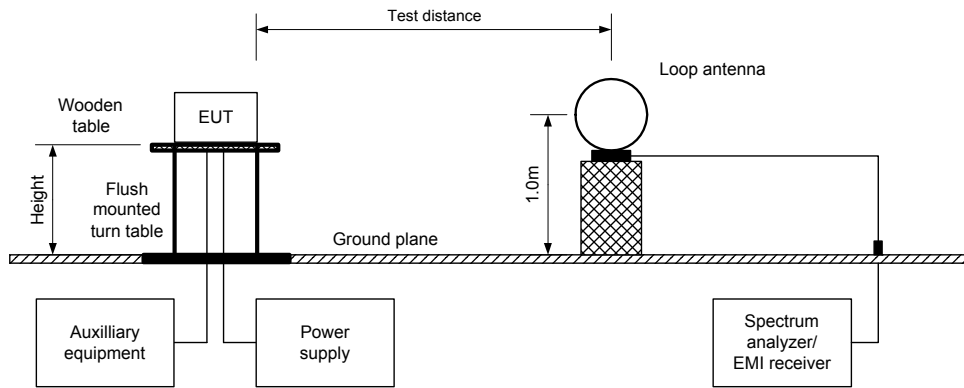
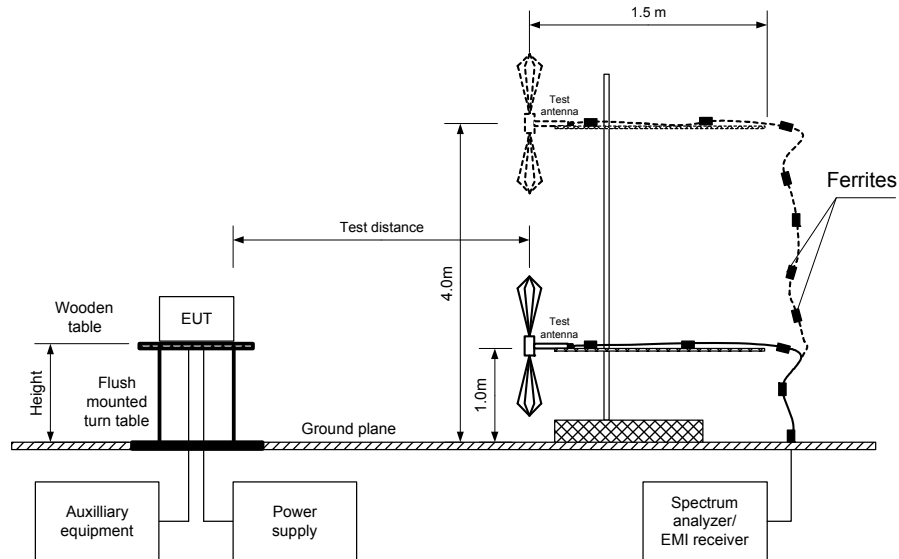

Figure 7.4.2 Setup for spurious emission field strength measurements above 30 MHz





Test specification:		Section 15.247(d), RSS-210 section A8.5, Radiated spurious emissions	
Test procedure:		FCC New Guidance on Measurements for DTS in section 15.247(c)/ANSI C63.4, Section 13.1.4	
Test mode:	Compliance	Verdict:	PASS
Date & Time:	11/12/2008 2:52:30 PM		
Temperature: 21°C	Air Pressure: 1010 hPa	Relative Humidity: 43%	Power Supply: 48 VDC
Remarks: 24 dBi integrated flat antenna			

Table 7.4.2 Field strength of emissions outside restricted bands

ASSIGNED FREQUENCY: 5725-5850 MHz
 INVESTIGATED FREQUENCY RANGE: 0.009 - 40000 MHz
 TEST DISTANCE: 3 m
 MODULATION: 64QAM
 MODULATING SIGNAL: OFDM
 DUTY CYCLE: 100 %
 TRANSMITTER OUTPUT POWER SETTINGS: Maximum
 DETECTOR USED: Peak
 RESOLUTION BANDWIDTH: 100 kHz
 VIDEO BANDWIDTH: 300 kHz
 TEST ANTENNA TYPE: Active loop (9 kHz – 30 MHz)
 Biconical (30 MHz – 200 MHz)
 Log periodic (200 MHz – 1000 MHz)
 Biconilog (30 MHz – 1000 MHz)
 Double ridged guide (above 1000 MHz)

Frequency, MHz	Field strength of spurious, dB(μV/m)	Antenna polarization	Antenna height, m	Azimuth, degrees*	Field strength of carrier, dB(μV/m)	Attenuation below carrier, dBc	Limit, dBc	Margin, dB**	Verdict
Low carrier frequency									
No emissions were found							20.0	NA	Pass
Mid carrier frequency									
No emissions were found							20.0	NA	Pass
High carrier frequency									
No emissions were found							20.0	NA	Pass

*- EUT front panel refers to 0 degrees position of turntable.
 **- Margin = Attenuation below carrier – specification limit.



Test specification:	Section 15.247(d), RSS-210 section A8.5, Radiated spurious emissions		
Test procedure:	FCC New Guidance on Measurements for DTS in section 15.247(c)/ANSI C63.4, Section 13.1.4		
Test mode:	Compliance	Verdict:	PASS
Date & Time:	11/12/2008 2:52:30 PM		
Temperature: 21°C	Air Pressure: 1010 hPa	Relative Humidity: 43%	Power Supply: 48 VDC
Remarks: 24 dBi integrated flat antenna			

Table 7.4.3 Field strength of spurious emissions above 1 GHz within restricted bands

ASSIGNED FREQUENCY: 5725 - 5850 MHz
 INVESTIGATED FREQUENCY RANGE: 1000 - 40000 MHz
 TEST DISTANCE: 3 m
 MODULATION: 64QAM
 MODULATING SIGNAL: OFDM
 DUTY CYCLE: 100 %
 TRANSMITTER OUTPUT POWER SETTINGS: Maximum
 DETECTOR USED: Peak
 RESOLUTION BANDWIDTH: 1000 kHz
 TEST ANTENNA TYPE: Double ridged guide

Frequency, MHz	Antenna		Azimuth, degrees*	Peak field strength(VBW=3 MHz)			Average field strength (VBW=10 Hz)				Verdict
	Polarization	Height, m		Measured, dB(µV/m)	Limit, dB(µV/m)	Margin, dB**	Measured, dB(µV/m)	Calculated, dB(µV/m)	Limit, dB(µV/m)	Margin, dB***	
5 MHz channel bandwidth											
Low carrier frequency											
1600.0	Vertical	1.5	30	46.95	74.00	-27.05	42.04	42.04	54	-11.96	Pass
5033.8	Vertical	1.1	0	58.24	74.00	-15.76	45.34	45.34	54	-8.66	
Mid carrier frequency											
1600.0	Vertical	1.5	30	46.98	74.00	-27.02	42.05	42.05	54	-11.95	Pass
5033.3	Vertical	1.1	0	58.53	74.00	-15.47	45.61	45.61	54	-8.39	
High carrier frequency											
1600.0	Vertical	1.5	30	46.88	74.00	-27.12	42.03	42.03	54	-11.97	Pass
5032.8	Vertical	1.1	0	58.69	74.00	-15.31	45.75	45.75	54	-8.25	
20 MHz channel bandwidth											
Low carrier frequency											
1600.0	Vertical	1.5	30	45.85	74.00	-28.15	42.01	42.01	54	-11.99	Pass
5033.6	Vertical	1.1	0	58.59	74.00	-15.41	45.6	45.6	54	-8.4	
Mid carrier frequency											
1600.0	Vertical	1.5	30	46.55	74.00	-27.45	41.95	41.95	54	-12.05	Pass
5033.8	Vertical	1.1	0	58.08	74.00	-15.92	46.06	46.06	54	-7.94	
High carrier frequency											
1600.0	Vertical	1.5	30	46.40	74.00	-27.6	41.85	41.85	54	-12.15	Pass
5033.7	Vertical	1.1	0	59.01	74.00	-14.99	46.03	46.03	54	-7.97	

*- EUT front panel refers to 0 degrees position of turntable.
 **- Margin = Measured field strength - specification limit.
 ***- Margin = Calculated field strength - specification limit,
 where Calculated field strength = Measured field strength + average factor.

Table 7.4.4 Average factor calculation

Transmission pulse		Transmission burst		Transmission train duration, ms	Average factor, dB
Duration, ms	Period, ms	Duration, ms	Period, ms		
EUT was configured for continuous transmission – no average factor was used					

*- Average factor was calculated as follows
 for pulse train shorter than 100 ms: $Average\ factor = 20 \times \log_{10} \left(\frac{Pulse\ duration}{Pulse\ period} \times \frac{Burst\ duration}{Train\ duration} \times Number\ of\ bursts\ within\ pulse\ train \right)$
 for pulse train longer than 100 ms: $Average\ factor = 20 \times \log_{10} \left(\frac{Pulse\ duration}{Pulse\ period} \times \frac{Burst\ duration}{100\ ms} \times Number\ of\ bursts\ within\ 100\ ms \right)$



HERMON LABORATORIES

Test specification: Section 15.247(d), RSS-210 section A8.5, Radiated spurious emissions			
Test procedure: FCC New Guidance on Measurements for DTS in section 15.247(c)/ANSI C63.4, Section 13.1.4			
Test mode: Compliance	Verdict: PASS		
Date & Time: 11/12/2008 2:52:30 PM			
Temperature: 21°C	Air Pressure: 1010 hPa	Relative Humidity: 43%	Power Supply: 48 VDC
Remarks: 24 dBm integrated flat antenna			

Table 7.4.5 Field strength of spurious emissions below 1 GHz within restricted bands

ASSIGNED FREQUENCY: 5725 - 5850 MHz
 INVESTIGATED FREQUENCY RANGE: 0.009 – 1000 MHz
 TEST DISTANCE: 3 m
 MODULATION: 64QAM
 MODULATING SIGNAL: OFDM
 DUTY CYCLE: 100 %
 TRANSMITTER OUTPUT POWER SETTINGS: Maximum
 RESOLUTION BANDWIDTH: 0.2 kHz (9 kHz – 150 kHz); 9.0 kHz (150 kHz – 30 MHz)
 120 kHz (30 MHz – 1000 MHz)
 VIDEO BANDWIDTH: > Resolution bandwidth
 TEST ANTENNA TYPE: Active loop (9 kHz – 30 MHz); Biconilog (30 MHz – 1000 MHz)

Frequency, MHz	Peak emission, dB(µV/m)	Quasi-peak			Antenna polarization	Antenna height, m	Turn-table position**, degrees	Verdict
		Measured emission, dB(µV/m)	Limit, dB(µV/m)	Margin, dB*				
5 MHz CBW, Low carrier frequency								
83.725	38.10	34.50	40.00	-5.50	Vertical	1.0	270	Pass
450.000	41.00	39.50	46.00	-6.50	Vertical	1.0	90	
760.575	37.80	35.40	46.00	-10.60	Vertical	1.0	0	
800.005	45.90	42.50	46.00	-3.50	Vertical	1.0	0	
933.335	43.30	41.20	46.00	-4.80	Vertical	1.0	180	
5 MHz CBW, Mid carrier frequency								
83.725	37.70	34.80	40.00	-5.20	Vertical	1.0	270	Pass
450.000	41.10	39.60	46.00	-6.40	Vertical	1.0	90	
760.575	37.70	35.20	46.00	-10.80	Vertical	1.0	0	
800.005	45.80	42.50	46.00	-3.50	Vertical	1.0	0	
933.335	43.10	41.10	46.00	-4.90	Vertical	1.0	180	
5 MHz CBW, High carrier frequency								
83.725	37.90	35.00	40.00	-5.00	Vertical	1.0	270	Pass
450.000	41.50	39.90	46.00	-6.10	Vertical	1.0	90	
760.575	38.20	35.80	46.00	-10.20	Vertical	1.0	0	
800.005	45.70	42.40	46.00	-3.60	Vertical	1.0	0	
933.335	43.00	41.10	46.00	-4.90	Vertical	1.0	180	
20 MHz CBW, Low carrier frequency								
83.725	38.10	34.50	40.00	-5.50	Vertical	1.0	270	Pass
450.000	41.20	39.60	46.00	-6.40	Vertical	1.0	90	
760.575	37.90	35.40	46.00	-10.60	Vertical	1.0	0	
800.005	45.80	42.30	46.00	-3.70	Vertical	1.0	0	
933.335	43.00	40.80	46.00	-5.20	Vertical	1.0	180	
20 MHz CBW, Mid carrier frequency								
83.725	37.90	35.00	40.00	-5.00	Vertical	1.0	270	Pass
450.000	37.70	35.20	46.00	-10.80	Vertical	1.0	90	
760.575	38.10	35.60	46.00	-10.40	Vertical	1.0	0	
800.005	45.80	42.50	46.00	-3.50	Vertical	1.0	0	
933.335	42.80	40.90	46.00	-5.10	Vertical	1.0	180	
20 MHz CBW, High carrier frequency								
83.725	37.70	34.80	40.00	-5.20	Vertical	1.0	270	Pass
450.000	41.00	39.50	46.00	-6.50	Vertical	1.0	90	
760.575	38.10	35.60	46.00	-10.40	Vertical	1.0	0	
800.005	45.90	42.50	46.00	-3.50	Vertical	1.0	0	
933.335	42.70	40.80	46.00	-5.20	Vertical	1.0	180	

*- Margin = Measured emission - specification limit.

** - EUT front panel refer to 0 degrees position of turntable.



HERMON LABORATORIES

Test specification:	Section 15.247(d), RSS-210 section A8.5, Radiated spurious emissions		
Test procedure:	FCC New Guidance on Measurements for DTS in section 15.247(c)/ANSI C63.4, Section 13.1.4		
Test mode:	Compliance	Verdict:	PASS
Date & Time:	11/12/2008 2:52:30 PM		
Temperature: 21°C	Air Pressure: 1010 hPa	Relative Humidity: 43%	Power Supply: 48 VDC
Remarks: 24 dBi integrated flat antenna			

Table 7.4.6 Restricted bands

MHz	MHz	MHz	MHz	MHz	GHz
0.09 - 0.11	8.37625 - 8.38675	73 - 74.6	399.9 - 410	2690 - 2900	10.6 - 12.7
0.495 - 0.505	8.41425 - 8.41475	74.8 - 75.2	608 - 614	3260 - 3267	13.25 - 13.4
2.1735 - 2.1905	12.29 - 12.293	108 - 121.94	960 - 1240	3332 - 3339	14.47 - 14.5
4.125 - 4.128	12.51975 - 12.52025	123 - 138	1300 - 1427	3345.8 - 3358	15.35 - 16.2
4.17725 - 4.17775	12.57675 - 12.57725	149.9 - 150.05	1435 - 1626.5	3600 - 4400	17.7 - 21.4
4.20725 - 4.20775	13.36 - 13.41	156.52475 - 156.52525	1645.5 - 1646.5	4500 - 5150	22.01 - 23.12
6.215 - 6.218	16.42 - 16.423	156.7 - 156.9	1660 - 1710	5350 - 5460	23.6 - 24
6.26775 - 6.26825	16.69475 - 16.69525	162.0125 - 167.17	1718.8 - 1722.2	7250 - 7750	31.2 - 31.8
6.31175 - 6.31225	16.80425 - 16.80475	167.72 - 173.2	2200 - 2300	8025 - 8500	36.43 - 36.5
8.291 - 8.294	25.5 - 25.67	240 - 285	2310 - 2390	9000 - 9200	Above 38.6
8.362 - 8.366	37.5 - 38.25	322 - 335.4	2483.5 - 2500	9300 - 9500	

Reference numbers of test equipment used

HL 0466	HL 0521	HL 0554	HL 0768	HL 0769	HL 0784	HL 1003	HL 1984
HL 2910	HL 2911	HL 2254	HL 2260	HL 2261	HL 3123	HL 3206	

Full description is given in Appendix A.



HERMON LABORATORIES

Test specification:	Section 15.247(d), RSS-210 section A8.5, Radiated spurious emissions		
Test procedure:	FCC New Guidance on Measurements for DTS in section 15.247(c)/ANSI C63.4, Section 13.1.4		
Test mode:	Compliance	Verdict:	PASS
Date & Time:	11/12/2008 2:52:30 PM		
Temperature: 21°C	Air Pressure: 1010 hPa	Relative Humidity: 43%	Power Supply: 48 VDC
Remarks: 24 dBi integrated flat antenna			

Plot 7.4.1 Radiated emission measurements from 9 to 150 kHz at the low carrier frequency

TEST SITE: Semi anechoic chamber
 TEST DISTANCE: 3 m
 ANTENNA POLARIZATION: Vertical
 CHANNEL BANDWIDTH: 5 MHz

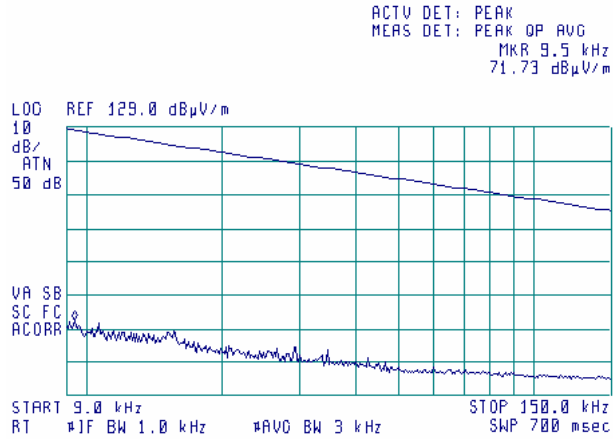

Plot 7.4.2 Radiated emission measurements from 9 to 150 kHz at the mid carrier frequency

TEST SITE: Semi anechoic chamber
 TEST DISTANCE: 3 m
 ANTENNA POLARIZATION: Vertical
 CHANNEL BANDWIDTH: 5 MHz

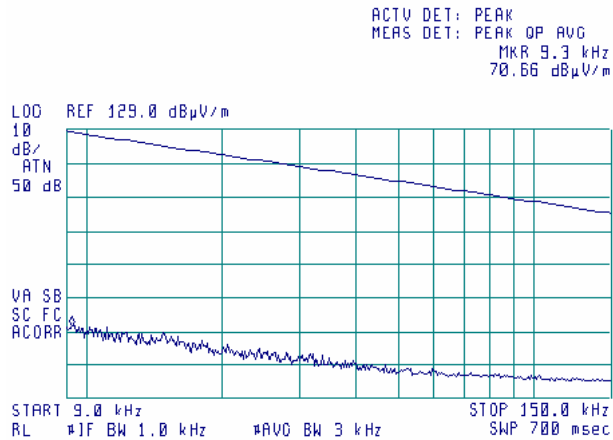



HERMON LABORATORIES

Test specification: Section 15.247(d), RSS-210 section A8.5, Radiated spurious emissions			
Test procedure: FCC New Guidance on Measurements for DTS in section 15.247(c)/ANSI C63.4, Section 13.1.4			
Test mode: Compliance	Verdict: PASS		
Date & Time: 11/12/2008 2:52:30 PM			
Temperature: 21°C	Air Pressure: 1010 hPa	Relative Humidity: 43%	Power Supply: 48 VDC
Remarks: 24 dBi integrated flat antenna			

Plot 7.4.3 Radiated emission measurements from 9 to 150 kHz at the high carrier frequency

TEST SITE: Semi anechoic chamber
 TEST DISTANCE: 3 m
 ANTENNA POLARIZATION: Vertical
 CHANNEL BANDWIDTH: 5 MHz

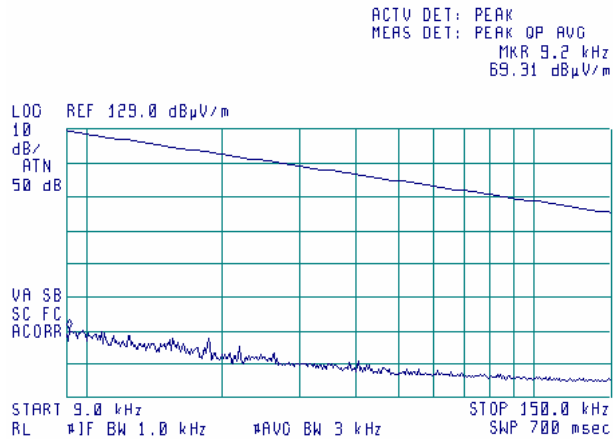

Plot 7.4.4 Radiated emission measurements from 9 to 150 kHz at the low carrier frequency

TEST SITE: Semi anechoic chamber
 TEST DISTANCE: 3 m
 ANTENNA POLARIZATION: Vertical
 CHANNEL BANDWIDTH: 20 MHz

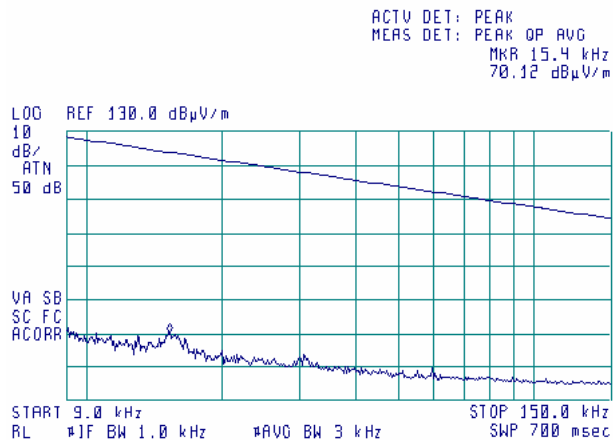



HERMON LABORATORIES

Test specification: Section 15.247(d), RSS-210 section A8.5, Radiated spurious emissions			
Test procedure: FCC New Guidance on Measurements for DTS in section 15.247(c)/ANSI C63.4, Section 13.1.4			
Test mode: Compliance	Verdict: PASS		
Date & Time: 11/12/2008 2:52:30 PM			
Temperature: 21°C	Air Pressure: 1010 hPa	Relative Humidity: 43%	Power Supply: 48 VDC
Remarks: 24 dBi integrated flat antenna			

Plot 7.4.5 Radiated emission measurements from 9 to 150 kHz at the mid carrier frequency

TEST SITE: Semi anechoic chamber
 TEST DISTANCE: 3 m
 ANTENNA POLARIZATION: Vertical
 CHANNEL BANDWIDTH: 20 MHz

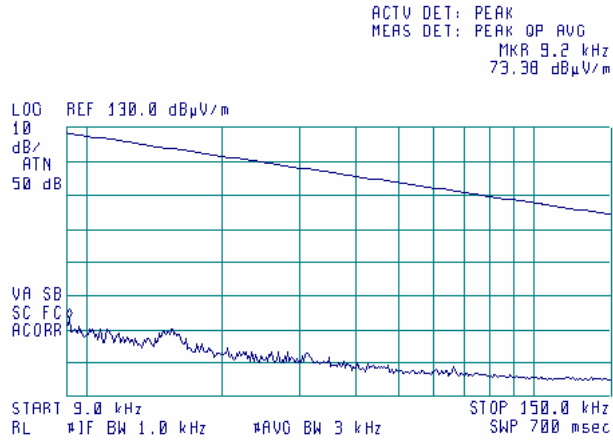

Plot 7.4.6 Radiated emission measurements from 9 to 150 kHz at the high carrier frequency

TEST SITE: Semi anechoic chamber
 TEST DISTANCE: 3 m
 ANTENNA POLARIZATION: Vertical
 CHANNEL BANDWIDTH: 20 MHz

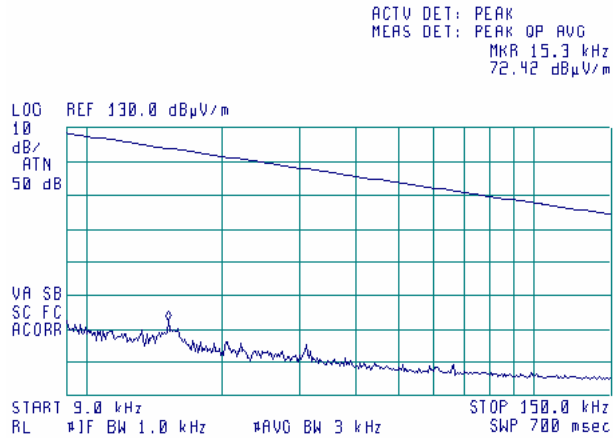



HERMON LABORATORIES

Test specification: Section 15.247(d), RSS-210 section A8.5, Radiated spurious emissions			
Test procedure: FCC New Guidance on Measurements for DTS in section 15.247(c)/ANSI C63.4, Section 13.1.4			
Test mode: Compliance	Verdict: PASS		
Date & Time: 11/12/2008 2:52:30 PM			
Temperature: 21°C	Air Pressure: 1010 hPa	Relative Humidity: 43%	Power Supply: 48 VDC
Remarks: 24 dBi integrated flat antenna			

Plot 7.4.7 Radiated emission measurements from 0.15 to 30 MHz at the low carrier frequency

TEST SITE: Semi anechoic chamber
 TEST DISTANCE: 3 m
 ANTENNA POLARIZATION: Vertical
 CHANNEL BANDWIDTH: 5 MHz

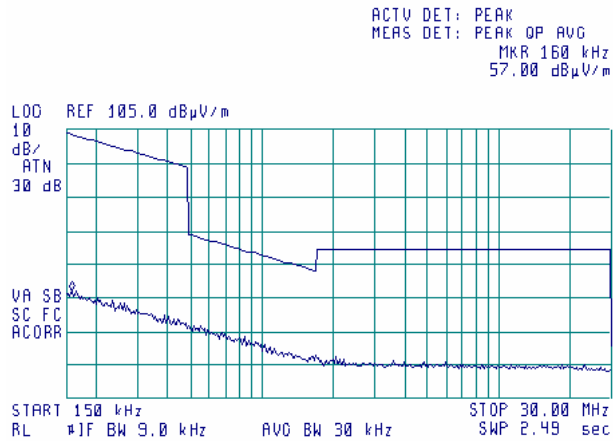

Plot 7.4.8 Radiated emission measurements from 0.15 to 30 MHz at the mid carrier frequency

TEST SITE: Semi anechoic chamber
 TEST DISTANCE: 3 m
 ANTENNA POLARIZATION: Vertical
 CHANNEL BANDWIDTH: 5 MHz

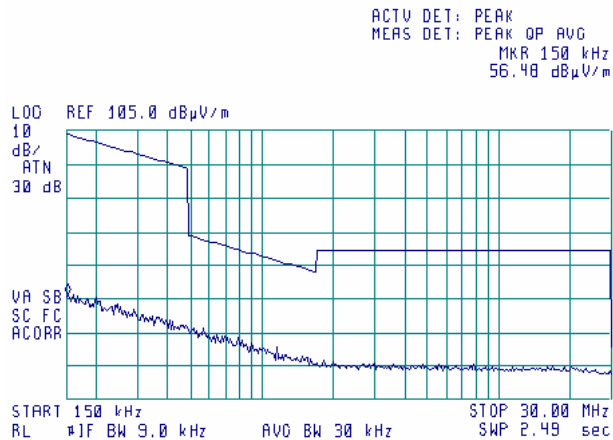



HERMON LABORATORIES

Test specification: Section 15.247(d), RSS-210 section A8.5, Radiated spurious emissions			
Test procedure: FCC New Guidance on Measurements for DTS in section 15.247(c)/ANSI C63.4, Section 13.1.4			
Test mode: Compliance	Verdict: PASS		
Date & Time: 11/12/2008 2:52:30 PM			
Temperature: 21°C	Air Pressure: 1010 hPa	Relative Humidity: 43%	Power Supply: 48 VDC
Remarks: 24 dBi integrated flat antenna			

Plot 7.4.9 Radiated emission measurements from 0.15 to 30 MHz at the high carrier frequency

TEST SITE: Semi anechoic chamber
 TEST DISTANCE: 3 m
 ANTENNA POLARIZATION: Vertical
 CHANNEL BANDWIDTH: 5 MHz

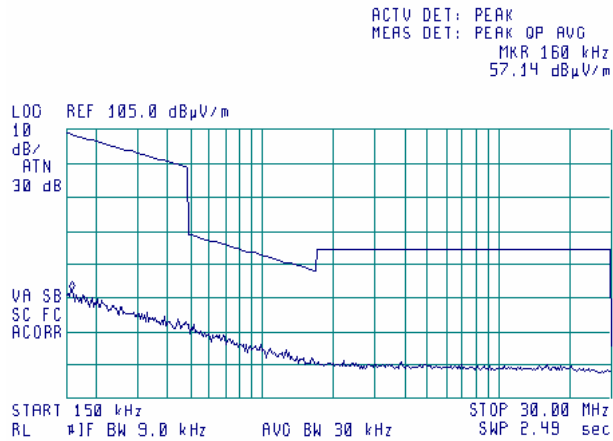

Plot 7.4.10 Radiated emission measurements from 0.15 to 30 MHz at the low carrier frequency

TEST SITE: Semi anechoic chamber
 TEST DISTANCE: 3 m
 ANTENNA POLARIZATION: Vertical
 CHANNEL BANDWIDTH: 20 MHz

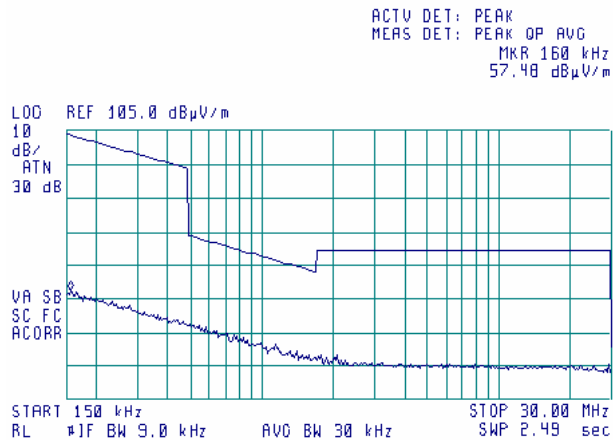



HERMON LABORATORIES

Test specification:	Section 15.247(d), RSS-210 section A8.5, Radiated spurious emissions		
Test procedure:	FCC New Guidance on Measurements for DTS in section 15.247(c)/ANSI C63.4, Section 13.1.4		
Test mode:	Compliance	Verdict:	PASS
Date & Time:	11/12/2008 2:52:30 PM		
Temperature: 21°C	Air Pressure: 1010 hPa	Relative Humidity: 43%	Power Supply: 48 VDC
Remarks: 24 dBi integrated flat antenna			

Plot 7.4.11 Radiated emission measurements from 0.15 to 30 MHz at the mid carrier frequency

TEST SITE: Semi anechoic chamber
 TEST DISTANCE: 3 m
 ANTENNA POLARIZATION: Vertical
 CHANNEL BANDWIDTH: 20 MHz

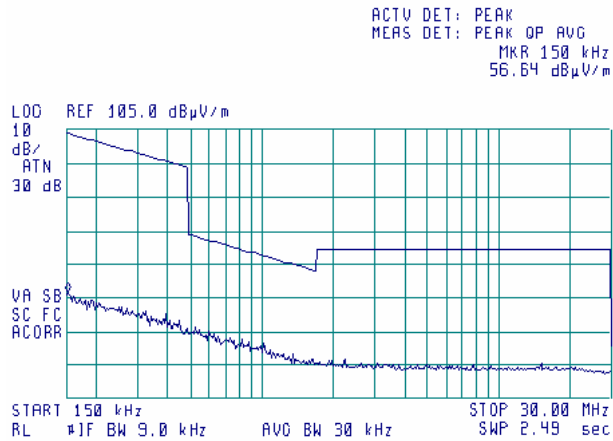

Plot 7.4.12 Radiated emission measurements from 0.15 to 30 MHz at the high carrier frequency

TEST SITE: Semi anechoic chamber
 TEST DISTANCE: 3 m
 ANTENNA POLARIZATION: Vertical
 CHANNEL BANDWIDTH: 20 MHz

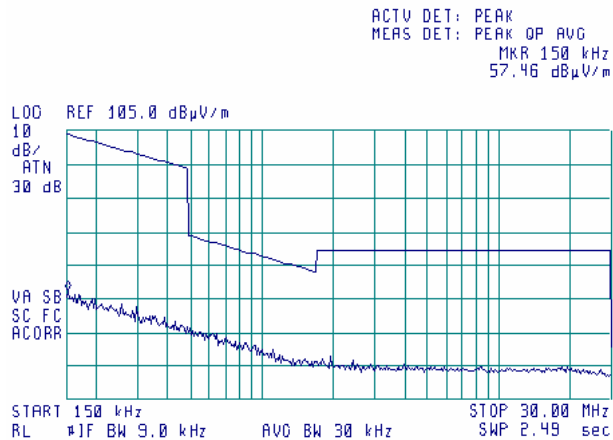



HERMON LABORATORIES

Test specification: Section 15.247(d), RSS-210 section A8.5, Radiated spurious emissions			
Test procedure: FCC New Guidance on Measurements for DTS in section 15.247(c)/ANSI C63.4, Section 13.1.4			
Test mode: Compliance	Verdict: PASS		
Date & Time: 11/12/2008 2:52:30 PM			
Temperature: 21°C	Air Pressure: 1010 hPa	Relative Humidity: 43%	Power Supply: 48 VDC
Remarks: 24 dBi integrated flat antenna			

Plot 7.4.13 Radiated emission measurements from 30 to 1000 MHz at the low carrier frequency

TEST SITE: Semi anechoic chamber
 TEST DISTANCE: 3 m
 ANTENNA POLARIZATION: Vertical
 CHANNEL BANDWIDTH: 5 MHz

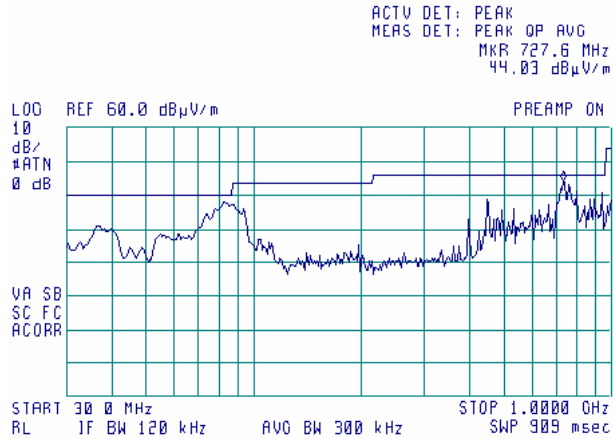

Plot 7.4.14 Radiated emission measurements from 30 to 1000 MHz at the mid carrier frequency

TEST SITE: Semi anechoic chamber
 TEST DISTANCE: 3 m
 ANTENNA POLARIZATION: Vertical
 CHANNEL BANDWIDTH: 5 MHz

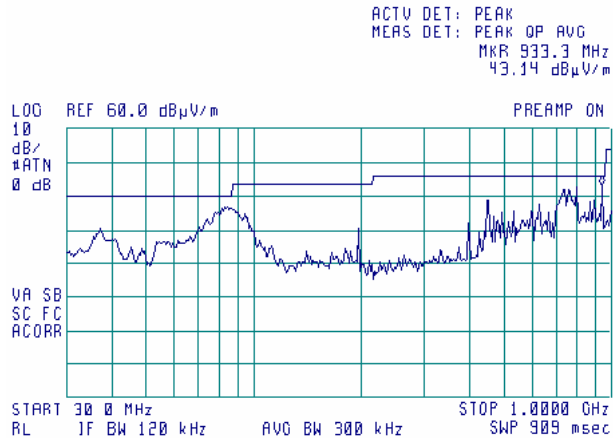



HERMON LABORATORIES

Test specification: Section 15.247(d), RSS-210 section A8.5, Radiated spurious emissions			
Test procedure: FCC New Guidance on Measurements for DTS in section 15.247(c)/ANSI C63.4, Section 13.1.4			
Test mode: Compliance	Verdict: PASS		
Date & Time: 11/12/2008 2:52:30 PM			
Temperature: 21°C	Air Pressure: 1010 hPa	Relative Humidity: 43%	Power Supply: 48 VDC
Remarks: 24 dBi integrated flat antenna			

Plot 7.4.15 Radiated emission measurements from 30 to 1000 MHz at the high carrier frequency

TEST SITE: Semi anechoic chamber
 TEST DISTANCE: 3 m
 ANTENNA POLARIZATION: Vertical
 CHANNEL BANDWIDTH: 5 MHz

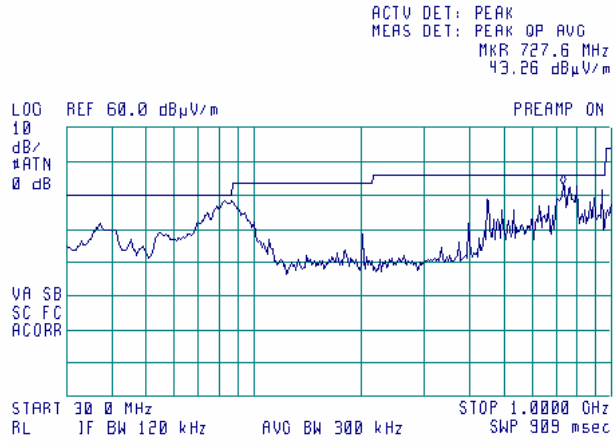

Plot 7.4.16 Radiated emission measurements from 30 to 1000 MHz at the low carrier frequency

TEST SITE: Semi anechoic chamber
 TEST DISTANCE: 3 m
 ANTENNA POLARIZATION: Vertical
 CHANNEL BANDWIDTH: 20 MHz

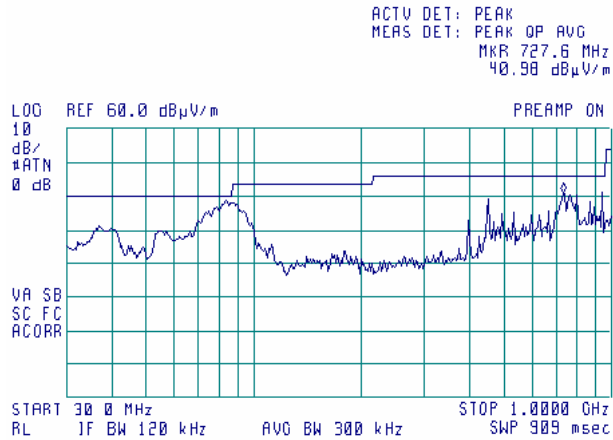



HERMON LABORATORIES

Test specification: Section 15.247(d), RSS-210 section A8.5, Radiated spurious emissions			
Test procedure: FCC New Guidance on Measurements for DTS in section 15.247(c)/ANSI C63.4, Section 13.1.4			
Test mode: Compliance	Verdict: PASS		
Date & Time: 11/12/2008 2:52:30 PM			
Temperature: 21°C	Air Pressure: 1010 hPa	Relative Humidity: 43%	Power Supply: 48 VDC
Remarks: 24 dBi integrated flat antenna			

Plot 7.4.17 Radiated emission measurements from 30 to 1000 MHz at the mid carrier frequency

TEST SITE: Semi anechoic chamber
 TEST DISTANCE: 3 m
 ANTENNA POLARIZATION: Vertical
 CHANNEL BANDWIDTH: 20 MHz

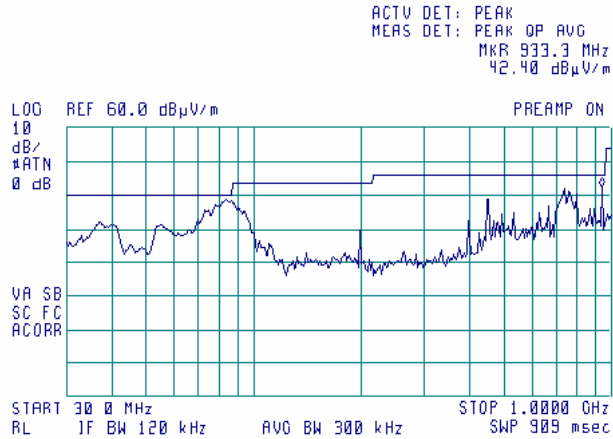

Plot 7.4.18 Radiated emission measurements from 30 to 1000 MHz at the high carrier frequency

TEST SITE: Semi anechoic chamber
 TEST DISTANCE: 3 m
 ANTENNA POLARIZATION: Vertical
 CHANNEL BANDWIDTH: 20 MHz

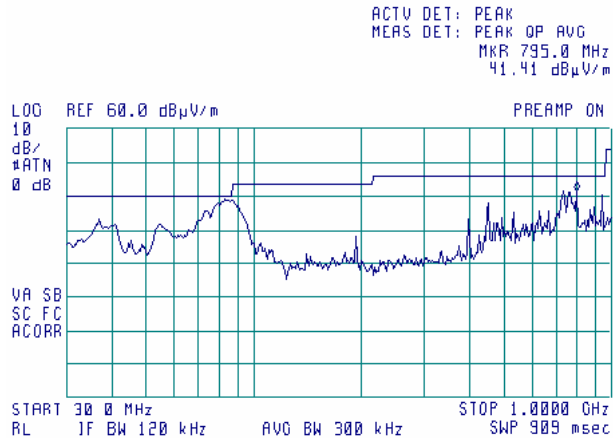



HERMON LABORATORIES

Test specification: Section 15.247(d), RSS-210 section A8.5, Radiated spurious emissions			
Test procedure: FCC New Guidance on Measurements for DTS in section 15.247(c)/ANSI C63.4, Section 13.1.4			
Test mode: Compliance	Verdict: PASS		
Date & Time: 11/12/2008 2:52:30 PM			
Temperature: 21°C	Air Pressure: 1010 hPa	Relative Humidity: 43%	Power Supply: 48 VDC
Remarks: 24 dBi integrated flat antenna			

Plot 7.4.19 Radiated emission measurements from 1000 to 2900 MHz at the low carrier frequency

TEST SITE: Semi anechoic chamber
 TEST DISTANCE: 3 m
 ANTENNA POLARIZATION: Vertical
 CHANNEL BANDWIDTH: 5 MHz

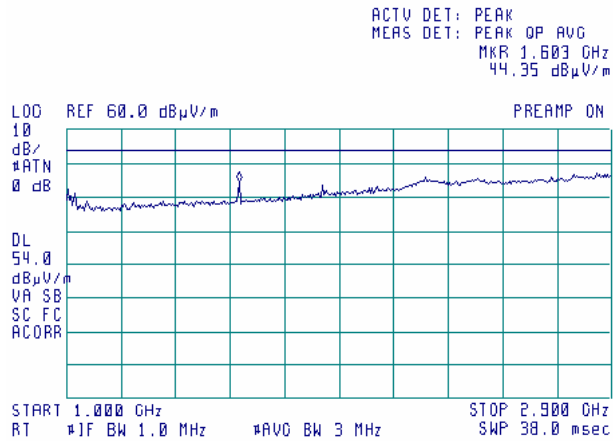

Plot 7.4.20 Radiated emission measurements from 1000 to 2900 MHz at the mid carrier frequency

TEST SITE: Semi anechoic chamber
 TEST DISTANCE: 3 m
 ANTENNA POLARIZATION: Vertical
 CHANNEL BANDWIDTH: 5 MHz

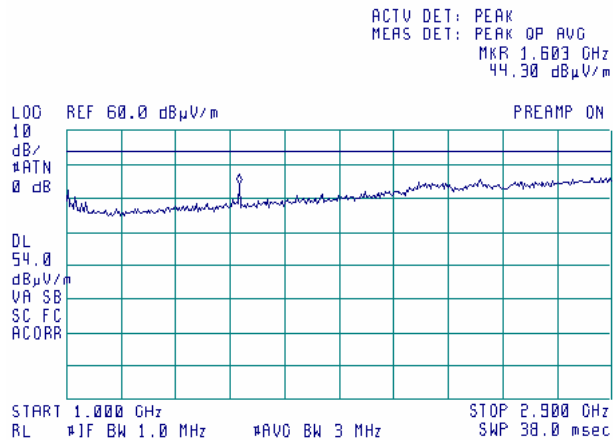



HERMON LABORATORIES

Test specification: Section 15.247(d), RSS-210 section A8.5, Radiated spurious emissions			
Test procedure: FCC New Guidance on Measurements for DTS in section 15.247(c)/ANSI C63.4, Section 13.1.4			
Test mode: Compliance	Verdict: PASS		
Date & Time: 11/12/2008 2:52:30 PM			
Temperature: 21°C	Air Pressure: 1010 hPa	Relative Humidity: 43%	Power Supply: 48 VDC
Remarks: 24 dBi integrated flat antenna			

Plot 7.4.21 Radiated emission measurements from 1000 to 2900 MHz at the high carrier frequency

TEST SITE: Semi anechoic chamber
 TEST DISTANCE: 3 m
 ANTENNA POLARIZATION: Vertical
 CHANNEL BANDWIDTH: 5 MHz

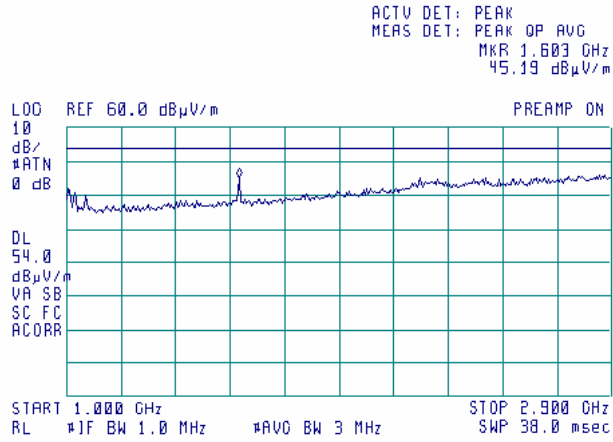

Plot 7.4.22 Radiated emission measurements from 1000 to 2900 MHz at the low carrier frequency

TEST SITE: Semi anechoic chamber
 TEST DISTANCE: 3 m
 ANTENNA POLARIZATION: Vertical
 CHANNEL BANDWIDTH: 20 MHz

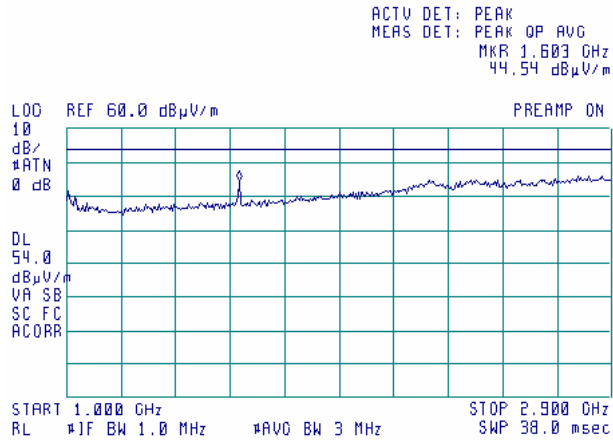



HERMON LABORATORIES

Test specification: Section 15.247(d), RSS-210 section A8.5, Radiated spurious emissions			
Test procedure: FCC New Guidance on Measurements for DTS in section 15.247(c)/ANSI C63.4, Section 13.1.4			
Test mode: Compliance	Verdict: PASS		
Date & Time: 11/12/2008 2:52:30 PM			
Temperature: 21°C	Air Pressure: 1010 hPa	Relative Humidity: 43%	Power Supply: 48 VDC
Remarks: 24 dBi integrated flat antenna			

Plot 7.4.23 Radiated emission measurements from 1000 to 2900 MHz at the mid carrier frequency

TEST SITE: Semi anechoic chamber
 TEST DISTANCE: 3 m
 ANTENNA POLARIZATION: Vertical
 CHANNEL BANDWIDTH: 20 MHz

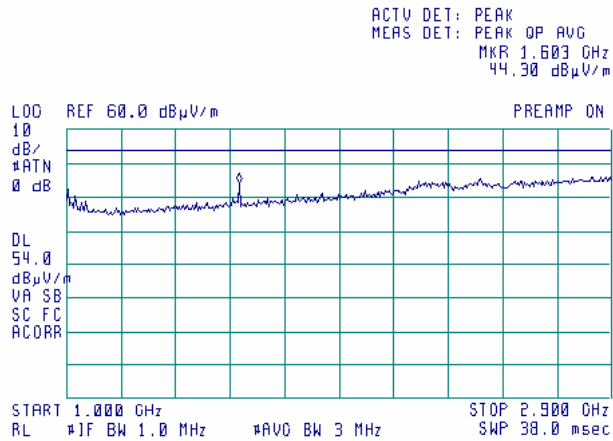

Plot 7.4.24 Radiated emission measurements from 1000 to 2900 MHz at the high carrier frequency

TEST SITE: Semi anechoic chamber
 TEST DISTANCE: 3 m
 ANTENNA POLARIZATION: Vertical
 CHANNEL BANDWIDTH: 20 MHz

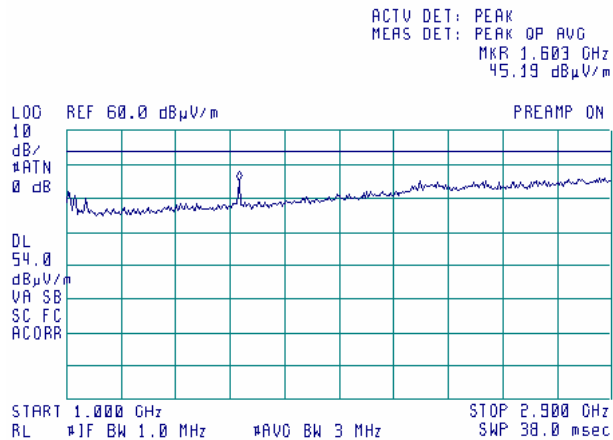



HERMON LABORATORIES

Test specification: Section 15.247(d), RSS-210 section A8.5, Radiated spurious emissions			
Test procedure: FCC New Guidance on Measurements for DTS in section 15.247(c)/ANSI C63.4, Section 13.1.4			
Test mode: Compliance	Verdict: PASS		
Date & Time: 11/12/2008 2:52:30 PM			
Temperature: 21°C	Air Pressure: 1010 hPa	Relative Humidity: 43%	Power Supply: 48 VDC
Remarks: 24 dBi integrated flat antenna			

Plot 7.4.25 Radiated emission measurements from 2900 to 8000 MHz at the low carrier frequency

TEST SITE: Semi anechoic chamber
 TEST DISTANCE: 3 m
 ANTENNA POLARIZATION: Vertical
 CHANNEL BANDWIDTH: 5 MHz
 DETECTOR: Peak

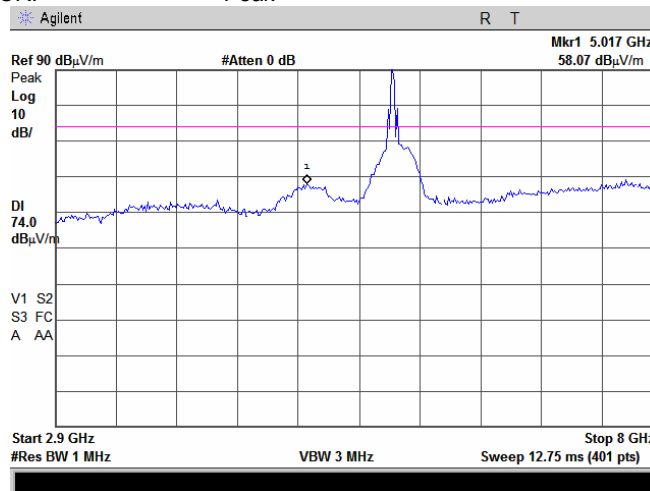

Plot 7.4.26 Radiated emission measurements from 2900 to 8000 MHz at the low carrier frequency

TEST SITE: Semi anechoic chamber
 TEST DISTANCE: 3 m
 ANTENNA POLARIZATION: Vertical
 CHANNEL BANDWIDTH: 5 MHz
 DETECTOR: Average

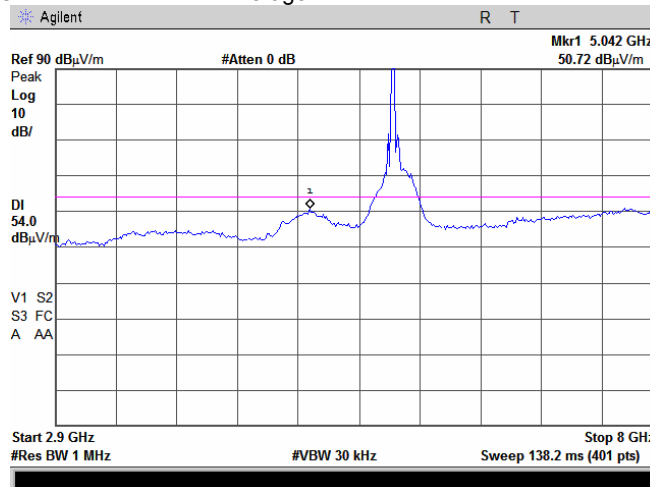



HERMON LABORATORIES

Test specification: Section 15.247(d), RSS-210 section A8.5, Radiated spurious emissions			
Test procedure: FCC New Guidance on Measurements for DTS in section 15.247(c)/ANSI C63.4, Section 13.1.4			
Test mode: Compliance	Verdict: PASS		
Date & Time: 11/12/2008 2:52:30 PM			
Temperature: 21°C	Air Pressure: 1010 hPa	Relative Humidity: 43%	Power Supply: 48 VDC
Remarks: 24 dBi integrated flat antenna			

Plot 7.4.27 Radiated emission measurements from 2900 to 8000 MHz at the mid carrier frequency

TEST SITE: Semi anechoic chamber
TEST DISTANCE: 3 m
ANTENNA POLARIZATION: Vertical
CHANNEL BANDWIDTH: 5 MHz
DETECTOR: Peak

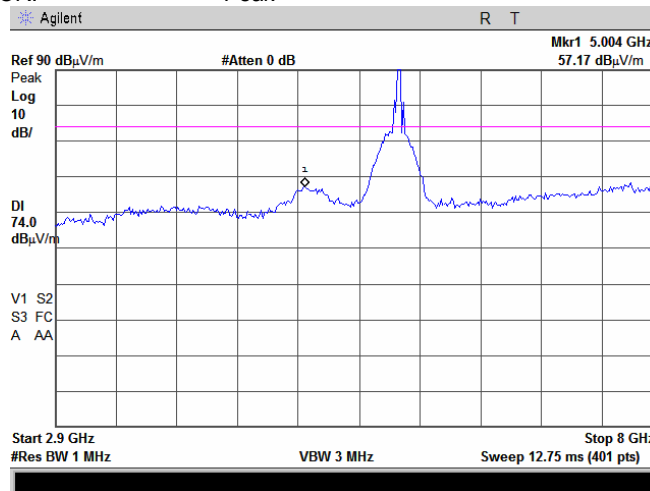

Plot 7.4.28 Radiated emission measurements from 2900 to 8000 MHz at the mid carrier frequency

TEST SITE: Semi anechoic chamber
TEST DISTANCE: 3 m
ANTENNA POLARIZATION: Vertical
CHANNEL BANDWIDTH: 5 MHz
DETECTOR: Average

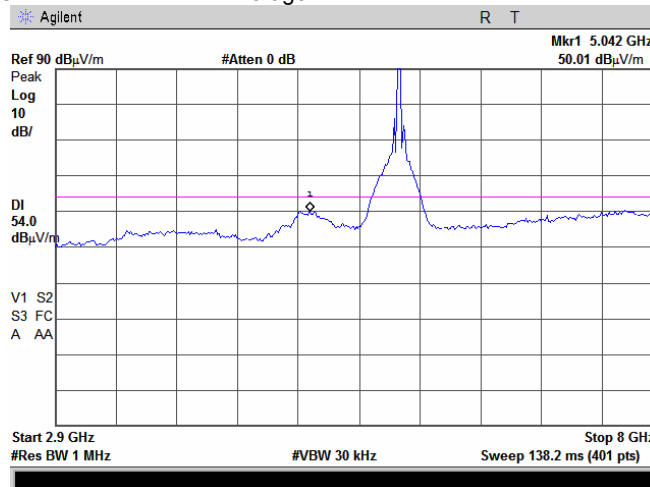



HERMON LABORATORIES

Test specification: Section 15.247(d), RSS-210 section A8.5, Radiated spurious emissions			
Test procedure: FCC New Guidance on Measurements for DTS in section 15.247(c)/ANSI C63.4, Section 13.1.4			
Test mode: Compliance	Verdict: PASS		
Date & Time: 11/12/2008 2:52:30 PM			
Temperature: 21°C	Air Pressure: 1010 hPa	Relative Humidity: 43%	Power Supply: 48 VDC
Remarks: 24 dBi integrated flat antenna			

Plot 7.4.29 Radiated emission measurements from 2900 to 8000 MHz at the high carrier frequency

TEST SITE: Semi anechoic chamber
 TEST DISTANCE: 3 m
 ANTENNA POLARIZATION: Vertical
 CHANNEL BANDWIDTH: 5 MHz
 DETECTOR: Peak

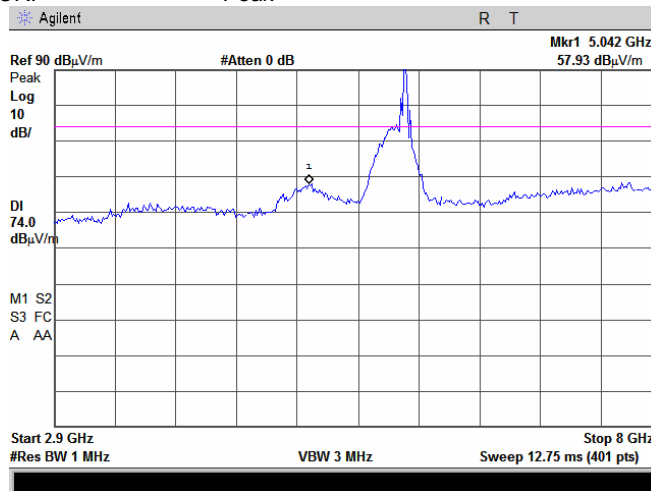

Plot 7.4.30 Radiated emission measurements from 2900 to 8000 MHz at the high carrier frequency

TEST SITE: Semi anechoic chamber
 TEST DISTANCE: 3 m
 ANTENNA POLARIZATION: Vertical
 CHANNEL BANDWIDTH: 5 MHz
 DETECTOR: Average

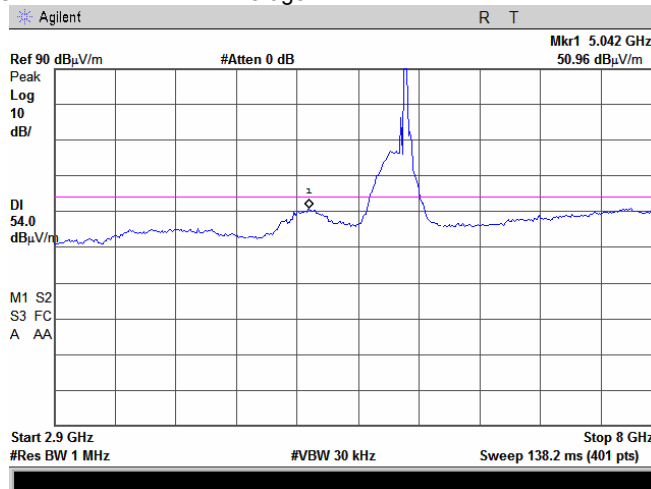



HERMON LABORATORIES

Test specification: Section 15.247(d), RSS-210 section A8.5, Radiated spurious emissions			
Test procedure: FCC New Guidance on Measurements for DTS in section 15.247(c)/ANSI C63.4, Section 13.1.4			
Test mode: Compliance	Verdict: PASS		
Date & Time: 11/12/2008 2:52:30 PM			
Temperature: 21°C	Air Pressure: 1010 hPa	Relative Humidity: 43%	Power Supply: 48 VDC
Remarks: 24 dBi integrated flat antenna			

Plot 7.4.31 Radiated emission measurements from 2900 to 8000 MHz at the low carrier frequency

TEST SITE: Semi anechoic chamber
TEST DISTANCE: 3 m
ANTENNA POLARIZATION: Vertical
CHANNEL BANDWIDTH: 20 MHz
DETECTOR: Peak

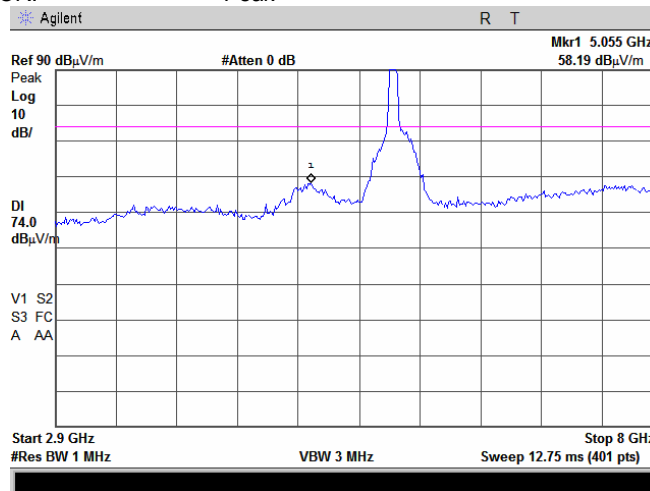

Plot 7.4.32 Radiated emission measurements from 2900 to 8000 MHz at the low carrier frequency

TEST SITE: Semi anechoic chamber
TEST DISTANCE: 3 m
ANTENNA POLARIZATION: Vertical
CHANNEL BANDWIDTH: 20 MHz
DETECTOR: Average

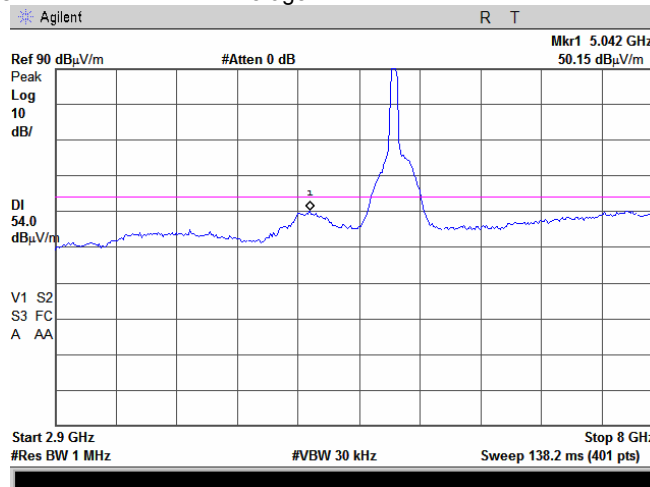



HERMON LABORATORIES

Test specification: Section 15.247(d), RSS-210 section A8.5, Radiated spurious emissions			
Test procedure: FCC New Guidance on Measurements for DTS in section 15.247(c)/ANSI C63.4, Section 13.1.4			
Test mode: Compliance	Verdict: PASS		
Date & Time: 11/12/2008 2:52:30 PM			
Temperature: 21°C	Air Pressure: 1010 hPa	Relative Humidity: 43%	Power Supply: 48 VDC
Remarks: 24 dBi integrated flat antenna			

Plot 7.4.33 Radiated emission measurements from 2900 to 8000 MHz at the mid carrier frequency

TEST SITE: Semi anechoic chamber
TEST DISTANCE: 3 m
ANTENNA POLARIZATION: Vertical
CHANNEL BANDWIDTH: 20 MHz
DETECTOR: Peak

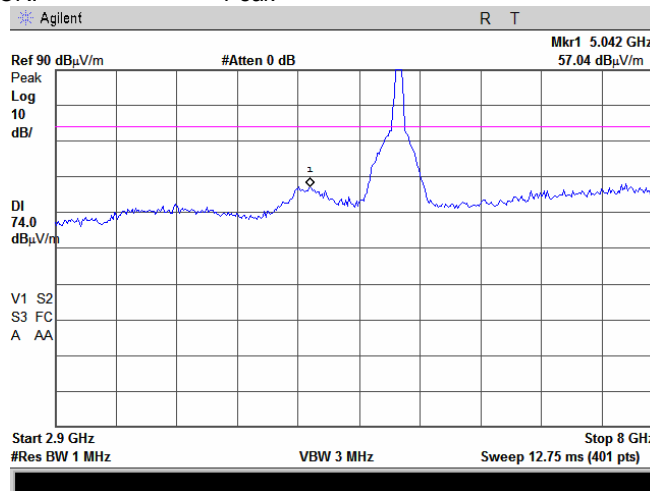

Plot 7.4.34 Radiated emission measurements from 2900 to 8000 MHz at the mid carrier frequency

TEST SITE: Semi anechoic chamber
TEST DISTANCE: 3 m
ANTENNA POLARIZATION: Vertical
CHANNEL BANDWIDTH: 20 MHz
DETECTOR: Average

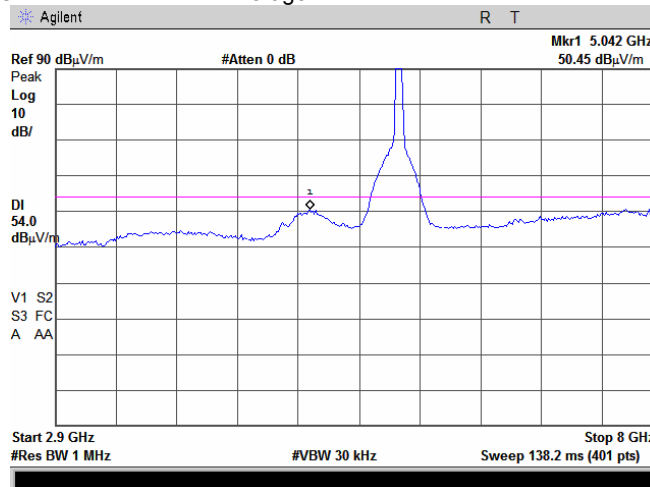



HERMON LABORATORIES

Test specification: Section 15.247(d), RSS-210 section A8.5, Radiated spurious emissions			
Test procedure: FCC New Guidance on Measurements for DTS in section 15.247(c)/ANSI C63.4, Section 13.1.4			
Test mode: Compliance	Verdict: PASS		
Date & Time: 11/12/2008 2:52:30 PM			
Temperature: 21°C	Air Pressure: 1010 hPa	Relative Humidity: 43%	Power Supply: 48 VDC
Remarks: 24 dBi integrated flat antenna			

Plot 7.4.35 Radiated emission measurements from 2900 to 8000 MHz at the high carrier frequency

TEST SITE: Semi anechoic chamber
TEST DISTANCE: 3 m
ANTENNA POLARIZATION: Vertical
CHANNEL BANDWIDTH: 20 MHz
DETECTOR: Peak

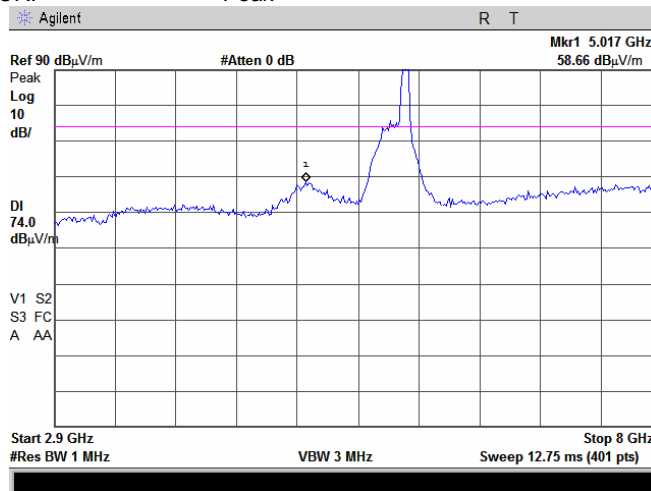

Plot 7.4.36 Radiated emission measurements from 2900 to 8000 MHz at the high carrier frequency

TEST SITE: Semi anechoic chamber
TEST DISTANCE: 3 m
ANTENNA POLARIZATION: Vertical
CHANNEL BANDWIDTH: 20 MHz
DETECTOR: Average

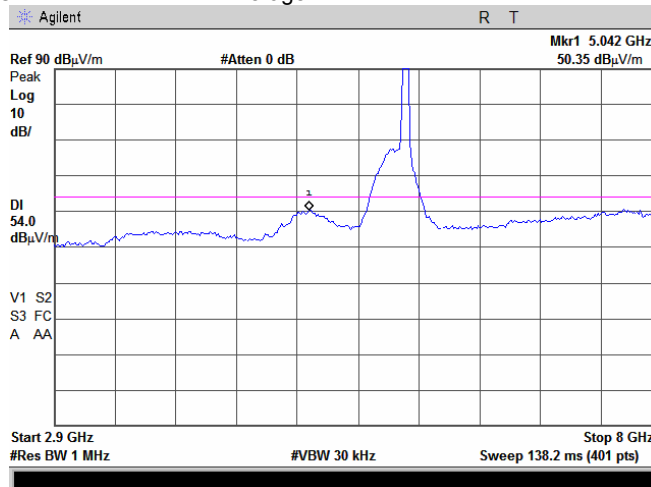



HERMON LABORATORIES

Test specification: Section 15.247(d), RSS-210 section A8.5, Radiated spurious emissions			
Test procedure: FCC New Guidance on Measurements for DTS in section 15.247(c)/ANSI C63.4, Section 13.1.4			
Test mode: Compliance	Verdict: PASS		
Date & Time: 11/12/2008 2:52:30 PM			
Temperature: 21°C	Air Pressure: 1010 hPa	Relative Humidity: 43%	Power Supply: 48 VDC
Remarks: 24 dBi integrated flat antenna			

Plot 7.4.37 Radiated emission measurements from 8.0 to 14.0 GHz at the low carrier frequency

TEST SITE: OATS
 TEST DISTANCE: 3 m
 ANTENNA POLARIZATION: Vertical and Horizontal
 CHANNEL BANDWIDTH: 20 MHz
 DETECTOR: Peak

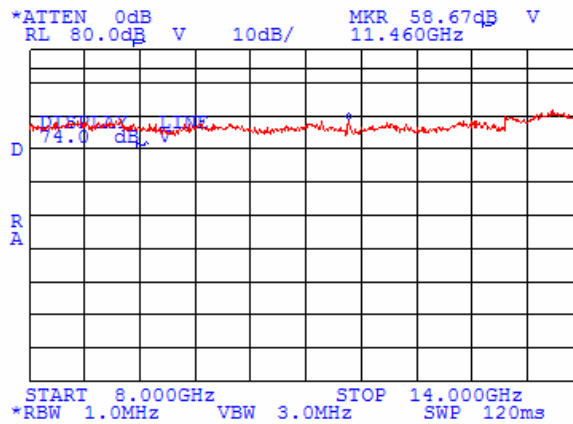

Plot 7.4.38 Radiated emission measurements from 8.0 to 14.0 GHz at the low carrier frequency

TEST SITE: OATS
 TEST DISTANCE: 3 m
 ANTENNA POLARIZATION: Vertical and Horizontal
 CHANNEL BANDWIDTH: 20 MHz
 DETECTOR: Average

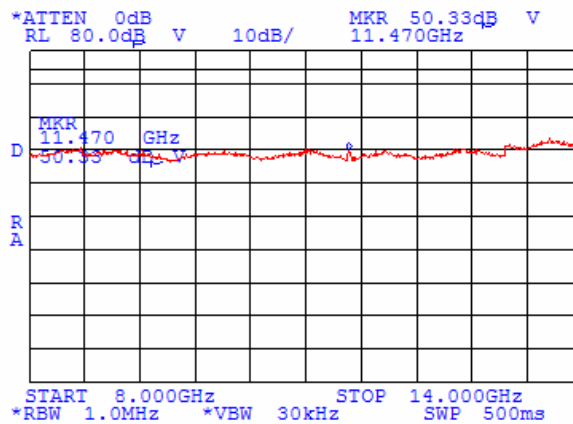



HERMON LABORATORIES

Test specification:		Section 15.247(d), RSS-210 section A8.5, Radiated spurious emissions	
Test procedure:		FCC New Guidance on Measurements for DTS in section 15.247(c)/ANSI C63.4, Section 13.1.4	
Test mode:	Compliance	Verdict:	PASS
Date & Time:	11/12/2008 2:52:30 PM		
Temperature: 21°C	Air Pressure: 1010 hPa	Relative Humidity: 43%	Power Supply: 48 VDC
Remarks: 24 dBi integrated flat antenna			

Plot 7.4.39 Radiated emission measurements from 8.0 to 14.0 GHz at the mid carrier frequency

TEST SITE: OATS
 TEST DISTANCE: 3 m
 ANTENNA POLARIZATION: Vertical and Horizontal
 CHANNEL BANDWIDTH: 20 MHz
 DETECTOR: Peak

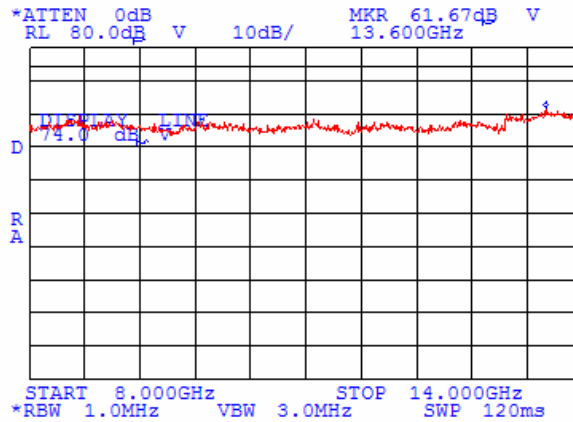

Plot 7.4.40 Radiated emission measurements from 8.0 to 14.0 GHz at the mid carrier frequency

TEST SITE: OATS
 TEST DISTANCE: 3 m
 ANTENNA POLARIZATION: Vertical and Horizontal
 CHANNEL BANDWIDTH: 20 MHz
 DETECTOR: Average

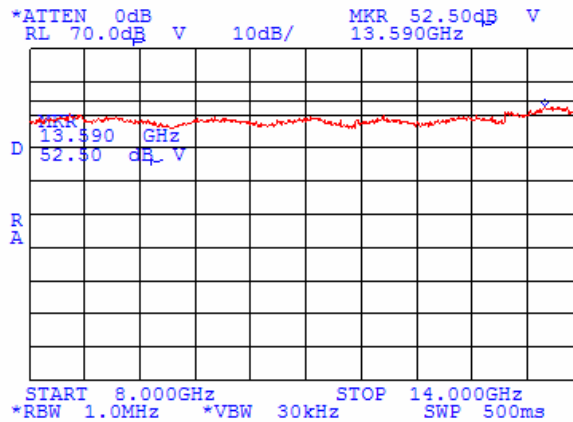



Test specification:	Section 15.247(d), RSS-210 section A8.5, Radiated spurious emissions		
Test procedure:	FCC New Guidance on Measurements for DTS in section 15.247(c)/ANSI C63.4, Section 13.1.4		
Test mode:	Compliance	Verdict: PASS	
Date & Time:	11/12/2008 2:52:30 PM		
Temperature: 21°C	Air Pressure: 1010 hPa	Relative Humidity: 43%	Power Supply: 48 VDC
Remarks: 24 dBi integrated flat antenna			

Plot 7.4.41 Radiated emission measurements from 8.0 to 14.0 GHz at the high carrier frequency

TEST SITE: OATS
 TEST DISTANCE: 3 m
 ANTENNA POLARIZATION: Vertical and Horizontal
 CHANNEL BANDWIDTH: 20 MHz
 DETECTOR: Peak

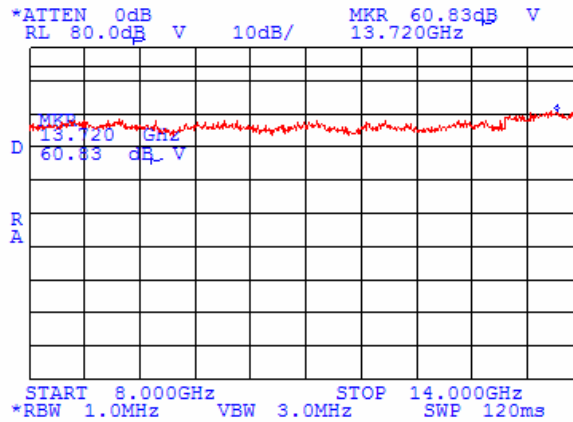

Plot 7.4.42 Radiated emission measurements from 8.0 to 14.0 GHz at the high carrier frequency

TEST SITE: OATS
 TEST DISTANCE: 3 m
 ANTENNA POLARIZATION: Vertical and Horizontal
 CHANNEL BANDWIDTH: 20 MHz
 DETECTOR: Average

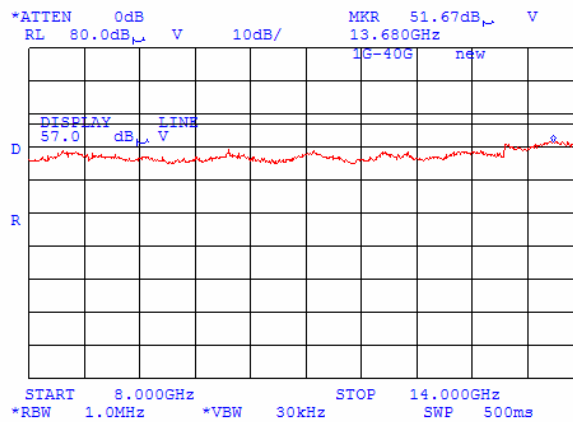

NOTE: the specified limit is 54 dBuV/m



HERMON LABORATORIES

Test specification:	Section 15.247(d), RSS-210 section A8.5, Radiated spurious emissions		
Test procedure:	FCC New Guidance on Measurements for DTS in section 15.247(c)/ANSI C63.4, Section 13.1.4		
Test mode:	Compliance	Verdict:	PASS
Date & Time:	11/12/2008 2:52:30 PM		
Temperature: 21°C	Air Pressure: 1010 hPa	Relative Humidity: 43%	Power Supply: 48 VDC
Remarks: 24 dBi integrated flat antenna			

Plot 7.4.43 Radiated emission measurements from 8.0 to 14.0 GHz at the low carrier frequency

TEST SITE: OATS
 TEST DISTANCE: 3 m
 ANTENNA POLARIZATION: Vertical and Horizontal
 CHANNEL BANDWIDTH: 5 MHz
 DETECTOR: Peak

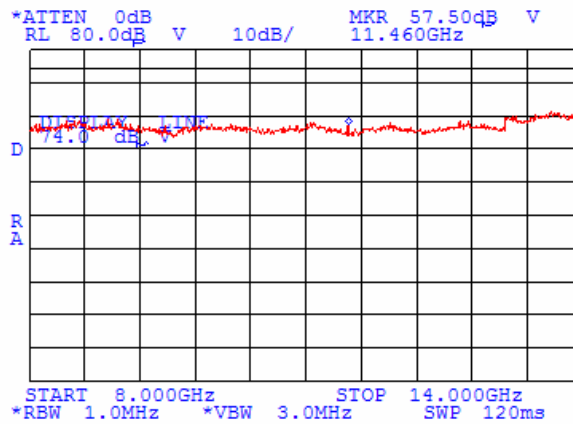

Plot 7.4.44 Radiated emission measurements from 8.0 to 14.0 GHz at the low carrier frequency

TEST SITE: OATS
 TEST DISTANCE: 3 m
 ANTENNA POLARIZATION: Vertical and Horizontal
 CHANNEL BANDWIDTH: 5 MHz
 DETECTOR: Average

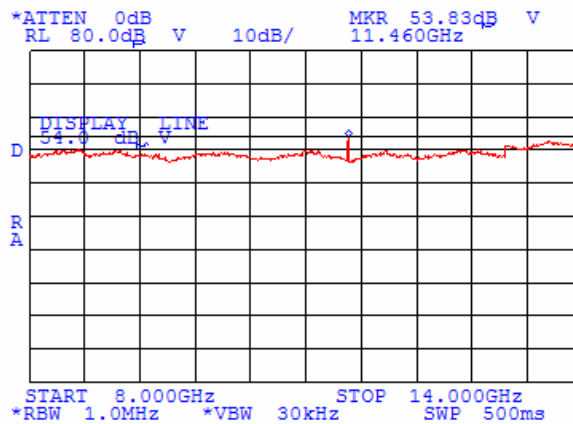



HERMON LABORATORIES

Test specification:	Section 15.247(d), RSS-210 section A8.5, Radiated spurious emissions		
Test procedure:	FCC New Guidance on Measurements for DTS in section 15.247(c)/ANSI C63.4, Section 13.1.4		
Test mode:	Compliance	Verdict:	PASS
Date & Time:	11/12/2008 2:52:30 PM		
Temperature: 21°C	Air Pressure: 1010 hPa	Relative Humidity: 43%	Power Supply: 48 VDC
Remarks: 24 dBi integrated flat antenna			

Plot 7.4.45 Radiated emission measurements from 8.0 to 14.0 GHz at the mid carrier frequency

TEST SITE: OATS
 TEST DISTANCE: 3 m
 ANTENNA POLARIZATION: Vertical and Horizontal
 CHANNEL BANDWIDTH: 5 MHz
 DETECTOR: Peak

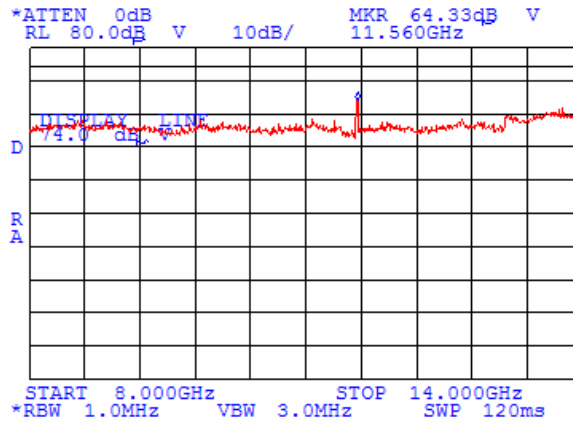

Plot 7.4.46 Radiated emission measurements from 8.0 to 14.0 GHz at the mid carrier frequency

TEST SITE: OATS
 TEST DISTANCE: 3 m
 ANTENNA POLARIZATION: Vertical and Horizontal
 CHANNEL BANDWIDTH: 5 MHz
 DETECTOR: Average

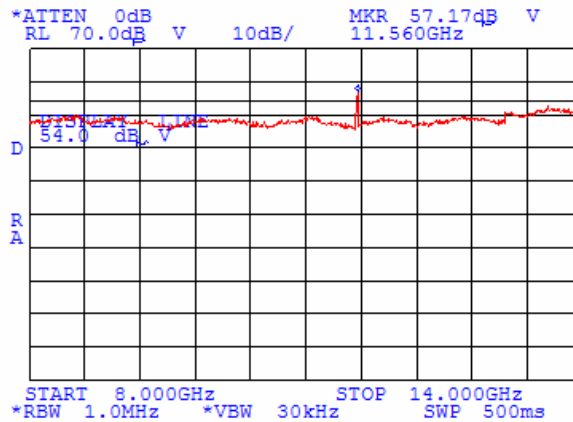



HERMON LABORATORIES

Test specification: Section 15.247(d), RSS-210 section A8.5, Radiated spurious emissions			
Test procedure: FCC New Guidance on Measurements for DTS in section 15.247(c)/ANSI C63.4, Section 13.1.4			
Test mode: Compliance	Verdict: PASS		
Date & Time: 11/12/2008 2:52:30 PM			
Temperature: 21°C	Air Pressure: 1010 hPa	Relative Humidity: 43%	Power Supply: 48 VDC
Remarks: 24 dBi integrated flat antenna			

Plot 7.4.47 Radiated emission measurements from 8.0 to 14.0 GHz at the high carrier frequency

TEST SITE: OATS
 TEST DISTANCE: 3 m
 ANTENNA POLARIZATION: Vertical and Horizontal
 CHANNEL BANDWIDTH: 5 MHz
 DETECTOR: Peak

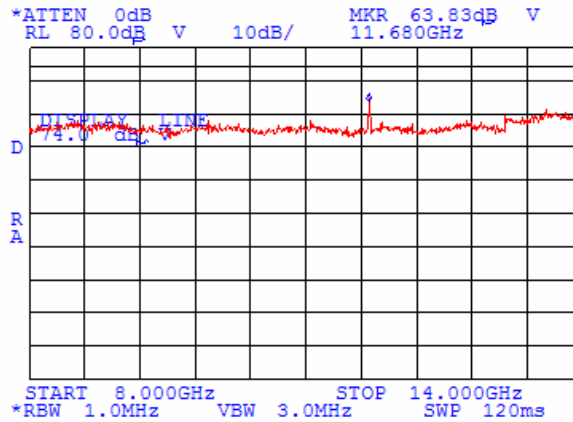

Plot 7.4.48 Radiated emission measurements from 8.0 to 14.0 GHz at the high carrier frequency

TEST SITE: OATS
 TEST DISTANCE: 3 m
 ANTENNA POLARIZATION: Vertical and Horizontal
 CHANNEL BANDWIDTH: 5 MHz
 DETECTOR: Average

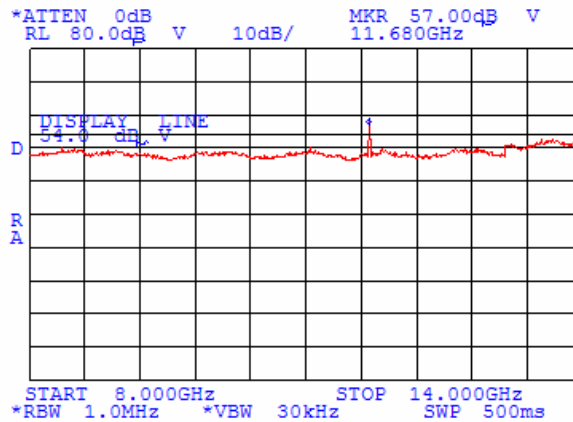



HERMON LABORATORIES

Test specification: Section 15.247(d), RSS-210 section A8.5, Radiated spurious emissions			
Test procedure: FCC New Guidance on Measurements for DTS in section 15.247(c)/ANSI C63.4, Section 13.1.4			
Test mode: Compliance	Verdict: PASS		
Date & Time: 11/12/2008 2:52:30 PM			
Temperature: 21°C	Air Pressure: 1010 hPa	Relative Humidity: 43%	Power Supply: 48 VDC
Remarks: 24 dBi integrated flat antenna			

Plot 7.4.49 Radiated emission measurements from 14 to 18 GHz at the low carrier frequency

TEST SITE: OATS
 TEST DISTANCE: 3 m
 ANTENNA POLARIZATION: Vertical and Horizontal
 CBW: 20 MHz
 DETECTOR: Peak

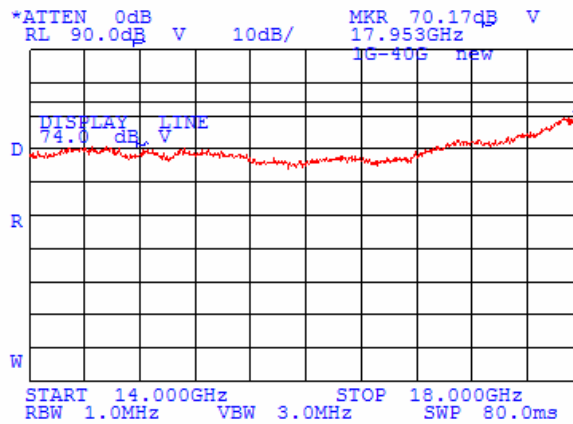

Plot 7.4.50 Radiated emission measurements from 14 to 18 GHz at the low carrier frequency

TEST SITE: OATS
 TEST DISTANCE: 3 m
 ANTENNA POLARIZATION: Vertical and Horizontal
 CBW: 20 MHz
 DETECTOR: Average

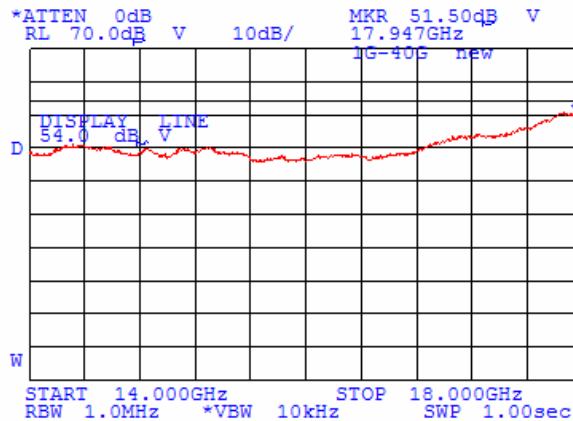



HERMON LABORATORIES

Test specification:	Section 15.247(d), RSS-210 section A8.5, Radiated spurious emissions		
Test procedure:	FCC New Guidance on Measurements for DTS in section 15.247(c)/ANSI C63.4, Section 13.1.4		
Test mode:	Compliance	Verdict:	PASS
Date & Time:	11/12/2008 2:52:30 PM		
Temperature: 21°C	Air Pressure: 1010 hPa	Relative Humidity: 43%	Power Supply: 48 VDC
Remarks: 24 dBi integrated flat antenna			

Plot 7.4.51 Radiated emission measurements from 14 to 18 GHz at the mid carrier frequency

TEST SITE: OATS
 TEST DISTANCE: 3 m
 ANTENNA POLARIZATION: Vertical and Horizontal
 CBW: 20 MHz
 DETECTOR: Peak

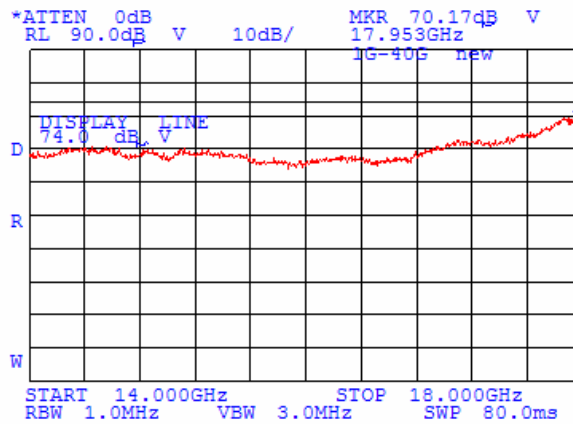

Plot 7.4.52 Radiated emission measurements from 14 to 18 GHz at the mid carrier frequency

TEST SITE: OATS
 TEST DISTANCE: 3 m
 ANTENNA POLARIZATION: Vertical and Horizontal
 CBW: 20 MHz
 DETECTOR: Average

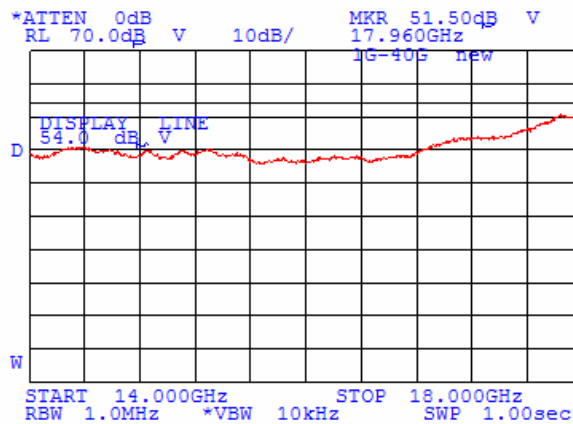



Test specification: Section 15.247(d), RSS-210 section A8.5, Radiated spurious emissions			
Test procedure: FCC New Guidance on Measurements for DTS in section 15.247(c)/ANSI C63.4, Section 13.1.4			
Test mode: Compliance	Verdict: PASS		
Date & Time: 11/12/2008 2:52:30 PM			
Temperature: 21°C	Air Pressure: 1010 hPa	Relative Humidity: 43%	Power Supply: 48 VDC
Remarks: 24 dBi integrated flat antenna			

Plot 7.4.53 Radiated emission measurements from 14 to 18 GHz at the high carrier frequency

TEST SITE: OATS
 TEST DISTANCE: 3 m
 ANTENNA POLARIZATION: Vertical and Horizontal
 CBW 20 MHz
 DETECTOR: Peak

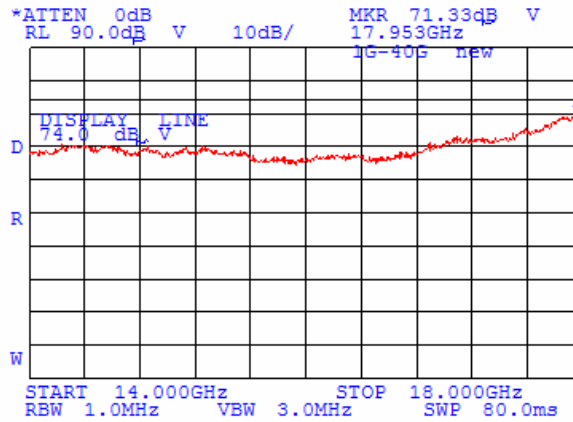

Plot 7.4.54 Radiated emission measurements from 14 to 18 GHz at the high carrier frequency

TEST SITE: OATS
 TEST DISTANCE: 3 m
 ANTENNA POLARIZATION: Vertical and Horizontal
 CBW 20 MHz
 DETECTOR: Average

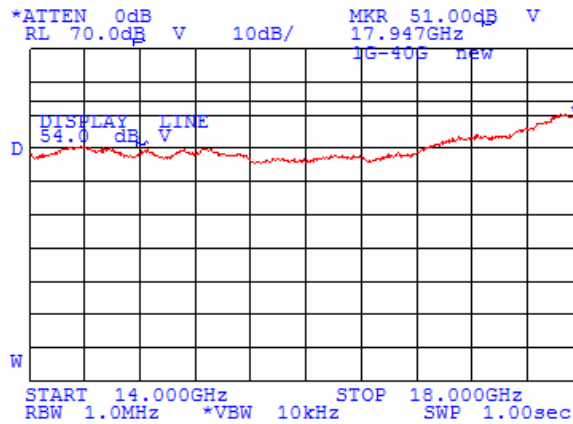



Test specification: Section 15.247(d), RSS-210 section A8.5, Radiated spurious emissions			
Test procedure: FCC New Guidance on Measurements for DTS in section 15.247(c)/ANSI C63.4, Section 13.1.4			
Test mode: Compliance	Verdict: PASS		
Date & Time: 11/12/2008 2:52:30 PM			
Temperature: 21°C	Air Pressure: 1010 hPa	Relative Humidity: 43%	Power Supply: 48 VDC
Remarks: 24 dBi integrated flat antenna			

Plot 7.4.55 Radiated emission measurements from 14 to 18 GHz at the low carrier frequency

TEST SITE: OATS
 TEST DISTANCE: 3 m
 ANTENNA POLARIZATION: Vertical and Horizontal
 CBW: 5 MHz
 DETECTOR: Peak

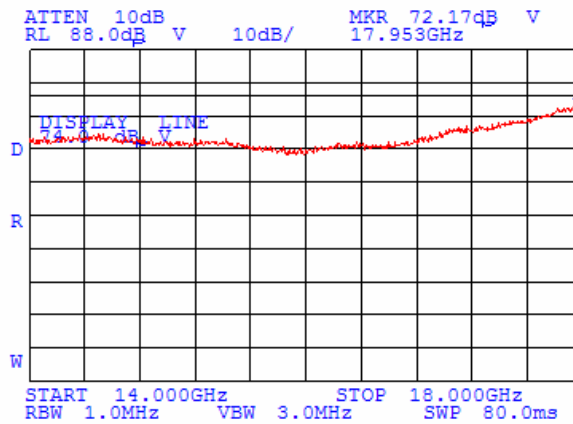

Plot 7.4.56 Radiated emission measurements from 14 to 18 GHz at the low carrier frequency

TEST SITE: OATS
 TEST DISTANCE: 3 m
 ANTENNA POLARIZATION: Vertical and Horizontal
 CBW: 5 MHz
 DETECTOR: Average

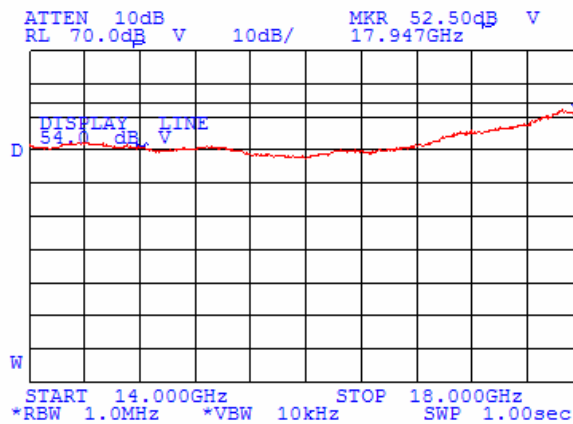



HERMON LABORATORIES

Test specification: Section 15.247(d), RSS-210 section A8.5, Radiated spurious emissions			
Test procedure: FCC New Guidance on Measurements for DTS in section 15.247(c)/ANSI C63.4, Section 13.1.4			
Test mode: Compliance	Verdict: PASS		
Date & Time: 11/12/2008 2:52:30 PM			
Temperature: 21°C	Air Pressure: 1010 hPa	Relative Humidity: 43%	Power Supply: 48 VDC
Remarks: 24 dBi integrated flat antenna			

Plot 7.4.57 Radiated emission measurements from 14 to 18 GHz at the mid carrier frequency

TEST SITE: OATS
TEST DISTANCE: 3 m
ANTENNA POLARIZATION: Vertical and Horizontal
CBW: 5 MHz
DETECTOR: Peak

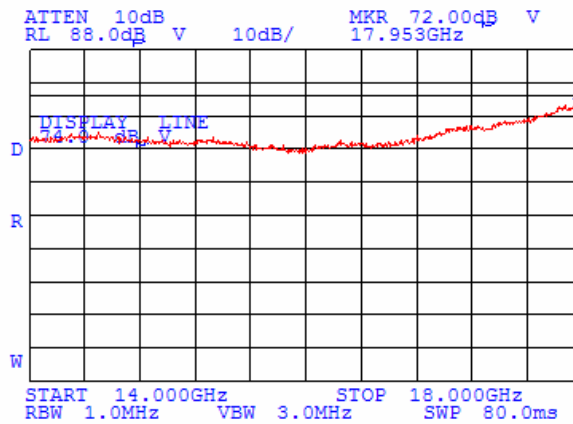

Plot 7.4.58 Radiated emission measurements from 14 to 18 GHz at the mid carrier frequency

TEST SITE: OATS
TEST DISTANCE: 3 m
ANTENNA POLARIZATION: Vertical and Horizontal
CBW: 5 MHz
DETECTOR: Average

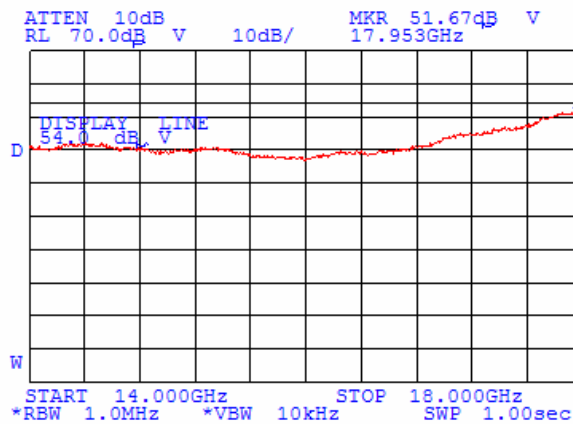



Test specification: Section 15.247(d), RSS-210 section A8.5, Radiated spurious emissions			
Test procedure: FCC New Guidance on Measurements for DTS in section 15.247(c)/ANSI C63.4, Section 13.1.4			
Test mode: Compliance	Verdict: PASS		
Date & Time: 11/12/2008 2:52:30 PM			
Temperature: 21°C	Air Pressure: 1010 hPa	Relative Humidity: 43%	Power Supply: 48 VDC
Remarks: 24 dBi integrated flat antenna			

Plot 7.4.59 Radiated emission measurements from 14 to 18 GHz at the high carrier frequency

TEST SITE: OATS
 TEST DISTANCE: 3 m
 ANTENNA POLARIZATION: Vertical and Horizontal
 CBW: 5 MHz
 DETECTOR: Peak

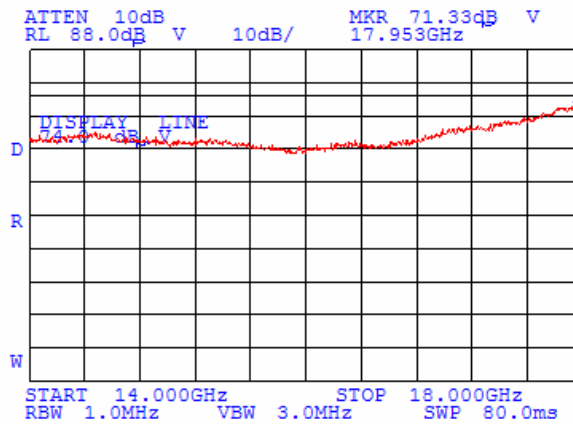

Plot 7.4.60 Radiated emission measurements from 14 to 18 GHz at the high carrier frequency

TEST SITE: OATS
 TEST DISTANCE: 3 m
 ANTENNA POLARIZATION: Vertical and Horizontal
 CBW: 5 MHz
 DETECTOR: Average

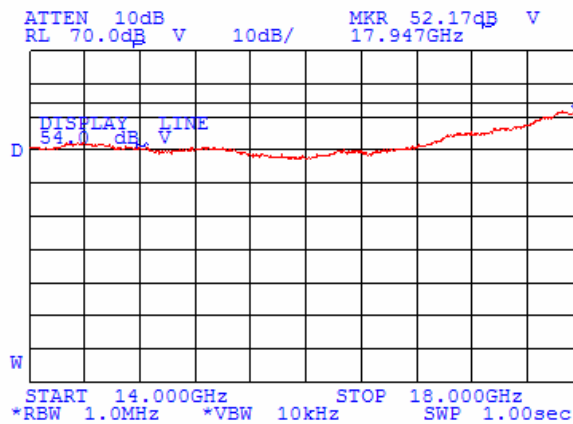



HERMON LABORATORIES

Test specification: Section 15.247(d), RSS-210 section A8.5, Radiated spurious emissions			
Test procedure: FCC New Guidance on Measurements for DTS in section 15.247(c)/ANSI C63.4, Section 13.1.4			
Test mode: Compliance	Verdict: PASS		
Date & Time: 11/12/2008 2:52:30 PM			
Temperature: 21°C	Air Pressure: 1010 hPa	Relative Humidity: 43%	Power Supply: 48 VDC
Remarks: 24 dBi integrated flat antenna			

Plot 7.4.61 Radiated emission measurements from 18 to 26.5 GHz at the low carrier frequency

TEST SITE: OATS
 TEST DISTANCE: 3 m
 ANTENNA POLARIZATION: Vertical and Horizontal
 CBW 20 MHz

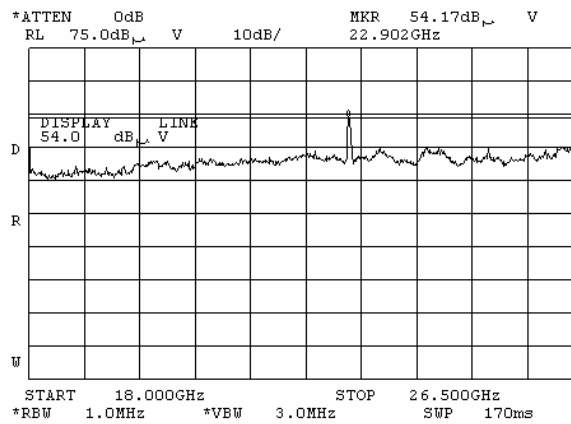

Plot 7.4.62 Radiated emission measurements from 18 to 26.5 GHz at the mid carrier frequency

TEST SITE: OATS
 TEST DISTANCE: 3 m
 ANTENNA POLARIZATION: Vertical and Horizontal
 CBW 20 MHz

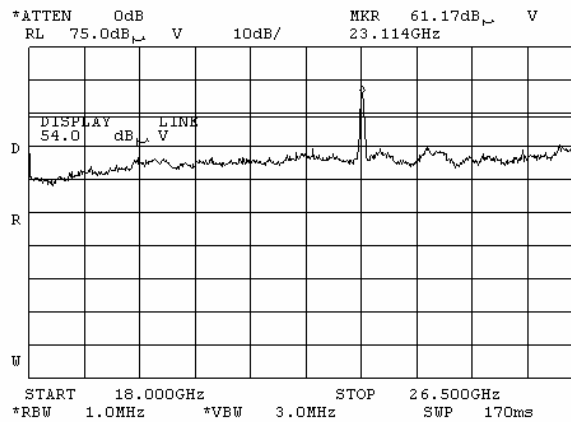



HERMON LABORATORIES

Test specification: Section 15.247(d), RSS-210 section A8.5, Radiated spurious emissions			
Test procedure: FCC New Guidance on Measurements for DTS in section 15.247(c)/ANSI C63.4, Section 13.1.4			
Test mode: Compliance	Verdict: PASS		
Date & Time: 11/12/2008 2:52:30 PM			
Temperature: 21°C	Air Pressure: 1010 hPa	Relative Humidity: 43%	Power Supply: 48 VDC
Remarks: 24 dBi integrated flat antenna			

Plot 7.4.63 Radiated emission measurements from 18 to 26.5 GHz at the high carrier frequency

TEST SITE: OATS
 TEST DISTANCE: 3 m
 ANTENNA POLARIZATION: Vertical and Horizontal
 CBW 20 MHz

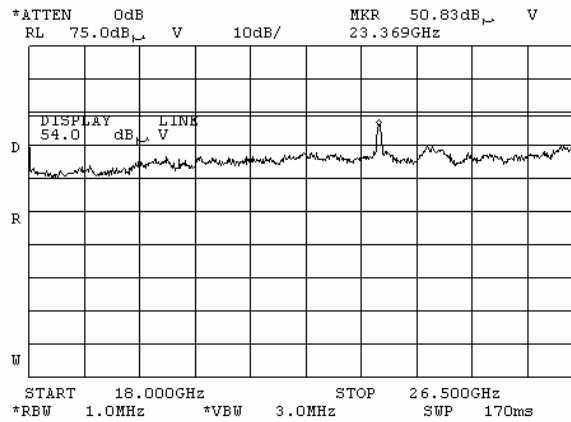

Plot 7.4.64 Radiated emission measurements from 18 to 26.5 GHz at the low carrier frequency

TEST SITE: OATS
 TEST DISTANCE: 3 m
 ANTENNA POLARIZATION: Vertical and Horizontal
 CBW 5 MHz

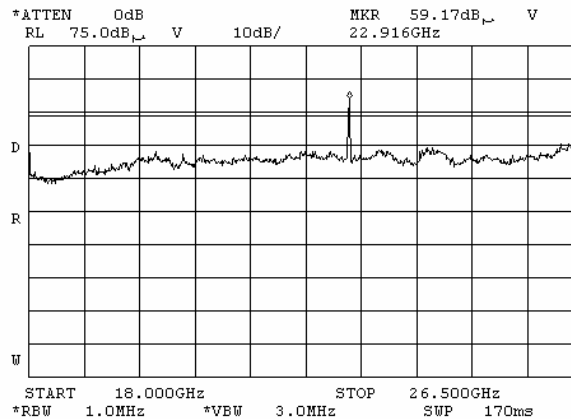



HERMON LABORATORIES

Test specification: Section 15.247(d), RSS-210 section A8.5, Radiated spurious emissions			
Test procedure: FCC New Guidance on Measurements for DTS in section 15.247(c)/ANSI C63.4, Section 13.1.4			
Test mode: Compliance	Verdict: PASS		
Date & Time: 11/12/2008 2:52:30 PM			
Temperature: 21°C	Air Pressure: 1010 hPa	Relative Humidity: 43%	Power Supply: 48 VDC
Remarks: 24 dBi integrated flat antenna			

Plot 7.4.65 Radiated emission measurements from 18 to 26.5 GHz at the mid carrier frequency

TEST SITE: OATS
 TEST DISTANCE: 3 m
 ANTENNA POLARIZATION: Vertical and Horizontal
 CBW 5 MHz

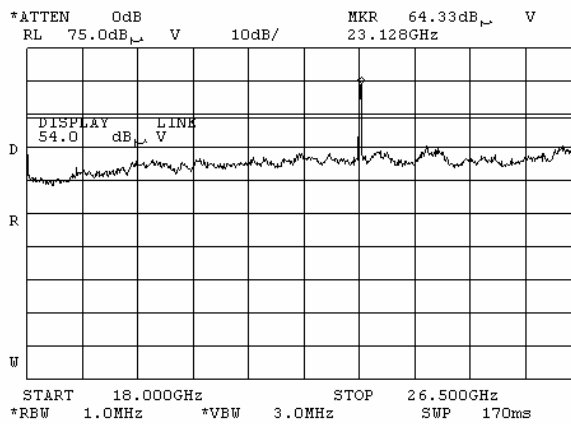

Plot 7.4.66 Radiated emission measurements from 18 to 26.5 GHz at the high carrier frequency

TEST SITE: OATS
 TEST DISTANCE: 3 m
 ANTENNA POLARIZATION: Vertical and Horizontal
 CBW 5 MHz

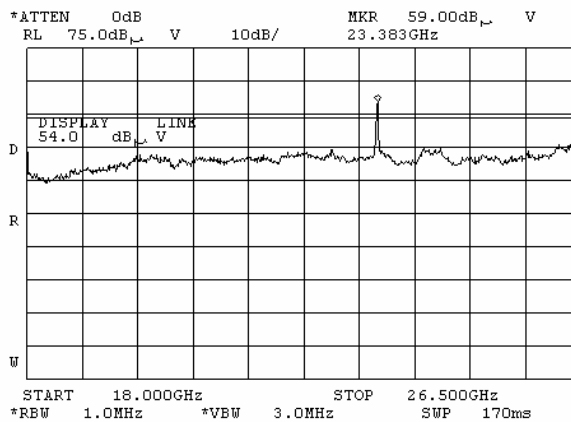



HERMON LABORATORIES

Test specification:	Section 15.247(d), RSS-210 section A8.5, Radiated spurious emissions		
Test procedure:	FCC New Guidance on Measurements for DTS in section 15.247(c)/ANSI C63.4, Section 13.1.4		
Test mode:	Compliance	Verdict:	PASS
Date & Time:	11/12/2008 2:52:30 PM		
Temperature: 21°C	Air Pressure: 1010 hPa	Relative Humidity: 43%	Power Supply: 48 VDC
Remarks: 24 dBi integrated flat antenna			

Plot 7.4.67 Radiated emission measurements from 26.5 to 33 GHz at the low carrier frequency

TEST SITE: OATS
 TEST DISTANCE: 3 m
 ANTENNA POLARIZATION: Vertical and Horizontal
 CBW 20 MHz

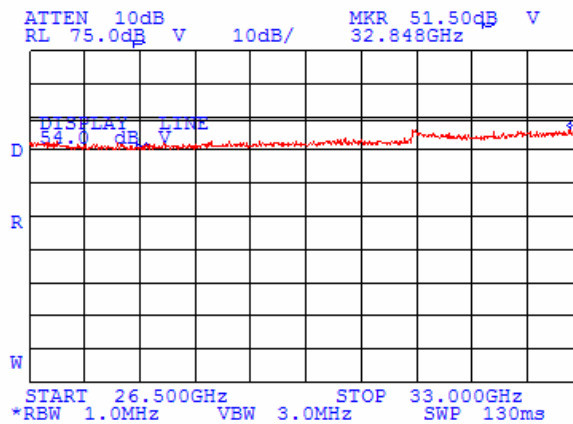



HERMON LABORATORIES

Test specification:	Section 15.247(d), RSS-210 section A8.5, Radiated spurious emissions		
Test procedure:	FCC New Guidance on Measurements for DTS in section 15.247(c)/ANSI C63.4, Section 13.1.4		
Test mode:	Compliance	Verdict:	PASS
Date & Time:	11/12/2008 2:52:30 PM		
Temperature: 21°C	Air Pressure: 1010 hPa	Relative Humidity: 43%	Power Supply: 48 VDC
Remarks: 24 dBi integrated flat antenna			

Plot 7.4.68 Radiated emission measurements from 26.5 to 33 GHz at the mid carrier frequency

TEST SITE: OATS
 TEST DISTANCE: 3 m
 ANTENNA POLARIZATION: Vertical and Horizontal
 CBW 20 MHz



Plot 7.4.69 Radiated emission measurements from 26.5 to 33 GHz at the high carrier frequency

TEST SITE: OATS
 TEST DISTANCE: 3 m
 ANTENNA POLARIZATION: Vertical and Horizontal
 CBW 20 MHz

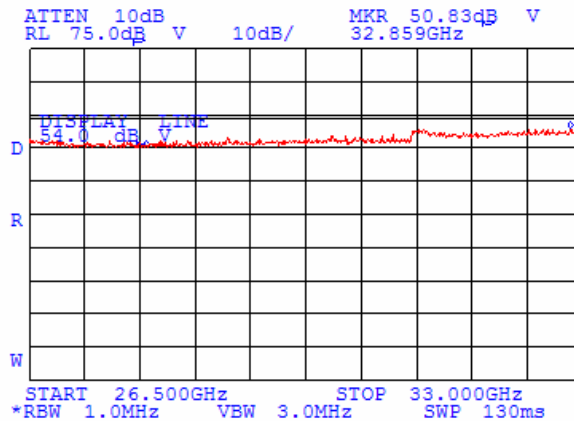



HERMON LABORATORIES

Test specification: Section 15.247(d), RSS-210 section A8.5, Radiated spurious emissions			
Test procedure: FCC New Guidance on Measurements for DTS in section 15.247(c)/ANSI C63.4, Section 13.1.4			
Test mode: Compliance	Verdict: PASS		
Date & Time: 11/12/2008 2:52:30 PM			
Temperature: 21°C	Air Pressure: 1010 hPa	Relative Humidity: 43%	Power Supply: 48 VDC
Remarks: 24 dBi integrated flat antenna			

Plot 7.4.70 Radiated emission measurements from 26.5 to 33 GHz at the low carrier frequency

TEST SITE: OATS
 TEST DISTANCE: 3 m
 ANTENNA POLARIZATION: Vertical and Horizontal
 CBW 5 MHz

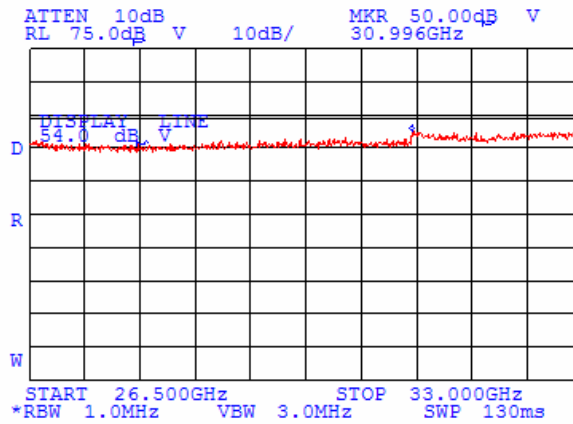

Plot 7.4.71 Radiated emission measurements from 26.5 to 33 GHz at the mid carrier frequency

TEST SITE: OATS
 TEST DISTANCE: 3 m
 ANTENNA POLARIZATION: Vertical and Horizontal
 CBW 5 MHz

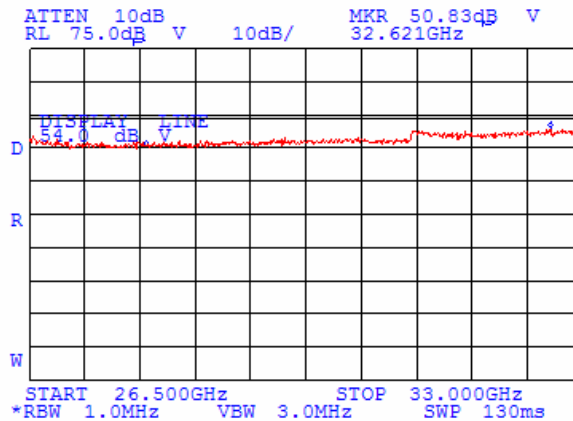



Test specification: Section 15.247(d), RSS-210 section A8.5, Radiated spurious emissions			
Test procedure: FCC New Guidance on Measurements for DTS in section 15.247(c)/ANSI C63.4, Section 13.1.4			
Test mode: Compliance	Verdict: PASS		
Date & Time: 11/12/2008 2:52:30 PM			
Temperature: 21°C	Air Pressure: 1010 hPa	Relative Humidity: 43%	Power Supply: 48 VDC
Remarks: 24 dBi integrated flat antenna			

Plot 7.4.72 Radiated emission measurements from 26.5 to 33 GHz at the high carrier frequency

TEST SITE: OATS
 TEST DISTANCE: 3 m
 ANTENNA POLARIZATION: Vertical and Horizontal
 CBW: 5 MHz

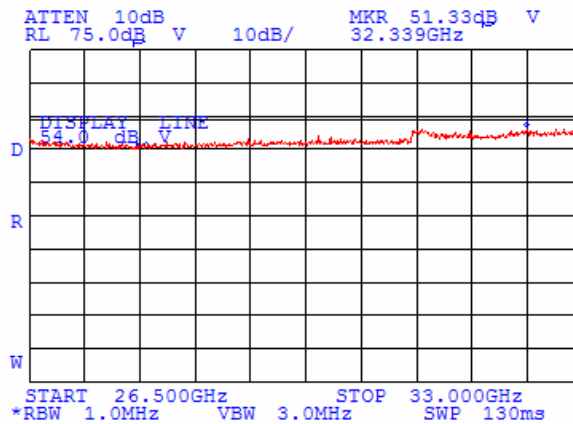

Plot 7.4.73 Radiated emission measurements from 33 to 40 GHz at the low carrier frequency

TEST SITE: OATS
 TEST DISTANCE: 3 m
 ANTENNA POLARIZATION: Vertical and Horizontal
 CBW: 20 MHz

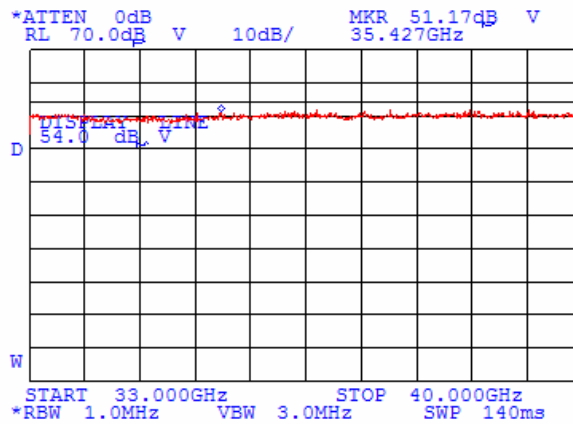



HERMON LABORATORIES

Test specification: Section 15.247(d), RSS-210 section A8.5, Radiated spurious emissions			
Test procedure: FCC New Guidance on Measurements for DTS in section 15.247(c)/ANSI C63.4, Section 13.1.4			
Test mode: Compliance	Verdict: PASS		
Date & Time: 11/12/2008 2:52:30 PM			
Temperature: 21°C	Air Pressure: 1010 hPa	Relative Humidity: 43%	Power Supply: 48 VDC
Remarks: 24 dBi integrated flat antenna			

Plot 7.4.74 Radiated emission measurements from 33 to 40 GHz at the mid carrier frequency

TEST SITE: OATS
 TEST DISTANCE: 3 m
 ANTENNA POLARIZATION: Vertical and Horizontal
 CBW 20 MHz

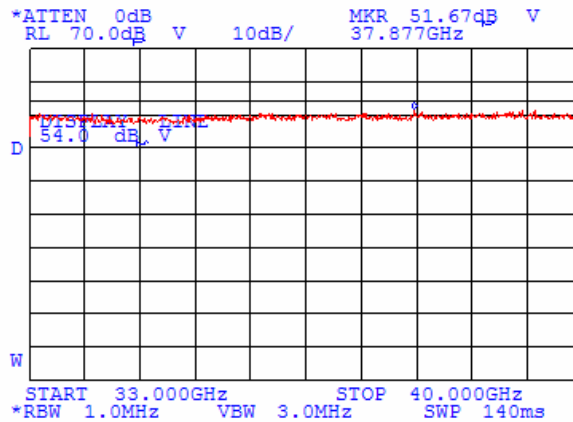

Plot 7.4.75 Radiated emission measurements from 33 to 40 GHz at the high carrier frequency

TEST SITE: OATS
 TEST DISTANCE: 3 m
 ANTENNA POLARIZATION: Vertical and Horizontal
 CBW 20 MHz

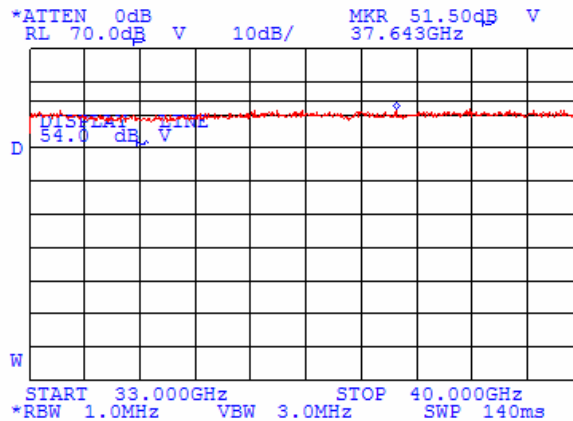



HERMON LABORATORIES

Test specification: Section 15.247(d), RSS-210 section A8.5, Radiated spurious emissions			
Test procedure: FCC New Guidance on Measurements for DTS in section 15.247(c)/ANSI C63.4, Section 13.1.4			
Test mode: Compliance	Verdict: PASS		
Date & Time: 11/12/2008 2:52:30 PM			
Temperature: 21°C	Air Pressure: 1010 hPa	Relative Humidity: 43%	Power Supply: 48 VDC
Remarks: 24 dBi integrated flat antenna			

Plot 7.4.76 Radiated emission measurements from 33 to 40 GHz at the low carrier frequency

TEST SITE: OATS
 TEST DISTANCE: 3 m
 ANTENNA POLARIZATION: Vertical and Horizontal
 CBW 5 MHz

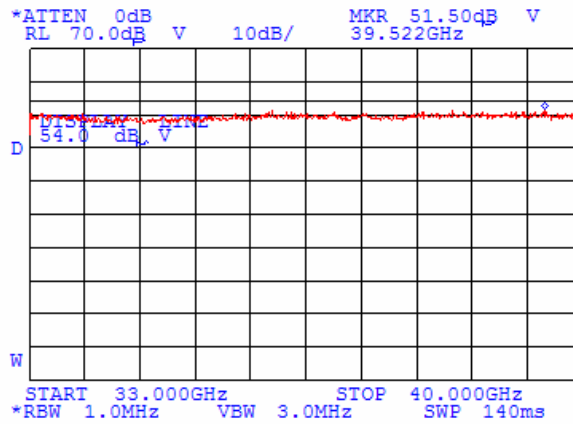

Plot 7.4.77 Radiated emission measurements from 33 to 40 GHz at the mid carrier frequency

TEST SITE: OATS
 TEST DISTANCE: 3 m
 ANTENNA POLARIZATION: Vertical and Horizontal
 CBW 5 MHz

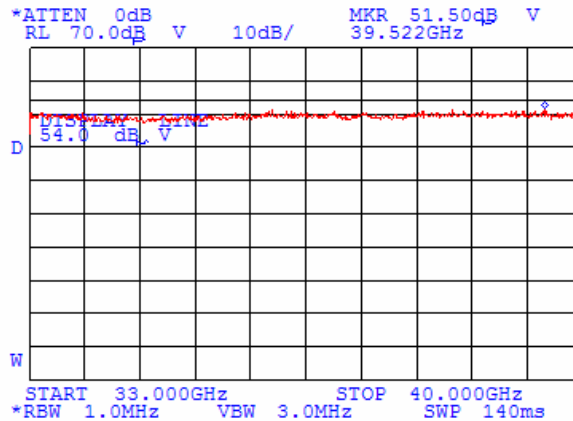



HERMON LABORATORIES

Test specification: Section 15.247(d), RSS-210 section A8.5, Radiated spurious emissions			
Test procedure: FCC New Guidance on Measurements for DTS in section 15.247(c)/ANSI C63.4, Section 13.1.4			
Test mode: Compliance	Verdict: PASS		
Date & Time: 11/12/2008 2:52:30 PM			
Temperature: 21°C	Air Pressure: 1010 hPa	Relative Humidity: 43%	Power Supply: 48 VDC
Remarks: 24 dBi integrated flat antenna			

Plot 7.4.78 Radiated emission measurements from 33 to 40 GHz at the high carrier frequency

TEST SITE: OATS
 TEST DISTANCE: 3 m
 ANTENNA POLARIZATION: Vertical and Horizontal
 CBW 5 MHz

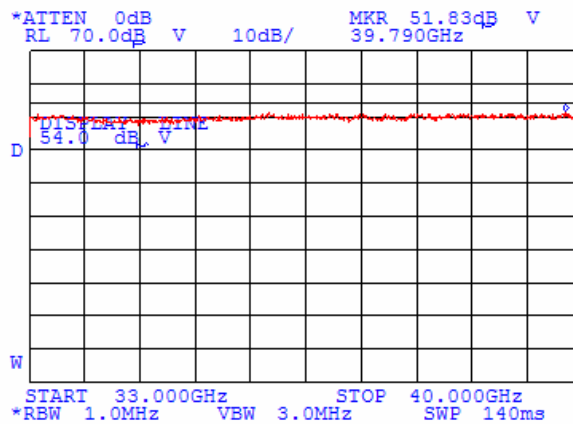



HERMON LABORATORIES

Test specification:	Section 15.247(d), RSS-210 section A8.5, Radiated spurious emissions		
Test procedure:	FCC New Guidance on Measurements for DTS in section 15.247(c)/ANSI C63.4, Section 13.1.4		
Test mode:	Compliance	Verdict:	PASS
Date & Time:	11/12/2008 2:52:30 PM		
Temperature: 21°C	Air Pressure: 1010 hPa	Relative Humidity: 43%	Power Supply: 48 VDC
Remarks: 24 dBi integrated flat antenna			

Plot 7.4.79 Radiated emission measurements at the second harmonic of low carrier frequency

TEST SITE: OATS
 TEST DISTANCE: 3 m
 CBW: 20 MHz
 DETECTOR: Peak

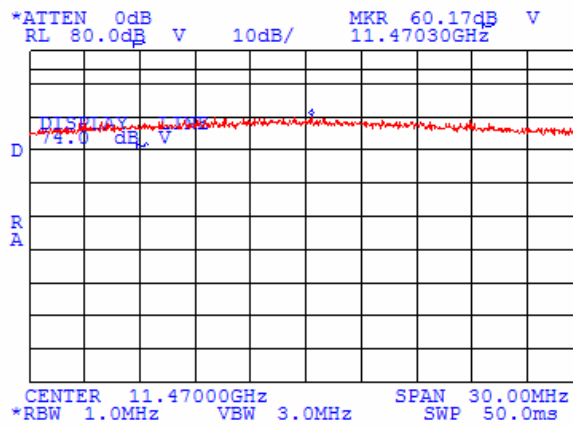

Plot 7.4.80 Radiated emission measurements at the second harmonic of low carrier frequency

TEST SITE: OATS
 TEST DISTANCE: 3 m
 CBW: 20 MHz
 DETECTOR: Average

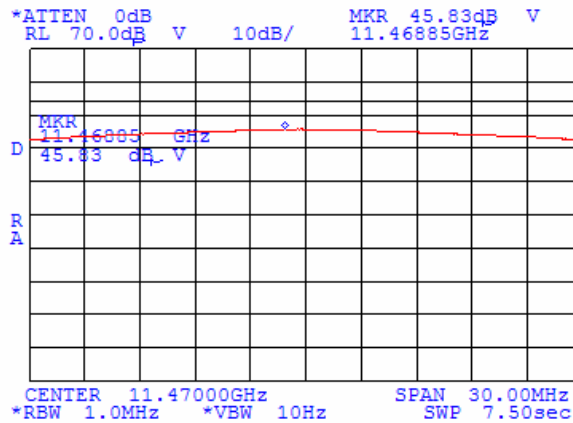



HERMON LABORATORIES

Test specification:	Section 15.247(d), RSS-210 section A8.5, Radiated spurious emissions		
Test procedure:	FCC New Guidance on Measurements for DTS in section 15.247(c)/ANSI C63.4, Section 13.1.4		
Test mode:	Compliance	Verdict:	PASS
Date & Time:	11/12/2008 2:52:30 PM		
Temperature: 21°C	Air Pressure: 1010 hPa	Relative Humidity: 43%	Power Supply: 48 VDC
Remarks: 24 dBi integrated flat antenna			

Plot 7.4.81 Radiated emission measurements at the second harmonic of mid carrier frequency

TEST SITE: OATS
 TEST DISTANCE: 3 m
 CBW: 20 MHz
 DETECTOR: Peak

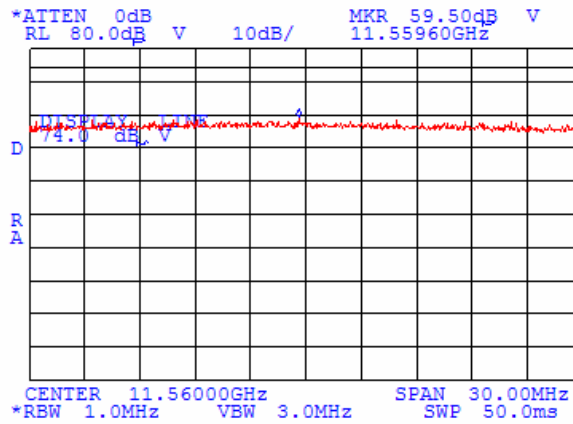

Plot 7.4.82 Radiated emission measurements at the second harmonic of mid carrier frequency

TEST SITE: OATS
 TEST DISTANCE: 3 m
 CBW: 20 MHz
 DETECTOR: Average

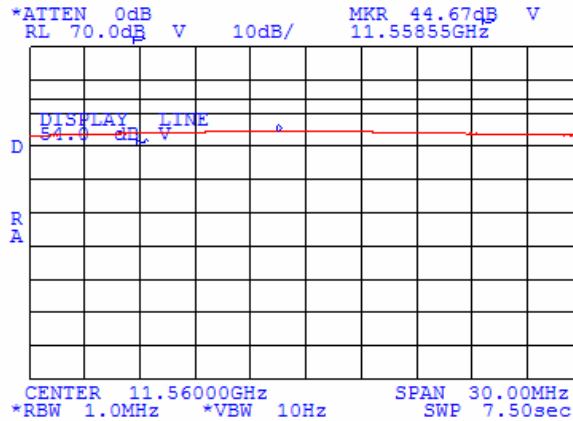



HERMON LABORATORIES

Test specification:	Section 15.247(d), RSS-210 section A8.5, Radiated spurious emissions		
Test procedure:	FCC New Guidance on Measurements for DTS in section 15.247(c)/ANSI C63.4, Section 13.1.4		
Test mode:	Compliance	Verdict:	PASS
Date & Time:	11/12/2008 2:52:30 PM		
Temperature: 21°C	Air Pressure: 1010 hPa	Relative Humidity: 43%	Power Supply: 48 VDC
Remarks: 24 dBi integrated flat antenna			

Plot 7.4.83 Radiated emission measurements at the second harmonic of high carrier frequency

TEST SITE: OATS
 TEST DISTANCE: 3 m
 CBW: 20 MHz
 DETECTOR: Peak

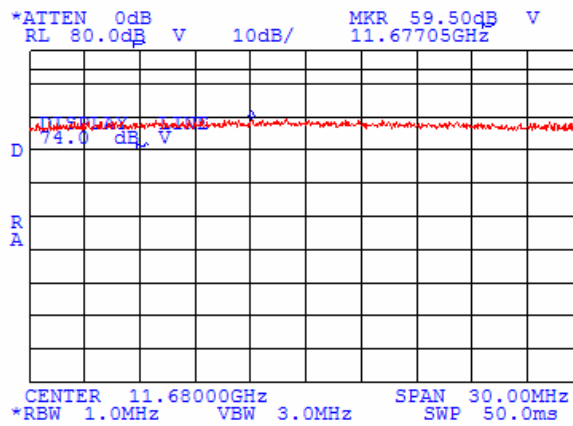

Plot 7.4.84 Radiated emission measurements at the second harmonic of high carrier frequency

TEST SITE: OATS
 TEST DISTANCE: 3 m
 CBW: 20 MHz
 DETECTOR: Average

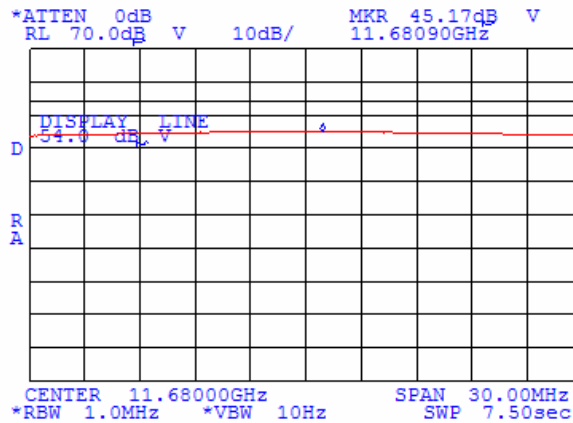



HERMON LABORATORIES

Test specification: Section 15.247(d), RSS-210 section A8.5, Radiated spurious emissions			
Test procedure: FCC New Guidance on Measurements for DTS in section 15.247(c)/ANSI C63.4, Section 13.1.4			
Test mode: Compliance	Verdict: PASS		
Date & Time: 11/12/2008 2:52:30 PM			
Temperature: 21°C	Air Pressure: 1010 hPa	Relative Humidity: 43%	Power Supply: 48 VDC
Remarks: 24 dBi integrated flat antenna			

Plot 7.4.85 Radiated emission measurements at the second harmonic of low carrier frequency

TEST SITE: OATS
TEST DISTANCE: 3 m
CBW: 5 MHz
DETECTOR: Peak

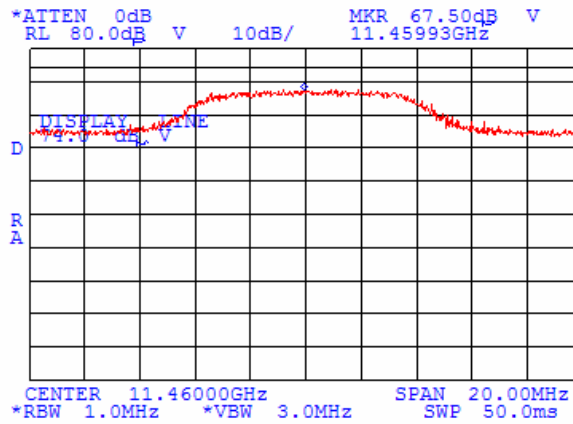

Plot 7.4.86 Radiated emission measurements at the second harmonic of low carrier frequency

TEST SITE: OATS
TEST DISTANCE: 3 m
CBW: 5 MHz
DETECTOR: Average

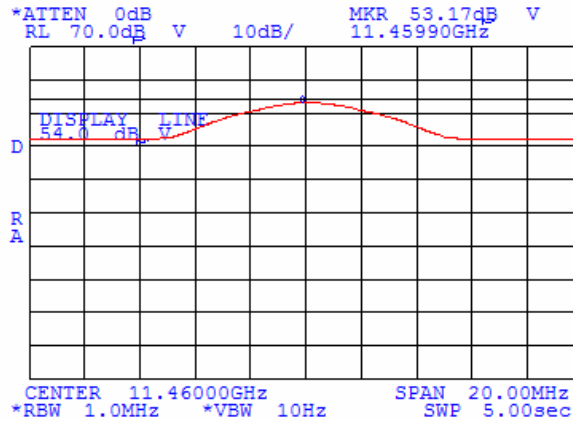



HERMON LABORATORIES

Test specification:	Section 15.247(d), RSS-210 section A8.5, Radiated spurious emissions		
Test procedure:	FCC New Guidance on Measurements for DTS in section 15.247(c)/ANSI C63.4, Section 13.1.4		
Test mode:	Compliance	Verdict:	PASS
Date & Time:	11/12/2008 2:52:30 PM		
Temperature: 21°C	Air Pressure: 1010 hPa	Relative Humidity: 43%	Power Supply: 48 VDC
Remarks: 24 dBi integrated flat antenna			

Plot 7.4.87 Radiated emission measurements at the second harmonic of mid carrier frequency

TEST SITE: OATS
TEST DISTANCE: 3 m
CBW: 5 MHz
DETECTOR: Peak

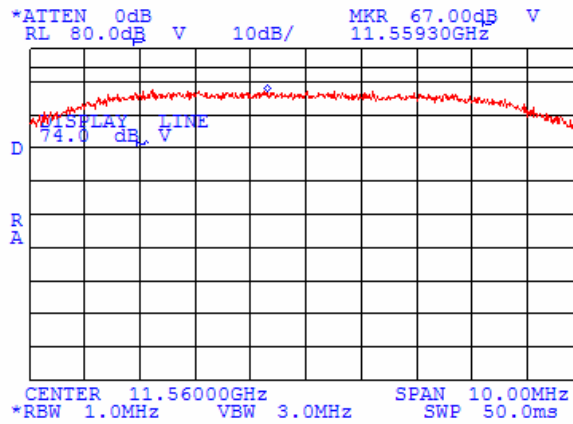

Plot 7.4.88 Radiated emission measurements at the second harmonic of mid carrier frequency

TEST SITE: OATS
TEST DISTANCE: 3 m
CBW: 5 MHz
DETECTOR: Average

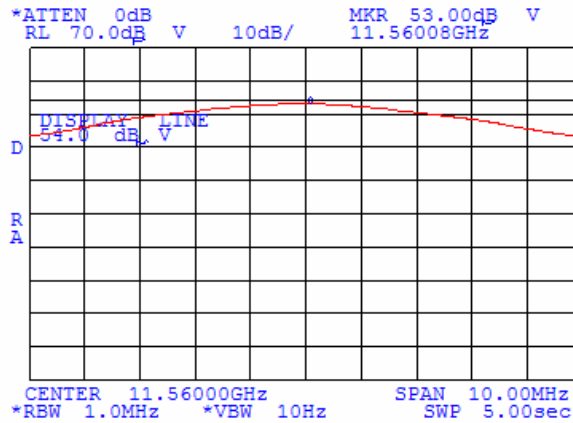



HERMON LABORATORIES

Test specification: Section 15.247(d), RSS-210 section A8.5, Radiated spurious emissions			
Test procedure: FCC New Guidance on Measurements for DTS in section 15.247(c)/ANSI C63.4, Section 13.1.4			
Test mode: Compliance	Verdict: PASS		
Date & Time: 11/12/2008 2:52:30 PM			
Temperature: 21°C	Air Pressure: 1010 hPa	Relative Humidity: 43%	Power Supply: 48 VDC
Remarks: 24 dBi integrated flat antenna			

Plot 7.4.89 Radiated emission measurements at the second harmonic of high carrier frequency

TEST SITE: OATS
TEST DISTANCE: 3 m
CBW: 5 MHz
DETECTOR: Peak

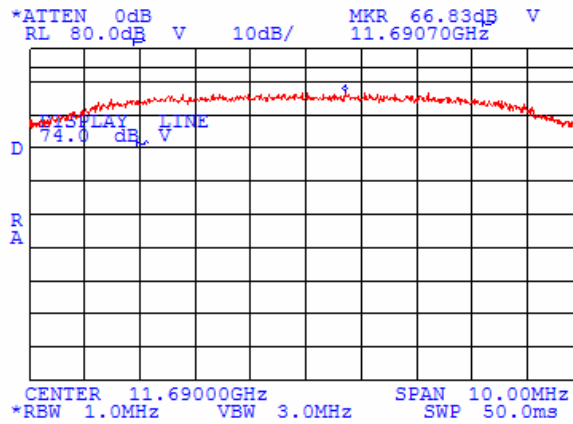

Plot 7.4.90 Radiated emission measurements at the second harmonic of high carrier frequency

TEST SITE: OATS
TEST DISTANCE: 3 m
CBW: 5 MHz
DETECTOR: Average

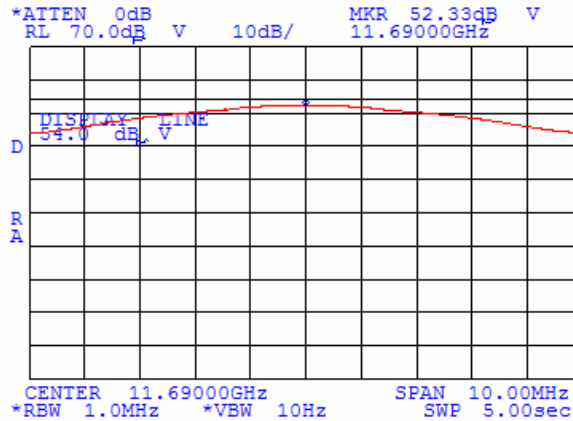



HERMON LABORATORIES

Test specification: Section 15.247(d), RSS-210 section A8.5, Radiated spurious emissions			
Test procedure: FCC New Guidance on Measurements for DTS in section 15.247(c)/ANSI C63.4, Section 13.1.4			
Test mode: Compliance	Verdict: PASS		
Date & Time: 11/12/2008 2:52:30 PM			
Temperature: 21°C	Air Pressure: 1010 hPa	Relative Humidity: 43%	Power Supply: 48 VDC
Remarks: 24 dBi integrated flat antenna			

Plot 7.4.91 Radiated emission measurements at the fourth harmonic of low carrier frequency

TEST SITE: OATS
TEST DISTANCE: 3 m
CBW: 20 MHz
DETECTOR: Peak

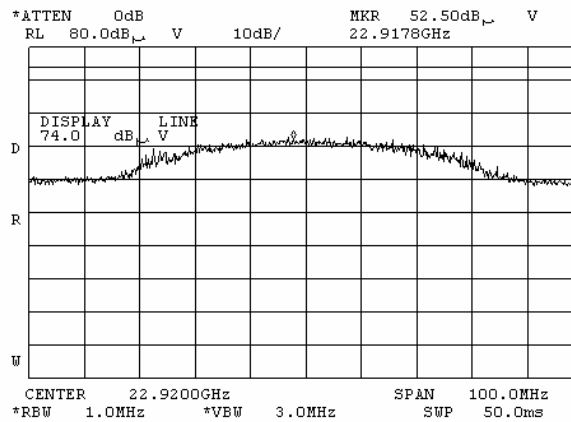

Plot 7.4.92 Radiated emission measurements at the fourth harmonic of low carrier frequency

TEST SITE: OATS
TEST DISTANCE: 3 m
CBW: 20 MHz
DETECTOR: Average

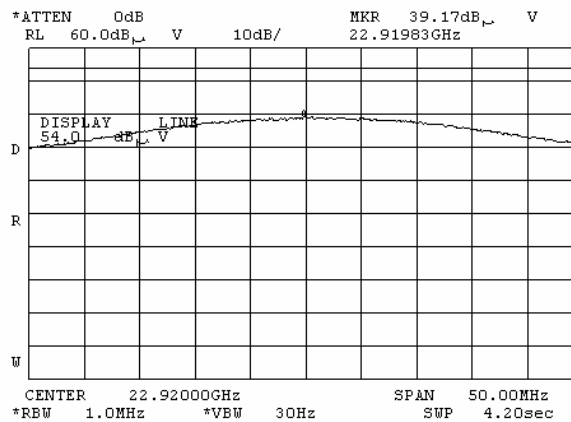



HERMON LABORATORIES

Test specification: Section 15.247(d), RSS-210 section A8.5, Radiated spurious emissions			
Test procedure: FCC New Guidance on Measurements for DTS in section 15.247(c)/ANSI C63.4, Section 13.1.4			
Test mode: Compliance	Verdict: PASS		
Date & Time: 11/12/2008 2:52:30 PM			
Temperature: 21°C	Air Pressure: 1010 hPa	Relative Humidity: 43%	Power Supply: 48 VDC
Remarks: 24 dBi integrated flat antenna			

Plot 7.4.93 Radiated emission measurements at the fourth harmonic of mid carrier frequency

TEST SITE: OATS
TEST DISTANCE: 3 m
CBW: 20 MHz
DETECTOR: Peak

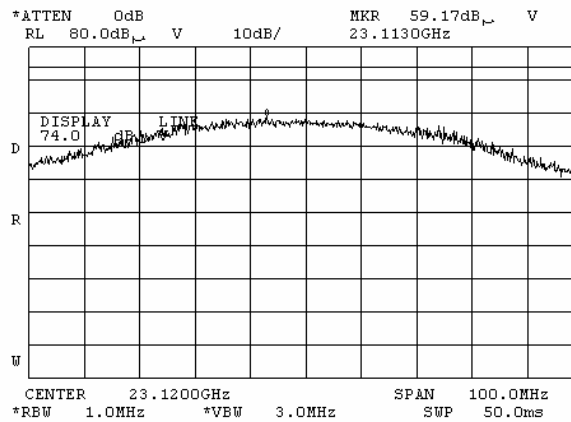

Plot 7.4.94 Radiated emission measurements at the fourth harmonic of mid carrier frequency

TEST SITE: OATS
TEST DISTANCE: 3 m
CBW: 20 MHz
DETECTOR: Average

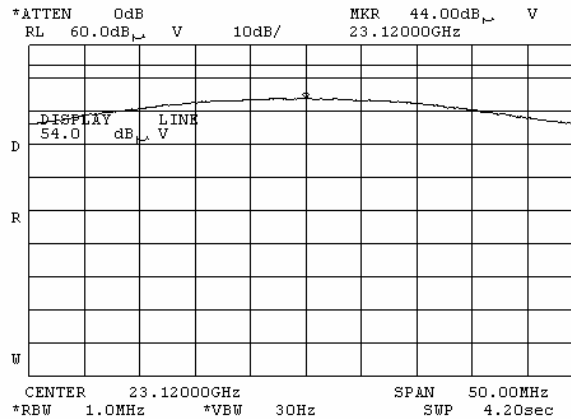



HERMON LABORATORIES

Test specification: Section 15.247(d), RSS-210 section A8.5, Radiated spurious emissions			
Test procedure: FCC New Guidance on Measurements for DTS in section 15.247(c)/ANSI C63.4, Section 13.1.4			
Test mode: Compliance	Verdict: PASS		
Date & Time: 11/12/2008 2:52:30 PM			
Temperature: 21°C	Air Pressure: 1010 hPa	Relative Humidity: 43%	Power Supply: 48 VDC
Remarks: 24 dBi integrated flat antenna			

Plot 7.4.95 Radiated emission measurements at the fourth harmonic of high carrier frequency

TEST SITE: OATS
TEST DISTANCE: 3 m
CBW: 20 MHz
DETECTOR: Peak

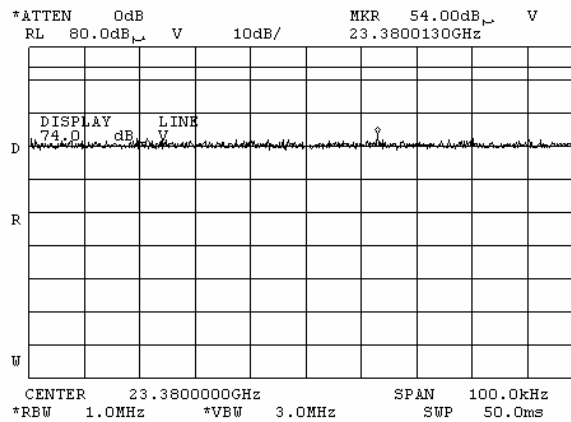

Plot 7.4.96 Radiated emission measurements at the fourth harmonic of high carrier frequency

TEST SITE: OATS
TEST DISTANCE: 3 m
CBW: 20 MHz
DETECTOR: Average

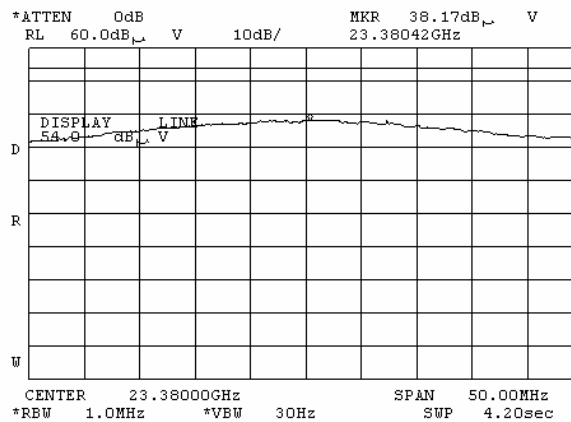



HERMON LABORATORIES

Test specification: Section 15.247(d), RSS-210 section A8.5, Radiated spurious emissions			
Test procedure: FCC New Guidance on Measurements for DTS in section 15.247(c)/ANSI C63.4, Section 13.1.4			
Test mode: Compliance	Verdict: PASS		
Date & Time: 11/12/2008 2:52:30 PM			
Temperature: 21°C	Air Pressure: 1010 hPa	Relative Humidity: 43%	Power Supply: 48 VDC
Remarks: 24 dBi integrated flat antenna			

Plot 7.4.97 Radiated emission measurements at the fourth harmonic of low carrier frequency

TEST SITE: OATS
 TEST DISTANCE: 3 m
 CBW: 5 MHz
 DETECTOR: Peak

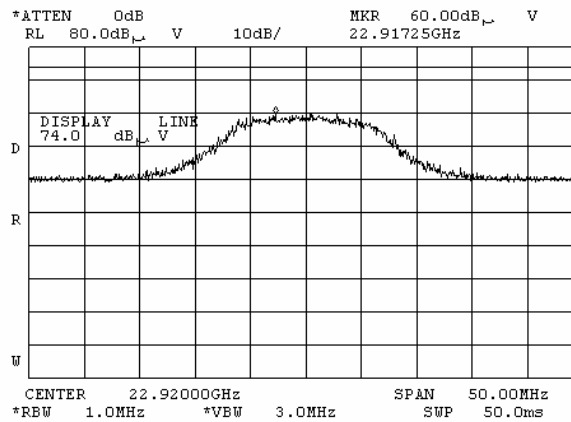

Plot 7.4.98 Radiated emission measurements at the fourth harmonic of low carrier frequency

TEST SITE: OATS
 TEST DISTANCE: 3 m
 CBW: 5 MHz
 DETECTOR: Average

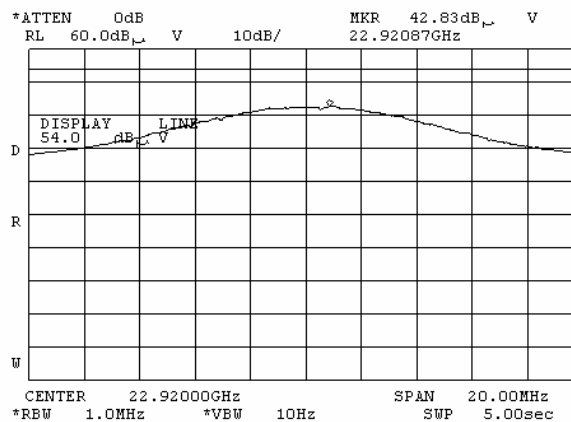



HERMON LABORATORIES

Test specification: Section 15.247(d), RSS-210 section A8.5, Radiated spurious emissions			
Test procedure: FCC New Guidance on Measurements for DTS in section 15.247(c)/ANSI C63.4, Section 13.1.4			
Test mode: Compliance	Verdict: PASS		
Date & Time: 11/12/2008 2:52:30 PM			
Temperature: 21°C	Air Pressure: 1010 hPa	Relative Humidity: 43%	Power Supply: 48 VDC
Remarks: 24 dBi integrated flat antenna			

Plot 7.4.99 Radiated emission measurements at the fourth harmonic of mid carrier frequency

TEST SITE: OATS
 TEST DISTANCE: 3 m
 CBW: 5 MHz
 DETECTOR: Peak

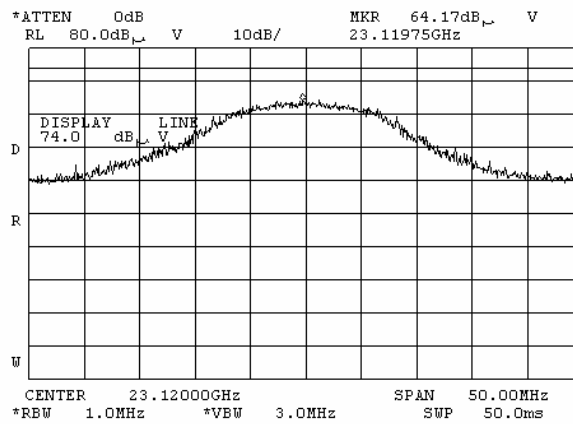

Plot 7.4.100 Radiated emission measurements at the fourth harmonic of mid carrier frequency

TEST SITE: OATS
 TEST DISTANCE: 3 m
 CBW: 5 MHz
 DETECTOR: Average

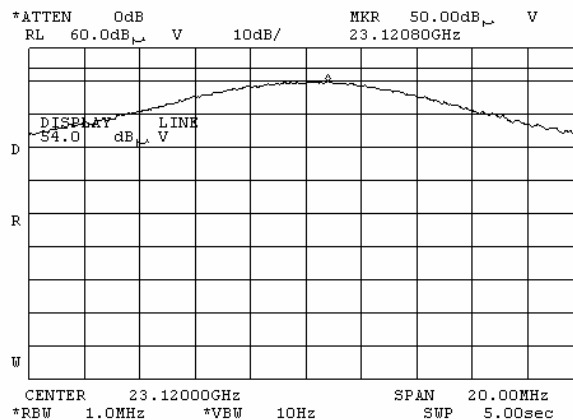



HERMON LABORATORIES

Test specification: Section 15.247(d), RSS-210 section A8.5, Radiated spurious emissions			
Test procedure: FCC New Guidance on Measurements for DTS in section 15.247(c)/ANSI C63.4, Section 13.1.4			
Test mode: Compliance	Verdict: PASS		
Date & Time: 11/12/2008 2:52:30 PM			
Temperature: 21°C	Air Pressure: 1010 hPa	Relative Humidity: 43%	Power Supply: 48 VDC
Remarks: 24 dBi integrated flat antenna			

Plot 7.4.101 Radiated emission measurements at the fourth harmonic of high carrier frequency

TEST SITE: OATS
 TEST DISTANCE: 3 m
 CBW: 5 MHz
 DETECTOR: Peak

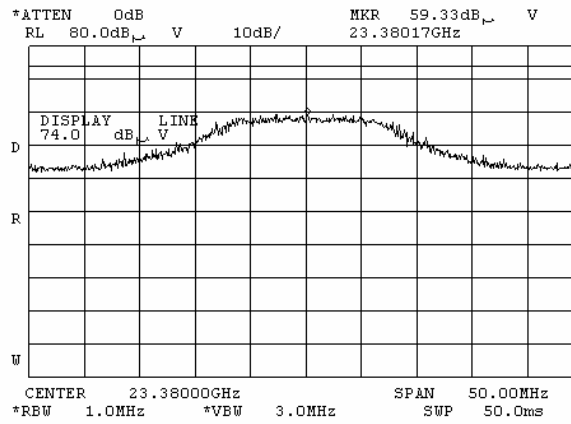

Plot 7.4.102 Radiated emission measurements at the fourth harmonic of high carrier frequency

TEST SITE: OATS
 TEST DISTANCE: 3 m
 CBW: 5 MHz
 DETECTOR: Average

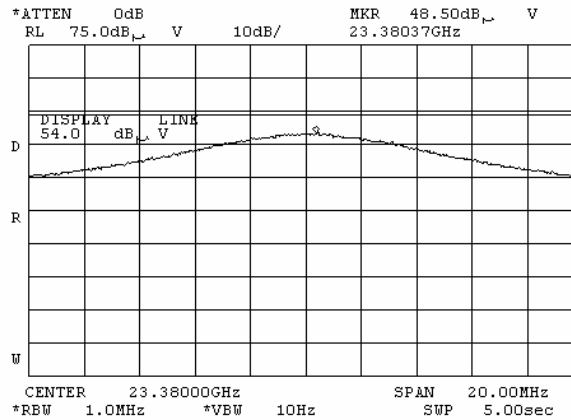



Test specification:		Section 15.247(d), RSS-210 section A8.5, Radiated spurious emissions	
Test procedure:		FCC New Guidance on Measurements for DTS in section 15.247(c)/ANSI C63.4, Section 13.1.4	
Test mode:	Compliance	Verdict: PASS	
Date & Time:	11/12/2008 7:22:59 PM		
Temperature: 21°C	Air Pressure: 1010 hPa	Relative Humidity: 43%	Power Supply: 48 VDC
Remarks: with 28 dBi external dish antenna			

Table 7.4.7 Field strength of emissions outside restricted bands

ASSIGNED FREQUENCY: 5725 - 5850 MHz MHz
 INVESTIGATED FREQUENCY RANGE: 0.009 - 40000 MHz
 TEST DISTANCE: 3 m
 MODULATION: 64QAM
 MODULATING SIGNAL: OFDM
 DUTY CYCLE: 100 %
 TRANSMITTER OUTPUT POWER SETTINGS: Maximum
 DETECTOR USED: Peak
 RESOLUTION BANDWIDTH: 100 kHz
 VIDEO BANDWIDTH: 300 kHz
 TEST ANTENNA TYPE: Active loop (9 kHz – 30 MHz)
 Biconical (30 MHz – 200 MHz)
 Log periodic (200 MHz – 1000 MHz)
 Biconilog (30 MHz – 1000 MHz)
 Double ridged guide (above 1000 MHz)

Frequency, MHz	Field strength of spurious, dB(µV/m)	Antenna polarization	Antenna height, m	Azimuth, degrees*	Field strength of carrier, dB(µV/m)	Attenuation below carrier, dBc	Limit, dBc	Margin, dB**	Verdict
Low carrier frequency									
No emissions were found							20.0	NA	Pass
Mid carrier frequency									
No emissions were found							20.0	NA	Pass
High carrier frequency									
No emissions were found							20.0	NA	Pass

*- EUT front panel refers to 0 degrees position of turntable.
 **- Margin = Attenuation below carrier – specification limit.



Test specification:		Section 15.247(d), RSS-210 section A8.5, Radiated spurious emissions	
Test procedure:		FCC New Guidance on Measurements for DTS in section 15.247(c)/ANSI C63.4, Section 13.1.4	
Test mode:	Compliance	Verdict: PASS	
Date & Time:	11/12/2008 7:22:59 PM		
Temperature: 21°C	Air Pressure: 1010 hPa	Relative Humidity: 43%	Power Supply: 48 VDC
Remarks: with 28 dBi external dish antenna			

Table 7.4.8 Field strength of spurious emissions above 1 GHz within restricted bands

ASSIGNED FREQUENCY: 5725 - 5850 MHz
 INVESTIGATED FREQUENCY RANGE: 1000 – 40000 MHz
 TEST DISTANCE: 3 m
 MODULATION: 64QAM
 MODULATING SIGNAL: OFDM
 DUTY CYCLE: 100 %
 TRANSMITTER OUTPUT POWER SETTINGS: Maximum
 DETECTOR USED: Peak
 RESOLUTION BANDWIDTH: 1000 kHz
 TEST ANTENNA TYPE: Double ridged guide

Frequency, MHz	Antenna		Azimuth, degrees*	Peak field strength(VBW=3 MHz)			Average field strength(VBW=10 Hz)				Verdict
	Polarization	Height, m		Measured, dB(µV/m)	Limit, dB(µV/m)	Margin, dB**	Measured, dB(µV/m)	Calculated, dB(µV/m)	Limit, dB(µV/m)	Margin, dB***	
5 MHz channel bandwidth											
Low carrier frequency											
5085.05	Vertical	1.0	0	50.59	74.00	-23.41	38.65	38.65	54.00	-15.35	Pass
Mid carrier frequency											
5084.0	Vertical	1.0	0	51.33	74.00	-22.67	39.44	39.44	54.00	-14.56	Pass
High carrier frequency											
5043.5	Vertical	1.0	0	53.78	74.00	-20.22	37.95	37.95	54.00	-16.05	Pass
20 MHz channel bandwidth											
Low carrier frequency											
5046.0	Vertical	1.0	0	52.81	74.00	-21.19	39.34	39.34	54.00	-14.66	Pass
Mid carrier frequency											
5065.0	Vertical	1.0	0	53.05	74.00	-20.95	39.55	39.55	54.00	-14.45	Pass
High carrier frequency											
5070.78	Vertical	1.0	0	53.62	74.00	-20.38	39.02	39.02	54.00	-14.98	Pass

*- EUT front panel refers to 0 degrees position of turntable.
 **- Margin = Measured field strength - specification limit.
 ***- Margin = Calculated field strength - specification limit,
 where Calculated field strength = Measured field strength + average factor.

Table 7.4.9 Average factor calculation

Transmission pulse		Transmission burst		Transmission train duration, ms	Average factor, dB
Duration, ms	Period, ms	Duration, ms	Period, ms		
EUT was configured for continuous transmission – no average factor was used					

*- Average factor was calculated as follows
 for pulse train shorter than 100 ms: $Average\ factor = 20 \times \log_{10} \left(\frac{Pulse\ duration}{Pulse\ period} \times \frac{Burst\ duration}{Train\ duration} \times Number\ of\ bursts\ within\ pulse\ train \right)$
 for pulse train longer than 100 ms: $Average\ factor = 20 \times \log_{10} \left(\frac{Pulse\ duration}{Pulse\ period} \times \frac{Burst\ duration}{100\ ms} \times Number\ of\ bursts\ within\ 100\ ms \right)$



Test specification: Section 15.247(d), RSS-210 section A8.5, Radiated spurious emissions			
Test procedure: FCC New Guidance on Measurements for DTS in section 15.247(c)/ANSI C63.4, Section 13.1.4			
Test mode: Compliance	Verdict: PASS		
Date & Time: 11/12/2008 7:22:59 PM			
Temperature: 21°C	Air Pressure: 1010 hPa	Relative Humidity: 43%	Power Supply: 48 VDC
Remarks: with 28 dBi external dish antenna			

Table 7.4.10 Field strength of spurious emissions below 1 GHz within restricted bands

ASSIGNED FREQUENCY: 5725 - 5850 MHz
 INVESTIGATED FREQUENCY RANGE: 0.009 – 1000 MHz
 TEST DISTANCE: 3 m
 MODULATION: 64QAM
 MODULATING SIGNAL: OFDM
 DUTY CYCLE: 100 %
 TRANSMITTER OUTPUT POWER SETTINGS: Maximum
 RESOLUTION BANDWIDTH: 0.2 kHz (9 kHz – 150 kHz); 9.0 kHz (150 kHz – 30 MHz)
 120 kHz (30 MHz – 1000 MHz)
 VIDEO BANDWIDTH: > Resolution bandwidth
 TEST ANTENNA TYPE: Active loop (9 kHz – 30 MHz); Biconilog (30 MHz – 1000 MHz)

Frequency, MHz	Peak emission, dB(µV/m)	Quasi-peak			Antenna polarization	Antenna height, m	Turn-table position**, degrees	Verdict
		Measured emission, dB(µV/m)	Limit, dB(µV/m)	Margin, dB*				
5 MHz channel bandwidth ***								
66.300	25.90	23.20	40.00	-16.80	Vertical	1.0	0	Pass
79.225	26.35	23.20	40.00	-16.80	Vertical	1.0	0	
74.541	25.80	23.10	40.00	-16.90	Vertical	1.0	0	
83.400	26.80	24.50	40.00	-15.50	Vertical	1.0	0	
108.808	26.30	21.20	43.50	-22.30	Vertical	1.0	0	
20 MHz channel bandwidth ***								
66.300	25.80	23.10	40.00	-16.90	Vertical	1.0	0	Pass
79.230	26.10	22.50	40.00	-17.50	Vertical	1.0	0	
91.560	24.90	19.20	43.50	-24.30	Vertical	1.0	0	
104.750	25.50	19.00	43.50	-24.50	Vertical	1.0	0	
108.800	26.20	22.20	43.50	-21.30	Vertical	1.0	0	

*- Margin = Measured emission - specification limit.
 **- EUT front panel refer to 0 degrees position of turntable.
 *** - the highest emission for each three frequencies (low, mid and high) was obtained

Table 7.4.11 Restricted bands

MHz	MHz	MHz	MHz	MHz	GHz
0.09 - 0.11	8.37625 - 8.38675	73 - 74.6	399.9 - 410	2690 - 2900	10.6 - 12.7
0.495 - 0.505	8.41425 - 8.41475	74.8 - 75.2	608 - 614	3260 - 3267	13.25 - 13.4
2.1735 - 2.1905	12.29 - 12.293	108 - 121.94	960 - 1240	3332 - 3339	14.47 - 14.5
4.125 - 4.128	12.51975 - 12.52025	123 - 138	1300 - 1427	3345.8 - 3358	15.35 - 16.2
4.17725 - 4.17775	12.57675 - 12.57725	149.9 - 150.05	1435 - 1626.5	3600 - 4400	17.7 - 21.4
4.20725 - 4.20775	13.36 - 13.41	156.52475 - 156.52525	1645.5 - 1646.5	4500 - 5150	22.01 - 23.12
6.215 - 6.218	16.42 - 16.423	156.7 - 156.9	1660 - 1710	5350 - 5460	23.6 - 24
6.26775 - 6.26825	16.69475 - 16.69525	162.0125 - 167.17	1718.8 - 1722.2	7250 - 7750	31.2 - 31.8
6.31175 - 6.31225	16.80425 - 16.80475	167.72 - 173.2	2200 - 2300	8025 - 8500	36.43 - 36.5
8.291 - 8.294	25.5 - 25.67	240 - 285	2310 - 2390	9000 - 9200	Above 38.6
8.362 - 8.366	37.5 - 38.25	322 - 335.4	2483.5 - 2500	9300 - 9500	

Reference numbers of test equipment used

HL 0446	HL 0521	HL 0554	HL 0768	HL 0769	HL 0784	HL 1003	HL 1984
HL 2910	HL 2911	HL 2254	HL 2260	HL 2261	HL 3123	HL 3206	

Full description is given in Appendix A.



HERMON LABORATORIES

Test specification: Section 15.247(d), RSS-210 section A8.5, Radiated spurious emissions			
Test procedure: FCC New Guidance on Measurements for DTS in section 15.247(c)/ANSI C63.4, Section 13.1.4			
Test mode: Compliance	Verdict: PASS		
Date & Time: 11/12/2008 7:22:59 PM			
Temperature: 21°C	Air Pressure: 1010 hPa	Relative Humidity: 43%	Power Supply: 48 VDC
Remarks: with 28 dBi external dish antenna			

Plot 7.4.103 Radiated emission measurements from 9 to 150 kHz at the low, mid and high carrier frequency

TEST SITE: Semi anechoic chamber
TEST DISTANCE: 3 m
ANTENNA POLARIZATION: Vertical
CHANNEL BANDWIDTH: 5 MHz

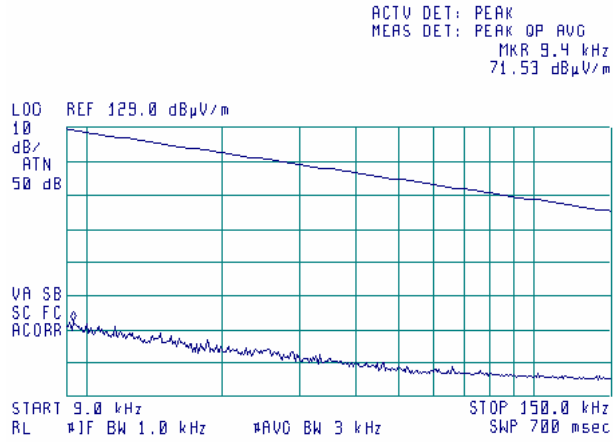

Plot 7.4.104 Radiated emission measurements from 9 to 150 kHz at the low, mid and high carrier frequency

TEST SITE: Semi anechoic chamber
TEST DISTANCE: 3 m
ANTENNA POLARIZATION: Vertical
CHANNEL BANDWIDTH: 20 MHz

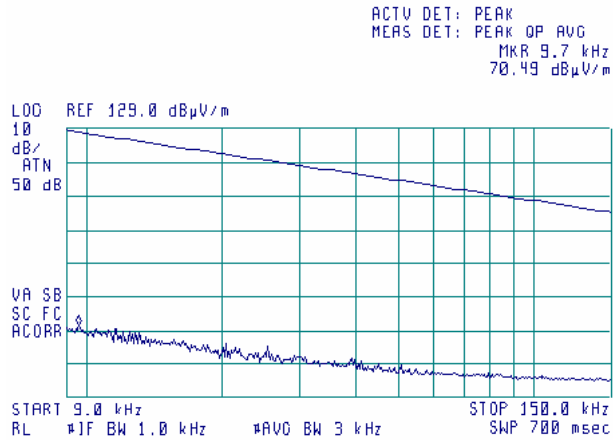



HERMON LABORATORIES

Test specification: Section 15.247(d), RSS-210 section A8.5, Radiated spurious emissions			
Test procedure: FCC New Guidance on Measurements for DTS in section 15.247(c)/ANSI C63.4, Section 13.1.4			
Test mode: Compliance	Verdict: PASS		
Date & Time: 11/12/2008 7:22:59 PM			
Temperature: 21°C	Air Pressure: 1010 hPa	Relative Humidity: 43%	Power Supply: 48 VDC
Remarks: with 28 dBi external dish antenna			

Plot 7.4.105 Radiated emission measurements from 0.15 to 30 MHz at the low, mid and high carrier frequency

TEST SITE: Semi anechoic chamber
 TEST DISTANCE: 3 m
 ANTENNA POLARIZATION: Vertical
 CHANNEL BANDWIDTH: 5 MHz

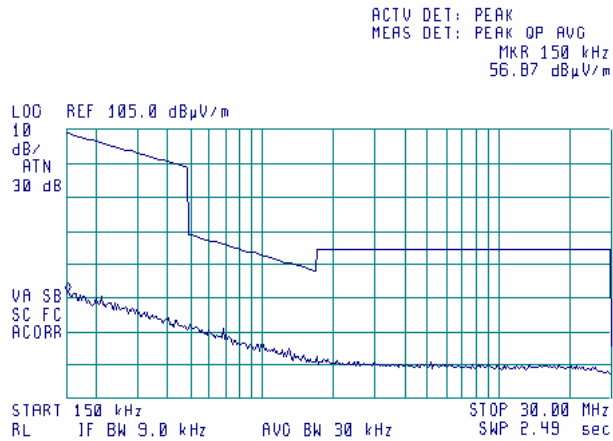

Plot 7.4.106 Radiated emission measurements from 0.15 to 30 MHz at the mid carrier frequency

TEST SITE: Semi anechoic chamber
 TEST DISTANCE: 3 m
 ANTENNA POLARIZATION: Vertical
 CHANNEL BANDWIDTH: 20 MHz

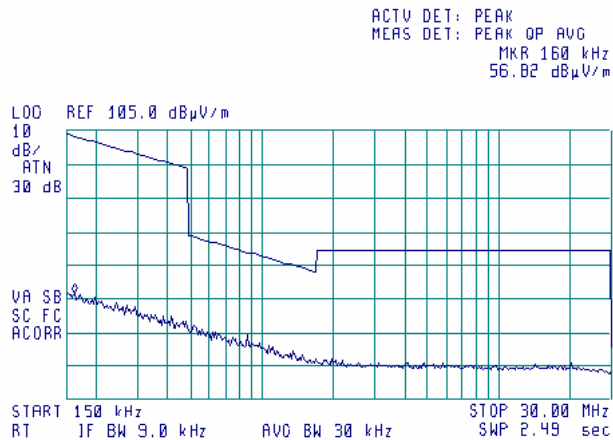



HERMON LABORATORIES

Test specification: Section 15.247(d), RSS-210 section A8.5, Radiated spurious emissions			
Test procedure: FCC New Guidance on Measurements for DTS in section 15.247(c)/ANSI C63.4, Section 13.1.4			
Test mode: Compliance	Verdict: PASS		
Date & Time: 11/12/2008 7:22:59 PM			
Temperature: 21°C	Air Pressure: 1010 hPa	Relative Humidity: 43%	Power Supply: 48 VDC
Remarks: with 28 dBi external dish antenna			

Plot 7.4.107 Radiated emission measurements from 30 to 1000 MHz at the low carrier frequency

TEST SITE: Semi anechoic chamber
 TEST DISTANCE: 3 m
 ANTENNA POLARIZATION: Vertical
 CHANNEL BANDWIDTH: 5 MHz

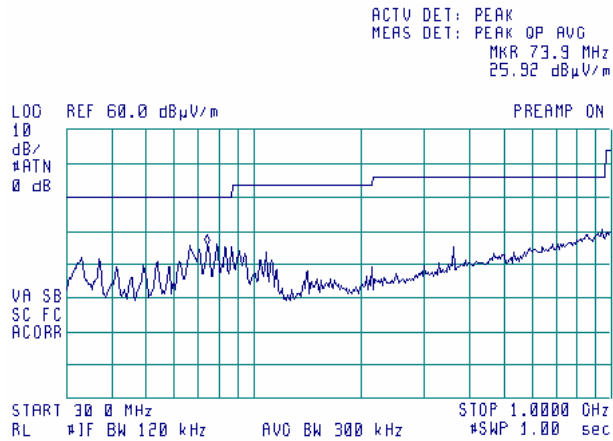

Plot 7.4.108 Radiated emission measurements from 30 to 1000 MHz at the mid carrier frequency

TEST SITE: Semi anechoic chamber
 TEST DISTANCE: 3 m
 ANTENNA POLARIZATION: Vertical
 CHANNEL BANDWIDTH: 5 MHz

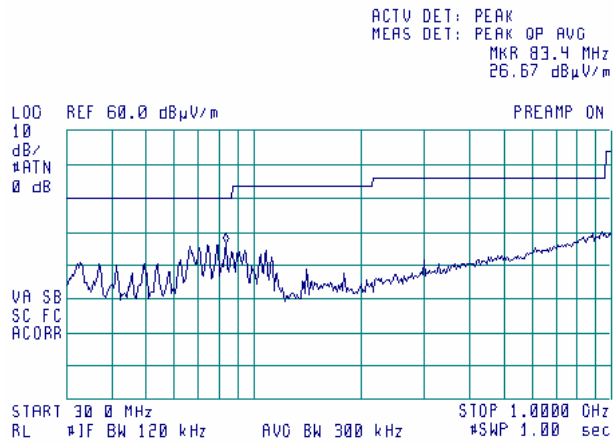



HERMON LABORATORIES

Test specification: Section 15.247(d), RSS-210 section A8.5, Radiated spurious emissions			
Test procedure: FCC New Guidance on Measurements for DTS in section 15.247(c)/ANSI C63.4, Section 13.1.4			
Test mode: Compliance	Verdict: PASS		
Date & Time: 11/12/2008 7:22:59 PM			
Temperature: 21°C	Air Pressure: 1010 hPa	Relative Humidity: 43%	Power Supply: 48 VDC
Remarks: with 28 dBi external dish antenna			

Plot 7.4.109 Radiated emission measurements from 30 to 1000 MHz at the high carrier frequency

TEST SITE: Semi anechoic chamber
 TEST DISTANCE: 3 m
 ANTENNA POLARIZATION: Vertical
 CHANNEL BANDWIDTH: 5 MHz

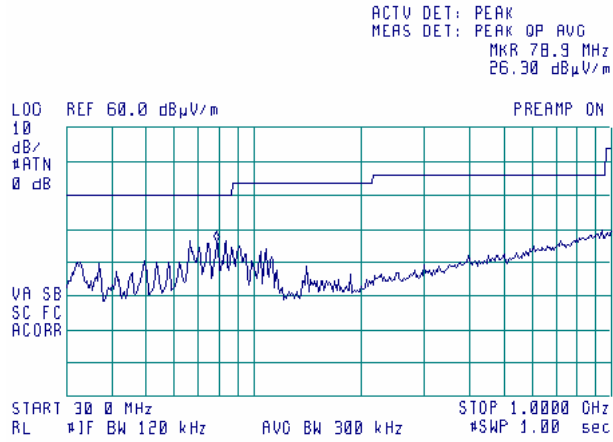

Plot 7.4.110 Radiated emission measurements from 30 to 1000 MHz at the low carrier frequency

TEST SITE: Semi anechoic chamber
 TEST DISTANCE: 3 m
 ANTENNA POLARIZATION: Vertical
 CHANNEL BANDWIDTH: 20 MHz

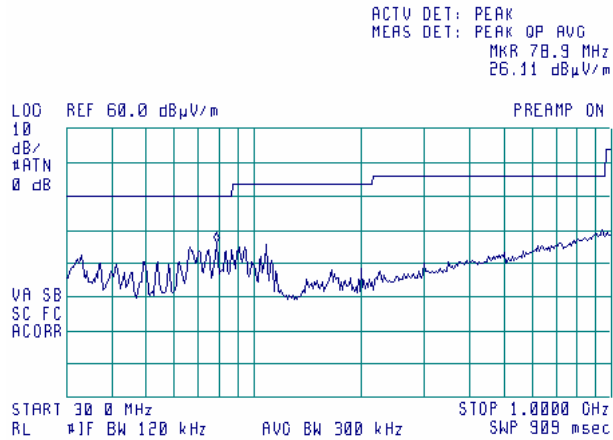



HERMON LABORATORIES

Test specification: Section 15.247(d), RSS-210 section A8.5, Radiated spurious emissions			
Test procedure: FCC New Guidance on Measurements for DTS in section 15.247(c)/ANSI C63.4, Section 13.1.4			
Test mode: Compliance	Verdict: PASS		
Date & Time: 11/12/2008 7:22:59 PM			
Temperature: 21°C	Air Pressure: 1010 hPa	Relative Humidity: 43%	Power Supply: 48 VDC
Remarks: with 28 dBi external dish antenna			

Plot 7.4.111 Radiated emission measurements from 30 to 1000 MHz at the mid carrier frequency

TEST SITE: Semi anechoic chamber
 TEST DISTANCE: 3 m
 ANTENNA POLARIZATION: Vertical
 CHANNEL BANDWIDTH: 20 MHz

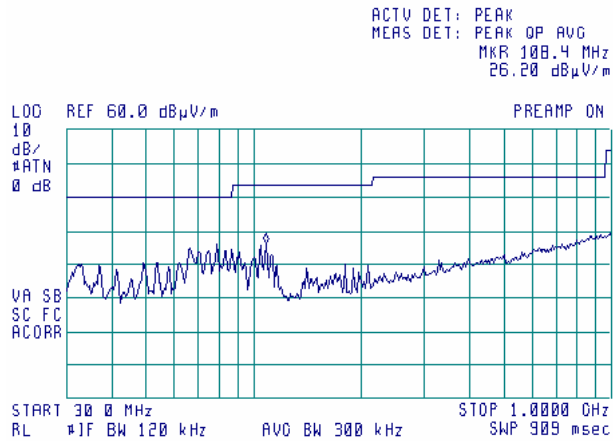

Plot 7.4.112 Radiated emission measurements from 30 to 1000 MHz at the high carrier frequency

TEST SITE: Semi anechoic chamber
 TEST DISTANCE: 3 m
 ANTENNA POLARIZATION: Vertical
 CHANNEL BANDWIDTH: 20 MHz

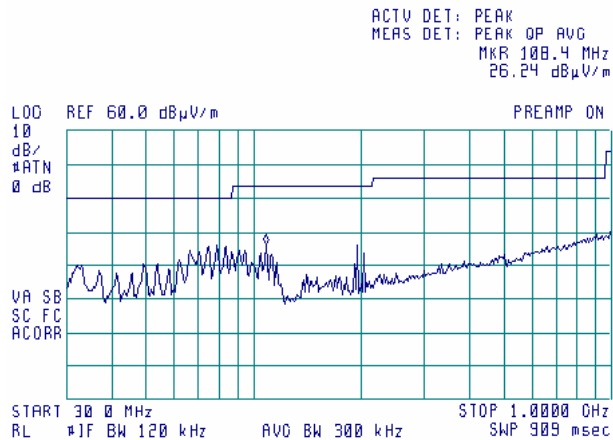



HERMON LABORATORIES

Test specification: Section 15.247(d), RSS-210 section A8.5, Radiated spurious emissions			
Test procedure: FCC New Guidance on Measurements for DTS in section 15.247(c)/ANSI C63.4, Section 13.1.4			
Test mode: Compliance	Verdict: PASS		
Date & Time: 11/12/2008 7:22:59 PM			
Temperature: 21°C	Air Pressure: 1010 hPa	Relative Humidity: 43%	Power Supply: 48 VDC
Remarks: with 28 dBi external dish antenna			

Plot 7.4.113 Radiated emission measurements from 1000 to 5500 MHz at the low carrier frequency

TEST SITE: Semi anechoic chamber
 TEST DISTANCE: 3 m
 ANTENNA POLARIZATION: Vertical
 CHANNEL BANDWIDTH: 5 MHz
 DETECTOR: Peak

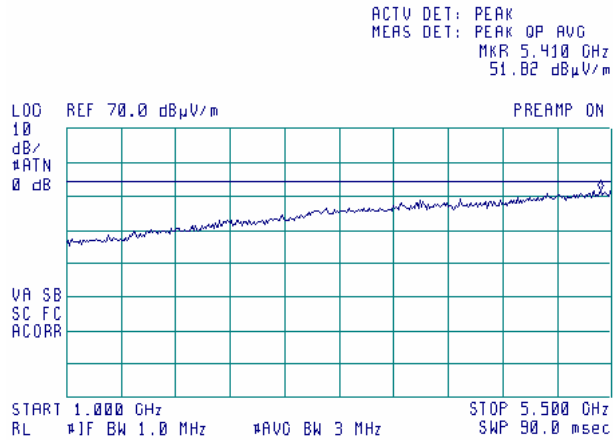

Plot 7.4.114 Radiated emission measurements from 4000 to 5500 MHz at the low carrier frequency

TEST SITE: Semi anechoic chamber
 TEST DISTANCE: 3 m
 ANTENNA POLARIZATION: Vertical
 CHANNEL BANDWIDTH: 5 MHz
 DETECTOR: Average

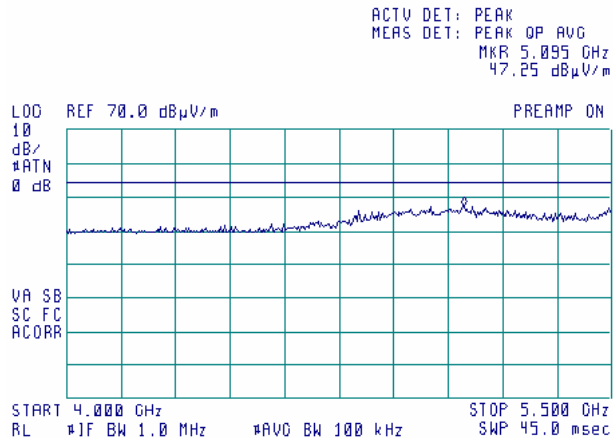



HERMON LABORATORIES

Test specification: Section 15.247(d), RSS-210 section A8.5, Radiated spurious emissions			
Test procedure: FCC New Guidance on Measurements for DTS in section 15.247(c)/ANSI C63.4, Section 13.1.4			
Test mode: Compliance	Verdict: PASS		
Date & Time: 11/12/2008 7:22:59 PM			
Temperature: 21°C	Air Pressure: 1010 hPa	Relative Humidity: 43%	Power Supply: 48 VDC
Remarks: with 28 dBi external dish antenna			

Plot 7.4.115 Radiated emission measurements from 1000 to 5500 MHz at the mid carrier frequency

TEST SITE: Semi anechoic chamber
 TEST DISTANCE: 3 m
 ANTENNA POLARIZATION: Vertical
 CHANNEL BANDWIDTH: 5 MHz
 DETECTOR: Peak

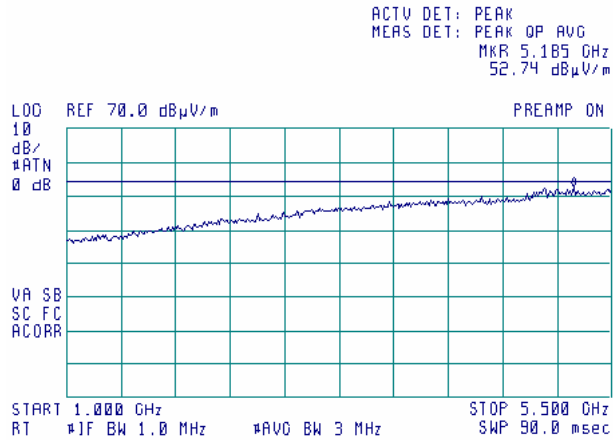

Plot 7.4.116 Radiated emission measurements from 4000 to 5500 MHz at the mid carrier frequency

TEST SITE: Semi anechoic chamber
 TEST DISTANCE: 3 m
 ANTENNA POLARIZATION: Vertical
 CHANNEL BANDWIDTH: 5 MHz
 DETECTOR: Average

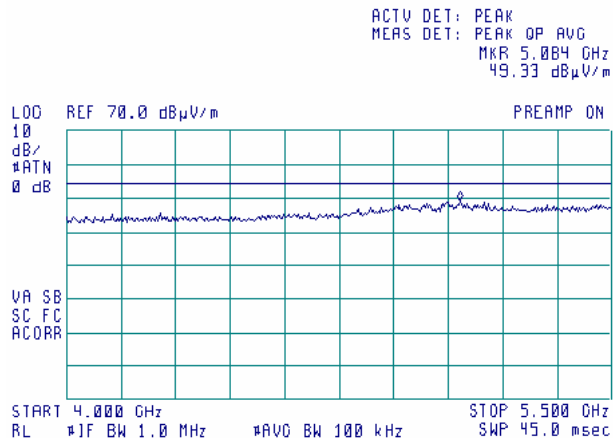



HERMON LABORATORIES

Test specification: Section 15.247(d), RSS-210 section A8.5, Radiated spurious emissions			
Test procedure: FCC New Guidance on Measurements for DTS in section 15.247(c)/ANSI C63.4, Section 13.1.4			
Test mode: Compliance	Verdict: PASS		
Date & Time: 11/12/2008 7:22:59 PM			
Temperature: 21°C	Air Pressure: 1010 hPa	Relative Humidity: 43%	Power Supply: 48 VDC
Remarks: with 28 dBi external dish antenna			

Plot 7.4.117 Radiated emission measurements from 1000 to 5500 MHz at the high carrier frequency

TEST SITE: Semi anechoic chamber
 TEST DISTANCE: 3 m
 ANTENNA POLARIZATION: Vertical
 CHANNEL BANDWIDTH: 5 MHz
 DETECTOR: Peak

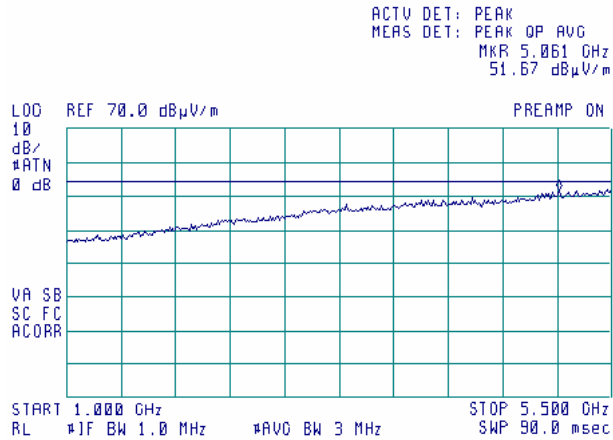

Plot 7.4.118 Radiated emission measurements from 4000 to 5500 MHz at the high carrier frequency

TEST SITE: Semi anechoic chamber
 TEST DISTANCE: 3 m
 ANTENNA POLARIZATION: Vertical
 CHANNEL BANDWIDTH: 5 MHz
 DETECTOR: Average

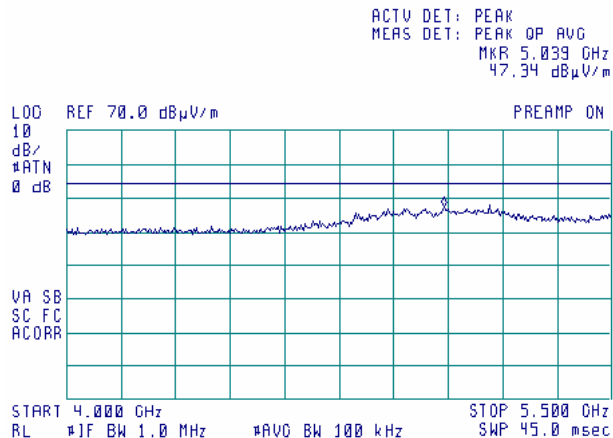



HERMON LABORATORIES

Test specification: Section 15.247(d), RSS-210 section A8.5, Radiated spurious emissions			
Test procedure: FCC New Guidance on Measurements for DTS in section 15.247(c)/ANSI C63.4, Section 13.1.4			
Test mode: Compliance	Verdict: PASS		
Date & Time: 11/12/2008 7:22:59 PM			
Temperature: 21°C	Air Pressure: 1010 hPa	Relative Humidity: 43%	Power Supply: 48 VDC
Remarks: with 28 dBi external dish antenna			

Plot 7.4.119 Radiated emission measurements from 1000 to 5500 MHz at the low carrier frequency

TEST SITE: Semi anechoic chamber
 TEST DISTANCE: 3 m
 ANTENNA POLARIZATION: Vertical
 CHANNEL BANDWIDTH: 20 MHz
 DETECTOR: Peak

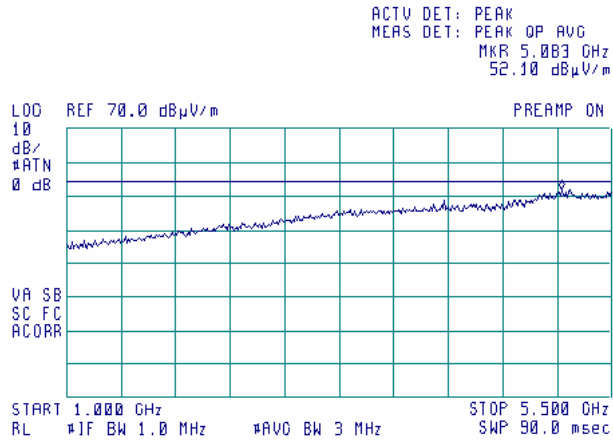

Plot 7.4.120 Radiated emission measurements from 4000 to 5500 MHz at the low carrier frequency

TEST SITE: Semi anechoic chamber
 TEST DISTANCE: 3 m
 ANTENNA POLARIZATION: Vertical
 CHANNEL BANDWIDTH: 20 MHz
 DETECTOR: Average

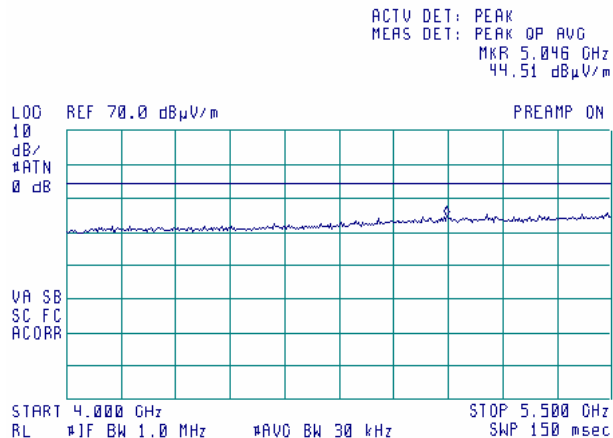



HERMON LABORATORIES

Test specification: Section 15.247(d), RSS-210 section A8.5, Radiated spurious emissions			
Test procedure: FCC New Guidance on Measurements for DTS in section 15.247(c)/ANSI C63.4, Section 13.1.4			
Test mode: Compliance	Verdict: PASS		
Date & Time: 11/12/2008 7:22:59 PM			
Temperature: 21°C	Air Pressure: 1010 hPa	Relative Humidity: 43%	Power Supply: 48 VDC
Remarks: with 28 dBi external dish antenna			

Plot 7.4.121 Radiated emission measurements from 1000 to 5500 MHz at the mid carrier frequency

TEST SITE: Semi anechoic chamber
 TEST DISTANCE: 3 m
 ANTENNA POLARIZATION: Vertical
 CHANNEL BANDWIDTH: 20 MHz
 DETECTOR: Peak

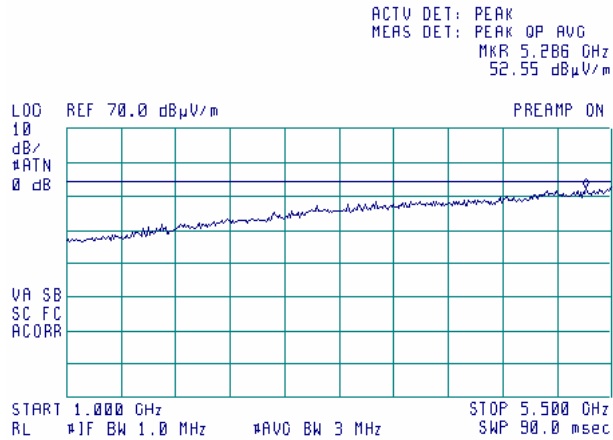

Plot 7.4.122 Radiated emission measurements from 4000 to 5500 MHz at the mid carrier frequency

TEST SITE: Semi anechoic chamber
 TEST DISTANCE: 3 m
 ANTENNA POLARIZATION: Vertical
 CHANNEL BANDWIDTH: 20 MHz
 DETECTOR: Average

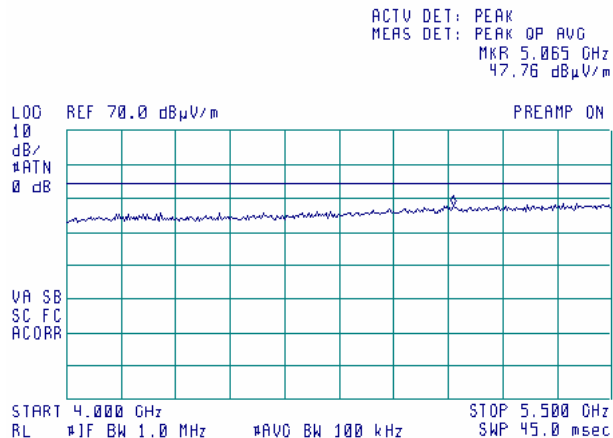



HERMON LABORATORIES

Test specification: Section 15.247(d), RSS-210 section A8.5, Radiated spurious emissions			
Test procedure: FCC New Guidance on Measurements for DTS in section 15.247(c)/ANSI C63.4, Section 13.1.4			
Test mode: Compliance	Verdict: PASS		
Date & Time: 11/12/2008 7:22:59 PM			
Temperature: 21°C	Air Pressure: 1010 hPa	Relative Humidity: 43%	Power Supply: 48 VDC
Remarks: with 28 dBi external dish antenna			

Plot 7.4.123 Radiated emission measurements from 1000 to 5500 MHz at the high carrier frequency

TEST SITE: Semi anechoic chamber
 TEST DISTANCE: 3 m
 ANTENNA POLARIZATION: Vertical
 CHANNEL BANDWIDTH: 20 MHz
 DETECTOR: Peak

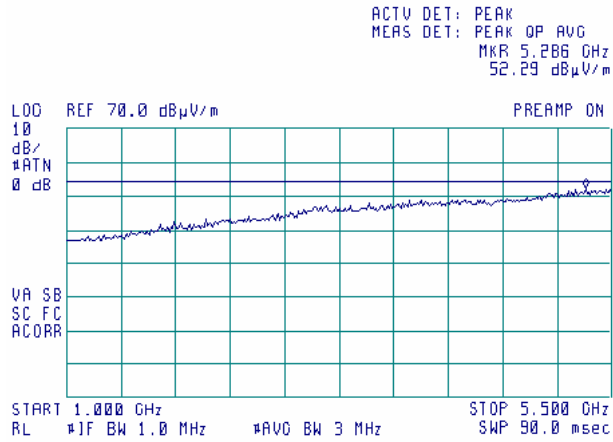

Plot 7.4.124 Radiated emission measurements from 4000 to 5500 MHz at the high carrier frequency

TEST SITE: Semi anechoic chamber
 TEST DISTANCE: 3 m
 ANTENNA POLARIZATION: Vertical
 CHANNEL BANDWIDTH: 20 MHz
 DETECTOR: Average

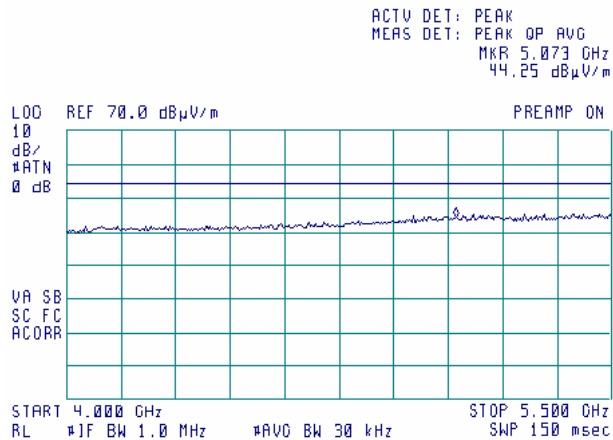



HERMON LABORATORIES

Test specification:	Section 15.247(d), RSS-210 section A8.5, Radiated spurious emissions		
Test procedure:	FCC New Guidance on Measurements for DTS in section 15.247(c)/ANSI C63.4, Section 13.1.4		
Test mode:	Compliance	Verdict:	PASS
Date & Time:	11/12/2008 7:22:59 PM		
Temperature: 21°C	Air Pressure: 1010 hPa	Relative Humidity: 43%	Power Supply: 48 VDC
Remarks: with 28 dBi external dish antenna			

Plot 7.4.125 Radiated emission measurements from 7.25 to 7.75 GHz at the low carrier frequency

TEST SITE: OATS
 TEST DISTANCE: 3 m
 ANTENNA POLARIZATION: Vertical and Horizontal
 CHANNEL BANDWIDTH: 20 MHz

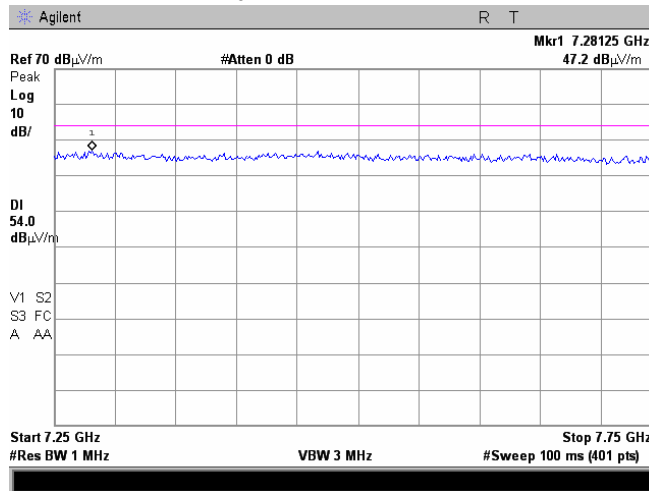

Plot 7.4.126 Radiated emission measurements from 7.25 to 7.75 GHz at the mid carrier frequency

TEST SITE: OATS
 TEST DISTANCE: 3 m
 ANTENNA POLARIZATION: Vertical and Horizontal
 CHANNEL BANDWIDTH: 20 MHz

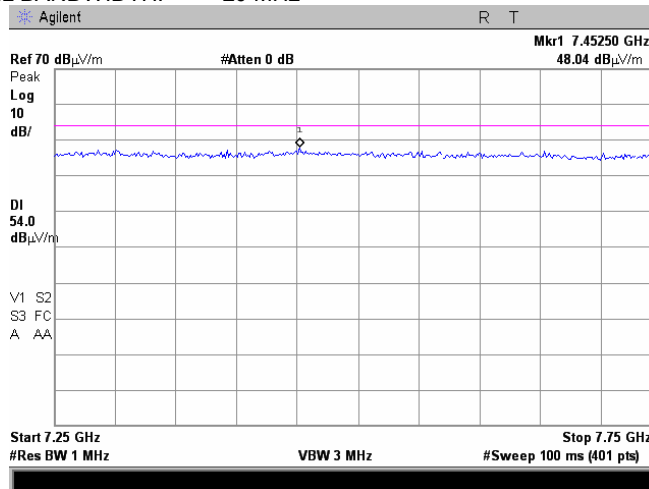



HERMON LABORATORIES

Test specification: Section 15.247(d), RSS-210 section A8.5, Radiated spurious emissions			
Test procedure: FCC New Guidance on Measurements for DTS in section 15.247(c)/ANSI C63.4, Section 13.1.4			
Test mode: Compliance	Verdict: PASS		
Date & Time: 11/12/2008 7:22:59 PM			
Temperature: 21°C	Air Pressure: 1010 hPa	Relative Humidity: 43%	Power Supply: 48 VDC
Remarks: with 28 dBi external dish antenna			

Plot 7.4.127 Radiated emission measurements from 7.25 to 7.75 GHz at the high carrier frequency

TEST SITE: OATS
 TEST DISTANCE: 3 m
 ANTENNA POLARIZATION: Vertical and Horizontal
 CHANNEL BANDWIDTH: 20 MHz

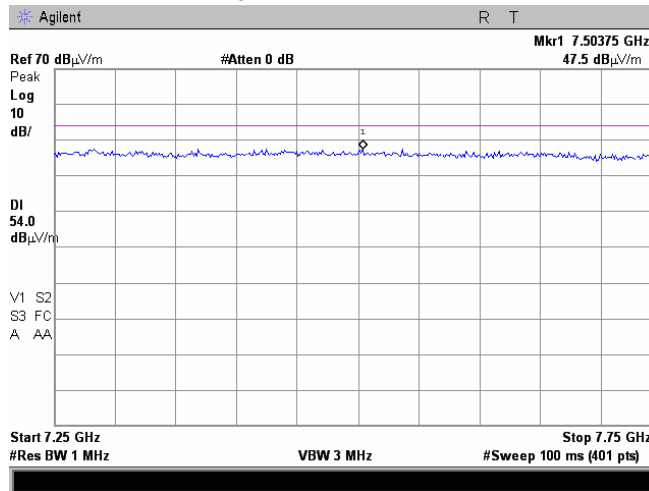

Plot 7.4.128 Radiated emission measurements from 7.25 to 7.75 GHz at the low carrier frequency

TEST SITE: OATS
 TEST DISTANCE: 3 m
 ANTENNA POLARIZATION: Vertical and Horizontal
 CHANNEL BANDWIDTH: 5 MHz

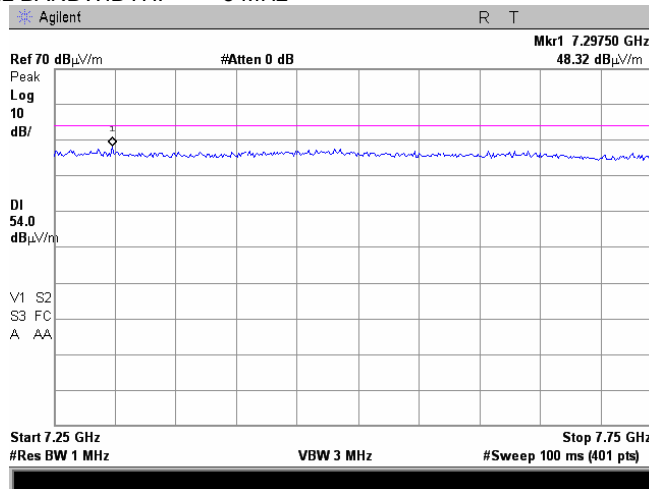



HERMON LABORATORIES

Test specification:	Section 15.247(d), RSS-210 section A8.5, Radiated spurious emissions		
Test procedure:	FCC New Guidance on Measurements for DTS in section 15.247(c)/ANSI C63.4, Section 13.1.4		
Test mode:	Compliance	Verdict:	PASS
Date & Time:	11/12/2008 7:22:59 PM		
Temperature: 21°C	Air Pressure: 1010 hPa	Relative Humidity: 43%	Power Supply: 48 VDC
Remarks: with 28 dBi external dish antenna			

Plot 7.4.129 Radiated emission measurements from 7.25 to 7.75 GHz at the mid carrier frequency

TEST SITE: OATS
 TEST DISTANCE: 3 m
 ANTENNA POLARIZATION: Vertical and Horizontal
 CHANNEL BANDWIDTH: 5 MHz

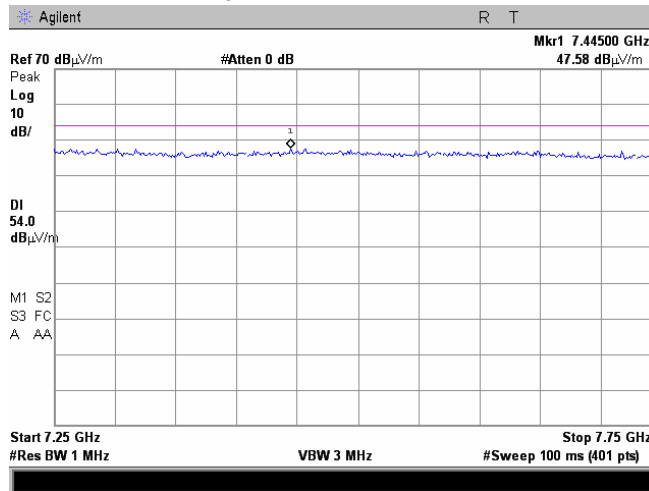

Plot 7.4.130 Radiated emission measurements from 7.25 to 7.75 GHz at the high carrier frequency

TEST SITE: OATS
 TEST DISTANCE: 3 m
 ANTENNA POLARIZATION: Vertical and Horizontal
 CHANNEL BANDWIDTH: 5 MHz

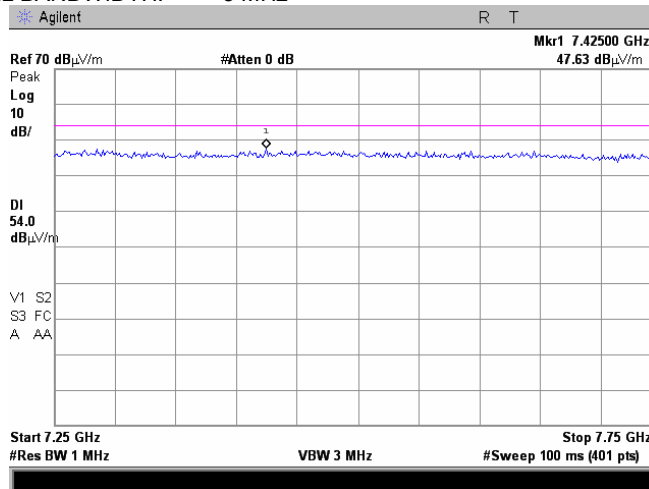



HERMON LABORATORIES

Test specification:	Section 15.247(d), RSS-210 section A8.5, Radiated spurious emissions		
Test procedure:	FCC New Guidance on Measurements for DTS in section 15.247(c)/ANSI C63.4, Section 13.1.4		
Test mode:	Compliance	Verdict:	PASS
Date & Time:	11/12/2008 7:22:59 PM		
Temperature: 21°C	Air Pressure: 1010 hPa	Relative Humidity: 43%	Power Supply: 48 VDC
Remarks: with 28 dBi external dish antenna			

Plot 7.4.131 Radiated emission measurements from 8.0 to 14.0 GHz at the low carrier frequency

TEST SITE: OATS
 TEST DISTANCE: 3 m
 ANTENNA POLARIZATION: Vertical and Horizontal
 CHANNEL BANDWIDTH: 20 MHz
 DETECTOR: Peak

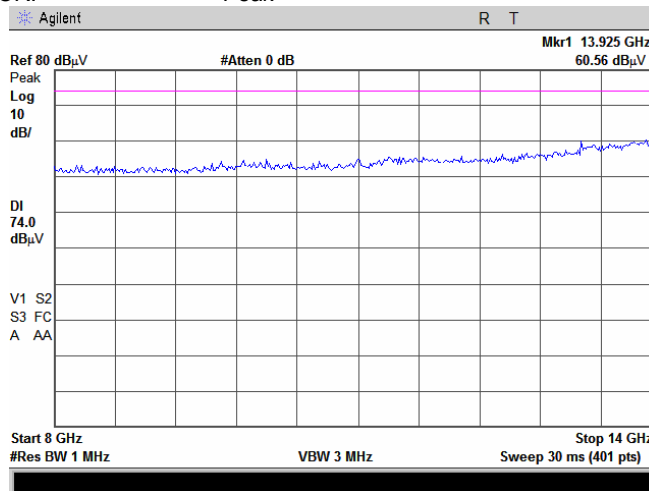

Plot 7.4.132 Radiated emission measurements from 8.0 to 14.0 GHz at the low carrier frequency

TEST SITE: OATS
 TEST DISTANCE: 3 m
 ANTENNA POLARIZATION: Vertical and Horizontal
 CHANNEL BANDWIDTH: 20 MHz
 DETECTOR: Average

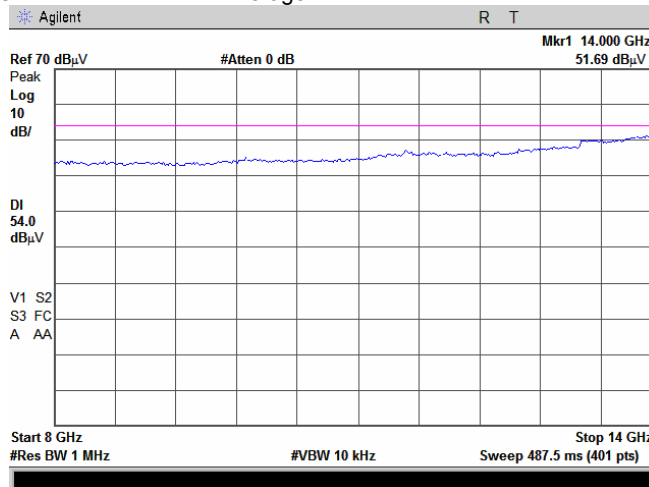



HERMON LABORATORIES

Test specification:	Section 15.247(d), RSS-210 section A8.5, Radiated spurious emissions		
Test procedure:	FCC New Guidance on Measurements for DTS in section 15.247(c)/ANSI C63.4, Section 13.1.4		
Test mode:	Compliance	Verdict:	PASS
Date & Time:	11/12/2008 7:22:59 PM		
Temperature: 21°C	Air Pressure: 1010 hPa	Relative Humidity: 43%	Power Supply: 48 VDC
Remarks: with 28 dBi external dish antenna			

Plot 7.4.133 Radiated emission measurements from 8.0 to 14.0 GHz at the mid carrier frequency

TEST SITE: OATS
 TEST DISTANCE: 3 m
 ANTENNA POLARIZATION: Vertical and Horizontal
 CHANNEL BANDWIDTH: 20 MHz
 DETECTOR: Peak

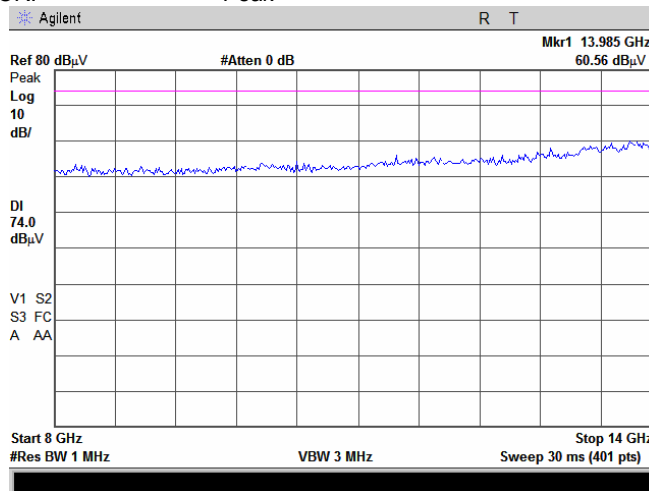

Plot 7.4.134 Radiated emission measurements from 8.0 to 14.0 GHz at the mid carrier frequency

TEST SITE: OATS
 TEST DISTANCE: 3 m
 ANTENNA POLARIZATION: Vertical and Horizontal
 CHANNEL BANDWIDTH: 20 MHz
 DETECTOR: Average

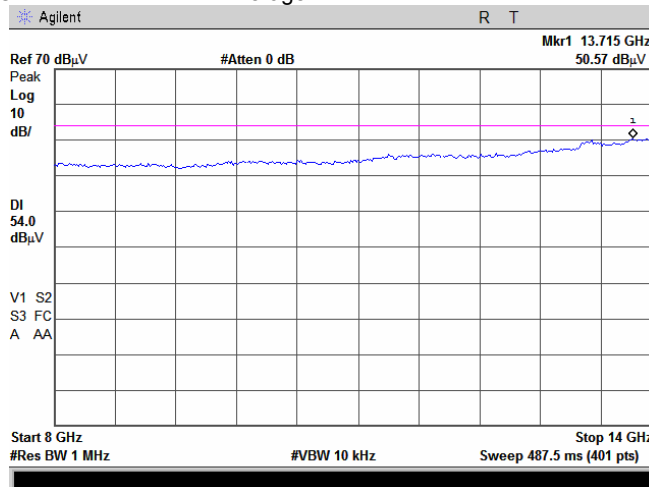



HERMON LABORATORIES

Test specification: Section 15.247(d), RSS-210 section A8.5, Radiated spurious emissions			
Test procedure: FCC New Guidance on Measurements for DTS in section 15.247(c)/ANSI C63.4, Section 13.1.4			
Test mode: Compliance	Verdict: PASS		
Date & Time: 11/12/2008 7:22:59 PM			
Temperature: 21°C	Air Pressure: 1010 hPa	Relative Humidity: 43%	Power Supply: 48 VDC
Remarks: with 28 dBi external dish antenna			

Plot 7.4.135 Radiated emission measurements from 8.0 to 14.0 GHz at the high carrier frequency

TEST SITE: OATS
 TEST DISTANCE: 3 m
 ANTENNA POLARIZATION: Vertical and Horizontal
 CHANNEL BANDWIDTH: 20 MHz
 DETECTOR: Peak

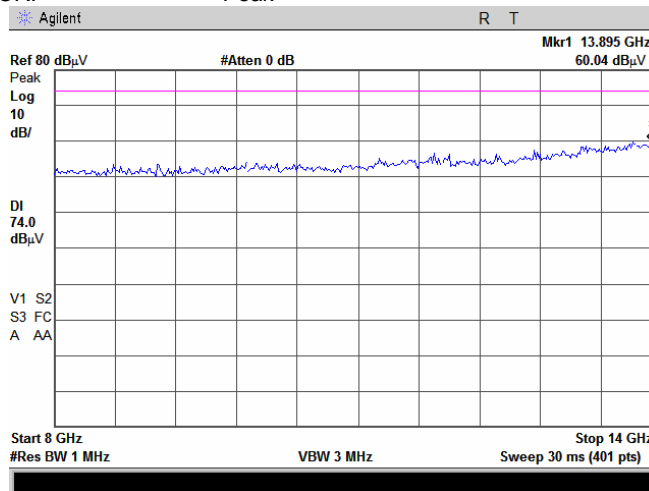

Plot 7.4.136 Radiated emission measurements from 8.0 to 14.0 GHz at the high carrier frequency

TEST SITE: OATS
 TEST DISTANCE: 3 m
 ANTENNA POLARIZATION: Vertical and Horizontal
 CHANNEL BANDWIDTH: 20 MHz
 DETECTOR: Average

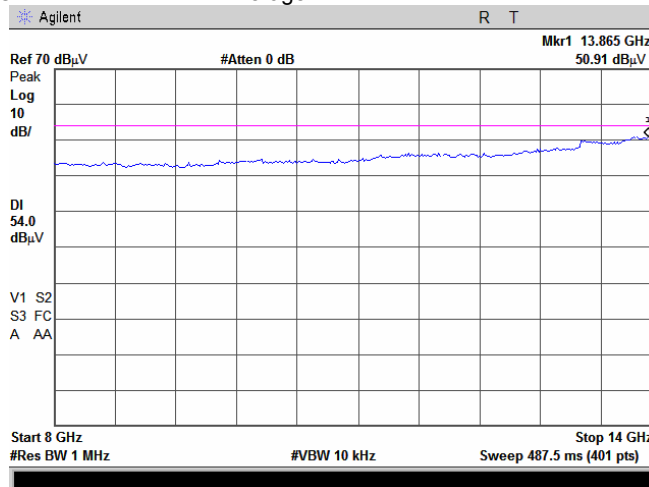



HERMON LABORATORIES

Test specification:	Section 15.247(d), RSS-210 section A8.5, Radiated spurious emissions		
Test procedure:	FCC New Guidance on Measurements for DTS in section 15.247(c)/ANSI C63.4, Section 13.1.4		
Test mode:	Compliance	Verdict:	PASS
Date & Time:	11/12/2008 7:22:59 PM		
Temperature: 21°C	Air Pressure: 1010 hPa	Relative Humidity: 43%	Power Supply: 48 VDC
Remarks: with 28 dBi external dish antenna			

Plot 7.4.137 Radiated emission measurements from 8.0 to 14.0 GHz at the low carrier frequency

TEST SITE: OATS
 TEST DISTANCE: 3 m
 ANTENNA POLARIZATION: Vertical and Horizontal
 CHANNEL BANDWIDTH: 5 MHz
 DETECTOR: Peak

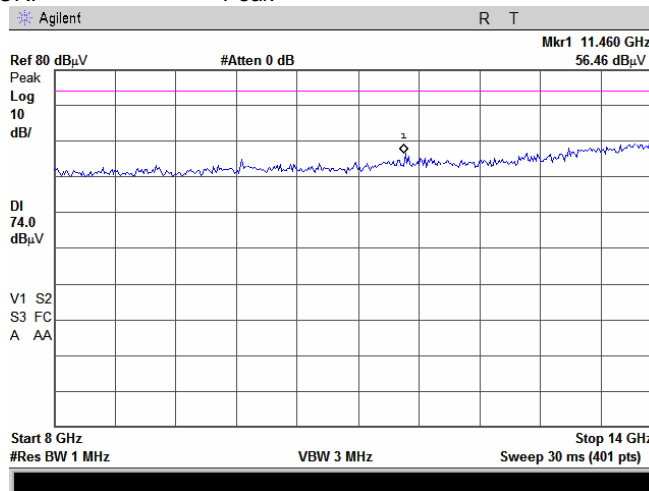

Plot 7.4.138 Radiated emission measurements from 8.0 to 14.0 GHz at the low carrier frequency

TEST SITE: OATS
 TEST DISTANCE: 3 m
 ANTENNA POLARIZATION: Vertical and Horizontal
 CHANNEL BANDWIDTH: 5 MHz
 DETECTOR: Average

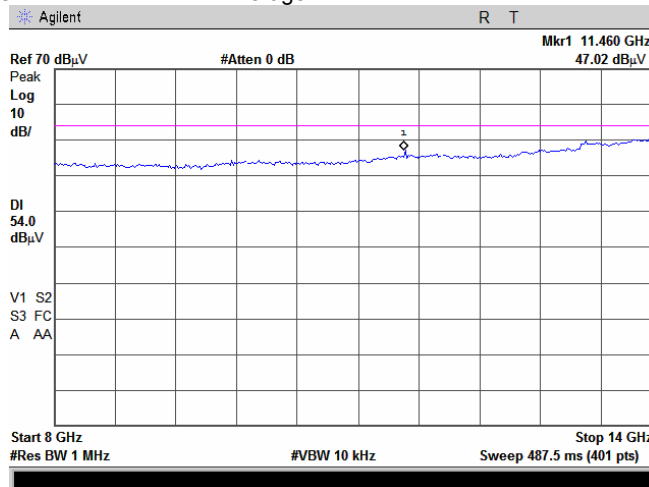



HERMON LABORATORIES

Test specification:	Section 15.247(d), RSS-210 section A8.5, Radiated spurious emissions		
Test procedure:	FCC New Guidance on Measurements for DTS in section 15.247(c)/ANSI C63.4, Section 13.1.4		
Test mode:	Compliance	Verdict:	PASS
Date & Time:	11/12/2008 7:22:59 PM		
Temperature: 21°C	Air Pressure: 1010 hPa	Relative Humidity: 43%	Power Supply: 48 VDC
Remarks: with 28 dBi external dish antenna			

Plot 7.4.139 Radiated emission measurements from 8.0 to 14.0 GHz at the mid carrier frequency

TEST SITE: OATS
 TEST DISTANCE: 3 m
 ANTENNA POLARIZATION: Vertical and Horizontal
 CHANNEL BANDWIDTH: 5 MHz
 DETECTOR: Peak

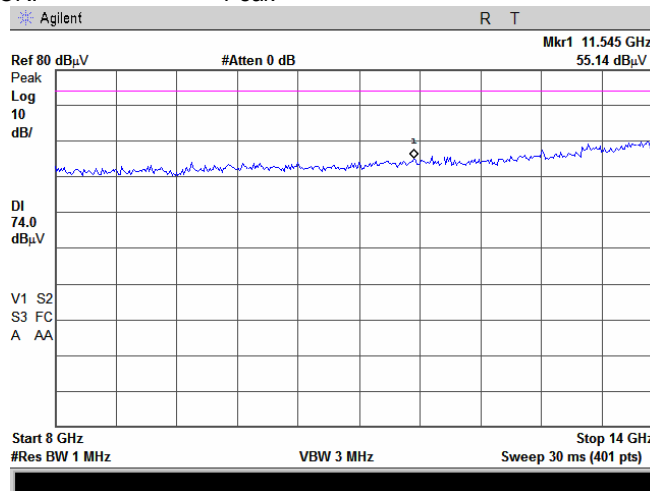

Plot 7.4.140 Radiated emission measurements from 8.0 to 14.0 GHz at the mid carrier frequency

TEST SITE: OATS
 TEST DISTANCE: 3 m
 ANTENNA POLARIZATION: Vertical and Horizontal
 CHANNEL BANDWIDTH: 5 MHz
 DETECTOR: Average

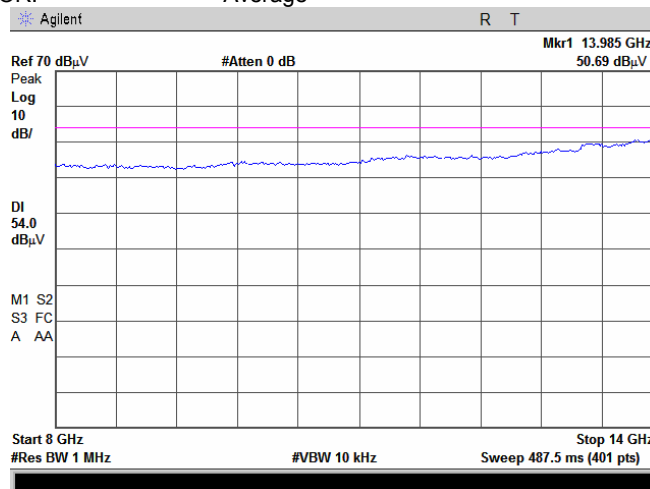



HERMON LABORATORIES

Test specification: Section 15.247(d), RSS-210 section A8.5, Radiated spurious emissions			
Test procedure: FCC New Guidance on Measurements for DTS in section 15.247(c)/ANSI C63.4, Section 13.1.4			
Test mode: Compliance	Verdict: PASS		
Date & Time: 11/12/2008 7:22:59 PM			
Temperature: 21°C	Air Pressure: 1010 hPa	Relative Humidity: 43%	Power Supply: 48 VDC
Remarks: with 28 dBi external dish antenna			

Plot 7.4.141 Radiated emission measurements from 8.0 to 14.0 GHz at the high carrier frequency

TEST SITE: OATS
 TEST DISTANCE: 3 m
 ANTENNA POLARIZATION: Vertical and Horizontal
 CHANNEL BANDWIDTH: 5 MHz
 DETECTOR: Peak

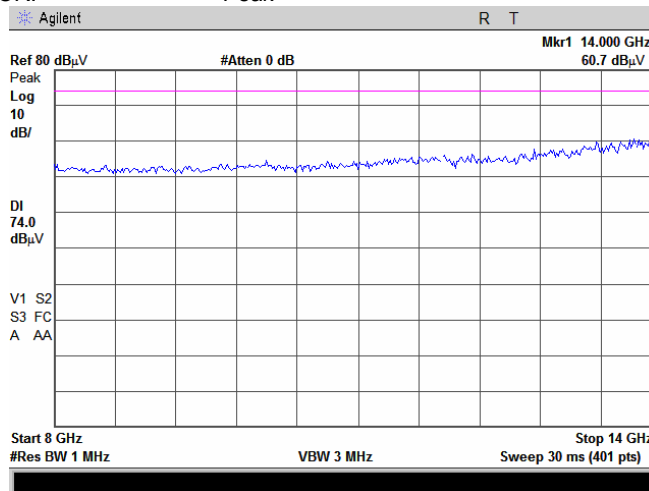

Plot 7.4.142 Radiated emission measurements from 8.0 to 14.0 GHz at the high carrier frequency

TEST SITE: OATS
 TEST DISTANCE: 3 m
 ANTENNA POLARIZATION: Vertical and Horizontal
 CHANNEL BANDWIDTH: 5 MHz
 DETECTOR: Average

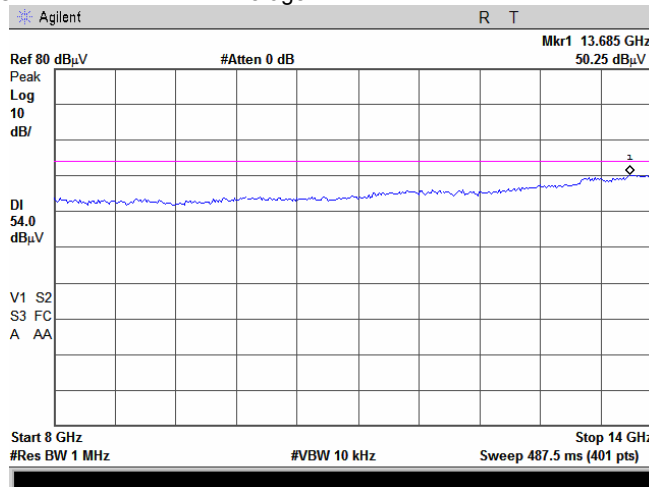



HERMON LABORATORIES

Test specification: Section 15.247(d), RSS-210 section A8.5, Radiated spurious emissions			
Test procedure: FCC New Guidance on Measurements for DTS in section 15.247(c)/ANSI C63.4, Section 13.1.4			
Test mode: Compliance	Verdict: PASS		
Date & Time: 11/12/2008 7:22:59 PM			
Temperature: 21°C	Air Pressure: 1010 hPa	Relative Humidity: 43%	Power Supply: 48 VDC
Remarks: with 28 dBi external dish antenna			

Plot 7.4.143 Radiated emission measurements from 14 to 18 GHz at the low carrier frequency

TEST SITE: OATS
 TEST DISTANCE: 3 m
 ANTENNA POLARIZATION: Vertical and Horizontal
 CBW: 20 MHz
 DETECTOR: Peak

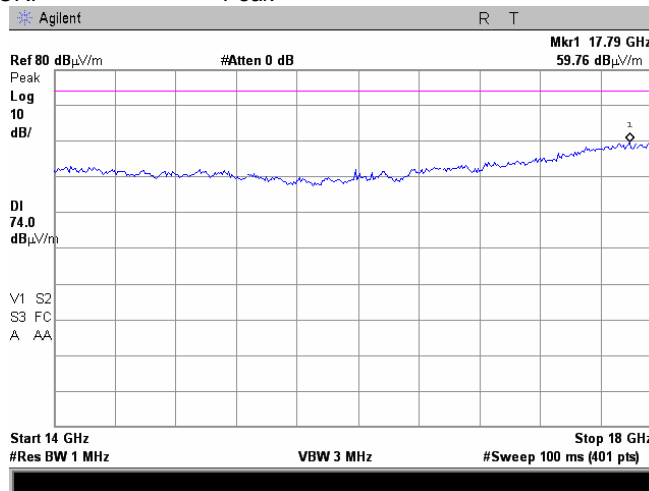

Plot 7.4.144 Radiated emission measurements from 14 to 18 GHz at the low carrier frequency

TEST SITE: OATS
 TEST DISTANCE: 3 m
 ANTENNA POLARIZATION: Vertical and Horizontal
 CBW: 20 MHz
 DETECTOR: Average

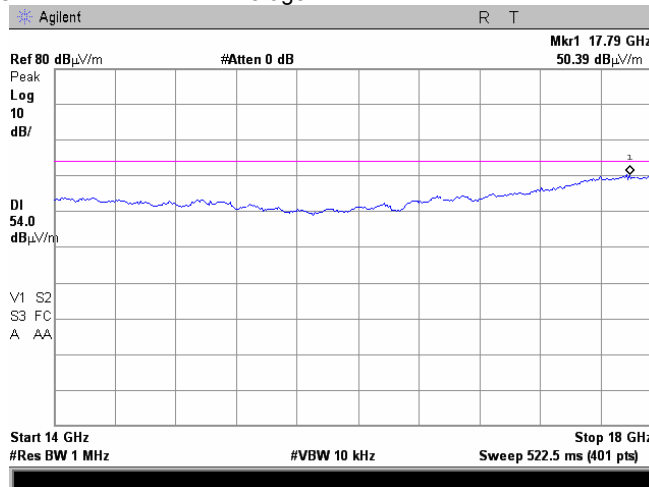



HERMON LABORATORIES

Test specification: Section 15.247(d), RSS-210 section A8.5, Radiated spurious emissions			
Test procedure: FCC New Guidance on Measurements for DTS in section 15.247(c)/ANSI C63.4, Section 13.1.4			
Test mode: Compliance	Verdict: PASS		
Date & Time: 11/12/2008 7:22:59 PM			
Temperature: 21°C	Air Pressure: 1010 hPa	Relative Humidity: 43%	Power Supply: 48 VDC
Remarks: with 28 dBi external dish antenna			

Plot 7.4.145 Radiated emission measurements from 14 to 18 GHz at the mid carrier frequency

TEST SITE: OATS
 TEST DISTANCE: 3 m
 ANTENNA POLARIZATION: Vertical and Horizontal
 CBW: 20 MHz
 DETECTOR: Peak

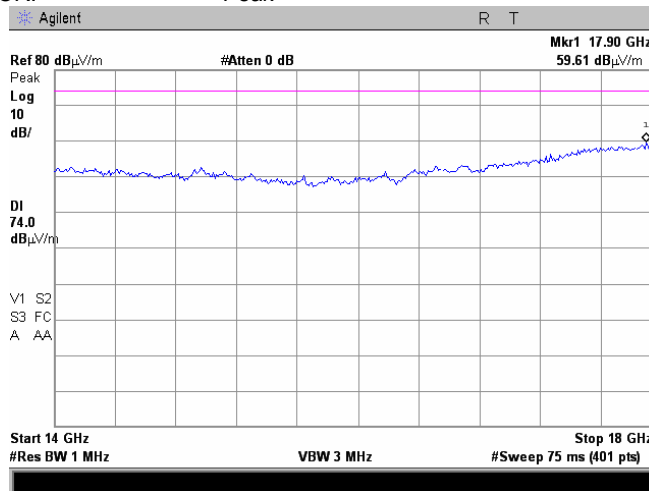

Plot 7.4.146 Radiated emission measurements from 14 to 18 GHz at the mid carrier frequency

TEST SITE: OATS
 TEST DISTANCE: 3 m
 ANTENNA POLARIZATION: Vertical and Horizontal
 CBW: 20 MHz
 DETECTOR: Average

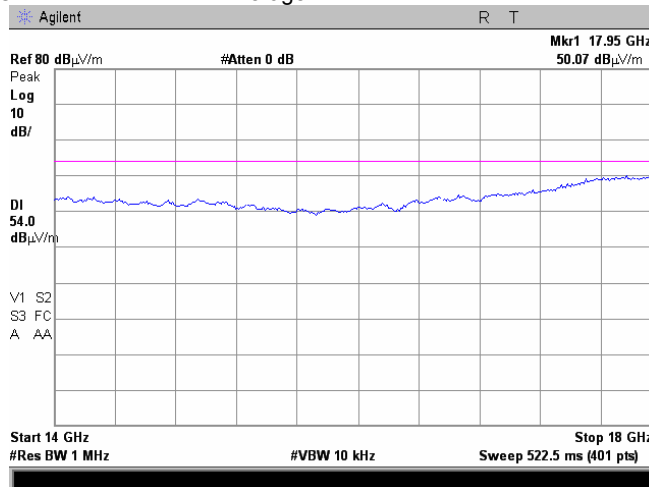



HERMON LABORATORIES

Test specification:	Section 15.247(d), RSS-210 section A8.5, Radiated spurious emissions		
Test procedure:	FCC New Guidance on Measurements for DTS in section 15.247(c)/ANSI C63.4, Section 13.1.4		
Test mode:	Compliance	Verdict:	PASS
Date & Time:	11/12/2008 7:22:59 PM		
Temperature: 21°C	Air Pressure: 1010 hPa	Relative Humidity: 43%	Power Supply: 48 VDC
Remarks: with 28 dBi external dish antenna			

Plot 7.4.147 Radiated emission measurements from 14 to 18 GHz at the high carrier frequency

TEST SITE: OATS
 TEST DISTANCE: 3 m
 ANTENNA POLARIZATION: Vertical and Horizontal
 CBW: 20 MHz
 DETECTOR: Peak

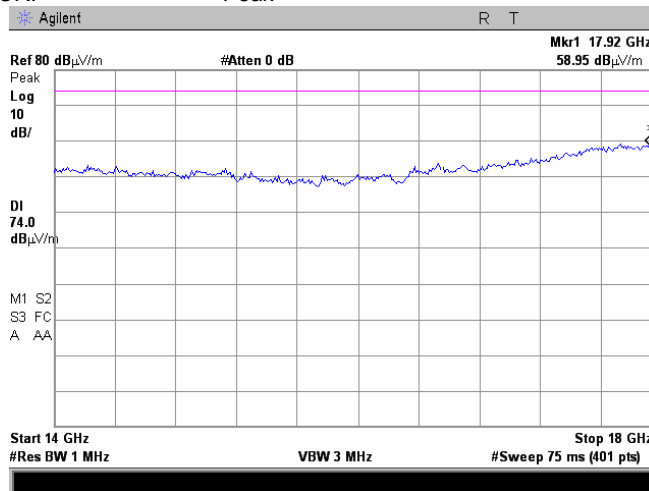

Plot 7.4.148 Radiated emission measurements from 14 to 18 GHz at the high carrier frequency

TEST SITE: OATS
 TEST DISTANCE: 3 m
 ANTENNA POLARIZATION: Vertical and Horizontal
 CBW: 20 MHz
 DETECTOR: Average

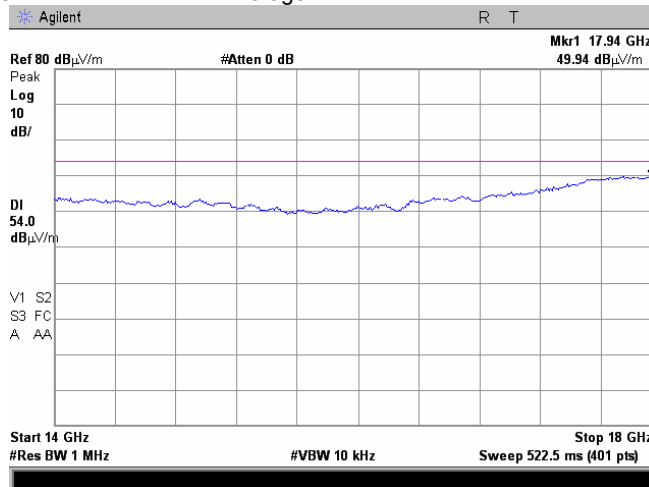



HERMON LABORATORIES

Test specification: Section 15.247(d), RSS-210 section A8.5, Radiated spurious emissions			
Test procedure: FCC New Guidance on Measurements for DTS in section 15.247(c)/ANSI C63.4, Section 13.1.4			
Test mode: Compliance	Verdict: PASS		
Date & Time: 11/12/2008 7:22:59 PM			
Temperature: 21°C	Air Pressure: 1010 hPa	Relative Humidity: 43%	Power Supply: 48 VDC
Remarks: with 28 dBi external dish antenna			

Plot 7.4.149 Radiated emission measurements from 14 to 18 GHz at the low carrier frequency

TEST SITE: OATS
 TEST DISTANCE: 3 m
 ANTENNA POLARIZATION: Vertical and Horizontal
 CBW: 5 MHz
 DETECTOR: Peak

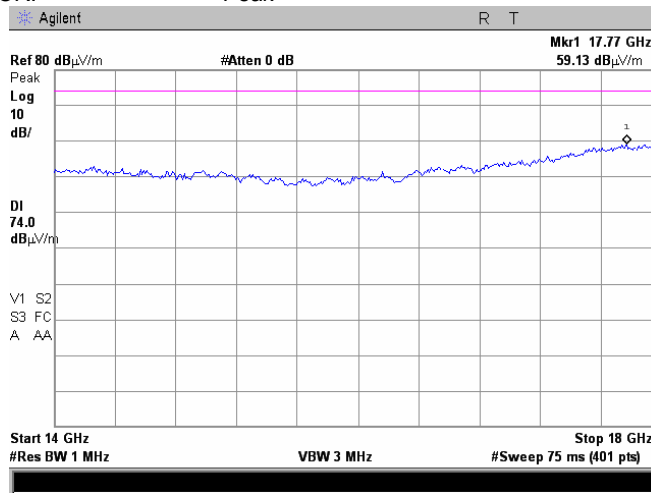

Plot 7.4.150 Radiated emission measurements from 14 to 18 GHz at the low carrier frequency

TEST SITE: OATS
 TEST DISTANCE: 3 m
 ANTENNA POLARIZATION: Vertical and Horizontal
 CBW: 5 MHz
 DETECTOR: Average

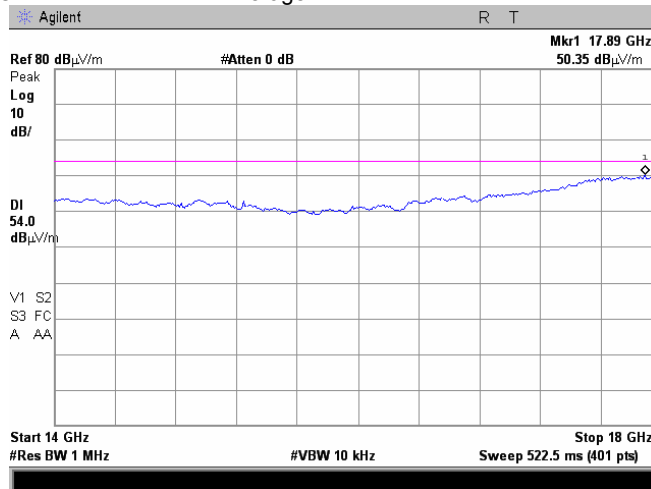



HERMON LABORATORIES

Test specification: Section 15.247(d), RSS-210 section A8.5, Radiated spurious emissions			
Test procedure: FCC New Guidance on Measurements for DTS in section 15.247(c)/ANSI C63.4, Section 13.1.4			
Test mode: Compliance	Verdict: PASS		
Date & Time: 11/12/2008 7:22:59 PM			
Temperature: 21°C	Air Pressure: 1010 hPa	Relative Humidity: 43%	Power Supply: 48 VDC
Remarks: with 28 dBi external dish antenna			

Plot 7.4.151 Radiated emission measurements from 14 to 18 GHz at the mid carrier frequency

TEST SITE: OATS
 TEST DISTANCE: 3 m
 ANTENNA POLARIZATION: Vertical and Horizontal
 CBW: 5 MHz
 DETECTOR: Peak

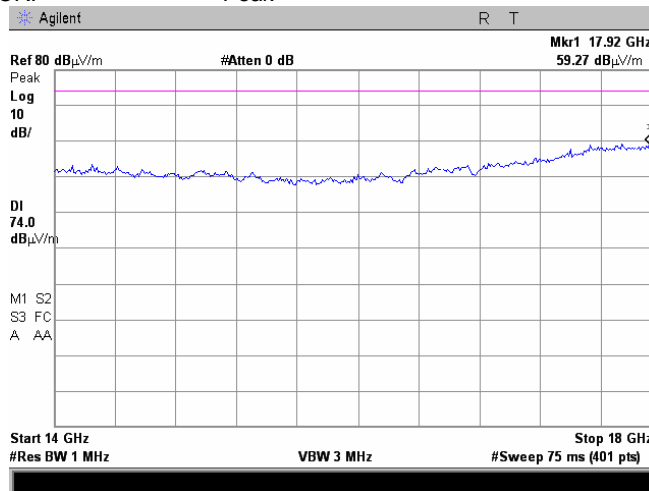

Plot 7.4.152 Radiated emission measurements from 14 to 18 GHz at the mid carrier frequency

TEST SITE: OATS
 TEST DISTANCE: 3 m
 ANTENNA POLARIZATION: Vertical and Horizontal
 CBW: 5 MHz
 DETECTOR: Average

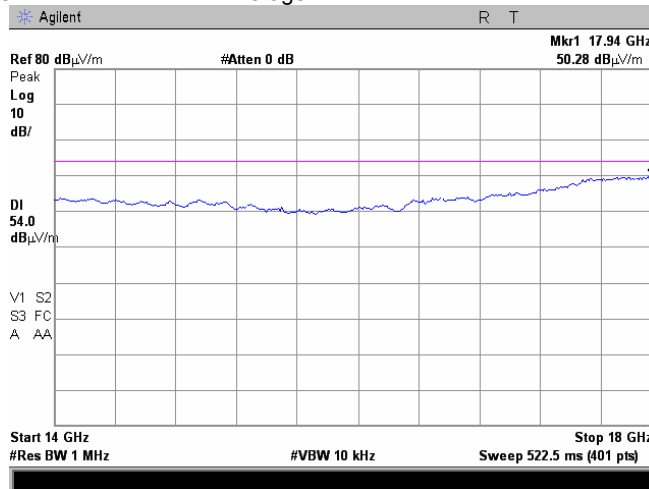



HERMON LABORATORIES

Test specification: Section 15.247(d), RSS-210 section A8.5, Radiated spurious emissions			
Test procedure: FCC New Guidance on Measurements for DTS in section 15.247(c)/ANSI C63.4, Section 13.1.4			
Test mode: Compliance	Verdict: PASS		
Date & Time: 11/12/2008 7:22:59 PM			
Temperature: 21°C	Air Pressure: 1010 hPa	Relative Humidity: 43%	Power Supply: 48 VDC
Remarks: with 28 dBi external dish antenna			

Plot 7.4.153 Radiated emission measurements from 14 to 18 GHz at the high carrier frequency

TEST SITE: OATS
 TEST DISTANCE: 3 m
 ANTENNA POLARIZATION: Vertical and Horizontal
 CBW: 5 MHz
 DETECTOR: Peak

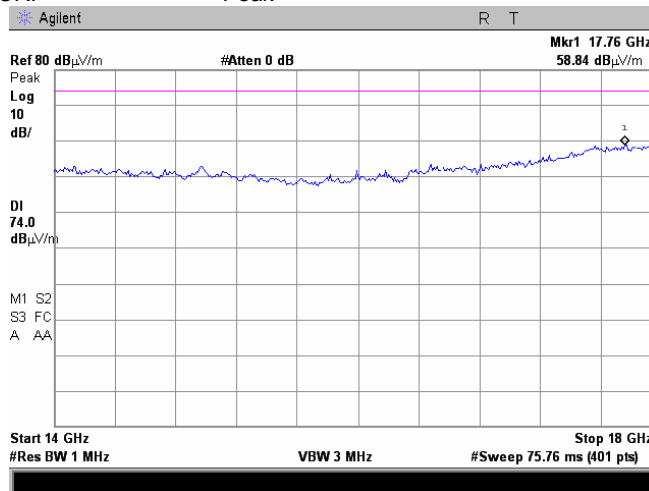

Plot 7.4.154 Radiated emission measurements from 14 to 18 GHz at the high carrier frequency

TEST SITE: OATS
 TEST DISTANCE: 3 m
 ANTENNA POLARIZATION: Vertical and Horizontal
 CBW: 5 MHz
 DETECTOR: Average

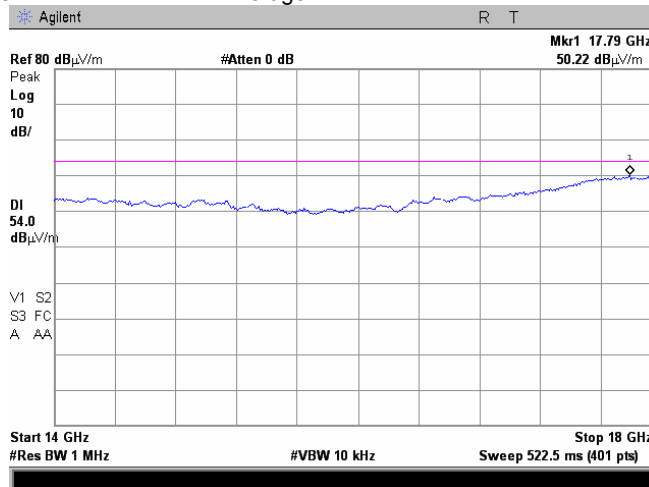



Test specification: Section 15.247(d), RSS-210 section A8.5, Radiated spurious emissions			
Test procedure: FCC New Guidance on Measurements for DTS in section 15.247(c)/ANSI C63.4, Section 13.1.4			
Test mode: Compliance	Verdict: PASS		
Date & Time: 11/12/2008 7:22:59 PM			
Temperature: 21°C	Air Pressure: 1010 hPa	Relative Humidity: 43%	Power Supply: 48 VDC
Remarks: with 28 dBi external dish antenna			

Plot 7.4.155 Radiated emission measurements from 18 to 26.5 GHz at the low carrier frequency

TEST SITE: OATS
TEST DISTANCE: 3 m
ANTENNA POLARIZATION: Vertical and Horizontal
CBW 20 MHz
DETECTOR: Peak

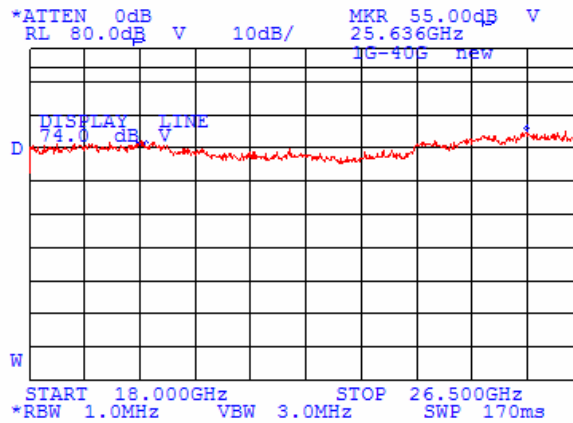

Plot 7.4.156 Radiated emission measurements from 18 to 26.5 GHz at the low carrier frequency

TEST SITE: OATS
TEST DISTANCE: 3 m
ANTENNA POLARIZATION: Vertical and Horizontal
CBW 20 MHz
DETECTOR: Average

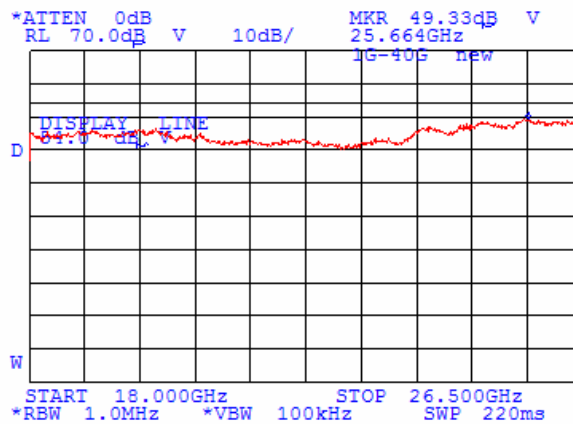



Test specification: Section 15.247(d), RSS-210 section A8.5, Radiated spurious emissions			
Test procedure: FCC New Guidance on Measurements for DTS in section 15.247(c)/ANSI C63.4, Section 13.1.4			
Test mode: Compliance	Verdict: PASS		
Date & Time: 11/12/2008 7:22:59 PM			
Temperature: 21°C	Air Pressure: 1010 hPa	Relative Humidity: 43%	Power Supply: 48 VDC
Remarks: with 28 dBi external dish antenna			

Plot 7.4.157 Radiated emission measurements from 18 to 26.5 GHz at the mid carrier frequency

TEST SITE: OATS
 TEST DISTANCE: 3 m
 ANTENNA POLARIZATION: Vertical and Horizontal
 CBW 20 MHz
 DETECTOR: Peak

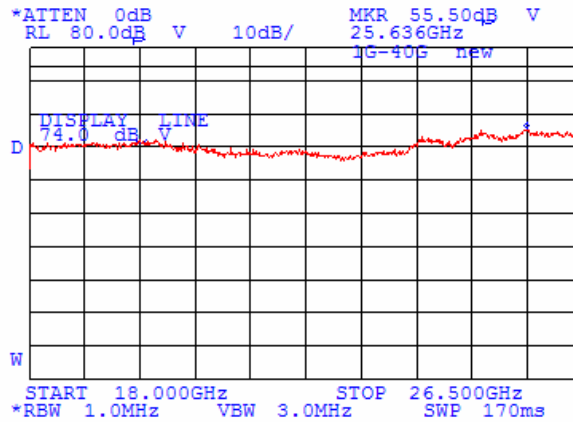

Plot 7.4.158 Radiated emission measurements from 18 to 26.5 GHz at the mid carrier frequency

TEST SITE: OATS
 TEST DISTANCE: 3 m
 ANTENNA POLARIZATION: Vertical and Horizontal
 CBW 20 MHz
 DETECTOR: Average

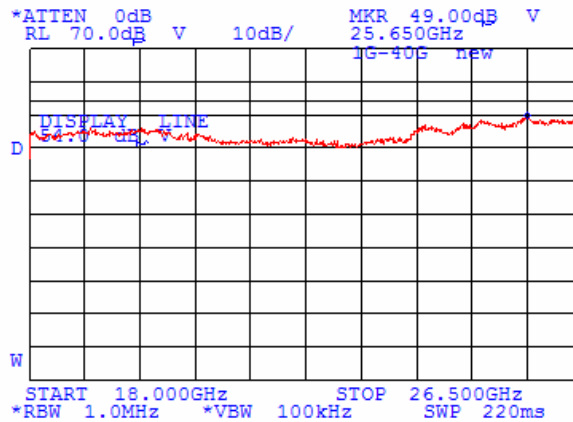



Test specification: Section 15.247(d), RSS-210 section A8.5, Radiated spurious emissions			
Test procedure: FCC New Guidance on Measurements for DTS in section 15.247(c)/ANSI C63.4, Section 13.1.4			
Test mode: Compliance	Verdict: PASS		
Date & Time: 11/12/2008 7:22:59 PM			
Temperature: 21°C	Air Pressure: 1010 hPa	Relative Humidity: 43%	Power Supply: 48 VDC
Remarks: with 28 dBi external dish antenna			

Plot 7.4.159 Radiated emission measurements from 18 to 26.5 GHz at the high carrier frequency

TEST SITE: OATS
 TEST DISTANCE: 3 m
 ANTENNA POLARIZATION: Vertical and Horizontal
 CBW 20 MHz
 DETECTOR: Peak

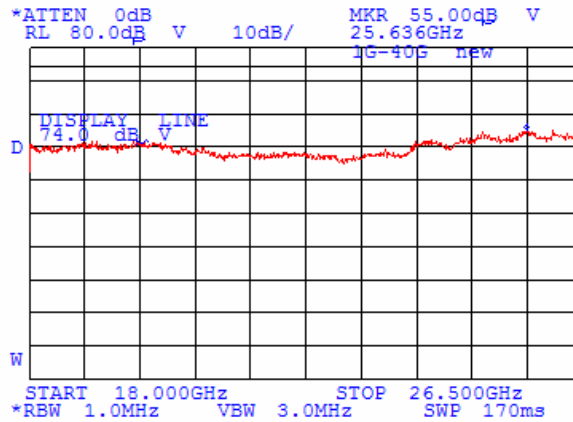

Plot 7.4.160 Radiated emission measurements from 18 to 26.5 GHz at the high carrier frequency

TEST SITE: OATS
 TEST DISTANCE: 3 m
 ANTENNA POLARIZATION: Vertical and Horizontal
 CBW 20 MHz
 DETECTOR: Average

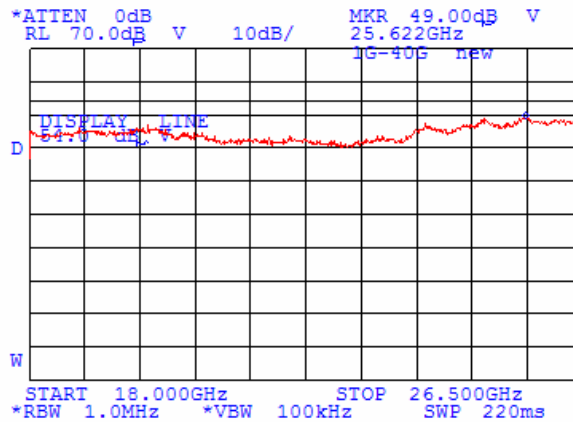



Test specification: Section 15.247(d), RSS-210 section A8.5, Radiated spurious emissions			
Test procedure: FCC New Guidance on Measurements for DTS in section 15.247(c)/ANSI C63.4, Section 13.1.4			
Test mode: Compliance	Verdict: PASS		
Date & Time: 11/12/2008 7:22:59 PM			
Temperature: 21°C	Air Pressure: 1010 hPa	Relative Humidity: 43%	Power Supply: 48 VDC
Remarks: with 28 dBi external dish antenna			

Plot 7.4.161 Radiated emission measurements from 18 to 26.5 GHz at the low carrier frequency

TEST SITE: OATS
 TEST DISTANCE: 3 m
 ANTENNA POLARIZATION: Vertical and Horizontal
 CBW 5 MHz
 DETECTOR: Peak

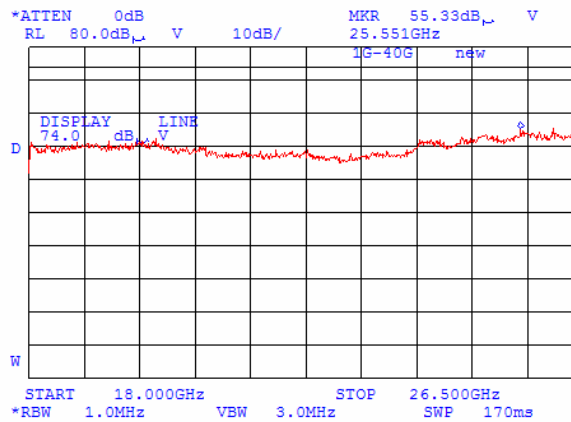

Plot 7.4.162 Radiated emission measurements from 18 to 26.5 GHz at the low carrier frequency

TEST SITE: OATS
 TEST DISTANCE: 3 m
 ANTENNA POLARIZATION: Vertical and Horizontal
 CBW 5 MHz
 DETECTOR: Average

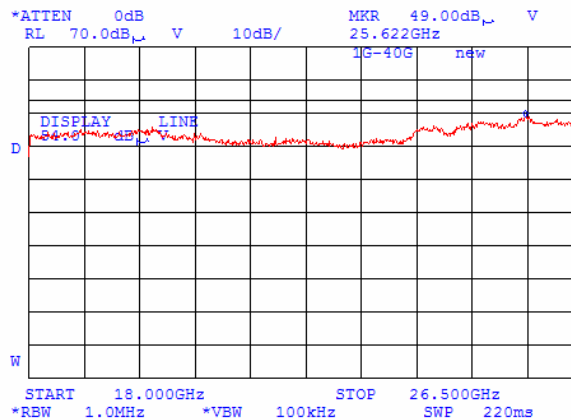



HERMON LABORATORIES

Test specification: Section 15.247(d), RSS-210 section A8.5, Radiated spurious emissions			
Test procedure: FCC New Guidance on Measurements for DTS in section 15.247(c)/ANSI C63.4, Section 13.1.4			
Test mode: Compliance	Verdict: PASS		
Date & Time: 11/12/2008 7:22:59 PM			
Temperature: 21°C	Air Pressure: 1010 hPa	Relative Humidity: 43%	Power Supply: 48 VDC
Remarks: with 28 dBi external dish antenna			

Plot 7.4.163 Radiated emission measurements from 18 to 26.5 GHz at the mid carrier frequency

TEST SITE: OATS
TEST DISTANCE: 3 m
ANTENNA POLARIZATION: Vertical and Horizontal
CBW 5 MHz
DETECTOR: Peak

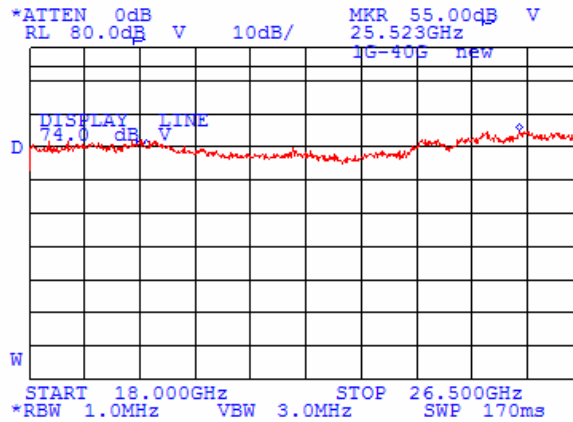

Plot 7.4.164 Radiated emission measurements from 18 to 26.5 GHz at the mid carrier frequency

TEST SITE: OATS
TEST DISTANCE: 3 m
ANTENNA POLARIZATION: Vertical and Horizontal
CBW 5 MHz
DETECTOR: Average

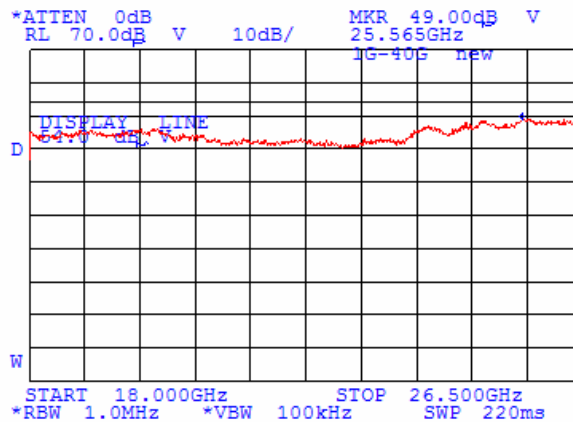



HERMON LABORATORIES

Test specification: Section 15.247(d), RSS-210 section A8.5, Radiated spurious emissions			
Test procedure: FCC New Guidance on Measurements for DTS in section 15.247(c)/ANSI C63.4, Section 13.1.4			
Test mode: Compliance	Verdict: PASS		
Date & Time: 11/12/2008 7:22:59 PM			
Temperature: 21°C	Air Pressure: 1010 hPa	Relative Humidity: 43%	Power Supply: 48 VDC
Remarks: with 28 dBi external dish antenna			

Plot 7.4.165 Radiated emission measurements from 18 to 26.5 GHz at the high carrier frequency

TEST SITE: OATS
TEST DISTANCE: 3 m
ANTENNA POLARIZATION: Vertical and Horizontal
CBW 5 MHz
DETECTOR: Peak

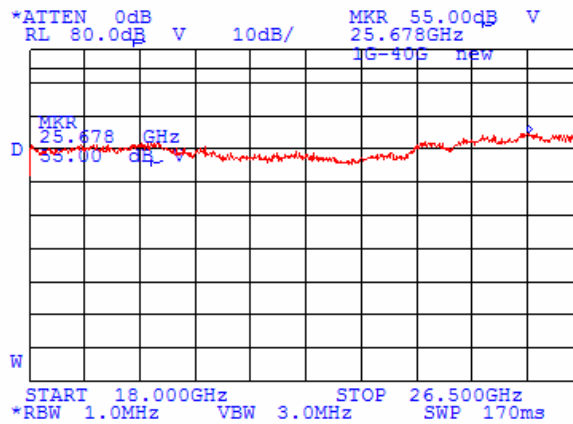

Plot 7.4.166 Radiated emission measurements from 18 to 26.5 GHz at the high carrier frequency

TEST SITE: OATS
TEST DISTANCE: 3 m
ANTENNA POLARIZATION: Vertical and Horizontal
CBW 5 MHz
DETECTOR: Average

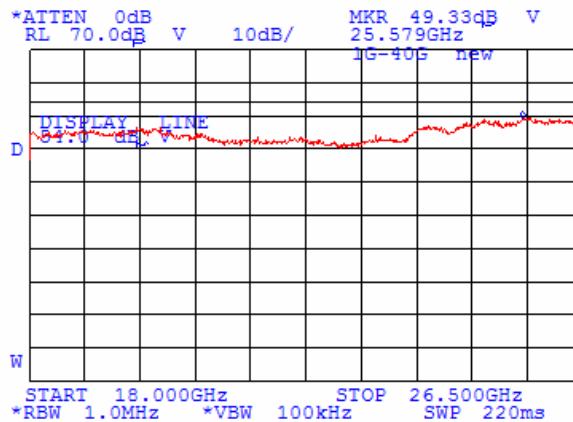



HERMON LABORATORIES

Test specification:	Section 15.247(d), RSS-210 section A8.5, Radiated spurious emissions		
Test procedure:	FCC New Guidance on Measurements for DTS in section 15.247(c)/ANSI C63.4, Section 13.1.4		
Test mode:	Compliance	Verdict: PASS	
Date & Time:	11/12/2008 7:22:59 PM		
Temperature: 21°C	Air Pressure: 1010 hPa	Relative Humidity: 43%	Power Supply: 48 VDC
Remarks: with 28 dBi external dish antenna			

Plot 7.4.167 Radiated emission measurements from 26.5 to 33 GHz at the low carrier frequency

TEST SITE: OATS
 TEST DISTANCE: 3 m
 ANTENNA POLARIZATION: Vertical and Horizontal
 CBW 20 MHz
 DETECTOR: Peak

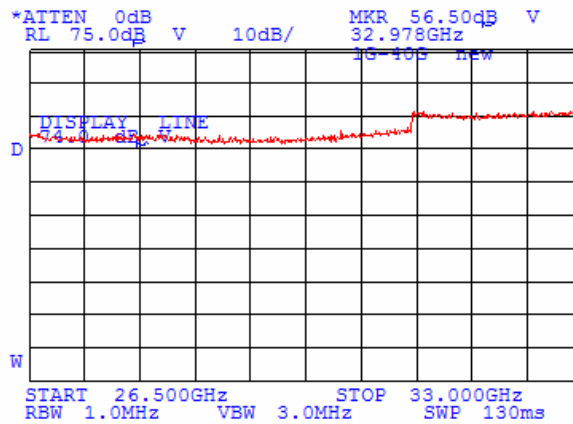

Plot 7.4.168 Radiated emission measurements from 26.5 to 33 GHz at the low carrier frequency

TEST SITE: OATS
 TEST DISTANCE: 3 m
 ANTENNA POLARIZATION: Vertical and Horizontal
 CBW 20 MHz
 DETECTOR: Average

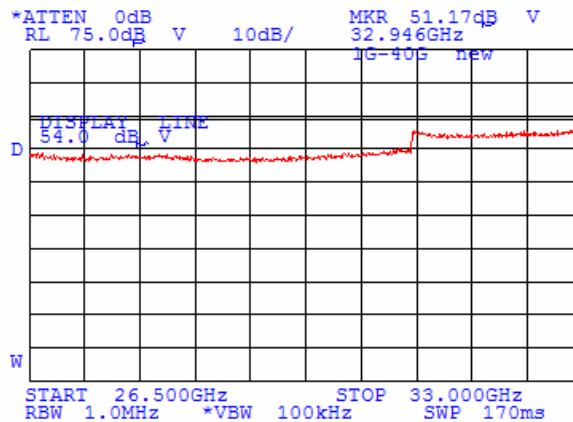



HERMON LABORATORIES

Test specification:	Section 15.247(d), RSS-210 section A8.5, Radiated spurious emissions		
Test procedure:	FCC New Guidance on Measurements for DTS in section 15.247(c)/ANSI C63.4, Section 13.1.4		
Test mode:	Compliance	Verdict:	PASS
Date & Time:	11/12/2008 7:22:59 PM		
Temperature: 21°C	Air Pressure: 1010 hPa	Relative Humidity: 43%	Power Supply: 48 VDC
Remarks: with 28 dBi external dish antenna			

Plot 7.4.169 Radiated emission measurements from 26.5 to 33 GHz at the mid carrier frequency

TEST SITE: OATS
 TEST DISTANCE: 3 m
 ANTENNA POLARIZATION: Vertical and Horizontal
 CBW 20 MHz
 DETECTOR: Peak

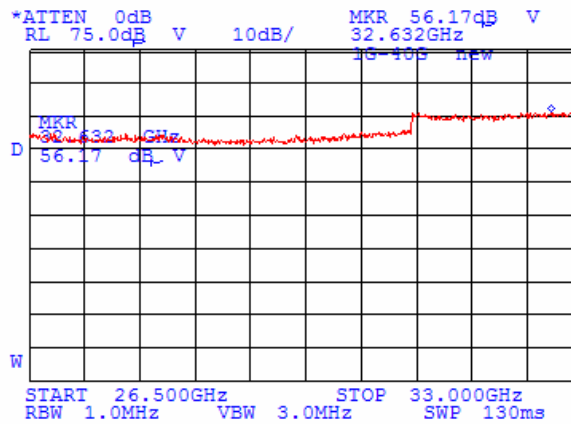

Plot 7.4.170 Radiated emission measurements from 26.5 to 33 GHz at the mid carrier frequency

TEST SITE: OATS
 TEST DISTANCE: 3 m
 ANTENNA POLARIZATION: Vertical and Horizontal
 CBW 20 MHz
 DETECTOR: Average

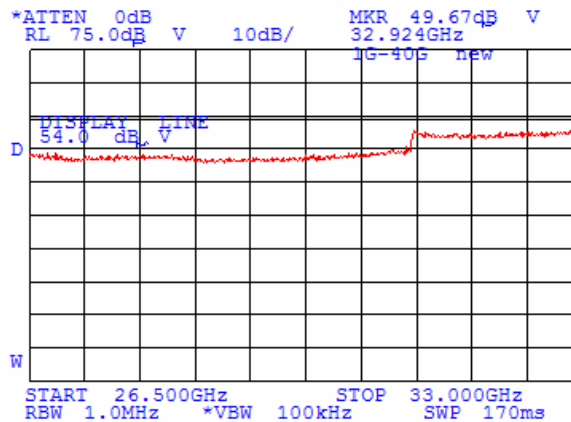



HERMON LABORATORIES

Test specification:	Section 15.247(d), RSS-210 section A8.5, Radiated spurious emissions		
Test procedure:	FCC New Guidance on Measurements for DTS in section 15.247(c)/ANSI C63.4, Section 13.1.4		
Test mode:	Compliance	Verdict:	PASS
Date & Time:	11/12/2008 7:22:59 PM		
Temperature: 21°C	Air Pressure: 1010 hPa	Relative Humidity: 43%	Power Supply: 48 VDC
Remarks: with 28 dBi external dish antenna			

Plot 7.4.171 Radiated emission measurements from 26.5 to 33 GHz at the high carrier frequency

TEST SITE: OATS
 TEST DISTANCE: 3 m
 ANTENNA POLARIZATION: Vertical and Horizontal
 CBW 20 MHz
 DETECTOR: Peak

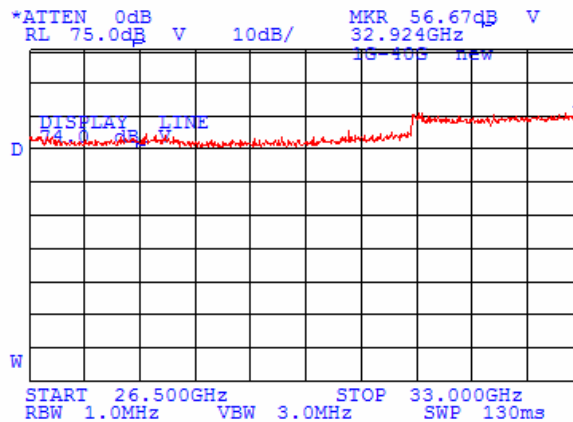

Plot 7.4.172 Radiated emission measurements from 26.5 to 33 GHz at the high carrier frequency

TEST SITE: OATS
 TEST DISTANCE: 3 m
 ANTENNA POLARIZATION: Vertical and Horizontal
 CBW 20 MHz
 DETECTOR: Average

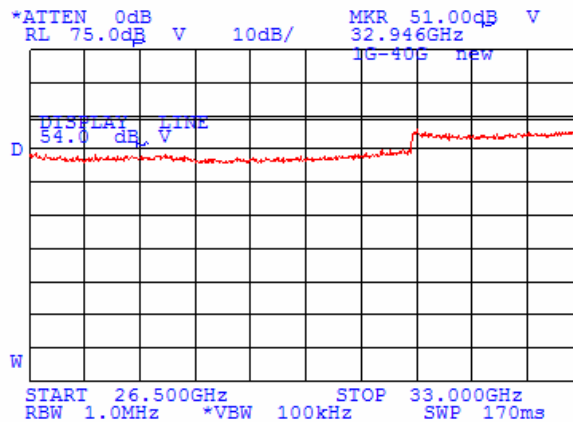



Test specification:	Section 15.247(d), RSS-210 section A8.5, Radiated spurious emissions		
Test procedure:	FCC New Guidance on Measurements for DTS in section 15.247(c)/ANSI C63.4, Section 13.1.4		
Test mode:	Compliance	Verdict:	PASS
Date & Time:	11/12/2008 7:22:59 PM		
Temperature: 21°C	Air Pressure: 1010 hPa	Relative Humidity: 43%	Power Supply: 48 VDC
Remarks: with 28 dBi external dish antenna			

Plot 7.4.173 Radiated emission measurements from 26.5 to 33 GHz at the low carrier frequency

TEST SITE: OATS
 TEST DISTANCE: 3 m
 ANTENNA POLARIZATION: Vertical and Horizontal
 CBW: 5 MHz
 DETECTOR: Peak

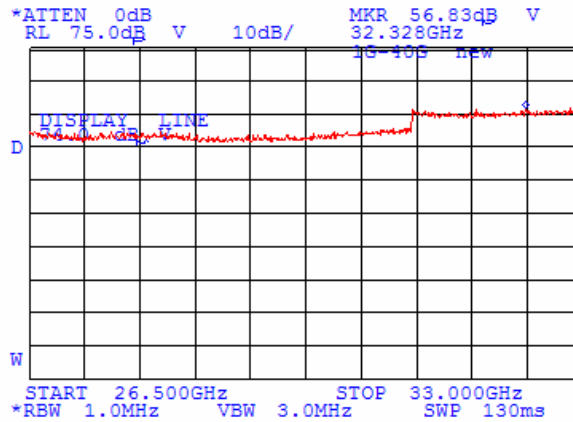

Plot 7.4.174 Radiated emission measurements from 26.5 to 33 GHz at the low carrier frequency

TEST SITE: OATS
 TEST DISTANCE: 3 m
 ANTENNA POLARIZATION: Vertical and Horizontal
 CBW: 5 MHz
 DETECTOR: Average

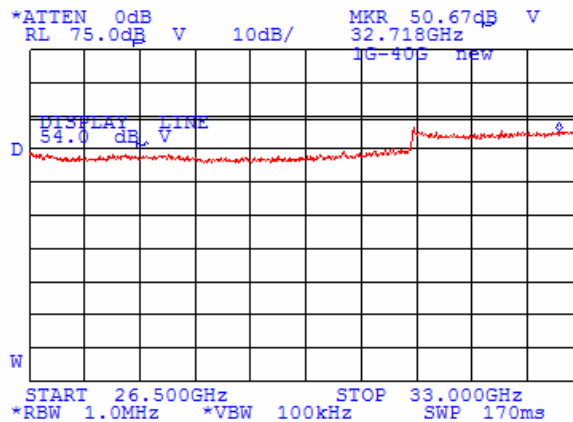



Test specification:	Section 15.247(d), RSS-210 section A8.5, Radiated spurious emissions		
Test procedure:	FCC New Guidance on Measurements for DTS in section 15.247(c)/ANSI C63.4, Section 13.1.4		
Test mode:	Compliance	Verdict:	PASS
Date & Time:	11/12/2008 7:22:59 PM		
Temperature: 21°C	Air Pressure: 1010 hPa	Relative Humidity: 43%	Power Supply: 48 VDC
Remarks: with 28 dBi external dish antenna			

Plot 7.4.175 Radiated emission measurements from 26.5 to 33 GHz at the mid carrier frequency

TEST SITE: OATS
 TEST DISTANCE: 3 m
 ANTENNA POLARIZATION: Vertical and Horizontal
 CBW 5 MHz
 DETECTOR: Peak

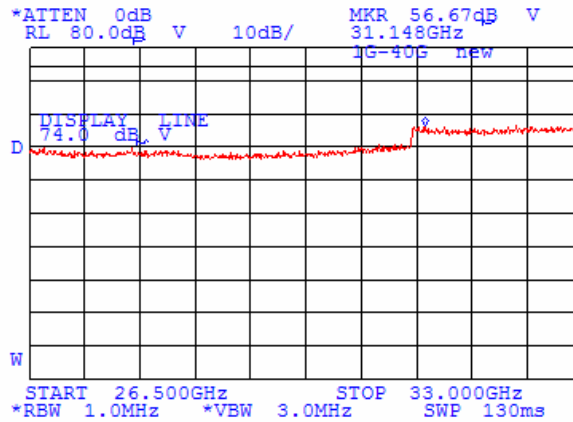

Plot 7.4.176 Radiated emission measurements from 26.5 to 33 GHz at the mid carrier frequency

TEST SITE: OATS
 TEST DISTANCE: 3 m
 ANTENNA POLARIZATION: Vertical and Horizontal
 CBW 5 MHz
 DETECTOR: Average

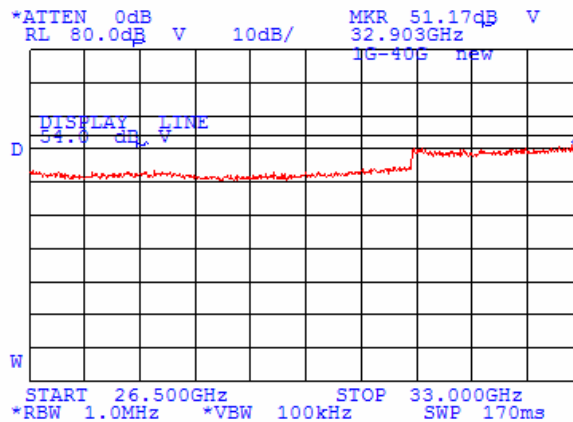



Test specification:	Section 15.247(d), RSS-210 section A8.5, Radiated spurious emissions		
Test procedure:	FCC New Guidance on Measurements for DTS in section 15.247(c)/ANSI C63.4, Section 13.1.4		
Test mode:	Compliance	Verdict:	PASS
Date & Time:	11/12/2008 7:22:59 PM		
Temperature: 21°C	Air Pressure: 1010 hPa	Relative Humidity: 43%	Power Supply: 48 VDC
Remarks: with 28 dBi external dish antenna			

Plot 7.4.177 Radiated emission measurements from 26.5 to 33 GHz at the high carrier frequency

TEST SITE: OATS
 TEST DISTANCE: 3 m
 ANTENNA POLARIZATION: Vertical and Horizontal
 CBW 5 MHz
 DETECTOR: Peak

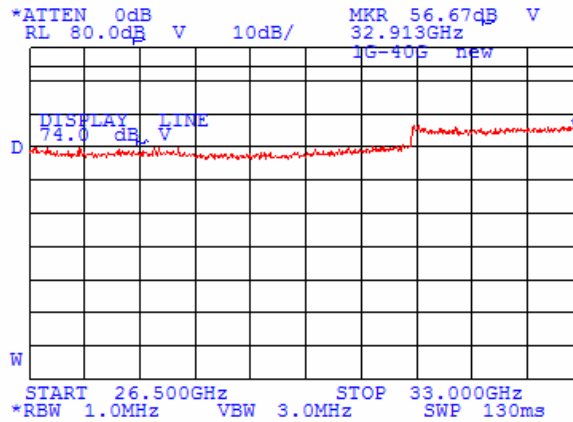

Plot 7.4.178 Radiated emission measurements from 26.5 to 33 GHz at the high carrier frequency

TEST SITE: OATS
 TEST DISTANCE: 3 m
 ANTENNA POLARIZATION: Vertical and Horizontal
 CBW 5 MHz
 DETECTOR: Average

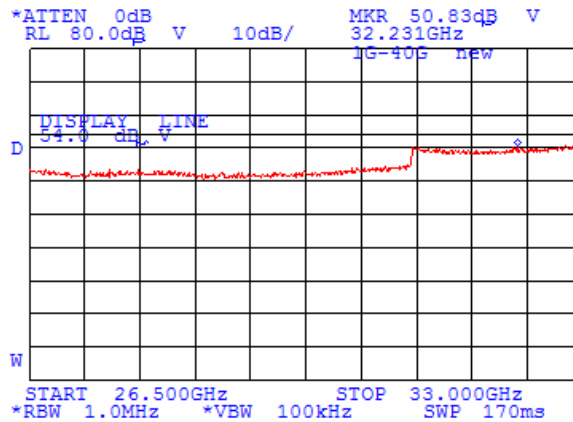



HERMON LABORATORIES

Test specification:	Section 15.247(d), RSS-210 section A8.5, Radiated spurious emissions		
Test procedure:	FCC New Guidance on Measurements for DTS in section 15.247(c)/ANSI C63.4, Section 13.1.4		
Test mode:	Compliance	Verdict:	PASS
Date & Time:	11/12/2008 7:22:59 PM		
Temperature: 21°C	Air Pressure: 1010 hPa	Relative Humidity: 43%	Power Supply: 48 VDC
Remarks: with 28 dBi external dish antenna			

Plot 7.4.179 Radiated emission measurements from 33 to 40 GHz at the low carrier frequency

TEST SITE: OATS
 TEST DISTANCE: 3 m
 ANTENNA POLARIZATION: Vertical and Horizontal
 CBW 20 MHz
 DETECTOR: Peak

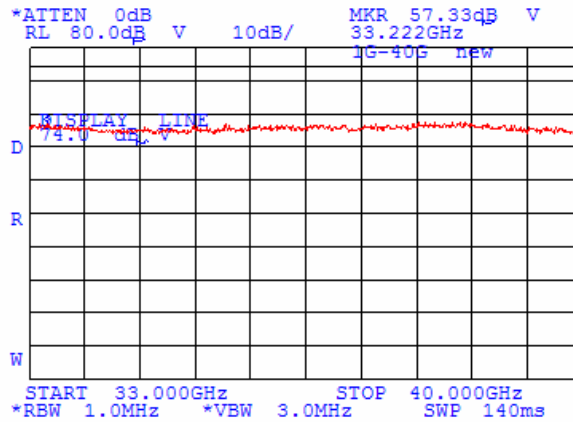

Plot 7.4.180 Radiated emission measurements from 33 to 40 GHz at the low carrier frequency

TEST SITE: OATS
 TEST DISTANCE: 3 m
 ANTENNA POLARIZATION: Vertical and Horizontal
 CBW 20 MHz
 DETECTOR: Average

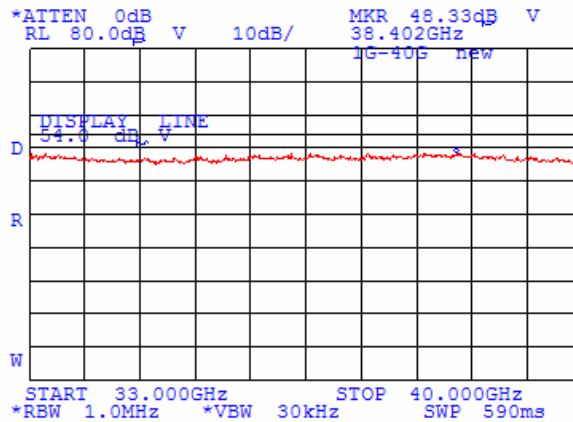



HERMON LABORATORIES

Test specification:	Section 15.247(d), RSS-210 section A8.5, Radiated spurious emissions		
Test procedure:	FCC New Guidance on Measurements for DTS in section 15.247(c)/ANSI C63.4, Section 13.1.4		
Test mode:	Compliance	Verdict: PASS	
Date & Time:	11/12/2008 7:22:59 PM		
Temperature: 21°C	Air Pressure: 1010 hPa	Relative Humidity: 43%	Power Supply: 48 VDC
Remarks: with 28 dBi external dish antenna			

Plot 7.4.181 Radiated emission measurements from 33 to 40 GHz at the mid carrier frequency

TEST SITE: OATS
 TEST DISTANCE: 3 m
 ANTENNA POLARIZATION: Vertical and Horizontal
 CBW 20 MHz
 DETECTOR: Peak

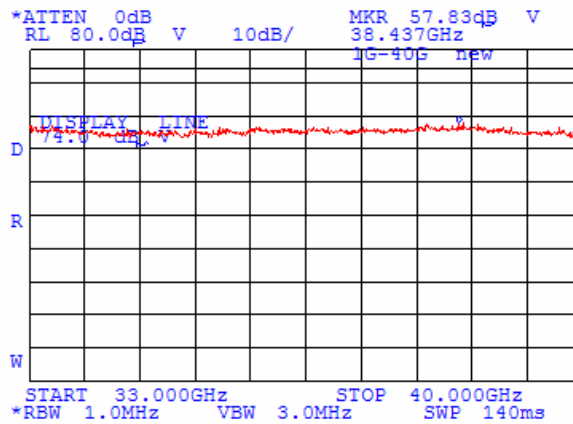

Plot 7.4.182 Radiated emission measurements from 33 to 40 GHz at the mid carrier frequency

TEST SITE: OATS
 TEST DISTANCE: 3 m
 ANTENNA POLARIZATION: Vertical and Horizontal
 CBW 20 MHz
 DETECTOR: Average

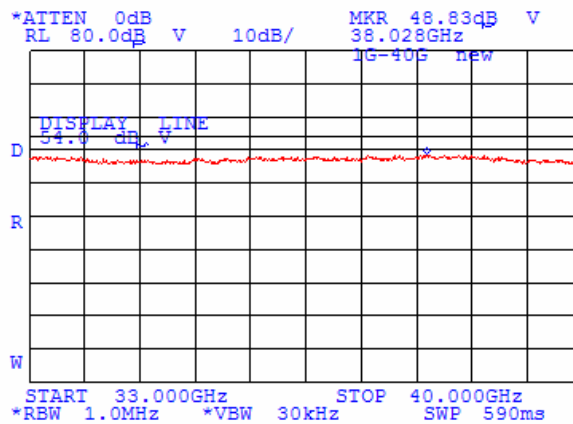



HERMON LABORATORIES

Test specification:	Section 15.247(d), RSS-210 section A8.5, Radiated spurious emissions		
Test procedure:	FCC New Guidance on Measurements for DTS in section 15.247(c)/ANSI C63.4, Section 13.1.4		
Test mode:	Compliance	Verdict:	PASS
Date & Time:	11/12/2008 7:22:59 PM		
Temperature: 21°C	Air Pressure: 1010 hPa	Relative Humidity: 43%	Power Supply: 48 VDC
Remarks: with 28 dBi external dish antenna			

Plot 7.4.183 Radiated emission measurements from 33 to 40 GHz at the high carrier frequency

TEST SITE: OATS
 TEST DISTANCE: 3 m
 ANTENNA POLARIZATION: Vertical and Horizontal
 CBW 20 MHz
 DETECTOR: Peak

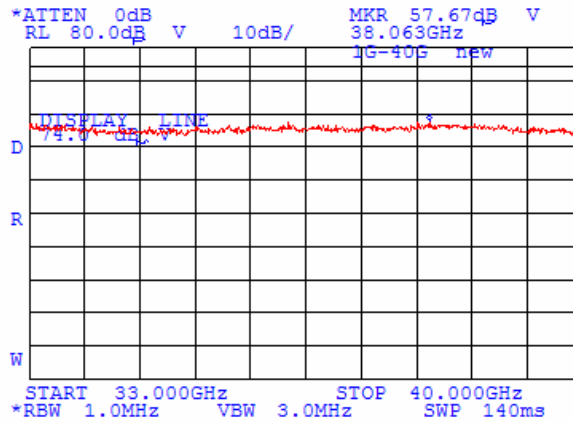

Plot 7.4.184 Radiated emission measurements from 33 to 40 GHz at the high carrier frequency

TEST SITE: OATS
 TEST DISTANCE: 3 m
 ANTENNA POLARIZATION: Vertical and Horizontal
 CBW 20 MHz
 DETECTOR: Average

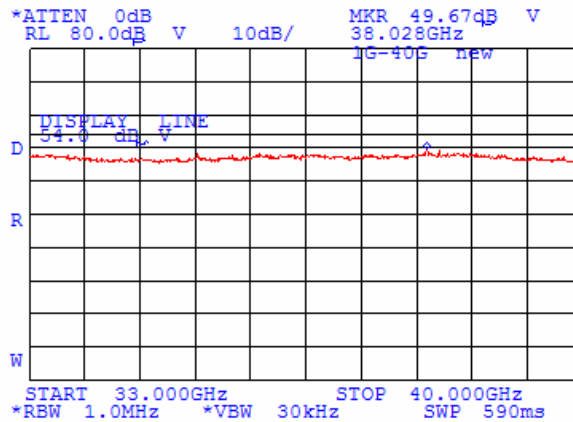



Test specification:	Section 15.247(d), RSS-210 section A8.5, Radiated spurious emissions		
Test procedure:	FCC New Guidance on Measurements for DTS in section 15.247(c)/ANSI C63.4, Section 13.1.4		
Test mode:	Compliance	Verdict: PASS	
Date & Time:	11/12/2008 7:22:59 PM		
Temperature: 21°C	Air Pressure: 1010 hPa	Relative Humidity: 43%	Power Supply: 48 VDC
Remarks: with 28 dBi external dish antenna			

Plot 7.4.185 Radiated emission measurements from 33 to 40 GHz at the low carrier frequency

TEST SITE: OATS
 TEST DISTANCE: 3 m
 ANTENNA POLARIZATION: Vertical and Horizontal
 CBW 5 MHz
 DETECTOR: Peak

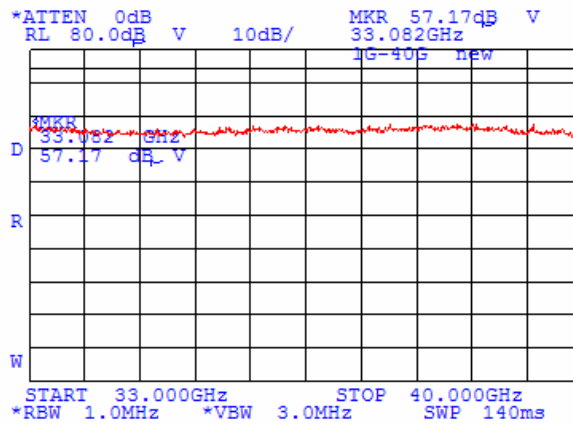

Plot 7.4.186 Radiated emission measurements from 33 to 40 GHz at the low carrier frequency

TEST SITE: OATS
 TEST DISTANCE: 3 m
 ANTENNA POLARIZATION: Vertical and Horizontal
 CBW 5 MHz
 DETECTOR: Average

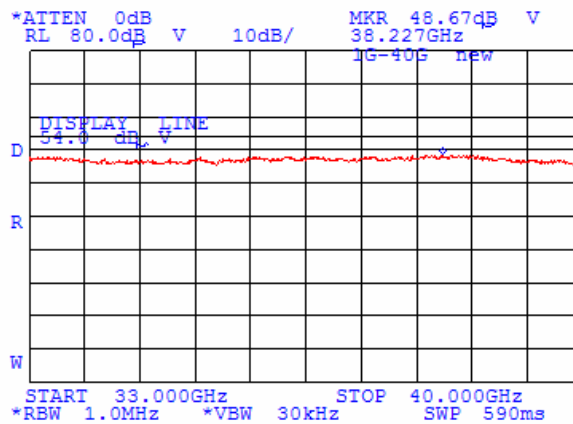



Test specification:	Section 15.247(d), RSS-210 section A8.5, Radiated spurious emissions		
Test procedure:	FCC New Guidance on Measurements for DTS in section 15.247(c)/ANSI C63.4, Section 13.1.4		
Test mode:	Compliance	Verdict:	PASS
Date & Time:	11/12/2008 7:22:59 PM		
Temperature: 21°C	Air Pressure: 1010 hPa	Relative Humidity: 43%	Power Supply: 48 VDC
Remarks: with 28 dBi external dish antenna			

Plot 7.4.187 Radiated emission measurements from 33 to 40 GHz at the mid carrier frequency

TEST SITE: OATS
 TEST DISTANCE: 3 m
 ANTENNA POLARIZATION: Vertical and Horizontal
 CBW: 5 MHz
 DETECTOR: Peak

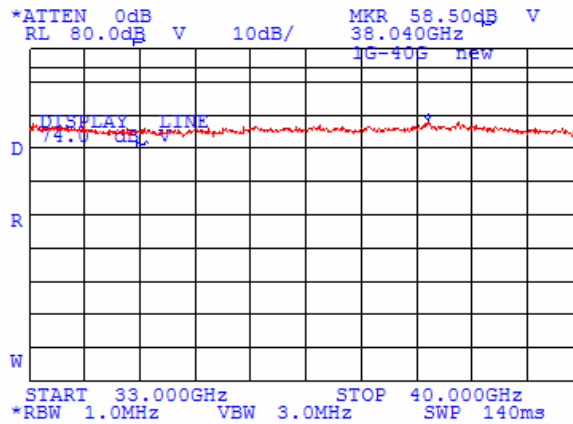

Plot 7.4.188 Radiated emission measurements from 33 to 40 GHz at the mid carrier frequency

TEST SITE: OATS
 TEST DISTANCE: 3 m
 ANTENNA POLARIZATION: Vertical and Horizontal
 CBW: 5 MHz
 DETECTOR: Average

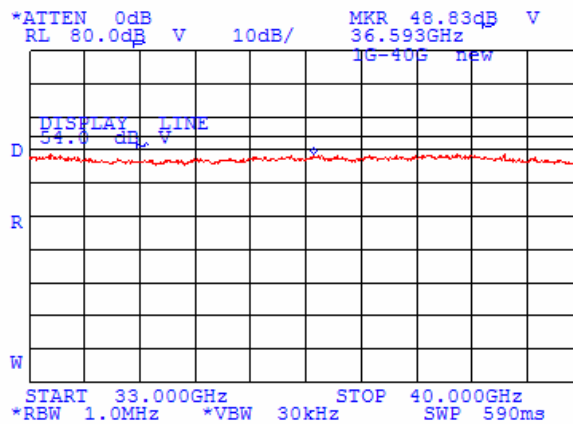



HERMON LABORATORIES

Test specification:	Section 15.247(d), RSS-210 section A8.5, Radiated spurious emissions		
Test procedure:	FCC New Guidance on Measurements for DTS in section 15.247(c)/ANSI C63.4, Section 13.1.4		
Test mode:	Compliance	Verdict: PASS	
Date & Time:	11/12/2008 7:22:59 PM		
Temperature: 21°C	Air Pressure: 1010 hPa	Relative Humidity: 43%	Power Supply: 48 VDC
Remarks: with 28 dBi external dish antenna			

Plot 7.4.189 Radiated emission measurements from 33 to 40 GHz at the high carrier frequency

TEST SITE: OATS
 TEST DISTANCE: 3 m
 ANTENNA POLARIZATION: Vertical and Horizontal
 CBW 5 MHz
 DETECTOR: Peak

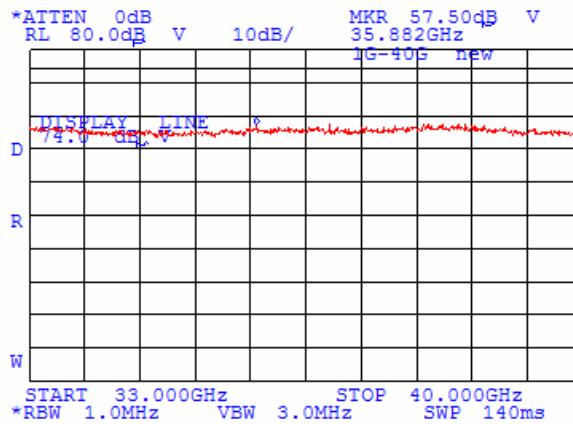

Plot 7.4.190 Radiated emission measurements from 33 to 40 GHz at the high carrier frequency

TEST SITE: OATS
 TEST DISTANCE: 3 m
 ANTENNA POLARIZATION: Vertical and Horizontal
 CBW 5 MHz
 DETECTOR: Average

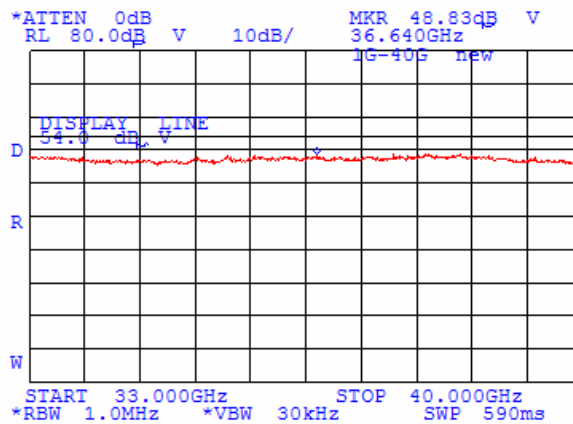



HERMON LABORATORIES

Test specification:	Section 15.247(d), RSS-210 section A8.5, Radiated spurious emissions		
Test procedure:	FCC New Guidance on Measurements for DTS in section 15.247(c)/ANSI C63.4, Section 13.1.4		
Test mode:	Compliance	Verdict:	PASS
Date & Time:	11/12/2008 7:22:59 PM		
Temperature: 21°C	Air Pressure: 1010 hPa	Relative Humidity: 43%	Power Supply: 48 VDC
Remarks: with 28 dBi external dish antenna			

Plot 7.4.191 Radiated emission measurements at the second harmonic of low carrier frequency

TEST SITE: OATS
 TEST DISTANCE: 3 m
 CBW: 20 MHz
 DETECTOR: Peak

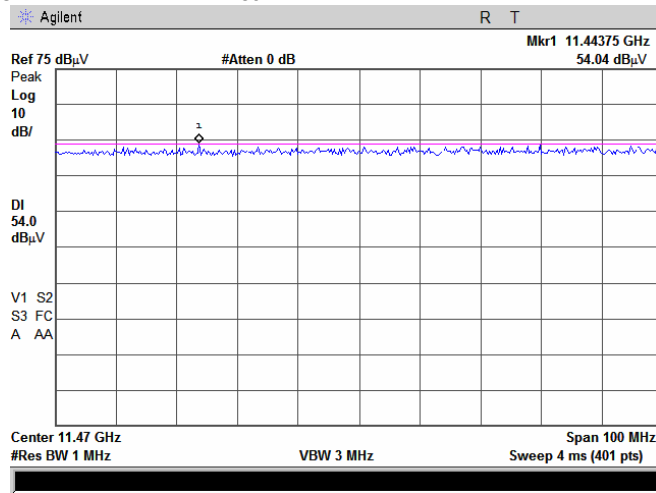

Plot 7.4.192 Radiated emission measurements at the second harmonic of low carrier frequency

TEST SITE: OATS
 TEST DISTANCE: 3 m
 CBW: 20 MHz
 DETECTOR: Average

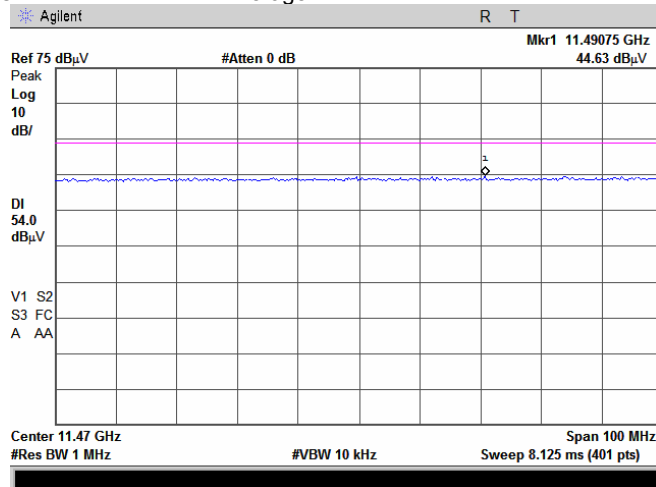



HERMON LABORATORIES

Test specification:	Section 15.247(d), RSS-210 section A8.5, Radiated spurious emissions		
Test procedure:	FCC New Guidance on Measurements for DTS in section 15.247(c)/ANSI C63.4, Section 13.1.4		
Test mode:	Compliance	Verdict:	PASS
Date & Time:	11/12/2008 7:22:59 PM		
Temperature: 21°C	Air Pressure: 1010 hPa	Relative Humidity: 43%	Power Supply: 48 VDC
Remarks: with 28 dBi external dish antenna			

Plot 7.4.193 Radiated emission measurements at the second harmonic of low carrier frequency

TEST SITE: OATS
 TEST DISTANCE: 3 m
 CBW: 5 MHz
 DETECTOR: Peak

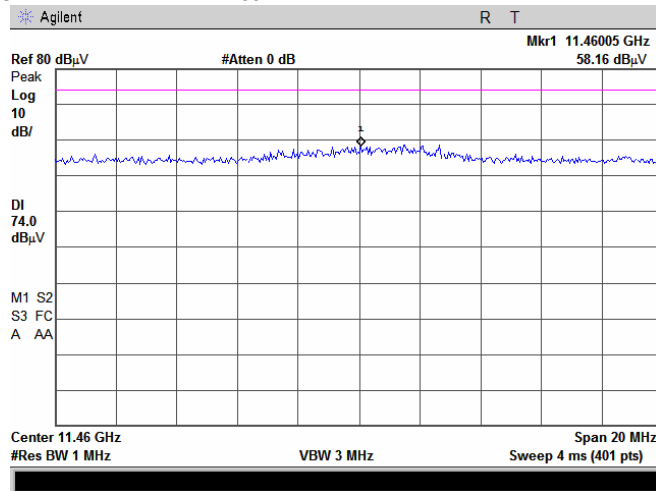

Plot 7.4.194 Radiated emission measurements at the second harmonic of low carrier frequency

TEST SITE: OATS
 TEST DISTANCE: 3 m
 CBW: 5 MHz
 DETECTOR: Average

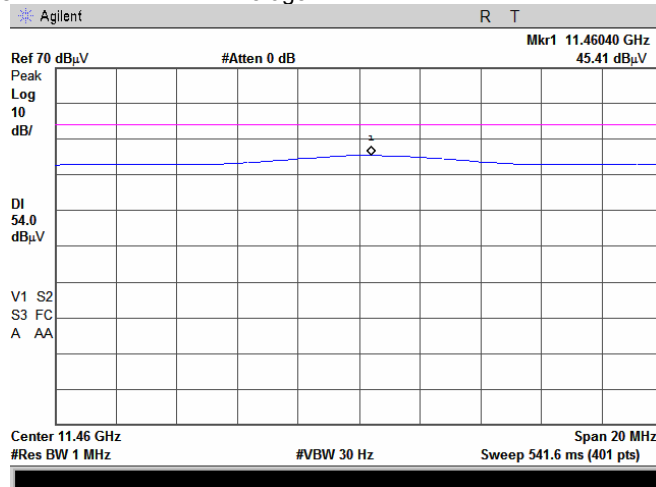



HERMON LABORATORIES

Test specification:	Section 15.247(d), RSS-210 section A8.5, Radiated spurious emissions		
Test procedure:	FCC New Guidance on Measurements for DTS in section 15.247(c)/ANSI C63.4, Section 13.1.4		
Test mode:	Compliance	Verdict:	PASS
Date & Time:	11/12/2008 7:22:59 PM		
Temperature: 21°C	Air Pressure: 1010 hPa	Relative Humidity: 43%	Power Supply: 48 VDC
Remarks: with 28 dBi external dish antenna			

Plot 7.4.195 Radiated emission measurements at the second harmonic of mid carrier frequency

TEST SITE: OATS
 TEST DISTANCE: 3 m
 CBW: 5 MHz
 DETECTOR: Peak

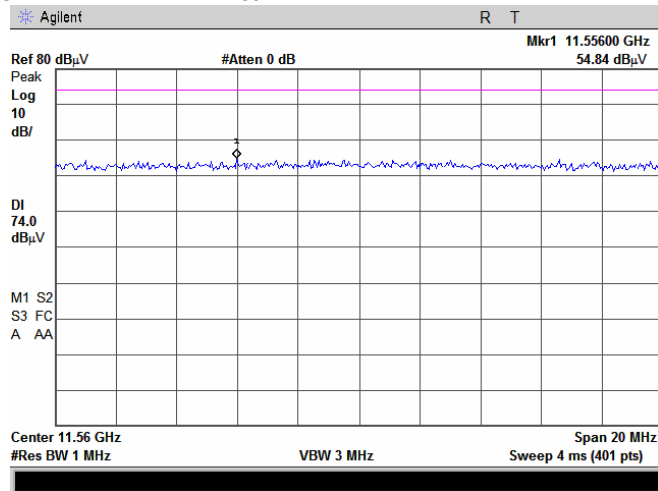

Plot 7.4.196 Radiated emission measurements at the second harmonic of mid carrier frequency

TEST SITE: OATS
 TEST DISTANCE: 3 m
 CBW: 5 MHz
 DETECTOR: Average

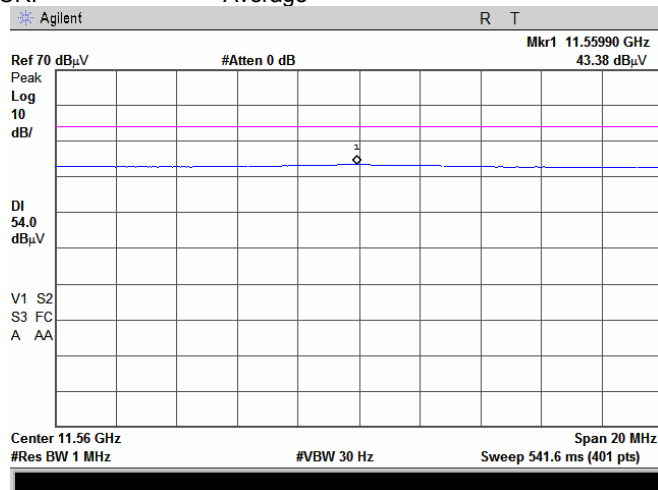



Test specification:		Section 15.247(e), RSS-210 section A8.2(b), Peak power density	
Test procedure:		FCC New Guidance on Measurements for DTS in section 15.247(d), Option 2	
Test mode:	Compliance	Verdict:	PASS
Date & Time:	10/30/2008 11:19:49 AM		
Temperature: 22°C	Air Pressure: 1008 hPa	Relative Humidity: 45%	Power Supply: 48 VDC
Remarks:			

7.5 Peak spectral power density

7.5.1 General

This test was performed to measure the peak spectral power density at the transmitter RF antenna connector. Specification test limits are given in **Error! Reference source not found.**

Table 7.5.1 Peak spectral power density limits

Assigned frequency range, MHz	Measurement bandwidth, kHz	Peak spectral power density, dBm
5725 - 5850	3.0	8.0

7.5.2 Test procedure

7.5.2.1 The EUT was set up as shown in Figure 7.5.1, energized and its proper operation was checked.

7.5.2.2 The EUT was adjusted to produce maximum available to end user RF output power.

7.5.2.3 The frequency span of spectrum analyzer was set to capture the entire 6 dB band of the transmitter, in peak hold mode with resolution bandwidth set to 1% of span, video bandwidth wider than resolution bandwidth, and sufficiently long sweep time. The spectrum lines spacing was verified to be wider than 3 kHz. Otherwise the resolution bandwidth was reduced until individual spectrum lines were resolved and the power of individual spectrum lines was integrated over 3 kHz band.

7.5.2.4 The peak of emission was zoomed with span set just wide enough to capture the emission peak area with resolution bandwidth set to 3kHz, video bandwidth wider than resolution bandwidth and sweep time was set equal to span width divided by resolution bandwidth. Peak spectral power density was measured as provided in Table 7.5.2 and associated plots.

Figure 7.5.1 Peak spectral power density test setup





Test specification:	Section 15.247(e), RSS-210 section A8.2(b), Peak power density		
Test procedure:	FCC New Guidance on Measurements for DTS in section 15.247(d), Option 2		
Test mode:	Compliance	Verdict:	PASS
Date & Time:	10/30/2008 11:19:49 AM		
Temperature: 22°C	Air Pressure: 1008 hPa	Relative Humidity: 45%	Power Supply: 48 VDC
Remarks:			

Table 7.5.2 Peak spectral power density test results

ASSIGNED FREQUENCY: 5725 – 5850 MHz
 MODULATION: BPSK / 64QAM
 MODULATING SIGNAL: OFDM
 TRANSMITTER OUTPUT POWER SETTINGS: Maximum
 DETECTOR USED: Peak
 RESOLUTION BANDWIDTH: 3 kHz
 VIDEO BANDWIDTH: 10 kHz

Carrier frequency, MHz	Spectrum analyzer reading, dBm	External attenuation, dB	Peak power density, dB(mW/3 kHz)	Total peak power density, dB(mW/3 kHz)*	Limit, dBm	Margin**, dB	Verdict
5 MHz BW, Low channel (5730 MHz)							
BPSK, 3.25	-1.325	included	-1.325	1.68	8.00	-6.33	Pass
64QAM, 32.5	0.622	included	0.622	3.62	8.00	-4.38	Pass
5 MHz BW, Mid channel (5780 MHz)							
BPSK, 3.25	-0.106	included	-0.106	2.89	8.00	-5.11	Pass
64QAM, 32.5	0.172	included	0.172	3.17	8.00	-4.83	Pass
5 MHz BW, High channel (5845 MHz)							
BPSK, 3.25	0.573	included	0.573	3.57	8.00	-4.43	Pass
64QAM, 32.5	-0.299	included	-0.299	2.70	8.00	-5.30	Pass
20 MHz BW, Low channel (5735 MHz)							
BPSK, 13	-3.563	included	-3.563	-0.56	8.00	-8.56	Pass
64QAM, 130	-4.578	included	-4.578	-1.58	8.00	-9.58	Pass
20 MHz BW, Mid channel (5780 MHz)							
BPSK, 13	-2.283	included	-2.283	0.72	8.00	-7.28	Pass
64QAM, 130	-4.417	included	-4.417	-1.42	8.00	-9.42	Pass
20 MHz BW, High channel (5840 MHz)							
BPSK, 13	-4.56	included	-4.56	-1.56	8.00	-9.56	Pass
64QAM, 130	-4.913	included	-4.913	-1.91	8.00	-9.91	Pass

* - The total peak power density summed across 2 antenna outputs in linear terms by adding 3 dB

** - Margin = Peak power density – specification limit.

Reference numbers of test equipment used

HL 2909	HL 3178	HL 3181	HL 3389			
---------	---------	---------	---------	--	--	--

Full description is given in Appendix A.



HERMON LABORATORIES

Test specification:	Section 15.247(e), RSS-210 section A8.2(b), Peak power density		
Test procedure:	FCC New Guidance on Measurements for DTS in section 15.247(d), Option 2		
Test mode:	Compliance	Verdict:	PASS
Date & Time:	10/30/2008 11:19:49 AM		
Temperature: 22°C	Air Pressure: 1008 hPa	Relative Humidity: 45%	Power Supply: 48 VDC
Remarks:			

Plot 7.5.1 Peak spectral power density at low frequency within 6 dB band

Channel bandwidth 20 MHz
 Modulation BPSK
 Bit Rate 13 Mbps

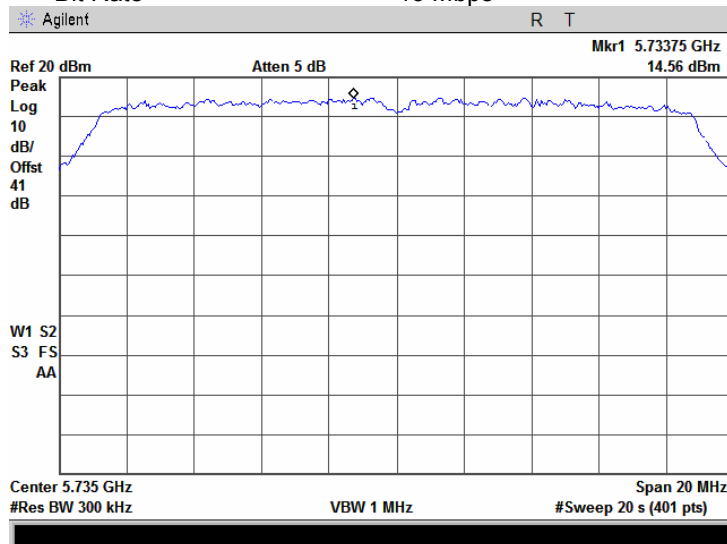

Plot 7.5.2 Peak spectral power density at low frequency zoomed at the peak

Channel bandwidth 20 MHz
 Modulation BPSK
 Bit Rate 13 Mbps

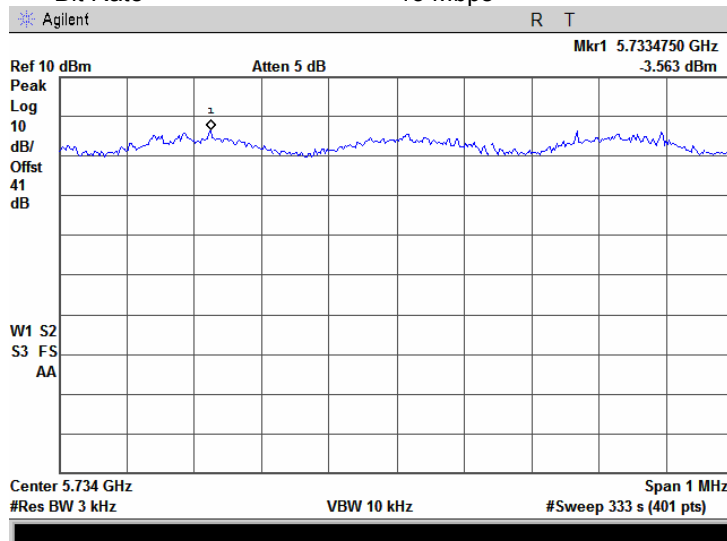



HERMON LABORATORIES

Test specification:	Section 15.247(e), RSS-210 section A8.2(b), Peak power density		
Test procedure:	FCC New Guidance on Measurements for DTS in section 15.247(d), Option 2		
Test mode:	Compliance	Verdict:	PASS
Date & Time:	10/30/2008 11:19:49 AM		
Temperature: 22°C	Air Pressure: 1008 hPa	Relative Humidity: 45%	Power Supply: 48 VDC
Remarks:			

Plot 7.5.3 Peak spectral power density at low frequency within 6 dB band

Channel bandwidth 20 MHz
 Modulation 64QAM
 Bit Rate 130 Mbps

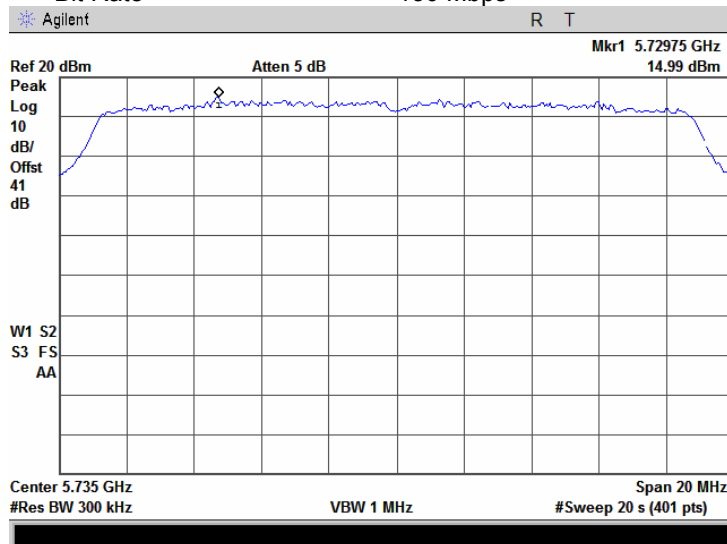

Plot 7.5.4 Peak spectral power density at low frequency zoomed at the peak

Channel bandwidth 20 MHz
 Modulation 64QAM
 Bit Rate 130 Mbps

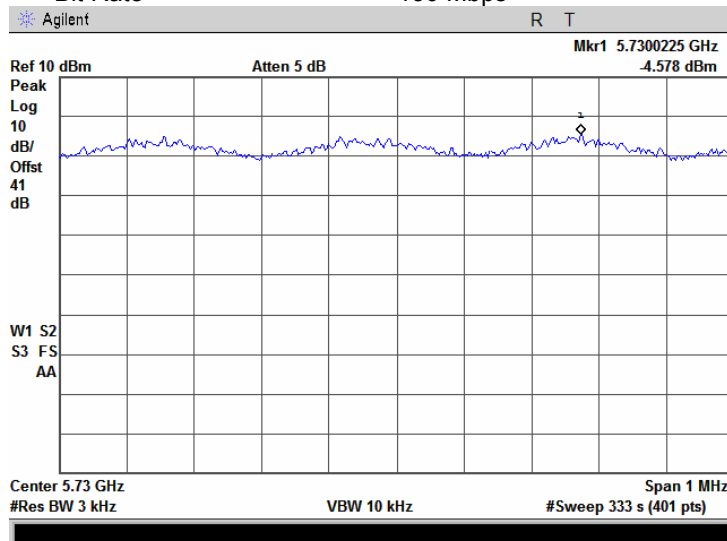



HERMON LABORATORIES

Test specification:	Section 15.247(e), RSS-210 section A8.2(b), Peak power density		
Test procedure:	FCC New Guidance on Measurements for DTS in section 15.247(d), Option 2		
Test mode:	Compliance	Verdict:	PASS
Date & Time:	10/30/2008 11:19:49 AM		
Temperature: 22°C	Air Pressure: 1008 hPa	Relative Humidity: 45%	Power Supply: 48 VDC
Remarks:			

Plot 7.5.5 Peak spectral power density at mid frequency within 6 dB band

Channel bandwidth 20 MHz
 Modulation BPSK
 Bit Rate 13 Mbps

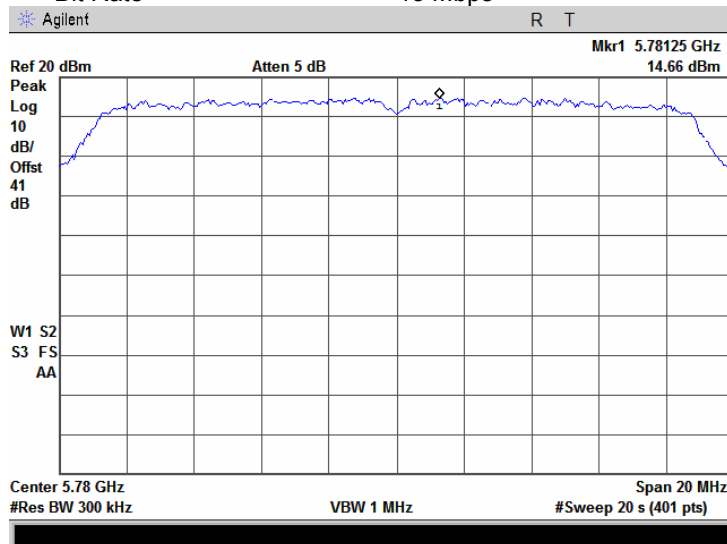

Plot 7.5.6 Peak spectral power density at mid frequency zoomed at the peak

Channel bandwidth 20 MHz
 Modulation BPSK
 Bit Rate 13 Mbps

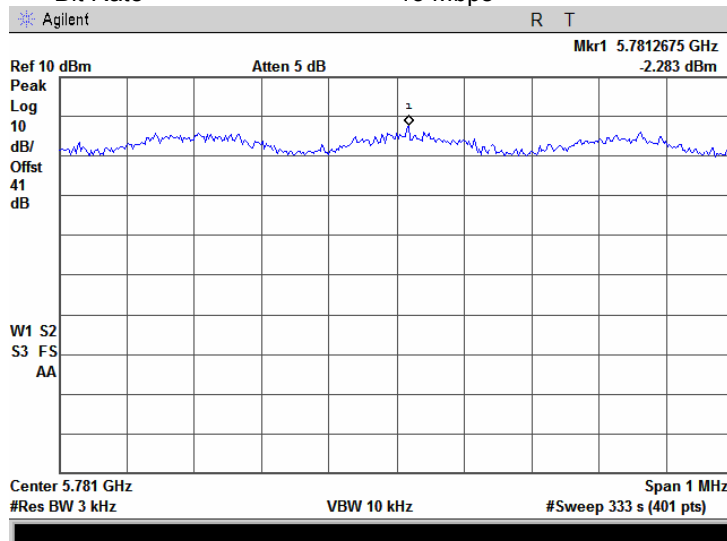



HERMON LABORATORIES

Test specification:	Section 15.247(e), RSS-210 section A8.2(b), Peak power density		
Test procedure:	FCC New Guidance on Measurements for DTS in section 15.247(d), Option 2		
Test mode:	Compliance	Verdict:	PASS
Date & Time:	10/30/2008 11:19:49 AM		
Temperature: 22°C	Air Pressure: 1008 hPa	Relative Humidity: 45%	Power Supply: 48 VDC
Remarks:			

Plot 7.5.7 Peak spectral power density at mid frequency within 6 dB band

Channel bandwidth 20 MHz
 Modulation 64QAM
 Bit Rate 130 Mbps

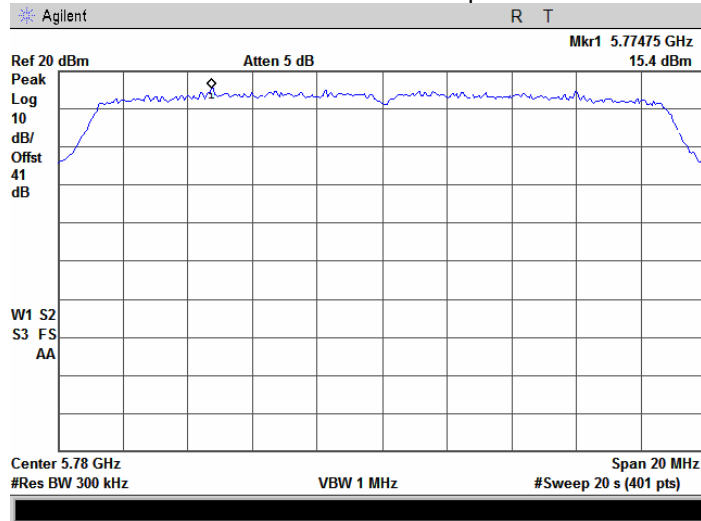

Plot 7.5.8 Peak spectral power density at mid frequency zoomed at the peak

Channel bandwidth 20 MHz
 Modulation 64QAM
 Bit Rate 130 Mbps

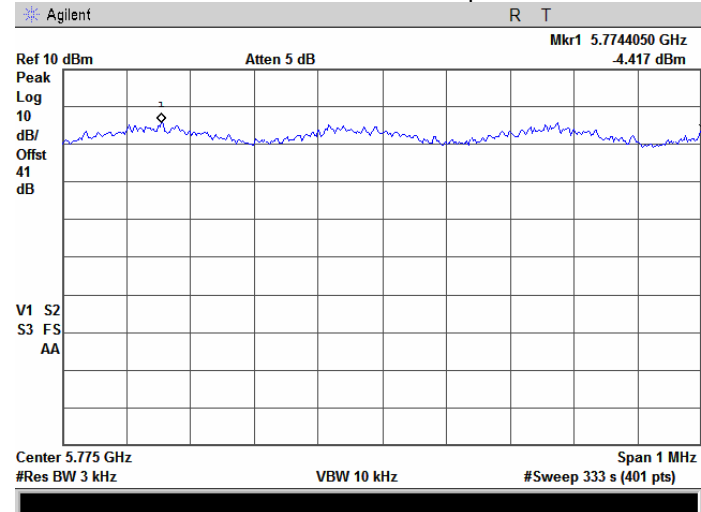



HERMON LABORATORIES

Test specification:	Section 15.247(e), RSS-210 section A8.2(b), Peak power density		
Test procedure:	FCC New Guidance on Measurements for DTS in section 15.247(d), Option 2		
Test mode:	Compliance	Verdict:	PASS
Date & Time:	10/30/2008 11:19:49 AM		
Temperature: 22°C	Air Pressure: 1008 hPa	Relative Humidity: 45%	Power Supply: 48 VDC
Remarks:			

Plot 7.5.9 Peak spectral power density at high frequency within 6 dB band

Channel bandwidth 20 MHz
 Modulation BPSK
 Bit Rate 13 Mbps

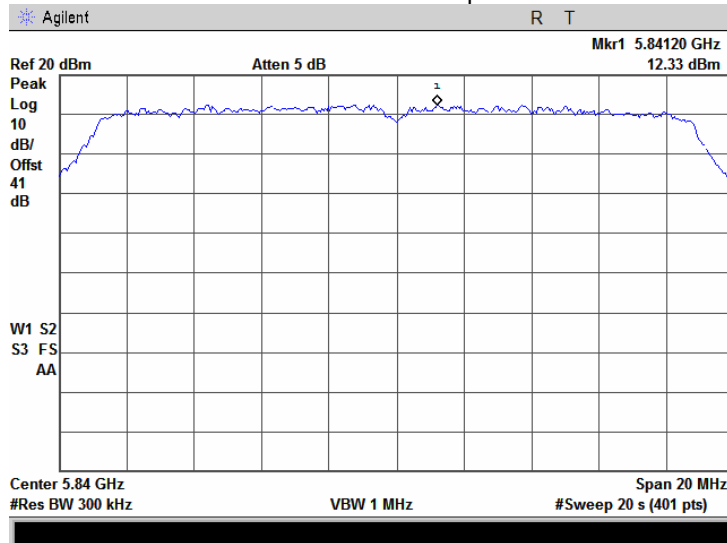

Plot 7.5.10 Peak spectral power density at high frequency zoomed at the peak

Channel bandwidth 20 MHz
 Modulation BPSK
 Bit Rate 13 Mbps

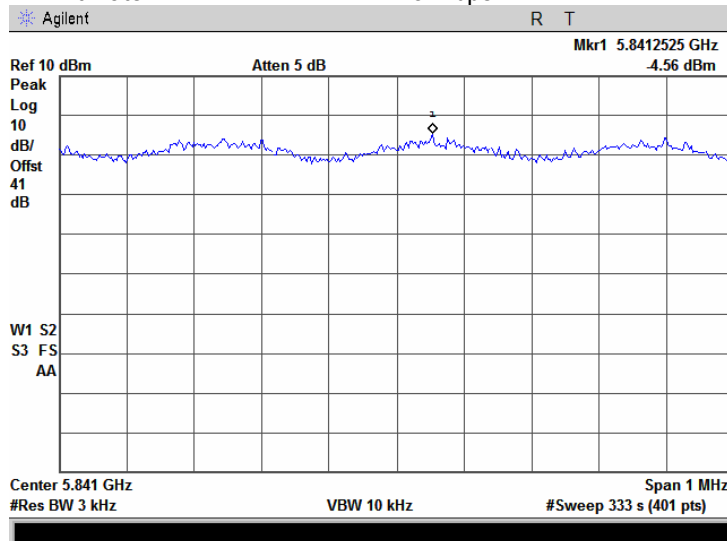



HERMON LABORATORIES

Test specification:	Section 15.247(e), RSS-210 section A8.2(b), Peak power density		
Test procedure:	FCC New Guidance on Measurements for DTS in section 15.247(d), Option 2		
Test mode:	Compliance	Verdict:	PASS
Date & Time:	10/30/2008 11:19:49 AM		
Temperature: 22°C	Air Pressure: 1008 hPa	Relative Humidity: 45%	Power Supply: 48 VDC
Remarks:			

Plot 7.5.11 Peak spectral power density at high frequency within 6 dB band

Channel bandwidth 20 MHz
 Modulation 64QAM
 Bit Rate 130 Mbps

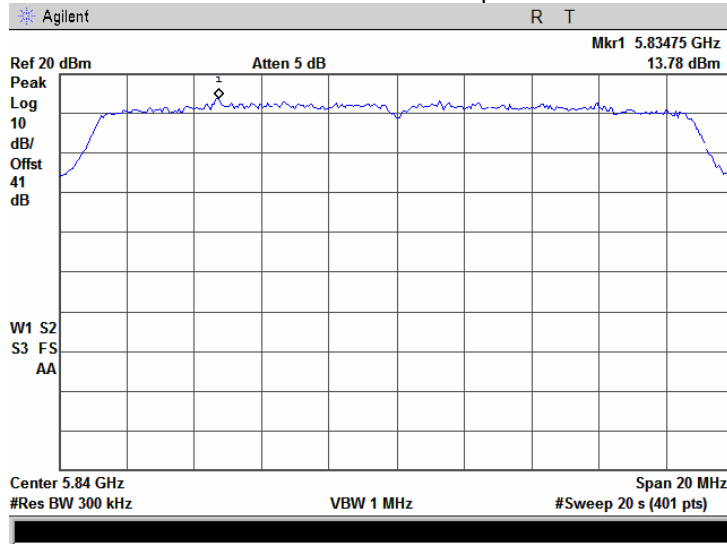

Plot 7.5.12 Peak spectral power density at high frequency zoomed at the peak

Channel bandwidth 20 MHz
 Modulation 64QAM
 Bit Rate 130 Mbps

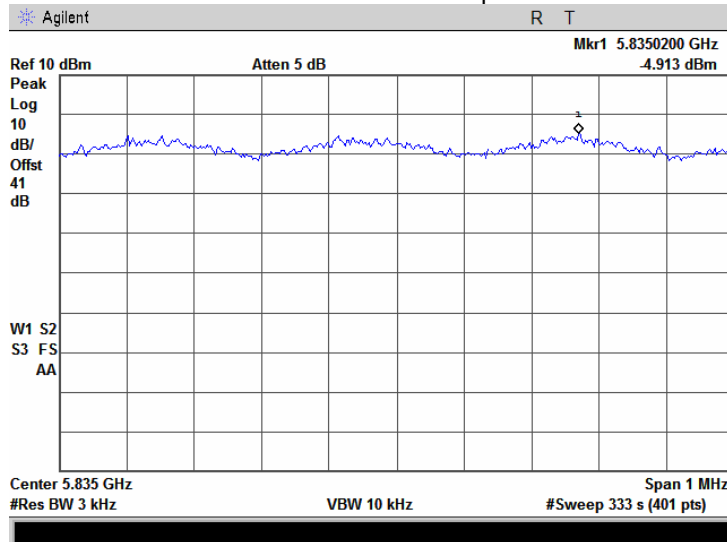



HERMON LABORATORIES

Test specification:	Section 15.247(e), RSS-210 section A8.2(b), Peak power density		
Test procedure:	FCC New Guidance on Measurements for DTS in section 15.247(d), Option 2		
Test mode:	Compliance	Verdict:	PASS
Date & Time:	10/30/2008 11:19:49 AM		
Temperature: 22°C	Air Pressure: 1008 hPa	Relative Humidity: 45%	Power Supply: 48 VDC
Remarks:			

Plot 7.5.13 Peak spectral power density at low frequency within 6 dB band

Channel bandwidth 10 MHz
 Modulation BPSK
 Bit Rate 6.5 Mbps

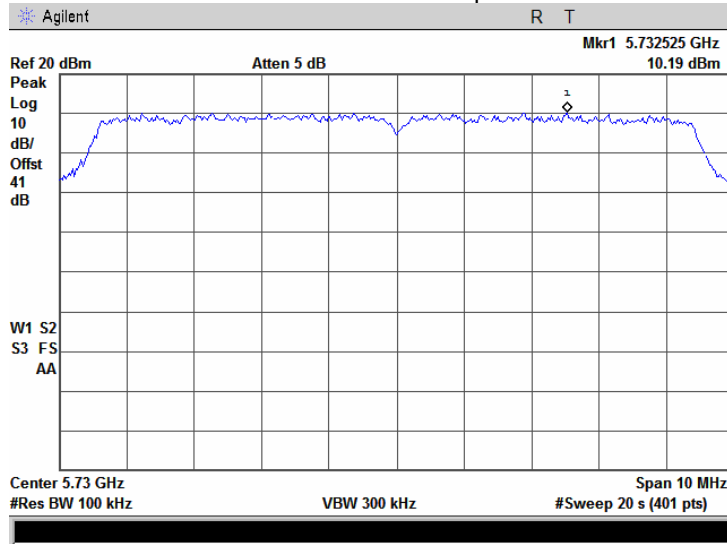

Plot 7.5.14 Peak spectral power density at low frequency zoomed at the peak

Channel bandwidth 10 MHz
 Modulation BPSK
 Bit Rate 6.5 Mbps

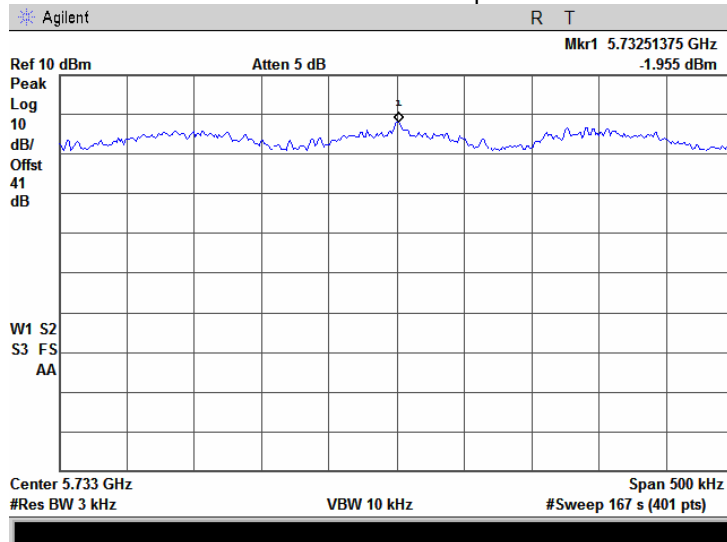



HERMON LABORATORIES

Test specification:	Section 15.247(e), RSS-210 section A8.2(b), Peak power density		
Test procedure:	FCC New Guidance on Measurements for DTS in section 15.247(d), Option 2		
Test mode:	Compliance	Verdict:	PASS
Date & Time:	10/30/2008 11:19:49 AM		
Temperature: 22°C	Air Pressure: 1008 hPa	Relative Humidity: 45%	Power Supply: 48 VDC
Remarks:			

Plot 7.5.15 Peak spectral power density at low frequency within 6 dB band

Channel bandwidth 10 MHz
 Modulation 64QAM
 Bit Rate 65 Mbps

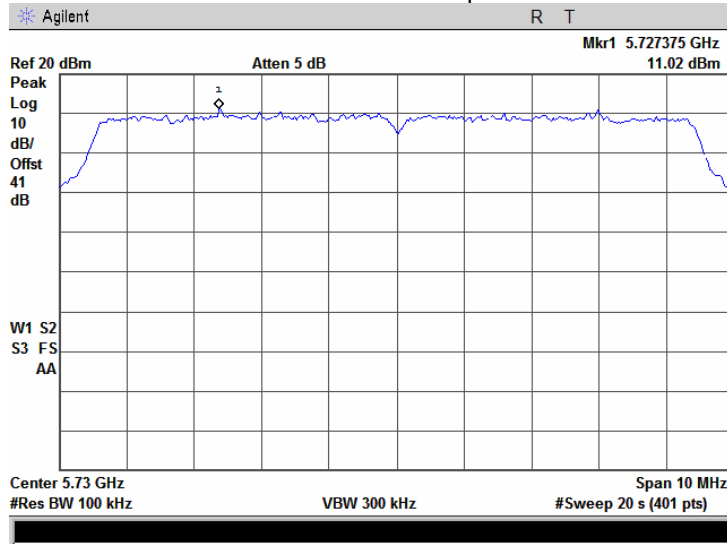

Plot 7.5.16 Peak spectral power density at low frequency zoomed at the peak

Channel bandwidth 10 MHz
 Modulation 64QAM
 Bit Rate 65 Mbps

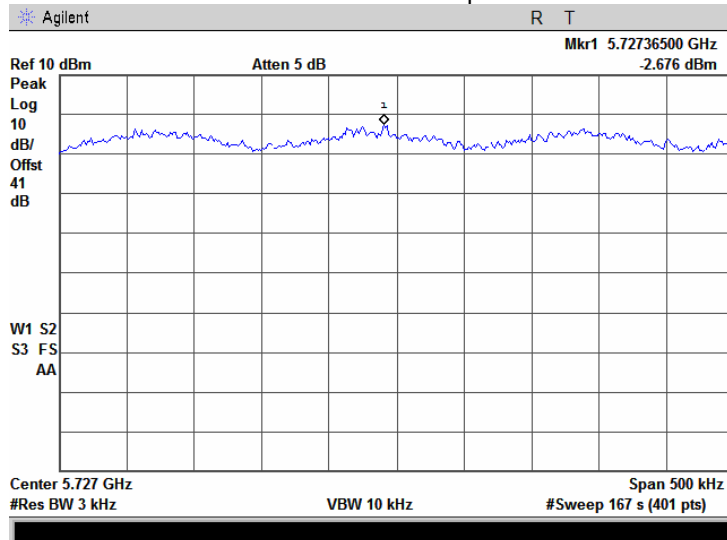



HERMON LABORATORIES

Test specification:	Section 15.247(e), RSS-210 section A8.2(b), Peak power density		
Test procedure:	FCC New Guidance on Measurements for DTS in section 15.247(d), Option 2		
Test mode:	Compliance	Verdict:	PASS
Date & Time:	10/30/2008 11:19:49 AM		
Temperature: 22°C	Air Pressure: 1008 hPa	Relative Humidity: 45%	Power Supply: 48 VDC
Remarks:			

Plot 7.5.17 Peak spectral power density at mid frequency within 6 dB band

Channel bandwidth 10 MHz
Modulation BPSK
Bit Rate 6.5 Mbps

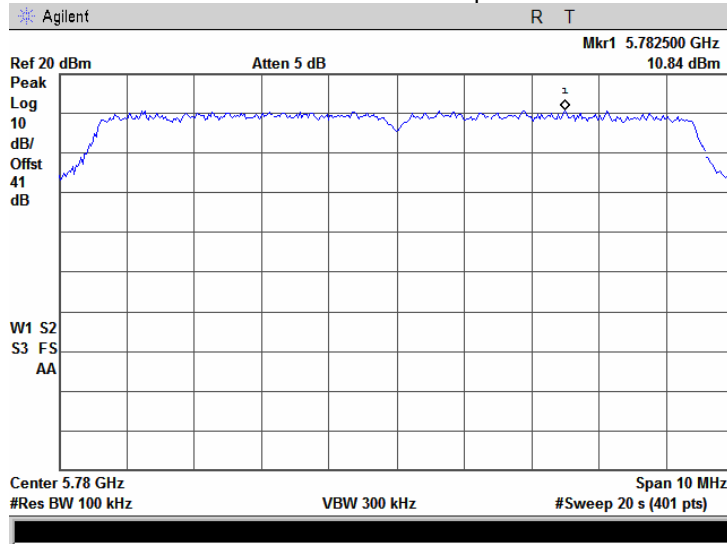

Plot 7.5.18 Peak spectral power density at mid frequency zoomed at the peak

Channel bandwidth 10 MHz
Modulation BPSK
Bit Rate 6.5 Mbps

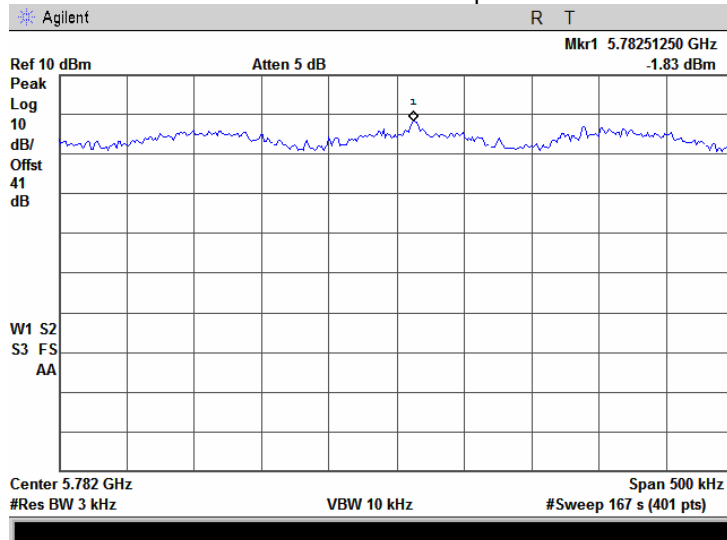



HERMON LABORATORIES

Test specification:	Section 15.247(e), RSS-210 section A8.2(b), Peak power density		
Test procedure:	FCC New Guidance on Measurements for DTS in section 15.247(d), Option 2		
Test mode:	Compliance	Verdict:	PASS
Date & Time:	10/30/2008 11:19:49 AM		
Temperature: 22°C	Air Pressure: 1008 hPa	Relative Humidity: 45%	Power Supply: 48 VDC
Remarks:			

Plot 7.5.19 Peak spectral power density at mid frequency within 6 dB band

Channel bandwidth 10 MHz
 Modulation 64QAM
 Bit Rate 65 Mbps

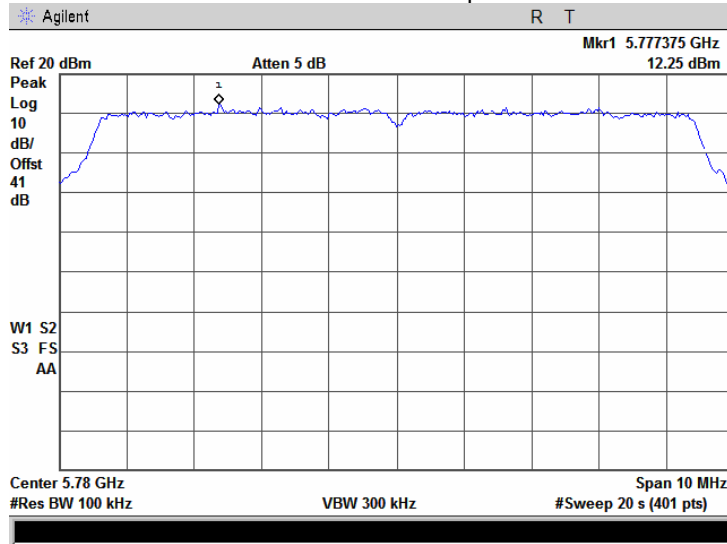

Plot 7.5.20 Peak spectral power density at mid frequency zoomed at the peak

Channel bandwidth 10 MHz
 Modulation 64QAM
 Bit Rate 65 Mbps

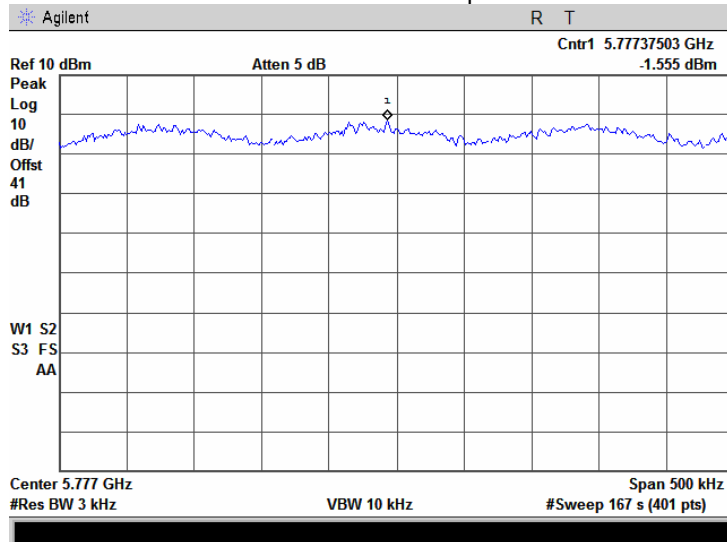



HERMON LABORATORIES

Test specification:	Section 15.247(e), RSS-210 section A8.2(b), Peak power density		
Test procedure:	FCC New Guidance on Measurements for DTS in section 15.247(d), Option 2		
Test mode:	Compliance	Verdict:	PASS
Date & Time:	10/30/2008 11:19:49 AM		
Temperature: 22°C	Air Pressure: 1008 hPa	Relative Humidity: 45%	Power Supply: 48 VDC
Remarks:			

Plot 7.5.21 Peak spectral power density at high frequency within 6 dB band

Channel bandwidth 10 MHz
 Modulation BPSK
 Bit Rate 6.5 Mbps

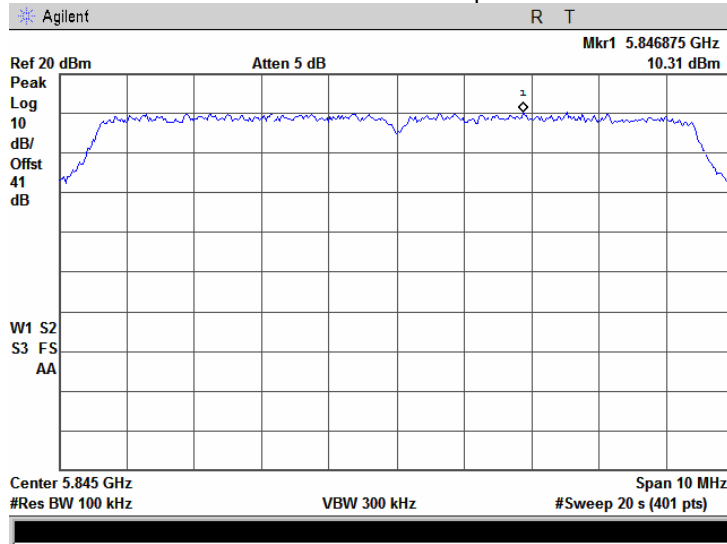

Plot 7.5.22 Peak spectral power density at high frequency zoomed at the peak

Channel bandwidth 10 MHz
 Modulation BPSK
 Bit Rate 6.5 Mbps

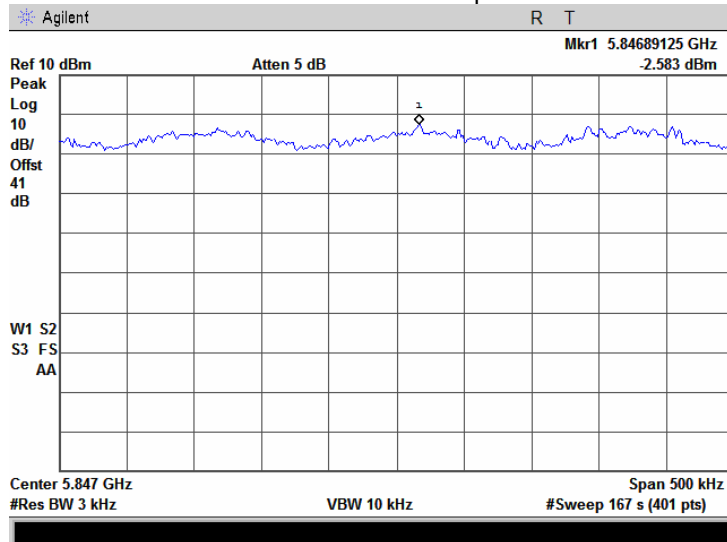



HERMON LABORATORIES

Test specification:	Section 15.247(e), RSS-210 section A8.2(b), Peak power density		
Test procedure:	FCC New Guidance on Measurements for DTS in section 15.247(d), Option 2		
Test mode:	Compliance	Verdict:	PASS
Date & Time:	10/30/2008 11:19:49 AM		
Temperature: 22°C	Air Pressure: 1008 hPa	Relative Humidity: 45%	Power Supply: 48 VDC
Remarks:			

Plot 7.5.23 Peak spectral power density at high frequency within 6 dB band

Channel bandwidth 10 MHz
 Modulation 64QAM
 Bit Rate 65 Mbps

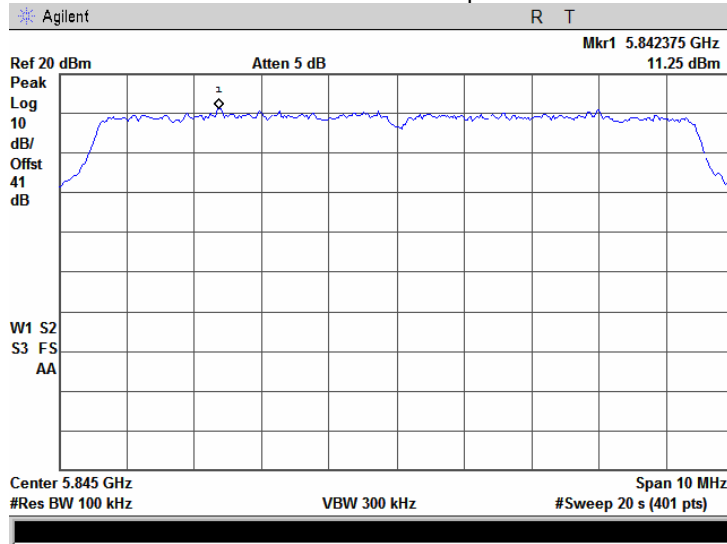

Plot 7.5.24 Peak spectral power density at high frequency zoomed at the peak

Channel bandwidth 10 MHz
 Modulation 64QAM
 Bit Rate 65 Mbps

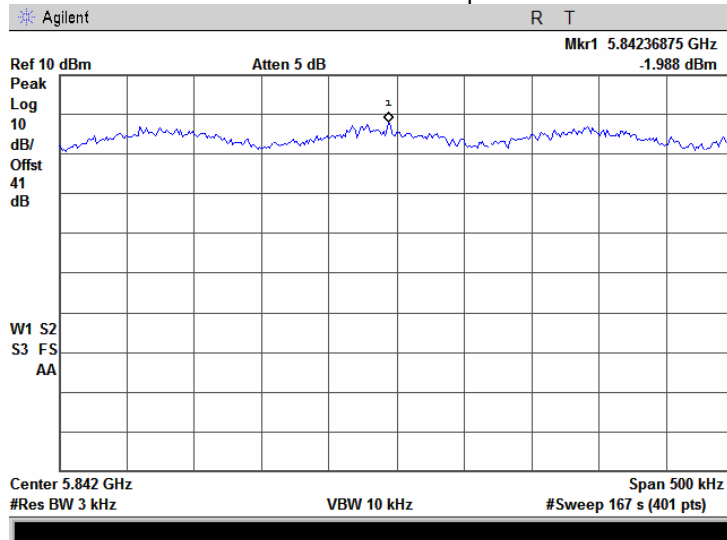



HERMON LABORATORIES

Test specification:	Section 15.247(e), RSS-210 section A8.2(b), Peak power density		
Test procedure:	FCC New Guidance on Measurements for DTS in section 15.247(d), Option 2		
Test mode:	Compliance	Verdict:	PASS
Date & Time:	10/30/2008 11:19:49 AM		
Temperature: 22°C	Air Pressure: 1008 hPa	Relative Humidity: 45%	Power Supply: 48 VDC
Remarks:			

Plot 7.5.25 Peak spectral power density at low frequency within 6 dB band

Channel bandwidth 5 MHz
 Modulation BPSK
 Bit Rate 3.25 Mbps

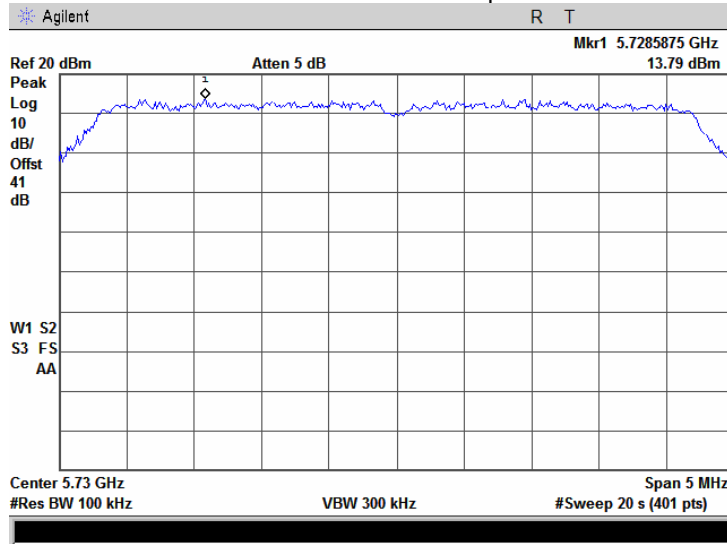

Plot 7.5.26 Peak spectral power density at low frequency zoomed at the peak

Channel bandwidth 5 MHz
 Modulation BPSK
 Bit Rate 3.25 Mbps

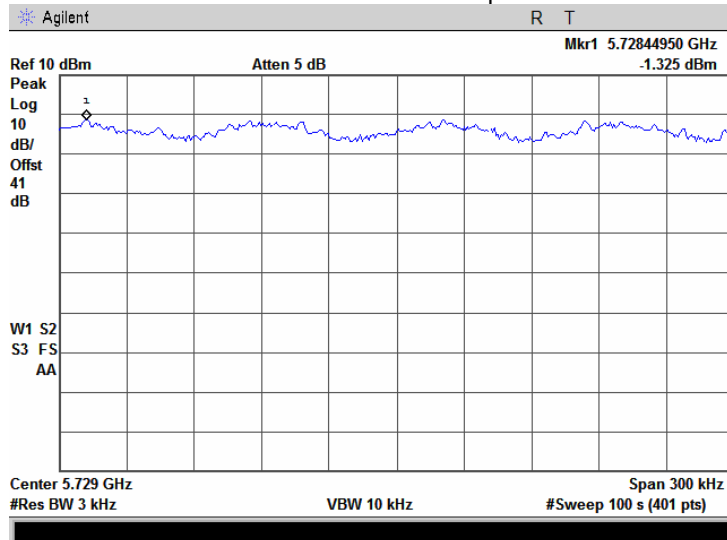



HERMON LABORATORIES

Test specification:	Section 15.247(e), RSS-210 section A8.2(b), Peak power density		
Test procedure:	FCC New Guidance on Measurements for DTS in section 15.247(d), Option 2		
Test mode:	Compliance	Verdict:	PASS
Date & Time:	10/30/2008 11:19:49 AM		
Temperature: 22°C	Air Pressure: 1008 hPa	Relative Humidity: 45%	Power Supply: 48 VDC
Remarks:			

Plot 7.5.27 Peak spectral power density at low frequency within 6 dB band

Channel bandwidth 5 MHz
 Modulation 64QAM
 Bit Rate 32.5 Mbps

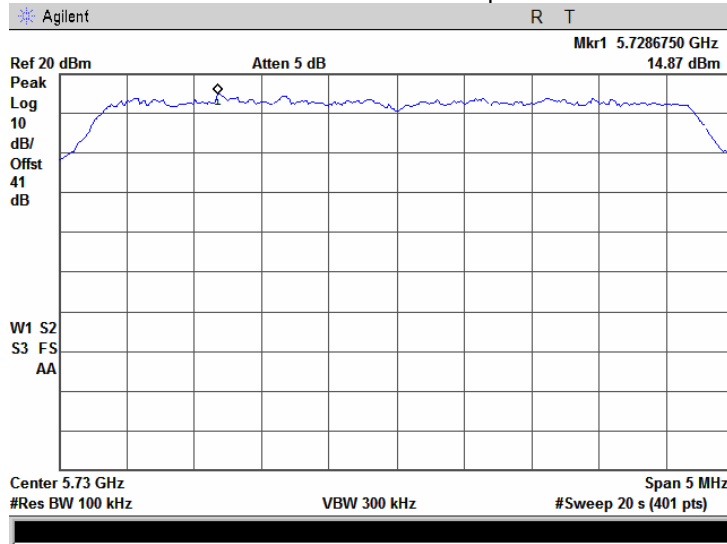

Plot 7.5.28 Peak spectral power density at low frequency zoomed at the peak

Channel bandwidth 5 MHz
 Modulation 64QAM
 Bit Rate 32.5 Mbps

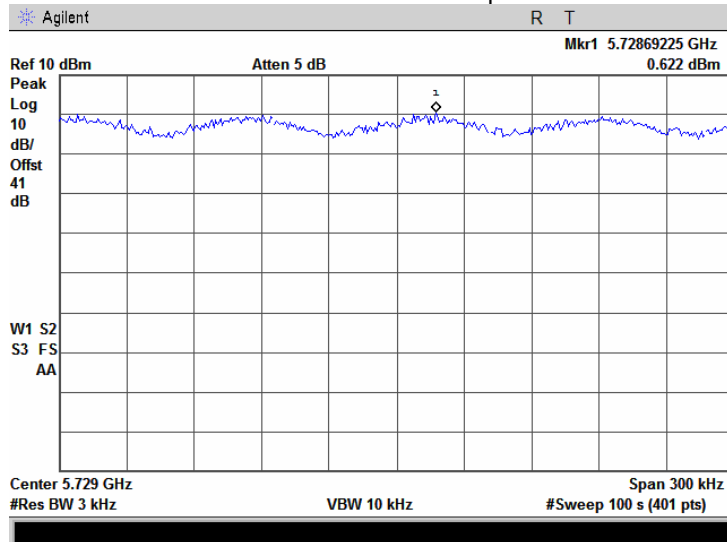



HERMON LABORATORIES

Test specification:	Section 15.247(e), RSS-210 section A8.2(b), Peak power density		
Test procedure:	FCC New Guidance on Measurements for DTS in section 15.247(d), Option 2		
Test mode:	Compliance	Verdict:	PASS
Date & Time:	10/30/2008 11:19:49 AM		
Temperature: 22°C	Air Pressure: 1008 hPa	Relative Humidity: 45%	Power Supply: 48 VDC
Remarks:			

Plot 7.5.29 Peak spectral power density at mid frequency within 6 dB band

Channel bandwidth 5 MHz
 Modulation BPSK
 Bit Rate 3.25 Mbps

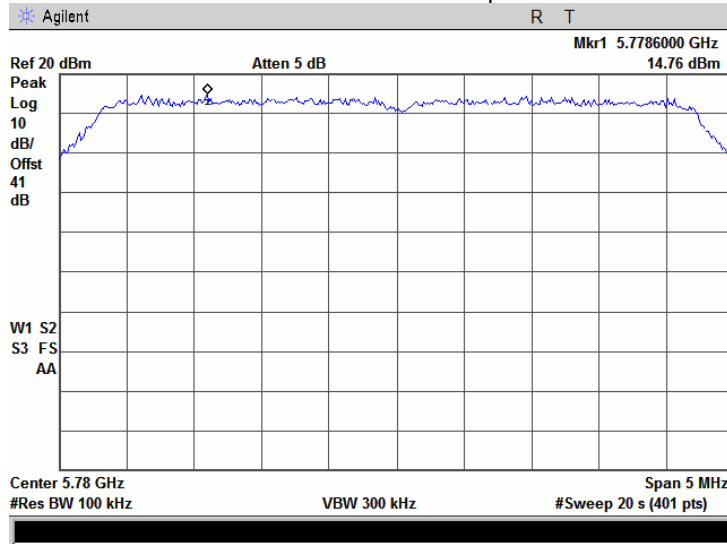

Plot 7.5.30 Peak spectral power density at mid frequency zoomed at the peak

Channel bandwidth 5 MHz
 Modulation BPSK
 Bit Rate 3.25 Mbps

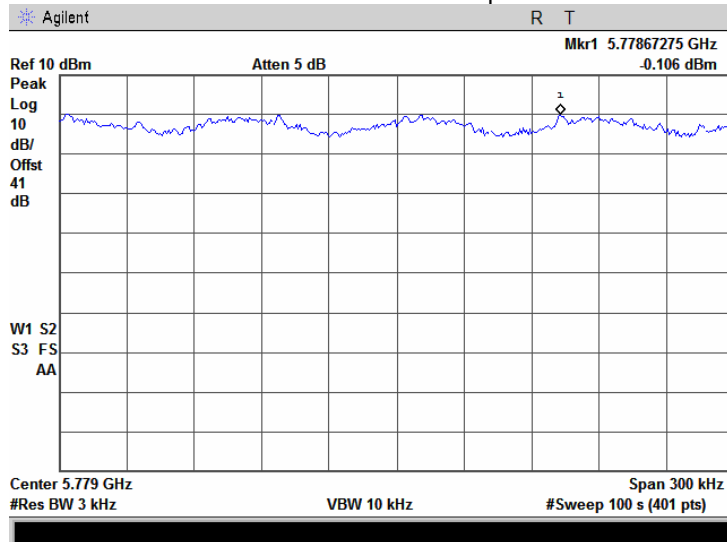



HERMON LABORATORIES

Test specification:	Section 15.247(e), RSS-210 section A8.2(b), Peak power density		
Test procedure:	FCC New Guidance on Measurements for DTS in section 15.247(d), Option 2		
Test mode:	Compliance	Verdict:	PASS
Date & Time:	10/30/2008 11:19:49 AM		
Temperature: 22°C	Air Pressure: 1008 hPa	Relative Humidity: 45%	Power Supply: 48 VDC
Remarks:			

Plot 7.5.31 Peak spectral power density at mid frequency within 6 dB band

Channel bandwidth 5 MHz
 Modulation 64QAM
 Bit Rate 32.5 Mbps

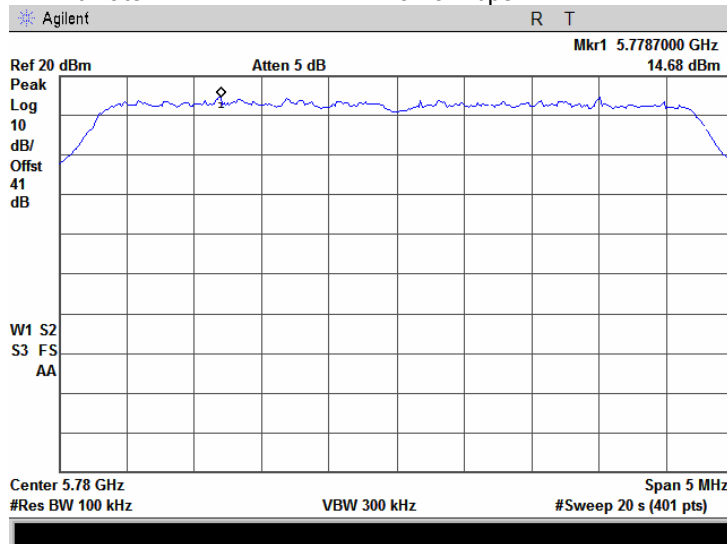

Plot 7.5.32 Peak spectral power density at mid frequency zoomed at the peak

Channel bandwidth 5 MHz
 Modulation 64QAM
 Bit Rate 32.5 Mbps

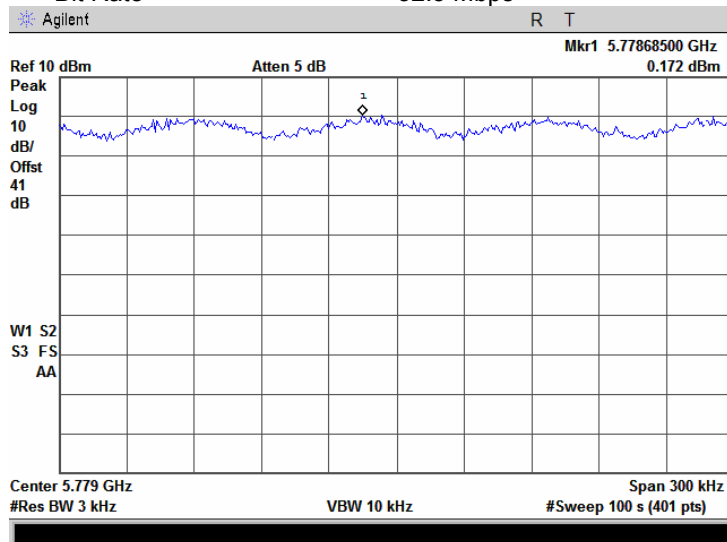



HERMON LABORATORIES

Test specification:	Section 15.247(e), RSS-210 section A8.2(b), Peak power density		
Test procedure:	FCC New Guidance on Measurements for DTS in section 15.247(d), Option 2		
Test mode:	Compliance	Verdict:	PASS
Date & Time:	10/30/2008 11:19:49 AM		
Temperature: 22°C	Air Pressure: 1008 hPa	Relative Humidity: 45%	Power Supply: 48 VDC
Remarks:			

Plot 7.5.33 Peak spectral power density at high frequency within 6 dB band

Channel bandwidth 5 MHz
 Modulation BPSK
 Bit Rate 3.25 Mbps

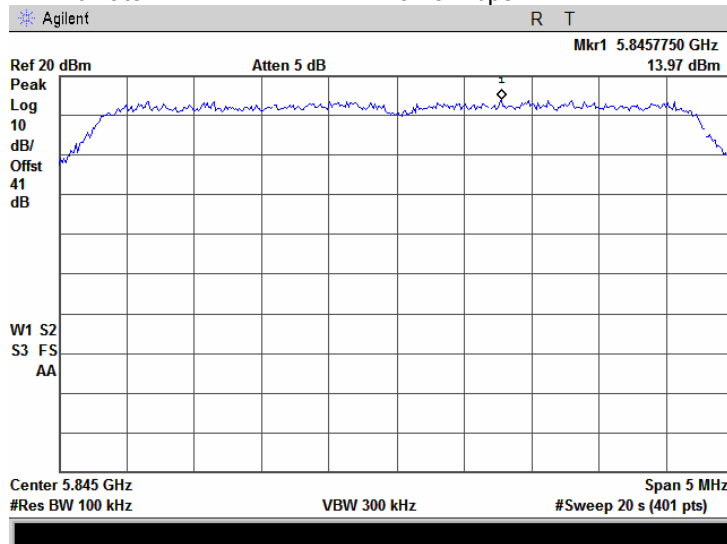

Plot 7.5.34 Peak spectral power density at high frequency zoomed at the peak

Channel bandwidth 5 MHz
 Modulation BPSK
 Bit Rate 3.25 Mbps

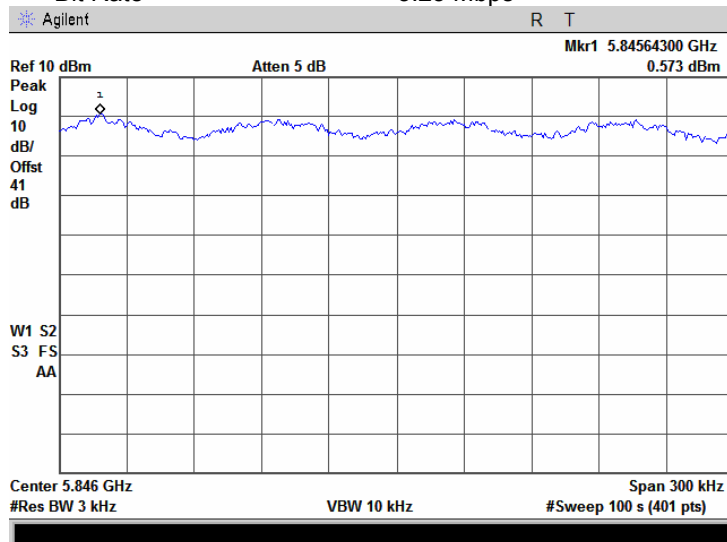



HERMON LABORATORIES

Test specification:	Section 15.247(e), RSS-210 section A8.2(b), Peak power density		
Test procedure:	FCC New Guidance on Measurements for DTS in section 15.247(d), Option 2		
Test mode:	Compliance	Verdict:	PASS
Date & Time:	10/30/2008 11:19:49 AM		
Temperature: 22°C	Air Pressure: 1008 hPa	Relative Humidity: 45%	Power Supply: 48 VDC
Remarks:			

Plot 7.5.35 Peak spectral power density at high frequency within 6 dB band

Channel bandwidth 5 MHz
 Modulation 64QAM
 Bit Rate 32.5 Mbps

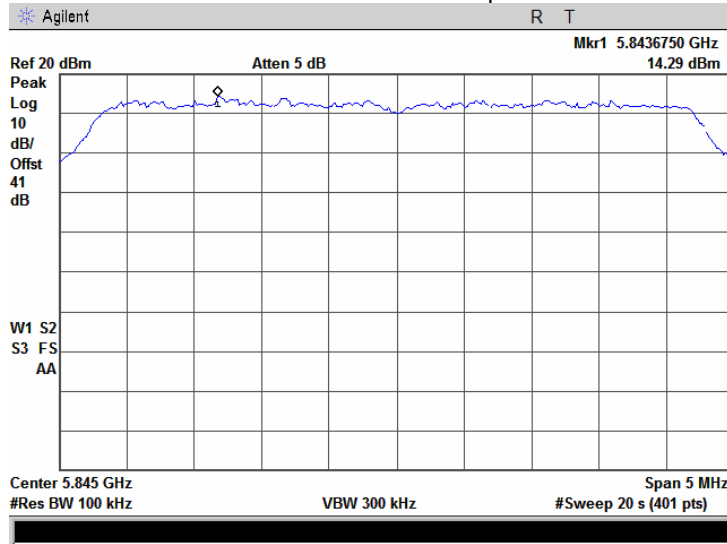

Plot 7.5.36 Peak spectral power density at high frequency zoomed at the peak

Channel bandwidth 5 MHz
 Modulation 64QAM
 Bit Rate 32.5 Mbps

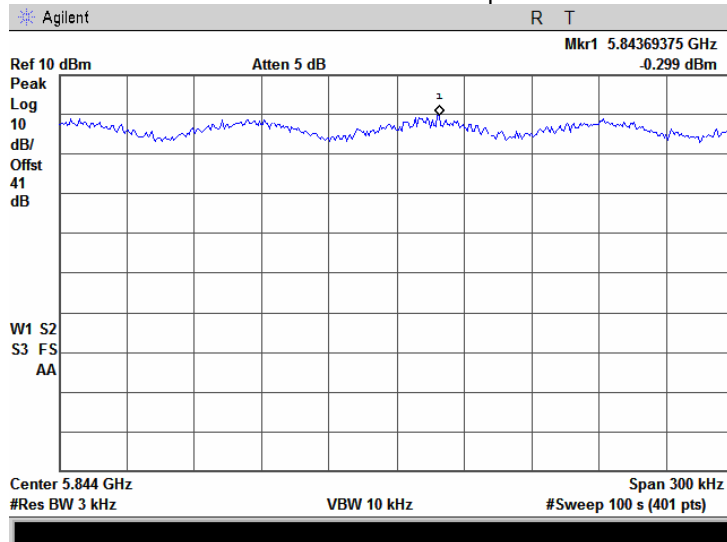

Test specification:	Section 15.207(a), RSS-Gen section 7.2.4, Conducted emission		
Test procedure:	ANSI C63.4, Section 13.1.3		
Test mode:	Compliance	Verdict:	PASS
Date & Time:	11/14/2008 10:20:33 AM		
Temperature: 21°C	Air Pressure: 1013 hPa	Relative Humidity: 48%	Power Supply: 48 VDC
Remarks:			

7.6 Conducted emissions

7.6.1 General

This test was performed to measure common mode conducted emissions at the power port. Specification test limits are given in Table 7.6.1.

Table 7.6.1 Limits for conducted emissions

Frequency, MHz	Class B limit, dB(μV)	
	QP	AVRG
0.15 - 0.5	66 - 56*	56 - 46*
0.5 - 5.0	56	46
5.0 - 30	60	50

* The limit decreases linearly with the logarithm of frequency.

7.6.2 Test procedure

7.6.2.1 The EUT was set up as shown in Figure 7.6.1, energized and the performance check was conducted.

7.6.2.2 The measurements were performed at power terminals with the LISN, connected to a spectrum analyzer in the frequency range referred to in Table 7.6.2. Unused coaxial connector of the LISN was terminated with 50 Ohm. Quasi-peak and average detectors were used throughout the testing.

7.6.2.3 The position of the device cables was varied to determine maximum emission level.

7.6.2.4 The worst test results (the lowest margins) were recorded in Table 7.6.2 and shown in the associated plots.

Figure 7.6.1 Setup for conducted emission measurements, table-top equipment

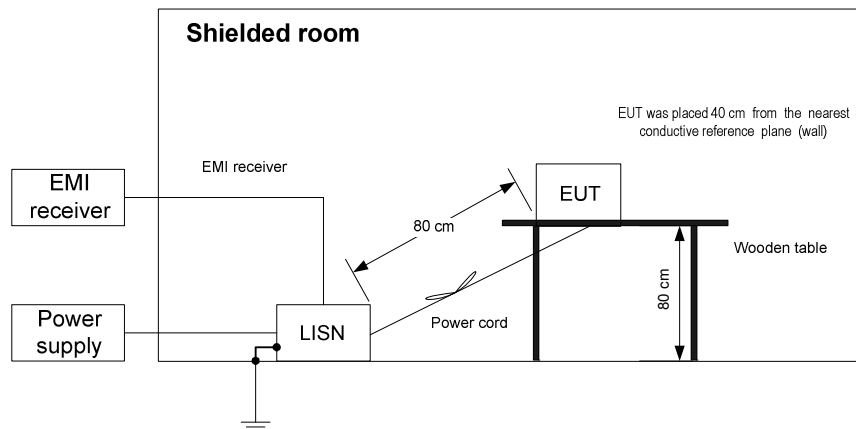



HERMON LABORATORIES

Test specification:	Section 15.207(a), RSS-Gen section 7.2.4, Conducted emission		
Test procedure:	ANSI C63.4, Section 13.1.3		
Test mode:	Compliance	Verdict: PASS	
Date & Time:	11/14/2008 10:20:33 AM		
Temperature: 21°C	Air Pressure: 1013 hPa	Relative Humidity: 48%	Power Supply: 48 VDC
Remarks:			

Table 7.6.2 Conducted emission test results

LINE: AC mains
 EUT OPERATING MODE: Transmit
 EUT SET UP: TABLE-TOP
 TEST SITE: SHIELDED ROOM
 DETECTORS USED: PEAK / QUASI-PEAK / AVERAGE
 FREQUENCY RANGE: 150 kHz - 30 MHz
 RESOLUTION BANDWIDTH: 9 kHz

Frequency, MHz	Peak emission, dB(μV)	Quasi-peak			Average			Line ID	Verdict
		Measured emission, dB(μV)	Limit, dB(μV)	Margin, dB*	Measured emission, dB(μV)	Limit, dB(μV)	Margin, dB*		
0.155246	54.40	48.68	65.74	-17.06	41.51	55.74	-14.23	L1	Pass
0.226417	44.68	43.61	62.64	-19.03	39.32	52.64	-13.32		
1.508967	43.22	42.64	56.00	-13.36	41.46	46.00	-4.54		
2.263405	43.62	43.11	56.00	-12.89	41.56	46.00	-4.44		
3.018541	43.39	42.77	56.00	-13.23	37.34	46.00	-8.66		
3.621406	43.75	43.11	56.00	-12.89	40.78	46.00	-5.22		
0.152216	53.71	50.08	65.89	-15.81	45.98	55.89	-9.91	L2	Pass
0.452098	44.02	43.20	56.90	-13.70	42.53	46.90	-4.37		
0.978975	43.45	42.68	56.00	-13.32	41.34	46.00	-4.66		
1.205022	43.15	42.53	56.00	-13.47	41.93	46.00	-4.07		
2.561571	44.23	43.50	56.00	-12.50	42.39	46.00	-3.61		
2.786787	43.75	43.21	56.00	-12.79	40.71	46.00	-5.29		

*- Margin = Measured emission - specification limit.

Reference numbers of test equipment used

HL 0163	HL 0787	HL 1430	HL 1500	HL 2888			
---------	---------	---------	---------	---------	--	--	--

Full description is given in Appendix A.



HERMON LABORATORIES

Test specification:	Section 15.207(a), RSS-Gen section 7.2.4, Conducted emission		
Test procedure:	ANSI C63.4, Section 13.1.3		
Test mode:	Compliance	Verdict: PASS	
Date & Time:	11/14/2008 10:20:33 AM		
Temperature: 21°C	Air Pressure: 1013 hPa	Relative Humidity: 48%	Power Supply: 48 VDC
Remarks:			

Plot 7.6.1 Conducted emission measurements

LINE: L1
EUT OPERATING MODE: Transmit at CBW = 20 MHz, Tx low - maximum peak power result;
LIMIT: QUASI-PEAK, AVERAGE
DETECTOR: PEAK

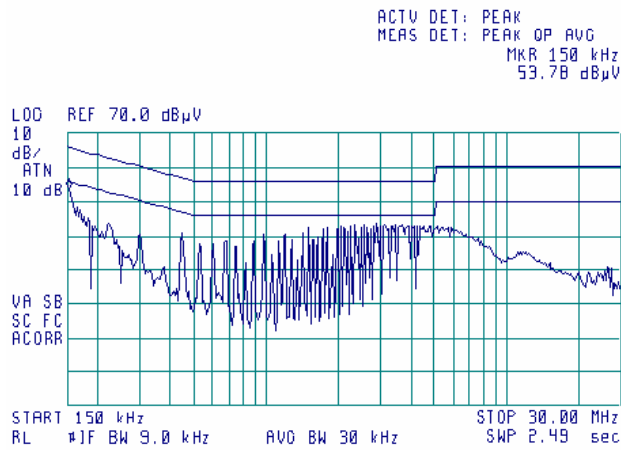

Plot 7.6.2 Conducted emission measurements

LINE: L2
EUT OPERATING MODE: Transmit at CBW = 20 MHz, Tx low - maximum peak power result;
LIMIT: QUASI-PEAK, AVERAGE
DETECTOR: PEAK

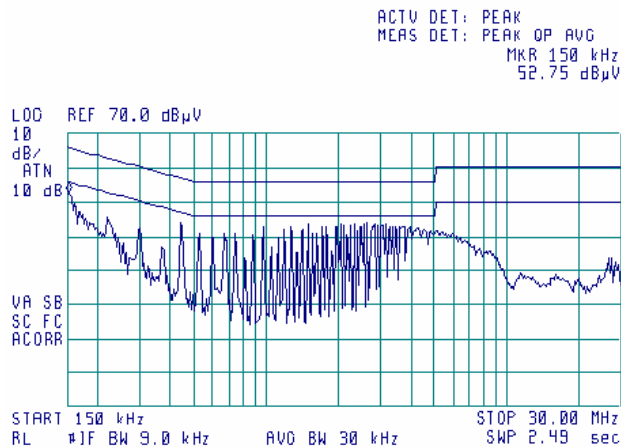



Test specification:	Section 15.203, RSS-Gen section 7.1.2, Antenna requirement		
Test procedure:	Visual inspection		
Test mode:	Compliance	Verdict:	PASS
Date & Time:	11/14/2008 11:16:25 AM		
Temperature: 21°C	Air Pressure: 1013 hPa	Relative Humidity: 48%	Power Supply: 48 VDC
Remarks:			

7.7 Antenna requirements

The EUT was verified for compliance with antenna requirements. A transmitter shall be designed to ensure that no antenna other than that furnished by the responsible party will be used with the device. It may be either permanently attached or employs a unique antenna connector for every antenna proposed for use with the EUT. This requirement does not apply to professionally installed transmitters. The rationale for compliance with the above requirements was either visual inspection results or supplier declaration. The summary of results is provided in Table 7.7.1.

Table 7.7.1 Antenna requirements

Requirement	Rationale	Verdict
The transmitter requires professional installation	Supplier declaration	Comply

Photograph 7.7.1 Antenna assembly, external





HERMON LABORATORIES

Test specification:	Section 15.203, RSS-Gen section 7.1.2, Antenna requirement		
Test procedure:	Visual inspection		
Test mode:	Compliance	Verdict:	PASS
Date & Time:	11/14/2008 11:16:25 AM		
Temperature: 21°C	Air Pressure: 1013 hPa	Relative Humidity: 48%	Power Supply: 48 VDC
Remarks:			

Photograph 7.7.2 Antenna assembly, integrated



Photograph 7.7.3 Antenna assembly, integrated



8 APPENDIX A Test equipment and ancillaries used for tests

HL No	Description	Manufacturer	Model	Ser. No.	Last Cal.	Due Cal.
0163	LISN FCC/VDE/50 Ohm/50 uH + 5 Ohm, MIL-STD-461E, CISPR 16-1	Electro-Metrics	ANS 25/2	1314	20-Nov-07	20-Nov-08
0446	Antenna, Loop, Active, 10 kHz - 30 MHz	EMCO	6502	2857	29-Jun-08	29-Jun-09
0521	EMI Receiver (Spectrum Analyzer) with RF filter section 9 kHz-6.5 GHz	Hewlett Packard Co	8546A	3617A 00319, 3448A002 53	29-Aug-08	29-Aug-09
0554	Amplifier, 2-18 GHz RF	Miteq	AFD4	104300	28-Feb-08	28-Feb-09
0768	Antenna Standard Gain Horn, 18-26.5 GHz, WR-42, 25 dB gain	Quinstar Technology	QWH-4200-BA	110	08-Dec-06	08-Dec-08
0769	Antenna Standard Gain Horn, 26.5-40 GHz, WR28, 25 dB gain	Quinstar Technology	QWH-2800-BA	112	08-Dec-06	08-Dec-08
0784	Antenna X-WING BILOG, 20 MHz - 2 GHz	Schaffner-Chase EMC	CBL6140 A	1120	10-Jan-08	10-Jan-09
0787	Transient Limiter 9 kHz-200 MHz	Hewlett Packard Co	11947A	3107A018 77	16-Oct-08	16-Oct-09
1003	Cable Coaxial, M17/164, 10 m	Hermon Laboratories	C17164-10	161	04-Sep-08	04-Sep-09
1424	Spectrum Analyzer, 30 Hz- 40 GHz	Agilent Technologies	8564EC	3946A002 19	30-Dec-07	30-Dec-08
1430	EMI Receiver, 9 kHz - 2.9 GHz, System: HL1431, HL1432	Agilent Technologies	8542E	3807A002 62,3705A0 0217	31-Aug-08	31-Aug-09
1500	Cable RF, 15 m, N/N-type	Suhner Switzerland	RG 214/U	1500	08-Sep-08	08-Sep-09
1906	Power Divider, 0.5-18.0 GHz, 80 W	Omni Spectra	2090-6204-0	1906	1-Dec-07	1-Dec-09
1984	Antenna, Double-Ridged Waveguide Horn, 1-18 GHz, 300 W	EMC Test Systems	3115	9911-5964	03-Mar-08	03-Mar-09
2254	Cable 40 GHz, 0.8 m, blue	Rhophase Microwave Limited	KPS-1503A-800-KPS	W4907	10-Jun-08	10-Jun-09
2260	Amplifier Low Noise 14-33 GHz	Sophia Wireless	LNA28-B	0233	30-Dec-07	30-Dec-08
2261	Amplifier Low Noise 33-40 GHz	Sophia Wireless	LNA38-B	0234	06-Nov-08	06-Nov-09
2888	LISN Two-line V-Network 50 Ohm / 50 uH + 5 Ohm, 16A, MIL STD 461E, CISPR16-1	Rolf Heine	NNB-2/16Z	02/10018	09-Jul-08	09-Jul-09
2909	Spectrum analyzer, ESA-E, 100 Hz to 26.5 GHz	Agilent Technologies	E4407B	MY414447 62	07-May-07	07-May-09
2910	Cable 18 GHz, 3 m, SMA-SMA	Gore	NA	989370	30-Dec-07	30-Dec-08
2911	Cable 18 GHz, 1.5 m, SMA-SMA	Gore	NA	89386	05-Oct-08	05-Oct-09
3123	Microwave Cable Assembly, 18 GHz, 6.4 m, SMA - SMA	Huber-Suhner	198-9155-00	3123	13-Dec-07	13-Dec-08
3175	Attenuator, N-type, 10 dB, DC to 18 GHz, 5 W	Mini-Circuits	BW-N10W5+	0708	07-May-08	07-May-09



HL No	Description	Manufacturer	Model	Ser. No.	Last Cal.	Due Cal.
3178	Attenuator, N-type, 20 dB, DC to 18 GHz, 5 W	Mini-Circuits	BW-N20W5+	0651	30-Dec-07	30-Dec-08
3179	Attenuator, N-type, 20 dB, DC to 18 GHz, 5 W	Mini-Circuits	BW-N20W5+	0651	07-May-08	07-May-09
3180	Attenuator, N-type, 20 dB, DC to 18 GHz, 5 W	Mini-Circuits	BW-N20W5+	0651	07-May-08	07-May-09
3181	Attenuator, N-type, 20 dB, DC to 18 GHz, 5 W	Mini-Circuits	BW-N20W5+	0651	07-May-08	07-May-09
3206	Cable 40GHz, 0.6 m	Gore	GOR245	05118336	10-Jun-08	10-Jun-09
3301	Power Meter, P-series, 50 MHz to 40 GHz	Agilent Technologies	N1911A	MY45101057	27-Jul-07	27-Jul-09
3302	Power sensor, P-Series, 50 MHz to 40 GHz, -35/30 to 20 dBm	Agilent Technologies	N1922A	MY45240586	25-Jul-07	25-Jul-09
3386	Microwave Cable Assembly, 26.5 GHz, 1.0 m, N type/N type	Suhner Sucoflex	104EA	3386	12-Feb-08	12-Feb-09
3389	Microwave Cable Assembly, 26.5 GHz, 1.0 m, N type/N type	Suhner Sucoflex	104EA	3389	12-Feb-08	12-Feb-09
3455	Medium Power Fixed Coaxial Attenuator DC to 40 GHz, 20 dB, 5 W	Aeroflex / Weinschel	75A-20-12	1182	17-Mar-08	17-Mar-09
3472	Cable, Coax, Microwave, DC-18 GHz, SMA-SMA, 1.0 m	Gore	65474	1003478	12-May-08	12-May-09
3473	Cable, Coax, Microwave, DC-18 GHz, SMA-SMA, 0.6 m	Gore	65474	1003478	12-May-08	12-May-09
3474	Cable, Coax, Microwave, DC-18 GHz, SMA-SMA, 0.6 m	Gore	65475	1640102	12-May-08	12-May-09

9 APPENDIX B Measurement uncertainties

Expanded uncertainty at 95% confidence in Hermon Labs EMC measurements

Test description	Expanded uncertainty
Conducted carrier power at RF antenna connector	Below 12.4 GHz: ± 1.7 dB 12.4 GHz to 40 GHz: ± 2.3 dB
Conducted emissions at RF antenna connector	9 kHz to 2.9 GHz: ± 2.6 dB 2.9 GHz to 6.46 GHz: ± 3.5 dB 6.46 GHz to 13.2 GHz: ± 4.3 dB 13.2 GHz to 22.0 GHz: ± 5.0 dB 22.0 GHz to 26.8 GHz: ± 5.5 dB 26.8 GHz to 40.0 GHz: ± 4.8 dB
Occupied bandwidth	± 8.0 %
Duty cycle, timing (Tx ON / OFF) and average factor measurements	± 1.0 %
Conducted emissions with LISN	9 kHz to 150 kHz: ± 3.9 dB 150 kHz to 30 MHz: ± 3.8 dB
Radiated emissions at 3 m measuring distance Horizontal polarization Vertical polarization	Biconilog antenna: ± 5.3 dB Biconical antenna: ± 5.0 dB Log periodic antenna: ± 5.3 dB Double ridged horn antenna: ± 5.3 dB Biconilog antenna: ± 6.0 dB Biconical antenna: ± 5.7 dB Log periodic antenna: ± 6.0 dB Double ridged horn antenna: ± 6.0 dB

Hermon Laboratories is accredited by A2LA for calibration according to present requirements of ISO/IEC 17025 and NCSL Z540-1. The accreditation is granted to perform calibration of parameters that are listed in the Scope of Hermon Laboratories Accreditation.

Hermon Laboratories calibrates its reference and transfer standards by calibration laboratories accredited to ISO/IEC 17025 by a mutually recognized Accreditation Body or by a recognized national metrology institute. All reference and transfer standards used in the calibration system are traceable to national or international standards.

In-house calibration of all test and measurement equipment is performed on a regular basis according to Hermon Laboratories calibration procedures, manufacturer calibration/verification procedures or procedures defined in the relevant standards. The Hermon Laboratories test and measurement equipment is calibrated within the tolerances specified by the manufacturers and/or by the relevant standards.

10 APPENDIX C Test laboratory description

Tests were performed at Hermon Laboratories Ltd., which is a fully independent, private, EMC, safety, environmental and telecommunication testing facility.

Hermon Laboratories is listed by the Federal Communications Commission (USA) for all parts of Code of Federal Regulations 47 (CFR 47), Registration Numbers 90624 for OATS and 90623 for the anechoic chamber; by Industry Canada for electromagnetic emissions (file numbers IC 2186A-1 for OATS, IC 2186A-2 for anechoic chamber, IC 2186A-3 for full-anechoic chamber for RE measurements above 1 GHz), certified by VCCI, Japan (the registration numbers are R-808 for OATS, R-1082 for anechoic chamber, G-27 for full-anechoic chamber for RE measurements above 1 GHz, C-845 for conducted emissions site, T-1606 for conducted emissions at telecommunication ports), has a status of a Telefication - Listed Testing Laboratory, Certificate No. L138/00. The laboratory is accredited by American Association for Laboratory Accreditation (USA) according to ISO/IEC 17025 for electromagnetic compatibility, product safety, telecommunications testing and environmental simulation (for exact scope please refer to Certificate No. 839.01). The FCC Designation Number is US1003.

Address: P.O. Box 23, Binyamina 30500, Israel.
Telephone: +972 4628 8001
Fax: +972 4628 8277
e-mail: mail@hermonlabs.com
website: www.hermonlabs.com

Person for contact: Mr. Alex Usoskin, CEO.

11 APPENDIX D Specification references

FCC 47CFR part 15: 2009	Radio Frequency Devices.
FR Vol.62	Federal Register, Volume 62, May 13, 1997
FCC New Guidance:2004	FCC New Guidance on Measurements for DTS
ANSI C63.2: 1996	American National Standard for Instrumentation-Electromagnetic Noise and Field Strength, 10 kHz to 40 GHz-Specifications.
ANSI C63.4: 2003	American National Standard for Methods of Measurement of Radio-Noise Emissions from Low-Voltage Electrical and Electronic Equipment in the Range of 9 kHz to 40 GHz.
RSS-210 Issue 8: 2010	Low Power Licence- Exempt Radiocommunication Devices
RSS-Gen Issue 3: 2010	General Requirements and Information for the certification of Radiocommunication Equipment

12 APPENDIX E Test equipment correction factors

Correction factor
Line impedance stabilization network
Model ANS-25/2, Electro-Metrics, HL 0163

Frequency, kHz	Correction factor, dB
10	4.9
15	2.86
20	1.83
25	1.25
30	0.91
35	0.69
40	0.53
50	0.35
60	0.25
70	0.18
80	0.14
90	0.11
100	0.09
125	0.06
150	0.04

The correction factor in dB is to be added to meter readings of an interference analyzer or a spectrum analyzer.

Correction factor
Line impedance stabilization network
Model NNB-2/16Z, Rolf Heine, HL 2888

Frequency, kHz	Insertion loss, dB		Measurement Uncertainty, dB
	L1	N	
10	0.48	0.79	±0.6
20	0.52	0.63	
30	0.31	0.35	
40	0.20	0.22	
50	0.16	0.17	
100	0.10	0.08	
300	0.08	0.06	
500	0.10	0.06	
600	0.09	0.07	
800	0.10	0.07	
1000	0.10	0.08	
2000	0.12	0.11	
3000	0.16	0.14	
4000	0.17	0.18	
6000	0.26	0.23	
10000	0.49	0.41	
14000	0.66	0.54	
16000	0.79	0.69	
18000	0.86	0.76	
20000	0.96	0.85	
25000	1.22	1.08	
28000	1.35	1.21	
30000	1.43	1.29	

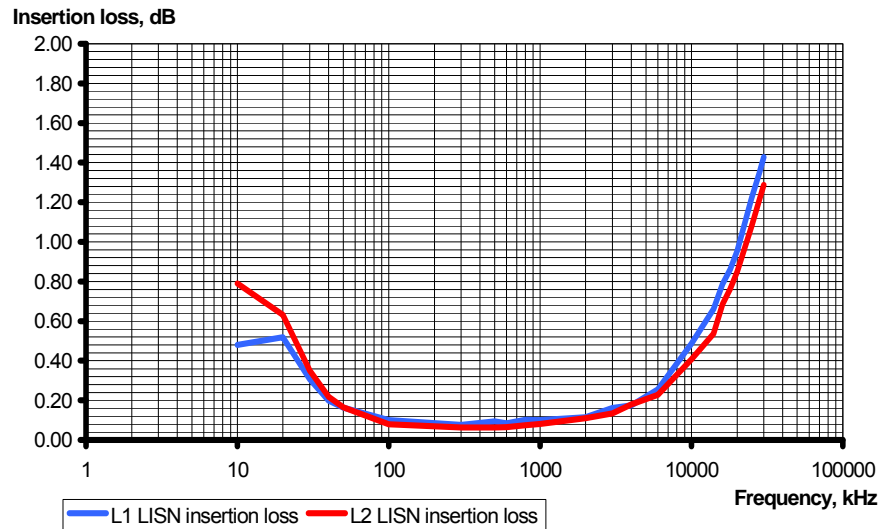

Antenna Factor
Active Loop Antenna
EMC Test Systems, model 6502, S/N 2857, HL 0446

Frequency, MHz	Magnetic Antenna Factor, dB(S/m)	Electric Antenna Factor, dB(1/m)
0.009	-32.8	18.7
0.010	-33.8	17.7
0.020	-38.3	13.2
0.050	-41.1	10.4
0.075	-41.3	10.2
0.100	-41.6	9.9
0.150	-41.7	9.8
0.250	-41.6	9.9
0.500	-41.8	9.7
0.750	-41.9	9.6
1.000	-41.4	10.1
2.000	-41.5	10.0
3.000	-41.4	10.1
4.000	-41.4	10.1
5.000	-41.5	10.0
10.000	-41.9	9.6
15.000	-41.9	9.6
20.000	-42.2	9.3
25.000	-42.8	8.7
30.000	-44.0	7.5

Antenna factor in dB(S/m) is to be added to receiver meter reading in dB(μ V) to convert it into field intensity in dB(μ A/m).
Antenna factor in dB(1/m) is to be added to receiver meter reading in dB(μ V) to convert it into field intensity in dB(μ V/m).

Antenna factor
Standard gain horn antenna
Quinstar Technology
Model QWH, Ser.No.112, HL 0768, 0769

Frequency min, GHz	Frequency max, GHz	Antenna factor, dB(1/m)
18.000	26.500	32.01
26.500	40.000	35.48
40.000	60.000	39.03
60.000	90.000	42.55
90.000	140.000	46.23
140.000	220.000	50.11

Antenna factor in dB(1/m) is to be added to receiver meter reading in dB(μ V) to convert it into field intensity in dB(μ V/m).

Antenna factor

Biconilog antenna EMCO, model 3141, serial number 1011, HL 0604

Frequency, MHz	Antenna factor, dB(1/m)	Frequency, MHz	Antenna factor, dB(1/m)	Frequency, MHz	Antenna factor, dB(1/m)
26	7.8	560	19.8	1300	27.0
28	7.8	580	20.6	1320	27.8
30	7.8	600	21.3	1340	28.3
40	7.2	620	21.5	1360	28.2
60	7.1	640	21.2	1380	27.9
70	8.5	660	21.4	1400	27.9
80	9.4	680	21.9	1420	27.9
90	9.8	700	22.2	1440	27.8
100	9.7	720	22.2	1460	27.8
110	9.3	740	22.1	1480	28.0
120	8.8	760	22.3	1500	28.5
130	8.7	780	22.6	1520	28.9
140	9.2	800	22.7	1540	29.6
150	9.8	820	22.9	1560	29.8
160	10.2	840	23.1	1580	29.6
170	10.4	860	23.4	1600	29.5
180	10.4	880	23.8	1620	29.3
190	10.3	900	24.1	1640	29.2
200	10.6	920	24.1	1660	29.4
220	11.6	940	24.0	1680	29.6
240	12.4	960	24.1	1700	29.8
260	12.8	980	24.5	1720	30.3
280	13.7	1000	24.9	1740	30.8
300	14.7	1020	25.0	1760	31.1
320	15.2	1040	25.2	1780	31.0
340	15.4	1060	25.4	1800	30.9
360	16.1	1080	25.6	1820	30.7
380	16.4	1100	25.7	1840	30.6
400	16.6	1120	26.0	1860	30.6
420	16.7	1140	26.4	1880	30.6
440	17.0	1160	27.0	1900	30.6
460	17.7	1180	27.0	1920	30.7
480	18.1	1200	26.7	1940	30.9
500	18.5	1220	26.5	1960	31.2
520	19.1	1240	26.5	1980	31.6
540	19.5	1260	26.5	2000	32.0
		1280	26.6		

Antenna factor in dB(1/m) is to be added to receiver meter reading in dB(μ V) to convert it into field intensity in dB(μ V/m).

**Antenna factor
Double-ridged wave guide horn antenna
Model 3115, S/N 9911-5964, HL 1984**

Frequency, MHz	Antenna factor, dB(1/m)
1000.0	24.7
1500.0	25.7
2000.0	27.6
2500.0	28.9
3000.0	31.2
3500.0	32.0
4000.0	32.5
4500.0	32.7
5000.0	33.6
5500.0	35.1
6000.0	35.4
6500.0	34.9
7000.0	36.1
7500.0	37.8
8000.0	38.0
8500.0	38.1
9000.0	39.1
9500.0	38.3
10000.0	38.6
10500.0	38.2
11000.0	38.7
11500.0	39.5
12000.0	40.0
12500.0	40.4
13000.0	40.5
13500.0	41.1
14000.0	41.6
14500.0	41.7
15000.0	38.7
15500.0	38.2
16000.0	38.8
16500.0	40.5
17000.0	42.5
17500.0	45.9
18000.0	49.4

Antenna factor in dB(1/m) is to be added to receiver meter reading in dB(μ V) to convert it into field intensity in dB(μ V/m).

Cable loss
Cable coaxial, M17/164, model: C17164-10, s/n 161, HL 1003

No.	Frequency, MHz	Cable loss, dB	Tolerance, dB	Measurement uncertainty, dB
1	30	0.41	≤ 12.5	±0.12
2	50	0.52		
3	100	0.75		
4	300	1.45		
5	500	2.01		
6	800	2.71		
7	1000	3.14		
8	1200	3.56		
9	1400	3.93		
10	1600	4.31		
11	1800	4.63		
12	2000	4.97		
13	2200	5.32		
14	2400	5.65		
15	2600	6.01		
16	2800	6.42	≤ 12.5	±0.12
17	3000	6.76		
18	3300	7.12		
19	3600	7.53		
20	3900	7.95		
21	4200	8.32		
22	4500	8.72		±0.17
23	4800	9.14		
24	5100	9.59		
25	5400	10.00		
26	5700	10.49		
27	6000	11.07		
28	6500	11.80		

Cable loss
Cable 40 GHz, 0.8 m, blue, model: KPS-1503A-800-KPS, S/N W4907, HL 2254

Frequency, GHz	Cable loss, dB	Frequency, GHz	Cable loss, dB	Frequency, GHz	Cable loss, dB
0.03	0.04	5.10	0.80	15.00	1.49
0.05	0.07	5.30	0.83	15.50	1.49
0.10	0.09	5.50	0.83	16.00	1.46
0.20	0.15	5.70	0.84	16.50	1.47
0.30	0.19	5.90	0.87	17.00	1.50
0.40	0.25	6.10	0.86	17.50	1.57
0.50	0.29	6.30	0.89	18.00	1.63
0.60	0.33	6.50	0.90	18.50	1.57
0.70	0.37	6.70	0.89	19.00	1.63
0.80	0.41	6.90	0.93	19.50	1.65
0.90	0.44	7.10	0.92	20.00	1.64
1.00	0.45	7.30	0.95	20.50	1.75
1.10	0.48	7.50	0.96	21.00	1.72
1.20	0.51	7.70	0.97	21.50	1.78
1.30	0.53	7.90	1.01	22.00	1.76
1.40	0.54	8.10	1.00	22.50	1.72
1.50	0.57	8.30	1.05	23.00	1.83
1.60	0.59	8.50	1.04	23.50	1.80
1.70	0.04	8.70	1.07	24.00	1.90
1.80	0.07	8.90	1.11	24.50	1.81
1.90	0.09	9.10	1.09	25.00	1.98
2.00	0.15	9.30	1.14	25.50	1.91
2.10	0.19	9.50	1.12	26.00	2.02
2.20	0.25	9.70	1.15	26.50	1.92
2.30	0.29	9.90	1.16	27.00	1.97
2.40	0.33	10.10	1.16	28.00	2.02
2.50	0.37	10.30	1.19	29.00	1.95
2.60	0.41	10.50	1.14	30.00	1.94
2.70	0.44	10.70	1.19	31.00	2.11
2.80	0.45	10.90	1.17	32.00	2.17
2.90	0.48	11.10	1.13	33.00	2.27
3.10	0.61	11.30	1.20	34.00	2.27
3.30	0.64	11.50	1.13	35.00	2.29
3.50	0.65	11.70	1.20	36.00	2.35
3.70	0.68	11.90	1.18	37.00	2.37
3.90	0.69	12.10	1.14	38.00	2.40
4.10	0.71	12.40	1.19	39.00	2.57
4.30	0.73	13.00	1.34	40.00	2.36
4.50	0.75	13.50	1.33		
4.70	0.77	14.00	1.48		
4.90	0.79	14.50	1.45		

Cable loss
Cable coaxial, Gore, 18 GHz, 3m, SMA-SMA, S/N 989370
HL 2910

Frequency, MHz	Cable loss, dB	Frequency, MHz	Cable loss, dB	Frequency, MHz	Cable loss, dB
10	0.07	5750	2.97	12000	5.05
30	0.19	6000	2.91	12250	4.44
100	0.36	6250	3.23	12500	4.82
250	0.53	6500	3.42	12750	5.22
500	0.77	6750	3.17	13000	5.02
750	0.94	7000	3.56	13250	5.00
1000	1.10	7250	3.77	13500	5.09
1250	1.19	7500	3.48	13750	4.70
1500	1.35	7750	3.81	14000	5.03
1750	1.51	8000	3.82	14250	5.17
2000	1.57	8250	3.62	14500	4.92
2250	1.69	8500	3.95	14750	4.91
2500	1.76	8750	4.00	15000	5.03
2750	1.83	9000	3.80	15250	4.93
3000	2.02	9250	4.09	15500	5.28
3250	2.17	9500	4.12	15750	5.60
3500	2.13	9750	4.11	16000	5.16
3750	2.23	10000	4.36	16250	5.45
4000	2.40	10250	4.75	16500	5.78
4250	2.31	10500	4.61	16750	5.47
4500	2.52	10750	4.26	17000	5.21
4750	2.77	11000	4.62	17250	5.53
5000	2.82	11250	4.55	17500	5.53
5250	2.77	11500	4.59	17750	5.71
5500	3.04	11750	5.20	18000	5.77

Cable loss
Cable coaxial, Gore, 18 GHz, 1.5 m, SMA-SMA, S/N 89386
HL 2911

Frequency, MHz	Cable loss, dB	Frequency, MHz	Cable loss, dB	Frequency, MHz	Cable loss, dB
10	0.06	5750	1.32	12000	2.04
30	0.09	6000	1.34	12250	2.04
100	0.16	6250	1.41	12500	2.07
250	0.27	6500	1.43	12750	1.96
500	0.38	6750	1.46	13000	1.97
750	0.49	7000	1.49	13250	2.01
1000	0.55	7250	1.52	13500	2.04
1250	0.62	7500	1.56	13750	2.12
1500	0.68	7750	1.66	14000	2.16
1750	0.74	8000	1.69	14250	2.16
2000	0.78	8250	1.78	14500	2.28
2250	0.83	8500	1.73	14750	2.26
2500	0.88	8750	1.71	15000	2.22
2750	0.97	9000	1.72	15250	2.34
3000	1.00	9250	1.74	15500	2.41
3250	1.03	9500	1.76	15750	2.45
3500	1.05	9750	1.80	16000	2.57
3750	1.09	10000	1.89	16250	2.54
4000	1.14	10250	1.94	16500	2.55
4250	1.17	10500	1.99	16750	2.52
4500	1.21	10750	1.92	17000	2.42
4750	1.22	11000	1.96	17250	2.49
5000	1.24	11250	1.97	17500	2.62
5250	1.28	11500	2.02	17750	2.70
5500	1.30	11750	2.07	18000	2.76

Cable loss
Microwave Cable Assembly, 18 GHz, 6.4 m, SMA – SMA, Huber-Suhner, model 198-9155-00
HL 3123

Frequency, MHz	Cable loss, dB	Frequency, MHz	Cable loss, dB	Frequency, MHz	Cable loss, dB	Frequency, MHz	Cable loss, dB	Frequency, MHz	Cable loss, dB
10	0.11	3600	1.97	7400	3.12	11200	3.90	15100	4.74
30	0.17	3700	1.97	7500	3.13	11300	3.93	15200	4.70
50	0.25	3800	2.03	7600	3.16	11400	3.88	15300	4.73
100	0.32	3900	2.04	7700	3.18	11500	3.87	15400	4.78
200	0.46	4000	2.10	7800	3.20	11600	3.90	15500	4.75
300	0.58	4100	1.97	7900	3.23	11700	3.86	15600	4.76
400	0.65	4200	1.97	8000	3.25	11800	3.88	15700	4.75
500	0.74	4300	2.03	8100	3.26	11900	3.86	15800	4.78
600	0.82	4400	2.04	8200	3.28	12000	3.89	15900	4.79
700	0.89	4500	2.10	8300	3.31	12100	3.94	16000	4.73
800	0.95	4600	1.97	8400	3.31	12200	3.92	16100	4.78
900	1.01	4700	1.97	8500	3.32	12300	3.96	16200	4.84
1000	1.07	4800	2.03	8600	3.34	12400	4.01	16300	4.90
1100	1.11	4900	2.04	8700	3.35	12500	4.07	16400	4.87
1200	1.17	5000	2.10	8800	3.37	12600	4.08	16500	4.90
1300	1.22	5100	2.53	8900	3.39	12700	4.17	16600	4.98
1400	1.27	5200	2.55	9000	3.42	12800	4.26	16700	5.05
1500	1.29	5300	2.60	9100	3.43	12900	4.16	16800	5.04
1600	1.35	5400	2.61	9200	3.51	13000	4.21	16900	5.02
1700	1.40	5500	2.64	9300	3.52	13100	4.24	17000	5.09
1800	1.44	5600	2.70	9400	3.54	13200	4.27	17100	5.07
1900	1.51	5700	2.67	9500	3.63	13300	4.31	17200	5.10
2000	1.49	5800	2.71	9600	3.61	13400	4.33	17300	5.13
2100	1.55	5900	2.74	9700	3.71	13500	4.25	17400	5.23
2200	1.58	6000	2.80	9800	3.66	13600	4.27	17500	5.21
2300	1.62	6100	2.79	9900	3.77	13700	4.33	17600	5.22
2400	1.72	6200	2.81	10000	3.75	13800	4.33	17700	5.36
2500	1.76	6300	2.83	10100	3.77	13900	4.31	17800	5.35
2600	1.78	6400	2.86	10200	3.80	14000	4.30	17900	5.45
2700	1.80	6500	2.88	10300	3.79	14100	4.30	18000	5.43
2800	1.86	6600	2.90	10400	3.87	14200	4.31		
2900	1.90	6700	2.92	10500	3.83	14300	4.37		
3000	1.90	6800	2.98	10600	3.88	14400	4.35		
3100	1.97	6900	2.98	10700	3.86	14600	4.53		
3200	1.97	7000	3.00	10800	3.87	14700	4.50		
3300	2.03	7100	3.02	10900	3.90	14800	4.62		
3400	2.04	7200	3.04	11000	3.84	14900	4.65		
3500	2.10	7300	3.06	11100	3.88	15000	4.79		

13 APPENDIX F Abbreviations and acronyms

A	ampere
AC	alternating current
A/m	ampere per meter
AM	amplitude modulation
AVRG	average (detector)
BB	broad band
cm	centimeter
dB	decibel
dBm	decibel referred to one milliwatt
dB(μ V)	decibel referred to one microvolt
dB(μ V/m)	decibel referred to one microvolt per meter
dB(μ A)	decibel referred to one microampere
dB Ω	decibel referred to one Ohm
DC	direct current
EIRP	equivalent isotropically radiated power
ERP	effective radiated power
EUT	equipment under test
F	frequency
GHz	gigahertz
GND	ground
H	height
HL	Hermon laboratories
Hz	hertz
k	kilo
kHz	kilohertz
LO	local oscillator
m	meter
MHz	megahertz
min	minute
mm	millimeter
ms	millisecond
μ s	microsecond
NA	not applicable
NB	narrow band
NT	not tested
OATS	open area test site
Ω	Ohm
QP	quasi-peak
PCB	printed circuit board
PM	pulse modulation
PS	power supply
RE	radiated emission
RF	radio frequency
rms	root mean square
Rx	receive
s	second
T	temperature
Tx	transmit
V	volt
VA	volt-ampere

END OF TEST REPORT

14 APPENDIX G RADWIN 1000/2000 Antenna List and Power Settings



RADWIN 1000/2000 Antenna List and Power Settings

FCC ID: Q3KRW2058, IC: 5100A-RW2054

The following table contains the antennas that are provided with the RADWIN 1000/2000 models operating in the 5725 – 5850 MHz band according to FCC Part 15 Subpart C Section 247 and IC Radio Standard Specification RSS-210. The output power ascribed to each antenna assembly gain is the maximum transmission power allowed to keep compliance with the standards mentioned.

Part Number	Type	Antenna Frequency [GHz]	Antenna Assembly Gain at 5725 - 5850 MHz [dBi]	Channel Frequency [MHz]	Channel Bandwidth [MHz]	Output Power [dBm]
RW-9721-5158	Dish - Dual Pole	4.9 - 6.06	28*	5730, 5780, 5845	5	29
				5730, 5780, 5845	10	28
				5735, 5780, 5840	20	29
				5745, 5780, 5830	40	28
RW-9611-4958INT	FP Dual Pole Integrated	4.9 - 6.0	24	5730, 5780, 5845	5	29
				5730, 5780, 5845	10	28
				5735, 5780, 5840	20	29
				5745, 5780, 5830	40	28
RW-9611-4958	FP Dual Pole External	5.15 - 6.09	23*	5730, 5780, 5845	5	29
				5730, 5780, 5845	10	28
				5735, 5780, 5840	20	29
				5745, 5780, 5830	40	28

* Antenna assembly gain = Antenna Gain - Feeder Loss



15 APPENDIX H RADWIN 5000 Antenna List and Power Settings



RADWIN 5000 Antenna List and Power Settings

FCC ID: Q3KRW2058, IC: 5100A-RW2054

The following table contains the antennas that are provided with the RADWIN 5000 model operating in the 5725 – 5850 MHz band according to FCC Part 15 Subpart C Section 247 and IC Radio Standard Specification RSS-210. The output power ascribed to each antenna assembly gain is the maximum transmission power allowed to keep compliance with the standards mentioned.

Part Number	Type	Antenna Frequency [GHz]	Antenna Assembly Gain at 5725 - 5850 MHz [dBi]	Channel Frequency [MHz]	Channel Bandwidth [MHz]	Output Power [dBm]
RW-9061-5001	FP Dual Pole External	4.9 - 5.95	13*	5730, 5780, 5845	5	23
				5730, 5780, 5845	10	23
				5735, 5780, 5840	20	23
				5745, 5780, 5830	40	23
RW-9061-5001	FP Dual Pole External	4.9 - 5.95	8*	5730, 5780, 5845	5	28
				5730, 5780, 5845	10	28
				5735, 5780, 5840	20	28
				5745, 5780, 5830	40	28
RW-9061-5002	FP Dual Pole External	4.9 - 6.06	15.5*	5730, 5780, 5845	5	20
				5730, 5780, 5845	10	20
				5735, 5780, 5840	20	20
				5745, 5780, 5830	40	20
RW-9061-5002	FP Dual Pole External	4.9 - 6.06	8*	5730, 5780, 5845	5	28
				5730, 5780, 5845	10	28
				5735, 5780, 5840	20	28
				5745, 5780, 5830	40	28

* Antenna assembly gain = Antenna Gain - Feeder Loss

