

TEST REPORT

ACCORDING TO: FCC part 15 subpart E and RSS-210 Issue 8, Annex 9

FOR:

RADWIN Ltd.

**Outdoor radio unit operating
in the 5.3 GHz band**

**Model: RADWIN 1000,
RADWIN 2000,
RADWIN 5000**

This report is in conformity with ISO/ IEC 17025. The "A2LA Accredited" symbol endorsement applies only to the tests and calibrations that are listed in the scope of Hermon Laboratories accreditation. The test results relate only to the items tested. This test report shall not be reproduced in any form except in full with the written approval of Hermon Laboratories Ltd.



Table of contents

1	Applicant information.....	3
2	Equipment under test attributes	3
3	Manufacturer information	3
4	Test details.....	3
5	Tests summary.....	4
6	EUT description.....	5
6.1	General information.....	5
6.2	Ports and lines	5
6.3	Support and test equipment	5
6.4	Changes made in the EUT	5
6.5	Test configuration.....	6
6.6	Transmitter characteristics	7
7	Transmitter tests according to 47CFR part 15 subpart E and RSS-210 Annex 9 requirements.....	8
7.1	Peak output power and peak spectral power density	8
7.2	Ratio of the peak excursion of the modulation envelope to the peak transmit power.....	67
7.3	Field strength of spurious emissions	88
7.4	Band edge spurious emission measurements.....	135
7.5	Frequency stability test.....	165
7.6	Antenna requirements.....	169
7.7	Conducted emissions.....	170
7.8	Receiver radiated spurious emission measurements.....	173
8	APPENDIX A Test equipment and ancillaries used for tests.....	182
9	APPENDIX B Measurement uncertainties.....	184
10	APPENDIX C Test laboratory description	185
11	APPENDIX D Specification references	185
12	APPENDIX E Test equipment correction factors.....	186
13	APPENDIX F Abbreviations and acronyms.....	196



HERMON LABORATORIES

1 Applicant information

Client name: RADWIN Ltd.
Address: 27 Habarzel str., Tel Aviv, Israel, 69710
Telephone: +972 3766 2988
Fax: +972 3766 2902
E-mail: shlomo_weiss@radwin.com
Contact name: Mr. Shlomo Weiss

2 Equipment under test attributes

Product name: Outdoor radio unit operating in 5.3 GHz band
Product type: Point to Point and Point to Multipoint transceiver
Model(s): RADWIN 1000, RADWIN 2000, RADWIN 5000
Receipt date 12/18/2008

3 Manufacturer information

Manufacturer name: RADWIN Ltd.
Address: 27 Habarzel str., Tel Aviv, Israel, 69710
Telephone: +972 3766 2988
Fax: +972 3766 2902
E-Mail: shlomo_weiss@radwin.com
Contact name: Mr. Shlomo Weiss

4 Test details

Project ID: 19240
Location: Hermon Laboratories Ltd. P.O.Box 23, Binyamina 30500, Israel
Test started: 12/18/2008
Test completed: 12/29/2008
Test specification(s): FCC part 15 subpart E;
RSS-210 Issue 8:2010, Annex 9
RSS-Gen Issue 3:2010



5 Tests summary

Test	Status
Transmitter characteristics	
FCC Section 15.407(a)(3) / RSS-Gen, Section 4.6, Occupied 26 dB bandwidth	Measured
FCC Section 15.407(a)(3) / RSS-210, Section A9.2, Maximum peak output power	Pass
FCC Section 15.407(a)(3) / RSS-210, Section A9.2, Peak power spectral density	Pass
FCC Section 15.407(a)(6), Ratio of the peak excursion of the modulation envelope to the peak transmit power	Pass
FCC Section 15.407(b) / RSS-210, Section A9.2, Unwanted radiated emission	Pass
FCC Section 15.407(b) / RSS-210, Section A9.2, Unwanted conducted emission	Pass
FCC Section 15.407(b)(6), 15.207/ RSS-Gen, Section 7.2.4, Conducted emission	Pass
FCC Section 15.407(f), / RSS-Gen, Section 5.6, RF exposure	Provided in documentation for Application
FCC Section 15.407(g), Frequency stability	Pass
RSS-Gen, Section 6, 4.10, Receiver spurious radiated emission	Pass
FCC section 15.203, RSS-Gen section 7.1.2, Antenna requirement	Pass

Note: The EUT model RADWIN 2000 with power setting that produced Maximum Output Power with maximum Antenna Gain 23.5 and 28 dBi was tested as the worst case between all RADWIN 1000,2000,5000 models. The more detailed description of RADWIN 1000,2000,5000 is provided in section 6.1 of the test report.

Testing was completed against all relevant requirements of the test standard. Results obtained indicate that the product under test complies in full with the requirements tested.
The test results relate only to the items tested. Pass/ fail decision was based on nominal values.

This test report replaces the previously issued test report identified by Doc ID "RDWRAD_FCC.19240_21882".

	Name and Title	Date	Signature
Tested by:	Mr. E. Plotnichenko, test engineer	December 29, 2008	
Reviewed by:	Ms. N. Averin, certification engineer	April 17, 2011	
Approved by:	Mr. M. Nikishin, EMC and Radio group manager	April 17, 2011	

6 EUT description

6.1 General information

The EUT, RADWIN 1000, RADWIN 2000, RADWIN 5000 is an outdoor unit (ODU). The power and Ethernet communication are supplied by an indoor unit (IDU) or PoE device. It has connectorized and integrated antenna configurations that can support dual pole antenna type. The RADWIN 1000 activates one RF port, RADWIN 2000 activates two RF ports for software configured Point to Point topology and RADWIN 5000 is identifier for software configured Point to Multipoint topology. For relevant output power setting versus each antenna type please refer to RADWIN 5000 Antenna List and Power Settings and RADWIN 1000/2000 Antenna List and Power Settings attached.

The EUT model RADWIN 2000 was tested as worst case representative.

6.2 Ports and lines

Port type	Port description	Connected		Connector type	Q-ty	Cable type	Cable length, m	Indoor / outdoor
		From	To					
Power	-48 VDC	AC/DC adapter	IDU	Terminal block	1	unshielded	1.5	Indoor
Power	AC power	mains	AC/DC adapter	IEC 60320	1	unshielded	1.5	Indoor
RF1	RF1 (Antenna 1)	EUT	antenna	N-type	1	shielded	1	Outdoor*
RF2	RF2 (Antenna 2)	EUT	antenna	N-type	1	shielded	1	Outdoor*
Signal	DC + Ethernet	IDU	EUT	RJ45	1	shielded	20	Outdoor
Signal	Ethernet	IDU	Laptop	RJ45	1	FTP	1.5	Indoor

* - for external antenna configuration only

6.3 Support and test equipment

Description	Manufacturer	Model number	Serial number
Laptop	Dell	Latitude/D530	NA
IDU (for configuration with ODU)	RadWin Ltd.	IDU-E	DE000201267
AC/DC	YCL	WMB480042-5G	S0714002271

6.4 Changes made in the EUT

No changes were implemented.

6.5 Test configuration

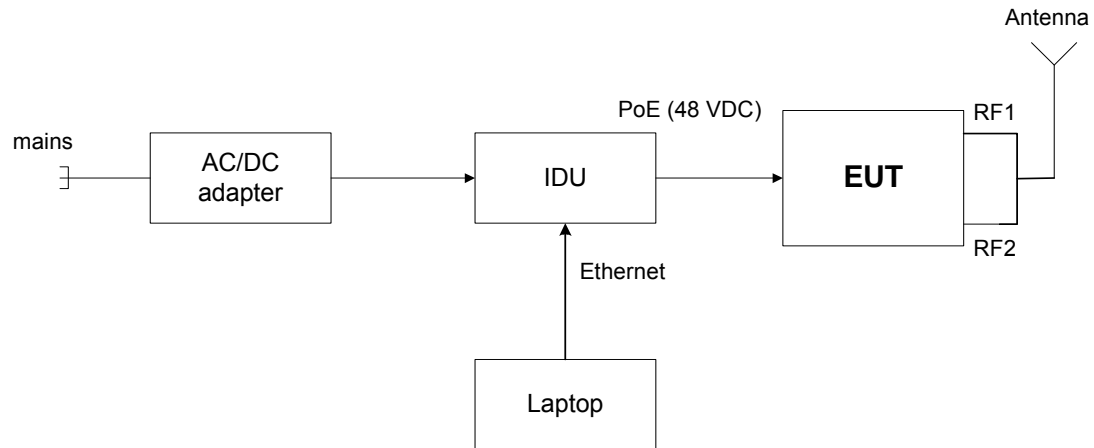

Error!



6.6 Transmitter characteristics

Type of equipment			
X	Stand-alone (Equipment with or without its own control provisions)		
Intended use		Condition of use	
X	fixed	Always at a distance more than 2 m from all people	
Assigned frequency range		5250 - 5350 MHz	
Operating frequency range		5260 - 5340 MHz	
Maximum rated output power		Peak (conducted)	
		7.5 dBm with 22.5 dBi antenna 6.5 dBm with 23.5 dBi antenna 1.9 dBm with 28 dBi antenna 7.4 dBm with 14.5 dBi antenna 7.4 dBm with 13.0 dBi antenna	
Antenna connection			
unique coupling	X	standard connector, N-type	integral
		X with temporary RF connector without temporary RF connector	
Antenna/s technical characteristics			
Type	Manufacturer	Model number	Gain
Flat Panel – Dual polarized Integrated	Radwin Ltd.	RW-9611-4958INT	23.5 dBi
Flat Panel – Dual polarized external	Radwin Ltd.	RW-9611-4958	23.5 dBi (feeder loss 1 dB)
Dish – Dual polarized External	Radwin Ltd.	RW-9721-5158	28.9 dBi (feeder loss 1 dB)
Flat Panel Dual Pole External	RADWIN Ltd.	RW-9061-5002	14.5 dBi (15.5 dBi with 1 dB feeder loss)
Flat Panel Dual Pole External	RADWIN Ltd.	RW-9061-5001	13.0 dBi (14.0 dBi with 1 dB feeder loss)
Transmitter 99% power bandwidth	Transmitter aggregate data rate/s, MBps		Type of modulation
5 MHz	3.25		BPSK
	32.5		64QAM
10 MHz	6.5		BPSK
	65		64QAM
20 MHz	13		BPSK
	130		64QAM
Maximum transmitter duty cycle in normal use	40%		
Transmitter duty cycle supplied for test	100%		

Table 6.6.1 Measurement frequencies

Channel bandwidth, MHz	Channel frequency, MHz		
	Low	Mid	High
5	5260	5300	5340
10	5265	5300	5335
20	5270	5300	5330



Test specification:	FCC section 15. 407(a)(1-3), RSS-210 Annex 9, section A9.2 Peak output power and peak power spectral density		
Test procedure:	FCC Public Notice DA 02-2138, Appendix A		
Test mode:	Compliance	Verdict:	PASS
Date:	12/18/2008		
Temperature: 22 °C	Air Pressure: 1010 hPa	Relative Humidity: 48 %	Power Supply: 48 VDC
Remarks:			

7 Transmitter tests according to 47CFR part 15 subpart E and RSS-210 Annex 9 requirements

7.1 Peak output power and peak spectral power density

7.1.1 General

This test was performed to measure the maximum peak output power and the peak spectral power density at the transmitter RF antenna connector. Specification test limits are given in Table 7.1.1.

Table 7.1.1 Peak output power and peak spectral power density limits

Assigned frequency range, MHz	Maximum peak transmit power*, dBm	Peak spectral power density*, dBm	Measurement bandwidth, MHz
5250 - 5350	The lesser of 250 mW or 11 dBm + 10 log B**	11.0	1.0

*Note 1: due to 22.5 dBi antenna assembly gain the limits of peak output power and peak power spectral density shall be reduced by 16.5 dB, due to 28 dBi antenna assembly gain the limits of peak output power and peak power spectral density shall be reduced by 22 dB;

**Note 2: "B" is the 26-dB emission bandwidth in MHz.

7.1.2 Test procedure

7.1.2.1 The EUT was set up as shown in Figure 7.1.1, energized and its proper operation was checked.

7.1.2.2 The EUT was set to transmit modulated carrier at maximum data rate.

7.1.2.3 The measurements were performed in continuous transmission mode of operation for carrier (channel) frequencies at low and high edges and at the middle of the frequency range shown in Table 7.1.1. The transmitter 26 dB bandwidth was measured with spectrum analyzer as frequency delta between reference points on modulation envelope and provided in Table 7.1.2, Table 7.1.4 and associated plots.

7.1.2.4 The EUT was adjusted to produce maximum available for end user RF output power.

7.1.2.5 The peak output power measurements were performed in continuous transmission mode of operation for carrier (channel) frequency at low, mid and high edges with a sample detector. The power was computed by integrating the spectrum across the 26 dB bandwidth of the signal as provided in Table 7.1.2, Table 7.1.4 and associated plots.

7.1.2.6 The peak power spectral density was measured using a sample detector and power averaging mode to find the highest level across the emission in any 1-MHz band after 100 sweeps of averaging. The test results are provided in Table 7.1.3, Table 7.1.5 and associated plots.

Figure 7.1.1 Peak output power test setup

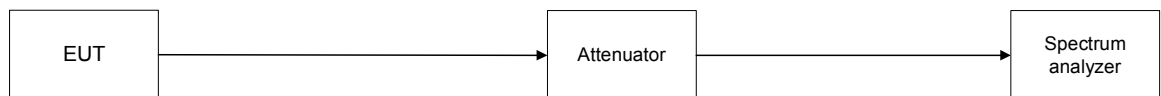



HERMON LABORATORIES

Test specification: FCC section 15. 407(a)(1-3), RSS-210 Annex 9, section A9.2 Peak output power and peak power spectral density				
Test procedure: FCC Public Notice DA 02-2138, Appendix A				
Test mode: Compliance		Verdict: PASS		
Date: 12/18/2008				
Temperature: 22 °C		Air Pressure: 1010 hPa	Relative Humidity: 48 %	Power Supply: 48 VDC
Remarks: EUT with 22.5 dBi antenna assembly gain				

Table 7.1.2 Conducted output power test results

ASSIGNED FREQUENCY RANGE: 5250-5350 MHz
 MODULATING SIGNAL: OFDM
 TRANSMITTER OUTPUT POWER SETTINGS: "9.5 dBm" at 5 MHz channel bandwidth
 "12 dBm" at 10 MHz channel bandwidth
 "15 dBm" at 20 MHz channel bandwidth
 DETECTOR USED: Peak
 RESOLUTION BANDWIDTH: 1 MHz
 VIDEO BANDWIDTH: 3 MHz
 METHOD OF POWER MEASUREMENTS: 1 (channel power across the 26 dB EBW)

Frequency, MHz	26 dB Bandwidth	Bit Rate, MBps	Modulation	Output power				Verdict
				Measured, dBm	Total power, dBm*	Limit, dBm	Margin, dB**	
Low channel								
5270	24.375	13	BPSK	4.17	7.17	7.50	-0.33	Pass
5270	23.850	130	64QAM	4.32	7.32	7.50	-0.18	Pass
5265	12.850	6.5	BPSK	0.62	3.62	5.59	-1.97	Pass
5265	12.600	65	64QAM	0.63	3.63	5.50	-1.87	Pass
5260	7.025	3.25	BPSK	-1.94	1.06	2.97	-1.91	Pass
5260	6.900	32.5	64QAM	-2.11	0.89	2.89	-2.00	Pass
Mid channel								
5300	24.075	13	BPSK	4.34	7.34	7.50	-0.16	Pass
5300	24.000	130	64QAM	4.3	7.3	7.50	-0.20	Pass
5300	12.600	6.5	BPSK	1.08	4.08	5.50	-1.42	Pass
5300	12.650	65	64QAM	0.94	3.94	5.52	-1.58	Pass
5300	6.925	3.25	BPSK	-1.35	1.65	2.90	-1.25	Pass
5300	7.025	32.5	64QAM	-1.38	1.62	2.97	-1.35	Pass
High channel								
5330	24.075	13	BPSK	4.48	7.48	7.50	-0.02	Pass
5330	24.375	130	64QAM	4.47	7.47	7.50	-0.03	Pass
5335	12.850	6.5	BPSK	1.08	4.08	5.59	-1.51	Pass
5335	12.600	65	64QAM	1.19	4.19	5.50	-1.31	Pass
5340	7.000	3.25	BPSK	-1.28	1.72	2.95	-1.23	Pass
5340	7.000	32.5	64QAM	-1.29	1.71	2.95	-1.24	Pass

*- Total peak power = Measured peak power + 3 dB. Both of antenna outputs are equal and transmit the same data.

** - Margin = Total peak power – specification limit.

Reference numbers of test equipment used

HL 2883	HL2909	HL 3180					
---------	--------	---------	--	--	--	--	--

Full description is given in Appendix A.



HERMON LABORATORIES

Test specification:	FCC section 15. 407(a)(1-3), RSS-210 Annex 9, section A9.2 Peak output power and peak power spectral density		
Test procedure:	FCC Public Notice DA 02-2138, Appendix A		
Test mode:	Compliance	Verdict:	PASS
Date:	12/18/2008		
Temperature: 22 °C	Air Pressure: 1010 hPa	Relative Humidity: 48 %	Power Supply: 48 VDC
Remarks: EUT with 22.5 dBi antenna assembly gain			

Table 7.1.3 Peak power spectral density test results

ASSIGNED FREQUENCY RANGE: 5250-5350 MHz
 MODULATING SIGNAL: OFDM
 TRANSMITTER OUTPUT POWER SETTINGS: "9.5 dBm" at 5 MHz channel bandwidth
 "12 dBm" at 10 MHz channel bandwidth
 "15 dBm" at 20 MHz channel bandwidth
 DETECTOR USED: Sample
 RESOLUTION BANDWIDTH: 1 MHz
 VIDEO BANDWIDTH: 3 MHz
 METHOD OF POWER DENSITY MEASUREMENTS: 2 (Sample detector and 100 power averaging)

Frequency, MHz	Bit Rate, MBps	Modulation	Peak power spectral density				Verdict
			Measured, dBm	Total peak power spectral density*, dBm	Limit, dBm	Margin, dB**	
Low channel							
5270	13	BPSK	-12.95	-9.95	-5.5	-4.45	Pass
5270	130	64QAM	-12.67	-9.67	-5.5	-4.17	Pass
5265	6.5	BPSK	-13.80	-10.80	-5.5	-5.30	Pass
5265	65	64QAM	-13.98	-10.98	-5.5	-5.48	Pass
5260	3.25	BPSK	-13.60	-10.60	-5.5	-5.10	Pass
5260	32.5	64QAM	-13.43	-10.43	-5.5	-4.93	Pass
Mid channel							
5300	13	BPSK	-12.93	-9.93	-5.5	-4.43	Pass
5300	130	64QAM	-12.78	-9.78	-5.5	-4.28	Pass
5300	6.5	BPSK	-13.47	-10.47	-5.5	-4.97	Pass
5300	65	64QAM	-13.23	-10.23	-5.5	-4.73	Pass
5300	3.25	BPSK	-12.58	-9.58	-5.5	-4.08	Pass
5300	32.5	64QAM	-12.97	-9.97	-5.5	-4.47	Pass
High channel							
5330	13	BPSK	-12.72	-9.72	-5.5	-4.22	Pass
5330	130	64QAM	-12.82	-9.82	-5.5	-4.32	Pass
5335	6.5	BPSK	-13.26	-10.26	-5.5	-4.76	Pass
5335	65	64QAM	-13.12	-10.12	-5.5	-4.62	Pass
5340	3.25	BPSK	-12.66	-9.66	-5.5	-4.16	Pass
5340	32.5	64QAM	-12.60	-9.60	-5.5	-4.10	Pass

*- Total peak power spectral density = Measured + 3 dB. Both of antenna outputs are equal and transmit the same data.

** - Margin = Total peak power density – specification limit.

Reference numbers of test equipment used

HL 2883	HL2909	HL 3180				
---------	--------	---------	--	--	--	--

Full description is given in Appendix A.



HERMON LABORATORIES

Test specification:		FCC section 15. 407(a)(1-3), RSS-210 Annex 9, section A9.2 Peak output power and peak power spectral density	
Test procedure:		FCC Public Notice DA 02-2138, Appendix A	
Test mode:	Compliance	Verdict:	PASS
Date:	12/18/2008		
Temperature: 22 °C	Air Pressure: 1010 hPa	Relative Humidity: 48 %	Power Supply: 48 VDC
Remarks: EUT with 22.5 dBi antenna assembly gain			

Plot 7.1.1 The 26 dB emission bandwidth

Frequency:	5270 MHz
Channel BW:	20 MHz
Modulation parameters:	BPSK, 13 Mbps

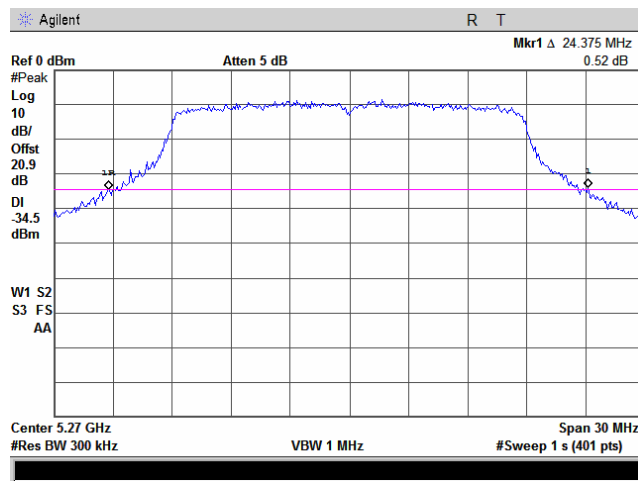

Plot 7.1.2 Peak output power

Frequency:	5270 MHz
Channel BW:	20 MHz
Modulation parameters:	BPSK, 13 Mbps

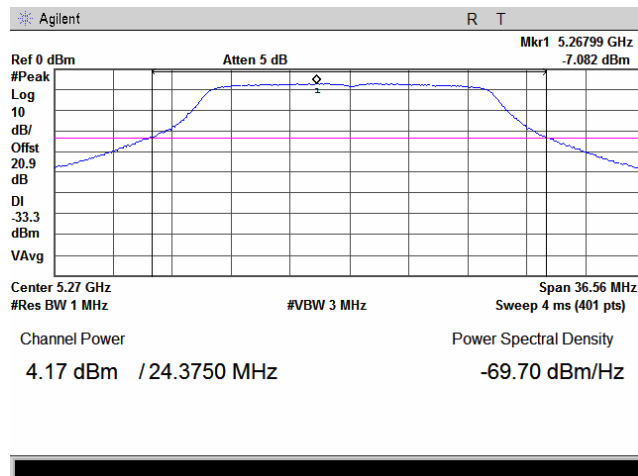



HERMON LABORATORIES

Test specification:		FCC section 15. 407(a)(1-3), RSS-210 Annex 9, section A9.2 Peak output power and peak power spectral density	
Test procedure:		FCC Public Notice DA 02-2138, Appendix A	
Test mode:	Compliance	Verdict:	PASS
Date:	12/18/2008		
Temperature: 22 °C	Air Pressure: 1010 hPa	Relative Humidity: 48 %	Power Supply: 48 VDC
Remarks: EUT with 22.5 dBi antenna assembly gain			

Plot 7.1.3 Peak spectral power density

Frequency:	5270 MHz
Channel BW:	20 MHz
Modulation parameters:	BPSK, 13 Mbps

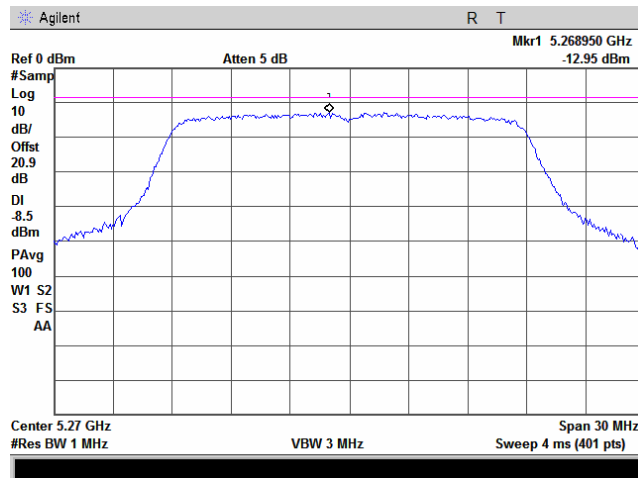

Plot 7.1.4 The 26 dB emission bandwidth

Frequency:	5270 MHz
Channel BW:	20 MHz
Modulation parameters:	BPSK, 130 Mbps

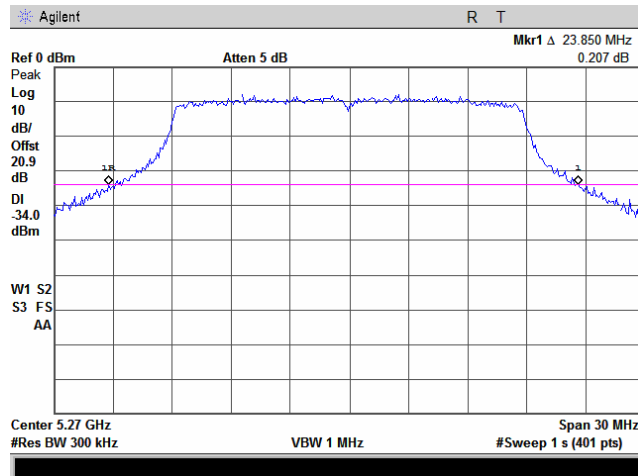



HERMON LABORATORIES

Test specification:		FCC section 15. 407(a)(1-3), RSS-210 Annex 9, section A9.2 Peak output power and peak power spectral density	
Test procedure:		FCC Public Notice DA 02-2138, Appendix A	
Test mode:	Compliance	Verdict:	PASS
Date:	12/18/2008		
Temperature: 22 °C	Air Pressure: 1010 hPa	Relative Humidity: 48 %	Power Supply: 48 VDC
Remarks: EUT with 22.5 dBi antenna assembly gain			

Plot 7.1.5 Peak output power

Frequency:	5270 MHz
Channel BW:	20 MHz
Modulation parameters:	BPSK, 130 Mbps

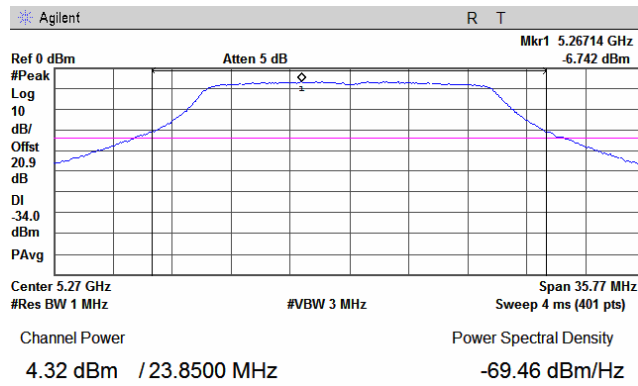

Plot 7.1.6 Peak spectral power density

Frequency:	5270 MHz
Channel BW:	20 MHz
Modulation parameters:	BPSK, 130 Mbps

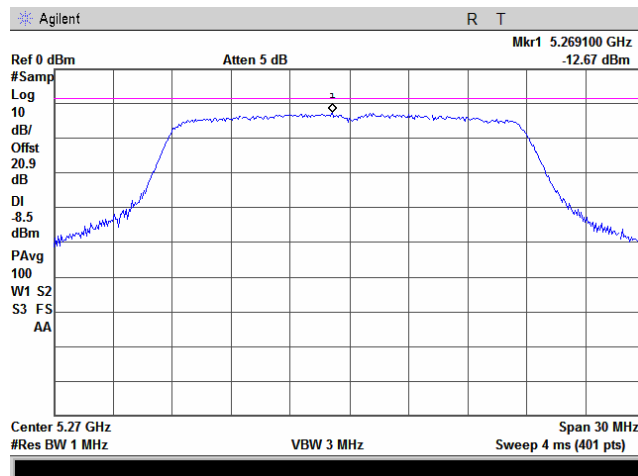



HERMON LABORATORIES

Test specification: FCC section 15. 407(a)(1-3), RSS-210 Annex 9, section A9.2 Peak output power and peak power spectral density			
Test procedure: FCC Public Notice DA 02-2138, Appendix A			
Test mode: Compliance	Verdict: PASS		
Date: 12/18/2008			
Temperature: 22 °C	Air Pressure: 1010 hPa	Relative Humidity: 48 %	Power Supply: 48 VDC
Remarks: EUT with 22.5 dBi antenna assembly gain			

Plot 7.1.7 The 26 dB emission bandwidth

Frequency:	5265 MHz
Channel BW:	10 MHz
Modulation parameters:	BPSK, 6.5 Mbps

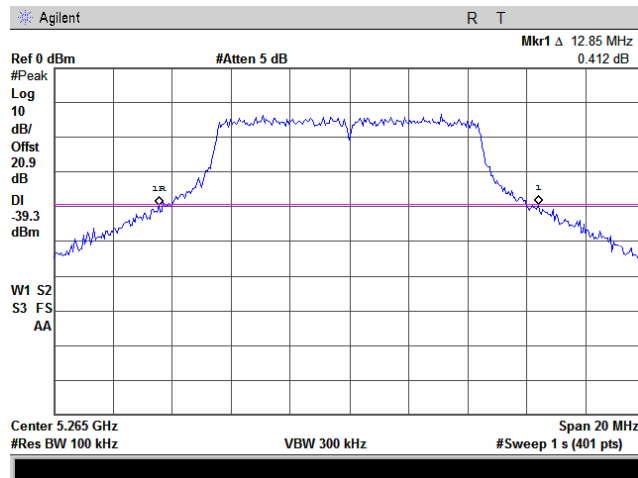

Plot 7.1.8 Peak output power

Frequency:	5265 MHz
Channel BW:	10 MHz
Modulation parameters:	BPSK, 6.5 Mbps

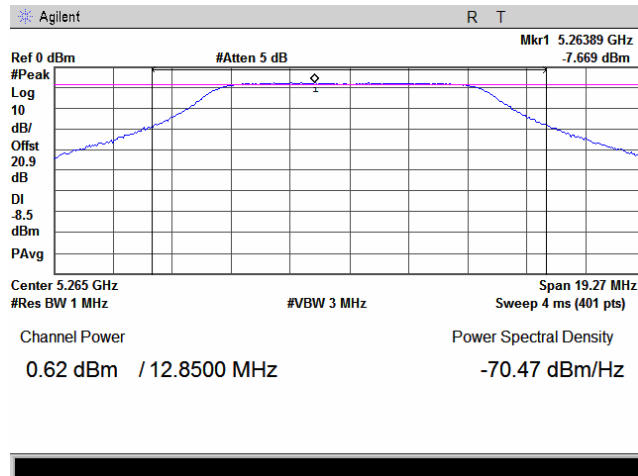



HERMON LABORATORIES

Test specification: FCC section 15. 407(a)(1-3), RSS-210 Annex 9, section A9.2 Peak output power and peak power spectral density			
Test procedure: FCC Public Notice DA 02-2138, Appendix A			
Test mode: Compliance	Verdict: PASS		
Date: 12/18/2008			
Temperature: 22 °C	Air Pressure: 1010 hPa	Relative Humidity: 48 %	Power Supply: 48 VDC
Remarks: EUT with 22.5 dBi antenna assembly gain			

Plot 7.1.9 Peak spectral power density

Frequency:	5265 MHz
Channel BW:	10 MHz
Modulation parameters:	BPSK, 6.5 Mbps

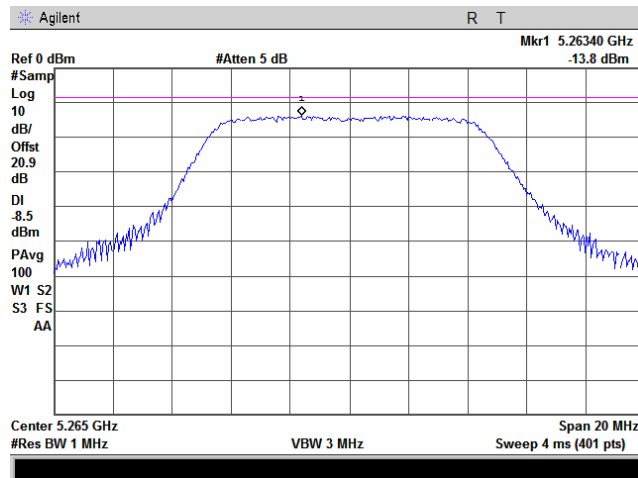

Plot 7.1.10 The 26 dB emission bandwidth

Frequency:	5265 MHz
Channel BW:	10 MHz
Modulation parameters:	BPSK, 65 Mbps

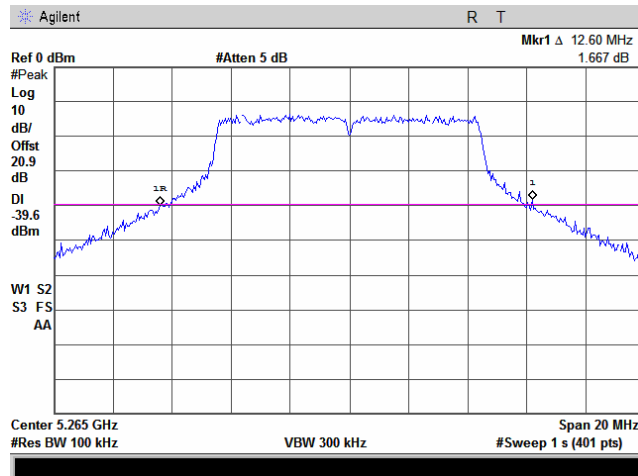



HERMON LABORATORIES

Test specification: FCC section 15. 407(a)(1-3), RSS-210 Annex 9, section A9.2 Peak output power and peak power spectral density			
Test procedure: FCC Public Notice DA 02-2138, Appendix A			
Test mode: Compliance	Verdict: PASS		
Date: 12/18/2008			
Temperature: 22 °C	Air Pressure: 1010 hPa	Relative Humidity: 48 %	Power Supply: 48 VDC
Remarks: EUT with 22.5 dBi antenna assembly gain			

Plot 7.1.11 Peak output power

Frequency:	5265 MHz
Channel BW:	10 MHz
Modulation parameters:	BPSK, 65 Mbps

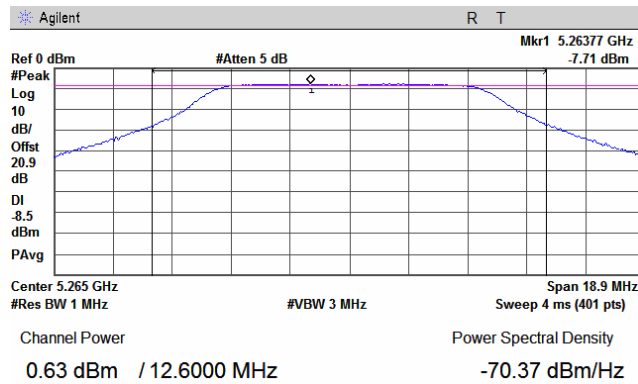

Plot 7.1.12 Peak spectral power density

Frequency:	5265 MHz
Channel BW:	10 MHz
Modulation parameters:	BPSK, 65 Mbps

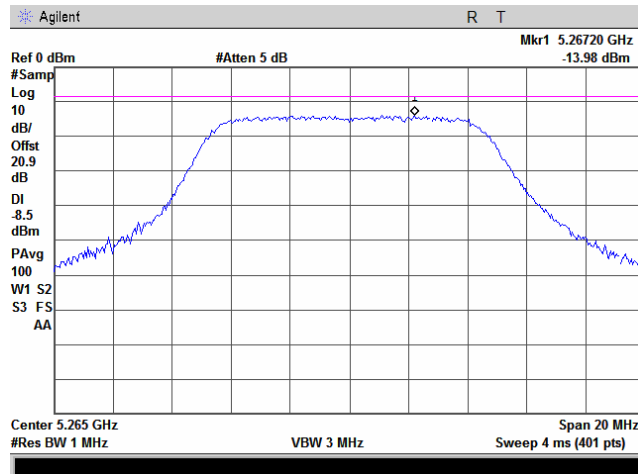



HERMON LABORATORIES

Test specification:		FCC section 15. 407(a)(1-3), RSS-210 Annex 9, section A9.2 Peak output power and peak power spectral density	
Test procedure:		FCC Public Notice DA 02-2138, Appendix A	
Test mode:	Compliance	Verdict:	PASS
Date:	12/18/2008		
Temperature: 22 °C	Air Pressure: 1010 hPa	Relative Humidity: 48 %	Power Supply: 48 VDC
Remarks: EUT with 22.5 dBi antenna assembly gain			

Plot 7.1.13 The 26 dB emission bandwidth

Frequency:	5260 MHz
Channel BW:	5 MHz
Modulation parameters:	BPSK, 3.25 Mbps

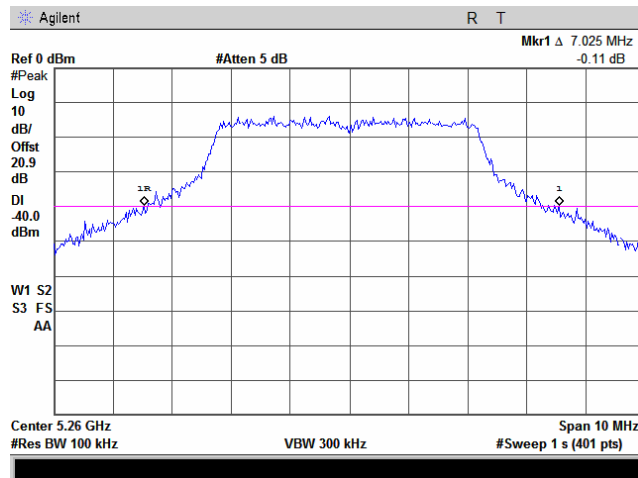

Plot 7.1.14 Peak output power

Frequency:	5260 MHz
Channel BW:	5 MHz
Modulation parameters:	BPSK, 3.25 Mbps

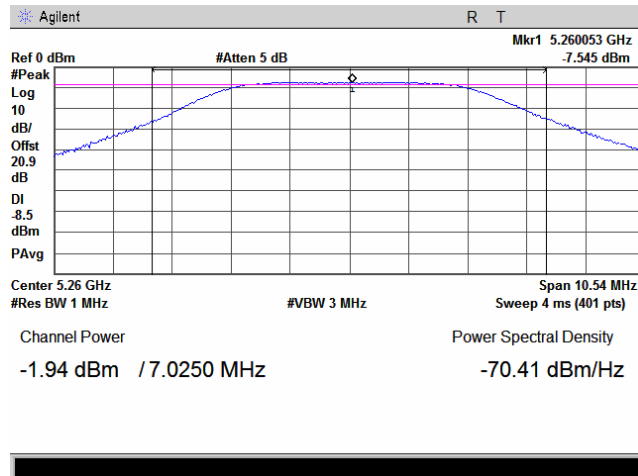



HERMON LABORATORIES

Test specification: FCC section 15. 407(a)(1-3), RSS-210 Annex 9, section A9.2 Peak output power and peak power spectral density			
Test procedure: FCC Public Notice DA 02-2138, Appendix A			
Test mode: Compliance	Verdict: PASS		
Date: 12/18/2008			
Temperature: 22 °C	Air Pressure: 1010 hPa	Relative Humidity: 48 %	Power Supply: 48 VDC
Remarks: EUT with 22.5 dBi antenna assembly gain			

Plot 7.1.15 Peak spectral power density

Frequency:	5260 MHz
Channel BW:	5 MHz
Modulation parameters:	BPSK, 3.25 Mbps

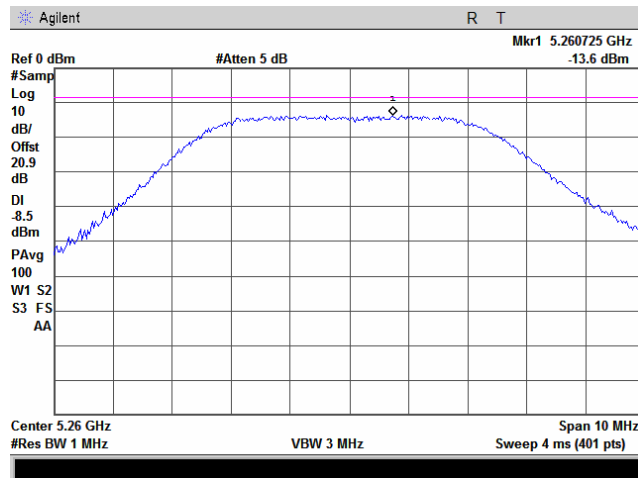

Plot 7.1.16 The 26 dB emission bandwidth

Frequency:	5260 MHz
Channel BW:	5 MHz
Modulation parameters:	BPSK, 3.25 Mbps

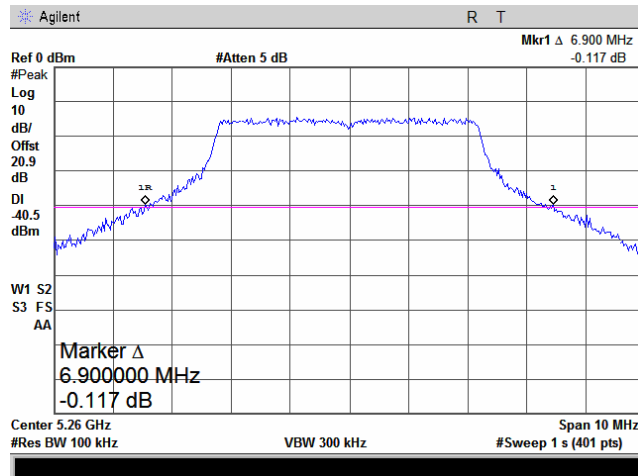



HERMON LABORATORIES

Test specification: FCC section 15. 407(a)(1-3), RSS-210 Annex 9, section A9.2 Peak output power and peak power spectral density			
Test procedure: FCC Public Notice DA 02-2138, Appendix A			
Test mode: Compliance	Verdict: PASS		
Date: 12/18/2008			
Temperature: 22 °C	Air Pressure: 1010 hPa	Relative Humidity: 48 %	Power Supply: 48 VDC
Remarks: EUT with 22.5 dBi antenna assembly gain			

Plot 7.1.17 Peak output power

Frequency:	5260 MHz
Channel BW:	5 MHz
Modulation parameters:	BPSK, 32.5 Mbps

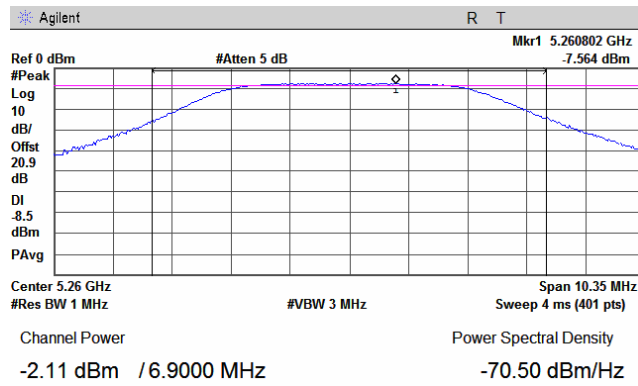

Plot 7.1.18 Peak spectral power density

Frequency:	5260 MHz
Channel BW:	5 MHz
Modulation parameters:	BPSK, 32.5 Mbps

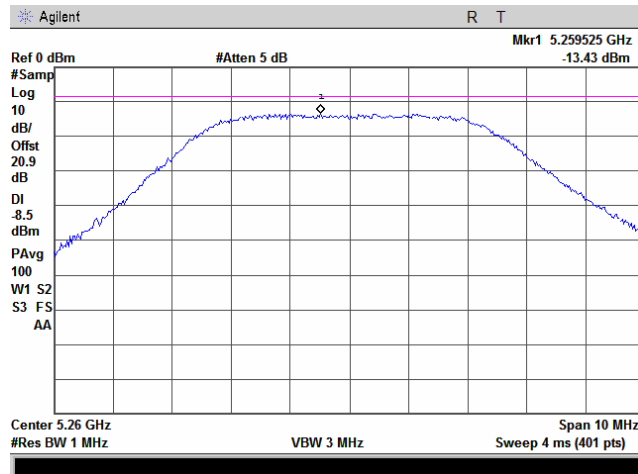



HERMON LABORATORIES

Test specification: FCC section 15. 407(a)(1-3), RSS-210 Annex 9, section A9.2 Peak output power and peak power spectral density			
Test procedure: FCC Public Notice DA 02-2138, Appendix A			
Test mode: Compliance	Verdict: PASS		
Date: 12/18/2008			
Temperature: 22 °C	Air Pressure: 1010 hPa	Relative Humidity: 48 %	Power Supply: 48 VDC
Remarks: EUT with 22.5 dBi antenna assembly gain			

Plot 7.1.19 The 26 dB emission bandwidth

Frequency:	5300 MHz
Channel BW:	20 MHz
Modulation parameters:	BPSK, 13 Mbps

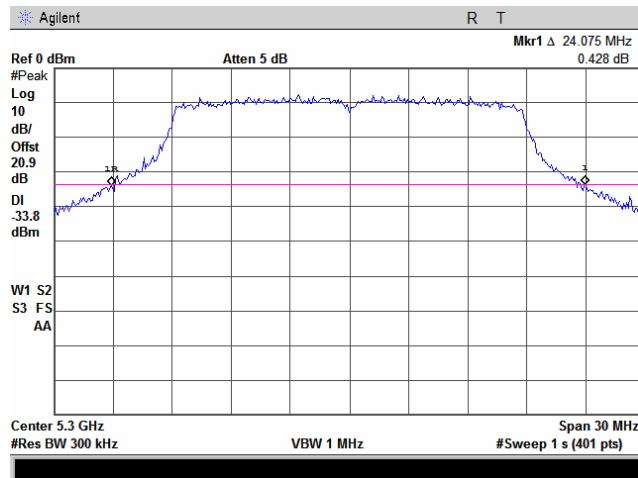

Plot 7.1.20 Peak output power

Frequency:	5300 MHz
Channel BW:	20 MHz
Modulation parameters:	BPSK, 13 Mbps

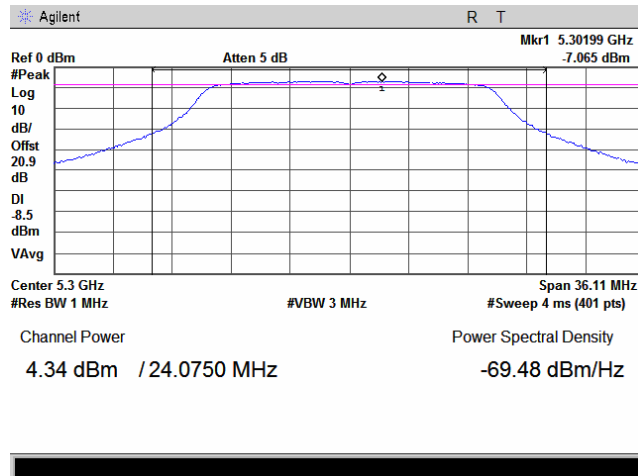



HERMON LABORATORIES

Test specification: FCC section 15. 407(a)(1-3), RSS-210 Annex 9, section A9.2 Peak output power and peak power spectral density			
Test procedure: FCC Public Notice DA 02-2138, Appendix A			
Test mode: Compliance	Verdict: PASS		
Date: 12/18/2008			
Temperature: 22 °C	Air Pressure: 1010 hPa	Relative Humidity: 48 %	Power Supply: 48 VDC
Remarks: EUT with 22.5 dBi antenna assembly gain			

Plot 7.1.21 Peak spectral power density

Frequency:	5300 MHz
Channel BW:	20 MHz
Modulation parameters:	BPSK, 13 Mbps

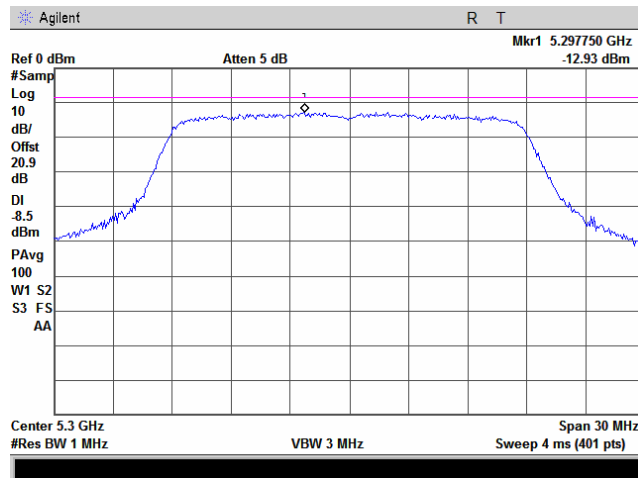

Plot 7.1.22 The 26 dB emission bandwidth

Frequency:	5300 MHz
Channel BW:	20 MHz
Modulation parameters:	BPSK, 130 Mbps

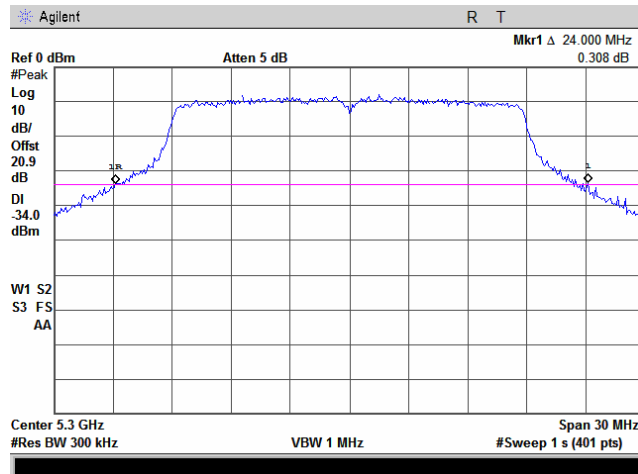



HERMON LABORATORIES

Test specification: FCC section 15. 407(a)(1-3), RSS-210 Annex 9, section A9.2 Peak output power and peak power spectral density			
Test procedure: FCC Public Notice DA 02-2138, Appendix A			
Test mode: Compliance	Verdict: PASS		
Date: 12/18/2008			
Temperature: 22 °C	Air Pressure: 1010 hPa	Relative Humidity: 48 %	Power Supply: 48 VDC
Remarks: EUT with 22.5 dBi antenna assembly gain			

Plot 7.1.23 Peak output power

Frequency:	5300 MHz
Channel BW:	20 MHz
Modulation parameters:	BPSK, 130 Mbps

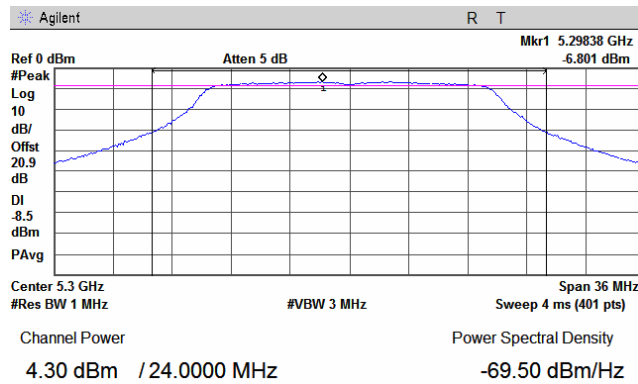

Plot 7.1.24 Peak spectral power density

Frequency:	5300 MHz
Channel BW:	20 MHz
Modulation parameters:	BPSK, 130 Mbps

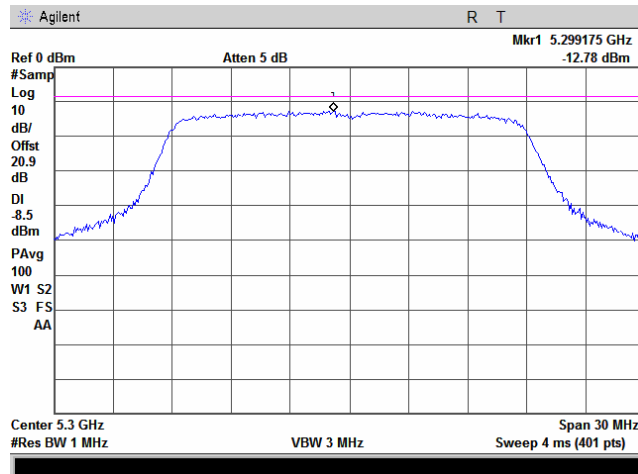



HERMON LABORATORIES

Test specification: FCC section 15. 407(a)(1-3), RSS-210 Annex 9, section A9.2 Peak output power and peak power spectral density			
Test procedure: FCC Public Notice DA 02-2138, Appendix A			
Test mode: Compliance	Verdict: PASS		
Date: 12/18/2008			
Temperature: 22 °C	Air Pressure: 1010 hPa	Relative Humidity: 48 %	Power Supply: 48 VDC
Remarks: EUT with 22.5 dBi antenna assembly gain			

Plot 7.1.25 The 26 dB emission bandwidth

Frequency:	5300 MHz
Channel BW:	10 MHz
Modulation parameters:	BPSK, 6.5 Mbps

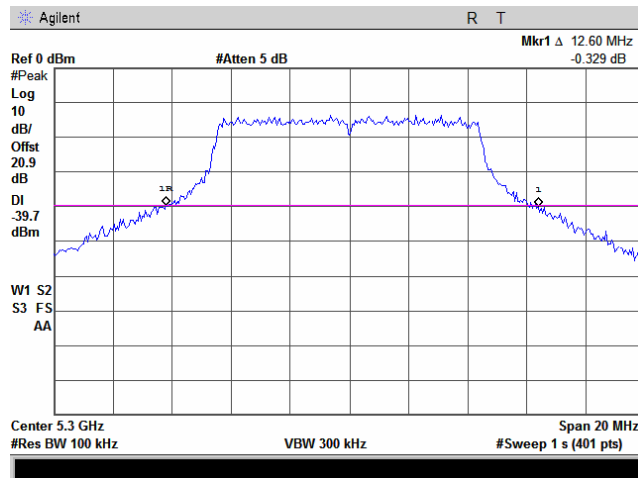

Plot 7.1.26 Peak output power

Frequency:	5300 MHz
Channel BW:	10 MHz
Modulation parameters:	BPSK, 6.5 Mbps

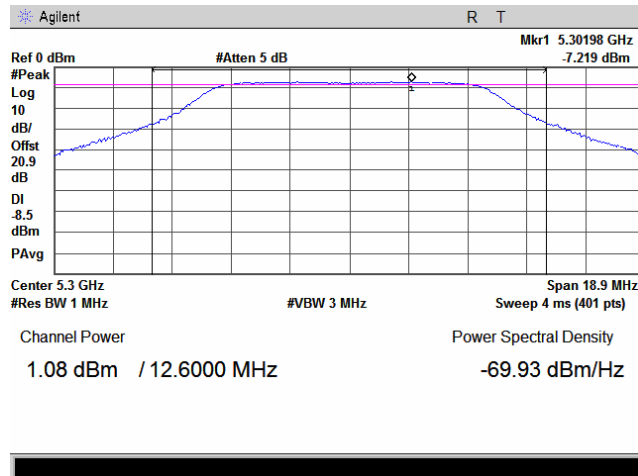



HERMON LABORATORIES

Test specification:		FCC section 15. 407(a)(1-3), RSS-210 Annex 9, section A9.2 Peak output power and peak power spectral density	
Test procedure:		FCC Public Notice DA 02-2138, Appendix A	
Test mode:	Compliance	Verdict:	PASS
Date:	12/18/2008		
Temperature: 22 °C	Air Pressure: 1010 hPa	Relative Humidity: 48 %	Power Supply: 48 VDC
Remarks: EUT with 22.5 dBi antenna assembly gain			

Plot 7.1.27 Peak spectral power density

Frequency:	5300 MHz
Channel BW:	10 MHz
Modulation parameters:	BPSK, 6.5 Mbps

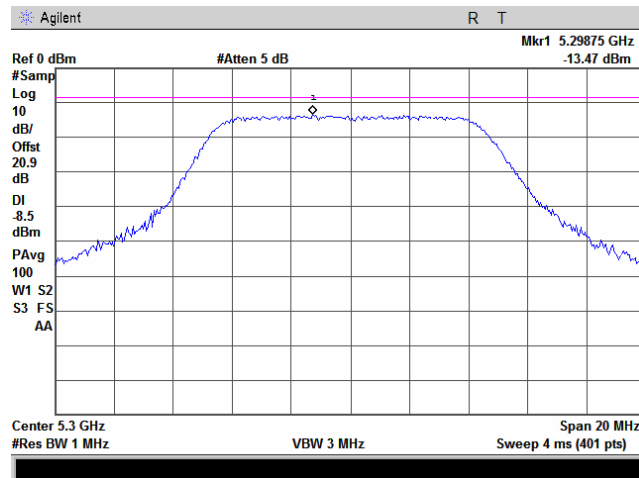

Plot 7.1.28 The 26 dB emission bandwidth

Frequency:	5300 MHz
Channel BW:	10 MHz
Modulation parameters:	BPSK, 6.5 Mbps

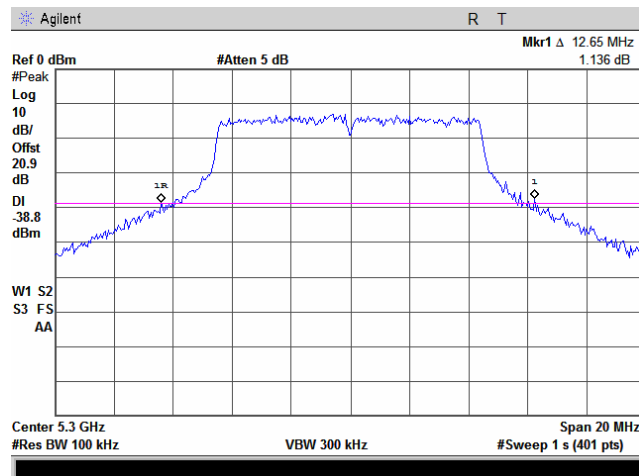



HERMON LABORATORIES

Test specification: FCC section 15. 407(a)(1-3), RSS-210 Annex 9, section A9.2 Peak output power and peak power spectral density			
Test procedure: FCC Public Notice DA 02-2138, Appendix A			
Test mode: Compliance	Verdict: PASS		
Date: 12/18/2008			
Temperature: 22 °C	Air Pressure: 1010 hPa	Relative Humidity: 48 %	Power Supply: 48 VDC
Remarks: EUT with 22.5 dBi antenna assembly gain			

Plot 7.1.29 Peak output power

Frequency:	5300 MHz
Channel BW:	10 MHz
Modulation parameters:	BPSK, 65 Mbps

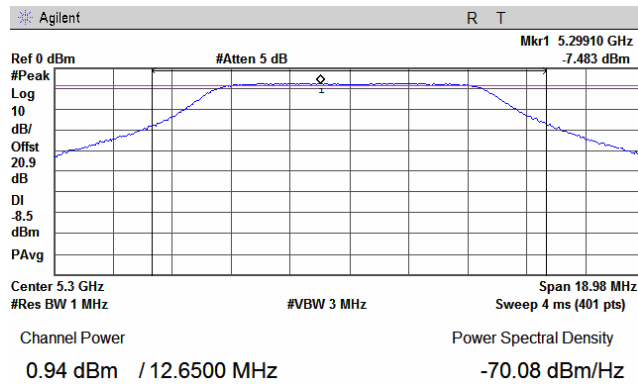

Plot 7.1.30 Peak spectral power density

Frequency:	5300 MHz
Channel BW:	10 MHz
Modulation parameters:	BPSK, 65 Mbps

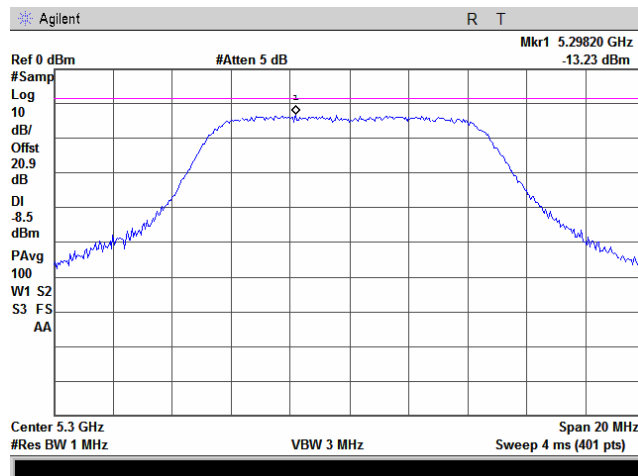



HERMON LABORATORIES

Test specification: FCC section 15. 407(a)(1-3), RSS-210 Annex 9, section A9.2 Peak output power and peak power spectral density			
Test procedure: FCC Public Notice DA 02-2138, Appendix A			
Test mode: Compliance	Verdict: PASS		
Date: 12/18/2008			
Temperature: 22 °C	Air Pressure: 1010 hPa	Relative Humidity: 48 %	Power Supply: 48 VDC
Remarks: EUT with 22.5 dBi antenna assembly gain			

Plot 7.1.31 The 26 dB emission bandwidth

Frequency:	5300 MHz
Channel BW:	5 MHz
Modulation parameters:	BPSK, 3.25 Mbps

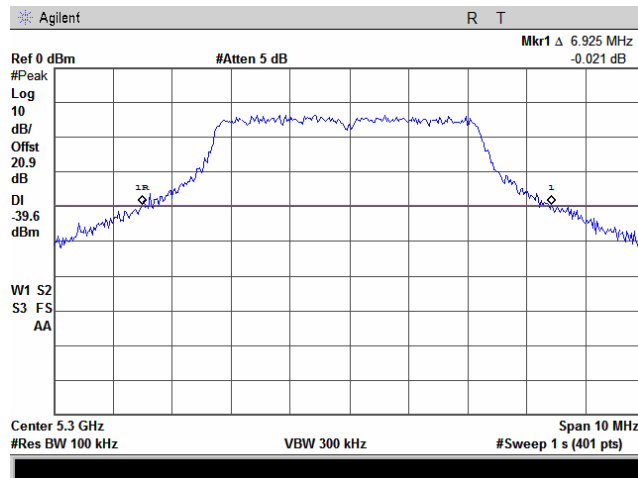

Plot 7.1.32 Peak output power

Frequency:	5300 MHz
Channel BW:	5 MHz
Modulation parameters:	BPSK, 3.25 Mbps

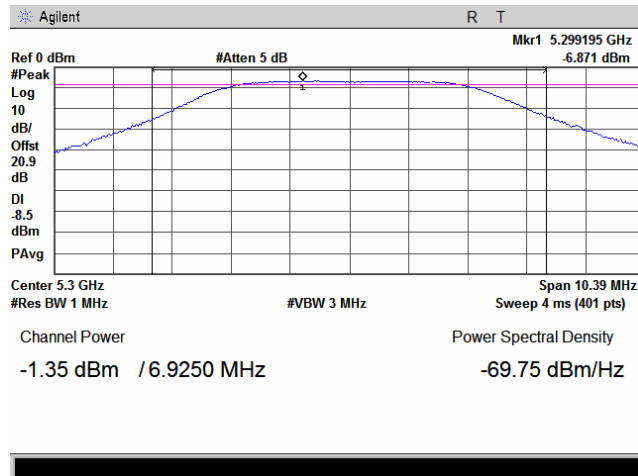



HERMON LABORATORIES

Test specification:		FCC section 15. 407(a)(1-3), RSS-210 Annex 9, section A9.2 Peak output power and peak power spectral density	
Test procedure:		FCC Public Notice DA 02-2138, Appendix A	
Test mode:	Compliance	Verdict:	PASS
Date:	12/18/2008		
Temperature: 22 °C	Air Pressure: 1010 hPa	Relative Humidity: 48 %	Power Supply: 48 VDC
Remarks: EUT with 22.5 dBi antenna assembly gain			

Plot 7.1.33 Peak spectral power density

Frequency:	5300 MHz
Channel BW:	5 MHz
Modulation parameters:	BPSK, 3.25 Mbps

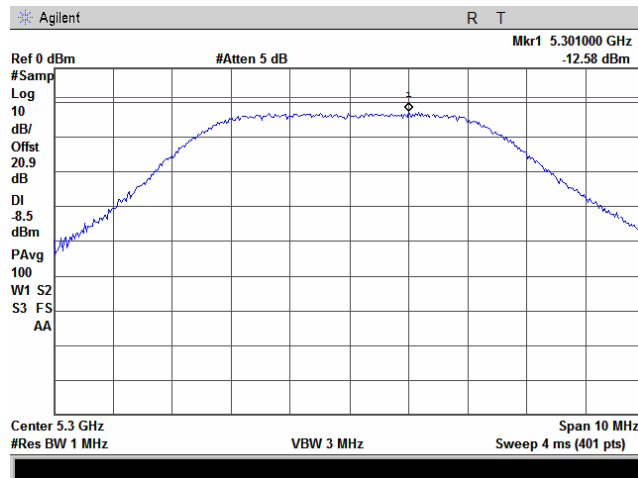

Plot 7.1.34 The 26 dB emission bandwidth

Frequency:	5300 MHz
Channel BW:	5 MHz
Modulation parameters:	BPSK, 3.25 Mbps

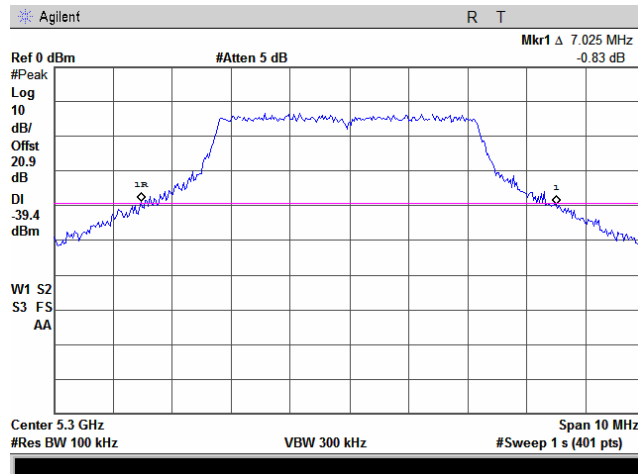



HERMON LABORATORIES

Test specification: FCC section 15. 407(a)(1-3), RSS-210 Annex 9, section A9.2 Peak output power and peak power spectral density			
Test procedure: FCC Public Notice DA 02-2138, Appendix A			
Test mode: Compliance	Verdict: PASS		
Date: 12/18/2008			
Temperature: 22 °C	Air Pressure: 1010 hPa	Relative Humidity: 48 %	Power Supply: 48 VDC
Remarks: EUT with 22.5 dBi antenna assembly gain			

Plot 7.1.35 Peak output power

Frequency:	5300 MHz
Channel BW:	5 MHz
Modulation parameters:	BPSK, 32.5 Mbps

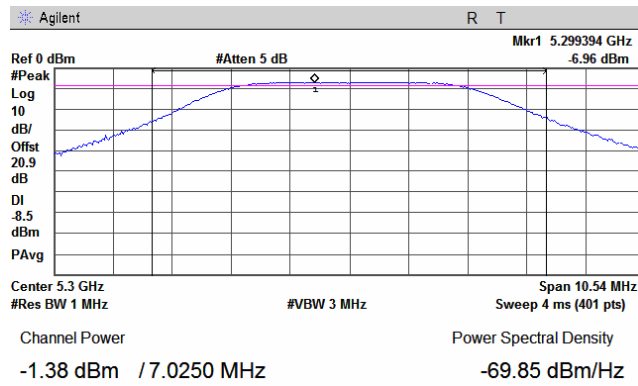

Plot 7.1.36 Peak spectral power density

Frequency:	5300 MHz
Channel BW:	5 MHz
Modulation parameters:	BPSK, 32.5 Mbps

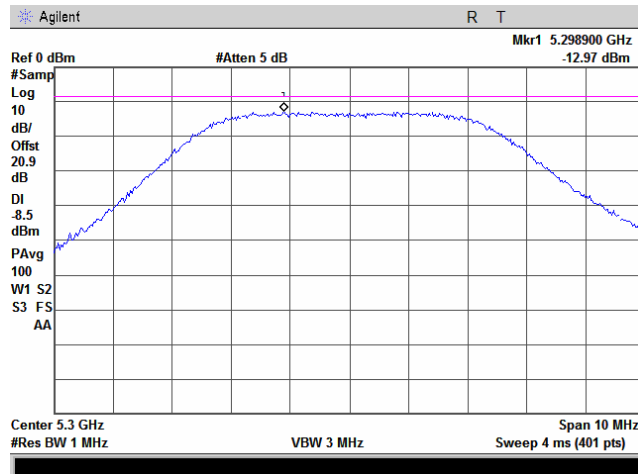



HERMON LABORATORIES

Test specification: FCC section 15. 407(a)(1-3), RSS-210 Annex 9, section A9.2 Peak output power and peak power spectral density			
Test procedure: FCC Public Notice DA 02-2138, Appendix A			
Test mode: Compliance	Verdict: PASS		
Date: 12/18/2008			
Temperature: 22 °C	Air Pressure: 1010 hPa	Relative Humidity: 48 %	Power Supply: 48 VDC
Remarks: EUT with 22.5 dBi antenna assembly gain			

Plot 7.1.37 The 26 dB emission bandwidth

Frequency:	5330 MHz
Channel BW:	20 MHz
Modulation parameters:	BPSK, 13 Mbps

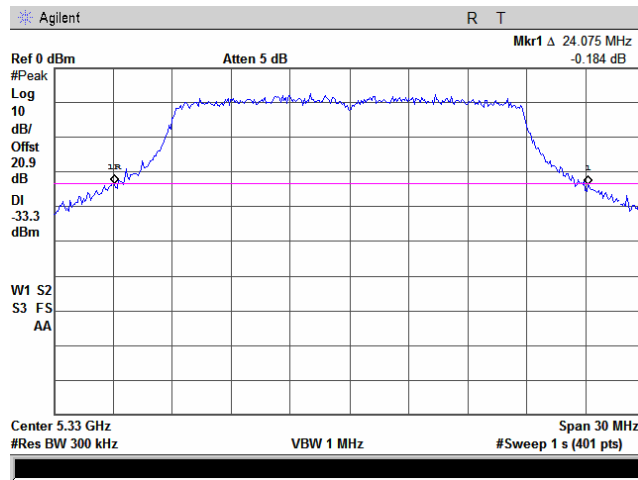

Plot 7.1.38 Peak output power

Frequency:	5330 MHz
Channel BW:	20 MHz
Modulation parameters:	BPSK, 13 Mbps

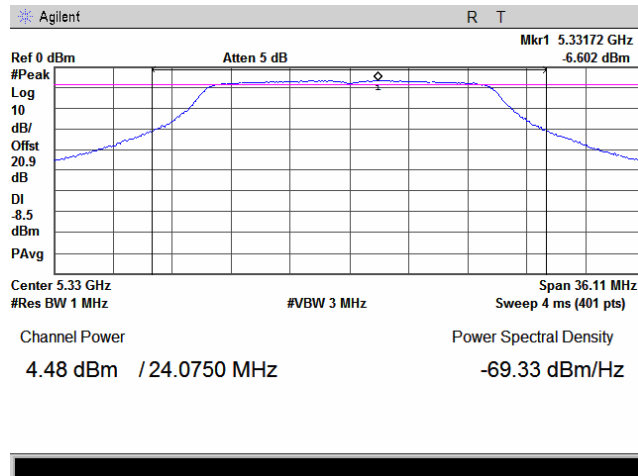



HERMON LABORATORIES

Test specification:		FCC section 15. 407(a)(1-3), RSS-210 Annex 9, section A9.2 Peak output power and peak power spectral density	
Test procedure:		FCC Public Notice DA 02-2138, Appendix A	
Test mode:	Compliance	Verdict:	PASS
Date:	12/18/2008		
Temperature: 22 °C	Air Pressure: 1010 hPa	Relative Humidity: 48 %	Power Supply: 48 VDC
Remarks: EUT with 22.5 dBi antenna assembly gain			

Plot 7.1.39 Peak spectral power density

Frequency:	5330 MHz
Channel BW:	20 MHz
Modulation parameters:	BPSK, 13 Mbps

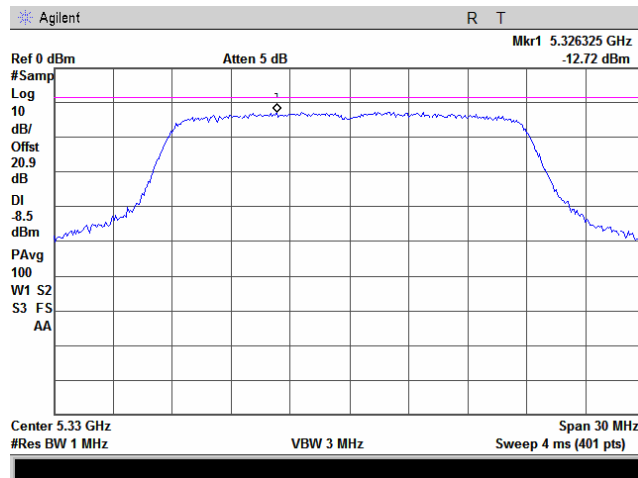

Plot 7.1.40 The 26 dB emission bandwidth

Frequency:	5330 MHz
Channel BW:	20 MHz
Modulation parameters:	BPSK, 130 Mbps

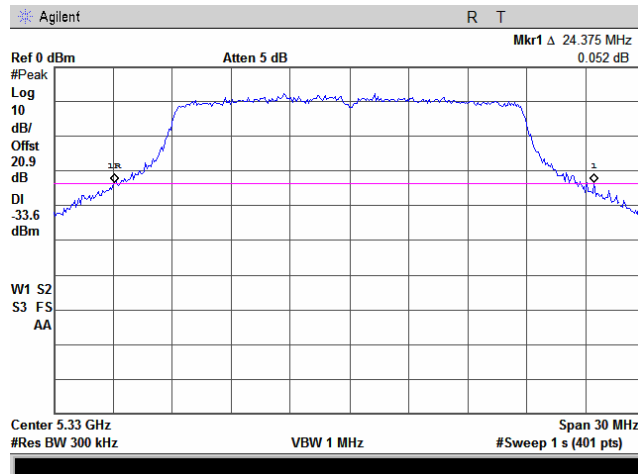



HERMON LABORATORIES

Test specification: FCC section 15. 407(a)(1-3), RSS-210 Annex 9, section A9.2 Peak output power and peak power spectral density			
Test procedure: FCC Public Notice DA 02-2138, Appendix A			
Test mode: Compliance	Verdict: PASS		
Date: 12/18/2008			
Temperature: 22 °C	Air Pressure: 1010 hPa	Relative Humidity: 48 %	Power Supply: 48 VDC
Remarks: EUT with 22.5 dBi antenna assembly gain			

Plot 7.1.41 Peak output power

Frequency:	5330 MHz
Channel BW:	20 MHz
Modulation parameters:	BPSK, 130 Mbps

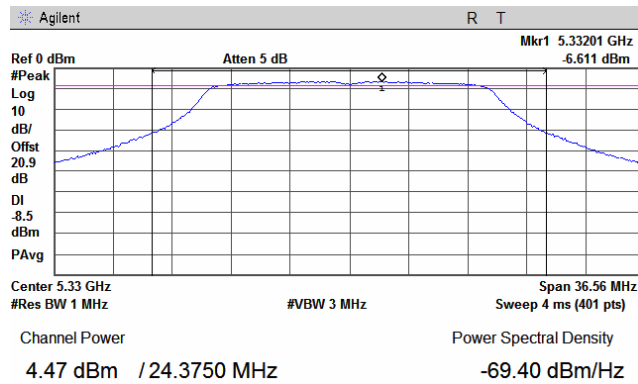

Plot 7.1.42 Peak spectral power density

Frequency:	5330 MHz
Channel BW:	20 MHz
Modulation parameters:	BPSK, 130 Mbps

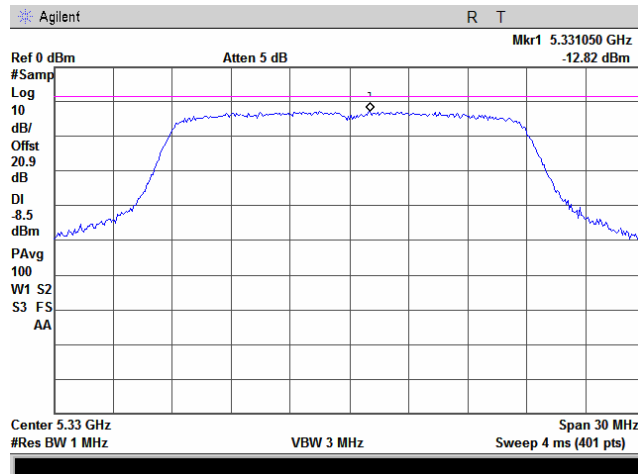



HERMON LABORATORIES

Test specification: FCC section 15. 407(a)(1-3), RSS-210 Annex 9, section A9.2 Peak output power and peak power spectral density			
Test procedure: FCC Public Notice DA 02-2138, Appendix A			
Test mode: Compliance	Verdict: PASS		
Date: 12/18/2008			
Temperature: 22 °C	Air Pressure: 1010 hPa	Relative Humidity: 48 %	Power Supply: 48 VDC
Remarks: EUT with 22.5 dBi antenna assembly gain			

Plot 7.1.43 The 26 dB emission bandwidth

Frequency:	5335 MHz
Channel BW:	10 MHz
Modulation parameters:	BPSK, 6.5 Mbps

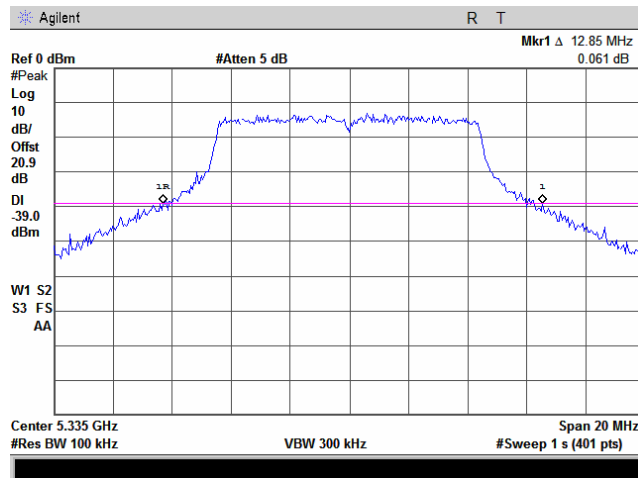

Plot 7.1.44 Peak output power

Frequency:	5335 MHz
Channel BW:	10 MHz
Modulation parameters:	BPSK, 6.5 Mbps

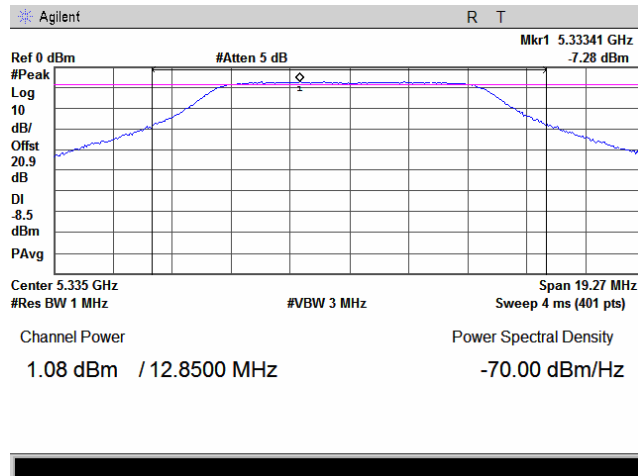



HERMON LABORATORIES

Test specification:		FCC section 15. 407(a)(1-3), RSS-210 Annex 9, section A9.2 Peak output power and peak power spectral density	
Test procedure:		FCC Public Notice DA 02-2138, Appendix A	
Test mode:	Compliance	Verdict:	PASS
Date:	12/18/2008		
Temperature: 22 °C	Air Pressure: 1010 hPa	Relative Humidity: 48 %	Power Supply: 48 VDC
Remarks: EUT with 22.5 dBi antenna assembly gain			

Plot 7.1.45 Peak spectral power density

Frequency:	5335 MHz
Channel BW:	10 MHz
Modulation parameters:	BPSK, 6.5 Mbps

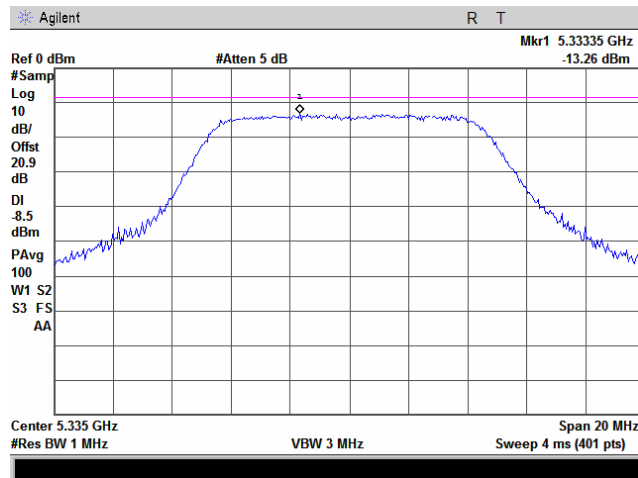

Plot 7.1.46 The 26 dB emission bandwidth

Frequency:	5335 MHz
Channel BW:	10 MHz
Modulation parameters:	BPSK, 6.5 Mbps

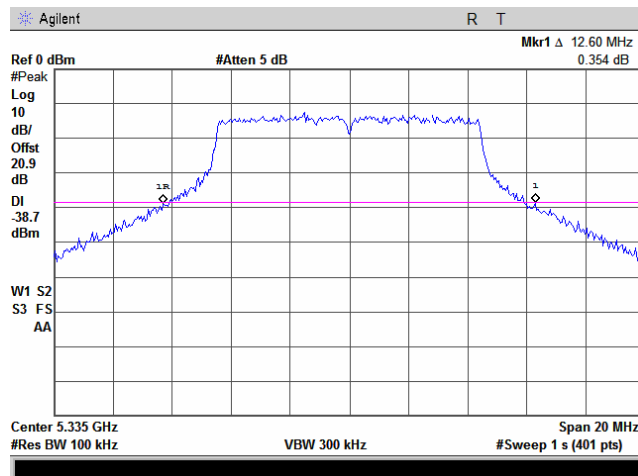



HERMON LABORATORIES

Test specification:		FCC section 15. 407(a)(1-3), RSS-210 Annex 9, section A9.2 Peak output power and peak power spectral density	
Test procedure:		FCC Public Notice DA 02-2138, Appendix A	
Test mode:	Compliance	Verdict:	PASS
Date:	12/18/2008		
Temperature: 22 °C	Air Pressure: 1010 hPa	Relative Humidity: 48 %	Power Supply: 48 VDC
Remarks: EUT with 22.5 dBi antenna assembly gain			

Plot 7.1.47 Peak output power

Frequency:	5335 MHz
Channel BW:	10 MHz
Modulation parameters:	BPSK, 65 Mbps

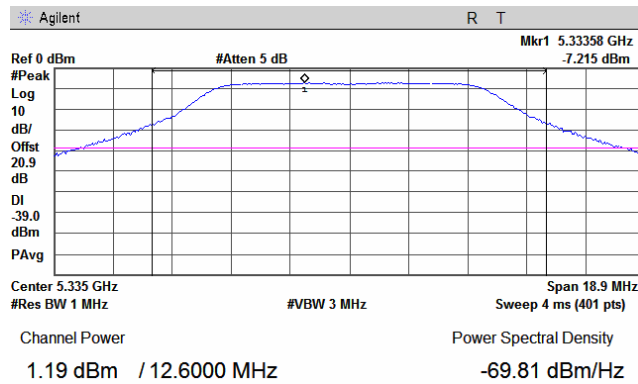

Plot 7.1.48 Peak spectral power density

Frequency:	5335 MHz
Channel BW:	10 MHz
Modulation parameters:	BPSK, 65 Mbps

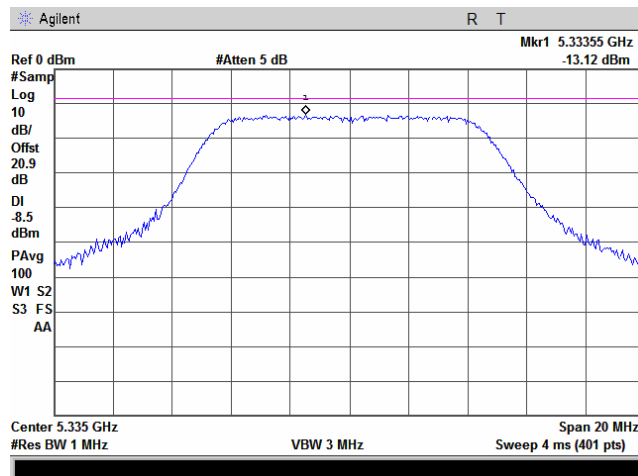



HERMON LABORATORIES

Test specification:		FCC section 15. 407(a)(1-3), RSS-210 Annex 9, section A9.2 Peak output power and peak power spectral density	
Test procedure:		FCC Public Notice DA 02-2138, Appendix A	
Test mode:	Compliance	Verdict:	PASS
Date:	12/18/2008		
Temperature: 22 °C	Air Pressure: 1010 hPa	Relative Humidity: 48 %	Power Supply: 48 VDC
Remarks: EUT with 22.5 dBi antenna assembly gain			

Plot 7.1.49 The 26 dB emission bandwidth

Frequency:	5340 MHz
Channel BW:	5 MHz
Modulation parameters:	BPSK, 3.25 Mbps

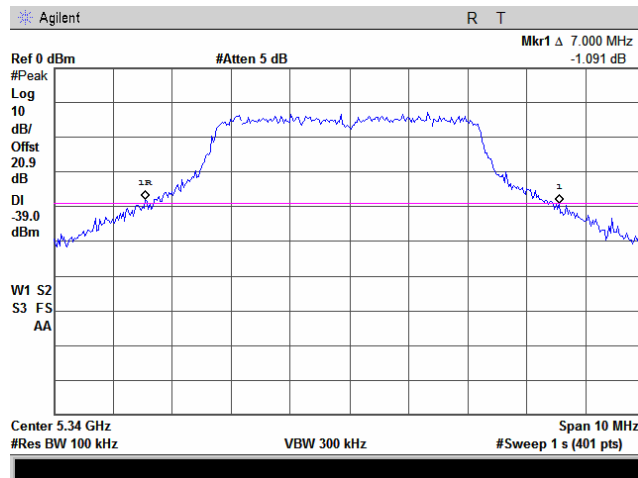

Plot 7.1.50 Peak output power

Frequency:	5340 MHz
Channel BW:	5 MHz
Modulation parameters:	BPSK, 3.25 Mbps

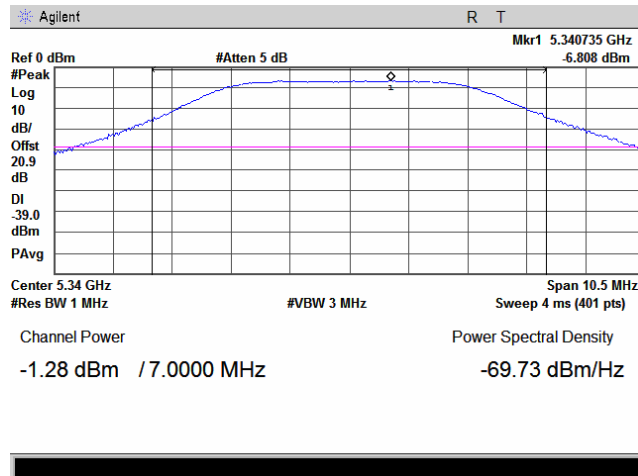



HERMON LABORATORIES

Test specification: FCC section 15. 407(a)(1-3), RSS-210 Annex 9, section A9.2 Peak output power and peak power spectral density			
Test procedure: FCC Public Notice DA 02-2138, Appendix A			
Test mode: Compliance	Verdict: PASS		
Date: 12/18/2008			
Temperature: 22 °C	Air Pressure: 1010 hPa	Relative Humidity: 48 %	Power Supply: 48 VDC
Remarks: EUT with 22.5 dBi antenna assembly gain			

Plot 7.1.51 Peak spectral power density

Frequency:	5340 MHz
Channel BW:	5 MHz
Modulation parameters:	BPSK, 3.25 Mbps

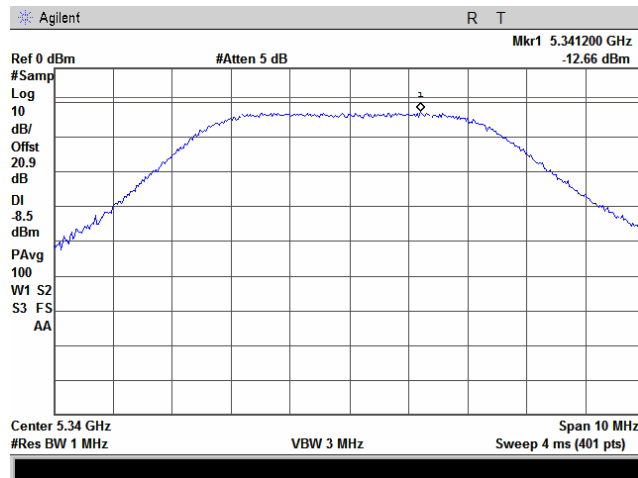

Plot 7.1.52 The 26 dB emission bandwidth

Frequency:	5340 MHz
Channel BW:	5 MHz
Modulation parameters:	BPSK, 3.25 Mbps

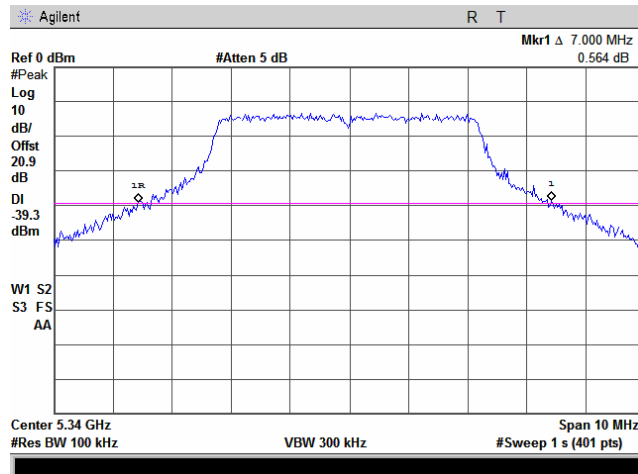



HERMON LABORATORIES

Test specification:		FCC section 15. 407(a)(1-3), RSS-210 Annex 9, section A9.2 Peak output power and peak power spectral density	
Test procedure:		FCC Public Notice DA 02-2138, Appendix A	
Test mode:	Compliance	Verdict:	PASS
Date:	12/18/2008		
Temperature: 22 °C	Air Pressure: 1010 hPa	Relative Humidity: 48 %	Power Supply: 48 VDC
Remarks: EUT with 22.5 dBi antenna assembly gain			

Plot 7.1.53 Peak output power

Frequency:	5340 MHz
Channel BW:	5 MHz
Modulation parameters:	BPSK, 32.5 Mbps

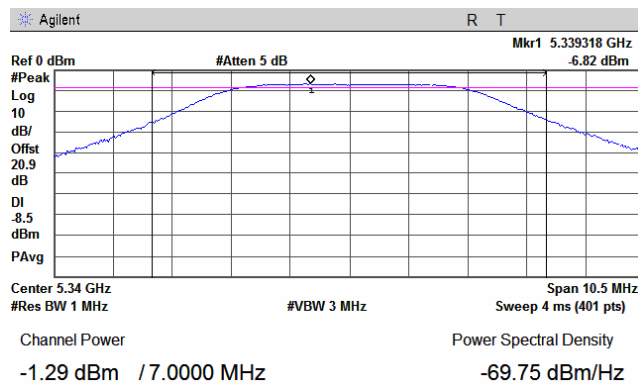

Plot 7.1.54 Peak spectral power density

Frequency:	5340 MHz
Channel BW:	5 MHz
Modulation parameters:	BPSK, 32.5 Mbps

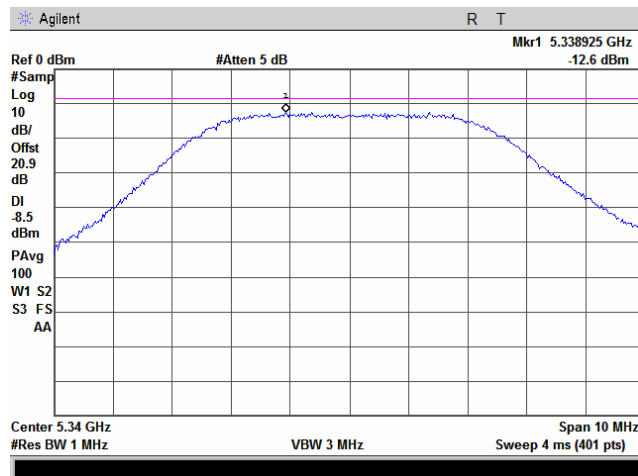



HERMON LABORATORIES

Test specification: FCC section 15. 407(a)(1-3), RSS-210 Annex 9, section A9.2 Peak output power and peak power spectral density			
Test procedure: FCC Public Notice DA 02-2138, Appendix A			
Test mode: Compliance		Verdict: PASS	
Date: 12/18/2008			
Temperature: 22 °C	Air Pressure: 1010 hPa	Relative Humidity: 48 %	Power Supply: 48 VDC
Remarks: EUT with 28 dBi antenna assembly gain			

Table 7.1.4 Conducted output power test results

ASSIGNED FREQUENCY RANGE: 5250-5350 MHz
 MODULATING SIGNAL: OFDM
 TRANSMITTER OUTPUT POWER SETTINGS: "4 dBm" at 5 MHz channel bandwidth
 "7.5 dBm" at 10 MHz channel bandwidth
 "9.5 dBm" at 20 MHz channel bandwidth
 DETECTOR USED: Peak
 RESOLUTION BANDWIDTH: 1 MHz
 VIDEO BANDWIDTH: 3 MHz
 METHOD OF POWER MEASUREMENTS: 1 (channel power across the 26 dB EBW)

Frequency, MHz	26 dB Bandwidth	Bit Rate, Mbps	Modulation	Output power				Verdict
				Measured, dBm	Total power, dBm	Limit, dBm	Margin, dB*	
Low channel								
5270	24.375	13	BPSK	-2.05	0.95	2.00	-1.05	Pass
5270	23.850	130	64QAM	-1.57	1.43	2.00	-0.57	Pass
5265	13.200	6.5	BPSK	-4.11	-1.11	0.21	-1.32	Pass
5265	12.750	65	64QAM	-4.08	-1.08	0.06	-1.14	Pass
5260	6.925	3.25	BPSK	-6.74	-3.74	-2.60	-1.14	Pass
5260	7.000	32.5	64QAM	-6.61	-3.61	-2.55	-1.06	Pass
Mid channel								
5300	24.750	13	BPSK	-1.21	1.79	2.00	-0.21	Pass
5300	24.300	130	64QAM	-1.15	1.85	2.00	-0.15	Pass
5300	12.650	6.5	BPSK	-3.59	-0.59	0.02	-0.61	Pass
5300	12.500	65	64QAM	-3.73	-0.73	-0.03	-0.70	Pass
5300	6.800	3.25	BPSK	-6.49	-3.49	-2.67	-0.82	Pass
5300	6.825	32.5	64QAM	-6.48	-3.48	-2.66	-0.82	Pass
High channel								
5330	24.075	13	BPSK	-1.18	1.82	2.00	-0.18	Pass
5330	24.075	130	64QAM	-1.12	1.88	2.00	-0.12	Pass
5335	13.500	6.5	BPSK	-2.89	0.11	0.30	-0.19	Pass
5335	13.050	65	64QAM	-2.98	0.02	0.16	-0.14	Pass
5340	6.925	3.25	BPSK	-5.79	-2.79	-2.60	-0.19	Pass
5340	6.875	32.5	64QAM	-5.71	-2.71	-2.63	-0.08	Pass

* - Margin = Total output power – specification limit.

Reference numbers of test equipment used

HL 2909	HL3179	HL 3386					
---------	--------	---------	--	--	--	--	--

Full description is given in Appendix A.



Test specification:	FCC section 15. 407(a)(1-3), RSS-210 Annex 9, section A9.2 Peak output power and peak power spectral density		
Test procedure:	FCC Public Notice DA 02-2138, Appendix A		
Test mode:	Compliance	Verdict:	PASS
Date:	12/18/2008		
Temperature: 22 °C	Air Pressure: 1010 hPa	Relative Humidity: 48 %	Power Supply: 48 VDC
Remarks: EUT with 28 dBi antenna assembly gain			

Table 7.1.5 Peak power spectral density test results

ASSIGNED FREQUENCY RANGE: 5250-5350 MHz
MODULATING SIGNAL: OFDM
TRANSMITTER OUTPUT POWER SETTINGS: "4 dBm" at 5 MHz channel bandwidth
"7.5 dBm" at 10 MHz channel bandwidth
"9.5 dBm" at 20 MHz channel bandwidth

DETECTOR USED: Sample
RESOLUTION BANDWIDTH: 1 MHz
VIDEO BANDWIDTH: 3 MHz
METHOD OF POWER DENSITY MEASUREMENTS: 2 (Sample detector and 100 power averaging)

Frequency, MHz	Bit Rate, Mbps	Modulation	Peak power spectral density				Verdict
			Measured, dBm	Total peak power spectral density dBm	Limit, dBm	Margin, dB*	
Low channel							
5270	13	BPSK	-19.54	-16.54	-11.0	-5.54	Pass
5270	130	64QAM	-18.75	-15.75	-11.0	-4.75	Pass
5265	6.5	BPSK	-18.85	-15.85	-11.0	-4.85	Pass
5265	65	64QAM	-18.11	-15.11	-11.0	-4.11	Pass
5260	3.25	BPSK	-18.49	-15.49	-11.0	-4.49	Pass
5260	32.5	64QAM	-18.55	-15.55	-11.0	-4.55	Pass
Mid channel							
5300	13	BPSK	-18.62	-15.62	-11.0	-4.62	Pass
5300	130	64QAM	-18.32	-15.32	-11.0	-4.32	Pass
5300	6.5	BPSK	-18.24	-15.24	-11.0	-4.24	Pass
5300	65	64QAM	-18.22	-15.22	-11.0	-4.22	Pass
5300	3.25	BPSK	-18.13	-15.13	-11.0	-4.13	Pass
5300	32.5	64QAM	-18.01	-15.01	-11.0	-4.01	Pass
High channel							
5330	13	BPSK	-18.25	-15.25	-11.0	-4.25	Pass
5330	130	64QAM	-18.67	-15.67	-11.0	-4.67	Pass
5335	6.5	BPSK	-17.67	-14.67	-11.0	-3.67	Pass
5335	65	64QAM	-17.65	-14.65	-11.0	-3.65	Pass
5340	3.25	BPSK	-17.53	-14.53	-11.0	-3.53	Pass
5340	32.5	64QAM	-17.41	-14.41	-11.0	-3.41	Pass

* - Margin = Total peak power density – specification limit.

Reference numbers of test equipment used

HL 2909	HL3179	HL 3386					
---------	--------	---------	--	--	--	--	--

Full description is given in Appendix A.



HERMON LABORATORIES

Test specification: FCC section 15. 407(a)(1-3), RSS-210 Annex 9, section A9.2 Peak output power and peak power spectral density			
Test procedure: FCC Public Notice DA 02-2138, Appendix A			
Test mode: Compliance	Verdict: PASS		
Date: 12/18/2008			
Temperature: 22 °C	Air Pressure: 1010 hPa	Relative Humidity: 48 %	Power Supply: 48 VDC
Remarks: EUT with 28 dBi antenna assembly gain			

Plot 7.1.55 The 26 dB emission bandwidth

Frequency:	5270 MHz
Channel BW:	20 MHz
Modulation parameters:	BPSK, 13 Mbps

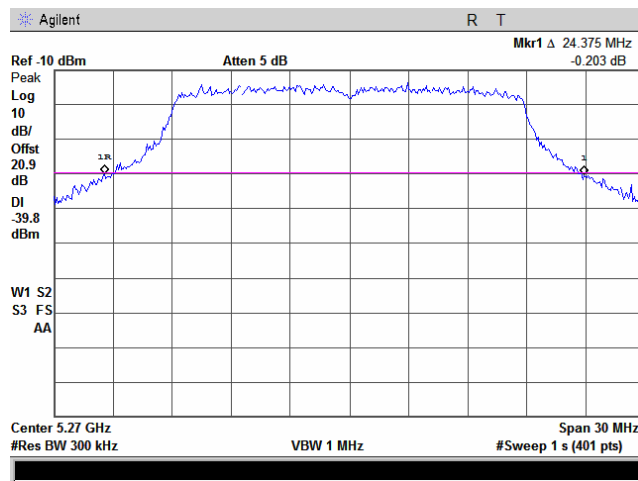

Plot 7.1.56 Peak output power

Frequency:	5270 MHz
Channel BW:	20 MHz
Modulation parameters:	BPSK, 13 Mbps

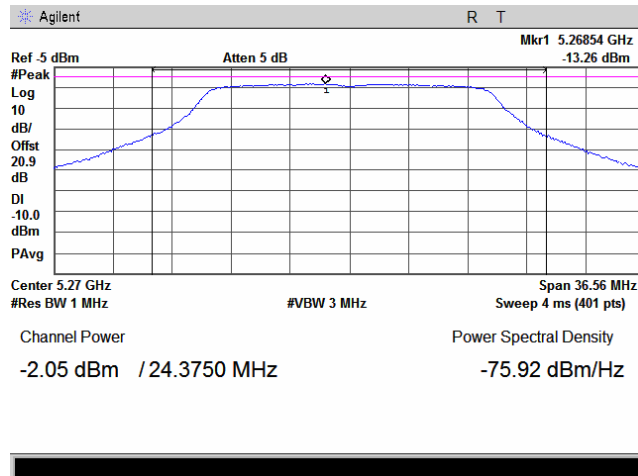



HERMON LABORATORIES

Test specification: FCC section 15. 407(a)(1-3), RSS-210 Annex 9, section A9.2 Peak output power and peak power spectral density			
Test procedure: FCC Public Notice DA 02-2138, Appendix A			
Test mode: Compliance	Verdict: PASS		
Date: 12/18/2008			
Temperature: 22 °C	Air Pressure: 1010 hPa	Relative Humidity: 48 %	Power Supply: 48 VDC
Remarks: EUT with 28 dBi antenna assembly gain			

Plot 7.1.57 Peak spectral power density

Frequency:	5270 MHz
Channel BW:	20 MHz
Modulation parameters:	BPSK, 13 Mbps

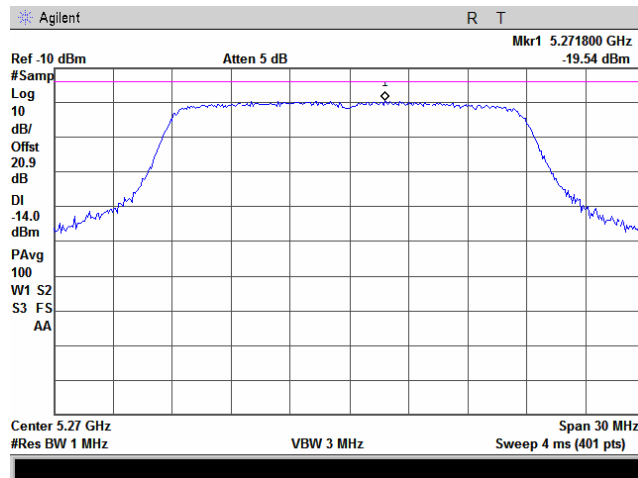

Plot 7.1.58 The 26 dB emission bandwidth

Frequency:	5270 MHz
Channel BW:	20 MHz
Modulation parameters:	BPSK, 130 Mbps

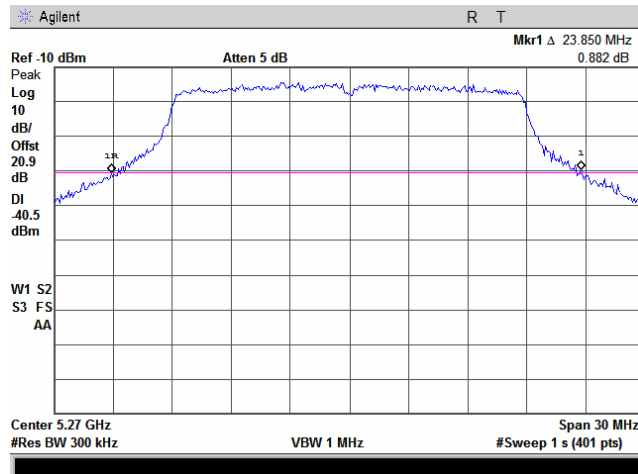



HERMON LABORATORIES

Test specification:		FCC section 15. 407(a)(1-3), RSS-210 Annex 9, section A9.2 Peak output power and peak power spectral density	
Test procedure:		FCC Public Notice DA 02-2138, Appendix A	
Test mode:	Compliance	Verdict:	PASS
Date:	12/18/2008		
Temperature: 22 °C	Air Pressure: 1010 hPa	Relative Humidity: 48 %	Power Supply: 48 VDC
Remarks: EUT with 28 dBi antenna assembly gain			

Plot 7.1.59 Peak output power

Frequency:	5270 MHz
Channel BW:	20 MHz
Modulation parameters:	BPSK, 130 Mbps

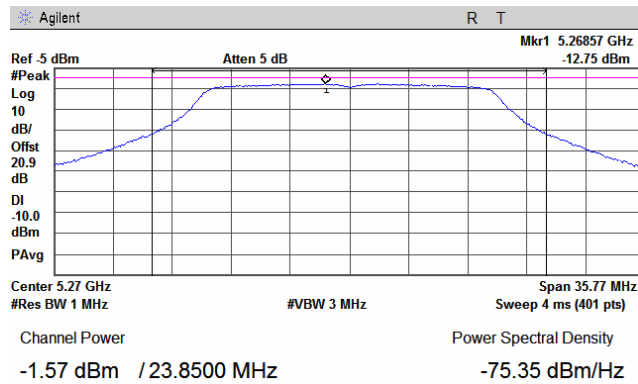

Plot 7.1.60 Peak spectral power density

Frequency:	5270 MHz
Channel BW:	20 MHz
Modulation parameters:	BPSK, 130 Mbps

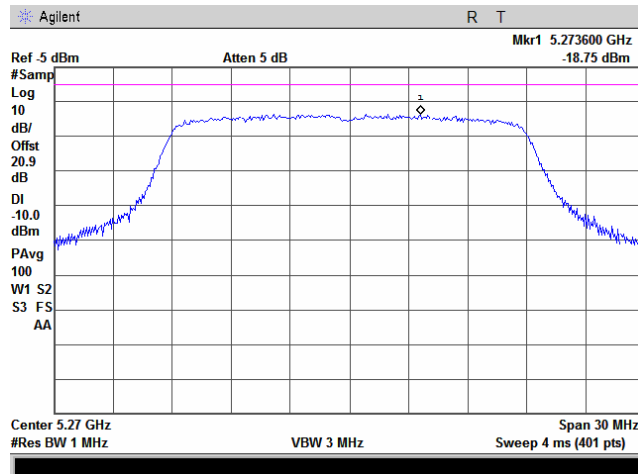



HERMON LABORATORIES

Test specification: FCC section 15. 407(a)(1-3), RSS-210 Annex 9, section A9.2 Peak output power and peak power spectral density			
Test procedure: FCC Public Notice DA 02-2138, Appendix A			
Test mode: Compliance	Verdict: PASS		
Date: 12/18/2008			
Temperature: 22 °C	Air Pressure: 1010 hPa	Relative Humidity: 48 %	Power Supply: 48 VDC
Remarks: EUT with 28 dBi antenna assembly gain			

Plot 7.1.61 The 26 dB emission bandwidth

Frequency:	5265 MHz
Channel BW:	10 MHz
Modulation parameters:	BPSK, 6.5 Mbps

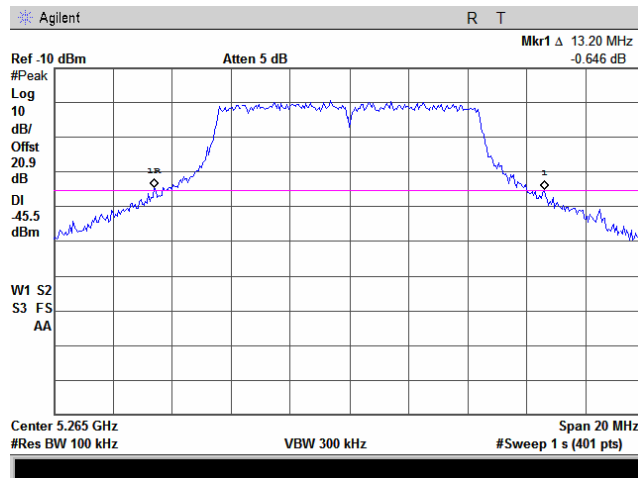

Plot 7.1.62 Peak output power

Frequency:	5265 MHz
Channel BW:	10 MHz
Modulation parameters:	BPSK, 6.5 Mbps

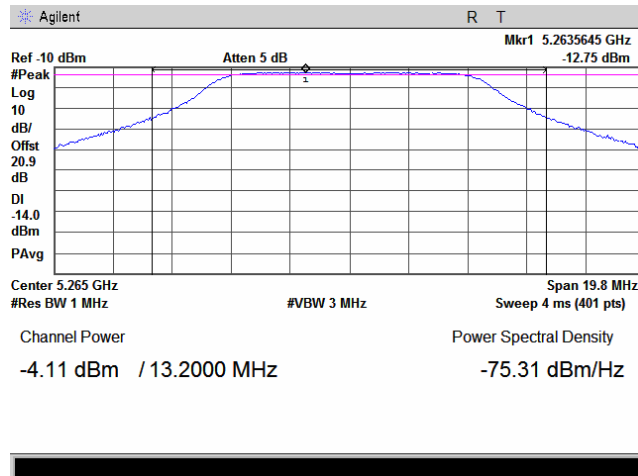



HERMON LABORATORIES

Test specification: FCC section 15. 407(a)(1-3), RSS-210 Annex 9, section A9.2 Peak output power and peak power spectral density			
Test procedure: FCC Public Notice DA 02-2138, Appendix A			
Test mode: Compliance	Verdict: PASS		
Date: 12/18/2008			
Temperature: 22 °C	Air Pressure: 1010 hPa	Relative Humidity: 48 %	Power Supply: 48 VDC
Remarks: EUT with 28 dBi antenna assembly gain			

Plot 7.1.63 Peak spectral power density

Frequency:	5265 MHz
Channel BW:	10 MHz
Modulation parameters:	BPSK, 6.5 Mbps

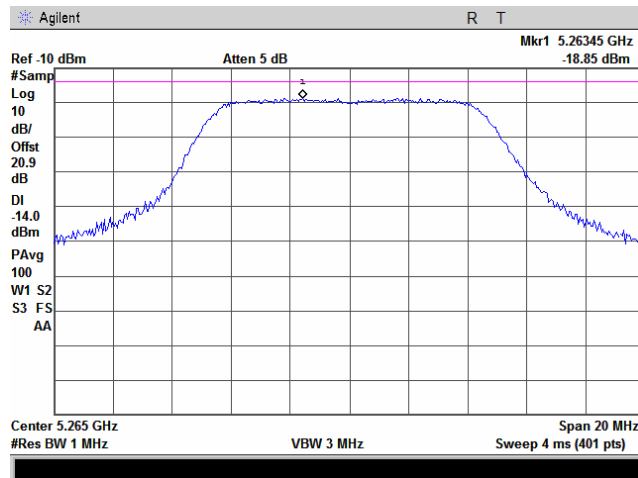

Plot 7.1.64 The 26 dB emission bandwidth

Frequency:	5265 MHz
Channel BW:	10 MHz
Modulation parameters:	BPSK, 6.5 Mbps

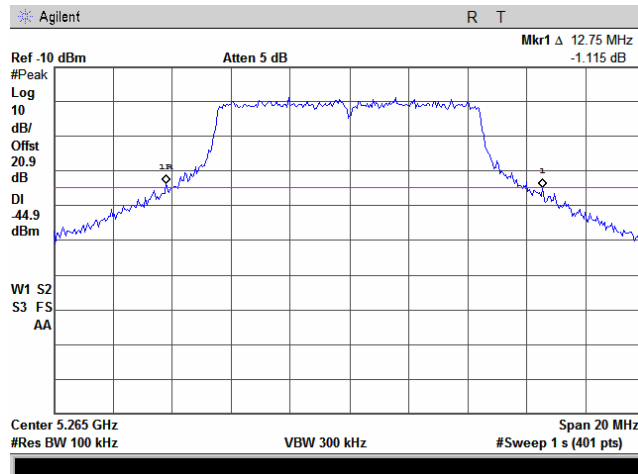



HERMON LABORATORIES

Test specification:		FCC section 15. 407(a)(1-3), RSS-210 Annex 9, section A9.2 Peak output power and peak power spectral density	
Test procedure:		FCC Public Notice DA 02-2138, Appendix A	
Test mode:	Compliance	Verdict:	PASS
Date:	12/18/2008		
Temperature: 22 °C	Air Pressure: 1010 hPa	Relative Humidity: 48 %	Power Supply: 48 VDC
Remarks: EUT with 28 dBi antenna assembly gain			

Plot 7.1.65 Peak output power

Frequency:	5265 MHz
Channel BW:	10 MHz
Modulation parameters:	BPSK, 65 Mbps

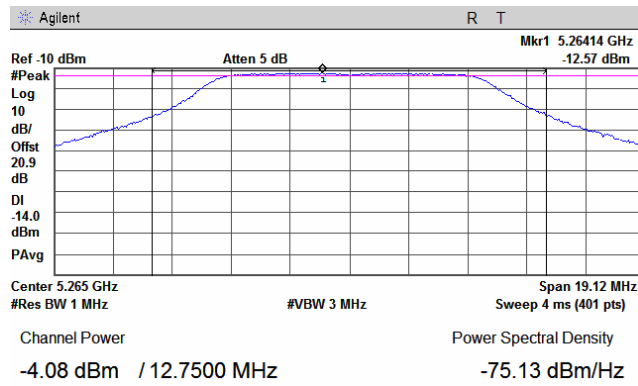

Plot 7.1.66 Peak spectral power density

Frequency:	5265 MHz
Channel BW:	10 MHz
Modulation parameters:	BPSK, 65 Mbps

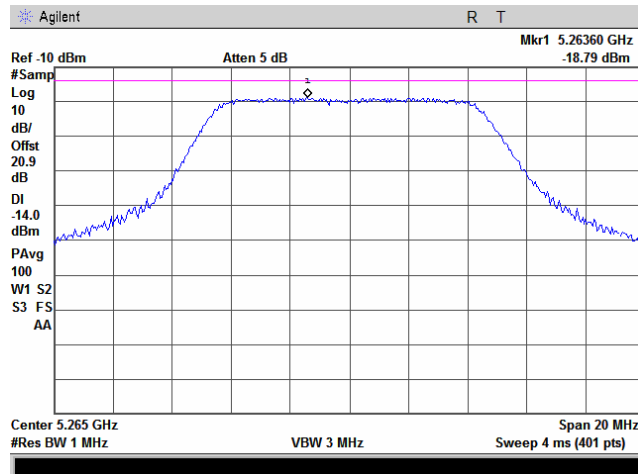



HERMON LABORATORIES

Test specification: FCC section 15. 407(a)(1-3), RSS-210 Annex 9, section A9.2 Peak output power and peak power spectral density			
Test procedure: FCC Public Notice DA 02-2138, Appendix A			
Test mode: Compliance	Verdict: PASS		
Date: 12/18/2008			
Temperature: 22 °C	Air Pressure: 1010 hPa	Relative Humidity: 48 %	Power Supply: 48 VDC
Remarks: EUT with 28 dBi antenna assembly gain			

Plot 7.1.67 The 26 dB emission bandwidth

Frequency:	5260 MHz
Channel BW:	5 MHz
Modulation parameters:	BPSK, 3.25 Mbps

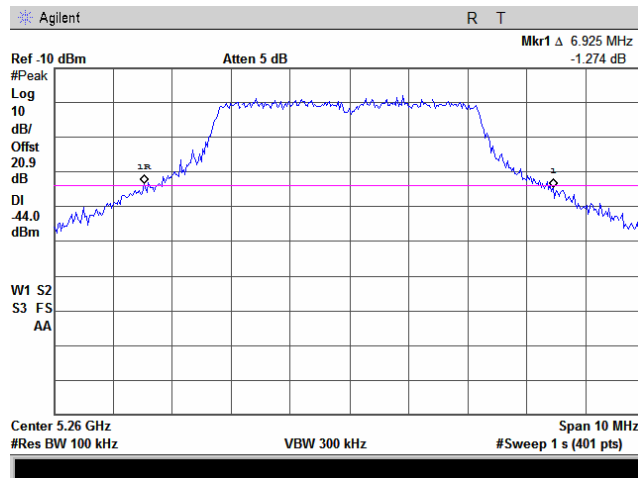

Plot 7.1.68 Peak output power

Frequency:	5260 MHz
Channel BW:	5 MHz
Modulation parameters:	BPSK, 3.25 Mbps

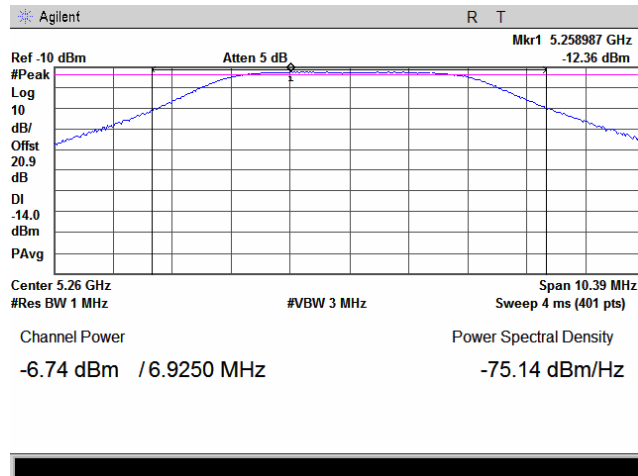



HERMON LABORATORIES

Test specification: FCC section 15. 407(a)(1-3), RSS-210 Annex 9, section A9.2 Peak output power and peak power spectral density			
Test procedure: FCC Public Notice DA 02-2138, Appendix A			
Test mode: Compliance	Verdict: PASS		
Date: 12/18/2008			
Temperature: 22 °C	Air Pressure: 1010 hPa	Relative Humidity: 48 %	Power Supply: 48 VDC
Remarks: EUT with 28 dBi antenna assembly gain			

Plot 7.1.69 Peak spectral power density

Frequency:	5260 MHz
Channel BW:	5 MHz
Modulation parameters:	BPSK, 3.25 Mbps

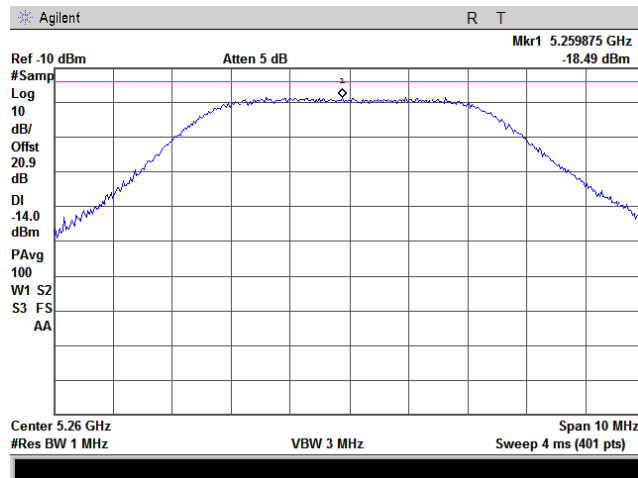

Plot 7.1.70 The 26 dB emission bandwidth

Frequency:	5260 MHz
Channel BW:	5 MHz
Modulation parameters:	BPSK, 32.5 Mbps

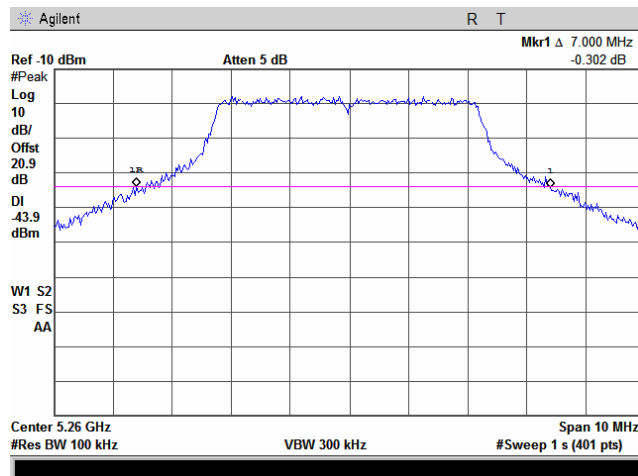



HERMON LABORATORIES

Test specification: FCC section 15. 407(a)(1-3), RSS-210 Annex 9, section A9.2 Peak output power and peak power spectral density			
Test procedure: FCC Public Notice DA 02-2138, Appendix A			
Test mode: Compliance	Verdict: PASS		
Date: 12/18/2008			
Temperature: 22 °C	Air Pressure: 1010 hPa	Relative Humidity: 48 %	Power Supply: 48 VDC
Remarks: EUT with 28 dBi antenna assembly gain			

Plot 7.1.71 Peak output power

Frequency:	5260 MHz
Channel BW:	5 MHz
Modulation parameters:	BPSK, 32.5 Mbps

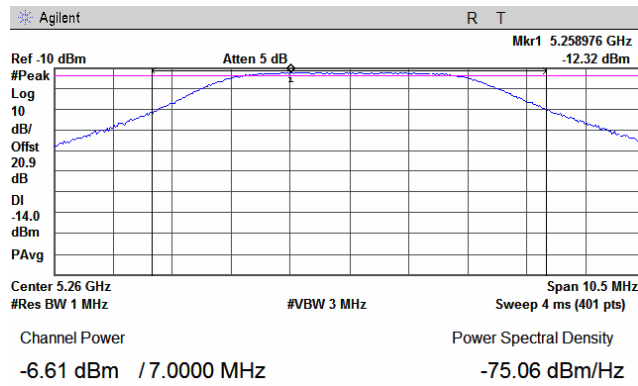

Plot 7.1.72 Peak spectral power density

Frequency:	5260 MHz
Channel BW:	5 MHz
Modulation parameters:	BPSK, 32.5 Mbps

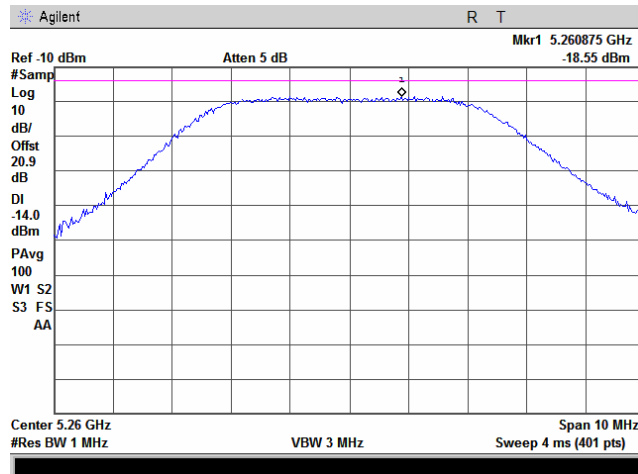



HERMON LABORATORIES

Test specification:		FCC section 15. 407(a)(1-3), RSS-210 Annex 9, section A9.2 Peak output power and peak power spectral density	
Test procedure:		FCC Public Notice DA 02-2138, Appendix A	
Test mode:	Compliance	Verdict:	PASS
Date:	12/18/2008		
Temperature: 22 °C	Air Pressure: 1010 hPa	Relative Humidity: 48 %	Power Supply: 48 VDC
Remarks: EUT with 28 dBi antenna assembly gain			

Plot 7.1.73 The 26 dB emission bandwidth

Frequency:	5300 MHz
Channel BW:	20 MHz
Modulation parameters:	BPSK, 13 Mbps

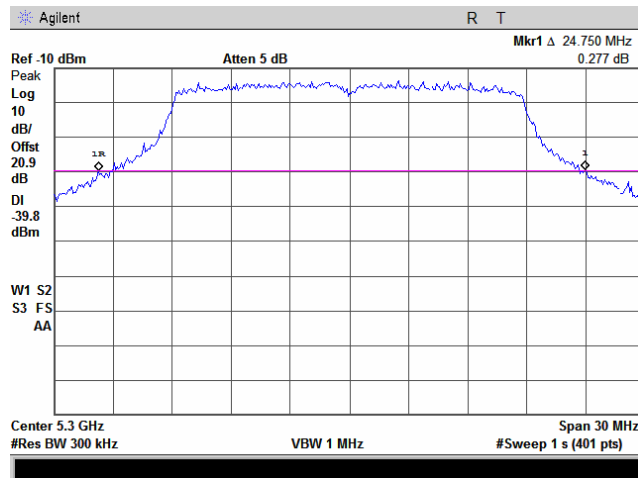

Plot 7.1.74 Peak output power

Frequency:	5300 MHz
Channel BW:	20 MHz
Modulation parameters:	BPSK, 13 Mbps

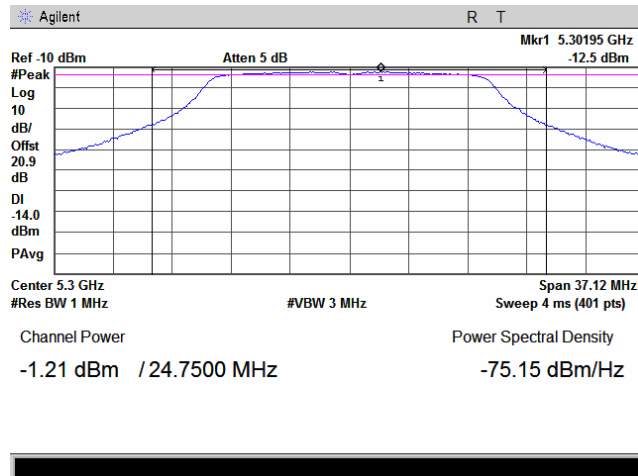



HERMON LABORATORIES

Test specification: FCC section 15. 407(a)(1-3), RSS-210 Annex 9, section A9.2 Peak output power and peak power spectral density			
Test procedure: FCC Public Notice DA 02-2138, Appendix A			
Test mode: Compliance	Verdict: PASS		
Date: 12/18/2008			
Temperature: 22 °C	Air Pressure: 1010 hPa	Relative Humidity: 48 %	Power Supply: 48 VDC
Remarks: EUT with 28 dBi antenna assembly gain			

Plot 7.1.75 Peak spectral power density

Frequency:	5300 MHz
Channel BW:	20 MHz
Modulation parameters:	BPSK, 13 Mbps

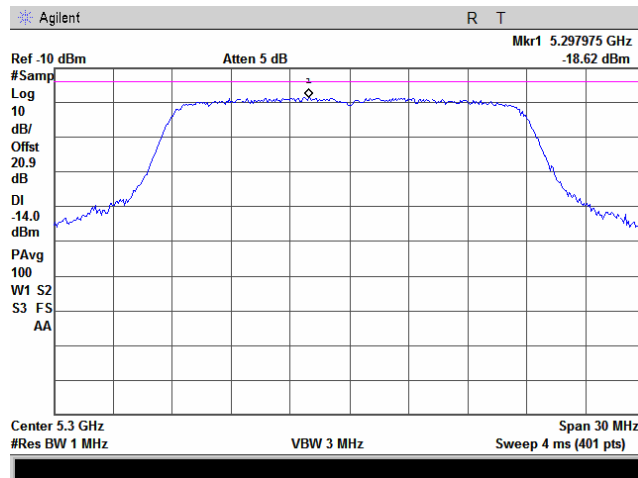

Plot 7.1.76 The 26 dB emission bandwidth

Frequency:	5300 MHz
Channel BW:	20 MHz
Modulation parameters:	BPSK, 130 Mbps

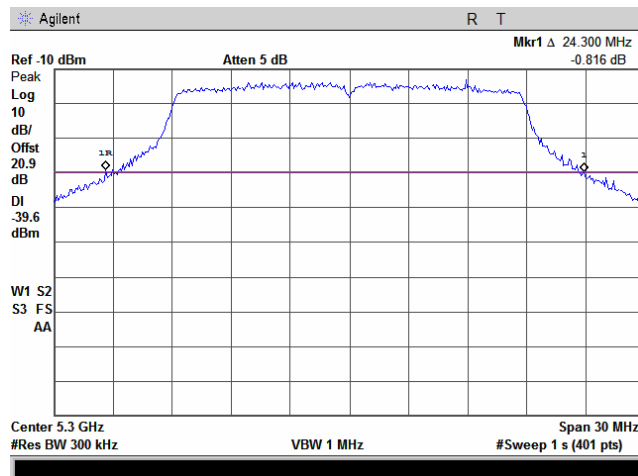



HERMON LABORATORIES

Test specification:		FCC section 15. 407(a)(1-3), RSS-210 Annex 9, section A9.2 Peak output power and peak power spectral density	
Test procedure:		FCC Public Notice DA 02-2138, Appendix A	
Test mode:	Compliance	Verdict:	PASS
Date:	12/18/2008		
Temperature: 22 °C	Air Pressure: 1010 hPa	Relative Humidity: 48 %	Power Supply: 48 VDC
Remarks: EUT with 28 dBi antenna assembly gain			

Plot 7.1.77 Peak output power

Frequency:	5300 MHz
Channel BW:	20 MHz
Modulation parameters:	BPSK, 130 Mbps

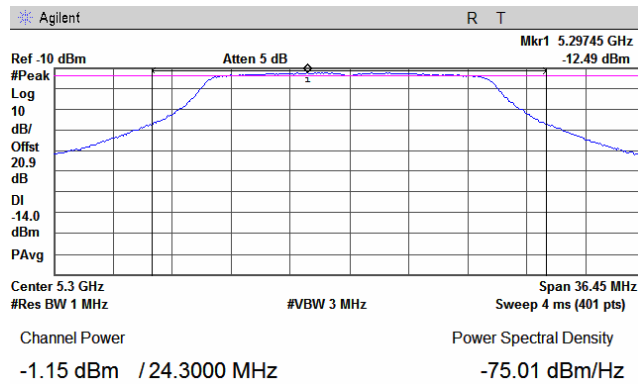

Plot 7.1.78 Peak spectral power density

Frequency:	5300 MHz
Channel BW:	20 MHz
Modulation parameters:	BPSK, 130 Mbps

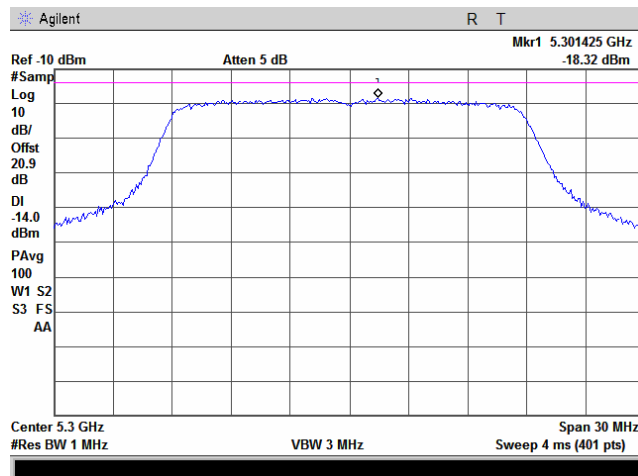



HERMON LABORATORIES

Test specification: FCC section 15. 407(a)(1-3), RSS-210 Annex 9, section A9.2 Peak output power and peak power spectral density			
Test procedure: FCC Public Notice DA 02-2138, Appendix A			
Test mode: Compliance	Verdict: PASS		
Date: 12/18/2008			
Temperature: 22 °C	Air Pressure: 1010 hPa	Relative Humidity: 48 %	Power Supply: 48 VDC
Remarks: EUT with 28 dBi antenna assembly gain			

Plot 7.1.79 The 26 dB emission bandwidth

Frequency:	5300 MHz
Channel BW:	10 MHz
Modulation parameters:	BPSK, 6.5 Mbps

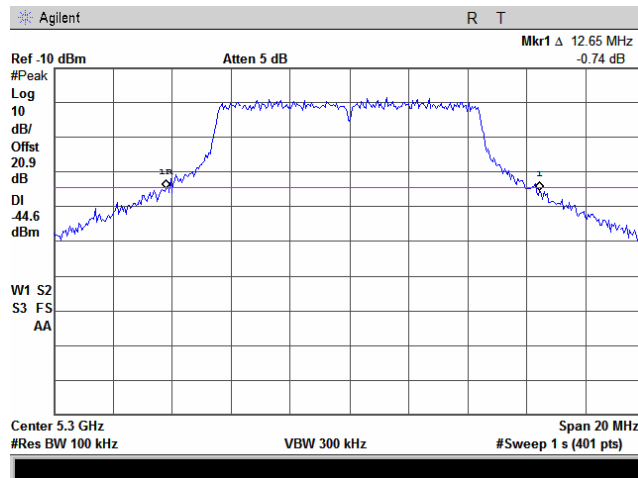

Plot 7.1.80 Peak output power

Frequency:	5300 MHz
Channel BW:	10 MHz
Modulation parameters:	BPSK, 6.5 Mbps

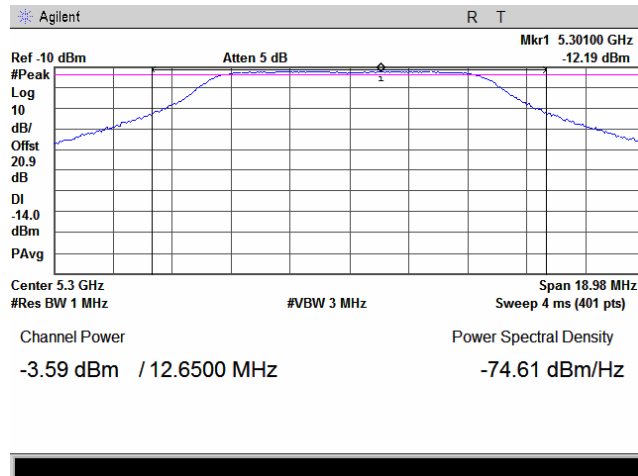



HERMON LABORATORIES

Test specification: FCC section 15. 407(a)(1-3), RSS-210 Annex 9, section A9.2 Peak output power and peak power spectral density			
Test procedure: FCC Public Notice DA 02-2138, Appendix A			
Test mode: Compliance	Verdict: PASS		
Date: 12/18/2008			
Temperature: 22 °C	Air Pressure: 1010 hPa	Relative Humidity: 48 %	Power Supply: 48 VDC
Remarks: EUT with 28 dBi antenna assembly gain			

Plot 7.1.81 Peak spectral power density

Frequency:	5300 MHz
Channel BW:	10 MHz
Modulation parameters:	BPSK, 6.5 Mbps

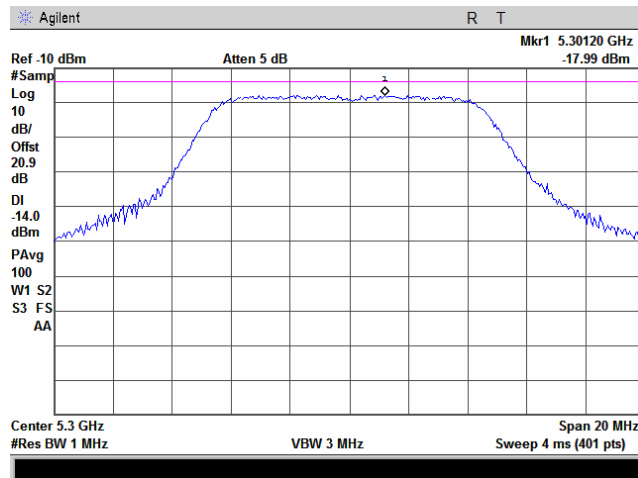

Plot 7.1.82 The 26 dB emission bandwidth

Frequency:	5300 MHz
Channel BW:	10 MHz
Modulation parameters:	BPSK, 6.5 Mbps

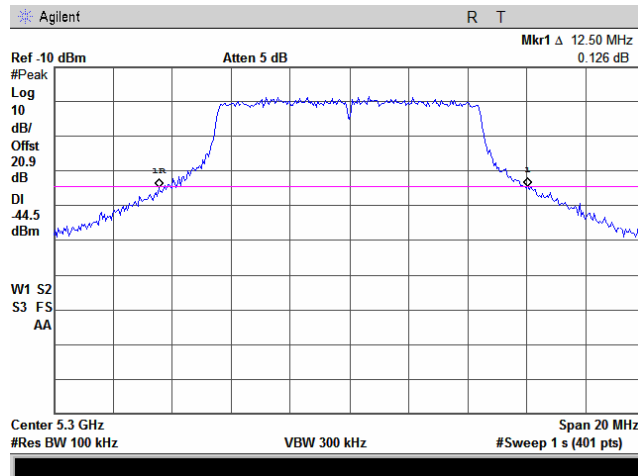



HERMON LABORATORIES

Test specification:		FCC section 15. 407(a)(1-3), RSS-210 Annex 9, section A9.2	
Test procedure:		Peak output power and peak power spectral density	
Test mode:	Compliance	Verdict:	PASS
Date:	12/18/2008		
Temperature: 22 °C	Air Pressure: 1010 hPa	Relative Humidity: 48 %	Power Supply: 48 VDC
Remarks: EUT with 28 dBi antenna assembly gain			

Plot 7.1.83 Peak output power

Frequency:	5300 MHz
Channel BW:	10 MHz
Modulation parameters:	BPSK, 65 Mbps

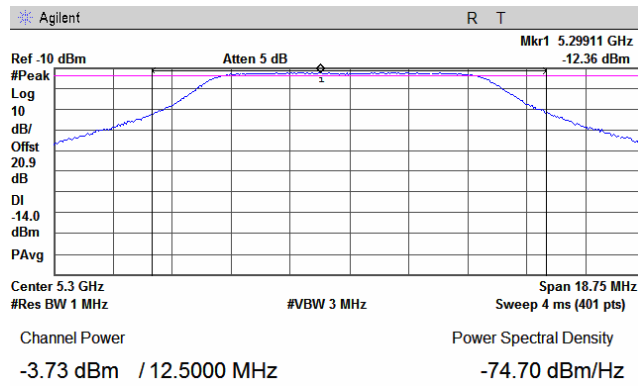

Plot 7.1.84 Peak spectral power density

Frequency:	5300 MHz
Channel BW:	10 MHz
Modulation parameters:	BPSK, 65 Mbps

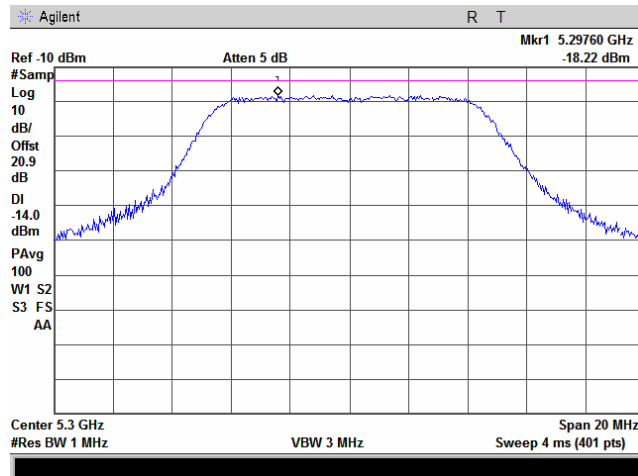



HERMON LABORATORIES

Test specification: FCC section 15. 407(a)(1-3), RSS-210 Annex 9, section A9.2 Peak output power and peak power spectral density			
Test procedure: FCC Public Notice DA 02-2138, Appendix A			
Test mode: Compliance	Verdict: PASS		
Date: 12/18/2008			
Temperature: 22 °C	Air Pressure: 1010 hPa	Relative Humidity: 48 %	Power Supply: 48 VDC
Remarks: EUT with 28 dBi antenna assembly gain			

Plot 7.1.85 The 26 dB emission bandwidth

Frequency:	5300 MHz
Channel BW:	5 MHz
Modulation parameters:	BPSK, 3.25 Mbps

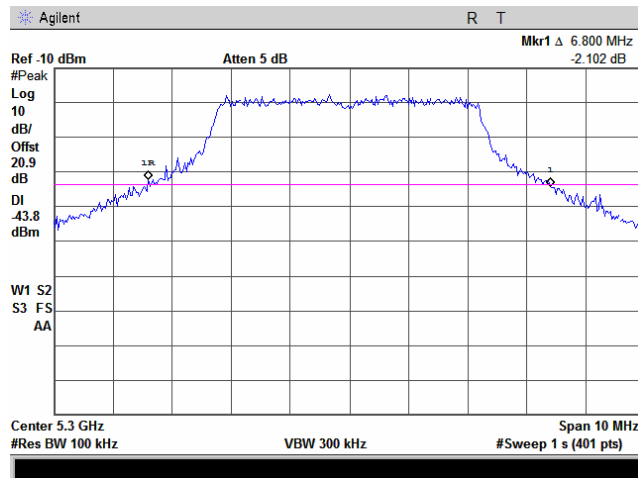

Plot 7.1.86 Peak output power

Frequency:	5300 MHz
Channel BW:	5 MHz
Modulation parameters:	BPSK, 3.25 Mbps

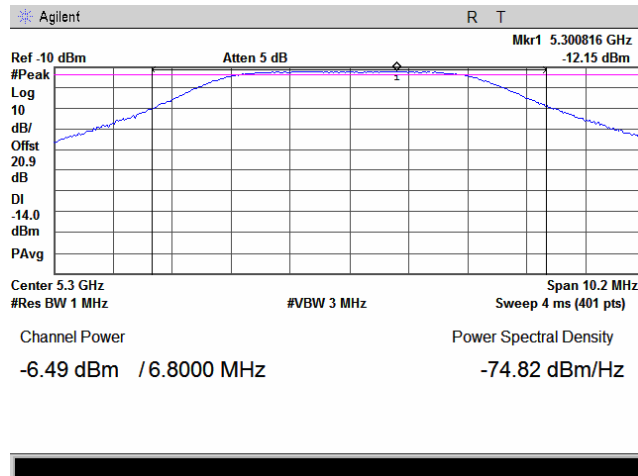



HERMON LABORATORIES

Test specification:		FCC section 15. 407(a)(1-3), RSS-210 Annex 9, section A9.2 Peak output power and peak power spectral density	
Test procedure:		FCC Public Notice DA 02-2138, Appendix A	
Test mode:	Compliance	Verdict:	PASS
Date:	12/18/2008		
Temperature: 22 °C	Air Pressure: 1010 hPa	Relative Humidity: 48 %	Power Supply: 48 VDC
Remarks: EUT with 28 dBi antenna assembly gain			

Plot 7.1.87 Peak spectral power density

Frequency:	5300 MHz
Channel BW:	5 MHz
Modulation parameters:	BPSK, 3.25 Mbps

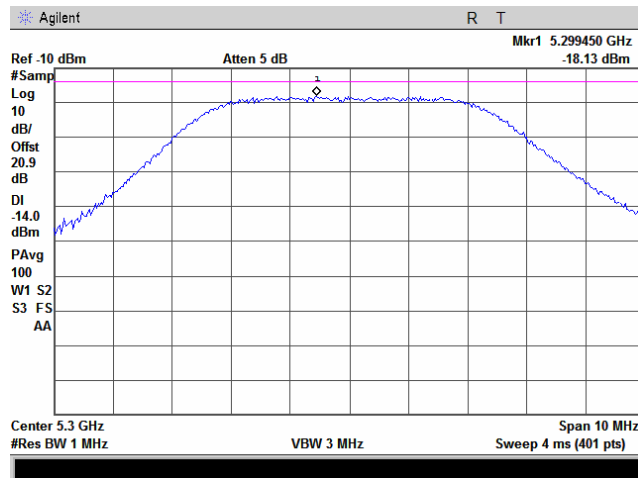

Plot 7.1.88 The 26 dB emission bandwidth

Frequency:	5300 MHz
Channel BW:	5 MHz
Modulation parameters:	BPSK, 32.5 Mbps

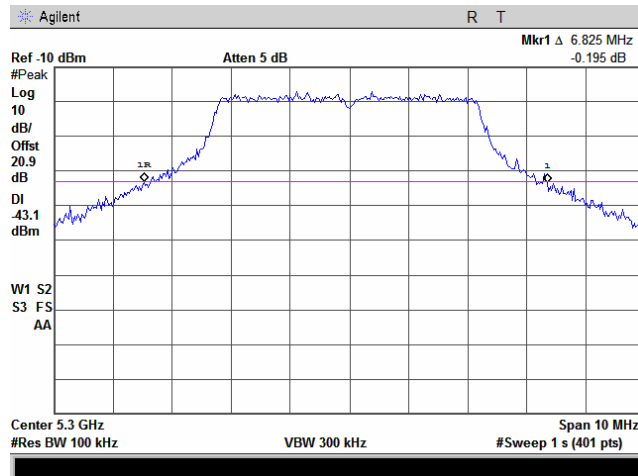



HERMON LABORATORIES

Test specification: FCC section 15. 407(a)(1-3), RSS-210 Annex 9, section A9.2 Peak output power and peak power spectral density			
Test procedure: FCC Public Notice DA 02-2138, Appendix A			
Test mode: Compliance	Verdict: PASS		
Date: 12/18/2008			
Temperature: 22 °C	Air Pressure: 1010 hPa	Relative Humidity: 48 %	Power Supply: 48 VDC
Remarks: EUT with 28 dBi antenna assembly gain			

Plot 7.1.89 Peak output power

Frequency:	5300 MHz
Channel BW:	5 MHz
Modulation parameters:	BPSK, 32.5 Mbps

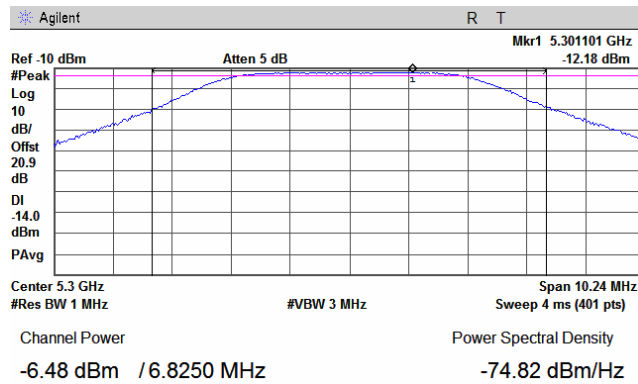

Plot 7.1.90 Peak spectral power density

Frequency:	5300 MHz
Channel BW:	5 MHz
Modulation parameters:	BPSK, 32.5 Mbps

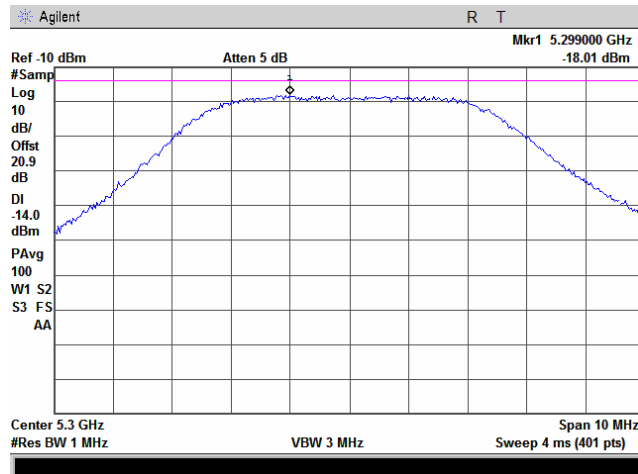



HERMON LABORATORIES

Test specification: FCC section 15. 407(a)(1-3), RSS-210 Annex 9, section A9.2 Peak output power and peak power spectral density			
Test procedure: FCC Public Notice DA 02-2138, Appendix A			
Test mode: Compliance	Verdict: PASS		
Date: 12/18/2008			
Temperature: 22 °C	Air Pressure: 1010 hPa	Relative Humidity: 48 %	Power Supply: 48 VDC
Remarks: EUT with 28 dBi antenna assembly gain			

Plot 7.1.91 The 26 dB emission bandwidth

Frequency:	5330 MHz
Channel BW:	20 MHz
Modulation parameters:	BPSK, 13 Mbps

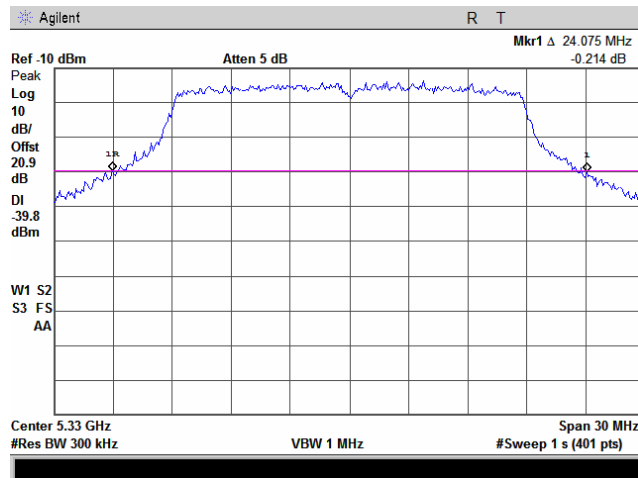

Plot 7.1.92 Peak output power

Frequency:	5330 MHz
Channel BW:	20 MHz
Modulation parameters:	BPSK, 13 Mbps

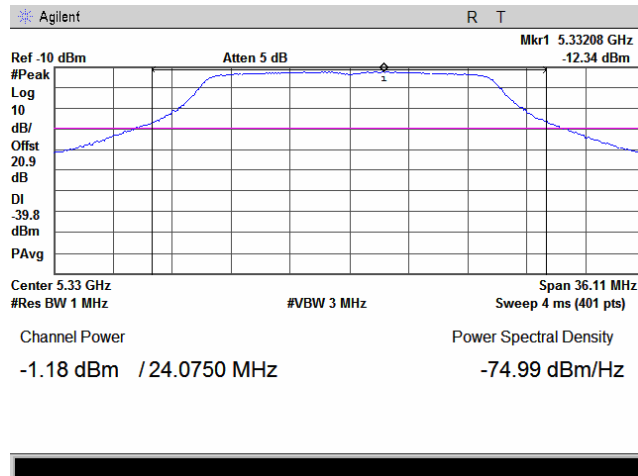



HERMON LABORATORIES

Test specification: FCC section 15. 407(a)(1-3), RSS-210 Annex 9, section A9.2 Peak output power and peak power spectral density			
Test procedure: FCC Public Notice DA 02-2138, Appendix A			
Test mode: Compliance	Verdict: PASS		
Date: 12/18/2008			
Temperature: 22 °C	Air Pressure: 1010 hPa	Relative Humidity: 48 %	Power Supply: 48 VDC
Remarks: EUT with 28 dBi antenna assembly gain			

Plot 7.1.93 Peak spectral power density

Frequency:	5330 MHz
Channel BW:	20 MHz
Modulation parameters:	BPSK, 13 Mbps

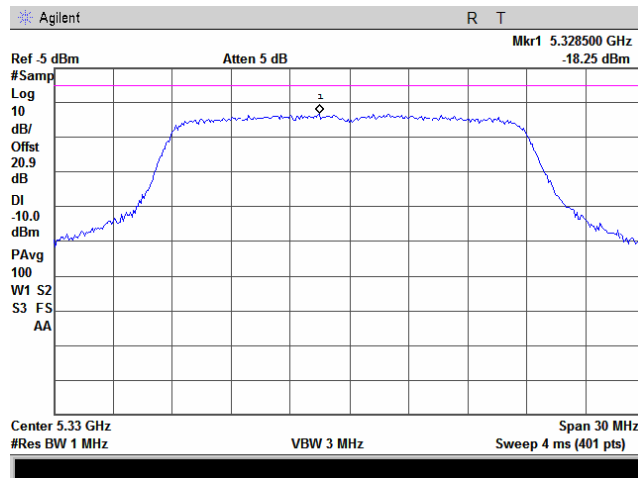

Plot 7.1.94 The 26 dB emission bandwidth

Frequency:	5330 MHz
Channel BW:	20 MHz
Modulation parameters:	BPSK, 130 Mbps

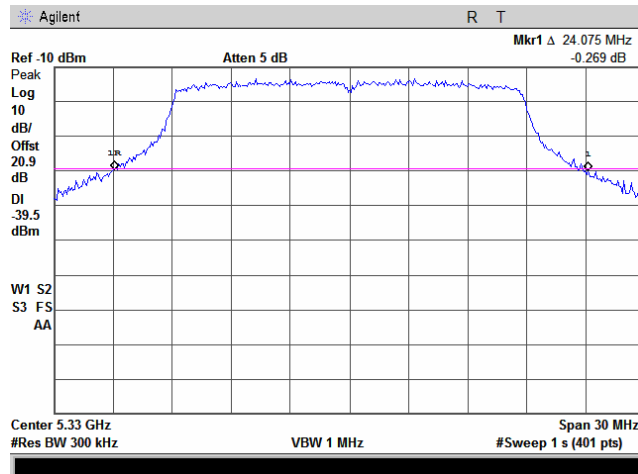



HERMON LABORATORIES

Test specification: FCC section 15. 407(a)(1-3), RSS-210 Annex 9, section A9.2 Peak output power and peak power spectral density			
Test procedure: FCC Public Notice DA 02-2138, Appendix A			
Test mode: Compliance	Verdict: PASS		
Date: 12/18/2008			
Temperature: 22 °C	Air Pressure: 1010 hPa	Relative Humidity: 48 %	Power Supply: 48 VDC
Remarks: EUT with 28 dBi antenna assembly gain			

Plot 7.1.95 Peak output power

Frequency:	5330 MHz
Channel BW:	20 MHz
Modulation parameters:	BPSK, 130 Mbps

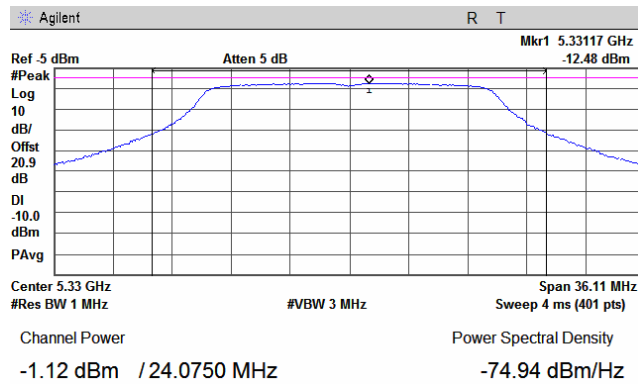

Plot 7.1.96 Peak spectral power density

Frequency:	5330 MHz
Channel BW:	20 MHz
Modulation parameters:	BPSK, 130 Mbps

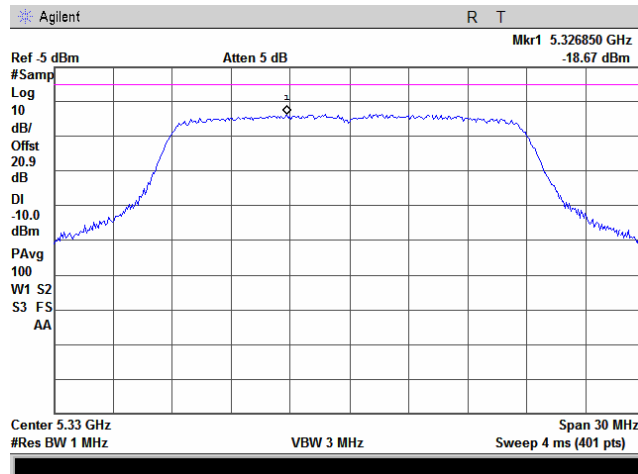



HERMON LABORATORIES

Test specification: FCC section 15. 407(a)(1-3), RSS-210 Annex 9, section A9.2 Peak output power and peak power spectral density			
Test procedure: FCC Public Notice DA 02-2138, Appendix A			
Test mode: Compliance	Verdict: PASS		
Date: 12/18/2008			
Temperature: 22 °C	Air Pressure: 1010 hPa	Relative Humidity: 48 %	Power Supply: 48 VDC
Remarks: EUT with 28 dBi antenna assembly gain			

Plot 7.1.97 The 26 dB emission bandwidth

Frequency:	5335 MHz
Channel BW:	10 MHz
Modulation parameters:	BPSK, 6.5 Mbps

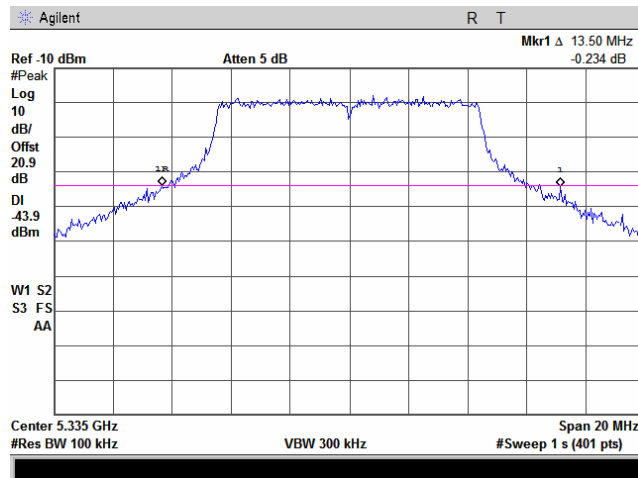

Plot 7.1.98 Peak output power

Frequency:	5335 MHz
Channel BW:	10 MHz
Modulation parameters:	BPSK, 6.5 Mbps

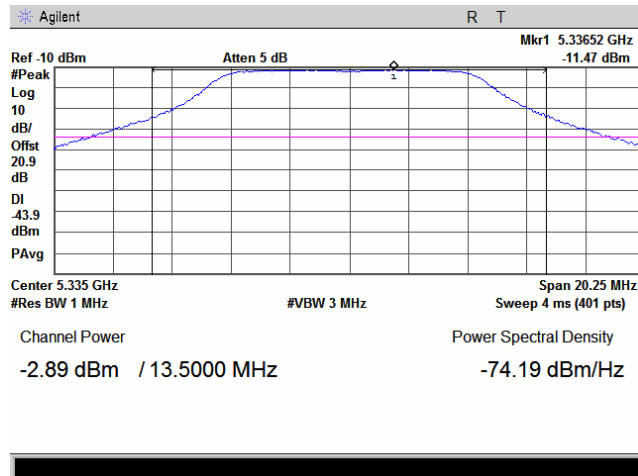



HERMON LABORATORIES

Test specification:		FCC section 15. 407(a)(1-3), RSS-210 Annex 9, section A9.2 Peak output power and peak power spectral density	
Test procedure:		FCC Public Notice DA 02-2138, Appendix A	
Test mode:	Compliance	Verdict:	PASS
Date:	12/18/2008		
Temperature: 22 °C	Air Pressure: 1010 hPa	Relative Humidity: 48 %	Power Supply: 48 VDC
Remarks: EUT with 28 dBi antenna assembly gain			

Plot 7.1.99 Peak spectral power density

Frequency:	5335 MHz
Channel BW:	10 MHz
Modulation parameters:	BPSK, 6.5 Mbps

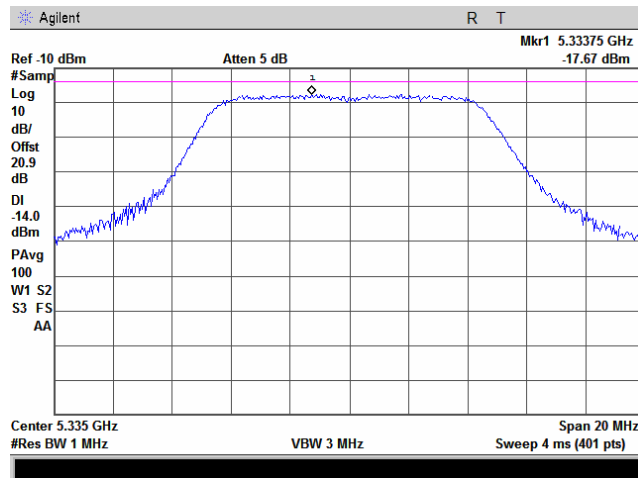

Plot 7.1.100 The 26 dB emission bandwidth

Frequency:	5335 MHz
Channel BW:	10 MHz
Modulation parameters:	BPSK, 6.5 Mbps

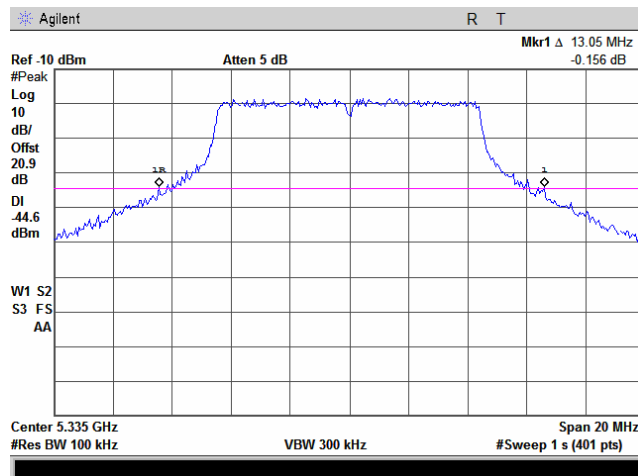



HERMON LABORATORIES

Test specification:		FCC section 15. 407(a)(1-3), RSS-210 Annex 9, section A9.2 Peak output power and peak power spectral density	
Test procedure:		FCC Public Notice DA 02-2138, Appendix A	
Test mode:	Compliance	Verdict:	PASS
Date:	12/18/2008		
Temperature: 22 °C	Air Pressure: 1010 hPa	Relative Humidity: 48 %	Power Supply: 48 VDC
Remarks: EUT with 28 dBi antenna assembly gain			

Plot 7.1.101 Peak output power

Frequency:	5335 MHz
Channel BW:	10 MHz
Modulation parameters:	BPSK, 65 Mbps

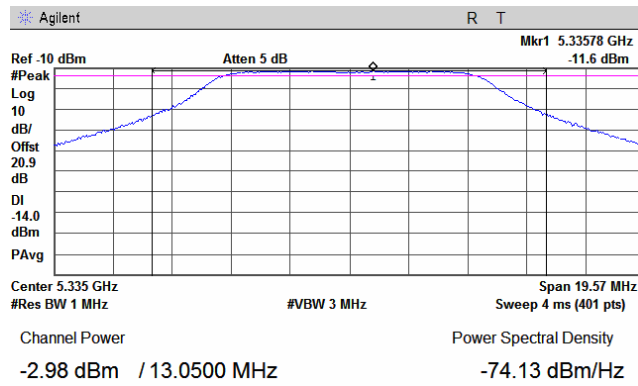

Plot 7.1.102 Peak spectral power density

Frequency:	5335 MHz
Channel BW:	10 MHz
Modulation parameters:	BPSK, 65 Mbps

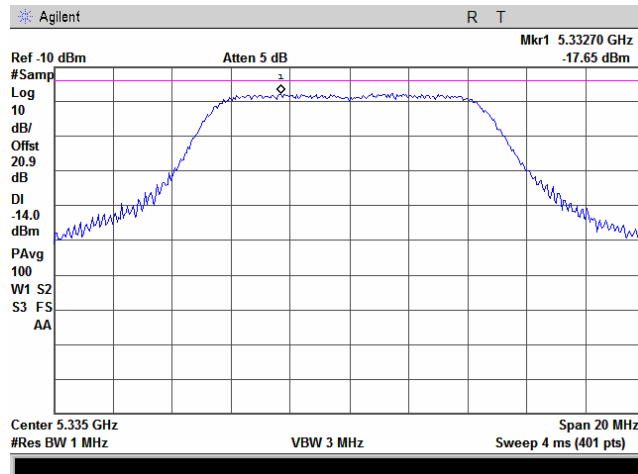



HERMON LABORATORIES

Test specification:		FCC section 15. 407(a)(1-3), RSS-210 Annex 9, section A9.2 Peak output power and peak power spectral density	
Test procedure:		FCC Public Notice DA 02-2138, Appendix A	
Test mode:	Compliance	Verdict:	PASS
Date:	12/18/2008		
Temperature: 22 °C	Air Pressure: 1010 hPa	Relative Humidity: 48 %	Power Supply: 48 VDC
Remarks: EUT with 28 dBi antenna assembly gain			

Plot 7.1.103 The 26 dB emission bandwidth

Frequency:	5340 MHz
Channel BW:	5 MHz
Modulation parameters:	BPSK, 3.25 Mbps

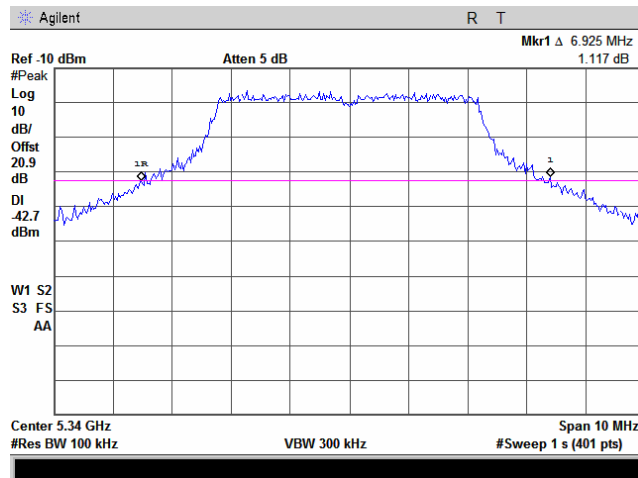

Plot 7.1.104 Peak output power

Frequency:	5340 MHz
Channel BW:	5 MHz
Modulation parameters:	BPSK, 3.25 Mbps

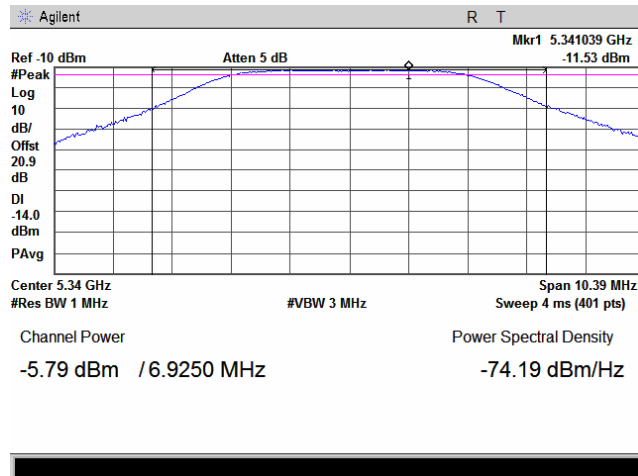



HERMON LABORATORIES

Test specification: FCC section 15. 407(a)(1-3), RSS-210 Annex 9, section A9.2 Peak output power and peak power spectral density			
Test procedure: FCC Public Notice DA 02-2138, Appendix A			
Test mode: Compliance	Verdict: PASS		
Date: 12/18/2008			
Temperature: 22 °C	Air Pressure: 1010 hPa	Relative Humidity: 48 %	Power Supply: 48 VDC
Remarks: EUT with 28 dBi antenna assembly gain			

Plot 7.1.105 Peak spectral power density

Frequency:	5340 MHz
Channel BW:	5 MHz
Modulation parameters:	BPSK, 3.25 Mbps

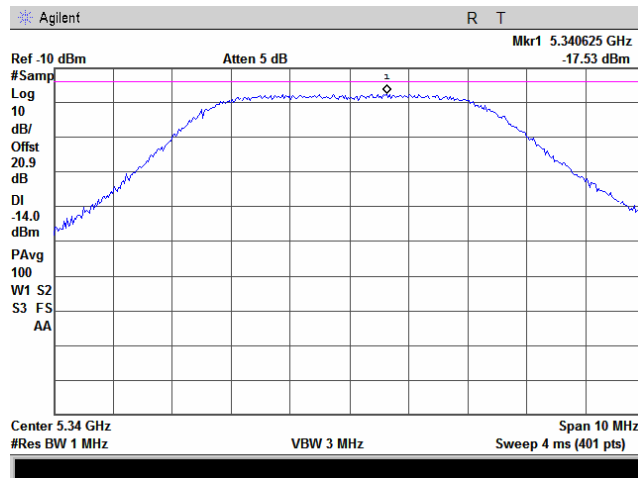

Plot 7.1.106 The 26 dB emission bandwidth

Frequency:	5340 MHz
Channel BW:	5 MHz
Modulation parameters:	BPSK, 32.5 Mbps

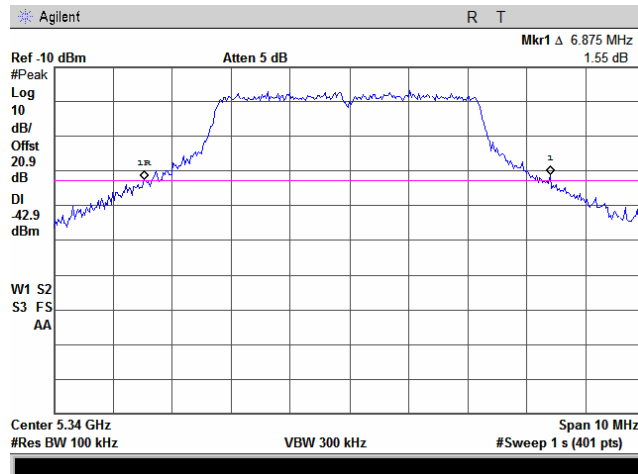



HERMON LABORATORIES

Test specification:		FCC section 15. 407(a)(1-3), RSS-210 Annex 9, section A9.2	
Test procedure:		Peak output power and peak power spectral density	
Test mode:	Compliance	Verdict:	PASS
Date:	12/18/2008		
Temperature: 22 °C	Air Pressure: 1010 hPa	Relative Humidity: 48 %	Power Supply: 48 VDC
Remarks: EUT with 28 dBi antenna assembly gain			

Plot 7.1.107 Peak output power

Frequency:	5340 MHz
Channel BW:	5 MHz
Modulation parameters:	BPSK, 32.5 Mbps

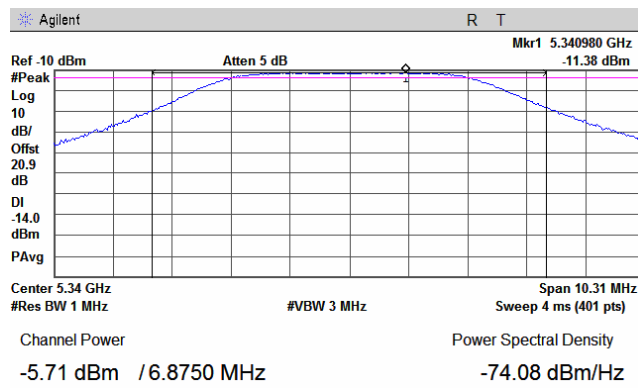

Plot 7.1.108 Peak spectral power density

Frequency:	5340 MHz
Channel BW:	5 MHz
Modulation parameters:	BPSK, 32.5 Mbps

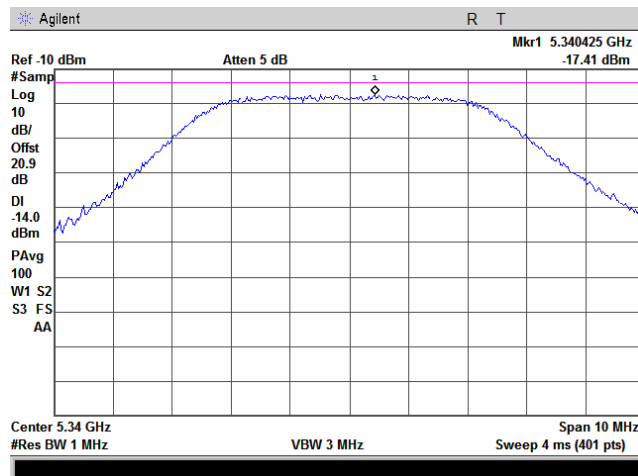



Test specification:	FCC section 15.407(a)(6), Ratio of the peak excursion of the modulation envelope to the peak transmit power		
Test procedure:	FCC Public Notice DA 02-2138, Appendix A		
Test mode:	Compliance	Verdict:	PASS
Date:	12/18/2008		
Temperature: 22 °C	Air Pressure: 1010 hPa	Relative Humidity: 48 %	Power Supply: 48 VDC
Remarks:			

7.2 Ratio of the peak excursion of the modulation envelope to the peak transmit power

7.2.1 General

This test was performed to measure the ratio of the peak excursion of the modulation envelope to the peak transmit power at RF antenna connector. Specification test limits are given in Table 7.2.1.

Table 7.2.1 Peak excursion limits

Assigned frequency, MHz	Maximum peak excursion, dB/MHz
5250 - 5350	13.0

7.2.2 Test procedure

7.2.2.1 The EUT was set up as shown in Figure 7.2.1, energized and its proper operation was checked.

7.2.2.2 The EUT was adjusted to produce maximum available to end user RF output power.

7.2.2.3 The measurements were performed in continuous transmission mode of operation for carrier (channel) frequency at low and high edges and at the middle of the frequency range.

The maximum peak excursion of modulation envelope was measured as a difference between 2 traces.

7.2.2.4 The test results were recorded in Table 7.2.2, Table 7.2.3 and shown in the associated plots.

Figure 7.2.1 Band edge emission test setup

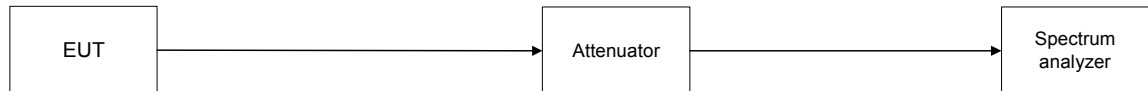



Test specification:		FCC section 15.407(a)(6), Ratio of the peak excursion of the modulation envelope to the peak transmit power			
Test procedure:		FCC Public Notice DA 02-2138, Appendix A			
Test mode:	Compliance	Verdict:		PASS	
Date:	12/18/2008				
Temperature: 22 °C	Air Pressure: 1010 hPa	Relative Humidity: 48 %	Power Supply: 48 VDC		
Remarks: EUT with 22.5 dBi antenna assembly gain					

Table 7.2.2 Peak excursion test results

ASSIGNED FREQUENCY RANGE: 5250 – 5350 MHz
 DETECTOR USED: 1-st trace: Peak, Max Hold
 2-nd trace: Peak, 100 Power Averaging
 TRANSMITTER OUTPUT POWER: 15 dBm at 20 MHz BW;
 12 dBm at 10 MHz BW;
 9.5 dBm at 5 MHz BW
 RESOLUTION BANDWIDTH: 1 MHz
 VIDEO BANDWIDTH: 3 MHz

Frequency, MHz	Bit Rate, MBps	1-st trace, dBm	2-nd trace, dBm	Peak excursion, dB	Limit, dB	Margin, dB	Verdict
Low channel							
5270	13	-2.855	-7.293	4.438	13	-8.562	Pass
5270	130	-2.195	-7.67	5.475	13	-7.525	Pass
5265	6.5	-3.745	-8.569	4.824	13	-8.176	Pass
5265	65	-3.773	-8.851	5.078	13	-7.922	Pass
5260	3.25	-2.842	-7.646	4.804	13	-8.196	Pass
5260	32.5	-2.937	-7.608	4.671	13	-8.329	Pass
Mid channel							
5300	13	-2.178	-6.919	4.741	13	-8.259	Pass
5300	130	-1.831	-7.467	5.636	13	-7.364	Pass
5300	6.5	-2.48	-7.733	5.253	13	-7.747	Pass
5300	65	-3.057	-7.918	4.861	13	-8.139	Pass
5300	3.25	-2.601	-7.493	4.892	13	-8.108	Pass
5300	32.5	-2.699	-7.624	4.925	13	-8.075	Pass
High channel							
5330	13	-2.067	-6.939	4.872	13	-8.128	Pass
5330	130	-1.662	-7.628	5.966	13	-7.034	Pass
5335	6.5	-2.396	-7.429	5.033	13	-7.967	Pass
5335	65	-2.037	-7.005	4.968	13	-8.032	Pass
5340	3.25	-2.033	-6.834	4.801	13	-8.199	Pass
5340	32.5	-1.914	-6.589	4.675	13	-8.325	Pass

* - Margin = Peak excursion – specification limit.

Reference numbers of test equipment used

HL 2780	HL 2883	HL 3180					
---------	---------	---------	--	--	--	--	--

Full description is given in Appendix A.



HERMON LABORATORIES

Test specification:	FCC section 15.407(a)(6), Ratio of the peak excursion of the modulation envelope to the peak transmit power		
Test procedure:	FCC Public Notice DA 02-2138, Appendix A		
Test mode:	Compliance	Verdict:	PASS
Date:	12/18/2008		
Temperature: 22 °C	Air Pressure: 1010 hPa	Relative Humidity: 48 %	Power Supply: 48 VDC
Remarks: EUT with 22.5 dBi antenna assembly gain			

Plot.7.2.1 Peak excursion measurement

Frequency: 5270 MHz
Channel BW: 20 MHz
Modulation parameters: BPSK; 13 MBps

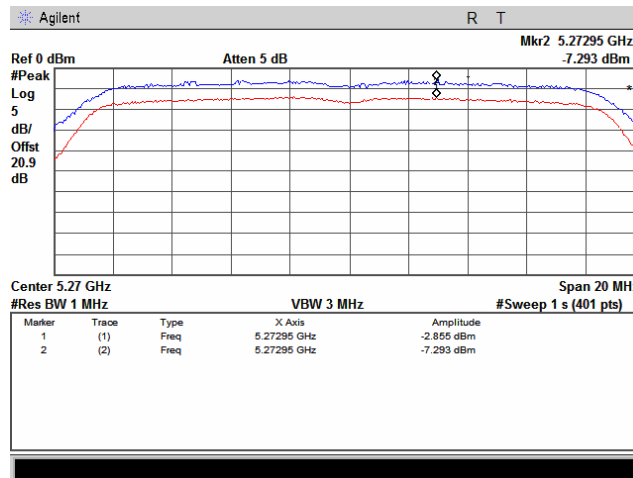

Plot.7.2.2 Peak excursion measurement

Frequency: 5270 MHz
Channel BW: 20 MHz
Modulation parameters: QPSK; 130 MBps

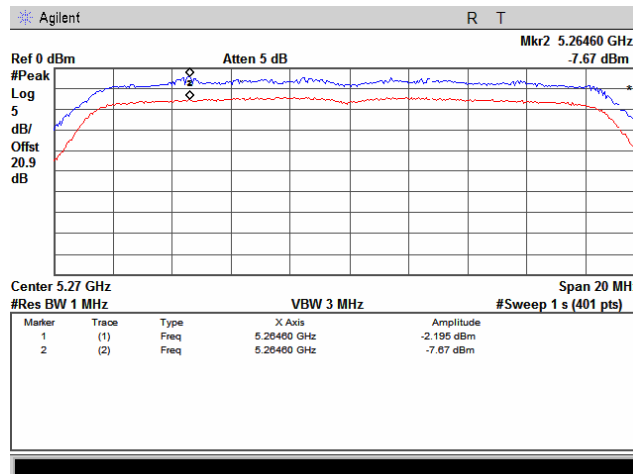



Test specification:	FCC section 15.407(a)(6), Ratio of the peak excursion of the modulation envelope to the peak transmit power		
Test procedure:	FCC Public Notice DA 02-2138, Appendix A		
Test mode:	Compliance	Verdict:	PASS
Date:	12/18/2008		
Temperature: 22 °C	Air Pressure: 1010 hPa	Relative Humidity: 48 %	Power Supply: 48 VDC
Remarks: EUT with 22.5 dBi antenna assembly gain			

Plot 7.2.3 Peak excursion measurement

Frequency:	5265 MHz
Channel BW:	10 MHz
Modulation parameters:	BPSK; 6.5 MBps

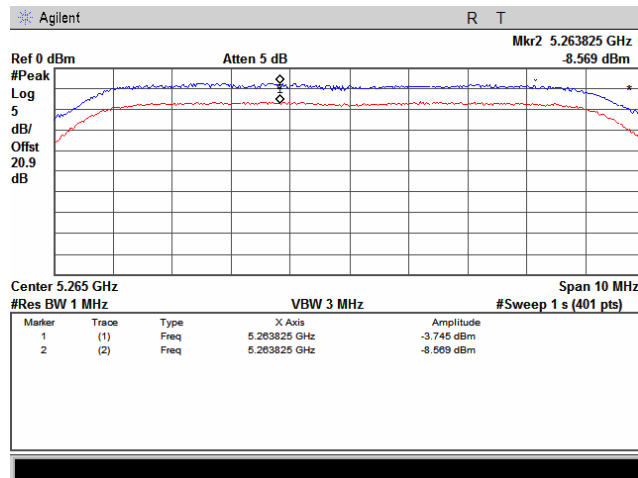

Plot 7.2.4 Peak excursion measurement

Frequency:	5265 MHz
Channel BW:	10 MHz
Modulation parameters:	QPSK; 65 MBps

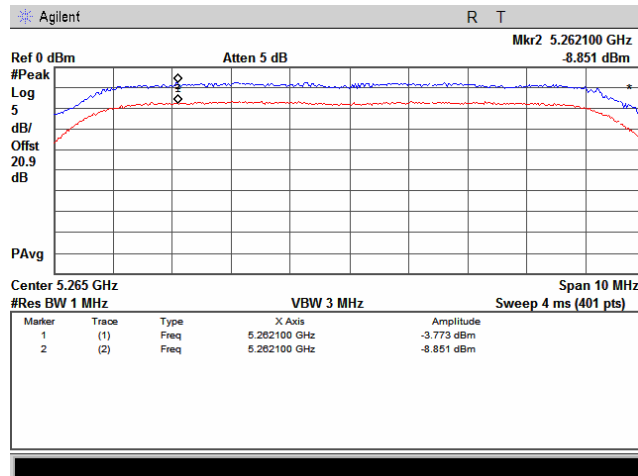



HERMON LABORATORIES

Test specification: FCC section 15.407(a)(6), Ratio of the peak excursion of the modulation envelope to the peak transmit power			
Test procedure: FCC Public Notice DA 02-2138, Appendix A			
Test mode: Compliance	Verdict: PASS		
Date: 12/18/2008			
Temperature: 22 °C	Air Pressure: 1010 hPa	Relative Humidity: 48 %	Power Supply: 48 VDC
Remarks: EUT with 22.5 dBi antenna assembly gain			

Plot 7.2.5 Peak excursion measurement

Frequency:	5260 MHz
Channel BW:	5 MHz
Modulation parameters:	BPSK; 3.25 MBps

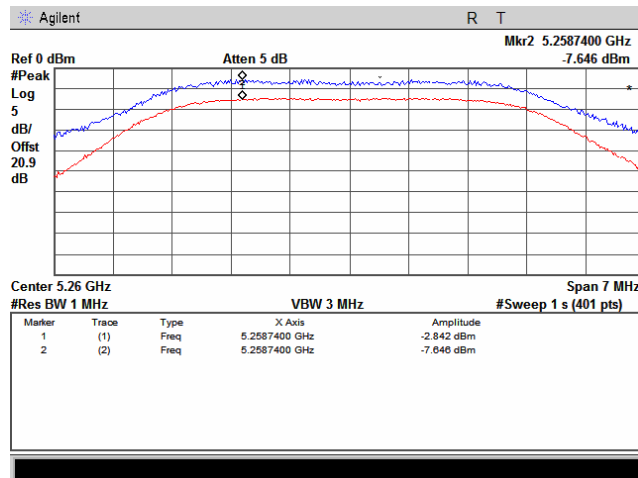

Plot 7.2.6 Peak excursion measurement

Frequency:	5260 MHz
Channel BW:	5 MHz
Modulation parameters:	64QAM; 32.5 MBps

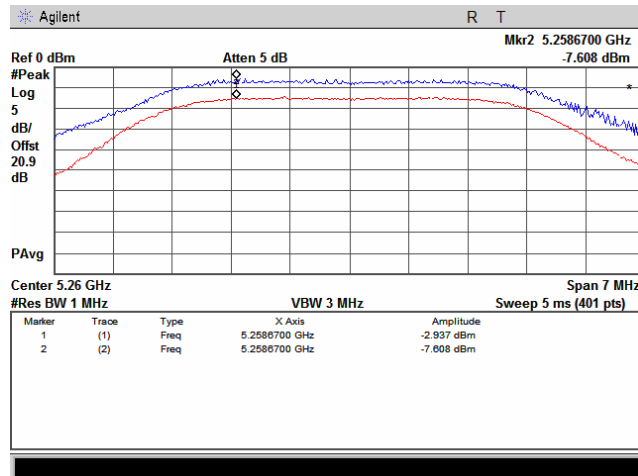



HERMON LABORATORIES

Test specification:	FCC section 15.407(a)(6), Ratio of the peak excursion of the modulation envelope to the peak transmit power		
Test procedure:	FCC Public Notice DA 02-2138, Appendix A		
Test mode:	Compliance	Verdict:	PASS
Date:	12/18/2008		
Temperature: 22 °C	Air Pressure: 1010 hPa	Relative Humidity: 48 %	Power Supply: 48 VDC
Remarks: EUT with 22.5 dBi antenna assembly gain			

Plot.7.2.7 Peak excursion measurement

Frequency: 5300 MHz
Channel BW: 20 MHz
Modulation parameters: BPSK; 13 MBps

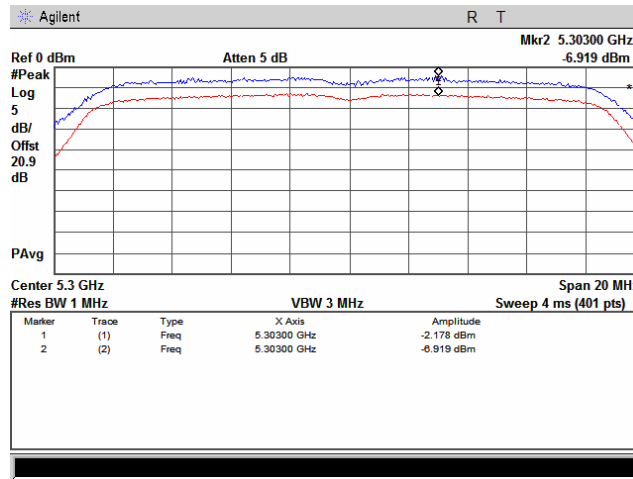

Plot.7.2.8 Peak excursion measurement

Frequency: 5300 MHz
Channel BW: 20 MHz
Modulation parameters: QPSK; 130 MBps

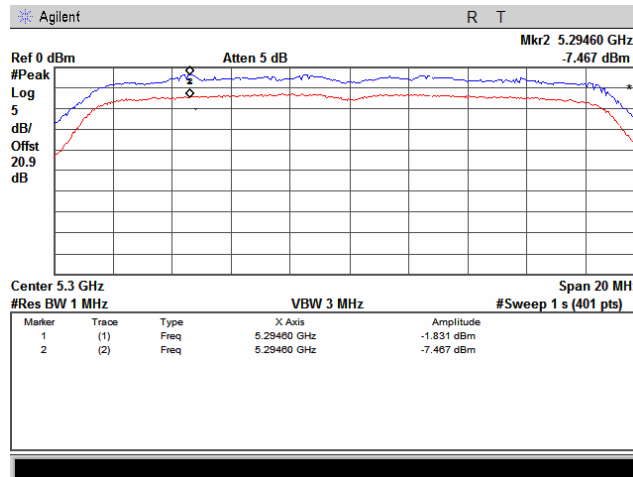



HERMON LABORATORIES

Test specification:	FCC section 15.407(a)(6), Ratio of the peak excursion of the modulation envelope to the peak transmit power		
Test procedure:	FCC Public Notice DA 02-2138, Appendix A		
Test mode:	Compliance	Verdict:	PASS
Date:	12/18/2008		
Temperature: 22 °C	Air Pressure: 1010 hPa	Relative Humidity: 48 %	Power Supply: 48 VDC
Remarks: EUT with 22.5 dBi antenna assembly gain			

Plot 7.2.9 Peak excursion measurement

Frequency:	5300 MHz
Channel BW:	10 MHz
Modulation parameters:	BPSK; 6.5 MBps

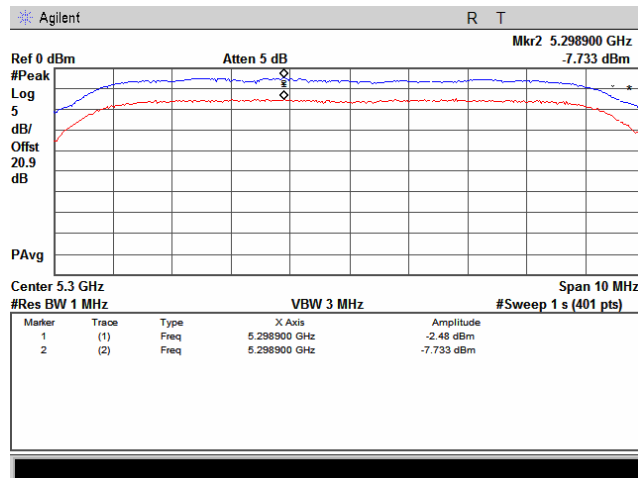

Plot 7.2.10 Peak excursion measurement

Frequency:	5300 MHz
Channel BW:	10 MHz
Modulation parameters:	QPSK; 65 MBps

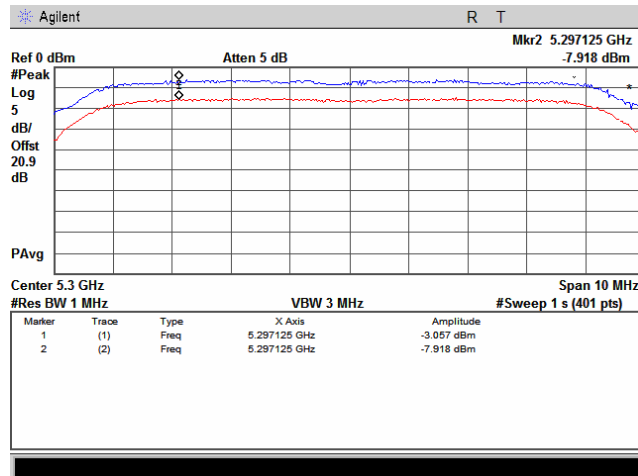



HERMON LABORATORIES

Test specification:	FCC section 15.407(a)(6), Ratio of the peak excursion of the modulation envelope to the peak transmit power		
Test procedure:	FCC Public Notice DA 02-2138, Appendix A		
Test mode:	Compliance	Verdict:	PASS
Date:	12/18/2008		
Temperature: 22 °C	Air Pressure: 1010 hPa	Relative Humidity: 48 %	Power Supply: 48 VDC
Remarks: EUT with 22.5 dBi antenna assembly gain			

Plot 7.2.11 Peak excursion measurement

Frequency:	5300 MHz
Channel BW:	5 MHz
Modulation parameters:	BPSK; 3.25 MBps

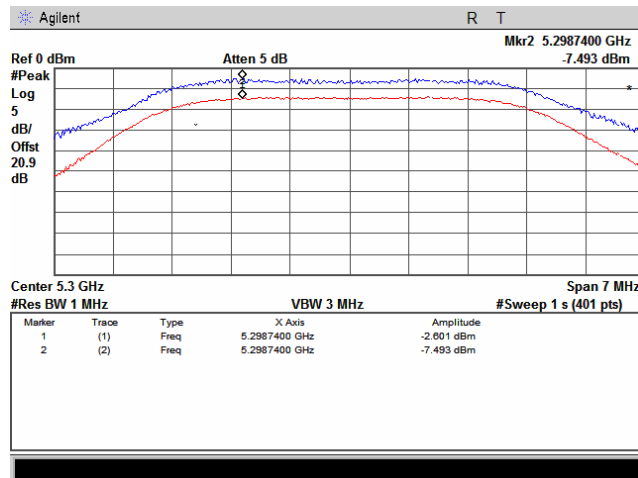

Plot 7.2.12 Peak excursion measurement

Frequency:	5300 MHz
Channel BW:	5 MHz
Modulation parameters:	64QAM; 32.5 MBps

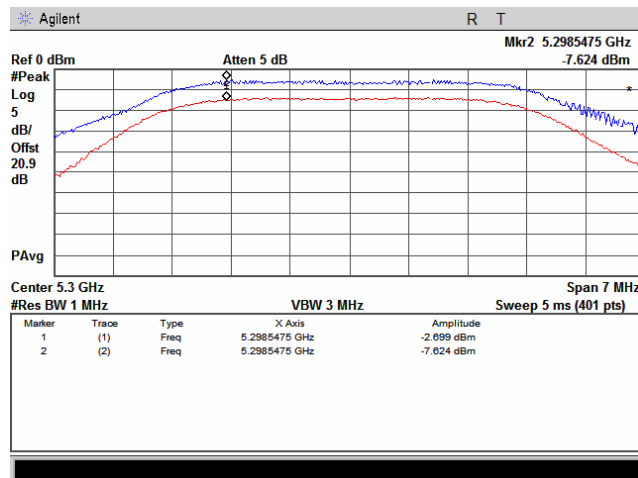



Test specification:	FCC section 15.407(a)(6), Ratio of the peak excursion of the modulation envelope to the peak transmit power		
Test procedure:	FCC Public Notice DA 02-2138, Appendix A		
Test mode:	Compliance	Verdict:	PASS
Date:	12/18/2008		
Temperature: 22 °C	Air Pressure: 1010 hPa	Relative Humidity: 48 %	Power Supply: 48 VDC
Remarks: EUT with 22.5 dBi antenna assembly gain			

Plot.7.2.13 Peak excursion measurement

Frequency: 5330 MHz
Channel BW: 20 MHz
Modulation parameters: BPSK; 13 MBps

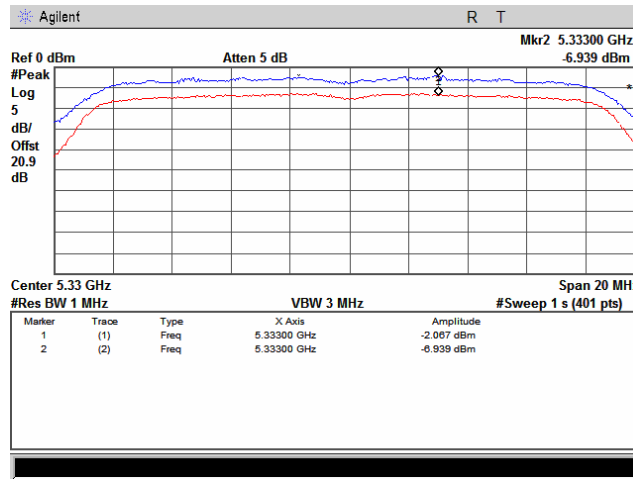

Plot.7.2.14 Peak excursion measurement

Frequency: 5330 MHz
Channel BW: 20 MHz
Modulation parameters: QPSK; 130 MBps

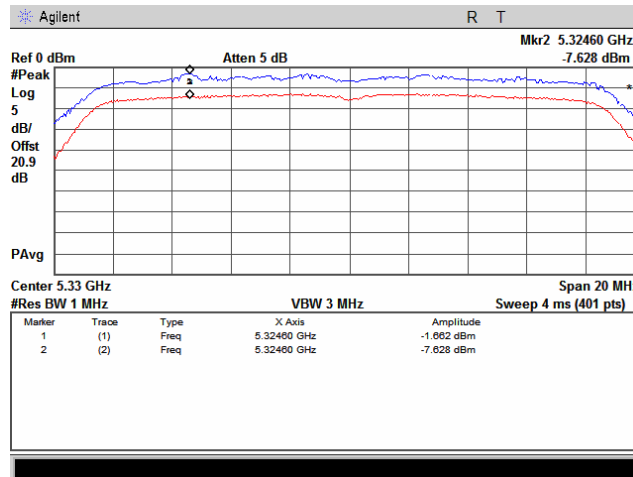



HERMON LABORATORIES

Test specification:	FCC section 15.407(a)(6), Ratio of the peak excursion of the modulation envelope to the peak transmit power		
Test procedure:	FCC Public Notice DA 02-2138, Appendix A		
Test mode:	Compliance	Verdict:	PASS
Date:	12/18/2008		
Temperature: 22 °C	Air Pressure: 1010 hPa	Relative Humidity: 48 %	Power Supply: 48 VDC
Remarks: EUT with 22.5 dBi antenna assembly gain			

Plot 7.2.15 Peak excursion measurement

Frequency:	5335 MHz
Channel BW:	10 MHz
Modulation parameters:	BPSK; 6.5 MBps

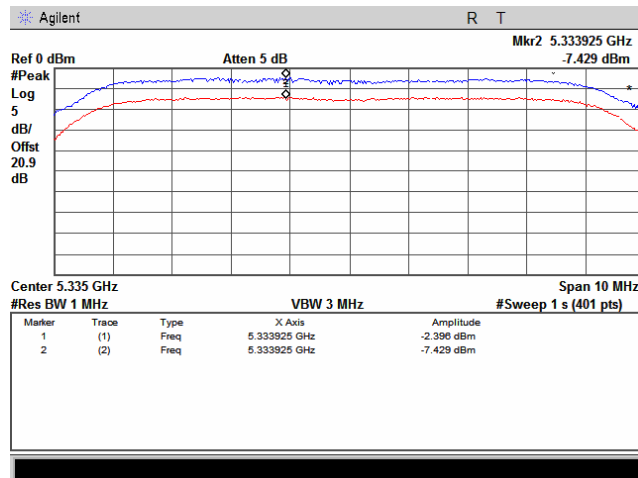

Plot 7.2.16 Peak excursion measurement

Frequency:	5335 MHz
Channel BW:	10 MHz
Modulation parameters:	QPSK; 65 MBps

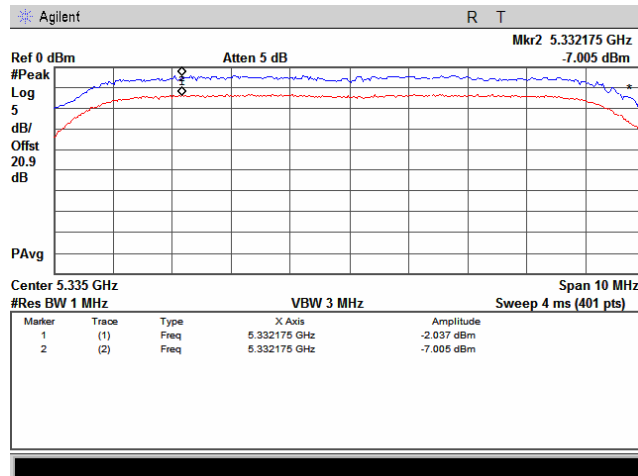



HERMON LABORATORIES

Test specification: FCC section 15.407(a)(6), Ratio of the peak excursion of the modulation envelope to the peak transmit power			
Test procedure: FCC Public Notice DA 02-2138, Appendix A			
Test mode: Compliance	Verdict: PASS		
Date: 12/18/2008			
Temperature: 22 °C	Air Pressure: 1010 hPa	Relative Humidity: 48 %	Power Supply: 48 VDC
Remarks: EUT with 22.5 dBi antenna assembly gain			

Plot 7.2.17 Peak excursion measurement

Frequency:	5340 MHz
Channel BW:	5 MHz
Modulation parameters:	BPSK; 3.25 MBps

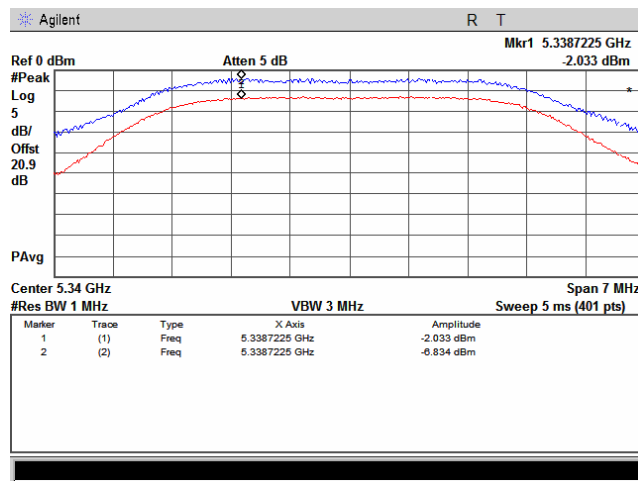

Plot 7.2.18 Peak excursion measurement

Frequency:	5340 MHz
Channel BW:	5 MHz
Modulation parameters:	64QAM; 32.5 MBps

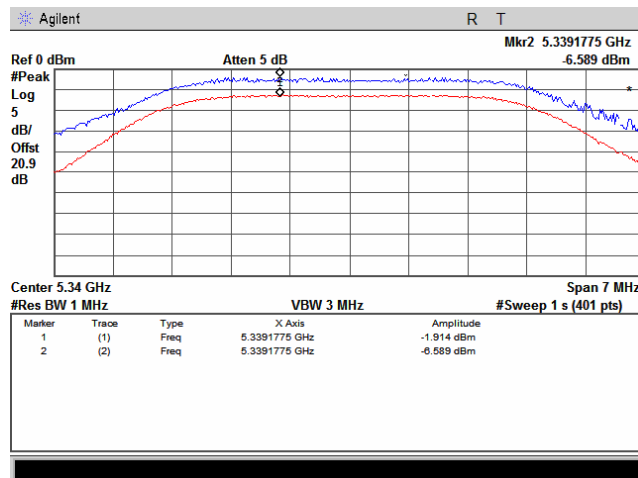



Test specification:	FCC section 15.407(a)(6), Ratio of the peak excursion of the modulation envelope to the peak transmit power		
Test procedure:	FCC Public Notice DA 02-2138, Appendix A		
Test mode:	Compliance	Verdict:	PASS
Date:	12/18/2008		
Temperature: 22 °C	Air Pressure: 1010 hPa	Relative Humidity: 48 %	Power Supply: 48 VDC
Remarks: EUT with 28 dBi antenna assembly gain			

Table 7.2.3 Peak excursion test results

ASSIGNED FREQUENCY RANGE: 5250 – 5350 MHz
 DETECTOR USED: 1-st trace: Peak, Max Hold
 2-nd trace: Peak, 100 Power Averaging
 TRANSMITTER OUTPUT POWER: 9.5 dBm at 20 MHz BW;
 7.5 dBm at 10 MHz BW;
 4 dBm at 5 MHz BW
 RESOLUTION BANDWIDTH: 1 MHz
 VIDEO BANDWIDTH: 3 MHz

Frequency, MHz	Bit Rate, MBps	1-st trace, dBm	2-nd trace, dBm	Peak excursion, dB	Limit, dB	Margin, dB	Verdict
Low channel							
5270	13	-8.808	-14.290	5.482	13	-7.518	Pass
5270	130	-8.529	-14.26	5.731	13	-7.269	Pass
5265	6.5	-8.268	-13.810	5.542	13	-7.458	Pass
5265	65	-7.719	-13.490	5.542	13	-7.458	Pass
5260	3.25	-8.075	-13.990	5.915	13	-7.085	Pass
5260	32.5	-8.161	-13.470	5.309	13	-7.691	Pass
Mid channel							
5300	13	-8.364	-13.340	4.976	13	-8.024	Pass
5300	130	-7.901	-14.030	6.129	13	-6.871	Pass
5300	6.5	-7.198	-12.41	5.212	13	-7.788	Pass
5300	65	-7.289	-12.280	4.991	13	-8.009	Pass
5300	3.25	-6.738	-11.790	5.052	13	-7.948	Pass
5300	32.5	-7.104	-12.490	5.386	13	-7.614	Pass
High channel							
5330	13	-8.22	-13.470	5.25	13	-7.75	Pass
5330	130	-7.922	-13.590	5.668	13	-7.332	Pass
5335	6.5	-6.558	-11.910	5.352	13	-7.648	Pass
5335	65	-6.835	-11.830	4.995	13	-8.005	Pass
5340	3.25	-6.505	-12.390	5.885	13	-7.115	Pass
5340	32.5	-6.763	-11.86	5.097	13	-7.903	Pass

* - Margin = Peak excursion – specification limit.

Reference numbers of test equipment used

HL 2780	HL 2883	HL 3180					
---------	---------	---------	--	--	--	--	--

Full description is given in Appendix A.

Test specification:	FCC section 15.407(a)(6), Ratio of the peak excursion of the modulation envelope to the peak transmit power		
Test procedure:	FCC Public Notice DA 02-2138, Appendix A		
Test mode:	Compliance	Verdict:	PASS
Date:	12/18/2008		
Temperature: 22 °C	Air Pressure: 1010 hPa	Relative Humidity: 48 %	Power Supply: 48 VDC
Remarks: EUT with 28 dBi antenna assembly gain			

Plot.7.2.19 Peak excursion measurement

Frequency: 5270 MHz
Channel BW: 20 MHz
Modulation parameters: BPSK; 13 MBps

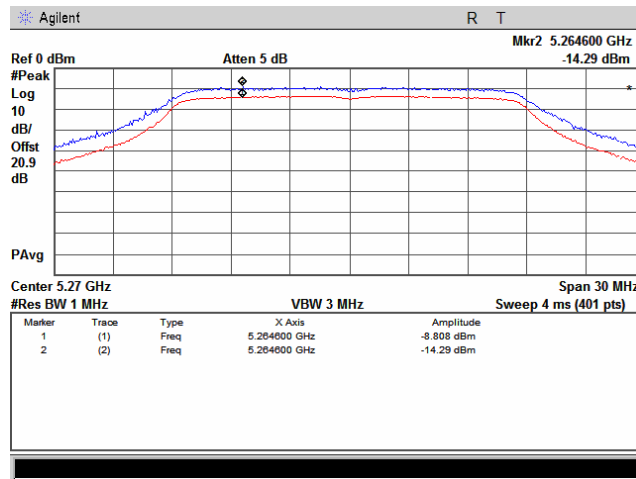

Plot.7.2.20 Peak excursion measurement

Frequency: 5270 MHz
Channel BW: 20 MHz
Modulation parameters: QPSK; 130 MBps

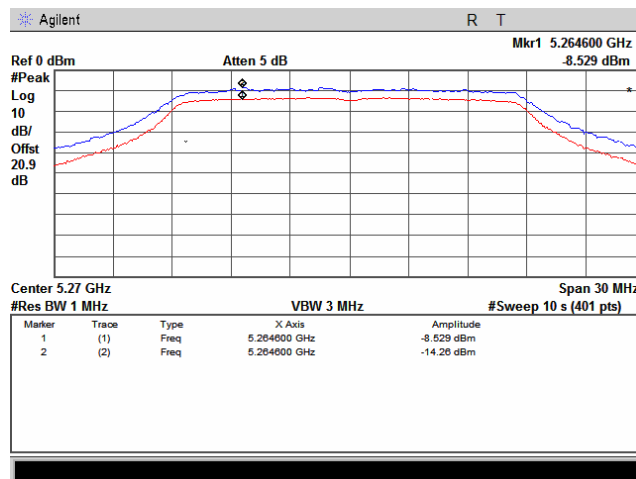

Test specification:	FCC section 15.407(a)(6), Ratio of the peak excursion of the modulation envelope to the peak transmit power		
Test procedure:	FCC Public Notice DA 02-2138, Appendix A		
Test mode:	Compliance	Verdict:	PASS
Date:	12/18/2008		
Temperature: 22 °C	Air Pressure: 1010 hPa	Relative Humidity: 48 %	Power Supply: 48 VDC
Remarks: EUT with 28 dBi antenna assembly gain			

Plot 7.2.21 Peak excursion measurement

Frequency:	5265 MHz
Channel BW:	10 MHz
Modulation parameters:	BPSK; 6.5 MBps

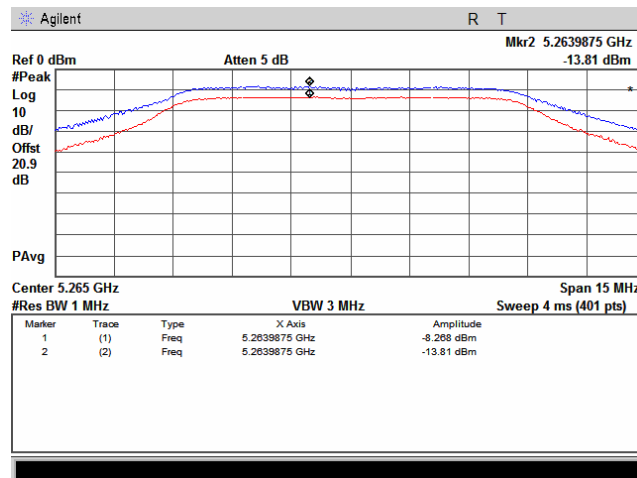

Plot 7.2.22 Peak excursion measurement

Frequency:	5265 MHz
Channel BW:	10 MHz
Modulation parameters:	QPSK; 65 MBps

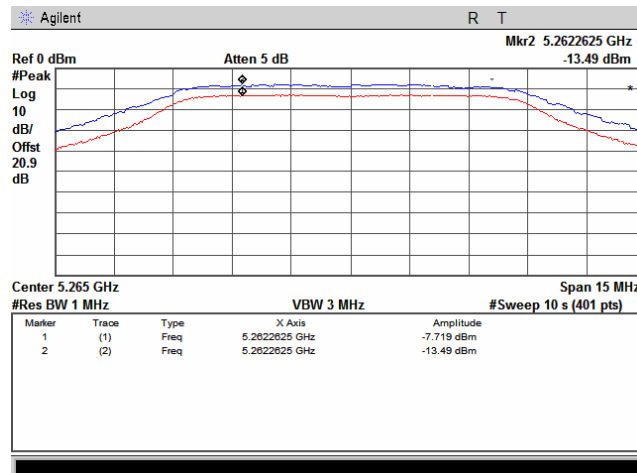

Test specification:	FCC section 15.407(a)(6), Ratio of the peak excursion of the modulation envelope to the peak transmit power		
Test procedure:	FCC Public Notice DA 02-2138, Appendix A		
Test mode:	Compliance	Verdict:	PASS
Date:	12/18/2008		
Temperature: 22 °C	Air Pressure: 1010 hPa	Relative Humidity: 48 %	Power Supply: 48 VDC
Remarks: EUT with 28 dBi antenna assembly gain			

Plot 7.2.23 Peak excursion measurement

Frequency:	5260 MHz
Channel BW:	5 MHz
Modulation parameters:	BPSK; 3.25 MBps

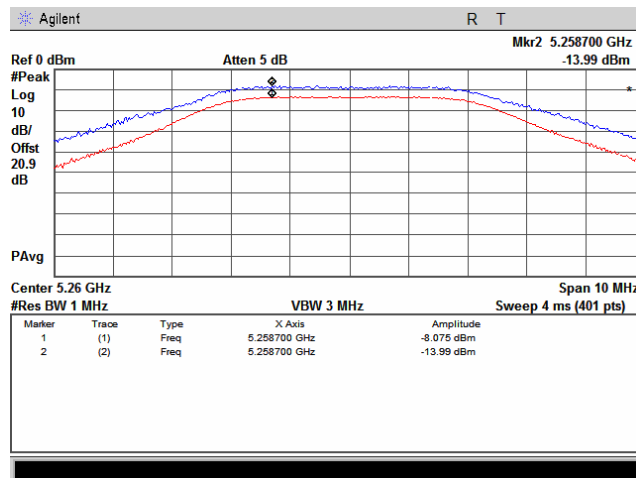

Plot 7.2.24 Peak excursion measurement

Frequency:	5260 MHz
Channel BW:	5 MHz
Modulation parameters:	64QAM; 32.5 MBps

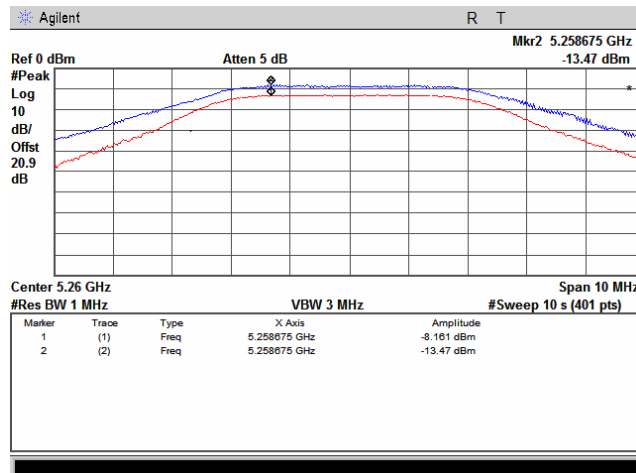

Test specification:	FCC section 15.407(a)(6), Ratio of the peak excursion of the modulation envelope to the peak transmit power		
Test procedure:	FCC Public Notice DA 02-2138, Appendix A		
Test mode:	Compliance	Verdict:	PASS
Date:	12/18/2008		
Temperature: 22 °C	Air Pressure: 1010 hPa	Relative Humidity: 48 %	Power Supply: 48 VDC
Remarks: EUT with 28 dBi antenna assembly gain			

Plot.7.2.25 Peak excursion measurement

Frequency: 5300 MHz
Channel BW: 20 MHz
Modulation parameters: BPSK; 13 MBps

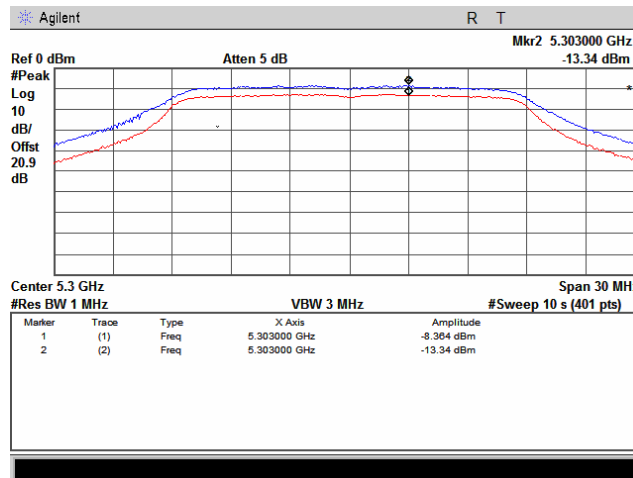

Plot.7.2.26 Peak excursion measurement

Frequency: 5300 MHz
Channel BW: 20 MHz
Modulation parameters: QPSK; 130 MBps

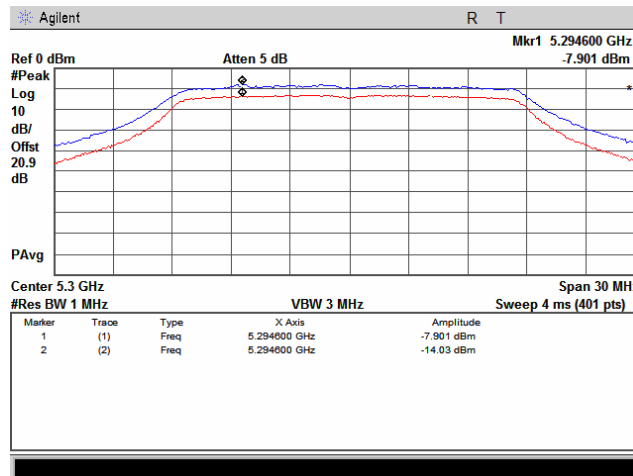

Test specification:	FCC section 15.407(a)(6), Ratio of the peak excursion of the modulation envelope to the peak transmit power		
Test procedure:	FCC Public Notice DA 02-2138, Appendix A		
Test mode:	Compliance	Verdict:	PASS
Date:	12/18/2008		
Temperature: 22 °C	Air Pressure: 1010 hPa	Relative Humidity: 48 %	Power Supply: 48 VDC
Remarks: EUT with 28 dBi antenna assembly gain			

Plot 7.2.27 Peak excursion measurement

Frequency:	5300 MHz
Channel BW:	10 MHz
Modulation parameters:	BPSK; 6.5 MBps

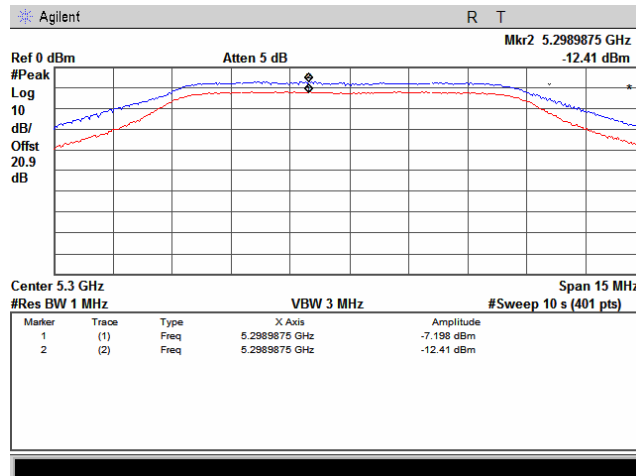

Plot 7.2.28 Peak excursion measurement

Frequency:	5300 MHz
Channel BW:	10 MHz
Modulation parameters:	QPSK; 65 MBps

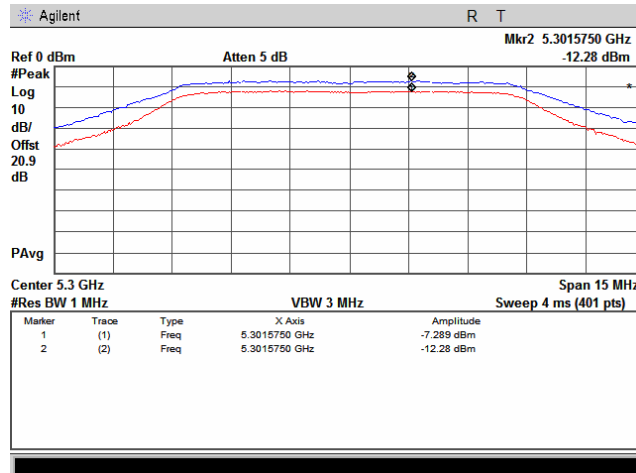

Test specification:	FCC section 15.407(a)(6), Ratio of the peak excursion of the modulation envelope to the peak transmit power		
Test procedure:	FCC Public Notice DA 02-2138, Appendix A		
Test mode:	Compliance	Verdict:	PASS
Date:	12/18/2008		
Temperature: 22 °C	Air Pressure: 1010 hPa	Relative Humidity: 48 %	Power Supply: 48 VDC
Remarks: EUT with 28 dBi antenna assembly gain			

Plot 7.2.29 Peak excursion measurement

Frequency:	5300 MHz
Channel BW:	5 MHz
Modulation parameters:	BPSK; 3.25 MBps

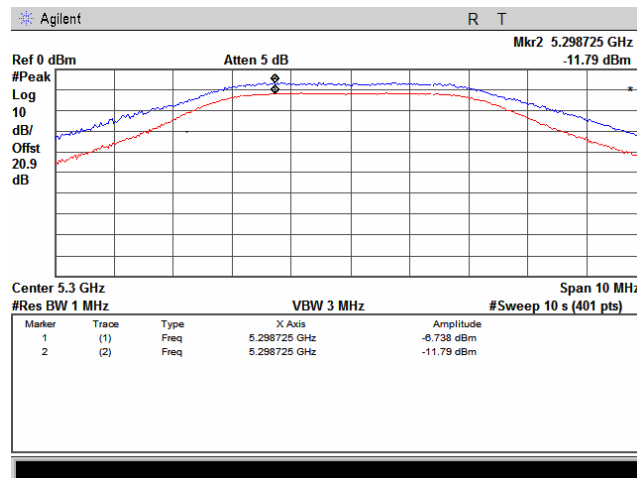

Plot 7.2.30 Peak excursion measurement

Frequency:	5300 MHz
Channel BW:	5 MHz
Modulation parameters:	64QAM; 32.5 MBps

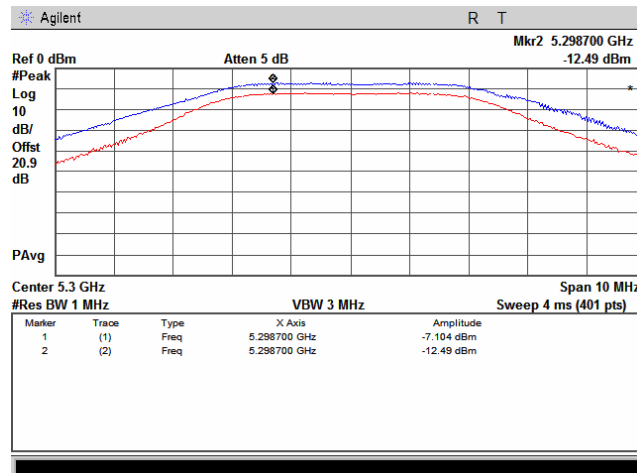

Test specification:	FCC section 15.407(a)(6), Ratio of the peak excursion of the modulation envelope to the peak transmit power		
Test procedure:	FCC Public Notice DA 02-2138, Appendix A		
Test mode:	Compliance	Verdict:	PASS
Date:	12/18/2008		
Temperature: 22 °C	Air Pressure: 1010 hPa	Relative Humidity: 48 %	Power Supply: 48 VDC
Remarks: EUT with 28 dBi antenna assembly gain			

Plot.7.2.31 Peak excursion measurement

Frequency: 5330 MHz
Channel BW: 20 MHz
Modulation parameters: BPSK; 13 MBps

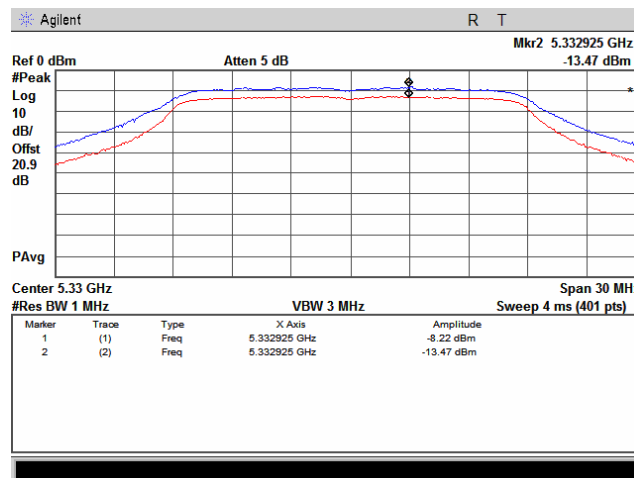

Plot.7.2.32 Peak excursion measurement

Frequency: 5330 MHz
Channel BW: 20 MHz
Modulation parameters: QPSK; 130 MBps

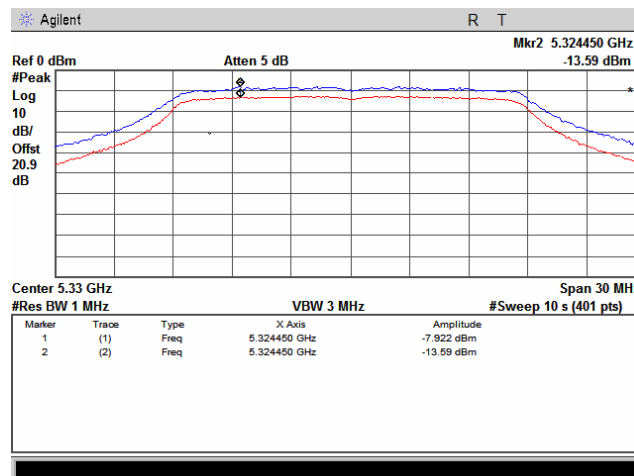

Test specification:	FCC section 15.407(a)(6), Ratio of the peak excursion of the modulation envelope to the peak transmit power		
Test procedure:	FCC Public Notice DA 02-2138, Appendix A		
Test mode:	Compliance	Verdict:	PASS
Date:	12/18/2008		
Temperature: 22 °C	Air Pressure: 1010 hPa	Relative Humidity: 48 %	Power Supply: 48 VDC
Remarks: EUT with 28 dBi antenna assembly gain			

Plot 7.2.33 Peak excursion measurement

Frequency:	5335 MHz
Channel BW:	10 MHz
Modulation parameters:	BPSK; 6.5 MBps

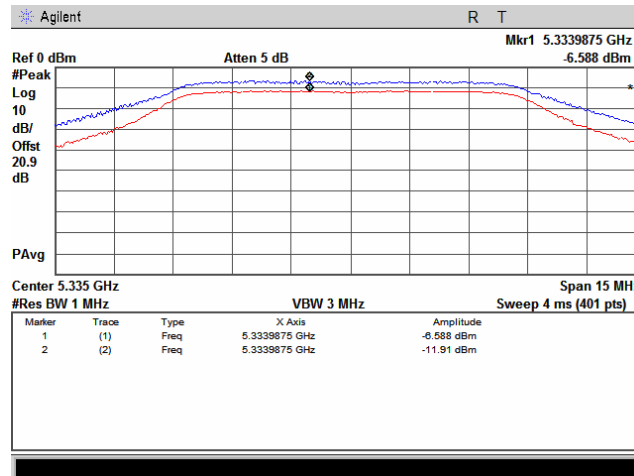

Plot 7.2.34 Peak excursion measurement

Frequency:	5335 MHz
Channel BW:	10 MHz
Modulation parameters:	QPSK; 65 MBps

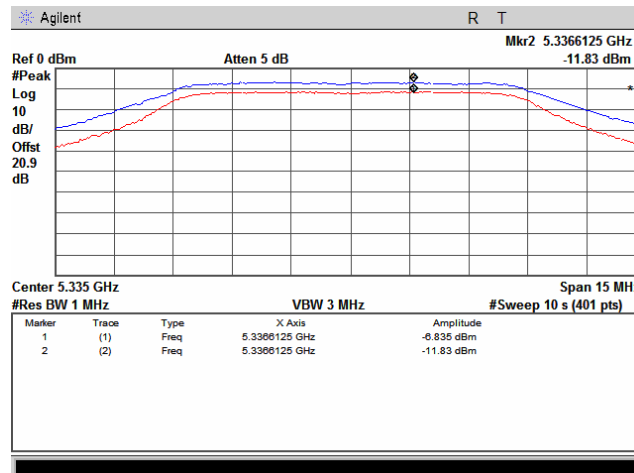

Test specification:	FCC section 15.407(a)(6), Ratio of the peak excursion of the modulation envelope to the peak transmit power		
Test procedure:	FCC Public Notice DA 02-2138, Appendix A		
Test mode:	Compliance	Verdict:	PASS
Date:	12/18/2008		
Temperature: 22 °C	Air Pressure: 1010 hPa	Relative Humidity: 48 %	Power Supply: 48 VDC
Remarks: EUT with 28 dBi antenna assembly gain			

Plot 7.2.35 Peak excursion measurement

Frequency:	5340 MHz
Channel BW:	5 MHz
Modulation parameters:	BPSK; 3.25 MBps

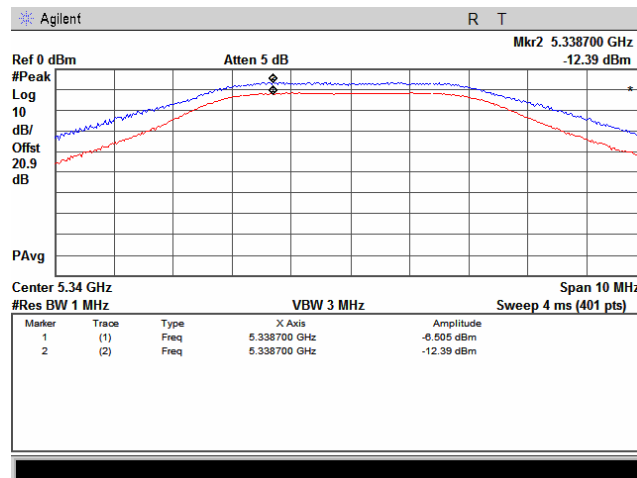

Plot 7.2.36 Peak excursion measurement

Frequency:	5340 MHz
Channel BW:	5 MHz
Modulation parameters:	64QAM; 32.5 MBps

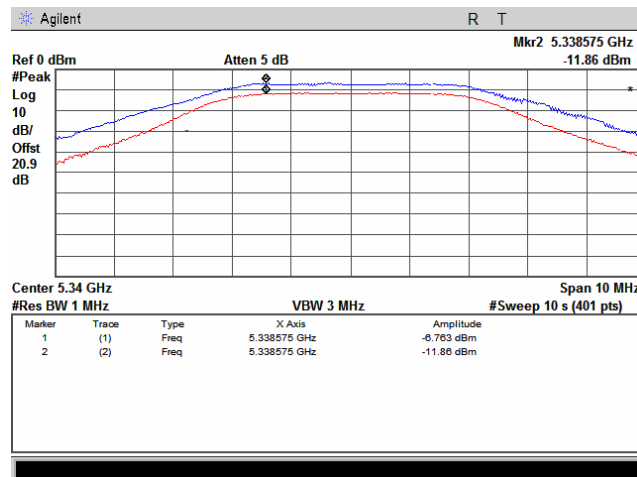



Test specification:	FCC section 15.407(b), RSS-210 Annex 9, section A9.2 Unwanted radiated emissions		
Test procedure:	Public notice DA 00-705 / ANSI C63.4, Section 13.1.4		
Test mode:	Compliance	Verdict:	PASS
Date:	12/29/2008		
Temperature: 21°C	Air Pressure: 1014 hPa	Relative Humidity: 44 %	Power Supply: 48 VDC
Remarks:			

7.3 Field strength of spurious emissions

7.3.1 General

This test was performed to measure field strength of spurious emissions from the EUT. Specification test limits are given in Table 7.3.1, Table 7.3.2.

Table 7.3.1 Radiated spurious emissions limits below 1 GHz and within restricted bands above 1 GHz

Frequency, MHz	Field strength at 3 m, dB(μ V/m) ^{***}		
	Peak	Quasi Peak	Average
0.009 – 0.490*	NA	128.5 – 93.8**	NA
0.490 – 1.705*		73.8 – 63.0**	
1.705 – 30.0*		69.5**	
30 – 88		40.0	
88 – 216		43.5	
216 – 960		46.0	
960 - 1000		54.0	
Above 1000		74.0	

*- The limit for 3 m test distance was calculated using the inverse square distance extrapolation factor as follows:
$$\text{LimS2} = \text{LimS1} + 40 \log(S1/S2),$$

where S1 and S2 – standard defined and test distance respectively in meters.

** - The limit decreases linearly with the logarithm of frequency.

*** - The field strength limits applied from the lowest radio frequency generated in the device, without going below 9 kHz up to the tenth harmonic of the highest fundamental frequency.

Table 7.3.2 EIRP of undesirable emissions limits outside restricted bands (above 1 GHz)

Frequency band, GHz	Out of band EIRP, dBm/MHz	Field strength at 3 m, dB(μ V/m)
5.47 – 5.725	-27	68.23

7.3.2 Test procedure for spurious emission field strength measurements in 9 kHz to 30 MHz band

7.3.2.1 The EUT was set up as shown in Figure 7.3.1, energized and the performance check was conducted.

7.3.2.2 The specified frequency range was investigated with antenna connected to spectrum analyzer/ EMI receiver. To find maximum radiation the turntable was rotated 360° and the measuring antenna was rotated around its vertical axis.

7.3.2.3 The worst test results (the lowest margins) were recorded and shown in the associated plots.

7.3.3 Test procedure for spurious emission field strength measurements above 30 MHz

7.3.3.1 The EUT was set up as shown in Figure 7.3.2, energized and the performance check was conducted.

7.3.3.2 The specified frequency range was investigated with antenna connected to spectrum analyzer/ EMI receiver. To find maximum radiation the turntable was rotated 360°, the measuring antenna height was changed from 1 to 4 m, its polarization was switched from vertical to horizontal.

7.3.3.3 The worst test results (the lowest margins) were recorded and shown in the associated plots.



Test specification:	FCC section 15.407(b), RSS-210 Annex 9, section A9.2 Unwanted radiated emissions		
Test procedure:	Public notice DA 00-705 / ANSI C63.4, Section 13.1.4		
Test mode:	Compliance	Verdict:	PASS
Date:	12/29/2008		
Temperature: 21°C	Air Pressure: 1014 hPa	Relative Humidity: 44 %	Power Supply: 48 VDC
Remarks:			

Figure 7.3.1 Setup for spurious emission field strength measurements below 30 MHz

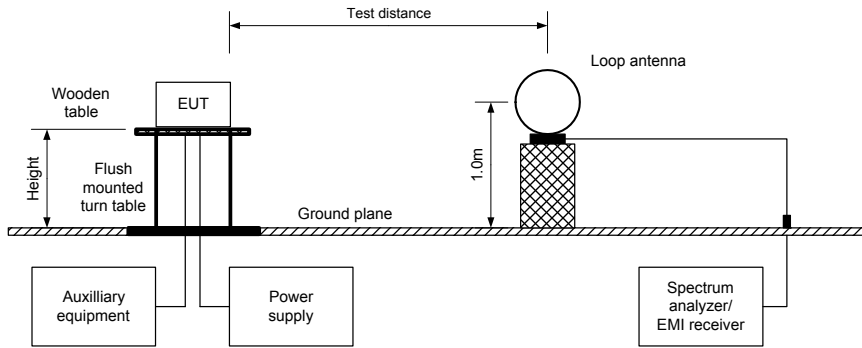
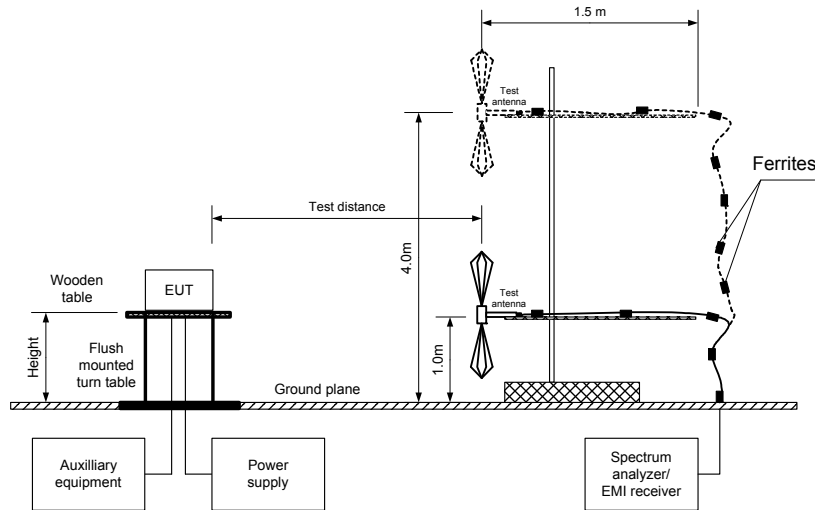

Figure 7.3.2 Setup for spurious emission field strength measurements above 30 MHz





HERMON LABORATORIES

Test specification:		FCC section 15.407(b), RSS-210 Annex 9, section A9.2 Unwanted radiated emissions	
Test procedure:		Public notice DA 00-705 / ANSI C63.4, Section 13.1.4	
Test mode:	Compliance	Verdict:	PASS
Date:	12/29/2008		
Temperature: 21°C	Air Pressure: 1014 hPa	Relative Humidity: 44 %	Power Supply: 48 VDC
Remarks: EUT with 22.5 dBi antenna assembly gain			

Table 7.3.3 Field strength of spurious emissions below 1 GHz

ASSIGNED FREQUENCY RANGE: 5250 - 5350 MHz
 INVESTIGATED FREQUENCY RANGE: 0.009 - 1000 MHz
 TEST SITE: Semi Anechoic Chamber
 TEST DISTANCE: 3 m
 MODULATION: OFDM BPSK***
 BIT RATE: 3.25 Mbps***
 DUTY CYCLE: 100 %
 TRANSMITTER OUTPUT POWER: Maximum
 RESOLUTION BANDWIDTH: 1.0 kHz (9 kHz – 150 kHz)
 9.0 kHz (150 kHz – 30 MHz)
 120 kHz (30 MHz – 1000 MHz)
 VIDEO BANDWIDTH: > Resolution bandwidth
 TEST ANTENNA TYPE: Active loop (9 kHz – 30 MHz)
 Biconilog (30 MHz – 1000 MHz)
 Double ridged guide (above 1000 MHz)

Frequency, MHz	Peak, dB(µV/m)	Quasi-peak dB(µV/m)			Antenna polariz.	Antenna height, m	Turntable position**, degrees	Verdict	
		Measured emission, dB(µV/m)	Limit, dB(µV/m)	Margin, dB*					
Low channel (5260 MHz)									
800.00	37.70	34.50	46.00	-11.50	Vertical	1.6	0	Pass	
892.00	40.50	38.80	46.00	-7.20	Vertical	1.4	120		
933.30	39.30	37.30	46.00	-8.70	Vertical	1.1	120		
Mid channel (5300 MHz)									
800.0	38.10	34.40	46.00	-11.60	Vertical	1.6	90		
892.00	40.40	38.50	46.00	-7.50	Vertical	1.4	120		
933.3	39.50	37.40	46.00	-8.60	Vertical	1.1	120		
High channel (5340 MHz)									
800.00	37.30	34.50	46.00	-11.50	Vertical	1.6	0		
892.00	40.30	38.70	46.00	-7.30	Vertical	1.4	120		
933.3	39.60	37.30	46.00	-8.70	Vertical	1.1	120		

*- Margin = Measured emission – specification limit.
 **- EUT front panel refers to 0 degrees position of turntable.
 ***- as the worst case in peak power spectral density test.

Reference numbers of test equipment used

HL 0446	HL 0521	HL 0589	HL 0604	HL 1425	HL 1556	HL 1984	HL 1947
HL 2009	HL 2909						

Full description is given in Appendix A.



Test specification: FCC section 15.407(b), RSS-210 Annex 9, section A9.2 Unwanted radiated emissions	
Test procedure: Public notice DA 00-705 / ANSI C63.4, Section 13.1.4	
Test mode: Compliance	Verdict: PASS
Date: 12/29/2008	
Temperature: 21°C	Air Pressure: 1014 hPa
Relative Humidity: 44 %	
Power Supply: 48 VDC	
Remarks: EUT with 22.5 dBi antenna assembly gain	

Table 7.3.4 Field strength of spurious emissions above 1 GHz

ASSIGNED FREQUENCY RANGE: 5250 - 5350 MHz
 INVESTIGATED FREQUENCY RANGE: 0.009 - 40000 MHz
 TEST SITE: Semi Anechoic Chamber
 TEST DISTANCE: 3 m
 MODULATION: OFDM BPSK***
 BIT RATE: 3.25 Mbps***
 DUTY CYCLE: 100 %
 TRANSMITTER OUTPUT POWER: Maximum
 RESOLUTION BANDWIDTH: 1000 kHz
 VIDEO BANDWIDTH: > Resolution bandwidth
 TEST ANTENNA TYPE: Double ridged guide (above 1000 MHz)

Frequency, MHz	Peak, dB(µV/m)			Average dB(µV/m)			Ant. polariz.	Ant. height, m	Turntable position**, degrees	Verdict	
	Measured emission, dB(µV/m)	Limit, dB(µV/m)	Margin, dB*	Measured emission, dB(µV/m)	Limit, dB(µV/m)	Margin, dB*					
Low channel (5260 MHz)											
1600.010	45.79	74.00	-28.21	40.39	54.00	-13.61	Vertical	1.0	0	Pass	
Mid channel (5300 MHz)											
1599.950	45.70	74.00	-28.30	40.45	54.00	-13.55	Vertical	1.0	0		
High channel (5340 MHz)											
1599.945	45.97	74.00	-28.03	40.41	54.00	-13.59	Vertical	1.6	0		
5378.175	56.36	74.00	-17.64	43.97	54.00	-10.03	Vertical	1.0	0		
5381.875	55.72	74.00	-18.28	42.50	54.00	-11.50	Vertical	1.0	0		

*- Margin = Measured emission – specification limit.
 **- EUT front panel refers to 0 degrees position of turntable.
 ***- as the worst case in peak power spectral density test.

Reference numbers of test equipment used

HL 0446	HL 0521	HL 0589	HL 0604	HL 1425	HL 1556	HL 1984	HL 1947
HL 2009	HL 2909						

Full description is given in Appendix A.



Test specification: FCC section 15.407(b), RSS-210 Annex 9, section A9.2 Unwanted radiated emissions	
Test procedure: Public notice DA 00-705 / ANSI C63.4, Section 13.1.4	
Test mode: Compliance	Verdict: PASS
Date: 12/29/2008	
Temperature: 21°C	Air Pressure: 1014 hPa
Relative Humidity: 44 %	
Power Supply: 48 VDC	
Remarks: EUT with 22.5 dBi antenna assembly gain	

Table 7.3.5 Restricted bands

MHz	MHz	MHz	MHz	MHz	GHz
0.09 - 0.11	8.37625 - 8.38675	73 - 74.6	399.9 - 410	2690 - 2900	10.6 - 12.7
0.495 - 0.505	8.41425 - 8.41475	74.8 - 75.2	608 - 614	3260 - 3267	13.25 - 13.4
2.1735 - 2.1905	12.29 - 12.293	108 - 121.94	960 - 1240	3332 - 3339	14.47 - 14.5
4.125 - 4.128	12.51975 - 12.52025	123 - 138	1300 - 1427	3345.8 - 3358	15.35 - 16.2
4.17725 - 4.17775	12.57675 - 12.57725	149.9 - 150.05	1435 - 1626.5	3600 - 4400	17.7 - 21.4
4.20725 - 4.20775	13.36 - 13.41	156.52475 - 156.52525	1645.5 - 1646.5	4500 - 5150	22.01 - 23.12
6.215 - 6.218	16.42 - 16.423	156.7 - 156.9	1660 - 1710	5350 - 5460	23.6 - 24
6.26775 - 6.26825	16.69475 - 16.69525	162.0125 - 167.17	1718.8 - 1722.2	7250 - 7750	31.2 - 31.8
6.31175 - 6.31225	16.80425 - 16.80475	167.72 - 173.2	2200 - 2300	8025 - 8500	36.43 - 36.5
8.291 - 8.294	25.5 - 25.67	240 - 285	2310 - 2390	9000 - 9200	Above 38.6
8.362 - 8.366	37.5 - 38.25	322 - 335.4	2483.5 - 2500	9300 - 9500	



HERMON LABORATORIES

Test specification: FCC section 15.407(b), RSS-210 Annex 9, section A9.2 Unwanted radiated emissions			
Test procedure: Public notice DA 00-705 / ANSI C63.4, Section 13.1.4			
Test mode: Compliance	Verdict: PASS		
Date: 12/29/2008			
Temperature: 21°C	Air Pressure: 1014 hPa	Relative Humidity: 44 %	Power Supply: 48 VDC
Remarks: EUT with 22.5 dBi antenna assembly gain			

Plot 7.3.1 Radiated emission measurements from 9 to 150 kHz at the low carrier frequency

TEST SITE: Anechoic chamber
TEST DISTANCE: 3 m
ANTENNA POLARIZATION: Vertical and Horizontal

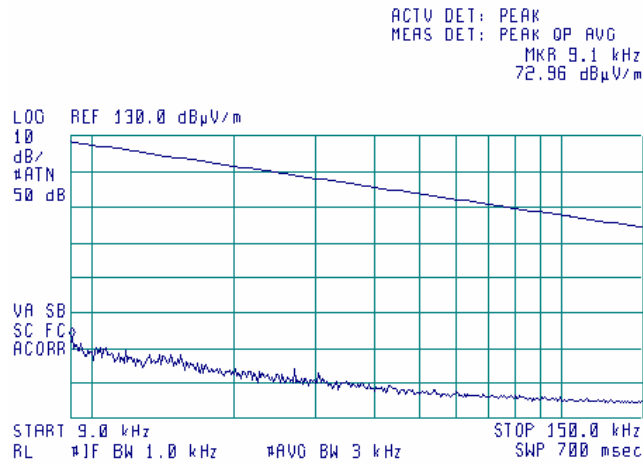

Plot 7.3.2 Radiated emission measurements from 9 to 150 kHz at the mid carrier frequency

TEST SITE: Anechoic chamber
TEST DISTANCE: 3 m
ANTENNA POLARIZATION: Vertical and Horizontal

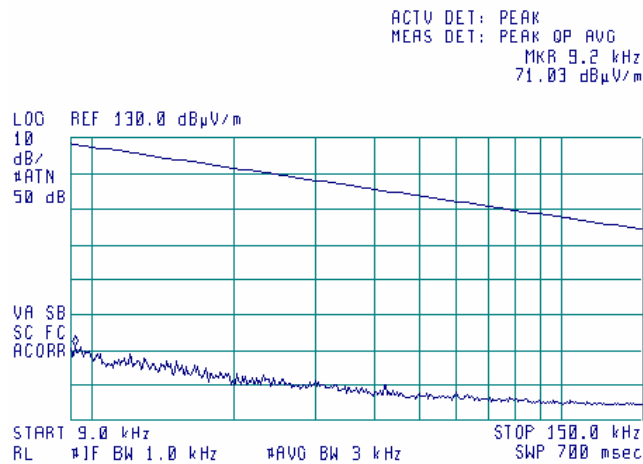



HERMON LABORATORIES

Test specification: FCC section 15.407(b), RSS-210 Annex 9, section A9.2 Unwanted radiated emissions			
Test procedure: Public notice DA 00-705 / ANSI C63.4, Section 13.1.4			
Test mode: Compliance	Verdict: PASS		
Date: 12/29/2008			
Temperature: 21°C	Air Pressure: 1014 hPa	Relative Humidity: 44 %	Power Supply: 48 VDC
Remarks: EUT with 22.5 dBi antenna assembly gain			

Plot 7.3.3 Radiated emission measurements from 9 to 150 kHz at the high carrier frequency

TEST SITE: Anechoic chamber
TEST DISTANCE: 3 m
ANTENNA POLARIZATION: Vertical and Horizontal

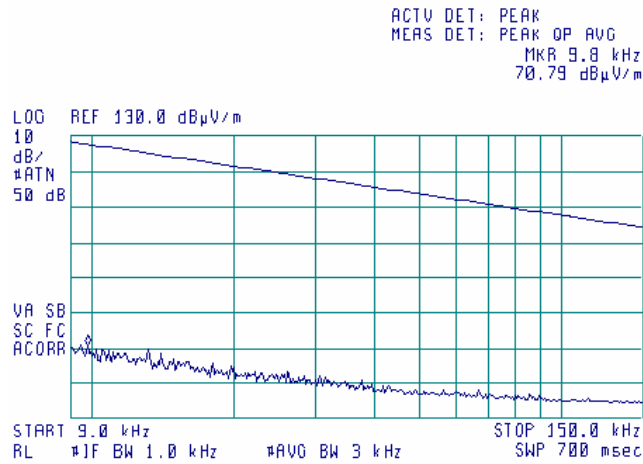

Plot 7.3.4 Radiated emission measurements from 0.15 MHz to 30 MHz at the low carrier frequency

TEST SITE: Anechoic chamber
TEST DISTANCE: 3 m
ANTENNA POLARIZATION: Vertical and Horizontal

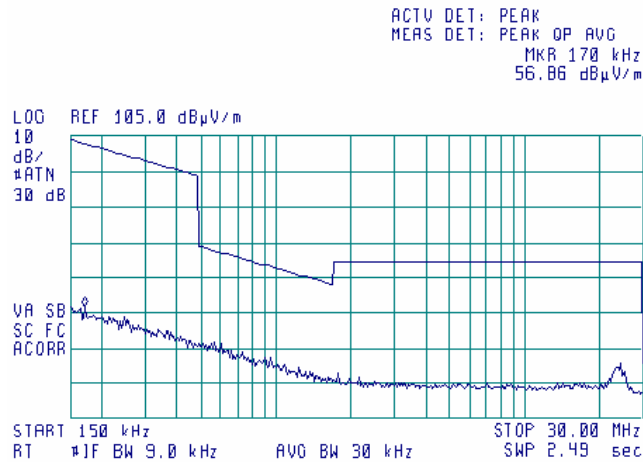



HERMON LABORATORIES

Test specification: FCC section 15.407(b), RSS-210 Annex 9, section A9.2 Unwanted radiated emissions			
Test procedure: Public notice DA 00-705 / ANSI C63.4, Section 13.1.4			
Test mode: Compliance	Verdict: PASS		
Date: 12/29/2008			
Temperature: 21°C	Air Pressure: 1014 hPa	Relative Humidity: 44 %	Power Supply: 48 VDC
Remarks: EUT with 22.5 dBi antenna assembly gain			

Plot 7.3.5 Radiated emission measurements from 0.15 MHz to 30 MHz at the mid carrier frequency

TEST SITE: Anechoic chamber
TEST DISTANCE: 3 m
ANTENNA POLARIZATION: Vertical and Horizontal

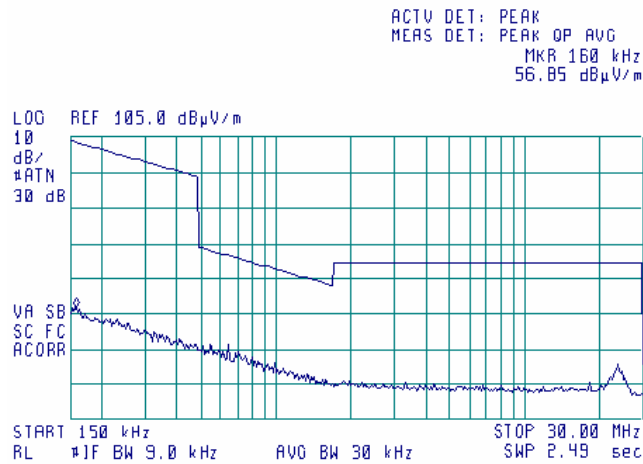

Plot 7.3.6 Radiated emission measurements from 0.15 MHz to 30 MHz at the high carrier frequency

TEST SITE: Anechoic chamber
TEST DISTANCE: 3 m
ANTENNA POLARIZATION: Vertical and Horizontal

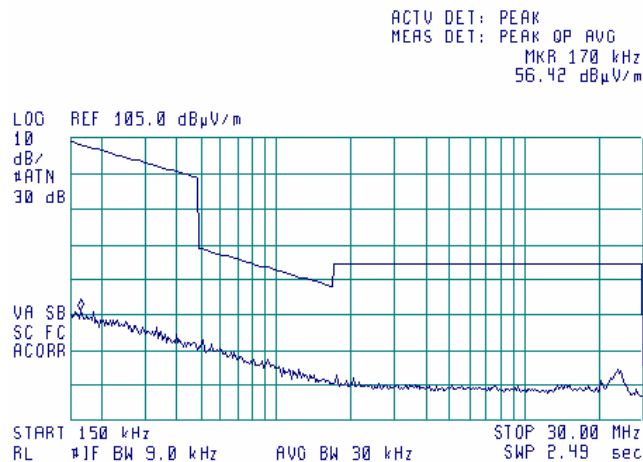



HERMON LABORATORIES

Test specification: FCC section 15.407(b), RSS-210 Annex 9, section A9.2 Unwanted radiated emissions			
Test procedure: Public notice DA 00-705 / ANSI C63.4, Section 13.1.4			
Test mode: Compliance	Verdict: PASS		
Date: 12/29/2008			
Temperature: 21°C	Air Pressure: 1014 hPa	Relative Humidity: 44 %	Power Supply: 48 VDC
Remarks: EUT with 22.5 dBi antenna assembly gain			

Plot 7.3.7 Radiated emission measurements from 30 MHz to 1000 MHz at the low carrier frequency

TEST SITE: Semi Anechoic chamber
TEST DISTANCE: 3 m
ANTENNA POLARIZATION: Vertical and Horizontal

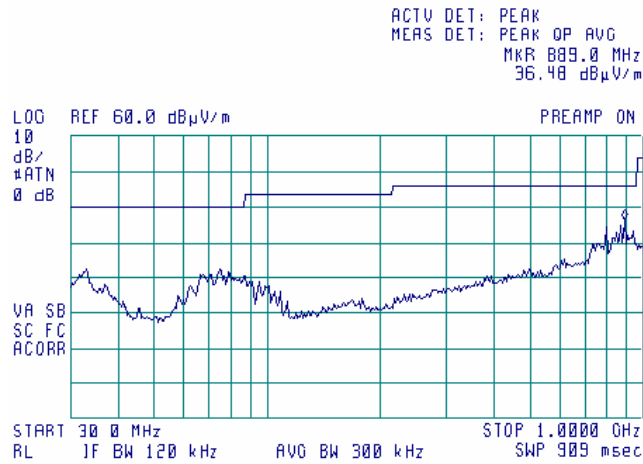

Plot 7.3.8 Radiated emission measurements from 30 MHz to 1000 MHz at the mid carrier frequency

TEST SITE: Anechoic chamber
TEST DISTANCE: 3 m
ANTENNA POLARIZATION: Vertical and Horizontal

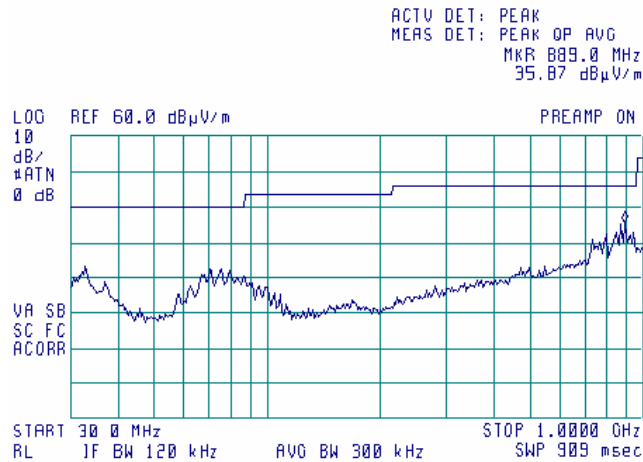



HERMON LABORATORIES

Test specification:		FCC section 15.407(b), RSS-210 Annex 9, section A9.2 Unwanted radiated emissions	
Test procedure:		Public notice DA 00-705 / ANSI C63.4, Section 13.1.4	
Test mode:	Compliance	Verdict:	PASS
Date:	12/29/2008		
Temperature: 21°C	Air Pressure: 1014 hPa	Relative Humidity: 44 %	Power Supply: 48 VDC
Remarks: EUT with 22.5 dBi antenna assembly gain			

Plot 7.3.9 Radiated emission measurements from 30 MHz to 1000 MHz at the high carrier frequency

TEST SITE: Anechoic chamber
 TEST DISTANCE: 3 m
 ANTENNA POLARIZATION: Vertical and Horizontal

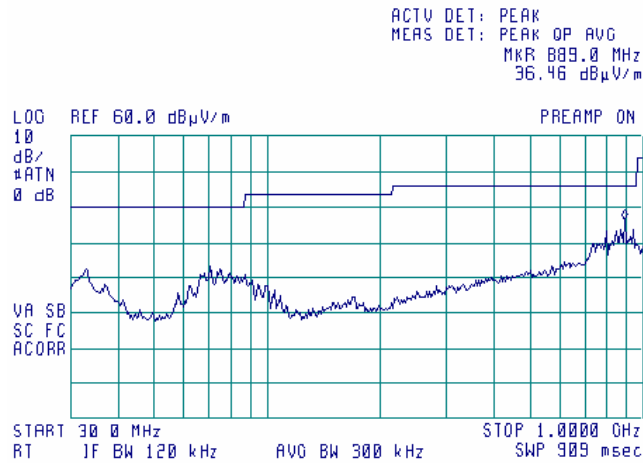



HERMON LABORATORIES

Test specification: FCC section 15.407(b), RSS-210 Annex 9, section A9.2 Unwanted radiated emissions			
Test procedure: Public notice DA 00-705 / ANSI C63.4, Section 13.1.4			
Test mode: Compliance	Verdict: PASS		
Date: 12/29/2008			
Temperature: 21°C	Air Pressure: 1014 hPa	Relative Humidity: 44 %	Power Supply: 48 VDC
Remarks: EUT with 22.5 dBi antenna assembly gain			

Plot 7.3.10 Radiated emission measurements from 1.0 to 5.15 GHz at the low carrier frequency

TEST SITE: Anechoic chamber
 TEST DISTANCE: 3 m
 ANTENNA POLARIZATION: Vertical and Horizontal
 DETECTOR: Peak

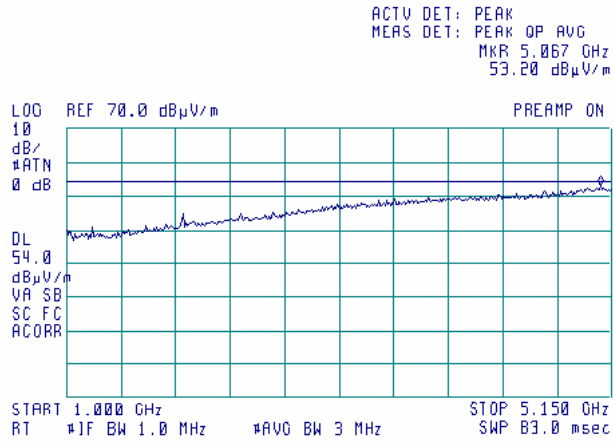

Plot 7.3.11 Radiated emission measurements from 1.0 to 5.15 GHz at the low carrier frequency

TEST SITE: Anechoic chamber
 TEST DISTANCE: 3 m
 ANTENNA POLARIZATION: Vertical and Horizontal
 DETECTOR: Average

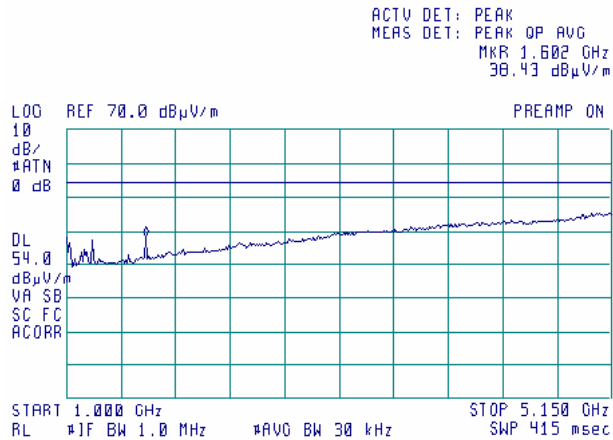



HERMON LABORATORIES

Test specification: FCC section 15.407(b), RSS-210 Annex 9, section A9.2 Unwanted radiated emissions			
Test procedure: Public notice DA 00-705 / ANSI C63.4, Section 13.1.4			
Test mode: Compliance	Verdict: PASS		
Date: 12/29/2008			
Temperature: 21°C	Air Pressure: 1014 hPa	Relative Humidity: 44 %	Power Supply: 48 VDC
Remarks: EUT with 22.5 dBi antenna assembly gain			

Plot 7.3.12 Radiated emission measurements from 1.0 to 5.15 GHz at the mid carrier frequency

TEST SITE: Anechoic chamber
 TEST DISTANCE: 3 m
 ANTENNA POLARIZATION: Vertical and Horizontal
 DETECTOR: Peak

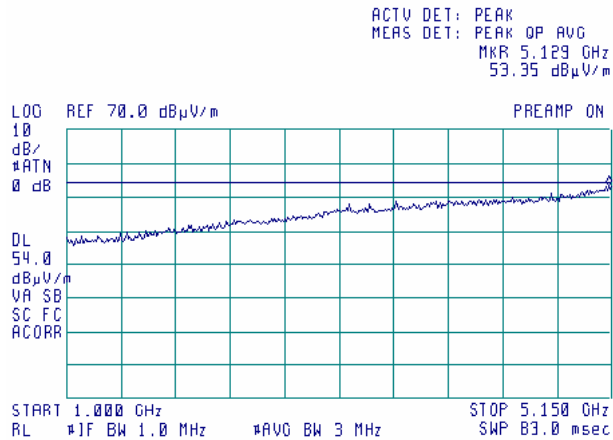

Plot 7.3.13 Radiated emission measurements from 1.0 to 5.15 GHz at the mid carrier frequency

TEST SITE: Anechoic chamber
 TEST DISTANCE: 3 m
 ANTENNA POLARIZATION: Vertical and Horizontal
 DETECTOR: Average

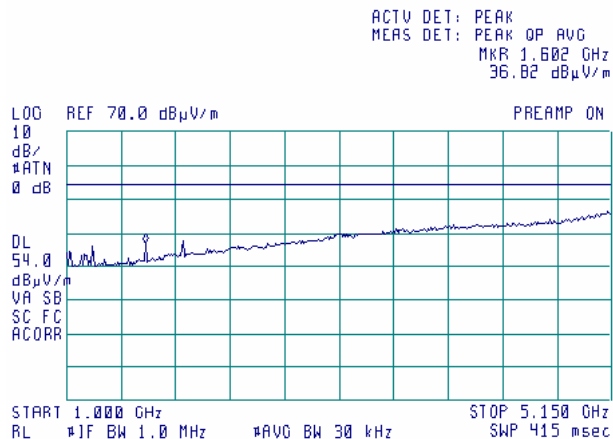



HERMON LABORATORIES

Test specification: FCC section 15.407(b), RSS-210 Annex 9, section A9.2 Unwanted radiated emissions			
Test procedure: Public notice DA 00-705 / ANSI C63.4, Section 13.1.4			
Test mode: Compliance	Verdict: PASS		
Date: 12/29/2008			
Temperature: 21°C	Air Pressure: 1014 hPa	Relative Humidity: 44 %	Power Supply: 48 VDC
Remarks: EUT with 22.5 dBi antenna assembly gain			

Plot 7.3.14 Radiated emission measurements from 1.0 to 5.15 GHz at the high carrier frequency

TEST SITE: Anechoic chamber
TEST DISTANCE: 3 m
ANTENNA POLARIZATION: Vertical and Horizontal
DETECTOR: Peak

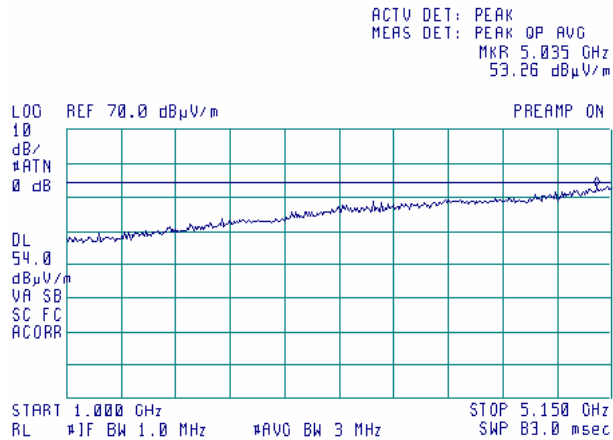

Plot 7.3.15 Radiated emission measurements from 1.0 to 5.15 GHz at the high carrier frequency

TEST SITE: Anechoic chamber
TEST DISTANCE: 3 m
ANTENNA POLARIZATION: Vertical and Horizontal
DETECTOR: Average

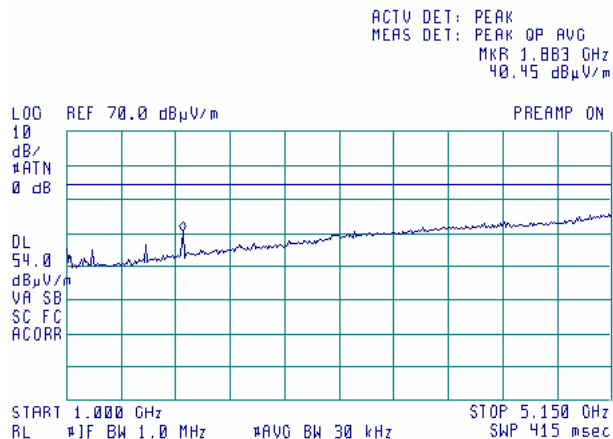



HERMON LABORATORIES

Test specification: FCC section 15.407(b), RSS-210 Annex 9, section A9.2 Unwanted radiated emissions			
Test procedure: Public notice DA 00-705 / ANSI C63.4, Section 13.1.4			
Test mode: Compliance	Verdict: PASS		
Date: 12/29/2008			
Temperature: 21°C	Air Pressure: 1014 hPa	Relative Humidity: 44 %	Power Supply: 48 VDC
Remarks: EUT with 22.5 dBi antenna assembly gain			

Plot 7.3.16 Radiated emission measurements from 5.35 to 5.46 GHz at the low carrier frequency

TEST SITE: Anechoic chamber
TEST DISTANCE: 3 m
ANTENNA POLARIZATION: Vertical and Horizontal
DETECTOR: Peak

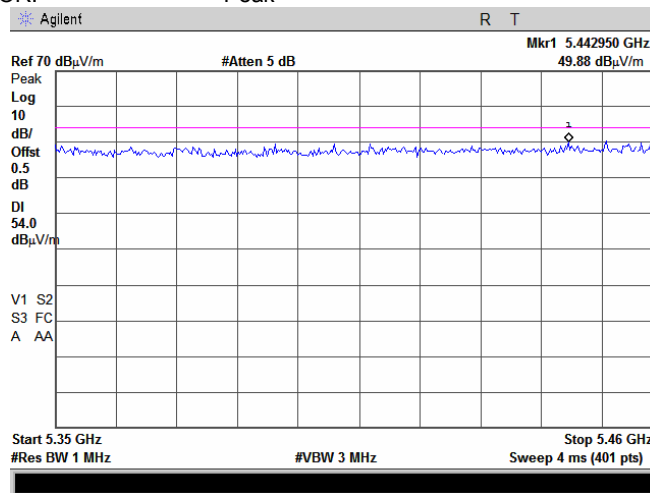

Plot 7.3.17 Radiated emission measurements from 5.35 to 5.46 GHz at the mid carrier frequency

TEST SITE: Anechoic chamber
TEST DISTANCE: 3 m
ANTENNA POLARIZATION: Vertical and Horizontal
DETECTOR: Peak

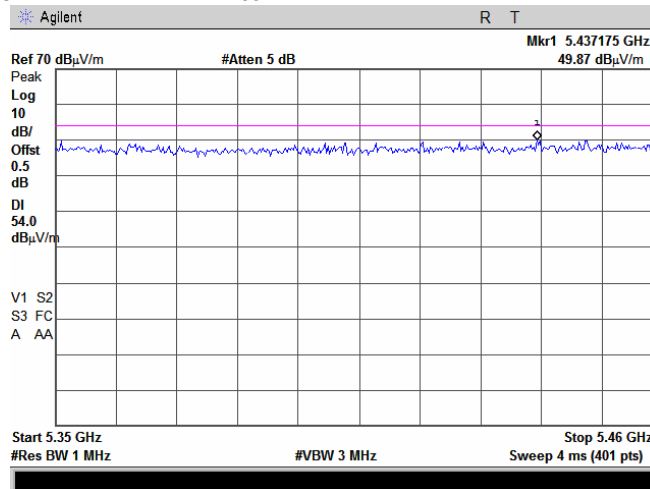



HERMON LABORATORIES

Test specification:	FCC section 15.407(b), RSS-210 Annex 9, section A9.2 Unwanted radiated emissions		
Test procedure:	Public notice DA 00-705 / ANSI C63.4, Section 13.1.4		
Test mode:	Compliance	Verdict:	PASS
Date:	12/29/2008		
Temperature: 21°C	Air Pressure: 1014 hPa	Relative Humidity: 44 %	Power Supply: 48 VDC
Remarks: EUT with 22.5 dBi antenna assembly gain			

Plot 7.3.18 Radiated emission measurements from 5.35 to 5.46 GHz at the high carrier frequency

TEST SITE: Anechoic chamber
 TEST DISTANCE: 3 m
 ANTENNA POLARIZATION: Vertical and Horizontal
 DETECTOR: Peak

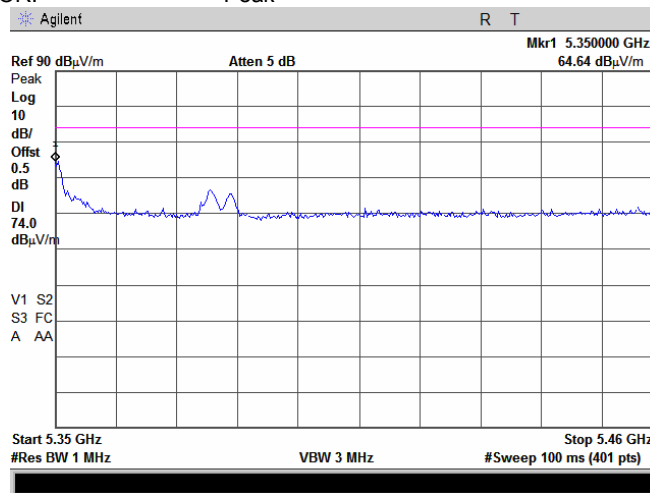

Plot 7.3.19 Radiated emission measurements from 5.35 to 5.46 GHz at the high carrier frequency

TEST SITE: Anechoic chamber
 TEST DISTANCE: 3 m
 ANTENNA POLARIZATION: Vertical and Horizontal
 DETECTOR: Average

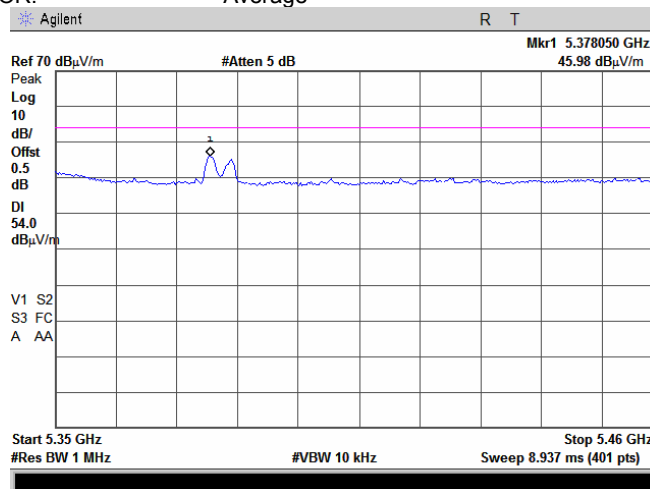



HERMON LABORATORIES

Test specification: FCC section 15.407(b), RSS-210 Annex 9, section A9.2 Unwanted radiated emissions			
Test procedure: Public notice DA 00-705 / ANSI C63.4, Section 13.1.4			
Test mode: Compliance	Verdict: PASS		
Date: 12/29/2008			
Temperature: 21°C	Air Pressure: 1014 hPa	Relative Humidity: 44 %	Power Supply: 48 VDC
Remarks: EUT with 22.5 dBi antenna assembly gain			

Plot 7.3.20 Radiated emission measurements from 5.46 to 8.0 GHz at the low carrier frequency

TEST SITE: Anechoic chamber
TEST DISTANCE: 3 m
ANTENNA POLARIZATION: Vertical and Horizontal
DETECTOR: Peak

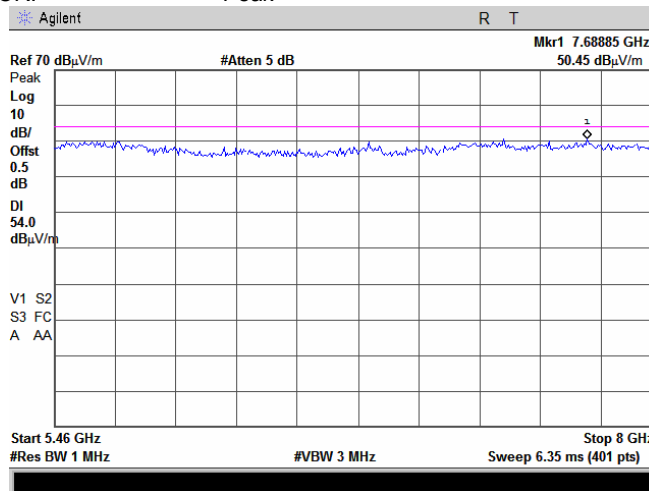

Plot 7.3.21 Radiated emission measurements from 5.46 to 8.0 GHz at the mid carrier frequency

TEST SITE: Anechoic chamber
TEST DISTANCE: 3 m
ANTENNA POLARIZATION: Vertical and Horizontal
DETECTOR: Peak

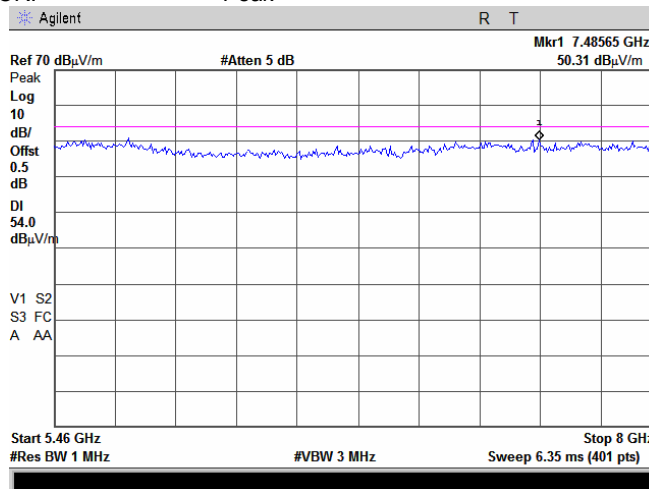



HERMON LABORATORIES

Test specification: FCC section 15.407(b), RSS-210 Annex 9, section A9.2 Unwanted radiated emissions			
Test procedure: Public notice DA 00-705 / ANSI C63.4, Section 13.1.4			
Test mode: Compliance	Verdict: PASS		
Date: 12/29/2008			
Temperature: 21°C	Air Pressure: 1014 hPa	Relative Humidity: 44 %	Power Supply: 48 VDC
Remarks: EUT with 22.5 dBi antenna assembly gain			

Plot 7.3.22 Radiated emission measurements from 5.46 to 8.0 GHz at the high carrier frequency

TEST SITE: Anechoic chamber
TEST DISTANCE: 3 m
ANTENNA POLARIZATION: Vertical and Horizontal
DETECTOR: Peak

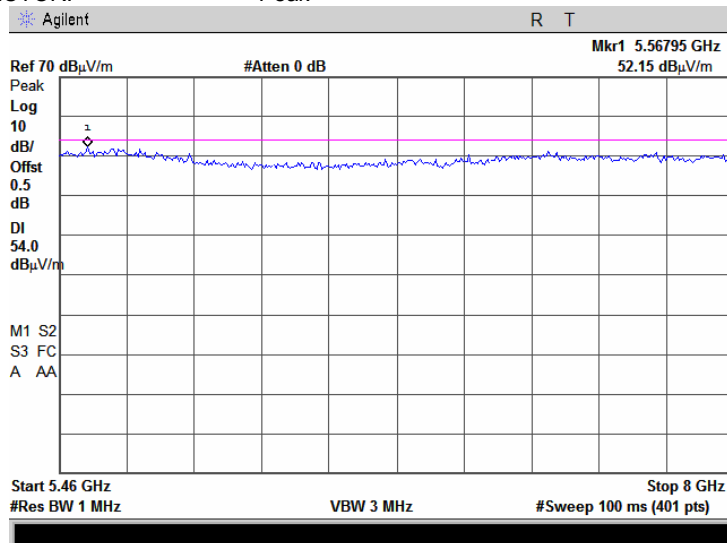



HERMON LABORATORIES

Test specification: FCC section 15.407(b), RSS-210 Annex 9, section A9.2 Unwanted radiated emissions			
Test procedure: Public notice DA 00-705 / ANSI C63.4, Section 13.1.4			
Test mode: Compliance	Verdict: PASS		
Date: 12/29/2008			
Temperature: 21°C	Air Pressure: 1014 hPa	Relative Humidity: 44 %	Power Supply: 48 VDC
Remarks: EUT with 22.5 dBi antenna assembly gain			

Plot 7.3.23 Radiated emission measurements from 8 to 18 GHz at the low carrier frequency

TEST SITE: Anechoic chamber
 TEST DISTANCE: 3 m
 ANTENNA POLARIZATION: Vertical and Horizontal
 DETECTOR: Peak

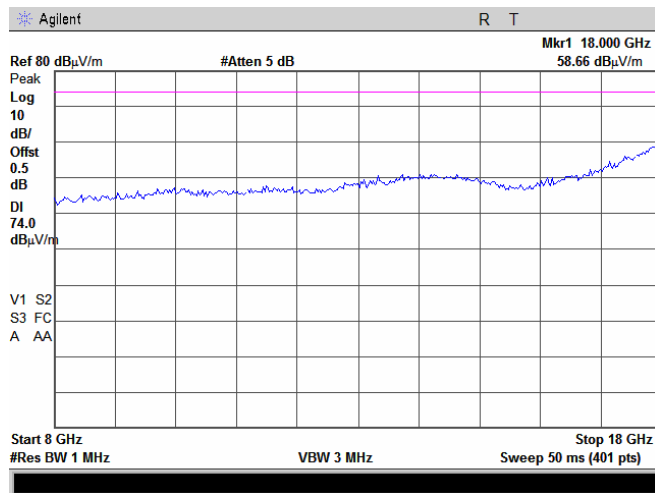

Plot 7.3.24 Radiated emission measurements from 8 to 18 GHz at the low carrier frequency

TEST SITE: Anechoic chamber
 TEST DISTANCE: 3 m
 ANTENNA POLARIZATION: Vertical and Horizontal
 DETECTOR: Average

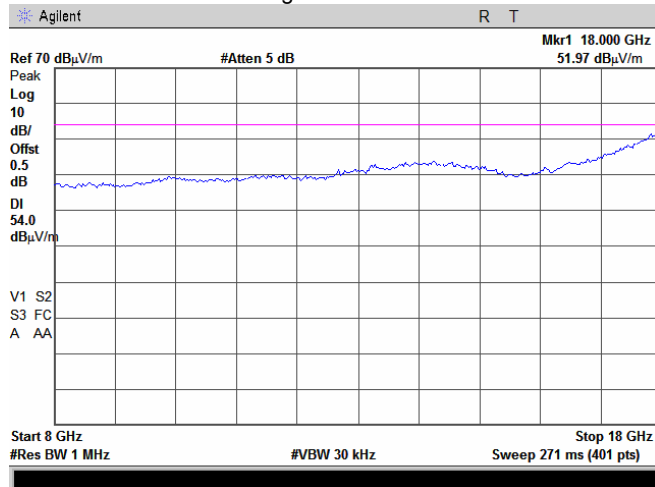



HERMON LABORATORIES

Test specification: FCC section 15.407(b), RSS-210 Annex 9, section A9.2 Unwanted radiated emissions			
Test procedure: Public notice DA 00-705 / ANSI C63.4, Section 13.1.4			
Test mode: Compliance	Verdict: PASS		
Date: 12/29/2008			
Temperature: 21°C	Air Pressure: 1014 hPa	Relative Humidity: 44 %	Power Supply: 48 VDC
Remarks: EUT with 22.5 dBi antenna assembly gain			

Plot 7.3.25 Radiated emission measurements from 8 to 18 GHz at the first mid carrier frequency

TEST SITE: Anechoic chamber
 TEST DISTANCE: 3 m
 ANTENNA POLARIZATION: Vertical and Horizontal
 DETECTOR: Peak

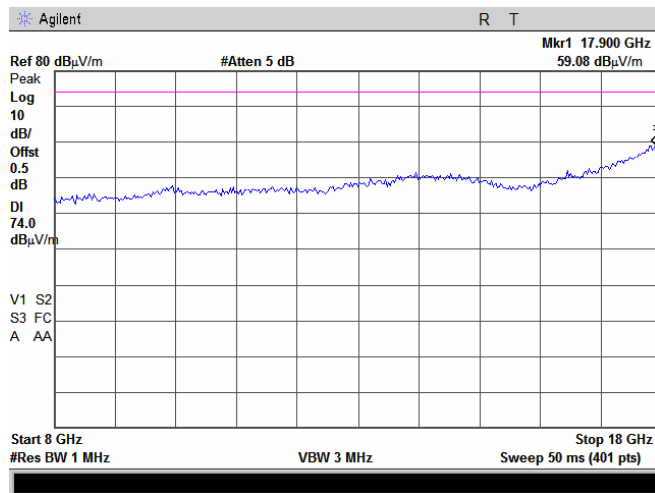

Plot 7.3.26 Radiated emission measurements from 8 to 18 GHz at the first mid carrier frequency

TEST SITE: Anechoic chamber
 TEST DISTANCE: 3 m
 ANTENNA POLARIZATION: Vertical and Horizontal
 DETECTOR: Average

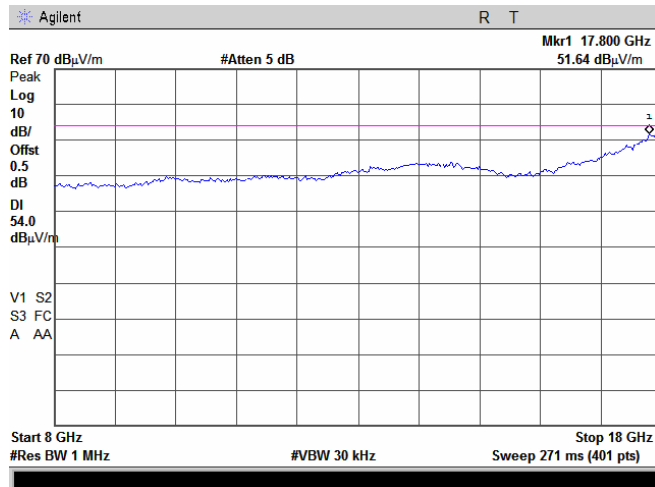



HERMON LABORATORIES

Test specification: FCC section 15.407(b), RSS-210 Annex 9, section A9.2 Unwanted radiated emissions			
Test procedure: Public notice DA 00-705 / ANSI C63.4, Section 13.1.4			
Test mode: Compliance	Verdict: PASS		
Date: 12/29/2008			
Temperature: 21°C	Air Pressure: 1014 hPa	Relative Humidity: 44 %	Power Supply: 48 VDC
Remarks: EUT with 22.5 dBi antenna assembly gain			

Plot 7.3.27 Radiated emission measurements from 8 to 18 GHz at the high carrier frequency

TEST SITE: Anechoic chamber
TEST DISTANCE: 3 m
ANTENNA POLARIZATION: Vertical and Horizontal
DETECTOR: Peak

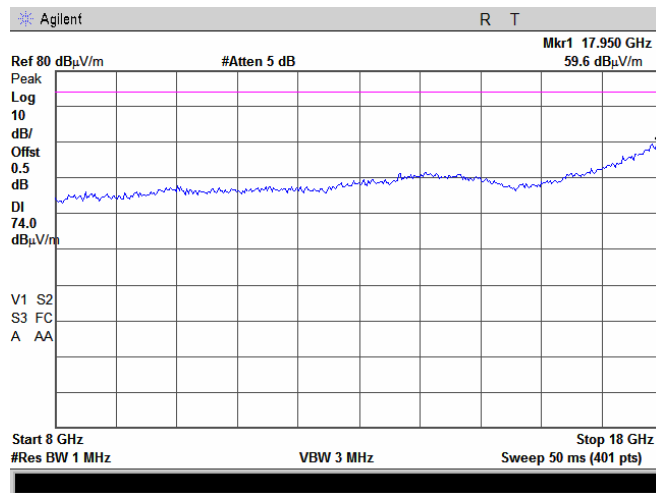

Plot 7.3.28 Radiated emission measurements from 8 to 18 GHz at the high carrier frequency

TEST SITE: Anechoic chamber
TEST DISTANCE: 3 m
ANTENNA POLARIZATION: Vertical and Horizontal
DETECTOR: Average

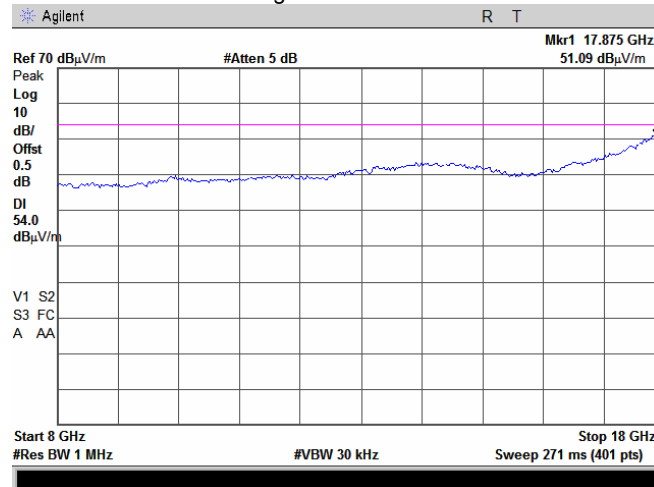



HERMON LABORATORIES

Test specification:		FCC section 15.407(b), RSS-210 Annex 9, section A9.2 Unwanted radiated emissions	
Test procedure:		Public notice DA 00-705 / ANSI C63.4, Section 13.1.4	
Test mode:	Compliance	Verdict:	PASS
Date:	12/29/2008		
Temperature: 21°C	Air Pressure: 1014 hPa	Relative Humidity: 44 %	Power Supply: 48 VDC
Remarks: EUT with 22.5 dBi antenna assembly gain			

Plot 7.3.29 Radiated emission measurements from 18 to 26.5 GHz at the low carrier frequency

TEST SITE: OATS
TEST DISTANCE: 3 m
ANTENNA POLARIZATION: Vertical and Horizontal
DETECTOR: Peak under average limit

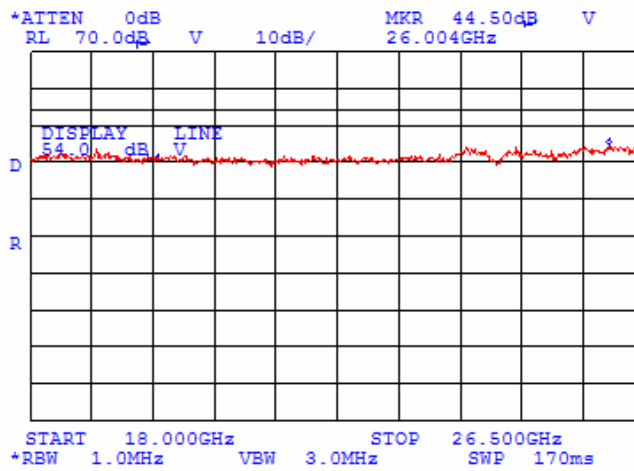

Plot 7.3.30 Radiated emission measurements from 18 to 26.5 GHz at the mid carrier frequency

TEST SITE: OATS
TEST DISTANCE: 3 m
ANTENNA POLARIZATION: Vertical and Horizontal
DETECTOR: Peak under average limit

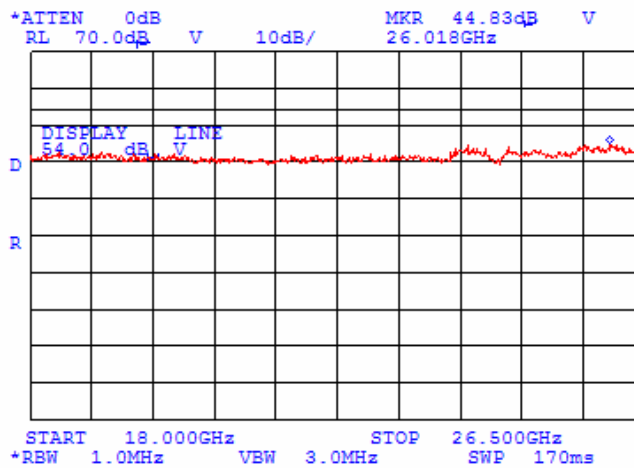



HERMON LABORATORIES

Test specification: FCC section 15.407(b), RSS-210 Annex 9, section A9.2 Unwanted radiated emissions			
Test procedure: Public notice DA 00-705 / ANSI C63.4, Section 13.1.4			
Test mode: Compliance	Verdict: PASS		
Date: 12/29/2008			
Temperature: 21°C	Air Pressure: 1014 hPa	Relative Humidity: 44 %	Power Supply: 48 VDC
Remarks: EUT with 22.5 dBi antenna assembly gain			

Plot 7.3.31 Radiated emission measurements from 18 to 26.5 GHz at the high carrier frequency

TEST SITE: OATS
TEST DISTANCE: 3 m
ANTENNA POLARIZATION: Vertical and Horizontal
DETECTOR: Peak under average limit

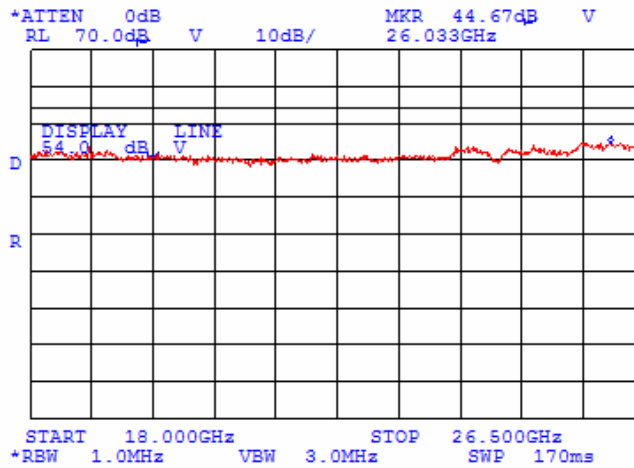



HERMON LABORATORIES

Test specification: FCC section 15.407(b), RSS-210 Annex 9, section A9.2 Unwanted radiated emissions			
Test procedure: Public notice DA 00-705 / ANSI C63.4, Section 13.1.4			
Test mode: Compliance	Verdict: PASS		
Date: 12/29/2008			
Temperature: 21°C	Air Pressure: 1014 hPa	Relative Humidity: 44 %	Power Supply: 48 VDC
Remarks: EUT with 22.5 dBi antenna assembly gain			

Plot 7.3.32 Radiated emission measurements from 26.5 to 40 GHz at the low carrier frequency

TEST SITE: OATS
TEST DISTANCE: 3 m
ANTENNA POLARIZATION: Vertical and Horizontal
DETECTOR: Peak

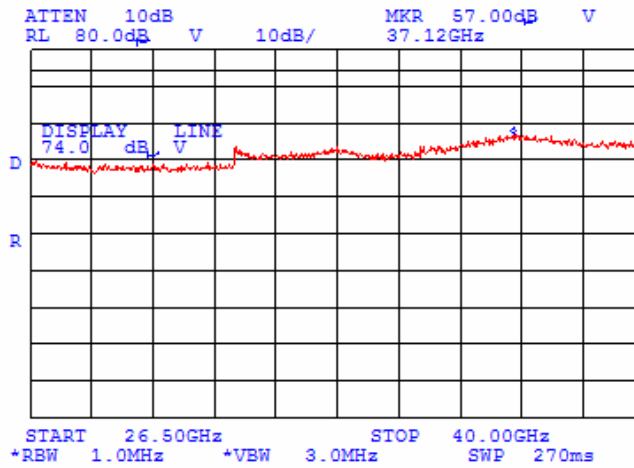

Plot 7.3.33 Radiated emission measurements from 26.5 to 40 GHz at the low carrier frequency

TEST SITE: OATS
TEST DISTANCE: 3 m
ANTENNA POLARIZATION: Vertical and Horizontal
DETECTOR: Average

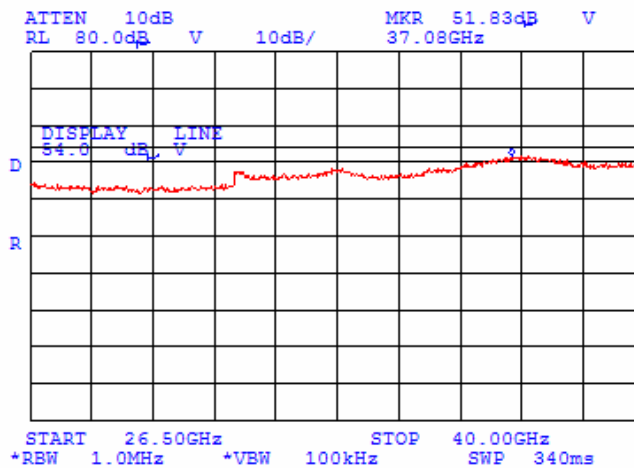



HERMON LABORATORIES

Test specification: FCC section 15.407(b), RSS-210 Annex 9, section A9.2 Unwanted radiated emissions			
Test procedure: Public notice DA 00-705 / ANSI C63.4, Section 13.1.4			
Test mode: Compliance	Verdict: PASS		
Date: 12/29/2008			
Temperature: 21°C	Air Pressure: 1014 hPa	Relative Humidity: 44 %	Power Supply: 48 VDC
Remarks: EUT with 22.5 dBi antenna assembly gain			

Plot 7.3.34 Radiated emission measurements from 26.5 to 40 GHz at the mid carrier frequency

TEST SITE: OATS
TEST DISTANCE: 3 m
ANTENNA POLARIZATION: Vertical and Horizontal
DETECTOR: Peak

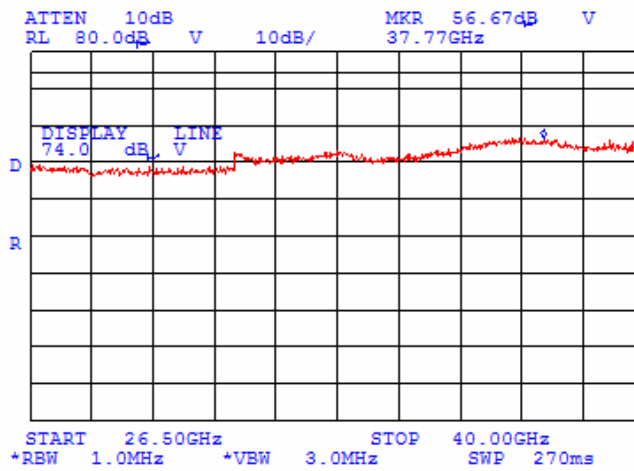

Plot 7.3.35 Radiated emission measurements from 26.5 to 40 GHz at the mid carrier frequency

TEST SITE: OATS
TEST DISTANCE: 3 m
ANTENNA POLARIZATION: Vertical and Horizontal
DETECTOR: Average

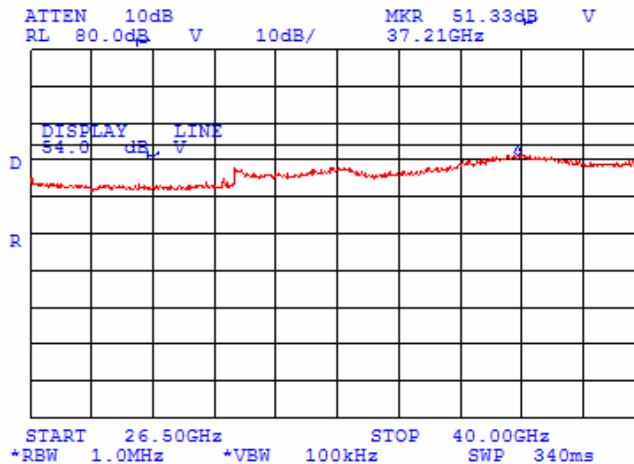



HERMON LABORATORIES

Test specification: FCC section 15.407(b), RSS-210 Annex 9, section A9.2 Unwanted radiated emissions			
Test procedure: Public notice DA 00-705 / ANSI C63.4, Section 13.1.4			
Test mode: Compliance	Verdict: PASS		
Date: 12/29/2008			
Temperature: 21°C	Air Pressure: 1014 hPa	Relative Humidity: 44 %	Power Supply: 48 VDC
Remarks: EUT with 22.5 dBi antenna assembly gain			

Plot 7.3.36 Radiated emission measurements from 26.5 to 40 GHz at the high carrier frequency

TEST SITE: OATS
TEST DISTANCE: 3 m
ANTENNA POLARIZATION: Vertical and Horizontal
DETECTOR: Peak

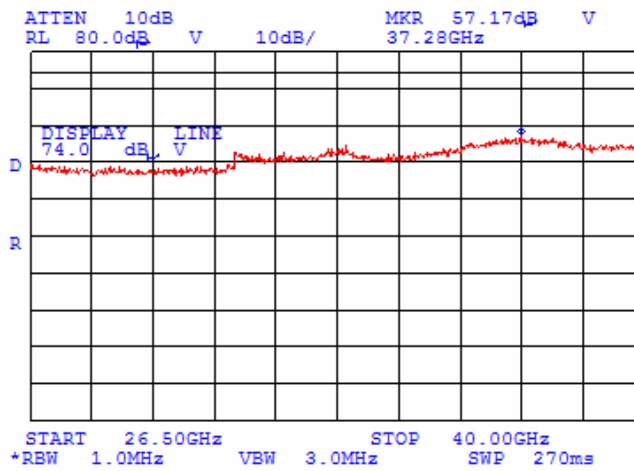

Plot 7.3.37 Radiated emission measurements from 26.5 to 40 GHz at the high carrier frequency

TEST SITE: OATS
TEST DISTANCE: 3 m
ANTENNA POLARIZATION: Vertical and Horizontal
DETECTOR: Average

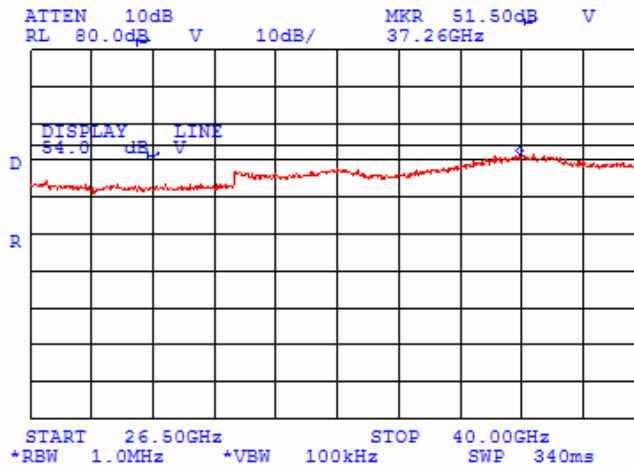



Test specification:		FCC section 15.407(b), RSS-210 Annex 9, section A9.2 Unwanted radiated emissions	
Test procedure:		Public notice DA 00-705 / ANSI C63.4, Section 13.1.4	
Test mode:	Compliance	Verdict:	PASS
Date:	12/29/2008		
Temperature: 21°C	Air Pressure: 1014 hPa	Relative Humidity: 44 %	Power Supply: 48 VDC
Remarks: EUT with 28 dBi antenna assembly gain			

Table 7.3.6 Field strength of spurious emissions below 1 GHz

ASSIGNED FREQUENCY RANGE: 5250 - 5350 MHz
 INVESTIGATED FREQUENCY RANGE: 0.009 - 1000 MHz
 TEST SITE: Semi Anechoic Chamber
 TEST DISTANCE: 3 m
 MODULATION: OFDM 64QAM***
 BIT RATE: 32.5 Mbps***
 DUTY CYCLE: 100 %
 TRANSMITTER OUTPUT POWER: Maximum
 RESOLUTION BANDWIDTH: 1.0 kHz (9 kHz – 150 kHz)
 9.0 kHz (150 kHz – 30 MHz)
 120 kHz (30 MHz – 1000 MHz)
 VIDEO BANDWIDTH: > Resolution bandwidth
 TEST ANTENNA TYPE: Active loop (9 kHz – 30 MHz)
 Biconilog (30 MHz – 1000 MHz)
 Double ridged guide (above 1000 MHz)

Frequency, MHz	Peak, dB(µV/m)	Quasi-peak dB(µV/m)			Antenna polariz.	Antenna height, m	Turntable position**, degrees	Verdict
		Measured emission, dB(µV/m)	Limit, dB(µV/m)	Margin, dB*				
No emissions were found								Pass

*- Margin = Measured emission – specification limit.
 **- EUT front panel refers to 0 degrees position of turntable.
 ***- as the worst case in peak power spectral density test.

Reference numbers of test equipment used

HL 0446	HL 0521	HL 0589	HL 0604	HL 1425	HL 1556	HL 1947	HL 1984
HL 2009	HL 2909						

Full description is given in Appendix A.



HERMON LABORATORIES

Test specification: FCC section 15.407(b), RSS-210 Annex 9, section A9.2 Unwanted radiated emissions			
Test procedure: Public notice DA 00-705 / ANSI C63.4, Section 13.1.4			
Test mode: Compliance		Verdict: PASS	
Date: 12/29/2008			
Temperature: 21°C	Air Pressure: 1014 hPa	Relative Humidity: 44 %	Power Supply: 48 VDC
Remarks: EUT with 28 dBi antenna assembly gain			

Table 7.3.7 Field strength of spurious emissions above 1 GHz

ASSIGNED FREQUENCY RANGE: 5250 - 5350 MHz
 INVESTIGATED FREQUENCY RANGE: 0.009 - 40000 MHz
 TEST SITE: Semi Anechoic Chamber
 TEST DISTANCE: 3 m
 MODULATION: OFDM, 64QAM***
 BIT RATE: 32.5 Mbps***
 DUTY CYCLE: 100 %
 TRANSMITTER OUTPUT POWER: Maximum
 RESOLUTION BANDWIDTH: 1000 kHz
 VIDEO BANDWIDTH: > Resolution bandwidth
 TEST ANTENNA TYPE: Double ridged guide

Frequency, MHz	Peak, dB(μV/m)			Average dB(μV/m)			Ant. polariz.	Ant. height, m	Turntable position**, degrees	Verdict	
	Measured emission, dB(μV/m)	Limit, dB(μV/m)	Margin, dB*	Measured emission, dB(μV/m)	Limit, dB(μV/m)	Margin, dB*					
Low channel (5260 MHz)											
1000.100	42.90	74.00	-31.10	35.90	54.00	-18.10	Vertical	1.0	0	Pass	
Mid channel (5300 MHz)											
1000.100	45.90	74.00	-28.10	38.70	54.00	-16.30	Vertical	1.2	090		
High channel (5340 MHz)											
1000.100	46.30	74.00	-34.70	38.90	54.00	-19.90	Vertical	1.2	090		
5378.320	57.00	74.00	-17.00	44.05	54.00	-9.95	Vertical	1.0	0		
5382.055	56.30	74.00	-17.70	42.85	54.00	-11.15	Vertical	1.0	0		

*- Margin = Measured emission – specification limit.
 **- EUT front panel refers to 0 degrees position of turntable.
 ***- as the worst case in peak power spectral density test.

Reference numbers of test equipment used

HL 0446	HL 0521	HL 0589	HL 0604	HL 1425	HL 1556	HL 1947	HL 1984
HL 2009	HL 2909						

Full description is given in Appendix A.

Table 7.3.8 Restricted bands

MHz	MHz	MHz	MHz	MHz	GHz
0.09 - 0.11	8.37625 - 8.38675	73 - 74.6	399.9 - 410	2690 - 2900	10.6 - 12.7
0.495 - 0.505	8.41425 - 8.41475	74.8 - 75.2	608 - 614	3260 - 3267	13.25 - 13.4
2.1735 - 2.1905	12.29 - 12.293	108 - 121.94	960 - 1240	3332 - 3339	14.47 - 14.5
4.125 - 4.128	12.51975 - 12.52025	123 - 138	1300 - 1427	3345.8 - 3358	15.35 - 16.2
4.17725 - 4.17775	12.57675 - 12.57725	149.9 - 150.05	1435 - 1626.5	3600 - 4400	17.7 - 21.4
4.20725 - 4.20775	13.36 - 13.41	156.52475 - 156.52525	1645.5 - 1646.5	4500 - 5150	22.01 - 23.12
6.215 - 6.218	16.42 - 16.423	156.7 - 156.9	1660 - 1710	5350 - 5460	23.6 - 24
6.26775 - 6.26825	16.69475 - 16.69525	162.0125 - 167.17	1718.8 - 1722.2	7250 - 7750	31.2 - 31.8
6.31175 - 6.31225	16.80425 - 16.80475	167.72 - 173.2	2200 - 2300	8025 - 8500	36.43 - 36.5
8.291 - 8.294	25.5 - 25.67	240 - 285	2310 - 2390	9000 - 9200	Above 38.6
8.362 - 8.366	37.5 - 38.25	322 - 335.4	2483.5 - 2500	9300 - 9500	



HERMON LABORATORIES

Test specification: FCC section 15.407(b), RSS-210 Annex 9, section A9.2 Unwanted radiated emissions			
Test procedure: Public notice DA 00-705 / ANSI C63.4, Section 13.1.4			
Test mode: Compliance	Verdict: PASS		
Date: 12/29/2008			
Temperature: 21°C	Air Pressure: 1014 hPa	Relative Humidity: 44 %	Power Supply: 48 VDC
Remarks: EUT with 28 dBi antenna assembly gain			

Plot 7.3.38 Radiated emission measurements from 9 to 150 kHz at the low carrier frequency

TEST SITE: Anechoic chamber
TEST DISTANCE: 3 m
ANTENNA POLARIZATION: Vertical and Horizontal

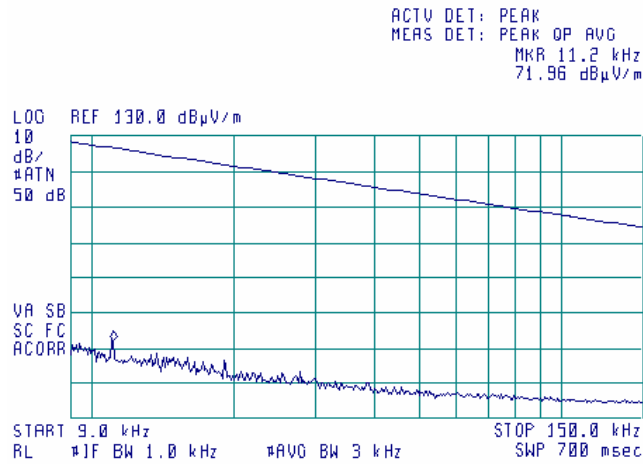

Plot 7.3.39 Radiated emission measurements from 9 to 150 kHz at the mid carrier frequency

TEST SITE: Anechoic chamber
TEST DISTANCE: 3 m
ANTENNA POLARIZATION: Vertical and Horizontal

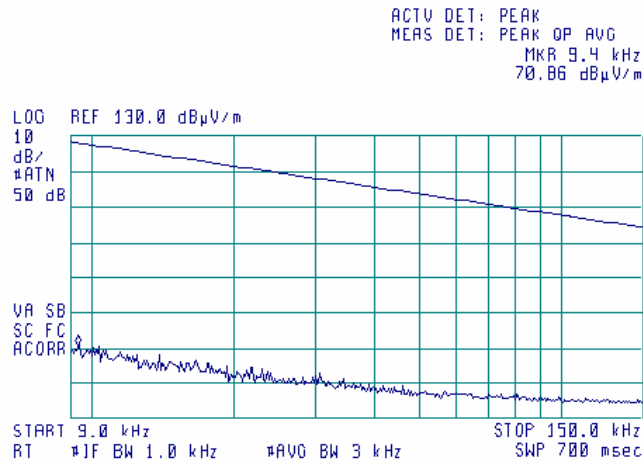



HERMON LABORATORIES

Test specification: FCC section 15.407(b), RSS-210 Annex 9, section A9.2 Unwanted radiated emissions			
Test procedure: Public notice DA 00-705 / ANSI C63.4, Section 13.1.4			
Test mode: Compliance	Verdict: PASS		
Date: 12/29/2008			
Temperature: 21°C	Air Pressure: 1014 hPa	Relative Humidity: 44 %	Power Supply: 48 VDC
Remarks: EUT with 28 dBi antenna assembly gain			

Plot 7.3.40 Radiated emission measurements from 9 to 150 kHz at the high carrier frequency

TEST SITE: Anechoic chamber
TEST DISTANCE: 3 m
ANTENNA POLARIZATION: Vertical and Horizontal

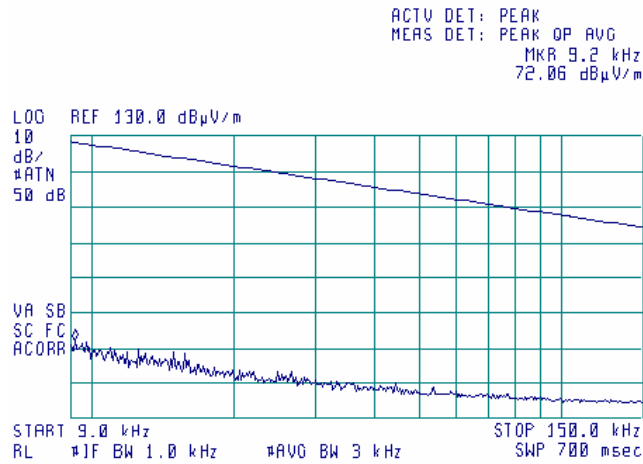

Plot 7.3.41 Radiated emission measurements from 0.15 MHz to 30 MHz at the low carrier frequency

TEST SITE: Anechoic chamber
TEST DISTANCE: 3 m
ANTENNA POLARIZATION: Vertical and Horizontal

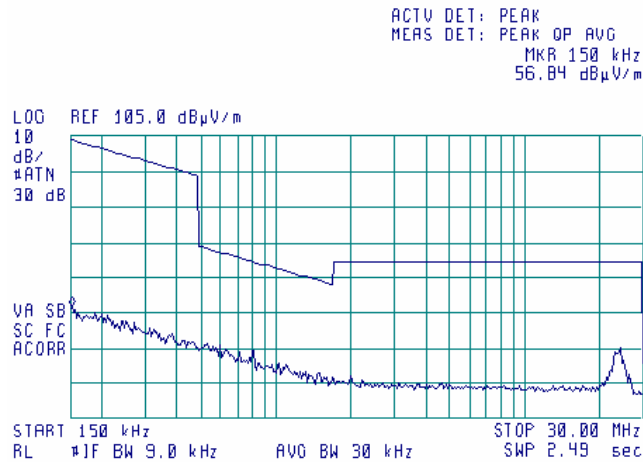



HERMON LABORATORIES

Test specification: FCC section 15.407(b), RSS-210 Annex 9, section A9.2 Unwanted radiated emissions			
Test procedure: Public notice DA 00-705 / ANSI C63.4, Section 13.1.4			
Test mode: Compliance	Verdict: PASS		
Date: 12/29/2008			
Temperature: 21°C	Air Pressure: 1014 hPa	Relative Humidity: 44 %	Power Supply: 48 VDC
Remarks: EUT with 28 dBi antenna assembly gain			

Plot 7.3.42 Radiated emission measurements from 0.15 MHz to 30 MHz at the mid carrier frequency

TEST SITE: Anechoic chamber
TEST DISTANCE: 3 m
ANTENNA POLARIZATION: Vertical and Horizontal

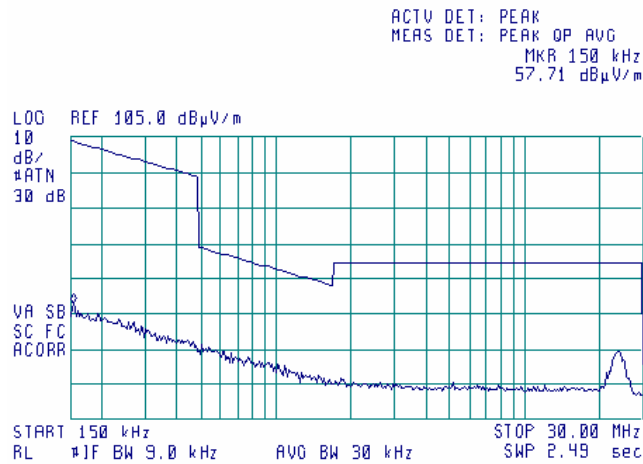

Plot 7.3.43 Radiated emission measurements from 0.15 MHz to 30 MHz at the high carrier frequency

TEST SITE: Anechoic chamber
TEST DISTANCE: 3 m
ANTENNA POLARIZATION: Vertical and Horizontal

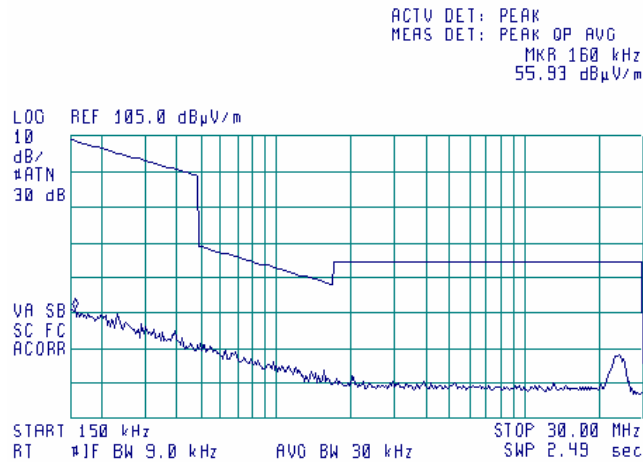



HERMON LABORATORIES

Test specification: FCC section 15.407(b), RSS-210 Annex 9, section A9.2 Unwanted radiated emissions			
Test procedure: Public notice DA 00-705 / ANSI C63.4, Section 13.1.4			
Test mode: Compliance	Verdict: PASS		
Date: 12/29/2008			
Temperature: 21°C	Air Pressure: 1014 hPa	Relative Humidity: 44 %	Power Supply: 48 VDC
Remarks: EUT with 28 dBi antenna assembly gain			

Plot 7.3.44 Radiated emission measurements from 30 MHz to 1000 MHz at the low carrier frequency

TEST SITE: Semi Anechoic chamber
TEST DISTANCE: 3 m
ANTENNA POLARIZATION: Vertical

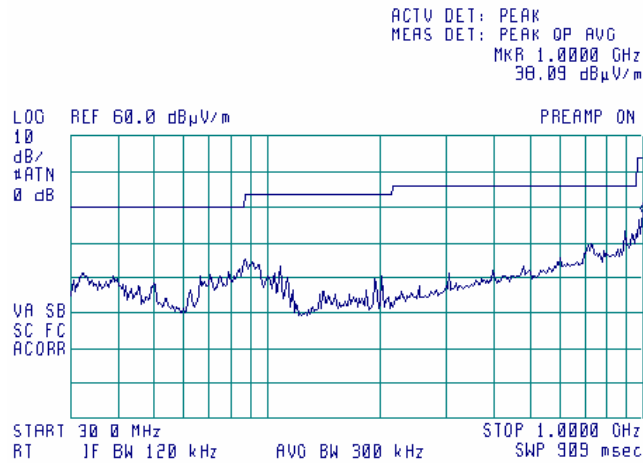

Plot 7.3.45 Radiated emission measurements from 30 MHz to 1000 MHz at the mid carrier frequency

TEST SITE: Anechoic chamber
TEST DISTANCE: 3 m
ANTENNA POLARIZATION: Vertical and Horizontal

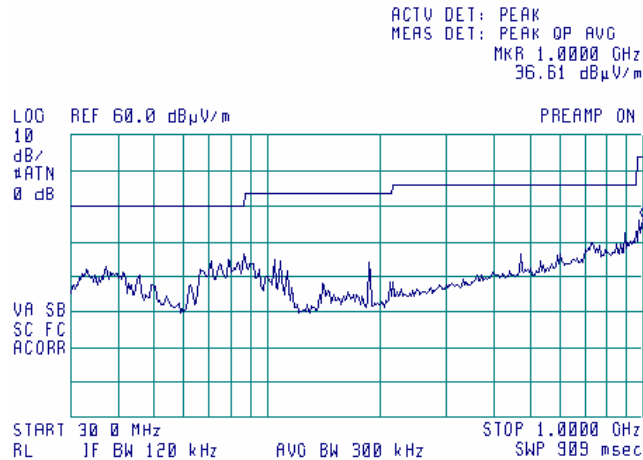



HERMON LABORATORIES

Test specification: FCC section 15.407(b), RSS-210 Annex 9, section A9.2 Unwanted radiated emissions			
Test procedure: Public notice DA 00-705 / ANSI C63.4, Section 13.1.4			
Test mode: Compliance	Verdict: PASS		
Date: 12/29/2008			
Temperature: 21°C	Air Pressure: 1014 hPa	Relative Humidity: 44 %	Power Supply: 48 VDC
Remarks: EUT with 28 dBi antenna assembly gain			

Plot 7.3.46 Radiated emission measurements from 30 MHz to 1000 MHz at the high carrier frequency

TEST SITE: Anechoic chamber
TEST DISTANCE: 3 m
ANTENNA POLARIZATION: Vertical and Horizontal

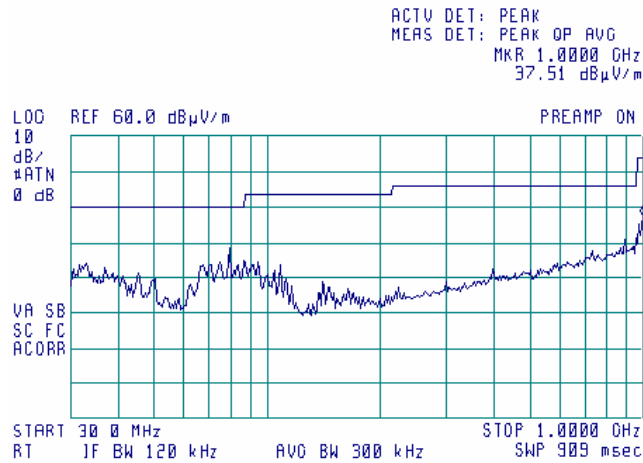



HERMON LABORATORIES

Test specification:		FCC section 15.407(b), RSS-210 Annex 9, section A9.2 Unwanted radiated emissions	
Test procedure:		Public notice DA 00-705 / ANSI C63.4, Section 13.1.4	
Test mode:	Compliance	Verdict:	PASS
Date:	12/29/2008		
Temperature: 21°C	Air Pressure: 1014 hPa	Relative Humidity: 44 %	Power Supply: 48 VDC
Remarks: EUT with 28 dBi antenna assembly gain			

Plot 7.3.47 Radiated emission measurements from 1.0 to 5.15 GHz at the low carrier frequency

TEST SITE: Anechoic chamber
 TEST DISTANCE: 3 m
 ANTENNA POLARIZATION: Vertical and Horizontal
 DETECTOR: Peak under average limit

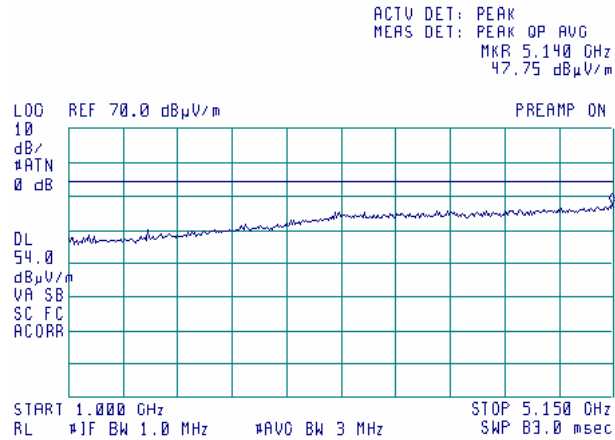

Plot 7.3.48 Radiated emission measurements from 1.0 to 5.15 GHz at the mid carrier frequency

TEST SITE: Anechoic chamber
 TEST DISTANCE: 3 m
 ANTENNA POLARIZATION: Vertical and Horizontal
 DETECTOR: Peak under average limit

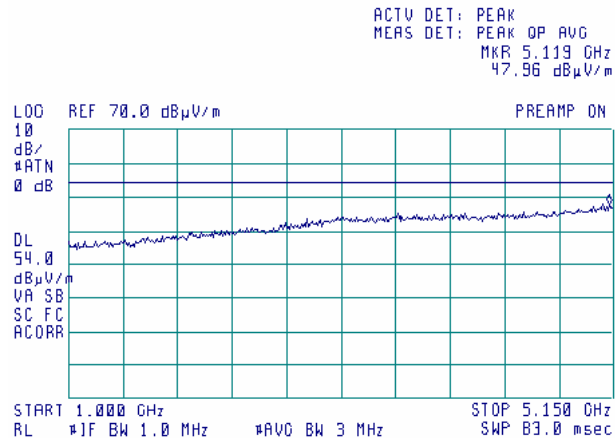



HERMON LABORATORIES

Test specification: FCC section 15.407(b), RSS-210 Annex 9, section A9.2 Unwanted radiated emissions			
Test procedure: Public notice DA 00-705 / ANSI C63.4, Section 13.1.4			
Test mode: Compliance	Verdict: PASS		
Date: 12/29/2008			
Temperature: 21°C	Air Pressure: 1014 hPa	Relative Humidity: 44 %	Power Supply: 48 VDC
Remarks: EUT with 28 dBi antenna assembly gain			

Plot 7.3.49 Radiated emission measurements from 1.0 to 5.15 GHz at the high carrier frequency

TEST SITE: Anechoic chamber
TEST DISTANCE: 3 m
ANTENNA POLARIZATION: Vertical and Horizontal
DETECTOR: Peak under average limit

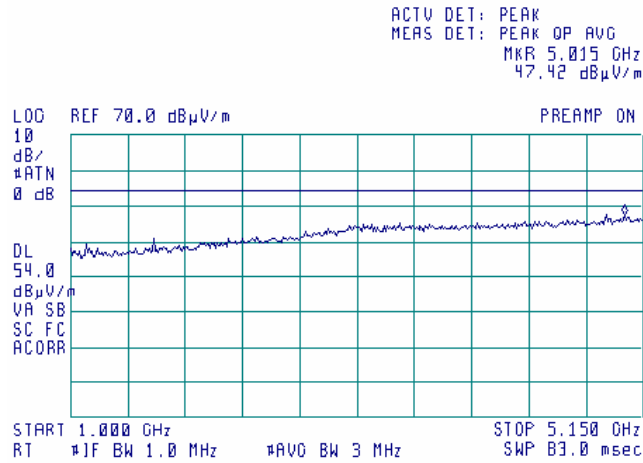



HERMON LABORATORIES

Test specification: FCC section 15.407(b), RSS-210 Annex 9, section A9.2 Unwanted radiated emissions			
Test procedure: Public notice DA 00-705 / ANSI C63.4, Section 13.1.4			
Test mode: Compliance	Verdict: PASS		
Date: 12/29/2008			
Temperature: 21°C	Air Pressure: 1014 hPa	Relative Humidity: 44 %	Power Supply: 48 VDC
Remarks: EUT with 28 dBi antenna assembly gain			

Plot 7.3.50 Radiated emission measurements from 5.35 to 5.46 GHz at the low carrier frequency

TEST SITE: Anechoic chamber
 TEST DISTANCE: 3 m
 ANTENNA POLARIZATION: Vertical and Horizontal
 DETECTOR: Peak under average limit

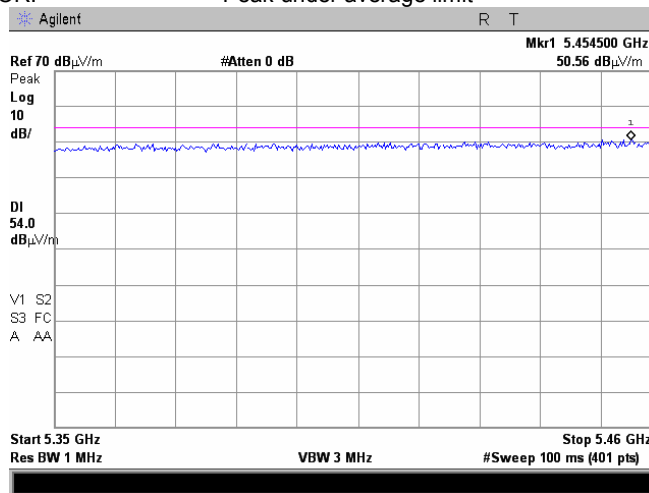

Plot 7.3.51 Radiated emission measurements from 5.35 to 5.46 GHz at the mid carrier frequency

TEST SITE: Anechoic chamber
 TEST DISTANCE: 3 m
 ANTENNA POLARIZATION: Vertical and Horizontal
 DETECTOR: Peak under average limit

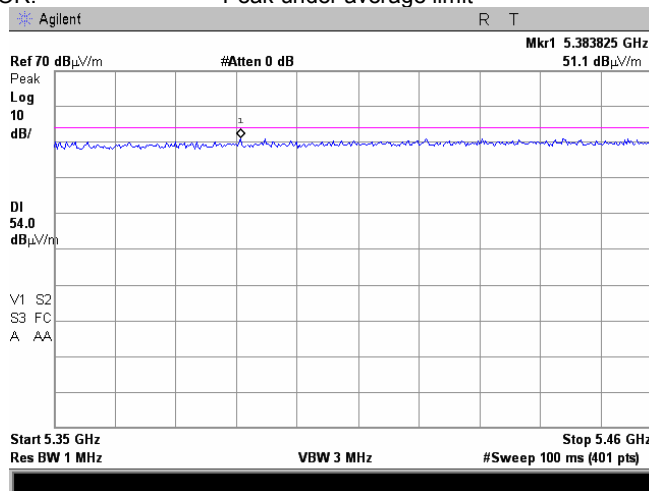



HERMON LABORATORIES

Test specification: FCC section 15.407(b), RSS-210 Annex 9, section A9.2 Unwanted radiated emissions			
Test procedure: Public notice DA 00-705 / ANSI C63.4, Section 13.1.4			
Test mode: Compliance	Verdict: PASS		
Date: 12/29/2008			
Temperature: 21°C	Air Pressure: 1014 hPa	Relative Humidity: 44 %	Power Supply: 48 VDC
Remarks: EUT with 28 dBi antenna assembly gain			

Plot 7.3.52 Radiated emission measurements from 5.35 to 5.46 GHz at the high carrier frequency

TEST SITE: Anechoic chamber
TEST DISTANCE: 3 m
ANTENNA POLARIZATION: Vertical and Horizontal
DETECTOR: Peak

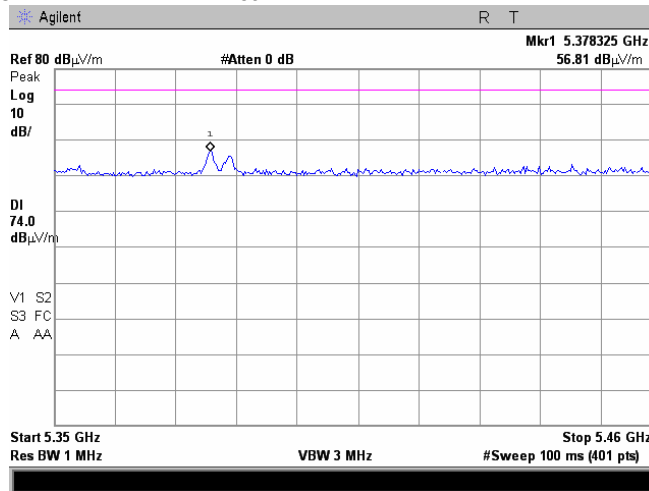

Plot 7.3.53 Radiated emission measurements from 5.35 to 5.46 GHz at the high carrier frequency

TEST SITE: Anechoic chamber
TEST DISTANCE: 3 m
ANTENNA POLARIZATION: Vertical and Horizontal
DETECTOR: Average

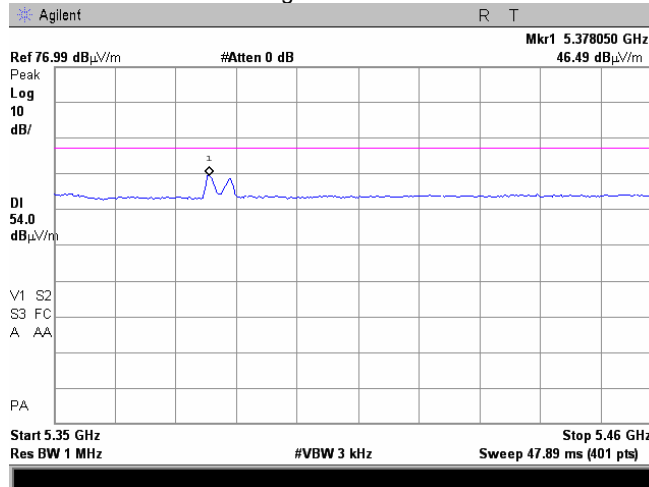



HERMON LABORATORIES

Test specification: FCC section 15.407(b), RSS-210 Annex 9, section A9.2 Unwanted radiated emissions			
Test procedure: Public notice DA 00-705 / ANSI C63.4, Section 13.1.4			
Test mode: Compliance	Verdict: PASS		
Date: 12/29/2008			
Temperature: 21°C	Air Pressure: 1014 hPa	Relative Humidity: 44 %	Power Supply: 48 VDC
Remarks: EUT with 28 dBi antenna assembly gain			

Plot 7.3.54 Radiated emission measurements from 5.46 to 8.0 GHz at the low carrier frequency

TEST SITE: Anechoic chamber
 TEST DISTANCE: 3 m
 ANTENNA POLARIZATION: Vertical and Horizontal
 DETECTOR: Peak

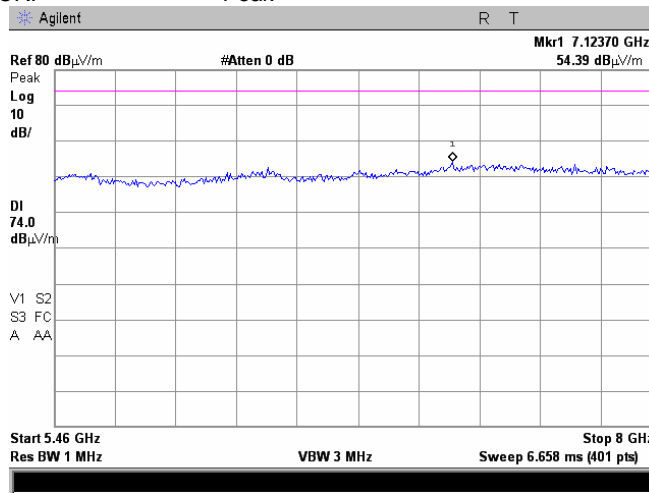

Plot 7.3.55 Radiated emission measurements from 5.46 to 8.0 GHz at the low carrier frequency

TEST SITE: Anechoic chamber
 TEST DISTANCE: 3 m
 ANTENNA POLARIZATION: Vertical and Horizontal
 DETECTOR: Average

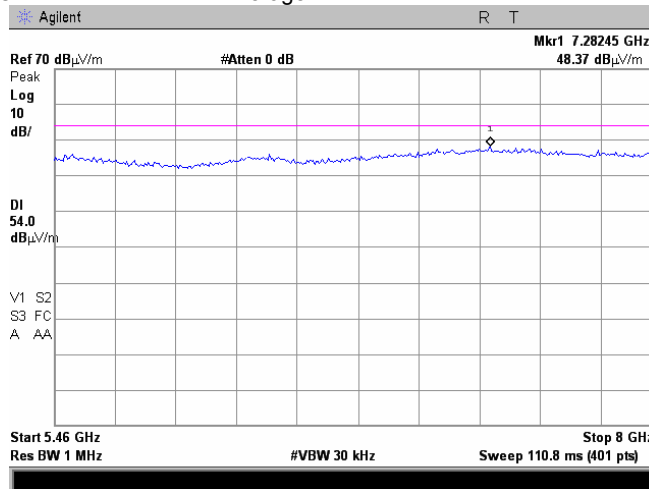



HERMON LABORATORIES

Test specification: FCC section 15.407(b), RSS-210 Annex 9, section A9.2 Unwanted radiated emissions			
Test procedure: Public notice DA 00-705 / ANSI C63.4, Section 13.1.4			
Test mode: Compliance	Verdict: PASS		
Date: 12/29/2008			
Temperature: 21°C	Air Pressure: 1014 hPa	Relative Humidity: 44 %	Power Supply: 48 VDC
Remarks: EUT with 28 dBi antenna assembly gain			

Plot 7.3.56 Radiated emission measurements from 5.46 to 8.0 GHz at the mid carrier frequency

TEST SITE: Anechoic chamber
TEST DISTANCE: 3 m
ANTENNA POLARIZATION: Vertical and Horizontal
DETECTOR: Peak

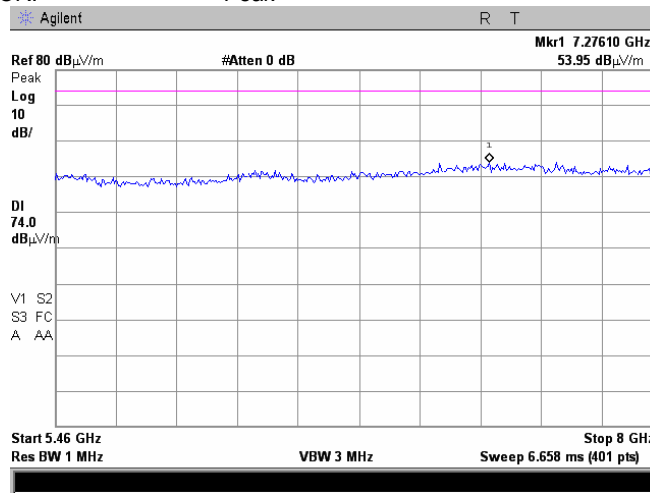

Plot 7.3.57 Radiated emission measurements from 5.46 to 8.0 GHz at the mid carrier frequency

TEST SITE: Anechoic chamber
TEST DISTANCE: 3 m
ANTENNA POLARIZATION: Vertical and Horizontal
DETECTOR: Average

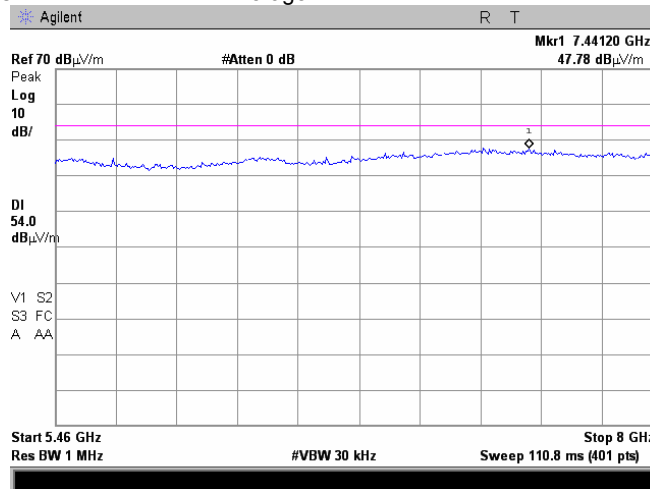



HERMON LABORATORIES

Test specification: FCC section 15.407(b), RSS-210 Annex 9, section A9.2 Unwanted radiated emissions			
Test procedure: Public notice DA 00-705 / ANSI C63.4, Section 13.1.4			
Test mode: Compliance	Verdict: PASS		
Date: 12/29/2008			
Temperature: 21°C	Air Pressure: 1014 hPa	Relative Humidity: 44 %	Power Supply: 48 VDC
Remarks: EUT with 28 dBi antenna assembly gain			

Plot 7.3.58 Radiated emission measurements from 5.46 to 8.0 GHz at the high carrier frequency

TEST SITE: Anechoic chamber
TEST DISTANCE: 3 m
ANTENNA POLARIZATION: Vertical and Horizontal
DETECTOR: Peak

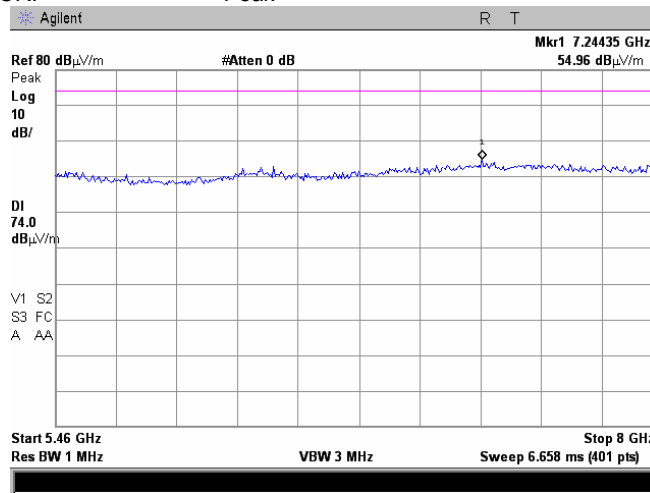

Plot 7.3.59 Radiated emission measurements from 5.46 to 8.0 GHz at the high carrier frequency

TEST SITE: Anechoic chamber
TEST DISTANCE: 3 m
ANTENNA POLARIZATION: Vertical and Horizontal
DETECTOR: Average

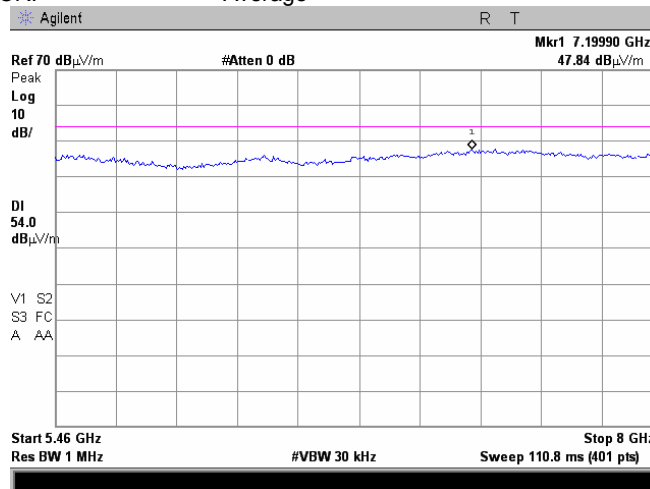



HERMON LABORATORIES

Test specification: FCC section 15.407(b), RSS-210 Annex 9, section A9.2 Unwanted radiated emissions			
Test procedure: Public notice DA 00-705 / ANSI C63.4, Section 13.1.4			
Test mode: Compliance	Verdict: PASS		
Date: 12/29/2008			
Temperature: 21°C	Air Pressure: 1014 hPa	Relative Humidity: 44 %	Power Supply: 48 VDC
Remarks: EUT with 28 dBi antenna assembly gain			

Plot 7.3.60 Radiated emission measurements from 8 to 18 GHz at the low carrier frequency

TEST SITE: Anechoic chamber
TEST DISTANCE: 3 m
ANTENNA POLARIZATION: Vertical and Horizontal
DETECTOR: Peak

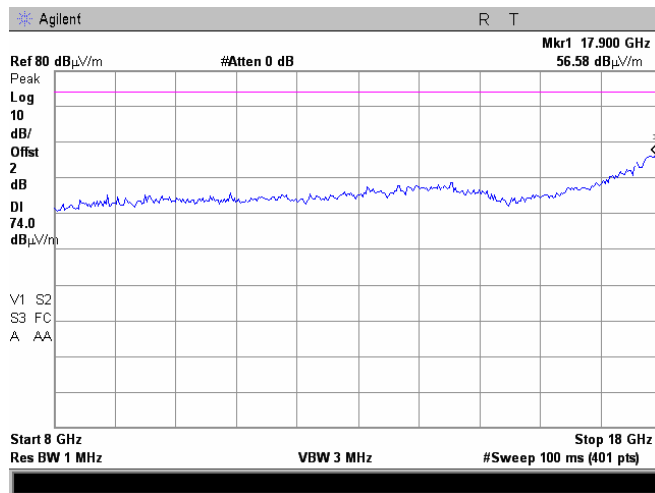

Plot 7.3.61 Radiated emission measurements from 8 to 18 GHz at the low carrier frequency

TEST SITE: Anechoic chamber
TEST DISTANCE: 3 m
ANTENNA POLARIZATION: Vertical and Horizontal
DETECTOR: Average

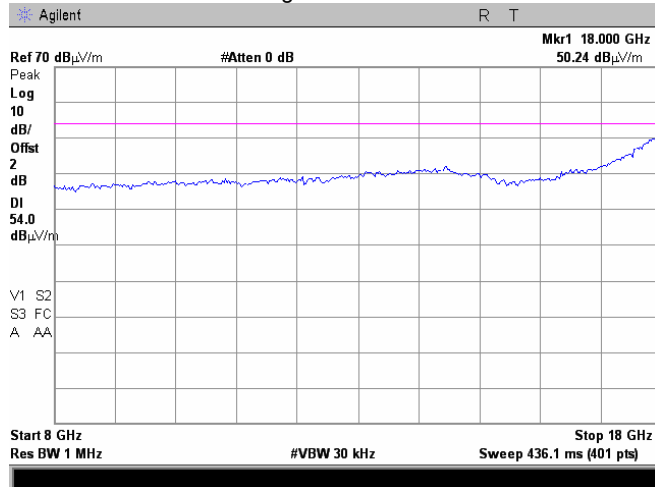



HERMON LABORATORIES

Test specification: FCC section 15.407(b), RSS-210 Annex 9, section A9.2 Unwanted radiated emissions			
Test procedure: Public notice DA 00-705 / ANSI C63.4, Section 13.1.4			
Test mode: Compliance	Verdict: PASS		
Date: 12/29/2008			
Temperature: 21°C	Air Pressure: 1014 hPa	Relative Humidity: 44 %	Power Supply: 48 VDC
Remarks: EUT with 28 dBi antenna assembly gain			

Plot 7.3.62 Radiated emission measurements from 8 to 18 GHz at the first mid carrier frequency

TEST SITE: Anechoic chamber
 TEST DISTANCE: 3 m
 ANTENNA POLARIZATION: Vertical and Horizontal
 DETECTOR: Peak

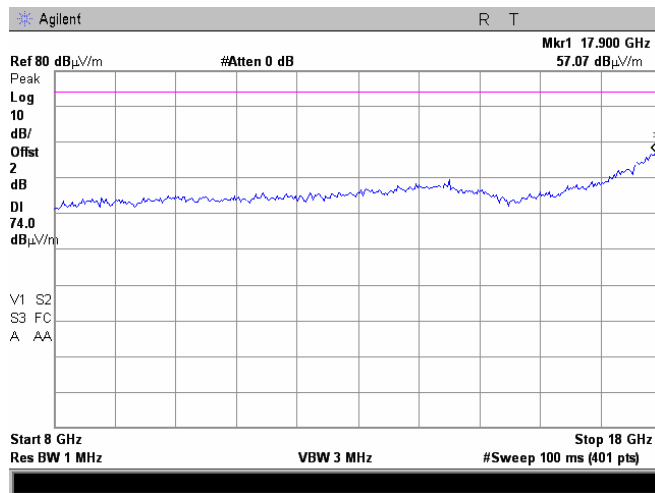

Plot 7.3.63 Radiated emission measurements from 8 to 18 GHz at the first mid carrier frequency

TEST SITE: Anechoic chamber
 TEST DISTANCE: 3 m
 ANTENNA POLARIZATION: Vertical and Horizontal
 DETECTOR: Average

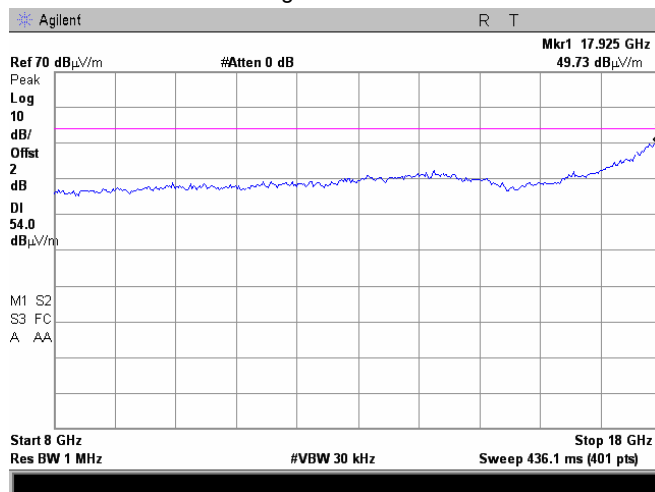



HERMON LABORATORIES

Test specification: FCC section 15.407(b), RSS-210 Annex 9, section A9.2 Unwanted radiated emissions			
Test procedure: Public notice DA 00-705 / ANSI C63.4, Section 13.1.4			
Test mode: Compliance	Verdict: PASS		
Date: 12/29/2008			
Temperature: 21°C	Air Pressure: 1014 hPa	Relative Humidity: 44 %	Power Supply: 48 VDC
Remarks: EUT with 28 dBi antenna assembly gain			

Plot 7.3.64 Radiated emission measurements from 8 to 18 GHz at the high carrier frequency

TEST SITE: Anechoic chamber
TEST DISTANCE: 3 m
ANTENNA POLARIZATION: Vertical and Horizontal
DETECTOR: Peak

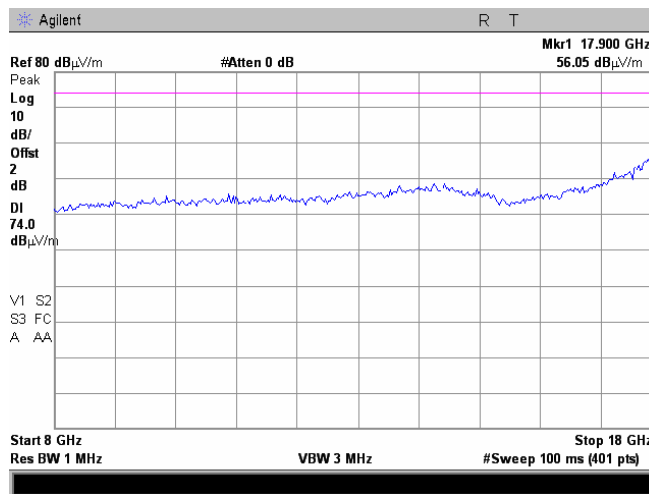

Plot 7.3.65 Radiated emission measurements from 8 to 18 GHz at the high carrier frequency

TEST SITE: Anechoic chamber
TEST DISTANCE: 3 m
ANTENNA POLARIZATION: Vertical and Horizontal
DETECTOR: Average

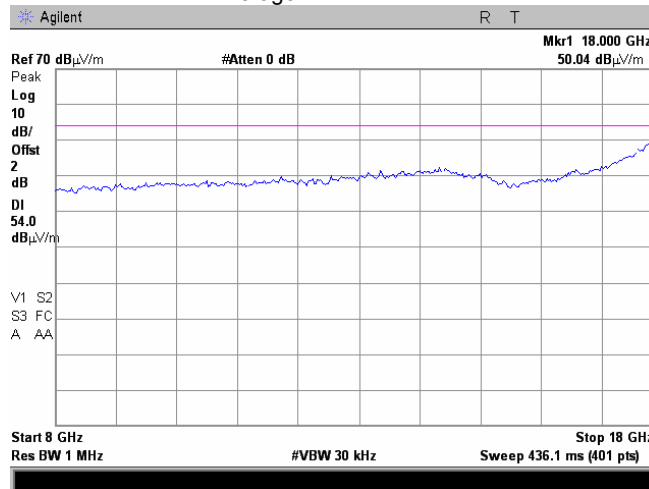



HERMON LABORATORIES

Test specification: FCC section 15.407(b), RSS-210 Annex 9, section A9.2 Unwanted radiated emissions			
Test procedure: Public notice DA 00-705 / ANSI C63.4, Section 13.1.4			
Test mode: Compliance	Verdict: PASS		
Date: 12/29/2008			
Temperature: 21°C	Air Pressure: 1014 hPa	Relative Humidity: 44 %	Power Supply: 48 VDC
Remarks: EUT with 28 dBi antenna assembly gain			

Plot 7.3.66 Radiated emission measurements from 18 to 26.5 GHz at the low carrier frequency

TEST SITE: OATS
TEST DISTANCE: 3 m
ANTENNA POLARIZATION: Vertical and Horizontal
DETECTOR: Peak under average limit

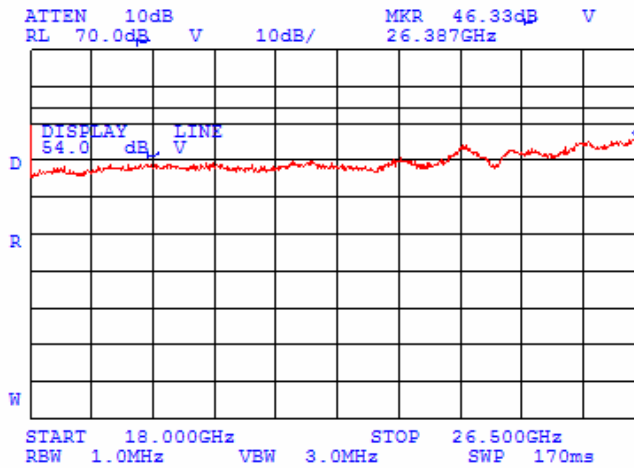

Plot 7.3.67 Radiated emission measurements from 18 to 26.5 GHz at the mid carrier frequency

TEST SITE: OATS
TEST DISTANCE: 3 m
ANTENNA POLARIZATION: Vertical and Horizontal
DETECTOR: Peak under average limit

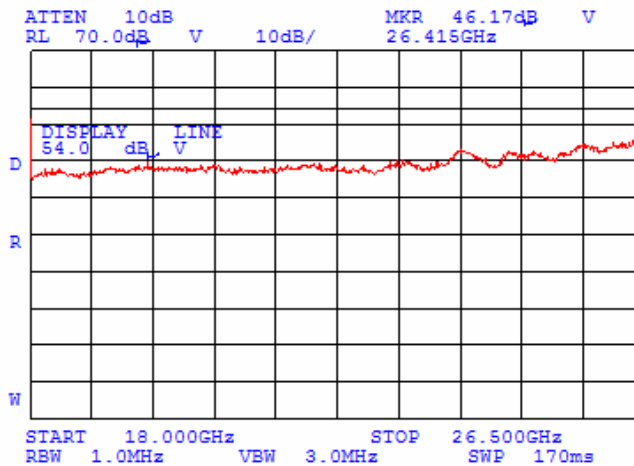



HERMON LABORATORIES

Test specification: FCC section 15.407(b), RSS-210 Annex 9, section A9.2 Unwanted radiated emissions			
Test procedure: Public notice DA 00-705 / ANSI C63.4, Section 13.1.4			
Test mode: Compliance	Verdict: PASS		
Date: 12/29/2008			
Temperature: 21°C	Air Pressure: 1014 hPa	Relative Humidity: 44 %	Power Supply: 48 VDC
Remarks: EUT with 28 dBi antenna assembly gain			

Plot 7.3.68 Radiated emission measurements from 18 to 26.5 GHz at the high carrier frequency

TEST SITE: OATS
TEST DISTANCE: 3 m
ANTENNA POLARIZATION: Vertical and Horizontal
DETECTOR: Peak under average limit

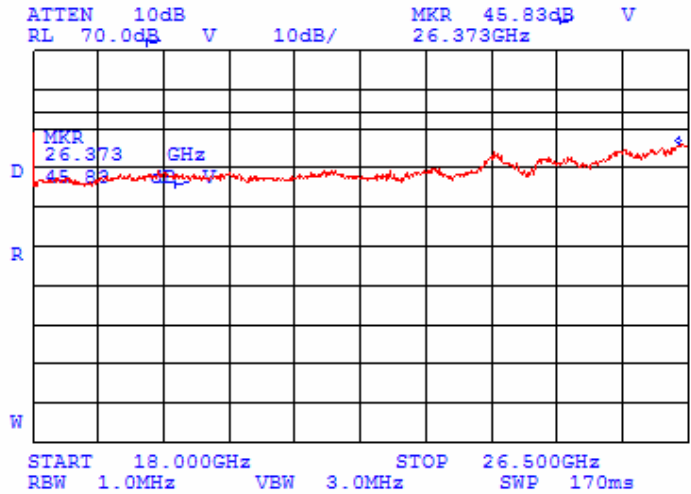



HERMON LABORATORIES

Test specification: FCC section 15.407(b), RSS-210 Annex 9, section A9.2 Unwanted radiated emissions			
Test procedure: Public notice DA 00-705 / ANSI C63.4, Section 13.1.4			
Test mode: Compliance	Verdict: PASS		
Date: 12/29/2008			
Temperature: 21°C	Air Pressure: 1014 hPa	Relative Humidity: 44 %	Power Supply: 48 VDC
Remarks: EUT with 28 dBi antenna assembly gain			

Plot 7.3.69 Radiated emission measurements from 26.5 to 40 GHz at the low carrier frequency

TEST SITE: OATS
 TEST DISTANCE: 3 m
 ANTENNA POLARIZATION: Vertical and Horizontal
 DETECTOR: Peak

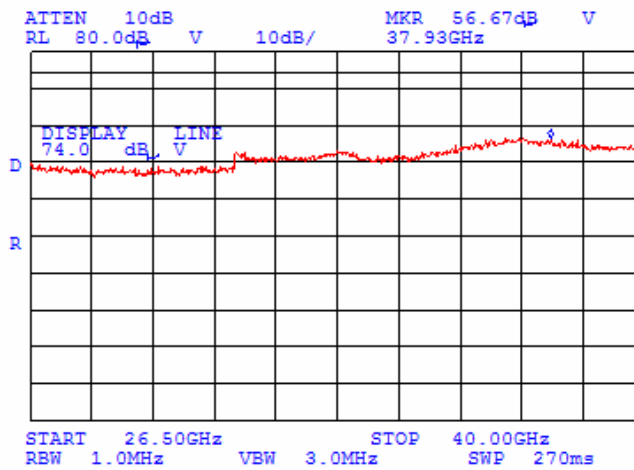

Plot 7.3.70 Radiated emission measurements from 26.5 to 40 GHz at the low carrier frequency

TEST SITE: OATS
 TEST DISTANCE: 3 m
 ANTENNA POLARIZATION: Vertical and Horizontal
 DETECTOR: Average

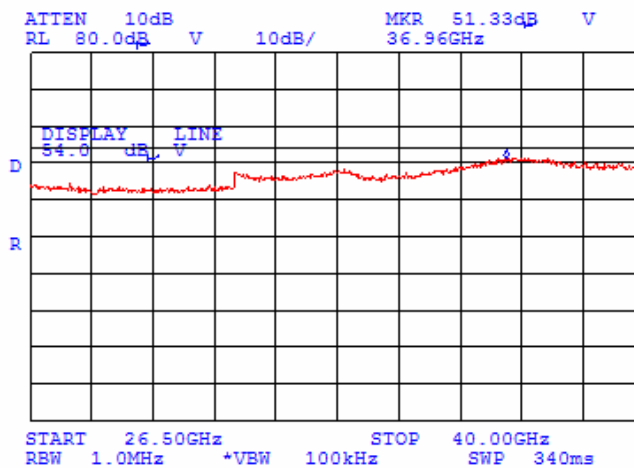



HERMON LABORATORIES

Test specification: FCC section 15.407(b), RSS-210 Annex 9, section A9.2 Unwanted radiated emissions			
Test procedure: Public notice DA 00-705 / ANSI C63.4, Section 13.1.4			
Test mode: Compliance	Verdict: PASS		
Date: 12/29/2008			
Temperature: 21°C	Air Pressure: 1014 hPa	Relative Humidity: 44 %	Power Supply: 48 VDC
Remarks: EUT with 28 dBi antenna assembly gain			

Plot 7.3.71 Radiated emission measurements from 26.5 to 40 GHz at the mid carrier frequency

TEST SITE: OATS
TEST DISTANCE: 3 m
ANTENNA POLARIZATION: Vertical and Horizontal
DETECTOR: Peak

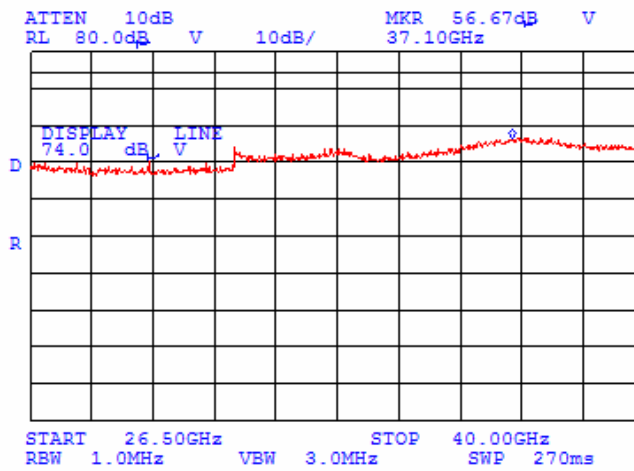

Plot 7.3.72 Radiated emission measurements from 26.5 to 40 GHz at the mid carrier frequency

TEST SITE: OATS
TEST DISTANCE: 3 m
ANTENNA POLARIZATION: Vertical and Horizontal
DETECTOR: Average

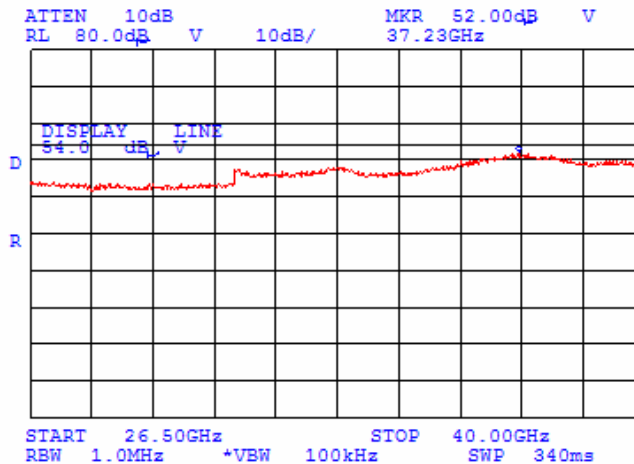



HERMON LABORATORIES

Test specification: FCC section 15.407(b), RSS-210 Annex 9, section A9.2 Unwanted radiated emissions			
Test procedure: Public notice DA 00-705 / ANSI C63.4, Section 13.1.4			
Test mode: Compliance	Verdict: PASS		
Date: 12/29/2008			
Temperature: 21°C	Air Pressure: 1014 hPa	Relative Humidity: 44 %	Power Supply: 48 VDC
Remarks: EUT with 28 dBi antenna assembly gain			

Plot 7.3.73 Radiated emission measurements from 26.5 to 40 GHz at the high carrier frequency

TEST SITE: OATS
TEST DISTANCE: 3 m
ANTENNA POLARIZATION: Vertical and Horizontal
DETECTOR: Peak

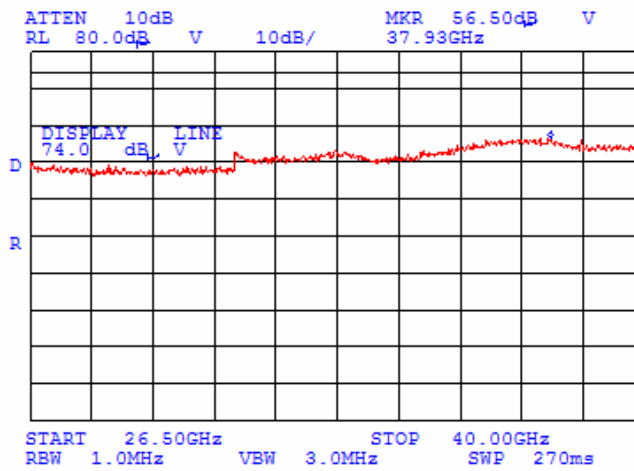

Plot 7.3.74 Radiated emission measurements from 26.5 to 40 GHz at the high carrier frequency

TEST SITE: OATS
TEST DISTANCE: 3 m
ANTENNA POLARIZATION: Vertical and Horizontal
DETECTOR: Average

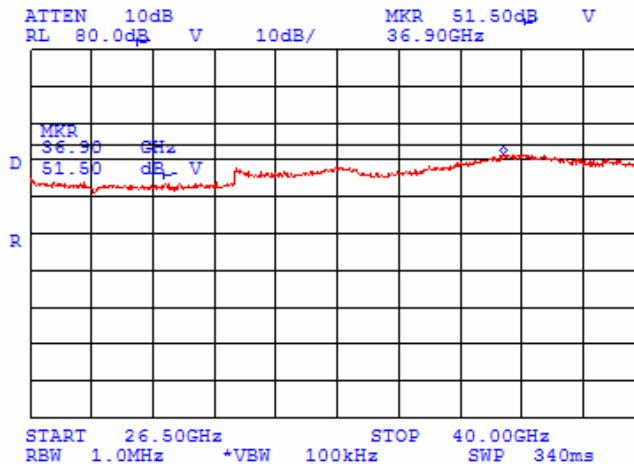



Test specification:	FCC section 15.407(b), RSS-210 Annex 9, section A9.2 Conducted emissions at band edges		
Test procedure:	Public notice DA 00-705 / ANSI C63.4, Section 13.1.4		
Test mode:	Compliance	Verdict:	PASS
Date:	12/28/2008		
Temperature: 21 °C	Air Pressure: 1011 hPa	Relative Humidity: 43 %	Power Supply: 48 VDC
Remarks:			

7.4 Band edge spurious emission measurements

7.4.1 General

This test was performed to measure conducted spurious emissions from the EUT near the band edges and within the pass band of the antenna. Specification test limits are given in Table 7.4.1.

Table 7.4.1 Spurious emission test limits

Assigned frequency range, MHz	EIRP of spurious, dBm/MHz	Antenna assembly gain, dBi	Resolution bandwidth, kHz
5250 - 5350	-27	22.5	1000
5250 - 5350	-27	28	1000

7.4.2 Test procedure for conducted spurious emission measurements

- 7.4.2.1 The EUT was set up as shown in Figure 7.4.1, energized normally modulated at the maximum data rate and its proper operation was checked.
- 7.4.2.2 The EUT was adjusted to produce maximum available to end user RF output power at the lowest carrier frequency.
- 7.4.2.3 The spectrum analyzer span was set to capture the carrier frequency and associated modulation products. The resolution bandwidth was set to 1 MHz.
- 7.4.2.4 The spectrum analyzer was set in max hold mode and allowed trace to stabilize. The highest emission level within the authorized band was measured.
- 7.4.2.5 The maximum band edge emission and modulation product outside of the band were measured as provided in, Table 7.4.5, Table 7.4.5 and associated plots.
- 7.4.2.6 The above procedure was repeated with the EUT adjusted to produce maximum RF output power at the mid and highest carrier frequencies.

Figure 7.4.1 Setup for conducted spurious emissions

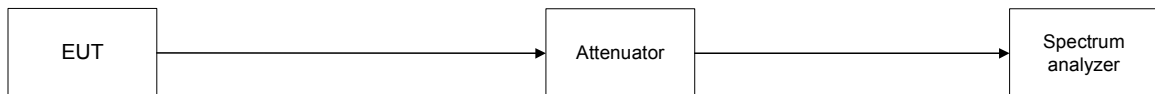

Reference numbers of test equipment used

HL 2780	HL 2883	HL 3176					
---------	---------	---------	--	--	--	--	--

Full description is given in Appendix A.



Test specification:		FCC section 15.407(b), RSS-210 Annex 9, section A9.2 Conducted emissions at band edges	
Test procedure:		Public notice DA 00-705 / ANSI C63.4, Section 13.1.4	
Test mode:	Compliance	Verdict:	PASS
Date:	12/28/2008		
Temperature: 21 °C	Air Pressure: 1011 hPa	Relative Humidity: 43 %	Power Supply: 48 VDC
Remarks:			

7.4.3 Test procedure for radiated spurious emission measurements

7.4.3.1 This test was performed to measure radiated spurious emission from the EUT near the band edge within the restricted bands. Specification test limits are given in Table 7.4.2.

7.4.3.2 The EUT and measurement equipment were arranged as shown in Figure 7.4.2.

7.4.3.3 Test results are shown in Table 7.4.4, Table 7.4.6 and the associated plots.

Table 7.4.2 Radiated spurious emissions limits within restricted bands

Frequency, MHz	Field strength at 3 m, dB(μV/m)***	
	Peak	Average
Above 1000	74.0	54.0

Figure 7.4.2 Setup for spurious emission field strength measurements above 1000 MHz

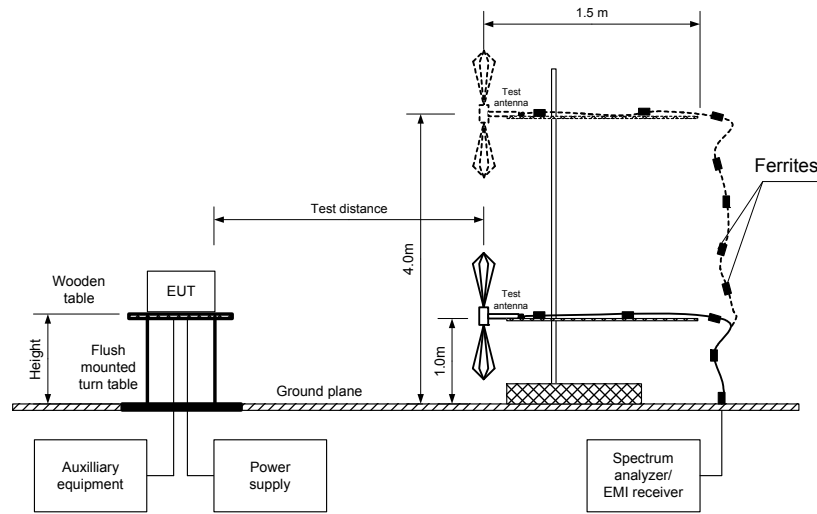



HERMON LABORATORIES

Test specification:		FCC section 15.407(b), RSS-210 Annex 9, section A9.2 Conducted emissions at band edges	
Test procedure:		Public notice DA 00-705 / ANSI C63.4, Section 13.1.4	
Test mode:	Compliance	Verdict: PASS	
Date:	12/28/2008		
Temperature: 21 °C	Air Pressure: 1011 hPa	Relative Humidity: 43 %	Power Supply: 48 VDC
Remarks: EUT with 22.5 dBi antenna assembly gain			

Table 7.4.3 Conducted band edge emission test results

ASSIGNED FREQUENCY RANGE: 5250 – 5350 MHz
 DETECTOR USED: Peak, 100 Power averaging
 RESOLUTION BANDWIDTH: 1000 kHz
 VIDEO BANDWIDTH: 3000 kHz
 MODULATING SIGNAL: OFDM
 MODULATION: BPSK/64QAM

Frequency, MHz	Modulation	Bit rate, Mbps	CBW, MHz	SA reading, dBm	Limit, dBm/MHz	Antenna assembly gain, dBi	EIRP*, dBm/MHz	Margin**, dB	Verdict
5250.0	BPSK	13	20	-51.54	-27	22.5	-29.04	-2.04	Pass
5250.0	64QAM	130		-51.13	-27	22.5	-28.63	-1.63	Pass
5250	BPSK	6.5	10	-64.63	-27	22.5	-42.13	-15.13	Pass
	64QAM	65		-63.95	-27	22.5	-41.45	-14.45	Pass
5260	BPSK	3.25	5	-68.40	-27	22.5	-45.90	-18.90	Pass
5222.00	BPSK	3.25		-61.16	-27	22.5	-38.66	-11.66	Pass
5218.25	BPSK	3.25		-62.46	-27	22.5	-39.96	-12.96	Pass
5260	64QAM	32.5		-68.14	-27	22.5	-45.64	-18.64	Pass
5221.75	64QAM	32.5		-61.15	-27	22.5	-38.65	-11.65	Pass
5218.50	64QAM	32.5		-62.65	-27	22.5	-40.15	-13.15	Pass

* - EIRP = SA reading (dBm) + Antenna assembly gain;

** - Margin = EIRP of spurious – specified limit.

Reference numbers of test equipment used

HL 2780	HL 2883	HL 3176					
---------	---------	---------	--	--	--	--	--

Full description is given in Appendix A.



HERMON LABORATORIES

Test specification: FCC section 15.407(b), RSS-210 Annex 9, section A9.2 Conducted emissions at band edges			
Test procedure: Public notice DA 00-705 / ANSI C63.4, Section 13.1.4			
Test mode: Compliance		Verdict: PASS	
Date: 12/28/2008			
Temperature: 21 °C	Air Pressure: 1011 hPa	Relative Humidity: 43 %	Power Supply: 48 VDC
Remarks: EUT with 22.5 dBi antenna assembly gain			

Table 7.4.4 Field strength of spurious emissions at high edge

ASSIGNED FREQUENCY: 5250 - 5350 MHz
 TEST DISTANCE: 3 m
 MODULATION: BPSK/64QAM
 TRANSMITTER OUTPUT POWER SETTINGS: Maximum
 DETECTOR USED: Peak
 RESOLUTION BANDWIDTH: 1000 kHz
 TEST ANTENNA TYPE: Double ridged guide
 ANTENNA POLARIZATION: Vertical

Frequency, MHz	Peak, dB(µV/m)			Average, dB(µV/m)			Bit rate, Mbps	Ant. height, m	Turntable position**, degrees	Verdict	
	Measured emission, dB(µV/m)	Limit, dB(µV/m)	Margin, dB*	Measured emission, dB(µV/m)	Limit, dB(µV/m)	Margin, dB*					
20 MHz EBW											
5350.0	72.69	74.00	-1.31	52.77	54	-1.23	13	1.0	0	Pass	
5350.1	72.69	74.00	-1.31	51.92	54	-2.08	130	1.0	0		
10 MHz EBW											
5350.0	53.93	74.00	-20.07	38.31	54	-15.69	6.5	1.0	0		
5350.0	54.01	74.00	-19.99	38.22	54	-15.78	65	1.0	0		
5 MHz EBW											
5350.0	52.12	74.00	-21.88	37.95	54	-16.05	3.25	1.0	0		
5350.0	51.07	74.00	-22.93	37.47	54	-16.53	32.5	1.0	0		

*- Margin = Measured emission – specification limit.
 **- EUT front panel refers to 0 degrees position of turntable.

Reference numbers of test equipment used

HL 0554	HL 1984	HL 2780	HL 3122	HL 3123			
---------	---------	---------	---------	---------	--	--	--

Full description is given in Appendix A.



HERMON LABORATORIES

Test specification: FCC section 15.407(b), RSS-210 Annex 9, section A9.2 Conducted emissions at band edges			
Test procedure: Public notice DA 00-705 / ANSI C63.4, Section 13.1.4			
Test mode: Compliance	Verdict: PASS		
Date: 12/28/2008			
Temperature: 21 °C	Air Pressure: 1011 hPa	Relative Humidity: 43 %	Power Supply: 48 VDC
Remarks: EUT with 22.5 dBi antenna assembly gain			

Plot 7.4.1 Conducted spurious emission measurements in the 5150 – 5250 MHz range

CARRIER FREQUENCY 5270 MHz
CHANNEL BANDWIDTH 20 MHz
MODULATION: BPSK 13 Mbps

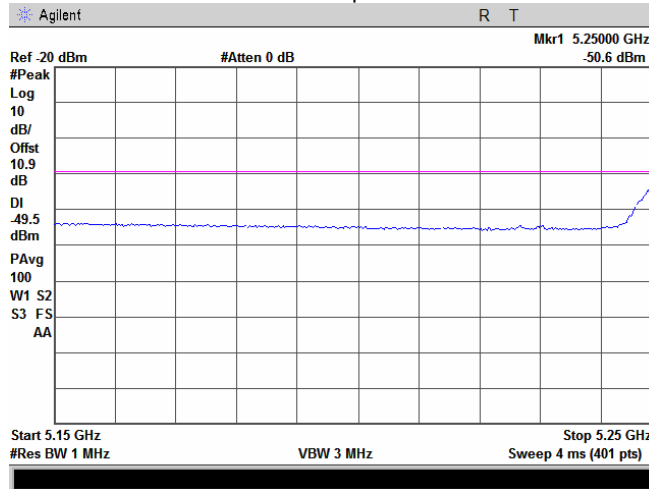

Plot 7.4.2 Conducted spurious emission measurements in the 5150 – 5250 MHz range

CARRIER FREQUENCY 5270 MHz
CHANNEL BANDWIDTH 20 MHz
MODULATION: 64QAM 130 Mbps

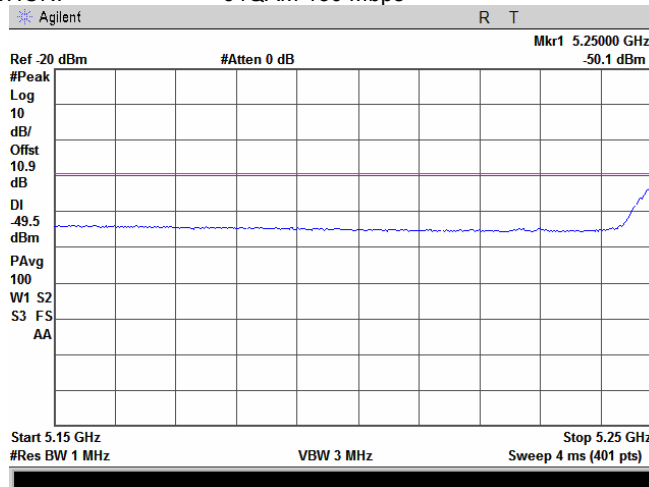



HERMON LABORATORIES

Test specification: FCC section 15.407(b), RSS-210 Annex 9, section A9.2 Conducted emissions at band edges			
Test procedure: Public notice DA 00-705 / ANSI C63.4, Section 13.1.4			
Test mode: Compliance	Verdict: PASS		
Date: 12/28/2008			
Temperature: 21 °C	Air Pressure: 1011 hPa	Relative Humidity: 43 %	Power Supply: 48 VDC
Remarks: EUT with 22.5 dBi antenna assembly gain			

Plot 7.4.3 Conducted spurious emission measurements at the band edges

CARRIER FREQUENCY 5270 MHz
CHANNEL BANDWIDTH 20 MHz
MODULATION: BPSK 13 Mbps

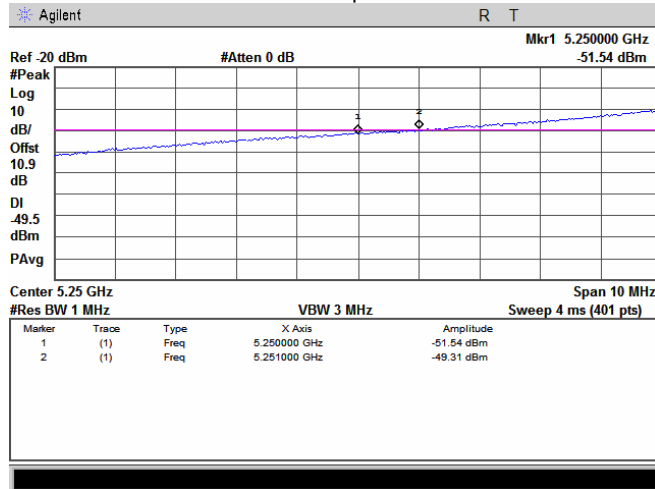

Plot 7.4.4 Conducted spurious emission measurements at the band edges

CARRIER FREQUENCY 5270 MHz
CHANNEL BANDWIDTH 20 MHz
MODULATION: 64QAM 130 Mbps

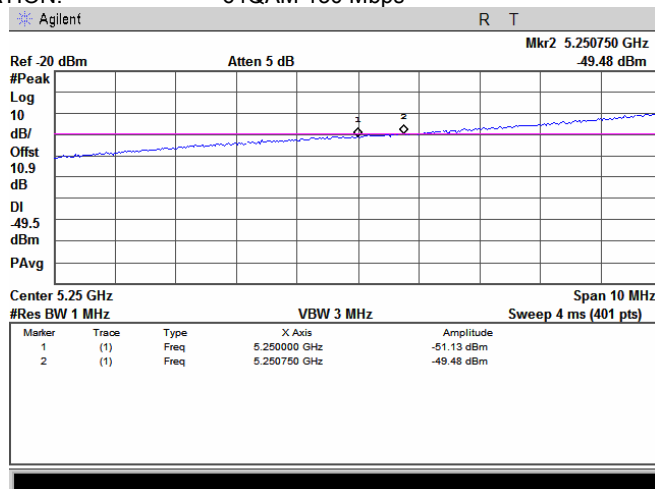



HERMON LABORATORIES

Test specification:		FCC section 15.407(b), RSS-210 Annex 9, section A9.2 Conducted emissions at band edges	
Test procedure:		Public notice DA 00-705 / ANSI C63.4, Section 13.1.4	
Test mode:	Compliance	Verdict:	PASS
Date:	12/28/2008		
Temperature: 21 °C	Air Pressure: 1011 hPa	Relative Humidity: 43 %	Power Supply: 48 VDC
Remarks: EUT with 22.5 dBi antenna assembly gain			

Plot 7.4.5 Radiated spurious emission measurements at the band edges

CARRIER FREQUENCY 5330 MHz
 CHANNEL BANDWIDTH 20 MHz
 MODULATION: BPSK 13 Mbps
 DETECTOR Peak

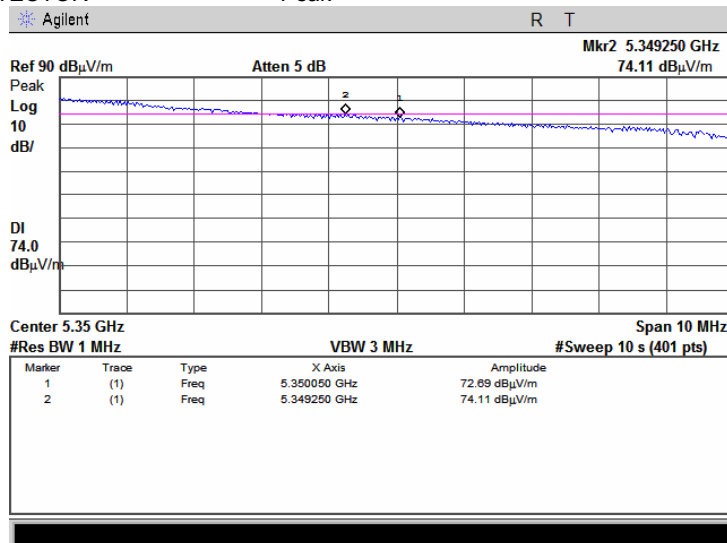

Plot 7.4.6 Radiated spurious emission measurements at the band edges

CARRIER FREQUENCY 5330 MHz
 CHANNEL BANDWIDTH 20 MHz
 MODULATION: BPSK 13 Mbps
 DETECTOR Average

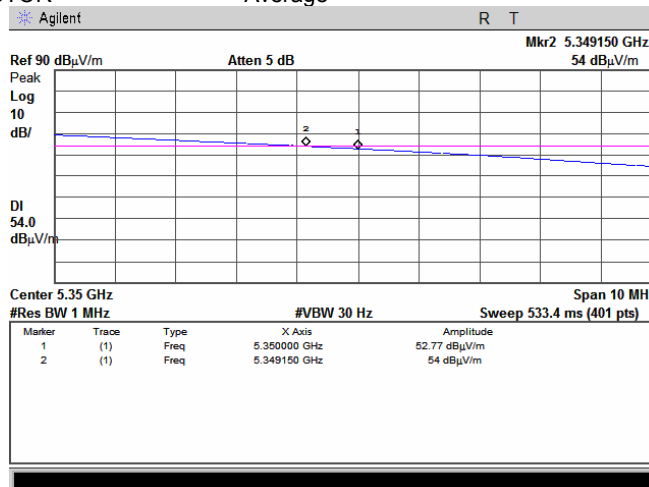



HERMON LABORATORIES

Test specification: FCC section 15.407(b), RSS-210 Annex 9, section A9.2 Conducted emissions at band edges			
Test procedure: Public notice DA 00-705 / ANSI C63.4, Section 13.1.4			
Test mode: Compliance	Verdict: PASS		
Date: 12/28/2008			
Temperature: 21 °C	Air Pressure: 1011 hPa	Relative Humidity: 43 %	Power Supply: 48 VDC
Remarks: EUT with 22.5 dBi antenna assembly gain			

Plot 7.4.7 Radiated spurious emission measurements at the band edges

CARRIER FREQUENCY 5330 MHz
 CHANNEL BANDWIDTH 20 MHz
 MODULATION: 64QAM 130 Mbps
 DETECTOR Peak

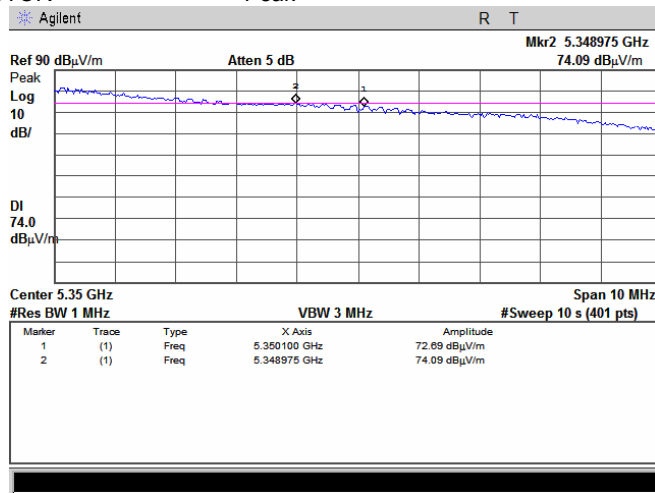

Plot 7.4.8 Radiated spurious emission measurements at the band edges

CARRIER FREQUENCY 5330 MHz
 CHANNEL BANDWIDTH 20 MHz
 MODULATION: 64QAM 130 Mbps
 DETECTOR Average

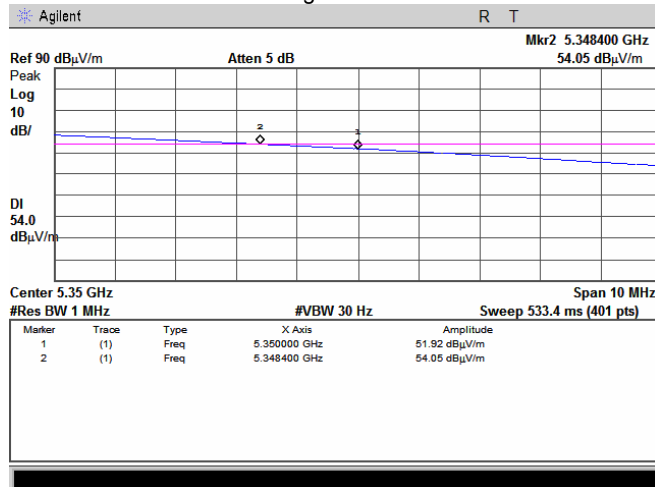



Test specification: FCC section 15.407(b), RSS-210 Annex 9, section A9.2 Conducted emissions at band edges			
Test procedure: Public notice DA 00-705 / ANSI C63.4, Section 13.1.4			
Test mode: Compliance	Verdict: PASS		
Date: 12/28/2008			
Temperature: 21 °C	Air Pressure: 1011 hPa	Relative Humidity: 43 %	Power Supply: 48 VDC
Remarks: EUT with 22.5 dBi antenna assembly gain			

Plot 7.4.9 Conducted spurious emission measurements in the 5150 – 5250 MHz range

CARRIER FREQUENCY 5265 MHz
CHANNEL BANDWIDTH 10 MHz
MODULATION: BPSK 6.5 Mbps

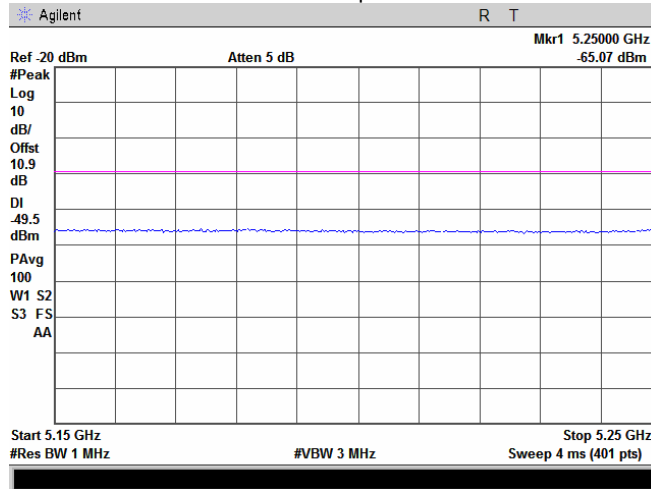

Plot 7.4.10 Conducted spurious emission measurements in the 5150 – 5250 MHz range

CARRIER FREQUENCY 5265 MHz
CHANNEL BANDWIDTH 10 MHz
MODULATION: 64QAM 65 Mbps

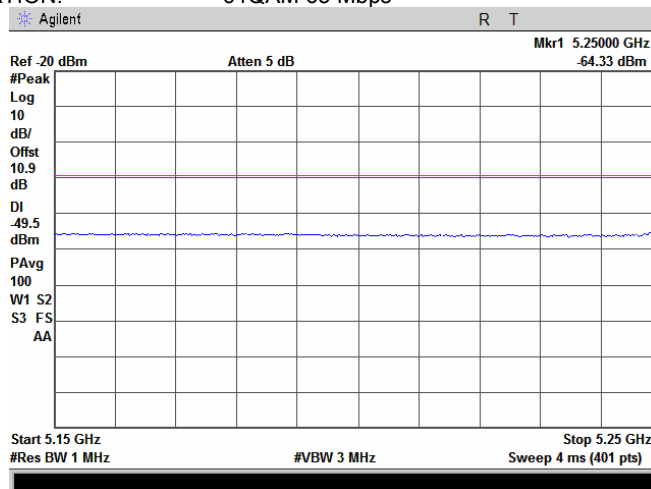



HERMON LABORATORIES

Test specification: FCC section 15.407(b), RSS-210 Annex 9, section A9.2 Conducted emissions at band edges			
Test procedure: Public notice DA 00-705 / ANSI C63.4, Section 13.1.4			
Test mode: Compliance	Verdict: PASS		
Date: 12/28/2008			
Temperature: 21 °C	Air Pressure: 1011 hPa	Relative Humidity: 43 %	Power Supply: 48 VDC
Remarks: EUT with 22.5 dBi antenna assembly gain			

Plot 7.4.11 Conducted spurious emission measurements at the band edges

CARRIER FREQUENCY 5265 MHz
CHANNEL BANDWIDTH 10 MHz
MODULATION: BPSK 6.5 Mbps

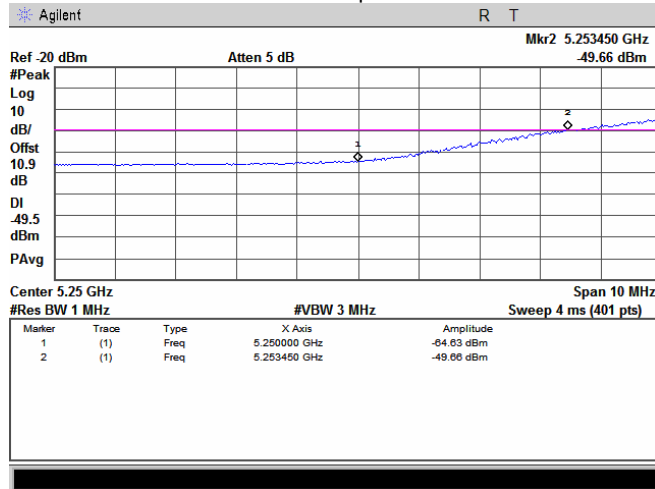

Plot 7.4.12 Conducted spurious emission measurements at the band edges

CARRIER FREQUENCY 5265 MHz
CHANNEL BANDWIDTH 10 MHz
MODULATION: 64QAM 65 Mbps

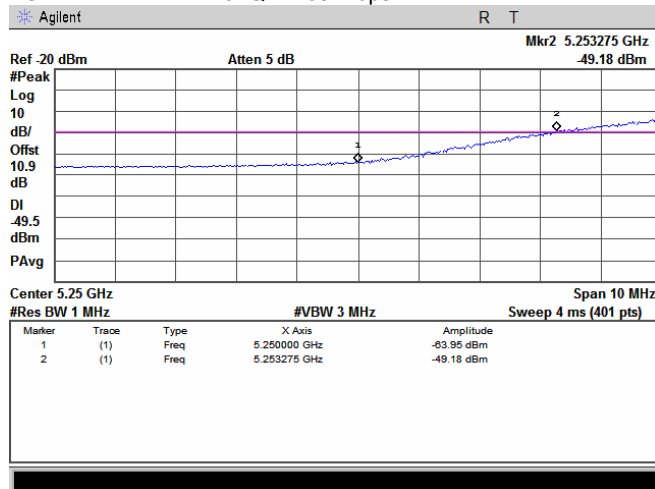



HERMON LABORATORIES

Test specification:	FCC section 15.407(b), RSS-210 Annex 9, section A9.2 Conducted emissions at band edges		
Test procedure:	Public notice DA 00-705 / ANSI C63.4, Section 13.1.4		
Test mode:	Compliance	Verdict:	PASS
Date:	12/28/2008		
Temperature: 21 °C	Air Pressure: 1011 hPa	Relative Humidity: 43 %	Power Supply: 48 VDC
Remarks: EUT with 22.5 dBi antenna assembly gain			

Plot 7.4.13 Radiated spurious emission measurements at the band edges

CARRIER FREQUENCY 5335 MHz
 CHANNEL BANDWIDTH 10 MHz
 MODULATION: BPSK 6.5 Mbps
 DETECTOR Peak

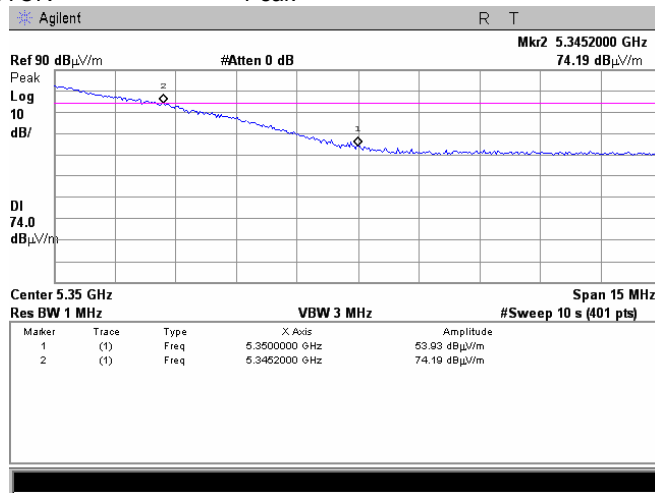

Plot 7.4.14 Radiated spurious emission measurements at the band edges

CARRIER FREQUENCY 5335 MHz
 CHANNEL BANDWIDTH 10 MHz
 MODULATION: BPSK 6.5 Mbps
 DETECTOR Average

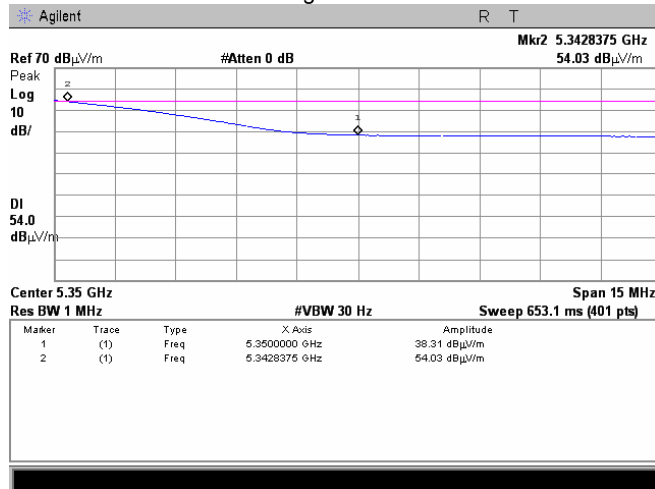



HERMON LABORATORIES

Test specification: FCC section 15.407(b), RSS-210 Annex 9, section A9.2 Conducted emissions at band edges			
Test procedure: Public notice DA 00-705 / ANSI C63.4, Section 13.1.4			
Test mode: Compliance	Verdict: PASS		
Date: 12/28/2008			
Temperature: 21 °C	Air Pressure: 1011 hPa	Relative Humidity: 43 %	Power Supply: 48 VDC
Remarks: EUT with 22.5 dBi antenna assembly gain			

Plot 7.4.15 Radiated spurious emission measurements at the band edges

CARRIER FREQUENCY 5335 MHz
 CHANNEL BANDWIDTH 10 MHz
 MODULATION: 64QAM 65 Mbps
 DETECTOR Peak

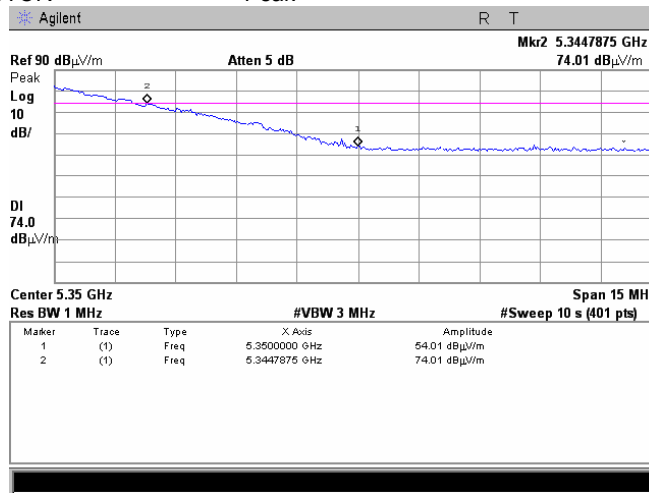

Plot 7.4.16 Radiated spurious emission measurements at the band edges

CARRIER FREQUENCY 5335 MHz
 CHANNEL BANDWIDTH 10 MHz
 MODULATION: 64QAM 65 Mbps
 DETECTOR Average

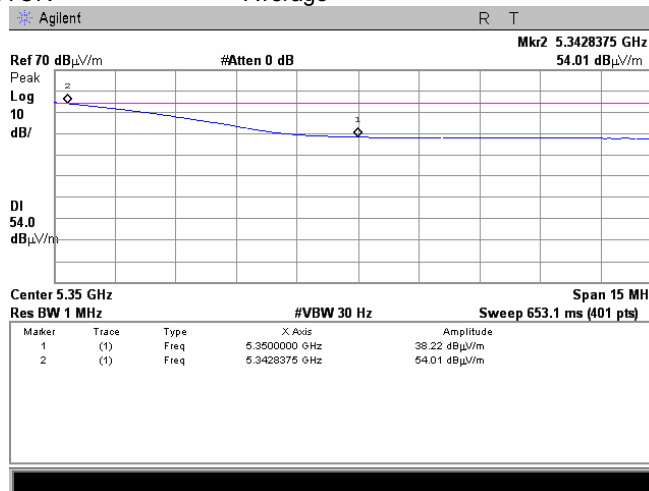



HERMON LABORATORIES

Test specification: FCC section 15.407(b), RSS-210 Annex 9, section A9.2 Conducted emissions at band edges			
Test procedure: Public notice DA 00-705 / ANSI C63.4, Section 13.1.4			
Test mode: Compliance	Verdict: PASS		
Date: 12/28/2008			
Temperature: 21 °C	Air Pressure: 1011 hPa	Relative Humidity: 43 %	Power Supply: 48 VDC
Remarks: EUT with 22.5 dBi antenna assembly gain			

Plot 7.4.17 Conducted spurious emission measurements in the 5150 – 5250 MHz range

CARRIER FREQUENCY 5260 MHz
CHANNEL BANDWIDTH 5 MHz
MODULATION: BPSK 3.25 Mbps

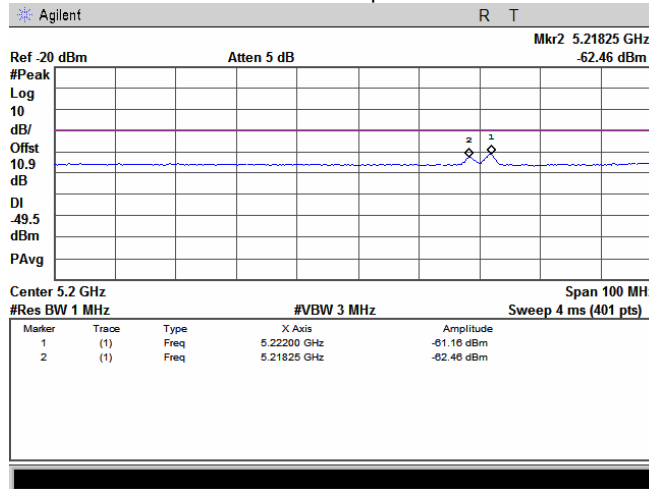

Plot 7.4.18 Conducted spurious emission measurements in the 5150 – 5250 MHz range

CARRIER FREQUENCY 5260 MHz
CHANNEL BANDWIDTH 5 MHz
MODULATION: 64QAM 32.5 Mbps

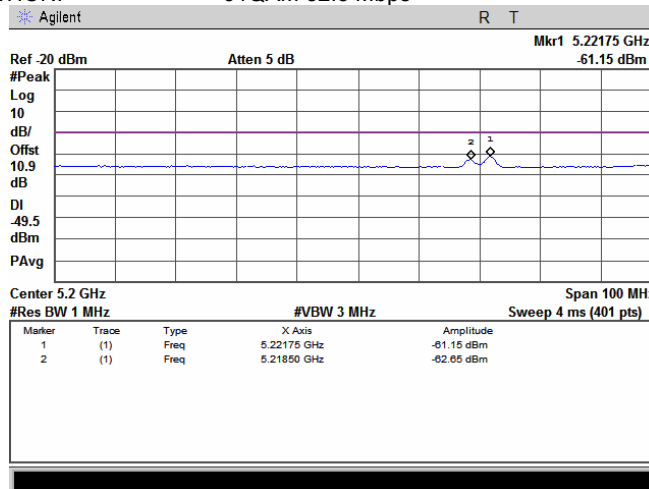



HERMON LABORATORIES

Test specification: FCC section 15.407(b), RSS-210 Annex 9, section A9.2 Conducted emissions at band edges			
Test procedure: Public notice DA 00-705 / ANSI C63.4, Section 13.1.4			
Test mode: Compliance	Verdict: PASS		
Date: 12/28/2008			
Temperature: 21 °C	Air Pressure: 1011 hPa	Relative Humidity: 43 %	Power Supply: 48 VDC
Remarks: EUT with 22.5 dBi antenna assembly gain			

Plot 7.4.19 Conducted spurious emission measurements at the band edge

CARRIER FREQUENCY 5260 MHz
CHANNEL BANDWIDTH 5 MHz
MODULATION: BPSK 3.25 Mbps

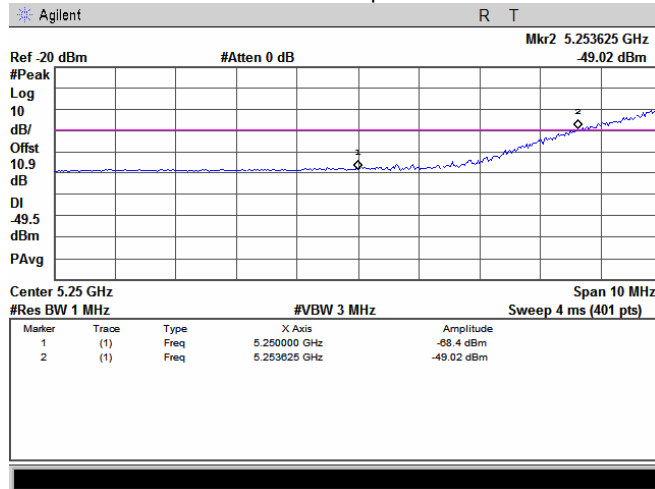

Plot 7.4.20 Conducted spurious emission measurements at the band edge

CARRIER FREQUENCY 5260 MHz
CHANNEL BANDWIDTH 5 MHz
MODULATION: 64QAM 32.5 Mbps

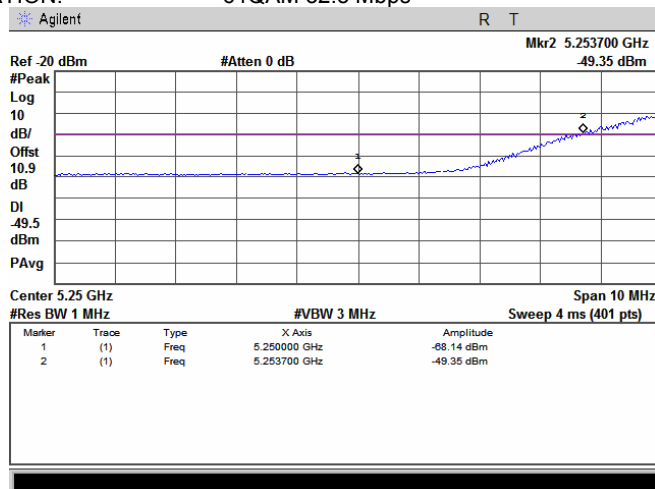



HERMON LABORATORIES

Test specification: FCC section 15.407(b), RSS-210 Annex 9, section A9.2 Conducted emissions at band edges			
Test procedure: Public notice DA 00-705 / ANSI C63.4, Section 13.1.4			
Test mode: Compliance	Verdict: PASS		
Date: 12/28/2008			
Temperature: 21 °C	Air Pressure: 1011 hPa	Relative Humidity: 43 %	Power Supply: 48 VDC
Remarks: EUT with 22.5 dBi antenna assembly gain			

Plot 7.4.21 Radiated spurious emission measurements at the band edges

CARRIER FREQUENCY 5340 MHz
 CHANNEL BANDWIDTH 5 MHz
 MODULATION: BPSK 3.25 Mbps
 DETECTOR Peak

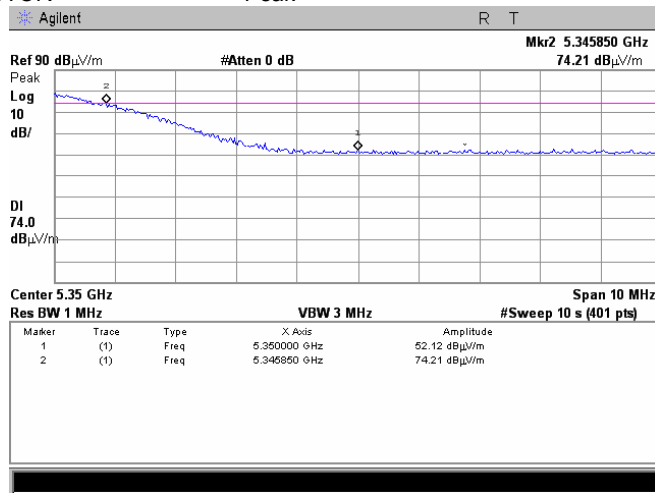

Plot 7.4.22 Radiated spurious emission measurements at the band edges

CARRIER FREQUENCY 5340 MHz
 CHANNEL BANDWIDTH 5 MHz
 MODULATION: BPSK 3.25 Mbps
 DETECTOR Average

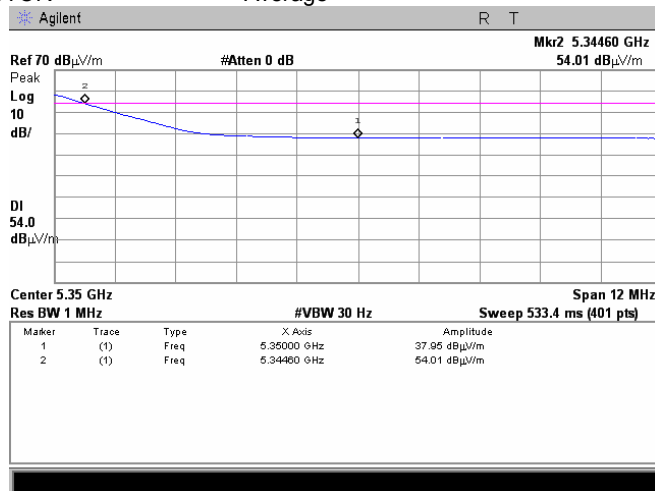



HERMON LABORATORIES

Test specification:	FCC section 15.407(b), RSS-210 Annex 9, section A9.2 Conducted emissions at band edges		
Test procedure:	Public notice DA 00-705 / ANSI C63.4, Section 13.1.4		
Test mode:	Compliance	Verdict:	PASS
Date:	12/28/2008		
Temperature: 21 °C	Air Pressure: 1011 hPa	Relative Humidity: 43 %	Power Supply: 48 VDC
Remarks: EUT with 22.5 dBi antenna assembly gain			

Plot 7.4.23 Radiated spurious emission measurements at the band edges

CARRIER FREQUENCY 5340 MHz
 CHANNEL BANDWIDTH 5 MHz
 MODULATION: 64QAM 32.5 Mbps
 DETECTOR Peak

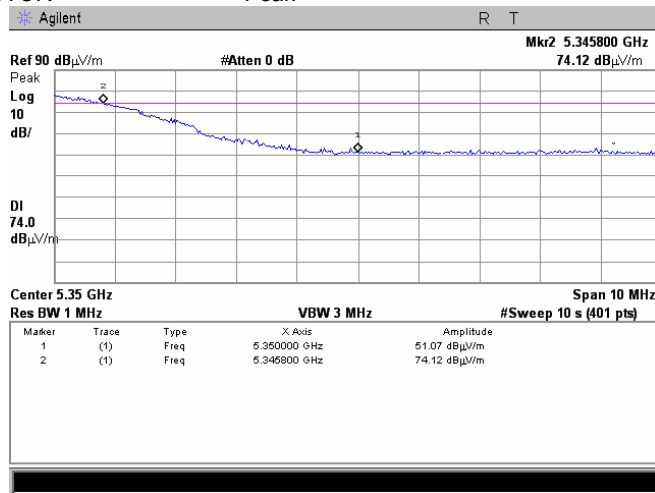

Plot 7.4.24 Radiated spurious emission measurements at the band edges

CARRIER FREQUENCY 5340 MHz
 CHANNEL BANDWIDTH 5 MHz
 MODULATION: 64QAM 32.5 Mbps
 DETECTOR Average

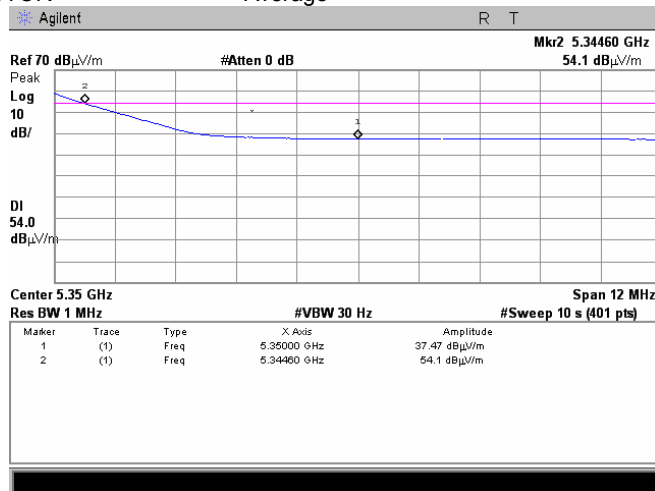



HERMON LABORATORIES

Test specification:	FCC section 15.407(b), RSS-210 Annex 9, section A9.2 Conducted emissions at band edges		
Test procedure:	Public notice DA 00-705 / ANSI C63.4, Section 13.1.4		
Test mode:	Compliance	Verdict:	PASS
Date:	12/28/2008		
Temperature: 21 °C	Air Pressure: 1011 hPa	Relative Humidity: 43 %	Power Supply: 48 VDC
Remarks: EUT with 28 dBi antenna assembly gain			

Table 7.4.5 Conducted band edge emission test results

ASSIGNED FREQUENCY RANGE: 5250 – 5350 MHz
 DETECTOR USED: Peak, 100 Power averaging
 RESOLUTION BANDWIDTH: 1000 kHz
 VIDEO BANDWIDTH: 3000 kHz
 MODULATING SIGNAL: OFDM
 MODULATION: BPSK/64QAM

Frequency, MHz	Modulation	Bit rate, Mbps	CBW, MHz	SA reading, dBm	Limit*, dBm/MHz	Antenna assembly gain, dBi	EIRP, dBm/MHz	Margin**, dB	Verdict
5250.0	BPSK	13	20	-57.03	-27	28	-29.03	-2.03	Pass
5249.9	64QAM	130		-57.27	-27	28	-29.27	-2.27	Pass
5250	BPSK	6.5	10	-66.42	-27	28	-38.42	-11.42	Pass
	64QAM	65		-66.32	-27	28	-38.32	-11.32	Pass
5260	BPSK	3.25	5	-69.76	-27	28	-41.76	-14.76	Pass
5221.75	BPSK	3.25		-65.19	-27	28	-37.19	-10.19	Pass
5218.25	BPSK	3.25		-66.99	-27	28	-38.99	-11.99	Pass
5260	64QAM	32.5		-69.78	-27	28	-41.78	-14.78	Pass
5221.75	64QAM	32.5		-65.40	-27	28	-37.40	-10.40	Pass
5218.25	64QAM	32.5		-66.97	-27	28	-38.97	-11.97	Pass

* - EIRP = SA reading (dBm) + Antenna assembly gain;
 ** - Margin = EIRP of spurious – specified limit.

Reference numbers of test equipment used

HL 2780	HL 2883	HL 3176				
---------	---------	---------	--	--	--	--

Full description is given in Appendix A.



HERMON LABORATORIES

Test specification:		FCC section 15.407(b), RSS-210 Annex 9, section A9.2 Conducted emissions at band edges	
Test procedure:		Public notice DA 00-705 / ANSI C63.4, Section 13.1.4	
Test mode:	Compliance	Verdict:	PASS
Date:	12/28/2008		
Temperature: 21 °C	Air Pressure: 1011 hPa	Relative Humidity: 43 %	Power Supply: 48 VDC
Remarks: EUT with 28 dBi antenna assembly gain			

Table 7.4.6 Field strength of spurious emissions at high edge

ASSIGNED FREQUENCY: 5250 – 5350 MHz
 TEST DISTANCE: 3 m
 MODULATION: BPSK/64QAM
 TRANSMITTER OUTPUT POWER SETTINGS: Maximum
 DETECTOR USED: Peak
 RESOLUTION BANDWIDTH: 1000 kHz
 TEST ANTENNA TYPE: Double ridged guide
 ANTENNA POLARIZATION: Vertical

Frequency, MHz	Peak, dB(µV/m)			Average, dB(µV/m)			Bit rate, Mbps	Ant. height, m	Turntable position**, degrees	Verdict	
	Measured emission, dB(µV/m)	Limit, dB(µV/m)	Margin, dB*	Measured emission, dB(µV/m)	Limit, dB(µV/m)	Margin, dB*					
20 MHz EBW											
5350.0	69.36	74.00	-4.64	50.78	54.00	-3.22	13	1.0	0	Pass	
5350.0	69.22	74.00	-4.78	50.75	54.00	-3.25	130	1.0	0		
10 MHz EBW											
5350.0	58.00	74.00	-16.00	39.24	54.00	-14.76	6.5	1.0	0		
5350.0	56.07	74.00	-17.93	40.28	54.00	-13.72	65	1.0	0		
5 MHz EBW											
5350.0	53.06	74.00	-20.94	39.73	54.00	-14.27	3.25	1.0	0		
5350.0	53.85	74.00	-20.15	39.44	54.00	-14.56	32.5	1.0	0		

*- Margin = Measured emission – specification limit.

**- EUT front panel refers to 0 degrees position of turntable.

Reference numbers of test equipment used

HL 0554	HL 1984	HL 2780	HL 3122	HL 3123			
---------	---------	---------	---------	---------	--	--	--

Full description is given in Appendix A.



HERMON LABORATORIES

Test specification: FCC section 15.407(b), RSS-210 Annex 9, section A9.2 Conducted emissions at band edges			
Test procedure: Public notice DA 00-705 / ANSI C63.4, Section 13.1.4			
Test mode: Compliance	Verdict: PASS		
Date: 12/28/2008			
Temperature: 21 °C	Air Pressure: 1011 hPa	Relative Humidity: 43 %	Power Supply: 48 VDC
Remarks: EUT with 28 dBi antenna assembly gain			

Plot 7.4.25 Conducted spurious emission measurements in the 5150 – 5250 MHz range

CARRIER FREQUENCY 5270 MHz
CHANNEL BANDWIDTH 20 MHz
MODULATION: BPSK 13 Mbps

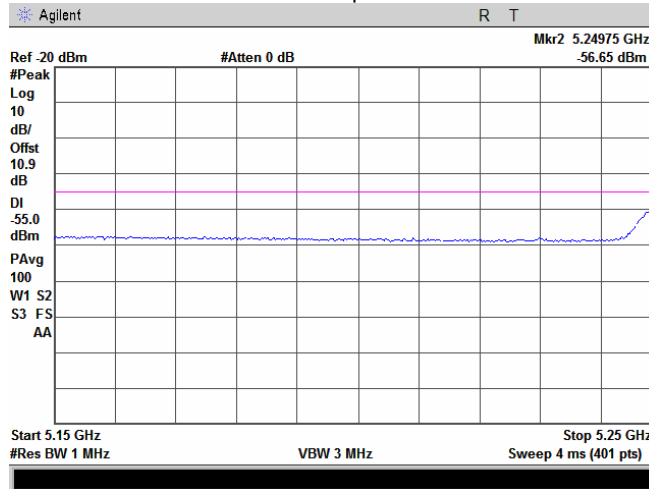

Plot 7.4.26 Conducted spurious emission measurements in the 5150 – 5250 MHz range

CARRIER FREQUENCY 5270 MHz
CHANNEL BANDWIDTH 20 MHz
MODULATION: 64QAM 130 Mbps

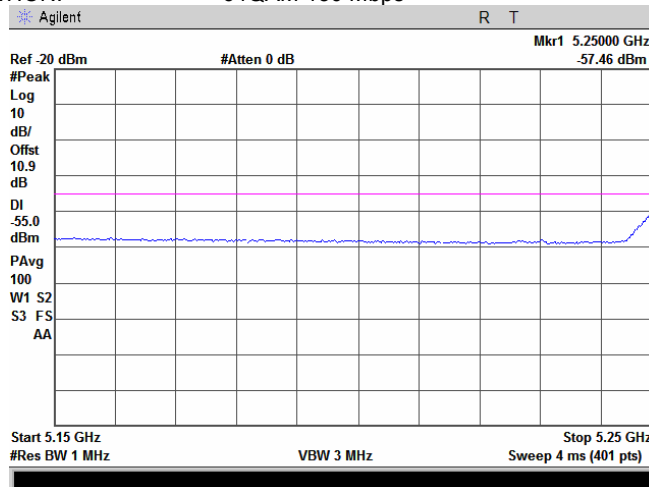



HERMON LABORATORIES

Test specification: FCC section 15.407(b), RSS-210 Annex 9, section A9.2 Conducted emissions at band edges			
Test procedure: Public notice DA 00-705 / ANSI C63.4, Section 13.1.4			
Test mode: Compliance	Verdict: PASS		
Date: 12/28/2008			
Temperature: 21 °C	Air Pressure: 1011 hPa	Relative Humidity: 43 %	Power Supply: 48 VDC
Remarks: EUT with 28 dBi antenna assembly gain			

Plot 7.4.27 Conducted spurious emission measurements at the band edges

CARRIER FREQUENCY 5270 MHz
CHANNEL BANDWIDTH 20 MHz
MODULATION: BPSK 13 Mbps

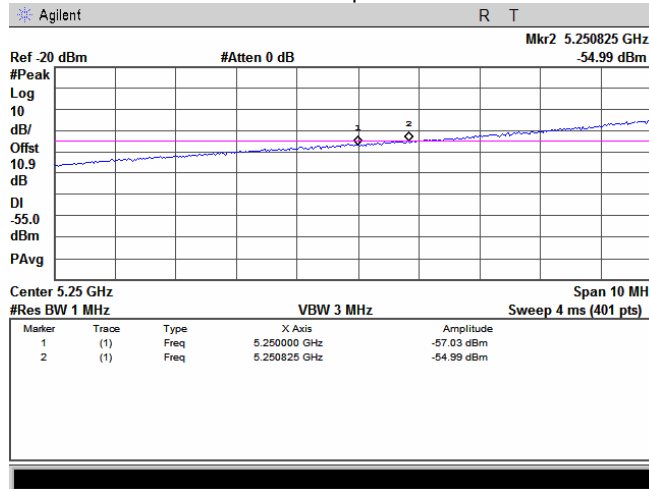

Plot 7.4.28 Conducted spurious emission measurements at the band edges

CARRIER FREQUENCY 5270 MHz
CHANNEL BANDWIDTH 20 MHz
MODULATION: 64QAM 130 Mbps

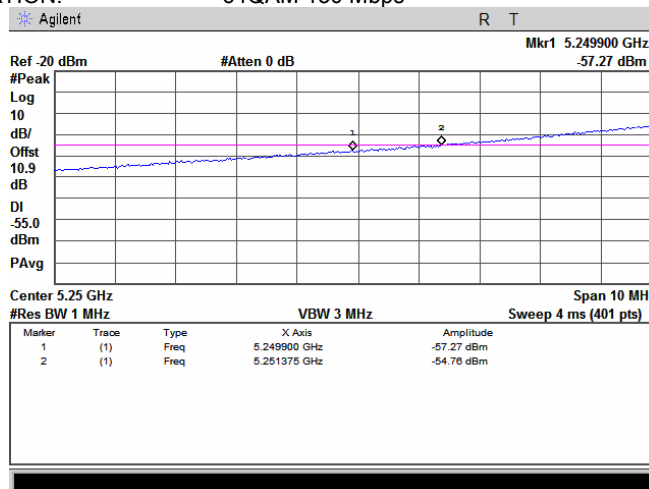



HERMON LABORATORIES

Test specification:		FCC section 15.407(b), RSS-210 Annex 9, section A9.2 Conducted emissions at band edges	
Test procedure:		Public notice DA 00-705 / ANSI C63.4, Section 13.1.4	
Test mode:	Compliance	Verdict:	PASS
Date:	12/28/2008		
Temperature: 21 °C	Air Pressure: 1011 hPa	Relative Humidity: 43 %	Power Supply: 48 VDC
Remarks: EUT with 28 dBi antenna assembly gain			

Plot 7.4.29 Radiated spurious emission measurements at the band edges

CARRIER FREQUENCY 5330 MHz
CHANNEL BANDWIDTH 20 MHz
MODULATION: BPSK 13 Mbps
DETECTOR Peak

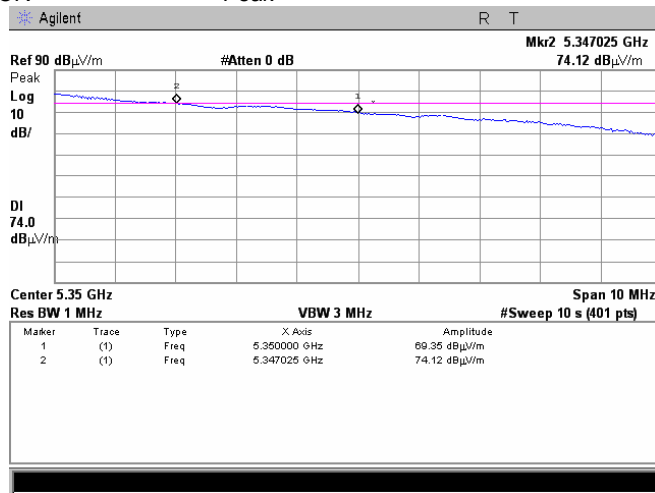

Plot 7.4.30 Radiated spurious emission measurements at the band edges

CARRIER FREQUENCY 5330 MHz
CHANNEL BANDWIDTH 20 MHz
MODULATION: BPSK 13 Mbps
DETECTOR Average

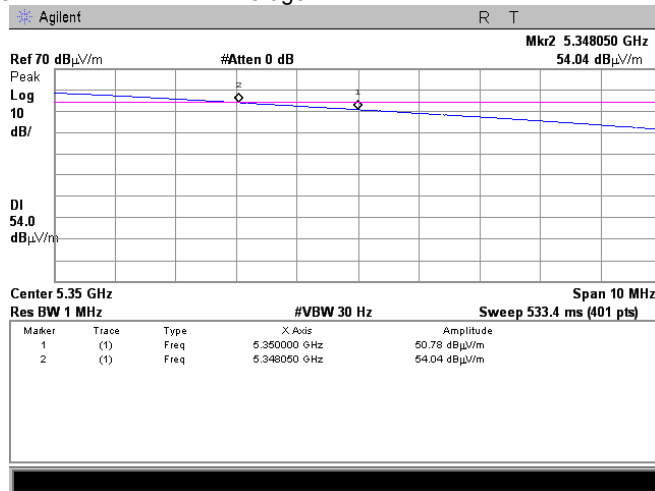



HERMON LABORATORIES

Test specification:	FCC section 15.407(b), RSS-210 Annex 9, section A9.2 Conducted emissions at band edges		
Test procedure:	Public notice DA 00-705 / ANSI C63.4, Section 13.1.4		
Test mode:	Compliance	Verdict:	PASS
Date:	12/28/2008		
Temperature: 21 °C	Air Pressure: 1011 hPa	Relative Humidity: 43 %	Power Supply: 48 VDC
Remarks: EUT with 28 dBi antenna assembly gain			

Plot 7.4.31 Radiated spurious emission measurements at the band edges

CARRIER FREQUENCY 5330 MHz
 CHANNEL BANDWIDTH 20 MHz
 MODULATION: 64QAM 130 Mbps
 DETECTOR Peak

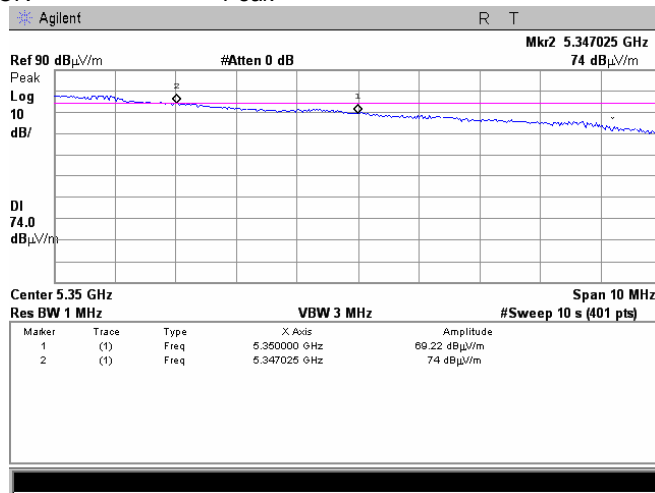

Plot 7.4.32 Radiated spurious emission measurements at the band edges

CARRIER FREQUENCY 5330 MHz
 CHANNEL BANDWIDTH 20 MHz
 MODULATION: 64QAM 130 Mbps
 DETECTOR Average

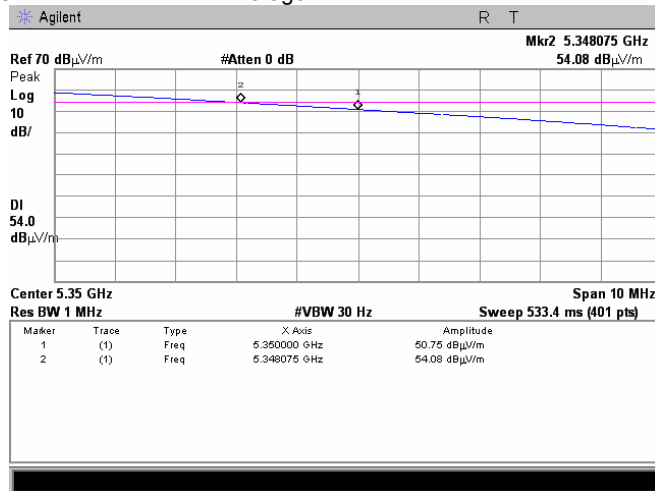



HERMON LABORATORIES

Test specification: FCC section 15.407(b), RSS-210 Annex 9, section A9.2 Conducted emissions at band edges			
Test procedure: Public notice DA 00-705 / ANSI C63.4, Section 13.1.4			
Test mode: Compliance	Verdict: PASS		
Date: 12/28/2008			
Temperature: 21 °C	Air Pressure: 1011 hPa	Relative Humidity: 43 %	Power Supply: 48 VDC
Remarks: EUT with 28 dBi antenna assembly gain			

Plot 7.4.33 Conducted spurious emission measurements in the 5150 – 5250 MHz range

CARRIER FREQUENCY 5265 MHz
CHANNEL BANDWIDTH 10 MHz
MODULATION: BPSK 6.5 Mbps

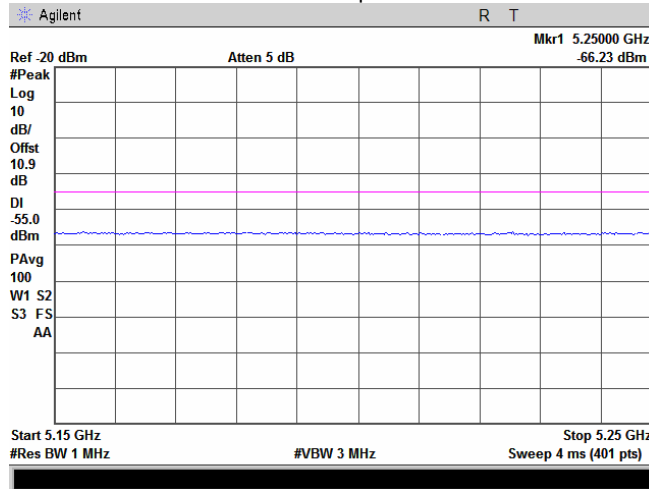

Plot 7.4.34 Conducted spurious emission measurements in the 5150 – 5250 MHz range

CARRIER FREQUENCY 5265 MHz
CHANNEL BANDWIDTH 10 MHz
MODULATION: 64QAM 65 Mbps

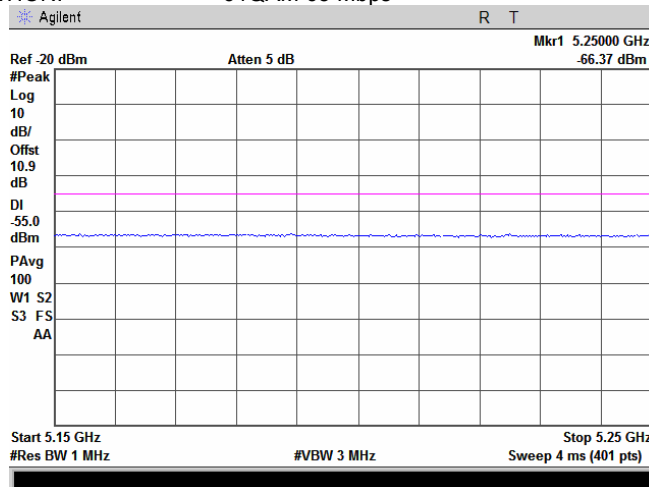



HERMON LABORATORIES

Test specification: FCC section 15.407(b), RSS-210 Annex 9, section A9.2 Conducted emissions at band edges			
Test procedure: Public notice DA 00-705 / ANSI C63.4, Section 13.1.4			
Test mode: Compliance	Verdict: PASS		
Date: 12/28/2008			
Temperature: 21 °C	Air Pressure: 1011 hPa	Relative Humidity: 43 %	Power Supply: 48 VDC
Remarks: EUT with 28 dBi antenna assembly gain			

Plot 7.4.35 Conducted spurious emission measurements at the band edges

CARRIER FREQUENCY 5265 MHz
CHANNEL BANDWIDTH 10 MHz
MODULATION: BPSK 6.5 Mbps

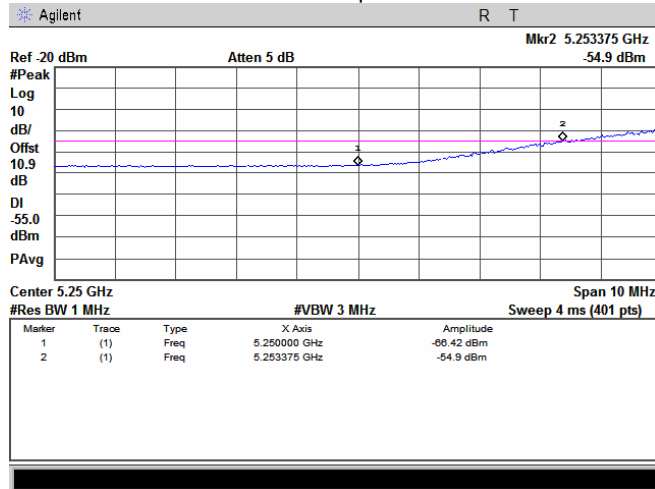

Plot 7.4.36 Conducted spurious emission measurements at the band edges

CARRIER FREQUENCY 5265 MHz
CHANNEL BANDWIDTH 10 MHz
MODULATION: 64QAM 65 Mbps

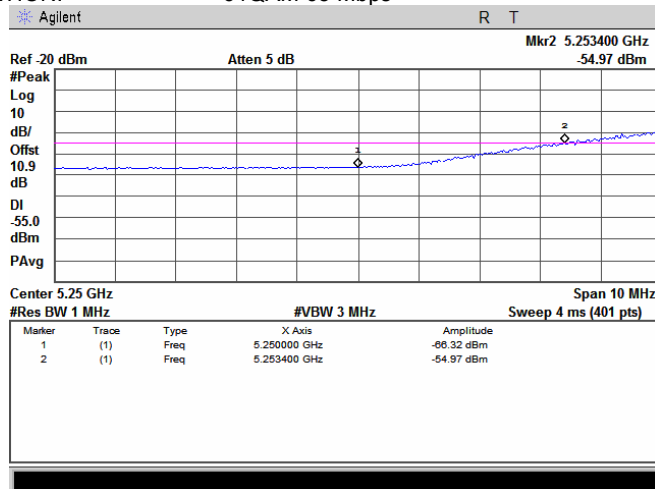



HERMON LABORATORIES

Test specification: FCC section 15.407(b), RSS-210 Annex 9, section A9.2 Conducted emissions at band edges			
Test procedure: Public notice DA 00-705 / ANSI C63.4, Section 13.1.4			
Test mode: Compliance	Verdict: PASS		
Date: 12/28/2008			
Temperature: 21 °C	Air Pressure: 1011 hPa	Relative Humidity: 43 %	Power Supply: 48 VDC
Remarks: EUT with 28 dBi antenna assembly gain			

Plot 7.4.37 Radiated spurious emission measurements at the band edges

CARRIER FREQUENCY 5335 MHz
CHANNEL BANDWIDTH 10 MHz
MODULATION: BPSK 6.5 Mbps
DETECTOR Peak

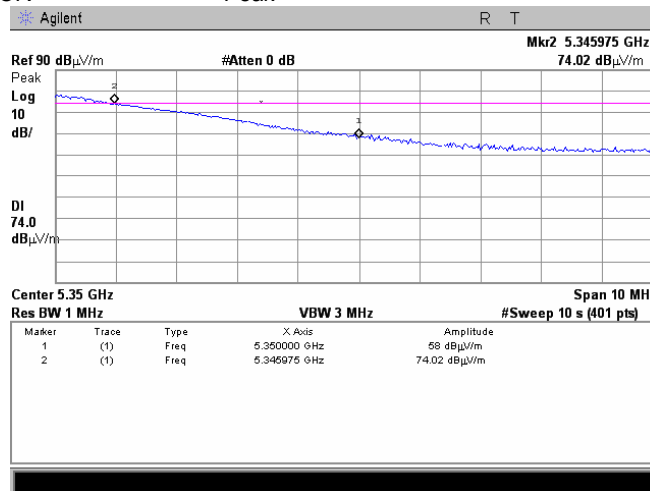

Plot 7.4.38 Radiated spurious emission measurements at the band edges

CARRIER FREQUENCY 5335 MHz
CHANNEL BANDWIDTH 10 MHz
MODULATION: BPSK 6.5 Mbps
DETECTOR Average

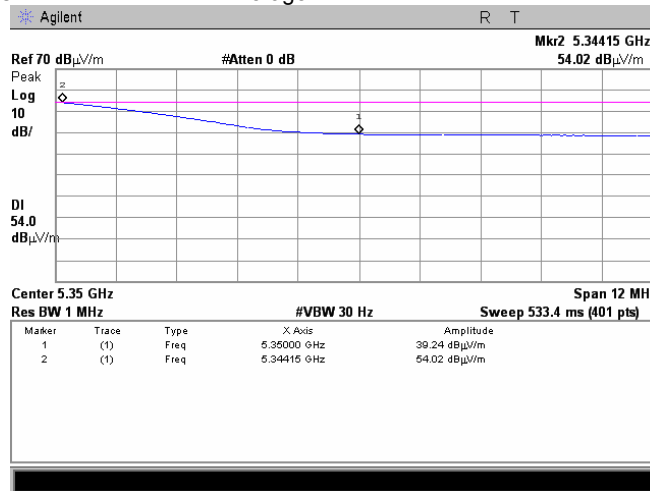



HERMON LABORATORIES

Test specification:		FCC section 15.407(b), RSS-210 Annex 9, section A9.2 Conducted emissions at band edges	
Test procedure:		Public notice DA 00-705 / ANSI C63.4, Section 13.1.4	
Test mode:	Compliance	Verdict:	PASS
Date:	12/28/2008		
Temperature: 21 °C	Air Pressure: 1011 hPa	Relative Humidity: 43 %	Power Supply: 48 VDC
Remarks: EUT with 28 dBi antenna assembly gain			

Plot 7.4.39 Radiated spurious emission measurements at the band edges

CARRIER FREQUENCY 5335 MHz
CHANNEL BANDWIDTH 10 MHz
MODULATION: 64QAM 65 Mbps
DETECTOR Peak

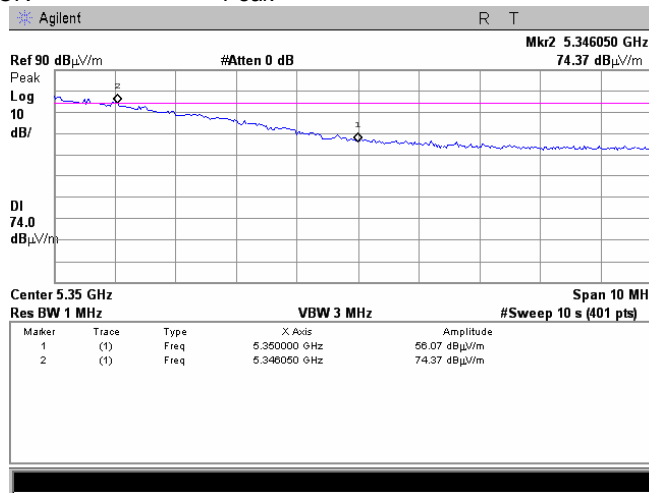

Plot 7.4.40 Radiated spurious emission measurements at the band edges

CARRIER FREQUENCY 5335 MHz
CHANNEL BANDWIDTH 10 MHz
MODULATION: 64QAM 65 Mbps
DETECTOR Average

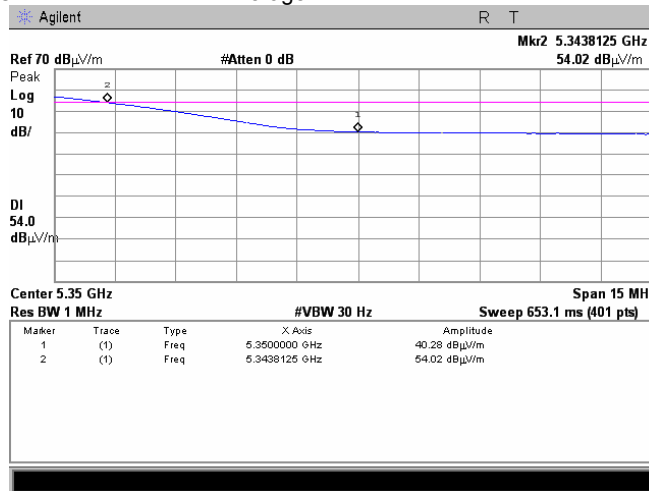



HERMON LABORATORIES

Test specification: FCC section 15.407(b), RSS-210 Annex 9, section A9.2 Conducted emissions at band edges			
Test procedure: Public notice DA 00-705 / ANSI C63.4, Section 13.1.4			
Test mode: Compliance	Verdict: PASS		
Date: 12/28/2008			
Temperature: 21 °C	Air Pressure: 1011 hPa	Relative Humidity: 43 %	Power Supply: 48 VDC
Remarks: EUT with 28 dBi antenna assembly gain			

Plot 7.4.41 Conducted spurious emission measurements in the 5150 – 5250 MHz range

CARRIER FREQUENCY 5260 MHz
CHANNEL BANDWIDTH 5 MHz
MODULATION: BPSK 3.25 Mbps

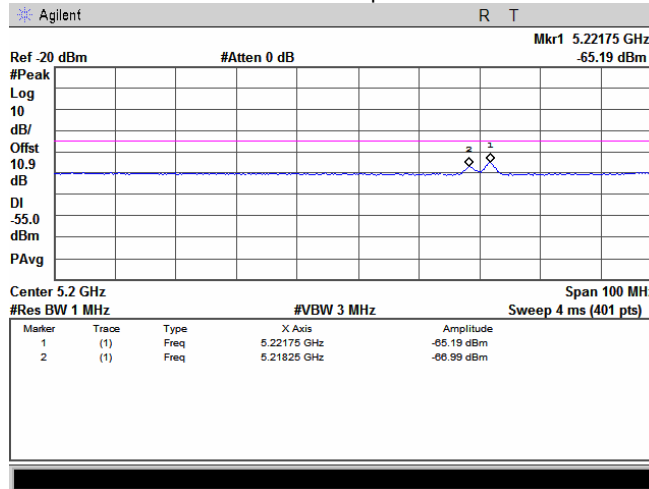

Plot 7.4.42 Conducted spurious emission measurements in the 5150 – 5250 MHz range

CARRIER FREQUENCY 5260 MHz
CHANNEL BANDWIDTH 5 MHz
MODULATION: 64QAM 32.5 Mbps

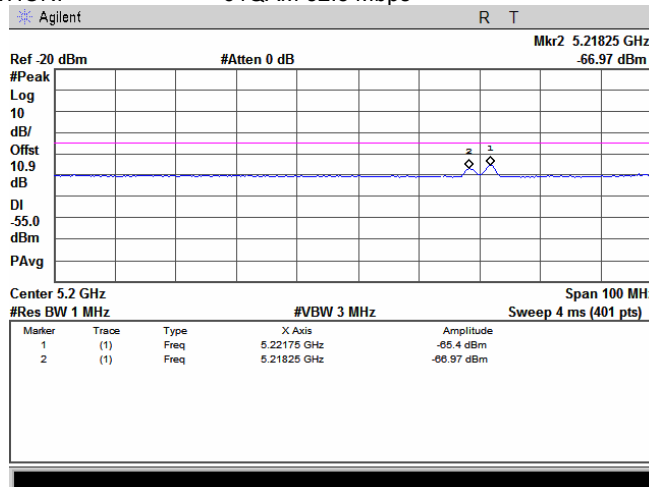



HERMON LABORATORIES

Test specification: FCC section 15.407(b), RSS-210 Annex 9, section A9.2 Conducted emissions at band edges			
Test procedure: Public notice DA 00-705 / ANSI C63.4, Section 13.1.4			
Test mode: Compliance	Verdict: PASS		
Date: 12/28/2008			
Temperature: 21 °C	Air Pressure: 1011 hPa	Relative Humidity: 43 %	Power Supply: 48 VDC
Remarks: EUT with 28 dBi antenna assembly gain			

Plot 7.4.43 Conducted spurious emission measurements at the band edges

CARRIER FREQUENCY 5260 MHz
CHANNEL BANDWIDTH 5 MHz
MODULATION: BPSK 3.25 Mbps

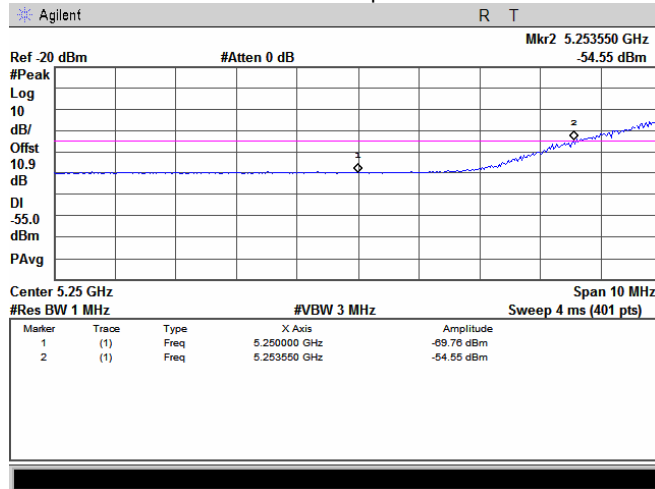

Plot 7.4.44 Conducted spurious emission measurements at the band edges

CARRIER FREQUENCY 5260 MHz
CHANNEL BANDWIDTH 5 MHz
MODULATION: 64QAM 32.5 Mbps

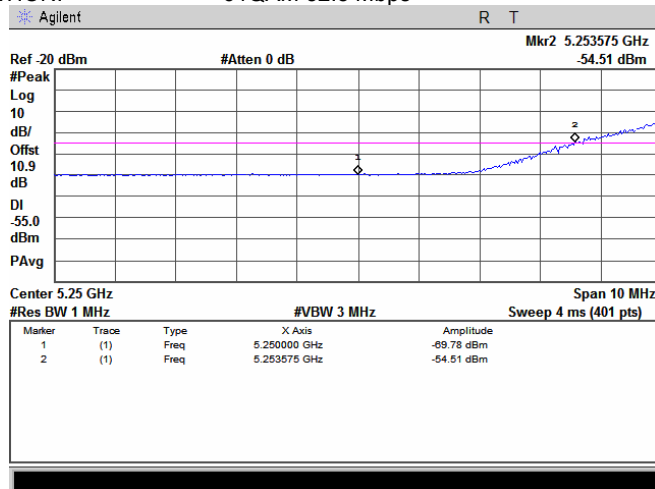



HERMON LABORATORIES

Test specification: FCC section 15.407(b), RSS-210 Annex 9, section A9.2 Conducted emissions at band edges			
Test procedure: Public notice DA 00-705 / ANSI C63.4, Section 13.1.4			
Test mode: Compliance	Verdict: PASS		
Date: 12/28/2008			
Temperature: 21 °C	Air Pressure: 1011 hPa	Relative Humidity: 43 %	Power Supply: 48 VDC
Remarks: EUT with 28 dBi antenna assembly gain			

Plot 7.4.45 Radiated spurious emission measurements at the band edges

CARRIER FREQUENCY 5340 MHz
CHANNEL BANDWIDTH 5 MHz
MODULATION: BPSK 3.25 Mbps
DETECTOR Peak

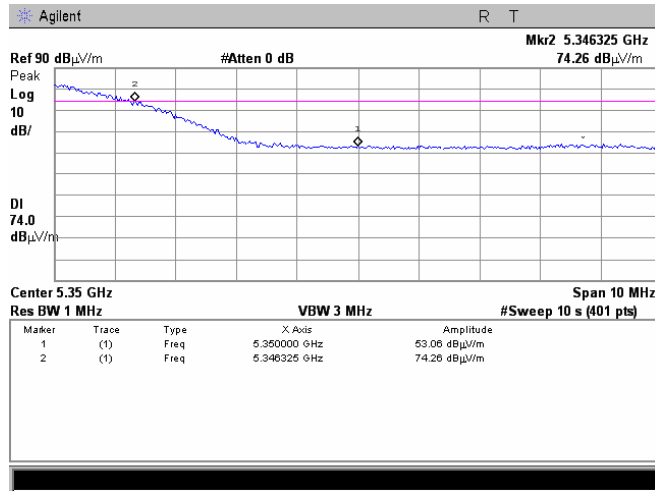

Plot 7.4.46 Radiated spurious emission measurements at the band edges

CARRIER FREQUENCY 5340 MHz
CHANNEL BANDWIDTH 5 MHz
MODULATION: BPSK 3.25 Mbps
DETECTOR Average

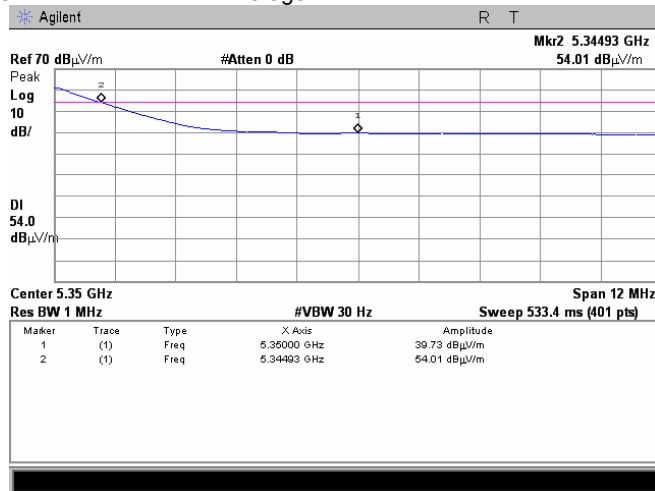



HERMON LABORATORIES

Test specification:	FCC section 15.407(b), RSS-210 Annex 9, section A9.2 Conducted emissions at band edges		
Test procedure:	Public notice DA 00-705 / ANSI C63.4, Section 13.1.4		
Test mode:	Compliance	Verdict:	PASS
Date:	12/28/2008		
Temperature: 21 °C	Air Pressure: 1011 hPa	Relative Humidity: 43 %	Power Supply: 48 VDC
Remarks: EUT with 28 dBi antenna assembly gain			

Plot 7.4.47 Radiated spurious emission measurements at the band edges

CARRIER FREQUENCY 5340 MHz
CHANNEL BANDWIDTH 5 MHz
MODULATION: 64QAM 32.5 Mbps
DETECTOR Peak

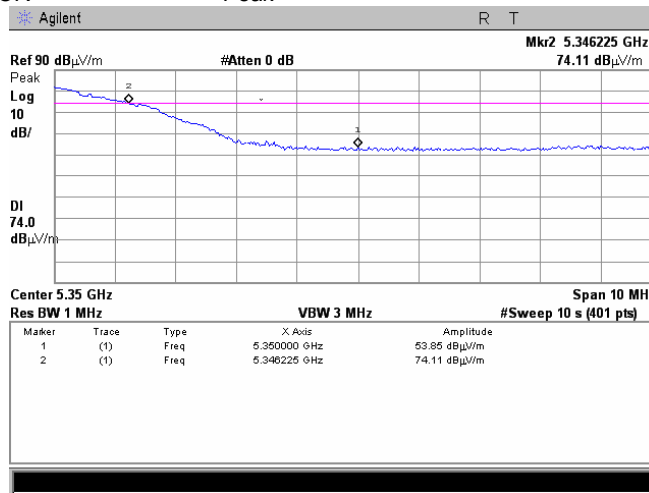

Plot 7.4.48 Radiated spurious emission measurements at the band edges

CARRIER FREQUENCY 5340 MHz
CHANNEL BANDWIDTH 5 MHz
MODULATION: 64QAM 32.5 Mbps
DETECTOR Average

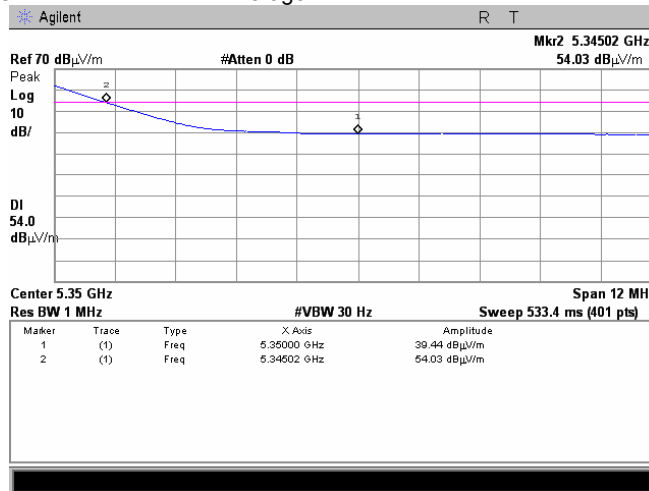



Test specification: FCC section 15.407(g), Frequency stability			
Test procedure: Section 2.1055			
Test mode: Compliance	Verdict: PASS		
Date: 12/28/2008			
Temperature: 21 °C	Air Pressure: 1011 hPa	Relative Humidity: 43 %	Power Supply: 120 VAC
Remarks:			

7.5 Frequency stability test

7.5.1 General

This test was performed to measure frequency stability of transmitter RF carrier. Specification test limits are given in Table 7.5.1.

Table 7.5.1 Frequency stability limits

Assigned frequency band, MHz	Maximum allowed frequency displacement
5250 - 5350	Manufacturers of U-NII devices are responsible for ensuring frequency stability such that an emission is maintained within the band of operation under all conditions of normal operation as specified in the users manual

7.5.2 Test procedure

- 7.5.2.1 The EUT was set up as shown in Figure 7.5.1, energized and its proper operation was checked.
- 7.5.2.2 The EUT power was turned off. Temperature within test chamber was set to the required one and a period of time sufficient to stabilize all of the oscillator circuit components was allowed.
- 7.5.2.3 The EUT was powered on and carrier frequency was measured on the modulation slope at -27 dBm level at start up moment and then after 2, 5 and 10 minutes. The EUT was powered off.
- 7.5.2.4 The above procedure was repeated at the rest of the test temperatures and voltages as provided in Table 7.5.2, Table 7.5.3.
- 7.5.2.5 Frequency displacement was calculated and compared with the limit as provided in Table 7.5.2, Table 7.5.3.

Figure 7.5.1 Frequency stability test setup

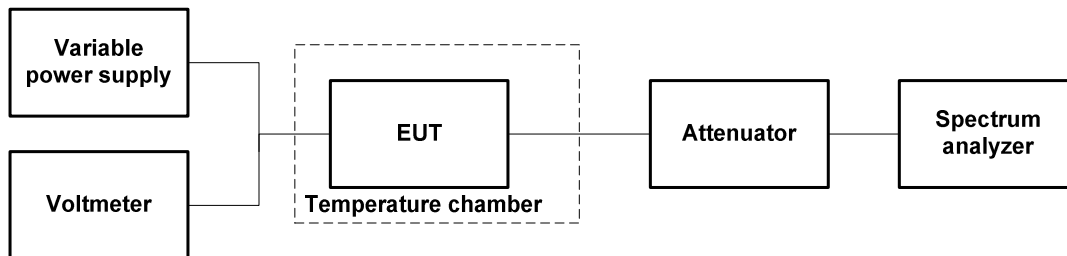



Test specification: FCC section 15.407(g), Frequency stability	
Test procedure: Section 2.1055	
Test mode: Compliance	Verdict: PASS
Date: 12/28/2008	
Temperature: 21 °C	Air Pressure: 1011 hPa
Relative Humidity: 43 %	
Power Supply: 120 VAC	
Remarks:	

Table 7.5.2 Frequency stability test results

ASSIGNID FREQUENCY BAND: 5250 - 5350 MHz
 NOMINAL POWER VOLTAGE: 120 VAC
 TEMPERATURE STABILIZATION PERIOD: 20 min
 POWER DURING TEMPERATURE TRANSITION: Off
 SPECTRUM ANALYZER MODE: Frequency counter
 RESOLUTION BANDWIDTH: 1 kHz
 VIDEO BANDWIDTH: 3 kHz

Temperature, °C	Voltage, V	Frequency, MHz				Max frequency drift, Hz		Verdict
		Start up	2 nd min	5 th min	10 th min	Positive	Negative	
Low frequency:								
-45	Nominal	5269.9810	5270.0135	5270.0150	5270.0158	35600	0	Pass
20	Nominal +15%	5269.9818	5269.9786	5269.9782	5269.9781	1600	2100	
20	Nominal	5269.9850	5269.9818	5269.9808	5269.9802	4800	0	
20	Nominal -15%	5269.9810	5269.9786	5269.9784	5269.9783	800	1900	
60	Nominal	5269.9942	5270.0213	5270.0245	5270.0261	45900	0	
High frequency:								
-45	Nominal	5329.9887	5330.0145	5330.0150	5330.0152	36500	0	Pass
20	Nominal +15%	5329.9854	5329.9781	5329.9778	5329.9776	6700	1100	
20	Nominal	5329.9840	5329.9802	5329.9795	5329.9787	5300	0	
20	Nominal -15%	5329.9820	5329.9789	5329.9785	5329.9784	3300	300	
60	Nominal	5329.9776	5330.0072	5330.0174	5330.0223	34900	1100	

Note: The lowest frequency margin to the assigned band edges is 750 kHz and shown in the associated plots. Obtained maximum frequency drift – 36.5 kHz is more than sufficient to guarantee that the intentional emission will remain in the band over the entire operating range of the EUT.

Reference numbers of test equipment used

HL 0493	HL 1194	HL 1424	HL 2869	HL 3233	HL 3435		
---------	---------	---------	---------	---------	---------	--	--

Full description is given in Appendix A.



HERMON LABORATORIES

Test specification: FCC section 15.407(g), Frequency stability			
Test procedure: Section 2.1055			
Test mode: Compliance	Verdict: PASS		
Date: 12/28/2008			
Temperature: 21 °C	Air Pressure: 1011 hPa	Relative Humidity: 43 %	Power Supply: 120 VAC
Remarks:			

Plot 7.5.1 Conducted spurious emission measurements at the low band edge

CARRIER FREQUENCY 5270 MHz
CHANNEL BANDWIDTH 20 MHz
MODULATION: 64QAM 130 Mbps

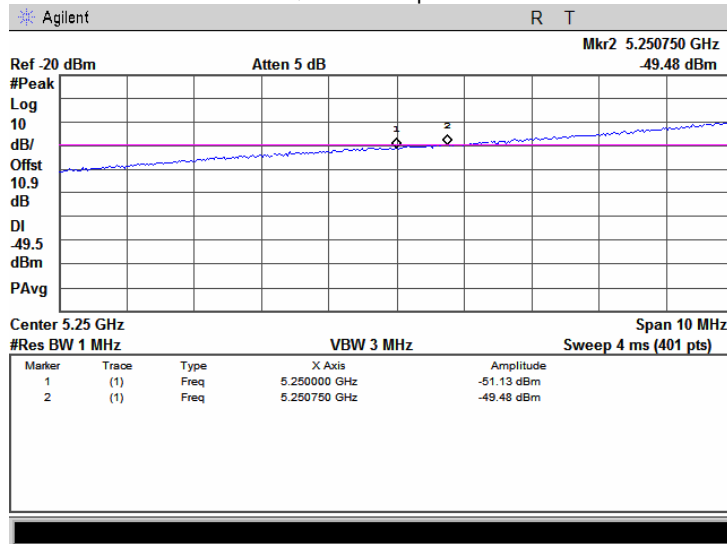



HERMON LABORATORIES

Test specification: FCC section 15.407(g), Frequency stability			
Test procedure: Section 2.1055			
Test mode: Compliance	Verdict: PASS		
Date: 12/28/2008			
Temperature: 21 °C	Air Pressure: 1011 hPa	Relative Humidity: 43 %	Power Supply: 120 VAC
Remarks:			

Plot 7.5.2 Conducted spurious emission measurements at the high band edge

CARRIER FREQUENCY 5330 MHz
CHANNEL BANDWIDTH 20 MHz
MODULATION: BPSK 13 Mbps
DETECTOR Peak

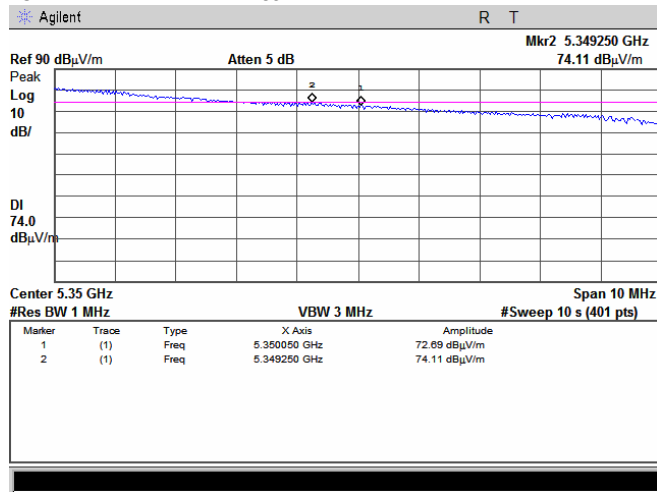

Plot 7.5.3 Conducted spurious emission measurements at the high band edge

CARRIER FREQUENCY 5330 MHz
CHANNEL BANDWIDTH 20 MHz
MODULATION: BPSK 13 Mbps
DETECTOR Average

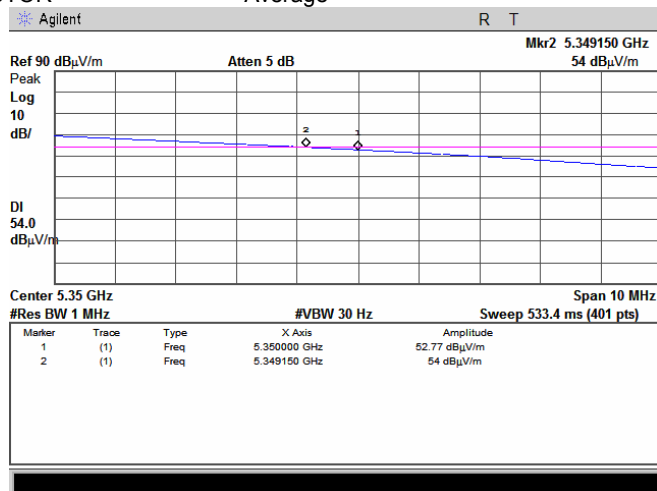



Test specification: FCC Part 15, section 203, RSS-Gen section 7.1.2, Antenna requirements	
Test procedure: Visual inspection / supplier declaration	
Test mode: Compliance	Verdict: PASS
Date: 12/28/2008	
Temperature: 21 °C	Air Pressure: 1011 hPa
Relative Humidity: 43 %	
Power Supply: 48 VDC	
Remarks:	

7.6 Antenna requirements

The EUT was verified for compliance with antenna requirements. A transmitter shall be designed to ensure that no antenna other than that furnished by the responsible party will be used with the device. It may be either permanently attached or employs a unique antenna connector for every antenna proposed for use with the EUT. This requirement does not apply to professionally installed transmitters. The rationale for compliance with the above requirements was either visual inspection results or supplier declaration. The summary of results is provided in Table 7.6.1.

Table 7.6.1 Antenna requirements

Requirement	Rationale	Verdict
The transmitter antenna is permanently attached (integral)	Visual inspection	Comply
The transmitter employs a unique antenna connector	NA	
The transmitter requires professional installation (external)	Visual inspection	



Test specification:	FCC part 15 section 15.207(a), RSS-Gen section 7.2.4, Conducted emission		
Test procedure:	ANSI C63.4, Section 13.1.3		
Test mode:	Compliance	Verdict:	PASS
Date:	12/28/2008		
Temperature: 21 °C	Air Pressure: 1011 hPa	Relative Humidity: 43 %	Power Supply: 48 VDC
Remarks:			

7.7 Conducted emissions

7.7.1 General

This test was performed to measure common mode conducted emissions at the power port. Specification test limits are given in Table 7.7.1.

Table 7.7.1 Limits for conducted emissions

Frequency, MHz	Class B limit, dB(μV)	
	QP	AVRG
0.15 - 0.5	66 - 56*	56 - 46*
0.5 - 5.0	56	46
5.0 - 30	60	50

* - The limit decreases linearly with the logarithm of frequency.

7.7.2 Test procedure

7.7.2.1 The EUT was set up as shown in Figure 7.7.1, energized and the performance check was conducted.

7.7.2.2 The measurements were performed at power terminals with the LISN, connected to a spectrum analyzer while unused coaxial connector of the LISN was terminated with 50 Ohm.

7.7.2.3 The position of the device cables was varied to determine maximum emission level.

7.7.2.4 The worst test results (the lowest margins) were recorded in Table 7.7.2 and shown in the associated plots.

Figure 7.7.1 Setup for conducted emission measurements, table-top equipment

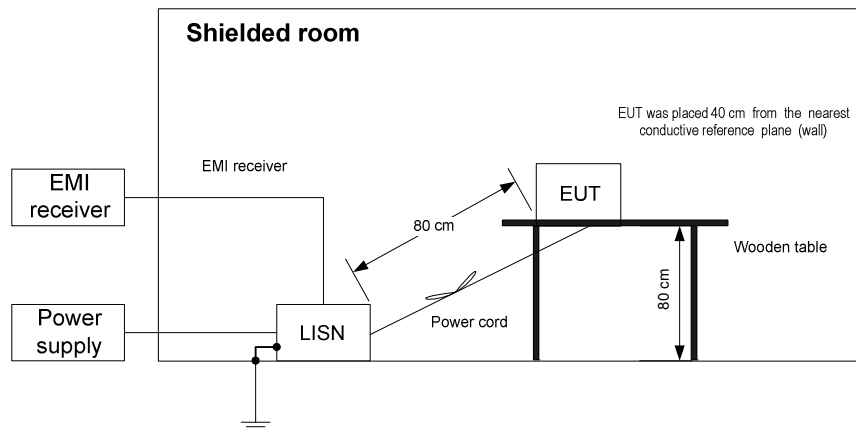



HERMON LABORATORIES

Test specification: FCC part 15 section 15.207(a), RSS-Gen section 7.2.4, Conducted emission	
Test procedure: ANSI C63.4, Section 13.1.3	
Test mode: Compliance	Verdict: PASS
Date: 12/28/2008	
Temperature: 21 °C	Air Pressure: 1011 hPa
Relative Humidity: 43 %	
Power Supply: 48 VDC	
Remarks:	

Table 7.7.2 Conducted emission test results

LINE: AC mains
 EUT OPERATING MODE: Transmit at 5300 MHz, 5 MHz CBW, 3.25 Mbps, maximum power
 EUT SET UP: TABLE-TOP
 TEST SITE: SHIELDED ROOM
 FREQUENCY RANGE: 150 kHz - 30 MHz
 RESOLUTION BANDWIDTH: 9 kHz

Frequency, MHz	Peak emission, dB(µV)	Quasi-peak			Average			Line ID	Verdict
		Measured emission, dB(µV)	Limit, dB(µV)	Margin, dB*	Measured emission, dB(µV)	Limit, dB(µV)	Margin, dB*		
0.153465	44.55	39.88	65.83	-25.95	36.81	55.83	-19.02	L1	Pass
0.530048	32.81	32.15	56.00	-23.85	31.72	46.00	-14.28		
2.041715	32.98	32.26	56.00	-23.74	30.95	46.00	-15.05		
2.721444	33.09	32.38	56.00	-23.62	31.66	46.00	-14.34		
0.154482	43.89	39.51	65.78	-26.27	35.71	55.78	-20.07	L2	Pass
0.529069	32.81	31.93	56.00	-24.07	31.67	46.00	-14.33		
3.099189	33.66	32.91	56.00	-23.09	32.18	46.00	-13.82		
3.477056	33.56	32.71	56.00	-23.29	31.98	46.00	-14.02		

*- Margin = Measured emission - specification limit.

Reference numbers of test equipment used

HL 0580	HL 1430	HL 1513	HL 2888	HL 3612			
---------	---------	---------	---------	---------	--	--	--

Full description is given in Appendix A.



HERMON LABORATORIES

Test specification: FCC part 15 section 15.207(a), RSS-Gen section 7.2.4, Conducted emission			
Test procedure: ANSI C63.4, Section 13.1.3			
Test mode: Compliance	Verdict: PASS		
Date: 12/28/2008			
Temperature: 21 °C	Air Pressure: 1011 hPa	Relative Humidity: 43 %	Power Supply: 48 VDC
Remarks:			

Plot 7.7.1 Conducted emission measurements

LINE: L1
EUT OPERATING MODE: Transmit at 5300 MHz, 5 MHz CBW, 3.25 Mbps maximum power
LIMIT: QUASI-PEAK, AVERAGE
DETECTOR: PEAK

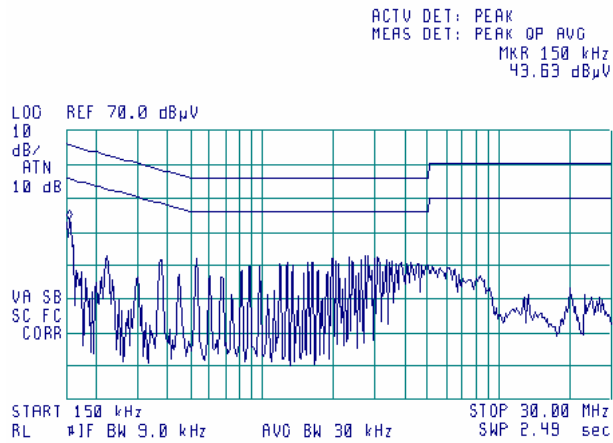

Plot 7.7.2 Conducted emission measurements

LINE: L2
EUT OPERATING MODE: Transmit at 5300 MHz, 5 MHz CBW, 3.25 Mbps maximum power
LIMIT: QUASI-PEAK, AVERAGE
DETECTOR: PEAK

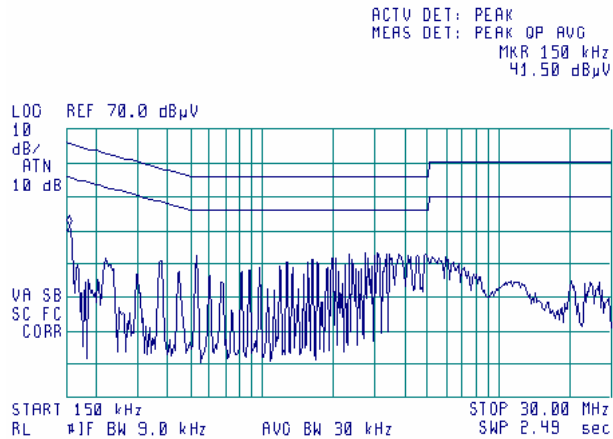

Test specification: RSS-Gen sections 6, 4.10, spurious radiated emission			
Test procedure: ANSI C63.4, Section 13.1.3			
Test mode: Compliance		Verdict: PASS	
Date: 12/28/2008			
Temperature: 21 °C	Air Pressure: 1011 hPa	Relative Humidity: 43 %	Power Supply: 48 VDC
Remarks:			

7.8 Receiver radiated spurious emission measurements

7.8.1 General

This test was performed to measure radiated emissions from the EUT enclosure. Specification test limits are given in Table 7.8.1.

Table 7.8.1 Radiated emission limits

Frequency, MHz	Field strength limit at 3 m test distance, dB(μ V/m)
30 - 88	40.0
88 - 216	43.5
216 - 960	46.0
Above 960 -3 rd harmonic*	54.0

* - harmonic of the highest frequency the EUT generates, uses, operates or tunes to.

7.8.2 Test procedure

7.8.2.1 The EUT was set up as shown in Figure 7.8.1, energized and the performance check was conducted.

7.8.2.2 The specified frequency range was investigated with biconilog antenna connected to EMI receiver. To find maximum radiation the turntable was rotated 360°, the measuring antenna height was changed from 1 to 4 m, its polarization was switched from vertical to horizontal and the EUT cables position was varied.

7.8.2.3 The worst test results (the lowest margins) were provided in the associated tables and plots.

Figure 7.8.1 Setup for radiated emission measurements in anechoic chamber, table-top equipment

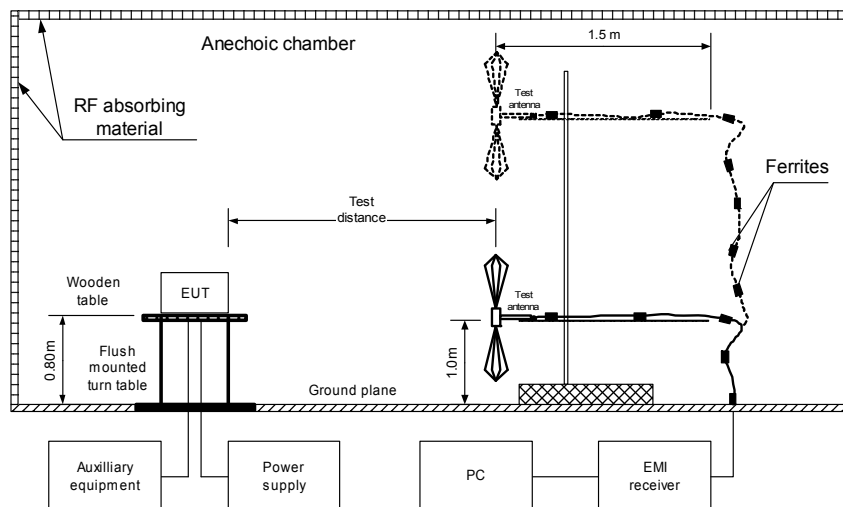



HERMON LABORATORIES

Test specification: RSS-Gen sections 6, 4.10, spurious radiated emission			
Test procedure: ANSI C63.4, Section 13.1.3			
Test mode: Compliance	Verdict: PASS		
Date: 12/28/2008			
Temperature: 21 °C	Air Pressure: 1011 hPa	Relative Humidity: 43 %	Power Supply: 48 VDC
Remarks: EUT with 22.5 dBi antenna assembly gain			

Table 7.8.2 Radiated emission test results

EUT SET UP: TABLE-TOP
 EUT OPERATING MODE: Receive
 TEST SITE: SEMI ANECHOIC CHAMBER
 TEST DISTANCE: 3 m

FREQUENCY RANGE: 30 MHz – 1000 MHz
 RESOLUTION BANDWIDTH: 120 kHz

Frequency, MHz	Peak emission, dB(µV/m)	Quasi-peak			Antenna polarization	Antenna height, m	Turn-table position**, degrees	Verdict
		Measured emission, dB(µV/m)	Limit, dB(µV/m)	Margin, dB*				
Mid Rx channel (5300 MHz)								Pass
108.80	27.50	26.40	43.5	-17.10	Vertical	1.0	90	

FREQUENCY RANGE: 1000 MHz – 16500 MHz
 RESOLUTION BANDWIDTH: 1000 kHz

Frequency, MHz	Peak emission, dB(µV/m)	Average			Antenna polarization	Antenna height, m	Turn-table position**, degrees	Verdict
		Measured emission, dB(µV/m)	Limit, dB(µV/m)	Margin, dB*				
Mid Rx channel (5300 MHz)								Pass
No emissions were found								

*- Margin = Measured emission - specification limit.
 **- EUT front panel refer to 0 degrees position of turntable.

Reference numbers of test equipment used

HL 0446	HL 0521	HL 0589	HL 0604	HL 1425	HL 1556	HL 1947	HL 1984
HL 2009	HL 2909						

Full description is given in Appendix A.



HERMON LABORATORIES

Test specification: RSS-Gen sections 6, 4.10, spurious radiated emission			
Test procedure: ANSI C63.4, Section 13.1.3			
Test mode: Compliance	Verdict: PASS		
Date: 12/28/2008			
Temperature: 21 °C	Air Pressure: 1011 hPa	Relative Humidity: 43 %	Power Supply: 48 VDC
Remarks: EUT with 22.5 dBi antenna assembly gain			

Plot 7.8.1 Radiated emission measurements from 9 to 150 kHz at the mid Rx channel frequency

TEST SITE: Anechoic chamber
TEST DISTANCE: 3 m
ANTENNA POLARIZATION: Vertical and Horizontal

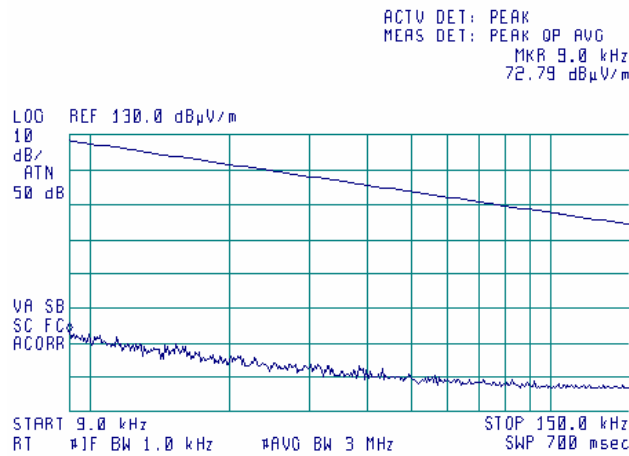

Plot 7.8.2 Radiated emission measurements from 0.15 MHz to 30 MHz at the mid Rx channel frequency

TEST SITE: Anechoic chamber
TEST DISTANCE: 3 m
ANTENNA POLARIZATION: Vertical and Horizontal

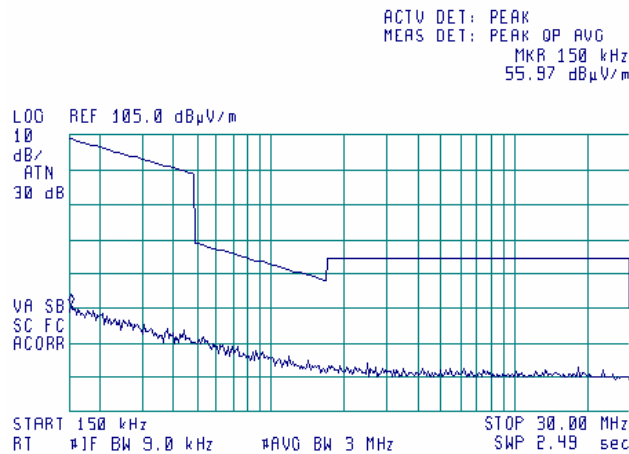



HERMON LABORATORIES

Test specification: RSS-Gen sections 6, 4.10, spurious radiated emission			
Test procedure: ANSI C63.4, Section 13.1.3			
Test mode: Compliance	Verdict: PASS		
Date: 12/28/2008			
Temperature: 21 °C	Air Pressure: 1011 hPa	Relative Humidity: 43 %	Power Supply: 48 VDC
Remarks: EUT with 22.5 dBi antenna assembly gain			

Plot 7.8.3 Radiated emission measurements from 30 MHz to 1000 MHz at the mid Rx channel frequency

TEST SITE: Anechoic chamber
TEST DISTANCE: 3 m
ANTENNA POLARIZATION: Vertical and Horizontal

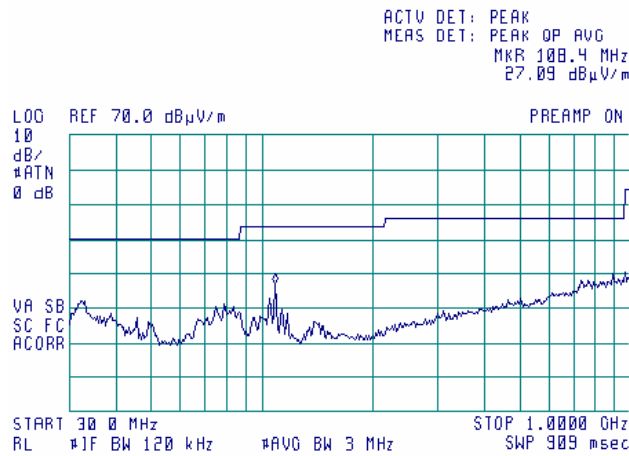

Plot 7.8.4 Radiated emission measurements from 1.0 to 6.5 GHz at the mid Rx channel frequency

TEST SITE: Anechoic chamber
TEST DISTANCE: 3 m
ANTENNA POLARIZATION: Vertical and Horizontal
DETECTOR: Peak under average limit

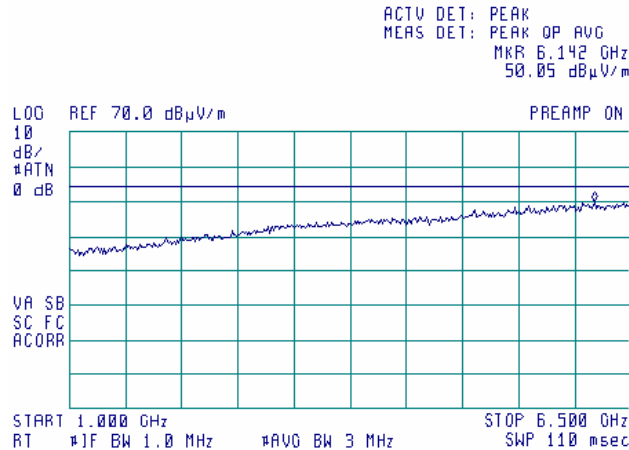



HERMON LABORATORIES

Test specification: RSS-Gen sections 6, 4.10, spurious radiated emission			
Test procedure: ANSI C63.4, Section 13.1.3			
Test mode: Compliance	Verdict: PASS		
Date: 12/28/2008			
Temperature: 21 °C	Air Pressure: 1011 hPa	Relative Humidity: 43 %	Power Supply: 48 VDC
Remarks: EUT with 22.5 dBi antenna assembly gain			

Plot 7.8.5 Radiated emission measurements from 6.5 to 16.5 GHz at the mid Rx channel frequency

TEST SITE: Anechoic chamber
TEST DISTANCE: 3 m
ANTENNA POLARIZATION: Vertical and Horizontal
DETECTOR: Peak under average limit

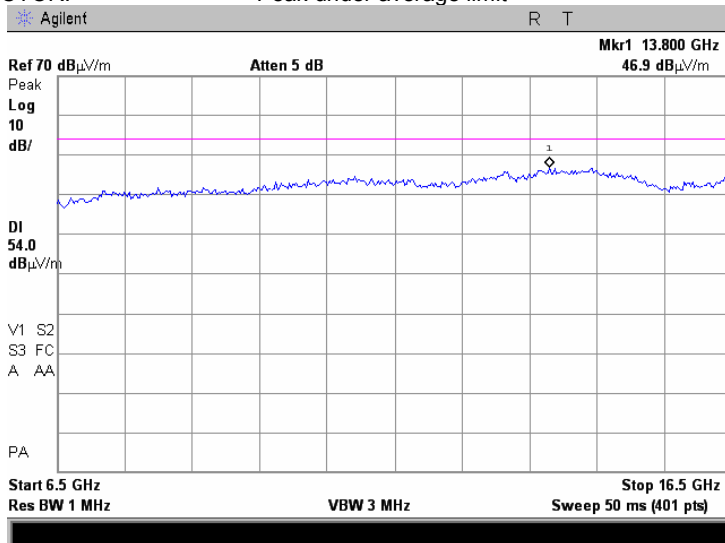



HERMON LABORATORIES

Test specification: RSS-Gen sections 6, 4.10, spurious radiated emission			
Test procedure: ANSI C63.4, Section 13.1.3			
Test mode: Compliance	Verdict: PASS		
Date: 12/28/2008			
Temperature: 21 °C	Air Pressure: 1011 hPa	Relative Humidity: 43 %	Power Supply: 48 VDC
Remarks: EUT with 28 dBi antenna assembly gain			

Table 7.8.3 Radiated emission test results

EUT SET UP: TABLE-TOP
 EUT OPERATING MODE: Receive
 TEST SITE: SEMI ANECHOIC CHAMBER
 TEST DISTANCE: 3 m

FREQUENCY RANGE: 30 MHz – 1000 MHz
 RESOLUTION BANDWIDTH: 120 kHz

Frequency, MHz	Peak, dB(μV/m)	Quasi-peak dB(μV/m)			Antenna polariz.	Antenna height, m	Turntable position**, degrees	Verdict
		Measured emission, dB(μV/m)	Limit, dB(μV/m)	Margin, dB*				
Mid Rx channel (5300 MHz)								Pass
108.80	25.60	24.80	43.50	-18.70	Vertical	1.0	0	

TEST DISTANCE: 3 m
 FREQUENCY RANGE: 1000 MHz – 16500 MHz
 RESOLUTION BANDWIDTH: 1000 kHz

Frequency, MHz	Peak emission, dB(μV/m)	Average			Antenna polarization	Antenna height, m	Turn-table position**, degrees	Verdict
		Measured emission, dB(μV/m)	Limit, dB(μV/m)	Margin, dB*				
Mid Rx channel (5300 MHz)								Pass

*- Margin = Measured emission - specification limit.
 **- EUT front panel refer to 0 degrees position of turntable.

Reference numbers of test equipment used

HL 0446	HL 0521	HL 0589	HL 0604	HL 1425	HL 1556	HL 1947	HL 1984
HL 2009	HL 2909						

Full description is given in Appendix A.



HERMON LABORATORIES

Test specification: RSS-Gen sections 6, 4.10, spurious radiated emission			
Test procedure: ANSI C63.4, Section 13.1.3			
Test mode: Compliance	Verdict: PASS		
Date: 12/28/2008			
Temperature: 21 °C	Air Pressure: 1011 hPa	Relative Humidity: 43 %	Power Supply: 48 VDC
Remarks: EUT with 28 dBi antenna assembly gain			

Plot 7.8.6 Radiated emission measurements from 9 to 150 kHz at the mid Rx carrier frequency

TEST SITE: Anechoic chamber
TEST DISTANCE: 3 m
ANTENNA POLARIZATION: Vertical and Horizontal

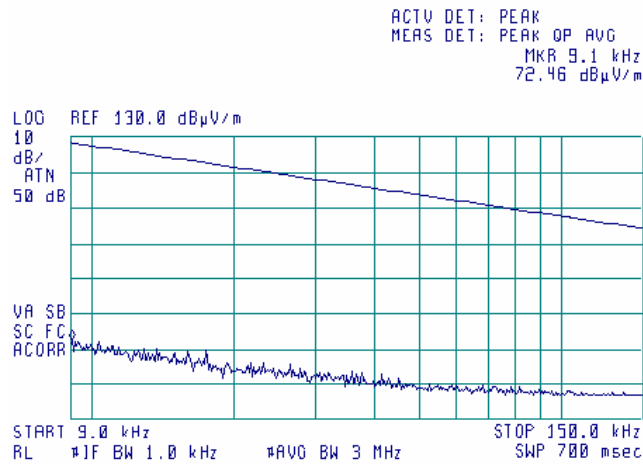

Plot 7.8.7 Radiated emission measurements from 0.15 MHz to 30 MHz at the mid Rx channel frequency

TEST SITE: Anechoic chamber
TEST DISTANCE: 3 m
ANTENNA POLARIZATION: Vertical and Horizontal

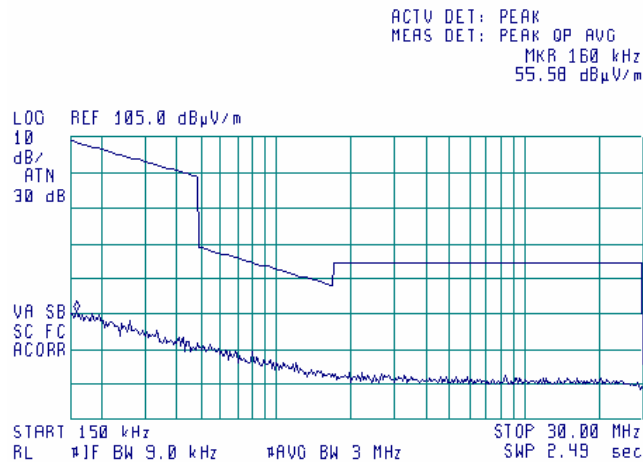



HERMON LABORATORIES

Test specification: RSS-Gen sections 6, 4.10, spurious radiated emission			
Test procedure: ANSI C63.4, Section 13.1.3			
Test mode: Compliance	Verdict: PASS		
Date: 12/28/2008			
Temperature: 21 °C	Air Pressure: 1011 hPa	Relative Humidity: 43 %	Power Supply: 48 VDC
Remarks: EUT with 28 dBi antenna assembly gain			

Plot 7.8.8 Radiated emission measurements from 30 MHz to 1000 MHz at the mid Rx channel frequency

TEST SITE: Anechoic chamber
TEST DISTANCE: 3 m
ANTENNA POLARIZATION: Vertical and Horizontal

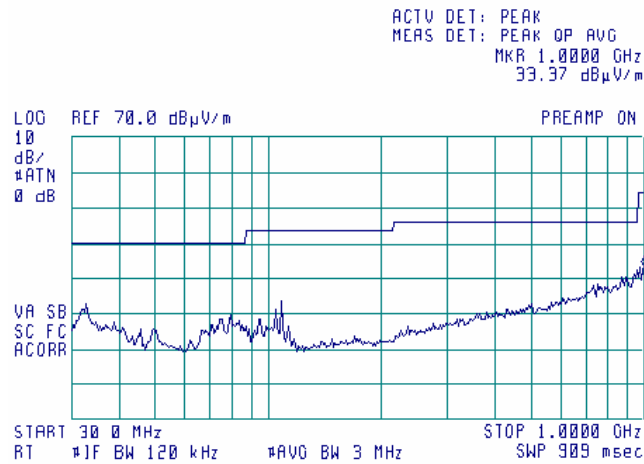

Plot 7.8.9 Radiated emission measurements from 1.0 to 6.5 GHz at the mid Rx channel frequency

TEST SITE: Anechoic chamber
TEST DISTANCE: 3 m
ANTENNA POLARIZATION: Vertical and Horizontal
DETECTOR: Peak under average limit

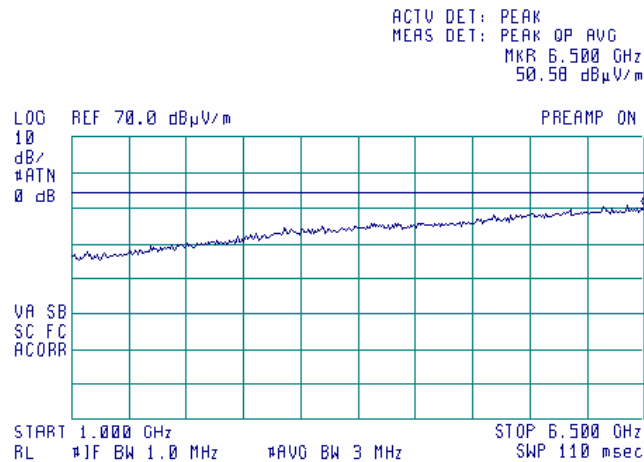



HERMON LABORATORIES

Test specification: RSS-Gen sections 6, 4.10, spurious radiated emission			
Test procedure: ANSI C63.4, Section 13.1.3			
Test mode: Compliance	Verdict: PASS		
Date: 12/28/2008			
Temperature: 21 °C	Air Pressure: 1011 hPa	Relative Humidity: 43 %	Power Supply: 48 VDC
Remarks: EUT with 28 dBi antenna assembly gain			

Plot 7.8.10 Radiated emission measurements from 6.5 to 16.5 GHz at the mid Rx channel frequency

TEST SITE: Anechoic chamber
TEST DISTANCE: 3 m
ANTENNA POLARIZATION: Vertical and Horizontal
DETECTOR: Peak

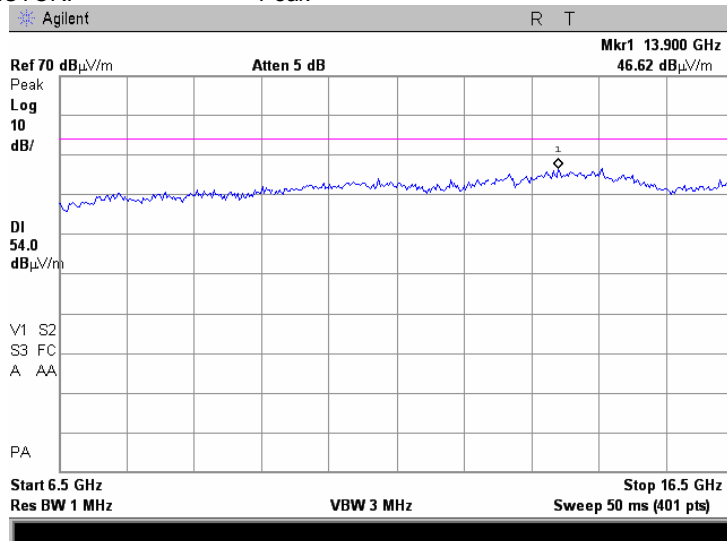



8 APPENDIX A Test equipment and ancillaries used for tests

HL No	Description	Manufacturer	Model	Ser. No.	Last Cal.	Due Cal.
0446	Antenna, Loop, Active, 10 kHz - 30 MHz	EMCO	6502	2857	29-Jun-08	29-Jun-09
0493	Temperature Chamber -45...175 deg C	Thermotron	S-1.2 Mini-Max	14016	19-May-08	19-May-09
0521	EMI Receiver (Spectrum Analyzer) with RF filter section 9 kHz-6.5 GHz	Hewlett Packard Co	8546A	3617A 00319, 3448A002 53	29-Aug-08	29-Aug-09
0554	Amplifier, 2-18 GHz RF	Miteq	AFD4	104300	28-Feb-08	28-Feb-09
0580	DC block adaptor 10 kHz - 2.2 GHz	Anritsu	MA8601 A	580	23-Nov-08	23-Nov-09
0589	Cable Coaxial, GORE A2P01POL118, 2.3 m, 6.5 GHz	Hermon Laboratories	GORE-3	176	01-Jan-09	01-Jan-10
0604	Antenna BiconiLog Log-Periodic/T Bow-TIE, 26 - 2000 MHz	EMCO	3141	9611-1011	10-Jan-08	10-Jan-09
1194	Variac, 220 V/ 2.5 A	Matsunaga		2962	06-Jan-08	06-Jan-09
1424	Spectrum Analyzer, 30 Hz- 40 GHz	Agilent Technologies	8564EC	3946A002 19	01-Jan-09	01-Jan-10
1425	EMI Receiver, 9 kHz - 2.9 GHz, System: HL1426, HL1427	Agilent Technologies	8542E	3710A002 22, 3705A002 04	03-Sep-08	03-Sep-09
1430	EMI Receiver, 9 kHz - 2.9 GHz, System: HL1431, HL1432	Agilent Technologies	8542E	3807A002 62,3705A0 0217	31-Aug-08	31-Aug-09
1513	Cable RF, 8 m, BNC/BNC	Belden	M17/167 MIL-C-17	1513	03-Sep-08	03-Sep-09
1556	Cable RF, 0.5 m	Telequis	MIL-C- 17F-RG 058 CU	1556	01-Jan-09	01-Jan-10
1947	Cable 18GHz, 6.5 m, blue	Rhophase Microwave Limited	NPS- 1803A- 6500-NPS	T4974	01-Jan-09	01-Jan-10
1984	Antenna, Double-Ridged Waveguide Horn, 1-18 GHz, 300 W	EMC Test Systems	3115	9911-5964	03-Mar-08	03-Mar-09
2009	Cable RF, 8 m	Alpha Wire	RG-214	C-56	01-Jan-09	01-Jan-10
2780	EMC analyzer, 100 Hz to 26.5 GHz	Agilent Technologies	E7405A	MY451024 6	11-Jun-07	11-Jun-09
2869	Cable, 18 GHz, 1.2 m, SMA - SMA, Right Angle	Gore	NA	91P72073	11-Feb-08	11-Feb-09
2883	Cable, 18 GHz N-type, M-F, 3 m	Bird	TC- MNFN-3.0	211539 003	07-Dec-08	07-Dec-09
2888	LISN Two-line V-Network 50 Ohm / 50 uH + 5 Ohm, 16A, MIL STD 461E, CISPR 16-1	Rolf Heine	NNB- 2/16Z	02/10018	09-Jul-08	09-Jul-09
2909	Spectrum analyzer, ESA-E, 100 Hz to 26.5 GHz	Agilent Technologies	E4407B	MY414447 62	07-May-07	07-May-09
3122	Microwave Cable Assembly, 18 GHz, 6.4 m, SMA - SMA	Huber-Suhner	198-9155- 00	3122	07-Dec-08	07-Dec-09
3123	Microwave Cable Assembly, 18 GHz, 6.4 m, SMA - SMA	Huber-Suhner	198-9155- 00	3123	07-Dec-08	07-Dec-09
3176	Attenuator, N-type, 10 dB, DC to 18 GHz, 5 W	Mini-Circuits	BW- N10W5+	0708	07-May-08	07-May-09
3179	Attenuator, N-type, 20 dB, DC to 18 GHz, 5 W	Mini-Circuits	BW- N20W5+	0651	07-May-08	07-May-09
3180	Attenuator, N-type, 20 dB, DC to 18 GHz, 5 W	Mini-Circuits	BW- N20W5+	0651	07-May-08	07-May-09



HERMON LABORATORIES

HL No	Description	Manufacturer	Model	Ser. No.	Last Cal.	Due Cal.
3233	Multimeter	Fluke	115C	93771523	15-Jul-08	15-Jul-09
3386	Microwave Cable Assembly, 26.5 GHz, 1.0 m, N type/N type	Suhner Sucoflex	104EA	3386	12-Feb-08	12-Feb-09
3435	Precision Fixed Attenuator, 50 Ohm, 5 W, 10 dB, DC to 18 GHz	Mini-Circuits	BW-S10W5+	NA	09-Mar-08	09-Mar-09
3612	Cable RF, 17.5 m, N type-N type	Teldor	RG-214/U	NA	17-Nov-08	17-Nov-09

9 APPENDIX B Measurement uncertainties

Expanded uncertainty at 95% confidence in Hermon Labs EMC measurements

Test description	Expanded uncertainty
Conducted carrier power at RF antenna connector	Below 12.4 GHz: ± 1.7 dB 12.4 GHz to 40 GHz: ± 2.3 dB
Conducted emissions at RF antenna connector	9 kHz to 2.9 GHz: ± 2.6 dB 2.9 GHz to 6.46 GHz: ± 3.5 dB 6.46 GHz to 13.2 GHz: ± 4.3 dB 13.2 GHz to 22.0 GHz: ± 5.0 dB 22.0 GHz to 26.8 GHz: ± 5.5 dB 26.8 GHz to 40.0 GHz: ± 4.8 dB
Occupied bandwidth	± 8.0 %
Conducted emissions with LISN	9 kHz to 150 kHz: ± 3.9 dB 150 kHz to 30 MHz: ± 3.8 dB
Radiated emissions at 3 m measuring distance Horizontal polarization Vertical polarization	Biconilog antenna: ± 5.3 dB Biconical antenna: ± 5.0 dB Log periodic antenna: ± 5.3 dB Double ridged horn antenna: ± 5.3 dB Biconilog antenna: ± 6.0 dB Biconical antenna: ± 5.7 dB Log periodic antenna: ± 6.0 dB Double ridged horn antenna: ± 6.0 dB

Hermon Laboratories is accredited by A2LA for calibration according to present requirements of ISO/IEC 17025 and NCSL Z540-1. The accreditation is granted to perform calibration of parameters that are listed in the Scope of Hermon Laboratories Accreditation.

Hermon Laboratories calibrates its reference and transfer standards by calibration laboratories accredited to ISO/IEC 17025 by a mutually recognized Accreditation Body or by a recognized national metrology institute. All reference and transfer standards used in the calibration system are traceable to national or international standards.

In-house calibration of all test and measurement equipment is performed on a regular basis according to Hermon Laboratories calibration procedures, manufacturer calibration/verification procedures or procedures defined in the relevant standards. The Hermon Laboratories test and measurement equipment is calibrated within the tolerances specified by the manufacturers and/or by the relevant standards.

10 APPENDIX C Test laboratory description

Tests were performed at Hermon Laboratories Ltd., which is a fully independent, private, EMC, safety, environmental and telecommunication testing facility.

Hermon Laboratories is listed by the Federal Communications Commission (USA) for all parts of Code of Federal Regulations 47 (CFR 47), Registration Numbers 90624 for OATS and 90623 for the anechoic chamber; by Industry Canada for electromagnetic emissions (file numbers IC 2186A-1 for OATS, IC 2186A-2 for anechoic chamber, IC 2186A-3 for full-anechoic chamber for RE measurements above 1 GHz), certified by VCCI, Japan (the registration numbers are R-808 for OATS, R-1082 for anechoic chamber, G-27 for full-anechoic chamber for RE measurements above 1 GHz, C-845 for conducted emissions site, T-1606 for conducted emissions at telecommunication ports), has a status of a Telefication - Listed Testing Laboratory, Certificate No. L138/00. The laboratory is accredited by American Association for Laboratory Accreditation (USA) according to ISO/IEC 17025 for electromagnetic compatibility, product safety, telecommunications testing and environmental simulation (for exact scope please refer to Certificate No. 839.01). The FCC Designation Number is US1003.

Address: P.O. Box 23, Binyamina 30500, Israel.
Telephone: +972 4628 8001
Fax: +972 4628 8277
e-mail: mail@hermonlabs.com
website: www.hermonlabs.com

Person for contact: Mr. Alex Usoskin, CEO.

11 APPENDIX D Specification references

47CFR part 15: 2009	Radio Frequency Devices.
FCC Public Notice DA 02-2138 August 30, 2002	Measurement procedure updated for peak transmit power in U-NII bands
ANSI C63.2: 1996	American National Standard for Instrumentation-Electromagnetic Noise and Field Strength, 10 kHz to 40 GHz-Specifications.
ANSI C63.4: 2003	American National Standard for Methods of Measurement of Radio-Noise Emissions from Low-Voltage Electrical and Electronic Equipment in the Range of 9 kHz to 40 GHz.
RSS-210 Issue 8: 2010	Low Power Licence- Exempt Radiocommunication Devices (All frequency bands), Category I Equipment
RSS-Gen Issue 3: 2010	General Requirements and Information for the Certification of Radiocommunication Equipment

12 APPENDIX E Test equipment correction factors

Correction factor
Line impedance stabilization network
Model NNB-2/16Z, Rolf Heine, HL 2888

Frequency, kHz	Insertion loss, dB		Measurement Uncertainty, dB
	L1	N	
10	0.48	0.79	±0.6
20	0.52	0.63	
30	0.31	0.35	
40	0.20	0.22	
50	0.16	0.17	
100	0.10	0.08	
300	0.08	0.06	
500	0.10	0.06	
600	0.09	0.07	
800	0.10	0.07	
1000	0.10	0.08	
2000	0.12	0.11	
3000	0.16	0.14	
4000	0.17	0.18	
6000	0.26	0.23	
10000	0.49	0.41	
14000	0.66	0.54	
16000	0.79	0.69	
18000	0.86	0.76	
20000	0.96	0.85	
25000	1.22	1.08	
28000	1.35	1.21	
30000	1.43	1.29	

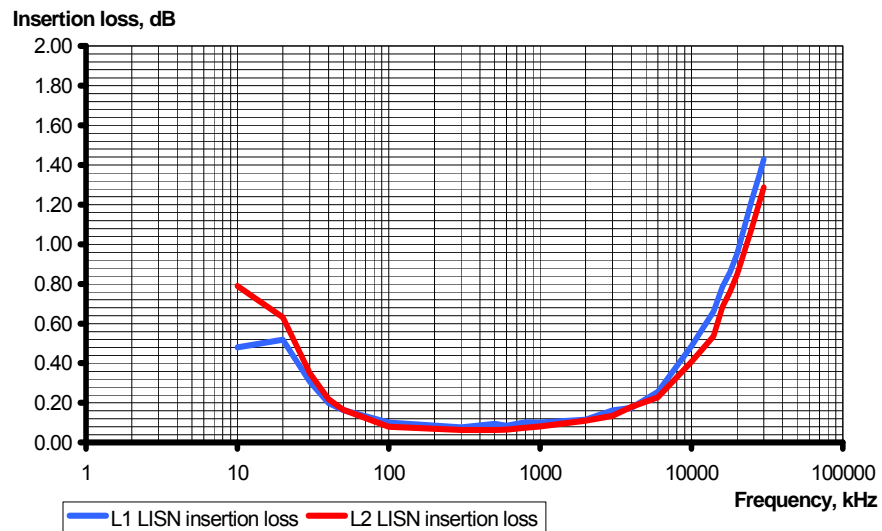

Antenna Factor
Active Loop Antenna
EMC Test Systems, model 6502, serial number 2857, HL 0446

Frequency, MHz	Magnetic Antenna Factor, dB(S/m)	Electric Antenna Factor, dB(1/m)
0.009	-32.8	18.7
0.010	-33.8	17.7
0.020	-38.3	13.2
0.050	-41.1	10.4
0.075	-41.3	10.2
0.100	-41.6	9.9
0.150	-41.7	9.8
0.250	-41.6	9.9
0.500	-41.8	9.7
0.750	-41.9	9.6
1.000	-41.4	10.1
2.000	-41.5	10.0
3.000	-41.4	10.1
4.000	-41.4	10.1
5.000	-41.5	10.0
10.000	-41.9	9.6
15.000	-41.9	9.6
20.000	-42.2	9.3
25.000	-42.8	8.7
30.000	-44.0	7.5

Antenna factor in dB(S/m) is to be added to receiver meter reading in dB(μ V) to convert it into field intensity in dB(μ A/m).

Antenna factor
Biconilog antenna EMCO, model 3141, serial number 1011, HL 0604

Frequency, MHz	Antenna factor, dB(1/m)	Frequency, MHz	Antenna factor, dB(1/m)	Frequency, MHz	Antenna factor, dB(1/m)
26	7.8	560	19.8	1300	27.0
28	7.8	580	20.6	1320	27.8
30	7.8	600	21.3	1340	28.3
40	7.2	620	21.5	1360	28.2
60	7.1	640	21.2	1380	27.9
70	8.5	660	21.4	1400	27.9
80	9.4	680	21.9	1420	27.9
90	9.8	700	22.2	1440	27.8
100	9.7	720	22.2	1460	27.8
110	9.3	740	22.1	1480	28.0
120	8.8	760	22.3	1500	28.5
130	8.7	780	22.6	1520	28.9
140	9.2	800	22.7	1540	29.6
150	9.8	820	22.9	1560	29.8
160	10.2	840	23.1	1580	29.6
170	10.4	860	23.4	1600	29.5
180	10.4	880	23.8	1620	29.3
190	10.3	900	24.1	1640	29.2
200	10.6	920	24.1	1660	29.4
220	11.6	940	24.0	1680	29.6
240	12.4	960	24.1	1700	29.8
260	12.8	980	24.5	1720	30.3
280	13.7	1000	24.9	1740	30.8
300	14.7	1020	25.0	1760	31.1
320	15.2	1040	25.2	1780	31.0
340	15.4	1060	25.4	1800	30.9
360	16.1	1080	25.6	1820	30.7
380	16.4	1100	25.7	1840	30.6
400	16.6	1120	26.0	1860	30.6
420	16.7	1140	26.4	1880	30.6
440	17.0	1160	27.0	1900	30.6
460	17.7	1180	27.0	1920	30.7
480	18.1	1200	26.7	1940	30.9
500	18.5	1220	26.5	1960	31.2
520	19.1	1240	26.5	1980	31.6
540	19.5	1260	26.5	2000	32.0
		1280	26.6		

Antenna factor in dB(1/m) is to be added to receiver meter reading in dB(μ V) to convert it into field intensity in dB(μ V/m).

Antenna factor
Double-ridged wave guide horn antenna
EMC Test Systems, model 3115, serial no: 9911-5964, HL 1984

Frequency, MHz	Antenna gain, dBi	Antenna factor. dB(1/m)
1000.0	5.8	24.5
1500.0	9.0	24.8
2000.0	8.6	27.7
2500.0	9.5	28.7
3000.0	8.9	30.8
3500.0	8.2	32.9
4000.0	9.6	32.7
4500.0	11.2	32.1
5000.0	10.6	33.6
5500.0	9.8	35.3
6000.0	10.1	35.7
6500.0	10.7	35.8
7000.0	10.9	36.2
7500.0	10.5	37.2
8000.0	11.1	37.2
8500.0	10.8	38.1
9000.0	10.7	38.6
9500.0	11.5	38.3
10000.0	11.8	38.4
10500.0	12.3	38.3
11000.0	12.3	38.8
11500.0	11.5	39.9
12000.0	12.2	39.6
12500.0	12.6	39.5
13000.0	12.0	40.5
13500.0	11.7	41.1
14000.0	11.7	41.5
14500.0	12.7	40.8
15000.0	14.2	39.5
15500.0	16.0	38.1
16000.0	16.2	38.1
16500.0	14.5	40.1
17000.0	12.2	42.6
17500.0	9.7	45.4
18000.0	6.6	48.7

Antenna factor is to be added to receiver meter reading in dB(μ V) to convert it into field intensity in dB(μ V/m).

Cable loss
Cable Coaxial, GORE A2P01POL118, 2.3 m, model:GORE-3, HL 0589
+ Cable Coaxial, ANDREW PSWJ4, 6m, model: ANDREW-6, HL 1004

No.	Frequency, MHz	Cable loss, dB	Tolerance (Specification), dB	Measurement uncertainty, dB
1	30	0.33	≤ 6.5	±0.12
2	50	0.40		
3	100	0.57		
4	300	0.97		
5	500	1.25		
6	800	1.59		
7	1000	1.81		
8	1200	1.97		
9	1400	2.15		
10	1600	2.28		
11	1800	2.43		
12	2000	2.61		
13	2200	2.75		
14	2400	2.89		
15	2600	2.97		
16	2800	3.21	≤ 6.5	±0.12
17	3000	3.32		
18	3300	3.47		
19	3600	3.62		
20	3900	3.84		
21	4200	3.92		
22	4500	4.07		
23	4800	4.36		±0.17
24	5100	4.62		
25	5400	4.78		
26	5700	5.16		
27	6000	5.67		
28	6500	5.99		

Cable loss
Cable 18 GHz, 6.5 m, blue, model: NPS-1803A-6500-NPS, S/N T4974, HL 1947

Frequency, GHz	Cable loss, dB
0.03	0.30
0.05	0.38
0.10	0.53
0.20	0.74
0.30	0.91
0.40	1.05
0.50	1.18
0.60	1.29
0.70	1.40
0.80	1.50
0.90	1.59
1.00	1.68
1.10	1.77
1.20	1.86
1.30	1.94
1.40	2.01
1.50	2.08
1.60	2.16
1.70	2.22
1.80	2.29
1.90	2.36
2.00	2.42
2.10	2.48
2.20	2.54
2.30	2.60
2.40	2.66
2.50	2.71
2.60	2.77
2.70	2.83
2.80	2.89
2.90	2.95
3.10	3.06
3.30	3.17
3.50	3.28
3.70	3.39
3.90	3.51
4.10	3.62
4.30	3.76
4.50	3.87
4.70	4.01
4.90	4.10
5.10	4.21
5.30	4.31
5.50	4.43
5.70	4.56
5.90	4.71

Frequency, GHz	Cable loss, dB
6.10	4.87
6.30	4.95
6.50	4.94
6.70	4.88
6.90	4.87
7.10	4.83
7.30	4.85
7.50	4.86
7.70	4.91
7.90	4.96
8.10	5.03
8.30	5.08
8.50	5.13
8.70	5.21
8.90	5.22
9.10	5.34
9.30	5.35
9.50	5.52
9.70	5.51
9.90	5.66
10.10	5.70
10.30	5.78
10.50	5.79
10.70	5.82
10.90	5.86
11.10	5.94
11.30	6.06
11.50	6.21
11.70	6.44
11.90	6.61
12.10	6.76
12.40	6.68
13.00	6.66
13.50	6.81
14.00	6.90
14.50	6.90
15.00	6.97
15.50	7.17
16.00	7.28
16.50	7.27
17.00	7.38
17.50	7.68
18.00	7.92

Cable loss
RF cable 8 m, model RG-214, HL 2009

No.	Frequency, MHz	Cable loss, dB	Tolerance (Specification), dB	Measurement uncertainty, dB
1	1	0.10	NA	±0.12
2	10	0.14		
3	30	0.25		
4	50	0.34		
5	100	0.53		
6	300	0.99		
7	500	1.31		
8	800	1.73		
9	1000	1.98		
10	1100	2.11		
11	1200	2.21		
12	1300	2.35		
13	1400	2.46		
14	1500	2.55		
15	1600	2.68		
16	1700	2.78		
17	1800	2.88		
18	1900	2.98		
19	2000	3.09		

Cable loss
Cable coaxial, Gore, 18 GHz, 1.1 m, SMA - SMA, model Right Angle, S/N 91P72071
HL 2869

Frequency, MHz	Cable loss, dB	Frequency, MHz	Cable loss, dB	Frequency, MHz	Cable loss, dB
10	0.06	5750	0.87	12000	1.30
30	0.06	6000	0.87	12250	1.33
100	0.10	6250	0.89	12500	1.35
250	0.18	6500	0.92	12750	1.36
500	0.25	6750	0.94	13000	1.38
750	0.27	7000	0.98	13250	1.41
1000	0.34	7250	0.99	13500	1.39
1250	0.35	7500	1.02	13750	1.41
1500	0.42	7750	1.03	14000	1.42
1750	0.44	8000	1.04	14250	1.46
2000	0.49	8250	1.04	14500	1.39
2250	0.52	8500	1.08	14750	1.46
2500	0.55	8750	1.08	15000	1.40
2750	0.59	9000	1.12	15250	1.47
3000	0.61	9250	1.12	15500	1.36
3250	0.64	9500	1.15	15750	1.49
3500	0.67	9750	1.14	16000	1.51
3750	0.69	10000	1.19	16250	1.60
4000	0.70	10250	1.20	16500	1.56
4250	0.74	10500	1.23	16750	1.66
4500	0.76	10750	1.24	17000	1.71
4750	0.77	11000	1.24	17250	1.78
5000	0.79	11250	1.25	17500	1.75
5250	0.82	11500	1.28	17750	1.77
5500	0.84	11750	1.29	18000	1.86

Cable loss
Cable coaxial, Bird, 18 GHz, N-type, M-F, model TC-MNFN-3.0, S/N 211539 003
HL 2883

Frequency, MHz	Cable loss, dB	Frequency, MHz	Cable loss, dB	Frequency, MHz	Cable loss, dB
10	0.06	5750	1.70	12000	2.46
30	0.12	6000	1.75	12250	2.48
100	0.21	6250	1.80	12500	2.52
250	0.34	6500	1.81	12750	2.50
500	0.47	6750	1.86	13000	2.54
750	0.59	7000	1.86	13250	2.48
1000	0.67	7250	1.92	13500	2.63
1250	0.76	7500	1.96	13750	2.65
1500	0.84	7750	1.98	14000	2.72
1750	0.92	8000	2.02	14250	2.67
2000	0.98	8250	2.03	14500	2.70
2250	1.05	8500	2.05	14750	2.72
2500	1.12	8750	2.11	15000	2.79
2750	1.17	9000	2.17	15250	2.80
3000	1.22	9250	2.17	15500	2.83
3250	1.27	9500	2.20	15750	2.75
3500	1.33	9750	2.19	16000	2.82
3750	1.38	10000	2.22	16250	2.85
4000	1.42	10250	2.25	16500	2.90
4250	1.46	10500	2.30	16750	2.89
4500	1.51	10750	2.28	17000	2.88
4750	1.54	11000	2.32	17250	2.85
5000	1.59	11250	2.34	17500	2.96
5250	1.62	11500	2.39	17750	3.04
5500	1.65	11750	2.42	18000	3.04

Cable loss
Microwave Cable Assembly, 18 GHz, 6.4 m, SMA – SMA, Huber-Suhner, model 198-9155-00
HL 3123

Frequency, MHz	Cable loss, dB	Frequency, MHz	Cable loss, dB	Frequency, MHz	Cable loss, dB	Frequency, MHz	Cable loss, dB	Frequency, MHz	Cable loss, dB
10	0.11	3600	1.97	7400	3.12	11200	3.90	15100	4.74
30	0.17	3700	1.97	7500	3.13	11300	3.93	15200	4.70
50	0.25	3800	2.03	7600	3.16	11400	3.88	15300	4.73
100	0.32	3900	2.04	7700	3.18	11500	3.87	15400	4.78
200	0.46	4000	2.10	7800	3.20	11600	3.90	15500	4.75
300	0.58	4100	1.97	7900	3.23	11700	3.86	15600	4.76
400	0.65	4200	1.97	8000	3.25	11800	3.88	15700	4.75
500	0.74	4300	2.03	8100	3.26	11900	3.86	15800	4.78
600	0.82	4400	2.04	8200	3.28	12000	3.89	15900	4.79
700	0.89	4500	2.10	8300	3.31	12100	3.94	16000	4.73
800	0.95	4600	1.97	8400	3.31	12200	3.92	16100	4.78
900	1.01	4700	1.97	8500	3.32	12300	3.96	16200	4.84
1000	1.07	4800	2.03	8600	3.34	12400	4.01	16300	4.90
1100	1.11	4900	2.04	8700	3.35	12500	4.07	16400	4.87
1200	1.17	5000	2.10	8800	3.37	12600	4.08	16500	4.90
1300	1.22	5100	2.53	8900	3.39	12700	4.17	16600	4.98
1400	1.27	5200	2.55	9000	3.42	12800	4.26	16700	5.05
1500	1.29	5300	2.60	9100	3.43	12900	4.16	16800	5.04
1600	1.35	5400	2.61	9200	3.51	13000	4.21	16900	5.02
1700	1.40	5500	2.64	9300	3.52	13100	4.24	17000	5.09
1800	1.44	5600	2.70	9400	3.54	13200	4.27	17100	5.07
1900	1.51	5700	2.67	9500	3.63	13300	4.31	17200	5.10
2000	1.49	5800	2.71	9600	3.61	13400	4.33	17300	5.13
2100	1.55	5900	2.74	9700	3.71	13500	4.25	17400	5.23
2200	1.58	6000	2.80	9800	3.66	13600	4.27	17500	5.21
2300	1.62	6100	2.79	9900	3.77	13700	4.33	17600	5.22
2400	1.72	6200	2.81	10000	3.75	13800	4.33	17700	5.36
2500	1.76	6300	2.83	10100	3.77	13900	4.31	17800	5.35
2600	1.78	6400	2.86	10200	3.80	14000	4.30	17900	5.45
2700	1.80	6500	2.88	10300	3.79	14100	4.30	18000	5.43
2800	1.86	6600	2.90	10400	3.87	14200	4.31		
2900	1.90	6700	2.92	10500	3.83	14300	4.37		
3000	1.90	6800	2.98	10600	3.88	14400	4.35		
3100	1.97	6900	2.98	10700	3.86	14600	4.53		
3200	1.97	7000	3.00	10800	3.87	14700	4.50		
3300	2.03	7100	3.02	10900	3.90	14800	4.62		
3400	2.04	7200	3.04	11000	3.84	14900	4.65		
3500	2.10	7300	3.06	11100	3.88	15000	4.79		

13 APPENDIX F Abbreviations and acronyms

A	ampere
AC	alternating current
A/m	ampere per meter
AM	amplitude modulation
AVRG	average (detector)
cm	centimeter
dB	decibel
dBm	decibel referred to one milliwatt
dB(μV)	decibel referred to one microvolt
dB(μV/m)	decibel referred to one microvolt per meter
dB(μA)	decibel referred to one microampere
dBΩ	decibel referred to one Ohm
DC	direct current
DTS	digital transmission system
EIRP	equivalent isotropically radiated power
ERP	effective radiated power
EUT	equipment under test
F	frequency
FHSS	frequency hopping spread spectrum
GHz	gigahertz
GND	ground
H	height
HL	Hermon laboratories
Hz	hertz
ITE	information technology equipment
k	kilo
kHz	kilohertz
LISN	line impedance stabilization network
LO	local oscillator
m	meter
MHz	megahertz
min	minute
mm	millimeter
ms	millisecond
μs	microsecond
NA	not applicable
NT	not tested
OATS	open area test site
Ω	Ohm
PCB	printed circuit board
PM	pulse modulation
PS	power supply
ppm	part per million (10 ⁻⁶)
QP	quasi-peak
RE	radiated emission
RF	radio frequency
rms	root mean square
Rx	receive
s	second
T	temperature
Tx	transmit
V	volt
VA	volt-ampere

END OF TEST REPORT

14 APPENDIX G RADWIN 1000/2000 Antenna List and Power Settings

RADWIN

FCC ID: Q3KRW2054, IC: 5100A-RW2054

The following tables contain the antennas that are provided with the RADWIN 1000/2000 models operating in the 5250-5350 MHz and 5470-5725 MHz bands according to FCC Part 15 Subpart E Section 407 and IC Radio Standard Specification RSS-210. The output power ascribed to each antenna assembly gain is the maximum transmission power allowed to keep compliance with the standards mentioned.

5250 – 5350 MHz Band

Part Number	Type	Antenna Frequency [GHz]	Antenna Assembly Gain at 5250-5350 MHz [dBi]	Channel Frequency [MHz]	Channel Bandwidth [MHz]	Output Power [dBm]
RW-9721-5158	Dish - Dual Pole	4.9 - 6.06	28*	5257.5, 5300, 5342.5	5	-2.9
				5265, 5300, 5335	10	0
				5260, 5340	10	-0.4
				5270, 5300, 5330	20	1.9
				5265, 5335	20	-0.6
				5285, 5300, 5315	40	1.8
				5275, 5325	40	-1.1
RW-9721-5158	Dish - Dual Pole	4.9 - 6.06	6*	5260, 5300, 5340	5	18.9
				5255, 5345	5	9.4
				5265, 5300, 5335	10	21.8
				5260, 5340	10	14
				5275, 5300, 5325	20	23.5
				5265, 5335	20	15.4
				5285, 5300, 5315	40	22.4
RW-9611-4958INT	FP Dual Pole Integrated	4.9 - 6.0	23.5	5257.5, 5300, 5342.5	5	1.8
				5260, 5300, 5340	10	3
				5270, 5300, 5330	20	6.5
				5265, 5335	20	0.8
				5285, 5300, 5315	40	7.4
				5275, 5325	40	1.5
RW-9611-4958	FP Dual Pole External	5.15 - 6.09	22.5*	5257.5, 5300, 5342.5	5	2.5
				5260, 5300, 5340	10	3.9
				5270, 5300, 5330	20	7.4
				5265, 5335	20	1.5
				5285, 5300, 5315	40	7.4
				5275, 5325	40	1.5
RW-9611-4958	FP Dual Pole External	5.15 - 6.09	6*	5260, 5300, 5340	5	18.9
				5255, 5345	5	9.4
				5265, 5300, 5335	10	21.8
				5260, 5340	10	14
				5275, 5300, 5325	20	23.5
				5265, 5335	20	15.4
				5285, 5300, 5315	40	22.4
5275, 5325	40	14.4				

* Antenna assembly gain = Antenna Gain - Feeder Loss

15 APPENDIX H RADWIN 5000 Antenna List and Power Settings

RADWIN

FCC ID: Q3KRW2054, IC: 5100A-RW2054

The following tables contain the antennas that are provided with the RADWIN 5000 model operating in the 5250-5350 MHz and 5470-5725 MHz bands according to FCC Part 15 Subpart E Section 407 and IC Radio Standard Specification RSS-210. The output power ascribed to each antenna assembly gain is the maximum transmission power allowed to keep compliance with the standards mentioned.

5250 – 5350 MHz Band

Part Number	Type	Antenna Frequency [GHz]	Antenna Assembly Gain at 5250-5350 MHz [dBi]	Channel Frequency [MHz]	Channel Bandwidth [MHz]	Output Power [dBm]
RW-9061-5001	FP Dual Pole External	4.9 - 5.95	13*	5257.5, 5300, 5342.5	5	2.5
				5260, 5300, 5340	10	3.9
				5270, 5300, 5330	20	7.4
				5265, 5335	20	1.5
				5285, 5300, 5315	40	7.4
				5275, 5325	40	1.5
RW-9061-5001	FP Dual Pole External	4.9 - 5.95	6*	5260, 5300, 5340	5	18.9
				5255, 5345	5	9.4
				5265, 5300, 5335	10	21.7
				5260, 5340	10	14
				5275, 5300, 5325	20	23.5
				5265, 5335	20	15.4
				5285, 5300, 5315	40	22.3
5275, 5325	40	14.4				
RW-9061-5002	FP Dual Pole External	4.9 - 6.06	14.5*	5257.5, 5300, 5342.5	5	2.5
				5260, 5300, 5340	10	3.9
				5270, 5300, 5330	20	7.4
				5265, 5335	20	1.5
				5285, 5300, 5315	40	7.4
				5275, 5325	40	1.5
RW-9061-5002	FP Dual Pole External	4.9 - 6.06	6*	5260, 5300, 5340	5	18.9
				5255, 5345	5	9.4
				5265, 5300, 5335	10	21.7
				5260, 5340	10	14
				5275, 5300, 5325	20	23.5
				5265, 5335	20	15.4
				5285, 5300, 5315	40	22.3
5275, 5325	40	14.4				

* Antenna assembly gain = Antenna Gain - Feeder Loss