

Test of RADWIN 2000

To: FCC 47 CFR Part 15.407

Test Report Serial No.: RDWN02-A4 Rev A



TEST REPORT

FROM



Test of
RADWIN 2000
to
To: FCC 47 CFR Part 15.407

Test Report Serial No.: RDWN02-A4 Rev A

This report supersedes NONE

Applicant: Radwin Ltd
32 Habarzel Street
Tel-Aviv 69710
Israel

Product Function: Point to Point Transceiver

Copy No: pdf Issue Date: 15th December 2008

This Test Report is Issued Under the Authority of:

MiCOM Labs, Inc.
440 Boulder Court, Suite 200
Pleasanton, CA 94566 USA
Phone: +1 (925) 462-0304
Fax: +1 (925) 462-0306
www.micomlabs.com



CERTIFICATE #2381.01

MiCOM Labs is an ISO 17025 Accredited Testing Laboratory



Title: RADWIN 2000
To: FCC 47 CFR Part 15.407
Serial #: RDWN02-A4 Rev A
Issue Date: 15th December 2008
Page: 3 of 54

This page has been left intentionally blank

This test report may be reproduced in full only. The document may only be updated by MiCOM Labs personnel. Any changes will be noted in the Document History section of the report.



TABLE OF CONTENTS

ACCREDITATION, LISTINGS & RECOGNITION	6
1. TEST RESULT CERTIFICATE	9
2. REFERENCES AND MEASUREMENT UNCERTAINTY	10
2.1. Normative References	10
2.2. Test and Uncertainty Procedures	11
3. PRODUCT DETAILS AND TEST CONFIGURATIONS	12
3.1. Technical Details	12
3.2. Scope of Test Program	13
3.3. Equipment Model(s) and Serial Number(s)	15
3.4. Antenna Details	15
3.5. Cabling and I/O Ports	15
3.6. Test Configurations	16
3.7. Equipment Modifications	16
3.8. Deviations from the Test Standard	16
4. TEST SUMMARY	17
5. TEST RESULTS	18
5.1. Device Characteristics	18
5.1.1. 99 % Bandwidth	18
6. Dynamic Frequency Selection (DFS)	21
6.1. Test Procedure and Setup	21
6.1.1. Interference Threshold values, Master or Client incorporating In-Service Monitoring	21
6.1.2. DFS Response requirement values	21
6.1.3. Radar Test Waveforms	22
6.1.4. Frequency Hopping Radar Test Waveform	25
6.1.5. Radar Waveform Calibration	25
6.1.6. Test Set Up:	26
6.2. Dynamic Frequency Selection (DFS) Test Results (Master Device)	28
6.2.1. UNII Detection Bandwidth:	28
6.2.2. Initial Channel Availability Check Time	30
6.2.3. Radar Burst at the Beginning of the Channel Availability Check Time:	32
6.2.4. Radar Burst at the End of the Channel Availability Check Time:	34
6.2.5. Master Device - In-Service Monitoring for Channel Move Time, Channel Closing Transmission Time and Non-Occupancy Period	36
6.2.6. Statistical Performance Check	44
6.3. Verification of Dynamic Frequency Selection (DFS) Radiated Detection Test Results (Master Device)	47
6.3.1. UNII Detection Bandwidth:	47
7. PHOTOGRAPHS	48
7.1. Dynamic Frequency Selection – Conducted Test Set-Up	48
7.2. Dynamic Frequency Selection – Radiated Test Set-Up	50

This test report may be reproduced in full only. The document may only be updated by MiCOM Labs personnel. Any changes will be noted in the Document History section of the report.



Title: RADWIN 2000
To: FCC 47 CFR Part 15.407
Serial #: RDWN02-A4 Rev A
Issue Date: 15th December 2008
Page: 5 of 54

7.3. Dynamic Frequency Selection – Radiated Test Set-Up	51
7.4. Dynamic Frequency Selection – Radiated Test Set-Up	52
8. TEST EQUIPMENT DETAILS.....	53

This test report may be reproduced in full only. The document may only be updated by MiCOM Labs personnel. Any changes will be noted in the Document History section of the report.

ACCREDITATION, LISTINGS & RECOGNITION

MiCOM Labs, Inc. an accredited laboratory complies with the international standard BS EN ISO/IEC 17025. The company is accredited by the American Association for Laboratory Accreditation (A2LA) www.a2la.org test laboratory number 2381.01. MiCOM Labs test schedule is available at the following URL; <http://www.a2la.org/scopepdf/2381-01.pdf>



This test report may be reproduced in full only. The document may only be updated by MiCOM Labs personnel. Any changes will be noted in the Document History section of the report.



Title: RADWIN 2000
To: FCC 47 CFR Part 15.407
Serial #: RDWN02-A4 Rev A
Issue Date: 15th December 2008
Page: 7 of 54

LISTINGS

MiCOM Labs test facilities are listed by the following organizations;

North America

United States of America

Federal Communications Commission (FCC) Listing #: 102167

Canada

Industry Canada (IC) Listing #:4143A-2

RECOGNITION

APEC MRA (Asia-Pacific Economic Community Mutual Recognition Agreement)

Conformity Assessment Body (CAB) – MiCOM Labs

Test data generated by MiCOM Labs is accepted in the following countries under the APEC MRA.

Country	Recognition Body	Phase	CAB Identification No.
Australia	Australian Communications and Media Authority (ACMA)	I	US0159
Hong Kong	Office of the Telecommunication Authority (OFTA)	I	
Korea	Ministry of Information and Communication Radio Research Laboratory (RRL)	I	
Singapore	Infocomm Development Authority (IDA)	I	
Taiwan	Directorate General of Telecommunications (DGT) Bureau of Standards, Metrology and Inspection (BSMI)	I	

This test report may be reproduced in full only. The document may only be updated by MiCOM Labs personnel. Any changes will be noted in the Document History section of the report.



Title: RADWIN 2000
To: FCC 47 CFR Part 15.407
Serial #: RDWN02-A4 Rev A
Issue Date: 15th December 2008
Page: 8 of 54

DOCUMENT HISTORY

Document History		
Revision	Date	Comments
Draft		
Rev A	15 th December 2008	Initial release.

This test report may be reproduced in full only. The document may only be updated by MiCOM Labs personnel. Any changes will be noted in the Document History section of the report.



Title: RADWIN 2000
To: FCC 47 CFR Part 15.407
Serial #: RDWN02-A4 Rev A
Issue Date: 15th December 2008
Page: 9 of 54

1. TEST RESULT CERTIFICATE

Applicant:	Radwin Ltd 32 Habarzel Street Tel-Aviv 69710 Israel	Tested By:	MiCOM Labs, Inc. 440 Boulder Court Suite 200 Pleasanton California, 94566, USA
EUT:	Outdoor Radio Unit	Telephone:	+1 925 462 0304
Model:	RADWIN 2000	Fax:	+1 925 462 0306
S/N:	Prototype		
Test Date(s):	10th to 11th November 2008	Website:	www.micomlabs.com

STANDARD(S)	TEST RESULTS
FCC 47 CFR Part 15.407 (DFS Only)	EQUIPMENT COMPLIES

MiCOM Labs, Inc. tested the equipment mentioned in accordance with the requirements set forth in the above standards. Test results indicate that the equipment tested is capable of demonstrating compliance with the requirements as documented within this report.

Notes:

1. This document reports conditions under which testing was conducted and the results of testing performed.
2. Details of test methods used have been recorded and kept on file by the laboratory.
3. Test results apply only to the item(s) tested.

Approved & Released for MiCOM Labs, Inc. by:





Graeme Grieve
Quality Manager MiCOM Labs,

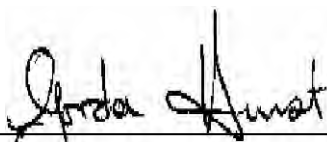

Gordon Hurst
President & CEO MiCOM Labs, Inc.

CERTIFICATE #2381.01

This test report may be reproduced in full only. The document may only be updated by MiCOM Labs personnel. Any changes will be noted in the Document History section of the report.

2. REFERENCES AND MEASUREMENT UNCERTAINTY

2.1. Normative References

Ref.	Publication	Year	Title
(i)	FCC 47 CFR Part 15.407	2007	Code of Federal Regulations
(ii)	FCC 06-96	June 2006	Memorandum Opinion and Order
(iii)	ANSI C63.4	2003	American National Standards for Methods of Measurement of Radio-Noise Emissions from Low-Voltage Electrical and Electronic Equipment in the Range of 9 kHz to 40 GHz
(iv)	CISPR 22/ EN 55022	1997 1998	Limits and Methods of Measurements of Radio Disturbance Characteristics of Information Technology Equipment
(v)	M 3003	Edition 1 Dec. 1997	Expression of Uncertainty and Confidence in Measurements
(vi)	LAB34	Edition 1 Aug 2002	The expression of uncertainty in EMC Testing
(vii)	ETSI TR 100 028	2001	Parts 1 and 2 Electromagnetic compatibility and Radio Spectrum Matters (ERM); Uncertainties in the measurement of mobile radio equipment characteristics
(viii)	A2LA	14 th September 2005	Reference to A2LA Accreditation Status – A2LA Advertising Policy
(ix)	FCC Public Notice – DA 02-2138	2002	Guidelines for Assessing Unlicensed National Information Infrastructure (U-NII) Devices

This test report may be reproduced in full only. The document may only be updated by MiCOM Labs personnel. Any changes will be noted in the Document History section of the report.



Title: RADWIN 2000
To: FCC 47 CFR Part 15.407
Serial #: RDWN02-A4 Rev A
Issue Date: 15th December 2008
Page: 11 of 54

2.2. Test and Uncertainty Procedures

Conducted and radiated emission measurements were conducted in accordance with American National Standards Institute ANSI C63.4, listed in the Normative References section of this report.

Measurement uncertainty figures are calculated in accordance with ETSI TR 100 028 Parts 1 and 2.

Measurement uncertainties stated are based on a standard uncertainty multiplied by a coverage factor $k = 2$, providing a level of confidence of approximately 95 % in accordance with UKAS document M 3003 listed in the Normative References section of this report.

This test report may be reproduced in full only. The document may only be updated by MiCOM Labs personnel. Any changes will be noted in the Document History section of the report.



Title: RADWIN 2000
To: FCC 47 CFR Part 15.407
Serial #: RDWN02-A4 Rev A
Issue Date: 15th December 2008
Page: 12 of 54

3. PRODUCT DETAILS AND TEST CONFIGURATIONS

3.1. Technical Details

Details	Description
Purpose:	DFS testing of the RADWIN 2000 in the frequency ranges 5250 to 5350 MHz, and 5470 to 5,725 MHz to FCC Part 15.407.
Applicant:	Radwin Ltd 32 Habarzel Street Tel-Aviv 69710 Israel
Manufacturer:	As applicant
Laboratory performing the tests:	MiCOM Labs, Inc. 440 Boulder Court, Suite 200 Pleasanton, California 94566 USA
Test report reference number:	RDWN02-A4 Rev A
Date EUT received:	10 th November 2008
Standard(s) applied:	FCC 47 CFR Part 15.407
Dates of test (from - to):	10th to 11th November 2008
No of Units Tested:	One
Type of Equipment:	Outdoor Radio Unit
Model(s):	RADWIN 2000
Software Release	2
Hardware Release:	Prototype
Location for use:	Outdoor
Declared Frequency Range(s):	5,250 to 5,350 MHz 5,470 to 5,725 MHz
Type of Modulation:	Per 802.11 – OFDM
Declared Nominal Output Power: (Average Power)	+24 dBm
EUT Modes of Operation:	802.11n
Transmit/Receive Operation:	Time Division Duplex
Rated Input Voltage and Current:	Nominal ; -24 Vdc; -48 Vdc
Operating Temperature Range:	Declared range -35 to +60°C
Frequency Stability:	±20 ppm max
Equipment Dimensions:	18 cm X 27 cm X 5.5 cm (W x H x D)
Weight:	1.5 kg / 3 lbs
Primary function of equipment:	Outdoor Radio Unit for transmitting and receiving data and voice

This test report may be reproduced in full only. The document may only be updated by MiCOM Labs personnel. Any changes will be noted in the Document History section of the report.



Title: RADWIN 2000
To: FCC 47 CFR Part 15.407
Serial #: RDWN02-A4 Rev A
Issue Date: 15th December 2008
Page: 13 of 54

3.2. Scope of Test Program

The scope of this program was to test the RADWIN 2000 Point to Point Transceiver in a 20MHz Channel Bandwidth configuration for compliance with the Dynamic Frequency Selection (DFS) requirements of FCC 47 CFR Part 15.407 and the FCC specification Memorandum Opinion and Order FCC 06-96.

The RADWIN 2000 has an external antenna with an N-type connector. The antennas used with the product are detailed in section 3.4 "Antenna Details".

One frequency was chosen (5,500 MHz) from the operating channels of the UUT within the 5,250 – 5,350 MHz and 5,470 – 5,725 MHz bands for DFS testing per the requirements of FCC specification "Memorandum Opinion and Order FCC 06-96", Section 7.8 "DFS Conformance Test Procedures".

U-NII devices operating in the 5,250 – 5,350 MHz and 5,470 - 5,725 MHz bands shall employ a DFS radar detection mechanism to detect the presence of radar systems and to avoid co-channel operation with radar systems.

DFS performance testing was completed conductively. Additional radiated checks were completed to verify radar detection using antennas.

In addition to DFS testing the 99% bandwidth was measured to verify detection bandwidth.

Radwin claimed that the RADWIN 1000 product has identical DFS and radio functionality to the RADWIN 2000 product documented within this report.

This test report may be reproduced in full only. The document may only be updated by MiCOM Labs personnel. Any changes will be noted in the Document History section of the report.

**RADWIN 2000
Outdoor Radio Unit**



This test report may be reproduced in full only. The document may only be updated by MiCOM Labs personnel. Any changes will be noted in the Document History section of the report.



Title: RADWIN 2000
To: FCC 47 CFR Part 15.407
Serial #: RDWN02-A4 Rev A
Issue Date: 15th December 2008
Page: 15 of 54

3.3. Equipment Model(s) and Serial Number(s)

Type (EUT/Support)	Equipment Description (Including Brand Name)	Mfr	Model No.	Serial No.
EUT	Access Point	Radwin	RADWIN 2000	Prototype
Support	POE Power Supply	Li Shin International Enterprises Co	--	--
Support	Laptop PC	IBM	Thinkpad	None

3.4. Antenna Details

1. 5150 – 5850 MHz
 - a. 9.5 dBi directional antenna (Kenbotong Communication Ltd TDJ-5158BKF9-Y)

Conducted DFS detection testing was performed according to a 6 dBi antenna threshold.

3.5. Cabling and I/O Ports

Number and type of I/O ports

1. Serial communication SYNC port
2. 10/100 Ethernet + 48Vdc supply connector screened port.

This test report may be reproduced in full only. The document may only be updated by MiCOM Labs personnel. Any changes will be noted in the Document History section of the report.



3.6. Test Configurations

Matrix of test configurations

Model	Operational Mode	Test Frequency (MHz)	Band Width Variant (MHz)
RADWIN 2000	802.11n	5500	20 MHz

DFS testing was performed on the customer equipment configured as a Master device. The operation of the customer equipment was also verified radiatively over the air with the equipment configured with antennas acting as a Master device.

Requirement	Master Device - Operational Modes
DFS Detection Threshold	Yes
Channel Closing Transmission Time	Yes
Channel Move Time	Yes
U-NII Detection Bandwidth	Yes
Channel Availability Check	Yes
Non-Occupancy Period	Yes

3.7. **Equipment Modifications**

The following modifications were required to bring the equipment into compliance:

1. NONE

3.8. **Deviations from the Test Standard**

The following deviations from the test standard were required in order to complete the test program:

1. NONE



4. TEST SUMMARY

List of Measurements

The following table represents the list of measurements required under the **FCC CFR47 Part 15.407**.

Section(s)	Test Items	Description	Condition	Result	Test Report Section
15.407(a)	99% Emission BW	Emission bandwidth measurement	Conducted	Complies	5.1.1

Dynamic Frequency Selection (DFS)

The following table represents the list of measurements required under the **FCC CFR47 Part 15.407(h)(2)** and **FCC Memorandum Opinion and Order FCC 06-96 (Compliance Measurement procedures for Unlicensed National Information Infrastructure devices operating in the 5250-5350 MHz and 5470-5725 MHz bands incorporating dynamic frequency selection)**.

Tests performed on EUT Master Device

Section	Test Items	Description	Condition	Result	Test Report Section
7.8.1	Detection Bandwidth	UNII Detection Bandwidth	Conducted	Complies	6.2.1
7.8.2.1	Performance Requirements Check	Initial Channel Availability Check Time	Conducted	Complies	6.2.2
7.8.2.2		Radar Burst at the Beginning of the Channel Availability Check Time	Conducted	Complies	6.2.3
7.8.2.3		Radar Burst at the End of the Channel Availability Check Time	Conducted	Complies	6.2.4
7.8.3	In-Service Monitoring	In-Service Monitoring for Channel Move Time, Channel Closing Transmission Time and Non-Occupancy Period	Conducted	Complies	6.2.5
7.8.4	Radar Detection	Statistical Performance Check	Conducted & Radiated	Complies	6.2.6

Note 1: Test results reported in this document relate only to the items tested

Note 2: The required tests demonstrated compliance as per client declaration of test configuration, monitoring methodology and associated pass/fail criteria

Note 3: **Section 3.7** Equipment Modifications highlights the equipment modifications that were required to bring the product into compliance with the above test matrix

This test report may be reproduced in full only. The document may only be updated by MiCOM Labs personnel. Any changes will be noted in the Document History section of the report.

5. TEST RESULTS

5.1. Device Characteristics

5.1.1. 99 % Bandwidth

FCC, Part 15 Subpart C §15.407(a)

Test Procedure

The bandwidth at 99 % is measured with a spectrum analyzer connected to the antenna terminal, while EUT is operating in transmission mode at the appropriate center frequency.

Test Measurement Set up

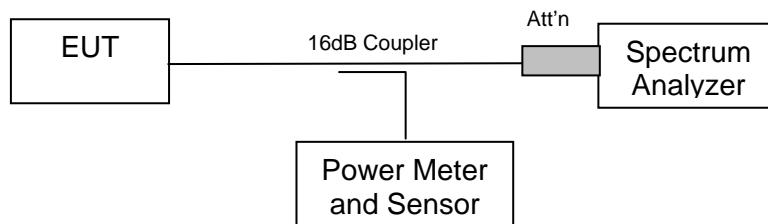

Measurement set up for 99 % bandwidth test

Radio Parameters

Duty Cycle: 50%

Output: Modulated Carrier

Power: Maximum Default Power



Measurement Results for 99 % Operational Bandwidth(s)

Ambient conditions.

Temperature: 17 to 23 °C Relative humidity: 31 to 57 % Pressure: 999 to 1012 mbar

TABLE OF RESULTS – 802.11n 20 MHz Bandwidth

Center Frequency (MHz)	99 % BW (MHz)
5,500	17.71543086

5,500 MHz 802.11N - 20 MHz 99 % Bandwidth

 Marker 1 [T1] RBW 200 kHz RF Att 0 dB
 Ref Lvl -3.32 dBm VBW 300 kHz
 27.3 dBm 5.50252505 GHz SWT 20 s Unit dBm

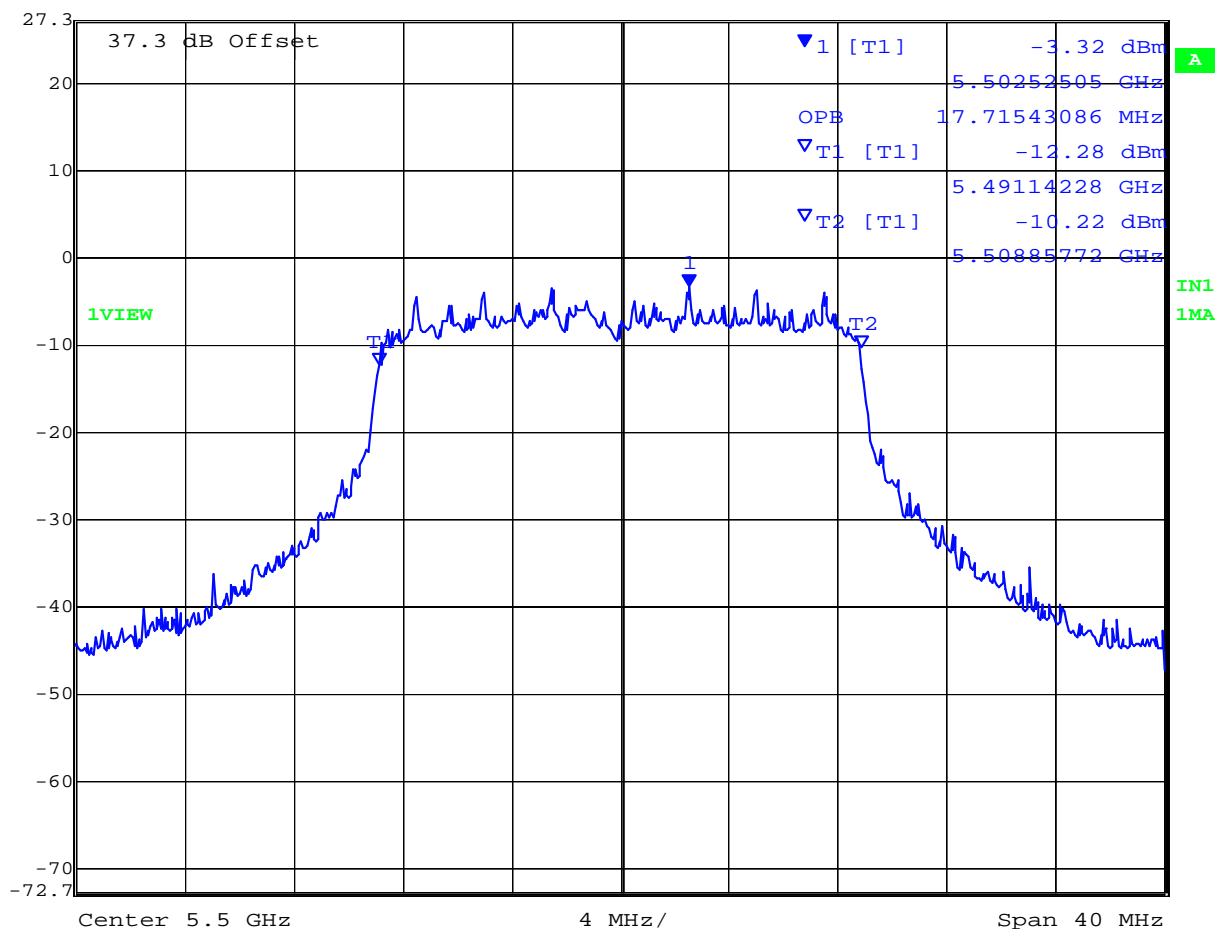

Date: 11.NOV.2008 16:36:45

This test report may be reproduced in full only. The document may only be updated by MiCOM Labs personnel. Any changes will be noted in the Document History section of the report.



Specification

Limits

FCC, Part 15 §15.407 (a)(1), (a)(2)

(a)(1) For the band 5.15-5.25 GHz the maximum conducted output power over the frequency band of operation shall not exceed the lesser of 50 mW or $+4 \text{ dBm} + 10 \log B$, where B is the 26 dB emission bandwidth in megahertz. In addition, the peak power spectral density shall not exceed +4 dBm in any 1 megahertz band.

(a)(2) For the 5.25-5.35 GHz band the maximum conducted output power over the frequency band of operation shall not exceed the lesser of 250 mW or $+11 \text{ dBm} + 10 \log B$, where B is the 26 dB emission bandwidth in megahertz. In addition, the peak power spectral density shall not exceed +11 dBm in any 1 megahertz band.

Laboratory Measurement Uncertainty for Spectrum Measurement

Measurement uncertainty	$\pm 2.81 \text{ dB}$
-------------------------	-----------------------

Traceability

Method	Test Equipment Used
Measurements were made per work instruction WI-03 'Measurement of RF Spectrum Mask'	0158, 0193, 0252, 0313, 0314, 0070, 0116, 0117

This test report may be reproduced in full only. The document may only be updated by MiCOM Labs personnel. Any changes will be noted in the Document History section of the report.



6. Dynamic Frequency Selection (DFS)

6.1. Test Procedure and Setup

FCC, Part 15 Subpart C §15.407(h)
FCC 06-96 Memorandum Opinion and Order

6.1.1. Interference Threshold values, Master or Client incorporating In-Service Monitoring

Maximum Transmit Power	Value (see note)
≥ 200 milliwatt	-64 dBm
< 200 milliwatt	-62 dBm
Note 1: This is the level at the input of the receiver assuming a 0 dBi receive antenna	

6.1.2. DFS Response requirement values

Parameter	Value
<i>Non-occupancy period</i>	Minimum 30 minutes
<i>Channel Availability Check Time</i>	60 seconds
<i>Channel Move Time</i>	10 seconds See Note 1.
<i>Channel Closing Transmission Time</i>	200 milliseconds + an aggregate of 60 milliseconds over remaining 10 second period. See Notes 1 and 2.
<i>U-NII Detection Bandwidth</i>	Minimum 80% of the 99% power bandwidth See Note 3.

Note 1: The instant that the *Channel Move Time* and the *Channel Closing Transmission Time* begins is as follows:

- For the Short pulse radar Test Signals this instant is the end of the *Burst*.
- For the Frequency Hopping radar Test Signal, this instant is the end of the last radar *Burst* generated.
- For the Long Pulse radar Test Signal this instant is the end of the 12 second period defining the radar transmission.

Note 2: The *Channel Closing Transmission Time* is comprised of 200 milliseconds starting at the beginning of the *Channel Move Time* plus any additional intermittent control signals required to facilitate *Channel* changes (an aggregate of 60 milliseconds) during the remainder of the 10 second period. The aggregate duration of control signals will not count quiet periods in between transmissions.

Note 3: During the *U-NII Detection Bandwidth* detection test, radar type 1 is used and for each frequency step the minimum percentage of detection is 90%. Measurements are performed with no data traffic.



6.1.3. Radar Test Waveforms

This section provides the parameters for required test waveforms, minimum percentage of successful detections, and the minimum number of trials that must be used for determining DFS conformance. Step intervals of 0.1 microsecond for Pulse Width, 1 microsecond for PRI, 1 MHz for chirp width and 1 for the number of pulses will be utilized for the random determination of specific test waveforms.

Short Pulse Radar Test Waveforms

Radar Type	Pulse Width (μsec)	PRI (μsec)	Number of Pulses	Minimum Percentage of Successful Detection	Minimum Trials
1	1	1428	18	60%	30
2	1-5	150-230	23-29	60%	30
3	6-10	200-500	16-18	60%	30
4	11-20	200-500	12-16	60%	30
Aggregate (Radar Types 1-4)				80%	120

A minimum of 30 unique waveforms are required for each of the short pulse radar types 2 through 4. For short pulse radar type 1, the same waveform is used a minimum of 30 times. If more than 30 waveforms are used for short pulse radar types 2 through 4, then each additional waveform must also be unique and not repeated from the previous waveforms. The aggregate is the average of the percentage of successful detections of short pulse radar types 1-4.

Long Pulse Radar Test Waveform

Radar Type	Pulse Width (μsec)	Chirp Width (MHz)	PRI (μsec)	Number of Pulses per Burst	Number of Bursts	Minimum Percentage of Successful Detection	Minimum Trials
5	50-100	5-20	1000-2000	1-3	8-20	80%	30

The parameters for this waveform are randomly chosen. Thirty unique waveforms are required for the Long Pulse radar test signal. If more than 30 waveforms are used for the Long Pulse radar test signal, then each additional waveform must also be unique and not repeated from the previous waveforms.



Title: RADWIN 2000
To: FCC 47 CFR Part 15.407
Serial #: RDWN02-A4 Rev A
Issue Date: 15th December 2008
Page: 23 of 54

Each waveform is defined as follows:

- 1) The transmission period for the Long Pulse Radar test signal is 12 seconds.
- 2) There are a total of 8 to 20 *Bursts* in the 12 second period, with the number of *Bursts* being randomly chosen. This number is *Burst Count*.
- 3) Each *Burst* consists of 1 to 3 pulses, with the number of pulses being randomly chosen. Each *Burst* within the 12 second sequence may have a different number of pulses.
- 4) The pulse width is between 50 and 100 microseconds, with the pulse width being randomly chosen. Each pulse within a *Burst* will have the same pulse width. Pulses in different *Bursts* may have different pulse widths.
- 5) Each pulse has a linear FM chirp between 5 and 20 MHz, with the chirp width being randomly chosen. Each pulse within a *Burst* will have the same chirp width. Pulses in different *Bursts* may have different chirp widths. The chirp is centered on the pulse. For example, with a radar frequency of 5300 MHz and a 20 MHz chirped signal, the chirp starts at 5290 MHz and ends at 5310 MHz.
- 6) If more than one pulse is present in a *Burst*, the time between the pulses will be between 1000 and 2000 microseconds, with the time being randomly chosen. If three pulses are present in a *Burst*, the time between the first and second pulses is chosen independently of the time between the second and third pulses.
- 7) The 12 second transmission period is divided into even intervals. The number of intervals is equal to *Burst_Count*. Each interval is of length $(12,000,000 / \textit{Burst_Count})$ microseconds. Each interval contains one *Burst*. The start time for the *Burst*, relative to the beginning of the interval, is between 1 and $[(12,000,000 / \textit{Burst_Count}) - (\textit{Total Burst Length}) + (\textit{One Random PRI Interval})]$ microseconds, with the start time being randomly chosen. The step interval for the start time is 1 microsecond. The start time for each *Burst* is chosen independently.

This test report may be reproduced in full only. The document may only be updated by MiCOM Labs personnel. Any changes will be noted in the Document History section of the report.

A representative example of a Long Pulse radar test waveform:

- 1) The total test signal length is 12 seconds.
- 2) 8 *Bursts* are randomly generated for the *Burst_Count*.
- 3) *Burst 1* has 2 randomly generated pulses.
- 4) The pulse width (for both pulses) is randomly selected to be 75 microseconds.
- 5) The PRI is randomly selected to be at 1213 microseconds.
- 6) *Bursts 2* through 8 are generated using steps 3 – 5.
- 7) Each *Burst* is contained in even intervals of 1,500,000 microseconds. The starting location for Pulse 1, *Burst 1* is randomly generated (1 to 1,500,000 minus the total *Burst 1* length + 1 random PRI interval) at the 325,001 microsecond step. *Bursts 2* through 8 randomly fall in successive 1,500,000 microsecond intervals (i.e. *Burst 2* falls in the 1,500,001 – 3,000,000 microsecond range).

Graphical representation of the Long Pulse radar Test Waveform.

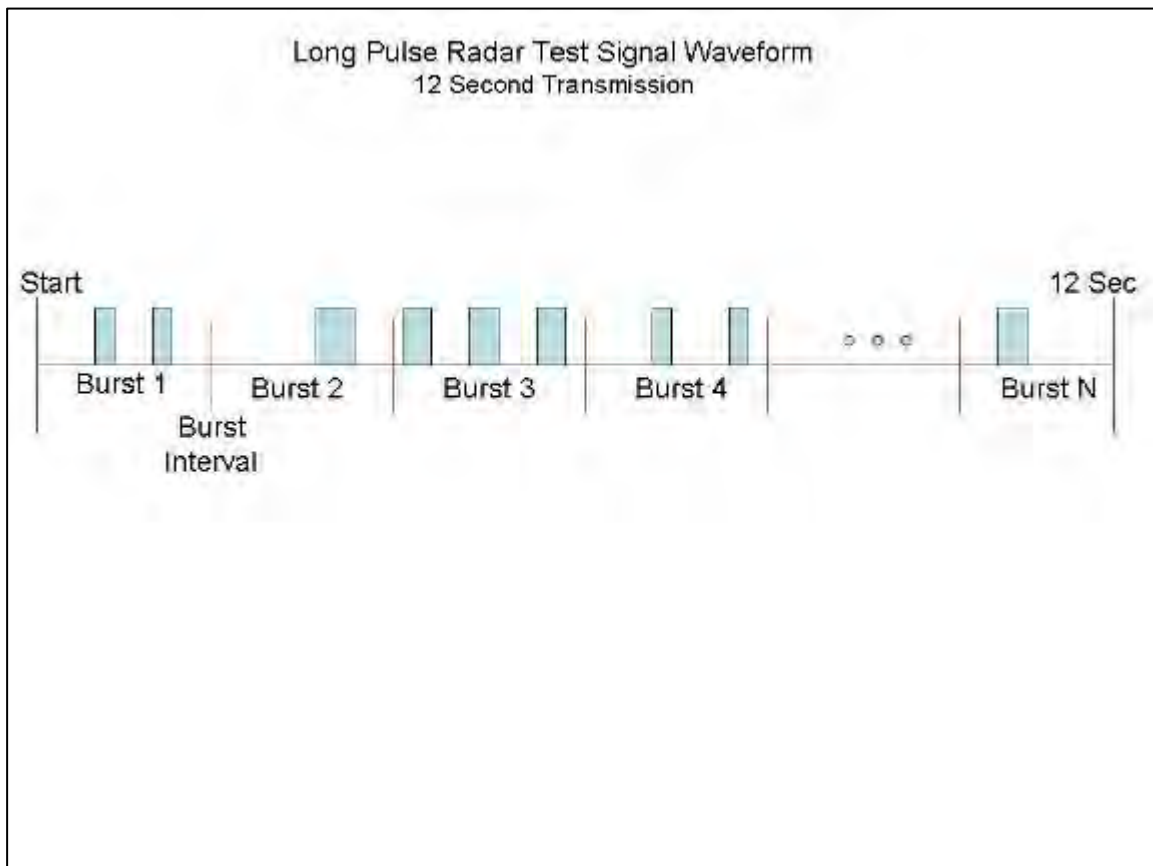

This test report may be reproduced in full only. The document may only be updated by MiCOM Labs personnel. Any changes will be noted in the Document History section of the report.

6.1.4. Frequency Hopping Radar Test Waveform

Frequency Hopping Radar Test Waveform

Radar Type	Pulse Width (µsec)	PRI (µsec)	Pulses per Hop	Hopping Rate (kHz)	Hopping Sequence Length (msec)	Minimum Percentage of Successful Detection	Minimum Trials
6	1	333	9	.333	300	70%	30

For the Frequency Hopping Radar Type, the same *Burst* parameters are used for each waveform. The hopping sequence is different for each waveform and a 100-length segment is selected from the hopping sequence defined by the following algorithm:

6.1.5. Radar Waveform Calibration

The following equipment setup was used to calibrate the conducted Radar Waveform. A spectrum analyzer was used to establish the test signal level for each radar type. During this process there were no transmissions by either the Master or Client Device. The spectrum analyzer was switched to the zero span (Time Domain) mode at the frequency of the Radar Waveform generator. Peak detection was utilized. The spectrum analyzer resolution bandwidth (RBW) and video bandwidth (VBW) were set to 3 MHz.

The signal generator amplitude was set so that the power level measured at the spectrum analyzer was -57dBm (Ref Section 6.1.6). The 30dB amplifier gain was entered as an amplitude offset on the spectrum analyzer.

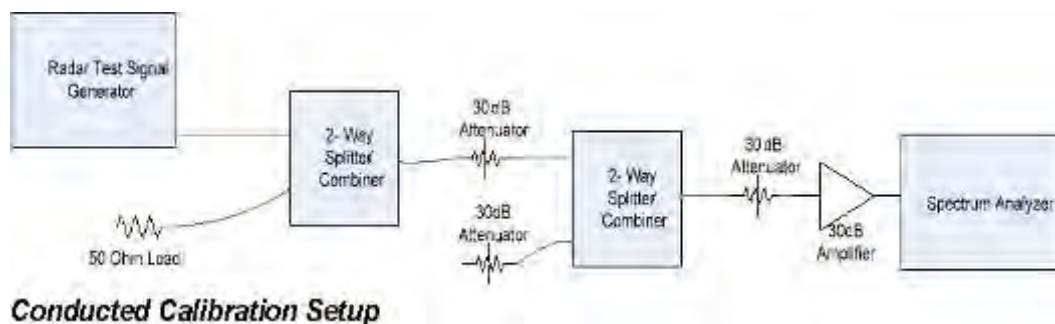

This test report may be reproduced in full only. The document may only be updated by MiCOM Labs personnel. Any changes will be noted in the Document History section of the report.

6.1.6. Test Set Up:

Block Diagram(s) of Test Setup

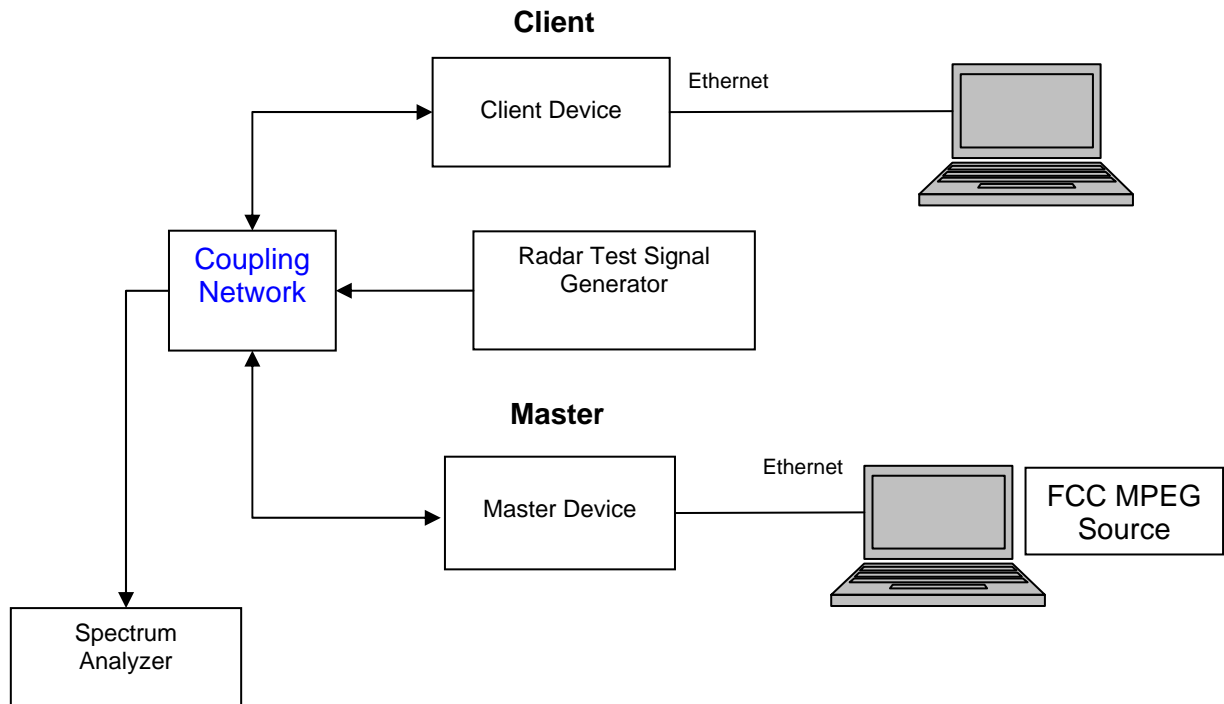

This test report may be reproduced in full only. The document may only be updated by MiCOM Labs personnel. Any changes will be noted in the Document History section of the report.



For the frequency band 5,470 – 5,725 MHz, the Master device provides, on aggregate, uniform loading of the spectrum across all devices by selecting an operating channel among the available channels using a random algorithm.

Declared minimum antenna gain 6 dBi. ;

Radar receive signal level = -64 dBm + minimum antenna gain - 1 dB

$$= -64 + 6 - 1$$

Radar receive signal level = -57 dBm

Measurement Results - Dynamic Frequency Selection (DFS)

Ambient conditions.

Temperature: 17 to 23 °C Relative humidity: 31 to 57% Pressure: 999 to 1012 mbar

Radio parameters.

Test methodology: Conducted

Device Type: Master

Transmit Power: Maximum

Tests Performed with EUT configured as Master Device

Requirement	Operational Mode
	Master
DFS Detection Threshold	Yes
Channel Closing Transmission Time	Yes
Channel Move Time	Yes
U-NII Detection Bandwidth	Yes
Channel Availability Check	Yes
Non-Occupancy Period	Yes

This test report may be reproduced in full only. The document may only be updated by MiCOM Labs personnel. Any changes will be noted in the Document History section of the report.



Title: RADWIN 2000
To: FCC 47 CFR Part 15.407
Serial #: RDWN02-A4 Rev A
Issue Date: 15th December 2008
Page: 28 of 54

6.2. Dynamic Frequency Selection (DFS) Test Results (Master Device)

6.2.1. UNII Detection Bandwidth:

All UNII channels for this device have identical channel bandwidths and DFS testing was completed on channel 5,500 MHz with the EUT operating at 20MHz bandwidth setting.

The generating equipment is configured as shown in the Conducted Test Setup above. A single Burst of the short pulse radar Type 1 through 6 was produced at 5,500 MHz at a level of -57 dBm (Ref Section 6.1.6). The EUT is set up as a standalone device (no associated Client and no traffic).

A single radar Burst is generated for a minimum of 10 trials, and the response of the EUT is noted. The EUT must detect the Radar Waveform 90% or more of the time.

The radar frequency is increased in 1 MHz steps, repeating the above test sequence, until the detection rate falls below 90%. The highest frequency at which detection is greater than or equal to 90% is denoted as F_H .

The radar frequency is decreased in 1 MHz steps, repeating the above test sequence, until the detection rate falls below 90%. The lowest frequency at which detection is greater than or equal to 90% is denoted as F_L .

The U-NII Detection Bandwidth is calculated as follows:

$$\text{U-NII Detection Bandwidth} = F_H - F_L$$

The U-NII Detection Bandwidth must be at least 80% of the EUT transmitter 99% power



Detection Bandwidth;- 20 MHz Bandwidth Configuration

EUT Frequency= 5500 MHz (Detection = √, No Detection = 0)											
Radar Frequency (MHz)	1	2	3	4	5	6	7	8	9	10	Detection Rate (%)
-15											%
-14											%
-13											%
-12											%
F _L -11(5489 MHz)	√	√	0	√	√	√	√	√	0	√	80 %
-10	√	√	√	√	√	√	√	√	√	√	100 %
-9	√	√	√	√	0	√	√	√	√	√	90 %
-8	√	√	√	√	√	√	√	√	√	√	100 %
-7	√	√	√	√	√	√	√	√	√	√	100 %
-6	√	√	√	√	√	√	√	√	√	√	100 %
-5	√	√	√	√	√	√	√	√	√	√	100 %
-4	√	√	√	√	√	√	√	√	√	√	100 %
-3	√	√	√	√	√	√	√	√	√	√	100 %
-2	√	√	√	√	√	√	√	√	√	√	100 %
-1	√	√	√	√	√	√	√	√	√	√	100 %
F ₀	√	√	√	√	√	√	√	√	√	√	100 %
+1	√	√	√	√	√	√	√	√	√	√	100 %
+2	√	√	√	√	√	√	√	√	√	√	100 %
+3	√	√	√	√	√	√	√	√	√	√	100 %
+4	√	√	√	0	√	√	√	√	√	√	90 %
+5	√	√	√	√	√	0	√	√	√	√	90 %
+6	√	√	√	√	√	√	√	√	√	√	100 %
+7	√	√	√	√	√	√	√	√	√	√	100 %
+8	√	√	√	√	√	√	√	√	√	√	100 %
+9	√	√	√	√	√	√	√	√	√	√	100 %
+10	√	√	√	√	0	√	√	√	√	√	90 %
F _H +11(5511 MHz)	√	√	√	√	√	√	√	√	√	0	90 %
+12	√	0	0	√	√	√	√	√	√	√	80 %
+13											%
+14											%
+15											%
Detection Bandwidth = F _H -F _L = 5511 – 5490 MHz = 22 MHz											
EUT 99% Bandwidth = 17.715 MHz (ref. bandwidth channel 5500 MHz)											
17.715 MHz *80% = 14.172 MHz											

For each frequency step the minimum percentage detection is 90%



Title: RADWIN 2000
To: FCC 47 CFR Part 15.407
Serial #: RDWN02-A4 Rev A
Issue Date: 15th December 2008
Page: 30 of 54

6.2.2. Initial Channel Availability Check Time

This test verifies that the EUT does not emit pulse, control, or data signals on the test Channel until the power-up sequence has been completed and the U-NII device checks for Radar Waveforms for one minute on the test Channel. This test does not use any Radar Waveforms.

The U-NII device is powered on and be instructed to operate at 5,500 MHz. At the same time the EUT is powered on, the spectrum analyzer is set for zero span with a 1 MHz resolution bandwidth at 5,500 MHz with a 300 second sweep time. The analyzer's sweep will be started the same time power is applied to the U-NII device.

The EUT should not transmit any pulse or data transmissions until at least 1 minute after the completion of the power-on cycle.

The first red marker line shown on the following plot denotes the instant when the EUT starts its power-up sequence i.e. T_0 (as defined within the FCC's MO&O 06-96 Normative Reference 2). The power-up reference T_0 is determined by the time it takes for the EUT to start "beaconing" i.e. initial beacon – 60 secs = end of power-up.

The Channel Availability Check Time commences at instant T_0 and will end no sooner than $T_0 + 60$ seconds.

The EUT Master device requires 63.85 seconds to complete its power-on cycle.

20MHz BW Initial Channel Availability Check Time during power up of EUT
Ch 5,500 MHz

	Marker 1 [T1]	RBW	1 MHz	RF Att	10 dB	
	Ref Lvl	-108.01 dBm	VBW	1 MHz		
	-40 dBm	63.847695 s	SWT	300 s	Unit	dBm

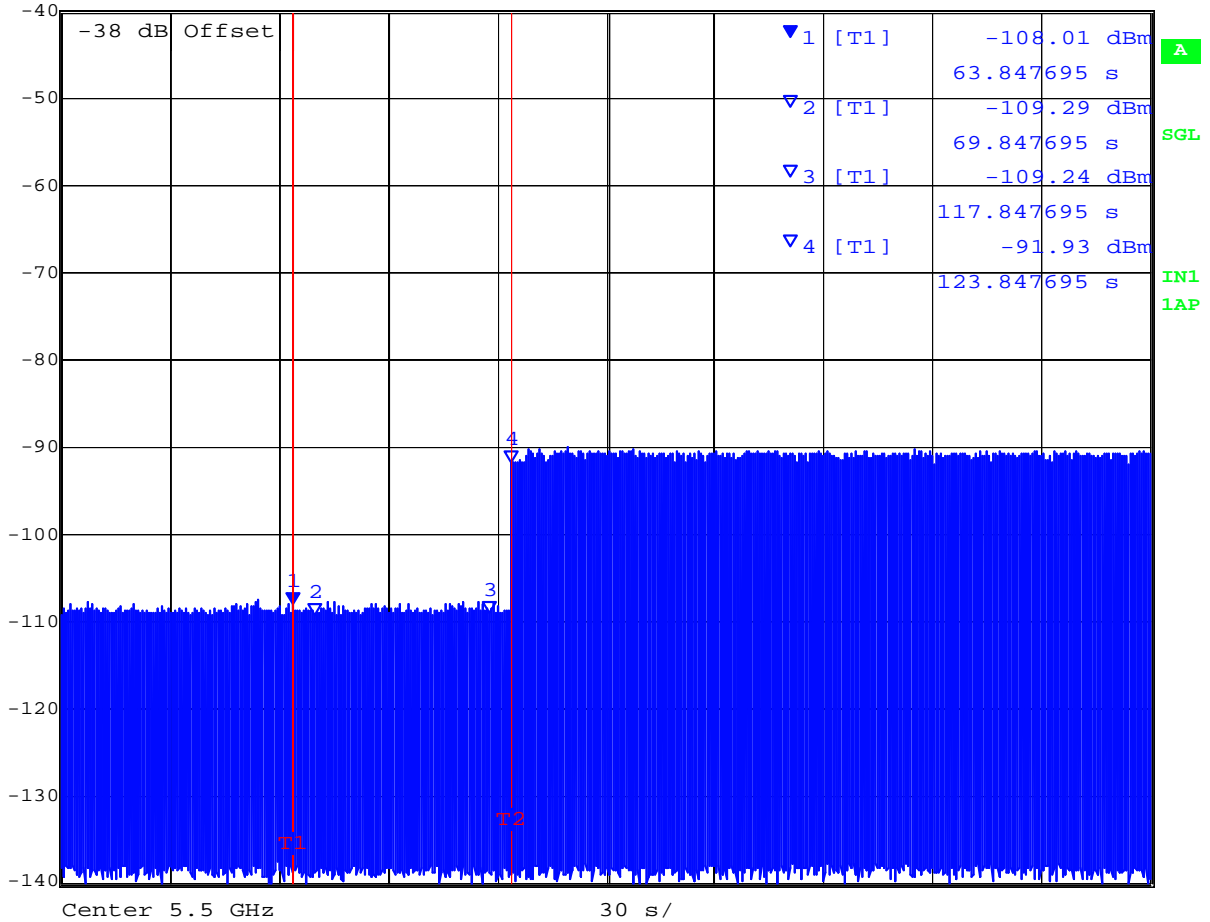

Date: 11.NOV.2008 12:05:48

This test report may be reproduced in full only. The document may only be updated by MiCOM Labs personnel. Any changes will be noted in the Document History section of the report.



Title: RADWIN 2000
To: FCC 47 CFR Part 15.407
Serial #: RDWN02-A4 Rev A
Issue Date: 15th December 2008
Page: 32 of 54

6.2.3. Radar Burst at the Beginning of the Channel Availability Check Time:

The steps below define the procedure to verify successful radar detection on the selected Channel during a period equal to the Channel Availability Check Time and avoidance of operation on that Channel when a radar Burst with a level equal to the DFS Detection Threshold -1 dB (-57 dBm Ref Section 6.1.6) occurs at the beginning of the Channel Availability Check Time.

A single Burst of short pulse of radar Type 1 will commence within a 6 second window starting at T_0 (first red marker line on the following plot).

Visual indication on the EUT of successful detection of the radar Burst will be recorded and reported. Observation of emissions at 5,500MHz will continue for 2.5 minutes after the radar burst has been generated.

This test report may be reproduced in full only. The document may only be updated by MiCOM Labs personnel. Any changes will be noted in the Document History section of the report.



20 MHz BW Channel Availability Check Time at the start of the 60 second Check Time
Ch 5,500 MHz

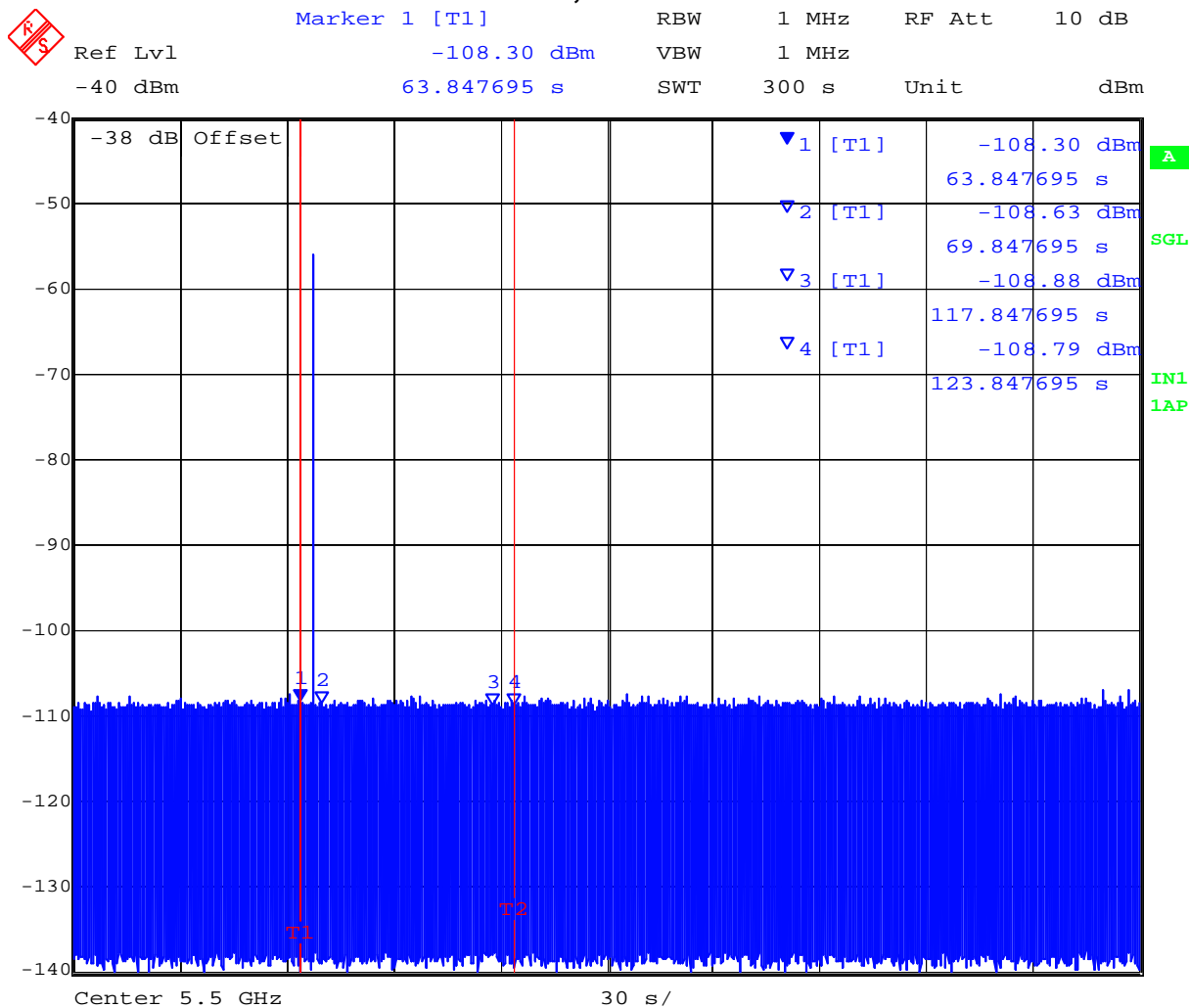

Date: 11.NOV.2008 12:12:33

This test report may be reproduced in full only. The document may only be updated by MiCOM Labs personnel. Any changes will be noted in the Document History section of the report.



Title: RADWIN 2000
To: FCC 47 CFR Part 15.407
Serial #: RDWN02-A4 Rev A
Issue Date: 15th December 2008
Page: 34 of 54

6.2.4. Radar Burst at the End of the Channel Availability Check Time:

The steps below define the procedure to verify successful radar detection on the selected Channel during a period equal to the Channel Availability Check Time and avoidance of operation on that Channel when a radar Burst with a level equal to the DFS Detection Threshold occurs at the end of the Channel Availability Check Time.

A single Burst of short pulse of radar type 1 will commence within a 6 second window starting at $T_0 + 54$ seconds. The window will commence at marker 2 and end at the red frequency line T_2 .

Visual indication on the EUT of successful detection of the radar Burst will be recorded and reported. Observation of emissions at 5,500MHz will continue for 2.5 minutes after the radar burst has been generated.

This test report may be reproduced in full only. The document may only be updated by MiCOM Labs personnel. Any changes will be noted in the Document History section of the report.



20 MHz BW Channel Availability Check Time at the end of the 60 second Check Time
Ch 5,500 MHz

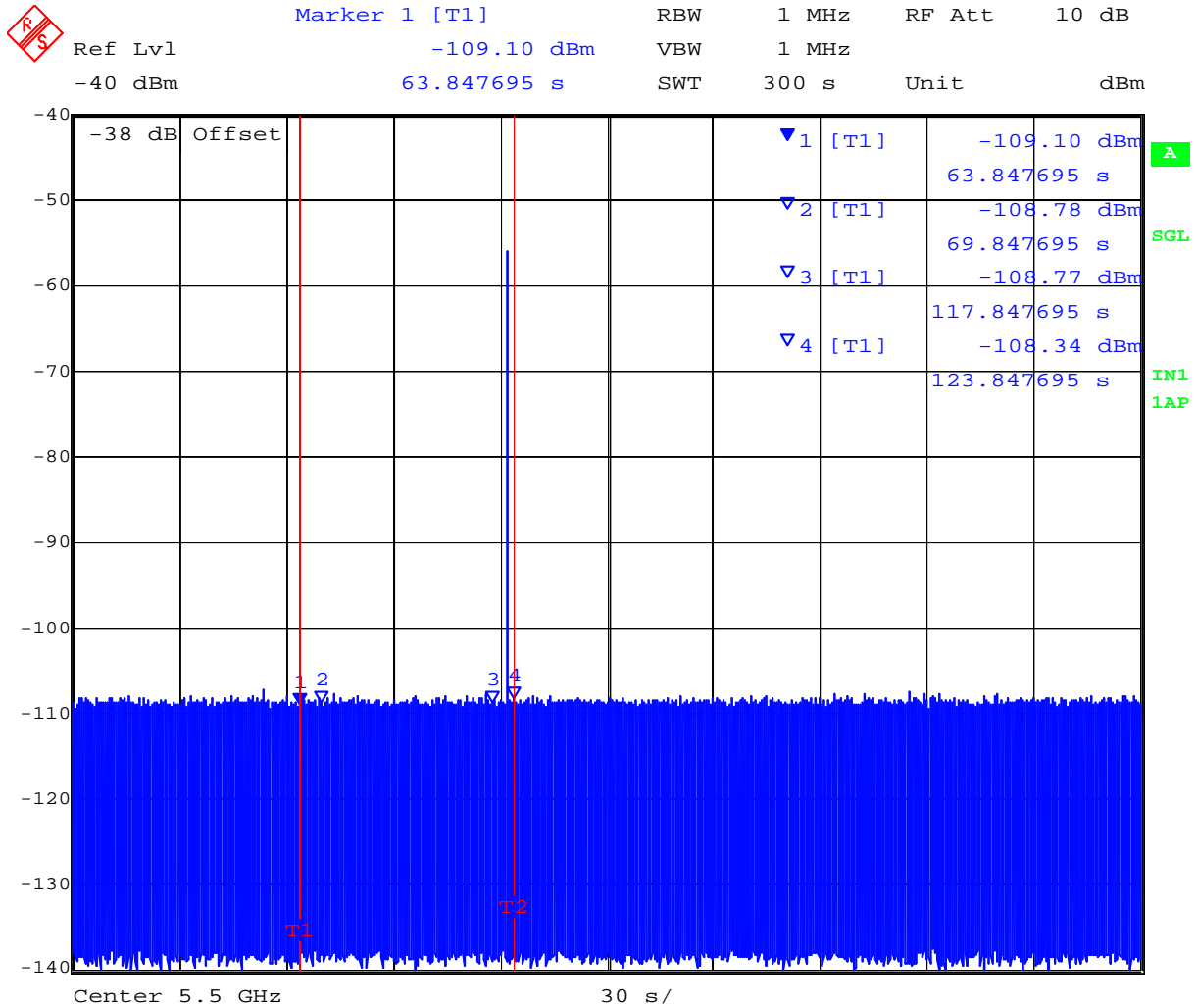

Date: 11.NOV.2008 12:18:09

This test report may be reproduced in full only. The document may only be updated by MiCOM Labs personnel. Any changes will be noted in the Document History section of the report.



6.2.5. Master Device - In-Service Monitoring for Channel Move Time, Channel Closing Transmission Time and Non-Occupancy Period

FCC §15.407(h)(2)(iii)

The steps below define the procedure to determine the above mentioned parameters when a radar Burst with a level equal to the DFS Detection Threshold is generated on the Operating Channel of the U-NII device.

A U-NII device operating as a Client Device will associate with the EUT (Master). The requisite MPEG video file ("TestFile.mpg" available on the NTIA website at the following link <http://ntiacsd.ntia.doc.gov/dfs/>) is streamed from the master device (AP) to the client.

20 MHz Band Width Channel Closing Transmission Time - Measurement

A Type 1 waveform was introduced to the EUT, from which a 12 second transmission record was digitally captured, collecting nearly 250M samples of data, which included in excess of 600 ms of pre-trigger data. This Type 1 waveform had an integral marker built into its construction, marking the start of the radar waveform play, which directly triggered the PXI digitizer's data capture via the PXI backplane trigger bus.

The test system was set-up to capture all transmission data for access point events above a threshold level of -50 dBm. The test equipment time stamps all captured events with respect to T_0 (zero time indicating the start of the measurements sequence) starting the 612.1 ms pre-trigger period followed by the radar type 1 burst period.

Radar (Type 1) Pre-trigger period 612.1 ms

Type 1 burst period 25.705 ms

(The period of the 18 pulse burst includes [18 pulses * 1.428mS PRI] = 25.704 ms. Then add 1 μ s pulse width for the final pulse.)

Channel Closing Transmission Time starts immediately after the last radar pulse is transmitted i.e. 637.8 ms after the start of the trace capture period.

Therefore, pulses seen after this 637.8 ms boundary are identified and totaled to provide an aggregate total of transmissions in order to determine whether the EUT is compliant with the Channel Closing Transmission Time requirements as described in MO&O FCC 06-96. In this case, it was found that an aggregate total of 11.532 ms of transmission time accrued. This value is found at the right hand side at the foot of the following plot (10s Total).

Channel Closing Transmission Time = 11.532 mSecs (limit 260 mSecs)

Master Device 20 MHz BW - Channel Move Time, Channel Closing Transmission Time for Type 1 Radar - Captured by the Test System - 0 to 2 seconds

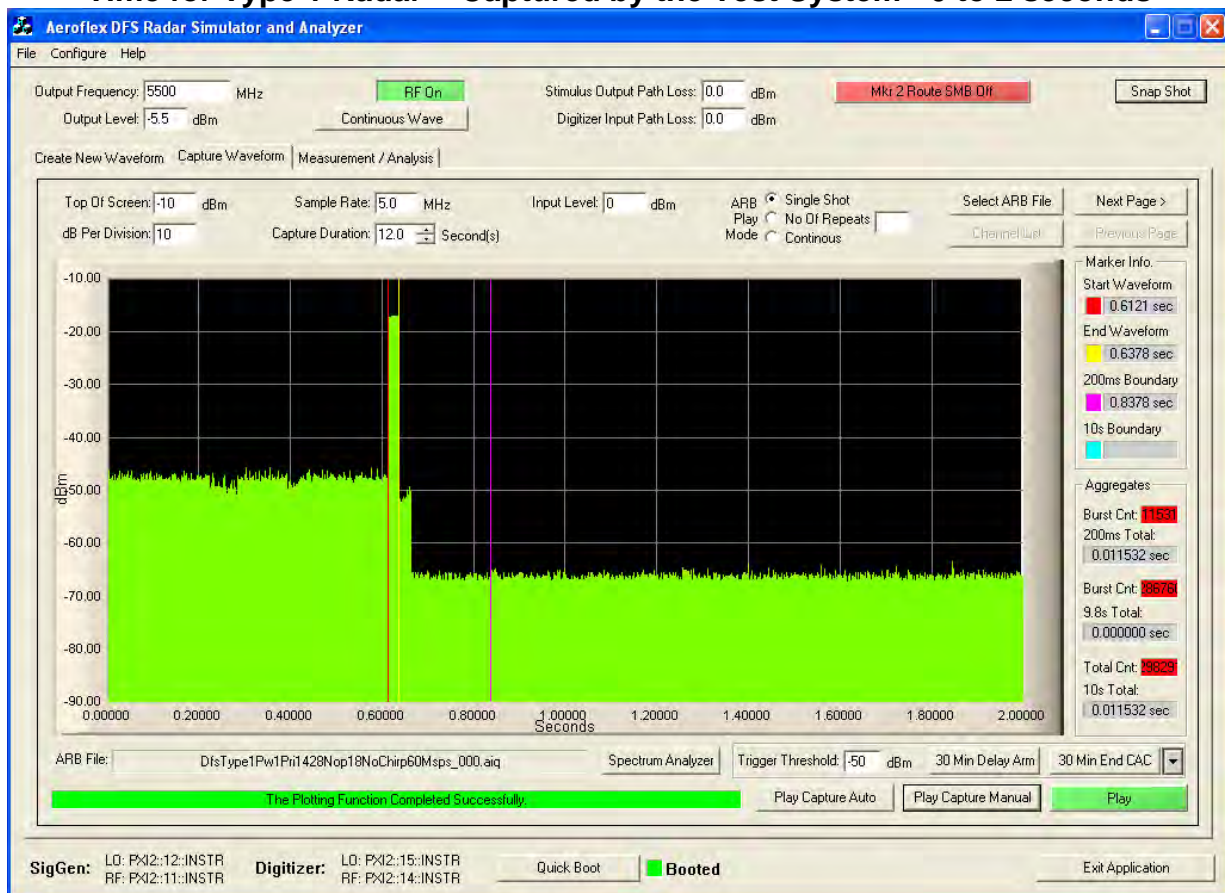

From the plot above it can be seen that the transmission activity within the 200 mS window is 11.532 mS (see 200 mS Total). From the following plots which show all additional activity within the remainder of the 10 sec measurement window it can be determined that the aggregate transmission is 0.0 mS. This is less than the 60 mS limit.

Last Transmitter Activity = 0.670 Seconds

Last Radar Activity = 0.6378 Seconds

Channel Move Time = Last Transmitter Activity – Last Radar Activity = 0.670 – 0.6378

Channel Move Time = 32.2 msecs (Limit 10 secs)

This test report may be reproduced in full only. The document may only be updated by MiCOM Labs personnel. Any changes will be noted in the Document History section of the report.

Master Device 20 MHz BW - Channel Move Time, Channel Closing Transmission Time for Type 1 Radar
Captured by the Test System - 2 to 4 seconds

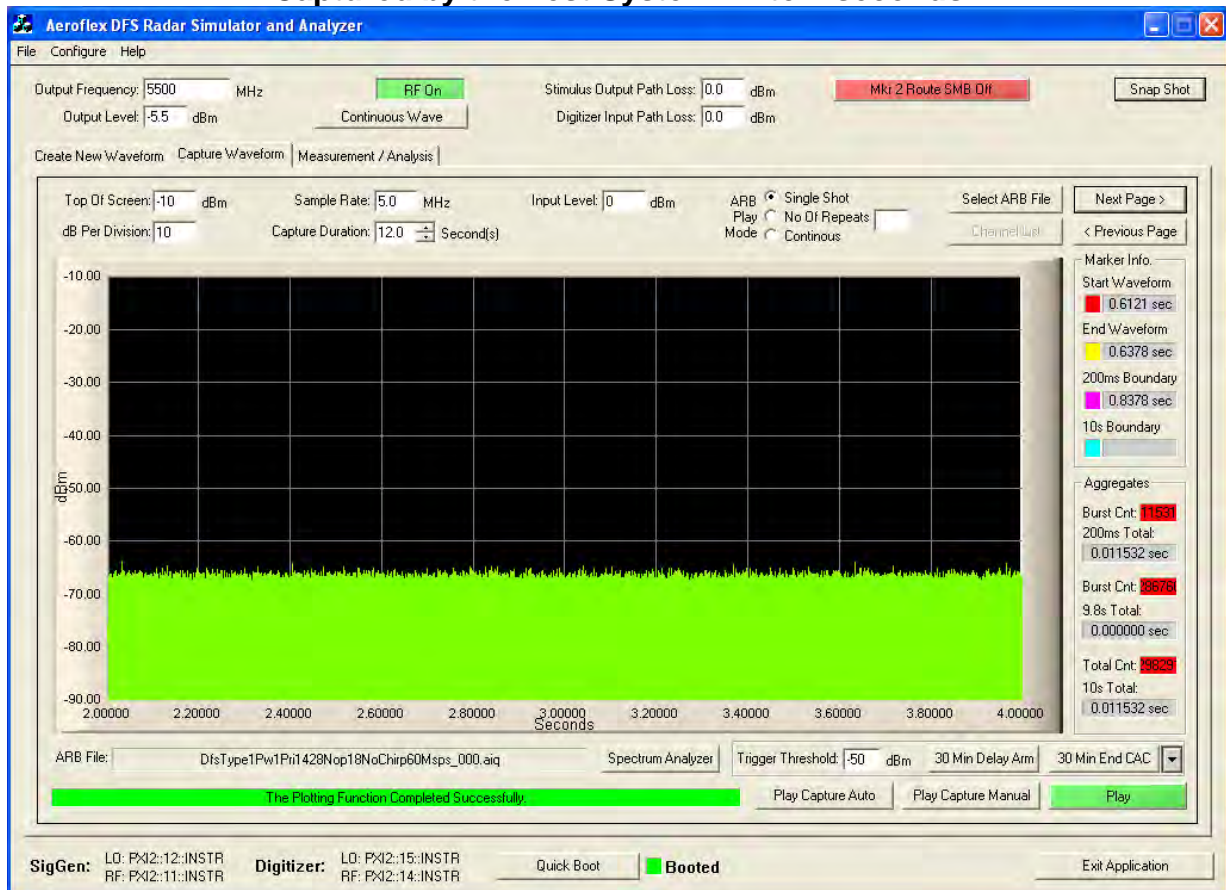

This test report may be reproduced in full only. The document may only be updated by MiCOM Labs personnel. Any changes will be noted in the Document History section of the report.

Master Device 20 MHz BW - Channel Move Time, Channel Closing Transmission Time for Type 1 Radar
Captured by the Test System - 4 to 6 seconds

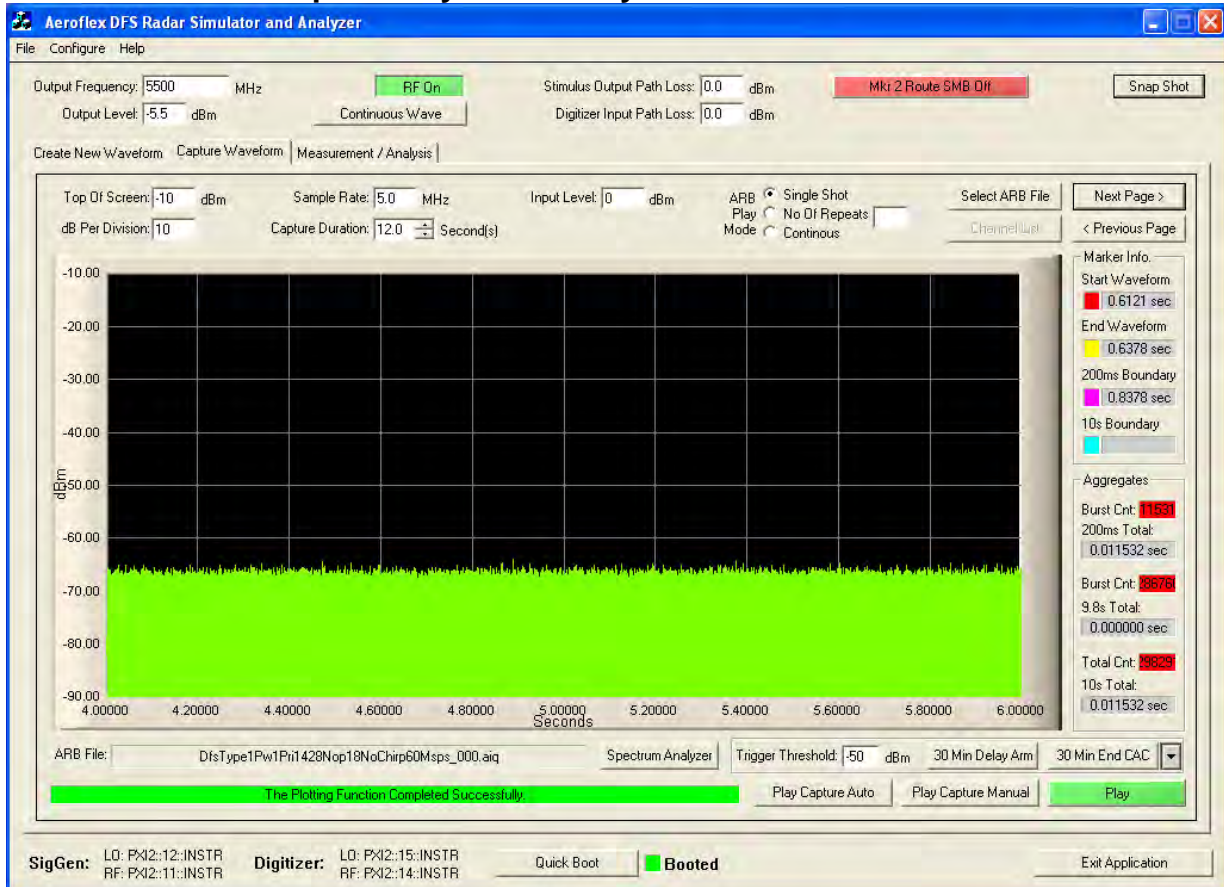

This test report may be reproduced in full only. The document may only be updated by MiCOM Labs personnel. Any changes will be noted in the Document History section of the report.

Master Device 20 MHz BW - Channel Move Time, Channel Closing Transmission Time for Type 1 Radar
Captured by the Test System - 6 to 8 seconds

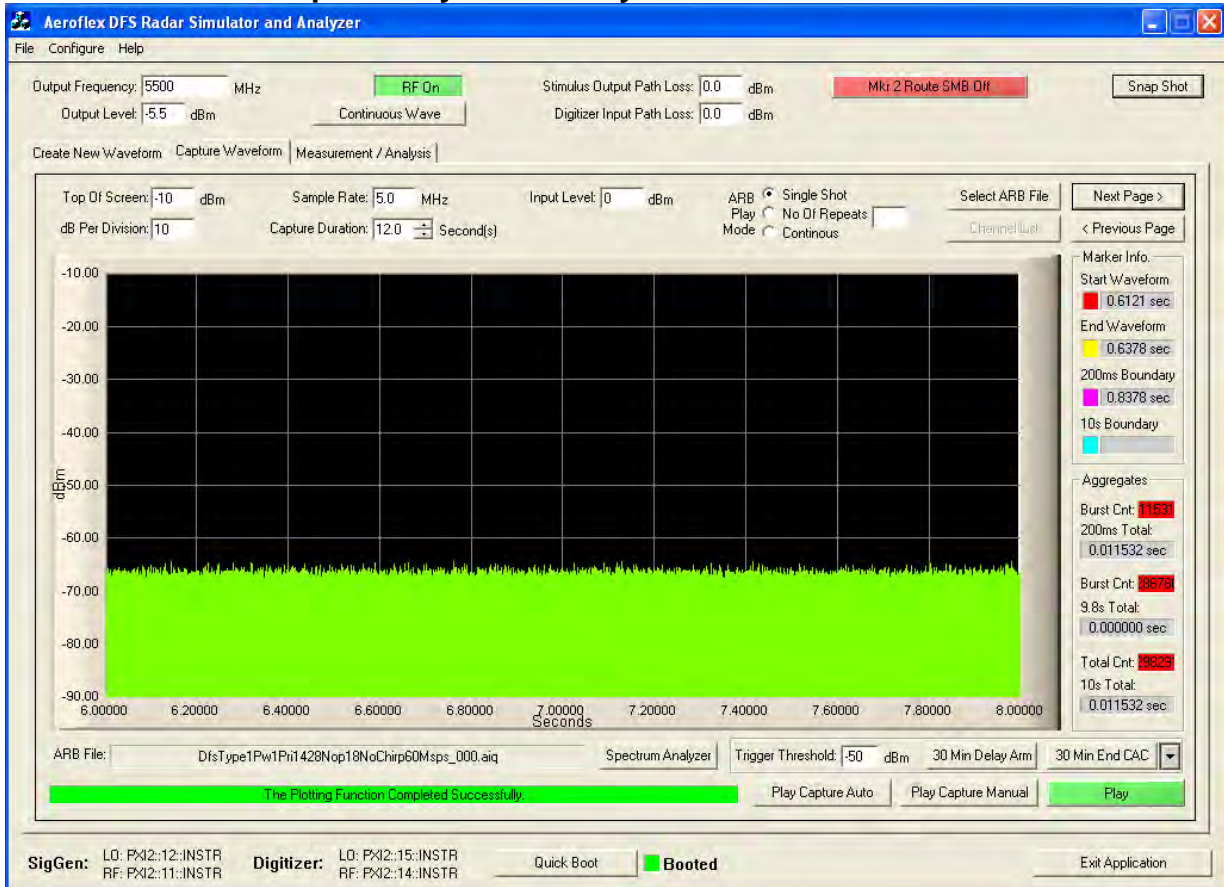

This test report may be reproduced in full only. The document may only be updated by MiCOM Labs personnel. Any changes will be noted in the Document History section of the report.

Master Device 20 MHz BW - Channel Move Time, Channel Closing Transmission Time for Type 1 Radar
Captured by the Test System - 8 to 10 seconds

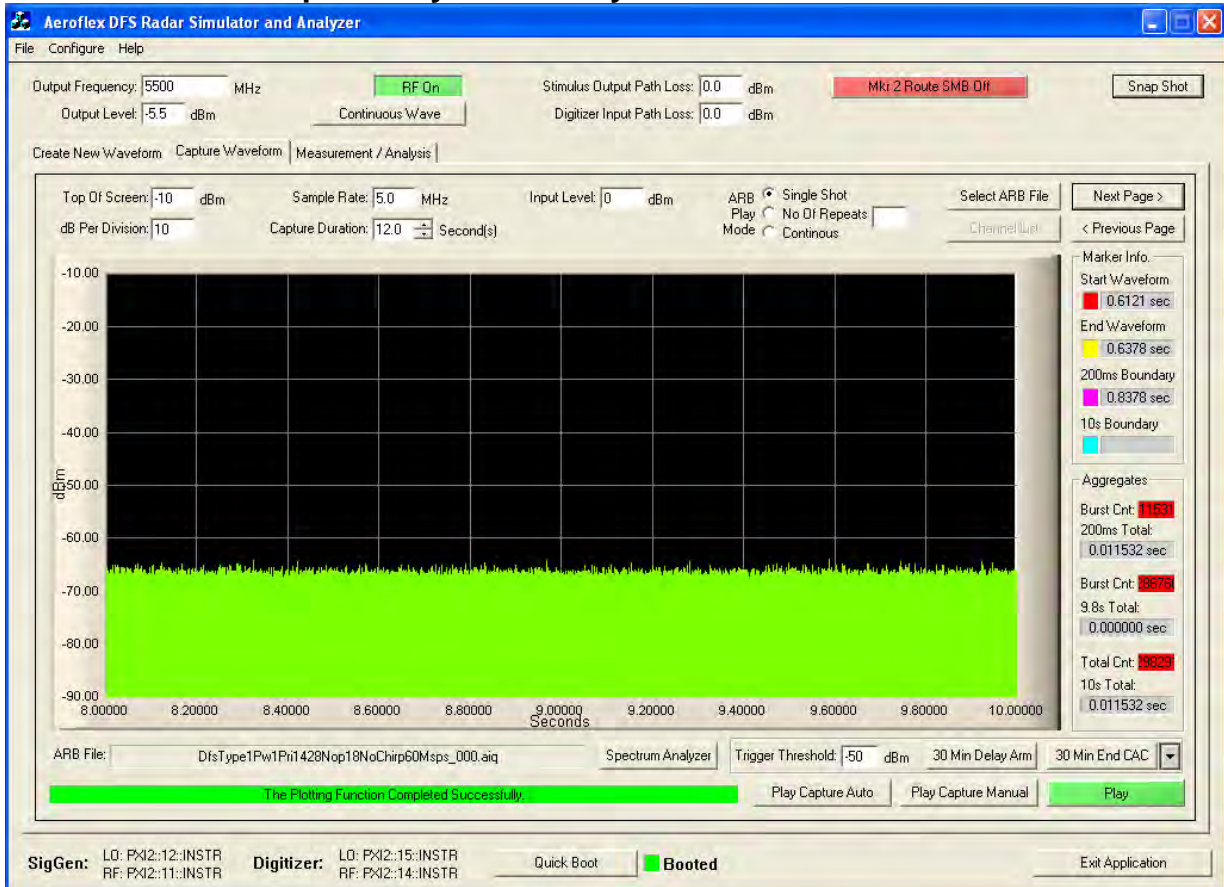

This test report may be reproduced in full only. The document may only be updated by MiCOM Labs personnel. Any changes will be noted in the Document History section of the report.

**Master Device 20 MHz BW - Channel Move Time, Channel Closing Transmission
 Time for Type 1 Radar
 Captured by the Test System - 10 to 12 seconds**

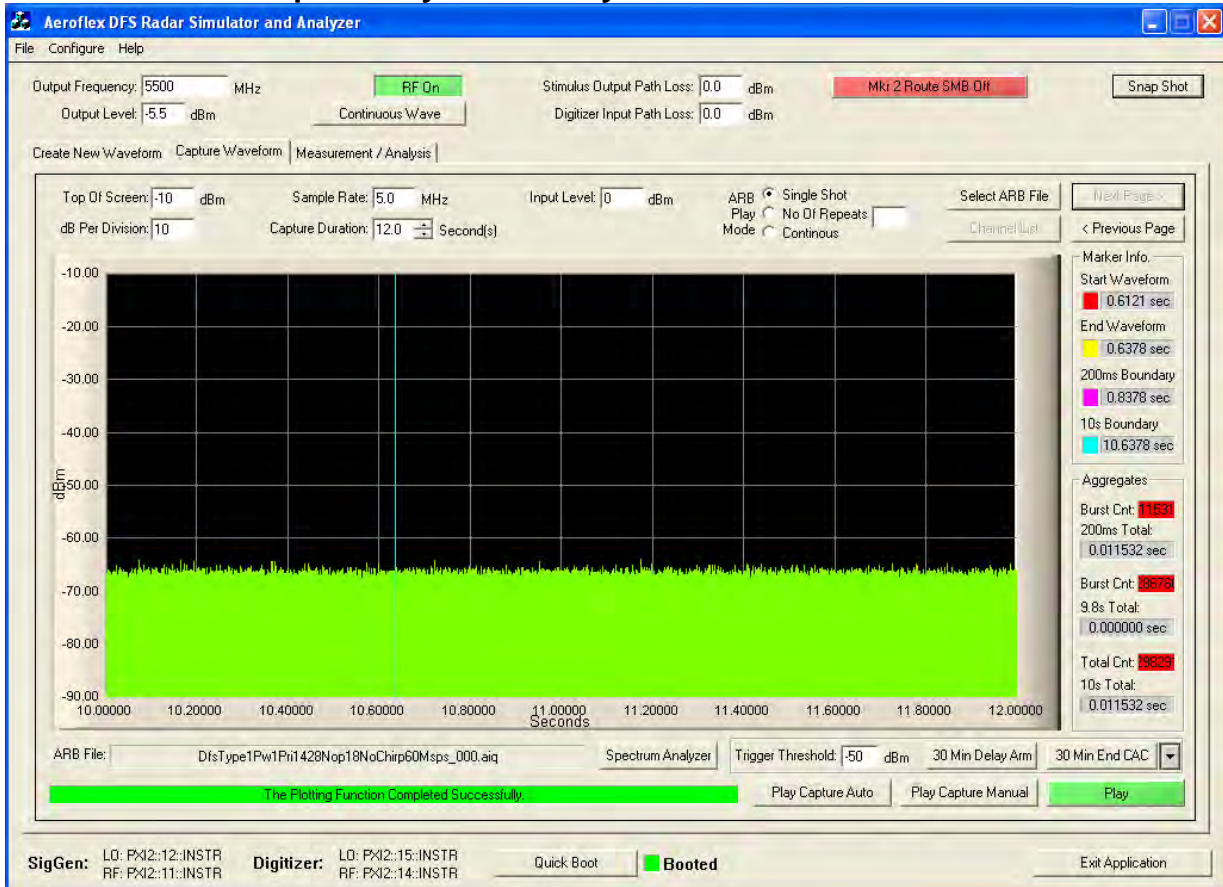

This test report may be reproduced in full only. The document may only be updated by MiCOM Labs personnel. Any changes will be noted in the Document History section of the report.



30 Minute Non-Occupancy Period

The EUT is monitored for more than 30 minutes following the channel close/move time to verify no transmissions, including beacons, resume on this Channel. Radar signature #1 was used to trigger the access point.

20 MHz Band Width 30 Minute Non-Occupancy Period Type 1 Radar Ch 5,500 MHz

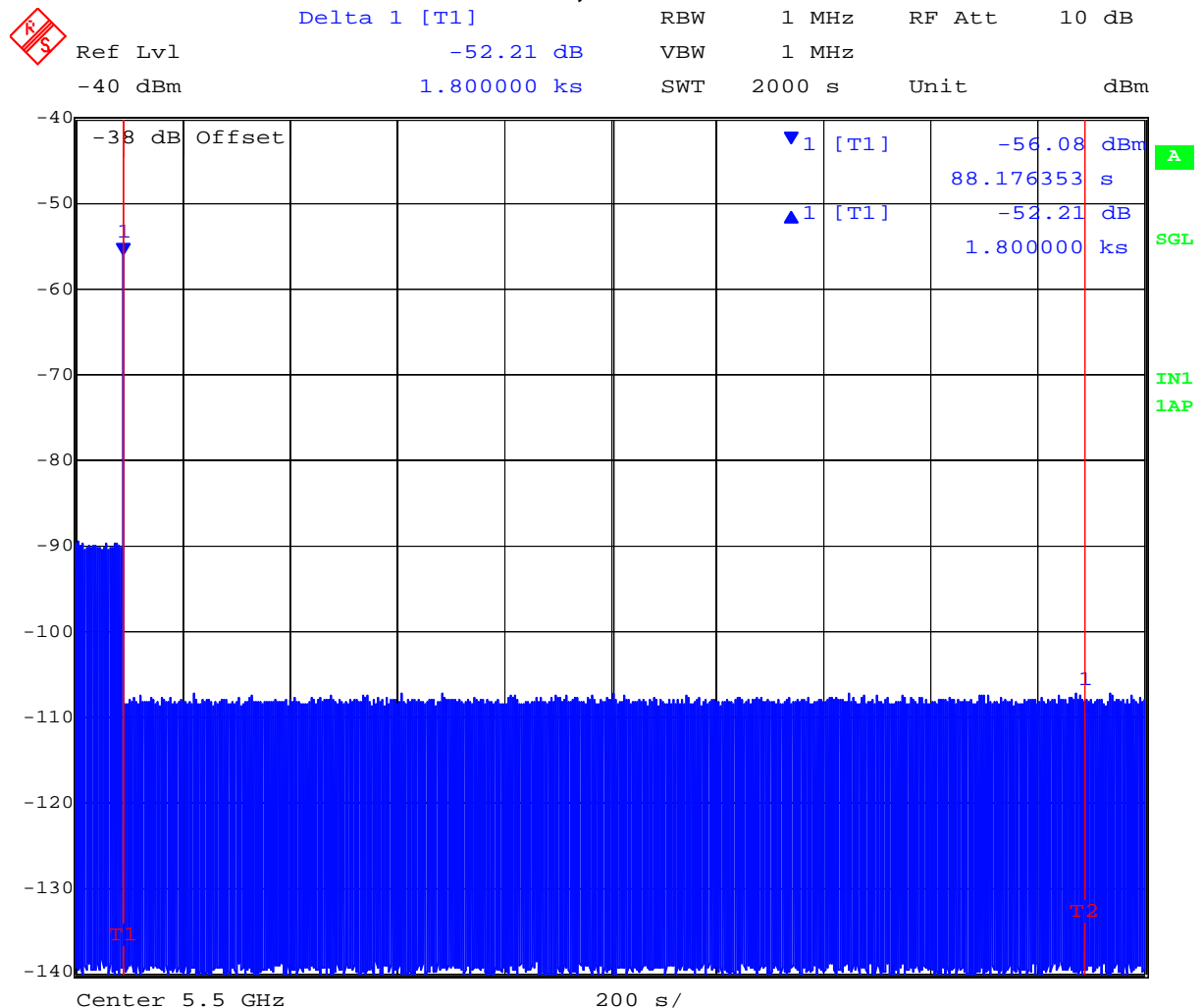

Date: 11.NOV.2008 13:15:11

This test report may be reproduced in full only. The document may only be updated by MiCOM Labs personnel. Any changes will be noted in the Document History section of the report.



Title: RADWIN 2000
To: FCC 47 CFR Part 15.407
Serial #: RDWN02-A4 Rev A
Issue Date: 15th December 2008
Page: 44 of 54

6.2.6. Statistical Performance Check

The steps below define the procedure to determine the minimum percentage of detection when a radar burst with a level equal to the DFS Detection Threshold is generated on the Operating Channel of the U-NII device.

A U-NII device operating as a Client Device will associate with the UUT (Master) at 5,500 MHz. Stream the MPEG test file from the Master Device to the Client Device on the selected Channel for the entire period of the test.

The Radar Waveform generator sends the individual waveform for each of the radar types 1-6. Statistical data will be gathered to determine the ability of the device to detect the radar test waveforms. The device can utilize a test mode to demonstrate when detection occurs to prevent the need to reset the device between trial runs. The percentage of successful detection is calculated by:

Total # of detections ÷ Total # of Trials × 100 = Probability of Detection

The Minimum number of trails, minimum percentage of successful detection and the average minimum percentage of successful detection are found in the Radar Test Waveforms section. The radar frequency was offset by -5 MHz (i.e. set at 5495 MHz) from the EUT channel centre frequency of 5500 MHz

This test report may be reproduced in full only. The document may only be updated by MiCOM Labs personnel. Any changes will be noted in the Document History section of the report.



20 MHz Bandwidth - Verification of Detection

Trial #	Detection = √, No Detection = 0					
	Type 1	Type 2	Type 3	Type 4	Type 5	Type 6
1	√	√	√	√	√	√
2	√	√	√	√	√	0
3	√	√	√	√	√	√
4	√	√	√	0	√	√
5	√	√	√	√	0	√
6	√	√	√	√	√	√
7	√	√	√	√	√	√
8	√	√	√	√	√	√
9	√	√	√	√	0	√
10	√	√	√	√	√	√
11	√	√	√	√	√	√
12	√	√	√	√	√	√
13	√	√	√	√	√	√
14	√	√	√	√	√	√
15	√	√	√	√	√	√
16	√	√	√	√	√	√
17	√	√	√	√	√	√
18	√	√	√	√	0	√
19	√	√	√	√	0	√
20	√	√	√	√	√	√
21	√	√	√	√	√	√
22	√	√	√	√	√	√
23	√	√	√	√	√	√
24	√	√	√	√	0	√
25	√	√	√	√	√	√
26	√	√	√	√	√	√
27	√	√	√	√	√	√
28	√	√	√	√	√	√
29	√	√	√	√	√	√
30	√	√	√	√	0	√
Detection Percentage	100% (≥60%)	100% (≥60%)	100% (≥60%)	96.6% (≥60%)	80% (≥80%)	96.6% (≥70%)

In addition an average minimum percentage of successful detection across all four Short pulse radar test waveforms is required and calculated as follows;

$$(P_{d1} + P_{d2} + P_{d3} + P_{d4}) / 4 = (100\% + 100\% + 100\% + 96.6\%) / 4 = 99.1\% (\geq 80\%)$$

This test report may be reproduced in full only. The document may only be updated by MiCOM Labs personnel. Any changes will be noted in the Document History section of the report.



Title: RADWIN 2000
To: FCC 47 CFR Part 15.407
Serial #: RDWN02-A4 Rev A
Issue Date: 15th December 2008
Page: 46 of 54

Measurement Uncertainty Time/Power

Measurement uncertainty	
- Time	4%
- Power	1.33dB

Traceability

Test Equipment Used
0072, 0083, 0098, 0116, 0132, 0158, 0313, 0314, 0193, 0223, 0252, 0253, 0251, 0256, 0328, 0329

This test report may be reproduced in full only. The document may only be updated by MiCOM Labs personnel. Any changes will be noted in the Document History section of the report.



6.3. Verification of Dynamic Frequency Selection (DFS) Radiated Detection Test Results (Master Device)

6.3.1. UNII Detection Bandwidth:

As a verification of performance the customer equipment was configured in a semi-anechoic test chamber to transmit the FCC MPEG video over the air. The Radar Test Signal Generator (PXI) was set up outside the test chamber and connected to a horn antenna in the test chamber to transmit the radar test waveforms.

The PXI system was put into CW mode and the received level on the client antenna output was verified with a power meter to verify that the power level for the radar at the Client antenna was set to the radar detection threshold.

A series of tests were performed using a random sample of 5 different waveforms from the 30 Type 5 Radar Test Waveforms (numbered # 000 to # 029) used during conducted Radar Detection testing with the radar centre frequency offset -5 MHz with respect to the channel centre frequency of the customer equipment. The RADWIN 2000 detected all of the test radar waveforms as shown on the following table of results.

20 MHz Bandwidth – Radiated test - Verification of Detection

Trial Number	Type 5 Radar Test Waveforms	(Detection = √, No Detection = 0)
1	# 000	√
2	# 014	√
3	# 018	√
4	# 004	√
5	# 027	√

7. PHOTOGRAPHS

7.1. Dynamic Frequency Selection – Conducted Test Set-Up

General DFS Test Setup

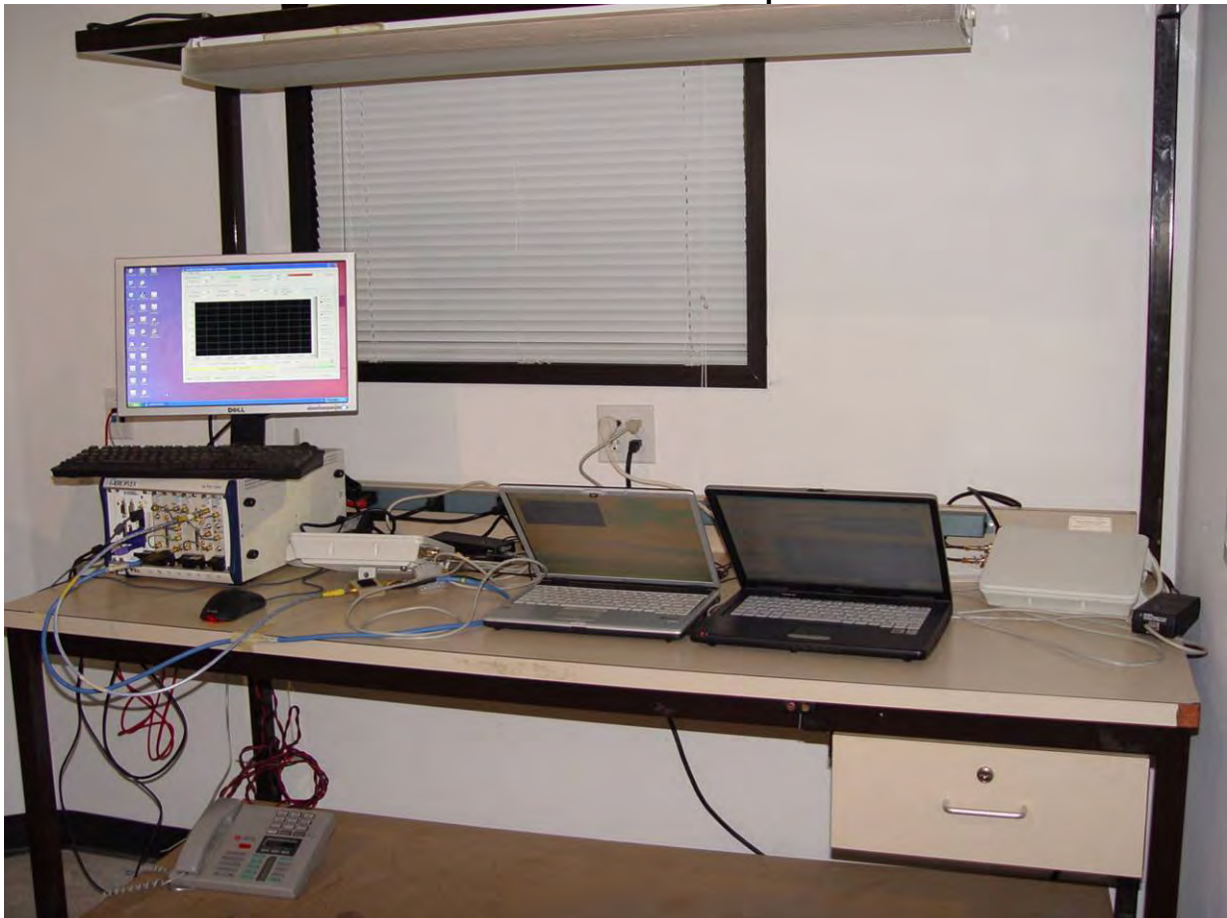

This test report may be reproduced in full only. The document may only be updated by MiCOM Labs personnel. Any changes will be noted in the Document History section of the report.

DFS Test Equipment



This test report may be reproduced in full only. The document may only be updated by MiCOM Labs personnel. Any changes will be noted in the Document History section of the report.

7.2. Dynamic Frequency Selection – Radiated Test Set-Up



This test report may be reproduced in full only. The document may only be updated by MiCOM Labs personnel. Any changes will be noted in the Document History section of the report.

7.3. Dynamic Frequency Selection – Radiated Test Set-Up



This test report may be reproduced in full only. The document may only be updated by MiCOM Labs personnel. Any changes will be noted in the Document History section of the report.

7.4. Dynamic Frequency Selection – Radiated Test Set-Up



This test report may be reproduced in full only. The document may only be updated by MiCOM Labs personnel. Any changes will be noted in the Document History section of the report.



Title: RADWIN 2000
To: FCC 47 CFR Part 15.407
Serial #: RDWN02-A4 Rev A
Issue Date: 15th December 2008
Page: 53 of 54

8. TEST EQUIPMENT DETAILS

Asset #	Instrument	Manufacturer	Part #	Serial #
0158	Barometer /Thermometer	Control Co.	4196	E2846
0193	EMI Receiver	Rhode & Schwartz	ESI 7	838496/007
0252	SMA Cable	Megaphase	Sucoflex 104	None
0310	2m SMA Cable	Micro-Coax	UFA210A-0-0787-3G03G0	209089-001
0312	3m SMA Cable	Micro-Coax	UFA210A-1-1181-3G0300	209092-001
0313	Coupler	Hewlett Packard	86205A	3140A01285
0314	30dB N-Type Attenuator	ARRA	N9444-30	1623
0070	Power Meter	Hewlett Packard	437B	3125U11552
0116	Power Sensor	Hewlett Packard	8485A	3318A19694
0117	Power Sensor	Hewlett Packard	8487D	3318A00371
0184	Pulse Limiter	Rhode & Schwartz	ESH3Z2	357.8810.52
0293	BNC Cable	Megaphase	1689 1GVT4	15F50B001
0307	BNC Cable	Megaphase	1689 1GVT4	15F50B002
0335	1-18GHz Horn Antenna	ETS- Lindgren	3117	00066580
0338	Antenna	Sunol Sciences	JB-3	A052907

This test report may be reproduced in full only. The document may only be updated by MiCOM Labs personnel. Any changes will be noted in the Document History section of the report.



440 Boulder Court, Suite 200
Pleasanton, CA 94566, USA
Tel: 1.925.462.0304
Fax: 1.925.462.0306
www.micomlabs.com