

TEST REPORT

ACCORDING TO: FCC CFR 47 PART 90 subpart Y and RSS-111 Issue 3

FOR:

RADWIN Ltd.

**Outdoor radio unit operating
in the 4.9 GHz band**

**Model: RADWIN 1000,
RADWIN 2000,
RADWIN 5000**

This report is in conformity with ISO/ IEC 17025. The "A2LA Accredited" symbol endorsement applies only to the tests and calibrations that are listed in the scope of Hermon Laboratories accreditation. The test results relate only to the items tested. This test report shall not be reproduced in any form except in full with the written approval of Hermon Laboratories Ltd.



Table of contents

1	Applicant information	3
2	Equipment under test attributes	3
3	Manufacturer information	3
4	Test details	3
5	Tests summary	4
6	EUT description	5
6.1	General information	5
6.2	Ports and lines	5
6.3	Support and test equipment	5
6.4	Changes made in the EUT	5
6.5	Test configuration	6
6.6	Transmitter characteristics	7
7	Transmitter tests according to 47CFR part 90 and RSS-111 requirements	8
7.1	Peak output power and power spectral density tests	8
7.2	Occupied bandwidth test	33
7.3	Emission mask test	46
7.4	Spurious emissions at RF antenna connector test	59
7.5	Radiated spurious emission measurements	73
8	Frequency stability test	112
9	Receiver tests	114
9.1	Receiver spurious emissions at RF antenna connector	114
10	APPENDIX A Test equipment and ancillaries used for tests	118
11	APPENDIX B Measurement uncertainties	120
12	APPENDIX C Test laboratory description	121
13	APPENDIX D Specification references	121
14	APPENDIX E Test equipment correction factors	122
15	APPENDIX F Abbreviations and acronyms	129
16	APPENDIX G RADWIN 1000/2000/5000 Antenna List and Power Settings	129



HERMON LABORATORIES

1 Applicant information

Client name: RADWIN Ltd.
Address: 27 Habarzel str., Tel Aviv 69710, Israel
Telephone: +972 3766 2988
Fax: +972 3766 2902
E-mail: shlomo_weiss@radwin.com
Contact name: Mr. Shlomo Weiss

2 Equipment under test attributes

Product name: Outdoor radio unit operating in the 4.9 GHz band
Product type: Point to Point and Point to Multipoint transceiver
Model(s): RADWIN 1000, RADWIN 2000, RADWIN 5000
Receipt date 23/12/2008

3 Manufacturer information

Manufacturer name: RADWIN Ltd.
Address: 27 Habarzel str., Tel Aviv 69710, Israel
Telephone: +972 3766 2988
Fax: +972 3766 2902
E-Mail: shlomo_weiss@radwin.com
Contact name: Mr. Shlomo Weiss

4 Test details

Project ID: 19328
Location: Hermon Laboratories Ltd. P.O.Box 23, Binyamina 30500, Israel
Test started: 23/12/2008
Test completed: 22/02/2009
Test specification(s): 47CFR part 90 subpart Y:2007; RSS-111 issue 3



HERMON LABORATORIES

5 Tests summary

Test	Status
Transmitter characteristics	
FCC sections 90.205, 90.1215, RSS-111 section 5.3, Maximum output power and peak power spectral density	Pass
FCC section 90.209, RSS-Gen section 4.6.1, Occupied bandwidth	Pass
FCC section 90.210 (m), RSS-111 section 5.4, Emission mask	Pass
FCC section 90.210, RSS-111 section 5.4, Conducted spurious emissions	Pass
FCC section 90.210, RSS-111 section 5.4, Radiated spurious emissions	Pass
RSS-111 section 5.5, Receiver spurious emissions	Pass
FCC section 90.213, RSS-111 section 5.2, Frequency stability	Tested without limit
FCC section 90.214, Transient frequency behaviour	Not required
FCC section 2.1091, RSS-Gen section 5.6, RF radiation exposure evaluation	Pass, provided in Application for certification exhibit

The test results relate only to the items tested. Pass/ fail decision was based on nominal values.

This test report replaces the previously issued test report identified by Doc ID:RDWRAD_FCC.19328_21882_rev1.

	Name and Title	Date	Signature
Tested by:	Mr. E. Plotnichenko, test engineer	February 22, 2009	
Reviewed by:	Ms. N. Averin, certification engineer	April 17, 2011	
Approved by:	Mr. M. Nikishin, EMC and Radio group manager	April 17, 2011	

6 EUT description

6.1 General information

The EUT, RADWIN 1000, RADWIN 2000, RADWIN 5000 is an outdoor unit (ODU). The power and Ethernet communication are supplied by an indoor unit (IDU) or PoE device. It has connectorized and integrated antenna configurations that can support dual pole antenna type. The RADWIN 1000 activates one RF port, RADWIN 2000 activates two RF ports for software configured Point to Point topology and RADWIN 5000 is identifier for software configured Point to Multipoint topology. For relevant output power setting versus each antenna type please refer to "RADWIN 1000/2000/5000 Antenna List and Power Settings" attached.

The EUT model RADWIN 2000 was tested as a worst case representative.

6.2 Ports and lines

Port type	Port description	Connected		Connector type	Q-ty	Cable type	Cable length, m	Indoor / outdoor
		From	To					
Power	-48 VDC	AC/DC adapter	IDU	Terminal block	1	unshielded	1.5	Indoor
Power	AC power	mains	AC/DC adapter	IEC 60320	1	unshielded	1.5	Indoor
RF	Antenna	EUT	antenna	N-type	2	shielded	1	Outdoor*
Signal	DC+ Ethernet	IDU	EUT	RJ45	1	FTP	20	Outdoor
Signal	Ethernet	IDU	Laptop	RJ45	1	shielded	1.5	Indoor

* - for external antenna configuration only, 1 dB loss at each port

6.3 Support and test equipment

Description	Manufacturer	Model number	Serial number
Laptop	Dell	Latitude/D530	NA
IDU (for configuration with ODU)	RadWin Ltd.	IDU-E	DE2E2000123
AC/DC	YCL	WMB480042-5G	S0714002271

6.4 Changes made in the EUT

No changes were implemented.

6.5 Test configuration

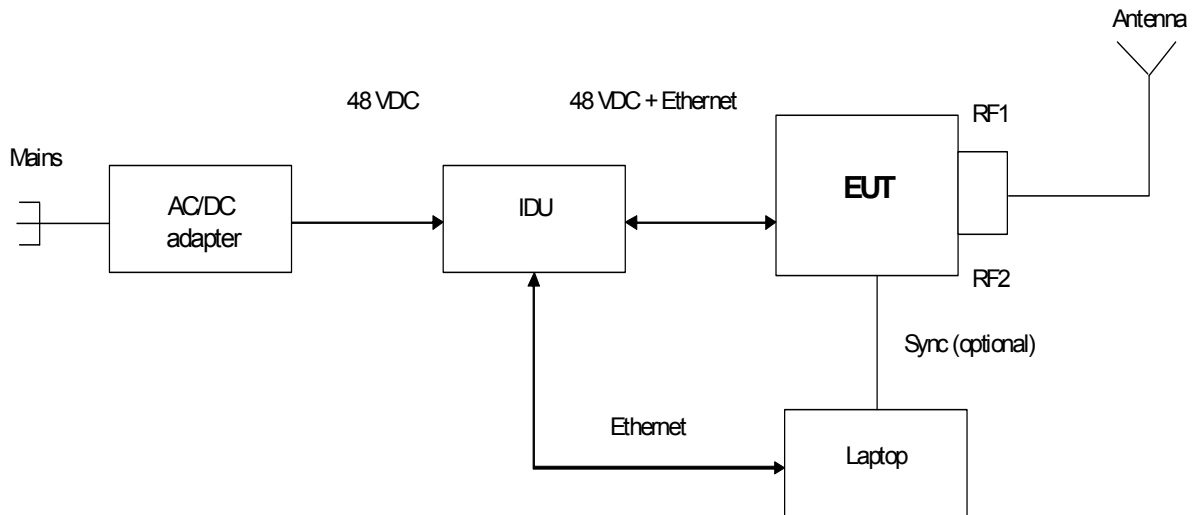

6.6 Transmitter characteristics

Type of equipment				
V	Stand-alone (Equipment with or without its own control provisions)			
	Combined equipment (Equipment where the radio part is fully integrated within another type of equipment)			
	Plug-in card (Equipment intended for a variety of host systems)			
Intended use		Condition of use		
V	Fixed	Always at a distance more than 2 m from all people		
	mobile	Always at a distance more than 20 cm from all people		
	portable	May operate at a distance closer than 20 cm to human body		
Assigned frequency range		4940 – 4990 MHz		
Operating frequency range		4942.5 – 4987.5 MHz for 5 MHz channel bandwidth 4945 – 4985 MHz for 10 MHz channel bandwidth; 4950 – 4980 MHz for 20 MHz channel bandwidth		
RF channel bandwidth		5 MHz, 10 MHz, 20 MHz		
Maximum rated output power		At transmitter 50 Ω RF output connector	26 dBm for 5 MHz CBW; 28.6 dBm for 10 MHz CBW; 31 dBm for 20 MHz CBW	
Is transmitter output power variable?		No		
		V	Yes	continuous variable
				stepped variable with stepsize
			maximum RF power	31 dBm
Antenna connection				
unique coupling	V	standard connector	Integral with temporary RF connector without temporary RF connector	
Antenna/s technical characteristics				
Type	Manufacturer	Model number	Antenna assembly gain	
Dish – Dual polarized External	RADW IN Ltd.	RW-9722-4958	27.0 dBi (28.0 dBi with 1.0 dB feeder loss)	
Flat Panel – Dual polarized Integrated	RADW IN Ltd	RW-9611-4958INT	21 dBi	
Flat Panel – Dual polarized External	RADW IN Ltd	RW-9611-4960	20.0 dBi (21.0 dBi with 1.0 dB feeder loss)	
Flat Panel - Dual Pole External	RADW IN Ltd.	RW-9061-5002	14 dBi(15.0 dBi with 1.0 dB feeder loss)	
Flat Panel - Dual Pole External	RADW IN Ltd.	RW-9061-5001	13 dBi(14.0 dBi with 1.0 dB feeder loss)	
Transmitter 99% power bandwidth	Transmitter aggregate data rate/s, MBps		Type of modulation (OFDM)	
5 MHz	3.25		BPSK	
	6.5, 9.75		QPSK	
	13, 19.5		16QAM	
	26, 29.5, 32.5		64QAM	
10 MHz	6.5		BPSK	
	13, 19.5		QPSK	
	26, 39		16QAM	
	52, 58.5, 65		64QAM	
20 MHz	13		BPSK	
	26, 39		QPSK	
	52, 78		16QAM	
	104, 117, 130		64QAM	
Modulating test signal (baseband)		OFDM		
Maximum transmitter duty cycle in normal use		50%		
Maximum transmitter duty cycle for test purposes		100%		
Transmitter power source				
V	DC	Nominal rated voltage	48 VDC from IDU unit powered by 120 VAC	
	AC mains	Nominal rated voltage	Frequency	
			Hz	
Common power source for transmitter and receiver		V	yes no	

Test specification:		FCC section 90.1215, RSS-111 section 5.3, Maximum output power	
Test procedure:		47 CFR, Section 2.1046; TIA/EIA-603-C, Section 2.2.1	
Test mode:	Compliance	Verdict:	PASS
Date:	04/01/2009		
Temperature: 22°C	Air Pressure: 1012 hPa	Relative Humidity: 48%	Power Supply: 48 VDC
Remarks:			

7 Transmitter tests according to 47CFR part 90 and RSS-111 requirements

7.1 Peak output power and power spectral density tests

7.1.1 General

This test was performed to measure the peak output power and power spectral density at RF antenna connector. Specification test limits are given in Table 7.1.1.

Table 7.1.1 Peak output power and spectral density limits

Assigned frequency range, MHz	Channel bandwidth, MHz	Maximum peak output power		Power spectral density, dBm/MHz
		mW	dBm	
4940.0 – 4990.0	5	500	27.0	21
	10	1000	30.0	
	20	2000	33.0	

*- If transmitting antennas of directional gain greater than 9 dBi are used, both the peak output power and peak power spectral density limit should be reduced below the stated value as follows:

- by the amount in dB that the directional gain of antenna exceeds 9 dBi;
- **without any corresponding reduction for high power devices fixed point-to-point and point-to- multipoint transmitters employing antennas with directional gain up to 26 dBi;**
- corresponding reduction in the peak output power and peak power spectral density limit should be the amount in dB that the directional gain of antenna exceeds 26 dBi for high power devices.

7.1.2 Test procedure

7.1.2.1 The EUT was set up as shown in Figure 7.1.1, energized and its proper operation was checked.

7.1.2.2 The EUT was adjusted to produce maximum available to the end user RF output power.

7.1.2.3 The peak output power was measured with a spectrum analyzer at each EUT RF output and obtained results were summed in linear terms as provided in Table 7.1.2, Table 7.1.4, Table 7.1.6, Table 7.1.8 and associated plots. The power spectral density was measured with spectrum analyzer at each EUT RF output and obtained results were summed in linear terms as provided in Table 7.1.3, Table 7.1.5, Table 7.1.7, Table 7.1.9 and the associated plots.

Figure 7.1.1 Peak output power test setup

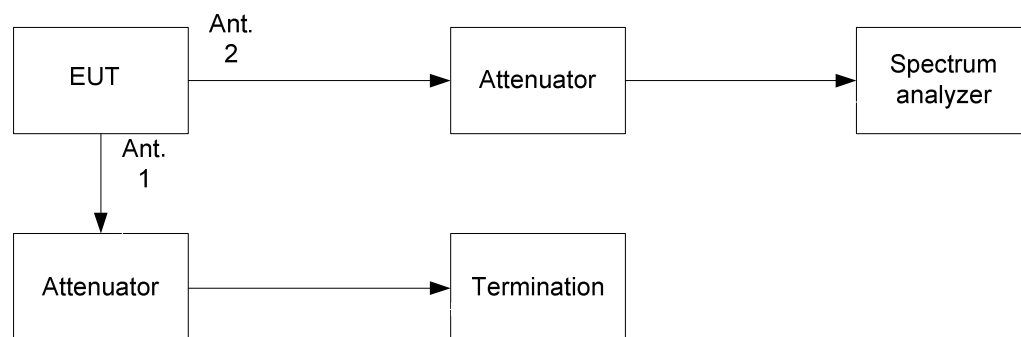

Test specification:		FCC section 90.1215, RSS-111 section 5.3, Maximum output power	
Test procedure:		47 CFR, Section 2.1046; TIA/EIA-603-C, Section 2.2.1	
Test mode:	Compliance	Verdict: PASS	
Date:	22/02/2009		
Temperature: 22°C	Air Pressure: 1008 hPa	Relative Humidity: 46%	Power Supply: 48 VDC
Remarks: 5MHz CBW			

Table 7.1.2 Peak output power test results for 5 MHz channel bandwidth

ASSIGNED FREQUENCY RANGE: 4940 – 4990 MHz
DETECTOR USED: Spectrum Analyzer
MODULATION: BPSK/64QAM
MODULATING SIGNAL: OFDM
TRANSMITTER OUTPUT POWER: Maximum

Carrier frequency, MHz	Spectrum analyzer reading, dBm		Total RF output power*, dBm	Limit**, dBm	Margin, dB***	Verdict
	Measured at "Ant.1" output	Measured at "Ant.2" output				
64QAM, Bit Rate: 32.5 Mbps						
4942.5	22.87	22.81	25.85	26	-0.15	Pass
4962.5	22.82	22.34	25.60	26	-0.40	Pass
4987.5	22.30	22.14	25.23	26	-0.77	Pass
BPSK, Bit Rate: 3.25 Mbps						
4942.5	22.91	22.46	25.70	26	-0.30	Pass
4962.5	22.87	22.82	25.86	26	-0.14	Pass
4987.5	22.80	22.17	25.51	26	-0.49	Pass

* - RF output power = SA reading at both antenna outputs summed in linear terms = $10\log [10^\wedge (\text{Pant1}/10) + 10^\wedge (\text{Pant2}/10)]$
** - Limit was reduced 1 dB due to the directional antenna gain exceeds 26 dBi (external antenna with 27 dBi assembly gain). Only one power setting applied for different antenna types use.
***- Margin = Calculated output power –specified limit.

Reference numbers of test equipment used

HL 2909	HL 3179	HL 3385	HL 3442			
---------	---------	---------	---------	--	--	--

Full description is given in Appendix A.

Test specification:		FCC section 90.1215, RSS-111 section 5.3, Maximum output power	
Test procedure:		47 CFR, Section 2.1046; TIA/EIA-603-C, Section 2.2.1	
Test mode:	Compliance	Verdict:	PASS
Date:	22/02/2009		
Temperature: 22°C	Air Pressure: 1008 hPa	Relative Humidity: 46%	Power Supply: 48 VDC
Remarks: 5MHz CBW			

Table 7.1.3 Power spectral density test results for 5 MHz channel bandwidth

ASSIGNED FREQUENCY RANGE: 4940 – 4990 MHz
DETECTOR USED: Peak
RESOLUTION BANDWIDTH: 1000 kHz
VIDEO BANDWIDTH: 3000 kHz
MODULATION: BPSK/64QAM
MODULATING SIGNAL: OFDM
TRANSMITTER OUTPUT POWER: Maximum

Carrier frequency, MHz	Spectrum analyzer reading, dBm/Hz		Integration factor*, dB	Power density**, dBm/MHz	Limit***, dBm/MHz	Margin, dB****	Verdict
	Measured at "Ant.1" output	Measured at "Ant.2" output					
64QAM, Bit Rate: 32.5 Mbps							
4942.5	-44.12	-44.18	60	18.86	20	-1.14	Pass
4962.5	-44.17	-44.65	60	18.61	20	-1.39	Pass
4987.5	-44.69	-44.85	60	18.24	20	-1.76	Pass
BPSK, Bit Rate: 3.25 Mbps							
4942.5	-44.08	-44.53	60	18.71	20	-1.29	Pass
4962.5	-44.12	-44.12	60	18.89	20	-1.11	Pass
4987.5	-44.19	-44.82	60	18.52	20	-1.48	Pass

* - Integration factor = $10 \cdot \log(\text{MHz/Hz}) = 10 \cdot \log(1000000) = 60 \text{ dB}$

** - Power density SA reading at both antenna outputs summed in linear terms = $10 \log \{ 10^\wedge \{ (\text{PSDant1} + 60) / 10 \} + 10^\wedge \{ (\text{PSDant2} + 60) / 10 \} \}$

*** - Limit was reduced 1 dB due to the directional antenna gain exceeds 26 dBi (external antenna with 27 dBi assembly gain). Only one power setting applied for different antenna types use.

****- Margin = Calculated power density –specified limit.

Reference numbers of test equipment used

HL 2909	HL 3179	HL 3385	HL 3442				
---------	---------	---------	---------	--	--	--	--

Full description is given in Appendix A.

Test specification: FCC section 90.1215, RSS-111 section 5.3, Maximum output power			
Test procedure: 47 CFR, Section 2.1046; TIA/EIA-603-C, Section 2.2.1			
Test mode: Compliance	Verdict: PASS		
Date: 22/02/2009			
Temperature: 22°C	Air Pressure: 1008 hPa	Relative Humidity: 46%	Power Supply: 48 VDC
Remarks: 5MHz CBW			

Plot 7.1.1 Peak output power test results at low frequency

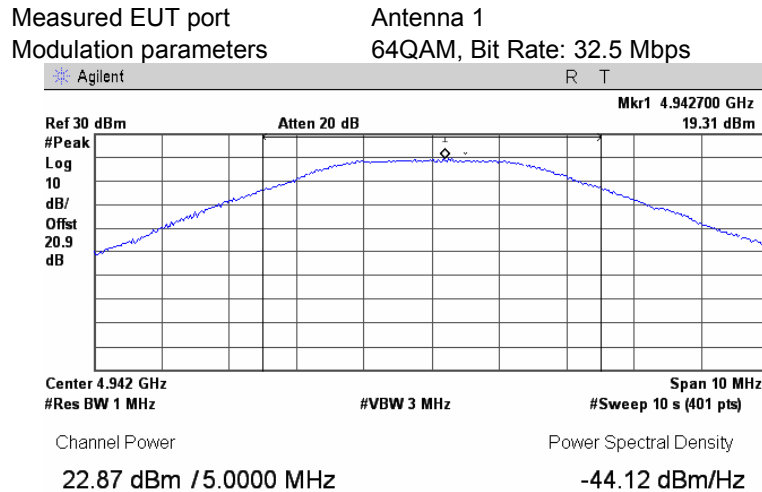

Plot 7.1.2 Peak output power test results at mid frequency

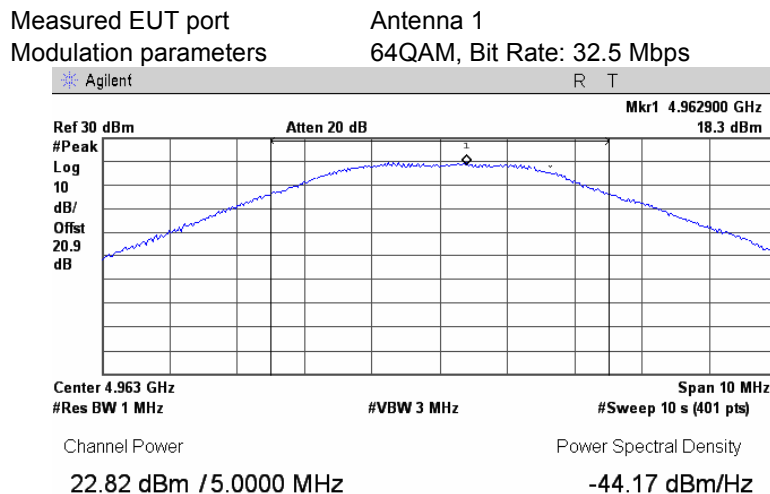

Test specification:	FCC section 90.1215, RSS-111 section 5.3, Maximum output power		
Test procedure:	47 CFR, Section 2.1046; TIA/EIA-603-C, Section 2.2.1		
Test mode:	Compliance	Verdict: PASS	
Date:	22/02/2009		
Temperature: 22°C	Air Pressure: 1008 hPa	Relative Humidity: 46%	Power Supply: 48 VDC
Remarks: 5MHz CBW			

Plot 7.1.3 Peak output power test results at high frequency

Measured EUT port Antenna 1
Modulation parameters 64QAM, Bit Rate: 32.5 Mbps

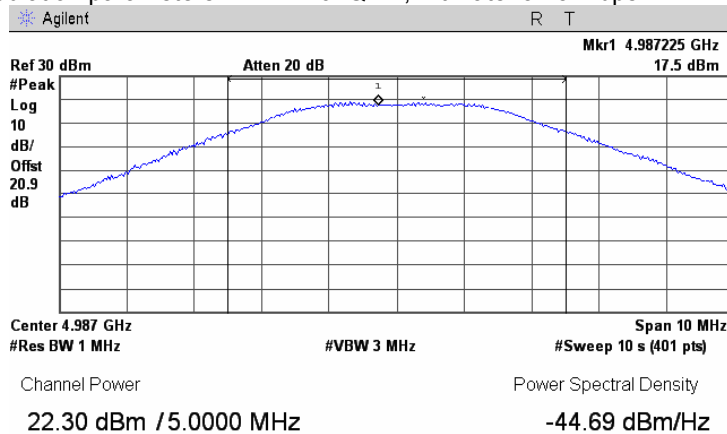

Plot 7.1.4 Peak output power test results at low frequency

Measured EUT port Antenna 1
Modulation parameters BPSK, Bit Rate: 3.25 Mbps

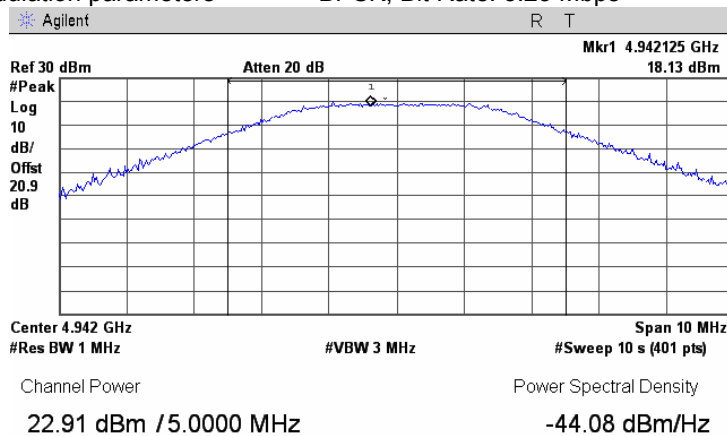

Test specification:		FCC section 90.1215, RSS-111 section 5.3, Maximum output power	
Test procedure:		47 CFR, Section 2.1046; TIA/EIA-603-C, Section 2.2.1	
Test mode:	Compliance	Verdict:	PASS
Date:	22/02/2009		
Temperature: 22°C	Air Pressure: 1008 hPa	Relative Humidity: 46%	Power Supply: 48 VDC
Remarks: 5MHz CBW			

Plot 7.1.5 Peak output power test results at mid frequency

Measured EUT port Antenna 1
Modulation parameters BPSK, Bit Rate: 3.25 Mbps

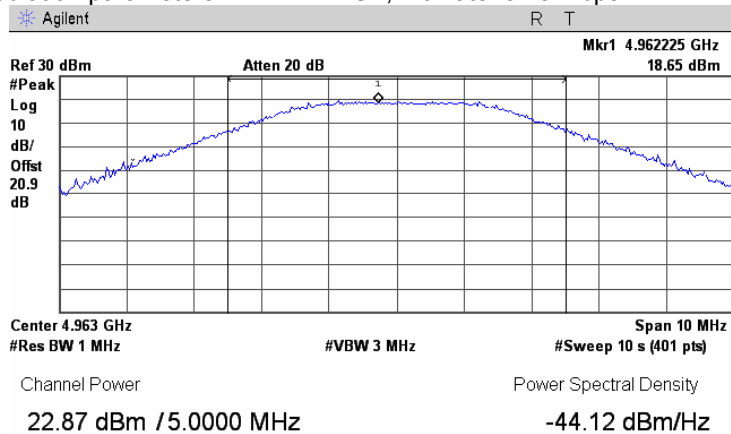

Plot 7.1.6 Peak output power test results at high frequency

Measured EUT port Antenna 1
Modulation parameters BPSK, Bit Rate: 3.25 Mbps

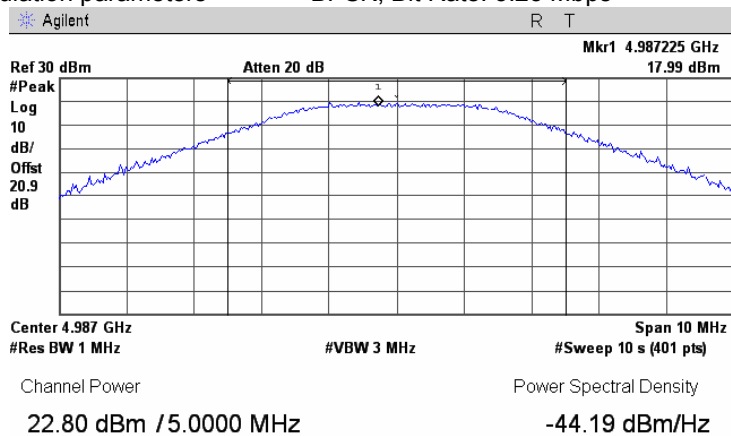

Test specification: FCC section 90.1215, RSS-111 section 5.3, Maximum output power			
Test procedure: 47 CFR, Section 2.1046; TIA/EIA-603-C, Section 2.2.1			
Test mode: Compliance	Verdict: PASS		
Date: 22/02/2009			
Temperature: 22°C	Air Pressure: 1008 hPa	Relative Humidity: 46%	Power Supply: 48 VDC
Remarks: 5MHz CBW			

Plot 7.1.7 Peak output power test results at low frequency

Measured EUT port Antenna 2
Modulation parameters 64QAM, Bit Rate: 32.5 Mbps

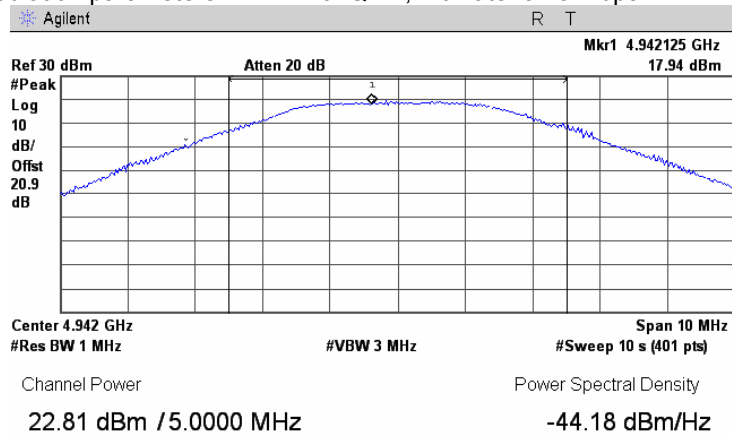

Plot 7.1.8 Peak output power test results at mid frequency

Measured EUT port Antenna 2
Modulation parameters 64QAM, Bit Rate: 32.5 Mbps

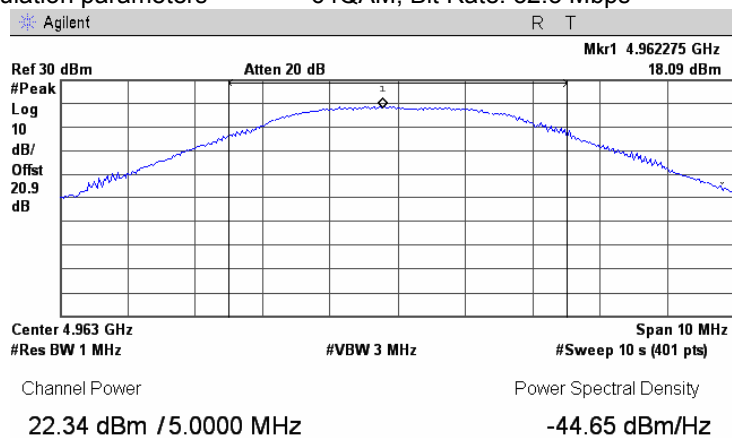

Test specification:	FCC section 90.1215, RSS-111 section 5.3, Maximum output power		
Test procedure:	47 CFR, Section 2.1046; TIA/EIA-603-C, Section 2.2.1		
Test mode:	Compliance	Verdict: PASS	
Date:	22/02/2009		
Temperature: 22°C	Air Pressure: 1008 hPa	Relative Humidity: 46%	Power Supply: 48 VDC
Remarks: 5MHz CBW			

Plot 7.1.9 Peak output power test results at high frequency

Measured EUT port Antenna 2
Modulation parameters 64QAM, Bit Rate: 32.5 Mbps

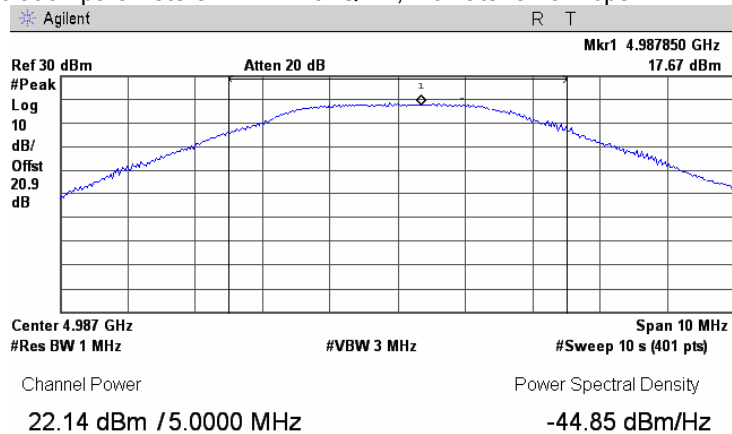

Plot 7.1.10 Peak output power test results at low frequency

Measured EUT port Antenna 2
Modulation parameters BPSK, Bit Rate: 3.25 Mbps

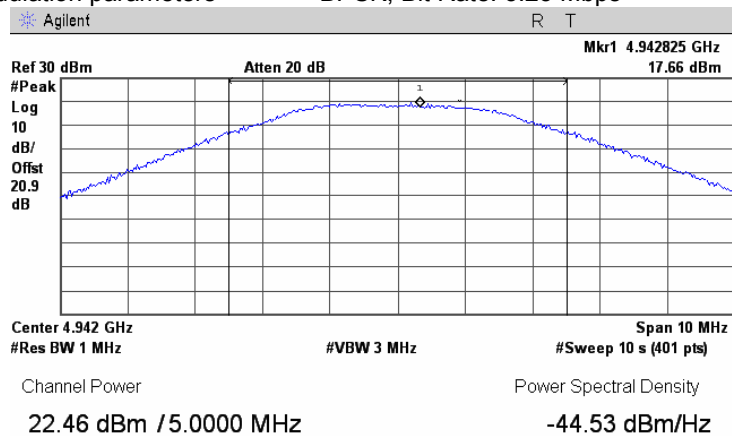

Test specification: FCC section 90.1215, RSS-111 section 5.3, Maximum output power			
Test procedure: 47 CFR, Section 2.1046; TIA/EIA-603-C, Section 2.2.1			
Test mode: Compliance	Verdict: PASS		
Date: 22/02/2009			
Temperature: 22°C	Air Pressure: 1008 hPa	Relative Humidity: 46%	Power Supply: 48 VDC
Remarks: 5MHz CBW			

Plot 7.1.11 Peak output power test results at mid frequency

Measured EUT port Antenna 2
Modulation parameters BPSK, Bit Rate: 3.25 Mbps

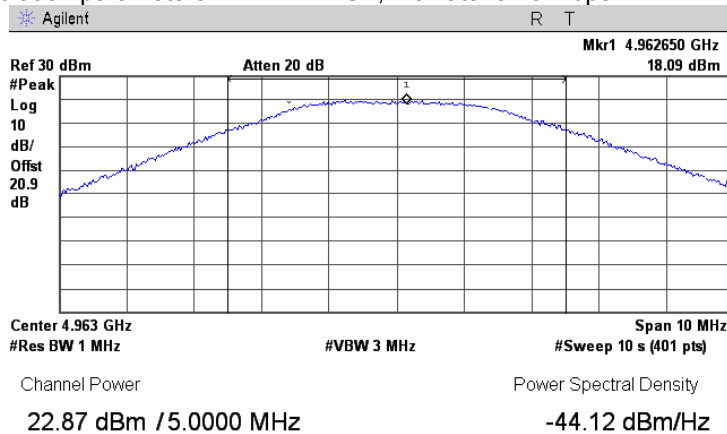

Plot 7.1.12 Peak output power test results at high frequency

Measured EUT port Antenna 2
Modulation parameters BPSK, Bit Rate: 3.25 Mbps

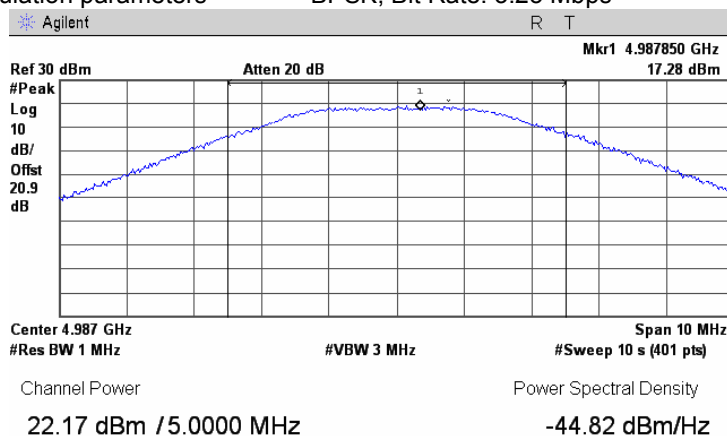

Test specification:		FCC section 90.1215, RSS-111 section 5.3, Maximum output power			
Test procedure:		47 CFR, Section 2.1046; TIA/EIA-603-C, Section 2.2.1			
Test mode:	Compliance	Verdict:		PASS	
Date:	29/12/2008				
Temperature: 22°C	Air Pressure: 1012 hPa	Relative Humidity: 48%	Power Supply: 48 VDC		
Remarks: 10 MHz CBW					

Table 7.1.4 Peak output power test results for 10 MHz channel bandwidth

ASSIGNED FREQUENCY RANGE: 4940 – 4990 MHz
DETECTOR USED: Peak power meter
MODULATION: BPSK/64QAM
MODULATING SIGNAL: OFDM
TRANSMITTER OUTPUT POWER: Maximum

Carrier frequency, MHz	Spectrum analyzer reading, dBm		Total RF output power*, dBm	Limit**, dBm	Margin, dB***	Verdict
	Measured at "Ant.1" output	Measured at "Ant.2" output				
64QAM, Bit Rate: 65 Mbps						
4945.0	25.57	25.58	28.59	29	-0.41	Pass
4965.0	24.79	25.21	28.02	29	-0.98	Pass
4985.0	25.40	25.60	28.51	29	-0.49	Pass
BPSK, Bit Rate: 6.5 Mbps						
4945.0	24.83	24.92	27.89	29	-1.11	Pass
4965.0	25.05	24.99	28.03	29	-0.97	Pass
4985.0	25.65	24.72	28.22	29	-0.78	Pass

* - RF output power = SA reading at both antenna outputs summed in linear terms = 10log [10^Λ (Pant1/10) + 10^Λ (Pant2/10)]
** - Limit was reduced 1 dB due to the directional antenna gain exceeds 26 dBi (external antenna with 27 dBi assembly gain).
Only one power setting applied for different antenna types use.
***- Margin = Calculated output power –specified limit.

Test specification: FCC section 90.1215, RSS-111 section 5.3, Maximum output power			
Test procedure: 47 CFR, Section 2.1046; TIA/EIA-603-C, Section 2.2.1			
Test mode: Compliance	Verdict: PASS		
Date: 29/12/2008			
Temperature: 22°C	Air Pressure: 1012 hPa	Relative Humidity: 48%	Power Supply: 48 VDC
Remarks: 10 MHz CBW			

Table 7.1.5 Power spectral density test results for 10 MHz channel bandwidth

ASSIGNED FREQUENCY RANGE: 4940 – 4990 MHz
DETECTOR USED: Peak
RESOLUTION BANDWIDTH: 1000 kHz
VIDEO BANDWIDTH: 3000 kHz
MODULATION: BPSK/ 64QAM
MODULATING SIGNAL: OFDM
TRANSMITTER OUTPUT POWER: Maximum

Carrier frequency, MHz	Spectrum analyzer reading, dBm/Hz		Integration factor*, dB	Power density**, dBm/MHz	Limit***, dBm/MHz	Margin, dB****	Verdict
	Measured at "Ant.1" output	Measured at "Ant.2" output					
64QAM, Bit Rate: 65 Mbps							
4945.0	-44.43	-44.42	60.00	18.59	20	-1.41	Pass
4965.0	-45.21	-44.79	60.00	18.02	20	-1.98	Pass
4985.0	-44.60	-44.40	60.00	18.51	20	-1.49	Pass
BPSK, Bit Rate: 6.5 Mbps							
4945.0	-45.17	-45.08	60.00	17.89	20	-2.11	Pass
4965.0	-44.95	-45.01	60.00	18.03	20	-1.97	Pass
4985.0	-44.35	-45.28	60.00	18.22	20	-1.78	Pass

* - Integration factor = $10 \cdot \log(\text{MHz/Hz}) = 10 \cdot \log(1000000) = 60 \text{ dB}$

** - Power density SA reading at both antenna outputs summed in linear terms = $10 \log \{ 10 \wedge [(\text{PSDant1} + 60)/10] + 10 \wedge [(\text{PSDant2} + 60)/10] \}$

*** - Limit was reduced 1 dB due to the directional antenna gain exceeds 26 dBi (external antenna with 27 dBi assembly gain). Only one power setting applied for different antenna types use.

**** - Margin = Calculated power density – specified limit.

Reference numbers of test equipment used

HL 2909	HL 2953	HL 3442				
---------	---------	---------	--	--	--	--

Full description is given in Appendix A.

Test specification:	FCC section 90.1215, RSS-111 section 5.3, Maximum output power		
Test procedure:	47 CFR, Section 2.1046; TIA/EIA-603-C, Section 2.2.1		
Test mode:	Compliance	Verdict:	PASS
Date:	29/12/2008		
Temperature: 22°C	Air Pressure: 1012 hPa	Relative Humidity: 48%	Power Supply: 48 VDC
Remarks: 10 MHz CBW			

Plot 7.1.13 Peak output power test results at low frequency

Measured EUT port Antenna 1
Modulation parameters 64QAM, Bit Rate: 65 Mbps

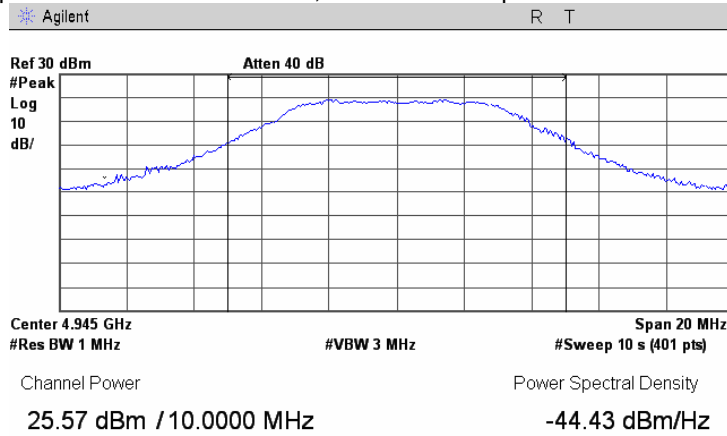

Plot 7.1.14 Peak output power test results at mid frequency

Measured EUT port Antenna 1
Modulation parameters 64QAM, Bit Rate: 65 Mbps

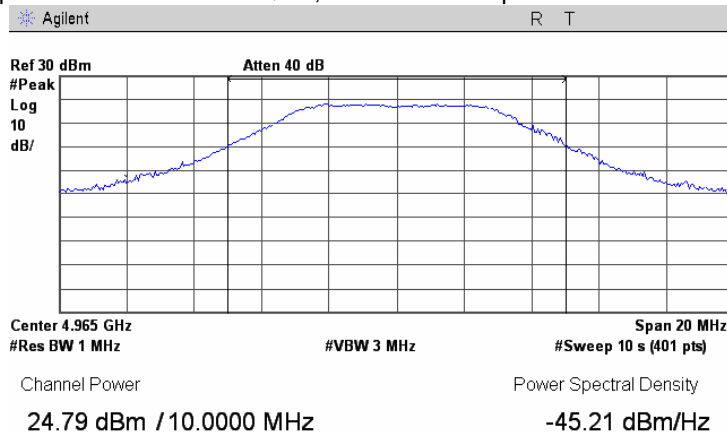

Test specification:	FCC section 90.1215, RSS-111 section 5.3, Maximum output power		
Test procedure:	47 CFR, Section 2.1046; TIA/EIA-603-C, Section 2.2.1		
Test mode:	Compliance	Verdict:	PASS
Date:	29/12/2008		
Temperature: 22°C	Air Pressure: 1012 hPa	Relative Humidity: 48%	Power Supply: 48 VDC
Remarks: 10 MHz CBW			

Plot 7.1.15 Peak output power test results at high frequency

Measured EUT port Antenna 1
Modulation parameters 64QAM, Bit Rate: 65 Mbps

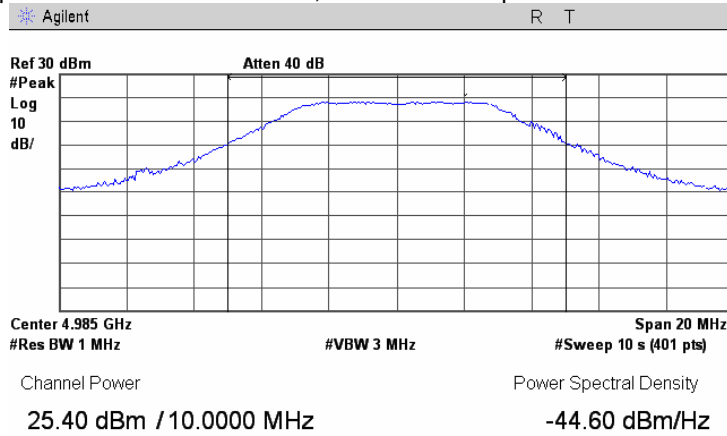

Plot 7.1.16 Peak output power test results at low frequency

Measured EUT port Antenna 1
Modulation parameters BPSK, Bit Rate: 6.5 Mbps

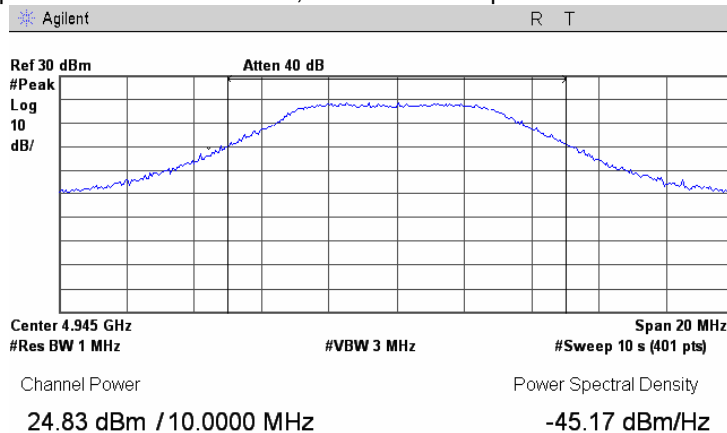

Test specification:	FCC section 90.1215, RSS-111 section 5.3, Maximum output power		
Test procedure:	47 CFR, Section 2.1046; TIA/EIA-603-C, Section 2.2.1		
Test mode:	Compliance	Verdict:	PASS
Date:	29/12/2008		
Temperature: 22°C	Air Pressure: 1012 hPa	Relative Humidity: 48%	Power Supply: 48 VDC
Remarks: 10 MHz CBW			

Plot 7.1.17 Peak output power test results at mid frequency

Measured EUT port Antenna 1
Modulation parameters BPSK, Bit Rate: 6.5 Mbps

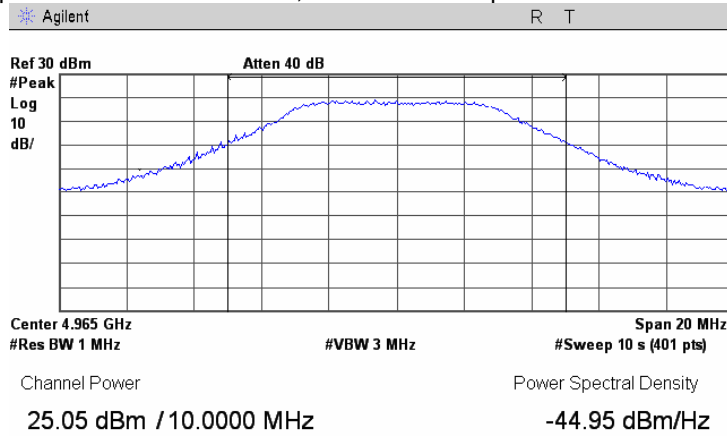

Plot 7.1.18 Peak output power test results at high frequency

Measured EUT port Antenna 1
Modulation parameters BPSK, Bit Rate: 6.5 Mbps

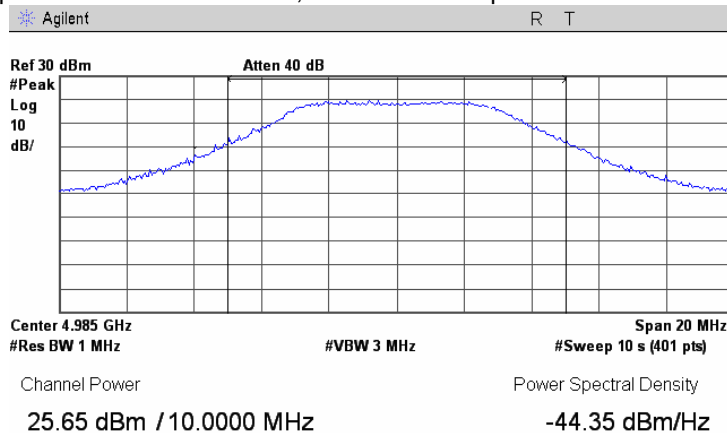

Test specification:	FCC section 90.1215, RSS-111 section 5.3, Maximum output power		
Test procedure:	47 CFR, Section 2.1046; TIA/EIA-603-C, Section 2.2.1		
Test mode:	Compliance	Verdict:	PASS
Date:	29/12/2008		
Temperature: 22°C	Air Pressure: 1012 hPa	Relative Humidity: 48%	Power Supply: 48 VDC
Remarks: 10 MHz CBW			

Plot 7.1.19 Peak output power test results at low frequency

Measured EUT port Antenna 2
Modulation parameters 64QAM, Bit Rate: 65 Mbps

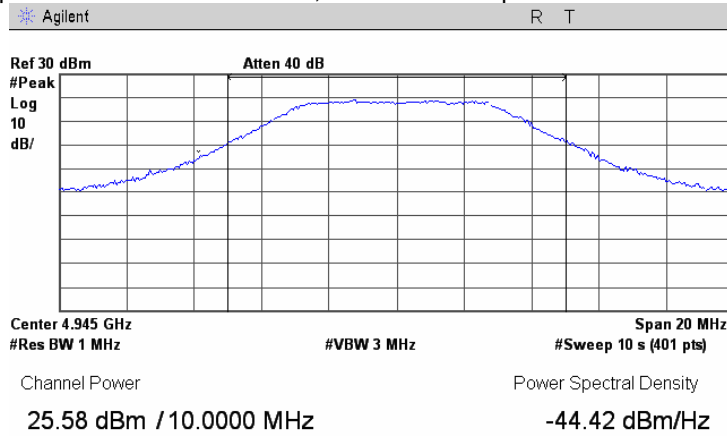

Plot 7.1.20 Peak output power test results at mid frequency

Measured EUT port Antenna 2
Modulation parameters 64QAM, Bit Rate: 65 Mbps

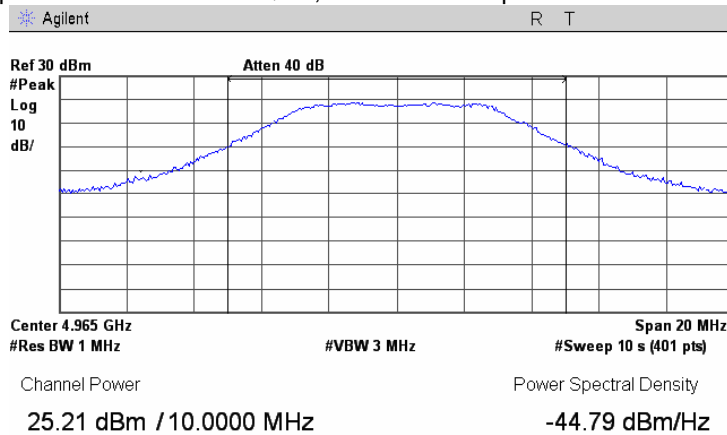

Test specification: FCC section 90.1215, RSS-111 section 5.3, Maximum output power			
Test procedure: 47 CFR, Section 2.1046; TIA/EIA-603-C, Section 2.2.1			
Test mode: Compliance	Verdict: PASS		
Date: 29/12/2008			
Temperature: 22°C	Air Pressure: 1012 hPa	Relative Humidity: 48%	Power Supply: 48 VDC
Remarks: 10 MHz CBW			

Plot 7.1.21 Peak output power test results at high frequency

Measured EUT port Antenna 2
Modulation parameters 64QAM, Bit Rate: 65 Mbps

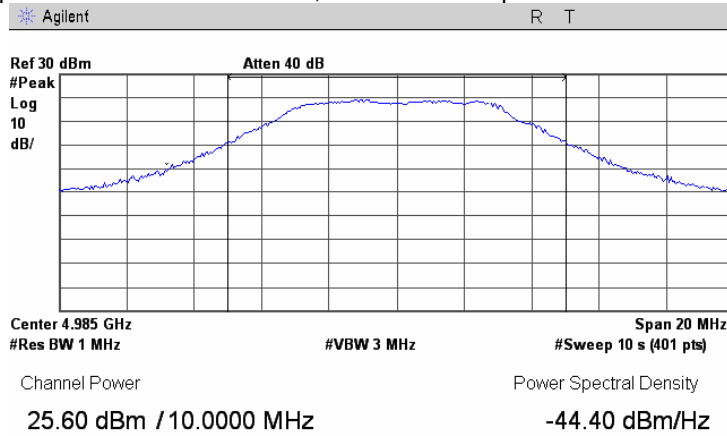

Plot 7.1.22 Peak output power test results at low frequency

Measured EUT port Antenna 2
Modulation parameters BPSK, Bit Rate: 6.5 Mbps

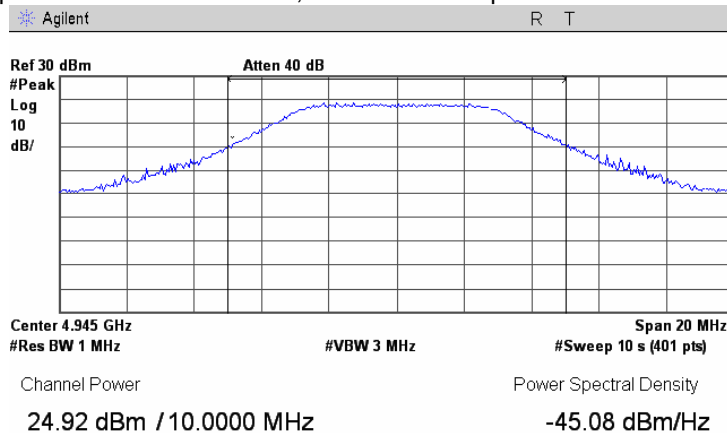

Test specification: FCC section 90.1215, RSS-111 section 5.3, Maximum output power			
Test procedure: 47 CFR, Section 2.1046; TIA/EIA-603-C, Section 2.2.1			
Test mode: Compliance	Verdict: PASS		
Date: 29/12/2008			
Temperature: 22°C	Air Pressure: 1012 hPa	Relative Humidity: 48%	Power Supply: 48 VDC
Remarks: 10 MHz CBW			

Plot 7.1.23 Peak output power test results at mid frequency

Measured EUT port Antenna 2
Modulation parameters BPSK, Bit Rate: 6.5 Mbps

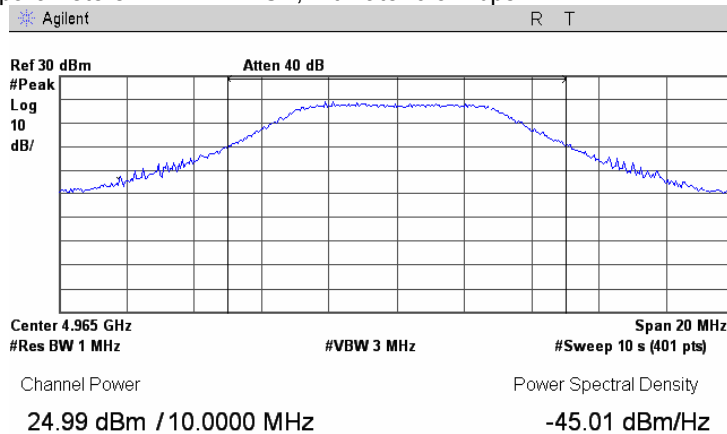

Plot 7.1.24 Peak output power test results at high frequency

Measured EUT port Antenna 2
Modulation parameters BPSK, Bit Rate: 6.5 Mbps

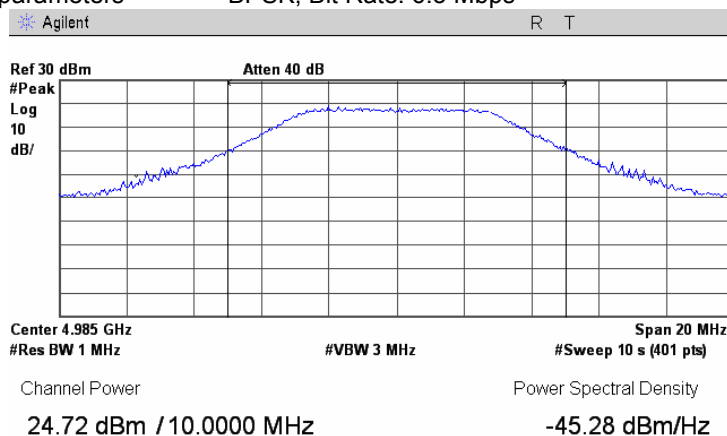

Test specification:		FCC section 90.1215, RSS-111 section 5.3, Maximum output power	
Test procedure:		47 CFR, Section 2.1046; TIA/EIA-603-C, Section 2.2.1	
Test mode:	Compliance	Verdict:	PASS
Date:	29/12/2008		
Temperature: 22°C	Air Pressure: 1012 hPa	Relative Humidity: 48%	Power Supply: 48 VDC
Remarks: 20 MHz CBW			

Table 7.1.6 Peak output power test results for 20 MHz channel bandwidth

ASSIGNED FREQUENCY RANGE: 4940 – 4990 MHz
DETECTOR USED: Spectrum analyzer
MODULATION: BPSK/64QAM
MODULATING SIGNAL: OFDM
TRANSMITTER OUTPUT POWER: Maximum

Carrier frequency, MHz	Spectrum analyzer reading, dBm		Total RF output power*, dBm	Limit**, dBm	Margin, dB***	Verdict
	Measured at "Ant.1" output	Measured at "Ant.2" output				
64QAM, Bit Rate: 130 Mbps						
4950	27.97	28.10	31.05	32	-0.95	Pass
4965	27.42	27.82	30.63	32	-1.37	Pass
4980	27.64	27.73	30.70	32	-1.30	Pass
BPSK, Bit Rate: 13 Mbps						
4950	27.14	27.31	30.24	32	-1.76	Pass
4965	26.96	27.49	30.24	32	-1.76	Pass
4980	26.83	27.25	30.06	32	-1.94	Pass

* - RF output power = SA reading at both antenna outputs summed in linear terms = $10\log [10^\wedge (\text{Pant1}/10) + 10^\wedge (\text{Pant2}/10)]$
** - Limit was reduced 1 dB due to the directional antenna gain exceeds 26 dBi (external antenna with 27 dBi assembly gain). Only one power setting applied for different antenna types use.
***- Margin = Calculated output power –specified limit.

Test specification: FCC section 90.1215, RSS-111 section 5.3, Maximum output power	
Test procedure: 47 CFR, Section 2.1046; TIA/EIA-603-C, Section 2.2.1	
Test mode: Compliance	Verdict: PASS
Date: 29/12/2008	
Temperature: 22°C	Air Pressure: 1012 hPa
Relative Humidity: 48%	
Power Supply: 48 VDC	
Remarks: 20 MHz CBW	

Table 7.1.7 Power spectral density test results for 20 MHz channel bandwidth

ASSIGNED FREQUENCY RANGE: 4940 – 4990 MHz
DETECTOR USED: Peak
RESOLUTION BANDWIDTH: 1000 kHz
VIDEO BANDWIDTH: 3000 kHz
MODULATION: BPSK/ 64QAM
MODULATING SIGNAL: OFDM
TRANSMITTER OUTPUT POWER: Maximum (according to Table 7.1.12)

Carrier frequency, MHz	Spectrum analyzer reading, dBm/Hz		Integration factor*, dB	Power density**, dBm/MHz	Limit***, dBm/MHz	Margin, dB****	Verdict
	Measured at "Ant.1" output	Measured at "Ant.2" output					
64QAM, Bit Rate: 130 Mbps							
4950	-45.08	-44.91	60.00	18.02	20	-1.98	Pass
4965	-45.59	-45.19	60.00	17.62	20	-2.38	Pass
4980	-45.37	-45.28	60.00	17.69	20	-2.31	Pass
BPSK, Bit Rate: 13 Mbps							
4950	-45.87	-45.70	60.00	17.23	20	-2.77	Pass
4965	-46.05	-45.52	60.00	17.23	20	-2.77	Pass
4980	-46.18	-45.76	60.00	17.05	20	-2.95	Pass

* - Integration factor = $10 \cdot \log(\text{MHz/Hz}) = 10 \cdot \log(1000000) = 60 \text{ dB}$

** - Power density SA reading at both antenna outputs summed in linear terms = $10 \log \{ 10 \wedge [(\text{PSDant1} + 60)/10] + 10 \wedge [(\text{PSDant2} + 60)/10] \}$

*** - Limit was reduced 1 dB due to the directional antenna gain exceeds 26 dBi (external antenna with 27 dBi assembly gain). Only one power setting applied for different antenna types use.

**** - Margin = Calculated power density – specified limit.

Reference numbers of test equipment used

HL 2909	HL 3179	HL 3385				
---------	---------	---------	--	--	--	--

Full description is given in Appendix A.

Test specification:	FCC section 90.1215, RSS-111 section 5.3, Maximum output power		
Test procedure:	47 CFR, Section 2.1046; TIA/EIA-603-C, Section 2.2.1		
Test mode:	Compliance	Verdict: PASS	
Date:	29/12/2008		
Temperature: 22°C	Air Pressure: 1012 hPa	Relative Humidity: 48%	Power Supply: 48 VDC
Remarks: 20 MHz CBW			

Plot 7.1.25 Peak output power test results at low frequency

Measured EUT port Antenna1
Modulation parameters 64QAM, Bit Rate: 130 Mbps

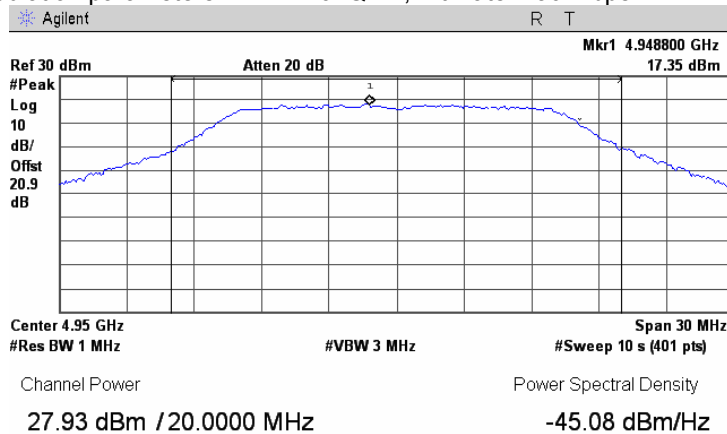

Plot 7.1.26 Peak output power test results at mid frequency

Measured EUT port Antenna1
Modulation parameters 64QAM, Bit Rate: 130 Mbps

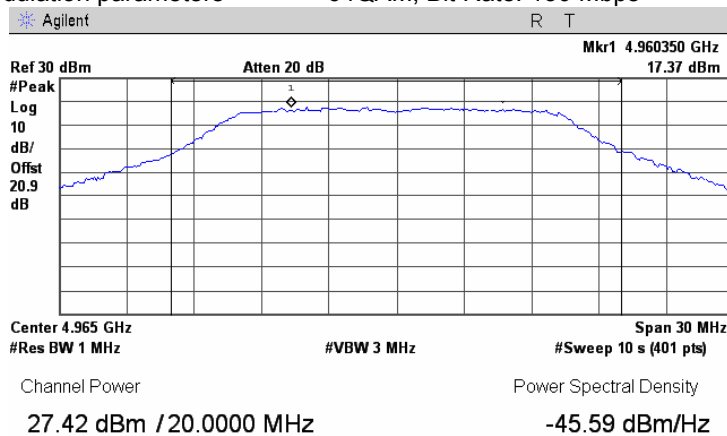

Test specification: FCC section 90.1215, RSS-111 section 5.3, Maximum output power			
Test procedure: 47 CFR, Section 2.1046; TIA/EIA-603-C, Section 2.2.1			
Test mode: Compliance	Verdict: PASS		
Date: 29/12/2008			
Temperature: 22°C	Air Pressure: 1012 hPa	Relative Humidity: 48%	Power Supply: 48 VDC
Remarks: 20 MHz CBW			

Plot 7.1.29 Peak output power test results at mid frequency

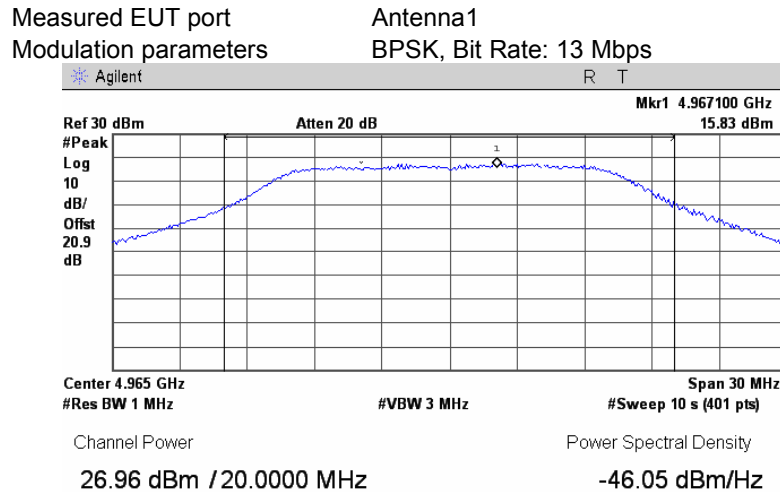

Plot 7.1.30 Peak output power test results at high frequency

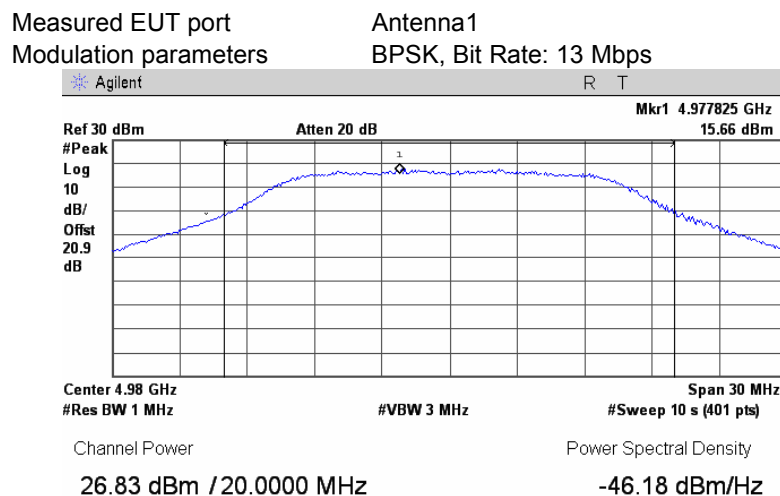

Test specification: FCC section 90.1215, RSS-111 section 5.3, Maximum output power			
Test procedure: 47 CFR, Section 2.1046; TIA/EIA-603-C, Section 2.2.1			
Test mode: Compliance	Verdict: PASS		
Date: 29/12/2008			
Temperature: 22°C	Air Pressure: 1012 hPa	Relative Humidity: 48%	Power Supply: 48 VDC
Remarks: 20 MHz CBW			

Plot 7.1.31 Peak output power test results at low frequency

Measured EUT port Antenna 2
Modulation parameters 64QAM, Bit Rate: 130 Mbps

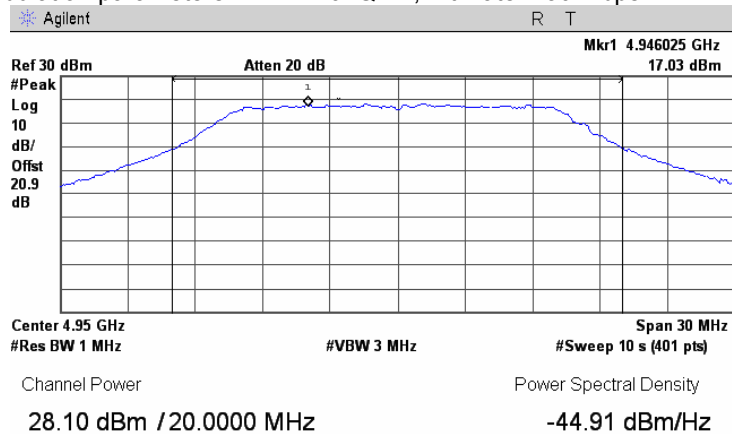

Plot 7.1.32 Peak output power test results at mid frequency

Measured EUT port Antenna 2
Modulation parameters 64QAM, Bit Rate: 130 Mbps

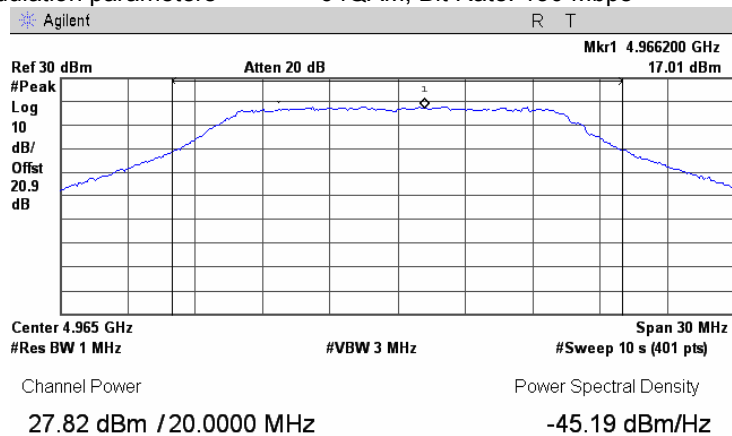

Test specification:	FCC section 90.1215, RSS-111 section 5.3, Maximum output power		
Test procedure:	47 CFR, Section 2.1046; TIA/EIA-603-C, Section 2.2.1		
Test mode:	Compliance	Verdict: PASS	
Date:	29/12/2008		
Temperature: 22°C	Air Pressure: 1012 hPa	Relative Humidity: 48%	Power Supply: 48 VDC
Remarks: 20 MHz CBW			

Plot 7.1.33 Peak output power test results at high frequency

Measured EUT port Antenna 2
Modulation parameters 64QAM, Bit Rate: 130 Mbps

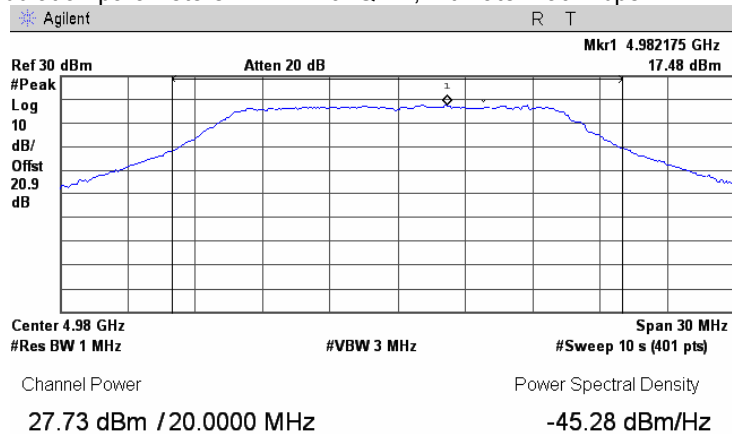

Plot 7.1.34 Peak output power test results at low frequency

Measured EUT port Antenna 2
Modulation parameters BPSK, Bit Rate: 13 Mbps

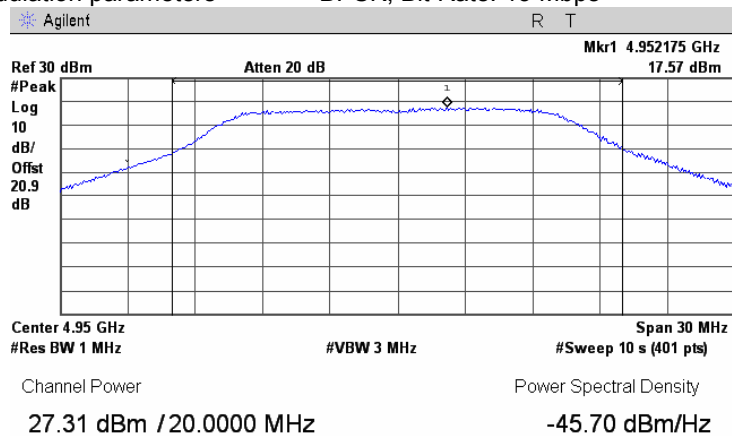

Test specification: FCC section 90.1215, RSS-111 section 5.3, Maximum output power			
Test procedure: 47 CFR, Section 2.1046; TIA/EIA-603-C, Section 2.2.1			
Test mode: Compliance	Verdict: PASS		
Date: 29/12/2008			
Temperature: 22°C	Air Pressure: 1012 hPa	Relative Humidity: 48%	Power Supply: 48 VDC
Remarks: 20 MHz CBW			

Plot 7.1.35 Peak output power test results at mid frequency

Measured EUT port Antenna 2
Modulation parameters BPSK, Bit Rate: 13 Mbps

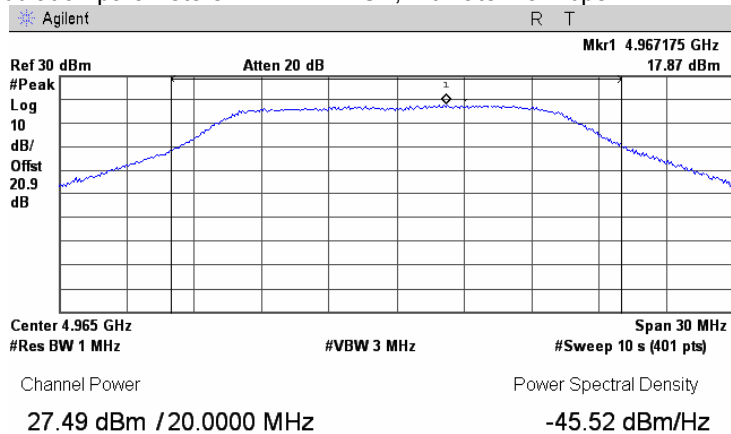

Plot 7.1.36 Peak output power test results at high frequency

Measured EUT port Antenna 2
Modulation parameters BPSK, Bit Rate: 13 Mbps

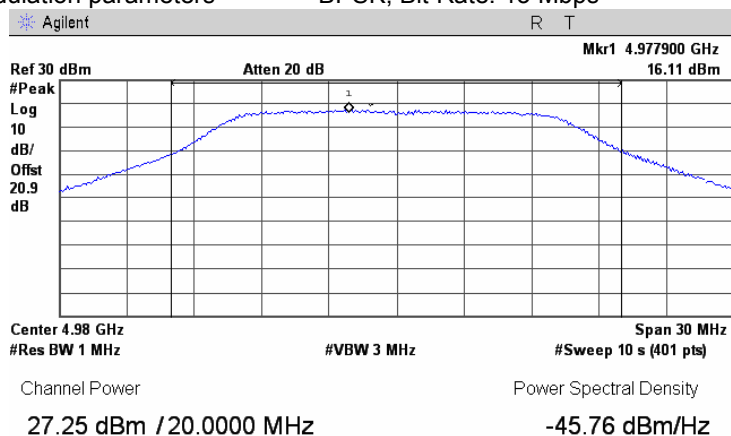

Test specification:		FCC section 90.209, RSS-Gen section 4.6.1, Occupied bandwidth	
Test procedure:		47 CFR, Section 2.1049	
Test mode:	Compliance	Verdict:	PASS
Date:	05/01/2009		
Temperature: 22°C	Air Pressure: 1012 hPa	Relative Humidity: 48%	Power Supply: 48 VDC
Remarks:			

7.2 Occupied bandwidth test

7.2.1 General

This test was performed to measure transmitter occupied bandwidth. Specification test limits are given in Table 7.2.1.

Table 7.2.1 Occupied bandwidth limits

Assigned frequency, MHz	Modulation envelope reference points*, dBc	Channel bandwidth, MHz	Maximum allowed bandwidth, MHz
4940 – 4990	26	5	5
		10	10
		20	20

* - Modulation envelope reference points are provided in terms of attenuation below the maximum peak output power of carrier.

7.2.2 Test procedure

7.2.2.1 The EUT was set up as shown in Figure 7.2.1, energized and its proper operation was checked.

7.2.2.2 The total output power integrated over the emission bandwidth of carrier was taken as the reference level.

7.2.2.3 The transmitter occupied bandwidth was measured with spectrum analyzer as a frequency delta between the reference points on modulation envelope and provided in Table 7.2.2, Table 7.2.3, Table 7.2.4 and the associated plots.

Figure 7.2.1 Occupied bandwidth test setup

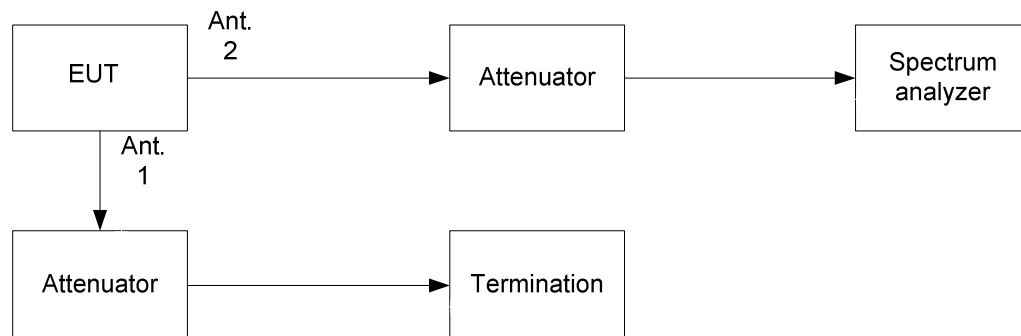

Test specification: FCC section 90.209, RSS-Gen section 4.6.1, Occupied bandwidth	
Test procedure: 47 CFR, Section 2.1049	
Test mode: Compliance	Verdict: PASS
Date: 05/01/2009	
Temperature: 22°C	Air Pressure: 1012 hPa
Relative Humidity: 48%	
Power Supply: 48 VDC	
Remarks: 5 MHz CBW	

Table 7.2.2 Occupied bandwidth test results for 5 MHz channel bandwidth

RESOLUTION BANDWIDTH: 100 kHz*
 VIDEO BANDWIDTH: 300 kHz
 MODULATION ENVELOPE REFERENCE POINTS: 26 dBc
 MODULATING SIGNAL: OFDM

Carrier frequency, MHz	Occupied bandwidth, MHz	Limit, MHz	Margin, MHz	Verdict
64QAM, Bit Rate 32.5 Mbps				
4942.5	3.275	5	-1.725	Pass
4962.5	3.325	5	-1.675	Pass
4987.5	3.350	5	-1.650	Pass
BPSK , Bit Rate 3.25 Mbps				
4942.5	3.300	5	-1.700	Pass
4962.5	3.350	5	-1.650	Pass
4987.5	3.313	5	-1.687	Pass

* - RBW ≥ 1% of OBW; 1 % of 5 MHz is 50 kHz, hence, RBW=100 kHz was chosen for the measurements.

Reference numbers of test equipment used

HL 2909	HL 3179	HL 3385					
---------	---------	---------	--	--	--	--	--

Full description is given in Appendix A.

Test specification: FCC section 90.209, RSS-Gen section 4.6.1, Occupied bandwidth			
Test procedure: 47 CFR, Section 2.1049			
Test mode: Compliance	Verdict: PASS		
Date: 05/01/2009			
Temperature: 22°C	Air Pressure: 1012 hPa	Relative Humidity: 48%	Power Supply: 48 VDC
Remarks: 5 MHz CBW			

Plot 7.2.1 Occupied bandwidth test result at low frequency, 64QAM Bit rate 32.5 Mbps

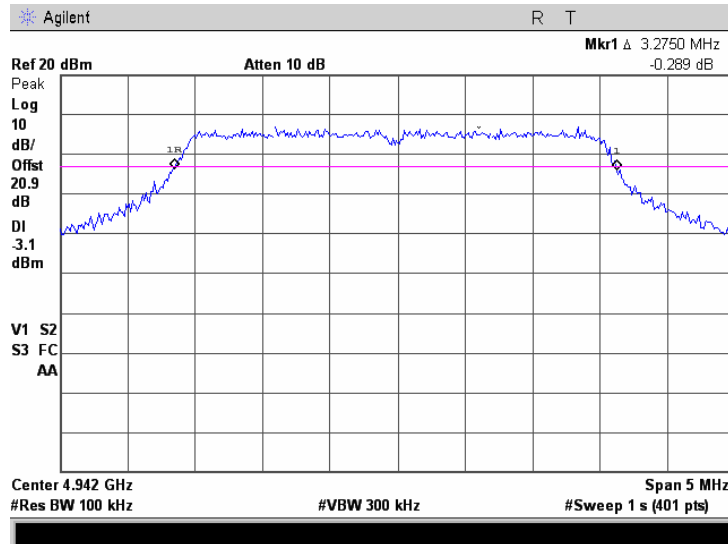

Plot 7.2.2 Occupied bandwidth test result at mid frequency, 64QAM Bit rate 32.5 Mbps

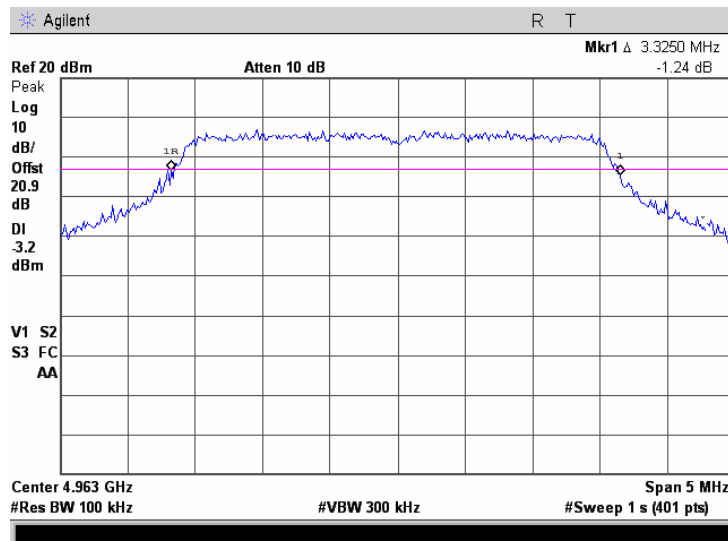

Test specification: FCC section 90.209, RSS-Gen section 4.6.1, Occupied bandwidth			
Test procedure: 47 CFR, Section 2.1049			
Test mode: Compliance	Verdict: PASS		
Date: 05/01/2009			
Temperature: 22°C	Air Pressure: 1012 hPa	Relative Humidity: 48%	Power Supply: 48 VDC
Remarks: 5 MHz CBW			

Plot 7.2.3 Occupied bandwidth test result at high frequency, 64QAM Bit rate 32.5 Mbps

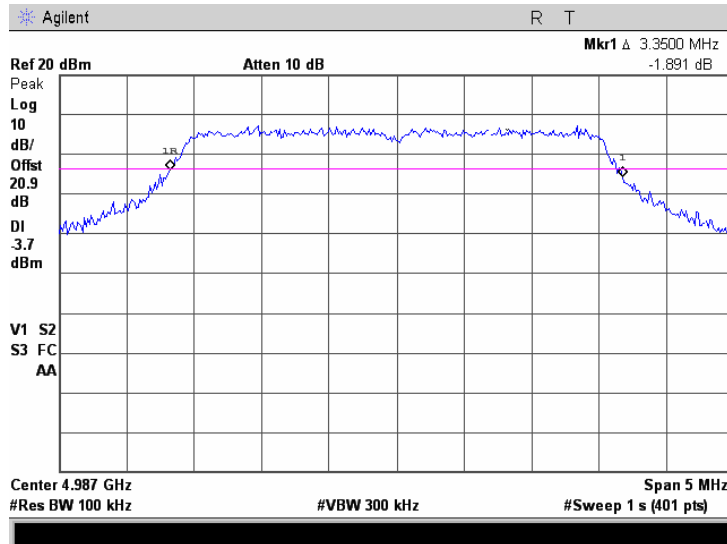

Plot 7.2.4 Occupied bandwidth test result at low frequency, BPSK Bit rate 3.25 Mbps

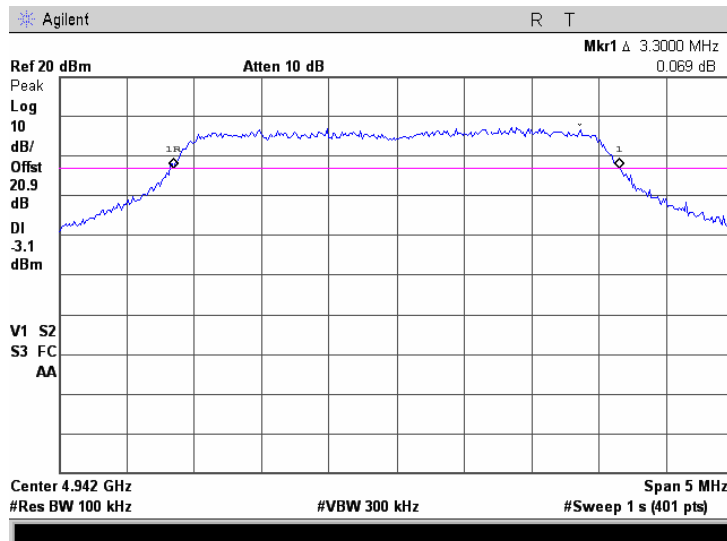

Test specification: FCC section 90.209, RSS-Gen section 4.6.1, Occupied bandwidth			
Test procedure: 47 CFR, Section 2.1049			
Test mode: Compliance	Verdict: PASS		
Date: 05/01/2009			
Temperature: 22°C	Air Pressure: 1012 hPa	Relative Humidity: 48%	Power Supply: 48 VDC
Remarks: 5 MHz CBW			

Plot 7.2.5 Occupied bandwidth test result at mid frequency, BPSK Bit rate 3.25 Mbps

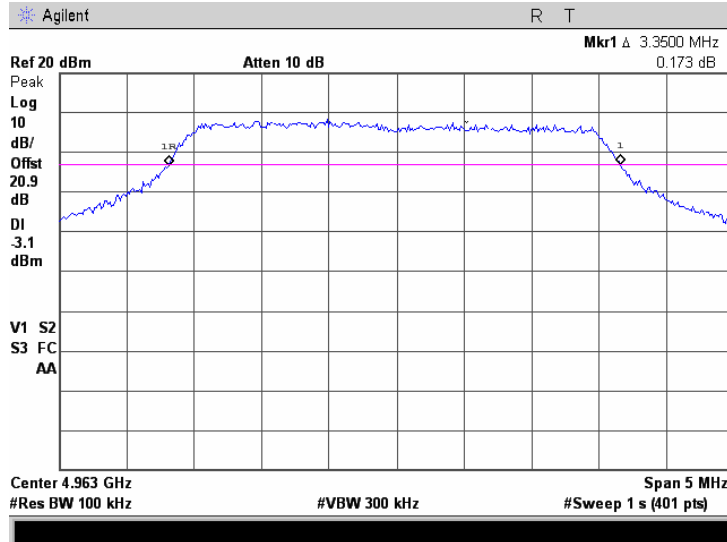

Plot 7.2.6 Occupied bandwidth test result at high frequency, BPSK Bit rate 3.25 Mbps

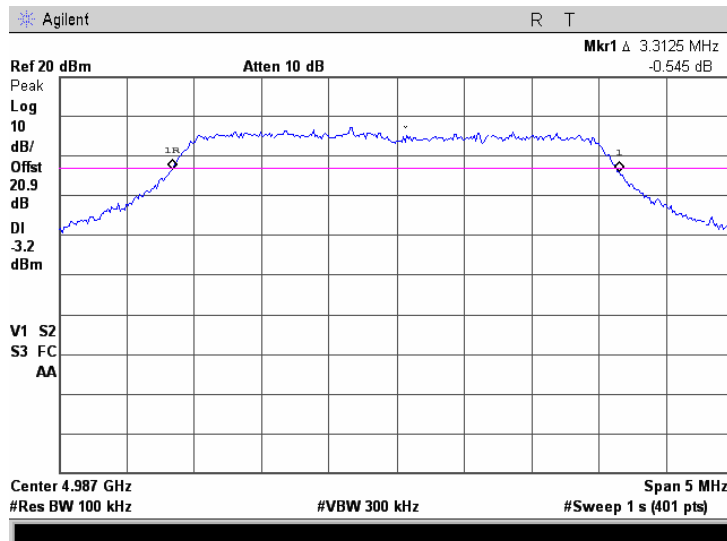

Test specification: FCC section 90.209, RSS-Gen section 4.6.1, Occupied bandwidth	
Test procedure: 47 CFR, Section 2.1049	
Test mode: Compliance	Verdict: PASS
Date: 05/01/2009	
Temperature: 22°C	Air Pressure: 1012 hPa
Relative Humidity: 48%	
Power Supply: 48 VDC	
Remarks: 10 MHz CBW	

Table 7.2.3 Occupied bandwidth test results 10 MHz channel bandwidth

RESOLUTION BANDWIDTH: 100 kHz*
 VIDEO BANDWIDTH: 300 kHz
 MODULATION ENVELOPE REFERENCE POINTS: 26 dBc
 MODULATING SIGNAL: OFDM

Carrier frequency, MHz	Occupied bandwidth, MHz	Limit, MHz	Margin, MHz	Verdict
64QAM, Bit Rate 65 Mbps				
4945.0	6.375	10	-3.125	Pass
4965.0	6.350	10	-3.150	Pass
4985.0	6.350	10	-3.150	Pass
BPSK, Bit Rate 6.5 Mbps				
4945.0	6.325	10	-3.175	Pass
4965.0	6.350	10	-3.150	Pass
4985.0	6.350	10	-3.150	Pass

* - RBW ≥ 1% of OBW; 1 % of 10 MHz is 100 kHz, hence, RBW=100 kHz was chosen for the measurements.

Reference numbers of test equipment used

HL 2909	HL 3176	HL 3179	HL 3386				
---------	---------	---------	---------	--	--	--	--

Full description is given in Appendix A.

Test specification: FCC section 90.209, RSS-Gen section 4.6.1, Occupied bandwidth			
Test procedure: 47 CFR, Section 2.1049			
Test mode: Compliance	Verdict: PASS		
Date: 05/01/2009			
Temperature: 22°C	Air Pressure: 1012 hPa	Relative Humidity: 48%	Power Supply: 48 VDC
Remarks: 10 MHz CBW			

Plot 7.2.7 Occupied bandwidth test result at low frequency, 64QAM Bit rate 65 Mbps

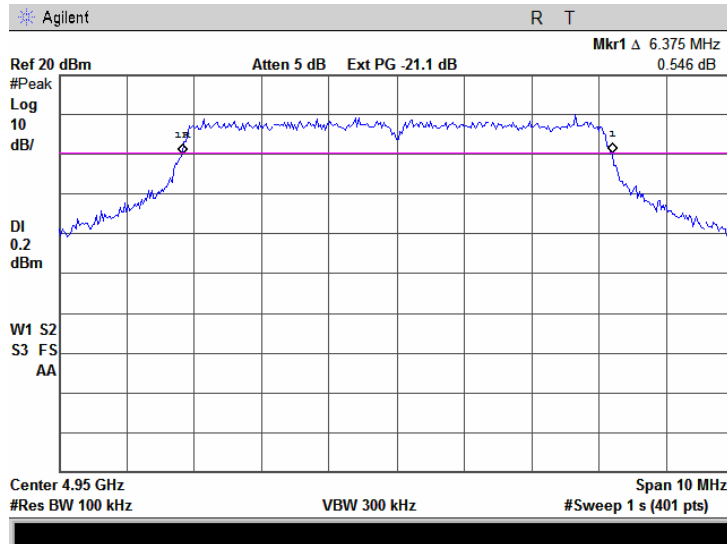

Plot 7.2.8 Occupied bandwidth test result at mid frequency, 64QAM Bit rate 65 Mbps

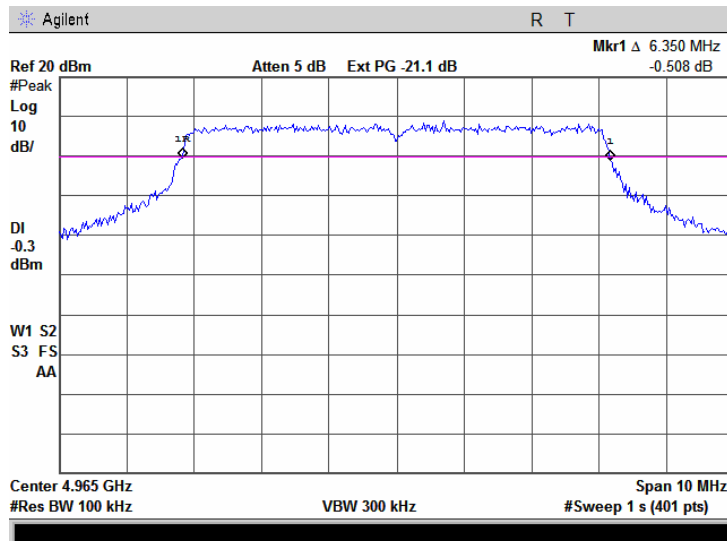

Test specification:	FCC section 90.209, RSS-Gen section 4.6.1, Occupied bandwidth		
Test procedure:	47 CFR, Section 2.1049		
Test mode:	Compliance	Verdict: PASS	
Date:	05/01/2009		
Temperature: 22°C	Air Pressure: 1012 hPa	Relative Humidity: 48%	Power Supply: 48 VDC
Remarks: 10 MHz CBW			

Plot 7.2.9 Occupied bandwidth test result at high frequency, 64QAM Bit rate 65 Mbps

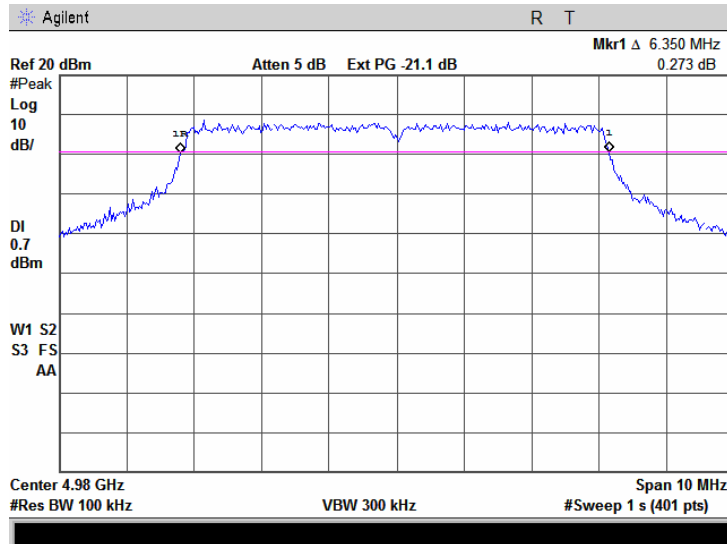

Plot 7.2.10 Occupied bandwidth test result at low frequency, BPSK Bit rate 6.5 Mbps

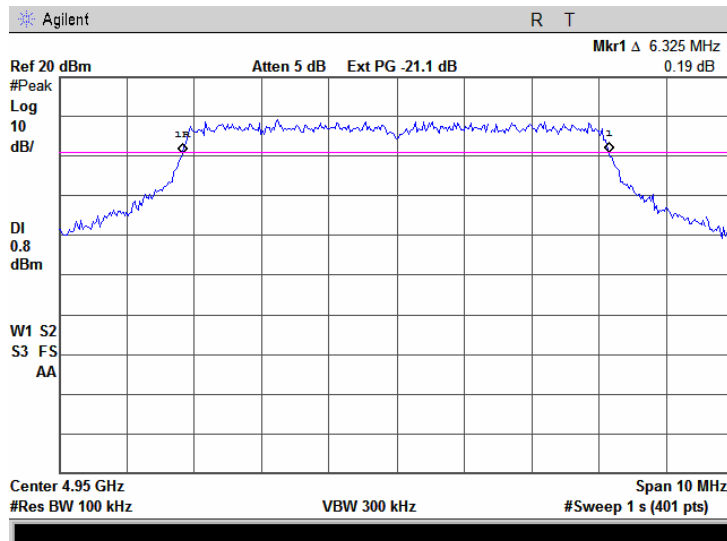

Test specification: FCC section 90.209, RSS-Gen section 4.6.1, Occupied bandwidth			
Test procedure: 47 CFR, Section 2.1049			
Test mode: Compliance	Verdict: PASS		
Date: 05/01/2009			
Temperature: 22°C	Air Pressure: 1012 hPa	Relative Humidity: 48%	Power Supply: 48 VDC
Remarks: 10 MHz CBW			

Plot 7.2.11 Occupied bandwidth test result at mid frequency, BPSK Bit rate 6.5 Mbps

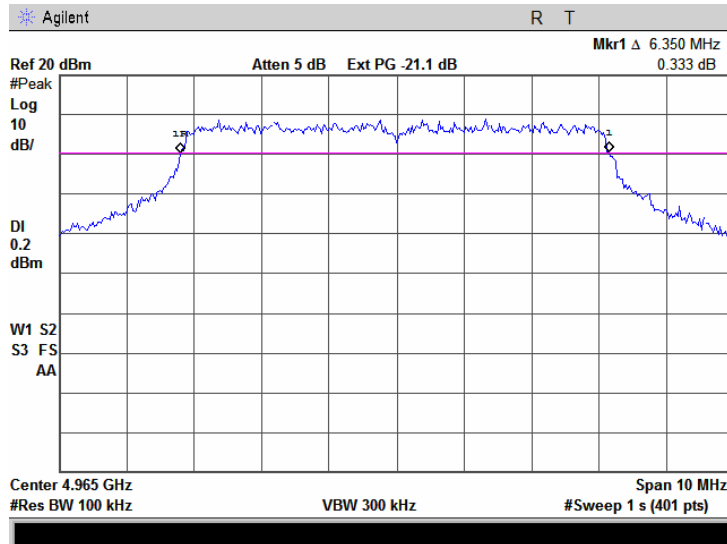

Plot 7.2.12 Occupied bandwidth test result at high frequency, BPSK Bit rate 6.5 Mbps

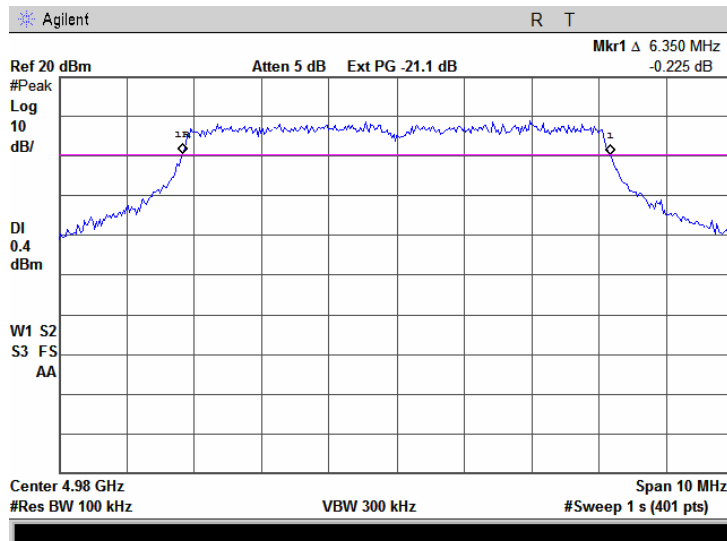

Test specification: FCC section 90.209, RSS-Gen section 4.6.1, Occupied bandwidth	
Test procedure: 47 CFR, Section 2.1049	
Test mode: Compliance	Verdict: PASS
Date: 05/01/2009	
Temperature: 22°C	Air Pressure: 1012 hPa
Relative Humidity: 48%	
Power Supply: 48 VDC	
Remarks: 20 MHz CBW	

Table 7.2.4 Occupied bandwidth test results 20 MHz channel bandwidth

RESOLUTION BANDWIDTH: 300 kHz*
 VIDEO BANDWIDTH: 1000 kHz
 MODULATION ENVELOPE REFERENCE POINTS: 26 dBc
 MODULATING SIGNAL: OFDM

Carrier frequency, MHz	Occupied bandwidth, MHz	Limit, MHz	Margin, MHz	Verdict
64QAM, Bit Rate 130 Mbps				
4950.0	15.75	20	-4.25	Pass
4965.0	15.75	20	-4.25	Pass
4980.0	15.75	20	-4.25	Pass
BPSK ,Bit Rate 13 Mbps				
4950.0	15.70	20	-4.30	Pass
4965.0	15.50	20	-4.50	Pass
4980.0	15.60	20	-4.40	Pass

* - RBW ≥ 1% of OBW; 1 % of 20 MHz is 200 kHz, hence, RBW=300 kHz was chosen for the measurements.

Reference numbers of test equipment used

HL 2909	HL 3179	HL 3385				
---------	---------	---------	--	--	--	--

Full description is given in Appendix A.

Test specification: FCC section 90.209, RSS-Gen section 4.6.1, Occupied bandwidth			
Test procedure: 47 CFR, Section 2.1049			
Test mode: Compliance	Verdict: PASS		
Date: 05/01/2009			
Temperature: 22°C	Air Pressure: 1012 hPa	Relative Humidity: 48%	Power Supply: 48 VDC
Remarks: 20 MHz CBW			

Plot 7.2.13 Occupied bandwidth test result at low frequency, 64QAM Bit rate 130 Mbps

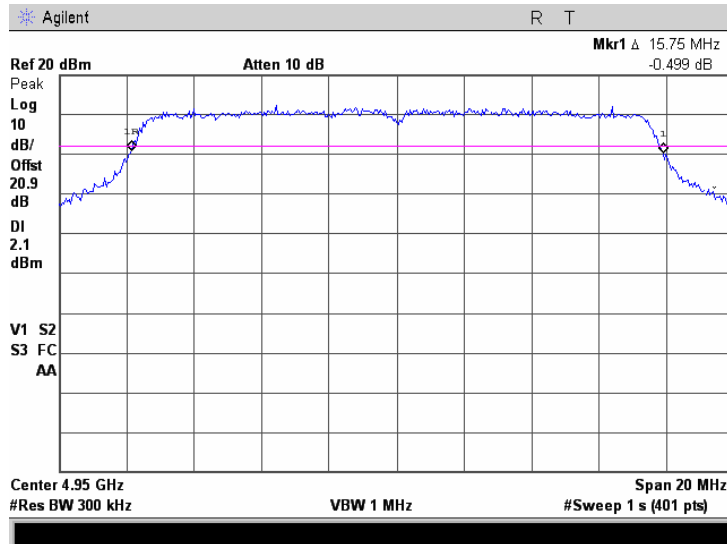

Plot 7.2.14 Occupied bandwidth test result at mid frequency, 64QAM Bit rate 130 Mbps

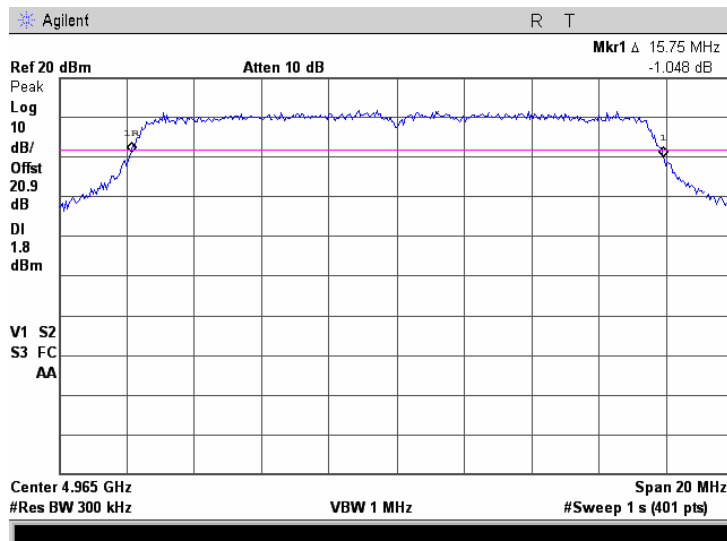

Test specification: FCC section 90.209, RSS-Gen section 4.6.1, Occupied bandwidth			
Test procedure: 47 CFR, Section 2.1049			
Test mode: Compliance	Verdict: PASS		
Date: 05/01/2009			
Temperature: 22°C	Air Pressure: 1012 hPa	Relative Humidity: 48%	Power Supply: 48 VDC
Remarks: 20 MHz CBW			

Plot 7.2.15 Occupied bandwidth test result at high frequency, 64QAM Bit rate 130 Mbps

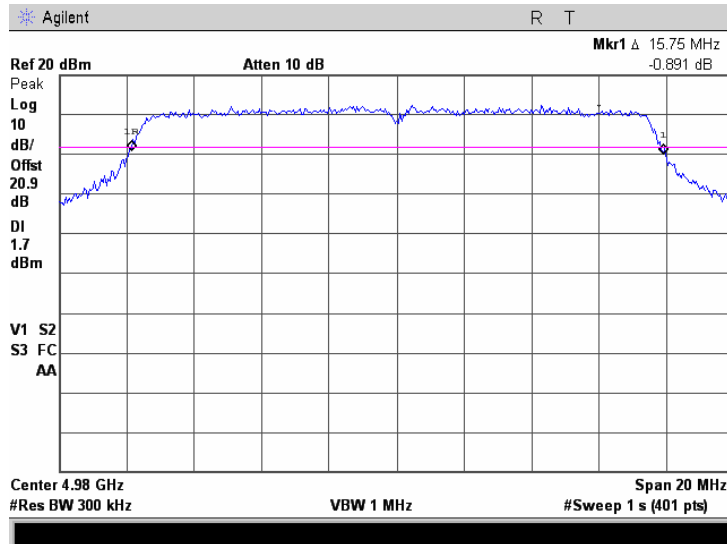

Plot 7.2.16 Occupied bandwidth test result at low frequency, BPSK Bit rate 13 Mbps

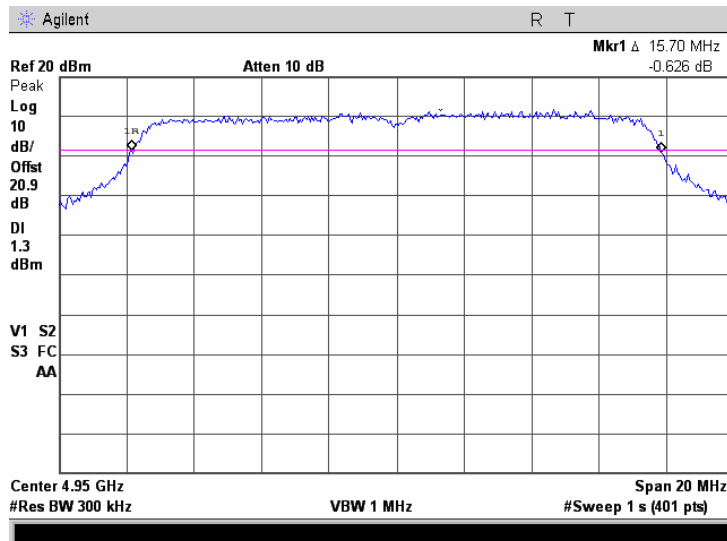

Test specification: FCC section 90.209, RSS-Gen section 4.6.1, Occupied bandwidth			
Test procedure: 47 CFR, Section 2.1049			
Test mode: Compliance	Verdict: PASS		
Date: 05/01/2009			
Temperature: 22°C	Air Pressure: 1012 hPa	Relative Humidity: 48%	Power Supply: 48 VDC
Remarks: 20 MHz CBW			

Plot 7.2.17 Occupied bandwidth test result at mid frequency, BPSK Bit rate 13 Mbps

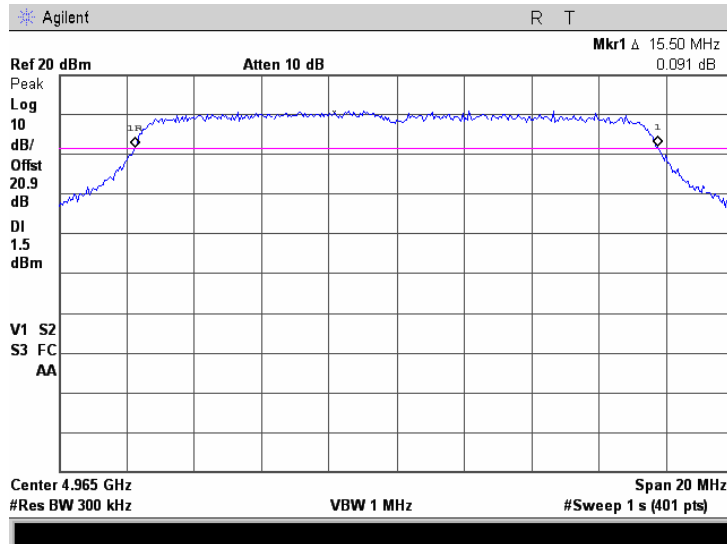

Plot 7.2.18 Occupied bandwidth test result at high frequency, BPSK Bit rate 13 Mbps

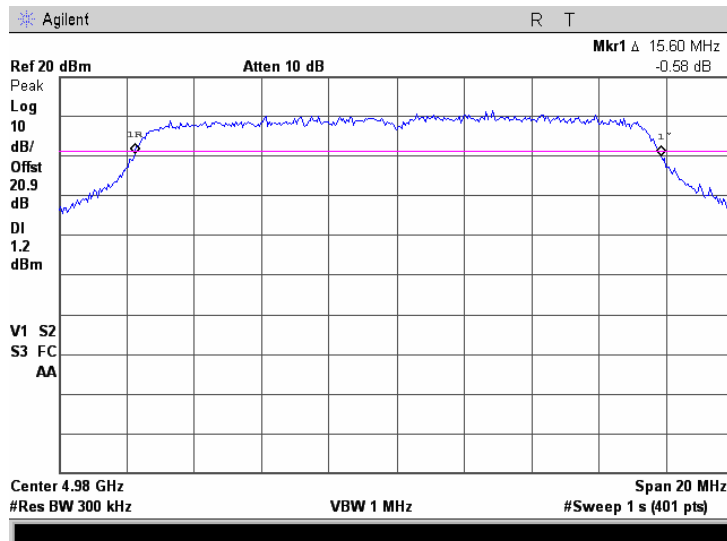

Test specification:		FCC section 90.210, RSS-111 section 5.4, Emission mask	
Test procedure:		47 CFR, Sections 2.1051, 2.1047 and 90.210(m); TIA/EIA-603-C, Section 2.2.13	
Test mode:	Compliance	Verdict:	PASS
Date:	05/01/2009		
Temperature: 22°C	Air Pressure: 1014 hPa	Relative Humidity: 52%	Power Supply: 48 VDC
Remarks:			

7.3 Emission mask test

7.3.1 General

This test was performed to measure emission mask at RF antenna connector. Specification test limits are given in Table 7.3.1, Table 7.3.3, Table 7.3.5.

7.3.2 Test procedure

7.3.2.1 The EUT was set up as shown in Figure 7.3.1, energized and its proper operation was checked.

7.3.2.2 The emission mask was measured with spectrum analyzer as provided in the associated plots. The test results are provided in Table 7.3.2, Table 7.3.4, Table 7.3.6.

Figure 7.3.1 Emission mask test setup

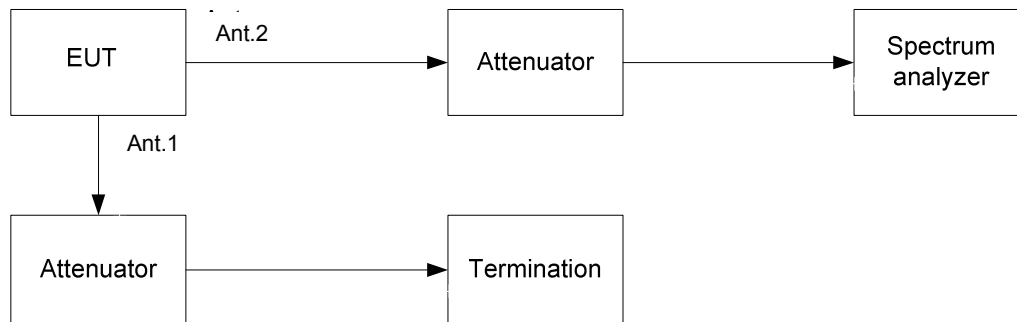

Test specification:	FCC section 90.210, RSS-111 section 5.4, Emission mask		
Test procedure:	47 CFR, Sections 2.1051, 2.1047 and 90.210(m); TIA/EIA-603-C, Section 2.2.13		
Test mode:	Compliance	Verdict:	PASS
Date:	05/01/2009		
Temperature: 22°C	Air Pressure: 1014 hPa	Relative Humidity: 52%	Power Supply: 48 VDC
Remarks: 5 MHz CBW			

Table 7.3.1 Emission mask limits for 5 MHz channel bandwidth

Frequency displacement from carrier	Attenuation below carrier, dBc
Emission mask M (Channel bandwidth 5 MHz)	
0 – 2.25 MHz	0
2.25 – 2.5 MHz	568log(F*/2.25)
2.5 – 2.75 MHz	26+145log(F*/2.5)
2.75 – 5.0 MHz	32+31log(F*/2.75)
5.0 – 7.5 MHz	40+57log(F*/5.0)
More than** 7.5 MHz	50 or 55+10logP(W) (whichever is the lesser attenuation)

* - F – frequency in MHz removed from center

** - emission mask includes carrier modulation envelope within ± 150 % of the authorized bandwidth; the frequency range removed beyond ± 150 % of the authorized bandwidth from carrier was investigated as spurious emission

Table 7.3.2 Emission mask test results for 5 MHz channel bandwidth

DETECTOR USED: Sample; 100 video averaging
 EUT RF OUTPUT: Antenna 1 (as worst case in power and PSD test)
 MODULATION: 64 QAM / BPSK
 MODULATING SIGNAL: OFDM
 TRANSMITTER OUTPUT POWER SETTINGS: Maximum

Carrier frequency, MHz	Limit	Verdict
4942.5	Emission mask M	Pass
4962.5		
4987.5		

Note: 50 dBc was used for emission mask.

Reference numbers of test equipment used

HL 2909	HL 3176	HL 3383	HL 3442				
---------	---------	---------	---------	--	--	--	--

Full description is given in Appendix A.

Test specification: FCC section 90.210, RSS-111 section 5.4, Emission mask			
Test procedure: 47 CFR, Sections 2.1051, 2.1047 and 90.210(m); TIA/EIA-603-C, Section 2.2.13			
Test mode: Compliance	Verdict: PASS		
Date: 05/01/2009			
Temperature: 22°C	Air Pressure: 1014 hPa	Relative Humidity: 52%	Power Supply: 48 VDC
Remarks: 5 MHz CBW			

Plot 7.3.1 Emission mask test results at low carrier frequency, BPSK, 3.25 Mbps

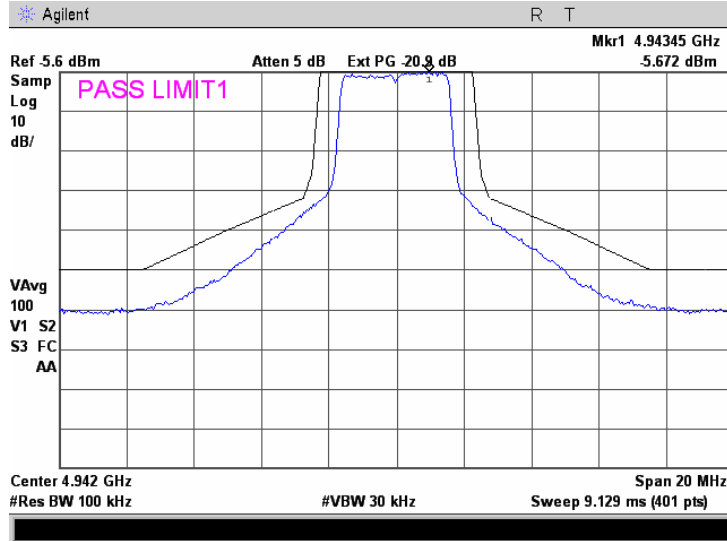

Plot 7.3.2 Emission mask test results at mid carrier frequency, BPSK, 3.25 Mbps

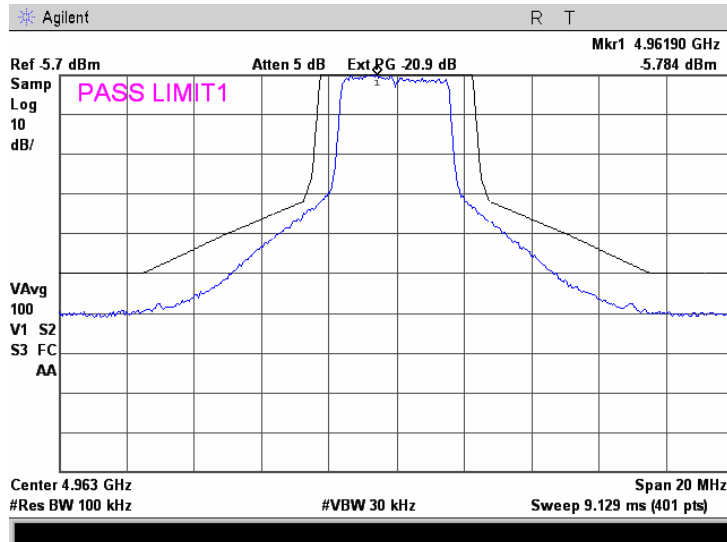

Test specification: FCC section 90.210, RSS-111 section 5.4, Emission mask			
Test procedure: 47 CFR, Sections 2.1051, 2.1047 and 90.210(m); TIA/EIA-603-C, Section 2.2.13			
Test mode: Compliance	Verdict: PASS		
Date: 05/01/2009			
Temperature: 22°C	Air Pressure: 1014 hPa	Relative Humidity: 52%	Power Supply: 48 VDC
Remarks: 5 MHz CBW			

Plot 7.3.3 Emission mask test results at high carrier frequency, BPSK, 3.25 Mbps

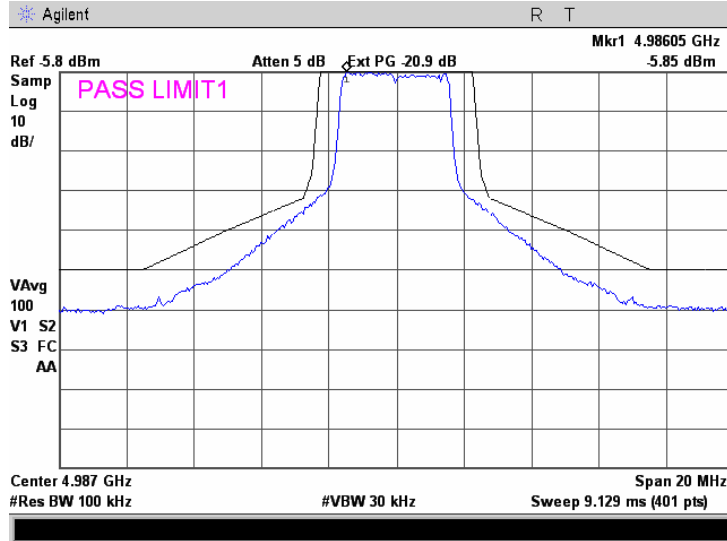

Plot 7.3.4 Emission mask test results at low carrier frequency, 64 QAM, 32.5 Mbps

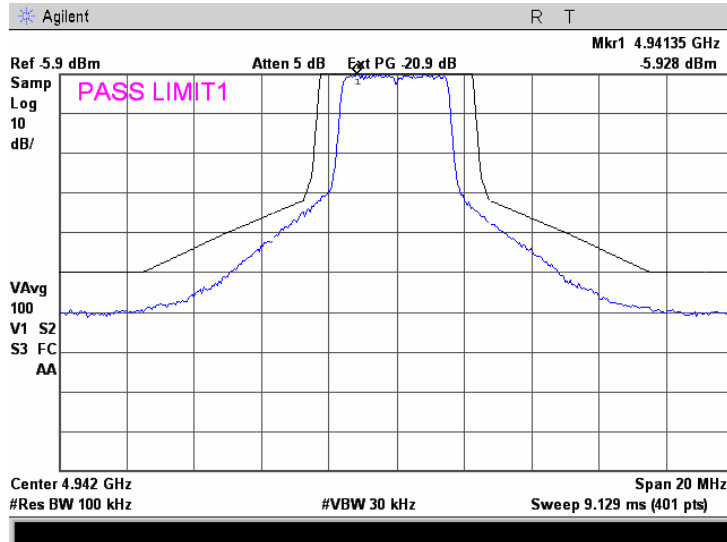

Test specification: FCC section 90.210, RSS-111 section 5.4, Emission mask			
Test procedure: 47 CFR, Sections 2.1051, 2.1047 and 90.210(m); TIA/EIA-603-C, Section 2.2.13			
Test mode: Compliance	Verdict: PASS		
Date: 05/01/2009			
Temperature: 22°C	Air Pressure: 1014 hPa	Relative Humidity: 52%	Power Supply: 48 VDC
Remarks: 5 MHz CBW			

Plot 7.3.5 Emission mask test results at mid carrier frequency, 64 QAM, 32.5 Mbps

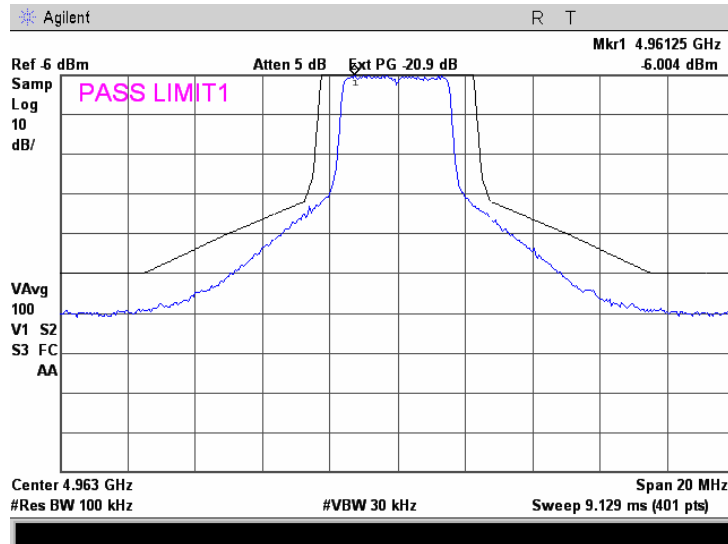

Plot 7.3.6 Emission mask test results at high carrier frequency, 64 QAM, 32.5 Mbps

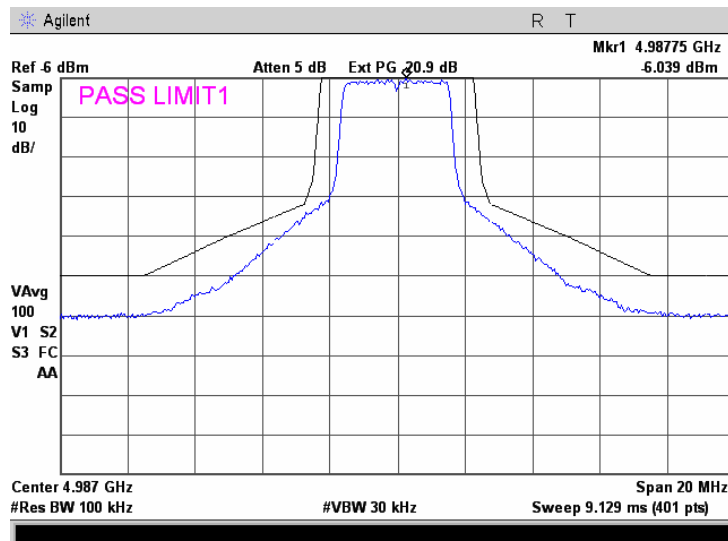

Test specification: FCC section 90.210, RSS-111 section 5.4, Emission mask	
Test procedure: 47 CFR, Sections 2.1051, 2.1047 and 90.210(m); TIA/EIA-603-C, Section 2.2.13	
Test mode: Compliance	Verdict: PASS
Date: 05/01/2009	
Temperature: 22°C	Air Pressure: 1014 hPa
Relative Humidity: 52%	
Power Supply: 48 VDC	
Remarks: 10 MHz CBW	

Table 7.3.3 Emission mask limits for 10 MHz channel bandwidth

Frequency displacement from carrier	Attenuation below carrier, dBc
Emission mask M (Channel bandwidth 10 MHz)	
0 – 4.5 MHz	0
4.5 – 5 MHz	568log(F*/4.5)
5 – 5.5 MHz	26+145log(F*/5.0)
5.5 – 10.0 MHz	32+31log(F*/5.5)
10.0 – 15 MHz	40+57log(F*/10.0)
More than** 15 MHz	50 or 55+10logP(W) (whichever is the lesser attenuation)

* - F – frequency in MHz removed from center

** - emission mask includes carrier modulation envelope within ± 150 % of the authorized bandwidth; the frequency range removed beyond ± 150 % of the authorized bandwidth from carrier was investigated as spurious emission

Table 7.3.4 Emission mask test results for 10 MHz channel bandwidth

DETECTOR USED: Sample; 100 video averaging
 EUT RF OUTPUT: Antenna 1 (as worst case in power and PSD test)
 MODULATION: 64 QAM / BPSK
 MODULATING SIGNAL: OFDM
 TRANSMITTER OUTPUT POWER SETTINGS: Maximum

Carrier frequency, MHz	Limit	Verdict
4945	Emission mask M	Pass
4965		
4985		

Note: 50 dBc was used for emission mask.

Reference numbers of test equipment used

HL 2909	HL 2953	HL 3181	HL 3442				
---------	---------	---------	---------	--	--	--	--

Full description is given in Appendix A.

Test specification: FCC section 90.210, RSS-111 section 5.4, Emission mask			
Test procedure: 47 CFR, Sections 2.1051, 2.1047 and 90.210(m); TIA/EIA-603-C, Section 2.2.13			
Test mode: Compliance	Verdict: PASS		
Date: 05/01/2009			
Temperature: 22°C	Air Pressure: 1014 hPa	Relative Humidity: 52%	Power Supply: 48 VDC
Remarks: 10 MHz CBW			

Plot 7.3.7 Emission mask test results at low carrier frequency, BPSK, 6.5 Mbps

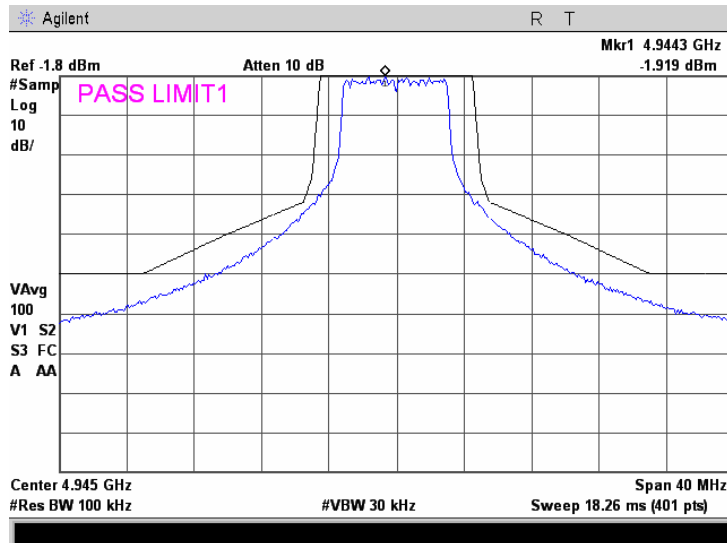

Plot 7.3.8 Emission mask test results at mid carrier frequency, BPSK, 6.5 Mbps

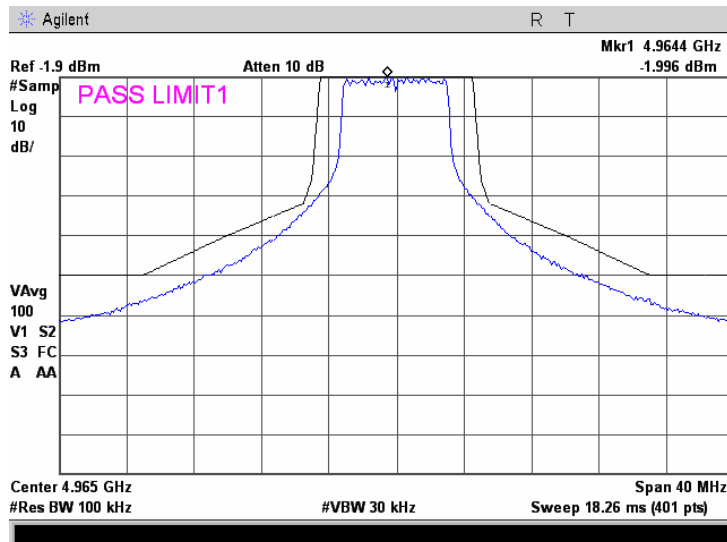

Test specification: FCC section 90.210, RSS-111 section 5.4, Emission mask			
Test procedure: 47 CFR, Sections 2.1051, 2.1047 and 90.210(m); TIA/EIA-603-C, Section 2.2.13			
Test mode: Compliance	Verdict: PASS		
Date: 05/01/2009			
Temperature: 22°C	Air Pressure: 1014 hPa	Relative Humidity: 52%	Power Supply: 48 VDC
Remarks: 10 MHz CBW			

Plot 7.3.9 Emission mask test results at high carrier frequency, BPSK, 6.5 Mbps

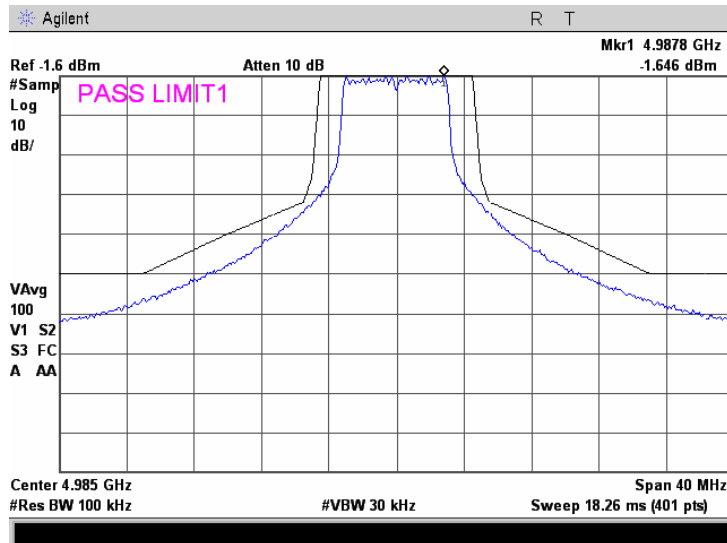

Plot 7.3.10 Emission mask test results at low carrier frequency, 64 QAM 65Mbps

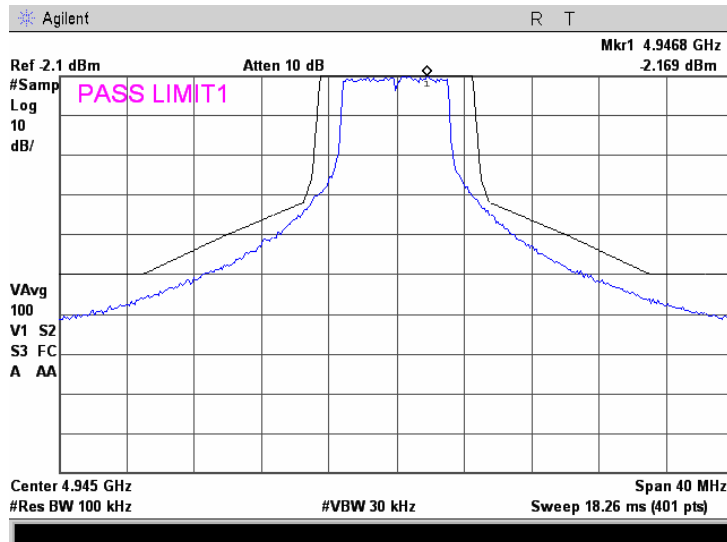

Test specification: FCC section 90.210, RSS-111 section 5.4, Emission mask			
Test procedure: 47 CFR, Sections 2.1051, 2.1047 and 90.210(m); TIA/EIA-603-C, Section 2.2.13			
Test mode: Compliance	Verdict: PASS		
Date: 05/01/2009			
Temperature: 22°C	Air Pressure: 1014 hPa	Relative Humidity: 52%	Power Supply: 48 VDC
Remarks: 10 MHz CBW			

Plot 7.3.11 Emission mask test results at mid carrier frequency, 64 QAM 65Mbps

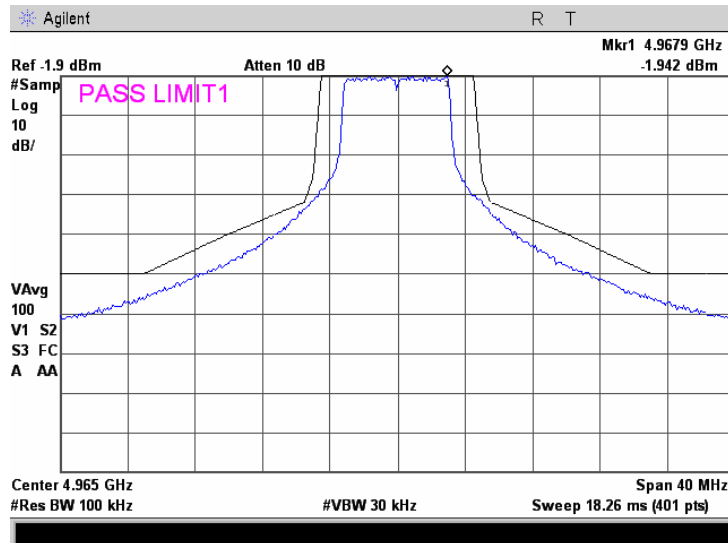

Plot 7.3.12 Emission mask test results at high carrier frequency, 64 QAM 65Mbps

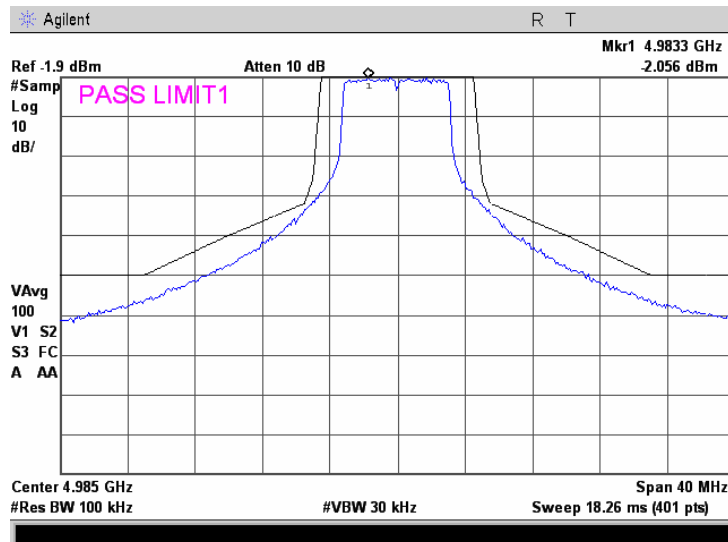



Test specification: FCC section 90.210, RSS-111 section 5.4, Emission mask	
Test procedure: 47 CFR, Sections 2.1051, 2.1047 and 90.210(m); TIA/EIA-603-C, Section 2.2.13	
Test mode: Compliance	Verdict: PASS
Date: 05/01/2009	
Temperature: 22°C	Air Pressure: 1014 hPa
Relative Humidity: 52%	
Power Supply: 48 VDC	
Remarks: 20 MHz CBW	

Table 7.3.5 Emission mask limits for 20 MHz channel bandwidth

Frequency displacement from carrier	Attenuation below carrier, dBc
Emission mask M (Channel bandwidth 20 MHz)	
0 – 9 MHz	0
9 – 10 MHz	568log(F*/4.5)
10 – 11 MHz	26+145log(F*/5.0)
11 – 20.0 MHz	32+31log(F*/5.5)
20.0 – 30 MHz	40+57log(F*/10.0)
More than** 30 MHz	50 or 55+10logP(W) (whichever is the lesser attenuation)

* - F – frequency in MHz removed from center

** - emission mask includes carrier modulation envelope within ± 150 % of the authorized bandwidth; the frequency range removed beyond ± 150 % of the authorized bandwidth from carrier was investigated as spurious emission

Table 7.3.6 Emission mask test results for 20 MHz channel bandwidth

DETECTOR USED: Sample; 100 video averaging
 EUT RF OUTPUT: Antenna 2 (as worst case in power and PSD test)
 MODULATION: 64 QAM / BPSK
 MODULATING SIGNAL: OFDM
 TRANSMITTER OUTPUT POWER SETTINGS: Maximum

Carrier frequency, MHz	Limit	Verdict
4950	Emission mask M	Pass
4965		
4980		

Note: 50 dBc was used for emission mask.

Reference numbers of test equipment used

HL 2909	HL 3176	HL 3383	HL 3442				
---------	---------	---------	---------	--	--	--	--

Full description is given in Appendix A.

Test specification: FCC section 90.210, RSS-111 section 5.4, Emission mask			
Test procedure: 47 CFR, Sections 2.1051, 2.1047 and 90.210(m); TIA/EIA-603-C, Section 2.2.13			
Test mode: Compliance	Verdict: PASS		
Date: 05/01/2009			
Temperature: 22°C	Air Pressure: 1014 hPa	Relative Humidity: 52%	Power Supply: 48 VDC
Remarks: 20 MHz CBW			

Plot 7.3.13 Emission mask test results at low carrier frequency, BPSK, 13 Mbps

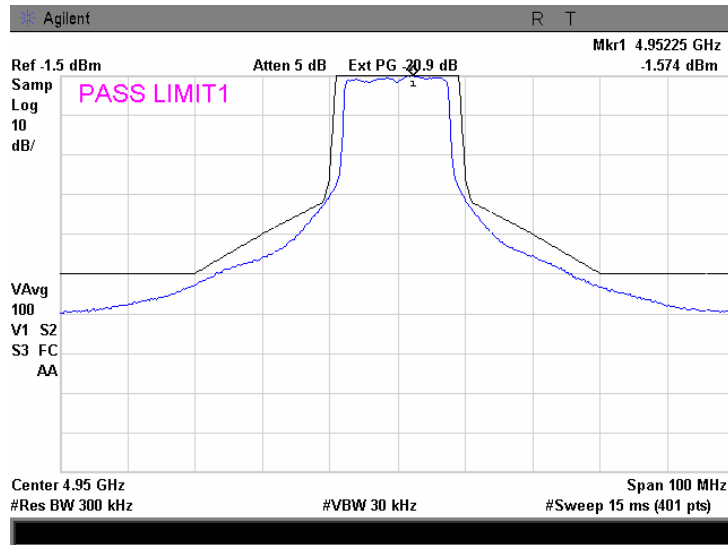

Plot 7.3.14 Emission mask test results at mid carrier frequency, BPSK, 13 Mbps

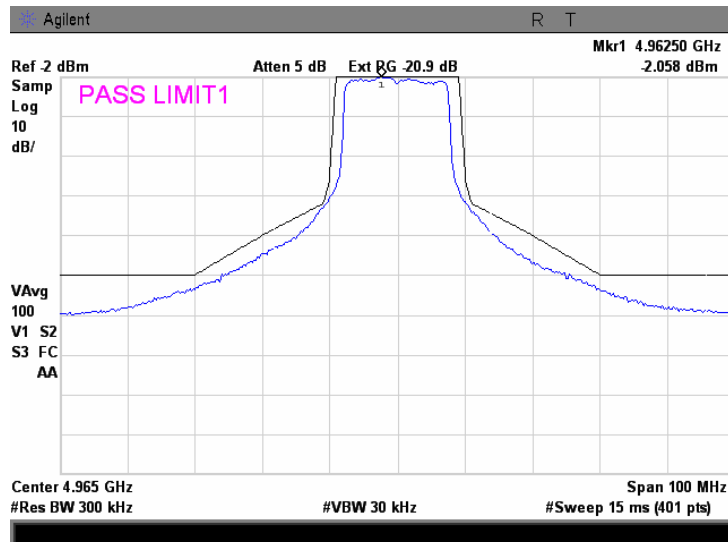

Test specification: FCC section 90.210, RSS-111 section 5.4, Emission mask			
Test procedure: 47 CFR, Sections 2.1051, 2.1047 and 90.210(m); TIA/EIA-603-C, Section 2.2.13			
Test mode: Compliance	Verdict: PASS		
Date: 05/01/2009			
Temperature: 22°C	Air Pressure: 1014 hPa	Relative Humidity: 52%	Power Supply: 48 VDC
Remarks: 20 MHz CBW			

Plot 7.3.15 Emission mask test results at high carrier frequency, BPSK, 13 Mbps

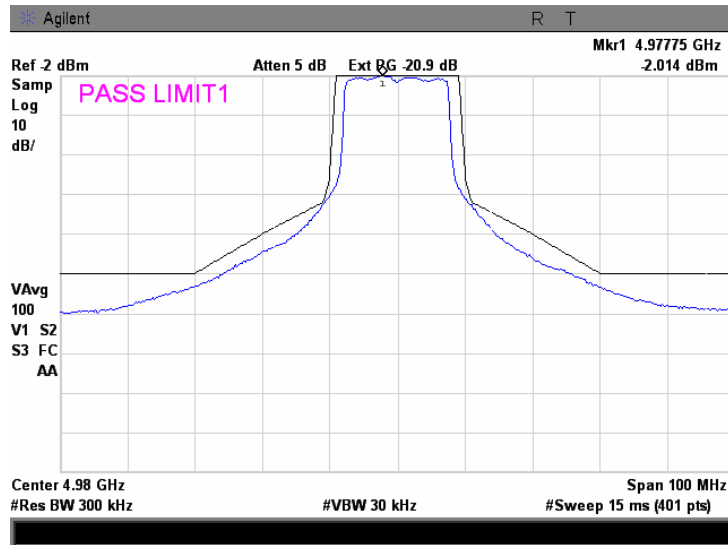

Plot 7.3.16 Emission mask test results at low carrier frequency, 64 QAM, 130Mbps

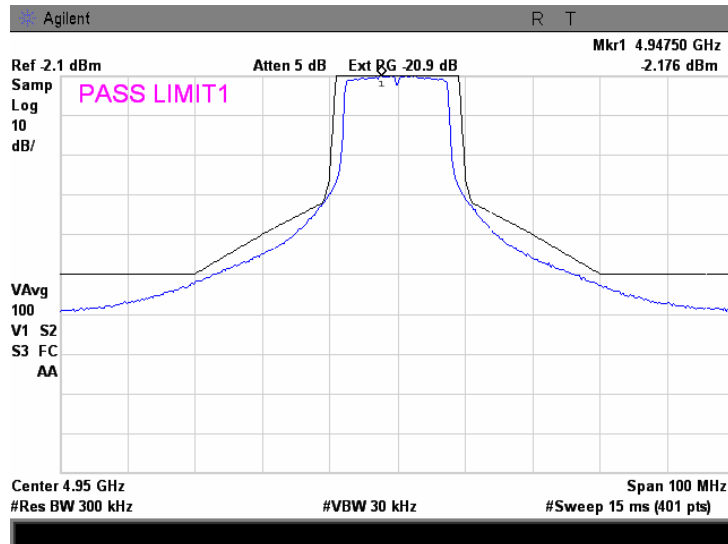

Test specification: FCC section 90.210, RSS-111 section 5.4, Emission mask			
Test procedure: 47 CFR, Sections 2.1051, 2.1047 and 90.210(m); TIA/EIA-603-C, Section 2.2.13			
Test mode: Compliance	Verdict: PASS		
Date: 05/01/2009			
Temperature: 22°C	Air Pressure: 1014 hPa	Relative Humidity: 52%	Power Supply: 48 VDC
Remarks: 20 MHz CBW			

Plot 7.3.17 Emission mask test results at mid carrier frequency, 64 QAM, 130Mbps

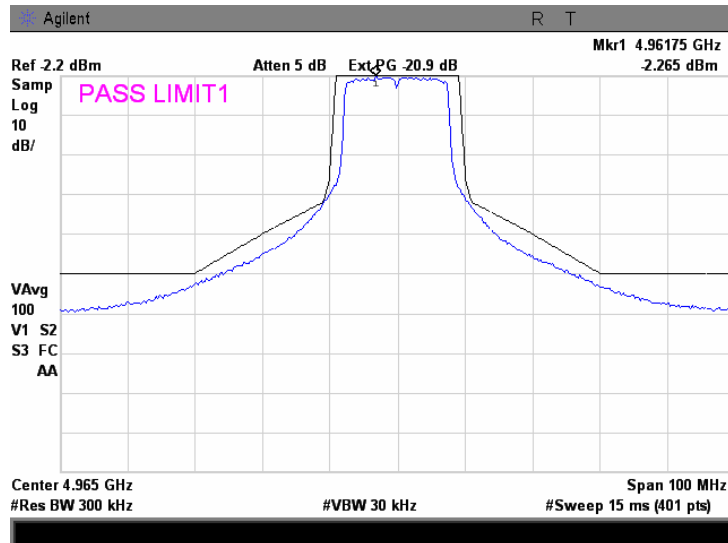

Plot 7.3.18 Emission mask test results at high carrier frequency, 64 QAM, 130Mbps

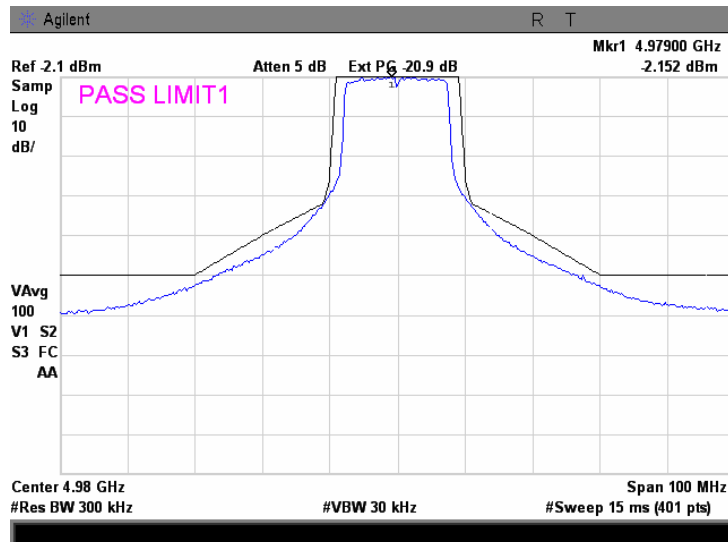

Test specification: FCC section 90.210, RSS-111 section 5.4, Conducted spurious emissions			
Test procedure: 47 CFR, Sections 2.1051 and 90.210(m); TIA/EIA-603-C, Section 2.2.13			
Test mode: Compliance	Verdict: PASS		
Date: 30/12/2008			
Temperature: 22°C	Air Pressure: 1014 hPa	Relative Humidity: 52%	Power Supply: 48 VDC
Remarks:			

7.4 Spurious emissions at RF antenna connector test

7.4.1 General

This test was performed to measure spurious emissions at RF antenna connector. Specification test limits are given in Table 7.4.1.

Table 7.4.1 Spurious emission limits

Frequency, MHz	Attenuation below carrier, dBc	ERP of spurious**, dBm	
0.009 – 10 th harmonic*	50 (mask M) {55 + 10 log P (W)}	Low carrier frequency	-25
		Mid carrier frequency	-25
		High carrier frequency	-25

* - spurious emission limits do not apply to the in band emission within $\pm 150\%$ of the authorized bandwidth from the carrier; investigated in course of emission mask testing

** - ERP of spurious = P (dBm) - {55 + 10 log P (W)} = -25 dBm

7.4.2 Test procedure for individual chain testing

7.4.2.1 The EUT was set up as shown in Figure 7.4.1, energized and its proper operation was checked.

7.4.2.2 The EUT was adjusted to produce maximum available to end user RF output power.

7.4.2.3 The highest emission level within the authorized band was measured.

7.4.2.4 The spurious emission was measured with spectrum analyzer as provided in Table 7.4.2 and associated plots, and referenced to the highest emission level measured within the authorized band.

7.4.3 Test procedure for combined chain testing

7.4.3.1 The EUT was set up as shown in Figure 7.4.2, energized and its proper operation was checked.

7.4.3.2 The EUT was adjusted to produce maximum available to end user RF output power.

7.4.3.3 The highest emission level within the authorized band was measured.

7.4.3.4 The spurious emission was measured with spectrum analyzer as provided in Table 7.4.3 and associated plots and referenced to the highest emission level measured within the authorized band.

Figure 7.4.1 Spurious emission test setup - individual Tx chain

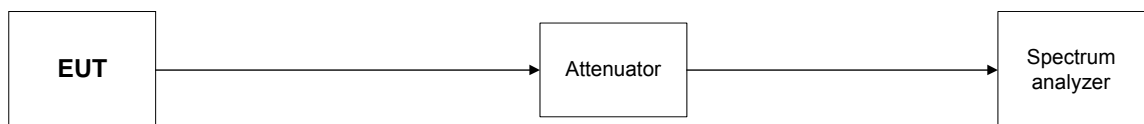
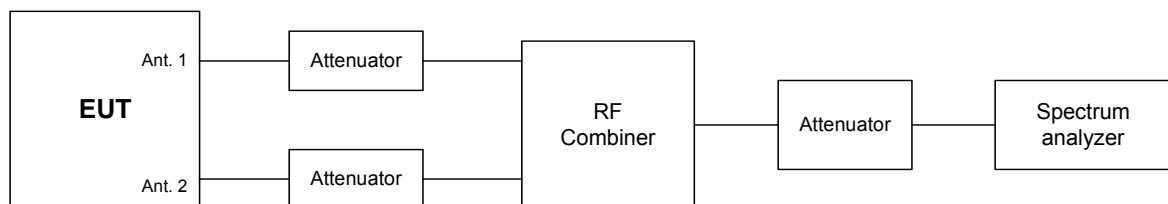

Figure 7.4.2 Spurious emission test setup– combined Tx chains



Test specification:	FCC section 90.210, RSS-111 section 5.4, Conducted spurious emissions		
Test procedure:	47 CFR, Sections 2.1051 and 90.210(m); TIA/EIA-603-C, Section 2.2.13		
Test mode:	Compliance	Verdict:	PASS
Date:	30/12/2008		
Temperature: 22°C	Air Pressure: 1014 hPa	Relative Humidity: 52%	Power Supply: 48 VDC
Remarks:			

Table 7.4.2 Spurious emission test results, individual Tx chain

ASSIGNED FREQUENCY RANGE: 4940 – 4990 MHz
 INVESTIGATED FREQUENCY RANGE: 0.009 – 40000 MHz
 DETECTOR USED: Peak
 VIDEO BANDWIDTH: >Resolution bandwidth
 MODULATING SIGNAL: OFDM
 EUT OUTPUT: Antenna 1
 BIT RATE: 130 Mbps, 64QAM*
 CHANNEL BANDWIDTH: 20 MHz
 TRANSMITTER OUTPUT POWER SETTINGS: According to peak output power test result

Frequency, MHz	SA reading, dBm	Attenuator, dB	Cable loss, dB	RBW, kHz	Spurious emission, dBm	Attenuation below carrier, dBc	Limit, dBc	Margin, dB**	Verdict
No emissions were found									Pass

*- Maximum peak output power was measured from EUT output "Antenna 1" at 64QAM modulation, bit rate 130 Mbps.
 **- Margin = Spurious emission – specification limit.

Note: Limit (-25 dBm) was used.

Table 7.4.3 Spurious emission test results, combined Tx chains

ASSIGNED FREQUENCY RANGE: 4940 – 4990 MHz
 INVESTIGATED FREQUENCY RANGE: 1000 – 18000 MHz
 DETECTOR USED: Peak
 VIDEO BANDWIDTH: >Resolution bandwidth
 MODULATING SIGNAL: OFDM
 EUT OUTPUT: Antenna 1 and 2 connected over RF combiner
 BIT RATE: 130 Mbps, 64QAM*
 CHANNEL BANDWIDTH: 20 MHz
 TRANSMITTER OUTPUT POWER SETTINGS: According to peak output power test result

Frequency, MHz	SA reading, dBm	Attenuator, dB	Cable loss, dB	RBW, kHz	Spurious emission, dBm	Attenuation below carrier, dBc	Limit, dBc	Margin, dB**	Verdict
No emissions were found									Pass

*- Maximum total peak output power was measured at 64QAM modulation, bit rate 130 Mbps.
 **- Margin = Spurious emission – specification limit.

Note: Limit (-25 dBm) was used.

Reference numbers of test equipment used

HL 1292	HL 1378	HL 1424	HL 2013	HL 2254	HL 2909	HL 2951	HL 3176
HL 3180	HL 3441	HL 3442	HL 3472	HL 3473			

Full description is given in Appendix A.

Test specification: FCC section 90.210, RSS-111 section 5.4, Conducted spurious emissions			
Test procedure: 47 CFR, Sections 2.1051 and 90.210(m); TIA/EIA-603-C, Section 2.2.13			
Test mode: Compliance	Verdict: PASS		
Date: 30/12/2008			
Temperature: 22°C	Air Pressure: 1014 hPa	Relative Humidity: 52%	Power Supply: 48 VDC
Remarks:			

Plot 7.4.1 Spurious emission measurements in 9 - 150 kHz range at low carrier frequency, individual Tx chain

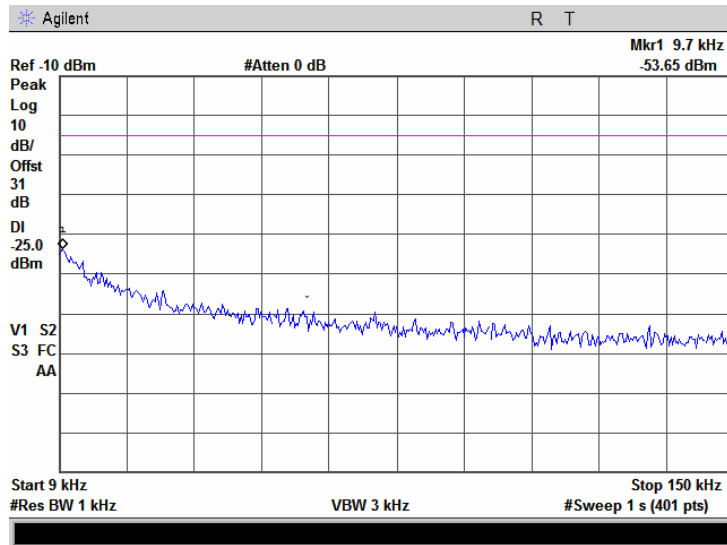

Plot 7.4.2 Spurious emission measurements in 9 - 150 kHz range at mid carrier frequency, individual Tx chain

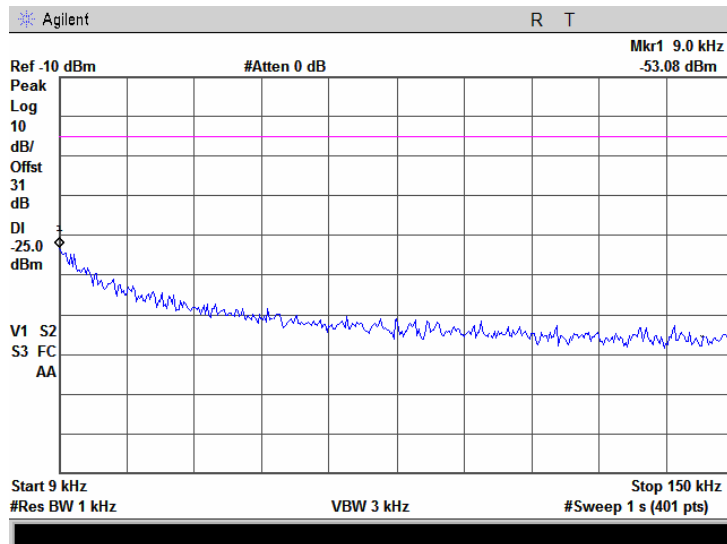

Test specification:		FCC section 90.210, RSS-111 section 5.4, Conducted spurious emissions	
Test procedure:		47 CFR, Sections 2.1051 and 90.210(m); TIA/EIA-603-C, Section 2.2.13	
Test mode:	Compliance	Verdict:	PASS
Date:	30/12/2008		
Temperature: 22°C	Air Pressure: 1014 hPa	Relative Humidity: 52%	Power Supply: 48 VDC
Remarks:			

Plot 7.4.3 Spurious emission measurements in 9 - 150 kHz range at high carrier frequency, individual Tx chain

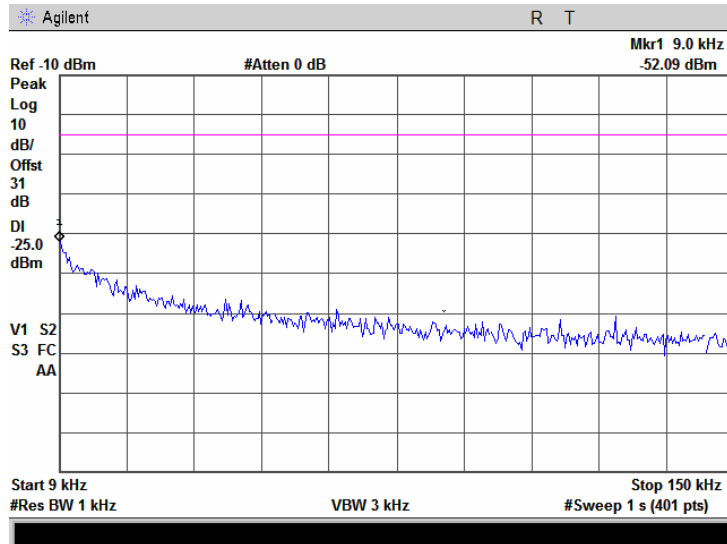

Plot 7.4.4 Spurious emission measurements in 0.15 - 30.0 MHz range at low carrier frequency, individual Tx chain

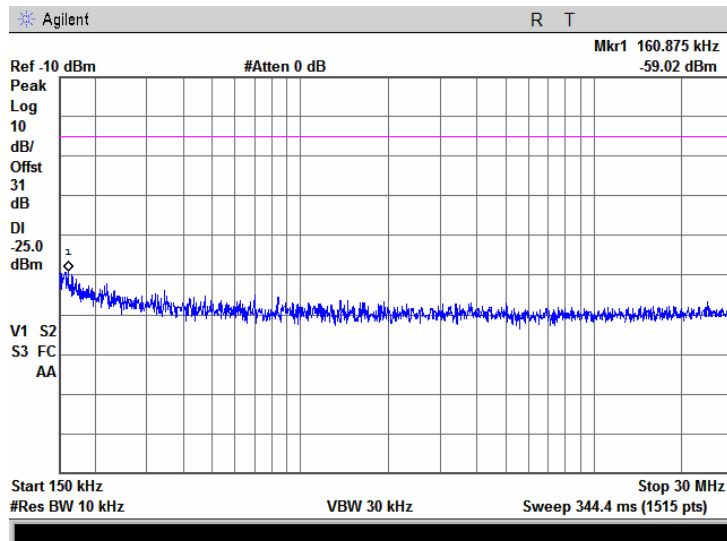

Test specification:	FCC section 90.210, RSS-111 section 5.4, Conducted spurious emissions		
Test procedure:	47 CFR, Sections 2.1051 and 90.210(m); TIA/EIA-603-C, Section 2.2.13		
Test mode:	Compliance	Verdict:	PASS
Date:	30/12/2008		
Temperature: 22°C	Air Pressure: 1014 hPa	Relative Humidity: 52%	Power Supply: 48 VDC
Remarks:			

Plot 7.4.5 Spurious emission measurements in 0.15 - 30.0 MHz range at mid carrier frequency, individual Tx chain

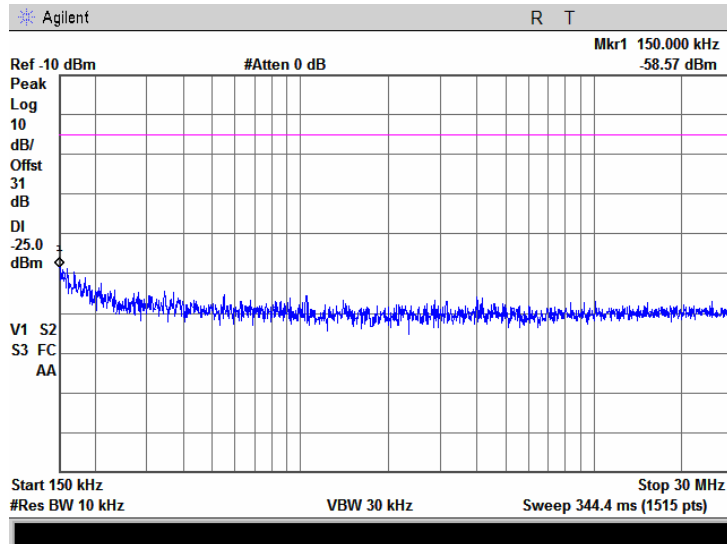

Plot 7.4.6 Spurious emission measurements in 0.15 – 30.0 MHz range at high carrier frequency, individual Tx chain

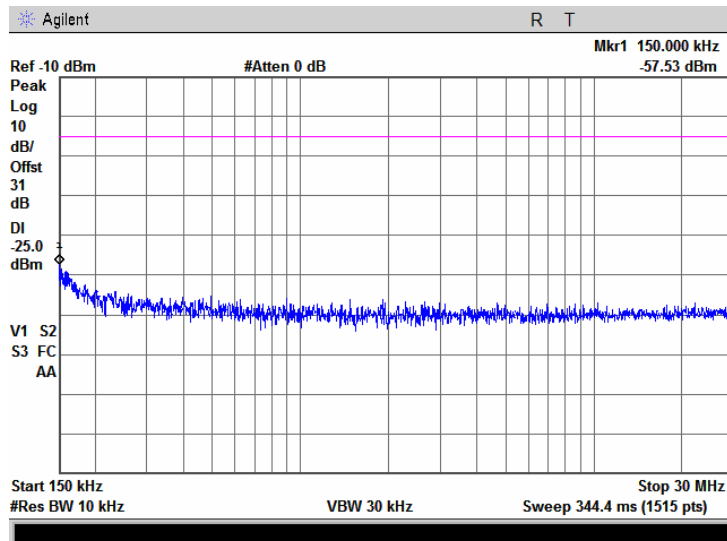

Test specification:	FCC section 90.210, RSS-111 section 5.4, Conducted spurious emissions		
Test procedure:	47 CFR, Sections 2.1051 and 90.210(m); TIA/EIA-603-C, Section 2.2.13		
Test mode:	Compliance	Verdict:	PASS
Date:	30/12/2008		
Temperature: 22°C	Air Pressure: 1014 hPa	Relative Humidity: 52%	Power Supply: 48 VDC
Remarks:			

Plot 7.4.7 Spurious emission measurements in 30.0 - 1000 MHz range at low carrier frequency, individual Tx chain

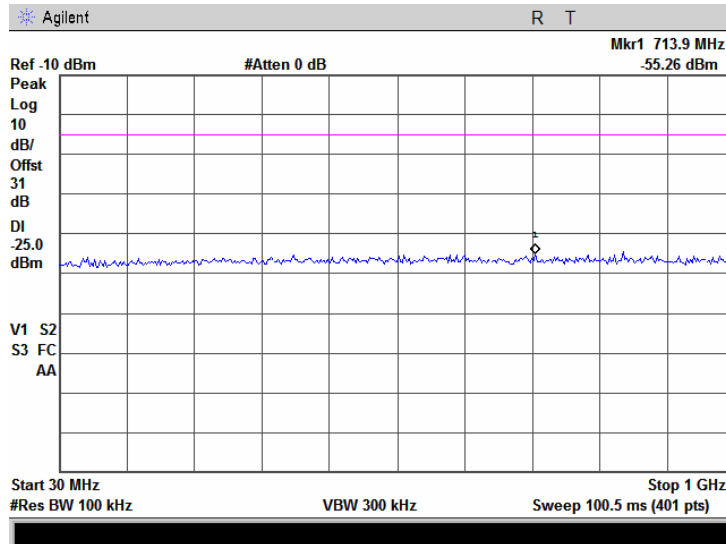

Plot 7.4.8 Spurious emission measurements in 30.0 - 1000 MHz range at mid carrier frequency, individual Tx chain

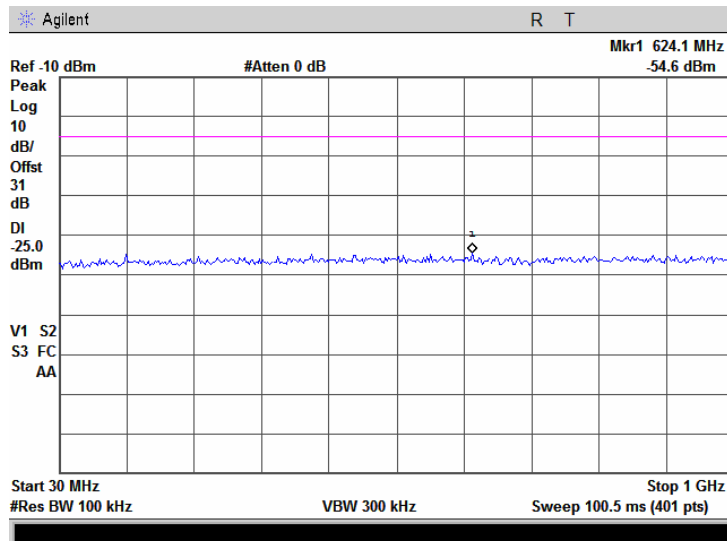

Test specification:	FCC section 90.210, RSS-111 section 5.4, Conducted spurious emissions		
Test procedure:	47 CFR, Sections 2.1051 and 90.210(m); TIA/EIA-603-C, Section 2.2.13		
Test mode:	Compliance	Verdict:	PASS
Date:	30/12/2008		
Temperature: 22°C	Air Pressure: 1014 hPa	Relative Humidity: 52%	Power Supply: 48 VDC
Remarks:			

Plot 7.4.9 Spurious emission measurements in 30.0 - 1000 MHz range at high carrier frequency, individual Tx chain

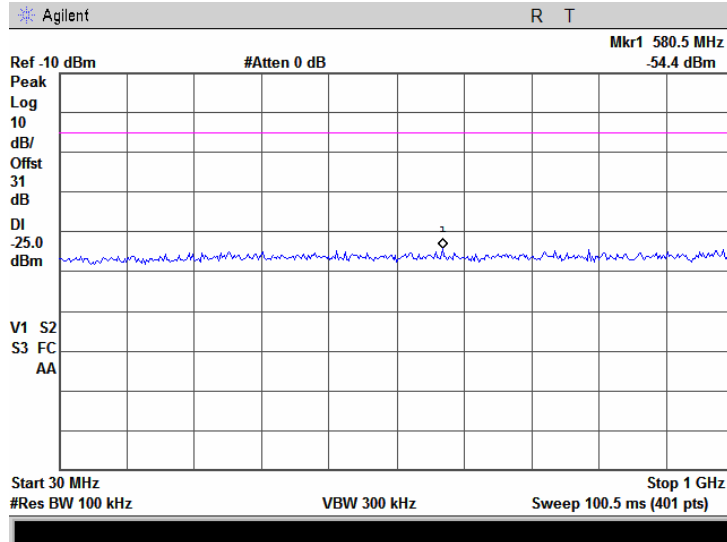

Test specification:		FCC section 90.210, RSS-111 section 5.4, Conducted spurious emissions	
Test procedure:		47 CFR, Sections 2.1051 and 90.210(m); TIA/EIA-603-C, Section 2.2.13	
Test mode:	Compliance	Verdict:	PASS
Date:	30/12/2008		
Temperature: 22°C	Air Pressure: 1014 hPa	Relative Humidity: 52%	Power Supply: 48 VDC
Remarks:			

Plot 7.4.10 Spurious emission measurements in 1000 - 18000 MHz range at low carrier frequency, individual Tx chain

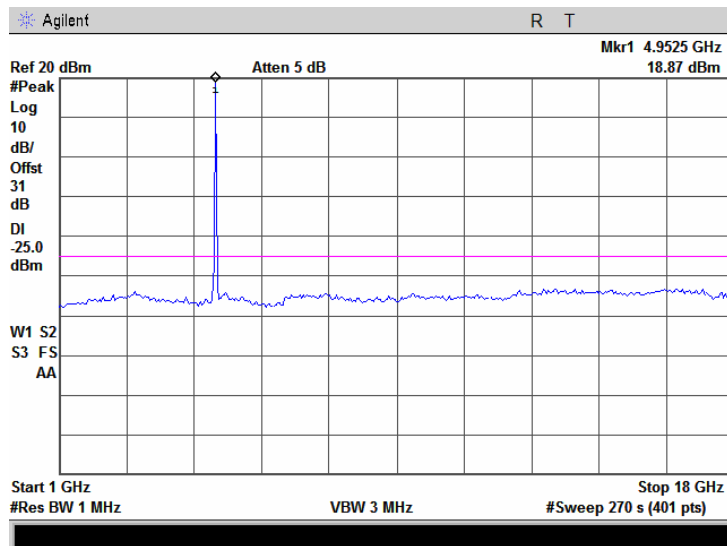

Plot 7.4.11 Spurious emission measurements in 1000 - 18000 MHz range at mid carrier frequency, individual Tx chain

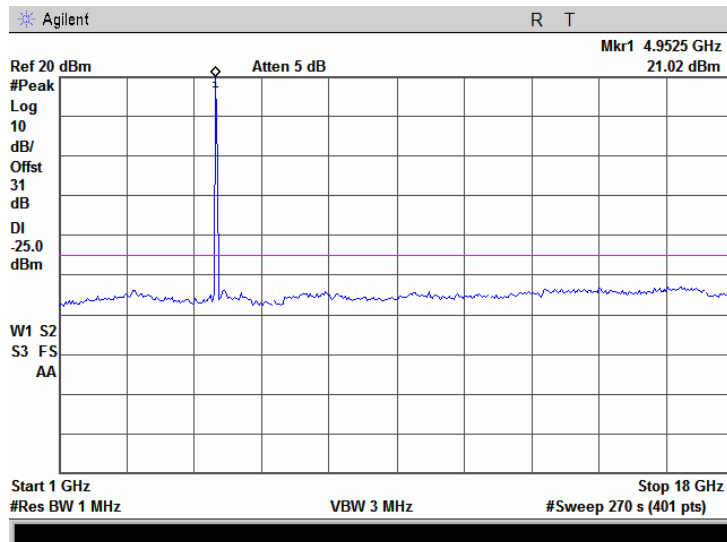

Test specification:	FCC section 90.210, RSS-111 section 5.4, Conducted spurious emissions		
Test procedure:	47 CFR, Sections 2.1051 and 90.210(m); TIA/EIA-603-C, Section 2.2.13		
Test mode:	Compliance	Verdict:	PASS
Date:	30/12/2008		
Temperature: 22°C	Air Pressure: 1014 hPa	Relative Humidity: 52%	Power Supply: 48 VDC
Remarks:			

Plot 7.4.12 Spurious emission measurements in 1000 - 18000 MHz at high carrier frequency, individual Tx chain

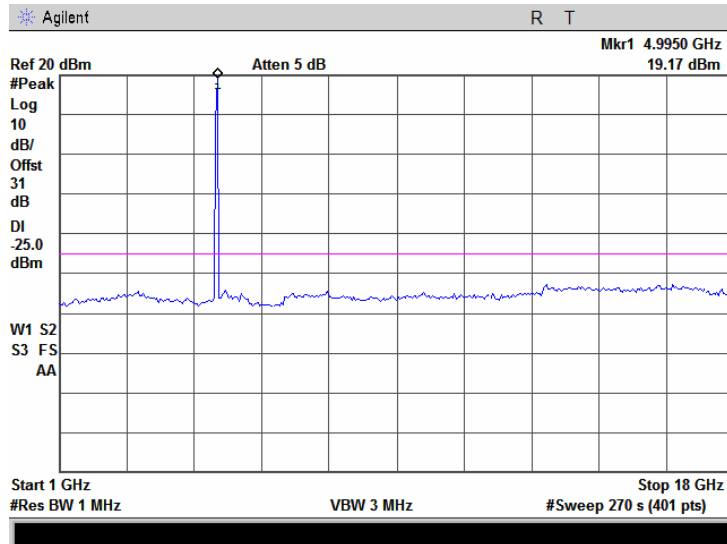

Plot 7.4.13 Spurious emission measurements in 18000 - 26500 MHz range at low carrier frequency, individual Tx chain

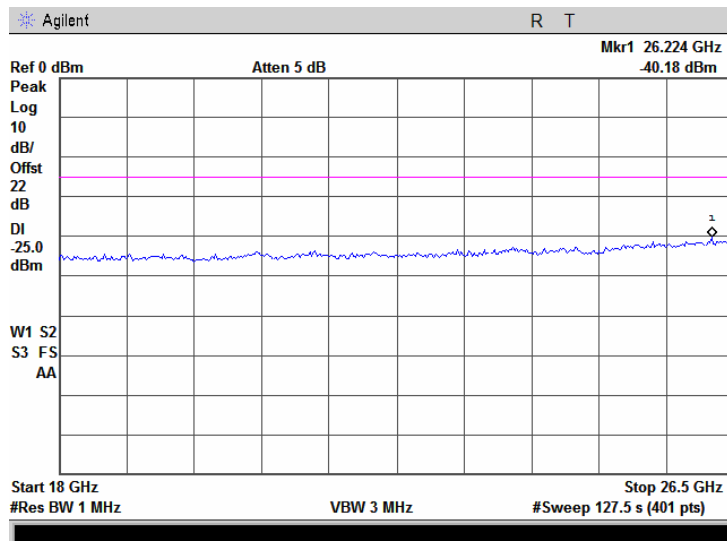

Test specification: FCC section 90.210, RSS-111 section 5.4, Conducted spurious emissions			
Test procedure: 47 CFR, Sections 2.1051 and 90.210(m); TIA/EIA-603-C, Section 2.2.13			
Test mode: Compliance	Verdict: PASS		
Date: 30/12/2008			
Temperature: 22°C	Air Pressure: 1014 hPa	Relative Humidity: 52%	Power Supply: 48 VDC
Remarks:			

Plot 7.4.14 Spurious emission measurements in 18000 - 26500 MHz range at mid carrier frequency, individual Tx chain

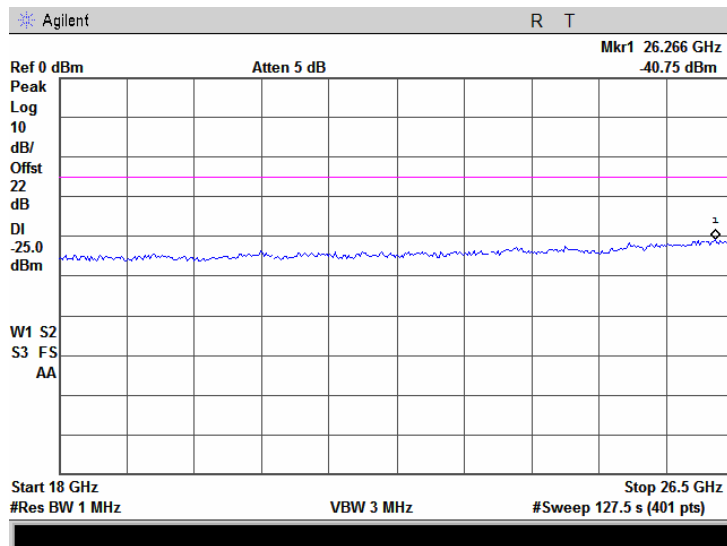

Plot 7.4.15 Spurious emission measurements in 18000 - 26500 MHz range at high carrier frequency, individual Tx chain

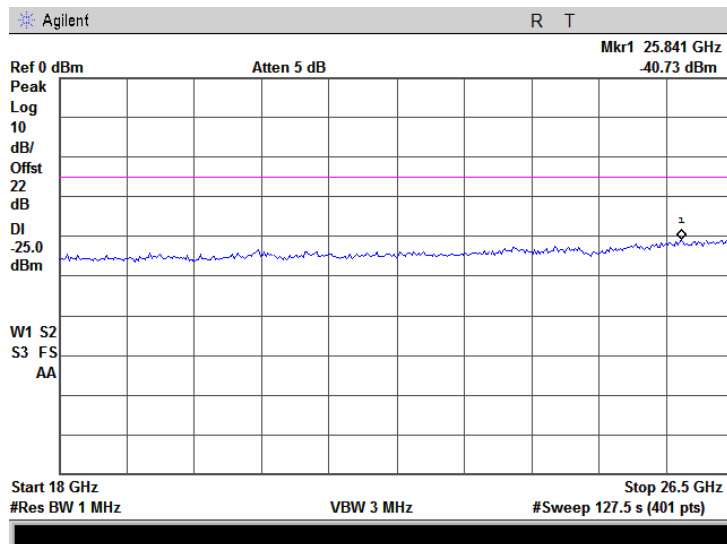

Test specification:	FCC section 90.210, RSS-111 section 5.4, Conducted spurious emissions		
Test procedure:	47 CFR, Sections 2.1051 and 90.210(m); TIA/EIA-603-C, Section 2.2.13		
Test mode:	Compliance	Verdict:	PASS
Date:	30/12/2008		
Temperature: 22°C	Air Pressure: 1014 hPa	Relative Humidity: 52%	Power Supply: 48 VDC
Remarks:			

Plot 7.4.16 Spurious emission measurements in 26500 - 40000 MHz range at low carrier frequency, individual Tx chain

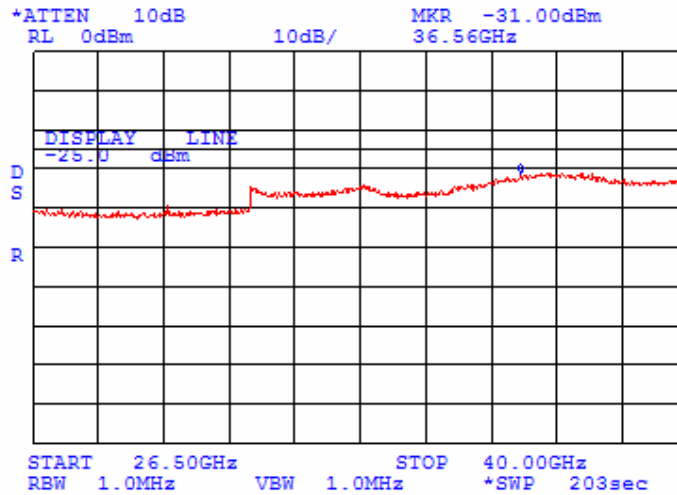

Plot 7.4.17 Spurious emission measurements in 26500 - 40000 MHz range at mid carrier frequency, individual Tx chain

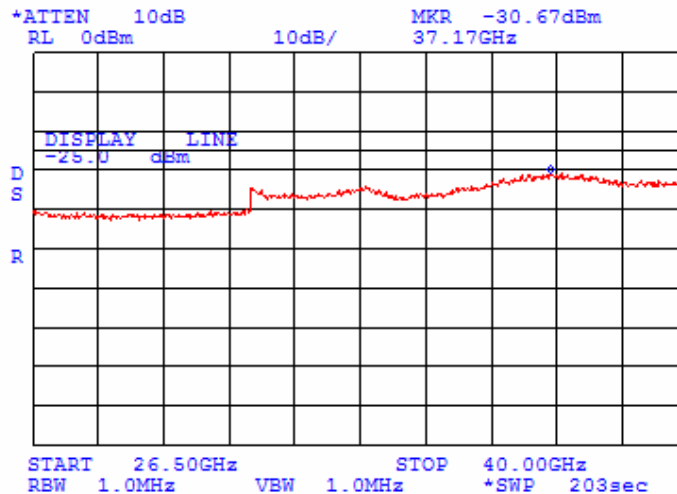

Test specification:		FCC section 90.210, RSS-111 section 5.4, Conducted spurious emissions	
Test procedure:		47 CFR, Sections 2.1051 and 90.210(m); TIA/EIA-603-C, Section 2.2.13	
Test mode:	Compliance	Verdict:	PASS
Date:	30/12/2008		
Temperature: 22°C	Air Pressure: 1014 hPa	Relative Humidity: 52%	Power Supply: 48 VDC
Remarks:			

Plot 7.4.18 Spurious emission measurements in 26500 - 40000 MHz range at high carrier frequency, individual Tx chain

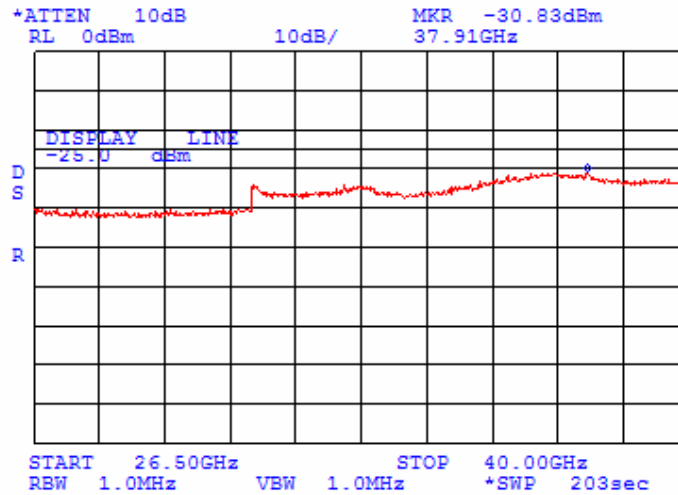

Test specification:	FCC section 90.210, RSS-111 section 5.4, Conducted spurious emissions		
Test procedure:	47 CFR, Sections 2.1051 and 90.210(m); TIA/EIA-603-C, Section 2.2.13		
Test mode:	Compliance	Verdict:	PASS
Date:	30/12/2008		
Temperature: 22°C	Air Pressure: 1014 hPa	Relative Humidity: 52%	Power Supply: 48 VDC
Remarks:			

Plot 7.4.19 Spurious emission measurements in 1000 - 18000 MHz range at low carrier frequency, combined Tx chains

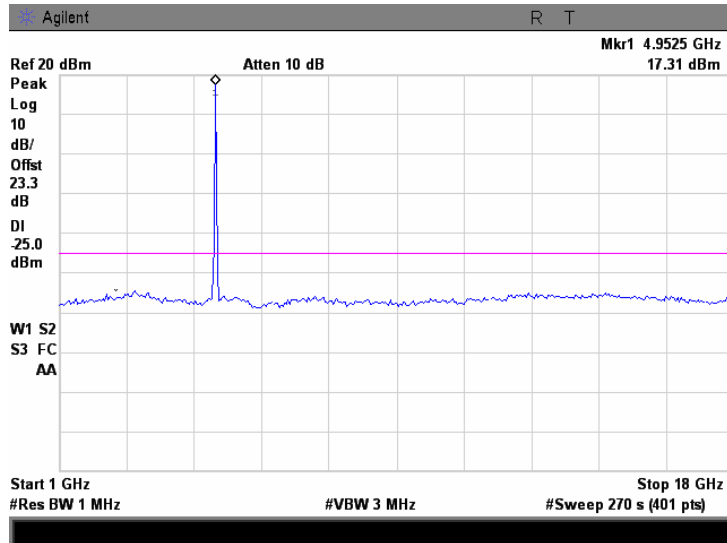

Plot 7.4.20 Spurious emission measurements in 1000 - 18000 MHz range at mid carrier frequency, combined Tx chains

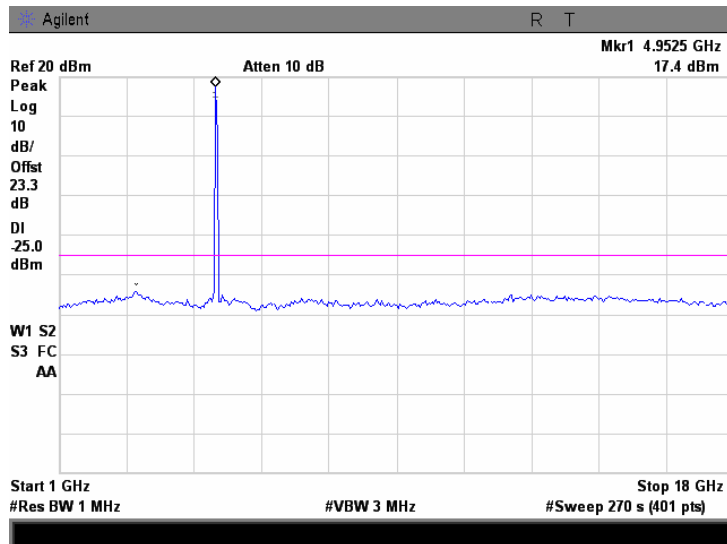

Test specification:		FCC section 90.210, RSS-111 section 5.4, Conducted spurious emissions	
Test procedure:		47 CFR, Sections 2.1051 and 90.210(m); TIA/EIA-603-C, Section 2.2.13	
Test mode:	Compliance	Verdict:	PASS
Date:	30/12/2008		
Temperature: 22°C	Air Pressure: 1014 hPa	Relative Humidity: 52%	Power Supply: 48 VDC
Remarks:			

Plot 7.4.21 Spurious emission measurements in 1000 - 18000 MHz at high carrier frequency, combined Tx chains

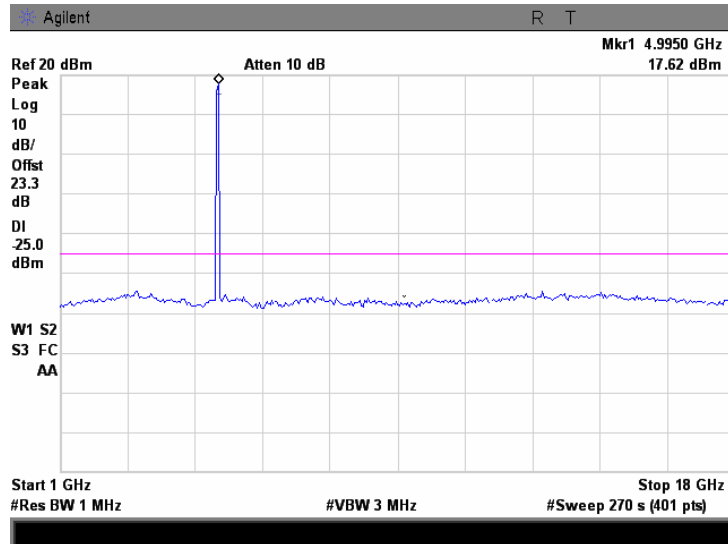



Test specification:	FCC section 90.210, RSS-111 section 5.4, Radiated spurious emissions		
Test procedure:	47 CFR, Sections 2.1053 and 90.210(m); TIA/EIA-603-C, Section 2.2.12		
Test mode:	Compliance	Verdict:	PASS
Date:	06/01/2009		
Temperature: 23°C	Air Pressure: 1007 hPa	Relative Humidity: 50%	Power Supply: 48 VDC
Remarks:			

7.5 Radiated spurious emission measurements

7.5.1 General

This test was performed to measure radiated spurious emissions from the EUT. Specification test limits are given in Table 7.5.1.

Table 7.5.1 Radiated spurious emission test limits

Frequency, MHz	Attenuation below carrier, dBc	ERP of spurious, dBm	Equivalent field strength limit @ 3m, dB(μ V/m)**
0.009 – 40000	55+10logP	-25	70.23

ERP of spurious = P (dBm) - {55 + 10 log P (W)} = -25 dBm

* - Excluding the in band emission within ± 150 % of the authorized bandwidth from the carrier

** - Equivalent field strength limit was calculated from maximum allowed ERP of spurious as follows:

$E = \sqrt{30 \times P \times 1.64} / r$, where P is ERP in Watts, 1.64 is numeric gain of ideal dipole and r is antenna to EUT distance in meters.

7.5.2 Test procedure for spurious emission field strength measurements in 9 kHz to 30 MHz band

7.5.2.1 The EUT was set up as shown in Figure 7.5.1, energized and the performance check was conducted.

7.5.2.2 The specified frequency range was investigated with antenna connected to spectrum analyzer. To find maximum radiation the turntable was rotated 360° and the measuring antenna was rotated around its vertical axis.

7.5.2.3 The worst test results (the lowest margins) were recorded in Table 7.5.2, Table 7.5.4, Table 7.5.6 and shown in the associated plots.

7.5.3 Test procedure for spurious emission field strength measurements above 30 MHz

7.5.3.1 The EUT was set up as shown in Figure 7.5.2, energized and the performance check was conducted.

7.5.3.2 The specified frequency range was investigated with antenna connected to spectrum analyzer. To find maximum radiation the turntable was rotated 360° and the measuring antenna height was swept from 1 to 4 m in both, vertical and horizontal, polarizations.

7.5.3.3 The worst test results (the lowest margins) were recorded in Table 7.5.2, Table 7.5.4, Table 7.5.6 and shown in the associated plots.

7.5.4 Test procedure for substitution ERP measurements of spurious

7.5.4.1 The test equipment was set up as shown in Figure 7.5.3 and energized.

7.5.4.2 RF signal generator was set to the frequency of investigated spurious emission and the RF output level was preliminary adjusted to produce the same field strength as it was measured from the EUT.

7.5.4.3 The test antenna height was swept from 1 to 4 m to find maximum emission from substitution antenna and RF signal generator output was fine adjusted to produce the same field strength as it was measured from the EUT.

7.5.4.4 The above procedure was performed in both, horizontal and vertical, polarizations of the test and substitution antennas.

7.5.4.5 The ERP of spurious emissions was calculated as a sum of signal generator output power in dBm and antenna gain in dBd reduced by cable loss in dB.

7.5.4.6 The above procedure was repeated at the rest of investigated frequencies.

7.5.4.7 The worst test results (the lowest margins) were recorded in Table 7.5.3, Table 7.5.5, Table 7.5.7 and shown in the associated plots.



Test specification:	FCC section 90.210, RSS-111 section 5.4, Radiated spurious emissions		
Test procedure:	47 CFR, Sections 2.1053 and 90.210(m); TIA/EIA-603-C, Section 2.2.12		
Test mode:	Compliance	Verdict:	PASS
Date:	06/01/2009		
Temperature: 23°C	Air Pressure: 1007 hPa	Relative Humidity: 50%	Power Supply: 48 VDC
Remarks:			

Figure 7.5.1 Setup for spurious emission field strength measurements in 9 kHz to 30 MHz band

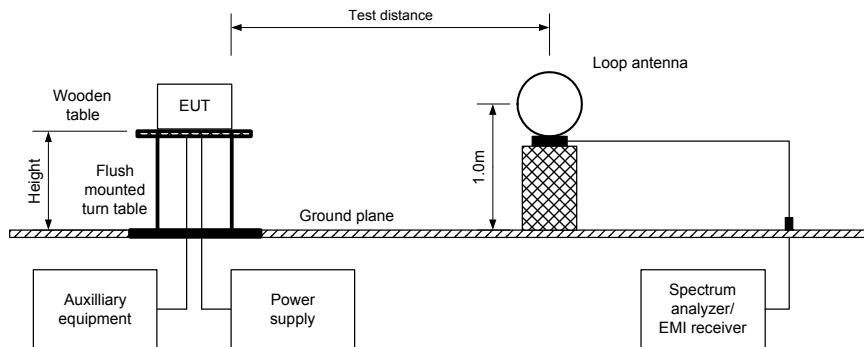
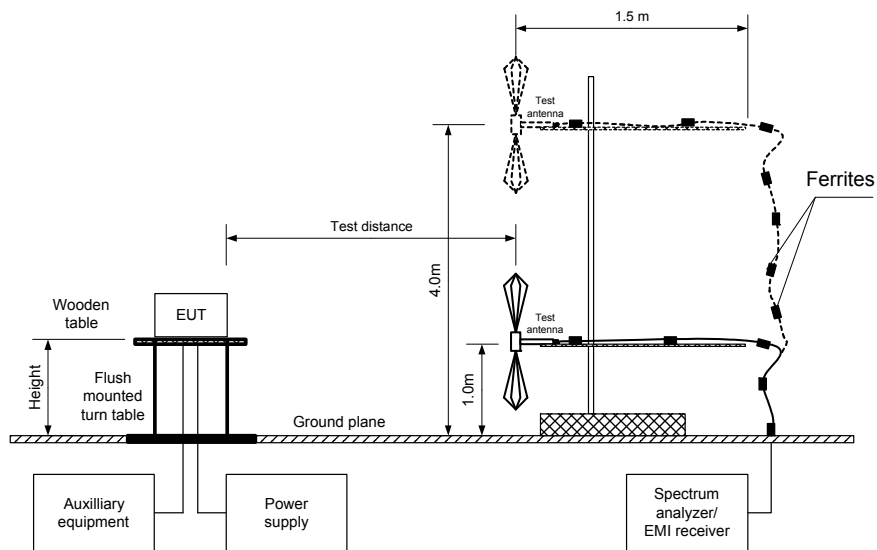

Figure 7.5.2 Setup for spurious emission field strength measurements above 30 MHz





HERMON LABORATORIES

Test specification:	FCC section 90.210, RSS-111 section 5.4, Radiated spurious emissions		
Test procedure:	47 CFR, Sections 2.1053 and 90.210(m); TIA/EIA-603-C, Section 2.2.12		
Test mode:	Compliance	Verdict:	PASS
Date:	06/01/2009		
Temperature: 23°C	Air Pressure: 1007 hPa	Relative Humidity: 50%	Power Supply: 48 VDC
Remarks:			

Figure 7.5.3 Setup for substitution ERP measurements of spurious

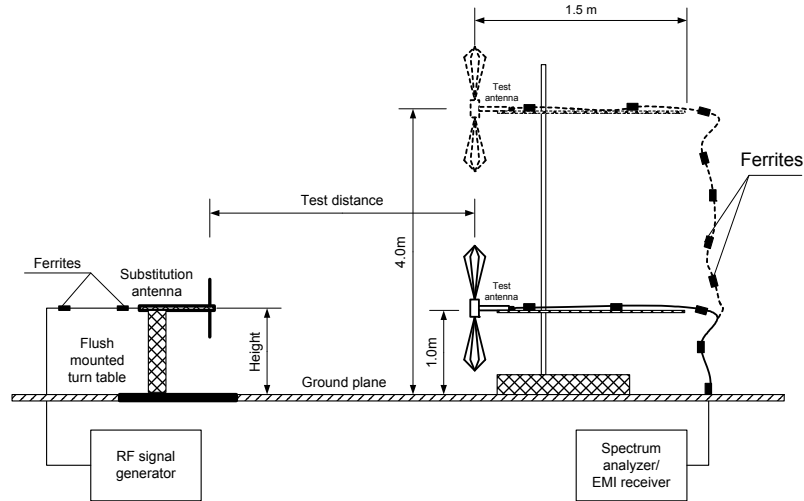

Test specification: FCC section 90.210, RSS-111 section 5.4, Radiated spurious emissions			
Test procedure: 47 CFR, Sections 2.1053 and 90.210(m); TIA/EIA-603-C, Section 2.2.12			
Test mode: Compliance	Verdict: PASS		
Date: 06/01/2009			
Temperature: 23°C	Air Pressure: 1007 hPa	Relative Humidity: 50%	Power Supply: 48 VDC
Remarks: 50 Ohm termination at the both RF connectors			

Table 7.5.2 Spurious emission field strength test results for 5 MHz channel bandwidth

ASSIGNED FREQUENCY RANGE: 4940 - 4990 MHz
TEST DISTANCE: 3 m
TEST SITE: OATS
EUT HEIGHT: 0.8 m
INVESTIGATED FREQUENCY RANGE: 0.009 – 40000 MHz
DETECTOR USED: Peak
VIDEO BANDWIDTH: > Resolution bandwidth
TEST ANTENNA TYPE: Active loop (9 kHz – 30 MHz)
Biconilog (30 MHz – 1000 MHz)
Double ridged guide (1000 MHz – 18000 MHz)
Standard gain horn (above 18000 MHz)
MODULATING SIGNAL: OFDM
BIT RATE: 32.5 Mbps BPSK
CHANNEL BANDWIDTH: 5 MHz
TRANSMITTER OUTPUT POWER SETTINGS: Maximum (according to Table 7.1.2)

Frequency, MHz	Field strength, dB(μV/m)	Limit, dB(μV/m)	Margin, dB*	RBW, kHz	Antenna polarization	Antenna height, m	Turn-table position**, degrees
Low carrier frequency							
9891.400	69.53	70.23	-0.70	1000	Vertical	1.2	76
Mid carrier frequency							
9929.900	66.52	70.23	-3.71	1000	Vertical	1.2	45
High carrier frequency							
9969.050	63.78	70.23	-6.45	1000	Vertical	1.2	55

*- Margin = Field strength of spurious – calculated field strength limit.

** - EUT front panel refers to 0 degrees position of turntable.

Table 7.5.3 Substitution ERP of spurious test results for 5 MHz channel bandwidth

ASSIGNED FREQUENCY RANGE: 4940 - 4990 MHz
TEST SITE: OATS
TEST DISTANCE: 3 m
SUBSTITUTION ANTENNA HEIGHT: 0.8 m
DETECTOR USED: Peak
VIDEO BANDWIDTH: > Resolution bandwidth
SUBSTITUTION ANTENNA TYPE: Double ridged guide (1000 MHz – 18000 MHz)

Frequency, MHz	Field strength, dB(μV/m)	RBW, kHz	Antenna polarization	RF generator output, dBm	Ant gain, dBd	Cable loss, dB	ERP, dBm	Limit, dBm	Margin, dB*	Verdict
Low carrier frequency										
9891.400	69.53	1000	Vertical	-30.58	9.76	7.04	-27.86	-25.00	-2.86	Pass
Mid carrier frequency										
9929.900	66.52	1000	Vertical	-33.59	9.79	7.04	-30.84	-25.00	-5.84	Pass
High carrier frequency										
9969.050	63.78	1000	Vertical	-36.33	9.82	7.04	-33.55	-25.00	-8.55	Pass

*- Margin = Spurious emission – specification limit.

Test specification: FCC section 90.210, RSS-111 section 5.4, Radiated spurious emissions	
Test procedure: 47 CFR, Sections 2.1053 and 90.210(m); TIA/EIA-603-C, Section 2.2.12	
Test mode: Compliance	Verdict: PASS
Date: 06/01/2009	
Temperature: 23°C	Air Pressure: 1007 hPa
Relative Humidity: 50%	
Power Supply: 48 VDC	
Remarks: 50 Ohm termination at the both RF connectors	

Table 7.5.4 Spurious emission field strength test results for 10 MHz channel bandwidth

ASSIGNED FREQUENCY RANGE: 4940 - 4990 MHz
 TEST DISTANCE: 3 m
 TEST SITE: OATS
 EUT HEIGHT: 0.8 m
 INVESTIGATED FREQUENCY RANGE: 0.009 – 40000 MHz
 DETECTOR USED: Peak
 VIDEO BANDWIDTH: > Resolution bandwidth
 TEST ANTENNA TYPE: Active loop (9 kHz – 30 MHz)
 Biconilog (30 MHz – 1000 MHz)
 Double ridged guide (1000 MHz – 18000 MHz)
 Standard gain horn (above 18000 MHz)
 MODULATING SIGNAL: OFDM
 BIT RATE: 65 Mbps 64QAM
 CHANNEL BANDWIDTH: 10 MHz
 TRANSMITTER OUTPUT POWER SETTINGS: Maximum (according to Table 7.1.4)

Frequency, MHz	Field strength, dB(μV/m)	Limit, dB(μV/m)	Margin, dB*	RBW, kHz	Antenna polarization	Antenna height, m	Turn-table position**, degrees
Low carrier frequency							
9888.800	62.04	70.23	-8.19	1000	Vert	1.2	76
Mid carrier frequency							
9929.250	60.08	70.23	-10.15	1000	Vert	1.2	45
High carrier frequency							
9969.625	60.79	70.23	-9.44	1000	Vert	1.2	55

*- Margin = Field strength of spurious – calculated field strength limit.

** - EUT front panel refers to 0 degrees position of turntable.

Table 7.5.5 Substitution ERP of spurious test results for 10 MHz channel bandwidth

ASSIGNED FREQUENCY RANGE: 4940 - 4990 MHz
 TEST SITE: OATS
 TEST DISTANCE: 3 m
 SUBSTITUTION ANTENNA HEIGHT: 0.8 m
 DETECTOR USED: Peak
 VIDEO BANDWIDTH: > Resolution bandwidth
 SUBSTITUTION ANTENNA TYPE: Double ridged guide (1000 MHz – 18000 MHz)

Frequency, MHz	Field strength, dB(μV/m)	RBW, kHz	Antenna polarization	RF generator output, dBm	Ant gain, dBd	Cable loss, dB	ERP, dBm	Limit, dBm	Margin, dB*	Verdict
Low carrier frequency										
9888.800	62.04	1000	Vertica	-38.07	9.76	7.04	-35.35	-25	-10.35	Pass
Mid carrier frequency										
9929.250	60.08	1000	Vertica	-40.03	9.79	7.04	-37.28	-25	-12.28	Pass
High carrier frequency										
9969.625	60.79	1000	Vertica	-39.32	9.82	7.04	-36.54	-25	-11.54	Pass

*- Margin = Spurious emission – specification limit.

Test specification: FCC section 90.210, RSS-111 section 5.4, Radiated spurious emissions	
Test procedure: 47 CFR, Sections 2.1053 and 90.210(m); TIA/EIA-603-C, Section 2.2.12	
Test mode: Compliance	Verdict: PASS
Date: 06/01/2009	
Temperature: 23°C	Air Pressure: 1007 hPa
Relative Humidity: 50%	
Power Supply: 48 VDC	
Remarks: 50 Ohm termination at the both RF connectors	

Table 7.5.6 Spurious emission field strength test results for 20 MHz channel bandwidth

ASSIGNED FREQUENCY RANGE: 4940 - 4990 MHz
TEST DISTANCE: 3 m
TEST SITE: OATS
EUT HEIGHT: 0.8 m
INVESTIGATED FREQUENCY RANGE: 0.009 – 40000 MHz
DETECTOR USED: Peak
VIDEO BANDWIDTH: > Resolution bandwidth
TEST ANTENNA TYPE: Active loop (9 kHz – 30 MHz)
Biconilog (30 MHz – 1000 MHz)
Double ridged guide (1000 MHz – 18000 MHz)
Standard gain horn (above 18000 MHz)
MODULATING SIGNAL: OFDM
BIT RATE: 130 Mbps 64QAM
CHANNEL BANDWIDTH: 20 MHz
TRANSMITTER OUTPUT POWER SETTINGS: Maximum (according to Table 7.1.6)

Frequency, MHz	Field strength, dB(μV/m)	Limit, dB(μV/m)	Margin, dB*	RBW, kHz	Antenna polarization	Antenna height, m	Turn-table position**, degrees
Low carrier frequency							
9902.750	59.78	70.23	-10.45	1000	Vertical	1.2	180
Mid carrier frequency							
9930.500	61.27	70.23	-8.96	1000	Vertical	1.2	180
High carrier frequency							
9958.750	63.02	70.23	-7.21	1000	Vertical	1.2	180

*- Margin = Field strength of spurious – calculated field strength limit.
**- EUT front panel refers to 0 degrees position of turntable.

Table 7.5.7 Substitution ERP of spurious test results for 20 MHz channel bandwidth

ASSIGNED FREQUENCY RANGE: 4940 - 4990 MHz
TEST SITE: OATS
TEST DISTANCE: 3 m
SUBSTITUTION ANTENNA HEIGHT: 0.8 m
DETECTOR USED: Peak
VIDEO BANDWIDTH: > Resolution bandwidth
SUBSTITUTION ANTENNA TYPE: Double ridged guide (1000 MHz – 18000 MHz)

Frequency, MHz	Field strength, dB(μV/m)	RBW, kHz	Antenna polarization	RF generator output, dBm	Ant gain, dBd	Cable loss, dB	ERP, dBm	Limit, dBm	Margin, dB*	Verdict
Low carrier frequency										
9902.750	59.78	1000	Vertical	-42.49	11.7	5.9	-36.67	-25.00	-11.67	Pass
Mid carrier frequency										
9930.500	61.27	1000	Vertical	-41.05	11.7	5.9	-35.20	-25.00	-10.20	Pass
High carrier frequency										
9958.750	63.02	1000	Vertical	-38.99	11.8	5.9	-33.11	-28.00	-8.11	Pass

*- Margin = Spurious emission – specification limit.

Reference numbers of test equipment used

HL 0446	HL 0521	HL 0554	HL 0604	HL 0661	HL 0768	HL 0769	HL 1293
HL 1296	HL 1424	HL 1984	HL 2254	HL 2387	HL 2432	HL 3121	HL 3123
HL 3207	HL 3473	HL 3532	HL 3534	HL 3535	HL 3559		

Full description is given in Appendix A.

Test specification: FCC section 90.210, RSS-111 section 5.4, Radiated spurious emissions			
Test procedure: 47 CFR, Sections 2.1053 and 90.210(m); TIA/EIA-603-C, Section 2.2.12			
Test mode: Compliance	Verdict: PASS		
Date: 06/01/2009			
Temperature: 23°C	Air Pressure: 1007 hPa	Relative Humidity: 50%	Power Supply: 48 VDC
Remarks: 50 Ohm termination at the both RF connectors			

Plot 7.5.1 Radiated emission measurements in 9 - 150 kHz range

TEST SITE: Semi anechoic chamber
 CARRIER FREQUENCY: Low
 CHANNEL BANDWIDTH: 5 MHz
 ANTENNA POLARIZATION: Vertical and Horizontal
 TEST DISTANCE: 3 m

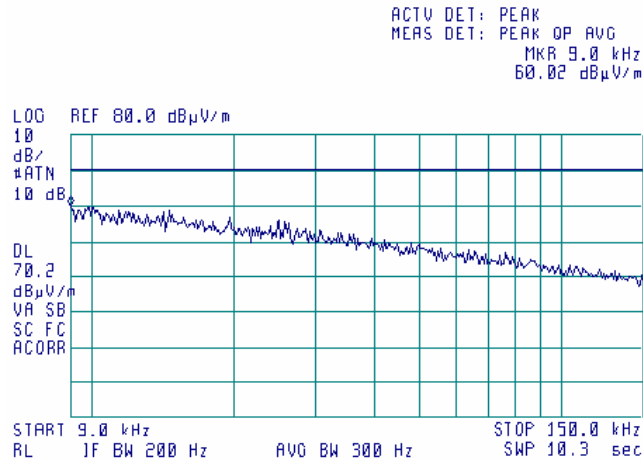

Plot 7.5.2 Radiated emission measurements in 9 - 150 kHz range

TEST SITE: Semi anechoic chamber
 CARRIER FREQUENCY: Mid
 CHANNEL BANDWIDTH: 5 MHz
 ANTENNA POLARIZATION: Vertical and Horizontal
 TEST DISTANCE: 3 m

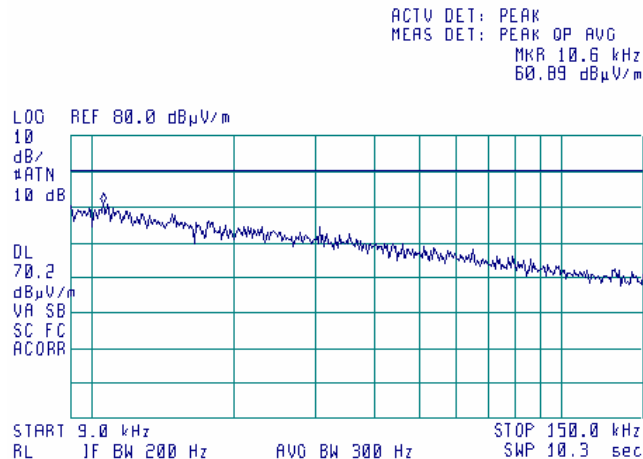

Test specification: FCC section 90.210, RSS-111 section 5.4, Radiated spurious emissions			
Test procedure: 47 CFR, Sections 2.1053 and 90.210(m); TIA/EIA-603-C, Section 2.2.12			
Test mode: Compliance	Verdict: PASS		
Date: 06/01/2009			
Temperature: 23°C	Air Pressure: 1007 hPa	Relative Humidity: 50%	Power Supply: 48 VDC
Remarks: 50 Ohm termination at the both RF connectors			

Plot 7.5.3 Radiated emission measurements in 9 - 150 kHz range

TEST SITE:	Semi anechoic chamber
CARRIER FREQUENCY:	High
CHANNEL BANDWIDTH:	5 MHz
ANTENNA POLARIZATION:	Vertical and Horizontal
TEST DISTANCE:	3 m

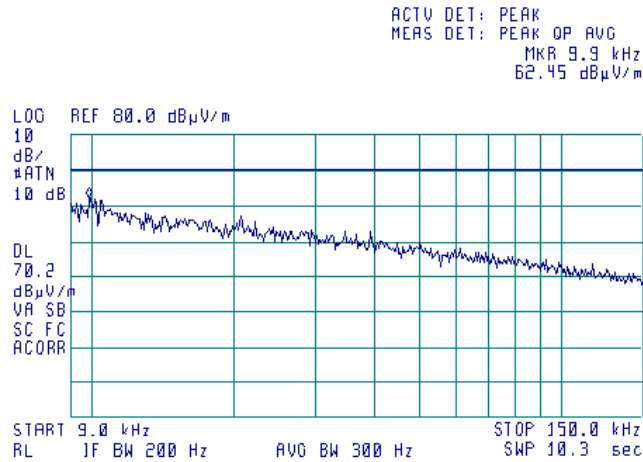

Plot 7.5.4 Radiated emission measurements in 0.15 - 30 MHz range

TEST SITE:	Semi anechoic chamber
CARRIER FREQUENCY:	Low
CHANNEL BANDWIDTH:	5 MHz
ANTENNA POLARIZATION:	Vertical and Horizontal
TEST DISTANCE:	3 m

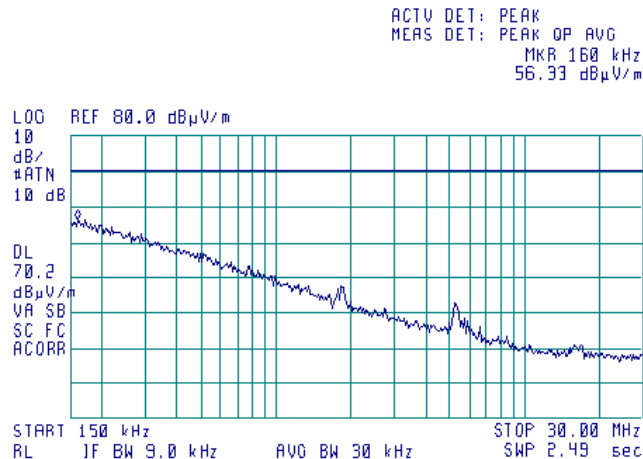

Test specification: FCC section 90.210, RSS-111 section 5.4, Radiated spurious emissions			
Test procedure: 47 CFR, Sections 2.1053 and 90.210(m); TIA/EIA-603-C, Section 2.2.12			
Test mode: Compliance	Verdict: PASS		
Date: 06/01/2009			
Temperature: 23°C	Air Pressure: 1007 hPa	Relative Humidity: 50%	Power Supply: 48 VDC
Remarks: 50 Ohm termination at the both RF connectors			

Plot 7.5.5 Radiated emission measurements in 0.15 - 30 MHz range

TEST SITE: Semi anechoic chamber
 CARRIER FREQUENCY: Mid
 CHANNEL BANDWIDTH: 5 MHz
 ANTENNA POLARIZATION: Vertical and Horizontal
 TEST DISTANCE: 3 m

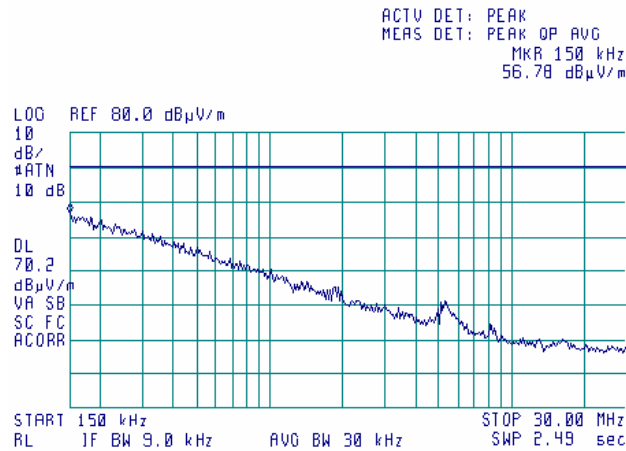

Plot 7.5.6 Radiated emission measurements in 0.15 - 30 MHz range

TEST SITE: Semi anechoic chamber
 CARRIER FREQUENCY: High
 CHANNEL BANDWIDTH: 5 MHz
 ANTENNA POLARIZATION: Vertical and Horizontal
 TEST DISTANCE: 3 m

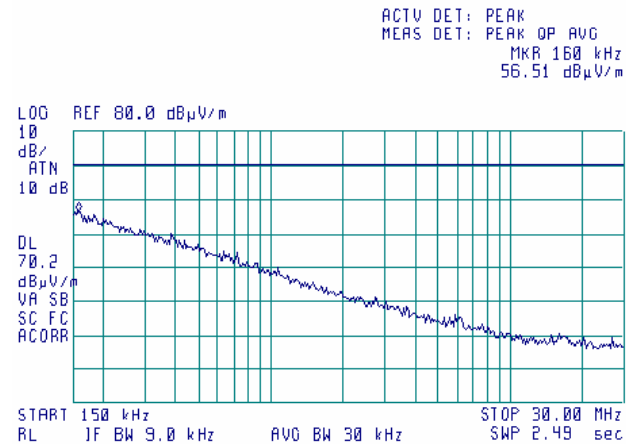

Test specification: FCC section 90.210, RSS-111 section 5.4, Radiated spurious emissions			
Test procedure: 47 CFR, Sections 2.1053 and 90.210(m); TIA/EIA-603-C, Section 2.2.12			
Test mode: Compliance	Verdict: PASS		
Date: 06/01/2009			
Temperature: 23°C	Air Pressure: 1007 hPa	Relative Humidity: 50%	Power Supply: 48 VDC
Remarks: 50 Ohm termination at the both RF connectors			

Plot 7.5.7 Radiated emission measurements in 30 - 1000 MHz range

TEST SITE: Semi anechoic chamber
 CARRIER FREQUENCY: Low
 CHANNEL BANDWIDTH: 5 MHz
 ANTENNA POLARIZATION: Vertical and Horizontal
 TEST DISTANCE: 3 m

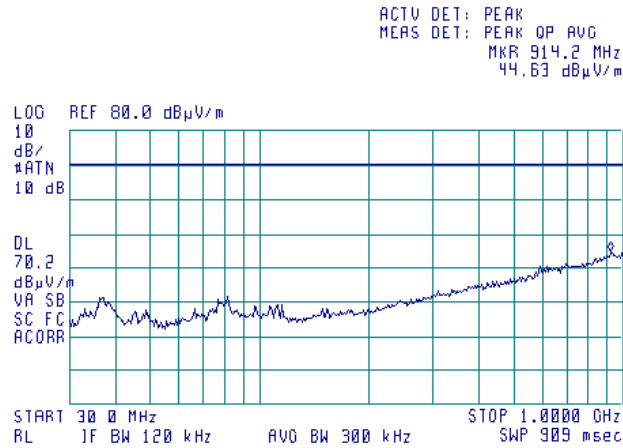

Plot 7.5.8 Radiated emission measurements in 30 - 1000 MHz range

TEST SITE: Semi anechoic chamber
 CARRIER FREQUENCY: Mid
 CHANNEL BANDWIDTH: 5 MHz
 ANTENNA POLARIZATION: Vertical and Horizontal
 TEST DISTANCE: 3 m

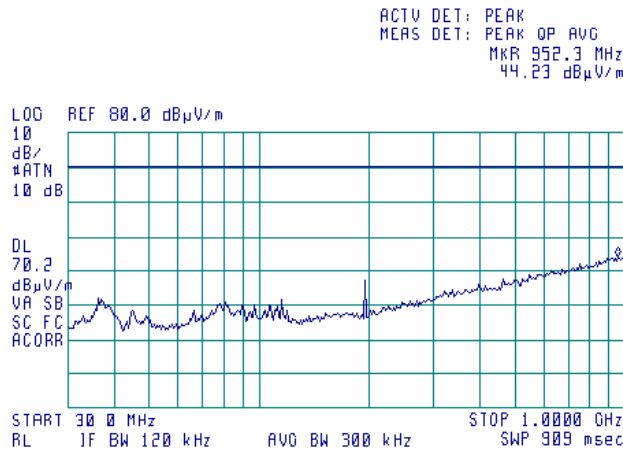

Test specification: FCC section 90.210, RSS-111 section 5.4, Radiated spurious emissions			
Test procedure: 47 CFR, Sections 2.1053 and 90.210(m); TIA/EIA-603-C, Section 2.2.12			
Test mode: Compliance	Verdict: PASS		
Date: 06/01/2009			
Temperature: 23°C	Air Pressure: 1007 hPa	Relative Humidity: 50%	Power Supply: 48 VDC
Remarks: 50 Ohm termination at the both RF connectors			

Plot 7.5.9 Radiated emission measurements in 30 - 1000 MHz range

TEST SITE: Semi anechoic chamber
 CARRIER FREQUENCY: High
 CHANNEL BANDWIDTH: 5 MHz
 ANTENNA POLARIZATION: Vertical and Horizontal
 TEST DISTANCE: 3 m

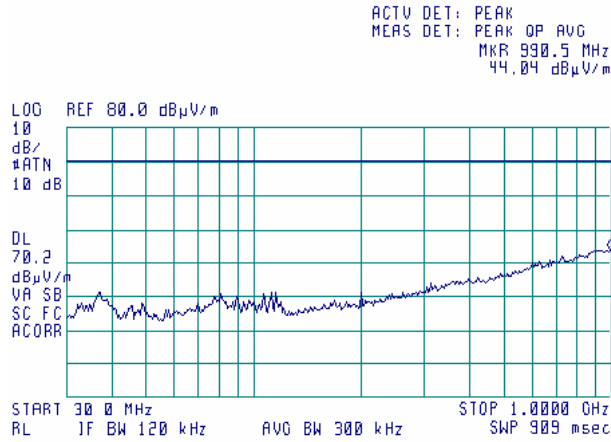

Plot 7.5.10 Radiated emission measurements in 1000 – 2900 MHz range

TEST SITE: Semi anechoic chamber
 CARRIER FREQUENCY: Low
 CHANNEL BANDWIDTH: 5 MHz
 ANTENNA POLARIZATION: Vertical and Horizontal
 TEST DISTANCE: 3 m

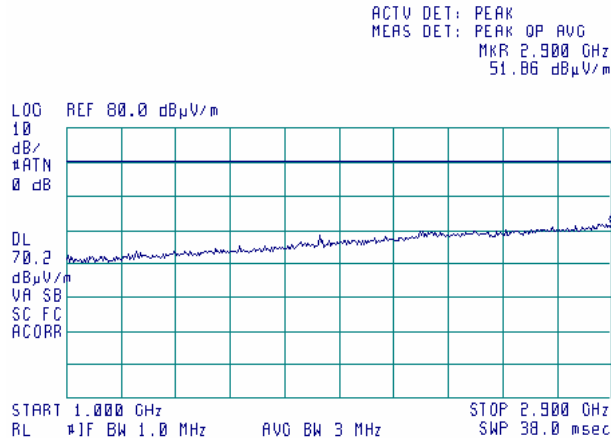

Test specification: FCC section 90.210, RSS-111 section 5.4, Radiated spurious emissions			
Test procedure: 47 CFR, Sections 2.1053 and 90.210(m); TIA/EIA-603-C, Section 2.2.12			
Test mode: Compliance	Verdict: PASS		
Date: 06/01/2009			
Temperature: 23°C	Air Pressure: 1007 hPa	Relative Humidity: 50%	Power Supply: 48 VDC
Remarks: 50 Ohm termination at the both RF connectors			

Plot 7.5.11 Radiated emission measurements in 1000 – 2900 MHz range

TEST SITE: Semi anechoic chamber
 CARRIER FREQUENCY: Mid
 CHANNEL BANDWIDTH: 5 MHz
 ANTENNA POLARIZATION: Vertical and Horizontal
 TEST DISTANCE: 3 m

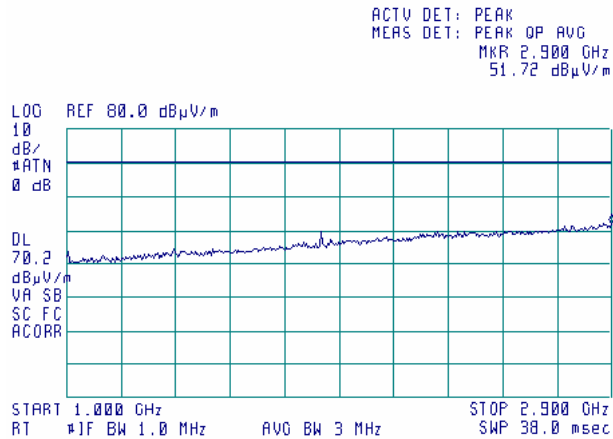

Plot 7.5.12 Radiated emission measurements in 1000 – 2900 MHz range

TEST SITE: Semi anechoic chamber
 CARRIER FREQUENCY: High
 CHANNEL BANDWIDTH: 5 MHz
 ANTENNA POLARIZATION: Vertical and Horizontal
 TEST DISTANCE: 3 m

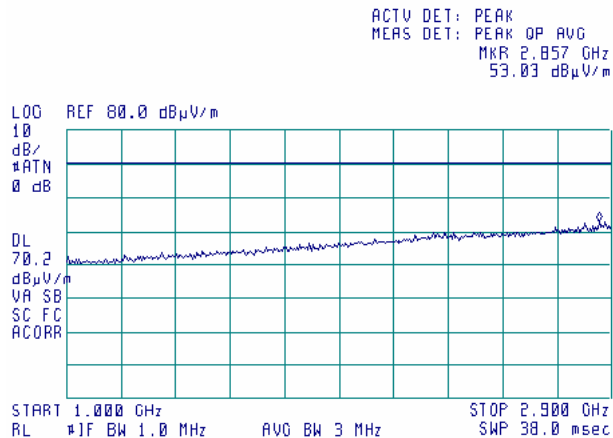

Test specification:	FCC section 90.210, RSS-111 section 5.4, Radiated spurious emissions		
Test procedure:	47 CFR, Sections 2.1053 and 90.210(m); TIA/EIA-603-C, Section 2.2.12		
Test mode:	Compliance	Verdict:	PASS
Date:	06/01/2009		
Temperature: 23°C	Air Pressure: 1007 hPa	Relative Humidity: 50%	Power Supply: 48 VDC
Remarks: 50 Ohm termination at the both RF connectors			

Plot 7.5.13 Radiated emission measurements in 2900 – 14000 MHz range

TEST SITE:	Semi anechoic chamber
CHANNEL BANDWIDTH	5 MHz
CARRIER FREQUENCY:	Low
ANTENNA POLARIZATION:	Vertical and Horizontal
TEST DISTANCE:	3 m

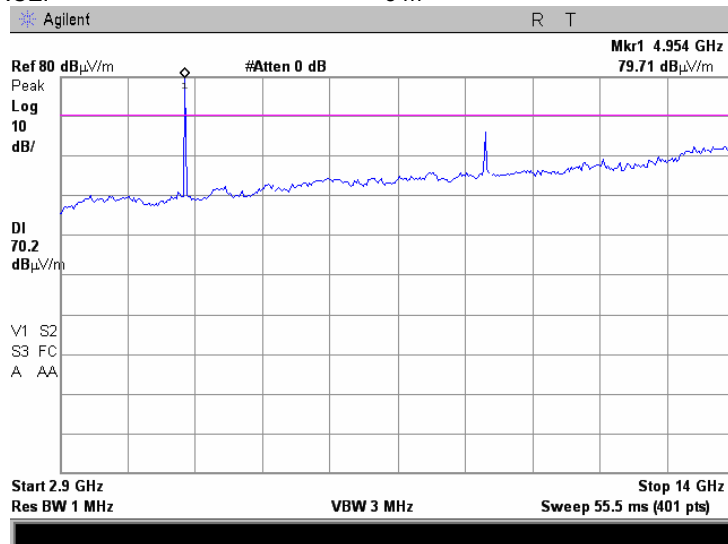

Test specification: FCC section 90.210, RSS-111 section 5.4, Radiated spurious emissions			
Test procedure: 47 CFR, Sections 2.1053 and 90.210(m); TIA/EIA-603-C, Section 2.2.12			
Test mode: Compliance	Verdict: PASS		
Date: 06/01/2009			
Temperature: 23°C	Air Pressure: 1007 hPa	Relative Humidity: 50%	Power Supply: 48 VDC
Remarks: 50 Ohm termination at the both RF connectors			

Plot 7.5.14 Radiated emission measurements at 9893 MHz

TEST SITE: Semi anechoic chamber
 CHANNEL BANDWIDTH: 5 MHz
 CARRIER FREQUENCY: Low
 ANTENNA POLARIZATION: Vertical
 TEST DISTANCE: 3 m

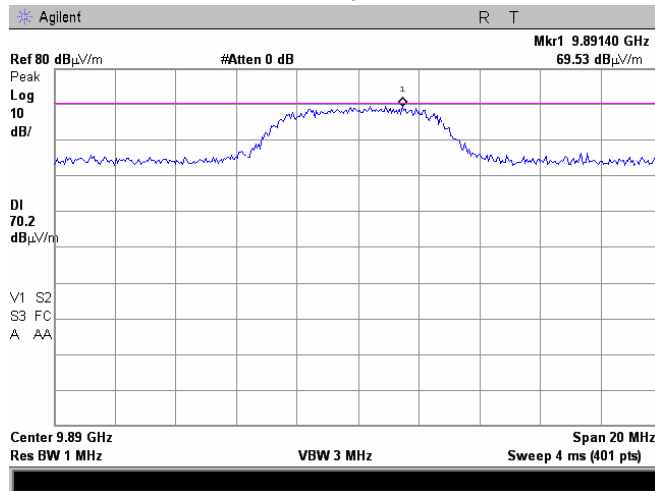

Plot 7.5.15 Radiated emission measurements at 9893 MHz

TEST SITE: Semi anechoic chamber
 CHANNEL BANDWIDTH: 5 MHz
 CARRIER FREQUENCY: Low
 ANTENNA POLARIZATION: Horizontal
 TEST DISTANCE: 3 m

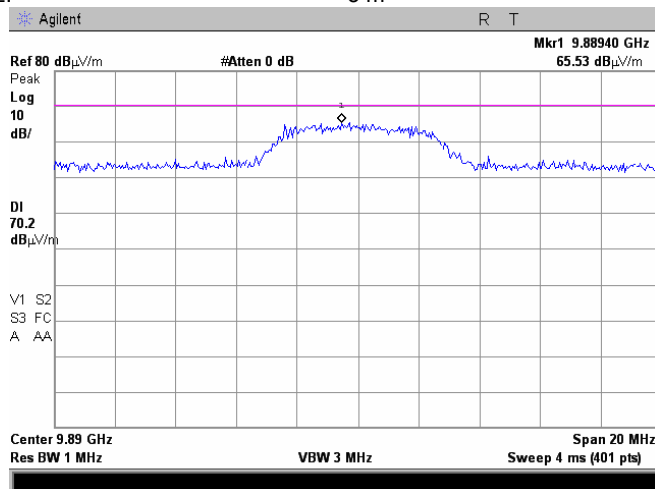

Test specification: FCC section 90.210, RSS-111 section 5.4, Radiated spurious emissions			
Test procedure: 47 CFR, Sections 2.1053 and 90.210(m); TIA/EIA-603-C, Section 2.2.12			
Test mode: Compliance	Verdict: PASS		
Date: 06/01/2009			
Temperature: 23°C	Air Pressure: 1007 hPa	Relative Humidity: 50%	Power Supply: 48 VDC
Remarks: 50 Ohm termination at the both RF connectors			

Plot 7.5.16 Radiated emission measurements in 2900 – 14000 MHz range

TEST SITE: Semi anechoic chamber
 CHANNEL BANDWIDTH: 5 MHz
 CARRIER FREQUENCY: Mid
 ANTENNA POLARIZATION: Vertical and Horizontal
 TEST DISTANCE: 3 m

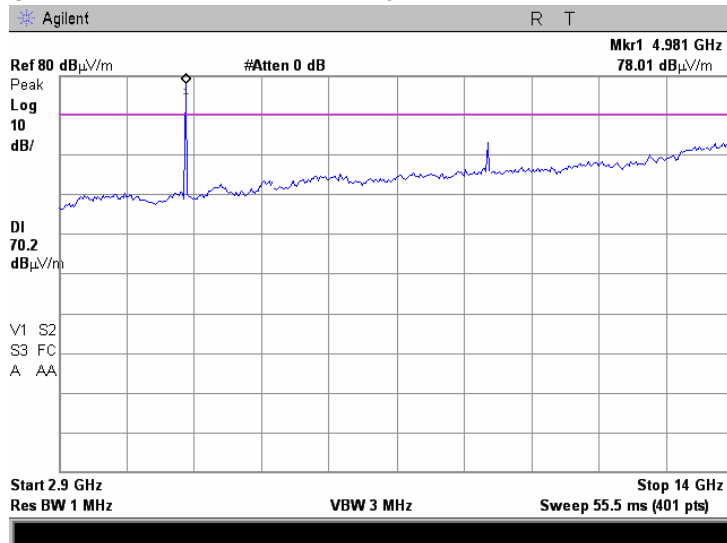

Test specification: FCC section 90.210, RSS-111 section 5.4, Radiated spurious emissions			
Test procedure: 47 CFR, Sections 2.1053 and 90.210(m); TIA/EIA-603-C, Section 2.2.12			
Test mode: Compliance	Verdict: PASS		
Date: 06/01/2009			
Temperature: 23°C	Air Pressure: 1007 hPa	Relative Humidity: 50%	Power Supply: 48 VDC
Remarks: 50 Ohm termination at the both RF connectors			

Plot 7.5.17 Radiated emission measurements at 9930.0 MHz

TEST SITE: Semi anechoic chamber
 CHANNEL BANDWIDTH: 5 MHz
 CARRIER FREQUENCY: Mid
 ANTENNA POLARIZATION: Vertical
 TEST DISTANCE: 3 m

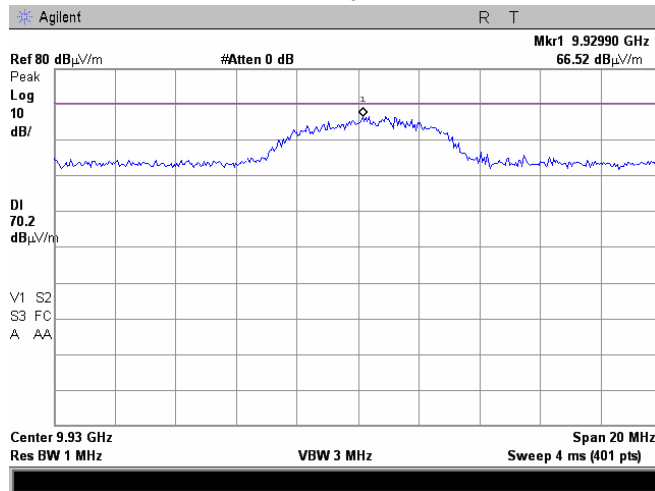

Plot 7.5.18 Radiated emission measurements at 9930.0 MHz

TEST SITE: Semi anechoic chamber
 CHANNEL BANDWIDTH: 5 MHz
 CARRIER FREQUENCY: Mid
 ANTENNA POLARIZATION: Horizontal
 TEST DISTANCE: 3 m

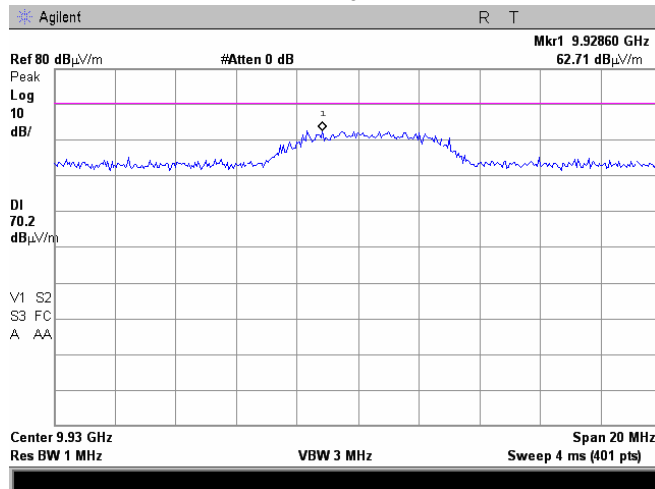

Test specification: FCC section 90.210, RSS-111 section 5.4, Radiated spurious emissions			
Test procedure: 47 CFR, Sections 2.1053 and 90.210(m); TIA/EIA-603-C, Section 2.2.12			
Test mode: Compliance	Verdict: PASS		
Date: 06/01/2009			
Temperature: 23°C	Air Pressure: 1007 hPa	Relative Humidity: 50%	Power Supply: 48 VDC
Remarks: 50 Ohm termination at the both RF connectors			

Plot 7.5.19 Radiated emission measurements in 2900 – 14000 MHz range

TEST SITE:	Semi anechoic chamber
CHANNEL BANDWIDTH:	5 MHz
CARRIER FREQUENCY:	High
ANTENNA POLARIZATION:	Vertical and Horizontal
TEST DISTANCE:	3 m

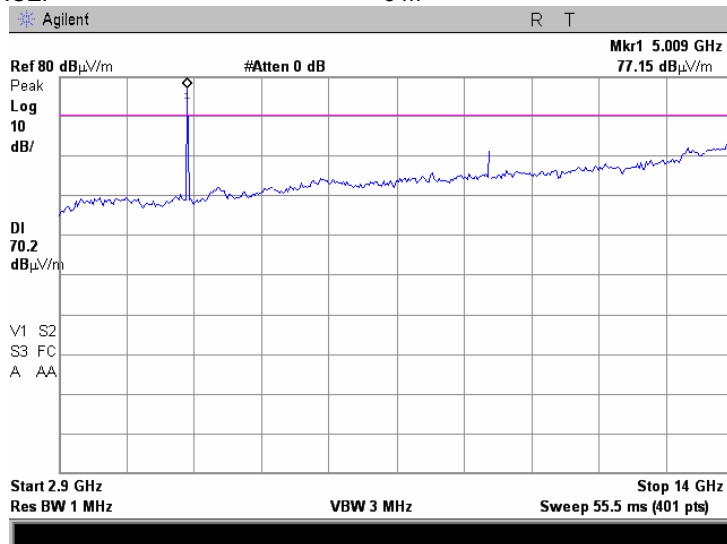

Test specification: FCC section 90.210, RSS-111 section 5.4, Radiated spurious emissions			
Test procedure: 47 CFR, Sections 2.1053 and 90.210(m); TIA/EIA-603-C, Section 2.2.12			
Test mode: Compliance	Verdict: PASS		
Date: 06/01/2009			
Temperature: 23°C	Air Pressure: 1007 hPa	Relative Humidity: 50%	Power Supply: 48 VDC
Remarks: 50 Ohm termination at the both RF connectors			

Plot 7.5.20 Radiated emission measurements at 9976.100 MHz

TEST SITE: Semi anechoic chamber
 CHANNEL BANDWIDTH: 5 MHz
 CARRIER FREQUENCY: High
 ANTENNA POLARIZATION: Vertical
 TEST DISTANCE: 3 m

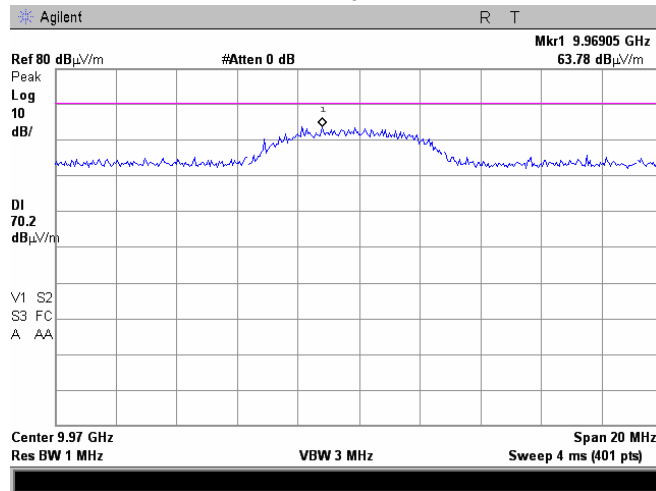

Plot 7.5.21 Radiated emission measurements at 9976.100 MHz

TEST SITE: Semi anechoic chamber
 CHANNEL BANDWIDTH: 5 MHz
 CARRIER FREQUENCY: High
 ANTENNA POLARIZATION: Horizontal
 TEST DISTANCE: 3 m

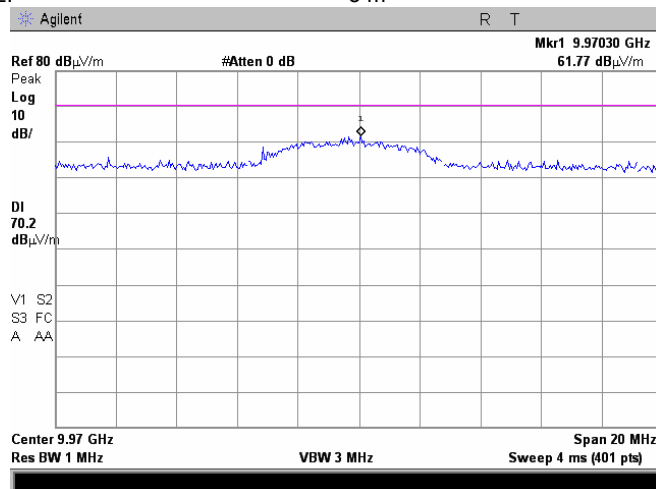

Test specification: FCC section 90.210, RSS-111 section 5.4, Radiated spurious emissions			
Test procedure: 47 CFR, Sections 2.1053 and 90.210(m); TIA/EIA-603-C, Section 2.2.12			
Test mode: Compliance	Verdict: PASS		
Date: 06/01/2009			
Temperature: 23°C	Air Pressure: 1007 hPa	Relative Humidity: 50%	Power Supply: 48 VDC
Remarks: 50 Ohm termination at the both RF connectors			

Plot 7.5.22 Radiated emission measurements in 14000 – 18000 MHz range

TEST SITE: OATS
 CHANNEL BANDWIDTH: 5 MHz
 CARRIER FREQUENCY: Low
 ANTENNA POLARIZATION: Vertical and Horizontal
 TEST DISTANCE: 3 m

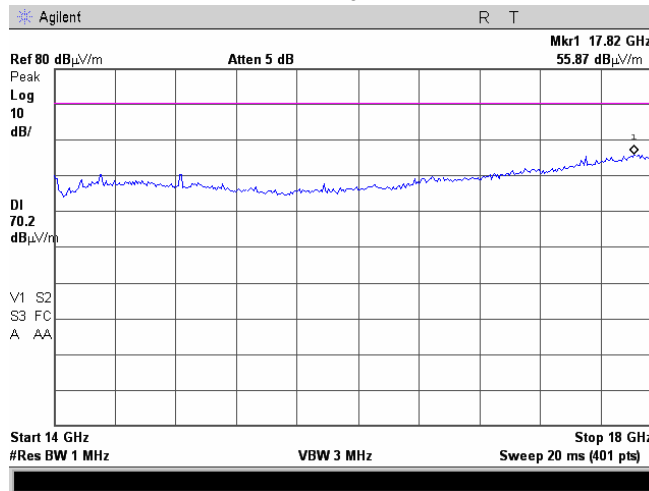

Plot 7.5.23 Radiated emission measurements in 14000 – 18000 MHz range

TEST SITE: OATS
 CHANNEL BANDWIDTH: 5 MHz
 CARRIER FREQUENCY: Mid
 ANTENNA POLARIZATION: Vertical and Horizontal
 TEST DISTANCE: 3 m

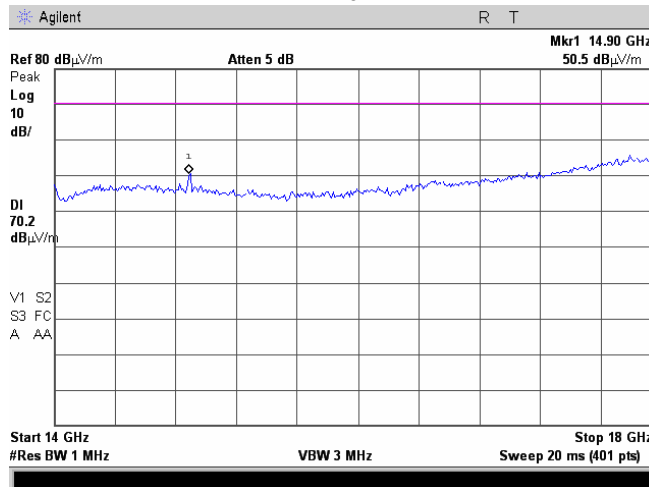

Test specification: FCC section 90.210, RSS-111 section 5.4, Radiated spurious emissions			
Test procedure: 47 CFR, Sections 2.1053 and 90.210(m); TIA/EIA-603-C, Section 2.2.12			
Test mode: Compliance	Verdict: PASS		
Date: 06/01/2009			
Temperature: 23°C	Air Pressure: 1007 hPa	Relative Humidity: 50%	Power Supply: 48 VDC
Remarks: 50 Ohm termination at the both RF connectors			

Plot 7.5.24 Radiated emission measurements in 14000 – 18000 MHz range

TEST SITE: OATS
 CHANNEL BANDWIDTH: 5 MHz
 CARRIER FREQUENCY: High
 ANTENNA POLARIZATION: Vertical and Horizontal
 TEST DISTANCE: 3 m

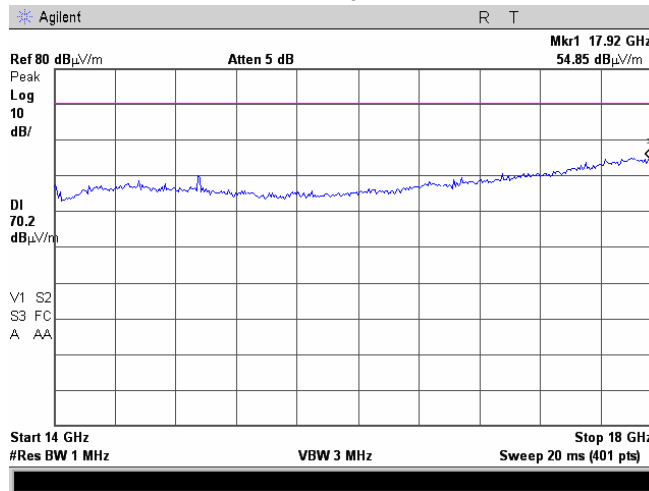

Plot 7.5.25 Radiated emission measurements in 2900 – 14000 MHz range

TEST SITE: Semi anechoic chamber
 CARRIER FREQUENCY: Low
 CHANNEL BANDWIDTH: 10 MHz
 ANTENNA POLARIZATION: Vertical and Horizontal
 TEST DISTANCE: 3 m

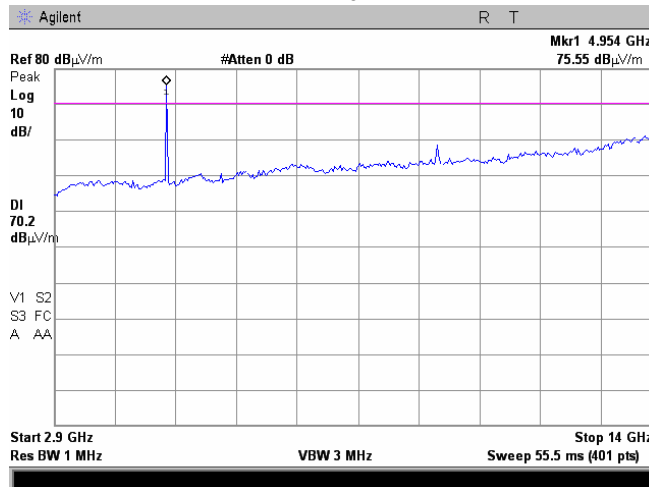

Test specification: FCC section 90.210, RSS-111 section 5.4, Radiated spurious emissions			
Test procedure: 47 CFR, Sections 2.1053 and 90.210(m); TIA/EIA-603-C, Section 2.2.12			
Test mode: Compliance	Verdict: PASS		
Date: 06/01/2009			
Temperature: 23°C	Air Pressure: 1007 hPa	Relative Humidity: 50%	Power Supply: 48 VDC
Remarks: 50 Ohm termination at the both RF connectors			

Plot 7.5.26 Radiated emission measurements at 9893 MHz

TEST SITE: Semi anechoic chamber
 CARRIER FREQUENCY: Low
 CHANNEL BANDWIDTH: 10 MHz
 ANTENNA POLARIZATION: Vertical
 TEST DISTANCE: 3 m

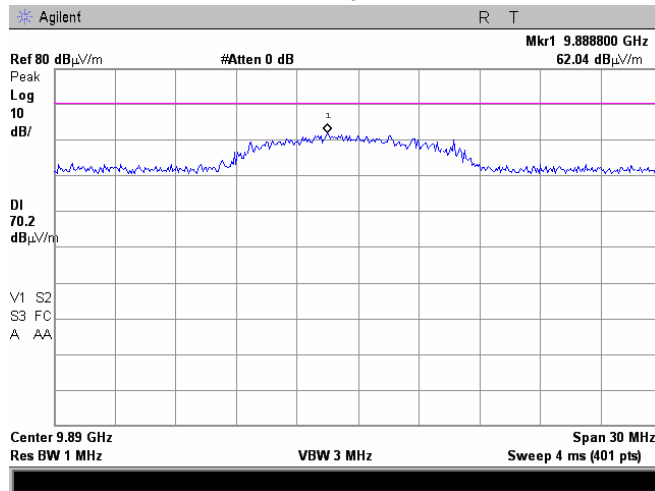

Plot 7.5.27 Radiated emission measurements at 9893 MHz

TEST SITE: Semi anechoic chamber
 CARRIER FREQUENCY: Low
 CHANNEL BANDWIDTH: 10 MHz
 ANTENNA POLARIZATION: Horizontal
 TEST DISTANCE: 3 m

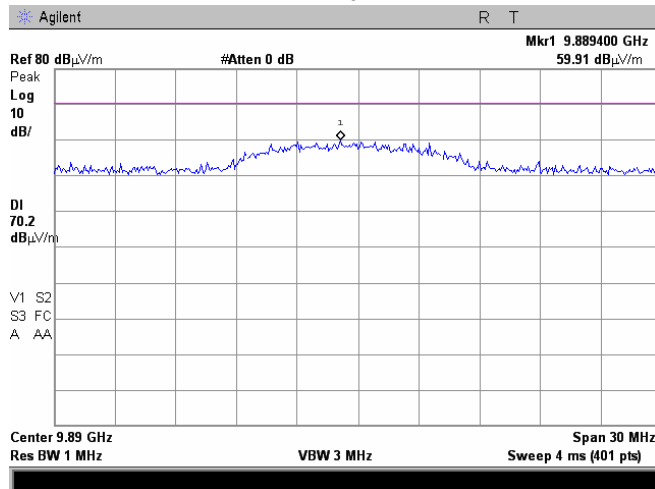

Test specification: FCC section 90.210, RSS-111 section 5.4, Radiated spurious emissions			
Test procedure: 47 CFR, Sections 2.1053 and 90.210(m); TIA/EIA-603-C, Section 2.2.12			
Test mode: Compliance	Verdict: PASS		
Date: 06/01/2009			
Temperature: 23°C	Air Pressure: 1007 hPa	Relative Humidity: 50%	Power Supply: 48 VDC
Remarks: 50 Ohm termination at the both RF connectors			

Plot 7.5.28 Radiated emission measurements in 2900 – 14000 MHz range

TEST SITE: Semi anechoic chamber
 CARRIER FREQUENCY: Mid
 CHANNEL BANDWIDTH: 10 MHz
 ANTENNA POLARIZATION: Vertical and Horizontal
 TEST DISTANCE: 3 m

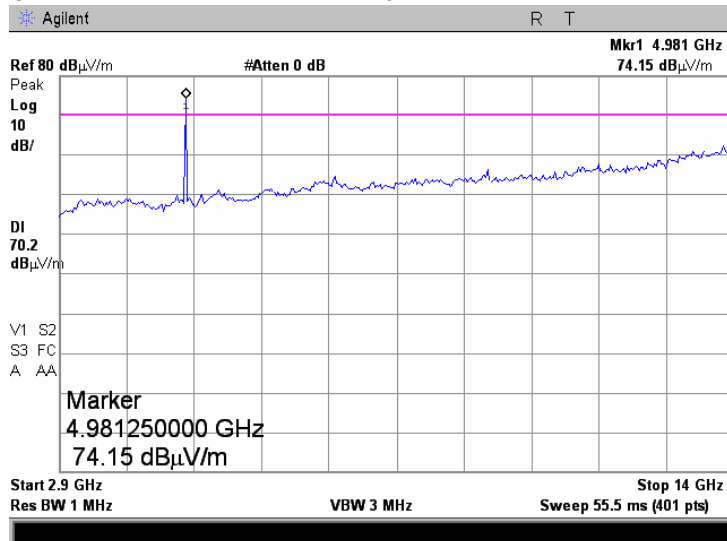

Test specification: FCC section 90.210, RSS-111 section 5.4, Radiated spurious emissions			
Test procedure: 47 CFR, Sections 2.1053 and 90.210(m); TIA/EIA-603-C, Section 2.2.12			
Test mode: Compliance	Verdict: PASS		
Date: 06/01/2009			
Temperature: 23°C	Air Pressure: 1007 hPa	Relative Humidity: 50%	Power Supply: 48 VDC
Remarks: 50 Ohm termination at the both RF connectors			

Plot 7.5.29 Radiated emission measurements at 9930.0 MHz

TEST SITE: Semi anechoic chamber
 CARRIER FREQUENCY: Mid
 CHANNEL BANDWIDTH: 10 MHz
 ANTENNA POLARIZATION: Vertical
 TEST DISTANCE: 3 m

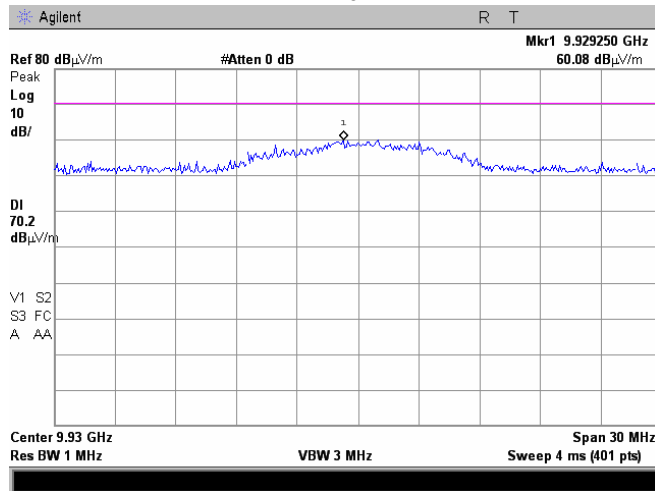

Plot 7.5.30 Radiated emission measurements at 9930.0 MHz

TEST SITE: Semi anechoic chamber
 CARRIER FREQUENCY: Mid
 CHANNEL BANDWIDTH: 10 MHz
 ANTENNA POLARIZATION: Horizontal
 TEST DISTANCE: 3 m

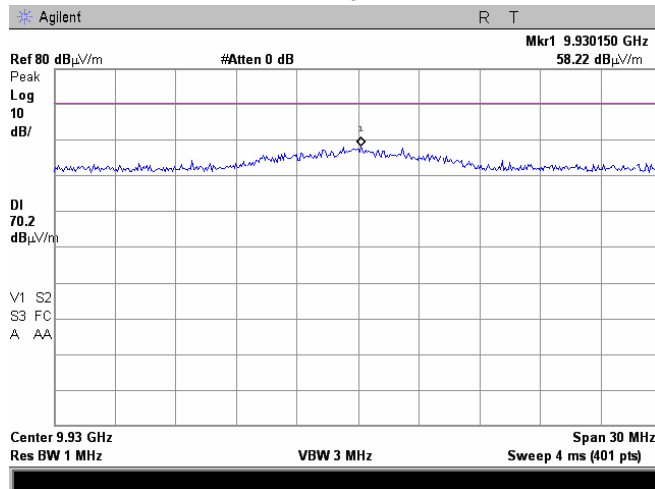

Test specification:	FCC section 90.210, RSS-111 section 5.4, Radiated spurious emissions		
Test procedure:	47 CFR, Sections 2.1053 and 90.210(m); TIA/EIA-603-C, Section 2.2.12		
Test mode:	Compliance	Verdict:	PASS
Date:	06/01/2009		
Temperature: 23°C	Air Pressure: 1007 hPa	Relative Humidity: 50%	Power Supply: 48 VDC
Remarks: 50 Ohm termination at the both RF connectors			

Plot 7.5.31 Radiated emission measurements in 2900 – 14000 MHz range

TEST SITE:	Semi anechoic chamber
CARRIER FREQUENCY:	High
CHANNEL BANDWIDTH:	10 MHz
ANTENNA POLARIZATION:	Vertical and Horizontal
TEST DISTANCE:	3 m

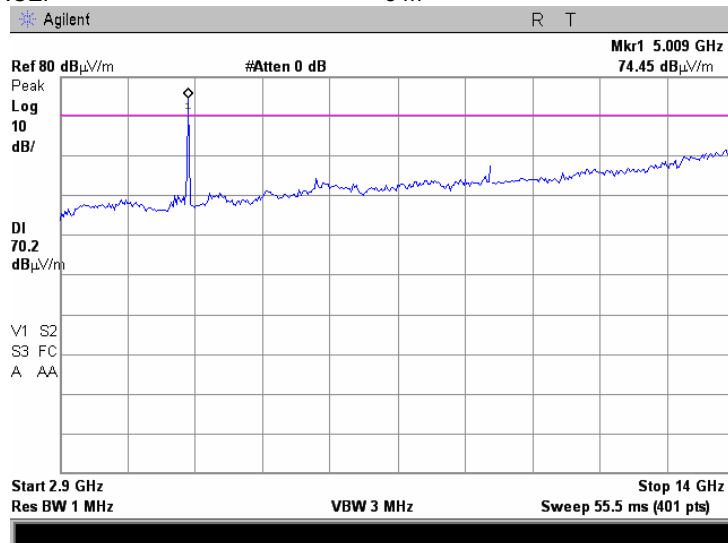

Test specification: FCC section 90.210, RSS-111 section 5.4, Radiated spurious emissions			
Test procedure: 47 CFR, Sections 2.1053 and 90.210(m); TIA/EIA-603-C, Section 2.2.12			
Test mode: Compliance	Verdict: PASS		
Date: 06/01/2009			
Temperature: 23°C	Air Pressure: 1007 hPa	Relative Humidity: 50%	Power Supply: 48 VDC
Remarks: 50 Ohm termination at the both RF connectors			

Plot 7.5.32 Radiated emission measurements at 9970.0 MHz

TEST SITE: Semi anechoic chamber
 CARRIER FREQUENCY: High
 CHANNEL BANDWIDTH: 10 MHz
 ANTENNA POLARIZATION: Vertical
 TEST DISTANCE: 3 m

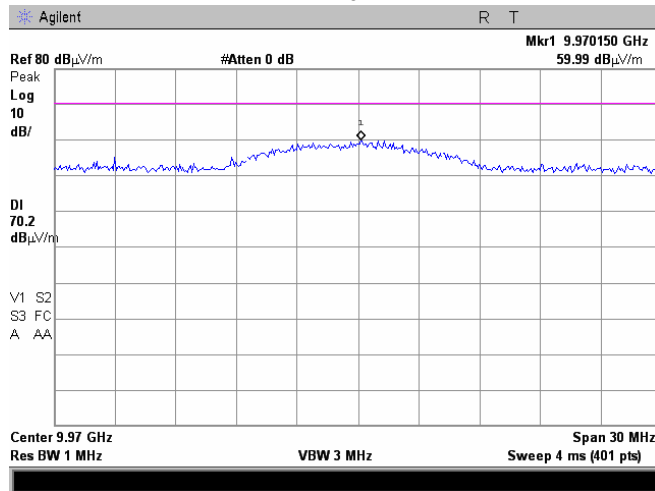

Plot 7.5.33 Radiated emission measurements at 9970.0 MHz

TEST SITE: Semi anechoic chamber
 CARRIER FREQUENCY: High
 CHANNEL BANDWIDTH: 10 MHz
 ANTENNA POLARIZATION: Horizontal
 TEST DISTANCE: 3 m

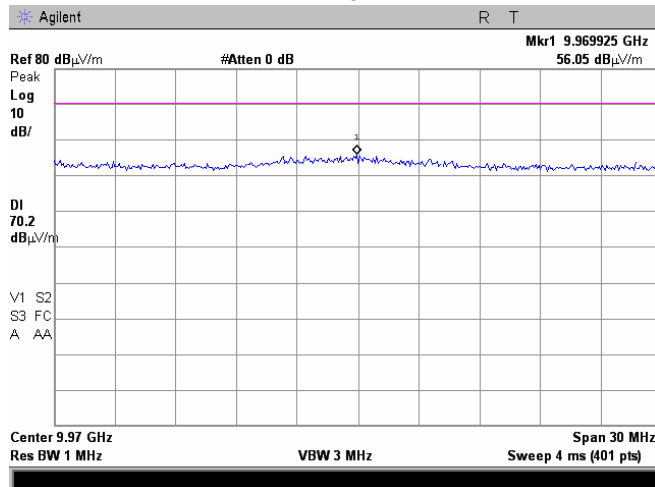

Test specification: FCC section 90.210, RSS-111 section 5.4, Radiated spurious emissions			
Test procedure: 47 CFR, Sections 2.1053 and 90.210(m); TIA/EIA-603-C, Section 2.2.12			
Test mode: Compliance	Verdict: PASS		
Date: 06/01/2009			
Temperature: 23°C	Air Pressure: 1007 hPa	Relative Humidity: 50%	Power Supply: 48 VDC
Remarks: 50 Ohm termination at the both RF connectors			

Plot 7.5.34 Radiated emission measurements in 14000 – 18000 MHz range

TEST SITE: OATS
 CARRIER FREQUENCY: Low
 CHANNEL BANDWIDTH: 10 MHz
 ANTENNA POLARIZATION: Vertical and Horizontal
 TEST DISTANCE: 3 m

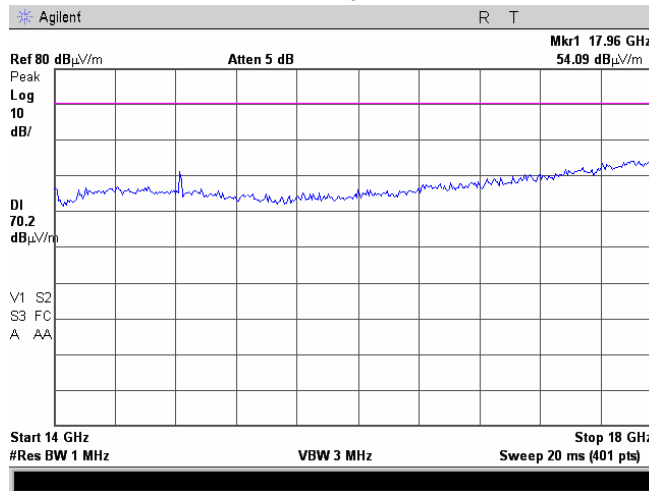

Plot 7.5.35 Radiated emission measurements in 14000 – 18000 MHz range

TEST SITE: OATS
 CARRIER FREQUENCY: Mid
 CHANNEL BANDWIDTH: 10 MHz
 ANTENNA POLARIZATION: Vertical and Horizontal
 TEST DISTANCE: 3 m

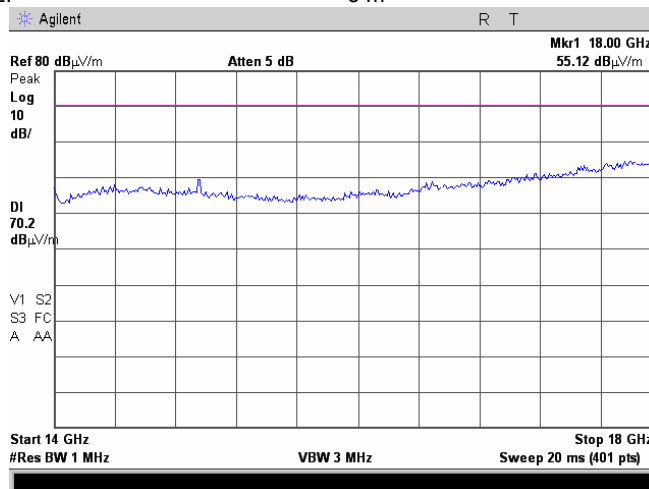

Test specification: FCC section 90.210, RSS-111 section 5.4, Radiated spurious emissions			
Test procedure: 47 CFR, Sections 2.1053 and 90.210(m); TIA/EIA-603-C, Section 2.2.12			
Test mode: Compliance	Verdict: PASS		
Date: 06/01/2009			
Temperature: 23°C	Air Pressure: 1007 hPa	Relative Humidity: 50%	Power Supply: 48 VDC
Remarks: 50 Ohm termination at the both RF connectors			

Plot 7.5.36 Radiated emission measurements in 14000 – 18000 MHz range

TEST SITE: OATS
 CARRIER FREQUENCY: High
 CHANNEL BANDWIDTH: 10 MHz
 ANTENNA POLARIZATION: Vertical and Horizontal
 TEST DISTANCE: 3 m

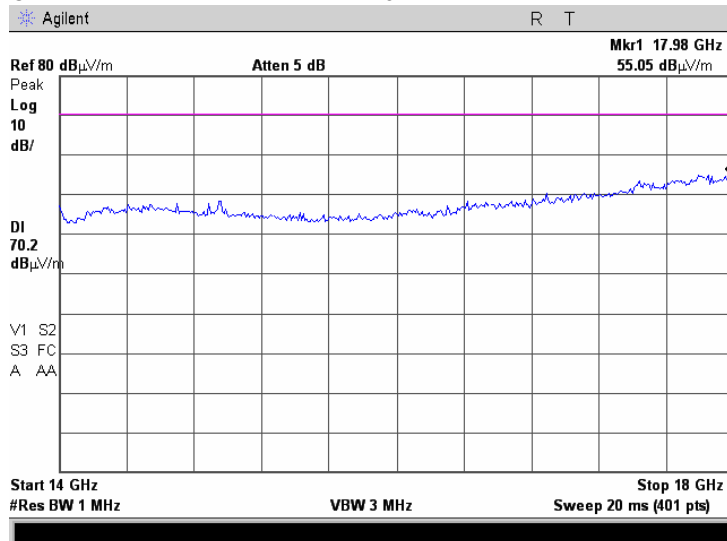

Test specification: FCC section 90.210, RSS-111 section 5.4, Radiated spurious emissions			
Test procedure: 47 CFR, Sections 2.1053 and 90.210(m); TIA/EIA-603-C, Section 2.2.12			
Test mode: Compliance	Verdict: PASS		
Date: 06/01/2009			
Temperature: 23°C	Air Pressure: 1007 hPa	Relative Humidity: 50%	Power Supply: 48 VDC
Remarks: 50 Ohm termination at the both RF connectors			

Plot 7.5.37 Radiated emission measurements in 2900 – 6000 MHz range

TEST SITE: Semi anechoic chamber
 CARRIER FREQUENCY: Low
 CHANNEL BANDWIDTH: 20 MHz
 ANTENNA POLARIZATION: Vertical and Horizontal
 TEST DISTANCE: 3 m

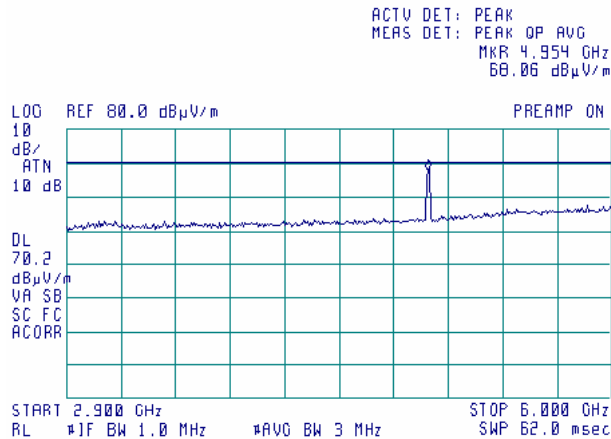

Plot 7.5.38 Radiated emission measurements in 2900 – 6000 MHz range

TEST SITE: Semi anechoic chamber
 CARRIER FREQUENCY: Mid
 CHANNEL BANDWIDTH: 20 MHz
 ANTENNA POLARIZATION: Vertical and Horizontal
 TEST DISTANCE: 3 m

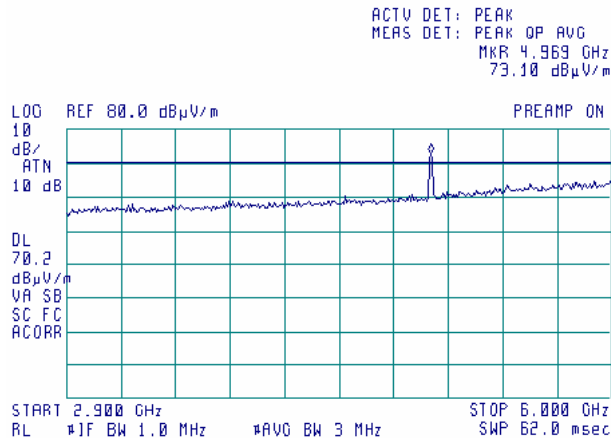

Test specification: FCC section 90.210, RSS-111 section 5.4, Radiated spurious emissions			
Test procedure: 47 CFR, Sections 2.1053 and 90.210(m); TIA/EIA-603-C, Section 2.2.12			
Test mode: Compliance	Verdict: PASS		
Date: 06/01/2009			
Temperature: 23°C	Air Pressure: 1007 hPa	Relative Humidity: 50%	Power Supply: 48 VDC
Remarks: 50 Ohm termination at the both RF connectors			

Plot 7.5.39 Radiated emission measurements in 2900 – 6000 MHz range

TEST SITE: Semi anechoic chamber
 CARRIER FREQUENCY: High
 CHANNEL BANDWIDTH: 20 MHz
 ANTENNA POLARIZATION: Vertical and Horizontal
 TEST DISTANCE: 3 m

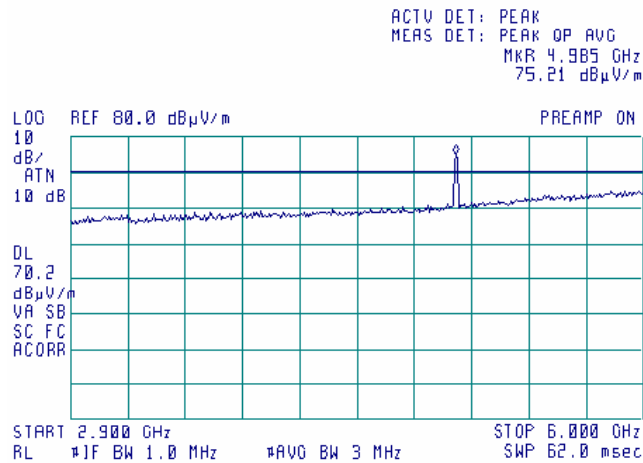

Plot 7.5.40 Radiated emission measurements in 6000 – 18000 MHz range

TEST SITE: Semi anechoic chamber
 CARRIER FREQUENCY: Low
 CHANNEL BANDWIDTH: 20 MHz
 ANTENNA POLARIZATION: Vertical and Horizontal
 TEST DISTANCE: 3 m

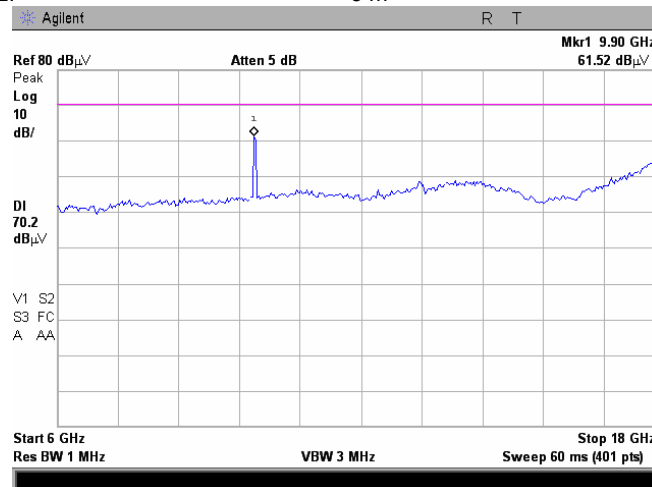

Test specification: FCC section 90.210, RSS-111 section 5.4, Radiated spurious emissions			
Test procedure: 47 CFR, Sections 2.1053 and 90.210(m); TIA/EIA-603-C, Section 2.2.12			
Test mode: Compliance	Verdict: PASS		
Date: 06/01/2009			
Temperature: 23°C	Air Pressure: 1007 hPa	Relative Humidity: 50%	Power Supply: 48 VDC
Remarks: 50 Ohm termination at the both RF connectors			

Plot 7.5.41 Radiated emission measurements at 9900.0 MHz

TEST SITE: Semi anechoic chamber
 CARRIER FREQUENCY: Low
 CHANNEL BANDWIDTH: 20 MHz
 ANTENNA POLARIZATION: Vertical
 TEST DISTANCE: 3 m

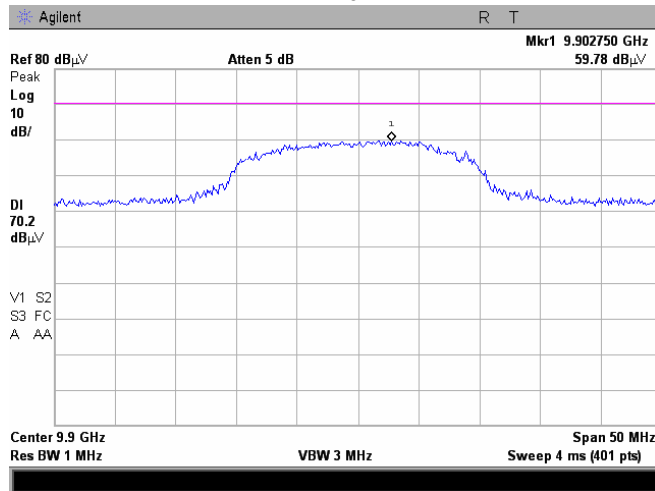

Plot 7.5.42 Radiated emission measurements at 9900.0 MHz

TEST SITE: Semi anechoic chamber
 CARRIER FREQUENCY: Low
 CHANNEL BANDWIDTH: 20 MHz
 ANTENNA POLARIZATION: Horizontal
 TEST DISTANCE: 3 m

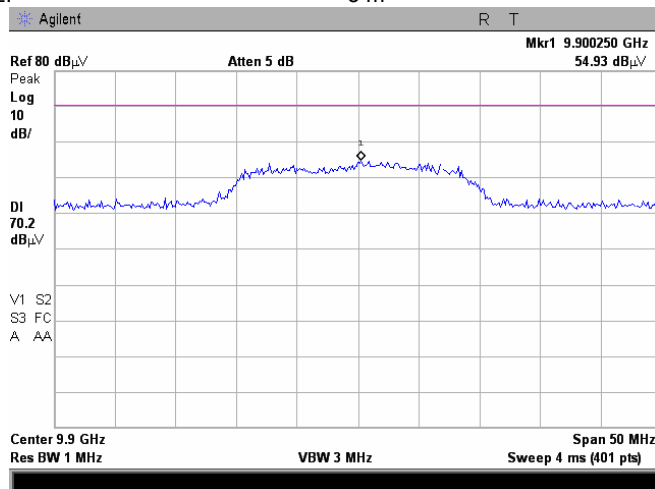

Test specification: FCC section 90.210, RSS-111 section 5.4, Radiated spurious emissions			
Test procedure: 47 CFR, Sections 2.1053 and 90.210(m); TIA/EIA-603-C, Section 2.2.12			
Test mode: Compliance	Verdict: PASS		
Date: 06/01/2009			
Temperature: 23°C	Air Pressure: 1007 hPa	Relative Humidity: 50%	Power Supply: 48 VDC
Remarks: 50 Ohm termination at the both RF connectors			

Plot 7.5.43 Radiated emission measurements in 6000 – 18000 MHz range

TEST SITE: Semi anechoic chamber
 CARRIER FREQUENCY: Mid
 CHANNEL BANDWIDTH: 20 MHz
 ANTENNA POLARIZATION: Vertical and Horizontal
 TEST DISTANCE: 3 m

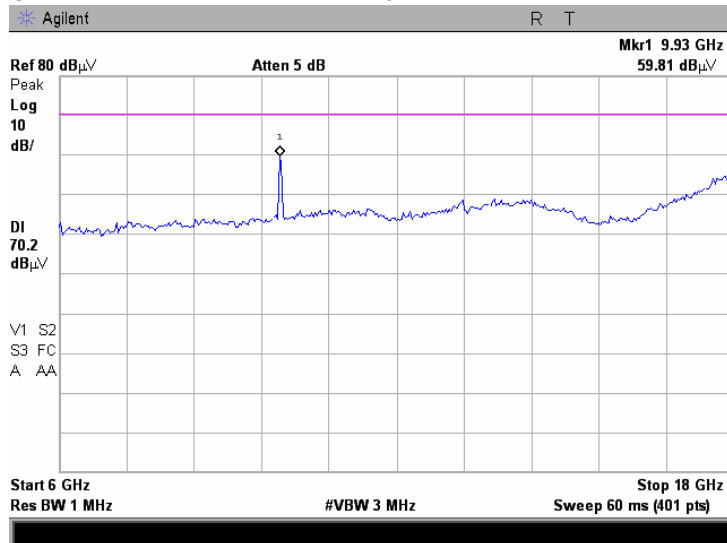

Test specification:	FCC section 90.210, RSS-111 section 5.4, Radiated spurious emissions		
Test procedure:	47 CFR, Sections 2.1053 and 90.210(m); TIA/EIA-603-C, Section 2.2.12		
Test mode:	Compliance	Verdict:	PASS
Date:	06/01/2009		
Temperature: 23°C	Air Pressure: 1007 hPa	Relative Humidity: 50%	Power Supply: 48 VDC
Remarks: 50 Ohm termination at the both RF connectors			

Plot 7.5.44 Radiated emission measurements at 9930.0 MHz

TEST SITE: Semi anechoic chamber
 CARRIER FREQUENCY: Mid
 CHANNEL BANDWIDTH: 20 MHz
 ANTENNA POLARIZATION: Vertical
 TEST DISTANCE: 3 m

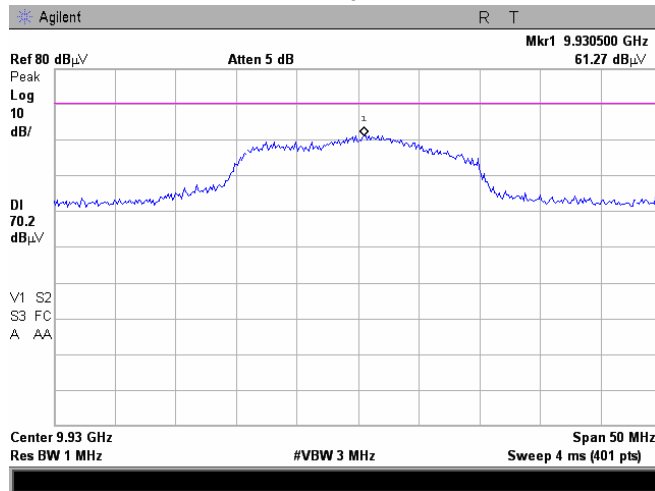

Plot 7.5.45 Radiated emission measurements at 9930.0 MHz

TEST SITE: Semi anechoic chamber
 CARRIER FREQUENCY: Mid
 CHANNEL BANDWIDTH: 20 MHz
 ANTENNA POLARIZATION: Horizontal
 TEST DISTANCE: 3 m

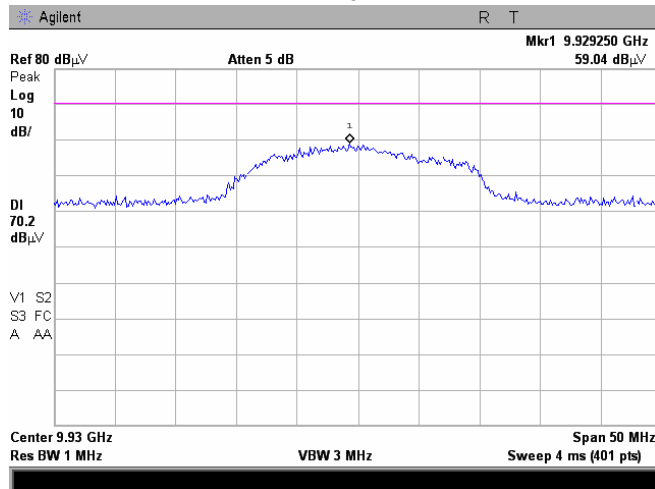

Test specification: FCC section 90.210, RSS-111 section 5.4, Radiated spurious emissions			
Test procedure: 47 CFR, Sections 2.1053 and 90.210(m); TIA/EIA-603-C, Section 2.2.12			
Test mode: Compliance	Verdict: PASS		
Date: 06/01/2009			
Temperature: 23°C	Air Pressure: 1007 hPa	Relative Humidity: 50%	Power Supply: 48 VDC
Remarks: 50 Ohm termination at the both RF connectors			

Plot 7.5.46 Radiated emission measurements in 6000 – 18000 MHz range

TEST SITE: Semi anechoic chamber
 CARRIER FREQUENCY: High
 CHANNEL BANDWIDTH: 20 MHz
 ANTENNA POLARIZATION: Vertical and Horizontal
 TEST DISTANCE: 3 m

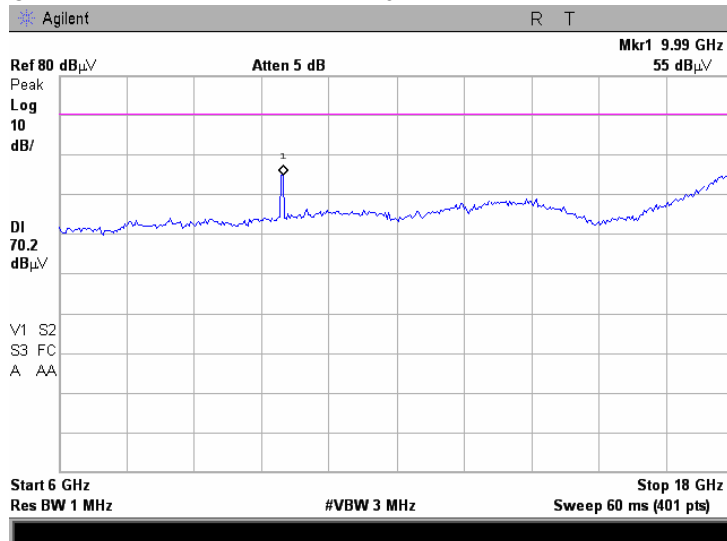

Test specification:	FCC section 90.210, RSS-111 section 5.4, Radiated spurious emissions		
Test procedure:	47 CFR, Sections 2.1053 and 90.210(m); TIA/EIA-603-C, Section 2.2.12		
Test mode:	Compliance	Verdict:	PASS
Date:	06/01/2009		
Temperature: 23°C	Air Pressure: 1007 hPa	Relative Humidity: 50%	Power Supply: 48 VDC
Remarks: 50 Ohm termination at the both RF connectors			

Plot 7.5.47 Radiated emission measurements at 9960.0 MHz

TEST SITE: Semi anechoic chamber
 CARRIER FREQUENCY: High
 CHANNEL BANDWIDTH: 20 MHz
 ANTENNA POLARIZATION: Vertical
 TEST DISTANCE: 3 m

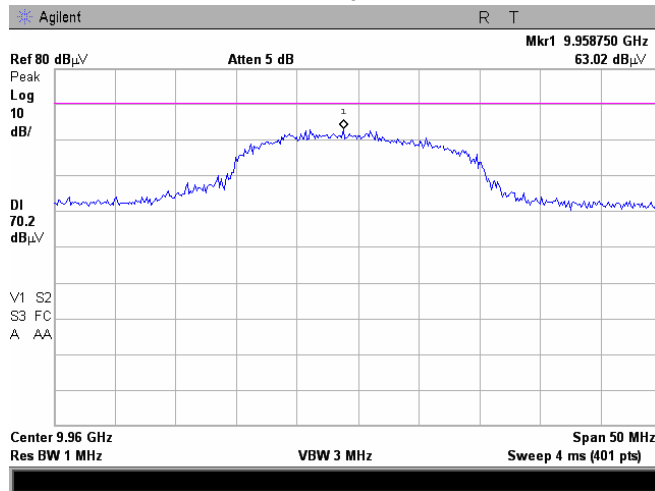

Plot 7.5.48 Radiated emission measurements at 9960.0 MHz

TEST SITE: Semi anechoic chamber
 CARRIER FREQUENCY: High
 CHANNEL BANDWIDTH: 20 MHz
 ANTENNA POLARIZATION: Horizontal
 TEST DISTANCE: 3 m

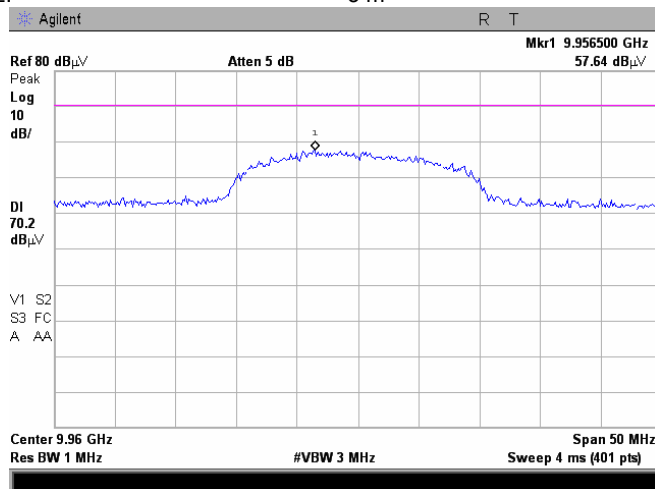

Test specification: FCC section 90.210, RSS-111 section 5.4, Radiated spurious emissions			
Test procedure: 47 CFR, Sections 2.1053 and 90.210(m); TIA/EIA-603-C, Section 2.2.12			
Test mode: Compliance	Verdict: PASS		
Date: 06/01/2009			
Temperature: 23°C	Air Pressure: 1007 hPa	Relative Humidity: 50%	Power Supply: 48 VDC
Remarks: 50 Ohm termination at the both RF connectors			

Plot 7.5.49 Radiated emission measurements in 18000 – 26500 MHz range

TEST SITE: OATS
 CARRIER FREQUENCY: Low
 CHANNEL BANDWIDTH: 5 MHz
 ANTENNA POLARIZATION: Vertical and Horizontal
 TEST DISTANCE: 3 m

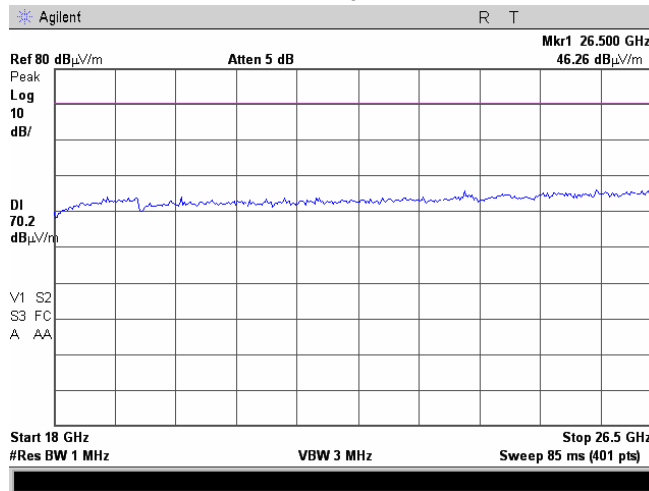

Plot 7.5.50 Radiated emission measurements in 18000 – 26500 MHz range

TEST SITE: OATS
 CARRIER FREQUENCY: Mid
 CHANNEL BANDWIDTH: 5 MHz
 ANTENNA POLARIZATION: Vertical and Horizontal
 TEST DISTANCE: 3 m

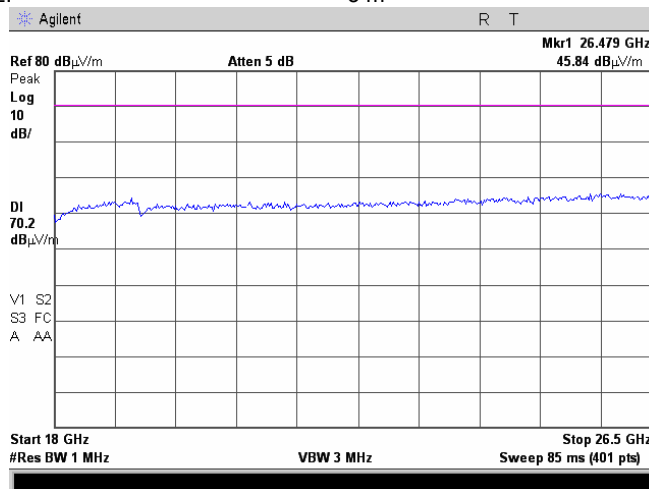

Test specification: FCC section 90.210, RSS-111 section 5.4, Radiated spurious emissions			
Test procedure: 47 CFR, Sections 2.1053 and 90.210(m); TIA/EIA-603-C, Section 2.2.12			
Test mode: Compliance	Verdict: PASS		
Date: 06/01/2009			
Temperature: 23°C	Air Pressure: 1007 hPa	Relative Humidity: 50%	Power Supply: 48 VDC
Remarks: 50 Ohm termination at the both RF connectors			

Plot 7.5.51 Radiated emission measurements in 18000 – 26500 MHz range

TEST SITE: OATS
 CARRIER FREQUENCY: High
 CHANNEL BANDWIDTH: 5 MHz
 ANTENNA POLARIZATION: Vertical and Horizontal
 TEST DISTANCE: 3 m

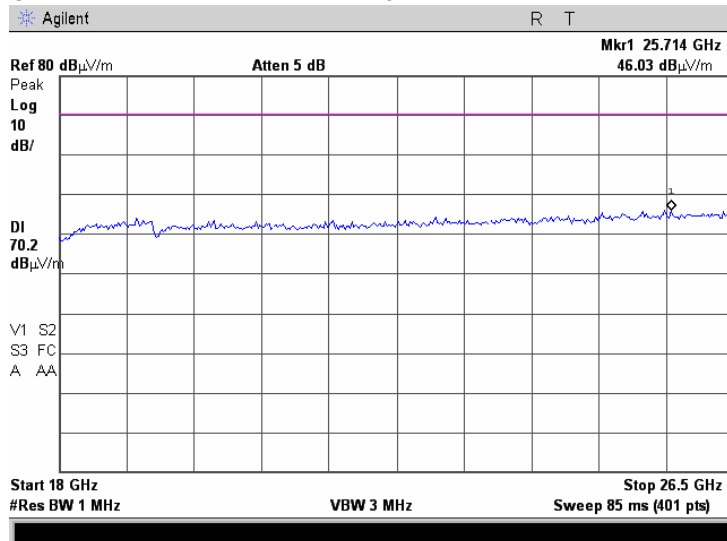

Test specification: FCC section 90.210, RSS-111 section 5.4, Radiated spurious emissions			
Test procedure: 47 CFR, Sections 2.1053 and 90.210(m); TIA/EIA-603-C, Section 2.2.12			
Test mode: Compliance	Verdict: PASS		
Date: 06/01/2009			
Temperature: 23°C	Air Pressure: 1007 hPa	Relative Humidity: 50%	Power Supply: 48 VDC
Remarks: 50 Ohm termination at the both RF connectors			

Plot 7.5.52 Radiated emission measurements in 26500 – 40000 MHz range

TEST SITE: OATS
 CARRIER FREQUENCY: Low
 CHANNEL BANDWIDTH: 5 MHz
 ANTENNA POLARIZATION: Vertical and Horizontal
 TEST DISTANCE: 3 m

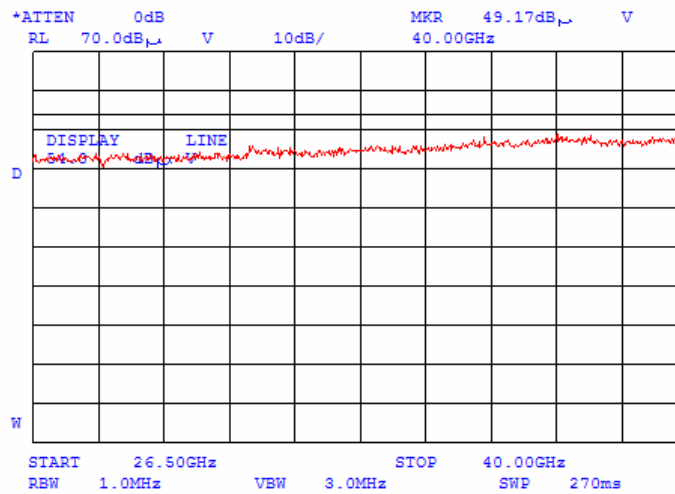

Note: The specified limit is 70.23dBuV/m



HERMON LABORATORIES

Test specification: FCC section 90.210, RSS-111 section 5.4, Radiated spurious emissions			
Test procedure: 47 CFR, Sections 2.1053 and 90.210(m); TIA/EIA-603-C, Section 2.2.12			
Test mode: Compliance	Verdict: PASS		
Date: 06/01/2009			
Temperature: 23°C	Air Pressure: 1007 hPa	Relative Humidity: 50%	Power Supply: 48 VDC
Remarks: 50 Ohm termination at the both RF connectors			

Plot 7.5.53 Radiated emission measurements in 26500 – 40000 MHz range

TEST SITE:	OATS
CARRIER FREQUENCY:	Mid
CHANNEL BANDWIDTH:	5 MHz
ANTENNA POLARIZATION:	Vertical and Horizontal
TEST DISTANCE:	3 m

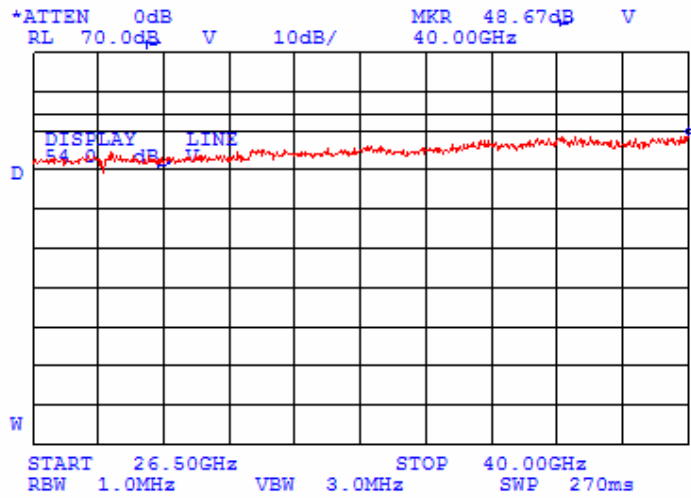

Note: The specified limit is 70.23dBuV/m

Test specification: FCC section 90.210, RSS-111 section 5.4, Radiated spurious emissions			
Test procedure: 47 CFR, Sections 2.1053 and 90.210(m); TIA/EIA-603-C, Section 2.2.12			
Test mode: Compliance	Verdict: PASS		
Date: 06/01/2009			
Temperature: 23°C	Air Pressure: 1007 hPa	Relative Humidity: 50%	Power Supply: 48 VDC
Remarks: 50 Ohm termination at the both RF connectors			

Plot 7.5.54 Radiated emission measurements in 26500 – 40000 MHz range

TEST SITE: OATS
 CARRIER FREQUENCY: High
 CHANNEL BANDWIDTH: 5 MHz
 ANTENNA POLARIZATION: Vertical and Horizontal
 TEST DISTANCE: 3 m

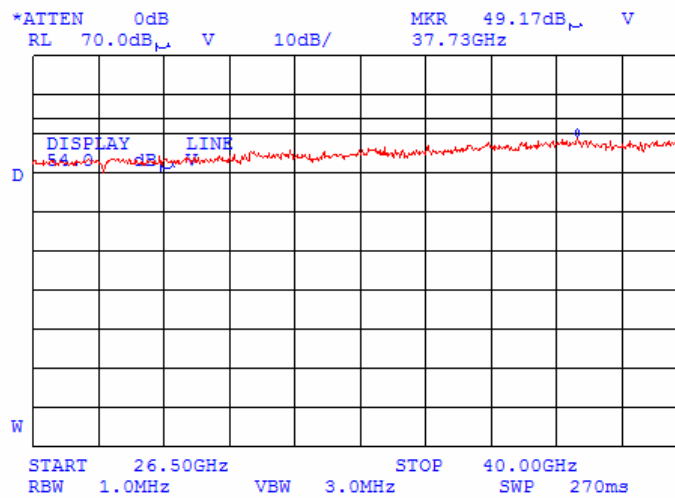

Note: The specified limit is 70.23dBuV/m

Test specification: FCC section 90.213, RSS-111 section 5.2, Frequency stability	
Test procedure: 47 CFR, Section 2.1055; TIA/EIA-603-C Section 2.2.2	
Test mode: Compliance	Verdict: PASS
Date: 08/01/2009	
Temperature: 23°C	Air Pressure: 1007 hPa
Relative Humidity: 50%	
Power Supply: 48 VDC	
Remarks:	

8 Frequency stability test

8.1.1 General

This test was performed to measure frequency stability of transmitter RF carrier. Specification test limits are given in Table 7.5.1.

Table 7.5.1 Frequency stability limits

Operating frequency, MHz	Maximum allowed frequency displacement	
	ppm	Hz
4940 - 4990	NA	NA

8.1.2 Test procedure

- 8.1.2.1 The EUT was set up as shown in Figure 7.5.1, energized and its proper operation was checked.
- 8.1.2.2 The EUT power was turned off. Temperature within test chamber was set to +30°C and a period of time sufficient to stabilize all of the oscillator circuit components was allowed.
- 8.1.2.3 The EUT was powered on and carrier frequency was measured at start up moment and then every minute until frequency had been stabilized or 10 minutes elapsed whichever reached the last. The EUT was powered off.
- 8.1.2.4 The above procedure was repeated at 0°C and at the lowest test temperature.
- 8.1.2.5 The EUT was powered on and carrier frequency was measured at start up moment and at the end of stabilization period at the rest of test temperatures and voltages. The EUT was powered off.
- 8.1.2.6 Frequency displacement was calculated and compared with the limit as provided in Table 7.5.2.

Figure 7.5.1 Frequency stability test setup

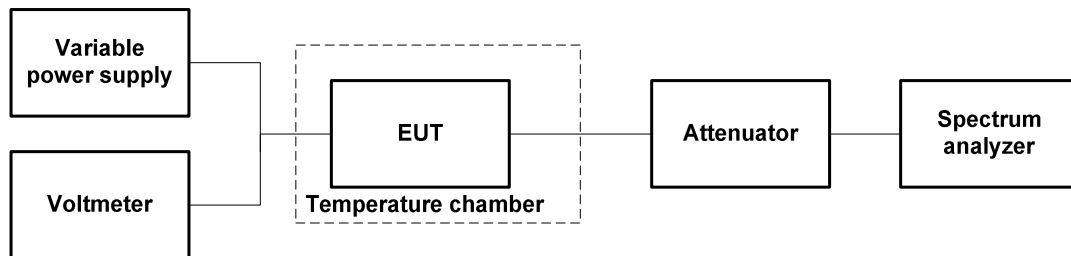



HERMON LABORATORIES

Test specification:		FCC section 90.213, RSS-111 section 5.2, Frequency stability			
Test procedure:		47 CFR, Section 2.1055; TIA/EIA-603-C Section 2.2.2			
Test mode:		Compliance		Verdict: PASS	
Date:		08/01/2009			
Temperature: 23°C		Air Pressure: 1007 hPa		Relative Humidity: 50%	
Remarks:		Power Supply: 48 VDC			

Table 7.5.2 Frequency stability test results

OPERATING FREQUENCY: 4945 – 4985 MHz
 NOMINAL POWER VOLTAGE: 120 VAC
 TEMPERATURE STABILIZATION PERIOD: 20 min
 POWER DURING TEMPERATURE TRANSITION: Off
 SPECTRUM ANALYZER MODE: Counter
 RESOLUTION BANDWIDTH: 100 Hz
 VIDEO BANDWIDTH: 300 Hz
 MODULATION: Unmodulated

Temp, °C	Voltage, V	Frequency, MHz							Max frequency drift, Hz		Limit, Hz	Margin, Hz	Verdict
		Start up	1 st min	2 nd min	3 rd min	4 th min	5 th min	10 th min	Posit.	Negat.			
Low frequency													
-30	nominal	4945.0085	4945.0163	4945.0172	4945.0174	4945.0175	4945.0175	4945.0176	29000.0	0	NA	NA	Pass
-20	nominal	4945.0135	NA	NA	NA	NA	NA	4945.0191	30500.0	0		NA	Pass
-10	nominal	4945.0188	NA	NA	NA	NA	NA	4945.0144	30200.0	0		NA	Pass
0	nominal	4945.0171	4945.0095	4945.0073	4945.0069	4945.0063	4945.0062	4945.0061	28500.0	0		NA	Pass
10	nominal	4945.0051	NA	NA	NA	NA	NA	4944.9965	16500.0	0		NA	Pass
20	+15%	4944.9881	NA	NA	NA	NA	NA	4944.9832	0	5400.0		NA	Pass
20	nominal	4945.0000	NA	NA	NA	NA	NA	4944.9886	11400.0	0		NA	Pass
20	-15%	4944.9872	NA	NA	NA	NA	NA	4944.9832	0	5400.0		NA	Pass
30	nominal	4944.9907	4944.9843	4944.9837	4944.9835	4944.9835	4944.9834	4944.9834	2100.0	5180.0		NA	Pass
40	nominal	4944.9843	NA	NA	NA	NA	NA	4944.9850	0	4300.0		NA	Pass
50	nominal	4944.9832	NA	NA	NA	NA	NA	4944.9952	6600.0	5400.0	NA	Pass	
Mid frequency													
-30	nominal	4965.0094	4965.0160	4965.0167	4965.0168	4965.0168	4965.0169	4965.0169	31200.0	0	NA	NA	Pass
-20	nominal	4965.0155	NA	NA	NA	NA	NA	4965.0191	33400.0	0		NA	Pass
-10	nominal	4965.0194	NA	NA	NA	NA	NA	4965.0144	33700.0	0		NA	Pass
0	nominal	4965.0157	4965.0083	4965.0069	4965.0065	4965.0064	4965.0063	4965.0062	30000.0	0		NA	Pass
10	nominal	4965.0088	NA	NA	NA	NA	NA	4964.9964	23100.0	0		NA	Pass
20	+15%	4964.9883	NA	NA	NA	NA	NA	4964.9834	2600.0	2300.0		NA	Pass
20	nominal	4964.9930	NA	NA	NA	NA	NA	4964.9857	7300.0	0.0		NA	Pass
20	-15%	4964.9889	NA	NA	NA	NA	NA	4964.9833	3200.0	2400.0		NA	Pass
30	nominal	4964.9883	4964.9839	4964.9835	4964.9834	4964.9834	4964.9834	4964.9834	2600.0	2315.0		NA	Pass
40	nominal	4964.9853	NA	NA	NA	NA	NA	4964.9849	0	800.0		NA	Pass
50	nominal	4964.9845	NA	NA	NA	NA	NA	4964.9960	10300.0	1200.0	NA	Pass	
High frequency													
-30	nominal	4985.0136	4985.0150	4985.0174	4985.0178	4985.0179	4985.0180	4985.0180	33800.0	0	NA	NA	Pass
-20	nominal	4985.0158	NA	NA	NA	NA	NA	4985.0192	35000.0	0		NA	Pass
-10	nominal	4985.0197	NA	NA	NA	NA	NA	4985.0145	35500.0	0		NA	Pass
0	nominal	4985.0126	4985.0077	4985.0067	4985.0065	4985.0064	4985.0063	4985.0062	28400.0	0		NA	Pass
10	nominal	4985.0104	NA	NA	NA	NA	NA	4984.9963	26200.0	0		NA	Pass
20	+15%	4984.9882	NA	NA	NA	NA	NA	4984.9836	4000.0	600.0		NA	Pass
20	nominal	4984.9910	NA	NA	NA	NA	NA	4984.9842*	6800.0	0		NA	Pass
20	-15%	4984.9931	NA	NA	NA	NA	NA	4984.9838	8900.0	400.0		NA	Pass
30	nominal	4984.9865	4984.9837	4984.9834	4984.9833	4984.9833	4984.9833	4984.9833	2300.0	900.0		NA	Pass
40	nominal	4984.9858	NA	NA	NA	NA	NA	4984.9846	1600.0	0		NA	Pass
50	nominal	4984.9857	NA	NA	NA	NA	NA	4984.9964	12200.0	0	NA	Pass	

* - Reference frequency

Reference numbers of test equipment used

HL 0493	HL 1194	HL 1424	HL 3323	HL 3386	HL 3440	
---------	---------	---------	---------	---------	---------	--

Full description is given in Appendix A.

Test specification:		RSS-111 section 5.5, Receiver spurious emissions	
Test procedure:		RSS-Gen, Section 4.10	
Test mode:	Compliance	Verdict:	PASS
Date:	06/01/2009		
Temperature: 23°C	Air Pressure: 1007 hPa	Relative Humidity: 50%	Power Supply: 48 VDC
Remarks:			

9 Receiver tests

9.1 Receiver spurious emissions at RF antenna connector

9.1.1 General

This test was performed to measure spurious emissions at RF antenna connector of receiver. Specification test limits are given in Table 9.1.1.

Table 9.1.1 Receiver spurious emission limits

Frequency range, MHz	Maximum ERP, nW	Maximum ERP, dBm	Measurement bandwidth, (min) kHz
30 – 1000	2	-57	4
1000 - 15000	5	-53	4

9.1.2 Test procedure

9.1.2.1 The EUT was set up as shown in Figure 9.1.1, energized and its proper operation was checked.

9.1.2.2 The EUT was set in receive mode.

9.1.2.3 Spurious emission was measured with spectrum analyzer as provided in Table 9.1.2 and the associated plots.

Figure 9.1.1 Receiver spurious emission test set up

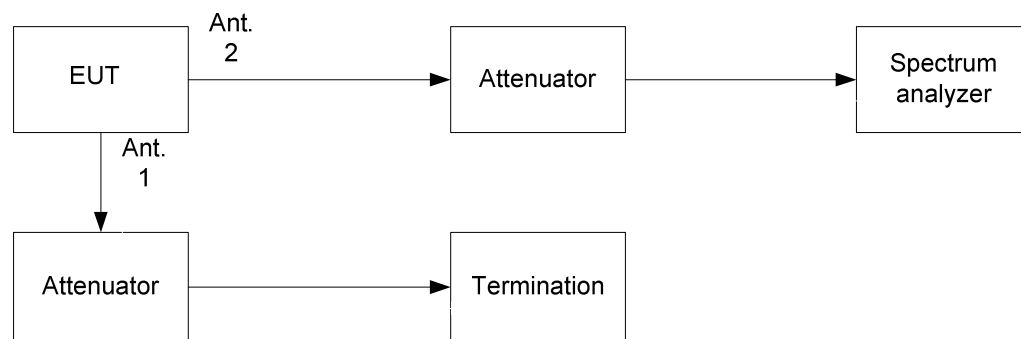



Test specification:		RSS-111 section 5.5, Receiver spurious emissions	
Test procedure:		RSS-Gen, Section 4.10	
Test mode:	Compliance	Verdict:	PASS
Date:	06/01/2009		
Temperature: 23°C	Air Pressure: 1007 hPa	Relative Humidity: 50%	Power Supply: 48 VDC
Remarks:			

Table 9.1.2 Receiver spurious emission test results

ASSIGNED FREQUENCY RANGE: 4940 – 4990 MHz
DETECTOR USED: Peak
RESOLUTION BANDWIDTH: 120 kHz in the 30 – 1000 MHz frequency range;
1000 kHz in the 1000 – 15000 MHz frequency range
VIDEO BANDWIDTH: > RBW

Receive frequency, MHz	Unwanted frequency, MHz	Unwanted emission, dBm	Unwanted emission limit, dBm	Margin, dB	Verdict
4965.0	No emissions were found				Pass

Reference numbers of test equipment used

HL 2780	HL 3386						
---------	---------	--	--	--	--	--	--

Full description is given in Appendix A.

Test specification: RSS-111 section 5.5, Receiver spurious emissions			
Test procedure: RSS-Gen, Section 4.10			
Test mode: Compliance	Verdict: PASS		
Date: 06/01/2009			
Temperature: 23°C	Air Pressure: 1007 hPa	Relative Humidity: 50%	Power Supply: 48 VDC
Remarks:			

ANTENNA 1

Plot 9.1.1 Receiver spurious emission test results in 30 – 1000 MHz range

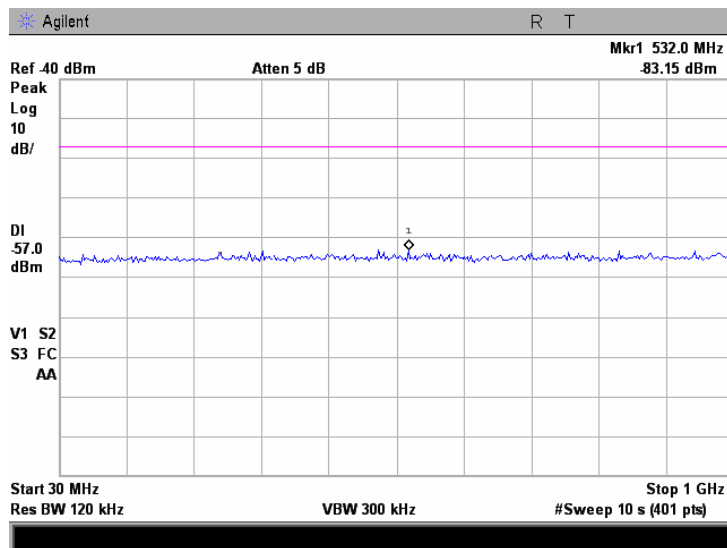

Plot 9.1.2 Receiver spurious emission test results in 1.0 – 15.0 GHz range

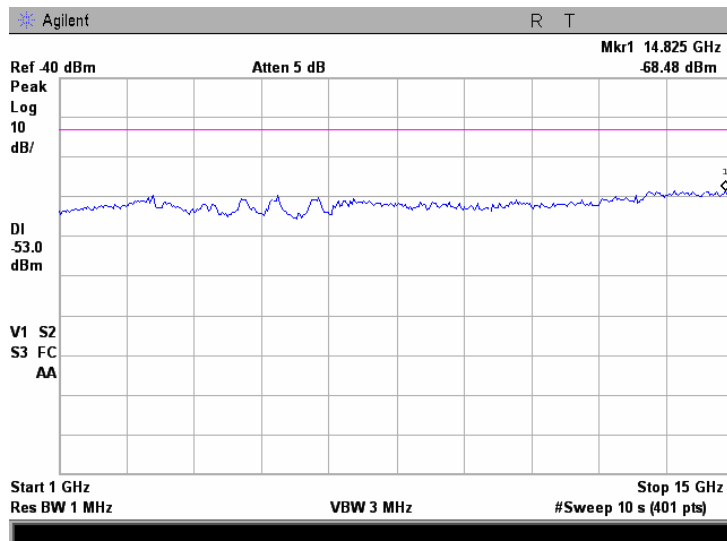

Test specification: RSS-111 section 5.5, Receiver spurious emissions			
Test procedure: RSS-Gen, Section 4.10			
Test mode: Compliance	Verdict: PASS		
Date: 06/01/2009			
Temperature: 23°C	Air Pressure: 1007 hPa	Relative Humidity: 50%	Power Supply: 48 VDC
Remarks:			

ANTENNA 2

Plot 9.1.3 Receiver spurious emission test results in 30 – 1000 MHz range

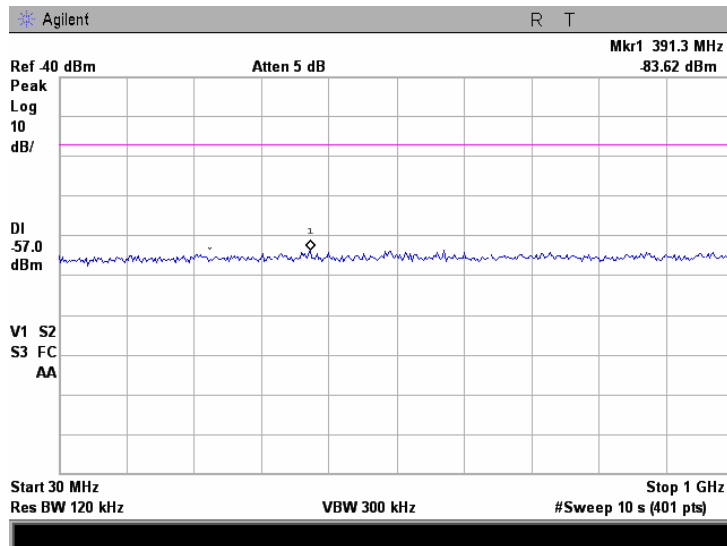

Plot 9.1.4 Receiver spurious emission test results in 1.0 – 15.0 GHz range

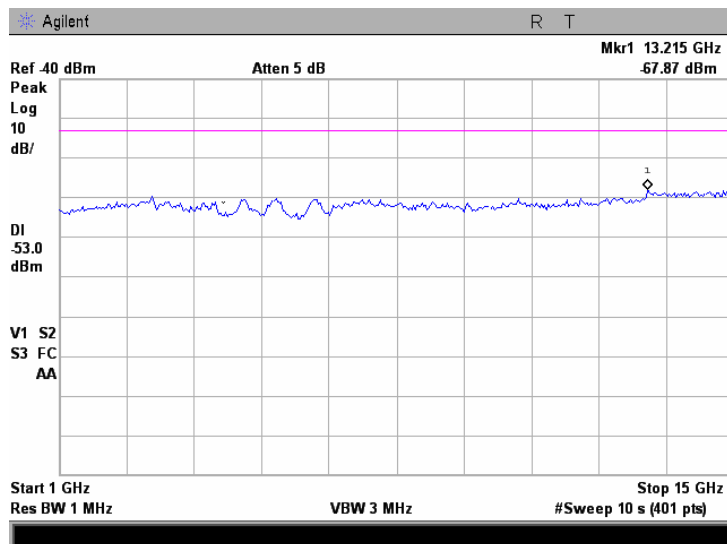

10 APPENDIX A Test equipment and ancillaries used for tests

HL No	Description	Manufacturer	Model	Ser. No.	Last Cal.*	Due Cal.*
0446	Antenna, Loop, Active, 10 kHz - 30 MHz	EMCO	6502	2857	29-Jun-08	29-Jun-09
0493	Temperature Chamber -45...175 deg C	Thermotron	S-1.2 Mini-Max	14016	19-May-08	19-May-09
0521	EMI Receiver (Spectrum Analyzer) with RF filter section 9 kHz-6.5 GHz	Hewlett Packard Co	8546A	3617A 00319, 3448A002 53	29-Aug-08	29-Aug-09
0554	Amplifier, 2-18 GHz RF	Miteq	AFD4	104300	28-Feb-09	28-Feb-10
0604	Antenna BiconiLog Log-Periodic/T Bow-TIE, 26 - 2000 MHz	EMCO	3141	9611-1011	11-Jan-09	11-Jan-10
0661	Generator Swept Signal, 10 MHz to 40 GHz, + 10 dBm	HP	83640B	3614A002 66	17-Sep-08	17-Sep-09
0768	Antenna Standard Gain Horn, 18-26.5 GHz, WR-42, 25 dB gain	Quinstar Technology	QWH-4200-BA	110	08-Dec-06	08-Dec-09
0769	Antenna Standard Gain Horn, 26.5-40 GHz, WR28, 25 dB gain	Quinstar Technology	QWH-2800-BA	112	08-Dec-06	08-Dec-09
1194	Variac, 220 V/ 2.5 A	Matsunaga		2962	06-Jan-09	06-Jan-10
1293	Adapter 35WR42Kf, 18 - 26.5 GHz	Getronics	35WR42K F	1293	30-Aug-07	30-Aug-10
1296	Adapter 35WR28Kf, 26.5-40 GHz	Wiltron	35WR28K F	1296	30-Aug-07	30-Aug-10
1424	Spectrum Analyzer, 30 Hz- 40 GHz	Agilent Technologies	8564EC	3946A002 19	01-Jan-09	01-Jan-10
1984	Antenna, Double-Ridged Waveguide Horn, 1-18 GHz, 300 W	EMC Test Systems	3115	9911-5964	03-Mar-08	03-Mar-09
2254	Cable 40 GHz, 0.8 m, blue	Rhophase Microwave Limited	KPS-1503A-800-KPS	W4907	10-Jun-08	10-Jun-09
2387	Filter Bandpass, 8-14 GHz	Hermon Laboratories	FBP8-14	2387	05-Jun-07	05-Jun-09
2432	Antenna, Double-Ridged Waveguide Horn 1-18 GHz	EMC Test Systems	3115	00027177	03-Mar-08	03-Mar-09
2780	EMC analyzer, 100 Hz to 26.5 GHz	Agilent Technologies	E7405A	MY451024 6	11-Jun-07	11-Jun-09
2909	Spectrum analyzer, ESA-E, 100 Hz to 26.5 GHz	Agilent Technologies	E4407B	MY414447 62	07-May-07	07-May-09
2953	Cable, RF, 18 GHz, 1.2 m, SMA-SMA	Gore	10020014	NA	05-Oct-08	05-Oct-09
3121	Microwave Cable Assembly, 18 GHz, 6.4 m, SMA - SMA	Huber-Suhner	198-9155-00	3121	07-Dec-08	07-Dec-09
3123	Microwave Cable Assembly, 18 GHz, 6.4 m, SMA - SMA	Huber-Suhner	198-9155-00	3123	01-Jan-09	01-Jan-10
3176	Attenuator, N-type, 10 dB, DC to 18 GHz, 5 W	Mini-Circuits	BW-N10W5+	0708	07-May-08	07-May-09
3179	Attenuator, N-type, 20 dB, DC to 18 GHz, 5 W	Mini-Circuits	BW-N20W5+	0651	07-May-08	07-May-09
3180	Attenuator, N-type, 20 dB, DC to 18 GHz, 5 W	Mini-Circuits	BW-N20W5+	0651	07-May-08	07-May-09
3181	Attenuator, N-type, 20 dB, DC to 18 GHz, 5 W	Mini-Circuits	BW-N20W5+	0651	01-Jan-09	01-Jan-10
3207	Cable 40 GHz, 1.2 m	Gore	GOR245	05118337	10-Jun-08	10-Jun-09
3323	UHF TEM CELL, 100 MHz to 3000 MHz	TESCOM CO., LTD	TC-5060B	506039018 8	27-Aug-08	27-Aug-09
3386	Microwave Cable Assembly, 26.5 GHz, 1.0 m, N type/N type	Suhner Sucoflex	104EA	3386	12-Feb-09	12-Feb-10



HL No	Description	Manufacturer	Model	Ser. No.	Last Cal.*	Due Cal.*
3440	Precision Fixed Attenuator, 50 Ohm, 5 W, 20 dB, DC to 18 GHz	Mini-Circuits	BW-S20W5+	NA	09-Mar-08	09-Mar-09
3442	Precision Fixed Attenuator, 50 Ohm, 5 W, 20 dB, DC to 18 GHz	Mini-Circuits	BW-S20W5+	NA	09-Mar-08	09-Mar-09
3455	Medium Power Fixed Coaxial Attenuator DC to 40 GHz, 20 dB, 5 W	Aeroflex / Weinschel	75A-20-12	1182	17-Mar-08	17-Mar-09
3473	Cable, Coax, Microwave, DC-18 GHz, SMA-SMA, 0.6 m	Gore	GORE 65474	1003478	12-May-08	12-May-09
3532	Amplifier, low noise, 2 to 8 GHz	Quinstar Technology	QLJ-02084040-J0	11159002001	23-Nov-08	23-Nov-09
3534	Amplifier, low noise, 6 to 18 GHz	Quinstar Technology	QLJ-06184040-J0	11159001002	07-Dec-08	07-Dec-09
3535	Amplifier, low noise, 18 to 40 GHz	Quinstar Technology	QLJ-18404537-J0	11159003001	07-Dec-08	07-Dec-09
3559	Cable 40 GHz, SMA-SMA, 0.95 m, Blue	Gore	PHASEFL EX	03771245	10-Aug-08	10-Aug-09

*Note: The calibration dates were valid at the testing time.

11 APPENDIX B Measurement uncertainties

Expanded uncertainty at 95% confidence in Hermon Labs EMC measurements

Test description	Expanded uncertainty
Transmitter tests	
Carrier power conducted at antenna connector	± 1.7 dB
Carrier power radiated (substitution method)	± 4.5 dB
Occupied bandwidth	±8%
Conducted emissions at RF antenna connector	9 kHz to 2.9 GHz: ± 2.6 dB 2.9 GHz to 6.46 GHz: ± 3.5 dB 6.46 GHz to 13.2 GHz: ± 4.3 dB 13.2 GHz to 22.0 GHz: ± 5.0 dB 22.0 GHz to 26.8 GHz: ± 5.5 dB 26.8 GHz to 40.0 GHz: ± 4.8 dB
Spurious emissions radiated 30 MHz – 40 GHz (substitution method)	± 4.5 dB
Frequency error	30 – 300 MHz: ± 50.5 Hz (1.68 ppm) 300 – 1000 MHz: ± 168 Hz (0.56 ppm)
Transient frequency behaviour	187 Hz ± 13.9 %
Duty cycle, timing (Tx ON / OFF) and average factor measurements	± 1.0 %

Hermon Laboratories is accredited by A2LA for calibration according to present requirements of ISO/IEC 17025 and NCSL Z540-1. The accreditation is granted to perform calibration of parameters that are listed in the Scope of Hermon Laboratories Accreditation.

Hermon Laboratories calibrates its reference and transfer standards by calibration laboratories accredited to ISO/IEC 17025 by a mutually recognized Accreditation Body or by a recognized national metrology institute. All reference and transfer standards used in the calibration system are traceable to national or international standards.

In-house calibration of all test and measurement equipment is performed on a regular basis according to Hermon Laboratories calibration procedures, manufacturer calibration/verification procedures or procedures defined in the relevant standards. The Hermon Laboratories test and measurement equipment is calibrated within the tolerances specified by the manufacturers and/or by the relevant standards.

12 APPENDIX C Test laboratory description

Tests were performed at Hermon Laboratories Ltd., which is a fully independent, private, EMC, safety, environmental and telecommunication testing facility.

Hermon Laboratories is listed by the Federal Communications Commission (USA) for all parts of Code of Federal Regulations 47 (CFR 47), Registration Numbers 90624 for OATS and 90623 for the anechoic chamber; by Industry Canada for electromagnetic emissions (file numbers IC 2186A-1 for OATS, IC 2186A-2 for anechoic chamber, IC 2186A-3 for full-anechoic chamber for RE measurements above 1 GHz), certified by VCCI, Japan (the registration numbers are R-808 for OATS, R-1082 for anechoic chamber, G-27 for full-anechoic chamber for RE measurements above 1 GHz, C-845 for conducted emissions site, T-1606 for conducted emissions at telecommunication ports), has a status of a Telefication - Listed Testing Laboratory, Certificate No. L138/00. The laboratory is accredited by American Association for Laboratory Accreditation (USA) according to ISO/IEC 17025 for electromagnetic compatibility, product safety, telecommunications testing and environmental simulation (for exact scope please refer to Certificate No. 839.01). The FCC Designation Number is US1003.

Address: P.O. Box 23, Binyamina 30500, Israel.
Telephone: +972 4628 8001
Fax: +972 4628 8277
e-mail: mail@hermonlabs.com
website: www.hermonlabs.com

Person for contact: Mr. Alex Usoskin, CEO.

13 APPENDIX D Specification references

47CFR part 90: 2009	Private land mobile radio services
RSS-111 issue 3:2009	Broadband Public Safety Equipment Operating in the Band 4940-4990 MHz
47CFR part 2: 2009	Frequency allocations and radio treaty matters; general rules and regulations
RSS-Gen issue 3:2010	General Requirements and Information for the Certification of Radiocommunication Equipment
ANSI C63.2: 1996	American National Standard for Instrumentation-Electromagnetic Noise and Field Strength, 10 kHz to 40 GHz-Specifications.
ANSI C63.4: 2003	American National Standard for Methods of Measurement of Radio-Noise Emissions from Low-Voltage Electrical and Electronic Equipment in the Range of 9 kHz to 40 GHz.
ANSI/TIA/EIA-603-C:2004	Land Mobile FM or PM Communications Equipment Measurement and Performance Standards

14 APPENDIX E Test equipment correction factors

Antenna Factor
Active Loop Antenna
EMC Test Systems, model 6502, S/N 2857, HL 0446

Frequency, MHz	Magnetic Antenna Factor, dB(S/m)	Electric Antenna Factor, dB(1/m)
0.009	-32.8	18.7
0.010	-33.8	17.7
0.020	-38.3	13.2
0.050	-41.1	10.4
0.075	-41.3	10.2
0.100	-41.6	9.9
0.150	-41.7	9.8
0.250	-41.6	9.9
0.500	-41.8	9.7
0.750	-41.9	9.6
1.000	-41.4	10.1
2.000	-41.5	10.0
3.000	-41.4	10.1
4.000	-41.4	10.1
5.000	-41.5	10.0
10.000	-41.9	9.6
15.000	-41.9	9.6
20.000	-42.2	9.3
25.000	-42.8	8.7
30.000	-44.0	7.5

Antenna factor in dB(S/m) is to be added to receiver meter reading in dB(μ V) to convert it into field intensity in dB(μ A/m).
Antenna factor in dB(1/m) is to be added to receiver meter reading in dB(μ V) to convert it into field intensity in dB(μ V/m).

Antenna factor
Standard gain horn antenna
Quinstar Technology
Model QWH, Ser.No.112, HL 0768, 0769

Frequency min, GHz	Frequency max, GHz	Antenna factor, dB(1/m)
18.000	26.500	32.01
26.500	40.000	35.48
40.000	60.000	39.03
60.000	90.000	42.55
90.000	140.000	46.23
140.000	220.000	50.11

Antenna factor in dB(1/m) is to be added to receiver meter reading in dB(μ V) to convert it into field intensity in dB(μ V/m).



Antenna factor

Biconilog antenna EMCO, model 3141, serial number 1011, HL 0604

Frequency, MHz	Antenna factor, dB(1/m)	Frequency, MHz	Antenna factor, dB(1/m)	Frequency, MHz	Antenna factor, dB(1/m)
26	7.8	560	19.8	1300	27.0
28	7.8	580	20.6	1320	27.8
30	7.8	600	21.3	1340	28.3
40	7.2	620	21.5	1360	28.2
60	7.1	640	21.2	1380	27.9
70	8.5	660	21.4	1400	27.9
80	9.4	680	21.9	1420	27.9
90	9.8	700	22.2	1440	27.8
100	9.7	720	22.2	1460	27.8
110	9.3	740	22.1	1480	28.0
120	8.8	760	22.3	1500	28.5
130	8.7	780	22.6	1520	28.9
140	9.2	800	22.7	1540	29.6
150	9.8	820	22.9	1560	29.8
160	10.2	840	23.1	1580	29.6
170	10.4	860	23.4	1600	29.5
180	10.4	880	23.8	1620	29.3
190	10.3	900	24.1	1640	29.2
200	10.6	920	24.1	1660	29.4
220	11.6	940	24.0	1680	29.6
240	12.4	960	24.1	1700	29.8
260	12.8	980	24.5	1720	30.3
280	13.7	1000	24.9	1740	30.8
300	14.7	1020	25.0	1760	31.1
320	15.2	1040	25.2	1780	31.0
340	15.4	1060	25.4	1800	30.9
360	16.1	1080	25.6	1820	30.7
380	16.4	1100	25.7	1840	30.6
400	16.6	1120	26.0	1860	30.6
420	16.7	1140	26.4	1880	30.6
440	17.0	1160	27.0	1900	30.6
460	17.7	1180	27.0	1920	30.7
480	18.1	1200	26.7	1940	30.9
500	18.5	1220	26.5	1960	31.2
520	19.1	1240	26.5	1980	31.6
540	19.5	1260	26.5	2000	32.0
		1280	26.6		

Antenna factor in dB(1/m) is to be added to receiver meter reading in dB(μV) to convert it into field intensity in dB(μV/m).

Antenna factor
Double-ridged wave guide horn antenna
Model 3115, S/N 9911-5964, HL 1984

Frequency, MHz	Antenna factor, dB(1/m)
1000.0	24.7
1500.0	25.7
2000.0	27.6
2500.0	28.9
3000.0	31.2
3500.0	32.0
4000.0	32.5
4500.0	32.7
5000.0	33.6
5500.0	35.1
6000.0	35.4
6500.0	34.9
7000.0	36.1
7500.0	37.8
8000.0	38.0
8500.0	38.1
9000.0	39.1
9500.0	38.3
10000.0	38.6
10500.0	38.2
11000.0	38.7
11500.0	39.5
12000.0	40.0
12500.0	40.4
13000.0	40.5
13500.0	41.1
14000.0	41.6
14500.0	41.7
15000.0	38.7
15500.0	38.2
16000.0	38.8
16500.0	40.5
17000.0	42.5
17500.0	45.9
18000.0	49.4

Antenna factor in dB(1/m) is to be added to receiver meter reading in dB(μ V) to convert it into field intensity in dB(μ V/m).

**Antenna factor
Double-ridged guide horn antenna
Model 3115, serial number: 00027177, HL 2432**

Frequency, MHz	Antenna factor. dB(1/m)
1000.0	24.7
1500.0	25.7
2000.0	27.8
2500.0	28.9
3000.0	30.7
3500.0	31.8
4000.0	33.0
4500.0	32.8
5000.0	34.2
5500.0	34.9
6000.0	35.2
6500.0	35.4
7000.0	36.3
7500.0	37.3
8000.0	37.5
8500.0	38.0
9000.0	38.3
9500.0	38.3
10000.0	38.7
10500.0	38.7
11000.0	38.9
11500.0	39.5
12000.0	39.5
12500.0	39.4
13000.0	40.5
13500.0	40.8
14000.0	41.5
14500.0	41.3
15000.0	40.2
15500.0	38.7
16000.0	38.5
16500.0	39.8
17000.0	41.9
17500.0	45.8
18000.0	49.1

Antenna factor in dB(1/m) is to be added to receiver meter reading in dB(μ V) to convert it into field intensity in dB(μ V/m).

Cable loss
Cable 40 GHz, 0.8 m, blue, model: KPS-1503A-800-KPS, S/N W4907, HL 2254

Frequency, GHz	Cable loss, dB	Frequency, GHz	Cable loss, dB	Frequency, GHz	Cable loss, dB
0.03	0.04	5.10	0.80	15.00	1.49
0.05	0.07	5.30	0.83	15.50	1.49
0.10	0.09	5.50	0.83	16.00	1.46
0.20	0.15	5.70	0.84	16.50	1.47
0.30	0.19	5.90	0.87	17.00	1.50
0.40	0.25	6.10	0.86	17.50	1.57
0.50	0.29	6.30	0.89	18.00	1.63
0.60	0.33	6.50	0.90	18.50	1.57
0.70	0.37	6.70	0.89	19.00	1.63
0.80	0.41	6.90	0.93	19.50	1.65
0.90	0.44	7.10	0.92	20.00	1.64
1.00	0.45	7.30	0.95	20.50	1.75
1.10	0.48	7.50	0.96	21.00	1.72
1.20	0.51	7.70	0.97	21.50	1.78
1.30	0.53	7.90	1.01	22.00	1.76
1.40	0.54	8.10	1.00	22.50	1.72
1.50	0.57	8.30	1.05	23.00	1.83
1.60	0.59	8.50	1.04	23.50	1.80
1.70	0.04	8.70	1.07	24.00	1.90
1.80	0.07	8.90	1.11	24.50	1.81
1.90	0.09	9.10	1.09	25.00	1.98
2.00	0.15	9.30	1.14	25.50	1.91
2.10	0.19	9.50	1.12	26.00	2.02
2.20	0.25	9.70	1.15	26.50	1.92
2.30	0.29	9.90	1.16	27.00	1.97
2.40	0.33	10.10	1.16	28.00	2.02
2.50	0.37	10.30	1.19	29.00	1.95
2.60	0.41	10.50	1.14	30.00	1.94
2.70	0.44	10.70	1.19	31.00	2.11
2.80	0.45	10.90	1.17	32.00	2.17
2.90	0.48	11.10	1.13	33.00	2.27
3.10	0.61	11.30	1.20	34.00	2.27
3.30	0.64	11.50	1.13	35.00	2.29
3.50	0.65	11.70	1.20	36.00	2.35
3.70	0.68	11.90	1.18	37.00	2.37
3.90	0.69	12.10	1.14	38.00	2.40
4.10	0.71	12.40	1.19	39.00	2.57
4.30	0.73	13.00	1.34	40.00	2.36
4.50	0.75	13.50	1.33		
4.70	0.77	14.00	1.48		
4.90	0.79	14.50	1.45		



Cable loss
Cable coaxial, Gore, 25.5 GHz, 1.2 m, SMA-SMA, S/N 10020014
HL 2953

Frequency, MHz	Cable loss, dB	Frequency, MHz	Cable loss, dB	Frequency, MHz	Cable loss, dB
10	0.06	8750	1.28	18000	1.84
30	0.06	9000	1.30	18250	1.91
100	0.12	9250	1.35	18500	1.94
250	0.19	9500	1.34	18750	1.92
500	0.27	9750	1.36	19000	1.95
750	0.34	10000	1.33	19250	2.00
1000	0.40	10250	1.38	19500	1.96
1250	0.45	10500	1.39	19750	2.02
1500	0.50	10750	1.39	20000	1.92
1750	0.54	11000	1.43	20250	2.04
2000	0.57	11250	1.42	20500	2.00
2250	0.60	11500	1.48	20750	2.09
2500	0.64	11750	1.49	21000	2.01
2750	0.67	12000	1.59	21250	2.07
3000	0.70	12250	1.50	21500	2.20
3250	0.74	12500	1.55	21750	2.10
3500	0.76	12750	1.55	22000	2.24
3750	0.80	13000	1.61	22250	2.25
4000	0.83	13250	1.62	22500	2.12
4250	0.85	13500	1.56	22750	2.05
4500	0.87	13750	1.61	23000	2.10
4750	0.91	14000	1.57	23250	2.03
5000	0.92	14250	1.66	23500	2.08
5250	0.96	14500	1.58	23750	2.14
5500	0.99	14750	1.69	24000	2.16
5750	0.99	15000	1.71	24250	2.25
6000	1.03	15250	1.74	24500	2.17
6250	1.05	15500	1.75	24750	2.32
6500	1.07	15750	1.72	25000	2.32
6750	1.08	16000	1.89	25250	2.32
7000	1.12	16250	1.79	25500	2.41
7250	1.13	16500	1.84	25750	2.31
7500	1.15	16750	1.82	26000	2.28
7750	1.20	17000	1.79	26250	2.32
8000	1.20	17250	1.78	26500	2.29
8250	1.23	17500	1.85		
8500	1.27	17750	1.83		

Cable loss
Microwave Cable Assembly, 18 GHz, 6.4 m, SMA – SMA, Huber-Suhner, model 198-9155-00
HL 3121

Frequency, MHz	Cable loss, dB	Frequency, MHz	Cable loss, dB	Frequency, MHz	Cable loss, dB	Frequency, MHz	Cable loss, dB	Frequency, MHz	Cable loss, dB
10	0.08	3600	2.10	7400	3.08	11200	3.85	15100	4.58
30	0.18	3700	2.14	7500	3.11	11300	3.85	15200	4.60
50	0.26	3800	2.18	7600	3.14	11400	3.86	15300	4.63
100	0.34	3900	2.19	7700	3.16	11500	3.86	15400	4.65
200	0.47	4000	2.25	7800	3.18	11600	3.87	15500	4.71
300	0.59	4100	2.25	7900	3.20	11700	3.85	15600	4.70
400	0.66	4200	2.28	8000	3.22	11800	3.96	15700	4.69
500	0.75	4300	2.35	8100	3.26	11900	3.92	15800	4.71
600	0.83	4400	2.35	8200	3.27	12000	3.92	15900	4.74
700	0.90	4500	2.38	8300	3.29	12100	3.94	16000	4.69
800	0.96	4600	2.43	8400	3.30	12200	3.94	16100	4.72
900	1.02	4700	2.43	8500	3.31	12300	3.99	16200	4.71
1000	1.07	4800	2.45	8600	3.33	12400	4.02	16300	4.74
1100	1.12	4900	2.48	8700	3.35	12500	4.10	16400	4.74
1200	1.15	5000	2.55	8800	3.36	12600	4.09	16500	4.75
1300	1.22	5100	2.54	8900	3.38	12700	4.15	16600	4.78
1400	1.28	5200	2.56	9000	3.40	12800	4.15	16700	4.86
1500	1.29	5300	2.58	9100	3.41	12900	4.08	16800	4.84
1600	1.36	5400	2.61	9200	3.45	13000	4.21	16900	4.83
1700	1.40	5500	2.64	9300	3.48	13100	4.19	17000	4.86
1800	1.45	5600	2.69	9400	3.52	13200	4.29	17100	4.83
1900	1.51	5700	2.67	9500	3.54	13300	4.24	17200	4.90
2000	1.50	5800	2.71	9600	3.59	13400	4.26	17300	4.91
2100	1.56	5900	2.73	9700	3.59	13500	4.26	17400	4.94
2200	1.59	6000	2.75	9800	3.62	13600	4.29	17500	4.93
2300	1.63	6100	2.81	9900	3.70	13700	4.35	17600	4.93
2400	1.73	6200	2.80	10000	3.70	13800	4.31	17700	5.00
2500	1.73	6300	2.82	10100	3.72	13900	4.29	17800	5.01
2600	1.78	6400	2.85	10200	3.73	14000	4.32	17900	5.00
2700	1.84	6500	2.87	10300	3.75	14100	4.33	18000	5.00
2800	1.84	6600	2.90	10400	3.76	14200	4.34		
2900	1.91	6700	2.91	10500	3.77	14300	4.36		
3000	1.91	6800	2.94	10600	3.79	14400	4.38		
3100	1.97	6900	2.96	10700	3.80	14600	4.42		
3200	1.98	7000	2.98	10800	3.81	14700	4.42		
3300	2.04	7100	3.01	10900	3.81	14800	4.55		
3400	2.04	7200	3.02	11000	3.83	14900	4.55		
3500	2.10	7300	3.04	11100	3.84	15000	4.55		

Cable loss
Microwave Cable Assembly, 18 GHz, 6.4 m, SMA – SMA, Huber-Suhner, model 198-9155-00
HL 3123

Frequency, MHz	Cable loss, dB	Frequency, MHz	Cable loss, dB	Frequency, MHz	Cable loss, dB	Frequency, MHz	Cable loss, dB	Frequency, MHz	Cable loss, dB
10	0.11	3600	1.97	7400	3.12	11200	3.90	15100	4.74
30	0.17	3700	1.97	7500	3.13	11300	3.93	15200	4.70
50	0.25	3800	2.03	7600	3.16	11400	3.88	15300	4.73
100	0.32	3900	2.04	7700	3.18	11500	3.87	15400	4.78
200	0.46	4000	2.10	7800	3.20	11600	3.90	15500	4.75
300	0.58	4100	1.97	7900	3.23	11700	3.86	15600	4.76
400	0.65	4200	1.97	8000	3.25	11800	3.88	15700	4.75
500	0.74	4300	2.03	8100	3.26	11900	3.86	15800	4.78
600	0.82	4400	2.04	8200	3.28	12000	3.89	15900	4.79
700	0.89	4500	2.10	8300	3.31	12100	3.94	16000	4.73
800	0.95	4600	1.97	8400	3.31	12200	3.92	16100	4.78
900	1.01	4700	1.97	8500	3.32	12300	3.96	16200	4.84
1000	1.07	4800	2.03	8600	3.34	12400	4.01	16300	4.90
1100	1.11	4900	2.04	8700	3.35	12500	4.07	16400	4.87
1200	1.17	5000	2.10	8800	3.37	12600	4.08	16500	4.90
1300	1.22	5100	2.53	8900	3.39	12700	4.17	16600	4.98
1400	1.27	5200	2.55	9000	3.42	12800	4.26	16700	5.05
1500	1.29	5300	2.60	9100	3.43	12900	4.16	16800	5.04
1600	1.35	5400	2.61	9200	3.51	13000	4.21	16900	5.02
1700	1.40	5500	2.64	9300	3.52	13100	4.24	17000	5.09
1800	1.44	5600	2.70	9400	3.54	13200	4.27	17100	5.07
1900	1.51	5700	2.67	9500	3.63	13300	4.31	17200	5.10
2000	1.49	5800	2.71	9600	3.61	13400	4.33	17300	5.13
2100	1.55	5900	2.74	9700	3.71	13500	4.25	17400	5.23
2200	1.58	6000	2.80	9800	3.66	13600	4.27	17500	5.21
2300	1.62	6100	2.79	9900	3.77	13700	4.33	17600	5.22
2400	1.72	6200	2.81	10000	3.75	13800	4.33	17700	5.36
2500	1.76	6300	2.83	10100	3.77	13900	4.31	17800	5.35
2600	1.78	6400	2.86	10200	3.80	14000	4.30	17900	5.45
2700	1.80	6500	2.88	10300	3.79	14100	4.30	18000	5.43
2800	1.86	6600	2.90	10400	3.87	14200	4.31		
2900	1.90	6700	2.92	10500	3.83	14300	4.37		
3000	1.90	6800	2.98	10600	3.88	14400	4.35		
3100	1.97	6900	2.98	10700	3.86	14600	4.53		
3200	1.97	7000	3.00	10800	3.87	14700	4.50		
3300	2.03	7100	3.02	10900	3.90	14800	4.62		
3400	2.04	7200	3.04	11000	3.84	14900	4.65		
3500	2.10	7300	3.06	11100	3.88	15000	4.79		

Cable loss
Cable coaxial, GORE-TEX, GOR245, 40 GHz, 1.2 m, SMA-SMA, S/N 05118337
HL 3207

Frequency, MHz	Cable loss, dB	Frequency, MHz	Cable loss, dB	Frequency, MHz	Cable loss, dB	Frequency, MHz	Cable loss, dB	Frequency, MHz	Cable loss, dB
10	0.17	5000	1.54	10200	2.26	15500	2.77	31500	4.07
30	0.14	5100	1.54	10300	2.26	15600	2.78	32000	4.03
50	0.16	5200	1.56	10400	2.24	15700	2.81	32500	3.93
100	0.22	5300	1.59	10500	2.23	15800	2.81	33000	4.00
200	0.30	5400	1.60	10600	2.25	15900	2.84	33500	4.09
300	0.38	5500	1.61	10700	2.31	16000	2.91	34000	4.08
400	0.44	5600	1.63	10800	2.34	16100	2.92	34500	4.13
500	0.48	5700	1.66	10900	2.38	16200	2.88	35000	4.15
600	0.54	5800	1.68	11000	2.38	16300	2.90	35500	4.18
700	0.58	5900	1.68	11100	2.38	16400	2.93	36000	4.22
800	0.62	6000	1.71	11200	2.37	16500	2.92	36500	4.25
900	0.65	6100	1.71	11300	2.38	16600	2.97	37000	4.26
1000	0.69	6200	1.73	11400	2.40	16700	3.02	37500	4.40
1100	0.73	6300	1.75	11500	2.41	16800	3.02	38000	4.40
1200	0.76	6400	1.76	11600	2.44	16900	3.01	38500	4.52
1300	0.78	6500	1.78	11700	2.44	17000	3.04	39000	4.54
1400	0.81	6600	1.77	11800	2.44	17100	3.08	39500	4.36
1500	0.85	6700	1.79	11900	2.45	17200	3.05	40000	4.48
1600	0.87	6800	1.80	12000	2.46	17300	3.06		
1700	0.90	6900	1.83	12100	2.45	17400	3.06		
1800	0.93	7000	1.84	12200	2.45	17500	3.07		
1900	0.96	7100	1.86	12300	2.48	17600	3.08		
2000	0.95	7200	1.88	12400	2.49	17700	3.09		
2100	0.98	7300	1.86	12500	2.51	17800	3.12		
2200	1.00	7400	1.87	12600	2.53	17900	3.09		
2300	1.02	7500	1.90	12700	2.51	18000	3.08		
2400	1.04	7600	1.91	12800	2.52	18500	3.11		
2500	1.06	7700	1.95	12900	2.54	19000	3.14		
2600	1.08	7800	1.98	13000	2.56	19500	3.20		
2700	1.11	7900	1.99	13100	2.56	20000	3.24		
2800	1.14	8000	1.98	13200	2.59	20500	3.31		
2900	1.15	8100	1.98	13300	2.59	21000	3.38		
3000	1.17	8200	2.00	13400	2.60	21500	3.44		
3100	1.19	8300	2.01	13500	2.65	22000	3.45		
3200	1.20	8400	2.05	13600	2.71	22500	3.45		
3300	1.24	8500	2.07	13700	2.71	23000	3.47		
3400	1.26	8600	2.08	13800	2.69	23500	3.47		
3500	1.27	8700	2.09	13900	2.67	24000	3.54		
3600	1.28	8800	2.09	14000	2.68	24500	3.62		
3700	1.32	8900	2.10	14100	2.68	25000	3.73		
3800	1.32	9000	2.12	14200	2.74	25500	3.77		
3900	1.35	9100	2.12	14300	2.77	26000	3.71		
4000	1.36	9200	2.15	14400	2.80	26500	3.73		
4100	1.39	9300	2.13	14600	2.74	27000	3.73		
4200	1.40	9400	2.16	14700	2.73	27500	3.78		
4300	1.41	9500	2.17	14800	2.75	28000	3.81		
4400	1.43	9600	2.17	14900	2.75	28500	3.81		
4500	1.47	9700	2.18	15000	2.77	29000	3.80		
4600	1.46	9800	2.16	15100	2.76	29500	3.81		
4700	1.49	9900	2.17	15200	2.76	30000	3.89		
4800	1.50	10000	2.20	15300	2.77	30500	4.03		
4900	1.52	10100	2.22	15400	2.79	31000	4.01		



Cable loss
Cable coaxial, Microwave Cable Assembly, 104EA, 26.5 GHz, 1.0 m
Suhner Sucoflex, HL 3886

Frequency, MHz	Cable loss, dB	Frequency, MHz	Cable loss, dB	Frequency, MHz	Cable loss, dB	Frequency, MHz	Cable loss, dB
10	0.04	5000	0.62	10200	0.92	15500	1.16
30	0.06	5100	0.64	10300	0.94	15600	1.19
50	0.07	5200	0.67	10400	0.94	15700	1.18
100	0.09	5300	0.70	10500	0.91	15800	1.20
200	0.12	5400	0.71	10600	1.00	15900	1.20
300	0.16	5500	0.72	10700	0.88	16000	1.18
400	0.18	5600	0.75	10800	0.90	16100	1.19
500	0.19	5700	0.74	10900	0.90	16200	1.17
600	0.19	5800	0.74	11000	0.88	16300	1.18
700	0.23	5900	0.82	11100	0.93	16400	1.19
800	0.27	6000	0.83	11200	0.94	16500	1.18
900	0.26	6100	0.86	11300	1.00	16600	1.15
1000	0.27	6200	0.85	11400	0.98	16700	1.15
1100	0.28	6300	0.78	11500	0.92	16800	1.14
1200	0.32	6400	0.78	11600	0.93	16900	1.16
1300	0.28	6500	0.77	11700	1.01	17000	1.18
1400	0.32	6600	0.85	11800	1.00	17100	1.21
1500	0.32	6700	0.85	11900	1.01	17200	1.20
1600	0.34	6800	0.89	12000	0.98	17300	1.20
1700	0.35	6900	0.85	12100	1.03	17400	1.24
1800	0.36	7000	0.80	12200	1.04	17500	1.22
1900	0.42	7100	0.79	12300	1.08	17600	1.20
2000	0.36	7200	0.81	12400	1.09	17700	1.19
2100	0.37	7300	0.84	12500	1.03	17800	1.20
2200	0.40	7400	0.87	12600	1.02	17900	1.21
2300	0.41	7500	0.89	12700	1.04	18000	1.22
2400	0.43	7600	0.87	12800	1.04	18500	1.05
2500	0.43	7700	0.89	12900	1.04	19000	1.68
2600	0.44	7800	0.86	13000	1.07	19500	0.82
2700	0.46	7900	0.86	13100	1.08	20000	1.58
2800	0.46	8000	0.91	13200	1.11	20500	1.00
2900	0.47	8100	0.93	13300	1.14	21000	1.45
3000	0.48	8200	0.97	13400	1.15	21500	1.33
3100	0.48	8300	0.91	13500	1.14	22000	1.24
3200	0.49	8400	0.92	13600	1.12	22500	1.03
3300	0.50	8500	0.84	13700	1.13	23000	1.61
3400	0.51	8600	0.85	13800	1.13	23500	0.60
3500	0.54	8700	0.89	13900	1.17	24000	1.97
3600	0.57	8800	0.95	14000	1.14	24500	1.32
3700	0.55	8900	0.90	14100	1.15	25000	1.85
3800	0.55	9000	0.89	14200	1.13	25500	-0.24
3900	0.56	9100	0.87	14300	1.15	26000	0.68
4000	0.56	9200	0.87	14400	1.13	26500	0.86
4100	0.58	9300	0.85	14600	1.12		
4200	0.59	9400	0.86	14700	1.15		
4300	0.60	9500	0.87	14800	1.18		
4400	0.63	9600	0.89	14900	1.20		
4500	0.62	9700	0.87	15000	1.16		
4600	0.63	9800	0.89	15100	1.17		
4700	0.63	9900	0.91	15200	1.15		
4800	0.62	10000	0.89	15300	1.17		
4900	0.61	10100	0.88	15400	1.16		

15 APPENDIX F Abbreviations and acronyms

A	ampere
AC	alternating current
A/m	ampere per meter
AM	amplitude modulation
AVRG	average (detector)
BB	broad band
cm	centimeter
dB	decibel
dBm	decibel referred to one milliwatt
dB(μ V)	decibel referred to one microvolt
dB(μ V/m)	decibel referred to one microvolt per meter
dB(μ A)	decibel referred to one microampere
dB Ω	decibel referred to one Ohm
DC	direct current
EIRP	equivalent isotropically radiated power
ERP	effective radiated power
EUT	equipment under test
F	frequency
GHz	gigahertz
GND	ground
H	height
HL	Hermon laboratories
Hz	hertz
k	kilo
kHz	kilohertz
LO	local oscillator
m	meter
MHz	megahertz
min	minute
mm	millimeter
ms	millisecond
μ s	microsecond
NA	not applicable
NB	narrow band
NT	not tested
OATS	open area test site
Ω	Ohm
QP	quasi-peak
PCB	printed circuit board
PM	pulse modulation
PS	power supply
RE	radiated emission
RF	radio frequency
rms	root mean square
Rx	receive
s	second
T	temperature
Tx	transmit
V	volt
VA	volt-ampere

END OF TEST REPORT

16 APPENDIX G RADWIN 1000/2000/5000 Antenna List and Power Settings



Antenna List and Power Settings RADWIN 1000/2000/5000

FCC ID: Q3KRW2049, IC: 5100A-RW2054

The following table contains the antennas that are provided with the RADWIN 1000/2000/5000 models operating in the 4940 – 4990 MHz band according to FCC Part 90 Subpart Y and IC Radio Standard Specification RSS-111. The output power ascribed to each antenna assembly gain is the maximum transmission power allowed to keep compliance with the standards mentioned.

Part Number	Type	Antenna Frequency [GHz]	Antenna Assembly Gain at 4940 - 4990 MHz [dBi]	Channel Frequency [MHz]	Channel Bandwidth [MHz]	Output Power [dBm]
RW-9722-4958	Dish - Dual Pole	4.9 - 5.8	27*	4942.5, 4962.5, 4987.5	5	25.9
				4945, 4965, 4985	10	29.6
				4950, 4965, 4980	20	31
RW-9611-4958INT	FP Dual Pole Integrated	4.9 - 6.0	21	4942.5, 4962.5, 4987.5	5	25.9
				4945, 4965, 4985	10	29.6
				4950, 4965, 4980	20	31
RW-9611-4960	FP Dual Pole External	4.9 - 6.06	20*	4942.5, 4962.5, 4987.5	5	25.9
				4945, 4965, 4985	10	29.6
				4950, 4965, 4980	20	31
RW-9061-5001	FP Dual Pole External	4.9 - 5.95	13*	4942.5, 4962.5, 4987.5	5	25.9
				4945, 4965, 4985	10	29.6
				4950, 4965, 4980	20	31
RW-9061-5002	FP Dual Pole External	4.9 - 6.06	14*	4942.5, 4962.5, 4987.5	5	25.9
				4945, 4965, 4985	10	29.6
				4950, 4965, 4980	20	31

* Antenna assembly gain = Antenna Gain - Feeder Loss

