

Site Preparation

Planning the Link Site

Overview

Link site planning consists of a set of surveys, which must be carried out before any equipment is brought to the site. If for some reason, the outcome of any of these surveys is negative, site re-location will need to be considered.

A Site Survey consists of three stages:

1. Preliminary survey - The proposed link is analyzed **in the office** using a topographic map.
2. Physical survey - The locations of the RADWIN 1000/2000 indoor and outdoor equipment are determined **on-site**.
3. Radio Frequency (RF) survey - It is recommended that the installation area be scanned with a spectrum analyzer, to identify RF interference so as to determine a clear channel for RADWIN 1000/2000 installation (**on-site**).

The Site Survey

Introduction

RADWIN 1000/2000 wireless links must be planned before installation. The designated installation site must be appraised to determine that the wireless system is able to operate efficiently and provide connectivity without signal degradation.

RADWIN 1000/2000 offers a wide operating frequency range. A free frequency channel must be determined within the operating range, for optimum performance.

Recommended Equipment

Stage 1: Preliminary Survey

- Topological map of the area

- Urban map of the area
- Compass

Stage 2: Physical Survey

- 100 meter tape measure
- Ohmmeter, to check ground connection
- Binoculars
- Map
- Digital camera
- Paper, pencil, and a clipboard
- GPS device (optional)
- Compass (optional)

Stage 3: RF Survey

- Spectrum Analyzer with Max Hold function and screen capture facility that can store multiple images, for documentation purposes
- RF accessories (connectors and cables)
- Communication devices (for example, cellular phones, or a set of walkie-talkies)

Stage 1: Preliminary Survey

A preliminary survey is necessary before visiting potential installation sites. As much detail as possible should be obtained about the two designated ODU installation sites and the area between them.

➤ **To perform a preliminary survey:**

1. Mark the two designated installation sites on a topographic map of the area.
2. Measure the distance between the sites; check that it is within the specified range of the RADWIN 1000/2000.
3. On the urban map, check for developed areas situated between the two installation sites. Pay attention to these areas when performing the physical site survey; there may be tall buildings, RF towers, or transmitters, which could cause interference to the link.
4. Check the area between the two sites for obstructions such as:
 - High ground - hills or mountains
 - Lakes or large bodies of water. Water has a reflection effect on RF signals like a building. This type of reflection causes the received amplitude to be reduced. As a rule of thumb, the presence of a large body of water between the link sites may double the required antenna height.
5. Determine and record the compass bearings between both ODUs, relative to north.
6. If there are obstructions between the two sites, calculate the Fresnel Zone (see appendix **D** for details).

7. If the site chosen does not meet requirements, consider alternative sites.
8. Use the Link Budget Calculator (on the CD supplied with the RADWIN 1000/2000 or using the RADWIN Manager) to determine the expected performance.

Stage 2: Physical Survey

The physical site survey reviews the environment of the proposed RADWIN 1000/2000 installation location, to ensure that the link sites are suitable for the wireless network. The results of the physical site survey should be recorded.



Note

It is advisable to go on a clear day, so you can more easily see any obstructions between the two sites.

➤ To perform a physical survey:

1. From the compass readings taken in the preliminary survey, find the azimuth (horizontal position) that the ODU should face towards the second ODU.
2. Using binoculars, locate any obstructions such as tall trees, high buildings, hills or mountains. Look for other RF towers between the two sites. Mark the locations of the obstructions on the map.
3. Determine the location for the ODU (having regard for existing rooftop installations and tower space). It should be above any obstructions, considering the Fresnel zone (see appendix D).
4. If you need to install the ODU on a tower, make sure that the tower is far away from overhead electric power lines.
5. Determine a location for the indoor equipment; it should be as close as possible to the ODU. At an existing site, there is probably an equipment room with cable-routing channels.



Note

The IDU - ODU cable length limit is 100m, in accordance with IEEE 10/100BaseT standards.

6. Measure and record the path length of the cable from the ODU position to the indoor equipment room.
7. Determine the ground and lightning connection points of the installation. The RADWIN 1000/2000 ODU and IDU must both be grounded.
8. Using the Ohmmeter, measure and record the resistance of the required installation to the grounding point. The resistance must be less than 10 ohm.

9. Review the results of the physical site survey. Decide if the site is suitable for the RADWIN 1000/2000 wireless network installation.
 - If the site is suitable, continue with stage 3, the RF survey
 - If the site is not suitable, survey another site

Additional Outdoor Site Requirements

The ambient outdoor operating temperature should be -35 to 60°C (-31 to 140°F).

Additional Indoor Site Requirements

The following requirements guarantee proper operation of the system:

- For IDU-C units, allow at least 90 cm (36 ") of front clearance for operating and maintenance accessibility. Allow at least 10 cm (4 ") clearance at the rear of the unit for signal lines and interface cables
- The ambient operating temperature should be 0 to 50°C (32 to 122 °F) at a humidity of up to 90%, non condensing

Stage 3: RF Survey

The RF survey examines the wireless environment of the RADWIN 1000/2000 installation site, to determine whether there are available channels within the RADWIN 1000/2000 operating frequency band. An RF survey is performed using a spectrum analyzer.

It is advisable to familiarize yourself with the spectrum analyzer before going out on site, specifically the Max Hold and Marker functions.

You should perform the RF survey at both proposed link sites.

The survey should be carried out during a busy time of day, to best judge the worst-case radio interference. Allow 2-4 hours duration for a good RF survey.



Note

It is possible to install the RADWIN 1000/2000 link and use the RADWIN Manager to find a clear channel. Each frequency channel can be evaluated in turn. Achievement of a clear channel is indicated by the Quality bar on the Channel Setting window (see [figure 4-13](#)) becoming green.

Hardware Installation

This chapter sets out the requirements and procedures for the hardware installation and alignment of a RADWIN 1000/2000 link in accordance with the prior planning as set out in chapter 2. It is intended to guide qualified field technicians.



Outdoor units and antennas should be installed **ONLY** by experienced installation professionals who are familiar with local building and safety codes and, wherever applicable, are licensed by the appropriate government regulatory authorities. Failure to do so may expose the end user or the service provider to legal and financial liabilities. RADWIN and its resellers or distributors are not liable for injury, damage or violation of regulations associated with the installation of outdoor units or antennas.

Safety Practices

Preventing overexposure to RF energy

To protect against overexposure to RF energy, install the ODUs so as to provide and maintain minimal separation distances from all persons.

When the system is operational, avoid standing directly in front of the antenna. Strong RF fields are present when the transmitter is on. The ODU must not be deployed in a location where it is possible for people to stand or walk inadvertently in front of the antenna.

Grounding

All RADWIN products should be grounded during operation. In addition:

- The **ODU** should be earthed by a wire with diameter of at least **12AWG**.

The RADWIN 1000/2000 ODU must be properly grounded to protect against lightning. It is the user's responsibility to install the equipment in accordance with Section 810 of the National Electric Code, ANSI/NFPA No.70-1984 or Section 54 of the Canadian Electrical Code. These codes describe correct installation procedures for grounding the outdoor unit, mast, lead-in wire and discharge unit. It

also lays down the size of grounding conductors and connection requirements for grounding electrodes.

The RADWIN 1000/2000 ODU must be grounded to a Protective Earth as described in appendix E and in accordance with the Local Electrical Regulations.

- The earth lug on the **IDU-C** should be connected to the protective earth at all times, by a wire with a diameter of **18 AWG** or wider. Rack-mounted equipment should be mounted only in earthed racks and cabinets.

Further, you should -

- Always make the ground connection first and disconnect it last
- Never connect telecommunication cables to ungrounded equipment
- Ensure that all other cables are disconnected before disconnecting the ground

More detailed guidelines are supplied in appendix E.

Protection against Lightning

The use of lightning protection is dependent on regulatory and end user requirements. All of RADWIN outdoor units are designed with surge limiting circuits to minimize the risk of damage due to lightning strikes. RADWIN recommends the use of additional surge arrestor devices to protect the equipment from nearby lightning strikes.

See appendix E for detailed installation instructions of lightning protection devices.

General

- It is recommended that installation of the outdoor unit be contracted to a professional installer.
- Before working on equipment connected to power lines or telecommunication lines, you should remove jewelry or any other metallic object that may come into contact with energized parts.
- Use extreme care when installing antennas near power lines.
- Use extreme care when working at heights.
- When using an AC power source for RADWIN 1000/2000 always use the AC power adapter supplied by RADWIN.
- Use the right tools. In addition to standard tools required for any kind of ODU or antenna installation, RADWIN 1000/2000 requires additional specific tools detailed on [page 3-5](#) below.

Package Contents

The RADWIN 1000/2000 packages include the following items:

ODU Package Contents

The ODU package contains:

- One ODU - see [figure 3-2](#) below for front and rear view
- An ODU mounting kit - see [figure 3-1](#) below
- A CD containing -
 - the RADWIN Manager
 - Quick Start Guide
 - User Manual
 - Link Budget Calculator
- Label showing the MAC address and the alternative Community string. The label is self-adhesive. You should keep this label safe
- Cable glands (to be used with the ODU-IDU cable)

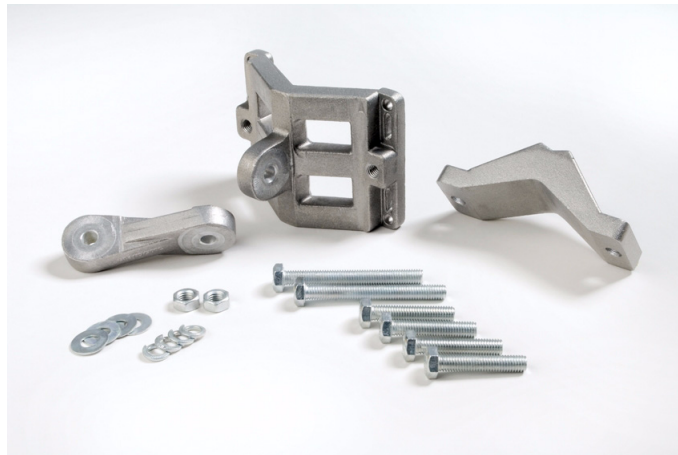

Figure 3-1: ODU Mounting kit

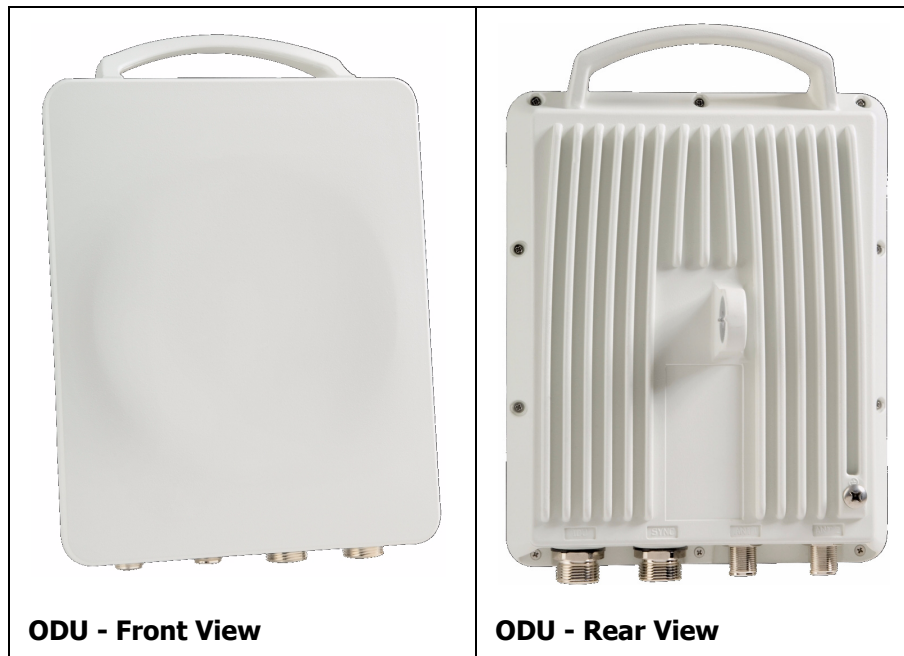
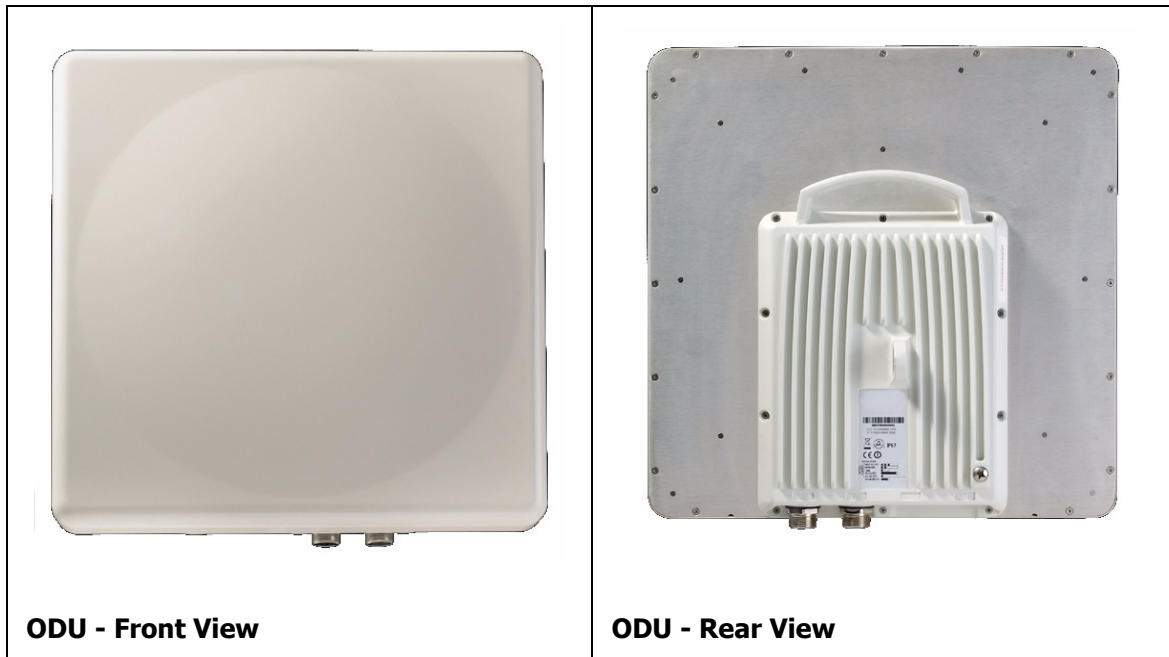

Figure 3-2: Connectorized ODU - Front and rear views



ODU - Front View

ODU - Rear View

Figure 3-3: Integrated ODU - Front and rear views

IDU Package Contents

The IDU package contains:

- IDU-C - see [figure 3-4](#) below.
- 19" rack mounting kit - see [figure 3-5](#) below
- Two DC power plugs for power cables - see [figure 3-5](#) below



Figure 3-4: IDU-C Package contents - the IDU-C



Figure 3-5: IDU-C Package contents - the mounting kit and DC power plugs

External Antenna Package Contents

- Antenna
- RF cable 1m (3') long; two cables supplied with bipolar antennas, single cable supplied with monopolar antennas
- Mounting kit

Additional Tools and Materials Required

The following is a list of the equipment and materials required to install RADWIN 1000/2000 hardware.

Tools and Materials

- Crimping tool for RJ-45 (if the ODU-IDU cable is without connectors)
- Spanner/wrench 13 mm (1/2")
- Drill (for wall mounting only)
- Cable ties
- Sealing material

Cables and connectors

- ODU grounding cable 12AWG
- IDU grounding cable 18AWG
- ODU-IDU cable (outdoor class, CAT-5e, 4 twisted pairs, 24AWG)

Hardware Installation Sequence

The following steps are required to install the RADWIN 1000/2000 system:

1. Mounting the ODUs, page [page 3-6](#).
2. Mounting the external antennas (if used), page [page 3-7](#).
3. Mounting the Lightning Protection devices (if used), page [page 3-7](#).
4. Outdoor connections, page [page 3-8](#).
5. Mounting the IDUs, page [page 3-8](#).
6. Indoor connections, page [page 3-11](#).
7. Aligning the ODUs/antennas, page [page 3-12](#).

See [figure 3-6](#) below, which illustrates a typical installation of RADWIN 1000/2000 with an external antenna.

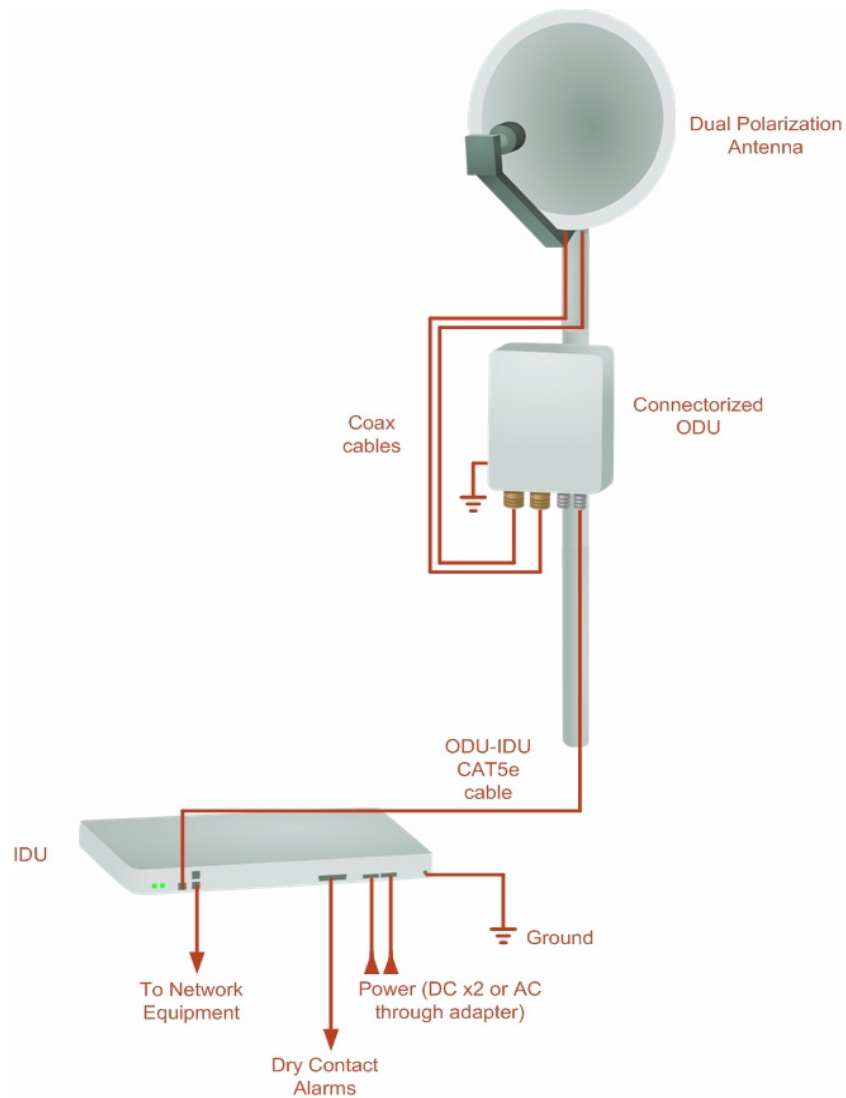

Figure 3-6: Typical Installation Diagram (with external antenna)

The installation steps are detailed in the following sections.

Outdoor installation

Mounting the ODU

The ODU can be mounted on a pole or a wall. In both installations, the supplied mounting kit is used to secure the ODU.



Note

A mast-sited ODU typically uses a pole attached to the mast.

A RADWIN 1000/2000 link operates in pairs of two ODUs with the same configuration. Both ODUs must be installed, and the antennas aligned for maximum throughput.

**Warning**

Prior to connecting cables to the ODU, the protective earth terminal (screw) of the ODU must be connected to an external protective ground conductor or to a grounded pole.

- Only a qualified person using the proper safety equipment should climb the antenna mast
- Only qualified professional personnel should install or dismantle ODUs and masts

➤ **To mount the ODU on a pole or a wall:**

1. Ensure that the ODU is properly grounded.
2. Mount the ODU onto the pole or wall. Ensure that the unit is oriented so that the cable connectors are at the bottom. **(If they are on top, water may penetrate into the unit causing damage.)**
3. Refer to [Appendix C, Pole and Wall Installation](#) for detailed ODU mounting kit contents and schematics.

**Note**

Do not tighten the ODU to its mounting brackets until the alignment process of the antenna is complete.

Ensure that there are no direct obstructions in front of the ODU or interference from man-made obstacles.

Mounting external antennas

If you are using ODU with an integrated antenna, skip to [Mounting the Lightning Protection Devices](#) below.

The supplied mounting kit is used to mount the antenna onto a pole. The antennas must be aligned for maximum throughput.

**Warning**

Do not stand in front of a live antenna.

➤ **To mount an external antenna:**

1. To mount an external antenna ensure that the antenna is properly grounded and then mount the antenna onto the pole. Refer to [Appendix C, Pole and Wall Installation](#) for detailed antenna mounting instructions.
2. Follow the mounting instructions supplied with the antenna.

Mounting the Lightning Protection Devices

The use of lightning protection is dependent on regulatory and end user requirements. The RADWIN 1000/2000 ODU is designed with surge limiting circuits to minimize the risk of damage due to lightning strikes. RADWIN

recommends the use of additional surge arrestor devices to protect the equipment from nearby lightning strikes.

Refer to appendix E for detailed installation instructions of lightning protection devices.

Outdoor Connections

➤ To complete the outdoor connections:

1. Connect the ground cable to the ODU chassis as marked on the ODU.
2. Connect the antenna cable(s) to the ODU.
3. Connect the lightning protection device to the ODU (see appendix E).
4. Attach the ODU-IDU cable to the ODU RJ-45 connector (see appendix B for the connector pin-out)
5. Screw in the cable glands to ensure hermetic sealing of the ODU.
6. Secure the cables to the pole, mast or brackets using UV-rated cable ties.

Indoor Installation

Mounting the IDUs

The RADWIN 1000/2000 IDUs are all rack mounted, as shown in [figure 1-6](#). A front panel keyed schematic of a rack mounted IDU-C is shown in [figure 3-7](#) below.

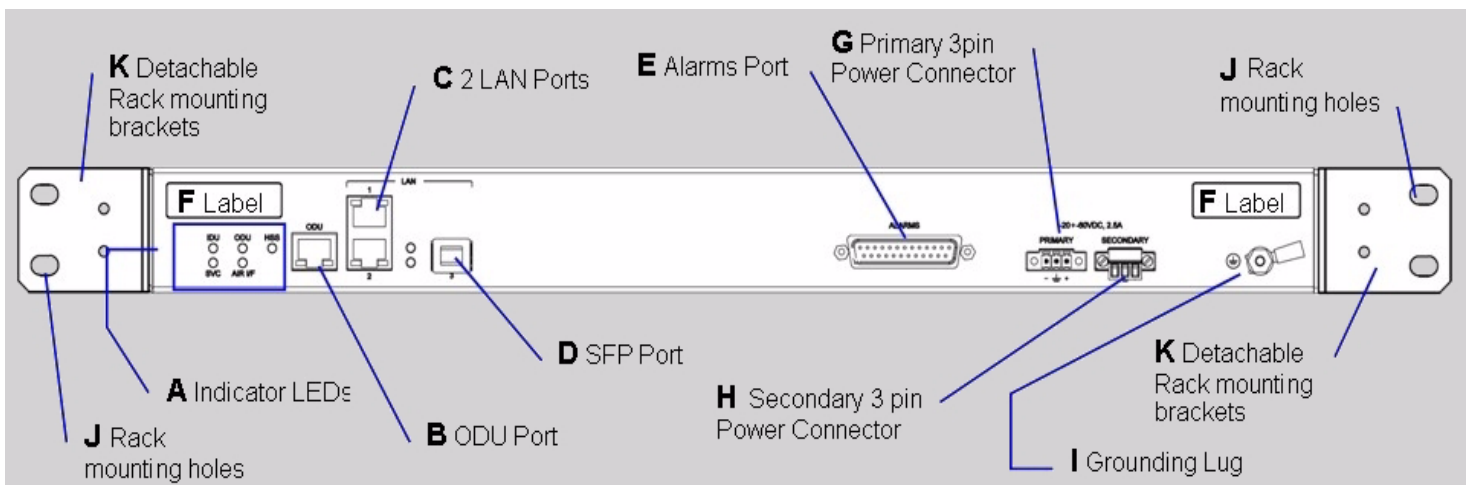

Figure 3-7: IDU-C front panel

In [figure 3-8](#) we display a perspective view of the IDU-C:

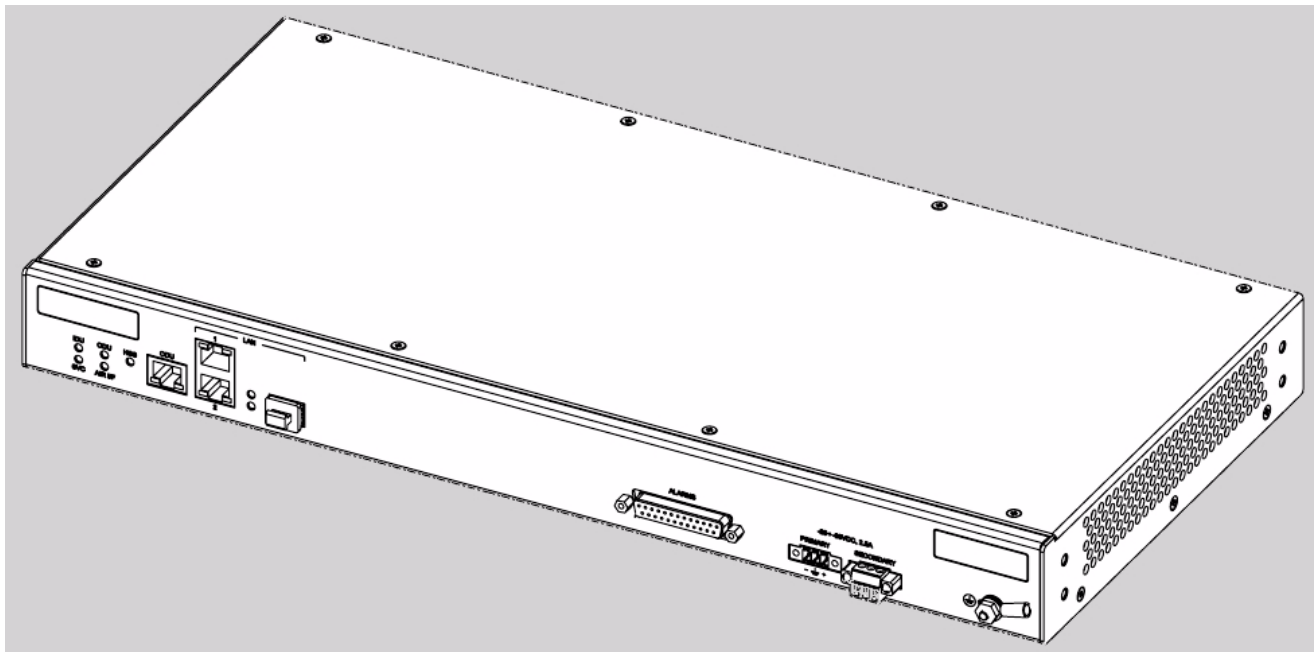

Figure 3-8: IDU-C - A perspective view

Further description of the keyed items in [figure 3-7](#) is shown in [table 3-1](#) below:

Table 3-1: Components of an IDU-C front panel

Key	Label	Remarks
A	Indicator LEDs	See figure 3-9 .
B	ODU Port	RJ-45 connector, see table B-1 .
C	2 LAN Ports	Ethernet, RJ-45 connector, see table B-2
D	SFP Port	The IDU-C is SFP ready.
E	Alarm Ports	Standard DB25 female connector, see table B-3 .
F	Label indent	Place for adhesive identification labels
G	Primary 3 pin Power Connector	Standard 3 pins in line power connector, see table B-4 .
H	Secondary 3 pin Power Connector	Standard 3 pins in line power connector, see table B-4 .
I	Grounding Lug	Use the lug supplied
J	Rack mounting holes	
K	Detachable Rack mounting brackets	

The Indicator LEDs (Item A in [table 3-1](#) above) are shown in more detail in [figure 3-9](#) below:



Figure 3-9: IDU-C LEDs

The purpose of the LEDs is shown in [table 3-2](#) below:

Table 3-2: IDU-C Front Panel LEDs

Name	Color	Function
IDU	Green Green Red	IDU operational During power-up only Failure
ODU	Green Red	ODU-to-IDU communication link is operating ODU-to-IDU communication link is disrupted
AIR I/F	Green Orange Red	Wireless link is synchronized During installation mode only Wireless link lost synchronization
SVC		Off
HSS		Off

➤ **To mount an IDU (using [figure 3-7](#) above):**

1. If the rack already holds other equipment, ensure that it is properly grounded.



Warning

Do not proceed with installation into a “live” rack unless it is properly grounded.

2. Attach the rack mounting brackets (K) to the IDU.
3. Bolt the IDU into an empty slot in the rack, ensuring that it sits securely.
4. Ground the IDU to the rack using grounding lug I. The IDU should be left permanently grounded.



Note

Instead of using the rack mounting brackets, the IDU may be rail mounted using the four screw holes on each of its sides.

Connecting power to the IDU

The IDU-C has redundant power connection circuits (items G and H in [figure 3-7](#) above). An enlarged schematic of the power connectors is shown in below:

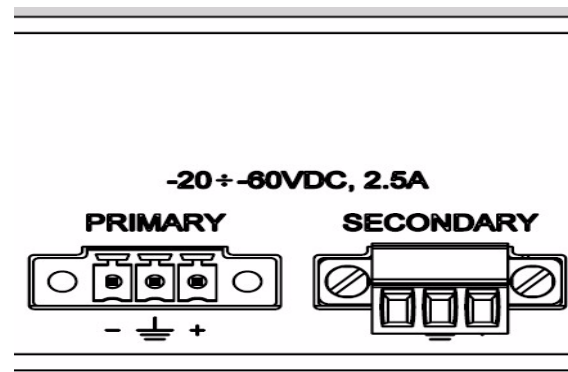

Figure 3-10: DU-C ower connectors

The connectors are 3 pin in line female, with polarities (left to right) minus, ground, plus. To avoid damage to the IDU, always use an AC/DC adapter supplied by RADWIN.

Ensure that the IDUs at both sites are powered up.

Connecting the ODU to the IDU

The ODU-IDU cable conducts all the user traffic between the IDU and the ODU, and also provides power to the ODU. The maximum length of the ODU-IDU cable is 100m (328 ') in accordance with 10/100BaseT standards.

The ODU-IDU cable is supplied pre-assembled with RJ-45 connectors, at the length specified when ordering, or as a cable drum with spare connectors. If the ODU-IDU cable was not ordered, use an outdoor class, CAT-5e 24AWG shielded cable. See appendix [B](#) for Wiring Specifications.

To connect the ODU to the IDU, route the cable from the ODU to the IDU, secure the cable along its path and connect the cable to the ODU RJ-45 connector on the IDU (see item B in [figure 3-7](#) above).

Installing a Link using PoE Devices

The PoE device is a very simple unit having a power input connector and two Ethernet ports. It is AC powered, and has a power LED.

➤ To prepare a link using PoE devices:

1. To connect the ODU to the PoE device, route the cable from the ODU to the PoE device, secure the cable along its path and connect the cable to the P-LAN-OUT RJ-45 connector on the PoE device.
2. Connect it to AC power.
3. Repeat steps 1 to 2 for the second link.

Connecting User Equipment

➤ To connect user equipment to the IDU:

- Connect user switch/router or any other compatible device to the IDU panel RJ-45 ports designated LAN (see item C in [figure 3-7](#) above).

Refer to appendix [B](#), [Wiring Specifications](#), for connector pinouts.



Note

Do not connect two LAN ports to the same network, or flooding may occur.

➤ To connect user equipment to the PoE device:

- Connect a user switch, router or any other compatible device to the PoE device RJ-45 port designated LAN-IN. Refer to appendix [B](#), [Wiring Specifications](#), for connector pinouts.

Connecting and Aligning ODUs / Antennas

You perform antenna alignment using the ODU's audible tone.

To speed up the installation time, alignment of a RADWIN 1000/2000 system should be performed by two teams simultaneously, at site A and at site B.

➤ To align ODUs with integrated antennas or external bipolar antennas:

1. For external bipolar antennas: Using a coax cable with N-Type connectors, connect the vertical polarization connector of the antenna to the ANT 1 connector of the ODU.
2. For external bipolar antennas: Using a coax cable with N-Type connectors, connect the horizontal polarization connector of the antenna to the ANT 2 connector of the ODU.
3. Ensure that power is connected to the IDUs at both sites.
4. Ensure normal operation of the IDUs by the LED indications on the front panel.

Provided that site A detects the signal from site B, the ODU starts beeping 20 seconds after power up, and continues beeping until the ODUs are aligned, and the installation is complete.

In the following steps, "antenna" refers both to an external antenna and an integrated antenna.

5. Direct the antenna of site B in the direction of site A. This is simplified if a previous site survey has been completed and azimuths are known.
-



Warning

When aligning the antennas, do not stand in front of a live antenna.

6. Make a horizontal sweep of 180 degrees with the site A antenna so that the strongest signal from site B can be detected.
7. Slowly turn the site A antenna back towards the position of site B, listening to the tone until the best signal is reached. See the following figure for audible signal variations.

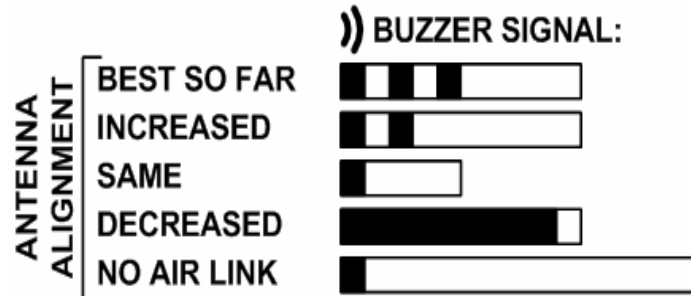

Figure 3-11: Bleep Sequence for antenna alignment



Note

- Three beeps and a pause is 'best signal so far'
- Two beeps and a pause is 'signal quality increased'
- One beep and pause is 'no change in signal'
- Long beep and short pause is 'signal quality decreased'
- One beep and a long pause is 'no air link'
- Any other signal does not relate to antenna alignment

8. Secure the site A antenna to the pole/wall.
9. Repeat steps 4 to 8 for site B.

➤ **To align two external monopolar antennas:**



Note

The ODU buzzer only works on the radio connected to the ANT 1 connector marked . You will therefore need to use ANT 1 to align both antennas in turn. Upon completion of the alignment procedure, you may connect the two antennas to ANT 1 and ANT 2 connectors.

1. Using a coax cable with N-Type connectors, connect one antenna to the ANT 1 connector of the ODU.
2. Follow the steps 3 to 7 above to align the antenna connected to the ODU connector ANT 1 on both sides of the link.
3. On both sides of the link, disconnect the antenna connected to the ODU connector ANT 1. Connect the other antenna to connector ANT 1 and follow the steps 3 to 7 above to align the second antenna.
4. Secure the antennas to the pole/wall.
5. Restore one of the antennas to ANT 2 on both sides of the link.