

Company: Radwin Ltd.

Test of: Outdoor Subscriber Radio Unit  
To: FCC CFR 47 Part 15 Subpart E 15.407

Report No.: RDWN44-U3 Rev A Report

**RADIATED, CONDUCTED TEST REPORT**



# RADIATED, CONDUCTED TEST REPORT



Test of: Radwin Ltd. Outdoor Subscriber Radio Unit

to

FCC CFR 47 Part 15 Subpart E 15.407 (Update to the New Rules)

Test Report Serial No.: RDWN44-U3 Rev A Report

This report supersedes: NONE

Applicant: Radwin Ltd.  
27 Habarzel Street  
Tel Aviv, 69710  
Israel

Product Function: Outdoor Subscriber Radio Unit

Issue Date: 20<sup>th</sup> December 2016

## **This Test Report is Issued Under the Authority of:**

**MiCOM Labs, Inc.**  
575 Boulder Court  
Pleasanton California 94566  
USA  
Phone: +1 (925) 462-0304  
Fax: +1 (925) 462-0306  
[www.micomlabs.com](http://www.micomlabs.com)



**MiCOM Labs is an ISO 17025 Accredited Testing Laboratory**



---

## Table of Contents

<b>1. ACCREDITATION, LISTINGS &amp; RECOGNITION.....</b>	<b>4</b>
1.1. Testing Accreditation .....	4
1.2. Recognition .....	5
1.3. Product Certifications.....	6
<b>2. DOCUMENT HISTORY .....</b>	<b>7</b>
<b>3. TEST RESULT CERTIFICATE.....</b>	<b>8</b>
<b>4. REFERENCES AND MEASUREMENT UNCERTAINTY .....</b>	<b>9</b>
4.1. Normative References .....	9
4.2. Test and Uncertainty Procedure .....	10
<b>5. PRODUCT DETAILS AND TEST CONFIGURATIONS .....</b>	<b>11</b>
5.1. Technical Details .....	11
5.2. Scope Of Test Program .....	12
5.3. Equipment Model(s) and Serial Number(s) .....	13
5.4. Antenna Details .....	13
5.5. Cabling and I/O Ports .....	13
5.6. Test Configurations.....	14
5.7. Equipment Modifications .....	14
5.8. Deviations from the Test Standard .....	14
<b>6. TEST SUMMARY .....</b>	<b>15</b>
<b>7. TEST EQUIPMENT CONFIGURATION(S) .....</b>	<b>16</b>
7.1. Conducted .....	16
7.2. Radiated Emissions - 3m Chamber.....	18
<b>8. MEASUREMENT AND PRESENTATION OF TEST DATA .....</b>	<b>21</b>
<b>9. TEST RESULTS .....</b>	<b>22</b>
9.1. Peak Transmit Power .....	22
9.2. 6 dB & 99% Bandwidth .....	26
9.3. Power Spectral Density .....	31
9.4. Radiated .....	37
9.4.1. <i>TX Spurious &amp; Restricted Band Emissions</i> .....	40
9.4.1.1. Radwin Ltd. MP0188280 .....	40
9.4.2. <i>Restricted Edge &amp; Band-Edge Emissions</i> .....	46
9.4.2.2. Radwin Ltd. MP0188280 .....	46
<b>A. APPENDIX - GRAPHICAL IMAGES .....</b>	<b>55</b>
A.1. 6 dB & 99% Bandwidth .....	56
A.2. Power Spectral Density .....	80
A.3. Radiated .....	116
A.3.1. <i>TX Spurious &amp; Restricted Band Emissions</i> .....	116
A.3.1.1. Radwin Ltd. MP0188280.....	116
A.3.2. <i>Restricted Edge &amp; Band-Edge Emissions</i> .....	122
A.3.2.2. Radwin Ltd. MP0188280.....	122

---

This test report may be reproduced in full only. The document may only be updated by MiCOM Labs personnel. All changes will be noted in the Document History section of the report.

## 1. ACCREDITATION, LISTINGS & RECOGNITION

### 1.1. Testing Accreditation

MiCOM Labs, Inc. is an accredited Electrical testing laboratory per the international standard ISO/IEC 17025:2005. The company is accredited by the American Association for Laboratory Accreditation (A2LA) [www.a2la.org](http://www.a2la.org) test laboratory number 2381.01. MiCOM Labs test schedule is available at the following URL; <http://www.a2la.org/scopepdf/2381-01.pdf>



### Accredited Laboratory

A2LA has accredited

**MICOM LABS**

Pleasanton, CA

for technical competence in the field of

**Electrical Testing**

This laboratory is accredited in accordance with the recognized International Standard ISO/IEC 17025:2005 General requirements for the competence of testing and calibration laboratories. This accreditation demonstrates technical competence for a defined scope and the operation of a laboratory quality management system (refer to joint ISO-ILAC-IAF Communiqué dated 8 January 2009).



Presented this 4<sup>th</sup> day of February 2016.



Senior Director of Quality & Communications  
For the Accreditation Council  
Certificate Number 2381.01  
Valid to November 30, 2017

For the tests or types of tests to which this accreditation applies, please refer to the laboratory's Electrical Scope of Accreditation.

This test report may be reproduced in full only. The document may only be updated by MiCOM Labs personnel. All changes will be noted in the Document History section of the report.



**Title:** Radwin Ltd. Outdoor Subscriber Radio Unit  
**To:** FCC CFR 47 Part 15 Subpart E 15.407  
**Serial #:** RDWN44-U3 Rev A Report  
**Issue Date:** 20<sup>th</sup> December 2016  
**Page:** 5 of 130

## 1.2. Recognition

MiCOM Labs, Inc has widely recognized wireless testing capabilities. Our international recognition includes Conformity Assessment Body designation by APEC MRA countries. MiCOM Labs test reports are accepted globally.

Country	Recognition Body	Status	Phase	Identification No.
USA	Federal Communications Commission (FCC)	TCB	-	US0159 Listing #: 102167
Canada	Industry Canada (IC)	FCB	APEC MRA 2	US0159 Listing #: 4143A-2 4143A-3
Japan	MIC (Ministry of Internal Affairs and Communication)	CAB	APEC MRA 2	RCB 210
	VCCI	--	--	A-0012
Europe	European Commission	NB	EU MRA	NB 2280
Australia	Australian Communications and Media Authority (ACMA)	CAB	APEC MRA 1	US0159
Hong Kong	Office of the Telecommunication Authority (OFTA)	CAB	APEC MRA 1	
Korea	Ministry of Information and Communication Radio Research Laboratory (RRL)	CAB	APEC MRA 1	
Singapore	Infocomm Development Authority (IDA)	CAB	APEC MRA 1	
Taiwan	National Communications Commission (NCC) Bureau of Standards, Metrology and Inspection (BSMI)	CAB	APEC MRA 1	
Vietnam	Ministry of Communication (MIC)	CAB	APEC MRA 1	

EU MRA – European Union Mutual Recognition Agreement.

NB – Notified Body

APEC MRA – Asia Pacific Economic Community Mutual Recognition Agreement. Recognition agreement under which test lab is accredited to regulatory standards of the APEC member countries.

Phase I - recognition for product testing

Phase II – recognition for both product testing and certification

This test report may be reproduced in full only. The document may only be updated by MiCOM Labs personnel. All changes will be noted in the Document History section of the report.

### 1.3. Product Certifications

MiCOM Labs, Inc. is an accredited Product Certification Body per the international standard ISO/IEC 17065:2012. The company is accredited by the American Association for Laboratory Accreditation (A2LA) [www.a2la.org](http://www.a2la.org) test laboratory number 2381.02. MiCOM Labs test schedule is available at the following URL; <http://www.a2la.org/scopepdf/2381-02.pdf>



## Accredited Product Certification Body

A2LA has accredited  
**MICOM LABS**  
Pleasanton, CA

This product certification body is accredited in accordance with the recognized International Standard ISO/IEC 17065:2012 *Requirements for bodies certifying products, processes and services*. This accreditation demonstrates technical competence for a defined scope and the operation of a management system.



Presented this 4<sup>th</sup> day of February 2016.



Senior Director of Quality & Communications  
For the Accreditation Council  
Certificate Number 2381.02  
Valid to November 30, 2017

For the product certification schemes to which this accreditation applies, please refer to the organization's Product Certification Scope of Accreditation.

United States of America – Telecommunication Certification Body (TCB)  
Industry Canada – Certification Body, CAB Identifier – US0159  
Europe – Notified Body (NB), NB Identifier - 2280  
Japan – Recognized Certification Body (RCB), RCB Identifier - 210



**Title:** Radwin Ltd. Outdoor Subscriber Radio Unit  
**To:** FCC CFR 47 Part 15 Subpart E 15.407  
**Serial #:** RDWN44-U3 Rev A Report  
**Issue Date:** 20<sup>th</sup> December 2016  
**Page:** 7 of 130

## 2. DOCUMENT HISTORY

Document History		
Revision	Date	Comments
Draft 2	xx <sup>th</sup> December 2016	Draft report for client review. Report underlines re testing done due to new requirements under 15.407 for band 3. For complete test results see MiCOM Labs test reports: RDWN41-U5 Rev A (Non-DFS Band) RDWN41-U9 Rev A (DFS Bnad)
Rev A	20 <sup>th</sup> December 2016	Initial Release
.		
.		
.		
.		
.		

In the above table the latest report revision will replace all earlier versions.

This test report may be reproduced in full only. The document may only be updated by MiCOM Labs personnel. All changes will be noted in the Document History section of the report.



**Title:** Radwin Ltd. Outdoor Subscriber Radio Unit  
**To:** FCC CFR 47 Part 15 Subpart E 15.407  
**Serial #:** RDWN44-U3 Rev A Report  
**Issue Date:** 20<sup>th</sup> December 2016  
**Page:** 8 of 130

### 3. TEST RESULT CERTIFICATE

<b>Manufacturer:</b> Radwin Ltd. 27 Habarzel Street Tel Aviv 69710 Israel	<b>Tested By:</b> MiCOM Labs, Inc. 575 Boulder Court Pleasanton California 94566 USA
<b>Model:</b> SU Pro, SU Air <b>Type Of Equipment:</b> Outdoor Subscriber Radio Unit	<b>Telephone:</b> +1 925 462 0304 <b>Fax:</b> +1 925 462 0306
<b>S/N's:</b> Prototype	
<b>Test Date(s):</b> 12 <sup>th</sup> - 14 <sup>th</sup> December 2016	<b>Website:</b> www.micomlabs.com

STANDARD(S)	TEST RESULTS
FCC CFR 47 Part 15 Subpart E 15.407	EQUIPMENT COMPLIES

MiCOM Labs, Inc. tested the equipment mentioned in accordance with the requirements set forth in the above standards. Test results indicate that the equipment tested is capable of demonstrating compliance with the requirements as documented within this report.

**Notes:**

1. This document reports conditions under which testing was conducted and the results of testing performed.
2. Details of test methods used have been recorded and kept on file by the laboratory.
3. Test results apply only to the item(s) tested.

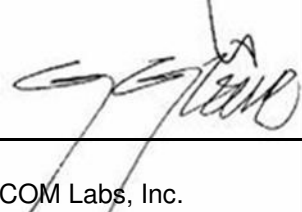

**Approved & Released for MiCOM Labs, Inc. by:**

  
\_\_\_\_\_  
Graeme Grieve  
Quality Manager MiCOM Labs, Inc.

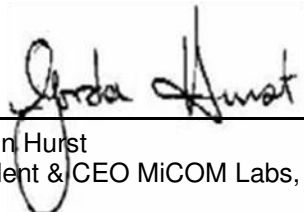
  
\_\_\_\_\_  
Gordon Hurst  
President & CEO MiCOM Labs, Inc.

This test report may be reproduced in full only. The document may only be updated by MiCOM Labs personnel. All changes will be noted in the Document History section of the report.



## 4. REFERENCES AND MEASUREMENT UNCERTAINTY

### 4.1. Normative References

REF.	PUBLICATION	YEAR	TITLE
I	KDB 662911 D01 & D02	Oct 31 2013	Guidance for measurement of output emission of devices that employ single transmitter with multiple outputs or systems with multiple transmitters operating simultaneously in the same frequency band
II	KDB 905462 D07 v02	22nd August 2016	Test guidance to demonstrate compliance for U-NII devices subject to DFS requirements.
III	KDB 926956 D01 v02	22nd August 2016	U-NII Device Transition Plan
IV	KDB 789033 D02 v01r03	22nd August 2016	General UNII Test Procedures New Rules
V	A2LA	June 2015	R105 - Requirement's When Making Reference to A2LA Accreditation Status
VI	ANSI C63.10	2013	American National Standard for Testing Unlicensed Wireless Devices
VII	ANSI C63.4	2014	American National Standards for Methods of Measurement of Radio-Noise Emissions from Low-Voltage Electrical and Electronic Equipment in the Range of 9 kHz to 40 GHz
VIII	CISPR 22	2008	Information technology equipment - Radio disturbance characteristics - Limits and methods of measurement
IX	ETSI TR 100 028	2001-12	Parts 1 and 2 Electromagnetic compatibility and Radio Spectrum Matters (ERM); Uncertainties in the measurement of mobile radio equipment characteristics
X	FCC 06-96	Jun 30 2006	Memorandum Opinion and Order
XI	FCC 47 CFR Part 15.407	2016	Radio Frequency Devices; Subpart E –Unlicensed National Information Infrastructure Devices
XII	ICES-003	Issue 6 Jan 2016	Spectrum Management and Telecommunications; Interference-Causing Equipment Standard. Information Technology Equipment (Including Digital Apparatus) – Limits and methods of measurement.
XIII	M 3003	Edition 3 Nov.2012	Expression of Uncertainty and Confidence in Measurements
XIV	RSS-247 Issue 1	May 2015	Digital Transmission Systems (DTSS), Frequency Hopping System (FHSs) and Licence-Exempt Local Area Network (LE-LEN) Devices
XV	RSS-Gen Issue 4	November 2014	General Requirements and Information for the Certification of Radiocommunication Equipment
XVI	KDB 644545 D03 v01	August 14th 2014	Guidance for IEEE 802.11ac New Rules
XVII	FCC 47 CFR Part 2.1033	2016	FCC requirements and rules regarding photographs and test setup diagrams.

This test report may be reproduced in full only. The document may only be updated by MiCOM Labs personnel. All changes will be noted in the Document History section of the report.



**Title:** Radwin Ltd. Outdoor Subscriber Radio Unit  
**To:** FCC CFR 47 Part 15 Subpart E 15.407  
**Serial #:** RDWN44-U3 Rev A Report  
**Issue Date:** 20<sup>th</sup> December 2016  
**Page:** 10 of 130

---

#### **4.2. Test and Uncertainty Procedure**

Conducted and radiated emission measurements were conducted in accordance with American National Standards Institute ANSI C63.4, listed in the Normative References section of this report.

Measurement uncertainty figures are calculated in accordance with ETSI TR 100 028 Parts 1 and 2.

Measurement uncertainties stated are based on a standard uncertainty multiplied by a coverage factor  $k = 2$ , providing a level of confidence of approximately 95 % in accordance with UKAS document M 3003 listed in the Normative References section of this report.

---

This test report may be reproduced in full only. The document may only be updated by MiCOM Labs personnel. All changes will be noted in the Document History section of the report.



**Title:** Radwin Ltd. Outdoor Subscriber Radio Unit  
**To:** FCC CFR 47 Part 15 Subpart E 15.407  
**Serial #:** RDWN44-U3 Rev A Report  
**Issue Date:** 20<sup>th</sup> December 2016  
**Page:** 11 of 130

## 5. PRODUCT DETAILS AND TEST CONFIGURATIONS

### 5.1. Technical Details

Details	Description
Purpose:	Test of the Radwin Ltd. SU Pro, SU Air to FCC CFR 47 Part 15 Subpart E 15.407. Radio Frequency Devices; Subpart E – Unlicensed National Information Infrastructure Devices to update the new rules on band 3 (5725-5850MHz)
Applicant:	Radwin 27 Habarzel Street Tel Aviv 69710 Israel
Manufacturer:	As Applicant
Laboratory performing the tests:	MiCOM Labs, Inc. 575 Boulder Court, Pleasanton California 94566 USA
Test report reference number:	RDWN44-U3 Rev A Report
Date EUT received:	12 <sup>th</sup> December 2016
Standard(s) applied:	FCC CFR 47 Part 15 Subpart E 15.407
Dates of test (from - to):	12 <sup>th</sup> – 14 <sup>th</sup> December 2016
No of Units Tested:	1
Type of Equipment:	Outdoor CPE 5 GHz 2x2 MIMO
Product Family Name:	RADWIN SU
Model(s):	SU Pro, SU Air
Location for use:	Outdoor
Tested Frequency Range(s):	5725 - 5850 MHz;
Primary function of equipment:	Outdoor Subscriber Radio Unit
Secondary function of equipment:	None Provided
Type of Modulation:	OFDM
EUT Modes of Operation:	10MHz; 20MHz; 40MHz; 80MHz;
Declared Nominal Output Power (Ave):	5725 – 5850 MHz: +29 dBm
Transmit/Receive Operation:	Transceiver - Full Duplex
Rated Input Voltage and Current:	POE (POE adaptor sold with unit) 24Vdc
Operating Temperature Range:	Declared Range -40°C to 60°C
ITU Emission Designator:	10 MHz 8M8W7W 20 MHz 17M5W7W 40 MHz 35M2W7W 80 MHz 74M0W7W
Equipment Dimensions:	7.5" x 7.1" x 1.2" inches
Weight:	0.4 kg
Hardware Rev:	Prototype
Software Rev:	Prototype

This test report may be reproduced in full only. The document may only be updated by MiCOM Labs personnel. All changes will be noted in the Document History section of the report.

## **5.2. Scope Of Test Program**

### **Radwin Ltd. SU Pro, SU Air**

The scope of the test program was to test the Radwin SU Pro, SU Air, Outdoor Subscriber Radio Unit configurations in the frequency ranges 5725 - 5850 MHz; for compliance against the new rules on band 3 of following specification:

#### **FCC CFR 47 Part 15 Subpart E 15.407**

Radio Frequency Devices; Subpart E – Unlicensed National Information Infrastructure Devices

For complete report please check MiCOM reports:

- RDWN41-U5 RevA (Non-DFS Band)
- RDWN41-U9 RevA (DFS Band)

#### **Radwin SU Pro, SU Air**



---

This test report may be reproduced in full only. The document may only be updated by MiCOM Labs personnel. All changes will be noted in the Document History section of the report.



**Title:** Radwin Ltd. Outdoor Subscriber Radio Unit  
**To:** FCC CFR 47 Part 15 Subpart E 15.407  
**Serial #:** RDWN44-U3 Rev A Report  
**Issue Date:** 20<sup>th</sup> December 2016  
**Page:** 13 of 130

### 5.3. Equipment Model(s) and Serial Number(s)

Type	Description	Manufacturer	Model	Serial no.	Delivery Date
EUT	Outdoor CPE 5 GHz 2x2 MIMO	Radwin Ltd.	SU Pro, SU Air	Prototype	21 June 2016
Support Equipment	55V-1A PoE Injector	Sinpro	0334B5555	A000040961-2	21 June 2016
Support Equipment	55V-1A PoE Injector	Sinpro	0334B5555	A000040961-3	21 June 2016
Support Equipment	24V-1A PoE Injector	GOSPELL	G0720-240-100	#RDWN41-2	21 June 2016
Support Equipment	24V-1A PoE Injector	Phining	FAS2400100-C56	#RDWN41-1	21 June 2016

### 5.4. Antenna Details

Type	Manufacturer	Model	Family	Gain (dBi)	BF Gain	Dir BW	X-Pol	Frequency Band (MHz)
integral	Radwin Ltd.	MP0188280	Flat DP	16.0	-	17.5° Hor. 29.1° Ver.	Y	5725 - 5850

MIMO array gain: +3 dB

BF Gain - Beamforming Gain  
Dir BW - Directional BeamWidth  
X-Pol - Cross Polarization

### 5.5. Cabling and I/O Ports

Port Type	Max Cable Length	# Of Ports	Screened	Conn Type	Data Type
Ethernet	100m	1	Y	RJ45	Data

This test report may be reproduced in full only. The document may only be updated by MiCOM Labs personnel. All changes will be noted in the Document History section of the report.



**Title:** Radwin Ltd. Outdoor Subscriber Radio Unit  
**To:** FCC CFR 47 Part 15 Subpart E 15.407  
**Serial #:** RDWN44-U3 Rev A Report  
**Issue Date:** 20<sup>th</sup> December 2016  
**Page:** 14 of 130

---

## 5.6. Test Configurations

Results for the following configurations are provided in this report:

Operational Mode(s)	Data Rate with Highest Power MBit/s	Channel Frequency (MHz)		
		Low	Mid	High
<b>5725 - 5850 MHz</b>				
10MHz	15	5730.00	5785.00	5845.00
20MHz	15	5735.00	5785.00	5840.00
40MHz	15	5745.00	5785.00	5830.00
80MHz	15	5765.00	5785.00	5810.00

## 5.7. Equipment Modifications

The following modifications were required to bring the equipment into compliance:

1. NONE

## 5.8. Deviations from the Test Standard

The following deviations from the test standard were required in order to complete the test program:

1. NONE

---

This test report may be reproduced in full only. The document may only be updated by MiCOM Labs personnel. All changes will be noted in the Document History section of the report.



## 6. TEST SUMMARY

List of Measurements

Test Header	Result	Data Link
<b>Conducted Testing</b>		
Peak Transmit Power	Complies	<a href="#">View Data</a>
6 dB & 99% Bandwidth	Complies	<a href="#">View Data</a>
Power Spectral Density	Complies	<a href="#">View Data</a>
<b>Radiated Testing</b>		
TX Spurious & Restricted Band Emissions	Complies	-
Radwin Ltd. MP0188280	Complies	<a href="#">View Data</a>
Restricted Edge & Band-Edge Emissions	Complies	-
Radwin Ltd. MP0188280	Complies	<a href="#">View Data</a>
<b>Digital Emissions</b>		
Digital Emissions	Not Tested	-
<b>AC Wireline Emissions</b>		
15.107 AC Wireline Emissions	Not Tested	

The above test summary for the Radwin SU Pro, SU Air underlines additional testing conducted and radiated due to updating to 15.407 new rules. For complete test results see MiCOM Labs test reports:

1. RDWN41-U5 Rev A FCC Part 15.407 (Non-DFS Band)
2. RDWN41-U9 Rev A FCC Part 15.407 (DFS Band)

## **7. TEST EQUIPMENT CONFIGURATION(S)**

### **7.1. Conducted**

Conducted RF Emission Test Set-up(s)

The following tests were performed using the conducted test set-up shown in the diagram below.

1. PEAK TRANSMIT POWER
2. POWER SPECTRAL DENSITY
3. 6 dB & 99% BANDWIDTH

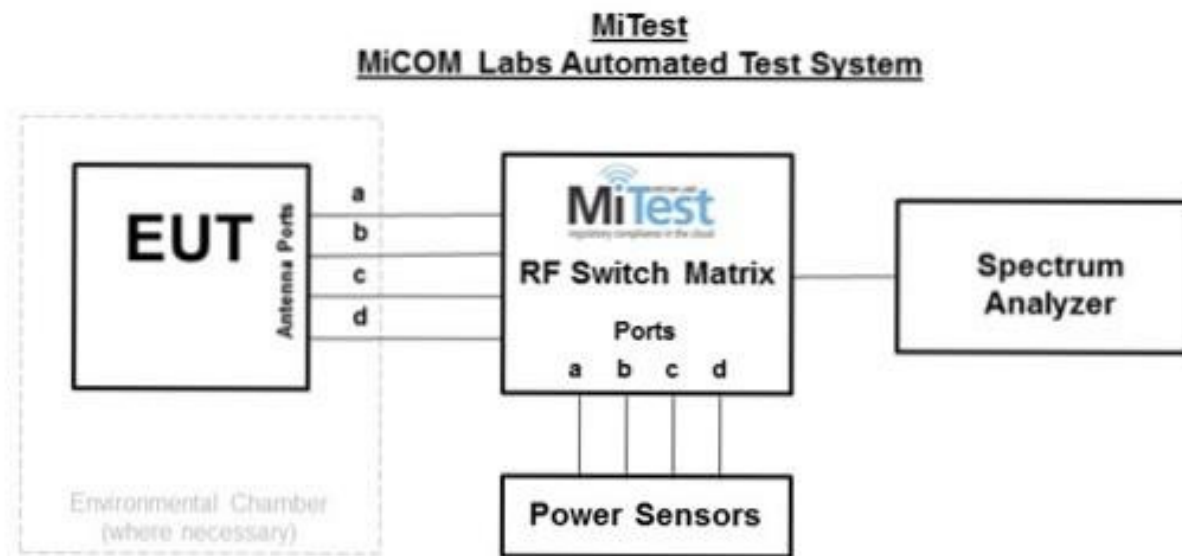

### **Conducted Test Measurement Setup**

A full system calibration was performed on the test station and any resulting system losses (or gains) were taken into account in the production of all final measurement data.





**Title:** Radwin Ltd. Outdoor Subscriber Radio Unit  
**To:** FCC CFR 47 Part 15 Subpart E 15.407  
**Serial #:** RDWN44-U3 Rev A Report  
**Issue Date:** 20<sup>th</sup> December 2016  
**Page:** 17 of 130

Asset#	Description	Manufacturer	Model#	Serial#	Calibration Due Date
127	Power Supply	HP	6674A	US36370530	Cal when used
158	Barometer/Thermometer	Control Company	4196	E2846	30 Nov 2017
248	Resistance Thermometer	Thermotronics	GR2105-02	9340 #1	21 Oct 2017
287	Rohde & Schwarz 40 GHz Receiver	Rhode & Schwarz	ESIB40	100201	2 May 2017
381	4x4 RF Switch Box	MiCOM Labs	MiTest RF Switch Box	MIC002	2 Jun 2017
398	Test Software	MiCOM	MiTest ATS	Version 4.1.0.76	Not Required
419	Laptop with Labview Software	Lenova	W520	TS02	Not Required
420	USB to GPIB Interface	National Instruments	GPIB-USB HS	1346738	Not Required
440	USB Wideband Power Sensor	Boonton	55006	9178	25 Dec 2016
442	USB Wideband Power Sensor	Boonton	55006	9181	6 Oct 2017
445	PoE Injector	D-Link	DPE-101GL	QTAH1E2000625	Not Required
460	Dell Computer	Dell	Optiplex330	BC944G1	Not Required
461	Spectrum Analyzer	Agilent	E4440A	MY46185537	13 Aug 2017
493	USB Wideband Power Sensor	Boonton	55006	9634	10 Mar 2017
494	USB Wideband Power Sensor	Boonton	55006	9726	10 Mar 2017
74	Environmental Chamber Chamber 3	Tenney	TTC	12808-1	29 Sep 2017
RF#2 GPIB#1	GPIB cable to Power Supply	HP	GPIB	None	Not Required
RF#2 SMA#1	EUT to Mitest box port 1	Flexco	SMA Cable port1	None	2 Jun 2017
RF#2 SMA#2	EUT to Mitest box port 2	Flexco	SMA Cable port2	None	2 Jun 2017
RF#2 SMA#3	EUT to Mitest box port 3	Flexco	SMA Cable port3	None	2 Jun 2017
RF#2 SMA#4	EUT to Mitest box port 4	Flexco	SMA Cable port4	None	2 Jun 2017
RF#2 SMA#SA	Mitest box to SA	Flexco	SMA Cable SA	None	2 Jun 2017
RF#2 USB#1	USB Cable to Mitest Box	Dynex	USB Cable	None	Not Required

This test report may be reproduced in full only. The document may only be updated by MiCOM Labs personnel. All changes will be noted in the Document History section of the report.

## 7.2. Radiated Emissions - 3m Chamber

The following tests were performed using the radiated test set-up shown in the diagram below;

- 1).. Radiated Spurious and Band-Edge Emissions
- 2).. Radiated Digital Emissions (0.03 – 1 GHz)

### Radiated Emission Measurement Setup Pictorial Representation

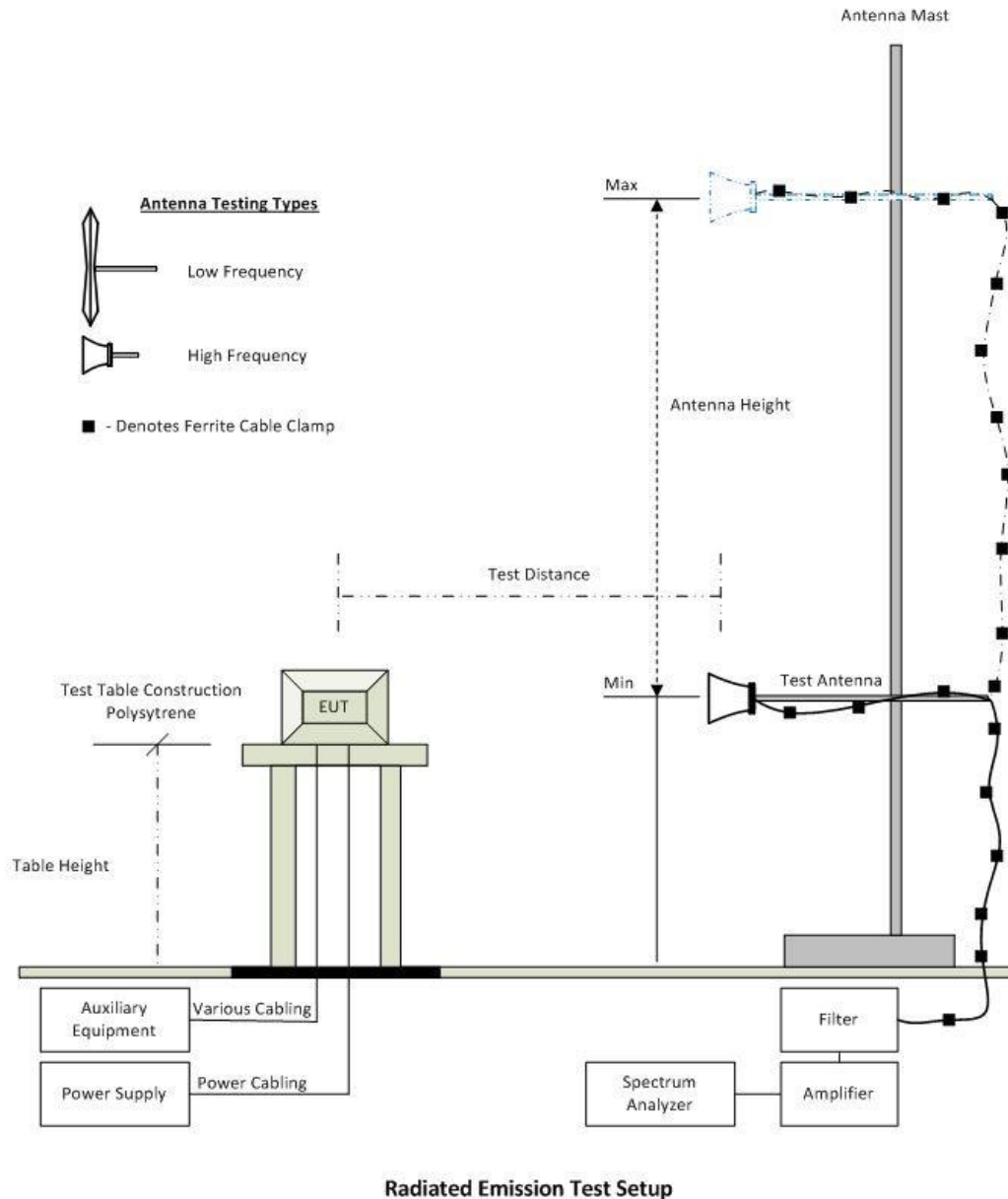

This test report may be reproduced in full only. The document may only be updated by MiCOM Labs personnel. All changes will be noted in the Document History section of the report.



**Title:** Radwin Ltd. Outdoor Subscriber Radio Unit  
**To:** FCC CFR 47 Part 15 Subpart E 15.407  
**Serial #:** RDWN44-U3 Rev A Report  
**Issue Date:** 20<sup>th</sup> December 2016  
**Page:** 19 of 130

A full system calibration was performed on the test station and any resulting system losses (or gains) were taken into account in the production of all final measurement data.

Asset#	Description	Manufacturer	Model#	Serial#	Calibration Due Date
158	Barometer/Thermometer	Control Company	4196	E2846	30 Nov 2017
170	Video System Controller for Semi Anechoic Chamber	Panasonic	WV-CU101	04R08507	Not Required
287	Rohde & Schwarz 40 GHz Receiver	Rhode & Schwarz	ESIB40	100201	2 May 2017
301	5470 to 5725 MHz Notch Filter	Microtronics	RBC50704	001	16 Aug 2017
302	5150 to 5350 MHz Notch Filter	Microtronics	BRC50703	002	16 Aug 2017
303	5725 to 5875 MHz Notch filter	Microtronics	BRC50705	003	16 Aug 2017
330	Variac 0-280 Vac	Staco Energy Co	3PN1020B	0546	Cal when used
336	Active loop Ant 10kHz to 30 MHz	EMCO	EMCO 6502	00060498	26 Sep 2017
338	Sunol 30 to 3000 MHz Antenna	Sunol	JB3	A052907	15 Aug 2017
343	5.15 GHz Notch Filter	EWT	EWT-14-0200	H1	16 Aug 2017
344	5.35 GHz Notch Filter	EWT	EWT-14-0201	H1	16 Aug 2017
345	5.46 GHz Notch Filter	EWT	EWT-14-0202	H1	16 Aug 2017
346	1.6 TO 10GHz High Pass Filter	EWT	EWT-57-0112	H1	16 Aug 2017
373	26III RMS Multimeter	Fluke	Fluke 26 series III	76080720	26 Oct 2017
377	Band Rejection Filter 5150 to 5880MHz	Microtronics	BRM50716	034	16 Aug 2017
393	DC - 1050 MHz Low Pass Filter	Microcircuits	VLFX-1050	N/A	16 Aug 2017
396	2.4 GHz Notch Filter	Microtronics	BRM50701	001	16 Aug 2017
397	Amp 10 - 2500MHz	MiCOM Labs	Amp 10 - 2500 MHz	NA	9 Jun 2017
399	ETS 1-18 GHz Horn Antenna	ETS	3117	00154575	10 Jan 2017
406	Amplifier for Radiated Emissions	MiCOM Labs	40dB 1 to 18GHz Amp	0406	9 Jun 2017
410	Desktop Computer	Dell	Inspiron 620	WS38	Not Required
411	Mast/Turntable Controller	Sunol Sciences	SC98V	060199-1D	Not Required
412	USB to GPIB Interface	National Instruments	GPIB-USB HS	11B8DC2	Not Required
413	Mast Controller	Sunol Science	TWR95-4	030801-3	Not Required
414	DC Power Supply 0-60V	HP	6274	1029A01285	Cal when used

This test report may be reproduced in full only. The document may only be updated by MiCOM Labs personnel. All changes will be noted in the Document History section of the report.



**Title:** Radwin Ltd. Outdoor Subscriber Radio Unit  
**To:** FCC CFR 47 Part 15 Subpart E 15.407  
**Serial #:** RDWN44-U3 Rev A Report  
**Issue Date:** 20<sup>th</sup> December 2016  
**Page:** 20 of 130

415	Turntable Controller	Sunol Sciences	Turntable Controller	None	Not Required
416	Gigabit ethernet filter	ETS-Lingren	Gigafoil 260366	None	Not Required
447	Rad Emissions Test Software	MiCOM	Test Software Version 1.0.109	447	Not Required
462	Schwarzbeck cable from Antenna to Amplifier.	Schwarzbeck	AK 9513	462	31 May 2017
463	Schwarzbeck cable from Amplifier to Bulkhead.	Schwarzbeck	AK 9513	463	31 May 2017
464	Schwarzbeck cable from Bulkhead to Receiver	Schwarzbeck	AK 9513	464	31 May 2017
465	Low Pass Filter DC-1000 MHz	Mini-Circuits	NLP-1200+	VUU01901402	2 Jun 2017
468	Low pass filter	Mini Circuits	SLP-550	None	16 Aug 2017
469	Low pass filter	Mini Circuit	SLP-1000	None	16 Aug 2017
470	High Pass filter	Mini Circuits	SHP-700	None	16 Aug 2017
476	Low Pass dc-2200MHz filter	Mini Circuits	15542 NLP-2400+	VUU13801345	16 Aug 2017
480	Cable - Bulkhead to Amp	SRC Haverhill	157-157-3050360	480	2 Jun 2017
481	Cable - Bulkhead to Receiver	SRC Haverhill	151-151-3050787	481	2 Jun 2017
482	Cable - Amp to Antenna	SRC Haverhill	157-157-3051574	482	2 Jun 2017
502	Test Software for Radiated Emissions	EMISoft	Vasona	Version 5 Build 59	Not Required
87	Uninterruptible Power Supply	Falcon Electric	ED2000-1/2LC	F3471 02/01	Cal when used
CC05	Confidence Check	MiCOM	CC05	None	26 Apr 2017
VLF-1700	Low pass filter DC-1700 MHz	Mini Circuits	VLF-1700	None	31 May 2017

This test report may be reproduced in full only. The document may only be updated by MiCOM Labs personnel. All changes will be noted in the Document History section of the report.

## 8. MEASUREMENT AND PRESENTATION OF TEST DATA

The measurement and graphical data presented in this test report was generated automatically using state-of-the-art technology creating an easy to read report structure. Numerical measurement data is separated from supporting graphical data (plots) through hyperlinks. Numerical measurement data can be reviewed without scrolling through numerous graphical pages to arrive at the next data matrix.

Plots have been relegated into the Appendix 'Graphical Data'.

Test and report automation was performed by [MiTest](#). [MiTest](#) is an automated test system developed by MiCOM Labs. [MiTest](#) is the first cloud based modular test system enabling end-to-end automation of regulatory compliance testing for conducted RF testing.



The MiCOM Labs "[MiTest](#)" Automated Test System" (Patent Pending)

This test report may be reproduced in full only. The document may only be updated by MiCOM Labs personnel. All changes will be noted in the Document History section of the report.



## 9. TEST RESULTS

### 9.1. Peak Transmit Power

Conducted Test Conditions for Maximum Conducted Output Power			
<b>Standard:</b>	FCC CFR 47:15.407	<b>Ambient Temp. (°C):</b>	24.0 - 27.5
<b>Test Heading:</b>	Maximum Conducted Output Power	<b>Rel. Humidity (%):</b>	32 - 45
<b>Standard Section(s):</b>	15.407 (a)	<b>Pressure (mBars):</b>	999 - 1001
<b>Reference Document(s):</b>	See Normative References		

#### Test Procedure for Maximum Conducted Output Power Measurement

Method PM (Measurement using an RF average power meter). KDB 789033 defines a methodology using an average wideband power meter. Measurements were made while the EUT was operating in a continuous transmission mode (100% duty cycle) at the appropriate center frequency. All operational modes and frequency bands were measured independently and the resultant calculated. Where the device operated with multiple antenna ports i.e. MIMO device, each port was measured and reported separately. A summation ( $\Sigma$ ) of each antenna port output power is provided which includes any offset due to Duty Cycle Correction Factor (DCCF). Testing was performed under ambient conditions at nominal voltage.

Test configuration and setup used for the measurement was per the Conducted Test Set-up section specified in this document.

Supporting Information

Calculated Power =  $A + G + Y + 10 \log(1/x)$  dBm

A = Total Power [ $10 \cdot \log_{10}(10^{a/10} + 10^{b/10} + 10^{c/10} + 10^{d/10})$ ]

G = Antenna Gain

Y = Beamforming Gain

x = Duty Cycle (average power measurements only)

#### Limits Maximum Conducted Output Power

##### Operating Frequency Band 5150-5250 MHz

15.407 (a)(1)

(i) For an outdoor access point operating in the band 5.15-5.25 GHz, the maximum conducted output power over the frequency band of operation shall not exceed 1 W provided the maximum antenna gain does not exceed 6 dBi. In addition, the maximum power spectral density shall not exceed 17 dBm in any 1 megahertz band. If transmitting antennas of directional gain greater than 6 dBi are used, both the maximum conducted output power and the maximum power spectral density shall be reduced by the amount in dB that the directional gain of the antenna exceeds 6 dBi. The maximum e.i.r.p. at any elevation angle above 30 degrees as measured from the horizon must not exceed 125 mW (21 dBm).

(ii) For an indoor access point operating in the band 5.15-5.25 GHz, the maximum conducted output power over the frequency band of operation shall not exceed 1 W provided the maximum antenna gain does not exceed 6 dBi. In addition, the maximum power spectral density shall not exceed 17 dBm in any 1 megahertz band. If transmitting antennas of directional gain greater than 6 dBi are used, both the maximum conducted output power and the maximum power spectral density shall be reduced by the amount in dB that the directional gain of the antenna exceeds 6 dBi.

(iii) For fixed point-to-point access points operating in the band 5.15-5.25 GHz, the maximum conducted output power over the frequency band of operation shall not exceed 1 W. In addition, the maximum power spectral density shall not exceed 17 dBm in any 1 megahertz band. Fixed point-to-point U-NII devices may employ antennas with directional gain up to 23 dBi without any corresponding reduction in the maximum conducted output power or maximum power spectral density. For fixed point-to-point transmitters that employ a directional antenna gain greater than 23 dBi, a 1 dB reduction in maximum conducted output power and maximum power spectral density is required for each 1 dB of antenna gain in excess of 23 dBi. Fixed, point-to-point operations exclude the use of point-to-multipoint systems, omnidirectional applications, and multiple collocated transmitters transmitting the same information. The operator of the U-NII device, or if the equipment is professionally installed, the installer, is responsible for ensuring that systems employing high gain directional antennas are used exclusively for fixed, point-to-point operations.

(iv) For mobile and portable client devices in the 5.15-5.25 GHz band, the maximum conducted output power over the frequency band

This test report may be reproduced in full only. The document may only be updated by MiCOM Labs personnel. All changes will be noted in the Document History section of the report.



**Title:** Radwin Ltd. Outdoor Subscriber Radio Unit  
**To:** FCC CFR 47 Part 15 Subpart E 15.407  
**Serial #:** RDWN44-U3 Rev A Report  
**Issue Date:** 20<sup>th</sup> December 2016  
**Page:** 23 of 130

---

of operation shall not exceed 250 mW provided the maximum antenna gain does not exceed 6 dBi. In addition, the maximum power spectral density shall not exceed 11 dBm in any 1 megahertz band. If transmitting antennas of directional gain greater than 6 dBi are used, both the maximum conducted output power and the maximum power spectral density shall be reduced by the amount in dB that the directional gain of the antenna exceeds 6 dBi.

**Operating Frequency Band 5250-5350 and 5470 – 5725 MHz**

15. 407 (a)(2)

For the 5.25-5.35 GHz and 5.47-5.725 GHz bands, the maximum conducted output power over the frequency bands of operation shall not exceed the lesser of 250 mW or  $11 \text{ dBm} + 10 \log B$ , where B is the 26 dB emission bandwidth in megahertz. In addition, the maximum power spectral density shall not exceed 11 dBm in any 1 megahertz band. If transmitting antennas of directional gain greater than 6 dBi are used, both the maximum conducted output power and the maximum power spectral density shall be reduced by the amount in dB that the directional gain of the antenna exceeds 6 dBi.

**Operating Frequency Band 5725 – 5850 MHz**

15. 407 (a)(3)

For the band 5.725-5.85 GHz, the maximum conducted output power over the frequency band of operation shall not exceed 1 W. In addition, the maximum power spectral density shall not exceed 30 dBm in any 500-kHz band. If transmitting antennas of directional gain greater than 6 dBi are used, both the maximum conducted output power and the maximum power spectral density shall be reduced by the amount in dB that the directional gain of the antenna exceeds 6 dBi. However, fixed point-to-point U-NII devices operating in this band may employ transmitting antennas with directional gain greater than 6 dBi without any corresponding reduction in transmitter conducted power. Fixed, point-to-point operations exclude the use of point-to-multipoint systems, omnidirectional applications, and multiple collocated transmitters transmitting the same information. The operator of the U-NII device, or if the equipment is professionally installed, the installer, is responsible for ensuring that systems employing high gain directional antennas are used exclusively for fixed, point-to-point operations.

---

This test report may be reproduced in full only. The document may only be updated by MiCOM Labs personnel. All changes will be noted in the Document History section of the report.



**Title:** Radwin Ltd. Outdoor Subscriber Radio Unit  
**To:** FCC CFR 47 Part 15 Subpart E 15.407  
**Serial #:** RDWN44-U3 Rev A Report  
**Issue Date:** 20<sup>th</sup> December 2016  
**Page:** 24 of 130

**Equipment Configuration for Peak Transmit Power**

<b>Variant:</b>	10MHz	<b>Duty Cycle (%):</b>	91.0
<b>Data Rate:</b>	15.00 MBit/s	<b>Antenna Gain (dBi):</b>	16.00
<b>Modulation:</b>	OFDM	<b>Beam Forming Gain (Y)(dB):</b>	Not Applicable
<b>TPC:</b>	Not Applicable	<b>Tested By:</b>	CC
<b>Engineering Test Notes:</b>	None		

**Test Measurement Results**

Test Frequency	Measured Conducted Output Power (dBm)				Calculated Total Power	Minimum 26 dB Bandwidth	Limit	Margin	EUT Power Setting
	Port(s)								
MHz	a	b	c	d	Σ Port(s) dBm	MHz	dBm	dB	
5730.0	24.15	25.19	--	--	27.71	--	30.00	-2.29	28.00
5785.0	25.03	25.34	--	--	28.20	--	30.00	-1.80	28.00
5845.0	25.13	26.29	--	--	28.76	--	30.00	-1.24	28.00

**Traceability to Industry Recognized Test Methodologies**

Work Instruction:	WI-01 MEASURING RF OUTPUT POWER
Measurement Uncertainty:	±1.33 dB

The above measurements are true pulse readings and therefore a Duty Cycling correction factor is not required.

**Equipment Configuration for Peak Transmit Power**

<b>Variant:</b>	20MHz	<b>Duty Cycle (%):</b>	91.0
<b>Data Rate:</b>	15.00 MBit/s	<b>Antenna Gain (dBi):</b>	16.00
<b>Modulation:</b>	OFDM	<b>Beam Forming Gain (Y)(dB):</b>	Not Applicable
<b>TPC:</b>	Not Applicable	<b>Tested By:</b>	CC
<b>Engineering Test Notes:</b>	None		

**Test Measurement Results**

Test Frequency	Measured Conducted Output Power (dBm)				Calculated Total Power	Minimum 26 dB Bandwidth	Limit	Margin	EUT Power Setting
	Port(s)								
MHz	a	b	c	d	Σ Port(s) dBm	MHz	dBm	dB	
5735.0	24.58	25.64	--	--	28.15	--	30.00	-1.85	28.00
5785.0	24.91	25.23	--	--	28.08	--	30.00	-1.92	28.00
5840.0	25.10	26.27	--	--	28.73	--	30.00	-1.27	28.00

**Traceability to Industry Recognized Test Methodologies**

Work Instruction:	WI-01 MEASURING RF OUTPUT POWER
Measurement Uncertainty:	±1.33 dB

The above measurements are true pulse readings and therefore a Duty Cycling correction factor is not required.

This test report may be reproduced in full only. The document may only be updated by MiCOM Labs personnel. All changes will be noted in the Document History section of the report.





**Title:** Radwin Ltd. Outdoor Subscriber Radio Unit  
**To:** FCC CFR 47 Part 15 Subpart E 15.407  
**Serial #:** RDWN44-U3 Rev A Report  
**Issue Date:** 20<sup>th</sup> December 2016  
**Page:** 25 of 130

**Equipment Configuration for Peak Transmit Power**

<b>Variant:</b>	40MHz	<b>Duty Cycle (%):</b>	88.0
<b>Data Rate:</b>	15.00 MBit/s	<b>Antenna Gain (dBi):</b>	16.00
<b>Modulation:</b>	OFDM	<b>Beam Forming Gain (Y)(dB):</b>	Not Applicable
<b>TPC:</b>	Not Applicable	<b>Tested By:</b>	CC
<b>Engineering Test Notes:</b>	None		

**Test Measurement Results**

Test Frequency	Measured Conducted Output Power (dBm)				Calculated Total Power	Minimum 26 dB Bandwidth	Limit	Margin	EUT Power Setting
	Port(s)								
MHz	a	b	c	d	Σ Port(s) dBm	MHz	dBm	dB	
5745.0	24.42	25.52	--	--	28.02	--	30.00	-1.98	28.00
5785.0	24.79	25.10	--	--	27.96	--	30.00	-2.04	28.00
5830.0	24.91	26.12	--	--	28.57	--	30.00	-1.43	28.00

**Traceability to Industry Recognized Test Methodologies**

Work Instruction:	WI-01 MEASURING RF OUTPUT POWER
Measurement Uncertainty:	±1.33 dB

The above measurements are true pulse readings and therefore a Duty Cycling correction factor is not required.

**Equipment Configuration for Peak Transmit Power**

<b>Variant:</b>	80MHz	<b>Duty Cycle (%):</b>	83.0
<b>Data Rate:</b>	15.00 MBit/s	<b>Antenna Gain (dBi):</b>	16.00
<b>Modulation:</b>	OFDM	<b>Beam Forming Gain (Y)(dB):</b>	Not Applicable
<b>TPC:</b>	Not Applicable	<b>Tested By:</b>	CC
<b>Engineering Test Notes:</b>	None		

**Test Measurement Results**

Test Frequency	Measured Conducted Output Power (dBm)				Calculated Total Power	Minimum 26 dB Bandwidth	Limit	Margin	EUT Power Setting
	Port(s)								
MHz	a	b	c	d	Σ Port(s) dBm	MHz	dBm	dB	
5765.0	22.19	23.11	--	--	25.68	--	30.00	-4.32	23.50
5785.0	25.33	25.63	--	--	28.49	--	30.00	-1.51	28.00
5810.0	22.17	23.95	--	--	26.16	--	30.00	-3.84	23.00

**Traceability to Industry Recognized Test Methodologies**

Work Instruction:	WI-01 MEASURING RF OUTPUT POWER
Measurement Uncertainty:	1.33 dB

The above measurements are true pulse readings and therefore a Duty Cycling correction factor is not required.

This test report may be reproduced in full only. The document may only be updated by MiCOM Labs personnel. All changes will be noted in the Document History section of the report.



**Title:** Radwin Ltd. Outdoor Subscriber Radio Unit  
**To:** FCC CFR 47 Part 15 Subpart E 15.407  
**Serial #:** RDWN44-U3 Rev A Report  
**Issue Date:** 20<sup>th</sup> December 2016  
**Page:** 26 of 130

## 9.2. 6 dB & 99% Bandwidth

Conducted Test Conditions for 6 dB and 99% Bandwidth			
<b>Standard:</b>	FCC CFR 47:15.407	<b>Ambient Temp. (°C):</b>	24.0 - 27.5
<b>Test Heading:</b>	6 dB and 99 % Bandwidth	<b>Rel. Humidity (%):</b>	32 - 45
<b>Standard Section(s):</b>	15.407 (a)	<b>Pressure (mBars):</b>	999 - 1001
<b>Reference Document(s):</b>	See Normative References		
<b>Test Procedure for 6 dB and 99% Bandwidth Measurement</b> The bandwidth at 6 dB and 99 % is measured with a spectrum analyzer connected to the antenna terminal, while EUT is operating in transmission mode at the appropriate center frequency. The Resolution Bandwidth was set to 100 kHz. Testing was performed under ambient conditions at nominal voltage. Where the device operated with multiple antenna ports i.e. MIMO device, each port was measured and reported.  Test configuration and setup used for the measurement was per the Conducted Test Set-up section specified in this document.			

This test report may be reproduced in full only. The document may only be updated by MiCOM Labs personnel. All changes will be noted in the Document History section of the report.



**Title:** Radwin Ltd. Outdoor Subscriber Radio Unit  
**To:** FCC CFR 47 Part 15 Subpart E 15.407  
**Serial #:** RDWN44-U3 Rev A Report  
**Issue Date:** 20<sup>th</sup> December 2016  
**Page:** 27 of 130

**Equipment Configuration for 6 dB & 99% Bandwidth**

<b>Variant:</b>	10MHz	<b>Duty Cycle (%):</b>	91.0
<b>Data Rate:</b>	15.00 MBit/s	<b>Antenna Gain (dBi):</b>	16.00
<b>Modulation:</b>	OFDM	<b>Beam Forming Gain (Y)(dB):</b>	Not Applicable
<b>TPC:</b>	Not Applicable	<b>Tested By:</b>	CC
<b>Engineering Test Notes:</b>	None		

**Test Measurement Results**

Test Frequency	Measured 6 dB Bandwidth (MHz)				6 dB Bandwidth (MHz)			
	Port(s)				Highest	Lowest		
MHz	a	b	c	d				
5730.0	<a href="#">8.778</a>	<a href="#">8.858</a>	--	--	8.858	8.778		
5785.0	<a href="#">8.818</a>	<a href="#">8.858</a>	--	--	8.858	8.818		
5845.0	<a href="#">8.778</a>	<a href="#">8.818</a>	--	--	8.818	8.778		

Test Frequency	Measured 99% Bandwidth (MHz)				99% Bandwidth (MHz)			
	Port(s)				Highest	Lowest		
MHz	a	b	c	d				
5730.0	<a href="#">14.549</a>	<a href="#">16.273</a>	--	--	16.273	14.549		
5785.0	<a href="#">15.631</a>	<a href="#">15.671</a>	--	--	15.671	15.631		
5845.0	<a href="#">14.990</a>	<a href="#">16.593</a>	--	--	16.593	14.990		

**Traceability to Industry Recognized Test Methodologies**

Work Instruction:	WI-03 MEASURING RF SPECTRUM MASK
Measurement Uncertainty:	±2.81 dB

Note: click the links in the above matrix to view the graphical image (plot).

This test report may be reproduced in full only. The document may only be updated by MiCOM Labs personnel. All changes will be noted in the Document History section of the report.



**Title:** Radwin Ltd. Outdoor Subscriber Radio Unit  
**To:** FCC CFR 47 Part 15 Subpart E 15.407  
**Serial #:** RDWN44-U3 Rev A Report  
**Issue Date:** 20<sup>th</sup> December 2016  
**Page:** 28 of 130

**Equipment Configuration for 6 dB & 99% Bandwidth**

<b>Variant:</b>	20MHz	<b>Duty Cycle (%):</b>	91.0
<b>Data Rate:</b>	15.00 MBit/s	<b>Antenna Gain (dBi):</b>	16.00
<b>Modulation:</b>	OFDM	<b>Beam Forming Gain (Y)(dB):</b>	Not Applicable
<b>TPC:</b>	Not Applicable	<b>Tested By:</b>	CC
<b>Engineering Test Notes:</b>	None		

**Test Measurement Results**

Test Frequency	Measured 6 dB Bandwidth (MHz)				6 dB Bandwidth (MHz)			
	Port(s)				Highest	Lowest		
MHz	a	b	c	d				
5735.0	<a href="#">17.555</a>	<a href="#">17.555</a>	--	--	17.555	17.555		
5785.0	<a href="#">17.315</a>	<a href="#">17.555</a>	--	--	17.555	17.315		
5840.0	<a href="#">17.154</a>	<a href="#">17.555</a>	--	--	17.555	17.154		

Test Frequency	Measured 99% Bandwidth (MHz)				99% Bandwidth (MHz)			
	Port(s)				Highest	Lowest		
MHz	a	b	c	d				
5735.0	<a href="#">26.453</a>	<a href="#">31.182</a>	--	--	31.182	26.453		
5785.0	<a href="#">29.980</a>	<a href="#">30.220</a>	--	--	30.220	29.980		
5840.0	<a href="#">28.617</a>	<a href="#">32.465</a>	--	--	32.465	28.617		

**Traceability to Industry Recognized Test Methodologies**

Work Instruction:	WI-03 MEASURING RF SPECTRUM MASK
Measurement Uncertainty:	±2.81 dB

Note: click the links in the above matrix to view the graphical image (plot).

This test report may be reproduced in full only. The document may only be updated by MiCOM Labs personnel. All changes will be noted in the Document History section of the report.



**Title:** Radwin Ltd. Outdoor Subscriber Radio Unit  
**To:** FCC CFR 47 Part 15 Subpart E 15.407  
**Serial #:** RDWN44-U3 Rev A Report  
**Issue Date:** 20<sup>th</sup> December 2016  
**Page:** 29 of 130

**Equipment Configuration for 6 dB & 99% Bandwidth**

<b>Variant:</b>	40MHz	<b>Duty Cycle (%):</b>	88.0
<b>Data Rate:</b>	15.00 MBit/s	<b>Antenna Gain (dBi):</b>	16.00
<b>Modulation:</b>	OFDM	<b>Beam Forming Gain (Y)(dB):</b>	Not Applicable
<b>TPC:</b>	Not Applicable	<b>Tested By:</b>	CC
<b>Engineering Test Notes:</b>	None		

**Test Measurement Results**

Test Frequency	Measured 6 dB Bandwidth (MHz)				6 dB Bandwidth (MHz)			
	Port(s)				Highest	Lowest		
MHz	a	b	c	d				
5745.0	<a href="#">35.110</a>	<a href="#">35.271</a>	--	--	35.271	35.110		
5785.0	<a href="#">35.110</a>	<a href="#">35.271</a>	--	--	35.271	35.110		
5830.0	<a href="#">34.950</a>	<a href="#">35.110</a>	--	--	35.110	34.950		

Test Frequency	Measured 99% Bandwidth (MHz)				99% Bandwidth (MHz)			
	Port(s)				Highest	Lowest		
MHz	a	b	c	d				
5745.0	<a href="#">52.585</a>	<a href="#">62.365</a>	--	--	62.365	52.585		
5785.0	<a href="#">59.639</a>	<a href="#">60.441</a>	--	--	60.441	59.639		
5830.0	<a href="#">56.112</a>	<a href="#">64.128</a>	--	--	64.128	56.112		

**Traceability to Industry Recognized Test Methodologies**

Work Instruction:	WI-03 MEASURING RF SPECTRUM MASK
Measurement Uncertainty:	±2.81 dB

Note: click the links in the above matrix to view the graphical image (plot).

This test report may be reproduced in full only. The document may only be updated by MiCOM Labs personnel. All changes will be noted in the Document History section of the report.



**Title:** Radwin Ltd. Outdoor Subscriber Radio Unit  
**To:** FCC CFR 47 Part 15 Subpart E 15.407  
**Serial #:** RDWN44-U3 Rev A Report  
**Issue Date:** 20<sup>th</sup> December 2016  
**Page:** 30 of 130

**Equipment Configuration for 6 dB & 99% Bandwidth**

<b>Variant:</b>	80MHz	<b>Duty Cycle (%):</b>	83.0
<b>Data Rate:</b>	15.00 MBit/s	<b>Antenna Gain (dBi):</b>	16.00
<b>Modulation:</b>	OFDM	<b>Beam Forming Gain (Y)(dB):</b>	Not Applicable
<b>TPC:</b>	Not Applicable	<b>Tested By:</b>	CC
<b>Engineering Test Notes:</b>	None		

**Test Measurement Results**

Test Frequency	Measured 6 dB Bandwidth (MHz)				6 dB Bandwidth (MHz)			
	Port(s)				Highest	Lowest		
MHz	a	b	c	d				
5765.0	<a href="#">72.786</a>	<a href="#">72.786</a>	--	--	72.786	72.786		
5785.0	<a href="#">74.068</a>	<a href="#">73.747</a>	--	--	74.068	73.747		
5810.0	<a href="#">72.786</a>	<a href="#">74.068</a>	--	--	74.068	72.786		

Test Frequency	Measured 99% Bandwidth (MHz)				99% Bandwidth (MHz)			
	Port(s)				Highest	Lowest		
MHz	a	b	c	d				
5765.0	<a href="#">124.088</a>	<a href="#">133.707</a>	--	--	133.707	124.088		
5785.0	<a href="#">130.180</a>	<a href="#">131.142</a>	--	--	131.142	130.180		
5810.0	<a href="#">131.142</a>	<a href="#">133.066</a>	--	--	133.066	131.142		

**Traceability to Industry Recognized Test Methodologies**

Work Instruction:	WI-03 MEASURING RF SPECTRUM MASK
Measurement Uncertainty:	±2.81 dB

Note: click the links in the above matrix to view the graphical image (plot).

This test report may be reproduced in full only. The document may only be updated by MiCOM Labs personnel. All changes will be noted in the Document History section of the report.



### 9.3. Power Spectral Density

Conducted Test Conditions for Power Spectral Density			
<b>Standard:</b>	FCC CFR 47:15.407	<b>Ambient Temp. (°C):</b>	24.0 - 27.5
<b>Test Heading:</b>	Power Spectral Density	<b>Rel. Humidity (%):</b>	32 - 45
<b>Standard Section(s):</b>	15.407 (a)	<b>Pressure (mBars):</b>	999 - 1001
<b>Reference Document(s):</b>	See Normative References		

#### Test Procedure for Power Spectral Density

The in-band power spectral density was measured using the test technique specified in KDB 789033. A 1 MHz measurement bandwidth was implemented for the analyzer sweep. Once the sweep is complete the analyzer trace data is downloaded and used for post processing purposes.

Where the device operated with multiple antenna ports i.e. MIMO device, each port was measured separately. The Peak Power Spectral Density is the highest level found across the emission bandwidth. With multiple antenna port measurements the numerical analyzer data from each port is summed (à) and a link to this additional graphic is provided.

Test configuration and setup used for the measurement was per the Conducted Test Set-up section specified in this document.

Measure and sum the spectra across the outputs. With this technique, spectra are measured at each output of the device at the required resolution bandwidth. The individual spectra are then summed mathematically in linear power units. Unlike in-band power measurements, in which the sum involves a single measured value (output power) from each output, measurements for compliance with PSD limits involve summing entire spectra across corresponding frequency bins on the various outputs. Consistency is maintained for any device with multiple transmitter outputs to be certain the individual outputs are all aligned with the same span and same number of points. In this instance, the linear power spectrum value within the first spectral bin of output 0 is summed with that in the first spectral bin of output 1, and the first spectral bin of output 2, and so on up to the Nth output to obtain the true value for the first frequency bin of the summed spectrum. The summed spectrum value for each frequency bin is computed in this fashion. These summed spectral values were post processed and the resulting numerical and graphical data presented.

NOTE: It may be observed that spectrum in some plots break the limit line however this in itself does NOT constitute a failure. In all cases a spectrum summation plot is provided in order to prove compliance. A failure occurs only after the summation of all spectrum plots have been summed and are found to be greater than the limit line.

#### Supporting Information

Calculated Power =  $A + 10 \log (1/x)$  dBm

$A = \text{Total Power Spectral Density } [10^* \text{Log}_{10} (10^{a/10} + 10^{b/10} + 10^{c/10} + 10^{d/10})]$

$x = \text{Duty Cycle}$

#### Limits Power Spectral Density

##### Operating Frequency Band 5150-5250 MHz

15.407 (a)(1)

(i) For an outdoor access point operating in the band 5.15-5.25 GHz, the maximum conducted output power over the frequency band of operation shall not exceed 1 W provided the maximum antenna gain does not exceed 6 dBi. In addition, the maximum power spectral density shall not exceed 17 dBm in any 1 megahertz band. If transmitting antennas of directional gain greater than 6 dBi are used, both the maximum conducted output power and the maximum power spectral density shall be reduced by the amount in dB that the directional gain of the antenna exceeds 6 dBi. The maximum e.i.r.p. at any elevation angle above 30 degrees as measured from the horizon must not exceed 125 mW (21 dBm).

(ii) For an indoor access point operating in the band 5.15-5.25 GHz, the maximum conducted output power over the frequency band of operation shall not exceed 1 W provided the maximum antenna gain does not exceed 6 dBi. In addition, the maximum power spectral density shall not exceed 17 dBm in any 1 megahertz band. If transmitting antennas of directional gain greater than 6 dBi are used, both the maximum conducted output power and the maximum power spectral density shall be reduced by the amount in dB that the directional gain of the antenna exceeds 6 dBi.

(iii) For fixed point-to-point access points operating in the band 5.15-5.25 GHz, the maximum conducted output power over the



**Title:** Radwin Ltd. Outdoor Subscriber Radio Unit  
**To:** FCC CFR 47 Part 15 Subpart E 15.407  
**Serial #:** RDWN44-U3 Rev A Report  
**Issue Date:** 20<sup>th</sup> December 2016  
**Page:** 32 of 130

frequency band of operation shall not exceed 1 W. In addition, the maximum power spectral density shall not exceed 17 dBm in any 1 megahertz band. Fixed point-to-point U-NII devices may employ antennas with directional gain up to 23 dBi without any corresponding reduction in the maximum conducted output power or maximum power spectral density. For fixed point-to-point transmitters that employ a directional antenna gain greater than 23 dBi, a 1 dB reduction in maximum conducted output power and maximum power spectral density is required for each 1 dB of antenna gain in excess of 23 dBi. Fixed, point-to-point operations exclude the use of point-to-multipoint systems, omnidirectional applications, and multiple collocated transmitters transmitting the same information. The operator of the U-NII device, or if the equipment is professionally installed, the installer, is responsible for ensuring that systems employing high gain directional antennas are used exclusively for fixed, point-to-point operations.

(iv) For mobile and portable client devices in the 5.15-5.25 GHz band, the maximum conducted output power over the frequency band of operation shall not exceed 250 mW provided the maximum antenna gain does not exceed 6 dBi. In addition, the maximum power spectral density shall not exceed 11 dBm in any 1 megahertz band. If transmitting antennas of directional gain greater than 6 dBi are used, both the maximum conducted output power and the maximum power spectral density shall be reduced by the amount in dB that the directional gain of the antenna exceeds 6 dBi.

#### **Operating Frequency Band 5250-5350 and 5470 – 5725 MHz**

##### 15. 407 (a)(2)

For the 5.25-5.35 GHz and 5.47-5.725 GHz bands, the maximum conducted output power over the frequency bands of operation shall not exceed the lesser of 250 mW or  $11 \text{ dBm} + 10 \log B$ , where B is the 26 dB emission bandwidth in megahertz. In addition, the maximum power spectral density shall not exceed 11 dBm in any 1 megahertz band. If transmitting antennas of directional gain greater than 6 dBi are used, both the maximum conducted output power and the maximum power spectral density shall be reduced by the amount in dB that the directional gain of the antenna exceeds 6 dBi.

#### **Operating Frequency Band 5725 – 5850 MHz**

##### 15. 407 (a)(3)

For the band 5.725-5.85 GHz, the maximum conducted output power over the frequency band of operation shall not exceed 1 W. In addition, the maximum power spectral density shall not exceed 30 dBm in any 500-kHz band. If transmitting antennas of directional gain greater than 6 dBi are used, both the maximum conducted output power and the maximum power spectral density shall be reduced by the amount in dB that the directional gain of the antenna exceeds 6 dBi. However, fixed point-to-point U-NII devices operating in this band may employ transmitting antennas with directional gain greater than 6 dBi without any corresponding reduction in transmitter conducted power. Fixed, point-to-point operations exclude the use of point-to-multipoint systems, omnidirectional applications, and multiple collocated transmitters transmitting the same information. The operator of the U-NII device, or if the equipment is professionally installed, the installer, is responsible for ensuring that systems employing high gain directional antennas are used exclusively for fixed, point-to-point operations.

This test report may be reproduced in full only. The document may only be updated by MiCOM Labs personnel. All changes will be noted in the Document History section of the report.





**Title:** Radwin Ltd. Outdoor Subscriber Radio Unit  
**To:** FCC CFR 47 Part 15 Subpart E 15.407  
**Serial #:** RDWN44-U3 Rev A Report  
**Issue Date:** 20<sup>th</sup> December 2016  
**Page:** 33 of 130

**Equipment Configuration for Power Spectral Density**

<b>Variant:</b>	10MHz	<b>Duty Cycle (%):</b>	91.0
<b>Data Rate:</b>	15.00 MBit/s	<b>Antenna Gain (dBi):</b>	16.00
<b>Modulation:</b>	OFDM	<b>Beam Forming Gain (Y)(dB):</b>	Not Applicable
<b>TPC:</b>	Not Applicable	<b>Tested By:</b>	CC
<b>Engineering Test Notes:</b>	None		

**Test Measurement Results**

Test Frequency	Measured Power Spectral Density				Summation Peak Marker + DCCF (+0.41 dB)	Limit	Margin
	Port(s) (dBm/500 KHz)						
MHz	a	b	c	d	dBm/500 KHz	dBm/500 KHz	dB
5730.0	<a href="#">10.399</a>	<a href="#">11.722</a>	--	--	<a href="#">13.793</a>	30.0	-16.2
5785.0	<a href="#">14.582</a>	<a href="#">10.684</a>	--	--	<a href="#">16.290</a>	30.0	-13.7
5845.0	<a href="#">5.108</a>	<a href="#">9.591</a>	--	--	<a href="#">10.602</a>	30.0	-19.4

**Traceability to Industry Recognized Test Methodologies**

Work Instruction:	WI-03 MEASURING RF SPECTRUM MASK
Measurement Uncertainty:	±2.81 dB

DCCF - Duty Cycle Correction Factor

Note: click the links in the above matrix to view the graphical image (plot).

This test report may be reproduced in full only. The document may only be updated by MiCOM Labs personnel. All changes will be noted in the Document History section of the report.



**Title:** Radwin Ltd. Outdoor Subscriber Radio Unit  
**To:** FCC CFR 47 Part 15 Subpart E 15.407  
**Serial #:** RDWN44-U3 Rev A Report  
**Issue Date:** 20<sup>th</sup> December 2016  
**Page:** 34 of 130

**Equipment Configuration for Power Spectral Density**

<b>Variant:</b>	20MHz	<b>Duty Cycle (%):</b>	91.0
<b>Data Rate:</b>	15.00 MBit/s	<b>Antenna Gain (dBi):</b>	16.00
<b>Modulation:</b>	OFDM	<b>Beam Forming Gain (Y)(dB):</b>	Not Applicable
<b>TPC:</b>	Not Applicable	<b>Tested By:</b>	CC
<b>Engineering Test Notes:</b>	None		

**Test Measurement Results**

Test Frequency	Measured Power Spectral Density				Summation Peak Marker + DCCF (+0.41 dB)	Limit	Margin
	Port(s) (dBm/500 KHz)						
MHz	a	b	c	d	dBm/500 KHz	dBm/500 KHz	dB
5735.0	<a href="#">8.437</a>	<a href="#">7.722</a>	--	--	<a href="#">10.924</a>	30.0	-19.1
5785.0	<a href="#">8.756</a>	<a href="#">6.304</a>	--	--	<a href="#">10.484</a>	30.0	-19.5
5840.0	<a href="#">8.215</a>	<a href="#">6.506</a>	--	--	<a href="#">10.298</a>	30.0	-19.7

**Traceability to Industry Recognized Test Methodologies**

Work Instruction:	WI-03 MEASURING RF SPECTRUM MASK
Measurement Uncertainty:	±2.81 dB

DCCF - Duty Cycle Correction Factor

Note: click the links in the above matrix to view the graphical image (plot).

This test report may be reproduced in full only. The document may only be updated by MiCOM Labs personnel. All changes will be noted in the Document History section of the report.



**Title:** Radwin Ltd. Outdoor Subscriber Radio Unit  
**To:** FCC CFR 47 Part 15 Subpart E 15.407  
**Serial #:** RDWN44-U3 Rev A Report  
**Issue Date:** 20<sup>th</sup> December 2016  
**Page:** 35 of 130

**Equipment Configuration for Power Spectral Density**

<b>Variant:</b>	40MHz	<b>Duty Cycle (%):</b>	88.0
<b>Data Rate:</b>	15.00 MBit/s	<b>Antenna Gain (dBi):</b>	16.00
<b>Modulation:</b>	OFDM	<b>Beam Forming Gain (Y)(dB):</b>	Not Applicable
<b>TPC:</b>	Not Applicable	<b>Tested By:</b>	CC
<b>Engineering Test Notes:</b>	None		

**Test Measurement Results**

Test Frequency	Measured Power Spectral Density				Summation Peak Marker + DCCF (+0.56 dB)	Limit	Margin
	Port(s) (dBm/500 KHz)						
MHz	a	b	c	d	dBm/500 KHz	dBm/500 KHz	dB
5745.0	<a href="#">6.140</a>	<a href="#">3.196</a>	--	--	<a href="#">7.974</a>	30.0	-22.0
5785.0	<a href="#">6.437</a>	<a href="#">4.903</a>	--	--	<a href="#">8.771</a>	30.0	-21.2
5830.0	<a href="#">5.692</a>	<a href="#">4.404</a>	--	--	<a href="#">7.761</a>	30.0	-22.2

**Traceability to Industry Recognized Test Methodologies**

Work Instruction:	WI-03 MEASURING RF SPECTRUM MASK
Measurement Uncertainty:	±2.81 dB

DCCF - Duty Cycle Correction Factor

Note: click the links in the above matrix to view the graphical image (plot).

This test report may be reproduced in full only. The document may only be updated by MiCOM Labs personnel. All changes will be noted in the Document History section of the report.



**Title:** Radwin Ltd. Outdoor Subscriber Radio Unit  
**To:** FCC CFR 47 Part 15 Subpart E 15.407  
**Serial #:** RDWN44-U3 Rev A Report  
**Issue Date:** 20<sup>th</sup> December 2016  
**Page:** 36 of 130

**Equipment Configuration for Power Spectral Density**

<b>Variant:</b>	80MHz	<b>Duty Cycle (%):</b>	83.0
<b>Data Rate:</b>	15.00 MBit/s	<b>Antenna Gain (dBi):</b>	16.00
<b>Modulation:</b>	OFDM	<b>Beam Forming Gain (Y)(dB):</b>	Not Applicable
<b>TPC:</b>	Not Applicable	<b>Tested By:</b>	CC
<b>Engineering Test Notes:</b>	None		

**Test Measurement Results**

Test Frequency	Measured Power Spectral Density				Summation Peak Marker + DCCF (+0.81 dB)	Limit	Margin
	Port(s) (dBm/500 KHz)						
MHz	a	b	c	d	dBm/500 KHz	dBm/500 KHz	dB
5765.0	<a href="#">1.287</a>	<a href="#">-0.646</a>	--	--	<a href="#">3.628</a>	30.0	-26.4
5785.0	<a href="#">-0.073</a>	<a href="#">0.708</a>	--	--	<a href="#">3.927</a>	30.0	-26.1
5810.0	<a href="#">2.757</a>	<a href="#">-1.487</a>	--	--	<a href="#">4.529</a>	30.0	-25.5

**Traceability to Industry Recognized Test Methodologies**

Work Instruction:	WI-03 MEASURING RF SPECTRUM MASK
Measurement Uncertainty:	±2.81 dB

DCCF - Duty Cycle Correction Factor

Note: click the links in the above matrix to view the graphical image (plot).

This test report may be reproduced in full only. The document may only be updated by MiCOM Labs personnel. All changes will be noted in the Document History section of the report.



## 9.4. Radiated

Radiated Test Conditions for Radiated Spurious and Band-Edge Emissions			
<b>Standard:</b>	FCC CFR 47:15.407	<b>Ambient Temp. (°C):</b>	20.0 - 24.5
<b>Test Heading:</b>	Radiated Spurious and Band-Edge Emissions	<b>Rel. Humidity (%):</b>	32 - 45
<b>Standard Section(s):</b>	15.407 (b), 15.205, 15.209	<b>Pressure (mBars):</b>	999 - 1001
<b>Reference Document(s):</b>	See Normative References		

### Test Procedure for Radiated Spurious and Band-Edge Emissions

Radiated emissions for restricted bands above 1 GHz are measured in the anechoic chamber at a 3-meter distance on every azimuth in both horizontal and vertical polarities. The emissions are recorded and maximized as a function of azimuth by rotation through 360° with a spectrum analyzer in peak hold mode. Depending on the frequency band spanned a notch filter was used to remove the fundamental frequency. The highest emissions relative to the limit are listed for each frequency spanned.

Measurements on any restricted band frequency or frequencies above 1 GHz are based on the use of measurement instrumentation employing peak and average detectors. All measurements were performed using a resolution bandwidth of 1 MHz.

Test configuration and setup for Undesirable Measurement were per the Radiated Test Set-up specified in this document.

15.407 (b) Undesirable emission limits. Except as shown in paragraph (b)(7) of this section, the maximum emissions outside of the frequency bands of operation shall be attenuated in accordance with the following limits:

- (1) For transmitters operating in the 5.15-5.25 GHz band: All emissions outside of the 5.15-5.35 GHz band shall not exceed an e.i.r.p. of -27 dBm/MHz.
- (2) For transmitters operating in the 5.25-5.35 GHz band: All emissions outside of the 5.15-5.35 GHz band shall not exceed an e.i.r.p. of -27 dBm/MHz.
- (3) For transmitters operating in the 5.47-5.725 GHz band: All emissions outside of the 5.47-5.725 GHz band shall not exceed an e.i.r.p. of -27 dBm/MHz.
- (4) For transmitters operating in the 5.725-5.85 GHz band: All emissions within the frequency range from the band edge to 10 MHz above or below the band edge shall not exceed an e.i.r.p. of -17 dBm/MHz; for frequencies 10 MHz or greater above or below the band edge, emissions shall not exceed an e.i.r.p. of -27 dBm/MHz.
- (5) The emission measurements shall be performed using a minimum resolution bandwidth of 1 MHz. A lower resolution bandwidth may be employed near the band edge, when necessary, provided the measured energy is integrated to show the total power over 1 MHz.
- (6) Unwanted emissions below 1 GHz must comply with the general field strength limits set forth in §15.209. Further, any U-NII devices using an AC power line are required to comply also with the conducted limits set forth in §15.207.
- (7) The provisions of §15.205 apply to intentional radiators operating under this section.
- (8) When measuring the emission limits, the nominal carrier frequency shall be adjusted as close to the upper and lower frequency band edges as the design of the equipment permits.

### Limits for Restricted Bands (15.205, 15.209)

**Peak emission: 74 dBuV/m**

**Average emission: 54 dBuV/m**

### Field Strength Calculation

The field strength is calculated by adding the Antenna Factor and Cable Loss, and subtracting Amplifier Gain from the measured reading. All factors are included in the reported data.

$$FS = R + AF + CORR - FO$$

where:

This test report may be reproduced in full only. The document may only be updated by MiCOM Labs personnel. All changes will be noted in the Document History section of the report.



**FS = Field Strength**  
**R = Measured Spectrum analyzer Input Amplitude**  
**AF = Antenna Factor**  
**CORR = Correction Factor = CL – AG + NFL**  
**CL = Cable Loss**  
**AG = Amplifier Gain**  
**FO = Distance Falloff Factor**  
**NFL = Notch Filter Loss**

**Example:**

The following formula is used to convert the equipment isotropic radiated power (eirp) to field strength (dBµV/m);

$$E = 1000000 \times \sqrt[3]{30P} \text{ } \mu\text{V/m}$$

where P is the EIRP in Watts

Therefore: -27 dBm/MHz equates to 68.23 dBuV/m

Conversion between dBmV/m (or dBmV) and mV/m (or mV) are as follows:  
 Level (dBmV/m) = 20 \* Log (level (mV/m))

40 dBmV/m = 100 mV/m  
 48 dBmV/m = 250 mV/m

**Restricted Bands of Operation (15.205)**

(a) Except as shown in paragraph (d) of this section, only spurious emissions are permitted in any of the frequency bands listed below:

Frequency Band			
MHz	MHz	MHz	GHz
0.090-0.110	16.42-16.423	399.9-410	4.5-5.15
0.495-0.505	16.69475-16.69525	608-614	5.35-5.46
2.1735-2.1905	16.80425-16.80475	960-1240	7.25-7.75
4.125-4.128	25.5-25.67	1300-1427	8.025-8.5
4.17725-4.17775	37.5-38.25	1435-1626.5	9.0-9.2
4.20725-4.20775	73-74.6	1645.5-1646.5	9.3-9.5
6.215-6.218	74.8-75.2	1660-1710	10.6-12.7
6.26775-6.26825	108-121.94	1718.8-1722.2	13.25-13.4
6.31175-6.31225	123-138	2200-2300	14.47-14.5
8.291-8.294	149.9-150.05	2310-2390	15.35-16.2
8.362-8.366	156.52475-156.52525	2483.5-2500	17.7-21.4
8.37625-8.38675	156.7-156.9	2690-2900	22.01-23.12
8.41425-8.41475	162.0125-167.17	3260-3267	23.6-24.0
12.29-12.293	167.72-173.2	3332-3339	31.2-31.8
12.51975-12.52025	240-285	3345.8-3358	36.43-36.5
12.57675-12.57725	322-335.4	3600-4400	Above 38.6

This test report may be reproduced in full only. The document may only be updated by MiCOM Labs personnel. All changes will be noted in the Document History section of the report.



**Title:** Radwin Ltd. Outdoor Subscriber Radio Unit  
**To:** FCC CFR 47 Part 15 Subpart E 15.407  
**Serial #:** RDWN44-U3 Rev A Report  
**Issue Date:** 20<sup>th</sup> December 2016  
**Page:** 39 of 130

13.36-13.41			
<p>(b) Except as provided in paragraphs (d) and (e) of this section, the field strength of emissions appearing within these frequency bands shall not exceed the limits shown in §15.209. At frequencies equal to or less than 1000 MHz, compliance with the limits in §15.209 shall be demonstrated using measurement instrumentation employing a CISPR quasi-peak detector. Above 1000 MHz, compliance with the emission limits in §15.209 shall be demonstrated based on the average value of the measured emissions. The provisions in §15.35 apply to these measurements.</p> <p>(c) Except as provided in paragraphs (d) and (e) of this section, regardless of the field strength limits specified elsewhere in this subpart, the provisions of this section apply to emissions from any intentional radiator.</p> <p>(d) The following devices are exempt from the requirements of this section:</p> <ul style="list-style-type: none"><li>(1) Swept frequency field disturbance sensors operating between 1.705 and 37 MHz provided their emissions only sweep through the bands listed in paragraph (a) of this section, the sweep is never stopped with the fundamental emission within the bands listed in paragraph (a) of this section, and the fundamental emission is outside of the bands listed in paragraph (a) of this section more than 99% of the time the device is actively transmitting, without compensation for duty cycle.</li><li>(2) Transmitters used to detect buried electronic markers at 101.4 kHz which are employed by telephone companies.</li><li>(3) Cable locating equipment operated pursuant to §15.213.</li><li>(4) Any equipment operated under the provisions of §15.253, 15.255, and 15.256 in the frequency band 75-85 GHz, or §15.257 of this part.</li><li>(5) Biomedical telemetry devices operating under the provisions of §15.242 of this part are not subject to the restricted band 608-614 MHz but are subject to compliance within the other restricted bands.</li><li>(6) Transmitters operating under the provisions of subparts D or F of this part.</li><li>(7) Devices operated pursuant to §15.225 are exempt from complying with this section for the 13.36-13.41 MHz band only.</li><li>(8) Devices operated in the 24.075-24.175 GHz band under §15.245 are exempt from complying with the requirements of this section for the 48.15-48.35 GHz and 72.225-72.525 GHz bands only, and shall not exceed the limits specified in §15.245(b).</li><li>(9) Devices operated in the 24.0-24.25 GHz band under §15.249 are exempt from complying with the requirements of this section for the 48.0-48.5 GHz and 72.0-72.75 GHz bands only, and shall not exceed the limits specified in §15.249(a).</li></ul> <p>(e) Harmonic emissions appearing in the restricted bands above 17.7 GHz from field disturbance sensors operating under the provisions of §15.245 shall not exceed the limits specified in §15.245(b).</p>			

This test report may be reproduced in full only. The document may only be updated by MiCOM Labs personnel. All changes will be noted in the Document History section of the report.



**Title:** Radwin Ltd. Outdoor Subscriber Radio Unit  
**To:** FCC CFR 47 Part 15 Subpart E 15.407  
**Serial #:** RDWN44-U3 Rev A Report  
**Issue Date:** 20<sup>th</sup> December 2016  
**Page:** 40 of 130

### 9.4.1. TX Spurious & Restricted Band Emissions

#### 9.4.1.1. Radwin Ltd. MP0188280

#### Equipment Configuration for TX Spurious & Restricted Band Emissions

<b>Antenna:</b>	Ltd. MP0188280	<b>Variant:</b>	10MHz
<b>Antenna Gain (dBi):</b>	16.00	<b>Modulation:</b>	OFDM
<b>Beam Forming Gain (Y):</b>	Not Applicable	<b>Duty Cycle (%):</b>	99
<b>Channel Frequency (MHz):</b>	5730.00	<b>Data Rate:</b>	15.00 MBit/s
<b>Power Setting:</b>	28	<b>Tested By:</b>	SB

#### Test Measurement Results

1000.00 - 18000.00 MHz												
Num	Frequency MHz	Raw dBµV	Cable Loss dB	AF dB	Level dBµV/m	Measurement Type	Pol	Hgt cm	Azt Deg	Limit dBµV/m	Margin dB	Pass /Fail
#1	1331.71	57.76	2.24	-15.03	44.97	Max Peak	Horizontal	198	338	74.0	-29.0	Pass
#2	1331.71	54.19	2.24	-15.03	41.40	Max Avg	Horizontal	198	338	54.0	-12.6	Pass
#3	1671.43	62.92	2.39	-15.38	49.93	Max Peak	Vertical	100	146	74.0	-24.1	Pass
#4	1671.43	39.66	2.39	-15.38	26.67	Max Avg	Vertical	100	146	54.0	-27.3	Pass
#5	2663.94	63.27	2.79	-11.31	54.75	Peak (NRB)	Vertical	147	190	--	--	Pass
#6	3215.83	54.83	2.99	-11.27	46.55	Peak (NRB)	Horizontal	101	0	--	--	Pass
#7	3819.92	62.78	3.22	-10.84	55.16	Max Peak	Vertical	100	206	74.0	-18.8	Pass
#8	3819.92	60.31	3.22	-10.84	52.69	Max Avg	Vertical	100	206	54.0	-1.3	Pass
#9	5729.22	65.06	3.80	-10.71	58.15	Fundamental	Vertical	101	0	--	--	
#10	11457.44	57.87	5.49	-4.91	58.45	Max Peak	Vertical	112	6	74.0	-15.6	Pass
#11	11457.44	42.15	5.49	-4.91	42.73	Max Avg	Vertical	112	6	54.0	-11.3	Pass

This test report may be reproduced in full only. The document may only be updated by MiCOM Labs personnel. All changes will be noted in the Document History section of the report.





**Title:** Radwin Ltd. Outdoor Subscriber Radio Unit  
**To:** FCC CFR 47 Part 15 Subpart E 15.407  
**Serial #:** RDWN44-U3 Rev A Report  
**Issue Date:** 20<sup>th</sup> December 2016  
**Page:** 41 of 130

**Equipment Configuration for TX Spurious & Restricted Band Emissions**

<b>Antenna:</b>	Ltd. MP0188280	<b>Variant:</b>	10MHz
<b>Antenna Gain (dBi):</b>	16.00	<b>Modulation:</b>	OFDM
<b>Beam Forming Gain (Y):</b>	Not Applicable	<b>Duty Cycle (%):</b>	99
<b>Channel Frequency (MHz):</b>	5785.00	<b>Data Rate:</b>	15.00 MBit/s
<b>Power Setting:</b>	28	<b>Tested By:</b>	SB

**Test Measurement Results**

1000.00 - 18000.00 MHz												
Num	Frequency MHz	Raw dBµV	Cable Loss dB	AF dB	Level dBµV/m	Measurement Type	Pol	Hgt cm	Azt Deg	Limit dBµV/m	Margin dB	Pass /Fail
#1	1331.98	59.47	2.24	-15.03	46.68	Max Peak	Horizontal	196	331	74.0	-27.3	Pass
#2	1331.98	56.24	2.24	-15.03	43.45	Max Avg	Horizontal	196	331	54.0	-10.6	Pass
#3	1664.96	63.28	2.40	-15.48	50.20	Max Peak	Vertical	157	341	74.0	-23.8	Pass
#4	1664.96	46.00	2.40	-15.48	32.92	Max Avg	Vertical	157	341	54.0	-21.1	Pass
#5	2663.83	51.38	2.79	-11.31	42.86	Peak (NRB)	Vertical	180	0	--	--	Pass
#6	3215.01	55.68	3.00	-11.28	47.40	Peak (NRB)	Horizontal	180	0	--	--	Pass
#7	3856.58	62.09	3.23	-10.81	54.51	Max Peak	Horizontal	160	240	74.0	-19.5	Pass
#8	3856.58	59.30	3.23	-10.81	51.72	Max Avg	Horizontal	160	240	54.0	-2.3	Pass
#9	5786.77	69.08	3.79	-10.43	62.44	Fundamental	Vertical	101	1	--	--	
#10	11569.70	62.44	5.46	-4.64	63.26	Max Peak	Horizontal	129	87	74.0	-10.7	Pass
#11	11569.70	48.57	5.46	-4.64	49.39	Max Avg	Horizontal	129	87	54.0	-4.6	Pass
#12	17356.31	47.90	6.27	-0.02	54.15	Peak (NRB)	Vertical	180	0	--	--	Pass

This test report may be reproduced in full only. The document may only be updated by MiCOM Labs personnel. All changes will be noted in the Document History section of the report.



**Title:** Radwin Ltd. Outdoor Subscriber Radio Unit  
**To:** FCC CFR 47 Part 15 Subpart E 15.407  
**Serial #:** RDWN44-U3 Rev A Report  
**Issue Date:** 20<sup>th</sup> December 2016  
**Page:** 42 of 130

**Equipment Configuration for TX Spurious & Restricted Band Emissions**

<b>Antenna:</b>	Ltd. MP0188280	<b>Variant:</b>	10MHz
<b>Antenna Gain (dBi):</b>	16.00	<b>Modulation:</b>	OFDM
<b>Beam Forming Gain (Y):</b>	Not Applicable	<b>Duty Cycle (%):</b>	99
<b>Channel Frequency (MHz):</b>	5845.00	<b>Data Rate:</b>	15.00 MBit/s
<b>Power Setting:</b>	28	<b>Tested By:</b>	SB

**Test Measurement Results**

1000.00 - 18000.00 MHz												
Num	Frequency MHz	Raw dBµV	Cable Loss dB	AF dB	Level dBµV/m	Measurement Type	Pol	Hgt cm	Azt Deg	Limit dBµV/m	Margin dB	Pass /Fail
#1	1332.27	56.61	2.24	-15.03	43.82	Max Peak	Horizontal	167	335	74.0	-30.2	Pass
#2	1332.27	52.36	2.24	-15.03	39.57	Max Avg	Horizontal	167	335	54.0	-14.4	Pass
#3	2663.83	53.39	2.79	-11.31	44.87	Peak (NRB)	Vertical	190	0	--	--	Pass
#4	3214.13	54.32	3.00	-11.28	46.04	Peak (NRB)	Horizontal	151	0	--	--	Pass
#5	3896.63	62.33	3.26	-10.73	54.86	Max Peak	Horizontal	119	250	74.0	-19.1	Pass
#6	3896.63	60.02	3.26	-10.73	52.55	Max Avg	Horizontal	119	250	54.0	-1.5	Pass
#7	5842.13	74.20	3.84	-10.18	67.86	Fundamental	Vertical	101	1	--	--	
#8	11687.53	58.98	5.55	-4.44	60.09	Max Peak	Horizontal	135	48	74.0	-13.9	Pass
#9	11687.53	44.22	5.55	-4.44	45.33	Max Avg	Horizontal	135	48	54.0	-8.7	Pass
#10	17525.53	43.08	6.15	-0.84	48.39	Peak (NRB)	Vertical	151	1	--	--	Pass
#11	17534.34	48.84	6.27	-0.89	54.22	Peak (NRB)	Vertical	151	57	--	--	Pass

This test report may be reproduced in full only. The document may only be updated by MiCOM Labs personnel. All changes will be noted in the Document History section of the report.



**Title:** Radwin Ltd. Outdoor Subscriber Radio Unit  
**To:** FCC CFR 47 Part 15 Subpart E 15.407  
**Serial #:** RDWN44-U3 Rev A Report  
**Issue Date:** 20<sup>th</sup> December 2016  
**Page:** 43 of 130

**Equipment Configuration for TX Spurious & Restricted Band Emissions**

<b>Antenna:</b>	Ltd. MP0188280	<b>Variant:</b>	80MHz
<b>Antenna Gain (dBi):</b>	16.00	<b>Modulation:</b>	OFDM
<b>Beam Forming Gain (Y):</b>	Not Applicable	<b>Duty Cycle (%):</b>	99
<b>Channel Frequency (MHz):</b>	5765.00	<b>Data Rate:</b>	15.00 MBit/s
<b>Power Setting:</b>	23.5	<b>Tested By:</b>	SB

**Test Measurement Results**

1000.00 - 18000.00 MHz												
Num	Frequency MHz	Raw dBµV	Cable Loss dB	AF dB	Level dBµV/m	Measurement Type	Pol	Hgt cm	Azt Deg	Limit dBµV/m	Margin dB	Pass /Fail
#1	1332.03	58.92	2.24	-15.03	46.13	Max Peak	Horizontal	165	338	74.0	-27.9	Pass
#2	1332.03	55.30	2.24	-15.03	42.51	Max Avg	Horizontal	165	338	54.0	-11.5	Pass
#3	2664.10	49.72	2.79	-11.31	41.20	Peak (NRB)	Vertical	151	27	--	--	Pass
#4	3214.23	55.36	3.00	-11.28	47.08	Peak (NRB)	Vertical	151	0	--	--	Pass
#5	3843.23	63.29	3.21	-10.82	55.68	Max Peak	Horizontal	104	265	74.0	-18.3	Pass
#6	3843.23	60.56	3.21	-10.82	52.95	Max Avg	Horizontal	104	265	54.0	-1.1	Pass
#7	5768.58	70.30	3.80	-10.53	63.57	Fundamental	Horizontal	151	0	--	--	
#8	6049.30	58.69	3.87	-9.66	52.90	Peak (NRB)	Vertical	151	0	--	--	Pass

This test report may be reproduced in full only. The document may only be updated by MiCOM Labs personnel. All changes will be noted in the Document History section of the report.



**Title:** Radwin Ltd. Outdoor Subscriber Radio Unit  
**To:** FCC CFR 47 Part 15 Subpart E 15.407  
**Serial #:** RDWN44-U3 Rev A Report  
**Issue Date:** 20<sup>th</sup> December 2016  
**Page:** 44 of 130

**Equipment Configuration for TX Spurious & Restricted Band Emissions**

<b>Antenna:</b>	Ltd. MP0188280	<b>Variant:</b>	80MHz
<b>Antenna Gain (dBi):</b>	16.00	<b>Modulation:</b>	OFDM
<b>Beam Forming Gain (Y):</b>	Not Applicable	<b>Duty Cycle (%):</b>	99
<b>Channel Frequency (MHz):</b>	5785.00	<b>Data Rate:</b>	15.00 MBit/s
<b>Power Setting:</b>	23.5	<b>Tested By:</b>	SB

**Test Measurement Results**

1000.00 - 18000.00 MHz												
Num	Frequency MHz	Raw dBµV	Cable Loss dB	AF dB	Level dBµV/m	Measurement Type	Pol	Hgt cm	Azt Deg	Limit dBµV/m	Margin dB	Pass /Fail
#1	1332.19	57.75	2.24	-15.03	44.96	Max Peak	Horizontal	195	337	74.0	-29.0	Pass
#2	1332.19	54.40	2.24	-15.03	41.61	Max Avg	Horizontal	195	337	54.0	-12.4	Pass
#3	2663.87	53.07	2.79	-11.31	44.55	Peak (NRB)	Vertical	153	0	--	--	Pass
#4	3214.27	52.55	3.00	-11.28	44.27	Peak (NRB)	Horizontal	101	0	--	--	Pass
#5	3856.47	61.95	3.23	-10.81	54.37	Max Peak	Horizontal	108	253	74.0	-19.6	Pass
#6	3856.47	58.87	3.23	-10.81	51.29	Max Avg	Horizontal	108	253	54.0	-2.7	Pass
#7	5799.36	66.65	3.80	-10.37	60.08	Peak (NRB)	Vertical	101	0	--	--	Pass
#8	5801.37	67.33	3.81	-10.36	60.78	Peak (NRB)	Vertical	101	0	--	--	Pass
#9	6074.40	63.35	3.87	-9.59	57.63	Peak (NRB)	Vertical	169	1	--	--	Pass
#10	11564.37	52.38	5.58	-4.65	53.31	Max Peak	Horizontal	182	35	74.0	-20.7	Pass
#11	11564.37	38.15	5.58	-4.65	39.08	Max Avg	Horizontal	182	35	54.0	-14.9	Pass

This test report may be reproduced in full only. The document may only be updated by MiCOM Labs personnel. All changes will be noted in the Document History section of the report.



**Title:** Radwin Ltd. Outdoor Subscriber Radio Unit  
**To:** FCC CFR 47 Part 15 Subpart E 15.407  
**Serial #:** RDWN44-U3 Rev A Report  
**Issue Date:** 20<sup>th</sup> December 2016  
**Page:** 45 of 130

**Equipment Configuration for TX Spurious & Restricted Band Emissions**

<b>Antenna:</b>	Ltd. MP0188280	<b>Variant:</b>	80MHz
<b>Antenna Gain (dBi):</b>	16.00	<b>Modulation:</b>	OFDM
<b>Beam Forming Gain (Y):</b>	Not Applicable	<b>Duty Cycle (%):</b>	99
<b>Channel Frequency (MHz):</b>	5810.00	<b>Data Rate:</b>	15.00 MBit/s
<b>Power Setting:</b>	23	<b>Tested By:</b>	SB

**Test Measurement Results**

1000.00 - 18000.00 MHz												
Num	Frequency MHz	Raw dB $\mu$ V	Cable Loss dB	AF dB	Level dB $\mu$ V/m	Measurement Type	Pol	Hgt cm	Azt Deg	Limit dB $\mu$ V/m	Margin dB	Pass /Fail
#1	1332.11	58.14	2.24	-15.03	45.35	Max Peak	Horizontal	167	337	74.0	-28.7	Pass
#2	1332.11	54.42	2.24	-15.03	41.63	Max Avg	Horizontal	167	337	54.0	-12.4	Pass
#3	2664.10	49.68	2.79	-11.31	41.16	Peak (NRB)	Vertical	100	0	--	--	Pass
#4	3214.23	55.61	3.00	-11.28	47.33	Peak (NRB)	Vertical	100	0	--	--	Pass
#5	3873.34	63.30	3.25	-10.77	55.78	Max Peak	Vertical	101	221	74.0	-18.2	Pass
#6	3873.34	61.13	3.25	-10.77	53.61	Max Avg	Vertical	101	221	54.0	-0.4	Pass
#7	5827.90	67.01	3.84	-10.24	60.61	Peak (NRB)	Vertical	101	0	--	--	Pass

This test report may be reproduced in full only. The document may only be updated by MiCOM Labs personnel. All changes will be noted in the Document History section of the report.



**Title:** Radwin Ltd. Outdoor Subscriber Radio Unit  
**To:** FCC CFR 47 Part 15 Subpart E 15.407  
**Serial #:** RDWN44-U3 Rev A Report  
**Issue Date:** 20<sup>th</sup> December 2016  
**Page:** 46 of 130

## 9.4.2. Restricted Edge & Band-Edge Emissions

### 9.4.2.1. Radwin Ltd. MP0188280

#### RESULTS SUMMARY FOR RADIATED BAND-EDGE EMISSIONS

##### 5725 MHz Radiated Lower Band-Edge Emissions

Ltd. MP0188280		Band-Edge Freq	Limit 68.2dB $\mu$ V/m	Limit 68.2dB $\mu$ V/m	Power Setting
Operational Mode	Operating Frequency (MHz)	MHz	dB $\mu$ V/m	dB $\mu$ V/m	
10MHz	5730.00	5725.00	80.86	102.75	28
20MHz	5735.00	5725.00	92.76	99.51	28
40MHz	5745.00	5725.00	92.54	96.64	28
80MHz	5765.00	5725.00	66.02	88.83	23.5

##### 5850 MHz Radiated Higher Band-Edge Emissions

Ltd. MP0188280		Band-Edge Freq	Limit 122.2dB $\mu$ V/m	Limit 110.8dB $\mu$ V/m	Power Setting
Operational Mode	Operating Frequency (MHz)	MHz	dB $\mu$ V/m	dB $\mu$ V/m	
10MHz	5845.00	5850.00	109.47	81.74	28
20MHz	5840.00	5850.00	100.08	92.94	28
40MHz	5830.00	5850.00	96.83	91.66	28
80MHz	5810.00	5850.00	90.15	66.22	23

Click on the links to view the data.

This test report may be reproduced in full only. The document may only be updated by MiCOM Labs personnel. All changes will be noted in the Document History section of the report.



**Title:** Radwin Ltd. Outdoor Subscriber Radio Unit  
**To:** FCC CFR 47 Part 15 Subpart E 15.407  
**Serial #:** RDWN44-U3 Rev A Report  
**Issue Date:** 20<sup>th</sup> December 2016  
**Page:** 47 of 130

**Equipment Configuration for 5725 MHz Radiated Band-Edge Emissions**

<b>Antenna:</b>	Ltd. MP0188280	<b>Variant:</b>	10MHz
<b>Antenna Gain (dBi):</b>	16.00	<b>Modulation:</b>	OFDM
<b>Beam Forming Gain (Y):</b>	Not Applicable	<b>Duty Cycle (%):</b>	99
<b>Channel Frequency (MHz):</b>	5730.00	<b>Data Rate:</b>	15.00 MBit/s
<b>Power Setting:</b>	28	<b>Tested By:</b>	SB

**Test Measurement Results**

**5550.00 - 5755.00 MHz**

Num	Frequency MHz	Raw dBµV	Cable Loss dB	AF dB	Level dBµV/m	Measurement Type	Pol	Hgt cm	Azt Deg	Limit dBµV/m	Margin dB	Pass /Fail
#1	5715.00	42.71	3.81	34.34	80.86	Max Avg	Horizontal	155	362	109.4	-28.5	Pass
#2	5725.00	64.61	3.79	34.35	102.75	Max Avg	Horizontal	155	362	122.2	-19.5	Pass
#3	5725.00	--	--	--	--	Band-Edge	--	--	--	--	--	--

Test Notes: initial PS 28, final PS 28

This test report may be reproduced in full only. The document may only be updated by MiCOM Labs personnel. All changes will be noted in the Document History section of the report.



**Title:** Radwin Ltd. Outdoor Subscriber Radio Unit  
**To:** FCC CFR 47 Part 15 Subpart E 15.407  
**Serial #:** RDWN44-U3 Rev A Report  
**Issue Date:** 20<sup>th</sup> December 2016  
**Page:** 48 of 130

**Equipment Configuration for 5725 MHz Radiated Band-Edge Emissions**

<b>Antenna:</b>	Ltd. MP0188280	<b>Variant:</b>	20MHz
<b>Antenna Gain (dBi):</b>	16.00	<b>Modulation:</b>	OFDM
<b>Beam Forming Gain (Y):</b>	Not Applicable	<b>Duty Cycle (%):</b>	99
<b>Channel Frequency (MHz):</b>	5735.00	<b>Data Rate:</b>	15.00 MBit/s
<b>Power Setting:</b>	28	<b>Tested By:</b>	SB

**Test Measurement Results**

**5550.00 - 5755.00 MHz**

Num	Frequency MHz	Raw dBµV	Cable Loss dB	AF dB	Level dBµV/m	Measurement Type	Pol	Hgt cm	Azt Deg	Limit dBµV/m	Margin dB	Pass /Fail
#1	5715.00	54.61	3.81	34.34	92.76	Max Avg	Horizontal	155	362	109.4	-16.6	Pass
#2	5725.00	61.37	3.79	34.35	99.51	Max Avg	Horizontal	155	362	122.2	-22.7	Pass
#3	5725.00	--	--	--	--	Band-Edge	--	--	--	--	--	--

Test Notes: initial PS 28, final PS 28

This test report may be reproduced in full only. The document may only be updated by MiCOM Labs personnel. All changes will be noted in the Document History section of the report.





**Title:** Radwin Ltd. Outdoor Subscriber Radio Unit  
**To:** FCC CFR 47 Part 15 Subpart E 15.407  
**Serial #:** RDWN44-U3 Rev A Report  
**Issue Date:** 20<sup>th</sup> December 2016  
**Page:** 49 of 130

**Equipment Configuration for 5725 MHz Radiated Band-Edge Emissions**

<b>Antenna:</b>	Ltd. MP0188280	<b>Variant:</b>	40MHz
<b>Antenna Gain (dBi):</b>	16.00	<b>Modulation:</b>	OFDM
<b>Beam Forming Gain (Y):</b>	Not Applicable	<b>Duty Cycle (%):</b>	99
<b>Channel Frequency (MHz):</b>	5745.00	<b>Data Rate:</b>	15.00 MBit/s
<b>Power Setting:</b>	28	<b>Tested By:</b>	SB

**Test Measurement Results**

**5550.00 - 5755.00 MHz**

Num	Frequency MHz	Raw dB $\mu$ V	Cable Loss dB	AF dB	Level dB $\mu$ V/m	Measurement Type	Pol	Hgt cm	Azt Deg	Limit dB $\mu$ V/m	Margin dB	Pass /Fail
#1	5715.00	54.39	3.81	34.34	92.54	Max Avg	Horizontal	155	362	109.4	-16.9	Pass
#2	5725.00	58.50	3.79	34.35	96.64	Max Avg	Horizontal	155	362	122.2	-25.6	Pass
#3	5725.00	--	--	--	--	Band-Edge	--	--	--	--	--	--

Test Notes: initial PS 28, final PS 28

This test report may be reproduced in full only. The document may only be updated by MiCOM Labs personnel. All changes will be noted in the Document History section of the report.



**Title:** Radwin Ltd. Outdoor Subscriber Radio Unit  
**To:** FCC CFR 47 Part 15 Subpart E 15.407  
**Serial #:** RDWN44-U3 Rev A Report  
**Issue Date:** 20<sup>th</sup> December 2016  
**Page:** 50 of 130

**Equipment Configuration for 5725 MHz Radiated Band-Edge Emissions**

<b>Antenna:</b>	Ltd. MP0188280	<b>Variant:</b>	80MHz
<b>Antenna Gain (dBi):</b>	16.00	<b>Modulation:</b>	OFDM
<b>Beam Forming Gain (Y):</b>	Not Applicable	<b>Duty Cycle (%):</b>	99
<b>Channel Frequency (MHz):</b>	5765.00	<b>Data Rate:</b>	15.00 MBit/s
<b>Power Setting:</b>	23.5	<b>Tested By:</b>	SB

**Test Measurement Results**

**5550.00 - 5755.00 MHz**

Num	Frequency MHz	Raw dBµV	Cable Loss dB	AF dB	Level dBµV/m	Measurement Type	Pol	Hgt cm	Azt Deg	Limit dBµV/m	Margin dB	Pass /Fail
#1	5650.09	28.09	3.75	34.18	66.02	Max Avg	Horizontal	155	362	68.2	-2.2	Pass
#2	5725.00	50.69	3.79	34.35	88.83	Max Avg	Horizontal	155	362	122.2	-33.4	Pass
#3	5725.00	--	--	--	--	Band-Edge	--	--	--	--	--	--

Test Notes: initial PS 28, final PS 23.5

This test report may be reproduced in full only. The document may only be updated by MiCOM Labs personnel. All changes will be noted in the Document History section of the report.



**Title:** Radwin Ltd. Outdoor Subscriber Radio Unit  
**To:** FCC CFR 47 Part 15 Subpart E 15.407  
**Serial #:** RDWN44-U3 Rev A Report  
**Issue Date:** 20<sup>th</sup> December 2016  
**Page:** 51 of 130

**Equipment Configuration for 5850 MHz Radiated Band-Edge Emissions**

<b>Antenna:</b>	Ltd. MP0188280	<b>Variant:</b>	10MHz
<b>Antenna Gain (dBi):</b>	16.00	<b>Modulation:</b>	OFDM
<b>Beam Forming Gain (Y):</b>	Not Applicable	<b>Duty Cycle (%):</b>	99
<b>Channel Frequency (MHz):</b>	5845.00	<b>Data Rate:</b>	15.00 MBit/s
<b>Power Setting:</b>	28	<b>Tested By:</b>	SB

**Test Measurement Results**

**5800.00 - 6000.00 MHz**

Num	Frequency MHz	Raw dB $\mu$ V	Cable Loss dB	AF dB	Level dB $\mu$ V/m	Measurement Type	Pol	Hgt cm	Azt Deg	Limit dB $\mu$ V/m	Margin dB	Pass /Fail
#1	5850.00	71.03	3.81	34.63	109.47	Max Avg	Horizontal	155	362	122.2	-12.7	Pass
#3	5860.00	43.23	3.86	34.65	81.74	Max Avg	Horizontal	155	362	109.4	-27.7	Pass
#2	5850.00	--	--	--	--	Band-Edge	--	--	--	--	--	--

Test Notes: initial PS 28, final PS 28

This test report may be reproduced in full only. The document may only be updated by MiCOM Labs personnel. All changes will be noted in the Document History section of the report.



**Title:** Radwin Ltd. Outdoor Subscriber Radio Unit  
**To:** FCC CFR 47 Part 15 Subpart E 15.407  
**Serial #:** RDWN44-U3 Rev A Report  
**Issue Date:** 20<sup>th</sup> December 2016  
**Page:** 52 of 130

**Equipment Configuration for 5850 MHz Radiated Band-Edge Emissions**

<b>Antenna:</b>	Ltd. MP0188280	<b>Variant:</b>	20MHz
<b>Antenna Gain (dBi):</b>	16.00	<b>Modulation:</b>	OFDM
<b>Beam Forming Gain (Y):</b>	Not Applicable	<b>Duty Cycle (%):</b>	99
<b>Channel Frequency (MHz):</b>	5840.00	<b>Data Rate:</b>	15.00 MBit/s
<b>Power Setting:</b>	28	<b>Tested By:</b>	SB

**Test Measurement Results**

**5800.00 - 6000.00 MHz**

Num	Frequency MHz	Raw dB $\mu$ V	Cable Loss dB	AF dB	Level dB $\mu$ V/m	Measurement Type	Pol	Hgt cm	Azt Deg	Limit dB $\mu$ V/m	Margin dB	Pass /Fail
#1	5850.00	61.64	3.81	34.63	100.08	Max Avg	Horizontal	155	362	122.2	-22.1	Pass
#3	5860.00	54.43	3.86	34.65	92.94	Max Avg	Horizontal	155	362	109.4	-16.5	Pass
#2	5850.00	--	--	--	--	Band-Edge	--	--	--	--	--	--

Test Notes: initial PS 28, final PS 28

This test report may be reproduced in full only. The document may only be updated by MiCOM Labs personnel. All changes will be noted in the Document History section of the report.



**Title:** Radwin Ltd. Outdoor Subscriber Radio Unit  
**To:** FCC CFR 47 Part 15 Subpart E 15.407  
**Serial #:** RDWN44-U3 Rev A Report  
**Issue Date:** 20<sup>th</sup> December 2016  
**Page:** 53 of 130

**Equipment Configuration for 5850 MHz Radiated Band-Edge Emissions**

<b>Antenna:</b>	Ltd. MP0188280	<b>Variant:</b>	40MHz
<b>Antenna Gain (dBi):</b>	16.00	<b>Modulation:</b>	OFDM
<b>Beam Forming Gain (Y):</b>	Not Applicable	<b>Duty Cycle (%):</b>	99
<b>Channel Frequency (MHz):</b>	5830.00	<b>Data Rate:</b>	15.00 MBit/s
<b>Power Setting:</b>	28	<b>Tested By:</b>	SB

**Test Measurement Results**

**5800.00 - 6000.00 MHz**

Num	Frequency MHz	Raw dBµV	Cable Loss dB	AF dB	Level dBµV/m	Measurement Type	Pol	Hgt cm	Azt Deg	Limit dBµV/m	Margin dB	Pass /Fail
#1	5850.00	58.39	3.81	34.63	96.83	Max Avg	Horizontal	155	362	122.2	-25.4	Pass
#3	5860.00	53.15	3.86	34.65	91.66	Max Avg	Horizontal	155	362	109.4	-17.7	Pass
#2	5850.00	--	--	--	--	Band-Edge	--	--	--	--	--	--

Test Notes: initial PS 28, final PS 28

This test report may be reproduced in full only. The document may only be updated by MiCOM Labs personnel. All changes will be noted in the Document History section of the report.



**Title:** Radwin Ltd. Outdoor Subscriber Radio Unit  
**To:** FCC CFR 47 Part 15 Subpart E 15.407  
**Serial #:** RDWN44-U3 Rev A Report  
**Issue Date:** 20<sup>th</sup> December 2016  
**Page:** 54 of 130

**Equipment Configuration for 5850 MHz Radiated Band-Edge Emissions**

<b>Antenna:</b>	Ltd. MP0188280	<b>Variant:</b>	80MHz
<b>Antenna Gain (dBi):</b>	16.00	<b>Modulation:</b>	OFDM
<b>Beam Forming Gain (Y):</b>	Not Applicable	<b>Duty Cycle (%):</b>	99
<b>Channel Frequency (MHz):</b>	5810.00	<b>Data Rate:</b>	15.00 MBit/s
<b>Power Setting:</b>	23	<b>Tested By:</b>	SB

**Test Measurement Results**

**5800.00 - 6000.00 MHz**

Num	Frequency MHz	Raw dB $\mu$ V	Cable Loss dB	AF dB	Level dB $\mu$ V/m	Measurement Type	Pol	Hgt cm	Azt Deg	Limit dB $\mu$ V/m	Margin dB	Pass /Fail
#1	5850.00	51.71	3.81	34.63	90.15	Max Avg	Horizontal	155	362	122.2	-32.1	Pass
#3	5926.53	27.56	3.83	34.83	66.22	Max Avg	Horizontal	155	362	68.2	-2.0	Pass
#2	5850.00	--	--	--	--	Band-Edge	--	--	--	--	--	--

Test Notes: initial PS 23, final PS 23

This test report may be reproduced in full only. The document may only be updated by MiCOM Labs personnel. All changes will be noted in the Document History section of the report.



**Title:** Radwin Ltd. Outdoor Subscriber Radio Unit  
**To:** FCC CFR 47 Part 15 Subpart E 15.407  
**Serial #:** RDWN44-U3 Rev A Report  
**Issue Date:** 20<sup>th</sup> December 2016  
**Page:** 55 of 130

---

## **A. APPENDIX - GRAPHICAL IMAGES**

---

This test report may be reproduced in full only. The document may only be updated by MiCOM Labs personnel. All changes will be noted in the Document History section of the report.



### A.1. 6 dB & 99% Bandwidth

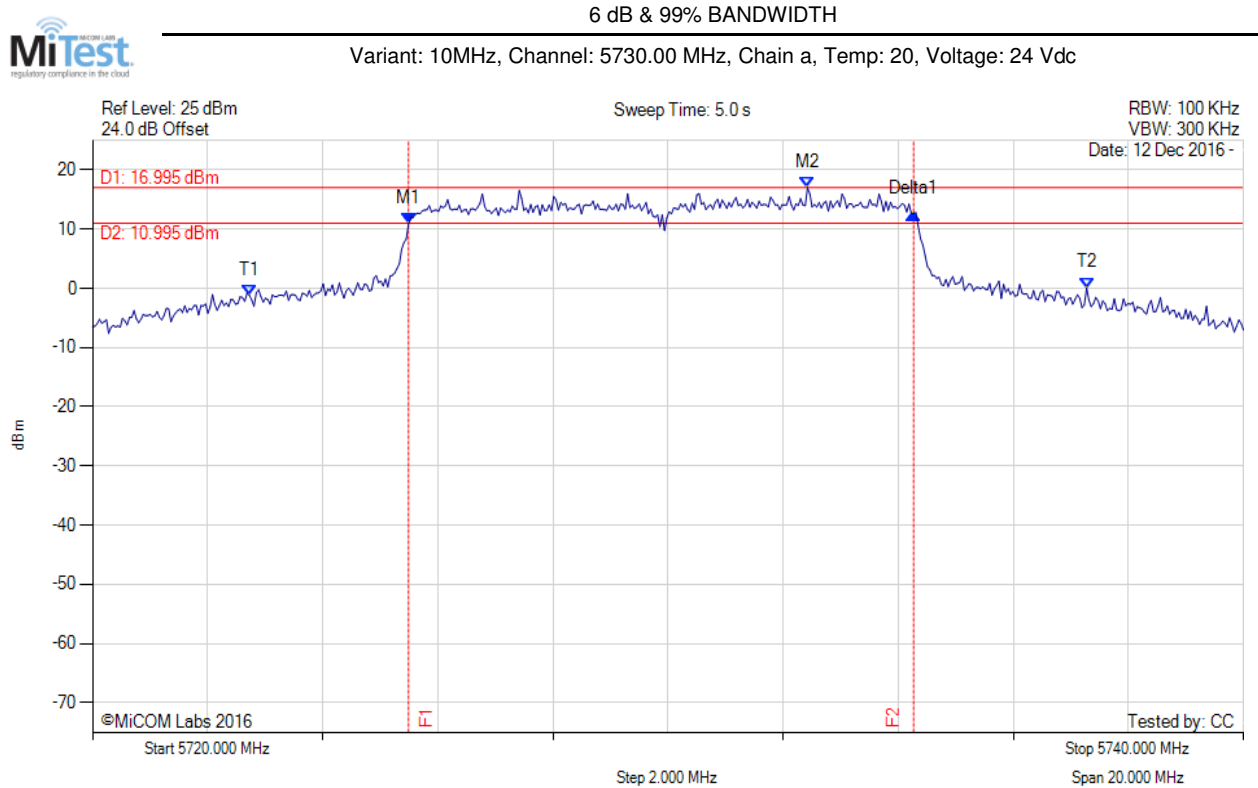

Analyzer Setup	Marker:Frequency:Amplitude	Test Results
Detector = MAX PEAK Sweep Count = 0 RF Atten (dB) = 20 Trace Mode = MAX HOLD	M1 : 5725.491 MHz : 10.888 dBm M2 : 5732.425 MHz : 16.995 dBm Delta1 : 8.778 MHz : 1.753 dB T1 : 5722.725 MHz : -1.158 dBm T2 : 5737.275 MHz : 0.070 dBm OBW : 14.549 MHz	Measured 6 dB Bandwidth: 8.778 MHz Measured 99% Bandwidth: 14.549 MHz

[back to matrix](#)

This test report may be reproduced in full only. The document may only be updated by MiCOM Labs personnel. All changes will be noted in the Document History section of the report.





6 dB & 99% BANDWIDTH

Variant: 10MHz, Channel: 5730.00 MHz, Chain b, Temp: 20, Voltage: 24 Vdc

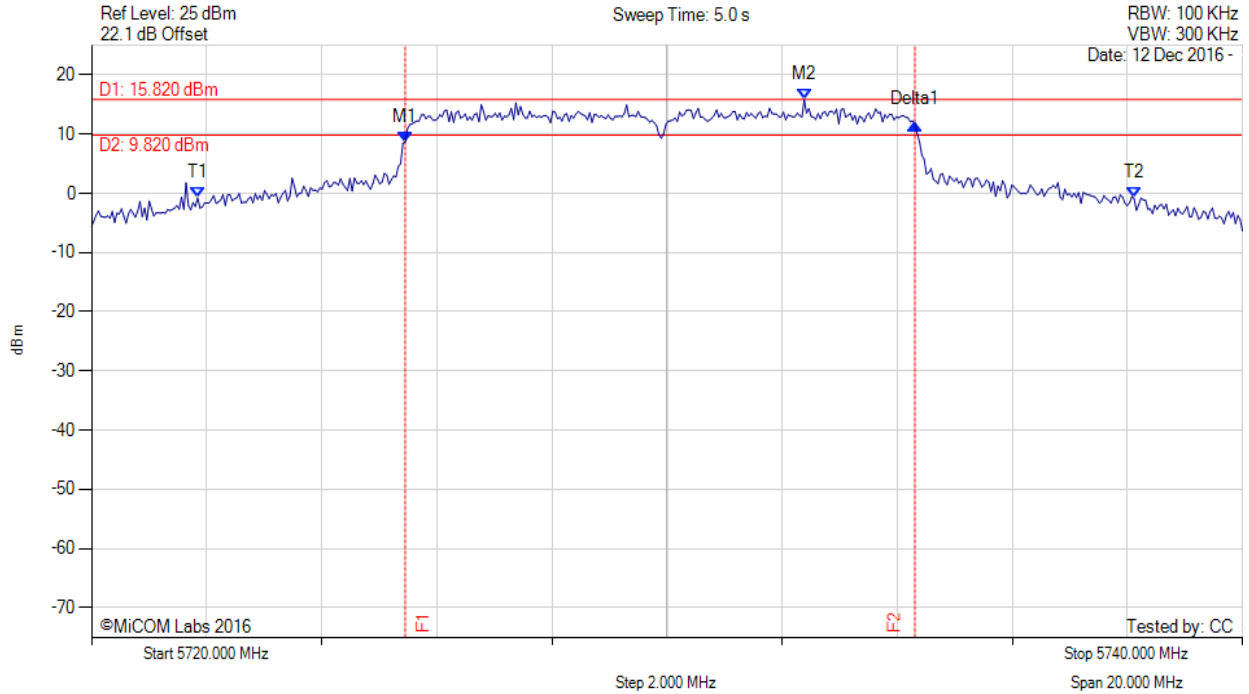

Analyzer Setup	Marker:Frequency:Amplitude	Test Results
Detector = MAX PEAK Sweep Count = 0 RF Atten (dB) = 20 Trace Mode = MAX HOLD	M1 : 5725.451 MHz : 8.622 dBm M2 : 5732.385 MHz : 15.820 dBm Delta1 : 8.858 MHz : 3.110 dB T1 : 5721.844 MHz : -0.768 dBm T2 : 5738.116 MHz : -0.839 dBm OBW : 16.273 MHz	Measured 6 dB Bandwidth: 8.858 MHz Measured 99% Bandwidth: 16.273 MHz

[back to matrix](#)

This test report may be reproduced in full only. The document may only be updated by MiCOM Labs personnel. All changes will be noted in the Document History section of the report.



6 dB & 99% BANDWIDTH

Variants: 10MHz, Channel: 5785.00 MHz, Chain a, Temp: 20, Voltage: 24 Vdc

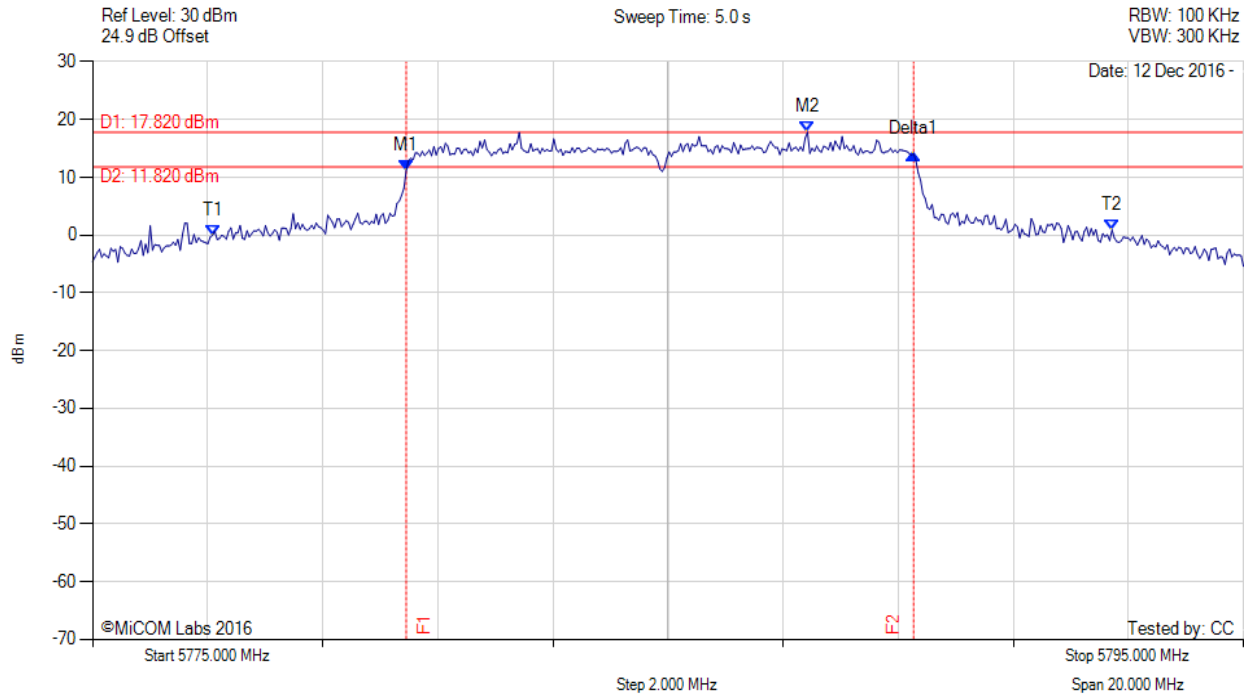

Analyzer Setup	Marker:Frequency:Amplitude	Test Results
Detector = MAX PEAK Sweep Count = 0 RF Atten (dB) = 20 Trace Mode = MAX HOLD	M1 : 5780.451 MHz : 11.149 dBm M2 : 5787.425 MHz : 17.820 dBm Delta1 : 8.818 MHz : 2.947 dB T1 : 5777.084 MHz : -0.030 dBm T2 : 5792.715 MHz : 0.881 dBm OBW : 15.631 MHz	Measured 6 dB Bandwidth: 8.818 MHz Measured 99% Bandwidth: 15.631 MHz

[back to matrix](#)

This test report may be reproduced in full only. The document may only be updated by MiCOM Labs personnel. All changes will be noted in the Document History section of the report.



6 dB & 99% BANDWIDTH

Variant: 10MHz, Channel: 5785.00 MHz, Chain b, Temp: 20, Voltage: 24 Vdc

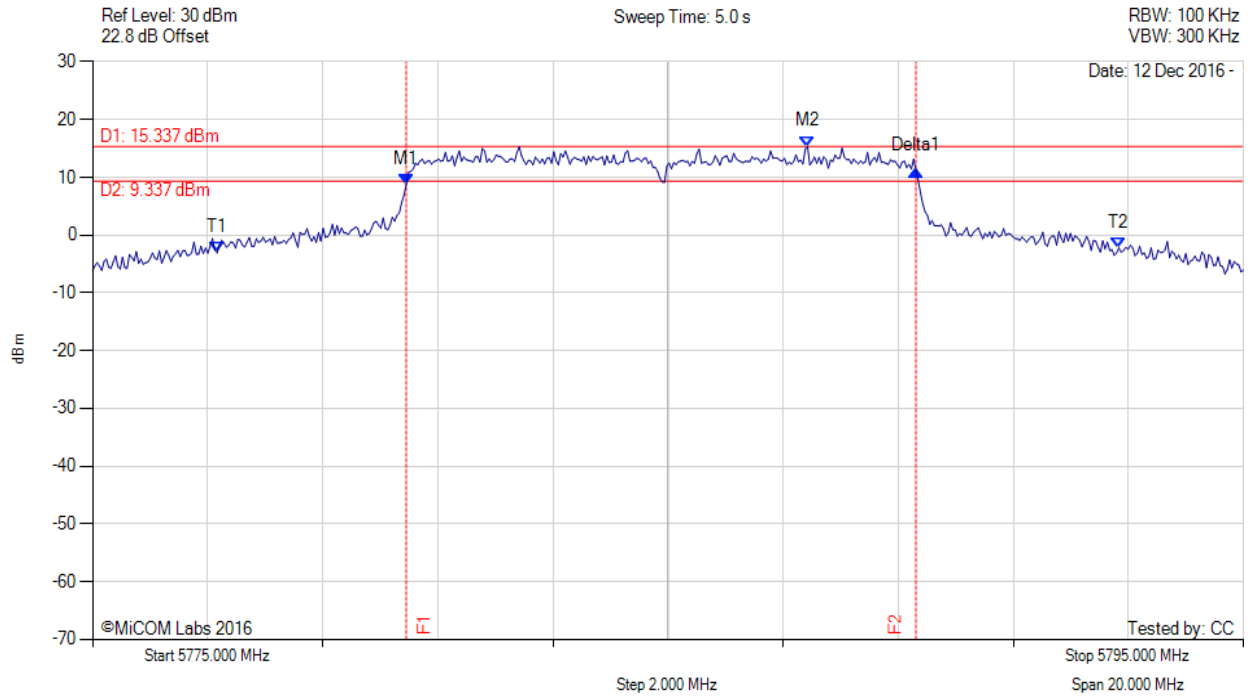

Analyzer Setup	Marker:Frequency:Amplitude	Test Results
Detector = MAX PEAK Sweep Count = 0 RF Atten (dB) = 20 Trace Mode = MAX HOLD	M1 : 5780.451 MHz : 8.762 dBm M2 : 5787.425 MHz : 15.337 dBm Delta1 : 8.858 MHz : 2.434 dB T1 : 5777.164 MHz : -3.059 dBm T2 : 5792.836 MHz : -2.223 dBm OBW : 15.671 MHz	Measured 6 dB Bandwidth: 8.858 MHz Measured 99% Bandwidth: 15.671 MHz

[back to matrix](#)

This test report may be reproduced in full only. The document may only be updated by MiCOM Labs personnel. All changes will be noted in the Document History section of the report.



6 dB & 99% BANDWIDTH

Variant: 10MHz, Channel: 5845.00 MHz, Chain a, Temp: 20, Voltage: 24 Vdc

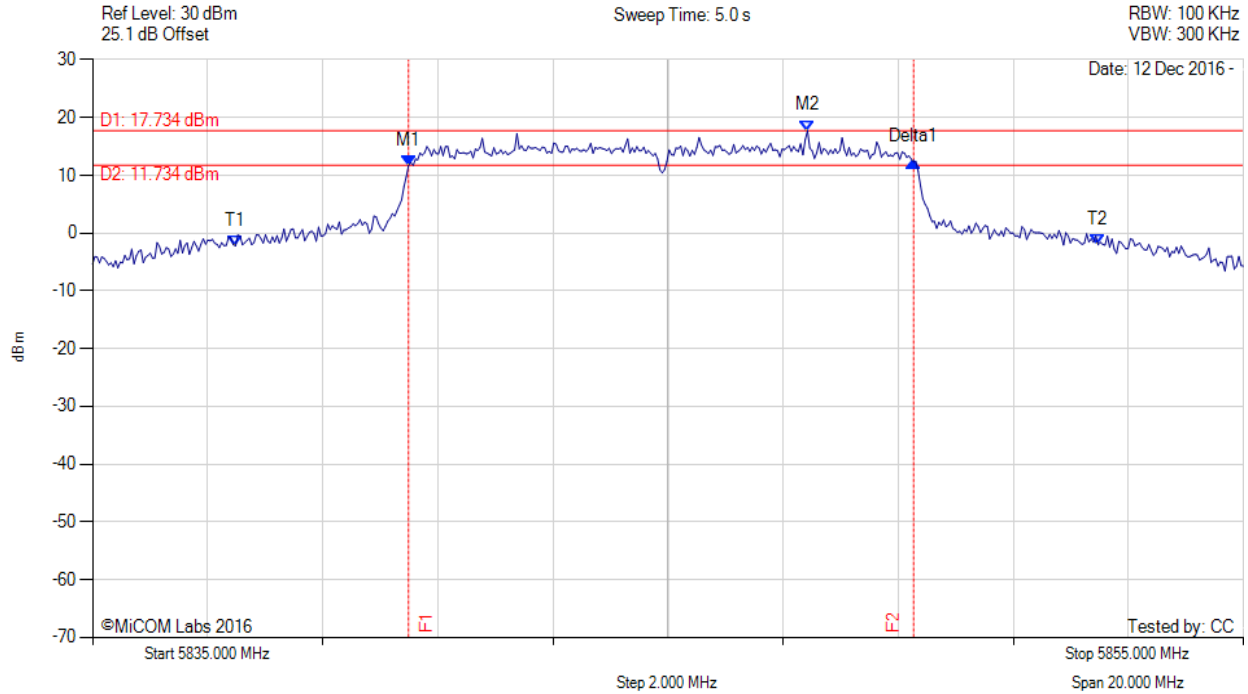

Analyzer Setup	Marker:Frequency:Amplitude	Test Results
Detector = MAX PEAK Sweep Count = 0 RF Atten (dB) = 20 Trace Mode = MAX HOLD	M1 : 5840.491 MHz : 11.727 dBm M2 : 5847.425 MHz : 17.734 dBm Delta1 : 8.778 MHz : 0.602 dB T1 : 5837.485 MHz : -2.215 dBm T2 : 5852.475 MHz : -2.027 dBm OBW : 14.990 MHz	Measured 6 dB Bandwidth: 8.778 MHz Measured 99% Bandwidth: 14.990 MHz

[back to matrix](#)

This test report may be reproduced in full only. The document may only be updated by MiCOM Labs personnel. All changes will be noted in the Document History section of the report.



6 dB & 99% BANDWIDTH

Variant: 10MHz, Channel: 5845.00 MHz, Chain b, Temp: 20, Voltage: 24 Vdc

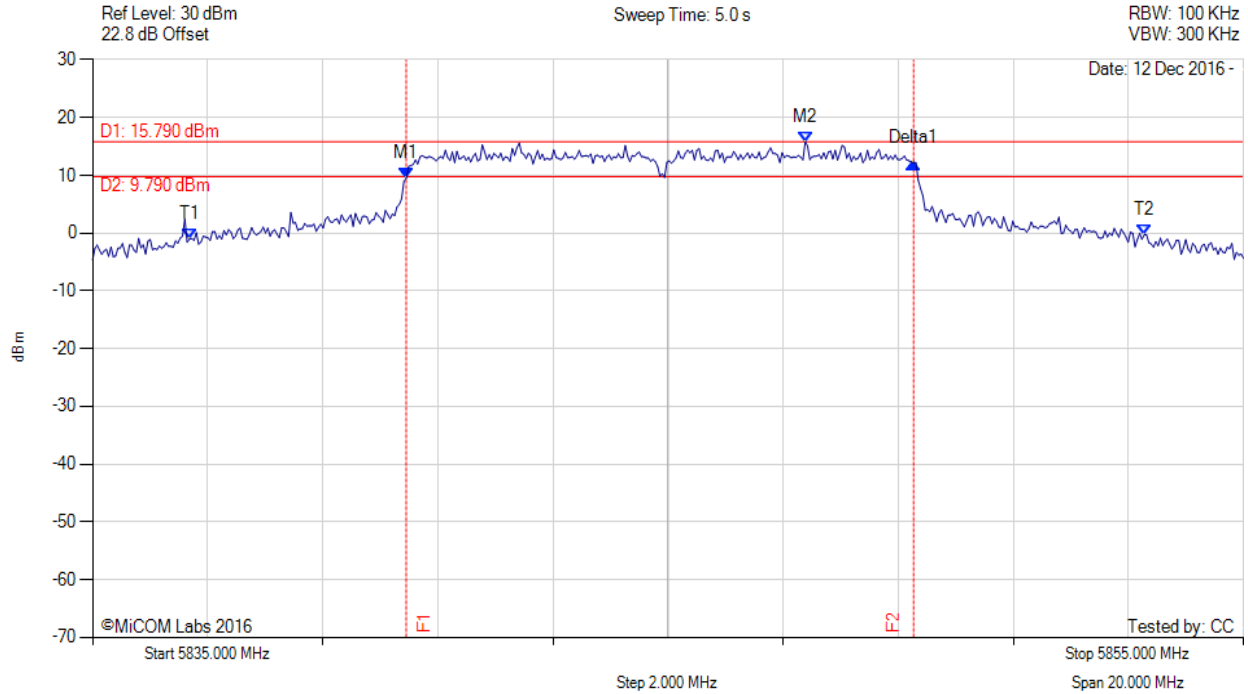

Analyzer Setup	Marker:Frequency:Amplitude	Test Results
Detector = MAX PEAK Sweep Count = 0 RF Atten (dB) = 20 Trace Mode = MAX HOLD	M1 : 5840.451 MHz : 9.441 dBm M2 : 5847.385 MHz : 15.790 dBm Delta1 : 8.818 MHz : 2.693 dB T1 : 5836.683 MHz : -1.063 dBm T2 : 5853.277 MHz : -0.299 dBm OBW : 16.593 MHz	Measured 6 dB Bandwidth: 8.818 MHz Measured 99% Bandwidth: 16.593 MHz

[back to matrix](#)

This test report may be reproduced in full only. The document may only be updated by MiCOM Labs personnel. All changes will be noted in the Document History section of the report.



6 dB & 99% BANDWIDTH

Variant: 20MHz, Channel: 5735.00 MHz, Chain a, Temp: 20, Voltage: 24 Vdc

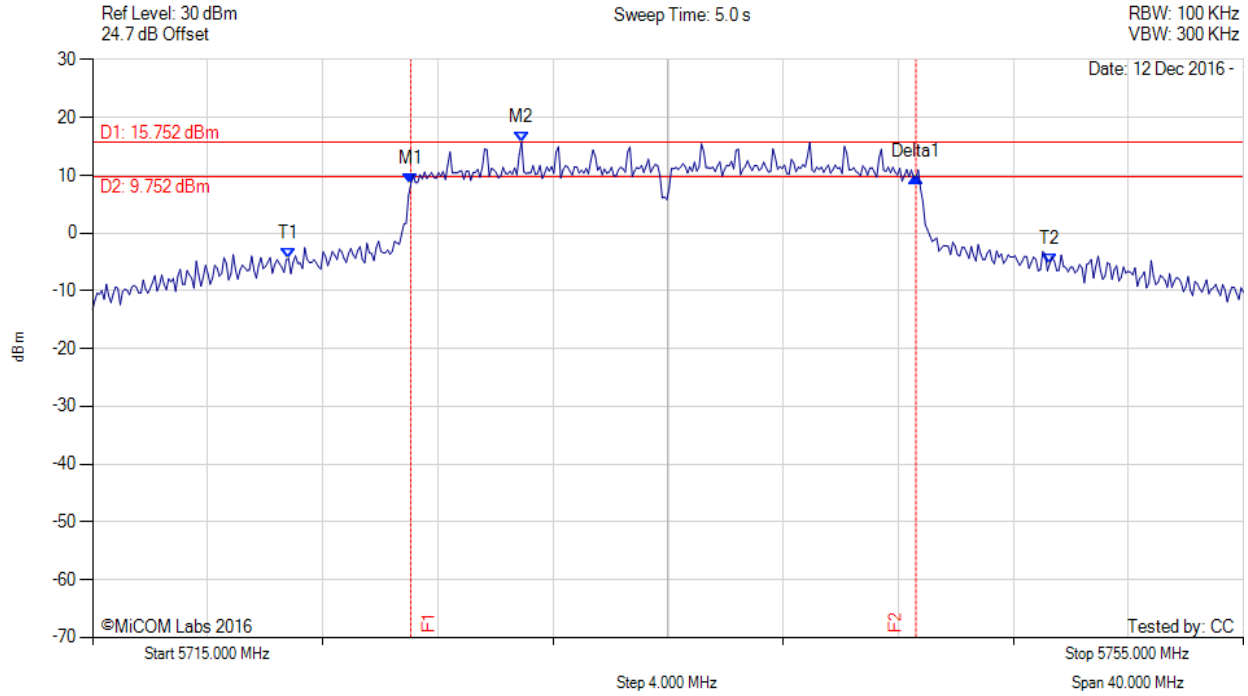

Analyzer Setup	Marker:Frequency:Amplitude	Test Results
Detector = MAX PEAK Sweep Count = 0 RF Atten (dB) = 20 Trace Mode = MAX HOLD	M1 : 5726.062 MHz : 8.430 dBm M2 : 5729.910 MHz : 15.752 dBm Delta1 : 17.555 MHz : 1.226 dB T1 : 5721.814 MHz : -4.415 dBm T2 : 5748.267 MHz : -5.300 dBm OBW : 26.453 MHz	Measured 6 dB Bandwidth: 17.555 MHz Measured 99% Bandwidth: 26.453 MHz

[back to matrix](#)

This test report may be reproduced in full only. The document may only be updated by MiCOM Labs personnel. All changes will be noted in the Document History section of the report.



6 dB & 99% BANDWIDTH

Variant: 20MHz, Channel: 5735.00 MHz, Chain b, Temp: 20, Voltage: 24 Vdc

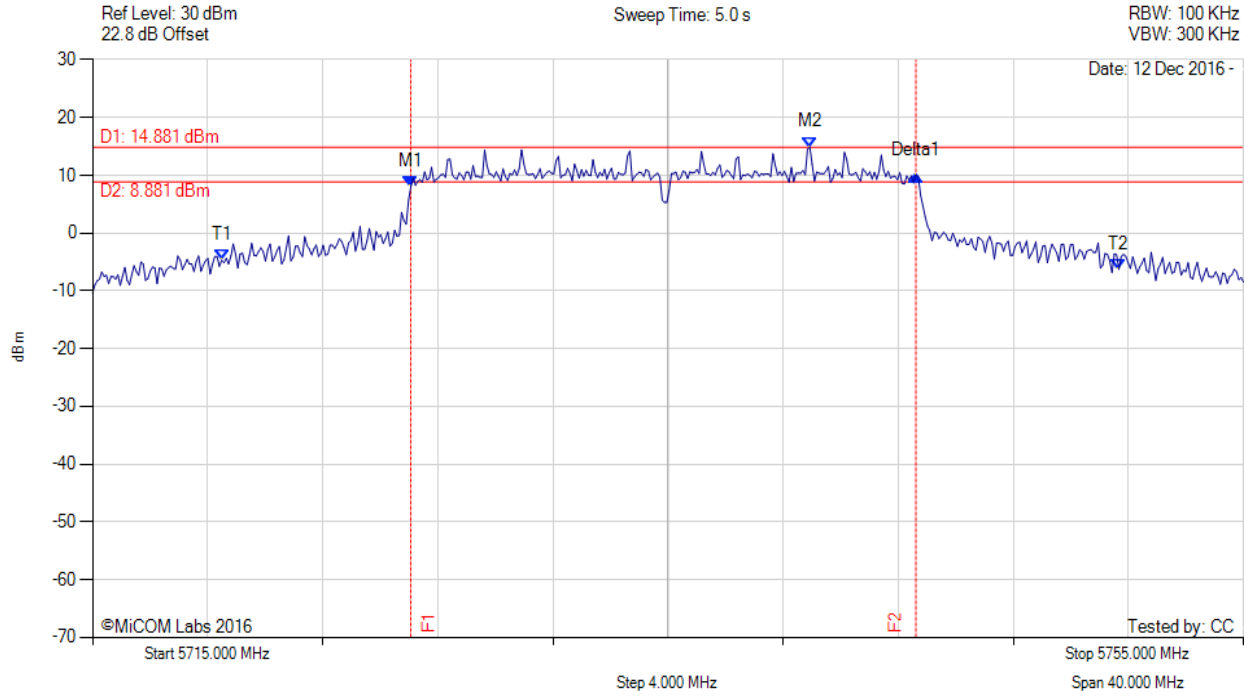

Analyzer Setup	Marker:Frequency:Amplitude	Test Results
Detector = MAX PEAK Sweep Count = 0 RF Atten (dB) = 20 Trace Mode = MAX HOLD	M1 : 5726.062 MHz : 7.999 dBm M2 : 5739.930 MHz : 14.881 dBm Delta1 : 17.555 MHz : 2.007 dB T1 : 5719.489 MHz : -4.684 dBm T2 : 5750.671 MHz : -6.233 dBm OBW : 31.182 MHz	Measured 6 dB Bandwidth: 17.555 MHz Measured 99% Bandwidth: 31.182 MHz

[back to matrix](#)

This test report may be reproduced in full only. The document may only be updated by MiCOM Labs personnel. All changes will be noted in the Document History section of the report.



6 dB & 99% BANDWIDTH

Variant: 20MHz, Channel: 5785.00 MHz, Chain a, Temp: 20, Voltage: 24 Vdc

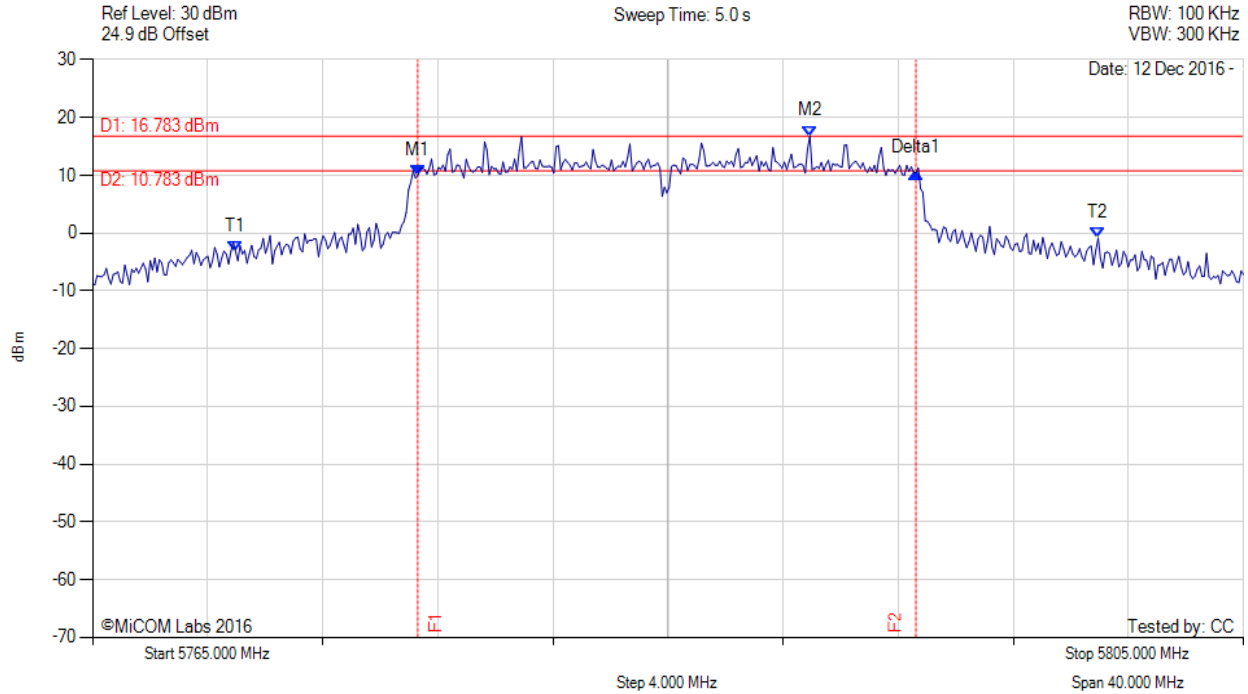

Analyzer Setup	Marker:Frequency:Amplitude	Test Results
Detector = MAX PEAK Sweep Count = 0 RF Atten (dB) = 20 Trace Mode = MAX HOLD	M1 : 5776.303 MHz : 10.004 dBm M2 : 5789.930 MHz : 16.783 dBm Delta1 : 17.315 MHz : 0.435 dB T1 : 5769.970 MHz : -3.179 dBm T2 : 5799.950 MHz : -0.874 dBm OBW : 29.980 MHz	Measured 6 dB Bandwidth: 17.315 MHz Measured 99% Bandwidth: 29.980 MHz

[back to matrix](#)

This test report may be reproduced in full only. The document may only be updated by MiCOM Labs personnel. All changes will be noted in the Document History section of the report.





**Title:** Radwin Ltd. Outdoor Subscriber Radio Unit  
**To:** FCC CFR 47 Part 15 Subpart E 15.407  
**Serial #:** RDWN44-U3 Rev A Report  
**Issue Date:** 20<sup>th</sup> December 2016  
**Page:** 65 of 130



6 dB & 99% BANDWIDTH

Variant: 20MHz, Channel: 5785.00 MHz, Chain b, Temp: 20, Voltage: 24 Vdc

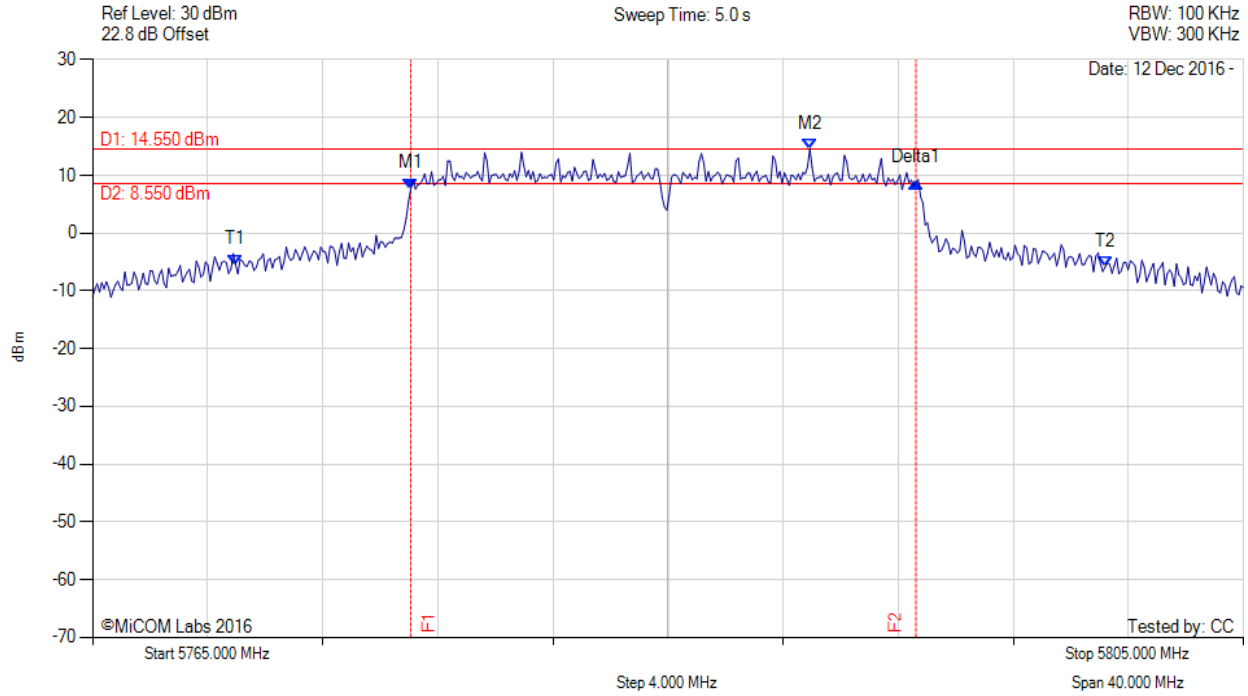

Analyzer Setup	Marker:Frequency:Amplitude	Test Results
Detector = MAX PEAK Sweep Count = 0 RF Atten (dB) = 20 Trace Mode = MAX HOLD	M1 : 5776.062 MHz : 7.690 dBm M2 : 5789.930 MHz : 14.550 dBm Delta1 : 17.555 MHz : 1.137 dB T1 : 5769.970 MHz : -5.483 dBm T2 : 5800.190 MHz : -5.902 dBm OBW : 30.220 MHz	Measured 6 dB Bandwidth: 17.555 MHz Measured 99% Bandwidth: 30.220 MHz

[back to matrix](#)

This test report may be reproduced in full only. The document may only be updated by MiCOM Labs personnel. All changes will be noted in the Document History section of the report.



6 dB & 99% BANDWIDTH

Variants: 20MHz, Channel: 5840.00 MHz, Chain a, Temp: 20, Voltage: 24 Vdc

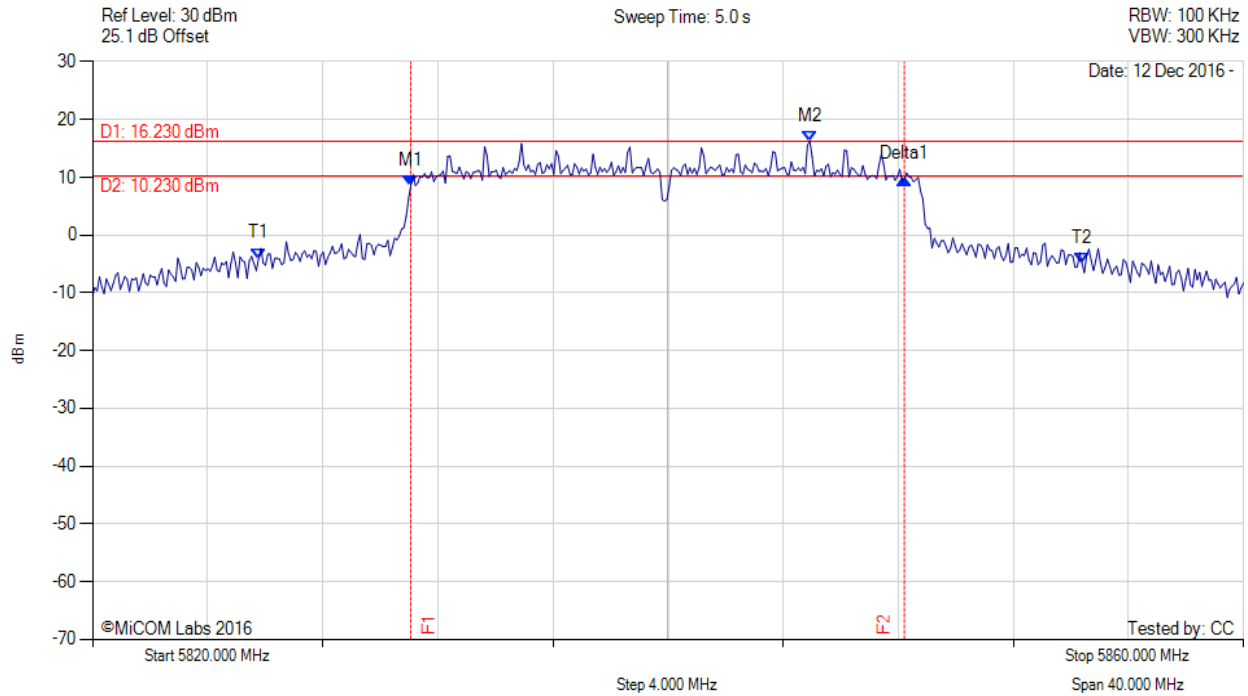

Analyzer Setup	Marker:Frequency:Amplitude	Test Results
Detector = MAX PEAK Sweep Count = 0 RF Atten (dB) = 20 Trace Mode = MAX HOLD	M1 : 5831.062 MHz : 8.544 dBm M2 : 5844.930 MHz : 16.230 dBm Delta1 : 17.154 MHz : 1.212 dB T1 : 5825.772 MHz : -4.059 dBm T2 : 5854.389 MHz : -4.921 dBm OBW : 28.617 MHz	Measured 6 dB Bandwidth: 17.154 MHz Measured 99% Bandwidth: 28.617 MHz

[back to matrix](#)

This test report may be reproduced in full only. The document may only be updated by MiCOM Labs personnel. All changes will be noted in the Document History section of the report.



6 dB & 99% BANDWIDTH

Variant: 20MHz, Channel: 5840.00 MHz, Chain b, Temp: 20, Voltage: 24 Vdc

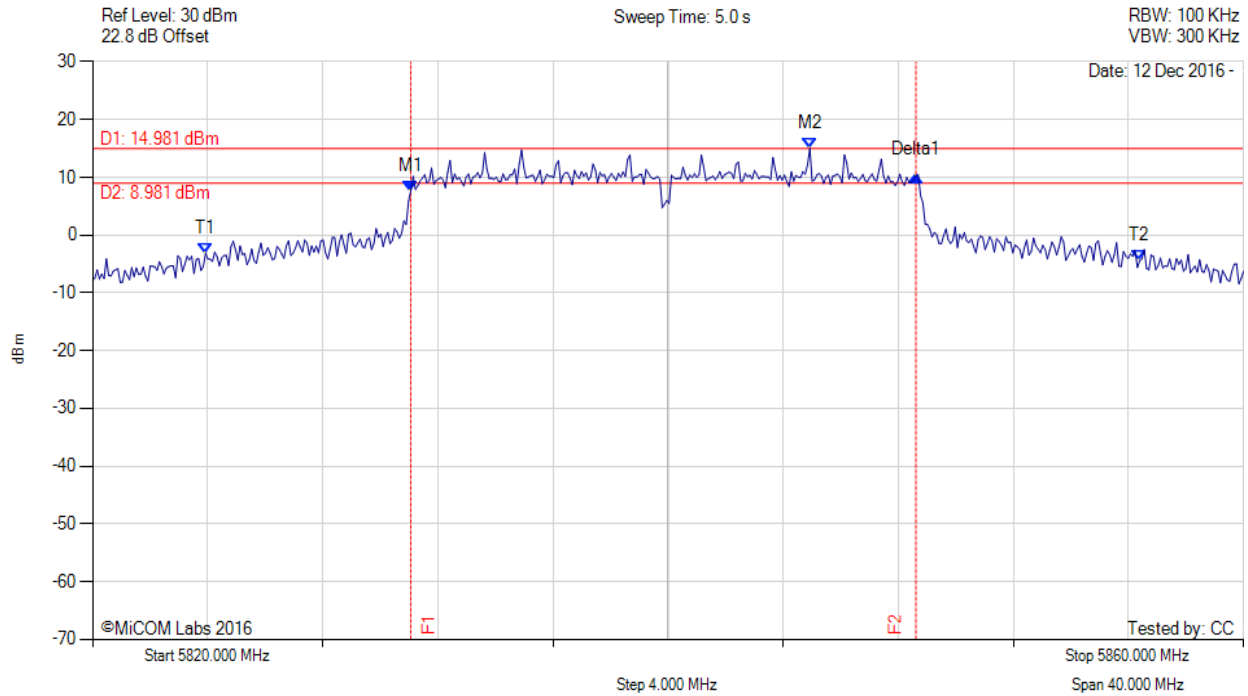

Analyzer Setup	Marker:Frequency:Amplitude	Test Results
Detector = MAX PEAK Sweep Count = 0 RF Atten (dB) = 20 Trace Mode = MAX HOLD	M1 : 5831.062 MHz : 7.659 dBm M2 : 5844.930 MHz : 14.981 dBm Delta1 : 17.555 MHz : 2.648 dB T1 : 5823.928 MHz : -3.174 dBm T2 : 5856.393 MHz : -4.439 dBm OBW : 32.465 MHz	Measured 6 dB Bandwidth: 17.555 MHz Measured 99% Bandwidth: 32.465 MHz

[back to matrix](#)

This test report may be reproduced in full only. The document may only be updated by MiCOM Labs personnel. All changes will be noted in the Document History section of the report.



6 dB & 99% BANDWIDTH

Variants: 40MHz, Channel: 5745.00 MHz, Chain a, Temp: 20, Voltage: 24 Vdc

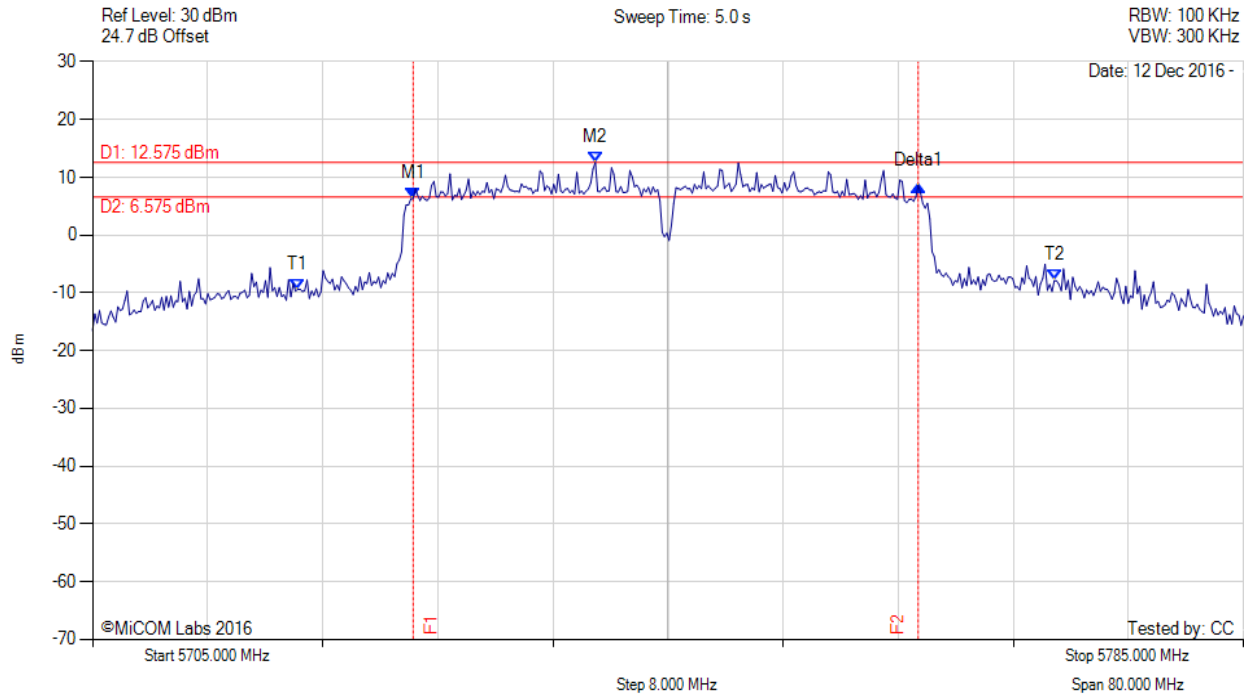

Analyzer Setup	Marker:Frequency:Amplitude	Test Results
Detector = MAX PEAK Sweep Count = 0 RF Atten (dB) = 20 Trace Mode = MAX HOLD	M1 : 5727.285 MHz : 6.329 dBm M2 : 5739.950 MHz : 12.575 dBm Delta1 : 35.110 MHz : 2.288 dB T1 : 5719.269 MHz : -9.377 dBm T2 : 5771.854 MHz : -7.858 dBm OBW : 52.585 MHz	Measured 6 dB Bandwidth: 35.110 MHz Measured 99% Bandwidth: 52.585 MHz

[back to matrix](#)

This test report may be reproduced in full only. The document may only be updated by MiCOM Labs personnel. All changes will be noted in the Document History section of the report.



6 dB & 99% BANDWIDTH

Variants: 40MHz, Channel: 5745.00 MHz, Chain b, Temp: 20, Voltage: 24 Vdc

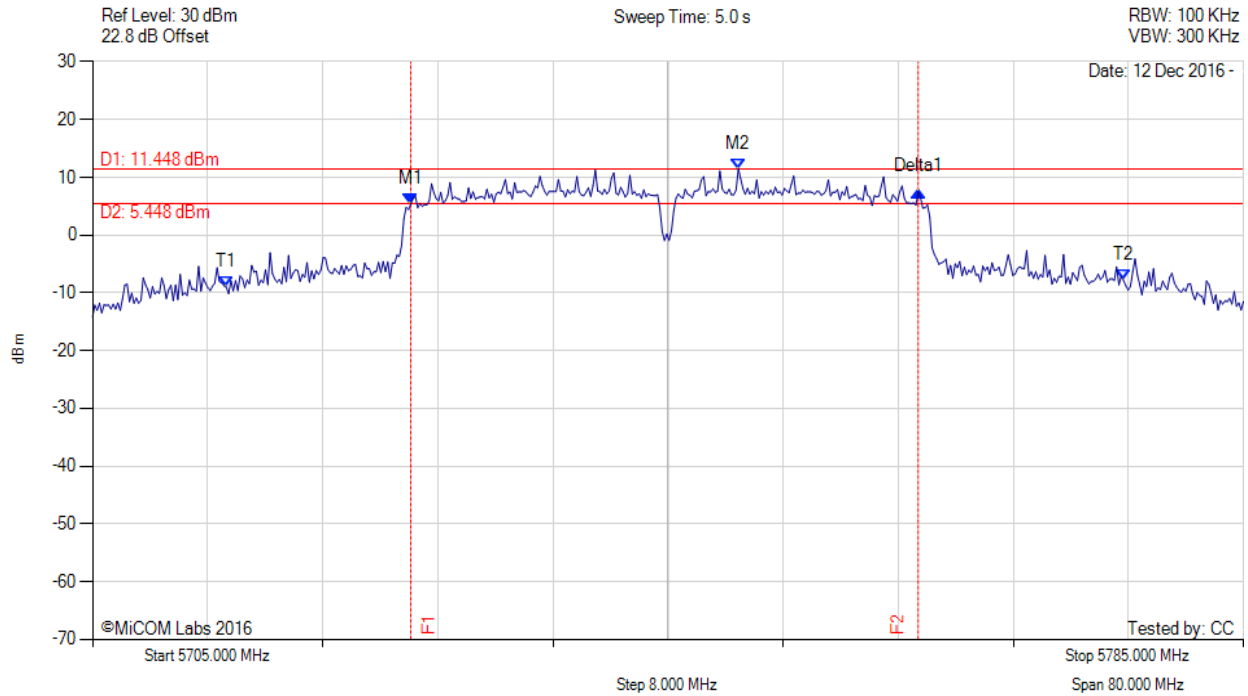

Analyzer Setup	Marker:Frequency:Amplitude	Test Results
Detector = MAX PEAK Sweep Count = 0 RF Atten (dB) = 20 Trace Mode = MAX HOLD	M1 : 5727.124 MHz : 5.386 dBm M2 : 5749.890 MHz : 11.448 dBm Delta1 : 35.271 MHz : 2.129 dB T1 : 5714.299 MHz : -9.005 dBm T2 : 5776.663 MHz : -7.854 dBm OBW : 62.365 MHz	Measured 6 dB Bandwidth: 35.271 MHz Measured 99% Bandwidth: 62.365 MHz

[back to matrix](#)

This test report may be reproduced in full only. The document may only be updated by MiCOM Labs personnel. All changes will be noted in the Document History section of the report.



6 dB & 99% BANDWIDTH

Variant: 40MHz, Channel: 5785.00 MHz, Chain a, Temp: 20, Voltage: 24 Vdc

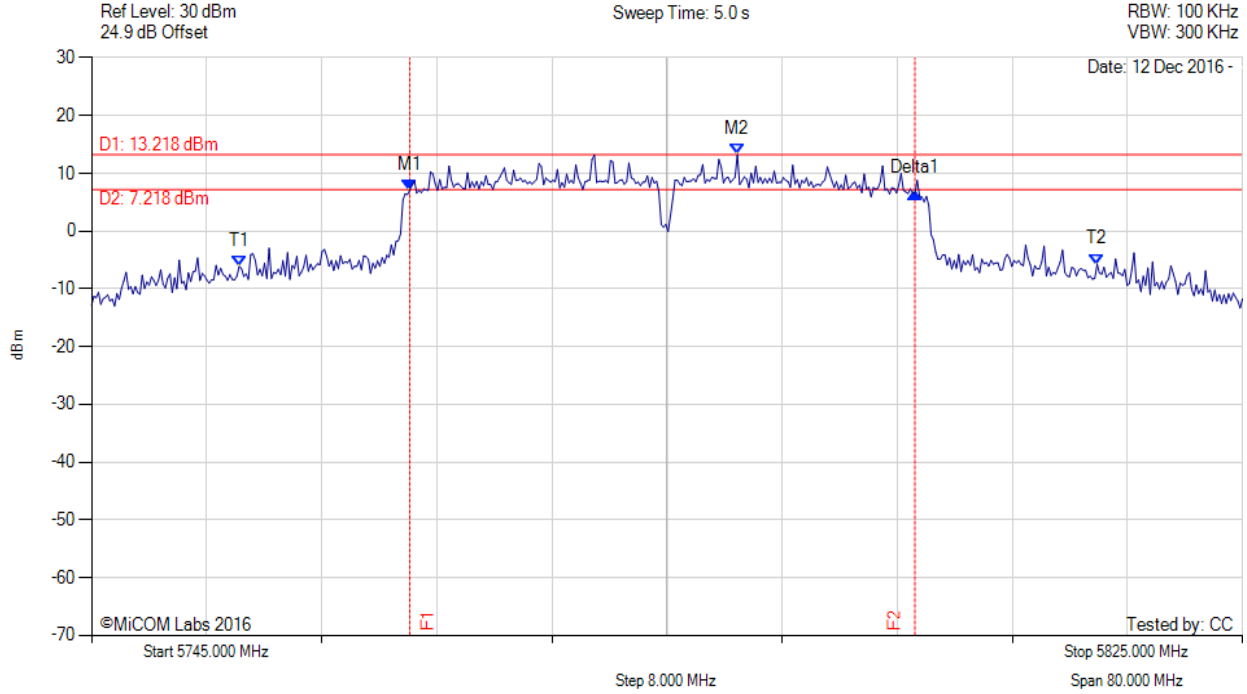

Analyzer Setup	Marker:Frequency:Amplitude	Test Results
Detector = MAX PEAK Sweep Count = 0 RF Atten (dB) = 20 Trace Mode = MAX HOLD	M1 : 5767.124 MHz : 7.102 dBm M2 : 5789.890 MHz : 13.218 dBm Delta1 : 35.110 MHz : -0.472 dB T1 : 5755.261 MHz : -6.138 dBm T2 : 5814.900 MHz : -5.737 dBm OBW : 59.639 MHz	Measured 6 dB Bandwidth: 35.110 MHz Measured 99% Bandwidth: 59.639 MHz

[back to matrix](#)

This test report may be reproduced in full only. The document may only be updated by MiCOM Labs personnel. All changes will be noted in the Document History section of the report.



6 dB & 99% BANDWIDTH

Variant: 40MHz, Channel: 5785.00 MHz, Chain b, Temp: 20, Voltage: 24 Vdc

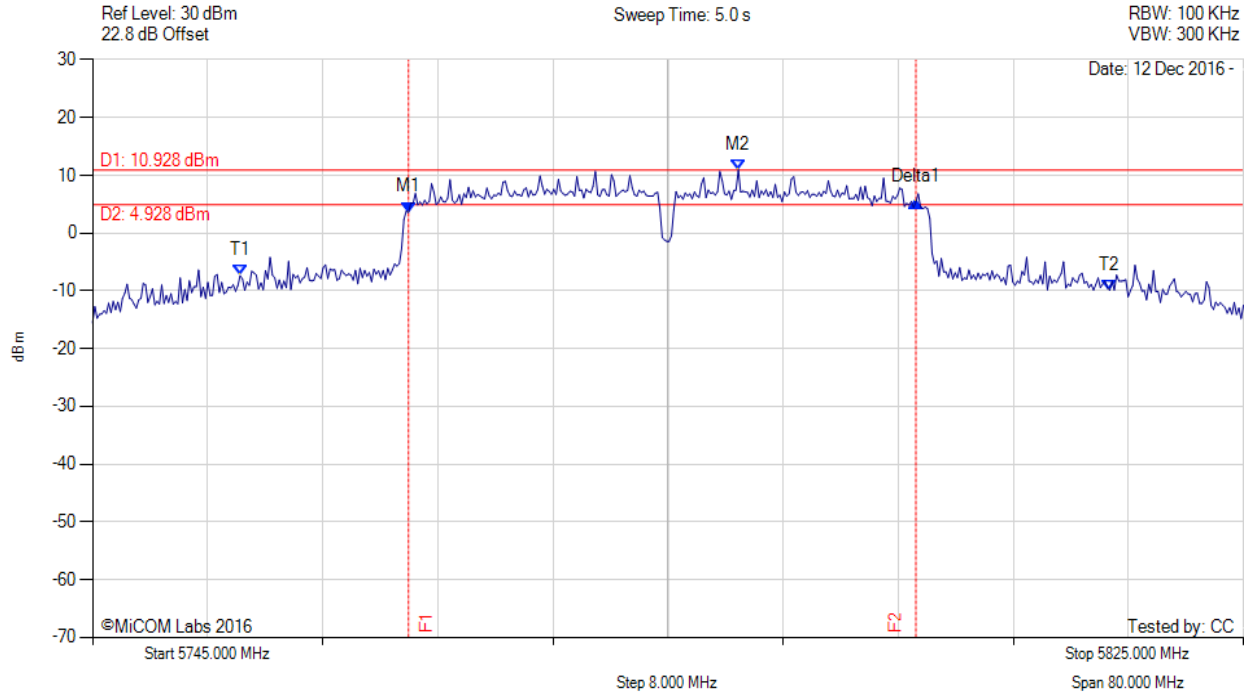

Analyzer Setup	Marker:Frequency:Amplitude	Test Results
Detector = MAX PEAK Sweep Count = 0 RF Atten (dB) = 20 Trace Mode = MAX HOLD	M1 : 5766.964 MHz : 3.598 dBm M2 : 5789.890 MHz : 10.928 dBm Delta1 : 35.271 MHz : 1.824 dB T1 : 5755.261 MHz : -7.374 dBm T2 : 5815.701 MHz : -9.904 dBm OBW : 60.441 MHz	Measured 6 dB Bandwidth: 35.271 MHz Measured 99% Bandwidth: 60.441 MHz

[back to matrix](#)

This test report may be reproduced in full only. The document may only be updated by MiCOM Labs personnel. All changes will be noted in the Document History section of the report.



6 dB & 99% BANDWIDTH

Variant: 40MHz, Channel: 5830.00 MHz, Chain a, Temp: 20, Voltage: 24 Vdc

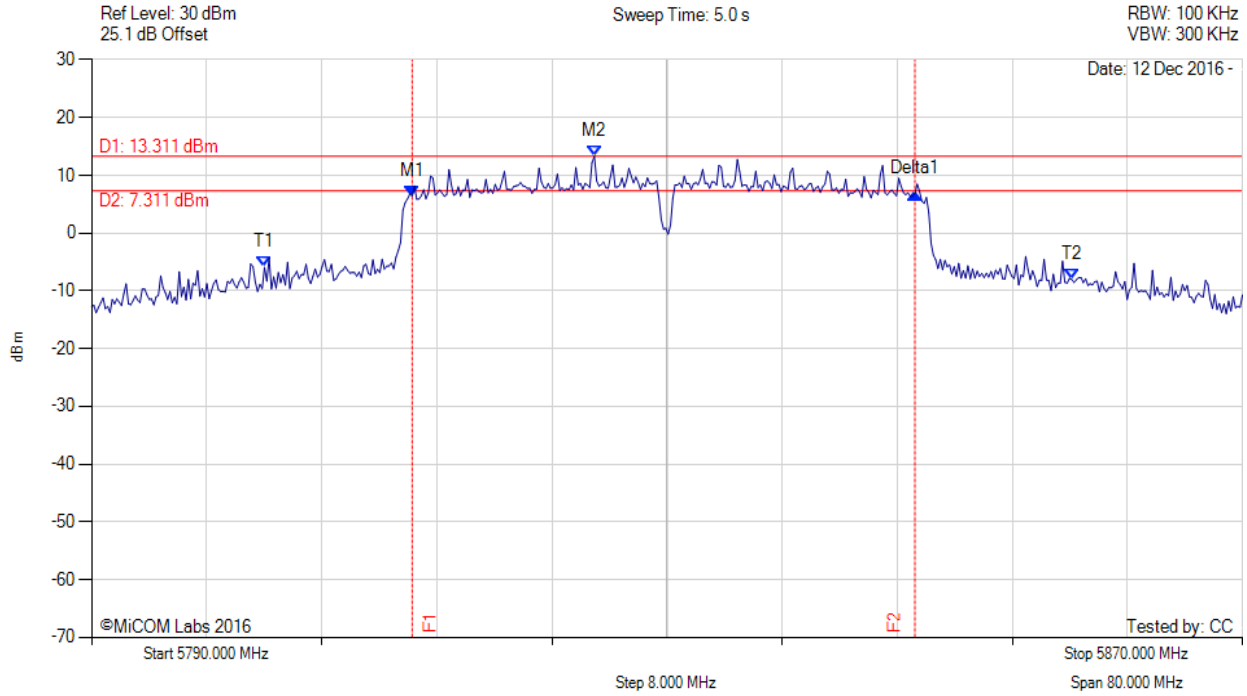

Analyzer Setup	Marker:Frequency:Amplitude	Test Results
Detector = MAX PEAK Sweep Count = 0 RF Atten (dB) = 20 Trace Mode = MAX HOLD	M1 : 5812.285 MHz : 6.417 dBm M2 : 5824.950 MHz : 13.311 dBm Delta1 : 34.950 MHz : 0.525 dB T1 : 5802.024 MHz : -5.932 dBm T2 : 5858.136 MHz : -8.023 dBm OBW : 56.112 MHz	Measured 6 dB Bandwidth: 34.950 MHz Measured 99% Bandwidth: 56.112 MHz

[back to matrix](#)

This test report may be reproduced in full only. The document may only be updated by MiCOM Labs personnel. All changes will be noted in the Document History section of the report.





6 dB & 99% BANDWIDTH

Variant: 40MHz, Channel: 5830.00 MHz, Chain b, Temp: 20, Voltage: 24 Vdc

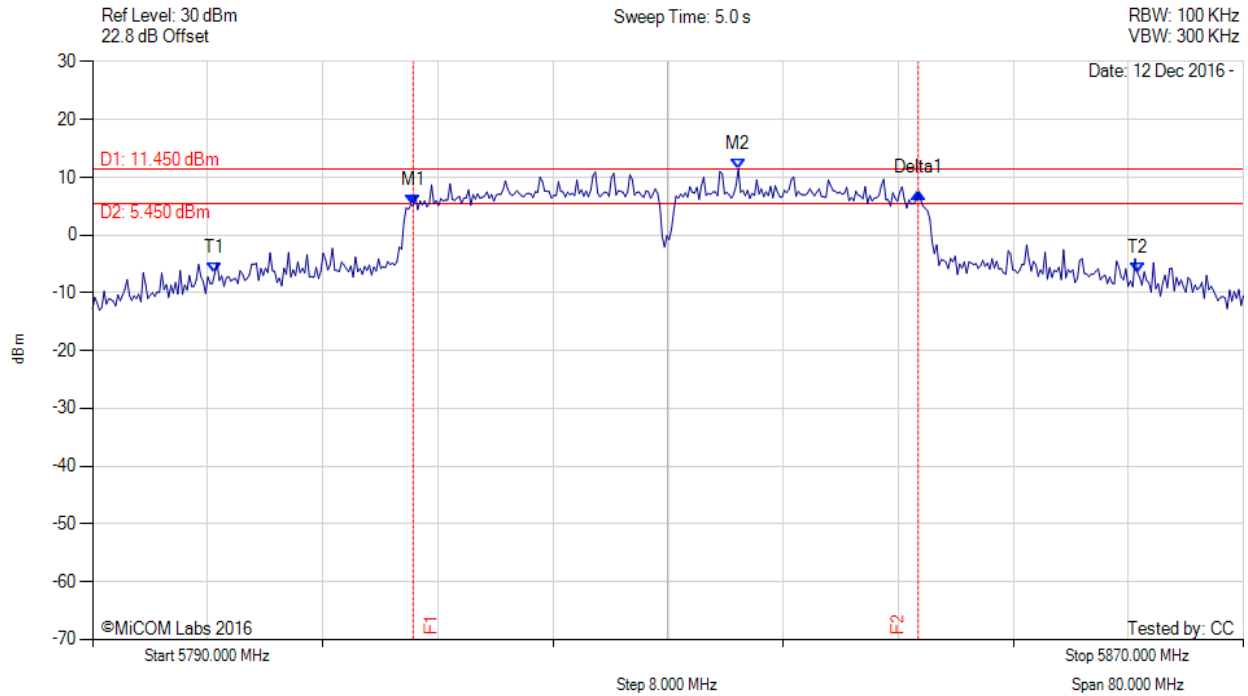

Analyzer Setup	Marker:Frequency:Amplitude	Test Results
Detector = MAX PEAK Sweep Count = 0 RF Atten (dB) = 20 Trace Mode = MAX HOLD	M1 : 5812.285 MHz : 5.150 dBm M2 : 5834.890 MHz : 11.450 dBm Delta1 : 35.110 MHz : 2.241 dB T1 : 5798.497 MHz : -6.616 dBm T2 : 5862.625 MHz : -6.479 dBm OBW : 64.128 MHz	Measured 6 dB Bandwidth: 35.110 MHz Measured 99% Bandwidth: 64.128 MHz

[back to matrix](#)

This test report may be reproduced in full only. The document may only be updated by MiCOM Labs personnel. All changes will be noted in the Document History section of the report.



6 dB & 99% BANDWIDTH

Variant: 80MHz, Channel: 5765.00 MHz, Chain a, Temp: 20, Voltage: 24 Vdc

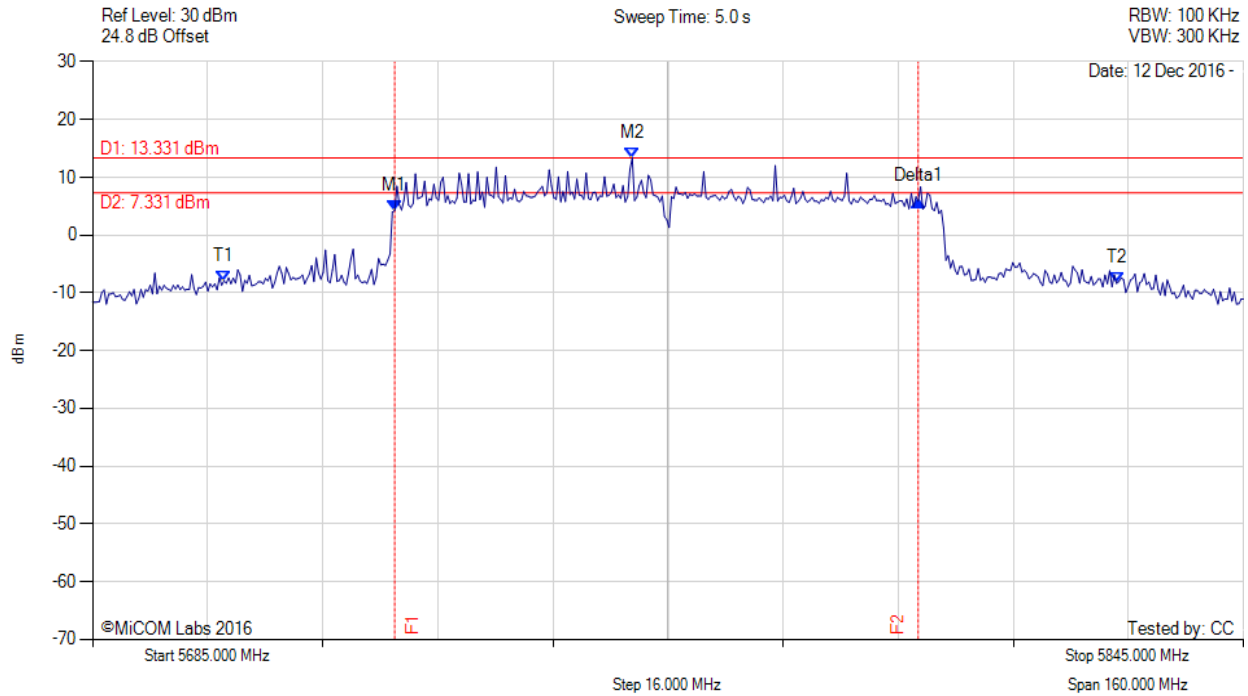

Analyzer Setup	Marker:Frequency:Amplitude	Test Results
Detector = MAX PEAK Sweep Count = 0 RF Atten (dB) = 20 Trace Mode = MAX HOLD	M1 : 5727.004 MHz : 4.249 dBm M2 : 5760.030 MHz : 13.331 dBm Delta1 : 72.786 MHz : 1.649 dB T1 : 5703.277 MHz : -7.927 dBm T2 : 5827.365 MHz : -8.350 dBm OBW : 124.088 MHz	Measured 6 dB Bandwidth: 72.786 MHz Measured 99% Bandwidth: 124.088 MHz

[back to matrix](#)

This test report may be reproduced in full only. The document may only be updated by MiCOM Labs personnel. All changes will be noted in the Document History section of the report.



6 dB & 99% BANDWIDTH

Variat: 80MHz, Channel: 5765.00 MHz, Chain b, Temp: 20, Voltage: 24 Vdc

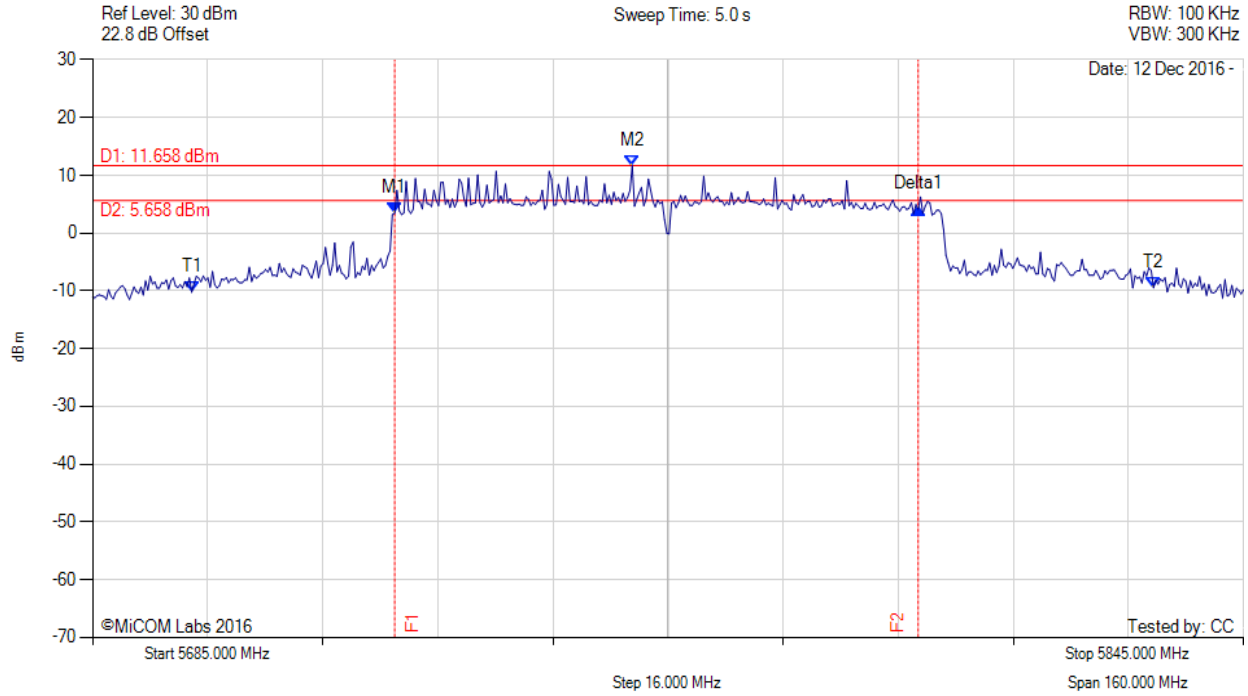

Analyzer Setup	Marker:Frequency:Amplitude	Test Results
Detector = MAX PEAK Sweep Count = 0 RF Atten (dB) = 20 Trace Mode = MAX HOLD	M1 : 5727.004 MHz : 3.439 dBm M2 : 5760.030 MHz : 11.658 dBm Delta1 : 72.786 MHz : 0.673 dB T1 : 5698.788 MHz : -10.234 dBm T2 : 5832.495 MHz : -9.471 dBm OBW : 133.707 MHz	Measured 6 dB Bandwidth: 72.786 MHz Measured 99% Bandwidth: 133.707 MHz

[back to matrix](#)

This test report may be reproduced in full only. The document may only be updated by MiCOM Labs personnel. All changes will be noted in the Document History section of the report.



6 dB & 99% BANDWIDTH

Variant: 80MHz, Channel: 5785.00 MHz, Chain a, Temp: 20, Voltage: 24 Vdc

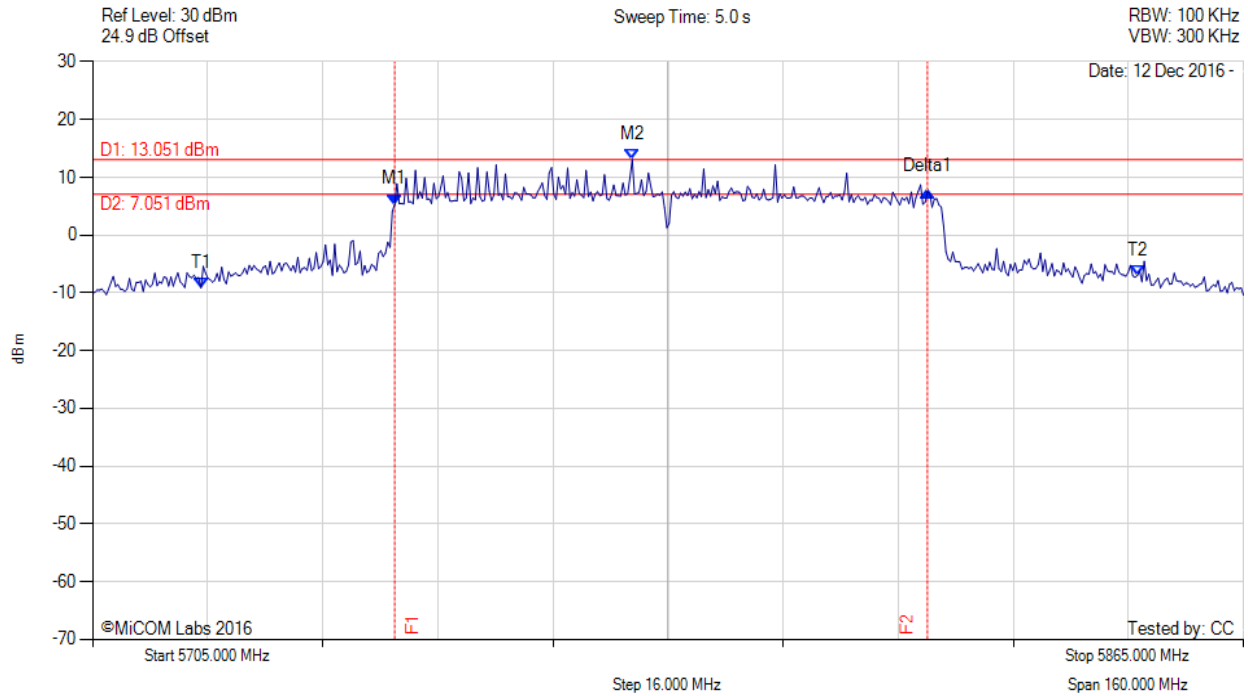

Analyzer Setup	Marker:Frequency:Amplitude	Test Results
Detector = MAX PEAK Sweep Count = 0 RF Atten (dB) = 20 Trace Mode = MAX HOLD	M1 : 5747.004 MHz : 5.292 dBm M2 : 5780.030 MHz : 13.051 dBm Delta1 : 74.068 MHz : 2.182 dB T1 : 5720.070 MHz : -9.125 dBm T2 : 5850.251 MHz : -6.982 dBm OBW : 130.180 MHz	Measured 6 dB Bandwidth: 74.068 MHz Measured 99% Bandwidth: 130.180 MHz

[back to matrix](#)

This test report may be reproduced in full only. The document may only be updated by MiCOM Labs personnel. All changes will be noted in the Document History section of the report.



6 dB & 99% BANDWIDTH

Variant: 80MHz, Channel: 5785.00 MHz, Chain b, Temp: 20, Voltage: 24 Vdc

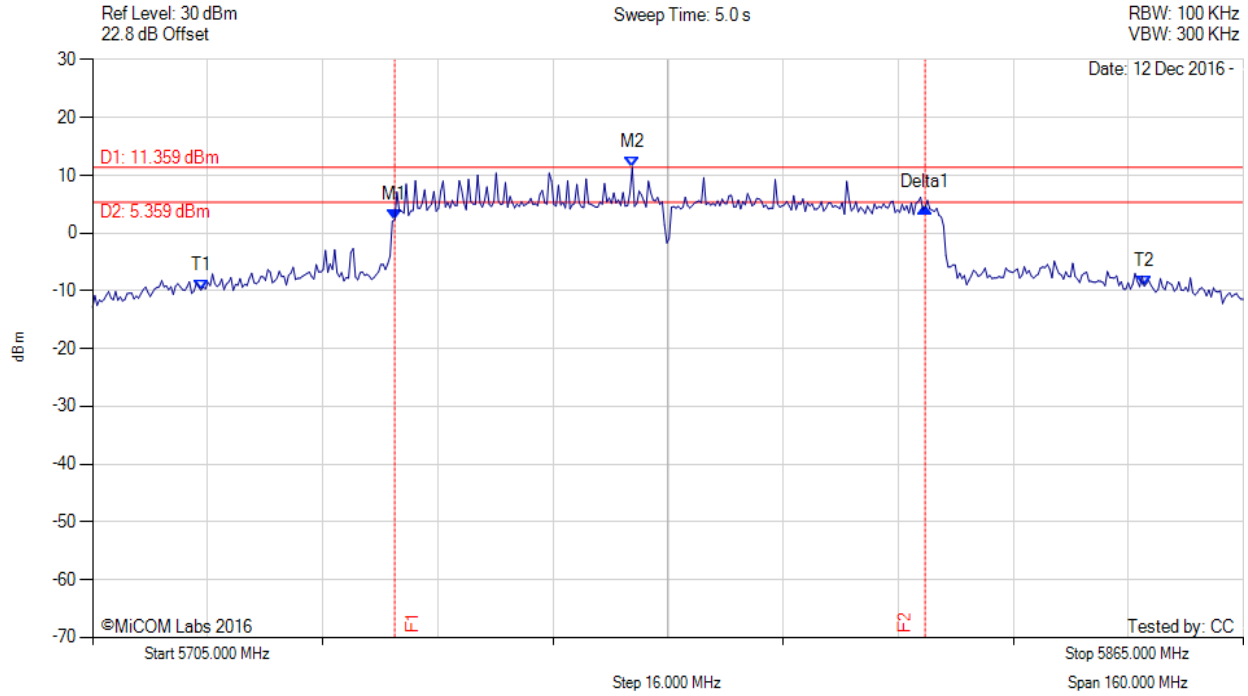

Analyzer Setup	Marker:Frequency:Amplitude	Test Results
Detector = MAX PEAK Sweep Count = 0 RF Atten (dB) = 20 Trace Mode = MAX HOLD	M1 : 5747.004 MHz : 2.304 dBm M2 : 5780.030 MHz : 11.359 dBm Delta1 : 73.747 MHz : 2.101 dB T1 : 5720.070 MHz : -9.853 dBm T2 : 5851.212 MHz : -9.190 dBm OBW : 131.142 MHz	Measured 6 dB Bandwidth: 73.747 MHz Measured 99% Bandwidth: 131.142 MHz

[back to matrix](#)

This test report may be reproduced in full only. The document may only be updated by MiCOM Labs personnel. All changes will be noted in the Document History section of the report.



6 dB & 99% BANDWIDTH

Variat: 80MHz, Channel: 5810.00 MHz, Chain a, Temp: 20, Voltage: 24 Vdc

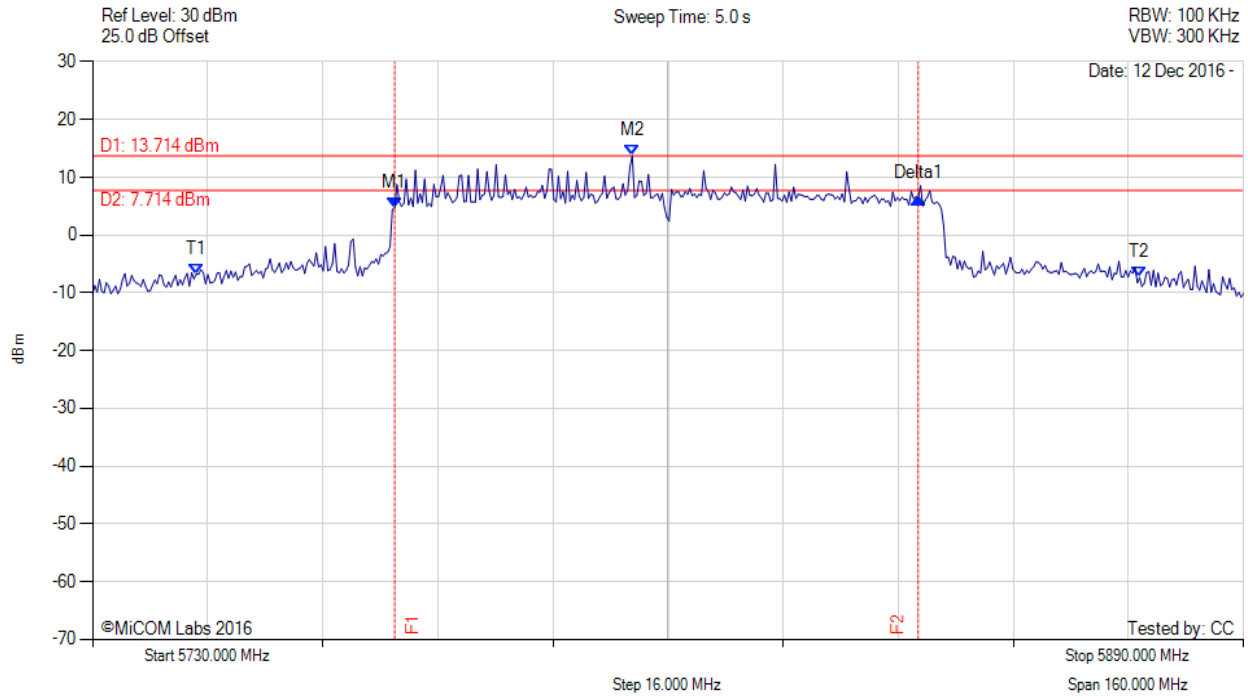

Analyzer Setup	Marker:Frequency:Amplitude	Test Results
Detector = MAX PEAK Sweep Count = 0 RF Atten (dB) = 20 Trace Mode = MAX HOLD	M1 : 5772.004 MHz : 4.692 dBm M2 : 5805.030 MHz : 13.714 dBm Delta1 : 72.786 MHz : 1.690 dB T1 : 5744.429 MHz : -6.727 dBm T2 : 5875.571 MHz : -7.374 dBm OBW : 131.142 MHz	Measured 6 dB Bandwidth: 72.786 MHz Measured 99% Bandwidth: 131.142 MHz

[back to matrix](#)

This test report may be reproduced in full only. The document may only be updated by MiCOM Labs personnel. All changes will be noted in the Document History section of the report.



6 dB & 99% BANDWIDTH

Variant: 80MHz, Channel: 5810.00 MHz, Chain b, Temp: 20, Voltage: 24 Vdc

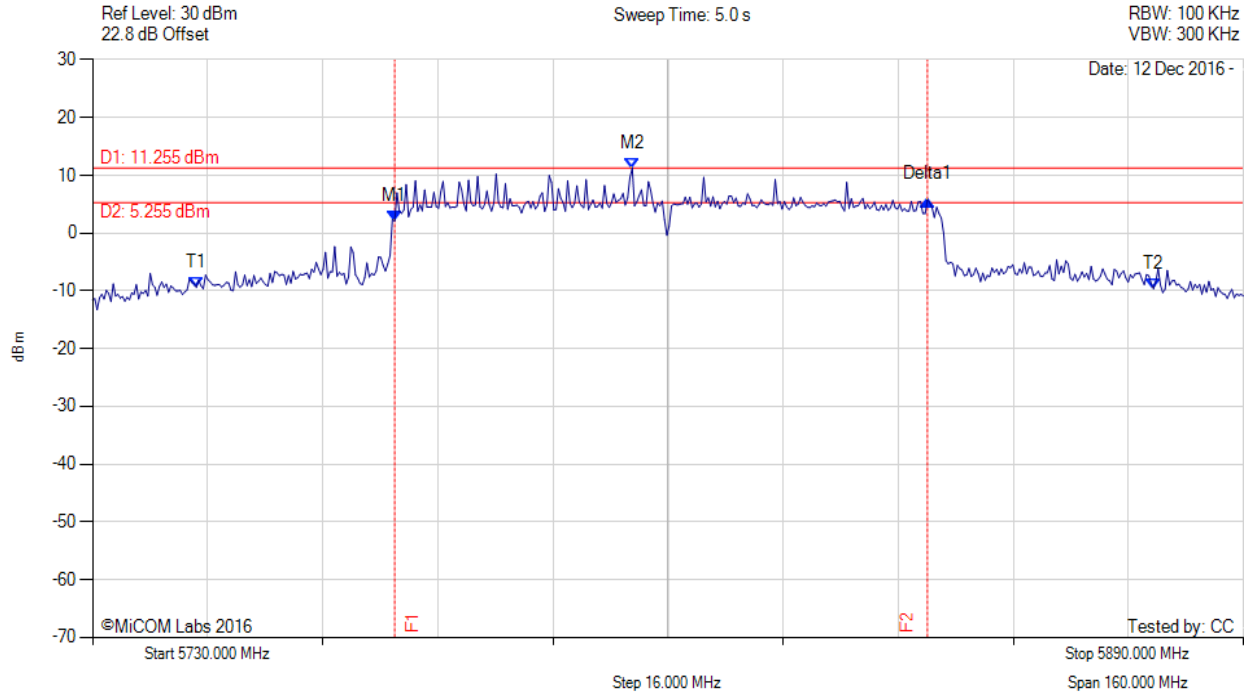

Analyzer Setup	Marker:Frequency:Amplitude	Test Results
Detector = MAX PEAK Sweep Count = 0 RF Atten (dB) = 20 Trace Mode = MAX HOLD	M1 : 5772.004 MHz : 2.087 dBm M2 : 5805.030 MHz : 11.255 dBm Delta1 : 74.068 MHz : 3.691 dB T1 : 5744.429 MHz : -9.371 dBm T2 : 5877.495 MHz : -9.638 dBm OBW : 133.066 MHz	Measured 6 dB Bandwidth: 74.068 MHz Measured 99% Bandwidth: 133.066 MHz

[back to matrix](#)

This test report may be reproduced in full only. The document may only be updated by MiCOM Labs personnel. All changes will be noted in the Document History section of the report.



## A.2. Power Spectral Density

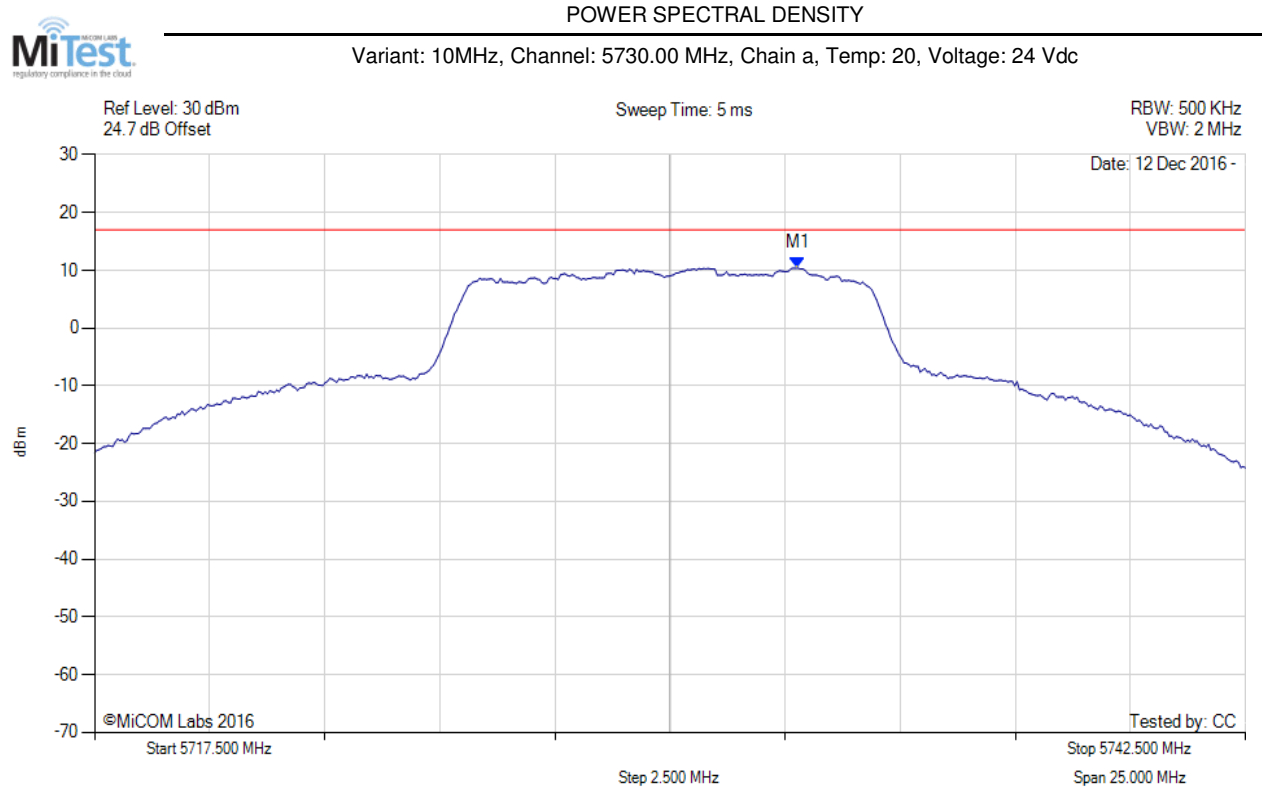

Analyzer Setup	Marker:Frequency:Amplitude	Test Results
Detector = RMS Sweep Count = 100 RF Atten (dB) = 20 Trace Mode = VIEW	M1 : 5732.781 MHz : 10.399 dBm	Limit: $\leq 16.990$ dBm

[back to matrix](#)

This test report may be reproduced in full only. The document may only be updated by MiCOM Labs personnel. All changes will be noted in the Document History section of the report.





POWER SPECTRAL DENSITY



Variant: 10MHz, Channel: 5730.00 MHz, Chain b, Temp: 20, Voltage: 24 Vdc

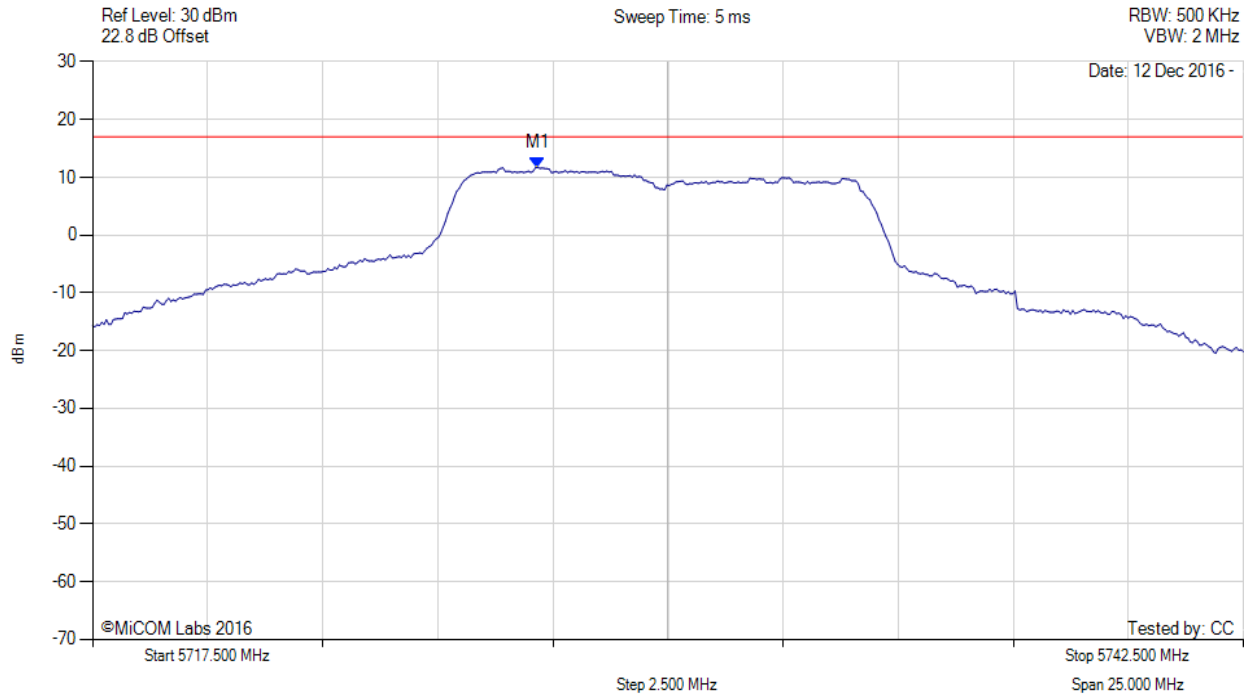

Analyzer Setup	Marker:Frequency:Amplitude	Test Results
Detector = RMS Sweep Count = 100 RF Atten (dB) = 20 Trace Mode = VIEWS	M1 : 5727.169 MHz : 11.722 dBm	Limit: $\leq 16.990$ dBm

[back to matrix](#)

This test report may be reproduced in full only. The document may only be updated by MiCOM Labs personnel. All changes will be noted in the Document History section of the report.



POWER SPECTRAL DENSITY



Variant: 10MHz, Channel: 5730.00 MHz, SUM, Temp: 20, Voltage: 24 Vdc

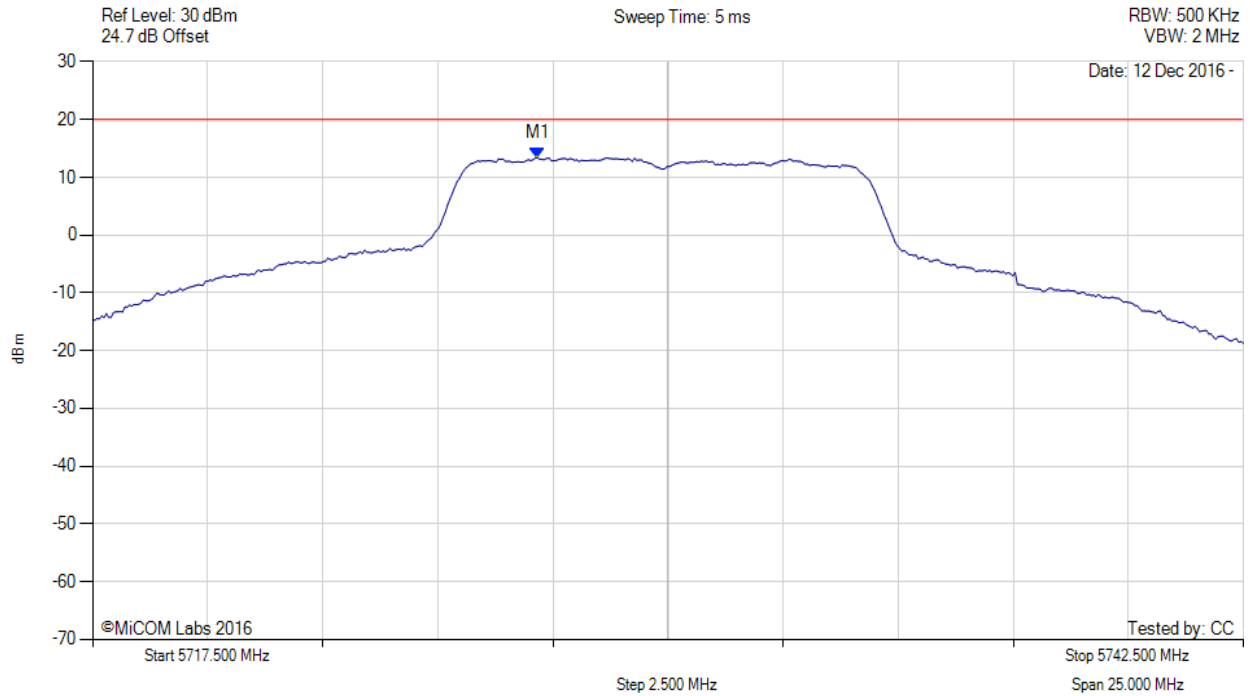

Analyzer Setup	Marker:Frequency:Amplitude	Test Results
Detector = RMS Sweep Count = 100 RF Atten (dB) = 20 Trace Mode = VIEW	M1 : 5727.200 MHz : 13.383 dBm M1 + DCCF : 5727.200 MHz : 13.793 dBm Duty Cycle Correction Factor : +0.41 dB	Limit: $\leq 30.0$ dBm Margin: -16.2 dB

[back to matrix](#)

This test report may be reproduced in full only. The document may only be updated by MiCOM Labs personnel. All changes will be noted in the Document History section of the report.



**Title:** Radwin Ltd. Outdoor Subscriber Radio Unit  
**To:** FCC CFR 47 Part 15 Subpart E 15.407  
**Serial #:** RDWN44-U3 Rev A Report  
**Issue Date:** 20<sup>th</sup> December 2016  
**Page:** 83 of 130

POWER SPECTRAL DENSITY



Variant: 10MHz, Channel: 5785.00 MHz, Chain a, Temp: 20, Voltage: 24 Vdc

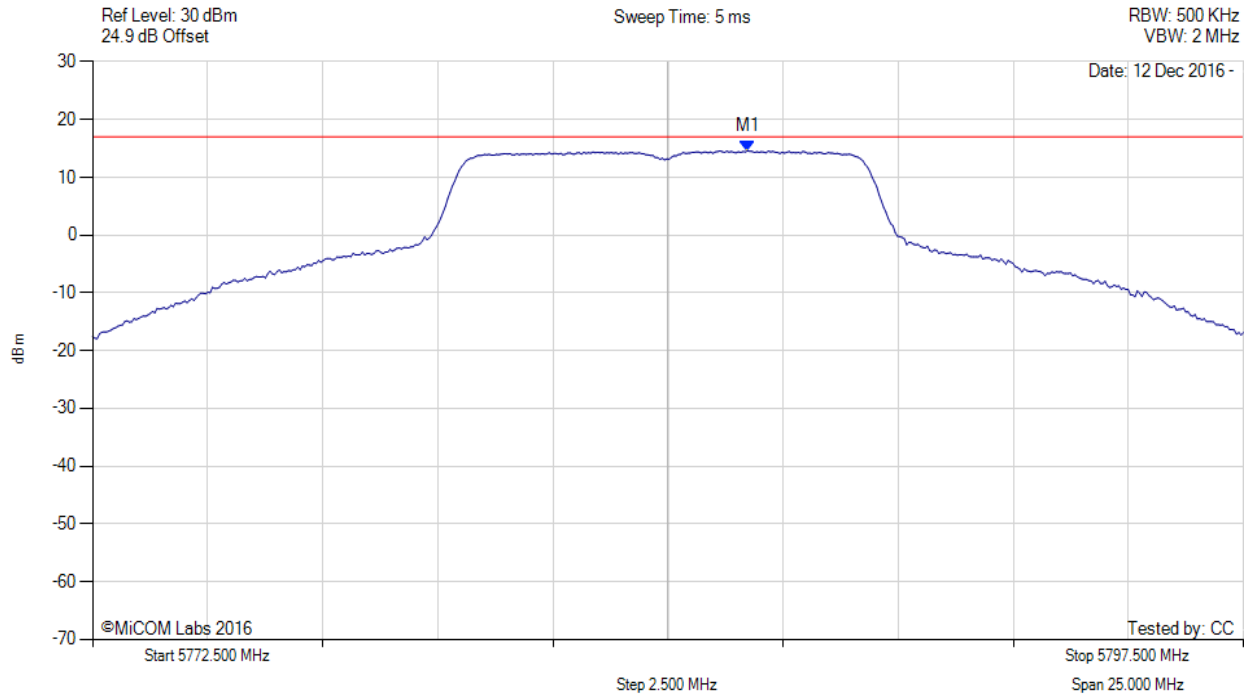

Analyzer Setup	Marker:Frequency:Amplitude	Test Results
Detector = RMS Sweep Count = 100 RF Atten (dB) = 20 Trace Mode = VIEW	M1 : 5786.728 MHz : 14.582 dBm	Limit: $\leq 16.990$ dBm

[back to matrix](#)

This test report may be reproduced in full only. The document may only be updated by MiCOM Labs personnel. All changes will be noted in the Document History section of the report.



**Title:** Radwin Ltd. Outdoor Subscriber Radio Unit  
**To:** FCC CFR 47 Part 15 Subpart E 15.407  
**Serial #:** RDWN44-U3 Rev A Report  
**Issue Date:** 20<sup>th</sup> December 2016  
**Page:** 84 of 130

POWER SPECTRAL DENSITY



Variant: 10MHz, Channel: 5785.00 MHz, Chain b, Temp: 20, Voltage: 24 Vdc

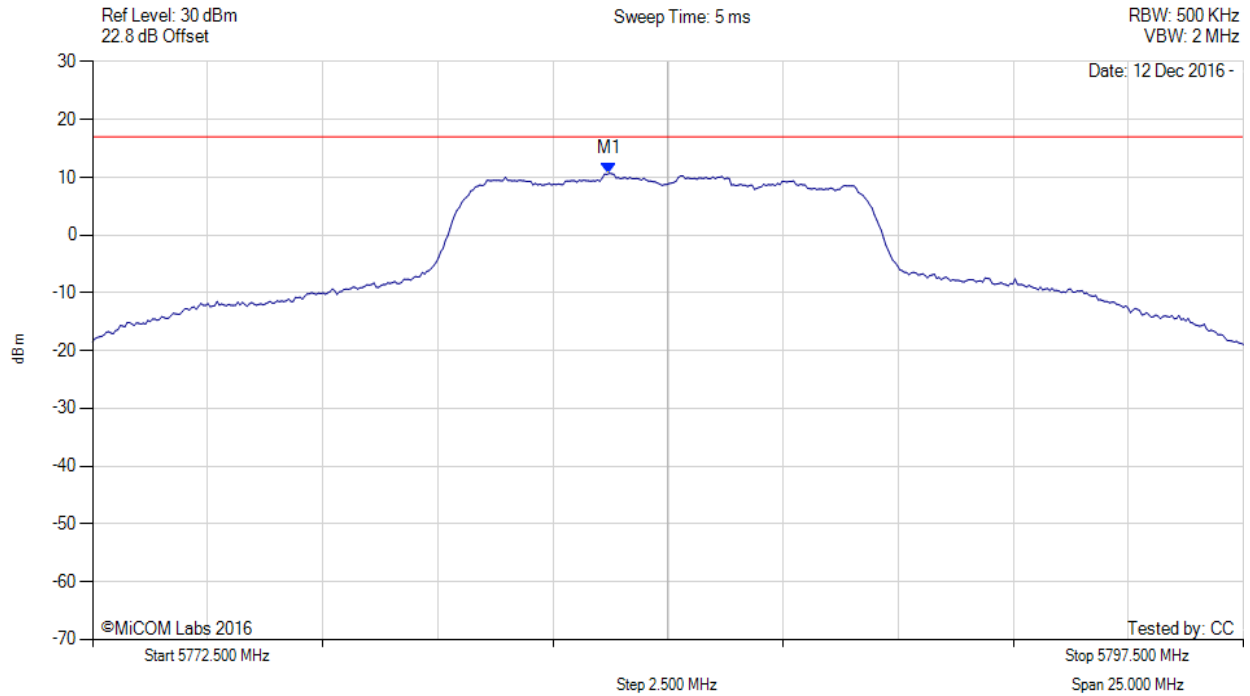

Analyzer Setup	Marker:Frequency:Amplitude	Test Results
Detector = RMS Sweep Count = 100 RF Atten (dB) = 20 Trace Mode = VIEW	M1 : 5783.722 MHz : 10.684 dBm	Channel Frequency: 5785.00 MHz

[back to matrix](#)

This test report may be reproduced in full only. The document may only be updated by MiCOM Labs personnel. All changes will be noted in the Document History section of the report.



POWER SPECTRAL DENSITY



Variant: 10MHz, Channel: 5785.00 MHz, SUM, Temp: 20, Voltage: 24 Vdc

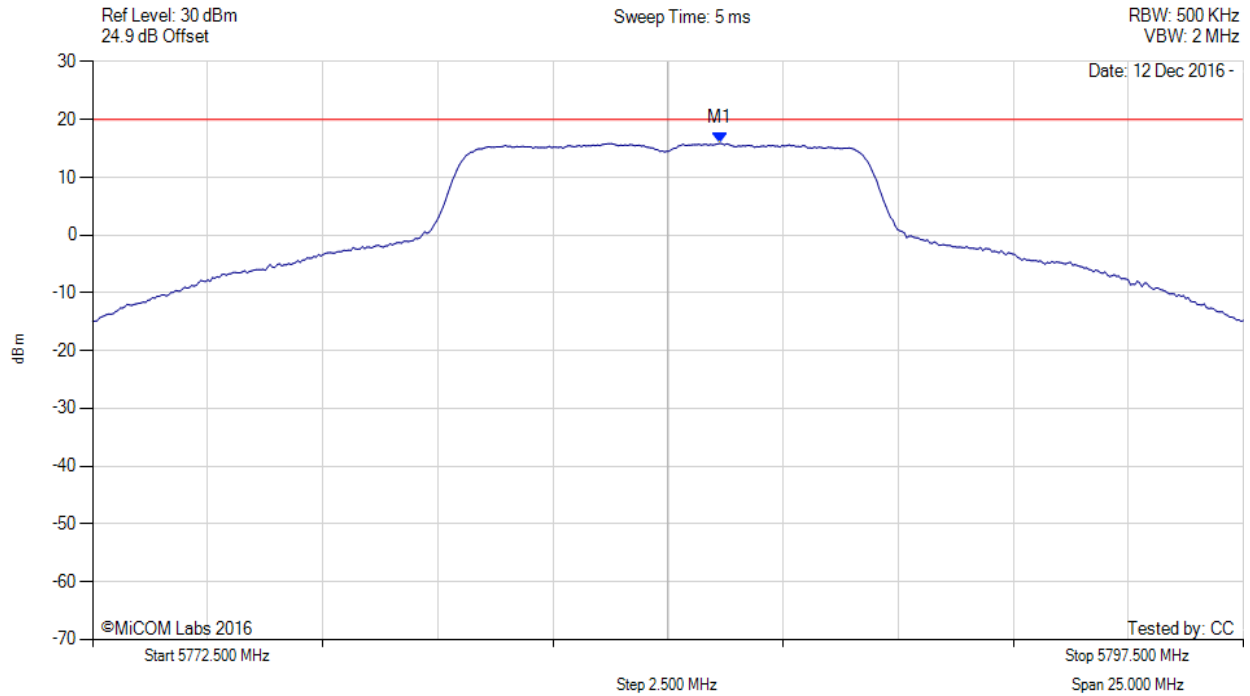

Analyzer Setup	Marker:Frequency:Amplitude	Test Results
Detector = RMS Sweep Count = 100 RF Atten (dB) = 20 Trace Mode = VIEW	M1 : 5786.100 MHz : 15.880 dBm M1 + DCCF : 5786.100 MHz : 16.290 dBm Duty Cycle Correction Factor : +0.41 dB	Limit: $\leq 30.0$ dBm Margin: -13.7 dB

[back to matrix](#)

This test report may be reproduced in full only. The document may only be updated by MiCOM Labs personnel. All changes will be noted in the Document History section of the report.



**Title:** Radwin Ltd. Outdoor Subscriber Radio Unit  
**To:** FCC CFR 47 Part 15 Subpart E 15.407  
**Serial #:** RDWN44-U3 Rev A Report  
**Issue Date:** 20<sup>th</sup> December 2016  
**Page:** 86 of 130



POWER SPECTRAL DENSITY

Variant: 10MHz, Channel: 5845.00 MHz, Chain a, Temp: 20, Voltage: 24 Vdc

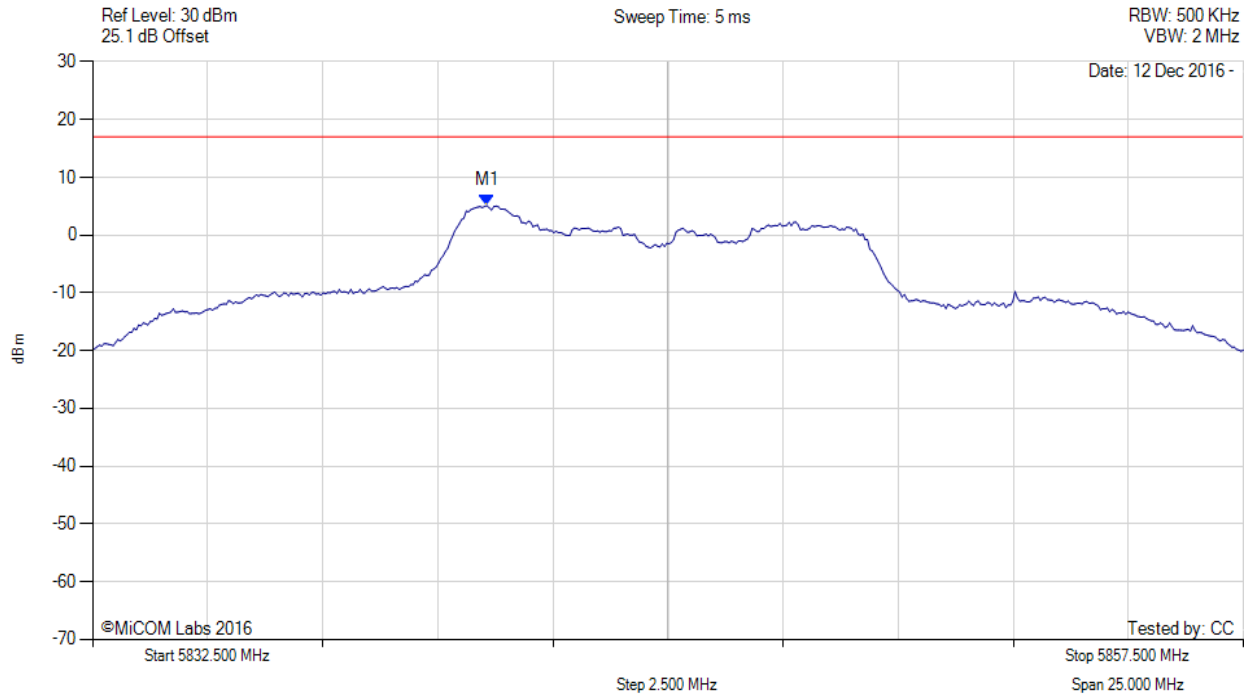

Analyzer Setup	Marker:Frequency:Amplitude	Test Results
Detector = RMS Sweep Count = 100 RF Atten (dB) = 20 Trace Mode = VIEWS	M1 : 5841.067 MHz : 5.108 dBm	Limit: ≤ 16.990 dBm

[back to matrix](#)

This test report may be reproduced in full only. The document may only be updated by MiCOM Labs personnel. All changes will be noted in the Document History section of the report.



**Title:** Radwin Ltd. Outdoor Subscriber Radio Unit  
**To:** FCC CFR 47 Part 15 Subpart E 15.407  
**Serial #:** RDWN44-U3 Rev A Report  
**Issue Date:** 20<sup>th</sup> December 2016  
**Page:** 87 of 130

POWER SPECTRAL DENSITY



Variant: 10MHz, Channel: 5845.00 MHz, Chain b, Temp: 20, Voltage: 24 Vdc

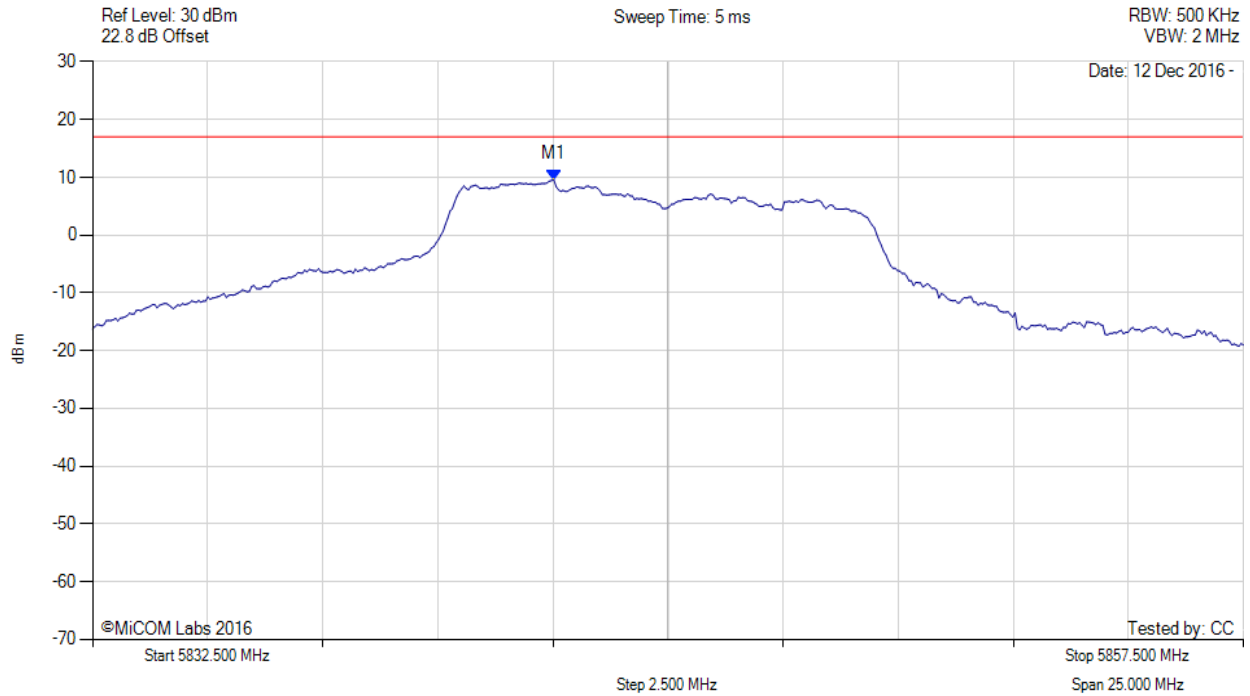

Analyzer Setup	Marker:Frequency:Amplitude	Test Results
Detector = RMS Sweep Count = 100 RF Atten (dB) = 20 Trace Mode = VIEWS	M1 : 5842.520 MHz : 9.591 dBm	Limit: $\leq 16.990$ dBm

[back to matrix](#)

This test report may be reproduced in full only. The document may only be updated by MiCOM Labs personnel. All changes will be noted in the Document History section of the report.



**Title:** Radwin Ltd. Outdoor Subscriber Radio Unit  
**To:** FCC CFR 47 Part 15 Subpart E 15.407  
**Serial #:** RDWN44-U3 Rev A Report  
**Issue Date:** 20<sup>th</sup> December 2016  
**Page:** 88 of 130



POWER SPECTRAL DENSITY

Variant: 10MHz, Channel: 5845.00 MHz, SUM, Temp: 20, Voltage: 24 Vdc

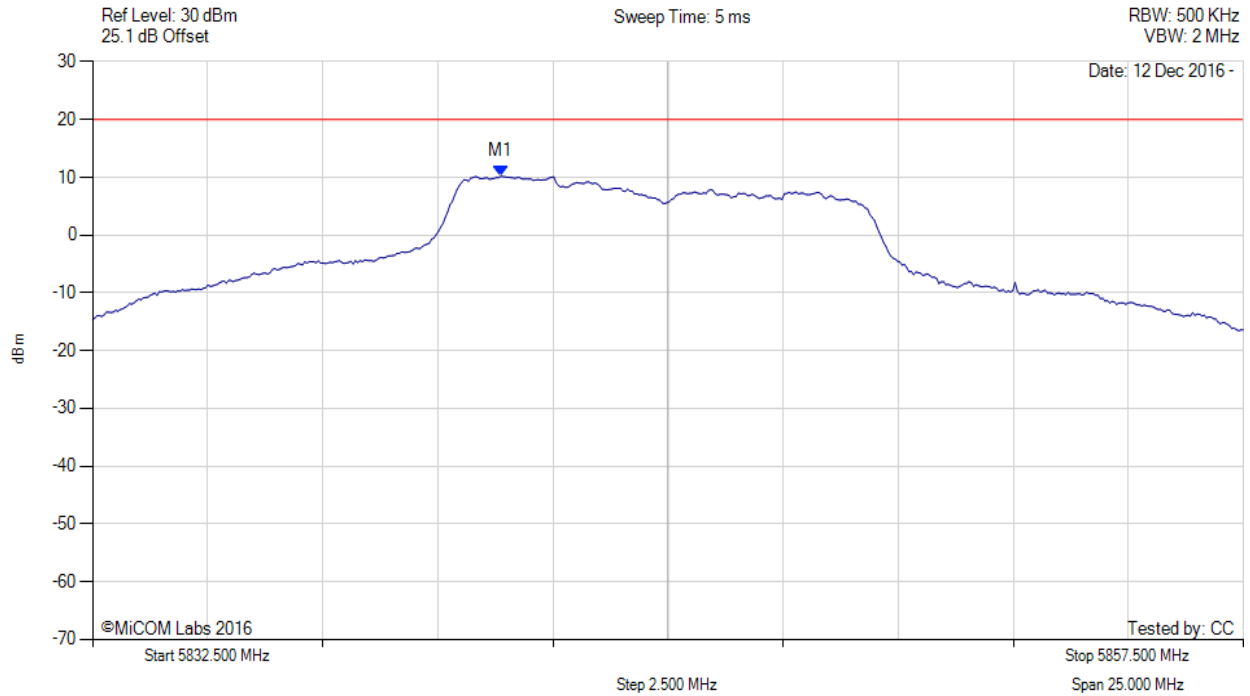

Analyzer Setup	Marker:Frequency:Amplitude	Test Results
Detector = RMS Sweep Count = 100 RF Atten (dB) = 20 Trace Mode = VIEW	M1 : 5841.400 MHz : 10.192 dBm M1 + DCCF : 5841.400 MHz : 10.602 dBm Duty Cycle Correction Factor : +0.41 dB	Limit: $\leq 20.0$ dBm Margin: -19.4 dB

[back to matrix](#)

This test report may be reproduced in full only. The document may only be updated by MiCOM Labs personnel. All changes will be noted in the Document History section of the report.





POWER SPECTRAL DENSITY



Variant: 20MHz, Channel: 5735.00 MHz, Chain a, Temp: 20, Voltage: 24 Vdc

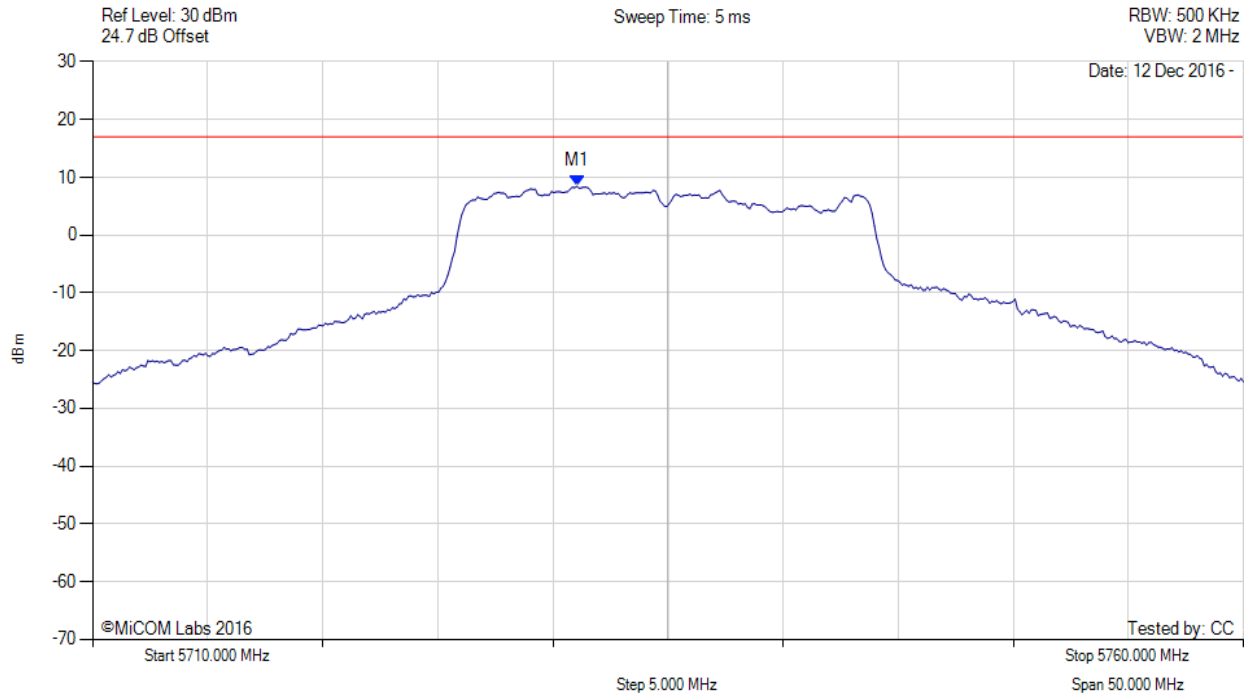

Analyzer Setup	Marker:Frequency:Amplitude	Test Results
Detector = RMS Sweep Count = 100 RF Atten (dB) = 20 Trace Mode = VIEWS	M1 : 5731.042 MHz : 8.437 dBm	Limit: $\leq 16.990$ dBm

[back to matrix](#)

This test report may be reproduced in full only. The document may only be updated by MiCOM Labs personnel. All changes will be noted in the Document History section of the report.



**Title:** Radwin Ltd. Outdoor Subscriber Radio Unit  
**To:** FCC CFR 47 Part 15 Subpart E 15.407  
**Serial #:** RDWN44-U3 Rev A Report  
**Issue Date:** 20<sup>th</sup> December 2016  
**Page:** 90 of 130

POWER SPECTRAL DENSITY



Variant: 20MHz, Channel: 5735.00 MHz, Chain b, Temp: 20, Voltage: 24 Vdc

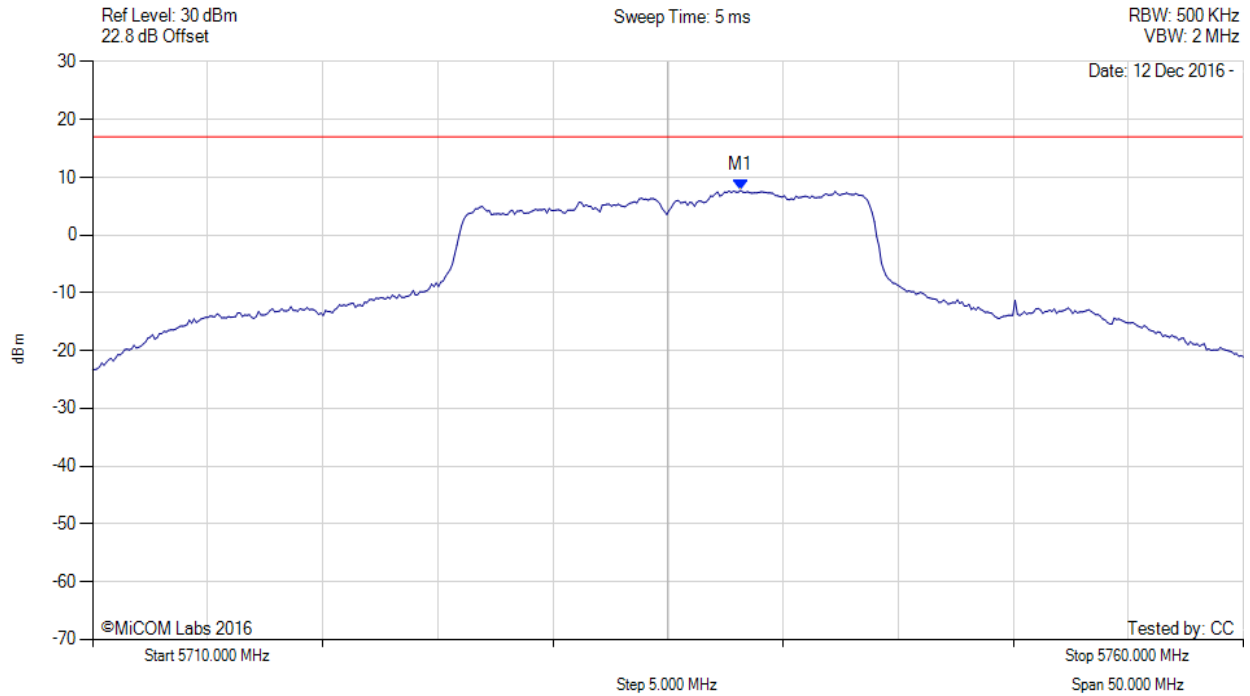

Analyzer Setup	Marker:Frequency:Amplitude	Test Results
Detector = RMS Sweep Count = 100 RF Atten (dB) = 20 Trace Mode = VIEWS	M1 : 5738.156 MHz : 7.722 dBm	Limit: ≤ 16.990 dBm

[back to matrix](#)

This test report may be reproduced in full only. The document may only be updated by MiCOM Labs personnel. All changes will be noted in the Document History section of the report.



**Title:** Radwin Ltd. Outdoor Subscriber Radio Unit  
**To:** FCC CFR 47 Part 15 Subpart E 15.407  
**Serial #:** RDWN44-U3 Rev A Report  
**Issue Date:** 20<sup>th</sup> December 2016  
**Page:** 91 of 130

POWER SPECTRAL DENSITY



Variant: 20MHz, Channel: 5735.00 MHz, SUM, Temp: 20, Voltage: 24 Vdc

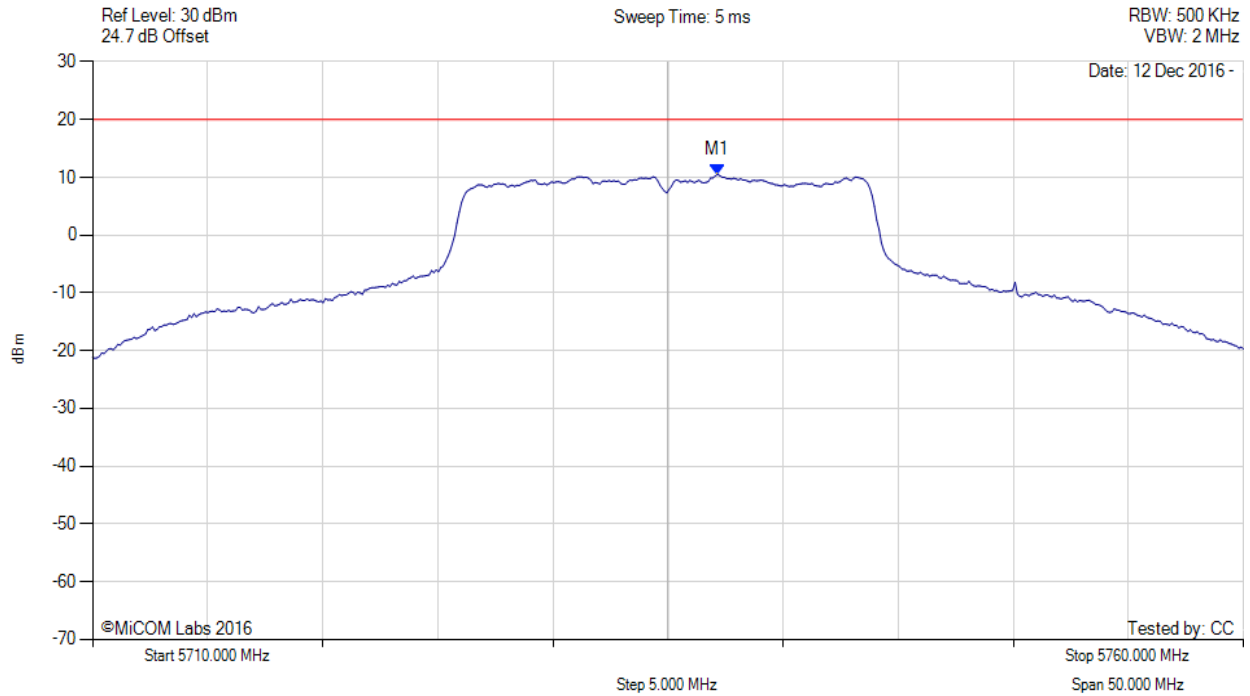

Analyzer Setup	Marker:Frequency:Amplitude	Test Results
Detector = RMS Sweep Count = 100 RF Atten (dB) = 20 Trace Mode = VIEW	M1 : 5737.200 MHz : 10.514 dBm M1 + DCCF : 5737.200 MHz : 10.924 dBm Duty Cycle Correction Factor : +0.41 dB	Limit: $\leq 30.0$ dBm Margin: -19.1 dB

[back to matrix](#)

This test report may be reproduced in full only. The document may only be updated by MiCOM Labs personnel. All changes will be noted in the Document History section of the report.



**Title:** Radwin Ltd. Outdoor Subscriber Radio Unit  
**To:** FCC CFR 47 Part 15 Subpart E 15.407  
**Serial #:** RDWN44-U3 Rev A Report  
**Issue Date:** 20<sup>th</sup> December 2016  
**Page:** 92 of 130



POWER SPECTRAL DENSITY

Variant: 20MHz, Channel: 5785.00 MHz, Chain a, Temp: 20, Voltage: 24 Vdc

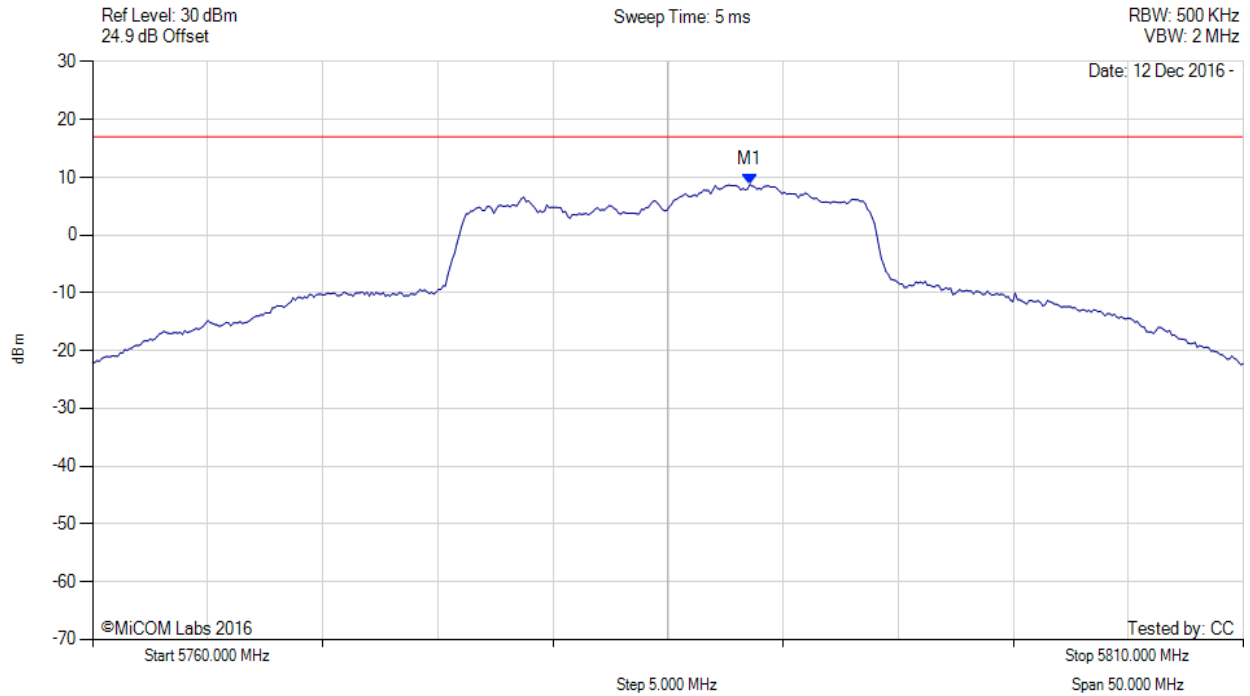

Analyzer Setup	Marker:Frequency:Amplitude	Test Results
Detector = RMS Sweep Count = 100 RF Atten (dB) = 20 Trace Mode = VIEWS	M1 : 5788.557 MHz : 8.756 dBm	Limit: $\leq 16.990$ dBm

[back to matrix](#)

This test report may be reproduced in full only. The document may only be updated by MiCOM Labs personnel. All changes will be noted in the Document History section of the report.



**Title:** Radwin Ltd. Outdoor Subscriber Radio Unit  
**To:** FCC CFR 47 Part 15 Subpart E 15.407  
**Serial #:** RDWN44-U3 Rev A Report  
**Issue Date:** 20<sup>th</sup> December 2016  
**Page:** 93 of 130



POWER SPECTRAL DENSITY

Variant: 20MHz, Channel: 5785.00 MHz, Chain b, Temp: 20, Voltage: 24 Vdc

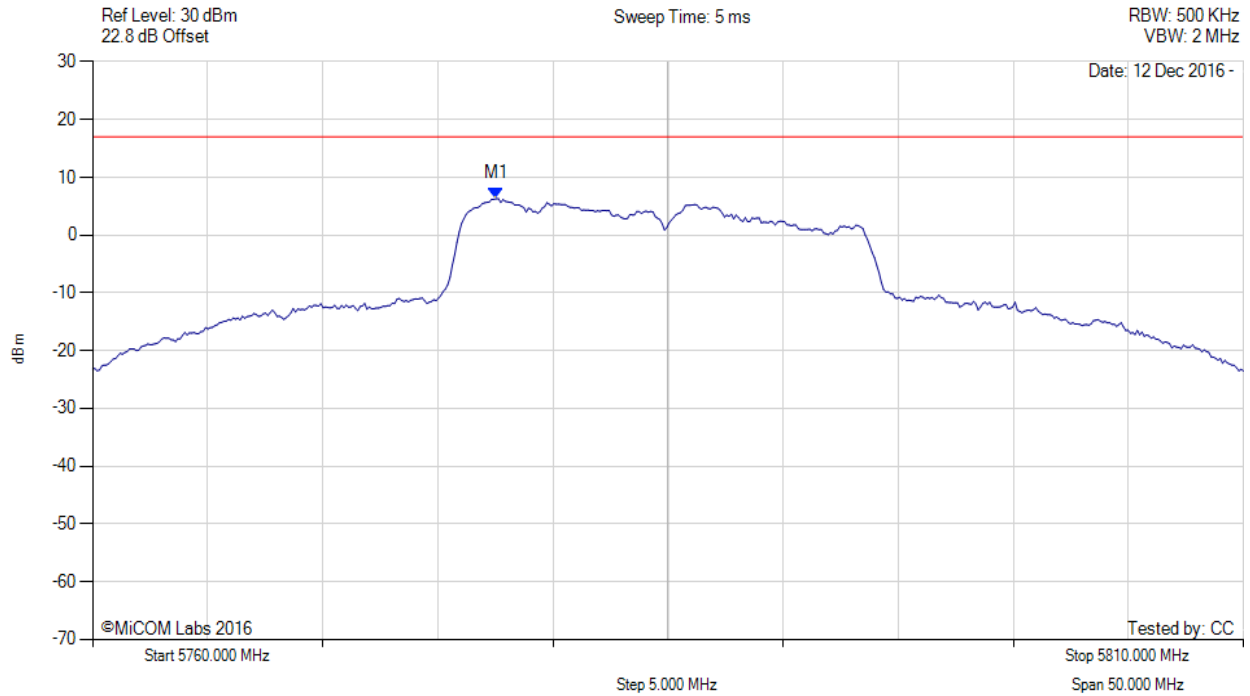

Analyzer Setup	Marker:Frequency:Amplitude	Test Results
Detector = RMS Sweep Count = 100 RF Atten (dB) = 20 Trace Mode = VIEW	M1 : 5777.535 MHz : 6.304 dBm	Channel Frequency: 5785.00 MHz

[back to matrix](#)

This test report may be reproduced in full only. The document may only be updated by MiCOM Labs personnel. All changes will be noted in the Document History section of the report.



**Title:** Radwin Ltd. Outdoor Subscriber Radio Unit  
**To:** FCC CFR 47 Part 15 Subpart E 15.407  
**Serial #:** RDWN44-U3 Rev A Report  
**Issue Date:** 20<sup>th</sup> December 2016  
**Page:** 94 of 130

POWER SPECTRAL DENSITY



Variant: 20MHz, Channel: 5785.00 MHz, SUM, Temp: 20, Voltage: 24 Vdc

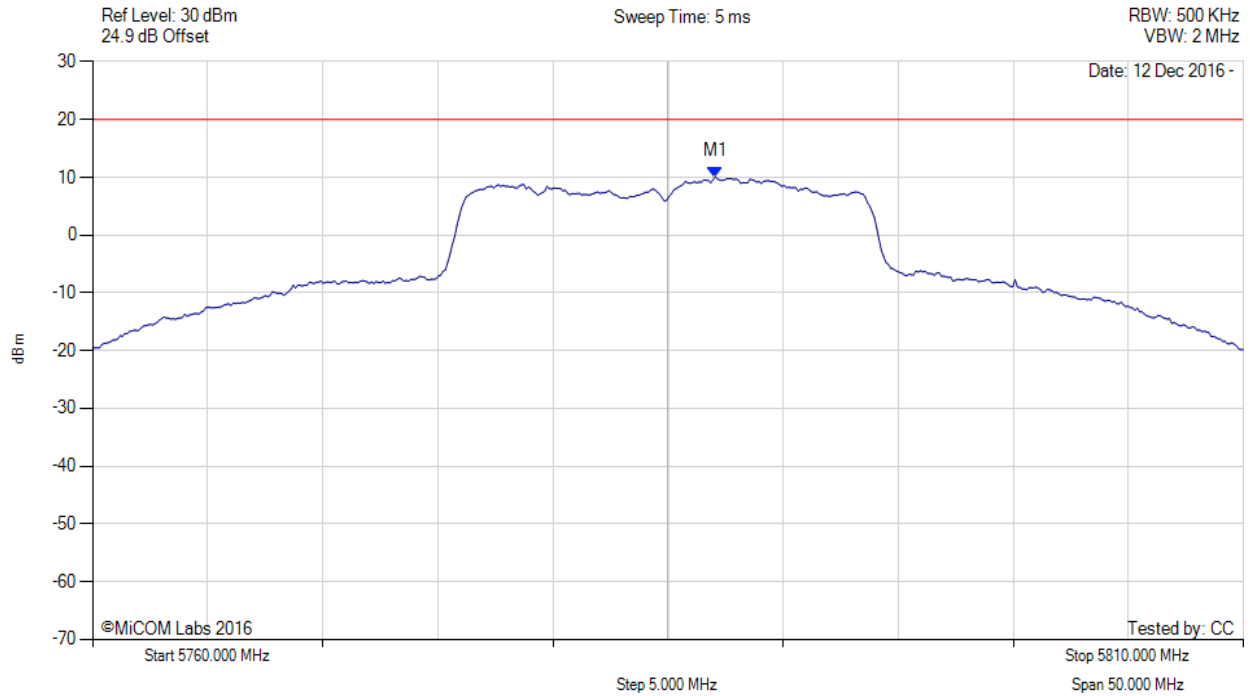

Analyzer Setup	Marker:Frequency:Amplitude	Test Results
Detector = RMS Sweep Count = 100 RF Atten (dB) = 20 Trace Mode = VIEW	M1 : 5787.100 MHz : 10.074 dBm M1 + DCCF : 5787.100 MHz : 10.484 dBm Duty Cycle Correction Factor : +0.41 dB	Limit: $\leq 30.0$ dBm Margin: -19.5 dB

[back to matrix](#)

This test report may be reproduced in full only. The document may only be updated by MiCOM Labs personnel. All changes will be noted in the Document History section of the report.



**Title:** Radwin Ltd. Outdoor Subscriber Radio Unit  
**To:** FCC CFR 47 Part 15 Subpart E 15.407  
**Serial #:** RDWN44-U3 Rev A Report  
**Issue Date:** 20<sup>th</sup> December 2016  
**Page:** 95 of 130

POWER SPECTRAL DENSITY



Variant: 20MHz, Channel: 5840.00 MHz, Chain a, Temp: 20, Voltage: 24 Vdc

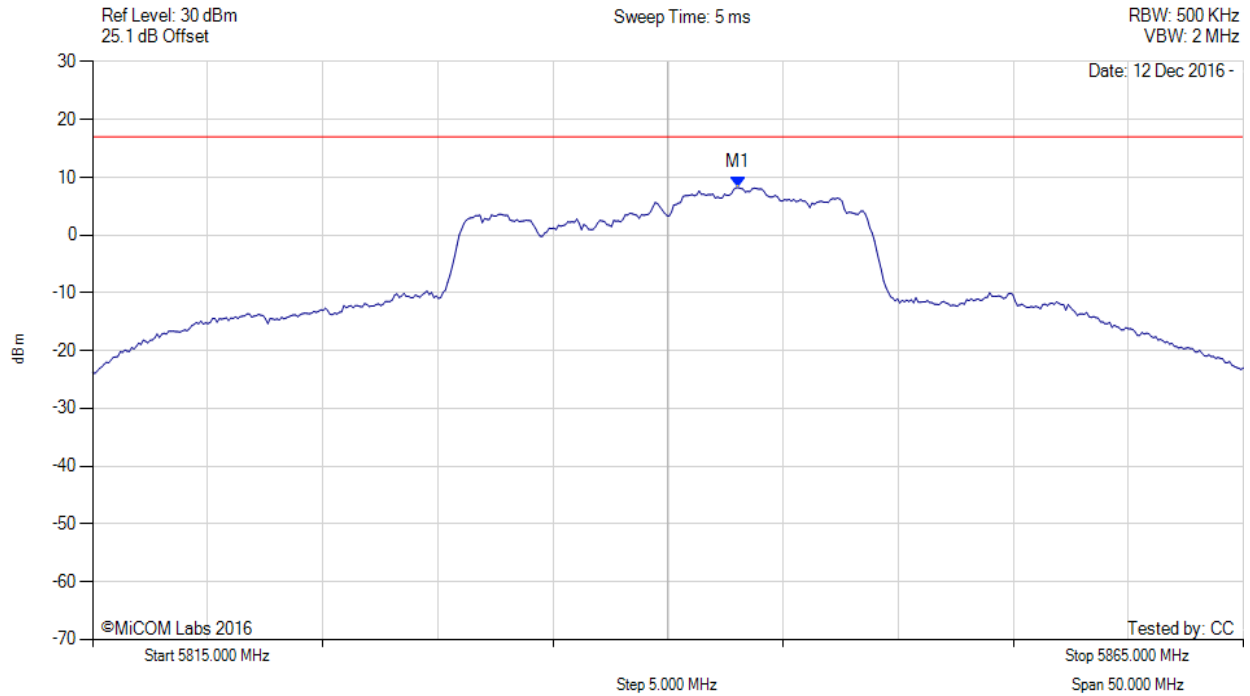

Analyzer Setup	Marker:Frequency:Amplitude	Test Results
Detector = RMS Sweep Count = 100 RF Atten (dB) = 20 Trace Mode = VIEWS	M1 : 5843.056 MHz : 8.215 dBm	Limit: $\leq 16.990$ dBm

[back to matrix](#)

This test report may be reproduced in full only. The document may only be updated by MiCOM Labs personnel. All changes will be noted in the Document History section of the report.



**Title:** Radwin Ltd. Outdoor Subscriber Radio Unit  
**To:** FCC CFR 47 Part 15 Subpart E 15.407  
**Serial #:** RDWN44-U3 Rev A Report  
**Issue Date:** 20<sup>th</sup> December 2016  
**Page:** 96 of 130

POWER SPECTRAL DENSITY



Variant: 20MHz, Channel: 5840.00 MHz, Chain b, Temp: 20, Voltage: 24 Vdc

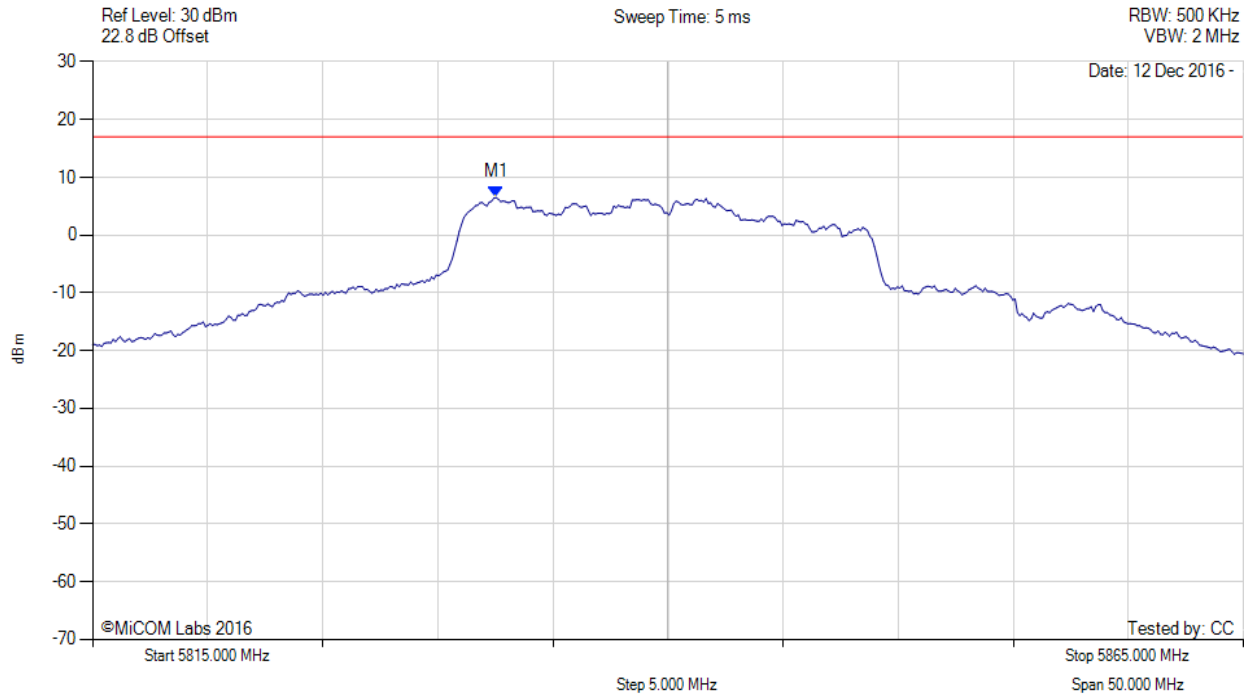

Analyzer Setup	Marker:Frequency:Amplitude	Test Results
Detector = RMS Sweep Count = 100 RF Atten (dB) = 20 Trace Mode = VIEWS	M1 : 5832.535 MHz : 6.506 dBm	Limit: $\leq 16.990$ dBm

[back to matrix](#)

This test report may be reproduced in full only. The document may only be updated by MiCOM Labs personnel. All changes will be noted in the Document History section of the report.





POWER SPECTRAL DENSITY

Variant: 20MHz, Channel: 5840.00 MHz, SUM, Temp: 20, Voltage: 24 Vdc

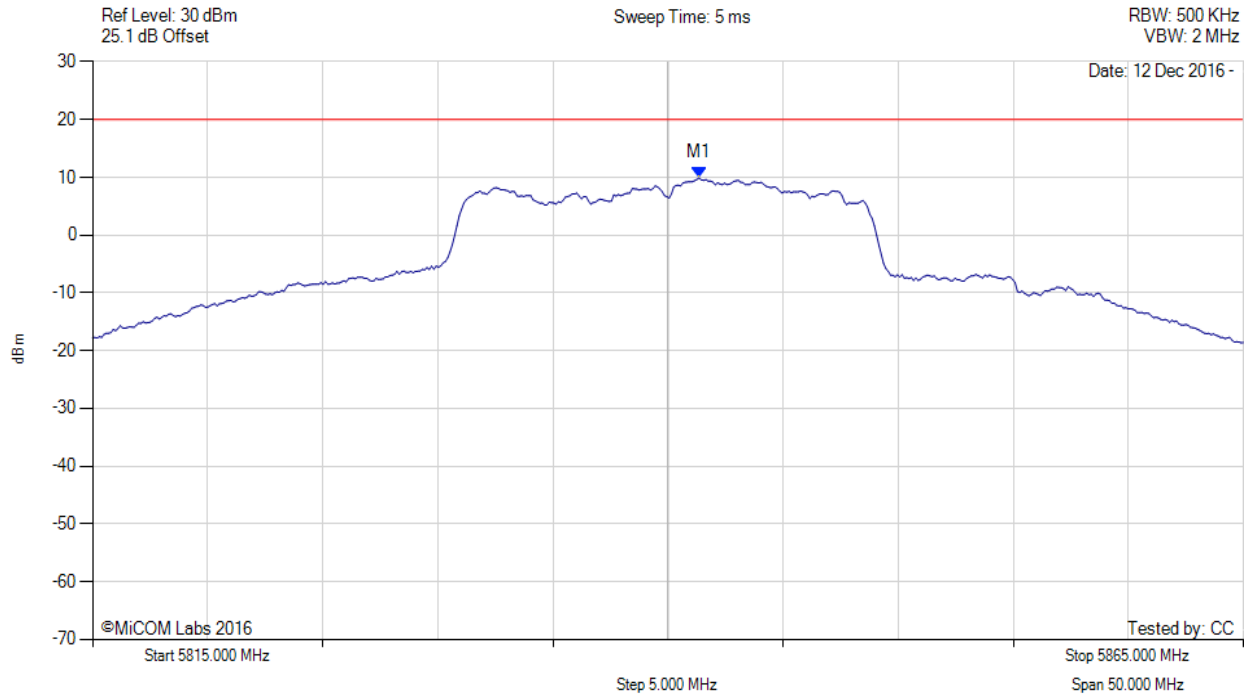

Analyzer Setup	Marker:Frequency:Amplitude	Test Results
Detector = RMS Sweep Count = 100 RF Atten (dB) = 20 Trace Mode = VIEW	M1 : 5841.400 MHz : 9.888 dBm M1 + DCCF : 5841.400 MHz : 10.298 dBm Duty Cycle Correction Factor : +0.41 dB	Limit: $\leq 30.0$ dBm Margin: -19.7 dB

[back to matrix](#)

This test report may be reproduced in full only. The document may only be updated by MiCOM Labs personnel. All changes will be noted in the Document History section of the report.



**Title:** Radwin Ltd. Outdoor Subscriber Radio Unit  
**To:** FCC CFR 47 Part 15 Subpart E 15.407  
**Serial #:** RDWN44-U3 Rev A Report  
**Issue Date:** 20<sup>th</sup> December 2016  
**Page:** 98 of 130

POWER SPECTRAL DENSITY



Variant: 40MHz, Channel: 5745.00 MHz, Chain a, Temp: 20, Voltage: 24 Vdc

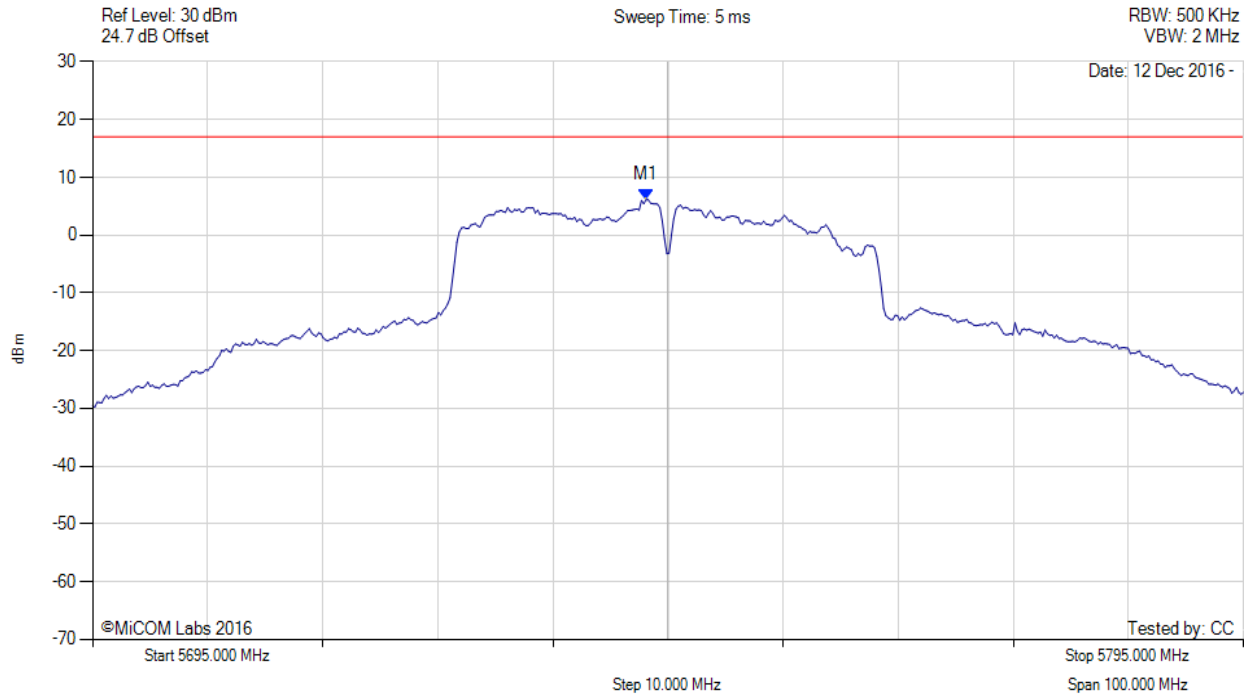

Analyzer Setup	Marker:Frequency:Amplitude	Test Results
Detector = RMS Sweep Count = 100 RF Atten (dB) = 20 Trace Mode = VIEW	M1 : 5743.096 MHz : 6.140 dBm	Limit: $\leq 16.990$ dBm

[back to matrix](#)

This test report may be reproduced in full only. The document may only be updated by MiCOM Labs personnel. All changes will be noted in the Document History section of the report.



**Title:** Radwin Ltd. Outdoor Subscriber Radio Unit  
**To:** FCC CFR 47 Part 15 Subpart E 15.407  
**Serial #:** RDWN44-U3 Rev A Report  
**Issue Date:** 20<sup>th</sup> December 2016  
**Page:** 99 of 130

POWER SPECTRAL DENSITY



Variant: 40MHz, Channel: 5745.00 MHz, Chain b, Temp: 20, Voltage: 24 Vdc

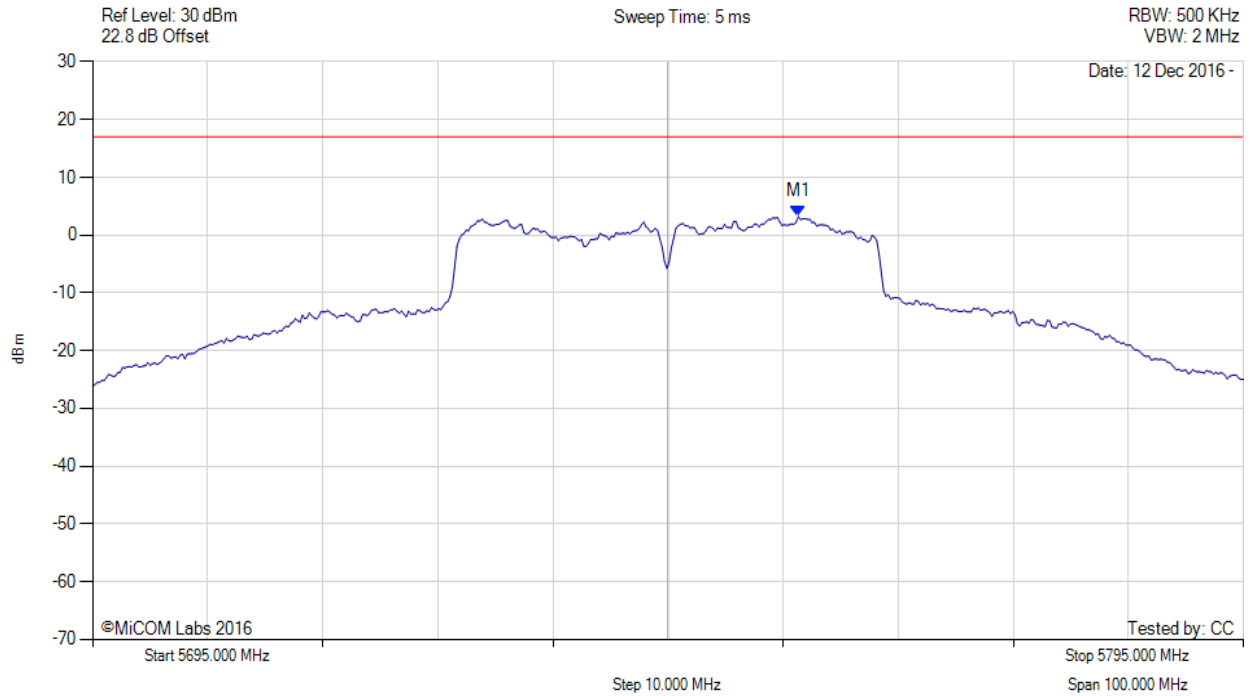

Analyzer Setup	Marker:Frequency:Amplitude	Test Results
Detector = RMS Sweep Count = 100 RF Atten (dB) = 20 Trace Mode = VIEW	M1 : 5756.323 MHz : 3.196 dBm	Limit: ≤ 16.990 dBm

[back to matrix](#)

This test report may be reproduced in full only. The document may only be updated by MiCOM Labs personnel. All changes will be noted in the Document History section of the report.



**Title:** Radwin Ltd. Outdoor Subscriber Radio Unit  
**To:** FCC CFR 47 Part 15 Subpart E 15.407  
**Serial #:** RDWN44-U3 Rev A Report  
**Issue Date:** 20<sup>th</sup> December 2016  
**Page:** 100 of 130



POWER SPECTRAL DENSITY

Variant: 40MHz, Channel: 5745.00 MHz, SUM, Temp: 20, Voltage: 24 Vdc

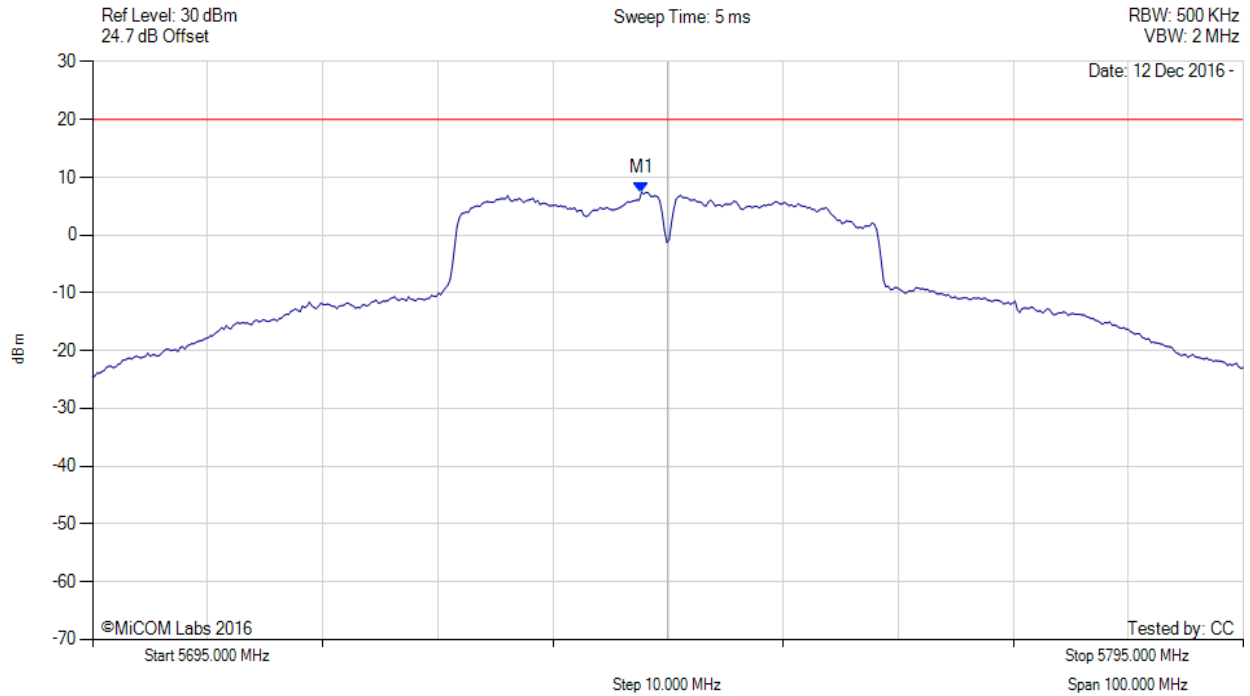

Analyzer Setup	Marker:Frequency:Amplitude	Test Results
Detector = RMS Sweep Count = 100 RF Atten (dB) = 20 Trace Mode = VIEW	M1 : 5742.700 MHz : 7.419 dBm M1 + DCCF : 5742.700 MHz : 7.974 dBm Duty Cycle Correction Factor : +0.56 dB	Limit: $\leq 30.0$ dBm Margin: -22.0 dB

[back to matrix](#)

This test report may be reproduced in full only. The document may only be updated by MiCOM Labs personnel. All changes will be noted in the Document History section of the report.



**Title:** Radwin Ltd. Outdoor Subscriber Radio Unit  
**To:** FCC CFR 47 Part 15 Subpart E 15.407  
**Serial #:** RDWN44-U3 Rev A Report  
**Issue Date:** 20<sup>th</sup> December 2016  
**Page:** 101 of 130

POWER SPECTRAL DENSITY



Variant: 40MHz, Channel: 5785.00 MHz, Chain a, Temp: 20, Voltage: 24 Vdc

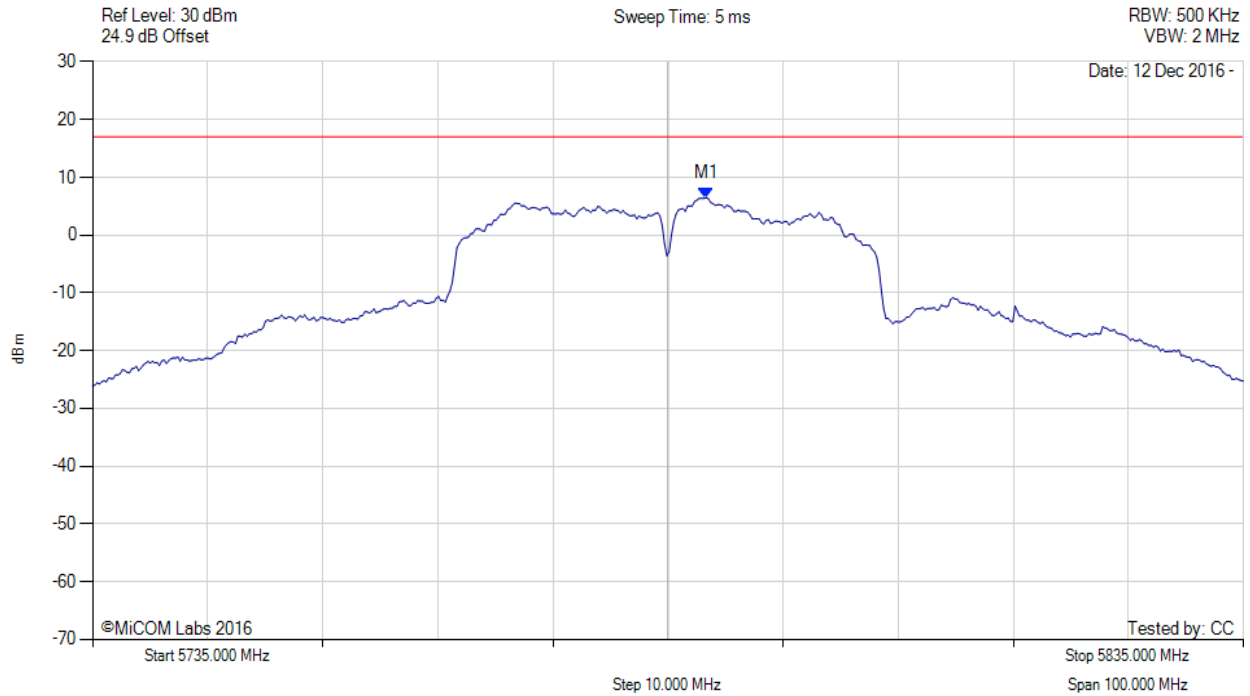

Analyzer Setup	Marker:Frequency:Amplitude	Test Results
Detector = RMS Sweep Count = 100 RF Atten (dB) = 20 Trace Mode = VIEW	M1 : 5788.307 MHz : 6.437 dBm	Limit: $\leq 16.990$ dBm

[back to matrix](#)

This test report may be reproduced in full only. The document may only be updated by MiCOM Labs personnel. All changes will be noted in the Document History section of the report.



**Title:** Radwin Ltd. Outdoor Subscriber Radio Unit  
**To:** FCC CFR 47 Part 15 Subpart E 15.407  
**Serial #:** RDWN44-U3 Rev A Report  
**Issue Date:** 20<sup>th</sup> December 2016  
**Page:** 102 of 130

POWER SPECTRAL DENSITY



Variant: 40MHz, Channel: 5785.00 MHz, Chain b, Temp: 20, Voltage: 24 Vdc

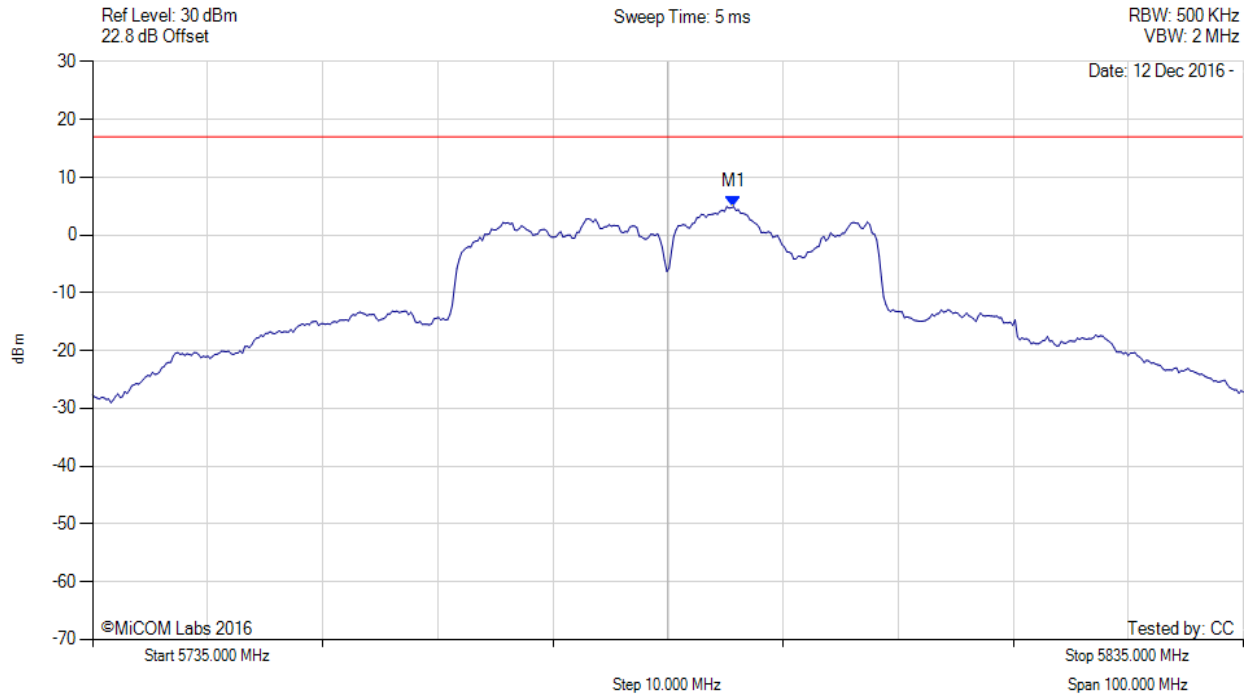

Analyzer Setup	Marker:Frequency:Amplitude	Test Results
Detector = RMS Sweep Count = 100 RF Atten (dB) = 20 Trace Mode = VIEW	M1 : 5790.711 MHz : 4.903 dBm	Channel Frequency: 5785.00 MHz

[back to matrix](#)

This test report may be reproduced in full only. The document may only be updated by MiCOM Labs personnel. All changes will be noted in the Document History section of the report.



**Title:** Radwin Ltd. Outdoor Subscriber Radio Unit  
**To:** FCC CFR 47 Part 15 Subpart E 15.407  
**Serial #:** RDWN44-U3 Rev A Report  
**Issue Date:** 20<sup>th</sup> December 2016  
**Page:** 103 of 130

POWER SPECTRAL DENSITY



Variant: 40MHz, Channel: 5785.00 MHz, SUM, Temp: 20, Voltage: 24 Vdc

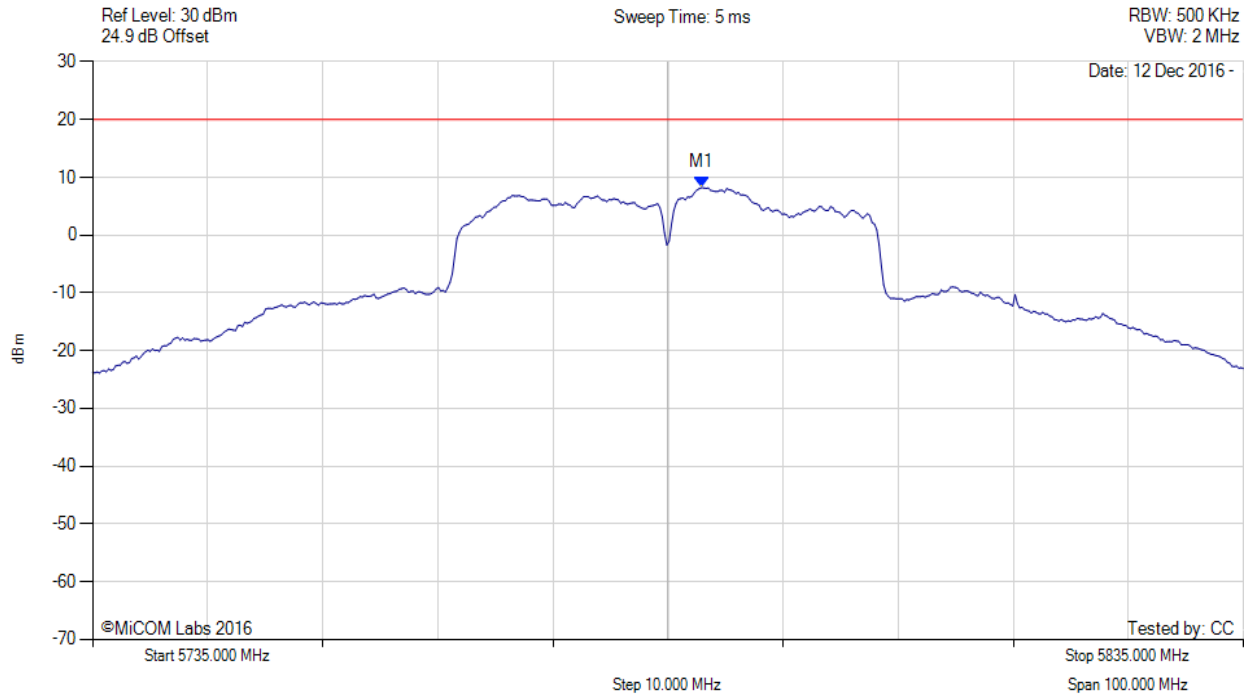

Analyzer Setup	Marker:Frequency:Amplitude	Test Results
Detector = RMS Sweep Count = 100 RF Atten (dB) = 20 Trace Mode = VIEW	M1 : 5787.900 MHz : 8.216 dBm M1 + DCCF : 5787.900 MHz : 8.771 dBm Duty Cycle Correction Factor : +0.56 dB	Limit: $\leq 30.0$ dBm Margin: -21.2 dB

[back to matrix](#)

This test report may be reproduced in full only. The document may only be updated by MiCOM Labs personnel. All changes will be noted in the Document History section of the report.



**Title:** Radwin Ltd. Outdoor Subscriber Radio Unit  
**To:** FCC CFR 47 Part 15 Subpart E 15.407  
**Serial #:** RDWN44-U3 Rev A Report  
**Issue Date:** 20<sup>th</sup> December 2016  
**Page:** 104 of 130

POWER SPECTRAL DENSITY



Variant: 40MHz, Channel: 5830.00 MHz, Chain a, Temp: 20, Voltage: 24 Vdc

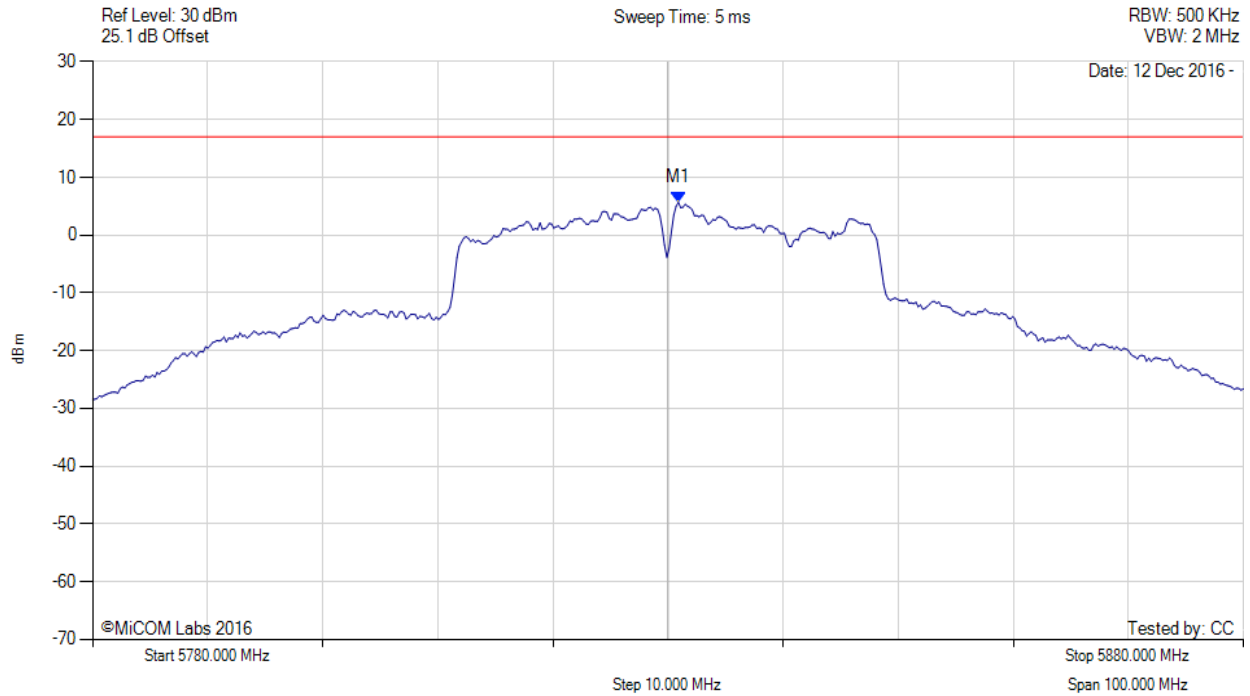

Analyzer Setup	Marker:Frequency:Amplitude	Test Results
Detector = RMS Sweep Count = 100 RF Atten (dB) = 20 Trace Mode = VIEWS	M1 : 5830.902 MHz : 5.692 dBm	Limit: $\leq 16.990$ dBm

[back to matrix](#)

This test report may be reproduced in full only. The document may only be updated by MiCOM Labs personnel. All changes will be noted in the Document History section of the report.





**Title:** Radwin Ltd. Outdoor Subscriber Radio Unit  
**To:** FCC CFR 47 Part 15 Subpart E 15.407  
**Serial #:** RDWN44-U3 Rev A Report  
**Issue Date:** 20<sup>th</sup> December 2016  
**Page:** 105 of 130

POWER SPECTRAL DENSITY



Variant: 40MHz, Channel: 5830.00 MHz, Chain b, Temp: 20, Voltage: 24 Vdc

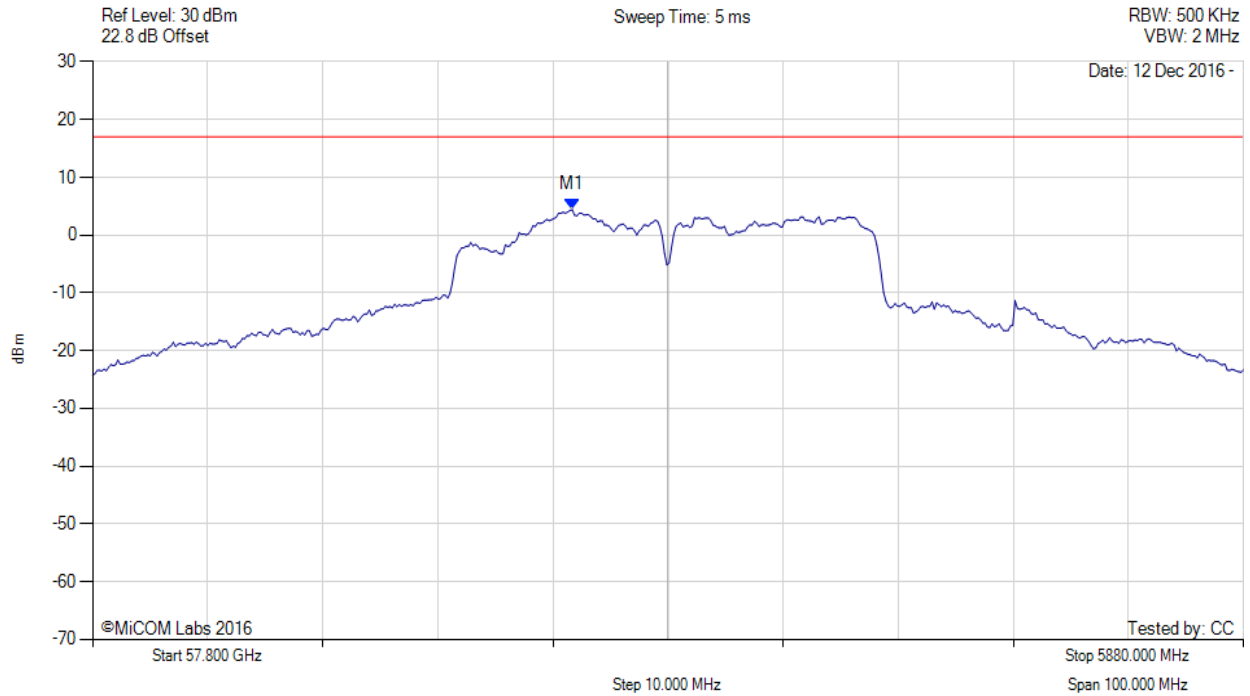

Analyzer Setup	Marker:Frequency:Amplitude	Test Results
Detector = RMS Sweep Count = 100 RF Atten (dB) = 20 Trace Mode = VIEWS	M1 : 5821.683 MHz : 4.404 dBm	Limit: $\leq 16.990$ dBm

[back to matrix](#)

This test report may be reproduced in full only. The document may only be updated by MiCOM Labs personnel. All changes will be noted in the Document History section of the report.



**Title:** Radwin Ltd. Outdoor Subscriber Radio Unit  
**To:** FCC CFR 47 Part 15 Subpart E 15.407  
**Serial #:** RDWN44-U3 Rev A Report  
**Issue Date:** 20<sup>th</sup> December 2016  
**Page:** 106 of 130



**POWER SPECTRAL DENSITY**

Variant: 40MHz, Channel: 5830.00 MHz, SUM, Temp: 20, Voltage: 24 Vdc

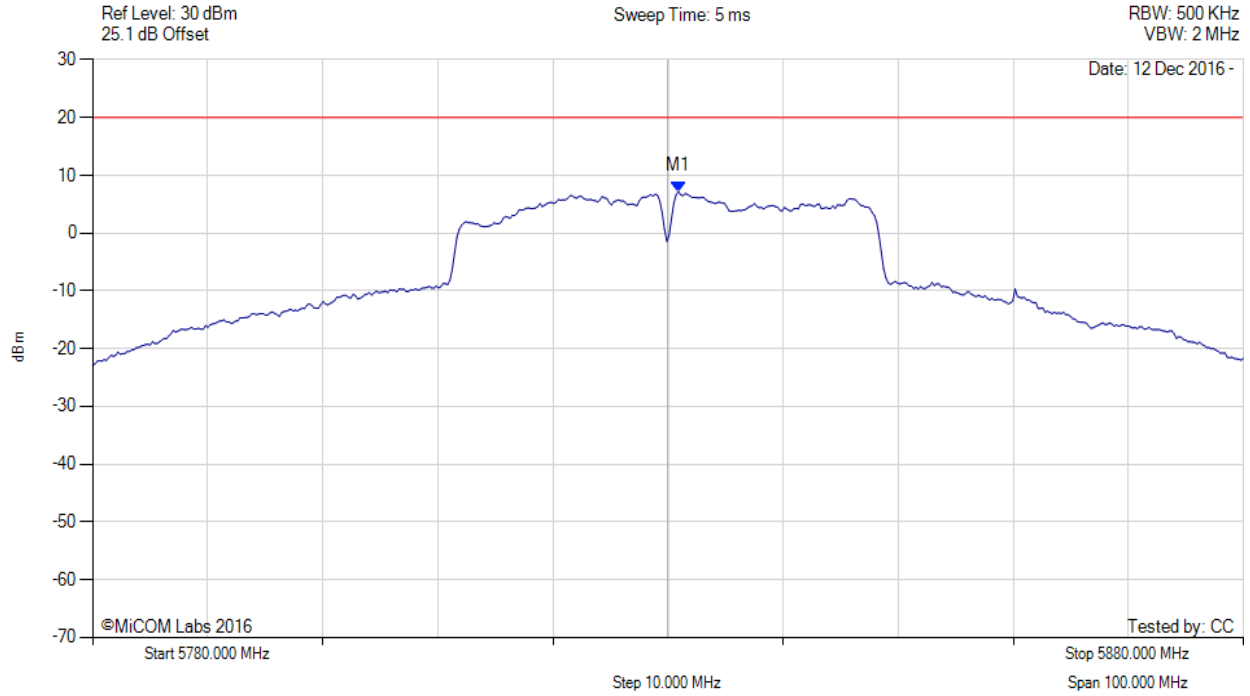

Analyzer Setup	Marker:Frequency:Amplitude	Test Results
Detector = RMS Sweep Count = 100 RF Atten (dB) = 20 Trace Mode = VIEW	M1 : 5830.900 MHz : 7.206 dBm M1 + DCCF : 5830.900 MHz : 7.761 dBm Duty Cycle Correction Factor : +0.56 dB	Limit: $\leq 30.0$ dBm Margin: -22.2 dB

[back to matrix](#)

This test report may be reproduced in full only. The document may only be updated by MiCOM Labs personnel. All changes will be noted in the Document History section of the report.



**Title:** Radwin Ltd. Outdoor Subscriber Radio Unit  
**To:** FCC CFR 47 Part 15 Subpart E 15.407  
**Serial #:** RDWN44-U3 Rev A Report  
**Issue Date:** 20<sup>th</sup> December 2016  
**Page:** 107 of 130

POWER SPECTRAL DENSITY



Variant: 80MHz, Channel: 5765.00 MHz, Chain a, Temp: 20, Voltage: 24 Vdc

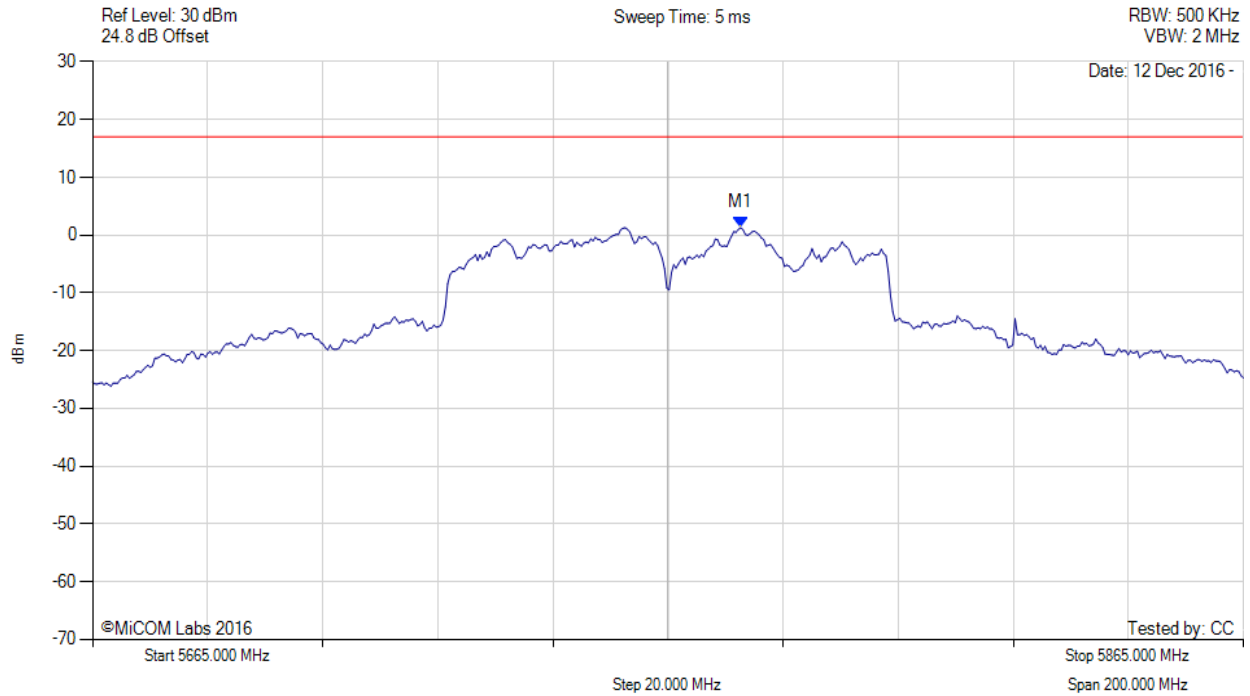

Analyzer Setup	Marker:Frequency:Amplitude	Test Results
Detector = RMS Sweep Count = 100 RF Atten (dB) = 20 Trace Mode = VIEW	M1 : 5777.625 MHz : 1.287 dBm	Limit: $\leq 16.990$ dBm

[back to matrix](#)

This test report may be reproduced in full only. The document may only be updated by MiCOM Labs personnel. All changes will be noted in the Document History section of the report.



**Title:** Radwin Ltd. Outdoor Subscriber Radio Unit  
**To:** FCC CFR 47 Part 15 Subpart E 15.407  
**Serial #:** RDWN44-U3 Rev A Report  
**Issue Date:** 20<sup>th</sup> December 2016  
**Page:** 108 of 130

POWER SPECTRAL DENSITY



Variant: 80MHz, Channel: 5765.00 MHz, Chain b, Temp: 20, Voltage: 24 Vdc

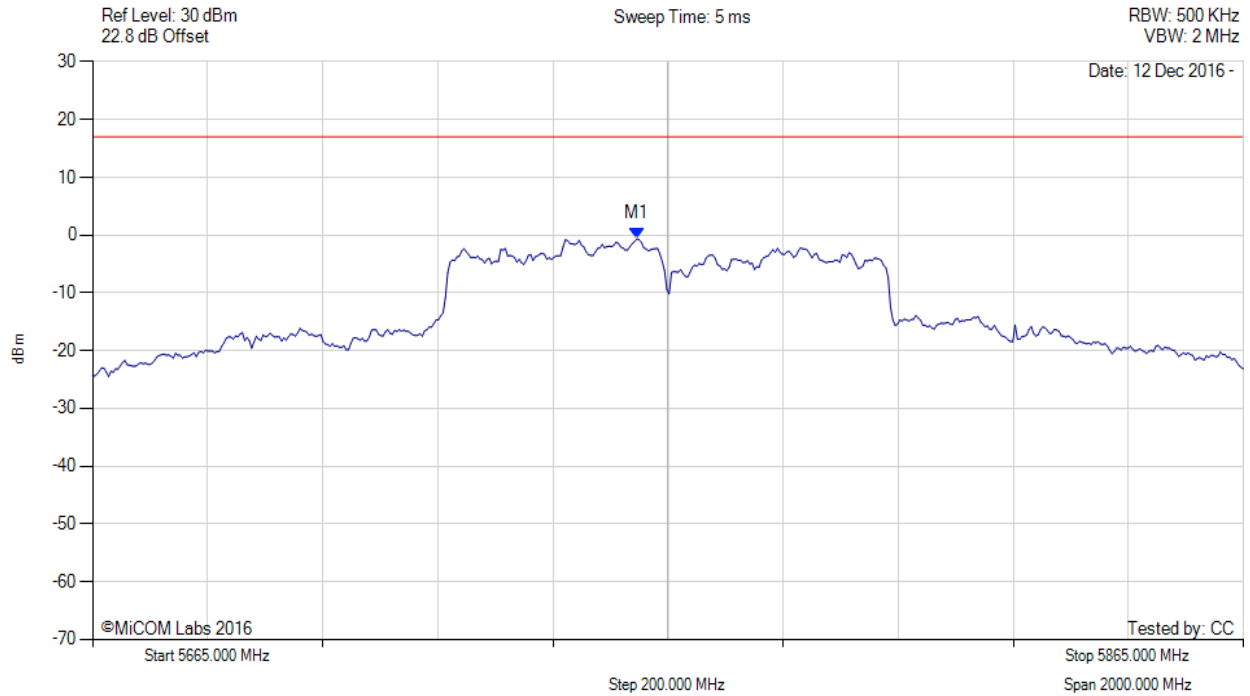

Analyzer Setup	Marker:Frequency:Amplitude	Test Results
Detector = RMS Sweep Count = 100 RF Atten (dB) = 20 Trace Mode = VIEWS	M1 : 5759.589 MHz : -0.646 dBm	Limit: ≤ 16.990 dBm

[back to matrix](#)

This test report may be reproduced in full only. The document may only be updated by MiCOM Labs personnel. All changes will be noted in the Document History section of the report.



**Title:** Radwin Ltd. Outdoor Subscriber Radio Unit  
**To:** FCC CFR 47 Part 15 Subpart E 15.407  
**Serial #:** RDWN44-U3 Rev A Report  
**Issue Date:** 20<sup>th</sup> December 2016  
**Page:** 109 of 130

POWER SPECTRAL DENSITY



Variant: 80MHz, Channel: 5765.00 MHz, SUM, Temp: 20, Voltage: 24 Vdc

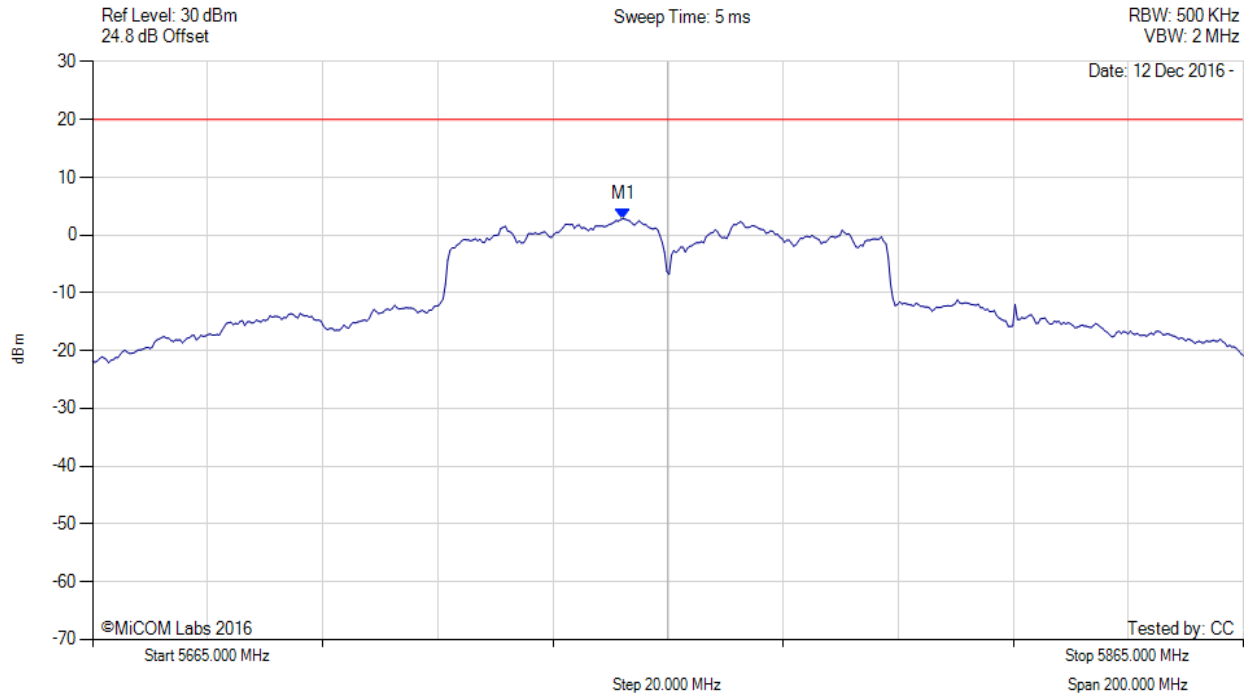

Analyzer Setup	Marker:Frequency:Amplitude	Test Results
Detector = RMS Sweep Count = 100 RF Atten (dB) = 20 Trace Mode = VIEW	M1 : 5757.200 MHz : 2.819 dBm M1 + DCCF : 5757.200 MHz : 3.628 dBm Duty Cycle Correction Factor : +0.81 dB	Limit: $\leq 30.0$ dBm Margin: -26.4 dB

[back to matrix](#)

This test report may be reproduced in full only. The document may only be updated by MiCOM Labs personnel. All changes will be noted in the Document History section of the report.



**Title:** Radwin Ltd. Outdoor Subscriber Radio Unit  
**To:** FCC CFR 47 Part 15 Subpart E 15.407  
**Serial #:** RDWN44-U3 Rev A Report  
**Issue Date:** 20<sup>th</sup> December 2016  
**Page:** 110 of 130

POWER SPECTRAL DENSITY



Variant: 80MHz, Channel: 5785.00 MHz, Chain a, Temp: 20, Voltage: 24 Vdc

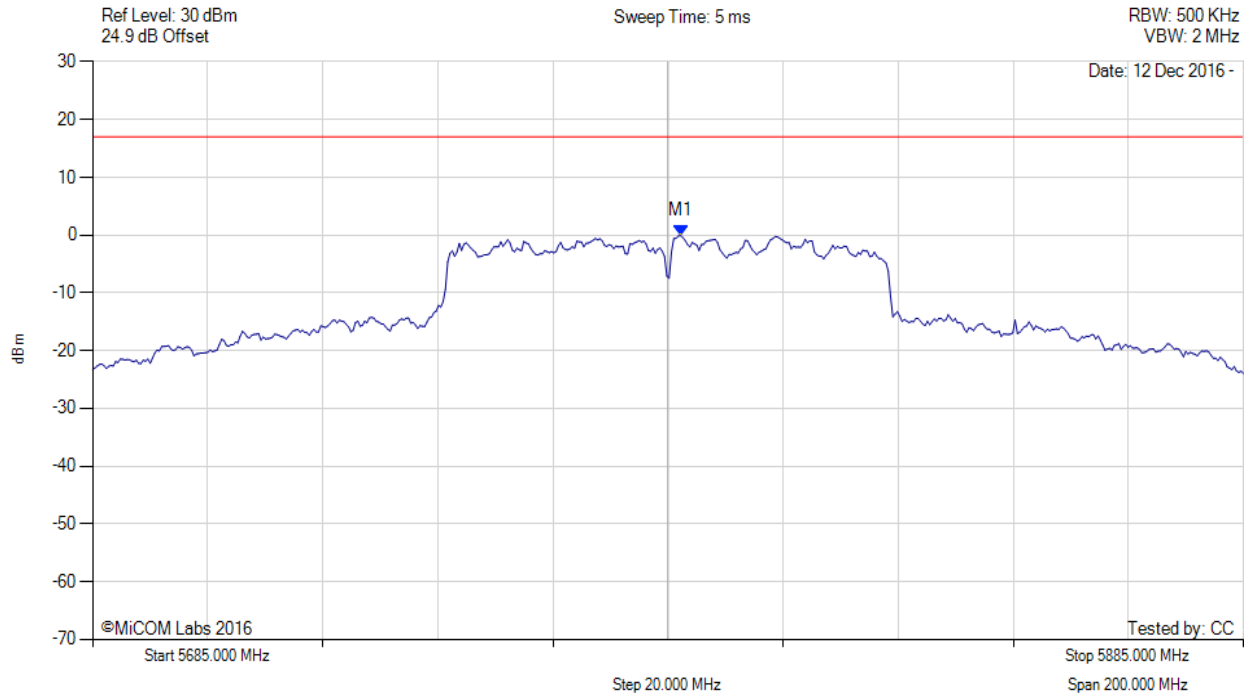

Analyzer Setup	Marker:Frequency:Amplitude	Test Results
Detector = RMS Sweep Count = 100 RF Atten (dB) = 20 Trace Mode = VIEW	M1 : 5787.204 MHz : -0.073 dBm	Limit: $\leq 16.990$ dBm

[back to matrix](#)

This test report may be reproduced in full only. The document may only be updated by MiCOM Labs personnel. All changes will be noted in the Document History section of the report.



**Title:** Radwin Ltd. Outdoor Subscriber Radio Unit  
**To:** FCC CFR 47 Part 15 Subpart E 15.407  
**Serial #:** RDWN44-U3 Rev A Report  
**Issue Date:** 20<sup>th</sup> December 2016  
**Page:** 111 of 130

POWER SPECTRAL DENSITY



Variant: 80MHz, Channel: 5785.00 MHz, Chain b, Temp: 20, Voltage: 24 Vdc

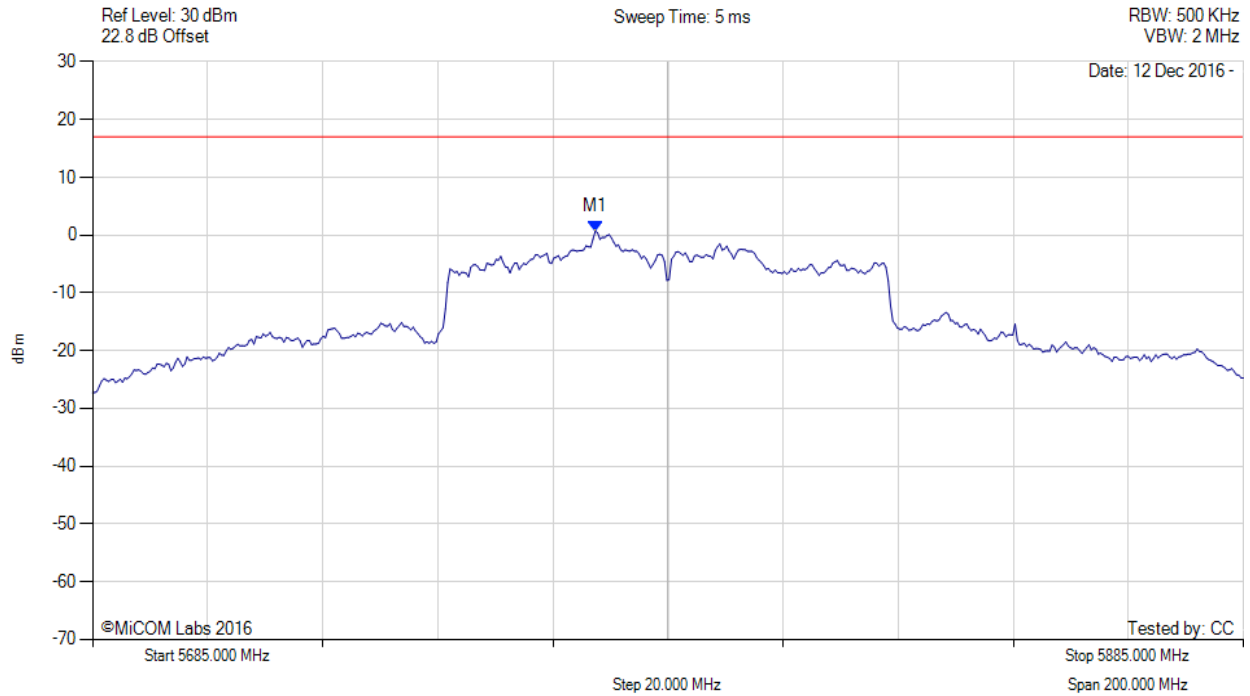

Analyzer Setup	Marker:Frequency:Amplitude	Test Results
Detector = RMS Sweep Count = 100 RF Atten (dB) = 20 Trace Mode = VIEW	M1 : 5772.375 MHz : 0.708 dBm	Channel Frequency: 5785.00 MHz

[back to matrix](#)

This test report may be reproduced in full only. The document may only be updated by MiCOM Labs personnel. All changes will be noted in the Document History section of the report.



**Title:** Radwin Ltd. Outdoor Subscriber Radio Unit  
**To:** FCC CFR 47 Part 15 Subpart E 15.407  
**Serial #:** RDWN44-U3 Rev A Report  
**Issue Date:** 20<sup>th</sup> December 2016  
**Page:** 112 of 130

POWER SPECTRAL DENSITY



Variant: 80MHz, Channel: 5785.00 MHz, SUM, Temp: 20, Voltage: 24 Vdc

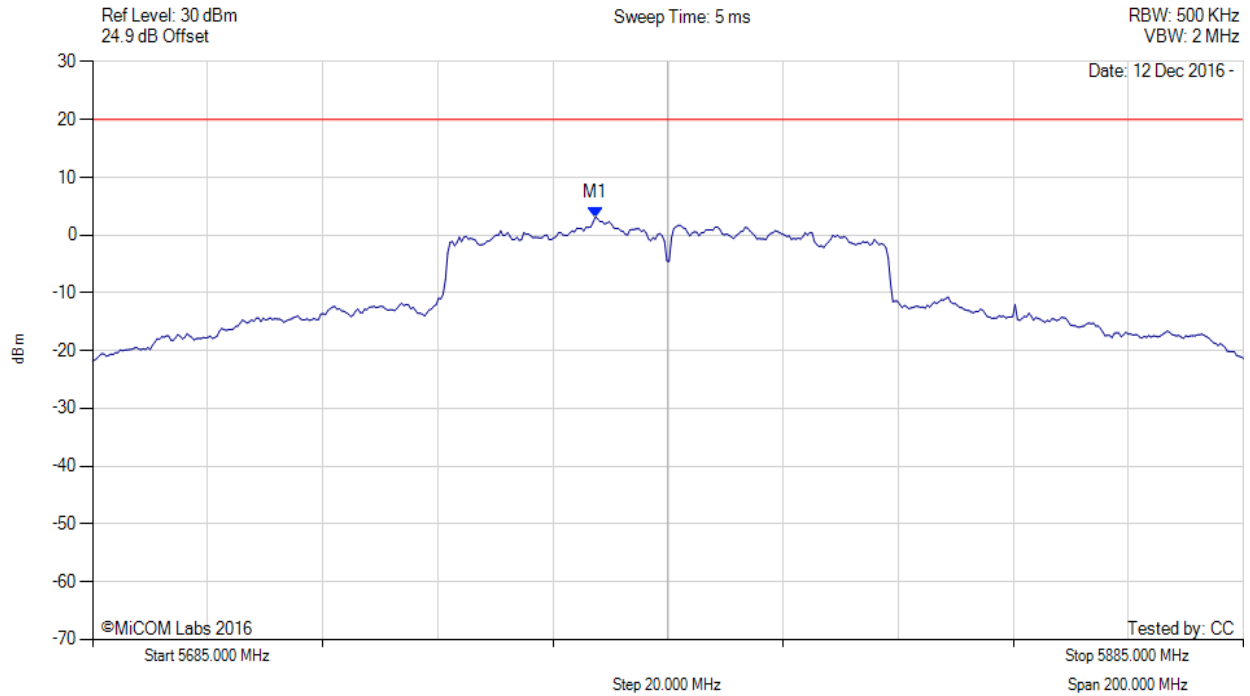

Analyzer Setup	Marker:Frequency:Amplitude	Test Results
Detector = RMS Sweep Count = 100 RF Atten (dB) = 20 Trace Mode = VIEW	M1 : 5772.400 MHz : 3.118 dBm M1 + DCCF : 5772.400 MHz : 3.927 dBm Duty Cycle Correction Factor : +0.81 dB	Limit: $\leq 30.0$ dBm Margin: -26.1 dB

[back to matrix](#)

This test report may be reproduced in full only. The document may only be updated by MiCOM Labs personnel. All changes will be noted in the Document History section of the report.





**Title:** Radwin Ltd. Outdoor Subscriber Radio Unit  
**To:** FCC CFR 47 Part 15 Subpart E 15.407  
**Serial #:** RDWN44-U3 Rev A Report  
**Issue Date:** 20<sup>th</sup> December 2016  
**Page:** 113 of 130

POWER SPECTRAL DENSITY



Variant: 80MHz, Channel: 5810.00 MHz, Chain a, Temp: 20, Voltage: 24 Vdc

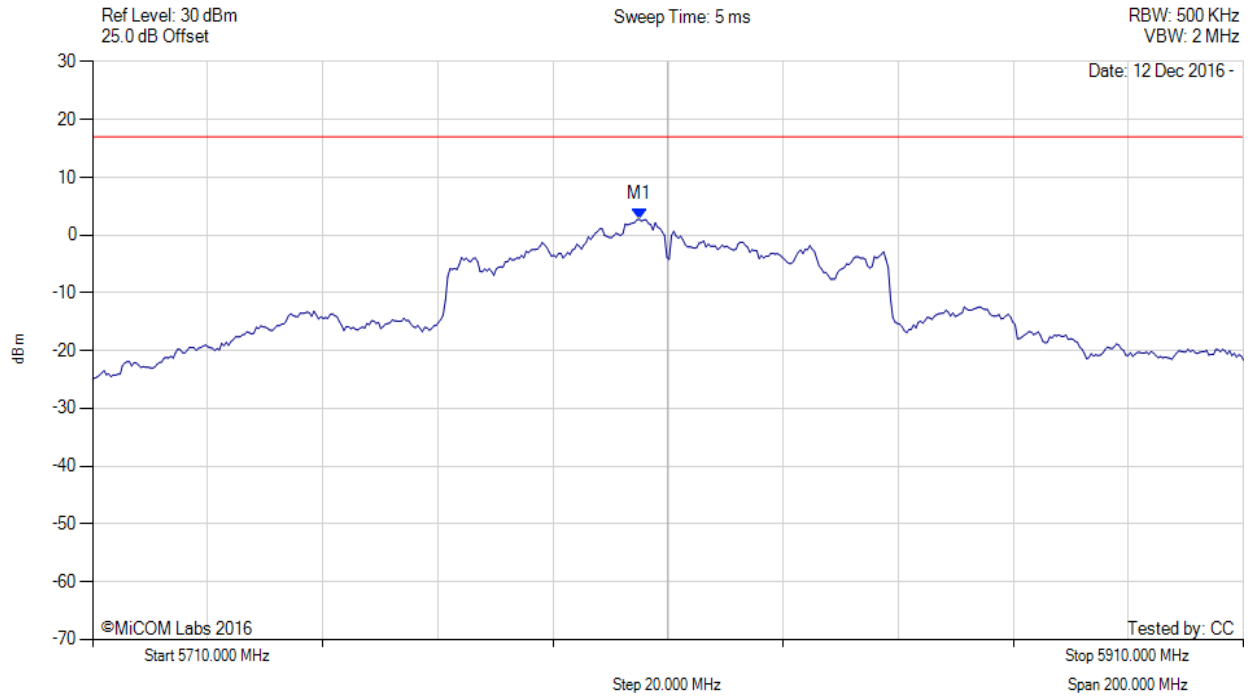

Analyzer Setup	Marker:Frequency:Amplitude	Test Results
Detector = RMS Sweep Count = 100 RF Atten (dB) = 20 Trace Mode = VIEWS	M1 : 5804.990 MHz : 2.757 dBm	Limit: $\leq 16.990$ dBm

[back to matrix](#)

This test report may be reproduced in full only. The document may only be updated by MiCOM Labs personnel. All changes will be noted in the Document History section of the report.



**Title:** Radwin Ltd. Outdoor Subscriber Radio Unit  
**To:** FCC CFR 47 Part 15 Subpart E 15.407  
**Serial #:** RDWN44-U3 Rev A Report  
**Issue Date:** 20<sup>th</sup> December 2016  
**Page:** 114 of 130

POWER SPECTRAL DENSITY



Variant: 80MHz, Channel: 5810.00 MHz, Chain b, Temp: 20, Voltage: 24 Vdc

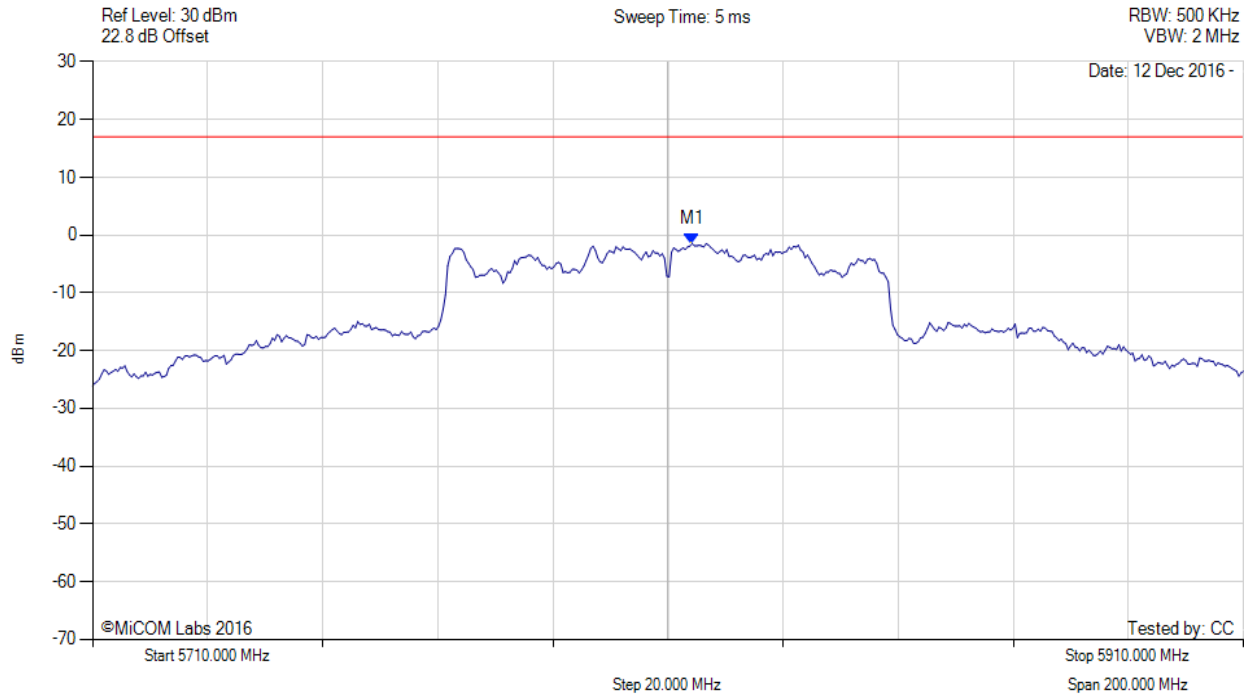

Analyzer Setup	Marker:Frequency:Amplitude	Test Results
Detector = RMS Sweep Count = 100 RF Atten (dB) = 20 Trace Mode = VIEWS	M1 : 5814.208 MHz : -1.487 dBm	Limit: $\leq 16.990$ dBm

[back to matrix](#)

This test report may be reproduced in full only. The document may only be updated by MiCOM Labs personnel. All changes will be noted in the Document History section of the report.



**Title:** Radwin Ltd. Outdoor Subscriber Radio Unit  
**To:** FCC CFR 47 Part 15 Subpart E 15.407  
**Serial #:** RDWN44-U3 Rev A Report  
**Issue Date:** 20<sup>th</sup> December 2016  
**Page:** 115 of 130

POWER SPECTRAL DENSITY



Variant: 80MHz, Channel: 5810.00 MHz, SUM, Temp: 20, Voltage: 24 Vdc

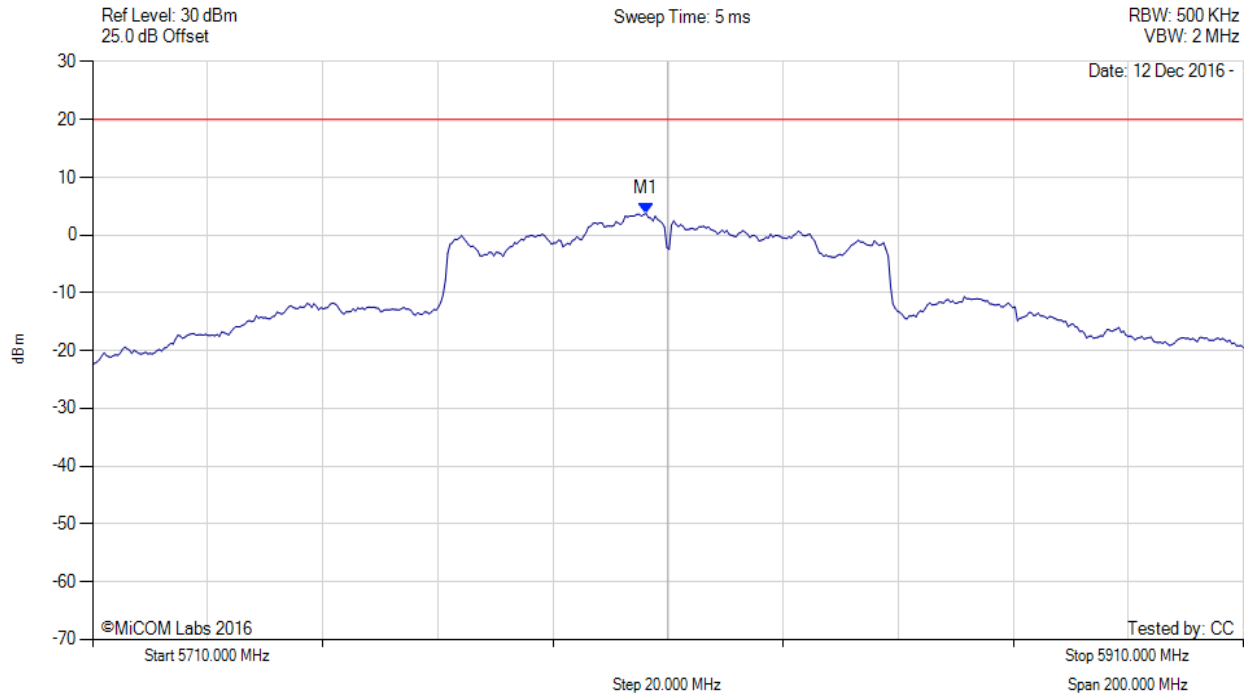

Analyzer Setup	Marker:Frequency:Amplitude	Test Results
Detector = RMS Sweep Count = 100 RF Atten (dB) = 20 Trace Mode = VIEW	M1 : 5806.200 MHz : 3.720 dBm M1 + DCCF : 5806.200 MHz : 4.529 dBm Duty Cycle Correction Factor : +0.81 dB	Limit: $\leq 30.0$ dBm Margin: -25.5 dB

[back to matrix](#)

This test report may be reproduced in full only. The document may only be updated by MiCOM Labs personnel. All changes will be noted in the Document History section of the report.



### A.3. Radiated

#### A.3.1. TX Spurious & Restricted Band Emissions

##### A.3.1.1. Radwin Ltd. MP0188280

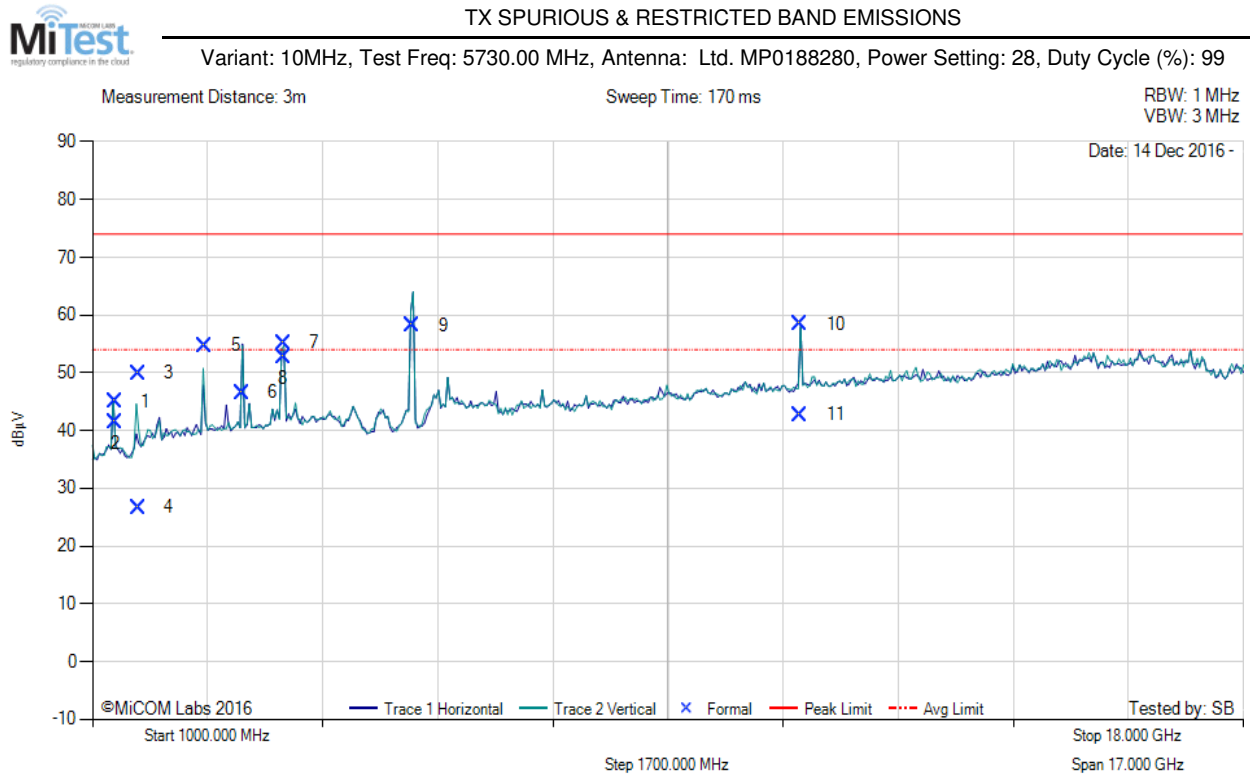

1000.00 - 18000.00 MHz												
Num	Frequency MHz	Raw dBμV	Cable Loss dB	AF dB	Level dBμV/m	Measurement Type	Pol	Hgt cm	Azt Deg	Limit dBμV/m	Margin dB	Pass /Fail
1	1331.71	57.76	2.24	-15.03	44.97	Max Peak	Horizontal	198	338	74.0	-29.0	Pass
2	1331.71	54.19	2.24	-15.03	41.40	Max Avg	Horizontal	198	338	54.0	-12.6	Pass
3	1671.43	62.92	2.39	-15.38	49.93	Max Peak	Vertical	100	146	74.0	-24.1	Pass
4	1671.43	39.66	2.39	-15.38	26.67	Max Avg	Vertical	100	146	54.0	-27.3	Pass
5	2663.94	63.27	2.79	-11.31	54.75	Peak (NRB)	Vertical	147	190	--	--	Pass
6	3215.83	54.83	2.99	-11.27	46.55	Peak (NRB)	Horizontal	101	0	--	--	Pass
7	3819.92	62.78	3.22	-10.84	55.16	Max Peak	Vertical	100	206	74.0	-18.8	Pass
8	3819.92	60.31	3.22	-10.84	52.69	Max Avg	Vertical	100	206	54.0	-1.3	Pass
9	5729.22	65.06	3.80	-10.71	58.15	Fundamental	Vertical	101	0	--	--	
10	11457.44	57.87	5.49	-4.91	58.45	Max Peak	Vertical	112	6	74.0	-15.6	Pass
11	11457.44	42.15	5.49	-4.91	42.73	Max Avg	Vertical	112	6	54.0	-11.3	Pass

[back to matrix](#)

This test report may be reproduced in full only. The document may only be updated by MiCOM Labs personnel. All changes will be noted in the Document History section of the report.



**Title:** Radwin Ltd. Outdoor Subscriber Radio Unit  
**To:** FCC CFR 47 Part 15 Subpart E 15.407  
**Serial #:** RDWN44-U3 Rev A Report  
**Issue Date:** 20<sup>th</sup> December 2016  
**Page:** 117 of 130



**TX SPURIOUS & RESTRICTED BAND EMISSIONS**

Variant: 10MHz, Test Freq: 5785.00 MHz, Antenna: Ltd. MP0188280, Power Setting: 28, Duty Cycle (%): 99

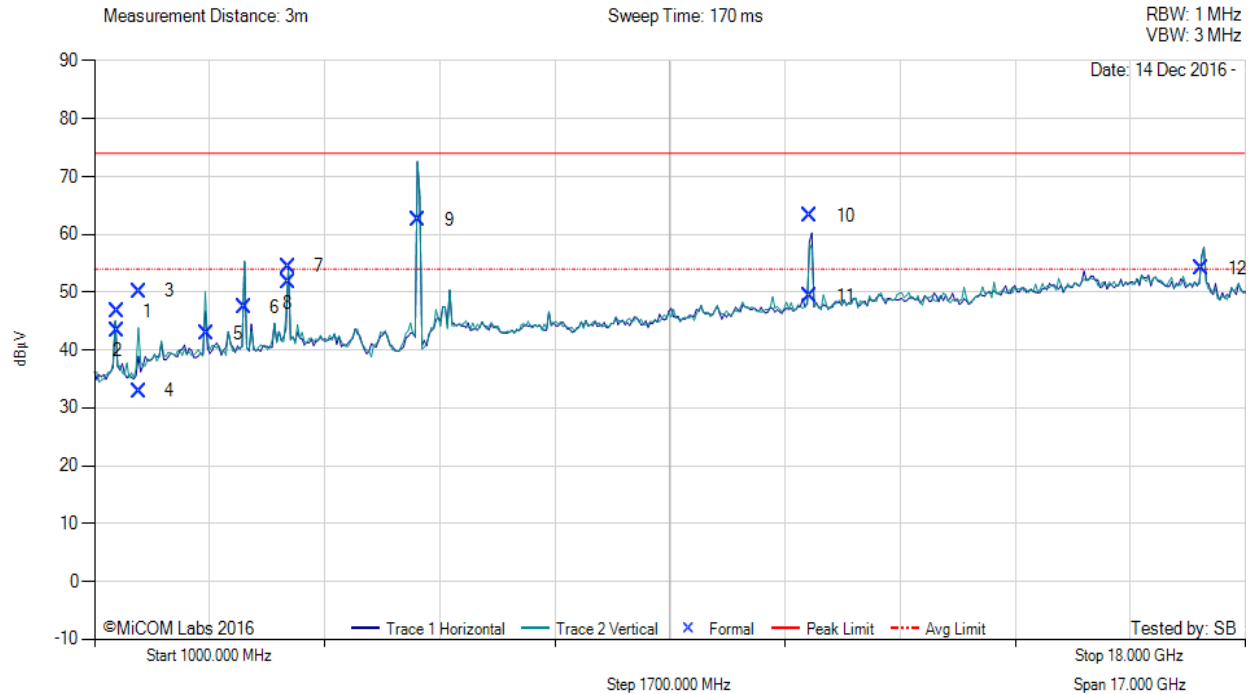

1000.00 - 18000.00 MHz												
Num	Frequency MHz	Raw dBµV	Cable Loss dB	AF dB	Level dBµV/m	Measurement Type	Pol	Hgt cm	Azt Deg	Limit dBµV/m	Margin dB	Pass /Fail
1	1331.98	59.47	2.24	-15.03	46.68	Max Peak	Horizontal	196	331	74.0	-27.3	Pass
2	1331.98	56.24	2.24	-15.03	43.45	Max Avg	Horizontal	196	331	54.0	-10.6	Pass
3	1664.96	63.28	2.40	-15.48	50.20	Max Peak	Vertical	157	341	74.0	-23.8	Pass
4	1664.96	46.00	2.40	-15.48	32.92	Max Avg	Vertical	157	341	54.0	-21.1	Pass
5	2663.83	51.38	2.79	-11.31	42.86	Peak (NRB)	Vertical	180	0	--	--	Pass
6	3215.01	55.68	3.00	-11.28	47.40	Peak (NRB)	Horizontal	180	0	--	--	Pass
7	3856.58	62.09	3.23	-10.81	54.51	Max Peak	Horizontal	160	240	74.0	-19.5	Pass
8	3856.58	59.30	3.23	-10.81	51.72	Max Avg	Horizontal	160	240	54.0	-2.3	Pass
9	5786.77	69.08	3.79	-10.43	62.44	Fundamental	Vertical	101	1	--	--	
10	11569.70	62.44	5.46	-4.64	63.26	Max Peak	Horizontal	129	87	74.0	-10.7	Pass
11	11569.70	48.57	5.46	-4.64	49.39	Max Avg	Horizontal	129	87	54.0	-4.6	Pass
12	17356.31	47.90	6.27	-0.02	54.15	Peak (NRB)	Vertical	180	0	--	--	Pass

[back to matrix](#)

This test report may be reproduced in full only. The document may only be updated by MiCOM Labs personnel. All changes will be noted in the Document History section of the report.



**Title:** Radwin Ltd. Outdoor Subscriber Radio Unit  
**To:** FCC CFR 47 Part 15 Subpart E 15.407  
**Serial #:** RDWN44-U3 Rev A Report  
**Issue Date:** 20<sup>th</sup> December 2016  
**Page:** 118 of 130



**TX SPURIOUS & RESTRICTED BAND EMISSIONS**

Variant: 10MHz, Test Freq: 5845.00 MHz, Antenna: Ltd. MP0188280, Power Setting: 28, Duty Cycle (%): 99

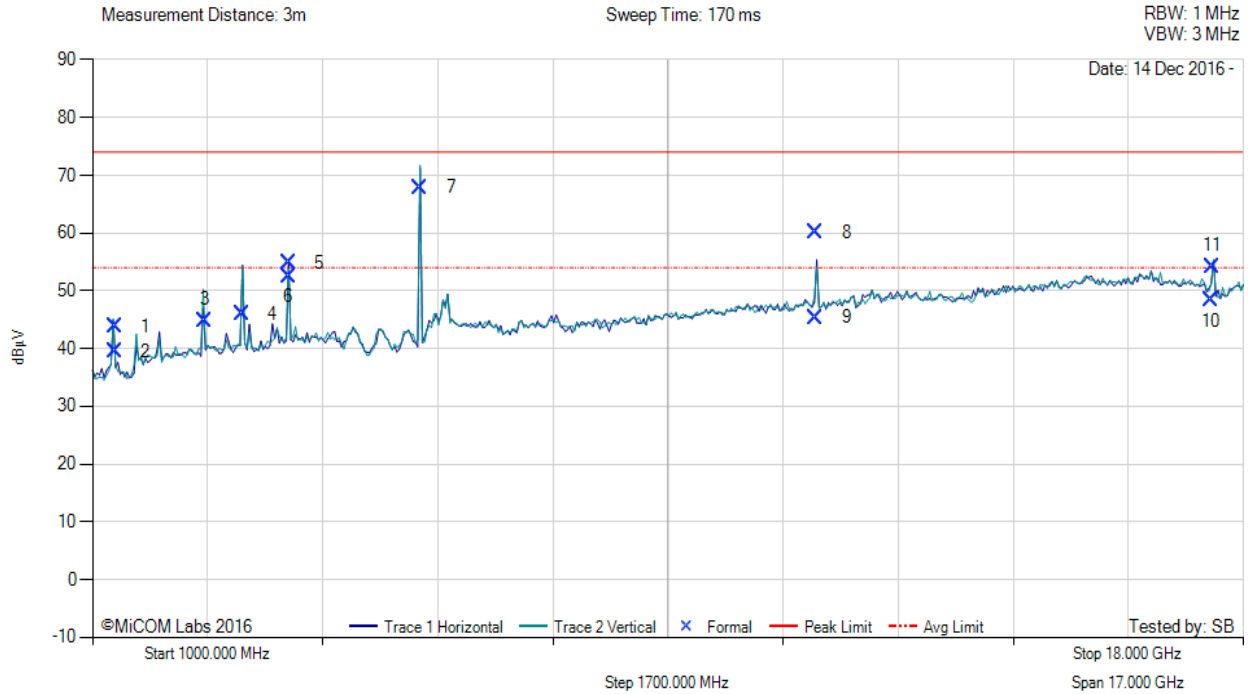

1000.00 - 18000.00 MHz												
Num	Frequency MHz	Raw dBµV	Cable Loss dB	AF dB	Level dBµV/m	Measurement Type	Pol	Hgt cm	Azt Deg	Limit dBµV/m	Margin dB	Pass /Fail
1	1332.27	56.61	2.24	-15.03	43.82	Max Peak	Horizontal	167	335	74.0	-30.2	Pass
2	1332.27	52.36	2.24	-15.03	39.57	Max Avg	Horizontal	167	335	54.0	-14.4	Pass
3	2663.83	53.39	2.79	-11.31	44.87	Peak (NRB)	Vertical	190	0	--	--	Pass
4	3214.13	54.32	3.00	-11.28	46.04	Peak (NRB)	Horizontal	151	0	--	--	Pass
5	3896.63	62.33	3.26	-10.73	54.86	Max Peak	Horizontal	119	250	74.0	-19.1	Pass
6	3896.63	60.02	3.26	-10.73	52.55	Max Avg	Horizontal	119	250	54.0	-1.5	Pass
7	5842.13	74.20	3.84	-10.18	67.86	Fundamental	Vertical	101	1	--	--	
8	11687.53	58.98	5.55	-4.44	60.09	Max Peak	Horizontal	135	48	74.0	-13.9	Pass
9	11687.53	44.22	5.55	-4.44	45.33	Max Avg	Horizontal	135	48	54.0	-8.7	Pass
10	17525.53	43.08	6.15	-0.84	48.39	Peak (NRB)	Vertical	151	1	--	--	Pass
11	17534.34	48.84	6.27	-0.89	54.22	Peak (NRB)	Vertical	151	57	--	--	Pass

[back to matrix](#)

This test report may be reproduced in full only. The document may only be updated by MiCOM Labs personnel. All changes will be noted in the Document History section of the report.



**TX SPURIOUS & RESTRICTED BAND EMISSIONS**

Variant: 80MHz, Test Freq: 5765.00 MHz, Antenna: Ltd. MP0188280, Power Setting: 23.5, Duty Cycle (%): 99

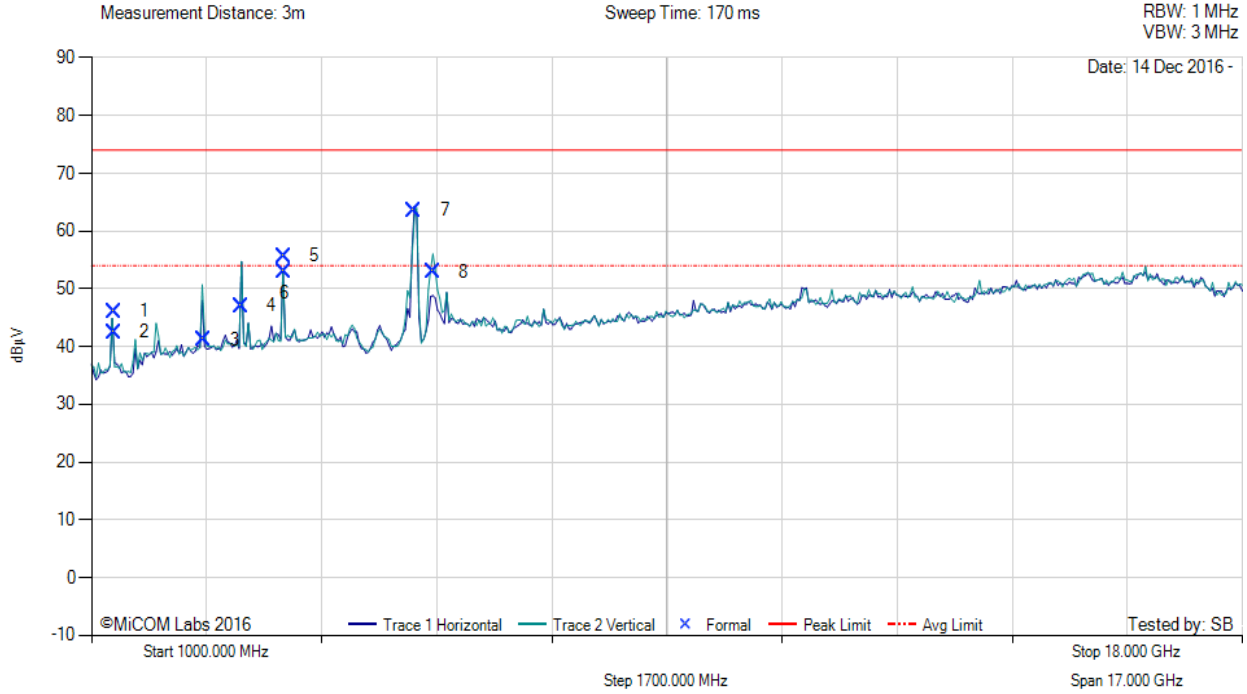

1000.00 - 18000.00 MHz												
Num	Frequency MHz	Raw dBµV	Cable Loss dB	AF dB	Level dBµV/m	Measurement Type	Pol	Hgt cm	Azt Deg	Limit dBµV/m	Margin dB	Pass /Fail
1	1332.03	58.92	2.24	-15.03	46.13	Max Peak	Horizontal	165	338	74.0	-27.9	Pass
2	1332.03	55.30	2.24	-15.03	42.51	Max Avg	Horizontal	165	338	54.0	-11.5	Pass
3	2664.10	49.72	2.79	-11.31	41.20	Peak (NRB)	Vertical	151	27	--	--	Pass
4	3214.23	55.36	3.00	-11.28	47.08	Peak (NRB)	Vertical	151	0	--	--	Pass
5	3843.23	63.29	3.21	-10.82	55.68	Max Peak	Horizontal	104	265	74.0	-18.3	Pass
6	3843.23	60.56	3.21	-10.82	52.95	Max Avg	Horizontal	104	265	54.0	-1.1	Pass
7	5768.58	70.30	3.80	-10.53	63.57	Fundamental	Horizontal	151	0	--	--	
8	6049.30	58.69	3.87	-9.66	52.90	Peak (NRB)	Vertical	151	0	--	--	Pass

[back to matrix](#)

This test report may be reproduced in full only. The document may only be updated by MiCOM Labs personnel. All changes will be noted in the Document History section of the report.



**Title:** Radwin Ltd. Outdoor Subscriber Radio Unit  
**To:** FCC CFR 47 Part 15 Subpart E 15.407  
**Serial #:** RDWN44-U3 Rev A Report  
**Issue Date:** 20<sup>th</sup> December 2016  
**Page:** 120 of 130



**TX SPURIOUS & RESTRICTED BAND EMISSIONS**

Variant: 80MHz, Test Freq: 5785.00 MHz, Antenna: Ltd. MP0188280, Power Setting: 23.5, Duty Cycle (%): 99

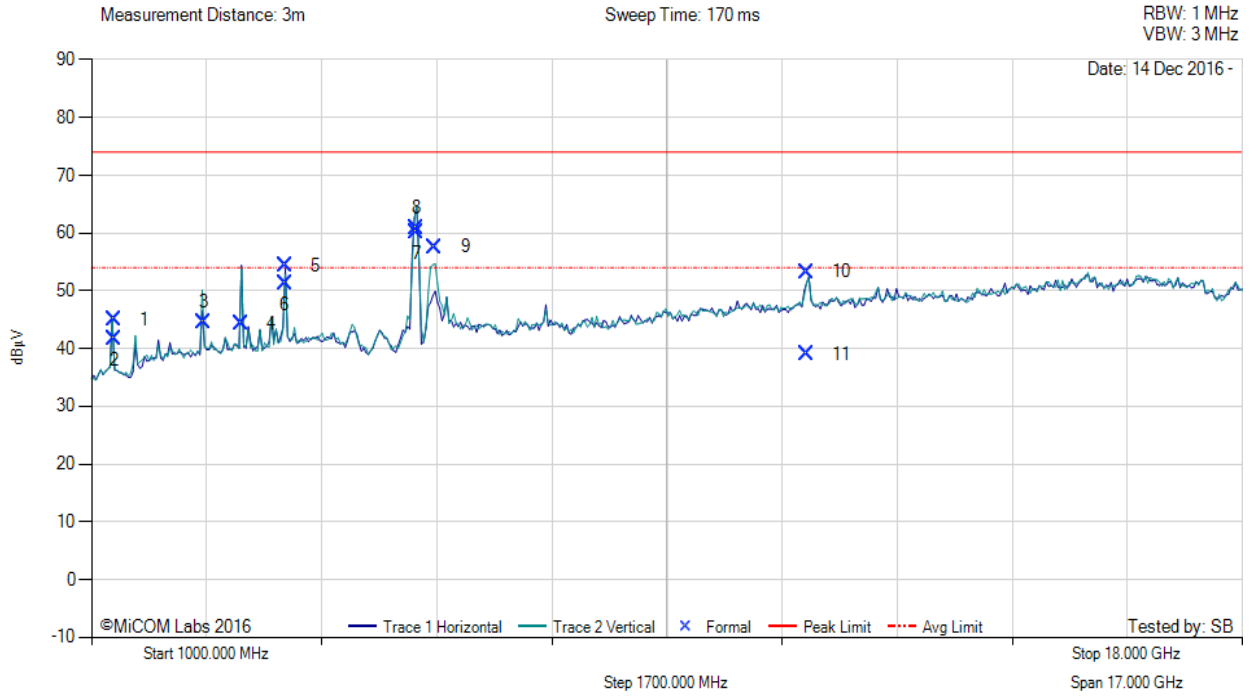

1000.00 - 18000.00 MHz												
Num	Frequency MHz	Raw dBµV	Cable Loss dB	AF dB	Level dBµV/m	Measurement Type	Pol	Hgt cm	Azt Deg	Limit dBµV/m	Margin dB	Pass /Fail
1	1332.19	57.75	2.24	-15.03	44.96	Max Peak	Horizontal	195	337	74.0	-29.0	Pass
2	1332.19	54.40	2.24	-15.03	41.61	Max Avg	Horizontal	195	337	54.0	-12.4	Pass
3	2663.87	53.07	2.79	-11.31	44.55	Peak (NRB)	Vertical	153	0	--	--	Pass
4	3214.27	52.55	3.00	-11.28	44.27	Peak (NRB)	Horizontal	101	0	--	--	Pass
5	3856.47	61.95	3.23	-10.81	54.37	Max Peak	Horizontal	108	253	74.0	-19.6	Pass
6	3856.47	58.87	3.23	-10.81	51.29	Max Avg	Horizontal	108	253	54.0	-2.7	Pass
7	5799.36	66.65	3.80	-10.37	60.08	Peak (NRB)	Vertical	101	0	--	--	Pass
8	5801.37	67.33	3.81	-10.36	60.78	Peak (NRB)	Vertical	101	0	--	--	Pass
9	6074.40	63.35	3.87	-9.59	57.63	Peak (NRB)	Vertical	169	1	--	--	Pass
10	11564.37	52.38	5.58	-4.65	53.31	Max Peak	Horizontal	182	35	74.0	-20.7	Pass
11	11564.37	38.15	5.58	-4.65	39.08	Max Avg	Horizontal	182	35	54.0	-14.9	Pass

[back to matrix](#)

This test report may be reproduced in full only. The document may only be updated by MiCOM Labs personnel. All changes will be noted in the Document History section of the report.





**Title:** Radwin Ltd. Outdoor Subscriber Radio Unit  
**To:** FCC CFR 47 Part 15 Subpart E 15.407  
**Serial #:** RDWN44-U3 Rev A Report  
**Issue Date:** 20<sup>th</sup> December 2016  
**Page:** 121 of 130



**TX SPURIOUS & RESTRICTED BAND EMISSIONS**

Variant: 80MHz, Test Freq: 5810.00 MHz, Antenna: Ltd. MP0188280, Power Setting: 23, Duty Cycle (%): 99

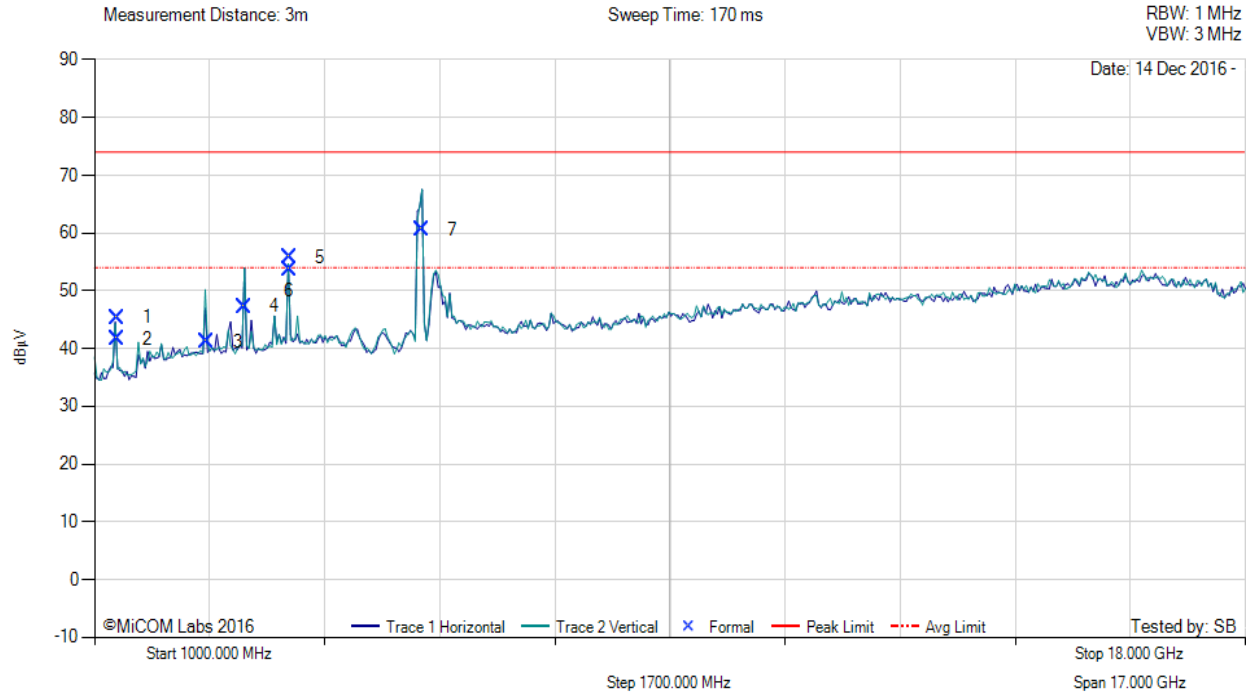

1000.00 - 18000.00 MHz												
Num	Frequency MHz	Raw dBµV	Cable Loss dB	AF dB	Level dBµV/m	Measurement Type	Pol	Hgt cm	Azt Deg	Limit dBµV/m	Margin dB	Pass /Fail
1	1332.11	58.14	2.24	-15.03	45.35	Max Peak	Horizontal	167	337	74.0	-28.7	Pass
2	1332.11	54.42	2.24	-15.03	41.63	Max Avg	Horizontal	167	337	54.0	-12.4	Pass
3	2664.10	49.68	2.79	-11.31	41.16	Peak (NRB)	Vertical	100	0	--	--	Pass
4	3214.23	55.61	3.00	-11.28	47.33	Peak (NRB)	Vertical	100	0	--	--	Pass
5	3873.34	63.30	3.25	-10.77	55.78	Max Peak	Vertical	101	221	74.0	-18.2	Pass
6	3873.34	61.13	3.25	-10.77	53.61	Max Avg	Vertical	101	221	54.0	-0.4	Pass
7	5827.90	67.01	3.84	-10.24	60.61	Peak (NRB)	Vertical	101	0	--	--	Pass

[back to matrix](#)

This test report may be reproduced in full only. The document may only be updated by MiCOM Labs personnel. All changes will be noted in the Document History section of the report.



**Title:** Radwin Ltd. Outdoor Subscriber Radio Unit  
**To:** FCC CFR 47 Part 15 Subpart E 15.407  
**Serial #:** RDWN44-U3 Rev A Report  
**Issue Date:** 20<sup>th</sup> December 2016  
**Page:** 122 of 130

### A.3.2. Restricted Edge & Band-Edge Emissions

#### A.3.2.1. Radwin Ltd. MP0188280



#### 5725 MHz RADIATED BAND-EDGE EMISSIONS

Variant: 10MHz, Test Freq: 5730.00 MHz, Antenna: Ltd. MP0188280, Power Setting: 28, Duty Cycle (%): 99

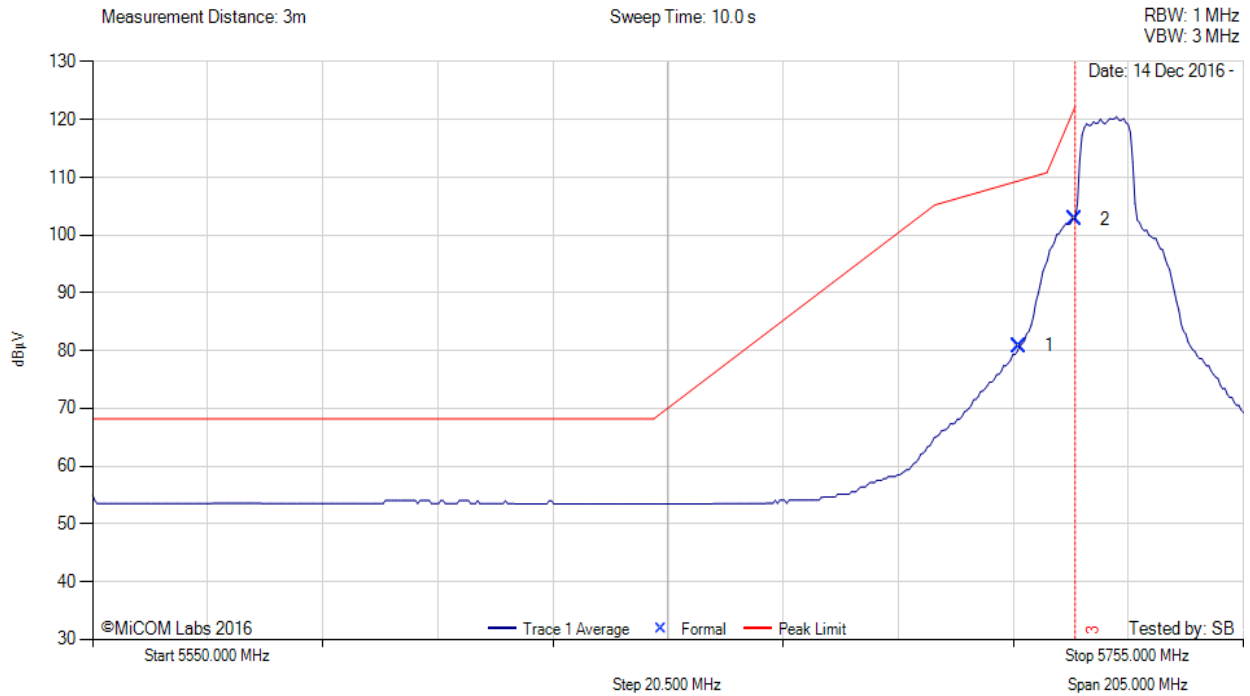

5550.00 - 5755.00 MHz												
Num	Frequency MHz	Raw dBµV	Cable Loss dB	AF dB	Level dBµV/m	Measurement Type	Pol	Hgt cm	Azt Deg	Limit dBµV/m	Margin dB	Pass /Fail
1	5715.00	42.71	3.81	34.34	80.86	Max Avg	Horizontal	155	362	109.4	-28.5	Pass
2	5725.00	64.61	3.79	34.35	102.75	Max Avg	Horizontal	155	362	122.2	-19.5	Pass
3	5725.00	--	--	--	--	Band-Edge	--	--	--	--	--	--

**Test Notes:** initial PS 28, final PS 28

[back to matrix](#)

This test report may be reproduced in full only. The document may only be updated by MiCOM Labs personnel. All changes will be noted in the Document History section of the report.



**Title:** Radwin Ltd. Outdoor Subscriber Radio Unit  
**To:** FCC CFR 47 Part 15 Subpart E 15.407  
**Serial #:** RDWN44-U3 Rev A Report  
**Issue Date:** 20<sup>th</sup> December 2016  
**Page:** 123 of 130



5725 MHz RADIATED BAND-EDGE EMISSIONS

Variant: 20MHz, Test Freq: 5735.00 MHz, Antenna: Ltd. MP0188280, Power Setting: 28, Duty Cycle (%): 99

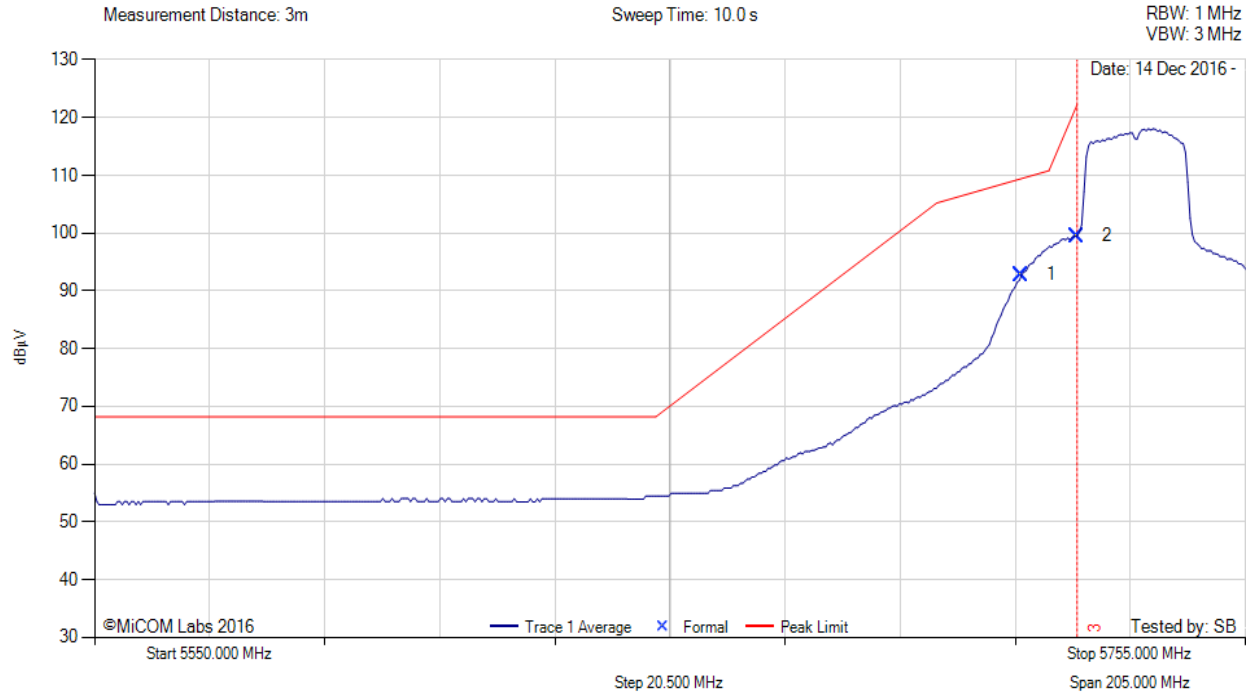

5550.00 - 5755.00 MHz												
Num	Frequency MHz	Raw dBµV	Cable Loss dB	AF dB	Level dBµV/m	Measurement Type	Pol	Hgt cm	Azt Deg	Limit dBµV/m	Margin dB	Pass /Fail
1	5715.00	54.61	3.81	34.34	92.76	Max Avg	Horizontal	155	362	109.4	-16.6	Pass
2	5725.00	61.37	3.79	34.35	99.51	Max Avg	Horizontal	155	362	122.2	-22.7	Pass
3	5725.00	--	--	--	--	Band-Edge	--	--	--	--	--	--

**Test Notes:** initial PS 28, final PS 28

[back to matrix](#)

This test report may be reproduced in full only. The document may only be updated by MiCOM Labs personnel. All changes will be noted in the Document History section of the report.



**Title:** Radwin Ltd. Outdoor Subscriber Radio Unit  
**To:** FCC CFR 47 Part 15 Subpart E 15.407  
**Serial #:** RDWN44-U3 Rev A Report  
**Issue Date:** 20<sup>th</sup> December 2016  
**Page:** 124 of 130



5725 MHz RADIATED BAND-EDGE EMISSIONS

Variant: 40MHz, Test Freq: 5745.00 MHz, Antenna: Ltd. MP0188280, Power Setting: 28, Duty Cycle (%): 99

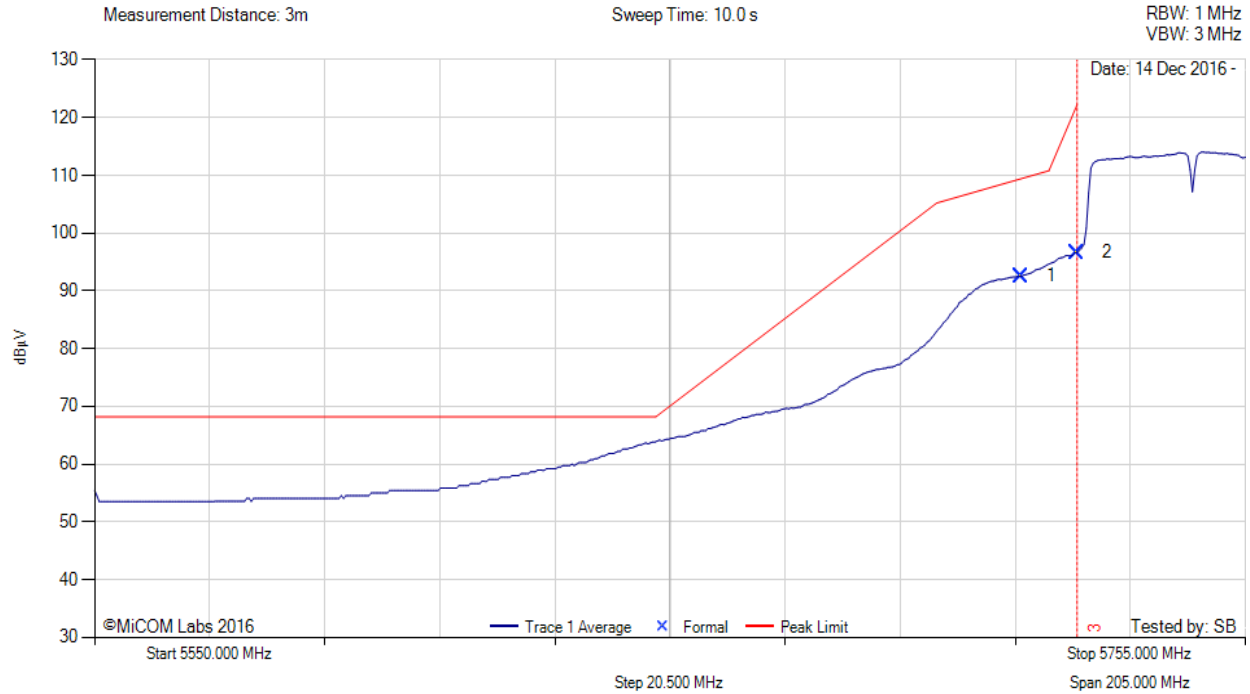

5550.00 - 5755.00 MHz												
Num	Frequency MHz	Raw dBµV	Cable Loss dB	AF dB	Level dBµV/m	Measurement Type	Pol	Hgt cm	Azt Deg	Limit dBµV/m	Margin dB	Pass /Fail
1	5715.00	54.39	3.81	34.34	92.54	Max Avg	Horizontal	155	362	109.4	-16.9	Pass
2	5725.00	58.50	3.79	34.35	96.64	Max Avg	Horizontal	155	362	122.2	-25.6	Pass
3	5725.00	--	--	--	--	Band-Edge	--	--	--	--	--	--

**Test Notes:** initial PS 28, final PS 28

[back to matrix](#)

This test report may be reproduced in full only. The document may only be updated by MiCOM Labs personnel. All changes will be noted in the Document History section of the report.



**Title:** Radwin Ltd. Outdoor Subscriber Radio Unit  
**To:** FCC CFR 47 Part 15 Subpart E 15.407  
**Serial #:** RDWN44-U3 Rev A Report  
**Issue Date:** 20<sup>th</sup> December 2016  
**Page:** 125 of 130



5725 MHz RADIATED BAND-EDGE EMISSIONS

Variant: 80MHz, Test Freq: 5765.00 MHz, Antenna: Ltd. MP0188280, Power Setting: 23.5, Duty Cycle (%): 99

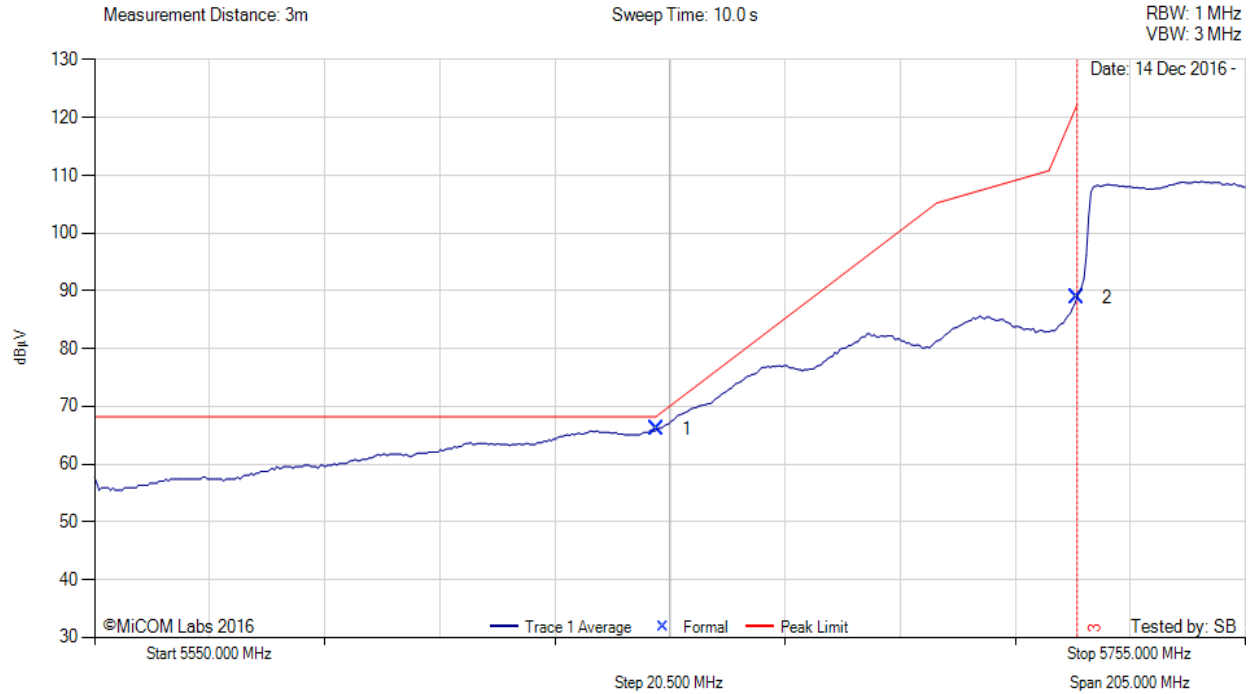

5550.00 - 5755.00 MHz												
Num	Frequency MHz	Raw dBµV	Cable Loss dB	AF dB	Level dBµV/m	Measurement Type	Pol	Hgt cm	Azt Deg	Limit dBµV/m	Margin dB	Pass /Fail
1	5650.09	28.09	3.75	34.18	66.02	Max Avg	Horizontal	155	362	68.2	-2.2	Pass
2	5725.00	50.69	3.79	34.35	88.83	Max Avg	Horizontal	155	362	122.2	-33.4	Pass
3	5725.00	--	--	--	--	Band-Edge	--	--	--	--	--	--

**Test Notes:** initial PS 28, final PS 23.5

[back to matrix](#)

This test report may be reproduced in full only. The document may only be updated by MiCOM Labs personnel. All changes will be noted in the Document History section of the report.



5850 MHz RADIATED BAND-EDGE EMISSIONS

Variant: 10MHz, Test Freq: 5845.00 MHz, Antenna: Ltd. MP0188280, Power Setting: 28, Duty Cycle (%): 99

Measurement Distance: 3m

Sweep Time: 10.0 s

RBW: 1 MHz  
VBW: 3 MHz

Date: 14 Dec 2016 -

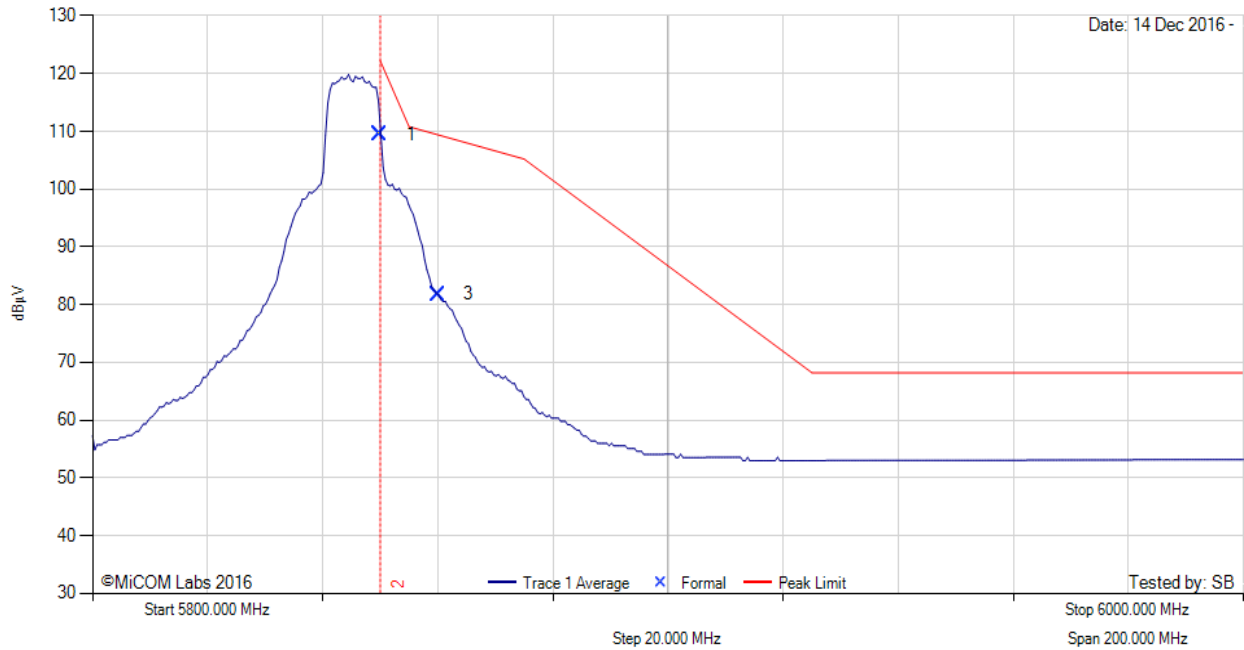

5800.00 - 6000.00 MHz												
Num	Frequency MHz	Raw dBµV	Cable Loss dB	AF dB	Level dBµV/m	Measurement Type	Pol	Hgt cm	Azt Deg	Limit dBµV/m	Margin dB	Pass /Fail
1	5850.00	71.03	3.81	34.63	109.47	Max Avg	Horizontal	155	362	122.2	-12.7	Pass
3	5860.00	43.23	3.86	34.65	81.74	Max Avg	Horizontal	155	362	109.4	-27.7	Pass
2	5850.00	--	--	--	--	Band-Edge	--	--	--	--	--	--

**Test Notes:** initial PS 28, final PS 28

[back to matrix](#)

This test report may be reproduced in full only. The document may only be updated by MiCOM Labs personnel. All changes will be noted in the Document History section of the report.



5850 MHz RADIATED BAND-EDGE EMISSIONS

Variant: 20MHz, Test Freq: 5840.00 MHz, Antenna: Ltd. MP0188280, Power Setting: 28, Duty Cycle (%): 99

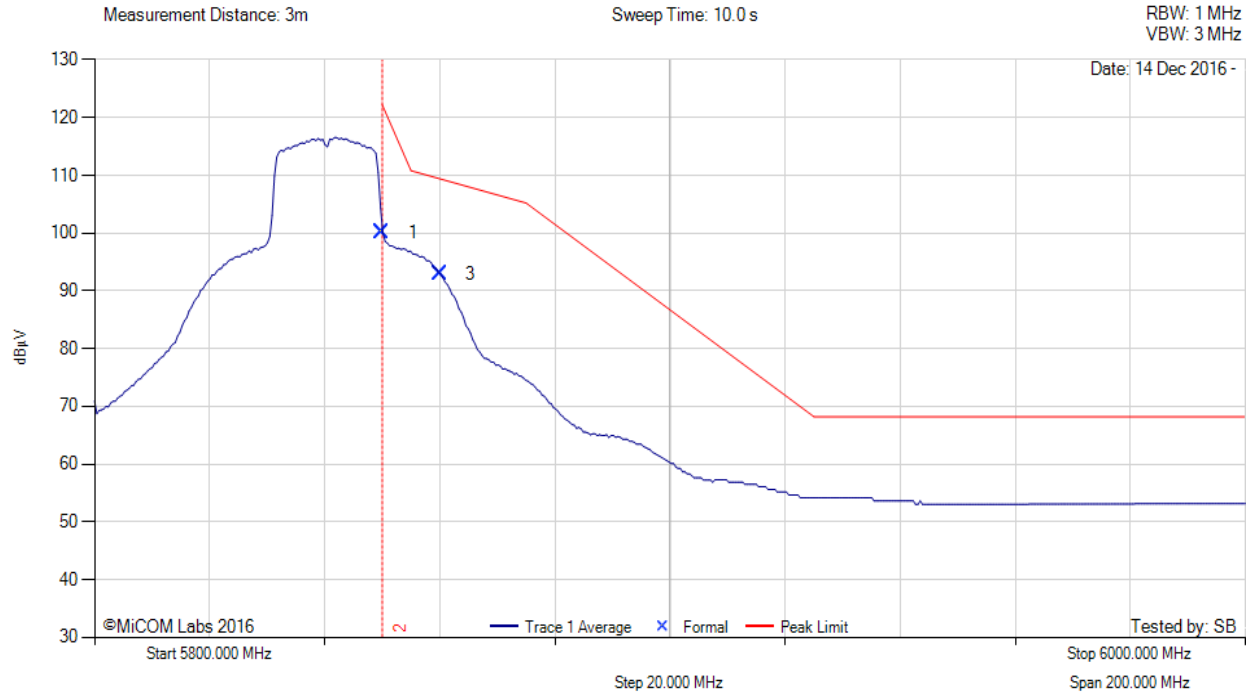

5800.00 - 6000.00 MHz												
Num	Frequency MHz	Raw dBµV	Cable Loss dB	AF dB	Level dBµV/m	Measurement Type	Pol	Hgt cm	Azt Deg	Limit dBµV/m	Margin dB	Pass /Fail
1	5850.00	61.64	3.81	34.63	100.08	Max Avg	Horizontal	155	362	122.2	-22.1	Pass
3	5860.00	54.43	3.86	34.65	92.94	Max Avg	Horizontal	155	362	109.4	-16.5	Pass
2	5850.00	--	--	--	--	Band-Edge	--	--	--	--	--	--

**Test Notes:** initial PS 28, final PS 28

[back to matrix](#)

This test report may be reproduced in full only. The document may only be updated by MiCOM Labs personnel. All changes will be noted in the Document History section of the report.



**Title:** Radwin Ltd. Outdoor Subscriber Radio Unit  
**To:** FCC CFR 47 Part 15 Subpart E 15.407  
**Serial #:** RDWN44-U3 Rev A Report  
**Issue Date:** 20<sup>th</sup> December 2016  
**Page:** 128 of 130



5850 MHz RADIATED BAND-EDGE EMISSIONS

Variant: 40MHz, Test Freq: 5830.00 MHz, Antenna: Ltd. MP0188280, Power Setting: 28, Duty Cycle (%): 99

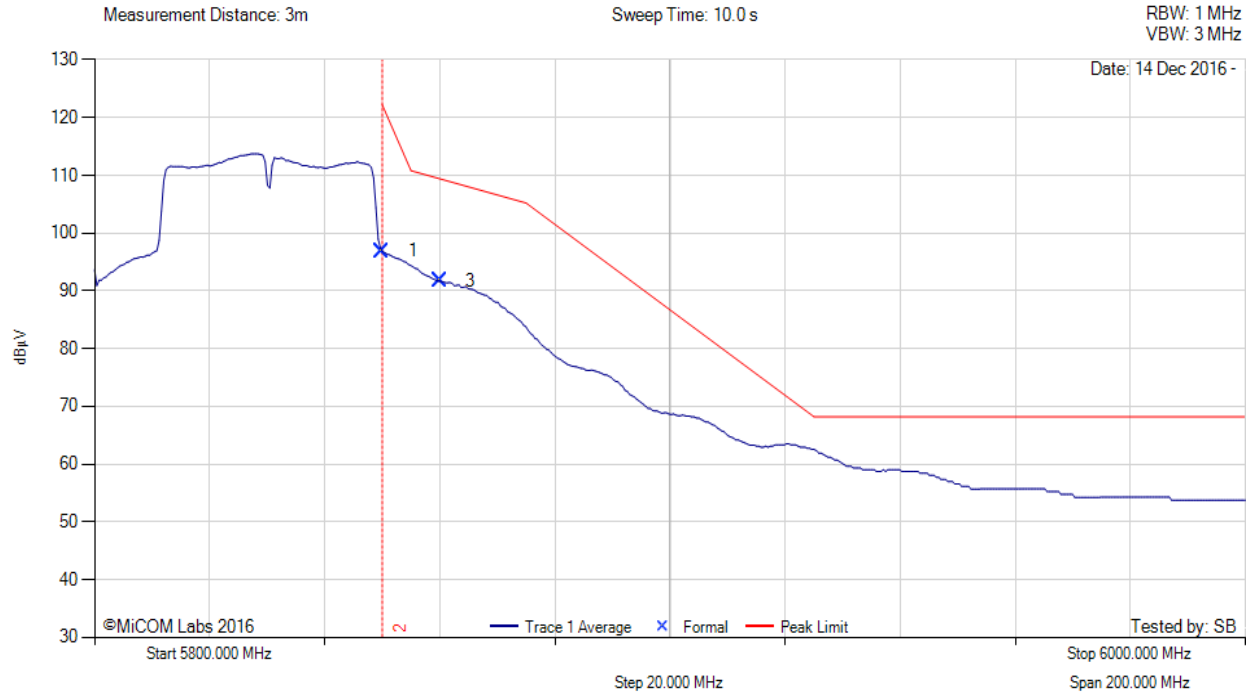

5800.00 - 6000.00 MHz												
Num	Frequency MHz	Raw dBµV	Cable Loss dB	AF dB	Level dBµV/m	Measurement Type	Pol	Hgt cm	Azt Deg	Limit dBµV/m	Margin dB	Pass /Fail
1	5850.00	58.39	3.81	34.63	96.83	Max Avg	Horizontal	155	362	122.2	-25.4	Pass
3	5860.00	53.15	3.86	34.65	91.66	Max Avg	Horizontal	155	362	109.4	-17.7	Pass
2	5850.00	--	--	--	--	Band-Edge	--	--	--	--	--	--

**Test Notes:** initial PS 28, final PS 28

[back to matrix](#)

This test report may be reproduced in full only. The document may only be updated by MiCOM Labs personnel. All changes will be noted in the Document History section of the report.





5850 MHz RADIATED BAND-EDGE EMISSIONS

Variant: 80MHz, Test Freq: 5810.00 MHz, Antenna: Ltd. MP0188280, Power Setting: 23, Duty Cycle (%): 99

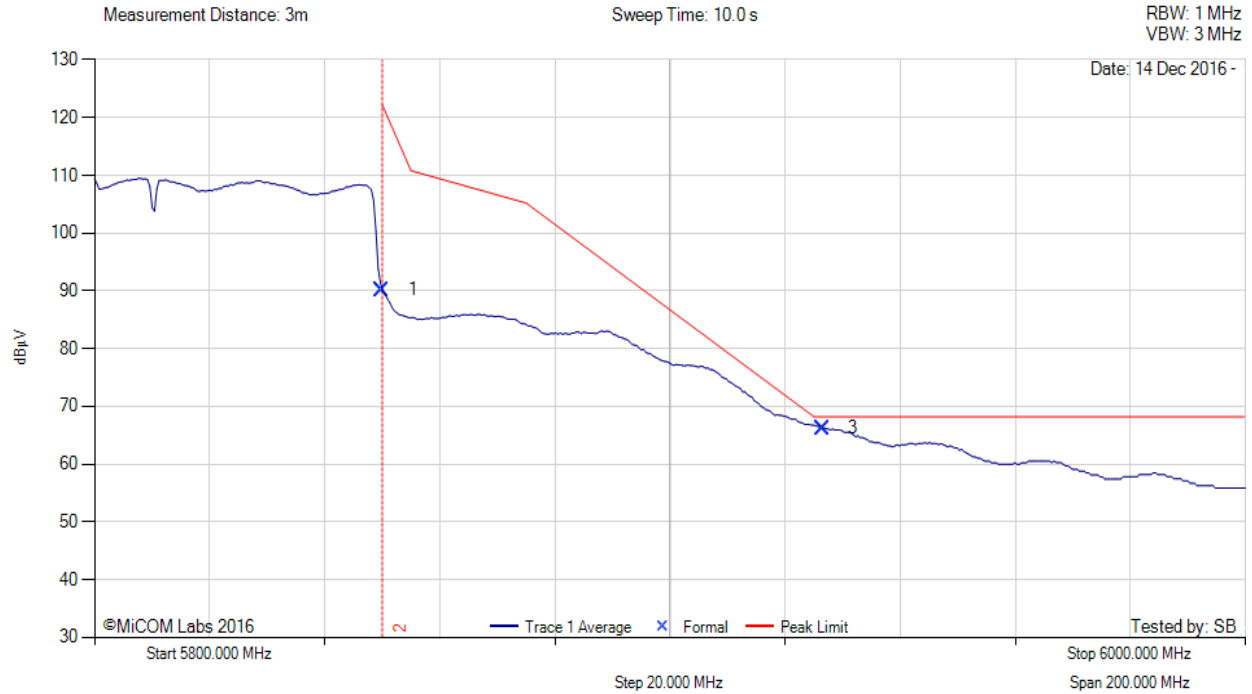

5800.00 - 6000.00 MHz												
Num	Frequency MHz	Raw dBµV	Cable Loss dB	AF dB	Level dBµV/m	Measurement Type	Pol	Hgt cm	Azt Deg	Limit dBµV/m	Margin dB	Pass /Fail
1	5850.00	51.71	3.81	34.63	90.15	Max Avg	Horizontal	155	362	122.2	-32.1	Pass
3	5926.53	27.56	3.83	34.83	66.22	Max Avg	Horizontal	155	362	68.2	-2.0	Pass
2	5850.00	--	--	--	--	Band-Edge	--	--	--	--	--	--

**Test Notes:** initial PS 23, final PS 23

[back to matrix](#)

This test report may be reproduced in full only. The document may only be updated by MiCOM Labs personnel. All changes will be noted in the Document History section of the report.

DRAFT



575 Boulder Court  
Pleasanton, California 94566, USA  
Tel: +1 (925) 462 0304  
Fax: +1 (925) 462 0306  
[www.micomlabs.com](http://www.micomlabs.com)