

Antenna Test Report

Report No.: E4/2015/40008
Test Plan: Non-compliance with ISO17025

Applicant Name: Darfon Electronics Corp.
Manufacturer Name: Darfon Electronic Corp

Product Name: INV_F_ANTENNA
Model Number: UH1B ANTENNA

Measurements performed at
SGS Taiwan Ltd.
Hwaya District, Taiwan

Issued Date: April 23, 2015

	Name	Date & Signature	Distribution
Prepared by:	Shawn Yen Sr. Engineer	<i>Shawn Yen</i> April 23, 2015	
Approved by:	Dragon Wu Asst. Manager	<i>Dragon Wu</i> April 23, 2015	

Unless otherwise stated the results shown in this test report refer only to the sample(s) tested and such sample(s) are retained for 90 days only.

除非另有說明，此報告結果僅對測試之樣品負責，同時此樣品僅保留90天。本報告未經本公司書面許可，不可部份複製。

This document is issued by the Company subject to its General Conditions of Service printed overleaf, available on request or accessible at www.sgs.com/terms_and_conditions.htm and, for electronic format documents, subject to Terms and Conditions for Electronic Documents at www.sgs.com/terms_e-document.htm. Attention is drawn to the limitation of liability, indemnification and jurisdiction issues defined therein. Any holder of this document is advised that information contained hereon reflects the Company's findings at the time of its intervention only and within the limits of Client's instructions, if any. The Company's sole responsibility is to its Client and this document does not exonerate parties to a transaction from exercising all their rights and obligations under the transaction documents. This document cannot be reproduced except in full, without prior written approval of the Company. Any unauthorized alteration, forgery or falsification of the content or appearance of this document is unlawful and offenders may be prosecuted to the fullest extent of the law.

Measurement System Information

General Information

Testing Condition:

- Temperature: $22 \pm 3^\circ\text{C}$
- Humidity: $< 80\%$

Measurement Facility:

- Measurement Chamber: Satimo 3D fully anechoic chamber and its measuring system (Stargate-24-L)
- Base Station Simulator: Anritsu MT8820C (or R&S CMU200)
- Network Analyzer: Agilent E5071C

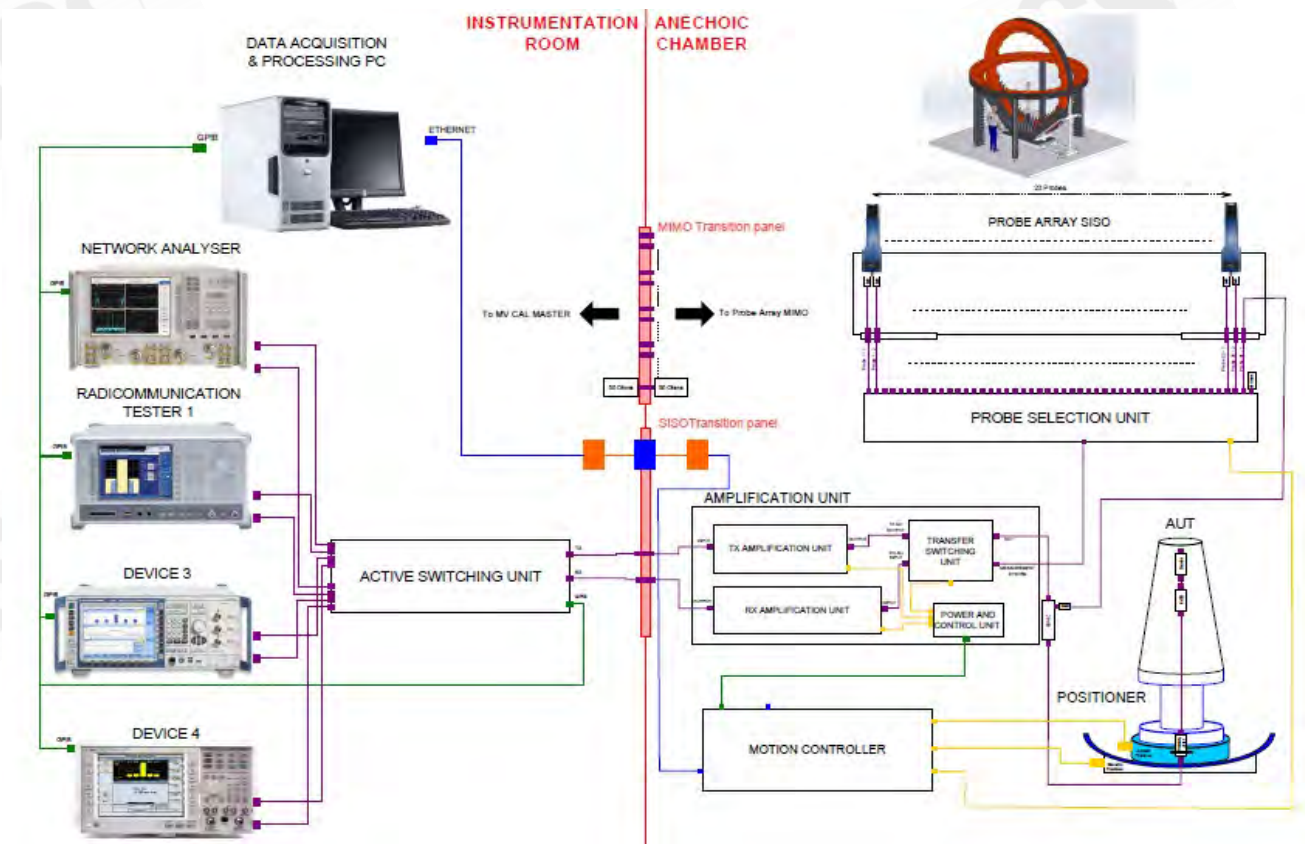

Unless otherwise stated the results shown in this test report refer only to the sample(s) tested and such sample(s) are retained for 90 days only.

除非另有說明，此報告結果僅對測試之樣品負責，同時此樣品僅保留90天。本報告未經本公司書面許可，不可部份複製。

This document is issued by the Company subject to its General Conditions of Service printed overleaf, available on request or accessible at www.sgs.com/terms_and_conditions.htm and, for electronic format documents, subject to Terms and Conditions for Electronic Documents at www.sgs.com/terms_e-document.htm. Attention is drawn to the limitation of liability, indemnification and jurisdiction issues defined therein. Any holder of this document is advised that information contained hereon reflects the Company's findings at the time of its intervention only and within the limits of Client's instructions, if any. The Company's sole responsibility is to its Client and this document does not exonerate parties to a transaction from exercising all their rights and obligations under the transaction documents. This document cannot be reproduced except in full, without prior written approval of the Company. Any unauthorized alteration, forgery or falsification of the content or appearance of this document is unlawful and offenders may be prosecuted to the fullest extent of the law.

Measurements are performed in a Satimo **Stargate-24-L** with the StarAct interface for a base station simulator. The **Stargate-24-L** has 23 probe antennas mounted with equal spacing on a circular arch. Electronic switching of the probe antennas provides outstanding measurement speed. The geometry of the setup, with only a Styrofoam column within 1.6 meters of the EUT, ensures minimum interference and low ripple on the measured radiation patterns. The DUT is placed on top of the pedestal, in the center of the system.

Typical Setup for Satimo Stargate-24-L:

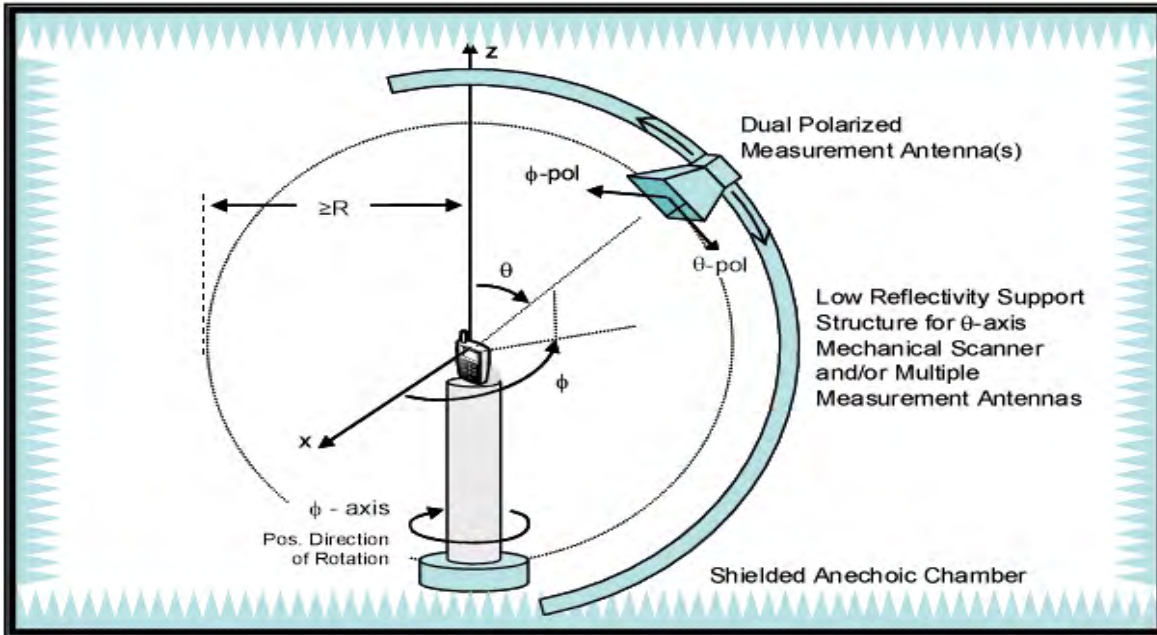

Instruments View

Inside View



Unless otherwise stated the results shown in this test report refer only to the sample(s) tested and such sample(s) are retained for 90 days only. 除非另有說明，此報告結果僅對測試之樣品負責，同時此樣品僅保留90天。本報告未經本公司書面許可，不可部份複製。

This document is issued by the Company subject to its General Conditions of Service printed overleaf, available on request or accessible at www.sgs.com/terms_and_conditions.htm and, for electronic format documents, subject to Terms and Conditions for Electronic Documents at www.sgs.com/terms_e-document.htm. Attention is drawn to the limitation of liability, indemnification and jurisdiction issues defined therein. Any holder of this document is advised that information contained hereon reflects the Company's findings at the time of its intervention only and within the limits of Client's instructions, if any. The Company's sole responsibility is to its Client and this document does not exonerate parties to a transaction from exercising all their rights and obligations under the transaction documents. This document cannot be reproduced except in full, without prior written approval of the Company. Any unauthorized alteration, forgery or falsification of the content or appearance of this document is unlawful and offenders may be prosecuted to the fullest extent of the law.

Testing Laboratory: Identification of the Responsible Test Laboratory.

- **OTA Laboratory:**
SGS Taiwan Ltd. Electronics & Communication Laboratory
 No.134, Wu Kung Road, New Taipei Industrial Park, Wuku District, New Taipei City, Taiwan 24803.
 Telephone: +886 2 2299 3279
 Fax: +886 2 2298 0488
 Internet: <http://www.tw.sgs.com>
- **Testing Location:**
 No. 2, Keji 1st Rd., Guishan Township, Hwaya District, Taoyuan County, Taiwan 33383.

Details of Applicant:

Applicant's name:	Darfon Electronics Corp.
Applicant's address:	167, Shanying Road, Gueishan, Taoyuan 33341, Taiwan, R.O.C.
Contact person:	Gianbi Chiang, Safety Engineer
Telephone:	03-250-8800#3588
Fax:	N/A
E-mail:	gianbi.chiang@darfon.com.tw

Details of Manufacturer:

Manufacturer's name:	Darfon Electronics Corp.
Manufacturer's address:	167, Shanying Road, Gueishan, Taoyuan 33341, Taiwan, R.O.C.
Contact person:	Gianbi Chiang, Safety Engineer
Telephone:	03-250-8800#3588
Fax:	N/A
E-mail:	gianbi.chiang@darfon.com.tw

Unless otherwise stated the results shown in this test report refer only to the sample(s) tested and such sample(s) are retained for 90 days only.

除非另有說明，此報告結果僅對測試之樣品負責，同時此樣品僅保留90天。本報告未經本公司書面許可，不可部份複製。

This document is issued by the Company subject to its General Conditions of Service printed overleaf, available on request or accessible at www.sgs.com/terms_and_conditions.htm and, for electronic format documents, subject to Terms and Conditions for Electronic Documents at www.sgs.com/terms_e-document.htm. Attention is drawn to the limitation of liability, indemnification and jurisdiction issues defined therein. Any holder of this document is advised that information contained hereon reflects the Company's findings at the time of its intervention only and within the limits of Client's instructions, if any. The Company's sole responsibility is to its Client and this document does not exonerate parties to a transaction from exercising all their rights and obligations under the transaction documents. This document cannot be reproduced except in full, without prior written approval of the Company. Any unauthorized alteration, forgery or falsification of the content or appearance of this document is unlawful and offenders may be prosecuted to the fullest extent of the law.

Details of EUT:

Device Description:	INV_F ANTENNA
Device Manufacturer:	Darfon Electronics Corp.
Device Model:	UH1B ANTENNA
Hardware Version:	N/A
Software Version:	N/A
IMEI:	N/A
FCC ID:	O62-UH1B
Frequency Range:	2400MHz ~ 2500MHz Step size: 10MHz
Antenna Type:	Internal antenna

Duration of Tests:

Sample Receive Date:	2015-04-20
Test Starting Date:	2015-04-20
Test Ending Date:	2015-04-20
Report Issued Date:	2015-04-23

Photographs of EUT:

Front View



Back View



Unless otherwise stated the results shown in this test report refer only to the sample(s) tested and such sample(s) are retained for 90 days only.

除非另有說明，此報告結果僅對測試之樣品負責，同時此樣品僅保留90天。本報告未經本公司書面許可，不可部份複製。

This document is issued by the Company subject to its General Conditions of Service printed overleaf, available on request or accessible at www.sgs.com/terms_and_conditions.htm and, for electronic format documents, subject to Terms and Conditions for Electronic Documents at www.sgs.com/terms_e-document.htm. Attention is drawn to the limitation of liability, indemnification and jurisdiction issues defined therein. Any holder of this document is advised that information contained hereon reflects the Company's findings at the time of its intervention only and within the limits of Client's instructions, if any. The Company's sole responsibility is to its Client and this document does not exonerate parties to a transaction from exercising all their rights and obligations under the transaction documents. This document cannot be reproduced except in full, without prior written approval of the Company. Any unauthorized alteration, forgery or falsification of the content or appearance of this document is unlawful and offenders may be prosecuted to the fullest extent of the law.

List of Equipment

Equipment Summary Sheet

Equipment Description	Manufacturer	Identification no.	Current calibration date	Next calibration date
Universal Radio Communication tester	Anritsu	MT8820C	2014/10/6	2015/10/6
Network Analyzer	Agilent	E5071C	2014/5/23	2015/5/23
Dual Ridge Horn	Satimo	SH600	2015/3/25	2016/3/25
Stargate-24-L probe array	Satimo	Stargate-24-L	2014/12/16	2015/12/16
Measurement software	Satimo	SPM V1.5	N/A	N/A

Unless otherwise stated the results shown in this test report refer only to the sample(s) tested and such sample(s) are retained for 90 days only.

除非另有說明，此報告結果僅對測試之樣品負責，同時此樣品僅保留90天。本報告未經本公司書面許可，不可部份複製。

This document is issued by the Company subject to its General Conditions of Service printed overleaf, available on request or accessible at www.sgs.com/terms_and_conditions.htm and, for electronic format documents, subject to Terms and Conditions for Electronic Documents at www.sgs.com/terms_e-document.htm. Attention is drawn to the limitation of liability, indemnification and jurisdiction issues defined therein. Any holder of this document is advised that information contained hereon reflects the Company's findings at the time of its intervention only and within the limits of Client's instructions, if any. The Company's sole responsibility is to its Client and this document does not exonerate parties to a transaction from exercising all their rights and obligations under the transaction documents. This document cannot be reproduced except in full, without prior written approval of the Company. Any unauthorized alteration, forgery or falsification of the content or appearance of this document is unlawful and offenders may be prosecuted to the fullest extent of the law.

Antenna Gain and Efficiency

UH1B ANTENNA			
Frequency	Peak. dBi	Efficiency	Average . dBi
2400000000	1.18	30.69%	-5.13
2410000000	1.05	30.06%	-5.22
2420000000	1.24	30.94%	-5.09
2430000000	1.27	30.85%	-5.11
2440000000	1.43	31.89%	-4.96
2450000000	1.39	31.31%	-5.04
2460000000	1.54	32.05%	-4.94
2470000000	1.21	30.96%	-5.09
2480000000	1.14	31.53%	-5.01
2490000000	0.96	30.49%	-5.16
2500000000	0.92	30.27%	-5.19

Test Setup

Free Space - Front View



Free Space - Side View



Unless otherwise stated the results shown in this test report refer only to the sample(s) tested and such sample(s) are retained for 90 days only.

除非另有說明，此報告結果僅對測試之樣品負責，同時此樣品僅保留90天。本報告未經本公司書面許可，不可部份複製。

This document is issued by the Company subject to its General Conditions of Service printed overleaf, available on request or accessible at www.sgs.com/terms_and_conditions.htm and, for electronic format documents, subject to Terms and Conditions for Electronic Documents at www.sgs.com/terms_e-document.htm. Attention is drawn to the limitation of liability, indemnification and jurisdiction issues defined therein. Any holder of this document is advised that information contained hereon reflects the Company's findings at the time of its intervention only and within the limits of Client's instructions, if any. The Company's sole responsibility is to its Client and this document does not exonerate parties to a transaction from exercising all their rights and obligations under the transaction documents. This document cannot be reproduced except in full, without prior written approval of the Company. Any unauthorized alteration, forgery or falsification of the content or appearance of this document is unlawful and offenders may be prosecuted to the fullest extent of the law.

Antenna 3D Plot Matrix

All plots in this section show the total EIRP ($EIRP_{\theta} + EIRP_{\phi}$) with the +x-axis pointing out of the page, +y-axis pointing right, and +z-axis pointing up.

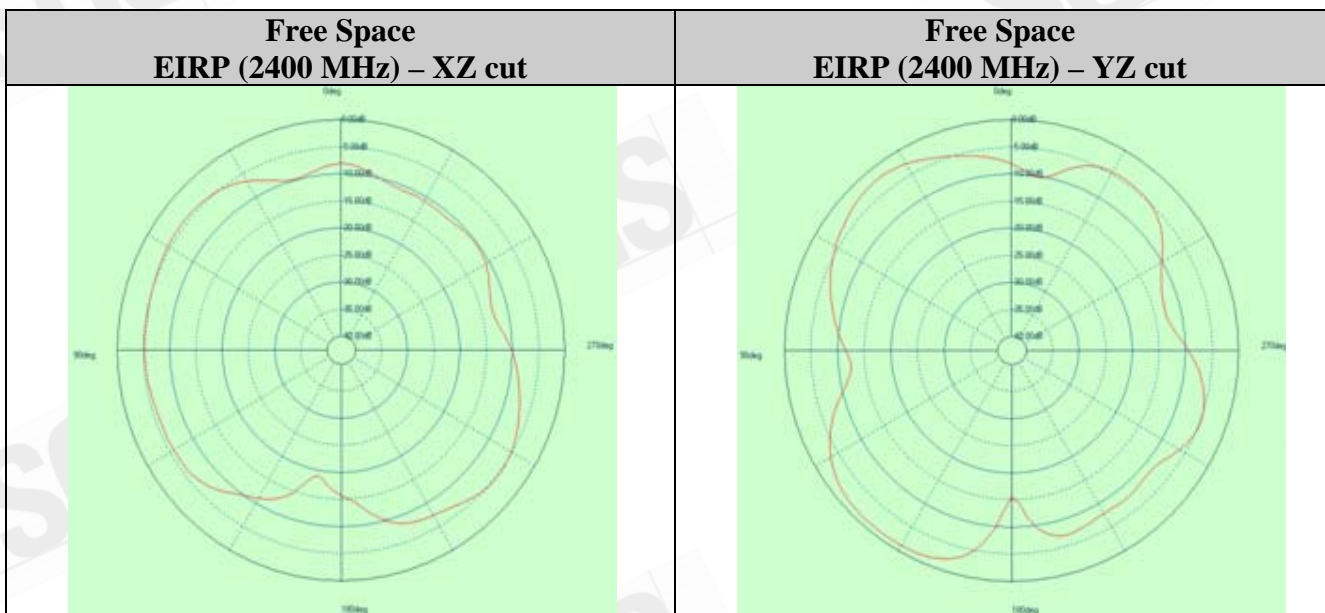
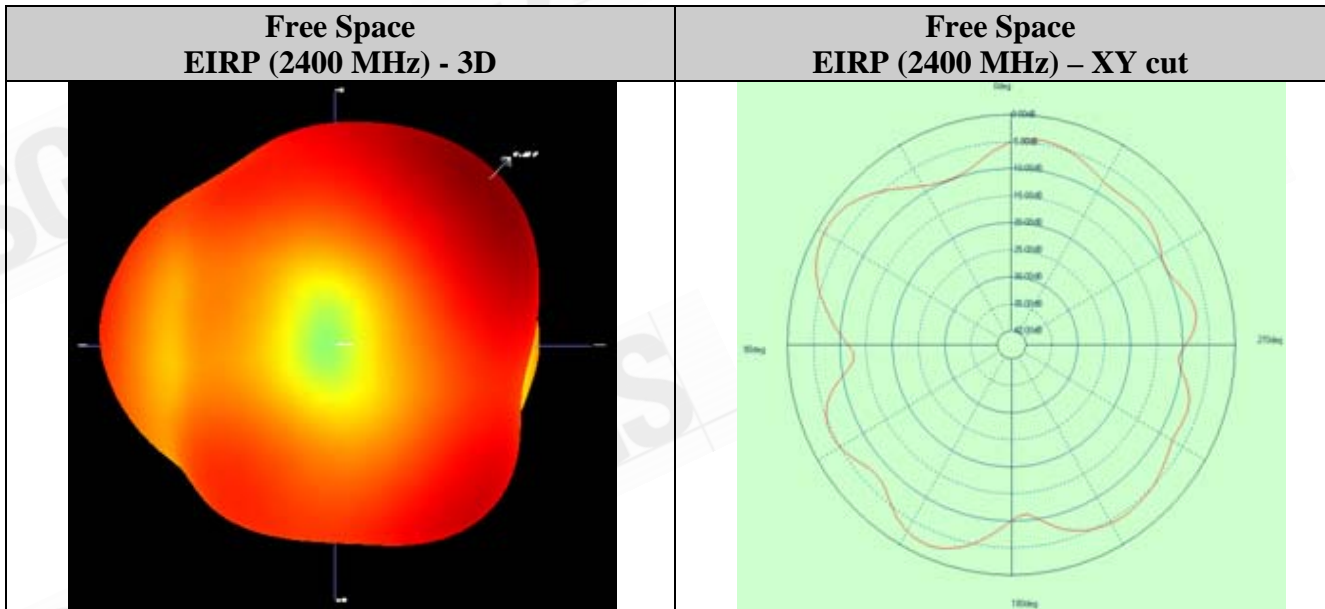

Unless otherwise stated the results shown in this test report refer only to the sample(s) tested and such sample(s) are retained for 90 days only.

除非另有說明，此報告結果僅對測試之樣品負責，同時此樣品僅保留90天。本報告未經本公司書面許可，不可部份複製。

This document is issued by the Company subject to its General Conditions of Service printed overleaf, available on request or accessible at www.sgs.com/terms_and_conditions.htm and, for electronic format documents, subject to Terms and Conditions for Electronic Documents at www.sgs.com/terms_e-document.htm. Attention is drawn to the limitation of liability, indemnification and jurisdiction issues defined therein. Any holder of this document is advised that information contained hereon reflects the Company's findings at the time of its intervention only and within the limits of Client's instructions, if any. The Company's sole responsibility is to its Client and this document does not exonerate parties to a transaction from exercising all their rights and obligations under the transaction documents. This document cannot be reproduced except in full, without prior written approval of the Company. Any unauthorized alteration, forgery or falsification of the content or appearance of this document is unlawful and offenders may be prosecuted to the fullest extent of the law.

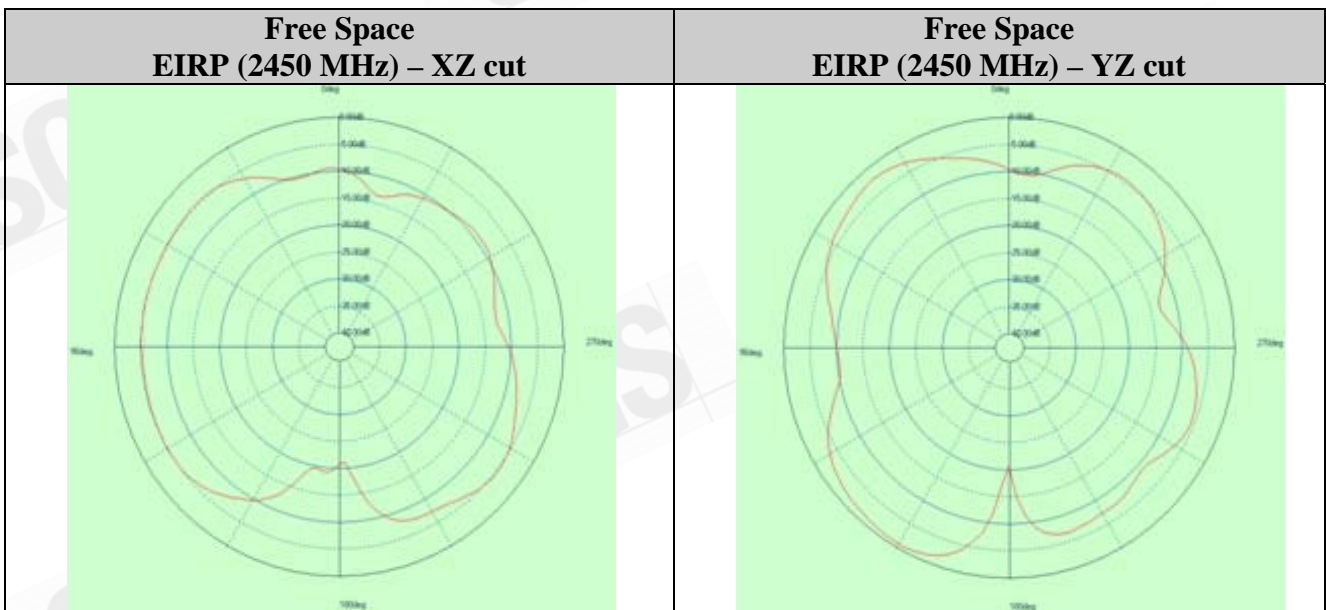
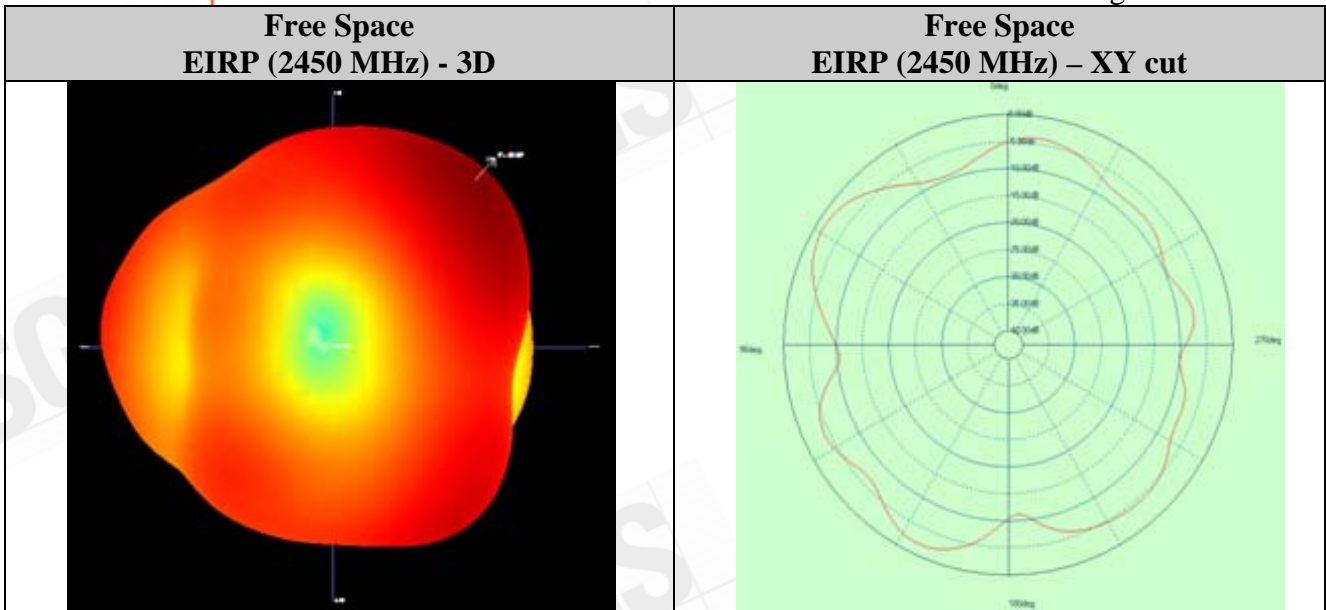

Unless otherwise stated the results shown in this test report refer only to the sample(s) tested and such sample(s) are retained for 90 days only.

除非另有說明，此報告結果僅對測試之樣品負責，同時此樣品僅保留90天。本報告未經本公司書面許可，不可部份複製。

This document is issued by the Company subject to its General Conditions of Service printed overleaf, available on request or accessible at www.sgs.com/terms_and_conditions.htm and, for electronic format documents, subject to Terms and Conditions for Electronic Documents at www.sgs.com/terms_e-document.htm. Attention is drawn to the limitation of liability, indemnification and jurisdiction issues defined therein. Any holder of this document is advised that information contained hereon reflects the Company's findings at the time of its intervention only and within the limits of Client's instructions, if any. The Company's sole responsibility is to its Client and this document does not exonerate parties to a transaction from exercising all their rights and obligations under the transaction documents. This document cannot be reproduced except in full, without prior written approval of the Company. Any unauthorized alteration, forgery or falsification of the content or appearance of this document is unlawful and offenders may be prosecuted to the fullest extent of the law.

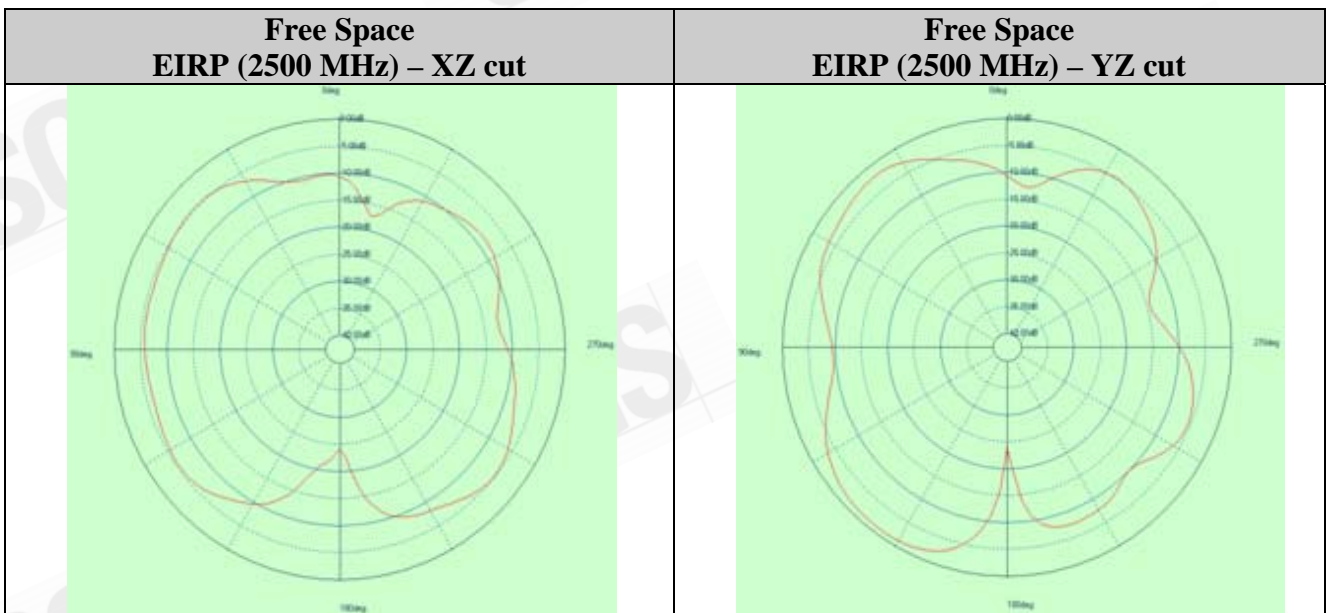
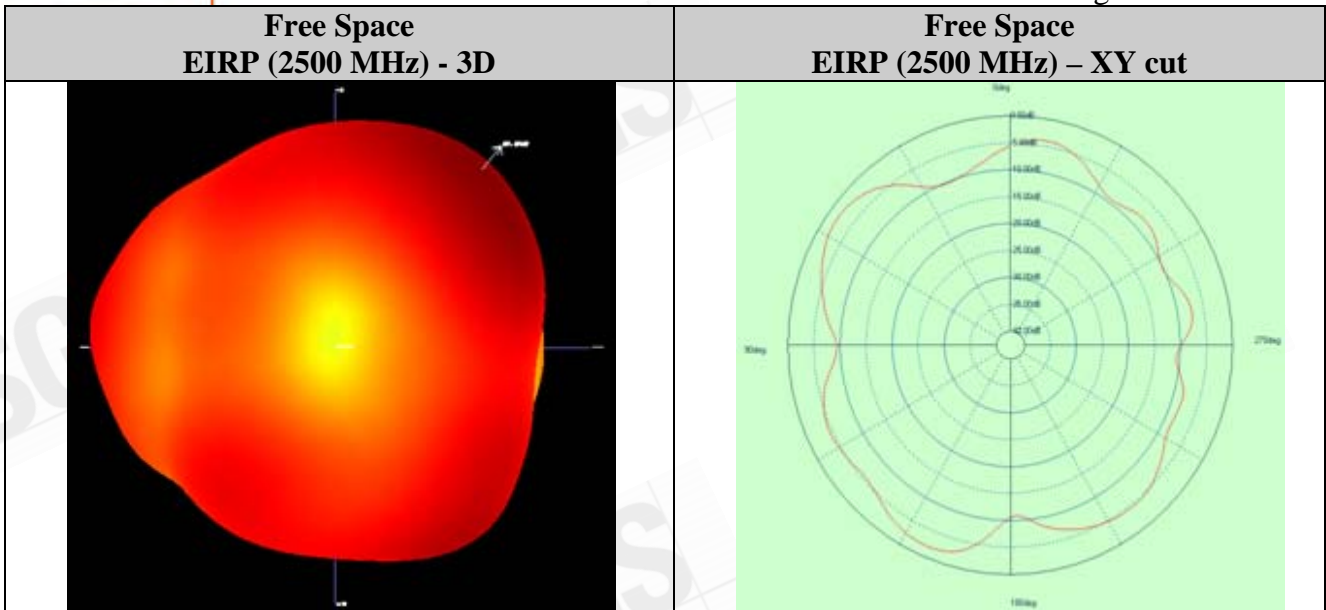

End of Report

Unless otherwise stated the results shown in this test report refer only to the sample(s) tested and such sample(s) are retained for 90 days only.

除非另有說明，此報告結果僅對測試之樣品負責，同時此樣品僅保留90天。本報告未經本公司書面許可，不可部份複製。

This document is issued by the Company subject to its General Conditions of Service printed overleaf, available on request or accessible at www.sgs.com/terms_and_conditions.htm and, for electronic format documents, subject to Terms and Conditions for Electronic Documents at www.sgs.com/terms_e-document.htm. Attention is drawn to the limitation of liability, indemnification and jurisdiction issues defined therein. Any holder of this document is advised that information contained hereon reflects the Company's findings at the time of its intervention only and within the limits of Client's instructions, if any. The Company's sole responsibility is to its Client and this document does not exonerate parties to a transaction from exercising all their rights and obligations under the transaction documents. This document cannot be reproduced except in full, without prior written approval of the Company. Any unauthorized alteration, forgery or falsification of the content or appearance of this document is unlawful and offenders may be prosecuted to the fullest extent of the law.