



# FCC TEST REPORT

**REPORT NO.:** RF941115L10D

**MODEL NO.:** PHL-7200 (refer to page 9 for other models)

**RECEIVED:** Aug. 28, 2006

**TESTED:** Aug. 31 ~ Sep. 13, 2006

**ISSUED:** Nov. 13, 2006

**APPLICANT:** Opticon Sensors Europe B.V.

**ADDRESS:** Opaallaan 35, 2132 XV Hoofddorp, The  
Netherlands

**ISSUED BY:** Advance Data Technology Corporation

**LAB ADDRESS:** No. 47, 14<sup>th</sup> Ling, Chia Pau Tsuen, Lin Kou  
Hsiang 244, Taipei Hsien, Taiwan, R.O.C.

**TEST LOCATION:** No. 19, Hwa Ya 2<sup>nd</sup> Rd., Wen Hwa Tsuen, Kwei  
Shan Hsiang, Taoyuan Hsien 333, Taiwan,  
R.O.C.

This test report consists of 96 pages in total. It may be duplicated completely for legal use with the approval of the applicant. It should not be reproduced except in full, without the written approval of our laboratory. The client should not use it to claim product endorsement by CNLA, A2LA or any government agencies. The test results in the report only apply to the tested sample.



## Table of Contents

1.	CERTIFICATION .....	5
2.	SUMMARY OF TEST RESULTS .....	6
2.1	MEASUREMENT UNCERTAINTY .....	7
3.	GENERAL INFORMATION .....	8
3.1	GENERAL DESCRIPTION OF EUT .....	8
3.2	DESCRIPTION OF TEST MODES .....	10
3.2.1	CONFIGURATION OF SYSTEM UNDER TEST .....	11
3.2.2	TEST MODE APPLICABILITY AND TESTED CHANNEL DETAIL .....	12
3.3	GENERAL DESCRIPTION OF APPLIED STANDARDS .....	16
3.4	DESCRIPTION OF SUPPORT UNITS .....	16
4.	TEST TYPES AND RESULTS (FOR WIRELESS LAN FUNCTION) .....	17
4.1	CONDUCTED EMISSION MEASUREMENT .....	17
4.1.1	LIMITS OF CONDUCTED EMISSION MEASUREMENT .....	17
4.1.2	TEST INSTRUMENTS .....	17
4.1.3	TEST PROCEDURES .....	18
4.1.4	DEVIATION FROM TEST STANDARD .....	18
4.1.5	TEST SETUP .....	19
4.1.6	EUT OPERATING CONDITIONS .....	19
4.1.7	TEST RESULTS .....	20
4.2	RADIATED EMISSION MEASUREMENT .....	26
4.2.1	LIMITS OF RADIATED EMISSION MEASUREMENT .....	26
4.2.2	TEST INSTRUMENTS .....	27
4.2.3	TEST PROCEDURES .....	28
4.2.4	DEVIATION FROM TEST STANDARD .....	28
4.2.5	TEST SETUP .....	29
4.2.6	EUT OPERATING CONDITIONS .....	29
4.2.7	TEST RESULTS .....	30
4.3	6dB BANDWIDTH MEASUREMENT .....	34
4.3.1	LIMITS OF 6dB BANDWIDTH MEASUREMENT .....	34
4.3.2	TEST INSTRUMENTS .....	34
4.3.3	TEST PROCEDURE .....	35
4.3.4	DEVIATION FROM TEST STANDARD .....	35
4.3.5	TEST SETUP .....	35
4.3.6	EUT OPERATING CONDITIONS .....	35
4.3.7	TEST RESULTS .....	36
4.4	MAXIMUM PEAK OUTPUT POWER .....	39
4.4.1	LIMITS OF MAXIMUM PEAK OUTPUT POWER MEASUREMENT .....	39
4.4.2	INSTRUMENTS .....	39
4.4.1	TEST PROCEDURES .....	40
4.4.2	DEVIATION FROM TEST STANDARD .....	40
4.4.3	TEST SETUP .....	40
4.4.4	EUT OPERATING CONDITIONS .....	40
4.4.3	TEST RESULTS .....	41
4.5	POWER SPECTRAL DENSITY MEASUREMENT .....	42
4.5.1	LIMITS OF POWER SPECTRAL DENSITY MEASUREMENT .....	42
4.5.2	TEST INSTRUMENTS .....	42
4.5.3	TEST PROCEDURE .....	43



4.5.4	DEVIATION FROM TEST STANDARD .....	43
4.5.5	TEST SETUP .....	43
4.5.6	EUT OPERATING CONDITION .....	43
4.5.7	TEST RESULTS .....	44
4.6	BAND EDGES MEASUREMENT .....	47
4.6.1	LIMITS OF BAND EDGES MEASUREMENT .....	47
4.6.2	TEST INSTRUMENTS .....	47
4.6.3	TEST PROCEDURE .....	47
4.6.4	DEVIATION FROM TEST STANDARD .....	47
4.6.5	EUT OPERATING CONDITION .....	47
4.6.6	TEST RESULTS .....	48
4.7	ANTENNA REQUIREMENT .....	52
4.7.1	STANDARD APPLICABLE .....	52
4.7.2	ANTENNA CONNECTED CONSTRUCTION .....	52
5.	TEST TYPES AND RESULTS (FOR BLUETOOTH FUNCTION) .....	53
5.1	CONDUCTED EMISSION MEASUREMENT .....	53
5.1.1	LIMITS OF CONDUCTED EMISSION MEASUREMENT .....	53
5.1.2	TEST INSTRUMENTS .....	53
5.1.3	TEST PROCEDURES .....	54
5.1.4	DEVIATION FROM TEST STANDARD .....	54
5.1.5	TEST SETUP .....	55
5.1.6	EUT OPERATING CONDITIONS .....	55
5.1.7	TEST RESULTS .....	56
5.2	RADIATED EMISSION MEASUREMENT .....	62
5.2.1	LIMITS OF RADIATED EMISSION MEASUREMENT .....	62
5.2.2	TEST INSTRUMENTS .....	63
5.2.3	TEST PROCEDURES .....	64
5.2.4	DEVIATION FROM TEST STANDARD .....	64
5.2.5	TEST SETUP .....	65
5.2.6	EUT OPERATING CONDITIONS .....	65
5.2.7	TEST RESULTS .....	66
5.3	NUMBER OF HOPPING FREQUENCY USED .....	70
5.3.1	LIMIT OF HOPPING FREQUENCY USED .....	70
5.3.2	TEST INSTRUMENTS .....	70
5.3.3	TEST PROCEDURES .....	70
5.3.4	DEVIATION FROM TEST STANDARD .....	71
5.3.5	TEST SETUP .....	71
5.3.6	TEST RESULTS .....	71
5.4	DWELL TIME ON EACH CHANNEL .....	73
5.4.1	LIMIT OF DWELL TIME USED .....	73
5.4.2	TEST INSTRUMENTS .....	73
5.4.3	TEST PROCEDURES .....	73
5.4.4	DEVIATION FROM TEST STANDARD .....	73
5.4.4	TEST SETUP .....	74
5.4.5	TEST RESULTS .....	74
5.5	CHANNEL BANDWIDTH .....	78
5.5.1	LIMITS OF CHANNEL BANDWIDTH .....	78
5.5.2	TEST INSTRUMENTS .....	78
5.5.3	TEST PROCEDURE .....	78
5.5.4	DEVIATION FROM TEST STANDARD .....	78



5.5.5	TEST SETUP .....	79
5.5.6	EUT OPERATING CONDITION.....	79
5.5.7	TEST RESULTS .....	79
5.6	HOPPING CHANNEL SEPARATION.....	82
5.6.1	LIMIT OF HOPPING CHANNEL SEPARATION .....	82
5.6.2	TEST INSTRUMENTS.....	82
5.6.3	TEST PROCEDURES .....	82
5.6.4	DEVIATION FROM TEST STANDARD .....	82
5.6.5	TEST SETUP .....	83
5.6.6	TEST RESULTS .....	83
5.7	MAXIMUM PEAK OUTPUT POWER.....	86
5.7.1	LIMITS OF MAXIMUM PEAK OUTPUT POWER MEASUREMENT .....	86
5.7.2	TEST INSTRUMENTS.....	86
5.7.3	TEST PROCEDURES .....	86
5.7.4	DEVIATION FROM TEST STANDARD .....	86
5.7.5	TEST SETUP .....	87
5.7.6	EUT OPERATING CONDITION.....	87
5.7.7	TEST RESULTS .....	87
5.8	BAND EDGES MEASUREMENT.....	90
5.8.1	LIMITS OF BAND EDGES MEASUREMENT.....	90
5.8.2	TEST INSTRUMENTS.....	90
5.8.3	TEST PROCEDURE.....	90
5.8.4	DEVIATION FROM TEST STANDARD .....	90
5.8.5	EUT OPERATING CONDITION .....	90
5.8.6	TEST RESULTS .....	91
5.9	ANTENNA REQUIREMENT .....	94
5.9.1	STANDARD APPLICABLE.....	94
5.9.2	ANTENNA CONNECTED CONSTRUCTION.....	94
6.	INFORMATION ON THE TESTING LABORATORIES .....	95
APPENDIX-A	.....	A-1



# 1. CERTIFICATION

**PRODUCT:** Portable Data Terminal  
**MODEL:** PHL-7200 (refer to page 9 for other models)  
**BRAND:** OPTICON  
**APPLICANT:** Opticon Sensors Europe B.V.  
**TESTED:** Aug. 31 ~ Sep. 13, 2006  
**TEST SAMPLE:** ENGINEERING SAMPLE  
**STANDARDS:** **FCC Part 15, Subpart C (Section 15.247),  
ANSI C63.4-2003**

The above equipment have been tested by **Advance Data Technology Corporation**, and found compliance with the requirement of the above standards. The test record, data evaluation & Equipment Under Test (EUT) configurations represented herein are true and accurate accounts of the measurements of the sample's EMC characteristics under the conditions specified in this report.

**PREPARED BY** : Wendy Liao , **DATE:** Nov. 13, 2006  
(Wendy Liao)

**TECHNICAL ACCEPTANCE** : Long Chen , **DATE:** Nov. 13, 2006  
Responsible for RF (Long Chen)

**APPROVED BY** : Gary Chang , **DATE:** Nov. 13, 2006  
(Gary Chang / Supervisor)

## 2. SUMMARY OF TEST RESULTS

The EUT has been tested according to the following specifications:

### FOR WIRELESS LAN FUNCTION:

APPLIED STANDARD: FCC Part 15, Subpart C			
Standard Section	Test Type and Limit	Result	Remark
15.207	AC Power Conducted Emission	PASS	Meet the requirement of limit. Minimum passing margin is -1.24dB at 0.513MHz
15.247(a)(2)	Spectrum Bandwidth of a Direct Sequence Spread Spectrum System Limit: min. 500kHz	PASS	Meet the requirement of limit.
15.247(b)	Maximum Peak Output Power Limit: max. 30dBm	PASS	Meet the requirement of limit.
15.247(d)	Radiated Emissions Limit: Table 15.209	PASS	Meet the requirement of limit. Minimum passing margin is -2.28dB at 2483.50MHz
15.247(e)	Power Spectral Density Limit: max. 8dBm	PASS	Meet the requirement of limit.
15.247(d)	Band Edge Measurement Limit: 20dB less than the peak value of fundamental frequency	PASS	Meet the requirement of limit.

**FOR BLUETOOTH FUNCTION:**

<b>APPLIED STANDARD: FCC Part 15, Subpart C</b>			
<b>STANDARD SECTION</b>	<b>TEST TYPE AND LIMIT</b>	<b>RESULT</b>	<b>REMARK</b>
15.207	AC Power Conducted Emission	PASS	Meet the requirement of limit Minimum passing margin is -1.58dB at 0.580MHz.
15.247(a)(1)(iii)	Number of Hopping Frequency Used Spec.: At least 15 channels	PASS	Meet the requirement of limit
15.247(a)(1)(iii)	Dwell Time on Each Channel Spec. : Max. 0.4 second within 31.6 second	PASS	Meet the requirement of limit
15.247(a)(1)	1. Hopping Channel Separation Spec. : Min. 25 kHz or 20 dB bandwidth, whichever is greater 2. Spectrum Bandwidth of a Frequency Hopping Sequence Spread Spectrum System	PASS	Meet the requirement of limit
15.247(b)	Maximum Peak Output Power Spec.: max. 30dBm	PASS	Meet the requirement of limit
15.247(d)	Transmitter Radiated Emissions Spec.: Table 15.209	PASS	Meet the requirement of limit Minimum passing margin is -4.53 dB at 191.34MHz.
15.247(d)	Band Edge Measurement	PASS	Meet the requirement of limit

**NOTE:** If The Frequency Hopping System operating in 2400-2483.5MHz band and the output power less than 125mW. The hopping channel carrier frequencies separated by a minimum of 25kHz or two-thirds of the 20dB bandwidth of hopping channel whichever is greater.

## 2.1 MEASUREMENT UNCERTAINTY

Where relevant, the following measurement uncertainty levels have been estimated for tests performed on the EUT as specified in CISPR 16-4:

<b>Measurement</b>	<b>Frequency</b>	<b>Uncertainty</b>
Conducted emissions	9kHz~30MHz	2.44 dB
Radiated emissions	30MHz ~ 200MHz	3.64 dB
	200MHz ~ 1000MHz	3.65 dB
	1GHz ~ 18GHz	2.26 dB
	18GHz ~ 40GHz	1.94 dB

This uncertainty represents an expanded uncertainty expressed at approximately the 95% confidence level using a coverage factor of k=2.

### 3. GENERAL INFORMATION

#### 3.1 GENERAL DESCRIPTION OF EUT

<b>EUT</b>	Portable Data Terminal
<b>MODEL NO.</b>	PHL-7200 (refer to Note 2 for other models)
<b>FCC ID</b>	Q2Q-PHL7200-BW
<b>POWER SUPPLY</b>	3.70Vdc from rechargeable lithium battery 5.00Vdc from power adapter
<b>MODULATION TYPE</b>	Wireless LAN: CCK, DQPSK, DBPSK for DSSS Bluetooth: GFSK for FHSS
<b>RADIO TECHNOLOGY</b>	DSSS, FHSS
<b>TRANSFER RATE</b>	Wireless LAN: 11/5.5/2/1Mbps Bluetooth: 723Kbps
<b>FREQUENCY RANGE</b>	Wireless LAN: 2412MHz ~ 2462MHz Bluetooth: 2.402 ~ 2.480GHz
<b>NUMBER OF CHANNEL</b>	Wireless LAN: 11 Bluetooth: 79
<b>OUTPUT POWER</b>	Wireless LAN: 20.324mW Bluetooth: 0.270mW
<b>ANTENNA TYPE</b>	Wireless LAN: PIFA antenna with -0.48dBi gain Bluetooth: PIFA antenna with -1.74dBi gain
<b>DATA CABLE</b>	1.9 m shielded USB cable with one core 1.2m non-shielded earphone cable
<b>I/O PORTS</b>	USB
<b>ASSOCIATED DEVICES</b>	NA



**NOTE:**

1. This report is issued as a duplicated report of ADT report no. RF941115L10B except for its different model, brand name and applicant.
2. The models as below are identical to each other except for the model names due to marketing requirement.

Brand name	Model name	Remark
OPTICON	PHL-7200	For marking different
OPTICON	PHL-7212	For marking different
OPTICON	PHL-7214	For marking different
OPTICON	PHL-7252	For marking different
OPTICON	PHL-7254	For marking different

3. The EUT is a Portable Data Terminal with Wireless LAN and Bluetooth functions.
4. The EUT operates in the 2.4GHz frequency spectrum with throughput of up to 11Mbps.
5. The EUT have lithium battery listed as below:

<b>STANDARD BATTERY:</b>	
<b>MODEL:</b>	BP05-000500
<b>RATING:</b>	3.7Vdc, 3000mAh

6. The EUT is powered by the following adapter.

<b>BRAND:</b>	ENG
<b>MODEL:</b>	3A-161DN05
<b>INPUT:</b>	100-240Vac ~ 50-60Hz, 0.6A,
<b>OUTPUT:</b>	5Vdc, 2.6A
<b>POWER LINE:</b>	DC 1.8m non-shielded cable with one core AC 16.m non-shielded cable without core

7. The above EUT information was declared by manufacturer and for more detailed features description, please refer to the manufacturer's specifications or User's Manual.

### 3.2 DESCRIPTION OF TEST MODES

#### WLAN FUNCTION:

11 channels are provided to the EUT:

CHANNEL	FREQUENCY	CHANNEL	FREQUENCY
1	2412 MHz	7	2442 MHz
2	2417 MHz	8	2447 MHz
3	2422 MHz	9	2452 MHz
4	2427 MHz	10	2457 MHz
5	2432 MHz	11	2462 MHz
6	2437 MHz		

#### Bluetooth Function:

79 channels are provided to this EUT:

CHANNEL	FREQ. (MHz)	CHANNEL	FREQ. (MHz)	CHANNEL	FREQ. (MHz)	CHANNEL	FREQ. (MHz)
0	2402	20	2422	40	2442	60	2462
1	2403	21	2423	41	2443	61	2463
2	2404	22	2424	42	2444	62	2464
3	2405	23	2425	43	2445	63	2465
4	2406	24	2426	44	2446	64	2466
5	2407	25	2427	45	2447	65	2467
6	2408	26	2428	46	2448	66	2468
7	2409	27	2429	47	2449	67	2469
8	2410	28	2430	48	2450	68	2470
9	2411	29	2431	49	2451	69	2471
10	2412	30	2431	50	2452	70	2472
11	2413	31	2433	51	2453	71	2473
12	2414	32	2434	52	2454	72	2474
13	2415	33	2435	53	2455	73	2475
14	2416	34	2436	54	2456	74	2476
15	2417	35	2437	55	2457	75	2477
16	2418	36	2438	56	2458	76	2478
17	2419	37	2439	57	2459	77	2479
18	2420	38	2440	58	2460	78	2480
19	2421	39	2441	59	2461		

### 3.2.1 CONFIGURATION OF SYSTEM UNDER TEST

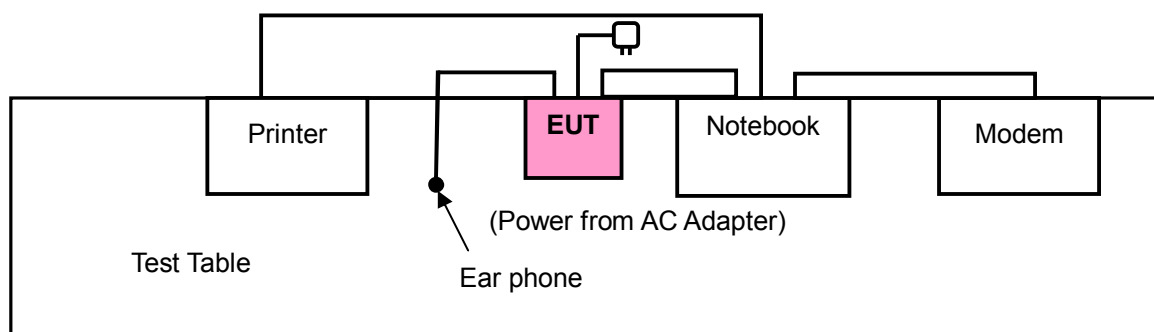

### 3.2.2 TEST MODE APPLICABILITY AND TESTED CHANNEL DETAIL

#### FOR WIRELESS LAN FUNCTION:

EUT CONFIGURE MODE	APPLICABLE TO				DESCRIPTION
	PLC	RE<1G	RE≥1G	APCM	
-	√	√	√	√	-

Where **PLC**: Power Line Conducted Emission      **RE<1G**: Radiated Emission below 1GHz  
**RE≥1G**: Radiated Emission above 1GHz      **APCM**: Antenna Port Conducted Measurement

#### Power Line Conducted Emission Test:

- Pre-Scan has been conducted to determine the worst-case mode from all possible combinations between available modulations, data rates and antenna ports (if EUT with antenna diversity architecture).
- Following channel(s) was (were) selected for the final test as listed below.

MODE	AVAILABLE CHANNEL	TESTED CHANNEL	MODULATION TECHNOLOGY	MODULATION TYPE	DATA RATE (Mbps)
802.11b	1 to 11	1, 6, 11	DSSS	DBPSK	1

#### Radiated Emission Test (Below 1 GHz):

- Pre-Scan has been conducted to determine the worst-case mode from all possible combinations between available modulations, data rates, antenna ports (if EUT with antenna diversity architecture), X, Y, Z Axis, and packet type.
- Following channel(s) was (were) selected for the final test as listed below.

MODE	AVAILABLE CHANNEL	TESTED CHANNEL	MODULATION TECHNOLOGY	MODULATION TYPE	DATA RATE (Mbps)	AXIS
802.11b	1 to 11	1, 6, 11	DSSS	DBPSK	1	Z

#### Radiated Emission Test (Above 1 GHz):

- Pre-Scan has been conducted to determine the worst-case mode from all possible combinations between available modulations, data rates, antenna ports (if EUT with antenna diversity architecture), X, Y, Z Axis, and packet type.
- Following channel(s) was (were) selected for the final test as listed below.

MODE	AVAILABLE CHANNEL	TESTED CHANNEL	MODULATION TECHNOLOGY	MODULATION TYPE	DATA RATE (Mbps)	AXIS
802.11b	1 to 11	1, 6, 11	DSSS	DBPSK	1	Z

#### Bandedge Measurement:

- Pre-Scan has been conducted to determine the worst-case mode from all possible combinations between available modulations, data rates and antenna ports (if EUT with antenna diversity architecture).
- Following channel(s) was (were) selected for the final test as listed below.

MODE	AVAILABLE CHANNEL	TESTED CHANNEL	MODULATION TECHNOLOGY	MODULATION TYPE	DATA RATE (Mbps)
802.11b	1 to 11	1, 11	DSSS	DBPSK	1

**Antenna Port Conducted Measurement:**

- Pre-Scan has been conducted to determine the worst-case mode from all possible combinations between available modulations, data rates and antenna ports (if EUT with antenna diversity architecture).
- Following channel(s) was (were) selected for the final test as listed below.

MODE	AVAILABLE CHANNEL	TESTED CHANNEL	MODULATION TECHNOLOGY	MODULATION TYPE	DATA RATE (Mbps)
802.11b	1 to 11	1, 6, 11	DSSS	DBPSK	1

**FOR BLUETOOTH FUNCTION:**

EUT CONFIGURE MODE	APPLICABLE TO				DESCRIPTION
	PLC	RE<1G	RE≥1G	APCM	
-	√	√	√	√	-

Where **PLC:** Power Line Conducted Emission      **RE<1G RE:** Radiated Emission below 1GHz  
**RE≥1G:** Radiated Emission above 1GHz      **APCM:** Antenna Port Conducted Measurement

**POWER LINE CONDUCTED EMISSION TEST:**

- Pre-Scan has been conducted to determine the worst-case mode from all possible combinations between available modulations, antenna ports (if EUT with antenna diversity architecture), and packet types.
- Following channel(s) was (were) selected for the final test as listed below.

AVAILABLE CHANNEL	TESTED CHANNEL	MODULATION TECHNOLOGY	MODULATION TYPE	PACKET TYPE
0 to 78	0, 39, 78	FHSS	GFSK	DH5

**RADIATED EMISSION TEST (BELOW 1 GHz):**

- Pre-Scan has been conducted to determine the worst-case mode from all possible combinations between available modulations, data rates, antenna ports (if EUT with antenna diversity architecture), X, Y, Z Axis, and packet type.
- Following channel(s) was (were) selected for the final test as listed below.

AVAILABLE CHANNEL	TESTED CHANNEL	MODULATION TECHNOLOGY	MODULATION TYPE	PACKET TYPE	AXIS
0 to 78	78	FHSS	GFSK	DH5	X

**RADIATED EMISSION TEST (ABOVE 1 GHz):**

- Pre-Scan has been conducted to determine the worst-case mode from all possible combinations between available modulations, data rates, antenna ports (if EUT with antenna diversity architecture), X, Y, Z Axis, and packet type.
- Following channel(s) was (were) selected for the final test as listed below.

AVAILABLE CHANNEL	TESTED CHANNEL	MODULATION TECHNOLOGY	MODULATION TYPE	PACKET TYPE	AXIS
0 to 78	0, 39, 78	FHSS	GFSK	DH5	X

**BANDEDGE MEASUREMENT:**

- Pre-Scan has been conducted to determine the worst-case mode from all possible combinations between available modulations, antenna ports (if EUT with antenna diversity architecture), and packet types.
- Following channel(s) was (were) selected for the final test as listed below.

AVAILABLE CHANNEL	TESTED CHANNEL	MODULATION TECHNOLOGY	MODULATION TYPE	PACKET TYPE
0 to 78	0, 78	FHSS	GFSK	DH5

**ANTENNA PORT CONDUCTED MEASUREMENT:**

- Pre-Scan has been conducted to determine the worst-case mode from all possible combinations between available modulations, antenna ports (if EUT with antenna diversity architecture), and packet types.
- Following channel(s) was (were) selected for the final test as listed below.

AVAILABLE CHANNEL	TESTED CHANNEL	MODULATION TECHNOLOGY	MODULATION TYPE	PACKET TYPE
0 to 78	0, 39, 78	FHSS	GFSK	DH5

### 3.3 GENERAL DESCRIPTION OF APPLIED STANDARDS

The EUT is a RF product. According to the specifications of the manufacturer, it must comply with the requirements of the following standards:

**FCC Part 15, Subpart C. (15.247)**

**ANSI C63.4- 2003**

All test items have been performed and recorded as per the above standards.

**NOTE:** The EUT is also considered as a kind of computer peripheral, because the connection to computer is necessary for typical use. It has been verified to comply with the requirements of FCC Part 15, Subpart B, Class B (DoC). The test report has been issued separately.

### 3.4 DESCRIPTION OF SUPPORT UNITS

The EUT has been tested as an independent unit together with other necessary accessories or support units. The following support units or accessories were used to form a representative test configuration during the tests.

NO.	PRODUCT	BRAND	MODEL NO.	SERIAL NO.	FCC ID
1	NOTEBOOK COMPUTER	DELL	PP05L	9954115984	E2K24CLNS
2	PRINTER	EPSON	LQ-300+	DCGY054146	FCC DoC Approved
3	MODEM	ACEEX	1414V/3	0401008260	IFAXDM1414

NO.	SIGNAL CABLE DESCRIPTION OF THE ABOVE SUPPORT UNITS
1	NA
2	1.2m shielded cable
3	1.2m shielded cable

**NOTE:** All power cords of the above support units are non-shielded (1.8m).



## 4. TEST TYPES AND RESULTS (FOR WIRELESS LAN FUNCTION)

### 4.1 CONDUCTED EMISSION MEASUREMENT

#### 4.1.1 LIMITS OF CONDUCTED EMISSION MEASUREMENT

FREQUENCY OF EMISSION (MHz)	CONDUCTED LIMIT (dB $\mu$ V)	
	Quasi-peak	Average
0.15-0.5	66 to 56	56 to 46
0.5-5	56	46
5-30	60	50

- NOTE:**
1. The lower limit shall apply at the transition frequencies.
  2. The limit decreases in line with the logarithm of the frequency in the range of 0.15 to 0.50 MHz.
  3. All emanations from a class A/B digital device or system, including any network of conductors and apparatus connected thereto, shall not exceed the level of field strengths specified above.

#### 4.1.2 TEST INSTRUMENTS

DESCRIPTION & MANUFACTURER	MODEL NO.	SERIAL NO.	CALIBRATED UNTIL
Test Receiver ROHDE & SCHWARZ	ESCS30	100288	Nov. 02, 2006
RF signal cable Woken	5D-FB	Cable-HYCO3-01	Jan. 06, 2007
LISN ROHDE & SCHWARZ	ESH2-Z5	100100	Jan. 09, 2007
LISN ROHDE & SCHWARZ	ESH3-Z5	100311	Jan. 22, 2007
Software ADT	ADT_Cond_V3	NA	NA

- NOTE:**
1. The calibration interval of the above test instruments is 12 months and the calibrations are traceable to NML/ROC and NIST/USA.
  2. The test was performed in HwaYa Shielded Room 2.
  3. The VCCI Site Registration No. is C-2047.

#### 4.1.3 TEST PROCEDURES

- a. The EUT was placed 0.4 meters from the conducting wall of the shielded room with EUT being connected to the power mains through a line impedance stabilization network (LISN). Other support units were connected to the power mains through another LISN. The two LISNs provide 50 ohm/ 50uH of coupling impedance for the measuring instrument.
- b. Both lines of the power mains connected to the EUT were checked for maximum conducted interference.
- c. The frequency range from 150kHz to 30MHz was searched. Emission levels under (Limit - 20dB) was not recorded.

#### 4.1.4 DEVIATION FROM TEST STANDARD

No deviation

#### 4.1.5 TEST SETUP

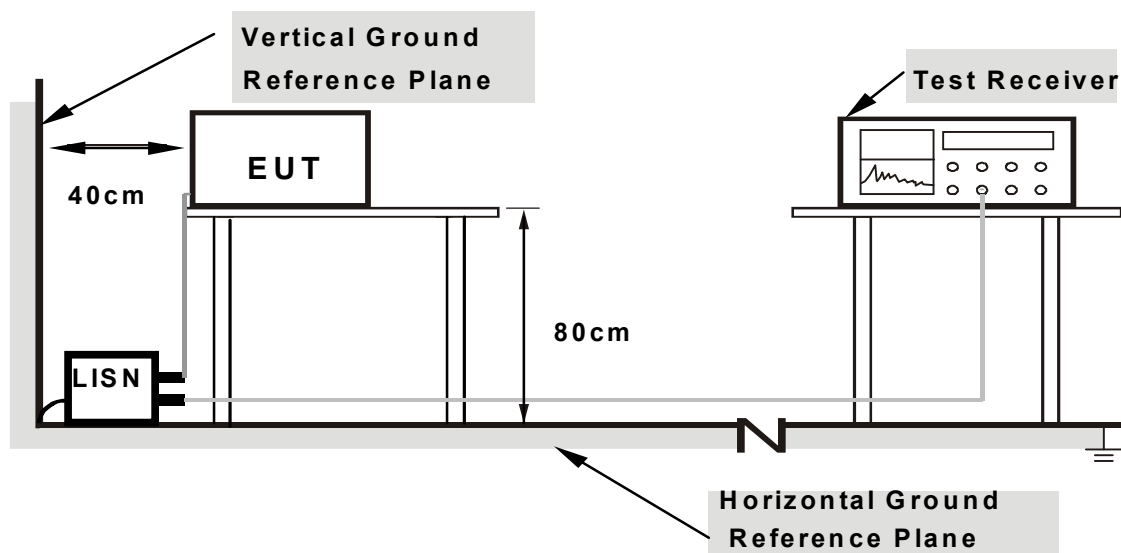

**Note: 1.Support units were connected to second LISN.**

**2.Both of LISNs (AMN) are 80 cm from EUT and at least 80 from other units and other metal planes**

For the actual test configuration, please refer to the related item – Photographs of the Test Configuration.

#### 4.1.6 EUT OPERATING CONDITIONS

- a. Connected the EUT into Notebook placed on a testing table.
- b. The notebook system ran a test program (provided by manufacturer) to enable EUT under transmission condition continuously at specific channel frequency.
- c. The notebook system sent "H" messages to its screen.
- d. The notebook system show "H" messages to modem.
- e. The notebook system sent "H" messages to printer and the printer prints them on paper.
- f. Steps c ~ e were repeated.

#### 4.1.7 TEST RESULTS

##### CONDUCTED WORST-CASE DATA

EUT TEST CONDITION		MEASUREMENT DETAIL	
CHANNEL	Channel 1	PHASE	Line 1
MODULATION TYPE	DBPSK	6dB BANDWIDTH	9 kHz
TRANSFER RATE	1Mbps	ENVIRONMENTAL CONDITIONS	20deg. C, 60%RH, 991hPa
INPUT POWER (SYSTEM)	120Vac, 60 Hz	TESTED BY	Match Tsui

No	Freq. [MHz]	Corr. Factor [dB]	Reading Value [dB (uV)]		Emission Level [dB (uV)]		Limit [dB (uV)]		Margin (dB)	
			Q.P.	AV.	Q.P.	AV.	Q.P.	AV.	Q.P.	AV.
1	0.194	0.10	56.00	46.30	56.10	46.40	63.85	53.85	-7.75	-7.45
2	0.255	0.10	50.12	-	50.22	-	61.58	51.58	-11.36	-
3	0.580	0.10	45.77	-	45.87	-	56.00	46.00	-10.13	-
4	1.156	0.12	42.83	-	42.95	-	56.00	46.00	-13.05	-
5	2.891	0.28	43.46	-	43.74	-	56.00	46.00	-12.26	-
6	11.438	0.44	35.10	-	35.54	-	60.00	50.00	-24.46	-

- REMARKS:**
1. Q.P. and AV. are abbreviations of quasi-peak and average individually.
  2. "-": The Quasi-peak reading value also meets average limit and measurement with the average detector is unnecessary.
  3. The emission levels of other frequencies were very low against the limit.
  4. Margin value = Emission level - Limit value
  5. Correction factor = Insertion loss + Cable loss
  6. Emission Level = Correction Factor + Reading Value.

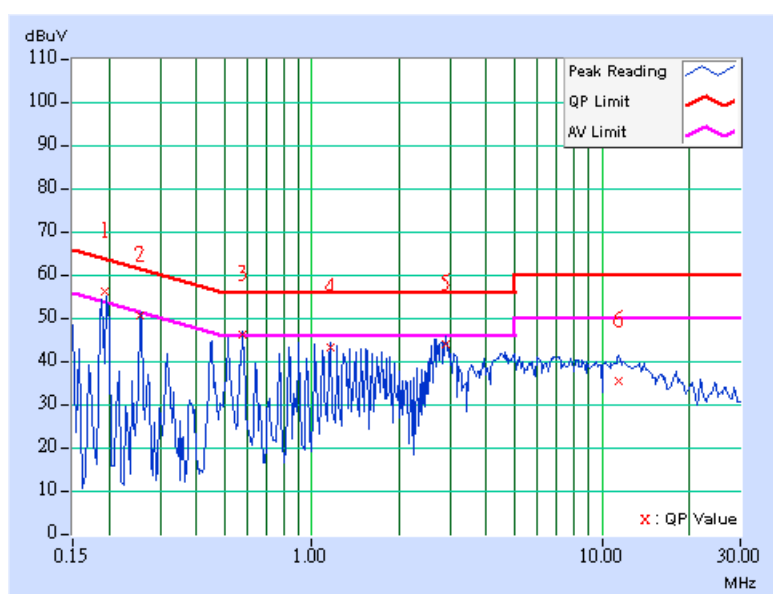

EUT TEST CONDITION		MEASUREMENT DETAIL	
CHANNEL	Channel 1	PHASE	Line 2
MODULATION TYPE	DBPSK	6dB BANDWIDTH	9 kHz
TRANSFER RATE	1Mbps	ENVIRONMENTAL CONDITIONS	20deg. C, 60%RH, 991hPa
INPUT POWER (SYSTEM)	120Vac, 60 Hz	TESTED BY	Match Tsui

No	Freq. [MHz]	Corr. Factor (dB)	Reading Value [dB (uV)]		Emission Level [dB (uV)]		Limit [dB (uV)]		Margin (dB)	
			Q.P.	AV.	Q.P.	AV.	Q.P.	AV.	Q.P.	AV.
1	0.193	0.10	58.25	48.86	58.35	48.96	63.91	53.91	-5.56	-4.95
2	0.259	0.10	50.40	-	50.50	-	61.45	51.45	-10.95	-
3	0.451	0.11	45.96	-	46.07	-	56.86	46.86	-10.79	-
4	0.709	0.15	43.08	-	43.23	-	56.00	46.00	-12.77	-
5	2.900	0.28	43.48	-	43.76	-	56.00	46.00	-12.24	-
6	11.852	0.52	35.18	-	35.70	-	60.00	50.00	-24.30	-

- REMARKS:**
1. Q.P. and AV. are abbreviations of quasi-peak and average individually.
  2. "-": The Quasi-peak reading value also meets average limit and measurement with the average detector is unnecessary.
  3. The emission levels of other frequencies were very low against the limit.
  4. Margin value = Emission level - Limit value
  5. Correction factor = Insertion loss + Cable loss
  6. Emission Level = Correction Factor + Reading Value.

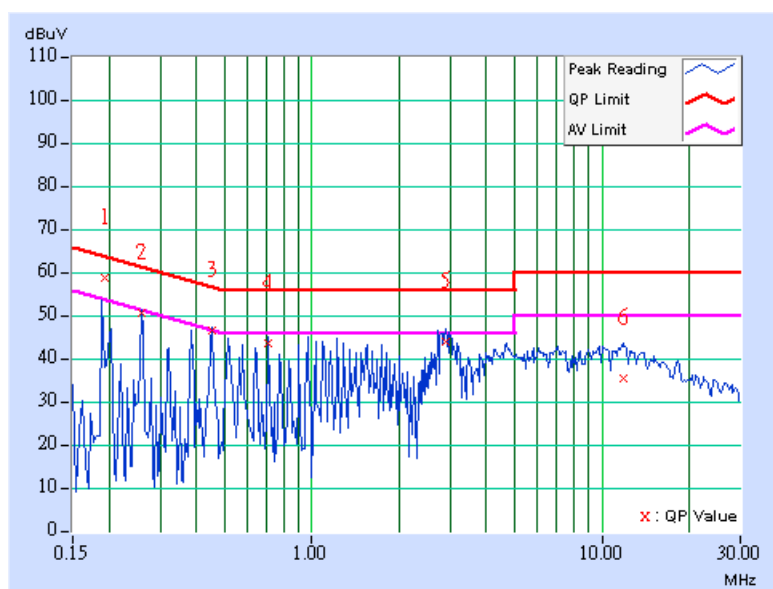

EUT TEST CONDITION		MEASUREMENT DETAIL	
CHANNEL	Channel 6	PHASE	Line 1
MODULATION TYPE	DBPSK	6dB BANDWIDTH	9 kHz
TRANSFER RATE	1Mbps	ENVIRONMENTAL CONDITIONS	20deg. C, 60%RH, 991hPa
INPUT POWER (SYSTEM)	120Vac, 60 Hz	TESTED BY	Match Tsui

No	Freq. [MHz]	Corr. Factor [dB]	Reading Value [dB (uV)]		Emission Level [dB (uV)]		Limit [dB (uV)]		Margin [dB]	
			Q.P.	AV.	Q.P.	AV.	Q.P.	AV.	Q.P.	AV.
			1	0.193	0.10	54.78	44.22	54.88	44.32	63.91
2	0.254	0.10	49.11	-	49.21	-	61.62	51.62	-12.41	-
3	0.505	0.10	48.42	44.34	48.52	44.44	56.00	46.00	-7.48	-1.56
4	0.577	0.10	47.34	42.45	47.44	42.55	56.00	46.00	-8.56	-3.45
5	2.828	0.27	42.25	-	42.52	-	56.00	46.00	-13.48	-
6	11.625	0.45	36.20	-	36.65	-	60.00	50.00	-23.35	-

- REMARKS:**
1. Q.P. and AV. are abbreviations of quasi-peak and average individually.
  2. "-": The Quasi-peak reading value also meets average limit and measurement with the average detector is unnecessary.
  3. The emission levels of other frequencies were very low against the limit.
  4. Margin value = Emission level - Limit value
  5. Correction factor = Insertion loss + Cable loss
  6. Emission Level = Correction Factor + Reading Value.

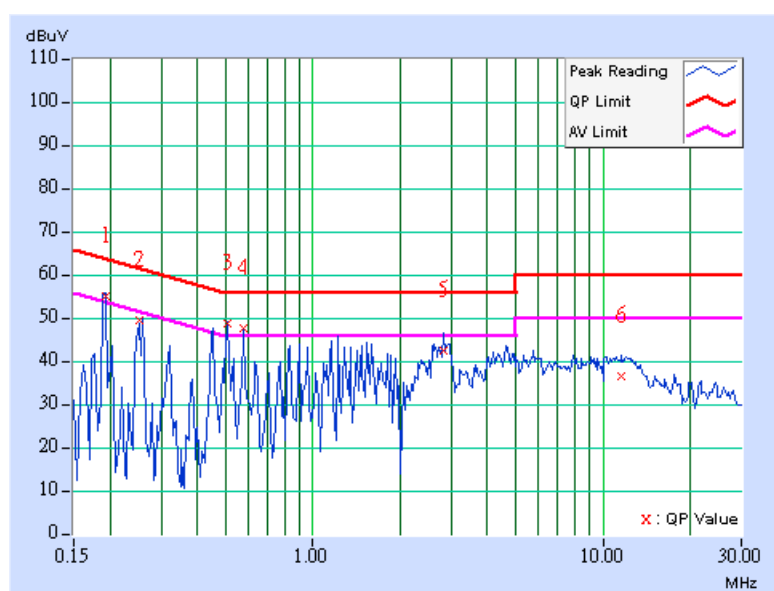

EUT TEST CONDITION		MEASUREMENT DETAIL	
CHANNEL	Channel 6	PHASE	Line 2
MODULATION TYPE	DBPSK	6dB BANDWIDTH	9 kHz
TRANSFER RATE	1Mbps	ENVIRONMENTAL CONDITIONS	20deg. C, 60%RH, 991hPa
TESTED BY	Match Tsui	INPUT POWER (SYSTEM)	120Vac, 60 Hz

No	Freq. [MHz]	Corr. Factor (dB)	Reading Value [dB (uV)]		Emission Level [dB (uV)]		Limit [dB (uV)]		Margin (dB)	
			Q.P.	AV.	Q.P.	AV.	Q.P.	AV.	Q.P.	AV.
1	0.192	0.10	55.72	45.74	55.82	45.84	63.97	53.97	-8.15	-8.13
2	0.451	0.11	45.07	-	45.18	-	56.86	46.86	-11.68	-
3	<b>0.513</b>	<b>0.12</b>	<b>47.00</b>	<b>44.64</b>	<b>47.12</b>	<b>44.76</b>	<b>56.00</b>	<b>46.00</b>	<b>-8.88</b>	<b>-1.24</b>
4	0.578	0.13	47.32	44.09	47.45	44.22	56.00	46.00	-8.55	-1.78
5	2.832	0.27	40.28	-	40.55	-	56.00	46.00	-15.45	-
6	10.996	0.49	34.64	-	35.13	-	60.00	50.00	-24.87	-

- REMARKS:**
1. Q.P. and AV. are abbreviations of quasi-peak and average individually.
  2. "-": The Quasi-peak reading value also meets average limit and measurement with the average detector is unnecessary.
  3. The emission levels of other frequencies were very low against the limit.
  4. Margin value = Emission level - Limit value
  5. Correction factor = Insertion loss + Cable loss
  6. Emission Level = Correction Factor + Reading Value.

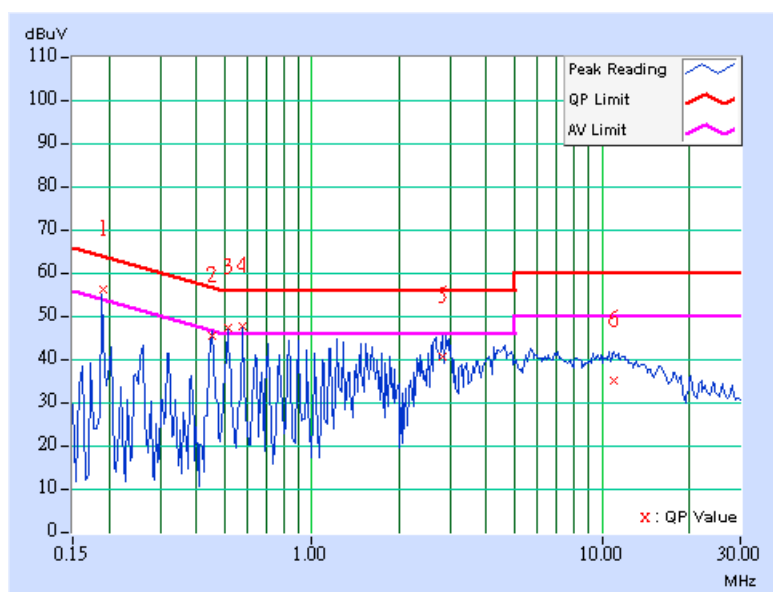

EUT TEST CONDITION		MEASUREMENT DETAIL	
CHANNEL	Channel 11	PHASE	Line 1
MODULATION TYPE	DBPSK	6dB BANDWIDTH	9 kHz
TRANSFER RATE	1Mbps	ENVIRONMENTAL CONDITIONS	20deg. C, 60%RH, 991hPa
TESTED BY	Match Tsui	INPUT POWER (SYSTEM)	120Vac, 60 Hz

No	Freq. [MHz]	Corr. Factor (dB)	Reading Value [dB (uV)]		Emission Level [dB (uV)]		Limit [dB (uV)]		Margin (dB)	
			Q.P.	AV.	Q.P.	AV.	Q.P.	AV.	Q.P.	AV.
			1	0.193	0.10	53.37	-	53.47	-	63.91
2	0.252	0.10	46.88	-	46.98	-	61.71	51.71	-14.73	-
3	0.505	0.10	47.96	42.25	48.06	42.35	56.00	46.00	-7.94	-3.65
4	0.576	0.10	46.73	38.59	46.83	38.69	56.00	46.00	-9.17	-7.31
5	2.945	0.28	40.34	-	40.62	-	56.00	46.00	-15.38	-
6	12.297	0.48	32.95	-	33.43	-	60.00	50.00	-26.57	-

- REMARKS:**
1. Q.P. and AV. are abbreviations of quasi-peak and average individually.
  2. "-": The Quasi-peak reading value also meets average limit and measurement with the average detector is unnecessary.
  3. The emission levels of other frequencies were very low against the limit.
  4. Margin value = Emission level - Limit value
  5. Correction factor = Insertion loss + Cable loss
  6. Emission Level = Correction Factor + Reading Value.

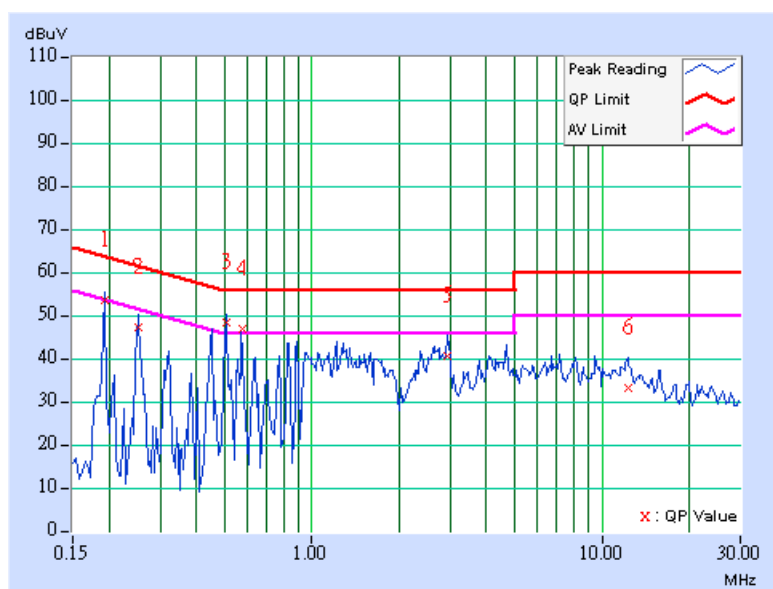



EUT TEST CONDITION		MEASUREMENT DETAIL	
CHANNEL	Channel 11	PHASE	Line 2
MODULATION TYPE	DBPSK	6dB BANDWIDTH	9 kHz
TRANSFER RATE	1Mbps	ENVIRONMENTAL CONDITIONS	20deg. C, 60%RH, 991hPa
TESTED BY	Match Tsui	INPUT POWER (SYSTEM)	120Vac, 60 Hz

No	Freq. [MHz]	Corr. Factor (dB)	Reading Value		Emission Level		Limit		Margin	
			[dB (uV)]		[dB (uV)]		[dB (uV)]		(dB)	
			Q.P.	AV.	Q.P.	AV.	Q.P.	AV.	Q.P.	AV.
1	0.192	0.10	54.45	42.80	54.55	42.90	63.96	53.96	-9.41	-11.06
2	0.255	0.10	49.20	-	49.30	-	61.58	51.58	-12.28	-
3	0.505	0.12	48.08	43.81	48.20	43.93	56.00	46.00	-7.80	-2.07
4	0.576	0.13	46.48	39.20	46.61	39.33	56.00	46.00	-9.39	-6.67
5	2.828	0.27	40.30	-	40.57	-	56.00	46.00	-15.43	-
6	12.254	0.54	34.33	-	34.87	-	60.00	50.00	-25.13	-

- REMARKS:**
1. Q.P. and AV. are abbreviations of quasi-peak and average individually.
  2. "-": The Quasi-peak reading value also meets average limit and measurement with the average detector is unnecessary.
  3. The emission levels of other frequencies were very low against the limit.
  4. Margin value = Emission level - Limit value
  5. Correction factor = Insertion loss + Cable loss
  6. Emission Level = Correction Factor + Reading Value.

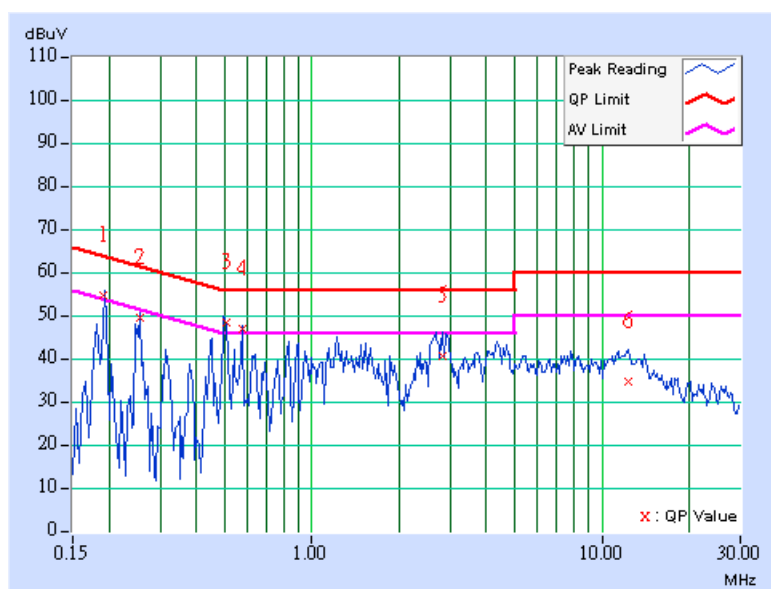

## 4.2 RADIATED EMISSION MEASUREMENT

### 4.2.1 LIMITS OF RADIATED EMISSION MEASUREMENT

Emissions radiated outside of the specified bands, shall be according to the general radiated limits in 15.209 as following:

Frequencies (MHz)	Field strength (microvolts/meter)	Measurement distance (meters)
0.009-0.490	2400/F(kHz)	300
0.490-1.705	24000/F(kHz)	30
1.705-30.0	30	30
30-88	100	3
88-216	150	3
216-960	200	3
Above 960	500	3

**NOTE:**

1. The lower limit shall apply at the transition frequencies.
2. Emission level (dBuV/m) = 20 log Emission level (uV/m).
3. As shown in 15.35(b), for frequencies above 1000MHz, the field strength limits are based on average detector, however, the peak field strength of any emission shall not exceed the maximum permitted average limits, specified above by more than 20dB under any condition of modulation.

#### 4.2.2 TEST INSTRUMENTS

DESCRIPTION & MANUFACTURER	MODEL NO.	SERIAL NO.	CALIBRATED UNTIL
Test Receiver ROHDE & SCHWARZ	ESIB7	100188	Dec. 20, 2006
Spectrum Analyzer ROHDE & SCHWARZ	FSP40	100039	Nov. 27, 2006
BILOG Antenna SCHWARZBECK	VULB9168	9168-157	Jan. 15, 2007
HORN Antenna SCHWARZBECK	BBHA 9120 D	9120D-407	Jan. 22, 2007
HORN Antenna SCHWARZBECK	BBHA 9170	BBHA9170147	Jan. 26, 2007
Preamplifier Agilent	8449B	3008A01961	Oct. 23, 2006
Preamplifier Agilent	8447D	2944A10629	Oct. 27, 2006
RF signal cable HUBER+SUHNER	SUCOFLEX 104	214380/4	Jan. 16, 2007
RF signal cable HUBER+SUHNER	SUCOFLEX 104	219266/4	Jan. 16, 2007
Software ADT.	ADT_Radiated_V5.14	NA	NA
Antenna Tower ADT.	AT100	AT93021702	NA
Turn Table ADT.	TT100.	TT93021702	NA
Controller ADT.	SC100.	SC93021702	NA

- NOTE:**
1. The calibration interval of the above test instruments is 12 months and the calibrations are traceable to NML/ROC and NIST/USA.
  2. The test was performed in HwaYa Chamber 2.
  3. The horn antenna and HP preamplifier (model: 8449B) are used only for the measurement of emission frequency above 1GHz if tested.
  4. The IC Site Registration No. is IC4924-2.

### 4.2.3 TEST PROCEDURES

- a. The EUT was placed on the top of a rotating table 0.8 meters above the ground at a 3 meters semi-anechoic chamber. The table was rotated 360 degrees to determine the position of the highest radiation.
- b. The EUT was set 3 meters away from the interference-receiving antenna, which was mounted on the top of a variable-height antenna tower.
- c. The antenna is a broadband antenna, and its height is varied from one meter to four meters above the ground to determine the maximum value of the field strength. Both horizontal and vertical polarizations of the antenna are set to make the measurement.
- d. For each suspected emission, the EUT was arranged to its worst case and then the antenna was tuned to heights from 1 meter to 4 meters and the rotatable table was turned from 0 degrees to 360 degrees to find the maximum reading.
- e. The test-receiver system was set to Peak Detect Function and Specified Bandwidth with Maximum Hold Mode.
- f. If the emission level of the EUT in peak mode was 10 dB lower than the limit specified, then testing could be stopped and the peak values of the EUT would be reported. Otherwise the emissions that did not have 10 dB margin would be re-tested one by one using the quasi-peak method or average method as specified and then reported in Data sheet peak mode and QP mode.

**NOTE:**

1. The resolution bandwidth and video bandwidth of test receiver/spectrum analyzer is 120kHz for Quasi-peak detection at frequency below 1GHz.
2. The resolution bandwidth of test receiver/spectrum analyzer is 1MHz and video bandwidth is 3MHz for Peak detection at frequency above 1GHz.
3. The resolution bandwidth of test receiver/spectrum analyzer is 1MHz and the video bandwidth is 1kHz for Average detection (AV) at frequency above 1GHz.

### 4.2.4 DEVIATION FROM TEST STANDARD

No deviation

#### 4.2.5 TEST SETUP

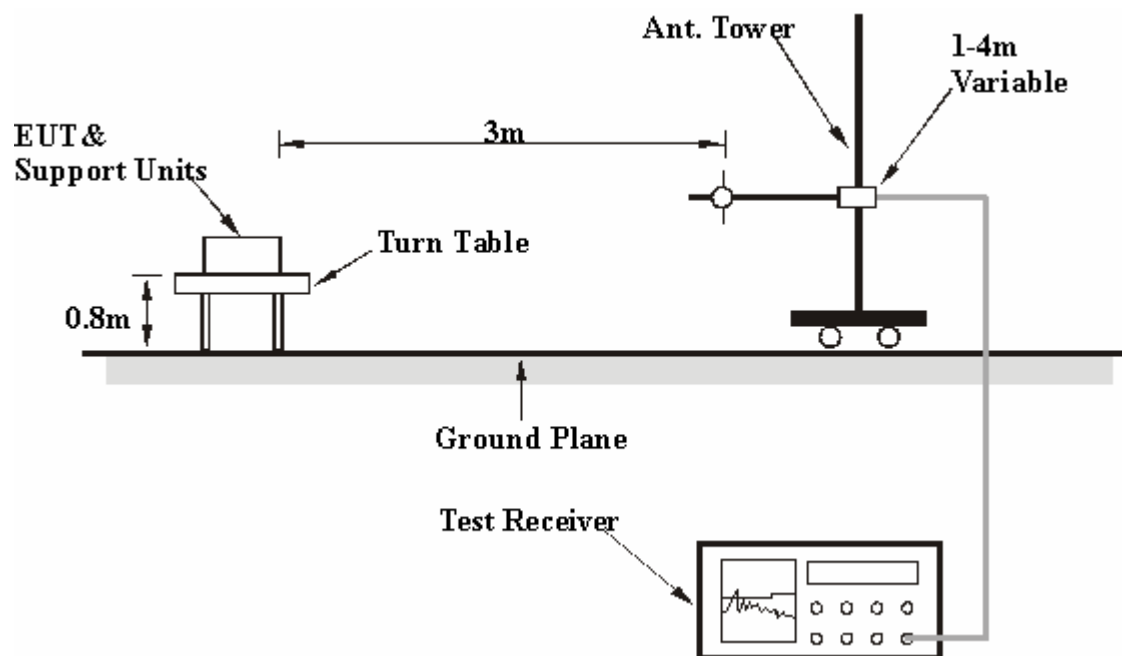

For the actual test configuration, please refer to the related item – Photographs of the Test Configuration.

#### 4.2.6 EUT OPERATING CONDITIONS

Same as 4.1.6

## 4.2.7 TEST RESULTS

### RADIATED WORST-CASE DATA: BELOW 1GHz

EUT TEST CONDITION		MEASUREMENT DETAIL	
CHANNEL	Channel 11	FREQUENCY RANGE	Below 1000MHz
MODULATION TYPE	DBPSK	DETECTOR FUNCTION	Quasi-Peak
TRANSFER RATE	1Mbps	ENVIRONMENTAL CONDITIONS	27deg. C, 71%RH, 991hPa
INPUT POWER (SYSTEM)	120Vac, 60 Hz	TESTED BY	Lori Chiu

ANTENNA POLARITY & TEST DISTANCE: HORIZONTAL AT 3 M								
No.	Freq. (MHz)	Emission Level (dBuV/m)	Limit (dBuV/m)	Margin (dB)	Antenna Height (m)	Table Angle (Degree)	Raw Value (dBuV)	Correction Factor (dB/m)
1	78.60	27.02 QP	40.00	-12.98	1.50 H	280	16.30	10.72
2	193.29	38.51 QP	43.50	-4.99	1.00 H	277	27.23	11.28
3	232.16	32.32 QP	46.00	-13.68	1.00 H	280	20.43	11.88
4	298.26	36.71 QP	46.00	-9.29	1.00 H	280	21.18	15.53
5	337.13	32.97 QP	46.00	-13.03	1.50 H	121	16.86	16.11
6	397.39	37.86 QP	46.00	-8.14	1.00 H	280	20.01	17.85
7	615.11	32.04 QP	46.00	-13.96	1.50 H	160	9.39	22.65
8	953.35	35.01 QP	46.00	-10.99	1.00 H	85	5.67	29.34

ANTENNA POLARITY & TEST DISTANCE: VERTICAL AT 3 M								
No.	Freq. (MHz)	Emission Level (dBuV/m)	Limit (dBuV/m)	Margin (dB)	Antenna Height (m)	Table Angle (Degree)	Raw Value (dBuV)	Correction Factor (dB/m)
1	78.60	32.79 QP	40.00	-7.21	1.00 V	91	22.08	10.72
2	193.29	36.21 QP	43.50	-7.29	1.00 V	13	24.93	11.28
3	228.28	32.12 QP	46.00	-13.88	1.00 V	328	20.36	11.76
4	335.19	32.00 QP	46.00	-14.00	1.00 V	307	15.91	16.08
5	397.39	33.12 QP	46.00	-12.88	1.00 V	268	15.27	17.85
6	445.99	32.41 QP	46.00	-13.59	1.00 V	157	13.54	18.87
7	498.48	33.86 QP	46.00	-12.14	1.00 V	10	13.83	20.03
8	879.48	31.45 QP	46.00	-14.55	1.50 V	259	4.53	26.91
9	947.52	34.19 QP	46.00	-11.81	1.00 V	307	4.89	29.30

- REMARKS:**
1. Emission level(dBuV/m)=Raw Value(dBuV) + Correction Factor(dB/m)
  2. Correction Factor(dB/m) = Antenna Factor (dB/m) + Cable Factor (dB)
  3. The other emission levels were very low against the limit.
  4. Margin value = Emission level – Limit value.

**802.11b DSSS modulation**

EUT TEST CONDITION		MEASUREMENT DETAIL	
CHANNEL	Channel 1	FREQUENCY RANGE	1 ~ 25GHz
MODULATION TYPE	DBPSK	DETECTOR FUNCTION	Peak(PK) Average (AV)
TRANSFER RATE	1Mbps	ENVIRONMENTAL CONDITIONS	27deg. C, 71%RH, 991hPa
INPUT POWER (SYSTEM)	120Vac, 60 Hz	TESTED BY	Lori Chiu

ANTENNA POLARITY & TEST DISTANCE: HORIZONTAL AT 3 M								
No.	Freq. (MHz)	Emission Level (dBuV/m)	Limit (dBuV/m)	Margin (dB)	Antenna Height (m)	Table Angle (Degree)	Raw Value (dBuV)	Correction Factor (dB/m)
1	2370.00	57.52 PK	74.00	-16.48	1.34 H	22	26.20	31.32
1	2370.00	47.51 AV	54.00	-6.49	1.34 H	22	16.19	31.32
2	2390.00	54.13 PK	74.00	-19.87	1.32 H	355	22.74	31.39
2	2390.00	44.51 AV	54.00	-9.49	1.32 H	355	13.12	31.39
3	*2412.00	101.02 PK			1.33 H	355	69.56	31.46
3	*2412.00	93.09 AV			1.33 H	355	61.63	31.46
4	4824.00	46.37 PK	74.00	-27.63	1.32 H	257	9.24	37.13
4	4824.00	32.56 AV	54.00	-21.44	1.32 H	257	-4.57	37.13

ANTENNA POLARITY & TEST DISTANCE: VERTICAL AT 3 M								
No.	Freq. (MHz)	Emission Level (dBuV/m)	Limit (dBuV/m)	Margin (dB)	Antenna Height (m)	Table Angle (Degree)	Raw Value (dBuV)	Correction Factor (dB/m)
1	2370.00	61.77 PK	74.00	-12.23	1.21 V	235	30.45	31.32
1	2370.00	51.57 AV	54.00	-2.43	1.21 V	235	20.25	31.32
2	2390.00	56.00 PK	74.00	-18.00	1.16 V	230	24.61	31.39
2	2390.00	45.92 AV	54.00	-8.08	1.16 V	230	14.53	31.39
3	*2412.00	106.52 PK			1.15 V	234	75.06	31.46
3	*2412.00	98.59 AV			1.15 V	234	67.13	31.46
4	4824.00	46.98 PK	74.00	-27.02	1.08 V	34	9.85	37.13
4	4824.00	33.44 AV	54.00	-20.56	1.08 V	34	-3.69	37.13

- REMARKS:**
1. Emission level(dBuV/m)=Raw Value(dBuV) + Correction Factor(dB/m)
  2. Correction Factor(dB/m) = Antenna Factor (dB/m) + Cable Factor (dB)
  3. The other emission levels were very low against the limit.
  4. Margin value = Emission level – Limit value.
  5. “ \* “ : Fundamental frequency

EUT TEST CONDITION		MEASUREMENT DETAIL	
CHANNEL	Channel 6	FREQUENCY RANGE	1 ~ 25GHz
MODULATION TYPE	DBPSK	DETECTOR FUNCTION	Peak(PK) Average (AV)
TRANSFER RATE	1Mbps	ENVIRONMENTAL CONDITIONS	27deg. C, 71%RH, 991hPa
INPUT POWER (SYSTEM)	120Vac, 60 Hz	TESTED BY	Lori Chiu

ANTENNA POLARITY & TEST DISTANCE: HORIZONTAL AT 3 M								
No.	Freq. (MHz)	Emission Level (dBuV/m)	Limit (dBuV/m)	Margin (dB)	Antenna Height (m)	Table Angle (Degree)	Raw Value (dBuV)	Correction Factor (dB/m)
1	*2437.00	101.25 PK			1.32 H	354	69.71	31.54
1	*2437.00	93.34 AV			1.32 H	354	61.80	31.54
2	4874.00	46.91 PK	74.00	-27.09	1.27 H	243	9.62	37.29
2	4874.00	33.05 AV	54.00	-20.95	1.27 H	243	-4.24	37.29

ANTENNA POLARITY & TEST DISTANCE: VERTICAL AT 3 M								
No.	Freq. (MHz)	Emission Level (dBuV/m)	Limit (dBuV/m)	Margin (dB)	Antenna Height (m)	Table Angle (Degree)	Raw Value (dBuV)	Correction Factor (dB/m)
1	*2437.00	106.68 PK			1.14 V	230	75.14	31.54
1	*2437.00	98.75 AV			1.14 V	230	67.21	31.54
2	4874.00	47.23 PK	74.00	-26.77	1.05 V	26	9.94	37.29
2	4874.00	33.69 AV	54.00	-20.31	1.05 V	26	-3.60	37.29

- REMARKS:**
1. Emission level(dBuV/m)=Raw Value(dBuV) + Correction Factor(dB/m)
  2. Correction Factor(dB/m) = Antenna Factor (dB/m) + Cable Factor (dB)
  3. The other emission levels were very low against the limit.
  4. Margin value = Emission level – Limit value.
  5. “ \* ” : Fundamental frequency



EUT TEST CONDITION		MEASUREMENT DETAIL	
CHANNEL	Channel 11	FREQUENCY RANGE	1 ~ 25GHz
MODULATION TYPE	DBPSK	DETECTOR FUNCTION	Peak(PK) Average (AV)
TRANSFER RATE	1Mbps	ENVIRONMENTAL CONDITIONS	27deg. C, 71%RH, 991hPa
INPUT POWER (SYSTEM)	120Vac, 60 Hz	TESTED BY	Lori Chiu

ANTENNA POLARITY & TEST DISTANCE: HORIZONTAL AT 3 M								
No.	Freq. (MHz)	Emission Level (dBuV/m)	Limit (dBuV/m)	Margin (dB)	Antenna Height (m)	Table Angle (Degree)	Raw Value (dBuV)	Correction Factor (dB/m)
1	*2462.00	101.41 PK			1.30 H	353	69.05	32.36
1	*2462.00	93.52 AV			1.30 H	353	61.16	32.36
2	2483.50	56.58 PK	74.00	-17.42	1.30 H	353	24.14	32.44
2	2483.50	46.40 AV	54.00	-7.60	1.30 H	353	13.96	32.44
3	4924.00	47.36 PK	74.00	-26.64	1.05 H	261	8.46	38.90
3	4924.00	33.88 AV	54.00	-20.12	1.05 H	261	-5.02	38.90

ANTENNA POLARITY & TEST DISTANCE: VERTICAL AT 3 M								
No.	Freq. (MHz)	Emission Level (dBuV/m)	Limit (dBuV/m)	Margin (dB)	Antenna Height (m)	Table Angle (Degree)	Raw Value (dBuV)	Correction Factor (dB/m)
1	*2462.00	106.71 PK			1.15 V	234	74.35	32.36
1	*2462.00	98.82 AV			1.15 V	234	66.46	32.36
2	2483.50	61.89 PK	74.00	-12.11	1.15 V	234	29.45	32.44
2	<b>2483.50</b>	<b>51.72 AV</b>	<b>54.00</b>	<b>-2.28</b>	<b>1.15 V</b>	<b>234</b>	<b>19.28</b>	<b>32.44</b>
3	4924.00	47.23 PK	74.00	-26.77	1.10 V	38	8.33	38.90
3	4924.00	33.69 AV	54.00	-20.31	1.10 V	38	-5.21	38.90

- REMARKS:**
1. Emission level(dBuV/m)=Raw Value(dBuV) + Correction Factor(dB/m)
  2. Correction Factor(dB/m) = Antenna Factor (dB/m) + Cable Factor (dB)
  3. The other emission levels were very low against the limit.
  4. Margin value = Emission level – Limit value.
  5. “ \* “ : Fundamental frequency



### 4.3 6dB BANDWIDTH MEASUREMENT

#### 4.3.1 LIMITS OF 6dB BANDWIDTH MEASUREMENT

The minimum of 6dB Bandwidth Measurement is 0.5 MHz.

#### 4.3.2 TEST INSTRUMENTS

Description & Manufacturer	Model No.	Serial No.	Calibrated Until
SPECTRUM ANALYZER	FSP40	100040	Jun. 07, 2007

**NOTE:** The calibration interval of the above test instruments is 12 months and the calibrations are traceable to NML/ROC and NIST/USA.

### 4.3.3 TEST PROCEDURE

The transmitter output was connected to the spectrum analyzer through an attenuator. The bandwidth of the fundamental frequency was measured by spectrum analyzer with 100kHz RBW and 100kHz VBW. The 6dB bandwidth is defined as the total spectrum the power of which is higher than peak power minus 6dB.

### 4.3.4 DEVIATION FROM TEST STANDARD

No deviation

### 4.3.5 TEST SETUP



### 4.3.6 EUT OPERATING CONDITIONS

The software provided by client to enable the EUT under transmission condition continuously at lowest, middle and highest channel frequencies individually.



### 4.3.7 TEST RESULTS

<b>MODULATION TYPE</b>	DBPSK	<b>TRANSFER RATE</b>	1Mbps
<b>INPUT POWER (SYSTEM)</b>	120Vac, 60 Hz	<b>ENVIRONMENTAL CONDITIONS</b>	27deg. C, 71%RH, 991hPa
<b>TESTED BY</b>	Match Tsui		

<b>CHANNEL</b>	<b>CHANNEL FREQUENCY (MHz)</b>	<b>6dB BANDWIDTH (MHz)</b>	<b>MINIMUM LIMIT (MHz)</b>	<b>PASS/FAIL</b>
1	2412	9.68	0.5	PASS
6	2437	9.68	0.5	PASS
11	2462	9.60	0.5	PASS

CH1

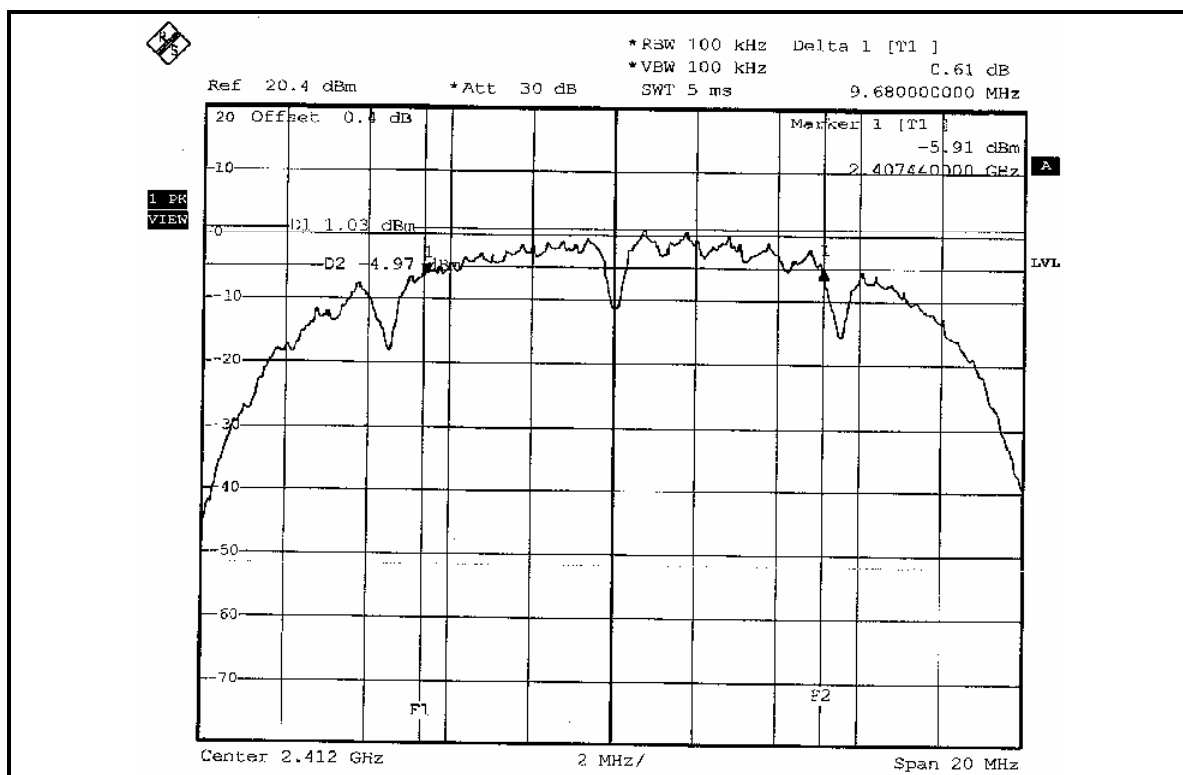

CH6

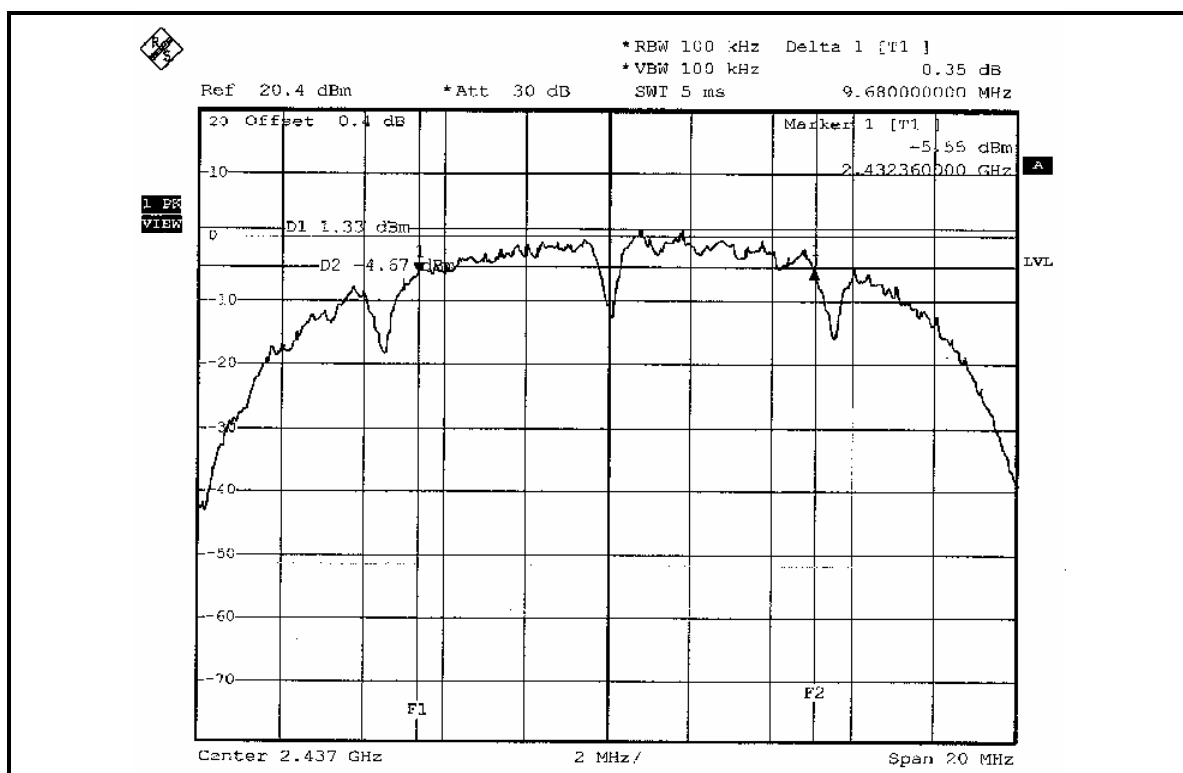

CH11

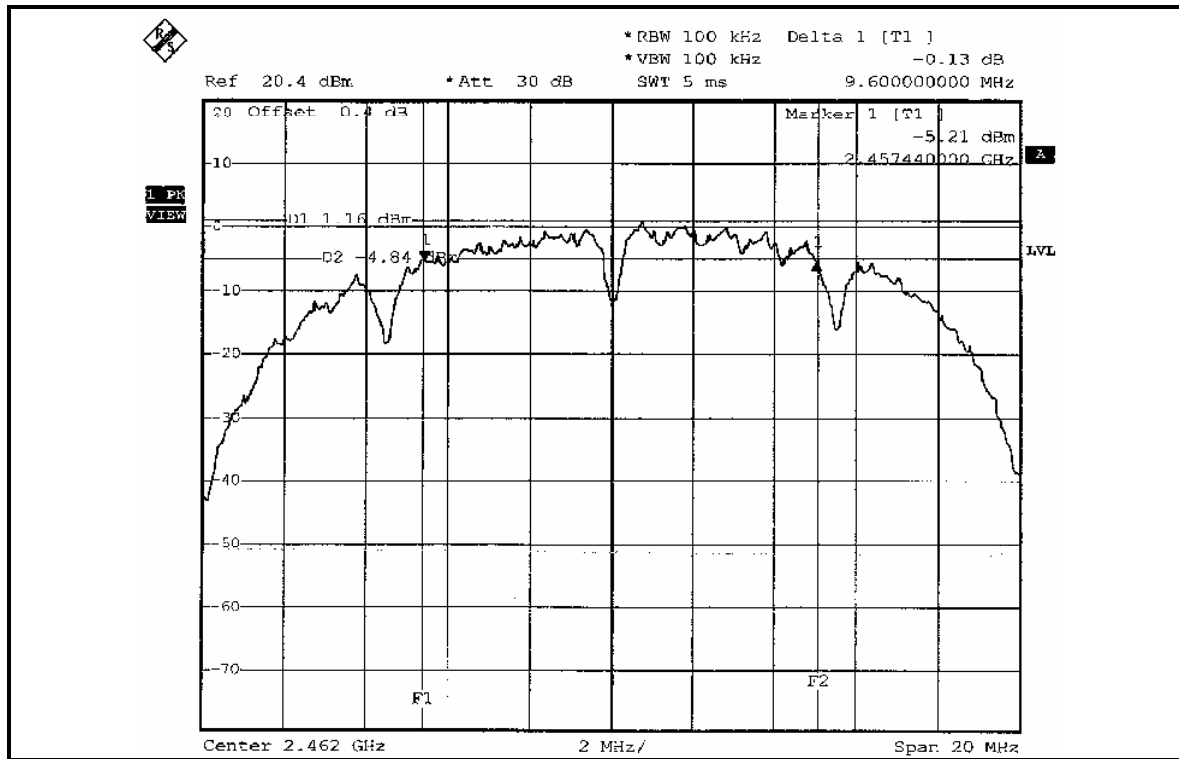



#### 4.4 MAXIMUM PEAK OUTPUT POWER

##### 4.4.1 LIMITS OF MAXIMUM PEAK OUTPUT POWER MEASUREMENT

The Maximum Peak Output Power Measurement is 30dBm.

##### 4.4.2 INSTRUMENTS

Description & Manufacturer	Model No.	Serial No.	Calibrated Until
R&S SPECTRUM ANALYZER	FSP40	100040	Jun. 07, 2007
AGILENT SIGNAL GENERATOR	E8257C	MY43320668	Dec. 07, 2006
TEKTRONIX OSCILLOSCOPE	TDS1012	C037299	Nov. 28, 2006
NARDA DETECTOR	4503A	FSCM99899	NA

**NOTE:** The calibration interval of the above test instruments is 12 months and the calibrations are traceable to NML/ROC and NIST/USA.

#### 4.4.1 TEST PROCEDURES

1. A detector was used on the output port of the EUT. An oscilloscope was used to read the response of the detector.
2. Replaced the EUT by the signal generator. The center frequency of the S.G was adjusted to the center frequency of the measured channel.
3. Adjusted the power to have the same reading on oscilloscope. Record the power level.

#### 4.4.2 DEVIATION FROM TEST STANDARD

No deviation

#### 4.4.3 TEST SETUP



#### 4.4.4 EUT OPERATING CONDITIONS

Same as Item 4.3.6





### 4.4.3 TEST RESULTS

<b>MODULATION TYPE</b>	DBPSK	<b>TRANSFER RATE</b>	1Mbps
<b>INPUT POWER (SYSTEM)</b>	120Vac, 60 Hz	<b>ENVIRONMENTAL CONDITIONS</b>	27deg. C, 71%RH, 991hPa
<b>TESTED BY</b>	Match Tsui		

<b>CHANNEL</b>	<b>CHANNEL FREQUENCY (MHz)</b>	<b>PEAK POWER OUTPUT (mW)</b>	<b>PEAK POWER OUTPUT (dBm)</b>	<b>PEAK POWER LIMIT (dBm)</b>	<b>PASS/FAIL</b>
1	2412	20.091	13.03	30	PASS
6	2437	20.324	13.08	30	PASS
11	2462	20.230	13.06	30	PASS



## 4.5 POWER SPECTRAL DENSITY MEASUREMENT

### 4.5.1 LIMITS OF POWER SPECTRAL DENSITY MEASUREMENT

The Maximum of Power Spectral Density Measurement is 8dBm.

### 4.5.2 TEST INSTRUMENTS

Description & Manufacturer	Model No.	Serial No.	Calibrated Until
R&S SPECTRUM ANALYZER	FSP40	100040	Jun. 07, 2007

**NOTE:**

The calibration interval of the above test instruments is 12 months and the calibrations are traceable to NML/ROC and NIST/USA.

#### 4.5.3 TEST PROCEDURE

The transmitter output was connected to the spectrum analyzer through an attenuator, the bandwidth of the fundamental frequency was measured with the spectrum analyzer using 3kHz RBW and 30kHz VBW, set sweep time = span/3kHz. The power spectral density was measured and recorded. The sweep time is allowed to be longer than span/3kHz for a full response of the mixer in the spectrum analyzer.

#### 4.5.4 DEVIATION FROM TEST STANDARD

No deviation

#### 4.5.5 TEST SETUP

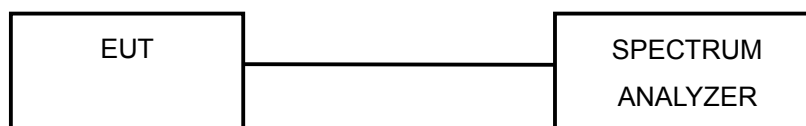

#### 4.5.6 EUT OPERATING CONDITION

Same as Item 4.3.6

#### 4.5.7 TEST RESULTS

<b>MODULATION TYPE</b>	DBPSK	<b>TRANSFER RATE</b>	1Mbps
<b>INPUT POWER (SYSTEM)</b>	120Vac, 60 Hz	<b>ENVIRONMENTAL CONDITIONS</b>	27deg. C, 71%RH, 991hPa
<b>TESTED BY</b>	Match Tsui		

CHANNEL	CHANNEL FREQUENCY (MHz )	RF POWER LEVEL IN 3kHz BW (dBm)	MAXIMUM LIMIT (dBm)	PASS/FAIL
1	2412	-10.87	8	PASS
6	2437	-10.90	8	PASS
11	2462	-10.47	8	PASS



CH11

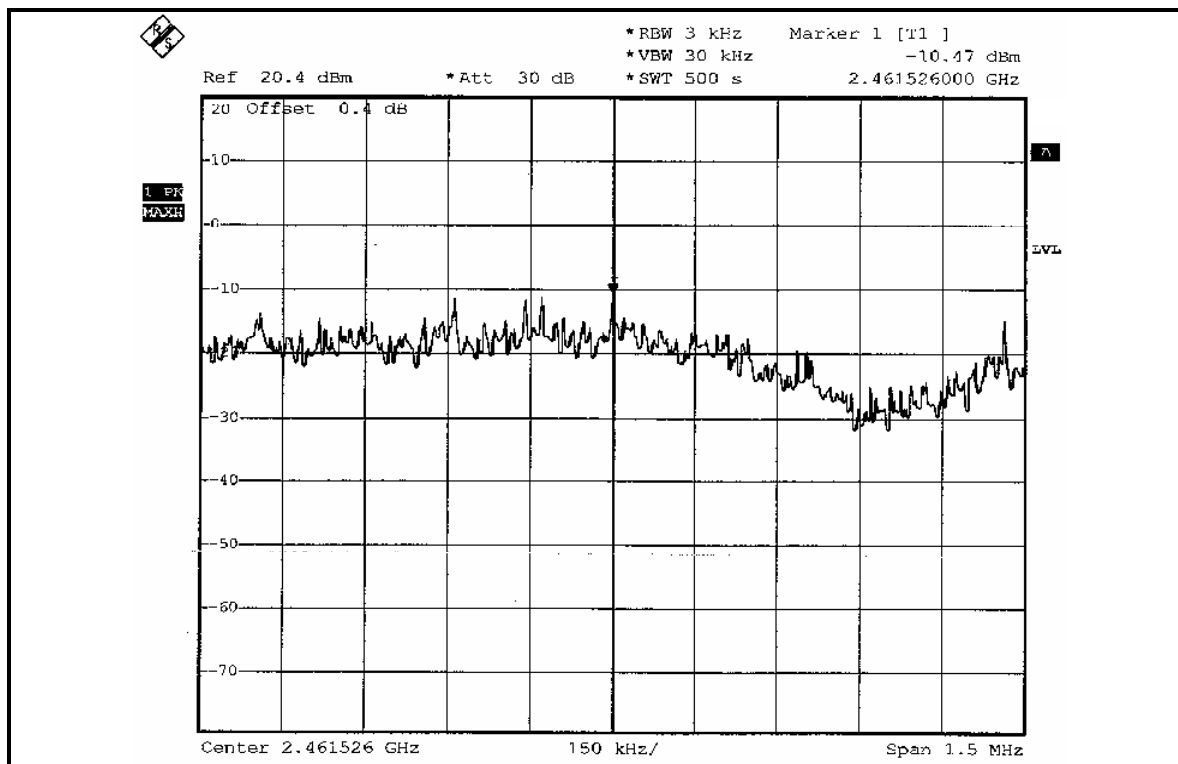

## 4.6 BAND EDGES MEASUREMENT

### 4.6.1 LIMITS OF BAND EDGES MEASUREMENT

Below  $-20\text{dB}$  of the highest emission level of operating band (in 100kHz Resolution Bandwidth).

### 4.6.2 TEST INSTRUMENTS

Description & Manufacturer	Model No.	Serial No.	Calibrated Until
R&S SPECTRUM ANALYZER	FSP40	100040	Jun. 07, 2007

**NOTE:** The calibration interval of the above test instruments is 12 months and the calibrations are traceable to NML/ROC and NIST/USA.

### 4.6.3 TEST PROCEDURE

The transmitter output was connected to the spectrum analyzer via a low lose cable. Set both RBW and VBW of spectrum analyzer to 100 kHz with suitable frequency span including 100 MHz bandwidth from band edge. The band edges was measured and recorded.

The spectrum plots (Peak RBW=VBW=100kHz ; Average RBW=1MHz, VBW=1kHz) are attached on the following pages.

### 4.6.4 DEVIATION FROM TEST STANDARD

No deviation

### 4.6.5 EUT OPERATING CONDITION

Same as Item 4.3.6

#### 4.6.6 TEST RESULTS

The spectrum plots are attached on the following 6 images. D1 line indicates the highest level, and D2 line indicates the 20dB offset below D1. It shows compliance with the requirement in part 15.247(d).

**NOTE 1:** The band edge emission plot on following first page shows 48.57dBc delta between carrier maximum power and local maximum emission in restrict band (2.36800GHz). The emission of carrier strength list in the test result of channel 1 at the item 4.2.7 is 106.52dBuV/m (Peak), so the maximum field strength in restrict band is  $106.52 - 48.57 = 57.95$ dBuV/m which is under 74dBuV/m limit.

The band edge emission plot on following first page shows 56.80dBc delta between carrier maximum power and local maximum emission in restrict band (2.37080GHz). The emission of carrier strength list in the test result of channel 1 at the item 4.2.7 is 98.59dBuV/m (Average), so the maximum field strength in restrict band is  $98.59 - 56.80 = 41.79$ dBuV/m which is under 54dBuV/m limit.

**NOTE 2:** The band edge emission plot on following second page shows 49.46dBc delta between carrier maximum power and local maximum emission in restrict band (2.4865GHz). The emission of carrier strength list in the test result of channel 11 at the item 4.2.7 is 106.71dBuV/m (Peak), so the maximum field strength in restrict band is  $106.71 - 49.46 = 57.25$ dBuV/m which is under 74dBuV/m limit.

The band edge emission plot on following third page shows 59.26dBc delta between carrier maximum power and local maximum emission in restrict band (2.4835GHz). The emission of carrier strength list in the test result of channel 11 at the item 4.2.7 is 98.82dBuV/m (Average), so the maximum field strength in restrict band is  $98.82 - 59.26 = 39.56$ dBuV/m which is under 54dBuV/m limit.



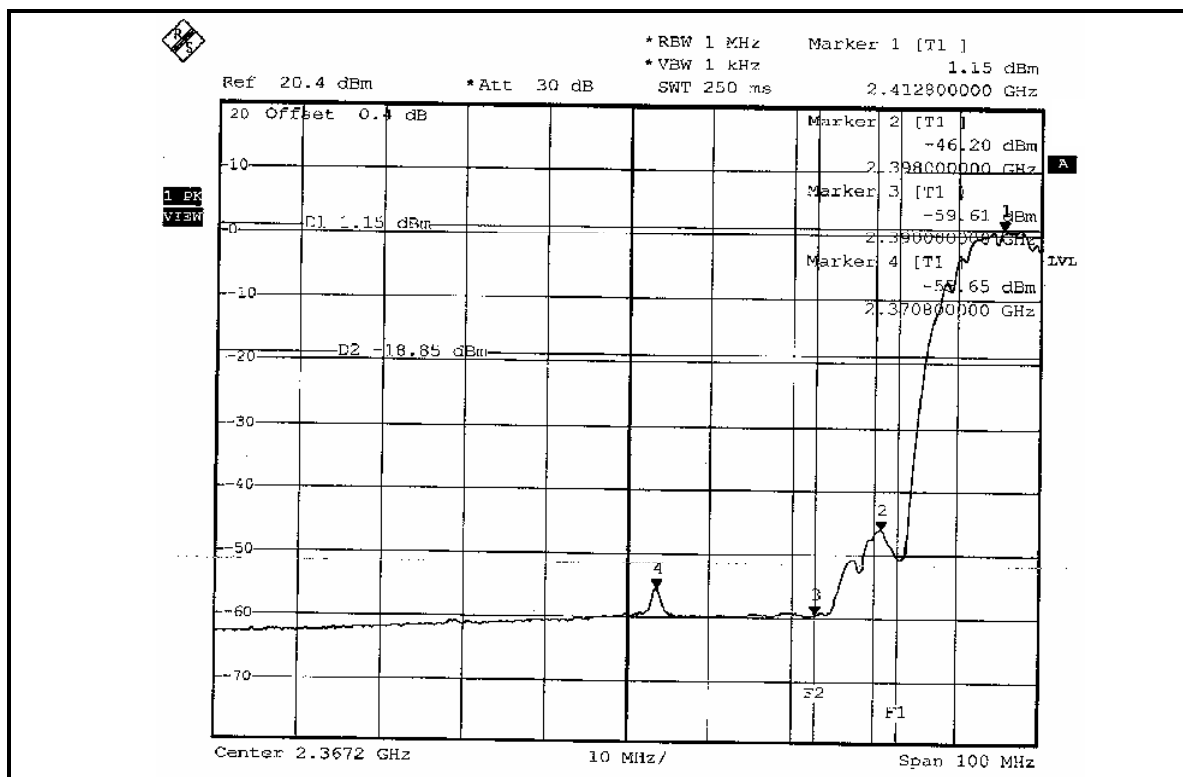
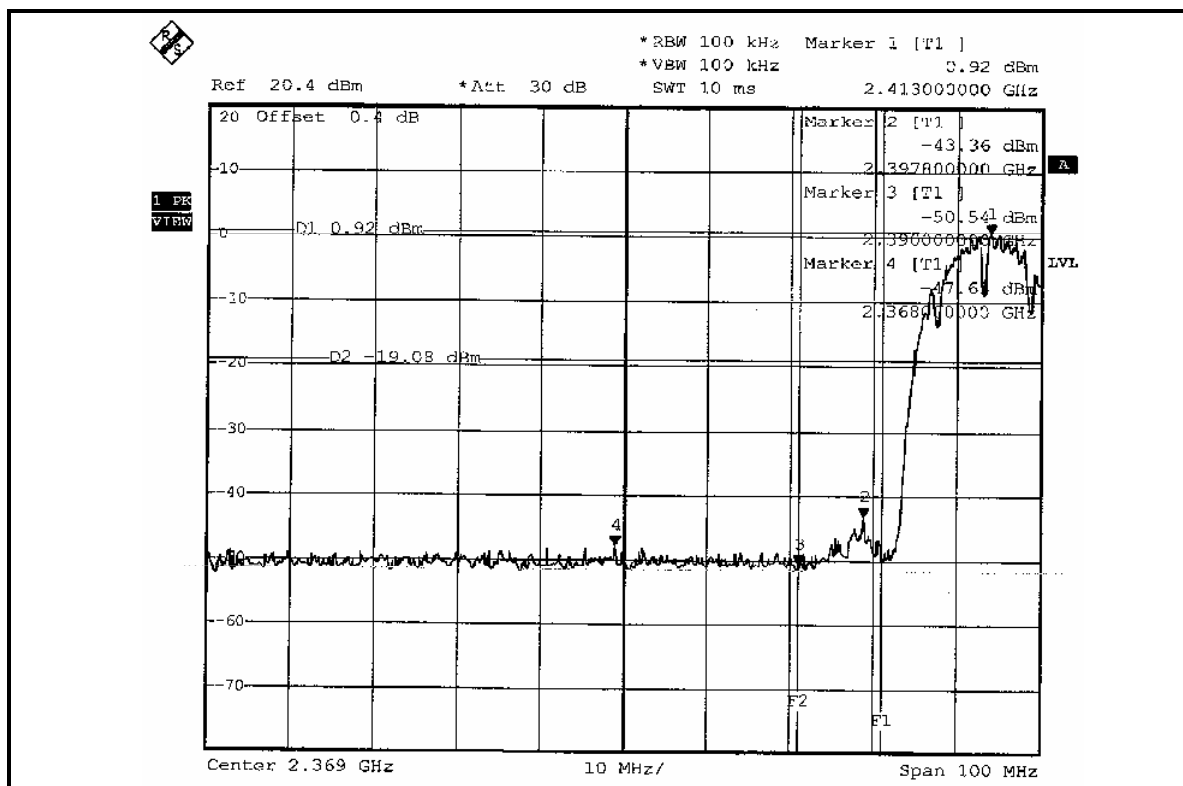

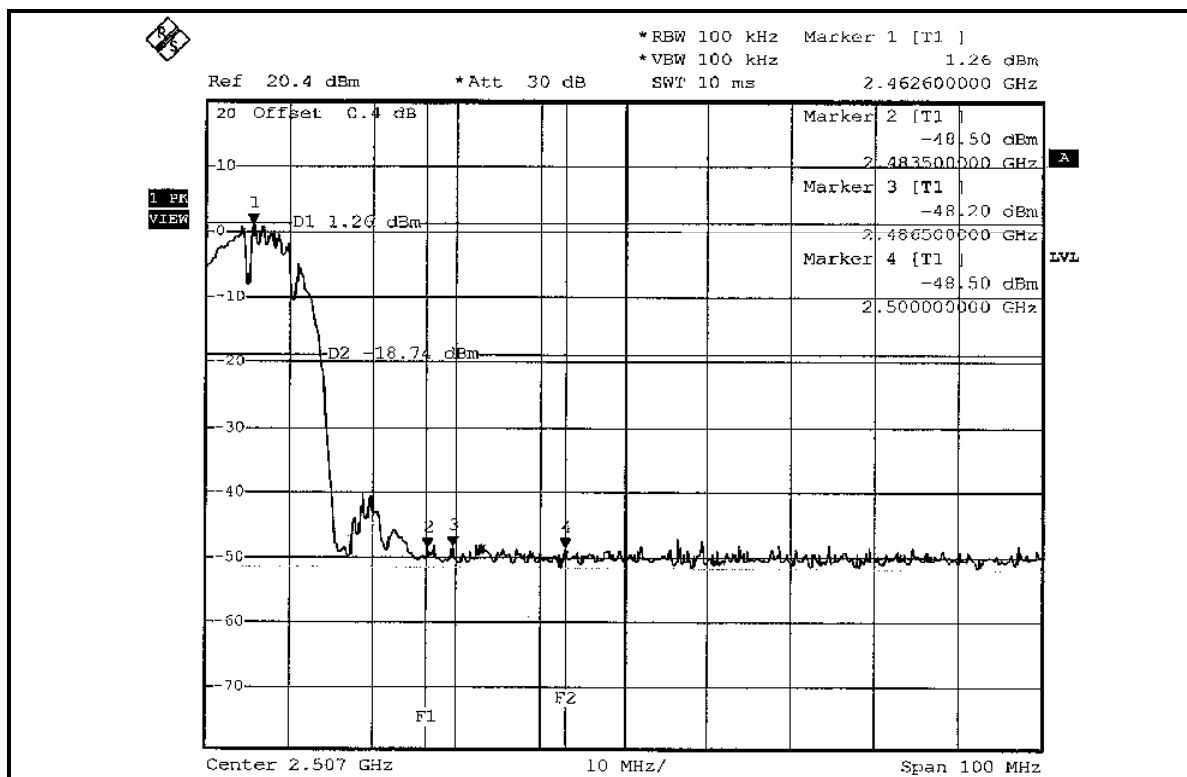
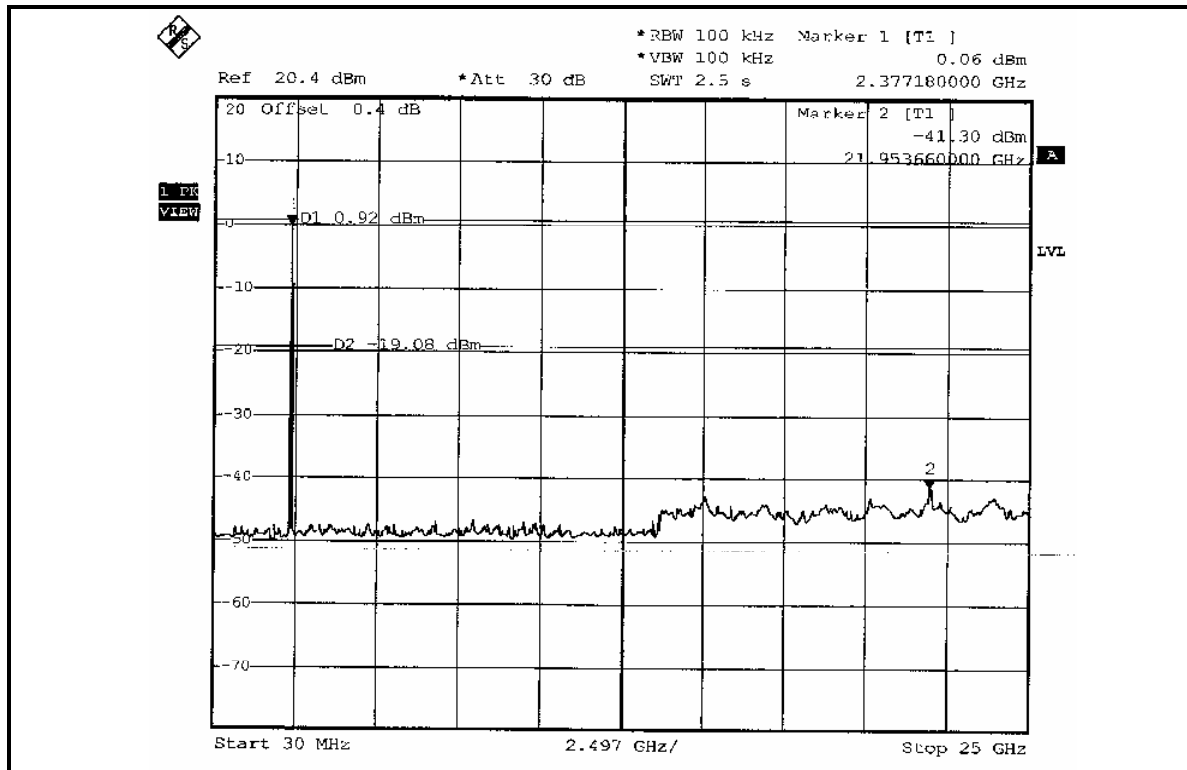

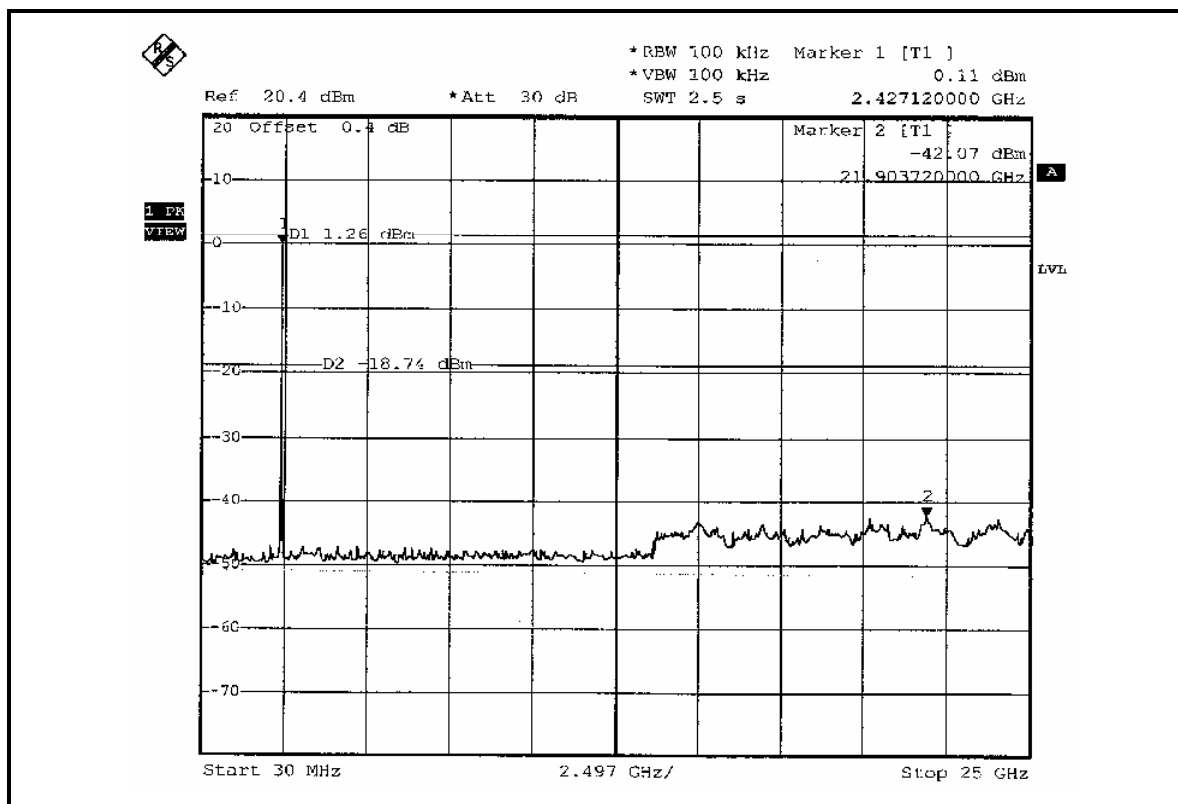
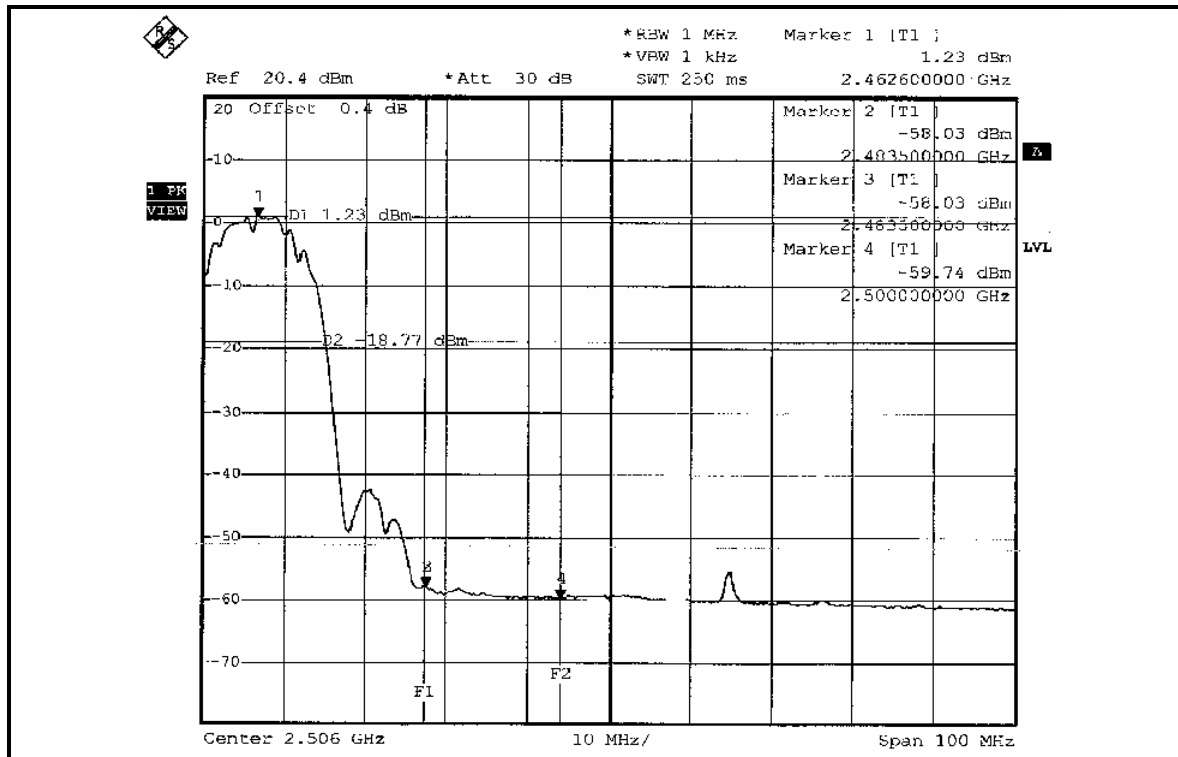

## 4.7 ANTENNA REQUIREMENT

### 4.7.1 STANDARD APPLICABLE

For intentional device, according to FCC 47 CFR Section 15.203, an intentional radiator shall be designed to ensure that no antenna other than that furnished by the responsible party shall be used with the device. And according to FCC 47 CFR Section 15.247 (b), if transmitting antennas of directional gain greater than 6dBi are used, the power shall be reduced by the amount in dB that the directional gain of the antenna exceeds 6dBi.

### 4.7.2 ANTENNA CONNECTED CONSTRUCTION

The antenna used in this product is PIFA antenna with UFL antenna connector. The maximum Gain of the antenna is  $-0.48\text{dBi}$ .

## 5. TEST TYPES AND RESULTS (FOR BLUETOOTH FUNCTION)

### 5.1 CONDUCTED EMISSION MEASUREMENT

#### 5.1.1 LIMITS OF CONDUCTED EMISSION MEASUREMENT

FREQUENCY OF EMISSION (MHz)	CONDUCTED LIMIT (dB $\mu$ V)	
	Quasi-peak	Average
0.15 ~ 0.5	66 to 56	56 to 46
0.5 ~ 5	56	46
5 ~ 30	60	50

- NOTE:**
1. The lower limit shall apply at the transition frequencies.
  2. The limit decreases in line with the logarithm of the frequency in the range of 0.15 to 0.50 MHz.
  3. All emanations from a class A/B digital device or system, including any network of conductors and apparatus connected thereto, shall not exceed the level of field strengths specified above.

#### 5.1.2 TEST INSTRUMENTS

DESCRIPTION & MANUFACTURER	MODEL NO.	SERIAL NO.	CALIBRATED UNTIL
Test Receiver ROHDE & SCHWARZ	ESCS30	100288	Nov. 02, 2006
RF signal cable Woken	5D-FB	Cable-HYCO3-01	Jan. 06, 2007
LISN ROHDE & SCHWARZ	ESH2-Z5	100100	Jan. 09, 2007
LISN ROHDE & SCHWARZ	ESH3-Z5	100311	Jan. 22, 2007
Software ADT	ADT_Cond_V3	NA	NA

- NOTE:**
1. The calibration interval of the above test instruments is 12 months and the calibrations are traceable to NML/ROC and NIST/USA.
  2. The test was performed in HwaYa Shielded Room 2.
  3. The VCCI Site Registration No. is C-2047.

### 5.1.3 TEST PROCEDURES

- a. The EUT was placed 0.4 meters from the conducting wall of the shielded room with EUT being connected to the power mains through a line impedance stabilization network (LISN). Other support units were connected to the power mains through another LISN. The two LISNs provide 50 ohm/ 50uH of coupling impedance for the measuring instrument.
- b. Both lines of the power mains connected to the EUT were checked for maximum conducted interference.
- c. The frequency range from 150kHz to 30MHz was searched. Emission levels under (Limit - 20dB) was not recorded.

### 5.1.4 DEVIATION FROM TEST STANDARD

No deviation

### 5.1.5 TEST SETUP

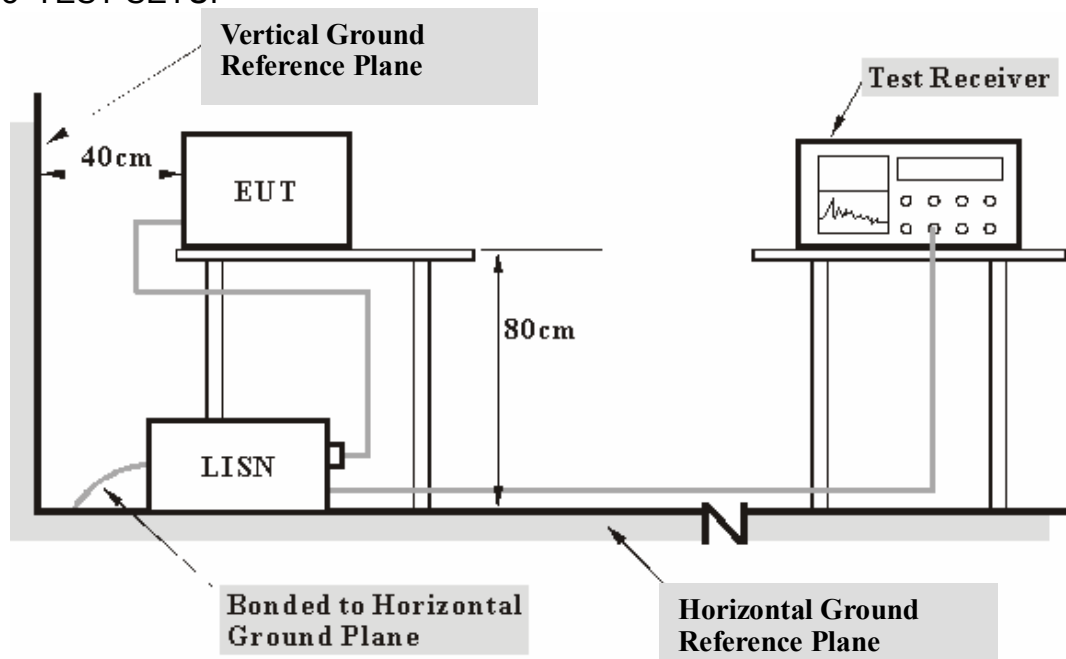

- Note:**
1. Support units were connected to second LISN.
  2. Both of LISNs (AMN) 80 cm from EUT and at the least 80 cm from other units and other metal planes support units.

For the actual test configuration, please refer to the related item – Photographs of the Test Configuration.

### 5.1.6 EUT OPERATING CONDITIONS

Same as 4.1.6

## 5.1.7 TEST RESULTS

### CONDUCTED WORST CASE DATA

EUT TEST CONDITION		MEASUREMENT DETAIL	
CHANNEL	Channel 0	PHASE	Line 1
MODULATION TYPE	GFSK	6dB BANDWIDTH	9 kHz
ENVIRONMENTAL CONDITIONS	20deg. C, 60%RH, 991hPa	INPUT POWER (SYSTEM)	120Vac, 60 Hz
TESTED BY	Match Tsui		

No	Freq. [MHz]	Corr. Factor (dB)	Reading Value [dB (uV)]		Emission Level [dB (uV)]		Limit [dB (uV)]		Margin (dB)	
			Q.P.	AV.	Q.P.	AV.	Q.P.	AV.	Q.P.	AV.
			1	0.193	0.10	55.24	43.12	55.34	43.22	63.91
2	0.255	0.10	49.68	-	49.78	-	61.58	51.58	-11.80	-
3	0.505	0.10	47.27	43.39	47.37	43.49	56.00	46.00	-8.63	-2.51
4	0.580	0.10	46.06	42.50	46.16	42.60	56.00	46.00	-9.84	-3.40
5	2.828	0.27	41.66	-	41.93	-	56.00	46.00	-14.07	-
6	11.957	0.47	34.32	-	34.79	-	60.00	50.00	-25.21	-

- REMARKS:**
1. Q.P. and AV. are abbreviations of quasi-peak and average individually.
  2. "-": The Quasi-peak reading value also meets average limit and measurement with the average detector is unnecessary.
  3. The emission levels of other frequencies were very low against the limit.
  4. Margin value = Emission level - Limit value
  5. Correction factor = Insertion loss + Cable loss
  6. Emission Level = Correction Factor + Reading Value.

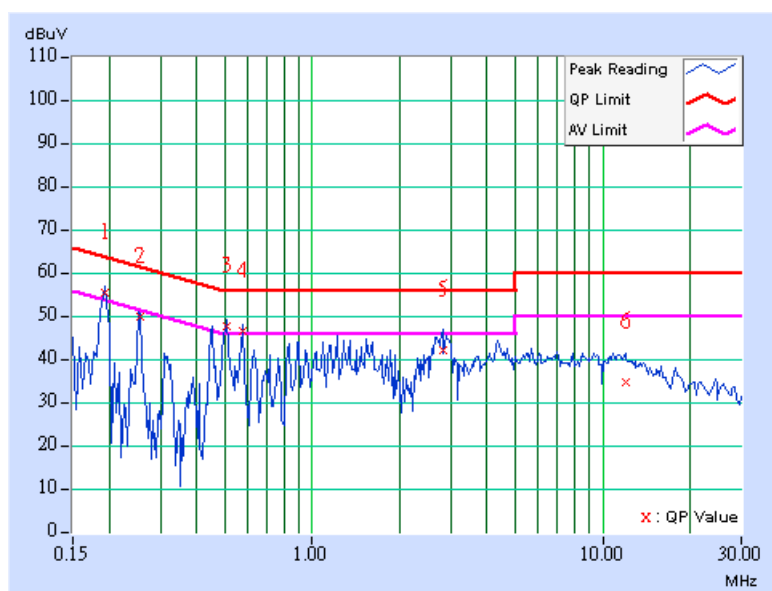



EUT TEST CONDITION		MEASUREMENT DETAIL	
CHANNEL	Channel 0	PHASE	Line 2
MODULATION TYPE	GFSK	6dB BANDWIDTH	9 kHz
ENVIRONMENTAL CONDITIONS	20deg. C, 60%RH, 991hPa	INPUT POWER (SYSTEM)	120Vac, 60 Hz
TESTED BY	Match Tsui		

No	Freq. [MHz]	Corr. Factor (dB)	Reading Value [dB (uV)]		Emission Level [dB (uV)]		Limit [dB (uV)]		Margin (dB)	
			Q.P.	AV.	Q.P.	AV.	Q.P.	AV.	Q.P.	AV.
1	0.193	0.10	56.84	46.65	56.94	46.75	63.91	53.91	-6.97	-7.16
2	0.255	0.10	50.10	-	50.20	-	61.58	51.58	-11.38	-
3	0.451	0.11	46.23	-	46.34	-	56.86	46.86	-10.52	-
4	0.580	0.13	46.81	44.27	46.94	44.40	56.00	46.00	-9.06	-1.60
5	2.960	0.28	42.90	-	43.18	-	56.00	46.00	-12.82	-
6	11.984	0.53	33.84	-	34.37	-	60.00	50.00	-25.63	-

- REMARKS:**
1. Q.P. and AV. are abbreviations of quasi-peak and average individually.
  2. "-": The Quasi-peak reading value also meets average limit and measurement with the average detector is unnecessary.
  3. The emission levels of other frequencies were very low against the limit.
  4. Margin value = Emission level - Limit value
  5. Correction factor = Insertion loss + Cable loss
  6. Emission Level = Correction Factor + Reading Value.

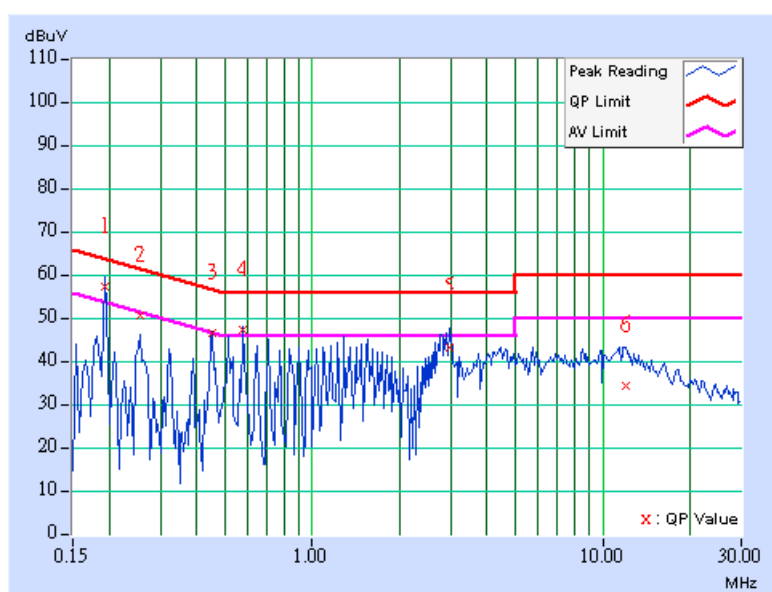

EUT TEST CONDITION		MEASUREMENT DETAIL	
CHANNEL	Channel 39	PHASE	Line 1
MODULATION TYPE	GFSK	6dB BANDWIDTH	9 kHz
ENVIRONMENTAL CONDITIONS	20deg. C, 60%RH, 991hPa	INPUT POWER (SYSTEM)	120Vac, 60 Hz
TESTED BY	Match Tsui		

No	Freq. [MHz]	Corr. Factor (dB)	Reading Value [dB (uV)]		Emission Level [dB (uV)]		Limit [dB (uV)]		Margin (dB)	
			Q.P.	AV.	Q.P.	AV.	Q.P.	AV.	Q.P.	AV.
			1	0.181	0.10	51.79	-	51.89	-	64.43
2	0.252	0.10	47.53	-	47.63	-	61.71	51.71	-14.08	-
3	0.502	0.10	48.48	42.52	48.58	42.62	56.00	46.00	-7.42	-3.38
4	0.576	0.10	43.28	-	43.38	-	56.00	46.00	-12.62	-
5	2.629	0.25	39.27	-	39.52	-	56.00	46.00	-16.48	-
6	8.191	0.36	32.20	-	32.56	-	60.00	50.00	-27.44	-

- REMARKS:**
1. Q.P. and AV. are abbreviations of quasi-peak and average individually.
  2. "-": The Quasi-peak reading value also meets average limit and measurement with the average detector is unnecessary.
  3. The emission levels of other frequencies were very low against the limit.
  4. Margin value = Emission level - Limit value
  5. Correction factor = Insertion loss + Cable loss
  6. Emission Level = Correction Factor + Reading Value.

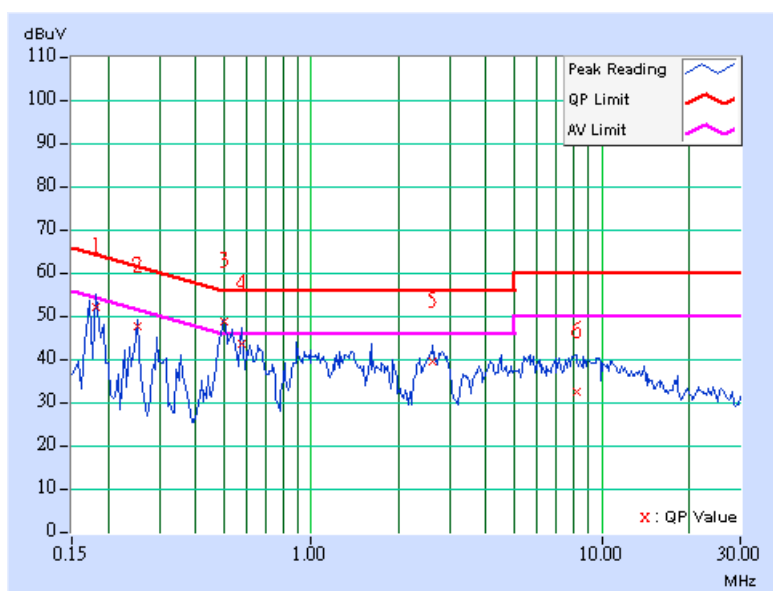

EUT TEST CONDITION		MEASUREMENT DETAIL	
CHANNEL	Channel 39	PHASE	Line 2
MODULATION TYPE	GFSK	6dB BANDWIDTH	9 kHz
ENVIRONMENTAL CONDITIONS	20deg. C, 60%RH, 991hPa	INPUT POWER (SYSTEM)	120Vac, 60 Hz
TESTED BY	Match Tsui		

No	Freq. [MHz]	Corr. Factor (dB)	Reading Value [dB (uV)]		Emission Level [dB (uV)]		Limit [dB (uV)]		Margin (dB)	
			Q.P.	AV.	Q.P.	AV.	Q.P.	AV.	Q.P.	AV.
			1	0.189	0.10	53.98	-	54.08	-	64.08
2	0.252	0.10	47.67	-	47.77	-	61.71	51.71	-13.94	-
3	0.505	0.12	48.24	42.73	48.36	42.85	56.00	46.00	-7.64	-3.15
4	0.580	0.13	44.58	-	44.71	-	56.00	46.00	-11.29	-
5	2.691	0.26	41.71	-	41.97	-	56.00	46.00	-14.03	-
6	9.375	0.45	34.09	-	34.54	-	60.00	50.00	-25.46	-

- REMARKS:**
1. Q.P. and AV. are abbreviations of quasi-peak and average individually.
  2. "-": The Quasi-peak reading value also meets average limit and measurement with the average detector is unnecessary.
  3. The emission levels of other frequencies were very low against the limit.
  4. Margin value = Emission level - Limit value
  5. Correction factor = Insertion loss + Cable loss
  6. Emission Level = Correction Factor + Reading Value.

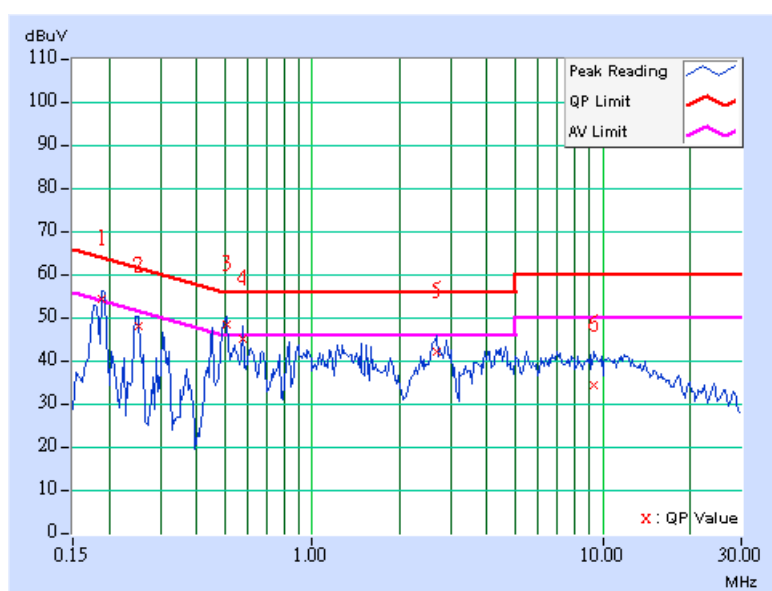

EUT TEST CONDITION		MEASUREMENT DETAIL	
CHANNEL	Channel 78	PHASE	Line 1
MODULATION TYPE	GFSK	6dB BANDWIDTH	9 kHz
ENVIRONMENTAL CONDITIONS	20deg. C, 60%RH, 991hPa	INPUT POWER (SYSTEM)	120Vac, 60 Hz
TESTED BY	Match Tsui		

No	Freq. [MHz]	Corr. Factor (dB)	Reading Value [dB (uV)]		Emission Level [dB (uV)]		Limit [dB (uV)]		Margin (dB)	
			Q.P.	AV.	Q.P.	AV.	Q.P.	AV.	Q.P.	AV.
1	0.192	0.10	54.77	44.49	54.87	44.59	63.97	53.97	-9.10	-9.38
2	0.252	0.10	47.02	-	47.12	-	61.71	51.71	-14.59	-
3	0.498	0.10	47.56	43.40	47.66	43.50	56.04	46.04	-8.38	-2.54
4	0.580	0.10	45.79	-	45.89	-	56.00	46.00	-10.11	-
5	2.828	0.27	41.68	-	41.95	-	56.00	46.00	-14.05	-
6	11.168	0.42	33.26	-	33.68	-	60.00	50.00	-26.32	-

- REMARKS:**
1. Q.P. and AV. are abbreviations of quasi-peak and average individually.
  2. "-": The Quasi-peak reading value also meets average limit and measurement with the average detector is unnecessary.
  3. The emission levels of other frequencies were very low against the limit.
  4. Margin value = Emission level - Limit value
  5. Correction factor = Insertion loss + Cable loss
  6. Emission Level = Correction Factor + Reading Value.

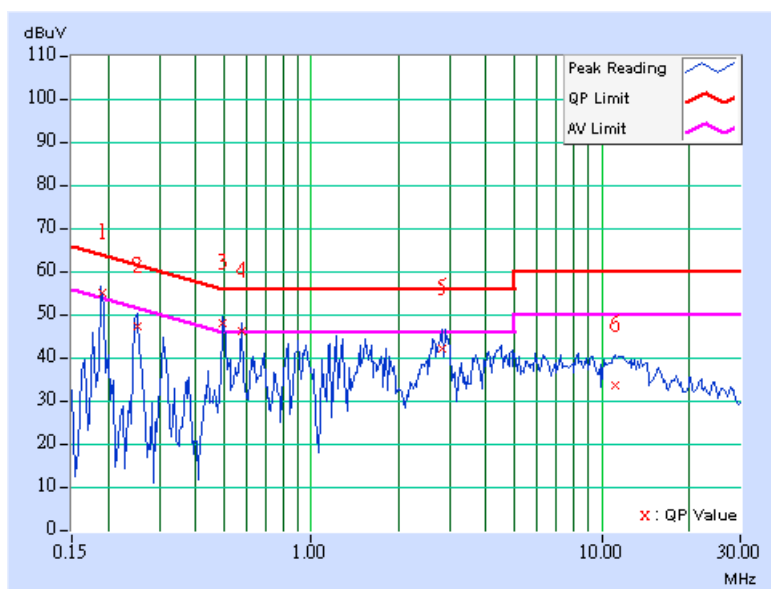

EUT TEST CONDITION		MEASUREMENT DETAIL	
CHANNEL	Channel 78	PHASE	Line 2
MODULATION TYPE	GFSK	6dB BANDWIDTH	9 kHz
ENVIRONMENTAL CONDITIONS	20deg. C, 60%RH, 991hPa	INPUT POWER (SYSTEM)	120Vac, 60 Hz
TESTED BY	Match Tsui		

No	Freq. [MHz]	Corr. Factor (dB)	Reading Value [dB (uV)]		Emission Level [dB (uV)]		Limit [dB (uV)]		Margin (dB)	
			Q.P.	AV.	Q.P.	AV.	Q.P.	AV.	Q.P.	AV.
			1	0.193	0.10	56.10	46.21	56.20	46.31	63.91
2	0.257	0.10	49.98	-	50.08	-	61.54	51.54	-11.46	-
3	0.509	0.12	48.50	43.12	48.62	43.24	56.00	46.00	-7.38	-2.76
4	<b>0.580</b>	<b>0.13</b>	<b>46.46</b>	<b>44.29</b>	<b>46.59</b>	<b>44.42</b>	<b>56.00</b>	<b>46.00</b>	<b>-9.41</b>	<b>-1.58</b>
5	2.957	0.28	42.43	-	42.71	-	56.00	46.00	-13.29	-
6	12.164	0.53	33.68	-	34.21	-	60.00	50.00	-25.79	-

- REMARKS:**
1. Q.P. and AV. are abbreviations of quasi-peak and average individually.
  2. "-": The Quasi-peak reading value also meets average limit and measurement with the average detector is unnecessary.
  3. The emission levels of other frequencies were very low against the limit.
  4. Margin value = Emission level - Limit value
  5. Correction factor = Insertion loss + Cable loss
  6. Emission Level = Correction Factor + Reading Value.

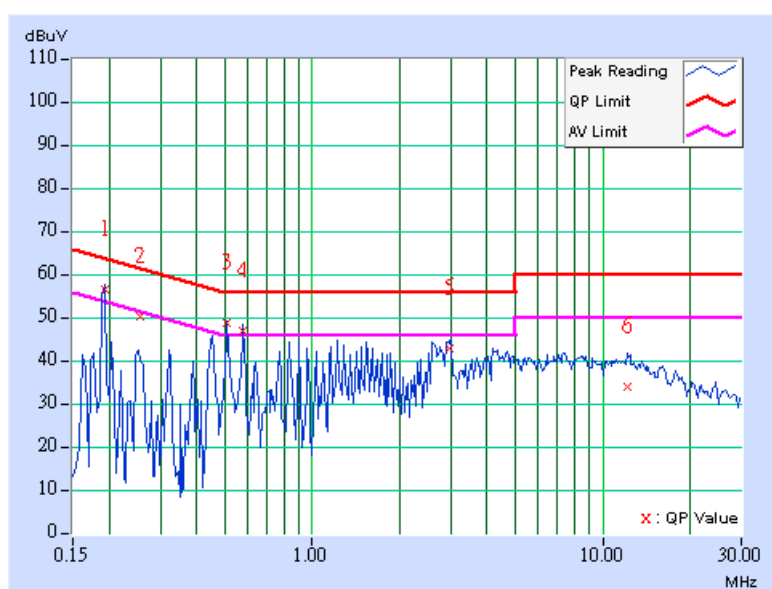

## 5.2 RADIATED EMISSION MEASUREMENT

### 5.2.1 LIMITS OF RADIATED EMISSION MEASUREMENT

Emissions radiated outside of the specified bands, shall be according to the general radiated limits in 15.209 as following:

FREQUENCIES (MHz)	FIELD STRENGTH (microvolts/meter)	MEASUREMENT DISTANCE (meters)
0.009-0.490	2400/F(kHz)	300
0.490-1.705	24000/F(kHz)	30
1.705-30.0	30	30
30-88	100	3
88-216	150	3
216-960	200	3
Above 960	500	3

**NOTE:**

1. The lower limit shall apply at the transition frequencies.
2. Emission level (dBuV/m) = 20 log Emission level (uV/m).
3. As shown in 15.35(b), for frequencies above 1000MHz, the field strength limits are based on average detector, however, the peak field strength of any emission shall not exceed the maximum permitted average limits, specified above by more than 20dB under any condition of modulation.



## 5.2.2 TEST INSTRUMENTS

DESCRIPTION & MANUFACTURER	MODEL NO.	SERIAL NO.	CALIBRATED UNTIL
Test Receiver ROHDE & SCHWARZ	ESIB7	100188	Dec. 20, 2006
Spectrum Analyzer ROHDE & SCHWARZ	FSP40	100039	Nov. 27, 2006
BILOG Antenna SCHWARZBECK	VULB9168	9168-157	Jan. 15, 2007
HORN Antenna SCHWARZBECK	BBHA 9120 D	9120D-407	Jan. 22, 2007
HORN Antenna SCHWARZBECK	BBHA 9170	BBHA9170147	Jan. 26, 2007
Preamplifier Agilent	8449B	3008A01961	Oct. 23, 2006
Preamplifier Agilent	8447D	2944A10629	Oct. 27, 2006
RF signal cable HUBER+SUHNER	SUCOFLEX 104	214380/4	Jan. 16, 2007
RF signal cable HUBER+SUHNER	SUCOFLEX 104	219266/4	Jan. 16, 2007
Software ADT.	ADT_Radiated_V5.14	NA	NA
Antenna Tower ADT.	AT100	AT93021702	NA
Turn Table ADT.	TT100.	TT93021702	NA
Controller ADT.	SC100.	SC93021702	NA

- NOTE:**
1. The calibration interval of the above test instruments is 12 months and the calibrations are traceable to NML/ROC and NIST/USA.
  2. The test was performed in HwaYa Chamber 2.
  3. The horn antenna and HP preamplifier (model: 8449B) are used only for the measurement of emission frequency above 1GHz if tested.
  4. The IC Site Registration No. is IC4924-2.

### 5.2.3 TEST PROCEDURES

- a. The EUT was placed on the top of a rotating table 0.8 meters above the ground at a 3 meters semi-anechoic chamber. The table was rotated 360 degrees to determine the position of the highest radiation.
- b. The EUT was set 3 meters away from the interference-receiving antenna, which was mounted on the top of a variable-height antenna tower.
- c. The antenna is a broadband antenna, and its height is varied from one meter to four meters above the ground to determine the maximum value of the field strength. Both horizontal and vertical polarizations of the antenna are set to make the measurement.
- d. For each suspected emission, the EUT was arranged to its worst case and then the antenna was tuned to heights from 1 meter to 4 meters and the rotatable table was turned from 0 degrees to 360 degrees to find the maximum reading.
- e. The test-receiver system was set to Peak Detect Function and Specified Bandwidth with Maximum Hold Mode.
- f. If the emission level of the EUT in peak mode was lower than the limit specified, then testing could be stopped and the peak values of the EUT would be reported. Otherwise the emissions would be re-tested one by one using peak, quasi-peak or average method as specified and then reported in a data sheet.

**NOTE:**

1. The resolution bandwidth and video bandwidth of test receiver/spectrum analyzer is 120kHz for Quasi-peak detection at frequency below 1GHz.
2. The resolution bandwidth of test receiver/spectrum analyzer is 1 MHz and video bandwidth is 3MHz for Peak detection at frequency above 1GHz.

### 5.2.4 DEVIATION FROM TEST STANDARD

No deviation



### 5.2.5 TEST SETUP

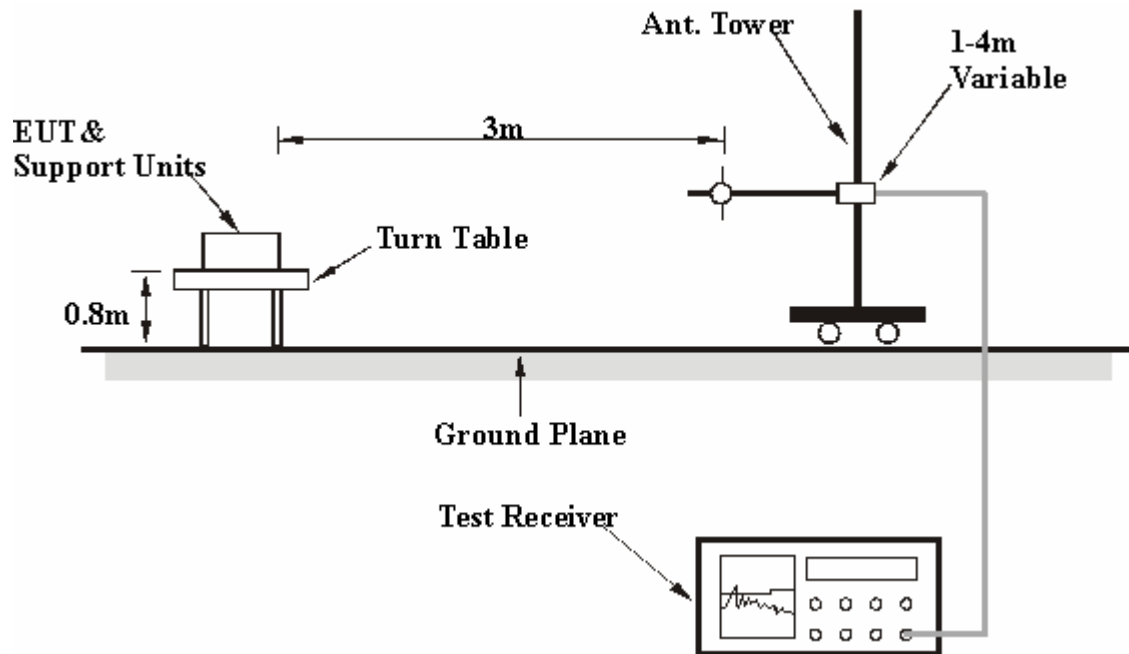

For the actual test configuration, please refer to the related item – Photographs of the Test Configuration.

### 5.2.6 EUT OPERATING CONDITIONS

Same as 4.1.6

## 5.2.7 TEST RESULTS

### RADIATED WORST CASE DATA:

EUT TEST CONDITION		MEASUREMENT DETAIL	
CHANNEL	Channel 78	FREQUENCY RANGE	Below 1000MHz
MODULATION TYPE	GFSK	DETECTOR FUNCTION	Quasi-Peak
ENVIRONMENTAL CONDITIONS	27deg. C, 71%RH, 991hPa	INPUT POWER (SYSTEM)	120Vac, 60 Hz
TESTED BY	Lori Chiu		

ANTENNA POLARITY & TEST DISTANCE: HORIZONTAL AT 3 M								
No.	Freq. (MHz)	Emission Level (dBuV/m)	Limit (dBuV/m)	Margin (dB)	Antenna Height (m)	Table Angle (Degree)	Raw Value (dBuV)	Correction Factor (dB/m)
1	78.60	27.45 QP	40.00	-12.55	1.50 H	337	16.73	10.72
2	<b>191.34</b>	<b>38.97 QP</b>	<b>43.50</b>	<b>-4.53</b>	<b>1.00 H</b>	<b>130</b>	<b>27.55</b>	<b>11.41</b>
3	298.26	38.46 QP	46.00	-7.54	1.50 H	13	22.93	15.53
4	329.36	35.96 QP	46.00	-10.04	1.50 H	115	19.95	16.01
5	397.39	33.23 QP	46.00	-12.77	1.50 H	13	15.38	17.85
6	498.48	36.67 QP	46.00	-9.33	1.00 H	100	16.64	20.03
7	945.57	34.13 QP	46.00	-11.87	1.00 H	100	4.92	29.21

ANTENNA POLARITY & TEST DISTANCE: VERTICAL AT 3 M								
No.	Freq. (MHz)	Emission Level (dBuV/m)	Limit (dBuV/m)	Margin (dB)	Antenna Height (m)	Table Angle (Degree)	Raw Value (dBuV)	Correction Factor (dB/m)
1	78.60	31.87 QP	40.00	-8.13	1.00 V	16	21.15	10.72
2	193.29	36.30 QP	43.50	-7.20	1.00 V	7	25.02	11.28
3	199.12	33.07 QP	43.50	-10.43	1.00 V	31	22.18	10.89
4	298.26	32.87 QP	46.00	-13.13	1.00 V	31	17.34	15.53
5	333.25	32.49 QP	46.00	-13.51	1.00 V	310	16.43	16.06
6	498.48	30.41 QP	46.00	-15.59	1.00 V	310	10.38	20.03
7	879.48	30.23 QP	46.00	-15.77	1.00 V	28	3.32	26.91
8	945.57	35.14 QP	46.00	-10.86	1.00 V	310	5.93	29.21

- REMARKS:**
1. Emission level(dBuV/m)=Raw Value(dBuV) + Correction Factor(dB/m)
  2. Correction Factor(dB/m) = Antenna Factor (dB/m) + Cable Factor (dB)
  3. The other emission levels were very low against the limit.
  4. Margin value = Emission level – Limit value.



### RADIATED WORST CASE DATA: ABOVE 1GHz

EUT TEST CONDITION		MEASUREMENT DETAIL	
CHANNEL	Channel 0	FREQUENCY RANGE	1 ~ 25GHz
MODULATION TYPE	GFSK	DETECTOR FUNCTION	Peak (PK) Average (AV)
INPUT POWER (SYSTEM)	120Vac, 60 Hz	ENVIRONMENTAL CONDITIONS	27deg. C, 71%RH, 991hPa
TESTED BY	Lori Chiu		

ANTENNA POLARITY & TEST DISTANCE: HORIZONTAL AT 3 M								
No.	Freq. (MHz)	Emission Level (dBuV/m)	Limit (dBuV/m)	Margin (dB)	Antenna Height (m)	Table Angle (Degree)	Raw Value (dBuV)	Correction Factor (dB/m)
1	2390.00	43.89 PK	74.00	-30.11	1.27 H	279	12.68	31.21
1	2390.00	38.42 AV	54.00	-15.58	1.27 H	279	7.21	31.21
2	*2402.00	99.22 PK			1.08 H	355	68.02	31.20
2	*2402.00	69.22 AV			1.08 H	355	38.02	31.20
3	7206.00	52.94 PK	74.00	-21.06	1.45 H	264	10.05	42.89
3	7206.00	22.94 AV	54.00	-31.06	1.45 H	264	-19.95	42.89

ANTENNA POLARITY & TEST DISTANCE: VERTICAL AT 3 M								
No.	Freq. (MHz)	Emission Level (dBuV/m)	Limit (dBuV/m)	Margin (dB)	Antenna Height (m)	Table Angle (Degree)	Raw Value (dBuV)	Correction Factor (dB/m)
1	2390.00	40.95 PK	74.00	-33.05	1.27 V	279	9.74	31.21
1	2390.00	35.59 AV	54.00	-18.41	1.27 V	279	4.38	31.21
2	*2402.00	91.90 PK			1.24 V	56	60.70	31.20
2	*2402.00	61.90 AV			1.24 V	56	30.70	31.20
3	7206.00	51.38 PK	74.00	-22.62	1.15 V	84	8.49	42.89
3	7206.00	21.38 AV	54.00	-32.62	1.15 V	84	-21.51	42.89

- REMARKS:**
1. Emission level (dBuV/m) = Raw Value (dBuV) + Correction Factor (dB/m).
  2. Correction Factor (dB/m) = Antenna Factor (dB/m) + Cable Factor (dB).
  3. The other emission levels were very low against the limit.
  4. Margin value = Emission level – Limit value.
  5. The DH5 packet was the worse case duty cycle for a transmit dwell time on a channel, based upon bluetooth theory the transmitter is on 0.625 \* 5 per 296.25 ms per channel. Therefore, the duty cycle be equal to:  $20\log(3.125/100) = -30$  dB.
  6. Average value = peak reading  $-20\log(\text{duty cycle})$ .



EUT TEST CONDITION		MEASUREMENT DETAIL	
CHANNEL	Channel 39	FREQUENCY RANGE	1 ~ 25GHz
MODULATION TYPE	GFSK	DETECTOR FUNCTION	Peak (PK) Average (AV)
INPUT POWER (SYSTEM)	120Vac, 60 Hz	ENVIRONMENTAL CONDITIONS	27deg. C, 71%RH, 991hPa
TESTED BY	Lori Chiu		

ANTENNA POLARITY & TEST DISTANCE: HORIZONTAL AT 3 M								
No.	Freq. (MHz)	Emission Level (dBuV/m)	Limit (dBuV/m)	Margin (dB)	Antenna Height (m)	Table Angle (Degree)	Raw Value (dBuV)	Correction Factor (dB/m)
1	*2441.00	99.34 PK			1.09 H	354	67.05	32.29
1	*2441.00	69.34 AV			1.09 H	354	37.05	32.29
2	7323.00	53.18 PK	74.00	-20.82	1.09 H	264	7.66	45.52
2	7323.00	23.18 AV	54.00	-30.82	1.09 H	264	-22.34	45.52

ANTENNA POLARITY & TEST DISTANCE: VERTICAL AT 3 M								
No.	Freq. (MHz)	Emission Level (dBuV/m)	Limit (dBuV/m)	Margin (dB)	Antenna Height (m)	Table Angle (Degree)	Raw Value (dBuV)	Correction Factor (dB/m)
1	*2441.00	91.85 PK			1.23 V	282	59.56	32.29
1	*2441.00	61.85 AV			1.23 V	282	29.56	32.29
2	7323.00	52.07 PK	74.00	-21.93	1.13 V	244	6.55	45.52
2	7323.00	22.07 AV	54.00	-31.93	1.13 V	244	-23.45	45.52

- REMARKS:**
1. Emission level (dBuV/m) = Raw Value (dBuV) + Correction Factor (dB/m).
  2. Correction Factor (dB/m) = Antenna Factor (dB/m) + Cable Factor (dB).
  3. The other emission levels were very low against the limit.
  4. Margin value = Emission level – Limit value.
  5. The DH5 packet was the worse case duty cycle for a transmit dwell time on a channel, based upon bluetooth theory the transmitter is on 0.625 \* 5 per 296.25 ms per channel. Therefore, the duty cycle be equal to:  $20\log(3.125/100) = -30$  dB.
  6. Average value = peak reading – 20log (duty cycle).



EUT TEST CONDITION		MEASUREMENT DETAIL	
CHANNEL	Channel 78	FREQUENCY RANGE	1 ~ 25GHz
MODULATION TYPE	GFSK	DETECTOR FUNCTION	Peak (PK) Average (AV)
INPUT POWER (SYSTEM)	120Vac, 60 Hz	ENVIRONMENTAL CONDITIONS	27deg. C, 71%RH, 991hPa
TESTED BY	Lori Chiu		

ANTENNA POLARITY & TEST DISTANCE: HORIZONTAL AT 3 M								
No.	Freq. (MHz)	Emission Level (dBuV/m)	Limit (dBuV/m)	Margin (dB)	Antenna Height (m)	Table Angle (Degree)	Raw Value (dBuV)	Correction Factor (dB/m)
1	*2480.00	99.35 PK			1.10 H	352	66.92	32.43
1	*2480.00	69.35 AV			1.10 H	352	36.92	32.43
2	2483.50	43.75 PK	74.00	-30.25	1.10 H	352	11.31	32.44
2	2483.50	38.36 AV	54.00	-15.64	1.10 H	352	5.92	32.44
3	7440.00	53.87 PK	74.00	-20.13	1.08 H	214	8.04	45.83
3	7440.00	23.87 AV	54.00	-30.13	1.08 H	214	-21.96	45.83

ANTENNA POLARITY & TEST DISTANCE: VERTICAL AT 3 M								
No.	Freq. (MHz)	Emission Level (dBuV/m)	Limit (dBuV/m)	Margin (dB)	Antenna Height (m)	Table Angle (Degree)	Raw Value (dBuV)	Correction Factor (dB/m)
1	*2480.00	91.85 PK			1.21 V	62	59.42	32.43
1	*2480.00	61.85 AV			1.21 V	62	29.42	32.43
2	2483.50	40.87 PK	74.00	-33.13	1.21 V	62	8.43	32.44
2	2483.50	35.48 AV	54.00	-18.52	1.21 V	62	3.04	32.44
3	7440.00	52.63 PK	74.00	-21.37	1.01 V	269	6.80	45.83
3	7440.00	22.63 AV	54.00	-31.37	1.01 V	269	-23.20	45.83

- REMARKS:**
1. Emission level (dBuV/m) = Raw Value (dBuV) + Correction Factor (dB/m).
  2. Correction Factor (dB/m) = Antenna Factor (dB/m) + Cable Factor (dB).
  3. The other emission levels were very low against the limit.
  4. Margin value = Emission level – Limit value.
  5. The DH5 packet was the worse case duty cycle for a transmit dwell time on a channel, based upon bluetooth theory the transmitter is on 0.625 \* 5 per 296.25 ms per channel. Therefore, the duty cycle be equal to:  $20\log(3.125/100) = -30$  dB.
  6. Average value = peak reading  $-20\log(\text{duty cycle})$ .



### 5.3 NUMBER OF HOPPING FREQUENCY USED

#### 5.3.1 LIMIT OF HOPPING FREQUENCY USED

At least 15 channels frequencies, and should be equally spaced.

#### 5.3.2 TEST INSTRUMENTS

DESCRIPTION & MANUFACTURER	MODEL NO.	SERIAL NO.	CALIBRATED UNTIL
SPECTRUM ANALYZER	FSP40	100040	Jun. 07, 2007

**NOTE:** The calibration interval of the above test instruments is 12 months. And the calibrations are traceable to NML/ROC and NIST/USA.

#### 5.3.3 TEST PROCEDURES

- a. Check the calibration of the measuring instrument (SA) using either an internal calibrator or a known signal from an external generator.
- b. Turn on the EUT and connect its antenna terminal to measurement via a low loss cable. Then set it to any one measured frequency within its operating range and make sure the instrument is operated in its linear range.
- c. Set the SA on MaxHold Mode, and then keep the EUT in hopping mode. Record all the signals from each channel until each one has been recorded.
- d. Set the SA on View mode and then plot the result on SA screen.
- e. Repeat above procedures until all frequencies measured were complete.

#### 5.3.4 DEVIATION FROM TEST STANDARD

No deviation.

#### 5.3.5 TEST SETUP

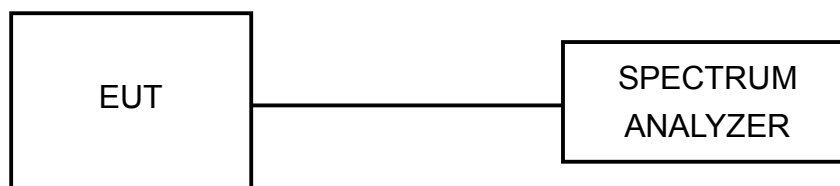

#### 5.3.6 TEST RESULTS

There are 79 hopping frequencies in the hopping mode. Please refer to next two pages for the test result. On the plots, it shows that the hopping frequencies are equally spaced.

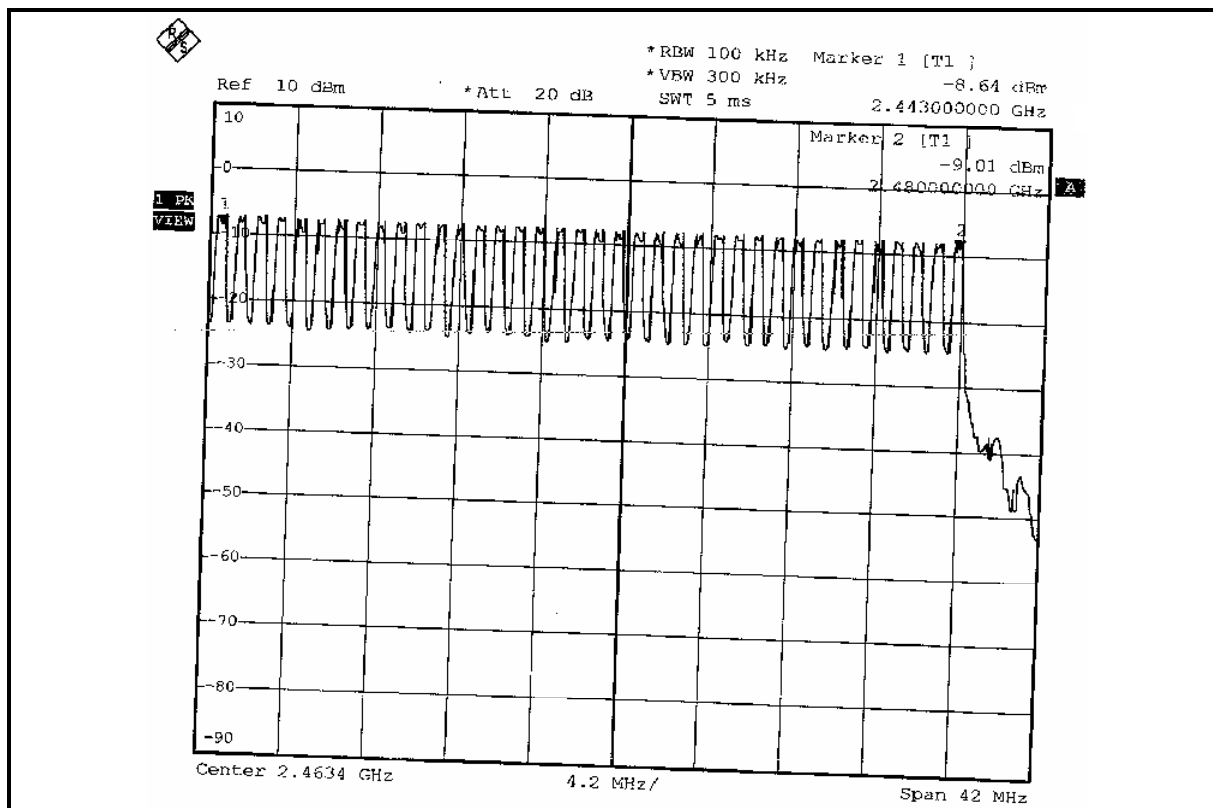
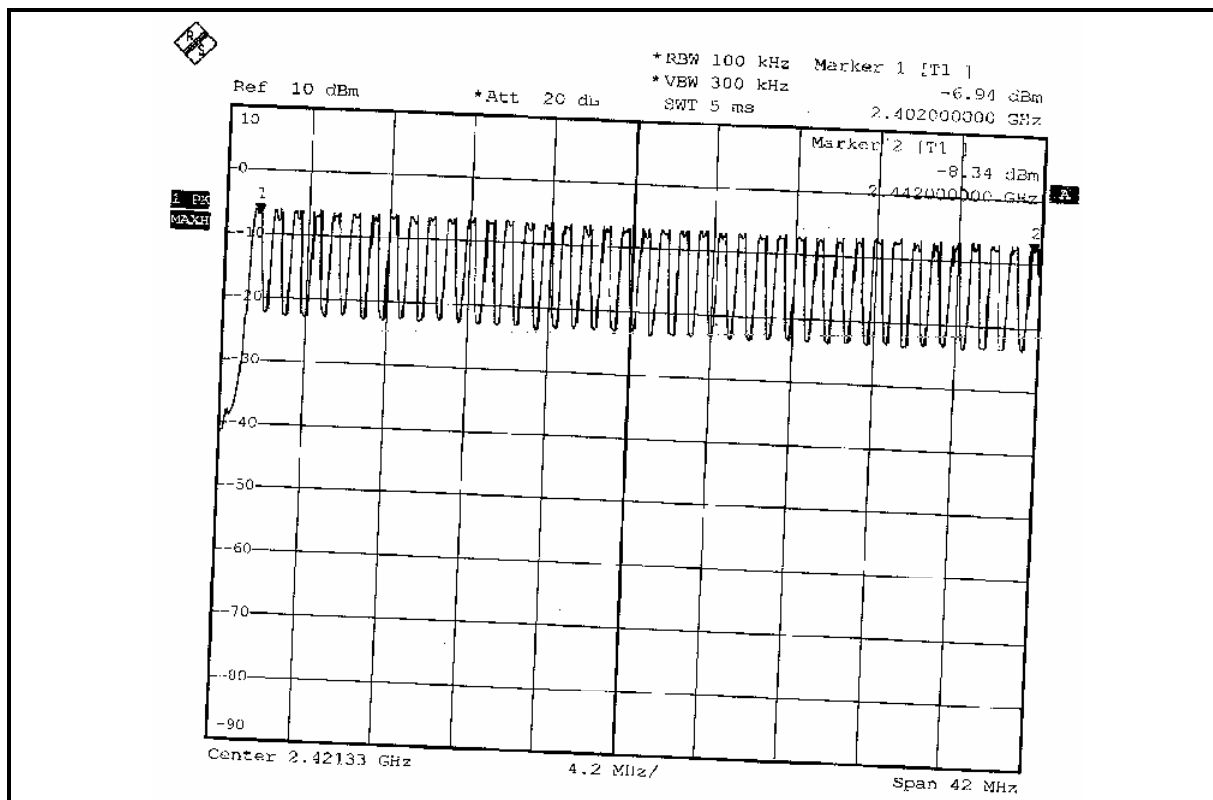





## 5.4 DWELL TIME ON EACH CHANNEL

### 5.4.1 LIMIT OF DWELL TIME USED

The average time of occupancy on any channel shall not be greater than 0.4 seconds within a period of 0.4 seconds multiplied by the number of hopping channels employed.

### 5.4.2 TEST INSTRUMENTS

DESCRIPTION & MANUFACTURER	MODEL NO.	SERIAL NO.	CALIBRATED UNTIL
SPECTRUM ANALYZER	FSP40	100040	Jun. 07, 2007

**NOTES:** The calibration interval of the above test instruments is 12 months. And the calibrations are traceable to NML/ROC and NIST/USA.

### 5.4.3 TEST PROCEDURES

- a. Check the calibration of the measuring instrument (SA) using either an internal calibrator or a known signal from an external generator.
- b. Turn on the EUT and connect its antenna terminal to measurement via a low loss cable. Then set it to any one measured frequency within its operating range and make sure the instrument is operated in its linear range.
- c. Adjust the center frequency of SA on any frequency be measured and set SA to zero span mode. And then, set RBW and VBW of spectrum analyzer to proper value.
- d. Measure the time duration of one transmission on the measured frequency. And then plot the result with time difference of this time duration.
- e. Repeat above procedures until all different time-slot modes have been completed.

### 5.4.4 DEVIATION FROM TEST STANDARD

No deviation.

#### 5.4.4 TEST SETUP

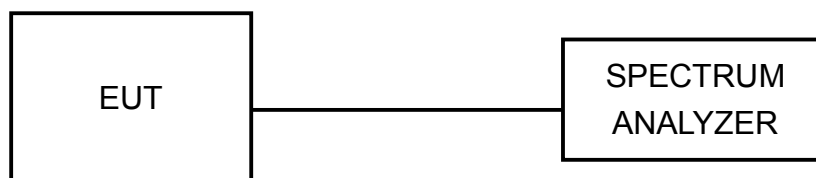

#### 5.4.5 TEST RESULTS

MODE	NUMBER OF TRANSMISSION IN A 31.6 (79HOPPING*0.4)	LENGTH OF TRANSMISSION TIME (msec)	RESULT (msec)	LIMIT (msec)
DH1	50 (times / 5 sec) * 6.32 = 316.00 times	0.492	155.472	400
DH3	25 (times / 5 sec) * 6.32 = 158.00 times	1.710	270.180	400
DH5	17 (times / 5 sec) * 6.32 = 107.44times	2.960	318.022	400

**NOTE:** Test plots of the transmitting time slot are shown on next 3 pages.

DH1

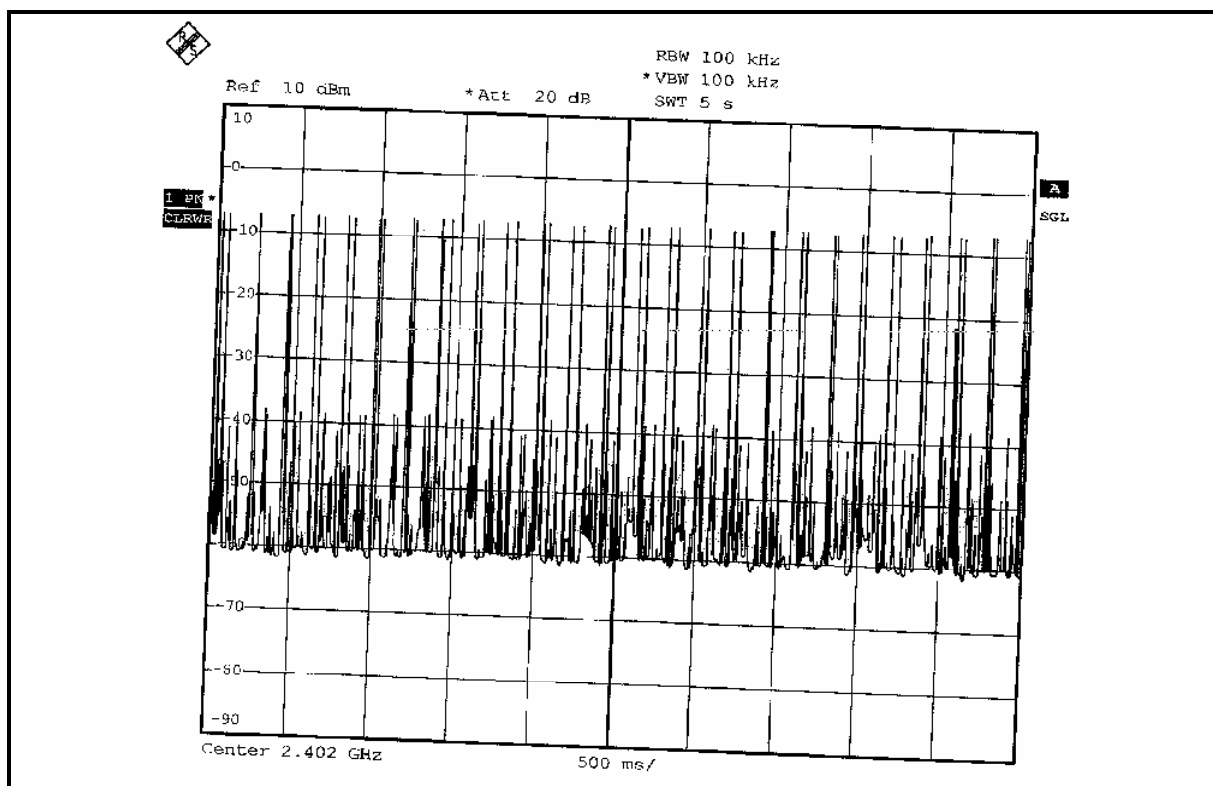
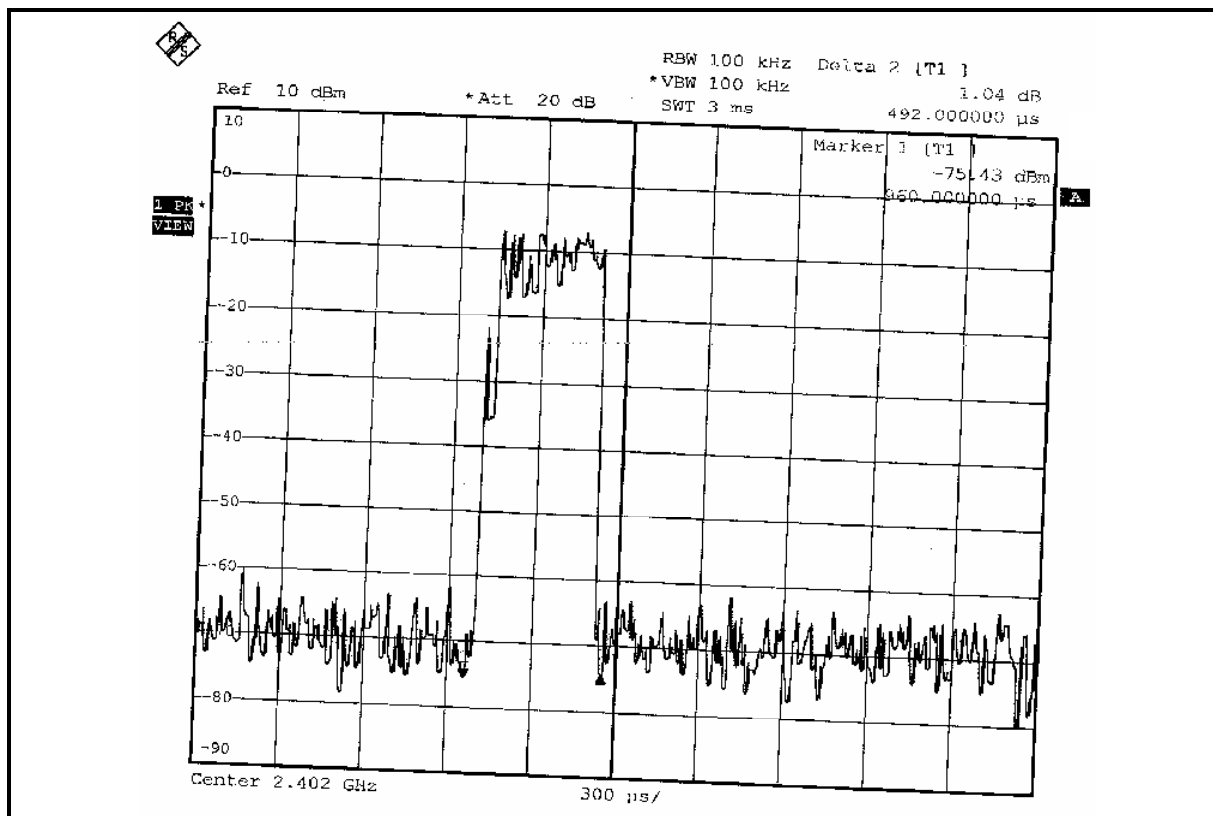

DH3

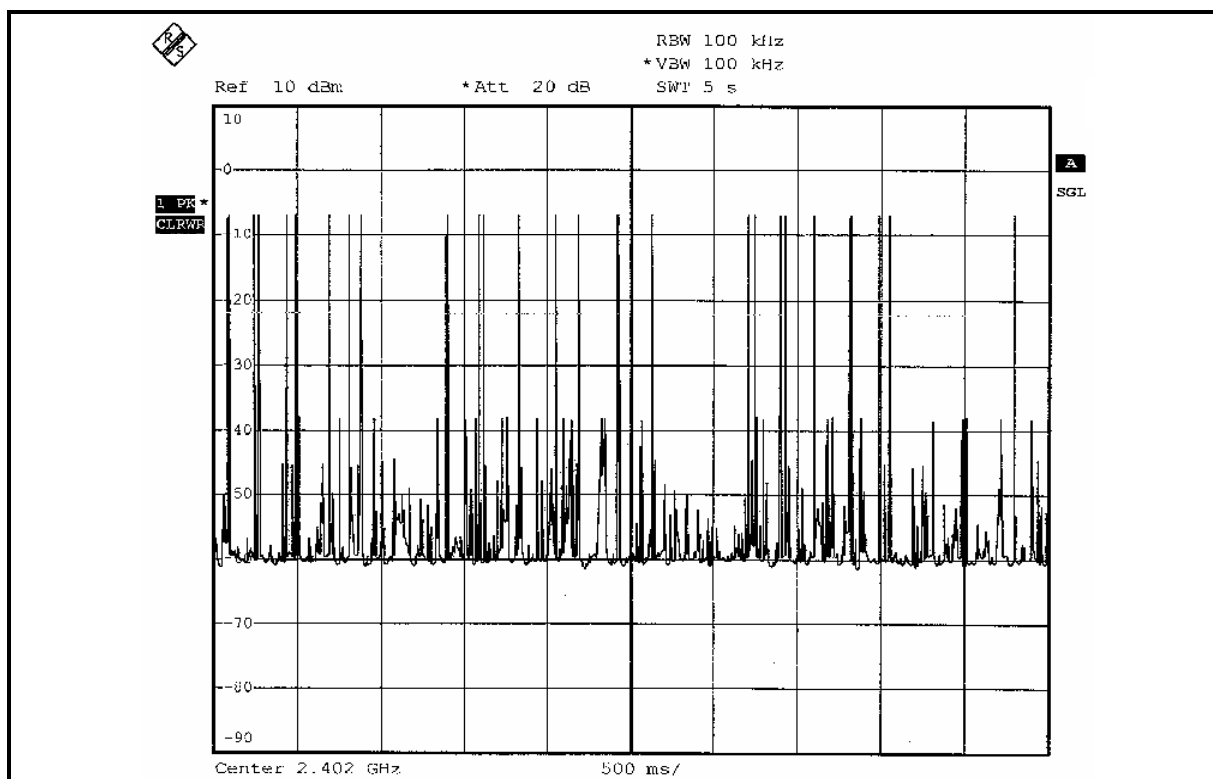
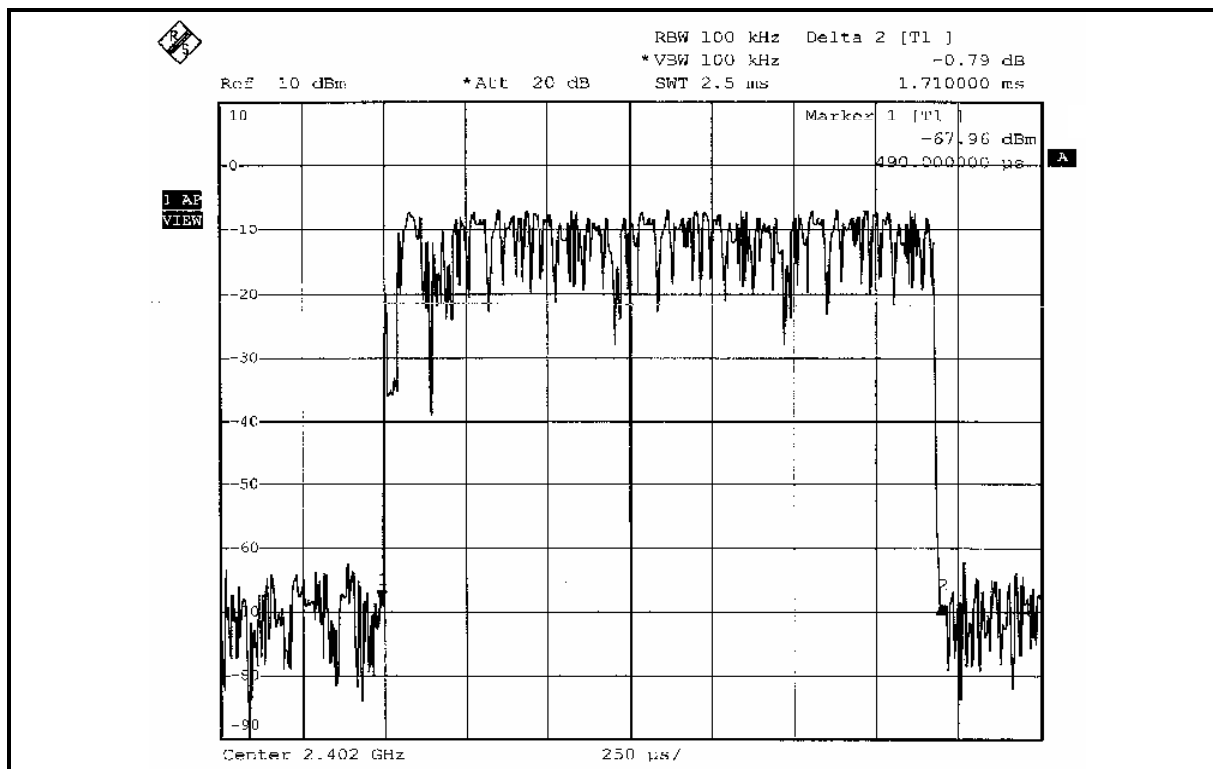





## 5.5 CHANNEL BANDWIDTH

### 5.5.1 LIMITS OF CHANNEL BANDWIDTH

For frequency hopping system operating in the 2400-2483.5MHz, If the 20dB bandwidth of hopping channel is greater than 25kHz, two-thirds 20dB bandwidth of hopping channel shall be a minimum limit for the hopping channel separation.

### 5.5.2 TEST INSTRUMENTS

DESCRIPTION & MANUFACTURER	MODEL NO.	SERIAL NO.	CALIBRATED UNTIL
SPECTRUM ANALYZER	FSP40	100040	Jun. 07, 2007

**NOTE:** The calibration interval of the above test instruments is 12 months. And the calibrations are traceable to NML/ROC and NIST/USA.

### 5.5.3 TEST PROCEDURE

- a. Check the calibration of the measuring instrument using either an internal calibrator or a known signal from an external generator.
- b. Turn on the EUT and connect it to measurement instrument. Then set it to any one convenient frequency within its operating range. Set a reference level on the measuring instrument equal to the highest peak value.
- c. Measure the frequency difference of two frequencies that were attenuated 20dB from the reference level. Record the frequency difference as the emission bandwidth.
- d. Repeat above procedures until all frequencies measured were complete.

### 5.5.4 DEVIATION FROM TEST STANDARD

No deviation.

### 5.5.5 TEST SETUP

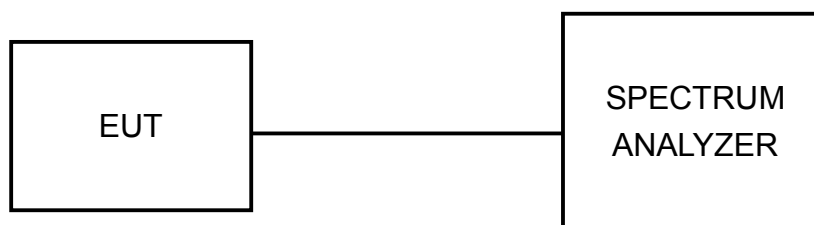

### 5.5.6 EUT OPERATING CONDITION

The software provided by client enabled the EUT to transmit and receive data at lowest, middle and highest channel frequencies individually.

### 5.5.7 TEST RESULTS

<b>MODULATION TYPE</b>	GFSK	<b>ENVIRONMENTAL CONDITIONS</b>	22deg. C, 68%RH, 991hPa
<b>INPUT POWER (SYSTEM)</b>	120Vac, 60 Hz	<b>TESTED BY</b>	Match Tsui

CHANNEL	CHANNEL FREQUENCY (MHz)	20dB BANDWIDTH (MHz)
0	2402	1.026
39	2441	1.020
78	2480	1.017

CH 0

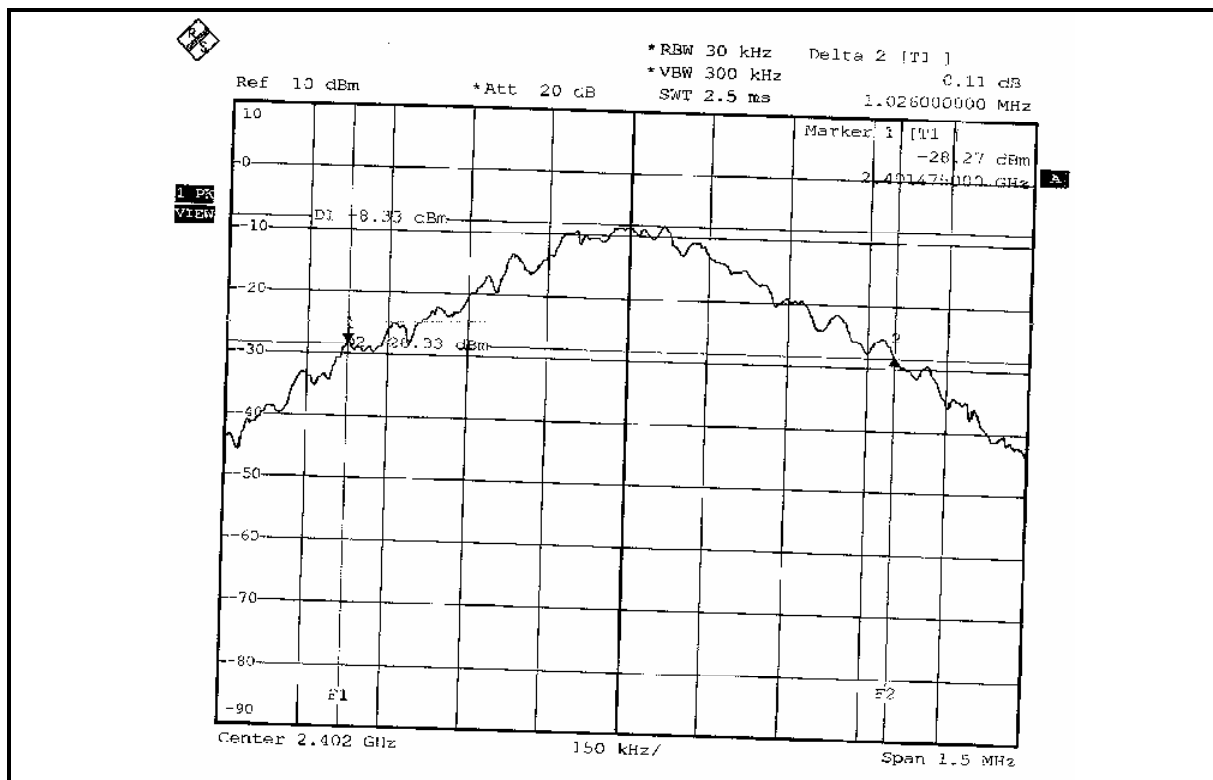

CH 39

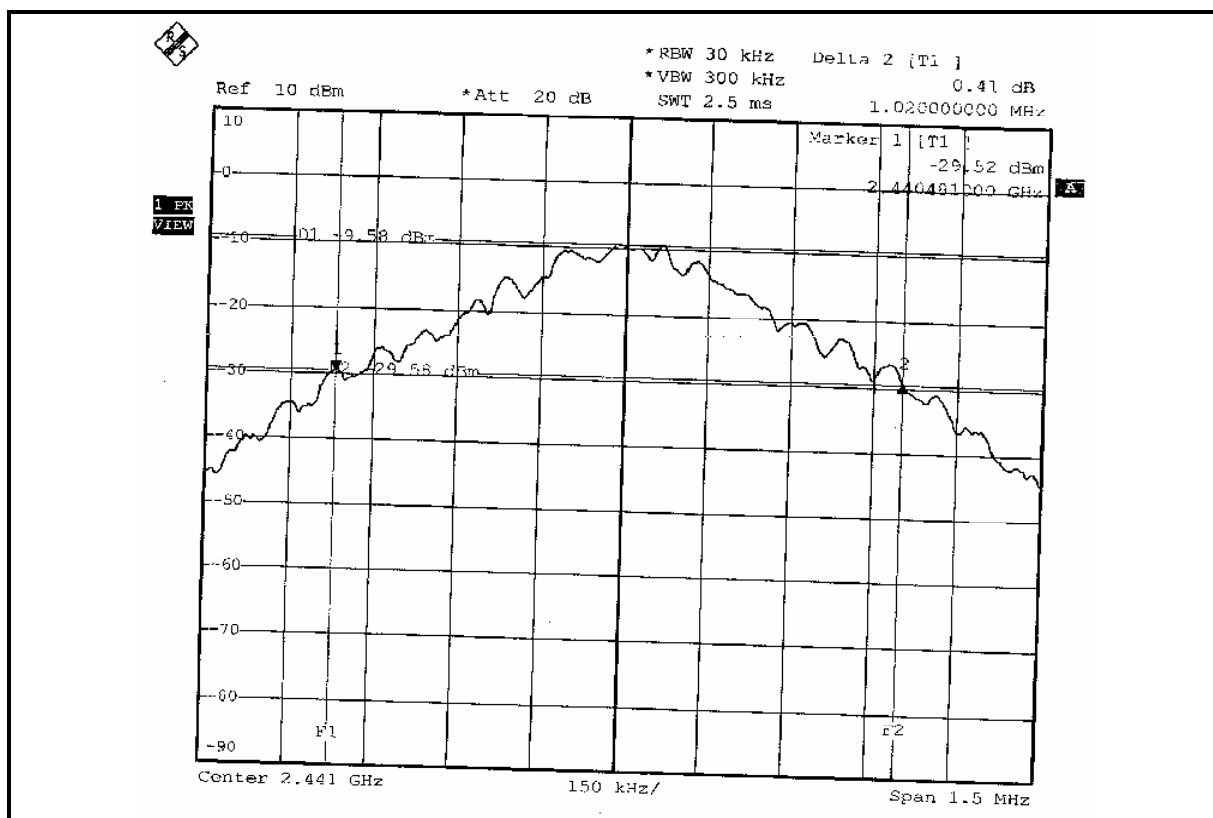



CH 78

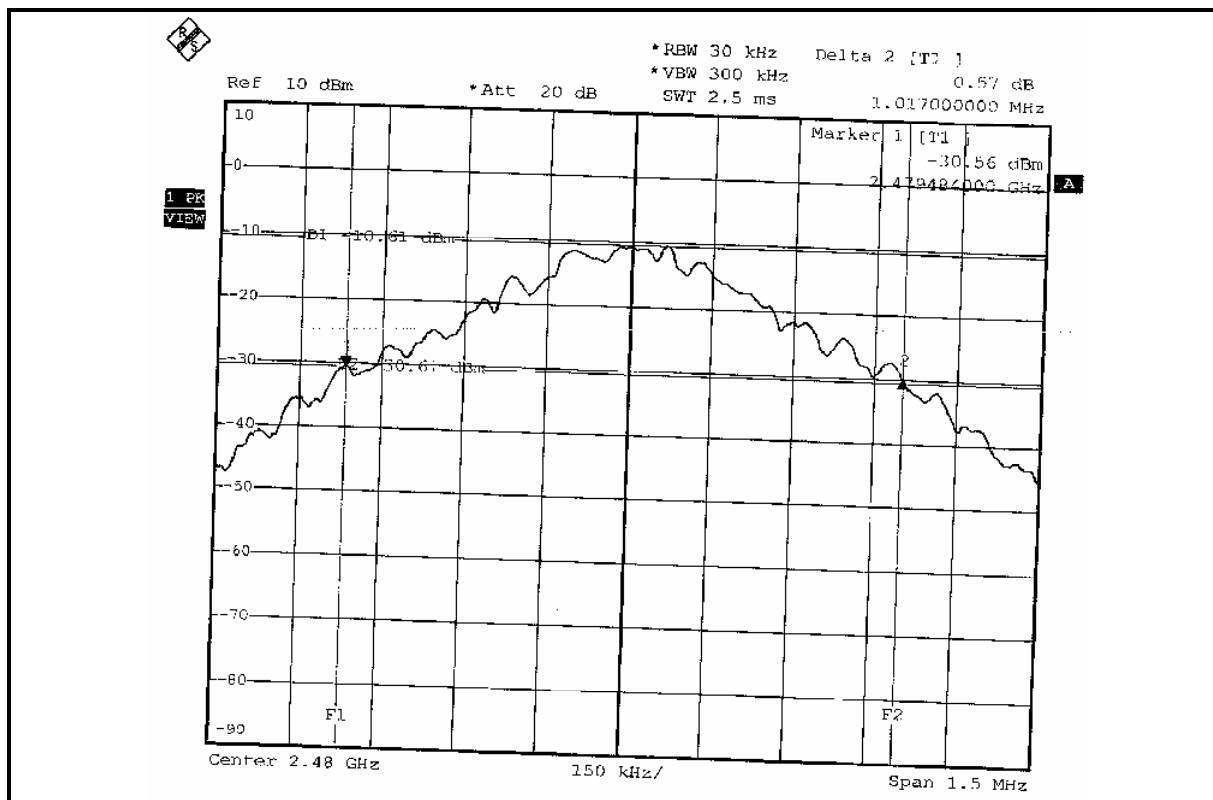

## 5.6 HOPPING CHANNEL SEPARATION

### 5.6.1 LIMIT OF HOPPING CHANNEL SEPARATION

At least 25kHz or two-third of 20dB hopping channel bandwidth (whichever is greater).

### 5.6.2 TEST INSTRUMENTS

DESCRIPTION & MANUFACTURER	MODEL NO.	SERIAL NO.	CALIBRATED UNTIL
SPECTRUM ANALYZER	FSP40	100040	Jun. 07, 2007

**NOTES:** The calibration interval of the above test instruments is 12 months. And the calibrations are traceable to NML/ROC and NIST/USA.

### 5.6.3 TEST PROCEDURES

1. Check the calibration of the measuring instrument using either an internal calibrator or a known signal from an external generator.
2. Turn on the EUT and connect it to measurement instrument. Then set it to any one convenient frequency within its operating range.
3. By using the MaxHold function record the separation of two adjacent channels.
4. Measure the frequency difference of these two adjacent channels by SA MARK function. And then plot the result on SA screen.
5. Repeat above procedures until all frequencies measured were complete.

### 5.6.4 DEVIATION FROM TEST STANDARD

No deviation

### 5.6.5 TEST SETUP

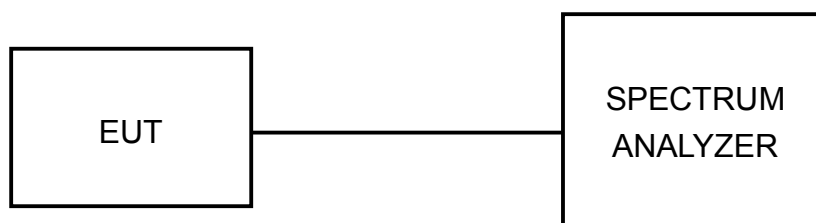

### 5.6.6 TEST RESULTS

<b>MODULATION TYPE</b>	GFSK	<b>ENVIRONMENTAL CONDITIONS</b>	22deg. C, 68%RH, 991hPa
<b>INPUT POWER (SYSTEM)</b>	120Vac, 60 Hz	<b>TESTED BY</b>	Match Tsui

CHANNEL	FREQUENCY (MHz)	ADJACENT CHANNEL SEPARATION (MHz)	20dB BANDWIDTH (MHz)	MINIMUM LIMIT (MHz)	PASS / FAIL
0	2402	1.015	1.026	0.684	PASS
39	2441	1.015	1.020	0.680	PASS
78	2480	1.005	1.017	0.678	PASS

**NOTE:** The minimum limit is two-third 20dB bandwidth. Test results please refer to next two pages.

### CH 0

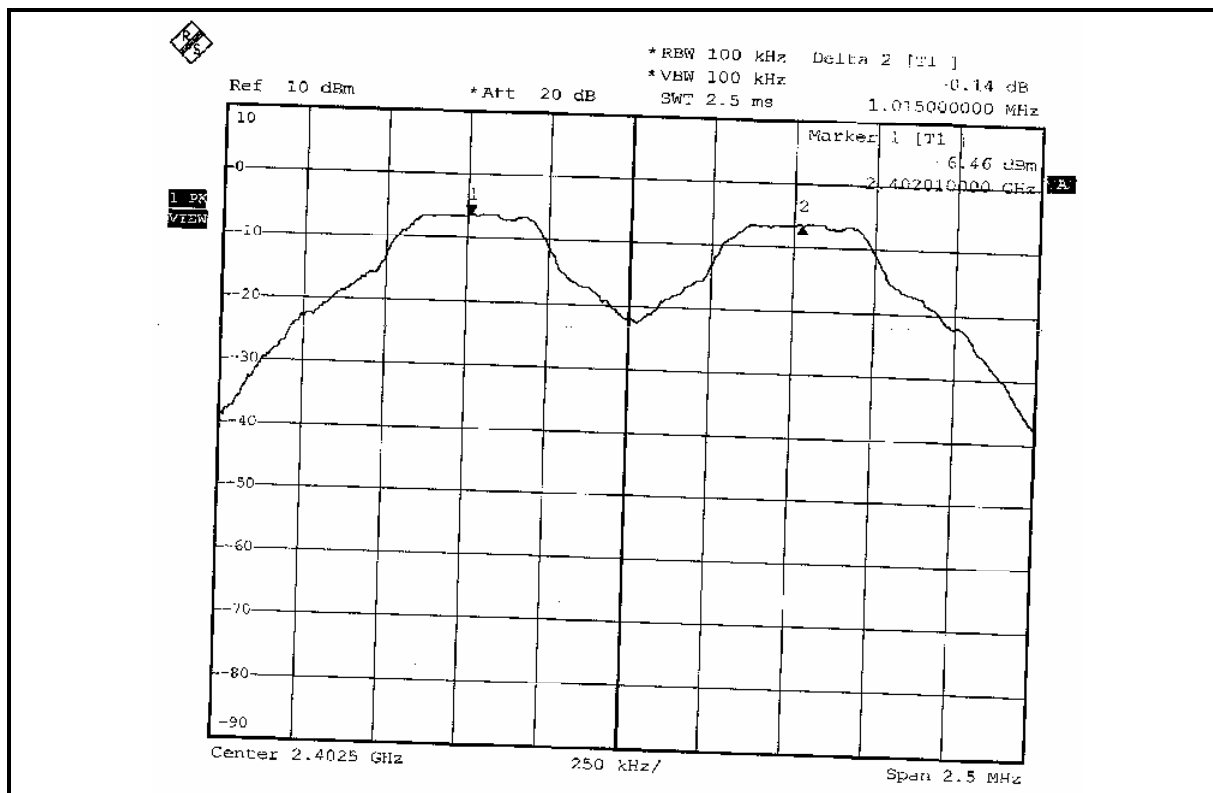

### CH 39

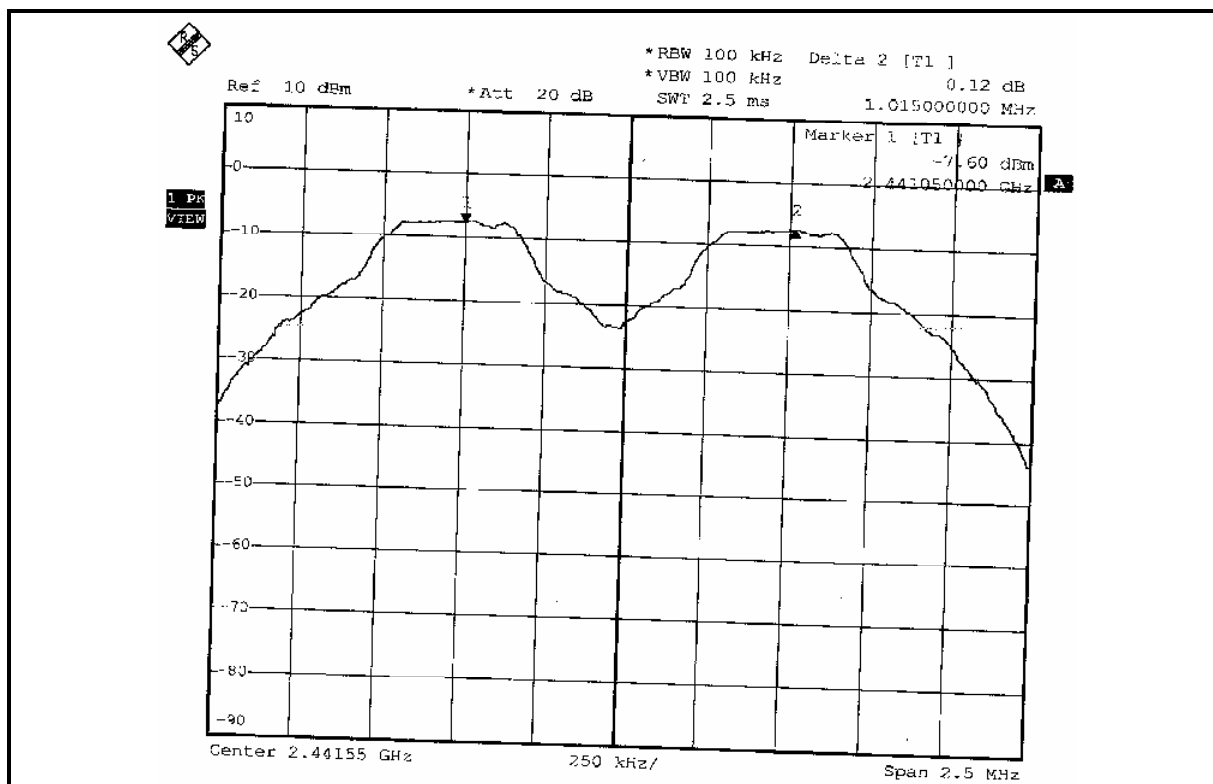

CH 78

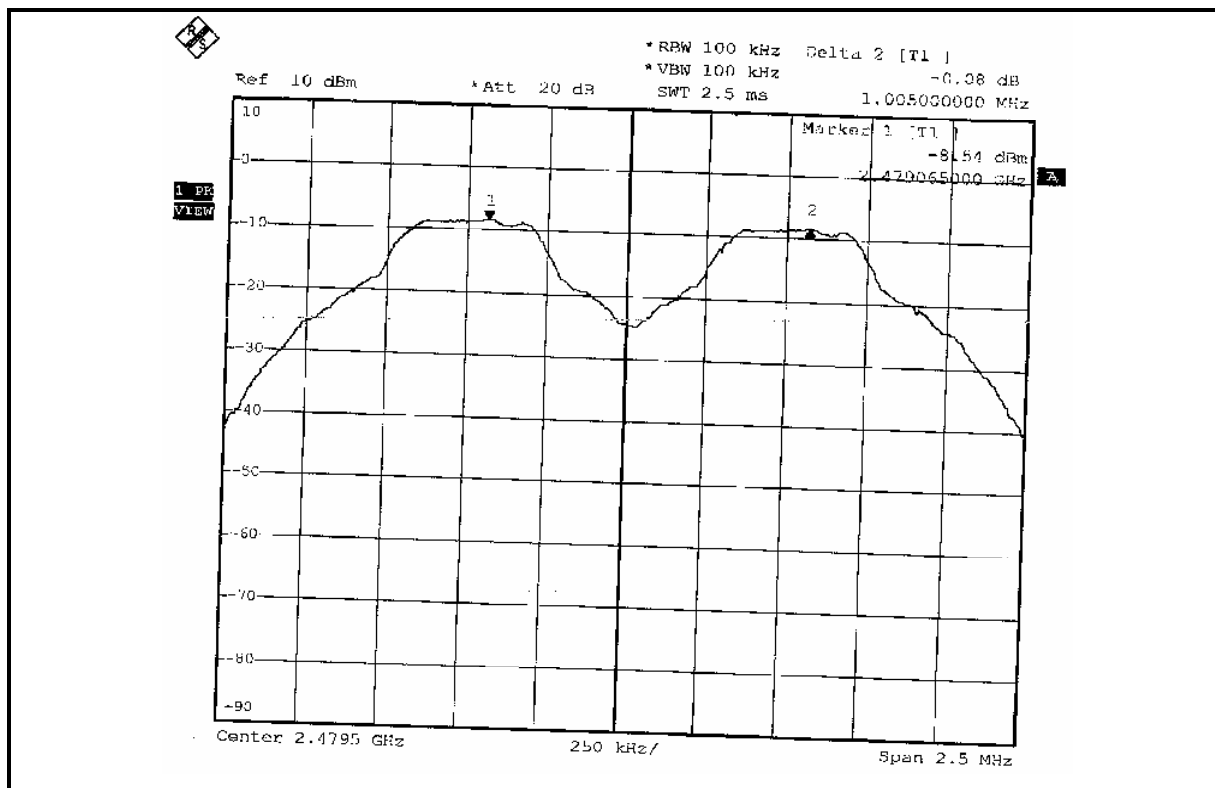



## 5.7 MAXIMUM PEAK OUTPUT POWER

### 5.7.1 LIMITS OF MAXIMUM PEAK OUTPUT POWER MEASUREMENT

The Maximum Peak Output Power Measurement is 125mW.

### 5.7.2 TEST INSTRUMENTS

DESCRIPTION & MANUFACTURER	MODEL NO.	SERIAL NO.	CALIBRATED UNTIL
SPECTRUM ANALYSEER	FSP40	100040	Jun. 07, 2007

**NOTE:** The calibration interval of the above test instruments is 12 months and the calibrations are traceable to NML/ROC and NIST/USA.

### 5.7.3 TEST PROCEDURES

- a. Check the calibration of the measuring instrument using either an internal calibrator or a known signal from an external generator.
- b. Turn on the EUT and connect it to measurement instrument. Then set it to any one convenient frequency within its operating range. Set a reference level on the measuring instrument equal to the highest peak value.
- c. The center frequency of the spectrum analyzer is set to the fundamental frequency and using 1 MHz RBW and 3 MHz VBW.
- d. Measure the captured power within the band and recording the plot.
- e. Repeat above procedures until all frequencies required were complete.

### 5.7.4 DEVIATION FROM TEST STANDARD

No deviation

### 5.7.5 TEST SETUP

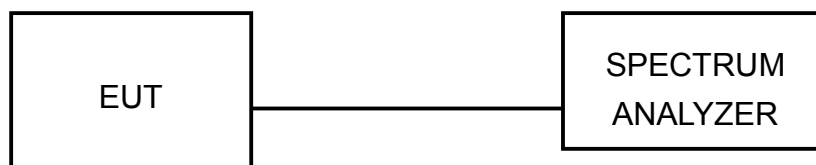

For the actual test configuration, please refer to the related Item – Photographs of the Test Configuration.

### 5.7.6 EUT OPERATING CONDITION

The software provided by client enabled the EUT to transmit and receive data at lowest, middle and highest channel frequencies individually.

### 5.7.7 TEST RESULTS

<b>MODULATION TYPE</b>	GFSK	<b>ENVIRONMENTAL CONDITIONS</b>	22deg. C, 68%RH, 991hPa
<b>INPUT POWER (SYSTEM)</b>	120Vac, 60 Hz	<b>TESTED BY</b>	Match Tsui

CHANNEL	CHANNEL FREQUENCY (MHz)	PEAK POWER OUTPUT (mW)	PEAK POWER OUTPUT (dBm)	PEAK POWER LIMIT (mW)	PASS/FAIL
0	2402	0.270	-5.69	125	PASS
39	2441	0.250	-6.88	125	PASS
78	2480	0.165	-7.82	125	PASS





CH 78

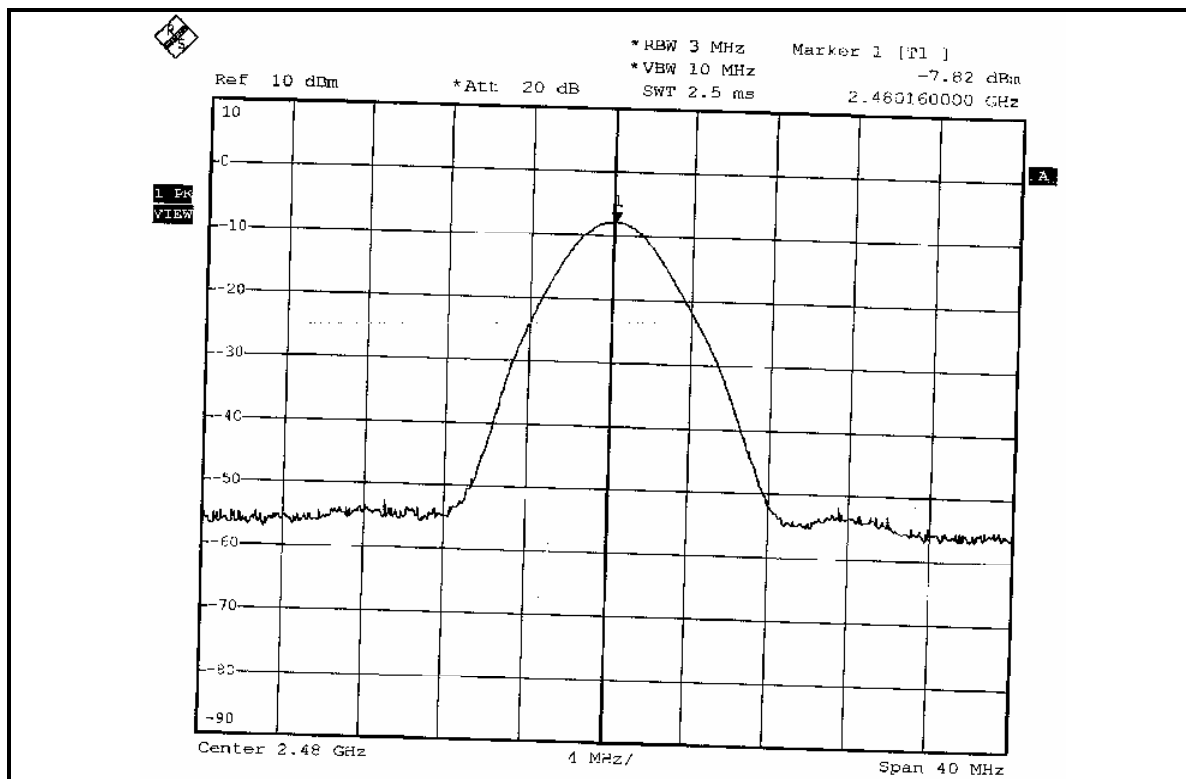

## 5.8 BAND EDGES MEASUREMENT

### 5.8.1 LIMITS OF BAND EDGES MEASUREMENT

Below –20dB of the highest emission level of operating band (in 100KHz RBW).

### 5.8.2 TEST INSTRUMENTS

DESCRIPTION & MANUFACTURER	MODEL NO.	SERIAL NO.	CALIBRATED UNTIL
SPECTRUM ANALYZER	FSP40	100040	Jun. 07, 2007

**NOTES:** The calibration interval of the above test instruments is 12 months. And the calibrations are traceable to NML/ROC and NIST/USA.

### 5.8.3 TEST PROCEDURE

The transmitter output was connected to the spectrum analyzer via a low loss cable. Set both RBW and VBW of spectrum analyzer to 100 kHz with suitable frequency span including 100 MHz bandwidth from band edge. The band edges was measured and recorded.

### 5.8.4 DEVIATION FROM TEST STANDARD

No deviation.

### 5.8.5 EUT OPERATING CONDITION

The software provided by client enabled the EUT to transmit and receive data at lowest, middle and highest channel frequencies individually.

## 5.8.6 TEST RESULTS

The spectrum plots are attached on the following 4 images. D1 line indicates the highest level, D2 line indicates the 20dB offset below D1. It shows compliance with the requirement in part 15.247(d).

### NOTE 1:

The band edge emission plot on next page shows 52.00dBc between carrier maximum power and local maximum emission in restrict band (2.38292GHz). The emission of carrier strength list in the test result of channel 0 at the item 5.2.7 is 99.22dBuV/m (Peak), so the maximum field strength in restrict band is  $99.22 - 52.00 = 47.22$  dBuV/m, which is under 74 dBuV/m limit.

Average value =  $47.22 - 30.00 = 17.22$  dBuV/m, which is under 54 dBuV/m limit.

\*The DH5 packet was the worse case duty cycle for a transmit dwell time on a channel, based upon bluetooth theory the transmitter is on  $0.625 * 5$  per 296.25 ms per channel. Therefore, the duty cycle be equal to:  $20\log(3.125/100) = -30$  dB.

Average value = peak reading -30

### NOTE 2:

The band edge emission plot on next second page shows 49.00dBc between carrier maximum power and local maximum emission in restrict band (2.48398GHz). The emission of carrier strength list in the test result of channel 78 at the item 5.2.7 is 99.35dBuV/m (Peak), so the maximum field strength in restrict band is  $99.35 - 49.00 = 50.35$  dBuV/m, which is under 74 dBuV/m limit.

Average value =  $50.35 - 30.00 = 20.35$  dBuV/m, which is under 54 dBuV/m limit.

\*The DH5 packet was the worse case duty cycle for a transmit dwell time on a channel, based upon bluetooth theory the transmitter is on  $0.625 * 5$  per 296.25 ms per channel. Therefore, the duty cycle be equal to:  $20\log(3.125/100) = -30$  dB.

Average value = peak reading -30

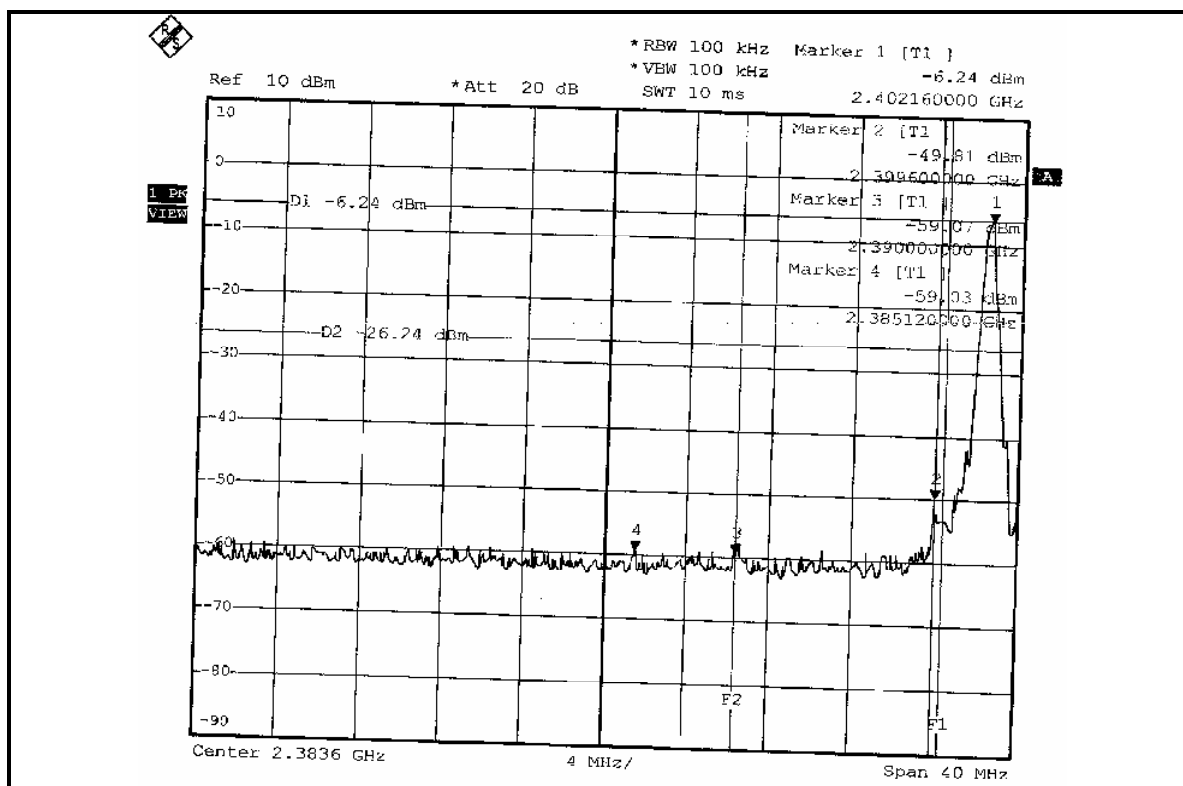
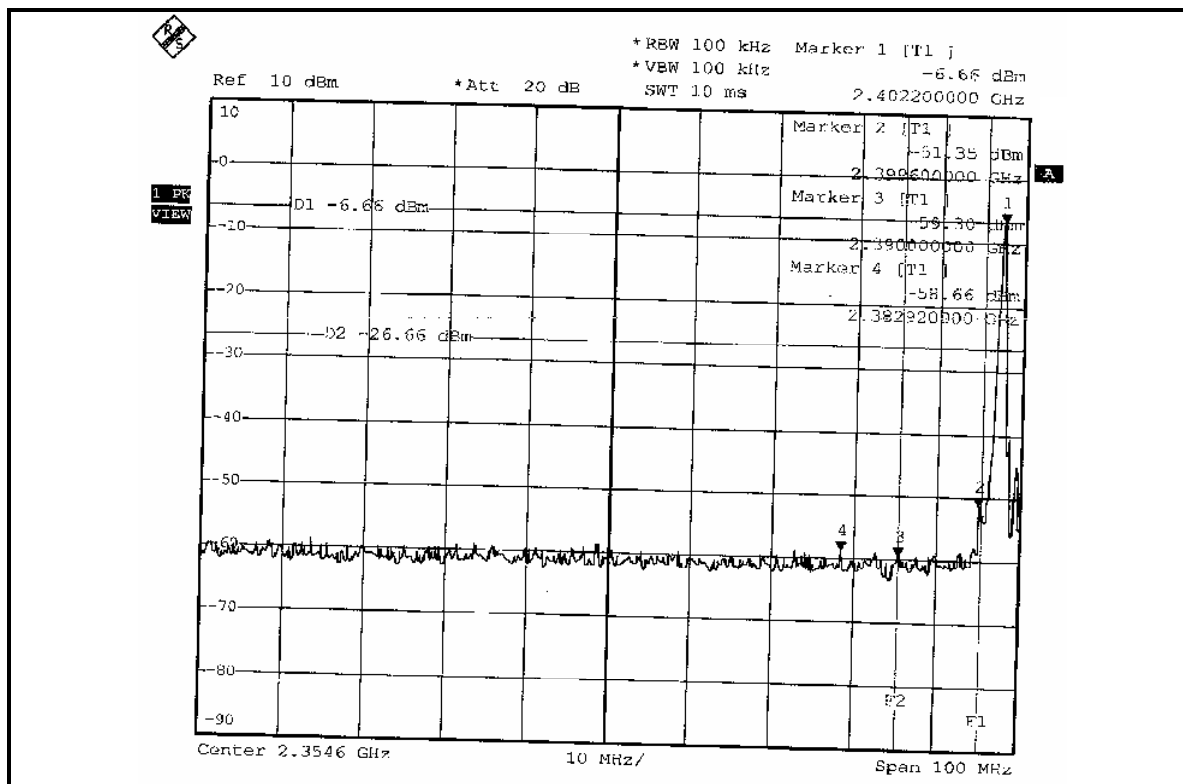

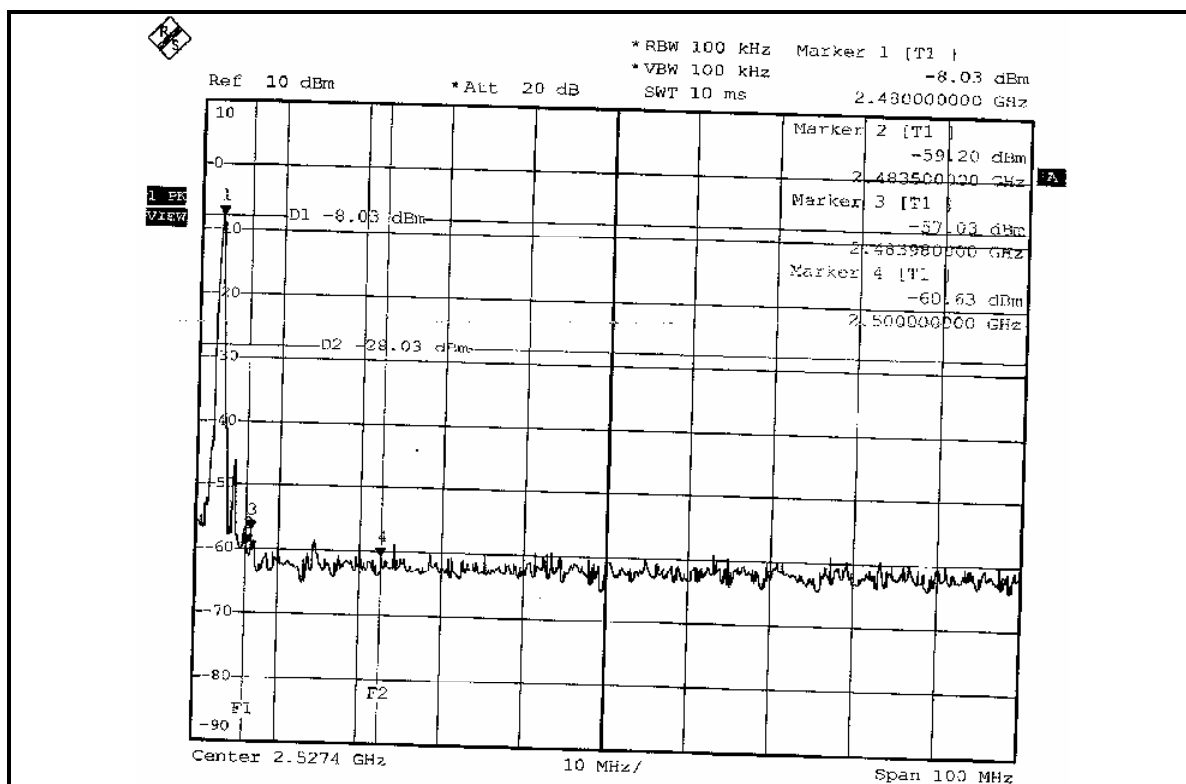
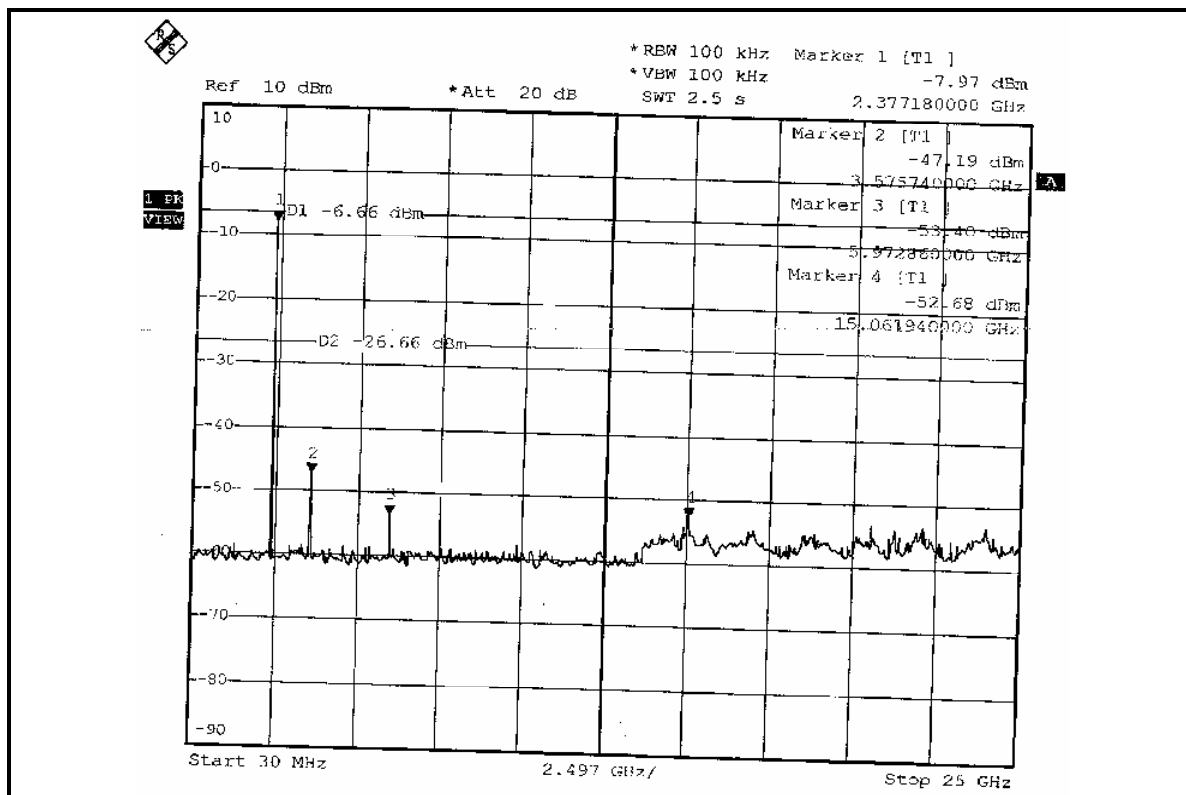

## **5.9 ANTENNA REQUIREMENT**

### **5.9.1 STANDARD APPLICABLE**

For intentional device, according to FCC 47 CFR Section 15.203, an intentional radiator shall be designed to ensure that no antenna other than that furnished by the responsible party shall be used with the device.

And according to FCC 47 CFR Section 15.247 (b), if transmitting antennas of directional gain greater than 6dBi are used, the power shall be reduced by the amount in dB that the directional gain of the antenna exceeds 6dBi.

### **5.9.2 ANTENNA CONNECTED CONSTRUCTION**

The antenna used in this product is PIFA antenna with UFL antenna connector. The maximum gain of this antenna is  $-1.74\text{dBi}$ .

## 6. INFORMATION ON THE TESTING LABORATORIES

We, ADT Corp., were founded in 1988 to provide our best service in EMC, Radio, Telecom and Safety consultation. Our laboratories are accredited and approved by the following approval agencies according to ISO/IEC 17025.

<b>USA</b>	FCC, UL, A2LA
<b>Germany</b>	TUV Rheinland
<b>Japan</b>	VCCI
<b>Norway</b>	NEMKO
<b>Canada</b>	INDUSTRY CANADA , CSA
<b>R.O.C.</b>	CNLA, BSMI, NCC
<b>Netherlands</b>	Telefication
<b>Singapore</b>	PSB , GOST-ASIA(MOU)
<b>Russia</b>	CERTIS(MOU)

Copies of accreditation certificates of our laboratories obtained from approval agencies can be downloaded from our web site:

[www.adt.com.tw/index.5/phtml](http://www.adt.com.tw/index.5/phtml). If you have any comments, please feel free to contact us at the following:

**Linko EMC/RF Lab:**

Tel: 886-2-26052180  
Fax: 886-2-26051924

**Hsin Chu EMC/RF Lab:**

Tel: 886-3-5935343  
Fax: 886-3-5935342

**Hwa Ya EMC/RF/Safety Telecom Lab:**

Tel: 886-3-3183232  
Fax: 886-3-3185050

**Web Site:** [www.adt.com.tw](http://www.adt.com.tw)

The address and road map of all our labs can be found in our web site also.



## **APPENDIX-A**

### **MODIFICATIONS RECORDERS FOR ENGINEERING CHANGES TO THE EUT BY THE LAB**

No any modifications are made to the EUT by the lab during the test.