

TEST REPORT

Report Number: 18051454HKG-005

Application for Original Grant of 47 CFR Part 15 Certification

Single New of RSS-247 Issue 2 Equipment
This report contains data of WiFi - 2.4GHz only

FCC ID: Q20-PULSE2I

IC: 152B-PULSE2I

PREPARED AND CHECKED BY:

APPROVED BY:

Signed On File
Lee Shui Tim, Tim
Senior Lead Engineer

Wong Kwok Yeung, Kenneth
Senior Lead Engineer
Date: October 26, 2018

TEST REPORT

GENERAL INFORMATION

Applicant Name:	Lenbrook Industries Ltd.
Applicant Address:	633 Granite Court Pickering ON L1W 3K1 Canada
FCC Specification Standard:	FCC Part 15, October 1, 2017 Edition
FCC ID:	Q2O-PULSE2I
FCC Model(s):	PULSE 2i
IC Specification Standard:	RSS-247 Issue 2, February 2017 RSS-Gen Issue 5, November 2014
IC:	152B-PULSE2I
PMN:	Premium Wireless Steaming Speaker
HVIN:	PULSE 2i
Type of EUT:	Spread Spectrum Transmitter
Description of EUT:	Premium Wireless Steaming Speaker
Serial Number:	N/A
Sample Receipt Date:	June 06, 2018
Date of Test:	June 06, 2018 to October 26, 2018
Report Date:	October 26, 2018
Environmental Conditions:	Temperature: +10 to 40°C Humidity: 10 to 90%
Conclusion:	Test was conducted by client submitted sample. The submitted sample as received complied with the 47 CFR Part 15 / RSS-247 Issue 2 Certification.

TEST REPORT

TABLE OF CONTENTS

1.0 Test Results Summary & Statement of Compliance.....4

 1.1 Summary of Test Results..... 4

 1.2 Statement of Compliance..... 4

2.0 General Description.....5

 2.1 Product Description 5

 2.2 Test Methodology 7

 2.3 Test Facility..... 7

 2.4 Related Submittal(s) Grants 7

3.0 System Test Configuration8

 3.1 Justification 8

 3.2 EUT Exercising Software 9

 3.3 Details of EUT and Description of Accessories..... 10

 3.4 Measurement Uncertainty..... 10

4.0 Test Results.....11

 4.1 Maximum Conducted Output Power at Antenna Terminals 11

 4.2 Minimum 6dB RF Bandwidth..... 14

 4.3 Maximum Power Spectral Density 23

 4.4 Out of Band Conducted Emissions 36

 4.5 Field Strength Calculation..... 72

 4.6 Transmitter Radiated Emissions in Restricted Bands and Spurious Emissions..... 73

 4.6.1 Radiated Emission Configuration Photograph 73

 4.6.2 Radiated Emission Data 73

 4.6.3 Radiated Emission Test Setup..... 87

 4.6.4 Transmitter Duty Cycle Calculation 88

 4.7 AC Power Line Conducted Emission 89

 4.7.1 AC Power Line Conducted Emission Configuration Photograph 89

 4.7.2 AC Power Line Conducted Emission Data 89

 4.7.3 Conducted Emission Test Setup 91

 4.8 Occupied Bandwidth 92

5.0 Equipment List96

TEST REPORT

EXHIBIT 1 TEST RESULTS SUMMARY & STATEMENT OF COMPLIANCE

1.0 TEST RESULTS SUMMARY & STATEMENT OF COMPLIANCE

1.1 Summary of Test Results

TEST ITEMS	FCC PART 15 SECTION	RSS-247/ RSS-GEN# SECTION	RESULTS	DETAILS SEE SECTION
Antenna Requirement	15.203	8.3#	Pass	2.1
Max. Conducted Output Power (Peak)	15.247(b)(3)&(4)	5.4(d)	Pass	4.1
Min. 6dB RF Bandwidth	15.247(a)(2)	5.2(a)	Pass	4.2
Max. Power Density (average)	15.247(e)	5.2(b)	Pass	4.3
Out of Band Antenna Conducted Emission	15.247(d)	5.5	Pass	4.4
Radiated Emission in Restricted Bands and Spurious Emissions	15.247(d), 15.209 & 15.109	5.5 8.10#	Pass	4.6
AC Power Line Conducted Emission	15.207 & 15.107	8.8#	Pass	4.7

Note: Pursuant to FCC Part 15 Section 15.215(c), the 20dB bandwidth of the emission was contained within the frequency band designated (mentioned as above) which the EUT operated. The effects, if any, from frequency sweeping, frequency hopping, other modulation techniques and frequency stability over expected variations in temperature and supply voltage were considered.

1.2 Statement of Compliance

The equipment under test is found to be complying with the following standard:

FCC Part 15, October 1, 2017 Edition
RSS-247 Issue 2, February 2017
RSS-Gen Issue 5, April 2018

TEST REPORT

EXHIBIT 2 GENERAL DESCRIPTION

2.0 GENERAL DESCRIPTION

2.1 Product Description

The Equipment-Under-Test (EUT) PULSE 2i is a Premium Wireless Steaming Speaker. The EUT contains both WLAN (WiFi) and Bluetooth modules. The Bluetooth module has Bluetooth 4.0 BLE and Bluetooth 3.0 features. The EUT can accept analog audio signal, digital audio signal and wireless audio signal via Bluetooth devices. An iOS/Android apps Bluesound installed in Smartphone can act as the remote control of the EUT. The EUT has internal power amplifiers and loudspeaker. It is powered by 100-240VAC. The EUT is powered by 100-240VAC.

For the WLAN (WiFi) module:

For 2.400-2.4835GHz:

The Equipment Under Test (EUT) operates at frequency range of 2412MHz to 2462MHz with 11 channels. For 802.11b mode, it operates at frequency range of 2412.000MHz to 2462.000MHz with 11 channels. It transmits via Direct-sequence spread spectrum (DSSS) modulation. Maximum bit rate can be up to 11Mbps.

For 802.11g mode, it operates at frequency range of 2412.000MHz to 2462.000MHz with 11 channels. It transmits via Orthogonal Frequency Division Multiplexing (OFDM) modulation. Maximum bit rate can be up to 54Mbps.

For 802.11n (with 20MHz bandwidth) mode, it operates at frequency range of 2412.000MHz to 2462.000MHz with 11 channels. It transmits via Orthogonal Frequency Division Multiplexing (OFDM) modulation. Maximum bit rate can support up to 65Mbps.

For 802.11n (with 40MHz bandwidth) mode, it operates at frequency range of 2422.000MHz to 2452.000MHz with 7 channels. It transmits via Orthogonal Frequency Division Multiplexing (OFDM) modulation. Maximum bit rate can support up to 65Mbps.

For 5.15-5.25GHz:

The Equipment Under Test (EUT) operates at frequency range of 5180MHz to 5240MHz with 4 channels.

For 802.11a mode, it operates at frequency range of 5180.00MHz to 5250.000MHz with 4 channels. It transmits via Orthogonal Frequency Division Multiplexing (OFDM) modulation. Maximum bit rate can be up to 54Mbps.

For 802.11n (with 20MHz bandwidth) mode, it operates at frequency range of 5180.00MHz to 5250.000MHz with 4 channels. It transmits via Orthogonal Frequency Division Multiplexing (OFDM) modulation. Maximum bit rate can support up to 65.0Mbps.

For 802.11n (with 40MHz bandwidth) mode, it operates at frequency range of 5190.00MHz to 5230.000MHz with 2 channels. It transmits via Orthogonal Frequency Division Multiplexing (OFDM) modulation. Maximum bit rate can support up to 135.0Mbps.

For 802.11ac (with 20MHz bandwidth) mode, it operates at frequency range of 5180.00MHz to 5250.000MHz with 4 channels. It transmits via Orthogonal Frequency Division Multiplexing (OFDM) modulation. Maximum bit rate can support up to 86.7Mbps.

For 802.11ac (with 40MHz bandwidth) mode, it operates at frequency range of 5190.00MHz to 5230.000MHz with 2 channels. It transmits via Orthogonal Frequency Division Multiplexing (OFDM) modulation. Maximum bit rate can support up to 180Mbps.

For 802.11ac (with 80MHz bandwidth) mode, it operates at frequency 5210MHz. It transmits via Orthogonal Frequency Division Multiplexing (OFDM) modulation. Maximum bit rate can support up to 390Mbps.

TEST REPORT

For 5.725-5.850GHz:

The Equipment Under Test (EUT) operates at frequency range of 5745MHz to 5825MHz with 5 channels. For 802.11a mode, it operates at frequency range of 5745.00MHz to 5825.000MHz with 5 channels. It transmits via Orthogonal Frequency Division Multiplexing (OFDM) modulation. Maximum bit rate can be up to 54Mbps.

For 802.11n (with 20MHz bandwidth) mode, it operates at frequency range of 5745MHz to 5825MHz with 5 channels. It transmits via Orthogonal Frequency Division Multiplexing (OFDM) modulation. Maximum bit rate can support up to 216.6Mbps.

For 802.11n (with 40MHz bandwidth) mode, it operates at frequency range of 5755.00MHz to 5795.000MHz with 2 channels. It transmits via Orthogonal Frequency Division Multiplexing (OFDM) modulation. Maximum bit rate can support up to 450Mbps.

For 802.11ac (with 20MHz bandwidth) mode, it operates at frequency range of 5745MHz to 5825MHz with 5 channels. It transmits via Orthogonal Frequency Division Multiplexing (OFDM) modulation. Maximum bit rate can support up to 260Mbps.

For 802.11ac (with 40MHz bandwidth) mode, it operates at frequency range of 5755.00MHz to 5795.000MHz with 2 channels. It transmits via Orthogonal Frequency Division Multiplexing (OFDM) modulation. Maximum bit rate can support up to 600Mbps.

For 802.11ac (with 80MHz bandwidth) mode, it operates at frequency 5775MHz. It transmits via Orthogonal Frequency Division Multiplexing (OFDM) modulation. Maximum bit rate can support up to 1300Mbps.

For the Bluetooth module:

For Bluetooth 4.0 BLE mode, it occupies a frequency range from 2402MHz to 2480MHz (40 channels with channel spacing of 2MHz). It transmits via GFSK modulation.

For Bluetooth 3.0 mode, it occupies a frequency range from 2402MHz to 2480MHz (79 channels with channel spacing of 1MHz). It transmits via GFSK modulation.

TEST REPORT

2.2 Test Methodology

Both AC power line-conducted and radiated emission measurements were performed according to the procedures in ANSI C63.10 (2013). Preliminary radiated scans and all radiated measurements were performed in radiated emission test sites. All Radiated tests were performed at an antenna to EUT distance of 3 meters, unless stated otherwise in the "**Justification Section**" of this Application. Antenna port conducted measurements were performed according to ANSI C63.10 (2013) and KDB Publication No.558074 D01 v04 (05-April-2017) All other measurements were made in accordance with the procedures in 47 CFR Part 2 and RSS-Gen Issue 5 (2014).

2.3 Test Facility

The radiated emission test site and antenna port conducted measurement facility used to collect the radiated data and conductive data are at Workshop No. 3, G/F., World-Wide Industrial Centre, 43-47 Shan Mei Street, Fo Tan, Sha Tin, N.T., Hong Kong. This test facility and site measurement data have been fully placed on file with the FCC and Industry Canada No.: 2042V-1.

2.4 Related Submittal(s) Grants

This is a single application for certification of a transceiver (Wi-Fi portion)

TEST REPORT

EXHIBIT 3 SYSTEM TEST CONFIGURATION

3.0 SYSTEM TEST CONFIGURATION

3.1 Justification

For radiated emissions testing, the equipment under test (EUT) was setup to transmit / receive continuously to simplify the measurement methodology. Care was taken to ensure proper power supply voltages during testing. During testing, all cables (if any) were manipulated to produce worst case emissions.

The EUT was powered by 120VAC.

For the measurements, the EUT was attached to a plastic stand if necessary and placed on the wooden turntable. If the base unit attached to peripherals, they were connected and operational (as typical as possible).

The signal was maximized through rotation and placement in the three orthogonal axes. The antenna height and polarization were varied during the search for maximum signal level. The antenna height was varied from 1 to 4 meters. Radiated emissions were taken at three meters unless the signal level was too low for measurement at that distance. If necessary, a pre-amplifier was used and/or the test was conducted at a closer distance.

For any intentional radiator powered by AC power line, measurements of the radiated signal level of the fundamental frequency component of the emission was performed with the supply voltage varied between 85% and 115% of the nominal rated supply voltage.

Radiated emission measurement for transmitter were performed from the lowest radio frequency signal generated in the device which is greater than 9 kHz to the tenth harmonic of the highest fundamental frequency or to 40 GHz, whichever is lower.

Emission that are directly caused by digital circuits in the transmit path and transmitter portion were measured, and the limit are according to FCC Part 15 Section 15.209 / RSS-247 2.5. Digital circuitries used to control additional functions other than the operation of the transmitter are subject to FCC Part 15 Section 15.109 / RSS-247 Section 5.5 Limits.

TEST REPORT

3.1 Justification – Cont'd

Detector function for radiated emissions was in peak mode. Average readings, when required, were taken by measuring the duty cycle of the equipment under test and subtracting the corresponding amount in dB from the measured peak readings. A detailed description for the calculation of the average factor can be found in section 4.8.3.

Determination of pulse desensitization was made according to *Hewlett Packard Application Note 150-2, Spectrum Analysis... Pulsed RF*. The effective period (Teff) was referred to Exhibit 4.8.3. With the resolution bandwidth 3MHz and spectrum analyzer IF bandwidth 3dB, the pulse desensitization factor was 0dB.

For AC line conducted emission test, the EUT along with its peripherals were placed on a 1.0m(W)x1.5m(L) and 0.8m in height wooden table and the EUT was adjusted to maintain a 0.4 meter space from a vertical reference plane. The EUT was connected to power mains through a line impedance stabilization network (LISN), which provided 50ohm coupling impedance for measuring instrument. The LISN housing, measuring instrument case, reference ground plane, and vertical ground plane were bounded together. The excess power cable between the EUT and the LISN was bundled.

All connecting cables of EUT and peripherals were manipulated to find the maximum emission.

Different data rates have been tested. Worst case is reported only.

All relevant operation modes have been tested, and the worst case data is included in this report.

For simultaneous transmission, both WiFi and Bluetooth portions are also switched on when taking radiated emission for determining worst-case spurious emission.

3.2 EUT Exercising Software

The EUT exercise program (if any) used during radiated and conducted testing was designed to exercise the various system components in a manner similar to a typical use.

TEST REPORT

3.3 Details of EUT and Description of Accessories

There are no special accessories necessary for compliance of this product.

Description of Accessories:

1. Earphone with cable of 1.2m meter long
2. 4GB USB flash drive
(Provided by Intertek)
3. LAN cable of 1.5m long with termination
4. Power Cable of 2m long
5. Analog In coaxial cable of 1.5m long with termination
(Provided by Applicant)

3.4 Measurement Uncertainty

When determining of the test conclusion, the Measurement Uncertainty of test at a level of confidence of 95% has been considered. The values of the Measurement uncertainty for radiated emission test and RF conducted measurement test are $\pm 5.3\text{dB}$ and $\pm 0.99\text{dB}$ respectively. The value of the Measurement uncertainty for conducted emission test is $\pm 4.2\text{dB}$.

Uncertainty and Compliance - Unless the standard specifically states that measured values are to be extended by the measurement uncertainty in determining compliance, all compliance determinations are based on the actual measured value.

TEST REPORT

EXHIBIT 4 TEST RESULTS

4.0 TEST RESULTS

4.1 Maximum Conducted (peak) Output Power at Antenna Terminals

RF Conduct Measurement Test Setup

The figure below shows the test setup, which is utilized to make these measurements.

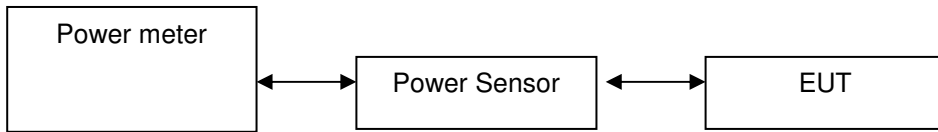

The antenna port of the EUT was connected to the input of a spectrum analyzer.

- The antenna power of the EUT was connected to the input of a power meter. Power was read directly and cable loss correction was added to the reading to obtain power at the EUT antenna terminals. The measurement procedure 9.1.3 was used.
- The EUT should be configured to transmit continuously (at a minimum duty cycle of 98%) at full power over the measurement duration. The measurement procedure AVG1 was used.

IEEE 802.11b (DSSS, 1 Mbps) Antenna Gain = 2 dBi

	Frequency (MHz)	Output in dBm	Output in mWatt
Low Channel:	2412	17.11	51.40
Middle Channel:	2437	17.20	52.48
High Channel:	2462	17.21	52.60

IEEE 802.11g (OFDM, 6 Mbps) Antenna Gain = 2 dBi

	Frequency (MHz)	Output in dBm	Output in mWatt
Low Channel:	2412	19.34	85.90
Middle Channel:	2437	19.89	97.50
High Channel:	2462	19.91	97.95

TEST REPORT

IEEE 802.11n (20MHz) (OFDM, MCS0) Antenna Gain = 2 dBi

Frequency (MHz)	Output in dBm	Output in mWatt
Low Channel: 2412	18.11	64.71
Middle Channel: 2437	18.76	75.16
High Channel: 2462	18.91	77.80

IEEE 802.11n (40MHz) (OFDM, MCS0) Antenna Gain = 2 dBi

Frequency (MHz)	Output in dBm	Output in mWatt
Low Channel: 2422	18.69	73.96
Middle Channel: 2437	19.01	79.62
High Channel: 2452	19.11	81.47

TEST REPORT

4.1 Maximum Conducted Output Power at Antenna Terminals – Cont'd

Cable loss : 0.5 dB External Attenuation : 0 dB

Cable loss, external attenuation: included in OFFSET function
 added to SA raw reading

IEEE 802.11b (DSSS, 1 Mbps)
max. conducted (peak) output level = 17.21 dBm

IEEE 802.11g (OFDM, 9 Mbps)
max. conducted (peak) output level = 19.91 dBm

IEEE 802.11n (20MHz) (OFDM, MCS0)
max. conducted (peak) output level = 18.91 dBm

IEEE 802.11n (40MHz) (OFDM, MCS0)
max. conducted (peak) output level = 19.11 dBm

Limits:

1W (30dBm) for antennas with gains of 6dBi or less

___ W (___ dBm) for antennas with gains more than 6dBi

The plots of conducted output power are saved as below.

TEST REPORT

4.2 Minimum 6dB RF Bandwidth

The antenna port of the EUT was connected to the input of a spectrum analyzer. The EBW measurement procedure was used. A PEAK output reading was taken, a DISPLAY line was drawn 6dB lower than PEAK level. The 6dB bandwidth was determined from where the channel output spectrum intersected the display line.

IEEE 802.11b (DSSS, 1 Mbps)

	Frequency (MHz)	6dB Bandwidth (MHz)
Low Channel:	2412	8.3
Middle Channel:	2437	8.3
High Channel:	2462	8.3

IEEE 802.11g (OFDM, 6 Mbps)

	Frequency (MHz)	6dB Bandwidth (MHz)
Low Channel:	2412	15.3
Middle Channel:	2437	15.3
High Channel:	2462	15.3

IEEE 802.11n (20MHz) (OFDM, MCS0)

	Frequency (MHz)	6dB Bandwidth (MHz)
Low Channel:	2412	17.9
Middle Channel:	2437	17.9
High Channel:	2462	17.9

IEEE 802.11n (40MHz) (OFDM, MCS0)

	Frequency (MHz)	6dB Bandwidth (MHz)
Low Channel:	2422	36.5
Middle Channel:	2437	36.6
High Channel:	2452	36.5

Limits

6 dB bandwidth shall be at least 500kHz

The plots of 6dB RF bandwidth are saved as below.

TEST REPORT

PLOTS OF 6dB RF BANDWIDTH

802.11b, Lowest Channel

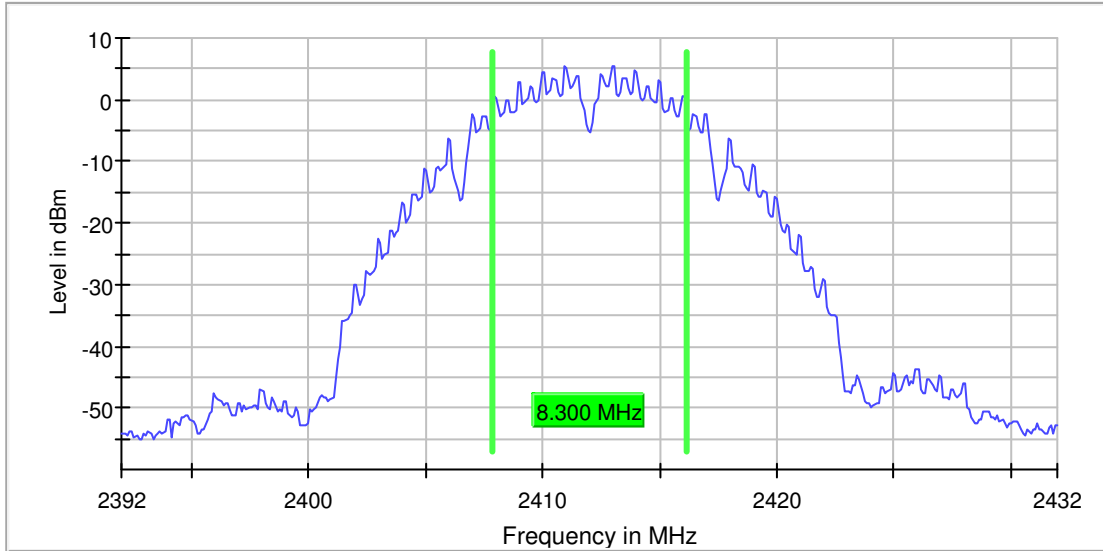

802.11b, Middle Channel

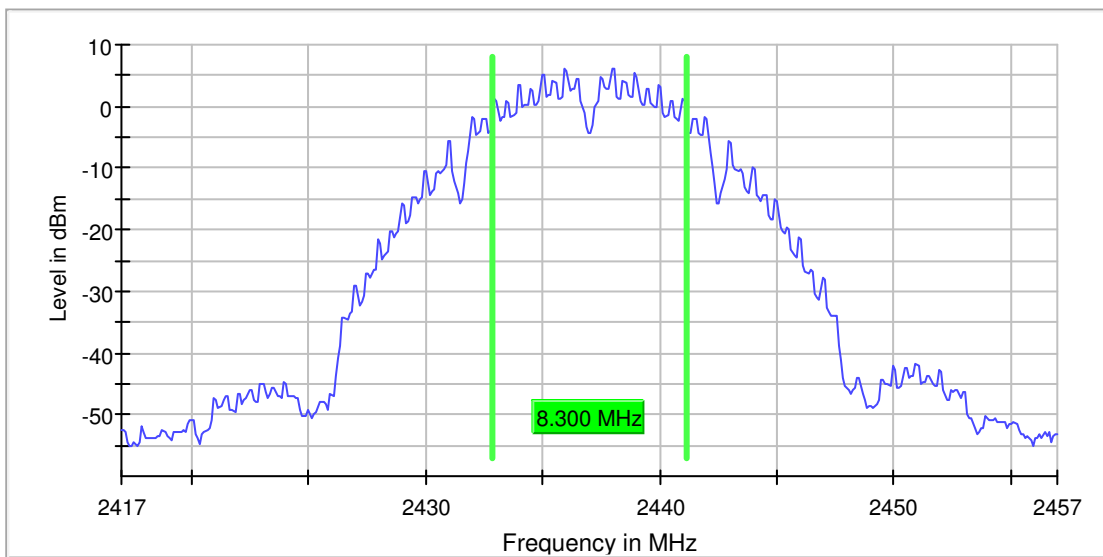

TEST REPORT

PLOTS OF 6dB RF BANDWIDTH

802.11b, Highest Channel

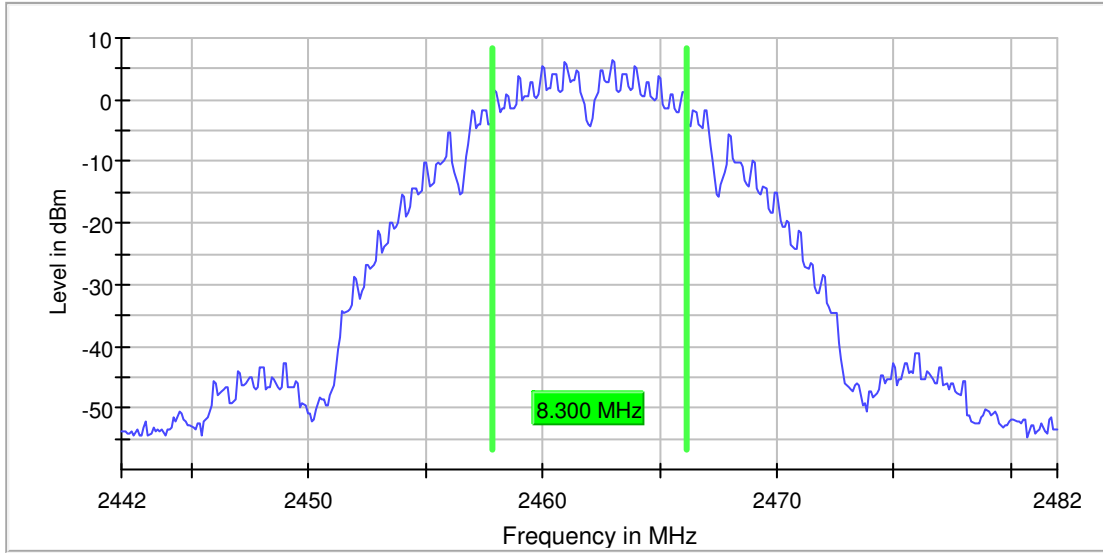

TEST REPORT

PLOTS OF 6dB RF BANDWIDTH

802.11g, Lowest Channel

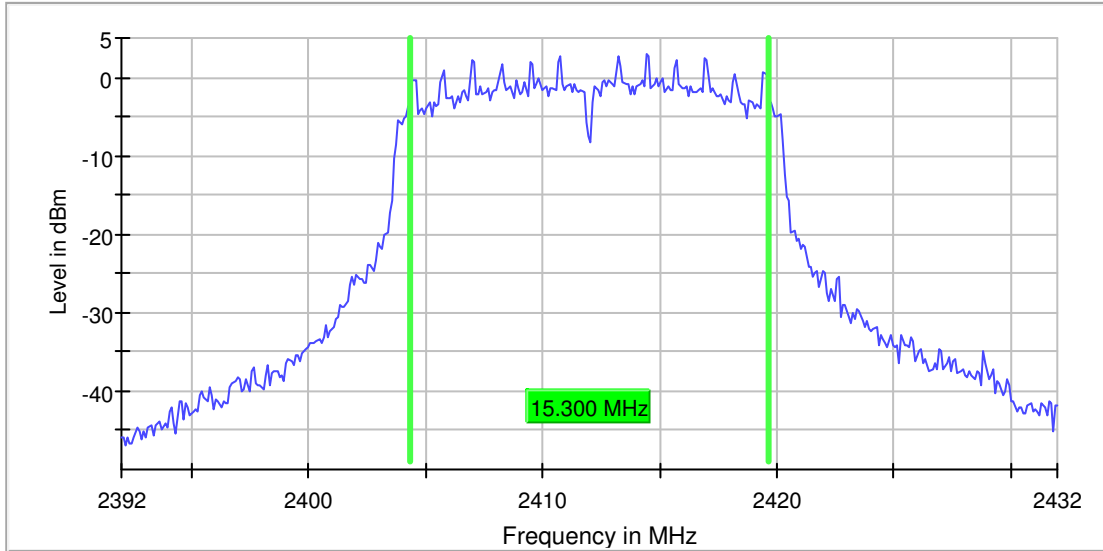

802.11g, Middle Channel

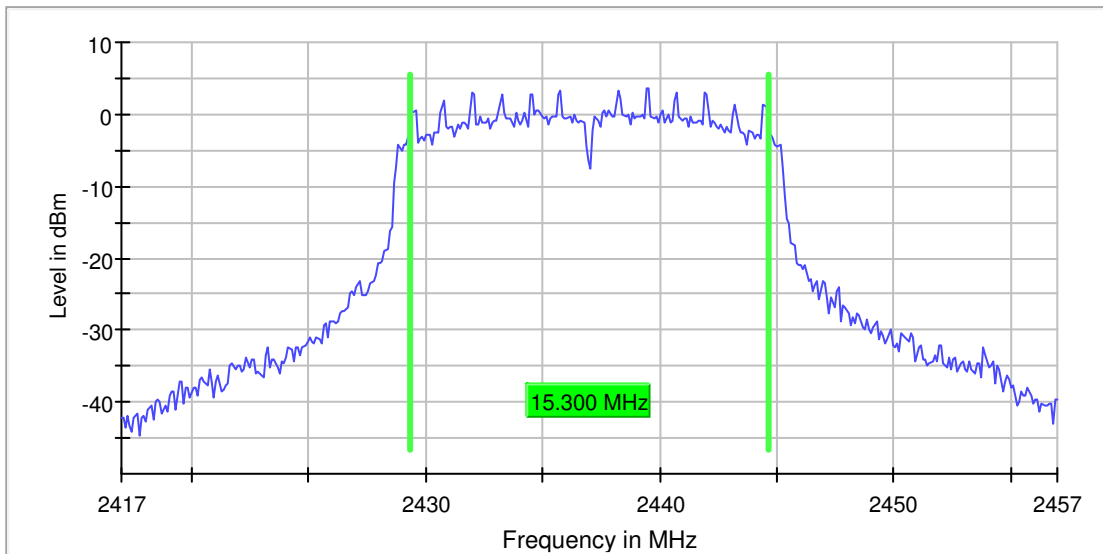

TEST REPORT

PLOTS OF 6dB RF BANDWIDTH

802.11g, Highest Channel

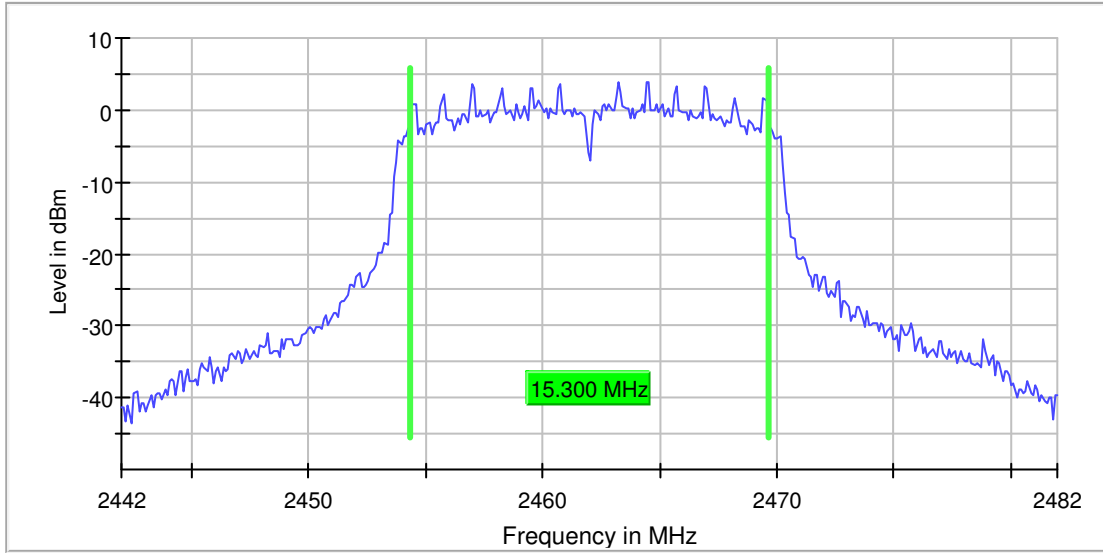

TEST REPORT

PLOTS OF 6dB RF BANDWIDTH

802.11n (20MHz), Lowest Channel

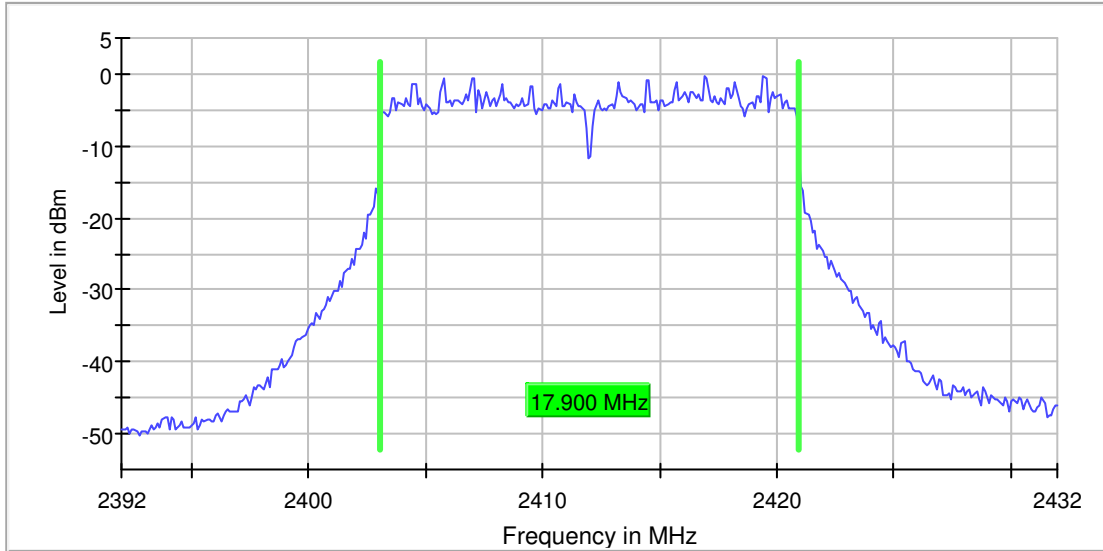

802.11n (20MHz), Middle Channel

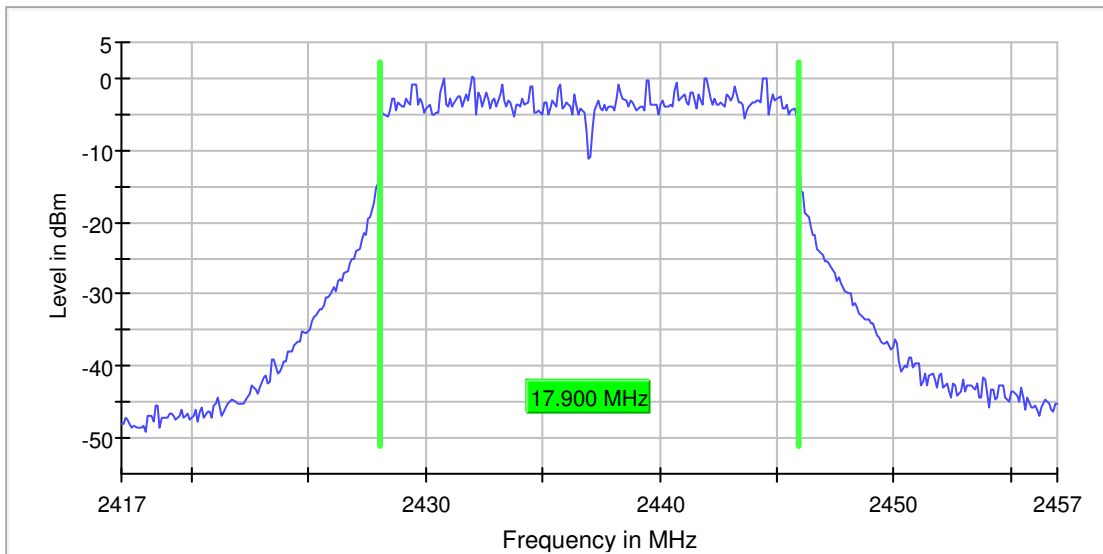

TEST REPORT

PLOTS OF 6dB RF BANDWIDTH

802.11n (20MHz), Highest Channel

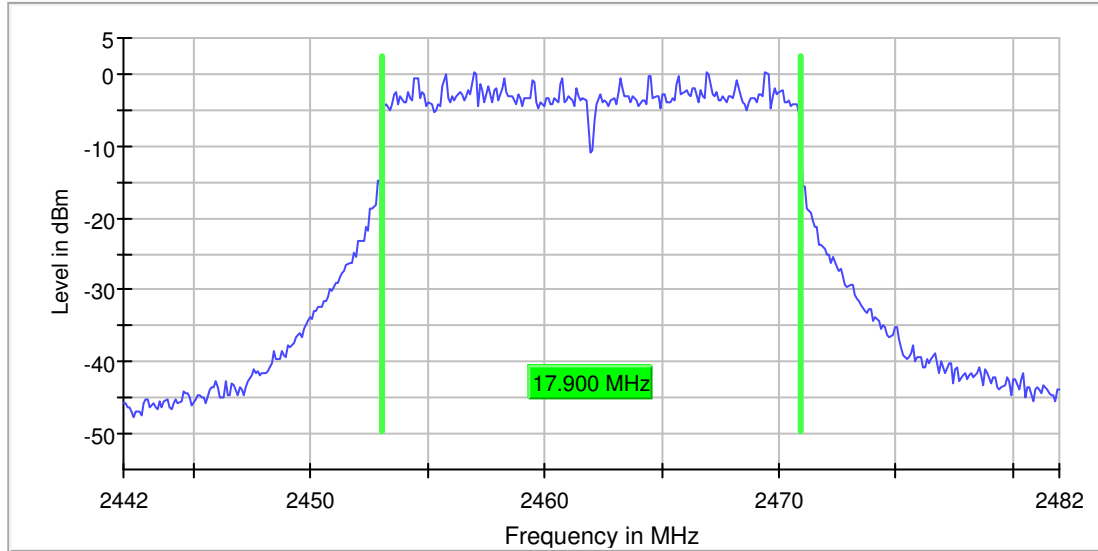

Measurement

Setting	Instrument Value	Target Value
Start Frequency	2.44200 GHz	2.44200 GHz
Stop Frequency	2.48200 GHz	2.48200 GHz
Span	40.000 MHz	40.000 MHz
RBW	100.000 kHz	~ 100.000 kHz
VBW	300.000 kHz	~ 300.000 kHz
SweepPoints	400	~ 400
Sweeptime	56.886 μ s	AUTO
Reference Level	0.000 dBm	-10.000 dBm
Attenuation	20.000 dB	AUTO
Detector	MaxPeak	MaxPeak
SweepCount	100	100
Filter	3 dB	3 dB
Trace Mode	Max Hold	Max Hold
Sweeptype	FFT	AUTO
Preamp	off	off
Stablemode	Trace	Trace
Stablevalue	0.50 dB	0.50 dB
Run	40 / max. 150	max. 150
Stable	5 / 5	5
Max Stable Difference	0.13 dB	0.50 dB

TEST REPORT

PLOTS OF 6dB RF BANDWIDTH

802.11n (40MHz), Lowest Channel

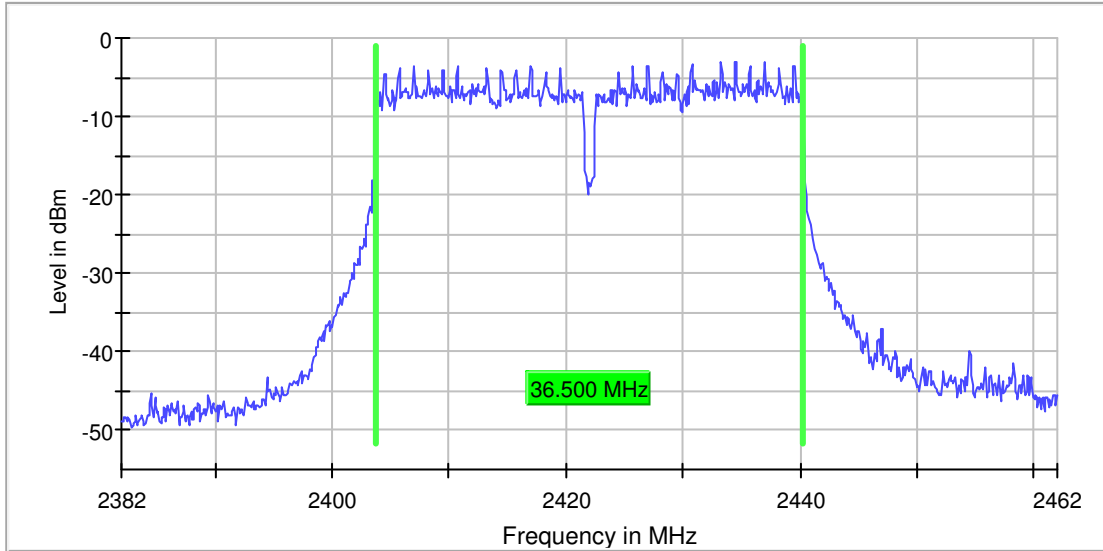

802.11n (40MHz), Middle Channel

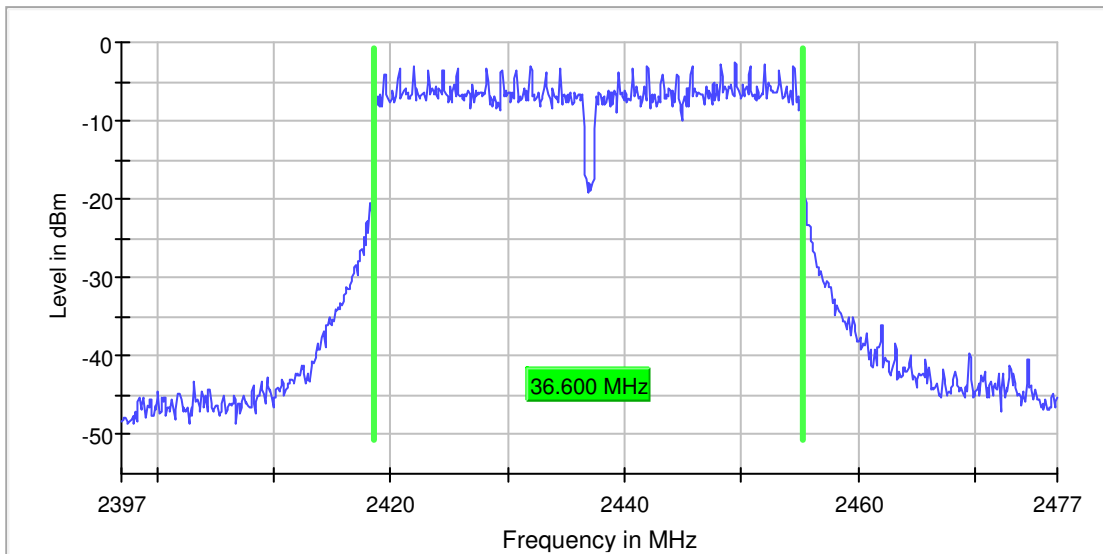

TEST REPORT

PLOTS OF 6dB RF BANDWIDTH

802.11n (40MHz), Highest Channel

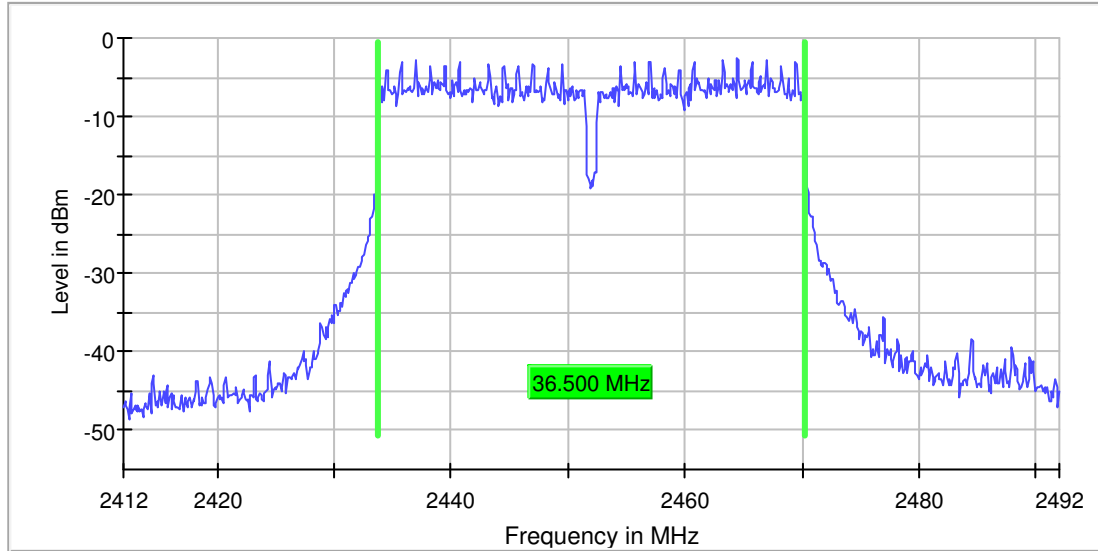

Measurement

Setting	Instrument Value	Target Value
Start Frequency	2.41200 GHz	2.41200 GHz
Stop Frequency	2.49200 GHz	2.49200 GHz
Span	80.000 MHz	80.000 MHz
RBW	100.000 kHz	~ 100.000 kHz
VBW	300.000 kHz	~ 300.000 kHz
SweepPoints	800	~ 800
Sweeptime	94.810 μ s	AUTO
Reference Level	10.000 dBm	10.000 dBm
Attenuation	30.000 dB	AUTO
Detector	MaxPeak	MaxPeak
SweepCount	100	100
Filter	3 dB	3 dB
Trace Mode	Max Hold	Max Hold
Sweeptype	FFT	AUTO
Preamp	off	off
Stablemode	Trace	Trace
Stablevalue	0.50 dB	0.50 dB
Run	10 / max. 10	max. 10
Stable	0 / 2	2
Max Stable Difference	1.06 dB	0.50 dB

TEST REPORT

4.3 Maximum Power Spectral Density

Antenna output of the EUT was coupled directly to spectrum analyzer. The measurement procedure 10.2 PKPSD was used. If an external attenuator and/or cable was used, these losses are compensated for using the OFFSET function of the analyser.

IEEE 802.11b (DSSS, 1 Mbps)

Frequency (MHz)	PSD in 100kHz (dBm)
Low Channel: 2412	5.503
Middle Channel: 2437	6.093
High Channel: 2462	6.198

IEEE 802.11G(DSSS, 1 Mbps)

Frequency (MHz)	PSD in 100kHz (dBm)
Low Channel: 2412	2.917
Middle Channel: 2437	3.640
High Channel: 2462	3.714

IEEE 802.11n (20MHz) (OFDM, MCS0)

Frequency (MHz)	PSD in 100kHz (dBm)
Low Channel: 2412	-0.272
Middle Channel: 2437	0.255
High Channel: 2462	0.404

IEEE 802.11n (40MHz) (OFDM, MCS0)

Frequency (MHz)	PSD in 100kHz (dBm)
Low Channel: 2422	-2.986
Middle Channel: 2437	-2.778
High Channel: 2452	-2.775

Cable Loss: 0.5 dB

Limit:
8dBm

The plots of power spectral density are as below.

TEST REPORT

PLOTS OF POWER SPECTRAL DENSITY

802.11b, Lowest channel

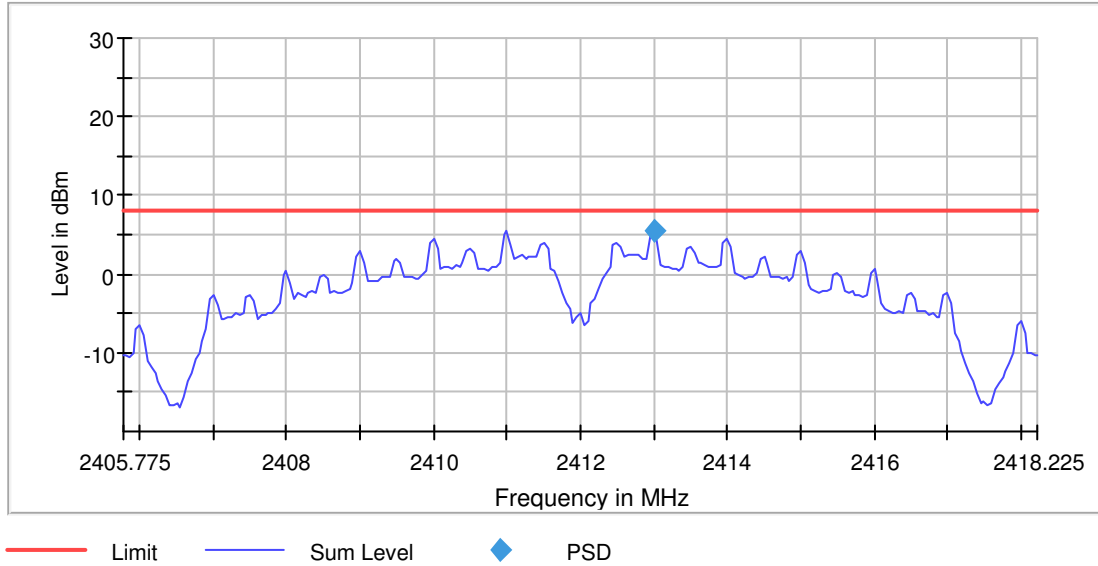

Measurement

Setting	Instrument Value	Target Value
Start Frequency	2.40578 GHz	2.40578 GHz
Stop Frequency	2.41823 GHz	2.41823 GHz
Span	12.450 MHz	12.450 MHz
RBW	100.000 kHz	<= 100.000 kHz
VBW	300.000 kHz	>= 300.000 kHz
SweepPoints	249	~ 249
Sweptime	1.020 ms	AUTO
Reference Level	-10.000 dBm	-10.000 dBm
Attenuation	10.000 dB	AUTO
Detector	MaxPeak	MaxPeak
SweepCount	100	100
Filter	3 dB	3 dB
Trace Mode	Max Hold	Max Hold
SweepType	Sweep	Sweep
Preamp	off	off
Stablemode	Trace	Trace
Stablevalue	0.50 dB	0.50 dB
Run	8 / max. 150	max. 150
Stable	2 / 2	2
Max Stable Difference	0.12 dB	0.50 dB

TEST REPORT

PLOTS OF POWER SPECTRAL DENSITY

802.11b, Middle channel

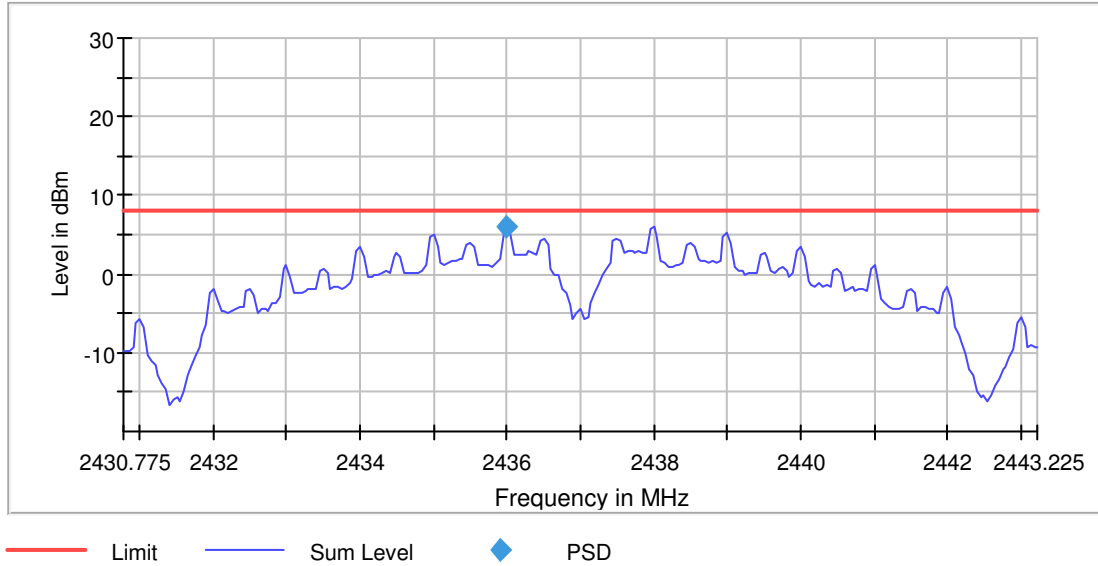

Measurement

Setting	Instrument Value	Target Value
Start Frequency	2.43078 GHz	2.43078 GHz
Stop Frequency	2.44323 GHz	2.44323 GHz
Span	12.450 MHz	12.450 MHz
RBW	100.000 kHz	<= 100.000 kHz
VBW	300.000 kHz	>= 300.000 kHz
SweepPoints	249	~ 249
Sweeptime	1.020 ms	AUTO
Reference Level	-10.000 dBm	-10.000 dBm
Attenuation	10.000 dB	AUTO
Detector	MaxPeak	MaxPeak
SweepCount	100	100
Filter	3 dB	3 dB
Trace Mode	Max Hold	Max Hold
SweepType	Sweep	Sweep
Preamp	off	off
Stablemode	Trace	Trace
Stablevalue	0.50 dB	0.50 dB
Run	7 / max. 150	max. 150
Stable	2 / 2	2
Max Stable Difference	0.02 dB	0.50 dB

TEST REPORT

PLOTS OF POWER SPECTRAL DENSITY

802.11b, Highest channel

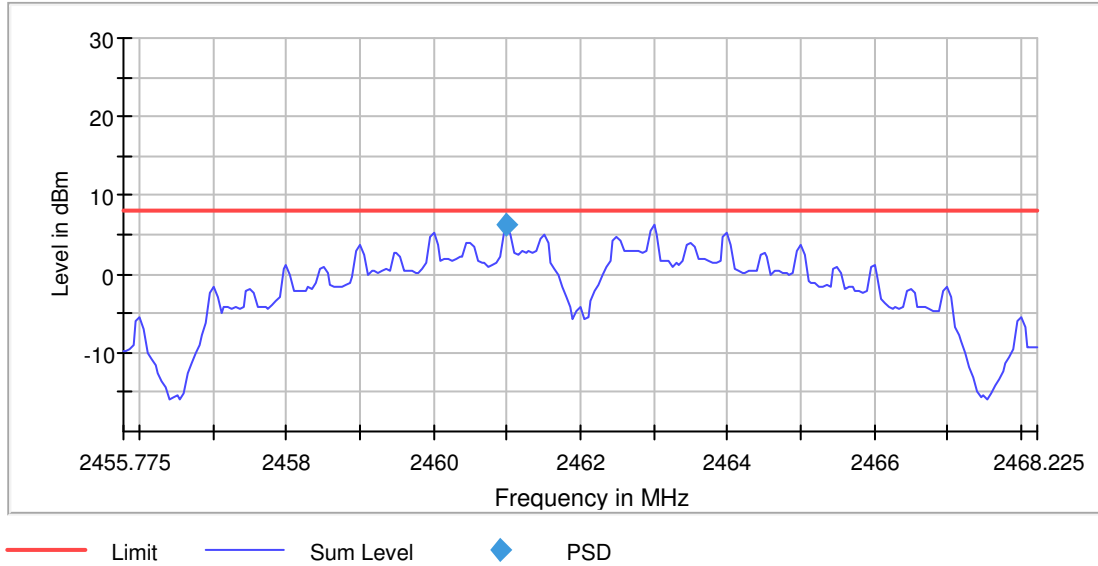

Measurement

Setting	Instrument Value	Target Value
Start Frequency	2.45578 GHz	2.45578 GHz
Stop Frequency	2.46823 GHz	2.46823 GHz
Span	12.450 MHz	12.450 MHz
RBW	100.000 kHz	<= 100.000 kHz
VBW	300.000 kHz	>= 300.000 kHz
SweepPoints	249	~ 249
Sweeptime	1.020 ms	AUTO
Reference Level	-10.000 dBm	-10.000 dBm
Attenuation	10.000 dB	AUTO
Detector	MaxPeak	MaxPeak
SweepCount	100	100
Filter	3 dB	3 dB
Trace Mode	Max Hold	Max Hold
SweepType	Sweep	Sweep
Preamp	off	off
Stablemode	Trace	Trace
Stablevalue	0.50 dB	0.50 dB
Run	10 / max. 150	max. 150
Stable	2 / 2	2
Max Stable Difference	0.24 dB	0.50 dB

TEST REPORT

PLOTS OF POWER SPECTRAL DENSITY

802.11g, Lowest channel

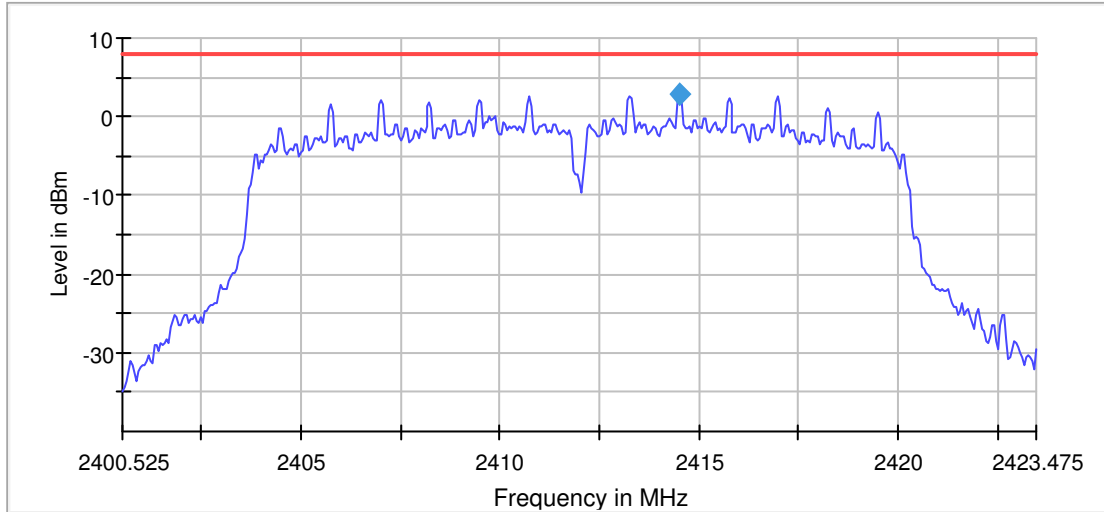

— Limit — Sum Level ◆ PSD

Measurement

Setting	Instrument Value	Target Value
Start Frequency	2.40053 GHz	2.40053 GHz
Stop Frequency	2.42348 GHz	2.42348 GHz
Span	22.950 MHz	22.950 MHz
RBW	100.000 kHz	<= 100.000 kHz
VBW	300.000 kHz	>= 300.000 kHz
SweepPoints	459	~ 459
SweepTime	1.060 ms	AUTO
Reference Level	-10.000 dBm	-10.000 dBm
Attenuation	10.000 dB	AUTO
Detector	MaxPeak	MaxPeak
SweepCount	100	100
Filter	3 dB	3 dB
Trace Mode	Max Hold	Max Hold
Sweeptype	Sweep	Sweep
Preamp	off	off
Stablemode	Trace	Trace
Stablevalue	0.50 dB	0.50 dB
Run	21 / max. 150	max. 150
Stable	2 / 2	2
Max Stable Difference	0.13 dB	0.50 dB

TEST REPORT

PLOTS OF POWER SPECTRAL DENSITY

802.11g, Middle channel

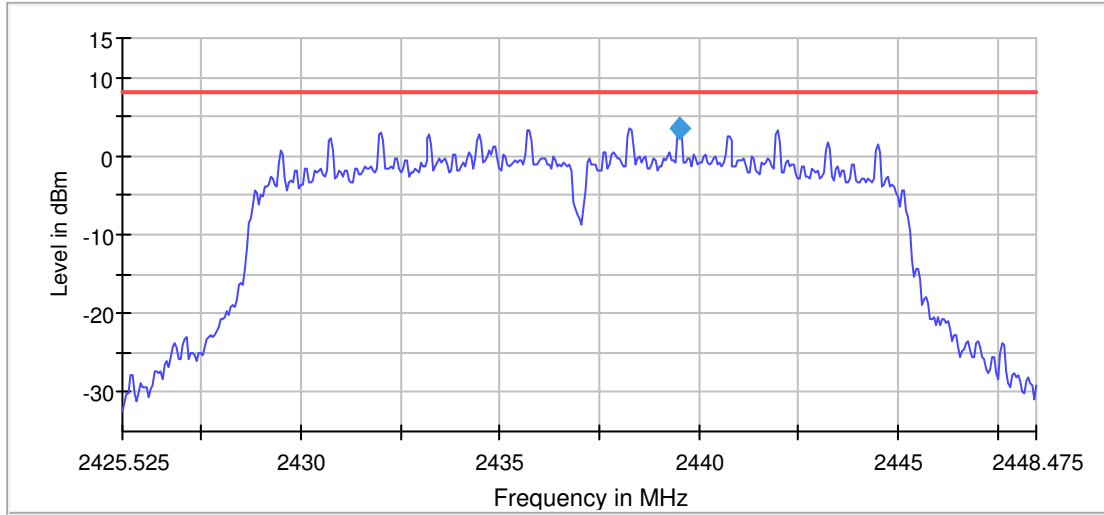

— Limit — Sum Level ◆ PSD

Measurement

Setting	Instrument Value	Target Value
Start Frequency	2.42553 GHz	2.42553 GHz
Stop Frequency	2.44848 GHz	2.44848 GHz
Span	22.950 MHz	22.950 MHz
RBW	100.000 kHz	<= 100.000 kHz
VBW	300.000 kHz	>= 300.000 kHz
SweepPoints	459	~ 459
SweepTime	1.060 ms	AUTO
Reference Level	-10.000 dBm	-10.000 dBm
Attenuation	10.000 dB	AUTO
Detector	MaxPeak	MaxPeak
SweepCount	100	100
Filter	3 dB	3 dB
Trace Mode	Max Hold	Max Hold
SweepType	Sweep	Sweep
Preamp	off	off
Stablemode	Trace	Trace
Stablevalue	0.50 dB	0.50 dB
Run	15 / max. 150	max. 150
Stable	2 / 2	2
Max Stable Difference	0.33 dB	0.50 dB

TEST REPORT

PLOTS OF POWER SPECTRAL DENSITY

802.11g, Highest channel

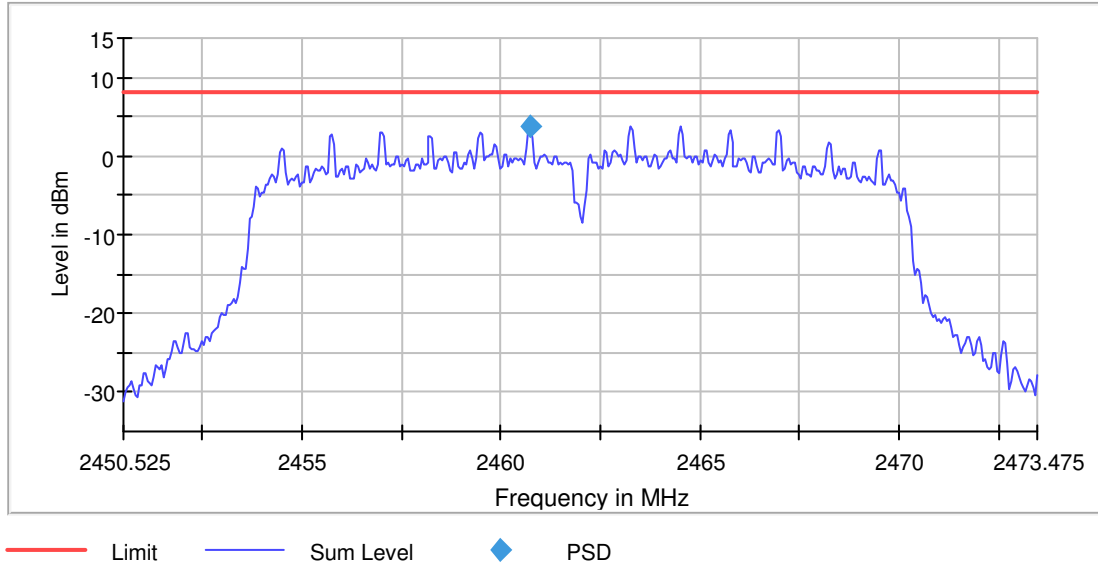

Measurement

Setting	Instrument Value	Target Value
Start Frequency	2.45053 GHz	2.45053 GHz
Stop Frequency	2.47348 GHz	2.47348 GHz
Span	22.950 MHz	22.950 MHz
RBW	100.000 kHz	<= 100.000 kHz
VBW	300.000 kHz	>= 300.000 kHz
SweepPoints	459	~ 459
Sweeptime	1.060 ms	AUTO
Reference Level	-10.000 dBm	-10.000 dBm
Attenuation	10.000 dB	AUTO
Detector	MaxPeak	MaxPeak
SweepCount	100	100
Filter	3 dB	3 dB
Trace Mode	Max Hold	Max Hold
Sweeptype	Sweep	Sweep
Preamp	off	off
Stablemode	Trace	Trace
Stablevalue	0.50 dB	0.50 dB
Run	18 / max. 150	max. 150
Stable	2 / 2	2
Max Stable Difference	0.50 dB	0.50 dB

TEST REPORT

PLOTS OF POWER SPECTRAL DENSITY

802.11n (20MHz), Lowest channel

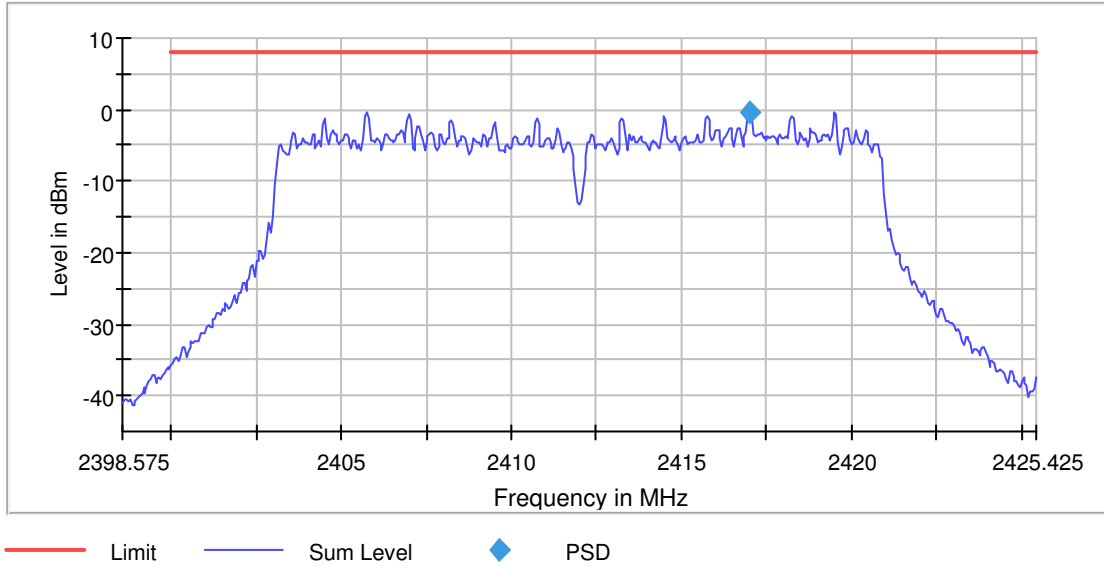

Measurement

Setting	Instrument Value	Target Value
Start Frequency	2.39858 GHz	2.39858 GHz
Stop Frequency	2.42543 GHz	2.42543 GHz
Span	26.850 MHz	26.850 MHz
RBW	100.000 kHz	<= 100.000 kHz
VBW	300.000 kHz	>= 300.000 kHz
SweepPoints	537	~ 537
Sweeptime	1.020 ms	AUTO
Reference Level	-10.000 dBm	-10.000 dBm
Attenuation	10.000 dB	AUTO
Detector	MaxPeak	MaxPeak
SweepCount	100	100
Filter	3 dB	3 dB
Trace Mode	Max Hold	Max Hold
Sweeptype	Sweep	Sweep
Preamp	off	off
Stablemode	Trace	Trace
Stablevalue	0.50 dB	0.50 dB
Run	26 / max. 150	max. 150
Stable	2 / 2	2
Max Stable Difference	0.46 dB	0.50 dB

TEST REPORT

PLOTS OF POWER SPECTRAL DENSITY

802.11n (20MHz), Middle channel

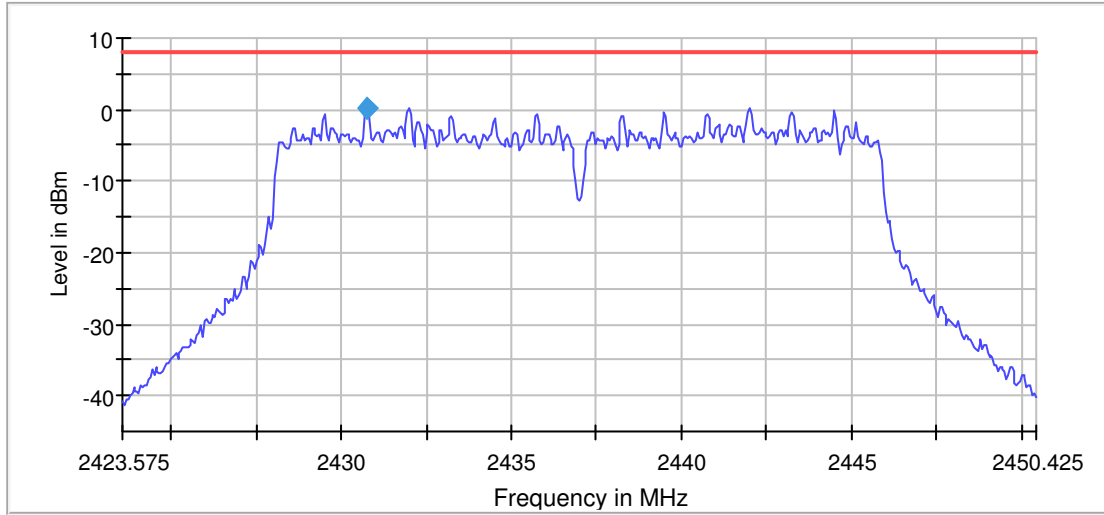

— Limit — Sum Level ◆ PSD

Measurement

Setting	Instrument Value	Target Value
Start Frequency	2.42358 GHz	2.42358 GHz
Stop Frequency	2.45043 GHz	2.45043 GHz
Span	26.850 MHz	26.850 MHz
RBW	100.000 kHz	<= 100.000 kHz
VBW	300.000 kHz	>= 300.000 kHz
SweepPoints	537	~ 537
SweepTime	1.020 ms	AUTO
Reference Level	-10.000 dBm	-10.000 dBm
Attenuation	10.000 dB	AUTO
Detector	MaxPeak	MaxPeak
SweepCount	100	100
Filter	3 dB	3 dB
Trace Mode	Max Hold	Max Hold
SweepType	Sweep	Sweep
Preamp	off	off
Stablemode	Trace	Trace
Stablevalue	0.50 dB	0.50 dB
Run	23 / max. 150	max. 150
Stable	2 / 2	2
Max Stable Difference	0.28 dB	0.50 dB

TEST REPORT

PLOTS OF POWER SPECTRAL DENSITY

802.11n (20MHz), Highest channel

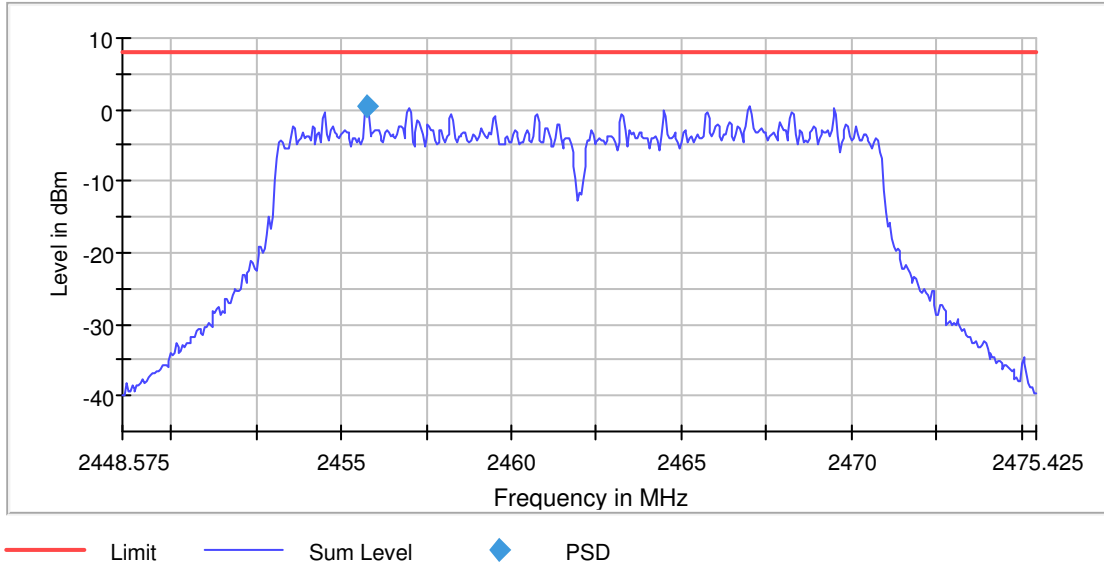

Measurement

Setting	Instrument Value	Target Value
Start Frequency	2.44858 GHz	2.44858 GHz
Stop Frequency	2.47543 GHz	2.47543 GHz
Span	26.850 MHz	26.850 MHz
RBW	100.000 kHz	<= 100.000 kHz
VBW	300.000 kHz	>= 300.000 kHz
SweepPoints	537	~ 537
Sweeptime	1.020 ms	AUTO
Reference Level	-10.000 dBm	-10.000 dBm
Attenuation	10.000 dB	AUTO
Detector	MaxPeak	MaxPeak
SweepCount	100	100
Filter	3 dB	3 dB
Trace Mode	Max Hold	Max Hold
Sweeptype	Sweep	Sweep
Preamp	off	off
Stablemode	Trace	Trace
Stablevalue	0.50 dB	0.50 dB
Run	20 / max. 150	max. 150
Stable	2 / 2	2
Max Stable Difference	0.46 dB	0.50 dB

TEST REPORT

PLOTS OF POWER SPECTRAL DENSITY

802.11n (40MHz), Lowest channel

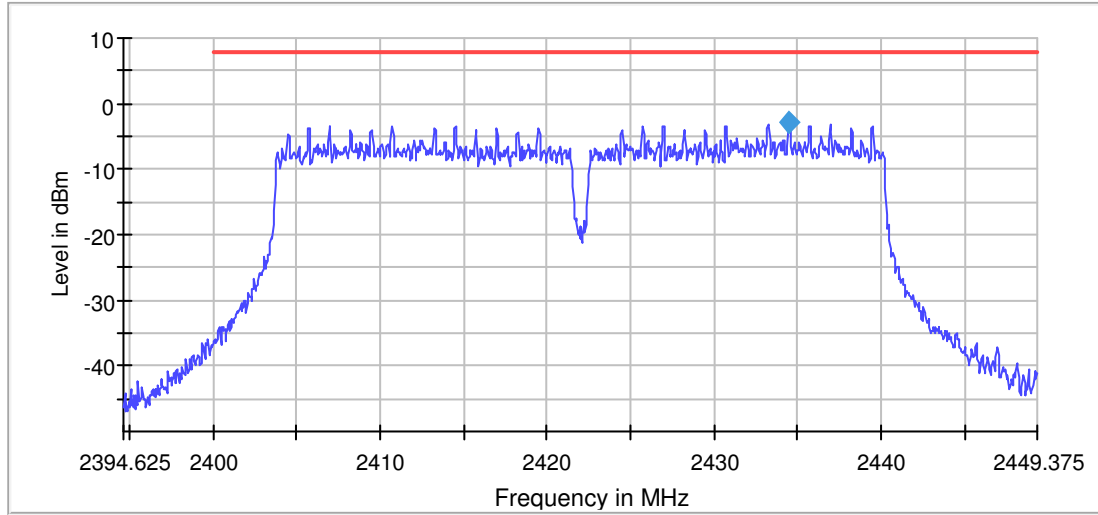

— Limit — Sum Level ◆ PSD

Measurement

Setting	Instrument Value	Target Value
Start Frequency	2.39463 GHz	2.39463 GHz
Stop Frequency	2.44938 GHz	2.44938 GHz
Span	54.750 MHz	54.750 MHz
RBW	100.000 kHz	<= 100.000 kHz
VBW	300.000 kHz	>= 300.000 kHz
SweepPoints	1095	~ 1095
Sweeptime	5.480 s	5.475 s
Reference Level	10.000 dBm	10.000 dBm
Attenuation	30.000 dB	AUTO
Detector	MaxPeak	MaxPeak
SweepCount	1	1
Filter	3 dB	3 dB
Trace Mode	Max Hold	Max Hold
SweepType	Sweep	Sweep
Preamp	off	off
Stablemode	Trace	Trace
Stablevalue	0.50 dB	0.50 dB
Run	1 / max. 1	max. 1
Stable	0 / 1	1
Max Stable Difference	0.00 dB	0.50 dB

TEST REPORT

PLOTS OF POWER SPECTRAL DENSITY

802.11n (40MHz), Middle channel

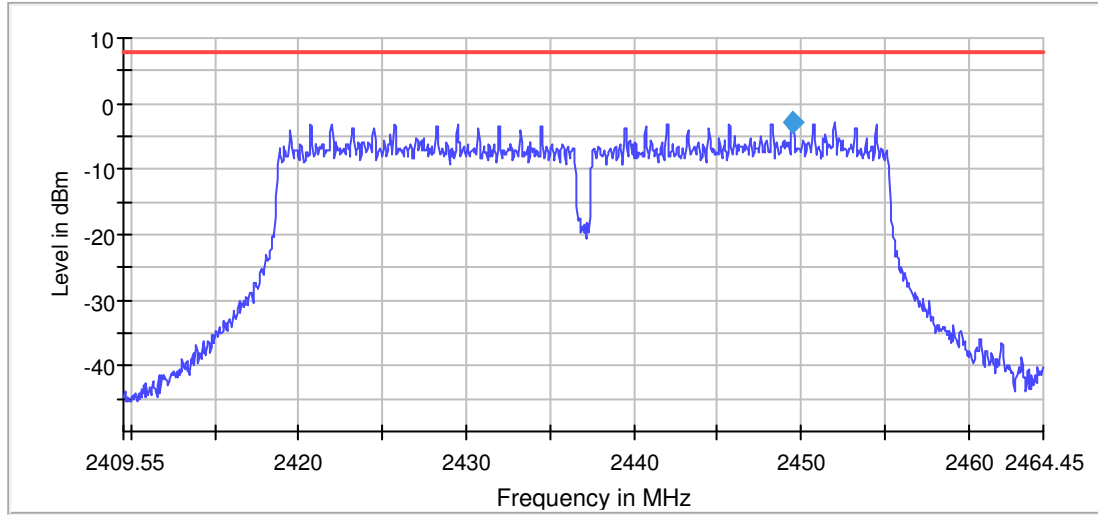

— Limit — Sum Level ◆ PSD

Measurement

Setting	Instrument Value	Target Value
Start Frequency	2.40955 GHz	2.40955 GHz
Stop Frequency	2.46445 GHz	2.46445 GHz
Span	54.900 MHz	54.900 MHz
RBW	100.000 kHz	<= 100.000 kHz
VBW	300.000 kHz	>= 300.000 kHz
SweepPoints	1098	~ 1098
Sweeptime	5.490 s	5.490 s
Reference Level	10.000 dBm	10.000 dBm
Attenuation	30.000 dB	AUTO
Detector	MaxPeak	MaxPeak
SweepCount	1	1
Filter	3 dB	3 dB
Trace Mode	Max Hold	Max Hold
SweepType	Sweep	Sweep
Preamp	off	off
Stablemode	Trace	Trace
Stablevalue	0.50 dB	0.50 dB
Run	1 / max. 1	max. 1
Stable	0 / 1	1
Max Stable Difference	0.00 dB	0.50 dB

TEST REPORT

PLOTS OF POWER SPECTRAL DENSITY

802.11n (40MHz), Highest channel

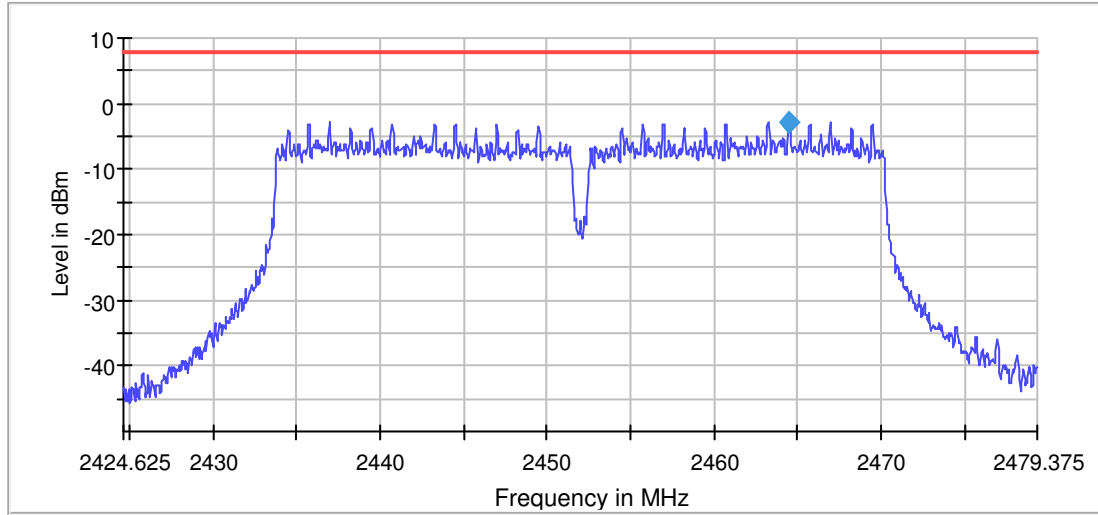

— Limit — Sum Level ◆ PSD

Measurement

Setting	Instrument Value	Target Value
Start Frequency	2.42463 GHz	2.42463 GHz
Stop Frequency	2.47938 GHz	2.47938 GHz
Span	54.750 MHz	54.750 MHz
RBW	100.000 kHz	<= 100.000 kHz
VBW	300.000 kHz	>= 300.000 kHz
SweepPoints	1095	~ 1095
Sweeptime	5.480 s	5.475 s
Reference Level	10.000 dBm	10.000 dBm
Attenuation	30.000 dB	AUTO
Detector	MaxPeak	MaxPeak
SweepCount	1	1
Filter	3 dB	3 dB
Trace Mode	Max Hold	Max Hold
SweepType	Sweep	Sweep
Preamp	off	off
Stablemode	Trace	Trace
Stablevalue	0.50 dB	0.50 dB
Run	1 / max. 1	max. 1
Stable	0 / 1	1
Max Stable Difference	0.00 dB	0.50 dB

TEST REPORT

4.4 Out of Band Conducted Emissions

The maximum conducted (peak) output power was used to demonstrate compliance as described in 9.1. Then the display line (in red) shown in the following plots denotes the limit at 20dB below maximum measured in-band peak PSD level in 100 KHz bandwidth.

The measurement procedures under sections 11 of KDB558074 D01 v04 (05-April-2017) were used.

Furthermore, delta measurement technique for measuring bandedge emissions was incorporated in the test of the edge at 2483.5MHz.

Limits:

All spurious emission and up to the tenth harmonic was measured and they were found to be at least 20dB below the maximum measured in-band peak PSD level.

TEST REPORT

PLOTS OF OUT OF BAND CONDUCTED EMISSIONS

802.11b, Lowest Channel

Result

DUT Frequency (MHz)	Result
2412.000000	PASS

Final measurements

Frequency (MHz)	Level Pre Measurement (dBm)	level (dBm)	Limit (dBm)	Margin (dB)	Result
---	---	---	---	---	---

Pre Measurements

Frequency (MHz)	Level (dBm)	Margin (dB)	Limit (dBm)
2398.750000	-39.7	25.2	-14.5
2397.250000	-40.0	25.5	-14.5
2398.250000	-40.2	25.7	-14.5
2397.750000	-40.5	26.0	-14.5
2399.250000	-40.8	26.3	-14.5
2395.750000	-40.9	26.4	-14.5
2396.750000	-41.2	26.7	-14.5
2400.000000	-41.4	26.9	-14.5
2399.750000	-41.4	26.9	-14.5
2396.250000	-41.5	27.0	-14.5
2390.250000	-42.2	27.7	-14.5
2395.250000	-42.4	27.9	-14.5
2384.750000	-42.8	28.3	-14.5
2387.250000	-43.0	28.5	-14.5
2389.750000	-43.3	28.8	-14.5

Measurement Settings

Start Frequency (MHz)	Stop Frequency (MHz)	Pre Measurement	Final Measurement
30.000000	1000.000000	1	1
1000.000000	2400.000000	2	2
2483.500000	7000.000000	2	2
7000.000000	18000.000000	2	2
18000.000000	26000.000000	2	2

TEST REPORT

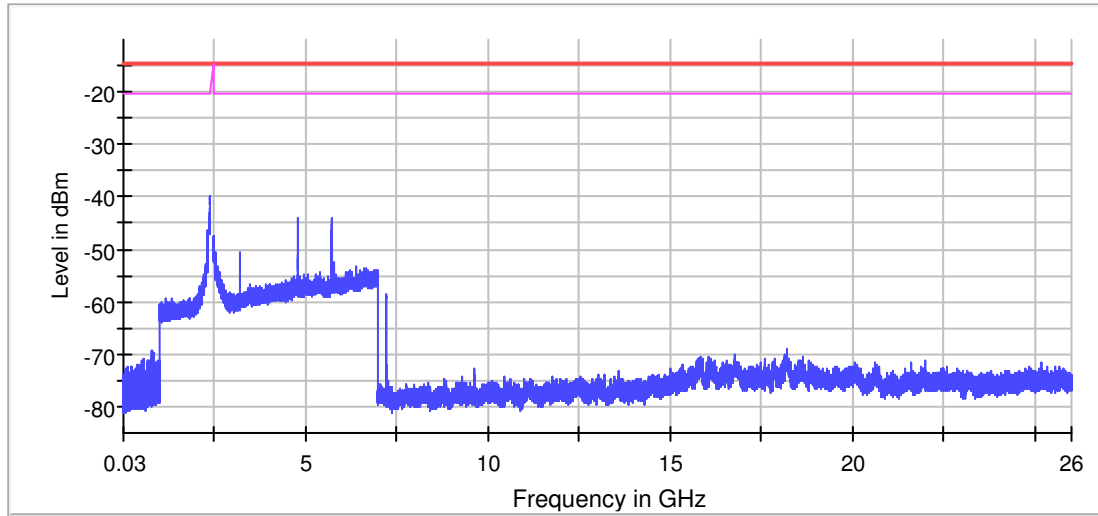

— Limit — Sum Level — Threshold × Critical × Final Critical

Pre Measurement 1

Setting	Instrument Value	Target Value
RBW	100.000 kHz	<= 100.000 kHz
VBW	300.000 kHz	>= 300.000 kHz
SweepPoints	19400	~ 19400
SweepTime	1.061 ms	AUTO
Reference Level	-10.000 dBm	-30.000 dBm
Attenuation	20.000 dB	AUTO
Detector	MaxPeak	MaxPeak
SweepCount	30	30
Filter	3 dB	3 dB
Trace Mode	Max Hold	Max Hold
SweepType	FFT	AUTO
Preamp	off	off
Stablemode	Trace	Trace
Stablevalue	0.50 dB	0.50 dB
Run	1 / max. 1	max. 1
Stable	0 / 1	1
Max Stable Difference	0.00 dB	0.50 dB

Pre Measurement 2

Setting	Instrument Value	Target Value
RBW	1.000 MHz	<= 1.000 MHz
VBW	3.000 MHz	>= 3.000 MHz
SweepPoints	2800	~ 2800
SweepTime	2.800 ms	AUTO
Reference Level	-10.000 dBm	-30.000 dBm
Attenuation	20.000 dB	AUTO
Detector	MaxPeak	MaxPeak
SweepCount	30	30
Filter	3 dB	3 dB
Trace Mode	Max Hold	Max Hold
SweepType	Sweep	AUTO
Preamp	off	off
Stablemode	Trace	Trace
Stablevalue	0.50 dB	0.50 dB
Run	22 / max. 150	max. 150
Stable	3 / 3	3
Max Stable Difference	0.14 dB	0.50 dB

TEST REPORT

802.11b, Middle Channel

Result

DUT Frequency (MHz)	Result
2437.000000	PASS

Final measurements

Frequency (MHz)	Level Pre Measurement (dBm)	level (dBm)	Limit (dBm)	Margin (dB)	Result
---	---	---	---	---	---

Pre Measurements

Frequency (MHz)	Level (dBm)	Margin (dB)	Limit (dBm)
2489.250000	-43.2	29.3	-13.9
4874.250000	-43.3	29.3	-13.9
2395.250000	-43.5	29.6	-13.9
2399.250000	-43.7	29.8	-13.9
2395.750000	-43.8	29.9	-13.9
4874.750000	-43.8	29.9	-13.9
4873.750000	-43.9	30.0	-13.9
2488.750000	-44.0	30.1	-13.9
2400.000000	-44.1	30.2	-13.9
2399.750000	-44.1	30.2	-13.9
2485.250000	-44.2	30.3	-13.9
2392.250000	-44.4	30.5	-13.9
2397.250000	-44.6	30.7	-13.9
2485.750000	-44.7	30.8	-13.9
2484.250000	-44.7	30.8	-13.9

Measurement Settings

Start Frequency (MHz)	Stop Frequency (MHz)	Pre Measurement	Final Measurement
30.000000	1000.000000	1	1
1000.000000	2400.000000	2	2
2483.500000	7000.000000	2	2
7000.000000	18000.000000	2	2
18000.000000	26000.000000	2	2

TEST REPORT

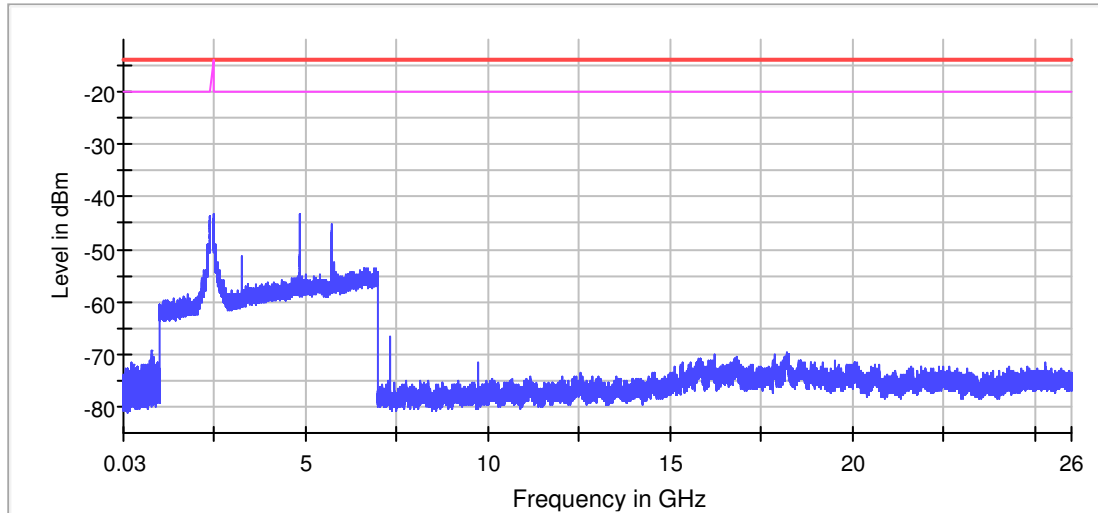

— Limit — Sum Level — Threshold × Critical × Final Critical

Pre Measurement 1

Setting	Instrument Value	Target Value
RBW	100.000 kHz	<= 100.000 kHz
VBW	300.000 kHz	>= 300.000 kHz
SweepPoints	19400	~ 19400
SweepTime	1.061 ms	AUTO
Reference Level	-10.000 dBm	-30.000 dBm
Attenuation	20.000 dB	AUTO
Detector	MaxPeak	MaxPeak
SweepCount	30	30
Filter	3 dB	3 dB
Trace Mode	Max Hold	Max Hold
SweepType	FFT	AUTO
Preamp	off	off
Stablemode	Trace	Trace
Stablevalue	0.50 dB	0.50 dB
Run	1 / max. 1	max. 1
Stable	0 / 1	1
Max Stable Difference	0.00 dB	0.50 dB

Pre Measurement 2

Setting	Instrument Value	Target Value
RBW	1.000 MHz	<= 1.000 MHz
VBW	3.000 MHz	>= 3.000 MHz
SweepPoints	2800	~ 2800
SweepTime	2.800 ms	AUTO
Reference Level	-10.000 dBm	-30.000 dBm
Attenuation	20.000 dB	AUTO
Detector	MaxPeak	MaxPeak
SweepCount	30	30
Filter	3 dB	3 dB
Trace Mode	Max Hold	Max Hold
SweepType	Sweep	AUTO
Preamp	off	off
Stablemode	Trace	Trace
Stablevalue	0.50 dB	0.50 dB
Run	26 / max. 150	max. 150
Stable	3 / 3	3
Max Stable Difference	0.00 dB	0.50 dB

TEST REPORT

PLOTS OF OUT OF BAND CONDUCTED EMISSIONS

802.11b, Highest Channel

Result

DUT Frequency (MHz)	Result
2462.000000	PASS

Final measurements

Frequency (MHz)	Level Pre Measurement (dBm)	level (dBm)	Limit (dBm)	Margin (dB)	Result
---	---	---	---	---	---

Pre Measurements

Frequency (MHz)	Level (dBm)	Margin (dB)	Limit (dBm)
2483.750000	-41.4	27.5	-13.8
2483.500000	-41.4	27.5	-13.8
2492.250000	-41.4	27.6	-13.8
2489.250000	-41.9	28.1	-13.8
2490.750000	-42.1	28.3	-13.8
2497.250000	-42.1	28.3	-13.8
2496.750000	-42.2	28.4	-13.8
2491.250000	-42.3	28.5	-13.8
2495.250000	-42.4	28.6	-13.8
2493.250000	-42.4	28.6	-13.8
2488.750000	-42.4	28.6	-13.8
2484.250000	-42.4	28.6	-13.8
2499.250000	-42.5	28.7	-13.8
2491.750000	-42.5	28.7	-13.8
2501.250000	-42.6	28.8	-13.8

Measurement Settings

Start Frequency (MHz)	Stop Frequency (MHz)	Pre Measurement	Final Measurement
30.000000	1000.000000	1	1
1000.000000	2400.000000	2	2
2483.500000	7000.000000	2	2
7000.000000	18000.000000	2	2
18000.000000	26000.000000	2	2

TEST REPORT

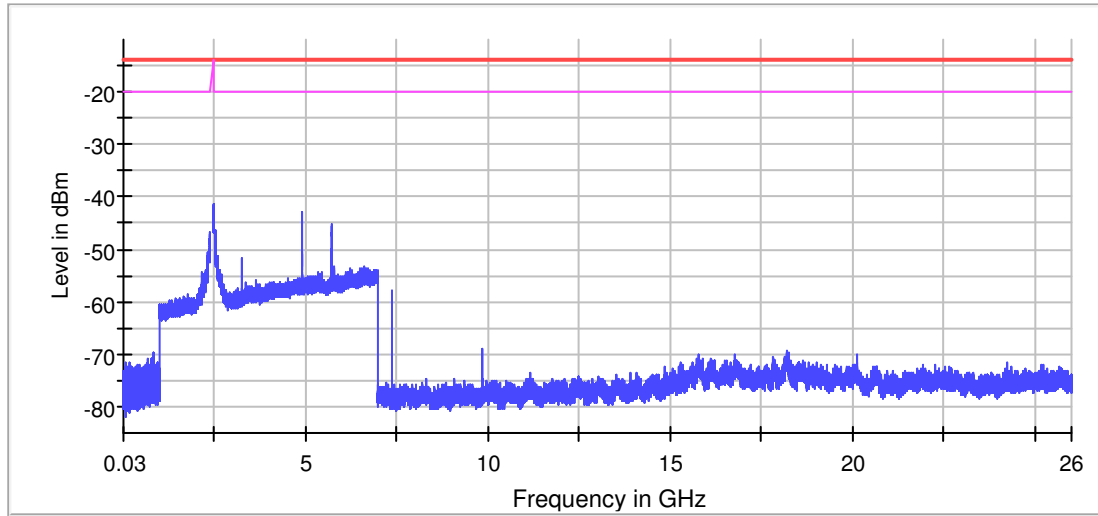

— Limit — Sum Level — Threshold × Critical × Final Critical

Pre Measurement 1

Setting	Instrument Value	Target Value
RBW	100.000 kHz	<= 100.000 kHz
VBW	300.000 kHz	>= 300.000 kHz
SweepPoints	19400	~ 19400
SweepTime	1.061 ms	AUTO
Reference Level	-10.000 dBm	-30.000 dBm
Attenuation	20.000 dB	AUTO
Detector	MaxPeak	MaxPeak
SweepCount	30	30
Filter	3 dB	3 dB
Trace Mode	Max Hold	Max Hold
SweepType	FFT	AUTO
Preamp	off	off
Stablemode	Trace	Trace
Stablevalue	0.50 dB	0.50 dB
Run	1 / max. 1	max. 1
Stable	0 / 1	1
Max Stable Difference	0.00 dB	0.50 dB

Pre Measurement 2

Setting	Instrument Value	Target Value
RBW	1.000 MHz	<= 1.000 MHz
VBW	3.000 MHz	>= 3.000 MHz
SweepPoints	2800	~ 2800
SweepTime	2.800 ms	AUTO
Reference Level	-10.000 dBm	-30.000 dBm
Attenuation	20.000 dB	AUTO
Detector	MaxPeak	MaxPeak
SweepCount	30	30
Filter	3 dB	3 dB
Trace Mode	Max Hold	Max Hold
SweepType	Sweep	AUTO
Preamp	off	off
Stablemode	Trace	Trace
Stablevalue	0.50 dB	0.50 dB
Run	45 / max. 150	max. 150
Stable	3 / 3	3
Max Stable Difference	0.00 dB	0.50 dB

TEST REPORT

PLOTS OF OUT OF BAND CONDUCTED EMISSIONS

802.11g, Lowest Channel

Result

DUT Frequency (MHz)	Result
2412.000000	PASS

Final measurements

Frequency (MHz)	Level Pre Measurement (dBm)	level (dBm)	Limit (dBm)	Margin (dB)	Result
---	---	---	---	---	---

Pre Measurements

Frequency (MHz)	Level (dBm)	Margin (dB)	Limit (dBm)
2400.000000	-24.8	7.7	-17.1
2399.750000	-24.8	7.7	-17.1
2399.250000	-27.0	9.9	-17.1
2398.750000	-28.5	11.4	-17.1
2398.250000	-28.6	11.5	-17.1
2397.250000	-30.8	13.8	-17.1
2396.750000	-31.4	14.3	-17.1
2397.750000	-31.7	14.6	-17.1
2396.250000	-32.6	15.5	-17.1
2395.750000	-34.3	17.2	-17.1
2394.250000	-34.8	17.8	-17.1
2394.750000	-35.0	17.9	-17.1
2395.250000	-35.9	18.8	-17.1
2393.250000	-35.9	18.9	-17.1
2393.750000	-36.1	19.0	-17.1

Measurement Settings

Start Frequency (MHz)	Stop Frequency (MHz)	Pre Measurement	Final Measurement
30.000000	1000.000000	1	1
1000.000000	2400.000000	2	2
2483.500000	7000.000000	2	2
7000.000000	18000.000000	2	2
18000.000000	26000.000000	2	2

TEST REPORT

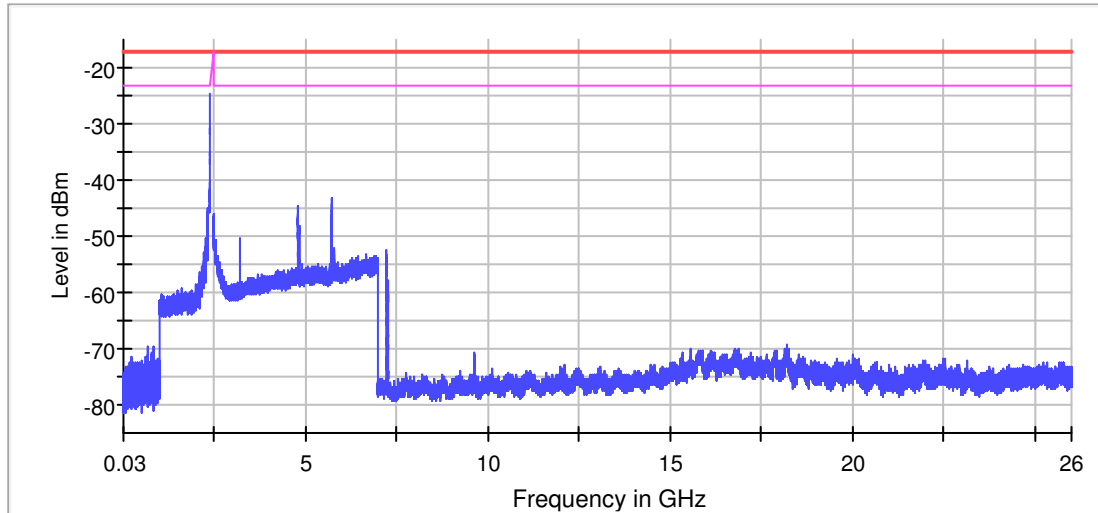

— Limit — Sum Level — Threshold × Critical × Final Critical

Pre Measurement 1

Setting	Instrument Value	Target Value
RBW	100.000 kHz	<= 100.000 kHz
VBW	300.000 kHz	>= 300.000 kHz
SweepPoints	19400	~ 19400
SweepTime	1.061 ms	AUTO
Reference Level	-10.000 dBm	-30.000 dBm
Attenuation	20.000 dB	AUTO
Detector	MaxPeak	MaxPeak
SweepCount	30	30
Filter	3 dB	3 dB
Trace Mode	Max Hold	Max Hold
SweepType	FFT	AUTO
Preamp	off	off
Stablemode	Trace	Trace
Stablevalue	0.50 dB	0.50 dB
Run	1 / max. 1	max. 1
Stable	0 / 1	1
Max Stable Difference	0.00 dB	0.50 dB

Pre Measurement 2

Setting	Instrument Value	Target Value
RBW	1.000 MHz	<= 1.000 MHz
VBW	3.000 MHz	>= 3.000 MHz
SweepPoints	2800	~ 2800
SweepTime	2.800 ms	AUTO
Reference Level	-10.000 dBm	-30.000 dBm
Attenuation	20.000 dB	AUTO
Detector	MaxPeak	MaxPeak
SweepCount	30	30
Filter	3 dB	3 dB
Trace Mode	Max Hold	Max Hold
SweepType	Sweep	AUTO
Preamp	off	off
Stablemode	Trace	Trace
Stablevalue	0.50 dB	0.50 dB
Run	10 / max. 150	max. 150
Stable	3 / 3	3
Max Stable Difference	0.00 dB	0.50 dB

TEST REPORT

802.11g, Middle Channel

Result

DUT Frequency (MHz)	Result
2437.000000	PASS

Final measurements

Frequency (MHz)	Level Pre Measurement (dBm)	level (dBm)	Limit (dBm)	Margin (dB)	Result
---	---	---	---	---	---

Pre Measurements

Frequency (MHz)	Level (dBm)	Margin (dB)	Limit (dBm)
2483.750000	-40.4	24.0	-16.4
2483.500000	-40.4	24.0	-16.4
2397.250000	-40.8	24.4	-16.4
2400.000000	-41.0	24.7	-16.4
2399.750000	-41.0	24.7	-16.4
2398.250000	-41.1	24.8	-16.4
2485.250000	-41.4	25.1	-16.4
2484.750000	-41.6	25.2	-16.4
2492.750000	-41.7	25.3	-16.4
2395.250000	-41.8	25.4	-16.4
2394.250000	-41.9	25.6	-16.4
2491.250000	-42.0	25.7	-16.4
2396.250000	-42.0	25.7	-16.4
2394.750000	-42.1	25.7	-16.4
2392.250000	-42.1	25.7	-16.4

Measurement Settings

Start Frequency (MHz)	Stop Frequency (MHz)	Pre Measurement	Final Measurement
30.000000	1000.000000	1	1
1000.000000	2400.000000	2	2
2483.500000	7000.000000	2	2
7000.000000	18000.000000	2	2
18000.000000	26000.000000	2	2

TEST REPORT

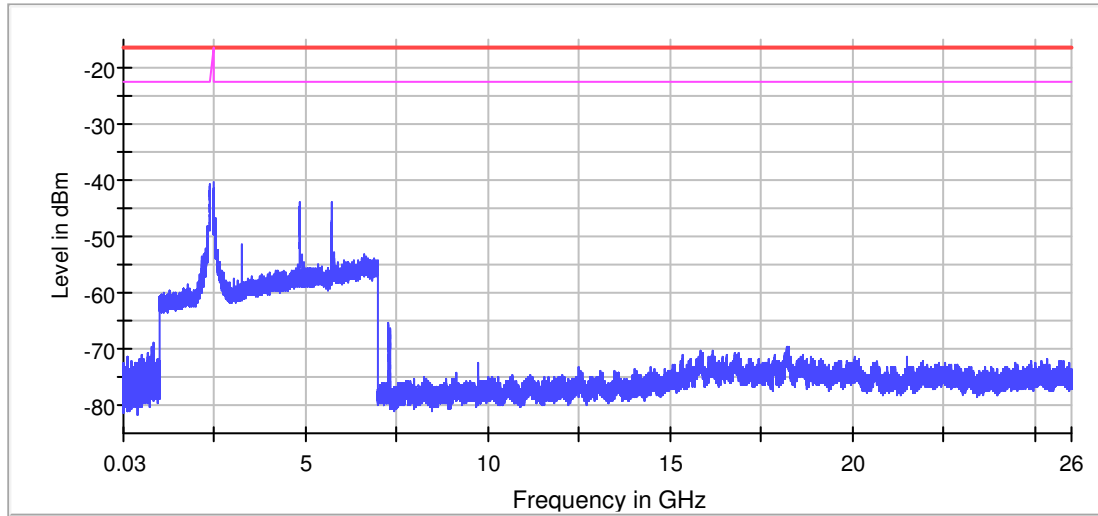

— Limit — Sum Level — Threshold × Critical × Final Critical

Pre Measurement 1

Setting	Instrument Value	Target Value
RBW	100.000 kHz	<= 100.000 kHz
VBW	300.000 kHz	>= 300.000 kHz
SweepPoints	19400	~ 19400
SweepTime	1.061 ms	AUTO
Reference Level	-10.000 dBm	-30.000 dBm
Attenuation	20.000 dB	AUTO
Detector	MaxPeak	MaxPeak
SweepCount	30	30
Filter	3 dB	3 dB
Trace Mode	Max Hold	Max Hold
SweepType	FFT	AUTO
Preamp	off	off
Stablemode	Trace	Trace
Stablevalue	0.50 dB	0.50 dB
Run	1 / max. 1	max. 1
Stable	0 / 1	1
Max Stable Difference	0.00 dB	0.50 dB

Pre Measurement 2

Setting	Instrument Value	Target Value
RBW	1.000 MHz	<= 1.000 MHz
VBW	3.000 MHz	>= 3.000 MHz
SweepPoints	2800	~ 2800
SweepTime	2.800 ms	AUTO
Reference Level	-10.000 dBm	-30.000 dBm
Attenuation	20.000 dB	AUTO
Detector	MaxPeak	MaxPeak
SweepCount	30	30
Filter	3 dB	3 dB
Trace Mode	Max Hold	Max Hold
SweepType	Sweep	AUTO
Preamp	off	off
Stablemode	Trace	Trace
Stablevalue	0.50 dB	0.50 dB
Run	32 / max. 150	max. 150
Stable	3 / 3	3
Max Stable Difference	0.35 dB	0.50 dB

TEST REPORT

PLOTS OF OUT OF BAND CONDUCTED EMISSIONS

802.11g, Highest Channel

Result

DUT Frequency (MHz)	Result
2462.000000	PASS

Final measurements

Frequency (MHz)	Level Pre Measurement (dBm)	level (dBm)	Limit (dBm)	Margin (dB)	Result
---	---	---	---	---	---

Pre Measurements

Frequency (MHz)	Level (dBm)	Margin (dB)	Limit (dBm)
2483.750000	-33.1	16.8	-16.3
2483.500000	-33.1	16.8	-16.3
2484.250000	-34.4	18.1	-16.3
2484.750000	-34.8	18.5	-16.3
2485.250000	-36.5	20.3	-16.3
2485.750000	-37.5	21.2	-16.3
2490.750000	-38.9	22.6	-16.3
2496.250000	-39.0	22.7	-16.3
2490.250000	-39.1	22.8	-16.3
2494.750000	-39.4	23.1	-16.3
2486.250000	-39.8	23.6	-16.3
2489.750000	-39.9	23.6	-16.3
2488.750000	-39.9	23.6	-16.3
2491.250000	-40.0	23.7	-16.3
2488.250000	-40.0	23.7	-16.3

Measurement Settings

Start Frequency (MHz)	Stop Frequency (MHz)	Pre Measurement	Final Measurement
30.000000	1000.000000	1	1
1000.000000	2400.000000	2	2
2483.500000	7000.000000	2	2
7000.000000	18000.000000	2	2
18000.000000	26000.000000	2	2

TEST REPORT

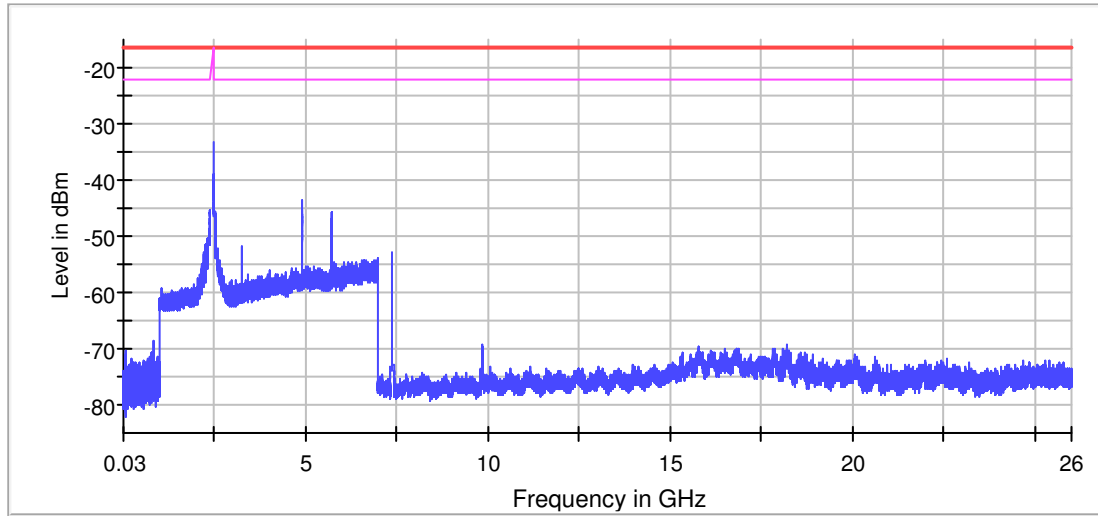

— Limit — Sum Level — Threshold × Critical × Final Critical

Pre Measurement 1

Setting	Instrument Value	Target Value
RBW	100.000 kHz	<= 100.000 kHz
VBW	300.000 kHz	>= 300.000 kHz
SweepPoints	19400	~ 19400
SweepTime	1.061 ms	AUTO
Reference Level	-10.000 dBm	-30.000 dBm
Attenuation	20.000 dB	AUTO
Detector	MaxPeak	MaxPeak
SweepCount	30	30
Filter	3 dB	3 dB
Trace Mode	Max Hold	Max Hold
SweepType	FFT	AUTO
Preamp	off	off
Stablemode	Trace	Trace
Stablevalue	0.50 dB	0.50 dB
Run	1 / max. 1	max. 1
Stable	0 / 1	1
Max Stable Difference	0.00 dB	0.50 dB

Pre Measurement 2

Setting	Instrument Value	Target Value
RBW	1.000 MHz	<= 1.000 MHz
VBW	3.000 MHz	>= 3.000 MHz
SweepPoints	2800	~ 2800
SweepTime	2.800 ms	AUTO
Reference Level	-10.000 dBm	-30.000 dBm
Attenuation	20.000 dB	AUTO
Detector	MaxPeak	MaxPeak
SweepCount	30	30
Filter	3 dB	3 dB
Trace Mode	Max Hold	Max Hold
SweepType	Sweep	AUTO
Preamp	off	off
Stablemode	Trace	Trace
Stablevalue	0.50 dB	0.50 dB
Run	32 / max. 150	max. 150
Stable	3 / 3	3
Max Stable Difference	0.31 dB	0.50 dB

TEST REPORT

PLOTS OF OUT OF BAND CONDUCTED EMISSIONS

802.11n (20MHz), Lowest Channel

Result

DUT Frequency (MHz)	Result
2412.000000	PASS

Final measurements

Frequency (MHz)	Level Pre Measurement (dBm)	level (dBm)	Limit (dBm)	Margin (dB)	Result
2400.000000	-21.3	-35.4	-20.3	15.1	PASS

Pre Measurements

Frequency (MHz)	Level (dBm)	Margin (dB)	Limit (dBm)
2400.000000	-21.3	1.0	-20.3
2399.750000	-21.3	1.0	-20.3
2399.250000	-23.4	3.1	-20.3
2398.750000	-26.3	6.0	-20.3
2398.250000	-29.3	9.1	-20.3
2396.250000	-31.3	11.1	-20.3
2397.750000	-32.4	12.2	-20.3
2397.250000	-32.8	12.5	-20.3
2394.750000	-33.3	13.0	-20.3
2396.750000	-34.4	14.1	-20.3
2395.250000	-35.1	14.8	-20.3
2393.750000	-35.1	14.9	-20.3
2394.250000	-35.7	15.4	-20.3
2391.250000	-36.4	16.1	-20.3
2390.750000	-37.0	16.7	-20.3

Measurement Settings

Start Frequency (MHz)	Stop Frequency (MHz)	Pre Measurement	Final Measurement
30.000000	1000.000000	1	1
1000.000000	2400.000000	2	2
2483.500000	7000.000000	2	2
7000.000000	18000.000000	2	2
18000.000000	26000.000000	2	2

TEST REPORT

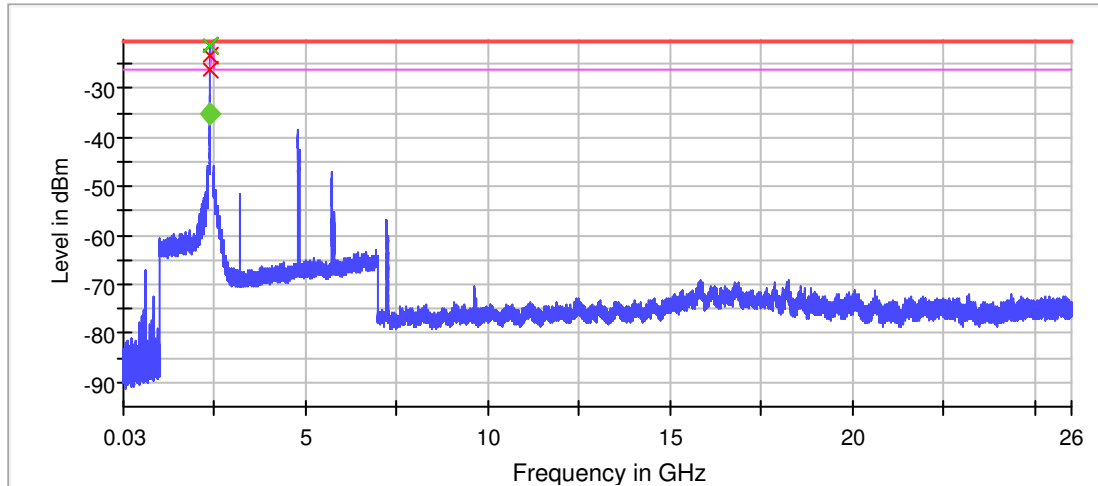

— Limit
× Final Critical
— Sum Level
◆ Fail
— Threshold
◆ Pass
× Critical

Pre Measurement 1

Setting	Instrument Value	Target Value
RBW	100.000 kHz	<= 100.000 kHz
VBW	300.000 kHz	>= 300.000 kHz
SweepPoints	19400	~ 19400
SweepTime	1.061 ms	AUTO
Reference Level	-20.000 dBm	-30.000 dBm
Attenuation	10.000 dB	AUTO
Detector	MaxPeak	MaxPeak
SweepCount	30	30
Filter	3 dB	3 dB
Trace Mode	Max Hold	Max Hold
SweepType	FFT	AUTO
Preamp	off	off
Stablemode	Trace	Trace
Stablevalue	0.50 dB	0.50 dB
Run	1 / max. 1	max. 1
Stable	0 / 1	1
Max Stable Difference	0.00 dB	0.50 dB

Pre Measurement 2

Setting	Instrument Value	Target Value
RBW	1.000 MHz	<= 1.000 MHz
VBW	3.000 MHz	>= 3.000 MHz
SweepPoints	2800	~ 2800
SweepTime	2.800 ms	AUTO
Reference Level	-10.000 dBm	-30.000 dBm
Attenuation	20.000 dB	AUTO
Detector	MaxPeak	MaxPeak
SweepCount	30	30
Filter	3 dB	3 dB
Trace Mode	Max Hold	Max Hold
SweepType	Sweep	AUTO
Preamp	off	off
Stablemode	Trace	Trace
Stablevalue	0.50 dB	0.50 dB
Run	11 / max. 150	max. 150
Stable	3 / 3	3
Max Stable Difference	0.00 dB	0.50 dB

TEST REPORT

Final Measurement 2

Setting	Instrument Value	Target Value
Span	ZeroSpan	ZeroSpan
RBW	1.000 MHz	~ 1.000 MHz
VBW	3.000 MHz	~ 3.000 MHz
SweepPoints	10001	~ 10001
Sweeptime	1.000 s	1.000 s
Reference Level	-10.000 dBm	-30.000 dBm
Attenuation	20.000 dB	AUTO
Detector	RMS	RMS
SweepCount	1	1
Filter	3 dB	3 dB
Trace Mode	Clear Write	Clear Write
SweepType	Sweep	AUTO
Preamp	off	off

TEST REPORT

PLOTS OF OUT OF BAND CONDUCTED EMISSIONS

802.11n (20MHz), Middle Channel

Result

DUT Frequency (MHz)	Result
2437.000000	PASS

Final measurements

Frequency (MHz)	Level Pre Measurement (dBm)	level (dBm)	Limit (dBm)	Margin (dB)	Result
---	---	---	---	---	---

Pre Measurements

Frequency (MHz)	Level (dBm)	Margin (dB)	Limit (dBm)
4865.250000	-37.9	18.1	-19.7
4876.750000	-38.2	18.4	-19.7
4875.250000	-38.2	18.5	-19.7
4873.750000	-38.2	18.5	-19.7
4875.750000	-38.2	18.5	-19.7
4874.750000	-38.3	18.5	-19.7
4876.250000	-38.3	18.5	-19.7
4874.250000	-38.4	18.6	-19.7
4871.250000	-38.6	18.8	-19.7
4869.750000	-38.6	18.9	-19.7
4872.750000	-38.8	19.0	-19.7
4873.250000	-38.9	19.1	-19.7
4882.750000	-38.9	19.2	-19.7
4869.250000	-39.0	19.3	-19.7
4864.750000	-39.0	19.3	-19.7

Measurement Settings

Start Frequency (MHz)	Stop Frequency (MHz)	Pre Measurement	Final Measurement
30.000000	1000.000000	1	1
1000.000000	2400.000000	2	2
2483.500000	7000.000000	2	2
7000.000000	18000.000000	2	2
18000.000000	26000.000000	2	2

TEST REPORT

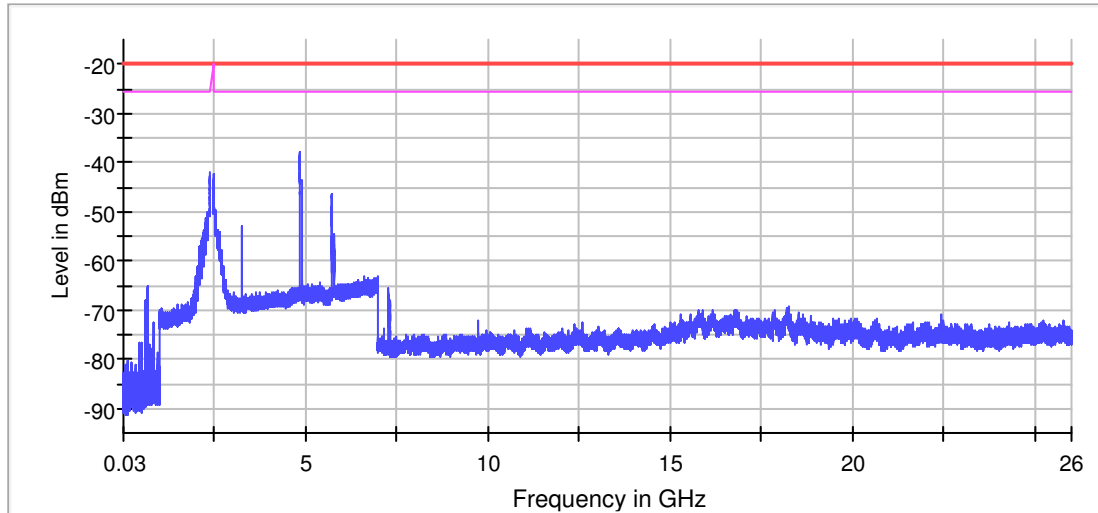

— Limit — Sum Level — Threshold × Critical × Final Critical

Pre Measurement 1

Setting	Instrument Value	Target Value
RBW	100.000 kHz	<= 100.000 kHz
VBW	300.000 kHz	>= 300.000 kHz
SweepPoints	19400	~ 19400
SweepTime	1.061 ms	AUTO
Reference Level	-20.000 dBm	-30.000 dBm
Attenuation	10.000 dB	AUTO
Detector	MaxPeak	MaxPeak
SweepCount	30	30
Filter	3 dB	3 dB
Trace Mode	Max Hold	Max Hold
SweepType	FFT	AUTO
Preamp	off	off
Stablemode	Trace	Trace
Stablevalue	0.50 dB	0.50 dB
Run	1 / max. 1	max. 1
Stable	0 / 1	1
Max Stable Difference	0.00 dB	0.50 dB

Pre Measurement 2

Setting	Instrument Value	Target Value
RBW	1.000 MHz	<= 1.000 MHz
VBW	3.000 MHz	>= 3.000 MHz
SweepPoints	2800	~ 2800
SweepTime	2.800 ms	AUTO
Reference Level	-20.000 dBm	-30.000 dBm
Attenuation	10.000 dB	AUTO
Detector	MaxPeak	MaxPeak
SweepCount	30	30
Filter	3 dB	3 dB
Trace Mode	Max Hold	Max Hold
SweepType	Sweep	AUTO
Preamp	off	off
Stablemode	Trace	Trace
Stablevalue	0.50 dB	0.50 dB
Run	17 / max. 150	max. 150
Stable	3 / 3	3
Max Stable Difference	0.01 dB	0.50 dB

TEST REPORT

PLOTS OF OUT OF BAND CONDUCTED EMISSIONS

802.11n (20MHz), Highest Channel

Result

DUT Frequency (MHz)	Result
2462.000000	PASS

Final measurements

Frequency (MHz)	Level Pre Measurement (dBm)	level (dBm)	Limit (dBm)	Margin (dB)	Result
---	---	---	---	---	---

Pre Measurements

Frequency (MHz)	Level (dBm)	Margin (dB)	Limit (dBm)
2484.250000	-30.8	11.2	-19.6
2484.750000	-31.1	11.5	-19.6
2483.750000	-31.4	11.8	-19.6
2483.500000	-31.4	11.8	-19.6
2485.250000	-31.8	12.2	-19.6
2485.750000	-32.5	12.9	-19.6
2488.750000	-32.7	13.1	-19.6
2486.750000	-32.7	13.1	-19.6
2487.750000	-32.7	13.1	-19.6
2488.250000	-32.8	13.2	-19.6
2486.250000	-33.4	13.8	-19.6
2489.250000	-33.6	14.0	-19.6
2491.750000	-33.9	14.3	-19.6
2487.250000	-33.9	14.3	-19.6
2492.250000	-34.1	14.5	-19.6

Measurement Settings

Start Frequency (MHz)	Stop Frequency (MHz)	Pre Measurement	Final Measurement
30.000000	1000.000000	1	1
1000.000000	2400.000000	2	2
2483.500000	7000.000000	2	2
7000.000000	18000.000000	2	2
18000.000000	26000.000000	2	2

TEST REPORT

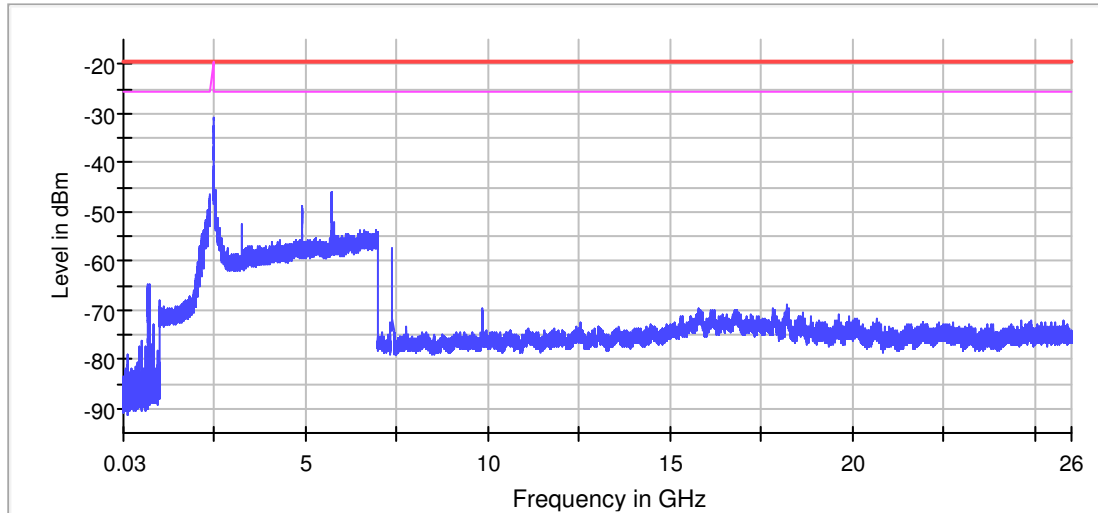

— Limit — Sum Level — Threshold × Critical × Final Critical

Pre Measurement 1

Setting	Instrument Value	Target Value
RBW	100.000 kHz	<= 100.000 kHz
VBW	300.000 kHz	>= 300.000 kHz
SweepPoints	19400	~ 19400
SweepTime	1.061 ms	AUTO
Reference Level	-20.000 dBm	-30.000 dBm
Attenuation	10.000 dB	AUTO
Detector	MaxPeak	MaxPeak
SweepCount	30	30
Filter	3 dB	3 dB
Trace Mode	Max Hold	Max Hold
SweepType	FFT	AUTO
Preamp	off	off
Stablemode	Trace	Trace
Stablevalue	0.50 dB	0.50 dB
Run	1 / max. 1	max. 1
Stable	0 / 1	1
Max Stable Difference	0.00 dB	0.50 dB

Pre Measurement 2

Setting	Instrument Value	Target Value
RBW	1.000 MHz	<= 1.000 MHz
VBW	3.000 MHz	>= 3.000 MHz
SweepPoints	2800	~ 2800
SweepTime	2.800 ms	AUTO
Reference Level	-20.000 dBm	-30.000 dBm
Attenuation	10.000 dB	AUTO
Detector	MaxPeak	MaxPeak
SweepCount	30	30
Filter	3 dB	3 dB
Trace Mode	Max Hold	Max Hold
SweepType	Sweep	AUTO
Preamp	off	off
Stablemode	Trace	Trace
Stablevalue	0.50 dB	0.50 dB
Run	34 / max. 150	max. 150
Stable	3 / 3	3
Max Stable Difference	0.02 dB	0.50 dB

TEST REPORT

PLOTS OF OUT OF BAND CONDUCTED EMISSIONS

802.11n (40MHz), Lowest Channel

Result

DUT Frequency (MHz)	Result
2422.000000	PASS

Final measurements

Frequency (MHz)	Level Pre Measurement (dBm)	level (dBm)	Limit (dBm)	Margin (dB)	Result
---	---	---	---	---	---

Pre Measurements

Frequency (MHz)	Level (dBm)	Margin (dB)	Limit (dBm)
2400.000000	-33.6	10.6	-23.0
2399.750000	-33.6	10.6	-23.0
2391.250000	-34.2	11.2	-23.0
2399.250000	-34.5	11.5	-23.0
2483.750000	-34.5	11.6	-23.0
2483.500000	-34.5	11.6	-23.0
2393.250000	-35.1	12.1	-23.0
2395.250000	-35.1	12.1	-23.0
2398.250000	-35.2	12.2	-23.0
2393.750000	-35.2	12.2	-23.0
2394.750000	-35.4	12.4	-23.0
2390.750000	-35.8	12.8	-23.0
2395.750000	-35.9	12.9	-23.0
2484.750000	-35.9	12.9	-23.0
2396.250000	-36.0	13.0	-23.0

Measurement Settings

Start Frequency (MHz)	Stop Frequency (MHz)	Pre Measurement	Final Measurement
30.000000	1000.000000	1	1
1000.000000	2400.000000	2	2
2483.500000	7000.000000	2	2
7000.000000	18000.000000	2	2
18000.000000	26000.000000	2	2

TEST REPORT

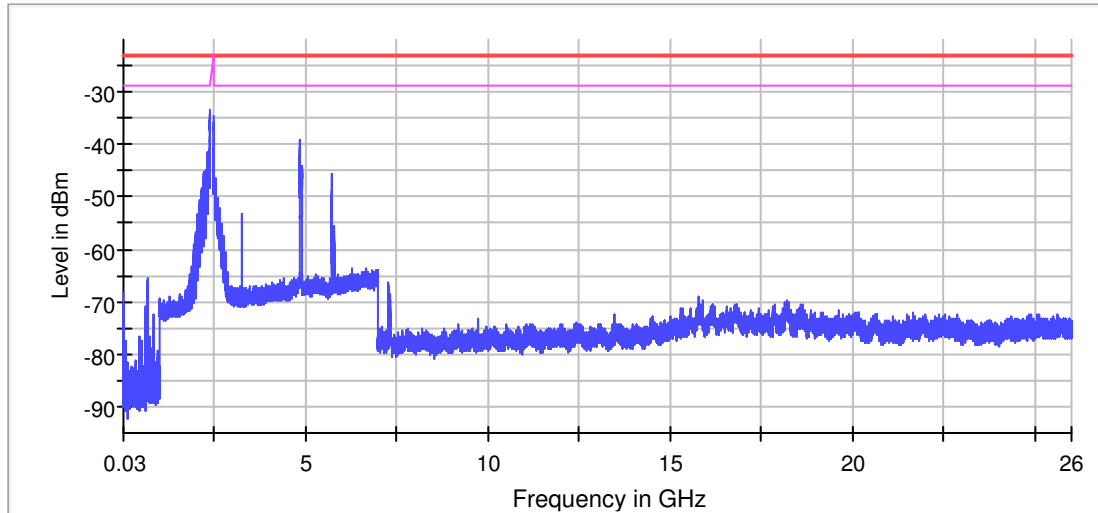

— Limit — Sum Level — Threshold × Critical × Final Critical

Pre Measurement 1

Setting	Instrument Value	Target Value
RBW	100.000 kHz	<= 100.000 kHz
VBW	300.000 kHz	>= 300.000 kHz
SweepPoints	19400	~ 19400
SweepTime	1.061 ms	AUTO
Reference Level	-20.000 dBm	-30.000 dBm
Attenuation	10.000 dB	AUTO
Detector	MaxPeak	MaxPeak
SweepCount	30	30
Filter	3 dB	3 dB
Trace Mode	Max Hold	Max Hold
SweepType	FFT	AUTO
Preamp	off	off
Stablemode	Trace	Trace
Stablevalue	0.50 dB	0.50 dB
Run	1 / max. 1	max. 1
Stable	0 / 1	1
Max Stable Difference	0.00 dB	0.50 dB

Pre Measurement 2

Setting	Instrument Value	Target Value
RBW	1.000 MHz	<= 1.000 MHz
VBW	3.000 MHz	>= 3.000 MHz
SweepPoints	2800	~ 2800
SweepTime	2.800 ms	AUTO
Reference Level	-20.000 dBm	-30.000 dBm
Attenuation	10.000 dB	AUTO
Detector	MaxPeak	MaxPeak
SweepCount	30	30
Filter	3 dB	3 dB
Trace Mode	Max Hold	Max Hold
SweepType	Sweep	AUTO
Preamp	off	off
Stablemode	Trace	Trace
Stablevalue	0.50 dB	0.50 dB
Run	32 / max. 150	max. 150
Stable	3 / 3	3
Max Stable Difference	0.00 dB	0.50 dB

TEST REPORT

PLOTS OF OUT OF BAND CONDUCTED EMISSIONS

802.11n (40MHz), Middle Channel

Result

DUT Frequency (MHz)	Result
2437.000000	PASS

Final measurements

Frequency (MHz)	Level Pre Measurement (dBm)	level (dBm)	Limit (dBm)	Margin (dB)	Result
---	---	---	---	---	---

Pre Measurements

Frequency (MHz)	Level (dBm)	Margin (dB)	Limit (dBm)
2400.000000	-30.8	8.0	-22.8
2399.750000	-30.8	8.0	-22.8
2399.250000	-33.5	10.7	-22.8
2398.250000	-34.3	11.5	-22.8
2484.750000	-34.9	12.1	-22.8
2398.750000	-35.7	12.9	-22.8
2394.250000	-35.9	13.1	-22.8
2483.750000	-36.1	13.3	-22.8
2483.500000	-36.1	13.3	-22.8
2396.250000	-36.2	13.4	-22.8
2484.250000	-36.2	13.4	-22.8
2395.750000	-36.2	13.5	-22.8
2385.750000	-36.2	13.5	-22.8
2392.750000	-36.3	13.5	-22.8
2485.250000	-36.5	13.7	-22.8

Measurement Settings

Start Frequency (MHz)	Stop Frequency (MHz)	Pre Measurement	Final Measurement
30.000000	1000.000000	1	1
1000.000000	2400.000000	2	2
2483.500000	7000.000000	2	2
7000.000000	18000.000000	2	2
18000.000000	26000.000000	2	2

TEST REPORT

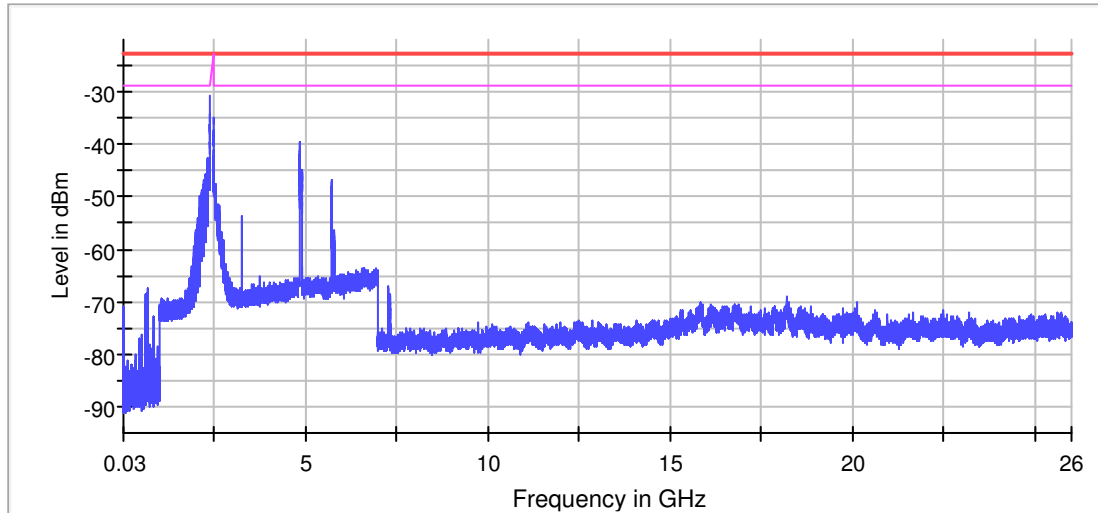

— Limit — Sum Level — Threshold × Critical × Final Critical

Pre Measurement 1

Setting	Instrument Value	Target Value
RBW	100.000 kHz	<= 100.000 kHz
VBW	300.000 kHz	>= 300.000 kHz
SweepPoints	19400	~ 19400
SweepTime	1.061 ms	AUTO
Reference Level	-20.000 dBm	-30.000 dBm
Attenuation	10.000 dB	AUTO
Detector	MaxPeak	MaxPeak
SweepCount	30	30
Filter	3 dB	3 dB
Trace Mode	Max Hold	Max Hold
SweepType	FFT	AUTO
Preamp	off	off
Stablemode	Trace	Trace
Stablevalue	0.50 dB	0.50 dB
Run	1 / max. 1	max. 1
Stable	0 / 1	1
Max Stable Difference	0.00 dB	0.50 dB

Pre Measurement 2

Setting	Instrument Value	Target Value
RBW	1.000 MHz	<= 1.000 MHz
VBW	3.000 MHz	>= 3.000 MHz
SweepPoints	2800	~ 2800
SweepTime	2.800 ms	AUTO
Reference Level	-20.000 dBm	-30.000 dBm
Attenuation	10.000 dB	AUTO
Detector	MaxPeak	MaxPeak
SweepCount	30	30
Filter	3 dB	3 dB
Trace Mode	Max Hold	Max Hold
SweepType	Sweep	AUTO
Preamp	off	off
Stablemode	Trace	Trace
Stablevalue	0.50 dB	0.50 dB
Run	17 / max. 150	max. 150
Stable	3 / 3	3
Max Stable Difference	0.00 dB	0.50 dB

TEST REPORT

PLOTS OF OUT OF BAND CONDUCTED EMISSIONS

802.11n (40MHz), Highest Channel

Result

DUT Frequency (MHz)	Result
2452.000000	PASS

Final measurements

Frequency (MHz)	Level Pre Measurement (dBm)	level (dBm)	Limit (dBm)	Margin (dB)	Result
2483.750000	-27.3	-42.2	-22.8	19.4	PASS

Pre Measurements

Frequency (MHz)	Level (dBm)	Margin (dB)	Limit (dBm)
2483.750000	-27.3	4.5	-22.8
2483.500000	-27.3	4.5	-22.8
2484.250000	-27.3	4.5	-22.8
2488.750000	-28.4	5.6	-22.8
2484.750000	-29.1	6.4	-22.8
2489.250000	-29.1	6.4	-22.8
2489.750000	-29.8	7.0	-22.8
2487.750000	-30.1	7.3	-22.8
2490.250000	-30.2	7.4	-22.8
2488.250000	-30.4	7.6	-22.8
2485.250000	-31.0	8.2	-22.8
2485.750000	-31.1	8.3	-22.8
2486.250000	-31.2	8.5	-22.8
2486.750000	-31.9	9.1	-22.8
2487.250000	-32.4	9.6	-22.8

Measurement Settings

Start Frequency (MHz)	Stop Frequency (MHz)	Pre Measurement	Final Measurement
30.000000	1000.000000	1	1
1000.000000	2400.000000	2	2
2483.500000	7000.000000	2	2
7000.000000	18000.000000	2	2
18000.000000	26000.000000	2	2

TEST REPORT

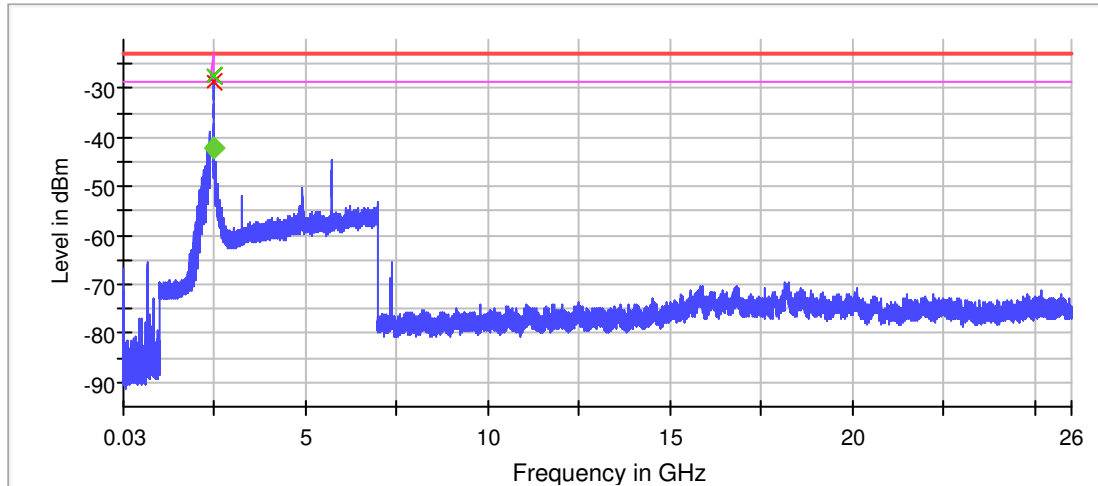

— Limit — Sum Level — Threshold ✗ Critical
✗ Final Critical ◆ Fail ◆ Pass

Pre Measurement 1

Setting	Instrument Value	Target Value
RBW	100.000 kHz	<= 100.000 kHz
VBW	300.000 kHz	>= 300.000 kHz
SweepPoints	19400	~ 19400
SweepTime	1.061 ms	AUTO
Reference Level	-20.000 dBm	-30.000 dBm
Attenuation	10.000 dB	AUTO
Detector	MaxPeak	MaxPeak
SweepCount	30	30
Filter	3 dB	3 dB
Trace Mode	Max Hold	Max Hold
SweepType	FFT	AUTO
Preamp	off	off
Stablemode	Trace	Trace
Stablevalue	0.50 dB	0.50 dB
Run	1 / max. 1	max. 1
Stable	0 / 1	1
Max Stable Difference	0.00 dB	0.50 dB

Pre Measurement 2

Setting	Instrument Value	Target Value
RBW	1.000 MHz	<= 1.000 MHz
VBW	3.000 MHz	>= 3.000 MHz
SweepPoints	2800	~ 2800
SweepTime	2.800 ms	AUTO
Reference Level	-20.000 dBm	-30.000 dBm
Attenuation	10.000 dB	AUTO
Detector	MaxPeak	MaxPeak
SweepCount	30	30
Filter	3 dB	3 dB
Trace Mode	Max Hold	Max Hold
SweepType	Sweep	AUTO
Preamp	off	off
Stablemode	Trace	Trace
Stablevalue	0.50 dB	0.50 dB
Run	42 / max. 150	max. 150
Stable	3 / 3	3
Max Stable Difference	0.00 dB	0.50 dB

TEST REPORT

Final Measurement 2

Setting	Instrument Value	Target Value
Span	ZeroSpan	ZeroSpan
RBW	1.000 MHz	~ 1.000 MHz
VBW	3.000 MHz	~ 3.000 MHz
SweepPoints	10001	~ 10001
SweepTime	1.000 s	1.000 s
Reference Level	-10.000 dBm	-10.000 dBm
Attenuation	10.000 dB	AUTO
Detector	RMS	RMS
SweepCount	1	1
Filter	3 dB	3 dB
Trace Mode	Clear Write	Clear Write
SweepType	Sweep	AUTO
Preamp	off	off

TEST REPORT

B mode

Band Edge low (2412 MHz; 0.000 dBm; 20 MHz)

Result

DUT Frequency (MHz)	Result
2412.000000	PASS

Inband Peak

Frequency (MHz)	Level (dBm)
2410.975000	5.5

Measurements

Frequency (MHz)	Level (dBm)	Margin (dB)	Limit (dBm)	Result
2398.475000	-47.5	33.0	-14.5	PASS
2396.475000	-47.5	33.0	-14.5	PASS
2395.975000	-47.5	33.0	-14.5	PASS
2396.525000	-47.6	33.1	-14.5	PASS
2397.975000	-47.6	33.1	-14.5	PASS
2398.525000	-47.6	33.2	-14.5	PASS
2396.025000	-47.9	33.4	-14.5	PASS
2398.975000	-48.0	33.5	-14.5	PASS
2398.025000	-48.0	33.5	-14.5	PASS
2397.475000	-48.2	33.7	-14.5	PASS
2399.025000	-48.3	33.9	-14.5	PASS
2397.525000	-48.5	34.0	-14.5	PASS
2397.425000	-48.6	34.1	-14.5	PASS
2397.675000	-48.8	34.3	-14.5	PASS
2396.425000	-48.8	34.3	-14.5	PASS

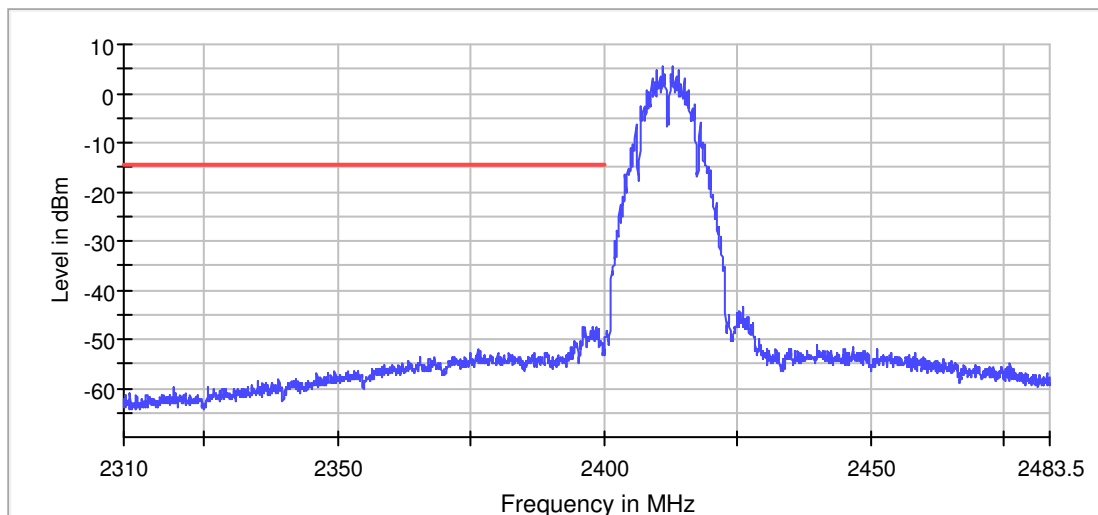

— Limit — Sum Level × Fail

TEST REPORT

Band Edge high (2462 MHz; 0.000 dBm; 20 MHz)

Result

DUT Frequency (MHz)	Result
2462.000000	PASS

Inband Peak

Frequency (MHz)	Level (dBm)
2460.975000	6.3

Measurements

Frequency (MHz)	Level (dBm)	Margin (dB)	Limit (dBm)	Result
2491.125000	-51.9	38.1	-13.8	PASS
2484.025000	-52.0	38.2	-13.8	PASS
2484.075000	-52.0	38.2	-13.8	PASS
2486.025000	-52.1	38.3	-13.8	PASS
2491.075000	-52.3	38.5	-13.8	PASS
2486.175000	-52.4	38.6	-13.8	PASS
2486.125000	-52.4	38.6	-13.8	PASS
2486.075000	-52.5	38.7	-13.8	PASS
2485.875000	-52.5	38.7	-13.8	PASS
2485.825000	-52.6	38.8	-13.8	PASS
2486.925000	-52.6	38.8	-13.8	PASS
2489.825000	-52.7	38.9	-13.8	PASS
2484.875000	-52.7	38.9	-13.8	PASS
2487.575000	-52.7	38.9	-13.8	PASS
2498.025000	-52.7	38.9	-13.8	PASS

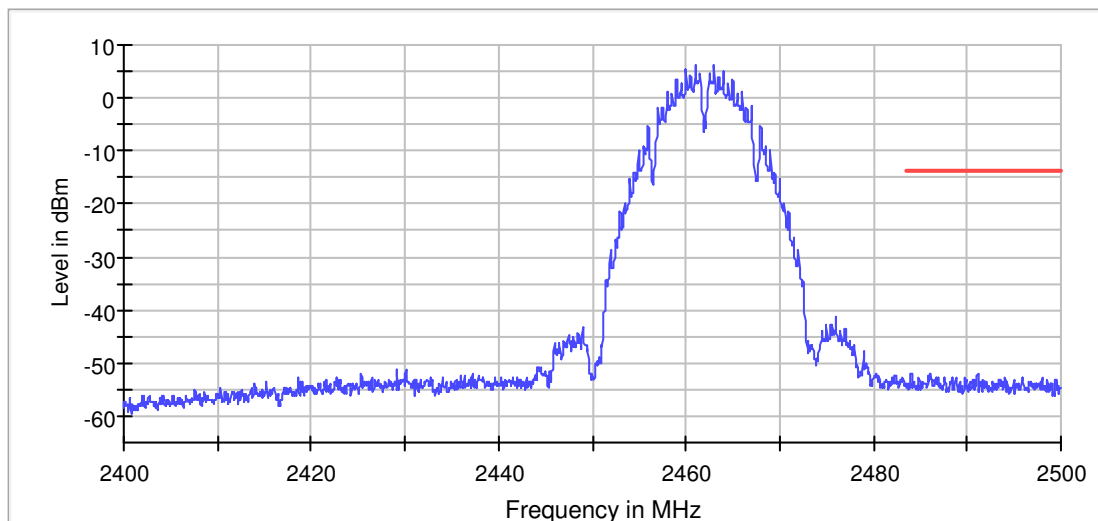

— Limit — Sum Level × Fail

TEST REPORT

G Mode

Band Edge low (2412 MHz; 0.000 dBm; 20 MHz)

Result

DUT Frequency (MHz)	Result
2412.000000	PASS

Inband Peak

Frequency (MHz)	Level (dBm)
2414.475000	2.7

Measurements

Frequency (MHz)	Level (dBm)	Margin (dB)	Limit (dBm)	Result
2399.875000	-34.5	17.4	-17.1	PASS
2399.725000	-34.6	17.5	-17.1	PASS
2399.975000	-34.7	17.7	-17.1	PASS
2399.775000	-34.8	17.7	-17.1	PASS
2399.825000	-34.9	17.9	-17.1	PASS
2399.475000	-35.2	18.1	-17.1	PASS
2399.525000	-35.3	18.2	-17.1	PASS
2399.925000	-35.5	18.4	-17.1	PASS
2399.675000	-35.7	18.6	-17.1	PASS
2399.125000	-35.8	18.7	-17.1	PASS
2399.075000	-35.9	18.8	-17.1	PASS
2399.175000	-36.1	19.0	-17.1	PASS
2399.225000	-36.3	19.2	-17.1	PASS
2399.625000	-36.4	19.3	-17.1	PASS
2398.225000	-36.5	19.4	-17.1	PASS

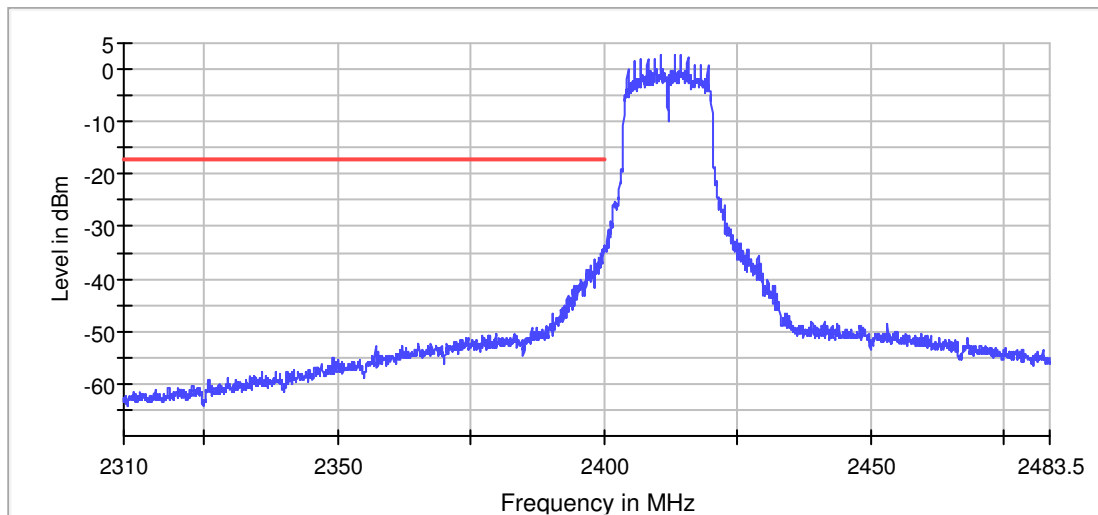

— Limit — Sum Level × Fail

TEST REPORT

Band Edge high (2462 MHz; 0.000 dBm; 20 MHz)

Result

DUT Frequency (MHz)	Result
2462.000000	PASS

Inband Peak

Frequency (MHz)	Level (dBm)
2460.725000	3.7

Measurements

Frequency (MHz)	Level (dBm)	Margin (dB)	Limit (dBm)	Result
2483.525000	-44.8	28.5	-16.3	PASS
2483.825000	-44.9	28.6	-16.3	PASS
2483.575000	-44.9	28.6	-16.3	PASS
2483.875000	-45.2	29.0	-16.3	PASS
2483.675000	-45.7	29.4	-16.3	PASS
2483.725000	-45.9	29.6	-16.3	PASS
2483.775000	-45.9	29.6	-16.3	PASS
2483.975000	-45.9	29.6	-16.3	PASS
2483.625000	-46.0	29.7	-16.3	PASS
2483.925000	-46.0	29.7	-16.3	PASS
2484.025000	-46.1	29.8	-16.3	PASS
2484.075000	-46.1	29.8	-16.3	PASS
2484.125000	-46.9	30.6	-16.3	PASS
2484.875000	-47.1	30.8	-16.3	PASS
2484.825000	-47.2	30.9	-16.3	PASS

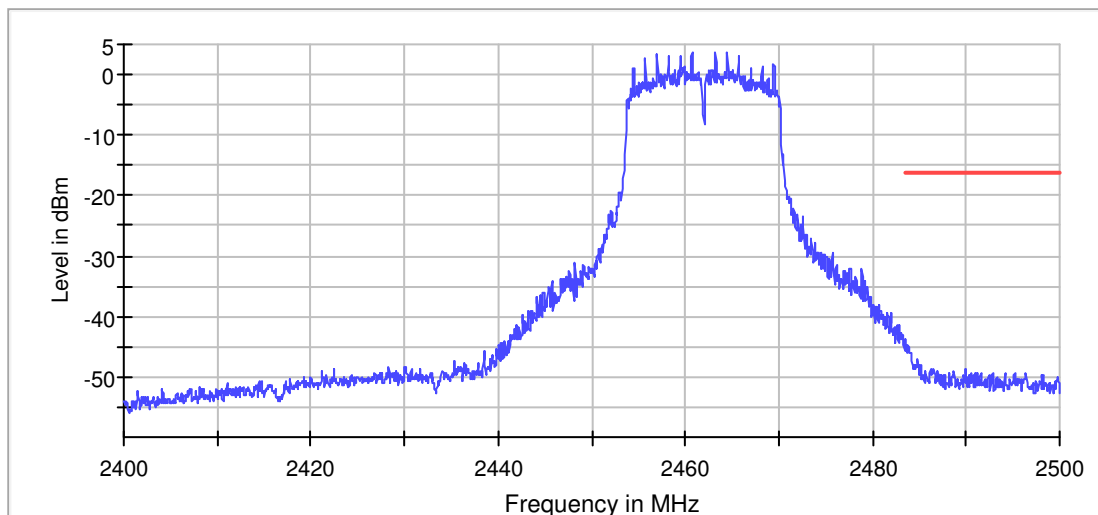

— Limit — Sum Level × Fail

Band Edge Connector 1_0

TEST REPORT

NHT20

Band Edge low (2412 MHz; 0.000 dBm; 20 MHz)

Result

DUT Frequency (MHz)	Result
2412.000000	PASS

Inband Peak

Frequency (MHz)	Level (dBm)
2419.475000	-0.2

Measurements

Frequency (MHz)	Level (dBm)	Margin (dB)	Limit (dBm)	Result
2399.975000	-36.3	16.1	-20.3	PASS
2399.775000	-36.9	16.7	-20.3	PASS
2399.725000	-37.0	16.8	-20.3	PASS
2399.825000	-37.1	16.8	-20.3	PASS
2399.875000	-37.1	16.9	-20.3	PASS
2399.925000	-37.6	17.3	-20.3	PASS
2399.625000	-37.8	17.5	-20.3	PASS
2399.675000	-38.0	17.7	-20.3	PASS
2399.575000	-38.1	17.8	-20.3	PASS
2399.375000	-38.5	18.2	-20.3	PASS
2399.325000	-38.6	18.3	-20.3	PASS
2399.525000	-38.7	18.4	-20.3	PASS
2399.475000	-39.0	18.7	-20.3	PASS
2399.275000	-39.4	19.2	-20.3	PASS
2399.425000	-39.7	19.4	-20.3	PASS

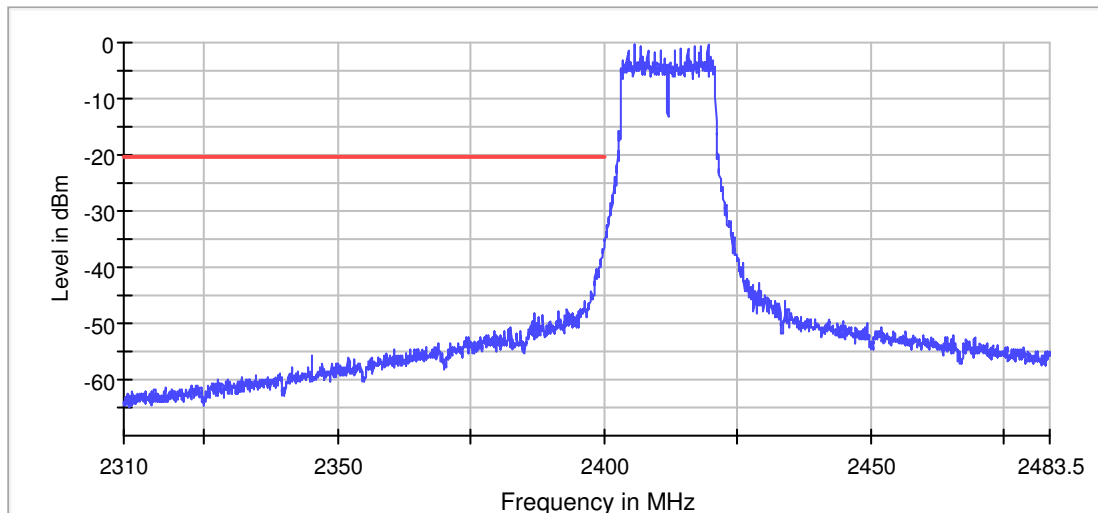

— Limit — Sum Level × Fail

TEST REPORT

Band Edge high (2462 MHz; 0.000 dBm; 20 MHz)

Result

DUT Frequency (MHz)	Result
2462.000000	PASS

Inband Peak

Frequency (MHz)	Level (dBm)
2455.725000	0.4

Measurements

Frequency (MHz)	Level (dBm)	Margin (dB)	Limit (dBm)	Result
2483.525000	-46.5	26.9	-19.6	PASS
2483.575000	-46.7	27.1	-19.6	PASS
2484.475000	-46.7	27.1	-19.6	PASS
2484.525000	-46.9	27.3	-19.6	PASS
2483.775000	-47.5	27.9	-19.6	PASS
2483.675000	-47.6	28.0	-19.6	PASS
2483.725000	-47.8	28.2	-19.6	PASS
2483.625000	-47.8	28.2	-19.6	PASS
2483.875000	-47.9	28.3	-19.6	PASS
2485.125000	-47.9	28.3	-19.6	PASS
2484.425000	-47.9	28.3	-19.6	PASS
2486.275000	-48.0	28.4	-19.6	PASS
2484.775000	-48.0	28.4	-19.6	PASS
2484.825000	-48.1	28.5	-19.6	PASS
2484.275000	-48.2	28.6	-19.6	PASS

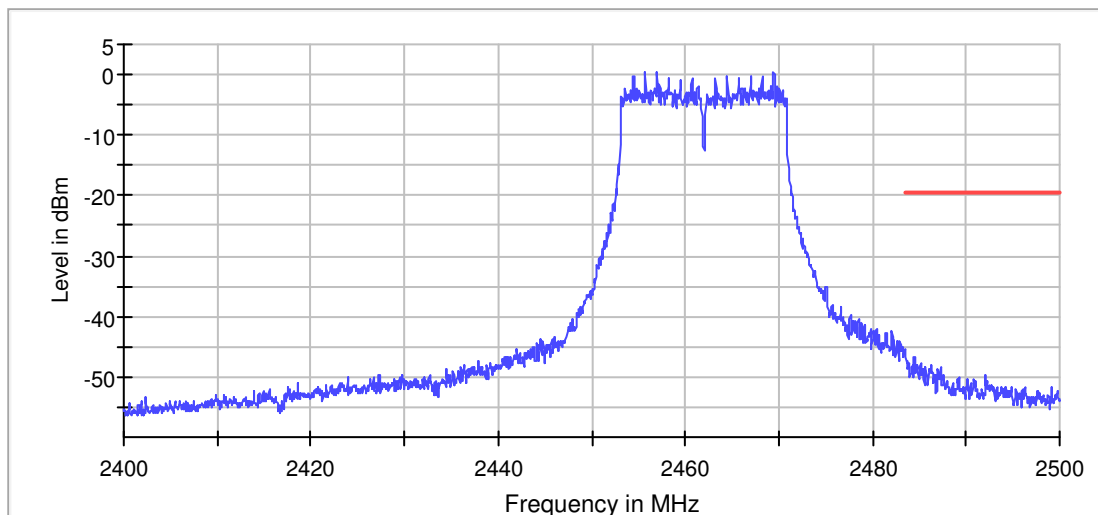

— Limit — Sum Level × Fail

TEST REPORT

NHT40

Band Edge low (2422 MHz; 20.000 dBm; 40 MHz)

Result

DUT Frequency (MHz)	Result
2422.000000	PASS

Inband Peak

Frequency (MHz)	Level (dBm)
2436.975000	-2.9

Measurements

Frequency (MHz)	Level (dBm)	Margin (dB)	Limit (dBm)	Result
2399.875000	-36.7	21.0	-15.6	PASS
2399.925000	-36.7	21.1	-15.6	PASS
2399.625000	-36.8	21.2	-15.6	PASS
2399.675000	-37.0	21.4	-15.6	PASS
2399.575000	-37.3	21.7	-15.6	PASS
2399.975000	-37.4	21.7	-15.6	PASS
2399.825000	-37.6	21.9	-15.6	PASS
2399.775000	-37.6	22.0	-15.6	PASS
2399.725000	-38.1	22.5	-15.6	PASS
2399.425000	-38.1	22.5	-15.6	PASS
2399.375000	-38.2	22.5	-15.6	PASS
2399.075000	-38.3	22.7	-15.6	PASS
2399.125000	-38.3	22.7	-15.6	PASS
2399.525000	-38.5	22.8	-15.6	PASS
2399.475000	-38.7	23.1	-15.6	PASS

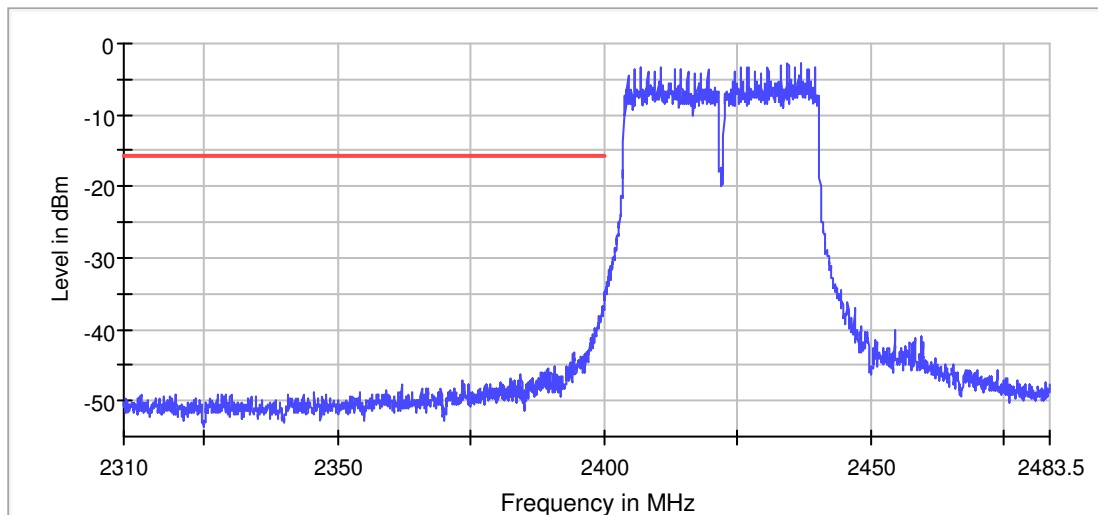

— Limit — Sum Level × Fail

TEST REPORT

Band Edge high (2452 MHz; 20.000 dBm; 40 MHz)

Result

DUT Frequency (MHz)	Result
2452.000000	PASS

Inband Peak

Frequency (MHz)	Level (dBm)
2436.975000	-2.8

Measurements

Frequency (MHz)	Level (dBm)	Margin (dB)	Limit (dBm)	Result
2484.475000	-38.9	38.9	0.0	PASS
2484.525000	-39.3	39.3	0.0	PASS
2484.425000	-39.6	39.6	0.0	PASS
2489.475000	-40.3	40.3	0.0	PASS
2489.425000	-40.4	40.4	0.0	PASS
2487.975000	-40.6	40.6	0.0	PASS
2487.925000	-40.8	40.8	0.0	PASS
2488.225000	-41.0	41.0	0.0	PASS
2489.525000	-41.3	41.3	0.0	PASS
2488.275000	-41.4	41.4	0.0	PASS
2485.825000	-41.5	41.5	0.0	PASS
2484.625000	-41.5	41.5	0.0	PASS
2485.775000	-41.7	41.7	0.0	PASS
2488.175000	-41.8	41.8	0.0	PASS
2487.375000	-41.9	41.9	0.0	PASS

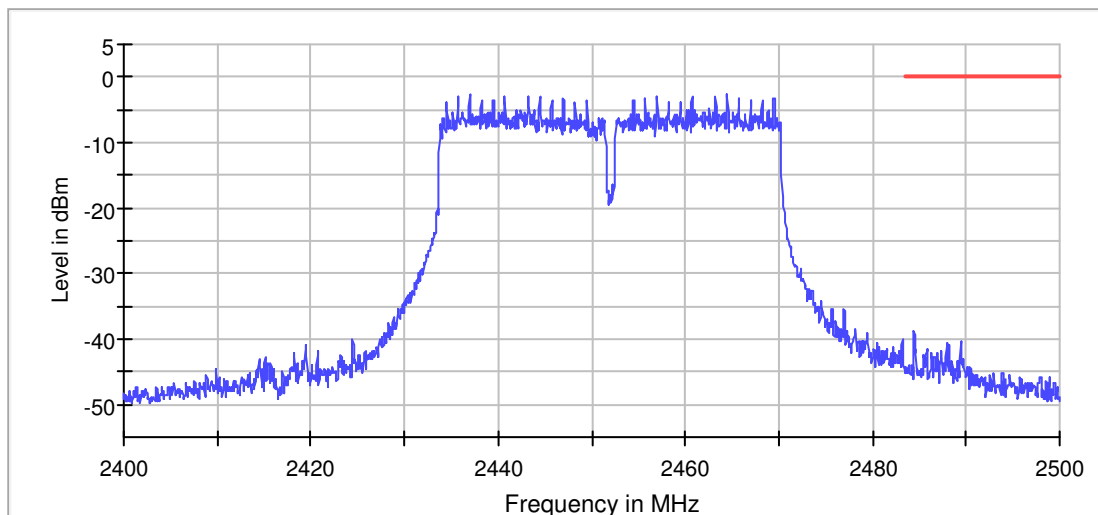

— Limit — Sum Level × Fail

TEST REPORT

Measurement 1

Setting	Instrument Value	Target Value
Start Frequency	2.40000 GHz	2.40000 GHz
Stop Frequency	2.48350 GHz	2.48350 GHz
Span	83.500 MHz	83.500 MHz
RBW	100.000 kHz	<= 100.000 kHz
VBW	300.000 kHz	>= 300.000 kHz
SweepPoints	1670	~ 1670
SweepTime	94.727 µs	AUTO
Reference Level	10.000 dBm	10.000 dBm
Attenuation	30.000 dB	AUTO
Detector	MaxPeak	MaxPeak
SweepCount	100	100
Filter	3 dB	3 dB
Trace Mode	Max Hold	Max Hold
SweepType	FFT	AUTO
Preamp	off	off
Stablemode	Trace	Trace
Stablevalue	0.50 dB	0.50 dB
Run	35 / max. 150	max. 150
Stable	3 / 3	3
Max Stable Difference	0.26 dB	0.50 dB

Measurement 2

Setting	Instrument Value	Target Value
Start Frequency	2.48350 GHz	2.48350 GHz
Stop Frequency	2.50000 GHz	2.50000 GHz
Span	16.500 MHz	16.500 MHz
RBW	100.000 kHz	<= 100.000 kHz
VBW	300.000 kHz	>= 300.000 kHz
SweepPoints	330	~ 330
SweepTime	18.945 µs	AUTO
Reference Level	10.000 dBm	10.000 dBm
Attenuation	30.000 dB	AUTO
Detector	MaxPeak	MaxPeak
SweepCount	100	100
Filter	3 dB	3 dB
Trace Mode	Max Hold	Max Hold
SweepType	FFT	AUTO
Preamp	off	off
Stablemode	Trace	Trace
Stablevalue	0.50 dB	0.50 dB
Run	4 / max. 150	max. 150
Stable	3 / 3	3
Max Stable Difference	0.00 dB	0.50 dB

TEST REPORT

4.5 Field Strength Calculation

The field strength is calculated by adding the reading on the Spectrum Analyzer to the factors associated with preamplifiers (if any), antennas, cables, pulse desensitization and average factors (when specified limit is in average and measurements are made with peak detectors). A sample calculation is included below.

$$FS = RA + AF + CF - AG + PD + AV$$

Where FS = Field Strength in dB μ V/m

RA = Receiver Amplitude (including preamplifier) in dB μ V

CF = Cable Attenuation Factor in dB

AF = Antenna Factor in dB

AG = Amplifier Gain in dB

PD = Pulse Desensitization in dB

AV = Average Factor in -dB

In the radiated emission table which follows, the reading shown on the data table may reflect the preamplifier gain. An example of the calculations, where the reading does not reflect the preamplifier gain, follows:

$$FS = RA + AF + CF - AG + PD + AV$$

Example

Assume a receiver reading of 62.0 dB μ V is obtained. The antenna factor of 7.4 dB and cable factor of 1.6 dB is added. The amplifier gain of 29.0 dB is subtracted. The pulse desensitization factor of the spectrum analyzer is 0.0 dB, and the resultant average factor is -10.0 dB. The net field strength for comparison to the appropriate emission limit is 32.0 dB μ V/m. This value in dB μ V/m is converted to its corresponding level in μ V/m.

$$RA = 62.0 \text{ dB}\mu\text{V}$$

$$AF = 7.4 \text{ dB}$$

$$CF = 1.6 \text{ dB}$$

$$AG = 29.0 \text{ dB}$$

$$PD = 0.0 \text{ dB}$$

$$AV = -10 \text{ dB}$$

$$FS = 62.0 + 7.4 + 1.6 - 29.0 + 0.0 + (-10.0) = 32.0 \text{ dB}\mu\text{V/m}$$

$$\text{Level in } \mu\text{V/m} = \text{Common Antilogarithm } [(32.0 \text{ dB}\mu\text{V/m})/20] = 39.8 \mu\text{V/m}$$

TEST REPORT

4.6 Transmitter Radiated Emissions in Restricted Bands and Spurious Emissions

Data is included of the worst case configuration (the configuration which resulted in the highest emission levels). A sample calculation, configuration photographs and data tables of the emissions are included.

The data on the following pages list the significant emission frequencies, the limit and the margin of compliance.

4.6.1 Radiated Emission Configuration Photograph

Worst Case Restricted Band Radiated Emission
at

374.986 MHz

The worst case radiated emission configuration photographs are saved with filename: config photos.pdf

4.6.2 Radiated Emission Data

The data in tables 1-4 list the significant emission frequencies, the limit and the margin of compliance.

Judgement -

Passed by 0.2 dB margin

TEST REPORT

RADIATED EMISSION DATA

Mode: TX-Channel 01

Table 1
IEEE 802.11b (DSSS, 1 Mbps)

Polari- zation	Frequency (MHz)	Reading (dBµV)	Pre-Amp Gain (dB)	Antenna Factor (dB)	Net at 3m (dBµV/m)	Average Limit at 3m (dBµV/m)	Margin (dB)
H	2390.000	52.1	33	29.4	48.5	54.0	-5.5
H	4824.000	45.9	33	34.9	47.8	54.0	-6.2
V	12060.000	34.6	33	40.5	42.1	54.0	-11.9
H	14472.000	35.8	33	40.0	42.8	54.0	-11.2

Polari- zation	Frequency (MHz)	Reading (dBµV)	Pre-Amp Gain (dB)	Antenna Factor (dB)	Net at 3m - Peak (dBµV/m)	Peak Limit at 3m (dBµV/m)	Margin (dB)
H	2390.000	52.1	33	29.4	48.5	74.0	-25.5
H	4824.000	45.9	33	34.9	47.8	74.0	-26.2
V	12060.000	34.6	33	40.5	42.1	74.0	-31.9
H	14472.000	35.8	33	40.0	42.8	74.0	-31.2

- NOTES:
1. Peak detector is used for the emission measurement.
 2. Average detector is used for the average data of emission measurement.
 3. All measurements were made at 3 meters. Radiated emissions not detected at the 3-meter distance were measured at 0.3-meter and an inverse proportional extrapolation was performed to compare the signal level to the 3-meter limit. No other radiated emissions than those reported were detected at a test distance of 0.3-meter.
 4. Negative value in the margin column shows emission below limit.
 5. Horn antenna is used for the emission over 1000MHz.

TEST REPORT

Mode: TX-Channel 06

Table 2
IEEE 802.11b (DSSS, 1 Mbps)

Polari- zation	Frequency (MHz)	Reading (dBμV)	Pre-Amp Gain (dB)	Antenna Factor (dB)	Net at 3m (dBμV/m)	Average Limit at 3m (dBμV/m)	Margin (dB)
H	4874.000	44.2	33	34.9	46.1	54.0	-7.9
H	7311.000	38.9	33	37.9	43.8	54.0	-10.2
V	12185.000	34.7	33	40.5	42.2	54.0	-11.8

Polari- zation	Frequency (MHz)	Reading (dBμV)	Pre-Amp Gain (dB)	Antenna Factor (dB)	Net at 3m - Peak (dBμV/m)	Peak Limit at 3m (dBμV/m)	Margin (dB)
H	4874.000	44.2	33	34.9	46.1	74.0	-27.9
H	7311.000	38.9	33	37.9	43.8	74.0	-30.2
V	12185.000	34.7	33	40.5	42.2	74.0	-31.8

- NOTES:
1. Peak detector is used for the emission measurement.
 2. Average detector is used for the average data of emission measurement
 3. All measurements were made at 3 meters. Radiated emissions not detected at the 3-meter distance were measured at 0.3-meter and an inverse proportional extrapolation was performed to compare the signal level to the 3-meter limit. No other radiated emissions than those reported were detected at a test distance of 0.3-meter.
 4. Negative value in the margin column shows emission below limit.
 5. Horn antenna is used for the emission over 1000MHz.

TEST REPORT

Mode: TX-Channel 11

Table 3
IEEE 802.11b (DSSS, 1 Mbps)

Polari- zation	Frequency (MHz)	Reading (dBµV)	Pre-Amp Gain (dB)	Antenna Factor (dB)	Net at 3m (dBµV/m)	Average Limit at 3m (dBµV/m)	Margin (dB)
H	2483.500	50.7	33	29.4	47.1	54.0	-6.9
H	4924.000	42.4	33	34.9	44.3	54.0	-9.7
H	7386.000	41.9	33	37.9	46.8	54.0	-7.2
H	12310.000	33.7	33	40.5	41.2	54.0	-12.8

Polari- zation	Frequency (MHz)	Reading (dBµV)	Pre-Amp Gain (dB)	Antenna Factor (dB)	Net at 3m - Peak (dBµV/m)	Peak Limit at 3m (dBµV/m)	Margin (dB)
H	2483.500	50.7	33	29.4	47.1	74.0	-26.9
H	4924.000	42.4	33	34.9	44.3	74.0	-29.7
H	7386.000	41.9	33	37.9	46.8	74.0	-27.2
H	12310.000	33.7	33	40.5	41.2	74.0	-32.8

- NOTES:
1. Peak detector is used for the emission measurement.
 2. Average detector is used for the average data of emission measurement
 3. All measurements were made at 3 meters. Radiated emissions not detected at the 3-meter distance were measured at 0.3-meter and an inverse proportional extrapolation was performed to compare the signal level to the 3-meter limit. No other radiated emissions than those reported were detected at a test distance of 0.3-meter.
 4. Negative value in the margin column shows emission below limit.
 5. Horn antenna is used for the emission over 1000MHz.

TEST REPORT

Mode: TX-Channel 01

Table 4
IEEE 802.11g (OFDM, 6 Mbps)

Polari- zation	Frequency (MHz)	Reading (dBµV)	Pre-Amp Gain (dB)	Antenna Factor (dB)	Net at 3m (dBµV/m)	Average Limit at 3m (dBµV/m)	Margin (dB)
H	2390.000	56.9	33	29.4	53.3	54.0	-0.7
H	4824.000	49.2	33	34.9	51.1	54.0	-2.9
H	12060.000	34.6	33	40.5	42.1	54.0	-11.9
V	14472.000	35.8	33	40.0	42.8	54.0	-11.2

Polari- zation	Frequency (MHz)	Reading (dBµV)	Pre-Amp Gain (dB)	Antenna Factor (dB)	Net at 3m - Peak (dBµV/m)	Peak Limit at 3m (dBµV/m)	Margin (dB)
H	2390.000	56.9	33	29.4	53.3	74.0	-20.7
H	4824.000	49.2	33	34.9	51.1	74.0	-22.9
H	12060.000	34.6	33	40.5	42.1	74.0	-31.9
V	14472.000	35.8	33	40.0	42.8	74.0	-31.2

- NOTES:
1. Peak detector is used for the emission measurement.
 2. Average detector is used for the average data of emission measurement
 3. All measurements were made at 3 meters. Radiated emissions not detected at the 3-meter distance were measured at 0.3-meter and an inverse proportional extrapolation was performed to compare the signal level to the 3-meter limit. No other radiated emissions than those reported were detected at a test distance of 0.3-meter.
 4. Negative value in the margin column shows emission below limit.
 5. Horn antenna is used for the emission over 1000MHz.

TEST REPORT

Mode: TX-Channel 06

Table 5
IEEE 802.11g (OFDM, 6 Mbps)

Polari- zation	Frequency (MHz)	Reading (dBμV)	Pre-Amp Gain (dB)	Antenna Factor (dB)	Net at 3m (dBμV/m)	Average Limit at 3m (dBμV/m)	Margin (dB)
H	4874.000	32.5	33	34.9	34.4	54.0	-19.6
H	7311.000	35.2	33	37.9	40.1	54.0	-13.9
H	12185.000	33.5	33	40.5	41.0	54.0	-13.0

Polari- zation	Frequency (MHz)	Reading (dBμV)	Pre-Amp Gain (dB)	Antenna Factor (dB)	Net at 3m - Peak (dBμV/m)	Peak Limit at 3m (dBμV/m)	Margin (dB)
H	4874.000	32.5	33	34.9	34.4	74.0	-39.6
H	7311.000	35.2	33	37.9	40.1	74.0	-33.9
H	12185.000	33.5	33	40.5	41.0	74.0	-33.0

- NOTES:
1. Peak detector is used for the emission measurement.
 2. Average detector is used for the average data of emission measurement
 3. All measurements were made at 3 meters. Radiated emissions not detected at the 3-meter distance were measured at 0.3-meter and an inverse proportional extrapolation was performed to compare the signal level to the 3-meter limit. No other radiated emissions than those reported were detected at a test distance of 0.3-meter.
 4. Negative value in the margin column shows emission below limit.
 5. Horn antenna is used for the emission over 1000MHz.

TEST REPORT

Mode: TX-Channel 11

Table 6
IEEE 802.11g (OFDM, 6 Mbps)

Polari- zation	Frequency (MHz)	Reading (dBµV)	Pre-Amp Gain (dB)	Antenna Factor (dB)	Net at 3m (dBµV/m)	Average Limit at 3m (dBµV/m)	Margin (dB)
H	2483.500	57.0	33	29.4	53.4	54.0	-0.6
H	4924.000	38.2	33	34.9	40.1	54.0	-13.9
H	7386.000	36.3	33	37.9	41.2	54.0	-12.8
H	12310.000	34.3	33	40.5	41.8	54.0	-12.2

Polari- zation	Frequency (MHz)	Reading (dBµV)	Pre-Amp Gain (dB)	Antenna Factor (dB)	Net at 3m - Peak (dBµV/m)	Peak Limit at 3m (dBµV/m)	Margin (dB)
H	2483.500	76.8	33	29.4	73.2	74.0	-0.8
H	4924.000	46.2	33	34.9	48.1	74.0	-25.9
H	7386.000	53.2	33	37.9	58.1	74.0	-15.9
H	12310.000	45.9	33	40.5	53.4	74.0	-20.6

- NOTES:
1. Peak detector is used for the emission measurement.
 2. Average detector is used for the average data of emission measurement
 3. All measurements were made at 3 meters. Radiated emissions not detected at the 3-meter distance were measured at 0.3-meter and an inverse proportional extrapolation was performed to compare the signal level to the 3-meter limit. No other radiated emissions than those reported were detected at a test distance of 0.3-meter.
 4. Negative value in the margin column shows emission below limit.
 5. Horn antenna is used for the emission over 1000MHz.

TEST REPORT

Mode: TX-Channel 01

Table 7
IEEE 802.11n (20MHz) (OFDM, MCS0)

Polari- zation	Frequency (MHz)	Reading (dBµV)	Pre-Amp Gain (dB)	Antenna Factor (dB)	Net at 3m (dBµV/m)	Average Limit at 3m (dBµV/m)	Margin (dB)
H	2390.000	54.3	33	29.4	50.7	54.0	-3.3
H	4824.000	38.2	33	34.9	40.1	54.0	-13.9
H	12060.000	33.3	33	40.5	40.8	54.0	-13.2
H	14472.000	6.2	33	40.0	13.2	54.0	-40.8

Polari- zation	Frequency (MHz)	Reading (dBµV)	Pre-Amp Gain (dB)	Antenna Factor (dB)	Net at 3m - Peak (dBµV/m)	Peak Limit at 3m (dBµV/m)	Margin (dB)
H	2390.000	69.6	33	29.4	66.0	74.0	-8.0
H	4824.000	46.5	33	34.9	48.4	74.0	-25.6
H	12060.000	44.6	33	40.5	52.1	74.0	-21.9
H	14472.000	46.5	33	40.0	53.5	74.0	-20.5

- NOTES:
1. Peak detector is used for the emission measurement.
 2. Average detector is used for the average data of emission measurement
 3. All measurements were made at 3 meters. Radiated emissions not detected at the 3-meter distance were measured at 0.3-meter and an inverse proportional extrapolation was performed to compare the signal level to the 3-meter limit. No other radiated emissions than those reported were detected at a test distance of 0.3-meter.
 4. Negative value in the margin column shows emission below limit.
 5. Horn antenna is used for the emission over 1000MHz.

TEST REPORT

Mode: TX-Channel 06

Table 8
IEEE 802.11n (20MHz) (OFDM, MCS0)

Polari- zation	Frequency (MHz)	Reading (dBμV)	Pre-Amp Gain (dB)	Antenna Factor (dB)	Net at 3m (dBμV/m)	Average Limit at 3m (dBμV/m)	Margin (dB)
H	4874.000	29.3	33	34.9	31.2	54.0	-22.8
H	7311.000	30.3	33	37.9	35.2	54.0	-18.8
H	12185.000	33.1	33	40.5	40.6	54.0	-13.4

Polari- zation	Frequency (MHz)	Reading (dBμV)	Pre-Amp Gain (dB)	Antenna Factor (dB)	Net at 3m - Peak (dBμV/m)	Peak Limit at 3m (dBμV/m)	Margin (dB)
H	4874.000	45.0	33	34.9	46.9	74.0	-27.1
H	7311.000	47.4	33	37.9	52.3	74.0	-21.7
H	12185.000	44.6	33	40.5	52.1	74.0	-21.9

- NOTES:
1. Peak detector is used for the emission measurement.
 2. Average detector is used for the average data of emission measurement
 3. All measurements were made at 3 meters. Radiated emissions not detected at the 3-meter distance were measured at 0.3-meter and an inverse proportional extrapolation was performed to compare the signal level to the 3-meter limit. No other radiated emissions than those reported were detected at a test distance of 0.3-meter.
 4. Negative value in the margin column shows emission below limit.
 5. Horn antenna is used for the emission over 1000MHz.

TEST REPORT

Mode: TX-Channel 11

Table 9
IEEE 802.11n (20MHz) (OFDM, MCS0)

Polari- zation	Frequency (MHz)	Reading (dBµV)	Pre-Amp Gain (dB)	Antenna Factor (dB)	Net at 3m (dBµV/m)	Average Limit at 3m (dBµV/m)	Margin (dB)
H	2483.500	56.9	33	29.4	53.3	54.0	-0.7
H	4924.000	35.2	33	34.9	37.1	54.0	-16.9
H	7386.000	35.2	33	37.9	40.1	54.0	-13.9
H	12310.000	33.5	33	40.5	41.0	54.0	-13.0

Polari- zation	Frequency (MHz)	Reading (dBµV)	Pre-Amp Gain (dB)	Antenna Factor (dB)	Net at 3m - Peak (dBµV/m)	Peak Limit at 3m (dBµV/m)	Margin (dB)
H	2483.500	73.8	33	29.4	70.2	74.0	-3.8
H	4924.000	43.2	33	34.9	45.1	74.0	-28.9
H	7386.000	48.4	33	37.9	53.3	74.0	-20.7
H	12310.000	46.3	33	40.5	53.8	74.0	-20.2

- NOTES:
1. Peak detector is used for the emission measurement.
 2. Average detector is used for the average data of emission measurement
 3. All measurements were made at 3 meters. Radiated emissions not detected at the 3-meter distance were measured at 0.3-meter and an inverse proportional extrapolation was performed to compare the signal level to the 3-meter limit. No other radiated emissions than those reported were detected at a test distance of 0.3-meter.
 4. Negative value in the margin column shows emission below limit.
 5. Horn antenna is used for the emission over 1000MHz.

TEST REPORT

Mode: TX-Channel 3

Table 10
IEEE 802.11n (40MHz) (OFDM, MCS0)

Polari- zation	Frequency (MHz)	Reading (dBµV)	Pre-Amp Gain (dB)	Antenna Factor (dB)	Net at 3m (dBµV/m)	Average Limit at 3m (dBµV/m)	Margin (dB)
H	2390.000	57.0	33	29.4	53.4	54.0	-0.6
H	4844.000	38.2	33	34.9	40.1	54.0	-13.9
H	7266.000	35.9	33	37.9	40.8	54.0	-13.2
V	12110.000	35.3	33	40.5	42.8	54.0	-11.2

Polari- zation	Frequency (MHz)	Reading (dBµV)	Pre-Amp Gain (dB)	Antenna Factor (dB)	Net at 3m - Peak (dBµV/m)	Peak Limit at 3m (dBµV/m)	Margin (dB)
H	2390.000	73.4	33	29.4	69.8	74.0	-4.2
H	4844.000	44.9	33	34.9	46.8	74.0	-27.2
H	7266.000	42.5	33	37.9	47.4	74.0	-26.6
V	12110.000	45.8	33	40.5	53.3	74.0	-20.7

- NOTES:
1. Peak detector is used for the emission measurement.
 2. Average detector is used for the average data of emission measurement
 3. All measurements were made at 3 meters. Radiated emissions not detected at the 3-meter distance were measured at 0.3-meter and an inverse proportional extrapolation was performed to compare the signal level to the 3-meter limit. No other radiated emissions than those reported were detected at a test distance of 0.3-meter.
 4. Negative value in the margin column shows emission below limit.
 5. Horn antenna is used for the emission over 1000MHz.

TEST REPORT

Mode: TX-Channel 6

Table 11
IEEE 802.11n (40MHz) (OFDM, MCS0)

Polari- zation	Frequency (MHz)	Reading (dBμV)	Pre-Amp Gain (dB)	Antenna Factor (dB)	Net at 3m (dBμV/m)	Average Limit at 3m (dBμV/m)	Margin (dB)
H	4874.000	32.2	33	34.9	34.1	54.0	-19.9
H	7311.000	34.2	33	37.9	39.1	54.0	-14.9
V	12185.000	33.3	33	40.5	40.8	54.0	-13.2

Polari- zation	Frequency (MHz)	Reading (dBμV)	Pre-Amp Gain (dB)	Antenna Factor (dB)	Net at 3m - Peak (dBμV/m)	Peak Limit at 3m (dBμV/m)	Margin (dB)
H	4874.000	45.8	33	34.9	47.7	74.0	-26.3
H	7311.000	43.7	33	37.9	48.6	74.0	-25.4
V	12185.000	45.1	33	40.5	52.6	74.0	-21.4

- NOTES:
1. Peak detector is used for the emission measurement.
 2. Average detector is used for the average data of emission measurement
 3. All measurements were made at 3 meters. Radiated emissions not detected at the 3-meter distance were measured at 0.3-meter and an inverse proportional extrapolation was performed to compare the signal level to the 3-meter limit. No other radiated emissions than those reported were detected at a test distance of 0.3-meter.
 4. Negative value in the margin column shows emission below limit.
 5. Horn antenna is used for the emission over 1000MHz.

TEST REPORT

Mode: TX-Channel 9

Table 12
IEEE 802.11n (40MHz) (OFDM, MCS0)

Polari- zation	Frequency (MHz)	Reading (dBµV)	Pre-Amp Gain (dB)	Antenna Factor (dB)	Net at 3m (dBµV/m)	Average Limit at 3m (dBµV/m)	Margin (dB)
H	2483.500	56.5	33	29.4	52.9	54.0	-1.1
H	4904.000	34.9	33	34.9	36.8	54.0	-17.2
H	7356.000	33.2	33	37.9	38.1	54.0	-15.9
H	12260.000	-5.5	33	40.5	2.0	54.0	-52.0

Polari- zation	Frequency (MHz)	Reading (dBµV)	Pre-Amp Gain (dB)	Antenna Factor (dB)	Net at 3m - Peak (dBµV/m)	Peak Limit at 3m (dBµV/m)	Margin (dB)
H	2483.500	73.5	33	29.4	69.9	74.0	-4.1
H	4904.000	43.9	33	34.9	45.8	74.0	-28.2
H	7356.000	44.2	33	37.9	49.1	74.0	-24.9
H	12260.000	46.3	33	40.5	53.8	74.0	-20.2

- NOTES:
1. Peak detector is used for the emission measurement.
 2. Average detector is used for the average data of emission measurement
 3. All measurements were made at 3 meters. Radiated emissions not detected at the 3-meter distance were measured at 0.3-meter and an inverse proportional extrapolation was performed to compare the signal level to the 3-meter limit. No other radiated emissions than those reported were detected at a test distance of 0.3-meter.
 4. Negative value in the margin column shows emission below limit.
 5. Horn antenna is used for the emission over 1000MHz.

TEST REPORT

Model: PULSE 2i

Worst-Case Operating Mode: WiFi + Bluetooth Audio Playing

Table 4
Pursuant to FCC Part 15 Section 15.209 / RSS-210 4.4 Requirement

Polarization	Frequency (MHz)	Reading (dBµV)	Pre-amp (dB)	Antenna Factor (dB)	Net at 3m (dBµV/m)	Limit at 3m (dBµV/m)	Margin (dB)
V	30.606	45.4	16	10.0	39.4	40.0	-0.6
V	31.394	44.4	16	10.0	38.4	40.0	-1.6
V	32.576	44.2	16	10.0	38.2	40.0	-1.8
V	43.822	44.8	16	10.0	38.8	40.0	-1.2
V	62.222	42.4	16	10.0	36.4	40.0	-3.6
V	77.196	45.5	16	6.0	35.5	40.0	-4.5
V	98.476	44.5	16	12.0	40.5	43.5	-3.0
V	101.872	41.2	16	13.0	38.2	43.5	-5.3
V	141.216	36.5	16	14.0	34.5	43.5	-9.0
V	203.175	33.6	16	16.0	33.6	43.5	-9.9
V	225.758	36.2	16	18.0	38.2	46.0	-7.8
V	249.978	33.4	16	20.0	37.4	46.0	-8.6
H	282.200	34.4	16	22.0	40.4	46.0	-5.6
H	304.784	33.4	16	22.0	39.4	46.0	-6.6
H	324.972	32.4	16	24.0	40.4	46.0	-5.6
H	374.986	37.8	16	24.0	45.8	46.0	-0.2
H	399.994	33.6	16	25.0	42.6	46.0	-3.4
H	499.995	32.2	16	26.0	42.2	46.0	-3.8
V	624.974	32.2	16	29.0	45.2	46.0	-0.8
V	750.044	27.2	16	30.0	41.2	46.0	-4.8
H	874.962	26.8	16	32.0	42.8	46.0	-3.2
H	999.970	27.0	16	33.0	44.0	54.0	-10.0

- NOTES:
1. Quasi-Peak detector is used for the emission measurement.
 2. All measurements were made at 3 meters. Radiated emissions not detected at the 3-meter distance were measured at 0.3-meter and an inverse proportional extrapolation was performed to compare the signal level to the 3-meter limit. No other radiated emissions than those reported were detected at a test distance of 0.3-meter.
 3. Negative value in the margin column shows emission below limit.
 4. Emission (the row indicated by **bold italic**) within the restricted band meets the requirement of FCC Part 15 Section 15.205 / RSS-Gen Section 8.10.

TEST REPORT

4.6.3 Radiated Emission Test Setup

The figure below shows the test setup, which is utilized to make these measurements.

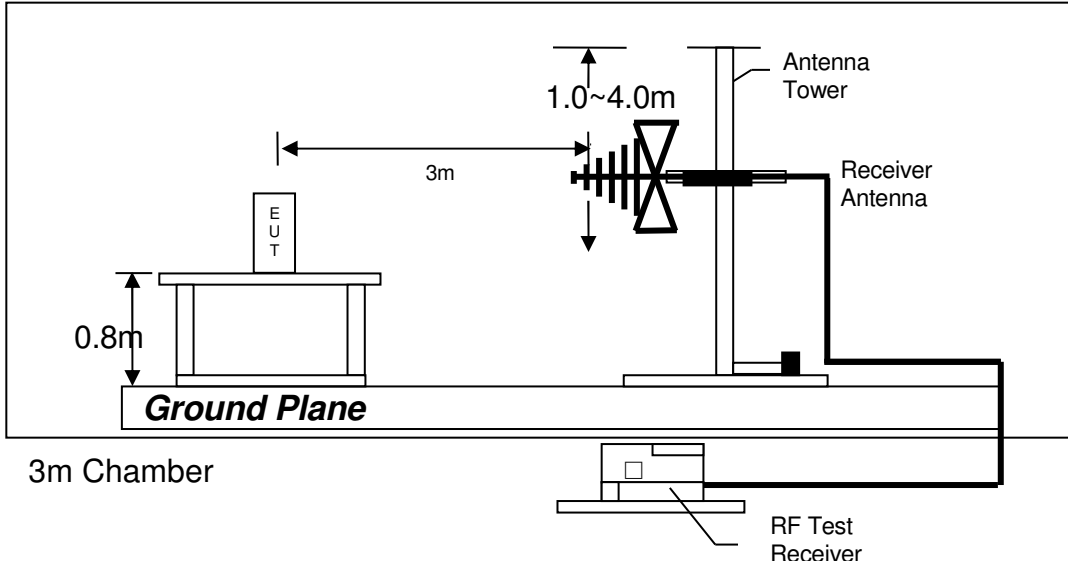

Test setup of radiated emissions up to 1GHz

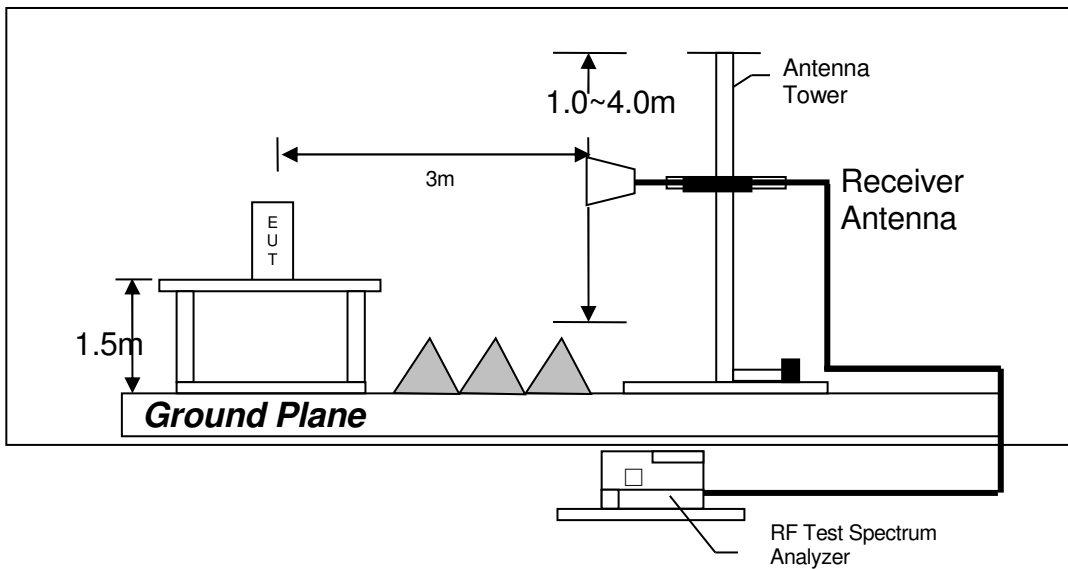

Test setup of radiated emissions above 1GHz

TEST REPORT

4.6.4 Transmitter Duty Cycle Calculation

Not applicable – No average factor is required.

TEST REPORT

4.7 AC Power Line Conducted Emission

- Not applicable – EUT is only powered by battery for operation.
- EUT connects to AC power line. Emission Data is listed in following pages.

- Base Unit connects to AC power line and has transmission. Handset connects to AC power line but has no transmission. Emission Data of Base Unit is listed in following pages.

4.7.1 AC Power Line Conducted Emission Configuration Photograph

Worst Case Line-Conducted Configuration
at

0.578 MHz

The worst case line conducted configuration photographs are attached in the Appendix and saved with filename: config photos.pdf

4.7.2 AC Power Line Conducted Emission Data

The plot(s) and data in the following pages list the significant emission frequencies, the limit and the margin of compliance.

Passed by 4.1 dB margin compare with CISPR Average limit

TEST REPORT

AC POWER LINE CONDUCTED EMISSION

Model: PULSE 2i

Worst-Case Operating Mode: WiFi + Bluetooth Audio Playing

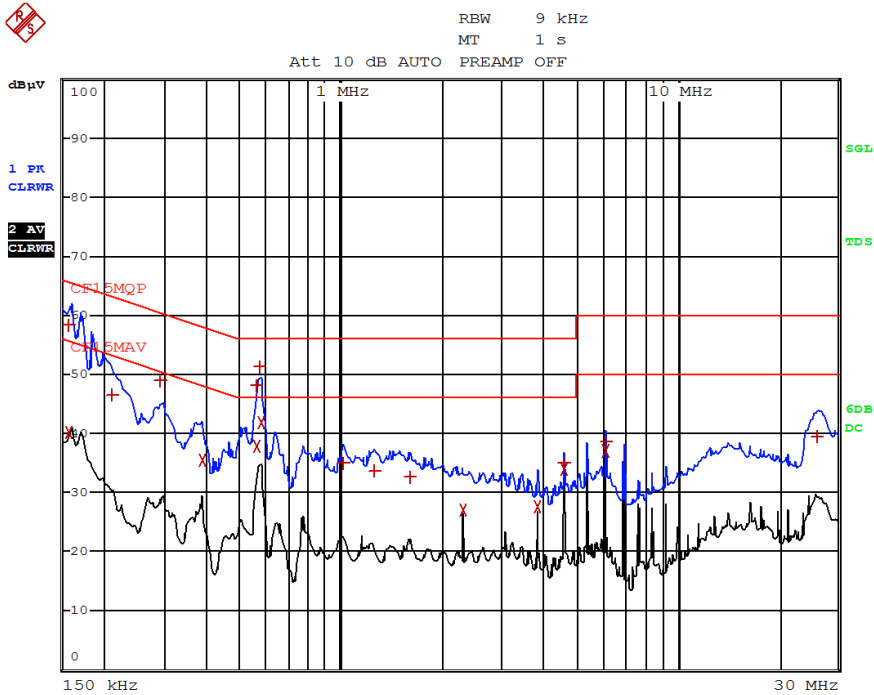

EDIT PEAK LIST (Final Measurement Results)				
Trace1:	CF15MQP			
Trace2:	CF15MAV			
Trace3:	---			
TRACE	FREQUENCY	LEVEL dBµV		DELTA LIMIT dB
1 Quasi Peak	159 kHz	58.41	N	-7.10
2 CISPR Average	159 kHz	40.30	L1	-15.21
1 Quasi Peak	213 kHz	46.50	N	-16.58
1 Quasi Peak	294 kHz	48.99	N	-11.41
2 CISPR Average	384 kHz	35.67	N	-12.51
1 Quasi Peak	564 kHz	48.21	N	-7.78
2 CISPR Average	564 kHz	38.04	N	-7.95
1 Quasi Peak	573 kHz	51.40	N	-4.59
2 CISPR Average	577.5 kHz	41.86	N	-4.13
1 Quasi Peak	1.0185 MHz	35.13	N	-20.86
1 Quasi Peak	1.2525 MHz	33.62	N	-22.37
1 Quasi Peak	1.599 MHz	32.64	N	-23.35
2 CISPR Average	2.3055 MHz	27.07	L1	-18.93
2 CISPR Average	3.84 MHz	27.60	L1	-18.39
1 Quasi Peak	4.6095 MHz	35.04	L1	-20.95
2 CISPR Average	4.6095 MHz	33.96	L1	-12.03
1 Quasi Peak	6.144 MHz	38.60	L1	-21.40
2 CISPR Average	6.144 MHz	37.19	L1	-12.80
1 Quasi Peak	25.917 MHz	39.49	L1	-20.50

Note: Measurement Uncertainty is ± 4.2 dB at a level of confidence of 95%.

TEST REPORT

4.7.3 Conducted Emission Test Setup

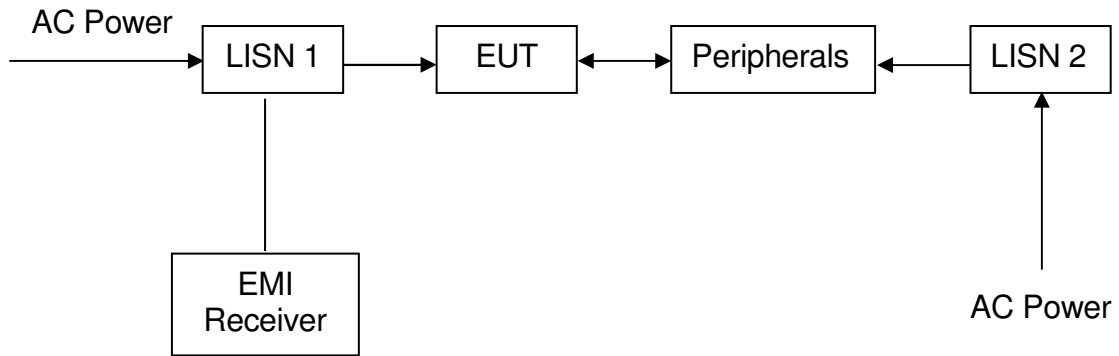

TEST REPORT

4.8 Occupied Bandwidth

B Mode :Emission Bandwidth 99%

DUT Frequency (MHz)	Bandwidth (MHz)	Limit Min (MHz)	Limit Max (MHz)	Band Edge Left (MHz)	Band Edge Right (MHz)	Max Level (dBm)
2462.000000	13.050000	---	---	2455.475000	2468.525000	6.3

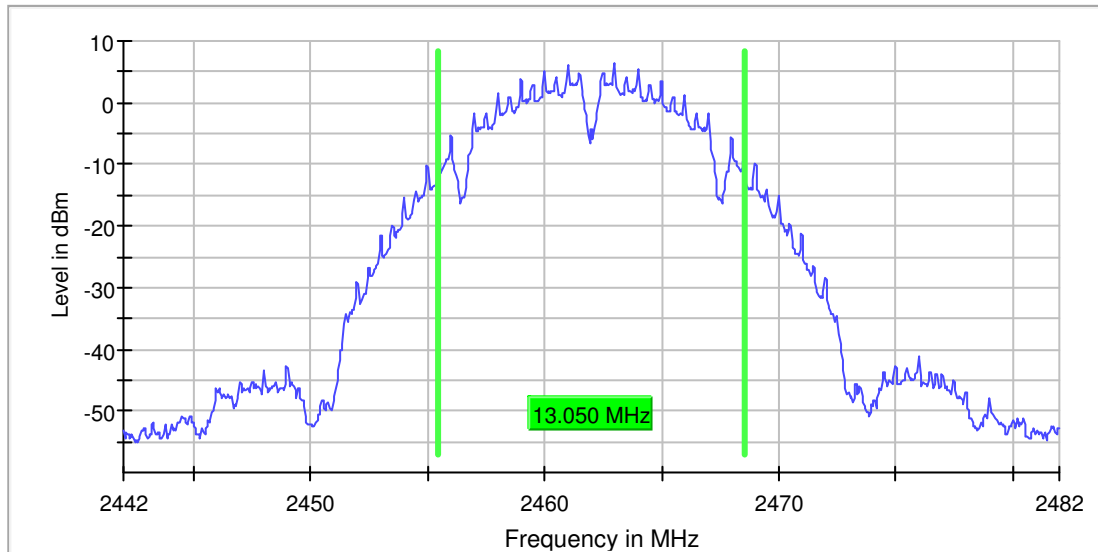

Measurement

Setting	Instrument Value	Target Value
Start Frequency	2.44200 GHz	2.44200 GHz
Stop Frequency	2.48200 GHz	2.48200 GHz
Span	40.000 MHz	40.000 MHz
RBW	100.000 kHz	~ 100.000 kHz
VBW	300.000 kHz	>= 300.000 kHz
SweepPoints	800	~ 800
SweepTime	56.836 μ s	AUTO
Reference Level	-10.000 dBm	-10.000 dBm
Attenuation	10.000 dB	AUTO
Detector	MaxPeak	MaxPeak
SweepCount	100	100
Filter	3 dB	3 dB
Trace Mode	Max Hold	Max Hold
Sweeptype	FFT	AUTO
Preamp	off	off
Stablemode	Trace	Trace
Stablevalue	0.50 dB	0.50 dB
Run	9 / max. 150	max. 150
Stable	5 / 5	5
Max Stable Difference	0.01 dB	0.50 dB

TEST REPORT

G Mode emission Bandwidth 99%

DUT Frequency (MHz)	Bandwidth (MHz)	Limit Min (MHz)	Limit Max (MHz)	Band Edge Left (MHz)	Band Edge Right (MHz)	Max Level (dBm)
2462.000000	16.250000	---	---	2453.875000	2470.125000	3.9

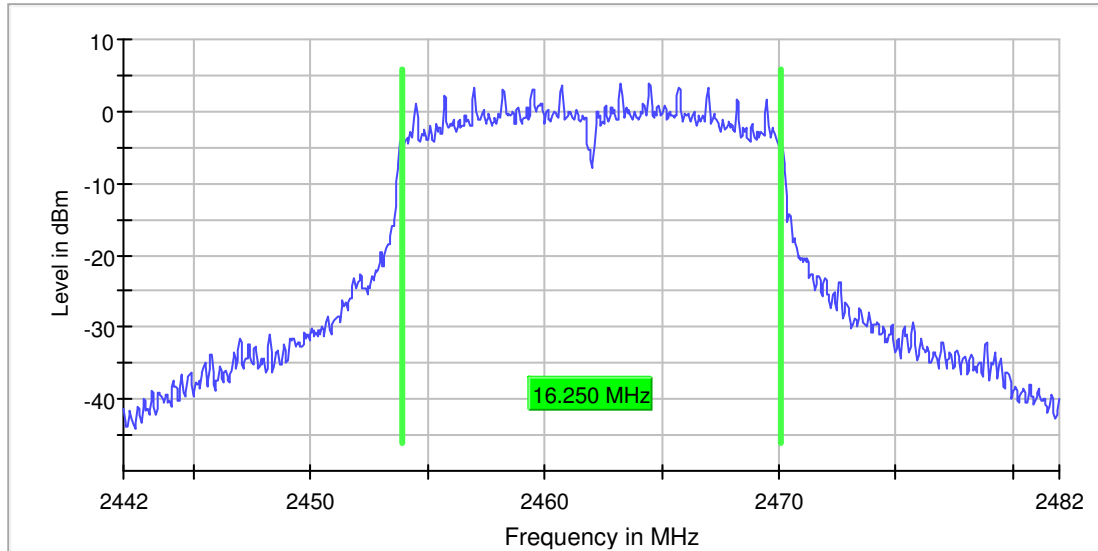

Measurement

Setting	Instrument Value	Target Value
Start Frequency	2.44200 GHz	2.44200 GHz
Stop Frequency	2.48200 GHz	2.48200 GHz
Span	40.000 MHz	40.000 MHz
RBW	100.000 kHz	~ 100.000 kHz
VBW	300.000 kHz	>= 300.000 kHz
SweepPoints	800	~ 800
Sweeptime	56.836 µs	AUTO
Reference Level	0.000 dBm	-10.000 dBm
Attenuation	20.000 dB	AUTO
Detector	MaxPeak	MaxPeak
SweepCount	100	100
Filter	3 dB	3 dB
Trace Mode	Max Hold	Max Hold
Sweeptype	FFT	AUTO
Preamp	off	off
Stablemode	Trace	Trace
Stablevalue	0.50 dB	0.50 dB
Run	36 / max. 150	max. 150
Stable	5 / 5	5
Max Stable Difference	0.13 dB	0.50 dB

TEST REPORT

NHT20 Emission Bandwidth 99%

DUT Frequency (MHz)	Bandwidth (MHz)	Limit Min (MHz)	Limit Max (MHz)	Band Edge Left (MHz)	Band Edge Right (MHz)	Max Level (dBm)
2462.000000	17.700000	---	---	2453.125000	2470.825000	0.4

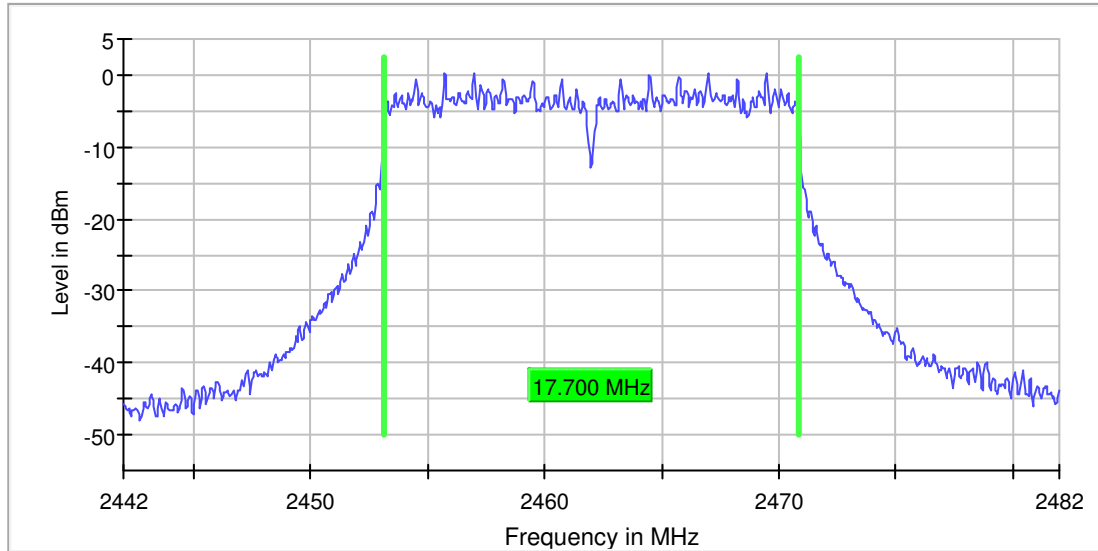

Measurement

Setting	Instrument Value	Target Value
Start Frequency	2.44200 GHz	2.44200 GHz
Stop Frequency	2.48200 GHz	2.48200 GHz
Span	40.000 MHz	40.000 MHz
RBW	100.000 kHz	~ 100.000 kHz
VBW	300.000 kHz	>= 300.000 kHz
SweepPoints	800	~ 800
Sweeptime	56.836 μ s	AUTO
Reference Level	0.000 dBm	-10.000 dBm
Attenuation	20.000 dB	AUTO
Detector	MaxPeak	MaxPeak
SweepCount	100	100
Filter	3 dB	3 dB
Trace Mode	Max Hold	Max Hold
SweepType	FFT	AUTO
Preamp	off	off
Stablemode	Trace	Trace
Stablevalue	0.50 dB	0.50 dB
Run	64 / max. 150	max. 150
Stable	5 / 5	5
Max Stable Difference	0.00 dB	0.50 dB

TEST REPORT

NHT40 Emission Bandwidth 99%

DUT Frequency (MHz)	Bandwidth (MHz)	Limit Min (MHz)	Limit Max (MHz)	Band Edge Left (MHz)	Band Edge Right (MHz)	Max Level (dBm)
2422.000000	36.250000	---	---	2403.875000	2440.125000	-2.9

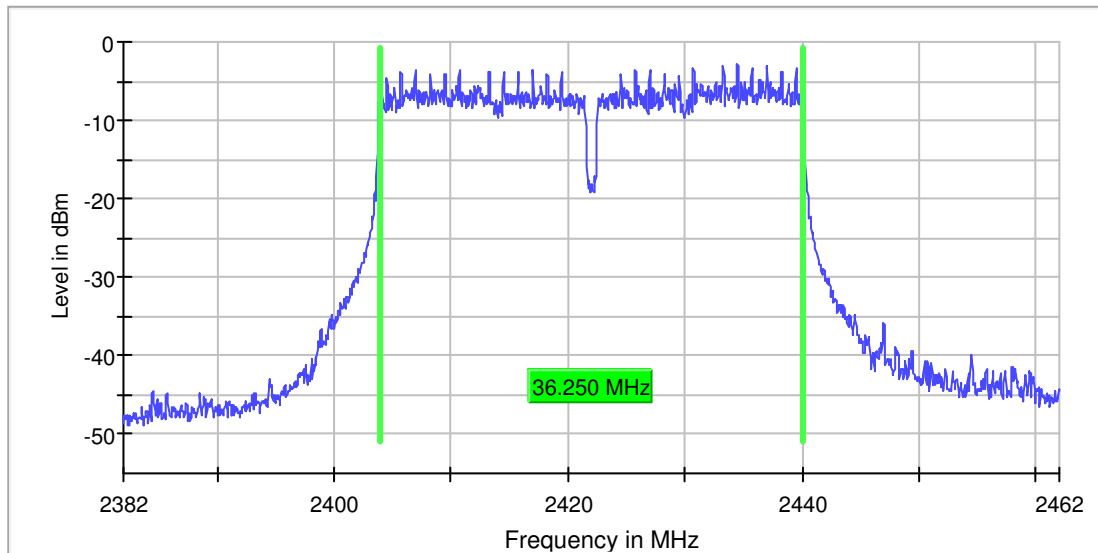

Measurement

Setting	Instrument Value	Target Value
Start Frequency	2.38200 GHz	2.38200 GHz
Stop Frequency	2.46200 GHz	2.46200 GHz
Span	80.000 MHz	80.000 MHz
RBW	100.000 kHz	~ 100.000 kHz
VBW	300.000 kHz	>= 300.000 kHz
SweepPoints	1600	~ 1600
Sweeptime	94.727 μ s	AUTO
Reference Level	10.000 dBm	10.000 dBm
Attenuation	30.000 dB	AUTO
Detector	MaxPeak	MaxPeak
SweepCount	100	100
Filter	3 dB	3 dB
Trace Mode	Max Hold	Max Hold
SweepType	FFT	AUTO
Preamp	off	off
Stablemode	Trace	Trace
Stablevalue	0.50 dB	0.50 dB
Run	75 / max. 150	max. 150
Stable	5 / 5	5
Max Stable Difference	0.24 dB	0.50 dB

TEST REPORT

EXHIBIT 5 EQUIPMENT LIST

5.0 EQUIPMENT LIST

1) Radiated Emissions Test

Equipment	EMI Test Receiver	Biconical Antenna	Log Periodic Antenna
Registration No.	EW-3156	EW-0954	EW-0447
Manufacturer	ROHDESCHWARZ	EMCO	EMCO
Model No.	ESR26	3104C	3146
Calibration Date	November 10, 2017	February 27, 2018	January 17, 2018
Calibration Due Date	November 10, 2018	August 27, 2019	July 17, 2019

Equipment	Active Loop H-field (9kHz to 30MHz)	12m Double Shield RF Cable (20MHz to 6GHz)	RF Cable (up to 40GHz)
Registration No.	EW-2313	EW-1852	EW-3155
Manufacturer	ELECTROMETRI	RADIALL	N/A
Model No.	EM-6876	N(m)-RG142 - N(m)	1-40 GHz
Calibration Date	March 08, 2018	January 19, 2018	January 29, 2018
Calibration Due Date	September 08, 2019	January 19, 2019	January 29, 2019

Equipment	Double Ridged Guide Antenna	Pyramidal Horn Antenna	Spectrum Analyzer
Registration No.	EW-1015	EW-0905	EW-3110
Manufacturer	EMCO	EMCO	R&S
Model No.	3115	3160-09	FSP30
Calibration Date	November 17, 2017	August 18, 2017	March 05, 2018
Calibration Due Date	May 17, 2019	February 18, 2019	March 05, 2019

Equipment	Notch Filter (cutoff frequency 2.4GHz to 2.5GHz)	Solid State Low Noise Preamplifier Assembly (1 - 18)GHz	RF Pre-amplifier (9kHz to 40GHz)
Registration No.	EW-2213	EW-3229	EW-3006
Manufacturer	MICROTRONICS	BONN ELEKTRO	SCHWARZBECK
Model No.	BRM50701-02	BLMA 0118-5G	BBV 9744
Calibration Date	May 24, 2018	January 30, 2018	April 26, 2018
Calibration Due Date	May 24, 2019	January 30, 2019	April 26, 2019

TEST REPORT

2) Bandedge/Bandwidth Measurement

Equipment	RF Cable (up to 40GHz) 1.5m length	Spectrum Analyzer
Registration No.	EW-3104	EW-3110
Manufacturer	N/A	R&S
Model No.	SMA-M to SMA-M	FSP30
Calibration Date	July 03, 2018	March 05, 2018
Calibration Due Date	July 03, 2019	March 05, 2019

3) Conducted Emissions Test

Equipment	Artificial Mains Network	RF Cable 240cm (RG142)	EMI Test Receiver
Registration No.	EW-2501	EW-2454	EW-3156
Manufacturer	ROHDESCHWARZ	RADIALL	ROHDESCHWARZ
Model No.	ENV-216	bnc m st / 142 /bnc m ra 240cm	ESR26
Calibration Date	February 14, 2018	March 27, 2018	November 10, 2017
Calibration Due Date	February 14, 2019	March 27, 2019	November 10, 2018

END OF TEST REPORT