

TEST REPORT

Report Number: 20080597HKG-001R1

Application for Original Grant of 47 CFR Part 15 Certification

New Family of RSS-247 Issue 2 Equipment

This report contains the data of 2.4GHz WLAN (WiFi) portion only

FCC ID: Q20-PSUBPBSW150

IC: 152B-PSUBPBSW150

This report supersedes previous report with report number 20080597HKG-001 dated November 16, 2020.

Please refer ICT-S20-0022 Letter issued on December 18, 2020 for amendment/ supersede notification.

Prepared and Checked by:

Approved by:

Signed On File
Wong Cheuk Ho, Herbert
Lead Engineer

Wong Kwok Yeung, Kenneth
Senior Lead Engineer
Date: December 18, 2020

TEST REPORT

GENERAL INFORMATION

Applicant Name:	Lenbrook Industries Limited
Applicant Address:	633 Granite Court, Pickering, ON Canada L1W 3K1
FCC Specification Standard:	FCC Part 15, October 1, 2019 Edition
FCC ID:	Q2O-PSUBPBSW150
FCC Model(s):	PULSE SUB+, BSW150
IC Specification Standard:	RSS-247 Issue 2, February 2017 RSS-Gen Issue 5 Amendment 1, March 2019
IC:	152B-PSUBPBSW150
PMN:	PULSE SUB+, BSW150
HVIN:	PULSE SUB+, BSW150
Type of EUT:	Spread Spectrum Transmitter
Description of EUT:	WIRELESS POWERED SUBWOOFER (PULSE SUB+), NETWORK POWERED SUBWOOFER (BSW150)
Serial Number:	N/A
Sample Receipt Date:	October 01, 2020
Date of Test:	October 01, 2020 to November 16, 2020
Report Date:	December 18, 2020
Environmental Conditions:	Temperature: +10 to 40°C Humidity: 10 to 90%
Conclusion:	Test was conducted by client submitted sample. The submitted sample as received complied with the 47 CFR Part 15 / RSS-247 Issue 2 Certification.

TEST REPORT

AMENDMENT HISTORY

Report No.	Issued Date	Content
20080597HKG-001	November 16, 2020	Original Report
20080597HKG-001R1	December 18, 2020	PLOTS OF OUT OF BAND CONDUCTED EMISSIONS (p.31 to p.46 of report 20010359HKG-001) are put into separate file PLOTS OF OUT OF BAND CONDUCTED EMISSIONS.pdf

TEST REPORT

TABLE OF CONTENTS

1.0 TEST RESULTS SUMMARY & STATEMENT OF COMPLIANCE 5

 1.1 Summary of Test Results5

 1.2 Statement of Compliance5

2.0 GENERAL DESCRIPTION..... 6

 2.1 Product Description.....6

 2.2 Test Methodology7

 2.3 Test Facility7

 2.4 Related Submittal(s) Grants.....7

3.0 SYSTEM TEST CONFIGURATION..... 8

 3.1 Justification8

 3.2 EUT Exercising Software9

 3.3 Details of EUT and Description of Accessories.....10

 3.4 Measurement Uncertainty10

4.0 TEST RESULTS 11

 4.1 Maximum Conducted Output Power at Antenna Terminals.....11

 4.2 Minimum 6dB RF Bandwidth13

 4.3 Maximum Power Spectral Density.....22

 4.4 Out of Band Conducted Emissions31

 4.5 Field Strength Calculation.....32

 4.6 Transmitter Radiated Emissions in Restricted Bands and Spurious Emissions.....33

 4.6.1 Radiated Emission Configuration Photograph33

 4.6.2 Radiated Emission Data33

 4.6.3 Radiated Emission Test Setup47

 4.6.4 Transmitter Duty Cycle Calculation48

 4.7 AC Power Line Conducted Emission.....49

 4.7.1 AC Power Line Conducted Emission Configuration Photograph49

 4.7.2 AC Power Line Conducted Emission Data.....49

 4.7.3 Conducted Emission Test Setup52

5.0 EQUIPMENT LIST 57

TEST REPORT

1.0 TEST RESULTS SUMMARY & STATEMENT OF COMPLIANCE

1.1 Summary of Test Results

Test Items	FCC Part 15 Section	RSS-247/ RSS-Gen# Section	Results	Details See Section
Antenna Requirement	15.203	7.1.2#	Pass	2.1
Max. Conducted Output Power (Peak)	15.247(b)(3)&(4)	5.4(4)	Pass	4.1
Min. 6dB RF Bandwidth	15.247(a)(2)	5.2(1)	Pass	4.2
Max. Power Density (average)	15.247(e)	5.2(2)	Pass	4.3
Out of Band Antenna Conducted Emission	15.247(d)	5.5	Pass	4.4
Radiated Emission in Restricted Bands and Spurious Emissions	15.247(d), 15.209 & 15.109	5.5	Pass	4.6
AC Power Line Conducted Emission	15.207 & 15.107	7.2.4#	Pass	4.7

Note: Pursuant to FCC Part 15 Section 15.215(c), the 20dB bandwidth of the emission was contained within the frequency band designated (mentioned as above) which the EUT operated. The effects, if any, from frequency sweeping, frequency hopping, other modulation techniques and frequency stability over expected variations in temperature and supply voltage were considered.

1.2 Statement of Compliance

The equipment under test is found to be complying with the following standard:

FCC Part 15, October 1, 2019 Edition
RSS-247 Issue 2, February 2017
RSS-Gen Issue 5 Amendment 1, March 2019

TEST REPORT

2.0 GENERAL DESCRIPTION

2.1 Product Description

The Equipment Under Test (EUT) is WIRELESS POWERED SUBWOOFER (Model/HVIN: PULSE SUB+) which contains a WLAN (WiFi) module for networking and control. The EUT has internal power amplifiers and loudspeaker.

For the WLAN (WiFi) module:

For 2.400-2.4835GHz:

The Equipment Under Test (EUT) operates at frequency range of 2412MHz to 2462MHz with 11 channels. For 802.11b mode, it operates at frequency range of 2412.000MHz to 2462.000MHz with 11 channels. It transmits via Direct-sequence spread spectrum (DSSS) modulation. Maximum bit rate can be up to 11Mbps.

For 802.11g mode, it operates at frequency range of 2412.000MHz to 2462.000MHz with 11 channels. It transmits via Orthogonal Frequency Division Multiplexing (OFDM) modulation. Maximum bit rate can be up to 54Mbps.

For 802.11n (with 20MHz bandwidth) mode, it operates at frequency range of 2412.000MHz to 2462.000MHz with 11 channels. It transmits via Orthogonal Frequency Division Multiplexing (OFDM) modulation. Maximum bit rate can support up to 65Mbps.

For 802.11n (with 40MHz bandwidth) mode, it operates at frequency range of 2422.000MHz to 2452.000MHz with 9 channels. It transmits via Orthogonal Frequency Division Multiplexing (OFDM) modulation. Maximum bit rate can support up to 150Mbps.

For FCC & IC, the Model/HVIN(s): BSW150 (NETWORK POWERED SUBWOOFER) is the same as the Model/HVIN: PULSE SUB+ (WIRELESS POWERED SUBWOOFER) in electronics/electrical designs including software & firmware, PCB layout and construction design/physical design/enclosure as declared by client. The only differences between these models are model number and brand name to be sold for marketing purpose as declared by client.

The EUT is power by 120VAC.

The antenna(s) used in the EUT is integral, and the test sample is a prototype.

The circuit description is saved with filename: descri.pdf.

This report contains the data of 2.4GHz WLAN (WiFi) portion only.

TEST REPORT

2.2 Test Methodology

Both AC power line-conducted and radiated emission measurements were performed according to the procedures in ANSI C63.10 (2013). Preliminary radiated scans and all radiated measurements were performed in radiated emission test sites. All Radiated tests were performed at an antenna to EUT distance of 3 meters, unless stated otherwise in the "**Justification Section**" of this Application. Antenna port conducted measurements were performed according to ANSI C63.10 (2013) and KDB Publication No.558074 D01 v05r01 (11-February-2019). All other measurements were made in accordance with the procedures in 47 CFR Part 2 and RSS-Gen Issue 5 + Amendment 1, March 2019.

2.3 Test Facility

The radiated emission test site and antenna port conducted measurement facility used to collect the radiated data and conductive data are at Workshop No. 3, G/F., World-Wide Industrial Centre, 43-47 Shan Mei Street, Fo Tan, Sha Tin, N.T., Hong Kong SAR, China. This test facility and site measurement data have been fully placed on file with the FCC and Industry Canada No.: 2042H.

2.4 Related Submittal(s) Grants

This is a single application for certification of a transceiver (WiFi portion).

TEST REPORT

3.0 SYSTEM TEST CONFIGURATION

3.1 Justification

For radiated emissions testing, the equipment under test (EUT) was setup to transmit / receive continuously to simplify the measurement methodology. Care was taken to ensure proper power supply voltages during testing. During testing, all cables (if any) were manipulated to produce worst case emissions.

The EUT was powered by 120VA.

For the measurements, the EUT was attached to a plastic stand if necessary and placed on the wooden turntable. If the base unit attached to peripherals, they were connected and operational (as typical as possible).

The signal was maximized through rotation and placement in the three orthogonal axes. The antenna height and polarization were varied during the search for maximum signal level. The antenna height was varied from 1 to 4 meters. Radiated emissions were taken at three meters unless the signal level was too low for measurement at that distance. If necessary, a pre-amplifier was used and/or the test was conducted at a closer distance.

For any intentional radiator powered by AC power line, measurements of the radiated signal level of the fundamental frequency component of the emission was performed with the supply voltage varied between 85% and 115% of the nominal rated supply voltage.

Radiated emission measurement for transmitter were performed from the lowest radio frequency signal generated in the device which is greater than 9 kHz to the tenth harmonic of the highest fundamental frequency or to 40 GHz, whichever is lower.

Emission that are directly caused by digital circuits in the transmit path and transmitter portion were measured, and the limit are according to FCC Part 15 Section 15.209 / RSS-247 2.5. Digital circuitries used to control additional functions other than the operation of the transmitter are subject to FCC Part 15 Section 15.109 / RSS-247 Section 5.5 Limits.

TEST REPORT

3.1 Justification – Cont'd

Detector function for radiated emissions was in peak mode. Average readings, when required, were taken by measuring the duty cycle of the equipment under test and subtracting the corresponding amount in dB from the measured peak readings. A detailed description for the calculation of the average factor can be found in section 4.8.3.

Determination of pulse desensitization was made according to *Hewlett Packard Application Note 150-2, Spectrum Analysis... Pulsed RF*. The effective period (Teff) was referred to Exhibit 4.8.3. With the resolution bandwidth 1MHz and spectrum analyzer IF bandwidth 3dB, the pulse desensitization factor was 0dB.

For AC line conducted emission test, the EUT along with its peripherals were placed on a 1.0m(W)x1.5m(L) and 0.8m in height wooden table and the EUT was adjusted to maintain a 0.4 meter space from a vertical reference plane. The EUT was connected to power mains through a line impedance stabilization network (LISN), which provided 50ohm coupling impedance for measuring instrument. The LISN housing, measuring instrument case, reference ground plane, and vertical ground plane were bounded together. The excess power cable between the EUT and the LISN was bundled.

All connecting cables of EUT and peripherals were manipulated to find the maximum emission.

Different data rates have been tested. Worst case is reported only.

All relevant operation modes have been tested, and the worst-case data is included in this report.

All data rates were tested under normal mode of WiFi. Only the worst-case data is shown in the report for DSSS and OFDM.

3.2 EUT Exercising Software

The EUT exercise program (if any) used during radiated and conducted testing was designed to exercise the various system components in a manner similar to a typical use.

TEST REPORT

3.3 Details of EUT and Description of Accessories

Details of EUT:

- (1) The EUT is powered by 120VAC

Description of Accessories:

1. 1 X LAN cable of 2 meter long with termination
2. 1 X Power Cable of 2 meter long
3. 1 X Analog coaxial cable of 2 meter long with termination
(Provided by Intertek)

3.4 Measurement Uncertainty

When determining of the test conclusion, the Measurement Uncertainty of test at a level of confidence of 95% has been considered. The values of the Measurement uncertainty for radiated emission test and RF conducted measurement test are $\pm 5.3\text{dB}$ and $\pm 0.99\text{dB}$ respectively. The value of the Measurement uncertainty for conducted emission test is $\pm 4.2\text{dB}$.

Uncertainty and Compliance - Unless the standard specifically states that measured values are to be extended by the measurement uncertainty in determining compliance, all compliance determinations are based on the actual measured value.

TEST REPORT

4.0 TEST RESULTS

4.1 Maximum Conducted (peak) Output Power at Antenna Terminals

RF Conduct Measurement Test Setup

The figure below shows the test setup, which is utilized to make these measurements.

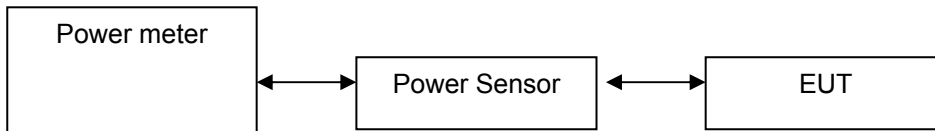

The antenna port of the EUT was connected to the input of a spectrum analyzer.

- The antenna power of the EUT was connected to the input of a power meter. Power was read directly and cable loss correction was added to the reading to obtain power at the EUT antenna terminals. The measurement procedure 9.1.2 was used.
- The EUT should be configured to transmit continuously (at a minimum duty cycle of 98%) at full power over the measurement duration. The measurement procedure AVG1 was used.

IEEE 802.11b (DSSS, 1 Mbps) Antenna Gain = 2 dBi

Frequency (MHz)	Output in dBm	Output in mWatt
Low Channel: 2412	11.4	13.8
Middle Channel: 2437	11.9	15.5
High Channel: 2462	12.2	16.6

IEEE 802.11g (OFDM, 6 Mbps) Antenna Gain = 2 dBi

Frequency (MHz)	Output in dBm	Output in mWatt
Low Channel: 2412	11.6	14.5
Middle Channel: 2437	12.2	16.6
High Channel: 2462	12.4	17.4

IEEE 802.11n (20MHz) (OFDM, MCS0) Antenna Gain = 2 dBi

Frequency (MHz)	Output in dBm	Output in mWatt
Low Channel: 2412	12.2	16.6
Middle Channel: 2437	12.4	17.4
High Channel: 2462	12.5	17.8

TEST REPORT

4.1 Maximum Conducted Output Power at Antenna Terminals – Cont’d

IEEE 802.11n (40MHz) (OFDM, MCS0) Antenna Gain = 2 dBi

Frequency (MHz)	Output in dBm	Output in mWatt
Low Channel: 2422	12.4	17.4
Middle Channel: 2437	12.5	17.8
High Channel: 2452	12.8	19.1

Cable loss : 0.5 dB External Attenuation : 0 dB

Cable loss, external attenuation: included in OFFSET function
 added to SA raw reading

IEEE 802.11b (DSSS, 1 Mbps)
max. conducted (peak) output level = 15.3 dBm

IEEE 802.11g (OFDM, 9 Mbps)
max. conducted (peak) output level = 17.8 dBm

IEEE 802.11n (20MHz) (OFDM, MCS0)
max. conducted (peak) output level = 18.4 dBm

IEEE 802.11n (40MHz) (OFDM, MCS0)
max. conducted (peak) output level = 19.8 dBm

Limits:
 1W (30dBm) for antennas with gains of 6dBi or less

___W (___dBm) for antennas with gains more than 6dBi

The plots of conducted output power are saved as below.

TEST REPORT

4.2 Minimum 6dB RF Bandwidth

The antenna port of the EUT was connected to the input of a spectrum analyzer. The EBW measurement procedure was used. A PEAK output reading was taken, a DISPLAY line was drawn 6dB lower than PEAK level. The 6dB bandwidth was determined from where the channel output spectrum intersected the display line.

IEEE 802.11b (DSSS, 1 Mbps)

Frequency (MHz)	6dB Bandwidth (MHz)
Low Channel: 2412	8.162
Middle Channel: 2437	8.162
High Channel: 2462	8.162

IEEE 802.11g (OFDM, 6 Mbps)

Frequency (MHz)	6dB Bandwidth (MHz)
Low Channel: 2412	15.369
Middle Channel: 2437	15.369
High Channel: 2462	15.195

IEEE 802.11n (20MHz) (OFDM, MCS0)

Frequency (MHz)	6dB Bandwidth (MHz)
Low Channel: 2412	15.369
Middle Channel: 2437	15.369
High Channel: 2462	15.369

IEEE 802.11n (40MHz) (OFDM, MCS0)

Frequency (MHz)	6dB Bandwidth (MHz)
Low Channel: 2422	35.46
Middle Channel: 2437	35.25
High Channel: 2452	35.30

Limits

6 dB bandwidth shall be at least 500kHz

The plots of 6dB RF bandwidth are saved as below.

TEST REPORT

PLOTS OF 6dB RF BANDWIDTH

802.11b, Lowest Channel

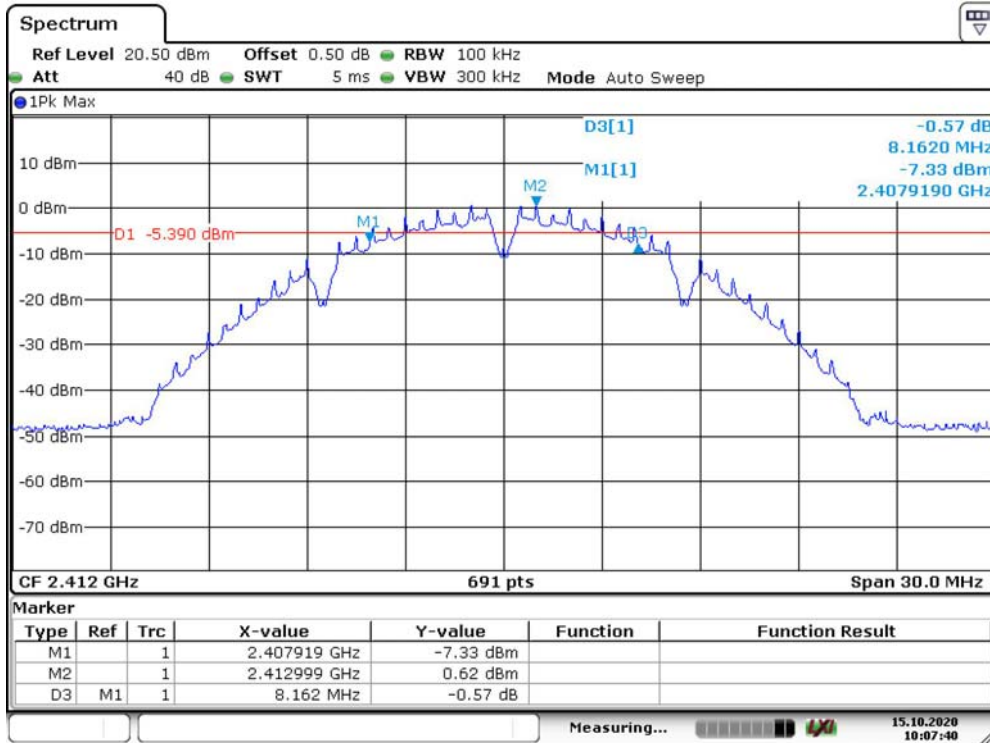

Date: 15.OCT.2020 10:07:40

802.11b, Middle Channel

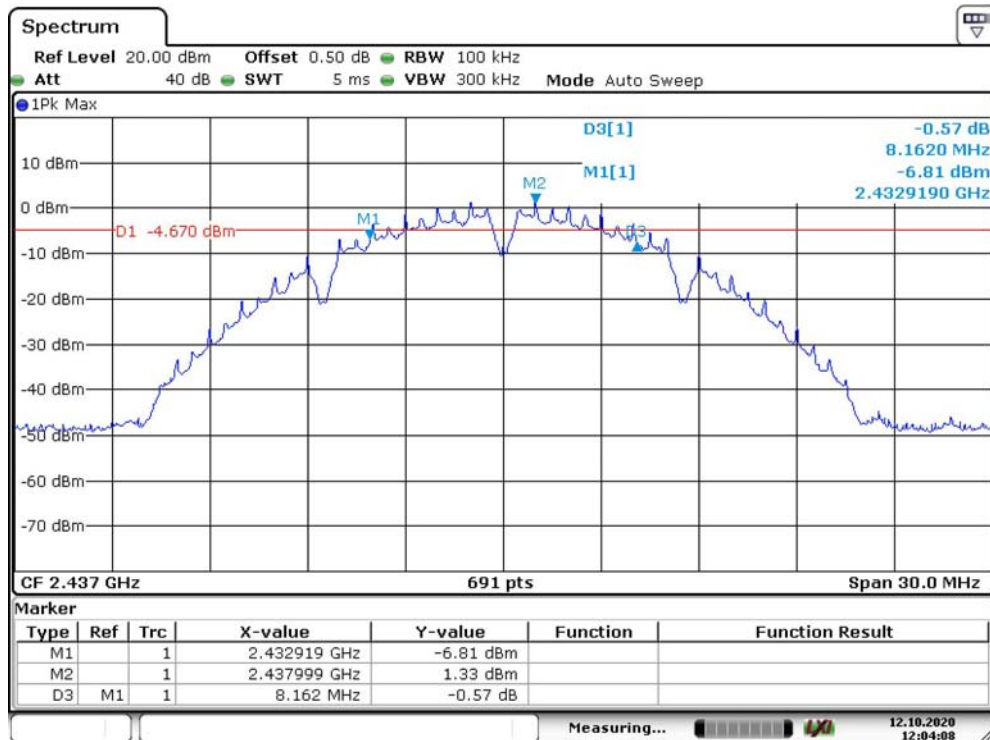

Date: 12.OCT.2020 12:04:09

TEST REPORT

PLOTS OF 6dB RF BANDWIDTH

802.11b, Highest Channel

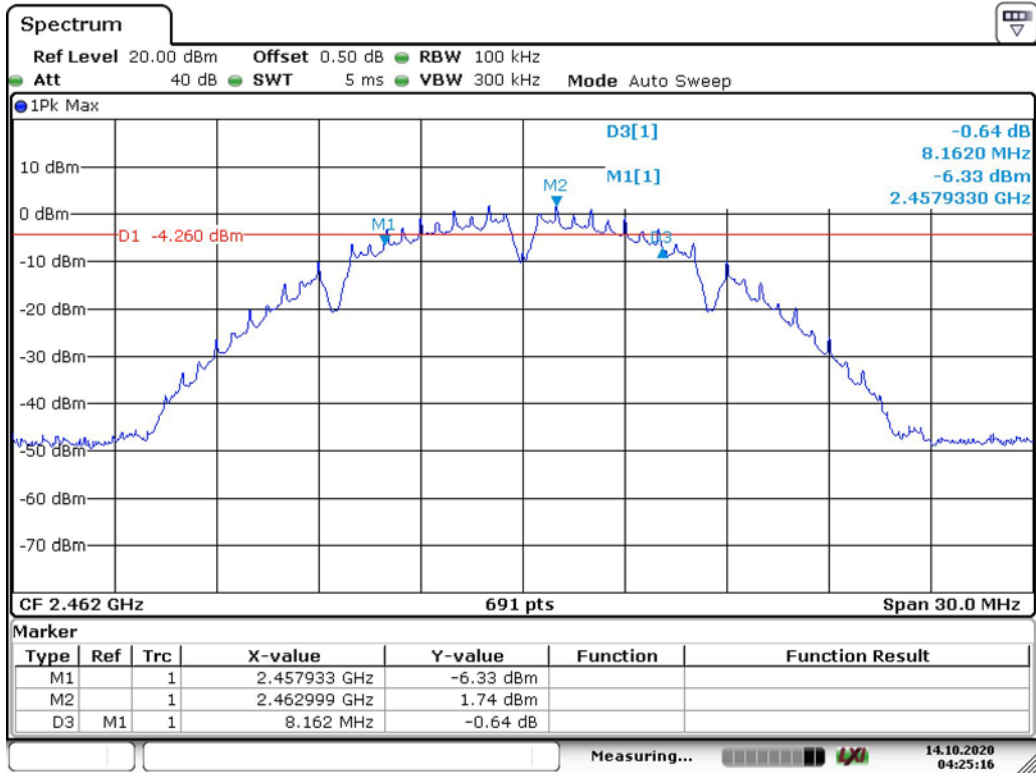

Date: 14.OCT.2020 04:25:16

TEST REPORT

PLOTS OF 6dB RF BANDWIDTH

802.11g, Lowest Channel

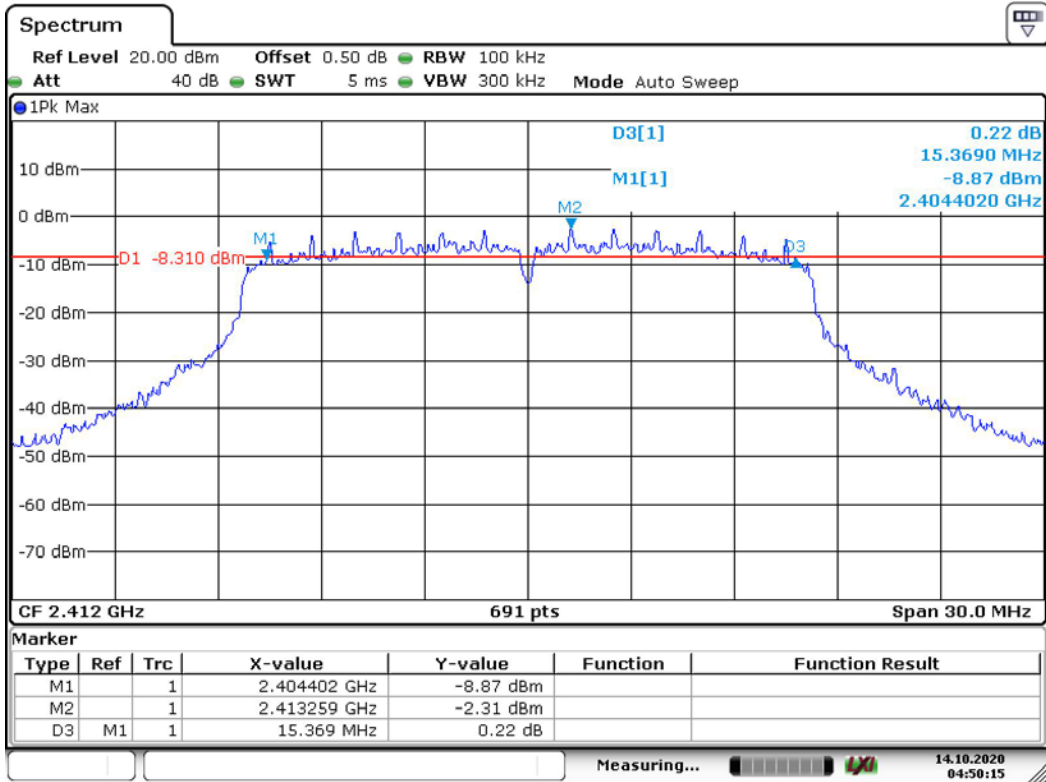

Date: 14.OCT.2020 04:50:16

802.11g, Middle Channel

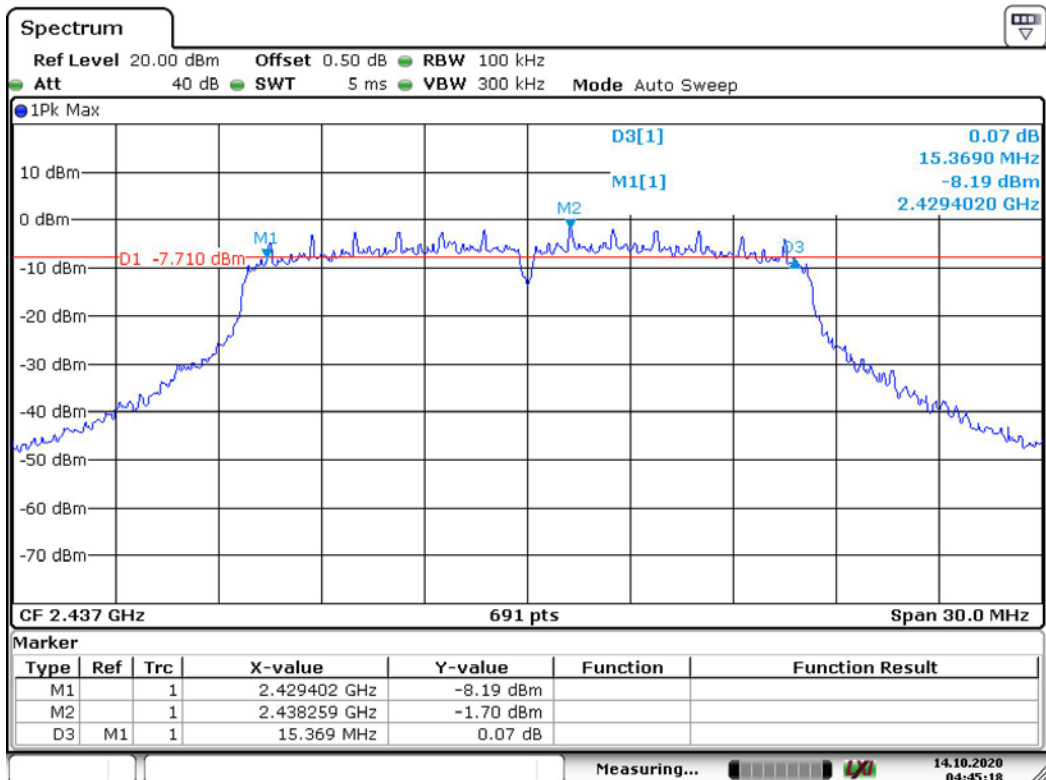

Date: 14.OCT.2020 04:45:18

TEST REPORT

PLOTS OF 6dB RF BANDWIDTH

802.11g, Highest Channel

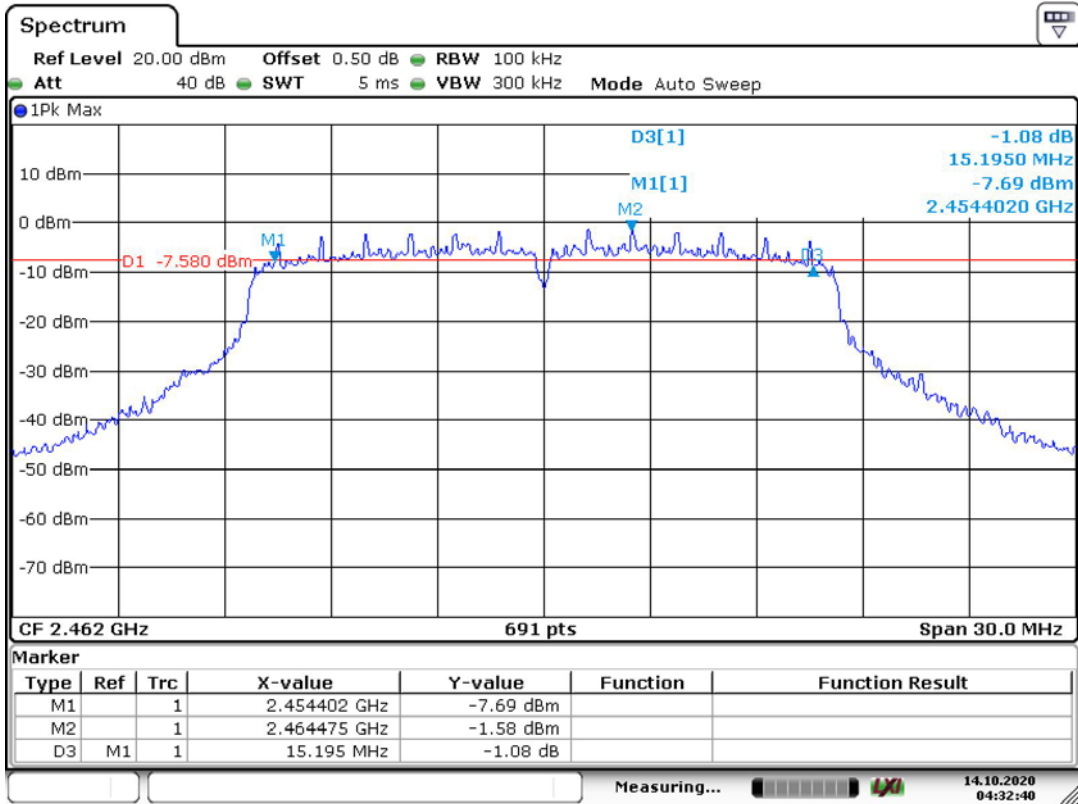

Date: 14.OCT.2020 04:32:41

TEST REPORT

PLOTS OF 6dB RF BANDWIDTH

802.11n (20MHz), Lowest Channel

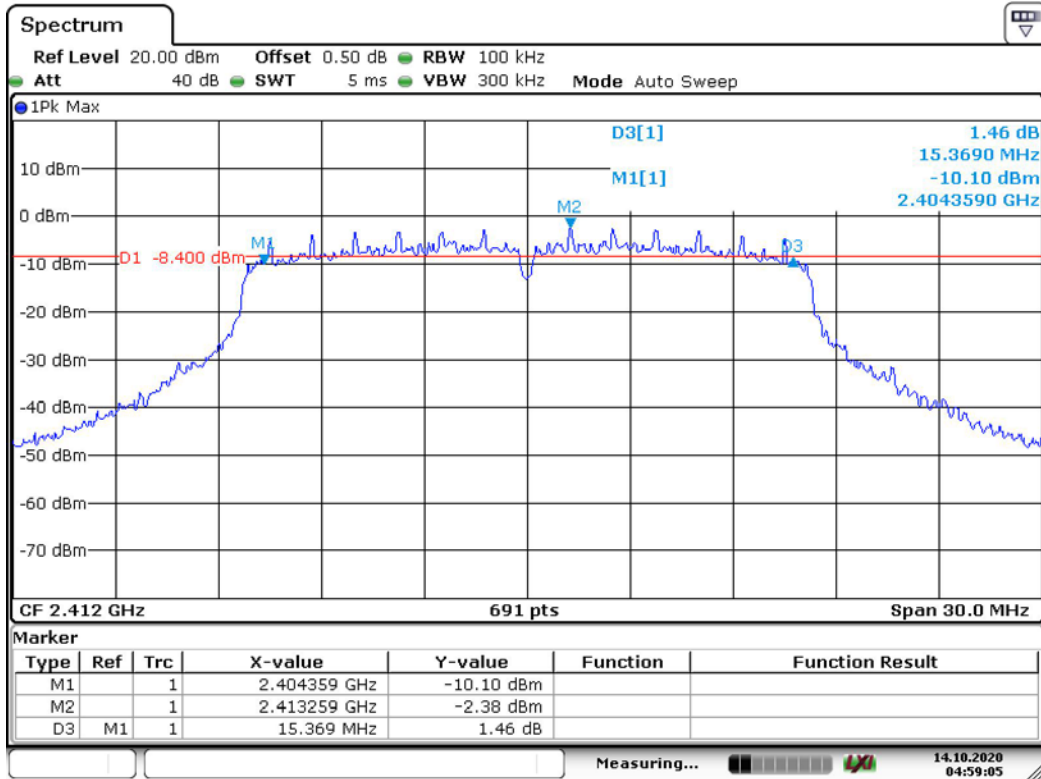

Date: 14.OCT.2020 04:59:05

802.11n (20MHz), Middle Channel

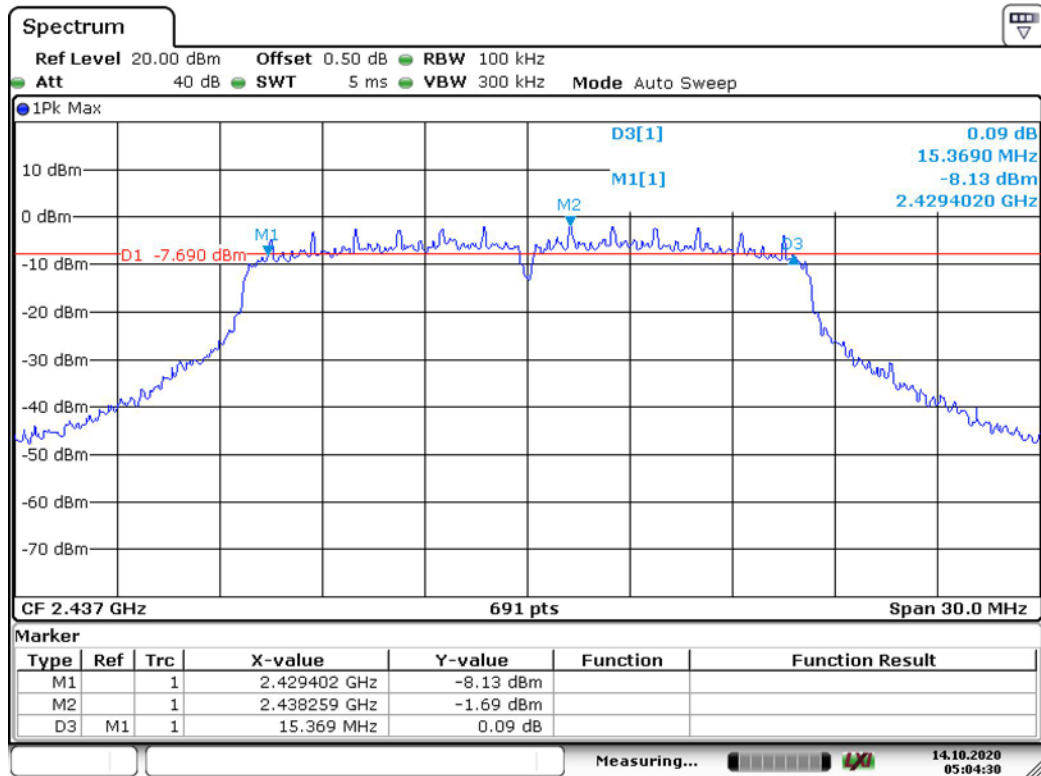

Date: 14.OCT.2020 05:04:31

TEST REPORT

PLOTS OF 6dB RF BANDWIDTH

802.11n (20MHz), Highest Channel

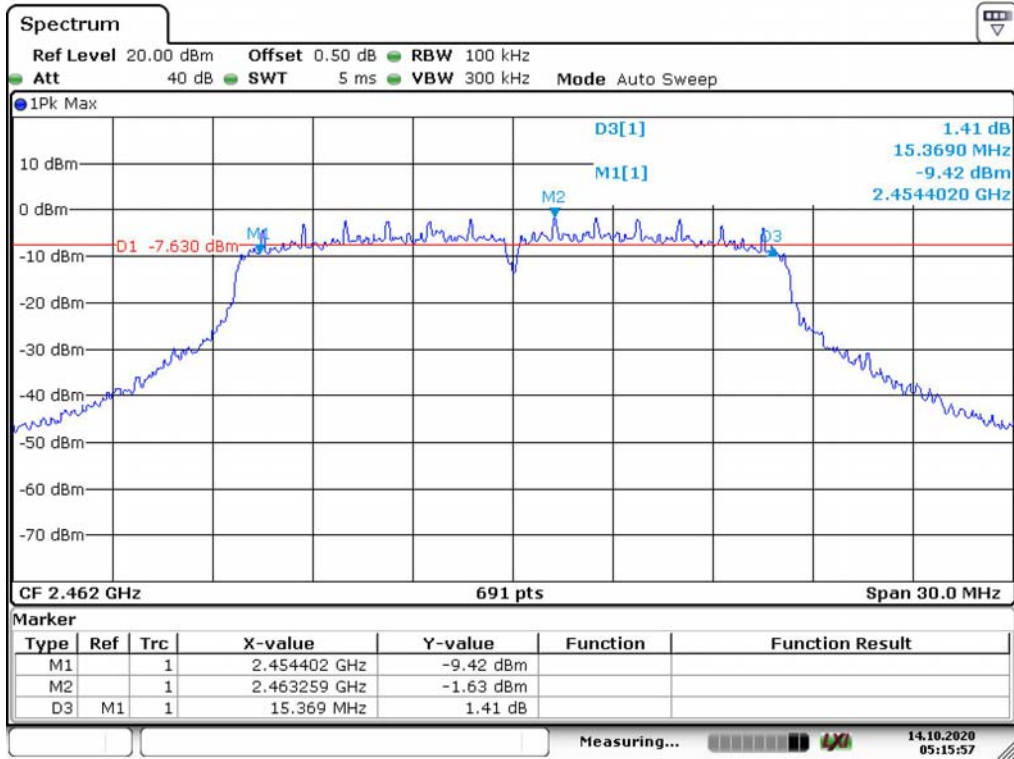

Date: 14.OCT.2020 05:15:57

TEST REPORT

PLOTS OF 6dB RF BANDWIDTH

802.11n (40MHz), Lowest Channel

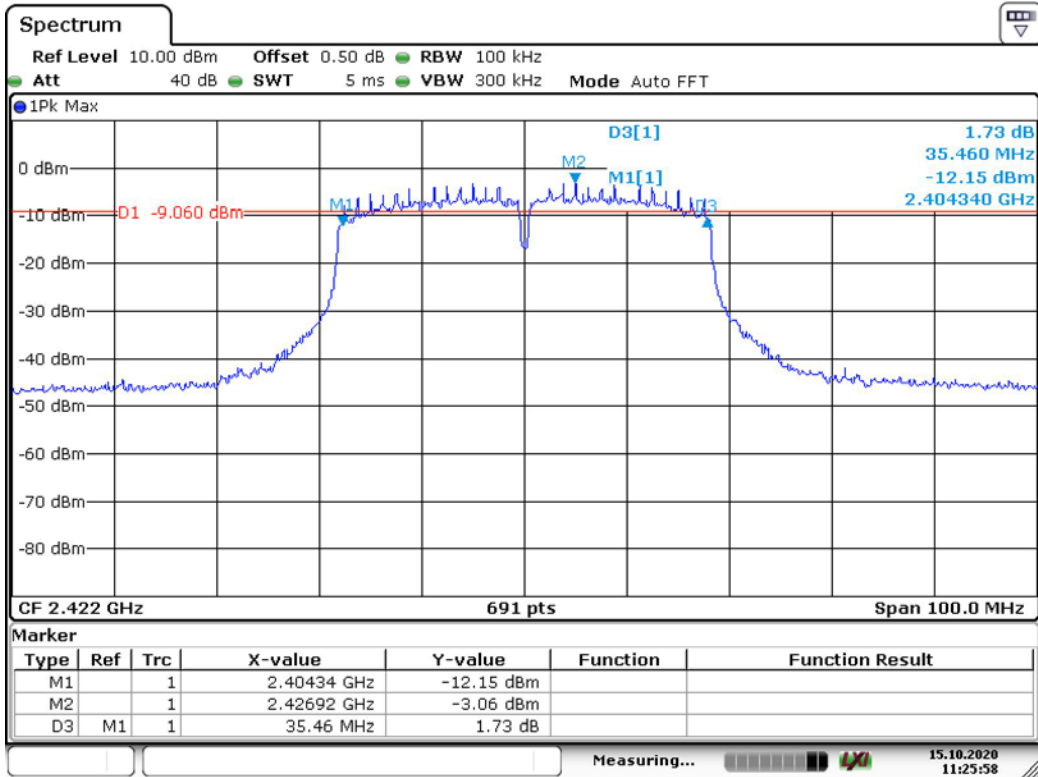

Date: 15.OCT.2020 11:25:58

802.11n (40MHz), Middle Channel

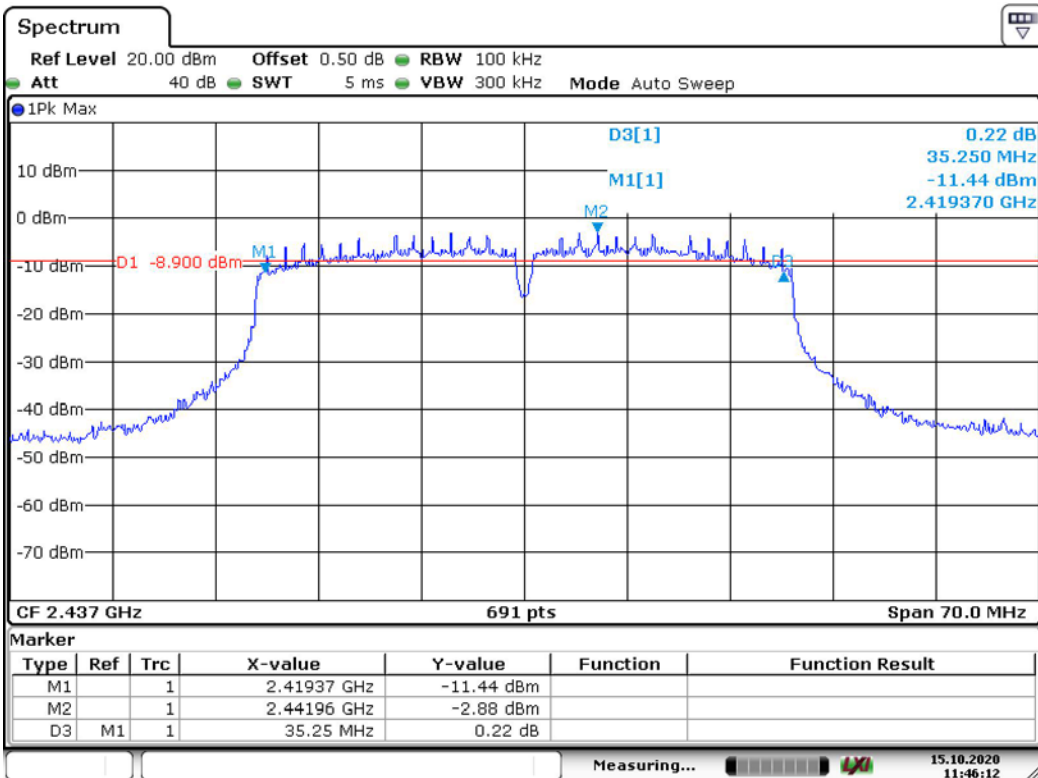

Date: 15.OCT.2020 11:46:12

TEST REPORT

PLOTS OF 6dB RF BANDWIDTH

802.11n (40MHz), Highest Channel

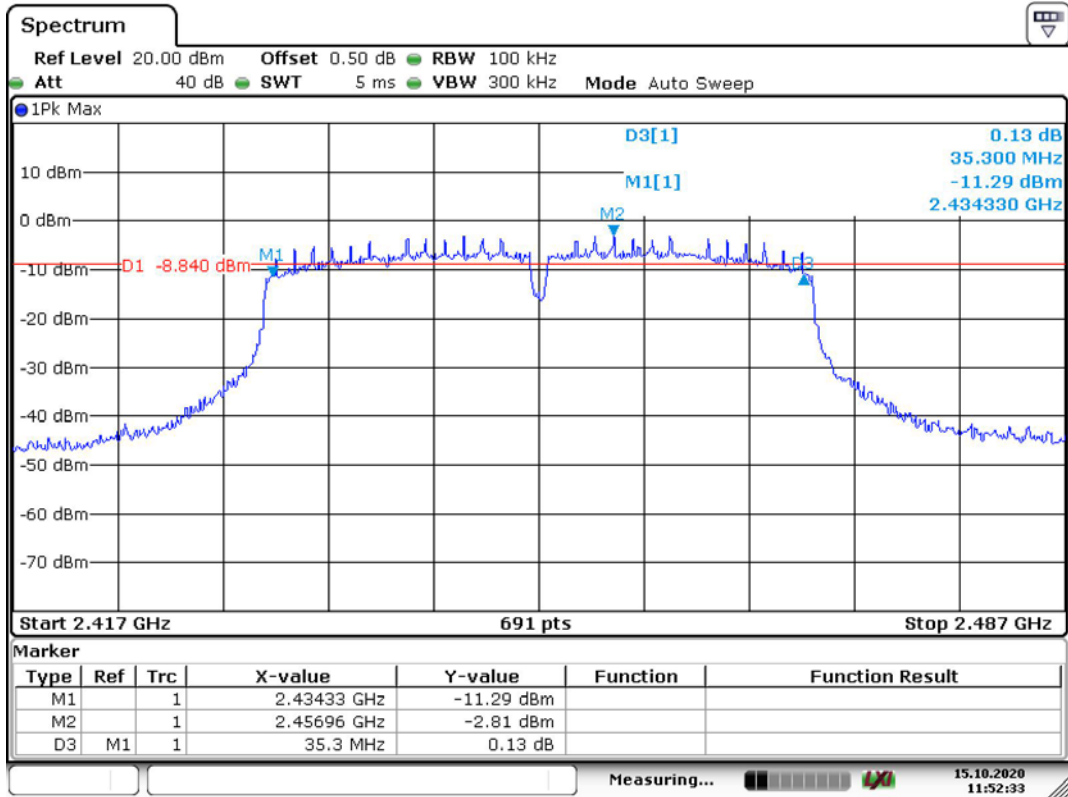

Date: 15.OCT.2020 11:52:33

TEST REPORT

4.3 Maximum Power Spectral Density

Antenna output of the EUT was coupled directly to spectrum analyzer. The measurement procedure 10.2 PKPSD was used. If an external attenuator and/or cable was used, these losses are compensated for using the OFFSET function of the analyser.

IEEE 802.11b (DSSS, 1 Mbps)

Frequency (MHz)	PSD in 100kHz (dBm)
Low Channel: 2412	0.69
Middle Channel: 2437	1.36
High Channel: 2462	1.74

IEEE 802.11g (OFDM, 6 Mbps)

Frequency (MHz)	PSD in 100kHz (dBm)
Low Channel: 2412	-2.39
Middle Channel: 2437	-1.67
High Channel: 2462	-1.52

IEEE 802.11n (20MHz) (OFDM, MCS0)

Frequency (MHz)	PSD in 100kHz (dBm)
Low Channel: 2412	-2.42
Middle Channel: 2437	-1.77
High Channel: 2462	-1.66

IEEE 802.11n (40MHz) (OFDM, MCS0)

Frequency (MHz)	PSD in 100kHz (dBm)
Low Channel: 2422	-3.27
Middle Channel: 2437	-2.91
High Channel: 2452	-2.85

Cable Loss: 0.5 dB

Limit:
8dBm

The plots of power spectral density are as below.

TEST REPORT

PLOTS OF POWER SPECTRAL DENSITY (100kHz RBW)

802.11b, Lowest channel

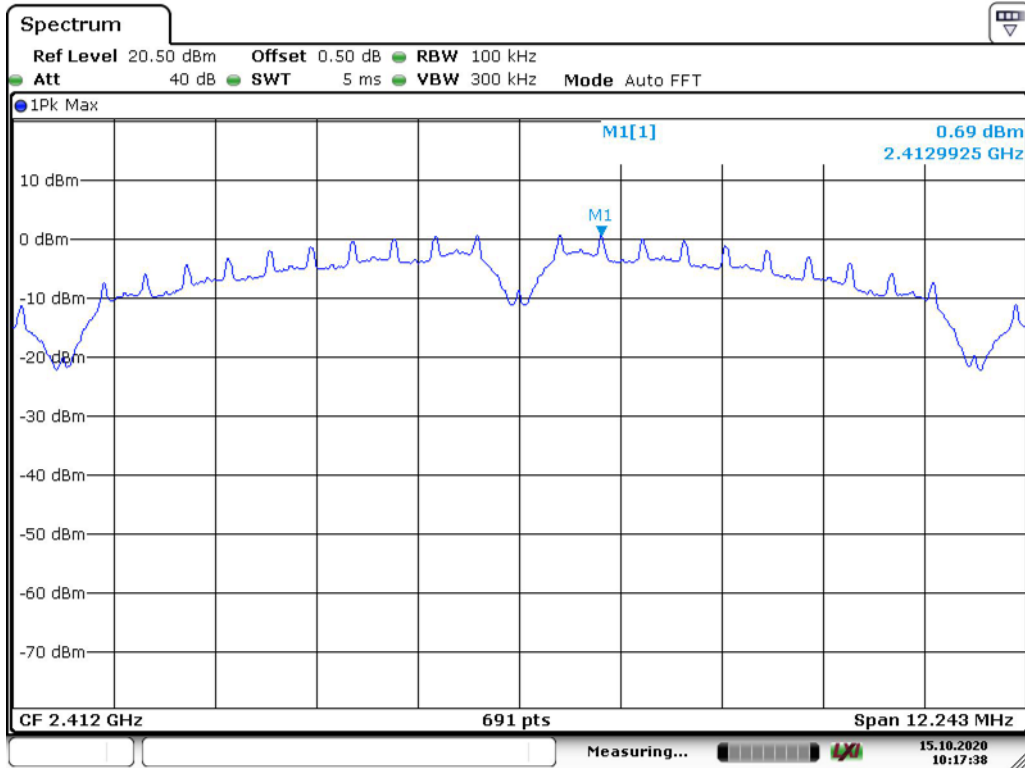

Date: 15.OCT.2020 10:17:38

802.11b, Middle channel

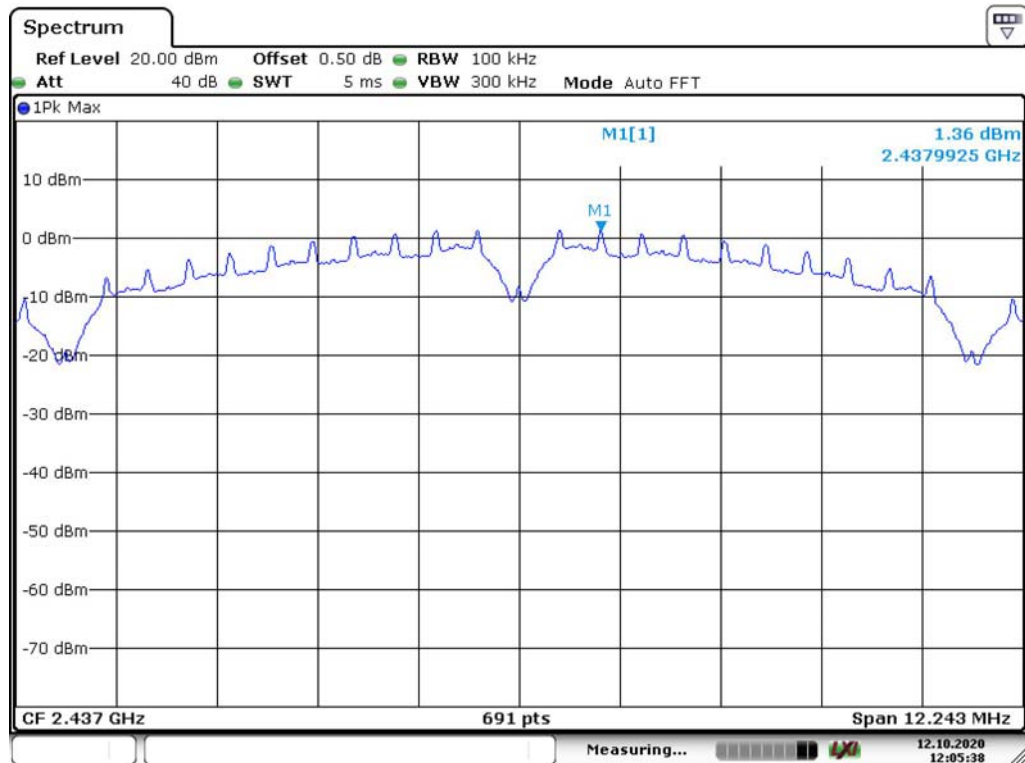

Date: 12.OCT.2020 12:05:38

PLOTS OF POWER SPECTRAL DENSITY (100kHz RBW)

TEST REPORT

802.11b, Highest channel

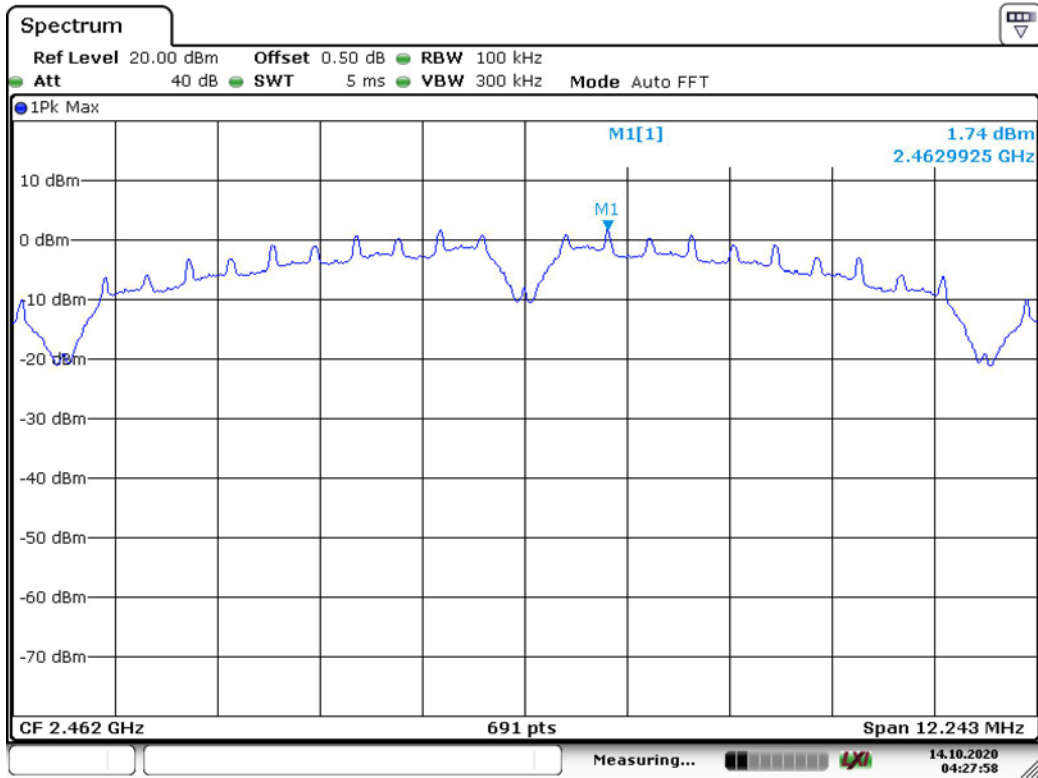

Date: 14.OCT.2020 04:27:59

TEST REPORT

PLOTS OF POWER SPECTRAL DENSITY

802.11g, Lowest channel

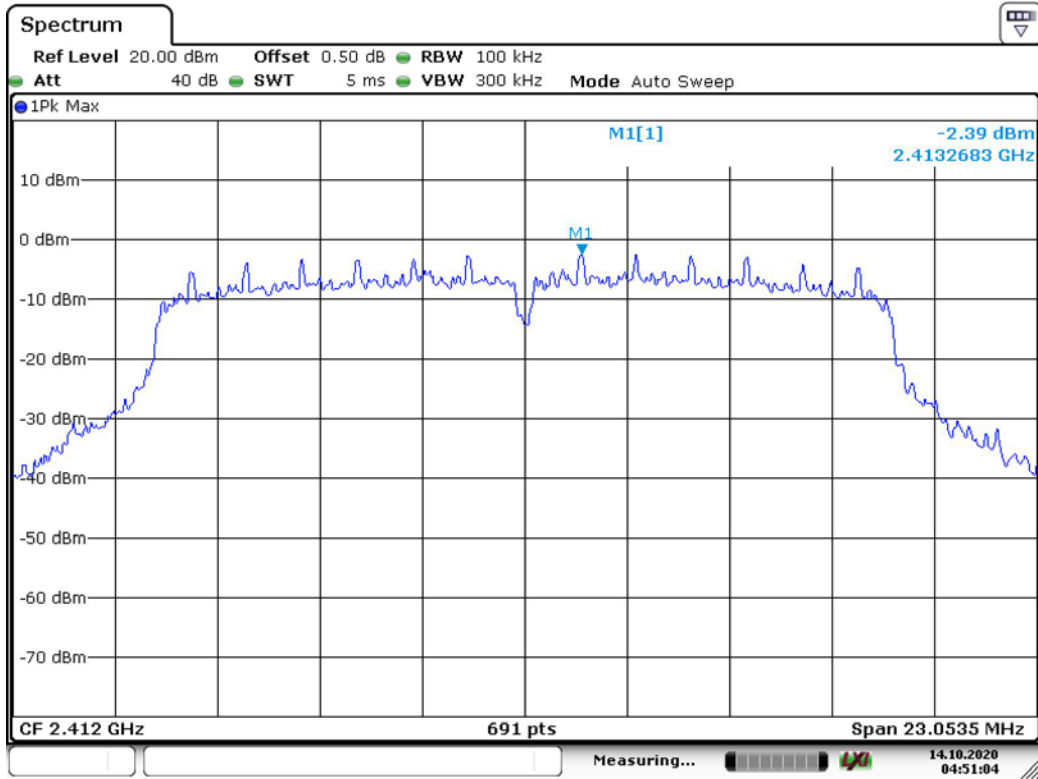

Date: 14.OCT.2020 04:51:04

802.11g, Middle channel

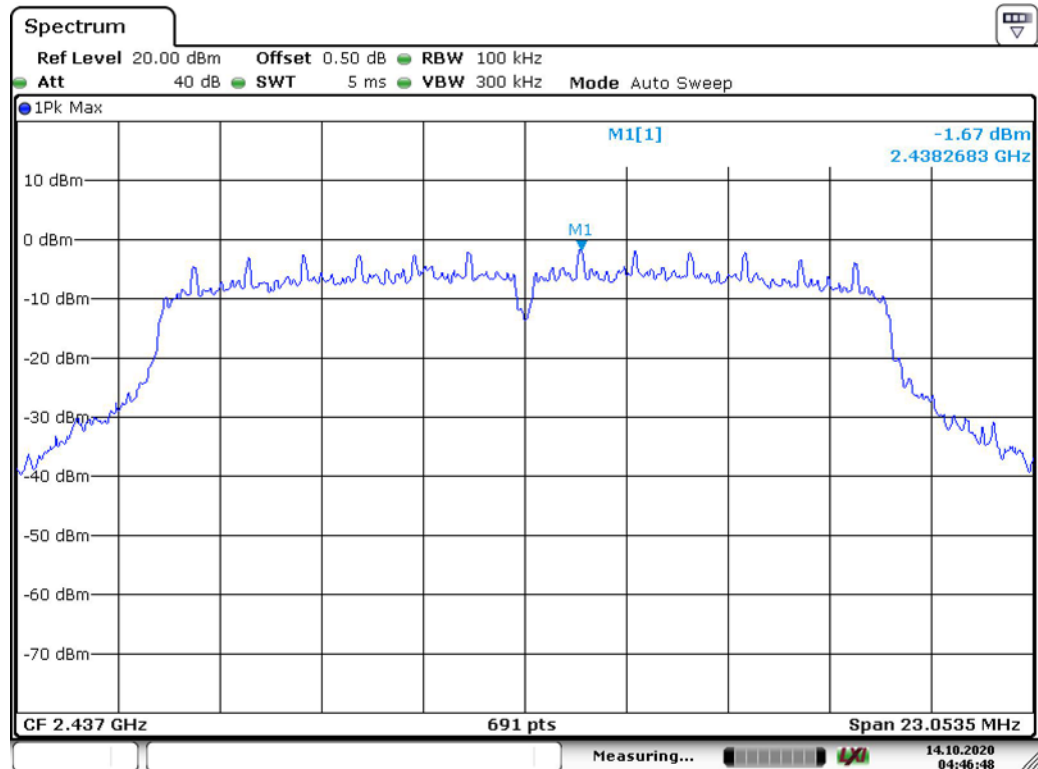

Date: 14.OCT.2020 04:46:49

TEST REPORT

PLOTS OF POWER SPECTRAL DENSITY

802.11g, Highest channel

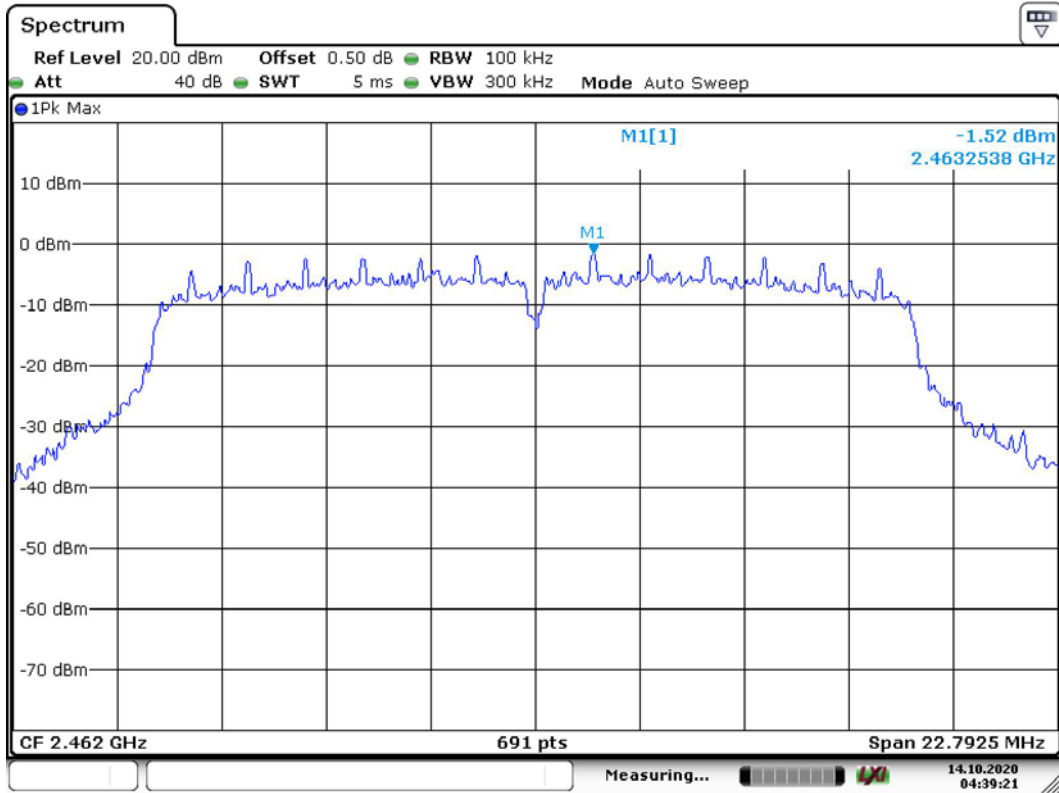

Date: 14.OCT.2020 04:39:22

TEST REPORT

PLOTS OF POWER SPECTRAL DENSITY

802.11n (20MHz), Lowest channel

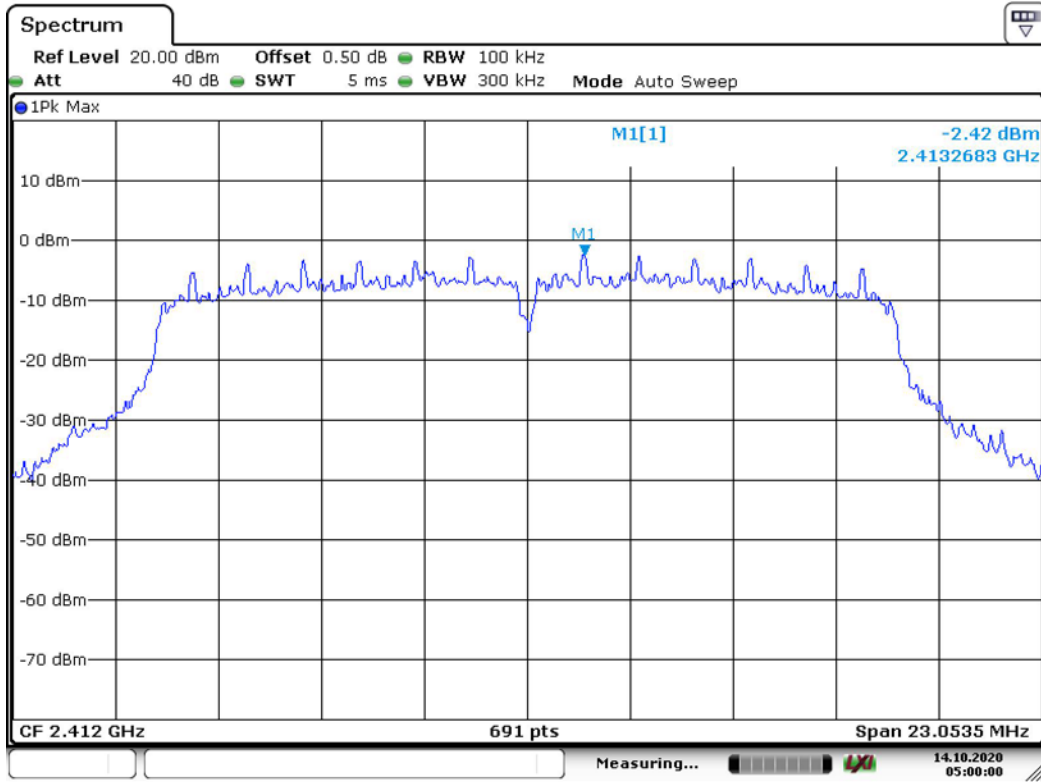

Date: 14.OCT.2020 05:00:01

802.11n (20MHz), Middle channel

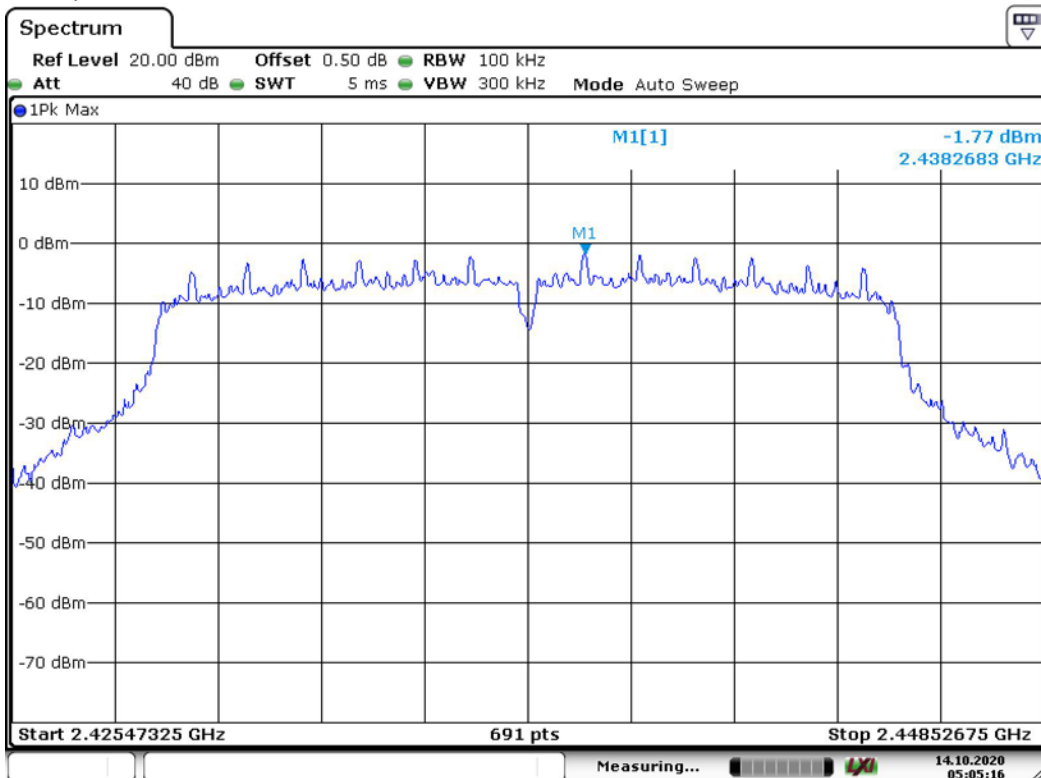

Date: 14.OCT.2020 05:05:17

TEST REPORT

PLOTS OF POWER SPECTRAL DENSITY

802.11n (20MHz), Highest channel

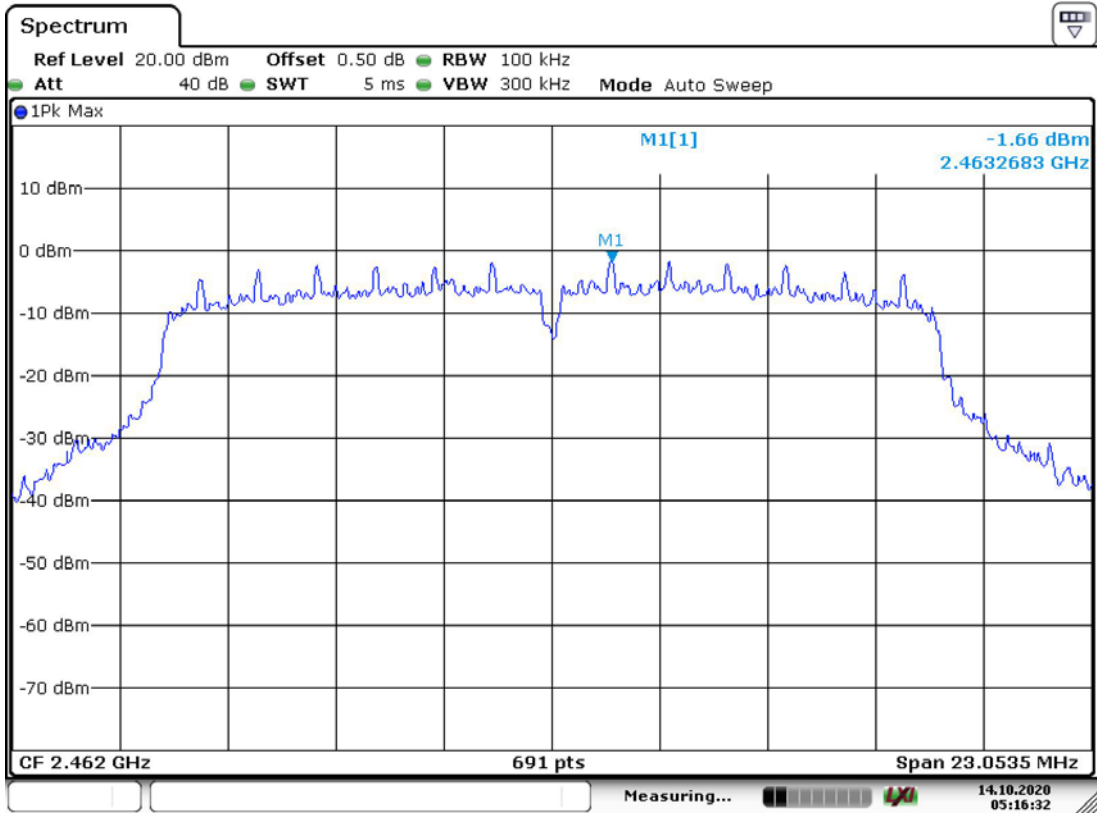

Date: 14.OCT.2020 05:16:33

TEST REPORT

PLOTS OF POWER SPECTRAL DENSITY

802.11n (40MHz), Lowest channel

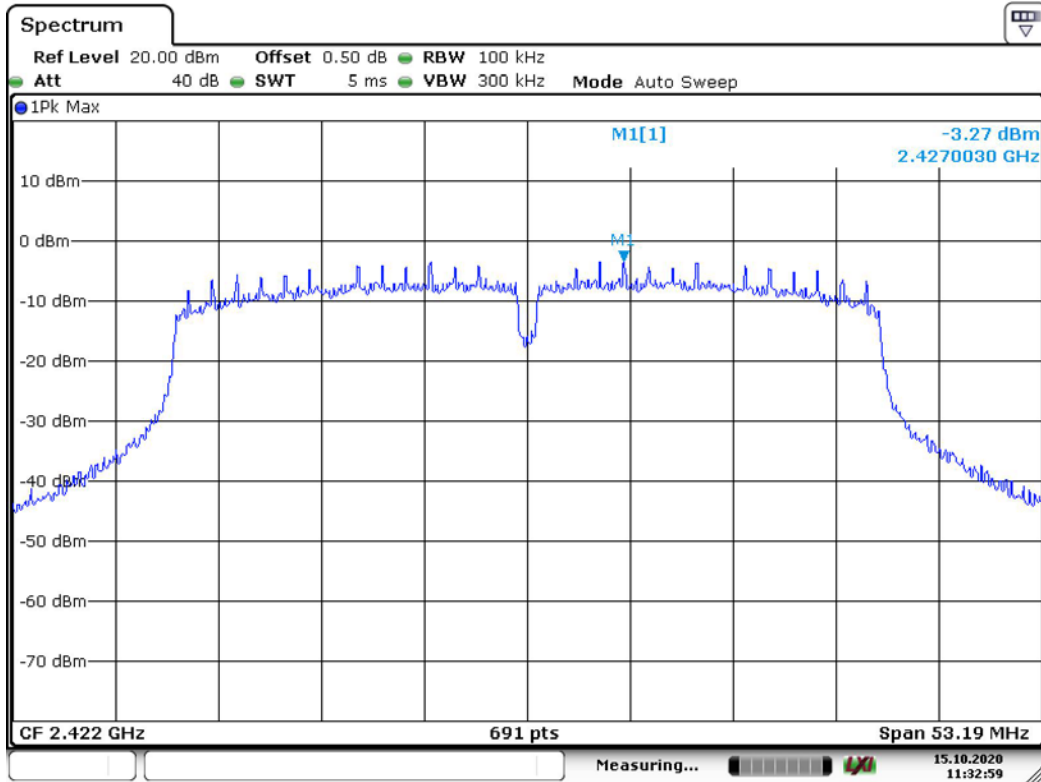

Date: 15.OCT.2020 11:32:59

802.11n (40MHz), Middle channel

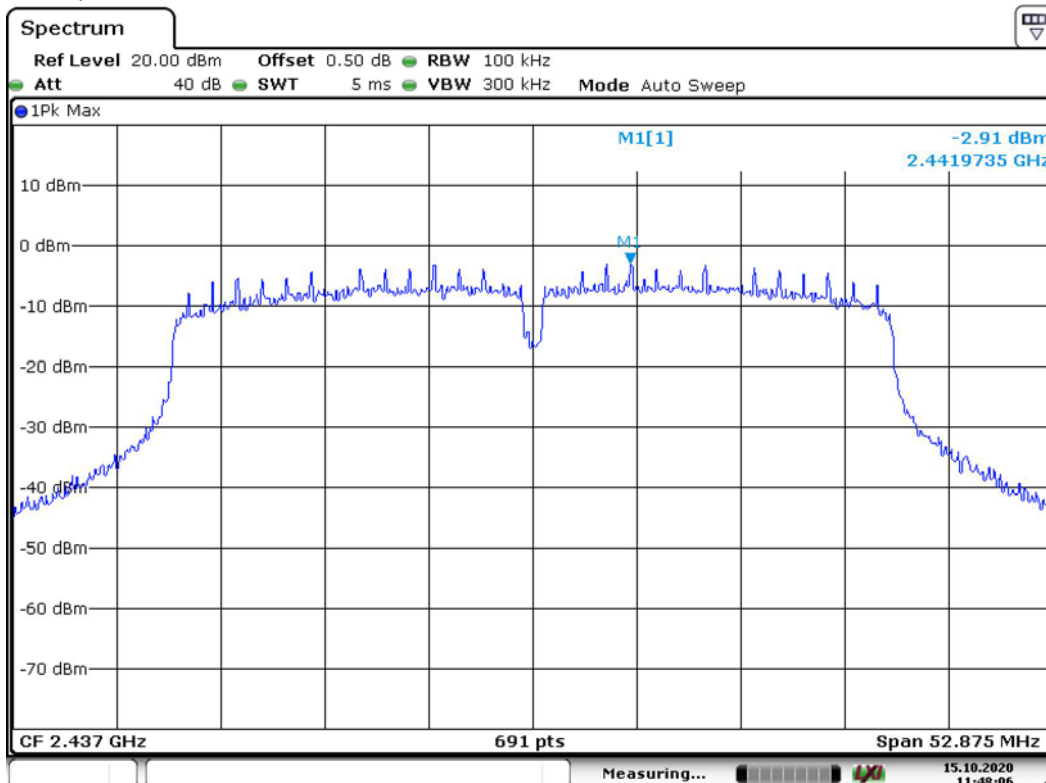

Date: 15.OCT.2020 11:48:06

TEST REPORT

PLOTS OF POWER SPECTRAL DENSITY

802.11n (20MHz), Highest channel

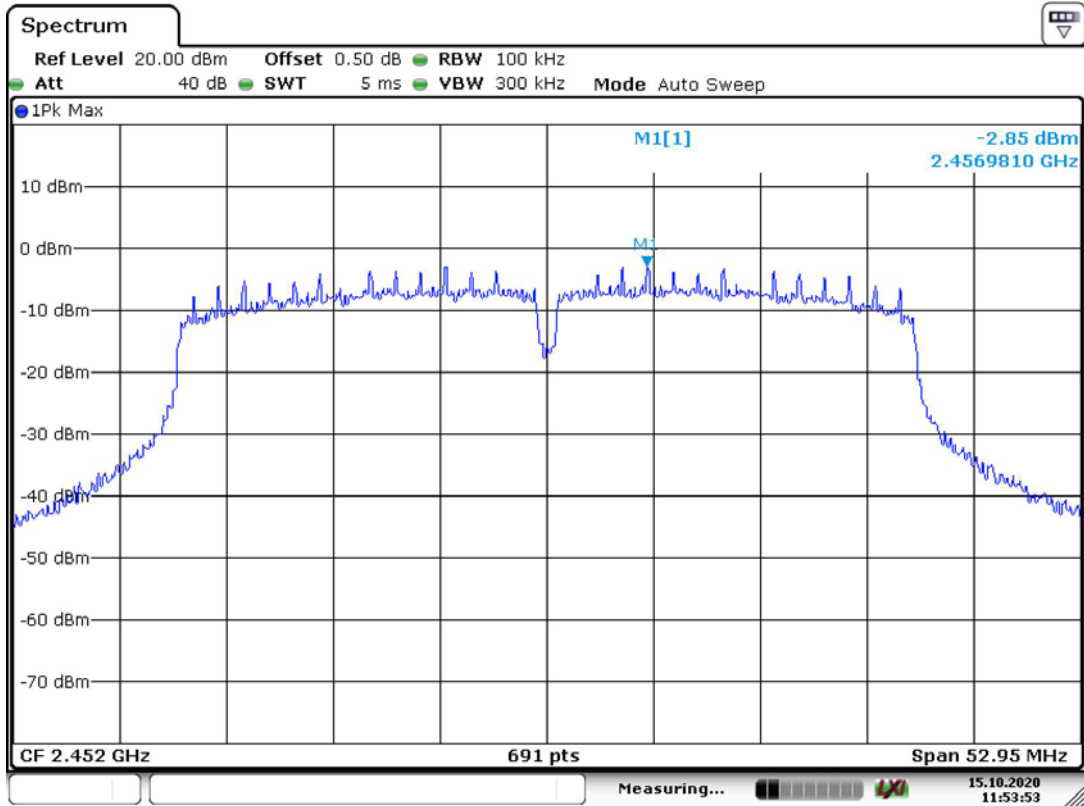

Date: 15.OCT.2020 11:53:53

TEST REPORT

4.4 Out of Band Conducted Emissions

The result is saved in the file **PLOTS OF OUT OF BAND CONDUCTED EMISSIONS.pdf**

For 802.11b/g/n20/n40MHz, the maximum conducted (peak) output power was used to demonstrate compliance as described in 9.1. Then the display line (in red) shown in the following plots denotes the limit at 20dB below maximum measured in-band peak PSD level in 100 KHz bandwidth for 802.11b/g/n20/n40MHz.

The measurement procedures under KDB Publication No.558074 D01 v05r01 (11-February-2019) were used.

Furthermore, delta measurement technique for measuring bandedge emissions was incorporated in the test of the edge at 2483.5MHz.

Limits:

All spurious emission and up to the tenth harmonic was measured and they were found to be at least 20dB below the maximum measured in-band peak PSD level for 802.11b,g,n20MHz, n40MHz.

TEST REPORT

4.5 Field Strength Calculation

The field strength is calculated by adding the reading on the Spectrum Analyzer to the factors associated with preamplifiers (if any), antennas, cables, pulse desensitization and average factors (when specified limit is in average and measurements are made with peak detectors). A sample calculation is included below.

$$FS = RA + AF + CF - AG + PD + AV$$

Where FS = Field Strength in dB μ V/m

RA = Receiver Amplitude (including preamplifier) in dB μ V

CF = Cable Attenuation Factor in dB

AF = Antenna Factor in dB

AG = Amplifier Gain in dB

PD = Pulse Desensitization in dB

AV = Average Factor in -dB

In the radiated emission table which follows, the reading shown on the data table may reflect the preamplifier gain. An example of the calculations, where the reading does not reflect the preamplifier gain, follows:

$$FS = RA + AF + CF - AG + PD + AV$$

Example

Assume a receiver reading of 62.0 dB μ V is obtained. The antenna factor of 7.4 dB and cable factor of 1.6 dB is added. The amplifier gain of 29.0 dB is subtracted. The pulse desensitization factor of the spectrum analyzer is 0.0 dB, and the resultant average factor is -10.0 dB. The net field strength for comparison to the appropriate emission limit is 32.0 dB μ V/m. This value in dB μ V/m is converted to its corresponding level in μ V/m.

$$RA = 62.0 \text{ dB}\mu\text{V}$$

$$AF = 7.4 \text{ dB}$$

$$CF = 1.6 \text{ dB}$$

$$AG = 29.0 \text{ dB}$$

$$PD = 0.0 \text{ dB}$$

$$AV = -10 \text{ dB}$$

$$FS = 62.0 + 7.4 + 1.6 - 29.0 + 0.0 + (-10.0) = 32.0 \text{ dB}\mu\text{V/m}$$

$$\text{Level in } \mu\text{V/m} = \text{Common Antilogarithm } [(32.0 \text{ dB}\mu\text{V/m})/20] = 39.8 \mu\text{V/m}$$

TEST REPORT

4.6 Transmitter Radiated Emissions in Restricted Bands and Spurious Emissions

Data is included of the worst case configuration (the configuration which resulted in the highest emission levels). A sample calculation, configuration photographs and data tables of the emissions are included.

The data on the following pages list the significant emission frequencies, the limit and the margin of compliance.

4.6.1 Radiated Emission Configuration Photograph

Worst Case Restricted Band Radiated Emission
at

2390.000 MHz

The worst case radiated emission configuration photographs are saved with filename: config photos.pdf

4.6.2 Radiated Emission Data

The data in tables 1-13 list the significant emission frequencies, the limit and the margin of compliance.

Judgement -

Passed by 0.2 dB margin

TEST REPORT

RADIATED EMISSION DATA

Mode: TX-Channel 01

Table 1
IEEE 802.11b (DSSS, 1 Mbps)

Polarization	Frequency (MHz)	Reading (dBμV)	Pre-Amp Gain (dB)	Antenna Factor (dB)	Net at 3m - Average (dBμV/m)	Average Limit at 3m (dBμV/m)	Margin (dB)
<i>H</i>	<i>2390.000</i>	<i>47.0</i>	<i>33</i>	<i>29.4</i>	<i>43.4</i>	<i>54.0</i>	<i>-10.6</i>
<i>H</i>	<i>4824.000</i>	<i>38.7</i>	<i>33</i>	<i>34.9</i>	<i>40.6</i>	<i>54.0</i>	<i>-13.4</i>
<i>H</i>	<i>12060.000</i>	<i>23.3</i>	<i>33</i>	<i>40.5</i>	<i>30.8</i>	<i>54.0</i>	<i>-23.2</i>

Polarization	Frequency (MHz)	Reading (dBμV)	Pre-Amp Gain (dB)	Antenna Factor (dB)	Net at 3m - Peak (dBμV/m)	Peak Limit at 3m (dBμV/m)	Margin (dB)
<i>H</i>	<i>2390.000</i>	<i>60.8</i>	<i>33</i>	<i>29.4</i>	<i>57.2</i>	<i>74.0</i>	<i>-16.8</i>
<i>H</i>	<i>4824.000</i>	<i>45.3</i>	<i>33</i>	<i>34.9</i>	<i>47.2</i>	<i>74.0</i>	<i>-26.8</i>
<i>H</i>	<i>12060.000</i>	<i>31.0</i>	<i>33</i>	<i>40.5</i>	<i>38.5</i>	<i>74.0</i>	<i>-35.5</i>

- NOTES:
1. Peak detector is used for the peak emission measurement.
 2. Average measurement method is according to ANSI C63.10
 3. All measurements were made at 3 meters.
 4. Negative value in the margin column shows emission below limit.
 5. Horn antenna is used for the emission over 1000MHz.
 6. Emission (the row indicated by ***bold italic***) within the restricted band meets the requirement of FCC Part 15 Section 15.205 / RSS-Gen 8.10.
 7. For the measurement of radiated emission, summation method was used which numerical integrating (in terms of linear power) over the transmitter occupied bandwidth.
 8. For the linear power measurement, data in 1MHz spacing was collected by spectrum analyzer with 1MHz resolution bandwidth.

TEST REPORT

Mode: TX-Channel 06

Table 2
IEEE 802.11b (DSSS, 1 Mbps)

Polari- zation	Frequency (MHz)	Reading (dBµV)	Pre-Amp Gain (dB)	Antenna Factor (dB)	Net at 3m - Average (dBµV/m)	Average Limit at 3m (dBµV/m)	Margin (dB)
<i>H</i>	<i>4874.000</i>	<i>37.9</i>	<i>33</i>	<i>34.9</i>	<i>39.8</i>	<i>54.0</i>	<i>-14.2</i>
<i>H</i>	<i>7311.000</i>	<i>25.1</i>	<i>33</i>	<i>37.9</i>	<i>30.0</i>	<i>54.0</i>	<i>-24.0</i>
<i>H</i>	<i>12185.000</i>	<i>22.5</i>	<i>33</i>	<i>40.5</i>	<i>30.0</i>	<i>54.0</i>	<i>-24.0</i>

Polari- zation	Frequency (MHz)	Reading (dBµV)	Pre-Amp Gain (dB)	Antenna Factor (dB)	Net at 3m - Peak (dBµV/m)	Peak Limit at 3m (dBµV/m)	Margin (dB)
<i>H</i>	<i>4874.000</i>	<i>44.7</i>	<i>33</i>	<i>34.9</i>	<i>46.6</i>	<i>74.0</i>	<i>-27.4</i>
<i>H</i>	<i>7311.000</i>	<i>33.5</i>	<i>33</i>	<i>37.9</i>	<i>38.4</i>	<i>74.0</i>	<i>-35.6</i>
<i>H</i>	<i>12185.000</i>	<i>30.7</i>	<i>33</i>	<i>40.5</i>	<i>38.2</i>	<i>74.0</i>	<i>-35.8</i>

- NOTES: 1. Peak detector is used for the peak emission measurement.
2. Average measurement method is according to ANSI C63.10
3. All measurements were made at 3 meters.
4. Negative value in the margin column shows emission below limit.
5. Horn antenna is used for the emission over 1000MHz.
6. Emission (the row indicated by ***bold italic***) within the restricted band meets the requirement of FCC Part 15 Section 15.205 / RSS-Gen 8.10.
7. For the measurement of radiated emission, summation method was used which numerical integrating (in terms of linear power) over the transmitter occupied bandwidth.
8. For the linear power measurement, data in 1MHz spacing was collected by spectrum analyzer with 1MHz resolution bandwidth.

TEST REPORT

Mode: TX-Channel 11

Table 3
IEEE 802.11b (DSSS, 1 Mbps)

Polari- zation	Frequency (MHz)	Reading (dBµV)	Pre-Amp Gain (dB)	Antenna Factor (dB)	Net at 3m - Average (dBµV/m)	Average Limit at 3m (dBµV/m)	Margin (dB)
<i>H</i>	<i>2483.500</i>	<i>46.0</i>	<i>33</i>	<i>29.4</i>	<i>42.4</i>	<i>54.0</i>	<i>-11.6</i>
<i>H</i>	<i>4924.000</i>	<i>36.9</i>	<i>33</i>	<i>34.9</i>	<i>38.8</i>	<i>54.0</i>	<i>-15.2</i>
<i>H</i>	<i>7386.000</i>	<i>25.9</i>	<i>33</i>	<i>37.9</i>	<i>30.8</i>	<i>54.0</i>	<i>-23.2</i>
<i>H</i>	<i>12310.000</i>	<i>23.3</i>	<i>33</i>	<i>40.5</i>	<i>30.8</i>	<i>54.0</i>	<i>-23.2</i>

Polari- zation	Frequency (MHz)	Reading (dBµV)	Pre-Amp Gain (dB)	Antenna Factor (dB)	Net at 3m - Peak (dBµV/m)	Peak Limit at 3m (dBµV/m)	Margin (dB)
<i>H</i>	<i>2483.500</i>	<i>60.4</i>	<i>33</i>	<i>29.4</i>	<i>56.8</i>	<i>74.0</i>	<i>-17.2</i>
<i>H</i>	<i>4924.000</i>	<i>44.3</i>	<i>33</i>	<i>34.9</i>	<i>46.2</i>	<i>74.0</i>	<i>-27.8</i>
<i>H</i>	<i>7386.000</i>	<i>33.6</i>	<i>33</i>	<i>37.9</i>	<i>38.5</i>	<i>74.0</i>	<i>-35.5</i>
<i>H</i>	<i>12310.000</i>	<i>30.9</i>	<i>33</i>	<i>40.5</i>	<i>38.4</i>	<i>74.0</i>	<i>-35.6</i>

- NOTES:
1. Peak detector is used for the peak emission measurement.
 2. Average measurement method is according to ANSI C63.10
 3. All measurements were made at 3 meters.
 4. Negative value in the margin column shows emission below limit.
 5. Horn antenna is used for the emission over 1000MHz.
 6. Emission (the row indicated by ***bold italic***) within the restricted band meets the requirement of FCC Part 15 Section 15.205 / RSS-Gen 8.10.
 7. For the measurement of radiated emission, summation method was used which numerical integrating (in terms of linear power) over the transmitter occupied bandwidth.
 8. For the linear power measurement, data in 1MHz spacing was collected by spectrum analyzer with 1MHz resolution bandwidth.

TEST REPORT

Mode: TX-Channel 01

Table 4
IEEE 802.11g (OFDM, 6 Mbps)

Polari- zation	Frequency (MHz)	Reading (dBμV)	Pre-Amp Gain (dB)	Antenna Factor (dB)	Net at 3m - Average (dBμV/m)	Average Limit at 3m (dBμV/m)	Margin (dB)
<i>H</i>	<i>2390.000</i>	<i>55.0</i>	<i>33</i>	<i>29.4</i>	<i>51.4</i>	<i>54.0</i>	<i>-2.6</i>
<i>H</i>	<i>4824.000</i>	<i>28.9</i>	<i>33</i>	<i>34.9</i>	<i>30.8</i>	<i>54.0</i>	<i>-23.2</i>
<i>H</i>	<i>12060.000</i>	<i>23.3</i>	<i>33</i>	<i>40.5</i>	<i>30.8</i>	<i>54.0</i>	<i>-23.2</i>

Polari- zation	Frequency (MHz)	Reading (dBμV)	Pre-Amp Gain (dB)	Antenna Factor (dB)	Net at 3m - Peak (dBμV/m)	Peak Limit at 3m (dBμV/m)	Margin (dB)
<i>H</i>	<i>2390.000</i>	<i>70.6</i>	<i>33</i>	<i>29.4</i>	<i>67.0</i>	<i>74.0</i>	<i>-7.0</i>
<i>H</i>	<i>4824.000</i>	<i>36.6</i>	<i>33</i>	<i>34.9</i>	<i>38.5</i>	<i>74.0</i>	<i>-35.5</i>
<i>H</i>	<i>12060.000</i>	<i>31.0</i>	<i>33</i>	<i>40.5</i>	<i>38.5</i>	<i>74.0</i>	<i>-35.5</i>

- NOTES: 1. Peak detector is used for the peak emission measurement.
2. Average measurement method is according to ANSI C63.10
3. All measurements were made at 3 meters.
4. Negative value in the margin column shows emission below limit.
5. Horn antenna is used for the emission over 1000MHz.
6. Emission (the row indicated by ***bold italic***) within the restricted band meets the requirement of FCC Part 15 Section 15.205 / RSS-Gen 8.10.
7. For the measurement of radiated emission, summation method was used which numerical integrating (in terms of linear power) over the transmitter occupied bandwidth.
8. For the linear power measurement, data in 1MHz spacing was collected by spectrum analyzer with 1MHz resolution bandwidth.

TEST REPORT

Mode: TX-Channel 06

Table 5
IEEE 802.11g (OFDM, 6 Mbps)

Polari- zation	Frequency (MHz)	Reading (dBµV)	Pre-Amp Gain (dB)	Antenna Factor (dB)	Net at 3m - Average (dBµV/m)	Average Limit at 3m (dBµV/m)	Margin (dB)
<i>H</i>	<i>4874.000</i>	<i>27.3</i>	<i>33</i>	<i>34.9</i>	<i>29.2</i>	<i>54.0</i>	<i>-24.8</i>
<i>H</i>	<i>7311.000</i>	<i>25.1</i>	<i>33</i>	<i>37.9</i>	<i>30.0</i>	<i>54.0</i>	<i>-24.0</i>
<i>H</i>	<i>12185.000</i>	<i>22.5</i>	<i>33</i>	<i>40.5</i>	<i>30.0</i>	<i>54.0</i>	<i>-24.0</i>

Polari- zation	Frequency (MHz)	Reading (dBµV)	Pre-Amp Gain (dB)	Antenna Factor (dB)	Net at 3m - Peak (dBµV/m)	Peak Limit at 3m (dBµV/m)	Margin (dB)
<i>H</i>	<i>4874.000</i>	<i>36.5</i>	<i>33</i>	<i>34.9</i>	<i>38.4</i>	<i>74.0</i>	<i>-35.6</i>
<i>H</i>	<i>7311.000</i>	<i>33.3</i>	<i>33</i>	<i>37.9</i>	<i>38.2</i>	<i>74.0</i>	<i>-35.8</i>
<i>H</i>	<i>12185.000</i>	<i>30.5</i>	<i>33</i>	<i>40.5</i>	<i>38.0</i>	<i>74.0</i>	<i>-36.0</i>

- NOTES:
1. Peak detector is used for the peak emission measurement.
 2. Average measurement method is according to ANSI C63.10
 3. All measurements were made at 3 meters.
 4. Negative value in the margin column shows emission below limit.
 5. Horn antenna is used for the emission over 1000MHz.
 6. Emission (the row indicated by ***bold italic***) within the restricted band meets the requirement of FCC Part 15 Section 15.205 / RSS-Gen 8.10.
 7. For the measurement of radiated emission, summation method was used which numerical integrating (in terms of linear power) over the transmitter occupied bandwidth.
 8. For the linear power measurement, data in 1MHz spacing was collected by spectrum analyzer with 1MHz resolution bandwidth.

TEST REPORT

Mode: TX-Channel 11

Table 6
IEEE 802.11g (OFDM, 6 Mbps)

Polarization	Frequency (MHz)	Reading (dBμV)	Pre-Amp Gain (dB)	Antenna Factor (dB)	Net at 3m - Average (dBμV/m)	Average Limit at 3m (dBμV/m)	Margin (dB)
<i>H</i>	2483.500	46.4	33	29.4	42.8	54.0	-11.2
<i>H</i>	4924.000	27.7	33	34.9	29.6	54.0	-24.4
<i>H</i>	7386.000	25.9	33	37.9	30.8	54.0	-23.2
<i>H</i>	12310.000	23.1	33	40.5	30.6	54.0	-23.4

Polarization	Frequency (MHz)	Reading (dBμV)	Pre-Amp Gain (dB)	Antenna Factor (dB)	Net at 3m - Peak (dBμV/m)	Peak Limit at 3m (dBμV/m)	Margin (dB)
<i>H</i>	2483.500	61.1	33	29.4	57.5	74.0	-16.5
<i>H</i>	4924.000	36.9	33	34.9	38.8	74.0	-35.2
<i>H</i>	7386.000	33.6	33	37.9	38.5	74.0	-35.5
<i>H</i>	12310.000	30.9	33	40.5	38.4	74.0	-35.6

- NOTES:
1. Peak detector is used for the peak emission measurement.
 2. Average measurement method is according to ANSI C63.10
 3. All measurements were made at 3 meters.
 4. Negative value in the margin column shows emission below limit.
 5. Horn antenna is used for the emission over 1000MHz.
 6. Emission (the row indicated by ***bold italic***) within the restricted band meets the requirement of FCC Part 15 Section 15.205 / RSS-Gen 8.10.
 7. For the measurement of radiated emission, summation method was used which numerical integrating (in terms of linear power) over the transmitter occupied bandwidth.
 8. For the linear power measurement, data in 1MHz spacing was collected by spectrum analyzer with 1MHz resolution bandwidth.

TEST REPORT

Mode: TX-Channel 01

Table 7
IEEE 802.11n (20MHz) (OFDM, MCS0)

Polarization	Frequency (MHz)	Reading (dBμV)	Pre-Amp Gain (dB)	Antenna Factor (dB)	Net at 3m - Average (dBμV/m)	Average Limit at 3m (dBμV/m)	Margin (dB)
H	2390.000	54.4	33	29.4	50.8	54.0	-3.2
H	4824.000	28.3	33	34.9	30.2	54.0	-23.8
H	12060.000	23.3	33	40.5	30.8	54.0	-23.2

Polarization	Frequency (MHz)	Reading (dBμV)	Pre-Amp Gain (dB)	Antenna Factor (dB)	Net at 3m - Peak (dBμV/m)	Peak Limit at 3m (dBμV/m)	Margin (dB)
H	2390.000	70.6	33	29.4	67.0	74.0	-7.0
H	4824.000	36.3	33	34.9	38.2	74.0	-35.8
H	12060.000	31.0	33	40.5	38.5	74.0	-35.5

- NOTES:
1. Peak detector is used for the peak emission measurement.
 2. Average measurement method is according to ANSI C63.10
 3. All measurements were made at 3 meters.
 4. Negative value in the margin column shows emission below limit.
 5. Horn antenna is used for the emission over 1000MHz.
 6. Emission (the row indicated by **bold italic**) within the restricted band meets the requirement of FCC Part 15 Section 15.205 / RSS-Gen 8.10.
 7. For the measurement of radiated emission, summation method was used which numerical integrating (in terms of linear power) over the transmitter occupied bandwidth.
 8. For the linear power measurement, data in 1MHz spacing was collected by spectrum analyzer with 1MHz resolution bandwidth.

TEST REPORT

Mode: TX-Channel 06

Table 8
IEEE 802.11n (20MHz) (OFDM, MCS0)

Polarization	Frequency (MHz)	Reading (dBμV)	Pre-Amp Gain (dB)	Antenna Factor (dB)	Net at 3m - Average (dBμV/m)	Average Limit at 3m (dBμV/m)	Margin (dB)
H	4874.000	28.9	33	34.9	30.8	54.0	-23.2
H	7311.000	25.1	33	37.9	30.0	54.0	-24.0
H	12185.000	22.5	33	40.5	30.0	54.0	-24.0

Polarization	Frequency (MHz)	Reading (dBμV)	Pre-Amp Gain (dB)	Antenna Factor (dB)	Net at 3m - Peak (dBμV/m)	Peak Limit at 3m (dBμV/m)	Margin (dB)
H	4874.000	36.7	33	34.9	38.6	74.0	-35.4
H	7311.000	33.5	33	37.9	38.4	74.0	-35.6
H	12185.000	30.7	33	40.5	38.2	74.0	-35.8

- NOTES:
1. Peak detector is used for the peak emission measurement.
 2. Average measurement method is according to ANSI C63.10
 3. All measurements were made at 3 meters.
 4. Negative value in the margin column shows emission below limit.
 5. Horn antenna is used for the emission over 1000MHz.
 6. Emission (the row indicated by **bold italic**) within the restricted band meets the requirement of FCC Part 15 Section 15.205 / RSS-Gen 8.10.
 7. For the measurement of radiated emission, summation method was used which numerical integrating (in terms of linear power) over the transmitter occupied bandwidth.
 8. For the linear power measurement, data in 1MHz spacing was collected by spectrum analyzer with 1MHz resolution bandwidth.

TEST REPORT

Mode: TX-Channel 11

Table 9
IEEE 802.11n (20MHz) (OFDM, MCS0)

Polarization	Frequency (MHz)	Reading (dBμV)	Pre-Amp Gain (dB)	Antenna Factor (dB)	Net at 3m - Average (dBμV/m)	Average Limit at 3m (dBμV/m)	Margin (dB)
<i>H</i>	2483.500	46.6	33	29.4	43.0	54.0	-11.0
<i>H</i>	4924.000	28.5	33	34.9	30.4	54.0	-23.6
<i>H</i>	7386.000	25.9	33	37.9	30.8	54.0	-23.2
<i>H</i>	12310.000	23.1	33	40.5	30.6	54.0	-23.4

Polarization	Frequency (MHz)	Reading (dBμV)	Pre-Amp Gain (dB)	Antenna Factor (dB)	Net at 3m - Peak (dBμV/m)	Peak Limit at 3m (dBμV/m)	Margin (dB)
<i>H</i>	2483.500	61.4	33	29.4	57.8	74.0	-16.2
<i>H</i>	4924.000	36.3	33	34.9	38.2	74.0	-35.8
<i>H</i>	7386.000	33.6	33	37.9	38.5	74.0	-35.5
<i>H</i>	12310.000	30.9	33	40.5	38.4	74.0	-35.6

- NOTES: 1. Peak detector is used for the peak emission measurement.
2. Average measurement method is according to ANSI C63.10
3. All measurements were made at 3 meters. Radiated emissions not detected at the 3-meter distance were measured at 0.3-meter and an inverse proportional extrapolation was performed to compare the signal level to the 3-meter limit. No other radiated emissions than those reported were detected at a test distance of 0.3-meter.
4. Negative value in the margin column shows emission below limit.
5. Horn antenna is used for the emission over 1000MHz.
6. Emission (the row indicated by **bold italic**) within the restricted band meets the requirement of FCC Part 15 Section 15.205 / RSS-Gen 8.10.
7. For the measurement of radiated emission, summation method was used which numerical integrating (in terms of linear power) over the transmitter occupied bandwidth.
8. For the linear power measurement, data in 1MHz spacing was collected by spectrum analyzer with 1MHz resolution bandwidth.

TEST REPORT

Mode: TX-Channel 01

Table 10
IEEE 802.11n (40MHz) (OFDM, MCS0)

Polarization	Frequency (MHz)	Reading (dBμV)	Pre-Amp Gain (dB)	Antenna Factor (dB)	Net at 3m - Average (dBμV/m)	Average Limit at 3m (dBμV/m)	Margin (dB)
<i>H</i>	<i>2390.000</i>	<i>56.8</i>	<i>33</i>	<i>29.4</i>	<i>53.2</i>	<i>54.0</i>	<i>-0.8</i>
<i>H</i>	<i>4844.000</i>	<i>28.5</i>	<i>33</i>	<i>34.9</i>	<i>30.4</i>	<i>54.0</i>	<i>-23.6</i>
<i>H</i>	<i>12110.000</i>	<i>23.3</i>	<i>33</i>	<i>40.5</i>	<i>30.8</i>	<i>54.0</i>	<i>-23.2</i>

Polarization	Frequency (MHz)	Reading (dBμV)	Pre-Amp Gain (dB)	Antenna Factor (dB)	Net at 3m - Peak (dBμV/m)	Peak Limit at 3m (dBμV/m)	Margin (dB)
<i>H</i>	<i>2390.000</i>	<i>77.4</i>	<i>33</i>	<i>29.4</i>	<i>73.8</i>	<i>74.0</i>	<i>-0.2</i>
<i>H</i>	<i>4844.000</i>	<i>36.9</i>	<i>33</i>	<i>34.9</i>	<i>38.8</i>	<i>74.0</i>	<i>-35.2</i>
<i>H</i>	<i>12110.000</i>	<i>31.0</i>	<i>33</i>	<i>40.5</i>	<i>38.5</i>	<i>74.0</i>	<i>-35.5</i>

- NOTES:
1. Peak detector is used for the peak emission measurement.
 2. Average measurement method is according to ANSI C63.10
 3. All measurements were made at 3 meters.
 4. Negative value in the margin column shows emission below limit.
 5. Horn antenna is used for the emission over 1000MHz.
 6. Emission (the row indicated by ***bold italic***) within the restricted band meets the requirement of FCC Part 15 Section 15.205 / RSS-Gen 8.10.
 7. For the measurement of radiated emission, summation method was used which numerical integrating (in terms of linear power) over the transmitter occupied bandwidth.
 8. For the linear power measurement, data in 1MHz spacing was collected by spectrum analyzer with 1MHz resolution bandwidth.

TEST REPORT

Mode: TX-Channel 06

Table 11
IEEE 802.11n (40MHz) (OFDM, MCS0)

Polarization	Frequency (MHz)	Reading (dBμV)	Pre-Amp Gain (dB)	Antenna Factor (dB)	Net at 3m - Average (dBμV/m)	Average Limit at 3m (dBμV/m)	Margin (dB)
<i>H</i>	<i>4874.000</i>	<i>28.3</i>	<i>33</i>	<i>34.9</i>	<i>30.2</i>	<i>54.0</i>	<i>-23.8</i>
<i>H</i>	<i>7311.000</i>	<i>25.1</i>	<i>33</i>	<i>37.9</i>	<i>30.0</i>	<i>54.0</i>	<i>-24.0</i>
<i>H</i>	<i>12185.000</i>	<i>22.5</i>	<i>33</i>	<i>40.5</i>	<i>30.0</i>	<i>54.0</i>	<i>-24.0</i>

Polarization	Frequency (MHz)	Reading (dBμV)	Pre-Amp Gain (dB)	Antenna Factor (dB)	Net at 3m - Peak (dBμV/m)	Peak Limit at 3m (dBμV/m)	Margin (dB)
<i>H</i>	<i>4874.000</i>	<i>36.9</i>	<i>33</i>	<i>34.9</i>	<i>38.8</i>	<i>74.0</i>	<i>-35.2</i>
<i>H</i>	<i>7311.000</i>	<i>33.5</i>	<i>33</i>	<i>37.9</i>	<i>38.4</i>	<i>74.0</i>	<i>-35.6</i>
<i>H</i>	<i>12185.000</i>	<i>30.7</i>	<i>33</i>	<i>40.5</i>	<i>38.2</i>	<i>74.0</i>	<i>-35.8</i>

- NOTES:
1. Peak detector is used for the peak emission measurement.
 2. Average measurement method is according to ANSI C63.10
 3. All measurements were made at 3 meters.
 4. Negative value in the margin column shows emission below limit.
 5. Horn antenna is used for the emission over 1000MHz.
 6. Emission (the row indicated by ***bold italic***) within the restricted band meets the requirement of FCC Part 15 Section 15.205 / RSS-Gen 8.10.
 7. For the measurement of radiated emission, summation method was used which numerical integrating (in terms of linear power) over the transmitter occupied bandwidth.
 8. For the linear power measurement, data in 1MHz spacing was collected by spectrum analyzer with 1MHz resolution bandwidth.

TEST REPORT

Mode: TX-Channel 11

Table 12
IEEE 802.11n (40MHz) (OFDM, MCS0)

Polarization	Frequency (MHz)	Reading (dBμV)	Pre-Amp Gain (dB)	Antenna Factor (dB)	Net at 3m - Average (dBμV/m)	Average Limit at 3m (dBμV/m)	Margin (dB)
H	2483.500	49.0	33	29.4	45.4	54.0	-8.6
H	4904.000	28.9	33	34.9	30.8	54.0	-23.2
H	7356.000	25.9	33	37.9	30.8	54.0	-23.2
H	12260.000	23.1	33	40.5	30.6	54.0	-23.4

Polarization	Frequency (MHz)	Reading (dBμV)	Pre-Amp Gain (dB)	Antenna Factor (dB)	Net at 3m - Peak (dBμV/m)	Peak Limit at 3m (dBμV/m)	Margin (dB)
H	2483.500	70.4	33	29.4	66.8	74.0	-7.2
H	4904.000	36.5	33	34.9	38.4	74.0	-35.6
H	7356.000	33.6	33	37.9	38.5	74.0	-35.5
H	12260.000	30.9	33	40.5	38.4	74.0	-35.6

- NOTES: 1. Peak detector is used for the peak emission measurement.
2. Average measurement method is according to ANSI C63.10
3. All measurements were made at 3 meters.
4. Negative value in the margin column shows emission below limit.
5. Horn antenna is used for the emission over 1000MHz.
6. Emission (the row indicated by **bold italic**) within the restricted band meets the requirement of FCC Part 15 Section 15.205 / RSS-Gen 8.10.
7. For the measurement of radiated emission, summation method was used which numerical integrating (in terms of linear power) over the transmitter occupied bandwidth.
8. For the linear power measurement, data in 1MHz spacing was collected by spectrum analyzer with 1MHz resolution bandwidth.

TEST REPORT

Mode: WIFI Operating and Audio Playing

Table 13

Polarization	Frequency (MHz)	Reading (dBµV)	Pre-amp (dB)	Antenna Factor (dB)	Net at 3m (dBµV/m)	Limit at 3m (dBµV/m)	Margin (dB)
V	131.763	28.8	16	14.0	26.8	43.5	-16.7
H	211.956	30.7	16	17.0	31.7	43.5	-11.8
H	249.981	30.1	16	20.0	34.1	46.0	-12.0
H	445.469	25.7	16	26.0	35.7	46.0	-10.3
H	499.947	25.0	16	26.0	35.0	46.0	-11.0
H	750.034	22.5	16	30.0	36.5	46.0	-9.5

- NOTES:
1. Quasi-Peak detector is used for the emission measurement.
 2. All measurements were made at 3 meters.
 3. Negative value in the margin column shows emission below limit.
 4. Emission (the row indicated by **bold italic**) within the restricted band meets the requirement of FCC Part 15 Section 15.205 / RSS-Gen Section 8.10.

TEST REPORT

4.6.3 Radiated Emission Test Setup

The figure below shows the test setup, which is utilized to make these measurements.

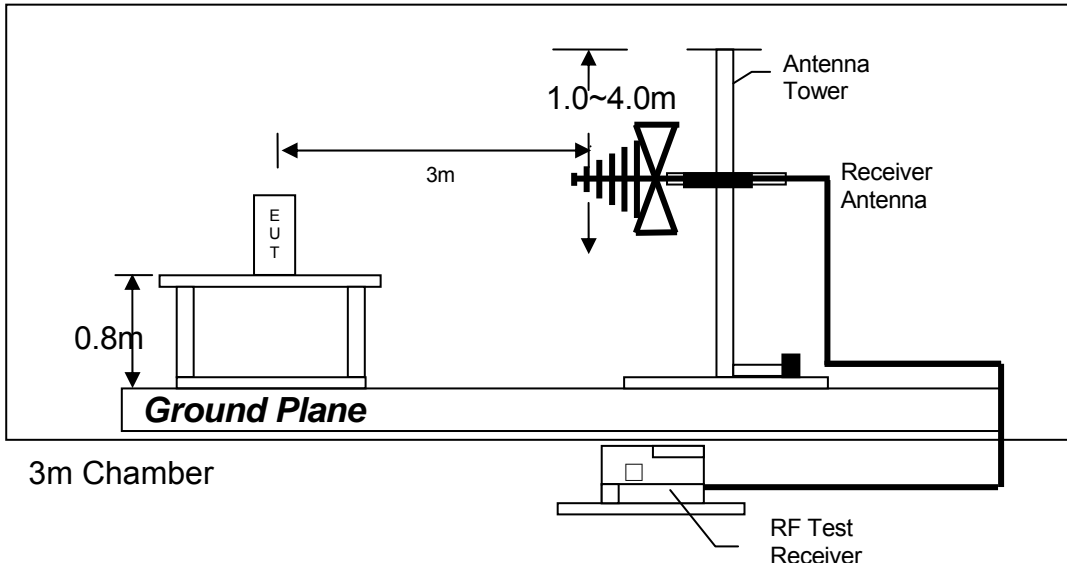

Test setup of radiated emissions up to 1GHz

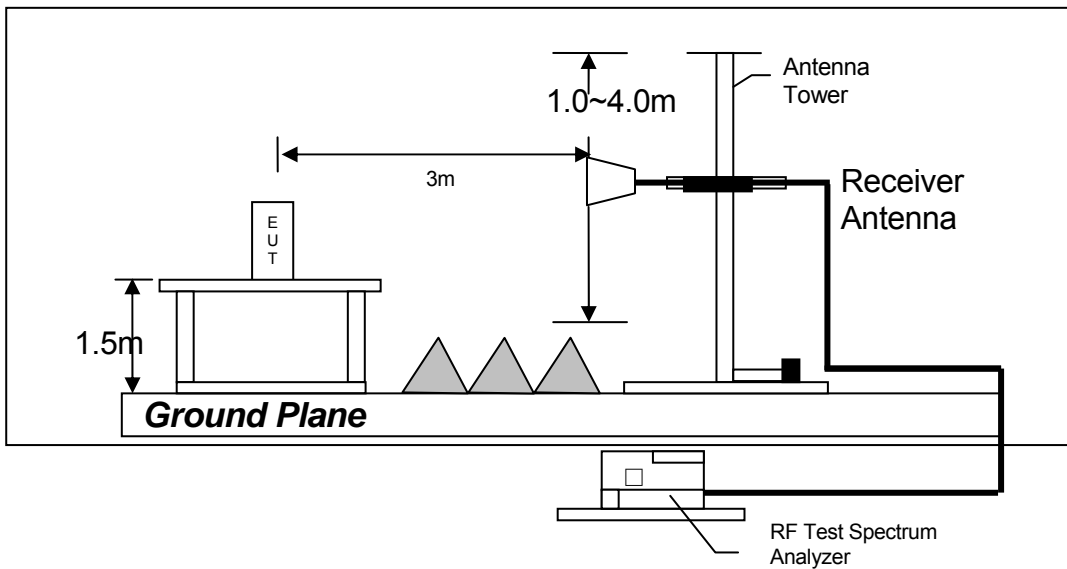

Test setup of radiated emissions above 1GHz

TEST REPORT

4.6.4 Transmitter Duty Cycle Calculation

Not applicable – No average factor is required.

TEST REPORT

4.7 AC Power Line Conducted Emission

- Not applicable – EUT is only powered by battery for operation.
- EUT connects to AC power line. Emission Data is listed in following pages.

- Base Unit connects to AC power line and has transmission. Handset connects to AC power line but has no transmission. Emission Data of Base Unit is listed in following pages.

4.7.1 AC Power Line Conducted Emission Configuration Photograph

Worst Case Line-Conducted Configuration
at

0.582 MHz

The worst-case line conducted configuration photographs are attached in the Appendix and saved with filename: config photos.pdf

4.7.2 AC Power Line Conducted Emission Data

The plot(s) and data in the following pages list the significant emission frequencies, the limit and the margin of compliance.

Passed by 7.0 dB margin

TEST REPORT

AC POWER LINE CONDUCTED EMISSION

Worst Case: WIFI Operating and Audio Playing

EDIT PEAK LIST (Final Measurement Results)					
TRACE		FREQUENCY	LEVEL dBµV		DELTA LIMIT dB
Trace1:	CF15MQP				
Trace2:	CF15MAV				
Trace3:	---				
1	Quasi Peak	168 kHz	53.12	N	-11.93
2	CISPR Average	195 kHz	37.22	N	-16.60
1	Quasi Peak	231 kHz	45.40	N	-17.01
2	CISPR Average	258 kHz	36.99	N	-14.50
1	Quasi Peak	316.5 kHz	34.14	L1	-25.65
2	CISPR Average	325.5 kHz	35.86	L1	-13.70
1	Quasi Peak	550.5 kHz	42.39	N	-13.60
2	CISPR Average	550.5 kHz	38.44	N	-7.55
1	Quasi Peak	582 kHz	43.10	N	-12.89
2	CISPR Average	582 kHz	39.04	N	-6.95
2	CISPR Average	973.5 kHz	28.60	N	-17.39
2	CISPR Average	1.491 MHz	27.63	L1	-18.36
2	CISPR Average	1.554 MHz	27.85	N	-18.14
2	CISPR Average	2.1705 MHz	26.62	L1	-19.38

Date: 16.NOV.2020 16:46:22

TEST REPORT

Worst Case: WIFI Operating and Audio Playing



RBW 9 kHz

MT 1 s

Att 10 dB AUTO PREAMP OFF

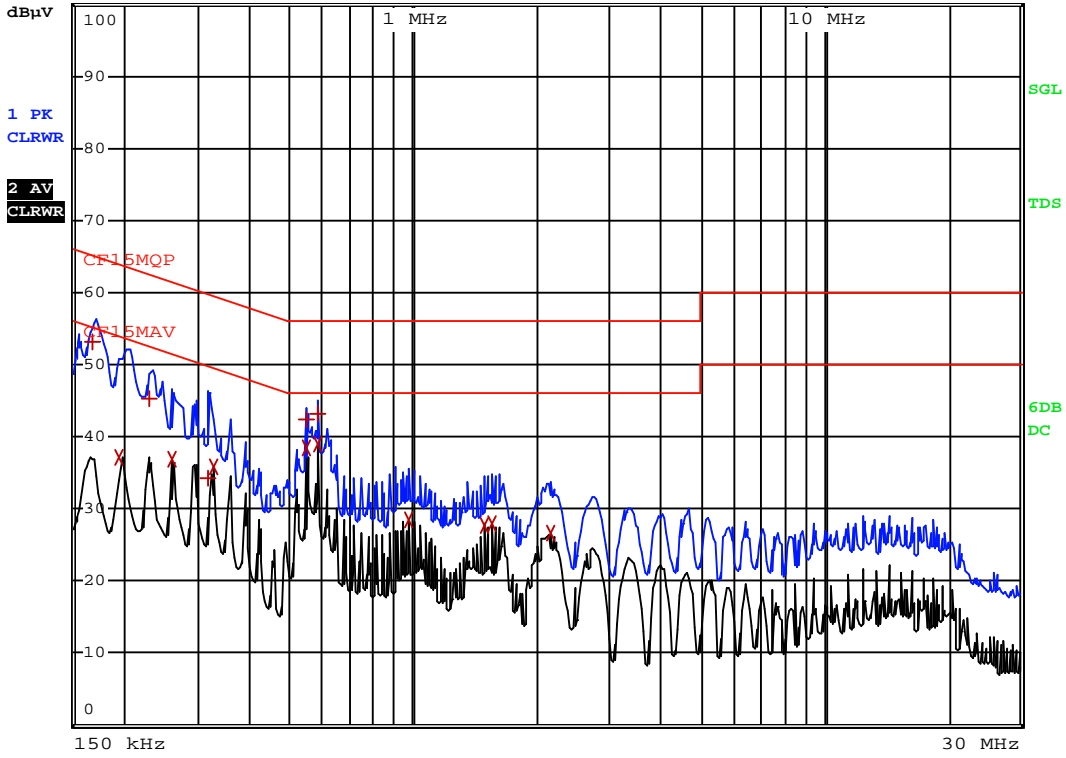

Date: 16.NOV.2020 16:46:40

TEST REPORT

4.7.3 Conducted Emission Test Setup

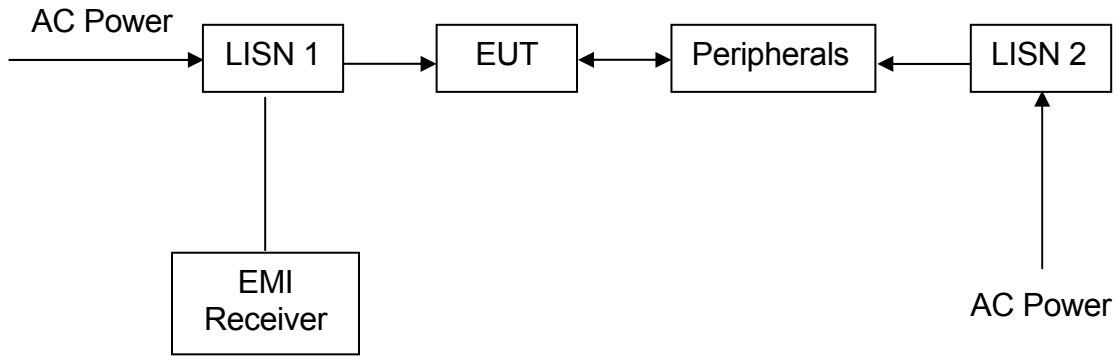

TEST REPORT

4.8 Occupied Bandwidth

Occupied Bandwidth Results: (802.11b)

(802.11b)	Occupied Bandwidth (MHz)
Low Channel: 2412	13.068
Middle Channel: 2437	13.068
High Channel: 2462	13.068

The worst case is shown as below

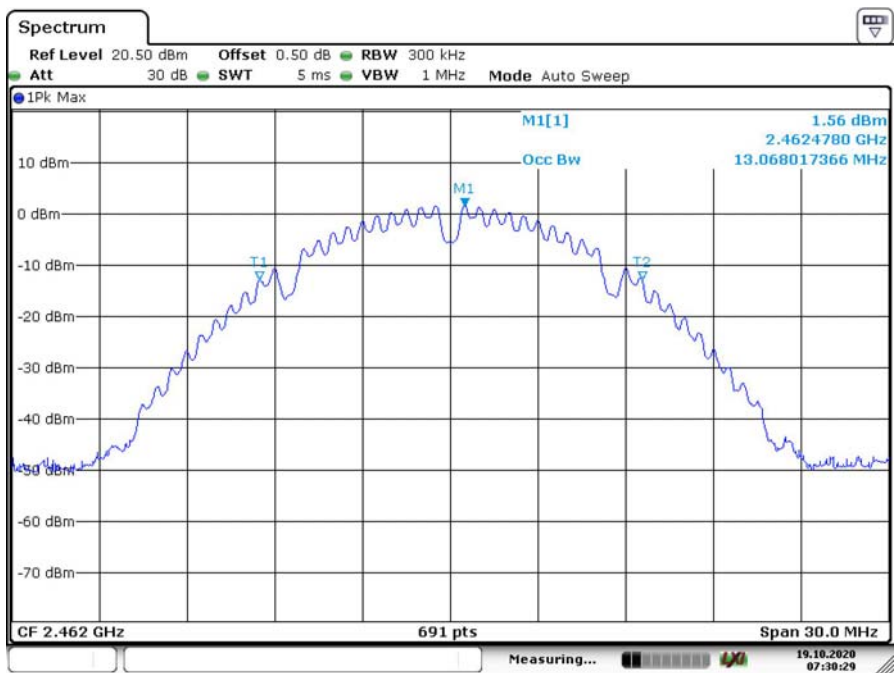

TEST REPORT

Occupied Bandwidth Results: (802.11g)

(802.11g)	Occupied Bandwidth (MHz)
Low Channel: 2412	16.324
Middle Channel: 2437	16.324
High Channel: 2462	16.324

The worst case is shown as below

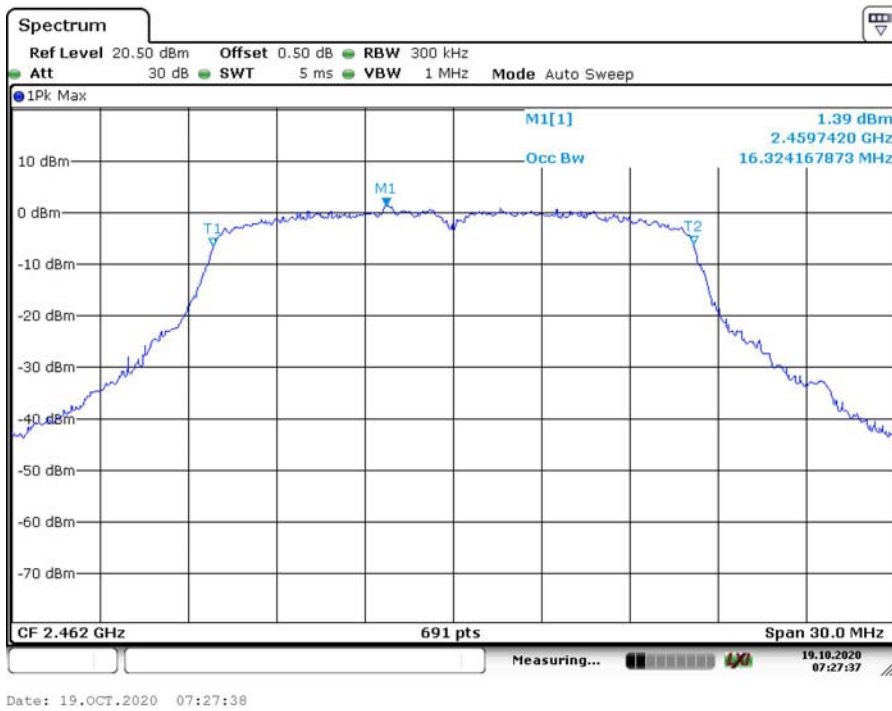

TEST REPORT

Occupied Bandwidth Results: (802.11n HT20)

(802.11n HT20)	Occupied Bandwidth (MHz)
Low Channel: 2412	17.410
Middle Channel: 2437	17.410
High Channel: 2462	17.366

The worst case is shown as below

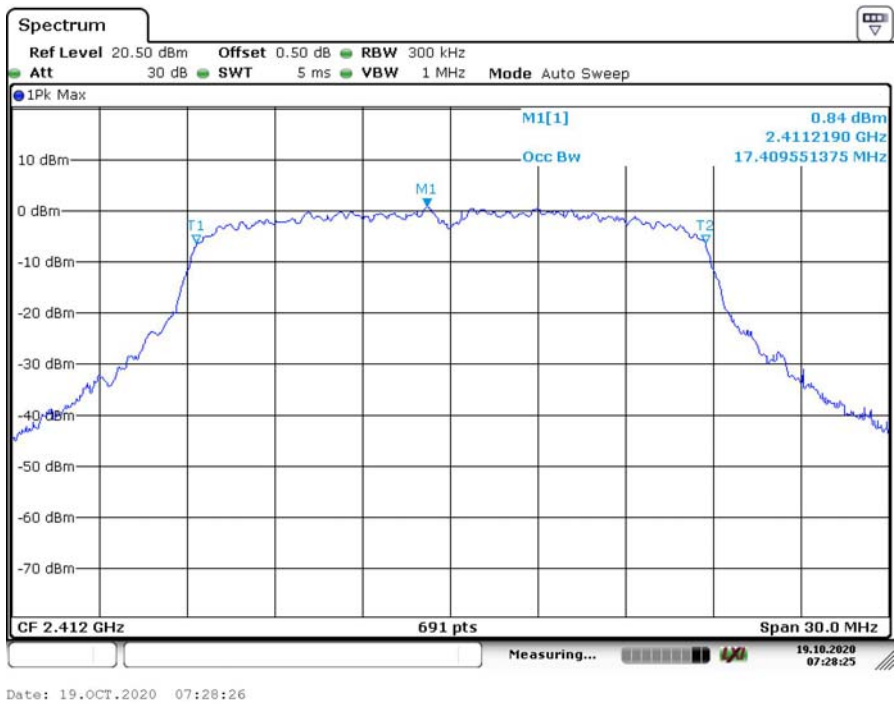

TEST REPORT

Occupied Bandwidth Results: (802.11n HT40)

(802.11n HT40)	Occupied Bandwidth (MHz)
Low Channel: 2422	36.107
Middle Channel: 2437	36.107
High Channel: 2452	36.035

The worst case is shown as below

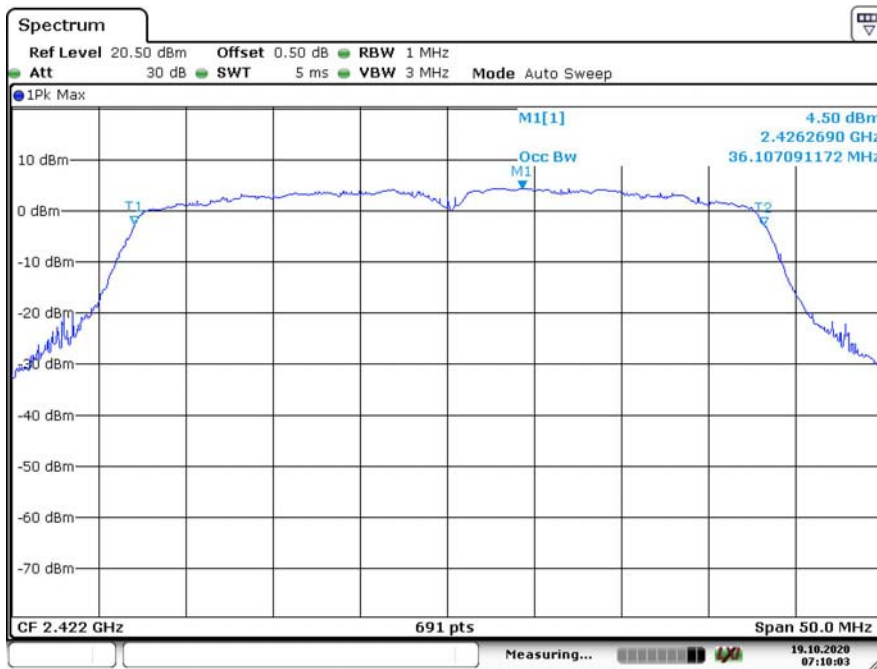

TEST REPORT

EQUIPMENT LIST

1) Radiated Emissions Test

Equipment	EMI Test Receiver (9kHz to 3GHz)	Spectrum Analyzer	Biconical Antenna
Registration No.	EW-2500	EW-2253	EW-0571
Manufacturer	ROHDESCHWARZ	ROHDESCHWARZ	EMCO
Model No.	ESCI	FSP40	3104C
Calibration Date	January 09, 2020	November 18, 2019	July 23, 2019
Calibration Due Date	January 09, 2021	November 18, 2020	January 23, 2021

Equipment	Log Periodic Antenna	Double Ridged Guide Antenna	RF Cable 14m (1GHz to 26.5GHz)
Registration No.	EW-0447	EW-1015	EW-3151
Manufacturer	EMCO	EMCO	GREATBILLION
Model No.	3146	3115	SMA m/SHF5MPU /SMA m ra14m,26G
Calibration Date	September 25, 2019	May 16, 2019	March 04, 2020
Calibration Due Date	March 25, 2021	November 16, 2020	March 04, 2021

Equipment	Active Loop H-field (9kHz to 30MHz)	RF Preamp (9kHz to 6000MHz)	2.4GHz Notch Filter
Registration No.	EW-2313	EW-3006b	EW-3435
Manufacturer	ELECTROMETRI	SCHWARZBECK	MICROWAVE
Model No.	EM-6876	BBV9718	N0324413
Calibration Date	December 17, 2019	November 25, 2019	November 16, 2019
Calibration Due Date	June 17, 2021	November 25, 2020	November 16, 2020

Equipment	14m Double Shield RF Cable (20MHz To 6GHz)	Pyramidal Horn Antenna
Registration No.	EW-2074	EW-0905
Manufacturer	RADIALL	EMCO
Model No.	nm / RG142 / sma 14m	3160-09
Calibration Date	August 29, 2020	July 23, 2019
Calibration Due Date	August 29, 2021	January 23, 2021

TEST REPORT

2) Conducted Emissions Test

Equipment	RF Cable 80cm (RG142) (9kHz to 30MHz)	Artificial Mains Network	EMI Test Receiver (9kHz to 3GHz)
Registration No.	EW-2451	EW-2501	EW-2500
Manufacturer	RADIALL	ROHDESCHWARZ	ROHDESCHWARZ
Model No.	RF Cable 80cm (RG142) (9kHz to 30MHz)	ENV-216	ESCI
Calibration Date	December 08, 2019	September 15, 2020	January 09, 2020
Calibration Due Date	December 08, 2020	September 15, 2021	January 09, 2021

3) Conductive Measurement Test

Equipment	Spectrum Analyzer	RF Cable (up to 40GHz) 1.5m length	RF Power Meter with Power Sensor
Registration No.	EW-3016	EW-2774	EW-3309
Manufacturer	ROHDESCHWARZ	N/A	ROHDESCHWARZ
Model No.	FSV40	SMA-M to SMA-M	NRP-Z81
Calibration Date	December 10, 2019	September 12, 2020	May 18, 2020
Calibration Due Date	December 10, 2020	September 12, 2021	May 18, 2021

4) Bandwidth/Bandedge Measurement Test

Equipment	RF Cable (up to 40GHz) 1.5m length	Spectrum Analyzer
Registration No.	EW-2774	EW-3016
Manufacturer	N/A	ROHDESCHWARZ
Model No.	SMA-M to SMA-M	FSV40
Calibration Date	September 12, 2020	December 10, 2019
Calibration Due Date	September 12, 2021	December 10, 2020

END OF TEST REPORT