

# iX101T1 User Handbook

Revision 1.01

06/14/2013

# Contents

---

Disclaimer . . . . .	4
Trademarks. . . . .	4
Copyright . . . . .	4
Publication information . . . . .	4
Declaration of conformity . . . . .	5
Warranty information. . . . .	5
Important safety information . . . . .	5

<b>Welcome</b>	<b>8</b>
----------------	----------

---

About your computer . . . . .	9
Package contents . . . . .	10
Optional accessories. . . . .	11
Contacting Xplore – service and questions. . . . .	12

<b>1 Getting Started</b>	<b>13</b>
--------------------------	-----------

---

Introduction . . . . .	13
Description . . . . .	13
Back view. . . . .	14
Right side view . . . . .	15
Left side view. . . . .	16
Bottom view. . . . .	17
LED indicators . . . . .	18
Quick-start guide. . . . .	20
First time Operation. . . . .	20
Turning On/Off and Suspend/Resume . . . . .	21
Input Operation. . . . .	23

---

<b>3</b>	<b>Maintaining the Tablet</b>	<b>24</b>
	Caring for the tablet . . . . .	24
	Checking power cords and connectors . . . . .	24
	Protecting the computer from damage . . . . .	25
	Storing the computer . . . . .	25
	Caring for the display screen . . . . .	26
	Protecting the display screen . . . . .	26

---

<b>A</b>	<b>Troubleshooting</b>	<b>27</b>
----------	------------------------	-----------

---

<b>B</b>	<b>Hardware Specifications</b>	<b>29</b>
----------	--------------------------------	-----------

---

<b>C</b>	<b>Agency Notices</b>	<b>36</b>
----------	-----------------------	-----------

---

## Disclaimer

---

Xplore Technologies® has made every effort to ensure the accuracy and completeness of this document; however, because ongoing development efforts are made to continually improve the capabilities of our products, we cannot guarantee the accuracy of the contents of this document. We disclaim liability for errors, omissions, or future changes herein.

## Trademarks

---

Xplore and the Xplore logo are registered trademarks of Xplore Technologies Corp. of America; iX104, iX104C5, iX101T1, iX104C5 Lite, and iX104C5 Dual Mode are trademarks of Xplore Technologies Corp.

Kensington and MicroSaver are registered trademarks of the Kensington Technology Group. Android is a registered trademark of Google Corporation.

MicroSD is registered trademark of the Personal Computer Memory Card International Association.

Wi-Fi is a trademark of the Wireless Ethernet Compatibility Alliance (WECA).

HDMI is a trademark of ""

All other brands, product names, company names, trademarks and service marks used herein are property of their respective companies.

## Copyright

Copyright © 2003-2013 Xplore Technologies Corp. All rights reserved.

No part of this publication may be copied, reproduced, or translated, without the prior written consent of Xplore Technologies. No part of this publication may be stored or transmitted in any electronic form without the prior consent of Xplore Technologies. Any unauthorized use is a violation of copyright laws.

---

## Publication information

PN: XX-0XXXX, Rev. x00 (Draft)

March 2013

---



## Declaration of conformity

---

DECLARATION OF CONFORMITY according to FCC Part 15, IC ICES-003, and RTT&E directives

Responsible Party Name: Xplore Technologies Corp.

Address: 14000 Summit Drive, Suite 900, Austin, Texas 78728

Telephone: 512.336.7797

Declares that product: Model Series: iX101T1 complies with Part 15 of the FCC Rules.

This device complies with Part 15 of the FCC rules. Operation is subject to the following two conditions: (1) This device may not cause harmful interference, and, (2) This device must accept any interference received, including interference that may cause undesired operation.

### **WARNING**

*Changes or modifications to this unit not expressly approved by the party responsible for compliance may void the user's authority to operate this equipment.*

For more information about FCC, IC, and EU rules and their applicability to the iX101T1, see Appendix E, "Agency Notices."

## Warranty information

---

The iX101T1 is backed by a standard 36-month International Limited Warranty. An extended International Limited Warranty is available. Check the service kit included with your computer for warranty terms and conditions.

## Important safety information

---

**Before you use the iX101T1 (referred to as the *tablet*), read these safety instructions and the operation instructions in this handbook.**

**Failure to observe all these instructions voids the Limited Warranty and may lead to suspension or denial of services to the offender, or legal action, or both.**

Follow any special regulations governing the use of the tablet and, if radio-enabled, always switch it off in areas where radio devices are forbidden or when the radio device can cause interference or danger.

Always follow any safety laws and regulations pertaining to the use of cell phones and two-way radios, because these laws and regulations typically apply to the use of the wireless-enabled tablet.

Observe all restrictions on the use of radio equipment in fuel depots (fuel storage and distribution areas), chemical plants, and wherever blasting operations are in progress or in any area in which restrictions on radio transmissions are imposed.

Switch off the tablet when in an aircraft. The tablet is not FAA-approved for use on aircraft. The effect of the use of the tablet in aircraft is unknown. Using the tablet in an aircraft may affect aircraft instrumentation, communication, and performance; may disrupt the network; and may be illegal.

Operating the wireless-enabled tablet may interfere with the functioning of inadequately protected medical devices such as pacemakers. Consult a physician or the manufacturer of the medical device if you have any questions.

Radio signals from your tablet will not affect the operation of most modern equipment, but certain electronic equipment, including automotive systems, may not be shielded against radio signals from your tablet. Check with the manufacturer of your motor vehicle or the manufacturer's representative to determine whether using the tablet will present any safety issues.

Avoid using the tablet in any environment that requires your full attention, such as when driving a vehicle. If you need to use your tablet while driving, have a passenger use it for you or find a safe location to halt your vehicle.

**WARNING BATTERIES**

*Use only battery types specified in this handbook. Using any other type of battery can be dangerous and can disable the tablet. Do not drop or mishandle the batteries, immerse them in water, or subject them to high heat. Doing so could increase the risk of explosion or leakage, and possibly cause injury. The lithium-ion batteries used in this equipment contain material that is hazardous to your health. If battery contents come in contact with the eyes, IMMEDIATELY flush the affected area with clean water for 15 minutes and have someone else summon medical attention for you. Unaffected persons should assist the affected individual in the vital first flushing of the eyes. RECHARGING THE BATTERY MUST ONLY BE CARRIED OUT IN ANON-HAZERDOUS AREA USING THE SUPPLIED ac ADAPTOR. The definition of hazardous areas can be found in Standard EN 60079-10.*

**WARNING**

When operating the tablet in a known explosive environment do not remove or replace the battery while the circuit is live. Before removing the battery verify that the area is known to be free of ignitable concentrations of flammable substances.

EXPLOSION HAZARD – DO NOT DISCONNECT WHILE CIRCUIT IS LIVE  
UNLESS AREA IS KNOWN TO BE NON-HAZERDOUS.

AVERISSEMENT – RISQUE D'EXPLOSION. NE PAS DÉBRANCHER TANT QUE  
LE CIRCUIT EST SOUS TENSION, À MOINS QU'IL NE S'AGISSE D'UN  
EMPLACEMENT NON DANGEREUX.

**WARNING**

EXPLOSION HAZARD - DO NOT  
REPLACE THE BATTERY UNLESS POWER HAS BEEN  
SWITCHED OFF OR THE AREA IS KNOWN TO BE  
NON-HAZARDOUS;

AVERTISSEMENT - RISQUE D'EXPLOSION -  
COUPER LE COURANT OU S'ASSURER QUE  
L'EMPLACEMENT EST DESIGNÉ NON DANGEREUX  
AVANT DE REPLACER LE BATTERY

**WARNING**

EXPLOSION HAZARD - SUBSTITUTION  
OF COMPONENTS MAY IMPAIR SUITABILITY  
FOR CLASS I, DIVISION 2;

AVERTISSEMENT - RISQUE D'EXPLOSION - LA  
SUBSTITUTION D'E COMPOSANTSP EUTR ENDRE  
CE MATERIEL INACCEPTABLE POUR LES EMBLEMENTS  
DE CLASSE I, DIVISION 2;

**WARNING**

*EXPLOSION HAZARD - DO NOT DISCONNECT EQUIPMENT UNLESS POWER HAS BEEN SWITCHED OFF OR THE AREA IS KNOWN TO BE NON-HAZARDOUS*

*AVERTISSEMENT - RISQUE D'EXPLOSION - AVANT DE DECONNECTER L'EQUIPEMENT, COUPER LE COURANT OU S'ASSURER QUE L'EMPLACEMENT EST DESIGNÉ NON DANGEREUX.*

**WARNING**

*Do not use any dock or any other accessory or attachment that is not manufactured or supplied by Xplore or an authorized Xplore accessories supplier. Use of any accessory or attachment that is not supplied or approved for use with the tablet by Xplore is not permitted because it may cause hazards.*

Operate the tablet only from the type of power source indicated on the marking label. (See page 54 for more information about the battery and power supply.) Route power supply cords so that they are not likely to be walked on or pinched by items placed upon or against them. Pay particular attention to cords at plugs and convenience receptacles, and at the point where cords exit from the tablet or its dock. Do not overload wall outlets, extension cords, or integral convenience receptacles because this can cause fire or electric shock.

Unplug the tablet and refer the tablet and dock for service to qualified service personnel if any of the following conditions occur:

- The power supply cord or plug is damaged.
- The tablet or dock does not operate normally when you follow the instructions in this book.
- The tablet or dock exhibits a distinct change in performance.

Adjust only controls for which there are instructions in this book. An improper adjustment of other controls can result in damage and may require extensive work by a qualified technician to restore the tablet or dock to normal operation.

**CAUTION**

*Avoid prolonged physical contact with the exposed metal surfaces on the front and back of the tablet. While the tablet may not feel hot to the touch, if you maintain physical contact with the tablet for a long time (for example, if you rest the tablet on your lap for a long time), your skin may suffer low-heat injury. In addition, be careful when you remove a PC card that has been used for a long time, because the card may be hot.*



## Welcome

---

Welcome to the Xplore Technologies® iX101T1™ tablet, the rugged tablet designed, tested, and manufactured to meet the environmental and physical real-world challenges faced by today's mobile workers. Based on years of experience in rugged mobile applications, the iX101T1 is designed to withstand the abuses of everyday wear and tear.

Advanced technology, innovative design, and a rugged case are just a few highlights of your iX101T1 system.

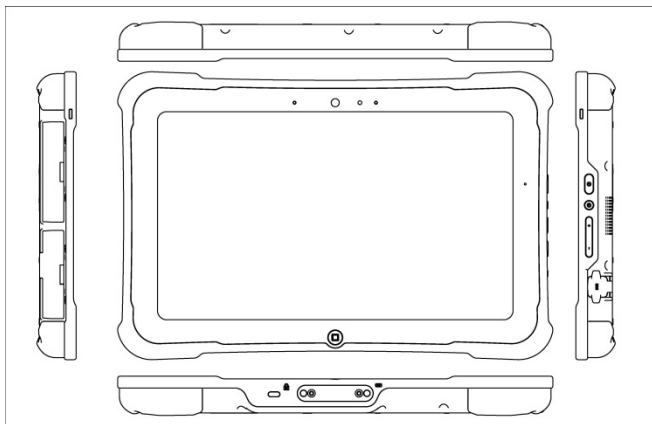

**Note:** This handbook assumes that you have basic experience using Tablets and Google® Android® operating system.

## About your computer

---

The iX101T1 is a high-performance tablet that runs on Google ® Android ® operating system.

The method you use to control the tablet is as follows:

<b>Tablet Model</b>	<b>Touchscreen</b>	<b>Control Method</b>
iX101T1	Projected Capacitive Touch (PCT)	<ul style="list-style-type: none"><li>· Special, enhanced pen (Optional with the tablet)</li><li>· One or two fingers</li></ul>

---

**Note:** In this handbook, all information applies to all models unless otherwise noted.

---

All iX101T1 tablets have been engineered and tested to meet Military Standards for Environmental Extremes (MIL STD 810G). Your tablet includes the following features that make it exceptionally rugged and durable:

- Durable, long-lasting, plastic enclosure
- Interior magnesium alloy frame
- Bumper system and gasket protection mechanisms
- Solid State storage memory
- Integrated, protected wireless LAN and WAN antennas for dual mode operation
- Chemically treated rugged Display Glass

## Package contents

---

Check to make sure your package includes the following items:

- Quick Start Guide
- AC adapter
- iX101T1 tablet
- Warranty information kit

### **Optional accessories**

---

Your package may also include any optional accessories you ordered.

#### ***Docking options***

- Vehicle Docking Station

#### ***Carrying cases***

- Carrying handle with Stylus and Shoulder Strap
- Tablet backside hand-strap

#### ***Memory***

- Internal “User secure” SD memory expansion up to 160GB

#### ***Additional accessories***

- CAC reader expansion bay
- HDMI-IN and 1Gb Ethernet expansion bay
- Auto adapter (cigarette lighter adapter)
- Capacitive stylus
- Replacement Battery kit

---

## Contacting Xplore – service and questions

---

**Note:** To troubleshoot problems (including wireless and GPS problems), before you call, read the FAQ page of the Xplore Technologies Web site. Go to <http://www.xploretech.com>; then select **Customer Support**; then **FAQ**.

---

If you purchased your tablet from an authorized Xplore dealer, contact the dealer for service and support.

If you purchased your tablet directly from Xplore, use any of the following methods to contact Xplore for service and support:

---

Web site	<a href="http://www.xploretech.com">http://www.xploretech.com</a>
E-mail	<a href="mailto:customersupport@xploretech.com">customersupport@xploretech.com</a>
Toll free	1-866-296-8541, extension 222
Fax	1-512-336-7791

---

Before you contact Xplore, have the following information ready so that the customer support representative can quickly provide a solution:

---

Product name: iX101T1

---

Product serial number

---

Purchase date

---

Conditions under which the problem occurred

---

Any error messages that were displayed

---

Type of device connected, if any

---



---

*The serial number is on the back of the tablet.*

# 1

## Getting Started

---

This chapter gives you an overview of your tablet and includes a quick-start guides.

### Front view

---

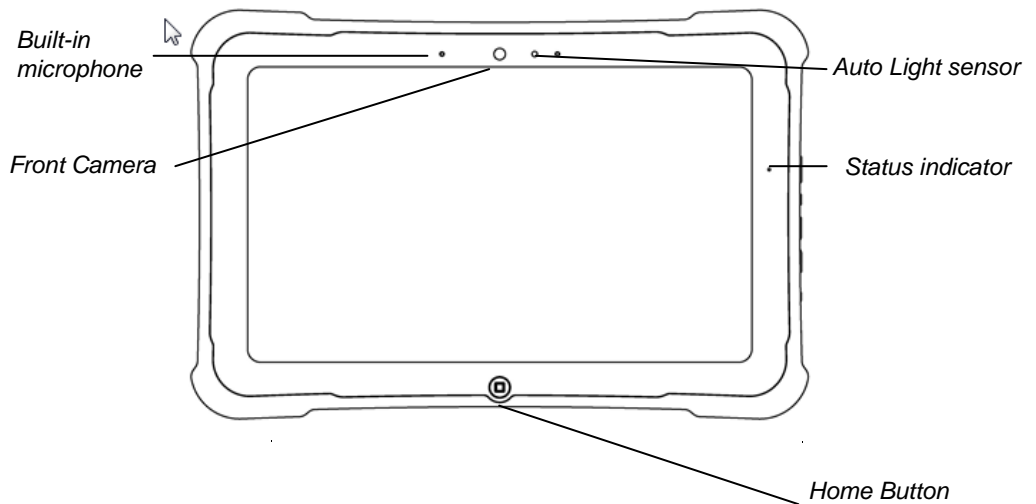

---

Built-in Microphone	Enables you to input mono audio
Front Camera	HD Video front facing camera for video conferencing, video capture or still picture capture.
Status indicator	Indicates the computer status (on, off, charging)
Home Button	Home Button for easy navigation within the Android environment.
Auto Light sensor.	Detects ambient light conditions

---

**Back view**

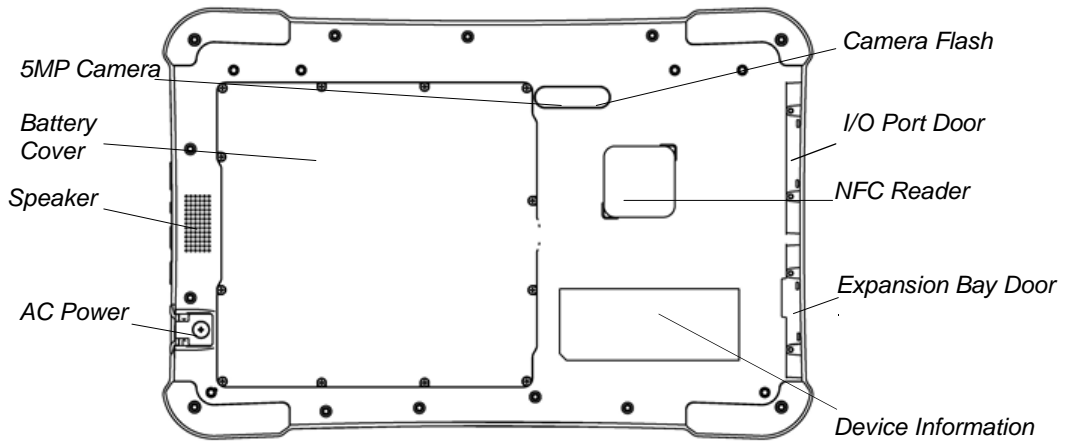

---

Speaker	Integrated Speaker for Audio Playback
---------	---------------------------------------

---

NFC Reader	NFC enabled devices or contactless RFID cards.
------------	--

---

AC Power	Powers the commuter when connected to AC power supply.
----------	--

---

Battery cover	Provides access to the battery
---------------	--------------------------------

---

Rear 5MP Camera	5MegaPixel rear facing camera for High Quality still photography or HD Video
-----------------	--

---

Rear 5MP Camera Flash	Flash light for the rear facing camera for dim light conditions
-----------------------	---

---

### Right side view

---

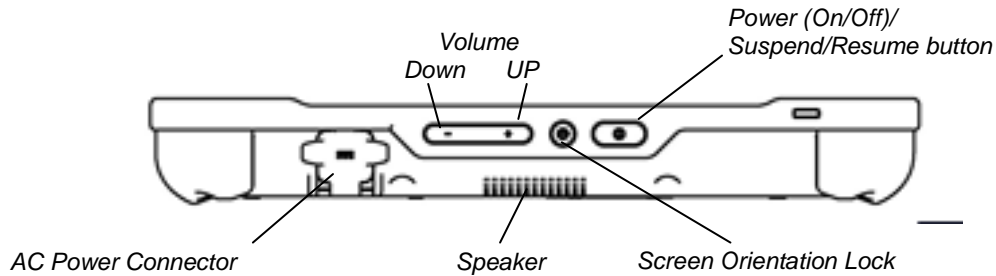

Power (On/Off)/ Suspend (On/Off)/	Press to power computer, press and hold for 4 seconds to force power off use Momentarily depress to enter/exit Suspend mode.
Screen Orientation lock	Locks the screen in current position regardless of tablet orientation when pressed. Press again to un-lock screen orientation.
Volume Up/Down	Press top of rocker button to increase Audio volume  Press bottom of rocker button to decrease Audio volume
AC Power connector	Pull back cover to expose connector Jack for AC power supply

---



## Left side view

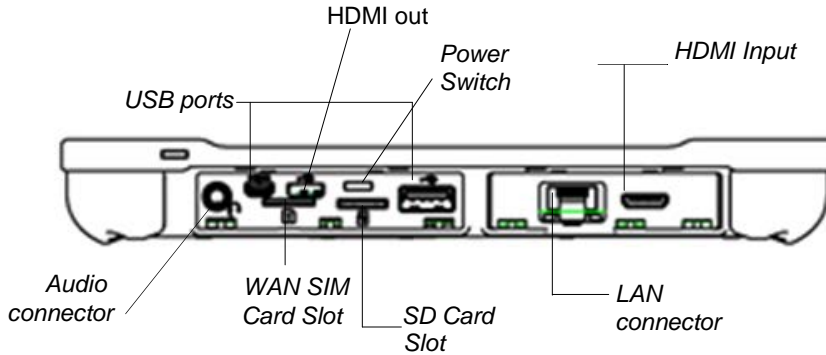

The connectors on the side of the computer are located behind the outer doors.

Audio connector	Headset connector for Apple compatible earphones and microphone
USB 2.0 ports	One Universal Serial Bus (compliant with USB Standard Revision 2.0) HOST and One Micro-B OTG connector.
HDMI Output	HDMI Micro connector for connection to External Monitor or HDTV device
WAN SIM Slot	Wireless Data Provider SIM card (insert contacts facing up).
Power Switch	Power Safety Switch to isolate Battery during shipping. It must be on (thrown toward tablet top) for the device to operate. See First time operation section.
SD Card Slot	microSD memory card slot for user memory expansion (insert contacts facing up)
(Optional) LAN Connector	RJ45 for Ethernet LAN data connection.
(Optional) HDMI Input	HDMI Mini connector for Input of Video1080i/720p content from a Set-top box or DVD player
(Optional) CAC reader	Conditional Access Card reader slot

## Chapter 1. Getting Started

---

Bottom view

### Bottom view

---

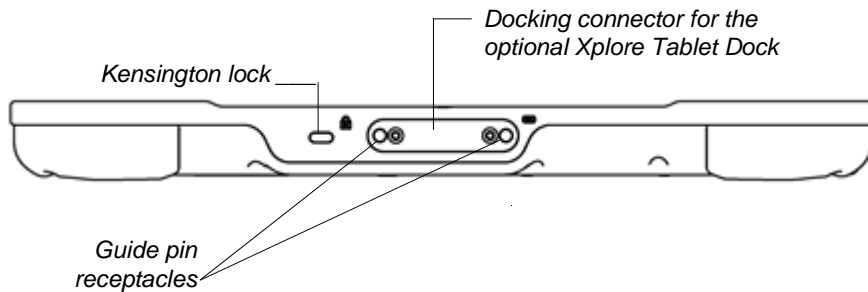

---

Docking connector	Enables you to connect the optional xStand Desktop Docking Station or xDock Vehicle Docking Stations.
Guide pin receptacles	Help assure a secure connection of the optional xStand or xDock. Note: See "Optional accessories" on page 16.
Kensington™ lock slot	Connector for the optional Kensington MicroSaver™ or equivalent compatible Security cable Note: Contact your reseller for information regarding the Kensington security cable.

---

### LED Status indicator

---

The LED Status indicator lights show the status of system functions.

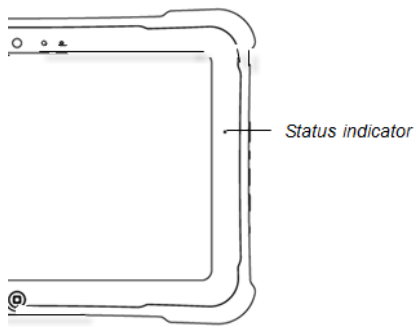

The following table defines the various LED states.

**Table 1** *Status LED indicator*

Mode/State	LED State	Meaning
On state	green, continuous	The computer is on, ready for use, and functioning normally. The battery is charged.
On Charging	green, blinking	The AC adapter is plugged in and the battery is charging.
Off state	off (no light)	The computer is off.
Off Charging	Red, blinking	The computer is off and the battery is charging

**Table 1** Status LED indicator (continued)

Mode/State	LED State	Meaning
On	red, blinking	The computer is powered on, running on battery power, and the charge level in the battery has reached a minimum warning state. Plug the computer into an AC/DC power source or install a charged battery.
On	red, continuous	The computer is on, running on battery power, and the charge level in the battery has reached a critical state. Plug the computer into an AC/DC power source or install a charged battery. Or: The computer has encountered a fault and is not operating normally. Contact your computer support personnel, such as your help desk.

---

## First-Time Operation

### First time Turning on the computer

---

1. Find and Turn the Battery switch ON. A small screwdriver or paperclip may be used for this purpose. For Safety reasons the tablet is shipped with the Battery switch OFF and ***the tablet will not operate if this step is not taken.*** It is not necessary to turn the Battery switch of the device ON or OFF during normal device operation so this operation is only needed on initial device operation.

*Battery Switch is ON when thrown toward the top side of the tablet.*

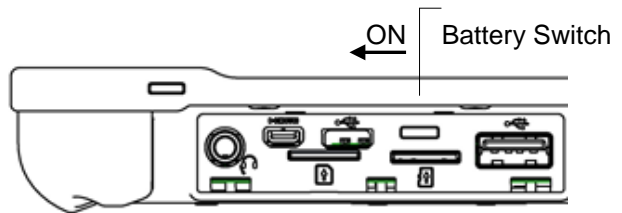

2. Make sure the battery is charged or that the computer is plugged into an external power source.
3. Press the Power On/Off/Suspend/Resume button.

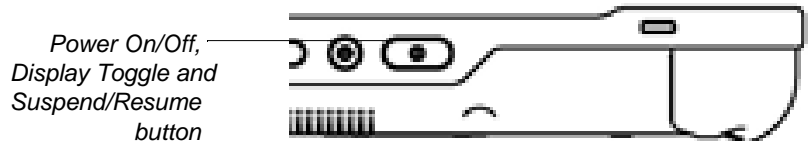

4. Xplore Technologies Logo should display. Allow device to finish boot-up and follow configuration instructions on your screen

## Chapter 2. Using the Tablet





### Turning On/Off the computer

---

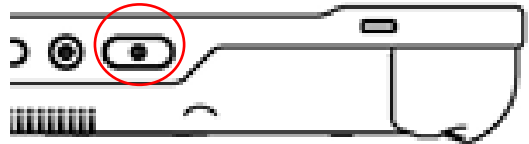
#### Turning on the computer

- 1 Press the Power On/Off/Suspend/Resume button.



2. Drag  to  with finger to unlock screen
  3. Or Drag  to  to start Camera application.
- 

#### Turning off the computer

1. If the computer is in Suspend mode, press the Power On/Off/Suspend/Resume button to resume operation.

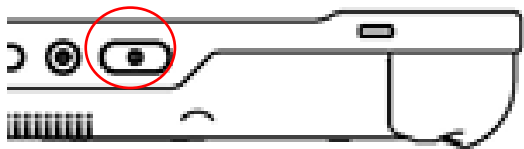

2. Make sure the battery is charged or that the computer is plugged in to an external power source.
  3. Save your work.
  4. Press and hold Power ON/OFF button for 3 seconds then release.
  5. When Dialog box is shown press OK.
-

---

## Chapter 2. Using the Tablet

### *Suspending and resuming operation*

---

#### Suspend operation

To conserve battery power when you do not want to turn off the computer, put the computer into Suspend mode. (You can suspend operation without closing any apps.). The default configuration at time of purchase is for the system to enter suspend mode automatically after 5 minutes of no activity.

To manually enter suspend mode press the Power switch briefly and release. The display should switch off, without any confirmation menu being presented.

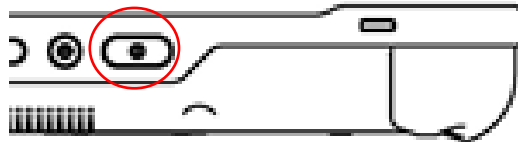

---

#### Resume operation

To resume tablet operation from Suspend mode follow the same procedure as turning the tablet on.

- 1 Press the Power On/Off/Suspend/Resume button.



2. Drag  to  with finger to unlock screen
3. Or Drag  to  to start Camera application.

If this is not successful the battery on the tablet may have fully discharged. Plug the tablet into AC power and repeat the procedure

---

---

## Chapter 2. Using the Tablet

### Screen Input Operation

---

#### Screen Input Operation



Touch - Select Item or option  
Touch and Hold – Open special options

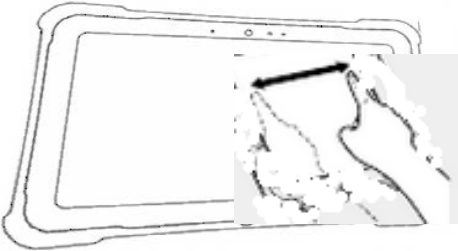

Drag – Scroll the screen  
Flick – Scroll the screen quickly  
Drag and drop – Move an item

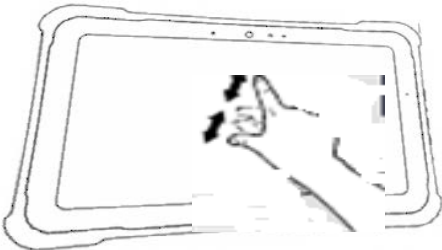

Pinch – Zoom in or out the screen



# 2

## Maintaining the Tablet

---

This chapter provides instructions for maintaining your tablet.

### Caring for the tablet

---

This section provides information about how to keep your tablet in top working condition.

#### Checking power cords and connectors

Check AC and DC power cords and power connectors periodically for damage. Replace the power cord immediately if you find any damage.

---

#### Protecting the computer from damage

- Your computer is designed to sustain a multiple-axis drop to a non-yielding surface. Do not intentionally drop the computer, because the cumulative effects of multiple drops may damage the computer.
- Do not place heavy objects on the computer.
- Do not disassemble the computer.
- Keep the computer at least 5 inches (13 centimeters) away from any electrical appliance that generates a strong magnetic field, such as a motor, magnet, TV, refrigerator, or large audio speakers.

### Storing the computer

You can store the computer in the Off state for about 30 days with a fully charged battery installed. After this period, recharge the battery or replace it with a charged battery.

---

### Caring for the display screen

To clean the display screen, dampen a soft cotton cloth with water and gently wipe the screen surface.

---

**Note:** Do not use isopropyl alcohol to clean the screen. Alcohol may damage the surface of the screen.

---

### Protecting the display screen

The screen protector is a durable, replaceable writing surface that protects the display screen from abrasion.

To obtain screen protectors, check with your reseller, or go to the Xplore Web site at [www.xploretech.com](http://www.xploretech.com) for ordering information. Additional information about installation is included with the screen protectors.

### ***Removing the screen protector***

Slide your fingernail under the edge of the screen protector and pull the protector away from the screen.

---

### ***Installing a new screen protector***

Follow the instructions included with your screen protector replacement kit.

**Note:** If a screen protector is already installed on the display screen, remove it before installing the new screen protector.

---

# A

## Troubleshooting

---

Table 7 contains solutions to some problems. If you cannot solve the problem by taking the actions described, contact your local help desk or your reseller for further assistance.

**Table 7** *Troubleshooting*

---

<b>Problem</b>	<b>Possible cause and solution</b>
Computer will not start.	<ul style="list-style-type: none"><li>· The battery may be defective or discharged to a critically low level. Connect an external power supply (such as the AC adapter) or install a charged battery. See “Using the battery” on page 54.</li><li>· Internal components may be above or below the acceptable operating range (below -20° C or above 60° C). After the temperature returns to safe operating range the computer will start.</li></ul>
The computer will not resume operation after being suspended.	<ul style="list-style-type: none"><li>· The battery may be defective or discharged to a critically low level. When the battery reaches a critically low level, the computer is forced into Suspend-to-RAM mode to avoid a total system power failure. Connect an external power supply (such as the AC adapter) or install a charged battery. See “Using the battery” on page 54.</li><li>· The computer may be at the critical thermal limit. To avoid damage to heat-sensitive components, the computer enters Suspend-to-RAM mode when the computer operates above 60° C. Operation automatically resumes when the computer cools to below 60° C. Move the computer to a cooler location.</li></ul>
The Status LED is red, continuous.	<ul style="list-style-type: none"><li>· The computer is on, running under battery power, and the charge level in the battery has reached a critical level. Plug the computer into an AC/DC power source or install a charged battery.</li><li>· The system has encountered a fault and is preventing normal operation. Contact your local help desk.</li></ul>
The Status LED is red, blinking.	The computer is powered on, running under battery power, and the charge level in the battery is at a minimum warning level. Plug the computer into an AC/DC power source or install a charged battery.

---

**Table 7** *Troubleshooting (continued)*

<b>Problem</b>	<b>Possible cause and solution</b>
Display screen is blank or difficult to read.	<ul style="list-style-type: none"><li>· Confirm that the computer is on (the Power icon is displayed continuously in the Status area).</li><li>· The brightness may be set too low, causing the screen to appear too dark. To change system brightness, press Settings Icon, Display, Brightness.</li><li>· The video time-out may have expired. Tap the display screen to reactivate the display. <b>Note:</b> This is a normal, power-saving feature.</li></ul>
Headphone or speaker volume is too low.	<ul style="list-style-type: none"><li>· The volume may be in Mute mode or set too low. Follow the Instruction to adjust headphone or speaker volume.</li><li>· Make sure the volume control in your audio software is set to an audible level.</li></ul>
An external device is not working with the computer.	The device may need to be enabled in the computer's configuration program. Contact your local help desk or reseller.

# B

## Hardware Specifications

### *Physical*

Dimensions	11.20" x 8.25" x 1.6" (WxHxD) 283.9mm x 209.3mm x 40.8mm
Weight	5.25 lbs. (2.38 kgs)*

### *Processing*

#### CPU

	OMAP4470 Dual core ARM A9
Chip set	
Processor speed	Up to 1.5 GHz*
* Varies according to your computer's configuration.	

### *Memory/storage*

Main RAM	1GB LPDDR2
RAM Options	None
L2 Cache	1MB cache
Storage	32GB eMMC
Storage Expansion	up to 160GB One User accessible micro SD One internal non User accessible microSD

*Display*

Display	<ul style="list-style-type: none"><li>· Color LCD</li><li>· Projected Capacitive Touch Panel</li><li>· 10.1 TFT WVGA (1366x768), 16M colors</li><li>· Brightness: up to 500 nits</li><li>· Viewing Angle:<ul style="list-style-type: none"><li>- Horizontal: 60 degrees (min.)</li><li>- Vertical: 10 degrees (min.)</li><li>- Contrast Ratio: Typ. 500:1, Min 100:1</li></ul></li></ul>
Graphics	Powerful Imagination PowerVR SX544 Graphics processor for low-power, high-performance 3D/2D graphics, video, and display capabilities.

*Interface*

Wireless Radios	<ul style="list-style-type: none"> <li>· One internal WiFi 802.11 abgn</li> <li>· One Bluetooth radio</li> <li>· One FM Transmitter</li> <li>· One NFC Transceiver</li> </ul>
Integrated Interfaces	<ul style="list-style-type: none"> <li>· DC-in</li> <li>· USB (2) 2.0</li> <li>· Headset and Microphone Jack</li> <li>· HDMI output</li> <li>· microSD Card slot</li> <li>· WAN SIM slot</li> <li>· LAN (RJ-45 optional)</li> <li>· CAC Reader (optional)</li> <li>· HDMI input (optional)</li> </ul>
KeyPad / User Controls	<ul style="list-style-type: none"> <li>· Application buttons with primary and secondary functions</li> <li>· Power On/Off/Suspend/Resume button</li> </ul>

*Power*

Main Battery	<ul style="list-style-type: none"> <li>· Serviceable Lithium Ion</li> <li>· 3.7V @ 9600mAh (35.52 Whr)</li> <li>· Recharge Time: 3.5 hours (90%)</li> <li>· Life: Up to 8 hours. (Battery life is dependent on operating system, power management, and applications in use.)</li> <li>· Suspend Life: Min. 5 days</li> </ul>
--------------	--



*Power (continued)*

AC Adapter	Auto-sensing 100-240V, supplying 19 VDC, with a current of 3.42 A

*Environmental*

Temperature	<ul style="list-style-type: none"><li>· Operating: -5° to 140° F (-23° to 60° C)</li><li>· Storage: -40° to 167° F (-40° to 75° C)</li></ul>
Humidity	0% to 95% non-condensing
Shock/Drop	Four-foot drop to plywood, operating, on all surfaces, edges and corners
Vibration	0.04g <sup>2</sup> /Hz, 20 Hz - 1000 Hz -6dB/octave 1000 Hz - 2000 Hz

*Environmental (continued)*

Enclosure Class	<p>Blowing rain: 4"/hr, 40 mph wind and MIL-STD-810G Method 506.4 Procedure 1</p> <p>Drip: 7 gal/ft<sup>2</sup>/hr MIL-STD-810G Method 506.4 Procedure III</p> <p>Sand and dust: Particle size &lt; 149 μm, 10 ± 7 g/m<sup>3</sup> particle density 1.5 m/s to 8.9 m/s wind speed MIL-STD-810G Method 510.4 Procedure 1</p> <p>Salt Fog: 5% saline for 48 hr (12 hr wet, 12 hr dry, 2 cycles) MIL-STD-810G Method 509.4</p> <p>Contamination by fluids: Detergents, brake fluid, aromatic hydrocarbons MIL-STD-810G Method 504</p> <p>Solar radiation: 1120 W/m<sup>2</sup> (355 Btu/ft<sup>2</sup>/hr) UVB @ 50° C, 7x24 hr cycles MIL-STD-810G Method 505.4</p>
-----------------	---

*Agency approvals*

EMC	CFR 47, FCC part 15 Class B, IC ICES-003, EN 55022, EN55024
Safety	TUV, UL, cUL UL60950 IEC60950-1 2 <sup>nd</sup> Ed, EN60950-1 2 <sup>nd</sup> Ed,

*Operating system*

Operating Systems	· Google Android 4.04 (Ice Cream Sandwich)
-------------------	--

# C

## Agency Notices

### **FCC notices**

This device complies with Part 15 of the FCC Rules .Operation is subject to the following two conditions: (1) this device may not cause harmful interference, and (2) this device must accept any interference received, including interference that may cause undesired operation.

Modifications not expressly approved by Xplore Technologies could void this user's authority to operate the equipment.

**Note:** This equipment has been tested and found to comply with the limits for a Class B digital device, pursuant to Part 15 of the FCC Rules.. These limits are designed to provide reasonable protection against harmful interference in a residential installation. This equipment generates, uses and can radiate radio frequency energy and, if not installed and used in accordance with the instructions, may cause harmful interference to radio communications. However, there is no guarantee that interference will not occur in a particular installation. If this equipment does cause harmful interference to radio or television reception, which can be determined by turning the equipment off and on, the user is encouraged to try to correct the interference by one or more of the following measures:

- Reorient or relocate the receiving antenna.
- Increase the separation between the equipment and receiver.
- Connect the equipment into an outlet on a circuit different from that to which the receiver is connected.
- Consult the dealer or an experienced radio/TV technician for help.

### **WLAN: (Wi-Fi)**

Please note that 5150-5250MHz (ch. 36-48) is restricted to indoor-use only in many countries including the United States.

### **RF exposure**

Tests for SAR are conducted using standard operating positions specified by the FCC with the tablet PC transmitting at its highest certified power level in all tested frequency bands. Although the SAR is determined at the highest certified power level, the actual SAR level of the tablet PC while operating can be well below the maximum value. This is because the tablet PC is designed to operate at multiple power levels so as to use only the power required to reach the network. In general, the closer you are to a wireless base station antenna, the lower the power output.



Before a tablet PC model is available for sale to the public, it must be tested and certified to the FCC and IC that it does not exceed the limit established by the government-adopted requirement for safe exposure. The tests are performed in positions and locations (e.g., next to body/lap) as required by the FCC for each model. (next to body/lap measurements may differ among tablet PC models, depending upon available accessories and FCC and IC requirements). "While there may be differences between the SAR levels of various tablet PCs and at various positions, they are all required to meet the government regulations for safe exposure. This device was evaluated and shown to comply with FCC and IC SAR RF exposure requirements. Avoid covering or holding antennas when transmitting. Antenna locations are shown in the following figure.

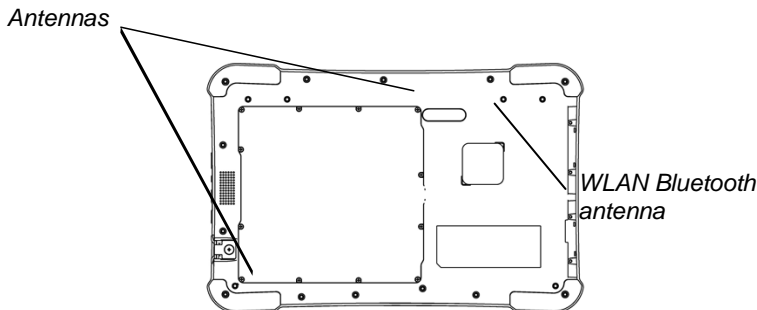

### Health and Safety Information

#### ***Exposure to Radio Frequency (RF) Signals***

Your wireless tablet PC is a radio transmitter and receiver. It is designed and manufactured not to exceed the emission limits for exposure to radio frequency (RF) energy set by the Federal Communications Commission of the U.S. Government as well as the RTT&E directive. These limits are part of comprehensive guidelines and establish permitted levels of RF energy for the general population. The guidelines are based on the safety standards previously set by both U.S. and international standards bodies:

- American National Standards Institute (ANSI) IEEE. C95.1-1992
- National Council on Radiation Protection and Measurement (NCRP). Report 86. 1986

- International Commission on Non-Ionizing Radiation Protection (ICNIRP) 1996
- Ministry of Health (Canada), Safety Code 6. The standards include a substantial safety margin designed to assure the safety of all persons, regardless of age and health.
- European Union RTT&E Directive for SAR

The exposure standard for wireless mobile tablet PCs employs a unit of measurement known as the Specific Absorption Rate, or SAR. The SAR limit set by the FCC is 1.6W/kg. The SAR limit set by the RTT&E is 2.0W/kg.

---

**Note:** In the U.S. and Canada, the SAR limit for mobile tablet PCs used by the public is 1.6 watts/kg (W/kg) averaged over one gram of tissue. In Europe the SAR limit for mobile tablet PCs used by the public is 2.0 watts/kg (W/kg) averaged over 10 grams of tissue. The standard incorporates a substantial margin of safety to give additional protection for the public and to account for any variations.

---

### **DOC (Industry Canada Notices)**

#### ***Notice to Users of Radio and Television***

This Class B digital apparatus meets all requirements of Canadian Interference-Causing Equipment Regulations per the ICES-003 CET appareil numérique de la class B respecte toutes les exigence du Règlement sur le matériel brouilleur du Canada.

---

---

### UL Notice

This unit requires an AC adapter to operate. Use only UL Listed Class 2 Adapters with an output rating of 19 VDC, with a current of 3.42 A. AC Adapter output polarity:



### For authorized repair technicians only

---

#### **WARNING**

*For continued protection against risk of fire, replace only with the same type and rating fuse.*

#### **WARNING**

*Danger of explosion if Lithium (clock) battery is incorrectly replaced. Replace only with the same equivalent type recommended by the manufacturer. Dispose of used batteries according to the manufacturer's instruction.*



### System disposal

In the event of system disposal, observe the following information regarding proper procedures in the State of Vermont.

The liquid crystal display (LCD) lamps used in this system contain mercury. In the event of system disposal, be sure to follow local guidelines.





## Declaration of Conformity

Xplore Technologies, Corp. hereby declares under our sole responsibility that the product

✓ Name: xRanger

Model: iX101T1

To which this declaration relates, is in compliance with all the applicable essential requirements, and other provisions of the European Council Directives listed. The conformity assessment procedure used for this declaration is Annex IV of Directive 1999/5/EC. This product will bear the CE Mark label (CE !)

#### DIRECTIVES:

- Directive 2004/108/EC (EMC Directive)
- Directive 2006/95/EC (Low Voltage Directive)
- Directive 1999/5/EC (Radio and Telecommunications Terminal Equipment) (R&TTE Directive)
- Directive 2002/96/EC (Waste of Electrical and Electronic Equipment) (WEEE Directive)
- Directive 2002/95/EC (Restriction of Hazardous Substances) (RoHS Directive)
- Directive 278/2009/EC (Energy Related Products) (ErP Directive)

Product compliance has been demonstrated on the basis of:

#### STANDARDS:

- EN 55022: 2010 (Class B)
- EN 55024: 2010
- EN 61000-3-2:2006+A2:2009
- EN 61000-3-3:2008
- EN 60950-1:2006+A11:2009, +A1:2010  
+A12:2011
- EN 50564:2011
- ETSI EN 301 357-1 (FM Trans)
- ETSI EN 301 357-2 V 1.3.1
- ETSI EN 301 489-1 V1.9.2
- IEC 62209-2: 2010
- ETSI EN 300 328 V1.8.1  
(WLAN/BT)
- ETSI EN 301 893 V1.1.1

David J Ball  
Senior Regulatory and Compliance Specialist

7 June 2013

Date

Austin, TX, USA

Place

The technical construction file is kept available at:  
Xplore Technologies Corp.  
14000 Summit Dr, Ste 900  
Austin, TX 78728  
USA 888-44-XPLORE, FAX: 512-338-7791, www.xploretech.com

