



iX104C⁴ USER'S HANDBOOK



Contents

Disclaimer	9
Trademarks.	9
Copyright	9
Publication information	9
Declaration of conformity	10
Warranty information.	10
Important safety information	10

Welcome **13**

About your computer	14
Package contents	15
Optional accessories.	16
Contacting Xplore – service and questions	17

1 Getting Started **19**

Front view	19
Back view.	21
Top view	22
Bottom view	23
Left side view.	24
Right side view.	25
LED indicators.	26
Quick-start guide	28
Application, Windows, and hot keys	28

2 Using the Tablet 31

Turning on the computer 31

Turning off the computer 32

 Using the Reset switch 32

Suspending and resuming operation 33

 Suspending operation 34

 Resuming operation 36

Using the pen 37

 Selecting Auto-Sense, Active, or Touch mode 38

 Using the digitizer to perform mouse functions 39

 Changing the pen double-click speed 40

 Positioning the pen and pen tether 41

Using the fingerprint scanner 43

Changing the screen orientation 44

Adjusting the screen brightness 45

 Windows XP 45

 Windows Vista 45

 Enabling automatic backlight control 46

 Optimizing screen settings for outdoor use 47

 Windows XP 47

 Windows Vista 47

Docking the tablet 48

Connecting devices 49

 Connecting to a local area network 49

 Connecting USB-compatible devices 49

 Connecting an external microphone 50

 Adjusting microphone volume – Windows XP 50

 Adjusting microphone volume – Windows Vista 50

Connecting a headphone or speakers	51
Adjusting headphone or speaker volume – Windows XP	51
Adjusting headphone or speaker volume – Windows Vista	51
Connecting a monitor or projection panel	52
Activating the monitor or projection panel	52
Connecting a device to the optional serial port	53
Connecting an XPL snap-on expansion module	53
Using the battery	54
Charging the battery pack	54
If you do not have an external battery charger	54
If you have an external battery charger	55
Removing and installing the battery	55
Removing the battery	55
Installing the battery	57
Discarding batteries	57
Using power options – Windows XP	58
Displaying power options	58
Changing the computer’s power schemes	59
Changing battery alarm settings	59
Checking battery power status	60
Selecting power settings	60
Enabling Hibernation mode	61
Using power options – Windows Vista	62
Checking battery power status	62
Selecting a power plan	62
Selecting power options	63
Selecting Power (On/Off)/Backlight(On/Off)/Resume button options	64
Tips for conserving battery power	65

Accessing the hard disk drive compartment	66
Re-installing the hard disk drive compartment cover	67
Accessing the PCMCIA compartment	68
Re-installing the PCMCIA compartment cover	69
Programming hot keys	70
Programming hot keys to start applications, open documents, or go to a Web site	71
Programming hot keys to perform pre-defined functions	75
Programming hot keys to perform other key functions	77

3 Maintaining the Tablet 81

Caring for the tablet.	81
Checking power cords and connectors.	81
Protecting the computer from damage.	81
Preventing the computer from overheating	82
Storing the computer	83
Caring for the display screen	83
Protecting the display screen	83
When to replace the pen	84
Calibrating the digitizer.	85
Calibrating the digitizer: iX104C4 – Windows XP	86
Calibrating the digitizer: iX104C4 – Windows Vista	88
Calibrating the digitizer: iX104C4 Dual Mode – Windows XP	90
Calibrating the digitizer: iX104C4 Dual Mode – Windows Vista.	93

A	Troubleshooting	97
----------	------------------------	-----------

B	Using BIOS and AOS Functions	99
----------	-------------------------------------	-----------

	Disabling the Auto Power feature	100
	Enabling automatic LCD backlight control	100

C	Glossary	101
----------	-----------------	------------

D	Hardware Specifications	105
----------	--------------------------------	------------

E	Agency Notices	111
----------	-----------------------	------------

F	Configuring Dual Mode Tablet Digitizer Input Methods	115
----------	---	------------

	Using the BIOS Setup Utility to set input method defaults	116
	Starting the BIOS Setup Utility	116
	Selecting the digitizer input method	117
	Setting digitizer input method security	118
	Using the Panel Control Center to configure temporary changes to the input method	119
	Summary: Dual Mode digitizer input method settings	121
	Sample implementations	126
	Sample 1	126
	Sample 2	126

	Index	129
--	--------------	------------

Disclaimer

Xplore Technologies® has made every effort to ensure the accuracy and completeness of this document; however, because ongoing development efforts are made to continually improve the capabilities of our products, we cannot guarantee the accuracy of the contents of this document. We disclaim liability for errors, omissions, or future changes herein.

Trademarks

Xplore and the Xplore logo are registered trademarks of Xplore Technologies Corp.; iX104, iX104C⁴, iX104C⁴ AllVue, and iX104C⁴ Dual Mode are trademarks of Xplore Technologies Corp.

Kensington and MicroSaver are registered trademarks of the Kensington Technology Group. Microsoft is a registered trademark of Microsoft Corporation. Windows 2000 Professional, Windows XP Professional, and Windows XP Tablet PC Edition are trademarks of Microsoft Corporation. PCMCIA and CardBus are registered trademarks of the Personal Computer Memory Card International Association. Intel, Pentium, and SpeedStep are registered trademarks of Intel Corporation. Wi-Fi is a trademark of the Wireless Ethernet Compatibility Alliance (WECA). FireWire is a registered trademark of Apple Computer, Inc. ISODAMP is a registered trademark of Aeero Company.

All other brands, product names, company names, trademarks and service marks used herein are property of their respective companies.

Copyright

Copyright © 2003-2008 Xplore Technologies Corp. All rights reserved. No part of this publication may be copied, reproduced, or translated, without the prior written consent of Xplore Technologies. No part of this publication may be stored or transmitted in any electronic form without the prior consent of Xplore Technologies. Any unauthorized use is a violation of copyright laws.

Publication information

PN: 95-01085, Rev. A
July 2008

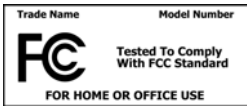

Declaration of conformity

DECLARATION OF CONFORMITY according to FCC Part 15

Responsible Party Name: Xplore Technologies Corp.

Address: 14000 Summit Drive, Suite 900, Austin, Texas 78728

Telephone: 512.336.7797

Declares that product: Model Series: iX104C⁴ complies with Part 15 of the FCC Rules.

This device complies with Part 15 of the FCC rules. Operation is subject to the following two conditions: (1) This device may not cause harmful interference, and, (2) This device must accept any interference received, including interference that may cause undesired operation.



WARNING

Changes or modifications to this unit not expressly approved by the party responsible for compliance may void the user's authority to operate this equipment.

For more information about FCC rules and their applicability to the iX104, see Appendix E, "Agency Notices."

Warranty information

The iX104C⁴ is backed by a standard 36-month International Limited Warranty. An extended International Limited Warranty is available. Check the service kit included with your computer for warranty terms and conditions.

Important safety information

Before you use the iX104C⁴ (referred to as the *tablet*), read these safety instructions and the operation instructions in this handbook.

Failure to observe all these instructions voids the Limited Warranty and may lead to suspension or denial of services to the offender, or legal action, or both.

Follow any special regulations governing the use of the tablet and, if radio-enabled, always switch it off in areas where radio devices are forbidden or when the radio device can cause interference or danger.

Always follow any safety laws and regulations pertaining to the use of cell phones and two-way radios, because these laws and regulations typically apply to the use of the wireless-enabled tablet.

Observe all restrictions on the use of radio equipment in fuel depots (fuel storage and distribution areas), chemical plants, and wherever blasting operations are in progress or in any area in which restrictions on radio transmissions are imposed.

Switch off the tablet when in an aircraft. The tablet is not FAA-approved for use on aircraft. The effect of the use of the tablet in aircraft is unknown. Using the tablet in an aircraft may affect aircraft instrumentation, communication, and performance; may disrupt the network; and may be illegal.

Operating the wireless-enabled tablet may interfere with the functioning of inadequately protected medical devices such as pacemakers. Consult a physician or the manufacturer of the medical device if you have any questions.

Radio signals from your tablet will not affect the operation of most modern equipment, but certain electronic equipment, including automotive systems, may not be shielded against radio signals from your tablet. Check with the manufacturer of your motor vehicle or the manufacturer's representative to determine whether using the tablet will present any safety issues.

Avoid using the tablet in any environment that requires your full attention, such as when driving a vehicle. If you need to use your tablet while driving, have a passenger use it for you or find a safe location to halt your vehicle.



WARNING

Use only battery types specified in this handbook. Using any other type of battery can be dangerous and can disable the tablet.



WARNING

Do not use any dock or any other accessory or attachment that is not manufactured or supplied by Xplore or an authorized Xplore accessories supplier. Use of any accessory or attachment that is not supplied or approved for use with the tablet by Xplore is not permitted because it may cause hazards.

Operate the tablet only from the type of power source indicated on the marking label. (See page 54 for more information about the battery and power supply.) Route power supply cords so that they are not likely to be walked on or pinched by items placed upon or against them. Pay particular attention to cords at plugs and convenience receptacles, and at the point where cords exit from the tablet or its dock. Do not overload wall outlets, extension cords, or integral convenience receptacles because this can cause fire or electric shock.

Unplug the tablet and refer the tablet and dock for service to qualified service personnel if any of the following conditions occur:

- The power supply cord or plug is damaged.
- The tablet or dock does not operate normally when you follow the instructions in this book.
- The tablet or dock exhibits a distinct change in performance.

Adjust only controls for which there are instructions in this book. An improper adjustment of other controls can result in damage and may require extensive work by a qualified technician to restore the tablet or dock to normal operation.



CAUTION

Avoid prolonged physical contact with the exposed metal surfaces on the front and back of the tablet. While the tablet may not feel hot to the touch, if you maintain physical contact with the tablet for a long time (for example, if you rest the tablet on your lap for a long time), your skin may suffer low-heat injury. In addition, be careful when you remove a PC card that has been used for a long time, because the card may be hot.

Welcome

Welcome to the Xplore Technologies® iX104C⁴™ tablet PC, the rugged tablet designed, tested, and manufactured to meet the environmental and physical real-world challenges faced by today's mobile workers. Based on years of experience in rugged mobile applications, the iX104C⁴ is designed to withstand the abuses of everyday wear and tear.

Advanced technology, innovative design, and a rugged case are just a few highlights of your iX104C⁴ system.

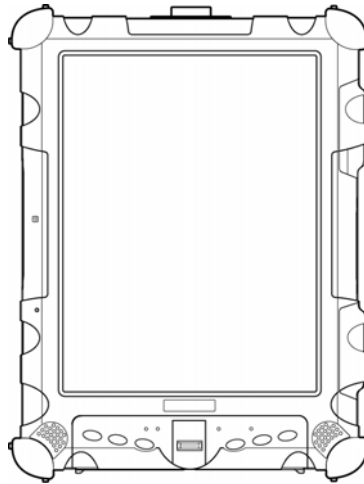

Note: This handbook assumes that you have basic experience using computers and Microsoft® Windows®.

About your computer

The iX104C⁴ is a high-performance tablet PC that runs on Microsoft Windows XP[®] Professional Tablet PC Edition and Vista Business operating systems.

The method you use to control the tablet depends on the tablet model, as follows:

Tablet Model	Digitizer/Touchscreen	Control Method
iX104C ⁴ Dual Mode	Inductive and resistive touch digitizer	<ul style="list-style-type: none">• Special, enhanced pen (included with the tablet)• Your finger• Any suitable pointing device
iX104C ⁴ Dual Mode AllVue Xtreme	Sunlight-viewable display with inductive and resistive digitizer	<ul style="list-style-type: none">• Special, enhanced pen (included with the tablet)• Your finger• Any suitable pointing device
iX104C ⁴ AllVue Xtreme	Sunlight-viewable display with inductive digitizer	<ul style="list-style-type: none">• Special, enhanced pen (included with the tablet)• Any suitable pointing device

Note: In this handbook, all information applies to all models unless otherwise noted.

All iX104C⁴ tablets have been engineered and tested to meet Military Standards for Environmental Extremes (MIL STD 810F). Your tablet includes the following features that make it exceptionally rugged and durable:

- Durable, long-lasting, dense magnesium enclosure
- Interior and exterior multi-layer magnesium frames and cavities
- ISODAMP[®] shock absorbing materials in patented bumping system and gasket protection mechanisms
- Shock-isolated hard disk
- Integrated, protected wireless LAN and WAN antennas for dual mode operation
- Locked in place memory, cables, and connectors
- Proprietary thermal management system

Package contents

Check to make sure your package includes the following items:

- Quick Start Guide
- Battery pack
- Power cord
- AC adapter
- Pen
- Pen tether
- iX104C⁴ tablet PC
- Warranty information kit

Optional accessories

Your package also includes any optional accessories you ordered.

Docking options

- xStand Desktop Docking Station
- xDock Vehicle Docking Station

Carrying cases

- Shoulder cases
- Portfolio case
- Dockable case

Storage options

- External USB floppy disk drive
- External USB CD-ROM drive

Memory

- 2 GB RAM
- 32 GB 2.5-inch solid state hard drive

Power options

- AC adapter with U.S. cord
- Main battery pack (41 watt hours)
- Extended life battery pack (55 watt hours)
- Auto adapter (cigarette lighter adapter)

Additional accessories

- USB non-rugged mini keyboard (83-key)
- USB rugged, backlit keyboard (83-key)
- Screen protectors (2-pack)
- Active stylus
- Pen tether

Contacting Xplore – service and questions

Note: To troubleshoot problems (including wireless and GPS problems), before you call, read the FAQ page of the Xplore Technologies Web site. Go to <http://www.xploretech.com>; then select **Customer Support**; then **FAQ**.

If you purchased your tablet from an authorized Xplore dealer, contact the dealer for service and support.

If you purchased your tablet directly from Xplore, use any of the following methods to contact Xplore for service and support:

Web site	http://www.xploretech.com
E-mail	customersupport@xploretech.com
Toll free	1-866-296-8541, extension 222
Fax	1-512-336-7791

Before you contact Xplore, have the following information ready so that the customer support representative can quickly provide a solution:

Product name: iX104C⁴

Product serial number

Purchase date

Conditions under which the problem occurred

Any error messages that were displayed

Type of device connected, if any

The serial number is on the back of the tablet. See page 21.

1

Getting Started

This chapter gives you an overview of your tablet and includes a quick-start guide to tablet keys.

Front view

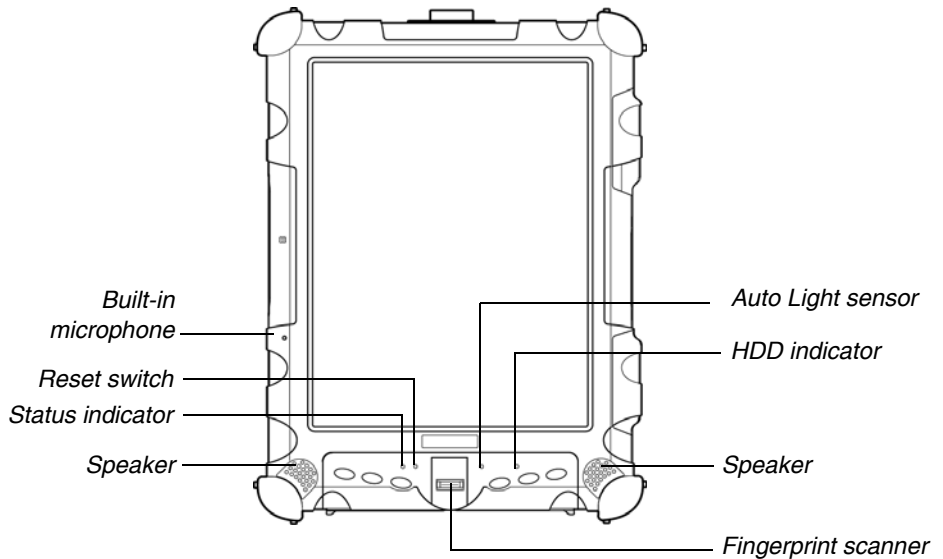

Built-in microphone	Enables you to input mono audio with noise cancellation. (See page 50.)
Reset switch	Enables you to turn off the computer when using the Power (On/Off)/Backlight (On/Off)/Resume key is not effective. (See page 32.)
Status indicator	Indicates the computer status (on, off, etc.). (See page 26.)
Speakers	Enable you to listen to stereo audio files. Sealed to provide protection from the environment.

Chapter 1. Getting Started

Front view

Auto Light sensor	Detects ambient light conditions.
HDD indicator	Indicates hard disk drive activity. (See page 26.)
Fingerprint scanner	Enables you to use fingerprint verification features. (See page 43.)

Back view

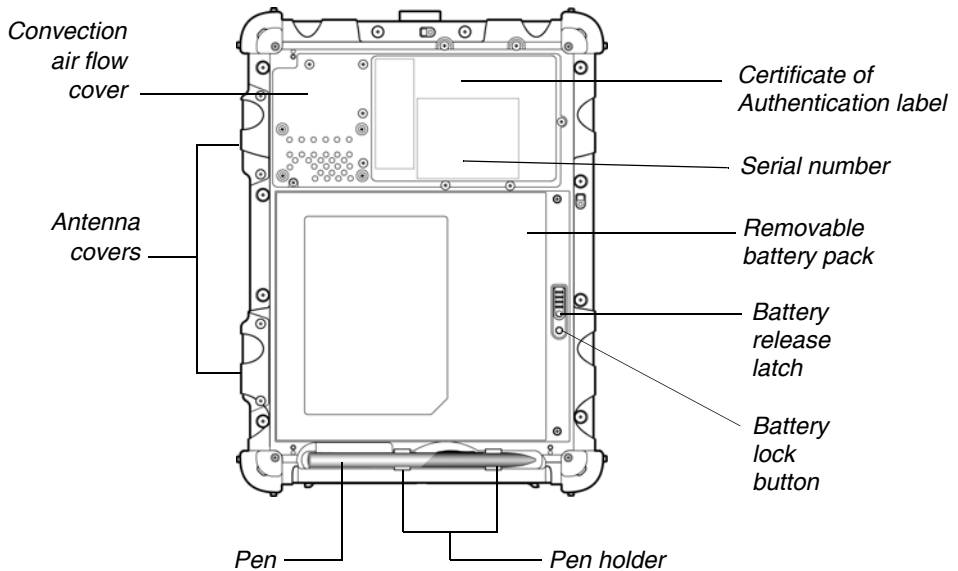

Convection air flow cover	Magnesium cover over the thermal transfer bay that manages heat movement out of the computer.
Antenna covers	For optional wireless LAN and WAN models, protect and secure the radio antennas (accessible by authorized service personnel only).
Pen	The main device you use to enter data and control applications (instead of a mouse or a keyboard). Also called the <i>stylus</i> . See "Using the pen" on page 37.
Pen holder	Provides a place to secure the pen when you are not using it.
Battery release latch	Provides access to the battery.
Battery lock button	Secures the battery inside the tablet.
Removable battery pack	Powers the computer when AC power is unavailable.
Certificate of Authentication label and serial number	Label that identifies the tablet's operation system as being genuine Microsoft software, and your tablet's serial number.

Chapter 1. Getting Started

Front view

Top view

Power (On/Off)/
Backlight (On/Off)/
Resume button

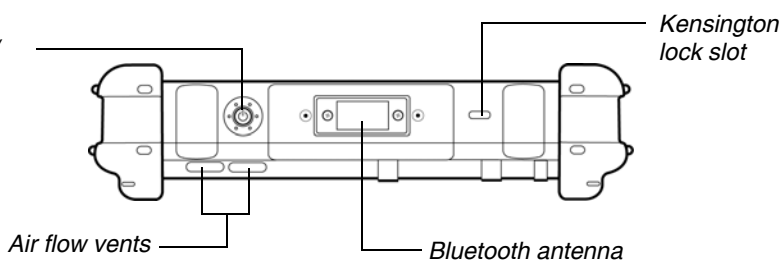

Power (On/Off)/
Backlight (On/Off)/
Resume button

Press the button to turn the computer on or off, to turn the backlight on or off, or to resume operation.

Air flow vents

Help prevent the computer from overheating by forcing heat away from the computer. (Do not block the vents.)

Bluetooth antenna

Bluetooth antenna.

Kensington™ lock slot

Connector for the optional Kensington MicroSaver™ or equivalent compatible security cable.
Note: Contact your reseller for information about the Kensington security cable.

Bottom view

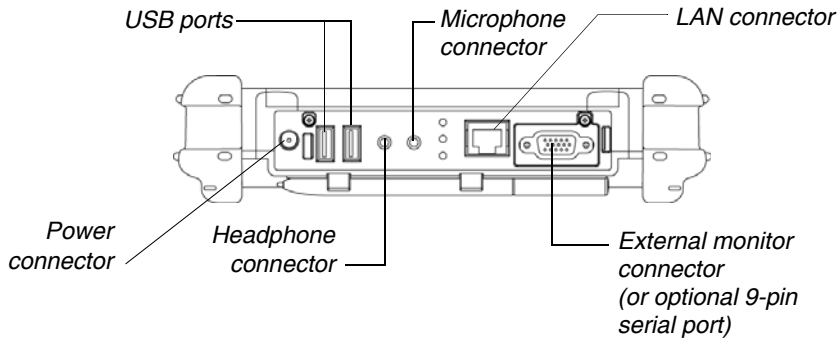

The connectors on the bottom of the computer are located behind the outer doors.

Power connector	For the optional AC adapter or auto adapter. (See “Optional accessories” on page 16.)
USB 2.0 ports	For Universal Serial Bus devices (compliant with USB Standard Revision 2.0). Note: The optional Office and Vehicle Docks include additional USB ports. See “Optional accessories” on page 16.
Headphone connector	For stereo headphones or speakers.
Microphone connector	For an external microphone.
LAN connector	For connecting a standard RJ-45 connector to the tablet’s internal local area network (LAN) card
External monitor connector	For an external monitor or projection panel.
(Optional) 9-pin serial port	For connecting terminals or other devices that use the RS-232, RS-422, or RS-485 data transfer standard.

Chapter 1. Getting Started

Front view

Left side view

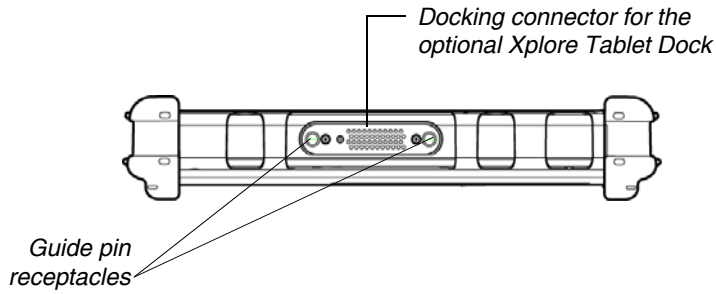

Docking connector	Enables you to connect the optional xStand Desktop Docking Station or xDock Vehicle Docking Station.
Guide pin receptacles	Help assure a secure connection of the optional xStand or xDock. Note: See "Optional accessories" on page 16.

Right side view

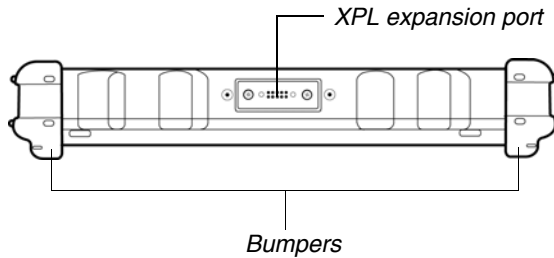

Bumpers	Fabricated from rugged material. Raised to help protect the computer from damage.
XPL expansion port	A USB port (compliant with USB Standard Revision 2.0) that enables you to connect XPL snap-on expansion modules with additional functionality such as GPS, barcode scanning, and magnetic stripe reading. Note: Contact your reseller for information about the XPL expansion module.

Front view

LED indicators

The LED indicator lights show the status of system functions.

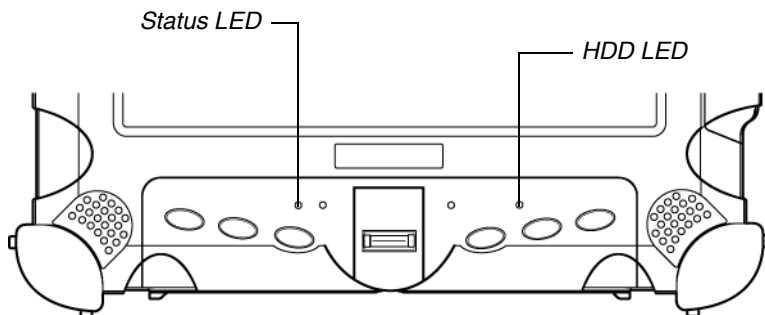

The following table defines the various LED states.

Table 1 Status LED indicator

Mode/State	LED State	Meaning
On state	green, continuous	The computer is on, ready for use, and functioning normally. The battery is fully charged.
Charging	green, blinking	The AC adapter is plugged in and the battery is charging.
Off state	off (no light)	The computer is off.
Suspend mode	yellow, continuous	The computer is on and is in Suspend or Hibernation mode.
Thermal control	yellow, blinking	The computer is on and is in Warm-up mode, with the LCD and backlight off. After the system has warmed to a safe level, the LCD and backlight turn on.

Table 1 Status LED indicator (continued)

Mode/State	LED State	Meaning
On	red, blinking	The computer is powered on, running on battery power, and the charge level in the battery has reached a minimum warning state. Plug the computer into an AC/DC power source or install a charged battery.
On	red, continuous	The computer is on, running on battery power, and the charge level in the battery has reached a critical state. Plug the computer into an AC/DC power source or install a charged battery. Or: The computer has encountered a fault and is not operating normally. Contact your computer support personnel, such as your help desk.

Quick-start guide

This section is a quick guide to using the main features of your tablet.
(See Chapter 2 for detailed information.)

Application, Windows, and hot keys

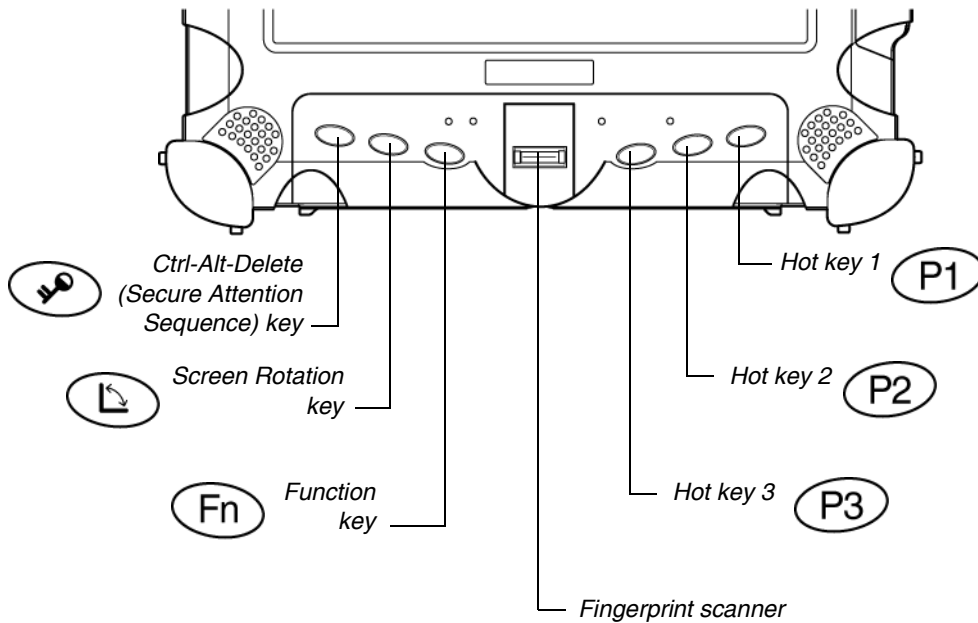















Table 2 Main keys

Press this key...	To perform this function
	Log on after resuming operation from power management, powering on, or locking. After logging on, launch Windows Task Manager.
	Rotate screen orientation between portrait (vertical) and landscape (horizontal).
	Use in combination with another key to perform various functions. (See page 30.)
	Fingerprint scanner.
	Open Help, or perform a user-definable function.
	Open Internet Explorer, or perform a user-definable function.
	Open your email application, or perform a user-definable function.

To define a function, see
“Programming hot keys” on
page 70.

Table 3 Function mode keys

Press these keys...	To perform this function
 	Default function: Send video display to a monitor or projection panel connected to the computer (and back to the computer again). You can program this key combination to perform a different function. (See “Programming hot keys to start applications, open documents, or go to a Web site” on page 71.)
 	Default function: iX104C4: Open a pre-defined program (see “Programming hot keys to start applications, open documents, or go to a Web site” on page 71). iX104C4 Dual Mode: Select Auto-Sense mode, Active mode, or Touch mode. This determines the input devices you can use. In Auto-Sense mode, you can use the pen, your finger, or another similar device interchangeably. In Active mode, you can use only the pen. In Touch mode, you can use your finger or another similar pointing device. You can program this key combination to perform a different function. (See “Programming hot keys to start applications, open documents, or go to a Web site” on page 71.)
 	Default function: Open the pen calibration program. You can program this key combination to perform a different function. (See “Programming hot keys to start applications, open documents, or go to a Web site” on page 71.)

2

Using the Tablet

This chapter contains detailed instructions for using the tablet.

Turning on the computer

1. Make sure the computer is off.

*When the computer is off,
the Status LED is off.*

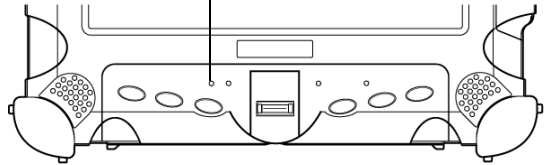

2. Make sure the battery is charged or that the computer is plugged in to an external power source.
3. Press the Power On/Off/Suspend/Resume button.

*Power On/Off/
Suspend/Resume
button*

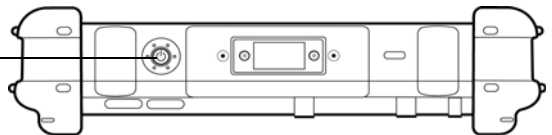

Turning off the computer

When the computer is in Suspend mode, the Status LED is continuously yellow.

1. If the computer is in Suspend mode, press the Power On/Off/Suspend/Resume button to resume operation. (See page 34 for information about Suspend mode.)

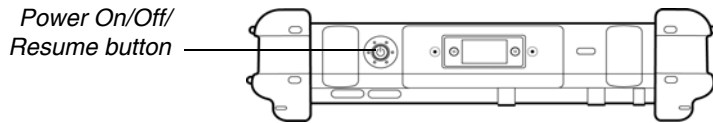

2. Make sure the battery is charged or that the computer is plugged in to an external power source.
3. Save your work and close all programs.
4. From the Windows Start menu, click Turn Off Computer.
5. The Turn off computer dialog box opens.
6. Click Turn Off.

Using the Reset switch

Use the Reset switch only if you cannot turn off the computer by any other means, because you may lose unsaved data.

If the computer does not seem to be accepting input and you cannot turn it off by using the method described in “Turning off the computer,” press the Reset switch. (Use the stylus or a similar instrument to press the switch).

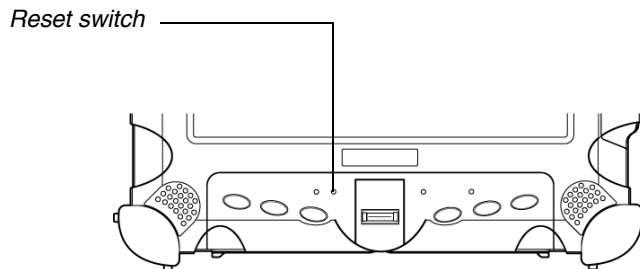

Suspending and resuming operation

To conserve battery power when you do not want to turn off the computer or when you need to install a charged battery pack, put the computer into Suspend mode. (You can suspend operation without closing any programs or Windows.)

When you suspend operation:

- Programs that are running stop (but do not close).
- Active data is saved.
- The system enters one of the following low-power modes:
 - Suspend-to-RAM mode – The Status LED light is continuously yellow. Active data is saved in RAM and most other components are turned off.

Although the computer uses very little power when in Suspend-to-RAM mode, eventually the battery's power does run out. If you do not plan to use the computer for an extended period of time, turn the computer off or put it in Hibernation mode instead of using Suspend-to-RAM.
 - Hibernation mode – Active data is saved on the hard disk and power usage is reduced to the same level as when the computer is turned off. In Hibernation mode, there is no danger of losing data if battery power is lost.

Note: For more information, see “Using power options – Windows XP” on page 58 or “Using power options – Windows Vista” on page 62.

If you have set your computer to turn power off (in the Power Options utility in Windows Control Panel), you cannot suspend operation. To change power settings, see “Using power options – Windows XP” on page 58 or “Using power options – Windows Vista” on page 62.

If the Suspend action of the Power On/Off/Suspend/Resume button has been disabled to prevent accidental interruption, pressing the button does not suspend the computer. You must use a software application to suspend the computer. For more information, contact your help desk or your iX104C⁴ dealer.

If your computer is connected to a network, the network may automatically log you off after a period of inactivity while system operation is suspended. Contact your help desk or system administrator to learn your log-off time limit.

Suspending operation

Use one of the following methods to suspend operation:

Method 1

Press and hold the Power (On/Off)/Backlight (On/Off)/Resume button for 4 seconds.

*Power (On/Off)/
Backlight (On/Off)/
Resume button*

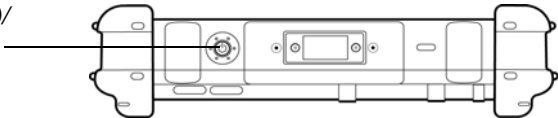

Note: In order to suspend operation, the Suspend option must be enabled in Windows Power Options. See “Using power options – Windows XP” on page 58 or “Using power options – Windows Vista” on page 62.

Method 2 – Windows XP

1. From the Windows Start menu, press Turn Off Computer.
The Turn off computer dialog box opens.
2. Press Stand By.

When operation is suspended, the Status LED displays a continuous yellow light.

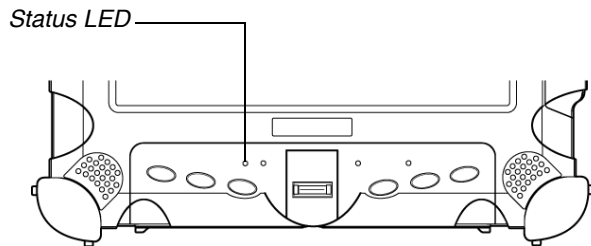
**Method 2 – Windows Vista**

1. From the Windows Start menu, press the right arrow in the lower right corner.
2. Press Sleep.

When operation is suspended, the Status LED displays a continuous yellow light.

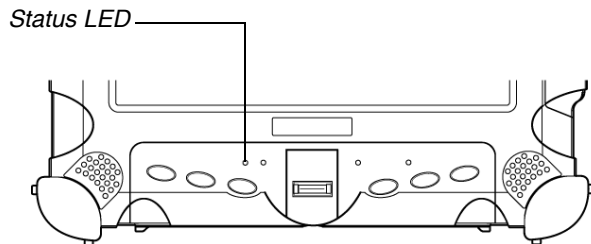

Resuming operation

To resume operation when the computer is in Suspend mode, press the Power (On/Off)/Backlight (On/Off)/Resume button.

Note: Press the button only *once*.

*Power (On/Off)/
Backlight (On/Off)/
Resume button*

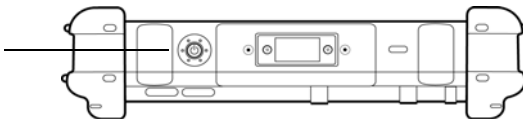

After a minute or two, the computer resumes normal operation. When the Status LED displays a continuous green light, you can begin using the computer.

Note: Resuming operation from Hibernation mode takes a little longer than from Suspend-to-RAM mode.

Using the pen

You can use the pen to select items and to navigate through programs.

If your computer is an iX104C⁴:

Use the special multi-function pen provided with the computer.

For more information about Dual Mode tablet input methods, see Appendix F, "Configuring Dual Mode Tablet Digitizer Input Methods."

If your computer is an iX104C⁴ Dual Mode:

You can use any of the following input methods:

Auto-Sense mode: Use either the multi-function pen or your finger interchangeably. The computer distinguishes between the two input modes and automatically adjusts accordingly. *This is the tablet's default state.*

Active mode: Use only the special multi-function pen provided with the computer.

Touch mode: Use your finger or another similar pointing device.

For more information, see "Selecting Auto-Sense, Active, or Touch mode" on page 38.

WARNING

Do not use items such as a ball point pen or a screwdriver that can damage the tablet. Damage caused by using an item not provided with the tablet is not covered by the tablet warranty.

Note: During the first use of the tablet, or if the action you are trying to perform does not occur when you use the pen or your finger to touch the screen, calibrate the digitizer as described in "Calibrating the digitizer" on page 85.



Selecting Auto-Sense, Active, or Touch mode

If your computer is the iX104C⁴ Dual Mode or iX104C⁴ Dual Mode AllVue Xtreme, use the **Fn-P2** key combination to select Auto-Sense mode (the default mode), Active-only mode, or Touch-only mode.

In **Auto-Sense** mode, you can use the multi-function pen provided with the tablet, your finger, or any other similar pointing device interchangeably, on the fly.

In **Active** mode, you can use only the special multi-function pen provided with the tablet.

In **Touch** mode, you can use your finger or another similar pointing device.

Note: The input methods available to you depend on the way your tablet has been configured. See Appendix F, "Configuring Dual Mode Tablet Digitizer Input Methods."

Using the digitizer to perform mouse functions

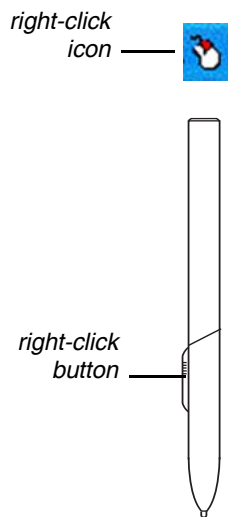

To perform this function...	Do this
Select an object (left button click).	Tap the pen tip once on the object.
Perform a double-click.	Quickly tap the pen tip twice on the object.
Perform a right-click.	<p>If your computer is an iX104C⁴:</p> <p>Hold the pen directly on the object for 1 second. The right-click icon appears.</p> <p><i>or</i></p> <p>Press the right-click button on the pen while you click the object.</p> <p>If your computer is an iX104C⁴Dual Mode:</p> <p>Touch mode:</p> <p>In the Windows taskbar, press the right-click icon; then click the object.</p> <p>Active mode:</p> <p>Hold the pen directly on the object for 1 second. The right-click icon appears.</p> <p><i>or</i></p> <p>Press the right-click button on the pen while you click the object.</p>
Move or drag an object.	Place the pen tip on the object; then continue to hold the pen tip against the screen as you move the pen.

Changing the pen double-click speed

The pen double-click speed is in sync with the mouse double-click speed. To change the speed, follow the instructions below.

Changing the pen double-click speed – Windows XP

1. Click the Windows Start button.
2. Click the Settings option.
3. Click the Control Panel option.
4. In the Control Panel window:

If your computer is an iX104C³ Tablet PC:

Click the Tablet and Pen Settings icon.

If your computer is an iX104C³ Dual Mode:

In **Active** mode: Click the Tablet and Pen Settings icon.

In **Touch** mode: Click the Pointer Devices icon.

5. Click the Windows tab.
6. Follow the instructions that appear in the Windows tab.

Changing the pen double-click speed – Windows Vista

1. Click the Windows Start button.
2. Click the Control Panel option.
3. In the Control Panel window:

If your computer is an iX104C⁴:

Click the Pen and Input Devices icon.

If your computer is an iX104C⁴ Dual Mode:

- a. Press the Pen and Input Devices icon.
 - b. In the Pen Options tab, select Double-tap.
 - c. Press Settings.
4. Drag the slider to a faster or slower speed; then press OK.

Positioning the pen and pen tether

The pen tether helps prevent the loss of your pen. The following illustrations show how to position the pen and pen tether.

Tether anchored at the top

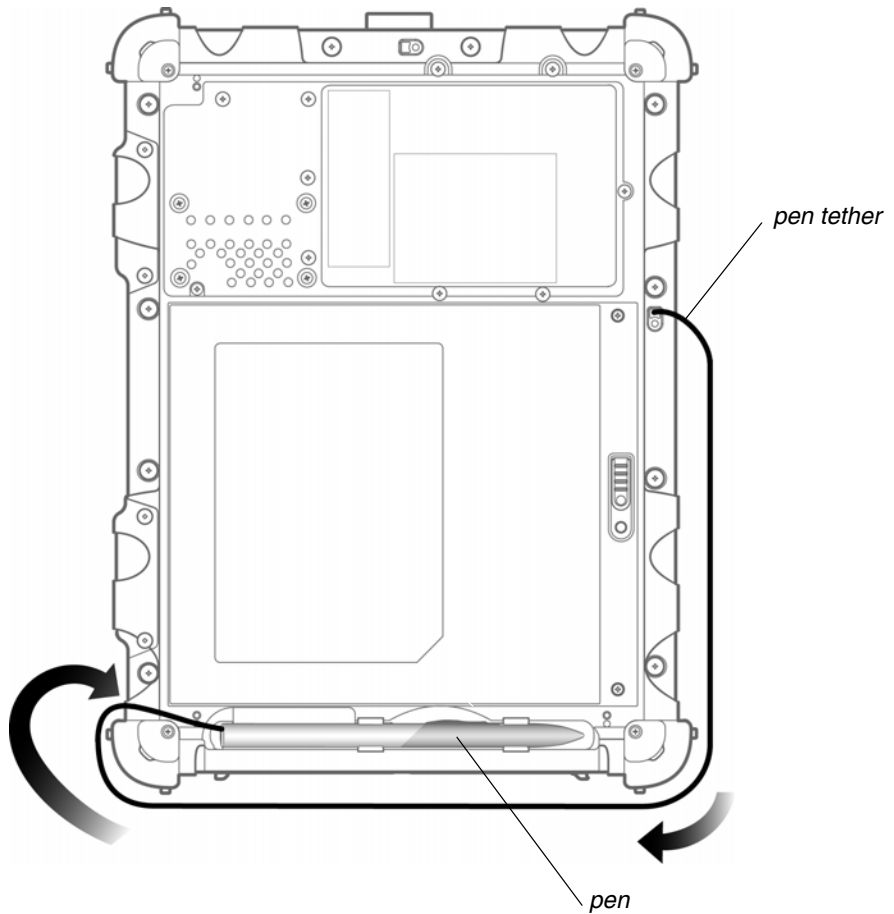

Tether anchored on the side

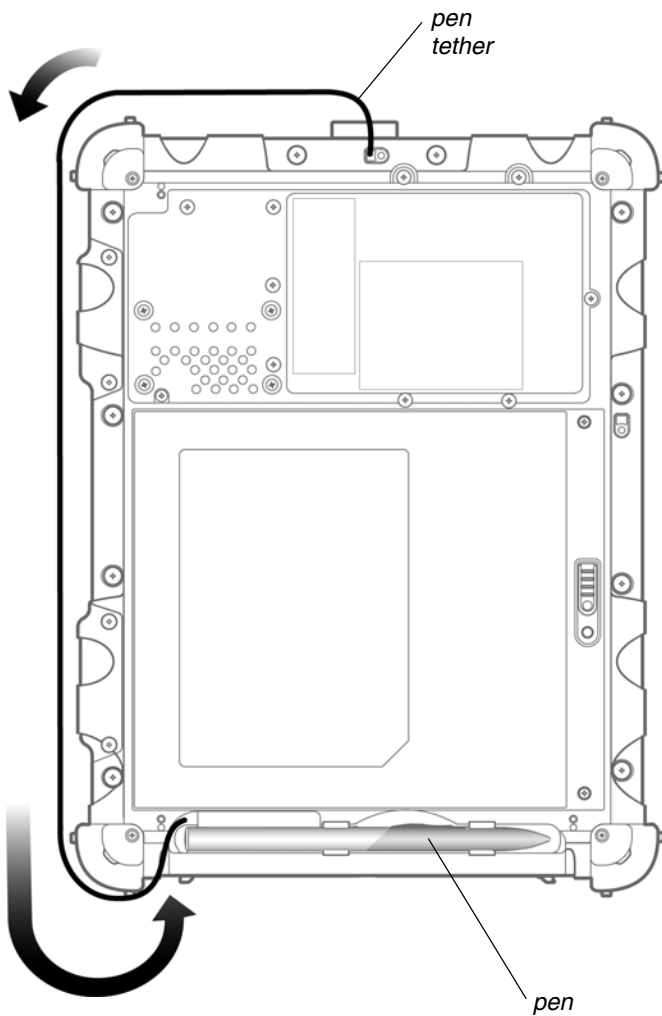

Using the fingerprint scanner

The fingerprint scanner and the associated Protector Suite QL software enable you to use fingerprint verification to protect the security of your data.

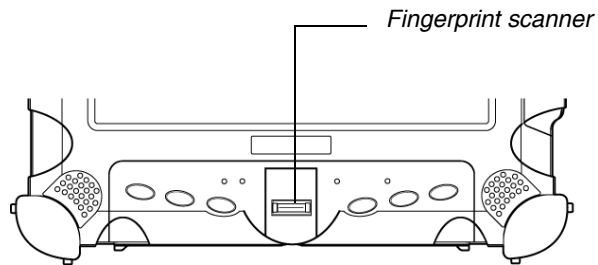

The first step for using fingerprint verification is to *enroll* your fingerprint to create an association between your username, password, and fingerprint.

After fingerprint enrollment you will be able to:

- Use your fingerprint as part of computer login security.
- Register Web pages and Windows applications to use your fingerprint instead of passwords.
- Launch applications by swiping your finger the sensor.
- Store confidential information in an encrypted form in a protected folder.

To launch the Enrollment Wizard, select:

Start > All Programs > Protector Suite QL > User Enrollment
and follow the wizard's instructions.

For more information about using the fingerprint scanner, see the Protector Suite QL User's Guide PDF included on your hard disk in the Protector Suite QL folder.

Changing the screen orientation



To rotate the screen orientation from portrait (vertical) to landscape (horizontal) mode or from landscape to portrait mode, press the screen rotation key.

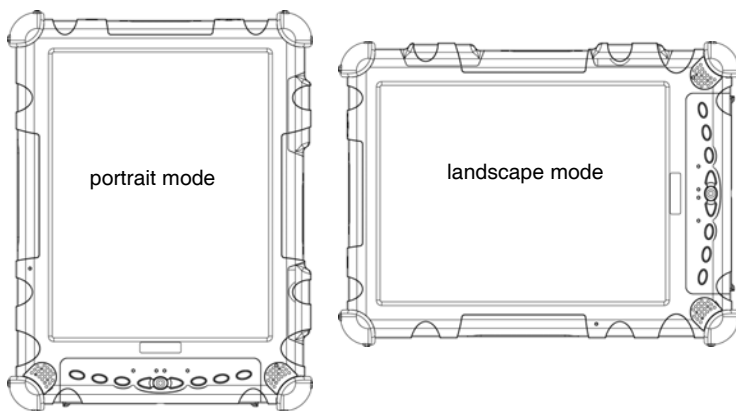

Adjusting the screen brightness

Windows XP

To adjust the screen brightness, click the brightness control icon on the Windows taskbar; then use the slider bar to make the adjustment.

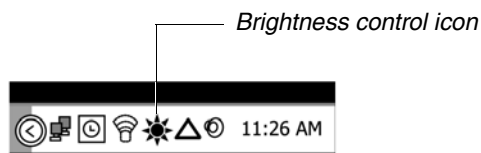

Windows Vista

To adjust the screen brightness:

1. Click Start.
2. Open the Control Panel.
3. Double-click the Windows Mobility Center icon.
4. Use the Display brightness slider to adjust the brightness.

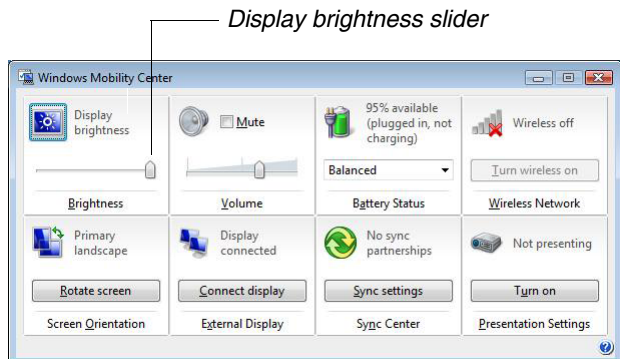

Enabling automatic backlight control

When the Auto Light sensor is enabled, the computer automatically controls the amount of backlight sent to the screen to provide optimum brightness for the lighting conditions in which you are working.

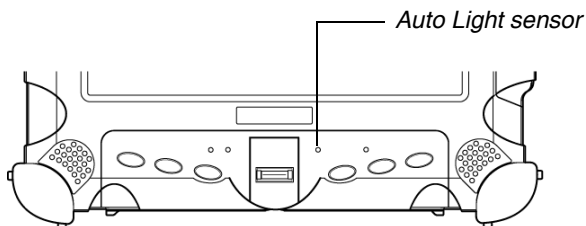

To enable automatic backlight control, see page 100.

Optimizing screen settings for outdoor use

Windows XP

1. Click Start; then select Control Panel.
2. Click the Desktop tab and set the background to None.
3. In the Control Panel, click Display.
4. Click the Appearance tab.
5. From the drop-down menu, select Windows Classic.
6. From the Windows and buttons drop-down menu, select High Contrast White.
7. Click the Effects button. Make sure that Use the following method to smooth edges of screen fonts is checked and that ClearType is selected from the drop-down list. Click OK.
8. Click the Settings tab. Make sure the Screen resolution setting is 1024 by 768 pixels and that the Color quality setting is Highest (32 bit). Click OK.

Windows Vista

1. Click Start; then select Control Panel.
2. In the Control Panel, click Control Panel Home.
3. Click Appearance and Personalization.
4. Click Change desktop background. In the Location area, select Solid Colors. For the background color, select white; then click OK.
5. In the Appearance and Personalization window, click Customize Colors.
6. Select Frost. Move the Color intensity slider bar to the far right; then click OK.

Docking the tablet

If you have the optional xStand office dock or xDock vehicle dock, connect it to the tablet at the docking port. (See the *iX104 Docking Stations Handbook*.)

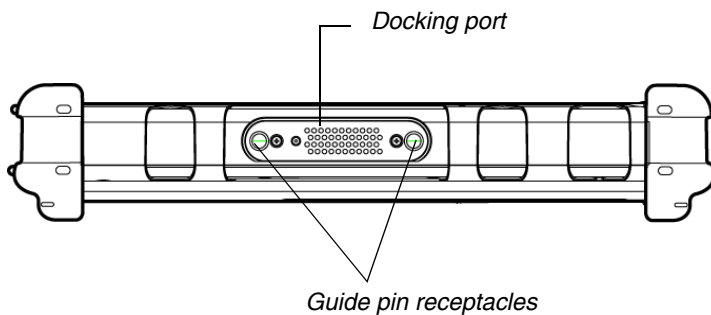

Connecting devices

Refer to the following subsections for information about connecting external devices to your computer.

Note: If the device you want to use does not appear to be working with your computer, the device may need to be enabled in the computer's configuration program. Contact your local help desk or Xplore reseller.

Connecting to a local area network

Connect a local area network (LAN) cable's RJ-45 connector to the internal LAN interface card. (See your network system administrator for more information.)

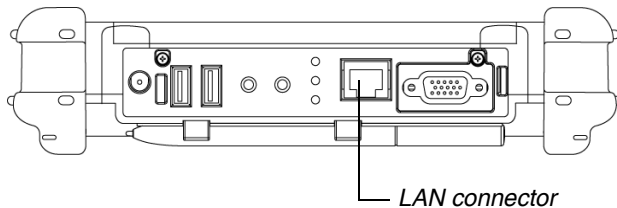

Connecting USB-compatible devices

Connect any USB-compatible devices to the computer's USB ports.

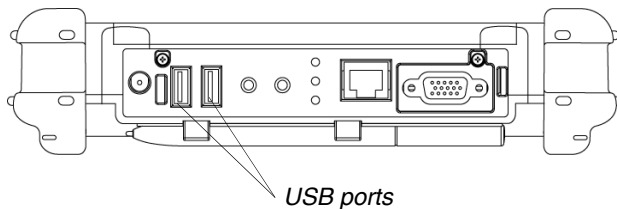

Devices must be in compliance with USB Standard Revision 2.0.

Connecting an external microphone

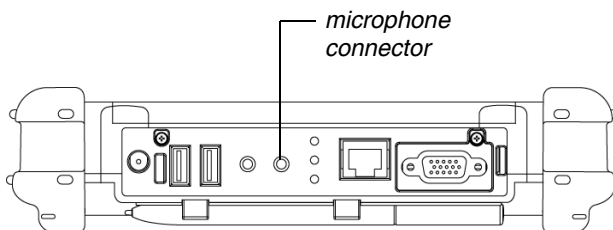

Adjusting microphone volume – Windows XP

If necessary, adjust the volume of the microphone as follows:

1. Press the Windows Start key; then open the Control Panel.
2. In the Control Panel window, double-click the Sounds and Audio Properties icon.
3. In the Sounds and Audio Properties window, click the Audio tab.
4. In the Sound recording area, click the Volume button.
5. Adjust the volume.
6. Click OK.

Adjusting microphone volume – Windows Vista

If necessary, adjust the volume of the microphone as follows:

1. Press the Windows Start key; then open the Control Panel.
2. In the Control Panel window, double-click the Sound icon.
3. In the Sound Properties window, click the Recording tab.
4. Select Microphone; then press Properties.
5. Select the Levels tab.
6. Adjust the microphone volume or boost.
7. Click OK.

Connecting a headphone or speakers

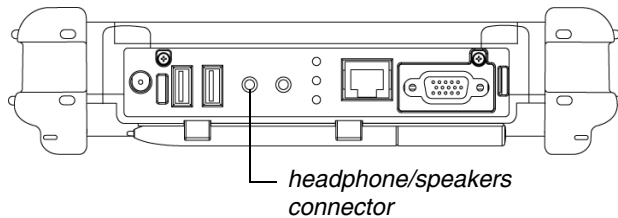

Adjusting headphone or speaker volume – Windows XP



1. Click the audio icon in the Status area of the Windows taskbar.
The volume control area opens.



2. If the Mute check box is checked, uncheck it.
3. Move the slider bar up or down to increase or decrease the volume.

Adjusting headphone or speaker volume – Windows Vista



1. Click the audio icon in the Status area of the Windows taskbar.
The volume control area opens.



2. If the Mute button indicates that sound is muted, click the button to turn on the sound.
3. Move the slider bar up or down to increase or decrease the volume.

Connecting a monitor or projection panel

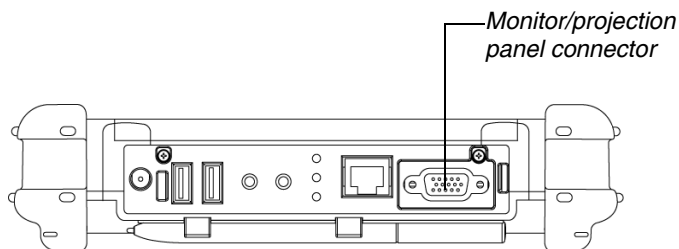

Activating the monitor or projection panel

To change the video output to the monitor or projection panel:

Press the Fn-P1 key combination.

To change the video output back to the computer:



Press the Fn-P1 key combination again.

Connecting a device to the optional serial port

If your tablet includes the optional serial port, you can connect a terminal or other device that uses the RS-232, RS-422, or RS-485 data transfer standard.

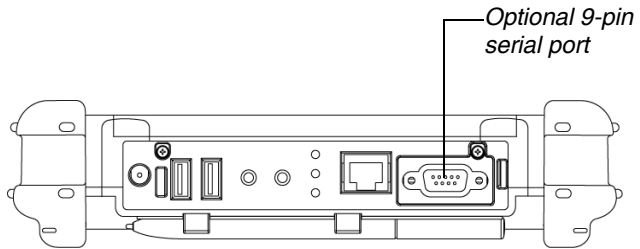

Connecting an XPL snap-on expansion module

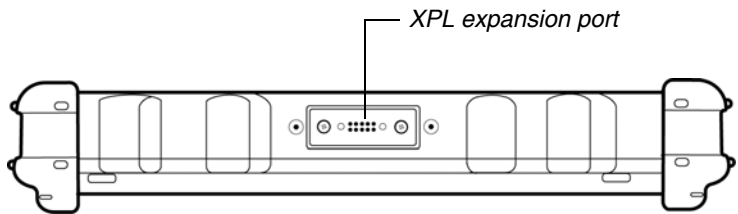

Using the battery

You can recharge, remove, and replace the battery pack.

Charging the battery pack

If you do not have an external battery charger

Follow these steps to charge the battery while it is installed in the computer:

1. Connect a power source, such as an AC adapter or cigarette lighter adapter, to the power connector on the computer.

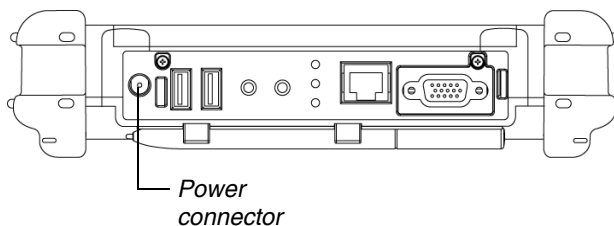

If the battery charge is below 90%, the battery begins charging and the Status LED flashes green. (If the battery charge is higher than 90%, the battery will not charge, preventing battery overcharge.)

2. Check the level of charge. (See “Checking battery power status” on page 60.)

The charging process continues until the battery charge reaches 100%.

Table 4 shows the approximate time required to charge the battery level to 100%.

Table 4 *Approximate battery charge time*

Battery pack capacity	Charge time
41 watt hours (5700 mAh)	2.5 hours
55 watt hours (7600 mAh)	3.5 hours

If you have an external battery charger

1. Remove the battery pack (see page 55).
2. Use the external battery charger to charge the battery.
3. Install the battery (see page 57).

Removing and installing the battery

You can remove the battery and use an (optional) external charger to charge it.

Removing the battery

1. **To swap with a charged battery:**

Use one of the methods described in “Suspending operation” on page 34 to suspend operation.

If a charged battery is not available:

Save your work and close all running programs; then shut down the computer or put the computer in Hibernation mode (see “Suspending operation” on page 34).

Note: To avoid losing unsaved data, wait until the computer has completed switching to Suspended mode before removing the battery.

2. Use the stylus or a pen to depress the battery lock button.
3. On the computer, slide the battery release latch toward the lock button.

The battery unlocks and slightly rises from the computer.

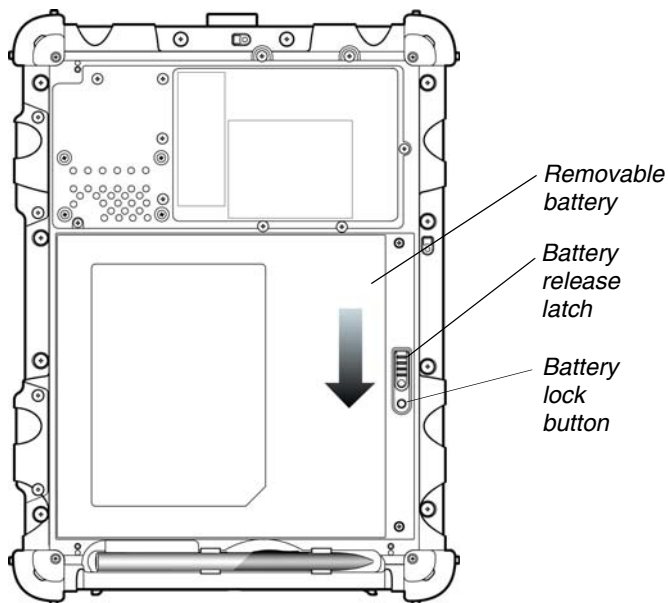

4. Pull the battery away from the computer and remove it.

Note: After removing the battery, you must replace the battery or connect the computer to an external power supply within **3 to 5 minutes** or the computer completely loses power.

Installing the battery

1. Orient the battery with the slides in the empty battery tray.

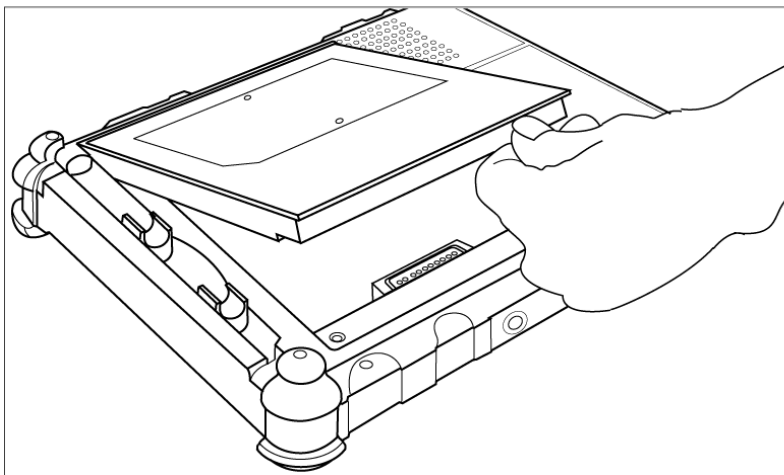

2. Slide the battery into the tray and press it firmly until it is seated.
3. Slide the battery release latch to its original position.

The lock button pops back into the locked position, securing the battery in place.

Discarding batteries

Dispose of batteries in accordance with your local government regulations. Under federal, state, or local law, it may be illegal to put batteries in the trash. Contact your system administrator, municipal waste disposal department/provider for information.

Using power options – Windows XP

Displaying power options



On the Windows taskbar, click the battery icon.

The Power Options Properties window opens.



Changing the computer's power schemes

In the Power Options Properties window, select the Power Schemes tab; then select options from the drop-down lists.

Changing battery alarm settings

In the Power Options Properties window (page 58), select the Alarms tab; then use the slider bars to change the alarm settings.

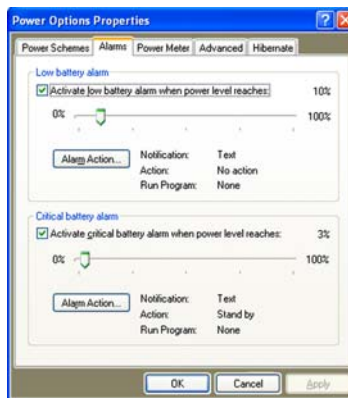

Checking battery power status

In the Power Options Properties window (page 58), select the Power Meter tab. The window shows the amount of power left in the battery.

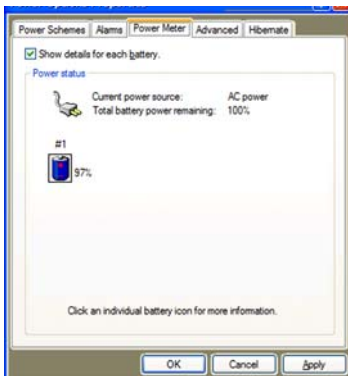

Selecting power settings

In the Power Options Properties window (page 58), select the Advanced tab; then select the power settings options you want to use.



Enabling Hibernation mode

In the Power Options Properties window (page 58), select the Hibernate tab; then check the Enable Hibernation check box.



Using power options – Windows Vista

Checking battery power status



On the Windows taskbar, click the battery icon.

The following window opens, displaying the percentage of power remaining in the battery:

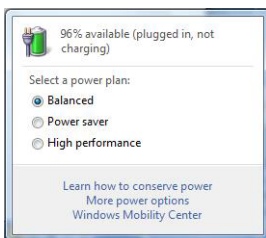

Selecting a power plan



1. On the Windows taskbar, click the battery icon.

The following window opens:

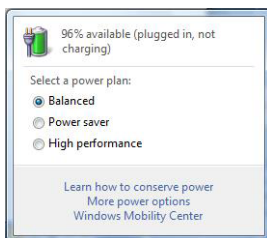

2. Select one of the following power plans:

Balanced – A balance between computer performance and battery life.

Power Saver – Longer battery life and lower performance.

High performance – Higher performance and shorter battery life.

Selecting power options



1. On the Windows taskbar, right-click the battery icon.
2. Select Power Options.

The following window opens.

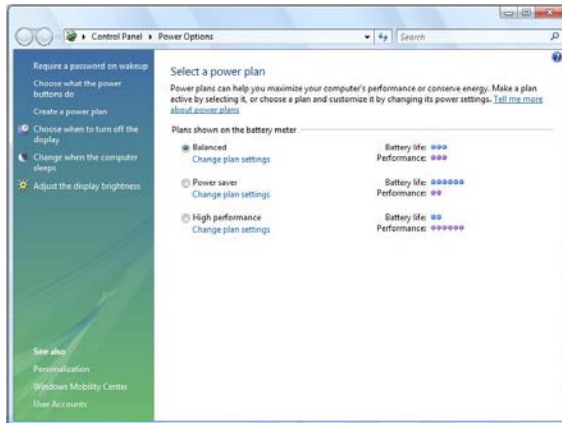

3. Under the selected power plan, press Change plan settings.
4. Select the power options you want to use.

Selecting Power (On/Off)/Backlight(On/Off)/Resume button options

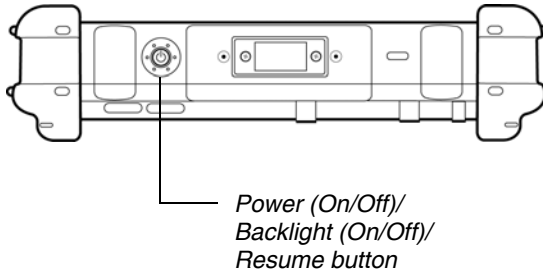

To change what happens when you press the button:



1. On the Windows taskbar, right-click the battery icon.
2. Select Power Options.

The following window opens.

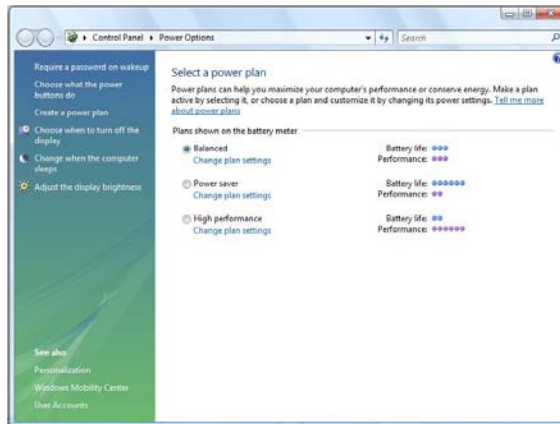

3. Press Choose what the power buttons do.
4. Select the options you want to use.

Tips for conserving battery power

The following tips help you extend the life of your battery by conserving battery power:

- Use an external power source such as the AC or auto adapter whenever available.
- Suspend operation if you know that you will not be using the system for a while. (See “Suspending operation” on page 34.)
- If you do not plan to use the computer for an extended period of time, turn it off.

Note: If your computer is running Windows XP, you also have the option of placing it in Hibernation mode. (See “Enabling Hibernation mode” on page 61.)

- Adjust power options to automatically conserve power. (See “Using power options – Windows XP” on page 58 or “Using power options – Windows Vista” on page 62.)

Accessing the hard disk drive compartment

When you install a new hard disk drive, follow the instructions in this section to access the hard disk drive compartment.

WARNING Failure to follow this procedure can result in damage to the case and the cover, which is not covered under the Xplore Technologies warranty. Xplore recommends that you use an approved Xplore Technologies service center for this procedure.

1. Turn off the computer.
2. Remove all power from the unit, including batteries and other power sources such as power supplies, cigarette lighter adapters, and mobile power sources.
3. Use an M1 Phillips screwdriver to remove the 10 screws from the compartment cover. (Do not use a power screwdriver.)

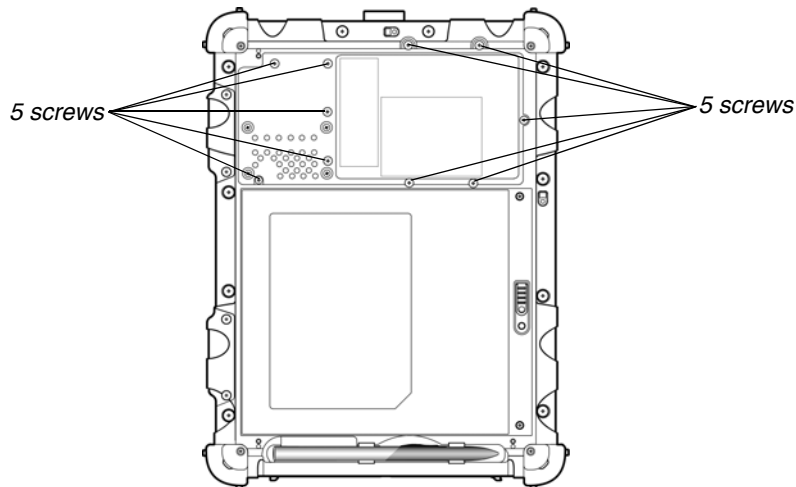

Re-installing the hard disk drive compartment cover

1. Make sure the sealing gasket is properly placed.
2. Reposition the cover on the compartment.
3. Use the M1 Phillips screwdriver and a torque wrench to replace the 10 screws.

Notes: Use a maximum torque of 3 kg-cm (2.6 lb-in) for each screw.

Do not use power tools.

Accessing the PCMCIA compartment

When you install a PCMCIA card, follow the instructions in this section to access the PCMCIA compartment.

WARNING Failure to follow this procedure can result in damage to the case and the cover, which is not covered under the Xplore Technologies warranty. Xplore recommends that you use an approved Xplore Technologies service center for this procedure.

1. Turn off the computer.
2. Remove all power from the unit, including batteries and other power sources such as power supplies, cigarette lighter adapters, and mobile power sources.
3. Remove the battery. (See “Removing and installing the battery” on page 55.)
4. Use an M1 Phillips screwdriver to remove the 6 screws from the compartment cover. (Do not use a power screwdriver.)

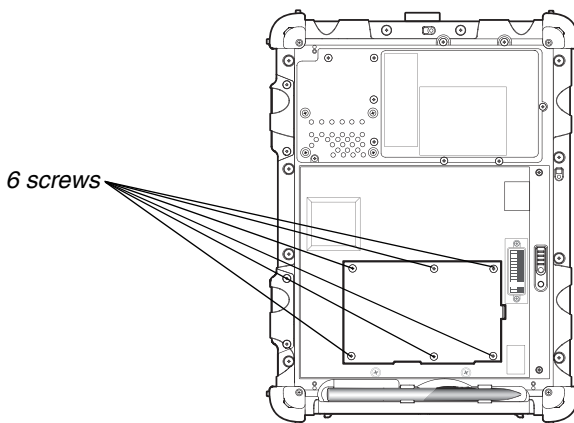

Re-installing the PCMCIA compartment cover

1. Make sure the sealing gasket is properly placed.
2. Reposition the cover on the compartment.
3. Use the M1 Phillips screwdriver and a torque wrench to replace the 6 screws.

Notes: Use a maximum torque of 3 kg-cm (2.6 lb-in) for each screw.

Do not use power tools.

Programming hot keys

Xplore pre-programs the P1, P2, and P3 hot keys and Function mode hot key combinations to perform certain functions by default. However, you can program them to perform different functions, as described in this section.

Table 5 Programmable hot keys









Key	Default function
	Starts Help.
	Starts Internet Explorer.
	Starts your email application.

Table 6 Programmable Function mode hot key combinations

Key combination	Default function
 	Sends video display to a monitor or projection panel.
 	iX104C ⁴ : Opens a pre-defined program. iX104C ⁴ Dual Mode: Selects the input device (see page 38).
 	Starts the pen calibration program.

Programming hot keys to start applications, open documents, or go to a Web site



1. In the Status area of the Windows taskbar, click the iX104C⁴ Configuration icon.

The Launch Button QuickShow dialog box opens.

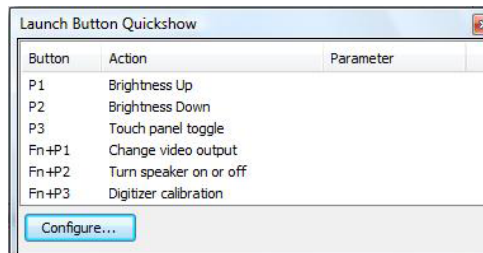

2. Click the Configure button.

The Panel Control Center window opens.

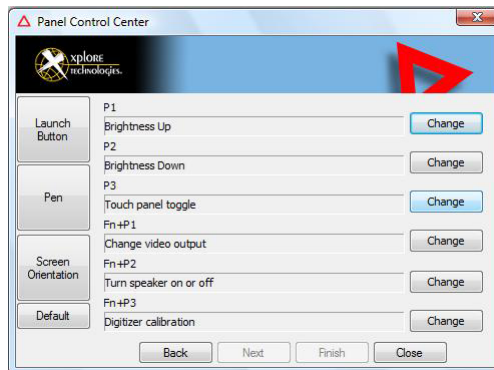

3. Click the **Change** button next to the key or key combination you want to program.

The following options appear:

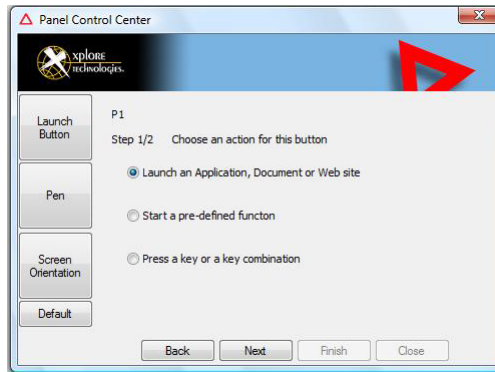

4. Click **Launch an Application, Document or Web site**.

The following options appear:

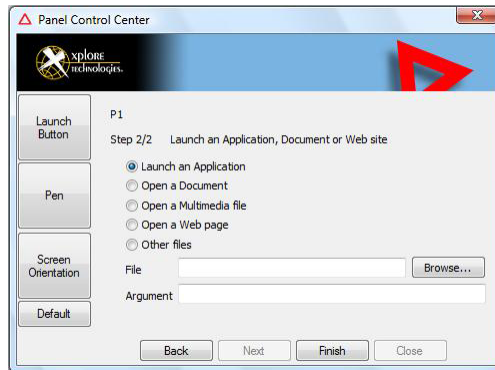

5. To start an application:

- a. Click Launch an Application.
- b. Press **Browse** to find the application you want the hot key or Function mode hot key combination to start (for example: word.exe, notepad.exe, excel.exe).

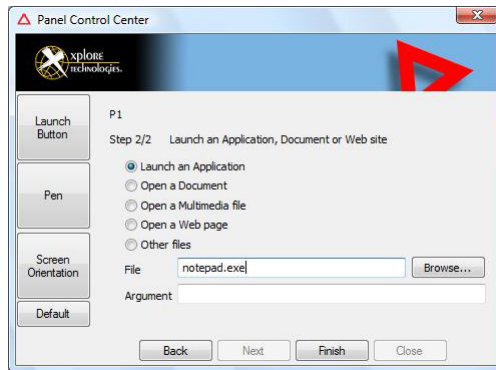

- c. Click Change.

6. To open a document:

- a. In the Click Open a Document.
- b. Press **Browse** to find the document you want the hot key or Function mode hot key combination to open. (For example: spreadsheet.xls, airports.doc, wiringdiagram.jpg)
- c. Click Change.

7. To open a multimedia file:

- a. Click Open a Multimedia file.
- b. Press Browse to find the name of the multimedia file you want the hot key or Function mode hot key combination to open. (For example: 911training.dir, demo.ppt)
- c. Click Change.

8. To open a Web page:

- a. Click Open a Web page.
- b. Press Browse to find the URL of the Web page you want the hot key or Function mode hot key combination to open. (For example: <http://www.xploretch.com>)
- c. Click Change.

9. Program more hot keys, or click Close to close the Panel Control Center window.

Programming hot keys to perform pre-defined functions



1. In the Status area of the Windows taskbar, click the iX104C⁴ Configuration icon.

The Launch Button QuickShow dialog box opens.

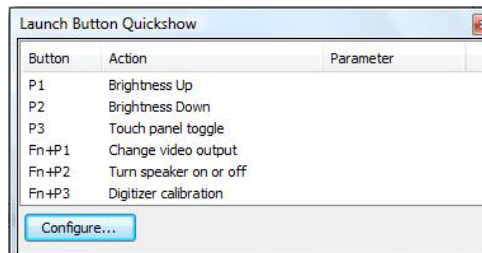

2. Click the Configure button.

The Panel Control Center window opens.

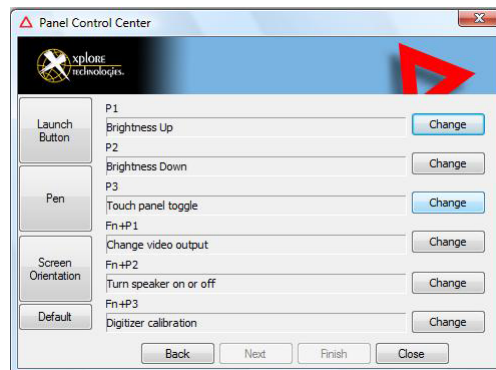

3. Next to the key or key combination you want to program, click the Change button.

The following options appear:

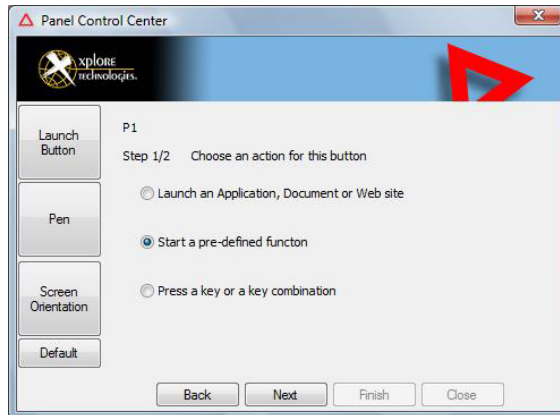

4. Click Start a pre-defined function.
5. In the Function selection drop-down list, select an option.

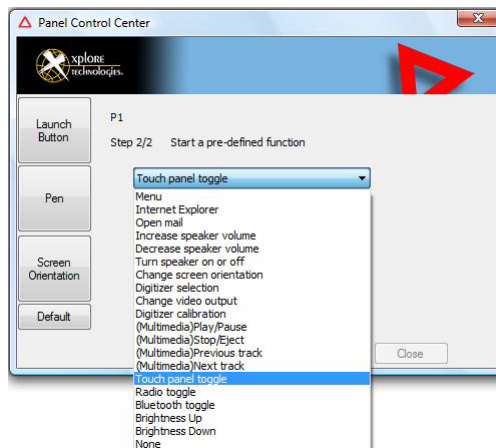

6. Program more hot keys, or click Close to close the Panel Control Center window.

Programming hot keys to perform other key functions



1. In the Status area of the Windows taskbar, click the iX104C⁴ Configuration icon.

The Launch Button QuickShow dialog box opens.

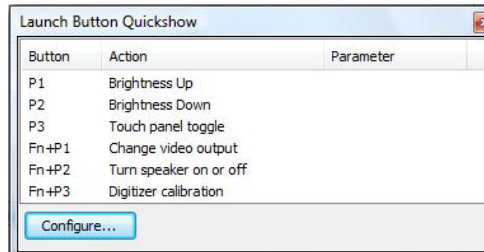

2. Click the Configure button.

The Panel Control Center window opens.

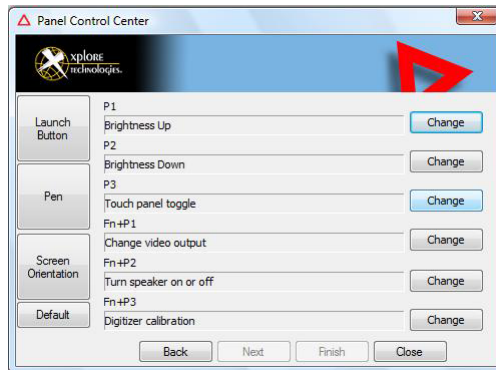

3. Next to the key or key combination you want to program, click the Change button.

The following options appear:

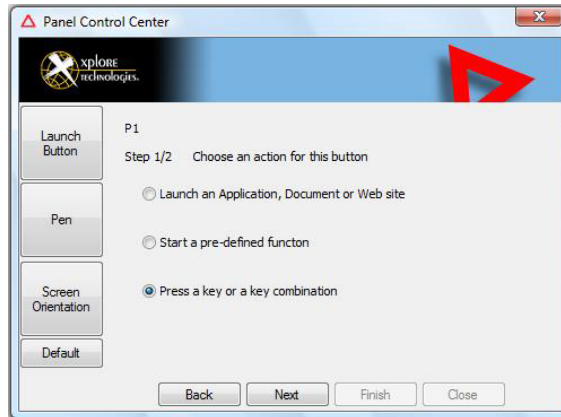

4. Click Press a key or key combination.

The following options appear:

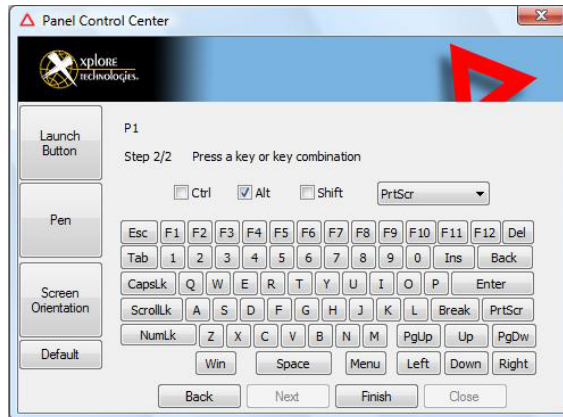

5. If you want the hot key or hot key combination to perform the function of a single key:

- a. If the Ctrl, Alt, or Shift boxes are checked, uncheck them.
- b. Click the key you want the hot key or hot key combination to perform. (For example: F6, G, or Caps Lock)

If you want the hot key or hot key combination to perform the function of a key combination:

- a. Check the Ctrl, Alt, or Shift box.
- b. From the drop-down list, select the additional key, or click the key on the keyboard.

Examples

To cause the hot key to perform the *print screen* function (Alt-Print Scrn): Check the Alt check box; then select PrtScr from the drop-down list.

To cause the hot key to perform the *paste* function (Ctrl-V): Check the Ctrl check box; then click the V key.

- 6.** Program more hot keys, or click Close to close the Panel Control Center window.

3

Maintaining the Tablet

This chapter provides instructions for maintaining your tablet.

Caring for the tablet

This section provides information about how to keep your tablet in top working condition.

Checking power cords and connectors

Check AC and DC power cords and power connectors periodically for damage. Replace the power cord immediately if you find any damage.

Protecting the computer from damage

- Your computer is designed to sustain a multiple-axis drop to a non-yielding surface. Do not intentionally drop the computer, because the cumulative effects of multiple drops may damage the computer.
- Do not place heavy objects on the computer.
- Do not disassemble the computer.
- Keep the computer at least 5 inches (13 centimeters) away from any electrical appliance that generates a strong magnetic field, such as a motor, magnet, TV, refrigerator, or large audio speakers.

Preventing the computer from overheating

The computer monitors its internal temperature. As the internal temperature approaches the tolerable limits of heat-sensitive components, system functions are automatically limited or turned off to prevent damage.

To prevent the computer from overheating, do not obstruct the computer's air vents.

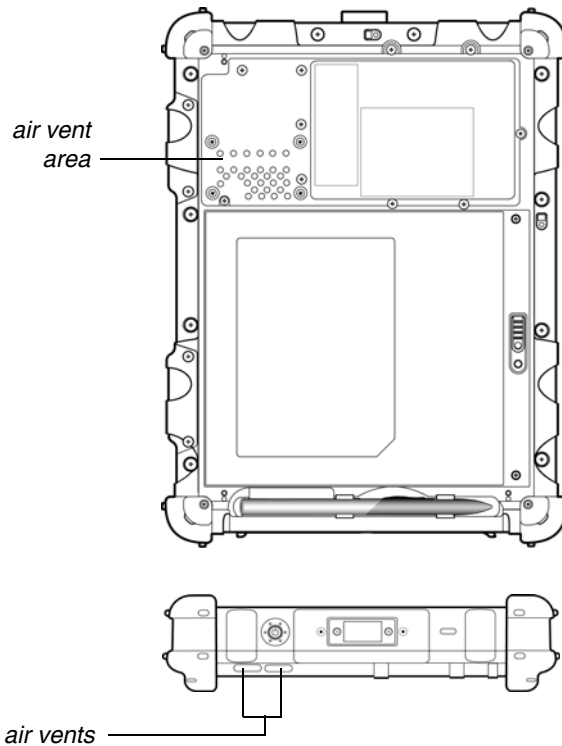

Storing the computer

You can store the computer in the Off state for about 30 days with a fully charged battery installed. After this period, recharge the battery or replace it with a charged battery.

If you intend to store the computer for more than 30 days, remove the battery pack and keep it in a cool place.

Caring for the display screen

To clean the display screen, dampen a soft cotton cloth with water and gently wipe the screen surface.

Note: Do not use isopropyl alcohol to clean the screen. Alcohol may damage the surface of the screen.

Protecting the display screen

The screen protector is a durable, replaceable writing surface that protects the display screen from abrasion.

To obtain additional screen protectors, check with your reseller, or go to the Xplore Web site at www.xploretech.com for ordering information. Additional information about installation is included with the screen protectors.

When to replace the pen

Removing the screen protector

Slide your fingernail under the edge of the screen protector and pull the protector away from the screen.

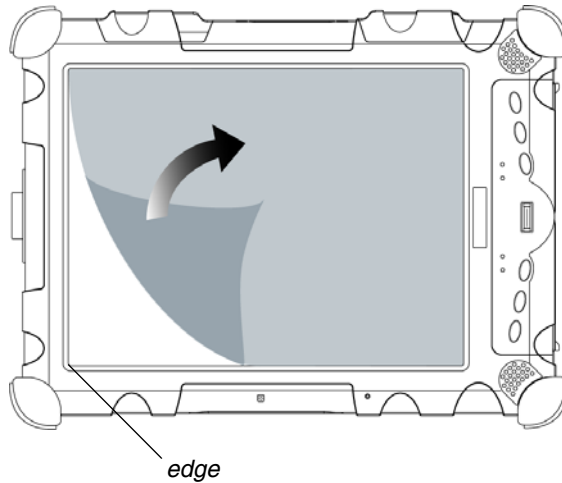

Installing a new screen protector

Follow the instructions included with your screen protector replacement kit.

Note: If a screen protector is already installed on the display screen, remove it before installing the new screen protector.

When to replace the pen

With use, the pen tip may become worn and can scratch the screen. If your pen exhibits one of the following problems, replace the pen:

- The pen does not move freely across the screen.
- The pen does not perform as expected.

Calibrating the digitizer

Calibrating the digitizer adjusts the cursor position on the screen relative to the position of the pen tip or finger. Calibrate the digitizer to adjust the distance error between where the pen or finger is actually touching the screen and where the computer is registering the pen or finger touch.

You may need to calibrate the digitizer in the following situations:

- You are using the computer for the first time.
- The previous user of the computer writes with the opposite hand or at a different pen angle.
- The computer has not been used for some time.
- The computer has been serviced.

Calibrating the digitizer: iX104C4 – Windows XP

Follow these instructions if your computer is running Windows XP.

1. From the Start menu, select Control Panel.

The Control Panel opens.

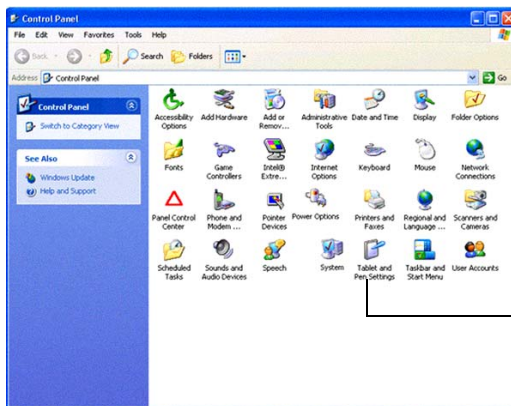

*Tablet and
Pen Settings
icon*

2. Click the Tablet and Pen Settings icon.

The Tablet and Pen Settings window opens.

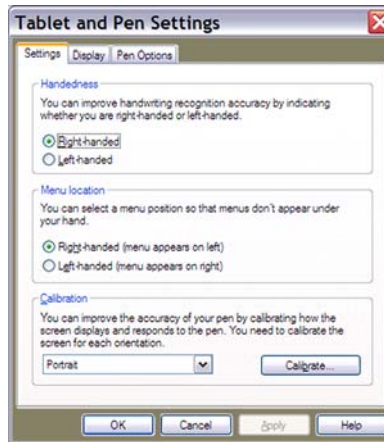

3. In the Calibration area drop-down list, select the mode for which you want to calibrate the pen: Landscape or Portrait; then click Calibrate.

The Calibration program starts.

4. Follow the instructions that appear on the screen.
5. When you finish, click OK.

Calibrating the digitizer: iX104C4 – Windows Vista

Follow these instructions if your computer is running Windows Vista.

1. From the Start menu, select Control Panel.

The Control Panel opens.

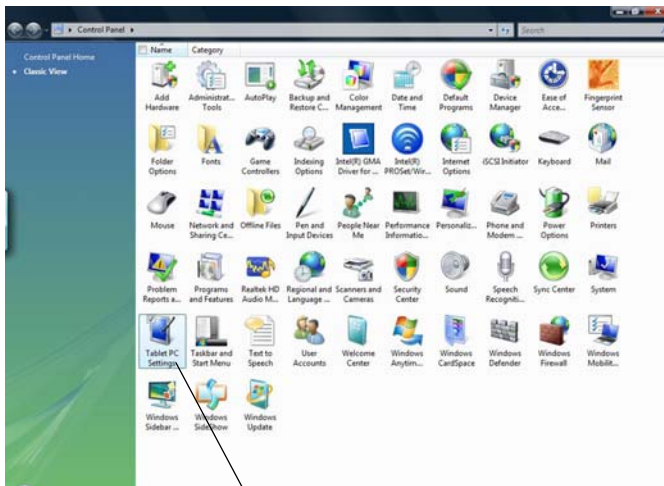

*Tablet PC Settings
icon*

2. Double-click the Tablet PC Settings icon.

The Tablet PC Settings window opens.

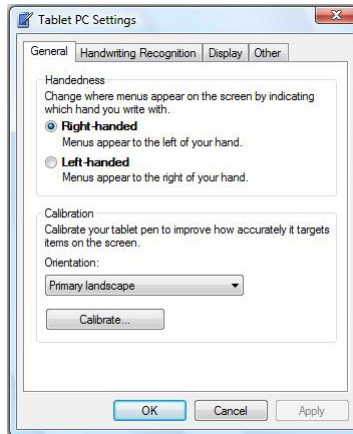

3. In the General tab, press the Calibrate button.
4. Follow the instructions that appear on the screen.
5. When you finish, click OK.
- 6.

Calibrating the digitizer: iX104C⁴ Dual Mode – Windows XP

Follow these instructions if your computer is running Windows XP.

In Active mode, you can use only the stylus included with the computer as the pointing device.

In Touch mode, you can use the stylus, a similar pointing device, or your finger.

Follow the instructions in the sections below to calibrate the digitizer for each mode.

See “Selecting Auto-Sense, Active, or Touch mode” on page 38.

Calibrating the digitizer: Active mode

1. From the Start menu, select Control Panel.

The Control Panel opens.

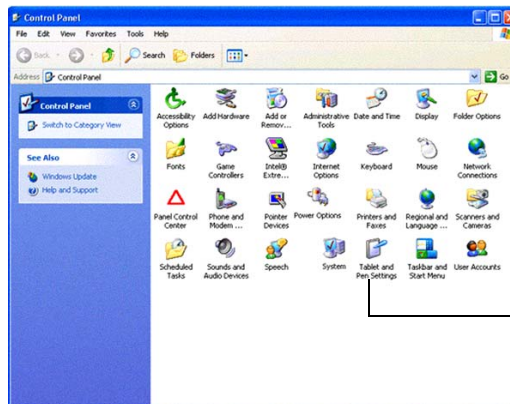

Tablet and Pen Settings icon

2. Click the Tablet and Pen Settings icon.

The Tablet and Pen Settings window opens.

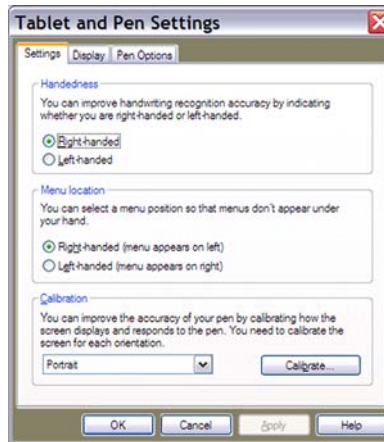

3. In the Calibration area drop-down list, select the mode for which you want to calibrate the pen: Landscape or Portrait; then click Calibrate.

The Calibration program starts.

4. Follow the instructions that appear on the screen.
5. When you finish, click OK.

Calibrating the digitizer: Touch mode

1. From the Start menu, select All Programs > Touch Utility.
The Touch Utility window opens.

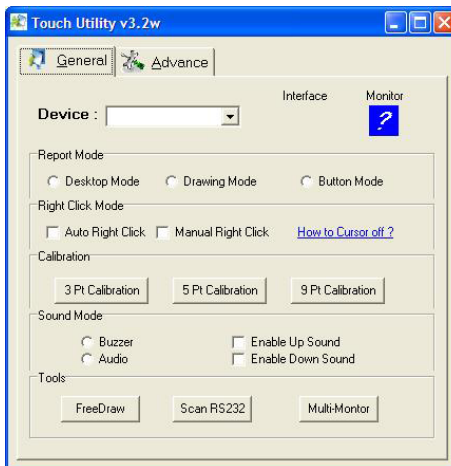

2. Click the appropriate Calibration button.

Note: Xplore Technologies recommends 5 Pt or 9 Pt calibration, for greater accuracy.

The Calibration program starts.

3. Follow the instructions that appear on the screen.
4. When you finish, click OK.

Calibrating the digitizer: iX104C⁴ Dual Mode – Windows Vista

Follow these instructions if your computer is running Windows Vista.

In Active mode, you can use only the stylus included with the computer as the pointing device.

In Touch mode, you can use the stylus, a similar pointing device, or your finger.

Follow the instructions in the sections below to calibrate the digitizer for each mode.

See “Selecting Auto-Sense, Active, or Touch mode” on page 38.

Calibrating the digitizer: Active mode

1. From the Start menu, select Control Panel.

The Control Panel opens.

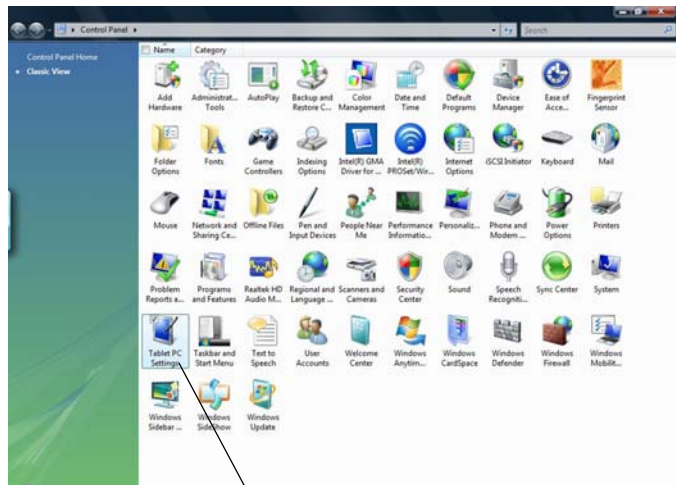

Tablet PC Settings
icon

2. Double-click the Tablet PC Settings icon.

The Tablet PC Settings window opens.

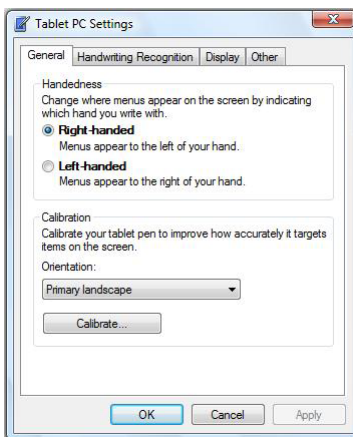

3. In the General tab, press the Calibrate button.
The Calibration program starts.
4. Follow the instructions that appear on the screen.
5. When you finish, click OK.

Calibrating the digitizer: Touch mode

1. From the Start menu, select All Programs > Touch Utility.
The iTouch window opens.

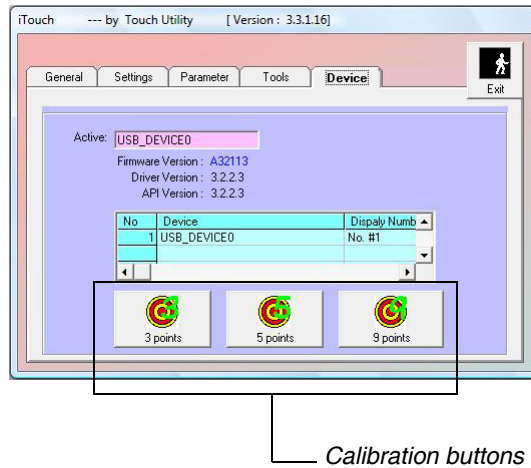

2. Select the Device tab.
3. Select the appropriate calibration button.

Note: Xplore Technologies recommends 5 Pt or 9 Pt calibration, for greater accuracy.

4. Press Exit.

A

Troubleshooting

Table 7 contains solutions to some problems. If you cannot solve the problem by taking the actions described, contact your local help desk or your reseller for further assistance.

Table 7 *Troubleshooting*

Problem	Possible cause and solution
Computer will not start.	<ul style="list-style-type: none">• The battery may be defective or discharged to a critically low level. Connect an external power supply (such as the AC adapter) or install a charged battery. See “Using the battery” on page 54.• Internal components may be above or below the acceptable operating range (below -20° C or above 60° C). After the temperature returns to safe operating range the computer will start.
The computer will not resume operation after being suspended.	<ul style="list-style-type: none">• The battery may be defective or discharged to a critically low level. When the battery reaches a critically low level, the computer is forced into Suspend- to-RAM mode to avoid a total system power failure. Connect an external power supply (such as the AC adapter) or install a charged battery. See “Using the battery” on page 54.• The computer may be at the critical thermal limit. To avoid damage to heat-sensitive components, the computer enters Suspend-to-RAM mode when the computer operates above 60° C. Operation automatically resumes when the computer cools to below 60° C. Move the computer to a cooler location.
The Status LED is red, continuous.	<ul style="list-style-type: none">• The computer is on, running under battery power, and the charge level in the battery has reached a critical level. Plug the computer into an AC/DC power source or install a charged battery.• The system has encountered a fault and is preventing normal operation. Contact your local help desk.
The Status LED is red, blinking.	The computer is powered on, running under battery power, and the charge level in the battery is at a minimum warning level. Plug the computer into an AC/DC power source or install a charged battery.

Table 7 *Troubleshooting (continued)*

Problem	Possible cause and solution
Display screen is blank or difficult to read.	<ul style="list-style-type: none">• Confirm that the computer is on (the Power icon is displayed continuously in the Status area).• The brightness may be set too low, causing the screen to appear too dark. To change system brightness, press the Fn and Start keys to open the Xplore menu and adjust the brightness. (See page 30.)• An external monitor may be selected. Press the Fn and P1 keys to select the computer display screen. (See page 30.)• The video time-out may have expired. Tap the display screen to reactivate the display. Note: This is a normal, power-saving feature.• If the Status light is blinking red, the computer is in Suspend-to-RAM mode because the temperature is below -20° C or above 60° C. When the temperature returns to a safe operating range, the display screen automatically comes back on. If possible, move the computer to a warmer or cooler location.• If the Status light is continually yellow, the computer is in Suspend or Hibernate mode. Press the Power On/Off key to resume.
Cursor is not tracking the pen.	Calibrate the pen. See “Calibrating the digitizer” on page 85.
Computer is not responding to the pen.	Connect an external USB keyboard to the computer. If the computer does not respond to the external keyboard, the application or operating system may have been corrupted. Press the Reset key. (See page 32.) If the system responds to a keyboard but not to the pen, contact your local help desk or reseller for further assistance.
Headphone or speaker volume is too low.	<ul style="list-style-type: none">• The volume may be in Mute mode or set too low. Follow the instructions in “Adjusting headphone or speaker volume – Windows XP” on page 51.• Make sure the volume control in your audio software is set to an audible level.
An external device is not working with the computer.	The device may need to be enabled in the computer’s configuration program (BIOS Setup). Contact your local help desk or reseller.

B







Using BIOS and AOS Functions

Note: Each button has its own blue-light LED. No matter which button you press, every blue-light LED is on for about 3 seconds, then off. When in Shifted mode, all blue-light LEDs flicker.

This appendix explains how to use the application and navigation buttons with the Basic Input-Output System (BIOS) program and the Advanced Operating System (AOS) Options menu.

Note: These functions are typically for use only by your system administrator or by authorized service technicians.

Table 8 Using BIOS and AOS functions

Button	BIOS Key	Function	In Shifted Mode	
			BIOS Key	Function
	F1	F1 continues message.	Up Arrow	Navigate up through Multi Boot options and BIOS menus.
	F2	Start the BIOS program: When the computer is booting, press the P2 button and follow the instructions that appear on the screen.	Down Arrow	Navigate down through Multi Boot options and BIOS menus.
	F8	Prompt Windows to select Safe mode.	Right Arrow	Navigate to the right.
	F11 (Lock Fn)	<ul style="list-style-type: none">• Press for less than one second for F11 function.• Press longer to enable Shifted mode.	Release Function	Press once to exit Shifted mode.
	F12	Enter Multi Boot mode.	F4	Change a BIOS setup value.
	Ctrl+Alt+Del	Reboot.	Enter	Enter.

Disabling the Auto Power feature

When Auto Power is enabled, the tablet automatically turns on if you dock it and the following conditions exist:

- The tablet is off or in Hibernation or Standby mode.
- The dock or the tablet is connected to an external power source (including power applied when a vehicle's ignition is started).

If you dock the tablet and the tablet is off and no power is present, the tablet turns on as soon as power is applied.

To disable the Auto Power feature:

1. When the computer is booting, press the P2 button to access the BIOS Setup Utility.
2. Select the Advanced tab.
3. Disable the Dock with Auto Power On option.

Note: When the tablet is in the docking station, it will shut down or go into Hibernation or Standby mode the same as it does when not in the docking station.

Enabling automatic LCD backlight control

When the LCD backlight control is in manual mode, the ambient light sensor is disabled and the computer does not automatically control the screen brightness.

Follow these steps to enable automatic LCD backlight control:

1. When the computer is booting, press the P2 button to start the BIOS Setup Utility.
2. Select the Main tab.
3. In the LCD Backlight Control drop-down list, select Automatic.
4. Click OK.

C

Glossary

Adapter. A device that provides an interface between two dissimilar electronic devices. For example, the AC adapter modifies the power from a wall outlet for use by the computer.

Advanced Power Management (APM). A facility consisting of one or more layers of software that support power management. The APM software interface enables applications, operating systems, device drivers, and the APM BIOS to work together to reduce power consumption.

Alternating Current (AC). Electric current that reverses its direction of flow at regular intervals.

Analog signal. A signal with characteristics such as amplitude and frequency that vary in proportion to (are an analog of) the value to be transmitted. Voice communications are analog signals.

Application. A program that performs specific tasks on your computer, such as word processing or creating spreadsheets.

BIOS. Programs that contain such basic hardware operations as an interaction with diskette drives, hard disk drives, and the memory.

Board. A circuit board. An internal card containing electronic components called chips, which perform a specific function or increase the capabilities of the system.

Boot. To load a program or operating system into system memory.

Bits Per Second (BPS). In serial transmission, the instantaneous bit speed with which a device or channel transmits a character.

Card. Synonym for board; see *board*.

Compact Disk-Read Only Memory (CD-ROM). Stores data on metal-plated plastic discs.

Compatibility. 1. The ability of one computer to accept and process data in the same method as another computer without modifying the data or the media upon which it is being transferred. 2. The ability of one device to connect or communicate with another system or component.

Configuration. The specific combination of hardware components of the computer, and their operating status. The configuration of your computer includes pre-defined memory, type and speed of microprocessor, type of and size of hard disk drive, etc.

Default. The preset parameter value automatically selected by the computer when you or a program do not provide instructions.

Device driver. A program that controls communication between a specific peripheral device (such as a printer or the pen/stylus) and the computer.

Disk drive. The physical device that enables the computer to read from, and write to, a disk.

Display. An image-producing device used to view computer output.

Double-click. To press and release the pen/stylus twice within a time frame you define, without moving the pointer off the choice.

Hard disk drive (HDD). A sealed mass storage device used for storage and fast retrieval of programs and data. The factory installs this disk and only a trained engineer can remove it for servicing.

Hardware. The physical electronic and mechanical components of a computer system. typically, the computer itself, CPU, memory, etc.

Hertz. A unit of wave frequency that equals one cycle per second.

Interface. 1. Hardware and/or software components used specifically to connect one computer or device to another. 2. To physically connect one system or device to another to exchange information. 3. The point of contact between user, the computer, and the program (for example, the pen/stylus or a menu).

Kilobyte (KB). A unit of 1024 bytes measuring storage space, typically in memory or on storage media such as a diskette or hard disk drive.

Local area network (LAN). Assembly of separate computers into an integrated network that connects the various computers together and to common devices such as printers and fax machines.

Light Emitting Diode (LED). A semiconductor device that emits light when a current is applied.

Liquid Crystal Display (LCD). liquid crystal sealed between two sheets of glass coated with transparent conducting material. Applying a voltage between the glass sheets darkens the liquid crystal to provide contrast to lighted portions of the display.

Megabyte (MB). A unit of data storage equal to 1024 kilobytes.

Megahertz (MHz). a unit of wave frequency that equals 1 million cycles per second.

Modem. A device that connects your computer to a telephone line, allowing it to communicate with another computer at another location.

PC Card. A plug-in accessory card that conforms to the PCMCIA standard.

Pen. See *stylus*.

Peripheral device. An input/output device that is external to the central processor and/or main memory such as a printer or scanner.

Pixel. Picture elements (tiny dots) that compose a screen image.

Port. The electrical connection through which the computer sends and receives data to and from devices or other computers.

Program. A set of instructions a computer can execute to tell the system what to do and how to do it.

Random Access Memory (RAM). A hardware component of your computer that temporarily stores active program code and data.

Reset. The act of hard stopping/shutting down the operating system.

Resolution. The number of pixels displayed on the screen. A higher resolution provides greater clarity and allows more information to be displayed on the screen at once.

Restart. Resetting a computer without turning it off (also called warm boot or soft reset).

Resume. The act of returning the computer to an active, operational state.

Read Only Memory (ROM). The portion of your computer's memory that contains permanent instructions, and which cannot be modified.

Status Indicator (LED). a light above the LCD screen which indicates the current status of a particular device or hardware component.

Stylus. A writing instrument. For pen computers, the stylus is used to interface with the LCD and digitizer.

Subscriber Identity Module (SIM). A smart card inside a GSM (Global System for Mobile communications) cellular device that encrypts voice and data transmissions and stores data about the specific user so that the user can be identified and authenticated by the network supplying the phone service. A SIM can be moved from one device to another and/or different SIMS can be inserted into any GSM radio.

Suspend mode. A power conservation mode in which electrical current is removed from most components of the computer.

Universal Serial Bus (USB). A serial interface that enables communication between devices and the computer.

D

Hardware Specifications

Physical

Dimensions	11.20" x 8.25" x 1.6" (WxHxD) 283.9mm x 209.3mm x 40.8mm
Weight	4.95 lbs. (2.50 kgs)*

Processing

CPU	Intel® Pentium® M U2500 processor – Ultra Low Voltage (5 W)*
Chip set	Intel 945GME-533 MHz
Processor speed	1.2 GHz*

* Varies according to your computer's configuration.

Memory/storage

Main RAM	<ul style="list-style-type: none">• 1GB DDR RAM (standard)• 144-pin SODIMM modules 2GB modules (optional)
L1 Cache (CPU)	32KB on-die
L2 Cache	2MB on-die
BIOS ROM	8Mbit (FWH)
Hard Disk Drive	2.5" HDD shock mounted 120GB 2.5" IDE HDD Ultra DMA 100, 5400 RPM

* Varies according to your computer's configuration.

Display

Display	<ul style="list-style-type: none">• Color LCD• Active Digital Sensor and Pen (iX104C4) and Resistive Touch Panel (iX104C4 Dual Mode)• 32-bit True color• 10.4" TFT XGA (1024x768), 16M colors• Brightness: 100 levels (min.)• Viewing Angle:<ul style="list-style-type: none">- Horizontal: 30 degrees (min.)- Vertical: 10 degrees (min.)- Contrast Ratio: Typ. 250:1, Min 100:1
VRAM	<p>Intel 945GME chipset with 128MB shared memory using Unified Memory Architecture (UMA) delivers low-power, high-performance 3D/2D graphics, video, and display capabilities. Dynamic Video Memory Technology (DVMT) dynamically responds to application requirements and efficiently allocates the proper amount of memory (128MB maximum) for optimal graphics and system performance.</p>

Interface

Wireless Radio Bays	<ul style="list-style-type: none"> • One user-accessible Type 1 or Type II PC Card slot (PCMCIA Cardbus version 3.0) • Two mini-PCI Express slots
Integrated Interfaces	<ul style="list-style-type: none"> • DC-in • USB (2) 2.0 • Microphone Jack • Headset Jack • LAN (RJ-45) • 15-pin D-SUB connector for external VGA monitor (or optional 9-pin serial port)
KeyPad / User Controls	<ul style="list-style-type: none"> • Application buttons with primary and secondary functions • Power On/Off/Suspend/Resume button • Emergency Shutoff/Reset button
Audio	<ul style="list-style-type: none"> • Realtec ACC 262 • On-board microphone with noise cancellation • On-board integrated stereo speakers (1W each)
Status Indicators	Power, Charge/DC-in, Warning

Power

Main Battery	<ul style="list-style-type: none"> • 6 cell • Removable Lithium Ion • 7.4V @ 5700mAh (41Whr) • Warm-swappable • Recharge Time: 2.5 hours (90%) • Life: Up to 3.5 hours. (Battery life is dependent on operating system, power management, and applications in use.) • Suspend Life: Min. 4 days
--------------	--

Power (continued)

Optional Spare Battery	<ul style="list-style-type: none"> • 8 cell • Removable Lithium Ion • 7.4V @ 7600mAh (55Wh) • Warm-swappable • Recharge Time: 3.5 hours • Life: Up to 4.5 hours. (Battery life is dependent on operating system, power management, and applications in use.) • Suspend Life: Min. 5 days • Off State: Approximately 30 days
Bridge Battery	<ul style="list-style-type: none"> • 6-cell Li Ion, 45mAh • Life: (with Suspend-to-RAM on bridge battery only): 3 to 5 minutes from full charge
AC Adapter	Auto-sensing 100-240V, supplying 19 VDC, with a current of 3.75 A

Environmental

Temperature	<ul style="list-style-type: none"> • Operating: -4° to 140° F (-20° to 60° C) • Storage: -40° to 167° F (-40° to 75° C)
Humidity	0% to 95% non-condensing
Shock/Drop	Four-foot drop to concrete, all surfaces, edges and corners
Vibration	0.04g ² /Hz, 20 Hz - 1000 Hz -6dB/octive 1000 Hz - 2000 Hz

Environmental (continued)

Enclosure Class	<p>Blowing rain: 4"/hr, 40 mph wind and MIL-STD-810F Method 506.4 Procedure 1</p> <p>Drip: 7 gal/ft²/hr MIL-STD-810F Method 506.4 Procedure III</p> <p>Sand and dust: Particle size < 149 µm, 10 ± 7 g/m³ particle density 1.5 m/s to 8.9 m/s wind speed MIL-STD-810F Method 510.4 Procedure 1</p> <p>Salt Fog: 5% saline for 48 hr (12 hr wet, 12 hr dry, 2 cycles) MIL-STD-810F Method 509.4</p> <p>Contamination by fluids: Detergents, brake fluid, aromatic hydrocarbons MIL-STD-810F Method 504</p> <p>Solar radiation: 1120 W/m² (355 Btu/ft²/hr) UVB @ 50° C, 7x24 hr cycles MIL-STD-810F Method 505.4</p>
-----------------	---

Agency approvals

EMC	<ul style="list-style-type: none"> • FCC Class B • European Union Directive 2004/108/EC
Safety	<ul style="list-style-type: none"> • UL and CUL Listed, UL 1950, 3rd Edition • TuV T-Mark, EN60950 • CSA and UL Listed, UL 1604

Operating system

Operating Systems	<ul style="list-style-type: none">• Microsoft Windows XP Professional Tablet PC Edition• Microsoft Windows Vista Business
-------------------	--

E

Agency Notices



FCC notices

This device complies with Part 15 of the FCC Rules. Operation is subject to the following two conditions: (1) this device may not cause harmful interference, and (2) this device must accept any interference received, including interference that may cause undesired operation.

Modifications not expressly approved by Xplore Technologies could void this user's authority to operate the equipment.

Note: This equipment has been tested and found to comply with the limits for a Class B digital device, pursuant to Part 15 of the FCC Rules. These limits are designed to provide reasonable protection against harmful interference in a residential installation. This equipment generates, uses and can radiate radio frequency energy and, if not installed and used in accordance with the instructions, may cause harmful interference to radio communications. However, there is no guarantee that interference will not occur in a particular installation. If this equipment does cause harmful interference to radio or television reception, which can be determined by turning the equipment off and on, the user is encouraged to try to correct the interference by one or more of the following measures:

- Reorient or relocate the receiving antenna.
 - Increase the separation between the equipment and receiver.
 - Connect the equipment into an outlet on a circuit different from that to which the receiver is connected.
 - Consult the dealer or an experienced radio/TV technician for help.
-

RF exposure

Tests for SAR are conducted using standard operating positions specified by the FCC with the tablet PC transmitting at its highest certified power level in all tested frequency bands. Although the SAR is determined at the highest certified power level, the actual SAR level of the tablet PC while operating can be well below the maximum value. This is because the tablet PC is designed to operate at multiple power levels so as to use only the power required to reach the network. In general, the closer you are to a wireless base station antenna, the lower the power output.

Before a tablet PC model is available for sale to the public, it must be tested and certified to the FCC that it does not exceed the limit established by the government-adopted requirement for safe exposure. The tests are performed in positions and locations (e.g., worn on the body) as required by the FCC for each model. (Body-worn measurements may differ among tablet PC models, depending upon available accessories and FCC requirements). While there may be differences between the SAR levels of various tablet PCs and at various positions, they all meet the government requirement for safe exposure.

This device was evaluated and shown to comply with FCC SAR guidelines. Avoid covering or holding antennas when transmitting. Antenna locations are shown in the following figure.

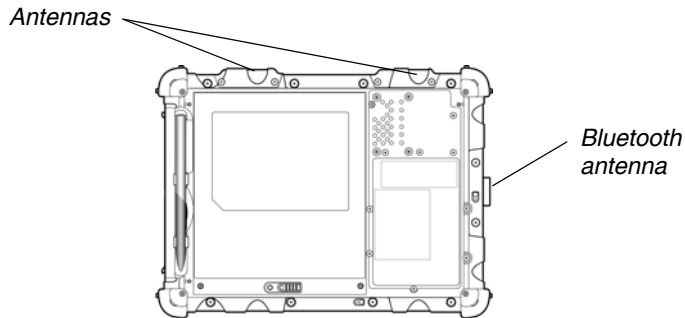

Health and Safety Information

Exposure to Radio Frequency (RF) Signals

Your wireless tablet PC is a radio transmitter and receiver. It is designed and manufactured not to exceed the emission limits for exposure to radio frequency (RF) energy set by the Federal Communications Commission of the U.S. Government. These limits are part of comprehensive guidelines and establish permitted levels of RF energy for the general population. The guidelines are based on the safety standards previously set by both U.S. and international standards bodies:

- American National Standards Institute (ANSI) IEEE. C95.1-1992
- National Council on Radiation Protection and Measurement (NCRP). Report 86. 1986

- International Commission on Non-Ionizing Radiation Protection (ICNIRP) 1996
- Ministry of Health (Canada), Safety Code 6. The standards include a substantial safety margin designed to assure the safety of all persons, regardless of age and health.

The exposure standard for wireless mobile tablet PCs employs a unit of measurement known as the Specific Absorption Rate, or SAR. The SAR limit set by the FCC is 1.6W/kg.

Note: In the U.S. and Canada, the SAR limit for mobile tablet PCs used by the public is 1.6 watts/kg (W/kg) averaged over one gram of tissue. The standard incorporates a substantial margin of safety to give additional protection for the public and to account for any variations.

DOC (Industry Canada Notices)

Notice to Users of Radio and Television

This Class B digital apparatus meets all requirements of Canadian Interference-Causing Equipment Regulations

CET appareil numérique de la class B respecte toutes les exigence du Règlement sur le matériel brouilleur du Canada.

Notice to Users of the Canadian Telephone Network

Notice: This equipment meets the applicable Industry Canada Terminal Equipment Technical Specifications. This is confirmed by the registration number. The abbreviation, IC, before the registration number signifies that registration was performed based on a Declaration of Conformity indicating that Industry Canada technical specifications were met. It does not imply that Industry Canada approved the equipment.

Before connecting this equipment to a telephone line the user should ensure that it is permissible to connect this equipment to the local telecommunication facilities. The user should be aware that compliance with the certification standards does not prevent service degradation in some situations.

Repairs to telecommunication equipment should be made by a Canadian authorized maintenance facility. Any repairs or alterations not expressly approved by Xplore or any equipment failures may give the telecommunication company cause to request the user to disconnect the equipment from the telephone line.

Notice: The Ringer Equivalence Number (REN) for this terminal equipment is 0.0. The REN assigned to each terminal equipment provides an indication of the maximum number of terminals allowed to be connected to a telephone interface. The termination on an interface may consist of any combination of devices subject only to the requirement that the sum of the Ringer Equivalence Numbers of all the devices does not exceed five.

UL Notice

This unit requires an AC adapter to operate. Use only UL Listed Class 2 Adapters with an output rating of 19 VDC, with a current of 3.75 A. AC Adapter output polarity:



For authorized repair technicians only

-  **WARNING**
For continued protection against risk of fire, replace only with the same type and rating fuse.

-  **WARNING**
Danger of explosion if Lithium (clock) battery is incorrectly replaced. Replace only with the same equivalent type recommended by the manufacturer. Dispose of used batteries according to the manufacturer's instruction.

System disposal

In the event of system disposal, observe the following information regarding proper procedures in the State of Vermont.

The liquid crystal display (LCD) lamps used in this system contain mercury. In the event of system disposal, be sure to follow local guidelines.



F

Configuring Dual Mode Tablet Digitizer Input Methods

This section explains how to use the BIOS Setup Utility and the Panel Control Center to configure the iX104C⁴ Dual Mode tablet digitizer input settings.

- Use the **BIOS Setup Utility** to set the default input method.
- Use the **Panel Control Center** to set controls for temporary changes to input methods for single sessions.

The section “Summary: Dual Mode digitizer input method settings” on page 121 provides an overview of settings to make in the BIOS Setup Utility and the Panel Control Center to achieve various input method configurations.

The section “Sample implementations” on page 126 explains how to set up two sample configurations.

Using the BIOS Setup Utility to set input method defaults

Using the BIOS Setup Utility to set input method defaults

Starting the BIOS Setup Utility

If your computer is running Windows XP:

When the computer is starting up, press the P2 key.

If your computer is running Windows Vista:

From the Start menu, select BIOS Setup Utility.

The BIOS Setup Utility window opens.

In this appendix, Windows Vista screens are shown. If your computer is running Windows XP, your screens look a little different.

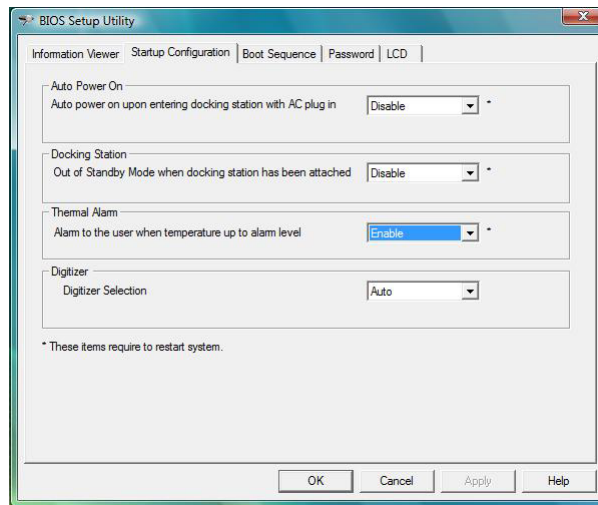

Selecting the digitizer input method

1. Select the Startup Configuration tab.

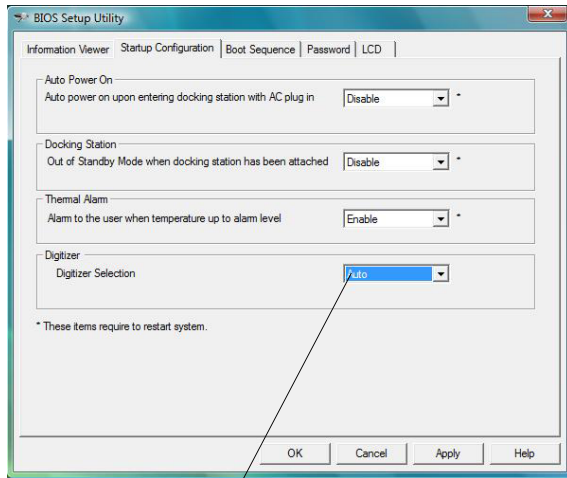

*Digitizer Selection
field*

2. In the Digitizer Selection field, select the value from the drop-down list as follows:

Value	Description
Auto	Enables automatic sensing (Auto Sense) of inputs from touch and from the active pen. Note: This is the default setting.
Touch Only	Enables touch input only. Active digitizer, pen inputs, and Auto Sense are all disabled.
Digitizer Only	Enables inputs from the active pen only. Touch input and Auto Sense are disabled.

Using the BIOS Setup Utility to set input method defaults

Setting digitizer input method security

Follow these steps to specify whether the tablet user can change the digitizer input method settings:

1. In the BIOS Setup Utility, select the Password tab.
2. In the Password Setting field, select a value from the drop-down list as follows:

Value	Description	Notes
No passwords set	Anyone can change the digitizer input settings.	This setting is not controlled by Windows User groups.
Supervisor password set only	A supervisor password must be entered in order to change the input settings.	The supervisor password must be entered before the BIOS Setup Utility will open.
User password set	The user cannot change the input settings.	Only the supervisor can change the input settings.

3. Click OK.
4. Reboot the computer.

Using the Panel Control Center to configure temporary changes to the input method

The Panel Control Center enables you to configure temporary, session-based changes to the Dual Mode tablet input method.

Notes:

Administrator rights are not required to make temporary settings.

When the tablet is restarted, the temporary settings are lost and the default values set in the BIOS Setup Utility are restored.

1. In the Windows taskbar, click the Panel Control Center icon.

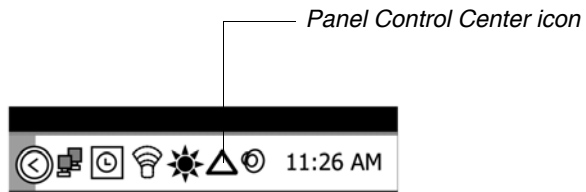

2. Click the Configure button.
3. Click the Change button next to the P key for the function you want to change.
4. Check Start a pre-defined function; then click Next.

Appendix F. Configuring Dual Mode Tablet Digitizer Input Methods

Using the Panel Control Center to configure temporary changes to the input method

- From the drop-down list, select Digitizer Selection or Touch Panel Toggle.

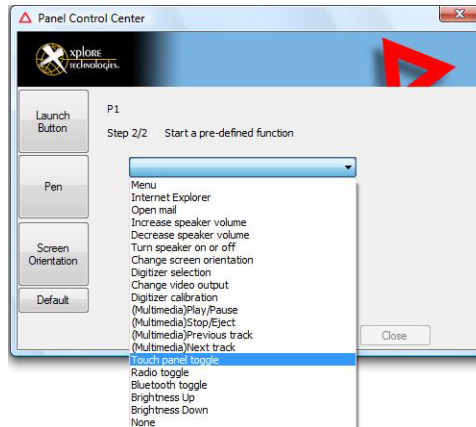

Value	Description
Digitizer Selection	If the digitizer input method is set to Auto in the BIOS Setup Utility, toggles from Auto to Digitizer Only to Touch Only .
Touch Panel Toggle	If the digitizer input method is set to Auto or Touch Only in the BIOS Setup Utility, temporarily disables touch only.

- Click Close.

Summary: Dual Mode digitizer input method settings

The following tables show the relationships of the BIOS Setup Utility and Panel Control Center settings.

Table 9 Settings: Digitizer Only

BIOS Setup Utility Digitizer Selection value	Panel Control Center Pre-defined Function value	On-screen description when key is pressed	Notes
Digitizer Only	Digitizer Selection	"Digitizer Only"	Input is possible only from peripherals and the digitizer. Digitizer is functional.



Appendix F. Configuring Dual Mode Tablet Digitizer Input Methods

Summary: Dual Mode digitizer input method settings

Table 10 Settings: Digitizer Only with Touch Screen disabled

BIOS Setup Utility Digitizer Selection value	Panel Control Center Pre-defined Function value	On-screen description when key is pressed	Notes
Digitizer Only	Touch Screen Toggle	“Digitizer Only”	Input is possible only from peripherals and the digitizer. Touch screen is disabled.



Table 11 Settings: Touch Panel only

BIOS Setup Utility Digitizer Selection value	Panel Control Center Pre-defined Function value	On-screen description when key is pressed	Notes
Touch Only	Digitizer Selection	“Touch Panel only”	Input is possible only from peripherals and touch. Touch is functional.



Appendix F. Configuring Dual Mode Tablet Digitizer Input Methods

Summary: Dual Mode digitizer input method settings

Table 12 Settings: Touch Panel off/on toggle

BIOS Setup Utility Digitizer Selection value	Panel Control Center Pre-defined Function value	On-screen description when key is pressed	Notes
Touch Only	Touch Panel Toggle	“Touch Panel off” “Touch Panel on”	Turns the Touch Screen on or off. Note: If Touch Screen is off and the computer goes into standby or hibernate mode, Touch Screen automatically turns on when operating mode returns to normal.

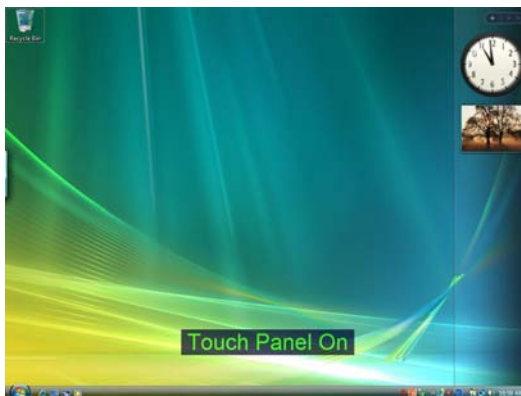
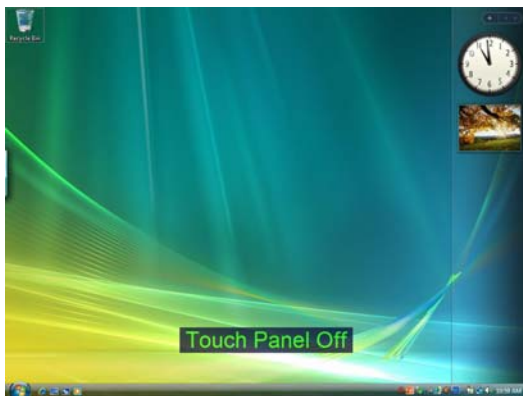

Table 13 Settings: Auto/Digitizer Only/Touch Only settings

BIOS Setup Utility Digitizer Selection value	Panel Control Center Pre-defined Function value	On-screen description when key is pressed	Notes
Auto	Digitizer Selection	“Auto” “Digitizer only” “Touch only”	Rotates through each mode, displaying each mode in turn.



Sample implementations

This section provides settings for two sample configurations. See “Using the BIOS Setup Utility to set input method defaults” on page 116 and “Using the Panel Control Center to configure temporary changes to the input method” on page 119 for information about how to make the settings.

Sample 1

To set the tablet to the following configuration:

- Default digitizer input control is **Touch only**.
- The user can turn off the touch screen.
- The user cannot change any digitizer input control settings.

Configure settings as follows:

1. Use the BIOS Setup Utility to set a Supervisor password. (This protects the digitizer selection and all other BIOS Setup Utility controls.)
2. In Windows Administrator mode, use the Panel Control Center to set one of the **P** keys to **Touch Panel Toggle**.
3. Use the **Add new user** function to create a user account.

Note: If the user already exists, the setting the administrator has set replicates to all the users of the computer.

Sample 2

To set the tablet to the following configuration:

- Default digitizer input control is **Auto Sense**.

- The user can temporarily change the digitizer input control settings.
- The user can change the default digitizer input control settings.

Configure settings as follows:

1. Do **not** use the BIOS Setup Utility to set a Supervisor password.
2. Use the Panel Control Center to set one of the **P** keys to **Digitizer Selection**.
3. Use the **Add new user** function to create a user account.

Note: If the user already exists, the setting the administrator has set replicates to all the users of the computer.

Index

A

- Active mode, selecting 38
- air flow vents, location 22
- Auto Light sensor
 - disabling 46
 - location 19
- antenna covers, location 21
- Auto Power feature, disabling 100
- Auto-Sense mode, selecting 38

B

- battery alarm settings, changing 59
- battery pack
 - charge time 55
 - charging 54
 - checking charge status 60
 - checking the charge 54
 - conserving power 65
 - installing 57
 - location 21
 - removing 55
- battery release latch, location 21
- BIOS Setup Utility, using 99

C

- convection air flow cover, location 21

D

- digitizer
 - calibrating 85
 - using to perform mouse functions 39
- double-click, performing with pen 39
- dragging and dropping, performing with pen 39
- Dual Mode tablet digitizer input method, setting up 115

E

- email, starting 29

H

- headphone connector, location 23
- headphone volume, adjusting 51
- headphone, connecting 51
- Hibernation mode
 - description 33
 - enabling 61
- hot keys, programming 70

I

- input device, selecting 30, 38, 115
- input method, Dual Mode tablet digitizer settings
 - changing 115
- Internet Explorer, starting 29
- iX104
 - accessories 16
 - preventing overheating 82
 - protecting from damage 81
 - storing 83

K

- Kensington lock slot, location 22
- keys
 - Ctrl-Alt-Del 29
 - description 29
 - Ctrl-Alt-Delete
 - location 28
 - descriptions 29
 - Function
 - description 29
 - location 28

keys (continued)

Function mode hot key combinations

default functions 70

descriptions 30

P1

default function 70

description 29

location 28

P2

default function 70

description 29

location 28

P3

default function 70

description 29

location 28

Power (On/Off)/Backlight (On/Off)/Resume

location 22

Power On/Off/Suspend/Resume

location 64

programming hot keys 70, 71

to perform other key functions 77

to perform pre-defined functions 75

quick-start diagram 28

Screen Rotation

description 29

location 28

Secure Attention Sequence (SAS) 28

L

LAN connector, location 23

LCD backlight

disabling automatic control 46

enabling manual control 100

LEDs 26

Status LED meanings 26

left button click, performing with pen 39

local area network (LAN), connecting to 49

logging on 29

M

microphone

connecting external 50

connector location 23

location 19

volume, adjusting 50

monitor

activating 52

connecting 52

sending video display to 30

monitor connector, location 23

mouse functions, performing 39

O

online help, opening 29

P

pen

double-click speed, changing 40

dragging and dropping 39

holder, location 21

location 21

performing a double-click 39

performing a right-click 39

performing left button click 39

positioning in holder 41

replacing 84

tether, using 41

using 37

pen calibration program

opening 30

Power (On/Off)/Backlight (On/Off)/Resume key

location 64

power connector, location 23

Power On/Off/ Suspend/Resume key

location 22

power schemes, changing 59

power settings, changing 60

power use, managing 58, 62
projection panel
 activating 52
 connecting 52
 sending video display to 30

Q

quick-start guide 28

R

Reset switch
 location 19
 using 32
resuming operation 36
right-click, performing with pen 39
RJ-45 connector 23

S

screen
 landscape mode 29
 portrait mode 29
 protecting 83
screen orientation
 changing 44
 landscape 44
 portrait 44
screen protector
 installing 84
 removing 84
 replacing 84
serial number, location 21
serial port
 compatible devices 53
 location 53
speaker volume, adjusting 51
speakers
 connecting 51
 location 19
storing the computer 83

support, contacting 17
Suspend mode
 description 33
 ending 36
 starting 34
suspending operation 34
Suspend-to-RAM mode, description 33

T

Touch mode, selecting 38
troubleshooting 97
turning off the computer 32
turning on the computer 31

U

USB port, location 23
USB-compatible device, connecting 49

V

video output
 changing from monitor to computer 52
 changing to monitor 52
volume
 adjusting headphone 51
 adjusting microphone 50
 adjusting speaker 51

W

Windows Task Manager, launching 29

X

XPL expansion module, connecting 53
XPL expansion port, location 25
Xplore Tablet Dock
 docking connector location 24
Xplore Technologies, contacting 17

