



ix104C² USER'S HANDBOOK





iX104C² USER'S HANDBOOK



Xplore Technologies® has made every effort to ensure the accuracy and completeness of this document; however, because ongoing development efforts are made to continually improve the capabilities of our products, we cannot guarantee the accuracy of the contents of this document. We disclaim liability for errors, omissions, or future changes herein.

Xplore and the Xplore logo are registered trademarks of Xplore Technologies Corp.; iX104, iX104C², iX104C² Tablet PC, and iX104C² Dual Mode are trademarks of Xplore Technologies Corp.

Kensington and MicroSaver are registered trademarks of the Kensington Technology Group.

Microsoft is a registered trademark of Microsoft Corporation. Windows 2000 Professional, Windows XP Professional, and Windows XP Tablet PC Edition are trademarks of Microsoft Corporation.

PCMCIA and CardBus are registered trademarks of the Personal Computer Memory Card International Association.

Intel, Pentium, and SpeedStep are registered trademarks of Intel Corporation.

Wi-Fi is a trademark of the Wireless Ethernet Compatibility Alliance (WECA).

FireWire is a registered trademark of Apple Computer, Inc.

ISODAMP is a registered trademark of Aearo Company.

All other brands, product names, company names, trademarks and service marks used herein are property of their respective companies.

Copyright © 2003-2004 Xplore Technologies Corp. All rights reserved. No part of this publication may be copied, reproduced, or translated, without the prior written consent of Xplore Technologies. No part of this publication may be stored or transmitted in any electronic form without the prior consent of Xplore Technologies. Any unauthorized use is a violation of copyright laws.

PN: 95-01030

Edition: First, August 2004

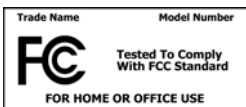

DECLARATION OF CONFORMITY according to FCC Part 15

Responsible Party Name: Xplore Technologies Corp.

Address: 14000 Summit Drive, Suite 900, Austin, Texas 78728

Telephone: 512.336.7797

Declares that product: Model Series: iX104C² complies with Part 15 of the FCC Rules

This device complies with Part 15 of the FCC rules. Operation is subject to the following two conditions: (1) This device may not cause harmful interference, and, (2) This device must accept any interference received, including interference that may cause undesired operation.



WARNING

Changes or modifications to this unit not expressly approved by the party responsible for compliance may void the user's authority to operate this equipment.

For more information about FCC rules and their applicability to the iX104, see Appendix E, "Agency Notices."

Warranty Information

The iX104C² Tablet PC, and iX104C² Dual Mode are backed by a standard 12-month International Limited Warranty. An extended International Limited Warranty is available. Check the service kit included with your computer for warranty terms and conditions.

Important safety information

Before you use the iX104C² Tablet PC or iX104C² Dual Mode (referred to as the *tablet*), read these safety instructions and the operation instructions in this handbook.

Failure to observe all these instructions voids the Limited Warranty and may lead to suspension or denial of services to the offender, or legal action, or both.

Follow any special regulations governing the use of the tablet and, if radio-enabled, always switch it off in areas where radio devices are forbidden or when the radio device can cause interference or danger.

Always follow any safety laws and regulations pertaining to the use of cell phones and two-way radios, because these laws and regulations typically apply to the use of the wireless-enabled tablet.

Observe all restrictions on the use of radio equipment in fuel depots (fuel storage and distribution areas), chemical plants, and wherever blasting operations are in progress or in any area in which restrictions on radio transmissions are imposed.

Switch off the tablet when in an aircraft. The tablet is not FAA-approved for use on aircraft. The effect of the use of the tablet in aircraft is unknown. Using the tablet in an aircraft may affect aircraft instrumentation, communication, and performance; may disrupt the network; and may be illegal.

Operating the wireless-enabled tablet may interfere with the functioning of inadequately protected medical devices such as pacemakers. Consult a physician or the manufacturer of the medical device if you have any questions.

Radio signals from your tablet will not affect the operation of most modern equipment, but certain electronic equipment, including automotive systems, may not be shielded against radio signals from your tablet. Check with the manufacturer of your motor vehicle or the manufacturer's representative to determine whether using the tablet will present any safety issues.

Avoid using the tablet in any environment that requires your full attention, such as when driving a vehicle. If you need to use your tablet while driving, have a passenger use it for you or find a safe location to halt your vehicle.

 **WARNING**
Use only battery types specified in this handbook. Using any other type of battery can be dangerous and can disable the tablet.

 **WARNING**
Do not use any dock or any other accessory or attachment that is not manufactured or supplied by Xplore or an authorized Xplore accessories supplier. Use of any accessory or attachment that is not supplied or approved for use with the tablet by Xplore is not permitted because it may cause hazards.

Operate the tablet only from the type of power source indicated on the marking label. (See page 56 for more information about the battery and power supply.) Route power supply cords so that they are not likely to be walked on or pinched by items placed upon or against them. Pay particular attention to cords at plugs and convenience receptacles, and at the point where cords exit from the tablet or its dock. Do not overload wall outlets, extension cords, or integral convenience receptacles because this can cause fire or electric shock.

Unplug the tablet and refer the tablet and dock for service to qualified service personnel if any of the following conditions occur:

- The power supply cord or plug is damaged.
- The tablet or dock does not operate normally when you follow the instructions in this book.
- The tablet or dock exhibits a distinct change in performance.

Adjust only controls for which there are instructions in this book. An improper adjustment of other controls can result in damage and may require extensive work by a qualified technician to restore the tablet or dock to normal operation.



CAUTION
Avoid prolonged physical contact with the exposed metal surfaces on the front and back of the tablet. While the tablet may not feel hot to the touch, if you maintain physical contact with the tablet for a long time (for example, if you rest the tablet on your lap for a long time), your skin may suffer low-heat injury. In addition, be careful when you remove a PC card that has been used for a long time, because the card may be hot.

Contents

Welcome **13**

Who this handbook is for	14
About your computer	15
Package contents	17
Optional accessories	17
Contacting Xplore	19

1 Getting Started **21**

Getting to know your tablet.	21
Features and controls	21
Front view	21
Back view	22
Top view	24
Bottom view	25
Right side view	26
Left side view	27
LED indicators	28
Quick-start guide	30
Application, Windows, and hot keys	30
Navigation keys	33
Navigation controls with the tablet in portrait mode	33
Navigation controls with the tablet in landscape mode	34

2 Using the iX104C2 35

Turning on the computer	35
Turning off the computer	36
Using the Reset switch.	37
Suspending and resuming operation	38
Suspending operation.	40
Resuming operation	41
Using the pen.	42
Selecting Auto-Sense, Active, or Touch mode	43
Using the digitizer to perform mouse functions.	43
Changing the pen double-click speed	45
Positioning the pen and pen tether	46
Using the joystick (the navigation control key)	47
Changing the screen orientation	48
Adjusting the screen brightness.	49
Disabling automatic backlight control	49
Docking the tablet	50
Connecting devices	50
Connecting to a local area network or telephone line	51
Connecting USB-compatible devices	51
Connecting an external microphone	52
Adjusting microphone volume	52
Connecting a headphone or speakers.	53
Adjusting headphone or speaker volume	53
Connecting a monitor or projection panel	54
Activating the monitor or projection panel.	54
Connecting an XPL snap-on expansion module	55

Using the battery	56
Charging the battery pack	56
If you do not have an external battery charger	56
If you have an external battery charger	57
Removing and installing the battery	58
Removing the battery	58
Installing the battery	60
Discarding a battery	60
Using power options	61
Changing the computer's power schemes	61
Changing battery alarm settings	62
Checking battery power status	62
Selecting power settings	63
Enabling Hibernation mode	63
Tips for conserving battery power	64
Programming hot keys	65
Programming hot keys to start applications, open documents, or go to a Web site	66
Programming hot keys to perform pre-defined functions	70
Programming hot keys to perform other key functions	72

3 Maintaining the iX104C2 75

Caring for the tablet.	75
Checking power cords and connectors.	75
Protecting the computer from damage.	75
Preventing the computer from overheating	76
Storing the computer	77
Caring for the display screen	77
Protecting the display screen	77

Calibrating the digitizer.	79
Calibrating the digitizer: iX104C ² Tablet PC	80
Calibrating the digitizer: iX104C ² Dual Mode	82
Calibrating the digitizer: Active mode	82
Calibrating the digitizer: Touch mode	84
When to replace the pen	85

A	Troubleshooting	87
----------	------------------------	-----------

B	Using BIOS and AOS Functions	91
----------	-------------------------------------	-----------

Enabling manual LCD backlight control	93
---	----

C	Glossary	95
----------	-----------------	-----------

D	Hardware Specifications	101
----------	--------------------------------	------------

E	Agency Notices	109
----------	-----------------------	------------

Index	115
--------------	------------

Welcome

Welcome to the Xplore Technologies® iX104C²[™], the rugged tablet PCs designed, tested, and manufactured to meet the environmental and physical real-world challenges faced by today's mobile workers. The iX104C² not only works the way you do, but can also take the abuses of everyday wear and tear. The iX104C² design is based on years of experience in rugged mobile applications.

Advanced technology, innovative design, and a rugged case are just a few highlights of your iX104C² system. Equally important is Xplore's commitment to ensuring that you are treated with the same respect and honesty you offer to your customers and peers every day.

Who this handbook is for

This handbook provides instructions for using Xplore Technologies iX104C² tablets.

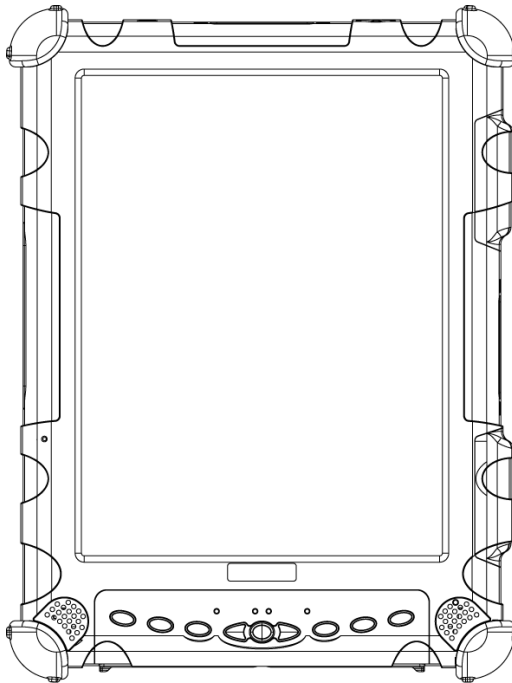

This handbook assumes that you have basic experience using computers and Microsoft® Windows®.

About your computer

The iX104C² is a high-performance tablet PC that runs on the Microsoft Windows XP[®] Professional Tablet PC Edition operating system.

The method you use to control the tablet depends on the tablet model, as follows:

Tablet Model	Digitizer/Touchscreen	Control Method
iX104C ² Tablet PC	Digitizer	Special, enhanced pen (included with the tablet)
iX104C ² Dual Mode	Combined digitizer and touchscreen	<ul style="list-style-type: none"> • Special, enhanced pen (included with the tablet) • Your finger • Any suitable pointing device

Note

In this handbook, all information applies to all models unless otherwise noted.

All iX104C² tablets have been engineered and tested to meet Military Standards for Environmental Extremes (MIL STD 810F). Your tablet includes the following features that make it exceptionally rugged and durable:

- Durable, long-lasting, dense magnesium enclosure
- Interior and exterior multi-layer magnesium frames and cavities

- ISODAMP® shock absorbing materials in patented bumping system and gasket protection mechanisms
- Shock-isolated hard disk
- Integrated, protected wireless LAN and WAN antennas for dual mode operation
- Locked in place memory, cables, and connectors
- Proprietary thermal management system

Package contents

Check to make sure your package includes the following items:

- Quick Start Guide
- Battery pack
- Power cord
- AC adapter
- Pen
- Pen tether
- iX104C² pen tablet
- Warranty information kit
- This handbook

Optional accessories

Your package also includes any optional accessories you ordered.

Optional accessories

Docking options

- X-Stand Desktop Docking Station
 - X-Dock Vehicle Docking Station
-

Carrying cases

- Ballistic nylon hands-free carry case
 - Leather portfolio case
-

Optional accessories (continued)

Storage options

- External USB floppy disk drive
 - External USB CD-ROM drive
-

Memory

- 512 MB and 1 GB PC3200 SODIMM DDR RAM
 - 80 GB 2.5-inch rugged hard disk
-

Power options

- AC adapter with U.S. cord
 - Main battery pack (42 watt hours)
 - Extended life battery pack (56 watt hours)
 - Auto adapter (cigarette lighter adapter)
-

Additional accessories

- USB non-rugged mini keyboard (83-key)
 - USB rugged, backlit mini keyboard (83-key)
 - Screen protectors (2-pack)
 - Passive stylus
 - Active stylus
 - Pen tether
 - Slipcover case with hand straps
-

Contacting Xplore

If you purchased your tablet from an authorized Xplore dealer, contact the dealer for service and support.

If you purchased your tablet directly from Xplore, use any of the following methods to contact Xplore for service and support:

Toll free	1-866-296-8541, extension 222
Fax	1-512-336-7791
E-mail	support@xploretech.com
Web site	http://www.xploretech.com

Before you contact Xplore, have the following information ready so that the customer support representative can quickly provide a solution:

Product name: iX104C ²
Product serial number
Purchase date
Conditions under which the problem occurred
Any error messages that were displayed
Type of device connected, if any

The serial number is on the back of the tablet. See page 22.

1 Getting Started

This chapter gives you an overview of your tablet and includes a quick-start guide to tablet keys.

Getting to know your tablet

For more information about each component, see Chapter 2.

This section shows the locations of some of your tablet's important components.

Features and controls

Front view

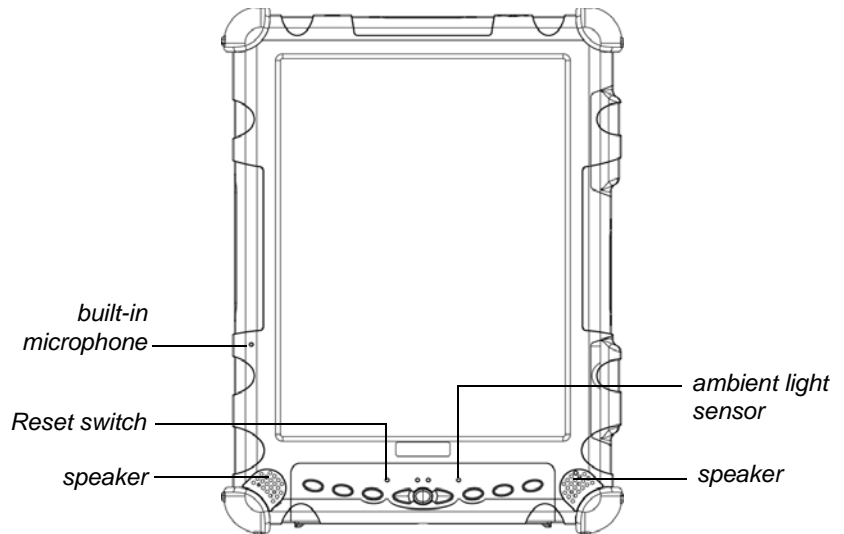

Built-in microphone – Enables you to input mono audio. Includes noise cancellation.

Reset switch – Enables you to turn off the computer when using the Power On/Off key is not effective. (See page 37.)

Speakers – Enable you to listen to stereo audio files. Sealed to provide protection from the environment.

Ambient light sensor – Automatically controls the amount of backlight sent to the screen. Provides optimum brightness for the lighting conditions in which you are working.

Back view

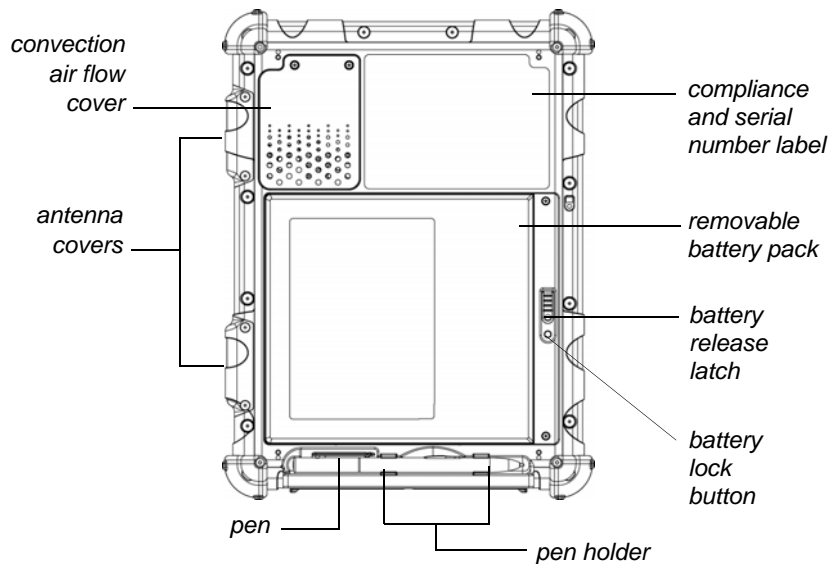

Convection air flow cover – Magnesium cover over the thermal transfer bay that manages heat movement out of the computer.

Antenna covers – For optional wireless LAN and WAN models, protect and secure the radio antennas (accessible by authorized service personnel only).

Pen – The main device you use to enter data and control applications (instead of a mouse or a keyboard). Also called the *stylus*. See “Using the pen” on page 42.

Pen holder – Provides a place to secure the pen when you are not using it.

Battery release latch – Provides access to the battery.

Battery lock button – Secures the battery inside the tablet.

Removable battery pack – Battery that runs the computer when battery power is required.

Compliance and serial number label – Includes regulatory compliance numbers and the computer’s unique serial number.

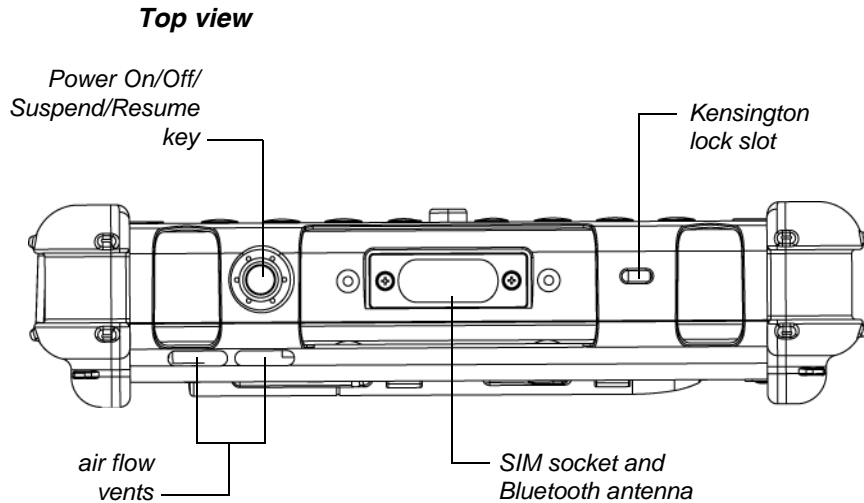

Power On/Off/Suspend/Resume key – Press the key to turn the computer on or off, or to suspend or resume operation.

Air flow vents – Helps prevent the computer from overheating by forcing heat away from the computer. (Do not block the vents.)

SIM socket and Bluetooth antenna – Remove this cover to access the following optional equipment:

- SIM card for your GPRS radio
- Bluetooth antenna

Kensington™ lock slot – Connector for the optional Kensington MicroSaver™-compatible security cable.

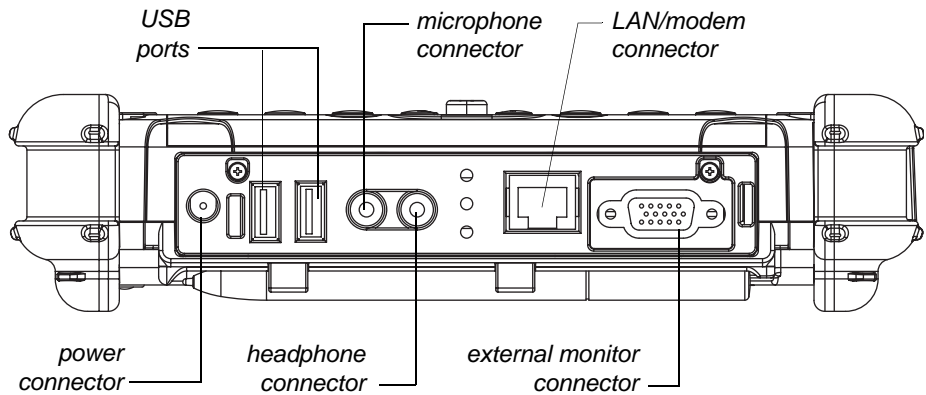
Bottom view

The connectors on the bottom of the computer are located behind the outer doors.

Power connector – For the optional AC adapter or auto adapter. (See “Optional accessories” on page 17.)

USB 2.0 ports – For Universal Serial Bus devices (compliant with USB Standard Revision 2.0).

Headphone connector – For stereo headphones or speakers.

Microphone connector – For an external microphone.

Dual LAN and modem connector – For connecting:

- A standard RJ-45 connector to the tablet’s internal local area network (LAN) card
- or
- A standard RJ-11 connector to an optional internal modem.

External monitor connector – For an external monitor or projection panel.

The optional Office and Vehicle Docks include additional USB ports. See “Optional accessories” on page 17.

Chapter 1. Getting Started

Getting to know your tablet

Right side view

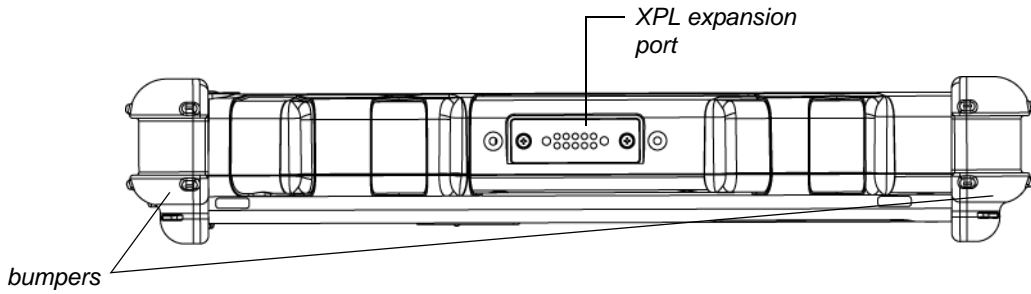

Bumpers – Fabricated from rugged material. Raised to help protect the computer from damage.

Contact your reseller for information about the XPL expansion module and the Kensington security cable.

XPL expansion port – A USB port (compliant with USB Standard Revision 2.0) that enables you to connect an XPL snap-on expansion module for devices such as cameras, radios, and fingerprint scanners.

Left side view

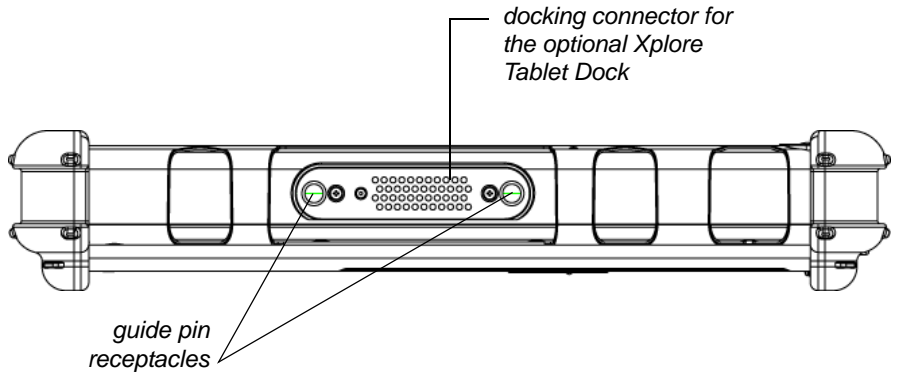

See “Optional accessories” on page 17.

Docking connector – Enables you to connect the optional X-Stand Desktop Docking Station or X-Dock Vehicle Docking Station.

Guide pin receptacles – Help assure secure connection of the optional X-Stand or X-Dock.

LED indicators

The LED indicator lights show the status of system functions such as power and battery levels.

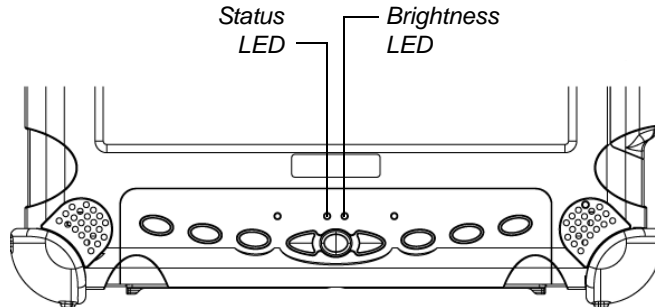

The following table defines the various LED states.

Table 1 Status LED indicator

Mode/State	LED State	Meaning
On state	green, continuous	The computer is on, ready for use, and functioning normally. The battery is fully charged.
Charging	green, blinking	The AC adapter is plugged in and the battery is charging.
Off state	off (no light)	The computer is off.
Suspend mode	yellow, continuous	The computer is on and is in Suspend or Hibernation mode.
Thermal control	yellow, blinking	The computer is on and is in Warm-up mode, with the LCD and backlight off. After the system has warmed to a safe level, the LCD and backlight turn on.

Table 1 Status LED indicator (continued)

Mode/State	LED State	Meaning
On state	red, blinking	The computer is powered on, running under battery power, and the charge level in the battery is at a minimum warning level. Plug the computer into an AC/DC power source or install a charged battery.
On state	red, continuous	<ul style="list-style-type: none"> • The computer is on, running under battery power, and the charge level in the battery has reached a critical level. Plug the computer into an AC/DC power source or install a charged battery. • The computer has encountered a fault and is preventing normal operation. (Contact your help desk.)

Table 2 Brightness LED indicator

Mode/State	LED State	Meaning
Auto state	yellow, continuous	Automatic backlight control is active.
Manual	off	Manual backlight control is enabled. The backlight is under your manual control. Note: This is the computer's default state.

Quick-start guide

This section is a quick guide to using the main features of your tablet.
(See Chapter 2 for detailed information.)

Application, Windows, and hot keys

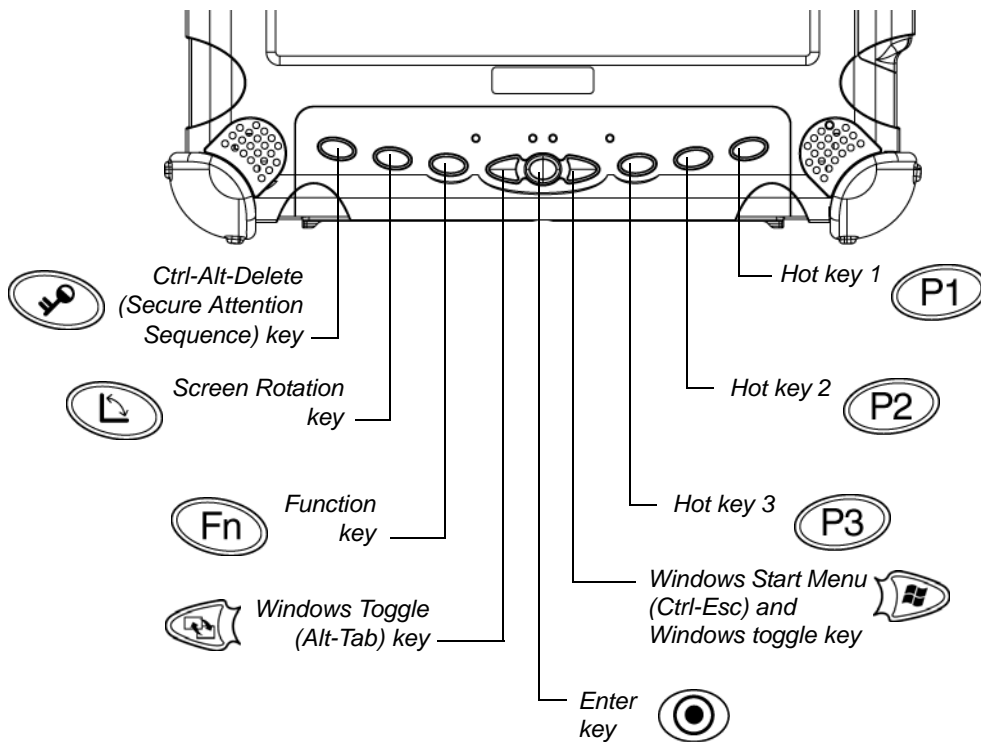

Table 3 Main keys





















Press this key...	To perform this function
	<ul style="list-style-type: none"> Log on after resuming operation from power management, powering on, or locking. After logging on, launch Windows Task Manager.
	Rotate screen orientation between portrait (vertical) and landscape (horizontal).
	Use in combination with another key to perform various functions. (See page 32.)
	Toggle between programs and/or windows (the same as pressing Alt-Tab on a keyboard).
	Perform the same functions as the Enter key on a keyboard.
	Open the Windows Start menu.
	Open Help, or perform a different function that you program this key to perform.
	Open Internet Explorer, or perform a different function that you program this key to perform.
	Open your email application, or perform a different function that you program this key to perform.

Table 4 Function mode keys







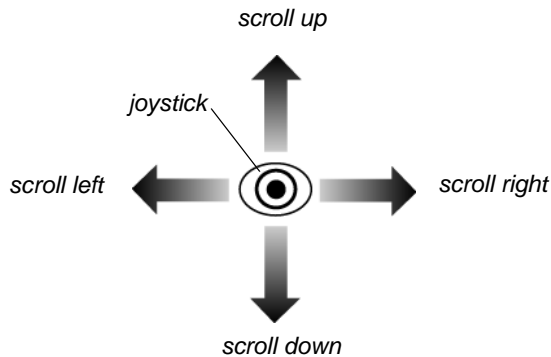

Press these keys...	To perform this function
 	Dim the brightness of the LCD backlight.
 	Increase the brightness of the LCD backlight.
 	Send video display to a monitor or projection panel connected to the computer (and back to the computer again). (This key combination is not programmable.)
 	<p>Default function:</p> <p>iX104C² Tablet PC: Open a pre-defined program (see “Programming hot keys to start applications, open documents, or go to a Web site” on page 66).</p> <p>iX104C² Dual Mode: Select Auto-Sense mode, Active mode, or Touch mode. This determines the input devices you can use. In Auto-Sense mode, you can use the pen, your finger, or another similar device interchangeably. In Active mode, you can use only the pen. In Touch mode, you can use your finger or another similar pointing device. You can program this key combination to perform a different function. (See “Programming hot keys to start applications, open documents, or go to a Web site” on page 66.)</p>
 	Default function: Open the pen calibration program. You can program this key combination to perform a different function.
 	Perform the same functions as the Esc key on a keyboard.

Navigation keys

The following illustrations and tables provide a quick reference for using the navigation keys.







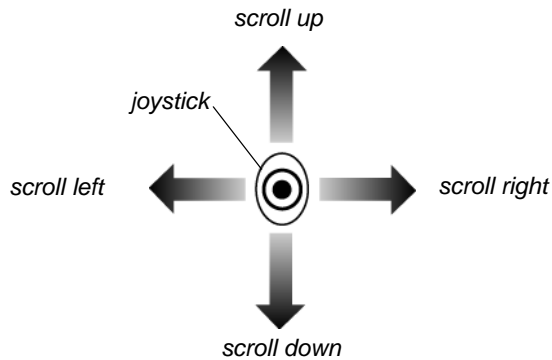

Navigation controls with the tablet in portrait mode



Press the Function key...	and move the joystick in this direction...	to perform this function
		Page Up
		Page Down
		Shift+Tab
		Tab

Navigation controls with the tablet in landscape mode



Press the Function key...	and move the joystick in this direction...	to perform this function
		Page Up
		Page Down
		Shift+Tab
		Tab

2 Using the iX104C²

This chapter contains detailed instructions for using your tablet.

Turning on the computer

1. Make sure the computer is off.

*When the computer is off,
the Status LED is off.*

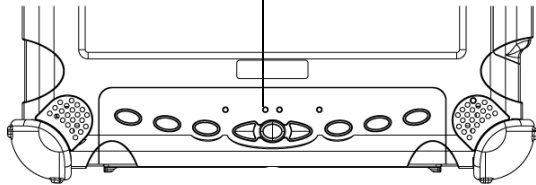

2. Make sure the battery is charged or that the computer is plugged in to an external power source.
3. Press the Power On/Off/Suspend/Resume button.

*Power On/Off/
Suspend/Resume
button*

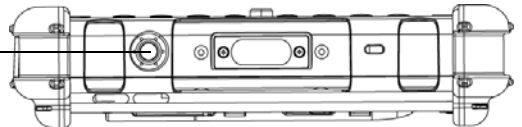

Turning off the computer

When the computer is in Suspend mode, the Status LED is continuously yellow.

1. If the computer is in Suspend mode, press the Power On/Off/Suspend/Resume button to resume operation. (See page 40 for information about Suspend mode.)

*Power On/Off/
Suspend/Resume
button*

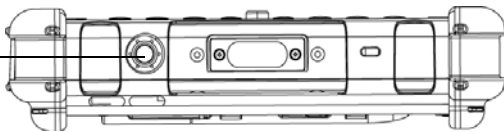

2. Make sure the battery is charged or that the computer is plugged in to an external power source.
3. Save your work and close all programs.
4. From the Windows Start menu, click Turn Off Computer.
5. The Turn off computer dialog box opens.
6. Click Turn Off.

Using the Reset switch

If the computer does not seem to be accepting input and you cannot turn it off by using the method described in “Turning off the computer,” press the **Reset switch**. (Use a ball point pen or similar instrument to press the switch).

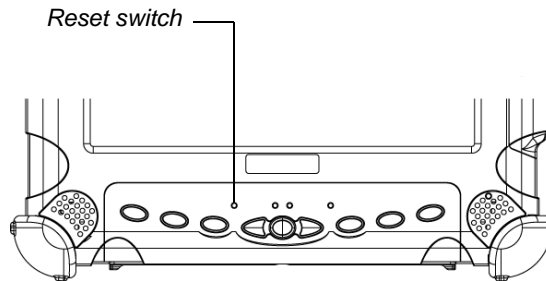

Note

Use the Reset switch only if you cannot turn off the computer by any other means, because you may lose unsaved data.

Suspending and resuming operation

To conserve battery power when you do not want to turn off the computer or when you need to install a charged battery pack, put the computer into Suspend mode. (You can suspend operation without closing any programs or Windows.)

When you suspend operation:

- Programs that are running stop (but do not close).
- Active data is saved.
- The system enters one of the following low-power modes:
 - Suspend-to-RAM mode – The Status LED light is continuously yellow. Active data is saved in RAM and most other components are turned off.

Although the computer uses very little power when in Suspend-to-RAM mode, eventually the battery's power does run out. If you will not be using the computer for an extended period of time, turn the computer off instead of using Suspend-to-RAM mode.

- Hibernation mode – Active data is saved on the hard disk and power usage is reduced to the same level as when the computer is turned off. In Hibernation mode, there is no danger of losing data if battery power is lost.

Note

For more information, see “Using power options” on page 61.

Notes

If you have set your computer to turn power off (in the Power Options utility in Windows Control Panel), you cannot suspend operation. To change power settings, see “Using power options” on page 61.

If the Suspend action of the Power On/Off/Suspend/Resume button has been disabled to prevent accidental interruption, pressing the button does not suspend the computer. You must use a software application to suspend the computer. For more information, contact your help desk or your iX104C² dealer.

If your computer is connected to a network, the network may automatically log you off after a period of inactivity while system operation is suspended. Contact your help desk or system administrator to learn your log-off time limit.

Suspending operation

Use one of the following methods to suspend operation:

Method 1

Press the Power On/Off/Suspend/Resume button.

*Power On/Off/
Suspend/Resume
button*

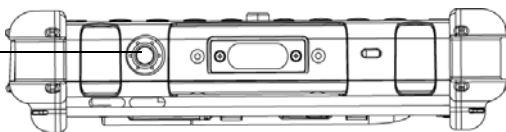

Method 2

1. From the Windows Start menu, press Turn Off Computer.
2. The Turn off computer dialog box opens.
3. Press Stand By.

When operation is suspended, the Status LED displays a continuous yellow light.

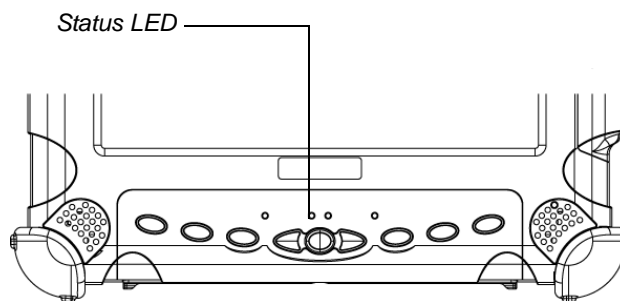

Resuming operation

To resume operation when the computer is in Suspend mode, press the Power On/Off/Suspend/Resume button.

Note

Press the button only *once*.

*Power On/Off/
Suspend/Resume
button*

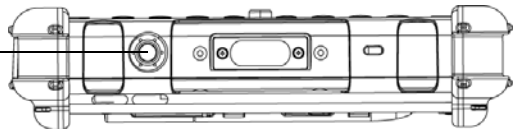

After a minute or two, the computer resumes normal operation. When the Status LED displays a continuous green light, you can begin using the computer.

Note

Resuming operation from Hibernation mode takes a little longer than from Suspend-to-RAM mode.

Using the pen

You can use the pen to select items and to navigate through programs.

If your computer is an iX104C² Tablet PC:

Use the special multi-function pen provided with the computer.

If your computer is an iX104C² Dual Mode:

You can use any of the following input methods:

Auto-Sense mode: Use either the multi-function pen or your finger interchangeably. The computer distinguishes between the two input modes and automatically adjusts accordingly.

This is the tablet's default state.

Active mode: Use only the special multi-function pen provided with the computer.

Touch mode: Use your finger or another similar pointing device.

For more information, see “Selecting Auto-Sense, Active, or Touch mode” on page 43.



WARNING

Do not use items such as a ball point pen or a screwdriver that can damage the tablet. Damage caused by using an item not provided with the tablet is not covered by the tablet warranty.

Note

Before you use the tablet the first time, or if the action you are trying to perform does not occur when you use the pen or your finger to touch the screen, calibrate the digitizer as described in “Calibrating the digitizer” on page 79.

Selecting Auto-Sense, Active, or Touch mode



If your computer is the iX104C² Dual Mode model, use the **Fn-P2** key combination to select Auto-Sense mode (the default mode), Active-only mode, or Touch-only mode.

In **Auto-Sense** mode, you can use the multi-function pen provided with the tablet, your finger, or any other similar pointing device interchangeably, on the fly.

In **Active** mode, you can use only the special multi-function pen provided with the tablet.

In **Touch** mode, you can use your finger or another similar pointing device.

Using the digitizer to perform mouse functions

To perform this function... Do this

Select an object (left button click).

Tap the pen tip once on the object.

Perform a double-click.

Quickly tap the pen tip twice on the object.

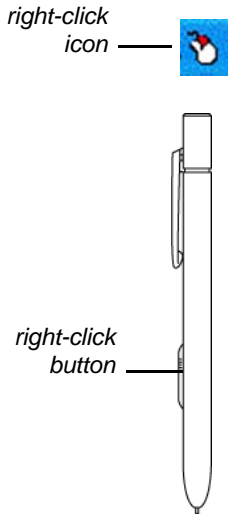

To perform this function...	Do this
-----------------------------	---------

Perform a right-click.

If your computer is an iX104C² Tablet PC:

Hold the pen directly on the object for 1 second. The right-click icon appears.

or

Press the right-click button on the pen while you click the object.

If your computer is an iX104C² Dual Mode:

Touch mode:

In the Windows taskbar, press the right-click icon; then click the object.

Active mode:

Hold the pen directly on the object for 1 second. The right-click icon appears.

or

Press the right-click button on the pen while you click the object.

Move or drag an object.

Place the pen tip on the object; then continue to hold the pen tip against the screen as you move the pen.

Changing the pen double-click speed

The pen double-click speed is in sync with the mouse double-click speed. To change the speed:

1. Click the Windows Start button.
2. Click the Settings option.
3. Click the Control Panel option.
4. In the Control Panel window:

If your computer is an iX104C² Tablet PC:

Click the Tablet and Pen Settings icon.

If your computer is an iX104C² Dual Mode:

In **Active** mode: Click the Tablet and Pen Settings icon.

In **Touch** mode: Click the Pointer Devices icon.

5. Click the Windows tab.
6. Follow the instructions that appear in the Windows tab.

Positioning the pen and pen tether

The pen tether helps prevent the loss of your pen. The following illustration shows how to position the pen and pen tether.

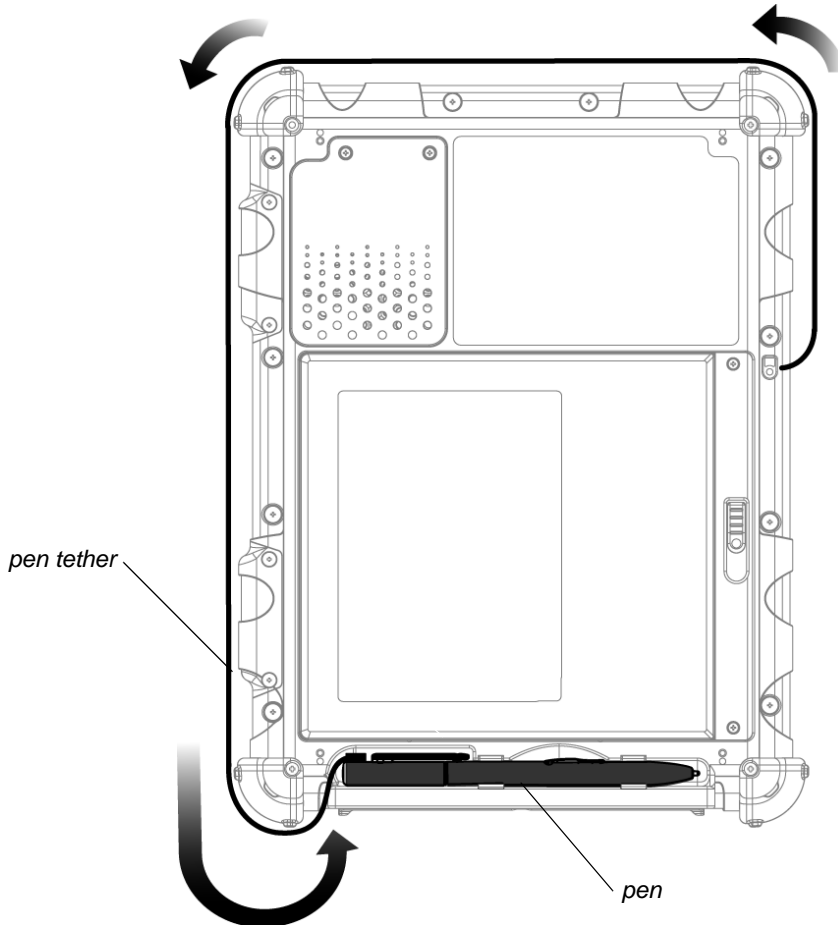

Using the joystick (the navigation control key)

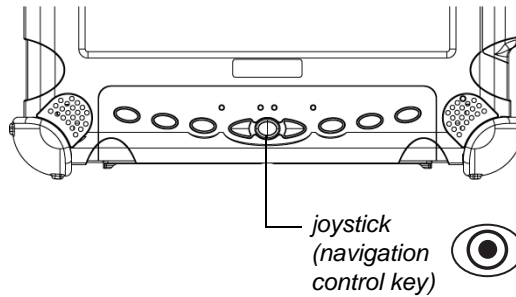

Press the joystick to perform the same functions as pressing Enter on a keyboard.

Push the joystick up, down, left or right to move a highlighted item accordingly (the same as pressing the arrow keys on a keyboard). Use the Fn key in combination with the joystick to perform other functions, such as Page Up and Tab.

Note

See page 33 and page 34 for diagrams of how to use the joystick and other navigation control buttons.

Changing the screen orientation



To rotate the screen orientation from portrait (vertical) to landscape (horizontal) mode or from landscape to portrait mode, press the screen rotation key.

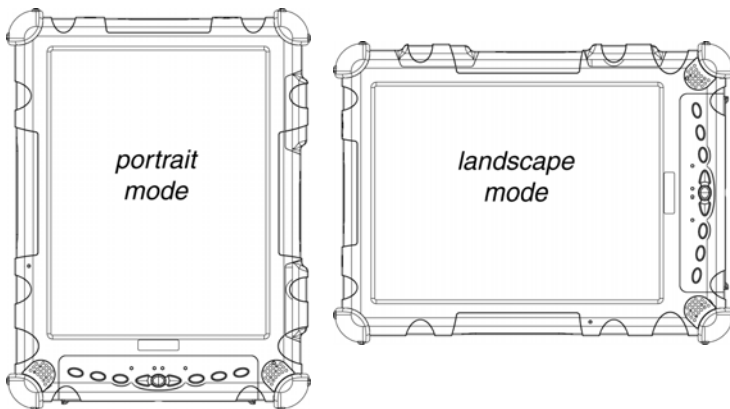

Adjusting the screen brightness

To dim the brightness of the LCD backlight:

Press the Function key and the Windows toggle key.



To increase the brightness of the LCD backlight:

Press the Function key and the Windows Start key.



Disabling automatic backlight control

When the ambient light sensor is enabled, the computer automatically controls the amount of backlight sent to the screen to provide optimum brightness for the lighting conditions in which you are working.

When the ambient light sensor is enabled, the Brightness LED glows continuously yellow. When the ambient light sensor is disabled and the backlight is under manual control, the Brightness LED is off.

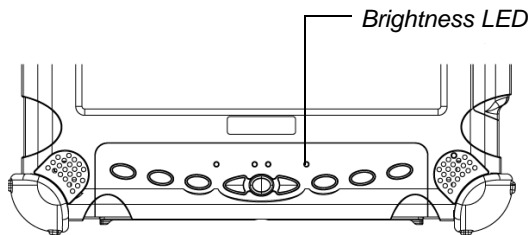

To disable automatic backlight control, see “Enabling manual LCD backlight control” on page 93.

Docking the tablet

If you have the optional X-Stand office dock or X-Dock vehicle dock, connect it to the tablet at the docking port. (See the *iX104 Docking Stations Handbook*.)

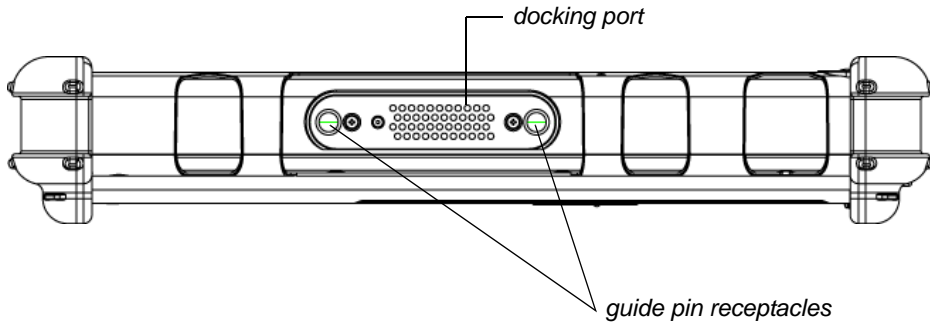

Connecting devices

Refer to the following subsections for information about connecting external devices to your computer.

Note

If the device you want to use does not appear to be working with your computer, the device may need to be enabled in the computer's configuration program. Contact your local help desk or Xplore reseller.

Connecting to a local area network or telephone line

Make either of the following connections:

- Connect a local area network (LAN) cable's RJ-45 connector to the internal LAN interface card. (See your network system administrator for more information.)
or
- Connect a landline telephone cable's RJ-11 connector to the optional internal modem card.

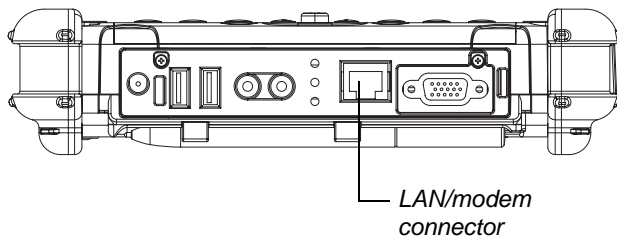

Connecting USB-compatible devices

Devices must be in compliance with USB Standard Revision 2.0.

Connect any USB-compatible devices to the computer's USB ports.

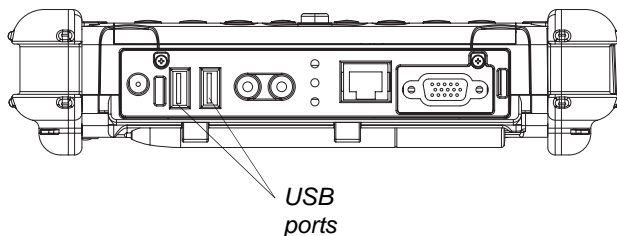

Connecting an external microphone

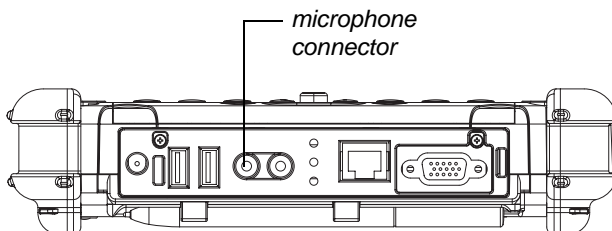

Adjusting microphone volume

If necessary, adjust the volume of the microphone as follows:



1. Press the Windows Start key.
2. Click the Control Panel option.
3. In the Control Panel window, double-click the Sounds and Audio Properties icon.
4. In the Sounds and Audio Properties window, click the Audio tab.
5. In the Sound recording area, click the Volume button.
6. Adjust the volume.
7. Click OK.

Connecting a headphone or speakers

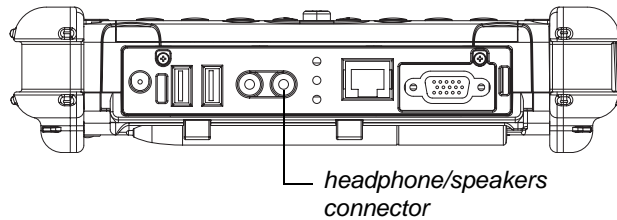

Adjusting headphone or speaker volume

1. Click the audio icon in the Status area of the Windows taskbar. 

The volume control area opens.

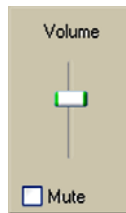

2. If the Mute check box is checked, uncheck it.
3. Move the slider bar up or down to increase or decrease the volume.

Connecting a monitor or projection panel

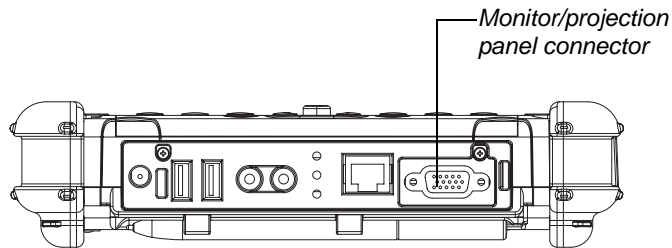

Activating the monitor or projection panel

To change the video output to the monitor or projection panel:

Press the Fn-P1 key combination.



To change the video output back to the computer screen:

Press the Fn-P1 key combination again.

Connecting an XPL snap-on expansion module

Side view

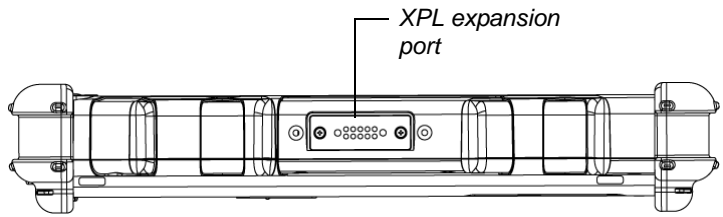

Using the battery

You can recharge, remove, and replace the battery pack.

Charging the battery pack

If you do not have an external battery charger

Follow these steps to charge the battery while it is installed in the computer:

1. Connect a power source, such as an AC adapter or cigarette lighter adapter, to the power connector on the computer.

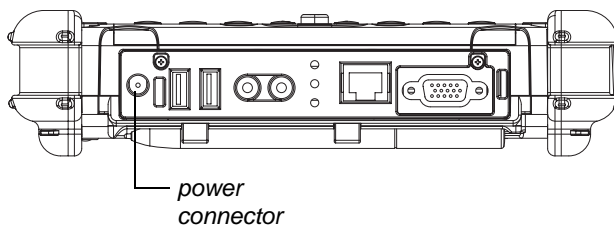

If the battery charge is below 90%, the battery begins charging and the Status LED flashes green. (If the battery charge is higher than 90%, the battery will not charge, preventing battery overcharge.)

2. Check the level of charge. (See “Checking battery power status” on page 62.)

The charging process continues until the battery charge reaches 100%.

Table 5 shows the approximate time required to charge the battery level to 100%.

Table 5 *Approximate battery charge time*

Battery pack capacity	Charge time
5700 mAh	2.5 hours
7600 mAh	3.5 hours

If you have an external battery charger

1. Remove the battery pack (see page 58).
2. Use the external battery charger to charge the battery.
3. Install the battery (see page 60).

Removing and installing the battery

You can remove the battery and use an (optional) external charger to charge it.

Removing the battery

1. To swap with a charged battery:

Use one of the methods described in “Suspending operation” on page 40 to suspend operation.

If a charged battery is not available:

Save your work and close all running programs; then shut down the computer or put the computer in Hibernation mode (see “Suspending operation” on page 40).

Note: To avoid losing unsaved data, wait until the computer has completed switching to Suspended mode before removing the battery.

- 2.** Use the stylus or a pen to depress the battery lock button.
- 3.** On the computer, slide the battery release latch toward the lock button.

The battery unlocks and slightly rises from the computer.

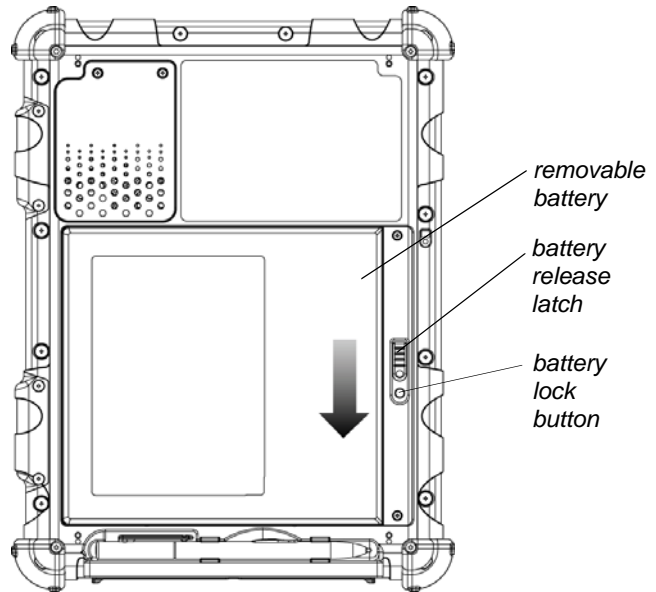

4. Pull the battery away from the computer and remove it.

Note

After removing the battery, you must replace the battery or connect the computer to an external power supply within **3 to 5 minutes** or the computer completely loses power.

Installing the battery

1. Orient the battery with the slides in the empty battery tray.

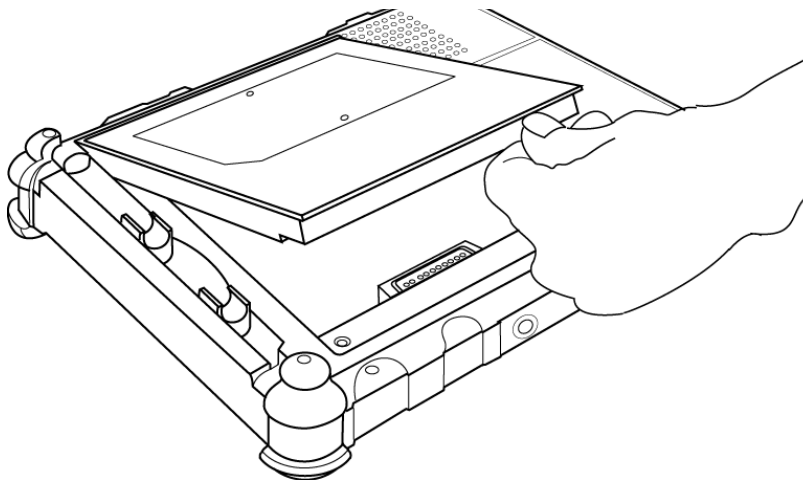

2. Slide the battery into the tray and press it firmly until it is seated.
3. Slide the battery release latch to its original position.
The lock button pops back into the locked position, securing the battery in place.

Discarding a battery

Dispose of a spent battery in accordance with your local government regulations. Under Federal, state, or local law, it may be illegal to put batteries in the trash. Contact your system administrator or your municipal solid waste disposal department or provider for information.

Using power options

This section explains how to use the Power Options Properties window to manage the computer's power use.



On the Windows taskbar, click the battery icon.

The Power Options Properties window opens.

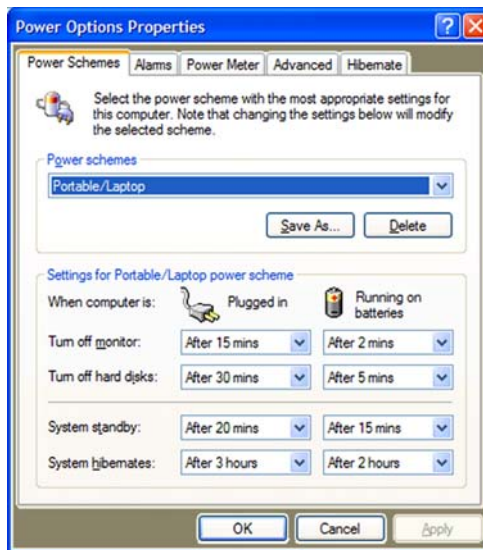

Changing the computer's power schemes

In the Power Options Properties window, select the Power Schemes tab; then select options from the drop-down lists.

Changing battery alarm settings

In the Power Options Properties window (page 61), select the Alarms tab; then use the slider bars to change the alarm settings.

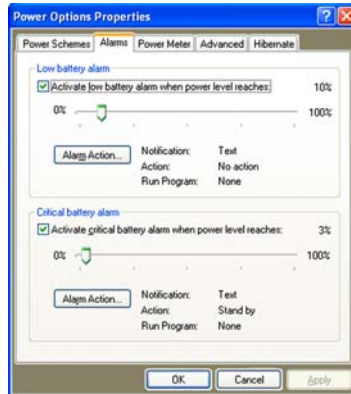

Checking battery power status

In the Power Options Properties window (page 61), select the Power Meter tab. The window shows the amount of power left in the battery.

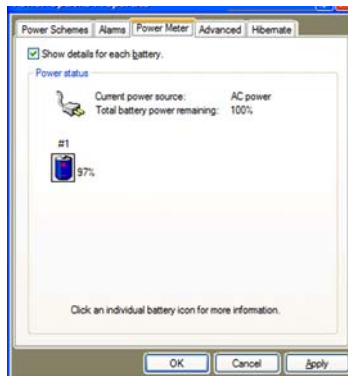

Selecting power settings

In the Power Options Properties window (page 61), select the Advanced tab; then select the power settings options you want to use.



Enabling Hibernation mode

In the Power Options Properties window (page 61), select the Hibernate tab; then check the Enable Hibernation check box.



Tips for conserving battery power

The following tips help you extend the life of your battery by conserving battery power:

- Use an external power source such as the AC or auto adapter whenever available.
- Suspend operation if you know that you will not be using the system for a while. (See “Suspending operation” on page 40.)
- Turn off the computer if you will not be using it for an extended period of time.
- Adjust power options to automatically conserve power. (See “Using power options” on page 61.)

Programming hot keys

Xplore pre-programs the P1, P2, and P3 hot keys and Function mode hot key combinations to perform certain functions by default. However, you can program them to perform different functions, as described in this section.

Table 6 Programmable hot keys









Key	Default function
	Starts Help.
	Starts Internet Explorer.
	Starts your email application.

Table 7 Programmable Function mode hot key combinations

Key combination	Default function
 	Sends video display to a monitor or projection panel. (Not programmable.)
 	iX104C ² Tablet PC: Opens a pre-defined program. iX104C ² Dual Mode: Selects the input device (see page 43).
 	Starts the pen calibration program.

Programming hot keys to start applications, open documents, or go to a Web site



1. In the Status area of the Windows taskbar, click the iX104C² Configuration icon.

The Launch Button QuickShow dialog box opens.

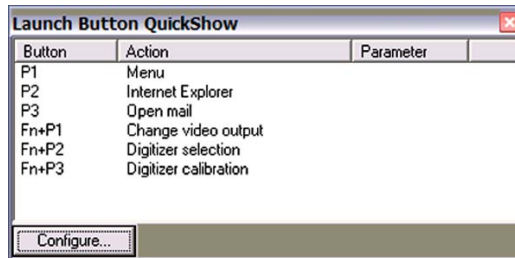

2. Click the Configure button.

The Panel Control Center window opens.

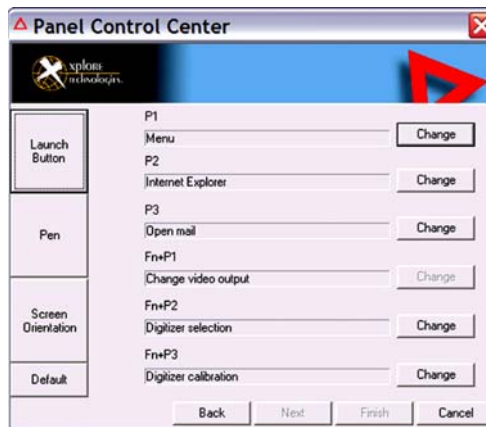

3. Click the Change button next to the key or key combination you want to program.

The following options appear:



4. Click Launch an Application, Document or Web site.

The following options appear:



5. **To start an application:**

- a Click Launch an Application.
- b In the File text box, type the name of the application you want the hot key or Function mode hot key combination to start.

Note: Type the name of executable file that starts the application. For example: word.exe, notepad.exe, excel.exe.



- c Click Change.

To open a document:

- a Click Open a Document.
- b In the File text box, type the name of the document you want the hot key or Function mode hot key combination to open. (For example: spreadsheet.xls, airports.doc, wiringdiagram.jpg)
- c Click Change.

To open a multimedia file:

- a** Click Open a Multimedia file.
- b** In the File text box, type the name of the multimedia file you want the hot key or Function mode hot key combination to open. (For example: 911training.dir, demo.ppt)
- c** Click Change.

To open a Web page:

- a** Click Open a Web page.
 - b** In the File text box, type the URL of the Web page you want the hot key or Function mode hot key combination to open. (For example: <http://www.xploretech.com>)
 - c** Click Change.
- 6.** Program more hot keys, or click Finish to close the Panel Control Center window.

Programming hot keys to perform pre-defined functions



1. In the Status area of the Windows taskbar, click the iX104C² Configuration icon.

The Launch Button QuickShow dialog box opens.

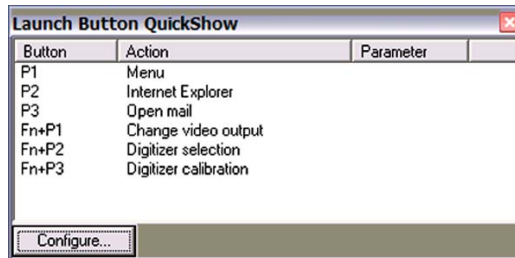

2. Click the Configure button.

The Panel Control Center window opens.

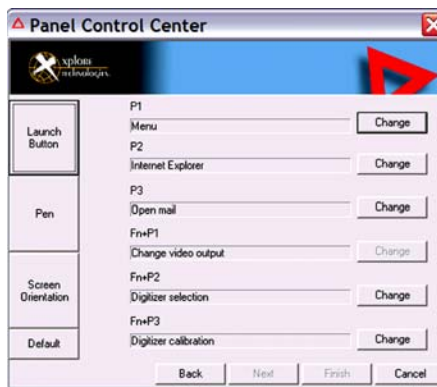

3. Next to the key or key combination you want to program, click the Change button.

The following options appear:



4. Click Start a pre-defined function.
5. In the Function selection drop-down list, select an option.



6. Program more hot keys, or click Finish to close the Panel Control Center window.

Programming hot keys to perform other key functions



1. In the Status area of the Windows taskbar, click the iX104C² Configuration icon.

The Launch Button QuickShow dialog box opens.

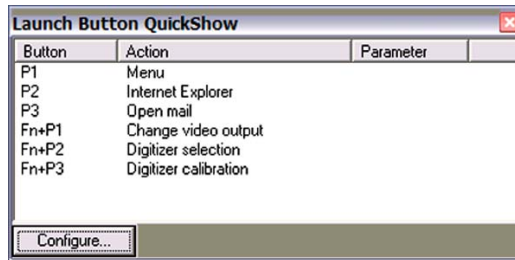

2. Click the Configure button.

The Panel Control Center window opens.

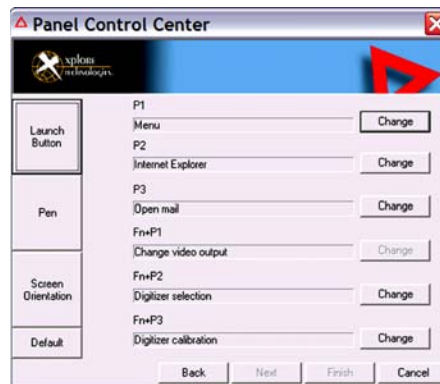

3. Next to the key or key combination you want to program, click the Change button.

The following options appear:



4. Click Press a key or key combination.

The following options appear:

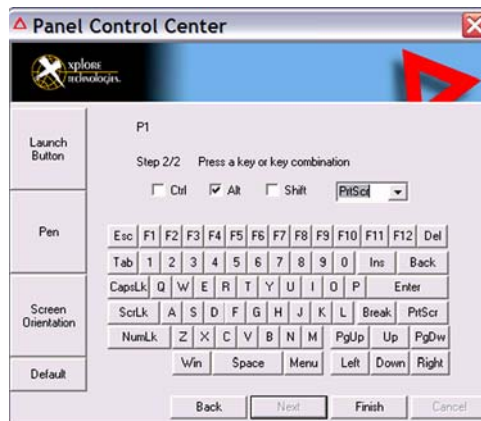

5. If you want the hot key or hot key combination to perform the function of a single key:

- a** If the Ctrl, Alt, or Shift boxes are checked, uncheck them.
- b** Click the key you want the hot key or hot key combination to perform. (For example: F6, G, or Caps Lock)

If you want the hot key or hot key combination to perform the function of a key combination:

- a** Check the Ctrl, Alt, or Shift box.
- b** From the drop-down list, select the additional key, or click the key on the keyboard.

Examples

To cause the hot key to perform the *print screen* function (Alt-Print Scrn): Check the Alt check box; then select PrtScr from the drop-down list.

To cause the hot key to perform the *paste* function (Ctrl-V): Check the Ctrl check box; then click the V key.

- 6.** Program more hot keys, or click Finish to close the Panel Control Center window.

3 Maintaining the iX104C2

This chapter provides instructions for maintaining your tablet.

Caring for the tablet

This section provides information about how to keep your tablet in top working condition.

Checking power cords and connectors

Check AC and DC power cords and power connectors periodically for damage. Replace the power cord immediately if you find any damage.

Protecting the computer from damage

- Your computer is designed to sustain a multiple-axis drop to a non-yielding surface. Do not intentionally drop the computer, because the cumulative effects of multiple drops may damage the computer.
- Do not place heavy objects on the computer.
- Do not disassemble the computer.
- Keep the computer at least 5 inches (13 centimeters) away from any electrical appliance that generates a strong magnetic field, such as a motor, magnet, TV, refrigerator, or large audio speakers.

Preventing the computer from overheating

The computer monitors its internal temperature. As the internal temperature approaches the tolerable limits of heat-sensitive components, system functions are automatically limited or turned off to prevent damage.

To prevent the computer from overheating, do not obstruct the computer's air vents.

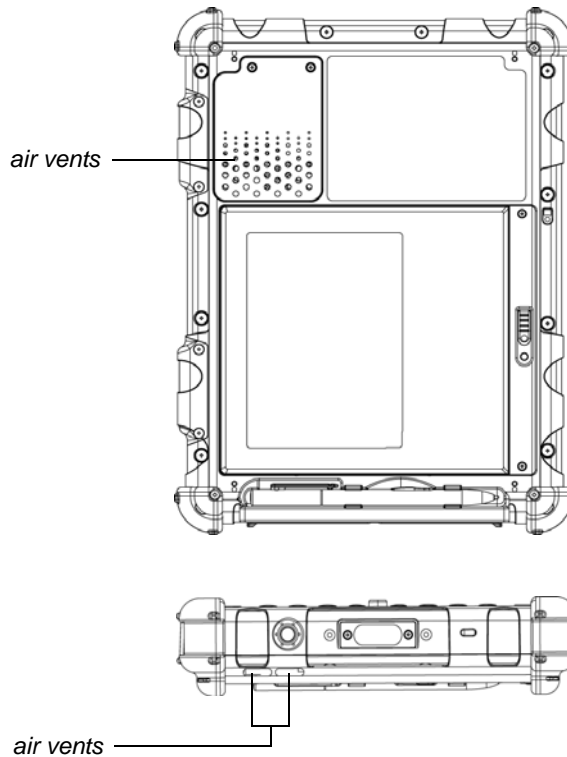

Storing the computer

You can store the computer in the Off state for about 30 days with a fully charged battery installed. After this period, recharge the battery or replace it with a charged battery.

If you intend to store the computer for more than 30 days, remove the battery pack and keep it in a cool place.

Caring for the display screen

To clean the display screen, dampen a soft cotton cloth with water or isopropyl alcohol and gently wipe the screen surface.

Protecting the display screen

The screen protector is a durable, replaceable writing surface that protects the display screen from abrasion.

To obtain additional screen protectors, check with your reseller, or go to the Xplore Web site at www.xploretech.com for ordering information. Additional information about installation is included with the screen protectors.

Removing the screen protector

Slide your fingernail under the edge of the screen protector and pull the protector away from the screen.

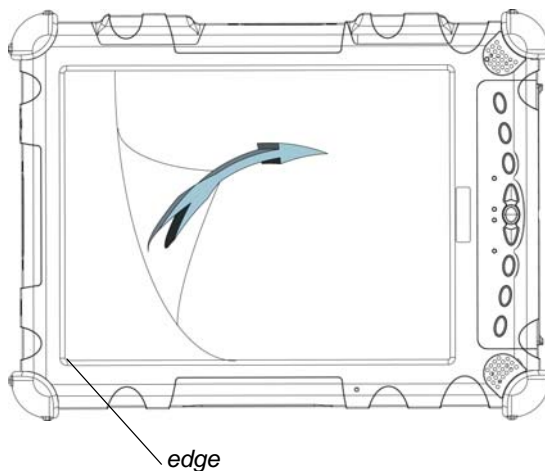

Installing a new screen protector

Follow the instructions included with your screen protector replacement kit.

Note

If a screen protector is already installed on the display screen, remove it before installing the new screen protector.

Calibrating the digitizer

Calibrating the digitizer adjusts the cursor position on the screen relative to the position of the pen tip or finger. Calibrate the digitizer to adjust the distance error between where the pen or finger is actually touching the screen and where the computer is registering the pen or finger touch.

You may need to calibrate the digitizer in the following situations:

- You are using the computer for the first time.
- The previous user of the computer writes with the opposite hand or at a different pen angle.
- The computer has not been used for some time.
- The computer has been serviced.

Calibrating the digitizer: iX104C² Tablet PC

1. From the Start menu, select Control Panel.

The Control Panel opens.

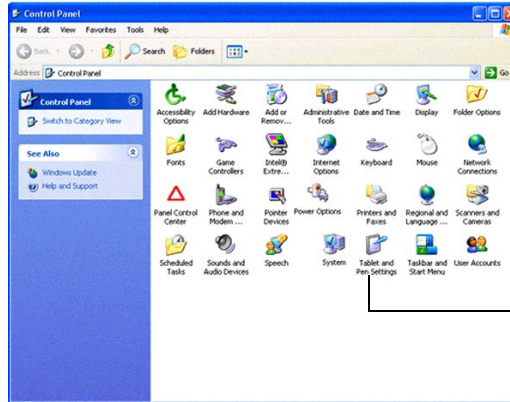

*Tablet and
Pen Settings
icon*

2. Click the Tablet and Pen Settings icon.

The Tablet and Pen Settings window opens.



3. In the Calibration area drop-down list, select the mode for which you want to calibrate the pen: Landscape or Portrait; then click Calibrate.

The Calibration program starts.

4. Follow the instructions that appear on the screen.
5. When you finish, click OK.

Calibrating the digitizer: iX104C² Dual Mode

In Active mode, you can use only the special pen included with the computer as the pointing device.

In Touch mode, you can use the pen, a similar pointing device, or your finger.

Follow the instructions in the sections below to calibrate the digitizer for each mode.

See “*Selecting Auto-Sense, Active, or Touch mode*” on page 43.

Calibrating the digitizer: Active mode

1. From the Start menu, select Control Panel.

The Control Panel opens.

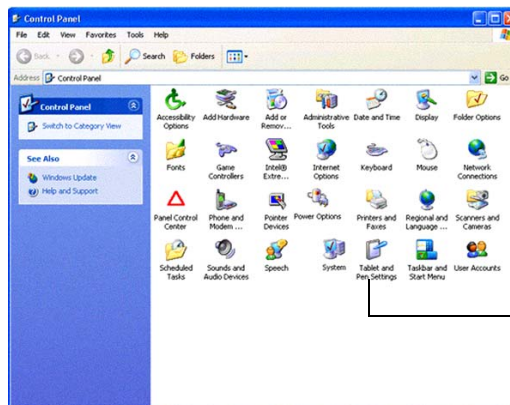

Tablet and Pen Settings icon

2. Click the Tablet and Pen Settings icon.

The Tablet and Pen Settings window opens.

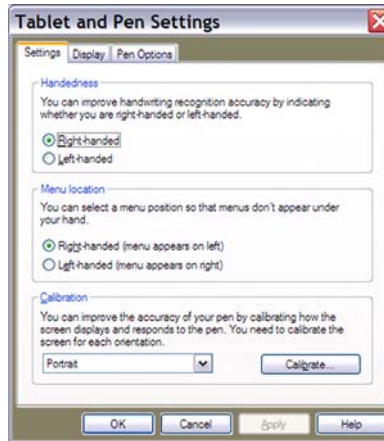

3. In the Calibration area drop-down list, select the mode for which you want to calibrate the pen: Landscape or Portrait; then click Calibrate.

The Calibration program starts.

4. Follow the instructions that appear on the screen.
5. When you finish, click OK.

Calibrating the digitizer: Touch mode

1. From the Start menu, select All Programs > Touch Utility.
The Touch Utility window opens.

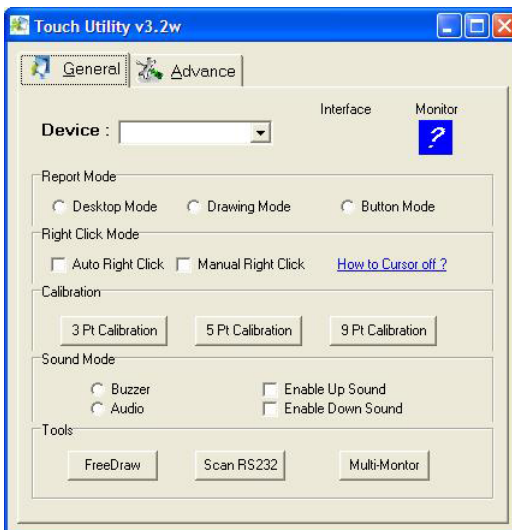

2. Click the appropriate Calibration button.

Note: Xplore Technologies recommends 5 Pt or 9 Pt calibration, for greater accuracy.

The Calibration program starts.

3. Follow the instructions that appear on the screen.
4. When you finish, click OK.

When to replace the pen

With use, the pen tip may become worn and can scratch the screen. If your pen exhibits one of the following problems, replace the pen:

- The pen does not move freely across the screen.
- The pen does not perform as expected.

A Troubleshooting

Table 8 contains solutions to some problems. If you cannot solve the problem by taking the actions described, contact your local help desk or your reseller for further assistance.

Table 8 *Troubleshooting*

Problem	Possible cause and solution
Computer will not start.	<ul style="list-style-type: none">• The battery may be defective or discharged to a critically low level. Connect an external power supply (such as the AC adapter) or install a charged battery. See “Using the battery” on page 56.• Internal components may be above or below the acceptable operating range (below -20° C or above 60° C). After the temperature returns to safe operating range the computer will start.
The computer will not resume operation after being suspended.	<ul style="list-style-type: none">• The battery may be defective or discharged to a critically low level. When the battery reaches a critically low level, the computer is forced into Suspend-to-RAM mode to avoid a total system power failure. Connect an external power supply (such as the AC adapter) or install a charged battery. See “Using the pen” on page 42 and “Using the battery” on page 56.• The computer may be at the critical thermal limit. To avoid damage to heat-sensitive components, the computer enters Suspend-to-RAM mode when the computer operates above 60° C. Operation automatically resumes when the computer cools to below 60° C. Move the computer to a cooler location.

Table 8 *Troubleshooting (continued)*

Problem	Possible cause and solution
Display screen is blank or difficult to read.	<ul style="list-style-type: none">• Confirm that the computer is on (the Power icon is displayed continuously in the Status area).• The brightness may be set too low, causing the screen to appear too dark. To change system brightness, press the Fn and Start keys to open the Xplore menu and adjust the brightness. (See page 32.)• An external monitor may be selected. Press the Fn and P1 keys to select the computer display screen. (See page 32.)• The video time-out may have expired. Tap the display screen to reactivate the display. Note: This is a normal, power-saving feature.• If the Status light is blinking red, the computer is in Suspend-to-RAM mode because the temperature is below -20° C or above 60° C. When the temperature returns to a safe operating range, the display screen automatically comes back on. If possible, move the computer to a warmer or cooler location.• If the Status light is continually yellow, the computer is in Suspend or Hibernate mode. Press the Power On/Off key to resume.
Cursor is not tracking the pen.	Calibrate the pen. See “Calibrating the digitizer” on page 79.
Computer is not responding to the pen.	Connect an external USB keyboard to the computer. If the computer does not respond to the external keyboard, the application or operating system may have been corrupted. Press the Reset key. (See page 37.) If the system responds to a keyboard but not to the pen, contact your local help desk or reseller for further assistance.

Table 8 *Troubleshooting (continued)*

Problem	Possible cause and solution
Headphone or speaker volume is too low.	<ul style="list-style-type: none"> • The volume may be in Mute mode or set too low. Follow the instructions in “Adjusting headphone or speaker volume” on page 53. • Make sure the volume control in your audio software is set to an audible level.
An external device is not working with the computer.	The device may need to be enabled in the computer’s configuration program (BIOS Setup). Contact your local help desk or reseller.
The Status LED is red, continuous.	<ul style="list-style-type: none"> • The computer is on, running under battery power, and the charge level in the battery has reached a critical level. Plug the computer into an AC/DC power source or install a charged battery. • The system has encountered a fault and is preventing normal operation. Contact your local help desk.
The Status LED is red, blinking.	The computer is powered on, running under battery power, and the charge level in the battery is at a minimum warning level. Plug the computer into an AC/DC power source or install a charged battery.

B Using BIOS and AOS Functions

This appendix explains how to use the application and navigation buttons with the Basic Input-Output System (BIOS) program and the Advanced Operating System (AOS) Options menu.

Note

These functions are typically for use only by your system administrator or by authorized service technicians.

Table 9 *Using BIOS and AOS functions*









Use this button...	To perform this function
	To start the BIOS program: When the computer is booting, press the P2 button and follow the instructions that appear on the screen.
 	Navigate. (You can also use the joystick to navigate, as described below.)
	Push the joystick control up, down, left or right to move a highlighted item accordingly (the same as pressing the arrow keys on a keyboard).
	Press the Enter button to perform the same functions as pressing Enter on a keyboard.

Table 9 *Using BIOS and AOS functions (continued)*

Use this button...	To perform this function
	When the system is displaying a BIOS error (such as an invalid checksum), press the P1 button to bypass the error message and attempt a normal boot sequence (the same as the F1 key on a keyboard).
	When the system is displaying the iX104 logo, press the P2 button to run the BIOS setup utility (the same as the F2 key on a keyboard).
	When the system is displaying the operating system boot screen, press the P3 button to open the Advanced Operation System Options menu (the same as the F8 key on a keyboard).

Enabling manual LCD backlight control

When the LCD backlight control is in manual mode, the ambient light sensor is disabled and the computer no longer automatically controls the screen brightness.

Follow these steps to disable the sensor and enable manual LCD backlight control:

1. When the computer is booting, press the Function and P2 buttons to start the BIOS Setup Utility.

The utility starts, displaying the Information Viewer tab.

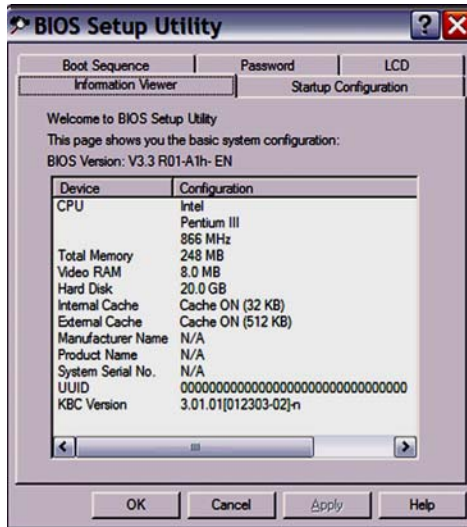

2. Select the LCD tab.

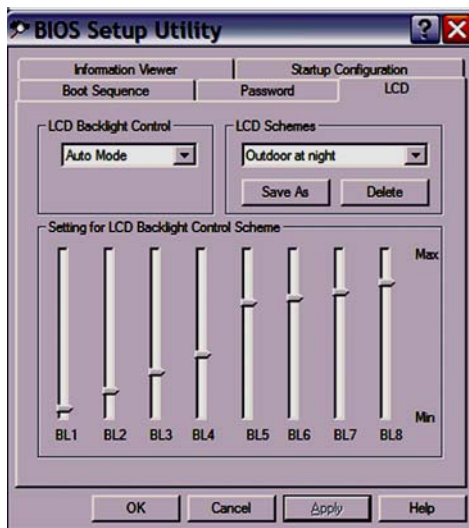

3. In the LCD Backlight Control drop-down list, select Manual.
4. Click OK.

C Glossary

Adapter. A device that provides an interface between two dissimilar electronic devices. For example, the AC adapter modifies the power from a wall outlet for use by the computer.

Advanced Power Management (APM). A facility consisting of one or more layers of software that support power management. The APM software interface enables applications, operating systems, device drivers, and the APM BIOS to work together to reduce power consumption.

Alternating Current (AC). Electric current that reverses its direction of flow at regular intervals.

Analog signal. A signal with characteristics such as amplitude and frequency that vary in proportion to (are an analog of) the value to be transmitted. Voice communications are analog signals.

Application. A program that performs specific tasks on your computer, such as word processing or creating spreadsheets.

BIOS. Programs that contain such basic hardware operations as an interaction with diskette drives, hard disk drives, and the memory.

Board. A circuit board. An internal card containing electronic components called chips, which perform a specific function or increase the capabilities of the system.

Boot. To load a program or operating system into system memory.

Bits Per Second (BPS). In serial transmission, the instantaneous bit speed with which a device or channel transmits a character.

Card. Synonym for board; see *board*.

Compact Disk-Read Only Memory (CD-ROM). Stores data on metal-plated plastic discs.

Compatibility. 1.The ability of one computer to accept and process data in the same method as another computer without modifying the data or the media upon which it is being transferred. 2.The ability of one device to connect or communicate with another system or component.

Configuration. The specific combination of hardware components of the computer, and their operating status. The configuration of your computer includes pre-defined memory, type and speed of microprocessor, type of and size of hard disk drive, etc.

Default. The preset parameter value automatically selected by the computer when you or a program do not provide instructions.

Device driver. A program that controls communication between a specific peripheral device and the computer.

Disk drive. The physical device that enables the computer to read from, and write to, a disk.

Display. An image-producing device used to view computer output.

Double-click. To press and release the pen/stylus twice within a time frame you define, without moving the pointer off the choice.

Driver. Software that allows an application program to communicate with a particular piece of equipment, such as a printer or the pen/stylus.

Hard disk drive (HDD). A sealed mass storage device used for storage and fast retrieval of programs and data. The factory installs this disk and only a trained engineer can remove it for servicing.

Hardware. The physical electronic and mechanical components of a computer system. typically, the computer itself, CPU, memory, etc.

Hertz. A unit of wave frequency that equals one cycle per second.

Interface. 1. Hardware and/or software components used specifically to connect one computer or device to another. 2. To physically connect one system or device to another to exchange information. 3. The point of contact between user, the computer, and the program (for example, the pen/stylus or a menu).

Kilobyte (KB). A unit of 1024 bytes measuring storage space, typically in memory or on storage media such as a diskette or hard disk drive.

Local area network (LAN). Assembly of separate computers into an integrated network that connects the various computers together and to common devices such as printers and fax machines.

Light Emitting Diode (LED). A semiconductor device that emits light when a current is applied.

Liquid Crystal Display (LCD). liquid crystal sealed between two sheets of glass coated with transparent conducting material. Applying a voltage between the glass sheets darkens the liquid crystal to provide contrast to lighted portions of the display.

Megabyte (MB). A unit of data storage equal to 1024 kilobytes.

Megahertz (MHz). a unit of wave frequency that equals 1 million cycles per second.

Modem. A device that connects your computer to a telephone line, allowing it to communicate with another computer at another location.

PC Card. A plug-in accessory card that conforms to the PCMCIA standard.

Pen. See *stylus*.

Peripheral device. An input/output device that is external to the central processor and/or main memory such as a printer or scanner.

Pixel. Picture elements (tiny dots) that compose a screen image.

Port. The electrical connection through which the computer sends and receives data to and from devices or other computers.

Program. A set of instructions a computer can execute to tell the system what to do and how to do it.

Random Access Memory (RAM). A hardware component of your computer that temporarily stores active program code and data.

Reset. The act of reloading the operating system.

Resolution. The number of pixels displayed on the screen. A higher resolution provides greater clarity and allows more information to be displayed on the screen at once.

Restart. Resetting a computer without turning it off (also called warm boot or soft reset).

Resume. The act of returning the computer to an active, operational state.

Read Only Memory (ROM). The portion of your computer's memory that contains permanent instructions, and which cannot be modified.

Status Indicator (LED). a light above the LCD screen which indicates the current status of a particular device or hardware component.

Stylus. A writing instrument. For pen computers, the stylus is used to interface with the LCD and digitizer.

Subscriber Identity Module (SIM). A smart card inside a GSM (Global System for Mobile communications) cellular device that encrypts voice and data transmissions and stores data about the specific user so that the user can be identified and authenticated by the network supplying the phone service. A SIM can be moved from one device to another and/or different SIMS can be inserted into any GSM radio.

Suspend mode. A power conservation mode in which electrical current is removed from most components of the computer.

Universal Serial Bus. A serial interface that enables communication between devices and the computer.

D Hardware Specifications

Physical specifications

Dimensions	11.20" x 8.25" x 1.6" (WxHxD) 283.9mm x 209.3mm x 40.8mm
Weight	4.45 lbs. (2.02kg)*

Processing specifications

CPU	Intel® Pentium® M 733 processor – Ultra Low Voltage (5 W)*
Chip set	Intel 855GME-400 MHz
Processor speed	1.1 GHz*

* Varies according to your computer's configuration.

Memory/storage specifications

Main RAM	<ul style="list-style-type: none">• 256MB DDR RAM (on-board/PC3200)• 144-pin SODIMM modules <p>512MB and 1GB modules available</p>
L1 Cache (CPU)	32KB on-die
L2 Cache	2MB on-die
BIOS ROM	8Mbit (FWH)
Hard Disk Drive	2.5" HDD shock mounted Minimum 40GB IDE HDD* Ultra DMA 100, 5400 RPM
BIOS ROM	8Mbit (FWH)

* Varies according to your computer's configuration.

Display specifications

<p>Display</p>	<ul style="list-style-type: none"> • Color LCD • Active Digital Sensor and Pen (iX104C² Tablet PC) and Resistive Touch Panel (iX104C² Dual Mode) • 32-bit True color • 10.4" TFT XGA (1024x768), 16M colors • Brightness: 16 levels • Viewing Angle: • Horizontal: 30 degrees (min.) • Vertical: 10 degrees (min.) • Contrast Ratio: Typ. 250:1, Min 100:1
<p>VRAM</p>	<p>Intel 855GME chipset with 64 MB shared memory using Unified Memory Architecture (UMA) delivers low-power, high-performance 3D/2D graphics, video, and display capabilities. Dynamic Video Memory Technology (DVMT) dynamically responds to application requirements and efficiently allocates the proper amount of memory (64 MB maximum) for optimal graphics and system performance.</p>

Interface specifications

<p>Wireless Radio Bays</p>	<ul style="list-style-type: none"> • One internal Type 1 or Type II PC Card slot (PCMCIA Cardbus version 3.0) • One Internal mini-PCI slot • One internal OEM radio bay
----------------------------	--

Interface specifications

Integrated Interfaces	<ul style="list-style-type: none">• DC-in• USB (2) 2.0• Microphone Jack• Headset Jack• Modem (RJ-11 in combo with RJ-45)• LAN (RJ-45)• 15-pin D-SUB connector for external VGA monitor
KeyPad / User Controls	<ul style="list-style-type: none">• Application buttons with primary and secondary functions• Power On/Off/Suspend/Resume button• Emergency Shutoff/Reset button• Integrated joystick slew control
Audio	<ul style="list-style-type: none">• AC 97 Codec• On-board microphone with noise cancellation• On-board integrated stereo speakers (1W each)
Status Indicators	Power, Charge/DC-in, Warning

Power specifications

Main Battery	<ul style="list-style-type: none"> • 2 cell • Removable Lithium Ion Prismatic • 7.4V @ 5700mAh (42Whr) • Warm-swappable • Recharge Time: 2.5 hours (90%) • Life: Up to 4 hours. (Battery life is dependent on operating system, power management, and applications in use.) • Suspend Life: Min. 4 days
Optional Spare Battery	<ul style="list-style-type: none"> • 4 cell • Removable Lithium ION Prismatic • 7.4V @ 7600mAh (56Wh) • Warm-swappable • Recharge Time: 3.5 hours • Suspend Life: Min. 5 days • Off State: Approximately 30 days
Bridge Battery	<ul style="list-style-type: none"> • 6-cell Li ION, 45mAh • Life: (with Suspend-to-RAM on bridge battery only): 3 to 5 minutes from full charge
AC Adapter	Auto-sensing 100-240V, supplying 19 VDC, with a current of 3.75 A

Appendix D. Hardware Specifications

Environmental specifications

Temperature	<ul style="list-style-type: none"> • Operating: -4° to 140° F (-20° to 60° C) • Storage: -40° to 167° F (-40° to 75° C)
Humidity	0% to 95% non-condensing
Shock/Drop	Four-foot drop to concrete, all surfaces, edges and corners
Vibration	0.04g ² /Hz, 20 Hz - 1000 Hz -6dB/octave 1000 Hz - 2000 Hz
Enclosure Class	<p>Blowing rain: 4"/hr, 40 mph wind and MIL-STD-810F Method 506.4 Procedure 1</p> <p>Immersion: Immerse system to 30 cm in water for 30 minutes. MIL-STD-810F Method 512.4 Procedure 1</p> <p>Drip: 7 gal/ft²/hr MIL-STD-810F Method 506.4 Procedure III</p> <p>Sand and dust: Particle size < 149 µm, 10 ± 7 g/m³ particle density 1.5 m/s to 8.9 m/s wind speed MIL-STD-810F Method 510.4 Procedure 1</p> <p>Salt Fog: 5% saline for 48 hr (12 hr wet, 12 hr dry, 2 cycles) MIL-STD-810F Method 509.4</p> <p>Contamination by fluids: Detergents, brake fluid, aromatic hydrocarbons MIL-STD-810F Method 504</p> <p>Solar radiation: 1120 W/m² (355 Btu/ft²/hr) UVB @ 50° C, 7x24 hr cycles MIL-STD-810F Method 505.4</p>

Agency approvals

Emissions	<ul style="list-style-type: none">• EN55022 (CISPR22) Class B• FCC 15, Class B• DOC Class B• CE MARK
Immunity	<ul style="list-style-type: none">• EN55024• FCC 15, Class B• DOC Class B
Safety	<ul style="list-style-type: none">• UL and CUL Listed, UL 1950, 3rd Edition• TuV T-Mark, EN60950• CSA and UL Listed, UL 1604

Operating system

Operating Systems	Microsoft Windows XP Professional Tablet PC 2005 Edition
-------------------	--

E Agency Notices



FCC notices

This device complies with Part 15 of the FCC Rules. Operation is subject to the following two conditions: (1) this device may not cause harmful interference, and (2) this device must accept any interference received, including interference that may cause undesired operation.

Modifications not expressly approved by Xplore Technologies could void this user's authority to operate the equipment.

Note

This equipment has been tested and found to comply with the limits for a Class B digital device, pursuant to Part 15 of the FCC Rules. These limits are designed to provide reasonable protection against harmful interference in a residential installation. This equipment generates, uses and can radiate radio frequency energy and, if not installed and used in accordance with the instructions, may cause harmful interference to radio communications. However, there is no guarantee that interference will not occur in a particular installation. If this equipment does cause harmful interference to radio or television reception, which can be determined by turning the equipment off and on, the user is encouraged to try to correct the interference by one or more of the following measures:

- Reorient or relocate the receiving antenna.
 - Increase the separation between the equipment and receiver.
 - Connect the equipment into an outlet on a circuit different from that to which the receiver is connected.
 - Consult the dealer or an experienced radio/TV technician for help.
-

RF exposure

Tests for SAR are conducted using standard operating positions specified by the FCC with the tablet PC transmitting at its highest certified power level in all tested frequency bands. Although the SAR is determined at the highest certified power level, the actual SAR level of the tablet PC while operating can be well below the maximum value. This is because the tablet PC is designed to operate at multiple power levels so as to use only the power required to reach the network. In general, the closer you are to a wireless base station antenna, the lower the power output.

Before a tablet PC model is available for sale to the public, it must be tested and certified to the FCC that it does not exceed the limit established by the government-adopted requirement for safe exposure. The tests are performed in positions and locations (e.g., worn on the body) as required by the FCC for each model. (Body-worn measurements may differ among tablet PC models, depending upon available accessories and FCC requirements). While there may be differences between the SAR levels of various tablet PCs and at various positions, they all meet the government requirement for safe exposure.

This device was evaluated and shown to comply with FCC SAR guidelines. Avoid covering or holding antennas when transmitting. Antenna locations are shown in the following figure.

antenna locations

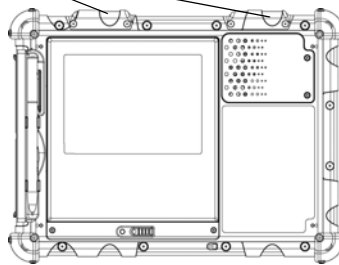

Health and Safety Information

Exposure to Radio Frequency (RF) Signals

Your wireless tablet PC is a radio transmitter and receiver. It is designed and manufactured not to exceed the emission limits for exposure to radio frequency (RF) energy set by the Federal Communications Commission of the U.S. Government. These limits are part of comprehensive guidelines and establish permitted levels of RF energy for the general population. The guidelines are based on the safety standards previously set by both U.S. and international standards bodies:

- American National Standards Institute (ANSI) IEEE. C95.1-1992
- National Council on Radiation Protection and Measurement (NCRP). Report 86. 1986
- International Commission on Non-Ionizing Radiation Protection (ICNIRP) 1996
- Ministry of Health (Canada), Safety Code 6. The standards include a substantial safety margin designed to assure the safety of all persons, regardless of age and health.

The exposure standard for wireless mobile tablet PCs employs a unit of measurement known as the Specific Absorption Rate, or SAR. The SAR limit set by the FCC is 1.6W/kg .

Note

In the U.S. and Canada, the SAR limit for mobile tablet PCs used by the public is 1.6 watts/kg (W/kg) averaged over one gram of tissue. The standard incorporates a substantial margin of safety to give additional protection for the public and to account for any variations in.

DOC (Industry Canada Notices)

Notice to Users of Radio and Television

This Class B digital apparatus meets all requirements of Canadian Interference-Causing Equipment Regulations

CET appareil numérique de la class B respecte toutes les exigence du Règlement sur le matériel brouilleur du Canada.

Notice to Users of the Canadian Telephone Network

Notice

This equipment meets the applicable Industry Canada Terminal Equipment Technical Specifications. This is confirmed by the registration number. The abbreviation, IC, before the registration number signifies that registration was performed based on a Declaration of Conformity indicating that Industry Canada technical specifications were met. It does not imply that Industry Canada approved the equipment.

Before connecting this equipment to a telephone line the user should ensure that it is permissible to connect this equipment to the local telecommunication facilities. The user should be aware that compliance with the certification standards does not prevent service degradation in some situations.

Repairs to telecommunication equipment should be made by a Canadian authorized maintenance facility. Any repairs or alterations not expressly approved by Xplore or any equipment failures may give the telecommunication company cause to request the user to disconnect the equipment from the telephone line.

Notice

The Ringer Equivalence Number (REN) for this terminal equipment is 0.0. The REN assigned to each terminal equipment provides an indication of the maximum number of terminals allowed to be connected to a telephone interface. The termination on an interface may consist of any combination of devices subject only to the requirement that the sum of the Ringer Equivalence Numbers of all the devices does not exceed five.

UL Notice

This unit requires an AC adapter to operate. Use only UL Listed Class 2 Adapters with an output rating of 19 VDC, with a current of 3.75 A. AC Adapter output polarity:

**For authorized repair technicians only**

⚡ WARNING
For continued protection against risk of fire, replace only with the same type and rating fuse.

⚡ WARNING
Danger of explosion if Lithium (clock) battery is incorrectly replaced. Replace only with the same equivalent type recommended by the manufacturer. Dispose of used batteries according to the manufacturer's instruction.

System disposal

In the event of system disposal, observe the following information regarding proper procedures in the State of Vermont.



The liquid crystal display (LCD) lamps used in this system contain mercury. In the event of system disposal, be sure to follow local guidelines.

Index

A

- Active mode, selecting 43
- air flow vents, location 24
- ambient light sensor
 - disabling 49
 - location 21
- antenna covers, location 22
- Auto-Sense mode, selecting 43

B

- battery alarm settings, changing 62
- battery pack
 - charge time 57
 - charging 56
 - checking charge status 62
 - checking the charge 56
 - conserving power 64
 - discarding 60
 - installing 60
 - location 22
 - removing 58
- battery release latch, location 22
- BIOS Setup Utility, using 91
- Bluetooth antenna 24

C

- convection air flow cover, location 22

D

- digitizer
 - calibrating 79
 - using to perform mouse functions 43
- double-click, performing with pen 43
- dragging and dropping, performing with pen 44

E

- email, starting 31

H

- headphone connector, location 25
- headphone volume, adjusting 53
- headphone, connecting 53
- Hibernation mode
 - description 38
 - enabling 63
- hot keys, programming, *see keys, programming hot keys*

I

- input device, selecting 32, 43
- Internet Explorer, starting 31
- iX104C²
 - accessories 17
 - maintaining 75
 - preventing overheating 76
 - protecting from damage 75
 - storing 77

J

joystick

- using 47
- using in landscape mode 34
- using in portrait mode 33

K

Kensington lock slot, location 24

keys

Alt-Tab

- description 31
- location 30

Ctrl-Alt-Del 31

- description 31

Ctrl-Alt-Delete

- location 30

Ctrl-Esc

- description 31
- location 30

descriptions 31

Enter

- description 31
- location 30

Esc, using 32

Function

- description 31
- location 30

Function mode hot key combinations

- default functions 65
- descriptions 32

navigation, using 33

P1

- default function 65
- description 31
- location 30

P2

- default function 65
- description 31
- location 30

P3

- default function 65
- description 31
- location 30

Power On/Off/Suspend/Resume

- location 24

programming hot keys 65, 66

- to perform other key functions 72
- to perform pre-defined functions 70

quick-start diagram 30

Screen Rotation

- description 31
- location 30

Secure Attention Sequence (SAS) 30

Windows Start Menu

- description 31
- location 30

Windows Toggle

- description 31
- location 30

L

LAN connector, location 25

LCD backlight

- decreasing brightness 32, 49
- disabling automatic control 49
- enabling manual control 93
- increasing brightness 32, 49

LEDs 28

- Brightness LED meanings 29
- Status LED meanings 28

left button click, performing with pen 43
local area network (LAN), connecting to 51
logging on 31

M

microphone
 connecting external 52
 connector location 25
 location 21
 volume, adjusting 52
modem, connector location 25
monitor
 activating 54
 connecting 54
 sending video display to 32
monitor connector, location 25
mouse functions, performing 43

N

navigating
 in landscape mode 34
 in portrait mode 33
Navigation 34
navigation control key, see joystick 47

O

online help, opening 31

P

Page Down
 performing in landscape mode 34
 performing in portrait mode 33

Page Up

 performing in landscape mode 34
 performing in portrait mode 33
pen
 double-click speed, changing 45
 dragging and dropping 44
 holder, location 22
 location 22
 performing a double-click 43
 performing a right-click 44
 performing left button click 43
 positioning in holder 46
 replacing 85
 tether, using 46
 using 42
pen calibration program
 opening 32
power connector, location 25
Power On/Off/ Suspend/Resume key
 location 24
Power Options Properties window
 opening 61
power schemes, changing 61
power settings, changing 63
power use, managing 61
projection panel
 activating 54
 connecting 54
 sending video display to 32

Q

quick-start guide 30

R

- Reset switch
 - location 21
 - using 37
- resuming operation 41
- right-click, performing with pen 44
- RJ-11 connector 25
- RJ-45 connector 25

S

- screen
 - landscape mode 31
 - portrait mode 31
 - protecting 77
- screen orientation
 - changing 48
 - landscape 48
 - navigating 34
 - portrait 48
 - navigating 33
- screen protector
 - installing 78
 - removing 78
 - replacing 78
- scrolling
 - performing in landscape mode 34
 - performing in Portrait mode 33
- serial number, location 22
- Shift+Tab
 - performing in landscape mode 34
 - performing in portrait mode 33
- SIM socket 24
- speaker volume, adjusting 53

- speakers
 - connecting 53
 - location 21
- storing the computer 77
- support, contacting 19
- Suspend mode
 - description 38
 - ending 41
 - starting 40
- suspending operation 40
- Suspend-to-RAM mode, description 38

T

- Tab
 - performing in landscape mode 34
 - performing in portrait mode 33
- Touch mode, selecting 43
- troubleshooting 87
- turning off the computer 36
- turning on the computer 35

U

- USB port, location 25
- USB-compatible device, connecting 51

V

- video output
 - changing from monitor to computer 54
 - changing to monitor 54
- volume
 - adjusting headphone 53
 - adjusting microphone 52
 - adjusting speaker 53

W

Windows Task Manager, launching 31

X

XPL expansion module, connecting 55

XPL expansion port, location 26

Xplore Tablet Dock

 docking connector location 27

Xplore Technologies, contacting 19

