



Inter|Lab®

# EMC Measurement/Technical Report on GSM Module MC75 Siemens Cellular Engine MC75

**Report Reference:** 4\_Siem\_0504\_GSM\_FCCa

with

Development Board DSB75

**Test Laboratory (Headquarter):**

7 Layers AG  
Borsigstr. 11  
40880 Ratingen  
Germany



TTI-P-G 178/99

**Note:**

The following test results relate only to the devices specified in this document. This report shall not be reproduced in parts without the written approval of the testing laboratory.

---

7 layers AG, Borsigstrasse 11  
40880 Ratingen, Germany  
Phone: +49 (0) 2102 749 0  
Fax: +49 (0) 2102 749 350  
<http://www.7Layers.com>

Aufsichtsratsvorsitzender -  
Chairman of the Supervisory Board:  
Michael Abels  
Vorstand - Board of Directors:  
Dr. Hans-Jürgen Meckelburg  
René Schildknecht

Registergericht - registered in:  
Düsseldorf, HRB 44096  
USt-IdNr VAT Nr:  
DE 203159652

Interlab is a registered trademark of 7 layers AG

---



## Table of Contents

<b>0. Summary</b>	<b>3</b>
0.1 Technical Report Summary	3
0.2 Measurement Summary	4
<b>1. Administrative Data</b>	<b>5</b>
1.1 Testing Laboratory	5
1.2 Project Data	5
1.3 Applicant Data	5
1.4 Manufacturer Data	5
<b>2. Testobject Data</b>	<b>6</b>
2.1 General EUT Description	6
2.2 EUT Main Components	7
2.3 Ancillary Equipment	7
2.4 EUT Setups	7
2.5 Operating Modes	7
<b>3. Test Results</b>	<b>8</b>
3.1 RF Power Output	8
3.2 Frequency Stability	13
3.3 Spurious Emissions at Antenna Terminals	16
3.4 Field Strength of Spurious Radiation	19
3.5 Emission and Occupied Bandwidth	22
3.6 Modulation Characteristics	
<b>4. Testequipment</b>	<b>25</b>
<b>5. Foto Report</b>	<b>28</b>
<b>6. Setup Drawings</b>	<b>30</b>
<b>7. Annex</b>	<b>33</b>
Measurement plots	



## 0 Summary

### 0.1 Technical Report Summary

#### Type of Authorization

Certification for a broadband PCS device

#### Applicable FCC Rules:

Prepared in accordance with the requirements of FCC Rules and Regulations as listed in 47 CFR Ch.1 Parts 0 to 19 and Parts 20 to 69 (10-1-98 Edition). The following subparts are applicable to the results in this test report.

#### Part 2

Subpart J - Equipment Authorization Procedures, Certification

- § 2.1046 Measurement required: RF power output
- § 2.1049 Measurement required: Occupied bandwidth
- § 2.1051 Measurement required: Spurious emissions at antenna terminals
- § 2.1053 Measurement required: Field strength of spurious emission
- § 2.1055 Measurement required: Frequency stability
- § 2.1057 Frequency spectrum to be investigated

#### Part 24

Subpart E - Broadband PCS

- § 24.232 Power and antenna height limits
- § 24.235 Frequency stability
- § 24.238 Emission limits

#### Summary Test Results:

**The EUT complied with all performed tests as listed in chapter 0.2 Measurement Summary.**

## 0.2 Measurement Summary

### RF Power Output

The measurement was performed according to FCC §2.1046 10-01-1998

OP-Mode	Setup	Port	Final Result
op-mode 1	01s400a02	antenna connector	passed
op-mode 2	01s400a02	antenna connector	passed
op-mode 3	01s400a02	antenna connector	passed

### Frequency stability

The measurement was performed according to FCC §2.1055 10-01-1998

OP-Mode	Setup	Port	Final Result
op-mode 2	01s400a03	antenna connector	passed

### Spurious emissions at antenna terminals

The measurement was performed according to FCC §2.1051 10-01-1998

OP-Mode	Setup	Port	Final Result
op-mode 1	01s400a02	antenna connector	passed
op-mode 2	01s400a02	antenna connector	passed
op-mode 3	01s400a02	antenna connector	passed

### Field strength of spurious radiation

The measurement was performed according to FCC §2.1053 10-01-1998

OP-Mode	Setup	Port	Final Result
op-mode 1	01s400a01	enclosure + antenna	passed
op-mode 2	01s400a01	enclosure + antenna	passed
op-mode 3	01s400a01	enclosure + antenna	passed

### Emission and Occupied Bandwidth

The measurement was performed according to FCC §2.1049 10-01-1998

OP-Mode	Setup	Port	Final Result
op-mode 1	01s400a02	antenna connector	passed
op-mode 2	01s400a02	antenna connector	passed
op-mode 3	01s400a02	antenna connector	passed

Responsible for  
Accreditation Scope: T. Hall

Responsible  
for Test Report: a. Pfl

## 1. Administrative Data

### 1.1 Testing Laboratory

Company Name: 7 Layers AG  
Address: Borsigstr. 11  
40880 Ratingen  
Germany

This facility has been fully described in a report submitted to the FCC and accepted under the registration number 96716 .

The test facility is also accredited by the following accreditation organisation:

- Deutscher Akkreditierungs Rat      DAR-Registration no. TTI-P-G 178/99

Responsible for Accreditation Scope: Dipl.-Ing Bernhard Retka  
Dipl.-Ing Arndt Stöcker  
Dipl.-Ing Thomas Hoell

### 1.2 Project Data

Responsible for testing and report: Andreas Petz  
Receipt of EUT: 2004-12-20  
Date of Test(s): 2005-01-04 to 2005-01-07  
Date of Report: 2005-01-17

### 1.3 Applicant Data

Company Name: Siemens AG (BLN)  
Address: Siemensdamm 50  
  
13629 Berlin  
Germany  
Contact Person: Thorsten Liebig

### 1.4 Manufacturer Data

Company Name: please see Applicant data  
Address:

Contact Person:

## 2. Testobject Data

### 2.1 General EUT Description

<b>Equipment under Test:</b>	GSM Module MC75
<b>Type Designation:</b>	Siemens Cellular Engine MC75
<b>Kind of Device: (optional)</b>	GSM 850/900/1800/1900
<b>Voltage Type:</b>	DC
<b>Nominal Voltage:</b>	4,5 V
<b>Maximum Voltage:</b>	4,5 V
<b>Minimum Voltage:</b>	3,2 V

#### **General product description:**

GSM module for mobile phones which is able to operate in the bands 850, 900, 1800 and 1900.

The manufacturer declared that nominal voltage is equal to high voltage.

#### **The EUT provides the following ports:**

##### **Ports**

antenna connector  
enclosure + antenna

**The main components of EUT are listed and described in Chapter 2.2**

## 2.2 EUT Main components:

### Type, S/N, Short Descriptions etc. used in this Test Report

Short Description	Equipment under Test	Type Designation	Serial No.	HW Status	SW Status	Date of Receipt
EUT A (Code: 01400z02)	GSM Module	MC75	IMEI: 004999003471868	B2.3	Revision 00.144	2005-01-03
EUT A is connected to the development board. The SMA antenna connector is provided by the development board. For radiated tests an external antenna will be used additionally..						
EUT B (Code: 014001aa)	Development Board	DSB75	DSB75_B1_0089	B1	-	2004-12-20
EUT C (Code: 014002aa)	Development Board	DSB75	DSB75_B1_0077	B1	-	2004-12-20

**NOTE: The short description is used to simplify the identification of the EUT in this test report**

## 2.3 Ancillary Equipment

For the purposes of this test report, ancillary equipment is defined as equipment which is used in conjunction with the EUT to provide operational and control features to the EUT. It is necessary to configure the system in a typical fashion, as a customer would normally use it. But never the less Ancillary Equipment can influence the test results.

Short Description	Equipment under Test	Type Designation	HW Status	SW Status	Serial No.	FCC Id
AE1	Allgon-MiniMAG Dualband Antenna	Ordering number: 1140.26	-	-	EMV Referenz Antenne_02	-

## 2.4 EUT Setups

This chapter describes the combination of EUT's and ancillary equipment used for testing.

Setup No.	Combination of EUTs	Description
01s400a01	EUT A + EUT B + AE1	setup for radiated spurious emissions tests
01s400a02	EUT A + EUT B	setup for conducted tests (DSB board in housing)
01s400a03	EUT A + EUT C	setup for conducted tests (DSB board)

## 2.5 Operating Modes

This chapter describes the operating modes of the EUT's used for testing.

Op. Mode	Description of Operating Modes	Remarks
op-mode 1	Call established on Traffic Channel (TCH) 512, Carrier Frequency 1850,2 MHz	512 is the lowest channel
op-mode 2	Call established on Traffic Channel (TCH) 661, Carrier Frequency 1880 MHz	661 is a mid channel of the full PCS band (blocks A to F)

op-mode 3 Call established on Traffic Channel (TCH)  
810, Carrier Frequency 1909,8 MHz

810 is the highest channel

---



### 3. Test Results

#### 3.1 RF Power Output

**Standard** FCC Part 24, 10-01-98  
Subpart E

**The test was performed according to:** FCC §2.1046 10-01-1998

##### 3.1.1 Test Description

1) The mobile station was coupled to the R&S Spectrum Analyser and a Digital Communication Tester through a Power Divider. Refer to chapter "Setup Drawings".

2) The total insertion losses for RF Path 1 and RF Path 2 were measured. The values were used to correct the readings from the R&S Spectrum Analyser and a Digital Communication Tester.

3) A speech call was established on a Traffic Channel (TCH) between the mobile station and the base station simulator.

Important Settings:

- Discontinuous Transmission: OFF
- Modulation Signal: PSR16-1 (Pseudo Random Sequenz)
- Output Power: Varied during measurements
- Channel (Frequency): Varied during measurements

4) The transmitted power of the mobile station was recorded for all possible power control level by using an internal measurement function of a Digital Communication Tester.

5) During this test the Spectrum Analyser was only used to check if the results are comprehensible.

##### 3.1.2 Test Requirements / Limits

§2.1046 Measurements Required: RF Power Output

(a) For transmitters other than single sideband, independent sideband and controlled carrier radiotelephone, power output shall be measured at the RF output terminals when the transmitter is adjusted in accordance with the tune-up procedure to give the values of current and voltage on the circuit elements specified in § 2.1033(c)(8). The electrical characteristics of the output terminals when this test is made shall be stated.

§24.232 Power and antenna height limits

(b) Mobile/portable stations are limited to 2 watts e.i.r.p peak power and the equipment must employ means to limit the power to the minimum necessary for succesful communications.

(c) Peak transmit power must be measured over any interval of continuous transmission using instrumentation calibrated in terms of an rms-equivalent voltage. The measurement results shall be properly adjusted for any instrument limitations, such as detector response times, limited resolution

bandwidth capability when compared to the emission bandwidth, sensitivity, etc., so as to obtain a true peak measurement for the emission in question over the full bandwidth of the channel.

### 3.1.3 Test Protocol

Temperature: 24 °C  
 Air Pressure: 1022 hPa  
 Humidity: 33 %

Op. Mode	Setup	Port
----------	-------	------

op-mode 1	01s400a02	antenna connector
-----------	-----------	----------------------

Power Control Level	Output power Nominal (dBm)	Output power Measured (dBm)	Difference dB
0	30	28,2	-1,80
1	28	26,7	-1,30
2	26	24,6	-1,40
3	24	22,3	-1,70
4	22	20	-2,00
5	20	17,5	-2,50
6	18	15,2	-2,80
7	16	12,8	-3,20
8	14	10,5	-3,50
9	12	8,2	-3,80
10	10	6,2	-3,80
11	8	4,2	-3,80
12	6	2,3	-3,70
13	4	0,9	-3,10
14	2	-0,8	-2,80
15	0	-1,7	-1,70

Remark: The EIRP including antenna gain (1.65 dBi) is 29.85 dBm.

Temperature: 24 °C  
 Air Pressure: 1022 hPa  
 Humidity: 33 %

**Op. Mode    Setup                    Port**

---

op-mode 2 01s400a02    antenna  
    connector

Power Control Level	Output power Nominal (dBm)	Output power Measured (dBm)	Difference dB
0	30	28,6	-1,40
1	28	26,8	-1,20
2	26	24,9	-1,10
3	24	22,6	-1,40
4	22	20,2	-1,80
5	20	17,8	-2,20
6	18	15,5	-2,50
7	16	13,1	-2,90
8	14	10,8	-3,20
9	12	8,5	-3,50
10	10	6,6	-3,40
11	8	4,6	-3,40
12	6	2,7	-3,30
13	4	1,3	-2,70
14	2	-0,4	-2,40
15	0	-1,2	-1,20

Remark: The EIRP including antenna gain (1.65 dBi) is 30.25 dBm.

Temperature: 24 %  
 Air Pressure: 1022 hPa  
 Humidity: 33 %

**Op. Mode    Setup            Port**

op-mode 3 01s400a02 antenna  
 connector

Power Control Level	Output power Nominal (dBm)	Output power Measured (dBm)	Difference dB
0	30	28,5	-1,50
1	28	26,8	-1,20
2	26	24,8	-1,20
3	24	22,5	-1,50
4	22	20,2	-1,80
5	20	17,9	-2,10
6	18	15,5	-2,50
7	16	13,2	-2,80
8	14	10,9	-3,10
9	12	8,6	-3,40
10	10	6,7	-3,30
11	8	4,7	-3,30
12	6	2,9	-3,10
13	4	1,5	-2,50
14	2	-0,1	-2,10
15	0	-1	-1,00

Remark: The EIRP including antenna gain (1.65 dBi) is 30.15 dBm.

**3.1.4 Test result: RF Power Output**

FCC Part 24, Subpart E				Op. Mode	Setup	Port	Result
				op-mode 1	01s400a02	antenna connector	<b>passed</b>
				op-mode 2	01s400a02	antenna connector	<b>passed</b>
				op-mode 3	01s400a02	antenna connector	<b>passed</b>

### 3.2 Frequency stability

**Standard** FCC Part 24, 10-01-98  
Subpart E

**The test was performed according to:** FCC §2.1055 10-01-1998

#### 3.2.1 Test Description

- 1) The PCS1900 mobile station was placed inside the climatic chamber.
- 2) The mobile station was coupled to a Digital Communication Tester. Refer to chapter "Setup Drawings".
- 3) The climatic chamber was cycled down/up to a certain temperature, starting with  $-30^{\circ}\text{C}$ .
- 4) After the temperature was stabilized (at least one hour) the mobile station was switched on and a speech call was established on a Traffic Channel (TCH) between the mobile station and the base station simulator.  
Important Settings:
  - Discontinuous Transmission: OFF
  - Modulation Signal: PSR16-1 (Pseudo Random Sequenz)
  - Output Power: Maximum
  - Channel : 661 [1880 MHz]
- 5) The frequency error of the mobile station were recorded by using an internal measurement function of a Digital Communication Tester immediately after the call was established, five minutes after the call was established and ten minutes after the call was established.
- 6) This measurement procedure was performed for all combinations of voltage (low, nominal, high) and temperature (from  $-30^{\circ}\text{C}$  to  $+50^{\circ}\text{C}$  in increments of  $10^{\circ}\text{C}$ ).

#### 3.2.2 Test Requirements / Limits

§2.1055 Measurements required: Frequency stability

(a) The frequency stability shall be measured with variation of ambient temperature as follows:

(1) From  $-30^{\circ}$  to  $+50^{\circ}$  centigrade for all equipment except that specified in paragraphs (a) (2) and (3) of this section.

(b) Frequency measurements shall be made at the extremes of the specified temperature range and at intervals of not more than  $10^{\circ}$  centigrade through the range. A period of time sufficient to stabilize all of the components of the oscillator circuit at each temperature level shall be allowed prior to frequency measurement. The short term transient effects on the frequency of the transmitter due to keying (except for broadcast transmitters) and any heating element cycling normally occurring at each ambient temperature level also shall be shown. Only the portion or portions of the transmitter containing the frequency determining and stabilizing circuitry need be subjected to the temperature variation test.



(d) The frequency stability shall be measured with variation of primary supply voltage as follows:

(1) Vary primary supply voltage from 85 to 115 percent of the nominal value for other than hand carried battery equipment.

(2) For hand carried, battery powered equipment, reduce primary supply voltage to the battery operating end point which shall be specified by the manufacturer.

(3) The supply voltage shall be measured at the input to the cable normally provided with the equipment, or at the power supply terminals if cables are not normally provided. Effects on frequency of transmitter keying (except for broadcast transmitters) and any heating element cycling at the nominal supply voltage and at each extreme also shall be shown.

#### §24.235 Frequency stability

The frequency stability shall be sufficient to ensure that the fundamental emission stays within the authorized frequency block.

### **3.2.3 Test Protocol**

Temperature: 24 °C  
 Air Pressure: 1026 hPa  
 Humidity: 27 %

**Op. Mode Setup Port**  
 op-mode 2 01s400a03 antenna  
 connector

Temperature °C	Duration min	Minimum Voltage / V		Normal Voltage / V		Maximum Voltage /V	
		3,2 V		4,5 V		4,5 V	
		Freq. error Average (Hz)	Freq. error Max. (Hz)	Freq. error Average (Hz)	Freq. error Max. (Hz)	Freq. error Average (Hz)	Freq. error Max. (Hz)
-30	0	21	42	3	14		
-30	5	16	38	-19	-37		
-30	10	-24	-40	44	66		
-20	0	26	60	-6	-25		
-20	5	-13	-26	11	58		
-20	10	43	63	-14	-30		
-10	0	-8	-28	-13	-32		
-10	5	30	45	-8	-22		
-10	10	13	32	36	58		
0	0	2	15	-9	-34		
0	5	11	32	25	46		
0	10	18	42	13	42		
10	0	-10	-23	-10	-24		
10	5	26	57	6	26		
10	10	-27	-44	-2	-14		
20	0	15	33	-29	-44		
20	5	-14	-27	-15	-35		
20	10	27	60	2	28		
30	0	1	15	-49	-58		
30	5	-29	-49	-10	-22		
30	10	-12	35	9	28		
40	0	-22	-38	-27	-45		
40	5	-4	-23	-2	-19		
40	10	-17	-32	-14	-31		
50	0	-36	-68	-21	-31		
50	5	7	41	-39	-79		
50	10	-50	-84	-18	-41		

Remark: The manufacturer declared normal = maximum voltage.

### 3.2.4 Test result: Frequency stability

FCC Part 24, Subpart E	Op. Mode	Setup	Port	Result
	op-mode 2	01s400a03	antenna connector	passed

### 3.3 Spurious emissions at antenna terminals

**Standard** FCC Part 24, 10-01-98  
Subpart E

**The test was performed according to:** FCC §2.1051 10-01-1998

#### 3.3.1 Test Description

1) The mobile station was coupled to the R&S Spectrum Analyser and thae Digital Communication Tester through a Power Divider. Refer to chapter "Setup Drawings".

2) The total insertion losses for RF Path 1 and RF Path 2 were measured. The values were used to correct the readings from the R&S Spectrum Analyser and Digital Communication Tester.

3) A speech call was established on a Traffic Channel (TCH) between the mobile station and the base station simulator.

Important Settings:

- Discontinuous Transmission: OFF
- Modulation Signal: PSR16-1 (Pseudo Random Sequenz)
- Output Power: Maximum
- Channel : Varied during measurements

(lowest channel: 512, mid channel: 661 and highest channel: 810)

4) Important Analyser Settings

- [Resolution Bandwidth / Video Bandwidth]:

a) [3 kHz / 10 kHz] in the Span of 1 MHz directly below and above the PCS-Band,

b) [10 kHz / 30 kHz] in case the curve of the analyser IF-Filter leads to an exceeding of the limit, in this case a worst case correction factor of 20 dB (1 MHz -> 10 kHz) was used

c) [1 MHz / 3 MHz] otherwise

- Sweep Time: Calculated by using a formula given in the Product Standard "PCS 11.10-1 edition 4" for spurious emissions measurements (depending on the transmitting signal, the span and the resolution bandwidth)

5) The spurious emissions (peak) were measured in the frequency range from 9 kHz to 20 GHz (up to the 10th harmonic) during the call is established on the lowest channel (512), mid channel (661) and on the highest channel (810).

#### 3.3.2 Test Requirements / Limits

§ 2.1051 Spurious emissions at antenna terminals

The radio frequency voltage or powers generated within the equipment and appearing on a spurious frequency shall be checked at the equipment output terminals when properly loaded with a suitable artificial antenna. Curves or equivalent data shall show the magnitude of each harmonic and other spurious emission that can be detected when the equipment is operated under the conditions specified in Sec. 2.1049 as appropriate. The magnitude of spurious emissions which are attenuated more than 20 dB below the permissible value need not be specified.





§ 2.1057 Frequency spectrum to be investigated.

(a) In all of the measurements set forth in Secs. 2.1051 and 2.1053, the spectrum shall be investigated from the lowest radio frequency signal generated in the equipment, without going below 9 kHz, up to at least the frequency shown below:

(1) If the equipment operates below 10 GHz: to the tenth harmonic of the highest fundamental frequency or to 40 GHz, whichever is lower.

(b) Particular attention should be paid to harmonics and subharmonics of the carrier frequency as well as to those frequencies removed from the carrier by multiples of the oscillator frequency. Radiation at the frequencies of multiplier stages should also be checked.

(c) The amplitude of spurious emissions which are attenuated more than 20 dB below the permissible value need not be reported.

(d) Unless otherwise specified, measurements above 40 GHz shall be performed using a minimum resolution bandwidth of 1 MHz.

§ 24.238 Emission Limits

(a) On any frequency outside a licensee's frequency block, the power of any emission shall be attenuated below the transmitter power (P) by at least  $43 + 10 \log (P)$  dB.

Remark of the test laboratory: This is calculated to be -13 dBm.

(b) Compliance with these provisions is based on the use of measurement instrumentation employing a resolution bandwidth of 1 MHz or greater. However, in the 1 MHz bands immediately outside and adjacent to the frequency block a resolution bandwidth of at least one percent of the emission bandwidth of the fundamental emission of the transmitter may be employed. The emission bandwidth is defined as the width of the signal between two points, one below the carrier center frequency and one above the carrier center frequency, outside of which all emissions are attenuated at least 26 dB below the transmitter power.

(c) When measuring the emission limits, the nominal carrier frequency shall be adjusted as close to the licensee's frequency block edges, both upper and lower, as the design permits.

(d) The measurements of emission power can be expressed in peak or average values, provided they are expressed in the same parameters as the transmitter power.

(e) When an emission outside of the authorized bandwidth causes harmful interference, the Commission may, at its discretion, require greater attenuation than specified in this section.

### 3.3.3 Test Protocol

Temperature: 24 °C  
 Air Pressure: 1022 hPa  
 Humidity: 33 %

**Op. Mode Setup Port**

op-mode 1 01s400a02 antenna  
 connector

Frequency MHz	Bandwidth kHz	Measured Level dBm	Limit dBm
1850,00	3,00	-17,59	-13,00

Remark: No (further) spurious emissions were found in the range 20 dB below the limit.

Temperature: 24 °C  
 Air Pressure: 1022 hPa  
 Humidity: 33 %

**Op. Mode Setup Port**

op-mode 2 01s400a02 antenna  
 connector

Frequency MHz	Bandwidth kHz	Measured Level dBm	Limit dBm
			-13,00

Remark: No (further) spurious emissions were found in the range 20 dB below the limit.

Temperature: 24 °C  
 Air Pressure: 1022 hPa  
 Humidity: 33 %

**Op. Mode Setup Port**

op-mode 3 01s400a02 antenna  
 connector

Frequency MHz	Bandwidth kHz	Measured Level dBm	Limit dBm
1910,00	3,00	-17,46	-13,00

Remark: No (further) spurious emissions were found in the range 20 dB below the limit.

**3.3.4 Test result: Spurious emissions at antenna terminals**

FCC Part 24, Subpart E	Op. Mode	Setup	Port	Result
	op-mode 1	01s400a02	antenna connector	passed
	op-mode 2	01s400a02	antenna connector	passed
	op-mode 3	01s400a02	antenna connector	passed

### 3.4 Field strength of spurious radiation

**Standard** FCC Part 24, 10-01-98  
Subpart E

**The test was performed according to:** FCC §2.1053 10-01-1998

#### 3.4.1 Test Description

1) The mobile station was placed inside a anechoic chamber. Refer to chapter "Setup Drawings". The mobile station was coupled to a Digital Communication Tester which was located outside the chamber via coaxial cable.

2) A speech call was established on a Traffic Channel (TCH) between the mobile station and the base station simulator.

Important Settings:

- Discontinuous Transmission: OFF
- Modulation Signal: PSR16-1 (Pseudo Random Sequenz)
- Output Power: Maximum
- Channel : Varied during measurements  
(lowest channel: 512, mid channel: 661 and highest channel: 810)

3) A pre-calibration procedure is used so that the readings from the spectrum analyser are corrected and represent directly the equivalent radiated power (related to a  $\lambda/2$  dipole).

4) All spurious radiation measurements were made with spectrum analyser and the appropriate calibrated antennas for the frequency range of 30 MHz to 20 GHz (up to the 10th harmonic of the transmit frequency).

5) Important Analyser Settings

- [Resolution Bandwidth / Video Bandwidth]:

- a) [3 kHz / 10 kHz] in the Span of 1 MHz directly below and above the PCS-Band,
- b) [10 kHz / 30 kHz] in case the curve of the analyser IF-Filter leads to an exceeding of the limit, in this case a worst case correction factor of 20 dB (1 MHz  $\rightarrow$  10 kHz) was used
- c) [1 MHz / 3 MHz] otherwise

- Sweep Time: Calculated by using a formula given in the Product Standard "PCS 11.10-1 edition 4" for spurious emissions measurements (depending on the transmitting signal, the span and the resolution bandwidth)

6) The spurious emissions (peak) were measured in both vertical and horizontal antenna polarisation during the call is established on the lowest channel (512), mid channel (661) and on the highest channel (810).

#### 3.4.2 Test Requirements / Limits

§ 2.1053 Measurements required: Field strength of spurious radiation.

(a) Measurements shall be made to detect spurious emissions that may be radiated directly from the cabinet, control circuits, power leads, or intermediate circuit elements under normal conditions of installation and operation. Curves or equivalent data shall be supplied showing the magnitude of each harmonic and other spurious emission. For this test,

single sideband, independent sideband, and controlled carrier transmitters shall be modulated under the conditions specified in paragraph (c) of Sec. 2.1049, as appropriate. For equipment operating on frequencies below 890 MHz, an open field test is normally required, with the measuring instrument antenna located in the far-field at all test frequencies. In the event it is either impractical or impossible to make open field measurements (e.g. a broadcast transmitter installed in a building) measurements will be accepted of the equipment as installed. Such measurements must be accompanied by a description of the site where the measurements were made showing the location of any possible source of reflections which might distort the field strength measurements. Information submitted shall include the relative radiated power of each spurious emission with reference to the rated power output of the transmitter, assuming all emissions are radiated from halfwave dipole antennas.

(b) The measurements specified in paragraph (a) of this section shall be made for the following equipment:

(2) All equipment operating on frequencies higher than 25 MHz.

§ 2.1057 Frequency spectrum to be investigated.

(a) In all of the measurements set forth in Secs. 2.1051 and 2.1053, the spectrum shall be investigated from the lowest radio frequency signal generated in the equipment, without going below 9 kHz, up to at least the frequency shown below:

(1) If the equipment operates below 10 GHz: to the tenth harmonic of the highest fundamental frequency or to 40 GHz, whichever is lower.

(b) Particular attention should be paid to harmonics and subharmonics of the carrier frequency as well as to those frequencies removed from the carrier by multiples of the oscillator frequency. Radiation at the frequencies of multiplier stages should also be checked.

(c) The amplitude of spurious emissions which are attenuated more than 20 dB below the permissible value need not be reported.

(d) Unless otherwise specified, measurements above 40 GHz shall be performed using a minimum resolution bandwidth of 1 MHz.

§ 24.238 Emission limits

(a) On any frequency outside a licensee's frequency block, the power of any emission shall be attenuated below the transmitter power (P) by at least  $43 + 10 \log (P)$  dB.

This is calculated to be -13 dBm (effective radiated power) which corresponds to 84.6 dB $\mu$ V/m (field strength) in a distance of 3 m.

### 3.4.3 Test Protocol

Temperature: 23 °C  
 Air Pressure: 1025 hPa  
 Humidity: 30 %

**Op. Mode    Setup                    Port**

op-mode 1 01s400a01 enclosure +  
 antenna

Frequency MHz	Antenna Polarisation vertical/horizontal	Bandwidth kHz	Measured Level dBm	Limit dBm
1850,00	Horizontal	3,00	-17,97	-13,00
9261,52	Vertical	1000,00	-22,16	-13,00

Remark: No (further) spurious emissions were found in the range 20 dB below the limit.

Temperature: 23 °C  
 Air Pressure: 1025 hPa  
 Humidity: 30 %

**Op. Mode    Setup                    Port**

op-mode 2 01s400a01 enclosure +  
 antenna

Frequency MHz	Antenna Polarisation vertical/horizontal	Bandwidth kHz	Measured Level dBm	Limit dBm
9384,17	Vertical	1000,00	-23,87	-13,00

Remark: No (further) spurious emissions were found in the range 20 dB below the limit.

Temperature: 23 °C  
 Air Pressure: 1025 hPa  
 Humidity: 30 %

**Op. Mode    Setup                    Port**

op-mode 3 01s400a01 enclosure +  
 antenna

Frequency MHz	Antenna Polarisation vertical/horizontal	Bandwidth kHz	Measured Level dBm	Limit dBm
1910,00	Horizontal	3,00	-17,63	-13,00
9537,47	Vertical	1000,00	-26,22	-13,00

Remark: No (further) spurious emissions were found in the range 20 dB below the limit.

**3.4.4 Test result: Field strength of spurious radiation**

FCC Part 24, Subpart E	Op. Mode	Setup	Port	Result
	op-mode 1	01s400a01	enclosure + antenna	<b>passed</b>
	op-mode 2	01s400a01	enclosure + antenna	<b>passed</b>
	op-mode 3	01s400a01	enclosure + antenna	<b>passed</b>

### 3.5 Emission and Occupied Bandwidth

**Standard** FCC Part 24, 10-01-98  
Subpart E

**The test was performed according to:** FCC §2.1049 10-01-1998

#### 3.5.1 Test Description

1) The mobile station was coupled to the R&S Spectrum Analyser and a Digital Communication Tester through a Power Divider. Refer to chapter "Setup Drawings".

2) The total insertion losses for RF Path 1 and RF Path 2 were measured. The values were used to correct the readings from the R&S Spectrum Analyser and Digital Communication Tester.

3) A speech call was established on a Traffic Channel (TCH) between the mobile station and the base station simulator.

Important Settings:

- Discontinuous Transmission: OFF
- Modulation Signal: PSR16-1 (Pseudo Random Sequenz)
- Output Power: Maximum
- Channel : Varied during measurements  
(lowest channel: 512, mid channel: 661 and highest channel: 810)

4) Important Analyser Settings:

- Resolution Bandwidth: 3 kHz (1% of the manufacturers stated occupied bandwidth)
- Video Bandwidth: 10 kHz (three times the Resolution Bandwidth)
- Sweep Span: 1 MHz ( at least 250% of the emission bandwidth)

5) The maximum spectral level of the modulated signal was recorded as the reference.

6) The emission bandwidth is measured as follows:

the two furthest frequencies above and below the frequency of the maximum reference level where the spectrum is  $-26$  dB down have to be found.

7) The occupied bandwidth (99% Bandwidth) is measured as follows:

the occupied bandwidth, that is the frequency bandwidth such that, below its lower and above its upper frequency limits, the mean powers radiated are each equal to 0.5 percent of the total mean power.

#### 3.5.2 Test Requirements / Limits

§ 2.1049 Measurements required: Occupied bandwidth

The occupied bandwidth, that is the frequency bandwidth such that, below its lower and above its upper frequency limits, the mean powers radiated are each equal to 0.5 percent of the total mean power radiated by a given emission shall be measured under the following conditions (as applicable):

(h) Transmitters employing digital modulation techniques - when modulated by an input signal such that its amplitude and symbol rate

represent the maximum rated conditions under which the equipment will be operated. The signal shall be applied through any filter networks, pseudo-random generators or other devices required in normal service. Additionally, the occupied bandwidth shall be shown for operation with any devices used for modifying the spectrum when such devices are optional at the discretion of the user.

(i) Transmitters designed for other types of modulation -

### 3.5.3 Test Protocol

Temperature: 24 °C  
 Air Pressure: 1022 hPa  
 Humidity: 33 %

Op. Mode	Setup	Port
----------	-------	------

op-mode 1	01s400a02	antenna connector
-----------	-----------	----------------------

Bandwidth kHz	Remarks
312	Please see annex for the measurement plot.

Remark: The given value is the result of the 26dB bandwidth measurement. The 99% Bandwidth is 240 kHz.

Temperature: 24 °C  
 Air Pressure: 1022 hPa  
 Humidity: 33 %

Op. Mode	Setup	Port
----------	-------	------

op-mode 2	01s400a02	antenna connector
-----------	-----------	----------------------

Bandwidth kHz	Remarks
314	Please see annex for the measurement plot.

Remark: The given value is the result of the 26dB bandwidth measurement. The 99% Bandwidth is 240 kHz.

Temperature: 24 °C  
 Air Pressure: 1022 hPa  
 Humidity: 33 %

Op. Mode	Setup	Port
----------	-------	------

op-mode 3	01s400a02	antenna connector
-----------	-----------	----------------------

Bandwidth kHz	Remarks
311	Please see annex for the measurement plot.

Remark: The given value is the result of the 26dB bandwidth measurement. The 99% Bandwidth is 240 kHz.

### 3.5.4 Test result: Emission and Occupied Bandwidth

FCC Part 24, Subpart E	Op. Mode	Setup	Port	Result
	op-mode 1	01s400 a02	antenna connector	<b>passed</b>
	op-mode 2	01s400 a02	antenna connector	<b>passed</b>
	op-mode 3	01s400 a02	antenna connector	<b>passed</b>



## 4. Test Equipment

### *EUT Digital Signalling System*

Equipment	Type	Serial No.	Manufacturer
Digital Radio Communication Tester	CMD 55	831050/020	Rohde & Schwarz
Signalling Unit for Bluetooth Spurious Emissions	PTW60	100004	Rohde & Schwarz
Universal Radio Communication Tester	CMU 200	102366	Rohde & Schwarz

### *EMI Test System*

Equipment	Type	Serial No.	Manufacturer
Comparison Noise Emitter	CNE III	99/016	York
EMI Analyzer	ESI 26	830482/004	Rohde & Schwarz
Signal Generator	SMR 20	846834/008	Rohde & Schwarz

### *EMI Radiated Auxiliary Equipment*

Equipment	Type	Serial No.	Manufacturer
Antenna mast 4m	MA 240	240/492	HD GmbH H. Deisel
Biconical dipole	VUBA 9117	9117108	Schwarzbeck
Broadband Amplifier 18MHz-26GHz	JS4-18002600-32-5P	849785	Miteq
Broadband Amplifier 30MHz-18GHz	JS4-00101800-35-5P	896037	Miteq
Broadband Amplifier 45MHz-27GHz	JS4-00102600-42-5A	619368	Miteq
Cable "ESI to EMI Antenna"	RTK081+Aircell7	W18.01+W38.01a	Huber+Suhner
Cable "ESI to EMI Antenna"	EcoFlex10	W18.01-2+W38.01-2	Kabel Kusch
Cable "ESI to Horn Antenna"	UFB311A+UFB293C	W18.02-2+W38.02-2	Rosenberger-Microcoax
Cable "ESI to Horn Antenna"	RTK 081	W18.04+3599/001	Rosenberger
Double-ridged horn	HF 906	357357/002	Rohde & Schwarz
Double-ridged horn	HF 906	357357/001	Rohde & Schwarz
High Pass Filter	5HC3500/12750-1.2-KK	200035008	Trilithic
High Pass Filter	5HC2700/12750-1.5-KK	9942012	Trilithic
High Pass Filter	4HC1600/12750-1.5-KK	9942011	Trilithic
KUEP pre amplifier	Kuep 00304000	001	7layers
Log.-per. Antenna	HL 562 Ultralog	830547/003	Rohde & Schwarz
Loop Antenna	HFH2-Z2	829324/006	Rohde & Schwarz
Pyramidal Horn Antenna 26,5 GHz	Model 3160-09	9910-1184	EMCO

### *EMI Conducted Auxiliary Equipment*

<b>Equipment</b>	<b>Type</b>	<b>Serial No.</b>	<b>Manufacturer</b>
Cable "LISN to ESI"	RG214	W18.03+W48.03	Huber+Suhner
Two-Line V-Network	ESH 3-Z5	828304/029	Rohde & Schwarz
Two-Line V-Network	ESH 3-Z5	829996/002	Rohde & Schwarz

### *Auxiliary Test Equipment*

<b>Equipment</b>	<b>Type</b>	<b>Serial No.</b>	<b>Manufacturer</b>
Broadband Resist. Power Divider N	1506A / 93459	LM390	Weinschel
Broadband Resist. Power Divider SMA	1515 / 93459	LN673	Weinschel
Digital Multimeter 01	Voltcraft M-3860M	IJ096055	Conrad
Digital Multimeter 02	Voltcraft M-3860M	IJ095955	Conrad
Digital Oscilloscope	TDS 784C	B021311	Tektronix
Fibre optic link Satellite	FO RS232 Link	181-018	Pontis
Fibre optic link Transceiver	FO RS232 Link	182-018	Pontis
I/Q Modulation Generator	AMIQ-B1	832085/018	Rohde & Schwarz
Notch Filter ultra stable	WRCA800/960-6EEK	24	Wainwright
Spectrum Analyzer 9KHz To 3GHz	FSP3	838164/004	Rohde & Schwarz
Temperature Chamber	VT 4002	58566002150010	Vötsch
Temperature Chamber	KWP 120/70	59226012190010	Weiss
ThermoHygro Datalogger 03	Opus10 THI (8152.00)	7482	Lufft Mess- und Regeltechn
ThermoHygro_01	430202		Fischer

### *Anechoic Chamber*

<b>Equipment</b>	<b>Type</b>	<b>Serial No.</b>	<b>Manufacturer</b>
Air Compressor (pneumatic)			Atlas Copco
Controller	HD 100	100/603	HD GmbH H. Deisel
EMC Camera	CE-CAM/1		CE-SYS
EMC Camera for observation of EUT	CCD-400E	0005033	Mitsubishi
Filter ISDN	B84312-C110-E1		Siemens&Matsushita
Filter telephone systems / modem	B84312-C40-B1		Siemens&Matsushita
Filter Universal 1A	B84312-C30-H3		Siemens&Matsushita
Fully/Semi AE Chamber	10.58x6.38x6		Frankonia
Turntable	DS 420S	420/573/99	HD GmbH, H. Deisel
Valve Control Unit (pneum.)	VE 615P	615/348/99	HD GmbH, H. Deisel



*7 layers Bluetooth™ Full RF Test Solution*

*Bluetooth RF Conformance Test System TS8960*

<b>Equipment</b>	<b>Type</b>	<b>Serial No.</b>	<b>Manufacturer</b>
10MHz Reference	MFS	5489/001	Efratom
Power Meter 832025/059	NRVD	832025/059	Rohde & Schwarz
Power Sensor A 832279/013	NRV-Z1	832279/013	Rohde & Schwarz
Power Sensor B 832279/015	NRV-Z1	832279/015	Rohde & Schwarz
Power Supply	E3632A	MY40003776	Agilent
Power Supply	PS-2403D	-	Conrad
RF Step Attenuator 833695/001	RSP	833695/001	Rohde & Schwarz
Rubidium Frequency Normal	MFS	002	Efratom
Signal Analyser FSIQ26 832695/007	FSIQ26	832695/007	Rohde & Schwarz
Signal Analyser FSP30 100051	FSP30	100051	Rohde & Schwarz
Signal Generator 101175	SMIQ03B	101175	Rohde & Schwarz
Signal Generator 833680/003	SMP 03	833680/003	Rohde & Schwarz
Signal Generator A 834344/002	SMIQ03B	834344/002	Rohde & Schwarz
Signal Generator B 832870/017	SMIQ03B	832870/017	Rohde & Schwarz
Signal Switching and Conditioning Unit	SSCU	338826/005	Rohde & Schwarz
Signalling Unit PTW60 838312/014	PTW60 for TS8960	838312/014	Rohde & Schwarz
System Controller 829323/008	PSM12	829323/008	Rohde & Schwarz

## 5. Foto Report



Picture 1 : EUT (GSM module)

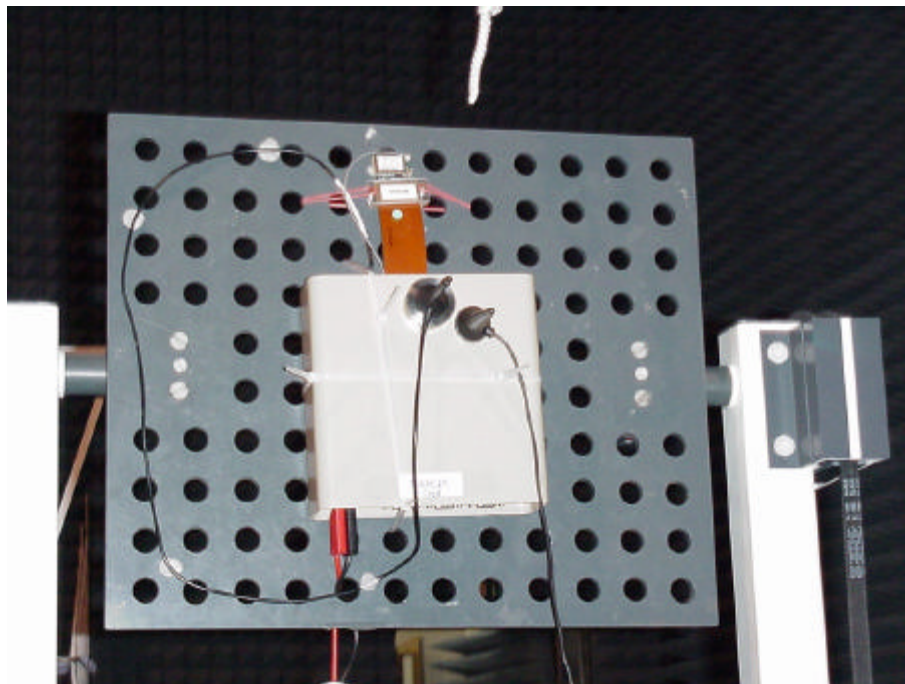

Picture 2 : Setup for radiated tests



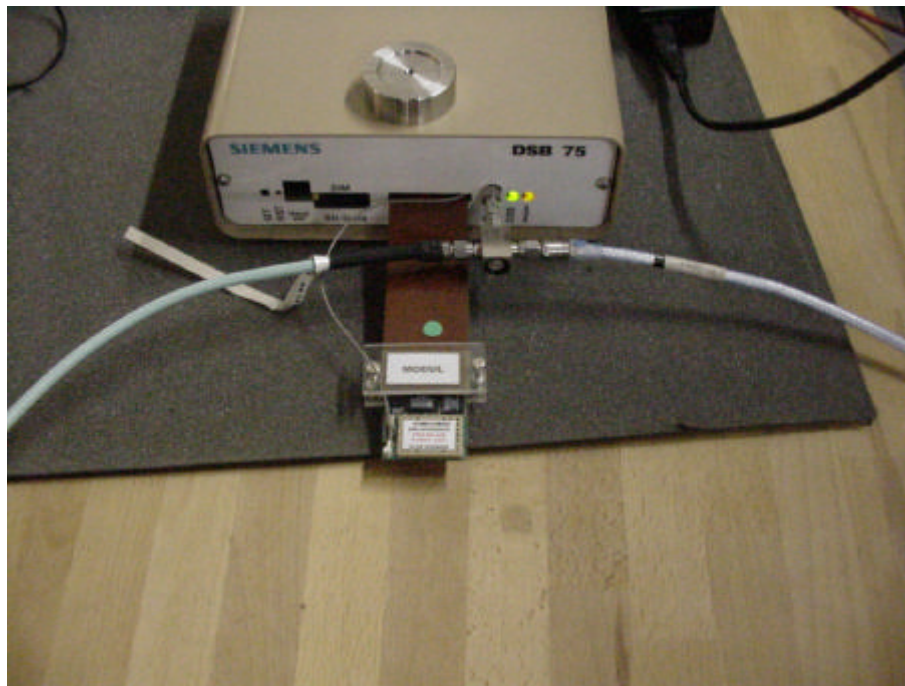

Picture 3 : Setup for conducted tests (setup 01s140a02)

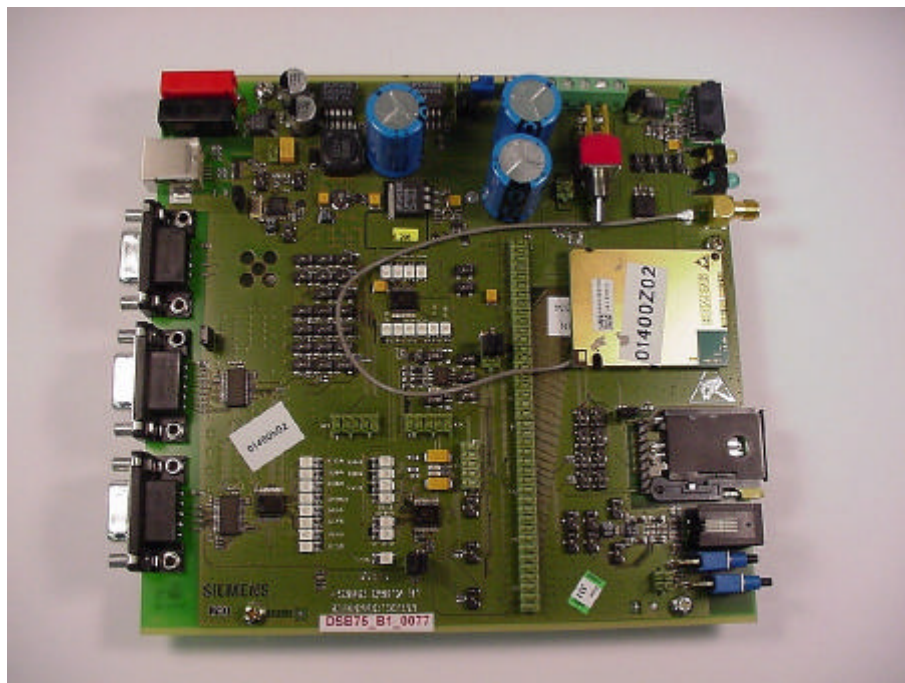

Picture 4 : Setup for conducted tests (setup 01s140a03, GSM module mounted to development board)

## 6. Setup Drawings

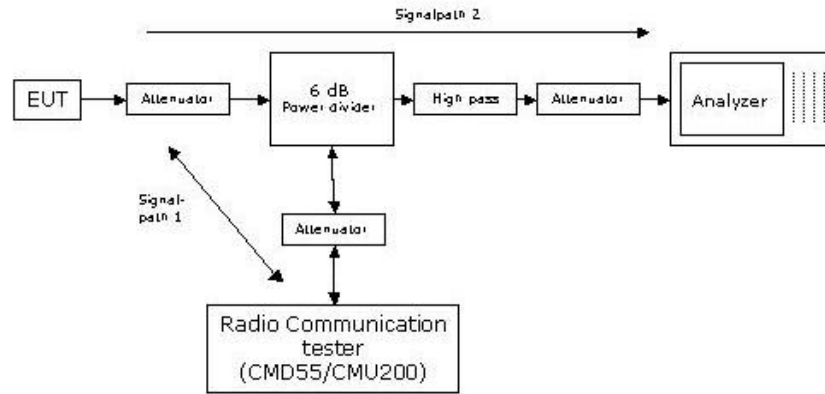

Remark: Depending on the frequency range suitable attenuators or high pass are used.

Drawing 1 : Setup for conducted measurements under nominal conditions (in principle)

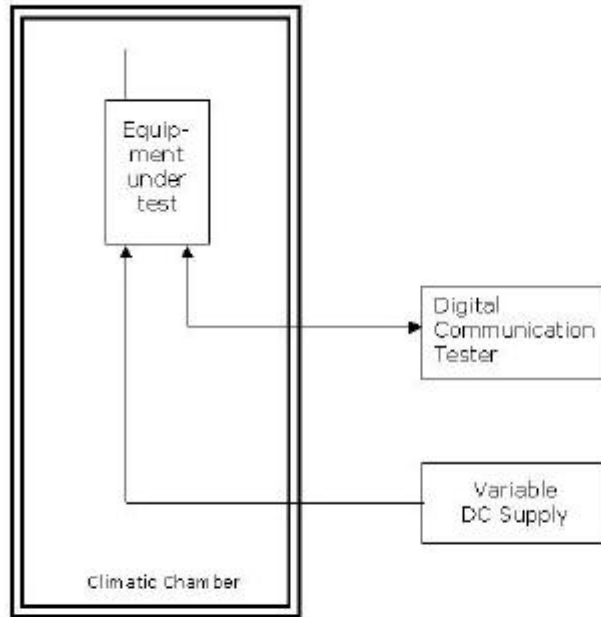

**Drawing 2** : Principle setup for tests under extreme test conditions

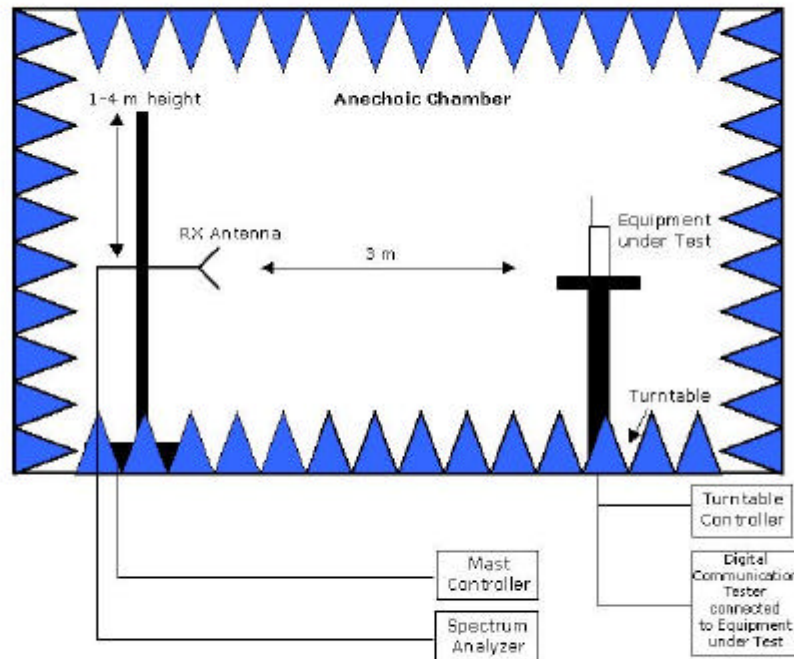

Remark: Depending on the frequency range suitable antenna types, attenuators or preamplifiers are used.

Drawing 3 : Principle setup for radiated measurements





## 7. Annex

### Measurement plots



# **Annex I: Emission and Occupied bandwidth**

Measurement plots

Test report reference: 4\_Siem\_0504\_GSM\_FCCa

Date: 2005-01-17

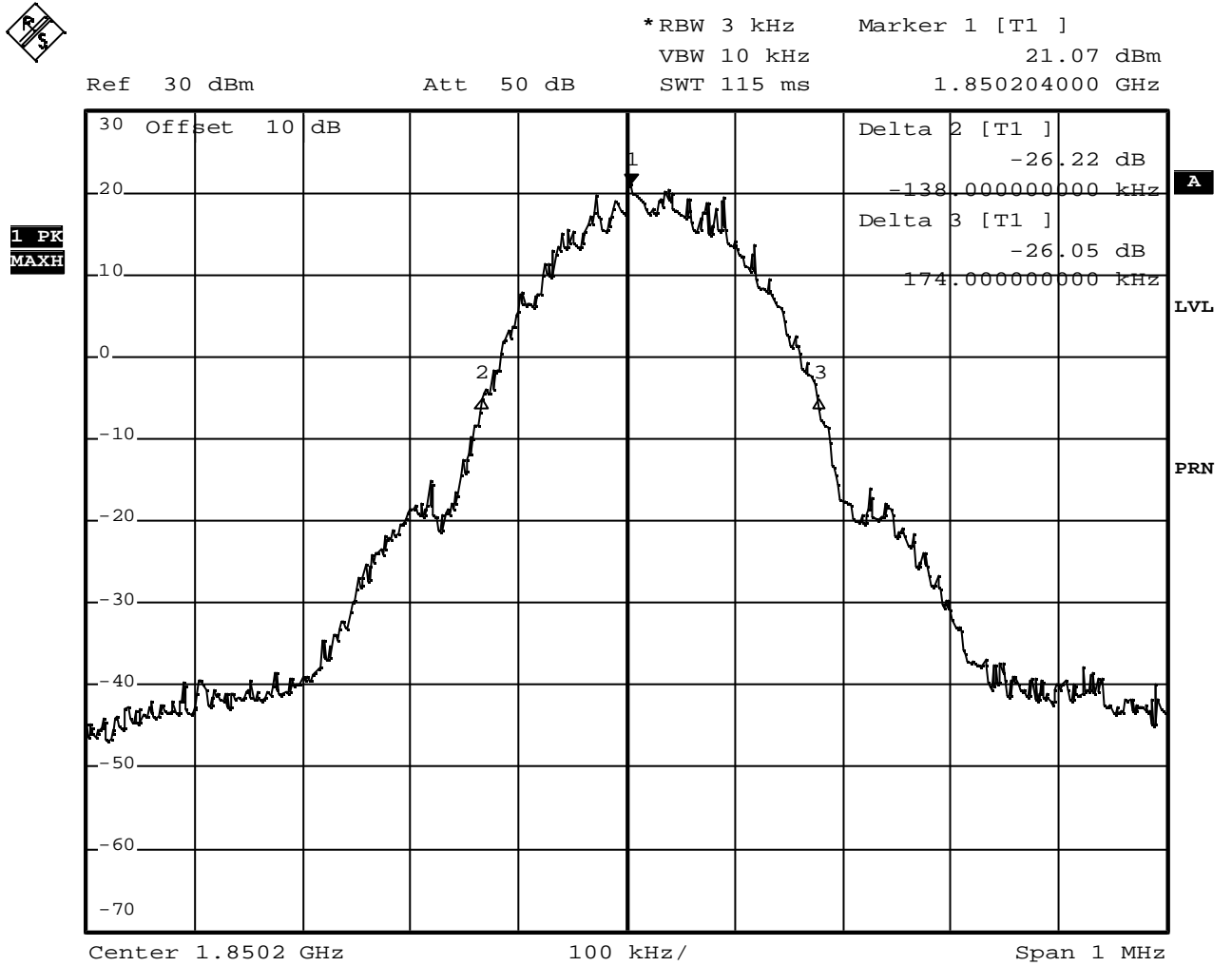

Date: 5.JAN.2005 16:59:46

Test: Emissions bandwidth (26 dB bandwidth), Channel 512 (1850.2 MHz)

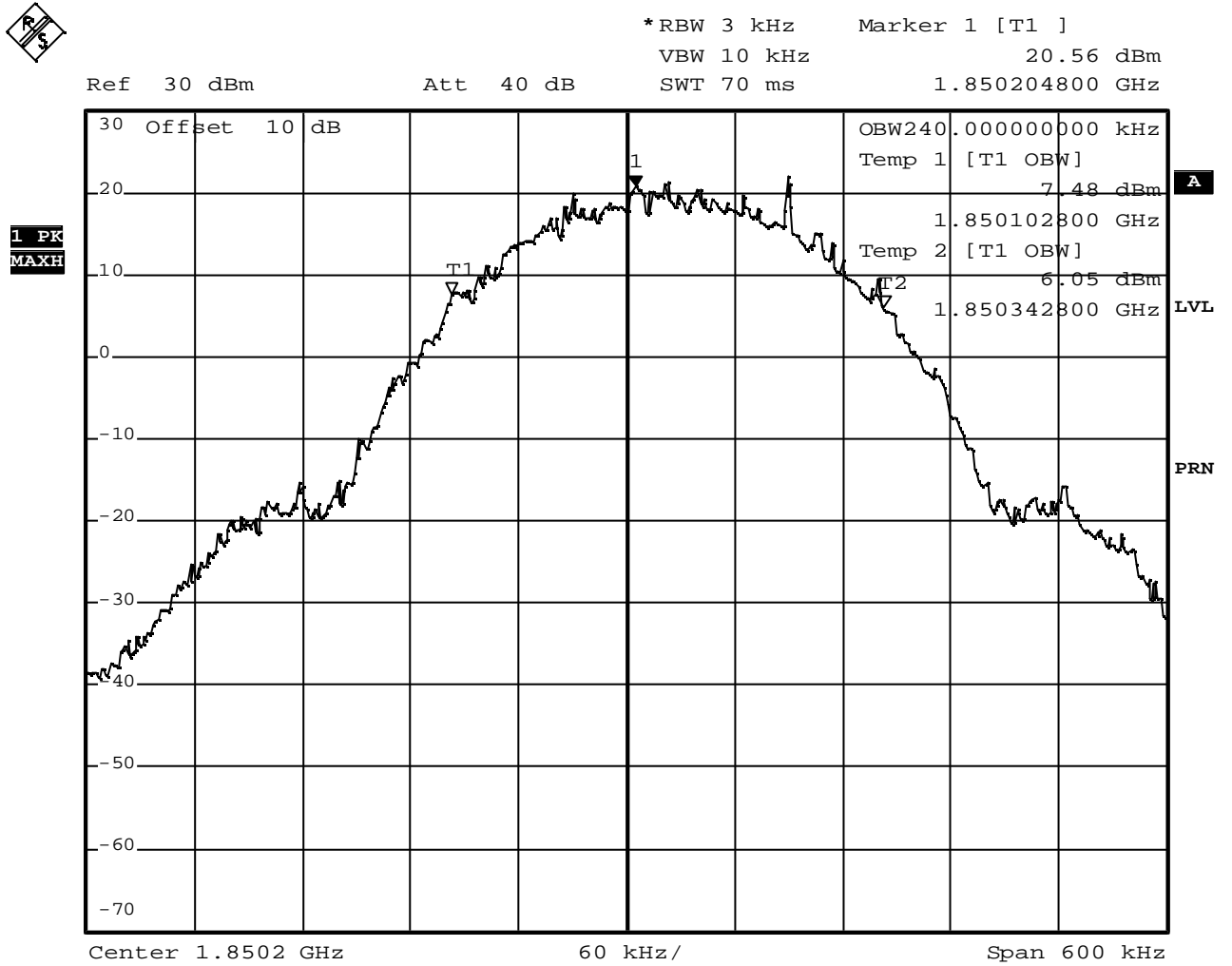

Date: 5.JAN.2005 16:39:54

Test: Occupied bandwidth, Channel 512 (1850.2 MHz)

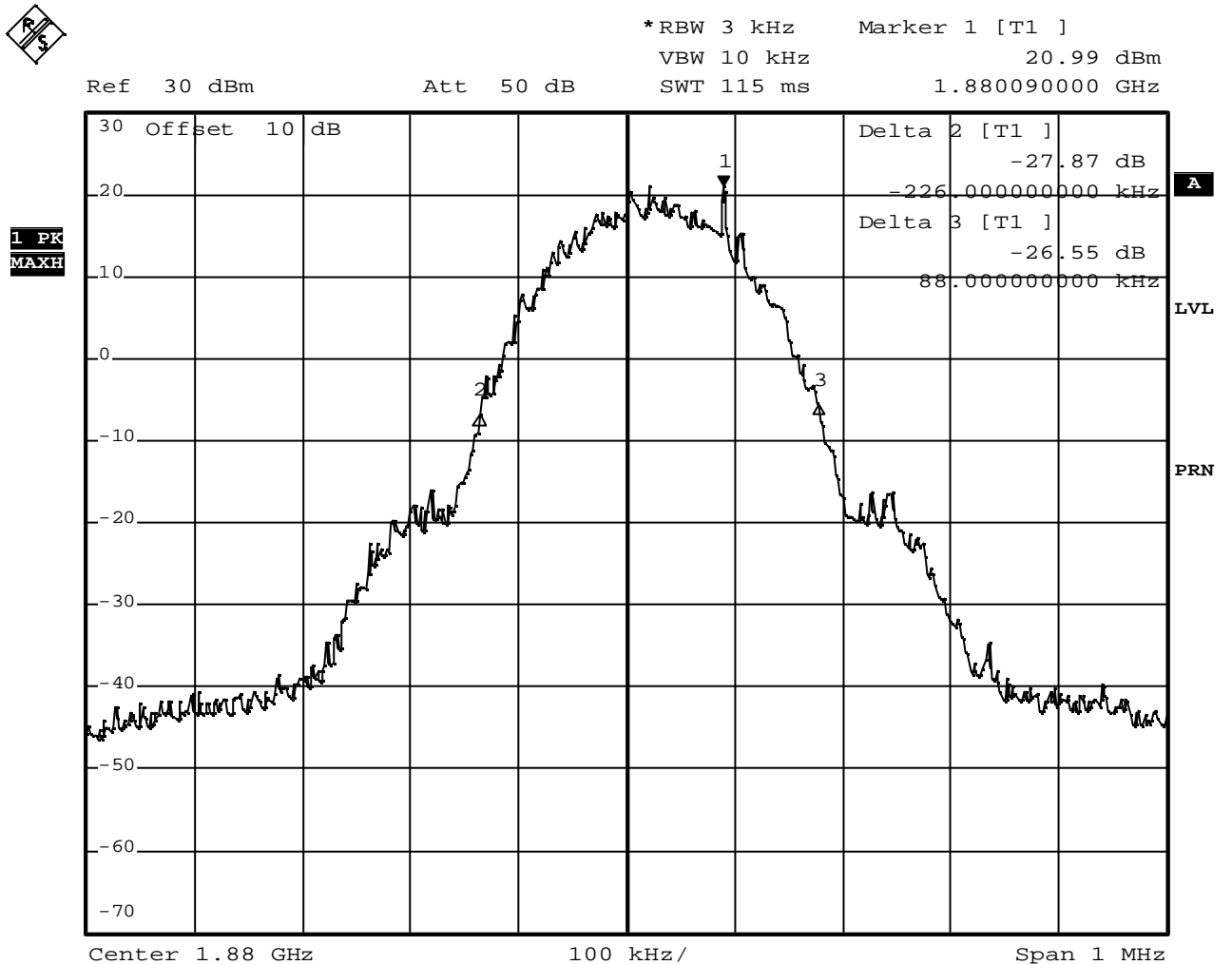

Date: 5.JAN.2005 16:55:58

Test: Emissions bandwidth (26 dB bandwidth), Channel 661 (1880 MHz)

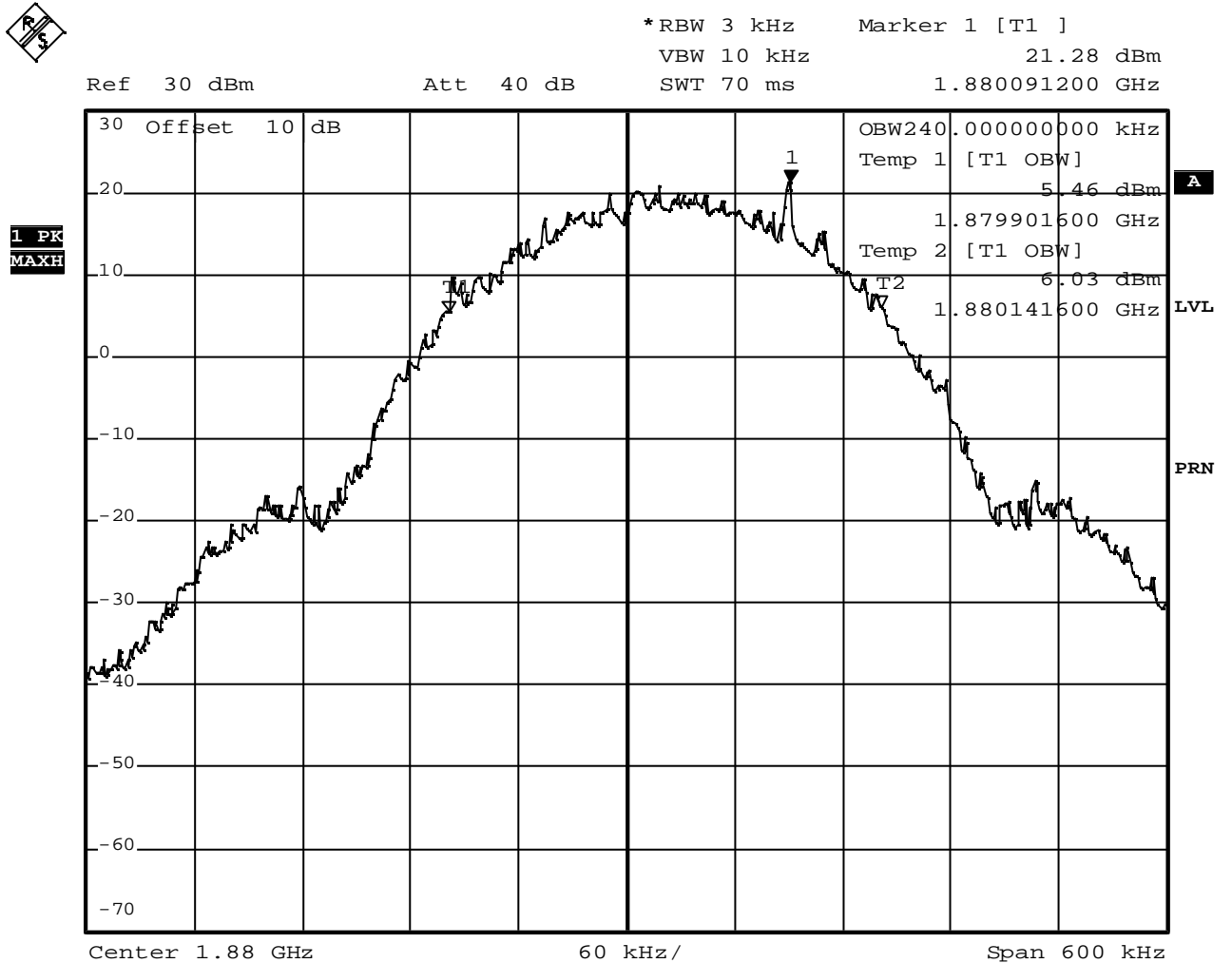

Date: 5.JAN.2005 16:44:20

Test: Occupied bandwidth, Channel 661 (1880 MHz)

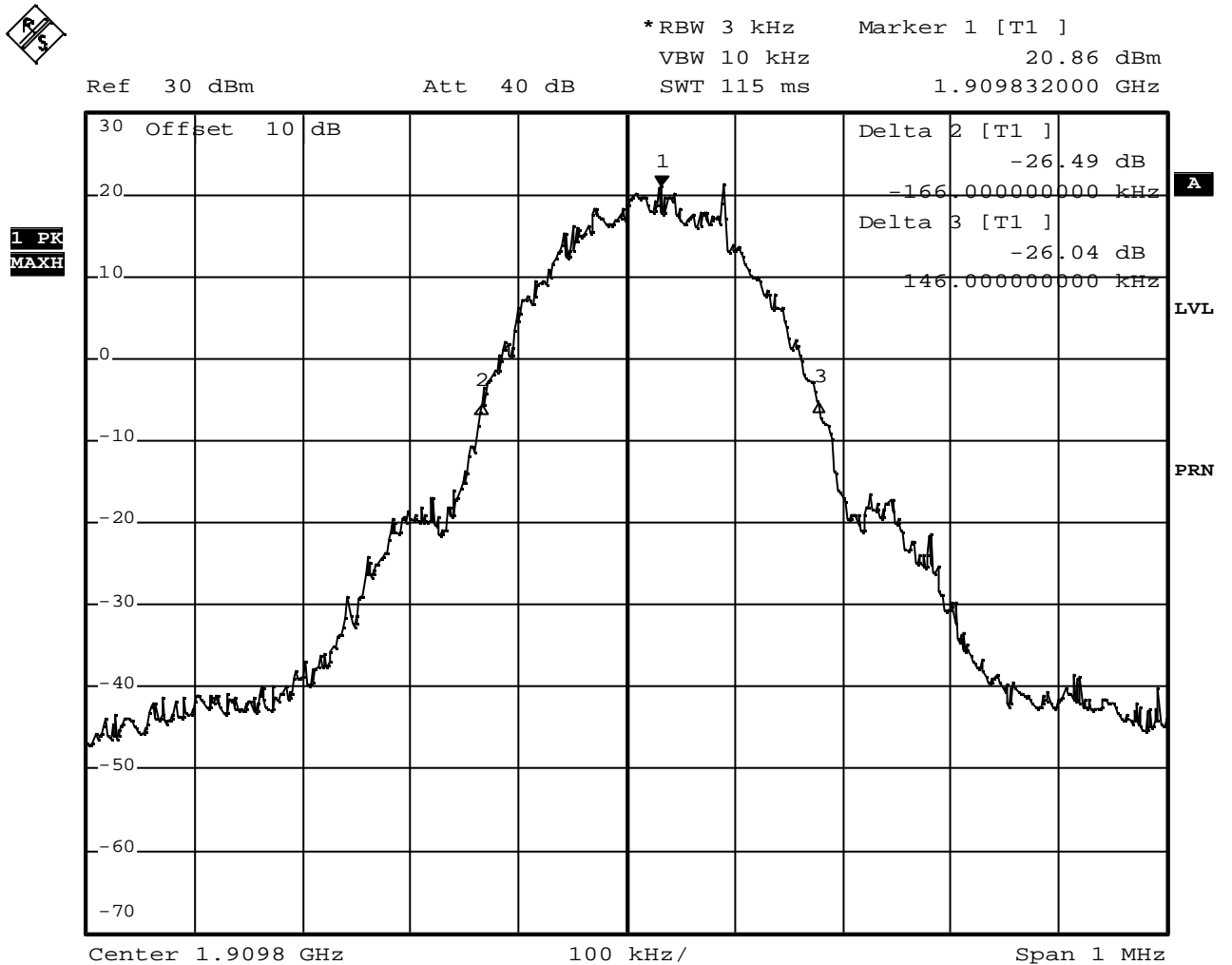

Date: 5.JAN.2005 16:52:49

Test: Emissions bandwidth (26 dB bandwidth), Channel 810 (1909.8 MHz)

Annex I: Emissions and Occupied bandwidth - Measurement plots

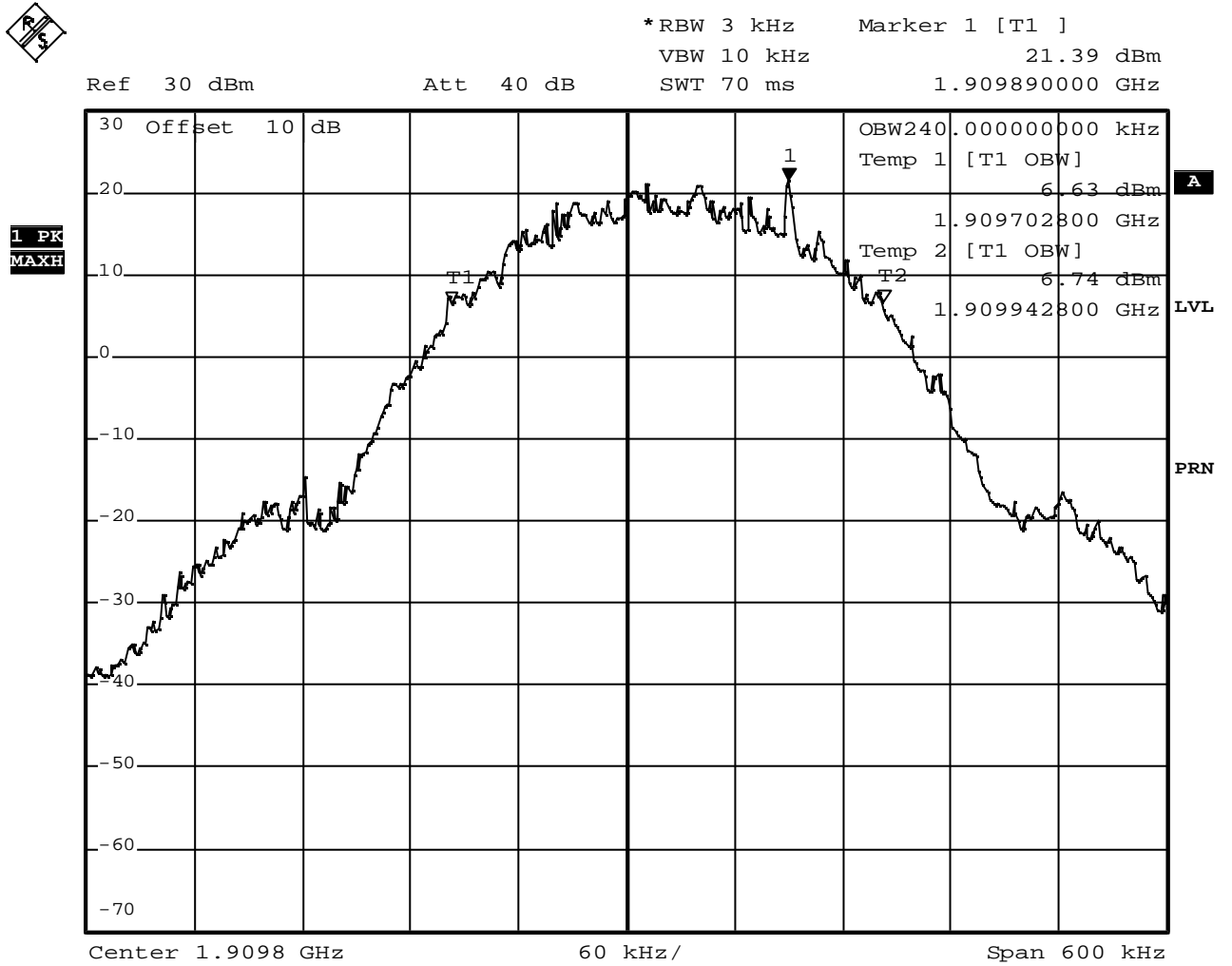

Date: 5.JAN.2005 16:49:08

Test: Occupied bandwidth, Channel 810 (1909.8 MHz)