

EMI Test Report



Research In Motion Limited

REPORT NO.: RIM-0204-04

PRODUCT Model No: PRD-4230-001 & PRD-4230-002
Type Name: RIM 1902G and 1902GS
FCC ID: L6AR6420GN

Approved by: Paul G. Cardinal
Paul G. Cardinal, Ph.D.
Manager, Compliance and Certification

Date: 9 May, 2002

Table of Contents

A) Scope	Pg. 2
B) Product Identification	Pg. 2
C) Support Equipment Used for Testing of the EUT	Pg. 3
D) Test Voltage	Pg. 3
E) Test Results Chart	Pg. 4
F) Modifications to EUT	Pg. 4
G) Summary of Results	Pg. 4
H) Compliance Test Equipment Used	Pg. 7
I) Declaration	Pg. 8
Appendix 1 Conducted Emissions Test Data/Plots	
Appendix 2 Conducted RF Output Power Test Data	
Appendix 3 Frequency Stability Test Data	
Appendix 4 Radiated Emissions Test Data	

A) Scope

This report details the results of compliance tests which were performed in accordance with the requirements of:

- FCC CFR 47 Part 22, Subpart H, Cellular Radiotelephone Services
- FCC CFR 47 Part 24, Subpart E, Broadband PCS
- Industry Canada, RSS-128 Issue 2, Rev 1, Nov. 6/99, 800 MHz Dual-Mode TDMA Cellular Telephones
- Industry Canada, RSS-133 Issue 2, Rev. 1 Nov. 6/99, 2.0 GHz Personal Communications Services

B) Product Identification

The equipment under test (EUT) was tested at the Research In Motion Limited (RIM) EMI test facility, located at:

305 Phillip Street
Waterloo, Ontario
Canada, N2L 3W8

The testing began on April 23, 2002 and completed on April 30, 2002. The sample equipment under test (EUT) were:

1. GPRS OEM Radio Modem kit, model number PRD-4230-001

The kit includes the following items:

- a. GPRS OEM Radio Modem, type RIM 1902G, model number R6420GN, IMEI 001020000070260, FCC ID L6AR6420GN (has 6 pin ZIF FPC connector for off-board SIM).
- b. AC Adapter, Globtek, model number SA-052AU-1, part number WR91A2400CCP, with an output voltage of 5volt dc.
- c. GPRS OEM Interface and Test Board, PCB-04020-002 Rev. A
- d. Broadcast Antenna, Andrew, Eclipse II, magnet mount
- e. Ribbon cable, Parlex Corp., part number 3999
- f. Ribbon cable, part number WIR-02214-001
- g. RF cable, MMCX male to SMA female, part number WIR-01908-001
- h. DB-9 to DB-9 straight through serial cable
- i. Audio headset, model number HDW-03458-001

2. GPRS OEM Radio Modem kit, model number PRD-4230-002

The kit includes the following items:

- a. GPRS OEM Radio Modem, type RIM 1902GS, model number R6420GN, IMEI 001020000070270, FCC ID L6AR6420GN (on-board SIM connector).
- b. AC Adapter, Globtek, model number SA-052AU-1, part number WR91A2400CCP, with an output voltage of 5volt dc.
- c. GPRS OEM Interface and Test Board, PCB-04020-002 Rev. A
- d. Broadcast Antenna, Andrew, Eclipse II, magnet mount
- e. Ribbon cable, part number WIR-02214-001
- f. RF cable, MMCX male to SMA female, part number WIR-01908-001
- g. DB-9 to DB-9 straight through serial cable
- h. Audio headset, model number HDW-03458-001

C) Support Equipment Used for the Testing of the EUT

- 1) Communication Tester, Rohde & Schwarz, model CMU200, serial number 837493/073
- 2) PC, Dell, model number MMP, serial number 6SPS20B
- 3) Monitor, KDS, model number KD-1460, serial number 4530019652
- 4) Printer, H/P, model number C5884A, serial number US8251W0VQ
- 5) DC Power Supply, H/P, model 6632B, serial number US37472179

D) Test Voltage

The ac input voltage to the ac Adapter, Globtek, model number SA-052AU-1 was 120 volts, 60 Hz. The ac adapter provided 5.0 volts dc to the GPRS OEM Radio Modem kit. This configuration was per RIM's specifications

E) Test Results Chart

SPECIFICATION	Test Type	MEETS REQUIREMENTS	Performed By
FCC CFR 47 Part 22, Subpart H IC RSS-128	Radiated Spurious/harmonic Emissions, ERP	Yes	Masud Attayi
FCC CFR 47 Part 22, Subpart H IC RSS-128	Conducted Emissions, Occupied Bandwidth, Frequency Stability	Yes	Jonathan Doll Maurice Battler
FCC CFR 47 Part 24, Subpart E IC RSS-133	Radiated Spurious/harmonic Emissions, EIRP	Yes	Masud Attayi
FCC CFR 47 Part 24, Subpart E IC RSS-133	Conducted Emissions, Occupied Bandwidth, Frequency Stability	Yes	Jonathan Doll Maurice Battler

F) Modifications to EUT

No modifications were required to the EUT.

G) Summary of Results

- 1) The EUT passed the Occupied Bandwidth and Spurious Emissions requirements in the GSM850 band as per 22.917. The channels measured were low, middle and high. See APPENDIX 1 for the test data.
- 2) The EUT passed the Occupied Bandwidth and Spurious Emissions requirements in the PCS band as per 24.238. The channels measured were low, middle and high. See APPENDIX 1 for the test data.
- 3) The EUT passed the Conducted Spurious Emissions requirements in the GSM850 band as per 22.917, 22.901(d). The EUT was measured on the low, middle and high channels. The frequency range investigated was from 10 MHz to 9 GHz. See APPENDIX 1 for the test data.

- 4) The EUT passed the Conducted Spurious Emissions requirements in the PCS band as per 24.238. The EUT was measured on the low, middle and high channels. The frequency range investigated was from 10 MHz to 19.1 GHz.
See APPENDIX 1 for the test data.
- 5) The EUT passed the Conducted RF Output Power requirements for both the PCS and GSM850 bands. The channels measured were low, middle and high.
See APPENDIX 2 for the test data.
- 6) The EUT passed the Frequency Stability vs. Temperature and Voltage requirements for the PCS band as per 24.235 and RSS-133. The maximum frequency error measured was less than 1 PPM.
The temperature range was from -30°C to +60°C in 10 degree temperature steps. The EUT was measured on low, middle and high channels at each temperature step. The EUT was measured at low (3.35 volts), nominal (3.8 volts) and high (4.7 volts) dc input voltage at each temperature step and channel at maximum output power.
See APPENDIX 3 for the test data.
- 7) The EUT passed the Frequency Stability vs. Temperature and Voltage requirements for GSM850 band as per 22.917 and RSS-128.
The maximum frequency error measured was less than 1 PPM.
The temperature range was from -30°C to +60°C in 10? temperature steps. The EUT was measured on low, middle and high channels at each temperature step. The EUT was measured at low (3.35 volts), nominal (3.8 volts) and high (4.7 volts) dc input voltage at each temperature step and channel at maximum output power.
See APPENDIX 3 for the test data.
- 8) The radiated spurious emissions harmonics and ERP/EIRP were measured for both GSM850 and PCS bands. The results are within the limits. The EUT was placed on a nonconductive wooden table, 80 cm high that was positioned on a remotely rotatable turntable. The test distance used between the EUT and the receiving antenna was three metres. The measurements were performed in a semi-anechoic chamber. The semi-anechoic chamber FCC registration number is **778487** and the Industry Canada file number is **IC4240**. The turntable was rotated to determine the azimuth of the peak emissions. At this point the emissions were maximized by elevating the antenna in the range of 1 to 4 metres. The maximum emission levels were recorded. The EUT was measured on low, middle and high channels.

The radiated spurious emissions investigated for the PCS band was not measurable since it was below the noise floor of the analyzer.

The worst test margin for radiated spurious emissions measured for the GSM850 band was 24.1 dB below the limit at 1675.2 MHz.

The highest EIRP in the PCS band measured was 26.0 dBm at 1850.2 MHz (channel 512).

The highest ERP in the GSM850 band measured was 28.6 dBm at 837.6 MHz (channel 195).

To view the test data see APPENDIX 4.

Sample Calculation:

Field Strength (dB μ V/M) is calculated as follows:

FS = Measured Level (dB μ V) + A.F. (dB/m) + Cable Loss (dB) - preamp (dB) + filter loss (dB)

Measurement Uncertainty ± 4.0 dB

H) Compliance Test Equipment Used

<u>UNIT</u>	<u>MANUFACTURER</u>	<u>MODEL / SERIAL NUMBER</u>	<u>CAL DUE DATE</u>	<u>USE</u>
Preamplifier system	TDK RF Solutions	PA-02 080010	02-06-21	Radiated Emissions
Preamplifier	EMC Automation	PA-02-1 030002	02-06-21	Radiated Emissions
Double Ridged Waveguide Horn Antenna.	EMC	3116 2538	02-06-21	Radiated Emissions
Linear Power Supply	EMC Automation	LPS-04 2001300	02-06-21	Radiated Emissions
Preamplifier	Sonoma	310N/11909A 185831	02-06-21	Radiated Emissions
EMC Analyzer	Agilent	E7405A US40240226	03-03-21	Radiated Emissions
L.I.S.N.	Emco	3816/2 1120	02-05-31	Conducted Emissions
L.I.S.N.	Emco	3816/2 1118	02-05-31	Conducted Emissions
Impulse Limiter	Rohde & Schwarz	ESHS-Z2 836248/052	02-05-03	Conducted Emissions
EMI Receiver	Agilent	85462A 3942A00517	03-04-04	Conducted Emissions
RF Filter Section	Agilent	85460A 3704A00481	03-04-04	Conducted Emissions
Spectrum Analyzer	Agilent	8563E 3745A08112	02-08-02	Conducted Emissions
DC Power Supply	HP	6632B US37472179	02-07-30	Conducted Emissions
Environmental Chamber	ESPEC Corp.	SH-240S1 91005607	N/R	Conducted Emissions
Temperature Probe	Hart Scientific	61161-302 21352860	03-09-10	Frequency Stability
Hybrid Log Antenna	TDK	HLP-3003C 17301	02-10-03	Radiated Emissions
Horn Antenna	TDK	HRN-0118 090301	02-10-03	Radiated Emissions
Horn Antenna	TDK	HRN-0118 090601	02-10-03	Radiated Emissions
Signal Generator	HP	83712B US37101080	02-08-14	Radiated Emissions
Wireless Communications Test Set	Rohde & Schwarz	CMU200 837493/073	03-03-27	Radiated Emissions
Dipole Antenna	Schwarzbeck	VHAP 1006	03-03-05	Radiated Emissions
Dipole Antenna	Schwarzbeck	VHAP 1007	03-03-05	Radiated Emissions

K) Declaration

Statement of Performance:

The GPRS OEM Radio Modem kit, model number PRD-4230-001 and model number PRD-4230-002, when configured and operated per RIM's operation instructions, performs within the requirements of the test standards.

Declaration:

We hereby certify that:

The test data reported herein is an accurate record of the performance of the sample(s) tested.

The test equipment used was suitable for the tests performed and within manufacturer's published specifications.

The test equipment was used within its published operating parameters.

The test methods were consistent with the methods described in the relevant standards.

Date: 7 May 2002

Masud S. Attayi, P.Eng.
Senior Engineer, Compliance and Certification



Reviewed and Approved by:
Paul G. Cardinal, Ph.D.
Manager, Compliance and Certification

Date: 9 May 2002

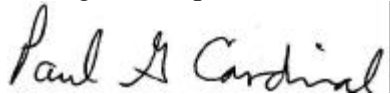

APPENDIX 1

CONDUCTED EMISSIONS TEST DATA/PLOTS

Conducted Emission Test Data

This appendix contains measurement data pertaining to 99% power bandwidth, -26 dBc bandwidth, conducted spurious emissions and the channel mask on the high and low channels of both the GSM850 and PCS bands.

Test Setup Diagram

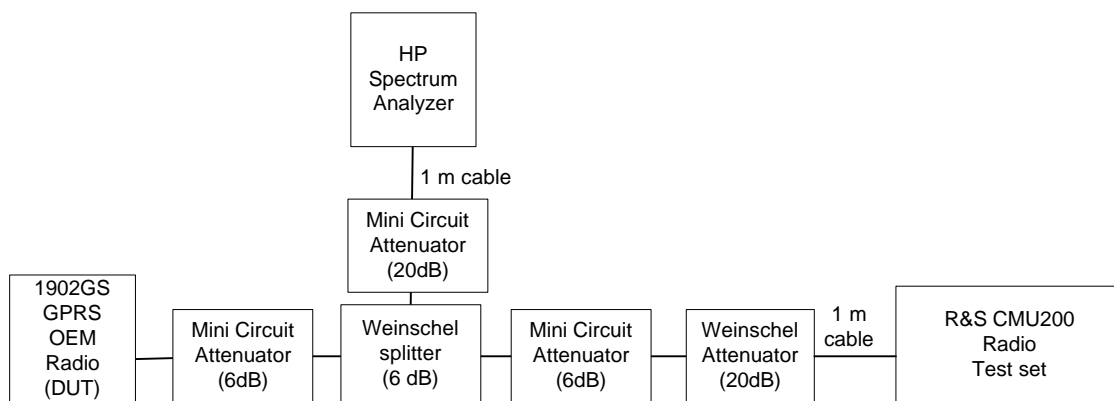

Test Equipment List

Test Instruments	Manufacturer	Model No.	Serial No.	Frequency Range
Spectrum Analyzer	HP	8563E	374A08112	30 Hz – 26.5 GHz
Combination Network	Weinschel	1515	--	DC – 18 GHz
Attenuator	Weinschel	1R-20	--	DC – 18 GHz
Attenuator	Mini Circuit	MCL BW-S6W2	--	DC – 18 GHz
Attenuator	Mini Circuit	MCL BW-S20W2	--	DC – 18 GHz
Universal Radio Communication Tester	Rohde & Schwarz	CMU200	100250	--

Conducted Emission Test Data Con't

Occupied Bandwidth (99%) and -26 dBc Bandwidth

For each carrier frequency of low, middle and high, the modulation spectrum were measured by both methods of 99% power bandwidth and -26 dBc bandwidth.

The resolution bandwidth required for out-of-band emissions in the 1 MHz bands immediately outside and adjacent to the frequency block, was determined to be at least 1% of the emission bandwidth.

The worst case emission bandwidth for the three PCS channels was measured to be 327 kHz, and for the three GSM850 channels was measured to be 317 kHz as shown below, which results in 3.0 kHz resolution bandwidth.

On any frequency outside the frequency block and outside the adjacent 1 MHz bands, a resolution bandwidth of at least 1 MHz was employed.

Test Data for PCS and GSM850 selected Frequencies

PCS Frequency (MHz)	99% Occupied Bandwidth (kHz)	-26dBc Bandwidth (kHz)
1850.2	243.3	322
1880.0	243.3	325
1909.8	245	327

GSM850 Frequency (MHz)	99% Occupied Bandwidth (kHz)	-26dBc Bandwidth (kHz)
824.2	241.7	317
837.6	246.7	315
848.8	245	313

Measurement Plots for PCS and GSM850

Refer to the following measurement plots for more detail.

Conducted Emission Test Data Con't

Figure 1: Low Channel PCS Occupied Bandwidth (99%)

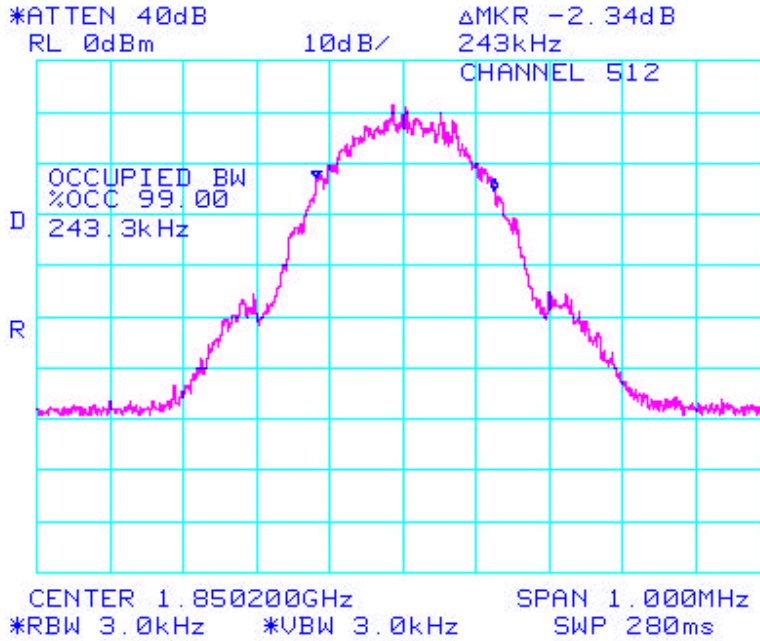
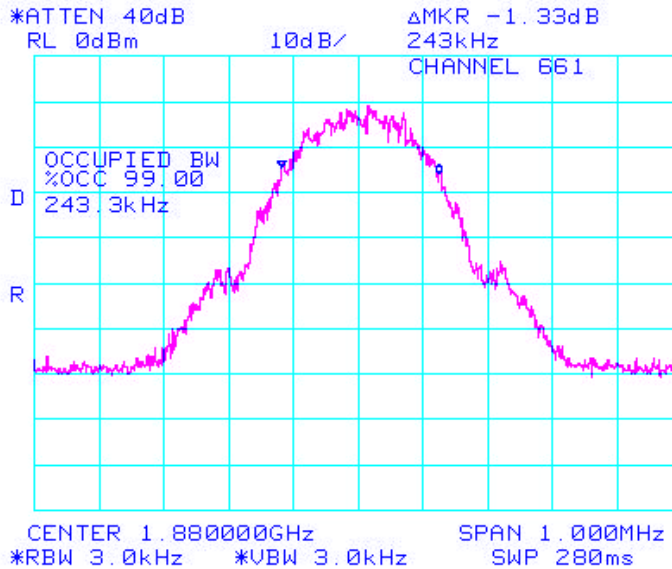

Figure 2: Middle Channel PCS Occupied Bandwidth (99%)



Conducted Emission Test Data Con't

Figure 5: Middle Channel GSM850 Occupied Bandwidth (99%)

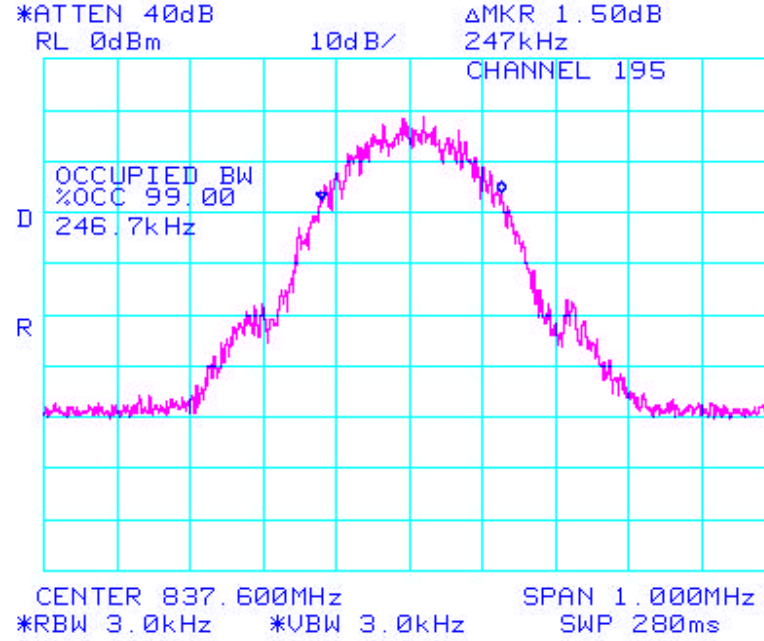
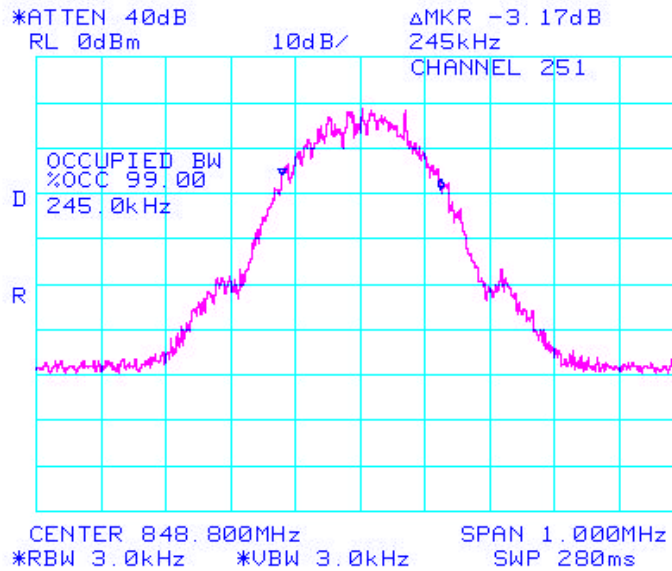

Figure 6: High Channel GSM850 Occupied Bandwidth (99%)



Conducted Emission Test Data Con't

Figure 7: Low Channel PCS -26 dBc Bandwidth (99%)

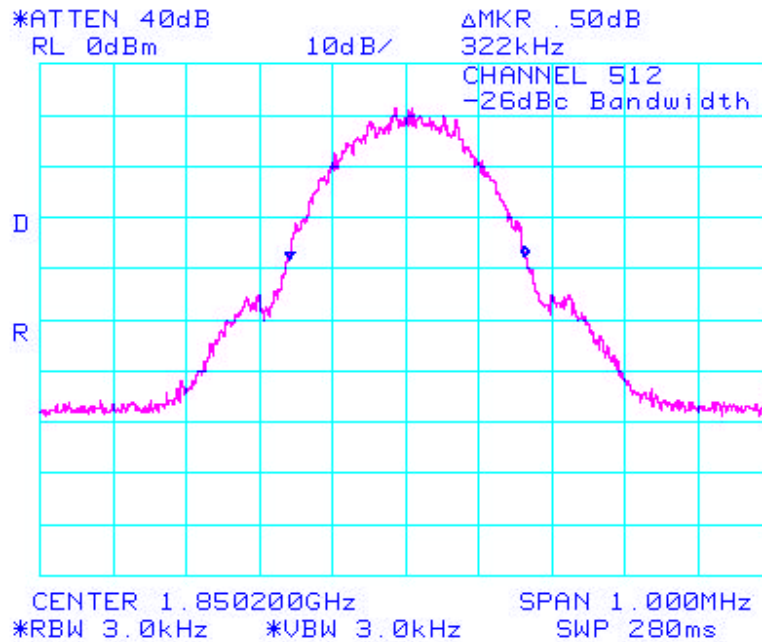
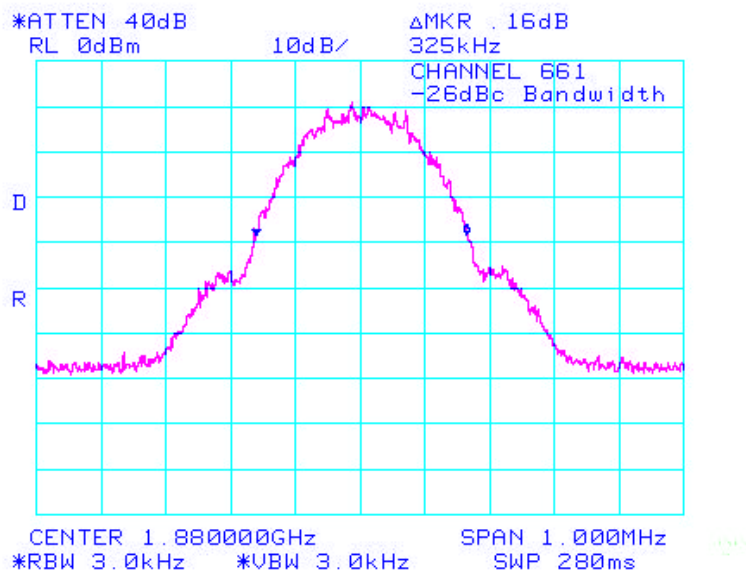

Figure 8: Middle Channel PCS -26 dBc Bandwidth (99%)



Conducted Emission Test Data Con't

Figure 9: High Channel PCS -26 dBc Bandwidth (99%)

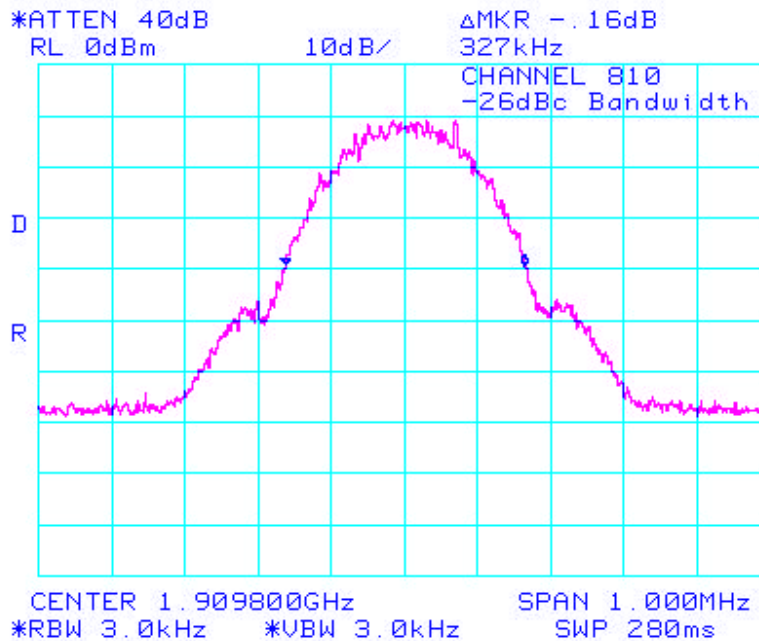
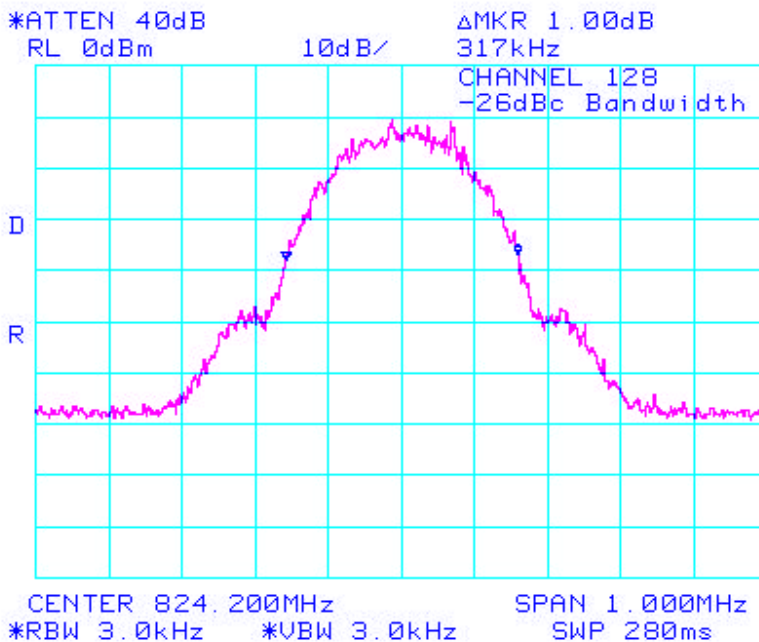

Figure 10: Low Channel GSM850 -26 dBc Bandwidth



Conducted Emission Test Data Con't

Figure 11: Middle Channel GSM850 -26 dBc Bandwidth

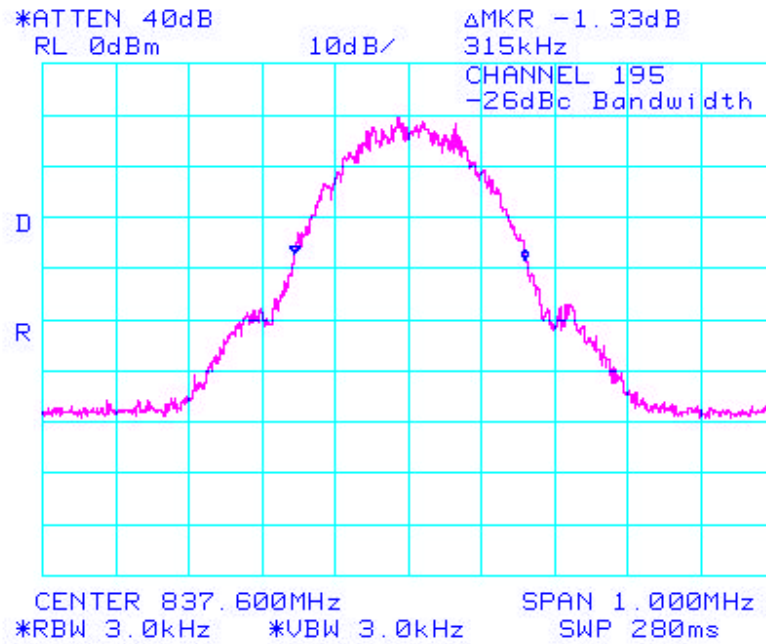
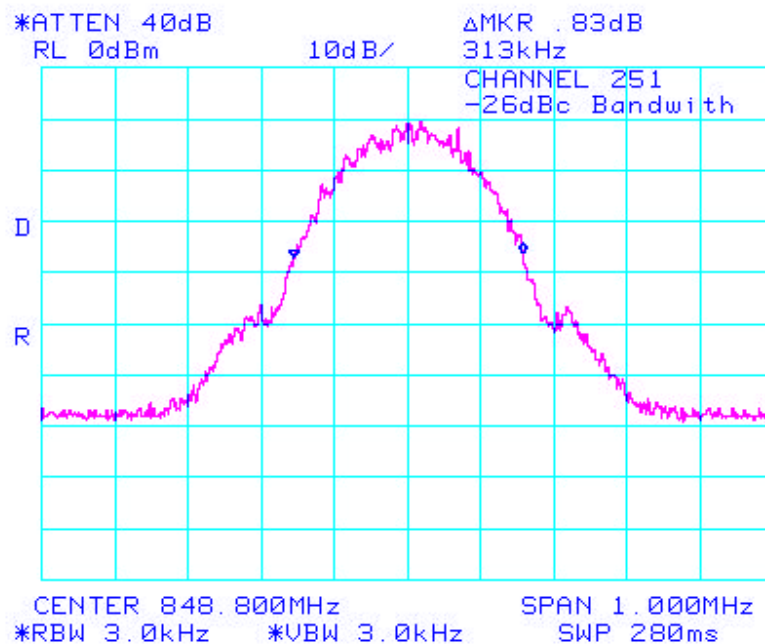

Figure 12: High Channel GSM850 -26 dBc Bandwidth



Conducted Emission Test Data Con't

Figure 15: PCS Middle Channel, Spurious Emissions

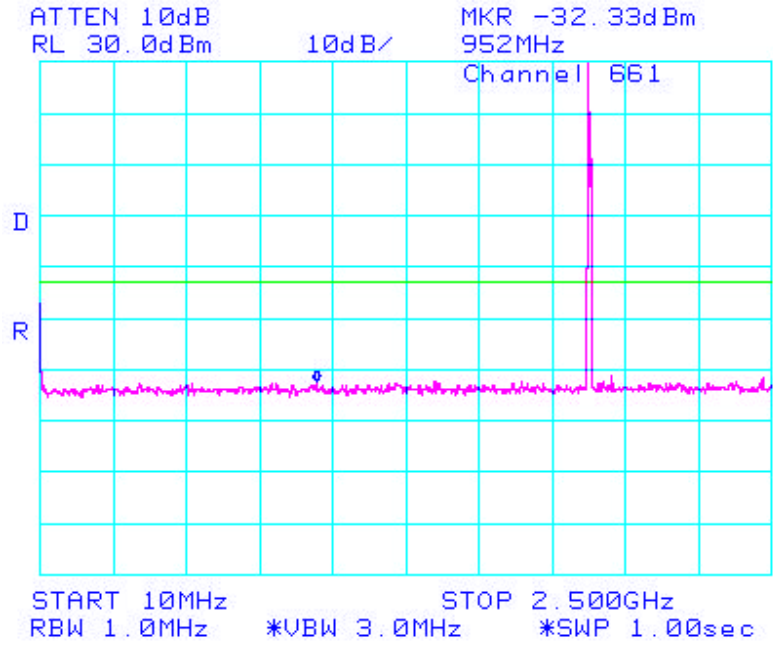
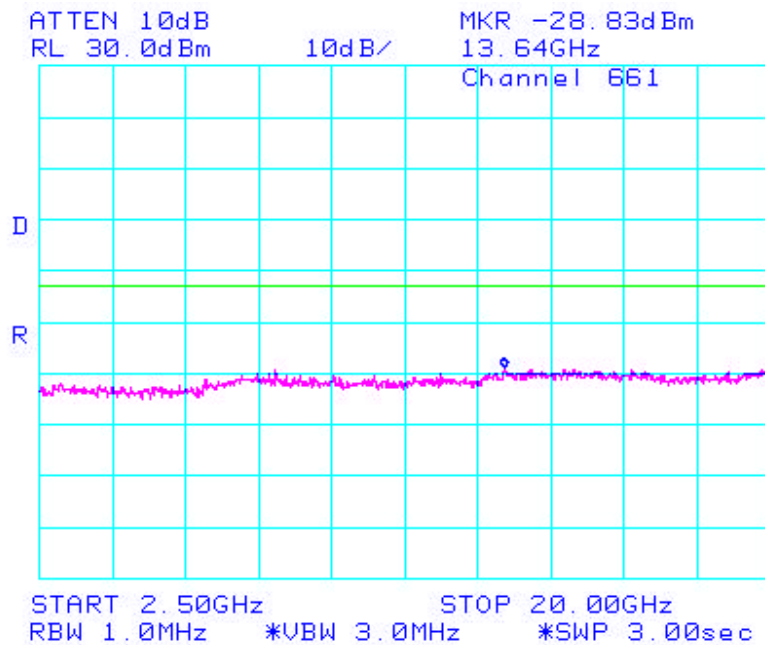

Figure 16: PCS Middle Channel, Spurious Emissions



Conducted Emission Test Data Con't

Figure 17: PCS High Channel, Spurious Emissions

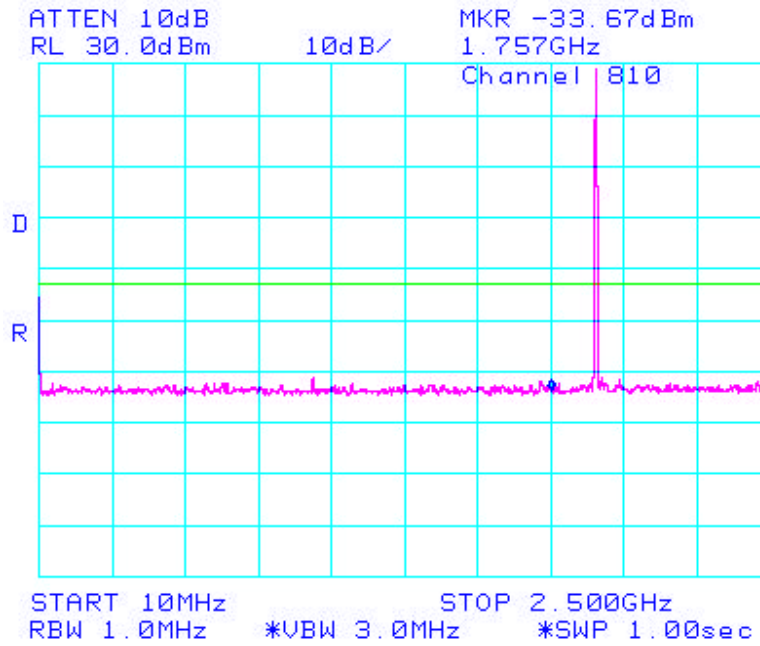
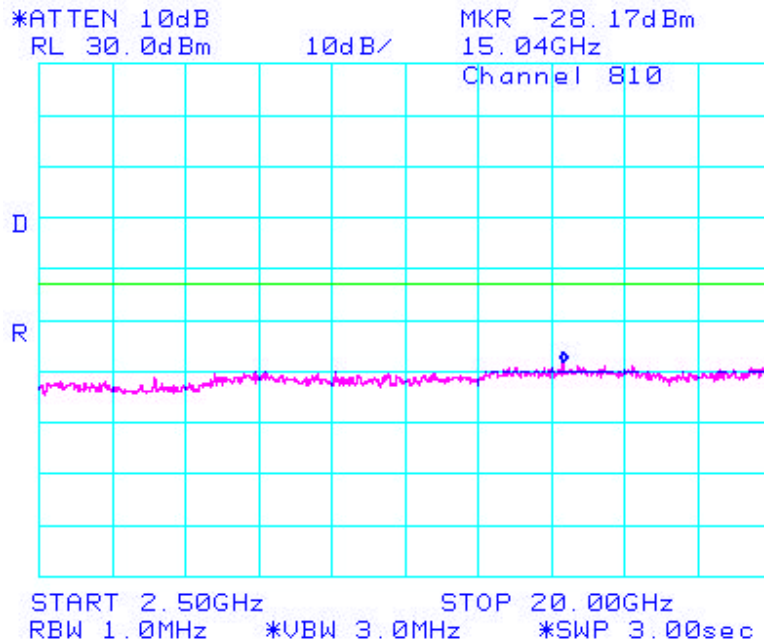

Figure 18: PCS High Channel, Spurious Emissions



Conducted Emission Test Data Con't

Figure 19: GSM850 low Channel, Spurious Emissions

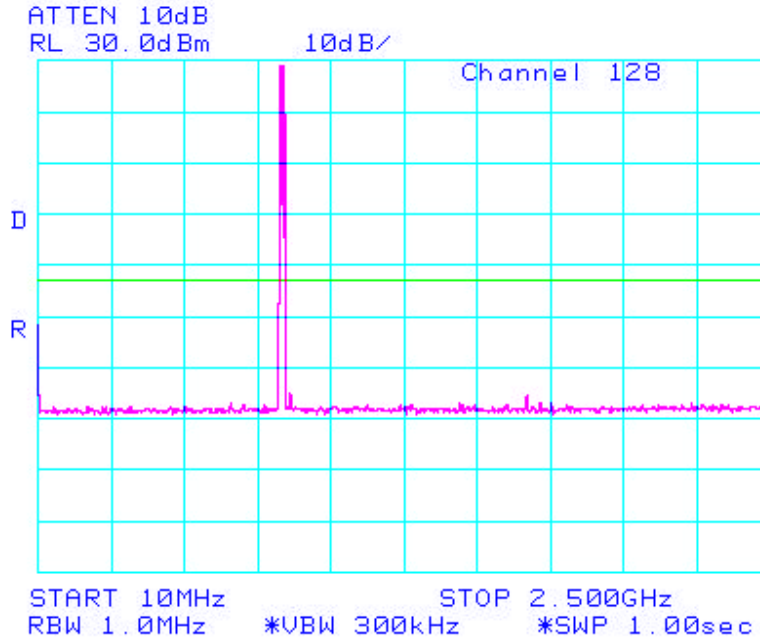
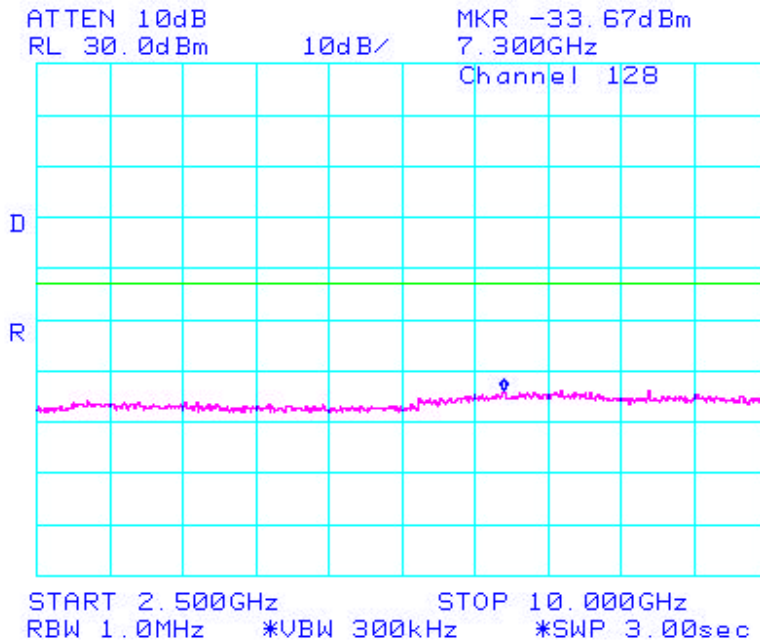

Figure 20: GSM850 low Channel, Spurious Emissions



Conducted Emission Test Data Con't

Figure 21: GSM850 Middle Channel, Spurious Emissions

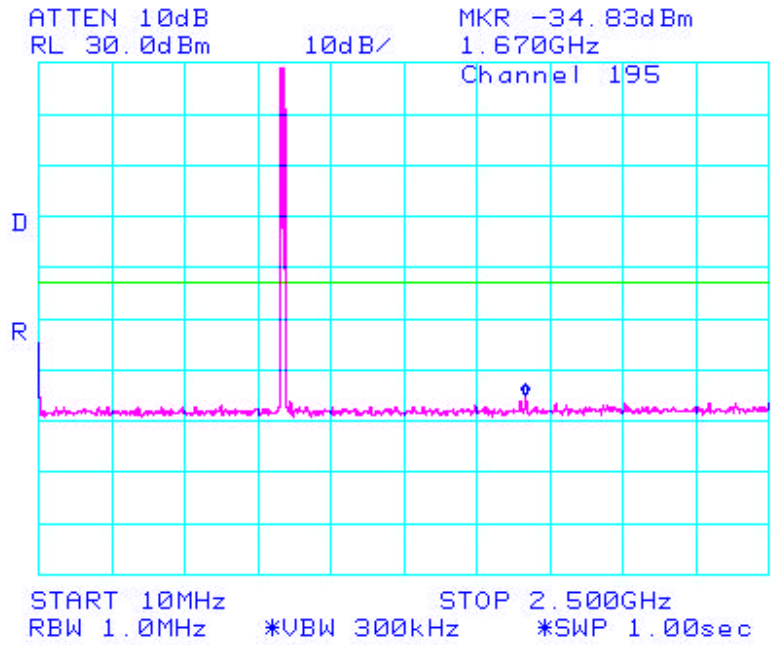
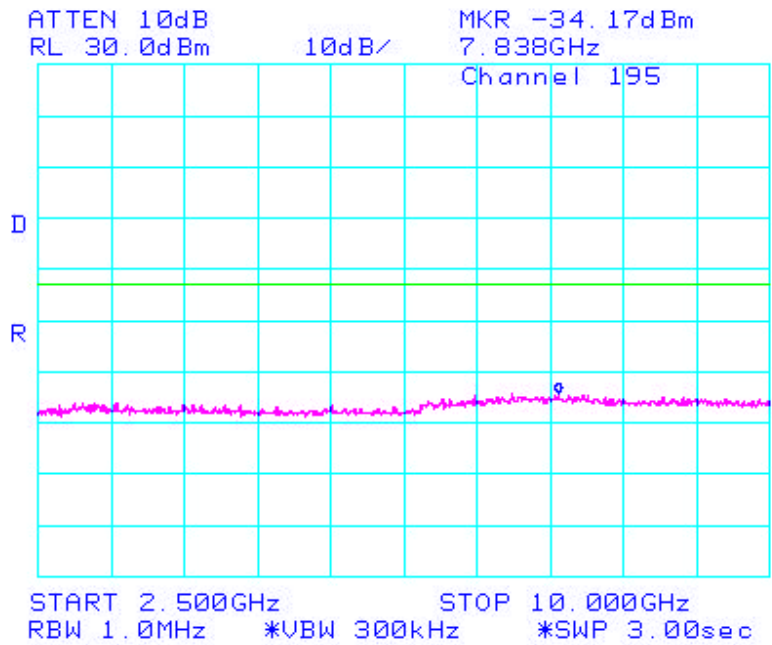

Figure 22: GSM850 Middle Channel, Spurious Emissions



Conducted Emission Test Data Con't

Figure 23: GSM850 High Channel, Spurious Emissions

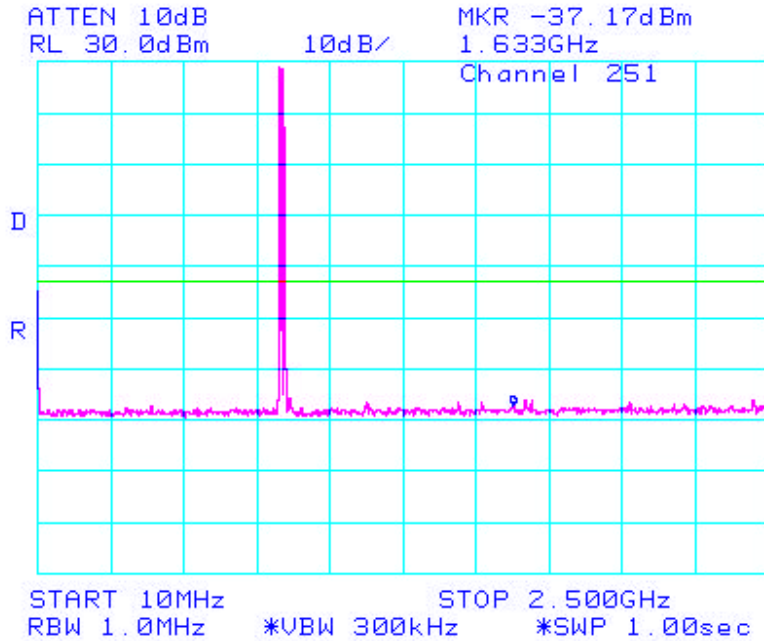
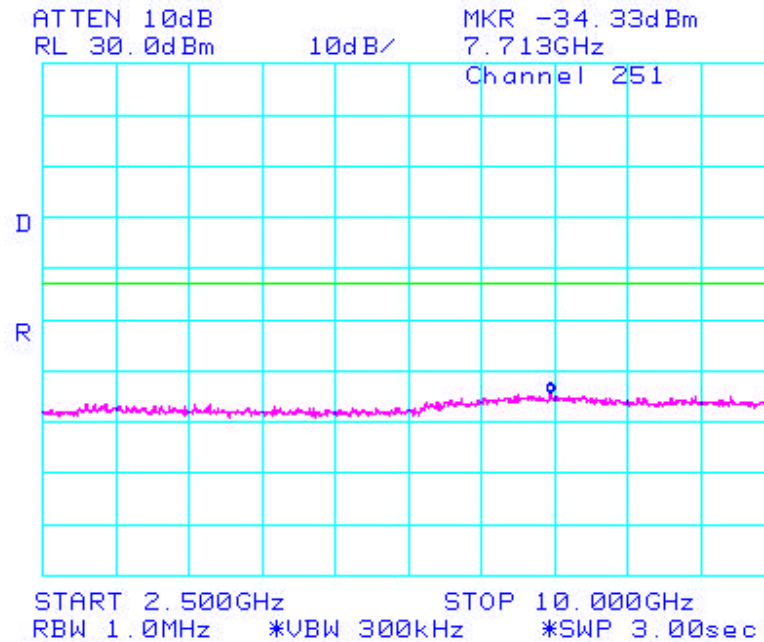

Figure 24: GSM850 High Channel, Spurious Emissions



Conducted Emission Test Data Con't

Figure 25: PCS Low Channel Mask

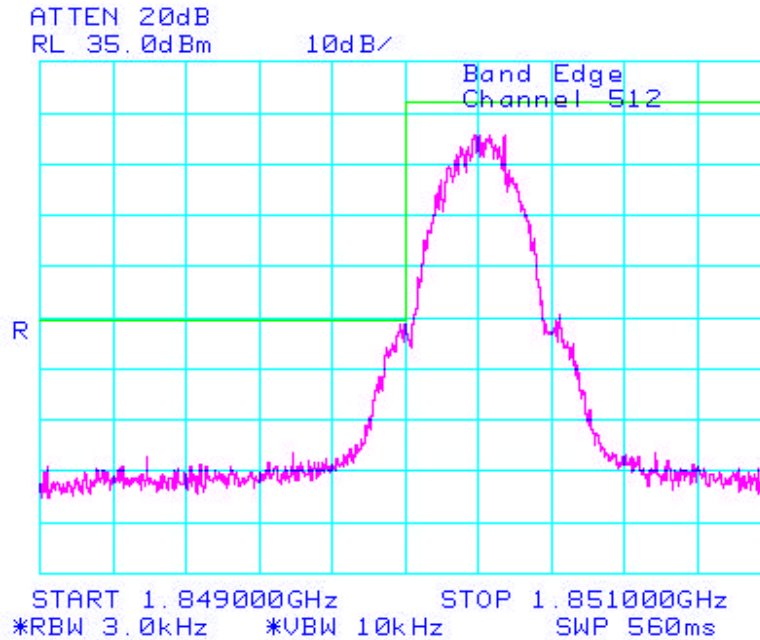
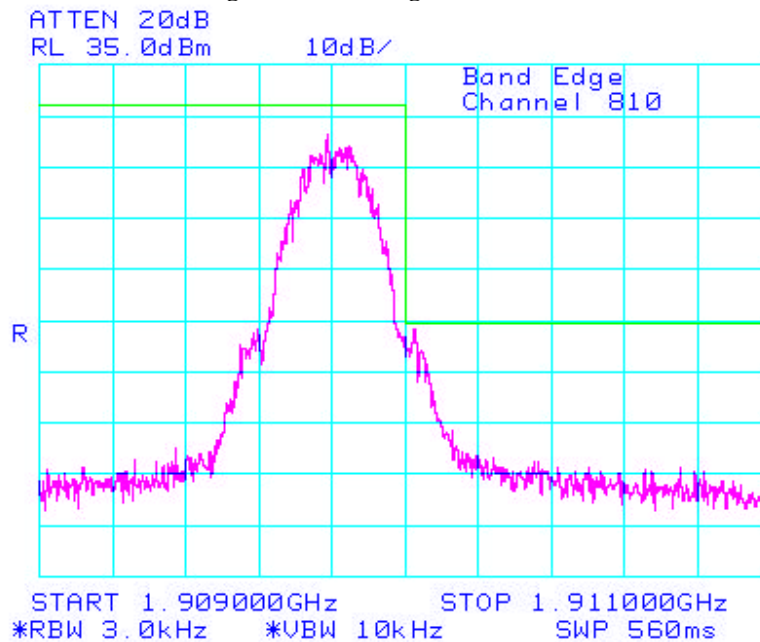

Figure 26: PCS High Channel Mask



Conducted Emission Test Data Con't

Figure 27: GSM850 Low Channel Mask

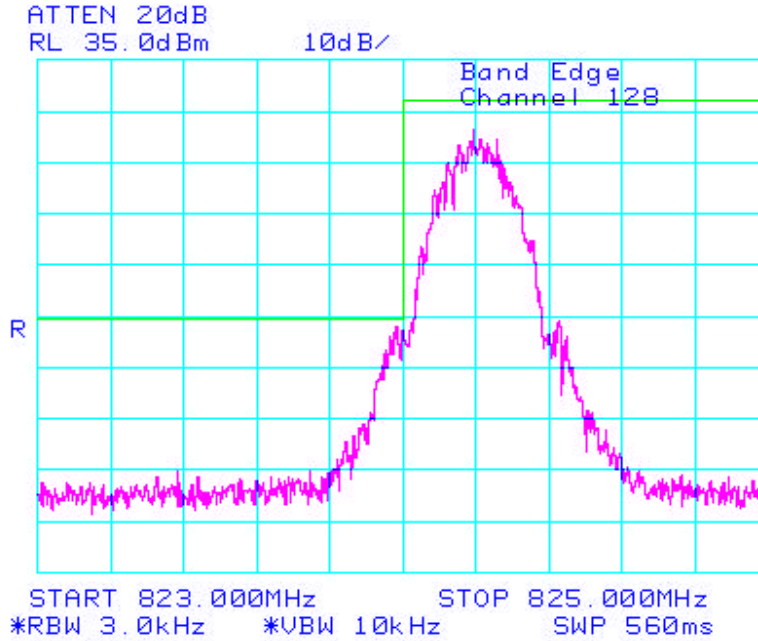
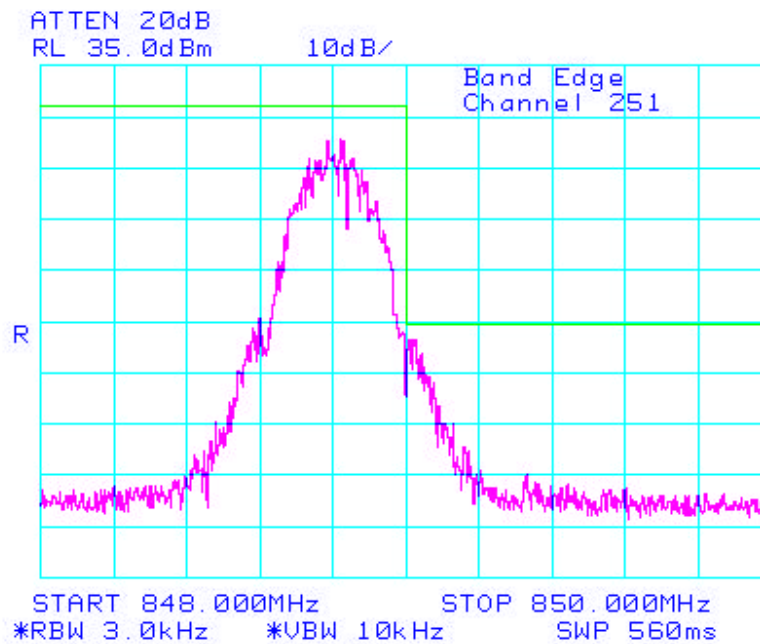

Figure 28: GSM850 High Channel Mask



Conducted Emission Test Data Con't

FCC CFR 47 Part 22, Subpart H, FCC CFR 47 Part 24, Subpart E

Test-Setup Photo

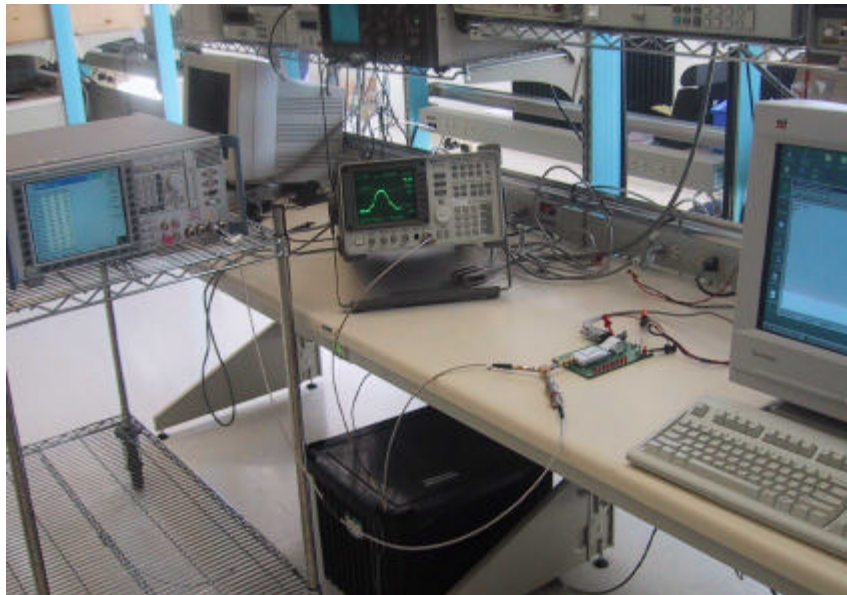

APPENDIX 2

CONDUCTED RF OUTPUT POWER TEST DATA

Conducted RF Output Power Test Data

Test Setup Diagram

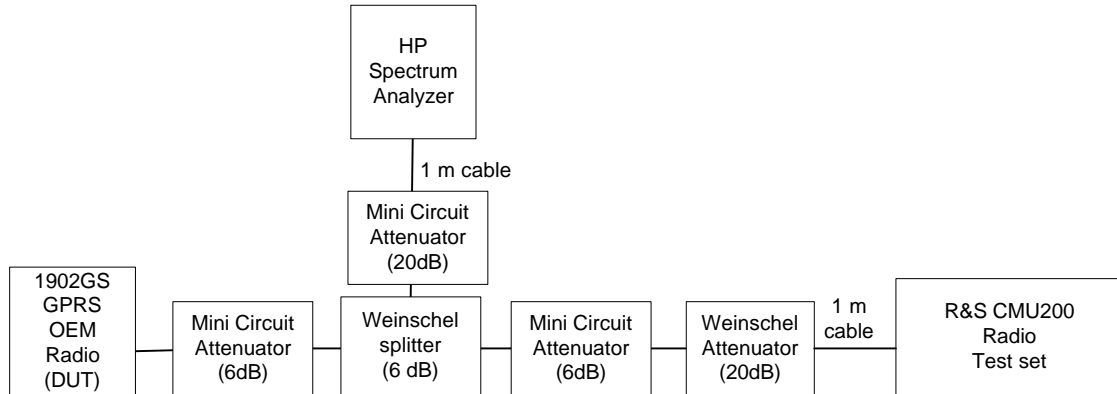

Test Equipment List

Test Instruments	Manufacturer	Model No.	Serial No.	Frequency Range
Spectrum Analyzer	HP	8563E	374A08112	30 Hz – 26.5 GHz
Combination Network	Weinschel	1515	--	DC – 18 GHz
Attenuator	Weinschel	1R-20	--	DC – 18 GHz
Attenuator	Mini Circuit	MCL BW-S6W2	--	DC – 18 GHz
Attenuator	Mini Circuit	MCL BW-S20W2	--	DC – 18 GHz
Universal Radio Communication Tester	Rohde & Schwarz	CMU200	100250	--

Power Output for PCS and GSM850

At three transmit frequencies the maximum radio output power level was measured using the Spectrum Analyzer. The calibrated insertion loss measured for the attenuator and cable assembly was added to the power measurements which produced the following results.

Conducted RF Output Power Test Data Con't

Test Data

Peak nominal output power is 30 dBm for PCS and 29 dBm for GSM850.

PCS Frequency (MHz)	Measured Peak Conducted Power (dBm)	Total Correction Factor (dB)	Corrected Peak Conducted Power (dBm)
1850.2	-2.0	32.3	30.3
1880.0	-2.33	32.3	29.97
1909.8	-2.83	32.3	29.47

GSM850 Frequency (MHz)	Measured Peak Conducted Power (dBm)	Total Correction Factor (dB)	Corrected Peak Conducted Power (dBm)
824.2	-3.0	32.3	29.3
837.6	-3.17	32.3	29.13
848.8	-3.33	32.3	28.97

Figure 29: Low Channel PCS Peak Power

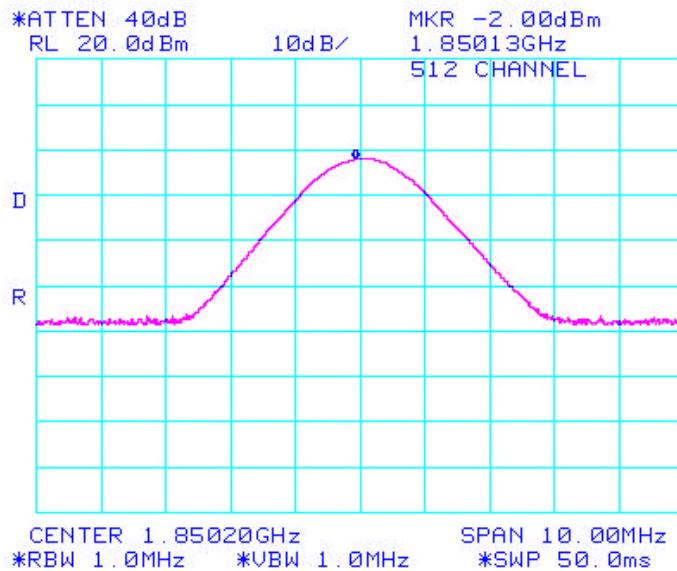

APPENDIX 3

FREQUENCY STABILITY TEST DATA

Frequency Stability Test Data

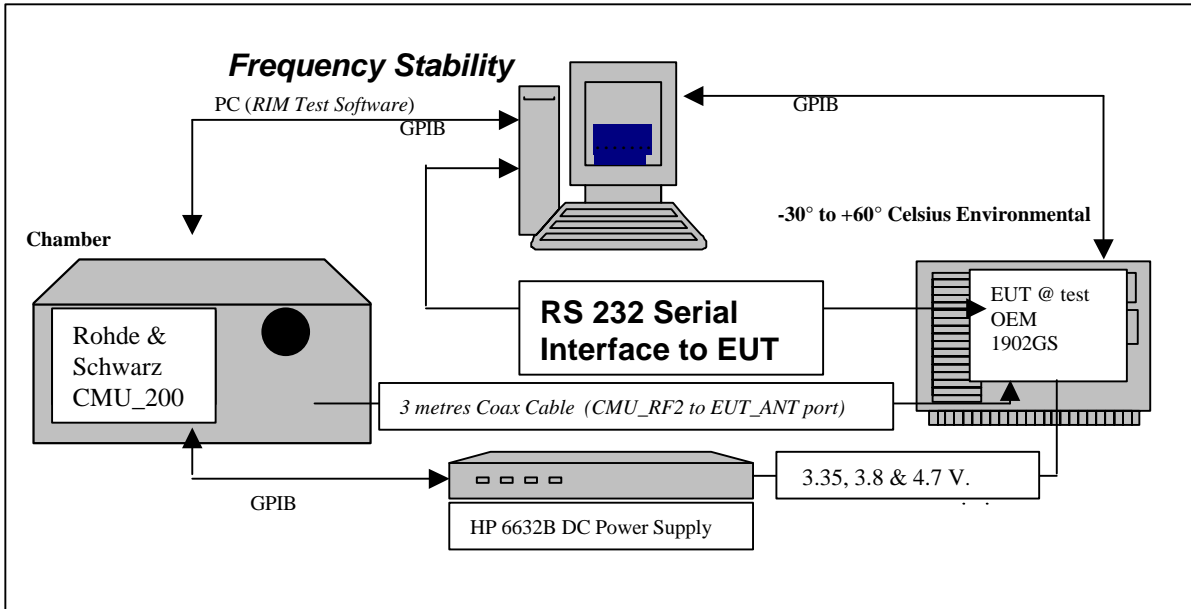

<i>SYSTEM</i>	<i>Model</i>	<i>Serial Number</i>	<i>Calibration Due Date.</i>
<i>R & S Universal Radio Communication Test Set</i>	CMU200	100250	21-March-2003
<i>HP System DC Power Supply</i>	6632B	20A80400711	30-July-2002
<i>Network Analyzer</i>	HP 8753D	20A80400806	07-Aug-2002
<i>Calibration Kit</i>	HP85033D	3423A02787	01-Nov-2002
<i>Espec Environmental Chamber</i>	SH240	91005607	N/A
<i>Hart Temperature Probe</i>	61161-302	21352860	10-Sept-2003

CFR 47 Chapter 1 - Federal Communications Commission Rules

Part 2 Required Measurements

- 2.995 Frequency Stability - Procedures
- (a,b) Frequency Stability - Temperature Variation
- (d) Frequency Stability - Voltage Variation

24.235 Frequency Stability.

The frequency stability shall be sufficient to ensure that the fundamental emission stays within the authorized frequency block.

The 1902GS GPRS OEM Radio Modem, (referred as EUT herein and after) transmitted frequencies are less than 0.1 ppm off the received frequency from the Rhode & Schwarz CMU 200 Universal Radio Communication Test Set. *The 1902GS GPRS OEM Radio Modem meets the requirements as stated in CFR 47 chapter 1, Section 24.235, Frequency Stability.*

Frequency Stability measurement devices were configured as presented in the block diagram recording frequency, power, data, temperatures, and stepped voltages controlled via a GPIB interface linked to the Environmental chamber, a DC power supply, and the Communications Test Set. A three-meter coax cable was calibrated to characterize the insertion loss for the transmitted frequencies between the RF input/output of the CMU 200 and the EUT antenna port; located inside the environmental chamber.

Calibration for the Cable Loss was performed in the RF Laboratory on May 1st, 2002.

Procedure:

Full_ Two port Calibration of 8720D using the 85033D was completed.

A three-meter long coax cable was used to complete the RF power measurement.

The cable assembly from the RF input to the RF output was measured at the following Frequencies:

PCS Frequency (MHz)	Cable loss (dB)
1850.2	6.7
1877.2.0	6.7
1904.2	6.7

GSM 850 Frequency (MHz)	Cable loss (dB)
824.2	4.0
836.4	4.0
848.6	4.0

Procedure:

The EUT was placed in the Temperature chamber and connected to the CMU 200 outside as shown in the figure above. Dry air was pumped inside the temperature chamber to maintain a backpressure during the test. The EUT was kept in the off condition at all times except when the measurements were to be made.

The chamber was switched on and the temperature was set to -30°C.

After the chamber stabilized at -30 °C there was a soak period of one hour to alleviate moisture in the chamber, then the EUT voltage was enabled.

The system software recorded the frequency, power, and associated measurements.

A Computer system controlled the automated software. This application was given the command of activating all machines intrinsic to the temperature and voltage tests controlling the CMU 200 via the GPIB Bus. The Environmental Chamber was instructed through an RS-232 serial line. The EUT dialogue was passed through a serial connection.

The EUT repetitively transmitted 100 bursts for each set of programmed parameters recording temperature, voltage settings, and systematically selected frequencies of 1850.2, 1877.2.0, & 1904.2 MHz.

The power supply was cycled from the minimum voltage of 3.35 volts, to 3.8 volts, and then to 4.7 volts nominal voltage.

The frequency error was measured at a maximum output power of 30 dBm and recorded by the automated system test software.

The EUT output power and frequency was measured at 3.35V, 3.8V, and 4.7VDC. The transmit frequency was varied in 3 steps consisting of 1850.2 MHz, 1877.2 MHz and 1904.2 MHz. This frequency was recorded in MHz and deviation from nominal, in Parts Per Million.

After the initial one-hour soak at the beginning of the start of the measurement tests, a period of thirty minutes soak was initialized between each ascending temperature step, before proceeding to the next measurement test cycle.

PROCEDURE PCS

The test system software for commencing the Frequency Stability Tests carried through the following cycle.

1. Switch on the HP 6632B power supply; CMU 200 Communications Test Set, and Environmental Chamber.
2. Start test program
3. Set the Temperature to -30 degrees Celsius and maintain a period of one- hour soak time, with the EUT supply voltage disabled.
4. Set power supply voltage to 3.35 Volts
5. Set up CMU 200 Radio Communication Tester
6. Command the CMU 200 to switch to 1850.2 MHz
7. Enable the voltage to the EUT, and connect a link to the CMU 200 test set
8. EUT is commanded to Transmit 100 Bursts
9. Software logs the following data from the CMU 200, power supply and temperature chamber: Traffic Channel Number, Traffic Channel Frequency, Power Level, Chamber Temperature, Supply Voltage, Power, Frequency Error.
10. The CMU 200 commands the EUT to change frequency to 1877.2 and 1904.2 MHz and repeats steps 7, to 9.
11. Repeat steps 5, to 10 changing the supply voltage to 3.8 Volts
12. Increase temperature by 10°C and soak for 1/2 hour.
13. Repeat steps 4 - 12 for temperatures -30 degrees to 60 degrees Celsius.
14. Repeat steps 5, to 10 changing the supply voltage to 4.7 Volts

Procedure 5, to 10 was repeated at room temperature (20°C) with the power supply voltage set to 3.35V, 3.8V, and 4.7 Volts

The CMU 200 was changed to the GSM 850 band and the EUT repetitively transmitted 100 bursts for each set of programmed parameters recording temperature, voltage settings, and systematically selected frequencies of 824.2, 836.4, & 848.6 MHz.

The power supply was cycled from minimum voltage 3.35 volts, to 3.8 volts to 4.7 volts nominal voltage. The frequency error was measured at a maximum output power of 29 dBm and recorded by the automated system test software.

The EUT output power and frequency was measured at 3.35V, 3.8V, and 4.7VDC. The transmit frequency was varied in 3 steps consisting of 824.2 MHz, 836.4 MHz and 848.6 MHz. This frequency was recorded in MHz and deviation from nominal, in Parts Per Million.

After the initial one-hour soak at the beginning of the start of the measurement tests, a period of thirty minutes soak was initialized between each ascending temperature step, before proceeding to the next measurement test cycle.

The power supply was cycled from the minimum voltage of 3.35 volts, to 3.8 volts, and then to 4.7 volts nominal voltage.

The frequency error was measured at a maximum output power of 29 dBm and recorded by the automated system test software.

The EUT output power and frequency was measured at 3.35V, 3.8V, and 4.7VDC. The transmit frequency was varied in 3 steps consisting of 824.2 MHz, 836.4 MHz and 848.6 MHz. This frequency was recorded in MHz and deviation from nominal, in Parts Per Million.

After the initial one-hour soak at the beginning of the start of the measurement tests, a period of thirty minutes soak was initialized between each ascending temperature step, before proceeding to the next measurement test cycle.

PROCEDURE GSM 850

The test system software for commencing the Frequency Stability Tests carried through the following cycle.

15. Switch on the HP 6632B power supply; CMU 200 Communications Test Set, and Environmental Chamber.
16. Start test program
17. Set the Temperature to -30 degrees Celsius and maintain a period of one- hour soak time, with the EUT supply voltage disabled.
18. Set power supply voltage to 3.35 Volts
19. Set up CMU 200 Radio Communication Tester
20. Command the CMU 200 to switch to 824.2 MHz
21. Enable the voltage to the EUT, and connect a link to the CMU 200 test set
22. EUT is commanded to Transmit 100 Bursts
23. Software logs the following data from the CMU 200, power supply and temperature chamber: Traffic Channel Number, Traffic Channel Frequency, Power Level, Chamber Temperature, Supply Voltage, Power, Frequency Error.
24. The CMU 200 commands the EUT to change frequency to 836.4 and 848.6 MHz and repeats steps 21, to 23.
25. Repeat steps 19, to 24 changing the supply voltage to 3.8 Volts
26. Increase temperature by 10°C and soak for 1/2 hour.
27. Repeat steps 18 - 26 for temperatures -30 degrees to 60 degrees Celsius.
28. Repeat steps 19, to 24 changing the supply voltage to 4.7 Volts

Procedure 19, to 24 was repeated at room temperature (20°C) with the power supply voltage set to 3.35V, 3.8V, and 4.7 Volts

GSM 850 Channel results: 128, 189, & 250 @ 20°C maximum transmitted power

<i>Traffic Channel Number</i>	<i>GSM 850 Frequency (MHz)</i>	<i>PCL (dBm)</i>	<i>Voltage (Volts)</i>	<i>Temperature (Celsius)</i>	<i>Frequency Error (Hz)</i>	<i>PPM</i>
128	824.2	29	3.35	20	24.99	-0.0030
189	836.4	29	3.35	20	26.54	-0.0032
250	848.6	29	3.35	20	17.95	-0.0021

<i>Traffic Channel Number</i>	<i>GSM 850 Frequency (MHz)</i>	<i>PCL (dBm)</i>	<i>Voltage (Volts)</i>	<i>Temperature (Celsius)</i>	<i>Frequency Error (Hz)</i>	<i>PPM</i>
128	824.2	29	3.8	20	24.28	-0.0029
189	836.4	29	3.8	20	25.38	-0.0030
250	848.6	29	3.8	20	23.57	-0.0028

<i>Traffic Channel Number</i>	<i>GSM 850 Frequency (MHz)</i>	<i>PCL (dBm)</i>	<i>Voltage (Volts)</i>	<i>Temperature (Celsius)</i>	<i>Frequency Error (Hz)</i>	<i>PPM</i>
128	824.2	29	4.7	20	25.12	-0.0030
189	836.4	29	4.7	20	25.83	-0.0031
250	848.6	29	4.7	20	20.66	-0.0024

PCS Channel results: 512, 647, & 782 @ 20°C maximum transmitted power

<i>Traffic Channel Number</i>	<i>PCS Frequency (MHz)</i>	<i>PCL (dBm)</i>	<i>Voltage (Volts)</i>	<i>Temperature (Celsius)</i>	<i>Frequency Error (Hz)</i>	<i>PPM</i>
512	1850.2	30	3.35	20	24.92	-0.0013
647	1877.2	30	3.35	20	19.44	-0.0010
782	1904.2	30	3.35	20	-29.32	0.0015

<i>Traffic Channel Number</i>	<i>PCS Frequency (MHz)</i>	<i>PCL (dBm)</i>	<i>Voltage (Volts)</i>	<i>Temperature (Celsius)</i>	<i>Frequency Error (Hz)</i>	<i>PPM</i>
512	1850.2	30	3.8	20	19.57	-0.0011
647	1877.2	30	3.8	20	23.25	-0.0012
782	1904.2	30	3.8	20	29.25	-0.0015

<i>Traffic Channel Number</i>	<i>PCS Frequency (MHz)</i>	<i>PCL (dBm)</i>	<i>Voltage (Volts)</i>	<i>Temperature (Celsius)</i>	<i>Frequency Error (Hz)</i>	<i>PPM</i>
512	1850.2	30	4.7	20	-28.73	0.0016
647	1877.2	30	4.7	20	-21.18	0.0011
782	1904.2	30	4.7	20	-28.41	0.0015

Channel Results: 128 @ maximum transmitted power

<i>Traffic Channel Number</i>	<i>Frequency (MHz)</i>	<i>PCL (dBm)</i>	<i>Voltage (Volts)</i>	<i>Temperature (Celsius)</i>	<i>Frequency Error (Hz)</i>	<i>PPM</i>
128	824.2	29	3.35	-30	22.66	-0.0027
128	824.2	29	3.35	-20	26.54	-0.0032
128	824.2	29	3.35	-10	22.28	-0.0027
128	824.2	29	3.35	0	21.76	-0.0026
128	824.2	29	3.35	10	15.82	-0.0019
128	824.2	29	3.35	20	24.99	-0.0030
128	824.2	29	3.35	30	27.38	-0.0033
128	824.2	29	3.35	40	26.6	-0.0032
128	824.2	29	3.35	50	34.74	-0.0042
128	824.2	29	3.35	60	24.73	-0.0030

<i>Traffic Channel Number</i>	<i>Frequency (MHz)</i>	<i>PCL (dBm)</i>	<i>Voltage (Volts)</i>	<i>Temperature (Celsius)</i>	<i>Frequency Error (Hz)</i>	<i>PPM</i>
128	824.2	29	3.8	-30	23.18	-0.0028
128	824.2	29	3.8	-20	24.86	-0.0030
128	824.2	29	3.8	-10	24.09	-0.0029
128	824.2	29	3.8	0	23.83	-0.0029
128	824.2	29	3.8	10	24.6	-0.0030
128	824.2	29	3.8	20	24.28	-0.0029
128	824.2	29	3.8	30	21.5	-0.0026
128	824.2	29	3.8	40	15.69	-0.0019
128	824.2	29	3.8	50	31.77	-0.0039
128	824.2	29	3.8	60	20.92	-0.0025

<i>Traffic Channel Number</i>	<i>Frequency (MHz)</i>	<i>PCL (dBm)</i>	<i>Voltage (Volts)</i>	<i>Temperature (Celsius)</i>	<i>Frequency Error (Hz)</i>	<i>PPM</i>
128	824.2	29	4.7	-30	25.76	-0.0031
128	824.2	29	4.7	-20	21.5	-0.0026
128	824.2	29	4.7	-10	24.86	-0.0030
128	824.2	29	4.7	0	32.09	-0.0039
128	824.2	29	4.7	10	25.38	-0.0031
128	824.2	29	4.7	20	25.12	-0.0030
128	824.2	29	4.7	30	34.35	-0.0042
128	824.2	29	4.7	40	21.57	-0.0026
128	824.2	29	4.7	50	37.19	-0.0045
128	824.2	29	4.7	60	24.54	-0.0030

Channel Results: 189 @ maximum transmitted power

<i>Traffic Channel Number</i>	<i>Frequency (MHz)</i>	<i>PCL (dBm)</i>	<i>Voltage (Volts)</i>	<i>Temperature (Celsius)</i>	<i>Frequency Error (Hz)</i>	<i>PPM</i>
189	836.4	29	3.35	-30	-22.15	-0.0026
189	836.4	29	3.35	-20	16.79	-0.0020
189	836.4	29	3.35	-10	17.82	-0.0021
189	836.4	29	3.35	0	24.8	-0.0030
189	836.4	29	3.35	10	24.67	-0.0029
189	836.4	29	3.35	20	26.54	-0.0032
189	836.4	29	3.35	30	17.05	-0.0020
189	836.4	29	3.35	40	16.27	-0.0019
189	836.4	29	3.35	50	30.41	-0.0036
189	836.4	29	3.35	60	20.66	-0.0025

<i>Traffic Channel Number</i>	<i>Frequency (MHz)</i>	<i>PCL (dBm)</i>	<i>Voltage (Volts)</i>	<i>Temperature (Celsius)</i>	<i>Frequency Error (Hz)</i>	<i>PPM</i>
189	836.4	29	3.8	-30	-16.59	0.0020
189	836.4	29	3.8	-20	18.4	-0.0022
189	836.4	29	3.8	-10	16.21	-0.0019
189	836.4	29	3.8	0	-17.76	0.0021
189	836.4	29	3.8	10	22.54	-0.0027
189	836.4	29	3.8	20	25.38	-0.0030
189	836.4	29	3.8	30	18.79	-0.0022
189	836.4	29	3.8	40	18.98	-0.0023
189	836.4	29	3.8	50	31.51	-0.0038
189	836.4	29	3.8	60	19.57	-0.0023

<i>Traffic Channel Number</i>	<i>Frequency (MHz)</i>	<i>PCL (dBm)</i>	<i>Voltage (Volts)</i>	<i>Temperature (Celsius)</i>	<i>Frequency Error (Hz)</i>	<i>PPM</i>
189	836.4	29	4.7	-30	-14.14	0.0017
189	836.4	29	4.7	-20	19.44	-0.0023
189	836.4	29	4.7	-10	-13.5	0.0016
189	836.4	29	4.7	0	12.07	-0.0014
189	836.4	29	4.7	10	20.99	-0.0025
189	836.4	29	4.7	20	25.83	-0.0031
189	836.4	29	4.7	30	17.31	-0.0021
189	836.4	29	4.7	40	26.54	-0.0032
189	836.4	29	4.7	50	28.15	-0.0034
189	836.4	29	4.7	60	16.27	-0.0019

Channel Results: 250 @ maximum transmitted power

<i>Traffic Channel Number</i>	<i>Frequency (MHz)</i>	<i>PCL (dBm)</i>	<i>Voltage (Volts)</i>	<i>Temperature (Celsius)</i>	<i>Frequency Error (Hz)</i>	<i>PPM</i>
250	848.6	29	3.35	-30	-16.47	0.0019
250	848.6	29	3.35	-20	25.83	-0.0030
250	848.6	29	3.35	-10	20.66	-0.0024
250	848.6	29	3.35	0	19.95	-0.0024
250	848.6	29	3.35	10	16.01	-0.0019
250	848.6	29	3.35	20	17.95	-0.0021
250	848.6	29	3.35	30	22.47	-0.0026
250	848.6	29	3.35	40	-15.43	0.0018
250	848.6	29	3.35	50	22.54	-0.0027
250	848.6	29	3.35	60	15.56	-0.0018

<i>Traffic Channel Number</i>	<i>Frequency (MHz)</i>	<i>PCL (dBm)</i>	<i>Voltage (Volts)</i>	<i>Temperature (Celsius)</i>	<i>Frequency Error (Hz)</i>	<i>PPM</i>
250	848.6	29	3.8	-30	-17.89	0.0021
250	848.6	29	3.8	-20	24.6	-0.0029
250	848.6	29	3.8	-10	16.21	-0.0019
250	848.6	29	3.8	0	20.6	-0.0024
250	848.6	29	3.8	10	25.63	-0.0030
250	848.6	29	3.8	20	23.57	-0.0028
250	848.6	29	3.8	30	11.75	-0.0014
250	848.6	29	3.8	40	16.14	-0.0019
250	848.6	29	3.8	50	26.73	-0.0031
250	848.6	29	3.8	60	15.05	-0.0018

<i>Traffic Channel Number</i>	<i>Frequency (MHz)</i>	<i>PCL (dBm)</i>	<i>Voltage (Volts)</i>	<i>Temperature (Celsius)</i>	<i>Frequency Error (Hz)</i>	<i>PPM</i>
250	848.6	29	4.7	-30	16.27	-0.0019
250	848.6	29	4.7	-20	25.51	-0.0030
250	848.6	29	4.7	-10	19.63	-0.0023
250	848.6	29	4.7	0	32.09	-0.0039
250	848.6	29	4.7	10	19.82	-0.0023
250	848.6	29	4.7	20	20.66	-0.0024
250	848.6	29	4.7	30	11.49	-0.0014
250	848.6	29	4.7	40	15.56	-0.0018
250	848.6	29	4.7	50	28.61	-0.0034
250	848.6	29	4.7	60	21.5	-0.0025

Channel Results: 512 @ maximum transmitted power

<i>Traffic Channel Number</i>	<i>Frequency (MHz)</i>	<i>PCL (dBm)</i>	<i>Voltage (Volts)</i>	<i>Temperature (Celsius)</i>	<i>Frequency Error (Hz)</i>	<i>PPM</i>
512	1850.2	30	3.35	-30	-27.51	0.0015
512	1850.2	30	3.35	-20	26.22	-0.0014
512	1850.2	30	3.35	-10	-26.02	0.0014
512	1850.2	30	3.35	0	21.5	-0.0012
512	1850.2	30	3.35	10	-38.16	0.0021
512	1850.2	30	3.35	20	24.92	-0.0013
512	1850.2	30	3.35	30	16.85	-0.0009
512	1850.2	30	3.35	40	-18.02	0.0010
512	1850.2	30	3.35	50	-24.15	0.0013
512	1850.2	30	3.35	60	-27.7	0.0015

<i>Traffic Channel Number</i>	<i>Frequency (MHz)</i>	<i>PCL (dBm)</i>	<i>Voltage (Volts)</i>	<i>Temperature (Celsius)</i>	<i>Frequency Error (Hz)</i>	<i>PPM</i>
512	1850.2	30	3.8	-30	-41.07	0.0022
512	1850.2	30	3.8	-20	27.12	-0.0015
512	1850.2	30	3.8	-10	30.61	-0.0017
512	1850.2	30	3.8	0	33.38	-0.0018
512	1850.2	30	3.8	10	19.69	-0.0011
512	1850.2	30	3.8	20	19.57	-0.0011
512	1850.2	30	3.8	30	-23.05	0.0012
512	1850.2	30	3.8	40	-27.06	0.0015
512	1850.2	30	3.8	50	-18.14	0.0010
512	1850.2	30	3.8	60	26.02	-0.0014

<i>Traffic Channel Number</i>	<i>Frequency (MHz)</i>	<i>PCL (dBm)</i>	<i>Voltage (Volts)</i>	<i>Temperature (Celsius)</i>	<i>Frequency Error (Hz)</i>	<i>PPM</i>
512	1850.2	30	4.7	-30	-32.35	0.0017
512	1850.2	30	4.7	-20	28.73	-0.0016
512	1850.2	30	4.7	-10	-33.19	0.0018
512	1850.2	30	4.7	0	37.13	-0.0020
512	1850.2	30	4.7	10	-27.64	0.0015
512	1850.2	30	4.7	20	-28.73	0.0016
512	1850.2	30	4.7	30	22.66	-0.0012
512	1850.2	30	4.7	40	-16.98	0.0009
512	1850.2	30	4.7	50	-22.92	0.0012
512	1850.2	30	4.7	60	27.06	-0.0015

Channel Results: 647 @ maximum transmitted power

<i>Traffic Channel Number</i>	<i>Frequency (MHz)</i>	<i>PCL (dBm)</i>	<i>Voltage (Volts)</i>	<i>Temperature (Celsius)</i>	<i>Frequency Error (Hz)</i>	<i>PPM</i>
647	1877.2	30	3.35	-30	-39.52	0.0021
647	1877.2	30	3.35	-20	34.09	-0.0018
647	1877.2	30	3.35	-10	-22.34	0.0012
647	1877.2	30	3.35	0	33.84	-0.0018
647	1877.2	30	3.35	10	29.32	-0.0016
647	1877.2	30	3.35	20	19.44	-0.0010
647	1877.2	30	3.35	30	18.4	-0.0010
647	1877.2	30	3.35	40	-34.09	0.0018
647	1877.2	30	3.35	50	-31.58	0.0017
647	1877.2	30	3.35	60	-35.77	0.0019

<i>Traffic Channel Number</i>	<i>Frequency (MHz)</i>	<i>PCL (dBm)</i>	<i>Voltage (Volts)</i>	<i>Temperature (Celsius)</i>	<i>Frequency Error (Hz)</i>	<i>PPM</i>
647	1877.2	30	3.8	-30	29.83	-0.0016
647	1877.2	30	3.8	-20	-25.44	0.0014
647	1877.2	30	3.8	-10	-26.54	0.0014
647	1877.2	30	3.8	0	-21.5	0.0011
647	1877.2	30	3.8	10	25.05	-0.0013
647	1877.2	30	3.8	20	23.25	-0.0012
647	1877.2	30	3.8	30	-23.5	0.0013
647	1877.2	30	3.8	40	-28.35	0.0015
647	1877.2	30	3.8	50	32.22	-0.0017
647	1877.2	30	3.8	60	22.99	0.0012

<i>Traffic Channel Number</i>	<i>Frequency (MHz)</i>	<i>PCL (dBm)</i>	<i>Voltage (Volts)</i>	<i>Temperature (Celsius)</i>	<i>Frequency Error (Hz)</i>	<i>PPM</i>
647	1877.2	30	4.7	-30	-48.3	0.0026
647	1877.2	30	4.7	-20	24.15	-0.0013
647	1877.2	30	4.7	-10	24.21	-0.0013
647	1877.2	30	4.7	0	-25.25	0.0013
647	1877.2	30	4.7	10	-21.57	0.0011
647	1877.2	30	4.7	20	-21.18	0.0011
647	1877.2	30	4.7	30	23.89	-0.0013
647	1877.2	30	4.7	40	19.89	-0.0011
647	1877.2	30	4.7	50	-21.7	0.0012
647	1877.2	30	4.7	60	30.99	-0.0014

Channel Results: 782 @ maximum transmitted power

<i>Traffic Channel Number</i>	<i>Frequency (MHz)</i>	<i>PCL (dBm)</i>	<i>Voltage (Volts)</i>	<i>Temperature (Celsius)</i>	<i>Frequency Error (Hz)</i>	<i>PPM</i>
782	1904.2	30	3.35	-30	-40.23	0.0021
782	1904.2	30	3.35	-20	-23.7	0.0012
782	1904.2	30	3.35	-10	-26.93	0.0014
782	1904.2	30	3.35	0	-23.5	0.0012
782	1904.2	30	3.35	10	-28.8	0.0015
782	1904.2	30	3.35	20	-29.32	0.0015
782	1904.2	30	3.35	30	-26.8	0.0014
782	1904.2	30	3.35	40	-39.39	0.0021
782	1904.2	30	3.35	50	-28.86	0.0015
782	1904.2	30	3.35	60	-40.68	0.0021

<i>Traffic Channel Number</i>	<i>Frequency (MHz)</i>	<i>PCL (dBm)</i>	<i>Voltage (Volts)</i>	<i>Temperature (Celsius)</i>	<i>Frequency Error (Hz)</i>	<i>PPM</i>
782	1904.2	30	3.8	-30	-31.25	0.0016
782	1904.2	30	3.8	-20	-19.89	0.0010
782	1904.2	30	3.8	-10	-33.84	0.0018
782	1904.2	30	3.8	0	33.38	-0.0018
782	1904.2	30	3.8	10	19.31	-0.0010
782	1904.2	30	3.8	20	29.25	-0.0015
782	1904.2	30	3.8	30	-31.58	0.0017
782	1904.2	30	3.8	40	-29.7	0.0016
782	1904.2	30	3.8	50	19.18	-0.0010
782	1904.2	30	3.8	60	20.34	-0.0011

<i>Traffic Channel Number</i>	<i>Frequency (MHz)</i>	<i>PCL (dBm)</i>	<i>Voltage (Volts)</i>	<i>Temperature (Celsius)</i>	<i>Frequency Error (Hz)</i>	<i>PPM</i>
782	1904.2	30	4.7	-30	-32.35	0.0017
782	1904.2	30	4.7	-20	-25.57	0.0013
782	1904.2	30	4.7	-10	-30.28	0.0016
782	1904.2	30	4.7	0	25.31	-0.0013
782	1904.2	30	4.7	10	-26.28	0.0014
782	1904.2	30	4.7	20	-28.41	0.0015
782	1904.2	30	4.7	30	23.89	-0.0013
782	1904.2	30	4.7	40	20.73	-0.0011
782	1904.2	30	4.7	50	-29.19	0.0015
782	1904.2	30	4.7	60	26.35	-0.0014

APPENDIX 4

RADIATED EMISSIONS TEST DATA

Radiated Emissions Test Data Results

										Substitution Method				
EUT				Rx Antenna		Spectrum Analyzer			Tracking Gen					
Type	Ch	Freq (MHz)	Band	Type	Pol	Dist (m)	Reading (dBuV)	Corrected Reading (dBuV)	Max (V,H)	Reading (dBm)	Corrected Reading (relative to dipole)	Pol	Limit	Diff to Limit (dB)
PCS Band (EIRP)														
F0	512	1850.20	1900	Horn	V	3	87.5	87.5	87.5	-6.3	25.96	VV	33	-7.04
F0	512	1850.20	1900	Horn	H	3	77.8	77.8		-5.3		HH		
F0	661	1880.00	1900	Horn	V	3	86.7	86.7	86.7	-6.8	25.76	VV	33	-7.24
F0	661	1880.00	1900	Horn	H	3	79.4	79.4		-5.5		HH		
F0	810	1909.80	1900	Horn	V	3	84.6	84.6	84.6	-8	24.36	VV	33	-8.64
F0	810	1909.80	1900	Horn	H	3	83.4	83.4		-6.9		HH		
PCS Band - Harmonics														
Low Channel														
2nd	512	3700.4	1900	Horn	V	3	NF	NF	0	---		VV	-13	1
2nd	512	3700.4	1900	Horn	H	3	NF	NF		---		HH		
3rd	512	5550.6	1900	Horn	V	3	NF	NF	0			VV	-13	-
3rd	512	5550.6	1900	Horn	H	3	NF	NF				HH		
4th	512	7400.8	1900	Horn	V	3	NF	NF	0			VV	-13	-
4th	512	7400.8	1900	Horn	H	3	NF	NF				HH		
5th	512	9251.0	1900	Horn	V	3	NF	NF	0			VV	-13	-
5th	512	9251.0	1900	Horn	H	3	NF	NF				HH		
6th	512	11101.2	1900	Horn	V	3	NF	NF	0			VV	-13	-
6th	512	11101.2	1900	Horn	H	3	NF	NF				HH		
7th	512	12951.4	1900	Horn	V	3	NF	NF	0			VV	-13	-
7th	512	12951.4	1900	Horn	H	3	NF	NF				HH		
8th	512	14801.6	1900	Horn	V	3	NF	NF	0			VV	-13	-
8th	512	14801.6	1900	Horn	H	3	NF	NF				HH		
9th	512	16651.8	1900	Horn	V	3	NF	NF	0			VV	-13	-
9th	512	16651.8	1900	Horn	H	3	NF	NF				HH		
10th	512	18502.0	1900	Horn	V	3	NF	NF	0			VV	-13	-
10th	512	18502.0	1900	Horn	H	3	NF	NF				HH		

Radiated Emissions Test Data Results Con't

										Substitution Method				
EUT				Rx Antenna			Spectrum Analyzer			Tracking Gen				
Type	Ch	Freq (MHz)	Band	Type	Pol	Dist (m)	Reading (dBuV)	Corrected Reading (dBuV)	Max (V,H)	Reading (dBm)	Corrected Reading (relative to dipole)	Pol	Limit	Diff to Limit (dB)
Middle Channel														
2nd	661	3760	1900	Horn	V	3	NF	NF	0	---		VV	-13	-
2nd	661	3760	1900	Horn	H	3	NF	NF		---		HH		
3rd	661	5640	1900	Horn	V	3	NF	NF	0			VV	-13	-
3rd	661	5640	1900	Horn	H	3	NF	NF				HH		
4th	661	7520	1900	Horn	V	3	NF	NF	0			VV	-13	-
4th	661	7520	1900	Horn	H	3	NF	NF				HH		
5th	661	9400	1900	Horn	V	3	NF	NF	0			VV	-13	-
5th	661	9400	1900	Horn	H	3	NF	NF				HH		
6th	661	11280	1900	Horn	V	3	NF	NF	0			VV	-13	-
6th	661	11280	1900	Horn	H	3	NF	NF				HH		
7th	661	13160	1900	Horn	V	3	NF	NF	0			VV	-13	-
7th	661	13160	1900	Horn	H	3	NF	NF				HH		
8th	661	15040	1900	Horn	V	3	NF	NF	0			VV	-13	-
8th	661	15040	1900	Horn	H	3	NF	NF				HH		
9th	661	16920	1900	Horn	V	3	NF	NF	0			VV	-13	-
9th	661	16920	1900	Horn	H	3	NF	NF				HH		
10th	661	18800	1900	Horn	V	3	NF	NF	0			VV	-13	-
10th	661	18800	1900	Horn	H	3	NF	NF				HH		
High Channel														
2nd	810	3819.6	1900	Horn	V	3	NF	NF	0	---		VV	-13	-
2nd	810	3819.6	1900	Horn	H	3	NF	NF		---		HH		
3rd	810	5729.4	1900	Horn	V	3	NF	NF	0			VV	-13	-
3rd	810	5729.4	1900	Horn	H	3	NF	NF				HH		
4th	810	7639.2	1900	Horn	V	3	NF	NF	0			VV	-13	-
4th	810	7639.2	1900	Horn	H	3	NF	NF				HH		

Radiated Emissions Test Data Results Con't

										Substitution Method				
EUT				Rx Antenna			Spectrum Analyzer			Tracking Gen				
Type	Ch	Freq (MHz)	Band	Type	Pol	Dist (m)	Reading (dBuV)	Corrected Reading (dBuV)	Max (V,H)	Reading (dBm)	Corrected Reading (relative to dipole)	Pol	Limit	Diff to Limit (dB)
5th	810	9549.0	1900	Horn	V	3	NF	NF	0			VV	-13	-
5th	810	9549.0	1900	Horn	H	3	NF	NF				HH		
6th	810	11458.8	1900	Horn	V	3	NF	NF	0			VV	-13	-
6th	810	11458.8	1900	Horn	H	3	NF	NF				HH		
7th	810	13368.6	1900	Horn	V	3	NF	NF	0			VV	-13	-
7th	810	13368.6	1900	Horn	H	3	NF	NF				HH		
8th	810	15278.4	1900	Horn	V	3	NF	NF	0			VV	-13	-
8th	810	15278.4	1900	Horn	H	3	NF	NF				HH		
9th	810	17188.2	1900	Horn	V	3	NF	NF	0			VV	-13	-
9th	810	17188.2	1900	Horn	H	3	NF	NF				HH		
10th	810	19098.0	1900	Horn	V	3	NF	NF	0			VV	-13	-
10th	810	19098.0	1900	Horn	H	3	NF	NF				HH		
GSM850 Band (ERP)														
F0	128	824.20	850	Dipole	V	3	84.3	84.3	84.3	10.2	27.2	VV	30.0	-2.8
F0	128	824.20	850	Dipole	H	3	76.2	76.2		8.3		HH		
F0	195	837.60	850	Dipole	V	3	85	85	85	11.3	28.3	VV	30.0	-1.7
F0	195	837.60	850	Dipole	H	3	76	76		9.4		HH		
F0	251	848.80	850	Dipole	V	3	84.4	84.4	84.4	10.7	27.7	VV	30.0	-2.3
F0	251	848.80	850	Dipole	H	3	75.8	75.8		8.8		HH		

Radiated Emissions Test Data Results Con't

											Substitution Method				
EUT				Rx Antenna			Spectrum Analyzer				Tracking Gen				
Type	Ch	Freq (MHz)	Band		Type	Pol	Dist (m)	Reading (dBuV)	Corrected Reading (dBuV)	Max (V,H)	Reading (dBm)	Corrected Reading (relative to dipole)	Pol	Limit	Diff to Limit (dB)
GSM850 Band (Harmonics)															
Low Channel															
2nd	128	1648.4	850		Horn	V	3	48.7	48.7	48.7	-42.6	-40.95	VV	-13	-28.0
2nd	128	1648.4	850		Horn	H	3	45.4	45.4		-41.2		HH		
3rd	128	2472.6	850		Horn	V	3	NF	NF	0			VV	-13	-
3rd	128	2472.6	850		Horn	H	3	NF	NF				HH		
4th	128	3296.8	850		Horn	V	3	NF	NF	0			VV	-13	-
4th	128	3296.8	850		Horn	H	3	NF	NF				HH		
5th	128	4121.0	850		Horn	V	3	NF	NF	NF	0		VV		
5th	128	4121.0	850		Horn	H	3	NF	NF	NF			HH		--
6th	128	4945.2	850		Horn	V	3	NF	NF	NF	0		VV		
6th	128	4945.2	850		Horn	H	3	NF	NF	NF			HH		-
7th	128	5769.4	850		Horn	V	3	NF	NF	NF	0		VV		
7th	128	5769.4	850		Horn	H	3	NF	NF	NF			HH		-
8th	128	6593.6	850		Horn	V	3	NF	NF	NF	0		VV		
8th	128	6593.6	850		Horn	H	3	NF	NF	NF			HH		-
9th	128	7417.8	850		Horn	V	3	NF	NF	NF	0		VV		
9th	128	7417.8	850		Horn	H	3	NF	NF	NF			HH		-
10th	128	8242.0	850		Horn	V	3	NF	NF	NF	0		VV		
10th	128	8242.0	850		Horn	H	3	NF	NF	NF			HH		-

Radiated Emissions Test Data Results Con't

											Substitution Method				
EUT				Rx Antenna			Spectrum Analyzer				Tracking Gen				
Type	Ch	Freq (MHz)	Band		Type	Pol	Dist (m)	Reading (dBuV)	Corrected Reading (dBuV)	Max (V,H)	Reading (dBm)	Corrected Reading (relative to dipole)	Pol	Limit	Diff to Limit (dB)
GSM850 Band (Harmonics)															
Middle Channel															
2nd	195	1675.2	850		Horn	V	3	52.8	52.8	52.8	-38.5	-37.05	VV	-13	-24.1
2nd	195	1675.2	850		Horn	H	3	49.2	49.2		-37.3		HH		
3rd	195	2512.8	850		Horn	V	3	NF	NF	0			VV	-13	-
3rd	195	2512.8	850		Horn	H	3	NF	NF				HH		
4th	195	3350.4	850		Horn	V	3	NF	NF	0			VV	-13	-
4th	195	3350.4	850		Horn	H	3	NF	NF				HH		
5th	195	4188.0	850		Horn	V	3	NF	NF	0			VV		-
5th	195	4188.0	850		Horn	H	3	NF	NF				HH		
6th	195	5025.6	850		Horn	V	3	NF	NF	0			VV		-
6th	195	5025.6	850		Horn	H	3	NF	NF				HH		
7th	195	5863.2	850		Horn	V	3	NF	NF	0			VV		-
7th	195	5863.2	850		Horn	H	3	NF	NF				HH		
8th	195	6700.8	850		Horn	V	3	NF	NF	0			VV		-
8th	195	6700.8	850		Horn	H	3	NF	NF				HH		
9th	195	7538.4	850		Horn	V	3	NF	NF	0			VV		-
9th	195	7538.4	850		Horn	H	3	NF	NF				HH		
10th	195	8376.0	850		Horn	V	3	NF	NF	0			VV		-
10th	195	8376.0	850		Horn	H	3	NF	NF				HH		

Radiated Emissions Test Data Results Con't

											Substitution Method				
EUT				Rx Antenna			Spectrum Analyzer				Tracking Gen				
Type	Ch	Freq (MHz)	Band		Type	Pol	Dist (m)	Reading (dBuV)	Corrected Reading (dBuV)	Max (V,H)	Reading (dBm)	Corrected Reading (relative to dipole)	Pol	Limit	Diff to Limit (dB)
GSM850 Band (Harmonics)															
High Channel															
2nd	251	1697.6	850		Horn	V	3	51.2	51.2	51.2	-38.8	-37.55	VV	-13	-24.6
2nd	251	1697.6	850		Horn	H	3	47.8	47.8		-37.8		HH		
3rd	251	2546.4	850		Horn	V	3	NF	NF	0			VV	-13	-
3rd	251	2546.4	850		Horn	H	3	NF	NF				HH		
4th	251	3395.2	850		Horn	V	3	NF	NF	0			VV	-13	-
4th	251	3395.2	850		Horn	H	3	NF	NF				HH		
5th	251	4244.0	850		Horn	V	3	NF	NF	NF	0		VV	-13	-
5th	251	4244.0	850		Horn	H	3	NF	NF	NF			HH		
6th	251	5092.8	850		Horn	V	3	NF	NF	NF	0		VV	-13	-
6th	251	5092.8	850		Horn	H	3	NF	NF	NF			HH		
7th	251	5941.6	850		Horn	V	3	NF	NF	NF	0		VV	-13	-
7th	251	5941.6	850		Horn	H	3	NF	NF	NF			HH		
8th	251	6790.4	850		Horn	V	3	NF	NF	NF	0		VV	-13	-
8th	251	6790.4	850		Horn	H	3	NF	NF	NF			HH		
9th	251	7639.2	850		Horn	V	3	NF	NF	NF	0		VV	-13	-
9th	251	7639.2	850		Horn	H	3	NF	NF	NF			HH		
10th	251	8488.0	850		Horn	V	3	NF	NF	NF	0		VV	-13	-
10th	251	8488.0	850	V	Horn	H	3	NF	NF	NF			HH		

Radiated Emissions Test Photo con't

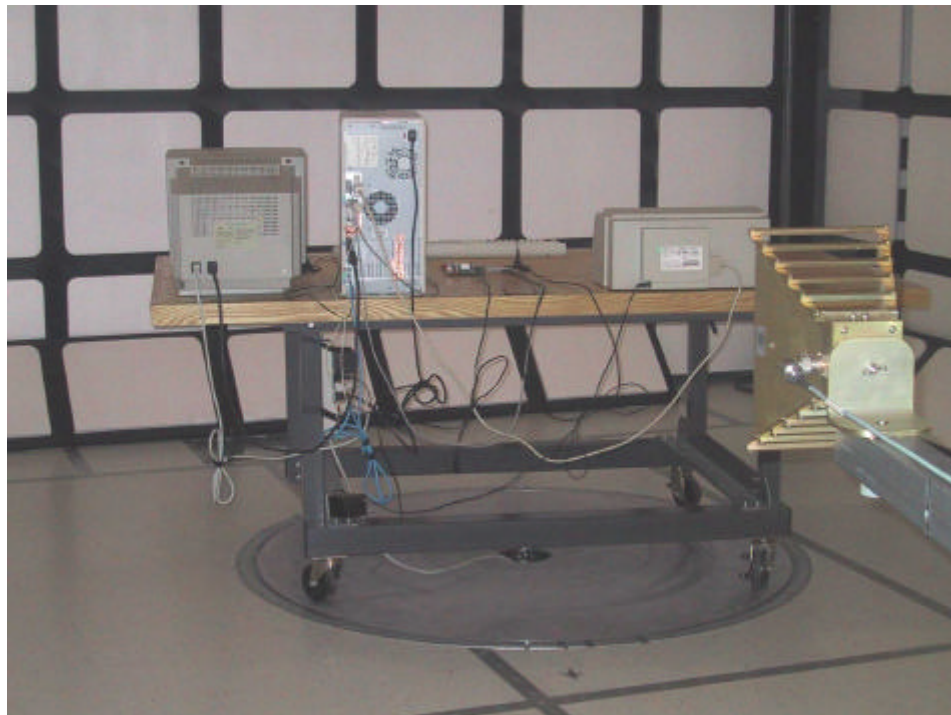
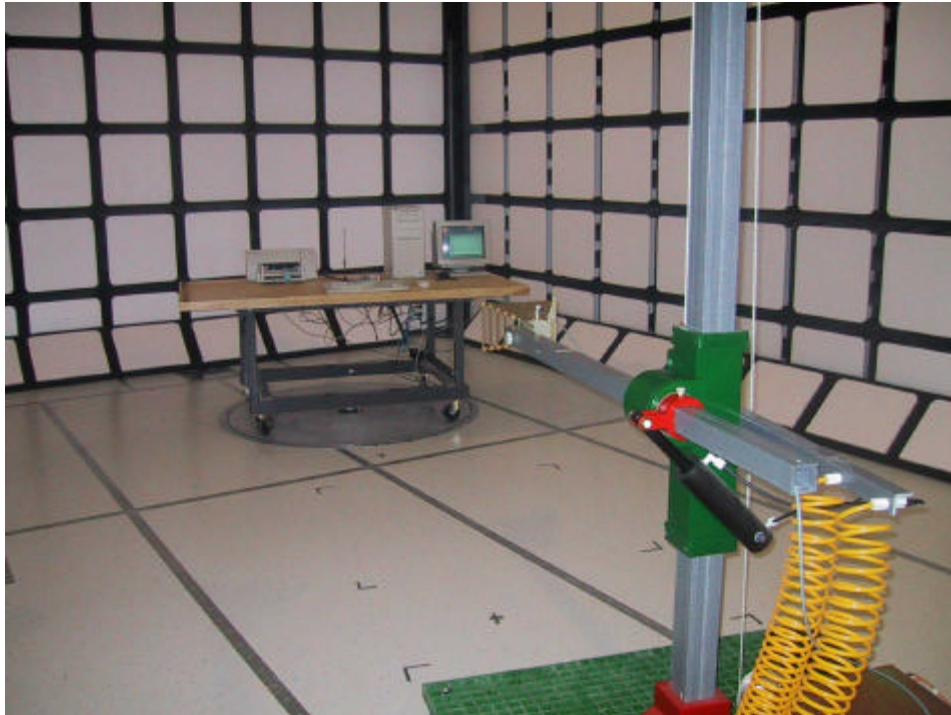

Radiated Emissions at 3.0 metres