



# iX104C5 USER'S HANDBOOK





# Contents

---

<b>Welcome</b>	<b>13</b>
About your computer . . . . .	14
Package contents . . . . .	15
Optional accessories . . . . .	15
Contacting Xplore – service and questions . . . . .	17
<b>1 Getting Started</b>	<b>19</b>
Front view . . . . .	19
Back view . . . . .	20
Left side view . . . . .	21
Right side view . . . . .	22
Bottom view . . . . .	23
Top view . . . . .	23
LED indicators . . . . .	24
Quick-start guide . . . . .	26
Application, Windows, and hot keys . . . . .	26
<b>2 Using the Tablet</b>	<b>29</b>
Turning on the computer . . . . .	29
Turning off the computer . . . . .	30
Using the Reset switch . . . . .	30
Suspending and resuming operation . . . . .	31
Suspending operation . . . . .	32
Resuming operation . . . . .	33

Using the pen . . . . .	34
Using the digitizer to perform mouse functions. . . . .	35
Changing the pen double-click speed . . . . .	35
Positioning the pen and pen tether . . . . .	36
Using the fingerprint scanner . . . . .	38
Changing the screen orientation . . . . .	39
Adjusting the screen brightness. . . . .	40
Enabling automatic backlight control . . . . .	41
Optimizing screen settings for outdoor use . . . . .	41
Docking the tablet . . . . .	42
Connecting devices . . . . .	43
Connecting to a local area network . . . . .	43
Connecting USB-compatible devices . . . . .	43
Connecting an external microphone . . . . .	44
Adjusting microphone volume . . . . .	44
Connecting a headphone or speakers. . . . .	45
Adjusting headphone or speaker volume . . . . .	45
Connecting a monitor or projection panel (optional). . . . .	46
Activating the monitor or projection panel. . . . .	46
Connecting a device to the serial port (standard). . . . .	47
Connecting an XPL expansion module . . . . .	47
Using the battery . . . . .	48
Charging the battery pack . . . . .	48
If you do not have an external battery charger . . . . .	48
If you have an external battery charger . . . . .	49
Removing and installing the battery . . . . .	49
Removing the battery . . . . .	49
Installing the battery . . . . .	51
Discarding batteries . . . . .	51

Using power options . . . . .	52
Displaying power options . . . . .	52
Checking battery power status . . . . .	52
Selecting a power plan . . . . .	53
Selecting power options . . . . .	54
Selecting Power (On/Off)/Backlight(On/Off)/Sleep/ Resume button options . . . . .	55
Tips for conserving battery power . . . . .	56
Accessing the Solid State Drive (SSD) cartridge . . . . .	57
Re-installing the drive carrier . . . . .	58
Accessing the MicroSD and SIM compartment . . . . .	59
Programming hot keys . . . . .	60
Programming hot keys to start applications, open documents, or go to a website . . . . .	<b>61</b>
Programming hot keys to perform pre-defined functions . . . . .	65
Programming hot keys to perform other key functions . . . . .	67

---

**3      Maintaining the Tablet      71**

Caring for the tablet. . . . .	71
Checking power cords and connectors. . . . .	71
Protecting the computer from damage . . . . .	71
Preventing the computer from overheating . . . . .	72
Storing the computer . . . . .	73
Caring for the display screen . . . . .	73
Protecting the display screen . . . . .	73
When to replace the pen . . . . .	74
Calibrating the digitizer. . . . .	75

<b>A</b>	<b>Troubleshooting</b>	<b>77</b>
<hr/>		
<b>B</b>	<b>Using BIOS and AOS Functions</b>	<b>79</b>
<hr/>		
	Disabling the Auto Power feature . . . . .	80
	Enabling automatic LCD backlight control . . . . .	80
<b>C</b>	<b>Glossary</b>	<b>81</b>
<hr/>		
<b>D</b>	<b>Hardware Specifications</b>	<b>87</b>
<hr/>		
<b>E</b>	<b>Agency Notices</b>	<b>93</b>
<hr/>		

## Disclaimer

---

Xplore Technologies® has made every effort to ensure the accuracy and completeness of this document; however, because ongoing development efforts are made to continually improve the capabilities of our products, we cannot guarantee the accuracy of the contents of this document. We disclaim liability for errors, omissions, or future changes herein.

## Trademarks

---

Xplore and the Xplore logo are registered trademarks of Xplore Technologies Corp.; iX104, iX104C5, iX104C5 Lite, and iX104C5 Dual Mode are trademarks of Xplore Technologies Corp. Kensington and MicroSaver are registered trademarks of the Kensington Technology Group. Microsoft is a registered trademark of Microsoft Corporation. Windows 7, Windows XP Professional, and Windows XP Tablet PC Edition are trademarks of Microsoft Corporation. MicroSD is registered trademark of the Personal Computer Memory Card International Association. Intel and iCore, are registered trademarks of Intel Corporation. Wi-Fi is a trademark of the Wireless Ethernet Compatibility Alliance (WECA). ISODAMP is a registered trademark of Aeero Company.

All other brands, product names, company names, trademarks and service marks used herein are property of their respective companies.

## Copyright

---

Copyright © 2003-2011 Xplore Technologies Corp. All rights reserved. No part of this publication may be copied, reproduced, or translated, without the prior written consent of Xplore Technologies. No part of this publication may be stored or transmitted in any electronic form without the prior consent of Xplore Technologies. Any unauthorized use is a violation of copyright laws.

## Publication information

---

PN: 95-01097, Rev. A  
August 2011

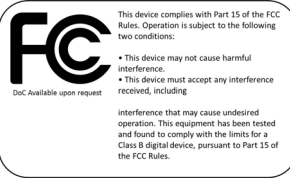

## Declaration of conformity

---

DECLARATION OF CONFORMITY according to FCC Part 15, IC ICES-003, and RTT&E directives

Responsible Party Name: Xplore Technologies Corp.

Address: 14000 Summit Drive, Suite 900, Austin, Texas 78728

Telephone: 512.336.7797

Declares that product: Model Series: iX104C5 complies with Part 15 of the FCC Rules.

This device complies with Part 15 of the FCC rules. Operation is subject to the following two conditions: (1) This device may not cause harmful interference, and, (2)

This device must accept any interference received, including interference that may cause undesired operation.



### **WARNING**

*Changes or modifications to this unit not expressly approved by the party responsible for compliance may void the user's authority to operate this equipment.*

For more information about FCC rules and their applicability to the iX104, see Appendix E, "Agency Notices."

## Energy Star Partner

---



## Warranty information

---

The iX104C5 is backed by a standard 36-month International Limited Warranty. An extended International Limited Warranty is available. Check the service kit included with your computer for warranty terms and conditions.



## Important safety information

---

**Before you use the iX104C5 (referred to as the *tablet*), read these safety instructions and the operation instructions in this handbook.**

**Failure to observe all these instructions voids the Limited Warranty and may lead to suspension or denial of services to the offender, or legal action, or both.**

Follow any special regulations governing the use of the tablet and, if radio-enabled, always switch it off in areas where radio devices are forbidden or when the radio device can cause interference or danger.

Always follow any safety laws and regulations pertaining to the use of cell phones and two-way radios, because these laws and regulations typically apply to the use of the wireless-enabled tablet.

Observe all restrictions on the use of radio equipment in fuel depots (fuel storage and distribution areas), chemical plants, and wherever blasting operations are in progress or in any area in which restrictions on radio transmissions are imposed.

Switch off the tablet when in an aircraft. The tablet is not FAA-approved for use on aircraft. The effect of the use of the tablet in aircraft is unknown. Using the tablet in an aircraft may affect aircraft instrumentation, communication, and performance; may disrupt the network; and may be illegal.

Operating the wireless-enabled tablet may interfere with the functioning of inadequately protected medical devices such as pacemakers. Consult a physician or the manufacturer of the medical device if you have any questions.

Radio signals from your tablet will not affect the operation of most modern equipment, but certain electronic equipment, including automotive systems, may not be shielded against radio signals from your tablet. Check with the manufacturer of your motor vehicle or the manufacturer's representative to determine whether using the tablet will present any safety issues.

Avoid using the tablet in any environment that requires your full attention, such as when driving a vehicle. If you need to use your tablet while driving, have a passenger use it for you or find a safe location to halt your vehicle.



### **WARNING – BATTERIES**

*Use only battery types specified in this handbook. Using any other type of battery can be dangerous and can disable the tablet. Do not drop or mishandle the batteries, immerse them in water, or subject them to high heat. Doing so could increase the risk of explosion or leakage, and possibly cause injury. The lithium-ion batteries used in this equipment contain material that is hazardous to your health. If battery contents come in contact with the eyes, IMMEDIATELY flush the affected area with clean water for 15 minutes and have someone else summon medical attention for you. Unaffected persons should assist the affected individual in the vital first flushing of the eyes. RECHARGING THE BATTERY MUST ONLY BE CARRIED OUT IN ANON-HAZERDOUS AREA USING THE SUPPLIED AC ADAPTOR. The definition of hazardous areas can be found in Standard EN 60079-10.*

**WARNING**



*When operating the tablet in a known explosive environment do not remove or replace the battery while the circuit is live. Before removing the battery verify that the area is known to be free of ignitable concentrations of flammable substances.*

**EXPLOSION HAZARD – DO NOT DISCONNECT WHILE CIRCUIT IS LIVE UNLESS AREA IS KNOWN TO BE NON-HAZARDOUS.**

**AVERISSEMENT – RISQUE D'EXPLOSION. NE PAS DÉBRANCHER TANT QUE LE CIRCUIT EST SOUS TENSION, À MOINS QU'IL NE S'AGISSE D'UN EMPLACEMENT NON DANGEREUX.**

**WARNING**



*EXPLOSION HAZARD – DO NOT REPLACE THE BATTERY UNLESS POWER HAS BEEN SWITCHED OFF OR THE AREA IS KNOWN TO BE NON-HAZARDOUS.*

**AVERTISSEMENT – RISQUE D'EXPLOSION – COUPER LE COURANT OU S'ASSURER QUE L'EMPLACEMENT EST DESIGNÉ NON DANGEREUX AVANT DE REPLACER LE BATTERY.**

**WARNING**



*EXPLOSION HAZARD - SUBSTITUTION OF COMPONENTS MAY IMPAIR SUITABILITY FOR CLASS I, DIVISION 2.*

**AVERTISSEMENT – RISQUE D'EXPLOSION – LA SUBSTITUTION D'E COMPOSANTS PEUT ENDRE CE MATÉRIEL INACCEPTABLE POUR LES EMPLACEMENTS DE CLASSE I, DIVISION 2.**

**WARNING**



*EXPLOSION HAZARD – DO NOT DISCONNECT EQUIPMENT UNLESS POWER HAS BEEN SWITCHED OFF OR THE AREA IS KNOWN TO BE NON-HAZARDOUS.*

**AVERTISSEMENT – RISQUE D'EXPLOSION – AVANT DE DECONNECTER L'EQUIPEMENT, COUPER LE COURANT OU S'ASSURER QUE L'EMPLACEMENT EST DESIGNÉ NON DANGEREUX.**

**WARNING**



*Do not use any dock or any other accessory or attachment that is not manufactured or supplied by Xplore or an authorized Xplore accessories supplier. Use of any accessory or attachment that is not supplied or approved for use with the tablet by Xplore is not permitted because it may cause hazards.*

Operate the tablet only from the type of power source indicated on the marking label. (See page 48 for more information about the battery and power supply.) Route power supply cords so that they are not likely to be walked on or pinched by items placed upon or against them. Pay particular attention to cords at plugs and convenience receptacles, and at the point where cords exit from the tablet or its dock. Do not overload wall outlets, extension cords, or integral convenience receptacles because this can cause fire or electric shock.

Unplug the tablet and refer the tablet and dock for service to qualified service personnel if any of the following conditions occur:

- The power supply cord or plug is damaged.
- The tablet or dock does not operate normally when you follow the instructions in this book.
- The tablet or dock exhibits a distinct change in performance.

Adjust only controls for which there are instructions in this book. An improper adjustment of other controls can result in damage and may require extensive work by a qualified technician to restore the tablet or dock to normal operation.



**CAUTION**

***Avoid prolonged physical contact with the exposed metal surfaces on the front and back of the tablet. While the tablet may not feel hot to the touch, if you maintain physical contact with the tablet for a long time (for example, if you rest the tablet on your lap for a long time), your skin may suffer low-heat injury. In addition, be careful when you remove a PC card that has been used for a long time, because the card may be hot.***



## Welcome

---

Welcome to the Xplore Technologies® iX104C5™ tablet PC, the rugged tablet designed, tested, and manufactured to meet the environmental and physical real-world challenges faced by today's mobile workers. Based on years of experience in rugged mobile applications, the iX104C5 is designed to withstand the abuses of everyday wear and tear.

Advanced technology, innovative design, and a rugged case are just a few highlights of your iX104C5 system.



*Tablet with enhanced performance antenna*

---

**Note:** This handbook assumes that you have basic experience using computers and Microsoft® Windows®.

---

## About your computer

---

The iX104C5 is a high-performance tablet PC that runs on Microsoft Windows 7 32-bit and 64-bit operating systems.

You can use any of the following methods to control the tablet:

- Special, enhanced pen (included with the tablet)
- Your finger
- Any suitable pointing device

---

**Note:** In this handbook, all information applies to all models unless otherwise noted.

---

All iX104C5 tablets have been engineered and tested to meet Military Standards for Environmental Extremes (MIL STD 810G). Your tablet includes the following features that make it exceptionally rugged and durable:

- Durable, long-lasting, rigid magnesium enclosure
- Interior and exterior multi-layer magnesium structure
- Bumper system and gasket protection mechanisms
- Specialized drive technology
- Removable, dual, Solid State Drive (SSD) cartridge
- Integrated, protected wireless LAN and WAN antennas for dual mode operation
- Locked-in-place memory, cables, and connectors
- Proprietary thermal management system

## Package contents

---

Check to make sure your package includes the following items:

- Quick Start Guide
- Battery pack
- Power cord
- AC adapter
- Pen (attached to tablet)
- Pen tether (attached to tablet)
- iX104C5 tablet PC
- Warranty information kit
- Operating System Recovery Guide

## Optional accessories

---

Your package also includes any optional accessories you ordered.

### ***Docking options***

- xStand Desktop Docking Station
- xDock Vehicle Docking Station

### ***Carrying cases***

- Shoulder cases
- Portfolio case
- Dockable case

### ***Memory***

- 2, 4, or 8 GB RAM
- 40, 80, or more GB Solid State Drive (SSD)

### ***Power options***

- AC adapter with U.S. cord
- Weight-reduced battery pack (56 watt hours)
- Extended life battery pack (68.5 watt hours)
- Auto adapter (cigarette lighter adapter)

### ***Additional accessories***

- Top-mounted Fast-Lock GPS II Pro (submeter accuracy)
- Non-rugged USB optical disk drive
- USB rugged, backlit keyboard (83-key)
- Replaceable drive cartridges
- Active stylus



---

## Contacting Xplore – service and questions

---

**Note:** To troubleshoot problems (including wireless and GPS problems), before you call, read the FAQ page of the Xplore Technologies Web site. Go to <http://www.xploretech.com>; then select **Customer Support**; then **FAQ**.

---

If you purchased your tablet from an authorized Xplore dealer, contact the dealer for service and support.

If you purchased your tablet directly from Xplore, use any of the following methods to contact Xplore for service and support:

---

Web site	<a href="http://www.xploretech.com">http://www.xploretech.com</a>
E-mail	<a href="mailto:customersupport@xploretech.com">customersupport@xploretech.com</a>
Toll free	1-866-296-8541, extension 222
Fax	1-512-336-7791

---

Before you contact Xplore, have the following information ready so that the customer support representative can quickly provide a solution:

---

Product name: iX104C5

---

Product serial number

---

Purchase date

---

Conditions under which the problem occurred

---

Any error messages that were displayed

---

Type of device connected, if any

---



# 1

## Getting Started

---

This chapter gives you an overview of your tablet and includes a quick-start guide to tablet keys.

### Front view

---

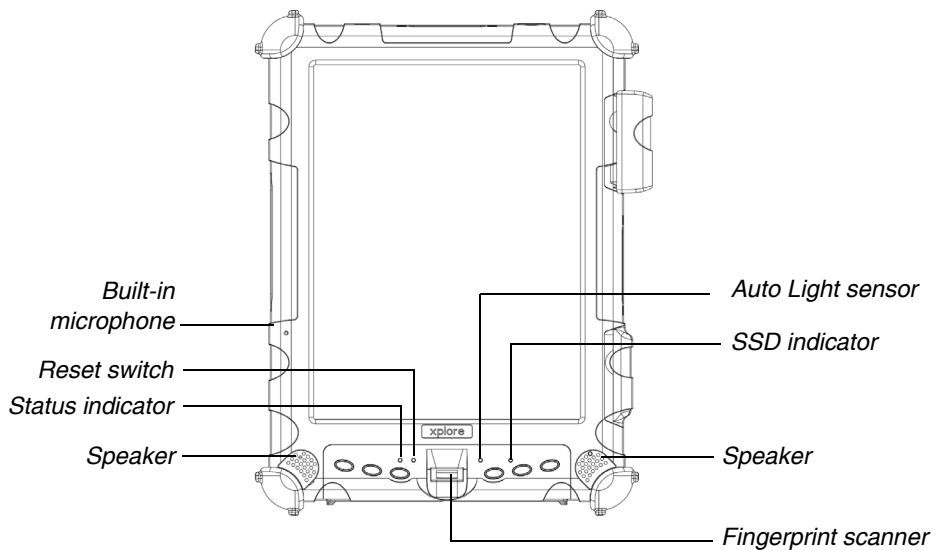

---

Built-in microphone	Enables you to input mono audio with noise cancellation. (See page 44.)
Reset switch	Enables you to turn off the computer when using the Power (On/Off)/Backlight (On/Off)/Resume key is not effective. (See page 30.)
Status indicator	Indicates the computer status (on, off, etc.). (See page 24.)
Speakers	Enable you to listen to stereo audio files. Sealed to provide protection from the environment.

---

## Chapter 1. Getting Started

---

### Back view

---

Auto Light sensor	Detects ambient light conditions.
SSD indicator	Indicates hard drive activity. (See page 24.)
Fingerprint scanner	Enables you to use fingerprint verification features. (See page 38.)

---

### Back view

---

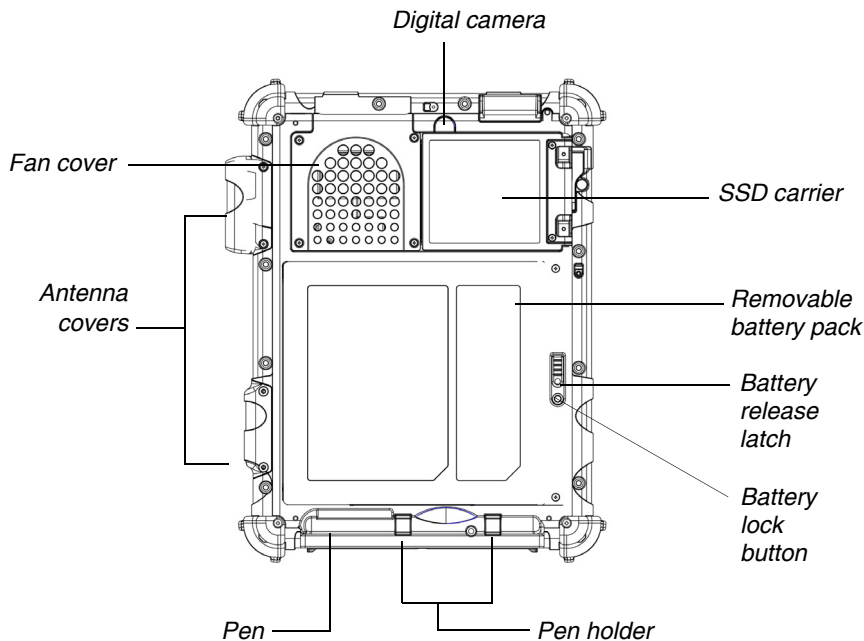

---

Fan cover	Plastic cover over the thermal transfer bay that manages heat movement out of the computer.
Antenna covers	For optional wireless LAN and WAN models, protect and secure the radio antennas (accessible by authorized service personnel only).
Pen	The main device you use to enter data and control applications (instead of a mouse or a keyboard). Also called the <i>stylus</i> . See “Using the pen” on page 34.

---

Pen holder	Provides a place to secure the pen when you are not using it.
Battery release latch	Provides access to the battery.
Battery lock button	Secures the battery inside the tablet.
Removable battery pack	Powers the computer when AC power is unavailable.
Digital camera	3-mega-pixel, auto-focus camera for taking color or black-and-white image or video.
SSD carrier	User-accessible drive carrier for SSD storage.

### Left side view

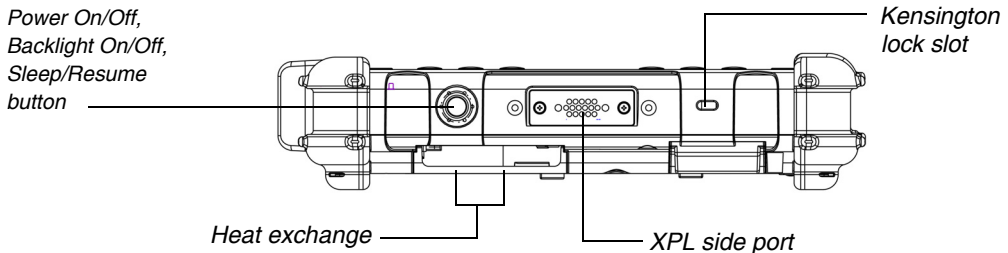

Power On/Off, Backlight On/Off, Sleep/Resume button	Press to power computer. Press and hold for more than 4 seconds to force power off.  Momentarily press to toggle the backlight on or off.
Heat exchange	Helps prevent the computer from overheating by forcing heat away from the computer. (Do not block the vents.)
XPL side port	Permits connection of special devices made expressly for the iX104C5.
Kensington™ lock slot	Connector for the optional Kensington MicroSaver™ or equivalent compatible security cable. Note: Contact your reseller for information about the Kensington security cable.

Right side view

### Right side view

---

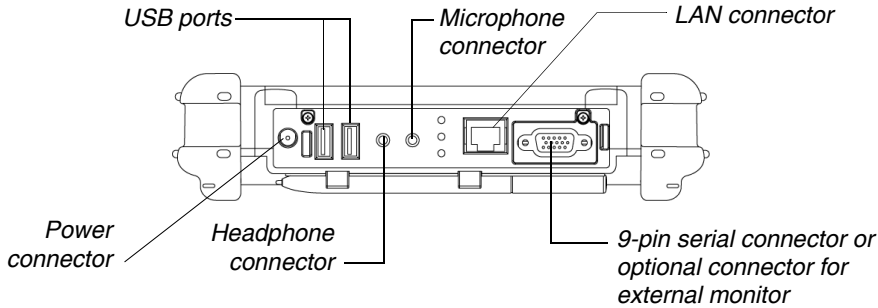

The connectors on the right side of the computer are located behind the outer doors.

---

Power connector	For the AC adapter or optional auto adapter. (See “Optional accessories” on page 15.)
USB 2.0 ports	For Universal Serial Bus devices (compliant with USB Standard Revision 2.0). Note: The optional Office and Vehicle Docks include additional USB ports. See “Optional accessories” on page 15.
Headphone connector	For stereo headphones or speakers.
Microphone connector	For an external microphone.
LAN connector	For connecting a standard RJ-45 connector to the tablet’s internal local area network (LAN) card
9-pin serial connector or optional external monitor connector	Serial connector for connecting terminals or other devices that use the RS-232, RS-422, or RS-485 data transfer standard, or an optional connector for an external monitor or projection panel.

---

## Bottom view

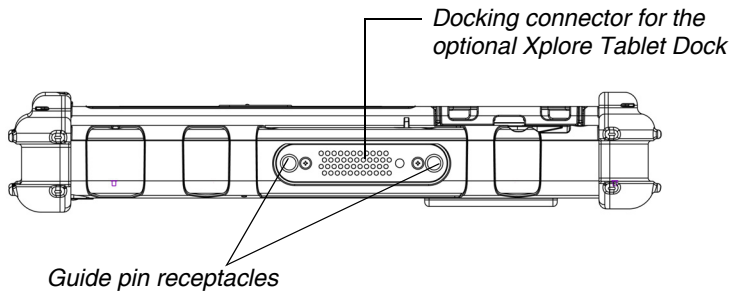

Docking connector	Enables you to connect the optional xStand Desktop Docking Station or xDock Vehicle Docking Stations.
-------------------	---

Guide pin receptacles	Help assure a secure connection of the optional xStand or xDock. Note: See "Optional accessories" on page 15.
-----------------------	--

## Top view

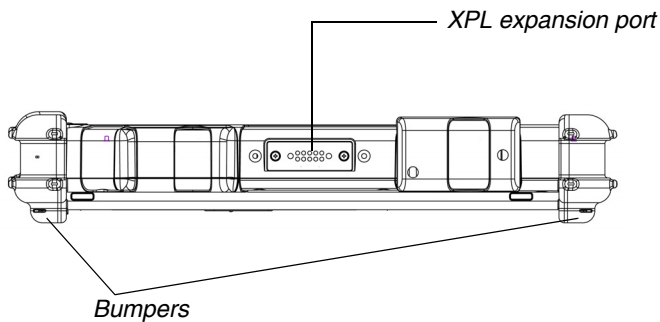

Bumpers	Fabricated from rugged material. Raised to help protect the computer from damage.
---------	---

XPL expansion port	A port that permits connection of special devices made expressly for the iX104C5.
--------------------	---

## LED indicators

---

The LED indicator lights show the status of system functions.

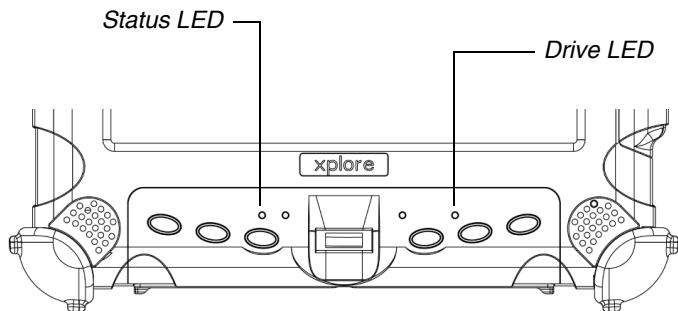

The following table defines the various LED states.

**Table 1** Status LED indicator

Mode/State	LED State	Meaning
On state	green, continuous	The computer is on, ready for use, and functioning normally. The battery is fully charged.
Charging	green, blinking	The AC adapter is plugged in and the battery is charging.
Off state	off (no light)	The computer is off.
Sleep mode	green, breathing	The computer is on and is in Sleep mode.
Thermal control	blue, blinking	The computer is on and is in Warm-up mode, with the LCD and backlight off. After the system has warmed to a safe level, the LCD and backlight turn on.



**Table 1** Status LED indicator (continued)

Mode/State	LED State	Meaning
On	red, blinking	The computer is powered on, running on battery power, and the charge level in the battery has reached a minimum warning state. Plug the computer into an AC/DC power source or install a charged battery.
On	red, continuous	The computer is on, running on battery power, and the charge level in the battery has reached a critical state. Plug the computer into an AC/DC power source or install a charged battery. <b>or</b> The computer has encountered a fault and is not operating normally. Contact your computer support personnel, such as your help desk. <b>or</b> The computer is off and you have inserted a battery that is at the critical low level and is incapable of running the computer.





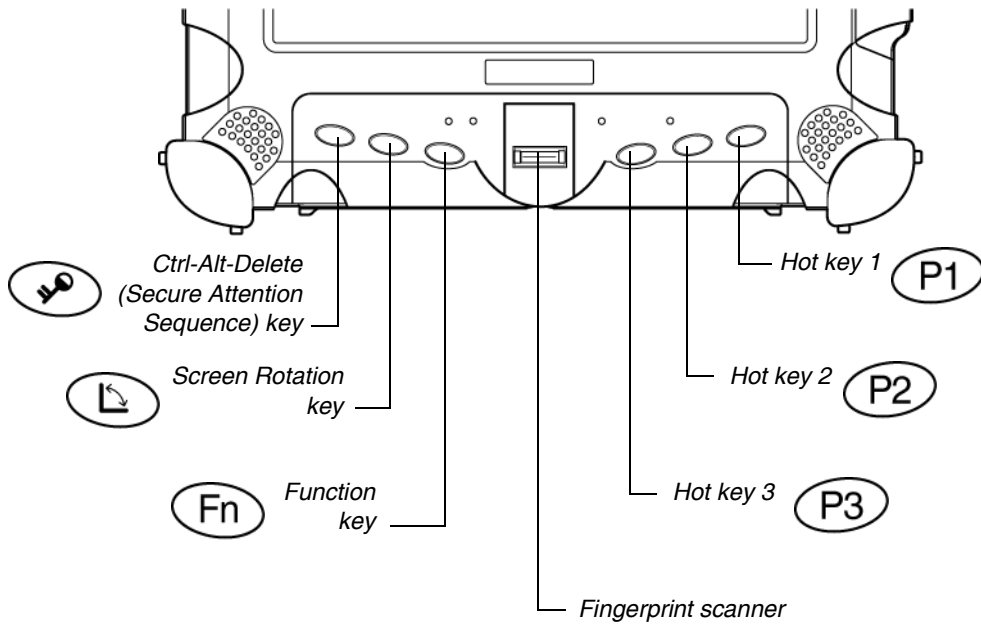

Quick-start guide

This section is a quick guide to using the main features of your tablet.  
(See Chapter 2 for detailed information.)

**Application, Windows, and hot keys**









**Table 2** Main keys

Press this key...	To perform this function
	Log on after resuming operation from power management, powering on, or locking. After logging on, launch Windows Task Manager.
	Rotate screen orientation between portrait (vertical) and landscape (horizontal).
	Use in combination with another key to perform various functions. (See page 27.)
	Fingerprint scanner.
	Display the Start menu.
	Open Internet Explorer, or perform a user-definable function.
	Put the computer in Sleep mode.

To define a function, see “Programming hot keys” on page 60.

In the default configuration, the P3 key puts the computer in Sleep mode and the Power button shuts down the computer. To change these settings, see page 52.

**Table 3** Function mode keys

Press these keys...	To perform this function
 	Default function: Send video display to a monitor or projection panel connected to the computer (and back to the computer again). You can program this key combination to perform a different function. (See “Programming hot keys to start applications, open documents, or go to a website” on page 61.)
 	Enable or disable Airplane mode, which toggles wireless radios on/off.
 	Bluetooth toggle.



# 2

## Using the Tablet

---

This chapter contains detailed instructions for using the tablet.

### Turning on the computer

---

1. Make sure the computer is off.

*When the computer is off,  
the Status LED is off.*

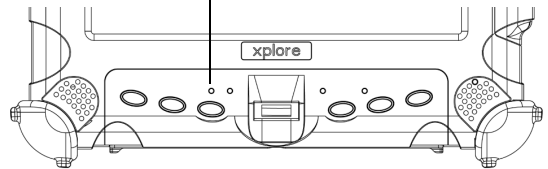

2. Make sure the battery is charged or that the computer is plugged in to an external power source.
3. Press the **Power On/Off, Backlight On/Off, Sleep/Resume** button.

*Power On/Off,  
Backlight On/Off,  
Sleep/Resume  
button*

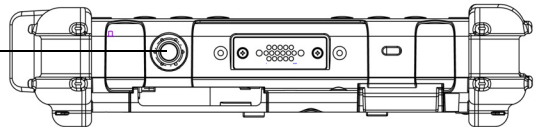

## Turning off the computer

---

*When the computer is in Sleep mode, the Status LED is breathing green.*

1. If the computer is in Sleep mode, press the **Power On/Off, Backlight On/Off, Sleep/Resume** button to resume operation. (See page 32 for information about Sleep mode.)

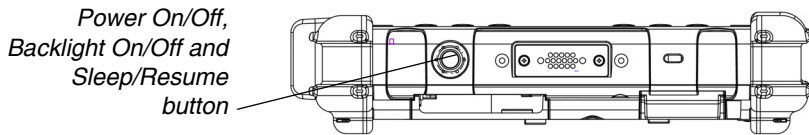

2. Make sure the battery is charged or that the computer is plugged in to an external power source.
3. Save your work and close all programs.
4. From the Windows **Start** menu, click **Turn Off Computer**.
5. The Turn off computer dialog box opens.
6. Click **Turn Off** or press the **Power** button continuously for more than 4 seconds.

## Using the Reset switch

---

*Use the Reset switch only if you cannot turn off the computer by any other means, because you may lose unsaved data.*

If the computer does not seem to be accepting input and you cannot turn it off by using the method described in “Turning off the computer,” press the **Reset** switch. (Use the stylus or a similar instrument to press the switch).

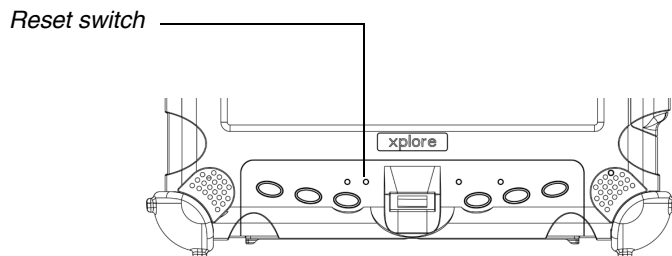

---

## Suspending and resuming operation

---

---

For more information, see “Checking battery power status” on page 52.

---

To conserve battery power when you do not want to turn off the computer or when you need to install a charged battery pack, put the computer into Sleep mode. (You can suspend operation without closing any programs or Windows.)

When you suspend operation:

- Programs that are running stop (but do not close).
- Active data is saved.
- The system enters one of the following low-power modes:
  - Sleep (Suspend-to-RAM) mode – The Status LED light is breathing green. Active data is saved in RAM and most other components are turned off.

Although the computer uses very little power when in Sleep mode, eventually the battery’s power does run out. If you do not plan to use the computer for an extended period of time, turn the computer off or put it in Hibernation mode instead of Sleep mode.

- Hibernation mode – Active data is saved on the SSD and power usage is reduced to the same level as when the computer is turned off. In Hibernation mode, there is no danger of losing data if battery power is lost.

---

**Notes:**

If you have set your computer to turn power off (in the Power Options utility in Windows Control Panel), you cannot suspend operation. To change power settings, see “Selecting Power (On/Off)/Backlight(On/Off)/Sleep/ Resume button options” on page 55.

In the default configuration, the P3 key puts the computer in Sleep mode and the Power button shuts down the computer. To change these settings, see “Programming hot keys to perform pre-defined functions” on page 65.

---

If your computer is connected to a network, the network may automatically log you off after a period of inactivity while system operation is suspended. Contact your help desk or system administrator to learn your log-off time limit.

## Suspending operation

*In order to suspend operation, the Sleep option must be enabled in Windows Power Options. See “Selecting Power (On/Off)/Backlight(On/Off)/Sleep/ Resume button options” on page 55.*

Use one of the following methods to suspend operation:

### Method 1

Press the **P3** key.

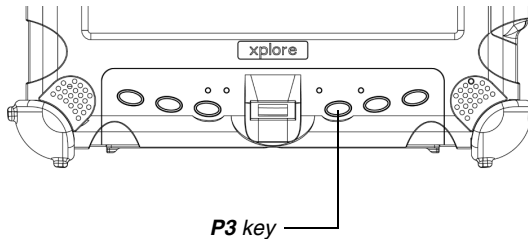

### Method 2

1. Press the Windows **Start** button; then press the right arrow next to the **Shutdown** button.
2. Press **Sleep**.

When operation is suspended, the Status LED displays a breathing green light.

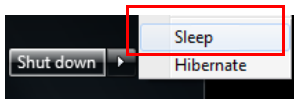
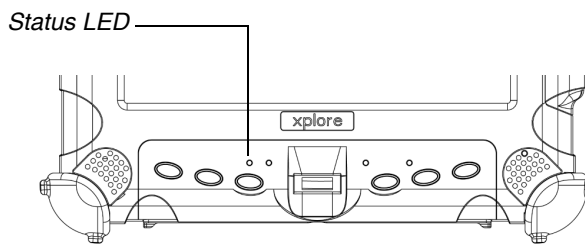



---

## Resuming operation

---

To resume operation when the computer is in Sleep mode, press the **Power On/Off, Backlight On/Off, Suspend/Resume** button.

---

**Note:** Press the button only *once*.

---

*Power On/Off,  
Backlight On/Off,  
Sleep/Resume  
button*

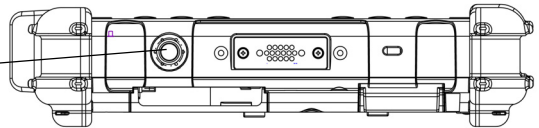

Approximately 20 seconds later, the computer resumes normal operation. When the Status LED displays a continuous green light, you can begin using the computer.

## Using the pen

---

You can use any of the following methods to select items and to navigate through programs.

- **Auto-Sense mode:** Use either the multifunction pen or your finger interchangeably. The computer distinguishes between the two input modes and automatically adjusts accordingly. *This is the tablet's default state.*
- **Digitizer mode:** Use only the special multifunction pen provided with the computer.

For more information, see “Programming hot keys to perform pre-defined functions” on page 65.

### **WARNING**

*Do not use items such as a ball point pen or a screwdriver that can damage the tablet. Damage caused by using an item not provided with the tablet is not covered by the tablet warranty.*

---

**Note:** During the first use of the tablet, or if the action you are trying to perform does not occur when you use the pen or your finger to touch the screen, calibrate the digitizer as described in “Calibrating the digitizer” on page 75.

---

---

## Using the digitizer to perform mouse functions

---

To perform this function...	Do this
Select an object (left button click).	Tap the pen tip once on the object.
Perform a double-click.	Quickly tap the pen tip twice on the object.
Perform a right-click.	Hold the pen or your finger directly on the object for 1 second.
Move or drag an object.	Place the pen tip or your finger on the object; then continue to hold the pen tip or your finger against the screen as you move the pen or your finger.

---

### Changing the pen double-click speed

The pen double-click speed is in sync with the mouse double-click speed. To change the speed, follow the instructions below.

1. Click the Windows **Start** button.
2. Click the **Control Panel** option.
3. In the Control Panel window, select **Hardware and Sound > Set up your Pen and Tablet**.
4. Drag the slider to a faster or slower speed.

## Positioning the pen and pen tether

The pen tether helps prevent the loss of your pen. The following illustrations show how to position the pen and pen tether.

### *Tether anchored at the bottom*

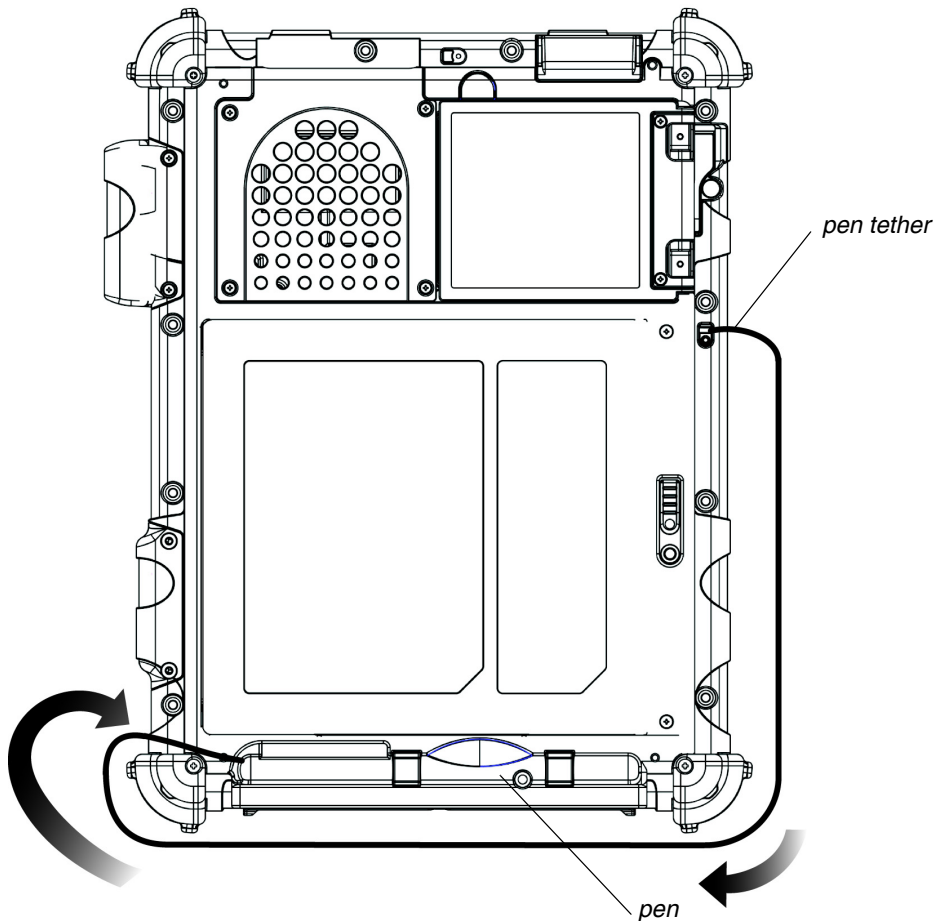

**Tether anchored on the side**

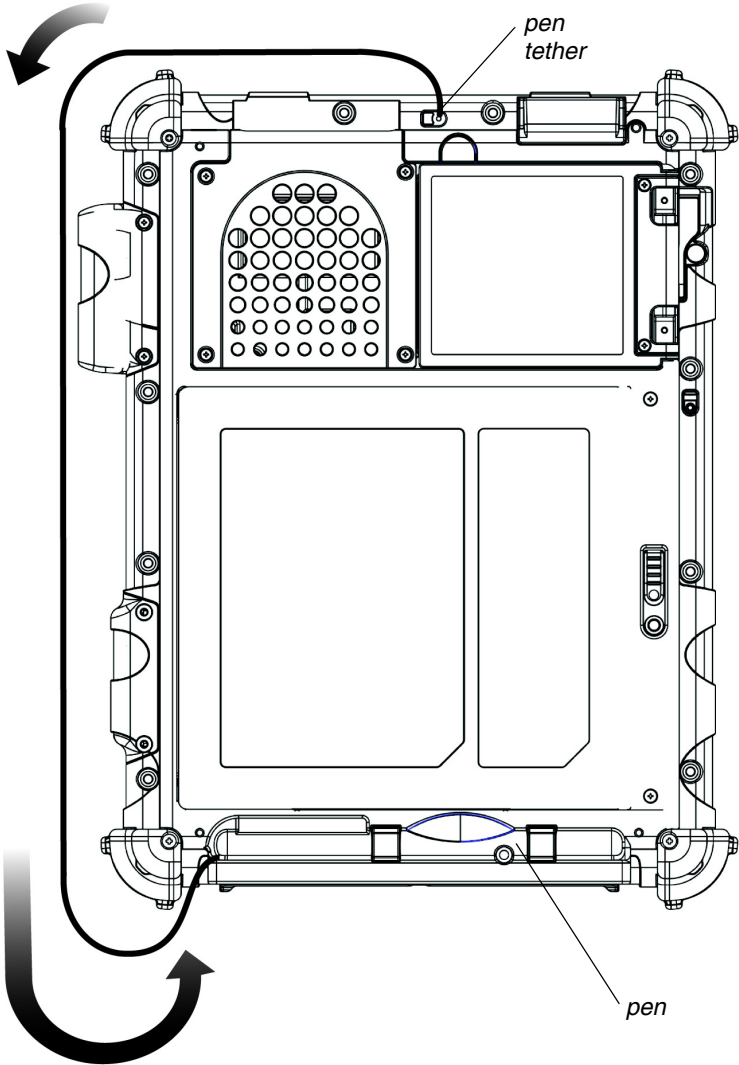

## Using the fingerprint scanner

---

The fingerprint scanner and the associated Protector Suite 2009 software enable you to use fingerprint verification to protect the security of your data.

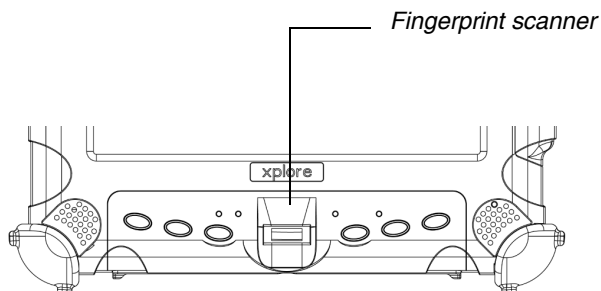

The first step for using fingerprint verification is to *enroll* your fingerprint to create an association between your username, password, and fingerprint.

After fingerprint enrollment you will be able to:

- Use your fingerprint as part of computer login security.
- Register Web pages and Windows applications to use your fingerprint instead of passwords.
- Launch applications by swiping your finger the sensor.
- Store confidential information in an encrypted form in a protected folder.

To launch the Enrollment Wizard, select:

**Start > All Programs > Protector Suite > Control Center > User Enrollment** and follow the wizard's instructions.

For more information about using the fingerprint scanner, see the Protector Suite 2009 User's Guide PDF included on your hard disk in the Protector Suite 2009 folder.

## Changing the screen orientation



To rotate the screen orientation from portrait (vertical) to landscape (horizontal) mode or from landscape to portrait mode, press the screen rotation key.

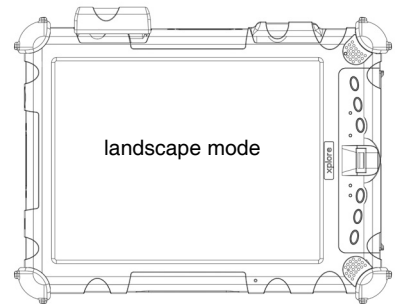
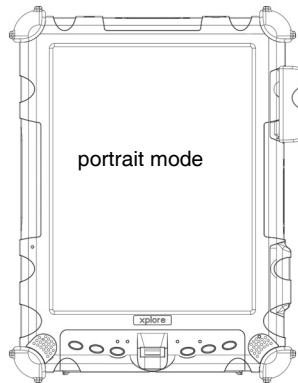

## Adjusting the screen brightness

Use either of the following methods to adjust the screen brightness:

### Method 1

1. Click **Start**.
2. Open the **Control Panel**.
3. In the **Hardware and Sound** area, select **Adjust commonly used mobility settings**. Use the **Brightness** slider to adjust the brightness.

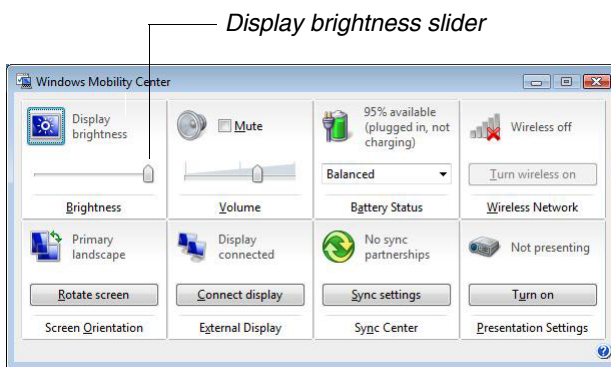

### Method 2



1. In the Windows taskbar, click the power management icon; then select **Adjust screen brightness**.
2. Move the slider bar (located at the bottom of the window) to change the screen brightness.





---

## Enabling automatic backlight control

---

When the Auto Light sensor is enabled, the computer automatically controls the amount of backlight sent to the screen to provide optimum brightness for the lighting conditions in which you are working.

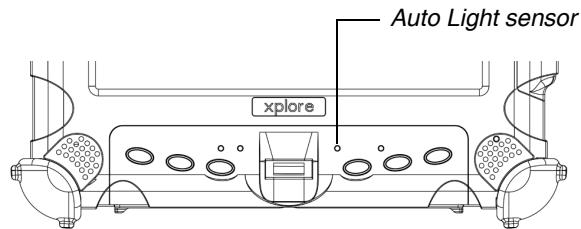

To enable automatic backlight control, see page 80.

---

## Optimizing screen settings for outdoor use

---

1. Click **Start > Control Panel > Appearance and Personalization > Personalization > Change desktop background.**
2. In the My Themes area, select **High Contrast White.**
3. Click the Back button.
4. Click **Display.**
5. Click **Medium - 125%** to enlarge the icon size; then click **Apply.**
6. Click **Adjust Resolution.** Make sure the screen resolution setting is **1024 by 768** pixels; then click **OK.**

## Docking the tablet

---

If you have the optional xStand office dock or xDock vehicle dock, connect it to the tablet at the docking port. (See the *iX104 Docking Stations Handbook*.)

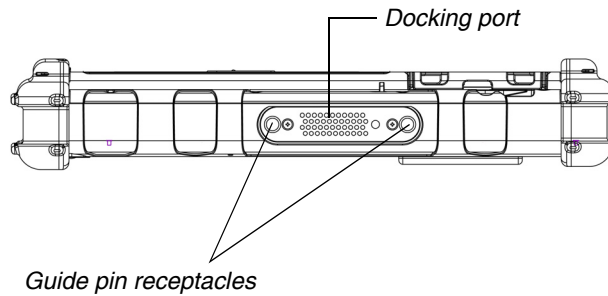

---

## Connecting devices

---

Refer to the following subsections for information about connecting external devices to your computer.

---

**Note:** If the device you want to use does not appear to be working with your computer, the device may need to be enabled in the computer's configuration program. Contact your local help desk or Xplore reseller.

---

### Connecting to a local area network

---

Connect a local area network (LAN) cable's RJ-45 connector to the internal LAN interface card. (See your network system administrator for more information.)

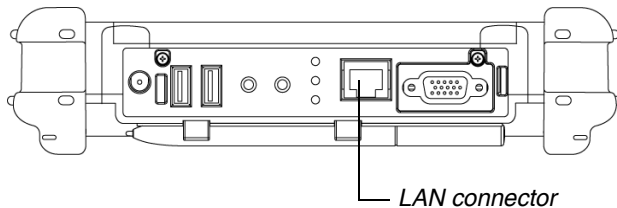

### Connecting USB-compatible devices

---

Connect any USB-compatible devices to the computer's USB ports.

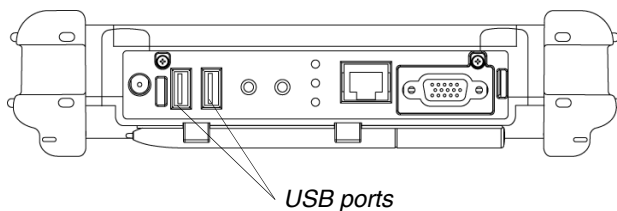

### Connecting an external microphone

---

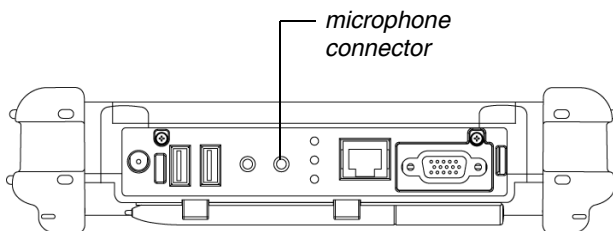

### Adjusting microphone volume

If necessary, adjust the volume of the microphone as follows:

1. Press the Windows **Start** key; then open the **Control Panel**.
2. Select **Hardware and Sound**; then select **Sound**.
3. Select the **Recording** tab.
4. Select **Microphone**; then select **Properties**.
5. Select the **Levels** tab.
6. Adjust the microphone volume or boost.
7. Click **OK**.

## Connecting a headphone or speakers

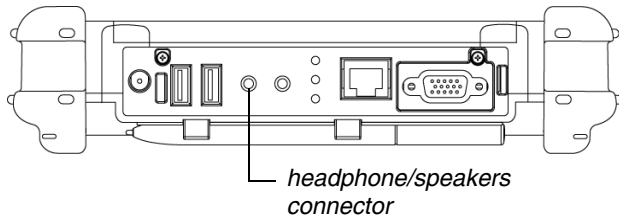

## Adjusting headphone or speaker volume



1. Click the audio icon in the Status area of the Windows taskbar.  
The volume control area opens.
2. If the **Mute** button indicates that sound is muted, click the button to turn on the sound.
3. Move the slider bar up or down to increase or decrease the volume.

## Connecting a monitor or projection panel (optional)

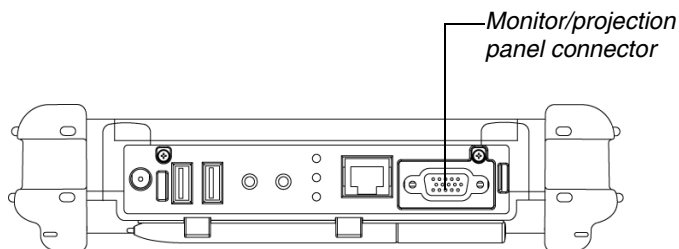

### Activating the monitor or projection panel

If your tablet includes the optional monitor/projection panel connector, you can change the video output as follows:

***To change the video output to the monitor or projection panel:***

Press the **Fn-P1** key combination.

***To change the video output back to the computer:***



Press the **Fn-P1** key combination again.

### Connecting a device to the serial port (standard)

If your tablet includes the standard serial port, you can connect a terminal or other device that uses the RS-232, RS-422, or RS-485 data transfer standard.

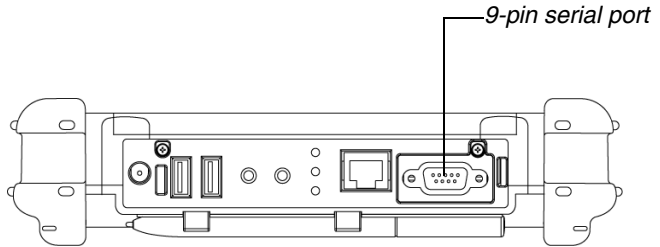

### Connecting an XPL expansion module

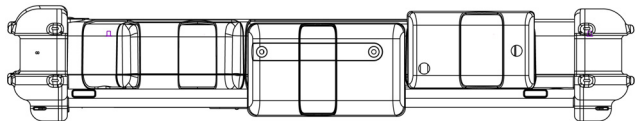
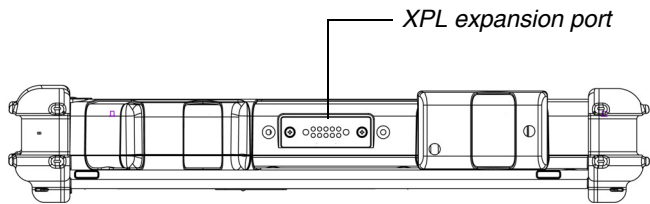

*Tablet with optional GPS II*

## Using the battery

---

You can recharge, remove, and replace the battery pack.

### Charging the battery pack

---

#### If you do not have an external battery charger

Follow these steps to charge the battery while it is installed in the computer:

1. Connect a power source, such as an AC adapter or cigarette lighter adapter, to the power connector on the computer.

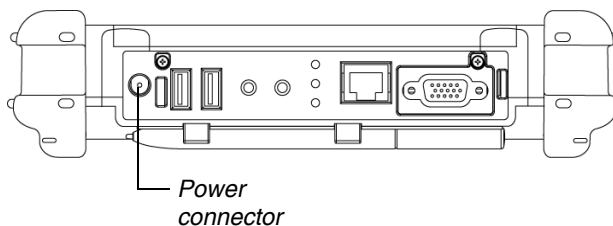

If the battery charge is below 95%, the battery begins charging and the Status LED flashes green. (If the battery charge is higher than 95%, the battery will not charge, preventing battery overcharge.)

2. Check the level of charge. (See “Checking battery power status” on page 52.)

The charging process continues until the battery charge reaches 100%.



Table 4 shows the approximate time required to charge the battery level to 100%.

**Table 4** *Approximate battery charge time*

Battery pack capacity	Charge time	Battery pack P/N
55 watt hours (7600 mAh)	1.5 hours	11-01018
68.5 watt hours (9250 mAh)	2.5 hours	11-01019

### If you have an external battery charger

1. Remove the battery pack (see page 49).
2. Use the external battery charger to charge the battery.
3. Install the battery (see page 51).

## Removing and installing the battery

You can remove the battery and use an (optional) external charger to charge it.

### Removing the battery

1. **To swap with a charged battery:**

Use one of the methods described in “Suspending operation” on page 32 to suspend operation.

**If a charged battery is not available:**

Save your work and close all running programs; then shut down the computer or put the computer in Hibernation mode (see “Suspending operation” on page 32).

**Note:** To avoid losing unsaved data, wait until the computer has completed switching to Hibernation mode before removing the battery.

2. Use the stylus or a pen to depress the battery lock button.  
The battery release latch returns to its original position.

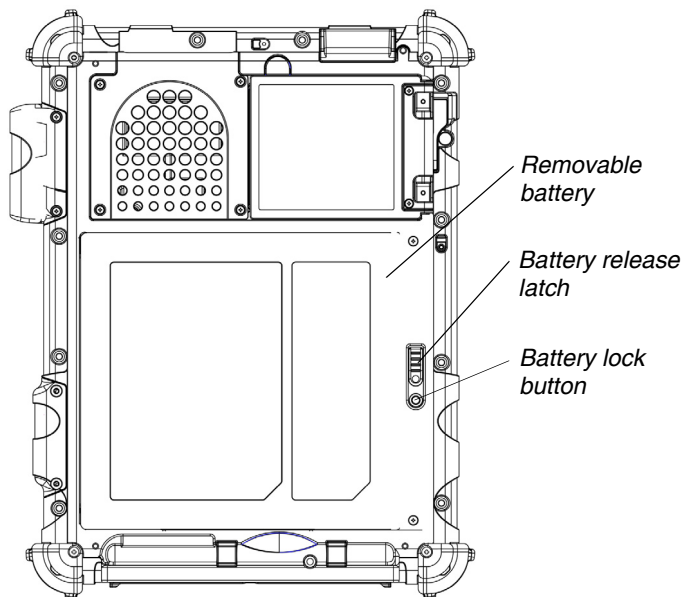

3. Pull the battery away from the computer and remove it.

---

**Note:** After removing the battery, you must replace the battery or connect the computer to an external power supply within **3 to 5 minutes** or the computer completely loses power.

---

### **Installing the battery**

1. Orient the battery with the slides in the empty battery tray.

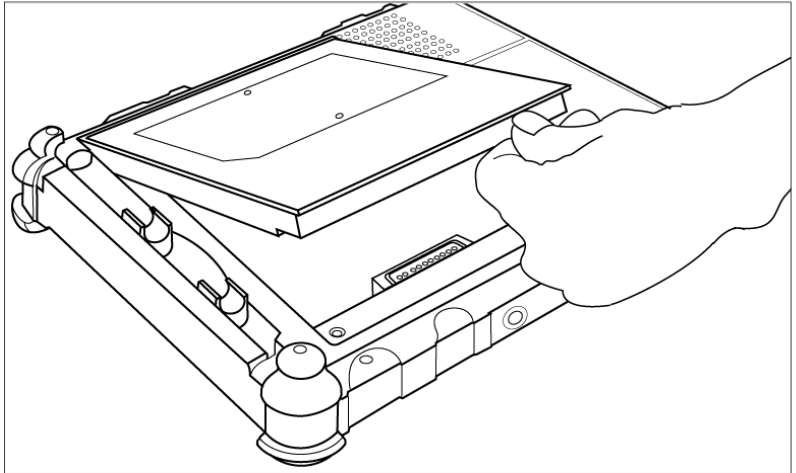

2. Slide the battery into the tray and press it firmly until it is seated.
3. Slide the battery release latch to its original position.

The lock button pops back into the locked position, securing the battery in place.

### **Discarding batteries**

---

Dispose of batteries in accordance with your local government regulations. Under federal, state, or local law, it may be illegal to put batteries in the trash. Contact your system administrator, municipal waste disposal department/provider for information.

## Using power options

---

### Displaying power options

---



On the Windows taskbar, click the battery icon; then select **More power options**. The Power Options window opens.

### Checking battery power status

---



On the Windows taskbar, click the battery icon.

The following window opens, displaying the percentage of power remaining in the battery:

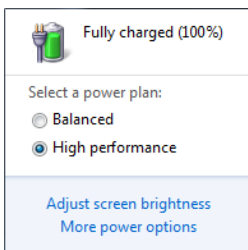

## Selecting a power plan



1. On the Windows taskbar, click the battery icon.

The following window opens:

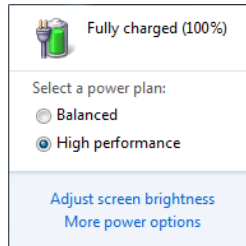

2. Select one of the following power plans: (select **More power options** in necessary)

**Balanced** – Balance between computer performance and battery life.

**Power Saver** – Longer battery life and lower performance.

**High performance** – Higher performance and shorter battery life.

## Selecting power options



1. On the Windows taskbar, right-click the battery icon.
2. Select **Power Options**.

The following window opens.

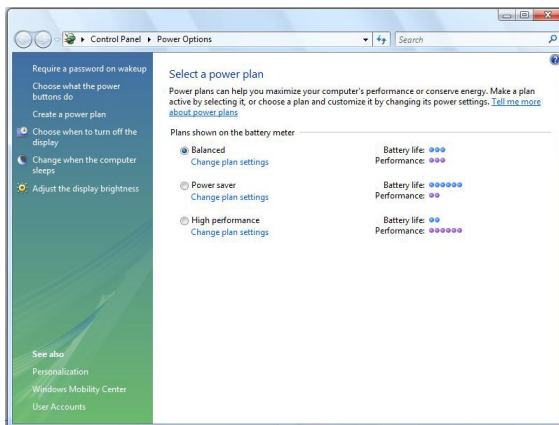

3. Under the selected power plan, press **Change plan settings**.
4. Select the power options you want to use.

## Selecting Power (On/Off)/Backlight(On/Off)/Sleep/Resume button options

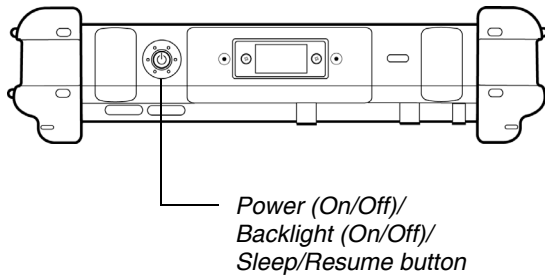

To change what happens when you press the button:



1. On the Windows taskbar, right-click the battery icon.
2. Select **Power Options**.

The following window opens.

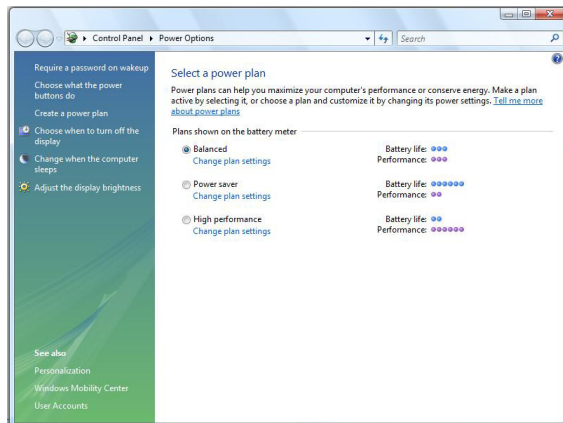

3. Press **Choose what the power buttons do**.
4. Select the options you want to use.

### **Tips for conserving battery power**

---

The following tips help you extend the life of your battery by conserving battery power:

- Use an external power source such as the AC or auto adapter whenever available.
- Suspend operation if you know that you will not be using the system for a while. (See page 32.)
- If you do not plan to use the computer for an extended period of time, turn it off.
- Adjust power options to automatically conserve power. (See page 54.)
- Adjust the display brightness to no brighter than necessary for comfortable viewing. The display can consume a large portion of the computer's power. (See page 40.)
- Set the LCD Brightness range to "Power Saving" in the BIOS Setup Utility. (See page 79.)



---

## Accessing the Solid State Drive (SSD) cartridge

---

When you install a new storage drive, follow the instructions in this section to access the hard drive carrier.

---

**WARNING** Failure to follow this procedure can result in damage to the case and the cover, which is not covered under the Xplore Technologies warranty. Xplore recommends that you use an approved Xplore Technologies service center for this procedure.

---

1. Turn off the computer.
2. Remove all power from the unit, including batteries and other power sources such as power supplies, cigarette lighter adapters, and mobile power sources.
3. Pinch the two center pins with one hand while pushing down on the lever with the other. The drive carrier will pop up (like the battery) and permit removal.

**Note:** Your drive carrier may have two screws installed. If so, remove them before you exchange the drive carrier.



#### Re-installing the drive carrier

---

1. Insert the drive with smooth edge into the bay at a slight angle.
2. Press down until the carrier clicks into place, while pinching the two center pins.



3. If your machine had the screws in place, re-attach them.

**Note:** Do not use power tools.

---

## Accessing the MicroSD and SIM compartment

---

*Note: This compartment can handle most MicroSD and SIM cards.*

---

When you install a MicroSD or SIM card, follow the instructions in this section to access the compartment.

---

**WARNING** Failure to follow this procedure can result in damage to the case and the cover, which is not covered under the Xplore Technologies warranty. Xplore recommends that you use an approved Xplore Technologies service center for this procedure.

---

1. Turn off the computer.
2. Remove all power from the unit, including batteries and other power sources such as power supplies, cigarette lighter adapters, and mobile power sources.
3. Remove the battery. (See “Removing and installing the battery” on page 49.)
4. Lift up on the D-ring and turn it clockwise  $\frac{1}{4}$  of a rotation. Once the lock is disengaged lift the door to open the compartment.



*Opening the compartment*



*Installing a MicroSD card*





*Installing a SIM card*

## Programming hot keys







---

Xplore pre-programs the P1, P2, and P3 hot keys and Function mode hot key combinations to perform certain functions by default. However, you can program them to perform different functions, as described in this section.

**Table 5** Programmable hot keys

Key	Default function
	Opens the Start menu.
	Starts Internet Explorer.
	Puts the computer in Sleep mode.

**Table 6** Programmable Function mode hot key combinations

Key combination	Default function
 	Sends video display to a monitor or projection panel.
 	Airplane mode toggle.
 	Bluetooth toggle.

## Programming hot keys to start applications, open documents, or go to a website



1. In the Status area of the Windows taskbar, click the iX104C5 **Configuration** icon.

The Launch Button QuickShow dialog box opens.

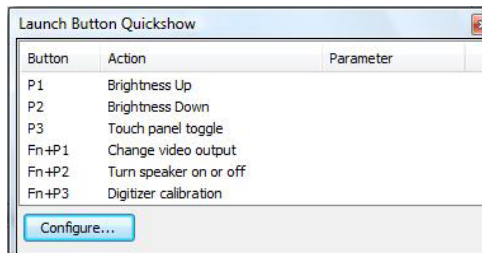

2. Click the **Configure** button.

The Panel Control Center window opens.

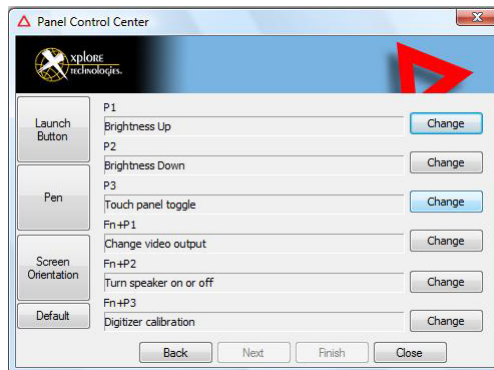

3. Click the **Change** button next to the key or key combination you want to program.

The following options appear:

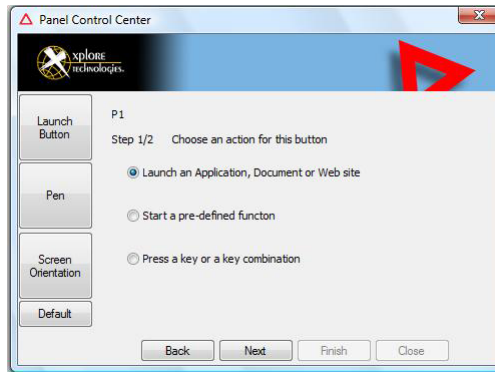

4. Click **Launch an Application, Document or Web site**.

The following options appear:

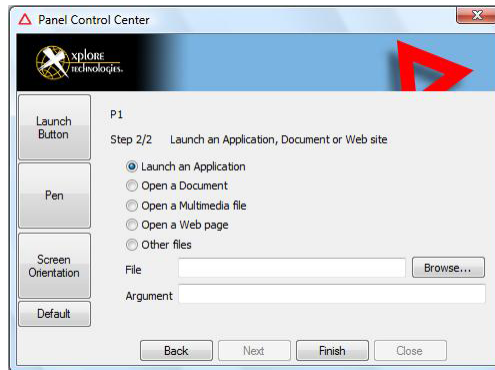

5. **To start an application:**

- a. Click **Launch an Application**.
- b. Press **Browse** to find the application you want the hot key or Function mode hot key combination to start (for example: **word.exe, notepad.exe, excel.exe**).

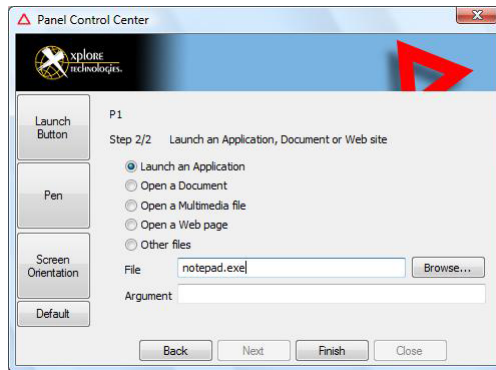

- c. Click **Change**.

6. **To open a document:**

- a. In the Click **Open a Document**.
- b. Press **Browse** to find the document you want the hot key or Function mode hot key combination to open. (For example: **spreadsheet.xls, airports.doc, wiringdiagram.jpg**)
- c. Click **Change**.

**7. To open a multimedia file:**

- a. Click **Open a Multimedia file**.
- b. Press **Browse** to find the name of the multimedia file you want the hot key or Function mode hot key combination to open. (For example: **911training.dir**, **demo.ppt**)
- c. Click **Change**.

**8. To open a Web page:**

- a. Click **Open a Web page**.
- b. Press **Browse** to find the URL of the Web page you want the hot key or Function mode hot key combination to open. (For example: **http://www.xplortech.com**)
- c. Click **Change**.

**9. Program more hot keys, or click **Close** to close the Panel Control Center window.**



## Programming hot keys to perform pre-defined functions



1. In the Status area of the Windows taskbar, click the iX104C5 **Configuration** icon.

The Launch Button QuickShow dialog box opens.

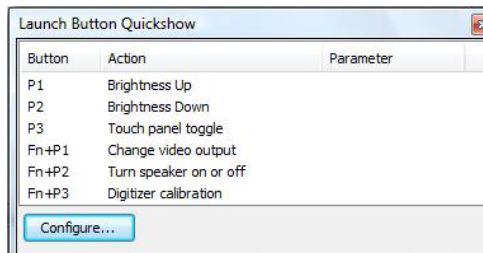

2. Click the **Configure** button.

The Panel Control Center window opens.

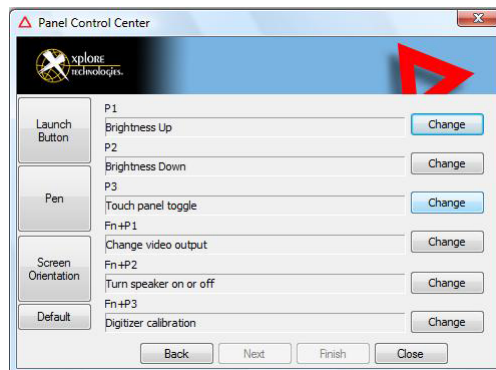

3. Next to the key or key combination you want to program, click the **Change** button.

The following options appear:

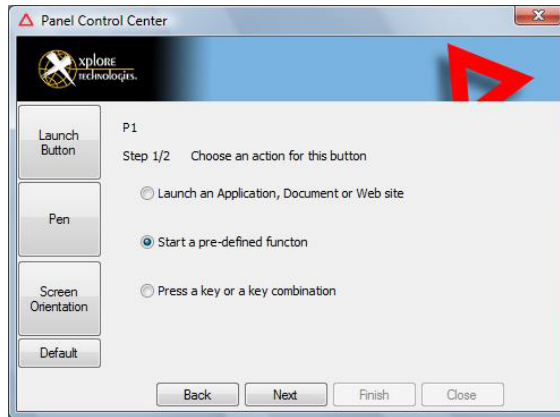

4. Click **Start a pre-defined function**.
5. In the **Function selection** drop-down list, select an option.

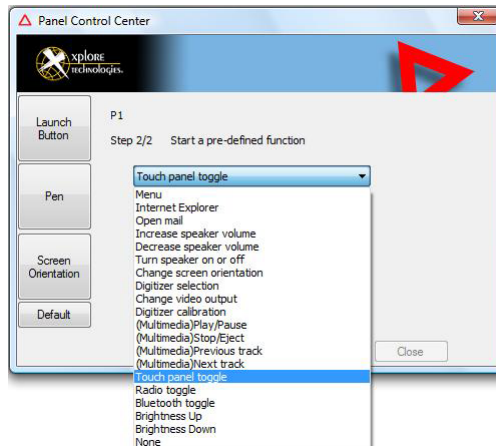

6. Program more hot keys, or click **Close** to close the Panel Control Center window.

## Programming hot keys to perform other key functions



1. In the Status area of the Windows taskbar, click the iX104C5 **Configuration** icon.

The Launch Button QuickShow dialog box opens.

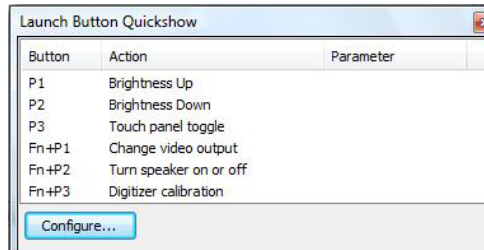

2. Click the **Configure** button.

The Panel Control Center window opens.

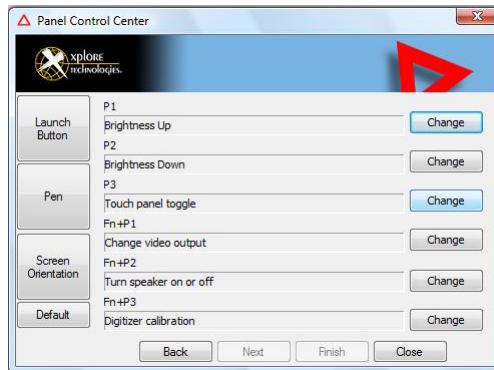

3. Next to the key or key combination you want to program, click the **Change** button.

The following options appear:

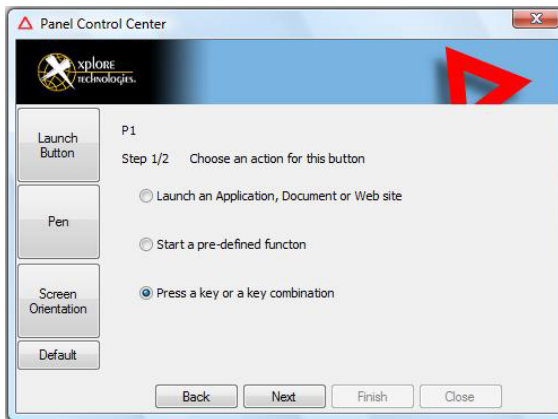

4. Click **Press a key or key combination**.

The following options appear:

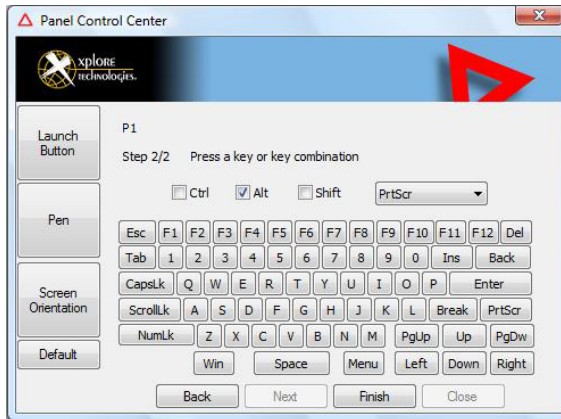

**5. If you want the hot key or hot key combination to perform the function of a single key:**

- a. If the **Ctrl**, **Alt**, or **Shift** boxes are checked, uncheck them.
- b. Click the key you want the hot key or hot key combination to perform. (For example: **F6**, **G**, or **Caps Lock**)

**If you want the hot key or hot key combination to perform the function of a key combination:**

- a. Check the **Ctrl**, **Alt**, or **Shift** box.
- b. From the drop-down list, select the additional key, or click the key on the keyboard.

**Examples**

To cause the hot key to perform the *print screen* function (**Alt-Print Scrn**): Check the **Alt** check box; then select **PrtScr** from the drop-down list.

To cause the hot key to perform the *paste* function (**Ctrl-V**): Check the **Ctrl** check box; then click the **V** key.

6. Program more hot keys, or click **Close** to close the Panel Control Center window.



# 3

## Maintaining the Tablet

---

This chapter provides instructions for maintaining your tablet.

### Caring for the tablet

---

This section provides information about how to keep your tablet in top working condition.

#### Checking power cords and connectors

---

Check AC and DC power cords and power connectors periodically for damage. Replace the power cord immediately if you find any damage.

#### Protecting the computer from damage

---

- Your computer is designed to sustain a multiple-axis drop to a non-yielding surface. Do not intentionally drop the computer, because the cumulative effects of multiple drops may damage the computer.
- Do not place heavy objects on the computer.
- Do not disassemble the computer.
- Keep the computer at least 5 inches (13 centimeters) away from any electrical appliance that generates a strong magnetic field, such as a motor, magnet, TV, refrigerator, or large audio speakers.

### Preventing the computer from overheating

---

The computer monitors its internal temperature. As the internal temperature approaches the tolerable limits of heat-sensitive components, system functions are automatically limited or turned off to prevent damage.

To prevent the computer from overheating, do not obstruct the computer's air vents.

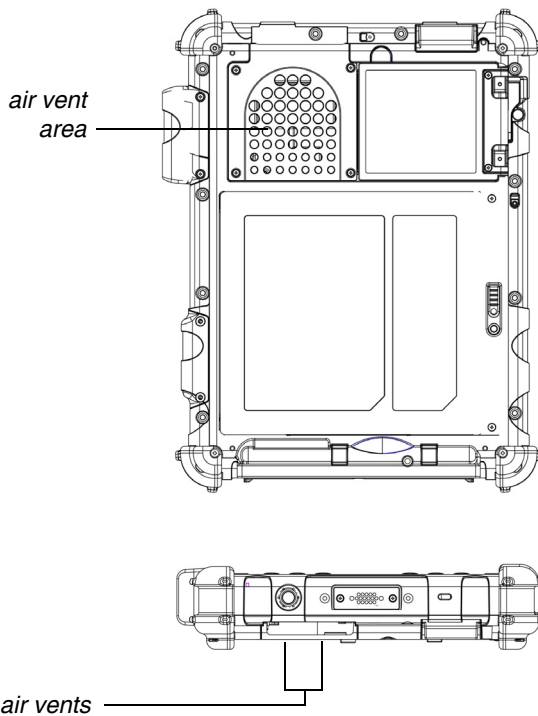



---

### **Storing the computer**

---

You can store the computer in the Off state for about 30 days with a fully charged battery installed. After this period, recharge the battery or replace it with a charged battery.

If you intend to store the computer for more than 30 days, remove the battery pack and keep it in a cool place.

---

### **Caring for the display screen**

---

To clean the display screen, dampen a soft cotton cloth with water and gently wipe the screen surface.

---

**Note:** Do not use isopropyl alcohol to clean the screen. Alcohol may damage the surface of the screen.

---

---

### **Protecting the display screen**

The screen protector is a durable, replaceable writing surface that protects the display screen from abrasion.

To obtain additional screen protectors, check with your reseller, or go to the Xplore Web site at [www.xploretch.com](http://www.xploretch.com) for ordering information. Additional information about installation is included with the screen protectors.

### When to replace the pen

#### **Removing the screen protector**

Slide your fingernail under the edge of the screen protector and pull the protector away from the screen.

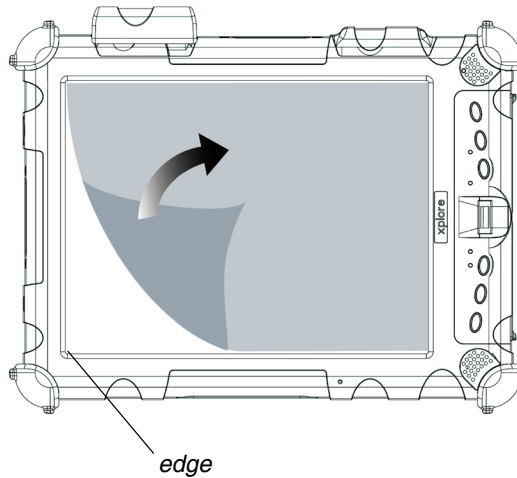

#### **Installing a new screen protector**

Follow the instructions included with your screen protector replacement kit.

---

**Note:** If a screen protector is already installed on the display screen, remove it before installing the new screen protector.

---

### When to replace the pen

---

With use, the pen tip may become worn and can scratch the screen. If your pen exhibits one of the following problems, replace the pen:

- The pen does not move freely across the screen.
- The pen does not perform as expected.

## Calibrating the digitizer

Calibrating the digitizer adjusts the cursor position on the screen relative to the position of the pen tip or finger. Calibrate the digitizer to adjust the distance error between where the pen or finger is actually touching the screen and where the computer is registering the pen or finger touch.

You may need to calibrate the digitizer in the following situations:

- You are using the computer for the first time.
- The previous user of the computer writes with the opposite hand or at a different pen angle.
- The computer has not been used for some time.
- The computer has been serviced.

1. From the **Start** menu, select **Control Panel**.

The Control Panel opens.

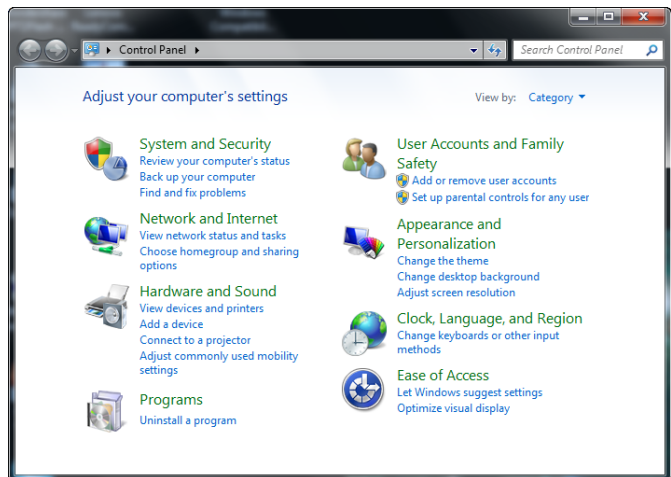

#### 2. Select **Hardware and Sound**.

*Hardware and Sound*

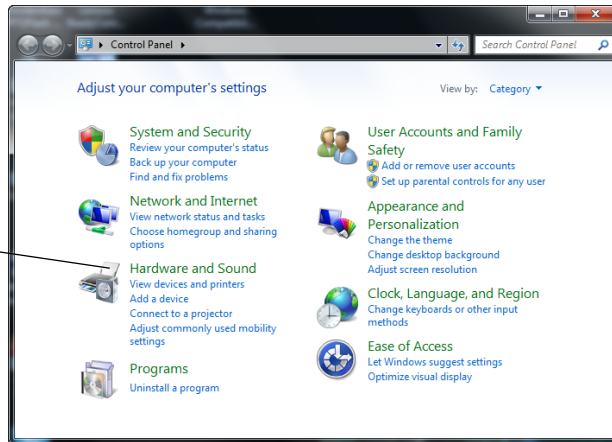

#### 3. In the Tablet PC Settings area, select **Calibrate the screen for pen or touch input**; then follow the instructions that appear on the screen..

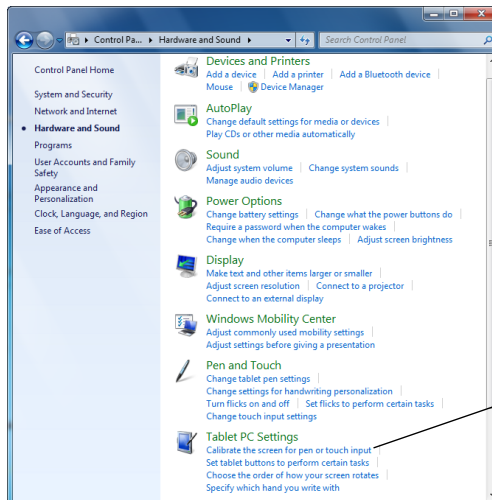

*Calibrate the screen for pen or touch input*

# A

## Troubleshooting

---

Table 7 contains solutions to some problems. If you cannot solve the problem by taking the actions described, contact your local help desk or your reseller for further assistance.

**Table 7** *Troubleshooting*

---

<b>Problem</b>	<b>Possible cause and solution</b>
Computer will not start.	<ul style="list-style-type: none"><li>• The battery may be defective or discharged to a critically low level. Connect an external power supply (such as the AC adapter) or install a charged battery. See “Using the battery” on page 48.</li><li>• Internal components may be above or below the acceptable operating range (below -20° C or above 60° C). After the temperature returns to safe operating range the computer will start.</li></ul>
The computer will not resume operation after being suspended.	<ul style="list-style-type: none"><li>• The battery may be defective or discharged to a critically low level. When the battery reaches a critically low level, the computer is forced into Sleep mode to avoid a total system power failure. Connect an external power supply (such as the AC adapter) or install a charged battery. See “Using the battery” on page 48.</li><li>• The computer may be at the critical thermal limit. To avoid damage to heat-sensitive components, the computer enters Sleep mode when the computer operates above 60° C. Operation automatically resumes when the computer cools to below 60° C. Move the computer to a cooler location.</li></ul>
The Status LED is red, continuous.	<ul style="list-style-type: none"><li>• The computer is on, running under battery power, and the charge level in the battery has reached a critical level. Plug the computer into an AC/DC power source or install a charged battery.</li><li>• The system has encountered a fault and is preventing normal operation. Contact your local help desk.</li></ul>
The Status LED is red, blinking.	The computer is powered on, running under battery power, and the charge level in the battery is at a minimum warning level. Plug the computer into an AC/DC power source or install a charged battery.

---

**Table 7** *Troubleshooting (continued)*

<b>Problem</b>	<b>Possible cause and solution</b>
Display screen is blank or difficult to read.	<ul style="list-style-type: none"><li>• Confirm that the computer is on (the Power icon is displayed continuously in the Status area).</li><li>• The brightness may be set too low, causing the screen to appear too dark. To change system brightness, press the Fn and Start keys to open the Xplore menu and adjust the brightness. (See page 27.)</li><li>• An external monitor may be selected. Press the Fn and P1 keys to select the computer display screen. (See page 27.)</li><li>• The video time-out may have expired. Tap the display screen to reactivate the display. <b>Note:</b> This is a normal, power-saving feature.</li><li>• If the Status light is blinking red, the computer is in Sleep mode because the temperature is below -20° C or above 60° C. When the temperature returns to a safe operating range, the display screen automatically comes back on. If possible, move the computer to a warmer or cooler location.</li><li>• If the Status light is continually yellow, the computer is in Sleep or Hibernate mode. Press the Power On/Off key to resume.</li></ul>
Cursor is not tracking the pen.	Calibrate the pen. See “Calibrating the digitizer” on page 75.
Computer is not responding to the pen.	Connect an external USB keyboard to the computer. If the computer does not respond to the external keyboard, the application or operating system may have been corrupted. Press the Reset key. (See page 30.) If the system responds to a keyboard but not to the pen, contact your local help desk or reseller for further assistance.
Headphone or speaker volume is too low.	<ul style="list-style-type: none"><li>• The volume may be in Mute mode or set too low. Follow the instructions in “Adjusting headphone or speaker volume” on page 45.</li><li>• Make sure the volume control in your audio software is set to an audible level.</li></ul>
An external device is not working with the computer.	The device may need to be enabled in the computer’s configuration program (BIOS Setup). Contact your local help desk or reseller.

# B







## Using BIOS and AOS Functions

**Note:** Each button has its own blue-light LED. No matter which button you press, every blue-light LED is on for about 3 seconds, then off. When in Shifted mode, all blue-light LEDs flicker.

This appendix explains how to use the application and navigation buttons with the Basic Input-Output System (BIOS) program and the Advanced Operating System (AOS) Options menu.

**Note:** These functions are typically for use only by your system administrator or by authorized service technicians.

**Table 8** Using BIOS and AOS functions

Button	BIOS Key	Function	In Shifted Mode	
			BIOS Key	Function
	F1	F1 continues message.	Up Arrow	Navigate up through Multi Boot options and BIOS menus.
	F2	Start the BIOS program: When the computer is booting, press the P2 button and follow the instructions that appear on the screen.	Down Arrow	Navigate down through Multi Boot options and BIOS menus.
	F8	Prompt Windows to select Safe mode.	Right Arrow	Navigate to the right.
	F11 (Lock Fn)	<ul style="list-style-type: none"><li>Press for less than one second for F11 function.</li><li>Press longer to enable Shifted mode.</li></ul>	Release Function	Press once to exit Shifted mode.
	F12	Enter Multi Boot mode.	F4	Change a BIOS setup value.
	Ctrl+Alt+Del	Reboot.	Enter	Enter.

## Disabling the Auto Power feature

---

When Auto Power is enabled, the tablet automatically turns on if you dock it and the following conditions exist:

- The tablet is off or in Hibernation or Sleep mode.
- The dock or the tablet is connected to an external power source (including power applied when a vehicle's ignition is started).

If you dock the tablet and the tablet is off and no power is present, the tablet turns on as soon as power is applied.

To disable the Auto Power feature:

1. When the computer is booting, press the P2 button to access the BIOS Setup Utility.
2. Select the Advanced tab.
3. Disable the **Dock with Auto Power On** option.

---

**Note:** When the tablet is in the docking station, it will shut down or go into Hibernation or Sleep mode the same as it does when not in the docking station.

## Enabling automatic LCD backlight control

---

When the LCD backlight control is in manual mode, the ambient light sensor is disabled and the computer does not automatically control the screen brightness.

Follow these steps to enable automatic LCD backlight control:

1. When the computer is booting, press the P2 button to start the BIOS Setup Utility.
2. Select the Main tab.
3. In the **LCD Backlight Control** drop-down list, select **Automatic**.
4. Click **OK**.



# C

## Glossary

---

**Adapter.** A device that provides an interface between two dissimilar electronic devices. For example, the AC adapter modifies the power from a wall outlet for use by the computer.

**Advanced Power Management (APM).** A facility consisting of one or more layers of software that support power management. The APM software interface enables applications, operating systems, device drivers, and the APM BIOS to work together to reduce power consumption.

**Alternating Current (AC).** Electric current that reverses its direction of flow at regular intervals.

**Analog signal.** A signal with characteristics such as amplitude and frequency that vary in proportion to (are an analog of) the value to be transmitted. Voice communications are analog signals.

**Application.** A program that performs specific tasks on your computer, such as word processing or creating spreadsheets.

**BIOS.** Programs that contain such basic hardware operations as an interaction with diskette drives, hard disk drives, and the memory.

**Board.** A circuit board. An internal card containing electronic components called chips, which perform a specific function or increase the capabilities of the system.

**Boot.** To load a program or operating system into system memory.

**Bits Per Second (BPS).** In serial transmission, the instantaneous bit speed with which a device or channel transmits a character.

**Card.** Synonym for board; see *board*.

**Compact Disk-Read Only Memory (CD-ROM).** Stores data on metal-plated plastic discs.

**Compatibility.** 1. The ability of one computer to accept and process data in the same method as another computer without modifying the data or the media upon which it is being transferred. 2. The ability of one device to connect or communicate with another system or component.

**Configuration.** The specific combination of hardware components of the computer, and their operating status. The configuration of your computer includes pre-defined memory, type and speed of microprocessor, type of and size of hard disk drive, etc.

**Default.** The preset parameter value automatically selected by the computer when you or a program do not provide instructions.

**Device driver.** A program that controls communication between a specific peripheral device (such as a printer or the pen/stylus) and the computer.

**Disk drive.** The physical device that enables the computer to read from, and write to, a disk.

**Display.** An image-producing device used to view computer output.

**Double-click.** To press and release the pen/stylus twice within a time frame you define, without moving the pointer off the choice.

**Hardware.** The physical electronic and mechanical components of a computer system. typically, the computer itself, CPU, memory, etc.

**Hertz.** A unit of wave frequency that equals one cycle per second.

**Interface.** 1. Hardware and/or software components used specifically to connect one computer or device to another. 2. To physically connect one system or device to another to exchange information. 3. The point of contact between user, the computer, and the program (for example, the pen/stylus or a menu).

**JBOD.** Two drives that appear in Window as two drives, Drive C and Drive D.

**Kilobyte (KB).** A unit of 1024 bytes measuring storage space, typically in memory or on storage media such as a diskette or hard disk drive.

**Local area network (LAN).** Assembly of separate computers into an integrated network that connects the various computers together and to common devices such as printers and fax machines.

**Light Emitting Diode (LED).** A semiconductor device that emits light when a current is applied.

**Liquid Crystal Display (LCD).** liquid crystal sealed between two sheets of glass coated with transparent conducting material. Applying a voltage between the glass sheets darkens the liquid crystal to provide contrast to lighted portions of the display.

**Megabyte (MB).** A unit of data storage equal to 1024 kilobytes.

**Megahertz (MHz).** a unit of wave frequency that equals 1 million cycles per second.

**Modem.** A device that connects your computer to a telephone line, allowing it to communicate with another computer at another location.

**Pen.** See *stylus*.

**Peripheral device.** An input/output device that is external to the central processor and/or main memory such as a printer or scanner.

**Pixel.** Picture elements (tiny dots) that compose a screen image.

**Port.** The electrical connection through which the computer sends and receives data to and from devices or other computers.

**Program.** A set of instructions a computer can execute to tell the system what to do and how to do it.

**RAID 0.** Two drives appear in Windows as one larger drive (two 80GB drives appear as one 160GB drive).

**RAID 1.** One drive has information mirrored to a duplicate drive. For example, information from one 80GB drive is mirrored to another 80GB drive. The two drives appear in Windows as a single drive.

**Random Access Memory (RAM).** A hardware component of your computer that temporarily stores active program code and data.

**Reset.** The act of hard stopping/shutting down the operating system.

**Resolution.** The number of pixels displayed on the screen. A higher resolution provides greater clarity and allows more information to be displayed on the screen at once.

**Restart.** Resetting a computer without turning it off (also called warm boot or soft reset).

**Resume.** The act of returning the computer to an active, operational state.

**Read Only Memory (ROM).** The portion of your computer's memory that contains permanent instructions, and which cannot be modified.

**Sleep mode.** A power conservation mode in which electrical current is removed from most components of the computer.

**Solid State Drive (SSD).** A sealed mass storage device used for storage and fast retrieval of programs and data. The SSD is contained in a drive cartridge for easy removal.

**Status Indicator (LED).** a light above the LCD screen which indicates the current status of a particular device or hardware component.

**Stylus.** A writing instrument. For pen computers, the stylus is used to interface with the LCD and digitizer.

**Subscriber Identity Module (SIM).** A smart card inside a GSM (Global System for Mobile communications) cellular device that encrypts voice and data transmissions and stores data about the specific user so that the user can be identified and authenticated by the network supplying the phone service. A SIM can be moved from one device to another and/or different SIMS can be inserted into any GSM radio.

**Universal Serial Bus (USB).** A serial interface that enables communication between devices and the computer.



# D

## Hardware Specifications

---

### *Physical*

Dimensions	11.20" x 8.25" x 1.6" (WxHxD) 283.9mm x 209.3mm x 40.8mm
Weight	5.25 lbs. (2.38 kgs)*

### *Processing*

CPU	Intel® i7® Core 620UE processor – Ultra Low Voltage
Chip set	Intel QM57
Processor speed	1.06 GHz*

\* Varies according to your computer's configuration.

### *Memory/storage*

Main RAM	<ul style="list-style-type: none"><li>• 1GB – 8GB DDR III RAM (2GB standard)</li><li>• 144-pin SODIMM modules</li></ul>
RAM options	2GB, 4 GB, 8GB DDR III (optional)
L2 Cache	4MB smart cache
BIOS ROM	8Mbit (FWH)
Storage	40GB SSD, or 80GB SSD, single or dual for RAID 0/1 and JBOD support

\* Varies according to your computer's configuration.

### Display

Display	<ul style="list-style-type: none"><li>• Color LCD</li><li>• Active Digital Sensor and Pen (iX104C5 and Resistive Touch Panel (iX104C5 Dual Mode))</li><li>• 32-bit True color</li><li>• 10.4" TFT XGA (1024x768), 16M colors</li><li>• Brightness: 100 levels (min.)</li><li>• Viewing Angle:<ul style="list-style-type: none"><li>- Horizontal: 30 degrees (min.)</li><li>- Vertical: 10 degrees (min.)</li><li>- Contrast Ratio: Typ. 600:1, Min 100:1</li></ul></li></ul>
VRAM	Intel i7 delivers low-power, high-performance 3D/2D graphics, video, and display capabilities, Intel HD graphics with Dynamic Frequency delivers graphics performance boost to graphics-intensive applications.



*Interface*

Wireless Radio Bays	<ul style="list-style-type: none"> <li>• One full mini-PCI Express slot for WWAN (3G)</li> <li>• One half mini-PCI Express slot for WiFi</li> </ul>
Integrated Interfaces	<ul style="list-style-type: none"> <li>• DC-in</li> <li>• USB (2) 2.0</li> <li>• Microphone Jack</li> <li>• Headset Jack</li> <li>• LAN (RJ-45)</li> <li>• 9-pin serial port) or optional 15-pin D-SUB connector for external VGA monitor</li> </ul>
KeyPad / User Controls	<ul style="list-style-type: none"> <li>• Application buttons with primary and secondary functions</li> <li>• Power On/Off/Suspend/Resume button</li> <li>• Emergency Shutoff/Reset button</li> </ul>
Audio	<ul style="list-style-type: none"> <li>• Realtec ACC 262</li> <li>• On-board microphone with noise cancellation</li> <li>• On-board integrated stereo speakers (1W each)</li> </ul>
Status Indicators	Power, Charge/DC-in, Warning

### Power

Main Battery	<ul style="list-style-type: none"> <li>• 10 cell 11-01019</li> <li>• Removable Lithium Ion</li> <li>• 7.4V @ 9250mAh (68.5 Whr)</li> <li>• Warm-swappable</li> <li>• Recharge time: 2.5 hours (100%)</li> <li>• Life: Up to 6.5 hours. (Battery life is dependent on operating system, power management, and applications in use.)</li> <li>• Suspend life: Min. 6 days</li> <li>• Off state: Approximately 90 days</li> </ul>
Optional Spare Battery	<ul style="list-style-type: none"> <li>• 8 cell, 11-01018</li> <li>• Removable Lithium Ion</li> <li>• 7.4C @ 7600mAh (55 Whr)</li> <li>• Warm-swappable</li> <li>• Recharge time: 2.5 hours</li> <li>• Life: Up to 4.5 hours. (Battery life is dependent on operating system, power management, and applications in use.)</li> <li>• Suspend life: Min. 5 days</li> <li>• Off state: Approximately 30 days</li> <li>• (IP65 only)</li> </ul>
Bridge Battery	<ul style="list-style-type: none"> <li>• 6-cell Li Ion, 45mAh</li> <li>• Life: (with Suspend-to-RAM on bridge battery only): 3 to 5 minutes from full charge</li> </ul>
AC Adapter	Auto-sensing 100-240V, supplying 19 VDC, with a current of 3.42 A

*Environmental*

Temperature	<ul style="list-style-type: none"> <li>• Operating: -7° to 140° F (-20° to 60° C) (iX104C5M minimum is -49° F, -45° C)</li> <li>• Storage: -40° to 167° F (-40° to 75° C)</li> </ul>
Humidity	0% to 95% non-condensing
Shock/Drop	Four-foot drop to concrete, all surfaces, edges and corners
Vibration	0.04g <sup>2</sup> /Hz, 20 Hz - 1000 Hz -6dB/octave 1000 Hz - 2000 Hz
Enclosure Class	<p>Blowing rain: 4"/hr, 40 mph wind and MIL-STD-810G Method 506.5 Procedure 1</p> <p>Ingress protection: IEC (60529) ingress tested to an IP67 standard</p> <p>Sand and dust: Particle size &lt; 149 µm, 10 ± 7 g/m<sup>3</sup> particle density 1.5 m/s to 8.9 m/s wind speed MIL-STD-810G Method 506.5 Procedure 1</p> <p>Salt Fog: 5% saline for 48 hr (12 hr wet, 12 hr dry, 2 cycles) MIL-STD-810G Method 506.5</p> <p>Contamination by fluids: Detergents, brake fluid, aromatic hydrocarbons MIL-STD-810G Method 506.5</p> <p>Solar radiation: 1120 W/m<sup>2</sup> (355 Btu/ft<sup>2</sup>/hr) UVB @ 50° C, 7x24 hr cycles MIL-STD-810G Method 506.5</p>

### *Agency approvals*

EMC	<ul style="list-style-type: none"><li>• CFR 47, FCC part 15B, IC ICES-003</li><li>• European Union Directive 2004/108/EC RTT&amp;E</li></ul>
Safety	<ul style="list-style-type: none"><li>• TUV Bauart, RoHS, 2002/95/EC, WEEE</li><li>• IEC600950-1 2nd Ed., EN60950-1 2nd Ed., UL60950-1 2nd Ed.</li><li>• ETL Listed: ANSIIISA-12.12.01-2007, C22.2 No. 213</li><li>• UL1604</li></ul>

### *Operating system*

Operating Systems	<ul style="list-style-type: none"><li>• Microsoft Windows 7 Professional – English, 32- and 64-bit</li></ul>
-------------------	--

# E

## Agency Notices

---



### FCC notices

This device complies with Part 15 of the FCC Rules. Operation is subject to the following two conditions: (1) this device may not cause harmful interference, and (2) this device must accept any interference received, including interference that may cause undesired operation.

Modifications not expressly approved by Xplore Technologies could void this user's authority to operate the equipment.

---

**Note:** This equipment has been tested and found to comply with the limits for a Class B digital device, pursuant to Part 15 of the FCC Rules. These limits are designed to provide reasonable protection against harmful interference in a residential installation. This equipment generates, uses and can radiate radio frequency energy and, if not installed and used in accordance with the instructions, may cause harmful interference to radio communications. However, there is no guarantee that interference will not occur in a particular installation. If this equipment does cause harmful interference to radio or television reception, which can be determined by turning the equipment off and on, the user is encouraged to try to correct the interference by one or more of the following measures:

- Reorient or relocate the receiving antenna.
  - Increase the separation between the equipment and receiver.
  - Connect the equipment into an outlet on a circuit different from that to which the receiver is connected.
  - Consult the dealer or an experienced radio/TV technician for help.
- 

### RF exposure

Tests for SAR are conducted using standard operating positions specified by the FCC with the tablet PC transmitting at its highest certified power level in all tested frequency bands. Although the SAR is determined at the highest certified power level, the actual SAR level of the tablet PC while operating can be well below the maximum value. This is because the tablet PC is designed to operate at multiple power levels so as to use only the power required to reach the network. In general, the closer you are to a wireless base station antenna, the lower the power output.

Before a tablet PC model is available for sale to the public, it must be tested and certified to the FCC that it does not exceed the limit established by the government-adopted requirement for safe exposure. The tests are performed in positions and locations (e.g., worn on the body) as required by the FCC for each model. (Body-worn measurements may differ among tablet PC models, depending upon available accessories and FCC requirements). While there may be differences between the SAR levels of various tablet PCs and at various positions, they all meet the government requirement for safe exposure.

This device was evaluated and shown to comply with FCC SAR guidelines. Avoid covering or holding antennas when transmitting. Antenna locations are shown in the following figure.

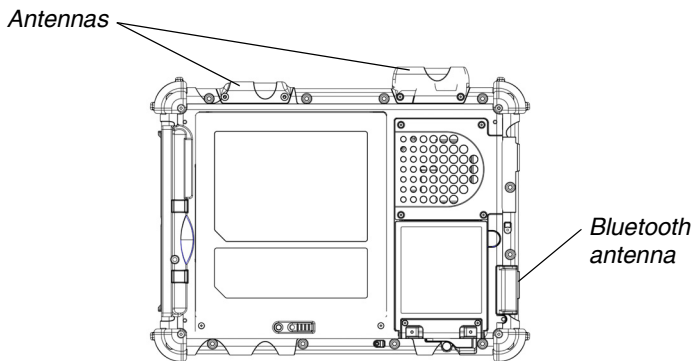

### Health and Safety Information

#### ***Exposure to Radio Frequency (RF) Signals***

Your wireless tablet PC is a radio transmitter and receiver. It is designed and manufactured not to exceed the emission limits for exposure to radio frequency (RF) energy set by the Federal Communications Commission of the U.S. Government as well as the RTT&E directive. These limits are part of comprehensive guidelines and establish permitted levels of RF energy for the general population. The guidelines are based on the safety standards previously set by both U.S. and international standards bodies:

- American National Standards Institute (ANSI) IEEE. C95.1-1992
- National Council on Radiation Protection and Measurement (NCRP). Report 86. 1986

- International Commission on Non-Ionizing Radiation Protection (ICNIRP) 1996
- Ministry of Health (Canada), Safety Code 6. The standards include a substantial safety margin designed to assure the safety of all persons, regardless of age and health.
- European Union RTT&E Directive for SAR

The exposure standard for wireless mobile tablet PCs employs a unit of measurement known as the Specific Absorption Rate, or SAR. The SAR limit set by the FCC is 1.6W/kg. The SAR limit set by the RTT&E is 2.0W/kg.

---

**Note:** In the U.S. and Canada, the SAR limit for mobile tablet PCs used by the public is 1.6 watts/kg (W/kg) averaged over 1 gram of tissue. In Europe the SAR limit for mobile table PCs used by the public is 2.0 watts/kg (W/kg) averaged over 10 grams of tissue. The standard incorporates a substantial margin of safety to give additional protection for the public and to account for any variations.

---

## **DOC (Industry Canada Notices)**

### ***Notice to Users of Radio and Television***

This Class B digital apparatus meets all requirements of Canadian Interference-Causing Equipment Regulations per the ICES-003

CET appareil numérique de la class B respecte toutes les exigence du Règlement sur le matériel brouilleur du Canada.

### ***Notice to Users of the Canadian Telephone Network***

---

**Notice:** This equipment meets the applicable Industry Canada Terminal Equipment Technical Specifications. This is confirmed by the registration number. The abbreviation, IC, before the registration number signifies that registration was performed based on a Declaration of Conformity indicating that Industry Canada technical specifications were met. It does not imply that Industry Canada approved the equipment.

---

Before connecting this equipment to a telephone line the user should ensure that it is permissible to connect this equipment to the local telecommunication facilities. The user should be aware that compliance with the certification standards does not prevent service degradation in some situations.

Repairs to telecommunication equipment should be made by a Canadian authorized maintenance facility. Any repairs or alterations not expressly

approved by Xplore or any equipment failures may give the telecommunication company cause to request the user to disconnect the equipment from the telephone line.

---

**Notice:** The Ringer Equivalence Number (REN) for this terminal equipment is 0.0. The REN assigned to each terminal equipment provides an indication of the maximum number of terminals allowed to be connected to a telephone interface. The termination on an interface may consist of any combination of devices subject only to the requirement that the sum of the Ringer Equivalence Numbers of all the devices does not exceed five.

---

### UL Notice

This unit requires an AC adapter to operate. Use only UL Listed Class 2 Adapters with an output rating of 19 VDC, with a current of 3.75 A. AC Adapter output polarity:



### For authorized repair technicians only



#### **WARNING**

*For continued protection against risk of fire, replace only with the same type and rating fuse.*



#### **WARNING**

*Danger of explosion if Lithium (clock) battery is incorrectly replaced. Replace only with the same equivalent type recommended by the manufacturer. Dispose of used batteries according to the manufacturer's instruction.*

### System disposal

In the event of system disposal, observe the following information regarding proper procedures in the State of Vermont.

The liquid crystal display (LCD) lamps used in this system contain mercury. In the event of system disposal, be sure to follow local guidelines.







## Declaration of Conformity

Xplore Technologies, Corp. hereby declares under our sole responsibility that the product

- ✓ Name: **Wildcat 5**
- ✓ Model: **iX104C5**

To which this declaration relates, is in compliance with all the applicable essential requirements, and other provisions of the European Council Directives listed. The conformity assessment procedure used for this declaration is Annex IV of **Directive 1999/5/EC**. This product will bear the CE Mark label (CE !)

### DIRECTIVES:

- **Directive 2004/108/EC** (EMC Directive)
- **Directive 2006/95/EC** (Low Voltage Directive)
- **Directive 1999/5/EC** (Radio and Telecommunications Terminal Equipment) (R&TTE Directive)
- **Directive 2002/96/EC** (Waste of Electrical and Electronic Equipment) (WEEE Directive)
- **Directive 2002/95/EC** (Restriction of Hazardous Substances) (RoHS Directive)

Product compliance has been demonstrated on the basis of:

### STANDARDS:

- EN 55022: 2006/A1:2007 (Class B)
- EN 55024: 1998/A1:2001/A2:2003
- EN 61000-3-2:2006+A2:2009
- EN 61000-3-3:2008
- EN 61000-4-2:2009
- EN 61000-4-3:2006+A2:2010
- EN 61000-4-4:2004+A1:2010
- EN 61000-4-5:2007
- EN 61000-4-6:2009
- EN 61000-4-8:2010
- EN 61000-4-11:2005
- EN 60950-1:2006+A11
- ATEX II 3 G Ex nA IIC T4
- EN 50371: 2002
- EN 301 489-1 V1.8.1 (2008)
- EN 301 489-07 V1.3.1 (2005)
- EN 301 489-17 V2.1.1 (2009)
- EN 301 489-24 V1.4.1
- EN 300 328 V1.7.1 (2006-10)
- EN 301 893 V1.5.1
- EN 301 511 V9.0.2 (2000-12)
- EN 301 908-1 V3.2.1
- EN 301 908-2 V3.2.1
- EN 60079-0:2006
- EN 60079-11:2007
- EN 60079-15:200

Jason L. Moreland  
Regulatory and Compliance Specialist

22 June 2011  
Date

Austin, TX, USA  
Place

The technical construction file is kept available at:  
Xplore Technologies Corp.  
14000 Summit Dr, Ste 900  
Austin, TX 78728  
USA 888-44-XPLORE, FAX: 512-485-1505, www.xploretech.com



PN 95-01200 Rev C

### Intel Advanced-N 6200 Country-specific Compliance Statements

Hereby, Xplore Technologies, declares that the Intel Advanced-N 6200 complies with the essential requirements and other relevant provisions of Directive 1999/5/EC. This equipment is marked with the CE symbol and can be used throughout the European community.

Country	Compliance Statement
•esky [Czech]	Xplore Technologies tímto prohlašuje, že tento Intel® Centrino® Advanced-N6200 je ve shodě se základními požadavky a dalšími příslušnými ustanoveními směrnice 1999/5/ES.
Dansk [Danish]	Undertegnede Xplore Technologies erklærer herved, at følgende udstyr, Intel® Centrino® Advanced-N 6200 overholder de væsentlige krav og øvrige relevante krav i direktiv 1999/5/EF.
Deutsch [German]	Hiermit erkläre Xplore Technologies, dass sich das Gerät Intel® Centrino® Advanced-N 6200 in Übereinstimmung mit den grundlegenden Anforderungen und den übrigen einschlägigen Bestimmungen der Richtlinie 1999/5/EG befindet.
Eesti [Estonian]	Käesolevaga kinnitab Xplore Technologies seadme Intel® Centrino® Advanced-N 6200 vastavust direktiivi 1999/5/EÜ põhinõuetele ja nimetatud direktiivist tulenevatele teistele asjakohastele sätetele.
English	Hereby, Xplore Technologies, declares that this Intel® Centrino® Advanced-N 6200 is in compliance with the essential requirements and other relevant provisions of Directive 1999/5/EC.
Español [Spanish]	Por medio de la presente Xplore Technologies declara que el Intel® Centrino® Advanced-N 6200 cumple con los requisitos esenciales y cualesquiera otras disposiciones aplicables o exigibles de la Directiva 1999/5/CE.
Ελληνικά [Greek]	ΜΕ ΤΗΝ ΠΑΡΟΥΣΑ Xplore Technologies ΔΗΛΩΝΕΙ ΟΤΙ Intel® Centrino® Advanced-N 6200 ΣΥΜΜΟΡΦΩΝΕΤΑΙ ΠΡΟΣ ΤΙΣ ΟΥΣΙΩΔΕΙΣ ΑΠΑΙΤΗΣΕΙΣ ΚΑΙ ΤΙΣ ΛΟΙΠΕΣ ΕΣΣΗΤΙΚΕΣ ΔΙΑΤΑΞΕΙΣ ΤΗΣ ΟΔΗΓΙΑΣ 1999/5/ΕΚ.
Français [French]	Par la présente Xplore Technologies déclare que l'appareil Intel® Centrino® Advanced-N 6200 est conforme aux exigences essentielles et aux autres dispositions pertinentes de la directive 1999/5/CE.
Italiano [Italian]	Con la presente Xplore Technologies dichiara che questo Intel® Centrino® Advanced-N 6200 è conforme ai requisiti essenziali ed alle altre disposizioni pertinenti stabilite dalla direttiva 1999/5/CE.
Latviski [Latvian]	Ar šo Xplore Technologies deklarā, ka Intel® Centrino® Advanced-N 6200 atbilst Direktīvas 1999/5/EK būtiskajiem prasībām un citiem ar to saistītajiem noteikumiem.
Lietuvi [Lithuanian]	Šiuo Xplore Technologies deklaruoja, kad šis Intel® Centrino® Advanced-N 6200 atitinka esminius reikalavimus ir kitas 1999/5/EB Direktivos nuostatas.
Nederlands [Dutch]	Hierbij verklaart Xplore Technologies dat het toestel Intel® Centrino® Advanced-N 6200 in overeenstemming is met de essentiële eisen en de andere relevante bepalingen van richtlijn 1999/5/EG.
Malti [Maltese]	Hawnhekk, Xplore Technologies, jiddikjara li dan Intel® Centrino® Advanced-N 6200 jikkonforma mal-•itijiet essenzi•ali u ma provvedimenti o•rajn rilevanti li hemm fid-•Dirrettiva 1999/5/EC.
Magyar [Hungarian]	Alulírott, Xplore Technologies nyilatkozom, hogy a Intel® Centrino® Advanced-N 6200 megfelel a vonatkozó alapvető követelményeknek és az 1999/5/EC irányelv egyéb előírásainak.
Norsk [Norwegian]	Xplore Technologies erklærer herved at utstyret Intel® Centrino® Advanced- N 6200 er i samsvar med de grunnleggende krav og øvrige relevante krav i direktiv 1999/5/EF.
Polski [Polish]	Niniejszym, Xplore Technologies, oświadczam, że Intel® Centrino® Advanced-N 6200 jest zgodne z zasadniczymi wymaganiami oraz innymi stosownymi postanowieniami Dyrektywy 1999/5/WE.
Português [Portuguese]	Xplore Technologies declara que este Intel® Centrino® Advanced-N 6200 está conforme com os requisitos essenciais e outras disposições da Directiva 1999/5/CE.
Slovensko [Slovenian]	Šiuo Xplore Technologies izjavlja, da je ta Intel® Centrino® Advanced-N 6200 v skladu z bistvenimi zahtevami in ostalimi relevantnimi določili direktive 1999/5/ES.
Slovensky [Slovak]	Xplore Technologies týmto vyhlasuje, že Intel® Centrino® Advanced-N 6200 sp••a základné požiadavky a všetky príslušné ustanovenia Smernice 1999/5/ES.
Suomi [Finnish]	Xplore Technologies vakuuttaa täten että Intel® Centrino® Advanced-N 6200 tyyppinen laite on direktiivin 1999/5/EY oleellisten vaatimusten ja sitä koskevien direktiivin muiden ehtojen mukainen.
Svenska [Swedish]	Härmed intygar Xplore Technologies att denna Intel® Centrino® Advanced-N 6200 står i överensstämmelse med de väsentliga egenskapskrav och övriga relevanta bestämmelser som framgår av direktiv 1999/5/EG.
Íslenska [Icelandic]	Hér með lýsir Xplore Technologies yfir því að Intel® Centrino® Advanced-N 6200 er í samræmi við grunnkröfur og aðrar kröfur, sem gerðar eru í tilskipun 1999/5/EC.



**Option NV GOBI2000 Country-specific Compliance Statements**

Hereby, Xplore Technologies, declares that the Option NV GOBI2000 complies with the essential requirements and other relevant provisions of Directive 1999/5/EC. This equipment is marked with the CE symbol and can be used throughout the European community.

Country	Compliance Statement
Český [Czech]	Xplore Technologies tímto prohlašuje, že tento Option NV® GOBI2000® je ve shodě se základními požadavky a dalšími příslušnými ustanoveními směrnice 1999/5/ES.
Dansk [Danish]	Undertegnede Xplore Technologies erklærer herved, at følgende udstyr: Option NV® GOBI2000® overholder de væsentlige krav og øvrige relevante krav i direktiv 1999/5/EF.
Deutsch [German]	Hiermit erkläre Xplore Technologies, dass sich das Gerät Intel® Option NV® GOBI3000® in Übereinstimmung mit den grundlegenden Anforderungen und den übrigen einschlägigen Bestimmungen der Richtlinie 1999/5/EG befindet.
Eesti [Estonian]	Käesolevaga kinnitab Xplore Technologies seadme Option NV® GOBI2000® vastavust direktiivi 1999/5/EÜ põhinõuetele ja nimetatud direktiivist tulenevatele teistele asjakohastele sätetele.
English	Hereby, Xplore Technologies, declares that this Option NV® GOBI2000® is in compliance with the essential requirements and other relevant provisions of Directive 1999/5/EC.
Español [Spanish]	Por medio de la presente Xplore Technologies declara que el Option NV® GOBI2000® cumple con los requisitos esenciales y cualesquiera otras disposiciones aplicables o exigibles de la Directiva 1999/5/CE.
Ελληνικά [Greek]	ΜΕ ΤΗΝ ΠΑΡΟΥΣΑ, Xplore Technologies ΔΗΛΩΝΕΙ ΟΤΙ Option NV® GOBI2000® ΣΥΜΜΟΡΦΩΝΕΤΑΙ ΠΡΟΣ ΤΙΣ ΟΥΣΙΩΔΕΙΣ ΑΠΑΙΤΗΣΕΙΣ ΚΑΙ ΤΙΣ ΛΟΙΠΕΣ ΣΥΝΕΤΙΚΕΣ ΔΙΑΤΑΞΕΙΣ ΤΗΣ ΟΔΗΓΙΑΣ 1999/5/Ε.
Français [French]	Par la présente Xplore Technologies déclare que l'appareil Option NV® GOBI2000® est conforme aux exigences essentielles et aux autres dispositions pertinentes de la directive 1999/5/CE.
Italiano [Italian]	Con la presente Xplore Technologies dichiara che questo Option NV® GOBI2000® è conforme ai requisiti essenziali ed alle altre disposizioni pertinenti stabilite dalla direttiva 1999/5/CE.
Latviski [Latvian]	Ar šo Xplore Technologies deklarā, ka Option NV® GOBI2000® atbilst Direktīvas 1999/5/EK būtiskajām prasībām un citiem ar to saistītajiem noteikumiem.
Lietuvi [Lithuanian]	Šiuo Xplore Technologies deklaruoja, kad šis Option NV® GOBI2000® atitinka esminius reikalavimus ir kitas 1999/5/EB Direktyvos nuostatas.
Nederlands [Dutch]	Hierbij verklaart Xplore Technologies dat het toestel Option NV® GOBI2000® in overeenstemming is met de essentiële eisen en de andere relevante bepalingen van richtlijn 1999/5/EG.
Malti [Maltese]	Hawnhekk, Xplore Technologies, jiddikjara li dan Option NV® GOBI2000®, jikkonforma mal-•tlijiel essenzjali u ma provvedimenti o•rajn rilevanti li hemm fid-Direttiva 1999/5/EC.
Magyar [Hungarian]	Alulírott, Xplore Technologies nyilatkozom, hogy a Option NV® GOBI2000® megfelel a vonatkozó alapvető követelményeknek és az 1999/5/EC irányelv egyéb előírásainak.
Norsk [Norwegian]	Xplore Technologies erklærer herved at utstyret Option NV® GOBI2000® er i samsvar med de grunnleggende krav og øvrige relevante krav i direktiv 1999/5/EF.
Polski [Polish]	Niniejszym, Xplore Technologies, oświadczam, że Option NV® GOBI2000® jest zgodna z zasadniczymi wymaganiami oraz innymi stosownymi postanowieniami Dyrektywy 1999/5/WE.
Português [Portugues e]	Xplore Technologies declara que este Option NV® GOBI2000® está conforme com os requisitos essenciais e outras disposições da Directiva 1999/5/CE.
Slovensko [Slovenian]	Šiuo Xplore Technologies izjavlja, da je ta Option NV® GOBI2000® v skladu z bistvenimi zahtevami in ostalimi relevantnimi določili direktive 1999/5/ES.
Slovenský [Slovak]	Xplore Technologies týmto vyhlasuje, že Option NV® GOBI2000® sp••a základné požiadavky a všetky príslušné ustanovenia Smernice 1999/5/ ES.
Suomi [Finnish]	Xplore Technologies vakuuttaa täten että Option NV® GOBI2000® tyypin laite on direktiivin 1999/5/EY oleellisten vaatimusten ja sitä koskevien direktiivin muiden ehtojen mukainen.
Svenska [Swedish]	Härmed intygar Xplore Technologies att denna Option NV® GOBI2000® står i överensstämmelse med de väsentliga egenskapskrav och övriga relevanta bestämmelser som framgår av direktiv 1999/5/EG.
Íslenska [Icelandic]	Hér með lýsir Xplore Technologies yfir því að Option NV® GOBI2000® er í samræmi við grunnkröfur og aðrar kröfur, sem gerðar eru í tilskipun 1999/5/EC.

## Sierra MC8795V Country-specific Compliance Statements

Hereby, Xplore Technologies, declares that the Sierra MC8795V complies with the essential requirements and other relevant provisions of Directive 1999/5/EC. This equipment is marked with the CE symbol and can be used throughout the European community.

Country	Compliance Statement
Česky [Czech]	Xplore Technologies tímto prohlašuje, že tento Sierra® MC8795V® je ve shodě se základními požadavky a dalšími příslušnými ustanoveními směrnice 1999/5/ES.
Dansk [Danish]	Undertegnede Xplore Technologies erklærer herved, at følgende udstyr: Option NV® GOBI2000® overholder de væsentlige krav og øvrige relevante krav i direktiv 1999/5/EF.
Deutsch [German]	Hiermit erkläre Xplore Technologies, dass sich das Gerät Sierra® MC8795V® in Übereinstimmung mit den grundlegenden Anforderungen und den übrigen einschlägigen Bestimmungen der Richtlinie 1999/5/EG befindet.
Eesti [Estonian]	Käesolevaga kinnitab Xplore Technologies seadme Sierra® MC8795V® vastavust direktiivi 1999/5/EU põhinõuetele ja nimetatud direktiivist tulenevatele teistele asjakohastele sätetele.
English	Hereby, Xplore Technologies, declares that this Sierra® MC8795V® is in compliance with the essential requirements and other relevant provisions of Directive 1999/5/EC.
Español [Spanish]	Por medio de la presente Xplore Technologies declara que el Sierra® MC8795V® cumple con los requisitos esenciales y cualesquiera otras disposiciones aplicables o exigibles de la Directiva 1999/5/CE.
Ελληνικά [Greek]	ΜΕ ΤΗΝ ΠΑΡΟΥΣΑ Xplore Technologies ΔΗΛΩΝΕΙ ΟΤΙ Sierra® MC8795V® ΣΥΜΜΟΡΦΩΝΕΤΑΙ ΠΡΟΣ ΤΙΣ ΟΥΣΙΩΔΕΙΣ ΑΠΑΙΤΗΣΕΙΣ ΚΑΙ ΤΙΣ ΛΟΙΠΕΣ ΕΞΕΤΙΚΕΣ ΔΙΑΤΑΞΕΙΣ ΤΗΣ ΟΔΗΓΙΑΣ 1999/5/Ε.
Français [French]	Par la présente Xplore Technologies déclare que l'appareil Sierra® MC8795V® est conforme aux exigences essentielles et aux autres dispositions pertinentes de la directive 1999/5/CE.
Italiano [Italian]	Con la presente Xplore Technologies dichiara che questo Sierra® MC8795V® è conforme ai requisiti essenziali ed alle altre disposizioni pertinenti stabilite dalla direttiva 1999/5/CE.
Latviski [Latvian]	Ar šo Xplore Technologies deklarā, ka Sierra® MC8795V® atbilst Direktīvas 1999/5/EK būtiskajām prasībām un citiem ar to saistītajiem noteikumiem.
Lietuvių [Lithuanian]	Šiuo Xplore Technologies deklaruoją, kad šis Sierra® MC8795V® atitinka esminius reikalavimus ir kitas 1999/5/EB Direktivos nuostatas.
Nederlands [Dutch]	Hierbij verklaart Xplore Technologies dat het toestel Sierra® MC8795V® in overeenstemming is met de essentiële eisen en de andere relevante bepalingen van richtlijn 1999/5/EG.
Malti [Maltese]	Hawnhekk, Xplore Technologies, jiddikjara li dan Sierra® MC8795V® jikkonforma mal- <del>le</del> liġiet essenzjali u ma provvedimenti o <del>tr</del> ain relevanti li hemm fid-Dirrettiva 1999/5/EC.
Magyar [Hungarian]	Alulírott, Xplore Technologies nyilatkozom, hogy a Sierra® MC8795V® megfelel a vonatkozó alapvető követelményeknek és az 1999/5/EC irányelv egyéb előírásainak.
Norsk [Norwegian]	Xplore Technologies erklærer herved at utstyret Sierra® MC8795V® er i samsvar med de grunnleggende krav og øvrige relevante krav i direktiv 1999/5/EF.
Polski [Polish]	Minijszym, Xplore Technologies, oświadczam, że Sierra® MC8795V® jest zgodne z zasadniczymi wymaganiami oraz innymi stosownymi postanowieniami Dyrektywy 1999/5/WE.
Português [Portuguese]	Xplore Technologies declara que este Sierra® MC8795V® está conforme com os requisitos essenciais e outras disposições da Directiva 1999/5/CE.
Slovensko [Slovenian]	Šiuo Xplore Technologies izjavyja, da je ta Sierra® MC8795V® v skladu z bistvenimi zahtevami in ostalimi relevantnimi določili direktive 1999/5/ES.
Slovenský [Slovak]	Xplore Technologies týmto vyhlasuje, že Sierra® MC8795V® spĺňa základné požiadavky a všetky príslušné ustanovenia Smernice 1999/5/ES.
Suomi [Finnish]	Xplore Technologies vakuuttaa täten että Sierra® MC8795V®-tuotteen laite on direktiivin 1999/5/EY oleellisten vaatimusten ja sitä koskevien direktiivin muiden ehtojen mukainen.
Svenska [Swedish]	Härmed intygar Xplore Technologies att denna Sierra® MC8795V® står i överensstämmelse med de väsentliga egenskapskrav och övriga relevanta bestämmelser som framgår av direktiv 1999/5/EG.
Íslenska [Icelandic]	Hér með lýsir Xplore Technologies yfir því að Sierra® MC8795V® er í samræmi við grunnkröfur og aðrar kröfur, sem gerðar eru í tilskipun 1999/5/EC.

### **Broadcom BCM2070 — EU Declaration of Conformity and Restrictions**

Hereby, Xplore Technologies, declares that the Broadcom BCM2070 Bluetooth complies with the essential requirements and other relevant provisions of Directive 1999/5/EC.

This equipment is marked with the CE symbol and can be used throughout the European community.

This indicates compliance with the R&TTE Directive 1999/5/EC and meets the relevant parts of following technical specifications:

- EN 300 328 – Electromagnetic compatibility and Radio spectrum Matters (ERM); Wideband Transmission Systems; Data transmission equipment operating in the 2.4GHz ISM band and using spread spectrum modulation techniques; Harmonized EN covering essential requirements under article 3.2 of the R&TTE directive.
- EN 301 489-17 - Electromagnetic Compatibility and Radio Spectrum Matters (ERM); Electromagnetic Compatibility (EMC) standard for radio equipment and services; Part 17 Specific Conditions for Wideband Data and HIPERLAN Equipment.
- EN 60950-1 - Safety of Information Technology Equipment.
- EN 50385 – Product standard to demonstrate the compliances of radio base stations and fixed terminal stations for wireless telecommunication systems with the basic restrictions or the reference levels related to human exposure to radio frequency electromagnetic fields.
- 

**France - 2.4GHz for Metropolitan France:**

**In all Metropolitan departments, wireless LAN frequencies can be used under the following conditions, either for public or private use:**

- Indoor use: maximum power (EIRP\*) of 100 mW for the entire 2400-2483.5 MHz frequency band
- Outdoor use: maximum power (EIRP\*) of 100 mW for the 2400-2454 MHz band and with maximum power (EIRP\*) of 10 mW for the 2454-2483 MHz band

# Index

---

## A

- air flow vents, location 21
- ambient light sensor, location 19
- antenna covers, location 20
- Auto Light sensor, disabling 41
- Auto Power feature, disabling 80

## B

- battery pack
  - charge time 49
  - charging 48
  - checking the charge 48
  - conserving power 56
  - installing 51
  - location 20
  - removing 49
- battery release latch, location 20
- BIOS Setup Utility, using 79

## C

- convection air flow cover, location 20

## D

- digitizer
  - calibrating 75
  - using to perform mouse functions 35
- double-click, performing with pen 35
- dragging and dropping, performing with pen 35

## H

- headphone connector, location 22
- headphone volume, adjusting 45
- headphone, connecting 45
- Hibernation mode, description 31
- hot keys, programming 61

hot keys, programming, *see keys, programming hot keys*

## I

- Internet Explorer, starting 27
- iX104
  - accessories 15
  - preventing overheating 72
  - protecting from damage 71
  - storing 73

## K

- Kensington lock slot, location 21

## keys

- Ctrl-Alt-Del 27
  - description 27
- Ctrl-Alt-Delete
  - location 26
- descriptions 27
- Function
  - description 27
  - location 26
- Function mode hot key combinations
  - default functions 60
  - descriptions 27
- P1
  - default function 60
  - location 26
- P2
  - default function 60
  - description 27
  - location 26
- P3
  - location 26
- Power On/Off/Sleep/Resume
  - location 55

- programming hot keys 60, 61
  - to perform other key functions 67
  - to perform pre-defined functions 65
- quick-start diagram 26
- Screen Rotation
  - description 27
  - location 26
- Secure Attention Sequence (SAS) 26

## L

- LAN connector, location 22
- LCD backlight
  - disabling automatic control 41
  - enabling manual control 80
- LEDs 24
  - Status LED meanings 24
- left button click, performing with pen 35
- local area network (LAN), connecting to 43
- logging on 27

## M

- microphone
  - connecting external 44
  - connector location 22
  - location 19
  - volume, adjusting 44
- monitor
  - activating 46
  - connecting 46
  - sending video display to 27
- mouse functions, performing 35

## P

- pen
  - double-click speed, changing 35
  - dragging and dropping 35
  - holder, location 20
  - location 20
  - performing a double-click 35

- performing a right-click 35
- performing left button click 35
- positioning in holder 36
- replacing 74
- tether, using 36
- Power (On/Off)/Backlight (On/Off)/Sleep/Resume key, location 55
- power connector, location 22
- Power On/Off/ Suspend/Resume key, location 21
- power use, managing 52
- projection panel
  - activating 46
  - connecting 46
  - sending video display to 27

## Q

- quick-start guide 26

## R

- Reset switch
  - location 19
  - using 30
- resuming operation 33
- right-click, performing with pen 35
- RJ-45 connector 22

## S

- screen
  - landscape mode 27
  - portrait mode 27
  - protecting 73
- screen orientation
  - changing 39
  - landscape 39
  - portrait 39
- screen protector
  - installing 74
  - removing 74
  - replacing 74



- serial port
  - compatible devices 47
  - location 47
- Sleep mode
  - ending 33
  - starting 32
- Sleep mode, description 31
- speaker volume, adjusting 45
- speakers
  - connecting 45
  - location 19
- storing the computer 73
- support, contacting 17
- suspending operation 32

**T**

- troubleshooting 77
- turning off the computer 30
- turning on the computer 29

**U**

- USB port, location 22
- USB-compatible device, connecting 43

**V**

- video output
  - changing from monitor to computer 46
  - changing to monitor 46
- volume
  - adjusting headphone 45
  - adjusting microphone 44
  - adjusting speaker 45

**W**

- Windows Task Manager, launching 27

**X**

- XPL expansion module, connecting 47
- XPL2 port 21, 23
- Xplore Technologies, contacting 17





95-01097  
Rev A