



RADIO TEST REPORT

Test Report No. : 32BE0197-HO-01-C

Applicant : DENSO WAVE INCORPORATED
Type of Equipment : High Frequency 13.56 MHz Transceiver
Model No. : CTAN10R-01
Test regulation : FCC Part 15 Subpart C: 2012
FCC ID : PZWCTAN10R01
Test Result : Complied

1. This test report shall not be reproduced in full or partial, without the written approval of UL Japan, Inc.
2. The results in this report apply only to the sample tested.
3. This sample tested is in compliance with above regulation.
4. The test results in this report are traceable to the national or international standards.
5. This test report must not be used by the customer to claim product certification, approval, or endorsement by NVLAP, NIST, or any agency of the Federal Government.

Date of test: October 26 to November 11, 2011

Representative test engineer: *K. Kawamura*
Keisuke Kawamura
Engineer of WiSE Japan,
UL Verification Service

Approved by: *T. Hatakeda*
Takahiro Hatakeda
Leader of WiSE Japan,
UL Verification Service

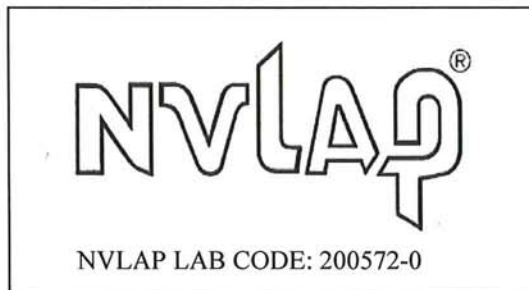

This laboratory is accredited by the NVLAP LAB CODE 200572-0, U.S.A. The tests reported herein have been performed in accordance with its terms of accreditation.
*As for the range of Accreditation in NVLAP, you may refer to the WEB address,
<http://www.ul.com/japan/jpn/pages/services/emc/about/mark1/index.jsp#nvlap>

CONTENTS	PAGE
SECTION 1: Customer information	3
SECTION 2: Equipment under test (E.U.T.)	3
SECTION 3: Test specification, procedures & results	4
SECTION 4: Operation of E.U.T. during testing	7
SECTION 5: Conducted emission	10
SECTION 6: Radiated emission (Fundamental , Spurious Emission and Spectrum Mask)	11
SECTION 7: Other test	12
APPENDIX 1: Data of EMI test	13
Conducted emission	13
Fundamental emission and Spectrum Mask.....	15
Spurious emission	17
20dB Bandwidth and 99% Occupied Bandwidth.....	21
Frequency Tolerance	23
APPENDIX 2: Test instruments	25
APPENDIX 3: Photographs of test setup	26
Conducted emission	26
Radiated emission	28
Worst Case Position.....	30

UL Japan, Inc.

Head Office EMC Lab.

4383-326 Asama-cho, Ise-shi, Mie-ken 516-0021 JAPAN

Telephone : +81 596 24 8116

Facsimile : +81 596 24 8124

SECTION 1: Customer information

Company Name : DENSO WAVE INCORPORATED
Address : 1 Yoshiike, Kusagi, Agui-cho, Chita-gun, Aichi 470-2297 Japan
Telephone Number : +81-569-49-5284
Facsimile Number : +81-569-49-5488
Contact Person : TOSHIHARU SHIMIZU

SECTION 2: Equipment under test (E.U.T.)

2.1 Identification of E.U.T.

Type of Equipment : High Frequency 13.56 MHz Transceiver
Model No. : CTAN10R-01
Serial No. : Refer to Section 4, Clause 4.2
Rating : DC 8.5V
Receipt Date of Sample : October 18, 2011
Country of Mass-production : Japan
Condition of EUT : Engineering prototype
(Not for Sale: This sample is equivalent to mass-produced items.)
Modification of EUT : No Modification by the test lab

2.2 Product Description

General Specification

Clock frequency(ies) in the system : 13.56MHz

Radio Specification

Radio Type : Transceiver
Frequency of Operation : 13.56MHz
Modulation : ASK
Power Supply (inner) : Transmitter: DC 7V, Receiver: DC 5V
Antenna type : Loop Coil
Operating Temperature : -10 deg. C. to +60 deg. C

UL Japan, Inc.

Head Office EMC Lab.

4383-326 Asama-cho, Ise-shi, Mie-ken 516-0021 JAPAN

Telephone : +81 596 24 8116

Facsimile : +81 596 24 8124

SECTION 3: Test specification, procedures & results

3.1 Test Specification

Test Specification : FCC Part 15 Subpart C: 2012, final revised on February 1, 2012

Title : FCC 47CFR Part15 Radio Frequency Device Subpart C Intentional Radiators
Section 15.207 : Conducted limits
Section 15.225 : Operation within the band 13.110-14.010MHz

*The revision on February 1, 2012 does not affect the test specification applied to the EUT.

3.2 Procedures and results

Item	Test Procedure	Specification	Worst margin	Results	Remarks
Conducted emission	ANSI C63.4:2003 7. AC powerline conducted emission measurements ----- <IC>RSS-Gen 7.2.2	Section 15.207 ----- <IC>RSS-Gen 7.2.2	[QP] 5.7dB, 4.59710MHz, L (RS-232C Communication) [AV] 6.7dB, 4.59710MHz, N (RS-232C Communication)	Complied	*1)
Electric Field Strength of Fundamental Emission	ANSI C63.4:2003 13. Measurement of intentional radiators ----- <IC> RSS-Gen 4.8, 4.11	Section 15.225(a) ----- <IC>RSS-210 A2.6	57.8dB, 13.56000MHz, QP, 0deg. (RS-422 Communication)	Complied	Radiated
Spectrum Mask	ANSI C63.4:2003 13. Measurement of intentional radiators ----- <IC>RSS-Gen 4.9, 4.11	Section 15.225(b)(c) ----- <IC> RSS-210 A2.6	22.6dB, 13.08540MHz, QP, 0deg. (RS-422 Communication)	Complied	Radiated
20dB Bandwidth	ANSI C63.4:2003 13. Measurement of intentional radiators ----- <IC> -	Section15.215(c) ----- <IC> -	See data	Complied	Radiated
Electric Field Strength of Spurious Emission	ANSI C63.4:2003 13. Measurement of intentional radiators ----- <IC>RSS-Gen 4.9, 4.11	Section15.209, Section 15.225 (d) ----- <IC>RSS-210 A2.6	3.9dB, 166.652MHz, Vertical, QP (RS-422 Communication)	Complied	Radiated
Frequency Tolerance	ANSI C63.4:2003 13. Measurement of intentional radiators ----- <IC>RSS-Gen 4.7	Section15.225(e) ----- <IC> RSS-210 A2.6	See data	Complied	Radiated

Note: UL Japan, Inc.'s EMI Work Procedures No. 13-EM-W0420 and 13-EM-W0422
*1) The test was performed on AC Power port of DC Power Supply.

FCC 15.31 (e)

This EUT provides stable voltage(Transmitter: DC 7V, Receiver: DC 5V) constantly to RF part regardless of input voltage. Therefore, this EUT complies with the requirement.

FCC Part 15.203 Antenna requirement

The antenna is not removable from the EUT. Therefore, the equipment complies with the antenna requirement of Section 15.203.

UL Japan, Inc.

Head Office EMC Lab.

4383-326 Asama-cho, Ise-shi, Mie-ken 516-0021 JAPAN

Telephone : +81 596 24 8116

Facsimile : +81 596 24 8124

3.3 Addition to standard

No.	Item	Test Procedure	Specification	Remarks	Deviation	Worst margin	Results
1	99% Occupied Band Width	RSS-Gen 4.6.1	RSS-Gen 4.6.1	Radiated	N/A	N/A	N/A

Other than above, no addition, exclusion nor deviation has been made from the standard.

3.4 Uncertainty

EMI

The following uncertainties have been calculated to provide a confidence level of 95% using a coverage factor k=2.

Test room (semi-anechoic chamber)	Conducted emission (+dB)
	150kHz-30MHz
No.1	3.5dB
No.2	3.6dB
No.3	3.6dB
No.4	3.6dB

Test room (semi-anechoic chamber)	Radiated emission						
	(3m*)(+dB)				(1m*)(+dB)		(0.5m*)(+dB)
	9kHz -30MHz	30MHz -300MHz	300MHz -1GHz	1GHz -10GHz	10GHz -18GHz	18GHz -26.5GHz	26.5GHz -40GHz
No.1	4.2dB	5.0dB	5.1dB	5.6dB	5.9dB	4.4dB	4.3dB
No.2	4.1dB	5.2dB	5.1dB	5.7dB	5.8dB	4.3dB	4.2dB
No.3	4.5dB	5.0dB	5.2dB	5.7dB	5.8dB	4.5dB	4.2dB
No.4	4.7dB	5.2dB	5.2dB	5.7dB	5.8dB	5.1dB	4.2dB

*3m/1m/0.5m = Measurement distance

Conducted emission test

The data listed in this test report has enough margin, more than the site margin.

Radiated emission test (3m)

The data listed in this report meets the limits unless the uncertainty is taken into consideration.

UL Japan, Inc.

Head Office EMC Lab.

4383-326 Asama-cho, Ise-shi, Mie-ken 516-0021 JAPAN

Telephone : +81 596 24 8116

Facsimile : +81 596 24 8124

3.5 Test Location

UL Japan, Inc. Head Office EMC Lab. *NVLAP Lab. code: 200572-0
4383-326 Asama-cho, Ise-shi, Mie-ken 516-0021 JAPAN
Telephone : +81 596 24 8116 Facsimile : +81 596 24 8124

	FCC Registration Number	IC Registration Number	Width x Depth x Height (m)	Size of reference ground plane (m) / horizontal conducting plane	Other rooms
No.1 semi-anechoic chamber	313583	2973C-1	19.2 x 11.2 x 7.7m	7.0 x 6.0m	No.1 Power source room
No.2 semi-anechoic chamber	655103	2973C-2	7.5 x 5.8 x 5.2m	4.0 x 4.0m	-
No.3 semi-anechoic chamber	148738	2973C-3	12.0 x 8.5 x 5.9m	6.8 x 5.75m	No.3 Preparation room
No.3 shielded room	-	-	4.0 x 6.0 x 2.7m	N/A	-
No.4 semi-anechoic chamber	134570	2973C-4	12.0 x 8.5 x 5.9m	6.8 x 5.75m	No.4 Preparation room
No.4 shielded room	-	-	4.0 x 6.0 x 2.7m	N/A	-
No.5 semi-anechoic chamber	-	-	6.0 x 6.0 x 3.9m	6.0 x 6.0m	-
No.6 shielded room	-	-	4.0 x 4.5 x 2.7m	4.75 x 5.4 m	-
No.6 measurement room	-	-	4.75 x 5.4 x 3.0m	4.75 x 4.15 m	-
No.7 shielded room	-	-	4.7 x 7.5 x 2.7m	4.7 x 7.5m	-
No.8 measurement room	-	-	3.1 x 5.0 x 2.7m	N/A	-
No.9 measurement room	-	-	8.0 x 4.5 x 2.8m	2.0 x 2.0m	-
No.10 measurement room	-	-	2.6 x 2.8 x 2.5m	2.4 x 2.4m	-
No.11 measurement room	-	-	3.1 x 3.4 x 3.0m	2.4 x 3.4m	-

* Size of vertical conducting plane (for Conducted Emission test) : 2.0 x 2.0m for No.1, No.2, No.3, and No.4 semi-anechoic chambers and No.3 and No.4 shielded rooms.

3.6 Test set up, Data of EMI, and Test instruments

Refer to APPENDIX.

SECTION 4: Operation of E.U.T. during testing

4.1 Operating Modes

The mode is used :

Mode	Remarks
Transmitting (Tx and Rx) mode - RS-232C Communication - RS-422 Communication	With Tag*
The EUT was operated in a manner similar to typical use during the tests. The EUT Transmits and Receives at the same time and there is no receiving mode. * This EUT has two modes, with tag or without tag. The worst case was confirmed with and without tag, as a result, the test with tag was the worst case. Therefore the test with tag was only performed.	

Test Item	Operating mode*
Conducted emission	Tx and Rx Mod on
Electric Field Strength of Fundamental Emission	Tx and Rx Mod on
Spectrum Mask	Tx and Rx Mod on
20dB Bandwidth and 99% Occupied Bandwidth	Tx and Rx Mod on
Electric Field Strength of Spurious Emission	Tx and Rx Mod on
Frequency Tolerance	Tx and Rx Mod off

Justification: The system was configured in typical fashion (as a customer would normally use it) for testing.

Frequency Tolerance:

Temperature : -30deg.C to +50deg.C Step 10deg.C

Voltage : Normal Voltage DC 24V

Maximum Voltage DC 27.6V, Minimum Voltage DC 20.4V (DC 24V ±15%)

* This EUT is generally used along with Interface Box, and power supply of EUT is generally provided from Interface Box. Therefore the test was performed with external input voltage of Interface Box.

UL Japan, Inc.

Head Office EMC Lab.

4383-326 Asama-cho, Ise-shi, Mie-ken 516-0021 JAPAN

Telephone : +81 596 24 8116

Facsimile : +81 596 24 8124

4.2 Configuration and peripherals

<For Conducted emission and Frequency Tolerance tests>

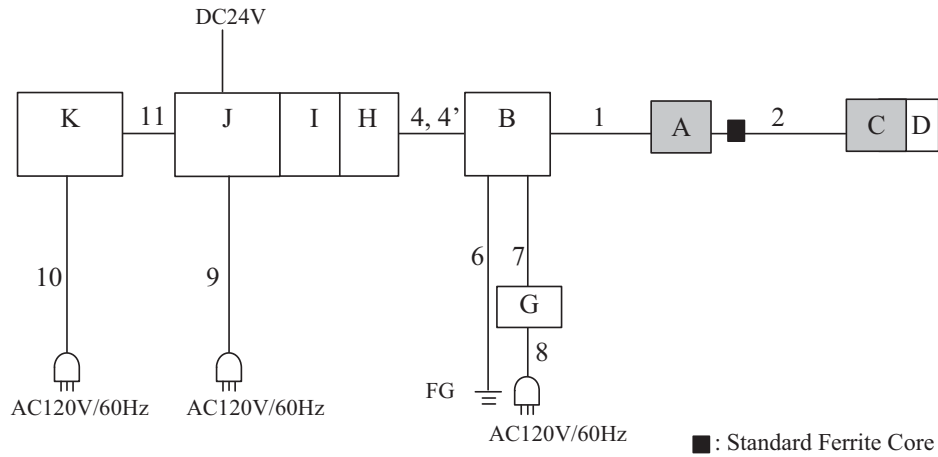

<For other tests except for Conducted emission and Frequency Tolerance tests>

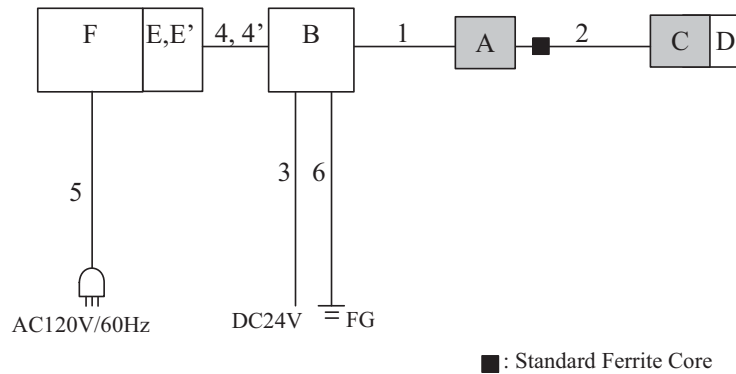

* Cabling and setup were taken into consideration and test data was taken under worse case conditions.

UL Japan, Inc.

Head Office EMC Lab.

4383-326 Asama-cho, Ise-shi, Mie-ken 516-0021 JAPAN

Telephone : +81 596 24 8116

Facsimile : +81 596 24 8124

Description of EUT and Support equipment

No.	Item	Model number	Serial number	Manufacturer	Remark
A	High Frequency 13.56 MHz Transceiver	CTAN10R-01	995750-0730	DENSO WAVE INCORPORATED	EUT
B	Interface Box	IFAN10R-RS-02	466200-4011	DENSO WAVE INCORPORATED	-
C	Cylinder Antenna	AN11R-02	466100-4020	DENSO WAVE INCORPORATED	EUT
D	Cylinder RFID Tag	TG11R-01	466000-4020	DENSO WAVE INCORPORATED	-
E	Serial Communication Unit	CJ1W-SCU21-V1	100828M 0167-Q0	OMRON	*1)
E'	Serial Communication Unit	CJ1W-SCU31-V1	101019M 0092	OMRON	*2)
F	Power Supply Unit	CJ1W-PA205R	101019YK 0197	OMRON	-
G	Power Supply	PMC35-2A	13090501	KIKUSUI	-
H	RS-232C Unit	QJ71C24N-R2	130510131460050-B	mitsubishi	-
I	RS-422 Unit	QJ71C24N-R4	120916122685035-B	mitsubishi	-
J	Power Supply Unit	Q61P	121005122760204-A	mitsubishi	-
K	Power Supply	S8VS-09024S	-	OMRON	-

List of cables used

No.	Name	Length (m)	Shield		Remark
			Cable	Connector	
1	Signal Cable	1.9	Shielded	Shielded	-
2	Antenna Cable	2.0	Shielded	Shielded	-
3	DC Cable	1.1	Unshielded	Unshielded	-
4	RS-232C Cable	2.1	Shielded	Shielded	*1)
4'	RS-422 Cable	9.8	Shielded	Shielded	*2)
5	AC Cable	3.2	Unshielded	Unshielded	-
6	FG Cable	1.2	Unshielded	Unshielded	-
7	DC Cable	1.1	Unshielded	Unshielded	-
8	AC Cable	2.0	Unshielded	Unshielded	-
9	AC Cable	2.2	Unshielded	Unshielded	-
10	AC Cable	1.9	Unshielded	Unshielded	-
11	DC Cable	0.5	Unshielded	Unshielded	-

*1) Used for Transmitting and Receiving mode (RS-232C Communication) only

*2) Used for Transmitting and Receiving mode (RS-422 Communication) only

UL Japan, Inc.

Head Office EMC Lab.

4383-326 Asama-cho, Ise-shi, Mie-ken 516-0021 JAPAN

Telephone : +81 596 24 8116

Facsimile : +81 596 24 8124

SECTION 5: Conducted emission

5.1 Operating environment

Test place : No.3 semi anechoic chamber.
Temperature : See data
Humidity : See data

5.2 Test configuration

EUT was placed on a urethane platform of nominal size, 1.0m by 1.5m, raised 0.8m above the conducting ground plane. The rear of tabletop was located 40cm to the vertical conducting plane. The rear of EUT and its peripherals was aligned and flushed with rear of tabletop. All other surfaces of tabletop were at least 80cm from any other grounded conducting surface. EUT was located 80cm from LISN/AMN and excess AC cable was bundled in center. I/O cables that were connected to the peripherals were bundled in center. They were folded back and forth forming a bundle 30cm to 40cm long and were hanged at a 40cm height to the ground plane. Each EUT current-carrying power lead, except the ground (safety) lead, was individually connected through a LISN/ an AMN to the input power source. All unused 50ohm connectors of the LISN/ AMN were resistively terminated in 50ohm when not connected to the measuring equipment. The AC Mains Terminal Continuous disturbance Voltage has been measured with the EUT on a horizontal conducting plane 4.0 x 4.0m and a vertical conducting plane 2.0 x 2.0m in a semi Anechoic Chamber. Photographs of the set up are shown in Appendix 3.

5.3 Test conditions

Frequency range : 0.15MHz-30MHz
EUT position : Table top
EUT operation mode : See Clause 4.1

5.4 Test procedure

The AC Mains Terminal Continuous disturbance Voltage had been measured with the EUT in the semi Anechoic Chamber. The EUT was connected to a Line Impedance Stabilization Network (LISN)/ Artificial Mains Network (AMN). An overview sweep with peak detection has been performed. The measurements had been performed with a quasi-peak detector and if required, with an average detector. The conducted emission measurements were made with the following detector function of the test receiver.

Detector Type : QP and AV
IF Bandwidth : 9kHz

5.5 Test result

Summary of the test results : Pass

UL Japan, Inc.

Head Office EMC Lab.

4383-326 Asama-cho, Ise-shi, Mie-ken 516-0021 JAPAN

Telephone : +81 596 24 8116

Facsimile : +81 596 24 8124

SECTION 6: Radiated emission (Fundamental , Spurious Emission and Spectrum Mask)

Test Procedure

EUT was placed on a urethane platform of nominal size, 0.5m by 1.0m, raised 0.8m above the conducting ground plane. The Radiated Electric Field Strength has been measured in a Semi Anechoic Chamber with a ground plane. The height of the measuring antenna varied between 1 and 4m and EUT was rotated a full revolution in order to obtain the maximum value of the electric field strength. The measurements were performed for both vertical (angle of loop antenna: 0deg., 45deg., 90deg., and 135 deg.) and horizontal antenna polarization with the Test Receiver, or the Spectrum Analyzer. The measurements were made with the following detector function of the test receiver and the Spectrum analyzer (in linear mode). The test was made with the detector (RBW/VBW) in the following table. When using Spectrum analyzer, the test was made with adjusting span to zero by using peak hold.

Test Antennas are used as below;

Frequency	Below 30MHz	30MHz to 300MHz	300MHz to 1GHz
Antenna Type	Loop	Biconical	Logperiodic

Frequency	From 9kHz to 90kHz and From 110kHz to 150kHz	From 90kHz to 110kHz	From 150kHz to 490kHz	From 490kHz to 30MHz	From 30MHz to 1GHz
Instrument used	Test Receiver				
Detector	PK/AV	QP	PK/AV	QP	QP
IF Bandwidth	200Hz	200Hz	9kHz	9kHz	120kHz

- The carrier level and noise levels were confirmed at each position of X, Y and Z axes of EUT to see the position of maximum noise, and the test was made at the position that has the maximum noise.

* FCC Part 15 Section 15.31 (f)(2) / IC RSS-Gen 4.11 (9kHz-30MHz)

$$9\text{kHz} - 490\text{kHz} [\text{Limit at 3m}] = [\text{Limit at 300m}] - 40 \log\left(\frac{3}{300}\right)$$

$$490\text{kHz} - 30\text{MHz} [\text{Limit at 3m}] = [\text{Limit at 30m}] - 40 \log\left(\frac{3}{30}\right)$$

Measurement range : 0.009M-1GHz
Test data : APPENDIX
Test result : Pass

SECTION 7: Other test

Test	Span	RBW	VBW	Sweep	Detector	Trace	Instrument used
20dB Bandwidth	100kHz	3kHz	10kHz	Auto	Peak	Max Hold	Spectrum Analyzer
99% Occupied Bandwidth	Enough width to display 20dB Bandwidth	3% of Span	Three times of RBW	Auto	Peak *1)	Max Hold *1)	Spectrum Analyzer
Frequency Tolerance	-	-	-	-	-	-	Frequency counter

*1) The measurement was performed with Peak detector, Max Hold since the duty cycle was not 100%.

Test data : APPENDIX
Test result : Pass

Figure 1: Direction of the Loop Antenna

Side View (Vertical)

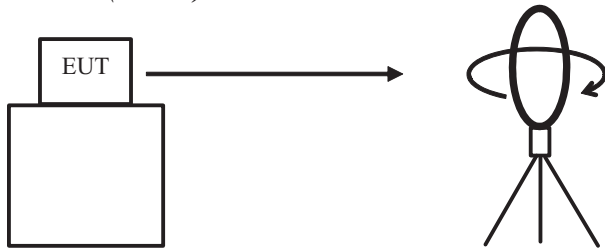

Top View (Horizontal)



Antenna was not rotated.

Top View (Vertical)

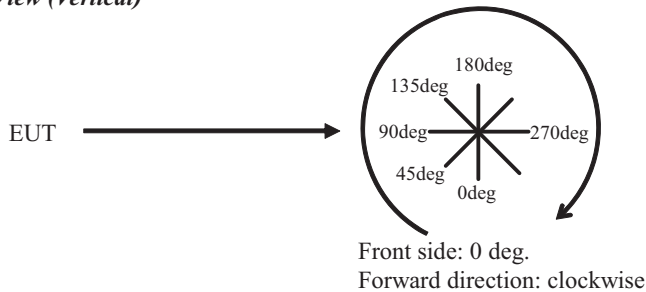

APPENDIX 1: Data of EMI test

Conducted emission
(RS-232C Communication)

DATA OF CONDUCTED EMISSION TEST

UL Japan, Inc. Head Office EMC Lab. No. 3 Semi Anechoic Chamber
Date : 2011/11/07

Report No. : 32BE0197-HO-01
Temp./Humi. : 23deg. C / 55%RH
Engineer : Tsubasa Takayama

Mode / Remarks : Transmitting (Tx and Rx) mode 13.56MHz, With Tag, RS-232C Communication

LIMIT : FCC15.207 QP
FCC15.207 AV

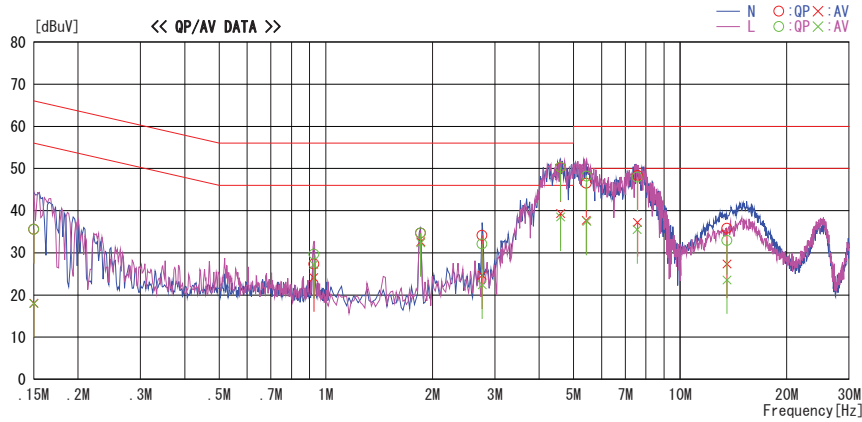

Frequency [MHz]	Reading		Corr. Factor	Results		Limit		Margin		Phase	Comment
	QP [dBuV]	AV [dBuV]		QP [dBuV]	AV [dBuV]	QP [dBuV]	AV [dBuV]	QP [dB]	AV [dB]		
0.15000	22.4	4.9	13.2	35.6	18.1	66.0	56.0	30.4	37.9	N	
0.92586	14.1	10.9	13.2	27.3	24.1	56.0	46.0	28.7	21.9	N	
1.85246	21.4	19.3	13.3	34.7	32.6	56.0	46.0	21.3	13.4	N	
2.76128	20.8	11.4	13.3	34.1	24.7	56.0	46.0	21.9	21.3	N	
4.59710	36.8	25.9	13.4	50.2	39.3	56.0	46.0	5.8	6.7	N	
5.43322	33.1	24.3	13.4	46.5	37.7	60.0	50.0	13.5	12.3	N	
7.57805	34.8	23.7	13.5	48.3	37.2	60.0	50.0	11.7	12.8	N	
13.56000	22.1	13.7	13.7	35.8	27.4	60.0	50.0	24.2	22.6	N	
0.15000	22.4	4.8	13.2	35.6	18.0	66.0	56.0	30.4	38.0	L	
0.92586	16.5	14.0	13.2	29.7	27.2	56.0	46.0	26.3	18.8	L	
1.85246	21.4	19.1	13.3	34.7	32.4	56.0	46.0	21.3	13.6	L	
2.76128	18.8	9.1	13.3	32.1	22.4	56.0	46.0	23.9	23.6	L	
4.59710	36.9	25.1	13.4	50.3	38.5	56.0	46.0	5.7	7.5	L	
5.45139	34.8	24.1	13.4	48.2	37.5	60.0	50.0	11.8	12.5	L	
7.55987	34.4	22.0	13.5	47.9	35.5	60.0	50.0	12.1	14.5	L	
13.56000	19.2	9.9	13.7	32.9	23.6	60.0	50.0	27.1	26.4	L	

CHART: WITH FACTOR, Peak hold data. CALCULATION: RESULT=READING+C.F.(LIGN LOSS + ATT LOSS + CABLE LOSS)
Except for the above table : adequate margin data below the limits.

*The test result is rounded off to one or two decimal places, so some differences might be observed.

Conducted emission
(RS-422 Communication)

DATA OF CONDUCTED EMISSION TEST

UL Japan, Inc. Head Office EMC Lab. No.3 Semi Anechoic Chamber
Date : 2011/11/07

Report No. : 32BE0197-HO-01
Temp./Humi. : 23deg.C / 55%RH
Engineer : Tsubasa Takayama

Mode / Remarks : Transmitting (Tx and Rx) mode 13.56MHz, With Tag, RS-422 Communication

LIMIT : FCC15.207 QP
FCC15.207 AV

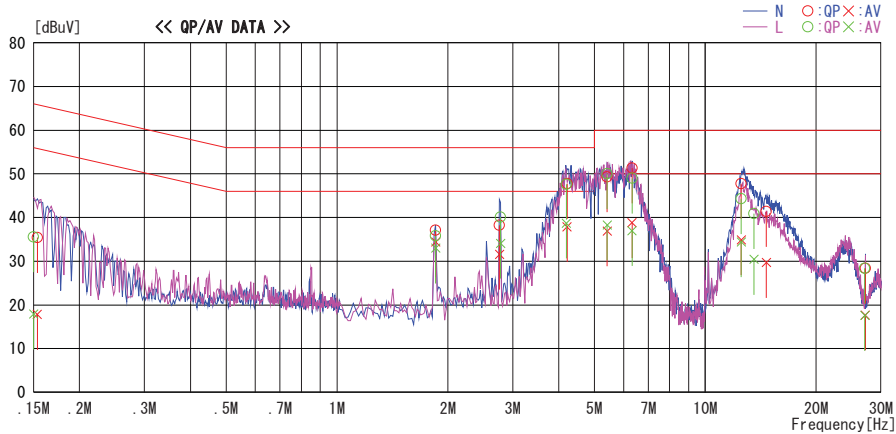

Frequency [MHz]	Reading Level		Corr. Factor [dB]	Results		Limit		Margin		Phase	Comment
	QP [dBuV]	AV [dBuV]		QP [dBuV]	AV [dBuV]	QP [dBuV]	AV [dBuV]	QP [dB]	AV [dB]		
0.15349	22.3	4.7	13.1	35.4	17.8	65.8	55.8	30.4	38.0	N	
1.85246	23.8	21.1	13.3	37.1	34.4	56.0	46.0	18.9	11.6	N	
2.76128	24.9	18.3	13.3	38.2	31.6	56.0	46.0	17.8	14.4	N	
4.21539	34.3	24.5	13.4	47.7	37.9	56.0	46.0	8.3	8.1	N	
5.41504	35.9	23.5	13.4	49.3	36.9	60.0	50.0	10.7	13.1	N	
6.32387	37.8	25.3	13.5	51.3	38.8	60.0	50.0	8.7	11.2	N	
12.52153	34.2	21.3	13.6	47.8	34.9	60.0	50.0	12.2	15.1	N	
14.65108	27.7	16.0	13.7	41.4	29.7	60.0	50.0	18.6	20.3	N	
27.18731	14.5	3.8	13.9	28.4	17.7	60.0	50.0	31.6	32.3	N	
0.15000	22.4	4.7	13.2	35.6	17.9	66.0	56.0	30.4	38.1	L	
1.85246	22.5	19.7	13.3	35.8	33.0	56.0	46.0	20.2	13.0	L	
2.77946	26.8	20.8	13.3	40.1	34.1	56.0	46.0	15.9	11.9	L	
4.19721	34.2	25.3	13.4	47.6	38.7	56.0	46.0	8.4	7.3	L	
5.41504	36.6	24.9	13.4	50.0	38.3	60.0	50.0	10.0	11.7	L	
6.32387	35.4	23.5	13.5	48.9	37.0	60.0	50.0	11.1	13.0	L	
12.52153	30.7	20.8	13.6	44.3	34.4	60.0	50.0	15.7	15.6	L	
13.56000	27.2	16.7	13.7	40.9	30.4	60.0	50.0	19.1	19.6	L	
27.11900	14.5	3.7	13.9	28.4	17.6	60.0	50.0	31.6	32.4	L	

CHART: WITH FACTOR, Peak hold data. CALCULATION: RESULT=READING+C.F (LISN LOSS + ATT LOSS + CABLE LOSS)
Except for the above table : adequate margin data below the limits.

*The test result is rounded off to one or two decimal places, so some differences might be observed.

Fundamental emission and Spectrum Mask (RS-232C Communication)

DATA OF RADIATED EMISSION TEST

UL Japan, Inc. Head Office EMC Lab. No.2 Semi Anechoic Chamber
Date : 2011/10/26

Report No. : 32BE0197-HO-01

Temp./ Humi. : 25deg. C / 50% RH
Engineer : Keisuke Kawamura

Mode / Remarks : Transmitting (Tx and Rx) mode 13.56MHz, With Tag, Axis-Check RS-232C Communication Worst-Axis:Y

LIMIT : FCC15.225 3m, 9-90kHz:PK, 110-490kHz:PK, other:QP
FCC15.225 3m, 9-90kHz:AV, 110-490kHz:AV, other:QP

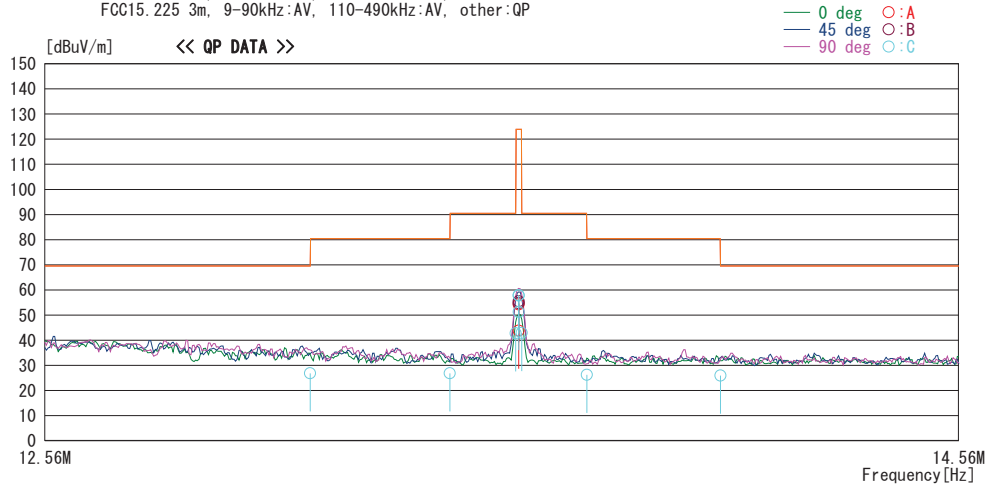

Freq. [MHz]	Reading [dBuV]	DET	Ant. Fac [dB/m]	Loss [dB]	Gain [dB]	Result [dBuV/m]	Limit [dBuV/m]	Margin [dB]	Antenna [deg]	Table	Comment
										[deg]	
13.11000	29.1	QP	23.1	6.9	32.2	26.9	69.5	42.6	90	C	264
13.41000	29.0	QP	23.2	6.9	32.2	26.9	80.5	53.6	90	C	264
13.55300	44.7	QP	23.3	6.9	32.2	42.7	90.4	47.7	90	C	264
13.56000	56.7	QP	23.3	6.9	32.2	54.7	123.9	69.2	0	B	167
13.56000	53.3	QP	23.3	6.9	32.2	51.3	123.9	72.6	90	C	101
13.56000	59.8	QP	23.3	6.9	32.2	57.8	123.9	66.1	270	C	264
13.56000	59.9	QP	23.3	6.9	32.2	57.9	123.9	66.0	90	C	264
13.56000	57.4	QP	23.3	6.9	32.2	55.4	123.9	68.5	45	B	67
13.56000	45.8	QP	23.3	6.9	32.2	43.8	123.9	80.1	0	A	45
13.56000	56.3	QP	23.3	6.9	32.2	54.3	123.9	69.6	135	A	297
13.56700	44.9	QP	23.3	6.9	32.2	42.9	90.4	47.5	90	C	264
13.71000	28.2	QP	23.3	7.0	32.2	26.3	80.5	54.2	90	C	264
14.01000	27.6	QP	23.5	7.0	32.2	25.9	69.5	43.6	90	C	264

CHART: WITH FACTOR, ANT TYPE: LOOP Except for the data below : adequate margin data below the limits.
CALCULATION : RESULT = READING + ANT FACTOR + LOSS(CABLE + ATTEN.) - GAIN(AMP.)

Fundamental emission and Spectrum Mask
(RS-422 Communication)

DATA OF RADIATED EMISSION TEST

UL Japan, Inc. Head Office EMC Lab. No.2 Semi Anechoic Chamber
Date : 2011/10/27

Report No. : 32BE0197-H0-01
Temp. / Humi. : 25deg. C / 50% RH
Engineer : Keisuke Kawamura

Mode / Remarks : Transmitting (Tx and Rx) mode 13.56MHz, With Tag, Axis-Check RS-422 Communication Worst-Axis:Y

LIMIT : FCC15.225 3m, 9-90kHz:PK, 110-490kHz:PK, other:QP
FCC15.225 3m, 9-90kHz:AV, 110-490kHz:AV, other:QP

— 0 deg ○ :A
— 45 deg ○ :B
— 90 deg ○ :C

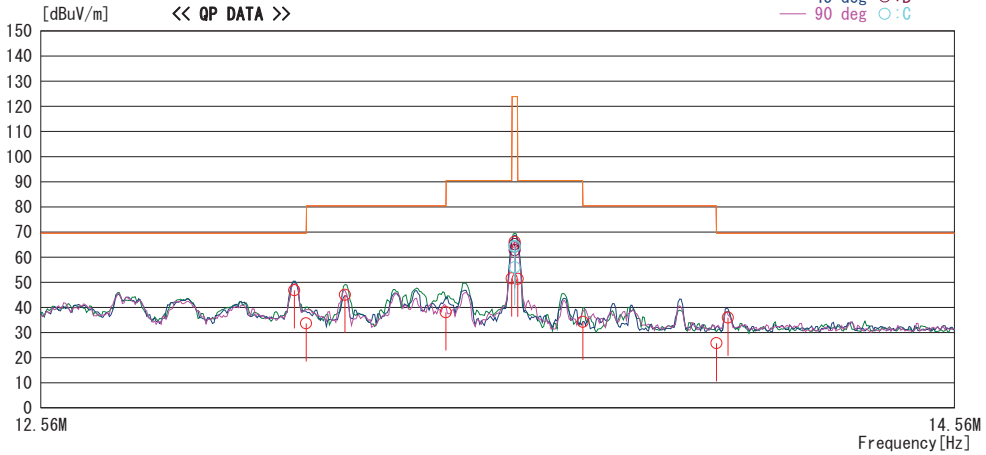

Freq.	Reading	DET	Ant. Fac	Loss	Gain	Result	Limit	Margin	Antenna	Table	Comment
[MHz]	[dBuV]		[dB/m]	[dB]	[dB]	[dBuV/m]	[dBuV/m]	[dB]	[deg]	[deg]	
13.08540	49.1	QP	23.1	6.9	32.2	46.9	69.5	22.6	0	A	199
13.11000	35.8	QP	23.1	6.9	32.2	33.6	69.5	35.9	0	A	199
13.19300	47.2	QP	23.1	6.9	32.2	45.0	80.5	35.5	0	A	199
13.41000	40.1	QP	23.2	6.9	32.2	38.0	80.5	42.5	0	A	199
13.55300	53.5	QP	23.3	6.9	32.2	51.5	90.4	38.9	0	A	199
13.56000	66.1	QP	23.3	6.9	32.2	64.1	123.9	59.8	180	C	354
13.56000	57.9	QP	23.3	6.9	32.2	55.9	123.9	68.0	0	C	183 Without-TAG
13.56000	68.1	QP	23.3	6.9	32.2	66.1	123.9	57.8	0	A	199 Worst
13.56000	67.1	QP	23.3	6.9	32.2	65.1	123.9	58.8	45	B	168
13.56000	66.4	QP	23.3	6.9	32.2	64.4	123.9	59.5	90	C	90
13.56000	66.1	QP	23.3	6.9	32.2	64.1	123.9	59.8	135	A	52
13.56000	64.8	QP	23.3	6.9	32.2	62.8	123.9	61.1	0	B	359
13.56700	53.4	QP	23.3	6.9	32.2	51.4	90.4	39.0	0	A	199
13.71000	36.1	QP	23.3	7.0	32.2	34.2	80.5	46.3	0	A	199
14.01000	27.5	QP	23.5	7.0	32.2	25.8	69.5	43.7	0	A	199
14.03580	37.6	QP	23.5	7.0	32.2	35.9	69.5	33.6	0	A	199

CHART: WITH FACTOR, ANT TYPE: LOOP Except for the data below : adequate margin data below the limits.
CALCULATION : RESULT = READING + ANT FACTOR + LOSS(CABLE + ATTEN.) - GAIN(AMP.)

Spurious emission
(RS-232C Communication)

DATA OF RADIATED EMISSION TEST

UL Japan, Inc. Head Office EMC Lab. No.2 Semi Anechoic Chamber
Date : 2011/10/27

Report No. : 32BE0197-HO-01
Temp. / Humi. : 23deg. C / 55% RH
Engineer : Satofumi Matsuyama

Mode / Remarks : Transmitting (Tx and Rx) mode 13.56MHz, With Tag, RS-232C Communication Worst-Axis Ant:Y Con:X

LIMIT : FCC15.225 3m, 9-90kHz:PK, 110-490kHz:PK, other:QP
FCC15.225 3m, 9-90kHz:AV, 110-490kHz:AV, other:QP

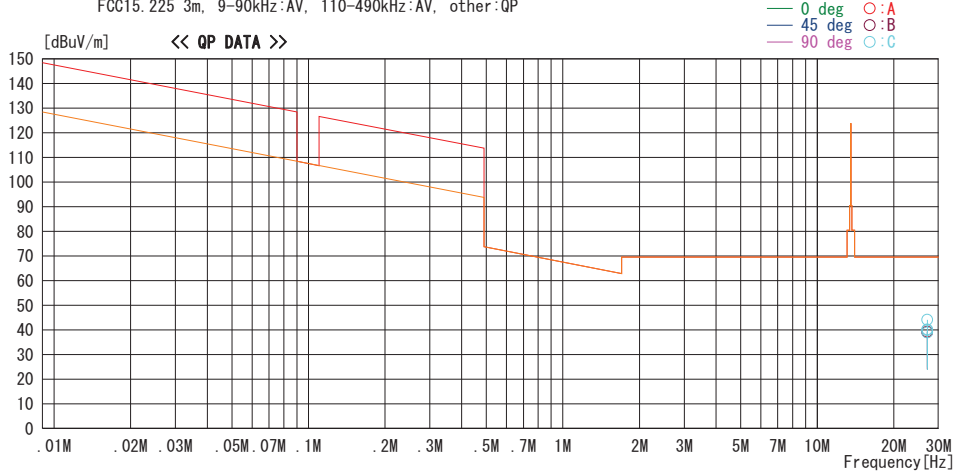

Freq.	Reading	DET	Ant. Fac	Loss	Gain	Result	Limit	Margin	Antenna	Table	Comment
[MHz]	[dBuV]		[dB/m]	[dB]	[dB]	[dBuV/m]	[dBuV/m]	[dB]	[deg]	[deg]	
27.12000	38.7	QP	25.3	7.4	32.2	39.2	69.5	30.3	0	A	50
27.12000	38.6	QP	25.3	7.4	32.2	39.1	69.5	30.4	45	B	46
27.12000	39.7	QP	25.3	7.4	32.2	40.2	69.5	29.3	90	C	24
27.12000	38.5	QP	25.3	7.4	32.2	39.0	69.5	30.5	135	C	292
27.12000	39.3	QP	25.3	7.4	32.2	39.8	69.5	29.7	180	C	304
27.12000	43.6	QP	25.3	7.4	32.2	44.1	69.5	25.4	0	C	14 Loop:Horizontal

CHART: WITH FACTOR, ANT TYPE: LOOP Except for the data below : adequate margin data below the limits.
CALCULATION : RESULT = READING + ANT FACTOR + LOSS(CABLE + ATTEN.) - GAIN(AMP.)

Spurious emission
(RS-232C Communication)

DATA OF RADIATED EMISSION TEST

UL Japan, Inc. Head Office EMC Lab. No. 2 Semi Anechoic Chamber
Date : 2011/10/27

Report No. : 32BE0197-HO-01

Temp./Humi. : 23deg. C / 55% RH
Engineer : Satofumi Matsuyama

Mode / Remarks : Transmitting (Tx and Rx) mode 13.56MHz, With Tag, RS-232C Communication Worst-Axis(Ant/Con H:X V:X)

LIMIT : FCC15.209 3m, below 1GHz:QP, above 1GHz:PK
All other spurious emissions were less than 20dB for the limit.

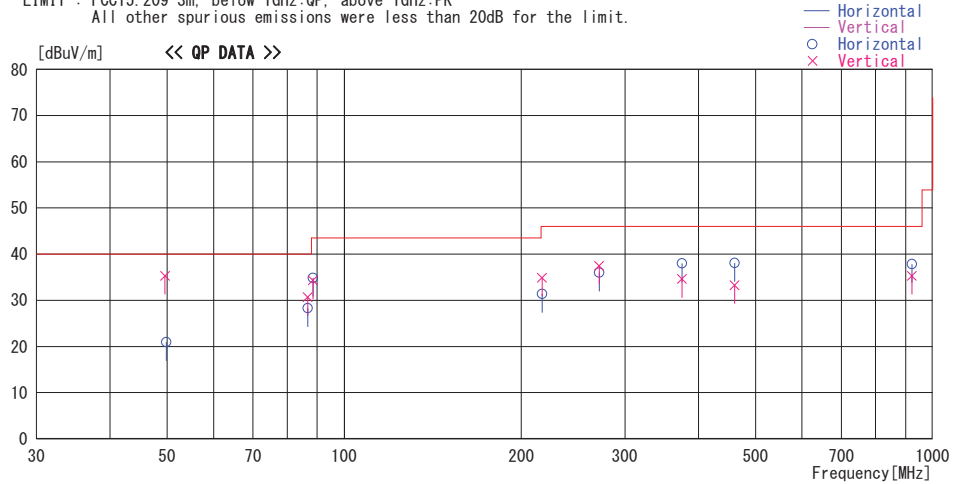

Frequency [MHz]	Reading [dBuV]	DET	Antenna	Loss&	Level	Angle	Height	Polar.	Limit	Margin	Comment
			Factor	Gain							
			[dB/m]	[dB]	[dBuV/m]	[Deg]	[cm]		[dBuV/m]	[dB]	
49.604	45.7	QP	11.2	-21.6	35.3	194	100	Vert.	40.0	4.7	
49.832	31.3	QP	11.2	-21.6	20.9	267	300	Hori.	40.0	19.1	
86.708	42.2	QP	7.1	-21.0	28.3	180	241	Hori.	40.0	11.7	
86.718	44.6	QP	7.1	-21.0	30.7	320	100	Vert.	40.0	9.3	
88.472	48.4	QP	7.4	-21.0	34.8	0	204	Hori.	43.5	8.7	
88.485	47.9	QP	7.4	-21.0	34.3	85	123	Vert.	43.5	9.2	
216.957	34.3	QP	16.7	-19.6	31.4	199	146	Hori.	46.0	14.6	
216.965	37.8	QP	16.7	-19.6	34.9	349	100	Vert.	46.0	11.1	
271.197	36.9	QP	18.1	-19.0	36.0	150	188	Hori.	46.0	10.0	
271.199	38.4	QP	18.1	-19.0	37.5	280	100	Vert.	46.0	8.5	
375.001	40.2	QP	16.7	-18.9	38.0	21	100	Hori.	46.0	8.0	
375.002	36.8	QP	16.7	-18.9	34.6	293	130	Vert.	46.0	11.4	
461.033	39.1	QP	18.0	-19.0	38.1	321	100	Hori.	46.0	7.9	
461.039	34.3	QP	18.0	-19.0	33.3	14	133	Vert.	46.0	12.7	
922.075	29.3	QP	22.4	-16.4	35.3	197	116	Vert.	46.0	10.7	
922.078	31.8	QP	22.4	-16.4	37.8	73	100	Hori.	46.0	8.2	

CHART: WITH FACTOR ANT TYPE: -30MHz: LOOP, 30-300MHz: BICONICAL, 300MHz-1000MHz: LOGPERIODIC, 1000MHz-: HORN
CALCULATION: RESULT = READING + ANT FACTOR + LOSS (CABLE+ATTEN.) - GAIN (AMP)

Spurious emission
(RS-422 Communication)

DATA OF RADIATED EMISSION TEST

UL Japan, Inc. Head Office EMC Lab. No. 2 Semi Anechoic Chamber
Date : 2011/10/27

Report No. : 32BE0197-HO-01
Temp. / Humi. : 23deg. C / 55% RH
Engineer : Satofumi Matsuyama

Mode / Remarks : Transmitting (Tx and Rx) mode 13.56MHz, With Tag, RS-422 Communication Worst-Axis Ant:Y Con:X

LIMIT : FCC15.225 3m, 9-90kHz:PK, 110-490kHz:PK, other:QP
FCC15.225 3m, 9-90kHz:AV, 110-490kHz:AV, other:QP

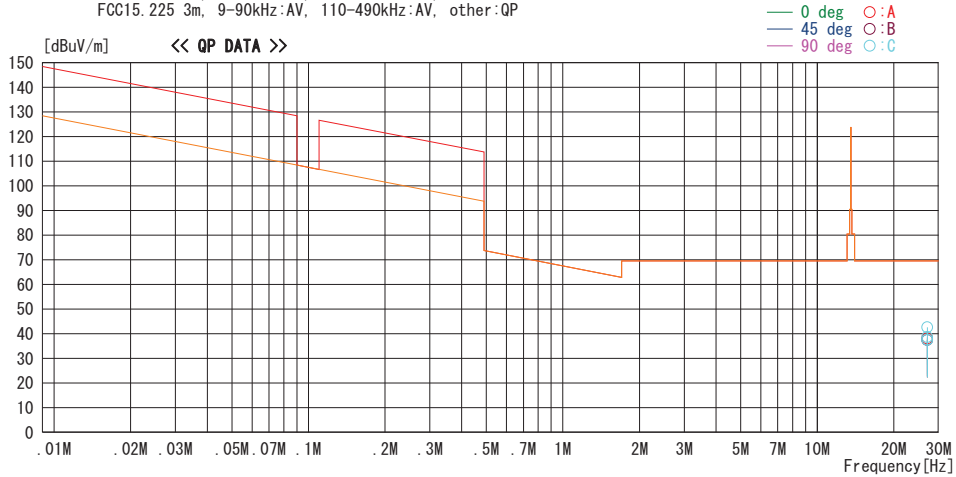

Freq. [MHz]	Reading [dBuV]	DET	Ant. Fac	Loss	Gain	Result	Limit	Margin	Antenna	Table	Comment
			[dB/m]	[dB]	[dB]	[dBuV/m]	[dBuV/m]	[dB]	[deg]	[deg]	
27.12000	37.5	QP	25.3	7.4	32.2	38.0	69.5	31.5	0	A	14
27.12000	37.0	QP	25.3	7.4	32.2	37.5	69.5	32.0	45	B	57
27.12000	38.2	QP	25.3	7.4	32.2	38.7	69.5	30.8	90	C	39
27.12000	37.0	QP	25.3	7.4	32.2	37.5	69.5	32.0	135	C	335
27.12000	37.1	QP	25.3	7.4	32.2	37.6	69.5	31.9	180	C	273
27.12000	42.1	QP	25.3	7.4	32.2	42.6	69.5	26.9	0	C	356 Loop:Horizontal

CHART: WITH FACTOR, ANT TYPE: LOOP Except for the data below : adequate margin data below the limits.
CALCULATION : RESULT = READING + ANT FACTOR + LOSS(CABLE + ATTEN.) - GAIN(AMP.)

Spurious emission
(RS-422 Communication)

DATA OF RADIATED EMISSION TEST

UL Japan, Inc. Head Office EMC Lab. No. 2 Semi Anechoic Chamber
Date : 2011/10/27

Report No. : 32BE0197-H0-01

Temp./Humi. : 23deg. C / 55% RH
Engineer : Satofumi Matsuyama

Mode / Remarks : Transmitting (Tx and Rx) mode 13.56MHz, With Tag, RS-422 Communication Worst-Axis (Ant/Con H:X V:X)

LIMIT : FCC15.209 3m, below 1GHz:QP, above 1GHz:PK
All other spurious emissions were less than 20dB for the limit.

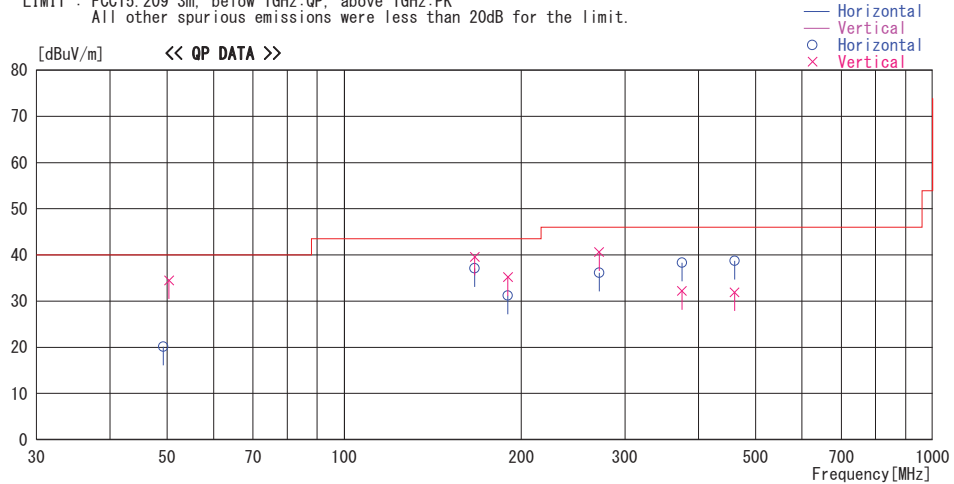

Frequency [MHz]	Reading [dBuV]	DET	Antenna	Loss&	Level	Angle	Height	Polar.	Limit	Margin	Comment
			Factor	Gain							
			[dB/m]	[dB]	[dBuV/m]	[Deg]	[cm]		[dBuV/m]	[dB]	
49.273	30.4	QP	11.3	-21.6	20.1	278	300	Hori.	40.0	19.9	
50.376	45.1	QP	11.0	-21.6	34.5	206	100	Vert.	40.0	5.5	
166.643	41.6	QP	15.6	-20.1	37.1	25	289	Hori.	43.5	6.4	
166.652	44.1	QP	15.6	-20.1	39.6	341	100	Vert.	43.5	3.9	
189.841	34.9	QP	16.2	-19.9	31.2	346	300	Hori.	43.5	12.3	
189.847	38.9	QP	16.2	-19.9	35.2	227	100	Vert.	43.5	8.3	
271.201	37.0	QP	18.1	-19.0	36.1	359	183	Hori.	46.0	9.9	
271.203	41.5	QP	18.1	-19.0	40.6	341	100	Vert.	46.0	5.4	
375.001	40.5	QP	16.7	-18.9	38.3	16	100	Hori.	46.0	7.7	
375.002	34.4	QP	16.7	-18.9	32.2	284	124	Vert.	46.0	13.8	
461.035	32.9	QP	18.0	-19.0	31.9	33	120	Vert.	46.0	14.1	
461.038	39.7	QP	18.0	-19.0	38.7	314	100	Hori.	46.0	7.3	

CHART: WITH FACTOR ANT TYPE: -30MHz: LOOP, 30-300MHz: BICONICAL, 300MHz-1000MHz: LOGPERIODIC, 1000MHz-: HORN
CALCULATION: RESULT = READING + ANT FACTOR + LOSS (CABLE+ATTEN.) - GAIN (AMP)

20dB Bandwidth and 99% Occupied Bandwidth
(RS-232C Communication)

Test place	Head Office EMC Lab. No.2 Semi Anechoic Chamber
Report No.	32BE0197-HO-01
Date	10/26/2011
Temperature/ Humidity	25 deg.C / 50% RH
Engineer	Keisuke Kawamura
Mode	Transmitting (Tx and Rx) mode 13.56MHz, With Tag, RS-232C Communication Mod on

FREQ [MHz]	20dB Bandwidth [kHz]	99% Occupied Bandwidth [kHz]
13.56	16.27	72.93

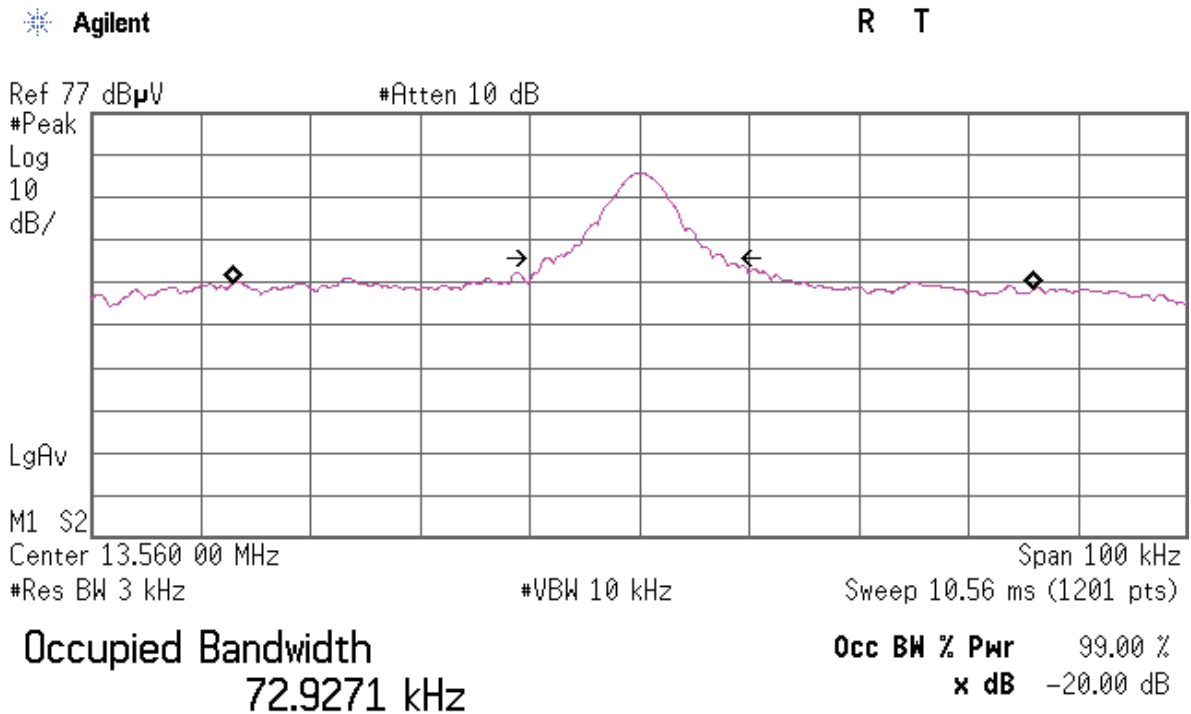

Transmit Freq Error -623.953 Hz
x dB Bandwidth 16.274 kHz

20dB Bandwidth and 99% Occupied Bandwidth
(RS-422 Communication)

Test place	Head Office EMC Lab. No.2 Semi Anechoic Chamber
Report No.	32BE0197-HO-01
Date	10/26/2011
Temperature/ Humidity	25 deg.C / 50% RH
Engineer	Keisuke Kawamura
Mode	Transmitting (Tx and Rx) mode 13.56MHz, With Tag, RS-422 Communication Mod on

FREQ [MHz]	20dB Bandwidth [kHz]	99% Occupied Bandwidth [kHz]
13.56	10.92	57.21

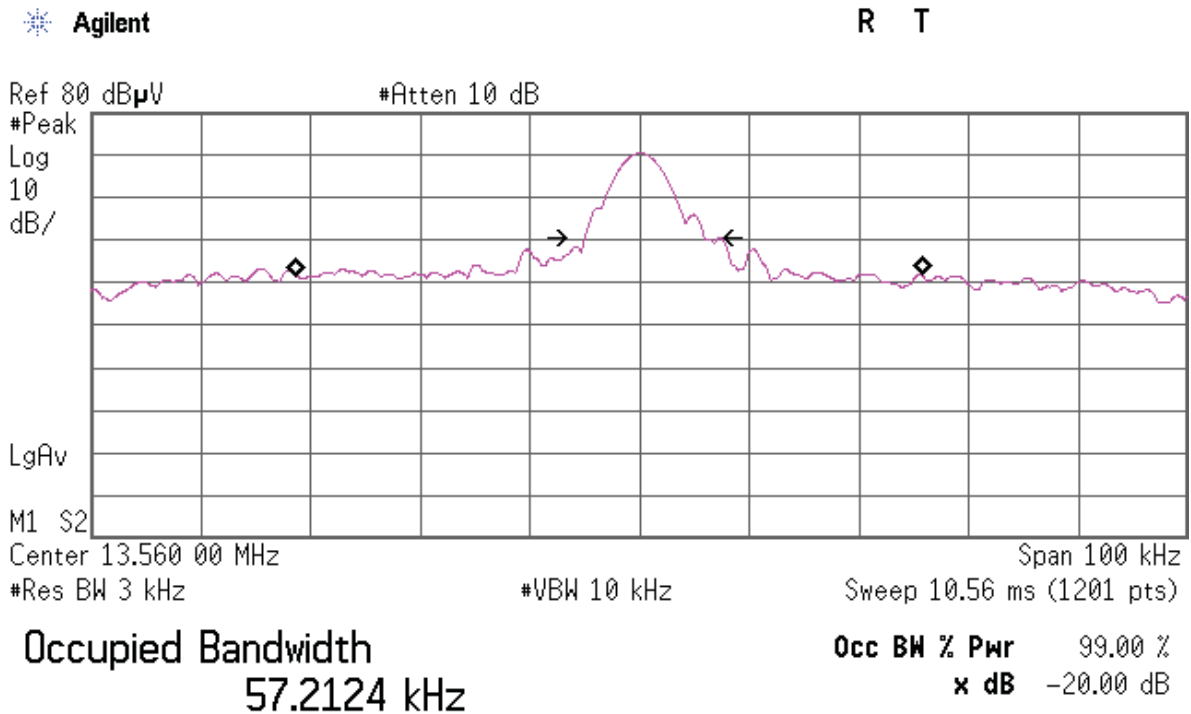

Transmit Freq Error -2.855 kHz
x dB Bandwidth 10.916 kHz

Frequency Tolerance (RS-232C Communication)

Test place : Head Office EMC Lab. No.7 measurement room
Report No. : 32BE0197-HO-01
Date : 11/11/2011
Temperature/ Humidity : 24 deg.C/ 51% RH
Engineer : Hisayoshi Sato
Mode : Transmitting (Tx and Rx) mode 13.56MHz, With Tag,
RS-232C Communication Mod off

Test Condition deg.C	Test Timing Volts	Measured freq [MHz]	Freq error [MHz]	Result [ppm]	Limit (+/- 0.01%) [+/- ppm]	Margin [ppm]	
20deg.C	20.4V	Power on	13.55997216	-0.00002784	-2.05	100.00	97.95
		on 2min.	13.55997199	-0.00002801	-2.07	100.00	97.93
		on 5min.	13.55997188	-0.00002812	-2.07	100.00	97.93
		on 10min.	13.55997172	-0.00002828	-2.09	100.00	97.91
	24V	Power on	13.55996221	-0.00003779	-2.79	100.00	97.21
		on 2min.	13.55996233	-0.00003767	-2.78	100.00	97.22
		on 5min.	13.55996134	-0.00003866	-2.85	100.00	97.15
		on 10min.	13.55996320	-0.00003680	-2.71	100.00	97.29
	27.6V	Power on	13.56000161	0.00000161	0.12	100.00	99.88
		on 2min.	13.55999210	-0.00000790	-0.58	100.00	99.42
		on 5min.	13.55998732	-0.00001268	-0.94	100.00	99.06
		on 10min.	13.55998057	-0.00001943	-1.43	100.00	98.57
50deg.C.	24V	Power on	13.55997691	-0.00002309	-1.70	100.00	98.30
on 2min.		13.55998452	-0.00001548	-1.14	100.00	98.86	
on 5min.		13.55998692	-0.00001308	-0.96	100.00	99.04	
on 10min.		13.55998889	-0.00001111	-0.82	100.00	99.18	
40deg.C.		Power on	13.55996772	-0.00003228	-2.38	100.00	97.62
on 2min.		13.55996793	-0.00003207	-2.37	100.00	97.63	
on 5min.		13.55996811	-0.00003189	-2.35	100.00	97.65	
on 10min.		13.55996833	-0.00003167	-2.34	100.00	97.66	
30deg.C.		Power on	13.55996732	-0.00003268	-2.41	100.00	97.59
on 2min.		13.55996723	-0.00003277	-2.42	100.00	97.58	
on 5min.		13.55996110	-0.00003890	-2.87	100.00	97.13	
on 10min.		13.55996020	-0.00003980	-2.94	100.00	97.06	
20deg.C.		Power on	13.55996221	-0.00003779	-2.79	100.00	97.21
on 2min.		13.55996233	-0.00003767	-2.78	100.00	97.22	
on 5min.		13.55996134	-0.00003866	-2.85	100.00	97.15	
on 10min.		13.55996320	-0.00003680	-2.71	100.00	97.29	
10deg.C.		Power on	13.55996837	-0.00003163	-2.33	100.00	97.67
on 2min.		13.55996754	-0.00003246	-2.39	100.00	97.61	
on 5min.		13.55997993	-0.00002007	-1.48	100.00	98.52	
on 10min.		13.55997996	-0.00002004	-1.48	100.00	98.52	
0deg.C.		Power on	13.56000216	0.00000216	0.16	100.00	99.84
on 2min.		13.56001280	0.00001280	0.94	100.00	99.06	
on 5min.		13.56003450	0.00003450	2.54	100.00	97.46	
on 10min.		13.56005601	0.00005601	4.13	100.00	95.87	
-10deg.C.	Power on	13.56000232	0.00000232	0.17	100.00	99.83	
on 2min.	13.56001633	0.00001633	1.20	100.00	98.80		
on 5min.	13.56001339	0.00001338	0.99	100.00	99.01		
on 10min.	13.56001434	0.00001434	1.06	100.00	98.94		
-20deg.C	Power on	13.55996344	-0.00003656	-2.70	100.00	97.30	
on 2min.	13.55996429	-0.00003571	-2.63	100.00	97.37		
on 5min.	13.55996130	-0.00003870	-2.85	100.00	97.15		
on 10min.	13.55995840	-0.00004160	-3.07	100.00	96.93		
-30deg.C	Power on	13.56000950	0.00000950	0.70	100.00	99.30	
on 2min.	13.56000950	0.00000950	0.70	100.00	99.30		
on 5min.	13.56000897	0.00000897	0.66	100.00	99.34		
on 10min.	13.56000889	0.00000889	0.66	100.00	99.34		

Limit : 13.56 13.56 MHz +/-0.01 % (+/- 100ppm) = +/- 0.001356 MHz

Frequency Tolerance (RS-422 Communication)

Test place Head Office EMC Lab. No.7 measurement room
Report No. 32BE0197-HO-01
Date 11/11/2011
Temperature/ Humidity 24 deg.C/ 51% RH
Engineer Hisayoshi Sato
Mode Transmitting (Tx and Rx) mode 13.56MHz, With Tag,
RS-422 Communication Mod off

Test Condition deg.C	Volts	Test Timing	Measured freq [MHz]	Freq error [MHz]	Result [ppm]	Limit (+/- 0.01%) [+/- ppm]	Margin [ppm]
20deg.C	20.4V	Power on	13.55994457	-0.00005543	-4.09	100.00	95.91
		on 2min.	13.55994547	-0.00005453	-4.02	100.00	95.98
		on 5min.	13.55994537	-0.00005463	-4.03	100.00	95.97
		on 10min.	13.55994572	-0.00005428	-4.00	100.00	96.00
	24V	Power on	13.55996112	-0.00003888	-2.87	100.00	97.13
		on 2min.	13.55996131	-0.00003869	-2.85	100.00	97.15
		on 5min.	13.55996231	-0.00003769	-2.78	100.00	97.22
		on 10min.	13.55996432	-0.00003568	-2.63	100.00	97.37
		Power on	13.56000212	0.00000212	0.16	100.00	99.84
		on 2min.	13.55999721	-0.00000279	-0.21	100.00	99.79
	27.6V	on 5min.	13.55999273	-0.00000727	-0.54	100.00	99.46
		on 10min.	13.55999306	-0.00000694	-0.51	100.00	99.49
Power on		13.55997347	-0.00002653	-1.96	100.00	98.04	
50deg.C.	on 2min.	13.55998435	-0.00001565	-1.15	100.00	98.85	
	on 5min.	13.55998537	-0.00001463	-1.08	100.00	98.92	
	on 10min.	13.55998439	-0.00001561	-1.15	100.00	98.85	
40deg.C.	Power on	13.55996644	-0.00003356	-2.48	100.00	97.52	
	on 2min.	13.55996565	-0.00003435	-2.53	100.00	97.47	
	on 5min.	13.55996454	-0.00003546	-2.62	100.00	97.38	
	on 10min.	13.55996722	-0.00003278	-2.42	100.00	97.58	
30deg.C.	Power on	13.55996434	-0.00003566	-2.63	100.00	97.37	
	on 2min.	13.55996547	-0.00003453	-2.55	100.00	97.45	
	on 5min.	13.55995361	-0.00004639	-3.42	100.00	96.58	
	on 10min.	13.55995466	-0.00004534	-3.34	100.00	96.66	
20deg.C.	Power on	13.55996112	-0.00003888	-2.87	100.00	97.13	
	on 2min.	13.55996131	-0.00003869	-2.85	100.00	97.15	
	on 5min.	13.55996231	-0.00003769	-2.78	100.00	97.22	
	on 10min.	13.55996432	-0.00003568	-2.63	100.00	97.37	
10deg.C.	Power on	13.55996544	-0.00003456	-2.55	100.00	97.45	
	on 2min.	13.55996655	-0.00003345	-2.47	100.00	97.53	
	on 5min.	13.55997550	-0.00002450	-1.81	100.00	98.19	
	on 10min.	13.55996466	-0.00003534	-2.61	100.00	97.39	
0deg.C.	Power on	13.55995786	-0.00004214	-3.11	100.00	96.89	
	on 2min.	13.55996532	-0.00003468	-2.56	100.00	97.44	
	on 5min.	13.55996531	-0.00003469	-2.56	100.00	97.44	
	on 10min.	13.55996433	-0.00003567	-2.63	100.00	97.37	
-10deg.C.	Power on	13.56004302	0.00004302	3.17	100.00	96.83	
	on 2min.	13.56003416	0.00003416	2.52	100.00	97.48	
	on 5min.	13.56003441	0.00003441	2.54	100.00	97.46	
	on 10min.	13.56004314	0.00004314	3.18	100.00	96.82	
-20deg.C	Power on	13.55995434	-0.00004566	-3.37	100.00	96.63	
	on 2min.	13.55995643	-0.00004357	-3.21	100.00	96.79	
	on 5min.	13.55995761	-0.00004239	-3.13	100.00	96.87	
	on 10min.	13.55996436	-0.00003564	-2.63	100.00	97.37	
-30deg.C	Power on	13.56000540	0.00000539	0.40	100.00	99.60	
	on 2min.	13.56000566	0.00000566	0.42	100.00	99.58	
	on 5min.	13.56000436	0.00000436	0.32	100.00	99.68	
	on 10min.	13.56000539	0.00000539	0.40	100.00	99.60	

Limit : 13.56 13.56 MHz +/-0.01 % (+/- 100ppm) = +/- 0.001356 MHz

APPENDIX 2: Test instruments

EMI test equipment

Control No.	Instrument	Manufacturer	Model No	Serial No	Test Item	Calibration Date * Interval(month)
MAEC-02	Semi Anechoic Chamber(NSA)	TDK	Semi Anechoic Chamber 3m	DA-06902	RE	2011/06/21 * 12
MOS-22	Thermo-Hygrometer	Custom	CTH-201	0003	RE	2011/02/23 * 12
MJM-14	Measure	KOMELON	KMC-36	-	RE	-
COTS-MEMI	EMI measurement program	TSJ	TEPTO-DV	-	RE/CE	-
MSA-04	Spectrum Analyzer	Agilent	E4448A	US44300523	RE	2011/04/08 * 12
MTR-03	Test Receiver	Rohde & Schwarz	ESCI	100300	RE	2011/04/15 * 12
LP-01	Loop Antenna	Rohde & Schwarz	HFH2-Z2	829425/014	RE	2010/12/08 * 12
MCC-13	Coaxial Cable	Fujikura	3D-2W(12m)/5D-2W(5m)/5D-2W(0.8m)/5D-2W(1m)	-	RE	2011/02/18 * 12
MCC-30	Coaxial cable	UL Japan	-	-	RE	2011/07/28 * 12
MPA-13	Pre Amplifier	SONOMA INSTRUMENT	310	260834	RE	2011/03/04 * 12
MAT-07	Attenuator(6dB)	Weinschel Corp	2	BK7970	RE	2011/11/02 * 12
MBA-02	Biconical Antenna	Schwarzbeck	BBA9106	VHA91032008	RE	2011/10/23 * 12
MLA-02	Logperiodic Antenna	Schwarzbeck	USLP9143	201	RE	2011/10/23 * 12
MCC-12	Coaxial Cable	Fujikura/Agilent	-	-	RE	2011/02/18 * 12
MPA-09	Pre Amplifier	Agilent	8447D	2944A10845	RE	2011/09/26 * 12
MAEC-03	Semi Anechoic Chamber(NSA)	TDK	Semi Anechoic Chamber 3m	DA-10005	CE	2011/02/22 * 12
MOS-13	Thermo-Hygrometer	Custom	CTH-180	-	CE	2011/02/23 * 12
MJM-06	Measure	PROMART	SEN1955	-	CE	
MSA-05	Spectrum Analyzer	Advantest	R3273	160400285	CE	2010/11/18 * 12
MTR-08	Test Receiver	Rohde & Schwarz	ESCI	100767	CE	2011/08/11 * 12
MLS-06	LISN(AMN)	Schwarzbeck	NSLK8127	8127363	CE(AE)	2011/02/20 * 12
MLS-07	LISN(AMN)	Schwarzbeck	NSLK8127	8127364	CE(EUT)	2011/02/22 * 12
MTA-31	Terminator	TME	CT-01	-	CE	2011/01/05 * 12
MCC-112	Coaxial cable	Fujikura/Suhner/TSJ	5D-2W(10m)/SFM141(3m)/sucoform141-PE(1m)/421-010(1.5m)/RFM-E321(Switcher)	-/00640	CE	2011/07/15 * 12
MAT-66	Attenuator(13dB)	JFW Industries, Inc.	50FP-013H2 N	-	CE	2011/02/22 * 12
KCH-01	Temperature and Humidity Chamber	Tabai Espec	PL-1KT	14007630	RE	2011/04/27 * 12
EST-09	Universal Counter	Agilent	53131A	KR01204716	RE	2011/05/11 * 12
MOS-04	Digital Humidity Indicator	N.T	NT-1800	MOS04	RE	2011/02/23 * 12

The expiration date of the calibration is the end of the expired month.

All equipment is calibrated with valid calibrations. Each measurement data is traceable to the national or international standards.

As for some calibrations performed after the tested dates, those test equipment have been controlled by means of an unbroken chains of calibrations.

Test Item: CE: Conducted Emission
RE: Radiated Emission

UL Japan, Inc.

Head Office EMC Lab.

4383-326 Asama-cho, Ise-shi, Mie-ken 516-0021 JAPAN

Telephone : +81 596 24 8116

Facsimile : +81 596 24 8124