

HAC RF-Emission Test Report

Report No. : HF200428C03H
Applicant : DENSO WAVE INCORPORATED
Address : 1 Yoshiike Kusagi Agui-cho, Chita-gun Aichi 470-2297, Japan
Product : 2D Code Handy Terminal
FCC ID : PZWBHTM80QWG
Brand : DENSO
Model No. : BHT-M80-QWG
Standards : FCC 47 CFR Part 20.19, ANSI C63.19-2011
KDB 285076 D01 v05, KDB 285076 D02 v03
Sample Received Date : Feb. 04, 2021
Date of Testing : Mar. 23, 2021 ~ Mar. 26, 2021
M-Rating Summary : M4
Lab Address : No. 47-2, 14th Ling, Chia Pau Vil., Lin Kou Dist., New Taipei City, Taiwan
Test Location : No. 19, Hwa Ya 2nd Rd., Wen Hwa Vil., Kwei Shan Dist., Taoyuan City, Taiwan

CERTIFICATION: The above equipment have been tested by **Bureau Veritas Consumer Products Services (H.K.) Ltd., Taoyuan Branch – Lin Kou Laboratories**, and found compliance with the requirement of the above standards. The test record, data evaluation & Equipment Under Test (EUT) configurations represented herein are true and accurate accounts of the measurements of the sample's HAC characteristics under the conditions specified in this report. It should not be reproduced except in full, without the written approval of our laboratory. The client should not use it to claim product certification, approval, or endorsement by TAF or any government agencies.

Prepared By :

Vera Huang

Vera Huang / Specialist

Approved By :

Gordon Lin

Gordon Lin / Manager



FCC Accredited No.: TW0003

This report is for your exclusive use. Any copying or replication of this report to or for any other person or entity, or use of our name or trademark, is permitted only with our prior written permission. This report sets forth our findings solely with respect to the test samples identified herein. The results set forth in this report are not indicative or representative of the quality or characteristics of the lot from which a test sample was taken or any similar or identical product unless specifically and expressly noted. Our report includes all of the tests requested by you and the results thereof based upon the information that you provided to us. You have 60 days from date of issuance of this report to notify us of any material error or omission caused by our negligence, provided, however, that such notice shall be in writing and shall specifically address the issue you wish to raise. A failure to raise such issue within the prescribed time shall constitute your unqualified acceptance of the completeness of this report, the tests conducted and the correctness of the report contents. Unless specific mention, the uncertainty of measurement has been explicitly taken into account to declare the compliance or non-compliance to the specification.

Table of Contents

| | |
|---|-----------|
| Release Control Record | 3 |
| 1. Summary of Maximum M-Rating | 4 |
| 2. Description of Equipment Under Test | 5 |
| 3. HAC RF Emission Measurement System | 7 |
| 3.1 SPEAG DASY6 System | 7 |
| 3.1.1 Robot..... | 8 |
| 3.1.2 Probes..... | 8 |
| 3.1.3 Data Acquisition Electronics (DAE) | 9 |
| 3.1.4 Phantoms..... | 9 |
| 3.1.5 Device Holder..... | 9 |
| 3.1.6 RF Emission Calibration Dipoles..... | 9 |
| 3.2 DASY6 System Verification..... | 10 |
| 3.3 EUT Measurements Reference and Plane..... | 11 |
| 3.4 HAC RF Emission Measurement Procedure..... | 12 |
| 3.5 Modulation Interference Factor | 14 |
| 4. HAC Measurement Evaluation..... | 16 |
| 4.1 M-Rating Category | 16 |
| 4.2 EUT Configuration and Setting..... | 16 |
| 4.3 System Verification..... | 16 |
| 4.4 Maximum Target Conducted Power | 17 |
| 4.5 Low Power Exemption Evaluation..... | 17 |
| 4.6 Measured Conducted Power Results..... | 18 |
| 4.7 HAC RF Emission Testing Results | 18 |
| 5. Calibration of Test Equipment..... | 19 |
| 6. Measurement Uncertainty..... | 20 |
| 7. Information of the Testing Laboratories..... | 21 |
| | |
| Appendix A. Plots of System Verification | |
| Appendix B. Plots of HAC RF Emission Measurement | |
| Appendix C. Calibration Certificate for Probe and Dipole | |
| Appendix D. Photographs of EUT and Setup | |



Release Control Record

| Report No. | Reason for Change | Date Issued |
|--------------|-------------------|---------------|
| HF200428C03H | Initial release | Mar. 26, 2021 |
| | | |
| | | |
| | | |
| | | |
| | | |
| | | |
| | | |
| | | |
| | | |
| | | |
| | | |
| | | |
| | | |
| | | |
| | | |
| | | |
| | | |
| | | |
| | | |

1. Summary of Maximum M-Rating

| Mode | Band | Maximum Audio Interference Level (dBV/m) | M-Rating |
|------------------|---------|--|----------|
| GSM | GSM850 | 37.40 | M4 |
| | GSM1900 | 29.47 | M4 |
| WCDMA | Band II | N/A | M4 |
| | Band V | N/A | M4 |
| FDD-LTE | Band 2 | N/A | M4 |
| | Band 4 | N/A | M4 |
| | Band 5 | N/A | M4 |
| | Band 7 | N/A | M4 |
| | Band 12 | N/A | M4 |
| | Band 13 | N/A | M4 |
| | Band 17 | N/A | M4 |
| M-Rating Summary | | | M4 |

Note:

1. The HAC RF emission limit (**M-rating Category M3**) is specified in FCC 47 CFR part 20.19 and ANSI C63.19.
2. The device RF emission rating is determined by the minimum rating.

2. Description of Equipment Under Test

| | |
|--|---|
| EUT Type | 2D Code Handy Terminal |
| FCC ID | PZWBHTM80QWG |
| Brand Name | DENSO |
| Model Name | BHT-M80-QWG |
| Tx Frequency Bands (Unit: MHz) | GSM GSM850 : 824.2 ~ 848.8 GSM1900 : 1850.2 ~ 1909.8 WCDMA Band II : 1852.4 ~ 1907.6 Band V : 826.4 ~ 846.6 FDD-LTE Band 2 : 1850.7 ~ 1909.3 (BW: 1.4M, 3M, 5M, 10M, 15M, 20M) Band 4 : 1710.7 ~ 1754.3 (BW: 1.4M, 3M, 5M, 10M, 15M, 20M) Band 5 : 824.7 ~ 848.3 (BW: 1.4M, 3M, 5M, 10M) Band 7 : 2502.5 ~ 2567.5 (BW: 5M, 10M, 15M, 20M) Band 12 : 699.7 ~ 715.3 (BW: 1.4M, 3M, 5M, 10M) Band 13 : 779.5 ~ 784.5 (BW: 5M, 10M) Band 17 : 706.5 ~ 713.5 (BW: 5M, 10M) Band 25 : 1850.7 ~ 1914.3 (BW: 1.4M, 3M, 5M, 10M, 15M, 20M) WLAN 2412 ~ 2462, 5180 ~ 5240, 5260 ~ 5320, 5500 ~ 5700, 5745 ~ 5825 Bluetooth 2402 ~ 2480 |
| Modulations Supported in Uplink | GSM & GPRS : GMSK EDGE : 8PSK WCDMA : QPSK LTE : QPSK, 16QAM 802.11b : DSSS 802.11a/g/n/ac : OFDM Bluetooth : GFSK, $\pi/4$ -DQPSK, 8-DPSK |
| Antenna Type | PIFA Antenna |
| EUT Stage | Engineering Sample |

Note:

- The above EUT information is declared by manufacturer and for more detailed features description please refers to the manufacturer's specifications or User's Manual.

List of Accessory:

| | | |
|------------------|---------------------|---------------------------|
| Battery 1 | Brand Name | DENSO |
| | Model Name | BT1 |
| | Power Rating | 3.85Vdc, 4020mAh, 15.47Wh |
| | Type | Li-ion |
| Battery 2 | Brand Name | DENSO |
| | Model Name | BT1S |
| | Power Rating | 3.85Vdc, 2900mAh, 11.16Wh |
| | Type | Li-ion |
| Battery 3 | Brand Name | DENSO |
| | Model Name | BT1L |
| | Power Rating | 3.85Vdc, 5800mAh, 22.33Wh |
| | Type | Li-ion |
| Battery 4 | Brand Name | DENSO |
| | Model Name | BT1S-W |
| | Power Rating | 3.85Vdc, 2900mAh, 11.16Wh |
| | Type | Li-ion |

HAC RF-Emission Test Report

Air Interface and Operational Mode:

| Air Interface | Bands | Transport Type | HAC Tested | Simultaneous But Not Tested | Name of Voice Service | Power Reduction |
|---|-----------|----------------|--|-----------------------------|-----------------------|-----------------|
| GSM | 850 | VO | YES | WLAN or BT | CMRS Voice | No |
| | 1900 | | | | | No |
| | EGPRS | DT | No | WLAN or BT | N/A | No |
| WCDMA | II | VO | No ⁽¹⁾ | WLAN or BT | CMRS Voice | No |
| | V | | | | | No |
| | HSPA | DT | No | WLAN or BT | N/A | No |
| FDD-LTE | 2 | VD | No ⁽¹⁾ | WLAN or BT | VoLTE ⁽¹⁾ | No |
| | 4 | | | | | No |
| | 5 | | | | | No |
| | 7 | | | | | No |
| | 12 | | | | | No |
| | 13 | | | | | No |
| | 17 | | | | | No |
| | 25 | | | | | No |
| WLAN | WLAN 2.4G | DT | No | WWAN | N/A | No |
| | WLAN 5.2G | | | | | No |
| | WLAN 5.3G | | | | | No |
| | WLAN 5.6G | | | | | No |
| | WLAN 5.8G | | | | | No |
| BT | 2.4G | DT | No | WWAN | N/A | No |
| Transport Type VO = Legacy Cellular Voice Service DT = Digital Transport Only (No Voice) VD = IP Voice Service over Digital Transport | | | Note 1. It applies the low power exemption per ANSI C63.19-2011. | | | |

3. HAC RF Emission Measurement System

3.1 SPEAG DASY6 System

The SPEAG DASY6 system consists of high precision robot, probe alignment sensor, phantom, robot controller, controlled measurement server and near-field probe. The robot includes six axes that can move to the precision position of the DASY6 software defined. The DASY6 software can define the area that is detected by the probe. The robot is connected to controlled box. Controlled measurement server is connected to the controlled robot box. The DAE includes amplifier, signal multiplexing, AD converter, offset measurement and surface detection. It is connected to the Electro-optical coupler (ECO). The ECO performs the conversion form the optical into digital electric signal of the DAE and transfers data to the PC.

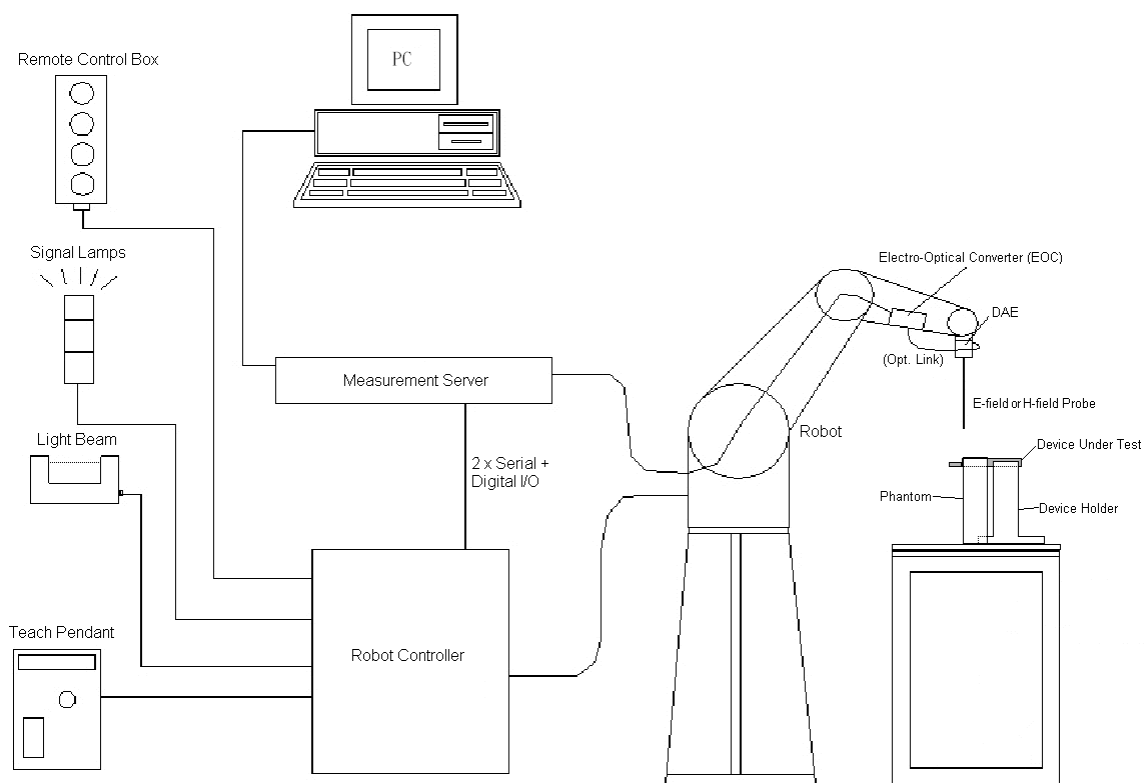

Fig-3.1 SPEAG DASY6 System Setup

HAC RF-Emission Test Report

3.1.1 Robot

The DASY6 system uses the high precision robots from Stäubli SA (France). For the 6-axis controller system, the robot controller version (DASY6: CS8c) from Stäubli is used. The Stäubli robot series have many features that are important for our application:

- High precision (repeatability ± 0.035 mm)
- High reliability (industrial design)
- Jerk-free straight movements
- Low ELF interference (the closed metallic construction shields against motor control fields)

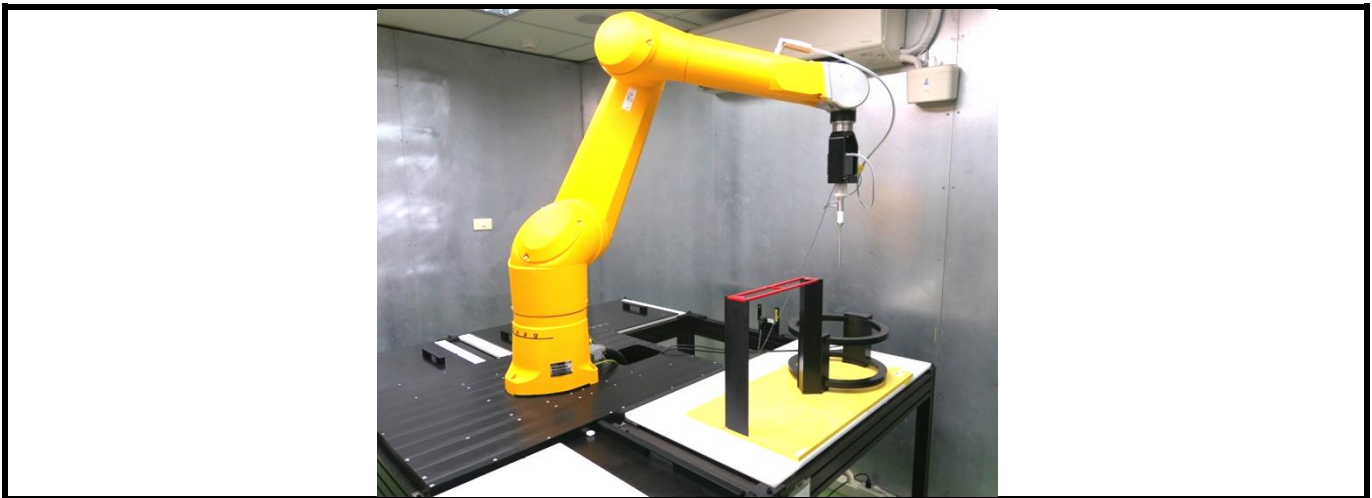



Fig-3.2 DASY6 Measurement System

3.1.2 Probes

| | | |
|----------------------|--|---|
| Model | ER3DV6 |  |
| Construction | One dipole parallel, two dipoles normal to probe axis Built-in shielding against static charges | |
| Frequency | 40 MHz to 3 GHz Linearity: ± 0.2 dB | |
| Directivity | ± 0.2 dB in air (rotation around probe axis) ± 0.4 dB in air (rotation normal to probe axis) | |
| Dynamic Range | 2 V/m to 1000 V/m Linearity: ± 0.2 dB | |
| Dimensions | Overall length: 337 mm (Tip: 16 mm) Tip diameter: 8 mm (Body: 12 mm) Distance from probe tip to dipole centers: 2.5 mm | |

| | | |
|----------------------|--|---|
| Model | EF3DV3 |  |
| Construction | One dipole parallel, two dipoles normal to probe axis Built-in shielding against static charges | |
| Frequency | 40 MHz to 6 GHz Linearity: ± 0.2 dB | |
| Directivity | ± 0.2 dB in air (rotation around probe axis) ± 0.4 dB in air (rotation normal to probe axis) | |
| Dynamic Range | 2 V/m to 1000 V/m Linearity: ± 0.2 dB | |
| Dimensions | Overall length: 337 mm (Tip: 20 mm) Tip diameter: 3.9 mm (Body: 12 mm) Distance from probe tip to dipole centers: 1.5 mm | |

HAC RF-Emission Test Report

3.1.3 Data Acquisition Electronics (DAE)

| | | |
|-----------------------------|---|---|
| Model | DAE3, DAE4 |  |
| Construction | Signal amplifier, multiplexer, A/D converter and control logic. Serial optical link for communication with DASY embedded system (fully remote controlled). Two step probe touch detector for mechanical surface detection and emergency robot stop. | |
| Measurement Range | -100 to +300 mV (16 bit resolution and two range settings: 4mV, 400mV) | |
| Input Offset Voltage | < 5µV (with auto zero) | |
| Input Bias Current | < 50 fA | |
| Dimensions | 60 x 60 x 68 mm | |

3.1.4 Phantoms

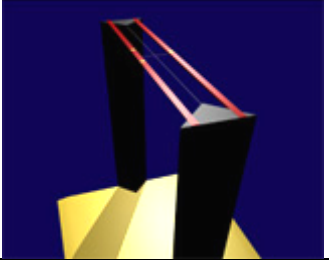
| | | |
|---------------------|--|---|
| Model | Test Arch |  |
| Construction | Enables easy and well defined positioning of the phone and validation dipoles as well as simple teaching of the robot. | |
| Dimensions | Length : 370 mm Width : 370 mm Height : 370 mm | |

3.1.5 Device Holder

| | | |
|---------------------|---|---|
| Model | Mounting Device |  |
| Construction | The Mounting Device enables the rotation of the mounted transmitter device in spherical coordinates. Rotation point is the ear opening point. Transmitter devices can be easily and accurately positioned according to ANSI C63.19. | |
| Material | POM | |

3.1.6 RF Emission Calibration Dipoles

| | | |
|-------------------------|---|---|
| Model | CD-Serial |  |
| Construction | Free space antenna Hearing Aid susceptibility measurements according to ANSI C63.19. Validation of Hearing Aid RF setup for wireless device emission measurements according to ANSI C63.19 | |
| Frequency | CD700V3 : 698 ~ 806 MHz CD835V3 : 800 ~ 960 MHz CD1880V3 : 1710 ~ 2000 MHz CD2450V3 : 2250 ~ 2650 MHz CD2600V3 : 2450 ~ 2750 MHz CD3500V3 : 3300 ~ 3950 MHz CD5500V3 : 5000 ~ 5900 MHz | |
| Return Loss | CD700V3 : > 15 dB (750 MHz > 20 dB) CD835V3 : > 15 dB (835 MHz > 25 dB) CD1880V3 : > 18 dB (1880 MHz > 20 dB) CD2450V3 : > 18 dB (2450 MHz > 25 dB) CD2600V3 : > 18 dB (2600 MHz > 20 dB) CD3500V3 : > 16 dB (3500 MHz > 20 dB) CD5500V3 : > 18 dB (5500 MHz > 20 dB) | |
| Power Capability | > 40 W continuous | |

3.2 DASY6 System Verification

The system check verifies that the system operates within its specifications. It is performed before every E-field measurement. The system check uses normal measurements in the center section of the arch phantom with a matched dipole at a specified distance. The system verification setup is shown as below.

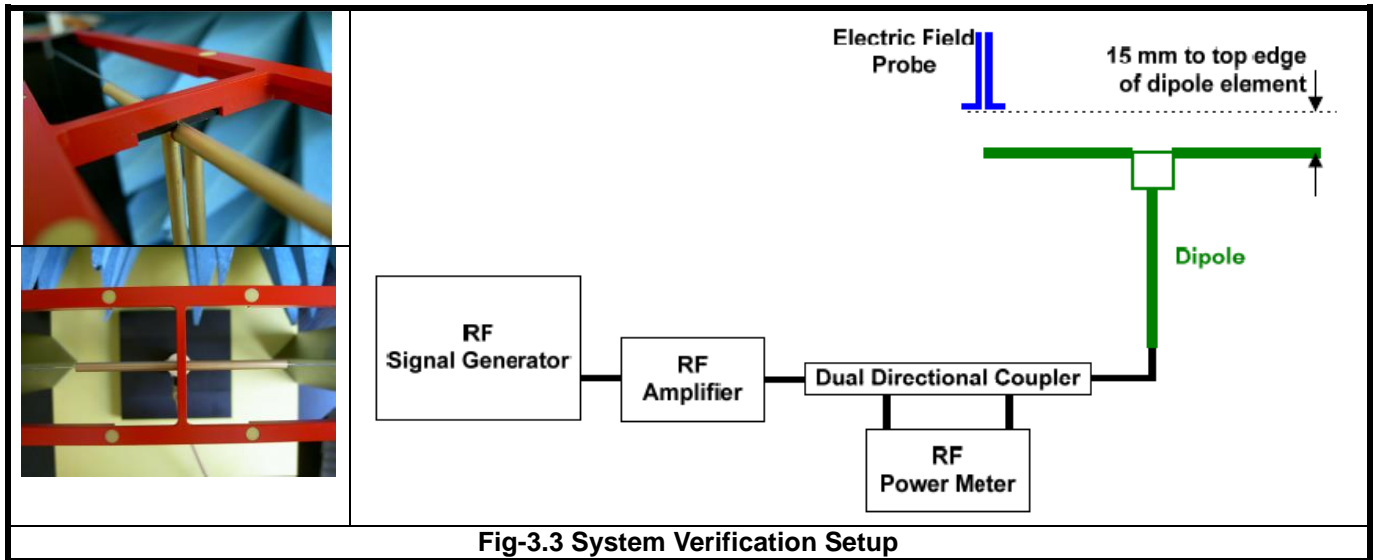

Fig-3.3 System Verification Setup

The validation dipole is placed beneath the center of arch phantom. The power meter measures the forward power at the location of the system check dipole connector. The signal generator is adjusted for the desired forward power, 100 mW (20 dBm) at the dipole connector and the RF power meter is read at that level. After connecting the cable to the dipole, the signal generator is readjusted for the same reading at RF power meter.

After system check testing, the E-field result will be compared with the reference value derived from validation dipole certificate report. The deviation of system check should be within 25 %.

The result of system verification is shown in section 4.3 of this report.

3.3 EUT Measurements Reference and Plane

The EUT is mounted in the device holder. The acoustic output of the EUT will coincide with the center point of the area formed by the dielectric wire and the middle bar of the arch's top frame. Then EUT will be moved vertically upwards until it touches the frame.

Fig-3.4 and Fig-3.5 illustrate the references and reference plane that is used in the RF emissions measurement.

- (a) The grid is 50 mm by 50 mm area that is divided into nine evenly sized blocks or sub-grids.
- (b) The grid is centered on the audio frequency output transducer of the EUT.
- (c) The grid is in a reference plane, which is defined as the planar area that contains the highest point in the area of the phone that normally rests against the user's ear. It is parallel to the centerline of the receiver area of the phone and is defined by the points of the receiver-end of the EUT handset, which in normal handset use rest against the ear.
- (d) The measurement plane is parallel to and 15 mm in front of the reference plane.



Fig-3.4 EUT Reference and Plane

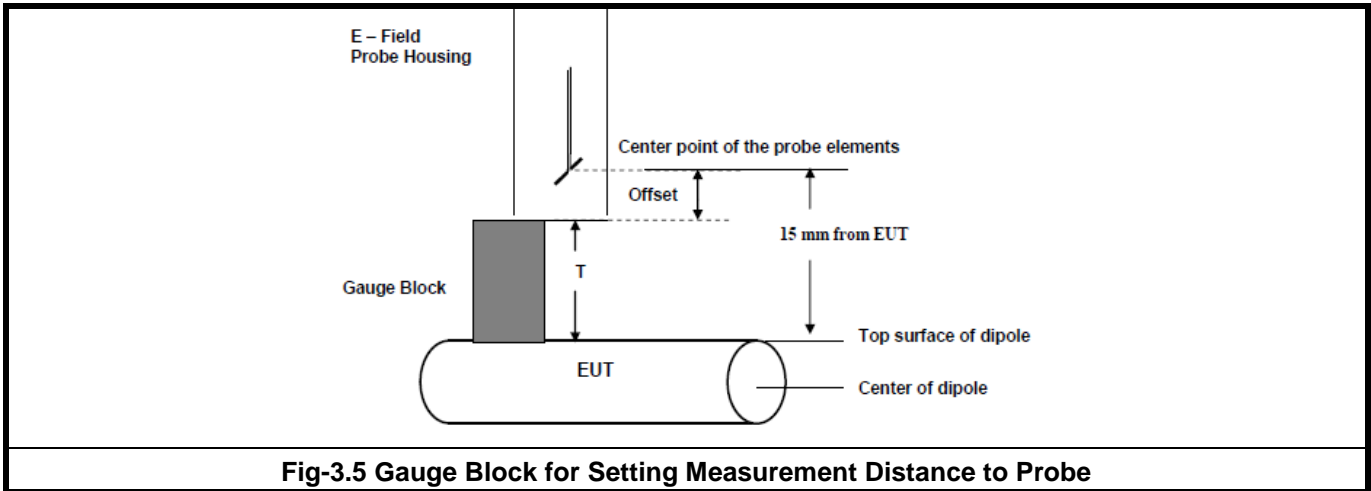

Fig-3.5 Gauge Block for Setting Measurement Distance to Probe

3.4 HAC RF Emission Measurement Procedure

The RF emissions test procedure for wireless communications device is as below.

1. Confirm the proper operation of the field probe, probe measurement system, and other instrumentation and the positioning system.
2. Position the WD in its intended test position.
3. Set the WD to transmit a fixed and repeatable combination of signal power and modulation characteristic that is representative of the worst case (highest interference potential) encountered in normal use. Transiently occurring start-up, changeover, or termination conditions, or other operations likely to occur less than 1% of the time during normal operation, may be excluded from consideration.
4. The center sub-grid shall be centered on the T-Coil mode perpendicular measurement point or the acoustic output, as appropriate. Locate the field probe at the initial test position in the 50 mm by 50 mm grid, which is contained in the measurement plane, illustrated in Fig-3.4. If the field alignment method is used, align the probe for maximum field reception.
5. Record the reading at the output of the measurement system.
6. Scan the entire 50 mm by 50 mm region in equally spaced increments and record the reading at each measurement point. The distance between measurement points shall be sufficient to assure the identification of the maximum reading.
7. Identify the five contiguous sub-grids around the center sub-grid whose maximum reading is the lowest of all available choices. This eliminates the three sub-grids with the maximum readings. Thus, the six areas to be used to determine the WD's highest emissions are identified.
8. Identify the maximum reading within the non-excluded sub-grids identified in step 7.
9. Indirect Measurement Method: The RF audio interference level in dB(V/m) is obtained by adding the MIF (in dB) to the maximum steady-state rms field-strength reading, in dB(V/m), from step 8. Use this result to determine the category rating.

10. Compare this RF audio interference level with the categories in section 4.1 and record the resulting WD category rating.
- 11 For the T-Coil mode M-rating assessment, determine whether the chosen perpendicular measurement point is contained in an included sub-grid of the first can. If so, then a second scan is not necessary. The first scan and resultant category rating may be used for the T-Coil mode M-rating. Otherwise, repeat step 1 through step 9, with the grid shifted so that it is centered on the perpendicular measurement point. Record the WD category rating.

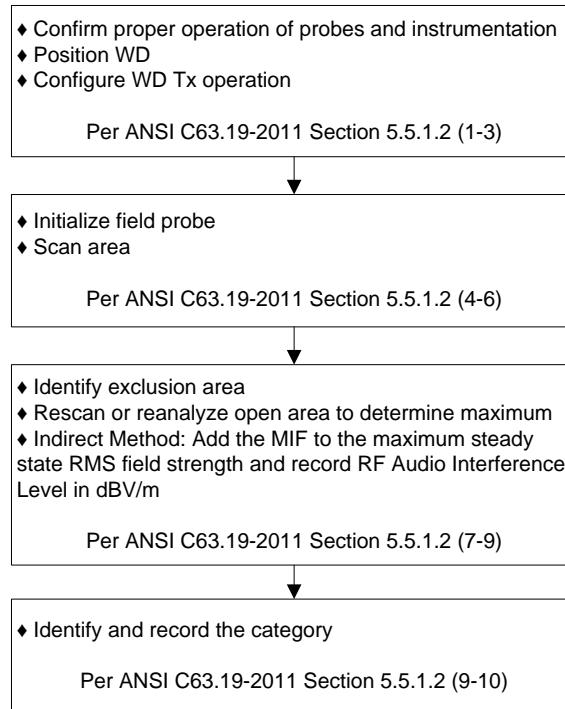

Fig-3.6 WD Near-Field Emission Test Flowchart

3.5 Modulation Interference Factor

The HAC Standard ANSI C63.19-2011 defines a new scaling using the Modulation Interference Factor (MIF) which replaces the need for the Articulation Weighting Factor (AWF) during the evaluation and is applicable to any modulation scheme.

The Modulation Interference Factor (MIF, in dB) is added to the measured average E-field (in dBV/m) and converts it to the RF audio interference potential (in dBV/m). This level considers the audible amplitude modulation components in the RF E-field. CW fields without amplitude modulation are assumed to not interfere with the hearing aid electronics. Modulations without time slots and low fluctuations at low frequencies have low MIF values, TDMA modulations with narrow transmission slots and repetition rates of few 100 Hz have high MIF values and give similar classification as ANSI C63.19-2007.

ER3D E-field probe have a bandwidth <10 kHz and can therefore not evaluate the RF envelope in the full audio band. DASY6 is therefore using the "indirect" measurement method according to ANSI C63.19-2011 which is the primary method. This near field probe read the averaged E-field. Especially for the new high peak-to-average (PAR) signal types, the probes shall be linearized by PMR calibration in order to not overestimate the field reading.

The evaluation method for the MIF is defined in ANSI C63.19-2011 section D.7. An RMS demodulated RF signal is fed to a spectral filter (similar to an A weighting filter) and forwarded to a temporal filter acting as a quasi-peak detector. The averaged output of these filtering is scaled to a 1 kHz 80% AM signal as reference. It may alternatively be determined through analysis and simulation, because it is constant and characteristic for a communication signal. DASY6 uses well-defined signals for PMR calibration. The MIF of these signals has been determined numerically. It allows a precise scaling and is therefore automatically applied.

The following table lists the MIF values evaluated by DASY6 manufacturer (SPEAG), and the test result will be calculated with the MIF parameter automatically. The detailed parameters for E-field probe can be found in the probe calibration report in appendix C.

| UID | Reversion | Communication System Name | MIF (dB) |
|-------|-----------|---|----------|
| 10021 | DAC | GSM-FDD (TDMA, GMSK) | 3.63 |
| 10025 | DAC | EDGE-FDD (TDMA, 8PSK, TN 0) | 3.75 |
| 10460 | AAA | UMTS-FDD (WCDMA, AMR) | -25.43 |
| 10225 | CAB | UMTS-FDD (HSPA+) | -20.39 |
| 10081 | CAB | CDMA2000 (1xRTT, RC3) | -19.71 |
| 10295 | AAB | CDMA2000, RC1, SO3, 1/8th Rate 25 fr. | 3.26 |
| 10403 | AAB | CDMA2000 (1xEV-DO, Rev. 0) | -17.67 |
| 10170 | CAE | LTE-FDD (SC-FDMA, 1 RB, 20 MHz, 16-QAM) | -9.76 |
| 10172 | CAG | LTE-TDD (SC-FDMA, 1 RB, 20 MHz, QPSK) | -1.62 |
| 10173 | CAG | LTE-TDD (SC-FDMA, 1 RB, 20 MHz, 16-QAM) | -1.44 |
| 10174 | CAG | LTE-TDD (SC-FDMA, 1 RB, 20 MHz, 64-QAM) | -1.54 |
| 10061 | CAB | IEEE 802.11b WiFi 2.4 GHz (DSSS, 11 Mbps) | -2.02 |
| 10077 | CAB | IEEE 802.11g WiFi 2.4 GHz (DSSS/OFDM, 54 Mbps) | 0.12 |
| 10427 | AAC | IEEE 802.11n (HT Greenfield, 150 Mbps, 64-QAM) | -13.44 |
| 10069 | CAD | IEEE 802.11a/h WiFi 5 GHz (OFDM, 54 Mbps) | -3.15 |
| 10616 | AAC | IEEE 802.11ac WiFi (40MHz, MCS0, 90pc duty cycle) | -5.57 |

HAC RF-Emission Test Report

The MIF measurement uncertainty listed in following table is estimated by SPEAG.

| MIF (dB) | MIF Measurement Uncertainty (dB) |
|------------|----------------------------------|
| -7 to +5 | 0.2 |
| -13 to +11 | 0.5 |
| > -20 | 1.0 |

4. HAC Measurement Evaluation

4.1 M-Rating Category

The HAC Standard ANSI C63.19-2011 represents performance requirements for acceptable interoperability of hearing aids with wireless communications devices. When these parameters are met, a hearing aid operates acceptably in close proximity to a wireless communications device.

| Emission Categories | E-Field Emissions < 960 MHz (dB V/m) | E-Field Emissions > 960 MHz (dB V/m) |
|---------------------|--------------------------------------|--------------------------------------|
| Category M1 | 50 - 55 | 40 - 45 |
| Category M2 | 45 - 50 | 35 - 40 |
| Category M3 | 40 - 45 | 30 - 35 |
| Category M4 | < 40 | < 30 |

4.2 EUT Configuration and Setting

For HAC RF emission testing, the EUT was linked and controlled by base station emulator. Communication between the EUT and the emulator was established by air link. The distance between the EUT and the communicating antenna of the emulator is larger than 50 cm and the output power radiated from the emulator antenna is at least 30 dB smaller than the output power of EUT. The EUT was set from the emulator to radiate maximum output power during HAC testing.

4.3 System Verification

The measuring results for system check are shown as below.

| Frequency (MHz) | Input Power (dBm) | Target Value (V/m) | E-Field 1 (V/m) | E-Field 2 (V/m) | Average E-Field (V/m) | Deviation (%) | Test Date |
|-----------------|-------------------|--------------------|-----------------|-----------------|-----------------------|---------------|---------------|
| 835 | 20.0 | 106.7 | 112.4 | 108.8 | 110.6 | 3.66 | Mar. 23, 2021 |
| 835 | 20.0 | 106.7 | 98.54 | 97.47 | 98.005 | -8.15 | Mar. 26, 2021 |
| 1880 | 20.0 | 88.2 | 83.47 | 81.45 | 82.46 | -6.51 | Mar. 23, 2021 |
| 1880 | 20.0 | 88.2 | 84.56 | 85.54 | 85.05 | -3.57 | Mar. 26, 2021 |

Note:

1. Comparing to the reference target value provided by SPEAG, the validation data should be within its specification of 25 %. The result indicates the system check can meet the variation criterion and the plots can be referred to Appendix A of this report.
2. For E-Field, the deviation is $[(E\text{-Field 1} + E\text{-Field 2}) / 2 - \text{Target Value}] / \text{Target Value} \times 100\%$

HAC RF-Emission Test Report

4.4 Maximum Target Conducted Power

The maximum conducted average power (Unit: dBm) including tune-up tolerance is shown as below.

| Air Interface | | Max. Tune-up Power |
|---------------|-------------|--------------------|
| GSM | GSM850 | 32.0 |
| | GSM1900 | 30.5 |
| WCDMA | Band II AMR | 24.5 |
| | Band V AMR | 24.5 |
| FDD-LTE | Band 2 | 23.5 |
| | Band 4 | 23.5 |
| | Band 5 | 23.5 |
| | Band 7 | 24.0 |
| | Band 12 | 23.5 |
| | Band 13 | 23.5 |
| | Band 17 | 23.5 |
| | Band 25 | 23.5 |

4.5 Low Power Exemption Evaluation

According to ANSI C63.19-2011 section 4, RF air interface technologies that have low power have been found to produce sufficiently low RF interference potential, so it is possible to exempt them from the product testing. An RF air interface technology of a device is exempt from testing when its average antenna input power plus its worst-case MIF is ≤ 17 dBm for any of its operating modes. If a device supports multiple RF air interfaces, each RF air interface shall be evaluated individually. An RF air interface technology that is exempted from testing by above method could be rated as M4.

The low power exemption for this device is analyzed in below.

| Air Interface | | Max. Tune-up Power (dBm) | Worst Case MIF (dB) | Power + MIF (dB) | C63.19 Testing Required |
|---------------|---------|--------------------------|---------------------|------------------|-------------------------|
| GSM | GSM850 | 32 | 3.63 | 35.63 | YES |
| | GSM1900 | 30.5 | 3.63 | 34.13 | YES |
| WCDMA | AMR | 24.5 | -25.43 | -0.93 | No |
| | FDD-LTE | 24.0 | -9.76 | 14.24 | No |

HAC RF-Emission Test Report

4.6 Measured Conducted Power Results

The measuring conducted average power (Unit: dBm) are shown as below.

| Band | GSM850 | | | GSM1900 | | |
|-----------------------|--------|-------|-------|---------|--------|--------|
| Channel | 128 | 189 | 251 | 512 | 661 | 810 |
| Frequency (MHz) | 824.2 | 836.4 | 848.8 | 1850.2 | 1880.0 | 1909.8 |
| GSM (GMSK, 1 Tx Slot) | 31.99 | 31.83 | 31.98 | 29.82 | 30.07 | 29.95 |

4.7 HAC RF Emission Testing Results

| Plot No. | Band | Mode | Channel | Battery | Audio Interference Level (dB V/m) | FCC Limit (dB V/m) | FCC Margin (dB) | M-Rating |
|----------|---------|-----------|---------|---------|-----------------------------------|--------------------|-----------------|-----------|
| | GSM850 | GSM Voice | 128 | 1 | 36.49 | 45 | -8.51 | M4 |
| | GSM850 | GSM Voice | 189 | 1 | 36.88 | 45 | -8.12 | M4 |
| P01 | GSM850 | GSM Voice | 251 | 1 | 37.40 | 45 | -7.6 | M4 |
| | GSM850 | GSM Voice | 251 | 2 | 36.89 | 45 | -8.11 | M4 |
| | GSM850 | GSM Voice | 251 | 3 | 36.88 | 45 | -8.12 | M4 |
| | GSM850 | GSM Voice | 251 | 4 | 36.85 | 45 | -8.15 | M4 |
| | GSM1900 | GSM Voice | 512 | 1 | 29.41 | 35 | -5.59 | M4 |
| | GSM1900 | GSM Voice | 661 | 1 | 28.58 | 35 | -6.42 | M4 |
| P02 | GSM1900 | GSM Voice | 810 | 1 | 29.81 | 35 | -5.19 | M4 |
| | GSM1900 | GSM Voice | 810 | 2 | 28.89 | 35 | -6.11 | M4 |
| | GSM1900 | GSM Voice | 810 | 3 | 29.65 | 35 | -5.35 | M4 |
| | GSM1900 | GSM Voice | 810 | 4 | 29.47 | 35 | -5.53 | M4 |

Test Engineer : Eric Wu

5. Calibration of Test Equipment

| Equipment | Manufacturer | Model | SN | Cal. Date | Cal. Interval |
|--------------------------------------|--------------|----------|------------|---------------|---------------|
| 835MHz Calibration Dipole | SPEAG | CD835V3 | 1041 | Jan. 22, 2020 | 3 Years |
| 1880MHz Calibration Dipole | SPEAG | CD1880V3 | 1032 | Jan. 22, 2020 | 3 Years |
| Isotropic E-Field Probe | SPEAG | EF3DV3 | 4049 | Jan. 25, 2021 | 1 Year |
| Data Acquisition Electronics | SPEAG | DAE4 | 1277 | Jan. 19, 2021 | 1 Year |
| Universal Radio Communication Tester | Anritsu | MT8821C | 6261786083 | Jun. 27, 2019 | 1 Year |
| Test Arch Phantom | SPEAG | Arch | N/A | N/A | N/A |

6. Measurement Uncertainty

| Error Description | Uncertainty Value (±%) | Probability Distribution | Divisor | Ci (E) | Standard Uncertainty (E) |
|--------------------------------------|------------------------|--------------------------|---------|--------|--------------------------|
| Measurement System | | | | | |
| Probe Calibration | 5.05 | Normal | 1 | 1 | ± 5.1 % |
| Axial Isotropy | 4.7 | Rectangular | √3 | 1 | ± 2.7 % |
| Sensor Displacement | 16.5 | Rectangular | √3 | 1 | ± 9.5 % |
| Boundary Effects | 2.4 | Rectangular | √3 | 1 | ± 1.4 % |
| Phantom Boundary Effect | 7.2 | Rectangular | √3 | 1 | ± 4.2 % |
| Linearity | 4.7 | Rectangular | √3 | 1 | ± 2.7 % |
| Scaling with PMR Calibration | 10.0 | Rectangular | √3 | 1 | ± 5.8 % |
| System Detection Limit | 0.25 | Rectangular | √3 | 1 | ± 0.1 % |
| Readout Electronics | 0.3 | Normal | 1 | 1 | ± 0.3 % |
| Response Time | 0.0 | Rectangular | √3 | 1 | ± 0.0 % |
| Integration Time | 2.6 | Rectangular | √3 | 1 | ± 1.5 % |
| RF Ambient Conditions | 3.0 | Rectangular | √3 | 1 | ± 1.7 % |
| RF Reflections | 12.0 | Rectangular | √3 | 1 | ± 6.9 % |
| Probe Positioner | 1.2 | Rectangular | √3 | 1 | ± 0.7 % |
| Probe Positioning | 4.7 | Rectangular | √3 | 1 | ± 2.7 % |
| Extrap. and Interpolation | 2.0 | Rectangular | √3 | 1 | ± 1.2 % |
| Test Sample Related | | | | | |
| Device Positioning Vertical | 4.7 | Rectangular | √3 | 1 | ± 2.7 % |
| Device Positioning Lateral | 1.0 | Rectangular | √3 | 1 | ± 0.6 % |
| Device Holder and Phantom | 2.4 | Rectangular | √3 | 1 | ± 1.4 % |
| Power Drift | 5.0 | Rectangular | √3 | 1 | ± 2.9 % |
| Phantom and Setup Related | | | | | |
| Phantom Thickness | 2.4 | Rectangular | √3 | 1 | ± 1.4 % |
| Combined Standard Uncertainty | | | | | ± 16.3 % |
| Coverage Factor for 95 % | | | | | K = 2 |
| Expanded Uncertainty | | | | | ± 32.6 % |

Uncertainty budget for HAC RF Emission

7. Information of the Testing Laboratories

We, Bureau Veritas Consumer Products Services (H.K.) Ltd., Taoyuan Branch, were founded in 1988 to provide our best service in EMC, Radio, Telecom and Safety consultation. Our laboratories are accredited and approved according to ISO/IEC 17025.

If you have any comments, please feel free to contact us at the following:

Taiwan Huaya Lab:

Add: No. 19, Huaya 2nd Rd., Guishan Dist., Taoyuan City 333, Taiwan

Tel: +886-(0)3-318-3232

Fax: +886-(0)3-211-5834

Taiwan Linkou Lab:

Add: No. 47-2, Baodoucuokeng, Linkou Dist., New Taipei City 244, Taiwan

Tel: +886-(0)2-2605-2180

Fax: +886-(0)2-2605-2943

Taiwan Hsinchu Lab1:

Add: E-2, No. 1, Lixing 1st Rd., East Dist., Hsinchu City 300, Taiwan

Tel: +886-(0)3-666-8565

Fax: +886-(0)3-666-8323

Taiwan Hsinchu Lab2:

Add: No. 49, Ln. 206, Wende Rd., Qionglin Township, Hsinchu County 307, Taiwan

Tel: +886-(0)3-512-0595

Fax: +886-(0)3-512-0568

Taiwan Xindian Lab:

Add: B2F., No. 215, Sec. 3, Beixin Rd., Xindian Dist., New Taipei City 231, Taiwan

Tel: +886-(0)2-8914-5882

Fax: +886-(0)2-8914-5840

Email: service.adt@tw.bureauveritas.com

Web Site: <https://ee.bureauveritas.com.tw/BVInternet/Default>

The road map of all our labs can be found in our web site also.

---END---

Appendix A. Plots of System Verification

The plots for system verification with largest deviation for each frequency band are shown as follows.

System Check_E-Field_835_210326

DUT: HAC Dipole 835 MHz; Type: CD835V3; SN: 1041

Communication System: UID 0, CW; Frequency: 835 MHz; Duty Cycle: 1:1

Medium: Air Medium parameters used: $\sigma = 0 \text{ S/m}$, $\epsilon_r = 1$; $\rho = 1000 \text{ kg/m}^3$

Ambient Temperature : 23.7 °C

DASY5 Configuration:

- Probe: EF3DV3 - SN4049; ConvF(1, 1, 1) @ 835 MHz; Calibrated: 2021/01/25
- Sensor-Surface: (Fix Surface)
- Electronics: DAE4 Sn1277; Calibrated: 2021/01/19
- Phantom: HAC Test Arch with AMCC; Type: SD HAC P01 BA;
- Measurement SW: DASY52, Version 52.10 (4); SEMCAD X Version 14.6.14 (7483)

Hearing Aid Compatibility (41x361x1): Interpolated grid: dx=0.5000 mm, dy=0.5000 mm

Device Reference Point: 0, 0, -6.3 mm

Reference Value = 102.6 V/m; Power Drift = -0.05 dB

E-field emissions = 98.54 V/m

| | | |
|--------------------------------------|--------------------------------------|--------------------------------------|
| Grid 1 M4 98.13 V/m | Grid 2 M4 98.54 V/m | Grid 3 M4 95.24 V/m |
| Grid 4 M4 53.15 V/m | Grid 5 M4 53.29 V/m | Grid 6 M4 52.08 V/m |
| Grid 7 M4 96.86 V/m | Grid 8 M4 97.47 V/m | Grid 9 M4 94.50 V/m |

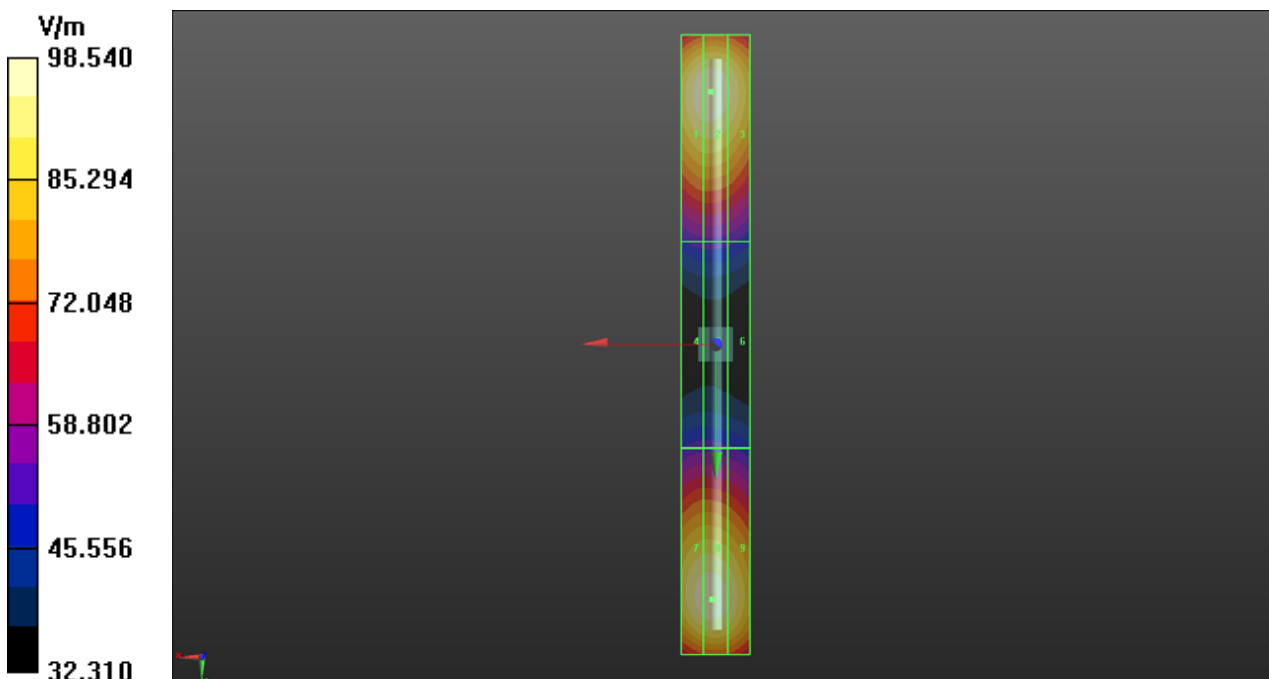

System Check_E-Field_1880_210323

DUT: HAC Dipole 1880 MHz; Type: CD1880V3; SN: 1032

Communication System: UID 0, CW; Frequency: 1880 MHz; Duty Cycle: 1:1

Medium: Air Medium parameters used: $\sigma = 0 \text{ S/m}$, $\epsilon_r = 1$; $\rho = 1000 \text{ kg/m}^3$

Ambient Temperature : 23.8 °C

DASY5 Configuration:

- Probe: EF3DV3 - SN4049; ConvF(1, 1, 1) @ 1880 MHz; Calibrated: 2021/01/25
- Sensor-Surface: (Fix Surface)
- Electronics: DAE4 Sn1277; Calibrated: 2021/01/19
- Phantom: HAC Test Arch with AMCC; Type: SD HAC P01 BA;
- Measurement SW: DASY52, Version 52.10 (4); SEMCAD X Version 14.6.14 (7483)

Hearing Aid Compatibility (41x181x1): Interpolated grid: dx=0.5000 mm, dy=0.5000 mm

Device Reference Point: 0, 0, -6.3 mm

Reference Value = 141.6 V/m; Power Drift = -0.01 dB

E-field emissions = 83.47 V/m

| | | |
|--------------------------------------|--------------------------------------|--------------------------------------|
| Grid 1 M3 82.61 V/m | Grid 2 M3 83.47 V/m | Grid 3 M3 81.04 V/m |
| Grid 4 M4 57.98 V/m | Grid 5 M4 58.26 V/m | Grid 6 M4 57.37 V/m |
| Grid 7 M3 80.97 V/m | Grid 8 M3 81.45 V/m | Grid 9 M3 78.76 V/m |

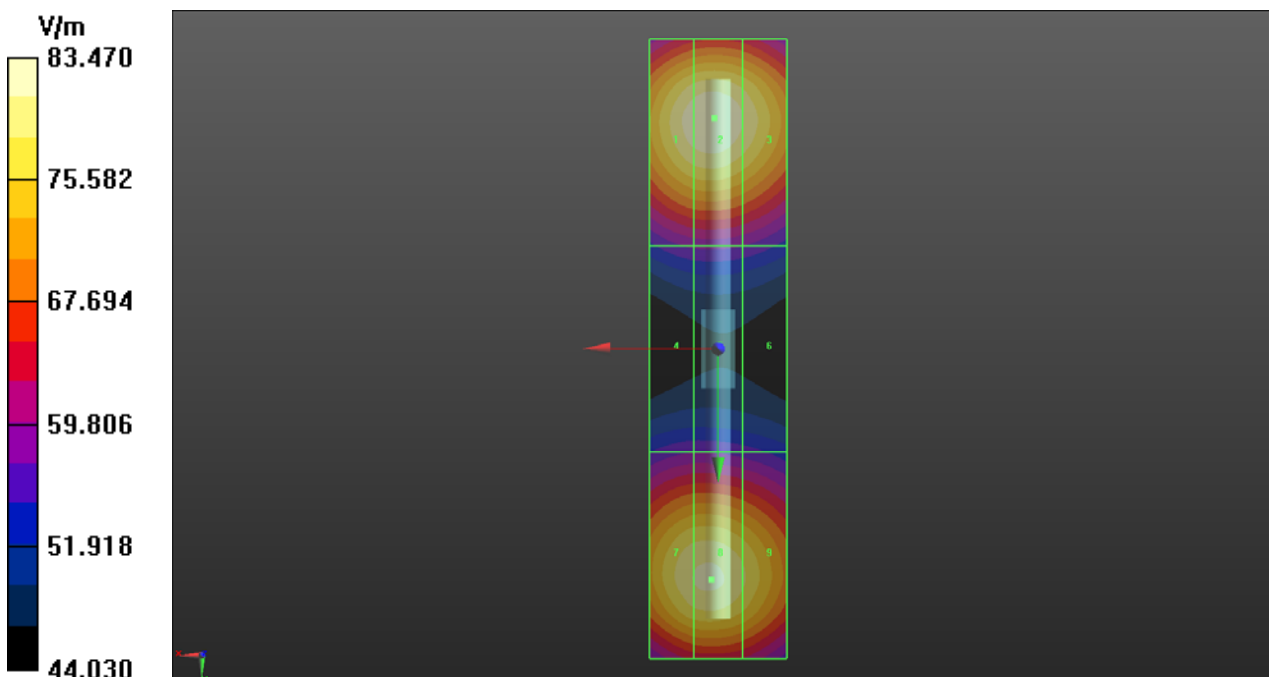

Appendix B. Plots of HAC RF Emission Measurement

The HAC plots for highest measured result in each wireless mode and frequency band combination are shown as follows.

P01 RF_E-Field_GSM850_GSM_Ch251_Battery1

DUT: 210204C02

Communication System: UID 10021 - DAC, GSM-FDD (TDMA, GMSK); Frequency: 848.8 MHz; Duty Cycle: 1:8.7

Medium: Air Medium parameters used: $\sigma = 0$ S/m, $\epsilon_r = 1$; $\rho = 1000$ kg/m³
 Ambient Temperature : 23.8 °C

DASY5 Configuration:

- Probe: EF3DV3 - SN4049; ConvF(1, 1, 1) @ 848.8 MHz; Calibrated: 2021/01/25
- Sensor-Surface: (Fix Surface)
- Electronics: DAE4 Sn1277; Calibrated: 2021/01/19
- Phantom: HAC Test Arch with AMCC; Type: SD HAC P01 BA;
- Measurement SW: DASY52, Version 52.10 (4); SEMCAD X Version 14.6.14 (7483)

Hearing Aid Compatibility (101x101x1): Interpolated grid: dx=0.5000 mm, dy=0.5000 mm

Device Reference Point: 0, 0, -6.3 mm

Reference Value = 62.62 V/m; Power Drift = -0.03 dB

MIF = 3.63 dB

RF audio interference level = 37.40 dBV/m

Emission category: M4

| | | |
|--|--|--|
| Grid 1 M4 36.28 dBV/m | Grid 2 M4 37.55 dBV/m | Grid 3 M4 37.43 dBV/m |
| Grid 4 M4 35.66 dBV/m | Grid 5 M4 37.4 dBV/m | Grid 6 M4 37.35 dBV/m |
| Grid 7 M4 34.82 dBV/m | Grid 8 M4 36.86 dBV/m | Grid 9 M4 36.86 dBV/m |

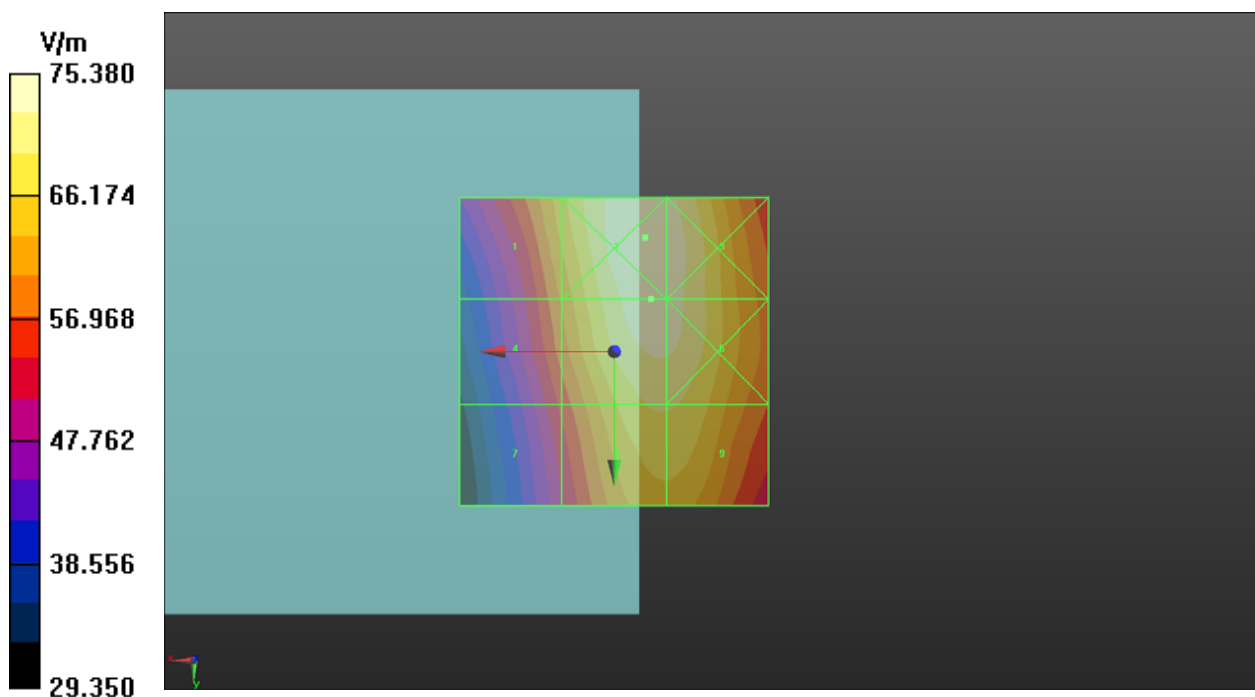

P02 RF_E-Field_GSM1900_GSM_Ch810_Battery1

DUT: 210204C02

Communication System: UID 10021 - DAC, GSM-FDD (TDMA, GMSK); Frequency: 1909.8 MHz; Duty Cycle: 1:8.7

Medium: Air Medium parameters used: $\sigma = 0$ S/m, $\epsilon_r = 1$; $\rho = 1000$ kg/m³
 Ambient Temperature : 23.7 °C

DASY5 Configuration:

- Probe: EF3DV3 - SN4049; ConvF(1, 1, 1) @ 1909.8 MHz; Calibrated: 2021/01/25
- Sensor-Surface: (Fix Surface)
- Electronics: DAE4 Sn1277; Calibrated: 2021/01/19
- Phantom: HAC Test Arch with AMCC; Type: SD HAC P01 BA;
- Measurement SW: DASY52, Version 52.10 (4); SEMCAD X Version 14.6.14 (7483)

Hearing Aid Compatibility (101x101x1): Interpolated grid: dx=0.5000 mm, dy=0.5000 mm

Device Reference Point: 0, 0, -6.3 mm

Reference Value = 19.17 V/m; Power Drift = 0.06 dB

MIF = 3.63 dB

RF audio interference level = 29.81 dBV/m

Emission category: M4

| | | |
|--|--|--|
| Grid 1 M4 29.81 dBV/m | Grid 2 M4 28.66 dBV/m | Grid 3 M4 29.18 dBV/m |
| Grid 4 M4 28.57 dBV/m | Grid 5 M4 29.35 dBV/m | Grid 6 M4 29.58 dBV/m |
| Grid 7 M4 29.78 dBV/m | Grid 8 M3 31.71 dBV/m | Grid 9 M3 31.66 dBV/m |

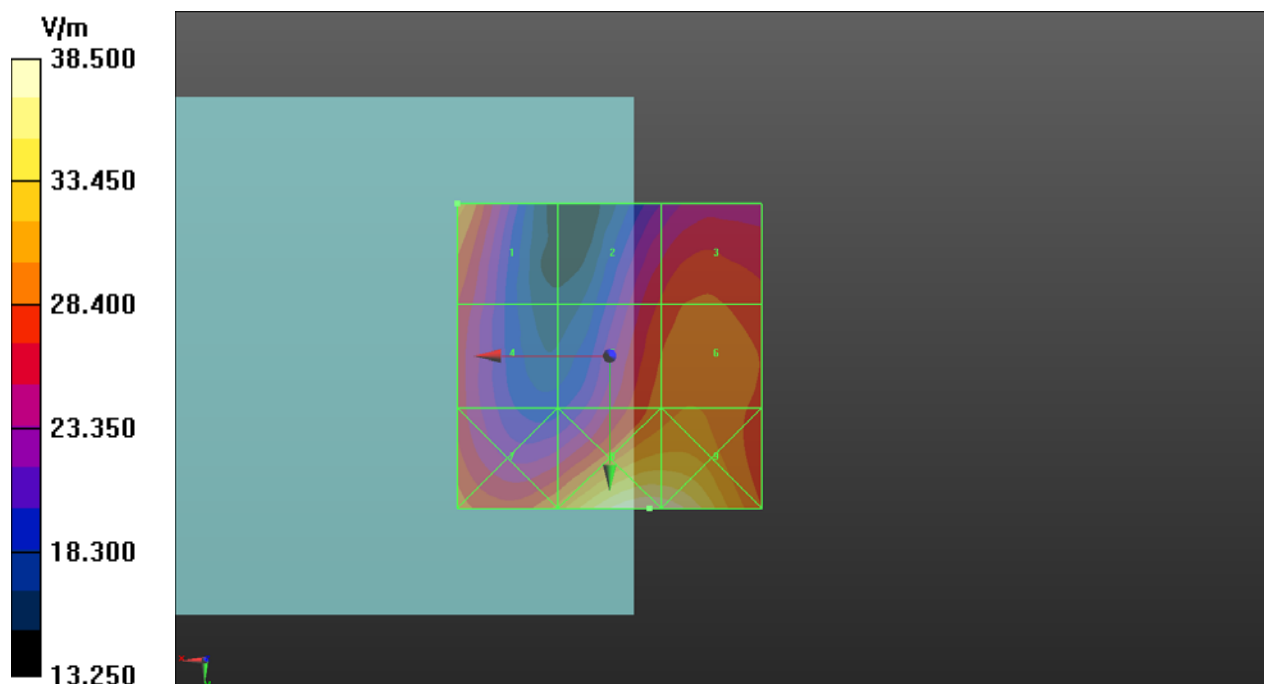

Appendix C. Calibration Certificate for Probe and Dipole

The SPEAG calibration certificates are shown as follows.



Accredited by the Swiss Accreditation Service (SAS)
The Swiss Accreditation Service is one of the signatories to the EA
Multilateral Agreement for the recognition of calibration certificates

Accreditation No.: **SCS 0108**

Client **B.V. ADT (Auden)**

Certificate No: **CD835V3-1041_Jan20**

CALIBRATION CERTIFICATE

Object **CD835V3 - SN: 1041**

Calibration procedure(s) **QA CAL-20.v7
Calibration Procedure for Validation Sources in air**

Calibration date: **January 22, 2020**

This calibration certificate documents the traceability to national standards, which realize the physical units of measurements (SI).
The measurements and the uncertainties with confidence probability are given on the following pages and are part of the certificate.

All calibrations have been conducted in the closed laboratory facility: environment temperature (22 ± 3)°C and humidity < 70%.

Calibration Equipment used (M&TE critical for calibration)

| Primary Standards | ID # | Cal Date (Certificate No.) | Scheduled Calibration |
|-----------------------------|--------------------|---------------------------------|-----------------------|
| Power meter NRP | SN: 104778 | 03-Apr-19 (No. 217-02892/02893) | Apr-20 |
| Power sensor NRP-Z91 | SN: 103244 | 03-Apr-19 (No. 217-02892) | Apr-20 |
| Power sensor NRP-Z91 | SN: 103245 | 03-Apr-19 (No. 217-02893) | Apr-20 |
| Reference 20 dB Attenuator | SN: 5058 (20k) | 04-Apr-19 (No. 217-02894) | Apr-20 |
| Type-N mismatch combination | SN: 5047.2 / 06327 | 04-Apr-19 (No. 217-02895) | Apr-20 |
| Probe EF3DV3 | SN: 4013 | 31-Dec-19 (No. EF3-4013_Dec19) | Dec-20 |
| DAE4 | SN: 781 | 27-Dec-19 (No. DAE4-781_Dec19) | Dec-20 |

| Secondary Standards | ID # | Check Date (in house) | Scheduled Check |
|---------------------------------|----------------|-----------------------------------|------------------------|
| Power meter Agilent 4419B | SN: GB42420191 | 09-Oct-09 (in house check Oct-17) | In house check: Oct-20 |
| Power sensor HP E4412A | SN: US38485102 | 05-Jan-10 (in house check Oct-17) | In house check: Oct-20 |
| Power sensor HP 8482A | SN: US37295597 | 09-Oct-09 (in house check Oct-17) | In house check: Oct-20 |
| RF generator R&S SMT-06 | SN: 837633/005 | 10-Jan-19 (in house check Jan-19) | In house check: Oct-20 |
| Network Analyzer Agilent E8358A | SN: US41080477 | 31-Mar-14 (in house check Oct-19) | In house check: Oct-20 |

Calibrated by: **Claudio Leubler** Laboratory Technician

Signature

Approved by: **Katja Pokovic** Technical Manager

Issued: January 23, 2020

This calibration certificate shall not be reproduced except in full without written approval of the laboratory.



Accredited by the Swiss Accreditation Service (SAS)

The Swiss Accreditation Service is one of the signatories to the EA
Multilateral Agreement for the recognition of calibration certificates

Accreditation No.: **SCS 0108**

References

- [1] ANSI-C63.19-2011
American National Standard, Methods of Measurement of Compatibility between Wireless Communications
Devices and Hearing Aids.

Methods Applied and Interpretation of Parameters:

- *Coordinate System:* y-axis is in the direction of the dipole arms. z-axis is from the basis of the antenna (mounted on the table) towards its feed point between the two dipole arms. x-axis is normal to the other axes. In coincidence with the standards [1], the measurement planes (probe sensor center) are selected to be at a distance of 15 mm above the top metal edge of the dipole arms.
- *Measurement Conditions:* Further details are available from the hardcopies at the end of the certificate. All figures stated in the certificate are valid at the frequency indicated. The forward power to the dipole connector is set with a calibrated power meter connected and monitored with an auxiliary power meter connected to a directional coupler. While the dipole under test is connected, the forward power is adjusted to the same level.
- *Antenna Positioning:* The dipole is mounted on a HAC Test Arch phantom using the matching dipole positioner with the arms horizontal and the feeding cable coming from the floor. The measurements are performed in a shielded room with absorbers around the setup to reduce the reflections. It is verified before the mounting of the dipole under the Test Arch phantom, that its arms are perfectly in a line. It is installed on the HAC dipole positioner with its arms parallel below the dielectric reference wire and able to move elastically in vertical direction without changing its relative position to the top center of the Test Arch phantom. The vertical distance to the probe is adjusted after dipole mounting with a DASY5 Surface Check job. Before the measurement, the distance between phantom surface and probe tip is verified. The proper measurement distance is selected by choosing the matching section of the HAC Test Arch phantom with the proper device reference point (upper surface of the dipole) and the matching grid reference point (tip of the probe) considering the probe sensor offset. The vertical distance to the probe is essential for the accuracy.
- *Feed Point Impedance and Return Loss:* These parameters are measured using a Vector Network Analyzer. The impedance is specified at the SMA connector of the dipole. The influence of reflections was eliminated by applying the averaging function while moving the dipole in the air, at least 70cm away from any obstacles.
- *E-field distribution:* E field is measured in the x-y-plane with an isotropic E-field probe with 100 mW forward power to the antenna feed point. In accordance with [1], the scan area is 20mm wide, its length exceeds the dipole arm length (180 or 90mm). The sensor center is 15 mm (in z) above the metal top of the dipole arms. Two 3D maxima are available near the end of the dipole arms. Assuming the dipole arms are perfectly in one line, the average of these two maxima (in subgrid 2 and subgrid 8) is determined to compensate for any non-parallelity to the measurement plane as well as the sensor displacement. The E-field value stated as calibration value represents the maximum of the interpolated 3D-E-field, in the plane above the dipole surface.

The reported uncertainty of measurement is stated as the standard uncertainty of measurement multiplied by the coverage factor $k=2$, which for a normal distribution corresponds to a coverage probability of approximately 95%.

Measurement Conditions

DASY system configuration, as far as not given on page 1.

| | | |
|------------------------------------|---------------------|----------|
| DASY Version | DASY5 | V52.10.3 |
| Phantom | HAC Test Arch | |
| Distance Dipole Top - Probe Center | 15 mm | |
| Scan resolution | dx, dy = 5 mm | |
| Frequency | 835 MHz \pm 1 MHz | |
| Input power drift | < 0.05 dB | |

Maximum Field values at 835 MHz

| E-field 15 mm above dipole surface | condition | Interpolated maximum |
|------------------------------------|--------------------|--|
| Maximum measured above high end | 100 mW input power | 107.7 V/m = 40.64 dBV/m |
| Maximum measured above low end | 100 mW input power | 105.7 V/m = 40.48 dBV/m |
| Averaged maximum above arm | 100 mW input power | 106.7 V/m \pm 12.8 % (k=2) |

Appendix (Additional assessments outside the scope of SCS 0108)

Antenna Parameters

| Frequency | Return Loss | Impedance |
|-----------|-------------|---------------------------------|
| 800 MHz | 15.6 dB | 38.4 Ω - 9.1 j Ω |
| 835 MHz | 33.2 dB | 50.1 Ω + 2.2 j Ω |
| 880 MHz | 18.1 dB | 58.4 Ω - 10.6 j Ω |
| 900 MHz | 17.7 dB | 50.3 Ω - 13.2 j Ω |
| 945 MHz | 21.7 dB | 48.9 Ω + 8.0 j Ω |

3.2 Antenna Design and Handling

The calibration dipole has a symmetric geometry with a built-in two stub matching network, which leads to the enhanced bandwidth.

The dipole is built of standard semirigid coaxial cable. The internal matching line is open ended. The antenna is therefore open for DC signals.

Do not apply force to dipole arms, as they are liable to bend. The soldered connections near the feedpoint may be damaged. After excessive mechanical stress or overheating, check the impedance characteristics to ensure that the internal matching network is not affected.

After long term use with 40W radiated power, only a slight warming of the dipole near the feedpoint can be measured.

Impedance Measurement Plot

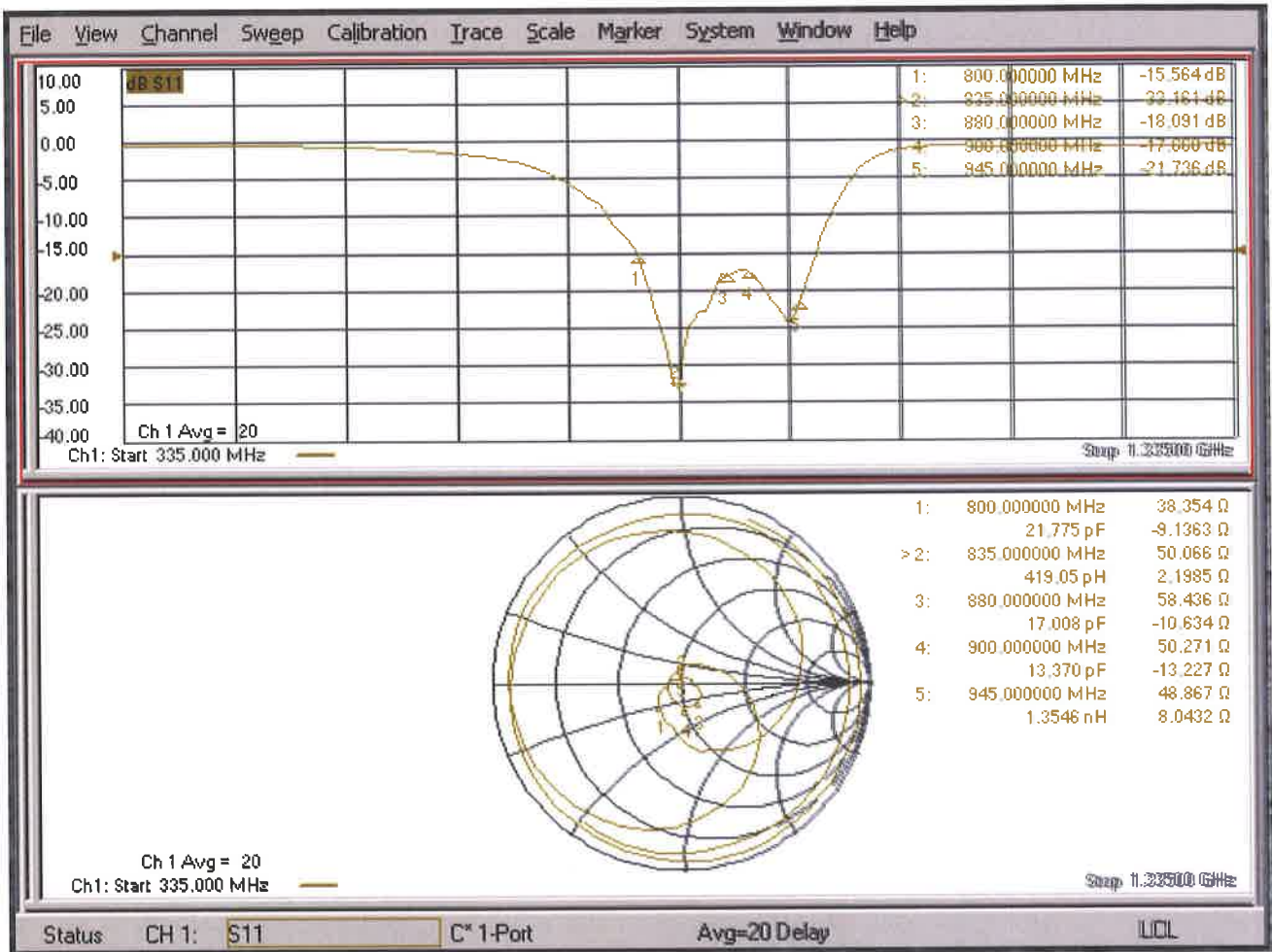

DASY5 E-field Result

Date: 22.01.2020

Test Laboratory: SPEAG Lab2

DUT: HAC-Dipole 835 MHz; Type: CD835V3; Serial: CD835V3 - SN: 1041

Communication System: UID 0 - CW; Frequency: 835 MHz

Medium parameters used: $\sigma = 0$ S/m, $\epsilon_r = 1$; $\rho = 0$ kg/m³

Phantom section: RF Section

Measurement Standard: DASY5 (IEEE/IEC/ANSI C63.19-2011)

DASY52 Configuration:

- Probe: EF3DV3 - SN4013; ConvF(1, 1, 1) @ 835 MHz; Calibrated: 31.12.2019
- Sensor-Surface: (Fix Surface)
- Electronics: DAE4 Sn781; Calibrated: 27.12.2019
- Phantom: HAC Test Arch with AMCC; Type: SD HAC P01 BA; Serial: 1070
- DASY52 52.10.3(1513); SEMCAD X 14.6.13(7474)

Dipole E-Field measurement @ 835MHz/E-Scan - 835MHz d=15mm/Hearing Aid Compatibility Test (41x361x1):

Interpolated grid: dx=0.5000 mm, dy=0.5000 mm

Device Reference Point: 0, 0, -6.3 mm

Reference Value = 125.0 V/m; Power Drift = -0.01 dB

Applied MIF = 0.00 dB

RF audio interference level = 40.64 dBV/m

Emission category: M3

MIF scaled E-field

| | | |
|--------------------------|--------------------------|--------------------------|
| Grid 1 M3 40.1 dBV/m | Grid 2 M3 40.64 dBV/m | Grid 3 M3 40.63 dBV/m |
| Grid 4 M4 35.29 dBV/m | Grid 5 M4 35.81 dBV/m | Grid 6 M4 35.81 dBV/m |
| Grid 7 M4 39.89 dBV/m | Grid 8 M3 40.48 dBV/m | Grid 9 M3 40.48 dBV/m |

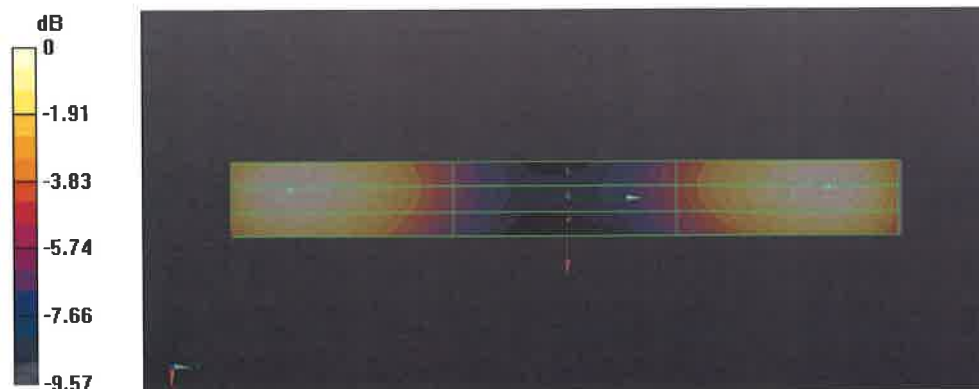

0 dB = 107.7 V/m = 40.64 dBV/m



Annual Confirmation of HAC Reference Dipole

Model : CD835V3

S/N : 1041

Measurement Date : 2021/1/21

| Frequency (MHz) | Type | Item | Previous Measurement | Annual Check | Deviation | Accepted Tolerance | Result |
|-----------------|------------|---------------------|----------------------|--------------|-----------|--------------------|--------|
| 835 | Free Space | Return Loss | -33.161 | -33.469 | 0.93% | ±20% | PASS |
| | | Real Impedance | 50.066 | 53.845 | 3.78 | ±5Ω | PASS |
| | | Imaginary Impedance | 2.1985 | 3.4898 | 1.29 | ±5Ω | PASS |

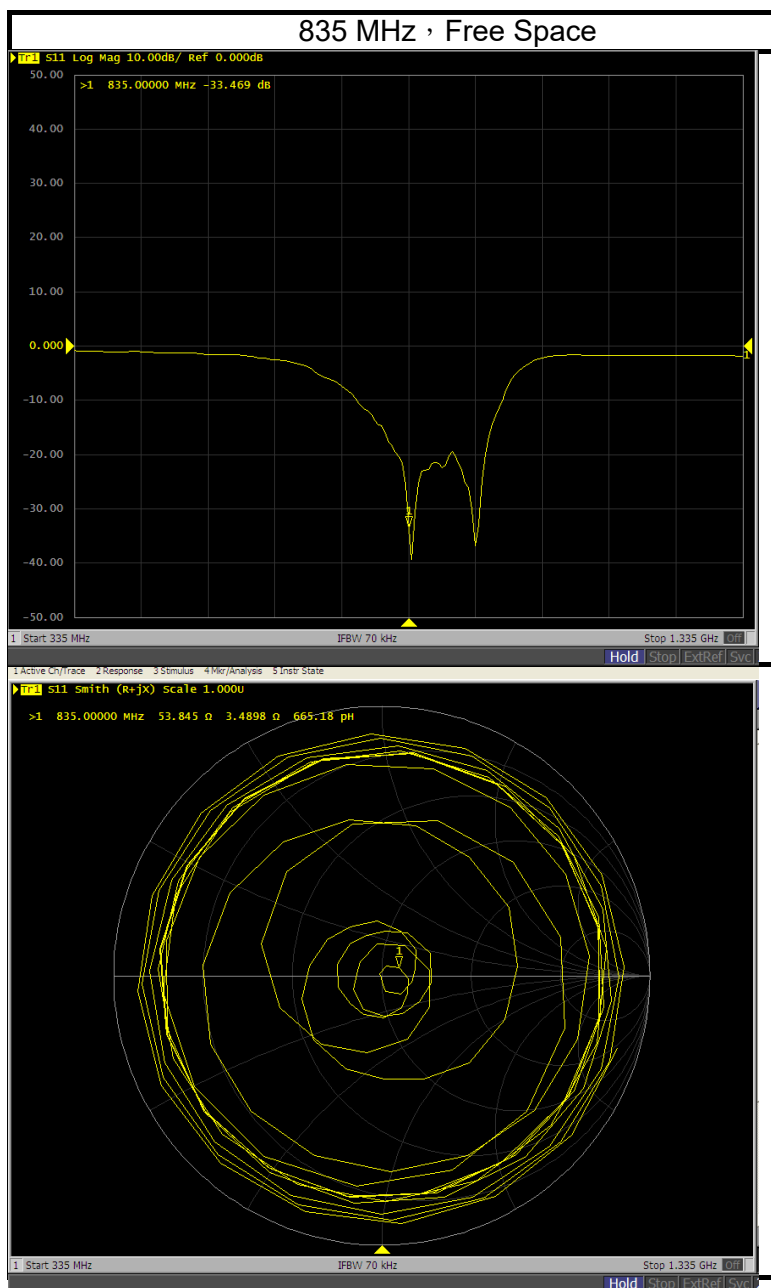



Accredited by the Swiss Accreditation Service (SAS)
The Swiss Accreditation Service is one of the signatories to the EA
Multilateral Agreement for the recognition of calibration certificates

Accreditation No.: **SCS 0108**

Client **B.V. ADT (Auden)**

Certificate No: **CD1880V3-1032_Jan20**

CALIBRATION CERTIFICATE

Object **CD1880V3 - SN: 1032**

Calibration procedure(s) **QA CAL-20.v7
Calibration Procedure for Validation Sources in air**

Calibration date: **January 22, 2020**

This calibration certificate documents the traceability to national standards, which realize the physical units of measurements (SI).
The measurements and the uncertainties with confidence probability are given on the following pages and are part of the certificate.

All calibrations have been conducted in the closed laboratory facility: environment temperature (22 ± 3)°C and humidity < 70%.

Calibration Equipment used (M&TE critical for calibration)

| Primary Standards | ID # | Cal Date (Certificate No.) | Scheduled Calibration |
|-----------------------------|--------------------|---------------------------------|-----------------------|
| Power meter NRP | SN: 104778 | 03-Apr-19 (No. 217-02892/02893) | Apr-20 |
| Power sensor NRP-Z91 | SN: 103244 | 03-Apr-19 (No. 217-02892) | Apr-20 |
| Power sensor NRP-Z91 | SN: 103245 | 03-Apr-19 (No. 217-02893) | Apr-20 |
| Reference 20 dB Attenuator | SN: 5058 (20k) | 04-Apr-19 (No. 217-02894) | Apr-20 |
| Type-N mismatch combination | SN: 5047.2 / 06327 | 04-Apr-19 (No. 217-02895) | Apr-20 |
| Probe EF3DV3 | SN: 4013 | 31-Dec-19 (No. EF3-4013_Dec19) | Dec-20 |
| DAE4 | SN: 781 | 27-Dec-19 (No. DAE4-781_Dec19) | Dec-20 |

| Secondary Standards | ID # | Check Date (in house) | Scheduled Check |
|---------------------------------|----------------|-----------------------------------|------------------------|
| Power meter Agilent 4419B | SN: GB42420191 | 09-Oct-09 (in house check Oct-17) | In house check: Oct-20 |
| Power sensor HP E4412A | SN: US38485102 | 05-Jan-10 (in house check Oct-17) | In house check: Oct-20 |
| Power sensor HP 8482A | SN: US37295597 | 09-Oct-09 (in house check Oct-17) | In house check: Oct-20 |
| RF generator R&S SMT-06 | SN: 837633/005 | 10-Jan-19 (in house check Jan-19) | In house check: Oct-20 |
| Network Analyzer Agilent E8358A | SN: US41080477 | 31-Mar-14 (in house check Oct-19) | In house check: Oct-20 |

Calibrated by: **Name** Claudio Leubler **Function** Laboratory Technician

Signature

Approved by: **Name** Katja Pokovic **Function** Technical Manager

Issued: January 23, 2020

This calibration certificate shall not be reproduced except in full without written approval of the laboratory.



Accredited by the Swiss Accreditation Service (SAS)

The Swiss Accreditation Service is one of the signatories to the EA
Multilateral Agreement for the recognition of calibration certificates

Accreditation No.: **SCS 0108**

References

- [1] ANSI-C63.19-2011
American National Standard, Methods of Measurement of Compatibility between Wireless Communications Devices and Hearing Aids.

Methods Applied and Interpretation of Parameters:

- *Coordinate System:* y-axis is in the direction of the dipole arms. z-axis is from the basis of the antenna (mounted on the table) towards its feed point between the two dipole arms. x-axis is normal to the other axes. In coincidence with the standards [1], the measurement planes (probe sensor center) are selected to be at a distance of 15 mm above the top metal edge of the dipole arms.
- *Measurement Conditions:* Further details are available from the hardcopies at the end of the certificate. All figures stated in the certificate are valid at the frequency indicated. The forward power to the dipole connector is set with a calibrated power meter connected and monitored with an auxiliary power meter connected to a directional coupler. While the dipole under test is connected, the forward power is adjusted to the same level.
- *Antenna Positioning:* The dipole is mounted on a HAC Test Arch phantom using the matching dipole positioner with the arms horizontal and the feeding cable coming from the floor. The measurements are performed in a shielded room with absorbers around the setup to reduce the reflections. It is verified before the mounting of the dipole under the Test Arch phantom, that its arms are perfectly in a line. It is installed on the HAC dipole positioner with its arms parallel below the dielectric reference wire and able to move elastically in vertical direction without changing its relative position to the top center of the Test Arch phantom. The vertical distance to the probe is adjusted after dipole mounting with a DASY5 Surface Check job. Before the measurement, the distance between phantom surface and probe tip is verified. The proper measurement distance is selected by choosing the matching section of the HAC Test Arch phantom with the proper device reference point (upper surface of the dipole) and the matching grid reference point (tip of the probe) considering the probe sensor offset. The vertical distance to the probe is essential for the accuracy.
- *Feed Point Impedance and Return Loss:* These parameters are measured using a Vector Network Analyzer. The impedance is specified at the SMA connector of the dipole. The influence of reflections was eliminated by applying the averaging function while moving the dipole in the air, at least 70cm away from any obstacles.
- *E-field distribution:* E field is measured in the x-y-plane with an isotropic E-field probe with 100 mW forward power to the antenna feed point. In accordance with [1], the scan area is 20mm wide, its length exceeds the dipole arm length (180 or 90mm). The sensor center is 15 mm (in z) above the metal top of the dipole arms. Two 3D maxima are available near the end of the dipole arms. Assuming the dipole arms are perfectly in one line, the average of these two maxima (in subgrid 2 and subgrid 8) is determined to compensate for any non-parallelity to the measurement plane as well as the sensor displacement. The E-field value stated as calibration value represents the maximum of the interpolated 3D-E-field, in the plane above the dipole surface.

The reported uncertainty of measurement is stated as the standard uncertainty of measurement multiplied by the coverage factor $k=2$, which for a normal distribution corresponds to a coverage probability of approximately 95%.

Measurement Conditions

DASY system configuration, as far as not given on page 1.

| | | |
|---|------------------|----------|
| DASY Version | DASY5 | V52.10.3 |
| Phantom | HAC Test Arch | |
| Distance Dipole Top - Probe Center | 15 mm | |
| Scan resolution | dx, dy = 5 mm | |
| Frequency | 1880 MHz ± 1 MHz | |
| Input power drift | < 0.05 dB | |

Maximum Field values at 1880 MHz

| E-field 15 mm above dipole surface | condition | Interpolated maximum |
|---|--------------------|--------------------------------|
| Maximum measured above high end | 100 mW input power | 89.8 V/m = 39.06 dBV/m |
| Maximum measured above low end | 100 mW input power | 86.6 V/m = 38.75 dBV/m |
| Averaged maximum above arm | 100 mW input power | 88.2 V/m ± 12.8 % (k=2) |

Appendix (Additional assessments outside the scope of SCS 0108)

Antenna Parameters

| Frequency | Return Loss | Impedance |
|------------------|--------------------|------------------|
| 1730 MHz | 25.6 dB | 54.6 Ω + 3.0 jΩ |
| 1880 MHz | 22.4 dB | 57.3 Ω + 3.5 jΩ |
| 1900 MHz | 22.7 dB | 57.8 Ω + 1.0 jΩ |
| 1950 MHz | 28.5 dB | 52.8 Ω - 2.6 jΩ |
| 2000 MHz | 24.9 dB | 47.7 Ω + 5.0 jΩ |

3.2 Antenna Design and Handling

The calibration dipole has a symmetric geometry with a built-in two stub matching network, which leads to the enhanced bandwidth.

The dipole is built of standard semirigid coaxial cable. The internal matching line is open ended. The antenna is therefore open for DC signals.

Do not apply force to dipole arms, as they are liable to bend. The soldered connections near the feedpoint may be damaged. After excessive mechanical stress or overheating, check the impedance characteristics to ensure that the internal matching network is not affected.

After long term use with 40W radiated power, only a slight warming of the dipole near the feedpoint can be measured.

Impedance Measurement Plot

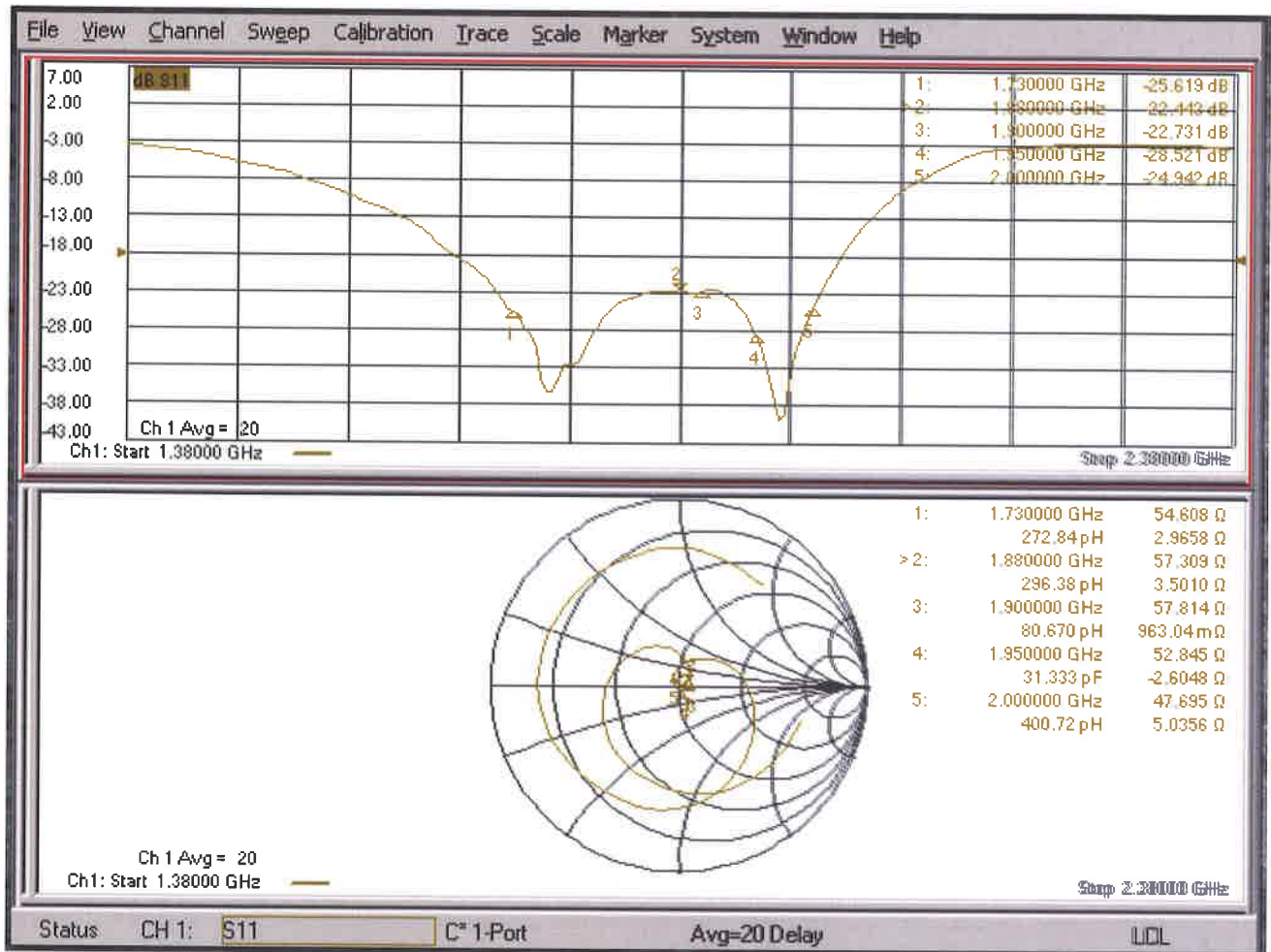

DASY5 E-field Result

Date: 22.01.2020

Test Laboratory: SPEAG Lab2

DUT: HAC Dipole 1880 MHz; Type: CD1880V3; Serial: CD1880V3 - SN: 1032

Communication System: UID 0 - CW; Frequency: 1880 MHz
Medium parameters used: $\sigma = 0$ S/m, $\epsilon_r = 1$; $\rho = 0$ kg/m³
Phantom section: RF Section
Measurement Standard: DASY5 (IEEE/IEC/ANSI C63.19-2011)

DASY52 Configuration:

- Probe: EF3DV3 - SN4013; ConvF(1, 1, 1) @ 1880 MHz; Calibrated: 31.12.2019
- Sensor-Surface: (Fix Surface)
- Electronics: DAE4 Sn781; Calibrated: 27.12.2019
- Phantom: HAC Test Arch with AMCC; Type: SD HAC P01 BA; Serial: 1070
- DASY52 52.10.3(1513); SEMCAD X 14.6.13(7474)

Dipole E-Field measurement @ 1880MHz/E-Scan - 1880MHz d=15mm/Hearing Aid Compatibility Test (41x181x1):

Interpolated grid: dx=0.5000 mm, dy=0.5000 mm
Device Reference Point: 0, 0, -6.3 mm
Reference Value = 147.5 V/m; Power Drift = -0.01 dB
Applied MIF = 0.00 dB
RF audio interference level = 39.06 dBV/m
Emission category: M2

MIF scaled E-field

| | | |
|--------------------------|--------------------------|--------------------------|
| Grid 1 M2 38.37 dBV/m | Grid 2 M2 39.06 dBV/m | Grid 3 M2 39.06 dBV/m |
| Grid 4 M2 35.95 dBV/m | Grid 5 M2 36.15 dBV/m | Grid 6 M2 36.12 dBV/m |
| Grid 7 M2 38.45 dBV/m | Grid 8 M2 38.75 dBV/m | Grid 9 M2 38.66 dBV/m |

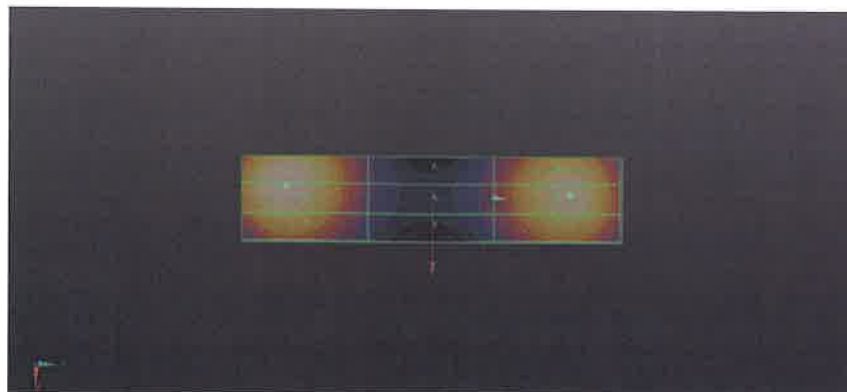
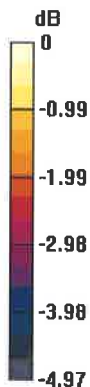

0 dB = 89.78 V/m = 39.06 dBV/m



Annual Confirmation of HAC Reference Dipole

Model : CD1880V3

S/N : 1032

Measurement Date : 2021/1/21

| Frequency (MHz) | Type | Item | Previous Measurement | Annual Check | Deviation | Accepted Tolerance | Result |
|-----------------|------------|---------------------|----------------------|--------------|-----------|--------------------|--------|
| 1880 | Free Space | Return Loss | -22.443 | -22.797 | 1.58% | ±20% | PASS |
| | | Real Impedance | 57.309 | 55.904 | -1.40 | ±5Ω | PASS |
| | | Imaginary Impedance | 3.5010 | 3.4615 | -0.04 | ±5Ω | PASS |

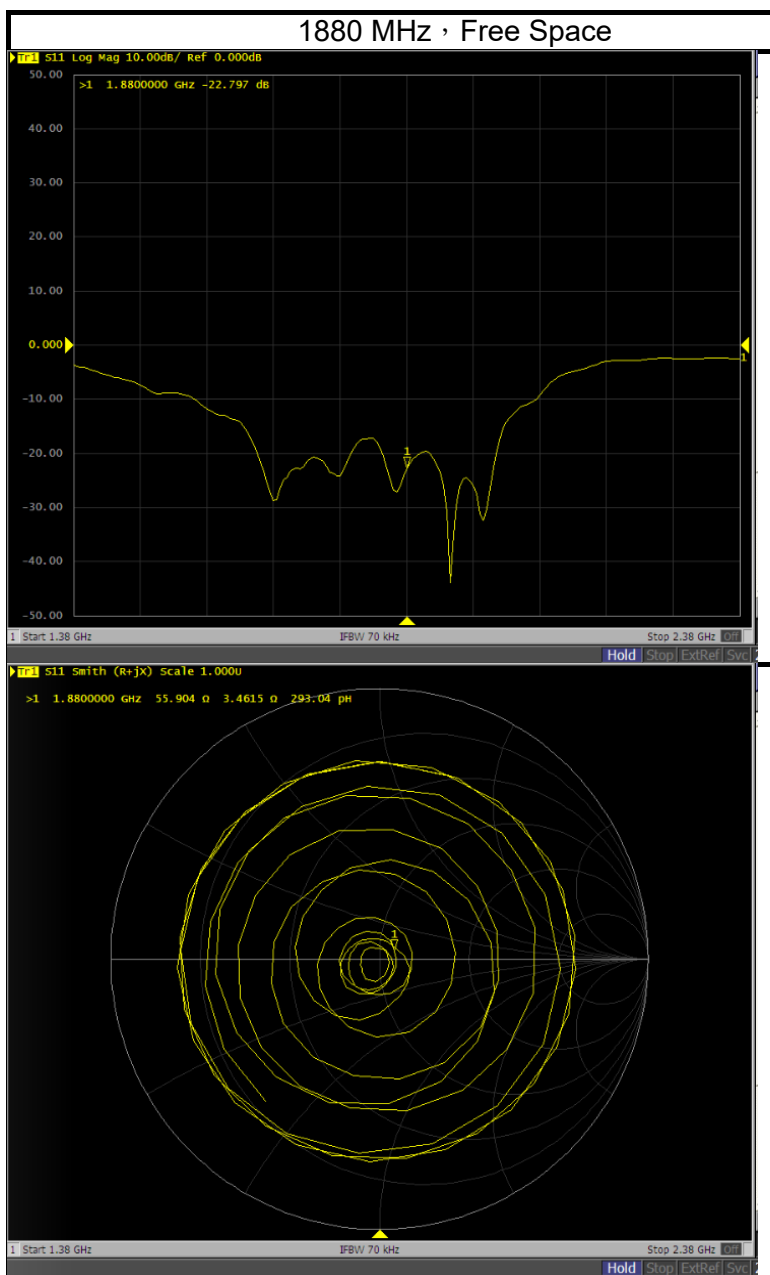



Accredited by the Swiss Accreditation Service (SAS)
The Swiss Accreditation Service is one of the signatories to the EA
Multilateral Agreement for the recognition of calibration certificates

Accreditation No.: **SCS 0108**

Client **B.V. ADT (Auden)**

Certificate No: **EF3-4049_Jan21**

CALIBRATION CERTIFICATE

Object **EF3DV3- SN:4049**

Calibration procedure(s) **QA CAL-02.v9, QA CAL-25.v7
Calibration procedure for E-field probes optimized for close near field
evaluations in air**

Calibration date: **January 25, 2021**

This calibration certificate documents the traceability to national standards, which realize the physical units of measurements (SI).
The measurements and the uncertainties with confidence probability are given on the following pages and are part of the certificate.

All calibrations have been conducted in the closed laboratory facility: environment temperature (22 ± 3)°C and humidity < 70%.

Calibration Equipment used (M&TE critical for calibration)

| Primary Standards | ID | Cal Date (Certificate No.) | Scheduled Calibration |
|----------------------------|------------------|-----------------------------------|------------------------|
| Power meter NRP | SN: 104778 | 01-Apr-20 (No. 217-03100/03101) | Apr-21 |
| Power sensor NRP-Z91 | SN: 103244 | 01-Apr-20 (No. 217-03100) | Apr-21 |
| Power sensor NRP-Z91 | SN: 103245 | 01-Apr-20 (No. 217-03101) | Apr-21 |
| Reference 20 dB Attenuator | SN: CC2552 (20x) | 31-Mar-20 (No. 217-03106) | Apr-21 |
| DAE4 | SN: 789 | 23-Dec-20 (No. DAE4-789_Dec20) | Dec-21 |
| Reference Probe ER3DV6 | SN: 2328 | 05-Oct-20 (No. ER3-2328_Oct20) | Oct-21 |
| | | | |
| Secondary Standards | ID | Check Date (in house) | Scheduled Check |
| Power meter E4419B | SN: GB41293874 | 06-Apr-16 (in house check Jun-20) | In house check: Jun-22 |
| Power sensor E4412A | SN: MY41498087 | 06-Apr-16 (in house check Jun-20) | In house check: Jun-22 |
| Power sensor E4412A | SN: 000110210 | 06-Apr-16 (in house check Jun-20) | In house check: Jun-22 |
| RF generator HP 8648C | SN: US3642U01700 | 04-Aug-99 (in house check Jun-20) | In house check: Jun-22 |
| Network Analyzer E8358A | SN: US41080477 | 31-Mar-14 (in house check Oct-20) | In house check: Oct-21 |

| | Name | Function | Signature |
|---|-----------------------|------------------------------|--------------------------|
| Calibrated by: | Jeton Kastrati | Laboratory Technician | |
| Approved by: | Katja Pokovic | Technical Manager | |
| | | | Issued: January 26, 2021 |
| This calibration certificate shall not be reproduced except in full without written approval of the laboratory. | | | |



Accredited by the Swiss Accreditation Service (SAS)

Accreditation No.: **SCS 0108**

The Swiss Accreditation Service is one of the signatories to the EA
Multilateral Agreement for the recognition of calibration certificates

Glossary:

| | |
|--------------------------|---|
| NORM _{x,y,z} | sensitivity in free space |
| DCP | diode compression point |
| CF | crest factor (1/duty_cycle) of the RF signal |
| A, B, C, D | modulation dependent linearization parameters |
| En | incident E-field orientation normal to probe axis |
| Ep | incident E-field orientation parallel to probe axis |
| Polarization φ | φ rotation around probe axis |
| Polarization ϑ | ϑ rotation around an axis that is in the plane normal to probe axis (at measurement center), i.e., $\vartheta = 0$ is normal to probe axis |
| Connector Angle | information used in DASY system to align probe sensor X to the robot coordinate system |

Calibration is Performed According to the Following Standards:

- IEEE Std 1309-2005, "IEEE Standard for calibration of electromagnetic field sensors and probes, excluding antennas, from 9 kHz to 40 GHz", December 2005
- CTIA Test Plan for Hearing Aid Compatibility, Rev 3.1.1, May 2017

Methods Applied and Interpretation of Parameters:

- NORM_{x,y,z}**: Assessed for E-field polarization $\vartheta = 0$ for XY sensors and $\vartheta = 90$ for Z sensor ($f \leq 900$ MHz in TEM-cell; $f > 1800$ MHz: R22 waveguide).
- NORM(f)_{x,y,z}** = NORM_{x,y,z} * frequency_response (see Frequency Response Chart).
- DCP_{x,y,z}**: DCP are numerical linearization parameters assessed based on the data of power sweep with CW signal (no uncertainty required). DCP does not depend on frequency nor media.
- PAR**: PAR is the Peak to Average Ratio that is not calibrated but determined based on the signal characteristics
- A_{x,y,z}; B_{x,y,z}; C_{x,y,z}; D_{x,y,z}; VR_{x,y,z}; A, B, C, D** are numerical linearization parameters assessed based on the data of power sweep for specific modulation signal. The parameters do not depend on frequency nor media. VR is the maximum calibration range expressed in RMS voltage across the diode.
- Spherical isotropy (3D deviation from isotropy)**: in a locally homogeneous field realized using an open waveguide setup.
- Sensor Offset**: The sensor offset corresponds to the offset of virtual measurement center from the probe tip (on probe axis). No tolerance required.
- Connector Angle**: The angle is assessed using the information gained by determining the NORM_x (no uncertainty required).

DASY/EASY - Parameters of Probe: EF3DV3 - SN:4049

Basic Calibration Parameters

| | Sensor X | Sensor Y | Sensor Z | Unc (k=2) |
|--------------------------|----------|----------|----------|--------------|
| Norm ($\mu V/(V/m)^2$) | 0.76 | 1.01 | 1.08 | $\pm 10.1\%$ |
| DCP (mV) ^B | 97.2 | 95.3 | 98.9 | |

Calibration results for Frequency Response (30 MHz – 6 GHz)

| Frequency MHz | Target E-Field V/m | Measured E-field (En) V/m | Deviation E-normal in % | Measured E-field (Ep) V/m | Deviation E-normal in % | Unc (k=2) % |
|---------------|--------------------|---------------------------|-------------------------|---------------------------|-------------------------|-------------|
| 30 | 77.1 | 77.0 | -0.1% | 77.0 | -0.2% | $\pm 5.1\%$ |
| 100 | 77.2 | 78.1 | 1.2% | 77.8 | 0.9% | $\pm 5.1\%$ |
| 450 | 77.2 | 78.3 | 1.4% | 78.2 | 1.3% | $\pm 5.1\%$ |
| 600 | 77.1 | 77.8 | 1.0% | 77.7 | 0.9% | $\pm 5.1\%$ |
| 750 | 77.1 | 77.7 | 0.8% | 77.6 | 0.7% | $\pm 5.1\%$ |
| 1800 | 143.4 | 139.8 | -2.5% | 140.0 | -2.3% | $\pm 5.1\%$ |
| 2000 | 135.1 | 131.8 | -2.4% | 131.3 | -2.8% | $\pm 5.1\%$ |
| 2200 | 127.7 | 123.9 | -2.9% | 125.3 | -1.9% | $\pm 5.1\%$ |
| 2500 | 125.3 | 122.7 | -2.1% | 124.0 | -1.1% | $\pm 5.1\%$ |
| 3000 | 79.4 | 76.0 | -4.4% | 77.0 | -3.0% | $\pm 5.1\%$ |
| 3500 | 256.0 | 242.1 | -4.9% | 239.4 | -5.0% | $\pm 5.1\%$ |
| 3700 | 249.4 | 236.7 | -4.9% | 235.3 | -4.7% | $\pm 5.1\%$ |
| 5200 | 50.7 | 51.5 | 1.6% | 51.6 | 1.8% | $\pm 5.1\%$ |
| 5500 | 47.3 | 47.2 | -0.2% | 48.2 | 1.8% | $\pm 5.1\%$ |
| 5800 | 48.9 | 48.8 | -0.3% | 47.5 | -3.0% | $\pm 5.1\%$ |

The reported uncertainty of measurement is stated as the standard uncertainty of measurement multiplied by the coverage factor k=2, which for a normal distribution corresponds to a coverage probability of approximately 95%.

^B Numerical linearization parameter: uncertainty not required.

^E Uncertainty is determined using the max. deviation from linear response applying rectangular distribution and is expressed for the square of the field value.

DASY/EASY - Parameters of Probe: EF3DV3 - SN:4049

Calibration Results for Modulation Response

| UID | Communication System Name | | A dB | B dB/μV | C | D dB | VR mV | Max dev. | Max Unc ^E (k=2) |
|-----------|-----------------------------|---|---------|------------|-------|---------|----------|-------------|----------------------------------|
| 0 | CW | X | 0.00 | 0.00 | 1.00 | 0.00 | 171.9 | ± 3.3 % | ± 4.7 % |
| | | Y | 0.00 | 0.00 | 1.00 | | 150.1 | | |
| | | Z | 0.00 | 0.00 | 1.00 | | 163.4 | | |
| 10352-AAA | Pulse Waveform (200Hz, 10%) | X | 2.95 | 66.37 | 10.69 | 10.00 | 60.0 | ± 2.3 % | ± 9.6 % |
| | | Y | 20.00 | 94.84 | 25.51 | | 60.0 | | |
| | | Z | 6.59 | 76.10 | 15.92 | | 60.0 | | |
| 10353-AAA | Pulse Waveform (200Hz, 20%) | X | 2.10 | 66.19 | 9.53 | 6.99 | 80.0 | ± 1.0 % | ± 9.6 % |
| | | Y | 20.00 | 95.15 | 24.14 | | 80.0 | | |
| | | Z | 15.74 | 87.39 | 18.35 | | 80.0 | | |
| 10354-AAA | Pulse Waveform (200Hz, 40%) | X | 1.16 | 65.22 | 8.18 | 3.98 | 95.0 | ± 1.2 % | ± 9.6 % |
| | | Y | 20.00 | 96.87 | 23.20 | | 95.0 | | |
| | | Z | 20.00 | 91.91 | 18.51 | | 95.0 | | |
| 10355-AAA | Pulse Waveform (200Hz, 60%) | X | 2.12 | 72.04 | 10.06 | 2.22 | 120.0 | ± 1.6 % | ± 9.6 % |
| | | Y | 20.00 | 101.26 | 23.80 | | 120.0 | | |
| | | Z | 20.00 | 98.35 | 20.36 | | 120.0 | | |
| 10387-AAA | QPSK Waveform, 1 MHz | X | 1.98 | 69.17 | 16.87 | 1.00 | 150.0 | ± 1.7 % | ± 9.6 % |
| | | Y | 2.26 | 68.77 | 17.52 | | 150.0 | | |
| | | Z | 2.13 | 69.66 | 17.62 | | 150.0 | | |
| 10388-AAA | QPSK Waveform, 10 MHz | X | 2.57 | 70.54 | 17.30 | 0.00 | 150.0 | ± 1.0 % | ± 9.6 % |
| | | Y | 3.15 | 72.68 | 18.24 | | 150.0 | | |
| | | Z | 3.02 | 73.00 | 18.54 | | 150.0 | | |
| 10396-AAA | 64-QAM Waveform, 100 kHz | X | 3.11 | 73.33 | 20.39 | 3.01 | 150.0 | ± 0.8 % | ± 9.6 % |
| | | Y | 4.52 | 76.38 | 22.07 | | 150.0 | | |
| | | Z | 3.78 | 75.61 | 21.18 | | 150.0 | | |
| 10399-AAA | 64-QAM Waveform, 40 MHz | X | 3.59 | 67.56 | 16.27 | 0.00 | 150.0 | ± 0.9 % | ± 9.6 % |
| | | Y | 3.90 | 68.40 | 16.79 | | 150.0 | | |
| | | Z | 3.86 | 68.75 | 16.95 | | 150.0 | | |
| 10414-AAA | WLAN CCDF, 64-QAM, 40MHz | X | 4.87 | 65.64 | 15.74 | 0.00 | 150.0 | ± 1.8 % | ± 9.6 % |
| | | Y | 5.26 | 65.92 | 15.99 | | 150.0 | | |
| | | Z | 4.99 | 65.79 | 15.88 | | 150.0 | | |

Note: For details on UID parameters see Appendix

The reported uncertainty of measurement is stated as the standard uncertainty of measurement multiplied by the coverage factor k=2, which for a normal distribution corresponds to a coverage probability of approximately 95%.

^B Numerical linearization parameter: uncertainty not required.

^E Uncertainty is determined using the max. deviation from linear response applying rectangular distribution and is expressed for the square of the field value.

DASY/EASY - Parameters of Probe: EF3DV3 - SN:4049

Sensor Frequency Model Parameters

| | Sensor X | Sensor Y | Sensor Z |
|----------------------|----------|----------|----------|
| Frequency Corr. (LF) | 0.05 | -0.04 | 5.63 |
| Frequency Corr. (HF) | 2.82 | 2.82 | 2.82 |

Sensor Model Parameters

| | C1 fF | C2 fF | α V^{-1} | T1 $ms.V^{-2}$ | T2 $ms.V^{-1}$ | T3 ms | T4 V^{-2} | T5 V^{-1} | T6 |
|---|----------|----------|----------------------|-------------------|-------------------|----------|----------------|----------------|------|
| X | 51.7 | 339.70 | 36.49 | 6.87 | 0.43 | 4.94 | 1.27 | 0.10 | 1.00 |
| Y | 92.0 | 621.28 | 38.44 | 25.95 | 1.96 | 5.10 | 0.00 | 0.70 | 1.01 |
| Z | 63.1 | 411.50 | 36.24 | 10.37 | 0.73 | 4.98 | 1.56 | 0.19 | 1.00 |

Other Probe Parameters

| | |
|---|-------------|
| Sensor Arrangement | Rectangular |
| Connector Angle (°) | -69.4 |
| Mechanical Surface Detection Mode | enabled |
| Optical Surface Detection Mode | disabled |
| Probe Overall Length | 337 mm |
| Probe Body Diameter | 12 mm |
| Tip Length | 25 mm |
| Tip Diameter | 4 mm |
| Probe Tip to Sensor X Calibration Point | 1.5 mm |
| Probe Tip to Sensor Y Calibration Point | 1.5 mm |
| Probe Tip to Sensor Z Calibration Point | 1.5 mm |

Receiving Pattern (ϕ), $\vartheta = 0^\circ$

f=600 MHz, TEM, 0°

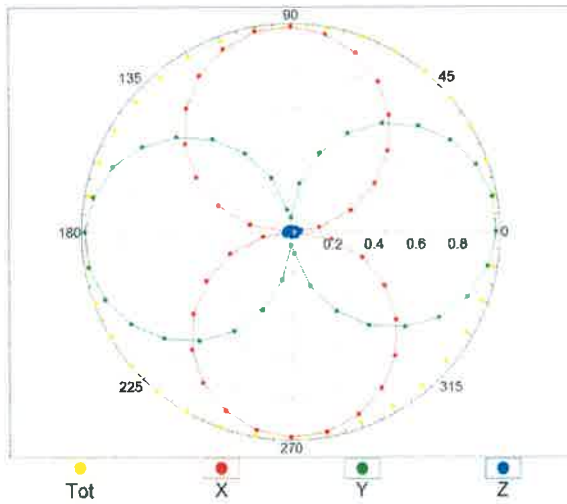

f=1800 MHz, R22, 0°

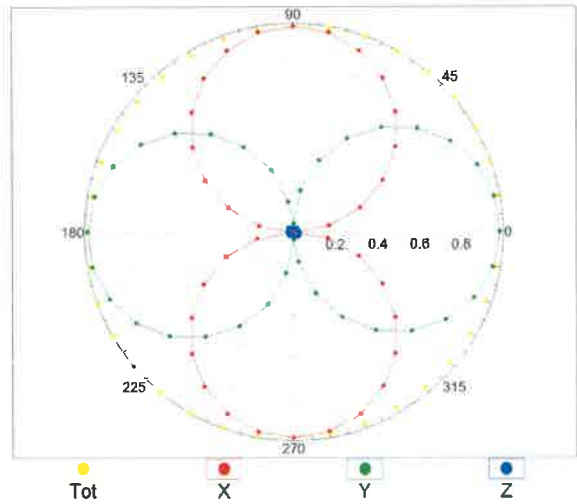

Receiving Pattern (ϕ), $\vartheta = 90^\circ$

f=600 MHz, TEM, 90°

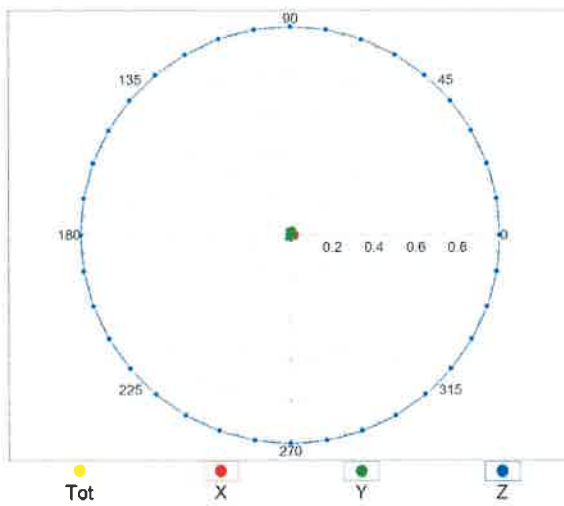

f=1800 MHz, R22, 90°

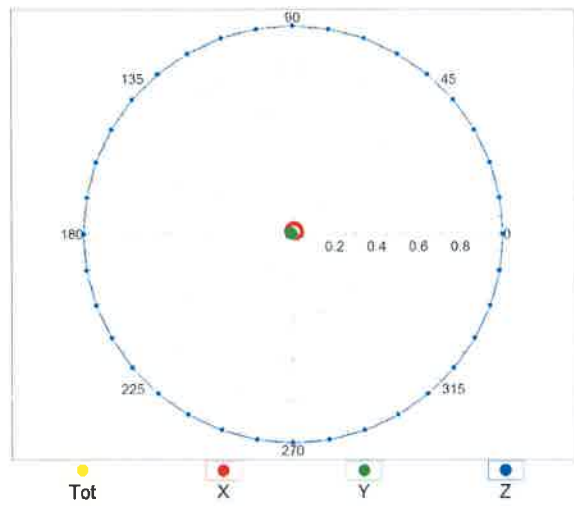

Receiving Pattern (ϕ), $\vartheta = 0^\circ$

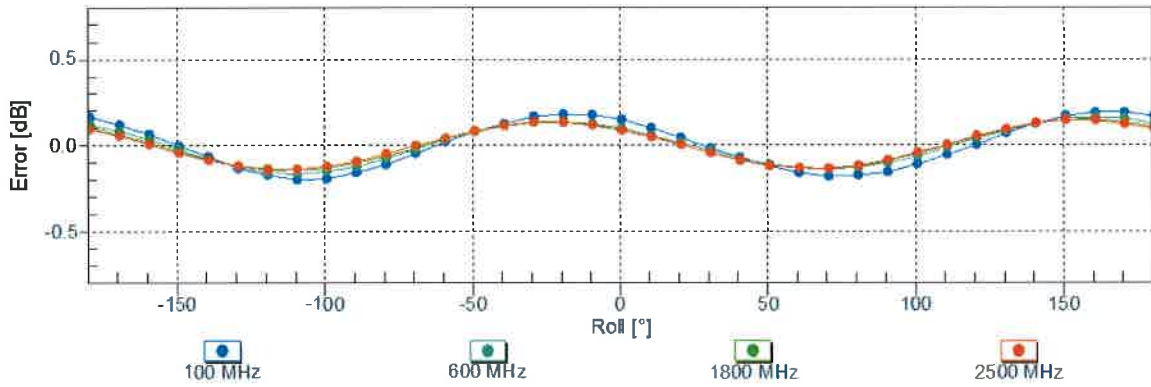

Uncertainty of Axial Isotropy Assessment: $\pm 0.5\%$ ($k=2$)

Receiving Pattern (ϕ), $\vartheta = 90^\circ$

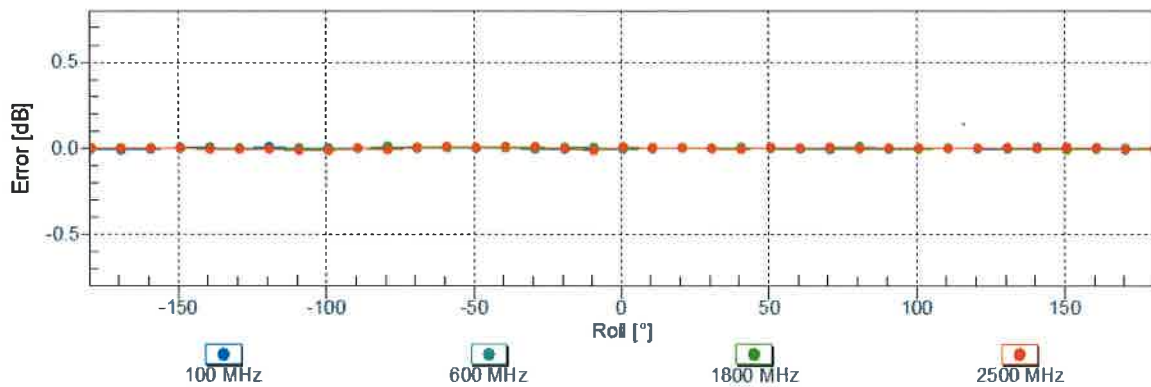

Uncertainty of Axial Isotropy Assessment: $\pm 0.5\%$ ($k=2$)

Dynamic Range f(E-field)

(TEM cell, f = 900 MHz)

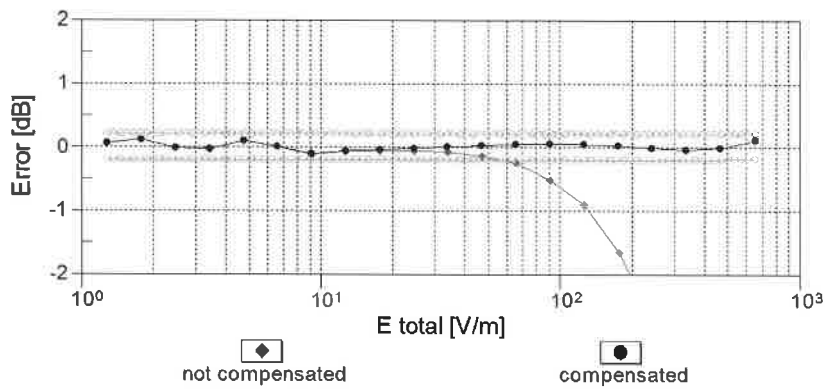
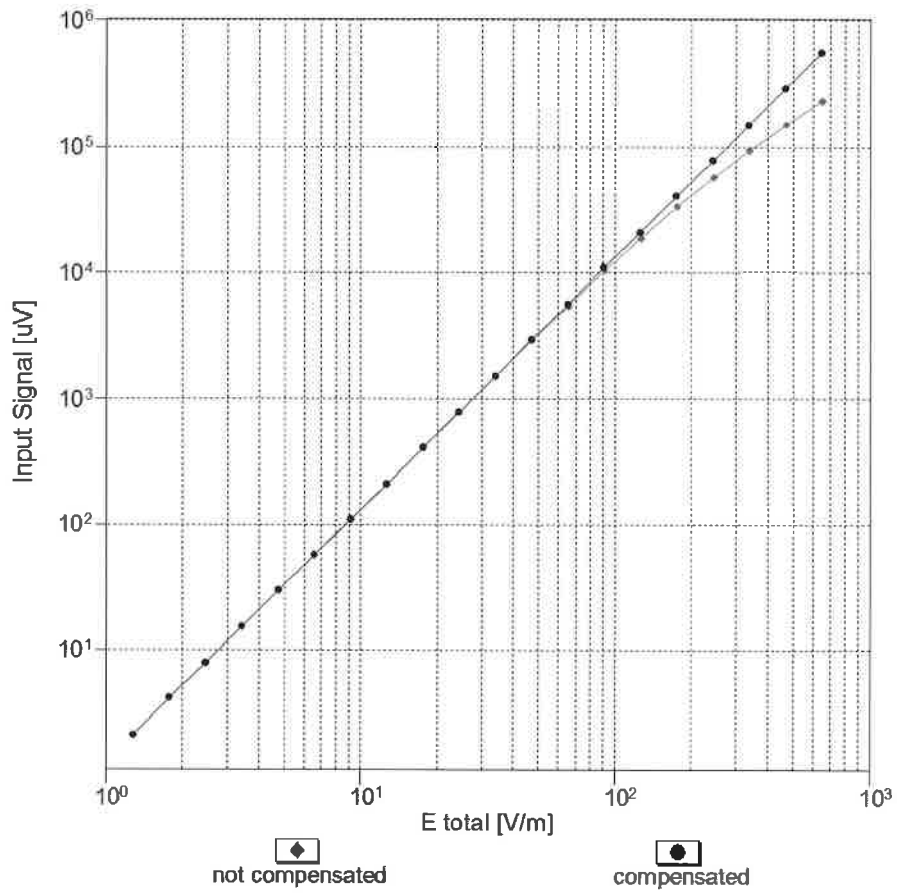

Uncertainty of Linearity Assessment: ± 0.6% (k=2)

Deviation from Isotropy in Air Error (ϕ, θ), $f = 900$ MHz

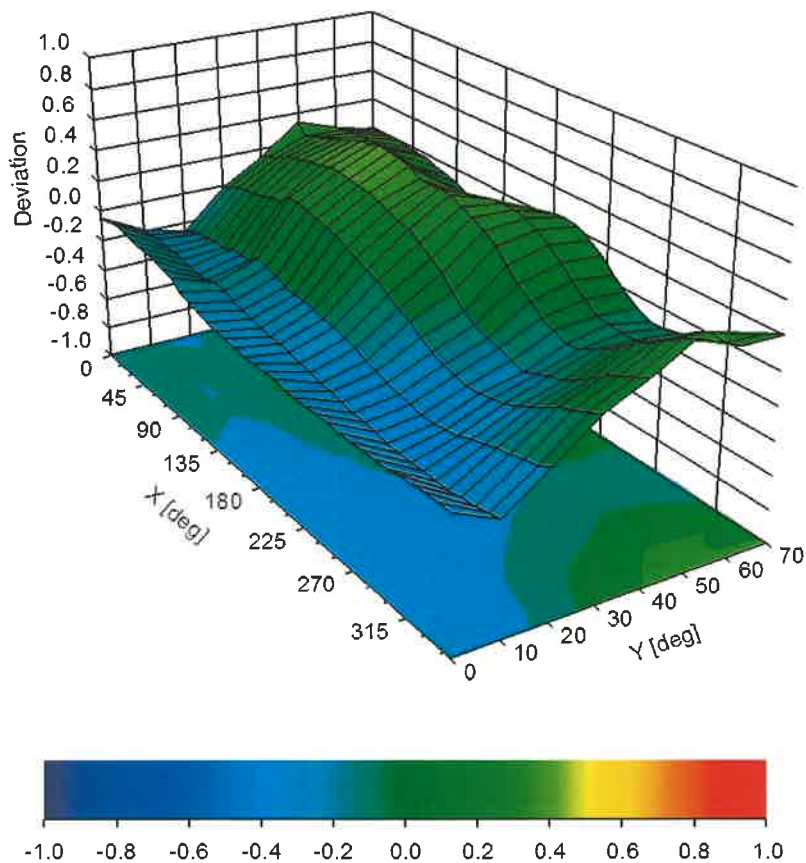

Uncertainty of Spherical Isotropy Assessment: $\pm 2.6\%$ ($k=2$)

Appendix: Modulation Calibration Parameters

| UID | Rev | Communication System Name | Group | PAR (dB) | Unc ^E (k=2) |
|-------|-----|---|-----------|----------|------------------------|
| 0 | | CW | CW | 0.00 | ± 4.7 % |
| 10010 | CAA | SAR Validation (Square, 100ms, 10ms) | Test | 10.00 | ± 9.6 % |
| 10011 | CAB | UMTS-FDD (WCDMA) | WCDMA | 2.91 | ± 9.6 % |
| 10012 | CAB | IEEE 802.11b WiFi 2.4 GHz (DSSS, 1 Mbps) | WLAN | 1.87 | ± 9.6 % |
| 10013 | CAB | IEEE 802.11g WiFi 2.4 GHz (DSSS-OFDM, 6 Mbps) | WLAN | 9.46 | ± 9.6 % |
| 10021 | DAC | GSM-FDD (TDMA, GMSK) | GSM | 9.39 | ± 9.6 % |
| 10023 | DAC | GPRS-FDD (TDMA, GMSK, TN 0) | GSM | 9.57 | ± 9.6 % |
| 10024 | DAC | GPRS-FDD (TDMA, GMSK, TN 0-1) | GSM | 6.56 | ± 9.6 % |
| 10025 | DAC | EDGE-FDD (TDMA, 8PSK, TN 0) | GSM | 12.62 | ± 9.6 % |
| 10026 | DAC | EDGE-FDD (TDMA, 8PSK, TN 0-1) | GSM | 9.55 | ± 9.6 % |
| 10027 | DAC | GPRS-FDD (TDMA, GMSK, TN 0-1-2) | GSM | 4.80 | ± 9.6 % |
| 10028 | DAC | GPRS-FDD (TDMA, GMSK, TN 0-1-2-3) | GSM | 3.55 | ± 9.6 % |
| 10029 | DAC | EDGE-FDD (TDMA, 8PSK, TN 0-1-2) | GSM | 7.78 | ± 9.6 % |
| 10030 | CAA | IEEE 802.15.1 Bluetooth (GFSK, DH1) | Bluetooth | 5.30 | ± 9.6 % |
| 10031 | CAA | IEEE 802.15.1 Bluetooth (GFSK, DH3) | Bluetooth | 1.87 | ± 9.6 % |
| 10032 | CAA | IEEE 802.15.1 Bluetooth (GFSK, DH5) | Bluetooth | 1.16 | ± 9.6 % |
| 10033 | CAA | IEEE 802.15.1 Bluetooth (PI/4-DQPSK, DH1) | Bluetooth | 7.74 | ± 9.6 % |
| 10034 | CAA | IEEE 802.15.1 Bluetooth (PI/4-DQPSK, DH3) | Bluetooth | 4.53 | ± 9.6 % |
| 10035 | CAA | IEEE 802.15.1 Bluetooth (PI/4-DQPSK, DH5) | Bluetooth | 3.83 | ± 9.6 % |
| 10036 | CAA | IEEE 802.15.1 Bluetooth (8-DPSK, DH1) | Bluetooth | 8.01 | ± 9.6 % |
| 10037 | CAA | IEEE 802.15.1 Bluetooth (8-DPSK, DH3) | Bluetooth | 4.77 | ± 9.6 % |
| 10038 | CAA | IEEE 802.15.1 Bluetooth (8-DPSK, DH5) | Bluetooth | 4.10 | ± 9.6 % |
| 10039 | CAB | CDMA2000 (1xRTT, RC1) | CDMA2000 | 4.57 | ± 9.6 % |
| 10042 | CAB | IS-54 / IS-136 FDD (TDMA/FDM, PI/4-DQPSK, Halfrate) | AMPS | 7.78 | ± 9.6 % |
| 10044 | CAA | IS-91/EIA/TIA-553 FDD (FDMA, FM) | AMPS | 0.00 | ± 9.6 % |
| 10048 | CAA | DECT (TDD, TDMA/FDM, GFSK, Full Slot, 24) | DECT | 13.80 | ± 9.6 % |
| 10049 | CAA | DECT (TDD, TDMA/FDM, GFSK, Double Slot, 12) | DECT | 10.79 | ± 9.6 % |
| 10056 | CAA | UMTS-TDD (TD-SCDMA, 1.28 Mcps) | TD-SCDMA | 11.01 | ± 9.6 % |
| 10058 | DAC | EDGE-FDD (TDMA, 8PSK, TN 0-1-2-3) | GSM | 6.52 | ± 9.6 % |
| 10059 | CAB | IEEE 802.11b WiFi 2.4 GHz (DSSS, 2 Mbps) | WLAN | 2.12 | ± 9.6 % |
| 10060 | CAB | IEEE 802.11b WiFi 2.4 GHz (DSSS, 5.5 Mbps) | WLAN | 2.83 | ± 9.6 % |
| 10061 | CAB | IEEE 802.11b WiFi 2.4 GHz (DSSS, 11 Mbps) | WLAN | 3.60 | ± 9.6 % |
| 10062 | CAD | IEEE 802.11a/h WiFi 5 GHz (OFDM, 6 Mbps) | WLAN | 8.68 | ± 9.6 % |
| 10063 | CAD | IEEE 802.11a/h WiFi 5 GHz (OFDM, 9 Mbps) | WLAN | 8.63 | ± 9.6 % |
| 10064 | CAD | IEEE 802.11a/h WiFi 5 GHz (OFDM, 12 Mbps) | WLAN | 9.09 | ± 9.6 % |
| 10065 | CAD | IEEE 802.11a/h WiFi 5 GHz (OFDM, 18 Mbps) | WLAN | 9.00 | ± 9.6 % |
| 10066 | CAD | IEEE 802.11a/h WiFi 5 GHz (OFDM, 24 Mbps) | WLAN | 9.38 | ± 9.6 % |
| 10067 | CAD | IEEE 802.11a/h WiFi 5 GHz (OFDM, 36 Mbps) | WLAN | 10.12 | ± 9.6 % |
| 10068 | CAD | IEEE 802.11a/h WiFi 5 GHz (OFDM, 48 Mbps) | WLAN | 10.24 | ± 9.6 % |
| 10069 | CAD | IEEE 802.11a/h WiFi 5 GHz (OFDM, 54 Mbps) | WLAN | 10.56 | ± 9.6 % |
| 10071 | CAB | IEEE 802.11g WiFi 2.4 GHz (DSSS/OFDM, 9 Mbps) | WLAN | 9.83 | ± 9.6 % |
| 10072 | CAB | IEEE 802.11g WiFi 2.4 GHz (DSSS/OFDM, 12 Mbps) | WLAN | 9.62 | ± 9.6 % |
| 10073 | CAB | IEEE 802.11g WiFi 2.4 GHz (DSSS/OFDM, 18 Mbps) | WLAN | 9.94 | ± 9.6 % |
| 10074 | CAB | IEEE 802.11g WiFi 2.4 GHz (DSSS/OFDM, 24 Mbps) | WLAN | 10.30 | ± 9.6 % |
| 10075 | CAB | IEEE 802.11g WiFi 2.4 GHz (DSSS/OFDM, 36 Mbps) | WLAN | 10.77 | ± 9.6 % |
| 10076 | CAB | IEEE 802.11g WiFi 2.4 GHz (DSSS/OFDM, 48 Mbps) | WLAN | 10.94 | ± 9.6 % |
| 10077 | CAB | IEEE 802.11g WiFi 2.4 GHz (DSSS/OFDM, 54 Mbps) | WLAN | 11.00 | ± 9.6 % |
| 10081 | CAB | CDMA2000 (1xRTT, RC3) | CDMA2000 | 3.97 | ± 9.6 % |
| 10082 | CAB | IS-54 / IS-136 FDD (TDMA/FDM, PI/4-DQPSK, Fullrate) | AMPS | 4.77 | ± 9.6 % |
| 10090 | DAC | GPRS-FDD (TDMA, GMSK, TN 0-4) | GSM | 6.56 | ± 9.6 % |
| 10097 | CAC | UMTS-FDD (HSDPA) | WCDMA | 3.98 | ± 9.6 % |
| 10098 | DAC | UMTS-FDD (HSUPA, Subtest 2) | WCDMA | 3.98 | ± 9.6 % |

| | | | | | |
|-------|-----|--|---------|-------|---------|
| 10099 | CAC | EDGE-FDD (TDMA, 8PSK, TN 0-4) | GSM | 9.55 | ± 9.6 % |
| 10100 | CAC | LTE-FDD (SC-FDMA, 100% RB, 20 MHz, QPSK) | LTE-FDD | 5.67 | ± 9.6 % |
| 10101 | CAB | LTE-FDD (SC-FDMA, 100% RB, 20 MHz, 16-QAM) | LTE-FDD | 6.42 | ± 9.6 % |
| 10102 | CAB | LTE-FDD (SC-FDMA, 100% RB, 20 MHz, 64-QAM) | LTE-FDD | 6.60 | ± 9.6 % |
| 10103 | DAC | LTE-TDD (SC-FDMA, 100% RB, 20 MHz, QPSK) | LTE-TDD | 9.29 | ± 9.6 % |
| 10104 | CAE | LTE-TDD (SC-FDMA, 100% RB, 20 MHz, 16-QAM) | LTE-TDD | 9.97 | ± 9.6 % |
| 10105 | CAE | LTE-TDD (SC-FDMA, 100% RB, 20 MHz, 64-QAM) | LTE-TDD | 10.01 | ± 9.6 % |
| 10108 | CAE | LTE-FDD (SC-FDMA, 100% RB, 10 MHz, QPSK) | LTE-FDD | 5.80 | ± 9.6 % |
| 10109 | CAG | LTE-FDD (SC-FDMA, 100% RB, 10 MHz, 16-QAM) | LTE-FDD | 6.43 | ± 9.6 % |
| 10110 | CAG | LTE-FDD (SC-FDMA, 100% RB, 5 MHz, QPSK) | LTE-FDD | 5.75 | ± 9.6 % |
| 10111 | CAG | LTE-FDD (SC-FDMA, 100% RB, 5 MHz, 16-QAM) | LTE-FDD | 6.44 | ± 9.6 % |
| 10112 | CAG | LTE-FDD (SC-FDMA, 100% RB, 10 MHz, 64-QAM) | LTE-FDD | 6.59 | ± 9.6 % |
| 10113 | CAG | LTE-FDD (SC-FDMA, 100% RB, 5 MHz, 64-QAM) | LTE-FDD | 6.62 | ± 9.6 % |
| 10114 | CAG | IEEE 802.11n (HT Greenfield, 13.5 Mbps, BPSK) | WLAN | 8.10 | ± 9.6 % |
| 10115 | CAG | IEEE 802.11n (HT Greenfield, 81 Mbps, 16-QAM) | WLAN | 8.46 | ± 9.6 % |
| 10116 | CAG | IEEE 802.11n (HT Greenfield, 135 Mbps, 64-QAM) | WLAN | 8.15 | ± 9.6 % |
| 10117 | CAG | IEEE 802.11n (HT Mixed, 13.5 Mbps, BPSK) | WLAN | 8.07 | ± 9.6 % |
| 10118 | CAD | IEEE 802.11n (HT Mixed, 81 Mbps, 16-QAM) | WLAN | 8.59 | ± 9.6 % |
| 10119 | CAD | IEEE 802.11n (HT Mixed, 135 Mbps, 64-QAM) | WLAN | 8.13 | ± 9.6 % |
| 10140 | CAD | LTE-FDD (SC-FDMA, 100% RB, 15 MHz, 16-QAM) | LTE-FDD | 6.49 | ± 9.6 % |
| 10141 | CAD | LTE-FDD (SC-FDMA, 100% RB, 15 MHz, 64-QAM) | LTE-FDD | 6.53 | ± 9.6 % |
| 10142 | CAD | LTE-FDD (SC-FDMA, 100% RB, 3 MHz, QPSK) | LTE-FDD | 5.73 | ± 9.6 % |
| 10143 | CAD | LTE-FDD (SC-FDMA, 100% RB, 3 MHz, 16-QAM) | LTE-FDD | 6.35 | ± 9.6 % |
| 10144 | CAC | LTE-FDD (SC-FDMA, 100% RB, 3 MHz, 64-QAM) | LTE-FDD | 6.65 | ± 9.6 % |
| 10145 | CAC | LTE-FDD (SC-FDMA, 100% RB, 1.4 MHz, QPSK) | LTE-FDD | 5.76 | ± 9.6 % |
| 10146 | CAC | LTE-FDD (SC-FDMA, 100% RB, 1.4 MHz, 16-QAM) | LTE-FDD | 6.41 | ± 9.6 % |
| 10147 | CAC | LTE-FDD (SC-FDMA, 100% RB, 1.4 MHz, 64-QAM) | LTE-FDD | 6.72 | ± 9.6 % |
| 10149 | CAE | LTE-FDD (SC-FDMA, 50% RB, 20 MHz, 16-QAM) | LTE-FDD | 6.42 | ± 9.6 % |
| 10150 | CAE | LTE-FDD (SC-FDMA, 50% RB, 20 MHz, 64-QAM) | LTE-FDD | 6.60 | ± 9.6 % |
| 10151 | CAE | LTE-TDD (SC-FDMA, 50% RB, 20 MHz, QPSK) | LTE-TDD | 9.28 | ± 9.6 % |
| 10152 | CAE | LTE-TDD (SC-FDMA, 50% RB, 20 MHz, 16-QAM) | LTE-TDD | 9.92 | ± 9.6 % |
| 10153 | CAE | LTE-TDD (SC-FDMA, 50% RB, 20 MHz, 64-QAM) | LTE-TDD | 10.05 | ± 9.6 % |
| 10154 | CAF | LTE-FDD (SC-FDMA, 50% RB, 10 MHz, QPSK) | LTE-FDD | 5.75 | ± 9.6 % |
| 10155 | CAF | LTE-FDD (SC-FDMA, 50% RB, 10 MHz, 16-QAM) | LTE-FDD | 6.43 | ± 9.6 % |
| 10156 | CAF | LTE-FDD (SC-FDMA, 50% RB, 5 MHz, QPSK) | LTE-FDD | 5.79 | ± 9.6 % |
| 10157 | CAE | LTE-FDD (SC-FDMA, 50% RB, 5 MHz, 16-QAM) | LTE-FDD | 6.49 | ± 9.6 % |
| 10158 | CAE | LTE-FDD (SC-FDMA, 50% RB, 10 MHz, 64-QAM) | LTE-FDD | 6.62 | ± 9.6 % |
| 10159 | CAG | LTE-FDD (SC-FDMA, 50% RB, 5 MHz, 64-QAM) | LTE-FDD | 6.56 | ± 9.6 % |
| 10160 | CAG | LTE-FDD (SC-FDMA, 50% RB, 15 MHz, QPSK) | LTE-FDD | 5.82 | ± 9.6 % |
| 10161 | CAG | LTE-FDD (SC-FDMA, 50% RB, 15 MHz, 16-QAM) | LTE-FDD | 6.43 | ± 9.6 % |
| 10162 | CAG | LTE-FDD (SC-FDMA, 50% RB, 15 MHz, 64-QAM) | LTE-FDD | 6.58 | ± 9.6 % |
| 10166 | CAG | LTE-FDD (SC-FDMA, 50% RB, 1.4 MHz, QPSK) | LTE-FDD | 5.46 | ± 9.6 % |
| 10167 | CAG | LTE-FDD (SC-FDMA, 50% RB, 1.4 MHz, 16-QAM) | LTE-FDD | 6.21 | ± 9.6 % |
| 10168 | CAG | LTE-FDD (SC-FDMA, 50% RB, 1.4 MHz, 64-QAM) | LTE-FDD | 6.79 | ± 9.6 % |
| 10169 | CAG | LTE-FDD (SC-FDMA, 1 RB, 20 MHz, QPSK) | LTE-FDD | 5.73 | ± 9.6 % |
| 10170 | CAG | LTE-FDD (SC-FDMA, 1 RB, 20 MHz, 16-QAM) | LTE-FDD | 6.52 | ± 9.6 % |
| 10171 | CAE | LTE-FDD (SC-FDMA, 1 RB, 20 MHz, 64-QAM) | LTE-FDD | 6.49 | ± 9.6 % |
| 10172 | CAE | LTE-TDD (SC-FDMA, 1 RB, 20 MHz, QPSK) | LTE-TDD | 9.21 | ± 9.6 % |
| 10173 | CAE | LTE-TDD (SC-FDMA, 1 RB, 20 MHz, 16-QAM) | LTE-TDD | 9.48 | ± 9.6 % |
| 10174 | CAF | LTE-TDD (SC-FDMA, 1 RB, 20 MHz, 64-QAM) | LTE-TDD | 10.25 | ± 9.6 % |
| 10175 | CAF | LTE-FDD (SC-FDMA, 1 RB, 10 MHz, QPSK) | LTE-FDD | 5.72 | ± 9.6 % |
| 10176 | CAF | LTE-FDD (SC-FDMA, 1 RB, 10 MHz, 16-QAM) | LTE-FDD | 6.52 | ± 9.6 % |
| 10177 | CAE | LTE-FDD (SC-FDMA, 1 RB, 5 MHz, QPSK) | LTE-FDD | 5.73 | ± 9.6 % |
| 10178 | CAE | LTE-FDD (SC-FDMA, 1 RB, 5 MHz, 16-QAM) | LTE-FDD | 6.52 | ± 9.6 % |
| 10179 | AAE | LTE-FDD (SC-FDMA, 1 RB, 10 MHz, 64-QAM) | LTE-FDD | 6.50 | ± 9.6 % |
| 10180 | CAG | LTE-FDD (SC-FDMA, 1 RB, 5 MHz, 64-QAM) | LTE-FDD | 6.50 | ± 9.6 % |

| | | | | | |
|-------|-----|---|---------|-------|---------|
| 10181 | CAG | LTE-FDD (SC-FDMA, 1 RB, 15 MHz, QPSK) | LTE-FDD | 5.72 | ± 9.6 % |
| 10182 | CAG | LTE-FDD (SC-FDMA, 1 RB, 15 MHz, 16-QAM) | LTE-FDD | 6.52 | ± 9.6 % |
| 10183 | CAG | LTE-FDD (SC-FDMA, 1 RB, 15 MHz, 64-QAM) | LTE-FDD | 6.50 | ± 9.6 % |
| 10184 | CAG | LTE-FDD (SC-FDMA, 1 RB, 3 MHz, QPSK) | LTE-FDD | 5.73 | ± 9.6 % |
| 10185 | CAI | LTE-FDD (SC-FDMA, 1 RB, 3 MHz, 16-QAM) | LTE-FDD | 6.51 | ± 9.6 % |
| 10186 | CAG | LTE-FDD (SC-FDMA, 1 RB, 3 MHz, 64-QAM) | LTE-FDD | 6.50 | ± 9.6 % |
| 10187 | CAG | LTE-FDD (SC-FDMA, 1 RB, 1.4 MHz, QPSK) | LTE-FDD | 5.73 | ± 9.6 % |
| 10188 | CAG | LTE-FDD (SC-FDMA, 1 RB, 1.4 MHz, 16-QAM) | LTE-FDD | 6.52 | ± 9.6 % |
| 10189 | CAE | LTE-FDD (SC-FDMA, 1 RB, 1.4 MHz, 64-QAM) | LTE-FDD | 6.50 | ± 9.6 % |
| 10193 | CAE | IEEE 802.11n (HT Greenfield, 6.5 Mbps, BPSK) | WLAN | 8.09 | ± 9.6 % |
| 10194 | AAD | IEEE 802.11n (HT Greenfield, 39 Mbps, 16-QAM) | WLAN | 8.12 | ± 9.6 % |
| 10195 | CAE | IEEE 802.11n (HT Greenfield, 65 Mbps, 64-QAM) | WLAN | 8.21 | ± 9.6 % |
| 10196 | CAE | IEEE 802.11n (HT Mixed, 6.5 Mbps, BPSK) | WLAN | 8.10 | ± 9.6 % |
| 10197 | AAE | IEEE 802.11n (HT Mixed, 39 Mbps, 16-QAM) | WLAN | 8.13 | ± 9.6 % |
| 10198 | CAF | IEEE 802.11n (HT Mixed, 65 Mbps, 64-QAM) | WLAN | 8.27 | ± 9.6 % |
| 10219 | CAF | IEEE 802.11n (HT Mixed, 7.2 Mbps, BPSK) | WLAN | 8.03 | ± 9.6 % |
| 10220 | AAF | IEEE 802.11n (HT Mixed, 43.3 Mbps, 16-QAM) | WLAN | 8.13 | ± 9.6 % |
| 10221 | CAC | IEEE 802.11n (HT Mixed, 72.2 Mbps, 64-QAM) | WLAN | 8.27 | ± 9.6 % |
| 10222 | CAC | IEEE 802.11n (HT Mixed, 15 Mbps, BPSK) | WLAN | 8.06 | ± 9.6 % |
| 10223 | CAD | IEEE 802.11n (HT Mixed, 90 Mbps, 16-QAM) | WLAN | 8.48 | ± 9.6 % |
| 10224 | CAD | IEEE 802.11n (HT Mixed, 150 Mbps, 64-QAM) | WLAN | 8.08 | ± 9.6 % |
| 10225 | CAD | UMTS-FDD (HSPA+) | WCDMA | 5.97 | ± 9.6 % |
| 10226 | CAD | LTE-TDD (SC-FDMA, 1 RB, 1.4 MHz, 16-QAM) | LTE-TDD | 9.49 | ± 9.6 % |
| 10227 | CAD | LTE-TDD (SC-FDMA, 1 RB, 1.4 MHz, 64-QAM) | LTE-TDD | 10.26 | ± 9.6 % |
| 10228 | CAD | LTE-TDD (SC-FDMA, 1 RB, 1.4 MHz, QPSK) | LTE-TDD | 9.22 | ± 9.6 % |
| 10229 | DAC | LTE-TDD (SC-FDMA, 1 RB, 3 MHz, 16-QAM) | LTE-TDD | 9.48 | ± 9.6 % |
| 10230 | CAC | LTE-TDD (SC-FDMA, 1 RB, 3 MHz, 64-QAM) | LTE-TDD | 10.25 | ± 9.6 % |
| 10231 | CAC | LTE-TDD (SC-FDMA, 1 RB, 3 MHz, QPSK) | LTE-TDD | 9.19 | ± 9.6 % |
| 10232 | CAD | LTE-TDD (SC-FDMA, 1 RB, 5 MHz, 16-QAM) | LTE-TDD | 9.48 | ± 9.6 % |
| 10233 | CAD | LTE-TDD (SC-FDMA, 1 RB, 5 MHz, 64-QAM) | LTE-TDD | 10.25 | ± 9.6 % |
| 10234 | CAD | LTE-TDD (SC-FDMA, 1 RB, 5 MHz, QPSK) | LTE-TDD | 9.21 | ± 9.6 % |
| 10235 | CAD | LTE-TDD (SC-FDMA, 1 RB, 10 MHz, 16-QAM) | LTE-TDD | 9.48 | ± 9.6 % |
| 10236 | CAD | LTE-TDD (SC-FDMA, 1 RB, 10 MHz, 64-QAM) | LTE-TDD | 10.25 | ± 9.6 % |
| 10237 | CAD | LTE-TDD (SC-FDMA, 1 RB, 10 MHz, QPSK) | LTE-TDD | 9.21 | ± 9.6 % |
| 10238 | CAB | LTE-TDD (SC-FDMA, 1 RB, 15 MHz, 16-QAM) | LTE-TDD | 9.48 | ± 9.6 % |
| 10239 | CAB | LTE-TDD (SC-FDMA, 1 RB, 15 MHz, 64-QAM) | LTE-TDD | 10.25 | ± 9.6 % |
| 10240 | CAB | LTE-TDD (SC-FDMA, 1 RB, 15 MHz, QPSK) | LTE-TDD | 9.21 | ± 9.6 % |
| 10241 | CAB | LTE-TDD (SC-FDMA, 50% RB, 1.4 MHz, 16-QAM) | LTE-TDD | 9.82 | ± 9.6 % |
| 10242 | CAD | LTE-TDD (SC-FDMA, 50% RB, 1.4 MHz, 64-QAM) | LTE-TDD | 9.86 | ± 9.6 % |
| 10243 | CAD | LTE-TDD (SC-FDMA, 50% RB, 1.4 MHz, QPSK) | LTE-TDD | 9.46 | ± 9.6 % |
| 10244 | CAD | LTE-TDD (SC-FDMA, 50% RB, 3 MHz, 16-QAM) | LTE-TDD | 10.06 | ± 9.6 % |
| 10245 | CAG | LTE-TDD (SC-FDMA, 50% RB, 3 MHz, 64-QAM) | LTE-TDD | 10.06 | ± 9.6 % |
| 10246 | CAG | LTE-TDD (SC-FDMA, 50% RB, 3 MHz, QPSK) | LTE-TDD | 9.30 | ± 9.6 % |
| 10247 | CAG | LTE-TDD (SC-FDMA, 50% RB, 5 MHz, 16-QAM) | LTE-TDD | 9.91 | ± 9.6 % |
| 10248 | CAG | LTE-TDD (SC-FDMA, 50% RB, 5 MHz, 64-QAM) | LTE-TDD | 10.09 | ± 9.6 % |
| 10249 | CAG | LTE-TDD (SC-FDMA, 50% RB, 5 MHz, QPSK) | LTE-TDD | 9.29 | ± 9.6 % |
| 10250 | CAG | LTE-TDD (SC-FDMA, 50% RB, 10 MHz, 16-QAM) | LTE-TDD | 9.81 | ± 9.6 % |
| 10251 | CAF | LTE-TDD (SC-FDMA, 50% RB, 10 MHz, 64-QAM) | LTE-TDD | 10.17 | ± 9.6 % |
| 10252 | CAF | LTE-TDD (SC-FDMA, 50% RB, 10 MHz, QPSK) | LTE-TDD | 9.24 | ± 9.6 % |
| 10253 | CAF | LTE-TDD (SC-FDMA, 50% RB, 15 MHz, 16-QAM) | LTE-TDD | 9.90 | ± 9.6 % |
| 10254 | CAB | LTE-TDD (SC-FDMA, 50% RB, 15 MHz, 64-QAM) | LTE-TDD | 10.14 | ± 9.6 % |
| 10255 | CAB | LTE-TDD (SC-FDMA, 50% RB, 15 MHz, QPSK) | LTE-TDD | 9.20 | ± 9.6 % |
| 10256 | CAB | LTE-TDD (SC-FDMA, 100% RB, 1.4 MHz, 16-QAM) | LTE-TDD | 9.96 | ± 9.6 % |
| 10257 | CAD | LTE-TDD (SC-FDMA, 100% RB, 1.4 MHz, 64-QAM) | LTE-TDD | 10.08 | ± 9.6 % |
| 10258 | CAD | LTE-TDD (SC-FDMA, 100% RB, 1.4 MHz, QPSK) | LTE-TDD | 9.34 | ± 9.6 % |
| 10259 | CAD | LTE-TDD (SC-FDMA, 100% RB, 3 MHz, 16-QAM) | LTE-TDD | 9.98 | ± 9.6 % |

| | | | | | |
|-------|-----|---|----------|-------|---------|
| 10260 | CAG | LTE-TDD (SC-FDMA, 100% RB, 3 MHz, 64-QAM) | LTE-TDD | 9.97 | ± 9.6 % |
| 10261 | CAG | LTE-TDD (SC-FDMA, 100% RB, 3 MHz, QPSK) | LTE-TDD | 9.24 | ± 9.6 % |
| 10262 | CAG | LTE-TDD (SC-FDMA, 100% RB, 5 MHz, 16-QAM) | LTE-TDD | 9.83 | ± 9.6 % |
| 10263 | CAG | LTE-TDD (SC-FDMA, 100% RB, 5 MHz, 64-QAM) | LTE-TDD | 10.16 | ± 9.6 % |
| 10264 | CAG | LTE-TDD (SC-FDMA, 100% RB, 5 MHz, QPSK) | LTE-TDD | 9.23 | ± 9.6 % |
| 10265 | CAG | LTE-TDD (SC-FDMA, 100% RB, 10 MHz, 16-QAM) | LTE-TDD | 9.92 | ± 9.6 % |
| 10266 | CAF | LTE-TDD (SC-FDMA, 100% RB, 10 MHz, 64-QAM) | LTE-TDD | 10.07 | ± 9.6 % |
| 10267 | CAF | LTE-TDD (SC-FDMA, 100% RB, 10 MHz, QPSK) | LTE-TDD | 9.30 | ± 9.6 % |
| 10268 | CAF | LTE-TDD (SC-FDMA, 100% RB, 15 MHz, 16-QAM) | LTE-TDD | 10.06 | ± 9.6 % |
| 10269 | CAB | LTE-TDD (SC-FDMA, 100% RB, 15 MHz, 64-QAM) | LTE-TDD | 10.13 | ± 9.6 % |
| 10270 | CAB | LTE-TDD (SC-FDMA, 100% RB, 15 MHz, QPSK) | LTE-TDD | 9.58 | ± 9.6 % |
| 10274 | CAB | UMTS-FDD (HSUPA, Subtest 5, 3GPP Rel8.10) | WCDMA | 4.87 | ± 9.6 % |
| 10275 | CAD | UMTS-FDD (HSUPA, Subtest 5, 3GPP Rel8.4) | WCDMA | 3.96 | ± 9.6 % |
| 10277 | CAD | PHS (QPSK) | PHS | 11.81 | ± 9.6 % |
| 10278 | CAD | PHS (QPSK, BW 884MHz, Rolloff 0.5) | PHS | 11.81 | ± 9.6 % |
| 10279 | CAG | PHS (QPSK, BW 884MHz, Rolloff 0.38) | PHS | 12.18 | ± 9.6 % |
| 10290 | CAG | CDMA2000, RC1, SO55, Full Rate | CDMA2000 | 3.91 | ± 9.6 % |
| 10291 | CAG | CDMA2000, RC3, SO55, Full Rate | CDMA2000 | 3.46 | ± 9.6 % |
| 10292 | CAG | CDMA2000, RC3, SO32, Full Rate | CDMA2000 | 3.39 | ± 9.6 % |
| 10293 | CAG | CDMA2000, RC3, SO3, Full Rate | CDMA2000 | 3.50 | ± 9.6 % |
| 10295 | CAG | CDMA2000, RC1, SO3, 1/8th Rate 25 fr. | CDMA2000 | 12.49 | ± 9.6 % |
| 10297 | CAF | LTE-FDD (SC-FDMA, 50% RB, 20 MHz, QPSK) | LTE-FDD | 5.81 | ± 9.6 % |
| 10298 | CAF | LTE-FDD (SC-FDMA, 50% RB, 3 MHz, QPSK) | LTE-FDD | 5.72 | ± 9.6 % |
| 10299 | CAF | LTE-FDD (SC-FDMA, 50% RB, 3 MHz, 16-QAM) | LTE-FDD | 6.39 | ± 9.6 % |
| 10300 | CAC | LTE-FDD (SC-FDMA, 50% RB, 3 MHz, 64-QAM) | LTE-FDD | 6.60 | ± 9.6 % |
| 10301 | CAC | IEEE 802.16e WiMAX (29:18, 5ms, 10MHz, QPSK, PUSC) | WiMAX | 12.03 | ± 9.6 % |
| 10302 | CAB | IEEE 802.16e WiMAX (29:18, 5ms, 10MHz, QPSK, PUSC, 3CTRL) | WiMAX | 12.57 | ± 9.6 % |
| 10303 | CAB | IEEE 802.16e WiMAX (31:15, 5ms, 10MHz, 64QAM, PUSC) | WiMAX | 12.52 | ± 9.6 % |
| 10304 | CAA | IEEE 802.16e WiMAX (29:18, 5ms, 10MHz, 64QAM, PUSC) | WiMAX | 11.86 | ± 9.6 % |
| 10305 | CAA | IEEE 802.16e WiMAX (31:15, 10ms, 10MHz, 64QAM, PUSC) | WiMAX | 15.24 | ± 9.6 % |
| 10306 | CAA | IEEE 802.16e WiMAX (29:18, 10ms, 10MHz, 64QAM, PUSC) | WiMAX | 14.67 | ± 9.6 % |
| 10307 | AAB | IEEE 802.16e WiMAX (29:18, 10ms, 10MHz, QPSK, PUSC) | WiMAX | 14.49 | ± 9.6 % |
| 10308 | AAB | IEEE 802.16e WiMAX (29:18, 10ms, 10MHz, 16QAM, PUSC) | WiMAX | 14.46 | ± 9.6 % |
| 10309 | AAB | IEEE 802.16e WiMAX (29:18, 10ms, 10MHz, 16QAM, AMC 2x3) | WiMAX | 14.58 | ± 9.6 % |
| 10310 | AAB | IEEE 802.16e WiMAX (29:18, 10ms, 10MHz, QPSK, AMC 2x3) | WiMAX | 14.57 | ± 9.6 % |
| 10311 | AAB | LTE-FDD (SC-FDMA, 100% RB, 15 MHz, QPSK) | LTE-FDD | 6.06 | ± 9.6 % |
| 10313 | AAD | iDEN 1:3 | iDEN | 10.51 | ± 9.6 % |
| 10314 | AAD | iDEN 1:6 | iDEN | 13.48 | ± 9.6 % |
| 10315 | AAD | IEEE 802.11b WiFi 2.4 GHz (DSSS, 1 Mbps, 96pc dc) | WLAN | 1.71 | ± 9.6 % |
| 10316 | AAD | IEEE 802.11g WiFi 2.4 GHz (ERP-OFDM, 6 Mbps, 96pc dc) | WLAN | 8.36 | ± 9.6 % |
| 10317 | AAA | IEEE 802.11a WiFi 5 GHz (OFDM, 6 Mbps, 96pc dc) | WLAN | 8.36 | ± 9.6 % |
| 10352 | AAA | Pulse Waveform (200Hz, 10%) | Generic | 10.00 | ± 9.6 % |
| 10353 | AAA | Pulse Waveform (200Hz, 20%) | Generic | 6.99 | ± 9.6 % |
| 10354 | AAA | Pulse Waveform (200Hz, 40%) | Generic | 3.98 | ± 9.6 % |
| 10355 | AAA | Pulse Waveform (200Hz, 60%) | Generic | 2.22 | ± 9.6 % |
| 10356 | AAA | Pulse Waveform (200Hz, 80%) | Generic | 0.97 | ± 9.6 % |
| 10387 | AAA | QPSK Waveform, 1 MHz | Generic | 5.10 | ± 9.6 % |
| 10388 | AAA | QPSK Waveform, 10 MHz | Generic | 5.22 | ± 9.6 % |
| 10396 | AAA | 64-QAM Waveform, 100 kHz | Generic | 6.27 | ± 9.6 % |
| 10399 | AAA | 64-QAM Waveform, 40 MHz | Generic | 6.27 | ± 9.6 % |
| 10400 | AAD | IEEE 802.11ac WiFi (20MHz, 64-QAM, 99pc dc) | WLAN | 8.37 | ± 9.6 % |
| 10401 | AAA | IEEE 802.11ac WiFi (40MHz, 64-QAM, 99pc dc) | WLAN | 8.60 | ± 9.6 % |
| 10402 | AAA | IEEE 802.11ac WiFi (80MHz, 64-QAM, 99pc dc) | WLAN | 8.53 | ± 9.6 % |
| 10403 | AAB | CDMA2000 (1xEV-DO, Rev. 0) | CDMA2000 | 3.76 | ± 9.6 % |
| 10404 | AAB | CDMA2000 (1xEV-DO, Rev. A) | CDMA2000 | 3.77 | ± 9.6 % |
| 10406 | AAD | CDMA2000, RC3, SO32, SCH0, Full Rate | CDMA2000 | 5.22 | ± 9.6 % |

| | | | | | |
|-------|-----|--|----------|-------|---------|
| 10410 | AAA | LTE-TDD (SC-FDMA, 1 RB, 10 MHz, QPSK, UL Sub=2,3,4,7,8,9) | LTE-TDD | 7.82 | ± 9.6 % |
| 10414 | AAA | WLAN CCDF, 64-QAM, 40MHz | Generic | 8.54 | ± 9.6 % |
| 10415 | AAA | IEEE 802.11b WiFi 2.4 GHz (DSSS, 1 Mbps, 99pc dc) | WLAN | 1.54 | ± 9.6 % |
| 10416 | AAA | IEEE 802.11g WiFi 2.4 GHz (ERP-OFDM, 6 Mbps, 99pc dc) | WLAN | 8.23 | ± 9.6 % |
| 10417 | AAA | IEEE 802.11a/h WiFi 5 GHz (OFDM, 6 Mbps, 99pc dc) | WLAN | 8.23 | ± 9.6 % |
| 10418 | AAA | IEEE 802.11g WiFi 2.4 GHz (DSSS-OFDM, 6 Mbps, 99pc, Long) | WLAN | 8.14 | ± 9.6 % |
| 10419 | AAA | IEEE 802.11g WiFi 2.4 GHz (DSSS-OFDM, 6 Mbps, 99pc, Short) | WLAN | 8.19 | ± 9.6 % |
| 10422 | AAA | IEEE 802.11n (HT Greenfield, 7.2 Mbps, BPSK) | WLAN | 8.32 | ± 9.6 % |
| 10423 | AAA | IEEE 802.11n (HT Greenfield, 43.3 Mbps, 16-QAM) | WLAN | 8.47 | ± 9.6 % |
| 10424 | AAE | IEEE 802.11n (HT Greenfield, 72.2 Mbps, 64-QAM) | WLAN | 8.40 | ± 9.6 % |
| 10425 | AAE | IEEE 802.11n (HT Greenfield, 15 Mbps, BPSK) | WLAN | 8.41 | ± 9.6 % |
| 10426 | AAE | IEEE 802.11n (HT Greenfield, 90 Mbps, 16-QAM) | WLAN | 8.45 | ± 9.6 % |
| 10427 | AAB | IEEE 802.11n (HT Greenfield, 150 Mbps, 64-QAM) | WLAN | 8.41 | ± 9.6 % |
| 10430 | AAB | LTE-FDD (OFDMA, 5 MHz, E-TM 3.1) | LTE-FDD | 8.28 | ± 9.6 % |
| 10431 | AAC | LTE-FDD (OFDMA, 10 MHz, E-TM 3.1) | LTE-FDD | 8.38 | ± 9.6 % |
| 10432 | AAB | LTE-FDD (OFDMA, 15 MHz, E-TM 3.1) | LTE-FDD | 8.34 | ± 9.6 % |
| 10433 | AAC | LTE-FDD (OFDMA, 20 MHz, E-TM 3.1) | LTE-FDD | 8.34 | ± 9.6 % |
| 10434 | AAG | W-CDMA (BS Test Model 1, 64 DPCH) | WCDMA | 8.60 | ± 9.6 % |
| 10435 | AAA | LTE-TDD (SC-FDMA, 1 RB, 20 MHz, QPSK, UL Sub) | LTE-TDD | 7.82 | ± 9.6 % |
| 10447 | AAA | LTE-FDD (OFDMA, 5 MHz, E-TM 3.1, Clipping 44%) | LTE-FDD | 7.56 | ± 9.6 % |
| 10448 | AAA | LTE-FDD (OFDMA, 10 MHz, E-TM 3.1, Clipping 44%) | LTE-FDD | 7.53 | ± 9.6 % |
| 10449 | AAC | LTE-FDD (OFDMA, 15 MHz, E-TM 3.1, Clipping 44%) | LTE-FDD | 7.51 | ± 9.6 % |
| 10450 | AAA | LTE-FDD (OFDMA, 20 MHz, E-TM 3.1, Clipping 44%) | LTE-FDD | 7.48 | ± 9.6 % |
| 10451 | AAA | W-CDMA (BS Test Model 1, 64 DPCH, Clipping 44%) | WCDMA | 7.59 | ± 9.6 % |
| 10453 | AAC | Validation (Square, 10ms, 1ms) | Test | 10.00 | ± 9.6 % |
| 10456 | AAC | IEEE 802.11ac WiFi (160MHz, 64-QAM, 99pc dc) | WLAN | 8.63 | ± 9.6 % |
| 10457 | AAC | UMTS-FDD (DC-HSDPA) | WCDMA | 6.62 | ± 9.6 % |
| 10458 | AAC | CDMA2000 (1xEV-DO, Rev. B, 2 carriers) | CDMA2000 | 6.55 | ± 9.6 % |
| 10459 | AAC | CDMA2000 (1xEV-DO, Rev. B, 3 carriers) | CDMA2000 | 8.25 | ± 9.6 % |
| 10460 | AAC | UMTS-FDD (WCDMA, AMR) | WCDMA | 2.39 | ± 9.6 % |
| 10461 | AAC | LTE-TDD (SC-FDMA, 1 RB, 1.4 MHz, QPSK, UL Sub) | LTE-TDD | 7.82 | ± 9.6 % |
| 10462 | AAC | LTE-TDD (SC-FDMA, 1 RB, 1.4 MHz, 16-QAM, UL Sub) | LTE-TDD | 8.30 | ± 9.6 % |
| 10463 | AAD | LTE-TDD (SC-FDMA, 1 RB, 1.4 MHz, 64-QAM, UL Sub) | LTE-TDD | 8.56 | ± 9.6 % |
| 10464 | AAD | LTE-TDD (SC-FDMA, 1 RB, 3 MHz, QPSK, UL Sub) | LTE-TDD | 7.82 | ± 9.6 % |
| 10465 | AAC | LTE-TDD (SC-FDMA, 1 RB, 3 MHz, 16-QAM, UL Sub) | LTE-TDD | 8.32 | ± 9.6 % |
| 10466 | AAC | LTE-TDD (SC-FDMA, 1 RB, 3 MHz, 64-QAM, UL Sub) | LTE-TDD | 8.57 | ± 9.6 % |
| 10467 | AAA | LTE-TDD (SC-FDMA, 1 RB, 5 MHz, QPSK, UL Sub) | LTE-TDD | 7.82 | ± 9.6 % |
| 10468 | AAF | LTE-TDD (SC-FDMA, 1 RB, 5 MHz, 16-QAM, UL Sub) | LTE-TDD | 8.32 | ± 9.6 % |
| 10469 | AAD | LTE-TDD (SC-FDMA, 1 RB, 5 MHz, 64-QAM, UL Sub) | LTE-TDD | 8.56 | ± 9.6 % |
| 10470 | AAD | LTE-TDD (SC-FDMA, 1 RB, 10 MHz, QPSK, UL Sub) | LTE-TDD | 7.82 | ± 9.6 % |
| 10471 | AAC | LTE-TDD (SC-FDMA, 1 RB, 10 MHz, 16-QAM, UL Sub) | LTE-TDD | 8.32 | ± 9.6 % |
| 10472 | AAC | LTE-TDD (SC-FDMA, 1 RB, 10 MHz, 64-QAM, UL Sub) | LTE-TDD | 8.57 | ± 9.6 % |
| 10473 | AAA | LTE-TDD (SC-FDMA, 1 RB, 15 MHz, QPSK, UL Sub) | LTE-TDD | 7.82 | ± 9.6 % |
| 10474 | AAC | LTE-TDD (SC-FDMA, 1 RB, 15 MHz, 16-QAM, UL Sub) | LTE-TDD | 8.32 | ± 9.6 % |
| 10475 | AAD | LTE-TDD (SC-FDMA, 1 RB, 15 MHz, 64-QAM, UL Sub) | LTE-TDD | 8.57 | ± 9.6 % |
| 10477 | AAC | LTE-TDD (SC-FDMA, 1 RB, 20 MHz, 16-QAM, UL Sub) | LTE-TDD | 8.32 | ± 9.6 % |
| 10478 | AAC | LTE-TDD (SC-FDMA, 1 RB, 20 MHz, 64-QAM, UL Sub) | LTE-TDD | 8.57 | ± 9.6 % |
| 10479 | AAC | LTE-TDD (SC-FDMA, 50% RB, 1.4 MHz, QPSK, UL Sub) | LTE-TDD | 7.74 | ± 9.6 % |
| 10480 | AAA | LTE-TDD (SC-FDMA, 50% RB, 1.4 MHz, 16-QAM, UL Sub) | LTE-TDD | 8.18 | ± 9.6 % |
| 10481 | AAA | LTE-TDD (SC-FDMA, 50% RB, 1.4 MHz, 64-QAM, UL Sub) | LTE-TDD | 8.45 | ± 9.6 % |
| 10482 | AAA | LTE-TDD (SC-FDMA, 50% RB, 3 MHz, QPSK, UL Sub) | LTE-TDD | 7.71 | ± 9.6 % |
| 10483 | AAA | LTE-TDD (SC-FDMA, 50% RB, 3 MHz, 16-QAM, Sub) | LTE-TDD | 8.39 | ± 9.6 % |
| 10484 | AAB | LTE-TDD (SC-FDMA, 50% RB, 3 MHz, 64-QAM, UL Sub) | LTE-TDD | 8.47 | ± 9.6 % |
| 10485 | AAB | LTE-TDD (SC-FDMA, 50% RB, 5 MHz, QPSK, UL Sub) | LTE-TDD | 7.59 | ± 9.6 % |
| 10486 | AAB | LTE-TDD (SC-FDMA, 50% RB, 5 MHz, 16-QAM, UL Sub) | LTE-TDD | 8.38 | ± 9.6 % |
| 10487 | AAC | LTE-TDD (SC-FDMA, 50% RB, 5 MHz, 64-QAM, UL Sub) | LTE-TDD | 8.60 | ± 9.6 % |

| | | | | | |
|-------|-----|---|---------|------|---------|
| 10488 | AAC | LTE-TDD (SC-FDMA, 50% RB, 10 MHz, QPSK, UL Sub) | LTE-TDD | 7.70 | ± 9.6 % |
| 10489 | AAC | LTE-TDD (SC-FDMA, 50% RB, 10 MHz, 16-QAM, UL Sub) | LTE-TDD | 8.31 | ± 9.6 % |
| 10490 | AAF | LTE-TDD (SC-FDMA, 50% RB, 10 MHz, 64-QAM, UL Sub) | LTE-TDD | 8.54 | ± 9.6 % |
| 10491 | AAF | LTE-TDD (SC-FDMA, 50% RB, 15 MHz, QPSK, UL Sub) | LTE-TDD | 7.74 | ± 9.6 % |
| 10492 | AAF | LTE-TDD (SC-FDMA, 50% RB, 15 MHz, 16-QAM, UL Sub) | LTE-TDD | 8.41 | ± 9.6 % |
| 10493 | AAF | LTE-TDD (SC-FDMA, 50% RB, 15 MHz, 64-QAM, UL Sub) | LTE-TDD | 8.55 | ± 9.6 % |
| 10494 | AAF | LTE-TDD (SC-FDMA, 50% RB, 20 MHz, QPSK, UL Sub) | LTE-TDD | 7.74 | ± 9.6 % |
| 10495 | AAF | LTE-TDD (SC-FDMA, 50% RB, 20 MHz, 16-QAM, UL Sub) | LTE-TDD | 8.37 | ± 9.6 % |
| 10496 | AAE | LTE-TDD (SC-FDMA, 50% RB, 20 MHz, 64-QAM, UL Sub) | LTE-TDD | 8.54 | ± 9.6 % |
| 10497 | AAE | LTE-TDD (SC-FDMA, 100% RB, 1.4 MHz, QPSK, UL Sub) | LTE-TDD | 7.67 | ± 9.6 % |
| 10498 | AAE | LTE-TDD (SC-FDMA, 100% RB, 1.4 MHz, 16-QAM, UL Sub) | LTE-TDD | 8.40 | ± 9.6 % |
| 10499 | AAC | LTE-TDD (SC-FDMA, 100% RB, 1.4 MHz, 64-QAM, UL Sub) | LTE-TDD | 8.68 | ± 9.6 % |
| 10500 | AAF | LTE-TDD (SC-FDMA, 100% RB, 3 MHz, QPSK, UL Sub) | LTE-TDD | 7.67 | ± 9.6 % |
| 10501 | AAF | LTE-TDD (SC-FDMA, 100% RB, 3 MHz, 16-QAM, UL Sub) | LTE-TDD | 8.44 | ± 9.6 % |
| 10502 | AAB | LTE-TDD (SC-FDMA, 100% RB, 3 MHz, 64-QAM, UL Sub) | LTE-TDD | 8.52 | ± 9.6 % |
| 10503 | AAB | LTE-TDD (SC-FDMA, 100% RB, 5 MHz, QPSK, UL Sub) | LTE-TDD | 7.72 | ± 9.6 % |
| 10504 | AAB | LTE-TDD (SC-FDMA, 100% RB, 5 MHz, 16-QAM, UL Sub) | LTE-TDD | 8.31 | ± 9.6 % |
| 10505 | AAC | LTE-TDD (SC-FDMA, 100% RB, 5 MHz, 64-QAM, UL Sub) | LTE-TDD | 8.54 | ± 9.6 % |
| 10506 | AAC | LTE-TDD (SC-FDMA, 100% RB, 10 MHz, QPSK, UL Sub) | LTE-TDD | 7.74 | ± 9.6 % |
| 10507 | AAC | LTE-TDD (SC-FDMA, 100% RB, 10 MHz, 16-QAM, UL Sub) | LTE-TDD | 8.36 | ± 9.6 % |
| 10508 | AAF | LTE-TDD (SC-FDMA, 100% RB, 10 MHz, 64-QAM, UL Sub) | LTE-TDD | 8.55 | ± 9.6 % |
| 10509 | AAF | LTE-TDD (SC-FDMA, 100% RB, 15 MHz, QPSK, UL Sub) | LTE-TDD | 7.99 | ± 9.6 % |
| 10510 | AAF | LTE-TDD (SC-FDMA, 100% RB, 15 MHz, 16-QAM, UL Sub) | LTE-TDD | 8.49 | ± 9.6 % |
| 10511 | AAF | LTE-TDD (SC-FDMA, 100% RB, 15 MHz, 64-QAM, UL Sub) | LTE-TDD | 8.51 | ± 9.6 % |
| 10512 | AAF | LTE-TDD (SC-FDMA, 100% RB, 20 MHz, QPSK, UL Sub) | LTE-TDD | 7.74 | ± 9.6 % |
| 10513 | AAF | LTE-TDD (SC-FDMA, 100% RB, 20 MHz, 16-QAM, UL Sub) | LTE-TDD | 8.42 | ± 9.6 % |
| 10514 | AAE | LTE-TDD (SC-FDMA, 100% RB, 20 MHz, 64-QAM, UL Sub) | LTE-TDD | 8.45 | ± 9.6 % |
| 10515 | AAE | IEEE 802.11b WiFi 2.4 GHz (DSSS, 2 Mbps, 99pc dc) | WLAN | 1.58 | ± 9.6 % |
| 10516 | AAE | IEEE 802.11b WiFi 2.4 GHz (DSSS, 5.5 Mbps, 99pc dc) | WLAN | 1.57 | ± 9.6 % |
| 10517 | AAF | IEEE 802.11b WiFi 2.4 GHz (DSSS, 11 Mbps, 99pc dc) | WLAN | 1.58 | ± 9.6 % |
| 10518 | AAF | IEEE 802.11a/h WiFi 5 GHz (OFDM, 9 Mbps, 99pc dc) | WLAN | 8.23 | ± 9.6 % |
| 10519 | AAF | IEEE 802.11a/h WiFi 5 GHz (OFDM, 12 Mbps, 99pc dc) | WLAN | 8.39 | ± 9.6 % |
| 10520 | AAB | IEEE 802.11a/h WiFi 5 GHz (OFDM, 18 Mbps, 99pc dc) | WLAN | 8.12 | ± 9.6 % |
| 10521 | AAB | IEEE 802.11a/h WiFi 5 GHz (OFDM, 24 Mbps, 99pc dc) | WLAN | 7.97 | ± 9.6 % |
| 10522 | AAB | IEEE 802.11a/h WiFi 5 GHz (OFDM, 36 Mbps, 99pc dc) | WLAN | 8.45 | ± 9.6 % |
| 10523 | AAC | IEEE 802.11a/h WiFi 5 GHz (OFDM, 48 Mbps, 99pc dc) | WLAN | 8.08 | ± 9.6 % |
| 10524 | AAC | IEEE 802.11a/h WiFi 5 GHz (OFDM, 54 Mbps, 99pc dc) | WLAN | 8.27 | ± 9.6 % |
| 10525 | AAC | IEEE 802.11ac WiFi (20MHz, MCS0, 99pc dc) | WLAN | 8.36 | ± 9.6 % |
| 10526 | AAF | IEEE 802.11ac WiFi (20MHz, MCS1, 99pc dc) | WLAN | 8.42 | ± 9.6 % |
| 10527 | AAF | IEEE 802.11ac WiFi (20MHz, MCS2, 99pc dc) | WLAN | 8.21 | ± 9.6 % |
| 10528 | AAF | IEEE 802.11ac WiFi (20MHz, MCS3, 99pc dc) | WLAN | 8.36 | ± 9.6 % |
| 10529 | AAF | IEEE 802.11ac WiFi (20MHz, MCS4, 99pc dc) | WLAN | 8.36 | ± 9.6 % |
| 10531 | AAF | IEEE 802.11ac WiFi (20MHz, MCS6, 99pc dc) | WLAN | 8.43 | ± 9.6 % |
| 10532 | AAF | IEEE 802.11ac WiFi (20MHz, MCS7, 99pc dc) | WLAN | 8.29 | ± 9.6 % |
| 10533 | AAE | IEEE 802.11ac WiFi (20MHz, MCS8, 99pc dc) | WLAN | 8.38 | ± 9.6 % |
| 10534 | AAE | IEEE 802.11ac WiFi (40MHz, MCS0, 99pc dc) | WLAN | 8.45 | ± 9.6 % |
| 10535 | AAE | IEEE 802.11ac WiFi (40MHz, MCS1, 99pc dc) | WLAN | 8.45 | ± 9.6 % |
| 10536 | AAF | IEEE 802.11ac WiFi (40MHz, MCS2, 99pc dc) | WLAN | 8.32 | ± 9.6 % |
| 10537 | AAF | IEEE 802.11ac WiFi (40MHz, MCS3, 99pc dc) | WLAN | 8.44 | ± 9.6 % |
| 10538 | AAF | IEEE 802.11ac WiFi (40MHz, MCS4, 99pc dc) | WLAN | 8.54 | ± 9.6 % |
| 10540 | AAA | IEEE 802.11ac WiFi (40MHz, MCS6, 99pc dc) | WLAN | 8.39 | ± 9.6 % |
| 10541 | AAA | IEEE 802.11ac WiFi (40MHz, MCS7, 99pc dc) | WLAN | 8.46 | ± 9.6 % |
| 10542 | AAA | IEEE 802.11ac WiFi (40MHz, MCS8, 99pc dc) | WLAN | 8.65 | ± 9.6 % |
| 10543 | AAC | IEEE 802.11ac WiFi (40MHz, MCS9, 99pc dc) | WLAN | 8.65 | ± 9.6 % |
| 10544 | AAC | IEEE 802.11ac WiFi (80MHz, MCS0, 99pc dc) | WLAN | 8.47 | ± 9.6 % |
| 10545 | AAC | IEEE 802.11ac WiFi (80MHz, MCS1, 99pc dc) | WLAN | 8.55 | ± 9.6 % |

| | | | | | |
|-------|-----|---|------|------|---------|
| 10546 | AAC | IEEE 802.11ac WiFi (80MHz, MCS2, 99pc dc) | WLAN | 8.35 | ± 9.6 % |
| 10547 | AAC | IEEE 802.11ac WiFi (80MHz, MCS3, 99pc dc) | WLAN | 8.49 | ± 9.6 % |
| 10548 | AAC | IEEE 802.11ac WiFi (80MHz, MCS4, 99pc dc) | WLAN | 8.37 | ± 9.6 % |
| 10550 | AAC | IEEE 802.11ac WiFi (80MHz, MCS6, 99pc dc) | WLAN | 8.38 | ± 9.6 % |
| 10551 | AAC | IEEE 802.11ac WiFi (80MHz, MCS7, 99pc dc) | WLAN | 8.50 | ± 9.6 % |
| 10552 | AAC | IEEE 802.11ac WiFi (80MHz, MCS8, 99pc dc) | WLAN | 8.42 | ± 9.6 % |
| 10553 | AAC | IEEE 802.11ac WiFi (80MHz, MCS9, 99pc dc) | WLAN | 8.45 | ± 9.6 % |
| 10554 | AAC | IEEE 802.11ac WiFi (160MHz, MCS0, 99pc dc) | WLAN | 8.48 | ± 9.6 % |
| 10555 | AAC | IEEE 802.11ac WiFi (160MHz, MCS1, 99pc dc) | WLAN | 8.47 | ± 9.6 % |
| 10556 | AAC | IEEE 802.11ac WiFi (160MHz, MCS2, 99pc dc) | WLAN | 8.50 | ± 9.6 % |
| 10557 | AAC | IEEE 802.11ac WiFi (160MHz, MCS3, 99pc dc) | WLAN | 8.52 | ± 9.6 % |
| 10558 | AAC | IEEE 802.11ac WiFi (160MHz, MCS4, 99pc dc) | WLAN | 8.61 | ± 9.6 % |
| 10560 | AAC | IEEE 802.11ac WiFi (160MHz, MCS6, 99pc dc) | WLAN | 8.73 | ± 9.6 % |
| 10561 | AAC | IEEE 802.11ac WiFi (160MHz, MCS7, 99pc dc) | WLAN | 8.56 | ± 9.6 % |
| 10562 | AAC | IEEE 802.11ac WiFi (160MHz, MCS8, 99pc dc) | WLAN | 8.69 | ± 9.6 % |
| 10563 | AAC | IEEE 802.11ac WiFi (160MHz, MCS9, 99pc dc) | WLAN | 8.77 | ± 9.6 % |
| 10564 | AAC | IEEE 802.11g WiFi 2.4 GHz (DSSS-OFDM, 9 Mbps, 99pc dc) | WLAN | 8.25 | ± 9.6 % |
| 10565 | AAC | IEEE 802.11g WiFi 2.4 GHz (DSSS-OFDM, 12 Mbps, 99pc dc) | WLAN | 8.45 | ± 9.6 % |
| 10566 | AAC | IEEE 802.11g WiFi 2.4 GHz (DSSS-OFDM, 18 Mbps, 99pc dc) | WLAN | 8.13 | ± 9.6 % |
| 10567 | AAC | IEEE 802.11g WiFi 2.4 GHz (DSSS-OFDM, 24 Mbps, 99pc dc) | WLAN | 8.00 | ± 9.6 % |
| 10568 | AAC | IEEE 802.11g WiFi 2.4 GHz (DSSS-OFDM, 36 Mbps, 99pc dc) | WLAN | 8.37 | ± 9.6 % |
| 10569 | AAC | IEEE 802.11g WiFi 2.4 GHz (DSSS-OFDM, 48 Mbps, 99pc dc) | WLAN | 8.10 | ± 9.6 % |
| 10570 | AAC | IEEE 802.11g WiFi 2.4 GHz (DSSS-OFDM, 54 Mbps, 99pc dc) | WLAN | 8.30 | ± 9.6 % |
| 10571 | AAC | IEEE 802.11b WiFi 2.4 GHz (DSSS, 1 Mbps, 90pc dc) | WLAN | 1.99 | ± 9.6 % |
| 10572 | AAC | IEEE 802.11b WiFi 2.4 GHz (DSSS, 2 Mbps, 90pc dc) | WLAN | 1.99 | ± 9.6 % |
| 10573 | AAC | IEEE 802.11b WiFi 2.4 GHz (DSSS, 5.5 Mbps, 90pc dc) | WLAN | 1.98 | ± 9.6 % |
| 10574 | AAC | IEEE 802.11b WiFi 2.4 GHz (DSSS, 11 Mbps, 90pc dc) | WLAN | 1.98 | ± 9.6 % |
| 10575 | AAC | IEEE 802.11g WiFi 2.4 GHz (DSSS-OFDM, 6 Mbps, 90pc dc) | WLAN | 8.59 | ± 9.6 % |
| 10576 | AAC | IEEE 802.11g WiFi 2.4 GHz (DSSS-OFDM, 9 Mbps, 90pc dc) | WLAN | 8.60 | ± 9.6 % |
| 10577 | AAC | IEEE 802.11g WiFi 2.4 GHz (DSSS-OFDM, 12 Mbps, 90pc dc) | WLAN | 8.70 | ± 9.6 % |
| 10578 | AAD | IEEE 802.11g WiFi 2.4 GHz (DSSS-OFDM, 18 Mbps, 90pc dc) | WLAN | 8.49 | ± 9.6 % |
| 10579 | AAD | IEEE 802.11g WiFi 2.4 GHz (DSSS-OFDM, 24 Mbps, 90pc dc) | WLAN | 8.36 | ± 9.6 % |
| 10580 | AAD | IEEE 802.11g WiFi 2.4 GHz (DSSS-OFDM, 36 Mbps, 90pc dc) | WLAN | 8.76 | ± 9.6 % |
| 10581 | AAD | IEEE 802.11g WiFi 2.4 GHz (DSSS-OFDM, 48 Mbps, 90pc dc) | WLAN | 8.35 | ± 9.6 % |
| 10582 | AAD | IEEE 802.11g WiFi 2.4 GHz (DSSS-OFDM, 54 Mbps, 90pc dc) | WLAN | 8.67 | ± 9.6 % |
| 10583 | AAD | IEEE 802.11a/h WiFi 5 GHz (OFDM, 6 Mbps, 90pc dc) | WLAN | 8.59 | ± 9.6 % |
| 10584 | AAD | IEEE 802.11a/h WiFi 5 GHz (OFDM, 9 Mbps, 90pc dc) | WLAN | 8.60 | ± 9.6 % |
| 10585 | AAD | IEEE 802.11a/h WiFi 5 GHz (OFDM, 12 Mbps, 90pc dc) | WLAN | 8.70 | ± 9.6 % |
| 10586 | AAD | IEEE 802.11a/h WiFi 5 GHz (OFDM, 18 Mbps, 90pc dc) | WLAN | 8.49 | ± 9.6 % |
| 10587 | AAA | IEEE 802.11a/h WiFi 5 GHz (OFDM, 24 Mbps, 90pc dc) | WLAN | 8.36 | ± 9.6 % |
| 10588 | AAA | IEEE 802.11a/h WiFi 5 GHz (OFDM, 36 Mbps, 90pc dc) | WLAN | 8.76 | ± 9.6 % |
| 10589 | AAA | IEEE 802.11a/h WiFi 5 GHz (OFDM, 48 Mbps, 90pc dc) | WLAN | 8.35 | ± 9.6 % |
| 10590 | AAA | IEEE 802.11a/h WiFi 5 GHz (OFDM, 54 Mbps, 90pc dc) | WLAN | 8.67 | ± 9.6 % |
| 10591 | AAA | IEEE 802.11n (HT Mixed, 20MHz, MCS0, 90pc dc) | WLAN | 8.63 | ± 9.6 % |
| 10592 | AAA | IEEE 802.11n (HT Mixed, 20MHz, MCS1, 90pc dc) | WLAN | 8.79 | ± 9.6 % |
| 10593 | AAA | IEEE 802.11n (HT Mixed, 20MHz, MCS2, 90pc dc) | WLAN | 8.64 | ± 9.6 % |
| 10594 | AAA | IEEE 802.11n (HT Mixed, 20MHz, MCS3, 90pc dc) | WLAN | 8.74 | ± 9.6 % |
| 10595 | AAA | IEEE 802.11n (HT Mixed, 20MHz, MCS4, 90pc dc) | WLAN | 8.74 | ± 9.6 % |
| 10596 | AAA | IEEE 802.11n (HT Mixed, 20MHz, MCS5, 90pc dc) | WLAN | 8.71 | ± 9.6 % |
| 10597 | AAA | IEEE 802.11n (HT Mixed, 20MHz, MCS6, 90pc dc) | WLAN | 8.72 | ± 9.6 % |
| 10598 | AAA | IEEE 802.11n (HT Mixed, 20MHz, MCS7, 90pc dc) | WLAN | 8.50 | ± 9.6 % |
| 10599 | AAA | IEEE 802.11n (HT Mixed, 40MHz, MCS0, 90pc dc) | WLAN | 8.79 | ± 9.6 % |
| 10600 | AAA | IEEE 802.11n (HT Mixed, 40MHz, MCS1, 90pc dc) | WLAN | 8.88 | ± 9.6 % |
| 10601 | AAA | IEEE 802.11n (HT Mixed, 40MHz, MCS2, 90pc dc) | WLAN | 8.82 | ± 9.6 % |
| 10602 | AAA | IEEE 802.11n (HT Mixed, 40MHz, MCS3, 90pc dc) | WLAN | 8.94 | ± 9.6 % |
| 10603 | AAA | IEEE 802.11n (HT Mixed, 40MHz, MCS4, 90pc dc) | WLAN | 9.03 | ± 9.6 % |

| | | | | | |
|-------|-----|---|-----------|-------|---------|
| 10604 | AAA | IEEE 802.11n (HT Mixed, 40MHz, MCS5, 90pc dc) | WLAN | 8.76 | ± 9.6 % |
| 10605 | AAA | IEEE 802.11n (HT Mixed, 40MHz, MCS6, 90pc dc) | WLAN | 8.97 | ± 9.6 % |
| 10606 | AAC | IEEE 802.11n (HT Mixed, 40MHz, MCS7, 90pc dc) | WLAN | 8.82 | ± 9.6 % |
| 10607 | AAC | IEEE 802.11ac WiFi (20MHz, MCS0, 90pc dc) | WLAN | 8.64 | ± 9.6 % |
| 10608 | AAC | IEEE 802.11ac WiFi (20MHz, MCS1, 90pc dc) | WLAN | 8.77 | ± 9.6 % |
| 10609 | AAC | IEEE 802.11ac WiFi (20MHz, MCS2, 90pc dc) | WLAN | 8.57 | ± 9.6 % |
| 10610 | AAC | IEEE 802.11ac WiFi (20MHz, MCS3, 90pc dc) | WLAN | 8.78 | ± 9.6 % |
| 10611 | AAC | IEEE 802.11ac WiFi (20MHz, MCS4, 90pc dc) | WLAN | 8.70 | ± 9.6 % |
| 10612 | AAC | IEEE 802.11ac WiFi (20MHz, MCS5, 90pc dc) | WLAN | 8.77 | ± 9.6 % |
| 10613 | AAC | IEEE 802.11ac WiFi (20MHz, MCS6, 90pc dc) | WLAN | 8.94 | ± 9.6 % |
| 10614 | AAC | IEEE 802.11ac WiFi (20MHz, MCS7, 90pc dc) | WLAN | 8.59 | ± 9.6 % |
| 10615 | AAC | IEEE 802.11ac WiFi (20MHz, MCS8, 90pc dc) | WLAN | 8.82 | ± 9.6 % |
| 10616 | AAC | IEEE 802.11ac WiFi (40MHz, MCS0, 90pc dc) | WLAN | 8.82 | ± 9.6 % |
| 10617 | AAC | IEEE 802.11ac WiFi (40MHz, MCS1, 90pc dc) | WLAN | 8.81 | ± 9.6 % |
| 10618 | AAC | IEEE 802.11ac WiFi (40MHz, MCS2, 90pc dc) | WLAN | 8.58 | ± 9.6 % |
| 10619 | AAC | IEEE 802.11ac WiFi (40MHz, MCS3, 90pc dc) | WLAN | 8.86 | ± 9.6 % |
| 10620 | AAC | IEEE 802.11ac WiFi (40MHz, MCS4, 90pc dc) | WLAN | 8.87 | ± 9.6 % |
| 10621 | AAC | IEEE 802.11ac WiFi (40MHz, MCS5, 90pc dc) | WLAN | 8.77 | ± 9.6 % |
| 10622 | AAC | IEEE 802.11ac WiFi (40MHz, MCS6, 90pc dc) | WLAN | 8.68 | ± 9.6 % |
| 10623 | AAC | IEEE 802.11ac WiFi (40MHz, MCS7, 90pc dc) | WLAN | 8.82 | ± 9.6 % |
| 10624 | AAC | IEEE 802.11ac WiFi (40MHz, MCS8, 90pc dc) | WLAN | 8.96 | ± 9.6 % |
| 10625 | AAC | IEEE 802.11ac WiFi (40MHz, MCS9, 90pc dc) | WLAN | 8.96 | ± 9.6 % |
| 10626 | AAC | IEEE 802.11ac WiFi (80MHz, MCS0, 90pc dc) | WLAN | 8.83 | ± 9.6 % |
| 10627 | AAC | IEEE 802.11ac WiFi (80MHz, MCS1, 90pc dc) | WLAN | 8.88 | ± 9.6 % |
| 10628 | AAC | IEEE 802.11ac WiFi (80MHz, MCS2, 90pc dc) | WLAN | 8.71 | ± 9.6 % |
| 10629 | AAC | IEEE 802.11ac WiFi (80MHz, MCS3, 90pc dc) | WLAN | 8.85 | ± 9.6 % |
| 10630 | AAC | IEEE 802.11ac WiFi (80MHz, MCS4, 90pc dc) | WLAN | 8.72 | ± 9.6 % |
| 10631 | AAC | IEEE 802.11ac WiFi (80MHz, MCS5, 90pc dc) | WLAN | 8.81 | ± 9.6 % |
| 10632 | AAC | IEEE 802.11ac WiFi (80MHz, MCS6, 90pc dc) | WLAN | 8.74 | ± 9.6 % |
| 10633 | AAC | IEEE 802.11ac WiFi (80MHz, MCS7, 90pc dc) | WLAN | 8.83 | ± 9.6 % |
| 10634 | AAC | IEEE 802.11ac WiFi (80MHz, MCS8, 90pc dc) | WLAN | 8.80 | ± 9.6 % |
| 10635 | AAC | IEEE 802.11ac WiFi (80MHz, MCS9, 90pc dc) | WLAN | 8.81 | ± 9.6 % |
| 10636 | AAC | IEEE 802.11ac WiFi (160MHz, MCS0, 90pc dc) | WLAN | 8.83 | ± 9.6 % |
| 10637 | AAC | IEEE 802.11ac WiFi (160MHz, MCS1, 90pc dc) | WLAN | 8.79 | ± 9.6 % |
| 10638 | AAC | IEEE 802.11ac WiFi (160MHz, MCS2, 90pc dc) | WLAN | 8.86 | ± 9.6 % |
| 10639 | AAC | IEEE 802.11ac WiFi (160MHz, MCS3, 90pc dc) | WLAN | 8.85 | ± 9.6 % |
| 10640 | AAC | IEEE 802.11ac WiFi (160MHz, MCS4, 90pc dc) | WLAN | 8.98 | ± 9.6 % |
| 10641 | AAC | IEEE 802.11ac WiFi (160MHz, MCS5, 90pc dc) | WLAN | 9.06 | ± 9.6 % |
| 10642 | AAC | IEEE 802.11ac WiFi (160MHz, MCS6, 90pc dc) | WLAN | 9.06 | ± 9.6 % |
| 10643 | AAC | IEEE 802.11ac WiFi (160MHz, MCS7, 90pc dc) | WLAN | 8.89 | ± 9.6 % |
| 10644 | AAC | IEEE 802.11ac WiFi (160MHz, MCS8, 90pc dc) | WLAN | 9.05 | ± 9.6 % |
| 10645 | AAC | IEEE 802.11ac WiFi (160MHz, MCS9, 90pc dc) | WLAN | 9.11 | ± 9.6 % |
| 10646 | AAC | LTE-TDD (SC-FDMA, 1 RB, 5 MHz, QPSK, UL Sub=2,7) | LTE-TDD | 11.96 | ± 9.6 % |
| 10647 | AAC | LTE-TDD (SC-FDMA, 1 RB, 20 MHz, QPSK, UL Sub=2,7) | LTE-TDD | 11.96 | ± 9.6 % |
| 10648 | AAC | CDMA2000 (1x Advanced) | CDMA2000 | 3.45 | ± 9.6 % |
| 10652 | AAC | LTE-TDD (OFDMA, 5 MHz, E-TM 3.1, Clipping 44%) | LTE-TDD | 6.91 | ± 9.6 % |
| 10653 | AAC | LTE-TDD (OFDMA, 10 MHz, E-TM 3.1, Clipping 44%) | LTE-TDD | 7.42 | ± 9.6 % |
| 10654 | AAC | LTE-TDD (OFDMA, 15 MHz, E-TM 3.1, Clipping 44%) | LTE-TDD | 6.96 | ± 9.6 % |
| 10655 | AAC | LTE-TDD (OFDMA, 20 MHz, E-TM 3.1, Clipping 44%) | LTE-TDD | 7.21 | ± 9.6 % |
| 10658 | AAC | Pulse Waveform (200Hz, 10%) | Test | 10.00 | ± 9.6 % |
| 10659 | AAC | Pulse Waveform (200Hz, 20%) | Test | 6.99 | ± 9.6 % |
| 10660 | AAC | Pulse Waveform (200Hz, 40%) | Test | 3.98 | ± 9.6 % |
| 10661 | AAC | Pulse Waveform (200Hz, 60%) | Test | 2.22 | ± 9.6 % |
| 10662 | AAC | Pulse Waveform (200Hz, 80%) | Test | 0.97 | ± 9.6 % |
| 10670 | AAC | Bluetooth Low Energy | Bluetooth | 2.19 | ± 9.6 % |
| 10671 | AAD | IEEE 802.11ax (20MHz, MCS0, 90pc dc) | WLAN | 9.09 | ± 9.6 % |

| | | | | | |
|-------|-----|---------------------------------------|------|------|---------|
| 10672 | AAD | IEEE 802.11ax (20MHz, MCS1, 90pc dc) | WLAN | 8.57 | ± 9.6 % |
| 10673 | AAD | IEEE 802.11ax (20MHz, MCS2, 90pc dc) | WLAN | 8.78 | ± 9.6 % |
| 10674 | AAD | IEEE 802.11ax (20MHz, MCS3, 90pc dc) | WLAN | 8.74 | ± 9.6 % |
| 10675 | AAD | IEEE 802.11ax (20MHz, MCS4, 90pc dc) | WLAN | 8.90 | ± 9.6 % |
| 10676 | AAD | IEEE 802.11ax (20MHz, MCS5, 90pc dc) | WLAN | 8.77 | ± 9.6 % |
| 10677 | AAD | IEEE 802.11ax (20MHz, MCS6, 90pc dc) | WLAN | 8.73 | ± 9.6 % |
| 10678 | AAD | IEEE 802.11ax (20MHz, MCS7, 90pc dc) | WLAN | 8.78 | ± 9.6 % |
| 10679 | AAD | IEEE 802.11ax (20MHz, MCS8, 90pc dc) | WLAN | 8.89 | ± 9.6 % |
| 10680 | AAD | IEEE 802.11ax (20MHz, MCS9, 90pc dc) | WLAN | 8.80 | ± 9.6 % |
| 10681 | AAG | IEEE 802.11ax (20MHz, MCS10, 90pc dc) | WLAN | 8.62 | ± 9.6 % |
| 10682 | AAF | IEEE 802.11ax (20MHz, MCS11, 90pc dc) | WLAN | 8.83 | ± 9.6 % |
| 10683 | AAA | IEEE 802.11ax (20MHz, MCS0, 99pc dc) | WLAN | 8.42 | ± 9.6 % |
| 10684 | AAC | IEEE 802.11ax (20MHz, MCS1, 99pc dc) | WLAN | 8.26 | ± 9.6 % |
| 10685 | AAC | IEEE 802.11ax (20MHz, MCS2, 99pc dc) | WLAN | 8.33 | ± 9.6 % |
| 10686 | AAC | IEEE 802.11ax (20MHz, MCS3, 99pc dc) | WLAN | 8.28 | ± 9.6 % |
| 10687 | AAE | IEEE 802.11ax (20MHz, MCS4, 99pc dc) | WLAN | 8.45 | ± 9.6 % |
| 10688 | AAE | IEEE 802.11ax (20MHz, MCS5, 99pc dc) | WLAN | 8.29 | ± 9.6 % |
| 10689 | AAD | IEEE 802.11ax (20MHz, MCS6, 99pc dc) | WLAN | 8.55 | ± 9.6 % |
| 10690 | AAE | IEEE 802.11ax (20MHz, MCS7, 99pc dc) | WLAN | 8.29 | ± 9.6 % |
| 10691 | AAB | IEEE 802.11ax (20MHz, MCS8, 99pc dc) | WLAN | 8.25 | ± 9.6 % |
| 10692 | AAA | IEEE 802.11ax (20MHz, MCS9, 99pc dc) | WLAN | 8.29 | ± 9.6 % |
| 10693 | AAA | IEEE 802.11ax (20MHz, MCS10, 99pc dc) | WLAN | 8.25 | ± 9.6 % |
| 10694 | AAA | IEEE 802.11ax (20MHz, MCS11, 99pc dc) | WLAN | 8.57 | ± 9.6 % |
| 10695 | AAA | IEEE 802.11ax (40MHz, MCS0, 90pc dc) | WLAN | 8.78 | ± 9.6 % |
| 10696 | AAA | IEEE 802.11ax (40MHz, MCS1, 90pc dc) | WLAN | 8.91 | ± 9.6 % |
| 10697 | AAA | IEEE 802.11ax (40MHz, MCS2, 90pc dc) | WLAN | 8.61 | ± 9.6 % |
| 10698 | AAA | IEEE 802.11ax (40MHz, MCS3, 90pc dc) | WLAN | 8.89 | ± 9.6 % |
| 10699 | AAA | IEEE 802.11ax (40MHz, MCS4, 90pc dc) | WLAN | 8.82 | ± 9.6 % |
| 10700 | AAA | IEEE 802.11ax (40MHz, MCS5, 90pc dc) | WLAN | 8.73 | ± 9.6 % |
| 10701 | AAA | IEEE 802.11ax (40MHz, MCS6, 90pc dc) | WLAN | 8.86 | ± 9.6 % |
| 10702 | AAA | IEEE 802.11ax (40MHz, MCS7, 90pc dc) | WLAN | 8.70 | ± 9.6 % |
| 10703 | AAA | IEEE 802.11ax (40MHz, MCS8, 90pc dc) | WLAN | 8.82 | ± 9.6 % |
| 10704 | AAA | IEEE 802.11ax (40MHz, MCS9, 90pc dc) | WLAN | 8.56 | ± 9.6 % |
| 10705 | AAA | IEEE 802.11ax (40MHz, MCS10, 90pc dc) | WLAN | 8.69 | ± 9.6 % |
| 10706 | AAC | IEEE 802.11ax (40MHz, MCS11, 90pc dc) | WLAN | 8.66 | ± 9.6 % |
| 10707 | AAC | IEEE 802.11ax (40MHz, MCS0, 99pc dc) | WLAN | 8.32 | ± 9.6 % |
| 10708 | AAC | IEEE 802.11ax (40MHz, MCS1, 99pc dc) | WLAN | 8.55 | ± 9.6 % |
| 10709 | AAC | IEEE 802.11ax (40MHz, MCS2, 99pc dc) | WLAN | 8.33 | ± 9.6 % |
| 10710 | AAC | IEEE 802.11ax (40MHz, MCS3, 99pc dc) | WLAN | 8.29 | ± 9.6 % |
| 10711 | AAC | IEEE 802.11ax (40MHz, MCS4, 99pc dc) | WLAN | 8.39 | ± 9.6 % |
| 10712 | AAC | IEEE 802.11ax (40MHz, MCS5, 99pc dc) | WLAN | 8.67 | ± 9.6 % |
| 10713 | AAC | IEEE 802.11ax (40MHz, MCS6, 99pc dc) | WLAN | 8.33 | ± 9.6 % |
| 10714 | AAC | IEEE 802.11ax (40MHz, MCS7, 99pc dc) | WLAN | 8.26 | ± 9.6 % |
| 10715 | AAC | IEEE 802.11ax (40MHz, MCS8, 99pc dc) | WLAN | 8.45 | ± 9.6 % |
| 10716 | AAC | IEEE 802.11ax (40MHz, MCS9, 99pc dc) | WLAN | 8.30 | ± 9.6 % |
| 10717 | AAC | IEEE 802.11ax (40MHz, MCS10, 99pc dc) | WLAN | 8.48 | ± 9.6 % |
| 10718 | AAC | IEEE 802.11ax (40MHz, MCS11, 99pc dc) | WLAN | 8.24 | ± 9.6 % |
| 10719 | AAC | IEEE 802.11ax (80MHz, MCS0, 90pc dc) | WLAN | 8.81 | ± 9.6 % |
| 10720 | AAC | IEEE 802.11ax (80MHz, MCS1, 90pc dc) | WLAN | 8.87 | ± 9.6 % |
| 10721 | AAC | IEEE 802.11ax (80MHz, MCS2, 90pc dc) | WLAN | 8.76 | ± 9.6 % |
| 10722 | AAC | IEEE 802.11ax (80MHz, MCS3, 90pc dc) | WLAN | 8.55 | ± 9.6 % |
| 10723 | AAC | IEEE 802.11ax (80MHz, MCS4, 90pc dc) | WLAN | 8.70 | ± 9.6 % |
| 10724 | AAC | IEEE 802.11ax (80MHz, MCS5, 90pc dc) | WLAN | 8.90 | ± 9.6 % |
| 10725 | AAC | IEEE 802.11ax (80MHz, MCS6, 90pc dc) | WLAN | 8.74 | ± 9.6 % |
| 10726 | AAC | IEEE 802.11ax (80MHz, MCS7, 90pc dc) | WLAN | 8.72 | ± 9.6 % |
| 10727 | AAC | IEEE 802.11ax (80MHz, MCS8, 90pc dc) | WLAN | 8.66 | ± 9.6 % |

| | | | | | |
|-------|-----|---|---------------|------|---------|
| 10728 | AAC | IEEE 802.11ax (80MHz, MCS9, 90pc dc) | WLAN | 8.65 | ± 9.6 % |
| 10729 | AAC | IEEE 802.11ax (80MHz, MCS10, 90pc dc) | WLAN | 8.64 | ± 9.6 % |
| 10730 | AAC | IEEE 802.11ax (80MHz, MCS11, 90pc dc) | WLAN | 8.67 | ± 9.6 % |
| 10731 | AAC | IEEE 802.11ax (80MHz, MCS0, 99pc dc) | WLAN | 8.42 | ± 9.6 % |
| 10732 | AAC | IEEE 802.11ax (80MHz, MCS1, 99pc dc) | WLAN | 8.46 | ± 9.6 % |
| 10733 | AAC | IEEE 802.11ax (80MHz, MCS2, 99pc dc) | WLAN | 8.40 | ± 9.6 % |
| 10734 | AAC | IEEE 802.11ax (80MHz, MCS3, 99pc dc) | WLAN | 8.25 | ± 9.6 % |
| 10735 | AAC | IEEE 802.11ax (80MHz, MCS4, 99pc dc) | WLAN | 8.33 | ± 9.6 % |
| 10736 | AAC | IEEE 802.11ax (80MHz, MCS5, 99pc dc) | WLAN | 8.27 | ± 9.6 % |
| 10737 | AAC | IEEE 802.11ax (80MHz, MCS6, 99pc dc) | WLAN | 8.36 | ± 9.6 % |
| 10738 | AAC | IEEE 802.11ax (80MHz, MCS7, 99pc dc) | WLAN | 8.42 | ± 9.6 % |
| 10739 | AAC | IEEE 802.11ax (80MHz, MCS8, 99pc dc) | WLAN | 8.29 | ± 9.6 % |
| 10740 | AAC | IEEE 802.11ax (80MHz, MCS9, 99pc dc) | WLAN | 8.48 | ± 9.6 % |
| 10741 | AAC | IEEE 802.11ax (80MHz, MCS10, 99pc dc) | WLAN | 8.40 | ± 9.6 % |
| 10742 | AAC | IEEE 802.11ax (80MHz, MCS11, 99pc dc) | WLAN | 8.43 | ± 9.6 % |
| 10743 | AAC | IEEE 802.11ax (160MHz, MCS0, 90pc dc) | WLAN | 8.94 | ± 9.6 % |
| 10744 | AAC | IEEE 802.11ax (160MHz, MCS1, 90pc dc) | WLAN | 9.16 | ± 9.6 % |
| 10745 | AAC | IEEE 802.11ax (160MHz, MCS2, 90pc dc) | WLAN | 8.93 | ± 9.6 % |
| 10746 | AAC | IEEE 802.11ax (160MHz, MCS3, 90pc dc) | WLAN | 9.11 | ± 9.6 % |
| 10747 | AAC | IEEE 802.11ax (160MHz, MCS4, 90pc dc) | WLAN | 9.04 | ± 9.6 % |
| 10748 | AAC | IEEE 802.11ax (160MHz, MCS5, 90pc dc) | WLAN | 8.93 | ± 9.6 % |
| 10749 | AAC | IEEE 802.11ax (160MHz, MCS6, 90pc dc) | WLAN | 8.90 | ± 9.6 % |
| 10750 | AAC | IEEE 802.11ax (160MHz, MCS7, 90pc dc) | WLAN | 8.79 | ± 9.6 % |
| 10751 | AAC | IEEE 802.11ax (160MHz, MCS8, 90pc dc) | WLAN | 8.82 | ± 9.6 % |
| 10752 | AAC | IEEE 802.11ax (160MHz, MCS9, 90pc dc) | WLAN | 8.81 | ± 9.6 % |
| 10753 | AAC | IEEE 802.11ax (160MHz, MCS10, 90pc dc) | WLAN | 9.00 | ± 9.6 % |
| 10754 | AAC | IEEE 802.11ax (160MHz, MCS11, 90pc dc) | WLAN | 8.94 | ± 9.6 % |
| 10755 | AAC | IEEE 802.11ax (160MHz, MCS0, 99pc dc) | WLAN | 8.64 | ± 9.6 % |
| 10756 | AAC | IEEE 802.11ax (160MHz, MCS1, 99pc dc) | WLAN | 8.77 | ± 9.6 % |
| 10757 | AAC | IEEE 802.11ax (160MHz, MCS2, 99pc dc) | WLAN | 8.77 | ± 9.6 % |
| 10758 | AAC | IEEE 802.11ax (160MHz, MCS3, 99pc dc) | WLAN | 8.69 | ± 9.6 % |
| 10759 | AAC | IEEE 802.11ax (160MHz, MCS4, 99pc dc) | WLAN | 8.58 | ± 9.6 % |
| 10760 | AAC | IEEE 802.11ax (160MHz, MCS5, 99pc dc) | WLAN | 8.49 | ± 9.6 % |
| 10761 | AAC | IEEE 802.11ax (160MHz, MCS6, 99pc dc) | WLAN | 8.58 | ± 9.6 % |
| 10762 | AAC | IEEE 802.11ax (160MHz, MCS7, 99pc dc) | WLAN | 8.49 | ± 9.6 % |
| 10763 | AAC | IEEE 802.11ax (160MHz, MCS8, 99pc dc) | WLAN | 8.53 | ± 9.6 % |
| 10764 | AAC | IEEE 802.11ax (160MHz, MCS9, 99pc dc) | WLAN | 8.54 | ± 9.6 % |
| 10765 | AAC | IEEE 802.11ax (160MHz, MCS10, 99pc dc) | WLAN | 8.54 | ± 9.6 % |
| 10766 | AAC | IEEE 802.11ax (160MHz, MCS11, 99pc dc) | WLAN | 8.51 | ± 9.6 % |
| 10767 | AAC | 5G NR (CP-OFDM, 1 RB, 5 MHz, QPSK, 15 kHz) | 5G NR FR1 TDD | 7.99 | ± 9.6 % |
| 10768 | AAC | 5G NR (CP-OFDM, 1 RB, 10 MHz, QPSK, 15 kHz) | 5G NR FR1 TDD | 8.01 | ± 9.6 % |
| 10769 | AAC | 5G NR (CP-OFDM, 1 RB, 15 MHz, QPSK, 15 kHz) | 5G NR FR1 TDD | 8.01 | ± 9.6 % |
| 10770 | AAC | 5G NR (CP-OFDM, 1 RB, 20 MHz, QPSK, 15 kHz) | 5G NR FR1 TDD | 8.02 | ± 9.6 % |
| 10771 | AAC | 5G NR (CP-OFDM, 1 RB, 25 MHz, QPSK, 15 kHz) | 5G NR FR1 TDD | 8.02 | ± 9.6 % |
| 10772 | AAC | 5G NR (CP-OFDM, 1 RB, 30 MHz, QPSK, 15 kHz) | 5G NR FR1 TDD | 8.23 | ± 9.6 % |
| 10773 | AAC | 5G NR (CP-OFDM, 1 RB, 40 MHz, QPSK, 15 kHz) | 5G NR FR1 TDD | 8.03 | ± 9.6 % |
| 10774 | AAC | 5G NR (CP-OFDM, 1 RB, 50 MHz, QPSK, 15 kHz) | 5G NR FR1 TDD | 8.02 | ± 9.6 % |
| 10775 | AAC | 5G NR (CP-OFDM, 50% RB, 5 MHz, QPSK, 15 kHz) | 5G NR FR1 TDD | 8.31 | ± 9.6 % |
| 10776 | AAC | 5G NR (CP-OFDM, 50% RB, 10 MHz, QPSK, 15 kHz) | 5G NR FR1 TDD | 8.30 | ± 9.6 % |
| 10777 | AAC | 5G NR (CP-OFDM, 50% RB, 15 MHz, QPSK, 15 kHz) | 5G NR FR1 TDD | 8.30 | ± 9.6 % |
| 10778 | AAC | 5G NR (CP-OFDM, 50% RB, 20 MHz, QPSK, 15 kHz) | 5G NR FR1 TDD | 8.34 | ± 9.6 % |
| 10779 | AAC | 5G NR (CP-OFDM, 50% RB, 25 MHz, QPSK, 15 kHz) | 5G NR FR1 TDD | 8.42 | ± 9.6 % |
| 10780 | AAC | 5G NR (CP-OFDM, 50% RB, 30 MHz, QPSK, 15 kHz) | 5G NR FR1 TDD | 8.38 | ± 9.6 % |
| 10781 | AAC | 5G NR (CP-OFDM, 50% RB, 40 MHz, QPSK, 15 kHz) | 5G NR FR1 TDD | 8.38 | ± 9.6 % |
| 10782 | AAC | 5G NR (CP-OFDM, 50% RB, 50 MHz, QPSK, 15 kHz) | 5G NR FR1 TDD | 8.43 | ± 9.6 % |
| 10783 | AAC | 5G NR (CP-OFDM, 100% RB, 5 MHz, QPSK, 15 kHz) | 5G NR FR1 TDD | 8.31 | ± 9.6 % |

| | | | | | |
|-------|-----|---|---------------|------|---------|
| 10784 | AAC | 5G NR (CP-OFDM, 100% RB, 10 MHz, QPSK, 15 kHz) | 5G NR FR1 TDD | 8.29 | ± 9.6 % |
| 10785 | AAC | 5G NR (CP-OFDM, 100% RB, 15 MHz, QPSK, 15 kHz) | 5G NR FR1 TDD | 8.40 | ± 9.6 % |
| 10786 | AAC | 5G NR (CP-OFDM, 100% RB, 20 MHz, QPSK, 15 kHz) | 5G NR FR1 TDD | 8.35 | ± 9.6 % |
| 10787 | AAC | 5G NR (CP-OFDM, 100% RB, 25 MHz, QPSK, 15 kHz) | 5G NR FR1 TDD | 8.44 | ± 9.6 % |
| 10788 | AAC | 5G NR (CP-OFDM, 100% RB, 30 MHz, QPSK, 15 kHz) | 5G NR FR1 TDD | 8.39 | ± 9.6 % |
| 10789 | AAC | 5G NR (CP-OFDM, 100% RB, 40 MHz, QPSK, 15 kHz) | 5G NR FR1 TDD | 8.37 | ± 9.6 % |
| 10790 | AAC | 5G NR (CP-OFDM, 100% RB, 50 MHz, QPSK, 15 kHz) | 5G NR FR1 TDD | 8.39 | ± 9.6 % |
| 10791 | AAC | 5G NR (CP-OFDM, 1 RB, 5 MHz, QPSK, 30 kHz) | 5G NR FR1 TDD | 7.83 | ± 9.6 % |
| 10792 | AAC | 5G NR (CP-OFDM, 1 RB, 10 MHz, QPSK, 30 kHz) | 5G NR FR1 TDD | 7.92 | ± 9.6 % |
| 10793 | AAC | 5G NR (CP-OFDM, 1 RB, 15 MHz, QPSK, 30 kHz) | 5G NR FR1 TDD | 7.95 | ± 9.6 % |
| 10794 | AAC | 5G NR (CP-OFDM, 1 RB, 20 MHz, QPSK, 30 kHz) | 5G NR FR1 TDD | 7.82 | ± 9.6 % |
| 10795 | AAC | 5G NR (CP-OFDM, 1 RB, 25 MHz, QPSK, 30 kHz) | 5G NR FR1 TDD | 7.84 | ± 9.6 % |
| 10796 | AAC | 5G NR (CP-OFDM, 1 RB, 30 MHz, QPSK, 30 kHz) | 5G NR FR1 TDD | 7.82 | ± 9.6 % |
| 10797 | AAC | 5G NR (CP-OFDM, 1 RB, 40 MHz, QPSK, 30 kHz) | 5G NR FR1 TDD | 8.01 | ± 9.6 % |
| 10798 | AAC | 5G NR (CP-OFDM, 1 RB, 50 MHz, QPSK, 30 kHz) | 5G NR FR1 TDD | 7.89 | ± 9.6 % |
| 10799 | AAC | 5G NR (CP-OFDM, 1 RB, 60 MHz, QPSK, 30 kHz) | 5G NR FR1 TDD | 7.93 | ± 9.6 % |
| 10801 | AAC | 5G NR (CP-OFDM, 1 RB, 80 MHz, QPSK, 30 kHz) | 5G NR FR1 TDD | 7.89 | ± 9.6 % |
| 10802 | AAC | 5G NR (CP-OFDM, 1 RB, 90 MHz, QPSK, 30 kHz) | 5G NR FR1 TDD | 7.87 | ± 9.6 % |
| 10803 | AAE | 5G NR (CP-OFDM, 1 RB, 100 MHz, QPSK, 30 kHz) | 5G NR FR1 TDD | 7.93 | ± 9.6 % |
| 10805 | AAD | 5G NR (CP-OFDM, 50% RB, 10 MHz, QPSK, 30 kHz) | 5G NR FR1 TDD | 8.34 | ± 9.6 % |
| 10806 | AAD | 5G NR (CP-OFDM, 50% RB, 15 MHz, QPSK, 30 kHz) | 5G NR FR1 TDD | 8.37 | ± 9.6 % |
| 10809 | AAD | 5G NR (CP-OFDM, 50% RB, 30 MHz, QPSK, 30 kHz) | 5G NR FR1 TDD | 8.34 | ± 9.6 % |
| 10810 | AAD | 5G NR (CP-OFDM, 50% RB, 40 MHz, QPSK, 30 kHz) | 5G NR FR1 TDD | 8.34 | ± 9.6 % |
| 10812 | AAD | 5G NR (CP-OFDM, 50% RB, 60 MHz, QPSK, 30 kHz) | 5G NR FR1 TDD | 8.35 | ± 9.6 % |
| 10817 | AAD | 5G NR (CP-OFDM, 100% RB, 5 MHz, QPSK, 30 kHz) | 5G NR FR1 TDD | 8.35 | ± 9.6 % |
| 10818 | AAD | 5G NR (CP-OFDM, 100% RB, 10 MHz, QPSK, 30 kHz) | 5G NR FR1 TDD | 8.34 | ± 9.6 % |
| 10819 | AAD | 5G NR (CP-OFDM, 100% RB, 15 MHz, QPSK, 30 kHz) | 5G NR FR1 TDD | 8.33 | ± 9.6 % |
| 10820 | AAD | 5G NR (CP-OFDM, 100% RB, 20 MHz, QPSK, 30 kHz) | 5G NR FR1 TDD | 8.30 | ± 9.6 % |
| 10821 | AAC | 5G NR (CP-OFDM, 100% RB, 25 MHz, QPSK, 30 kHz) | 5G NR FR1 TDD | 8.41 | ± 9.6 % |
| 10822 | AAD | 5G NR (CP-OFDM, 100% RB, 30 MHz, QPSK, 30 kHz) | 5G NR FR1 TDD | 8.41 | ± 9.6 % |
| 10823 | AAC | 5G NR (CP-OFDM, 100% RB, 40 MHz, QPSK, 30 kHz) | 5G NR FR1 TDD | 8.36 | ± 9.6 % |
| 10824 | AAD | 5G NR (CP-OFDM, 100% RB, 50 MHz, QPSK, 30 kHz) | 5G NR FR1 TDD | 8.39 | ± 9.6 % |
| 10825 | AAD | 5G NR (CP-OFDM, 100% RB, 60 MHz, QPSK, 30 kHz) | 5G NR FR1 TDD | 8.41 | ± 9.6 % |
| 10827 | AAD | 5G NR (CP-OFDM, 100% RB, 80 MHz, QPSK, 30 kHz) | 5G NR FR1 TDD | 8.42 | ± 9.6 % |
| 10828 | AAE | 5G NR (CP-OFDM, 100% RB, 90 MHz, QPSK, 30 kHz) | 5G NR FR1 TDD | 8.43 | ± 9.6 % |
| 10829 | AAD | 5G NR (CP-OFDM, 100% RB, 100 MHz, QPSK, 30 kHz) | 5G NR FR1 TDD | 8.40 | ± 9.6 % |
| 10830 | AAD | 5G NR (CP-OFDM, 1 RB, 10 MHz, QPSK, 60 kHz) | 5G NR FR1 TDD | 7.63 | ± 9.6 % |
| 10831 | AAD | 5G NR (CP-OFDM, 1 RB, 15 MHz, QPSK, 60 kHz) | 5G NR FR1 TDD | 7.73 | ± 9.6 % |
| 10832 | AAD | 5G NR (CP-OFDM, 1 RB, 20 MHz, QPSK, 60 kHz) | 5G NR FR1 TDD | 7.74 | ± 9.6 % |
| 10833 | AAD | 5G NR (CP-OFDM, 1 RB, 25 MHz, QPSK, 60 kHz) | 5G NR FR1 TDD | 7.70 | ± 9.6 % |
| 10834 | AAD | 5G NR (CP-OFDM, 1 RB, 30 MHz, QPSK, 60 kHz) | 5G NR FR1 TDD | 7.75 | ± 9.6 % |
| 10835 | AAD | 5G NR (CP-OFDM, 1 RB, 40 MHz, QPSK, 60 kHz) | 5G NR FR1 TDD | 7.70 | ± 9.6 % |
| 10836 | AAE | 5G NR (CP-OFDM, 1 RB, 50 MHz, QPSK, 60 kHz) | 5G NR FR1 TDD | 7.66 | ± 9.6 % |
| 10837 | AAD | 5G NR (CP-OFDM, 1 RB, 60 MHz, QPSK, 60 kHz) | 5G NR FR1 TDD | 7.68 | ± 9.6 % |
| 10839 | AAD | 5G NR (CP-OFDM, 1 RB, 80 MHz, QPSK, 60 kHz) | 5G NR FR1 TDD | 7.70 | ± 9.6 % |
| 10840 | AAD | 5G NR (CP-OFDM, 1 RB, 90 MHz, QPSK, 60 kHz) | 5G NR FR1 TDD | 7.67 | ± 9.6 % |
| 10841 | AAD | 5G NR (CP-OFDM, 1 RB, 100 MHz, QPSK, 60 kHz) | 5G NR FR1 TDD | 7.71 | ± 9.6 % |
| 10843 | AAD | 5G NR (CP-OFDM, 50% RB, 15 MHz, QPSK, 60 kHz) | 5G NR FR1 TDD | 8.49 | ± 9.6 % |
| 10844 | AAD | 5G NR (CP-OFDM, 50% RB, 20 MHz, QPSK, 60 kHz) | 5G NR FR1 TDD | 8.34 | ± 9.6 % |
| 10846 | AAD | 5G NR (CP-OFDM, 50% RB, 30 MHz, QPSK, 60 kHz) | 5G NR FR1 TDD | 8.41 | ± 9.6 % |
| 10854 | AAD | 5G NR (CP-OFDM, 100% RB, 10 MHz, QPSK, 60 kHz) | 5G NR FR1 TDD | 8.34 | ± 9.6 % |
| 10855 | AAD | 5G NR (CP-OFDM, 100% RB, 15 MHz, QPSK, 60 kHz) | 5G NR FR1 TDD | 8.36 | ± 9.6 % |
| 10856 | AAD | 5G NR (CP-OFDM, 100% RB, 20 MHz, QPSK, 60 kHz) | 5G NR FR1 TDD | 8.37 | ± 9.6 % |
| 10857 | AAD | 5G NR (CP-OFDM, 100% RB, 25 MHz, QPSK, 60 kHz) | 5G NR FR1 TDD | 8.35 | ± 9.6 % |
| 10858 | AAD | 5G NR (CP-OFDM, 100% RB, 30 MHz, QPSK, 60 kHz) | 5G NR FR1 TDD | 8.36 | ± 9.6 % |
| 10859 | AAD | 5G NR (CP-OFDM, 100% RB, 40 MHz, QPSK, 60 kHz) | 5G NR FR1 TDD | 8.34 | ± 9.6 % |

| | | | | | |
|-------|-----|--|---------------|------|---------|
| 10860 | AAD | 5G NR (CP-OFDM, 100% RB, 50 MHz, QPSK, 60 kHz) | 5G NR FR1 TDD | 8.41 | ± 9.6 % |
| 10861 | AAD | 5G NR (CP-OFDM, 100% RB, 60 MHz, QPSK, 60 kHz) | 5G NR FR1 TDD | 8.40 | ± 9.6 % |
| 10863 | AAD | 5G NR (CP-OFDM, 100% RB, 80 MHz, QPSK, 60 kHz) | 5G NR FR1 TDD | 8.41 | ± 9.6 % |
| 10864 | AAE | 5G NR (CP-OFDM, 100% RB, 90 MHz, QPSK, 60 kHz) | 5G NR FR1 TDD | 8.37 | ± 9.6 % |
| 10865 | AAD | 5G NR (CP-OFDM, 100% RB, 100 MHz, QPSK, 60 kHz) | 5G NR FR1 TDD | 8.41 | ± 9.6 % |
| 10866 | AAD | 5G NR (DFT-s-OFDM, 1 RB, 100 MHz, QPSK, 30 kHz) | 5G NR FR1 TDD | 5.68 | ± 9.6 % |
| 10868 | AAD | 5G NR (DFT-s-OFDM, 100% RB, 100 MHz, QPSK, 30 kHz) | 5G NR FR1 TDD | 5.89 | ± 9.6 % |
| 10869 | AAD | 5G NR (DFT-s-OFDM, 1 RB, 100 MHz, QPSK, 120 kHz) | 5G NR FR2 TDD | 5.75 | ± 9.6 % |
| 10870 | AAD | 5G NR (DFT-s-OFDM, 100% RB, 100 MHz, QPSK, 120 kHz) | 5G NR FR2 TDD | 5.86 | ± 9.6 % |
| 10871 | AAD | 5G NR (DFT-s-OFDM, 1 RB, 100 MHz, 16QAM, 120 kHz) | 5G NR FR2 TDD | 5.75 | ± 9.6 % |
| 10872 | AAD | 5G NR (DFT-s-OFDM, 100% RB, 100 MHz, 16QAM, 120 kHz) | 5G NR FR2 TDD | 6.52 | ± 9.6 % |
| 10873 | AAD | 5G NR (DFT-s-OFDM, 1 RB, 100 MHz, 64QAM, 120 kHz) | 5G NR FR2 TDD | 6.61 | ± 9.6 % |
| 10874 | AAD | 5G NR (DFT-s-OFDM, 100% RB, 100 MHz, 64QAM, 120 kHz) | 5G NR FR2 TDD | 6.65 | ± 9.6 % |
| 10875 | AAD | 5G NR (CP-OFDM, 1 RB, 100 MHz, QPSK, 120 kHz) | 5G NR FR2 TDD | 7.78 | ± 9.6 % |
| 10876 | AAD | 5G NR (CP-OFDM, 100% RB, 100 MHz, QPSK, 120 kHz) | 5G NR FR2 TDD | 8.39 | ± 9.6 % |
| 10877 | AAD | 5G NR (CP-OFDM, 1 RB, 100 MHz, 16QAM, 120 kHz) | 5G NR FR2 TDD | 7.95 | ± 9.6 % |
| 10878 | AAD | 5G NR (CP-OFDM, 100% RB, 100 MHz, 16QAM, 120 kHz) | 5G NR FR2 TDD | 8.41 | ± 9.6 % |
| 10879 | AAD | 5G NR (CP-OFDM, 1 RB, 100 MHz, 64QAM, 120 kHz) | 5G NR FR2 TDD | 8.12 | ± 9.6 % |
| 10880 | AAD | 5G NR (CP-OFDM, 100% RB, 100 MHz, 64QAM, 120 kHz) | 5G NR FR2 TDD | 8.38 | ± 9.6 % |
| 10881 | AAD | 5G NR (DFT-s-OFDM, 1 RB, 50 MHz, QPSK, 120 kHz) | 5G NR FR2 TDD | 5.75 | ± 9.6 % |
| 10882 | AAD | 5G NR (DFT-s-OFDM, 100% RB, 50 MHz, QPSK, 120 kHz) | 5G NR FR2 TDD | 5.96 | ± 9.6 % |
| 10883 | AAD | 5G NR (DFT-s-OFDM, 1 RB, 50 MHz, 16QAM, 120 kHz) | 5G NR FR2 TDD | 6.57 | ± 9.6 % |
| 10884 | AAD | 5G NR (DFT-s-OFDM, 100% RB, 50 MHz, 16QAM, 120 kHz) | 5G NR FR2 TDD | 6.53 | ± 9.6 % |
| 10885 | AAD | 5G NR (DFT-s-OFDM, 1 RB, 50 MHz, 64QAM, 120 kHz) | 5G NR FR2 TDD | 6.61 | ± 9.6 % |
| 10886 | AAD | 5G NR (DFT-s-OFDM, 100% RB, 50 MHz, 64QAM, 120 kHz) | 5G NR FR2 TDD | 6.65 | ± 9.6 % |
| 10887 | AAD | 5G NR (CP-OFDM, 1 RB, 50 MHz, QPSK, 120 kHz) | 5G NR FR2 TDD | 7.78 | ± 9.6 % |
| 10888 | AAD | 5G NR (CP-OFDM, 100% RB, 50 MHz, QPSK, 120 kHz) | 5G NR FR2 TDD | 8.35 | ± 9.6 % |
| 10889 | AAD | 5G NR (CP-OFDM, 1 RB, 50 MHz, 16QAM, 120 kHz) | 5G NR FR2 TDD | 8.02 | ± 9.6 % |
| 10890 | AAD | 5G NR (CP-OFDM, 100% RB, 50 MHz, 16QAM, 120 kHz) | 5G NR FR2 TDD | 8.40 | ± 9.6 % |
| 10891 | AAD | 5G NR (CP-OFDM, 1 RB, 50 MHz, 64QAM, 120 kHz) | 5G NR FR2 TDD | 8.13 | ± 9.6 % |
| 10892 | AAD | 5G NR (CP-OFDM, 100% RB, 50 MHz, 64QAM, 120 kHz) | 5G NR FR2 TDD | 8.41 | ± 9.6 % |
| 10897 | AAD | 5G NR (DFT-s-OFDM, 1 RB, 5 MHz, QPSK, 30 kHz) | 5G NR FR1 TDD | 5.66 | ± 9.6 % |
| 10898 | AAD | 5G NR (DFT-s-OFDM, 1 RB, 10 MHz, QPSK, 30 kHz) | 5G NR FR1 TDD | 5.67 | ± 9.6 % |
| 10899 | AAD | 5G NR (DFT-s-OFDM, 1 RB, 15 MHz, QPSK, 30 kHz) | 5G NR FR1 TDD | 5.67 | ± 9.6 % |
| 10900 | AAD | 5G NR (DFT-s-OFDM, 1 RB, 20 MHz, QPSK, 30 kHz) | 5G NR FR1 TDD | 5.68 | ± 9.6 % |
| 10901 | AAD | 5G NR (DFT-s-OFDM, 1 RB, 25 MHz, QPSK, 30 kHz) | 5G NR FR1 TDD | 5.68 | ± 9.6 % |
| 10902 | AAD | 5G NR (DFT-s-OFDM, 1 RB, 30 MHz, QPSK, 30 kHz) | 5G NR FR1 TDD | 5.68 | ± 9.6 % |
| 10903 | AAD | 5G NR (DFT-s-OFDM, 1 RB, 40 MHz, QPSK, 30 kHz) | 5G NR FR1 TDD | 5.68 | ± 9.6 % |
| 10904 | AAD | 5G NR (DFT-s-OFDM, 1 RB, 50 MHz, QPSK, 30 kHz) | 5G NR FR1 TDD | 5.68 | ± 9.6 % |
| 10905 | AAD | 5G NR (DFT-s-OFDM, 1 RB, 60 MHz, QPSK, 30 kHz) | 5G NR FR1 TDD | 5.68 | ± 9.6 % |
| 10906 | AAD | 5G NR (DFT-s-OFDM, 1 RB, 80 MHz, QPSK, 30 kHz) | 5G NR FR1 TDD | 5.68 | ± 9.6 % |
| 10907 | AAD | 5G NR (DFT-s-OFDM, 50% RB, 5 MHz, QPSK, 30 kHz) | 5G NR FR1 TDD | 5.78 | ± 9.6 % |
| 10908 | AAD | 5G NR (DFT-s-OFDM, 50% RB, 10 MHz, QPSK, 30 kHz) | 5G NR FR1 TDD | 5.93 | ± 9.6 % |
| 10909 | AAD | 5G NR (DFT-s-OFDM, 50% RB, 15 MHz, QPSK, 30 kHz) | 5G NR FR1 TDD | 5.96 | ± 9.6 % |
| 10910 | AAD | 5G NR (DFT-s-OFDM, 50% RB, 20 MHz, QPSK, 30 kHz) | 5G NR FR1 TDD | 5.83 | ± 9.6 % |
| 10911 | AAD | 5G NR (DFT-s-OFDM, 50% RB, 25 MHz, QPSK, 30 kHz) | 5G NR FR1 TDD | 5.93 | ± 9.6 % |
| 10912 | AAD | 5G NR (DFT-s-OFDM, 50% RB, 30 MHz, QPSK, 30 kHz) | 5G NR FR1 TDD | 5.84 | ± 9.6 % |
| 10913 | AAD | 5G NR (DFT-s-OFDM, 50% RB, 40 MHz, QPSK, 30 kHz) | 5G NR FR1 TDD | 5.84 | ± 9.6 % |
| 10914 | AAD | 5G NR (DFT-s-OFDM, 50% RB, 50 MHz, QPSK, 30 kHz) | 5G NR FR1 TDD | 5.85 | ± 9.6 % |
| 10915 | AAD | 5G NR (DFT-s-OFDM, 50% RB, 60 MHz, QPSK, 30 kHz) | 5G NR FR1 TDD | 5.83 | ± 9.6 % |
| 10916 | AAD | 5G NR (DFT-s-OFDM, 50% RB, 80 MHz, QPSK, 30 kHz) | 5G NR FR1 TDD | 5.87 | ± 9.6 % |
| 10917 | AAD | 5G NR (DFT-s-OFDM, 50% RB, 100 MHz, QPSK, 30 kHz) | 5G NR FR1 TDD | 5.94 | ± 9.6 % |
| 10918 | AAD | 5G NR (DFT-s-OFDM, 100% RB, 5 MHz, QPSK, 30 kHz) | 5G NR FR1 TDD | 5.86 | ± 9.6 % |
| 10919 | AAD | 5G NR (DFT-s-OFDM, 100% RB, 10 MHz, QPSK, 30 kHz) | 5G NR FR1 TDD | 5.86 | ± 9.6 % |
| 10920 | AAD | 5G NR (DFT-s-OFDM, 100% RB, 15 MHz, QPSK, 30 kHz) | 5G NR FR1 TDD | 5.87 | ± 9.6 % |
| 10921 | AAD | 5G NR (DFT-s-OFDM, 100% RB, 20 MHz, QPSK, 30 kHz) | 5G NR FR1 TDD | 5.84 | ± 9.6 % |

| | | | | | |
|-------|-----|---|---------------|-------|---------|
| 10922 | AAD | 5G NR (DFT-s-OFDM, 100% RB, 25 MHz, QPSK, 30 kHz) | 5G NR FR1 TDD | 5.82 | ± 9.6 % |
| 10923 | AAD | 5G NR (DFT-s-OFDM, 100% RB, 30 MHz, QPSK, 30 kHz) | 5G NR FR1 TDD | 5.84 | ± 9.6 % |
| 10924 | AAD | 5G NR (DFT-s-OFDM, 100% RB, 40 MHz, QPSK, 30 kHz) | 5G NR FR1 TDD | 5.84 | ± 9.6 % |
| 10925 | AAD | 5G NR (DFT-s-OFDM, 100% RB, 50 MHz, QPSK, 30 kHz) | 5G NR FR1 TDD | 5.95 | ± 9.6 % |
| 10926 | AAD | 5G NR (DFT-s-OFDM, 100% RB, 60 MHz, QPSK, 30 kHz) | 5G NR FR1 TDD | 5.84 | ± 9.6 % |
| 10927 | AAD | 5G NR (DFT-s-OFDM, 100% RB, 80 MHz, QPSK, 30 kHz) | 5G NR FR1 TDD | 5.94 | ± 9.6 % |
| 10928 | AAD | 5G NR (DFT-s-OFDM, 1 RB, 5 MHz, QPSK, 15 kHz) | 5G NR FR1 FDD | 5.52 | ± 9.6 % |
| 10929 | AAD | 5G NR (DFT-s-OFDM, 1 RB, 10 MHz, QPSK, 15 kHz) | 5G NR FR1 FDD | 5.52 | ± 9.6 % |
| 10930 | AAD | 5G NR (DFT-s-OFDM, 1 RB, 15 MHz, QPSK, 15 kHz) | 5G NR FR1 FDD | 5.52 | ± 9.6 % |
| 10931 | AAD | 5G NR (DFT-s-OFDM, 1 RB, 20 MHz, QPSK, 15 kHz) | 5G NR FR1 FDD | 5.51 | ± 9.6 % |
| 10932 | AAB | 5G NR (DFT-s-OFDM, 1 RB, 25 MHz, QPSK, 15 kHz) | 5G NR FR1 FDD | 5.51 | ± 9.6 % |
| 10933 | AAA | 5G NR (DFT-s-OFDM, 1 RB, 30 MHz, QPSK, 15 kHz) | 5G NR FR1 FDD | 5.51 | ± 9.6 % |
| 10934 | AAA | 5G NR (DFT-s-OFDM, 1 RB, 40 MHz, QPSK, 15 kHz) | 5G NR FR1 FDD | 5.51 | ± 9.6 % |
| 10935 | AAA | 5G NR (DFT-s-OFDM, 1 RB, 50 MHz, QPSK, 15 kHz) | 5G NR FR1 FDD | 5.51 | ± 9.6 % |
| 10936 | AAC | 5G NR (DFT-s-OFDM, 50% RB, 5 MHz, QPSK, 15 kHz) | 5G NR FR1 FDD | 5.90 | ± 9.6 % |
| 10937 | AAB | 5G NR (DFT-s-OFDM, 50% RB, 10 MHz, QPSK, 15 kHz) | 5G NR FR1 FDD | 5.77 | ± 9.6 % |
| 10938 | AAB | 5G NR (DFT-s-OFDM, 50% RB, 15 MHz, QPSK, 15 kHz) | 5G NR FR1 FDD | 5.90 | ± 9.6 % |
| 10939 | AAB | 5G NR (DFT-s-OFDM, 50% RB, 20 MHz, QPSK, 15 kHz) | 5G NR FR1 FDD | 5.82 | ± 9.6 % |
| 10940 | AAB | 5G NR (DFT-s-OFDM, 50% RB, 25 MHz, QPSK, 15 kHz) | 5G NR FR1 FDD | 5.89 | ± 9.6 % |
| 10941 | AAB | 5G NR (DFT-s-OFDM, 50% RB, 30 MHz, QPSK, 15 kHz) | 5G NR FR1 FDD | 5.83 | ± 9.6 % |
| 10942 | AAB | 5G NR (DFT-s-OFDM, 50% RB, 40 MHz, QPSK, 15 kHz) | 5G NR FR1 FDD | 5.85 | ± 9.6 % |
| 10943 | AAB | 5G NR (DFT-s-OFDM, 50% RB, 50 MHz, QPSK, 15 kHz) | 5G NR FR1 FDD | 5.95 | ± 9.6 % |
| 10944 | AAB | 5G NR (DFT-s-OFDM, 100% RB, 5 MHz, QPSK, 15 kHz) | 5G NR FR1 FDD | 5.81 | ± 9.6 % |
| 10945 | AAB | 5G NR (DFT-s-OFDM, 100% RB, 10 MHz, QPSK, 15 kHz) | 5G NR FR1 FDD | 5.85 | ± 9.6 % |
| 10946 | AAC | 5G NR (DFT-s-OFDM, 100% RB, 15 MHz, QPSK, 15 kHz) | 5G NR FR1 FDD | 5.83 | ± 9.6 % |
| 10947 | AAB | 5G NR (DFT-s-OFDM, 100% RB, 20 MHz, QPSK, 15 kHz) | 5G NR FR1 FDD | 5.87 | ± 9.6 % |
| 10948 | AAB | 5G NR (DFT-s-OFDM, 100% RB, 25 MHz, QPSK, 15 kHz) | 5G NR FR1 FDD | 5.94 | ± 9.6 % |
| 10949 | AAB | 5G NR (DFT-s-OFDM, 100% RB, 30 MHz, QPSK, 15 kHz) | 5G NR FR1 FDD | 5.87 | ± 9.6 % |
| 10950 | AAB | 5G NR (DFT-s-OFDM, 100% RB, 40 MHz, QPSK, 15 kHz) | 5G NR FR1 FDD | 5.94 | ± 9.6 % |
| 10951 | AAB | 5G NR (DFT-s-OFDM, 100% RB, 50 MHz, QPSK, 15 kHz) | 5G NR FR1 FDD | 5.92 | ± 9.6 % |
| 10952 | AAB | 5G NR DL (CP-OFDM, TM 3.1, 5 MHz, 64-QAM, 15 kHz) | 5G NR FR1 FDD | 8.25 | ± 9.6 % |
| 10953 | AAB | 5G NR DL (CP-OFDM, TM 3.1, 10 MHz, 64-QAM, 15 kHz) | 5G NR FR1 FDD | 8.15 | ± 9.6 % |
| 10954 | AAB | 5G NR DL (CP-OFDM, TM 3.1, 15 MHz, 64-QAM, 15 kHz) | 5G NR FR1 FDD | 8.23 | ± 9.6 % |
| 10955 | AAB | 5G NR DL (CP-OFDM, TM 3.1, 20 MHz, 64-QAM, 15 kHz) | 5G NR FR1 FDD | 8.42 | ± 9.6 % |
| 10956 | AAB | 5G NR DL (CP-OFDM, TM 3.1, 5 MHz, 64-QAM, 30 kHz) | 5G NR FR1 FDD | 8.14 | ± 9.6 % |
| 10957 | AAC | 5G NR DL (CP-OFDM, TM 3.1, 10 MHz, 64-QAM, 30 kHz) | 5G NR FR1 FDD | 8.31 | ± 9.6 % |
| 10958 | AAB | 5G NR DL (CP-OFDM, TM 3.1, 15 MHz, 64-QAM, 30 kHz) | 5G NR FR1 FDD | 8.61 | ± 9.6 % |
| 10959 | AAB | 5G NR DL (CP-OFDM, TM 3.1, 20 MHz, 64-QAM, 30 kHz) | 5G NR FR1 FDD | 8.33 | ± 9.6 % |
| 10960 | AAB | 5G NR DL (CP-OFDM, TM 3.1, 5 MHz, 64-QAM, 15 kHz) | 5G NR FR1 TDD | 9.32 | ± 9.6 % |
| 10961 | AAB | 5G NR DL (CP-OFDM, TM 3.1, 10 MHz, 64-QAM, 15 kHz) | 5G NR FR1 TDD | 9.36 | ± 9.6 % |
| 10962 | AAB | 5G NR DL (CP-OFDM, TM 3.1, 15 MHz, 64-QAM, 15 kHz) | 5G NR FR1 TDD | 9.40 | ± 9.6 % |
| 10963 | AAB | 5G NR DL (CP-OFDM, TM 3.1, 20 MHz, 64-QAM, 15 kHz) | 5G NR FR1 TDD | 9.55 | ± 9.6 % |
| 10964 | AAB | 5G NR DL (CP-OFDM, TM 3.1, 5 MHz, 64-QAM, 30 kHz) | 5G NR FR1 TDD | 9.29 | ± 9.6 % |
| 10965 | AAB | 5G NR DL (CP-OFDM, TM 3.1, 10 MHz, 64-QAM, 30 kHz) | 5G NR FR1 TDD | 9.37 | ± 9.6 % |
| 10966 | AAB | 5G NR DL (CP-OFDM, TM 3.1, 15 MHz, 64-QAM, 30 kHz) | 5G NR FR1 TDD | 9.55 | ± 9.6 % |
| 10967 | AAB | 5G NR DL (CP-OFDM, TM 3.1, 20 MHz, 64-QAM, 30 kHz) | 5G NR FR1 TDD | 9.42 | ± 9.6 % |
| 10968 | AAB | 5G NR DL (CP-OFDM, TM 3.1, 100 MHz, 64-QAM, 30 kHz) | 5G NR FR1 TDD | 9.49 | ± 9.6 % |
| 10972 | AAB | 5G NR (CP-OFDM, 1 RB, 20 MHz, QPSK, 15 kHz) | 5G NR FR1 TDD | 11.59 | ± 9.6 % |
| 10973 | AAB | 5G NR (DFT-s-OFDM, 1 RB, 100 MHz, QPSK, 30 kHz) | 5G NR FR1 TDD | 9.06 | ± 9.6 % |
| 10974 | AAB | 5G NR (CP-OFDM, 100% RB, 100 MHz, 256-QAM, 30 kHz) | 5G NR FR1 TDD | 10.28 | ± 9.6 % |

^E Uncertainty is determined using the max. deviation from linear response applying rectangular distribution and is expressed for the square of the field value.

Appendix D. Photographs of EUT and Setup

The photographs of EUT and setup for HAC measurement are shown as follows.