

FCC Test Report

Report No.: RF200428C03-4

FCC ID: PZWBHTM80QWG

Test Model: BHT-M80-QWG

Received Date: Apr. 28, 2020

Test Date: Aug. 27 ~ Oct. 21, 2020

Issued Date: Oct. 26, 2020

Applicant: DENSO WAVE INCORPORATED

Address: 1 Yoshiike Kusagi Agui-cho, Chita-gun Aichi 470-2297, Japan

Issued By: Bureau Veritas Consumer Products Services (H.K.) Ltd., Taoyuan Branch
Lin Kou Laboratories

Lab Address: No. 47-2, 14th Ling, Chia Pau Vil., Lin Kou Dist., New Taipei City, Taiwan

Test Location: No. 19, Hwa Ya 2nd Rd., Wen Hwa Vil., Kwei Shan Dist., Taoyuan City
33383, TAIWAN

**FCC Registration /
Designation Number:** 788550 / TW0003



This report is for your exclusive use. Any copying or replication of this report to or for any other person or entity, or use of our name or trademark, is permitted only with our prior written permission. This report sets forth our findings solely with respect to the test samples identified herein. The results set forth in this report are not indicative or representative of the quality or characteristics of the lot from which a test sample was taken or any similar or identical product unless specifically and expressly noted. Our report includes all of the tests requested by you and the results thereof based upon the information that you provided to us. You have 60 days from date of issuance of this report to notify us of any material error or omission caused by our negligence, provided, however, that such notice shall be in writing and shall specifically address the issue you wish to raise. A failure to raise such issue within the prescribed time shall constitute your unqualified acceptance of the completeness of this report, the tests conducted and the correctness of the report contents. Unless specifically mentioned, the uncertainty of measurement has been explicitly taken into account to declare the compliance or non-compliance to the specification.

Table of Contents

Release Control Record	4
1 Certificate of Conformity	5
2 Summary of Test Results	6
2.1 Measurement Uncertainty.....	6
2.2 Modification Record.....	6
3 General Information	7
3.1 General Description of EUT.....	7
3.2 Description of Test Modes.....	10
3.2.1 Test Mode Applicability and Tested Channel Detail.....	12
3.3 Duty Cycle of Test Signal.....	14
3.4 Description of Support Units.....	15
3.4.1 Configuration of System under Test.....	15
3.5 General Description of Applied Standards and References.....	16
4 Test Types and Results	17
4.1 Radiated Emission and Bandedge Measurement.....	17
4.1.1 Limits of Radiated Emission and Bandedge Measurement.....	17
4.1.2 Test Instruments.....	18
4.1.3 Test Procedures.....	19
4.1.4 Deviation from Test Standard.....	19
4.1.5 Test Setup.....	20
4.1.6 EUT Operating Conditions.....	21
4.1.7 Test Results.....	22
4.2 Conducted Emission Measurement.....	70
4.2.1 Limits of Conducted Emission Measurement.....	70
4.2.2 Test Instruments.....	70
4.2.3 Test Procedures.....	71
4.2.4 Deviation from Test Standard.....	71
4.2.5 Test Setup.....	71
4.2.6 EUT Operating Conditions.....	71
4.2.7 Test Results.....	72
4.3 Transmit Power Measurement.....	78
4.3.1 Limits of Transmit Power Measurement.....	78
4.3.2 Test Setup.....	78
4.3.3 Test Instruments.....	78
4.3.4 Test Procedure.....	79
4.3.5 Deviation from Test Standard.....	79
4.3.6 EUT Operating Conditions.....	79
4.3.7 Test Result.....	80
4.4 Occupied Bandwidth Measurement.....	91
4.4.1 Test Setup.....	91
4.4.2 Test Instruments.....	91
4.4.3 Test Procedure.....	91
4.4.4 Test Result.....	92
4.5 Peak Power Spectral Density Measurement.....	97
4.5.1 Limits of Peak Power Spectral Density Measurement.....	97
4.5.2 Test Setup.....	97
4.5.3 Test Instruments.....	97
4.5.4 Test Procedures.....	97
4.5.5 Deviation from Test Standard.....	98
4.5.6 EUT Operating Conditions.....	98
4.5.7 Test Results.....	99
4.6 Frequency Stability.....	106
4.6.1 Limits of Frequency Stability Measurement.....	106

4.6.2	Test Setup.....	106
4.6.3	Test Instruments	106
4.6.4	Test Procedure	107
4.6.5	Deviation from Test Standard	107
4.6.6	EUT Operating Condition	107
4.6.7	Test Results	108
4.7	6dB Bandwidth Measurement.....	109
4.7.1	Limits of 6dB Bandwidth Measurement.....	109
4.7.2	Test Setup.....	109
4.7.3	Test Instruments	109
4.7.4	Test Procedure	109
4.7.5	Deviation from Test Standard	109
4.7.6	EUT Operating Condition	109
4.7.7	Test Results	110
Annex A- Radiated Out of Band Emission (OOBE) Measurement (For U-NII-3 band).....		112
Annex B- Band Edge Measurement.....		115
5	Pictures of Test Arrangements.....	127
Appendix – Information of the Testing Laboratories		128

Release Control Record

Issue No.	Description	Date Issued
RF200428C03-4	Original release	Oct. 26, 2020

1 Certificate of Conformity

Product: 2D Code Handy Terminal

Brand: DENSO

Test Model: BHT-M80-QWG

Sample Status: Engineering sample

Applicant: DENSO WAVE INCORPORATED

Test Date: Aug. 27 ~ Oct. 21, 2020

Standards: 47 CFR FCC Part 15, Subpart E (Section 15.407)
ANSI C63.10:2013

The above equipment has been tested by **Bureau Veritas Consumer Products Services (H.K.) Ltd., Taoyuan Branch**, and found compliance with the requirement of the above standards. The test record, data evaluation & Equipment Under Test (EUT) configurations represented herein are true and accurate accounts of the measurements of the sample's RF characteristics under the conditions specified in this report.

Prepared by : , **Date:** Oct. 26, 2020
Polly Chien / Specialist

Approved by : , **Date:** Oct. 26, 2020
Bruce Chen / Senior Project Engineer

2 Summary of Test Results

47 CFR FCC Part 15, Subpart E (Section 15.407)			
FCC Clause	Test Item	Result	Remarks
15.407(b)(6)	AC Power Conducted Emissions	Pass	Meet the requirement of limit. Minimum passing margin is -18.85dB at 0.63400MHz.
15.407(b)(1/2/3/4(i/ii)/6)	Radiated Emissions & Band Edge Measurement	Pass	Meet the requirement of limit. Minimum passing margin is -0.8dB at 5350.00MHz.
15.407(a)(1/2/3)	Max Average Transmit Power	Pass	Meet the requirement of limit.
---	Occupied Bandwidth Measurement	-	Reference only.
15.407(a)(1/2/3)	Peak Power Spectral Density	Pass	Meet the requirement of limit.
15.407(e)	6dB bandwidth	Pass	Meet the requirement of limit. (U-NII-3 Band only)
15.407(g)	Frequency Stability	Pass	Meet the requirement of limit.
15.203	Antenna Requirement	Pass	Antenna connector is spring not a standard connector.

Note:

- Determining compliance based on the results of the compliance measurement, not taking into account measurement instrumentation uncertainty.
- For U-NII-3 band compliance with rule part 15.407(b)(4)(i), the OOB test plots were recorded in Annex A.
- For U-NII-1, U-NII-2A and U-NII-2C band compliance with rule 15.407(b) of the band-edge items, the test plots were recorded in Annex B. Test Procedures refer to report 4.1.3.

2.1 Measurement Uncertainty

Where relevant, the following measurement uncertainty levels have been estimated for tests performed on the EUT as specified in CISPR 16-4-2:

Measurement	Frequency	Expanded Uncertainty (k=2) (\pm)
Conducted Emissions at mains ports	150kHz ~ 30MHz	2.79 dB
Radiated Emissions up to 1 GHz	9kHz ~ 30MHz	3.04 dB
	30MHz ~ 200MHz	3.86 dB
	200MHz ~ 1000MHz	3.87 dB
Radiated Emissions above 1 GHz	1GHz ~ 18GHz	2.29 dB
	18GHz ~ 40GHz	2.29 dB

2.2 Modification Record

There were no modifications required for compliance.

3 General Information

3.1 General Description of EUT

Product	2D Code Handy Terminal
Brand	DENSO
Test Model	BHT-M80-QWG
Sample Status	Engineering sample
Power Supply Rating	3.85Vdc (Battery) 5.0Vdc / 9.0Vdc / 12.0Vdc (from adapter)
Modulation Type	256QAM, 64QAM, 16QAM, QPSK, BPSK
Modulation Technology	OFDM
Transfer Rate	802.11a: 54/48/36/24/18/12/9/6Mbps 802.11n: up to 300Mbps 802.11ac: up to 866.7Mbps
Operating Frequency	5180 ~ 5240MHz, 5260 ~ 5320MHz, 5500 ~ 5720MHz, 5745 ~ 5825MHz
Number of Channel	5180 ~ 5240MHz: 802.11a, 802.11n (HT20), 802.11ac (VHT20): 4 802.11n (HT40), 802.11ac (VHT40): 2 802.11ac (VHT80): 1 5260 ~ 5320MHz: 802.11a, 802.11n (HT20), 802.11ac (VHT20): 4 802.11n (HT40), 802.11ac (VHT40): 2 802.11ac (VHT80): 1 5500 ~ 5720MHz: 802.11a, 802.11n (HT20), 802.11ac (VHT20): 12 802.11n (HT40), 802.11ac (VHT40): 6 802.11ac (VHT80): 3 5745 ~ 5825MHz: 802.11a, 802.11n (HT20), 802.11ac (VHT20): 5 802.11n (HT40), 802.11ac (VHT40): 2 802.11ac (VHT80): 1
Output Power	5180 ~ 5240MHz: 249.141mW 5260 ~ 5320MHz: 228.379mW 5500 ~ 5720MHz: 236.187mW 5745 ~ 5825MHz: 428.943mW
Antenna Type	Refer to note
Antenna Connector	Refer to note
Accessory Device	Refer to note
Cable Supplied	Refer to note

Note:

1. The EUT incorporates a MIMO function. Physically, the EUT provides 2 completed transmitters and 2 receivers.

Modulation Mode	TX Function
802.11a	2TX
802.11n (HT20)	2TX
802.11n (HT40)	2TX
802.11ac (VHT20)	2TX
802.11ac (VHT40)	2TX
802.11ac (VHT80)	2TX

* The bandwidth and modulation are similar for HT20/HT40 on 802.11n mode and VHT20/VHT40 on 802.11ac mode. Therefore the investigated worst case is the representative mode in test report. (Final test mode refer section 3.2.1)

2. The EUT uses the following antennas.

Ant. Type	PIFA													
Ant. Connector	Spring													
Ant. 1 (WLAN)														
Frequency (MHz)	2412	2442	2484	5170	5180	5220	5320	5420	5520	5620	5720	5825	5835	
Peak Gain (dBi)	0.81	1.36	1.05	3.34	2.97	2.96	2.78	2.88	3.28	3.24	3.45	3.18	3.39	
Ant. 1 (BT)														
Frequency (MHz)	2402			2412			2442			2480				
Peak Gain (dBi)	-0.11			0.81			1.36			1.36				
Ant. 2 (WLAN)														
Frequency (MHz)	2412	2442	2484	5170	5180	5220	5320	5420	5520	5620	5720	5825	5835	
Peak Gain (dBi)	1.33	1.47	0.29	3.80	3.78	3.65	3.51	2.98	2.99	3.09	3.49	3.53	3.44	

* The max. gain was chosen for final tests.

* The above Antenna information is declared by manufacturer and for more detailed features description, please refer to the manufacturer's specifications, the laboratory shall not be held responsible.

3. The EUT contains following accessory devices.

Battery 1	
Brand	DENSO
Model	BT1
Rating	3.85Vdc, 4020mAh, 15.47Wh

Battery 2	
Brand	DENSO
Model	BT1S
Rating	3.85Vdc, 2900mAh, 11.16Wh

Adapter	
Brand	CHANNEL WELL TECHNOLOGY
Model	2ACP0183C
Input Power	100-240Vac~0.5A , 50/60Hz
Output Power	5.0Vdc / 3.0A, 15.0W 9.0Vdc / 2.0A, 18.0W 12.0Vdc / 1.5A, 18.0W
Data Cable	1.45 m shielded USB cable without core

Cradle 1: QC3.0 charge single Cradle (Option)	
Brand	DENSO
Model	CU-M80UQ
Adapter	
Brand	CHANNEL WELL TECHNOLOGY
Model	2ACP0183C
Input Power	100-240Vac, 50/60Hz, 0.5A
Output Power	5.0Vdc / 3.0A, 15.0W 9.0Vdc / 2.0A, 18.0W 12.0Vdc / 1.5A, 18.0W
Data Cable	1.45 m shielded USB cable without core

Cradle 2: USB Cradle with spare battery charge (Option)	
Brand	DENSO
Model	CU-M80U
Adapter	
Brand	Sunny
Model	SYS1548-5012-T3
Input Power	100-240Vac, 1.5A MAX, 50-60Hz
Output Power	+12.0Vdc, 4.16A
Power cable	DC: 1.16m cable with one core AC: 1.71m non-shielded cable without core
Data Cable	1.45 m shielded USB cable without core

4. The WWAN could transmit simultaneously either with WLAN 2.4GHz or 5GHz or BT at the same time.

3.2 Description of Test Modes

For 5180 ~ 5240MHz:

4 channels are provided for 802.11a, 802.11n (HT20), 802.11ac (VHT20):

Channel	Frequency	Channel	Frequency
36	5180 MHz	44	5220 MHz
40	5200 MHz	48	5240 MHz

2 channels are provided for 802.11n (HT40), 802.11ac (VHT40):

Channel	Frequency	Channel	Frequency
38	5190 MHz	46	5230 MHz

1 channel is provided for 802.11ac (VHT80):

Channel	Frequency
42	5210MHz

For 5260 ~ 5320MHz:

4 channels are provided for 802.11a, 802.11n (HT20), 802.11ac (VHT20):

Channel	Frequency	Channel	Frequency
52	5260 MHz	60	5300 MHz
56	5280 MHz	64	5320 MHz

2 channels are provided for 802.11n (HT40), 802.11ac (VHT40):

Channel	Frequency	Channel	Frequency
54	5270 MHz	62	5310 MHz

1 channel is provided for 802.11ac (VHT80):

Channel	Frequency
58	5290MHz

For 5500 ~ 5720MHz:

12 channels are provided for 802.11a, 802.11n (HT20), 802.11ac (VHT20):

Channel	Frequency	Channel	Frequency
100	5500 MHz	124	5620 MHz
104	5520 MHz	128	5640 MHz
108	5540 MHz	132	5660 MHz
112	5560 MHz	136	5680 MHz
116	5580 MHz	140	5700 MHz
120	5600 MHz	144	5720 MHz

6 channels are provided for 802.11n (HT40), 802.11ac (VHT40):

Channel	Frequency	Channel	Frequency
102	5510 MHz	126	5630 MHz
110	5550 MHz	134	5670 MHz
118	5590 MHz	142	5710 MHz

3 channels are provided for 802.11ac (VHT80):

Channel	Frequency	Channel	Frequency
106	5530 MHz	122	5610 MHz
138	5690 MHz		

For 5745 ~ 5825MHz:

5 channels are provided for 802.11a, 802.11n (HT20), 802.11ac (VHT20):

Channel	Frequency	Channel	Frequency
149	5745MHz	161	5805MHz
153	5765MHz	165	5825MHz
157	5785MHz		

2 channels are provided for 802.11n (HT40), 802.11ac (VHT40):

Channel	Frequency	Channel	Frequency
151	5755MHz	159	5795MHz

1 channel is provided for 802.11ac (VHT80):

Channel	Frequency
155	5775MHz

3.2.1 Test Mode Applicability and Tested Channel Detail

EUT Configure Mode	Applicable to				Description
	RE \geq 1G	RE<1G	PLC	APCM	
A	√	√	√	√	EUT with adapter
B	-	√	√	-	EUT with Cradle 1
C	-	√	√	-	EUT with Cradle 2

Where RE \geq 1G: Radiated Emission above 1GHz & Bandedge Measurement
 RE<1G: Radiated Emission below 1GHz
 PLC: Power Line Conducted Emission
 APCM: Antenna Port Conducted Measurement

- Note: The EUT had been pre-tested on the positioned of each 3 axis. The worst case was found when positioned on **X-plane** for mode A.
- "-" means no effect.

Radiated Emission Test (Above 1GHz):

- Pre-Scan has been conducted to determine the worst-case mode from all possible combinations between available modulations, data rates and antenna ports (if EUT with antenna diversity architecture).
- Following channel(s) was (were) selected for the final test as listed below.

EUT Configure Mode	Mode	Frequency Band (MHz)	Available Channel	Tested Channel	Modulation Technology	Data Rate (Mbps)
A	802.11a	5180-5240	36 to 48	36, 40, 48	OFDM	6.0
	802.11n (HT20)		36 to 48	36, 40, 48	OFDM	6.5
	802.11n (HT40)		38 to 46	38, 46	OFDM	13.5
	802.11ac (VHT80)		42	42	OFDM	29.3
A	802.11a	5260-5320	52 to 64	52, 60, 64	OFDM	6.0
	802.11n (HT20)		52 to 64	52, 60, 64	OFDM	6.5
	802.11n (HT40)		54 to 62	54, 62	OFDM	13.5
	802.11ac (VHT80)		58	58	OFDM	29.3
A	802.11a	5500-5720	100 to 144	100, 116, 140, 144	OFDM	6.0
	802.11n (HT20)		100 to 144	100, 116, 140, 144	OFDM	6.5
	802.11n (HT40)		102 to 142	102, 110, 134, 142	OFDM	13.5
	802.11ac (VHT80)		106 to 138	106, 122, 138	OFDM	29.3
A	802.11a	5745-5825	149 to 165	149, 157, 165	OFDM	6.0
	802.11n (HT20)		149 to 165	149, 157, 165	OFDM	6.5
	802.11n (HT40)		151 to 159	151, 159	OFDM	13.5
	802.11ac (VHT80)		155	155	OFDM	29.3

Radiated Emission Test (Below 1GHz):

- Pre-Scan has been conducted to determine the worst-case mode from all possible combinations between available modulations, data rates and antenna ports (if EUT with antenna diversity architecture).
- Following channel(s) was (were) selected for the final test as listed below.

EUT Configure Mode	Mode	Frequency Band (MHz)	Available Channel	Tested Channel	Modulation Technology	Data Rate (Mbps)
A, B, C	802.11a	36 to 48	36, 40, 48	157	OFDM	6.0
		52 to 64	52, 60, 64		OFDM	6.0
		100 to 144	100, 116, 140, 144		OFDM	6.0
		149 to 165	149, 157, 165		OFDM	6.0

Power Line Conducted Emission Test:

- Pre-Scan has been conducted to determine the worst-case mode from all possible combinations between available modulations, data rates and antenna ports (if EUT with antenna diversity architecture).
- Following channel(s) was (were) selected for the final test as listed below.

EUT Configure Mode	Mode	Frequency Band (MHz)	Available Channel	Tested Channel	Modulation Technology	Data Rate (Mbps)
A, B, C	802.11a	36 to 48	36, 40, 48	157	OFDM	6.0
		52 to 64	52, 60, 64		OFDM	6.0
		100 to 144	100, 116, 140, 144		OFDM	6.0
		149 to 165	149, 157, 165		OFDM	6.0

Antenna Port Conducted Measurement:

- This item includes all test value of each mode, but only includes spectrum plot of worst value of each mode.
- Pre-Scan has been conducted to determine the worst-case mode from all possible combinations between available modulations, data rates and antenna ports (if EUT with antenna diversity architecture).
- Following channel(s) was (were) selected for the final test as listed below.

EUT Configure Mode	Mode	Frequency Band (MHz)	Available Channel	Tested Channel	Modulation Technology	Data Rate (Mbps)
A	802.11a	5180-5240	36 to 48	36, 40, 48	OFDM	6.0
	802.11n (HT20)		36 to 48	36, 40, 48	OFDM	6.5
	802.11n (HT40)		38 to 46	38, 46	OFDM	13.5
	802.11ac (VHT80)		42	42	OFDM	29.3
A	802.11a	5260-5320	52 to 64	52, 60, 64	OFDM	6.0
	802.11n (HT20)		52 to 64	52, 60, 64	OFDM	6.5
	802.11n (HT40)		54 to 62	54, 62	OFDM	13.5
	802.11ac (VHT80)		58	58	OFDM	29.3
A	802.11a	5500-5720	100 to 144	100, 116, 140, 144	OFDM	6.0
	802.11n (HT20)		100 to 144	100, 116, 140, 144	OFDM	6.5
	802.11n (HT40)		102 to 142	102, 110, 134, 142	OFDM	13.5
	802.11ac (VHT80)		106 to 138	106, 122, 138	OFDM	29.3
A	802.11a	5745-5825	149 to 165	149, 157, 165	OFDM	6.0
	802.11n (HT20)		149 to 165	149, 157, 165	OFDM	6.5
	802.11n (HT40)		151 to 159	151, 159	OFDM	13.5
	802.11ac (VHT80)		155	155	OFDM	29.3

Test Condition:

Applicable to	Environmental Conditions	Input Power	Tested by
RE \geq 1G	22 deg. C, 66% RH	120Vac, 60Hz	Greg Lin
RE<1G	22 deg. C, 66% RH 22 deg. C, 68% RH	120Vac, 60Hz	Greg Lin
PLC	25 deg. C, 75% RH 23 deg. C, 66% RH	120Vac, 60Hz	Greg Lin, Titan Hsu
APCM	25 deg. C, 60% RH	120Vac, 60Hz	Ivan Tseng

3.3 Duty Cycle of Test Signal

Duty cycle of test signal is < 98%, duty factor is required.

802.11a: Duty cycle = 2.060/2.165 = 0.952, Duty factor = $10 \cdot \log(1/0.952) = 0.22$

802.11n (HT20): Duty cycle = 1.929/2.034 = 0.948, Duty factor = $10 \cdot \log(1/0.948) = 0.23$

802.11n (HT40): Duty cycle = 0.945/1.052 = 0.898, Duty factor = $10 \cdot \log(1/0.898) = 0.47$

802.11ac (VHT80): Duty cycle = 0.464/0.570 = 0.814, Duty factor = $10 \cdot \log(1/0.814) = 0.89$

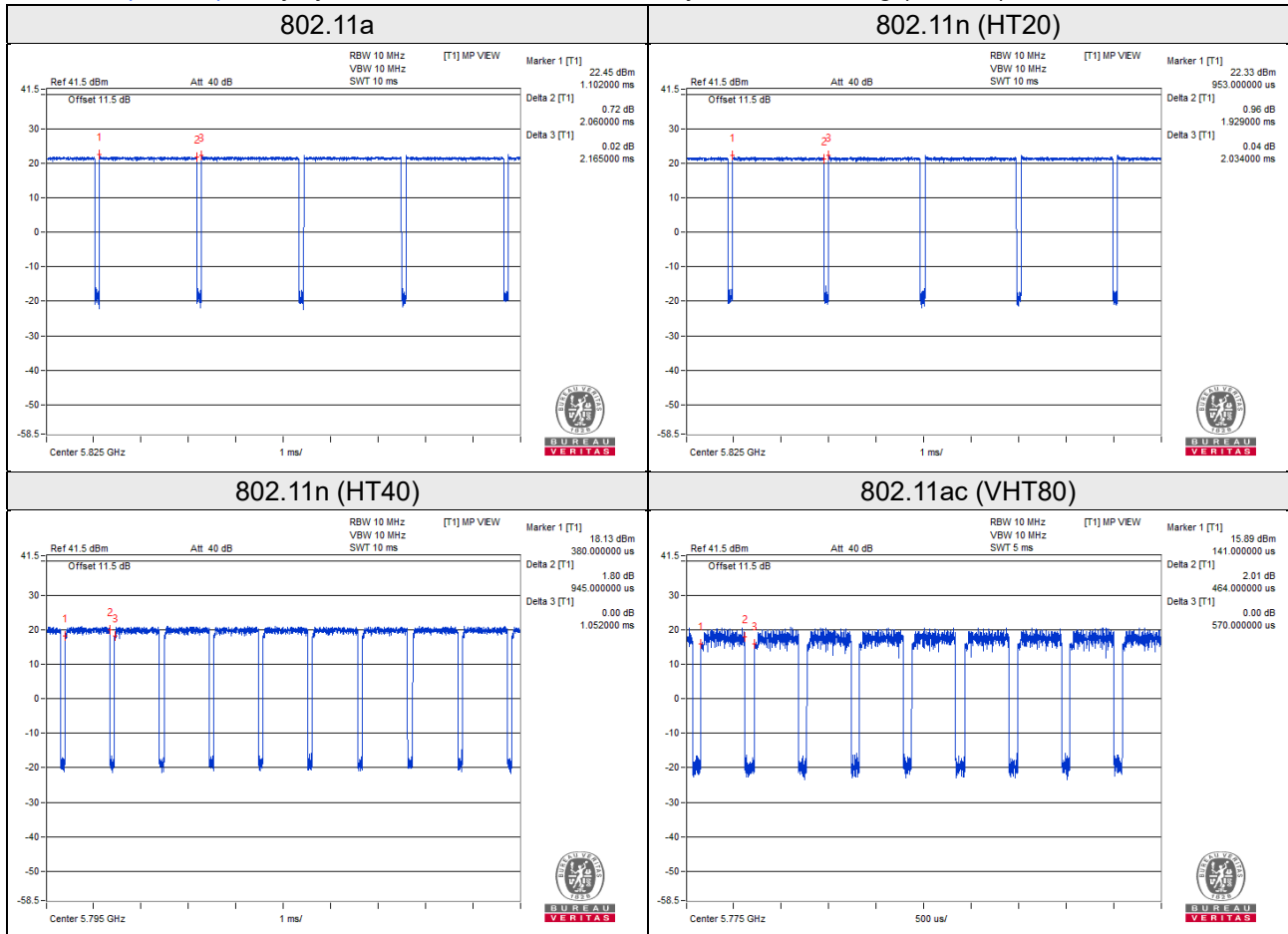

3.4 Description of Support Units

The EUT has been tested as an independent unit together with other necessary accessories or support units. The following support units or accessories were used to form a representative test configuration during the tests.

ID	Product	Brand	Model No.	Serial No.	FCC ID	Remarks
A.	Cradle 1	DENSO	CU-M80UQ	NA	NA	Provided by manufacturer
B.	Adapter	CHANNEL WELL TECHNOLOGY	2ACP0183C	NA	NA	Provided by manufacturer
C.	Cradle 2	DENSO	CU-M80U	NA	NA	Provided by manufacturer
D.	Adapter	Sunny	SYS1548-5012-T3	NA	NA	Provided by manufacturer

ID	Descriptions	Qty.	Length (m)	Shielding (Yes/No)	Cores (Qty.)	Remarks
1.	USB cable	1	1.45	Y	0	Accessory of EUT
2.	USB cable	1	1.45	Y	0	Provided by manufacturer
3.	USB cable	1	1.45	Y	0	Provided by manufacturer
4.	Power cable	1	1.16	-	1	Provided by manufacturer

Note: The core(s) is(are) originally attached to the cable(s).

3.4.1 Configuration of System under Test

Mode A

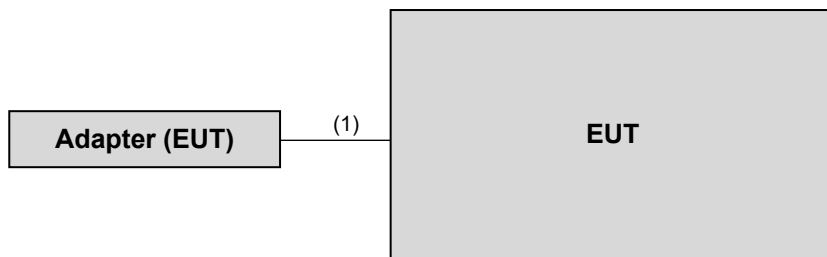

Mode B

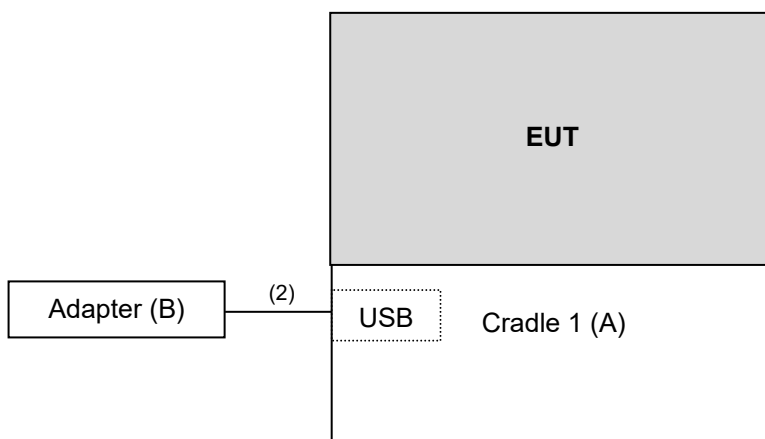

Mode C

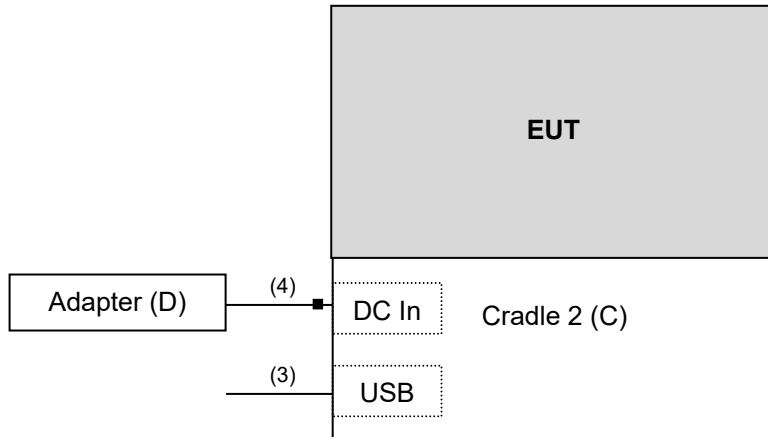

3.5 General Description of Applied Standards and References

The EUT is a RF Product. According to the specifications of the manufacturer, it must comply with the requirements of the following standards and references:

Test standard:

FCC Part 15, Subpart E (15.407)

ANSI C63.10:2013

All test items have been performed and recorded as per the above standards.

References Test Guidance:

KDB 789033 D02 General UNII Test Procedure New Rules v02r01

KDB 662911 D01 Multiple Transmitter Output v02r01

All test items have been performed as a reference to the above KDB test guidance.

4 Test Types and Results

4.1 Radiated Emission and Bandedge Measurement

4.1.1 Limits of Radiated Emission and Bandedge Measurement

Radiated emissions which fall in the restricted bands must comply with the radiated emission limits specified as below table.

Frequencies (MHz)	Field Strength (microvolts/meter)	Measurement Distance (meters)
0.009 ~ 0.490	2400/F(kHz)	300
0.490 ~ 1.705	24000/F(kHz)	30
1.705 ~ 30.0	30	30
30 ~ 88	100	3
88 ~ 216	150	3
216 ~ 960	200	3
Above 960	500	3

Note:

1. The lower limit shall apply at the transition frequencies.
2. Emission level (dBuV/m) = 20 log Emission level (uV/m).
3. For frequencies above 1000MHz, the field strength limits are based on average detector, however, the peak field strength of any emission shall not exceed the maximum permitted average limits, specified above by more than 20dB under any condition of modulation.

Limits of unwanted emission out of the restricted bands

Applicable To		Limit	
789033 D02 General UNII Test Procedure New Rules v02r01		Field Strength at 3m	
		PK: 74 (dBµV/m)	AV: 54 (dBµV/m)
Frequency Band	Applicable To	EIRP Limit	Equivalent Field Strength at 3m
5150~5250 MHz	15.407(b)(1)	PK: -27 (dBm/MHz)	PK: 68.2(dBµV/m)
5250~5350 MHz	15.407(b)(2)		
5470~5725 MHz	15.407(b)(3)		
5725~5850 MHz	<input checked="" type="checkbox"/> 15.407(b)(4)(i)	PK: -27 (dBm/MHz) ^{*1} PK: 10 (dBm/MHz) ^{*2} PK: 15.6 (dBm/MHz) ^{*3} PK: 27 (dBm/MHz) ^{*4}	PK: 68.2(dBµV/m) ^{*1} PK: 105.2 (dBµV/m) ^{*2} PK: 110.8(dBµV/m) ^{*3} PK: 122.2 (dBµV/m) ^{*4}
	<input type="checkbox"/> 15.407(b)(4)(ii)	Emission limits in section 15.247(d)	
^{*1} beyond 75 MHz or more above of the band edge.		^{*2} below the band edge increasing linearly to 10 dBm/MHz at 25 MHz above.	
^{*3} below the band edge increasing linearly to a level of 15.6 dBm/MHz at 5 MHz above.		^{*4} from 5 MHz above or below the band edge increasing linearly to a level of 27 dBm/MHz at the band edge.	

Note: The following formula is used to convert the equipment isotropic radiated power (eirp) to field strength:

$$E = \frac{1000000 \sqrt{30 P}}{3} \quad \mu\text{V/m, where } P \text{ is the eirp (Watts).}$$

4.1.2 Test Instruments

Description & Manufacturer	Model No.	Serial No.	Cal. Date	Cal. Due
Spectrum Analyzer ROHDE & SCHWARZ	ESR3	102579	Jul. 07, 2020	Jul. 06, 2021
Spectrum Analyzer ROHDE & SCHWARZ	FSV40	100980	Apr. 20, 2020	Apr. 19, 2021
Spectrum Analyzer ROHDE & SCHWARZ	FSP40	100269	Jun. 09, 2020	Jun. 08, 2021
BILOG Antenna SCHWARZBECK	VULB9168	9168-171	Nov. 11, 2019	Nov. 10, 2020
HORN Antenna SCHWARZBECK	9120D	209	Nov. 24, 2019	Nov. 23, 2020
HORN Antenna SCHWARZBECK	BBHA 9170	BBHA9170241	Nov. 24, 2019	Nov. 23, 2020
Loop Antenna TESEQ	HLA 6121	45745	Jul. 06, 2020	Jul. 05, 2021
Preamplifier Agilent (Below 1GHz)	8447D	2944A10738	Aug. 20, 2019	Aug. 19, 2020
			Aug. 16, 2020	Aug. 15, 2021
Preamplifier Agilent (Above 1GHz)	8449B	3008A02465	Mar. 23, 2020	Mar. 22, 2021
RF Coaxial Cable WOKEN With 5dB PAD	8D-FB	Cable-CH3-01	Aug. 20, 2019	Aug. 19, 2020
			Aug. 16, 2020	Aug. 15, 2021
RF signal cable HUBER+SUHNER	SUCOFLEX 104	Cable-CH3-03 (223653/4)	Aug. 20, 2019	Aug. 19, 2020
			Aug. 16, 2020	Aug. 15, 2021
RF signal cable HUBER+SUHNER& EMCI	SUCOFLEX 104&EMC104-SM- SM-8000	Cable-CH3-03 (309224+170907)	Aug. 20, 2019	Aug. 19, 2020
			Aug. 16, 2020	Aug. 15, 2021
Software BV ADT	ADT_Radiated_ V7.6.15.9.5	NA	NA	NA
Antenna Tower inn-co GmbH	MA 4000	013303	NA	NA
Antenna Tower Controller BV ADT	AT100	AT93021702	NA	NA
Turn Table BV ADT	TT100	TT93021702	NA	NA
Turn Table Controller BV ADT	SC100	SC93021702	NA	NA
Boresight Antenna Fixture	FBA-01	FBA-SIP01	NA	NA
USB Wideband Power Sensor KEYSIGHT	U2021XA	MY55050005/MY55190 004/MY55190007/MY55 210005	Jul. 13, 2020	Jul. 12, 2021
Pre-amplifier (18GHz-40GHz) EMC	EMC184045B	980175	Sep. 05, 2019	Sep. 04, 2020
			Sep. 04, 2020	Sep. 03, 2021

Note: 1. The calibration interval of the above test instruments is 12 months and the calibrations are traceable to NML/ROC and NIST/USA.

2. The test was performed in HwaYa Chamber 3.

4.1.3 Test Procedures

For Radiated emission below 30MHz

- a. The EUT was placed on the top of a rotating table 0.8 meters above the ground at a 3 meter chamber room. The table was rotated 360 degrees to determine the position of the highest radiation.
- b. The EUT was set 3 meters away from the interference-receiving antenna, which was mounted on the top of a variable-height antenna tower.
- c. Parallel, perpendicular, and ground-parallel orientations of the antenna are set to make the measurement.
- d. For each suspected emission, the EUT was arranged to its worst case and the rotatable table was turned from 0 degrees to 360 degrees to find the maximum reading.
- e. The test-receiver system was set to Quasi-Peak Detect Function and Specified Bandwidth with Maximum Hold Mode.

Note:

1. The resolution bandwidth and video bandwidth of test receiver/spectrum analyzer is 9kHz at frequency below 30MHz.

For Radiated emission above 30MHz

- a. The EUT was placed on the top of a rotating table 0.8 meters (for 30MHz ~ 1GHz) / 1.5 meters (for above 1GHz) above the ground at 3 meter chamber room for test. The table was rotated 360 degrees to determine the position of the highest radiation.
- b. The EUT was set 3 meters away from the interference-receiving antenna, which was mounted on the top of a variable-height antenna tower.
- c. The height of antenna is varied from one meter to four meters above the ground to determine the maximum value of the field strength. Both horizontal and vertical polarizations of the antenna are set to make the measurement.
- d. For each suspected emission, the EUT was arranged to its worst case and then the antenna was tuned to heights from 1 meter to 4 meters and the rotatable table was turned from 0 degrees to 360 degrees to find the maximum reading.
- e. The test-receiver system was set to quasi-peak detect function and specified bandwidth with maximum hold mode when the test frequency is below 1 GHz.
- f. The test-receiver system was set to peak and average detect function and specified bandwidth with maximum hold mode when the test frequency is above 1 GHz. If the peak reading value also meets average limit, measurement with the average detector is unnecessary.

Note:

1. The resolution bandwidth and video bandwidth of test receiver/spectrum analyzer is 120kHz for Quasi-peak detection (QP) at frequency below 1GHz.
2. The resolution bandwidth of test receiver/spectrum analyzer is 1 MHz and the video bandwidth is 3 MHz for Peak detection (PK) at frequency above 1GHz.
3. The resolution bandwidth of test receiver/spectrum analyzer is 1MHz and the video bandwidth is $\geq 1/T$ (Duty cycle < 98%) or 10Hz (Duty cycle $\geq 98\%$) for Average detection (AV) at frequency above 1GHz. (802.11a: RBW = 1MHz, VBW = 1kHz; 802.11n (HT20): RBW = 1MHz, VBW = 1kHz; 802.11n (HT40): RBW = 1MHz, VBW = 3kHz; 802.11ac (VHT80): RBW = 1MHz, VBW = 3kHz)
4. All modes of operation were investigated and the worst-case emissions are reported.

4.1.4 Deviation from Test Standard

No deviation.

4.1.5 Test Setup

For Radiated emission below 30MHz

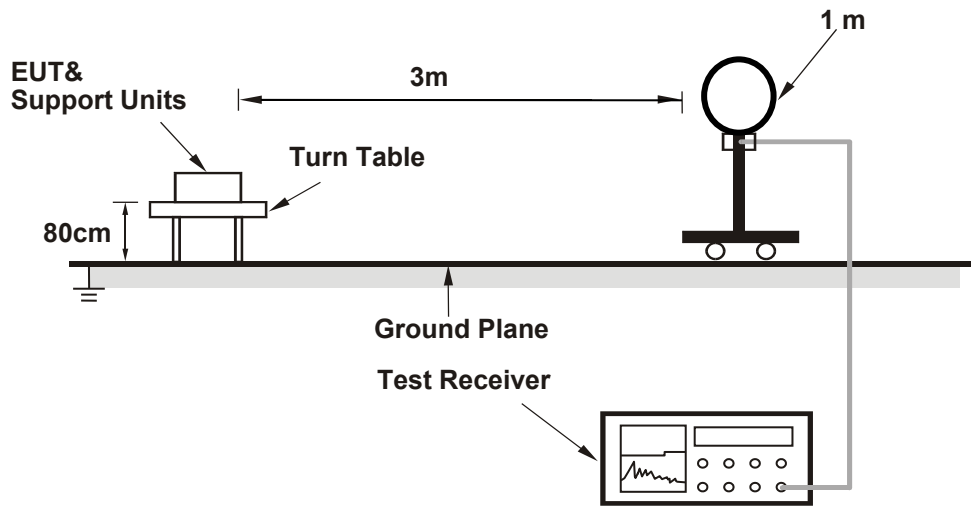

For Radiated emission 30MHz to 1GHz

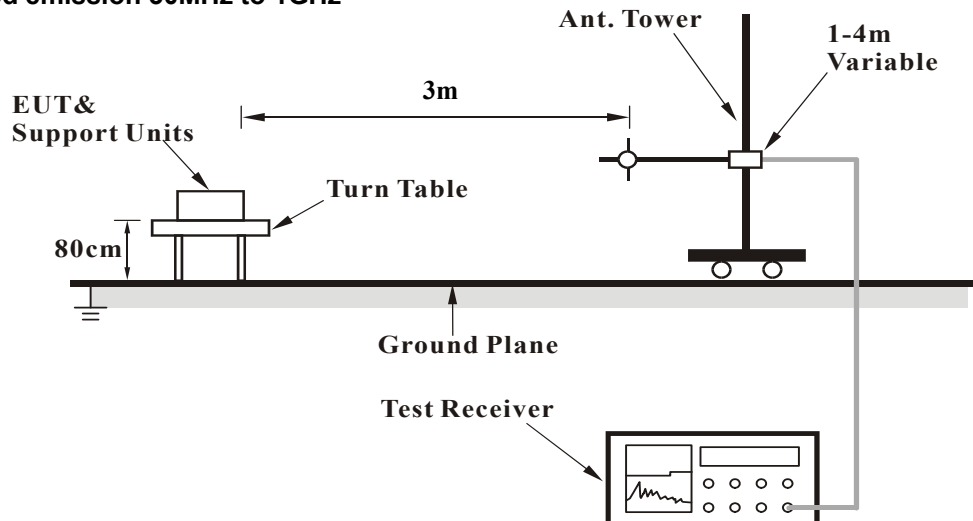

For Radiated emission above 1GHz

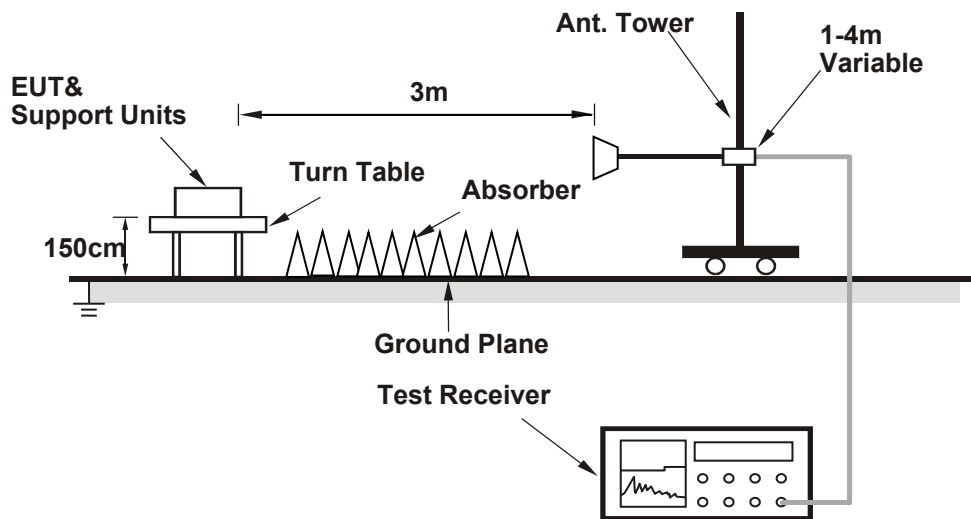

For the actual test configuration, please refer to the attached file (Test Setup Photo).

4.1.6 EUT Operating Conditions

- a. Placed the EUT on the testing table.
- b. The EUT under transmission condition continuously at specific channel frequency.

4.1.7 Test Results

Above 1GHz data:

802.11a

CHANNEL	TX Channel 36	DETECTOR FUNCTION	Peak (PK) Average (AV)
FREQUENCY RANGE	1GHz ~ 40GHz		

ANTENNA POLARITY & TEST DISTANCE: HORIZONTAL AT 3 M								
NO.	FREQ. (MHz)	EMISSION LEVEL (dBuV/m)	LIMIT (dBuV/m)	MARGIN (dB)	ANTENNA HEIGHT (m)	TABLE ANGLE (Degree)	RAW VALUE (dBuV)	CORRECTION FACTOR (dB/m)
1	5150.00	66.8 PK	74.0	-7.2	1.11 H	220	64.7	2.1
2	5150.00	52.8 AV	54.0	-1.2	1.11 H	220	50.7	2.1
3	*5180.00	110.1 PK			1.11 H	220	73.8	36.3
4	*5180.00	100.1 AV			1.11 H	220	63.8	36.3
5	#10360.00	56.4 PK	68.2	-11.8	3.14 H	115	41.3	15.1
ANTENNA POLARITY & TEST DISTANCE: VERTICAL AT 3 M								
NO.	FREQ. (MHz)	EMISSION LEVEL (dBuV/m)	LIMIT (dBuV/m)	MARGIN (dB)	ANTENNA HEIGHT (m)	TABLE ANGLE (Degree)	RAW VALUE (dBuV)	CORRECTION FACTOR (dB/m)
1	5150.00	66.0 PK	74.0	-8.0	2.19 V	166	63.9	2.1
2	5150.00	52.2 AV	54.0	-1.8	2.19 V	166	50.1	2.1
3	*5180.00	109.0 PK			2.19 V	166	72.7	36.3
4	*5180.00	98.9 AV			2.19 V	166	62.6	36.3
5	#10360.00	55.8 PK	68.2	-12.4	2.12 V	227	40.7	15.1

Remarks:

1. Emission Level(dBuV/m) = Raw Value(dBuV) + Correction Factor(dB/m).
2. Correction Factor(dB/m) = Antenna Factor(dB/m) + Cable Factor(dB) – Pre-Amplifier Factor(dB).
3. Margin value = Emission Level – Limit value.
4. The other emission levels were very low against the limit.
5. " * ": Fundamental frequency.
6. " # ": The radiated frequency is out of the restricted band.

CHANNEL	TX Channel 40	DETECTOR FUNCTION	Peak (PK) Average (AV)
FREQUENCY RANGE	1GHz ~ 40GHz		

ANTENNA POLARITY & TEST DISTANCE: HORIZONTAL AT 3 M								
NO.	FREQ. (MHz)	EMISSION LEVEL (dBuV/m)	LIMIT (dBuV/m)	MARGIN (dB)	ANTENNA HEIGHT (m)	TABLE ANGLE (Degree)	RAW VALUE (dBuV)	CORRECTION FACTOR (dB/m)
1	*5200.00	111.9 PK			1.12 H	219	75.7	36.2
2	*5200.00	101.9 AV			1.12 H	219	65.7	36.2
3	#10400.00	56.6 PK	68.2	-11.6	3.13 H	109	41.4	15.2

ANTENNA POLARITY & TEST DISTANCE: VERTICAL AT 3 M								
NO.	FREQ. (MHz)	EMISSION LEVEL (dBuV/m)	LIMIT (dBuV/m)	MARGIN (dB)	ANTENNA HEIGHT (m)	TABLE ANGLE (Degree)	RAW VALUE (dBuV)	CORRECTION FACTOR (dB/m)
1	*5200.00	110.7 PK			2.08 V	161	74.5	36.2
2	*5200.00	100.7 AV			2.08 V	161	64.5	36.2
3	#10400.00	56.0 PK	68.2	-12.2	1.96 V	223	40.8	15.2

Remarks:

1. Emission Level(dBuV/m) = Raw Value(dBuV) + Correction Factor(dB/m).
2. Correction Factor(dB/m) = Antenna Factor(dB/m) + Cable Factor(dB) – Pre-Amplifier Factor(dB).
3. Margin value = Emission Level – Limit value.
4. The other emission levels were very low against the limit.
5. " * ": Fundamental frequency.
6. " # ": The radiated frequency is out of the restricted band.

CHANNEL	TX Channel 48	DETECTOR FUNCTION	Peak (PK) Average (AV)
FREQUENCY RANGE	1GHz ~ 40GHz		

ANTENNA POLARITY & TEST DISTANCE: HORIZONTAL AT 3 M

NO.	FREQ. (MHz)	EMISSION LEVEL (dBuV/m)	LIMIT (dBuV/m)	MARGIN (dB)	ANTENNA HEIGHT (m)	TABLE ANGLE (Degree)	RAW VALUE (dBuV)	CORRECTION FACTOR (dB/m)
1	*5240.00	110.7 PK			1.88 H	239	74.6	36.1
2	*5240.00	100.7 AV			1.88 H	239	64.6	36.1
3	5350.00	51.2 PK	74.0	-22.8	1.88 H	239	49.2	2.0
4	5350.00	40.6 AV	54.0	-13.4	1.88 H	239	38.6	2.0
5	#10480.00	56.6 PK	68.2	-11.6	3.07 H	124	41.5	15.1

ANTENNA POLARITY & TEST DISTANCE: VERTICAL AT 3 M

NO.	FREQ. (MHz)	EMISSION LEVEL (dBuV/m)	LIMIT (dBuV/m)	MARGIN (dB)	ANTENNA HEIGHT (m)	TABLE ANGLE (Degree)	RAW VALUE (dBuV)	CORRECTION FACTOR (dB/m)
1	*5240.00	109.7 PK			1.97 V	154	73.6	36.1
2	*5240.00	99.7 AV			1.97 V	154	63.6	36.1
3	5350.00	50.3 PK	74.0	-23.7	1.97 V	154	48.3	2.0
4	5350.00	39.6 AV	54.0	-14.4	1.97 V	154	37.6	2.0
5	#10480.00	56.0 PK	68.2	-12.2	2.23 V	236	40.9	15.1

Remarks:

1. Emission Level(dBuV/m) = Raw Value(dBuV) + Correction Factor(dB/m).
2. Correction Factor(dB/m) = Antenna Factor(dB/m) + Cable Factor(dB) – Pre-Amplifier Factor(dB).
3. Margin value = Emission Level – Limit value.
4. The other emission levels were very low against the limit.
5. " * " : Fundamental frequency.
6. " # " : The radiated frequency is out of the restricted band.

CHANNEL	TX Channel 52	DETECTOR FUNCTION	Peak (PK) Average (AV)
FREQUENCY RANGE	1GHz ~ 40GHz		

ANTENNA POLARITY & TEST DISTANCE: HORIZONTAL AT 3 M

NO.	FREQ. (MHz)	EMISSION LEVEL (dBuV/m)	LIMIT (dBuV/m)	MARGIN (dB)	ANTENNA HEIGHT (m)	TABLE ANGLE (Degree)	RAW VALUE (dBuV)	CORRECTION FACTOR (dB/m)
1	5150.00	52.4 PK	74.0	-21.6	1.18 H	250	50.3	2.1
2	5150.00	41.8 AV	54.0	-12.2	1.18 H	250	39.7	2.1
3	*5260.00	110.8 PK			1.18 H	250	74.7	36.1
4	*5260.00	100.7 AV			1.18 H	250	64.6	36.1
5	#10520.00	55.9 PK	68.2	-12.3	3.23 H	104	40.7	15.2

ANTENNA POLARITY & TEST DISTANCE: VERTICAL AT 3 M

NO.	FREQ. (MHz)	EMISSION LEVEL (dBuV/m)	LIMIT (dBuV/m)	MARGIN (dB)	ANTENNA HEIGHT (m)	TABLE ANGLE (Degree)	RAW VALUE (dBuV)	CORRECTION FACTOR (dB/m)
1	5150.00	51.7 PK	74.0	-22.3	2.06 V	163	49.6	2.1
2	5150.00	41.5 AV	54.0	-12.5	2.06 V	163	39.4	2.1
3	*5260.00	109.9 PK			2.06 V	163	73.8	36.1
4	*5260.00	99.8 AV			2.06 V	163	63.7	36.1
5	#10520.00	55.4 PK	68.2	-12.8	2.13 V	227	40.2	15.2

Remarks:

1. Emission Level(dBuV/m) = Raw Value(dBuV) + Correction Factor(dB/m).
2. Correction Factor(dB/m) = Antenna Factor(dB/m) + Cable Factor(dB) – Pre-Amplifier Factor(dB).
3. Margin value = Emission Level – Limit value.
4. The other emission levels were very low against the limit.
5. " * " : Fundamental frequency.
6. " # " : The radiated frequency is out of the restricted band.

CHANNEL	TX Channel 60	DETECTOR FUNCTION	Peak (PK) Average (AV)
FREQUENCY RANGE	1GHz ~ 40GHz		

ANTENNA POLARITY & TEST DISTANCE: HORIZONTAL AT 3 M

NO.	FREQ. (MHz)	EMISSION LEVEL (dBuV/m)	LIMIT (dBuV/m)	MARGIN (dB)	ANTENNA HEIGHT (m)	TABLE ANGLE (Degree)	RAW VALUE (dBuV)	CORRECTION FACTOR (dB/m)
1	*5300.00	111.5 PK			1.16 H	245	75.4	36.1
2	*5300.00	101.4 AV			1.16 H	245	65.3	36.1
3	10600.00	56.4 PK	74.0	-17.6	3.32 H	109	40.8	15.6
4	10600.00	42.8 AV	54.0	-11.2	3.32 H	109	27.2	15.6

ANTENNA POLARITY & TEST DISTANCE: VERTICAL AT 3 M

NO.	FREQ. (MHz)	EMISSION LEVEL (dBuV/m)	LIMIT (dBuV/m)	MARGIN (dB)	ANTENNA HEIGHT (m)	TABLE ANGLE (Degree)	RAW VALUE (dBuV)	CORRECTION FACTOR (dB/m)
1	*5300.00	110.5 PK			2.16 V	152	74.4	36.1
2	*5300.00	100.4 AV			2.16 V	152	64.3	36.1
3	10600.00	55.9 PK	74.0	-18.1	2.11 V	226	40.3	15.6
4	10600.00	42.2 AV	54.0	-11.8	2.11 V	226	26.6	15.6

Remarks:

1. Emission Level(dBuV/m) = Raw Value(dBuV) + Correction Factor(dB/m).
2. Correction Factor(dB/m) = Antenna Factor(dB/m) + Cable Factor(dB) – Pre-Amplifier Factor(dB).
3. Margin value = Emission Level – Limit value.
4. The other emission levels were very low against the limit.
5. " * ": Fundamental frequency.

CHANNEL	TX Channel 64	DETECTOR FUNCTION	Peak (PK) Average (AV)
FREQUENCY RANGE	1GHz ~ 40GHz		

ANTENNA POLARITY & TEST DISTANCE: HORIZONTAL AT 3 M

NO.	FREQ. (MHz)	EMISSION LEVEL (dBuV/m)	LIMIT (dBuV/m)	MARGIN (dB)	ANTENNA HEIGHT (m)	TABLE ANGLE (Degree)	RAW VALUE (dBuV)	CORRECTION FACTOR (dB/m)
1	*5320.00	110.2 PK			1.26 H	247	74.0	36.2
2	*5320.00	100.1 AV			1.26 H	247	63.9	36.2
3	5350.00	64.1 PK	74.0	-9.9	1.26 H	247	62.1	2.0
4	5350.00	49.8 AV	54.0	-4.2	1.26 H	247	47.8	2.0
5	10640.00	56.6 PK	74.0	-17.4	3.08 H	115	40.8	15.8
6	10640.00	43.1 AV	54.0	-10.9	3.08 H	115	27.3	15.8

ANTENNA POLARITY & TEST DISTANCE: VERTICAL AT 3 M

NO.	FREQ. (MHz)	EMISSION LEVEL (dBuV/m)	LIMIT (dBuV/m)	MARGIN (dB)	ANTENNA HEIGHT (m)	TABLE ANGLE (Degree)	RAW VALUE (dBuV)	CORRECTION FACTOR (dB/m)
1	*5320.00	109.4 PK			2.18 V	159	73.2	36.2
2	*5320.00	99.2 AV			2.18 V	159	63.0	36.2
3	5350.00	63.3 PK	74.0	-10.7	2.18 V	159	61.3	2.0
4	5350.00	49.2 AV	54.0	-4.8	2.18 V	159	47.2	2.0
5	10640.00	56.0 PK	74.0	-18.0	2.11 V	229	40.2	15.8
6	10640.00	42.3 AV	54.0	-11.7	2.11 V	229	26.5	15.8

Remarks:

1. Emission Level(dBuV/m) = Raw Value(dBuV) + Correction Factor(dB/m).
2. Correction Factor(dB/m) = Antenna Factor(dB/m) + Cable Factor(dB) – Pre-Amplifier Factor(dB).
3. Margin value = Emission Level – Limit value.
4. The other emission levels were very low against the limit.
5. " * ": Fundamental frequency.

CHANNEL	TX Channel 100	DETECTOR FUNCTION	Peak (PK) Average (AV)
FREQUENCY RANGE	1GHz ~ 40GHz		

ANTENNA POLARITY & TEST DISTANCE: HORIZONTAL AT 3 M

NO.	FREQ. (MHz)	EMISSION LEVEL (dBuV/m)	LIMIT (dBuV/m)	MARGIN (dB)	ANTENNA HEIGHT (m)	TABLE ANGLE (Degree)	RAW VALUE (dBuV)	CORRECTION FACTOR (dB/m)
1	5460.00	60.2 PK	74.0	-13.8	1.07 H	253	57.5	2.7
2	5460.00	43.1 AV	54.0	-10.9	1.07 H	253	40.4	2.7
3	#5470.00	64.9 PK	68.2	-3.3	1.07 H	253	62.2	2.7
4	*5500.00	111.1 PK			1.07 H	253	74.1	37.0
5	*5500.00	101.1 AV			1.07 H	253	64.1	37.0
6	11000.00	57.7 PK	74.0	-16.3	3.25 H	104	40.8	16.9
7	11000.00	44.2 AV	54.0	-9.8	3.25 H	104	27.3	16.9

ANTENNA POLARITY & TEST DISTANCE: VERTICAL AT 3 M

NO.	FREQ. (MHz)	EMISSION LEVEL (dBuV/m)	LIMIT (dBuV/m)	MARGIN (dB)	ANTENNA HEIGHT (m)	TABLE ANGLE (Degree)	RAW VALUE (dBuV)	CORRECTION FACTOR (dB/m)
1	5460.00	59.4 PK	74.0	-14.6	2.35 V	167	56.7	2.7
2	5460.00	42.5 AV	54.0	-11.5	2.35 V	167	39.8	2.7
3	#5470.00	64.1 PK	68.2	-4.1	2.35 V	167	61.4	2.7
4	*5500.00	110.2 PK			2.35 V	167	73.2	37.0
5	*5500.00	100.2 AV			2.35 V	167	63.2	37.0
6	11000.00	57.2 PK	74.0	-16.8	2.24 V	235	40.3	16.9
7	11000.00	43.8 AV	54.0	-10.2	2.24 V	235	26.9	16.9

Remarks:

1. Emission Level(dBuV/m) = Raw Value(dBuV) + Correction Factor(dB/m).
2. Correction Factor(dB/m) = Antenna Factor(dB/m) + Cable Factor(dB) – Pre-Amplifier Factor(dB).
3. Margin value = Emission Level – Limit value.
4. The other emission levels were very low against the limit.
5. " * ": Fundamental frequency.
6. " # ": The radiated frequency is out of the restricted band.

CHANNEL	TX Channel 116	DETECTOR FUNCTION	Peak (PK) Average (AV)
FREQUENCY RANGE	1GHz ~ 40GHz		

ANTENNA POLARITY & TEST DISTANCE: HORIZONTAL AT 3 M

NO.	FREQ. (MHz)	EMISSION LEVEL (dBuV/m)	LIMIT (dBuV/m)	MARGIN (dB)	ANTENNA HEIGHT (m)	TABLE ANGLE (Degree)	RAW VALUE (dBuV)	CORRECTION FACTOR (dB/m)
1	*5580.00	111.9 PK			1.08 H	249	75.0	36.9
2	*5580.00	101.8 AV			1.08 H	249	64.9	36.9
3	11160.00	56.4 PK	74.0	-17.6	3.18 H	121	40.7	15.7
4	11160.00	42.8 AV	54.0	-11.2	3.18 H	121	27.1	15.7

ANTENNA POLARITY & TEST DISTANCE: VERTICAL AT 3 M

NO.	FREQ. (MHz)	EMISSION LEVEL (dBuV/m)	LIMIT (dBuV/m)	MARGIN (dB)	ANTENNA HEIGHT (m)	TABLE ANGLE (Degree)	RAW VALUE (dBuV)	CORRECTION FACTOR (dB/m)
1	*5580.00	111.0 PK			2.08 V	145	74.1	36.9
2	*5580.00	100.9 AV			2.08 V	145	64.0	36.9
3	11160.00	55.9 PK	74.0	-18.1	2.16 V	225	40.2	15.7
4	11160.00	42.4 AV	54.0	-11.6	2.16 V	225	26.7	15.7

Remarks:

1. Emission Level(dBuV/m) = Raw Value(dBuV) + Correction Factor(dB/m).
2. Correction Factor(dB/m) = Antenna Factor(dB/m) + Cable Factor(dB) – Pre-Amplifier Factor(dB).
3. Margin value = Emission Level – Limit value.
4. The other emission levels were very low against the limit.
5. " * ": Fundamental frequency.

CHANNEL	TX Channel 140	DETECTOR FUNCTION	Peak (PK) Average (AV)
FREQUENCY RANGE	1GHz ~ 40GHz		

ANTENNA POLARITY & TEST DISTANCE: HORIZONTAL AT 3 M								
NO.	FREQ. (MHz)	EMISSION LEVEL (dBuV/m)	LIMIT (dBuV/m)	MARGIN (dB)	ANTENNA HEIGHT (m)	TABLE ANGLE (Degree)	RAW VALUE (dBuV)	CORRECTION FACTOR (dB/m)
1	*5700.00	112.4 PK			1.12 H	255	75.2	37.2
2	*5700.00	102.3 AV			1.12 H	255	65.1	37.2
3	#5725.00	65.3 PK	68.2	-2.9	1.12 H	255	62.4	2.9
4	11400.00	56.8 PK	74.0	-17.2	3.22 H	122	40.9	15.9
5	11400.00	43.3 AV	54.0	-10.7	3.22 H	122	27.4	15.9

ANTENNA POLARITY & TEST DISTANCE: VERTICAL AT 3 M								
NO.	FREQ. (MHz)	EMISSION LEVEL (dBuV/m)	LIMIT (dBuV/m)	MARGIN (dB)	ANTENNA HEIGHT (m)	TABLE ANGLE (Degree)	RAW VALUE (dBuV)	CORRECTION FACTOR (dB/m)
1	*5700.00	111.5 PK			2.05 V	146	74.3	37.2
2	*5700.00	101.4 AV			2.05 V	146	64.2	37.2
3	#5725.00	64.7 PK	68.2	-3.5	2.05 V	146	61.8	2.9
4	11400.00	56.1 PK	74.0	-17.9	2.09 V	221	40.2	15.9
5	11400.00	42.3 AV	54.0	-11.7	2.09 V	221	26.4	15.9

Remarks:

1. Emission Level(dBuV/m) = Raw Value(dBuV) + Correction Factor(dB/m).
2. Correction Factor(dB/m) = Antenna Factor(dB/m) + Cable Factor(dB) – Pre-Amplifier Factor(dB).
3. Margin value = Emission Level – Limit value.
4. The other emission levels were very low against the limit.
5. " * " : Fundamental frequency.
6. " # " : The radiated frequency is out of the restricted band.

CHANNEL	TX Channel 144	DETECTOR FUNCTION	Peak (PK) Average (AV)
FREQUENCY RANGE	1GHz ~ 40GHz		

ANTENNA POLARITY & TEST DISTANCE: HORIZONTAL AT 3 M

NO.	FREQ. (MHz)	EMISSION LEVEL (dBuV/m)	LIMIT (dBuV/m)	MARGIN (dB)	ANTENNA HEIGHT (m)	TABLE ANGLE (Degree)	RAW VALUE (dBuV)	CORRECTION FACTOR (dB/m)
1	#5470.00	42.9 PK	68.2	-25.3	1.14 H	232	40.2	2.7
2	*5720.00	110.9 PK			1.14 H	232	73.7	37.2
3	*5720.00	101.1 AV			1.14 H	232	63.9	37.2
4	#5850.00	43.6 PK	68.2	-24.6	1.14 H	232	40.3	3.3
5	11440.00	56.8 PK	74.0	-17.2	3.18 H	118	41.2	15.6
6	11440.00	43.1 AV	54.0	-10.9	3.18 H	118	27.5	15.6

ANTENNA POLARITY & TEST DISTANCE: VERTICAL AT 3 M

NO.	FREQ. (MHz)	EMISSION LEVEL (dBuV/m)	LIMIT (dBuV/m)	MARGIN (dB)	ANTENNA HEIGHT (m)	TABLE ANGLE (Degree)	RAW VALUE (dBuV)	CORRECTION FACTOR (dB/m)
1	#5470.00	42.5 PK	68.2	-25.7	2.04 V	167	39.8	2.7
2	*5720.00	110.1 PK			2.04 V	167	72.9	37.2
3	*5720.00	100.2 AV			2.04 V	167	63.0	37.2
4	#5850.00	43.2 PK	68.2	-25.0	2.04 V	167	39.9	3.3
5	11440.00	56.2 PK	74.0	-17.8	1.97 V	221	40.6	15.6
6	11440.00	42.7 AV	54.0	-11.3	1.97 V	221	27.1	15.6

Remarks:

1. Emission Level(dBuV/m) = Raw Value(dBuV) + Correction Factor(dB/m).
2. Correction Factor(dB/m) = Antenna Factor(dB/m) + Cable Factor(dB) – Pre-Amplifier Factor(dB).
3. Margin value = Emission Level – Limit value.
4. The other emission levels were very low against the limit.
5. " * " : Fundamental frequency.
6. " # " : The radiated frequency is out of the restricted band.

CHANNEL	TX Channel 149	DETECTOR FUNCTION	Peak (PK) Average (AV)
FREQUENCY RANGE	1GHz ~ 40GHz		

ANTENNA POLARITY & TEST DISTANCE: HORIZONTAL AT 3 M

NO.	FREQ. (MHz)	EMISSION LEVEL (dBuV/m)	LIMIT (dBuV/m)	MARGIN (dB)	ANTENNA HEIGHT (m)	TABLE ANGLE (Degree)	RAW VALUE (dBuV)	CORRECTION FACTOR (dB/m)
1	#5647.20	54.4 PK	68.2	-13.8	1.07 H	252	51.7	2.7
2	*5745.00	114.9 PK			1.07 H	252	77.6	37.3
3	*5745.00	103.5 AV			1.07 H	252	66.2	37.3
4	#5932.80	54.4 PK	68.2	-13.8	1.07 H	252	51.1	3.3
5	11490.00	56.4 PK	74.0	-17.6	3.17 H	114	40.9	15.5
6	11490.00	42.8 AV	54.0	-11.2	3.17 H	114	27.3	15.5

ANTENNA POLARITY & TEST DISTANCE: VERTICAL AT 3 M

NO.	FREQ. (MHz)	EMISSION LEVEL (dBuV/m)	LIMIT (dBuV/m)	MARGIN (dB)	ANTENNA HEIGHT (m)	TABLE ANGLE (Degree)	RAW VALUE (dBuV)	CORRECTION FACTOR (dB/m)
1	#5644.00	53.7 PK	68.2	-14.5	2.77 V	350	51.0	2.7
2	*5745.00	113.9 PK			2.77 V	350	76.6	37.3
3	*5745.00	102.7 AV			2.77 V	350	65.4	37.3
4	#5972.80	54.3 PK	68.2	-13.9	2.77 V	350	51.1	3.2
5	11490.00	55.8 PK	74.0	-18.2	2.15 V	237	40.3	15.5
6	11490.00	42.3 AV	54.0	-11.7	2.15 V	237	26.8	15.5

Remarks:

1. Emission Level(dBuV/m) = Raw Value(dBuV) + Correction Factor(dB/m).
2. Correction Factor(dB/m) = Antenna Factor(dB/m) + Cable Factor(dB) – Pre-Amplifier Factor(dB).
3. Margin value = Emission Level – Limit value.
4. The other emission levels were very low against the limit.
5. " * " : Fundamental frequency.
6. " # " : The radiated frequency is out of the restricted band.

CHANNEL	TX Channel 157	DETECTOR FUNCTION	Peak (PK) Average (AV)
FREQUENCY RANGE	1GHz ~ 40GHz		

ANTENNA POLARITY & TEST DISTANCE: HORIZONTAL AT 3 M

NO.	FREQ. (MHz)	EMISSION LEVEL (dBuV/m)	LIMIT (dBuV/m)	MARGIN (dB)	ANTENNA HEIGHT (m)	TABLE ANGLE (Degree)	RAW VALUE (dBuV)	CORRECTION FACTOR (dB/m)
1	#5611.20	54.2 PK	68.2	-14.0	1.12 H	272	51.6	2.6
2	*5785.00	113.5 PK			1.12 H	272	76.0	37.5
3	*5785.00	102.8 AV			1.12 H	272	65.3	37.5
4	#5961.60	55.2 PK	68.2	-13.0	1.12 H	272	51.9	3.3
5	11570.00	56.0 PK	74.0	-18.0	3.17 H	120	40.8	15.2
6	11570.00	42.3 AV	54.0	-11.7	3.17 H	120	27.1	15.2

ANTENNA POLARITY & TEST DISTANCE: VERTICAL AT 3 M

NO.	FREQ. (MHz)	EMISSION LEVEL (dBuV/m)	LIMIT (dBuV/m)	MARGIN (dB)	ANTENNA HEIGHT (m)	TABLE ANGLE (Degree)	RAW VALUE (dBuV)	CORRECTION FACTOR (dB/m)
1	#5610.40	54.2 PK	68.2	-14.0	2.58 V	343	51.6	2.6
2	*5785.00	112.7 PK			2.58 V	343	75.2	37.5
3	*5785.00	102.1 AV			2.58 V	343	64.6	37.5
4	#5928.80	55.0 PK	68.2	-13.2	2.58 V	343	51.7	3.3
5	11570.00	55.3 PK	74.0	-18.7	2.17 V	226	40.1	15.2
6	11570.00	41.9 AV	54.0	-12.1	2.17 V	226	26.7	15.2

Remarks:

1. Emission Level(dBuV/m) = Raw Value(dBuV) + Correction Factor(dB/m).
2. Correction Factor(dB/m) = Antenna Factor(dB/m) + Cable Factor(dB) – Pre-Amplifier Factor(dB).
3. Margin value = Emission Level – Limit value.
4. The other emission levels were very low against the limit.
5. " * " : Fundamental frequency.
6. " # " : The radiated frequency is out of the restricted band.

CHANNEL	TX Channel 165	DETECTOR FUNCTION	Peak (PK) Average (AV)
FREQUENCY RANGE	1GHz ~ 40GHz		

ANTENNA POLARITY & TEST DISTANCE: HORIZONTAL AT 3 M								
NO.	FREQ. (MHz)	EMISSION LEVEL (dBuV/m)	LIMIT (dBuV/m)	MARGIN (dB)	ANTENNA HEIGHT (m)	TABLE ANGLE (Degree)	RAW VALUE (dBuV)	CORRECTION FACTOR (dB/m)
1	#5634.40	53.1 PK	68.2	-15.1	1.13 H	275	50.5	2.6
2	*5825.00	111.6 PK			1.13 H	275	74.2	37.4
3	*5825.00	101.6 AV			1.13 H	275	64.2	37.4
4	#5980.80	54.1 PK	68.2	-14.1	1.13 H	275	50.8	3.3
5	11650.00	55.7 PK	74.0	-18.3	3.05 H	112	40.5	15.2
6	11650.00	42.3 AV	54.0	-11.7	3.05 H	112	27.1	15.2

ANTENNA POLARITY & TEST DISTANCE: VERTICAL AT 3 M								
NO.	FREQ. (MHz)	EMISSION LEVEL (dBuV/m)	LIMIT (dBuV/m)	MARGIN (dB)	ANTENNA HEIGHT (m)	TABLE ANGLE (Degree)	RAW VALUE (dBuV)	CORRECTION FACTOR (dB/m)
1	#5637.60	53.5 PK	68.2	-14.7	2.72 V	354	50.9	2.6
2	*5825.00	111.0 PK			2.72 V	354	73.6	37.4
3	*5825.00	100.8 AV			2.72 V	354	63.4	37.4
4	#5940.00	54.1 PK	68.2	-14.1	2.72 V	354	50.8	3.3
5	11650.00	55.5 PK	74.0	-18.5	2.17 V	228	40.3	15.2
6	11650.00	42.0 AV	54.0	-12.0	2.17 V	228	26.8	15.2

Remarks:

1. Emission Level(dBuV/m) = Raw Value(dBuV) + Correction Factor(dB/m).
2. Correction Factor(dB/m) = Antenna Factor(dB/m) + Cable Factor(dB) – Pre-Amplifier Factor(dB).
3. Margin value = Emission Level – Limit value.
4. The other emission levels were very low against the limit.
5. " * " : Fundamental frequency.
6. " # " : The radiated frequency is out of the restricted band.

802.11n (HT20)

CHANNEL	TX Channel 36	DETECTOR FUNCTION	Peak (PK) Average (AV)
FREQUENCY RANGE	1GHz ~ 40GHz		

ANTENNA POLARITY & TEST DISTANCE: HORIZONTAL AT 3 M								
NO.	FREQ. (MHz)	EMISSION LEVEL (dBuV/m)	LIMIT (dBuV/m)	MARGIN (dB)	ANTENNA HEIGHT (m)	TABLE ANGLE (Degree)	RAW VALUE (dBuV)	CORRECTION FACTOR (dB/m)
1	5150.00	68.3 PK	74.0	-5.7	1.11 H	240	66.2	2.1
2	5150.00	51.8 AV	54.0	-2.2	1.11 H	240	49.7	2.1
3	*5180.00	109.7 PK			1.11 H	240	73.4	36.3
4	*5180.00	99.2 AV			1.11 H	240	62.9	36.3
5	#10360.00	55.8 PK	68.2	-12.4	3.23 H	117	40.7	15.1

ANTENNA POLARITY & TEST DISTANCE: VERTICAL AT 3 M								
NO.	FREQ. (MHz)	EMISSION LEVEL (dBuV/m)	LIMIT (dBuV/m)	MARGIN (dB)	ANTENNA HEIGHT (m)	TABLE ANGLE (Degree)	RAW VALUE (dBuV)	CORRECTION FACTOR (dB/m)
1	5150.00	67.5 PK	74.0	-6.5	2.07 V	154	65.4	2.1
2	5150.00	50.9 AV	54.0	-3.1	2.07 V	154	48.8	2.1
3	*5180.00	108.8 PK			2.07 V	154	72.5	36.3
4	*5180.00	98.3 AV			2.07 V	154	62.0	36.3
5	#10360.00	55.5 PK	68.2	-12.7	2.05 V	227	40.4	15.1

Remarks:

1. Emission Level(dBuV/m) = Raw Value(dBuV) + Correction Factor(dB/m).
2. Correction Factor(dB/m) = Antenna Factor(dB/m) + Cable Factor(dB) – Pre-Amplifier Factor(dB).
3. Margin value = Emission Level – Limit value.
4. The other emission levels were very low against the limit.
5. " * ": Fundamental frequency.
6. " # ": The radiated frequency is out of the restricted band.

CHANNEL	TX Channel 40	DETECTOR FUNCTION	Peak (PK) Average (AV)
FREQUENCY RANGE	1GHz ~ 40GHz		

ANTENNA POLARITY & TEST DISTANCE: HORIZONTAL AT 3 M

NO.	FREQ. (MHz)	EMISSION LEVEL (dBuV/m)	LIMIT (dBuV/m)	MARGIN (dB)	ANTENNA HEIGHT (m)	TABLE ANGLE (Degree)	RAW VALUE (dBuV)	CORRECTION FACTOR (dB/m)
1	*5200.00	112.0 PK			1.16 H	236	75.8	36.2
2	*5200.00	101.4 AV			1.16 H	236	65.2	36.2
3	#10400.00	56.2 PK	68.2	-12.0	3.19 H	117	41.0	15.2

ANTENNA POLARITY & TEST DISTANCE: VERTICAL AT 3 M

NO.	FREQ. (MHz)	EMISSION LEVEL (dBuV/m)	LIMIT (dBuV/m)	MARGIN (dB)	ANTENNA HEIGHT (m)	TABLE ANGLE (Degree)	RAW VALUE (dBuV)	CORRECTION FACTOR (dB/m)
1	*5200.00	110.4 PK			2.08 V	155	74.2	36.2
2	*5200.00	100.3 AV			2.08 V	155	64.1	36.2
3	#10400.00	55.8 PK	68.2	-12.4	2.12 V	231	40.6	15.2

Remarks:

1. Emission Level(dBuV/m) = Raw Value(dBuV) + Correction Factor(dB/m).
2. Correction Factor(dB/m) = Antenna Factor(dB/m) + Cable Factor(dB) – Pre-Amplifier Factor(dB).
3. Margin value = Emission Level – Limit value.
4. The other emission levels were very low against the limit.
5. " * ": Fundamental frequency.
6. " # ": The radiated frequency is out of the restricted band.

CHANNEL	TX Channel 48	DETECTOR FUNCTION	Peak (PK) Average (AV)
FREQUENCY RANGE	1GHz ~ 40GHz		

ANTENNA POLARITY & TEST DISTANCE: HORIZONTAL AT 3 M

NO.	FREQ. (MHz)	EMISSION LEVEL (dBuV/m)	LIMIT (dBuV/m)	MARGIN (dB)	ANTENNA HEIGHT (m)	TABLE ANGLE (Degree)	RAW VALUE (dBuV)	CORRECTION FACTOR (dB/m)
1	*5240.00	111.0 PK			1.08 H	251	74.9	36.1
2	*5240.00	100.3 AV			1.08 H	251	64.2	36.1
3	5350.00	51.8 PK	74.0	-22.2	1.08 H	251	49.8	2.0
4	5350.00	40.7 AV	54.0	-13.3	1.08 H	251	38.7	2.0
5	#10480.00	56.2 PK	68.2	-12.0	3.02 H	125	41.1	15.1

ANTENNA POLARITY & TEST DISTANCE: VERTICAL AT 3 M

NO.	FREQ. (MHz)	EMISSION LEVEL (dBuV/m)	LIMIT (dBuV/m)	MARGIN (dB)	ANTENNA HEIGHT (m)	TABLE ANGLE (Degree)	RAW VALUE (dBuV)	CORRECTION FACTOR (dB/m)
1	*5240.00	109.4 PK			2.16 V	151	73.3	36.1
2	*5240.00	99.4 AV			2.16 V	151	63.3	36.1
3	5350.00	50.9 PK	74.0	-23.1	2.16 V	151	48.9	2.0
4	5350.00	39.8 AV	54.0	-14.2	2.16 V	151	37.8	2.0
5	#10480.00	55.7 PK	68.2	-12.5	2.07 V	221	40.6	15.1

Remarks:

1. Emission Level(dBuV/m) = Raw Value(dBuV) + Correction Factor(dB/m).
2. Correction Factor(dB/m) = Antenna Factor(dB/m) + Cable Factor(dB) – Pre-Amplifier Factor(dB).
3. Margin value = Emission Level – Limit value.
4. The other emission levels were very low against the limit.
5. " * " : Fundamental frequency.
6. " # " : The radiated frequency is out of the restricted band.

CHANNEL	TX Channel 52	DETECTOR FUNCTION	Peak (PK) Average (AV)
FREQUENCY RANGE	1GHz ~ 40GHz		

ANTENNA POLARITY & TEST DISTANCE: HORIZONTAL AT 3 M

NO.	FREQ. (MHz)	EMISSION LEVEL (dBuV/m)	LIMIT (dBuV/m)	MARGIN (dB)	ANTENNA HEIGHT (m)	TABLE ANGLE (Degree)	RAW VALUE (dBuV)	CORRECTION FACTOR (dB/m)
1	5150.00	52.3 PK	74.0	-21.7	1.07 H	249	50.2	2.1
2	5150.00	41.5 AV	54.0	-12.5	1.07 H	249	39.4	2.1
3	*5260.00	109.0 PK			1.07 H	249	72.9	36.1
4	*5260.00	98.5 AV			1.07 H	249	62.4	36.1
5	#10520.00	55.8 PK	68.2	-12.4	3.26 H	107	40.6	15.2

ANTENNA POLARITY & TEST DISTANCE: VERTICAL AT 3 M

NO.	FREQ. (MHz)	EMISSION LEVEL (dBuV/m)	LIMIT (dBuV/m)	MARGIN (dB)	ANTENNA HEIGHT (m)	TABLE ANGLE (Degree)	RAW VALUE (dBuV)	CORRECTION FACTOR (dB/m)
1	5150.00	51.7 PK	74.0	-22.3	1.97 V	167	49.6	2.1
2	5150.00	41.0 AV	54.0	-13.0	1.97 V	167	38.9	2.1
3	*5260.00	107.9 PK			1.97 V	167	71.8	36.1
4	*5260.00	97.4 AV			1.97 V	167	61.3	36.1
5	#10520.00	55.0 PK	68.2	-13.2	2.06 V	223	39.8	15.2

Remarks:

1. Emission Level(dBuV/m) = Raw Value(dBuV) + Correction Factor(dB/m).
2. Correction Factor(dB/m) = Antenna Factor(dB/m) + Cable Factor(dB) – Pre-Amplifier Factor(dB).
3. Margin value = Emission Level – Limit value.
4. The other emission levels were very low against the limit.
5. " * " : Fundamental frequency.
6. " # " : The radiated frequency is out of the restricted band.

CHANNEL	TX Channel 60	DETECTOR FUNCTION	Peak (PK) Average (AV)
FREQUENCY RANGE	1GHz ~ 40GHz		

ANTENNA POLARITY & TEST DISTANCE: HORIZONTAL AT 3 M

NO.	FREQ. (MHz)	EMISSION LEVEL (dBuV/m)	LIMIT (dBuV/m)	MARGIN (dB)	ANTENNA HEIGHT (m)	TABLE ANGLE (Degree)	RAW VALUE (dBuV)	CORRECTION FACTOR (dB/m)
1	*5300.00	110.9 PK			1.09 H	256	74.8	36.1
2	*5300.00	100.4 AV			1.09 H	256	64.3	36.1
3	10600.00	56.5 PK	74.0	-17.5	3.26 H	111	40.9	15.6
4	10600.00	43.0 AV	54.0	-11.0	3.26 H	111	27.4	15.6

ANTENNA POLARITY & TEST DISTANCE: VERTICAL AT 3 M

NO.	FREQ. (MHz)	EMISSION LEVEL (dBuV/m)	LIMIT (dBuV/m)	MARGIN (dB)	ANTENNA HEIGHT (m)	TABLE ANGLE (Degree)	RAW VALUE (dBuV)	CORRECTION FACTOR (dB/m)
1	*5300.00	110.0 PK			2.08 V	153	73.9	36.1
2	*5300.00	99.5 AV			2.08 V	153	63.4	36.1
3	10600.00	56.0 PK	74.0	-18.0	2.19 V	221	40.4	15.6
4	10600.00	42.4 AV	54.0	-11.6	2.19 V	221	26.8	15.6

Remarks:

1. Emission Level(dBuV/m) = Raw Value(dBuV) + Correction Factor(dB/m).
2. Correction Factor(dB/m) = Antenna Factor(dB/m) + Cable Factor(dB) – Pre-Amplifier Factor(dB).
3. Margin value = Emission Level – Limit value.
4. The other emission levels were very low against the limit.
5. " * ": Fundamental frequency.

CHANNEL	TX Channel 64	DETECTOR FUNCTION	Peak (PK) Average (AV)
FREQUENCY RANGE	1GHz ~ 40GHz		

ANTENNA POLARITY & TEST DISTANCE: HORIZONTAL AT 3 M

NO.	FREQ. (MHz)	EMISSION LEVEL (dBuV/m)	LIMIT (dBuV/m)	MARGIN (dB)	ANTENNA HEIGHT (m)	TABLE ANGLE (Degree)	RAW VALUE (dBuV)	CORRECTION FACTOR (dB/m)
1	*5320.00	110.0 PK			1.05 H	248	73.8	36.2
2	*5320.00	99.6 AV			1.05 H	248	63.4	36.2
3	5350.00	61.7 PK	74.0	-12.3	1.05 H	248	59.7	2.0
4	5350.00	46.3 AV	54.0	-7.7	1.05 H	248	44.3	2.0
5	10640.00	56.6 PK	74.0	-17.4	3.31 H	125	40.8	15.8
6	10640.00	43.1 AV	54.0	-10.9	3.31 H	125	27.3	15.8

ANTENNA POLARITY & TEST DISTANCE: VERTICAL AT 3 M

NO.	FREQ. (MHz)	EMISSION LEVEL (dBuV/m)	LIMIT (dBuV/m)	MARGIN (dB)	ANTENNA HEIGHT (m)	TABLE ANGLE (Degree)	RAW VALUE (dBuV)	CORRECTION FACTOR (dB/m)
1	*5320.00	109.1 PK			2.15 V	147	72.9	36.2
2	*5320.00	98.7 AV			2.15 V	147	62.5	36.2
3	5350.00	60.9 PK	74.0	-13.1	2.15 V	147	58.9	2.0
4	5350.00	45.7 AV	54.0	-8.3	2.15 V	147	43.7	2.0
5	10640.00	56.0 PK	74.0	-18.0	2.09 V	226	40.2	15.8
6	10640.00	42.6 AV	54.0	-11.4	2.09 V	226	26.8	15.8

Remarks:

1. Emission Level(dBuV/m) = Raw Value(dBuV) + Correction Factor(dB/m).
2. Correction Factor(dB/m) = Antenna Factor(dB/m) + Cable Factor(dB) – Pre-Amplifier Factor(dB).
3. Margin value = Emission Level – Limit value.
4. The other emission levels were very low against the limit.
5. " * ": Fundamental frequency.

CHANNEL	TX Channel 100	DETECTOR FUNCTION	Peak (PK) Average (AV)
FREQUENCY RANGE	1GHz ~ 40GHz		

ANTENNA POLARITY & TEST DISTANCE: HORIZONTAL AT 3 M

NO.	FREQ. (MHz)	EMISSION LEVEL (dBuV/m)	LIMIT (dBuV/m)	MARGIN (dB)	ANTENNA HEIGHT (m)	TABLE ANGLE (Degree)	RAW VALUE (dBuV)	CORRECTION FACTOR (dB/m)
1	5460.00	59.1 PK	74.0	-14.9	1.27 H	254	56.4	2.7
2	5460.00	44.4 AV	54.0	-9.6	1.27 H	254	41.7	2.7
3	#5470.00	66.5 PK	68.2	-1.7	1.27 H	254	63.8	2.7
4	*5500.00	110.5 PK			1.27 H	254	73.5	37.0
5	*5500.00	100.1 AV			1.27 H	254	63.1	37.0
6	11000.00	57.8 PK	74.0	-16.2	3.19 H	107	40.9	16.9
7	11000.00	44.4 AV	54.0	-9.6	3.19 H	107	27.5	16.9

ANTENNA POLARITY & TEST DISTANCE: VERTICAL AT 3 M

NO.	FREQ. (MHz)	EMISSION LEVEL (dBuV/m)	LIMIT (dBuV/m)	MARGIN (dB)	ANTENNA HEIGHT (m)	TABLE ANGLE (Degree)	RAW VALUE (dBuV)	CORRECTION FACTOR (dB/m)
1	5460.00	58.3 PK	74.0	-15.7	2.37 V	165	55.6	2.7
2	5460.00	43.6 AV	54.0	-10.4	2.37 V	165	40.9	2.7
3	#5470.00	65.6 PK	68.2	-2.6	2.37 V	165	62.9	2.7
4	*5500.00	109.4 PK			2.37 V	165	72.4	37.0
5	*5500.00	99.2 AV			2.37 V	165	62.2	37.0
6	11000.00	57.3 PK	74.0	-16.7	2.09 V	227	40.4	16.9
7	11000.00	44.0 AV	54.0	-10.0	2.09 V	227	27.1	16.9

Remarks:

1. Emission Level(dBuV/m) = Raw Value(dBuV) + Correction Factor(dB/m).
2. Correction Factor(dB/m) = Antenna Factor(dB/m) + Cable Factor(dB) – Pre-Amplifier Factor(dB).
3. Margin value = Emission Level – Limit value.
4. The other emission levels were very low against the limit.
5. " * ": Fundamental frequency.
6. " # ": The radiated frequency is out of the restricted band.

CHANNEL	TX Channel 116	DETECTOR FUNCTION	Peak (PK) Average (AV)
FREQUENCY RANGE	1GHz ~ 40GHz		

ANTENNA POLARITY & TEST DISTANCE: HORIZONTAL AT 3 M

NO.	FREQ. (MHz)	EMISSION LEVEL (dBuV/m)	LIMIT (dBuV/m)	MARGIN (dB)	ANTENNA HEIGHT (m)	TABLE ANGLE (Degree)	RAW VALUE (dBuV)	CORRECTION FACTOR (dB/m)
1	*5580.00	111.3 PK			1.23 H	251	74.4	36.9
2	*5580.00	100.9 AV			1.23 H	251	64.0	36.9
3	11160.00	56.9 PK	74.0	-17.1	3.22 H	113	41.2	15.7
4	11160.00	43.2 AV	54.0	-10.8	3.22 H	113	27.5	15.7

ANTENNA POLARITY & TEST DISTANCE: VERTICAL AT 3 M

NO.	FREQ. (MHz)	EMISSION LEVEL (dBuV/m)	LIMIT (dBuV/m)	MARGIN (dB)	ANTENNA HEIGHT (m)	TABLE ANGLE (Degree)	RAW VALUE (dBuV)	CORRECTION FACTOR (dB/m)
1	*5580.00	110.5 PK			1.96 V	157	73.6	36.9
2	*5580.00	100.1 AV			1.96 V	157	63.2	36.9
3	11160.00	55.9 PK	74.0	-18.1	2.14 V	203	40.2	15.7
4	11160.00	42.4 AV	54.0	-11.6	2.14 V	203	26.7	15.7

Remarks:

1. Emission Level(dBuV/m) = Raw Value(dBuV) + Correction Factor(dB/m).
2. Correction Factor(dB/m) = Antenna Factor(dB/m) + Cable Factor(dB) – Pre-Amplifier Factor(dB).
3. Margin value = Emission Level – Limit value.
4. The other emission levels were very low against the limit.
5. " * ": Fundamental frequency.

CHANNEL	TX Channel 140	DETECTOR FUNCTION	Peak (PK) Average (AV)
FREQUENCY RANGE	1GHz ~ 40GHz		

ANTENNA POLARITY & TEST DISTANCE: HORIZONTAL AT 3 M								
NO.	FREQ. (MHz)	EMISSION LEVEL (dBuV/m)	LIMIT (dBuV/m)	MARGIN (dB)	ANTENNA HEIGHT (m)	TABLE ANGLE (Degree)	RAW VALUE (dBuV)	CORRECTION FACTOR (dB/m)
1	*5700.00	111.5 PK			1.12 H	252	74.3	37.2
2	*5700.00	101.0 AV			1.12 H	252	63.8	37.2
3	#5725.00	65.0 PK	68.2	-3.2	1.12 H	252	62.1	2.9
4	11400.00	56.7 PK	74.0	-17.3	3.18 H	117	40.8	15.9
5	11400.00	43.2 AV	54.0	-10.8	3.18 H	117	27.3	15.9

ANTENNA POLARITY & TEST DISTANCE: VERTICAL AT 3 M								
NO.	FREQ. (MHz)	EMISSION LEVEL (dBuV/m)	LIMIT (dBuV/m)	MARGIN (dB)	ANTENNA HEIGHT (m)	TABLE ANGLE (Degree)	RAW VALUE (dBuV)	CORRECTION FACTOR (dB/m)
1	*5700.00	110.6 PK			1.97 V	143	73.4	37.2
2	*5700.00	100.2 AV			1.97 V	143	63.0	37.2
3	#5725.00	64.6 PK	68.2	-3.6	1.97 V	143	61.7	2.9
4	11400.00	56.1 PK	74.0	-17.9	2.15 V	223	40.2	15.9
5	11400.00	42.3 AV	54.0	-11.7	2.15 V	223	26.4	15.9

Remarks:

1. Emission Level(dBuV/m) = Raw Value(dBuV) + Correction Factor(dB/m).
2. Correction Factor(dB/m) = Antenna Factor(dB/m) + Cable Factor(dB) – Pre-Amplifier Factor(dB).
3. Margin value = Emission Level – Limit value.
4. The other emission levels were very low against the limit.
5. " * ": Fundamental frequency.
6. " # ": The radiated frequency is out of the restricted band.

CHANNEL	TX Channel 144	DETECTOR FUNCTION	Peak (PK) Average (AV)
FREQUENCY RANGE	1GHz ~ 40GHz		

ANTENNA POLARITY & TEST DISTANCE: HORIZONTAL AT 3 M

NO.	FREQ. (MHz)	EMISSION LEVEL (dBuV/m)	LIMIT (dBuV/m)	MARGIN (dB)	ANTENNA HEIGHT (m)	TABLE ANGLE (Degree)	RAW VALUE (dBuV)	CORRECTION FACTOR (dB/m)
1	#5470.00	43.2 PK	68.2	-25.0	1.13 H	256	40.5	2.7
2	*5720.00	110.7 PK			1.13 H	256	73.5	37.2
3	*5720.00	100.5 AV			1.13 H	256	63.3	37.2
4	#5850.00	43.4 PK	68.2	-24.8	1.13 H	256	40.1	3.3
5	11440.00	56.6 PK	74.0	-17.4	3.22 H	121	41.0	15.6
6	11440.00	43.0 AV	54.0	-11.0	3.22 H	121	27.4	15.6

ANTENNA POLARITY & TEST DISTANCE: VERTICAL AT 3 M

NO.	FREQ. (MHz)	EMISSION LEVEL (dBuV/m)	LIMIT (dBuV/m)	MARGIN (dB)	ANTENNA HEIGHT (m)	TABLE ANGLE (Degree)	RAW VALUE (dBuV)	CORRECTION FACTOR (dB/m)
1	#5470.00	42.4 PK	68.2	-25.8	2.13 V	165	39.7	2.7
2	*5720.00	109.8 PK			2.13 V	165	72.6	37.2
3	*5720.00	99.6 AV			2.13 V	165	62.4	37.2
4	#5850.00	43.6 PK	68.2	-24.6	2.13 V	165	40.3	3.3
5	11440.00	56.1 PK	74.0	-17.9	2.09 V	225	40.5	15.6
6	11440.00	42.5 AV	54.0	-11.5	2.09 V	225	26.9	15.6

Remarks:

1. Emission Level(dBuV/m) = Raw Value(dBuV) + Correction Factor(dB/m).
2. Correction Factor(dB/m) = Antenna Factor(dB/m) + Cable Factor(dB) – Pre-Amplifier Factor(dB).
3. Margin value = Emission Level – Limit value.
4. The other emission levels were very low against the limit.
5. " * " : Fundamental frequency.
6. " # " : The radiated frequency is out of the restricted band.

CHANNEL	TX Channel 149	DETECTOR FUNCTION	Peak (PK) Average (AV)
FREQUENCY RANGE	1GHz ~ 40GHz		

ANTENNA POLARITY & TEST DISTANCE: HORIZONTAL AT 3 M

NO.	FREQ. (MHz)	EMISSION LEVEL (dBuV/m)	LIMIT (dBuV/m)	MARGIN (dB)	ANTENNA HEIGHT (m)	TABLE ANGLE (Degree)	RAW VALUE (dBuV)	CORRECTION FACTOR (dB/m)
1	#5610.40	54.8 PK	68.2	-13.4	1.00 H	255	52.2	2.6
2	*5745.00	113.4 PK			1.00 H	255	76.1	37.3
3	*5745.00	102.5 AV			1.00 H	255	65.2	37.3
4	#5967.20	55.0 PK	68.2	-13.2	1.00 H	255	51.8	3.2
5	11490.00	56.3 PK	74.0	-17.7	3.11 H	106	40.8	15.5
6	11490.00	42.9 AV	54.0	-11.1	3.11 H	106	27.4	15.5

ANTENNA POLARITY & TEST DISTANCE: VERTICAL AT 3 M

NO.	FREQ. (MHz)	EMISSION LEVEL (dBuV/m)	LIMIT (dBuV/m)	MARGIN (dB)	ANTENNA HEIGHT (m)	TABLE ANGLE (Degree)	RAW VALUE (dBuV)	CORRECTION FACTOR (dB/m)
1	#5640.00	54.2 PK	68.2	-14.0	2.70 V	351	51.6	2.6
2	*5745.00	112.6 PK			2.70 V	352	75.3	37.3
3	*5745.00	101.8 AV			2.70 V	352	64.5	37.3
4	#5931.20	54.4 PK	68.2	-13.8	2.70 V	352	51.1	3.3
5	11490.00	55.8 PK	74.0	-18.2	2.06 V	227	40.3	15.5
6	11490.00	42.5 AV	54.0	-11.5	2.06 V	227	27.0	15.5

Remarks:

1. Emission Level(dBuV/m) = Raw Value(dBuV) + Correction Factor(dB/m).
2. Correction Factor(dB/m) = Antenna Factor(dB/m) + Cable Factor(dB) – Pre-Amplifier Factor(dB).
3. Margin value = Emission Level – Limit value.
4. The other emission levels were very low against the limit.
5. " * " : Fundamental frequency.
6. " # " : The radiated frequency is out of the restricted band.

CHANNEL	TX Channel 157	DETECTOR FUNCTION	Peak (PK) Average (AV)
FREQUENCY RANGE	1GHz ~ 40GHz		

ANTENNA POLARITY & TEST DISTANCE: HORIZONTAL AT 3 M

NO.	FREQ. (MHz)	EMISSION LEVEL (dBuV/m)	LIMIT (dBuV/m)	MARGIN (dB)	ANTENNA HEIGHT (m)	TABLE ANGLE (Degree)	RAW VALUE (dBuV)	CORRECTION FACTOR (dB/m)
1	#5631.20	53.9 PK	68.2	-14.3	1.14 H	248	51.3	2.6
2	*5785.00	113.3 PK			1.14 H	248	75.8	37.5
3	*5785.00	102.3 AV			1.14 H	248	64.8	37.5
4	#5928.00	55.1 PK	68.2	-13.1	1.14 H	248	51.8	3.3
5	11570.00	55.9 PK	74.0	-18.1	3.25 H	127	40.7	15.2
6	11570.00	42.4 AV	54.0	-11.6	3.25 H	127	27.2	15.2

ANTENNA POLARITY & TEST DISTANCE: VERTICAL AT 3 M

NO.	FREQ. (MHz)	EMISSION LEVEL (dBuV/m)	LIMIT (dBuV/m)	MARGIN (dB)	ANTENNA HEIGHT (m)	TABLE ANGLE (Degree)	RAW VALUE (dBuV)	CORRECTION FACTOR (dB/m)
1	#5642.40	54.4 PK	68.2	-13.8	2.74 V	351	51.7	2.7
2	*5785.00	112.6 PK			2.74 V	351	75.1	37.5
3	*5785.00	101.5 AV			2.74 V	351	64.0	37.5
4	#5933.60	54.5 PK	68.2	-13.7	2.74 V	351	51.2	3.3
5	11570.00	55.4 PK	74.0	-18.6	2.09 V	225	40.2	15.2
6	11570.00	42.0 AV	54.0	-12.0	2.09 V	225	26.8	15.2

Remarks:

1. Emission Level(dBuV/m) = Raw Value(dBuV) + Correction Factor(dB/m).
2. Correction Factor(dB/m) = Antenna Factor(dB/m) + Cable Factor(dB) – Pre-Amplifier Factor(dB).
3. Margin value = Emission Level – Limit value.
4. The other emission levels were very low against the limit.
5. " * " : Fundamental frequency.
6. " # " : The radiated frequency is out of the restricted band.

CHANNEL	TX Channel 165	DETECTOR FUNCTION	Peak (PK) Average (AV)
FREQUENCY RANGE	1GHz ~ 40GHz		

ANTENNA POLARITY & TEST DISTANCE: HORIZONTAL AT 3 M								
NO.	FREQ. (MHz)	EMISSION LEVEL (dBuV/m)	LIMIT (dBuV/m)	MARGIN (dB)	ANTENNA HEIGHT (m)	TABLE ANGLE (Degree)	RAW VALUE (dBuV)	CORRECTION FACTOR (dB/m)
1	#5625.60	53.7 PK	68.2	-14.5	1.23 H	268	51.1	2.6
2	*5825.00	112.4 PK			1.23 H	268	75.0	37.4
3	*5825.00	101.6 AV			1.23 H	268	64.2	37.4
4	#5978.40	54.8 PK	68.2	-13.4	1.23 H	268	51.5	3.3
5	11650.00	55.9 PK	74.0	-18.1	3.22 H	121	40.7	15.2
6	11650.00	42.5 AV	54.0	-11.5	3.22 H	121	27.3	15.2

ANTENNA POLARITY & TEST DISTANCE: VERTICAL AT 3 M								
NO.	FREQ. (MHz)	EMISSION LEVEL (dBuV/m)	LIMIT (dBuV/m)	MARGIN (dB)	ANTENNA HEIGHT (m)	TABLE ANGLE (Degree)	RAW VALUE (dBuV)	CORRECTION FACTOR (dB/m)
1	#5623.20	53.1 PK	68.2	-15.1	2.76 V	349	50.5	2.6
2	*5825.00	111.6 PK			2.76 V	349	74.2	37.4
3	*5825.00	100.8 AV			2.76 V	349	63.4	37.4
4	#5988.00	54.0 PK	68.2	-14.2	2.76 V	349	50.7	3.3
5	11650.00	55.5 PK	74.0	-18.5	2.15 V	224	40.3	15.2
6	11650.00	42.1 AV	54.0	-11.9	2.15 V	224	26.9	15.2

Remarks:

1. Emission Level(dBuV/m) = Raw Value(dBuV) + Correction Factor(dB/m).
2. Correction Factor(dB/m) = Antenna Factor(dB/m) + Cable Factor(dB) – Pre-Amplifier Factor(dB).
3. Margin value = Emission Level – Limit value.
4. The other emission levels were very low against the limit.
5. " * " : Fundamental frequency.
6. " # " : The radiated frequency is out of the restricted band.

802.11n (HT40)

CHANNEL	TX Channel 38	DETECTOR FUNCTION	Peak (PK) Average (AV)
FREQUENCY RANGE	1GHz ~ 40GHz		

ANTENNA POLARITY & TEST DISTANCE: HORIZONTAL AT 3 M								
NO.	FREQ. (MHz)	EMISSION LEVEL (dBuV/m)	LIMIT (dBuV/m)	MARGIN (dB)	ANTENNA HEIGHT (m)	TABLE ANGLE (Degree)	RAW VALUE (dBuV)	CORRECTION FACTOR (dB/m)
1	5150.00	65.8 PK	74.0	-8.2	1.10 H	250	63.7	2.1
2	5150.00	52.7 AV	54.0	-1.3	1.10 H	250	50.6	2.1
3	*5190.00	104.8 PK			1.10 H	250	68.6	36.2
4	*5190.00	95.0 AV			1.10 H	250	58.8	36.2
5	#10380.00	55.7 PK	68.2	-12.5	3.15 H	107	40.5	15.2

ANTENNA POLARITY & TEST DISTANCE: VERTICAL AT 3 M								
NO.	FREQ. (MHz)	EMISSION LEVEL (dBuV/m)	LIMIT (dBuV/m)	MARGIN (dB)	ANTENNA HEIGHT (m)	TABLE ANGLE (Degree)	RAW VALUE (dBuV)	CORRECTION FACTOR (dB/m)
1	5150.00	64.9 PK	74.0	-9.1	2.14 V	153	62.8	2.1
2	5150.00	51.8 AV	54.0	-2.2	2.14 V	153	49.7	2.1
3	*5190.00	103.9 PK			2.14 V	153	67.7	36.2
4	*5190.00	94.0 AV			2.14 V	153	57.8	36.2
5	#10380.00	55.4 PK	68.2	-12.8	2.06 V	201	40.2	15.2

Remarks:

1. Emission Level(dBuV/m) = Raw Value(dBuV) + Correction Factor(dB/m).
2. Correction Factor(dB/m) = Antenna Factor(dB/m) + Cable Factor(dB) – Pre-Amplifier Factor(dB).
3. Margin value = Emission Level – Limit value.
4. The other emission levels were very low against the limit.
5. " * ": Fundamental frequency.
6. " # ": The radiated frequency is out of the restricted band.

CHANNEL	TX Channel 46	DETECTOR FUNCTION	Peak (PK) Average (AV)
FREQUENCY RANGE	1GHz ~ 40GHz		

ANTENNA POLARITY & TEST DISTANCE: HORIZONTAL AT 3 M

NO.	FREQ. (MHz)	EMISSION LEVEL (dBuV/m)	LIMIT (dBuV/m)	MARGIN (dB)	ANTENNA HEIGHT (m)	TABLE ANGLE (Degree)	RAW VALUE (dBuV)	CORRECTION FACTOR (dB/m)
1	*5230.00	107.0 PK			1.08 H	250	70.8	36.2
2	*5230.00	96.9 AV			1.08 H	250	60.7	36.2
3	5350.00	52.8 PK	74.0	-21.2	1.08 H	250	50.8	2.0
4	5350.00	40.6 AV	54.0	-13.4	1.08 H	250	38.6	2.0
5	#10460.00	55.6 PK	68.2	-12.6	3.27 H	119	40.5	15.1

ANTENNA POLARITY & TEST DISTANCE: VERTICAL AT 3 M

NO.	FREQ. (MHz)	EMISSION LEVEL (dBuV/m)	LIMIT (dBuV/m)	MARGIN (dB)	ANTENNA HEIGHT (m)	TABLE ANGLE (Degree)	RAW VALUE (dBuV)	CORRECTION FACTOR (dB/m)
1	*5230.00	106.1 PK			2.15 V	226	69.9	36.2
2	*5230.00	96.0 AV			2.15 V	226	59.8	36.2
3	5350.00	52.2 PK	74.0	-21.8	2.15 V	226	50.2	2.0
4	5350.00	40.3 AV	54.0	-13.7	2.15 V	226	38.3	2.0
5	#10460.00	55.2 PK	68.2	-13.0	1.96 V	221	40.1	15.1

Remarks:

1. Emission Level(dBuV/m) = Raw Value(dBuV) + Correction Factor(dB/m).
2. Correction Factor(dB/m) = Antenna Factor(dB/m) + Cable Factor(dB) – Pre-Amplifier Factor(dB).
3. Margin value = Emission Level – Limit value.
4. The other emission levels were very low against the limit.
5. " * " : Fundamental frequency.
6. " # " : The radiated frequency is out of the restricted band.

CHANNEL	TX Channel 54	DETECTOR FUNCTION	Peak (PK) Average (AV)
FREQUENCY RANGE	1GHz ~ 40GHz		

ANTENNA POLARITY & TEST DISTANCE: HORIZONTAL AT 3 M

NO.	FREQ. (MHz)	EMISSION LEVEL (dBuV/m)	LIMIT (dBuV/m)	MARGIN (dB)	ANTENNA HEIGHT (m)	TABLE ANGLE (Degree)	RAW VALUE (dBuV)	CORRECTION FACTOR (dB/m)
1	5150.00	51.7 PK	74.0	-22.3	1.16 H	251	49.6	2.1
2	5150.00	41.5 AV	54.0	-12.5	1.16 H	251	39.4	2.1
3	*5270.00	106.3 PK			1.16 H	251	70.2	36.1
4	*5270.00	96.1 AV			1.16 H	251	60.0	36.1
5	#10540.00	56.0 PK	68.2	-12.2	3.07 H	116	40.6	15.4

ANTENNA POLARITY & TEST DISTANCE: VERTICAL AT 3 M

NO.	FREQ. (MHz)	EMISSION LEVEL (dBuV/m)	LIMIT (dBuV/m)	MARGIN (dB)	ANTENNA HEIGHT (m)	TABLE ANGLE (Degree)	RAW VALUE (dBuV)	CORRECTION FACTOR (dB/m)
1	5150.00	51.5 PK	74.0	-22.5	2.17 V	146	49.4	2.1
2	5150.00	30.8 AV	54.0	-23.2	2.17 V	146	28.7	2.1
3	*5270.00	105.4 PK			2.17 V	146	69.3	36.1
4	*5270.00	95.3 AV			2.17 V	146	59.2	36.1
5	#10540.00	55.2 PK	68.2	-13.0	2.19 V	220	39.8	15.4

Remarks:

1. Emission Level(dBuV/m) = Raw Value(dBuV) + Correction Factor(dB/m).
2. Correction Factor(dB/m) = Antenna Factor(dB/m) + Cable Factor(dB) – Pre-Amplifier Factor(dB).
3. Margin value = Emission Level – Limit value.
4. The other emission levels were very low against the limit.
5. " * ": Fundamental frequency.
6. " # ": The radiated frequency is out of the restricted band.

CHANNEL	TX Channel 62	DETECTOR FUNCTION	Peak (PK) Average (AV)
FREQUENCY RANGE	1GHz ~ 40GHz		

ANTENNA POLARITY & TEST DISTANCE: HORIZONTAL AT 3 M

NO.	FREQ. (MHz)	EMISSION LEVEL (dBuV/m)	LIMIT (dBuV/m)	MARGIN (dB)	ANTENNA HEIGHT (m)	TABLE ANGLE (Degree)	RAW VALUE (dBuV)	CORRECTION FACTOR (dB/m)
1	*5310.00	103.7 PK			1.04 H	250	67.6	36.1
2	*5310.00	93.8 AV			1.04 H	250	57.7	36.1
3	5350.00	66.7 PK	74.0	-7.3	1.04 H	250	64.7	2.0
4	5350.00	52.6 AV	54.0	-1.4	1.04 H	250	50.6	2.0
5	10620.00	56.3 PK	74.0	-17.7	3.16 H	123	40.7	15.6
6	10620.00	42.7 AV	54.0	-11.3	3.16 H	123	27.1	15.6

ANTENNA POLARITY & TEST DISTANCE: VERTICAL AT 3 M

NO.	FREQ. (MHz)	EMISSION LEVEL (dBuV/m)	LIMIT (dBuV/m)	MARGIN (dB)	ANTENNA HEIGHT (m)	TABLE ANGLE (Degree)	RAW VALUE (dBuV)	CORRECTION FACTOR (dB/m)
1	*5310.00	102.9 PK			2.36 V	160	66.8	36.1
2	*5310.00	93.0 AV			2.36 V	160	56.9	36.1
3	5350.00	65.9 PK	74.0	-8.1	2.36 V	160	63.9	2.0
4	5350.00	51.8 AV	54.0	-2.2	2.36 V	160	49.8	2.0
5	10620.00	56.0 PK	74.0	-18.0	2.17 V	221	40.4	15.6
6	10620.00	42.4 AV	54.0	-11.6	2.17 V	221	26.8	15.6

Remarks:

1. Emission Level(dBuV/m) = Raw Value(dBuV) + Correction Factor(dB/m).
2. Correction Factor(dB/m) = Antenna Factor(dB/m) + Cable Factor(dB) – Pre-Amplifier Factor(dB).
3. Margin value = Emission Level – Limit value.
4. The other emission levels were very low against the limit.
5. " * ": Fundamental frequency.

CHANNEL	TX Channel 102	DETECTOR FUNCTION	Peak (PK) Average (AV)
FREQUENCY RANGE	1GHz ~ 40GHz		

ANTENNA POLARITY & TEST DISTANCE: HORIZONTAL AT 3 M

NO.	FREQ. (MHz)	EMISSION LEVEL (dBuV/m)	LIMIT (dBuV/m)	MARGIN (dB)	ANTENNA HEIGHT (m)	TABLE ANGLE (Degree)	RAW VALUE (dBuV)	CORRECTION FACTOR (dB/m)
1	5460.00	61.3 PK	74.0	-12.7	1.08 H	252	58.6	2.7
2	5460.00	51.3 AV	54.0	-2.7	1.08 H	252	48.6	2.7
3	#5470.00	66.5 PK	68.2	-1.7	1.08 H	252	63.8	2.7
4	*5510.00	105.7 PK			1.08 H	252	68.8	36.9
5	*5510.00	95.7 AV			1.08 H	252	58.8	36.9
6	11020.00	57.4 PK	74.0	-16.6	3.27 H	126	40.7	16.7
7	11020.00	43.7 AV	54.0	-10.3	3.27 H	126	27.0	16.7

ANTENNA POLARITY & TEST DISTANCE: VERTICAL AT 3 M

NO.	FREQ. (MHz)	EMISSION LEVEL (dBuV/m)	LIMIT (dBuV/m)	MARGIN (dB)	ANTENNA HEIGHT (m)	TABLE ANGLE (Degree)	RAW VALUE (dBuV)	CORRECTION FACTOR (dB/m)
1	5460.00	60.5 PK	74.0	-13.5	2.33 V	154	57.8	2.7
2	5460.00	50.9 AV	54.0	-3.1	2.33 V	154	48.2	2.7
3	#5470.00	65.6 PK	68.2	-2.6	2.33 V	154	62.9	2.7
4	*5510.00	105.1 PK			2.33 V	154	68.2	36.9
5	*5510.00	95.0 AV			2.33 V	154	58.1	36.9
6	11020.00	56.9 PK	74.0	-17.1	2.18 V	225	40.2	16.7
7	11020.00	43.3 AV	54.0	-10.7	2.18 V	225	26.6	16.7

Remarks:

1. Emission Level(dBuV/m) = Raw Value(dBuV) + Correction Factor(dB/m).
2. Correction Factor(dB/m) = Antenna Factor(dB/m) + Cable Factor(dB) – Pre-Amplifier Factor(dB).
3. Margin value = Emission Level – Limit value.
4. The other emission levels were very low against the limit.
5. " * ": Fundamental frequency.
6. " # ": The radiated frequency is out of the restricted band.

CHANNEL	TX Channel 110	DETECTOR FUNCTION	Peak (PK) Average (AV)
FREQUENCY RANGE	1GHz ~ 40GHz		

ANTENNA POLARITY & TEST DISTANCE: HORIZONTAL AT 3 M

NO.	FREQ. (MHz)	EMISSION LEVEL (dBuV/m)	LIMIT (dBuV/m)	MARGIN (dB)	ANTENNA HEIGHT (m)	TABLE ANGLE (Degree)	RAW VALUE (dBuV)	CORRECTION FACTOR (dB/m)
1	*5550.00	107.8 PK			1.09 H	253	70.9	36.9
2	*5550.00	97.6 AV			1.09 H	253	60.7	36.9
3	11100.00	56.4 PK	74.0	-17.6	3.12 H	126	40.5	15.9
4	11100.00	42.8 AV	54.0	-11.2	3.12 H	126	26.9	15.9

ANTENNA POLARITY & TEST DISTANCE: VERTICAL AT 3 M

NO.	FREQ. (MHz)	EMISSION LEVEL (dBuV/m)	LIMIT (dBuV/m)	MARGIN (dB)	ANTENNA HEIGHT (m)	TABLE ANGLE (Degree)	RAW VALUE (dBuV)	CORRECTION FACTOR (dB/m)
1	*5550.00	106.8 PK			1.99 V	164	69.9	36.9
2	*5550.00	96.7 AV			1.99 V	164	59.8	36.9
3	11100.00	55.7 PK	74.0	-18.3	2.01 V	222	39.8	15.9
4	11100.00	42.2 AV	54.0	-11.8	2.01 V	222	26.3	15.9

Remarks:

1. Emission Level(dBuV/m) = Raw Value(dBuV) + Correction Factor(dB/m).
2. Correction Factor(dB/m) = Antenna Factor(dB/m) + Cable Factor(dB) – Pre-Amplifier Factor(dB).
3. Margin value = Emission Level – Limit value.
4. The other emission levels were very low against the limit.
5. " * ": Fundamental frequency.
6. " # ": The radiated frequency is out of the restricted band.

CHANNEL	TX Channel 134	DETECTOR FUNCTION	Peak (PK) Average (AV)
FREQUENCY RANGE	1GHz ~ 40GHz		

ANTENNA POLARITY & TEST DISTANCE: HORIZONTAL AT 3 M

NO.	FREQ. (MHz)	EMISSION LEVEL (dBuV/m)	LIMIT (dBuV/m)	MARGIN (dB)	ANTENNA HEIGHT (m)	TABLE ANGLE (Degree)	RAW VALUE (dBuV)	CORRECTION FACTOR (dB/m)
1	*5670.00	108.3 PK			1.00 H	247	71.3	37.0
2	*5670.00	97.9 AV			1.00 H	247	60.9	37.0
3	#5725.00	66.6 PK	68.2	-1.6	1.00 H	247	63.7	2.9
4	11340.00	56.8 PK	74.0	-17.2	3.27 H	105	40.7	16.1
5	11340.00	43.2 AV	54.0	-10.8	3.27 H	105	27.1	16.1

ANTENNA POLARITY & TEST DISTANCE: VERTICAL AT 3 M

NO.	FREQ. (MHz)	EMISSION LEVEL (dBuV/m)	LIMIT (dBuV/m)	MARGIN (dB)	ANTENNA HEIGHT (m)	TABLE ANGLE (Degree)	RAW VALUE (dBuV)	CORRECTION FACTOR (dB/m)
1	*5670.00	107.4 PK			2.37 V	155	70.4	37.0
2	*5670.00	97.1 AV			2.37 V	155	60.1	37.0
3	#5725.00	65.7 PK	68.2	-2.5	2.37 V	155	62.8	2.9
4	11340.00	56.4 PK	74.0	-17.6	1.97 V	204	40.3	16.1
5	11340.00	42.8 AV	54.0	-11.2	1.97 V	204	26.7	16.1

Remarks:

1. Emission Level(dBuV/m) = Raw Value(dBuV) + Correction Factor(dB/m).
2. Correction Factor(dB/m) = Antenna Factor(dB/m) + Cable Factor(dB) – Pre-Amplifier Factor(dB).
3. Margin value = Emission Level – Limit value.
4. The other emission levels were very low against the limit.
5. " * ": Fundamental frequency.
6. " # ": The radiated frequency is out of the restricted band.

CHANNEL	TX Channel 142	DETECTOR FUNCTION	Peak (PK) Average (AV)
FREQUENCY RANGE	1GHz ~ 40GHz		

ANTENNA POLARITY & TEST DISTANCE: HORIZONTAL AT 3 M

NO.	FREQ. (MHz)	EMISSION LEVEL (dBuV/m)	LIMIT (dBuV/m)	MARGIN (dB)	ANTENNA HEIGHT (m)	TABLE ANGLE (Degree)	RAW VALUE (dBuV)	CORRECTION FACTOR (dB/m)
1	#5470.00	42.5 PK	68.2	-25.7	1.17 H	256	39.8	2.7
2	*5710.00	108.0 PK			1.17 H	256	70.8	37.2
3	*5710.00	97.9 AV			1.17 H	256	60.7	37.2
4	#5850.00	43.4 PK	68.2	-24.8	1.17 H	256	40.1	3.3
5	11420.00	56.5 PK	74.0	-17.5	3.18 H	126	40.7	15.8
6	11420.00	43.0 AV	54.0	-11.0	3.18 H	126	27.2	15.8

ANTENNA POLARITY & TEST DISTANCE: VERTICAL AT 3 M

NO.	FREQ. (MHz)	EMISSION LEVEL (dBuV/m)	LIMIT (dBuV/m)	MARGIN (dB)	ANTENNA HEIGHT (m)	TABLE ANGLE (Degree)	RAW VALUE (dBuV)	CORRECTION FACTOR (dB/m)
1	#5470.00	42.3 PK	68.2	-25.9	2.14 V	208	39.6	2.7
2	*5710.00	107.3 PK			2.14 V	208	70.1	37.2
3	*5710.00	97.1 AV			2.14 V	208	59.9	37.2
4	#5850.00	43.0 PK	68.2	-25.2	2.14 V	208	39.7	3.3
5	11420.00	56.0 PK	74.0	-18.0	2.32 V	241	40.2	15.8
6	11420.00	42.2 AV	54.0	-11.8	2.32 V	241	26.4	15.8

Remarks:

1. Emission Level(dBuV/m) = Raw Value(dBuV) + Correction Factor(dB/m).
2. Correction Factor(dB/m) = Antenna Factor(dB/m) + Cable Factor(dB) – Pre-Amplifier Factor(dB).
3. Margin value = Emission Level – Limit value.
4. The other emission levels were very low against the limit.
5. " * ": Fundamental frequency.
6. " # ": The radiated frequency is out of the restricted band.

CHANNEL	TX Channel 151	DETECTOR FUNCTION	Peak (PK) Average (AV)
FREQUENCY RANGE	1GHz ~ 40GHz		

ANTENNA POLARITY & TEST DISTANCE: HORIZONTAL AT 3 M

NO.	FREQ. (MHz)	EMISSION LEVEL (dBuV/m)	LIMIT (dBuV/m)	MARGIN (dB)	ANTENNA HEIGHT (m)	TABLE ANGLE (Degree)	RAW VALUE (dBuV)	CORRECTION FACTOR (dB/m)
1	#5639.20	59.5 PK	68.2	-8.7	1.06 H	246	56.9	2.6
2	*5755.00	110.1 PK			1.06 H	246	72.8	37.3
3	*5755.00	99.7 AV			1.06 H	246	62.4	37.3
4	#6000.00	54.6 PK	68.2	-13.6	1.06 H	246	51.3	3.3
5	11510.00	55.8 PK	74.0	-18.2	3.26 H	114	40.5	15.3
6	11510.00	42.2 AV	54.0	-11.8	3.26 H	114	26.9	15.3

ANTENNA POLARITY & TEST DISTANCE: VERTICAL AT 3 M

NO.	FREQ. (MHz)	EMISSION LEVEL (dBuV/m)	LIMIT (dBuV/m)	MARGIN (dB)	ANTENNA HEIGHT (m)	TABLE ANGLE (Degree)	RAW VALUE (dBuV)	CORRECTION FACTOR (dB/m)
1	#5640.80	56.5 PK	68.2	-11.7	2.78 V	344	53.8	2.7
2	*5755.00	109.3 PK			2.78 V	344	72.0	37.3
3	*5755.00	98.9 AV			2.78 V	344	61.6	37.3
4	#5943.20	54.6 PK	68.2	-13.6	2.78 V	344	51.3	3.3
5	11510.00	55.2 PK	74.0	-18.8	2.04 V	213	39.9	15.3
6	11510.00	41.9 AV	54.0	-12.1	2.04 V	213	26.6	15.3

Remarks:

1. Emission Level(dBuV/m) = Raw Value(dBuV) + Correction Factor(dB/m).
2. Correction Factor(dB/m) = Antenna Factor(dB/m) + Cable Factor(dB) – Pre-Amplifier Factor(dB).
3. Margin value = Emission Level – Limit value.
4. The other emission levels were very low against the limit.
5. " * " : Fundamental frequency.
6. " # " : The radiated frequency is out of the restricted band.

CHANNEL	TX Channel 159	DETECTOR FUNCTION	Peak (PK) Average (AV)
FREQUENCY RANGE	1GHz ~ 40GHz		

ANTENNA POLARITY & TEST DISTANCE: HORIZONTAL AT 3 M

NO.	FREQ. (MHz)	EMISSION LEVEL (dBuV/m)	LIMIT (dBuV/m)	MARGIN (dB)	ANTENNA HEIGHT (m)	TABLE ANGLE (Degree)	RAW VALUE (dBuV)	CORRECTION FACTOR (dB/m)
1	#5650.40	56.8 PK	68.5	-11.7	1.12 H	251	54.1	2.7
2	*5795.00	110.2 PK			1.12 H	251	72.7	37.5
3	*5795.00	99.5 AV			1.12 H	251	62.0	37.5
4	#5937.60	57.0 PK	68.2	-11.2	1.12 H	251	53.7	3.3
5	11590.00	55.7 PK	74.0	-18.3	3.15 H	112	40.6	15.1
6	11590.00	41.9 AV	54.0	-12.1	3.15 H	112	26.8	15.1

ANTENNA POLARITY & TEST DISTANCE: VERTICAL AT 3 M

NO.	FREQ. (MHz)	EMISSION LEVEL (dBuV/m)	LIMIT (dBuV/m)	MARGIN (dB)	ANTENNA HEIGHT (m)	TABLE ANGLE (Degree)	RAW VALUE (dBuV)	CORRECTION FACTOR (dB/m)
1	#5646.40	55.3 PK	68.2	-12.9	2.75 V	342	52.6	2.7
2	*5795.00	109.3 PK			2.75 V	342	71.8	37.5
3	*5795.00	98.7 AV			2.75 V	342	61.2	37.5
4	#5927.20	56.9 PK	68.2	-11.3	2.75 V	342	53.6	3.3
5	11590.00	55.3 PK	74.0	-18.7	2.05 V	211	40.2	15.1
6	11590.00	41.7 AV	54.0	-12.3	2.05 V	211	26.6	15.1

Remarks:

1. Emission Level(dBuV/m) = Raw Value(dBuV) + Correction Factor(dB/m).
2. Correction Factor(dB/m) = Antenna Factor(dB/m) + Cable Factor(dB) – Pre-Amplifier Factor(dB).
3. Margin value = Emission Level – Limit value.
4. The other emission levels were very low against the limit.
5. " * " : Fundamental frequency.
6. " # " : The radiated frequency is out of the restricted band.

802.11ac (VHT80)

CHANNEL	TX Channel 42	DETECTOR FUNCTION	Peak (PK) Average (AV)
FREQUENCY RANGE	1GHz ~ 40GHz		

ANTENNA POLARITY & TEST DISTANCE: HORIZONTAL AT 3 M

NO.	FREQ. (MHz)	EMISSION LEVEL (dBuV/m)	LIMIT (dBuV/m)	MARGIN (dB)	ANTENNA HEIGHT (m)	TABLE ANGLE (Degree)	RAW VALUE (dBuV)	CORRECTION FACTOR (dB/m)
1	5150.00	63.6 PK	74.0	-10.4	1.09 H	250	61.5	2.1
2	5150.00	51.6 AV	54.0	-2.4	1.09 H	250	49.5	2.1
3	*5210.00	101.4 PK			1.09 H	250	65.2	36.2
4	*5210.00	90.3 AV			1.09 H	250	54.1	36.2
5	5350.00	51.4 PK	74.0	-22.6	1.09 H	250	49.4	2.0
6	5350.00	41.8 AV	54.0	-12.2	1.09 H	250	39.8	2.0
7	#10420.00	55.6 PK	68.2	-12.6	3.23 H	117	40.4	15.2

ANTENNA POLARITY & TEST DISTANCE: VERTICAL AT 3 M

NO.	FREQ. (MHz)	EMISSION LEVEL (dBuV/m)	LIMIT (dBuV/m)	MARGIN (dB)	ANTENNA HEIGHT (m)	TABLE ANGLE (Degree)	RAW VALUE (dBuV)	CORRECTION FACTOR (dB/m)
1	5150.00	62.7 PK	74.0	-11.3	2.07 V	164	60.6	2.1
2	5150.00	50.6 AV	54.0	-3.4	2.07 V	164	48.5	2.1
3	*5210.00	100.4 PK			2.07 V	164	64.2	36.2
4	*5210.00	89.4 AV			2.07 V	164	53.2	36.2
5	5350.00	51.2 PK	74.0	-22.8	2.07 V	164	49.2	2.0
6	5350.00	40.9 AV	54.0	-13.1	2.07 V	164	38.9	2.0
7	#10420.00	55.0 PK	68.2	-13.2	2.15 V	236	39.8	15.2

Remarks:

1. Emission Level(dBuV/m) = Raw Value(dBuV) + Correction Factor(dB/m).
2. Correction Factor(dB/m) = Antenna Factor(dB/m) + Cable Factor(dB) – Pre-Amplifier Factor(dB).
3. Margin value = Emission Level – Limit value.
4. The other emission levels were very low against the limit.
5. " * ": Fundamental frequency.
6. " # ": The radiated frequency is out of the restricted band.

CHANNEL	TX Channel 58	DETECTOR FUNCTION	Peak (PK) Average (AV)
FREQUENCY RANGE	1GHz ~ 40GHz		

ANTENNA POLARITY & TEST DISTANCE: HORIZONTAL AT 3 M

NO.	FREQ. (MHz)	EMISSION LEVEL (dBuV/m)	LIMIT (dBuV/m)	MARGIN (dB)	ANTENNA HEIGHT (m)	TABLE ANGLE (Degree)	RAW VALUE (dBuV)	CORRECTION FACTOR (dB/m)
1	*5290.00	99.3 PK			1.27 H	215	63.2	36.1
2	*5290.00	89.5 AV			1.27 H	215	53.4	36.1
3	5350.00	63.7 PK	74.0	-10.3	1.27 H	215	61.7	2.0
4	5350.00	53.2 AV	54.0	-0.8	1.27 H	215	51.2	2.0
5	#10580.00	55.9 PK	68.2	-12.3	3.27 H	114	40.4	15.5

ANTENNA POLARITY & TEST DISTANCE: VERTICAL AT 3 M

NO.	FREQ. (MHz)	EMISSION LEVEL (dBuV/m)	LIMIT (dBuV/m)	MARGIN (dB)	ANTENNA HEIGHT (m)	TABLE ANGLE (Degree)	RAW VALUE (dBuV)	CORRECTION FACTOR (dB/m)
1	*5290.00	98.6 PK			2.11 V	162	62.5	36.1
2	*5290.00	88.4 AV			2.11 V	162	52.3	36.1
3	5350.00	62.9 PK	74.0	-11.1	2.11 V	162	60.9	2.0
4	5350.00	52.1 AV	54.0	-1.9	2.11 V	162	50.1	2.0
5	#10580.00	55.2 PK	68.2	-13.0	2.08 V	223	39.7	15.5

Remarks:

1. Emission Level(dBuV/m) = Raw Value(dBuV) + Correction Factor(dB/m).
2. Correction Factor(dB/m) = Antenna Factor(dB/m) + Cable Factor(dB) – Pre-Amplifier Factor(dB).
3. Margin value = Emission Level – Limit value.
4. The other emission levels were very low against the limit.
5. " * " : Fundamental frequency.
6. " # " : The radiated frequency is out of the restricted band.

CHANNEL	TX Channel 106	DETECTOR FUNCTION	Peak (PK) Average (AV)
FREQUENCY RANGE	1GHz ~ 40GHz		

ANTENNA POLARITY & TEST DISTANCE: HORIZONTAL AT 3 M

NO.	FREQ. (MHz)	EMISSION LEVEL (dBuV/m)	LIMIT (dBuV/m)	MARGIN (dB)	ANTENNA HEIGHT (m)	TABLE ANGLE (Degree)	RAW VALUE (dBuV)	CORRECTION FACTOR (dB/m)
1	5460.00	66.1 PK	74.0	-7.9	1.06 H	247	63.4	2.7
2	5460.00	51.8 AV	54.0	-2.2	1.06 H	247	49.1	2.7
3	#5470.00	66.8 PK	68.2	-1.4	1.06 H	247	64.1	2.7
4	*5530.00	102.5 PK			1.06 H	247	65.6	36.9
5	*5530.00	91.6 AV			1.06 H	247	54.7	36.9
6	#5725.00	52.2 PK	68.2	-16.0	1.06 H	247	49.3	2.9
7	11060.00	56.9 PK	74.0	-17.1	3.18 H	125	40.5	16.4
8	11060.00	43.2 AV	54.0	-10.8	3.18 H	125	26.8	16.4

ANTENNA POLARITY & TEST DISTANCE: VERTICAL AT 3 M

NO.	FREQ. (MHz)	EMISSION LEVEL (dBuV/m)	LIMIT (dBuV/m)	MARGIN (dB)	ANTENNA HEIGHT (m)	TABLE ANGLE (Degree)	RAW VALUE (dBuV)	CORRECTION FACTOR (dB/m)
1	5460.00	65.2 PK	74.0	-8.8	2.03 V	158	62.5	2.7
2	5460.00	50.9 AV	54.0	-3.1	2.03 V	158	48.2	2.7
3	#5470.00	66.4 PK	68.2	-1.8	2.03 V	158	63.7	2.7
4	*5530.00	101.5 PK			2.03 V	158	64.6	36.9
5	*5530.00	90.5 AV			2.03 V	158	53.6	36.9
6	#5725.00	52.1 PK	68.2	-16.1	1.06 V	245	49.2	2.9
7	11060.00	56.5 PK	74.0	-17.5	2.02 V	224	40.1	16.4
8	11060.00	42.7 AV	54.0	-11.3	2.02 V	224	26.3	16.4

Remarks:

1. Emission Level(dBuV/m) = Raw Value(dBuV) + Correction Factor(dB/m).
2. Correction Factor(dB/m) = Antenna Factor(dB/m) + Cable Factor(dB) – Pre-Amplifier Factor(dB).
3. Margin value = Emission Level – Limit value.
4. The other emission levels were very low against the limit.
5. " * ": Fundamental frequency.
6. " # ": The radiated frequency is out of the restricted band.

CHANNEL	TX Channel 122	DETECTOR FUNCTION	Peak (PK) Average (AV)
FREQUENCY RANGE	1GHz ~ 40GHz		

ANTENNA POLARITY & TEST DISTANCE: HORIZONTAL AT 3 M

NO.	FREQ. (MHz)	EMISSION LEVEL (dBuV/m)	LIMIT (dBuV/m)	MARGIN (dB)	ANTENNA HEIGHT (m)	TABLE ANGLE (Degree)	RAW VALUE (dBuV)	CORRECTION FACTOR (dB/m)
1	5460.00	54.8 PK	74.0	-19.2	1.00 H	254	52.1	2.7
2	5460.00	41.4 AV	54.0	-12.6	1.00 H	254	38.7	2.7
3	#5470.00	56.1 PK	68.2	-12.1	1.00 H	254	53.4	2.7
4	*5610.00	105.2 PK			1.00 H	254	68.3	36.9
5	*5610.00	94.2 AV			1.00 H	254	57.3	36.9
6	#5725.00	63.3 PK	68.2	-4.9	1.00 H	254	60.4	2.9
7	11220.00	55.9 PK	74.0	-18.1	3.01 H	102	40.4	15.5
8	11220.00	42.2 AV	54.0	-11.8	3.01 H	102	26.7	15.5

ANTENNA POLARITY & TEST DISTANCE: VERTICAL AT 3 M

NO.	FREQ. (MHz)	EMISSION LEVEL (dBuV/m)	LIMIT (dBuV/m)	MARGIN (dB)	ANTENNA HEIGHT (m)	TABLE ANGLE (Degree)	RAW VALUE (dBuV)	CORRECTION FACTOR (dB/m)
1	5460.00	54.4 PK	74.0	-19.6	2.14 V	166	51.7	2.7
2	5460.00	41.1 AV	54.0	-12.9	2.14 V	166	38.4	2.7
3	#5470.00	55.3 PK	68.2	-12.9	2.14 V	166	52.6	2.7
4	*5610.00	104.1 PK			2.14 V	166	67.2	36.9
5	*5610.00	93.3 AV			2.14 V	166	56.4	36.9
6	#5725.00	62.6 PK	68.2	-5.6	2.14 V	166	59.7	2.9
7	11220.00	55.2 PK	74.0	-18.8	2.18 V	221	39.7	15.5
8	11220.00	41.9 AV	54.0	-12.1	2.18 V	221	26.4	15.5

Remarks:

1. Emission Level(dBuV/m) = Raw Value(dBuV) + Correction Factor(dB/m).
2. Correction Factor(dB/m) = Antenna Factor(dB/m) + Cable Factor(dB) – Pre-Amplifier Factor(dB).
3. Margin value = Emission Level – Limit value.
4. The other emission levels were very low against the limit.
5. " * ": Fundamental frequency.
6. " # ": The radiated frequency is out of the restricted band.

CHANNEL	TX Channel 138	DETECTOR FUNCTION	Peak (PK) Average (AV)
FREQUENCY RANGE	1GHz ~ 40GHz		

ANTENNA POLARITY & TEST DISTANCE: HORIZONTAL AT 3 M

NO.	FREQ. (MHz)	EMISSION LEVEL (dBuV/m)	LIMIT (dBuV/m)	MARGIN (dB)	ANTENNA HEIGHT (m)	TABLE ANGLE (Degree)	RAW VALUE (dBuV)	CORRECTION FACTOR (dB/m)
1	#5470.00	51.6 PK	68.2	-16.6	1.15 H	255	48.9	2.7
2	*5690.00	105.4 PK			1.15 H	255	68.2	37.2
3	*5690.00	94.6 AV			1.15 H	255	57.4	37.2
4	#5850.00	55.3 PK	68.2	-12.9	1.15 H	255	52.0	3.3
5	11380.00	56.6 PK	74.0	-17.4	3.24 H	117	40.5	16.1
6	11380.00	43.1 AV	54.0	-10.9	3.24 H	117	27.0	16.1

ANTENNA POLARITY & TEST DISTANCE: VERTICAL AT 3 M

NO.	FREQ. (MHz)	EMISSION LEVEL (dBuV/m)	LIMIT (dBuV/m)	MARGIN (dB)	ANTENNA HEIGHT (m)	TABLE ANGLE (Degree)	RAW VALUE (dBuV)	CORRECTION FACTOR (dB/m)
1	#5470.00	50.8 PK	68.2	-17.4	1.97 V	155	48.1	2.7
2	*5690.00	104.5 PK			1.97 V	155	67.3	37.2
3	*5690.00	93.7 AV			1.97 V	155	56.5	37.2
4	#5850.00	54.5 PK	68.2	-13.7	1.97 V	155	51.2	3.3
5	11380.00	55.9 PK	74.0	-18.1	2.11 V	220	39.8	16.1
6	11380.00	42.5 AV	54.0	-11.5	2.11 V	220	26.4	16.1

Remarks:

1. Emission Level(dBuV/m) = Raw Value(dBuV) + Correction Factor(dB/m).
2. Correction Factor(dB/m) = Antenna Factor(dB/m) + Cable Factor(dB) – Pre-Amplifier Factor(dB).
3. Margin value = Emission Level – Limit value.
4. The other emission levels were very low against the limit.
5. " * ": Fundamental frequency.
6. " # ": The radiated frequency is out of the restricted band.

CHANNEL	TX Channel 155	DETECTOR FUNCTION	Peak (PK) Average (AV)
FREQUENCY RANGE	1GHz ~ 40GHz		

ANTENNA POLARITY & TEST DISTANCE: HORIZONTAL AT 3 M

NO.	FREQ. (MHz)	EMISSION LEVEL (dBuV/m)	LIMIT (dBuV/m)	MARGIN (dB)	ANTENNA HEIGHT (m)	TABLE ANGLE (Degree)	RAW VALUE (dBuV)	CORRECTION FACTOR (dB/m)
1	#5648.00	64.6 PK	68.2	-3.6	1.15 H	249	61.9	2.7
2	*5775.00	105.7 PK			1.15 H	249	68.2	37.5
3	*5775.00	94.7 AV			1.15 H	249	57.2	37.5
4	#5931.20	60.2 PK	68.2	-8.0	1.15 H	249	56.9	3.3
5	11550.00	55.7 PK	74.0	-18.3	3.03 H	128	40.4	15.3
6	11550.00	41.9 AV	54.0	-12.1	3.03 H	128	26.6	15.3

ANTENNA POLARITY & TEST DISTANCE: VERTICAL AT 3 M

NO.	FREQ. (MHz)	EMISSION LEVEL (dBuV/m)	LIMIT (dBuV/m)	MARGIN (dB)	ANTENNA HEIGHT (m)	TABLE ANGLE (Degree)	RAW VALUE (dBuV)	CORRECTION FACTOR (dB/m)
1	#5644.00	62.2 PK	68.2	-6.0	2.70 V	345	59.5	2.7
2	*5775.00	104.9 PK			2.70 V	345	67.4	37.5
3	*5775.00	94.0 AV			2.70 V	345	56.5	37.5
4	#5928.80	61.1 PK	68.2	-7.1	2.70 V	345	57.8	3.3
5	11550.00	55.0 PK	74.0	-19.0	2.06 V	233	39.7	15.3
6	11550.00	41.7 AV	54.0	-12.3	2.06 V	233	26.4	15.3

Remarks:

1. Emission Level(dBuV/m) = Raw Value(dBuV) + Correction Factor(dB/m).
2. Correction Factor(dB/m) = Antenna Factor(dB/m) + Cable Factor(dB) – Pre-Amplifier Factor(dB).
3. Margin value = Emission Level – Limit value.
4. The other emission levels were very low against the limit.
5. " * " : Fundamental frequency.
6. " # " : The radiated frequency is out of the restricted band.

Below 1GHz Worst-Case Data:

802.11a

CHANNEL	TX Channel 157	DETECTOR FUNCTION	Quasi-Peak (QP)
FREQUENCY RANGE	9kHz ~ 1GHz	TEST MODE	A

Antenna Polarity & Test Distance : Horizontal at 3 m								
No	Frequency (MHz)	Emission Level (dBuV/m)	Limit (dBuV/m)	Margin (dB)	Antenna Height (m)	Table Angle (Degree)	Raw Value (dBuV)	Correction Factor (dB/m)
1	50.37	22.5 QP	40.0	-17.5	1.25 H	210	31.7	-9.2
2	102.75	22.5 QP	43.5	-21.0	1.00 H	15	35.4	-12.9
3	175.50	27.4 QP	43.5	-16.1	1.25 H	256	36.9	-9.5
4	253.10	21.6 QP	46.0	-24.4	1.50 H	87	30.5	-8.9
5	543.13	23.9 QP	46.0	-22.1	1.00 H	41	26.2	-2.3
6	759.44	26.3 QP	46.0	-19.7	1.25 H	319	24.0	2.3

Remarks:

1. Emission Level(dBuV/m) = Raw Value(dBuV) + Correction Factor(dB/m).
2. Correction Factor(dB/m) = Antenna Factor(dB/m) + Cable Factor(dB) – Pre-Amplifier Factor(dB).
3. The other emission levels were very low against the limit of frequency range 30MHz ~ 1000MHz.
4. Margin value = Emission Level – Limit value.
5. The emission levels were very low against the limit of frequency range 9kHz ~ 30MHz: the amplitude of spurious emissions attenuated more than 20 dB below the permissible value to be report.

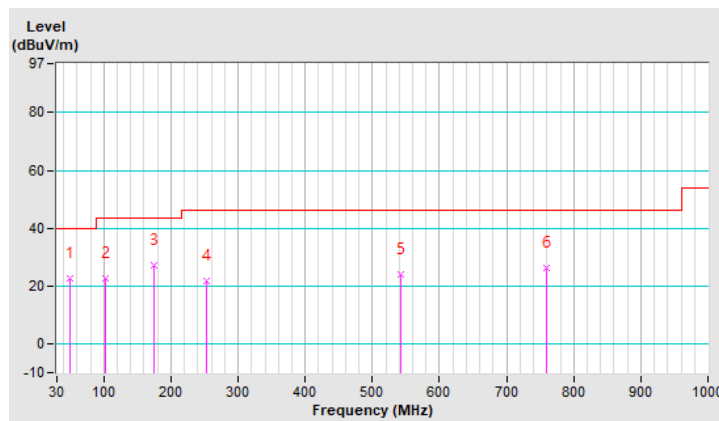

CHANNEL	TX Channel 157	DETECTOR FUNCTION	Quasi-Peak (QP)
FREQUENCY RANGE	9kHz ~ 1GHz	TEST MODE	A

Antenna Polarity & Test Distance : Vertical at 3m								
No	Frequency (MHz)	Emission Level (dBuV/m)	Limit (dBuV/m)	Margin (dB)	Antenna Height (m)	Table Angle (Degree)	Raw Value (dBuV)	Correction Factor (dB/m)
1	63.95	33.8 QP	40.0	-6.2	1.25 V	135	43.7	-9.9
2	112.45	34.9 QP	43.5	-8.6	1.00 V	135	46.6	-11.7
3	182.29	24.9 QP	43.5	-18.6	1.50 V	292	35.2	-10.3
4	609.09	23.4 QP	46.0	-22.6	1.25 V	124	23.9	-0.5
5	847.71	28.9 QP	46.0	-17.1	1.00 V	163	25.4	3.5
6	964.11	28.2 QP	54.0	-25.8	1.25 V	127	22.5	5.7

Remarks:

1. Emission Level(dBuV/m) = Raw Value(dBuV) + Correction Factor(dB/m).
2. Correction Factor(dB/m) = Antenna Factor(dB/m) + Cable Factor(dB) – Pre-Amplifier Factor(dB).
3. The other emission levels were very low against the limit of frequency range 30MHz ~ 1000MHz.
4. Margin value = Emission Level – Limit value.
5. The emission levels were very low against the limit of frequency range 9kHz ~ 30MHz: the amplitude of spurious emissions attenuated more than 20 dB below the permissible value to be report.

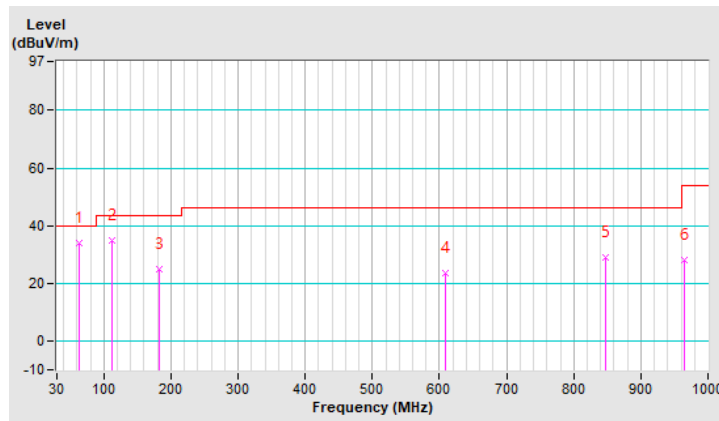

CHANNEL	TX Channel 157	DETECTOR FUNCTION	Quasi-Peak (QP)
FREQUENCY RANGE	9kHz ~ 1GHz	TEST MODE	B

Antenna Polarity & Test Distance : Horizontal at 3 m								
No	Frequency (MHz)	Emission Level (dBuV/m)	Limit (dBuV/m)	Margin (dB)	Antenna Height (m)	Table Angle (Degree)	Raw Value (dBuV)	Correction Factor (dB/m)
1	35.82	30.3 QP	40.0	-9.7	1.00 H	64	40.7	-10.4
2	59.10	26.3 QP	40.0	-13.7	1.50 H	25	35.6	-9.3
3	165.80	25.4 QP	43.5	-18.1	1.25 H	46	34.1	-8.7
4	197.81	23.7 QP	43.5	-19.8	1.00 H	233	35.3	-11.6
5	299.66	27.9 QP	46.0	-18.1	1.00 H	186	35.0	-7.1
6	909.79	38.3 QP	46.0	-7.7	1.25 H	19	33.4	4.9

Remarks:

1. Emission Level(dBuV/m) = Raw Value(dBuV) + Correction Factor(dB/m).
2. Correction Factor(dB/m) = Antenna Factor(dB/m) + Cable Factor(dB) – Pre-Amplifier Factor(dB).
3. The other emission levels were very low against the limit of frequency range 30MHz ~ 1000MHz.
4. Margin value = Emission Level – Limit value.
5. The emission levels were very low against the limit of frequency range 9kHz ~ 30MHz: the amplitude of spurious emissions attenuated more than 20 dB below the permissible value to be report.

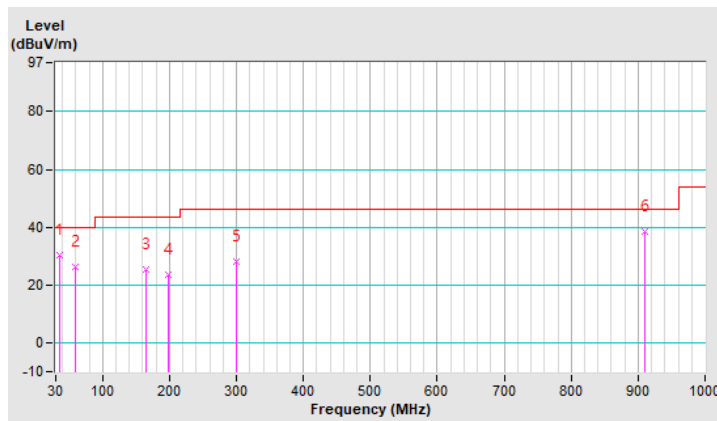

CHANNEL	TX Channel 157	DETECTOR FUNCTION	Quasi-Peak (QP)
FREQUENCY RANGE	9kHz ~ 1GHz	TEST MODE	B

Antenna Polarity & Test Distance : Vertical at 3m								
No	Frequency (MHz)	Emission Level (dBuV/m)	Limit (dBuV/m)	Margin (dB)	Antenna Height (m)	Table Angle (Degree)	Raw Value (dBuV)	Correction Factor (dB/m)
1	31.94	38.6 QP	40.0	-1.4	1.50 V	176	49.3	-10.7
2	80.44	24.9 QP	40.0	-15.1	1.00 V	219	38.4	-13.5
3	120.21	30.9 QP	43.5	-12.6	1.25 V	342	42.0	-11.1
4	274.44	27.0 QP	46.0	-19.0	1.50 V	126	34.7	-7.7
5	492.69	26.6 QP	46.0	-19.4	1.00 V	29	29.7	-3.1
6	909.79	37.7 QP	46.0	-8.3	1.25 V	83	32.8	4.9

Remarks:

1. Emission Level(dBuV/m) = Raw Value(dBuV) + Correction Factor(dB/m).
2. Correction Factor(dB/m) = Antenna Factor(dB/m) + Cable Factor(dB) – Pre-Amplifier Factor(dB).
3. The other emission levels were very low against the limit of frequency range 30MHz ~ 1000MHz.
4. Margin value = Emission Level – Limit value.
5. The emission levels were very low against the limit of frequency range 9kHz ~ 30MHz: the amplitude of spurious emissions attenuated more than 20 dB below the permissible value to be report.

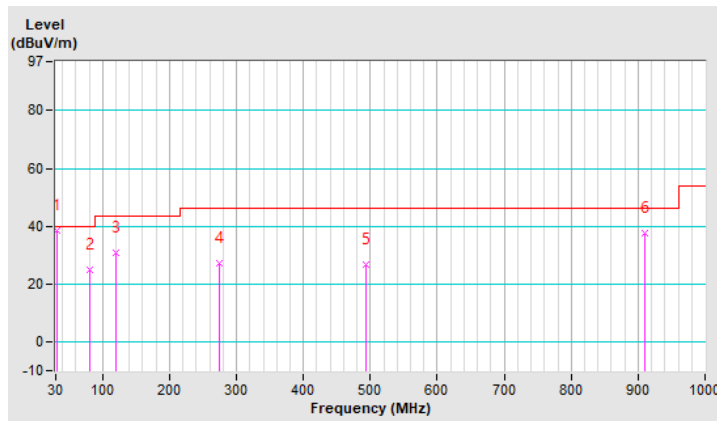

CHANNEL	TX Channel 157	DETECTOR FUNCTION	Quasi-Peak (QP)
FREQUENCY RANGE	9kHz ~ 1GHz	TEST MODE	C

Antenna Polarity & Test Distance : Horizontal at 3 m								
No	Frequency (MHz)	Emission Level (dBuV/m)	Limit (dBuV/m)	Margin (dB)	Antenna Height (m)	Table Angle (Degree)	Raw Value (dBuV)	Correction Factor (dB/m)
1	49.40	20.6 QP	40.0	-19.4	1.26 H	11	29.8	-9.2
2	69.77	18.6 QP	40.0	-21.4	1.51 H	186	29.5	-10.9
3	131.85	16.9 QP	43.5	-26.6	2.00 H	112	26.9	-10.0
4	165.80	19.1 QP	43.5	-24.4	1.51 H	16	27.8	-8.7
5	637.22	29.8 QP	46.0	-16.2	2.00 H	305	29.9	-0.1
6	879.72	39.2 QP	46.0	-6.8	2.00 H	141	35.1	4.1

Remarks:

1. Emission Level(dBuV/m) = Raw Value(dBuV) + Correction Factor(dB/m).
2. Correction Factor(dB/m) = Antenna Factor(dB/m) + Cable Factor(dB) – Pre-Amplifier Factor(dB).
3. The other emission levels were very low against the limit of frequency range 30MHz ~ 1000MHz.
4. Margin value = Emission Level – Limit value.
5. The emission levels were very low against the limit of frequency range 9kHz ~ 30MHz: the amplitude of spurious emissions attenuated more than 20 dB below the permissible value to be report.

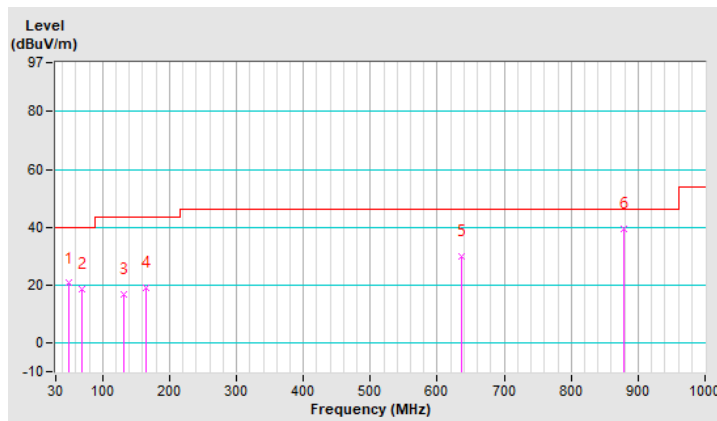

CHANNEL	TX Channel 157	DETECTOR FUNCTION	Quasi-Peak (QP)
FREQUENCY RANGE	9kHz ~ 1GHz	TEST MODE	C

Antenna Polarity & Test Distance : Vertical at 3m								
No	Frequency (MHz)	Emission Level (dBuV/m)	Limit (dBuV/m)	Margin (dB)	Antenna Height (m)	Table Angle (Degree)	Raw Value (dBuV)	Correction Factor (dB/m)
1	30.97	24.8 QP	40.0	-15.2	2.00 V	185	35.8	-11.0
2	57.16	29.8 QP	40.0	-10.2	1.24 V	45	39.3	-9.5
3	141.55	20.5 QP	43.5	-23.0	2.00 V	218	29.5	-9.0
4	165.80	19.0 QP	43.5	-24.5	2.00 V	48	27.7	-8.7
5	612.97	29.1 QP	46.0	-16.9	1.00 V	173	29.6	-0.5
6	835.10	38.7 QP	46.0	-7.3	1.50 V	74	35.4	3.3

Remarks:

1. Emission Level(dBuV/m) = Raw Value(dBuV) + Correction Factor(dB/m).
2. Correction Factor(dB/m) = Antenna Factor(dB/m) + Cable Factor(dB) – Pre-Amplifier Factor(dB).
3. The other emission levels were very low against the limit of frequency range 30MHz ~ 1000MHz.
4. Margin value = Emission Level – Limit value.
5. The emission levels were very low against the limit of frequency range 9kHz ~ 30MHz: the amplitude of spurious emissions attenuated more than 20 dB below the permissible value to be report.

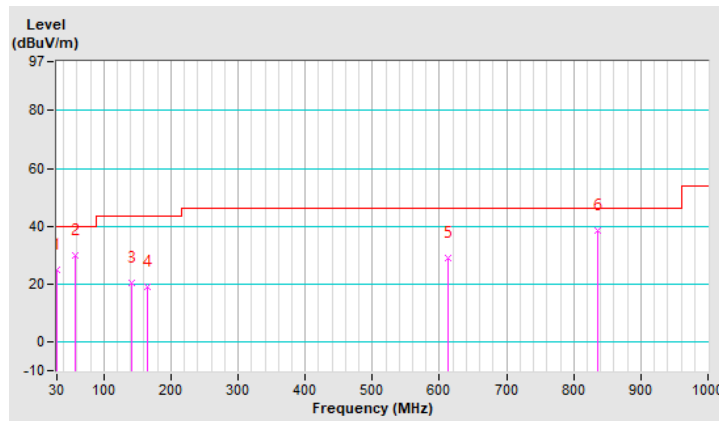

4.2 Conducted Emission Measurement

4.2.1 Limits of Conducted Emission Measurement

Frequency (MHz)	Conducted Limit (dBuV)	
	Quasi-peak	Average
0.15 - 0.5	66 - 56	56 - 46
0.50 - 5.0	56	46
5.0 - 30.0	60	50

Note: 1. The lower limit shall apply at the transition frequencies.

2. The limit decreases in line with the logarithm of the frequency in the range of 0.15 to 0.50MHz.

4.2.2 Test Instruments

Tested date: Sep. 05 ~ Oct. 21, 2020

Description & Manufacturer	Model No.	Serial No.	Cal. Date	Cal. Due
Test Receiver ROHDE & SCHWARZ	ESCI	100613	Dec. 11, 2019	Dec. 10, 2020
RF signal cable Woken	5D-FB	Cable-cond1-01	Sep. 04, 2020	Sep. 03, 2021
LISN ROHDE & SCHWARZ (EUT)	ENV216	101826	Feb. 20, 2020	Feb. 19, 2021
V-LISN ROHDE & SCHWARZ (Peripheral)	NNBL 8226-2	8226-142	Jul. 31, 2020	Jul. 30, 2021
Software ADT	BV ADT_Cond_ V7.3.7.4	NA	NA	NA

Note: 1. The calibration interval of the above test instruments is 12 months and the calibrations are traceable to NML/ROC and NIST/USA.

2. The test was performed in HwaYa Shielded Room 1 (Conduction 1).

3. The VCCI Site Registration No. is C-12040.

4.2.3 Test Procedures

- The EUT was placed 0.4 meters from the conducting wall of the shielded room with EUT being connected to the power mains through a line impedance stabilization network (LISN). Other support units were connected to the power mains through another LISN. The two LISNs provide 50 ohm/ 50uH of coupling impedance for the measuring instrument.
- Both lines of the power mains connected to the EUT were checked for maximum conducted interference.
- The frequency range from 150kHz to 30MHz was searched. Emission levels under (Limit - 20dB) was not recorded.

Note: The resolution bandwidth and video bandwidth of test receiver is 9kHz for quasi-peak detection (QP) and average detection (AV) at frequency 0.15MHz-30MHz.

4.2.4 Deviation from Test Standard

No deviation.

4.2.5 Test Setup

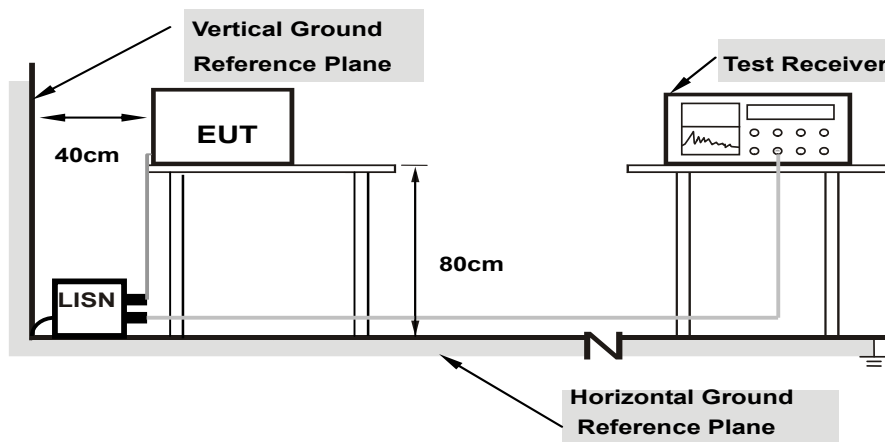

Note: 1.Support units were connected to second LISN.

For the actual test configuration, please refer to the attached file (Test Setup Photo).

4.2.6 EUT Operating Conditions

Same as 4.1.6.

4.2.7 Test Results

Worst-case data:

802.11a

Phase	Line (L)	Detector Function	Quasi-Peak (QP) / Average (AV)
Test Mode	A		

No	Freq. [MHz]	Corr. Factor (dB)	Reading Value [dB (uV)]		Emission Level [dB (uV)]		Limit [dB (uV)]		Margin (dB)	
			Q.P.	AV.	Q.P.	AV.	Q.P.	AV.	Q.P.	AV.
			1	0.15000	9.65	16.53	10.15	26.18	19.80	66.00
2	0.16600	9.65	17.94	10.70	27.59	20.35	65.16	55.16	-37.57	-34.81
3	0.19800	9.66	15.85	3.29	25.51	12.95	63.69	53.69	-38.18	-40.74
4	0.65000	9.66	9.07	2.08	18.73	11.74	56.00	46.00	-37.27	-34.26
5	0.75400	9.67	8.67	2.88	18.34	12.55	56.00	46.00	-37.66	-33.45
6	4.57400	9.74	17.67	2.36	27.41	12.10	56.00	46.00	-28.59	-33.90

Remarks:

1. Q.P. and AV. are abbreviations of quasi-peak and average individually.
2. The emission levels of other frequencies were very low against the limit.
3. Margin value = Emission level - Limit value
4. Correction factor = Insertion loss + Cable loss
5. Emission Level = Correction Factor + Reading Value.

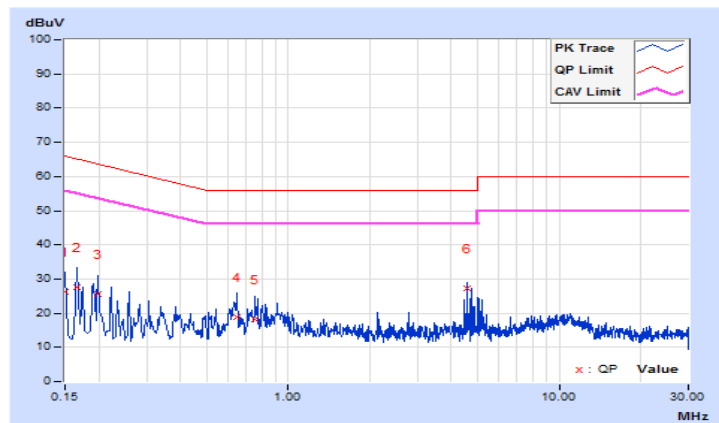

Phase	Neutral (N)	Detector Function	Quasi-Peak (QP) / Average (AV)
Test Mode	A		

No	Freq. [MHz]	Corr. Factor (dB)	Reading Value [dB (uV)]		Emission Level [dB (uV)]		Limit [dB (uV)]		Margin (dB)	
			Q.P.	AV.	Q.P.	AV.	Q.P.	AV.	Q.P.	AV.
			1	0.16600	9.68	18.49	3.13	28.17	12.81	65.16
2	0.19000	9.68	17.13	2.64	26.81	12.32	64.04	54.04	-37.23	-41.72
3	0.26200	9.68	9.48	1.64	19.16	11.32	61.37	51.37	-42.21	-40.05
4	0.37800	9.68	10.05	3.87	19.73	13.55	58.32	48.32	-38.59	-34.77
5	0.75000	9.69	8.83	2.30	18.52	11.99	56.00	46.00	-37.48	-34.01
6	4.57400	9.78	17.97	2.33	27.75	12.11	56.00	46.00	-28.25	-33.89

Remarks:

1. Q.P. and AV. are abbreviations of quasi-peak and average individually.
2. The emission levels of other frequencies were very low against the limit.
3. Margin value = Emission level - Limit value
4. Correction factor = Insertion loss + Cable loss
5. Emission Level = Correction Factor + Reading Value.

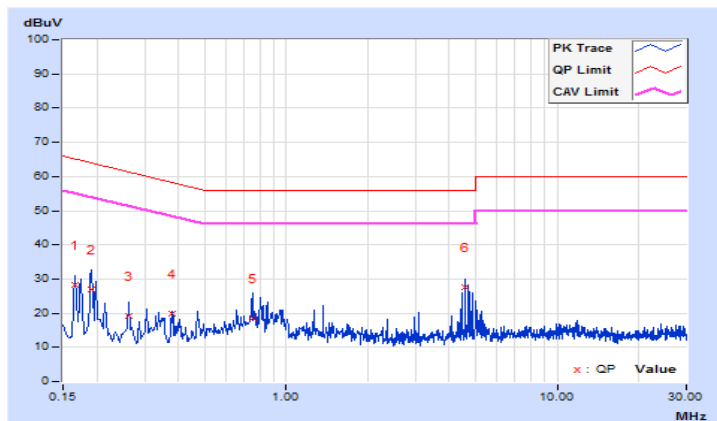

Phase	Line (L)	Detector Function	Quasi-Peak (QP) / Average (AV)
Test Mode	B		

No	Freq. [MHz]	Corr. Factor (dB)	Reading Value [dB (uV)]		Emission Level [dB (uV)]		Limit [dB (uV)]		Margin (dB)	
			Q.P.	AV.	Q.P.	AV.	Q.P.	AV.	Q.P.	AV.
			1	0.16600	9.83	28.78	15.32	38.61	25.15	65.16
2	0.19800	9.85	27.24	16.42	37.09	26.27	63.69	53.69	-26.60	-27.42
3	0.21400	9.85	24.89	15.15	34.74	25.00	63.05	53.05	-28.31	-28.05
4	0.63400	9.89	25.52	17.26	35.41	27.15	56.00	46.00	-20.59	-18.85
5	1.12600	9.91	17.27	8.79	27.18	18.70	56.00	46.00	-28.82	-27.30
6	2.21000	9.95	15.65	8.47	25.60	18.42	56.00	46.00	-30.40	-27.58

Remarks:

1. Q.P. and AV. are abbreviations of quasi-peak and average individually.
2. The emission levels of other frequencies were very low against the limit.
3. Margin value = Emission level - Limit value
4. Correction factor = Insertion loss + Cable loss
5. Emission Level = Correction Factor + Reading Value.

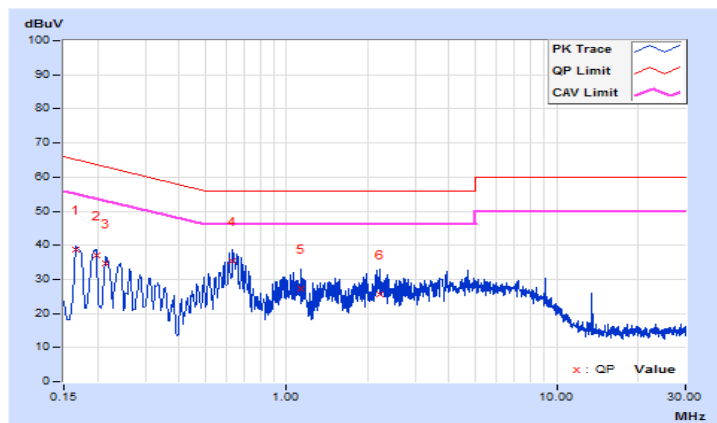

Phase	Neutral (N)	Detector Function	Quasi-Peak (QP) / Average (AV)
Test Mode	B		

No	Freq. [MHz]	Corr. Factor (dB)	Reading Value [dB (uV)]		Emission Level [dB (uV)]		Limit [dB (uV)]		Margin (dB)	
			Q.P.	AV.	Q.P.	AV.	Q.P.	AV.	Q.P.	AV.
			1	0.15400	9.84	28.83	13.60	38.67	23.44	65.78
2	0.17801	9.85	27.67	12.98	37.52	22.83	64.58	54.58	-27.06	-31.75
3	0.20095	9.85	26.68	12.08	36.53	21.93	63.57	53.57	-27.04	-31.64
4	0.22985	9.86	25.89	16.19	35.75	26.05	62.46	52.46	-26.71	-26.41
5	0.62600	9.92	19.05	8.63	28.97	18.55	56.00	46.00	-27.03	-27.45
6	4.57400	10.05	17.64	4.99	27.69	15.04	56.00	46.00	-28.31	-30.96

Remarks:

1. Q.P. and AV. are abbreviations of quasi-peak and average individually.
2. The emission levels of other frequencies were very low against the limit.
3. Margin value = Emission level - Limit value
4. Correction factor = Insertion loss + Cable loss
5. Emission Level = Correction Factor + Reading Value.

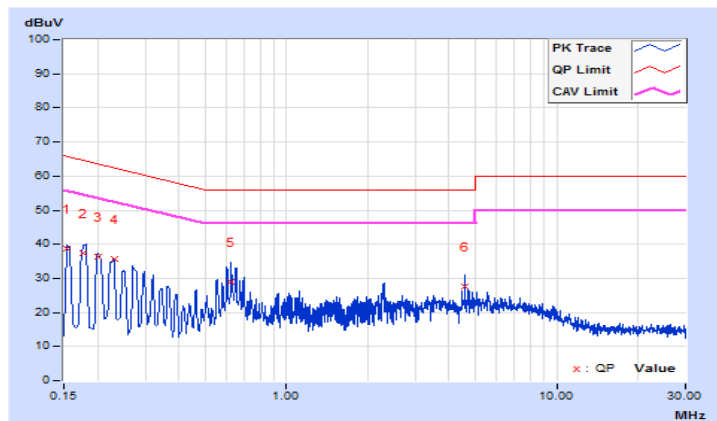

Phase	Line (L)	Detector Function	Quasi-Peak (QP) / Average (AV)
Test Mode	C		

No	Freq. [MHz]	Corr. Factor (dB)	Reading Value [dB (uV)]		Emission Level [dB (uV)]		Limit [dB (uV)]		Margin (dB)	
			Q.P.	AV.	Q.P.	AV.	Q.P.	AV.	Q.P.	AV.
			1	0.15400	9.65	31.86	8.75	41.51	18.40	65.78
2	0.17800	9.66	27.18	5.57	36.84	15.23	64.58	54.58	-27.74	-39.35
3	0.20200	9.66	22.74	2.88	32.40	12.54	63.53	53.53	-31.13	-40.99
4	0.39400	9.66	24.87	13.69	34.53	23.35	57.98	47.98	-23.45	-24.63
5	0.72200	9.67	11.15	3.14	20.82	12.81	56.00	46.00	-35.18	-33.19
6	21.84200	9.85	20.77	20.35	30.62	30.20	60.00	50.00	-29.38	-19.80

Remarks:

1. Q.P. and AV. are abbreviations of quasi-peak and average individually.
2. The emission levels of other frequencies were very low against the limit.
3. Margin value = Emission level - Limit value
4. Correction factor = Insertion loss + Cable loss
5. Emission Level = Correction Factor + Reading Value.

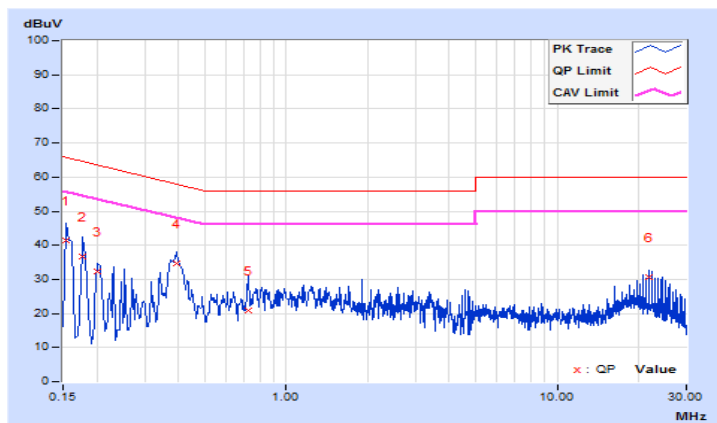

Phase	Neutral (N)	Detector Function	Quasi-Peak (QP) / Average (AV)
Test Mode	C		

No	Freq. [MHz]	Corr. Factor (dB)	Reading Value [dB (uV)]		Emission Level [dB (uV)]		Limit [dB (uV)]		Margin (dB)	
			Q.P.	AV.	Q.P.	AV.	Q.P.	AV.	Q.P.	AV.
			1	0.15800	9.68	30.86	10.07	40.54	19.75	65.57
2	0.18200	9.68	26.81	8.19	36.49	17.87	64.39	54.39	-27.90	-36.52
3	0.20600	9.68	22.74	5.30	32.42	14.98	63.37	53.37	-30.95	-38.39
4	0.39758	9.68	25.74	15.14	35.42	24.82	57.90	47.90	-22.48	-23.08
5	1.02600	9.69	17.15	6.77	26.84	16.46	56.00	46.00	-29.16	-29.54
6	21.29800	9.98	20.92	20.17	30.90	30.15	60.00	50.00	-29.10	-19.85

Remarks:

1. Q.P. and AV. are abbreviations of quasi-peak and average individually.
2. The emission levels of other frequencies were very low against the limit.
3. Margin value = Emission level - Limit value
4. Correction factor = Insertion loss + Cable loss
5. Emission Level = Correction Factor + Reading Value.

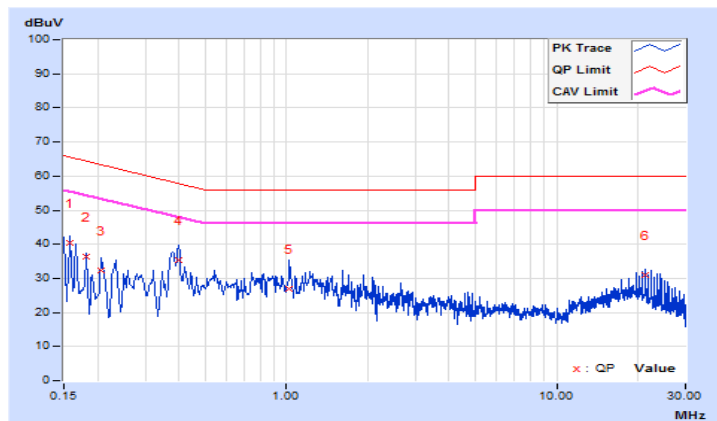

4.3 Transmit Power Measurement

4.3.1 Limits of Transmit Power Measurement

Operation Band	EUT Category		Limit
U-NII-1		Outdoor Access Point	1 Watt (30 dBm) (Max. e.i.r.p \leq 125mW(21 dBm) at any elevation angle above 30 degrees as measured from the horizon)
		Fixed point-to-point Access Point	1 Watt (30 dBm)
		Indoor Access Point	1 Watt (30 dBm)
	√	Mobile and Portable client device	250mW (24 dBm)
U-NII-2A	√		250mW (24 dBm) or 11 dBm+10 log B*
U-NII-2C	√		250mW (24 dBm) or 11 dBm+10 log B*
U-NII-3	√		1 Watt (30 dBm)

*B is the 26 dB emission bandwidth in megahertz

Per KDB 662911 Method of conducted output power measurement on IEEE 802.11 devices,

Array Gain = 0 dB (i.e., no array gain) for $N_{ANT} \leq 4$;

Array Gain = 0 dB (i.e., no array gain) for channel widths ≥ 40 MHz for any N_{ANT} ;

Array Gain = $5 \log(N_{ANT}/N_{SS})$ dB or 3 dB, whichever is less for 20-MHz channel widths with $N_{ANT} \geq 5$.

For power measurements on all other devices: Array Gain = $10 \log(N_{ANT}/N_{SS})$ dB.

4.3.2 Test Setup

For Power Output

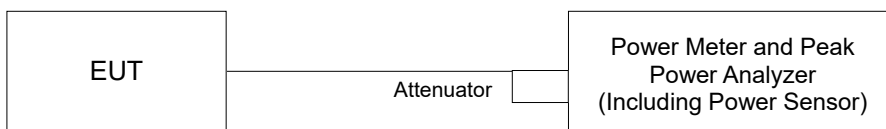

For Power Output (straddle channel)

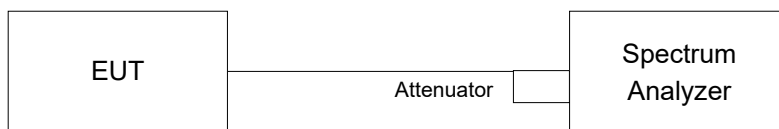

For 26dB Bandwidth

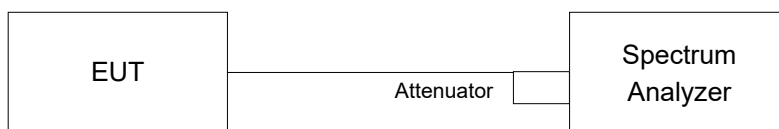

4.3.3 Test Instruments

Refer to section 4.1.2 to get information of above instrument.

4.3.4 Test Procedure

For Average Power Measurement

Method PM is used to perform output power measurement, trigger and gating function of wide band power meter is enabled to measure max output power of TX on burst and set the detector to average. Duty factor is not added to measured value.

For 802.11a, 802.11n (HT20), 802.11n (HT40)

Method PM is used to perform output power measurement, trigger and gating function of wide band power meter is enabled to measure max output power of TX on burst. Duty factor is not added to measured value.

For 802.11ac (VHT80) and straddle channels

- a. Set span to encompass the entire 26 dB EBW (or, alternatively, the entire 99% occupied bandwidth) of the signal.
- b. Set sweep trigger to "free run".
- c. Set RBW = 1 MHz
- d. Set VBW \geq 3 MHz
- e. Number of points in sweep \geq 2 Span / RBW
- f. Sweep time \leq (number of points in sweep) * T
- g. Using emission bandwidth to determine the frequency span for integration the channel bandwidth.
- h. Detector = RMS
- i. Trace mode = max hold
- j. Allow max hold to run for at least 60 seconds, or longer as needed to allow the trace to stabilize.
- k. Compute power by integrating the spectrum across the EBW (or, alternatively, the entire 99% occupied bandwidth) of the signal using the instrument's band power measurement function with band limits set equal to the EBW (or occupied bandwidth) band edges. If the instrument does not have a band power function, sum the spectrum levels (in power units) at 1 MHz intervals extending across the EBW (or, alternatively, the entire 99% occupied bandwidth) of the spectrum.

For 26dB Bandwidth

- a. Set RBW = approximately 1% of the emission bandwidth.
- b. Set the VBW > RBW.
- c. Detector = Peak.
- d. Trace mode = max hold.
- e. Measure the maximum width of the emission that is 26 dB down from the peak of the emission. Compare this with the RBW setting of the analyzer. Readjust RBW and repeat measurement as needed until the RBW/EBW ratio is approximately 1%.
- f. For channel aggregation (channel 138, 142, 144) measurement refer to KDB 789033 D02 Section III. CHANNEL AGGREGATION.

4.3.5 Deviation from Test Standard

No deviation.

4.3.6 EUT Operating Conditions

The software provided by client to enable the EUT under transmission condition continuously at lowest, middle and highest channel frequencies individually.

4.3.7 Test Result

Power Output:
802.11a

Chan.	Freq. (MHz)	Maximum Conducted Power (dBm)		Total Power (mW)	Total Power (dBm)	Power Limit (dBm)	Pass / Fail
		Chain 0	Chain 1				
36	5180	19.34	19.72	179.658	22.54	24.00	Pass
40	5200	19.23	19.65	176.010	22.46	24.00	Pass
48	5240	19.21	19.62	174.990	22.43	24.00	Pass
52	5260	19.69	19.98	192.651	22.85	24.00	Pass
60	5300	19.70	19.89	190.824	22.81	24.00	Pass
64	5320	19.73	19.90	191.696	22.83	24.00	Pass
100	5500	19.35	19.49	175.019	22.43	24.00	Pass
116	5580	19.36	19.44	174.200	22.41	24.00	Pass
140	5700	19.41	19.53	177.040	22.48	24.00	Pass
144	5720 (For U-NII-2C)	16.27	15.32	80.300	19.05	24.00	Pass
144	5720 (For U-NII-3)	8.45	8.90	15.513	11.91	30.00	Pass
149	5745	23.14	23.34	421.837	26.25	30.00	Pass
157	5785	23.03	23.58	428.943	26.32	30.00	Pass
165	5825	22.41	23.02	374.628	25.74	30.00	Pass

Note:

For U-NII-2A, U-NII-2C Band:

Chain 0

1. $11\text{dBm} + 10\log(25.07) = 24.99 > 24\text{dBm}$
2. $11\text{dBm} + 10\log(31.44) = 25.97 > 24\text{dBm}$
3. $11\text{dBm} + 10\log(31.18) = 25.93 > 24\text{dBm}$
4. $11\text{dBm} + 10\log(34.30) = 26.35 > 24\text{dBm}$
5. $11\text{dBm} + 10\log(34.49) = 26.37 > 24\text{dBm}$
6. $11\text{dBm} + 10\log(34.54) = 26.38 > 24\text{dBm}$
7. $11\text{dBm} + 10\log(5725.00 - 5703.18) = 24.38 > 24\text{dBm}$

Chain 1

1. $11\text{dBm} + 10\log(28.69) = 25.57 > 24\text{dBm}$
2. $11\text{dBm} + 10\log(31.60) = 25.99 > 24\text{dBm}$
3. $11\text{dBm} + 10\log(29.03) = 25.62 > 24\text{dBm}$
4. $11\text{dBm} + 10\log(31.15) = 25.93 > 24\text{dBm}$
5. $11\text{dBm} + 10\log(34.29) = 26.35 > 24\text{dBm}$
6. $11\text{dBm} + 10\log(34.47) = 26.37 > 24\text{dBm}$
7. $11\text{dBm} + 10\log(5725.00 - 5703.14) = 24.39 > 24\text{dBm}$

802.11n (HT20)

Chan.	Freq. (MHz)	Maximum Conducted Power (dBm)		Total Power (mW)	Total Power (dBm)	Power Limit (dBm)	Pass / Fail
		Chain 0	Chain 1				
36	5180	19.62	20.12	194.424	22.89	24.00	Pass
40	5200	19.73	20.11	196.538	22.93	24.00	Pass
48	5240	19.65	20.04	193.182	22.86	24.00	Pass
52	5260	19.62	19.64	183.667	22.64	24.00	Pass
60	5300	19.54	19.86	186.778	22.71	24.00	Pass
64	5320	19.53	19.63	181.576	22.59	24.00	Pass
100	5500	19.32	19.43	173.207	22.39	24.00	Pass
116	5580	19.24	19.33	169.650	22.30	24.00	Pass
140	5700	19.36	19.48	175.013	22.43	24.00	Pass
144	5720 (For U-NII-2C)	17.59	12.32	78.526	18.95	24.00	Pass
144	5720 (For U-NII-3)	11.11	7.46	19.490	12.90	30.00	Pass
149	5745	23.06	23.42	422.088	26.25	30.00	Pass
157	5785	22.73	23.60	416.586	26.20	30.00	Pass
165	5825	22.54	23.03	380.383	25.80	30.00	Pass

Note:

For U-NII-2A, U-NII-2C Band:

Chain 0

- $11\text{dBm} + 10\log(35.63) = 26.51 > 24\text{dBm}$
- $11\text{dBm} + 10\log(36.35) = 26.60 > 24\text{dBm}$
- $11\text{dBm} + 10\log(38.23) = 26.82 > 24\text{dBm}$
- $11\text{dBm} + 10\log(35.87) = 26.54 > 24\text{dBm}$
- $11\text{dBm} + 10\log(34.86) = 26.42 > 24\text{dBm}$
- $11\text{dBm} + 10\log(37.51) = 26.74 > 24\text{dBm}$
- $11\text{dBm} + 10\log(5725.00 - 5701.20) = 24.76 > 24\text{dBm}$

Chain 1

- $11\text{dBm} + 10\log(33.34) = 26.22 > 24\text{dBm}$
- $11\text{dBm} + 10\log(35.68) = 26.52 > 24\text{dBm}$
- $11\text{dBm} + 10\log(34.33) = 26.35 > 24\text{dBm}$
- $11\text{dBm} + 10\log(36.78) = 26.65 > 24\text{dBm}$
- $11\text{dBm} + 10\log(37.66) = 26.75 > 24\text{dBm}$
- $11\text{dBm} + 10\log(41.95) = 27.22 > 24\text{dBm}$
- $11\text{dBm} + 10\log(5725.00 - 5699.32) = 25.09 > 24\text{dBm}$

802.11n (HT40)

Chan.	Freq. (MHz)	Maximum Conducted Power (dBm)		Total Power (mW)	Total Power (dBm)	Power Limit (dBm)	Pass / Fail
		Chain 0	Chain 1				
38	5190	19.37	19.76	181.121	22.58	24.00	Pass
46	5230	20.76	21.14	249.141	23.96	24.00	Pass
54	5270	20.47	20.68	228.379	23.59	24.00	Pass
62	5310	18.90	19.17	160.229	22.05	24.00	Pass
102	5510	18.88	19.10	158.551	22.00	24.00	Pass
110	5550	20.58	20.86	236.187	23.73	24.00	Pass
134	5670	20.24	20.65	221.827	23.46	24.00	Pass
142	5710 (For U-NII-2C)	15.59	15.26	77.701	18.90	24.00	Pass
142	5710 (For U-NII-3)	3.43	5.74	6.627	8.21	30.00	Pass
151	5755	19.10	23.18	289.253	24.61	30.00	Pass
159	5795	20.86	23.35	338.171	25.29	30.00	Pass

Note:

For U-NII-2A, U-NII-2C Band:

Chain 0

1. $11\text{dBm} + 10\log(82.75) = 30.17 > 24\text{dBm}$
2. $11\text{dBm} + 10\log(43.18) = 27.35 > 24\text{dBm}$
3. $11\text{dBm} + 10\log(47.59) = 27.77 > 24\text{dBm}$
4. $11\text{dBm} + 10\log(90.82) = 30.58 > 24\text{dBm}$
5. $11\text{dBm} + 10\log(89.48) = 30.51 > 24\text{dBm}$
6. $11\text{dBm} + 10\log(5725.00 - 5663.54) = 28.88 > 24\text{dBm}$

Chain 1

1. $11\text{dBm} + 10\log(86.57) = 30.37 > 24\text{dBm}$
2. $11\text{dBm} + 10\log(48.47) = 27.85 > 24\text{dBm}$
3. $11\text{dBm} + 10\log(76.03) = 29.80 > 24\text{dBm}$
4. $11\text{dBm} + 10\log(98.06) = 30.91 > 24\text{dBm}$
5. $11\text{dBm} + 10\log(99.86) = 30.99 > 24\text{dBm}$
6. $11\text{dBm} + 10\log(5725.00 - 5660.00) = 29.12 > 24\text{dBm}$

802.11ac (VHT80)

Chan.	Freq. (MHz)	Maximum Conducted Power (dBm)		Total Power (mW)	Total Power (dBm)	Power Limit (dBm)	Pass / Fail
		Chain 0	Chain 1				
42	5210	18.80	19.23	159.611	22.03	24.00	Pass
58	5290	18.11	18.49	135.346	21.31	24.00	Pass
106	5530	18.82	19.46	164.516	22.16	24.00	Pass
122	5610	18.94	19.29	163.261	22.13	24.00	Pass
138	5690 (For U-NII-2C)	13.64	10.79	43.138	16.35	24.00	Pass
138	5690 (For U-NII-3)	3.54	-1.37	3.672	5.65	30.00	Pass
155	5775	21.32	21.81	287.224	24.58	30.00	Pass

Note:

For U-NII-2A, U-NII-2C Band:

Chain 0

1. $11\text{dBm} + 10\log(84.55) = 30.27 > 24\text{dBm}$
2. $11\text{dBm} + 10\log(131.83) = 32.20 > 24\text{dBm}$
3. $11\text{dBm} + 10\log(144.34) = 32.59 > 24\text{dBm}$
4. $11\text{dBm} + 10\log(5725.00 - 5594.09) = 32.16 > 24\text{dBm}$

Chain 1

1. $11\text{dBm} + 10\log(99.36) = 30.97 > 24\text{dBm}$
2. $11\text{dBm} + 10\log(183.55) = 33.63 > 24\text{dBm}$
3. $11\text{dBm} + 10\log(143.67) = 32.57 > 24\text{dBm}$
4. $11\text{dBm} + 10\log(5725.00 - 5626.46) = 30.93 > 24\text{dBm}$

Straddle channel power plots:

802.11a

Chain 0

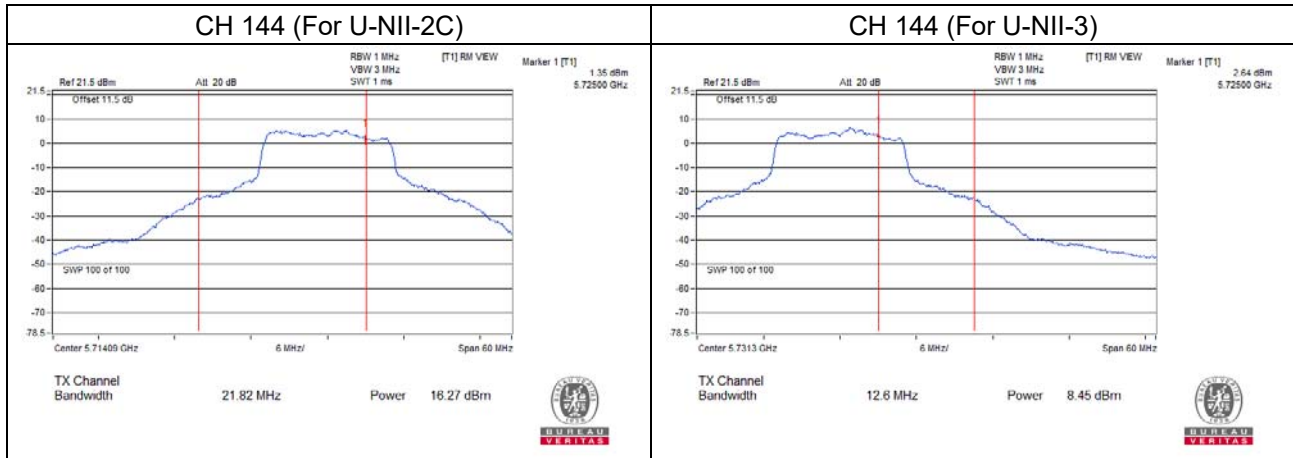

Chain 1

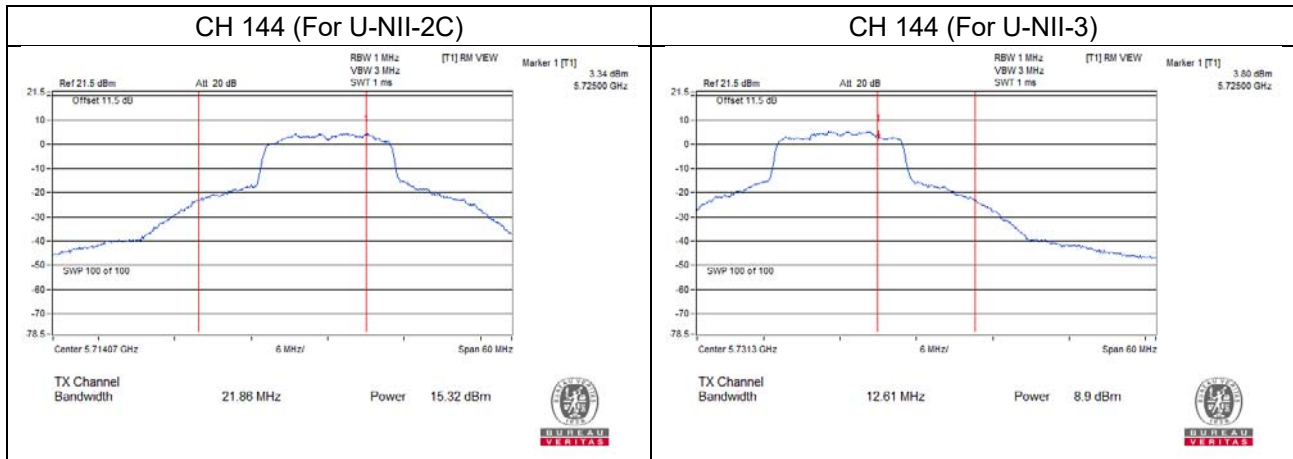

802.11n (HT20)
Chain 0

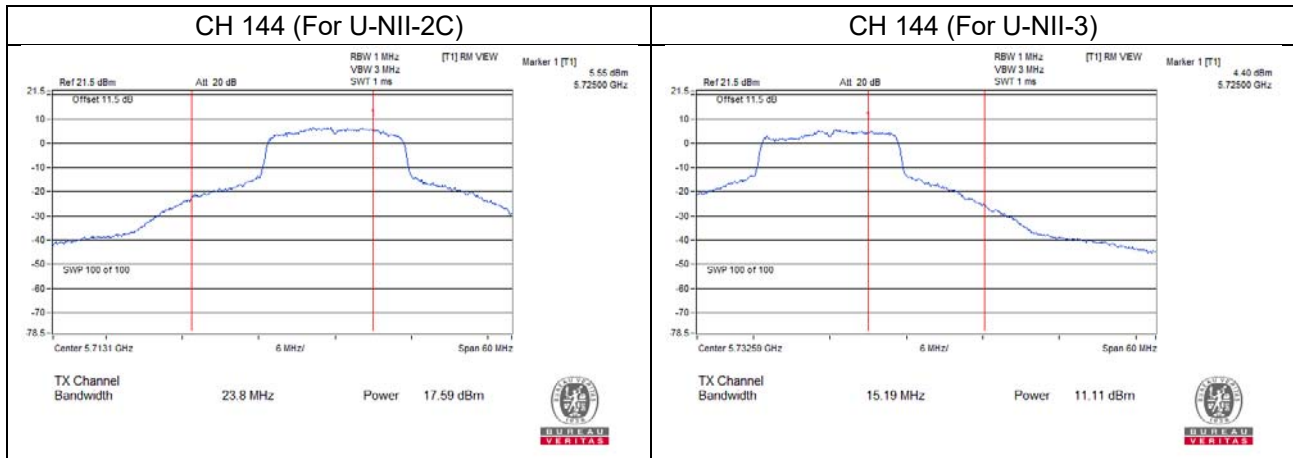

Chain 1

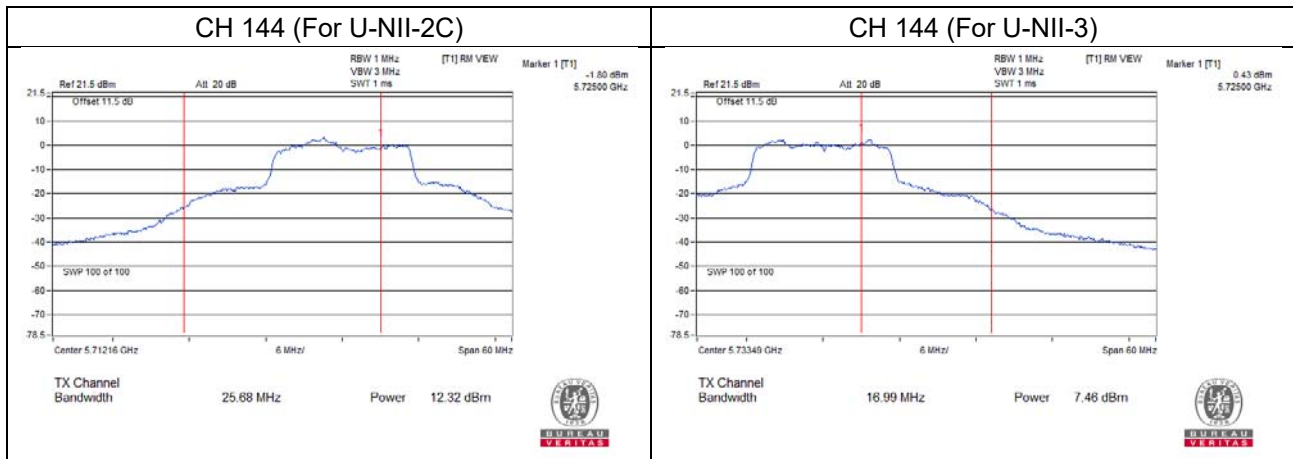

802.11n (HT40)
Chain 0

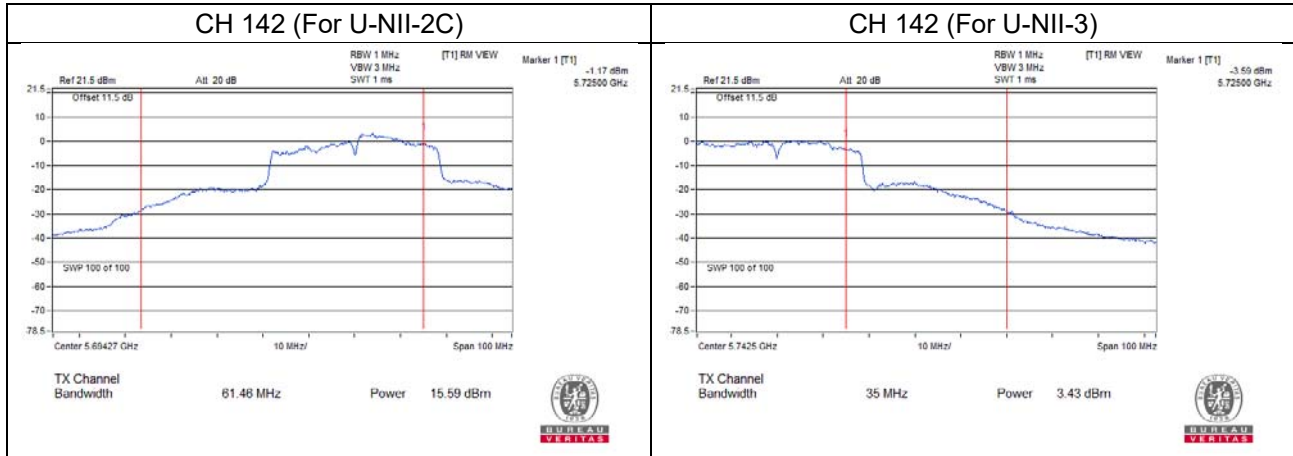

Chain 1

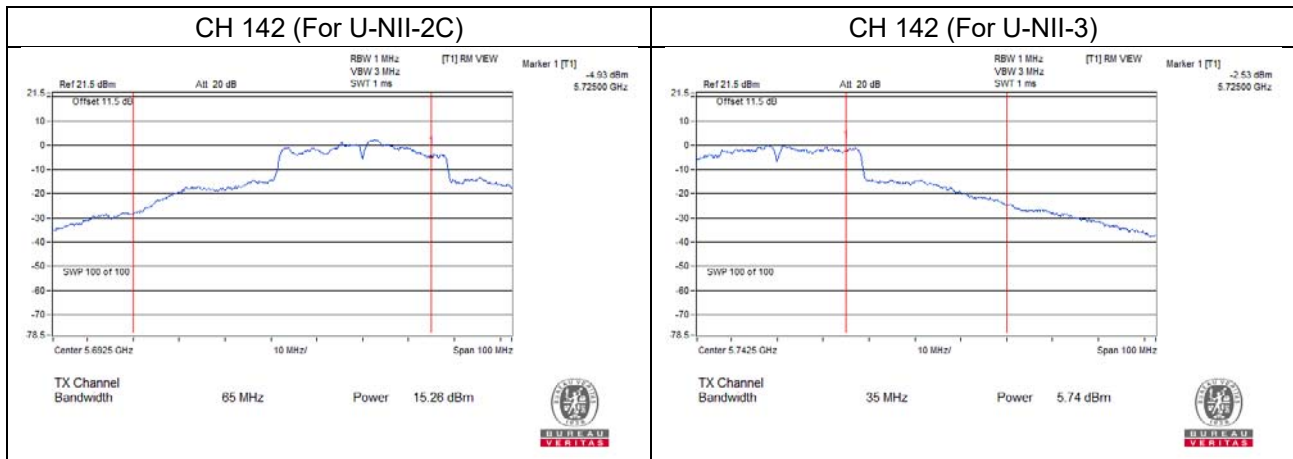

802.11ac (VHT80)
Chain 0

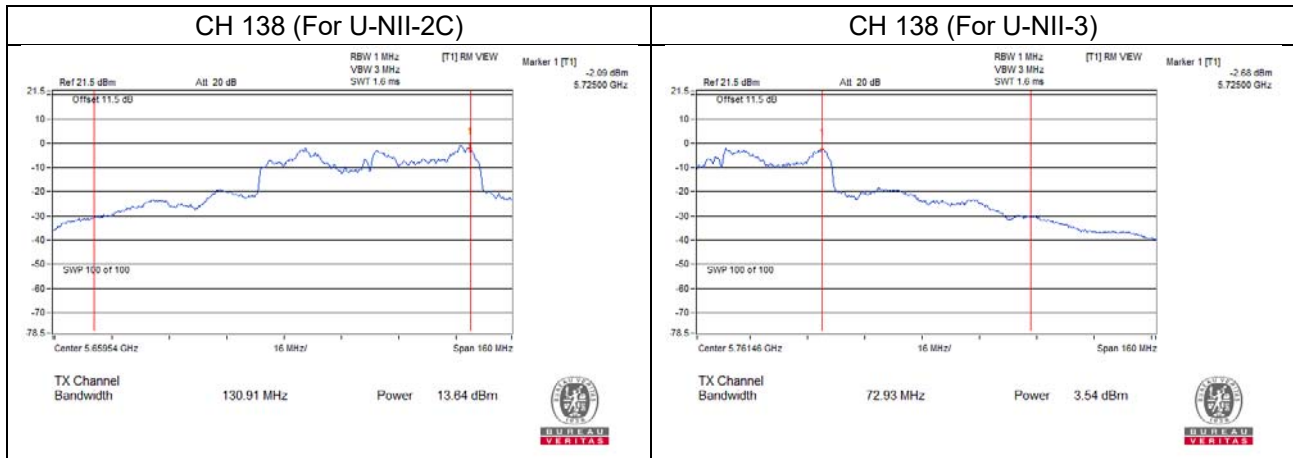

Chain 1

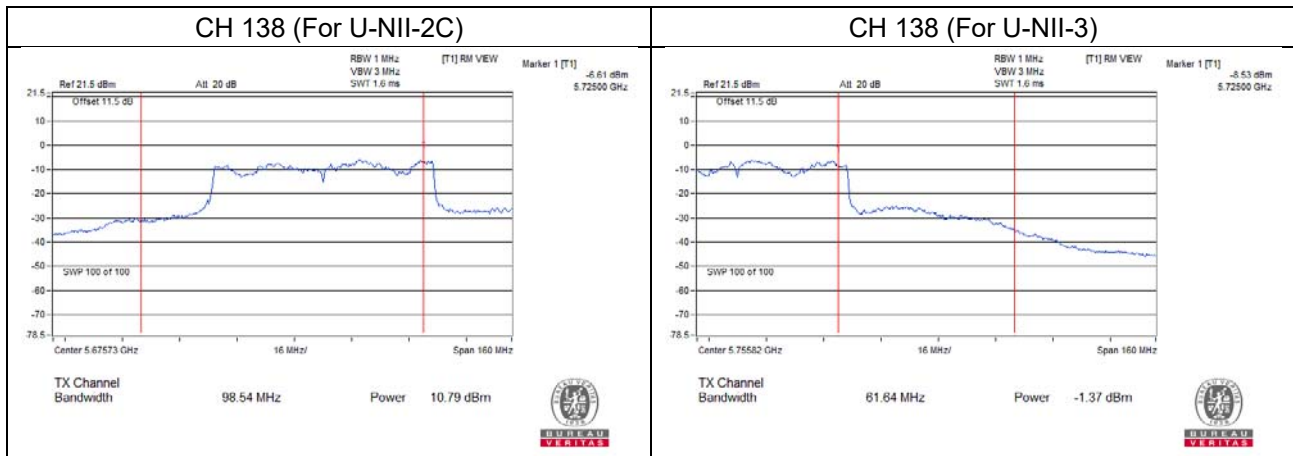

26dB Bandwidth:

802.11a

Chan.	Freq. (MHz)	26dBc Bandwidth (MHz)	
		Chain 0	Chain 1
52	5260	25.07	28.69
60	5300	31.44	31.60
64	5320	31.18	29.03
100	5500	34.30	31.15
116	5580	34.49	34.29
140	5700	34.54	34.47
144	5720 (For U-NII-2C)	21.82	21.86
144	5720 (For U-NII-3)	12.60	12.61

802.11n (HT20)

Chan.	Freq. (MHz)	26dBc Bandwidth (MHz)	
		Chain 0	Chain 1
52	5260	35.63	33.34
60	5300	36.35	35.68
64	5320	38.23	34.33
100	5500	35.87	36.78
116	5580	34.86	37.66
140	5700	37.51	41.95
144	5720 (For U-NII-2C)	23.80	25.68
144	5720 (For U-NII-3)	15.19	16.99

802.11n (HT40)

Chan.	Freq. (MHz)	26dBc Bandwidth (MHz)	
		Chain 0	Chain 1
54	5270	82.75	86.57
62	5310	43.18	48.47
102	5510	47.59	76.03
110	5550	90.82	98.06
134	5670	89.48	99.86
142	5710 (For U-NII-2C)	61.46	65.00
142	5710 (For U-NII-3)	35.00	35.00

802.11ac (VHT80)

Chan.	Freq. (MHz)	26dBc Bandwidth (MHz)	
		Chain 0	Chain 1
58	5290	84.55	99.36
106	5530	131.83	183.55
122	5610	144.34	143.67
138	5690 (For U-NII-2C)	130.91	98.54
138	5690 (For U-NII-3)	72.93	61.64

Spectrum Plot of Worst Value

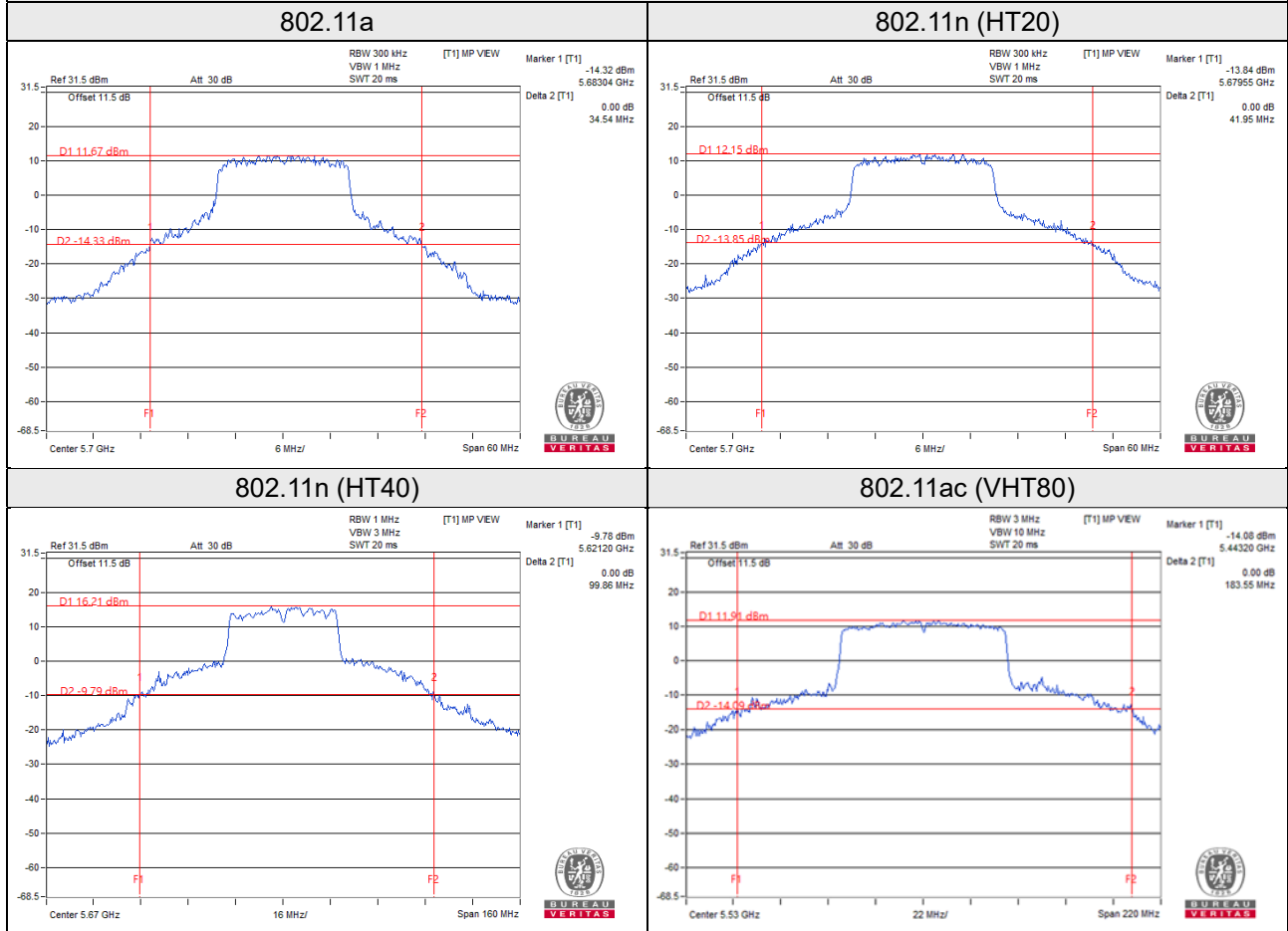

EUT Maximum Conducted Power

802.11a

Frequency Band (MHz)	Max. Power	
	Output Power (mW)	Output Power (dBm)
5250~5350	192.651	22.85
5470~5725	177.040	22.48

802.11n (HT20)

Frequency Band (MHz)	Max. Power	
	Output Power (mW)	Output Power (dBm)
5250~5350	186.778	22.71
5470~5725	175.013	22.43

802.11n (HT40)

Frequency Band (MHz)	Max. Power	
	Output Power (mW)	Output Power (dBm)
5250~5350	228.379	23.59
5470~5725	236.187	23.73

802.11ac (VHT80)

Frequency Band (MHz)	Max. Power	
	Output Power (mW)	Output Power (dBm)
5250~5350	135.346	21.31
5470~5725	164.516	22.16

4.4 Occupied Bandwidth Measurement

4.4.1 Test Setup

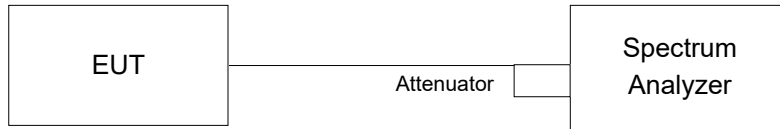

4.4.2 Test Instruments

Refer to section 4.1.2 to get information of above instrument.

4.4.3 Test Procedure

The transmitter output was connected to the spectrum analyzer through an attenuator. The bandwidth of the fundamental frequency was measured by spectrum analyzer with resolution bandwidth in the range of 1% to 5% of the anticipated emission bandwidth, and a video bandwidth at least 3x the resolution bandwidth and set the detector to sampling. The width of a frequency band such that, below the lower and above the upper frequency limits, the mean powers emitted are each equal to a specified percentage 0.5 %of the total mean power of a given emission.

4.4.4 Test Result

802.11a

Chan.	Freq. (MHz)	Occupied Bandwidth (MHz)	
		Chain 0	Chain 1
36	5180	18.84	20.76
40	5200	19.92	20.76
48	5240	20.04	23.16
52	5260	16.86	17.22
60	5300	17.64	18.00
64	5320	17.40	17.31
100	5500	18.96	17.40
116	5580	19.80	19.20
140	5700	19.56	19.92
144	5720 (For U-NII-2C)	14.72	14.72
144	5720 (For U-NII-3)	4.96	4.96
149	5745	32.04	33.24
157	5785	31.44	34.80
165	5825	32.16	32.28

802.11n (HT20)

Chan.	Freq. (MHz)	Occupied Bandwidth (MHz)	
		Chain 0	Chain 1
36	5180	19.68	25.32
40	5200	24.12	26.28
48	5240	24.84	23.76
52	5260	18.78	18.78
60	5300	21.00	21.12
64	5320	21.72	19.80
100	5500	21.48	22.32
116	5580	19.92	22.08
140	5700	22.80	25.20
144	5720 (For U-NII-2C)	16.52	17.24
144	5720 (For U-NII-3)	6.76	8.08
149	5745	34.08	35.88
157	5785	33.36	38.04
165	5825	33.96	34.80

802.11n (HT40)

Chan.	Freq. (MHz)	Occupied Bandwidth (MHz)	
		Chain 0	Chain 1
38	5190	36.84	36.72
46	5230	37.68	39.00
54	5270	37.08	38.16
62	5310	36.72	36.60
102	5510	36.72	37.08
110	5550	38.52	44.88
134	5670	37.68	48.00
142	5710 (For U-NII-2C)	34.20	39.00
142	5710 (For U-NII-3)	5.52	10.32
151	5755	44.88	48.84
159	5795	46.32	49.56

802.11ac (VHT80)

Chan.	Freq. (MHz)	Occupied Bandwidth (MHz)	
		Chain 0	Chain 1
42	5210	76.08	76.32
58	5290	75.84	75.84
106	5530	76.08	77.76
122	5610	76.32	77.04
138	5690 (For U-NII-2C)	75.56	73.16
138	5690 (For U-NII-3)	12.04	3.64
155	5775	97.92	99.84

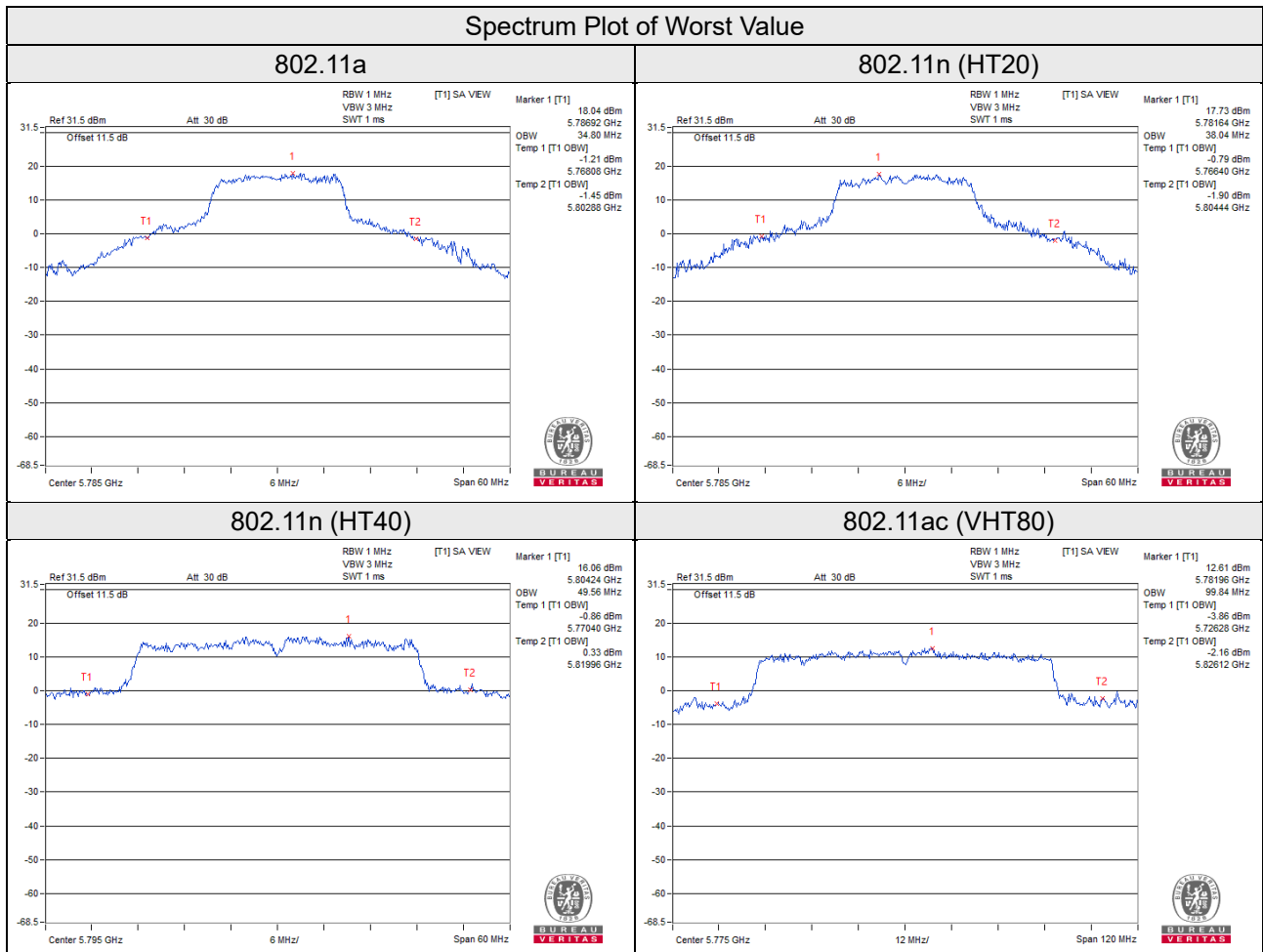

Spectrum Plot for near By DFS Band

802.11a / Chain 0 / CH 48

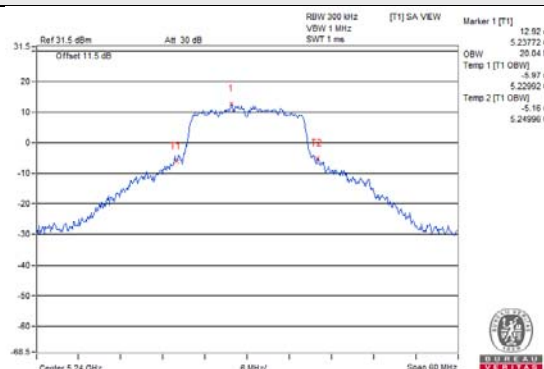

802.11a / Chain 1 / CH 48

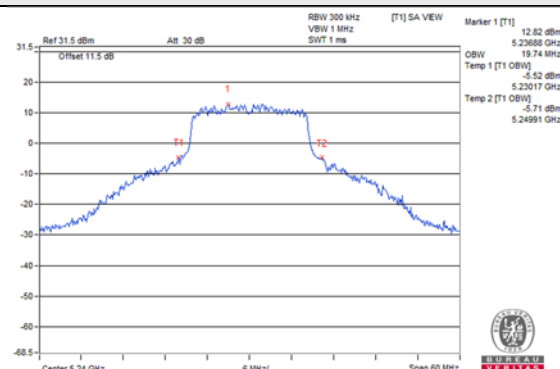

802.11n (HT20) / Chain 0 / CH 48

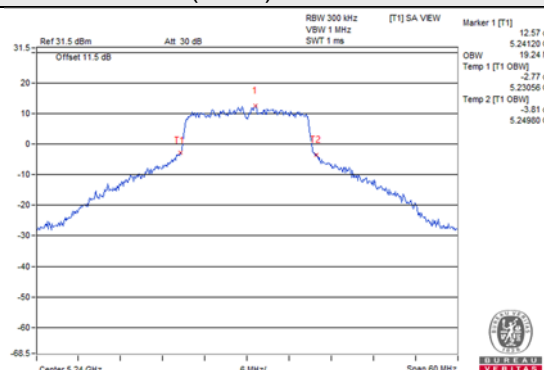

802.11n (HT20) / Chain 1 / CH 48

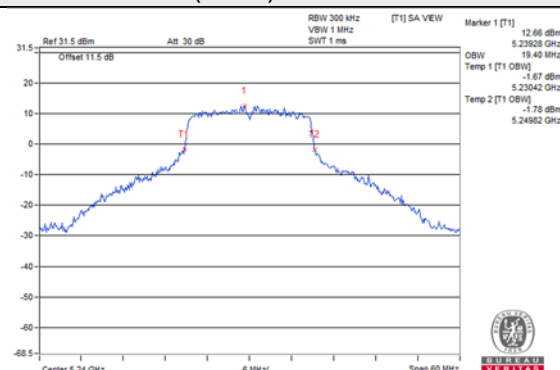

802.11n (HT40) / Chain 0 / CH 46

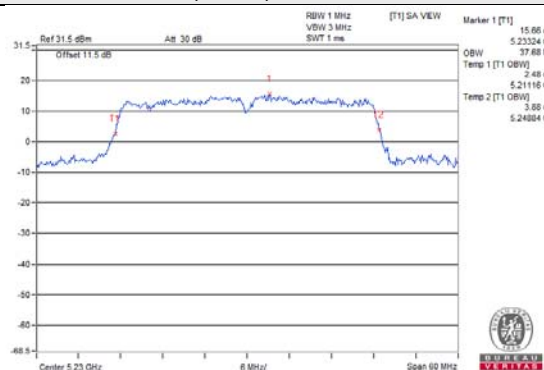

802.11n (HT40) / Chain 1 / CH 46

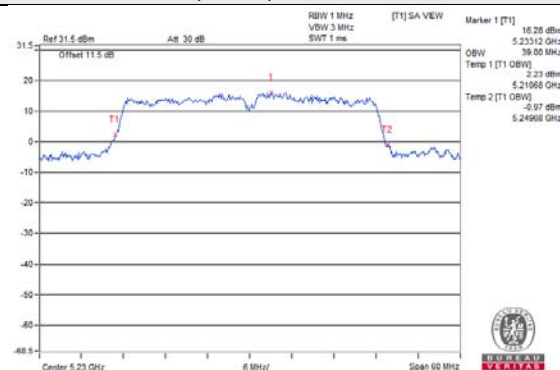

802.11ac (VHT80) / Chain 0 / CH 42

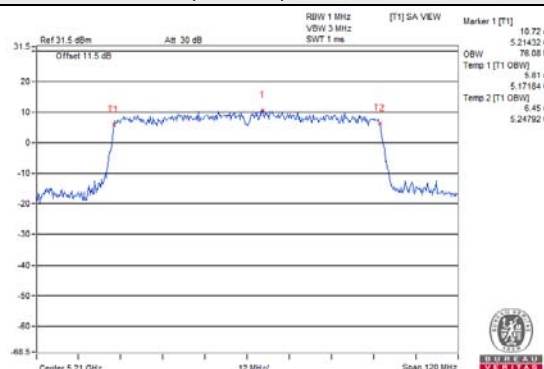

802.11ac (VHT80) / Chain 1 / CH 42

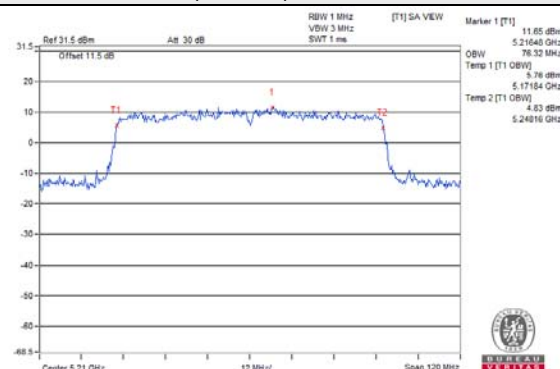

Spectrum Plot for near By DFS Band

802.11a / Chain 0 / CH 149

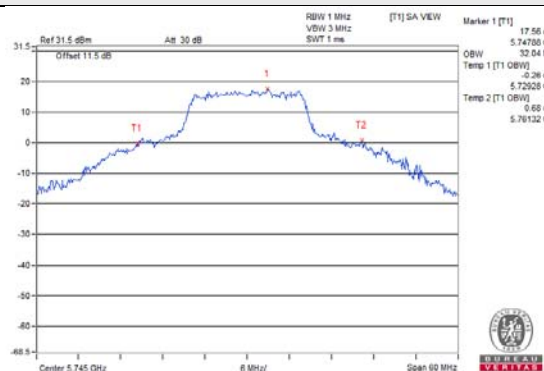

802.11a / Chain 1 / CH 149

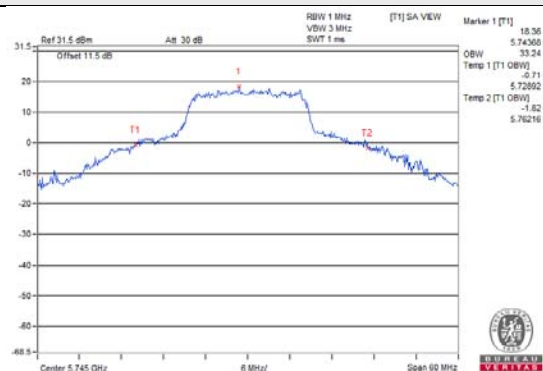

802.11n (HT20) / Chain 0 / CH 149

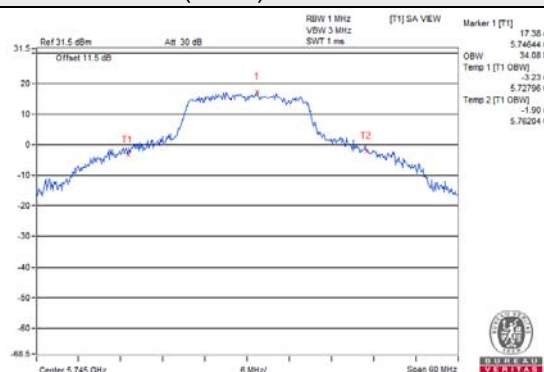

802.11n (HT20) / Chain 1 / CH 149

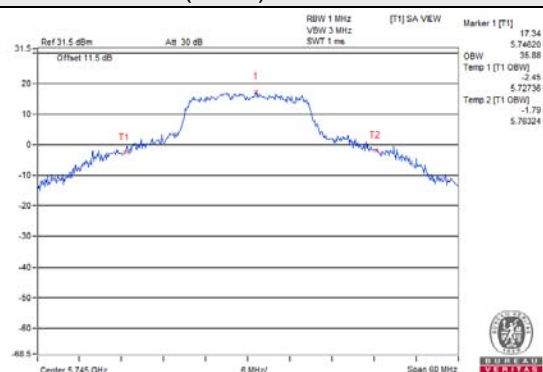

802.11n (HT40) / Chain 0 / CH 151

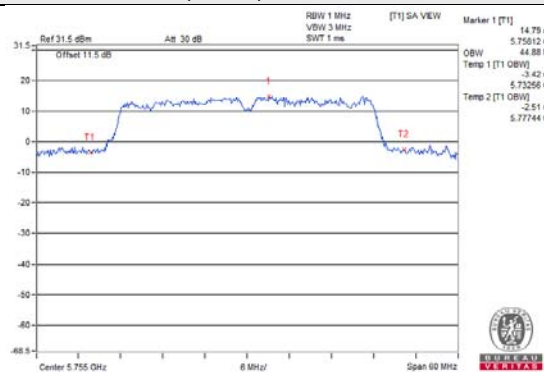

802.11n (HT40) / Chain 1 / CH 151

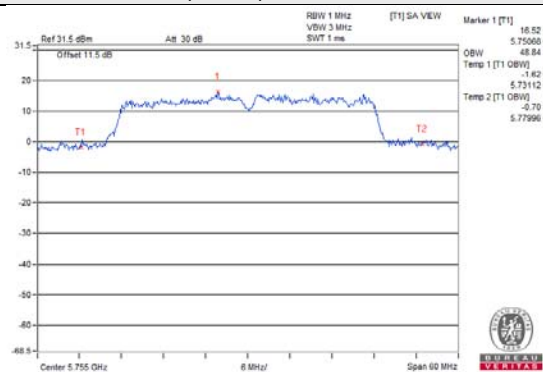

802.11ac (VHT80) / Chain 0 / CH 155

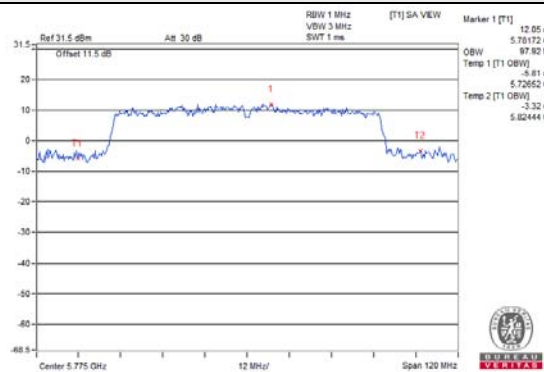

802.11ac (VHT80) / Chain 1 / CH 155

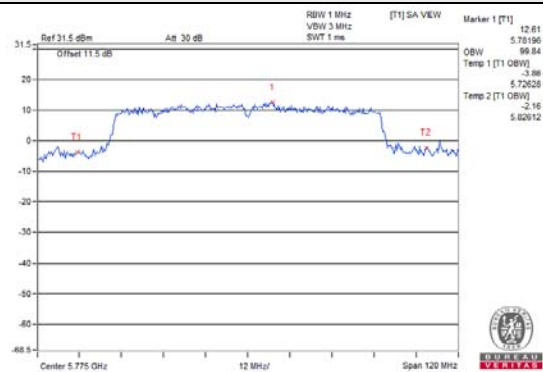

4.5 Peak Power Spectral Density Measurement

4.5.1 Limits of Peak Power Spectral Density Measurement

Operation Band	EUT Category		Limit
U-NII-1		Outdoor Access Point	17dBm/ MHz
		Fixed point-to-point Access Point	
		Indoor Access Point	
	√	Mobile and Portable client device	11dBm/ MHz
U-NII-2A	√		11dBm/ MHz
U-NII-2C	√		11dBm/ MHz
U-NII-3	√		30dBm/ 500kHz

4.5.2 Test Setup

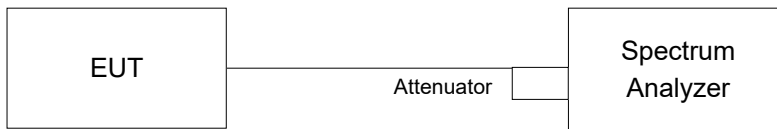

4.5.3 Test Instruments

Refer to section 4.1.2 to get information of above instrument.

4.5.4 Test Procedures

For U-NII-1, U-NII-2A and U-NII-2C band:

Duty cycle of test signal is < 98%

Using method SA-2

- Set span to encompass the entire emission bandwidth (EBW) of the signal.
- Set RBW = 1MHz, Set VBW \geq 3 MHz, Detector = RMS
- Set Channel power measure = 1MHz
- Sweep time = auto, trigger set to "free run".
- Trace average at least 100 traces in power averaging mode.
- Record the max value and add $10 \log (1/\text{duty cycle})$

For U-NII-3 band:

Duty cycle of test signal is < 98%

- a. Set span to encompass the entire emission bandwidth (EBW) of the signal.
- b. Set RBW = 300 kHz, Set VBW \geq 1 MHz, Detector = RMS
- c. Use the peak marker function to determine the maximum power level in any 300 kHz band segment within the fundamental EBW.
- d. Scale the observed power level to an equivalent value in 500 kHz by adjusting (raising) the measured power by a bandwidth correction factor (BWCF) where $BWCF = 10\log(500 \text{ kHz} / 300 \text{ kHz})$
- e. Sweep time = auto, trigger set to "free run".
- f. Trace average at least 100 traces in power averaging mode.
- g. Record the max value and add $10 \log (1/\text{duty cycle})$

4.5.5 Deviation from Test Standard

No deviation.

4.5.6 EUT Operating Conditions

Same as 4.3.6.

4.5.7 Test Results

For U-NII-1, U-NII-2A and U-NII-2C band:

802.11a

Chan.	Freq. (MHz)	PSD w/o Duty Factor (dBm/MHz)		Duty Factor (dB)	Total PSD with Duty Factor (dBm/MHz)	Max. Limit (dBm/MHz)	Pass / Fail
		Chain 0	Chain 1				
36	5180	6.55	7.44	0.22	10.24	10.42	Pass
40	5200	6.95	7.37	0.22	10.39	10.42	Pass
48	5240	6.67	7.24	0.22	10.19	10.42	Pass
52	5260	7.34	7.53	0.22	10.66	10.84	Pass
60	5300	7.66	7.49	0.22	10.80	10.84	Pass
64	5320	7.45	7.49	0.22	10.70	10.84	Pass
100	5500	7.41	6.96	0.22	10.42	10.52	Pass
116	5580	7.25	7.15	0.22	10.43	10.52	Pass
140	5700	7.35	7.15	0.22	10.48	10.52	Pass
144	5720	7.35	7.18	0.22	10.49	10.52	Pass

Note:

- Method E) 2) a) of power density measurement of KDB 662911 is using for calculating total power density. Total power density is summing entire spectra across corresponding frequency bins on the various outputs by computer.
- 5180~5240MHz: Directional gain = $10 \log[(10^{G1/20} + 10^{G2/20} + \dots + 10^{GN/20})^2/2] = 6.58\text{dBi} > 6\text{dBi}$, so the limit shall be reduced to $11 - (6.58 - 6) = 10.42\text{dBm}$.
 5260~5320MHz: Directional gain = $10 \log[(10^{G1/20} + 10^{G2/20} + \dots + 10^{GN/20})^2/2] = 6.16\text{dBi} > 6\text{dBi}$, so the limit shall be reduced to $11 - (6.16 - 6) = 10.84\text{dBm}$.
 5500~5720MHz: Directional gain = $10 \log[(10^{G1/20} + 10^{G2/20} + \dots + 10^{GN/20})^2/2] = 6.48\text{dBi} > 6\text{dBi}$, so the limit shall be reduced to $11 - (6.48 - 6) = 10.52\text{dBm}$.
- Refer to section 3.3 for duty cycle spectrum plot.

802.11n (HT20)

Chan.	Freq. (MHz)	PSD w/o Duty Factor (dBm/MHz)		Duty Factor (dB)	Total PSD with Duty Factor (dBm/MHz)	Max. Limit (dBm/MHz)	Pass / Fail
		Chain 0	Chain 1				
36	5180	7.04	7.21	0.23	10.37	10.42	Pass
40	5200	7.03	7.25	0.23	10.38	10.42	Pass
48	5240	6.90	7.42	0.23	10.41	10.42	Pass
52	5260	7.31	7.71	0.23	10.76	10.84	Pass
60	5300	7.45	7.58	0.23	10.76	10.84	Pass
64	5320	7.41	7.59	0.23	10.74	10.84	Pass
100	5500	7.14	7.33	0.23	10.48	10.52	Pass
116	5580	7.01	7.28	0.23	10.39	10.52	Pass
140	5700	7.14	7.33	0.23	10.48	10.52	Pass
144	5720	7.40	7.13	0.23	10.51	10.52	Pass

Note:

- Method E) 2) a) of power density measurement of KDB 662911 is using for calculating total power density. Total power density is summing entire spectra across corresponding frequency bins on the various outputs by computer.
- 5180~5240MHz: Directional gain = $10 \log[(10^{G1/20} + 10^{G2/20} + \dots + 10^{GN/20})^2/2] = 6.58\text{dBi} > 6\text{dBi}$, so the limit shall be reduced to $11 - (6.58 - 6) = 10.42\text{dBm}$.
 5260~5320MHz: Directional gain = $10 \log[(10^{G1/20} + 10^{G2/20} + \dots + 10^{GN/20})^2/2] = 6.16\text{dBi} > 6\text{dBi}$, so the limit shall be reduced to $11 - (6.16 - 6) = 10.84\text{dBm}$.
 5500~5720MHz: Directional gain = $10 \log[(10^{G1/20} + 10^{G2/20} + \dots + 10^{GN/20})^2/2] = 6.48\text{dBi} > 6\text{dBi}$, so the limit shall be reduced to $11 - (6.48 - 6) = 10.52\text{dBm}$.
- Refer to section 3.3 for duty cycle spectrum plot.

802.11n (HT40)

Chan.	Freq. (MHz)	PSD w/o Duty Factor (dBm/MHz)		Duty Factor (dB)	Total PSD with Duty Factor (dBm/MHz)	Max. Limit (dBm/MHz)	Pass / Fail
		Chain 0	Chain 1				
38	5190	3.69	3.99	0.47	7.32	10.42	Pass
46	5230	5.10	5.24	0.47	8.65	10.42	Pass
54	5270	4.34	5.20	0.47	8.27	10.84	Pass
62	5310	3.26	3.31	0.47	6.76	10.84	Pass
102	5510	3.00	3.66	0.47	6.82	10.52	Pass
110	5550	4.99	4.84	0.47	8.39	10.52	Pass
134	5670	4.56	4.77	0.47	8.14	10.52	Pass
142	5710	4.87	4.65	0.47	8.24	10.52	Pass

Note:

- Method E) 2) a) of power density measurement of KDB 662911 is using for calculating total power density. Total power density is summing entire spectra across corresponding frequency bins on the various outputs by computer.
- 5180~5240MHz: Directional gain = $10 \log[(10^{G1/20} + 10^{G2/20} + \dots + 10^{GN/20})^2/2]$ = 6.58dBi > 6dBi, so the limit shall be reduced to $11-(6.58-6) = 10.42$ dBm.
 5260~5320MHz: Directional gain = $10 \log[(10^{G1/20} + 10^{G2/20} + \dots + 10^{GN/20})^2/2]$ = 6.16dBi > 6dBi, so the limit shall be reduced to $11-(6.16-6) = 10.84$ dBm.
 5500~5720MHz: Directional gain = $10 \log[(10^{G1/20} + 10^{G2/20} + \dots + 10^{GN/20})^2/2]$ = 6.48dBi > 6dBi, so the limit shall be reduced to $11-(6.48-6) = 10.52$ dBm.
- Refer to section 3.3 for duty cycle spectrum plot.

802.11ac (VHT80)

Chan.	Freq. (MHz)	PSD w/o Duty Factor (dBm/MHz)		Duty Factor (dB)	Total PSD with Duty Factor (dBm/MHz)	Max. Limit (dBm/MHz)	Pass / Fail
		Chain 0	Chain 1				
42	5210	0.25	0.94	0.89	4.51	10.42	Pass
58	5290	-0.82	0.08	0.89	3.56	10.84	Pass
106	5530	-0.04	0.62	0.89	4.21	10.52	Pass
122	5610	0.27	0.42	0.89	4.25	10.52	Pass
138	5690	1.93	-0.76	0.89	4.69	10.52	Pass

Note:

- Method E) 2) a) of power density measurement of KDB 662911 is using for calculating total power density. Total power density is summing entire spectra across corresponding frequency bins on the various outputs by computer.
- 5180~5240MHz: Directional gain = $10 \log[(10^{G1/20} + 10^{G2/20} + \dots + 10^{GN/20})^2/2]$ = 6.58dBi > 6dBi, so the limit shall be reduced to $11-(6.58-6) = 10.42$ dBm.
 5260~5320MHz: Directional gain = $10 \log[(10^{G1/20} + 10^{G2/20} + \dots + 10^{GN/20})^2/2]$ = 6.16dBi > 6dBi, so the limit shall be reduced to $11-(6.16-6) = 10.84$ dBm.
 5500~5720MHz: Directional gain = $10 \log[(10^{G1/20} + 10^{G2/20} + \dots + 10^{GN/20})^2/2]$ = 6.48dBi > 6dBi, so the limit shall be reduced to $11-(6.48-6) = 10.52$ dBm.
- Refer to section 3.3 for duty cycle spectrum plot.

Spectrum Plot of Worst Value

802.11a / Chain 0 / CH 60

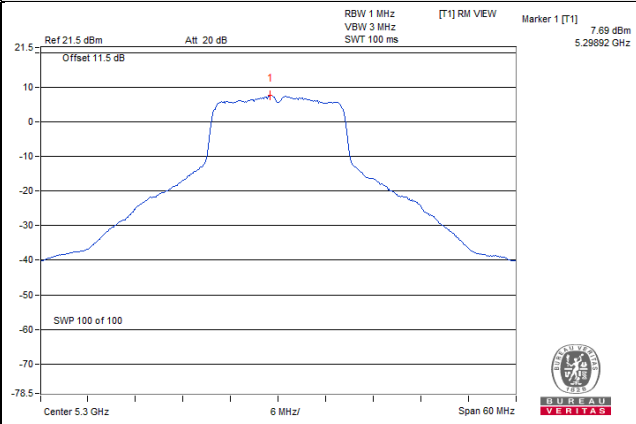

802.11n (HT20) / Chain 1 / CH 52

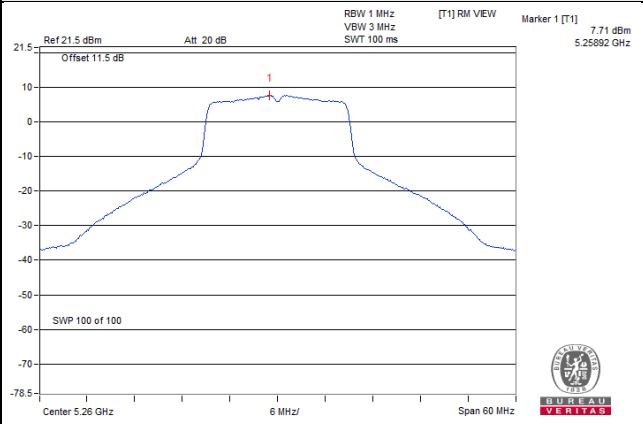

802.11n (HT40) / Chain 1 / CH 46

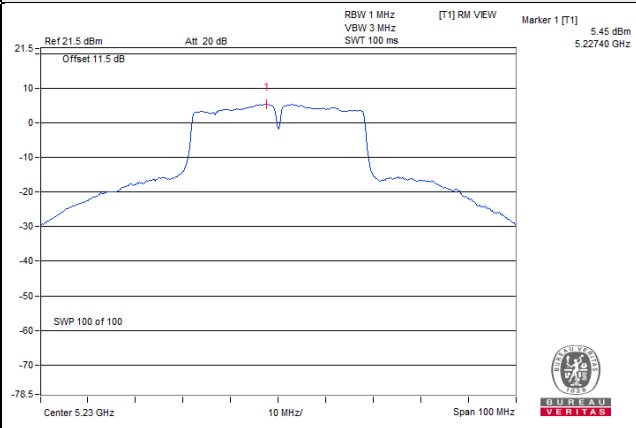

802.11ac (VHT80) / Chain 0 / 138

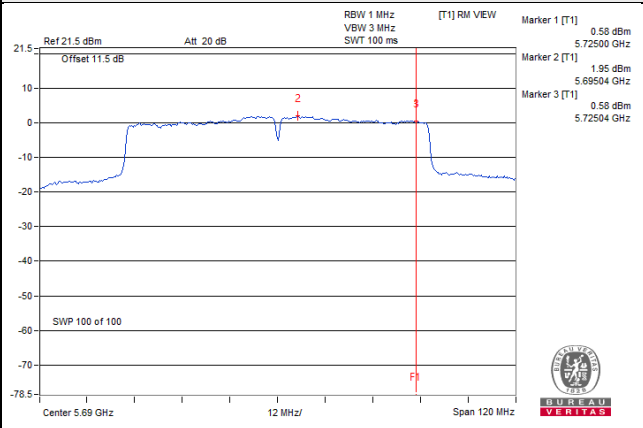

For U-NII-3 band:

802.11a

TX chain	Chan.	Freq. (MHz)	PSD W/O Duty Factor		10 log (N=2) dB	Duty Factor (dB)	Total PSD With Duty Factor (dBm/500kHz)	Limit (dBm/500kHz)	Pass / Fail
			(dBm/300kHz)	(dBm/500kHz)					
0	144	5720	-2.83	-0.61	3.01	0.22	2.62	29.53	Pass
	149	5745	0.26	2.48	3.01	0.22	5.71	29.53	Pass
	157	5785	-0.05	2.17	3.01	0.22	5.40	29.53	Pass
	165	5825	-0.01	2.21	3.01	0.22	5.44	29.53	Pass
1	144	5720	-2.97	-0.75	3.01	0.22	2.48	29.53	Pass
	149	5745	0.08	2.30	3.01	0.22	5.53	29.53	Pass
	157	5785	0.46	2.68	3.01	0.22	5.91	29.53	Pass
	165	5825	0.24	2.46	3.01	0.22	5.69	29.53	Pass

Note:

1. Method E) 2) c) of power density measurement of KDB 662911 is using for calculating total power density, Measure and add 10 log (N_{ANT}) dB.
2. Directional gain = $10 \log[(10^{G1/20} + 10^{G2/20} + \dots + 10^{GN/20})^2/2] = 6.47\text{dBi} > 6\text{dBi}$, so the limit shall be reduced to $30 - (6.47 - 6) = 29.53\text{dBm}$.
3. Refer to section 3.3 for duty cycle spectrum plot.

802.11n (HT20)

TX chain	Chan.	Freq. (MHz)	PSD W/O Duty Factor		10 log (N=2) dB	Duty Factor (dB)	Total PSD With Duty Factor (dBm/500kHz)	Limit (dBm/500kHz)	Pass / Fail
			(dBm/300kHz)	(dBm/500kHz)					
0	144	5720	-2.48	-0.26	3.01	0.23	2.98	29.53	Pass
	149	5745	-0.70	1.52	3.01	0.23	4.76	29.53	Pass
	157	5785	-0.75	1.47	3.01	0.23	4.71	29.53	Pass
	165	5825	-0.70	1.52	3.01	0.23	4.76	29.53	Pass
1	144	5720	-2.71	-0.49	3.01	0.23	2.75	29.53	Pass
	149	5745	-0.42	1.80	3.01	0.23	5.04	29.53	Pass
	157	5785	-0.33	1.89	3.01	0.23	5.13	29.53	Pass
	165	5825	-0.29	1.93	3.01	0.23	5.17	29.53	Pass

Note:

1. Method E) 2) c) of power density measurement of KDB 662911 is using for calculating total power density, Measure and add 10 log (N_{ANT}) dB.
2. Directional gain = $10 \log[(10^{G1/20} + 10^{G2/20} + \dots + 10^{GN/20})^2/2] = 6.47\text{dBi} > 6\text{dBi}$, so the limit shall be reduced to $30 - (6.47 - 6) = 29.53\text{dBm}$.
3. Refer to section 3.3 for duty cycle spectrum plot.

802.11n (HT40)

TX chain	Chan.	Freq. (MHz)	PSD W/O Duty Factor		10 log (N=2) dB	Duty Factor (dB)	Total PSD With Duty Factor (dBm/500kHz)	Limit (dBm/500kHz)	Pass / Fail
			(dBm/300kHz)	(dBm/500kHz)					
0	142	5710	-5.35	-3.13	3.01	0.47	0.35	29.53	Pass
	151	5755	-4.63	-2.41	3.01	0.47	1.07	29.53	Pass
	159	5795	-4.43	-2.21	3.01	0.47	1.27	29.53	Pass
1	142	5710	-5.98	-3.76	3.01	0.47	-0.28	29.53	Pass
	151	5755	-4.17	-1.95	3.01	0.47	1.53	29.53	Pass
	159	5795	-3.71	-1.49	3.01	0.47	1.99	29.53	Pass

Note:

- Method E) 2) c) of power density measurement of KDB 662911 is using for calculating total power density, Measure and add 10 log (N_{ANT}) dB.
- Directional gain = $10 \log[(10^{G1/20} + 10^{G2/20} + \dots + 10^{GN/20})^2/2] = 6.47\text{dBi} > 6\text{dBi}$, so the limit shall be reduced to $30 - (6.47 - 6) = 29.53\text{dBm}$.
- Refer to section 3.3 for duty cycle spectrum plot.

802.11ac (VHT80)

TX chain	Chan.	Freq. (MHz)	PSD W/O Duty Factor		10 log (N=2) dB	Duty Factor (dB)	Total PSD With Duty Factor (dBm/500kHz)	Limit (dBm/500kHz)	Pass / Fail
			(dBm/300kHz)	(dBm/500kHz)					
0	138	5690	-7.72	-5.50	3.01	0.89	-1.60	29.53	Pass
	155	5775	-7.30	-5.08	3.01	0.89	-1.18	29.53	Pass
1	138	5690	-10.02	-7.80	3.01	0.89	-3.90	29.53	Pass
	155	5775	-7.11	-4.89	3.01	0.89	-0.99	29.53	Pass

Note:

- Method E) 2) c) of power density measurement of KDB 662911 is using for calculating total power density, Measure and add 10 log (N_{ANT}) dB.
- Directional gain = $10 \log[(10^{G1/20} + 10^{G2/20} + \dots + 10^{GN/20})^2/2] = 6.47\text{dBi} > 6\text{dBi}$, so the limit shall be reduced to $30 - (6.47 - 6) = 29.53\text{dBm}$.
- Refer to section 3.3 for duty cycle spectrum plot.

Spectrum Plot of Worst Value

802.11a

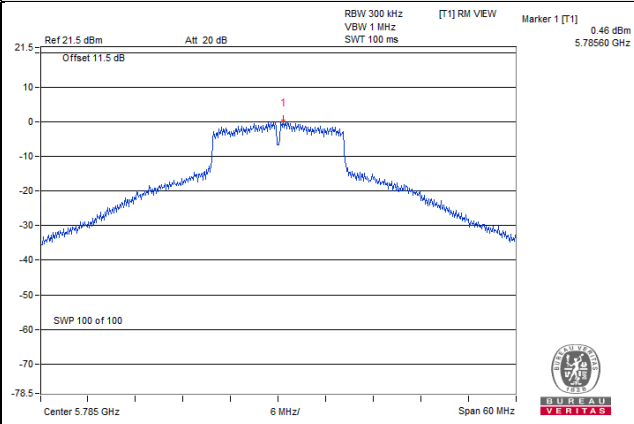

802.11n (HT20)

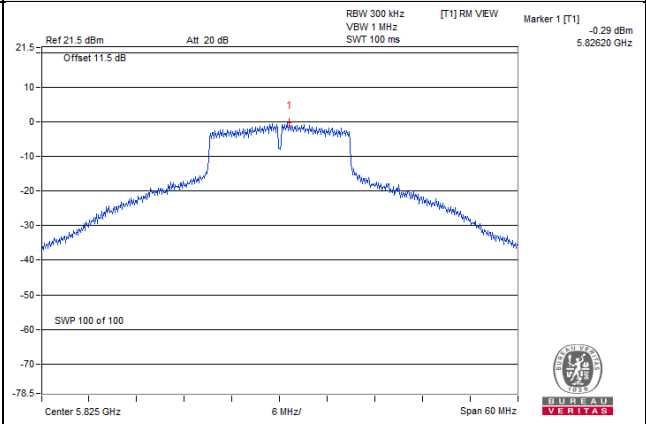

802.11n (HT40)

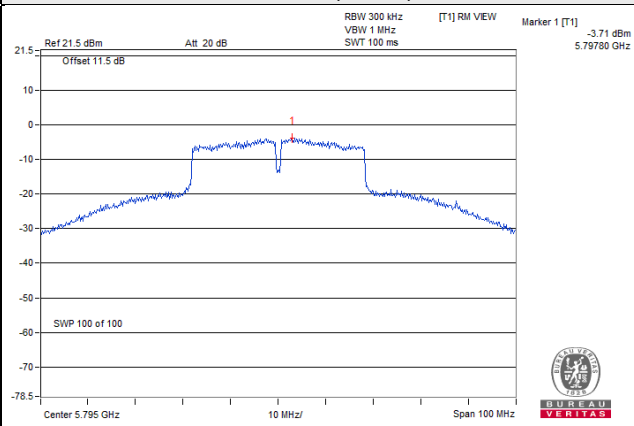

802.11ac (VHT80)

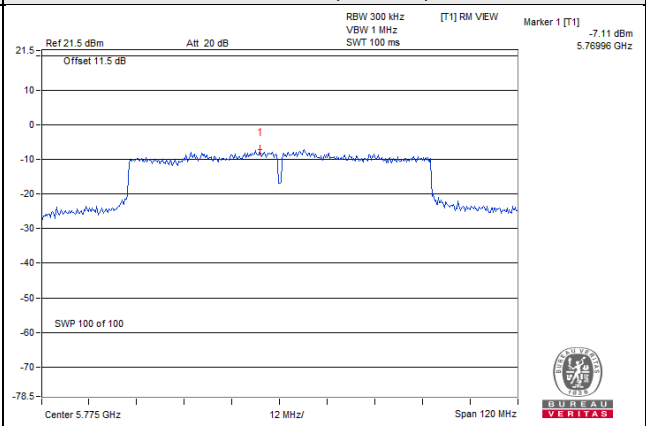

4.6 Frequency Stability

4.6.1 Limits of Frequency Stability Measurement

The frequency of the carrier signal shall be maintained within band of operation

4.6.2 Test Setup

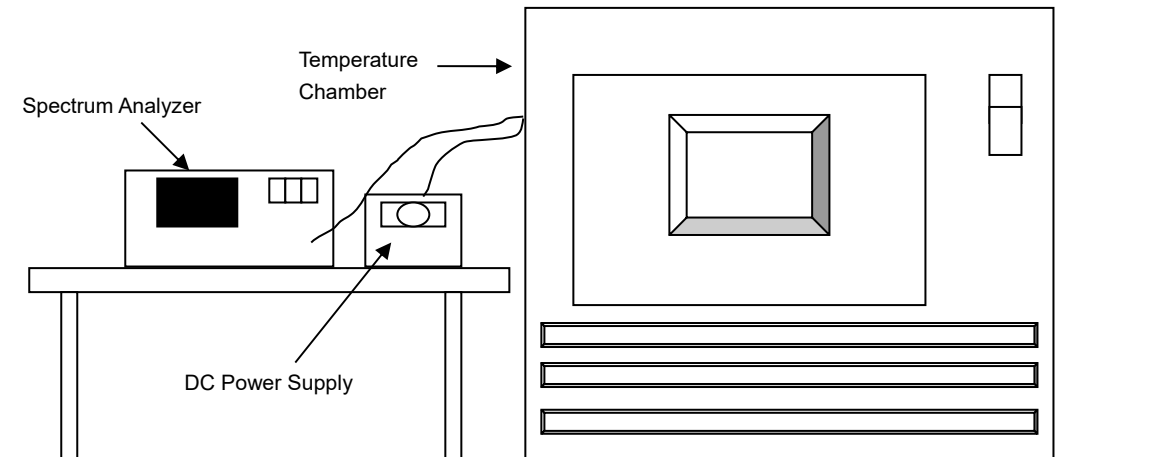

4.6.3 Test Instruments

Test Date: Sep. 14, 2020

Description & Manufacturer	Model No.	Serial No.	Cal. Date	Cal. Due
Spectrum Analyzer ROHDE & SCHWARZ	FSP40	100039	Jun. 12, 2019	Jun. 11, 2020
Standard Temperature And Humidity Chamber TERCHY	MHU-225AU	920842	May 27, 2020	May 26, 2021
Digital Multimeter Fluke	87-III	70360742	Jun. 23, 2020	Jun. 22, 2021
DC Power Supply Topward	6306A	727263	NA	NA

Note: 1. The calibration interval of the above test instruments is 12 months and the calibrations are traceable to NML/ROC and NIST/USA.

4.6.4 Test Procedure

- a. The EUT was placed inside the environmental test chamber and powered by nominal DC voltage.
- b. Turn the EUT on and couple its output to a spectrum analyzer.
- c. Turn the EUT off and set the chamber to the highest temperature specified.
- d. Allow sufficient time (approximately 30 min) for the temperature of the chamber to stabilize, turn the EUT on and measure the operating frequency after 2, 5, and 10 minutes.
- e. Repeat step (d) with the temperature chamber set to the next desired temperature until measurements down to the lowest specified temperature have been completed.
- f. The test chamber was allowed to stabilize at +20 degree C for a minimum of 30 minutes. The supply voltage was then adjusted on the EUT from 85% to 115% and the frequency record.

4.6.5 Deviation from Test Standard

No deviation.

4.6.6 EUT Operating Condition

Set the EUT transmit at un-modulation mode to test frequency stability.

4.6.7 Test Results

Frequency Stability Versus Temp.									
Operating Frequency: 5180MHz									
Temp. (°C)	Power Supply (Vdc)	0 Minute		2 Minute		5 Minute		10 Minute	
		Measured Frequency (MHz)	Result	Measured Frequency (MHz)	Result	Measured Frequency (MHz)	Result	Measured Frequency (MHz)	Result
50	3.8	5180.0039	Pass	5180.0013	Pass	5180.0007	Pass	5179.9998	Pass
40	3.8	5179.9797	Pass	5179.9822	Pass	5179.9832	Pass	5179.9807	Pass
30	3.8	5180.0165	Pass	5180.0142	Pass	5180.0123	Pass	5180.0138	Pass
20	3.8	5179.9937	Pass	5179.9953	Pass	5179.9972	Pass	5179.9947	Pass
10	3.8	5180.0096	Pass	5180.0086	Pass	5180.0061	Pass	5180.0074	Pass
0	3.8	5179.9909	Pass	5179.9874	Pass	5179.9876	Pass	5179.9918	Pass
-10	3.8	5180.0167	Pass	5180.0173	Pass	5180.0194	Pass	5180.0178	Pass
-20	3.8	5180.0276	Pass	5180.0281	Pass	5180.0261	Pass	5180.0249	Pass

Frequency Stability Versus Voltage									
Operating Frequency: 5180MHz									
Temp. (°C)	Power Supply (Vdc)	0 Minute		2 Minute		5 Minute		10 Minute	
		Measured Frequency (MHz)	Result	Measured Frequency (MHz)	Result	Measured Frequency (MHz)	Result	Measured Frequency (MHz)	Result
20	4.37	5179.9944	Pass	5179.9949	Pass	5179.9968	Pass	5179.9944	Pass
	3.8	5179.9937	Pass	5179.9953	Pass	5179.9972	Pass	5179.9947	Pass
	3.23	5179.993	Pass	5179.9959	Pass	5179.9982	Pass	5179.9947	Pass

4.7 6dB Bandwidth Measurement

4.7.1 Limits of 6dB Bandwidth Measurement

The minimum of 6dB Bandwidth Measurement is 0.5MHz.

4.7.2 Test Setup

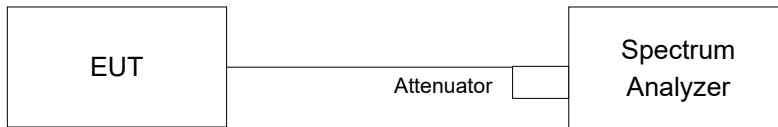

4.7.3 Test Instruments

Refer to section 4.1.2 to get information of above instrument.

4.7.4 Test Procedure

- Set resolution bandwidth (RBW) = 100kHz
- Set the video bandwidth (VBW) $\geq 3 \times$ RBW, Detector = Peak.
- Trace mode = max hold.
- Sweep = auto couple.
- Measure the maximum width of the emission that is constrained by the frequencies associated with the two amplitude points (upper and lower) that are attenuated by 6 dB relative to the maximum level measured in the fundamental emission

4.7.5 Deviation from Test Standard

No deviation.

4.7.6 EUT Operating Condition

The software provided by client to enable the EUT under transmission condition continuously at lowest, middle and highest channel frequencies individually.

4.7.7 Test Results

802.11a

Channel	Frequency (MHz)	6dB Bandwidth (MHz)		Minimum Limit (MHz)	Pass / Fail
		Chain 0	Chain 1		
144 (For U-NII-3)	5720	2.85	2.59	0.5	Pass
149	5745	15.22	16.34	0.5	Pass
157	5785	15.40	16.36	0.5	Pass
165	5825	15.79	16.32	0.5	Pass

802.11n (HT20)

Channel	Frequency (MHz)	6dB Bandwidth (MHz)		Minimum Limit (MHz)	Pass / Fail
		Chain 0	Chain 1		
144 (For U-NII-3)	5720	3.75	3.07	0.5	Pass
149	5745	17.24	17.63	0.5	Pass
157	5785	17.58	17.61	0.5	Pass
165	5825	17.24	17.6	0.5	Pass

802.11n (HT40)

Channel	Frequency (MHz)	6dB Bandwidth (MHz)		Minimum Limit (MHz)	Pass / Fail
		Chain 0	Chain 1		
142 (For U-NII-3)	5710	2.92	2.62	0.5	Pass
151	5755	35.29	35.27	0.5	Pass
159	5795	35.29	35.55	0.5	Pass

802.11ac (VHT80)

Channel	Frequency (MHz)	6dB Bandwidth (MHz)		Minimum Limit (MHz)	Pass / Fail
		Chain 0	Chain 1		
138 (For U-NII-3)	5690	2.67	2.70	0.5	Pass
155	5775	75.41	75.33	0.5	Pass

Spectrum Plot of Worst Value

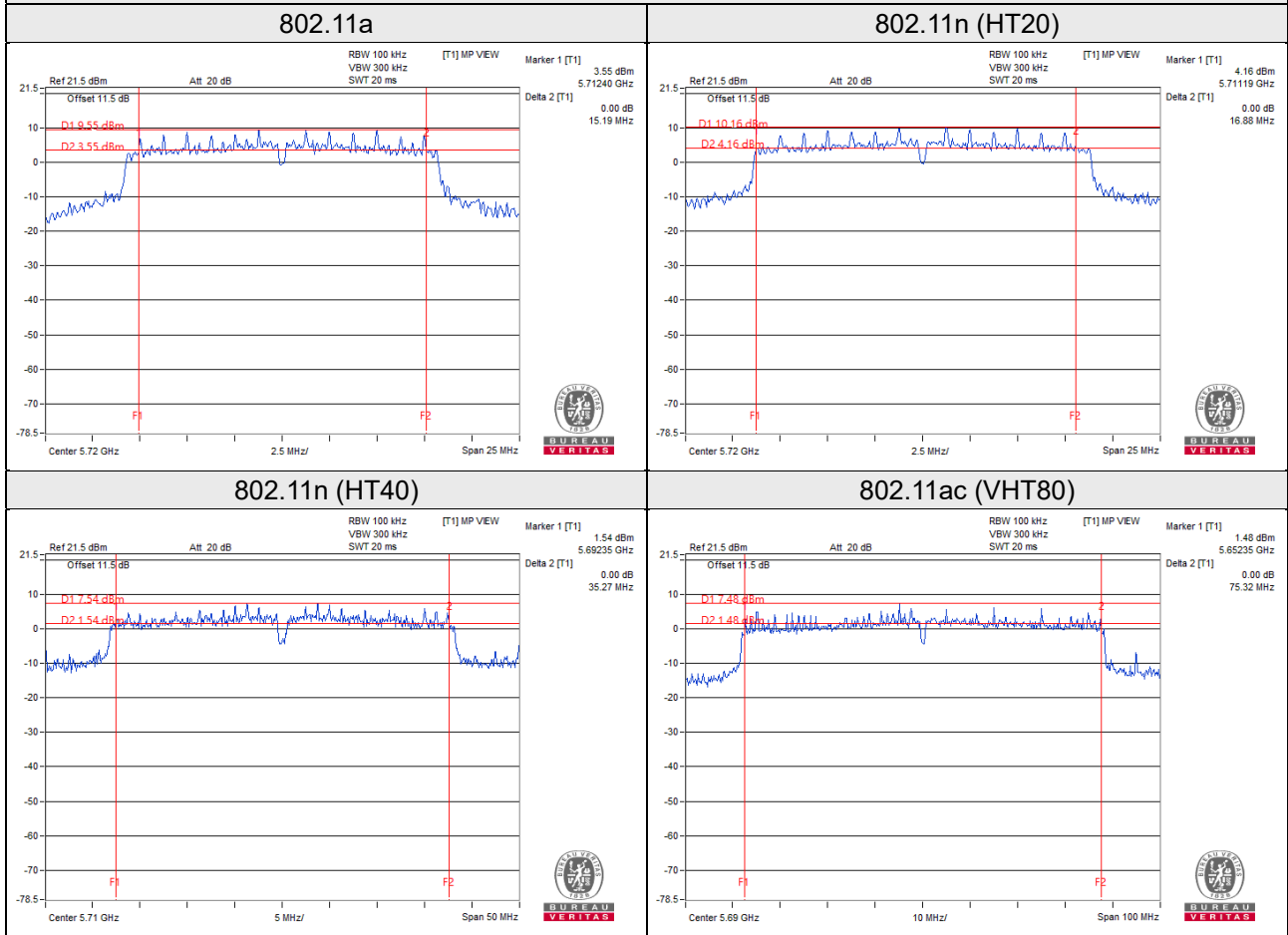

Note:

For CH144 (UNII-3 Band): The 6dB bandwidth above 5725MHz = Marker 1 + Delta 2 - 5725MHz

For CH142 (UNII-3 Band): The 6dB bandwidth above 5725MHz = Marker 1 + Delta 2 - 5725MHz

For CH138 (UNII-3 Band): The 6dB bandwidth above 5725MHz = Marker 1 + Delta 2 - 5725MHz

Annex A- Radiated Out of Band Emission (OOBE) Measurement (For U-NII-3 band)

802.11a

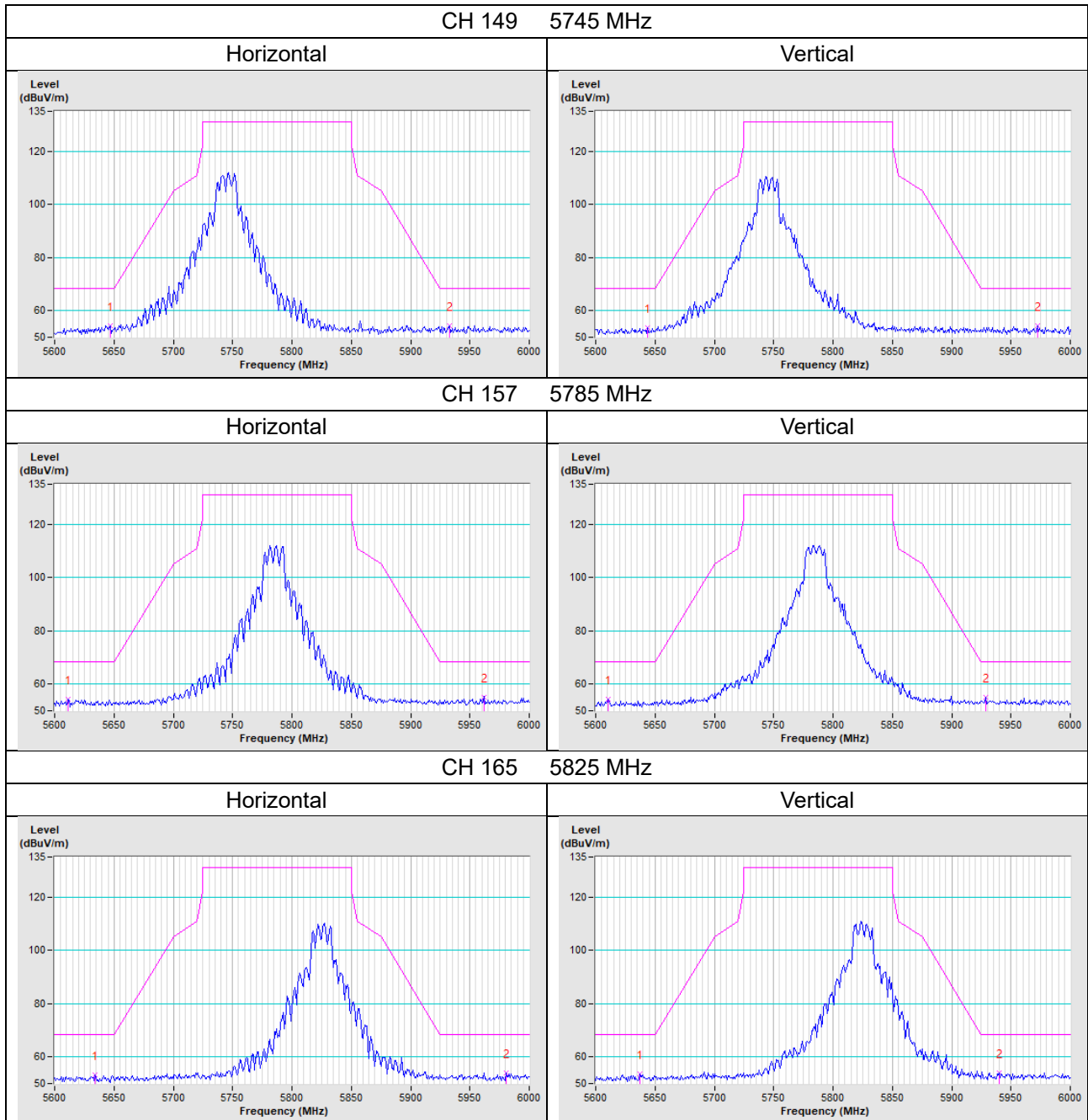

802.11n (HT20)

CH 149 5745 MHz

Horizontal

Vertical

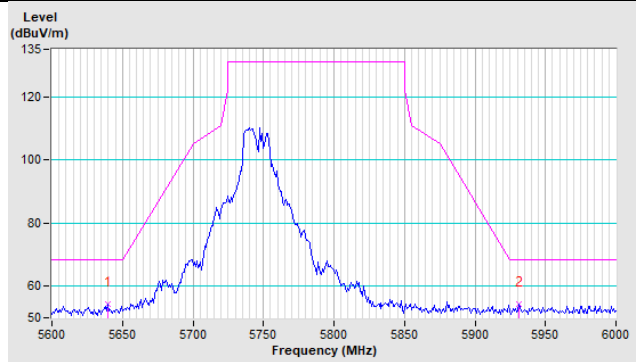
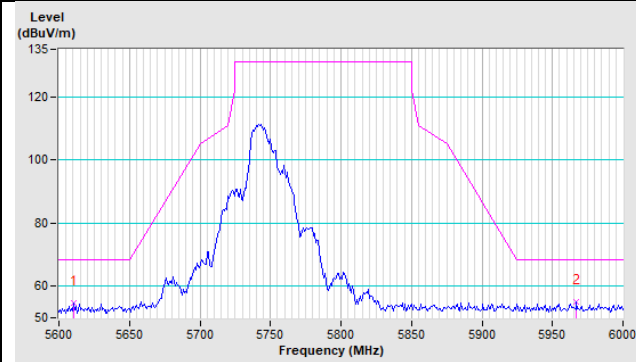

CH 157 5785 MHz

Horizontal

Vertical

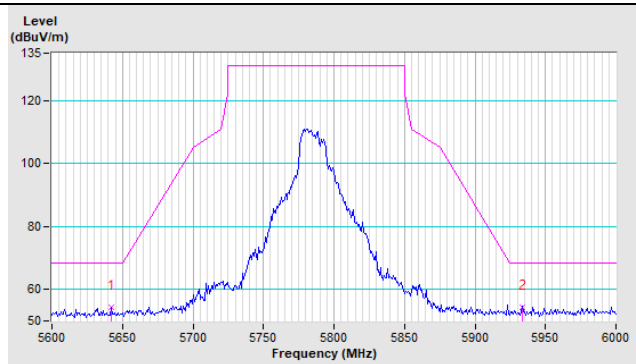
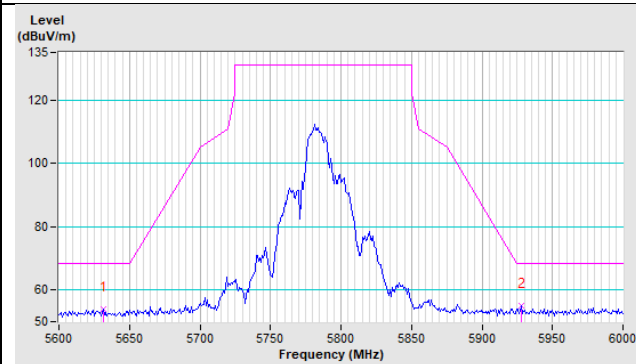

CH 165 5825 MHz

Horizontal

Vertical

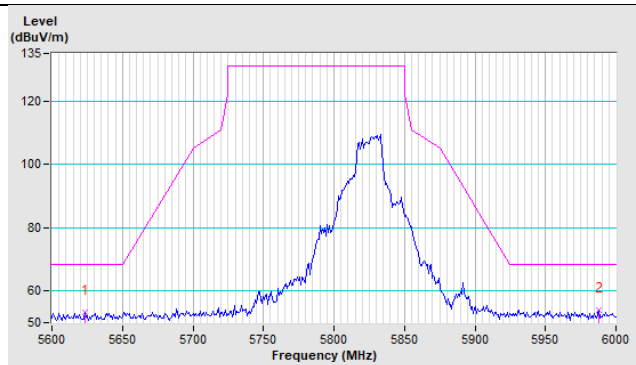
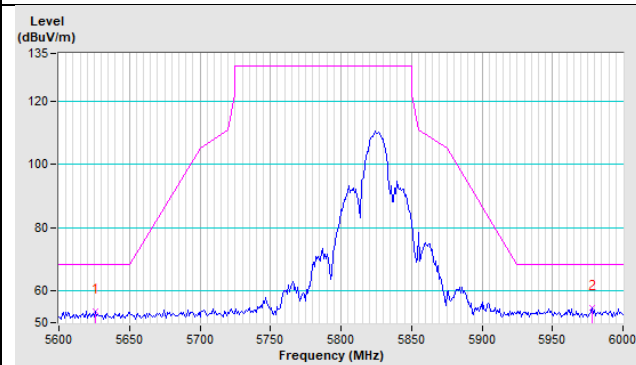

802.11n (HT40)

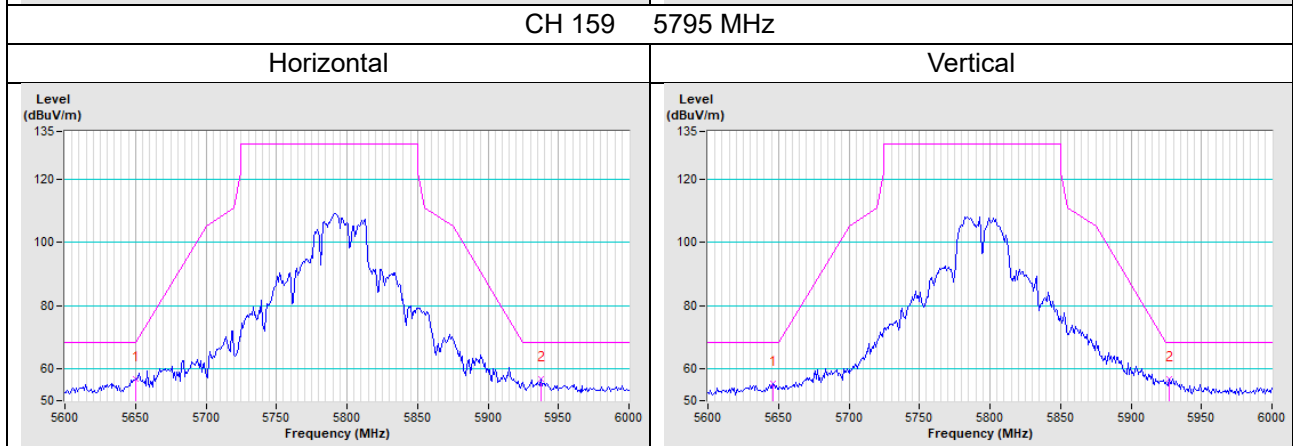
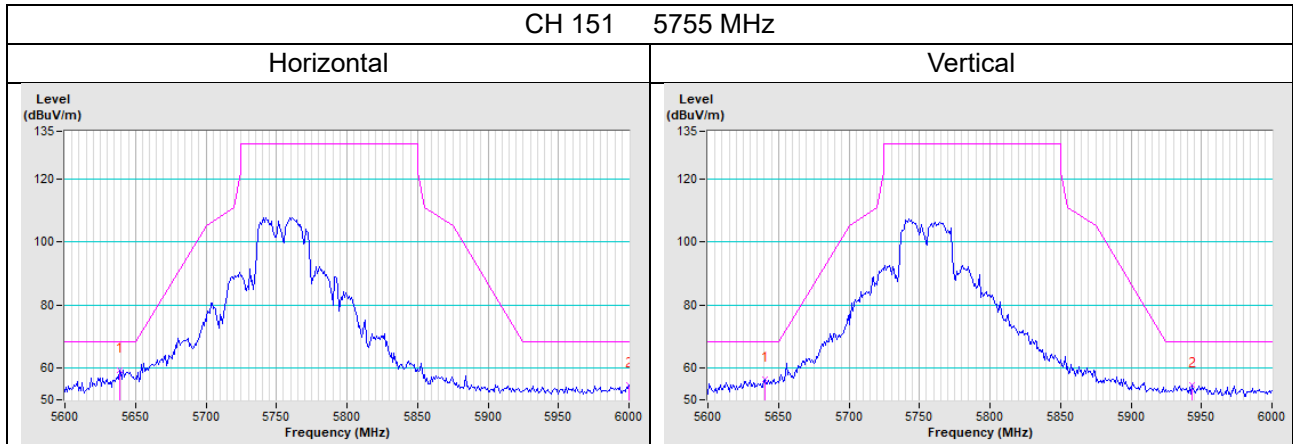

802.11ac (VHT80)

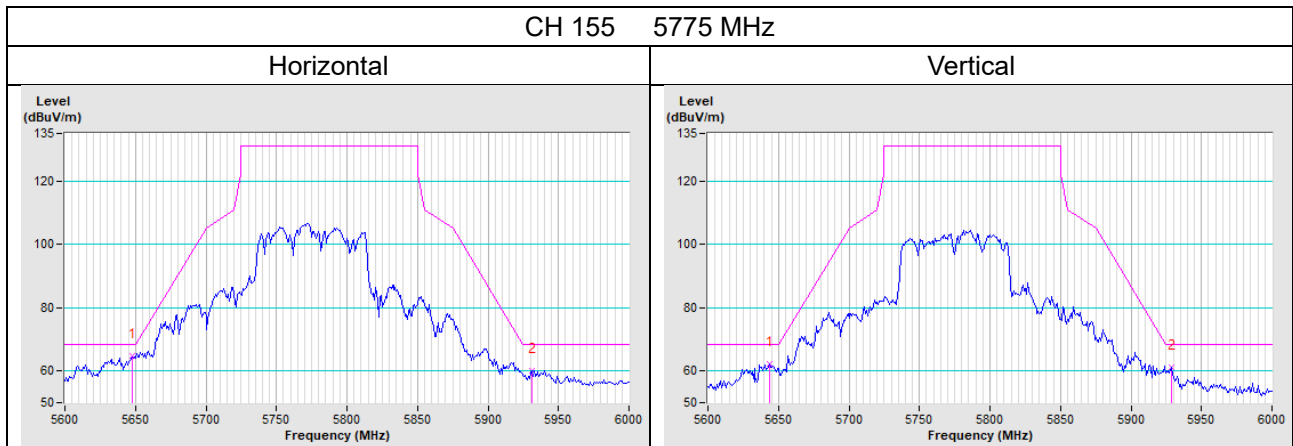

Annex B- Band Edge Measurement

802.11a

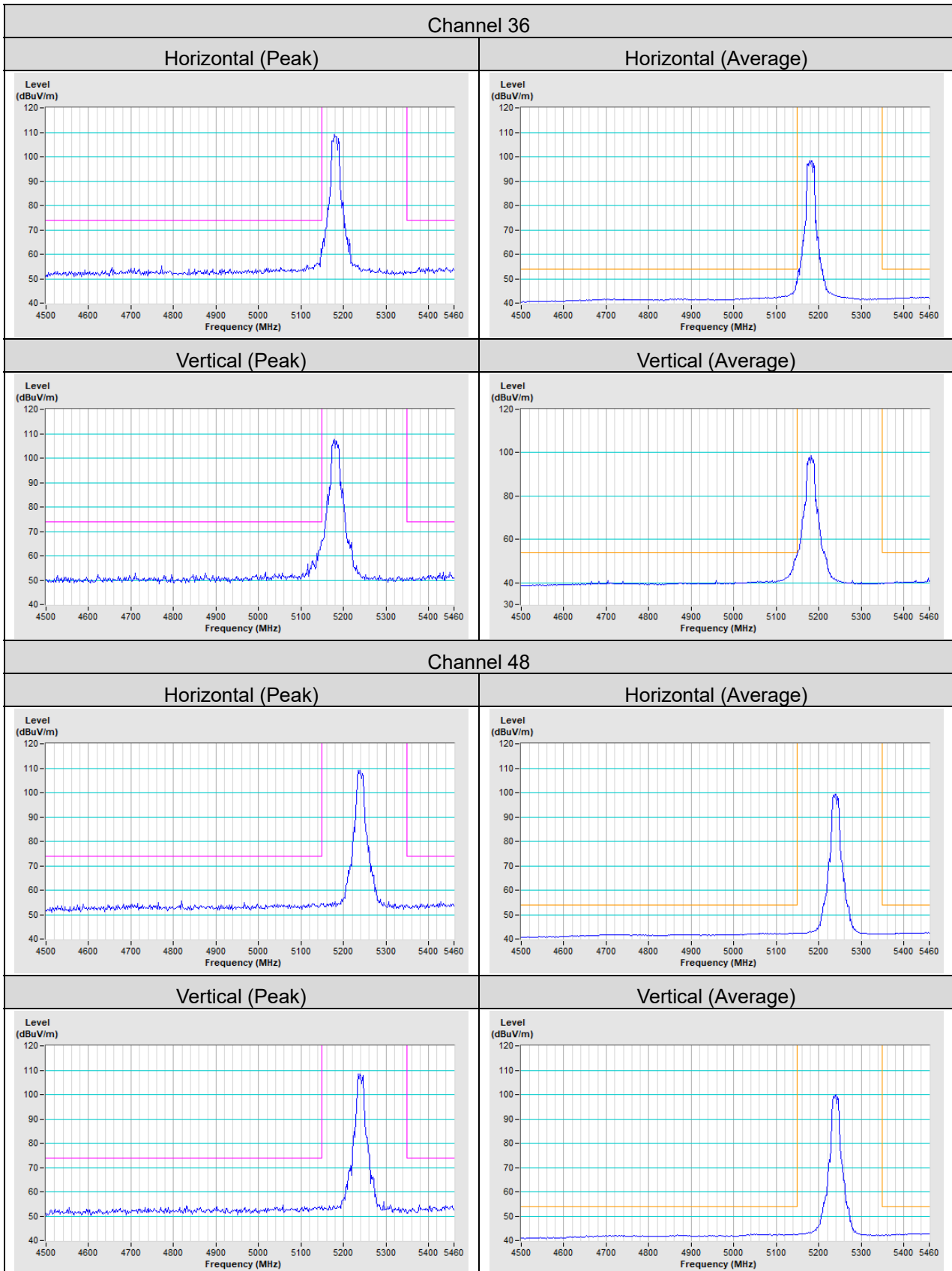

Channel 52

Horizontal (Peak)

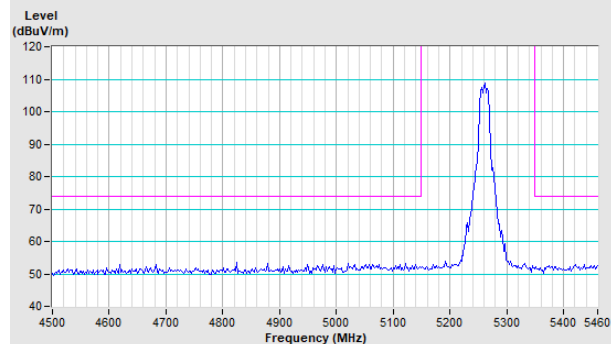

Horizontal (Average)

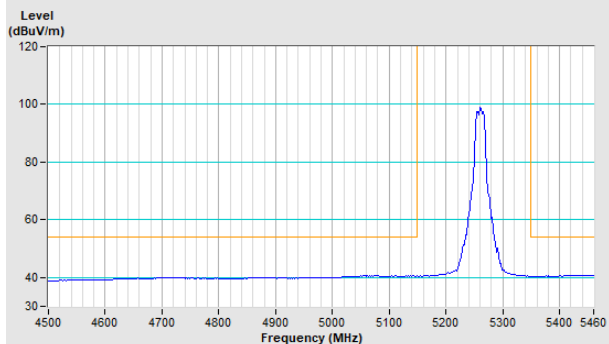

Vertical (Peak)

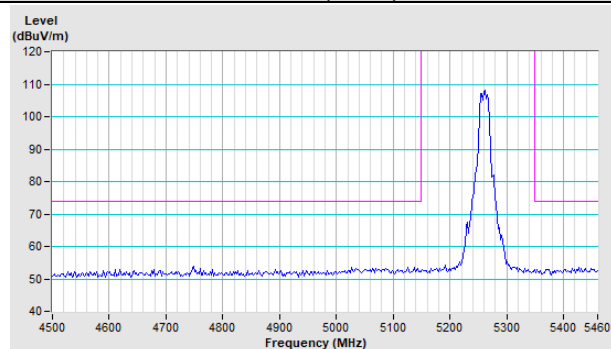

Vertical (Average)

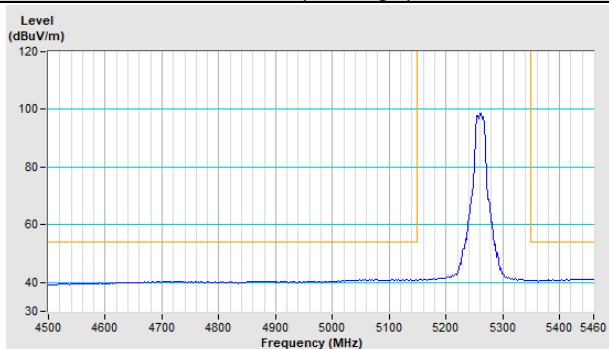

Channel 64

Horizontal (Peak)

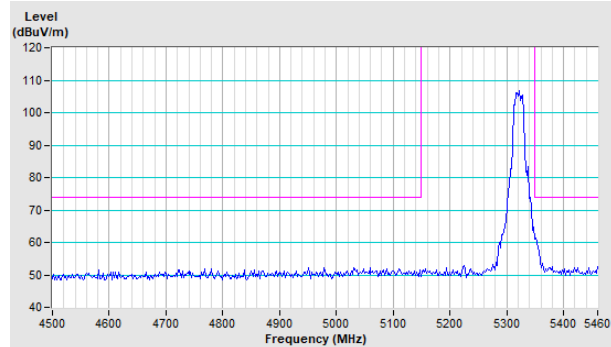

Horizontal (Average)

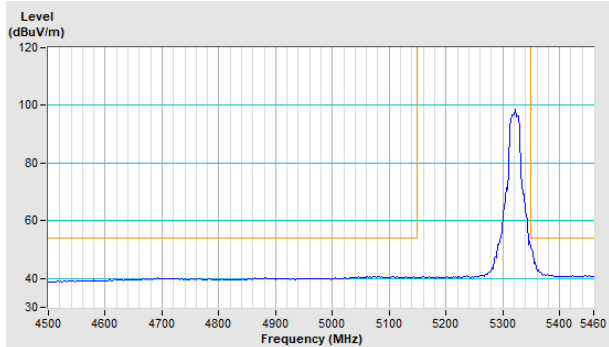

Vertical (Peak)

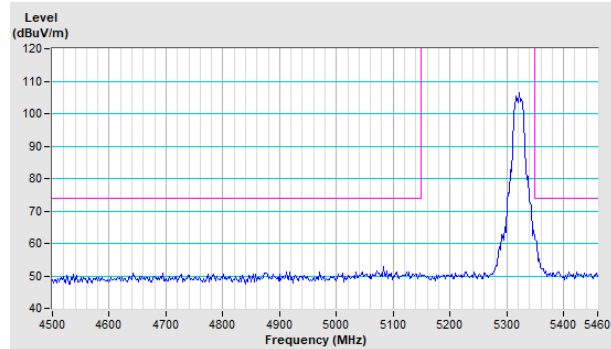

Vertical (Average)

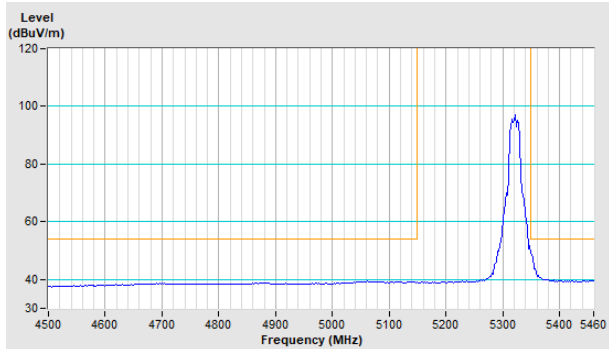

Channel 100

Horizontal (Peak)

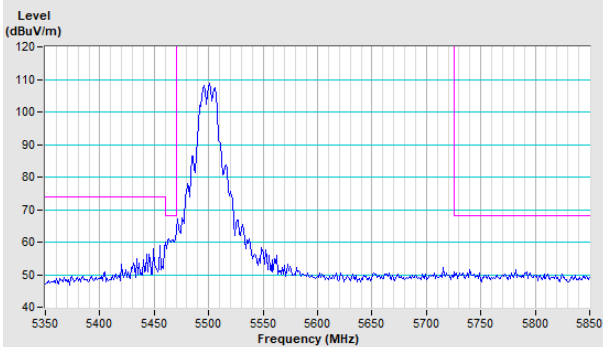

Horizontal (Average)

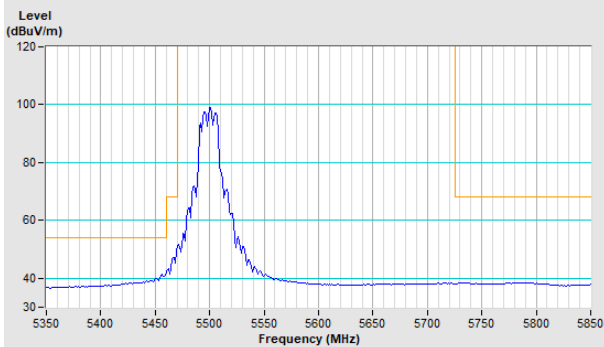

Vertical (Peak)

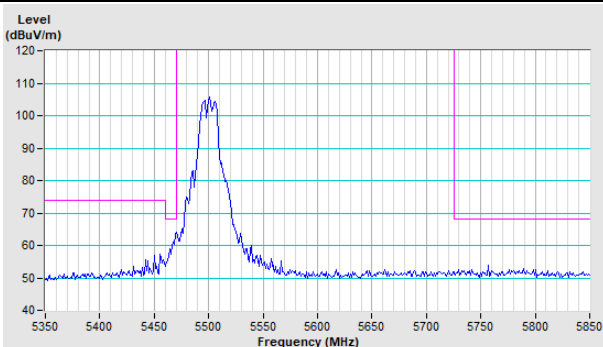

Vertical (Average)

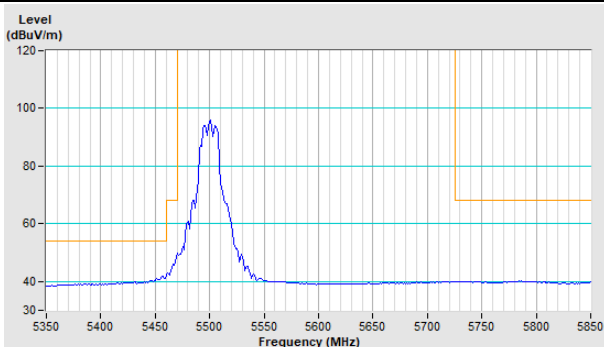

Channel 140

Horizontal (Peak)

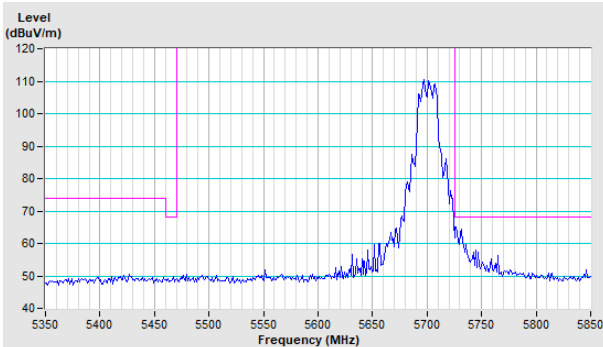

Vertical (Peak)

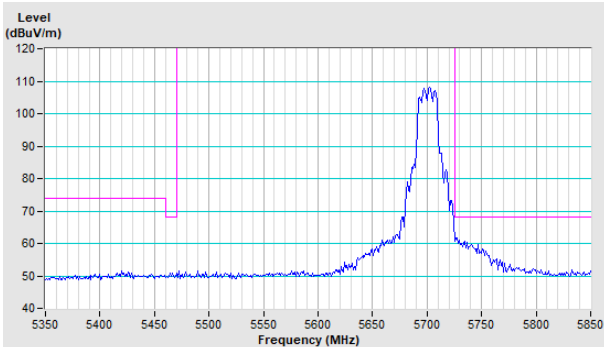

Channel 144

Horizontal (Peak)

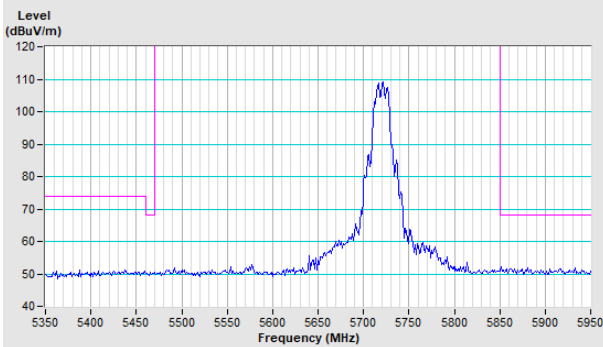

Vertical (Peak)

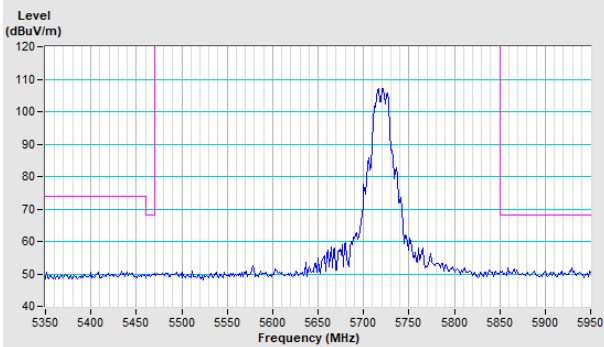

802.11n (HT20)

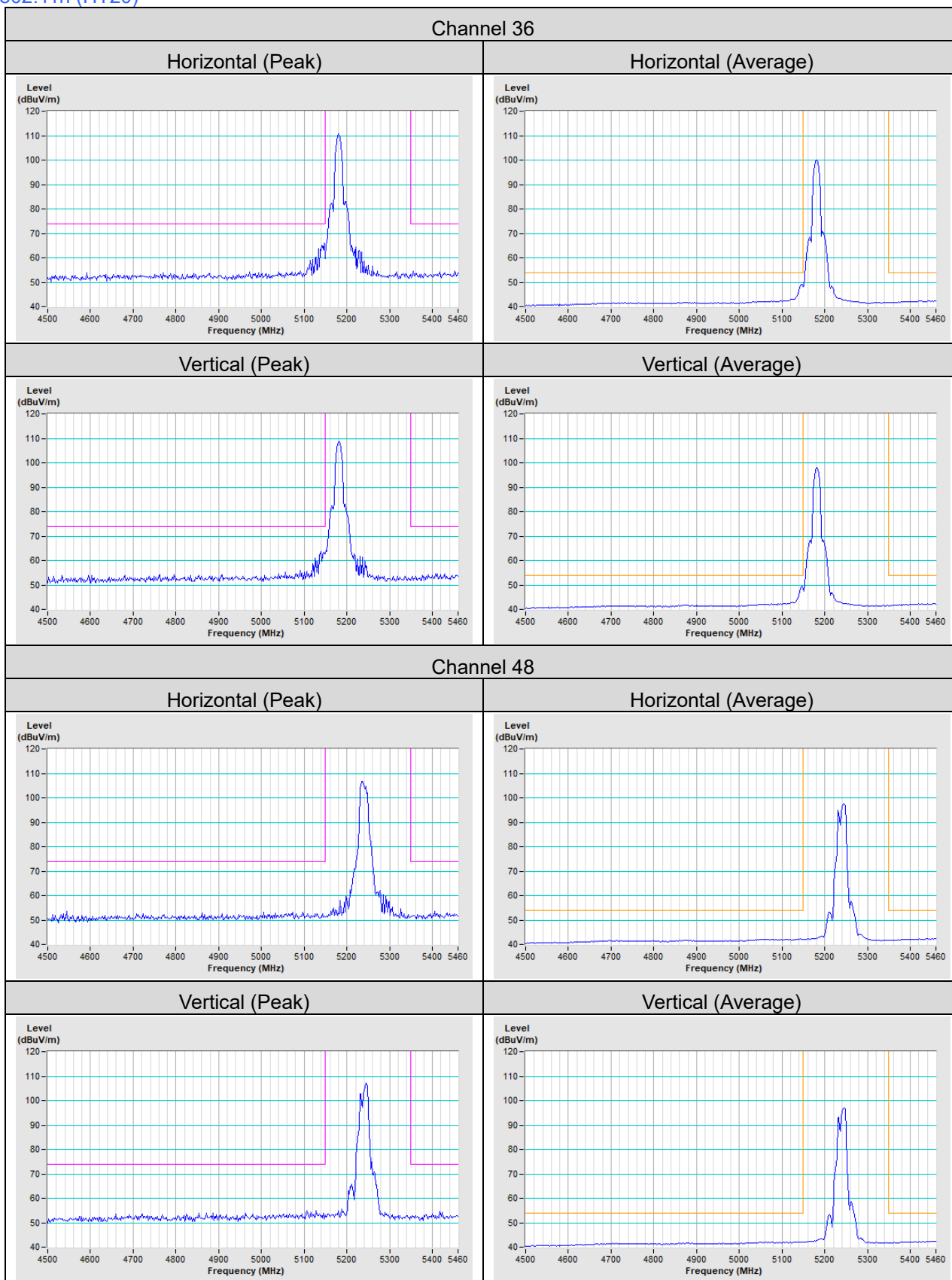

Channel 52

Horizontal (Peak)

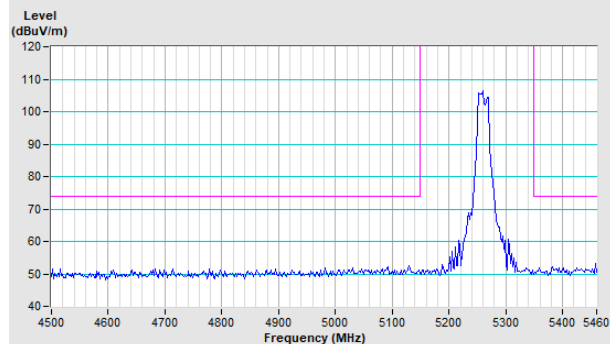

Horizontal (Average)

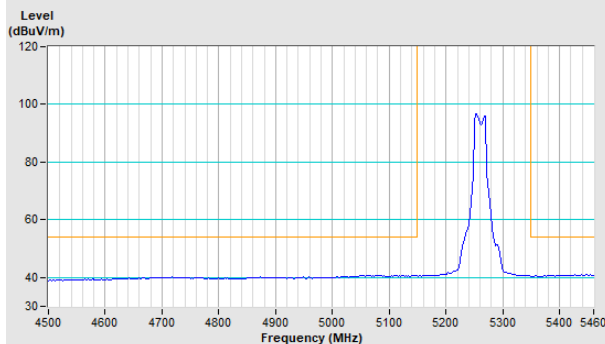

Vertical (Peak)

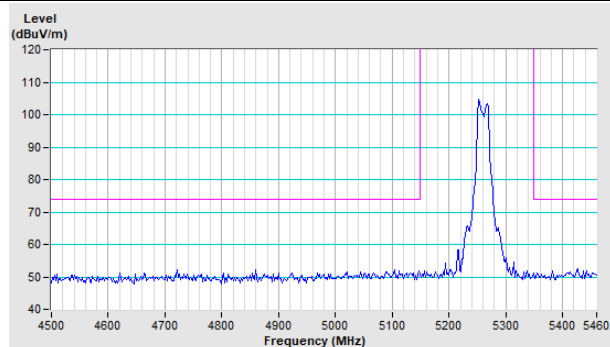

Vertical (Average)

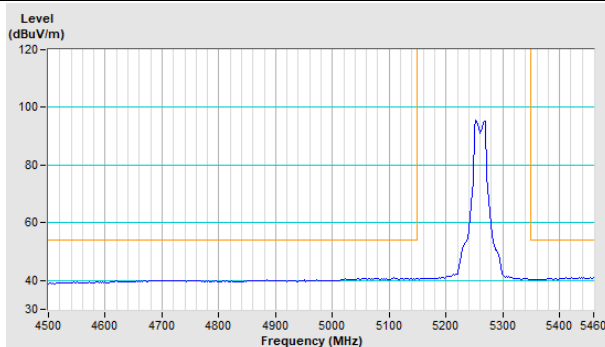

Channel 64

Horizontal (Peak)

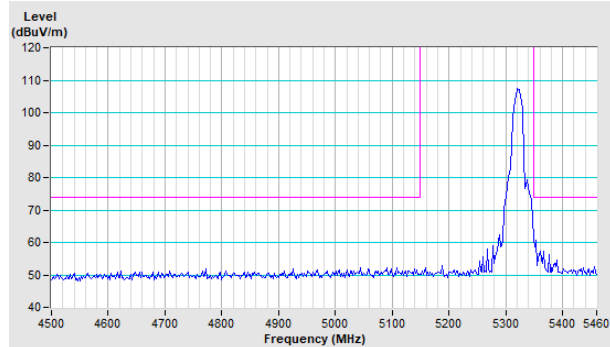

Horizontal (Average)

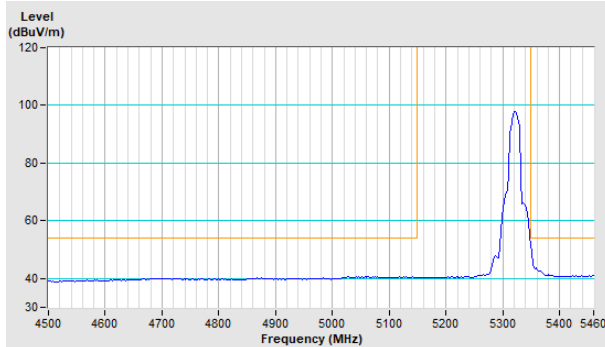

Vertical (Peak)

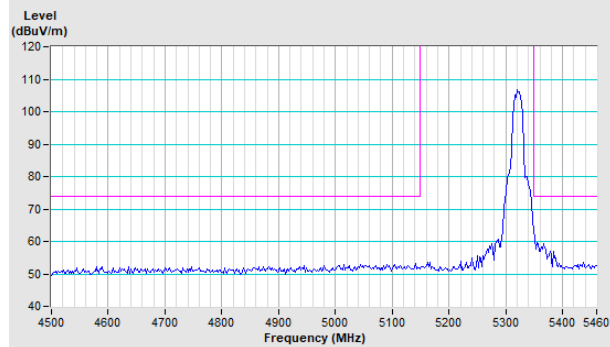

Vertical (Average)

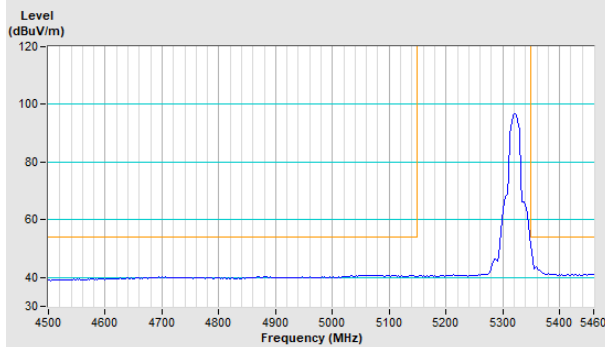

Channel 100

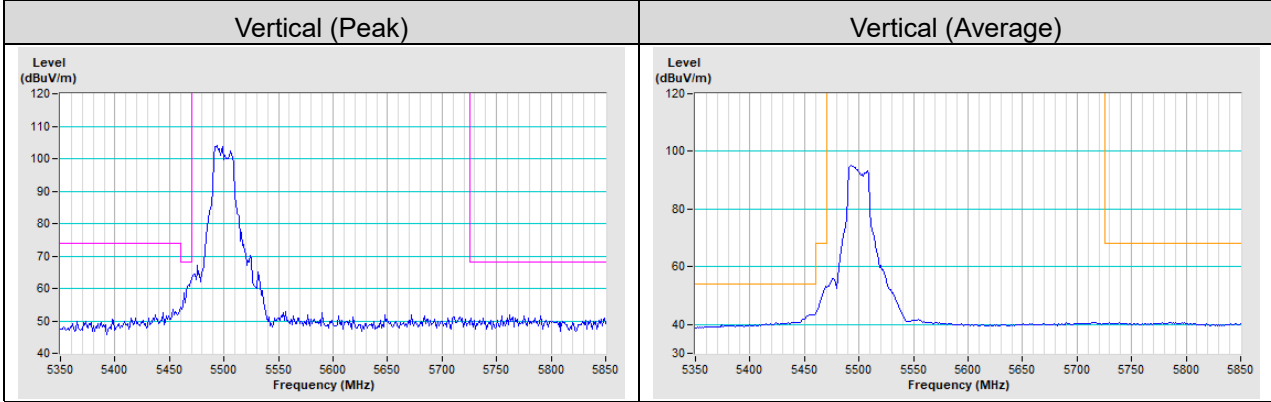
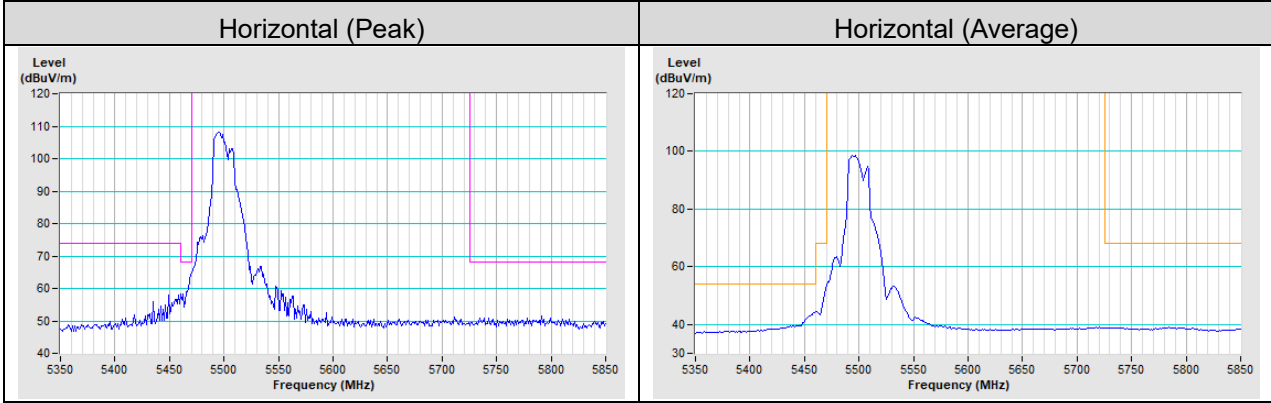

Channel 140

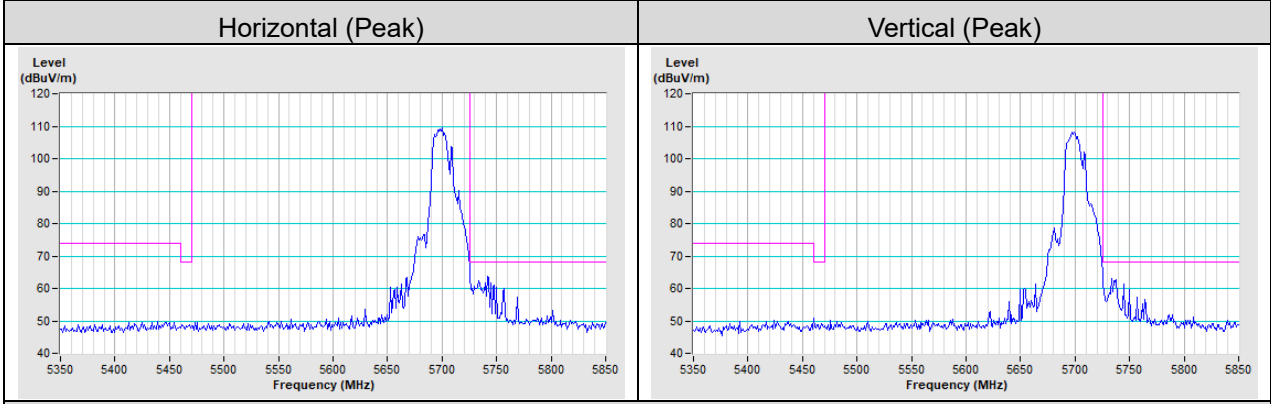

Channel 144

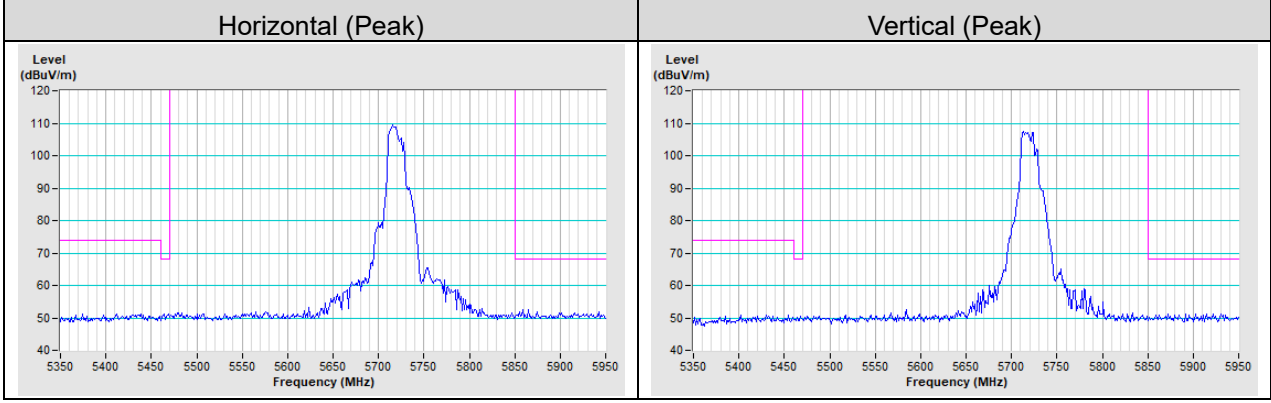

802.11n (HT40)

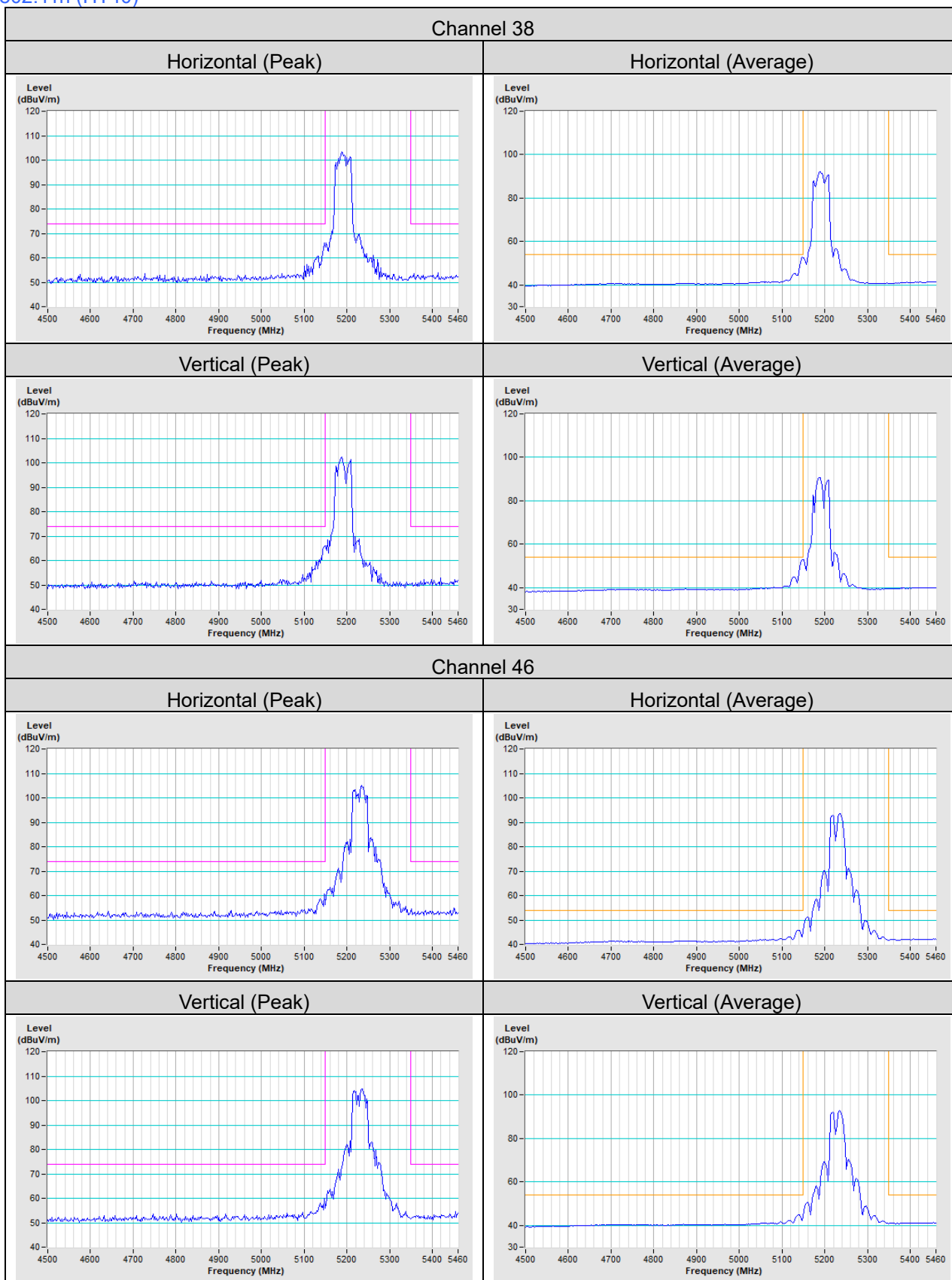

Channel 54

Horizontal (Peak)

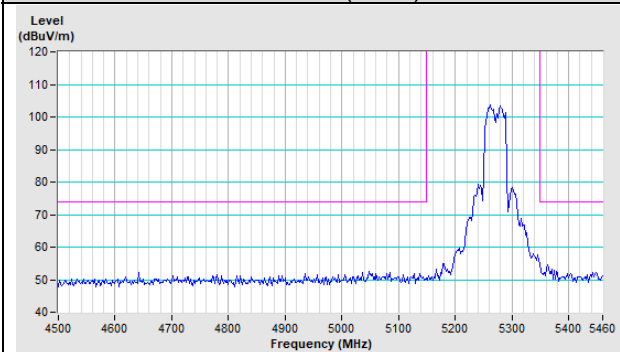

Horizontal (Average)

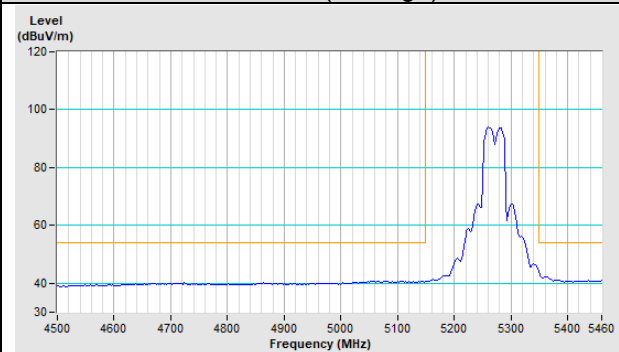

Vertical (Peak)

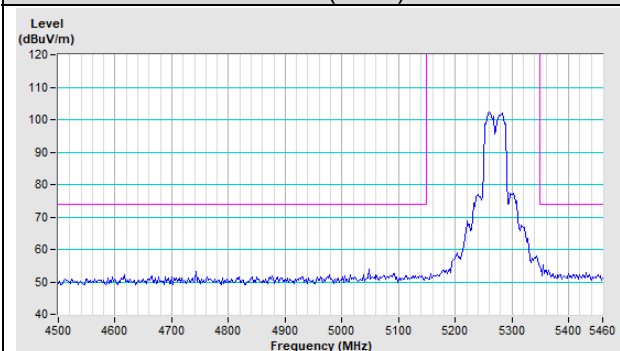

Vertical (Average)

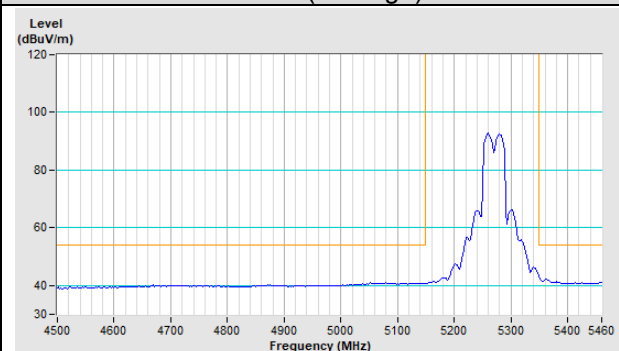

Channel 62

Horizontal (Peak)

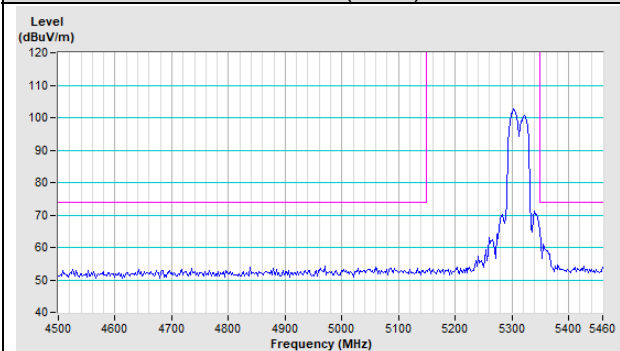

Horizontal (Average)

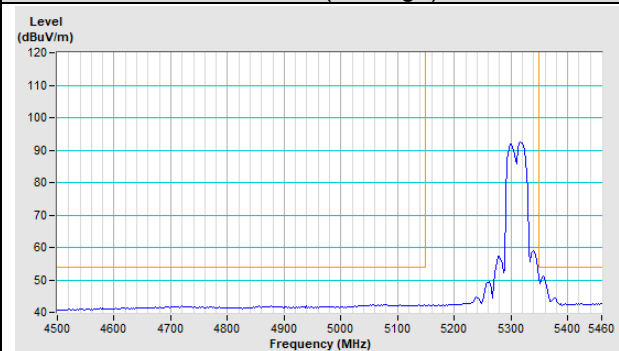

Vertical (Peak)

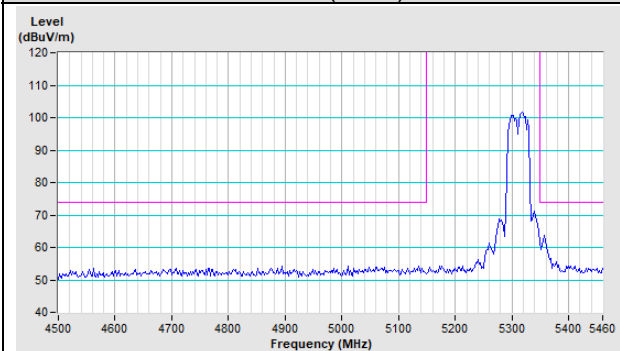

Vertical (Average)

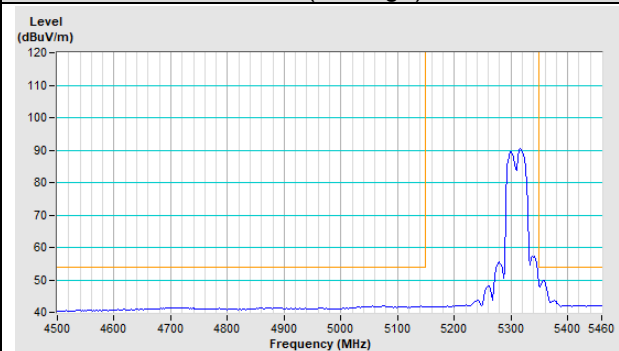

Channel 102

Horizontal (Peak)

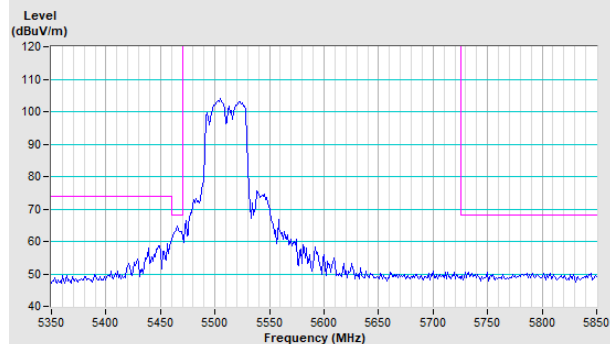

Horizontal (Average)

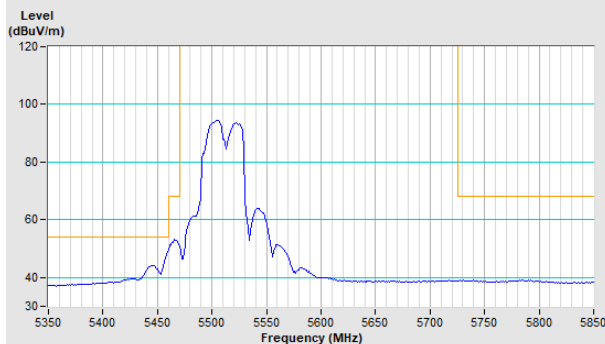

Vertical (Peak)

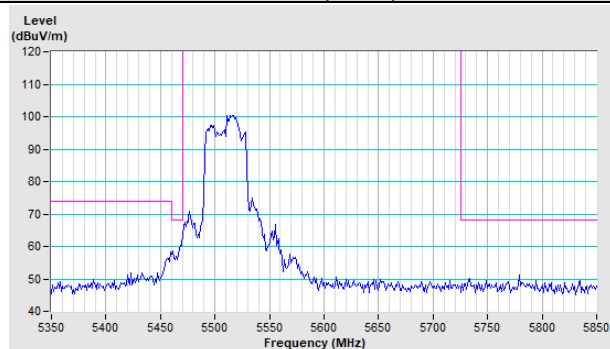

Vertical (Average)

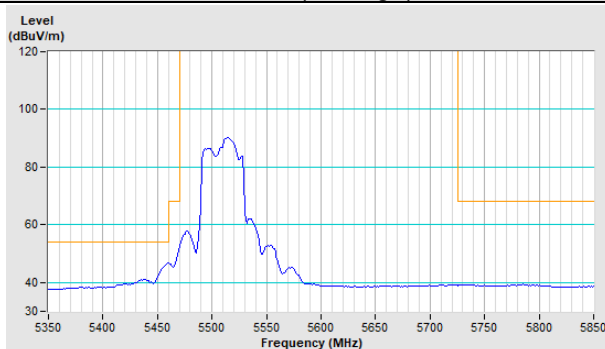

Channel 134

Horizontal (Peak)

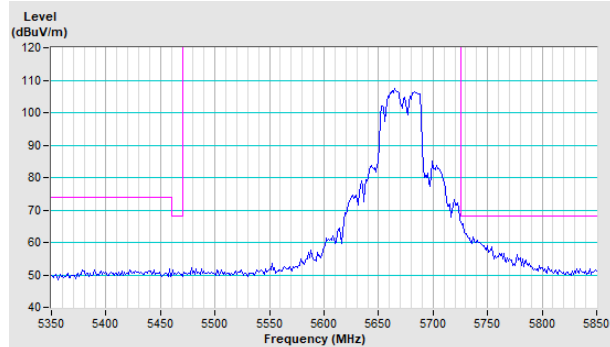

Vertical (Peak)

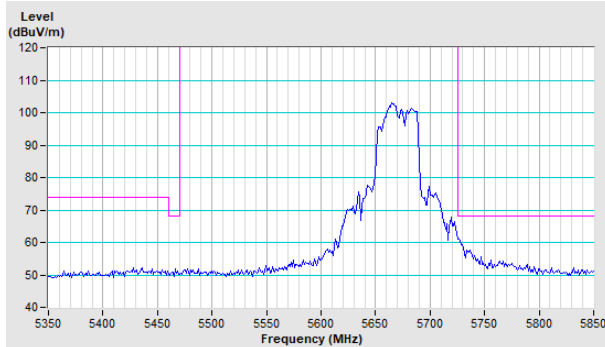

Channel 142

Horizontal (Peak)

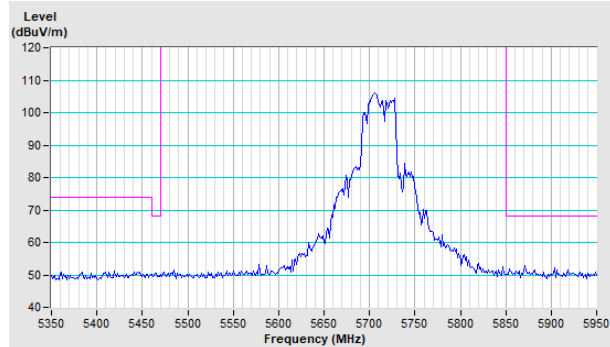

Vertical (Peak)

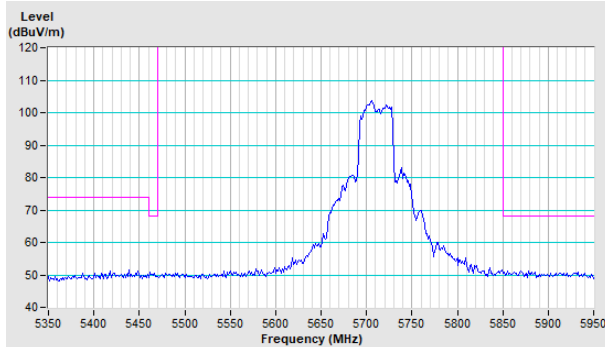

802.11ac (VHT80)

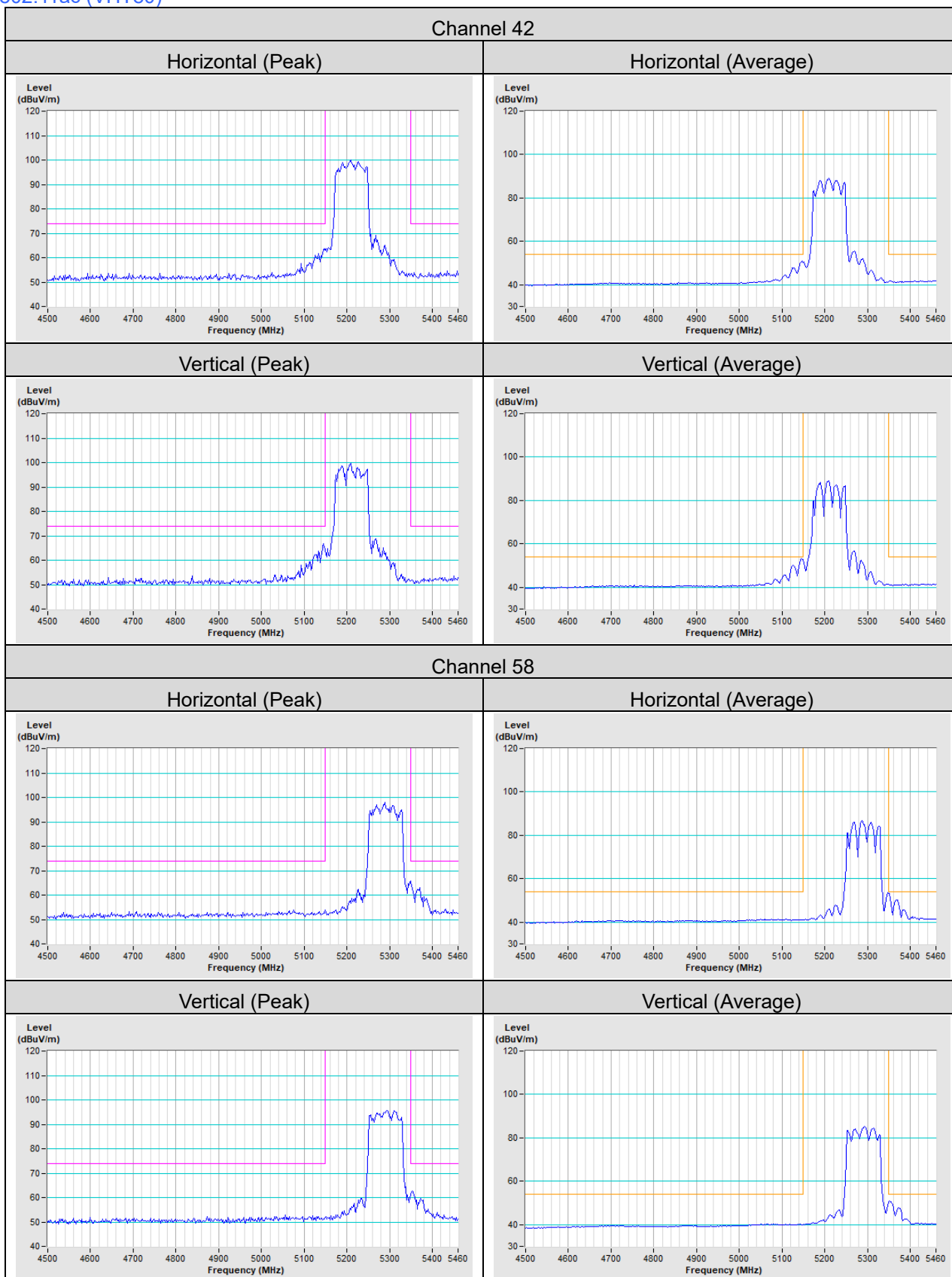

Channel 106

Horizontal (Peak)

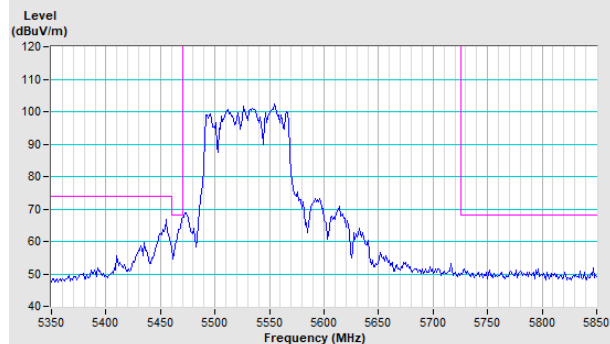

Horizontal (Average)

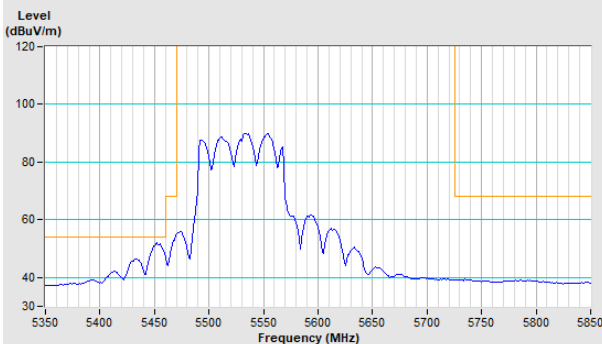

Vertical (Peak)

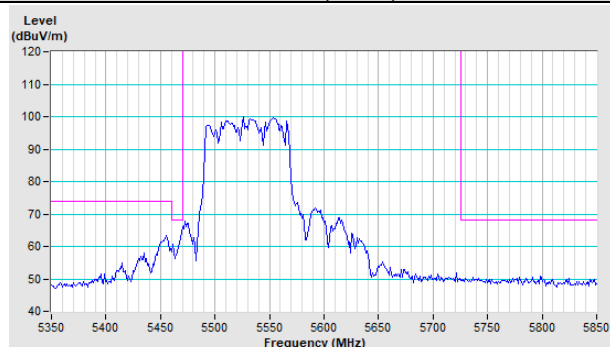

Vertical (Average)

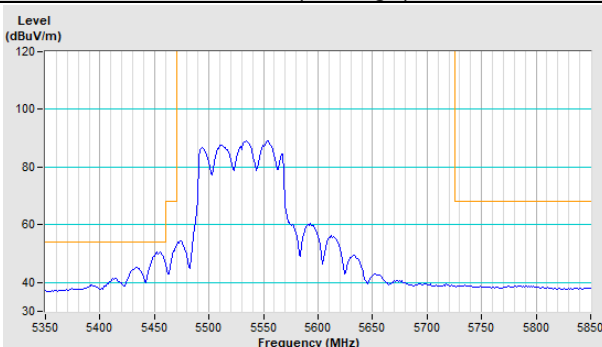

Channel 122

Horizontal (Peak)

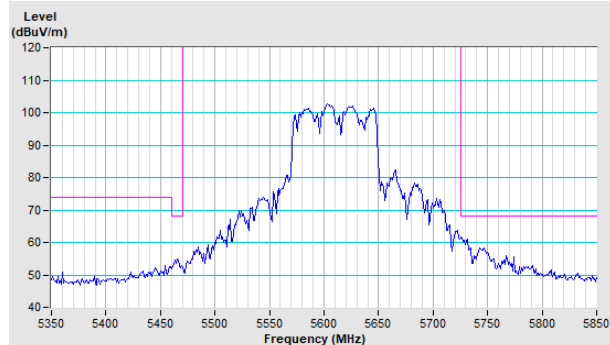

Horizontal (Average)

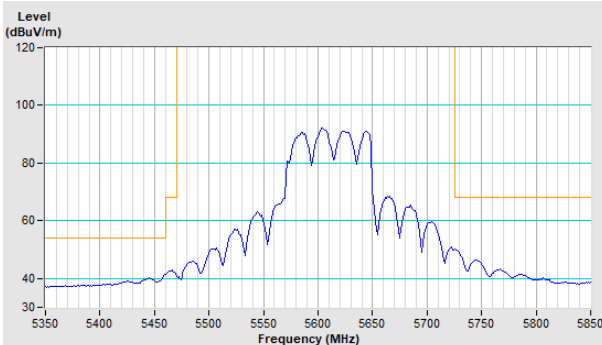

Vertical (Peak)

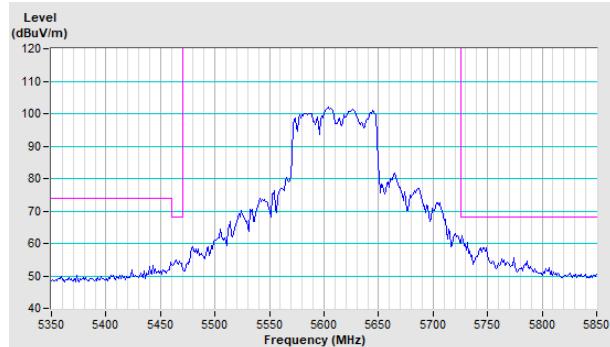

Vertical (Average)

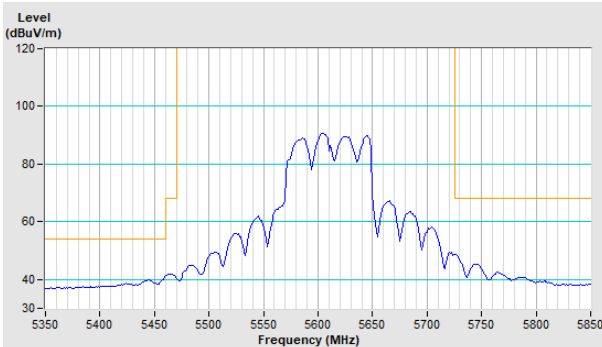

Channel 138

Horizontal (Peak)

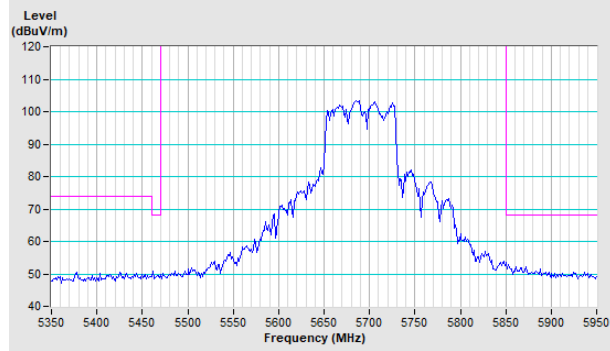

Vertical (Peak)

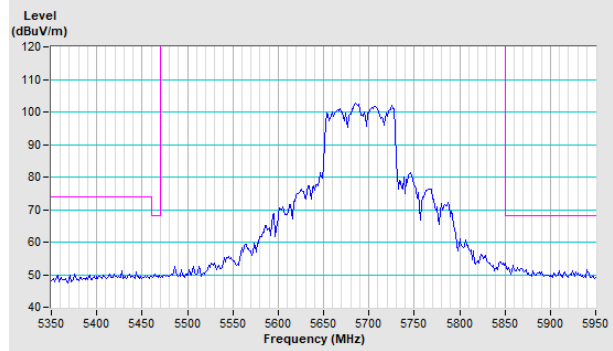

5 Pictures of Test Arrangements

Please refer to the attached file (Test Setup Photo).

Appendix – Information of the Testing Laboratories

We, Bureau Veritas Consumer Products Services (H.K.) Ltd., Taoyuan Branch, were founded in 1988 to provide our best service in EMC, Radio, Telecom and Safety consultation. Our laboratories are FCC recognized accredited test firms and accredited and approved according to ISO/IEC 17025.

If you have any comments, please feel free to contact us at the following:

Lin Kou EMC/RF Lab

Tel: 886-2-26052180

Fax: 886-2-26051924

Hsin Chu EMC/RF/Telecom Lab

Tel: 886-3-6668565

Fax: 886-3-6668323

Hwa Ya EMC/RF/Safety

Tel: 886-3-3183232

Fax: 886-3-3270892

Email: service.adt@tw.bureauveritas.com

Web Site: www.bureauveritas-adt.com

The address and road map of all our labs can be found in our web site also.

--- END ---