

FCC Test Report

Report No.: RF200615C06-6

FCC ID: PZWBHTM80QWG

Test Model: BHT-M80-QWG

Received Date: Apr. 28, 2020

Test Date: Sep. 04 ~ Oct. 21, 2020

Issued Date: Oct. 26, 2020

Applicant: DENSO WAVE INCORPORATED

Address: 1 Yoshiike Kusagi Agui-cho, Chita-gun Aichi 470-2297, Japan

Issued By: Bureau Veritas Consumer Products Services (H.K.) Ltd., Taoyuan Branch
Lin Kou Laboratories

Lab Address: No. 47-2, 14th Ling, Chia Pau Vil., Lin Kou Dist., New Taipei City, Taiwan

Test Location: No. 19, Hwa Ya 2nd Rd., Wen Hwa Vil., Kwei Shan Dist., Taoyuan City
33383, TAIWAN

**FCC Registration /
Designation Number:** 788550 / TW0003



This report is for your exclusive use. Any copying or replication of this report to or for any other person or entity, or use of our name or trademark, is permitted only with our prior written permission. This report sets forth our findings solely with respect to the test samples identified herein. The results set forth in this report are not indicative or representative of the quality or characteristics of the lot from which a test sample was taken or any similar or identical product unless specifically and expressly noted. Our report includes all of the tests requested by you and the results thereof based upon the information that you provided to us. You have 60 days from date of issuance of this report to notify us of any material error or omission caused by our negligence, provided, however, that such notice shall be in writing and shall specifically address the issue you wish to raise. A failure to raise such issue within the prescribed time shall constitute your unqualified acceptance of the completeness of this report, the tests conducted and the correctness of the report contents. Unless specific mention, the uncertainty of measurement has been explicitly taken into account to declare the compliance or non-compliance to the specification.

Table of Contents

Release Control Record	4
1 Certificate of Conformity	5
2 Summary of Test Results	6
2.1 Measurement Uncertainty.....	6
2.2 Modification Record.....	6
3 General Information	7
3.1 General Description of EUT.....	7
3.2 Description of Test Modes.....	9
3.2.1 Test Mode Applicability and Tested Channel Detail.....	10
3.3 Duty Cycle of Test Signal.....	12
3.4 Description of Support Units.....	13
3.4.1 Configuration of System under Test.....	13
3.5 General Description of Applied Standards and References.....	14
4 Test Types and Results	15
4.1 Radiated Emission and Bandedge Measurement.....	15
4.1.1 Limits of Radiated Emission and Bandedge Measurement.....	15
4.1.2 Test Instruments.....	16
4.1.3 Test Procedures.....	17
4.1.4 Deviation from Test Standard.....	17
4.1.5 Test Setup.....	18
4.1.6 EUT Operating Conditions.....	19
4.1.7 Test Results.....	20
4.2 Conducted Emission Measurement.....	32
4.2.1 Limits of Conducted Emission Measurement.....	32
4.2.2 Test Instruments.....	32
4.2.3 Test Procedures.....	33
4.2.4 Deviation from Test Standard.....	33
4.2.5 Test Setup.....	33
4.2.6 EUT Operating Conditions.....	33
4.2.7 Test Results.....	34
4.3 Number of Hopping Frequency Used.....	40
4.3.1 Limits of Hopping Frequency Used Measurement.....	40
4.3.2 Test Setup.....	40
4.3.3 Test Instruments.....	40
4.3.4 Test Procedure.....	40
4.3.5 Deviation from Test Standard.....	40
4.3.6 Test Results.....	41
4.4 Dwell Time on Each Channel.....	42
4.4.1 Limits of Dwell Time on Each Channel Measurement.....	42
4.4.2 Test Setup.....	42
4.4.3 Test Instruments.....	42
4.4.4 Test Procedures.....	42
4.4.5 Deviation from Test Standard.....	42
4.4.6 Test Results.....	43
4.5 Channel Bandwidth.....	45
4.5.1 Limits of Channel Bandwidth Measurement.....	45
4.5.2 Test Setup.....	45
4.5.3 Test Instruments.....	45
4.5.4 Test Procedure.....	45
4.5.5 Deviation from Test Standard.....	45
4.5.6 EUT Operating Condition.....	45
4.5.7 Test Results.....	46
4.6 Hopping Channel Separation.....	47

4.6.1	Limits of Hopping Channel Separation Measurement.....	47
4.6.2	Test Setup.....	47
4.6.3	Test Instruments	47
4.6.4	Test Procedure	47
4.6.5	Deviation from Test Standard	47
4.6.6	Test Results	48
4.7	Maximum Output Power.....	49
4.7.1	Limits of Maximum Output Power Measurement	49
4.7.2	Test Setup.....	49
4.7.3	Test Instruments	49
4.7.4	Test Procedure	49
4.7.5	Deviation from Test Standard	49
4.7.6	EUT Operating Condition	49
4.7.7	Test Results	50
4.8	Conducted Out of Band Emission Measurement.....	51
4.8.1	Limits Of Conducted Out Of Band Emission Measurement.....	51
4.8.2	Test Instruments	51
4.8.3	Test Procedure	51
4.8.4	Deviation from Test Standard	51
4.8.5	EUT Operating Condition	51
4.8.6	Test Results	51
Annex A- Band Edge Measurement.....		54
5	Pictures of Test Arrangements.....	56
Appendix – Information of the Testing Laboratories		57

Release Control Record

Issue No.	Description	Date Issued
RF200615C06-6	Original release	Oct. 26, 2020

1 Certificate of Conformity

Product: 2D Code Handy Terminal

Brand: DENSO

Test Model: BHT-M80-QWG

Sample Status: Engineering sample

Applicant: DENSO WAVE INCORPORATED

Test Date: Sep. 04 ~ Oct. 21, 2020

Standards: 47 CFR FCC Part 15, Subpart C (Section 15.247)
ANSI C63.10:2013

The above equipment has been tested by **Bureau Veritas Consumer Products Services (H.K.) Ltd., Taoyuan Branch**, and found compliance with the requirement of the above standards. The test record, data evaluation & Equipment Under Test (EUT) configurations represented herein are true and accurate accounts of the measurements of the sample's RF characteristics under the conditions specified in this report.

Prepared by :

Polly Chien / Specialist

Date:

Oct. 26, 2020

Approved by :

Bruce Chen / Senior Project Engineer

Date:

Oct. 26, 2020

2 Summary of Test Results

47 CFR FCC Part 15, Subpart C (Section 15.247)			
FCC Clause	Test Item	Result	Remarks
15.207	AC Power Conducted Emission	Pass	Meet the requirement of limit. Minimum passing margin is -17.87dB at 0.65400MHz.
15.247(a)(1)(iii)	Number of Hopping Frequency Used	Pass	Meet the requirement of limit.
15.247(a)(1)(iii)	Dwell Time on Each Channel	Pass	Meet the requirement of limit.
15.247(a)(1)	1. Hopping Channel Separation 2. Spectrum Bandwidth of a Frequency Hopping Sequence Spread Spectrum System	Pass	Meet the requirement of limit.
15.247(b)	Maximum Peak Output Power	Pass	Meet the requirement of limit.
15.205 / 15.209 / 15.247(d)	Radiated Emissions and Band Edge Measurement	Pass	Meet the requirement of limit. Minimum passing margin is -4.5dB at 32.91MHz.
15.247(d)	Antenna Port Emission	Pass	Meet the requirement of limit.
15.203	Antenna Requirement	Pass	Antenna connector is spring not a standard connector.

Note:

1. If The Frequency Hopping System operating in 2400-2483.5MHz band and the output power less than 125mW. The hopping channel carrier frequencies separated by a minimum of 25kHz or two-thirds of the 20dB bandwidth of hopping channel whichever is greater.
2. For 2.4G band compliance with rule 15.247(d) of the band-edge items, the test plots were recorded in Annex A. Test Procedures refer to report 4.1.3.
3. Determining compliance based on the results of the compliance measurement, not taking into account measurement instrumentation uncertainty.

2.1 Measurement Uncertainty

Where relevant, the following measurement uncertainty levels have been estimated for tests performed on the EUT as specified in CISPR 16-4-2:

Measurement	Frequency	Expanded Uncertainty (k=2) (±)
Conducted Emissions at mains ports	150kHz ~ 30MHz	2.79 dB
Radiated Emissions up to 1 GHz	9kHz ~ 30MHz	3.04 dB
	30MHz ~ 200MHz	3.86 dB
	200MHz ~ 1000MHz	3.87 dB
Radiated Emissions above 1 GHz	1GHz ~ 18GHz	2.29 dB
	18GHz ~ 40GHz	2.29 dB

2.2 Modification Record

There were no modifications required for compliance.

3 General Information

3.1 General Description of EUT

Product	2D Code Handy Terminal
Brand	DENSO
Test Model	BHT-M80-QWG
Sample Status	Engineering sample
Power Supply Rating	3.85Vdc (Battery) 5.0Vdc / 9.0Vdc / 12.0Vdc (from adapter)
Modulation Type	GFSK, $\pi/4$ -DQPSK, 8DPSK
Modulation Technology	FHSS
Transfer Rate	1/2/3Mbps
Operating Frequency	2402~2480MHz
Number of Channel	79
Output Power	1.274mW
Antenna Type	Refer to note
Antenna Connector	Refer to note
Accessory Device	Refer to note
Cable Supplied	Refer to note

Note:

- The EUT contains following accessory devices.

Battery 1	
Brand	DENSO
Model	BT1
Rating	3.85Vdc, 4020mAh, 15.47Wh

Battery 2	
Brand	DENSO
Model	BT1S
Rating	3.85Vdc, 2900mAh, 11.16Wh

Adapter	
Brand	CHANNEL WELL TECHNOLOGY
Model	2ACP0183C
Input Power	100-240Vac~0.5A, 50/60Hz
Output Power	5.0Vdc / 3.0A, 15.0W 9.0Vdc / 2.0A, 18.0W 12.0Vdc / 1.5A, 18.0W
Data Cable	1.45 m shielded USB cable without core

Cradle 1: QC3.0 charge single Cradle (Option)	
Brand	DENSO
Model	CU-M80UQ
Adapter	
Brand	CHANNEL WELL TECHNOLOGY
Model	2ACP0183C
Input Power	100-240Vac, 50/60Hz, 0.5A
Output Power	5.0Vdc / 3.0A, 15.0W 9.0Vdc / 2.0A, 18.0W 12.0Vdc / 1.5A, 18.0W
Data Cable	1.45 m shielded USB cable without core

Cradle 2: USB Cradle with spare battery charge (Option)	
Brand	DENSO
Model	CU-M80U
Adapter	
Brand	Sunny
Model	SYS1548-5012-T3
Input Power	100-240Vac, 1.5A MAX, 50-60Hz
Output Power	+12.0Vdc, 4.16A
Power cable	DC: 1.16m cable with one core AC: 1.71m non-shielded cable without core
Data Cable	1.45 m shielded USB cable without core

2. The EUT uses the following antennas.

Ant. Type	PIFA													
Ant. Connector	Spring													
Ant. 1 (WLAN)														
Frequency (MHz)	2412	2442	2484	5170	5180	5220	5320	5420	5520	5620	5720	5825	5835	
Peak Gain (dBi)	0.81	1.36	1.05	3.34	2.97	2.96	2.78	2.88	3.28	3.24	3.45	3.18	3.39	
Ant. 1 (BT)														
Frequency (MHz)	2402			2412			2442			2480				
Peak Gain (dBi)	-0.11			0.81			1.36			1.36				
Ant. 2 (WLAN)														
Frequency (MHz)	2412	2442	2484	5170	5180	5220	5320	5420	5520	5620	5720	5825	5835	
Peak Gain (dBi)	1.33	1.47	0.29	3.80	3.78	3.65	3.51	2.98	2.99	3.09	3.49	3.53	3.44	

* The max. gain was chosen for final tests.

* The above Antenna information is declared by manufacturer and for more detailed features description, please refer to the manufacturer's specifications, the laboratory shall not be held responsible.

3. The WWAN could transmit simultaneously either with WLAN 2.4GHz or 5GHz or BT at the same time.

3.2 Description of Test Modes

79 channels are provided to this EUT:

Channel	Freq. (MHz)	Channel	Freq. (MHz)	Channel	Freq. (MHz)	Channel	Freq. (MHz)
0	2402	20	2422	40	2442	60	2462
1	2403	21	2423	41	2443	61	2463
2	2404	22	2424	42	2444	62	2464
3	2405	23	2425	43	2445	63	2465
4	2406	24	2426	44	2446	64	2466
5	2407	25	2427	45	2447	65	2467
6	2408	26	2428	46	2448	66	2468
7	2409	27	2429	47	2449	67	2469
8	2410	28	2430	48	2450	68	2470
9	2411	29	2431	49	2451	69	2471
10	2412	30	2432	50	2452	70	2472
11	2413	31	2433	51	2453	71	2473
12	2414	32	2434	52	2454	72	2474
13	2415	33	2435	53	2455	73	2475
14	2416	34	2436	54	2456	74	2476
15	2417	35	2437	55	2457	75	2477
16	2418	36	2438	56	2458	76	2478
17	2419	37	2439	57	2459	77	2479
18	2420	38	2440	58	2460	78	2480
19	2421	39	2441	59	2461		

3.2.1 Test Mode Applicability and Tested Channel Detail

EUT Configure Mode	Applicable to				Description
	RE \geq 1G	RE<1G	PLC	APCM	
A	√	√	√	√	EUT with adapter
B	-	√	√	-	EUT with Cradle 1
C	-	√	√	-	EUT with Cradle 2

Where RE \geq 1G: Radiated Emission above 1GHz & Bandedge Measurement
 RE<1G: Radiated Emission below 1GHz
 PLC: Power Line Conducted Emission
 APCM: Antenna Port Conducted Measurement

- Note: The EUT had been pre-tested on the positioned of each 3 axis. The worst case was found when positioned on **X-plane** for mode A.
- "-" means no effect.

Radiated Emission Test (Above 1GHz):

- Pre-Scan has been conducted to determine the worst-case mode from all possible combinations between available modulations, data rates and antenna ports (if EUT with antenna diversity architecture).
- Following channel(s) was (were) selected for the final test as listed below.

EUT Configure Mode	Available Channel	Tested Channel	Modulation Technology	Modulation Type	Pakcet Type
A	0 to 78	0, 39, 78	FHSS	GFSK	DH5
A	0 to 78	0, 39, 78	FHSS	8DPSK	3DH5

Radiated Emission Test (Below 1GHz):

- Pre-Scan has been conducted to determine the worst-case mode from all possible combinations between available modulations, data rates and antenna ports (if EUT with antenna diversity architecture).
- Following channel(s) was (were) selected for the final test as listed below.

EUT Configure Mode	Available Channel	Tested Channel	Modulation Technology	Modulation Type	Pakcet Type
A, B, C	0 to 78	39	FHSS	GFSK	DH5

Power Line Conducted Emission Test:

- Pre-Scan has been conducted to determine the worst-case mode from all possible combinations between available modulations, data rates and antenna ports (if EUT with antenna diversity architecture).
- Following channel(s) was (were) selected for the final test as listed below.

EUT Configure Mode	Available Channel	Tested Channel	Modulation Technology	Modulation Type	Pakcet Type
A, B, C	0 to 78	39	FHSS	GFSK	DH5

Antenna Port Conducted Measurement:

- This item includes all test value of each mode, but only includes spectrum plot of worst value of each mode.
- Pre-Scan has been conducted to determine the worst-case mode from all possible combinations between available modulations, data rates and antenna ports (if EUT with antenna diversity architecture).
- Following channel(s) was (were) selected for the final test as listed below.

EUT Configure Mode	Available Channel	Tested Channel	Modulation Technology	Modulation Type	Pakcet Type
A	0 to 78	0, 39, 78	FHSS	GFSK	DH5
A	0 to 78	0, 39, 78	FHSS	8DPSK	3DH5

Test Condition:

Applicable to	Environmental Conditions	Input Power	Tested by
RE\geq1G	22 deg. C, 66% RH	120Vac, 60Hz	Han Wu
RE<1G	22 deg. C, 66% RH 22 deg. C, 68% RH	120Vac, 60Hz	Greg Lin
PLC	25 deg. C, 75% RH 23 deg. C, 66% RH	120Vac, 60Hz	Greg Lin, Titan Hsu
APCM	25 deg. C, 60% RH	120Vac, 60Hz	Chris Lin

3.3 Duty Cycle of Test Signal

Duty cycle = $2.88 \times 3 / 100 = 0.0864$, Duty factor = $20 \times \log(0.0864) = -21.30$

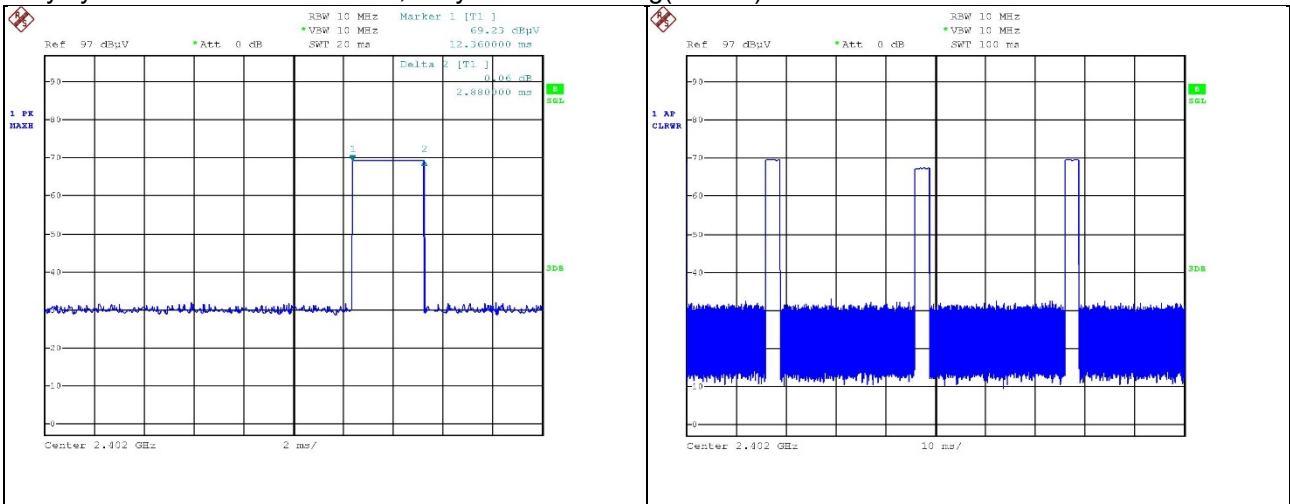

3.4 Description of Support Units

The EUT has been tested as an independent unit together with other necessary accessories or support units. The following support units or accessories were used to form a representative test configuration during the tests.

ID	Product	Brand	Model No.	Serial No.	FCC ID	Remarks
A.	Cradle 1	DENSO	CU-M80UQ	NA	NA	Provided by manufacturer
B.	Adapter	CHANNEL WELL TECHNOLOGY	2ACP0183C	NA	NA	Provided by manufacturer
C.	Cradle 2	DENSO	CU-M80U	NA	NA	Provided by manufacturer
D.	Adapter	Sunny	SYS1548-5012-T3	NA	NA	Provided by manufacturer

ID	Descriptions	Qty.	Length (m)	Shielding (Yes/No)	Cores (Qty.)	Remarks
1.	USB cable	1	1.45	Y	0	Accessory of EUT
2.	USB cable	1	1.45	Y	0	Provided by manufacturer
3.	USB cable	1	1.45	Y	0	Provided by manufacturer
4.	Power cable	1	1.16	-	1	Provided by manufacturer

Note: The core(s) is(are) originally attached to the cable(s).

3.4.1 Configuration of System under Test

Mode A

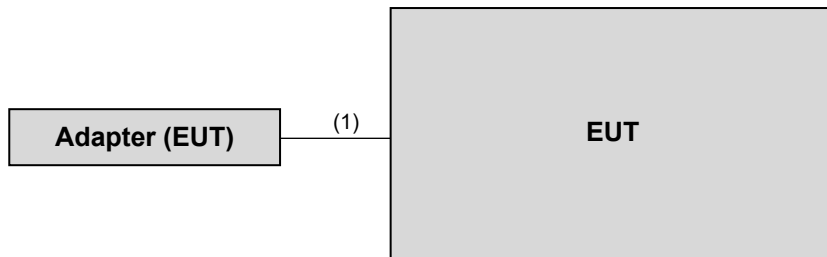

Mode B

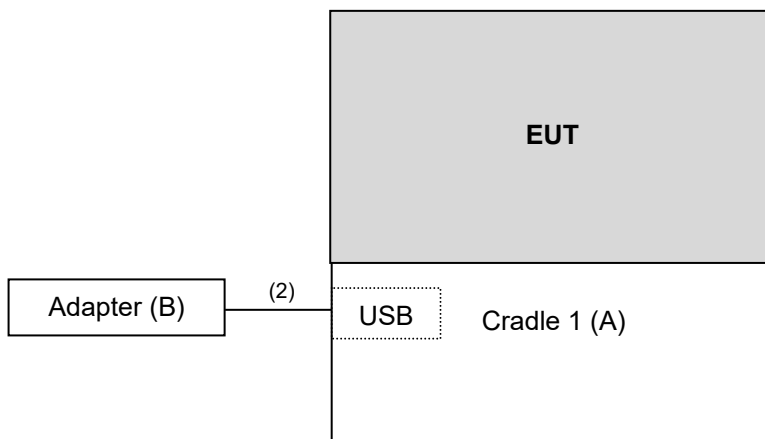

Mode C

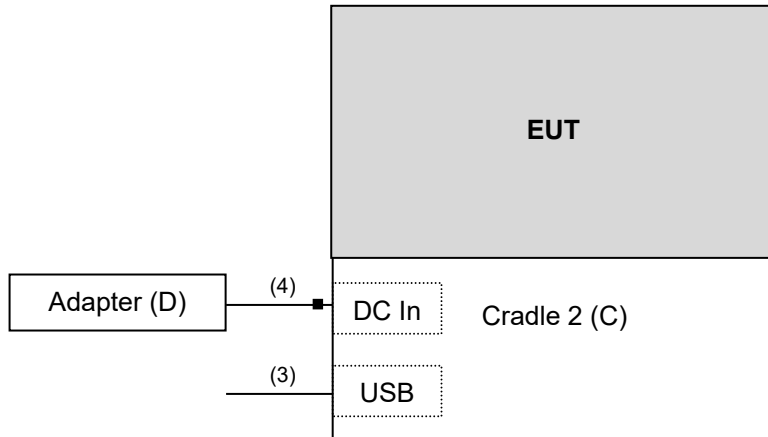

3.5 General Description of Applied Standards and References

The EUT is a RF Product. According to the specifications of the manufacturer, it must comply with the requirements of the following standards and references:

Test Standard:

FCC Part 15, Subpart C (15.247)

ANSI C63.10:2013

All test items have been performed and recorded as per the above standards.

References Test Guidance:

KDB 558074 D01 15.247 Meas Guidance v05r02

All test items have been performed as a reference to the above KDB test guidance.

4 Test Types and Results

4.1 Radiated Emission and Bandedge Measurement

4.1.1 Limits of Radiated Emission and Bandedge Measurement

Radiated emissions which fall in the restricted bands must comply with the radiated emission limits specified as below table. Other emissions shall be at least 20dB below the highest level of the desired power:

Frequencies (MHz)	Field Strength (microvolts/meter)	Measurement Distance (meters)
0.009 ~ 0.490	2400/F(kHz)	300
0.490 ~ 1.705	24000/F(kHz)	30
1.705 ~ 30.0	30	30
30 ~ 88	100	3
88 ~ 216	150	3
216 ~ 960	200	3
Above 960	500	3

Note:

1. The lower limit shall apply at the transition frequencies.
2. Emission level (dBuV/m) = 20 log Emission level (uV/m).
3. For frequencies above 1000MHz, the field strength limits are based on average detector, however, the peak field strength of any emission shall not exceed the maximum permitted average limits, specified above by more than 20dB under any condition of modulation.

4.1.2 Test Instruments

Description & Manufacturer	Model No.	Serial No.	Cal. Date	Cal. Due
Spectrum Analyzer ROHDE & SCHWARZ	ESR3	102579	Jul. 07, 2020	Jul. 06, 2021
Spectrum Analyzer ROHDE & SCHWARZ	FSV40	100980	Apr. 20, 2020	Apr. 19, 2021
Spectrum Analyzer ROHDE & SCHWARZ	FSP40	100269	Jun. 09, 2020	Jun. 08, 2021
BILOG Antenna SCHWARZBECK	VULB9168	9168-171	Nov. 11, 2019	Nov. 10, 2020
HORN Antenna SCHWARZBECK	9120D	209	Nov. 24, 2019	Nov. 23, 2020
HORN Antenna SCHWARZBECK	BBHA 9170	BBHA9170241	Nov. 24, 2019	Nov. 23, 2020
Loop Antenna TESEQ	HLA 6121	45745	Jul. 06, 2020	Jul. 05, 2021
Preamplifier Agilent (Below 1GHz)	8447D	2944A10738	Aug. 16, 2020	Aug. 15, 2021
Preamplifier Agilent (Above 1GHz)	8449B	3008A02465	Mar. 23, 2020	Mar. 22, 2021
RF Coaxial Cable WOKEN With 5dB PAD	8D-FB	Cable-CH3-01	Aug. 16, 2020	Aug. 15, 2021
RF signal cable HUBER+SUHNER	SUCOFLEX 104	Cable-CH3-03 (223653/4)	Aug. 16, 2020	Aug. 15, 2021
RF signal cable HUBER+SUHNER& EMCI	SUCOFLEX 104&EMC104-SM- SM-8000	Cable-CH3-03 (309224+170907)	Aug. 16, 2020	Aug. 15, 2021
Software BV ADT	ADT_Radiated_ V7.6.15.9.5	NA	NA	NA
Antenna Tower inn-co GmbH	MA 4000	013303	NA	NA
Antenna Tower Controller BV ADT	AT100	AT93021702	NA	NA
Turn Table BV ADT	TT100	TT93021702	NA	NA
Turn Table Controller BV ADT	SC100	SC93021702	NA	NA
Boresight Antenna Fixture	FBA-01	FBA-SIP01	NA	NA
USB Wideband Power Sensor KEYSIGHT	U2021XA	MY55050005/MY55190 004/MY55190007/MY55 210005	Jul. 13, 2020	Jul. 12, 2021

- Note: 1. The calibration interval of the above test instruments is 12 months and the calibrations are traceable to NML/ROC and NIST/USA.
2. The test was performed in HwaYa Chamber 3.

4.1.3 Test Procedures

For Radiated emission below 30MHz

- a. The EUT was placed on the top of a rotating table 0.8 meters above the ground at a 3 meter chamber room. The table was rotated 360 degrees to determine the position of the highest radiation.
- b. The EUT was set 3 meters away from the interference-receiving antenna, which was mounted on the top of a variable-height antenna tower.
- c. Parallel, perpendicular, and ground-parallel orientations of the antenna are set to make the measurement.
- d. For each suspected emission, the EUT was arranged to its worst case and the rotatable table was turned from 0 degrees to 360 degrees to find the maximum reading.
- e. The test-receiver system was set to Quasi-Peak Detect Function and Specified Bandwidth with Maximum Hold Mode.

Note:

1. The resolution bandwidth and video bandwidth of test receiver/spectrum analyzer is 9kHz at frequency below 30MHz.

For Radiated emission above 30MHz

- a. The EUT was placed on the top of a rotating table 0.8 meters (for 30MHz ~ 1GHz) / 1.5 meters (for above 1GHz) above the ground at 3 meter chamber room for test. The table was rotated 360 degrees to determine the position of the highest radiation.
- b. The EUT was set 3 meters away from the interference-receiving antenna, which was mounted on the top of a variable-height antenna tower.
- c. The height of antenna is varied from one meter to four meters above the ground to determine the maximum value of the field strength. Both horizontal and vertical polarizations of the antenna are set to make the measurement.
- d. For each suspected emission, the EUT was arranged to its worst case and then the antenna was tuned to heights from 1 meter to 4 meters and the rotatable table was turned from 0 degrees to 360 degrees to find the maximum reading.
- e. The test-receiver system was set to quasi-peak detect function and specified bandwidth with maximum hold mode when the test frequency is below 1 GHz.
- f. The test-receiver system was set to peak and average detect function and specified bandwidth with maximum hold mode when the test frequency is above 1 GHz. If the peak reading value also meets average limit, measurement with the average detector is unnecessary.

Note:

1. The resolution bandwidth and video bandwidth of test receiver/spectrum analyzer is 120kHz for Quasi-peak detection (QP) at frequency below 1GHz.
2. The resolution bandwidth of test receiver/spectrum analyzer is 1 MHz and the video bandwidth is 3 MHz for Peak detection (PK) at frequency above 1GHz. According to ANSI C63.10 section 7.5, the average value = peak value + duty cycle correction factor. The duty cycle correction factor refer to Chapter 3.3 of this report.
3. All modes of operation were investigated and the worst-case emissions are reported.

4.1.4 Deviation from Test Standard

No deviation.

4.1.5 Test Setup

For Radiated emission below 30MHz

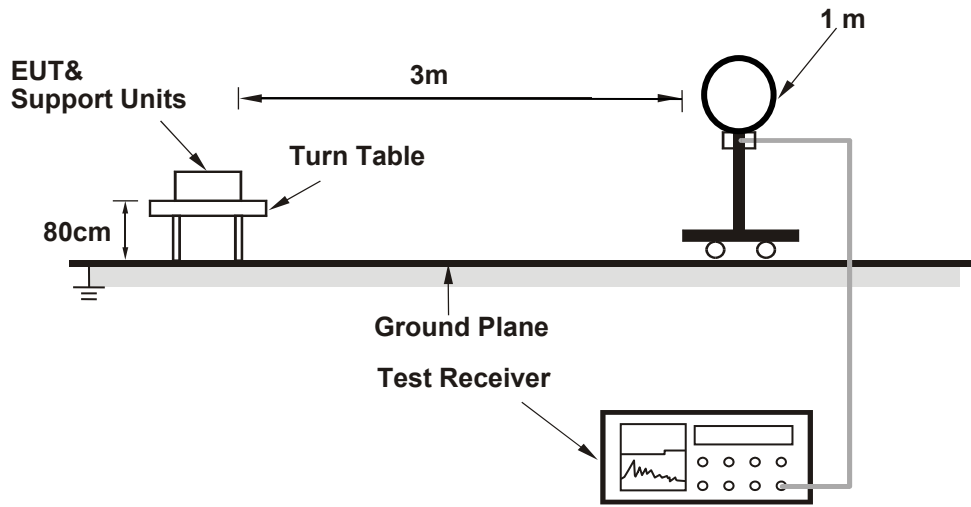

For Radiated emission 30MHz to 1GHz

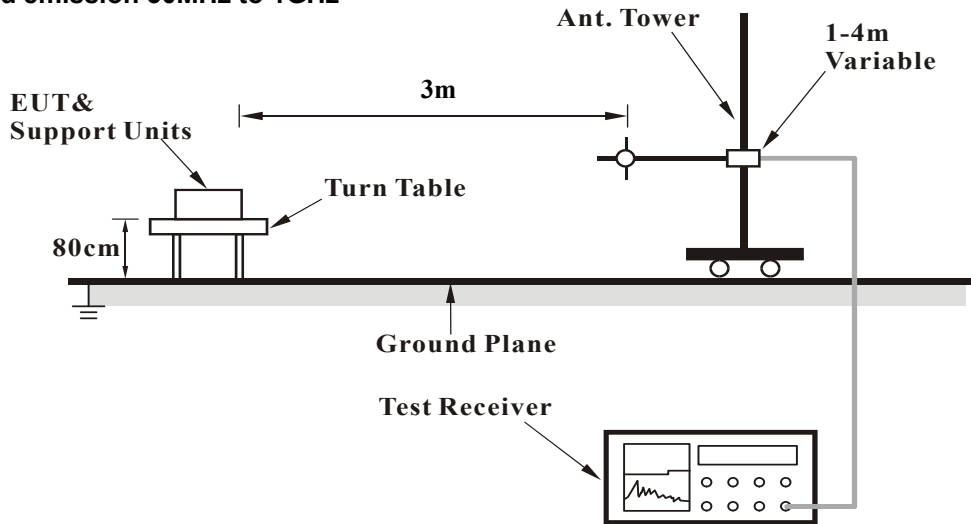

For Radiated emission above 1GHz

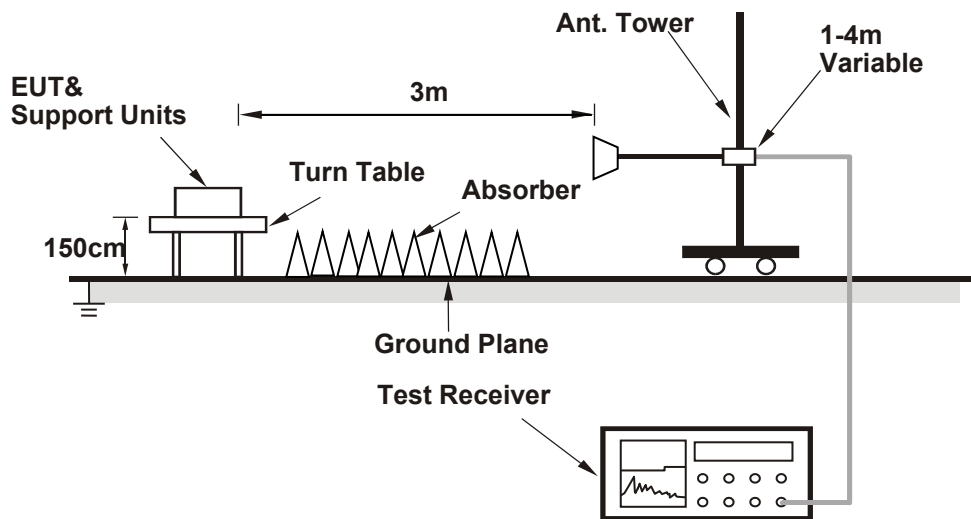

For the actual test configuration, please refer to the attached file (Test Setup Photo).

4.1.6 EUT Operating Conditions

- a. Placed the EUT on the testing table.
- b. The EUT under transmission condition continuously at specific channel frequency.

4.1.7 Test Results

Above 1GHz data:

GFSK

CHANNEL	TX Channel 0	DETECTOR FUNCTION	Peak (PK)
FREQUENCY RANGE	1GHz ~ 25GHz		Average (AV)

Antenna Polarity & Test Distance : Horizontal at 3 m								
No	Frequency (MHz)	Emission Level (dBuV/m)	Limit (dBuV/m)	Margin (dB)	Antenna Height (m)	Table Angle (Degree)	Raw Value (dBuV)	Correction Factor (dB/m)
1	2390.00	55.5 PK	74.0	-18.5	1.13 H	162	24.3	31.2
2	2390.00	43.2 AV	54.0	-10.8	1.13 H	162	12.0	31.2
3	*2402.00	101.3 PK			1.13 H	162	70.2	31.1
4	*2402.00	80.0 AV			1.13 H	162	48.9	31.1
5	4804.00	42.7 PK	74.0	-31.3	2.67 H	311	40.8	1.9
6	4804.00	21.4 AV	54.0	-32.6	2.67 H	311	19.5	1.9
Antenna Polarity & Test Distance : Vertical at 3m								
No	Frequency (MHz)	Emission Level (dBuV/m)	Limit (dBuV/m)	Margin (dB)	Antenna Height (m)	Table Angle (Degree)	Raw Value (dBuV)	Correction Factor (dB/m)
1	2390.00	55.7 PK	74.0	-18.3	1.27 V	213	24.5	31.2
2	2390.00	43.3 AV	54.0	-10.7	1.27 V	213	12.1	31.2
3	*2402.00	103.4 PK			1.27 V	213	72.3	31.1
4	*2402.00	82.1 AV			1.27 V	213	51.0	31.1
5	4804.00	43.8 PK	74.0	-30.2	2.69 V	121	41.9	1.9
6	4804.00	22.5 AV	54.0	-31.5	2.69 V	121	20.6	1.9

Remarks:

1. Emission Level(dBuV/m) = Raw Value(dBuV) + Correction Factor(dB/m)
2. Correction Factor(dB/m) = Antenna Factor(dB/m) + Cable Factor(dB) – Pre-Amplifier Factor(dB)
3. The other emission levels were very low against the limit.
4. Margin value = Emission Level – Limit value
5. " * ": Fundamental frequency.
6. for Fundamental frequency and bandedge & harmonic:
The average value of fundamental frequency is :average = peak value + 20log(Duty cycle)
where the duty factor is calculated from following formula:
 $20\text{Log}(\text{Duty cycle}) = 20 \log (2.88\text{ms} \cdot 3/100) = -21.30\text{dB}$ please refer to the plotted duty
(see section 3.3)

CHANNEL	TX Channel 39	DETECTOR FUNCTION	Peak (PK)
FREQUENCY RANGE	1GHz ~ 25GHz		Average (AV)

Antenna Polarity & Test Distance : Horizontal at 3 m

No	Frequency (MHz)	Emission Level (dBuV/m)	Limit (dBuV/m)	Margin (dB)	Antenna Height (m)	Table Angle (Degree)	Raw Value (dBuV)	Correction Factor (dB/m)
1	*2441.00	102.4 PK			1.09 H	173	71.3	31.1
2	*2441.00	81.1 AV			1.09 H	173	50.0	31.1
3	4882.00	43.2 PK	74.0	-30.8	2.72 H	312	41.2	2.0
4	4882.00	21.9 AV	54.0	-32.1	2.72 H	312	19.9	2.0

Antenna Polarity & Test Distance : Vertical at 3m

No	Frequency (MHz)	Emission Level (dBuV/m)	Limit (dBuV/m)	Margin (dB)	Antenna Height (m)	Table Angle (Degree)	Raw Value (dBuV)	Correction Factor (dB/m)
1	*2441.00	104.3 PK			1.18 V	221	73.2	31.1
2	*2441.00	83.0 AV			1.18 V	221	51.9	31.1
3	4882.00	44.3 PK	74.0	-29.7	2.83 V	134	42.3	2.0
4	4882.00	23.0 AV	54.0	-31.0	2.83 V	134	21.0	2.0

Remarks:

1. Emission Level(dBuV/m) = Raw Value(dBuV) + Correction Factor(dB/m)
2. Correction Factor(dB/m) = Antenna Factor(dB/m) + Cable Factor(dB) – Pre-Amplifier Factor(dB)
3. The other emission levels were very low against the limit.
4. Margin value = Emission Level – Limit value
5. " * " : Fundamental frequency.
6. for Fundamental frequency and bandedge & harmonic:
 The average value of fundamental frequency is :average = peak value + 20log(Duty cycle)
 where the duty factor is calculated from following formula:
 $20\text{Log}(\text{Duty cycle}) = 20 \log (2.88\text{ms} \cdot 3/100) = -21.30\text{dB}$ please refer to the plotted duty
 (see section 3.3)

CHANNEL	TX Channel 78	DETECTOR FUNCTION	Peak (PK)
FREQUENCY RANGE	1GHz ~ 25GHz		Average (AV)

Antenna Polarity & Test Distance : Horizontal at 3 m

No	Frequency (MHz)	Emission Level (dBuV/m)	Limit (dBuV/m)	Margin (dB)	Antenna Height (m)	Table Angle (Degree)	Raw Value (dBuV)	Correction Factor (dB/m)
1	*2480.00	101.7 PK			1.00 H	168	70.6	31.1
2	*2480.00	80.4 AV			1.00 H	168	49.3	31.1
3	2483.50	55.8 PK	74.0	-18.2	1.00 H	168	24.6	31.2
4	2483.50	34.5 AV	54.0	-19.5	1.00 H	168	3.3	31.2
5	4960.00	43.0 PK	74.0	-31.0	2.61 H	306	40.7	2.3
6	4960.00	21.7 AV	54.0	-32.3	2.61 H	306	19.4	2.3

Antenna Polarity & Test Distance : Vertical at 3m

No	Frequency (MHz)	Emission Level (dBuV/m)	Limit (dBuV/m)	Margin (dB)	Antenna Height (m)	Table Angle (Degree)	Raw Value (dBuV)	Correction Factor (dB/m)
1	*2480.00	103.9 PK			1.00 V	225	72.8	31.1
2	*2480.00	82.6 AV			1.00 V	225	51.5	31.1
3	2483.50	57.0 PK	74.0	-17.0	1.00 V	225	25.8	31.2
4	2483.50	35.7 AV	54.0	-18.3	1.00 V	225	4.5	31.2
5	4960.00	44.3 PK	74.0	-29.7	2.71 V	126	42.0	2.3
6	4960.00	23.0 AV	54.0	-31.0	2.71 V	126	20.7	2.3

Remarks:

1. Emission Level(dBuV/m) = Raw Value(dBuV) + Correction Factor(dB/m)
2. Correction Factor(dB/m) = Antenna Factor(dB/m) + Cable Factor(dB) – Pre-Amplifier Factor(dB)
3. The other emission levels were very low against the limit.
4. Margin value = Emission Level – Limit value
5. " * " : Fundamental frequency.
6. for Fundamental frequency and bandedge & harmonic:
 The average value of fundamental frequency is :average = peak value + 20log(Duty cycle)
 where the duty factor is calculated from following formula:
 $20\text{Log}(\text{Duty cycle}) = 20 \log (2.88\text{ms} \cdot 3/100) = -21.30\text{dB}$ please refer to the plotted duty
 (see section 3.3)

8DPSK

CHANNEL	TX Channel 0	DETECTOR FUNCTION	Peak (PK)
FREQUENCY RANGE	1GHz ~ 25GHz		Average (AV)

Antenna Polarity & Test Distance : Horizontal at 3 m

No	Frequency (MHz)	Emission Level (dBuV/m)	Limit (dBuV/m)	Margin (dB)	Antenna Height (m)	Table Angle (Degree)	Raw Value (dBuV)	Correction Factor (dB/m)
1	2390.00	55.6 PK	74.0	-18.4	1.07 H	174	24.4	31.2
2	2390.00	44.5 AV	54.0	-9.5	1.07 H	174	13.3	31.2
3	*2402.00	100.8 PK			1.07 H	174	69.7	31.1
4	*2402.00	79.5 AV			1.07 H	174	48.4	31.1
5	4804.00	42.8 PK	74.0	-31.2	2.57 H	301	40.9	1.9
6	4804.00	21.5 AV	54.0	-32.5	2.57 H	301	19.6	1.9

Antenna Polarity & Test Distance : Vertical at 3m

No	Frequency (MHz)	Emission Level (dBuV/m)	Limit (dBuV/m)	Margin (dB)	Antenna Height (m)	Table Angle (Degree)	Raw Value (dBuV)	Correction Factor (dB/m)
1	2390.00	55.8 PK	74.0	-18.2	1.32 V	201	24.6	31.2
2	2390.00	43.4 AV	54.0	-10.6	1.32 V	201	12.2	31.2
3	*2402.00	102.7 PK			1.32 V	201	71.6	31.1
4	*2402.00	81.4 AV			1.32 V	201	50.3	31.1
5	4804.00	44.3 PK	74.0	-29.7	2.69 V	131	42.4	1.9
6	4804.00	23.0 AV	54.0	-31.0	2.69 V	131	21.1	1.9

Remarks:

- Emission Level(dBuV/m) = Raw Value(dBuV) + Correction Factor(dB/m)
- Correction Factor(dB/m) = Antenna Factor(dB/m) + Cable Factor(dB) – Pre-Amplifier Factor(dB)
- The other emission levels were very low against the limit.
- Margin value = Emission Level – Limit value
- " * " : Fundamental frequency.
- for Fundamental frequency and bandedge & harmonic:
The average value of fundamental frequency is :average = peak value + 20log(Duty cycle)
where the duty factor is calculated from following formula:
 $20\text{Log}(\text{Duty cycle}) = 20 \log (2.88\text{ms} \cdot 3/100) = -21.30\text{dB}$ please refer to the plotted duty (see section 3.3)

CHANNEL	TX Channel 39	DETECTOR FUNCTION	Peak (PK)
FREQUENCY RANGE	1GHz ~ 25GHz		Average (AV)

Antenna Polarity & Test Distance : Horizontal at 3 m

No	Frequency (MHz)	Emission Level (dBuV/m)	Limit (dBuV/m)	Margin (dB)	Antenna Height (m)	Table Angle (Degree)	Raw Value (dBuV)	Correction Factor (dB/m)
1	*2441.00	101.3 PK			1.12 H	169	70.2	31.1
2	*2441.00	80.0 AV			1.12 H	169	48.9	31.1
3	4882.00	43.2 PK	74.0	-30.8	2.53 H	297	41.2	2.0
4	4882.00	21.9 AV	54.0	-32.1	2.53 H	297	19.9	2.0

Antenna Polarity & Test Distance : Vertical at 3m

No	Frequency (MHz)	Emission Level (dBuV/m)	Limit (dBuV/m)	Margin (dB)	Antenna Height (m)	Table Angle (Degree)	Raw Value (dBuV)	Correction Factor (dB/m)
1	*2441.00	103.2 PK			1.32 V	216	72.1	31.1
2	*2441.00	81.9 AV			1.32 V	216	50.8	31.1
3	4882.00	44.6 PK	74.0	-29.4	2.63 V	118	42.6	2.0
4	4882.00	23.3 AV	54.0	-30.7	2.63 V	118	21.3	2.0

Remarks:

1. Emission Level(dBuV/m) = Raw Value(dBuV) + Correction Factor(dB/m)
2. Correction Factor(dB/m) = Antenna Factor(dB/m) + Cable Factor(dB) – Pre-Amplifier Factor(dB)
3. The other emission levels were very low against the limit.
4. Margin value = Emission Level – Limit value
5. " * " : Fundamental frequency.
6. for Fundamental frequency and bandedge & harmonic:
 The average value of fundamental frequency is :average = peak value + 20log(Duty cycle)
 where the duty factor is calculated from following formula:
 $20\text{Log}(\text{Duty cycle}) = 20 \log (2.88\text{ms} \cdot 3/100) = -21.30\text{dB}$ please refer to the plotted duty
 (see section 3.3)

CHANNEL	TX Channel 78	DETECTOR FUNCTION	Peak (PK)
FREQUENCY RANGE	1GHz ~ 25GHz		Average (AV)

Antenna Polarity & Test Distance : Horizontal at 3 m

No	Frequency (MHz)	Emission Level (dBuV/m)	Limit (dBuV/m)	Margin (dB)	Antenna Height (m)	Table Angle (Degree)	Raw Value (dBuV)	Correction Factor (dB/m)
1	*2480.00	100.7 PK			1.05 H	172	69.6	31.1
2	*2480.00	79.4 AV			1.05 H	172	48.3	31.1
3	2483.50	55.7 PK	74.0	-18.3	1.05 H	172	24.5	31.2
4	2483.50	34.4 AV	54.0	-19.6	1.05 H	172	3.2	31.2
5	4960.00	43.1 PK	74.0	-30.9	2.55 H	312	40.8	2.3
6	4960.00	21.8 AV	54.0	-32.2	2.55 H	312	19.5	2.3

Antenna Polarity & Test Distance : Vertical at 3m

No	Frequency (MHz)	Emission Level (dBuV/m)	Limit (dBuV/m)	Margin (dB)	Antenna Height (m)	Table Angle (Degree)	Raw Value (dBuV)	Correction Factor (dB/m)
1	*2480.00	102.8 PK			1.43 V	221	71.7	31.1
2	*2480.00	81.5 AV			1.43 V	221	50.4	31.1
3	2483.50	56.3 PK	74.0	-17.7	1.43 V	221	25.1	31.2
4	2483.50	35.0 AV	54.0	-19.0	1.43 V	221	3.8	31.2
5	4960.00	44.4 PK	74.0	-29.6	2.78 V	121	42.1	2.3
6	4960.00	23.1 AV	54.0	-30.9	2.78 V	121	20.8	2.3

Remarks:

1. Emission Level(dBuV/m) = Raw Value(dBuV) + Correction Factor(dB/m)
2. Correction Factor(dB/m) = Antenna Factor(dB/m) + Cable Factor(dB) – Pre-Amplifier Factor(dB)
3. The other emission levels were very low against the limit.
4. Margin value = Emission Level – Limit value
5. " * ": Fundamental frequency.
6. for Fundamental frequency and bandedge & harmonic:
 The average value of fundamental frequency is :average = peak value + 20log(Duty cycle)
 where the duty factor is calculated from following formula:
 $20\text{Log}(\text{Duty cycle}) = 20 \log (2.88\text{ms} \cdot 3/100) = -21.30\text{dB}$ please refer to the plotted duty
 (see section 3.3)

Below 1GHz worst-case data:

GFSK

CHANNEL	TX Channel 39	DETECTOR FUNCTION	Quasi-Peak (QP)
FREQUENCY RANGE	9kHz ~ 1GHz	TEST MODE	A

ANTENNA POLARITY & TEST DISTANCE: HORIZONTAL AT 3 M								
NO.	FREQ. (MHz)	EMISSION LEVEL (dBuV/m)	LIMIT (dBuV/m)	MARGIN (dB)	ANTENNA HEIGHT (m)	TABLE ANGLE (Degree)	RAW VALUE (dBuV)	CORRECTION FACTOR (dB/m)
1	46.49	32.2 QP	40.0	-7.8	1.25 H	133	41.5	-9.3
2	95.96	27.8 QP	43.5	-15.7	1.25 H	330	41.8	-14.0
3	166.77	34.7 QP	43.5	-8.8	1.00 H	118	43.5	-8.8
4	299.66	35.9 QP	46.0	-10.1	1.50 H	272	43.0	-7.1
5	590.66	37.3 QP	46.0	-8.7	1.00 H	85	38.4	-1.1
6	893.30	36.6 QP	46.0	-9.4	1.25 H	198	32.3	4.3

Remarks:

1. Emission Level(dBuV/m) = Raw Value(dBuV) + Correction Factor(dB/m)
2. Correction Factor(dB/m) = Antenna Factor(dB/m) + Cable Factor(dB) – Pre-Amplifier Factor(dB)
3. The other emission levels were very low against the limit of frequency range 30MHz~1000MHz.
4. Margin value = Emission Level – Limit value
5. The emission levels were very low against the limit of frequency range 9kHz~30MHz: the amplitude of spurious emissions attenuated more than 20dB below the permissible value to be report.

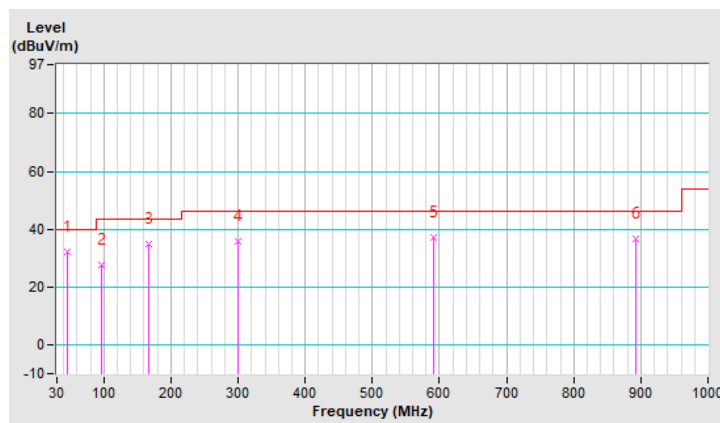

CHANNEL	TX Channel 39	DETECTOR FUNCTION	Quasi-Peak (QP)
FREQUENCY RANGE	9kHz ~ 1GHz	TEST MODE	A

ANTENNA POLARITY & TEST DISTANCE: VERTICAL AT 3 M								
NO.	FREQ. (MHz)	EMISSION LEVEL (dBuV/m)	LIMIT (dBuV/m)	MARGIN (dB)	ANTENNA HEIGHT (m)	TABLE ANGLE (Degree)	RAW VALUE (dBuV)	CORRECTION FACTOR (dB/m)
1	42.61	35.2 QP	40.0	-4.8	1.00 V	13	44.8	-9.6
2	58.13	26.0 QP	40.0	-14.0	1.25 V	279	35.4	-9.4
3	169.68	30.2 QP	43.5	-13.3	1.00 V	351	39.2	-9.0
4	256.01	34.2 QP	46.0	-11.8	1.50 V	13	42.9	-8.7
5	559.62	31.7 QP	46.0	-14.3	1.00 V	205	33.7	-2.0
6	945.68	36.0 QP	46.0	-10.0	1.25 V	79	30.6	5.4

Remarks:

1. Emission Level(dBuV/m) = Raw Value(dBuV) + Correction Factor(dB/m)
2. Correction Factor(dB/m) = Antenna Factor(dB/m) + Cable Factor(dB) – Pre-Amplifier Factor(dB)
3. The other emission levels were very low against the limit of frequency range 30MHz~1000MHz.
4. Margin value = Emission Level – Limit value
5. The emission levels were very low against the limit of frequency range 9kHz~30MHz: the amplitude of spurious emissions attenuated more than 20dB below the permissible value to be report.

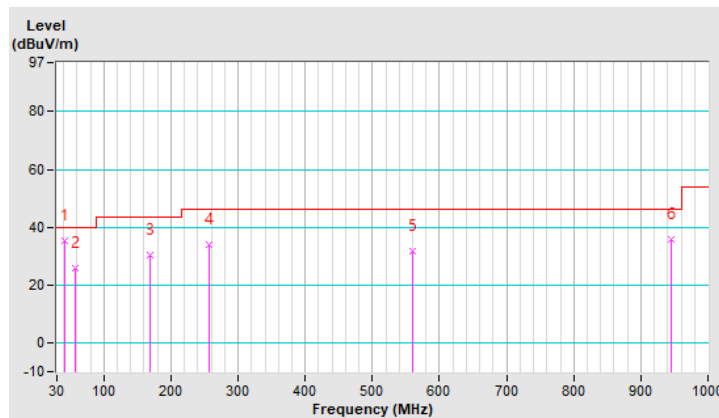

CHANNEL	TX Channel 39	DETECTOR FUNCTION	Quasi-Peak (QP)
FREQUENCY RANGE	9kHz ~ 1GHz	TEST MODE	B

ANTENNA POLARITY & TEST DISTANCE: HORIZONTAL AT 3 M								
NO.	FREQ. (MHz)	EMISSION LEVEL (dBuV/m)	LIMIT (dBuV/m)	MARGIN (dB)	ANTENNA HEIGHT (m)	TABLE ANGLE (Degree)	RAW VALUE (dBuV)	CORRECTION FACTOR (dB/m)
1	30.97	24.3 QP	40.0	-15.7	1.25 H	13	35.3	-11.0
2	95.96	23.0 QP	43.5	-20.5	1.00 H	253	37.0	-14.0
3	171.62	18.7 QP	43.5	-24.8	1.25 H	86	27.8	-9.1
4	297.72	20.8 QP	46.0	-25.2	1.50 H	304	27.9	-7.1
5	494.63	32.0 QP	46.0	-14.0	1.00 H	306	35.1	-3.1
6	907.85	33.6 QP	46.0	-12.4	1.50 H	195	28.8	4.8

Remarks:

1. Emission Level(dBuV/m) = Raw Value(dBuV) + Correction Factor(dB/m)
2. Correction Factor(dB/m) = Antenna Factor(dB/m) + Cable Factor(dB) – Pre-Amplifier Factor(dB)
3. The other emission levels were very low against the limit of frequency range 30MHz~1000MHz.
4. Margin value = Emission Level – Limit value
5. The emission levels were very low against the limit of frequency range 9kHz~30MHz: the amplitude of spurious emissions attenuated more than 20dB below the permissible value to be report.

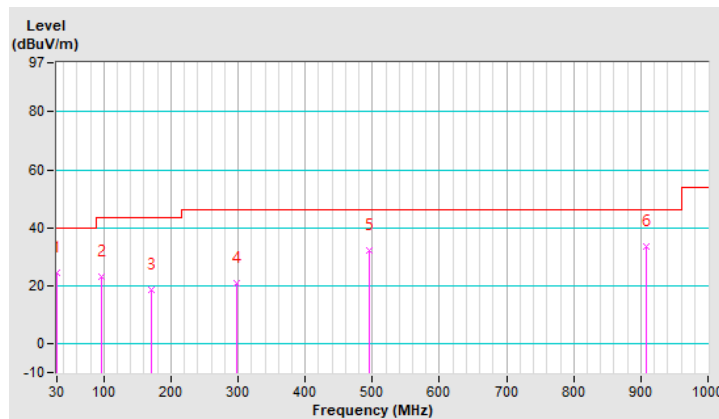

CHANNEL	TX Channel 39	DETECTOR FUNCTION	Quasi-Peak (QP)
FREQUENCY RANGE	9kHz ~ 1GHz	TEST MODE	B

ANTENNA POLARITY & TEST DISTANCE: VERTICAL AT 3 M								
NO.	FREQ. (MHz)	EMISSION LEVEL (dBuV/m)	LIMIT (dBuV/m)	MARGIN (dB)	ANTENNA HEIGHT (m)	TABLE ANGLE (Degree)	RAW VALUE (dBuV)	CORRECTION FACTOR (dB/m)
1	32.91	35.5 QP	40.0	-4.5	1.00 V	200	46.2	-10.7
2	72.68	20.6 QP	40.0	-19.4	1.50 V	61	32.1	-11.5
3	127.00	30.1 QP	43.5	-13.4	1.25 V	110	40.6	-10.5
4	169.68	19.3 QP	43.5	-24.2	1.00 V	44	28.3	-9.0
5	305.48	20.7 QP	46.0	-25.3	1.25 V	33	27.5	-6.8
6	909.79	37.0 QP	46.0	-9.0	1.00 V	191	32.1	4.9

Remarks:

1. Emission Level(dBuV/m) = Raw Value(dBuV) + Correction Factor(dB/m)
2. Correction Factor(dB/m) = Antenna Factor(dB/m) + Cable Factor(dB) – Pre-Amplifier Factor(dB)
3. The other emission levels were very low against the limit of frequency range 30MHz~1000MHz.
4. Margin value = Emission Level – Limit value
5. The emission levels were very low against the limit of frequency range 9kHz~30MHz: the amplitude of spurious emissions attenuated more than 20dB below the permissible value to be report.

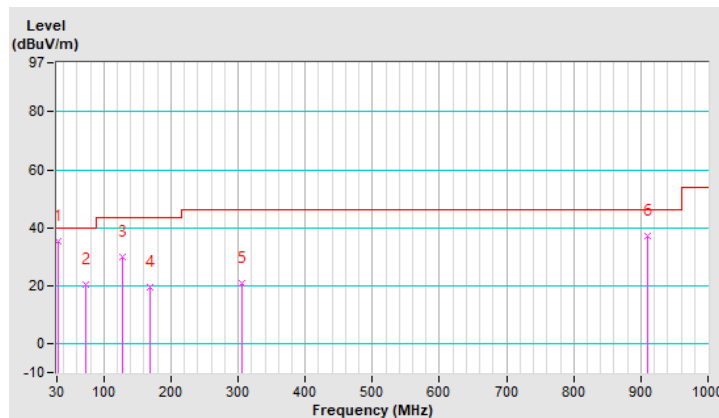

CHANNEL	TX Channel 39	DETECTOR FUNCTION	Quasi-Peak (QP)
FREQUENCY RANGE	9kHz ~ 1GHz	TEST MODE	C

ANTENNA POLARITY & TEST DISTANCE: HORIZONTAL AT 3 M								
NO.	FREQ. (MHz)	EMISSION LEVEL (dBuV/m)	LIMIT (dBuV/m)	MARGIN (dB)	ANTENNA HEIGHT (m)	TABLE ANGLE (Degree)	RAW VALUE (dBuV)	CORRECTION FACTOR (dB/m)
1	49.40	18.0 QP	40.0	-22.0	2.00 H	175	27.2	-9.2
2	77.53	25.2 QP	40.0	-14.8	1.24 H	175	38.0	-12.8
3	120.21	15.5 QP	43.5	-28.0	1.50 H	257	26.6	-11.1
4	165.80	19.1 QP	43.5	-24.4	2.00 H	15	27.8	-8.7
5	647.89	30.1 QP	46.0	-15.9	1.50 H	272	30.1	0.0
6	864.20	37.5 QP	46.0	-8.5	1.24 H	10	33.6	3.9

Remarks:

1. Emission Level(dBuV/m) = Raw Value(dBuV) + Correction Factor(dB/m)
2. Correction Factor(dB/m) = Antenna Factor(dB/m) + Cable Factor(dB) – Pre-Amplifier Factor(dB)
3. The other emission levels were very low against the limit of frequency range 30MHz~1000MHz.
4. Margin value = Emission Level – Limit value
5. The emission levels were very low against the limit of frequency range 9kHz~30MHz: the amplitude of spurious emissions attenuated more than 20dB below the permissible value to be report.

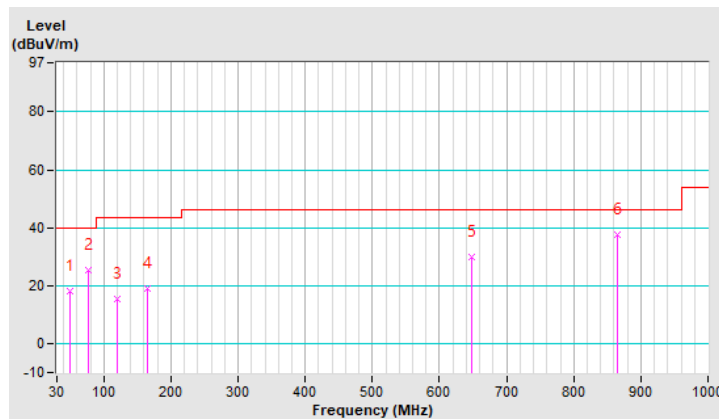

CHANNEL	TX Channel 39	DETECTOR FUNCTION	Quasi-Peak (QP)
FREQUENCY RANGE	9kHz ~ 1GHz	TEST MODE	C

ANTENNA POLARITY & TEST DISTANCE: VERTICAL AT 3 M								
NO.	FREQ. (MHz)	EMISSION LEVEL (dBuV/m)	LIMIT (dBuV/m)	MARGIN (dB)	ANTENNA HEIGHT (m)	TABLE ANGLE (Degree)	RAW VALUE (dBuV)	CORRECTION FACTOR (dB/m)
1	30.00	28.0 QP	40.0	-12.0	1.50 V	170	38.5	-10.5
2	63.95	20.0 QP	40.0	-20.0	2.00 V	42	29.9	-9.9
3	143.49	21.7 QP	43.5	-21.8	1.50 V	184	30.6	-8.9
4	166.77	19.2 QP	43.5	-24.3	2.00 V	19	28.0	-8.8
5	433.52	35.4 QP	46.0	-10.6	2.00 V	345	39.5	-4.1
6	835.10	38.8 QP	46.0	-7.2	2.00 V	188	35.5	3.3

Remarks:

1. Emission Level(dBuV/m) = Raw Value(dBuV) + Correction Factor(dB/m)
2. Correction Factor(dB/m) = Antenna Factor(dB/m) + Cable Factor(dB) – Pre-Amplifier Factor(dB)
3. The other emission levels were very low against the limit of frequency range 30MHz~1000MHz.
4. Margin value = Emission Level – Limit value
5. The emission levels were very low against the limit of frequency range 9kHz~30MHz: the amplitude of spurious emissions attenuated more than 20dB below the permissible value to be report.

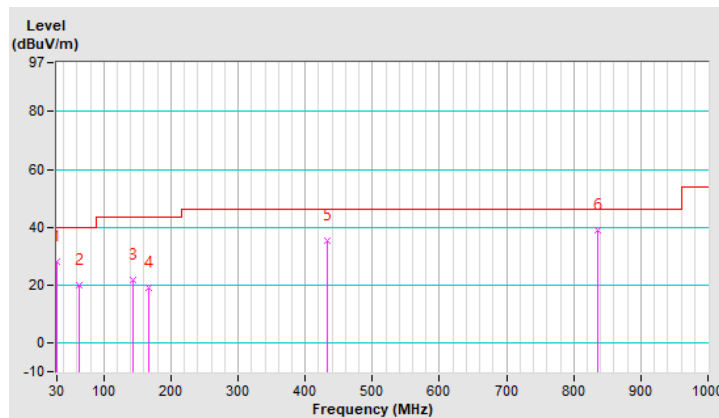

4.2 Conducted Emission Measurement

4.2.1 Limits of Conducted Emission Measurement

Frequency (MHz)	Conducted Limit (dBuV)	
	Quasi-peak	Average
0.15 - 0.5	66 - 56	56 - 46
0.50 - 5.0	56	46
5.0 - 30.0	60	50

4.2.2 Test Instruments

Tested date: Sep. 05 ~ Oct. 21, 2020

Description & Manufacturer	Model No.	Serial No.	Cal. Date	Cal. Due
Test Receiver ROHDE & SCHWARZ	ESCI	100613	Dec. 11, 2019	Dec. 10, 2020
RF signal cable Woken	5D-FB	Cable-cond1-01	Sep. 04, 2020	Sep. 03, 2021
LISN ROHDE & SCHWARZ (EUT)	ENV216	101826	Feb. 20, 2020	Feb. 19, 2021
V-LISN ROHDE & SCHWARZ (Peripheral)	NNBL 8226-2	8226-142	Jul. 31, 2020	Jul. 30, 2021
Software ADT	BV ADT_Cond_ V7.3.7.4	NA	NA	NA

- Note: 1. The calibration interval of the above test instruments is 12 months and the calibrations are traceable to NML/ROC and NIST/USA.
 2. The test was performed in HwaYa Shielded Room 1 (Conduction 1).
 3. The VCCI Site Registration No. is C-12040.

4.2.3 Test Procedures

- The EUT was placed 0.4 meters from the conducting wall of the shielded room with EUT being connected to the power mains through a line impedance stabilization network (LISN). Other support units were connected to the power mains through another LISN. The two LISNs provide 50 ohm/50 uH of coupling impedance for the measuring instrument.
- Both lines of the power mains connected to the EUT were checked for maximum conducted interference.
- The frequency range from 150 kHz to 30 MHz was searched. Emission levels under (Limit – 20 dB) was not recorded.

Note: The resolution bandwidth and video bandwidth of test receiver is 9 kHz for quasi-peak detection (QP) and average detection (AV) at frequency 0.15 MHz – 30 MHz.

4.2.4 Deviation from Test Standard

No deviation.

4.2.5 Test Setup

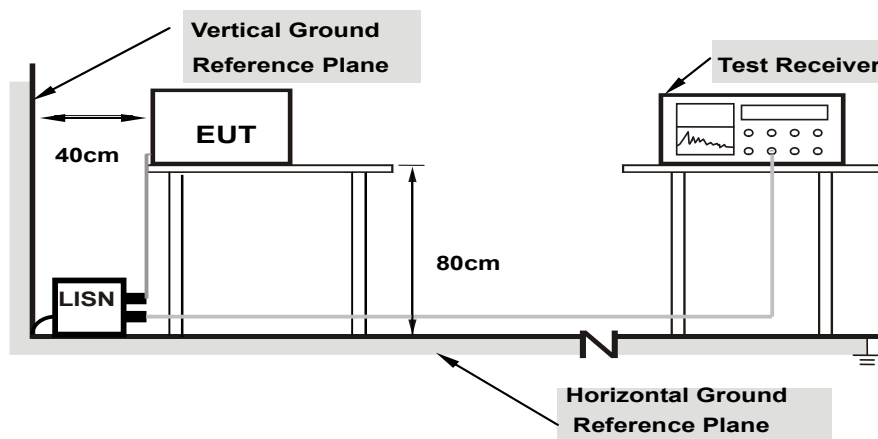

Note: 1.Support units were connected to second LISN.

For the actual test configuration, please refer to the attached file (Test Setup Photo).

4.2.6 EUT Operating Conditions

Same as 4.1.6.

4.2.7 Test Results

Worst-case data:

GFSK

Phase	Line (L)	Detector Function	Quasi-Peak (QP) / Average (AV)
Test Mode	A		

No	Freq. [MHz]	Corr. Factor (dB)	Reading Value [dB (uV)]		Emission Level [dB (uV)]		Limit [dB (uV)]		Margin (dB)	
			Q.P.	AV.	Q.P.	AV.	Q.P.	AV.	Q.P.	AV.
			1	0.16600	9.65	20.30	6.47	29.95	16.12	65.16
2	0.19367	9.66	18.73	5.62	28.39	15.28	63.88	53.88	-35.49	-38.60
3	0.21400	9.66	19.21	5.95	28.87	15.61	63.05	53.05	-34.18	-37.44
4	0.65000	9.66	12.74	5.77	22.40	15.43	56.00	46.00	-33.60	-30.57
5	0.80200	9.67	10.32	1.42	19.99	11.09	56.00	46.00	-36.01	-34.91
6	4.57800	9.74	16.47	2.44	26.21	12.18	56.00	46.00	-29.79	-33.82

Remarks:

1. Q.P. and AV. are abbreviations of quasi-peak and average individually.
2. The emission levels of other frequencies were very low against the limit.
3. Margin value = Emission level - Limit value
4. Correction factor = Insertion loss + Cable loss
5. Emission Level = Correction Factor + Reading Value.

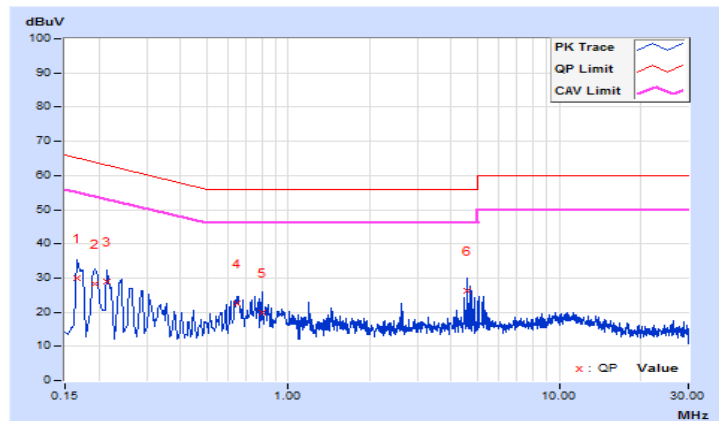

Phase	Neutral (N)	Detector Function	Quasi-Peak (QP) / Average (AV)
Test Mode	A		

No	Freq. [MHz]	Corr. Factor (dB)	Reading Value [dB (uV)]		Emission Level [dB (uV)]		Limit [dB (uV)]		Margin (dB)	
			Q.P.	AV.	Q.P.	AV.	Q.P.	AV.	Q.P.	AV.
			1	0.15400	9.68	15.78	12.04	25.46	21.72	65.78
2	0.17800	9.68	14.56	10.26	24.24	19.94	64.58	54.58	-40.34	-34.64
3	0.22600	9.68	10.17	3.15	19.85	12.83	62.60	52.60	-42.75	-39.77
4	0.29400	9.68	8.56	2.31	18.24	11.99	60.41	50.41	-42.17	-38.42
5	0.86200	9.69	8.94	2.41	18.63	12.10	56.00	46.00	-37.37	-33.90
6	5.08600	9.78	12.09	3.28	21.87	13.06	60.00	50.00	-38.13	-36.94

Remarks:

1. Q.P. and AV. are abbreviations of quasi-peak and average individually.
2. The emission levels of other frequencies were very low against the limit.
3. Margin value = Emission level - Limit value
4. Correction factor = Insertion loss + Cable loss
5. Emission Level = Correction Factor + Reading Value.

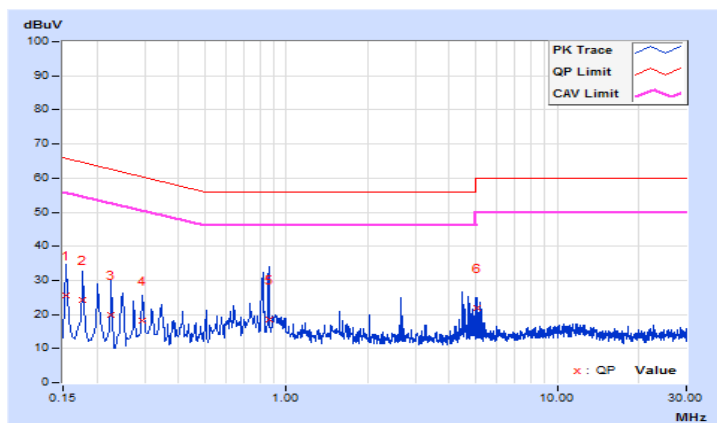

Phase	Line (L)	Detector Function	Quasi-Peak (QP) / Average (AV)
Test Mode	B		

No	Freq. [MHz]	Corr. Factor (dB)	Reading Value [dB (uV)]		Emission Level [dB (uV)]		Limit [dB (uV)]		Margin (dB)	
			Q.P.	AV.	Q.P.	AV.	Q.P.	AV.	Q.P.	AV.
			1	0.16600	9.83	28.49	15.12	38.32	24.95	65.16
2	0.18600	9.84	26.15	13.23	35.99	23.07	64.21	54.21	-28.22	-31.14
3	0.21000	9.85	24.50	13.62	34.35	23.47	63.21	53.21	-28.86	-29.74
4	0.23800	9.85	21.25	11.78	31.10	21.63	62.17	52.17	-31.07	-30.54
5	0.65400	9.89	26.06	18.24	35.95	28.13	56.00	46.00	-20.05	-17.87
6	1.38200	9.92	16.60	9.81	26.52	19.73	56.00	46.00	-29.48	-26.27

Remarks:

1. Q.P. and AV. are abbreviations of quasi-peak and average individually.
2. The emission levels of other frequencies were very low against the limit.
3. Margin value = Emission level - Limit value
4. Correction factor = Insertion loss + Cable loss
5. Emission Level = Correction Factor + Reading Value.

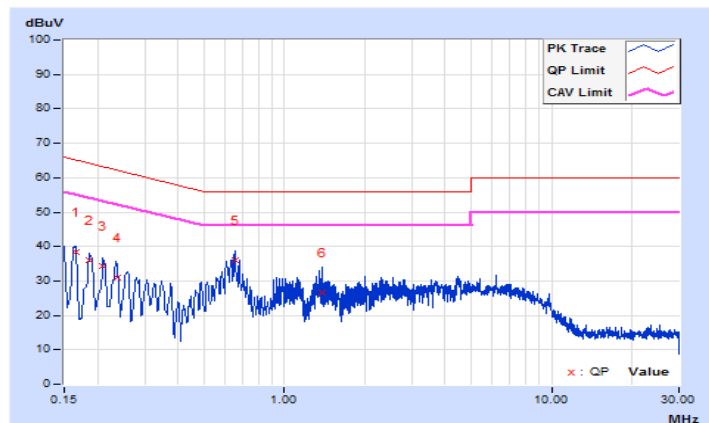

Phase	Neutral (N)	Detector Function	Quasi-Peak (QP) / Average (AV)
Test Mode	B		

No	Freq. [MHz]	Corr. Factor (dB)	Reading Value [dB (uV)]		Emission Level [dB (uV)]		Limit [dB (uV)]		Margin (dB)	
			Q.P.	AV.	Q.P.	AV.	Q.P.	AV.	Q.P.	AV.
			1	0.15000	9.84	28.28	13.27	38.12	23.11	66.00
2	0.17384	9.84	26.31	10.97	36.15	20.81	64.77	54.77	-28.62	-33.96
3	0.19400	9.85	27.15	11.56	37.00	21.41	63.86	53.86	-26.86	-32.45
4	0.21800	9.85	23.93	9.43	33.78	19.28	62.89	52.89	-29.11	-33.61
5	0.64200	9.92	19.59	10.89	29.51	20.81	56.00	46.00	-26.49	-25.19
6	4.57000	10.05	16.99	4.47	27.04	14.52	56.00	46.00	-28.96	-31.48

Remarks:

1. Q.P. and AV. are abbreviations of quasi-peak and average individually.
2. The emission levels of other frequencies were very low against the limit.
3. Margin value = Emission level - Limit value
4. Correction factor = Insertion loss + Cable loss
5. Emission Level = Correction Factor + Reading Value.

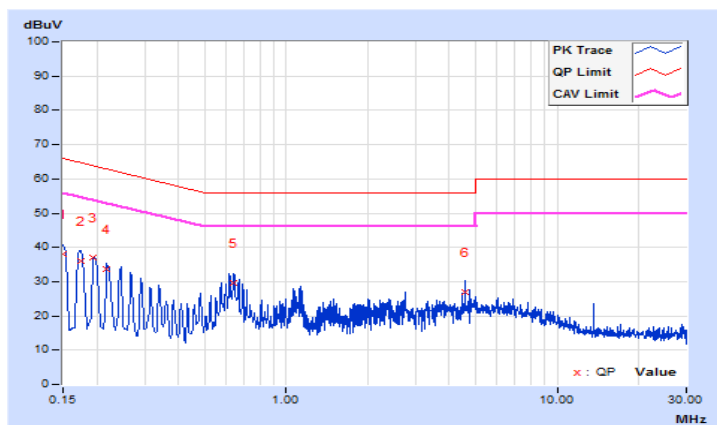

Phase	Line (L)	Detector Function	Quasi-Peak (QP) / Average (AV)
Test Mode	C		

No	Freq. [MHz]	Corr. Factor (dB)	Reading Value [dB (uV)]		Emission Level [dB (uV)]		Limit [dB (uV)]		Margin (dB)	
			Q.P.	AV.	Q.P.	AV.	Q.P.	AV.	Q.P.	AV.
			1	0.15400	9.65	31.62	8.29	41.27	17.94	65.78
2	0.17000	9.65	26.85	9.94	36.50	19.59	64.96	54.96	-28.46	-35.37
3	0.19400	9.66	22.80	8.38	32.46	18.04	63.86	53.86	-31.40	-35.82
4	0.22152	9.66	19.26	10.95	28.92	20.61	62.76	52.76	-33.84	-32.15
5	0.38929	9.66	23.92	12.18	33.58	21.84	58.08	48.08	-24.50	-26.24
6	20.75000	9.86	19.73	18.76	29.59	28.62	60.00	50.00	-30.41	-21.38

Remarks:

1. Q.P. and AV. are abbreviations of quasi-peak and average individually.
2. The emission levels of other frequencies were very low against the limit.
3. Margin value = Emission level - Limit value
4. Correction factor = Insertion loss + Cable loss
5. Emission Level = Correction Factor + Reading Value.

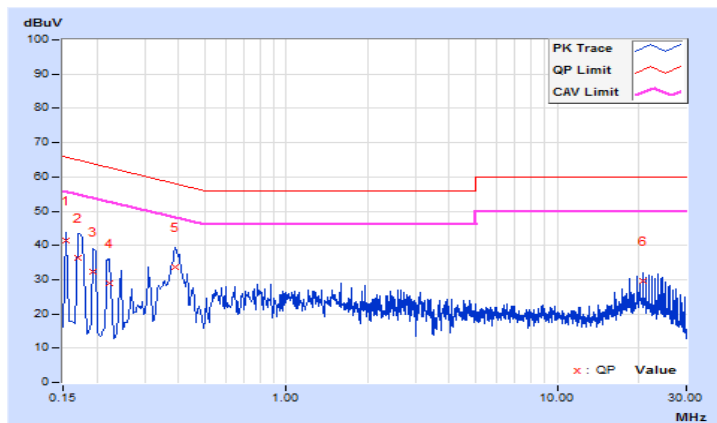

Phase	Neutral (N)	Detector Function	Quasi-Peak (QP) / Average (AV)
Test Mode	C		

No	Freq. [MHz]	Corr. Factor (dB)	Reading Value [dB (uV)]		Emission Level [dB (uV)]		Limit [dB (uV)]		Margin (dB)	
			Q.P.	AV.	Q.P.	AV.	Q.P.	AV.	Q.P.	AV.
			1	0.15400	9.68	31.89	10.68	41.57	20.36	65.78
2	0.17400	9.68	25.56	8.23	35.24	17.91	64.77	54.77	-29.53	-36.86
3	0.40600	9.68	23.41	12.44	33.09	22.12	57.73	47.73	-24.64	-25.61
4	1.67000	9.72	13.24	3.62	22.96	13.34	56.00	46.00	-33.04	-32.66
5	11.58600	9.86	6.89	2.12	16.75	11.98	60.00	50.00	-43.25	-38.02
6	22.39000	9.98	21.11	20.61	31.09	30.59	60.00	50.00	-28.91	-19.41

Remarks:

1. Q.P. and AV. are abbreviations of quasi-peak and average individually.
2. The emission levels of other frequencies were very low against the limit.
3. Margin value = Emission level - Limit value
4. Correction factor = Insertion loss + Cable loss
5. Emission Level = Correction Factor + Reading Value.

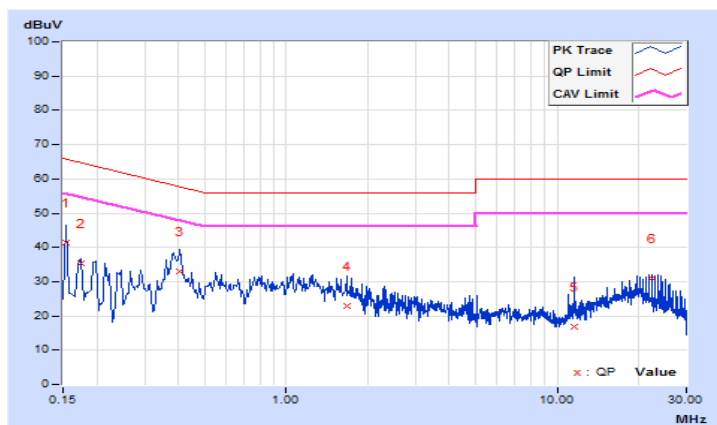

4.3 Number of Hopping Frequency Used

4.3.1 Limits of Hopping Frequency Used Measurement

At least 15 channels frequencies, and should be equally spaced.

4.3.2 Test Setup



4.3.3 Test Instruments

Refer to section 4.1.2 to get information of above instrument.

4.3.4 Test Procedure

- a. Check the calibration of the measuring instrument (SA) using either an internal calibrator or a known signal from an external generator.
- b. Turn on the EUT and connect its antenna terminal to measurement via a low loss cable. Then set it to any one measured frequency within its operating range and make sure the instrument is operated in its linear range.
- c. Set the SA on MaxHold Mode, and then keep the EUT in hopping mode. Record all the signals from each channel until each one has been recorded.
- d. Set the SA on View mode and then plot the result on SA screen.
- e. Repeat above procedures until all frequencies measured were complete.

4.3.5 Deviation from Test Standard

No deviation.

4.3.6 Test Results

There are 79 hopping frequencies in the hopping mode. Please refer to next page for the test result. On the plots, it shows that the hopping frequencies are equally spaced.

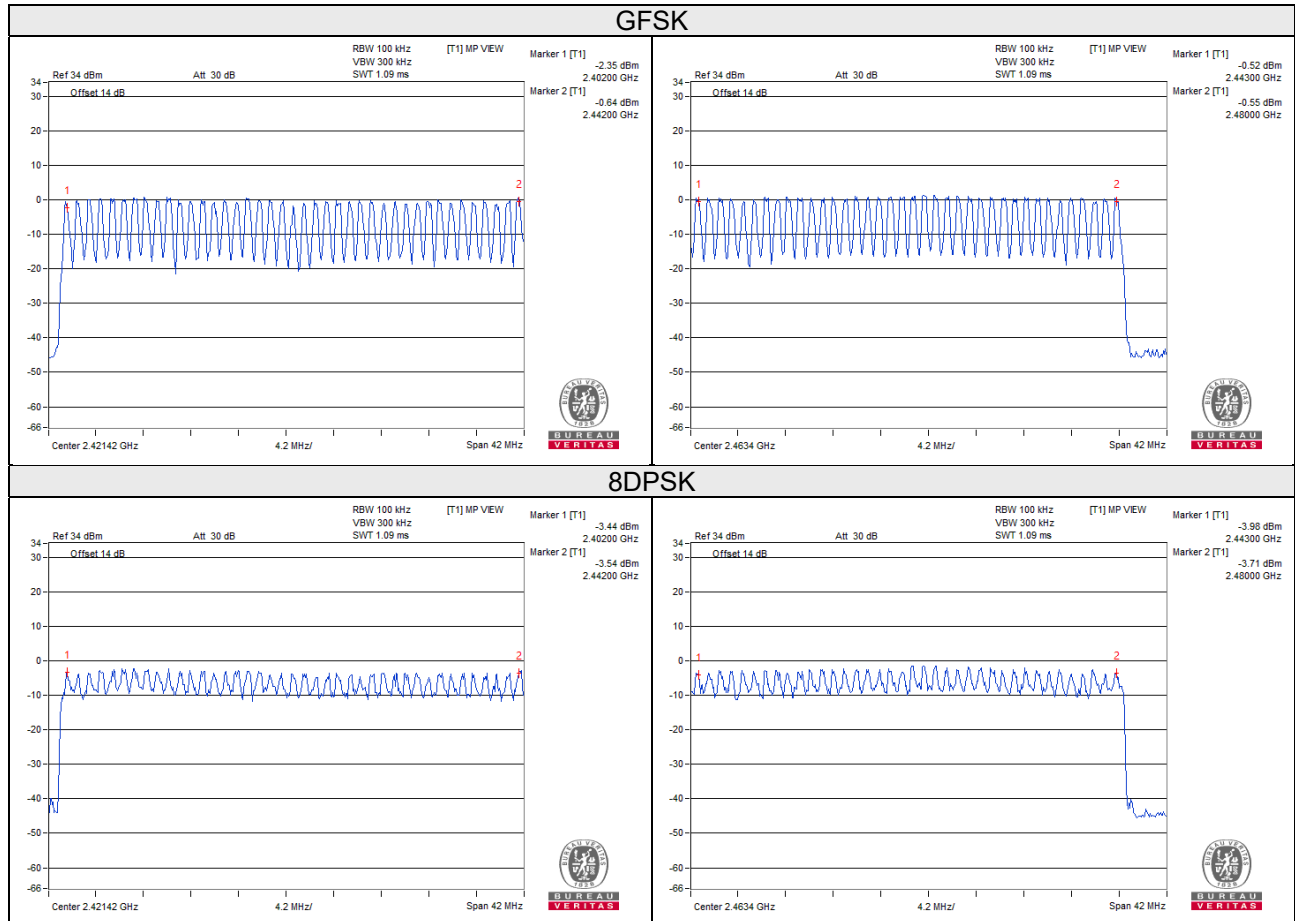

4.4 Dwell Time on Each Channel

4.4.1 Limits of Dwell Time on Each Channel Measurement

The average time of occupancy on any channel shall not be greater than 0.4 seconds within a period of 0.4 seconds multiplied by the number of hopping channels employed.

4.4.2 Test Setup

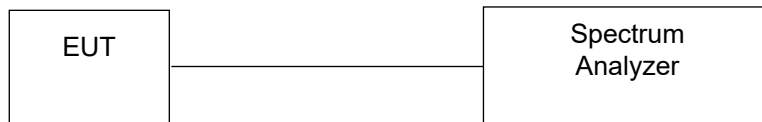

4.4.3 Test Instruments

Refer to section 4.1.2 to get information of above instrument.

4.4.4 Test Procedures

- a. Check the calibration of the measuring instrument (SA) using either an internal calibrator or a known signal from an external generator.
- b. Turn on the EUT and connect its antenna terminal to measurement via a low loss cable. Then set it to any one measured frequency within its operating range and make sure the instrument is operated in its linear range.
- c. Adjust the center frequency of SA on any frequency to be measured and set SA to zero span mode. And then, set RBW and VBW of spectrum analyzer to proper value.
- d. Measure the time duration of one transmission on the measured frequency. And then plot the result with time difference of this time duration.
- e. Repeat above procedures until all different time-slot modes have been completed.

4.4.5 Deviation from Test Standard

No deviation.

4.4.6 Test Results

GFSK

Mode	Number of transmission in a 31.6 (79Hopping*0.4)	Length of transmission time (msec)	Result (msec)	Limit (msec)
DH1	51 (times / 5 sec) * 6.32 = 323 times	0.450	145.350	400
DH3	27 (times / 5 sec) * 6.32 = 171 times	1.730	295.830	400
DH5	16 (times / 5 sec) * 6.32 = 102 times	2.927	298.554	400

Note: Test plots of the transmitting time slot are shown as below.



8DPSK

Mode	Number of transmission in a 31.6 (79Hopping*0.4)	Length of transmission time (msec)	Result (msec)	Limit (msec)
3DH1	50 (times / 5 sec) * 6.32 = 316 times	0.480	151.680	400
3DH3	25 (times / 5 sec) * 6.32 = 158 times	1.740	274.920	400
3DH5	17 (times / 5 sec) * 6.32 = 108 times	2.971	320.868	400

Note: Test plots of the transmitting time slot are shown as below.



4.5 Channel Bandwidth

4.5.1 Limits of Channel Bandwidth Measurement

For frequency hopping system operating in the 2400-2483.5MHz, If the 20dB bandwidth of hopping channel is greater than 25kHz, two-thirds 20dB bandwidth of hopping channel shall be a minimum limit for the hopping channel separation.

4.5.2 Test Setup



4.5.3 Test Instruments

Refer to section 4.1.2 to get information of above instrument.

4.5.4 Test Procedure

- Check the calibration of the measuring instrument using either an internal calibrator or a known signal from an external generator.
- Turn on the EUT and connect it to measurement instrument. Then set it to any one convenient frequency within its operating range. Set a reference level on the measuring instrument equal to the highest peak value.
- Measure the frequency difference of two frequencies that were attenuated 20dB from the reference level. Record the frequency difference as the emission bandwidth.
- Repeat above procedures until all frequencies measured were complete.

4.5.5 Deviation from Test Standard

No deviation.

4.5.6 EUT Operating Condition

The software provided by client enabled the EUT to transmit and receive data at lowest, middle and highest channel frequencies individually.

4.5.7 Test Results

Channel	Frequency (MHz)	20dB Bandwidth (MHz)	
		GFSK	8DPSK
0	2402	0.95	1.27
39	2441	0.95	1.30
78	2480	0.95	1.30

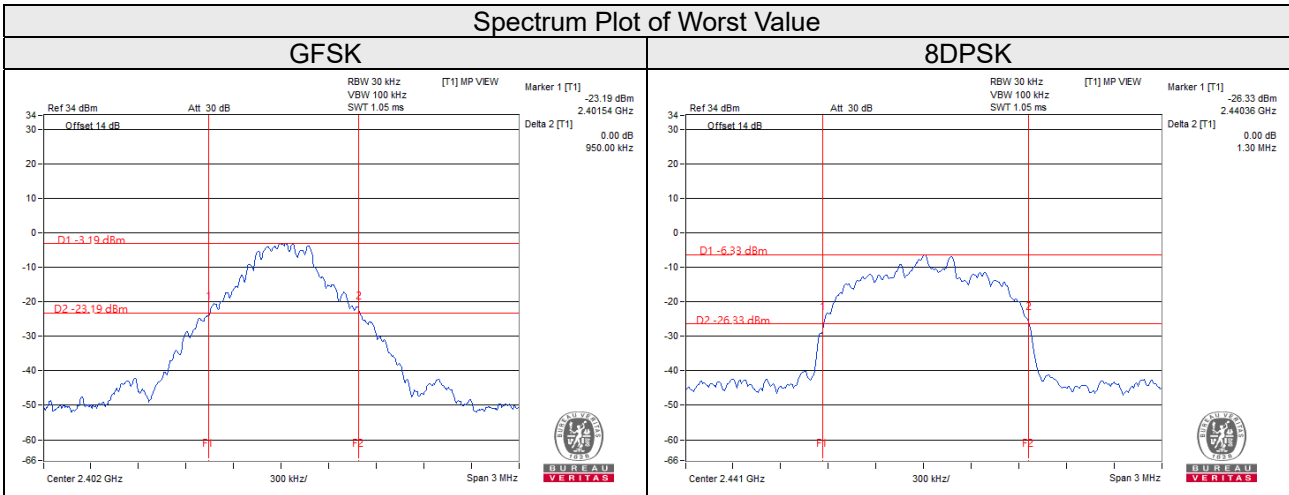

4.6 Hopping Channel Separation

4.6.1 Limits of Hopping Channel Separation Measurement

At least 25kHz or two-third of 20dB hopping channel bandwidth (whichever is greater).

4.6.2 Test Setup



4.6.3 Test Instruments

Refer to section 4.1.2 to get information of above instrument.

4.6.4 Test Procedure

Measurement Procedure REF

- Check the calibration of the measuring instrument using either an internal calibrator or a known signal from an external generator.
- Turn on the EUT and connect it to measurement instrument. Then set it to any one convenient frequency within its operating range.
- By using the MaxHold function record the separation of two adjacent channels.
- Measure the frequency difference of these two adjacent channels by SA MARK function. And then plot the result on SA screen.
- Repeat above procedures until all frequencies measured were complete.

4.6.5 Deviation from Test Standard

No deviation.

4.6.6 Test Results

Channel	Frequency (MHz)	Adjacent Channel Separation (MHz)		20dB Bandwidth (MHz)		Minimum Limit (MHz)		Pass / Fail
		GFSK	8DPSK	GFSK	8DPSK	GFSK	8DPSK	
0	2402	1.00	1.00	0.95	1.27	0.64	0.85	Pass
39	2441	1.00	1.00	0.95	1.30	0.64	0.87	Pass
78	2480	1.00	1.00	0.95	1.30	0.64	0.87	Pass

Note: The minimum limit is two-third 20dB bandwidth.

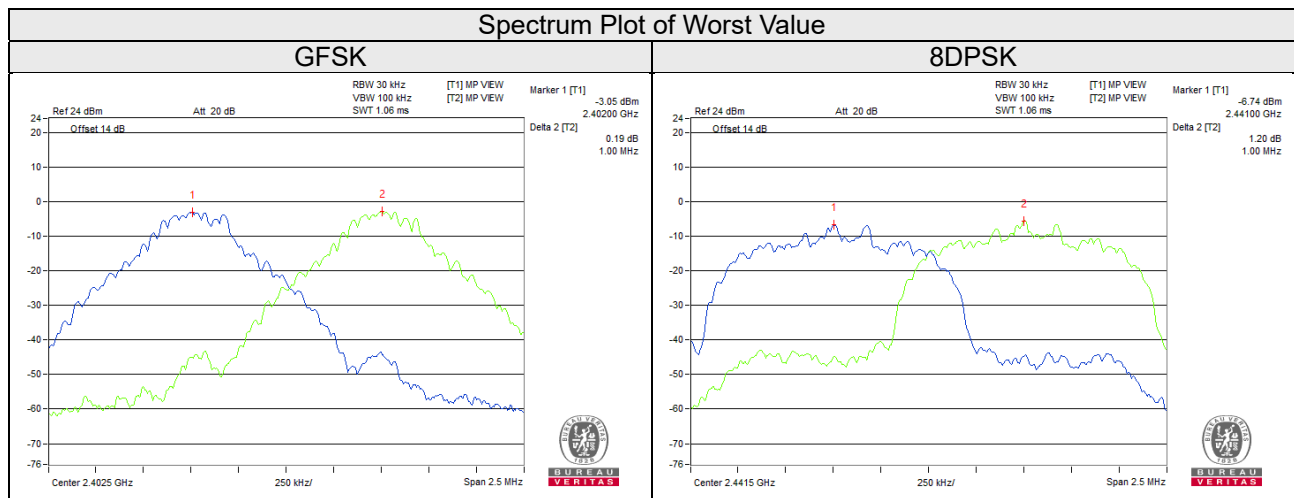

4.7 Maximum Output Power

4.7.1 Limits of Maximum Output Power Measurement

For frequency hopping systems operating in the 2400-2483.5 MHz band employing at least 75 non-overlapping hopping channels: 1 watt.

For all other frequency hopping systems in the 2400-2483.5 MHz band: 0.125 watts.

4.7.2 Test Setup

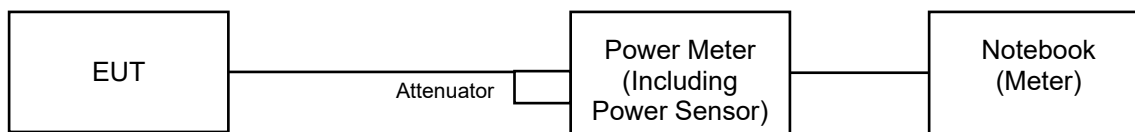

4.7.3 Test Instruments

Refer to section 4.1.2 to get information of above instrument.

4.7.4 Test Procedure

For Peak Power

A peak power sensor was used on the output port of the EUT. A power meter was used to read the response of the peak power sensor. Record the power level.

For Average Power

Average power sensor was used to perform output power measurement, trigger and gating function of wide band power meter is enabled to measure max output power of TX on burst. Duty factor is not added to measured value.

4.7.5 Deviation from Test Standard

No deviation.

4.7.6 EUT Operating Condition

The software provided by client enabled the EUT to transmit and receive data at lowest, middle and highest channel frequencies individually.

4.7.7 Test Results

For Peak Power

Channel	Frequency (MHz)	Peak Power (mW)		Peak Power (dBm)		Power Limit (mW)	Pass / Fail
		GFSK	8DPSK	GFSK	8DPSK		
0	2402	1.125	0.658	0.51	-1.82	125 / 1000 ^{Note}	Pass
39	2441	1.274	0.684	1.05	-1.65	125 / 1000 ^{Note}	Pass
78	2480	1.183	0.675	0.73	-1.71	125 / 1000 ^{Note}	Pass

Note: RF Output Power limit depends on the operating channel numbers, please refer to section 3.2 of the results.

For Average Power

Channel	Frequency (MHz)	Average Power (mW)		Average Power (dBm)	
		GFSK	8DPSK	GFSK	8DPSK
0	2402	1.089	0.625	0.37	-2.04
39	2441	1.239	0.644	0.93	-1.91
78	2480	1.156	0.653	0.63	-1.85

4.8 Conducted Out of Band Emission Measurement

4.8.1 Limits Of Conducted Out Of Band Emission Measurement

Below -20dB of the highest emission level of operating band (in 100kHz RBW).

4.8.2 Test Instruments

Refer to section 4.1.2 to get information of above instrument.

4.8.3 Test Procedure

The transmitter output was connected to the spectrum analyzer via a low lose cable. Set both RBW and VBW of spectrum analyzer to 100 kHz and 300 kHz with suitable frequency span including 100 MHz bandwidth from band edge. The band edges was measured and recorded.

4.8.4 Deviation from Test Standard

No deviation.

4.8.5 EUT Operating Condition

The software provided by client enabled the EUT to transmit and receive data at lowest, middle and highest channel frequencies individually.

4.8.6 Test Results

The spectrum plots are attached on the following images. D1 line indicates the highest level, D2 line indicates the 20dB offset below D1. It shows compliance with the requirement.

GFSK

Hopping disabled Low Channel

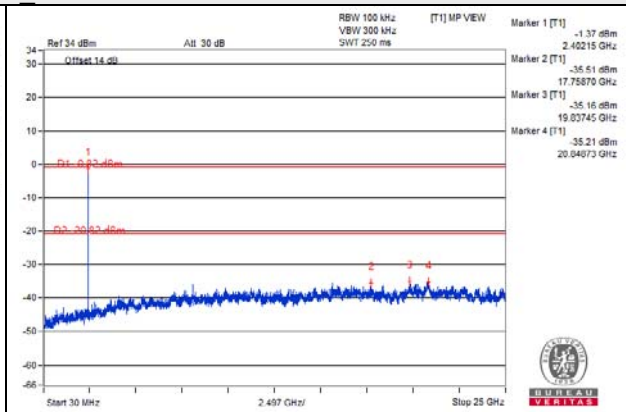
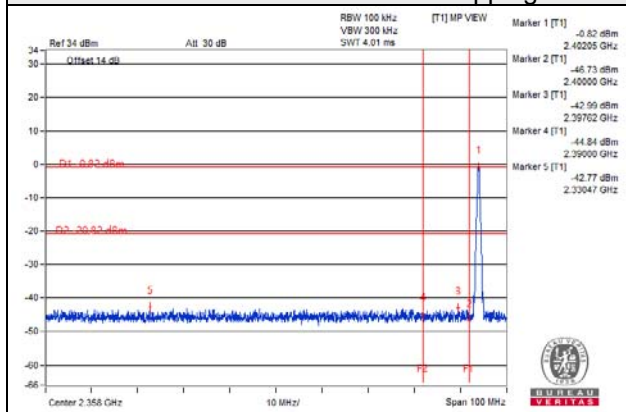

Hopping disabled High Channel

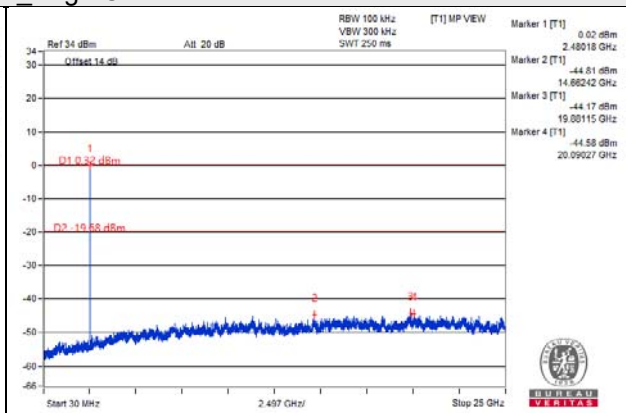
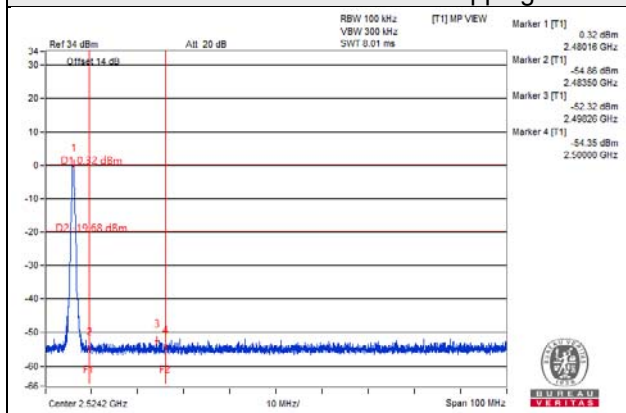

Hopping enabled Low Channel

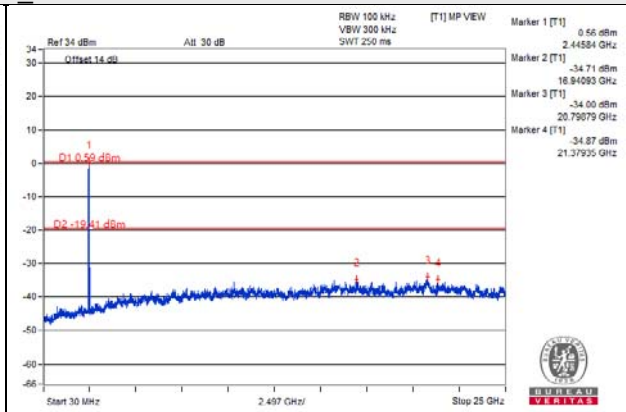
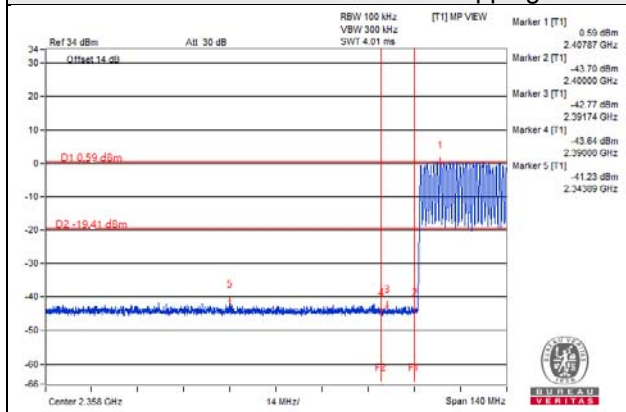

Hopping enabled High Channel

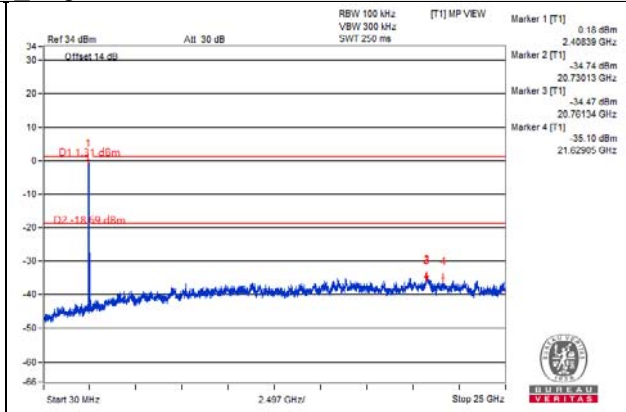
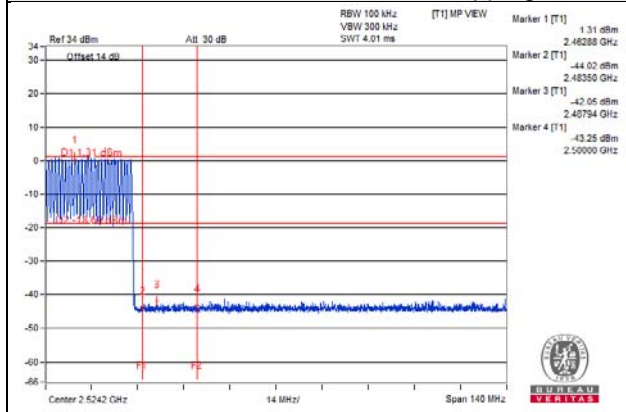

8DPSK

Hopping disabled Low Channel

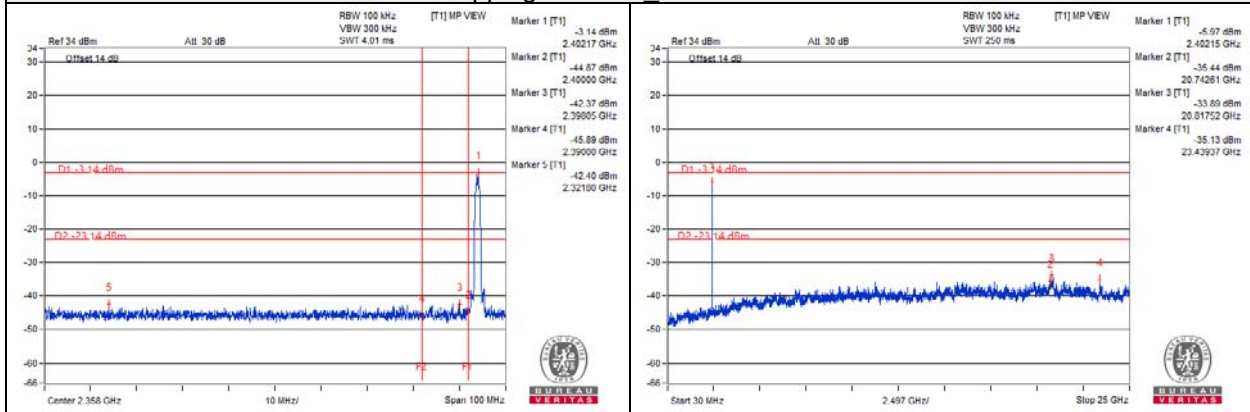

Hopping disabled High Channel

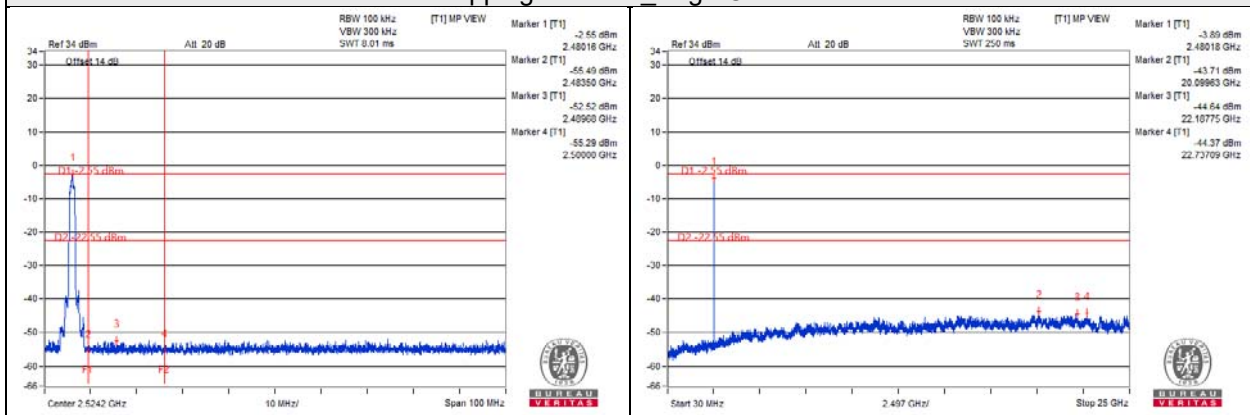

Hopping enabled Low Channel

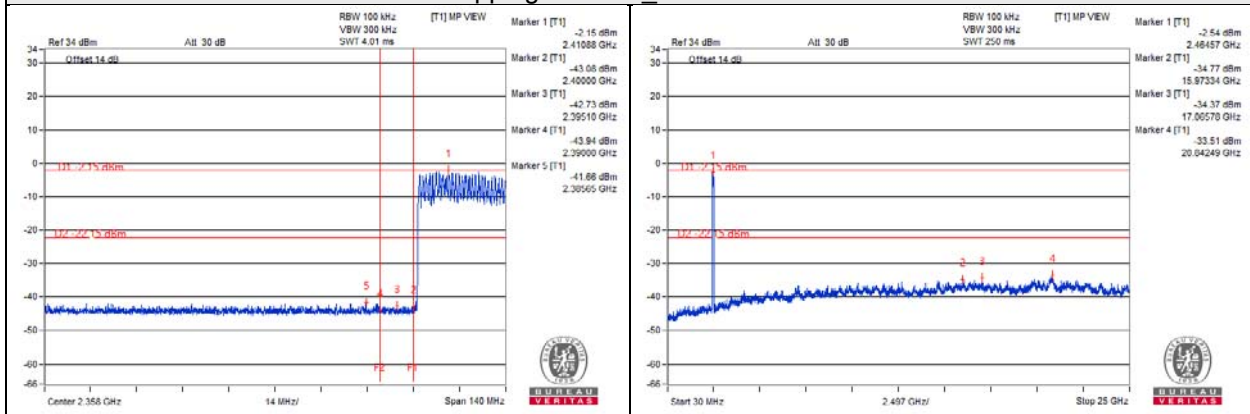

Hopping enabled High Channel

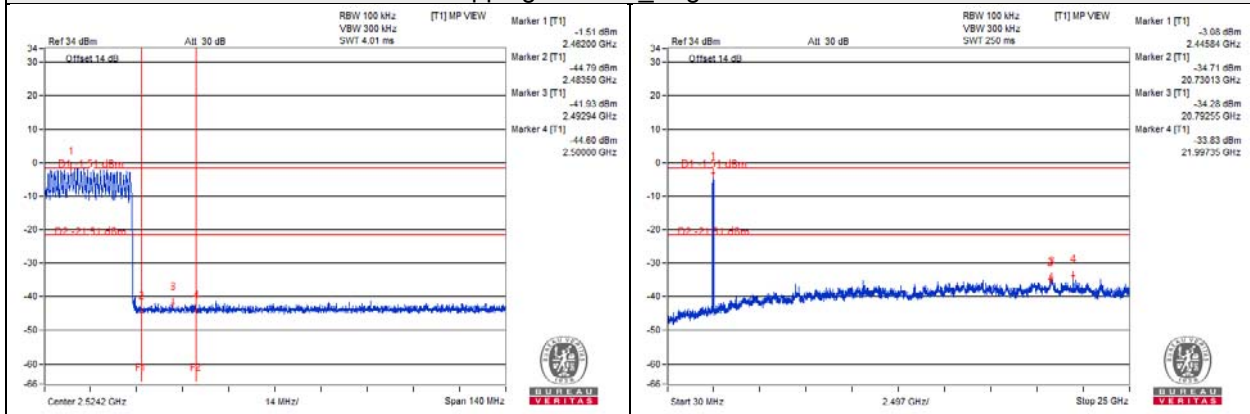

Annex A- Band Edge Measurement

GFSK

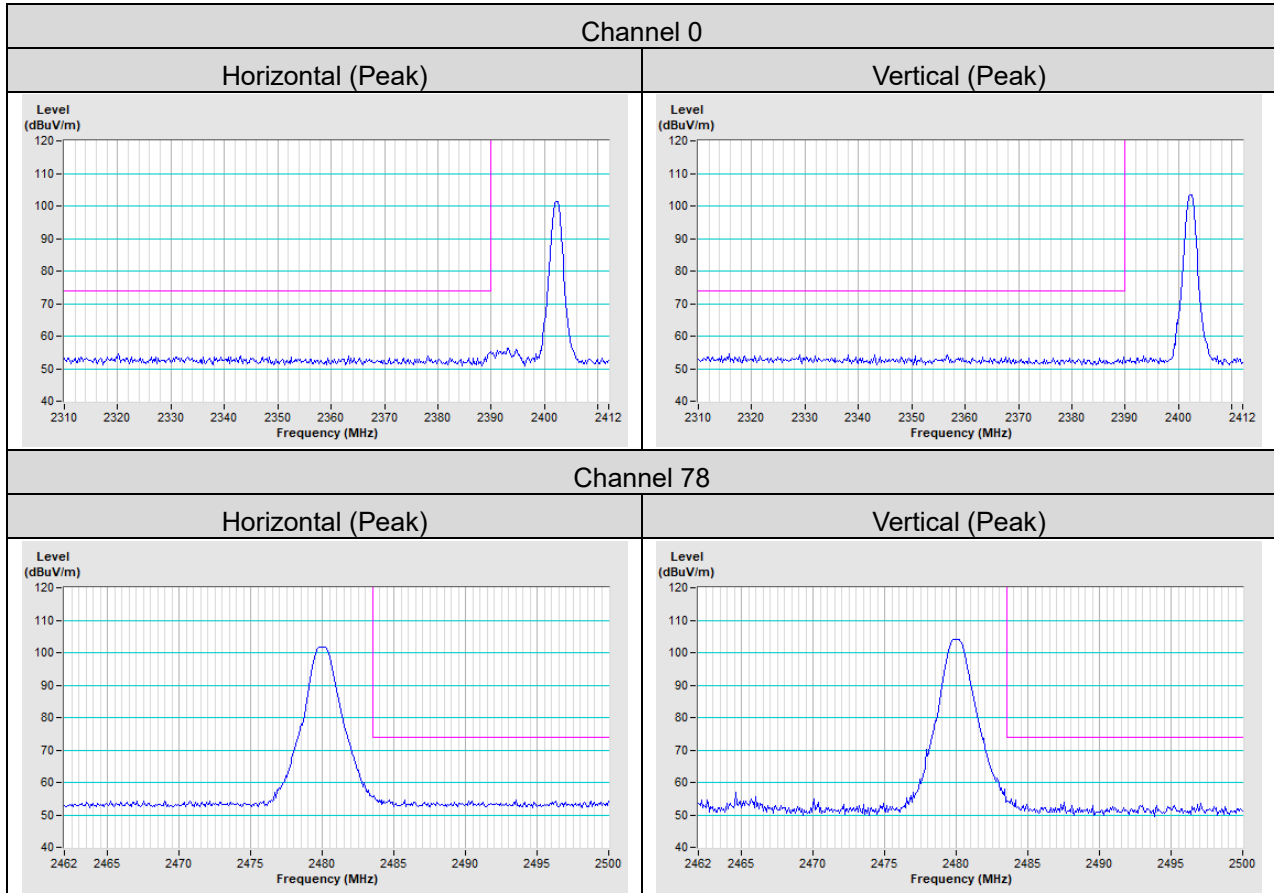

8DPSK

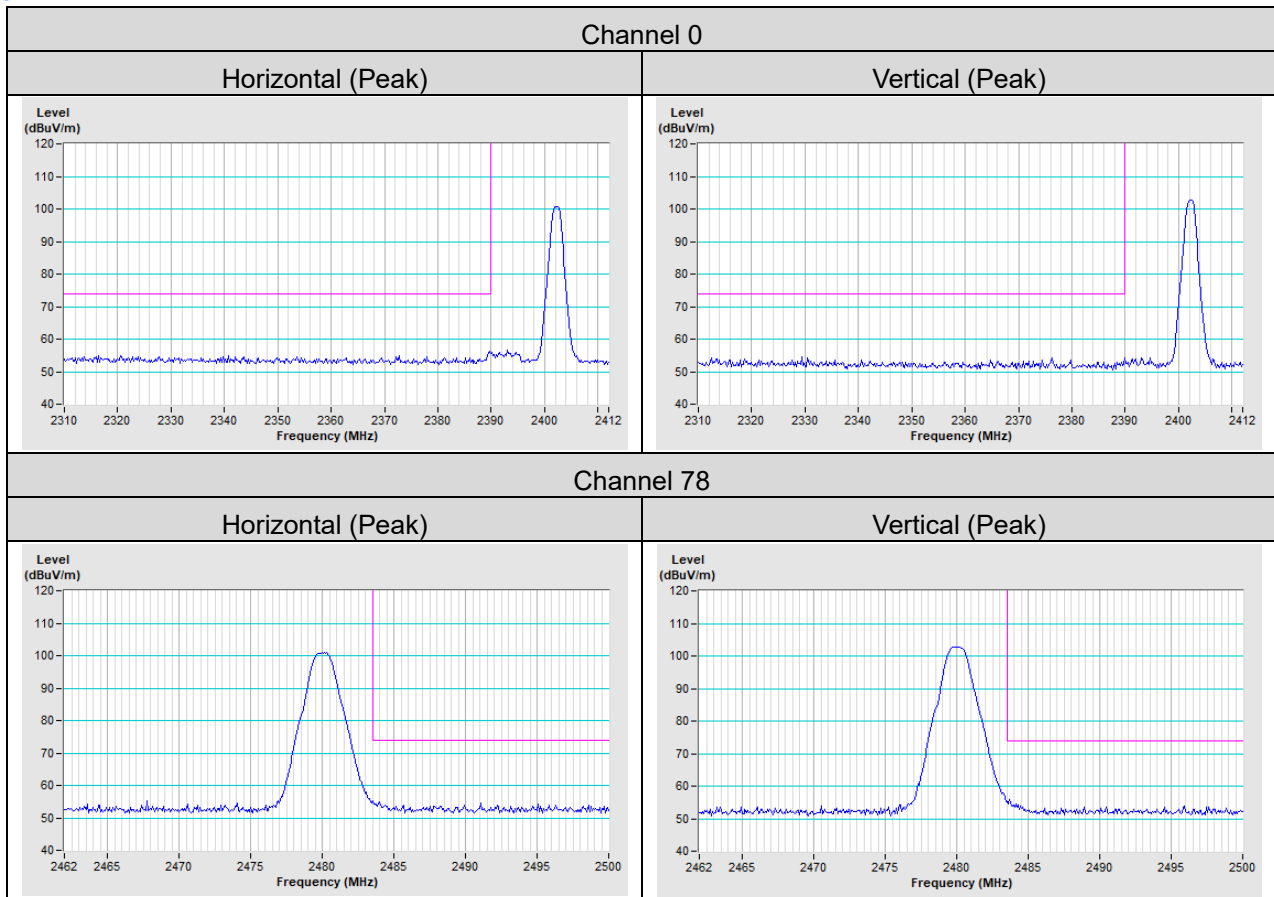

5 Pictures of Test Arrangements

Please refer to the attached file (Test Setup Photo).

Appendix – Information of the Testing Laboratories

We, Bureau Veritas Consumer Products Services (H.K.) Ltd., Taoyuan Branch, were founded in 1988 to provide our best service in EMC, Radio, Telecom and Safety consultation. Our laboratories are FCC recognized accredited test firms and accredited and approved according to ISO/IEC 17025.

If you have any comments, please feel free to contact us at the following:

Lin Kou EMC/RF Lab

Tel: 886-2-26052180

Fax: 886-2-26051924

Hsin Chu EMC/RF/Telecom Lab

Tel: 886-3-6668565

Fax: 886-3-6668323

Hwa Ya EMC/RF/Safety Lab

Tel: 886-3-3183232

Fax: 886-3-3270892

Email: service.adt@tw.bureauveritas.com

Web Site: www.bureauveritas-adt.com

The address and road map of all our labs can be found in our web site also.

--- END ---