

# SAR Test Report

**Report No.** : SF200428C03E  
**Applicant** : DENSO WAVE INCORPORATED  
**Address** : 1 Yoshiike Kusagi Agui-cho, Chita-gun Aichi 470-2297, Japan  
**Product** : 2D Code Handy Terminal  
**FCC ID** : PZWBHTM80QW  
**Brand** : DENSO  
**Model No.** : BHT-M80-QW  
**Standards** : FCC 47 CFR Part 2 (2.1093), IEEE C95.1:1992, IEEE Std 1528:2013  
KDB 865664 D01 v01r04, KDB 865664 D02 v01r02  
KDB 248227 D01 v02r02, KDB 447498 D01 v06, KDB 648474 D04 v01r03  
**Sample Received Date** : Aug. 25, 2020  
**Date of Testing** : Oct. 24, 2020 ~ Oct. 29, 2020  
**Lab Address** : No. 47-2, 14th Ling, Chia Pau Vil., Lin Kou Dist., New Taipei City, Taiwan  
**Test Location** : No. 19, Hwa Ya 2nd Rd., Wen Hwa Vil., Kwei Shan Dist., Taoyuan City, Taiwan

**CERTIFICATION:** The above equipment have been tested by **Bureau Veritas Consumer Products Services (H.K.) Ltd., Taoyuan Branch–Lin Kou Laboratories**, and found compliance with the requirement of the above standards. The test record, data evaluation & Equipment Under Test (EUT) configurations represented herein are true and accurate accounts of the measurements of the sample's SAR characteristics under the conditions specified in this report. It should not be reproduced except in full, without the written approval of our laboratory. The client should not use it to claim product certification, approval, or endorsement by TAF or any government agencies.

Prepared By :



Shelly Hsueh / Specialist

Approved By :



Gordon Lin / Manager



FCC Accredited No.: TW0003

This report is for your exclusive use. Any copying or replication of this report to or for any other person or entity, or use of our name or trademark, is permitted only with our prior written permission. This report sets forth our findings solely with respect to the test samples identified herein. The results set forth in this report are not indicative or representative of the quality or characteristics of the lot from which a test sample was taken or any similar or identical product unless specifically and expressly noted. Our report includes all of the tests requested by you and the results thereof based upon the information that you provided to us. You have 60 days from date of issuance of this report to notify us of any material error or omission caused by our negligence, provided, however, that such notice shall be in writing and shall specifically address the issue you wish to raise. A failure to raise such issue within the prescribed time shall constitute your unqualified acceptance of the completeness of this report, the tests conducted and the correctness of the report contents. Unless specific mention, the uncertainty of measurement has been explicitly taken into account to declare the compliance or non-compliance to the specification.

**Table of Contents**

<b>Release Control Record .....</b>	<b>3</b>
<b>1. Summary of Maximum SAR Value .....</b>	<b>4</b>
<b>2. Description of Equipment Under Test .....</b>	<b>5</b>
<b>3. SAR Measurement System .....</b>	<b>6</b>
3.1 Definition of Specific Absorption Rate (SAR) .....	6
3.2 SPEAG DASY6 System .....	6
3.2.1 Robot .....	7
3.2.2 Probes .....	8
3.2.3 Data Acquisition Electronics (DAE) .....	8
3.2.4 Phantoms .....	8
3.2.5 Device Holder .....	9
3.2.6 System Validation Dipoles .....	10
3.2.7 Power Source .....	10
3.2.8 Tissue Simulating Liquids .....	11
3.3 SAR System Verification .....	13
3.4 SAR Measurement Procedure .....	14
3.4.1 Area Scan and Zoom Scan Procedure .....	14
3.4.2 Volume Scan Procedure .....	15
3.4.3 Power Drift Monitoring .....	16
3.4.4 Spatial Peak SAR Evaluation .....	16
3.4.5 SAR Averaged Methods .....	16
<b>4. SAR Measurement Evaluation .....</b>	<b>17</b>
4.1 EUT Configuration and Setting .....	17
4.2 EUT Testing Position .....	20
4.2.1 Head Exposure Conditions .....	20
4.2.2 Body-worn Accessory Exposure Conditions .....	22
4.2.3 Product Specific (Phablet) Exposure Conditions .....	23
4.3 Tissue Verification .....	24
4.4 System Validation .....	25
4.5 System Verification .....	26
4.6 Maximum Output Power .....	26
4.6.1 Maximum Target Conducted Power .....	26
4.6.2 Measured Conducted Power Result .....	26
4.7 SAR Testing Results .....	27
4.7.1 SAR Test Reduction Considerations .....	27
4.7.2 SAR Results for Head Exposure Condition .....	29
4.7.3 SAR Results for Body-worn Exposure Condition (Test Separation Distance is 15 mm) .....	31
4.7.4 SAR Results for Product Specific (Phablet) Exposure Condition (Test Separation Distance is 0 mm) .....	32
4.7.5 SAR Measurement Variability .....	34
4.7.6 Simultaneous Multi-band Transmission Evaluation .....	35
<b>5. Calibration of Test Equipment .....</b>	<b>36</b>
<b>6. Measurement Uncertainty .....</b>	<b>37</b>
<b>7. Information of the Testing Laboratories .....</b>	<b>41</b>
<b>Appendix A. SAR Plots of System Verification</b>	
<b>Appendix B. SAR Plots of SAR Measurement</b>	
<b>Appendix C. Calibration Certificate for Probe and Dipole</b>	
<b>Appendix D. Photographs of EUT and Setup</b>	
<b>Appendix E. Maximum Target Conducted Power</b>	
<b>Appendix F. Measured Conducted Power Result</b>	
<b>Appendix G. Analysis of Simultaneous Transmission SAR</b>	



## Release Control Record

Report No.	Reason for Change	Date Issued
SF200428C03E	Initial release	Nov. 02, 2020

**1. Summary of Maximum SAR Value**

Equipment Class	Mode	Highest SAR-1g Head (W/kg)	Highest SAR-1g Body-worn Tested at 15 mm (W/kg)	Highest SAR-10g Product Specific Tested at 0 mm (W/kg)
DTS	2.4G WLAN	0.55	0.21	1.48
NII	5.2G WLAN	0.96	0.34	1.22
	5.6G WLAN	1.17	0.66	1.69
	5.8G WLAN	0.49	0.33	0.82
DSS	Bluetooth / EDR	0.01	0.00	0.01
DTS	Bluetooth / LE	N/A	N/A	N/A

Highest Simultaneous Transmission SAR	Highest SAR-1g Head (W/kg)	Highest SAR-1g Body-worn Tested at 15 mm (W/kg)	Highest SAR-10g Product Specific Tested at 0 mm (W/kg)
	1.17	0.66	1.70

**Note:**

- The SAR criteria (**Head & Body: SAR-1g 1.6 W/kg, and Extremity: SAR-10g 4.0 W/kg**) for general population/uncontrolled exposure is specified in FCC 47 CFR part 2 (2.1093) and ANSI/IEEE C95.1-1992.

# SAR Test Report

## 2. Description of Equipment Under Test

<b>EUT Type</b>	2D Code Handy Terminal
<b>FCC ID</b>	PZWBHTM80QW
<b>Brand Name</b>	DENSO
<b>Model Name</b>	BHT-M80-QW
<b>Tx Frequency Bands (Unit: MHz)</b>	WLAN : 2412 ~ 2462, 5180 ~ 5240, 5260 ~ 5320, 5500 ~ 5720, 5745 ~ 5825 Bluetooth : 2402 ~ 2480 NFC : 13.56
<b>Uplink Modulations</b>	802.11b : DSSS 802.11a/g/n/ac : OFDM Bluetooth : GFSK, $\pi/4$ -DQPSK, 8-DPSK NFC : ASK
<b>Maximum Tune-up Conducted Power (Unit: dBm)</b>	Please refer to section 4.6.1 of this report
<b>Antenna Type</b>	PIFA Antenna Ant 0: Peak Antenna Gain : 1.36 dBi for 2.4GHz, 3.45 dBi for 5GHz Ant 1: Peak Antenna Gain : 1.47 dBi for 2.4GHz, 3.80 dBi for 5GHz
<b>EUT Stage</b>	Engineering Sample

### Note:

- The above EUT information is declared by manufacturer and for more detailed features description please refers to the manufacturer's specifications or User's Manual.

### List of Accessory:

<b>Battery 1</b>	<b>Brand Name</b>	DENSO
	<b>Model Name</b>	BT1
	<b>Power Rating</b>	3.85Vdc, 4020mAh, 15.47Wh
	<b>Type</b>	Li-ion
<b>Battery 2</b>	<b>Brand Name</b>	DENSO
	<b>Model Name</b>	BT1S
	<b>Power Rating</b>	3.85Vdc, 2900mAh, 11.16Wh
	<b>Type</b>	Li-ion

### **3. SAR Measurement System**

#### **3.1 Definition of Specific Absorption Rate (SAR)**

SAR is related to the rate at which energy is absorbed per unit mass in an object exposed to a radio field. The SAR distribution in a biological body is complicated and is usually carried out by experimental techniques or numerical modeling. The standard recommends limits for two tiers of groups, occupational/controlled and general population/uncontrolled, based on a person's awareness and ability to exercise control over his or her exposure. In general, occupational/controlled exposure limits are higher than the limits for general population/uncontrolled.

The SAR definition is the time derivative (rate) of the incremental energy (dW) absorbed by (dissipated in) an incremental mass (dm) contained in a volume element (dv) of a given density ( $\rho$ ). The equation description is as below:

$$\text{SAR} = \frac{d}{dt} \left( \frac{dW}{dm} \right) = \frac{d}{dt} \left( \frac{dW}{\rho dv} \right)$$

SAR is expressed in units of Watts per kilogram (W/kg)

SAR measurement can be related to the electrical field in the tissue by

$$\text{SAR} = \frac{\sigma |E|^2}{\rho}$$

Where:  $\sigma$  is the conductivity of the tissue,  $\rho$  is the mass density of the tissue and E is the RMS electrical field strength.

#### **3.2 SPEAG DASY6 System**

DASY6 system consists of high precision robot, probe alignment sensor, phantom, robot controller, controlled measurement server and near-field probe. The robot includes six axes that can move to the precision position of the DASY6 software defined. The DASY6 software can define the area that is detected by the probe. The robot is connected to controlled box. Controlled measurement server is connected to the controlled robot box. The DAE includes amplifier, signal multiplexing, AD converter, offset measurement and surface detection. It is connected to the Electro-optical coupler (ECO). The ECO performs the conversion from the optical into digital electric signal of the DAE and transfers data to the PC.

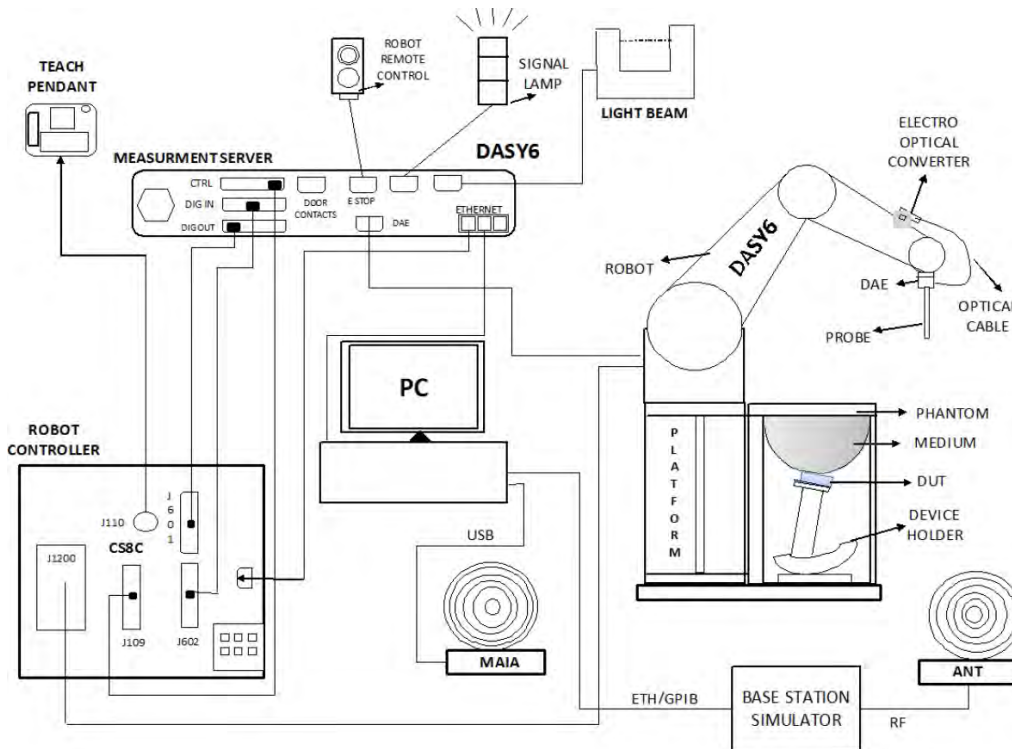

**Fig-3.1 SPEAG DASY6 System Setup**

**3.2.1 Robot**

The DASY6 systems use the high precision robots from Stäubli SA (France). For the 6-axis controller system, the robot controller version of CS8c from Stäubli is used. The Stäubli robot series have many features that are important for our application:

- High precision (repeatability  $\pm 0.035$  mm)
- High reliability (industrial design)
- Jerk-free straight movements
- Low ELF interference (the closed metallic construction shields against motor control fields)



**Fig-3.2 SPEAG DASY6 System**

## SAR Test Report

### 3.2.2 Probes

The SAR measurement is conducted with the dosimetric probe. The probe is specially designed and calibrated for use in liquid with high permittivity. The dosimetric probe has special calibration in liquid at different frequency.

<b>Model</b>	EX3DV4	
<b>Construction</b>	Symmetrical design with triangular core. Built-in shielding against static charges. PEEK enclosure material (resistant to organic solvents, e.g., DGBE).	
<b>Frequency</b>	4 MHz to 10 GHz Linearity: $\pm 0.2$ dB	
<b>Directivity</b>	$\pm 0.1$ dB in TSL (rotation around probe axis) $\pm 0.3$ dB in TSL (rotation normal to probe axis)	
<b>Dynamic Range</b>	10 $\mu$ W/g to 100 mW/g Linearity: $\pm 0.2$ dB (noise: typically $< 1$ $\mu$ W/g)	
<b>Dimensions</b>	Overall length: 337 mm (Tip: 20 mm) Tip diameter: 2.5 mm (Body: 12 mm) Typical distance from probe tip to dipole centers: 1 mm	

### 3.2.3 Data Acquisition Electronics (DAE)

<b>Model</b>	DAE3, DAE4	
<b>Construction</b>	Signal amplifier, multiplexer, A/D converter and control logic. Serial optical link for communication with DASY embedded system (fully remote controlled). Two step probe touch detector for mechanical surface detection and emergency robot stop.	
<b>Measurement Range</b>	-100 to +300 mV (16 bit resolution and two range settings: 4mV, 400mV)	
<b>Input Offset Voltage</b>	$< 5\mu$ V (with auto zero)	
<b>Input Bias Current</b>	$< 50$ fA	
<b>Dimensions</b>	60 x 60 x 68 mm	

### 3.2.4 Phantoms

<b>Model</b>	SAM-Twin Phantom	
<b>Construction</b>	The shell corresponds to the specifications of the Specific Anthropomorphic Mannequin (SAM) phantom defined in IEEE Std 1528 and IEC 62209-1. It enables the dosimetric evaluation of left and right hand phone usage as well as body-mounted usage at the flat phantom region. A cover prevents evaporation of the liquid. Reference markings on the phantom allow the complete setup of all predefined phantom positions and measurement grids by teaching three points with the robot.	
<b>Material</b>	Vinylester, fiberglass reinforced (VE-GF)	
<b>Shell Thickness</b>	$2 \pm 0.2$ mm ( $6 \pm 0.2$ mm at ear point)	
<b>Dimensions</b>	Length: 1000 mm Width: 500 mm Height: adjustable feet	
<b>Filling Volume</b>	approx. 25 liters	

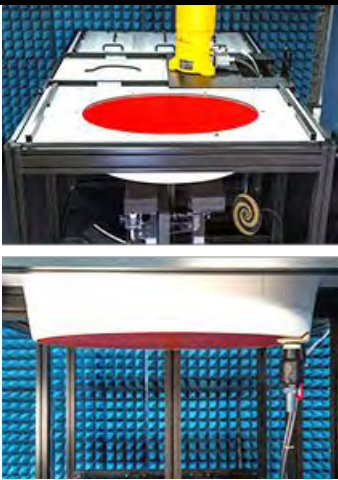

<b>Model</b>	ELI	
<b>Construction</b>	The ELI phantom is used for compliance testing of handheld and body-mounted wireless devices. ELI is fully compatible with the IEC 62209-2 standard and all known tissue simulating liquids. ELI has been optimized regarding its performance and can be integrated into our standard phantom tables. A cover prevents evaporation of the liquid. Reference markings on the phantom allow installation of the complete setup, including all predefined phantom positions and measurement grids, by teaching three points. The phantom is compatible with all SPEAG dosimetric probes and dipoles.	
<b>Material</b>	Vinylester, fiberglass reinforced (VE-GF)	
<b>Shell Thickness</b>	2.0 ± 0.2 mm (bottom plate)	
<b>Dimensions</b>	Major axis: 600 mm Minor axis: 400 mm	
<b>Filling Volume</b>	approx. 30 liters	

### 3.2.5 Device Holder

<b>Model</b>	MD4HHTV5 - Mounting Device for Hand-Held Transmitters	
<b>Construction</b>	In combination with the Twin SAM or ELI phantoms, the Mounting Device for Hand-Held Transmitters enables rotation of the mounted transmitter device to specified spherical coordinates. At the heads, the rotation axis is at the ear opening. Transmitter devices can be easily and accurately positioned according to IEC 62209-1, IEEE 1528, FCC, or other specifications. The device holder can be locked for positioning at different phantom sections (left head, right head, flat).	
<b>Material</b>	Polyoxymethylene (POM)	

<b>Model</b>	MDA4WTV5 - Mounting Device Adaptor for Ultra Wide Transmitters	
<b>Construction</b>	An upgrade kit to Mounting Device to enable easy mounting of wider devices like big smart-phones, e-books, small tablets, etc. It holds devices with width up to 140 mm.	
<b>Material</b>	Polyoxymethylene (POM)	

<b>Model</b>	MDA4SPV6 - Mounting Device Adaptor for Smart Phones	
<b>Construction</b>	The solid low-density MDA4SPV6 adaptor assuring no impact on the DUT radiation performance and is conform with any DUT design and shape.	
<b>Material</b>	ROHACELL	

## SAR Test Report

<b>Model</b>	MD4LAPV5 - Mounting Device for Laptops and other Body-Worn Transmitters	
<b>Construction</b>	In combination with the Twin SAM or ELI phantoms, the Mounting Device (Body-Worn) enables testing of transmitter devices according to IEC 62209-2 specifications. The device holder can be locked for positioning at a flat phantom section.	
<b>Material</b>	Polyoxymethylene (POM), PET-G, Foam	

### 3.2.6 System Validation Dipoles

<b>Model</b>	D-Serial	
<b>Construction</b>	Symmetrical dipole with 1/4 balun. Enables measurement of feed point impedance with NWA. Matched for use near flat phantoms filled with tissue simulating solutions.	
<b>Frequency</b>	750 MHz to 5800 MHz	
<b>Return Loss</b>	> 20 dB	
<b>Power Capability</b>	> 100 W (f < 1GHz), > 40 W (f > 1GHz)	

### 3.2.7 Power Source

<b>Model</b>	Powersource1	
<b>Signal Type</b>	Continuous Wave	
<b>Operating Frequencies</b>	600 MHz to 5850 MHz	
<b>Output Power</b>	-5.0 dBm to +17.0 dBm	
<b>Power Supply</b>	5V DC, via USB jack	
<b>Power Consumption</b>	<3 W	
<b>Applications</b>	System performance check and validation with a CW signal.	

# SAR Test Report

## 3.2.8 Tissue Simulating Liquids

For SAR measurement of the field distribution inside the phantom, the phantom must be filled with homogeneous tissue simulating liquid to a depth of at least 15 cm. For head SAR testing, the liquid height from the ear reference point (ERP) of the phantom to the liquid top surface is larger than 15 cm. For body SAR testing, the liquid height from the center of the flat phantom to the liquid top surface is larger than 15 cm. The nominal dielectric values of the tissue simulating liquids in the phantom and the tolerance of 10 % are listed in Table-3.1.

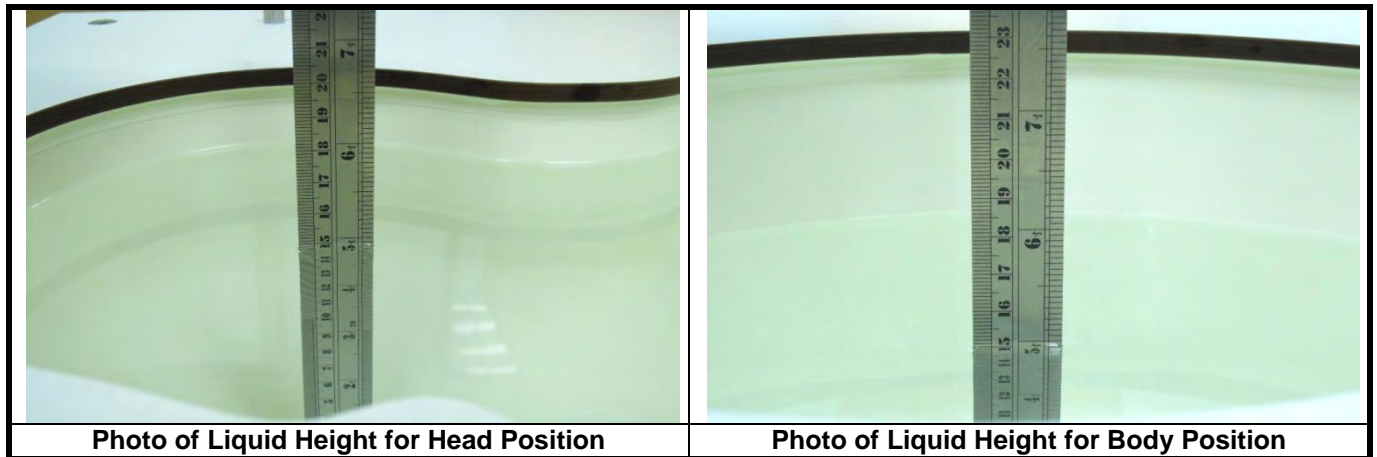

**Table-3.1 Targets of Tissue Simulating Liquid**

Frequency (MHz)	Target Permittivity	Range of $\pm 10\%$	Target Conductivity	Range of $\pm 10\%$
450	43.5	39.2 ~ 47.9	0.87	0.78 ~ 0.96
750	41.9	37.7 ~ 46.1	0.89	0.80 ~ 0.98
835	41.5	37.4 ~ 45.7	0.90	0.81 ~ 0.99
900	41.5	37.4 ~ 45.7	0.97	0.87 ~ 1.07
1450	40.5	36.5 ~ 44.6	1.20	1.08 ~ 1.32
1500	40.4	36.4 ~ 44.4	1.23	1.11 ~ 1.35
1640	40.2	36.2 ~ 44.2	1.31	1.18 ~ 1.44
1750	40.1	36.1 ~ 44.1	1.37	1.23 ~ 1.51
1800	40.0	36.0 ~ 44.0	1.40	1.26 ~ 1.54
1900	40.0	36.0 ~ 44.0	1.40	1.26 ~ 1.54
2000	40.0	36.0 ~ 44.0	1.40	1.26 ~ 1.54
2100	39.8	35.8 ~ 43.8	1.49	1.34 ~ 1.64
2300	39.5	35.6 ~ 43.5	1.67	1.50 ~ 1.84
2450	39.2	35.3 ~ 43.1	1.80	1.62 ~ 1.98
2600	39.0	35.1 ~ 42.9	1.96	1.76 ~ 2.16
3000	38.5	34.7 ~ 42.4	2.40	2.16 ~ 2.64
3500	37.9	34.1 ~ 41.7	2.91	2.62 ~ 3.20
4000	37.4	33.7 ~ 41.1	3.43	3.09 ~ 3.77
4500	36.8	33.1 ~ 40.5	3.94	3.55 ~ 4.33
5000	36.2	32.6 ~ 39.8	4.45	4.01 ~ 4.90
5200	36.0	32.4 ~ 39.6	4.66	4.19 ~ 5.13
5400	35.8	32.2 ~ 39.4	4.86	4.37 ~ 5.35
5600	35.5	32.0 ~ 39.1	5.07	4.56 ~ 5.58
5800	35.3	31.8 ~ 38.8	5.27	4.74 ~ 5.80
6000	35.1	31.6 ~ 38.6	5.48	4.93 ~ 6.03

## SAR Test Report

The dielectric properties of the tissue simulating liquids are defined in IEC 62209-1 and IEC 62209-2. The dielectric properties of the tissue simulating liquids were verified prior to the SAR evaluation using a dielectric assessment kit and a network analyzer.

Since the range of  $\pm 10\%$  of the required target values is used to measure relative permittivity and conductivity, the SAR correction procedure is applied to correct measured SAR for the deviations in permittivity and conductivity. Only positive correction has been used to scale up the measured SAR, and SAR result would not be corrected if the correction  $\Delta$  SAR has a negative sign.

The following table gives the recipes for tissue simulating liquids.

**Table-3.2 Recipes of Tissue Simulating Liquid**

Tissue Type	Bactericide	DGBE	HEC	NaCl	Sucrose	Triton X-100	Water	Diethylene Glycol Mono-hexylether
H750	0.2	-	0.2	1.5	56.0	-	42.1	-
H835	0.2	-	0.2	1.5	57.0	-	41.1	-
H900	0.2	-	0.2	1.4	58.0	-	40.2	-
H1450	-	43.3	-	0.6	-	-	56.1	-
H1640	-	45.8	-	0.5	-	-	53.7	-
H1750	-	47.0	-	0.4	-	-	52.6	-
H1800	-	44.5	-	0.3	-	-	55.2	-
H1900	-	44.5	-	0.2	-	-	55.3	-
H2000	-	44.5	-	0.1	-	-	55.4	-
H2300	-	44.9	-	0.1	-	-	55.0	-
H2450	-	45.0	-	0.1	-	-	54.9	-
H2600	-	45.1	-	0.1	-	-	54.8	-
H3500	-	8.0	-	0.2	-	20.0	71.8	-
H5G	-	-	-	-	-	17.2	65.5	17.3

**3.3 SAR System Verification**

The system check verifies that the system operates within its specifications. It is performed daily or before every SAR measurement. The system check uses normal SAR measurements in the flat section of the phantom with a matched dipole at a specified distance. The system verification setup is shown as below.

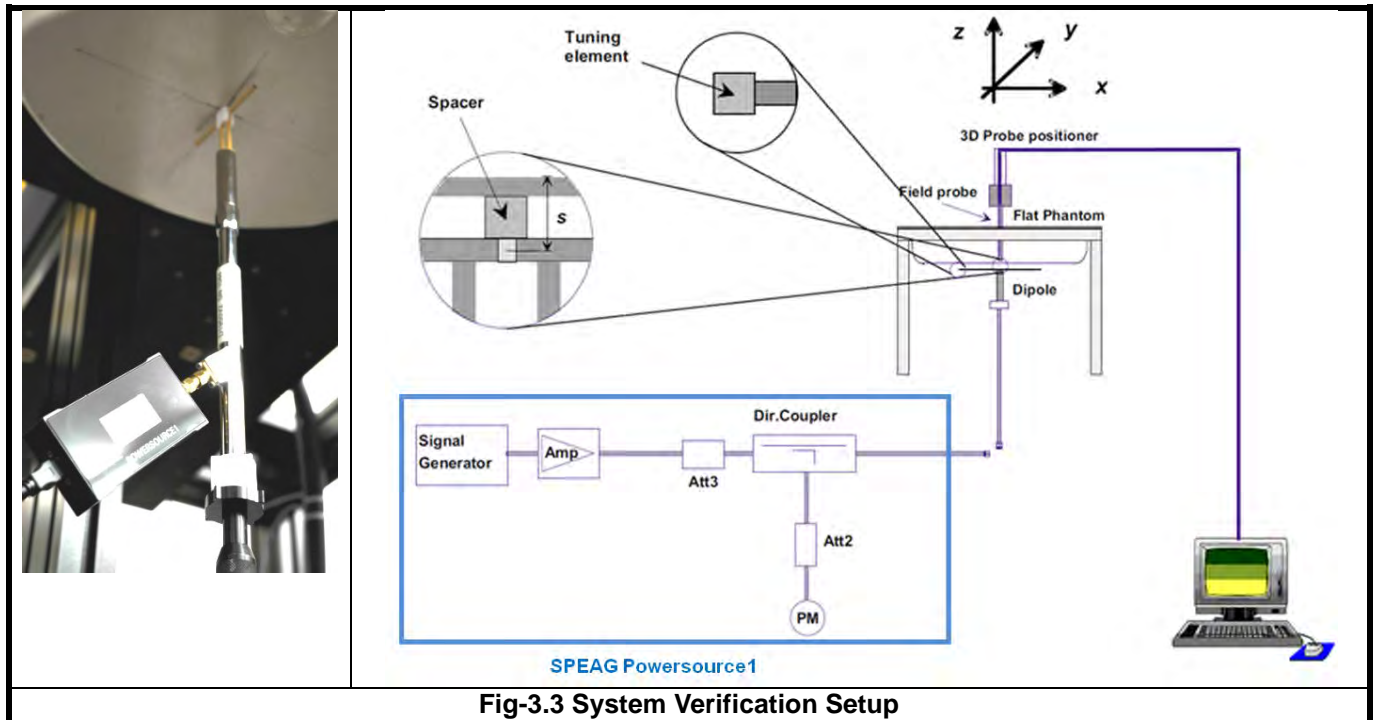

**Fig-3.3 System Verification Setup**

The SPEAG Powersource1 is a portable and very stable RF source providing a continuous wave (CW) signal. It is designed for conducting SAR system checks and SAR system validation of DASY and is compatible with IEC 62209-1, IEC 62209-2 and IEEE Std 1528 standards. The Powersource1 has been calibrated by SPEAG's ISO/IEC 17025-accredited calibration center. When using Powersource1, the setup can be simplified, as shown in Fig-3.3. The signal purity is warranted by design. Since the Powersource1 is calibrated, no additional equipment is needed and the Powersource1 can directly be connected to the SMA connector of the dipole without a cable as all separate components (signal generator, amplifier, coupler and power meter) are built into the unit.

The validation dipole is placed beneath the flat phantom with the specific spacer in place. The distance spacer is touch the phantom surface with a light pressure at the reference marking and be oriented parallel to the long side of the phantom. The Powersource1 is adjusted for the desired forward power of 17 dBm at the dipole connector and the RF output power would be turned on. After system check testing, the SAR result will be normalized to 1W forward input power and compared with the reference SAR value derived from validation dipole certificate report. The deviation of system check should be within 10 %.

## 3.4 SAR Measurement Procedure

According to the SAR test standard, the recommended procedure for assessing the peak spatial-average SAR value consists of the following steps:

- (a) Power reference measurement
- (b) Area scan
- (c) Zoom scan
- (d) Power drift measurement

The SAR measurement procedures for each of test conditions are as follows:

- (a) Make EUT to transmit maximum output power
- (b) Measure conducted output power through RF cable
- (c) Place the EUT in the specific position of phantom
- (d) Perform SAR testing steps on the DASY system
- (e) Record the SAR value

### 3.4.1 Area Scan and Zoom Scan Procedure

First area scan is used to locate the approximate location(s) of the local peak SAR value(s). The measurement grid within an area scan is defined by the grid extent, grid step size and grid offset. Next, in order to determine the EM field distribution in a three-dimensional spatial extension, zoom scan is required. The zoom scan is performed around the highest E-field value to determine the averaged SAR-distribution.

Measure the local SAR at a test point at 1.4 mm of the inner surface of the phantom recommended by SEPAG. The area scan (two-dimensional SAR distribution) is performed cover at least an area larger than the projection of the EUT or antenna. The measurement resolution and spatial resolution for interpolation shall be chosen to allow identification of the local peak locations to within one-half of the linear dimension of the corresponding side of the zoom scan volume. Following table provides the measurement parameters required for the area scan.

Parameter	$f \leq 3 \text{ GHz}$	$3 \text{ GHz} < f \leq 6 \text{ GHz}$
Maximum distance from closest measurement point to phantom surface	$5 \pm 1$	$\delta \ln(2)/2 \pm 0.5$
Maximum probe angle from probe axis to phantom surface normal at the measurement location	$30^\circ \pm 1^\circ$	$20^\circ \pm 1^\circ$
Maximum area scan spatial resolution: $\Delta x_{\text{Area}}, \Delta y_{\text{Area}}$	$\leq 2 \text{ GHz: } \leq 15 \text{ mm}$ $2 - 3 \text{ GHz: } \leq 12 \text{ mm}$	$3 - 4 \text{ GHz: } \leq 12 \text{ mm}$ $4 - 6 \text{ GHz: } \leq 10 \text{ mm}$

From the scanned SAR distribution, identify the position of the maximum SAR value, in addition identify the positions of any local maxima with SAR values within 2 dB of the maximum value that will not be within the zoom scan of other peaks. Additional peaks shall be measured only when the primary peak is within 2 dB of the SAR compliance limit (e.g. 1 W/kg for 1.6 W/kg, 1 g limit; or 1.26 W/kg for 2 W/kg, 10 g limit).



The zoom scan (three-dimensional SAR distribution) is performed at the local maxima locations identified in previous area scan procedure. The zoom scan volume must be larger than the required minimum dimensions. When graded grids are used, which only applies in the direction normal to the phantom surface, the initial grid separation closest to the phantom surface and subsequent graded grid increment ratios must satisfy the required protocols. The 1-g SAR averaging volume must be fully contained within the zoom scan measurement volume boundaries; otherwise, the measurement must be repeated by shifting or expanding the zoom scan volume. The similar requirements also apply to 10-g SAR measurements. Following table provides the measurement parameters required for the zoom scan.

Parameter		$f \leq 3$ GHz	$3 \text{ GHz} < f \leq 6$ GHz
Maximum zoom scan spatial resolution: $\Delta x_{\text{Zoom}}, \Delta y_{\text{Zoom}}$		$\leq 2$ GHz: $\leq 8$ mm 2 – 3 GHz: $\leq 5$ mm	3 – 4 GHz: $\leq 5$ mm 4 – 6 GHz: $\leq 4$ mm
Maximum zoom scan spatial resolution, normal to phantom surface	<i>uniform grid:</i> $\Delta z_{\text{Zoom}}(n)$	$\leq 5$ mm	3 – 4 GHz: $\leq 4$ mm 4 – 5 GHz: $\leq 3$ mm 5 – 6 GHz: $\leq 2$ mm
	<i>graded grids:</i> $\Delta z_{\text{Zoom}}(1)$	$\leq 4$ mm	3 – 4 GHz: $\leq 3.0$ mm 4 – 5 GHz: $\leq 2.5$ mm 5 – 6 GHz: $\leq 2.0$ mm
	$\Delta z_{\text{Zoom}}(n>1)$	$\leq 1.5 \cdot \Delta z_{\text{Zoom}}(n-1)$ mm	
Minimum zoom scan volume (x, y, z)		$\geq 30$ mm	3 – 4 GHz: $\geq 28$ mm 4 – 5 GHz: $\geq 25$ mm 5 – 6 GHz: $\geq 22$ mm

Per IEC 62209-2 AMD1, the successively higher resolution zoom scan is required if the zoom scan measured as defined above complies with both of the following criteria, or if the peak spatial-average SAR is below 0.1 W/kg, no additional measurements are needed:

- (1) The smallest horizontal distance from the local SAR peaks to all points 3 dB below the SAR peak shall be larger than the horizontal grid steps in both x and y directions ( $\Delta x, \Delta y$ ). This shall be checked for the measured zoom scan plane conformal to the phantom at the distance  $z_{M1}$ .
- (2) The ratio of the SAR at the second measured point (M2) to the SAR at the closest measured point (M1) at the x-y location of the measured maximum SAR value shall be at least 30 %.

If one or both of the above criteria are not met, the zoom scan measurement shall be repeated using a finer resolution. New horizontal and vertical grid steps shall be determined from the measured SAR distribution so that the above criteria are met. Compliance with the above two criteria shall be demonstrated for the new measured zoom scan.

### 3.4.2 Volume Scan Procedure

The volume scan is used for assess overlapping SAR distributions for antennas transmitting in different frequency bands. It is equivalent to an oversized zoom scan used in standalone measurements. The measurement volume will be used to enclose all the simultaneous transmitting antennas. For antennas transmitting simultaneously in different frequency bands, the volume scan is measured separately in each frequency band. In order to sum correctly to compute the 1g aggregate SAR, the EUT remain in the same test position for all measurements and all volume scan use the same spatial resolution and grid spacing. When all volume scan were completed, the software, SEMCAD postprocessor can combine and subsequently superpose these measurement data to calculating the multiband SAR.

### 3.4.3 Power Drift Monitoring

All SAR testing is under the EUT install full charged battery and transmit maximum output power. In DASY measurement software, the power reference measurement and power drift measurement procedures are used for monitoring the power drift of EUT during SAR test. Both these procedures measure the field at a specified reference position before and after the SAR testing. The software will calculate the field difference in dB. If the power drift more than 5%, the SAR will be retested.

### 3.4.4 Spatial Peak SAR Evaluation

The procedure for spatial peak SAR evaluation has been implemented according to the test standard. It can be conducted for 1g and 10g, as well as for user-specific masses. The DASY software includes all numerical procedures necessary to evaluate the spatial peak SAR value.

The base for the evaluation is a "cube" measurement. The measured volume must include the 1g and 10g cubes with the highest averaged SAR values. For that purpose, the center of the measured volume is aligned to the interpolated peak SAR value of a previously performed area scan.

The entire evaluation of the spatial peak values is performed within the post-processing engine (SEMCAD). The system always gives the maximum values for the 1g and 10g cubes. The algorithm to find the cube with highest averaged SAR is divided into the following stages:

- (a) Extraction of the measured data (grid and values) from the Zoom Scan
- (b) Calculation of the SAR value at every measurement point based on all stored data (A/D values and measurement parameters)
- (c) Generation of a high-resolution mesh within the measured volume
- (d) Interpolation of all measured values from the measurement grid to the high-resolution grid
- (e) Extrapolation of the entire 3-D field distribution to the phantom surface over the distance from sensor to surface
- (f) Calculation of the averaged SAR within masses of 1g and 10g

### 3.4.5 SAR Averaged Methods

In DASY, the interpolation and extrapolation are both based on the modified Quadratic Shepard's method. The interpolation scheme combines a least-square fitted function method and a weighted average method which are the two basic types of computational interpolation and approximation.

Extrapolation routines are used to obtain SAR values between the lowest measurement points and the inner phantom surface. The extrapolation distance is determined by the surface detection distance and the probe sensor offset. The uncertainty increases with the extrapolation distance. To keep the uncertainty within 1% for the 1 g and 10 g cubes, the extrapolation distance should not be larger than 5 mm.



## 4. SAR Measurement Evaluation

### 4.1 EUT Configuration and Setting

#### <Considerations Related to WLAN for Setup and Testing>

In general, various vendor specific external test software and chipset based internal test modes are typically used for SAR measurement. These chipset based test mode utilities are generally hardware and manufacturer dependent, and often include substantial flexibility to reconfigure or reprogram a device. A Wi-Fi device must be configured to transmit continuously at the required data rate, channel bandwidth and signal modulation, using the highest transmission duty factor supported by the test mode tools for SAR measurement. The test frequencies established using test mode must correspond to the actual channel frequencies. When 802.11 frame gaps are accounted for in the transmission, a maximum transmission duty factor of 92 - 96% is typically achievable in most test mode configurations. A minimum transmission duty factor of 85% is required to avoid certain hardware and device implementation issues related to wide range SAR scaling. In addition, a periodic transmission duty factor is required for current generation SAR systems to measure SAR correctly. The reported SAR must be scaled to 100% transmission duty factor to determine compliance at the maximum tune-up tolerance limit.

According to KDB 248227 D01, this device has installed WLAN engineering testing software which can provide continuous transmitting RF signal. During WLAN SAR testing, this device was operated to transmit continuously at the maximum transmission duty with specified transmission mode, operating frequency, lowest data rate, and maximum output power.

#### Initial Test Configuration

An initial test configuration is determined for OFDM transmission modes in 2.4 GHz and 5 GHz bands according to the channel bandwidth, modulation and data rate combination(s) with the highest maximum output power specified for production units in each standalone and aggregated frequency band. When the same maximum power is specified for multiple transmission modes in a frequency band, the largest channel bandwidth, lowest order modulation, lowest data rate and lowest order 802.11a/g/n/ac mode is used for SAR measurement, on the highest measured output power channel in the initial test configuration, for each frequency band.

#### Subsequent Test Configuration

SAR measurement requirements for the remaining 802.11 transmission mode configurations that have not been tested in the initial test configuration are determined separately for each standalone and aggregated frequency band, in each exposure condition, according to the maximum output power specified for production units. Additional power measurements may be required to determine if SAR measurements are required for subsequent highest output power channels in a subsequent test configuration. When the highest reported SAR for the initial test configuration according to the initial test position or fixed exposure position requirements, is adjusted by the ratio of the subsequent test configuration to initial test configuration specified maximum output power and the adjusted SAR is  $\leq 1.2$  W/kg, SAR is not required for that subsequent test configuration.

### SAR Test Configuration and Channel Selection

When multiple channel bandwidth configurations in a frequency band have the same specified maximum output power, the initial test configuration is using largest channel bandwidth, lowest order modulation, lowest data rate, and lowest order 802.11 mode (i.e., 802.11a is chosen over 802.11n then 802.11ac or 802.11g is chosen over 802.11n). After an initial test configuration is determined, if multiple test channels have the same measured maximum output power, the channel chosen for SAR measurement is determined according to the following.

- 1) The channel closest to mid-band frequency is selected for SAR measurement.
- 2) For channels with equal separation from mid-band frequency; for example, high and low channels or two mid-band channels, the higher frequency (number) channel is selected for SAR measurement.

### Test Reduction for U-NII-1 (5.2 GHz) and U-NII-2A (5.3 GHz) Bands

For devices that operate in both U-NII bands using the same transmitter and antenna(s), SAR test reduction is determined according to the following.

- 1) When the same maximum output power is specified for both bands, begin SAR measurement in U-NII-2A band by applying the OFDM SAR requirements. If the highest reported SAR for a test configuration is  $\leq 1.2$  W/kg, SAR is not required for U-NII-1 band for that configuration (802.11 mode and exposure condition).
- 2) When different maximum output power is specified for the bands, begin SAR measurement in the band with higher specified maximum output power. The highest reported SAR for the tested configuration is adjusted by the ratio of lower to higher specified maximum output power for the two bands. When the adjusted SAR is  $\leq 1.2$  W/kg, SAR is not required for the band with lower maximum output power in that test configuration.

# SAR Test Report

## <Considerations Related to Bluetooth for Setup and Testing>

This device has installed Bluetooth engineering testing software which can provide continuous transmitting RF signal. During Bluetooth SAR testing, this device was operated to transmit continuously at the maximum transmission duty with specified transmission mode, operating frequency, lowest data rate, and maximum output power.

The Bluetooth call box has been used during SAR measurement and the EUT was set to DH5 mode at the maximum output power. Its duty factor was calculated as below and the measured SAR for Bluetooth would be scaled to the 100% transmission duty factor to determine compliance.



**Time-domain plot for Bluetooth transmission signal**

The duty factor of Bluetooth signal has been calculated as following.

$$\text{Duty Factor} = \text{Pulse Width} / \text{Total Period} = 2.892 / 3.768 = 76.75 \%$$

## 4.2 EUT Testing Position

According to KDB 648474 D04, handsets are tested for SAR compliance in head, body-worn accessory and other use configurations described in the following subsections.

### 4.2.1 Head Exposure Conditions

Head exposure is limited to next to the ear voice mode operations. Head SAR compliance is tested according to the test positions defined in IEEE Std 1528-2003 using the SAM phantom illustrated as below.

1. Define two imaginary lines on the handset
  - (a) The vertical centerline passes through two points on the front side of the handset - the midpoint of the width  $w_t$  of the handset at the level of the acoustic output, and the midpoint of the width  $w_b$  of the bottom of the handset.
  - (b) The horizontal line is perpendicular to the vertical centerline and passes through the center of the acoustic output. The horizontal line is also tangential to the face of the handset at point A.
  - (c) The two lines intersect at point A. Note that for many handsets, point A coincides with the center of the acoustic output; however, the acoustic output may be located elsewhere on the horizontal line. Also note that the vertical centerline is not necessarily parallel to the front face of the handset, especially for clamshell handsets, handsets with flip covers, and other irregularly shaped handsets.

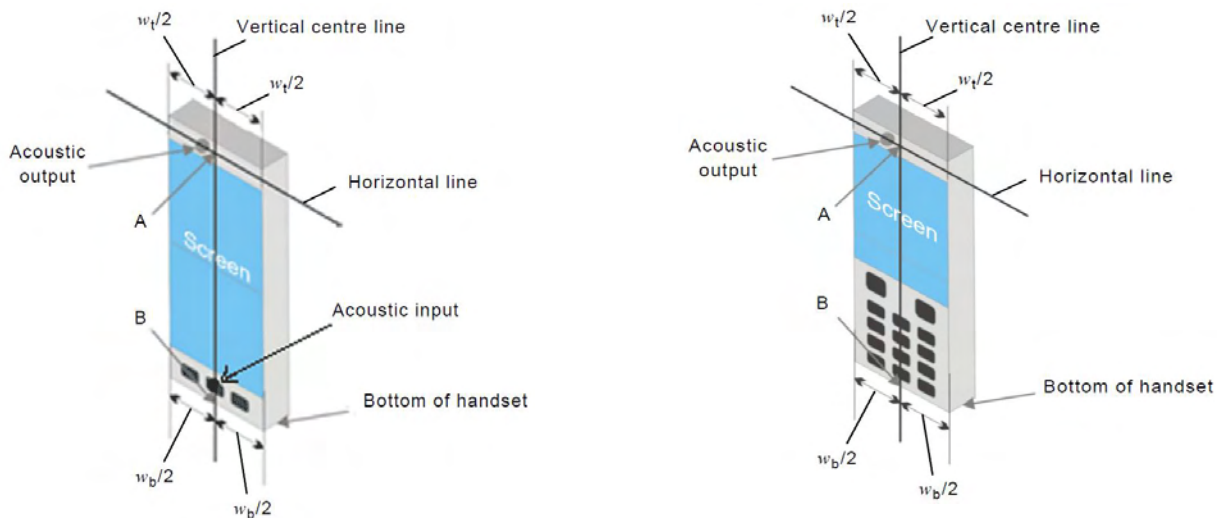

**Fig-4.1 Illustration for Handset Vertical and Horizontal Reference Lines**

2. Cheek Position

- (a) To position the device with the vertical center line of the body of the device and the horizontal line crossing the center piece in a plane parallel to the sagittal plane of the phantom. While maintaining the device in this plane, align the vertical center line with the reference plane containing the three ear and mouth reference point (M: Mouth, RE: Right Ear, and LE: Left Ear) and align the center of the ear piece with the line RE-LE.
- (b) To move the device towards the phantom with the ear piece aligned with the line LE-RE until the phone touched the ear. While maintaining the device in the reference plane and maintaining the phone contact with the ear, move the bottom of the phone until any point on the front side is in contact with the cheek of the phantom or until contact with the ear is lost (see Fig-4.2).

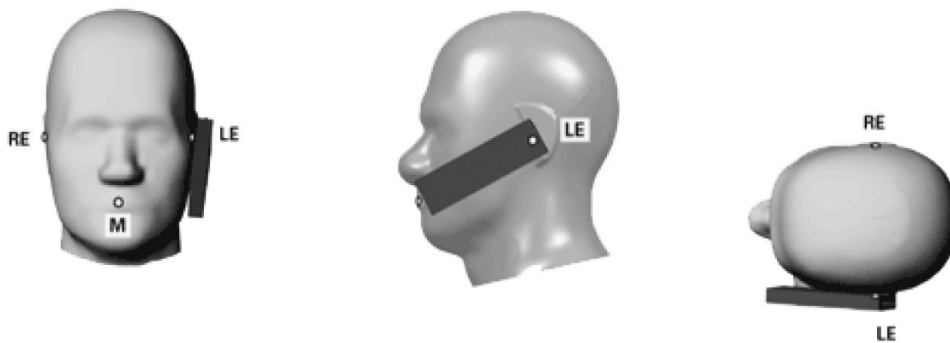

**Fig-4.2 Illustration for Cheek Position**

3. Tilted Position

- (a) To position the device in the “cheek” position described above.
- (b) While maintaining the device the reference plane described above and pivoting against the ear, moves it outward away from the mouth by an angle of 15 degrees or until contact with the ear is lost (see Fig-4.3).

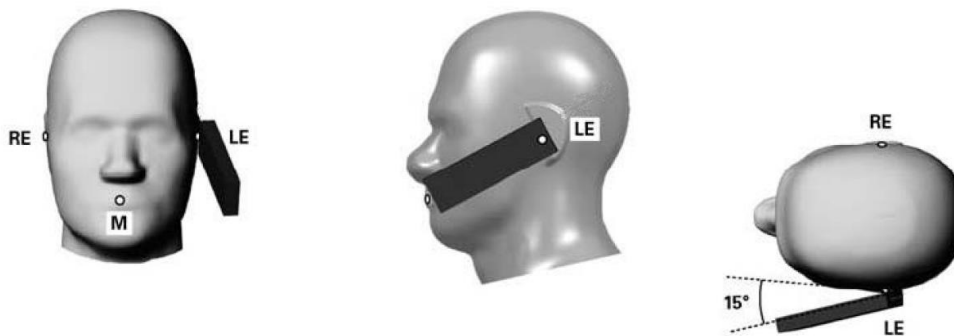

**Fig-4.3 Illustration for Tilted Position**

## 4.2.2 Body-worn Accessory Exposure Conditions

Body-worn accessory exposure is typically related to voice mode operations when handsets are carried in body-worn accessories. The body-worn accessory procedures in KDB 447498 are used to test for body-worn accessory SAR compliance, without a headset connected to it. This enables the test results for such configuration to be compatible with that required for hotspot mode when the body-worn accessory test separation distance is greater than or equal to that required for hotspot mode. When the reported SAR for a body-worn accessory, measured without a headset connected to the handset, is  $> 1.2 \text{ W/kg}$ , the highest reported SAR configuration for that wireless mode and frequency band should be repeated for that body-worn accessory with a headset attached to the handset.

Body-worn accessories that do not contain metallic or conductive components may be tested according to worst-case exposure configurations, typically according to the smallest test separation distance required for the group of body-worn accessories with similar operating and exposure characteristics. All body-worn accessories containing metallic components are tested in conjunction with the host device.

Body-worn accessory SAR compliance is based on a single minimum test separation distance for all wireless and operating modes applicable to each body-worn accessory used by the host, and according to the relevant voice and/or data mode transmissions and operations. If a body-worn accessory supports voice only operations in its normal and expected use conditions, testing of data mode for body-worn compliance is not required.

A conservative minimum test separation distance for supporting off-the-shelf body-worn accessories that may be acquired by users of consumer handsets is used to test for body-worn accessory SAR compliance. This distance is determined by the handset manufacturer, according to the requirements of Supplement C 01-01. Devices that are designed to operate on the body of users using lanyards and straps, or without requiring additional body-worn accessories, will be tested using a conservative minimum test separation distance  $\leq 5 \text{ mm}$  to support compliance.

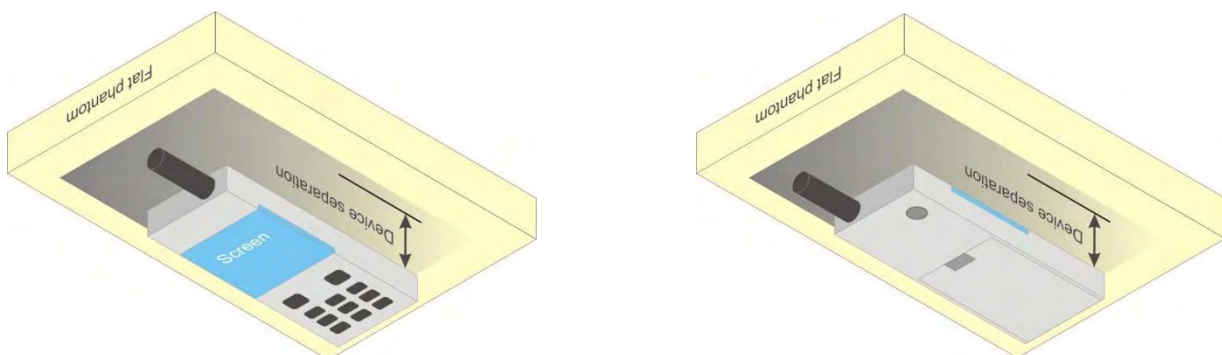

**Fig-4.4 Illustration for Body Worn Position**



### 4.2.3 Product Specific (Phablet) Exposure Conditions

For smart phones with a display diagonal dimension  $> 15$  cm or an overall diagonal dimension  $> 16$  cm that provide similar mobile web access and multimedia support found in mini-tablets or UMPC mini-tablets that support voice calls next to the ear, the following phablet procedures should be applied to evaluate SAR compliance for each applicable wireless modes and frequency band. Devices marketed as phablets, regardless of form factors and operating characteristics must be tested as a phablet to determine SAR compliance.

1. The normally required head and body-worn accessory SAR test procedures for handsets, including hotspot mode, must be applied.
2. The UMPC mini-tablet procedures must also be applied to test the SAR of all surfaces and edges with an antenna located at  $\leq 25$  mm from that surface or edge, in direct contact with a flat phantom, for 10-g extremity SAR according to the body-equivalent tissue dielectric parameters in KDB 865664 to address interactive hand use exposure conditions. The UMPC mini-tablet 1-g SAR at 5 mm is not required. When hotspot mode applies, 10-g extremity SAR is required only for the surfaces and edges with hotspot mode 1-g SAR  $> 1.2$  W/kg. The normal tablet procedures in KDB 616217 are required when the over diagonal dimension of the device is  $> 20$  cm. Hotspot mode SAR is not required when normal tablet procedures are applied. Extremity 10-g SAR is also not required for the front (top) surface of large form factor full size tablets. The more conservative tablet SAR results can be used to support the 10-g extremity SAR for phablet mode.
3. The simultaneous transmission operating configurations applicable to voice and data transmissions for both phone and mini-tablet modes must be taken into consideration separately for 1-g and 10-g SAR to determine the simultaneous transmission SAR test exclusion and measurement requirements for the relevant wireless modes and exposure conditions.

**4.3 Tissue Verification**

The measuring results for tissue simulating liquid are shown as below.

**Head / Body-worn**

Frequency (MHz)	Liquid Temp. (°C)	Measured Conductivity ( $\sigma$ )	Measured Permittivity ( $\epsilon_r$ )	Target Conductivity ( $\sigma$ )	Target Permittivity ( $\epsilon_r$ )	Conductivity Deviation (%)	Permittivity Deviation (%)	Test Date
2450	23.3	1.862	39.176	1.8	39.2	3.44	-0.06	Oct. 25, 2020
2450	23.3	1.869	38.083	1.8	39.2	3.83	-2.85	Oct. 26, 2020
2450	23.1	1.827	38.941	1.8	39.2	1.50	-0.66	Oct. 27, 2020
2450	23.3	1.848	37.854	1.8	39.2	2.67	-3.43	Oct. 28, 2020
5250	23.1	4.878	37.061	4.71	35.9	3.57	3.23	Oct. 24, 2020
5250	23.2	4.78	35.347	4.71	35.9	1.49	-1.54	Oct. 25, 2020
5250	23.2	4.735	36.962	4.71	35.9	0.53	2.96	Oct. 26, 2020
5250	23.3	4.828	36.023	4.71	35.9	2.51	0.34	Oct. 29, 2020
5600	23.2	5.159	34.746	5.07	35.5	1.76	-2.12	Oct. 25, 2020
5600	23.2	5.089	36.492	5.07	35.5	0.37	2.79	Oct. 26, 2020
5600	23.2	5.17	34.876	5.07	35.5	1.97	-1.76	Oct. 27, 2020
5600	23.3	5.216	35.485	5.07	35.5	2.88	-0.04	Oct. 29, 2020
5750	23.2	5.313	34.366	5.22	35.4	1.78	-2.92	Oct. 25, 2020
5750	23.3	5.249	36.271	5.22	35.4	0.56	2.46	Oct. 26, 2020
5750	23.3	5.354	35.468	5.22	35.4	2.57	0.19	Oct. 29, 2020

**Product Specific**

Frequency (MHz)	Liquid Temp. (°C)	Measured Conductivity ( $\sigma$ )	Measured Permittivity ( $\epsilon_r$ )	Target Conductivity ( $\sigma$ )	Target Permittivity ( $\epsilon_r$ )	Conductivity Deviation (%)	Permittivity Deviation (%)	Test Date
2450	23.1	1.873	38.311	1.8	39.2	4.06	-2.27	Oct. 24, 2020
2450	23.3	1.848	37.854	1.8	39.2	2.67	-3.43	Oct. 28, 2020
5250	23.1	4.878	37.061	4.71	35.9	3.57	3.23	Oct. 24, 2020
5250	23.3	4.828	36.023	4.71	35.9	2.51	0.34	Oct. 29, 2020
5600	23.1	5.278	36.522	5.07	35.5	4.10	2.88	Oct. 24, 2020
5600	23.3	5.216	35.485	5.07	35.5	2.88	-0.04	Oct. 29, 2020
5750	23.1	5.418	36.517	5.22	35.4	3.79	3.16	Oct. 24, 2020
5750	23.3	5.315	34.934	5.22	35.4	1.82	-1.32	Oct. 28, 2020

**Note:**

The dielectric properties of the tissue simulating liquid have been measured within 24 hours before the SAR testing and within  $\pm 10\%$  of the target values. Liquid temperature during the SAR testing has kept within  $\pm 2\text{ }^\circ\text{C}$ .



# SAR Test Report

## 4.4 System Validation

The SAR measurement system was validated according to procedures in KDB 865664 D01. The validation status in tabulated summary is as below.

### Head / Body-worn

Test Date	Probe S/N	Calibration Point	Measured Conductivity ( $\sigma$ )	Measured Permittivity ( $\epsilon_r$ )	Validation for CW			Validation for Modulation		
					Sensitivity Range	Probe Linearity	Probe Isotropy	Modulation Type	Duty Factor	PAR
Oct. 25, 2020	7537	2450	1.862	39.176	Pass	Pass	Pass	OFDM	N/A	Pass
Oct. 26, 2020	7537	2450	1.869	38.083	Pass	Pass	Pass	OFDM	N/A	Pass
Oct. 27, 2020	7537	2450	1.827	38.941	Pass	Pass	Pass	OFDM	N/A	Pass
Oct. 28, 2020	3820	2450	1.848	37.854	Pass	Pass	Pass	OFDM	N/A	Pass
Oct. 24, 2020	7537	5250	4.878	37.061	Pass	Pass	Pass	OFDM	N/A	Pass
Oct. 25, 2020	7537	5250	4.78	35.347	Pass	Pass	Pass	OFDM	N/A	Pass
Oct. 26, 2020	7537	5250	4.735	36.962	Pass	Pass	Pass	OFDM	N/A	Pass
Oct. 29, 2020	3820	5250	4.828	36.023	Pass	Pass	Pass	OFDM	N/A	Pass
Oct. 25, 2020	7537	5600	5.159	34.746	Pass	Pass	Pass	OFDM	N/A	Pass
Oct. 26, 2020	7537	5600	5.089	36.492	Pass	Pass	Pass	OFDM	N/A	Pass
Oct. 27, 2020	7537	5600	5.17	34.876	Pass	Pass	Pass	OFDM	N/A	Pass
Oct. 29, 2020	3820	5600	5.216	35.485	Pass	Pass	Pass	OFDM	N/A	Pass
Oct. 25, 2020	7537	5750	5.313	34.366	Pass	Pass	Pass	OFDM	N/A	Pass
Oct. 26, 2020	7537	5750	5.249	36.271	Pass	Pass	Pass	OFDM	N/A	Pass
Oct. 29, 2020	3820	5750	5.354	35.468	Pass	Pass	Pass	OFDM	N/A	Pass

### Product Specific

Test Date	Probe S/N	Calibration Point	Measured Conductivity ( $\sigma$ )	Measured Permittivity ( $\epsilon_r$ )	Validation for CW			Validation for Modulation		
					Sensitivity Range	Probe Linearity	Probe Isotropy	Modulation Type	Duty Factor	PAR
Oct. 24, 2020	7537	2450	1.873	38.311	Pass	Pass	Pass	OFDM	N/A	Pass
Oct. 28, 2020	3820	2450	1.848	37.854	Pass	Pass	Pass	OFDM	N/A	Pass
Oct. 24, 2020	7537	5250	4.878	37.061	Pass	Pass	Pass	OFDM	N/A	Pass
Oct. 29, 2020	3820	5250	4.828	36.023	Pass	Pass	Pass	OFDM	N/A	Pass
Oct. 24, 2020	7537	5600	5.278	36.522	Pass	Pass	Pass	OFDM	N/A	Pass
Oct. 29, 2020	3820	5600	5.216	35.485	Pass	Pass	Pass	OFDM	N/A	Pass
Oct. 24, 2020	7537	5750	5.418	36.517	Pass	Pass	Pass	OFDM	N/A	Pass
Oct. 28, 2020	3820	5750	5.315	34.934	Pass	Pass	Pass	OFDM	N/A	Pass

## 4.5 System Verification

The measuring result for system verification is tabulated as below.

### Head / Body-worn

Test Date	Frequency (MHz)	1W Target SAR-1g (W/kg)	Measured SAR-1g (W/kg)	Normalized to 1W SAR-1g (W/kg)	Deviation (%)	Dipole S/N	Probe S/N	DAE S/N
Oct. 25, 2020	2450	51.60	2.48	49.60	-3.88	737	7537	1277
Oct. 26, 2020	2450	51.60	2.35	47.00	-8.91	737	7537	1277
Oct. 27, 2020	2450	51.60	2.65	53.00	2.71	737	7537	1277
Oct. 28, 2020	2450	51.60	2.64	52.80	2.33	737	3820	1431
Oct. 24, 2020	5250	79.70	3.86	77.20	-3.14	1019	7537	1277
Oct. 25, 2020	5250	79.70	3.69	73.80	-7.40	1019	7537	1277
Oct. 26, 2020	5250	79.70	3.62	72.40	-9.16	1019	7537	1277
Oct. 29, 2020	5250	79.70	3.78	75.60	-5.14	1019	3820	1431
Oct. 25, 2020	5600	83.80	3.85	77.00	-8.11	1019	7537	1277
Oct. 26, 2020	5600	83.80	3.85	77.00	-8.11	1019	7537	1277
Oct. 27, 2020	5600	83.80	3.8	76.00	-9.31	1019	7537	1277
Oct. 29, 2020	5600	83.80	4.02	80.40	-4.06	1019	3820	1431
Oct. 25, 2020	5750	80.40	3.76	75.20	-6.47	1019	7537	1277
Oct. 26, 2020	5750	80.40	3.63	72.60	-9.70	1019	7537	1277
Oct. 29, 2020	5750	80.40	3.67	73.40	-8.71	1019	3820	1431

### Product Specific

Test Date	Frequency (MHz)	1W Target SAR-10g (W/kg)	Measured SAR-10g (W/kg)	Normalized to 1W SAR-10g (W/kg)	Deviation (%)	Dipole S/N	Probe S/N	DAE S/N
Oct. 24, 2020	2450	24.30	1.12	22.40	-7.82	737	7537	1277
Oct. 28, 2020	2450	24.30	1.25	25.00	2.88	737	3820	1431
Oct. 24, 2020	5250	22.80	1.17	23.40	2.63	1019	7537	1277
Oct. 29, 2020	5250	22.80	1.05	21.00	-7.89	1019	3820	1431
Oct. 24, 2020	5600	23.70	1.28	25.60	8.02	1019	7537	1277
Oct. 29, 2020	5600	23.70	1.1	22.00	-7.17	1019	3820	1431
Oct. 24, 2020	5750	22.80	1.07	21.40	-6.14	1019	7537	1277
Oct. 28, 2020	5750	22.80	1.05	21.00	-7.89	1019	3820	1431

**Note:** Comparing to the reference SAR value provided by SPEAG in dipole calibration certificate, the deviation of system check results is within its specification of 10 %. The result indicates the system check can meet the variation criterion and the plots please refer to Appendix A of this report.

## 4.6 Maximum Output Power

### 4.6.1 Maximum Target Conducted Power

Refer to Appendix E.

### 4.6.2 Measured Conducted Power Result

Refer to Appendix F.

## 4.7 SAR Testing Results

### 4.7.1 SAR Test Reduction Considerations

#### <KDB 447498 D01, General RF Exposure Guidance>

Testing of other required channels within the operating mode of a frequency band is not required when the reported SAR for the mid-band or highest output power channel is:

- (1)  $\leq 0.8$  W/kg or 2.0 W/kg, for 1-g or 10-g respectively, when the transmission band is  $\leq 100$  MHz
- (2)  $\leq 0.6$  W/kg or 1.5 W/kg, for 1-g or 10-g respectively, when the transmission band is between 100 MHz and 200 MHz
- (3)  $\leq 0.4$  W/kg or 1.0 W/kg, for 1-g or 10-g respectively, when the transmission band is  $\geq 200$  MHz

When SAR is not measured at the maximum power level allowed for production units, the measured SAR will be scaled to the maximum tune-up tolerance limit to determine compliance. The scaling factor for the tune-up power is defined as maximum tune-up limit (mW) / measured conducted power (mW). The reported SAR would be calculated by measured SAR x tune-up power scaling factor.

The SAR has been measured with highest transmission duty factor supported by the test mode tools for WLAN and/or Bluetooth. When the transmission duty factor could not achieve 100%, the reported SAR will be scaled to 100% transmission duty factor to determine compliance at the maximum tune-up power. The scaling factor for the duty factor is defined as 100% / transmission duty cycle (%). The reported SAR would be calculated by measured SAR x tune-up power scaling factor x duty cycle scaling factor.

#### <KDB 941225 D01, 3G SAR Measurement Procedures>

The mode tested for SAR is referred to as the primary mode. The equivalent modes considered for SAR test reduction are denoted as secondary modes. Both primary and secondary modes must be in the same frequency band. When the maximum output power and tune-up tolerance specified for production units in a secondary mode is  $\leq 1/4$  dB higher than the primary mode or when the highest reported SAR of the primary mode is scaled by the ratio of specified maximum output power and tune-up tolerance of secondary to primary mode and the adjusted SAR is  $\leq 1.2$  W/kg, SAR measurement is not required for the secondary mode.

#### <KDB 941225 D05, SAR Evaluation Considerations for LTE Devices>

- (1) QPSK with 1 RB and 50% RB allocation

Start with the largest channel bandwidth and measure SAR, using the RB offset and required test channel combination with the highest maximum output power among RB offsets at the upper edge, middle and lower edge of each required test channel. When the reported SAR is  $\leq 0.8$  W/kg, testing of the remaining RB offset configurations and required test channels is not required; otherwise, SAR is required for the remaining required test channels and only for the RB offset configuration with the highest output power for that channel. When the reported SAR of a required test channel is  $> 1.45$  W/kg, SAR is required for all three RB offset configurations for that required test channel.

## SAR Test Report

---

(2) QPSK with 100% RB allocation

SAR is not required when the highest maximum output power for 100% RB allocation is less than the highest maximum output power in 50% and 1 RB allocations and the highest reported SAR for 1 RB and 50% RB allocation are  $\leq 0.8$  W/kg. Otherwise, SAR is measured for the highest output power channel; and if the reported SAR is  $> 1.45$  W/kg, the remaining required test channels must also be tested.

(3) Higher order modulations

SAR is required only when the highest maximum output power for the configuration in the higher order modulation is  $>1/2$  dB higher than the same configuration in QPSK or when the reported SAR for the QPSK configuration is  $> 1.45$  W/kg.

(4) Other channel bandwidth

SAR is required when the highest maximum output power of the smaller channel bandwidth is  $>1/2$  dB higher than the equivalent channel configurations in the largest channel bandwidth configuration or the reported SAR of a configuration for the largest channel bandwidth is  $> 1.45$  W/kg.

### <KDB 248227 D01, SAR Guidance for Wi-Fi Transmitters>

- (1) For handsets operating next to ear, hotspot mode or mini-tablet configurations, the initial test position procedures were applied. The test position with the highest extrapolated peak SAR will be used as the initial test position. When the reported SAR of initial test position is  $\leq 0.4$  W/kg, SAR testing for remaining test positions is not required. Otherwise, SAR is evaluated at the subsequent highest peak SAR positions until the reported SAR result is  $\leq 0.8$  W/kg or all test positions are measured.
- (2) For WLAN 2.4 GHz, the highest measured maximum output power channel for DSSS was selected for SAR measurement. When the reported SAR is  $\leq 0.8$  W/kg, no further SAR testing is required. Otherwise, SAR is evaluated at the next highest measured output power channel. When any reported SAR is  $>1.2$  W/kg, SAR is required for the third channel. For OFDM modes (802.11g/n), SAR is not required when the highest reported SAR for DSSS is adjusted by the ratio of OFDM to DSSS specified maximum output power and it is  $\leq 1.2$  W/kg.
- (3) For WLAN 5GHz, the initial test configuration was selected according to the transmission mode with the highest maximum output power. When the reported SAR of initial test configuration is  $> 0.8$  W/kg, SAR is required for the subsequent highest measured output power channel until the reported SAR result is  $\leq 1.2$  W/kg or all required channels are measured. For other transmission modes, SAR is not required when the highest reported SAR for initial test configuration is adjusted by the ratio of subsequent test configuration to initial test configuration specified maximum output power and it is  $\leq 1.2$  W/kg.
- (4) For WLAN MIMO mode, the power-based standalone SAR test exclusion or the sum of SAR provision in KDB 447498 to determine simultaneous transmission SAR test exclusion should be applied. Otherwise, SAR for MIMO mode will be measured with all applicable antennas transmitting simultaneously at the specified maximum output power of MIMO operation.

# SAR Test Report

## 4.7.2 SAR Results for Head Exposure Condition

Plot No.	Band	Mode	Test Position	Ch.	Ant Status	Battery	Duty Cycle	Crest Factor	Max. Tune-up Power (dBm)	Measured Conducted Power (dBm)	Scaling Factor	Power Drift (dB)	Measured SAR-1g (W/kg)	Scaled SAR-1g (W/kg)
	WLAN2.4G	802.11b	Right Cheek	6	Ant 0	1	99.20	1.01	20.50	20.14	1.09	-0.11	0.436	0.48
	WLAN2.4G	802.11b	Right Tilted	6	Ant 0	1	99.20	1.01	20.50	20.14	1.09	0.02	0.301	0.33
	WLAN2.4G	802.11b	Left Cheek	6	Ant 0	1	99.20	1.01	20.50	20.14	1.09	-0.08	0.279	0.31
	WLAN2.4G	802.11b	Left Tilted	6	Ant 0	1	99.20	1.01	20.50	20.14	1.09	0.11	0.205	0.23
	WLAN2.4G	802.11b	Right Cheek	6	Ant 1	1	99.04	1.01	20.50	20.11	1.09	-0.18	0.223	0.25
	WLAN2.4G	802.11b	Right Tilted	6	Ant 1	1	99.04	1.01	20.50	20.11	1.09	0.05	0.185	0.20
	WLAN2.4G	802.11b	Left Cheek	6	Ant 1	1	99.04	1.01	20.50	20.11	1.09	-0.15	0.503	0.55
	WLAN2.4G	802.11b	Left Tilted	6	Ant 1	1	99.04	1.01	20.50	20.11	1.09	-0.12	0.241	0.27
	WLAN2.4G	802.11b	Right Cheek	6	Ant 0+1	1	99.12	1.01	23.50	23.24	1.06	0.02	0.466	0.50
01	WLAN2.4G	802.11b	Right Tilted	6	Ant 0+1	1	99.12	1.01	23.50	23.24	1.06	-0.03	0.51	0.55
	WLAN2.4G	802.11b	Left Cheek	6	Ant 0+1	1	99.12	1.01	23.50	23.24	1.06	0.01	0.346	0.37
	WLAN2.4G	802.11b	Left Tilted	6	Ant 0+1	1	99.12	1.01	23.50	23.24	1.06	-0.16	0.278	0.30
	WLAN2.4G	802.11b	Right Tilted	1	Ant 0+1	1	99.12	1.01	22.00	21.91	1.02	-0.02	0.322	0.33
	WLAN2.4G	802.11b	Right Tilted	11	Ant 0+1	1	99.12	1.01	21.60	21.40	1.05	0.05	0.267	0.28
	WLAN2.4G	802.11b	Right Tilted	6	Ant 0+1	2	99.12	1.01	23.50	23.24	1.06	-0.15	0.495	0.53
	WLAN5.2G	802.11n HT40	Right Cheek	46	Ant 0	1	87.98	1.14	20.50	20.50	1.00	0.08	0.631	0.72
	WLAN5.2G	802.11n HT40	Right Tilted	46	Ant 0	1	87.98	1.14	20.50	20.50	1.00	-0.11	0.619	0.71
	WLAN5.2G	802.11n HT40	Left Cheek	46	Ant 0	1	87.98	1.14	20.50	20.50	1.00	0.01	0.764	0.87
	WLAN5.2G	802.11n HT40	Left Tilted	46	Ant 0	1	87.98	1.14	20.50	20.50	1.00	-0.18	0.655	0.75
	WLAN5.2G	802.11n HT40	Right Cheek	46	Ant 1	1	86.67	1.15	21.00	20.60	1.10	0.05	0.085	0.11
	WLAN5.2G	802.11n HT40	Right Tilted	46	Ant 1	1	86.67	1.15	21.00	20.60	1.10	-0.15	0.068	0.09
	WLAN5.2G	802.11n HT40	Left Cheek	46	Ant 1	1	86.67	1.15	21.00	20.60	1.10	-0.18	0.162	0.20
	WLAN5.2G	802.11n HT40	Left Tilted	46	Ant 1	1	86.67	1.15	21.00	20.60	1.10	0.02	0.123	0.16
	WLAN5.2G	802.11n HT40	Right Cheek	46	Ant 0+1	1	88.41	1.13	24.00	23.68	1.08	0.02	0.696	0.85
	WLAN5.2G	802.11n HT40	Right Tilted	46	Ant 0+1	1	88.41	1.13	24.00	23.68	1.08	-0.18	0.591	0.72
02	WLAN5.2G	802.11n HT40	Left Cheek	46	Ant 0+1	1	88.41	1.13	24.00	23.68	1.08	-0.12	0.784	0.96
	WLAN5.2G	802.11n HT40	Left Tilted	46	Ant 0+1	1	88.41	1.13	24.00	23.68	1.08	0.05	0.749	0.91
	WLAN5.2G	802.11n HT40	Right Cheek	38	Ant 0	1	87.98	1.14	19.00	18.90	1.02	-0.15	0.486	0.57
	WLAN5.2G	802.11n HT40	Right Tilted	38	Ant 0	1	87.98	1.14	19.00	18.90	1.02	0.02	0.366	0.43
	WLAN5.2G	802.11n HT40	Left Cheek	38	Ant 0	1	87.98	1.14	19.00	18.90	1.02	0.08	0.707	0.82
	WLAN5.2G	802.11n HT40	Left Tilted	38	Ant 0	1	87.98	1.14	19.00	18.90	1.02	-0.01	0.528	0.61
	WLAN5.2G	802.11n HT40	Right Cheek	38	Ant 0+1	1	88.41	1.13	22.50	22.23	1.06	0.03	0.473	0.57
	WLAN5.2G	802.11n HT40	Right Tilted	38	Ant 0+1	1	88.41	1.13	22.50	22.23	1.06	-0.19	0.376	0.45
	WLAN5.2G	802.11n HT40	Left Cheek	38	Ant 0+1	1	88.41	1.13	22.50	22.23	1.06	-0.07	0.522	0.63
	WLAN5.2G	802.11n HT40	Left Tilted	38	Ant 0+1	1	88.41	1.13	22.50	22.23	1.06	-0.03	0.456	0.55
	WLAN5.2G	802.11n HT40	Left Cheek	46	Ant 0+1	2	88.41	1.13	24.00	23.68	1.08	0.11	0.659	0.80
	WLAN5.2G	802.11n HT40	Left Cheek	38	Ant 0+1	2	88.41	1.13	22.50	22.23	1.06	0.08	0.448	0.54

# SAR Test Report

Plot No.	Band	Mode	Test Position	Ch.	Ant Status	Battery	Duty Cycle	Crest Factor	Max. Tune-up Power (dBm)	Measured Conducted Power (dBm)	Scaling Factor	Power Drift (dB)	Measured SAR-1g (W/kg)	Scaled SAR-1g (W/kg)
	WLAN5.6G	802.11n HT40	Right Cheek	110	Ant 0	1	87.98	1.14	19.80	19.72	1.02	0.11	0.846	0.98
	WLAN5.6G	802.11n HT40	Right Tilted	110	Ant 0	1	87.98	1.14	19.80	19.72	1.02	0.13	0.747	0.87
	WLAN5.6G	802.11n HT40	Left Cheek	110	Ant 0	1	87.98	1.14	19.80	19.72	1.02	0.01	0.976	1.13
03	WLAN5.6G	802.11n HT40	Left Tilted	110	Ant 0	1	87.98	1.14	19.80	19.72	1.02	0.16	1.01	1.17
	WLAN5.6G	802.11n HT40	Right Cheek	110	Ant 1	1	86.67	1.15	20.00	19.99	1.00	0.03	0.171	0.20
	WLAN5.6G	802.11n HT40	Right Tilted	110	Ant 1	1	86.67	1.15	20.00	19.99	1.00	-0.19	0.181	0.21
	WLAN5.6G	802.11n HT40	Left Cheek	110	Ant 1	1	86.67	1.15	20.00	19.99	1.00	-0.07	0.27	0.31
	WLAN5.6G	802.11n HT40	Left Tilted	110	Ant 1	1	86.67	1.15	20.00	19.99	1.00	-0.03	0.327	0.38
	WLAN5.6G	802.11n HT40	Right Cheek	110	Ant 0+1	1	88.41	1.13	23.10	22.97	1.03	0.01	0.888	1.03
	WLAN5.6G	802.11n HT40	Right Tilted	110	Ant 0+1	1	88.41	1.13	23.10	22.97	1.03	0.16	0.752	0.88
	WLAN5.6G	802.11n HT40	Left Cheek	110	Ant 0+1	1	88.41	1.13	23.10	22.97	1.03	-0.08	0.913	1.06
	WLAN5.6G	802.11n HT40	Left Tilted	110	Ant 0+1	1	88.41	1.13	23.10	22.97	1.03	0.03	0.999	1.16
	WLAN5.6G	802.11n HT40	Right Cheek	102	Ant 0	1	87.98	1.14	19.00	18.55	1.11	0.05	0.596	0.75
	WLAN5.6G	802.11n HT40	Right Cheek	118	Ant 0	1	87.98	1.14	19.80	19.70	1.02	-0.15	0.753	0.88
	WLAN5.6G	802.11n HT40	Right Cheek	126	Ant 0	1	87.98	1.14	19.80	19.71	1.02	0.02	0.785	0.91
	WLAN5.6G	802.11n HT40	Right Cheek	134	Ant 0	1	87.98	1.14	19.50	19.12	1.09	0.08	0.685	0.85
	WLAN5.6G	802.11n HT40	Right Cheek	142	Ant 0	1	87.98	1.14	19.50	19.23	1.06	-0.01	0.738	0.89
	WLAN5.6G	802.11n HT40	Right Tilted	102	Ant 0	1	87.98	1.14	19.00	18.55	1.11	0.03	0.543	0.69
	WLAN5.6G	802.11n HT40	Right Tilted	118	Ant 0	1	87.98	1.14	19.80	19.70	1.02	-0.19	0.713	0.83
	WLAN5.6G	802.11n HT40	Right Tilted	126	Ant 0	1	87.98	1.14	19.80	19.71	1.02	-0.07	0.721	0.84
	WLAN5.6G	802.11n HT40	Right Tilted	134	Ant 0	1	87.98	1.14	19.50	19.12	1.09	-0.03	0.608	0.76
	WLAN5.6G	802.11n HT40	Right Tilted	142	Ant 0	1	87.98	1.14	19.50	19.23	1.06	0.01	0.627	0.76
	WLAN5.6G	802.11n HT40	Left Cheek	102	Ant 0	1	87.98	1.14	19.00	18.55	1.11	0.16	0.679	0.86
	WLAN5.6G	802.11n HT40	Left Cheek	118	Ant 0	1	87.98	1.14	19.80	19.70	1.02	-0.08	0.911	1.06
	WLAN5.6G	802.11n HT40	Left Cheek	126	Ant 0	1	87.98	1.14	19.80	19.71	1.02	0.03	0.923	1.07
	WLAN5.6G	802.11n HT40	Left Cheek	134	Ant 0	1	87.98	1.14	19.50	19.12	1.09	-0.19	0.839	1.04
	WLAN5.6G	802.11n HT40	Left Cheek	142	Ant 0	1	87.98	1.14	19.50	19.23	1.06	-0.07	0.923	1.12
	WLAN5.6G	802.11n HT40	Left Tilted	102	Ant 0	1	87.98	1.14	19.00	18.55	1.11	-0.03	0.728	0.92
	WLAN5.6G	802.11n HT40	Left Tilted	118	Ant 0	1	87.98	1.14	19.80	19.70	1.02	0.01	0.977	1.14
	WLAN5.6G	802.11n HT40	Left Tilted	126	Ant 0	1	87.98	1.14	19.80	19.71	1.02	0.03	0.936	1.09
	WLAN5.6G	802.11n HT40	Left Tilted	134	Ant 0	1	87.98	1.14	19.50	19.12	1.09	-0.19	0.905	1.12
	WLAN5.6G	802.11n HT40	Left Tilted	142	Ant 0	1	87.98	1.14	19.50	19.23	1.06	-0.07	0.902	1.09
	WLAN5.6G	802.11n HT40	Right Cheek	102	Ant 0+1	1	88.41	1.13	22.00	21.76	1.06	-0.03	0.606	0.73
	WLAN5.6G	802.11n HT40	Right Cheek	118	Ant 0+1	1	88.41	1.13	23.00	22.91	1.02	-0.03	0.797	0.92
	WLAN5.6G	802.11n HT40	Right Cheek	126	Ant 0+1	1	88.41	1.13	23.00	22.90	1.02	0.01	0.822	0.95
	WLAN5.6G	802.11n HT40	Right Cheek	134	Ant 0+1	1	88.41	1.13	22.60	22.40	1.05	0.16	0.666	0.79
	WLAN5.6G	802.11n HT40	Right Cheek	142	Ant 0+1	1	88.41	1.13	23.00	22.59	1.10	-0.08	0.698	0.87
	WLAN5.6G	802.11n HT40	Right Tilted	102	Ant 0+1	1	88.41	1.13	22.00	21.76	1.06	0.03	0.552	0.66
	WLAN5.6G	802.11n HT40	Right Tilted	118	Ant 0+1	1	88.41	1.13	23.00	22.91	1.02	0.05	0.613	0.71
	WLAN5.6G	802.11n HT40	Right Tilted	126	Ant 0+1	1	88.41	1.13	23.00	22.90	1.02	-0.15	0.629	0.72
	WLAN5.6G	802.11n HT40	Right Tilted	134	Ant 0+1	1	88.41	1.13	22.60	22.40	1.05	0.02	0.609	0.72
	WLAN5.6G	802.11n HT40	Right Tilted	142	Ant 0+1	1	88.41	1.13	23.00	22.59	1.10	0.08	0.627	0.78
	WLAN5.6G	802.11n HT40	Left Cheek	102	Ant 0+1	1	88.41	1.13	22.00	21.76	1.06	-0.01	0.631	0.76
	WLAN5.6G	802.11n HT40	Left Cheek	118	Ant 0+1	1	88.41	1.13	23.00	22.91	1.02	0.03	0.852	0.98
	WLAN5.6G	802.11n HT40	Left Cheek	126	Ant 0+1	1	88.41	1.13	23.00	22.90	1.02	-0.19	0.861	0.99
	WLAN5.6G	802.11n HT40	Left Cheek	134	Ant 0+1	1	88.41	1.13	22.60	22.40	1.05	-0.07	0.811	0.96
	WLAN5.6G	802.11n HT40	Left Cheek	142	Ant 0+1	1	88.41	1.13	23.00	22.59	1.10	-0.03	0.888	1.10
	WLAN5.6G	802.11n HT40	Left Tilted	102	Ant 0+1	1	88.41	1.13	22.00	21.76	1.06	0.01	0.715	0.86
	WLAN5.6G	802.11n HT40	Left Tilted	118	Ant 0+1	1	88.41	1.13	23.00	22.91	1.02	0.16	0.916	1.06
	WLAN5.6G	802.11n HT40	Left Tilted	126	Ant 0+1	1	88.41	1.13	23.00	22.90	1.02	-0.08	0.934	1.08
	WLAN5.6G	802.11n HT40	Left Tilted	134	Ant 0+1	1	88.41	1.13	22.60	22.40	1.05	-0.03	0.952	1.13
	WLAN5.6G	802.11n HT40	Left Tilted	142	Ant 0+1	1	88.41	1.13	23.00	22.59	1.10	0.01	0.922	1.15
	WLAN5.6G	802.11n HT40	Left Tilted	110	Ant 0	2	87.98	1.14	19.80	19.72	1.02	0.03	0.989	1.15
	WLAN5.6G	802.11n HT40	Left Tilted	102	Ant 0	2	87.98	1.14	19.00	18.55	1.11	-0.19	0.813	1.03
	WLAN5.6G	802.11n HT40	Left Tilted	118	Ant 0	2	87.98	1.14	19.80	19.70	1.02	-0.07	0.923	1.07
	WLAN5.6G	802.11n HT40	Left Tilted	126	Ant 0	2	87.98	1.14	19.80	19.71	1.02	-0.03	0.887	1.03
	WLAN5.6G	802.11n HT40	Left Tilted	134	Ant 0	2	87.98	1.14	19.50	19.12	1.09	-0.03	0.883	1.10
	WLAN5.6G	802.11n HT40	Left Tilted	142	Ant 0	2	87.98	1.14	19.50	19.23	1.06	-0.01	0.894	1.08
	WLAN5.6G	802.11n HT40	Left Tilted	110	Ant 0	1	87.98	1.14	19.80	19.72	1.02	0.15	0.998	1.16



# SAR Test Report

Plot No.	Band	Mode	Test Position	Ch.	Ant Status	Battery	Duty Cycle	Crest Factor	Max. Tune-up Power (dBm)	Measured Conducted Power (dBm)	Scaling Factor	Power Drift (dB)	Measured SAR-1g (W/kg)	Scaled SAR-1g (W/kg)
	WLAN5.8G	802.11ac VHT80	Right Cheek	155	Ant 0	1	83.93	1.19	16.50	16.32	1.04	0.01	0.341	0.42
	WLAN5.8G	802.11ac VHT80	Right Tilted	155	Ant 0	1	83.93	1.19	16.50	16.32	1.04	-0.08	0.291	0.36
04	WLAN5.8G	802.11ac VHT80	Left Cheek	155	Ant 0	1	83.93	1.19	16.50	16.32	1.04	0.15	0.393	0.49
	WLAN5.8G	802.11ac VHT80	Left Tilted	155	Ant 0	1	83.93	1.19	16.50	16.32	1.04	-0.18	0.353	0.44
	WLAN5.8G	802.11ac VHT80	Right Cheek	155	Ant 1	1	83.95	1.19	16.50	16.35	1.04	0.02	0.091	0.11
	WLAN5.8G	802.11ac VHT80	Right Tilted	155	Ant 1	1	83.95	1.19	16.50	16.35	1.04	-0.15	0.096	0.12
	WLAN5.8G	802.11ac VHT80	Left Cheek	155	Ant 1	1	83.95	1.19	16.50	16.35	1.04	0.15	0.151	0.19
	WLAN5.8G	802.11ac VHT80	Left Tilted	155	Ant 1	1	83.95	1.19	16.50	16.35	1.04	-0.11	0.158	0.20
	WLAN5.8G	802.11ac VHT80	Right Cheek	155	Ant 0+1	1	83.95	1.19	19.50	19.45	1.01	0.08	0.295	0.35
	WLAN5.8G	802.11ac VHT80	Right Tilted	155	Ant 0+1	1	83.95	1.19	19.50	19.45	1.01	-0.15	0.258	0.31
	WLAN5.8G	802.11ac VHT80	Left Cheek	155	Ant 0+1	1	83.95	1.19	19.50	19.45	1.01	-0.17	0.331	0.40
	WLAN5.8G	802.11ac VHT80	Left Tilted	155	Ant 0+1	1	83.95	1.19	19.50	19.45	1.01	0.16	0.343	0.41
	WLAN5.8G	802.11ac VHT80	Left Cheek	155	Ant 0	2	83.93	1.19	16.50	16.32	1.04	-0.11	0.336	0.42
05	BT	BR / EDR	Right Cheek	39	Ant 0	1	76.75	1.30	1.00	0.81	1.04	0.13	0.00491	0.01
	BT	BR / EDR	Right Tilted	39	Ant 0	1	76.75	1.30	1.00	0.81	1.04	-0.06	0.00449	0.01
	BT	BR / EDR	Left Cheek	39	Ant 0	1	76.75	1.30	1.00	0.81	1.04	0.08	0.00331	0.00
	BT	BR / EDR	Left Tilted	39	Ant 0	1	76.75	1.30	1.00	0.81	1.04	-0.15	0.00268	0.00
	BT	BR / EDR	Right Cheek	0	Ant 0	1	76.75	1.30	0.50	0.22	1.07	-0.04	0.00311	0.00
	BT	BR / EDR	Right Cheek	78	Ant 0	1	76.75	1.30	0.50	0.43	1.02	-0.09	0.00257	0.00
	BT	BR / EDR	Right Cheek	39	Ant 0	2	76.75	1.30	1.00	0.81	1.04	0.12	0.00475	0.01

## 4.7.3 SAR Results for Body-worn Exposure Condition (Test Separation Distance is 15 mm)

Plot No.	Band	Mode	Test Position	Ch.	Ant Status	Battery	Duty Cycle	Crest Factor	Max. Tune-up Power (dBm)	Measured Conducted Power (dBm)	Scaling Factor	Power Drift (dB)	Measured SAR-1g (W/kg)	Scaled SAR-1g (W/kg)
	WLAN2.4G	802.11b	Front Face	6	Ant 0	1	99.20	1.01	20.50	20.14	1.09	0.02	0.086	0.09
	WLAN2.4G	802.11b	Rear Face	6	Ant 0	1	99.20	1.01	20.50	20.14	1.09	-0.07	0.181	0.20
	WLAN2.4G	802.11b	Front Face	6	Ant 1	1	99.04	1.01	20.50	20.11	1.09	-0.01	0.083	0.09
	WLAN2.4G	802.11b	Rear Face	6	Ant 1	1	99.04	1.01	20.50	20.11	1.09	0.03	0.074	0.08
06	WLAN2.4G	802.11b	Front Face	6	Ant 0+1	1	99.12	1.01	23.50	23.24	1.06	-0.08	0.192	0.21
	WLAN2.4G	802.11b	Rear Face	6	Ant 0+1	1	99.12	1.01	23.50	23.24	1.06	-0.14	0.154	0.16
	WLAN2.4G	802.11b	Front Face	1	Ant 0+1	1	99.12	1.01	22.00	21.91	1.02	-0.11	0.139	0.14
	WLAN2.4G	802.11b	Front Face	11	Ant 0+1	1	99.12	1.01	21.60	21.40	1.05	-0.1	0.078	0.08
	WLAN2.4G	802.11b	Front Face	6	Ant 0+1	2	99.12	1.01	23.50	23.24	1.06	-0.18	0.188	0.20
	WLAN5.2G	802.11n HT40	Front Face	46	Ant 0	1	87.98	1.14	20.50	20.50	1.00	0.01	0.24	0.27
	WLAN5.2G	802.11n HT40	Rear Face	46	Ant 0	1	87.98	1.14	20.50	20.50	1.00	-0.09	0.269	0.31
	WLAN5.2G	802.11n HT40	Front Face	46	Ant 1	1	86.67	1.15	21.00	20.60	1.10	-0.16	0.047	0.06
	WLAN5.2G	802.11n HT40	Rear Face	46	Ant 1	1	86.67	1.15	21.00	20.60	1.10	-0.05	0.12	0.15
	WLAN5.2G	802.11n HT40	Front Face	46	Ant 0+1	1	88.41	1.13	24.00	23.68	1.08	-0.11	0.238	0.29
07	WLAN5.2G	802.11n HT40	Rear Face	46	Ant 0+1	1	88.41	1.13	24.00	23.68	1.08	-0.11	0.277	0.34
	WLAN5.2G	802.11n HT40	Rear Face	38	Ant 0+1	1	88.41	1.13	22.50	22.23	1.06	0.03	0.183	0.22
	WLAN5.2G	802.11n HT40	Rear Face	46	Ant 0+1	2	88.41	1.13	24.00	23.68	1.08	0.05	0.269	0.33
	WLAN5.6G	802.11n HT40	Front Face	110	Ant 0	1	87.98	1.14	19.80	19.72	1.02	0.03	0.271	0.32
	WLAN5.6G	802.11n HT40	Rear Face	110	Ant 0	1	87.98	1.14	19.80	19.72	1.02	-0.1	0.398	0.46
	WLAN5.6G	802.11n HT40	Front Face	110	Ant 1	1	86.67	1.15	20.00	19.99	1.00	-0.06	0.057	0.07
	WLAN5.6G	802.11n HT40	Rear Face	110	Ant 1	1	86.67	1.15	20.00	19.99	1.00	0.15	0.452	0.52
	WLAN5.6G	802.11n HT40	Front Face	110	Ant 0+1	1	88.41	1.13	23.10	22.97	1.03	0.01	0.335	0.39
	WLAN5.6G	802.11n HT40	Rear Face	110	Ant 0+1	1	88.41	1.13	23.10	22.97	1.03	-0.13	0.419	0.49
	WLAN5.6G	802.11n HT40	Rear Face	102	Ant 1	1	86.67	1.15	19.00	18.72	1.07	-0.17	0.333	0.41
	WLAN5.6G	802.11n HT40	Rear Face	118	Ant 1	1	86.67	1.15	20.00	19.92	1.02	0.02	0.497	0.58
	WLAN5.6G	802.11n HT40	Rear Face	126	Ant 1	1	86.67	1.15	20.00	19.85	1.04	-0.14	0.517	0.62
	WLAN5.6G	802.11n HT40	Rear Face	134	Ant 1	1	86.67	1.15	19.50	19.46	1.01	0.03	0.488	0.57
08	WLAN5.6G	802.11n HT40	Rear Face	142	Ant 1	1	86.67	1.15	20.00	19.70	1.07	-0.05	0.534	0.66
	WLAN5.6G	802.11n HT40	Rear Face	142	Ant 1	2	86.67	1.15	20.00	19.70	1.07	0.01	0.466	0.57
	WLAN5.8G	802.11ac VHT80	Front Face	155	Ant 0	1	83.93	1.19	16.50	16.32	1.04	-0.13	0.122	0.15
	WLAN5.8G	802.11ac VHT80	Rear Face	155	Ant 0	1	83.93	1.19	16.50	16.32	1.04	-0.04	0.186	0.23
	WLAN5.8G	802.11ac VHT80	Front Face	155	Ant 1	1	83.95	1.19	16.50	16.35	1.04	0.05	0.04	0.05
	WLAN5.8G	802.11ac VHT80	Rear Face	155	Ant 1	1	83.95	1.19	16.50	16.35	1.04	-0.05	0.253	0.31
	WLAN5.8G	802.11ac VHT80	Front Face	155	Ant 0+1	1	83.95	1.19	19.50	19.45	1.01	0.04	0.11	0.13
09	WLAN5.8G	802.11ac VHT80	Rear Face	155	Ant 0+1	1	83.95	1.19	19.50	19.45	1.01	-0.11	0.272	0.33
	WLAN5.8G	802.11ac VHT80	Rear Face	155	Ant 0+1	2	83.95	1.19	19.50	19.45	1.01	0.03	0.267	0.32
	BT	BR / EDR	Front Face	39	Ant 0	1	76.75	1.30	1.00	0.81	1.04	0.02	0.00175	0.00
10	BT	BR / EDR	Rear Face	39	Ant 0	1	76.75	1.30	1.00	0.81	1.04	0.1	0.00218	0.00
	BT	BR / EDR	Rear Face	0	Ant 0	1	76.75	1.30	0.50	0.22	1.07	-0.08	0.00158	0.00
	BT	BR / EDR	Rear Face	78	Ant 0	1	76.75	1.30	0.50	0.43	1.02	-0.11	0.00085	0.00
	BT	BR / EDR	Rear Face	39	Ant 0	2	76.75	1.30	1.00	0.81	1.04	-0.15	0.00213	0.00

# SAR Test Report

## 4.7.4 SAR Results for Product Specific (Phablet) Exposure Condition (Test Separation Distance is 0 mm)

Plot No.	Band	Mode	Test Position	Ch.	Ant Status	Battery	Duty Cycle	Crest Factor	Max. Tune-up Power (dBm)	Measured Conducted Power (dBm)	Scaling Factor	Power Drift (dB)	Measured SAR-10g (W/kg)	Scaled SAR-10g (W/kg)
	WLAN2.4G	802.11b	Front Face	6	Ant 0	1	99.20	1.01	20.50	20.14	1.09	0.02	0.253	0.28
	WLAN2.4G	802.11b	Rear Face	6	Ant 0	1	99.20	1.01	20.50	20.14	1.09	-0.15	0.313	0.34
	WLAN2.4G	802.11b	Left Side	6	Ant 0	1	99.20	1.01	20.50	20.14	1.09	-0.13	1.13	1.24
	WLAN2.4G	802.11b	Right Side	6	Ant 0	1	99.20	1.01	20.50	20.14	1.09	-0.18	0.059	0.06
	WLAN2.4G	802.11b	Top Side	6	Ant 0	1	99.20	1.01	20.50	20.14	1.09	0.05	0.606	0.67
	WLAN2.4G	802.11b	Bottom Side	6	Ant 0	1	99.20	1.01	20.50	20.14	1.09	0	<0.001	0.00
	WLAN2.4G	802.11b	Front Face	6	Ant 1	1	99.04	1.01	20.50	20.11	1.09	-0.06	0.261	0.29
	WLAN2.4G	802.11b	Rear Face	6	Ant 1	1	99.04	1.01	20.50	20.11	1.09	0.09	0.143	0.16
	WLAN2.4G	802.11b	Left Side	6	Ant 1	1	99.04	1.01	20.50	20.11	1.09	0	0.088	0.10
	WLAN2.4G	802.11b	Right Side	6	Ant 1	1	99.04	1.01	20.50	20.11	1.09	-0.08	1.27	1.40
	WLAN2.4G	802.11b	Top Side	6	Ant 1	1	99.04	1.01	20.50	20.11	1.09	-0.19	0.228	0.25
	WLAN2.4G	802.11b	Bottom Side	6	Ant 1	1	99.04	1.01	20.50	20.11	1.09	0.11	<0.001	0.00
	WLAN2.4G	802.11b	Front Face	6	Ant 0+1	1	99.12	1.01	23.50	23.24	1.06	0.02	0.399	0.43
	WLAN2.4G	802.11b	Rear Face	6	Ant 0+1	1	99.12	1.01	23.50	23.24	1.06	-0.05	0.283	0.30
	WLAN2.4G	802.11b	Left Side	6	Ant 0+1	1	99.12	1.01	23.50	23.24	1.06	-0.07	1.07	1.15
11	WLAN2.4G	802.11b	Right Side	6	Ant 0+1	1	99.12	1.01	23.50	23.24	1.06	-0.01	1.38	1.48
	WLAN2.4G	802.11b	Top Side	6	Ant 0+1	1	99.12	1.01	23.50	23.24	1.06	0.08	0.717	0.77
	WLAN2.4G	802.11b	Bottom Side	6	Ant 0+1	1	99.12	1.01	23.50	23.24	1.06	0.15	<0.001	0.00
	WLAN2.4G	802.11b	Right Side	1	Ant 0+1	1	99.12	1.01	22.00	21.91	1.02	0.03	1.05	1.08
	WLAN2.4G	802.11b	Right Side	11	Ant 0+1	1	99.12	1.01	21.60	21.40	1.05	0.11	0.962	1.02
	WLAN2.4G	802.11b	Right Side	6	Ant 0+1	2	99.12	1.01	23.50	23.24	1.06	0.08	1.33	1.42
	WLAN5.2G	802.11n HT40	Front Face	46	Ant 0	1	87.98	1.14	20.50	20.50	1.00	0.15	0.37	0.42
	WLAN5.2G	802.11n HT40	Rear Face	46	Ant 0	1	87.98	1.14	20.50	20.50	1.00	0.03	0.268	0.31
	WLAN5.2G	802.11n HT40	Left Side	46	Ant 0	1	87.98	1.14	20.50	20.50	1.00	0.11	0.97	1.11
	WLAN5.2G	802.11n HT40	Right Side	46	Ant 0	1	87.98	1.14	20.50	20.50	1.00	0.03	0.047	0.05
	WLAN5.2G	802.11n HT40	Top Side	46	Ant 0	1	87.98	1.14	20.50	20.50	1.00	-0.1	1.01	1.15
	WLAN5.2G	802.11n HT40	Bottom Side	46	Ant 0	1	87.98	1.14	20.50	20.50	1.00	0	<0.001	0.00
	WLAN5.2G	802.11n HT40	Front Face	46	Ant 1	1	86.67	1.15	21.00	20.60	1.10	-0.06	0.08	0.10
	WLAN5.2G	802.11n HT40	Rear Face	46	Ant 1	1	86.67	1.15	21.00	20.60	1.10	0.16	0.157	0.20
	WLAN5.2G	802.11n HT40	Left Side	46	Ant 1	1	86.67	1.15	21.00	20.60	1.10	0.11	0.036	0.05
	WLAN5.2G	802.11n HT40	Right Side	46	Ant 1	1	86.67	1.15	21.00	20.60	1.10	-0.08	0.423	0.54
	WLAN5.2G	802.11n HT40	Top Side	46	Ant 1	1	86.67	1.15	21.00	20.60	1.10	0.16	0.091	0.12
	WLAN5.2G	802.11n HT40	Bottom Side	46	Ant 1	1	86.67	1.15	21.00	20.60	1.10	-0.1	<0.001	0.00
	WLAN5.2G	802.11n HT40	Front Face	46	Ant 0+1	1	88.41	1.13	24.00	23.68	1.08	-0.13	0.35	0.43
	WLAN5.2G	802.11n HT40	Rear Face	46	Ant 0+1	1	88.41	1.13	24.00	23.68	1.08	-0.06	0.246	0.30
	WLAN5.2G	802.11n HT40	Left Side	46	Ant 0+1	1	88.41	1.13	24.00	23.68	1.08	0.16	0.791	0.97
	WLAN5.2G	802.11n HT40	Right Side	46	Ant 0+1	1	88.41	1.13	24.00	23.68	1.08	0.11	0.327	0.40
12	WLAN5.2G	802.11n HT40	Top Side	46	Ant 0+1	1	88.41	1.13	24.00	23.68	1.08	-0.11	1	1.22
	WLAN5.2G	802.11n HT40	Bottom Side	46	Ant 0+1	1	88.41	1.13	24.00	23.68	1.08	0.03	<0.001	0.00
	WLAN5.2G	802.11n HT40	Top Side	38	Ant 0+1	1	88.41	1.13	22.50	22.23	1.06	0.11	0.654	0.78
	WLAN5.2G	802.11n HT40	Top Side	46	Ant 0+1	2	88.41	1.13	24.00	23.68	1.08	0.01	0.948	1.16
	WLAN5.6G	802.11n HT40	Front Face	110	Ant 0	1	87.98	1.14	19.80	19.72	1.02	0.07	0.395	0.46
	WLAN5.6G	802.11n HT40	Rear Face	110	Ant 0	1	87.98	1.14	19.80	19.72	1.02	0	0.395	0.46
	WLAN5.6G	802.11n HT40	Left Side	110	Ant 0	1	87.98	1.14	19.80	19.72	1.02	-0.04	1.27	1.48
	WLAN5.6G	802.11n HT40	Right Side	110	Ant 0	1	87.98	1.14	19.80	19.72	1.02	0.16	0.037	0.04
	WLAN5.6G	802.11n HT40	Top Side	110	Ant 0	1	87.98	1.14	19.80	19.72	1.02	-0.1	0.773	0.90
	WLAN5.6G	802.11n HT40	Bottom Side	110	Ant 0	1	87.98	1.14	19.80	19.72	1.02	0	<0.001	0.00
	WLAN5.6G	802.11n HT40	Front Face	110	Ant 1	1	86.67	1.15	20.00	19.99	1.00	0	0.099	0.11
	WLAN5.6G	802.11n HT40	Rear Face	110	Ant 1	1	86.67	1.15	20.00	19.99	1.00	0.15	0.45	0.52
	WLAN5.6G	802.11n HT40	Left Side	110	Ant 1	1	86.67	1.15	20.00	19.99	1.00	-0.17	0.034	0.04
	WLAN5.6G	802.11n HT40	Right Side	110	Ant 1	1	86.67	1.15	20.00	19.99	1.00	-0.1	0.831	0.96
	WLAN5.6G	802.11n HT40	Top Side	110	Ant 1	1	86.67	1.15	20.00	19.99	1.00	0.01	0.199	0.23
	WLAN5.6G	802.11n HT40	Bottom Side	110	Ant 1	1	86.67	1.15	20.00	19.99	1.00	-0.14	<0.001	0.00
	WLAN5.6G	802.11n HT40	Front Face	110	Ant 0+1	1	88.41	1.13	23.10	22.97	1.03	0.15	0.478	0.56
	WLAN5.6G	802.11n HT40	Rear Face	110	Ant 0+1	1	88.41	1.13	23.10	22.97	1.03	-0.17	0.472	0.55
	WLAN5.6G	802.11n HT40	Left Side	110	Ant 0+1	1	88.41	1.13	23.10	22.97	1.03	0.05	1.21	1.41
	WLAN5.6G	802.11n HT40	Right Side	110	Ant 0+1	1	88.41	1.13	23.10	22.97	1.03	0.03	0.807	0.94
	WLAN5.6G	802.11n HT40	Top Side	110	Ant 0+1	1	88.41	1.13	23.10	22.97	1.03	0	0.731	0.85
	WLAN5.6G	802.11n HT40	Bottom Side	110	Ant 0+1	1	88.41	1.13	23.10	22.97	1.03	0.15	<0.001	0.00
	WLAN5.6G	802.11n HT40	Left Side	102	Ant 0	1	87.98	1.14	19.00	18.55	1.11	0.15	0.96	1.21
	WLAN5.6G	802.11n HT40	Left Side	118	Ant 0	1	87.98	1.14	19.80	19.70	1.02	0.07	1.31	1.52
	WLAN5.6G	802.11n HT40	Left Side	126	Ant 0	1	87.98	1.14	19.80	19.71	1.02	0.08	1.38	1.60
	WLAN5.6G	802.11n HT40	Left Side	134	Ant 0	1	87.98	1.14	19.50	19.12	1.09	0.01	1.26	1.57
13	WLAN5.6G	802.11n HT40	Left Side	142	Ant 0	1	87.98	1.14	19.50	19.23	1.06	-0.14	1.4	1.69
	WLAN5.6G	802.11n HT40	Left Side	142	Ant 0	2	87.98	1.14	19.50	19.23	1.06	-0.03	1.32	1.60

Note: The "< 0.001" means there is no SAR value or the SAR is too low to be measured.



# SAR Test Report

Plot No.	Band	Mode	Test Position	Ch.	Ant Status	Battery	Duty Cycle	Crest Factor	Max. Tune-up Power (dBm)	Measured Conducted Power (dBm)	Scaling Factor	Power Drift (dB)	Measured SAR-10g (W/kg)	Scaled SAR-10g (W/kg)
	WLAN5.8G	802.11ac VHT80	Front Face	155	Ant 0	1	83.93	1.19	16.50	16.32	1.04	0.03	0.15	0.19
	WLAN5.8G	802.11ac VHT80	Rear Face	155	Ant 0	1	83.93	1.19	16.50	16.32	1.04	0.09	0.18	0.22
	WLAN5.8G	802.11ac VHT80	Left Side	155	Ant 0	1	83.95	1.19	16.50	16.32	1.04	-0.1	0.653	0.81
	WLAN5.8G	802.11ac VHT80	Right Side	155	Ant 0	1	83.93	1.19	16.50	16.32	1.04	0	<0.001	0.00
	WLAN5.8G	802.11ac VHT80	Top Side	155	Ant 0	1	83.93	1.19	16.50	16.32	1.04	0.03	0.23	0.28
	WLAN5.8G	802.11ac VHT80	Bottom Side	155	Ant 0	1	83.93	1.19	16.50	16.32	1.04	0	<0.001	0.00
	WLAN5.8G	802.11ac VHT80	Front Face	155	Ant 1	1	83.95	1.19	16.50	16.35	1.04	0.15	0.056	0.07
	WLAN5.8G	802.11ac VHT80	Rear Face	155	Ant 1	1	83.95	1.19	16.50	16.35	1.04	-0.17	0.318	0.39
	WLAN5.8G	802.11ac VHT80	Left Side	155	Ant 1	1	83.95	1.19	16.50	16.35	1.04	0.11	0.017	0.02
	WLAN5.8G	802.11ac VHT80	Right Side	155	Ant 1	1	83.95	1.19	16.50	16.35	1.04	-0.07	0.545	0.67
	WLAN5.8G	802.11ac VHT80	Top Side	155	Ant 1	1	83.95	1.19	16.50	16.35	1.04	0.02	0.095	0.12
	WLAN5.8G	802.11ac VHT80	Bottom Side	155	Ant 1	1	83.95	1.19	16.50	16.35	1.04	0	<0.001	0.00
	WLAN5.8G	802.11ac VHT80	Front Face	155	Ant 0+1	1	83.95	1.19	19.50	19.45	1.01	0.02	0.163	0.20
	WLAN5.8G	802.11ac VHT80	Rear Face	155	Ant 0+1	1	83.95	1.19	19.50	19.45	1.01	0.12	0.331	0.40
14	WLAN5.8G	802.11ac VHT80	Left Side	155	Ant 0+1	1	83.95	1.19	19.50	19.45	1.01	-0.15	0.681	0.82
	WLAN5.8G	802.11ac VHT80	Right Side	155	Ant 0+1	1	83.95	1.19	19.50	19.45	1.01	0.18	0.599	0.72
	WLAN5.8G	802.11ac VHT80	Top Side	155	Ant 0+1	1	83.95	1.19	19.50	19.45	1.01	-0.01	0.252	0.30
	WLAN5.8G	802.11ac VHT80	Bottom Side	155	Ant 0+1	1	83.95	1.19	19.50	19.45	1.01	0	<0.001	0.00
	WLAN5.8G	802.11ac VHT80	Left Side	155	Ant 0+1	2	83.95	1.19	19.50	19.45	1.01	0.02	0.659	0.79
	BT	BR / EDR	Front Face	39	Ant 0	1	76.75	1.30	1.00	0.81	1.04	0.02	0.00247	0.00
	BT	BR / EDR	Rear Face	39	Ant 0	1	76.75	1.30	1.00	0.81	1.04	-0.01	0.00305	0.00
15	BT	BR / EDR	Left Side	39	Ant 0	1	76.75	1.30	1.00	0.81	1.04	-0.07	0.011	0.01
	BT	BR / EDR	Right Side	39	Ant 0	1	76.75	1.30	1.00	0.81	1.04	-0.05	0.000576	0.00
	BT	BR / EDR	Top Side	39	Ant 0	1	76.75	1.30	1.00	0.81	1.04	0.15	0.00592	0.01
	BT	BR / EDR	Bottom Side	39	Ant 0	1	76.75	1.30	1.00	0.81	1.04	0	<0.001	0.00
	BT	BR / EDR	Left Side	0	Ant 0	1	76.75	1.30	0.50	0.22	1.07	-0.17	0.00817	0.01
	BT	BR / EDR	Left Side	78	Ant 0	1	76.75	1.30	0.50	0.43	1.02	0.06	0.00747	0.01
	BT	BR / EDR	Left Side	39	Ant 0	2	76.75	1.30	1.00	0.81	1.04	-0.17	0.00981	0.01

**Note:** The "< 0.001" means there is no SAR value or the SAR is too low to be measured.

## 4.7.5 SAR Measurement Variability

According to KDB 865664 D01, SAR measurement variability was assessed for each frequency band, which is determined by the SAR probe calibration point and tissue-equivalent medium used for the device measurements. When both head and body tissue-equivalent media are required for SAR measurements in a frequency band, the variability measurement procedures should be applied to the tissue medium with the highest measured SAR, using the highest measured SAR configuration for that tissue-equivalent medium. Alternatively, if the highest measured SAR for both head and body tissue-equivalent media are  $\leq 1.45$  W/kg and the ratio of these highest SAR values, i.e., largest divided by smallest value, is  $\leq 1.10$ , the highest SAR configuration for either head or body tissue-equivalent medium maybe used to perform the repeated measurement. These additional measurements are repeated after the completion of all measurements requiring the same head or body tissue-equivalent medium in a frequency band. The test device should be returned to ambient conditions (normal room temperature) with the battery fully charged before it is re-mounted on the device holder for the repeated measurement(s) to minimize any unexpected variations in the repeated results.

SAR repeated measurement procedure:

1. When the highest measured SAR is  $< 0.80$  W/kg, repeated measurement is not required.
2. When the highest measured SAR is  $\geq 0.80$  W/kg, repeat that measurement once.
3. If the ratio of largest to smallest SAR for the original and first repeated measurements is  $> 1.20$ , or when the original or repeated measurement is  $\geq 1.45$  W/kg, perform a second repeated measurement.
4. If the ratio of largest to smallest SAR for the original, first and second repeated measurements is  $> 1.20$ , and the original, first or second repeated measurement is  $\geq 1.5$  W/kg, perform a third repeated measurement.

Band	Mode	Test Position	Ch.	Original Measured SAR-1g (W/kg)	1st Repeated SAR-1g (W/kg)	L/S Ratio	2nd Repeated SAR-1g (W/kg)	L/S Ratio	3rd Repeated SAR-1g (W/kg)	L/S Ratio
WLAN5.6G	802.11n HT40	Left Tilted	110	1.01	0.998	1.01	N/A	N/A	N/A	N/A

# SAR Test Report

## 4.7.6 Simultaneous Multi-band Transmission Evaluation

### <Possibilities of Simultaneous Transmission>

The simultaneous transmission possibilities for this device are listed as below.

Simultaneous TX Combination	Capable Transmit Configurations	Head Exposure Condition	Body Exposure Condition	Product Specific Exposure Condition
1	WLAN 2.4G + BT	Yes	Yes	Yes
2	WLAN 5G + BT	Yes	Yes	Yes

### Note:

1. The WLAN 2.4G and WLAN 5G cannot transmit simultaneously.

### <SAR Summation Analysis>

Simultaneous transmission SAR test exclusion is determined for each operating configuration and exposure condition according to the reported standalone SAR of each applicable simultaneous transmitting antenna. When the sum of SAR<sub>1g</sub> of all simultaneously transmitting antennas in an operating mode and exposure condition combination is within the SAR limit(SAR<sub>1g</sub> 1.6 W/kg), the simultaneous transmission SAR is not required. When the sum of SAR<sub>1g</sub> is greater than the SAR limit (SAR<sub>1g</sub> 1.6 W/kg), SAR test exclusion is determined by the SPLSR.

Refer to Appendix G

**Test Engineer** : Chienlun Huang, and Eric Wu

**5. Calibration of Test Equipment**

Equipment	Manufacturer	Model	SN	Cal. Date	Cal. Interval
System Validation Dipole	SPEAG	D2450V2	737	Aug. 13, 2020	1 Year
System Validation Dipole	SPEAG	D5GHzV2	1019	Mar. 13, 2020	1 Year
Dosimetric E-Field Probe	SPEAG	EX3DV4	7537	May. 29, 2020	1 Year
Dosimetric E-Field Probe	SPEAG	EX3DV4	3820	Jun. 25, 2020	1 Year
Data Acquisition Electronics	SPEAG	DAE4	1431	Mar. 18, 2020	1 Year
Data Acquisition Electronics	SPEAG	DAE4	1277	Jan. 24, 2020	1 Year
Spectrum Analyzer	R&S	FSL6	102006	Mar. 26, 2020	1 Year
Power Meter	Anritsu	ML2495A	1218009	Jun. 24, 2020	1 Year
Power Sensor	Anritsu	MA2411B	1207252	Jun. 24, 2020	1 Year
Universal Wireless Test Set	Anritsu	MT8870A/MU8 87000A	6201699387	Oct. 07, 2019	1 Year
Thermometer	YFE	YF-160A	150601220	May. 25, 2020	1 Year
Dielectric Assessment Kit	SPEAG	DAKS-3.5	1092	May. 26, 2020	1 Year
Powersource1	SPEAG	SE_UMS_160 BA	4010	Aug. 13, 2020	1 Year

**6. Measurement Uncertainty**

Source of Uncertainty	Uncertainty (± %)	Probability Distribution	Divisor	Ci (1g)	Ci (10g)	Standard Uncertainty (± %, 1g)	Standard Uncertainty (± %, 10g)	Vi
<b>Measurement System</b>								
Probe Calibration	6.0	Normal	1	1	1	6.0	6.0	∞
Axial Isotropy	4.7	Rectangular	√3	√0.5	√0.5	1.9	1.9	∞
Hemispherical Isotropy	9.6	Rectangular	√3	√0.5	√0.5	3.9	3.9	∞
Boundary Effect	1.0	Rectangular	√3	1	1	0.6	0.6	∞
Linearity	4.7	Rectangular	√3	1	1	2.7	2.7	∞
Detection Limits	0.25	Rectangular	√3	1	1	0.14	0.14	∞
Probe Modulation Response	4.8	Rectangular	√3	1	1	2.8	2.8	∞
Readout Electronics	0.3	Normal	1	1	1	0.3	0.3	∞
Response Time	0.0	Rectangular	√3	1	1	0.0	0.0	∞
Integration Time	1.7	Rectangular	√3	1	1	1.0	1.0	∞
RF Ambient Conditions – Noise	3.0	Rectangular	√3	1	1	1.7	1.7	∞
RF Ambient Conditions – Reflections	3.0	Rectangular	√3	1	1	1.7	1.7	∞
Probe Positioner Mechanical Tolerance	0.02	Rectangular	√3	1	1	0.01	0.01	∞
Probe Positioning with Respect to Phantom	0.4	Rectangular	√3	1	1	0.2	0.2	∞
Post-processing	2.0	Rectangular	√3	1	1	1.2	1.2	∞
<b>Test Sample Related</b>								
Test Sample Positioning	2.82 / 1.60	Normal	1	1	1	2.8	1.6	35
Device Holder Uncertainty	2.55 / 2.76	Normal	1	1	1	2.6	2.8	7
Power Drift of Measurement	5.0	Rectangular	√3	1	1	2.9	2.9	∞
PowerScaling	0.0	Rectangular	√3	1	1	0.0	0.0	∞
<b>Phantom and Setup</b>								
Phantom Uncertainty (Shape and Thickness Tolerances)	5.7	Rectangular	√3	1	1	3.3	3.3	∞
Liquid Conductivity (Temperature Uncertainty)	2.58	Rectangular	√3	0.78	0.71	1.2	1.1	∞
Liquid Conductivity (Measured)	2.95	Normal	1	0.78	0.71	2.3	2.1	61
Liquid Permittivity (Temperature Uncertainty)	1.97	Rectangular	√3	0.23	0.26	0.3	0.3	∞
Liquid Permittivity (Measured)	3.04	Normal	1	0.23	0.26	0.7	0.8	47
<b>Combined Standard Uncertainty</b>						± 10.9 %	± 10.7 %	
<b>Expanded Uncertainty (K=2)</b>						± 21.8 %	± 21.4 %	

**Head SAR Uncertainty Budget for Frequency Range of 300 MHz to 3 GHz**

# SAR Test Report

Source of Uncertainty	Uncertainty (± %)	Probability Distribution	Divisor	Ci (1g)	Ci (10g)	Standard Uncertainty (± %, 1g)	Standard Uncertainty (± %, 10g)	Vi
<b>Measurement System</b>								
Probe Calibration	6.55	Normal	1	1	1	6.55	6.55	∞
Axial Isotropy	4.7	Rectangular	√3	0.7	0.7	1.9	1.9	∞
Hemispherical Isotropy	9.6	Rectangular	√3	0.7	0.7	3.9	3.9	∞
Boundary Effect	2.0	Rectangular	√3	1	1	1.2	1.2	∞
Linearity	4.7	Rectangular	√3	1	1	2.7	2.7	∞
Detection Limits	0.25	Rectangular	√3	1	1	0.14	0.14	∞
Probe Modulation Response	4.8	Rectangular	√3	1	1	2.8	2.8	∞
Readout Electronics	0.3	Normal	1	1	1	0.3	0.3	∞
Response Time	0.0	Rectangular	√3	1	1	0.0	0.0	∞
Integration Time	1.7	Rectangular	√3	1	1	1.0	1.0	∞
RF Ambient Conditions – Noise	3.0	Rectangular	√3	1	1	1.7	1.7	∞
RF Ambient Conditions – Reflections	3.0	Rectangular	√3	1	1	1.7	1.7	∞
Probe Positioner Mechanical Tolerance	0.04	Rectangular	√3	1	1	0.02	0.02	∞
Probe Positioning with Respect to Phantom	0.8	Rectangular	√3	1	1	0.5	0.5	∞
Post-processing	4.0	Rectangular	√3	1	1	2.3	2.3	∞
<b>Test Sample Related</b>								
Test Sample Positioning	2.82 / 1.60	Normal	1	1	1	2.8	1.6	35
Device Holder Uncertainty	2.55 / 2.76	Normal	1	1	1	2.6	2.8	7
Power Drift of Measurement	5.0	Rectangular	√3	1	1	2.9	2.9	∞
PowerScaling	0.0	Rectangular	√3	1	1	0.0	0.0	∞
<b>Phantom and Setup</b>								
Phantom Uncertainty (Shape and Thickness Tolerances)	6.2	Rectangular	√3	1	1	3.6	3.6	∞
Liquid Conductivity (Temperature Uncertainty)	2.58	Rectangular	√3	0.78	0.71	1.2	1.1	∞
Liquid Conductivity (Measured)	2.95	Normal	1	0.78	0.71	2.3	2.1	61
Liquid Permittivity (Temperature Uncertainty)	1.97	Rectangular	√3	0.23	0.26	0.3	0.3	∞
Liquid Permittivity (Measured)	3.04	Normal	1	0.23	0.26	0.7	0.8	47
<b>Combined Standard Uncertainty</b>						± 11.6 %	± 11.3 %	
<b>Expanded Uncertainty (K=2)</b>						± 23.2 %	± 22.6 %	

## Head SAR Uncertainty Budget for Frequency Range of 3 GHz to 6 GHz

# SAR Test Report

Source of Uncertainty	Uncertainty (± %)	Probability Distribution	Divisor	Ci (1g)	Ci (10g)	Standard Uncertainty (± %, 1g)	Standard Uncertainty (± %, 10g)	Vi
<b>Measurement System</b>								
Probe Calibration	6.0	Normal	1	1	1	6.0	6.0	∞
Axial Isotropy	4.7	Rectangular	√3	√0.5	√0.5	1.9	1.9	∞
Hemispherical Isotropy	9.6	Rectangular	√3	√0.5	√0.5	3.9	3.9	∞
Boundary Effect	1.0	Rectangular	√3	1	1	0.6	0.6	∞
Linearity	4.7	Rectangular	√3	1	1	2.7	2.7	∞
Detection Limits	0.25	Rectangular	√3	1	1	0.14	0.14	∞
Probe Modulation Response	4.8	Rectangular	√3	1	1	2.8	2.8	∞
Readout Electronics	0.3	Normal	1	1	1	0.3	0.3	∞
Response Time	0.0	Rectangular	√3	1	1	0.0	0.0	∞
Integration Time	1.7	Rectangular	√3	1	1	1.0	1.0	∞
RF Ambient Conditions – Noise	3.0	Rectangular	√3	1	1	1.7	1.7	∞
RF Ambient Conditions – Reflections	3.0	Rectangular	√3	1	1	1.7	1.7	∞
Probe Positioner Mechanical Tolerance	0.02	Rectangular	√3	1	1	0.01	0.01	∞
Probe Positioning with Respect to Phantom	0.4	Rectangular	√3	1	1	0.2	0.2	∞
Post-processing	2.0	Rectangular	√3	1	1	1.2	1.2	∞
<b>Test Sample Related</b>								
Test Sample Positioning	3.68 / 1.73	Normal	1	1	1	3.7	1.7	29
Device Holder Uncertainty	2.55 / 2.76	Normal	1	1	1	2.6	2.8	7
Power Drift of Measurement	5.0	Rectangular	√3	1	1	2.9	2.9	∞
PowerScaling	0.0	Rectangular	√3	1	1	0.0	0.0	∞
<b>Phantom and Setup</b>								
Phantom Uncertainty (Shape and Thickness Tolerances)	7.2	Rectangular	√3	1	1	4.2	4.2	∞
Liquid Conductivity (Temperature Uncertainty)	2.58	Rectangular	√3	0.78	0.71	1.2	1.1	∞
Liquid Conductivity (Measured)	2.95	Normal	1	0.78	0.71	2.3	2.1	61
Liquid Permittivity (Temperature Uncertainty)	1.97	Rectangular	√3	0.23	0.26	0.3	0.3	∞
Liquid Permittivity (Measured)	3.04	Normal	1	0.23	0.26	0.7	0.8	47
<b>Combined Standard Uncertainty</b>						± 11.5 %	± 11.0 %	
<b>Expanded Uncertainty (K=2)</b>						± 23.0 %	± 22.0 %	

## Body SAR Uncertainty Budget for Frequency Range of 300 MHz to 3 GHz

# SAR Test Report

Source of Uncertainty	Uncertainty (± %)	Probability Distribution	Divisor	Ci (1g)	Ci (10g)	Standard Uncertainty (± %, 1g)	Standard Uncertainty (± %, 10g)	Vi
<b>Measurement System</b>								
Probe Calibration	6.55	Normal	1	1	1	6.55	6.55	∞
Axial Isotropy	4.7	Rectangular	√3	0.7	0.7	1.9	1.9	∞
Hemispherical Isotropy	9.6	Rectangular	√3	0.7	0.7	3.9	3.9	∞
Boundary Effect	2.0	Rectangular	√3	1	1	1.2	1.2	∞
Linearity	4.7	Rectangular	√3	1	1	2.7	2.7	∞
Detection Limits	0.25	Rectangular	√3	1	1	0.14	0.14	∞
Probe Modulation Response	4.8	Rectangular	√3	1	1	2.8	2.8	∞
Readout Electronics	0.3	Normal	1	1	1	0.3	0.3	∞
Response Time	0.0	Rectangular	√3	1	1	0.0	0.0	∞
Integration Time	1.7	Rectangular	√3	1	1	1.0	1.0	∞
RF Ambient Conditions – Noise	3.0	Rectangular	√3	1	1	1.7	1.7	∞
RF Ambient Conditions – Reflections	3.0	Rectangular	√3	1	1	1.7	1.7	∞
Probe Positioner Mechanical Tolerance	0.04	Rectangular	√3	1	1	0.02	0.02	∞
Probe Positioning with Respect to Phantom	0.8	Rectangular	√3	1	1	0.5	0.5	∞
Post-processing	4.0	Rectangular	√3	1	1	2.3	2.3	∞
<b>Test Sample Related</b>								
Test Sample Positioning	3.68 / 1.73	Normal	1	1	1	3.7	1.7	29
Device Holder Uncertainty	2.55 / 2.76	Normal	1	1	1	2.6	2.8	7
Power Drift of Measurement	5.0	Rectangular	√3	1	1	2.9	2.9	∞
PowerScaling	0.0	Rectangular	√3	1	1	0.0	0.0	∞
<b>Phantom and Setup</b>								
Phantom Uncertainty (Shape and Thickness Tolerances)	7.6	Rectangular	√3	1	1	4.4	4.4	∞
Liquid Conductivity (Temperature Uncertainty)	2.58	Rectangular	√3	0.78	0.71	1.2	1.1	∞
Liquid Conductivity (Measured)	2.95	Normal	1	0.78	0.71	2.3	2.1	61
Liquid Permittivity (Temperature Uncertainty)	1.97	Rectangular	√3	0.23	0.26	0.3	0.3	∞
Liquid Permittivity (Measured)	3.04	Normal	1	0.23	0.26	0.7	0.8	47
<b>Combined Standard Uncertainty</b>						± 12.1 %	± 11.6 %	
<b>Expanded Uncertainty (K=2)</b>						± 24.2 %	± 23.2 %	

## Body SAR Uncertainty Budget for Frequency Range of 3 GHz to 6 GHz



### 7. Information of the Testing Laboratories

We, Bureau Veritas Consumer Products Services (H.K.) Ltd., Taoyuan Branch, were founded in 1988 to provide our best service in EMC, Radio, Telecom and Safety consultation. Our laboratories are accredited and approved according to ISO/IEC 17025.

If you have any comments, please feel free to contact us at the following:

**Taiwan Huaya Lab:**

Add: No. 19, Huaya 2nd Rd., Guishan Dist., Taoyuan City 333, Taiwan

Tel: +886-(0)3-318-3232

Fax: +886-(0)3-211-5834

**Taiwan Linkou Lab:**

Add: No. 47-2, Baodoucuokeng, Linkou Dist., New Taipei City 244, Taiwan

Tel: +886-(0)2-2605-2180

Fax: +886-(0)2-2605-2943

**Taiwan Hsinchu Lab1:**

Add: E-2, No. 1, Lixing 1st Rd., East Dist., Hsinchu City 300, Taiwan

Tel: +886-(0)3-666-8565

Fax: +886-(0)3-666-8323

**Taiwan Hsinchu Lab2:**

Add: No. 49, Ln. 206, Wende Rd., Qionglin Township, Hsinchu County 307, Taiwan

Tel: +886-(0)3-512-0595

Fax: +886-(0)3-512-0568

**Taiwan Xindian Lab:**

Add: B2F., No. 215, Sec. 3, Beixin Rd., Xindian Dist., New Taipei City 231, Taiwan

Tel: +886-(0)2-8914-5882

Fax: +886-(0)2-8914-5840

**Email:** [service.adt@tw.bureauveritas.com](mailto:service.adt@tw.bureauveritas.com)

**Web Site:** <https://ee.bureauveritas.com.tw/BVInternet/Default>

The road map of all our labs can be found in our web site also.

---END---

## Appendix A. SAR Plots of System Verification

The plots for system verification with largest deviation for each SAR system combination are shown as follows.

## System Check\_H2450\_201026

**DUT: Dipole 2450 MHz; Type: D2450V2; SN: 737**

Communication System: UID 0, CW; Frequency: 2450 MHz; Duty Cycle: 1:1  
Medium: H19T27N1\_1026 Medium parameters used (interpolated):  $f = 2450$  MHz;  $\sigma = 1.869$  S/m;  
 $\epsilon_r = 38.083$ ;  $\rho = 1000$  kg/m<sup>3</sup>  
Ambient Temperature : 23.8 °C; Liquid Temperature : 23.3 °C

DASY5 Configuration:

- Probe: EX3DV4 - SN7537; ConvF(7.4, 7.4, 7.4) @ 2450 MHz; Calibrated: 2020/05/29
- Sensor-Surface: 1.4mm (Mechanical Surface Detection)
- Electronics: DAE4 Sn1277; Calibrated: 2020/01/24
- Phantom: Twin-SAM V8.0\_1988; Type: QD 000 P41 AA;
- Measurement SW: DASY52, Version 52.10 (4); SEMCAD X Version 14.6.14 (7483)

**Pin=50mW/Area Scan (81x81x1):** Interpolated grid: dx=1.200 mm, dy=1.200 mm  
Maximum value of SAR (interpolated) = 2.88 W/kg

**Pin=50mW/Zoom Scan (7x7x7)/Cube 0:** Measurement grid: dx=5mm, dy=5mm, dz=5mm  
Reference Value = 39.95 V/m; Power Drift = 0.03 dB  
Peak SAR (extrapolated) = 3.53 W/kg  
**SAR(1 g) = 2.35 W/kg; SAR(10 g) = 1.15 W/kg** (SAR corrected for target medium)  
Maximum value of SAR (measured) = 2.85 W/kg

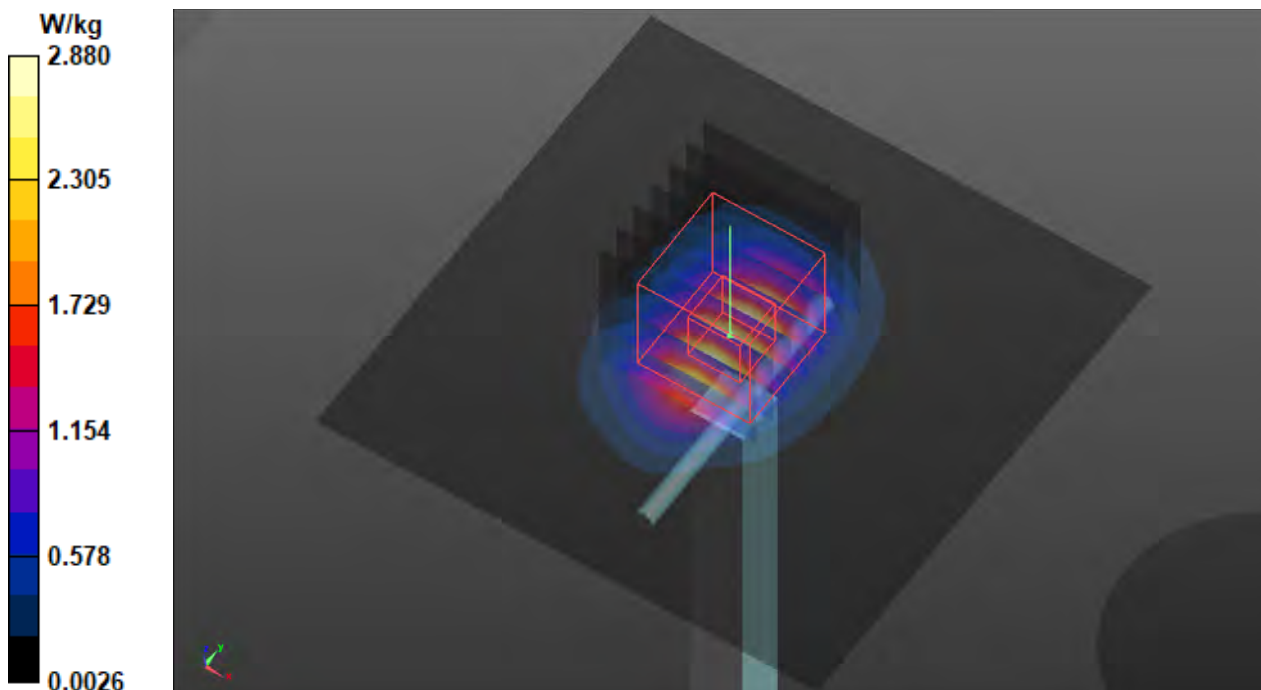

## System Check\_H5250\_201026

**DUT: Dipole 5 GHz; Type: D5GHzV2; SN: 1019**

Communication System: UID 0, CW; Frequency: 5250 MHz; Duty Cycle: 1:1  
Medium: H34T60N1\_1026 Medium parameters used (interpolated):  $f = 5250$  MHz;  $\sigma = 4.735$  S/m;  
 $\epsilon_r = 36.962$ ;  $\rho = 1000$  kg/m<sup>3</sup>  
Ambient Temperature : 23.7 °C; Liquid Temperature : 23.2 °C

DASY5 Configuration:

- Probe: EX3DV4 - SN7537; ConvF(5.35, 5.35, 5.35) @ 5250 MHz; Calibrated: 2020/05/29
- Sensor-Surface: 1.4mm (Mechanical Surface Detection)
- Electronics: DAE4 Sn1277; Calibrated: 2020/01/24
- Phantom: Twin-SAM V8.0\_1988; Type: QD 000 P41 AA;
- Measurement SW: DASY52, Version 52.10 (4); SEMCAD X Version 14.6.14 (7483)

**Pin=50mW/Area Scan (91x91x1):** Interpolated grid: dx=1.000 mm, dy=1.000 mm  
Maximum value of SAR (interpolated) = 8.02 W/kg

**Pin=50mW/Zoom Scan (7x7x7)/Cube 0:** Measurement grid: dx=4mm, dy=4mm, dz=1.4mm  
Reference Value = 46.12 V/m; Power Drift = -0.02 dB  
Peak SAR (extrapolated) = 13.2 W/kg  
**SAR(1 g) = 3.62 W/kg; SAR(10 g) = 1.04 W/kg** (SAR corrected for target medium)  
Maximum value of SAR (measured) = 8.57 W/kg

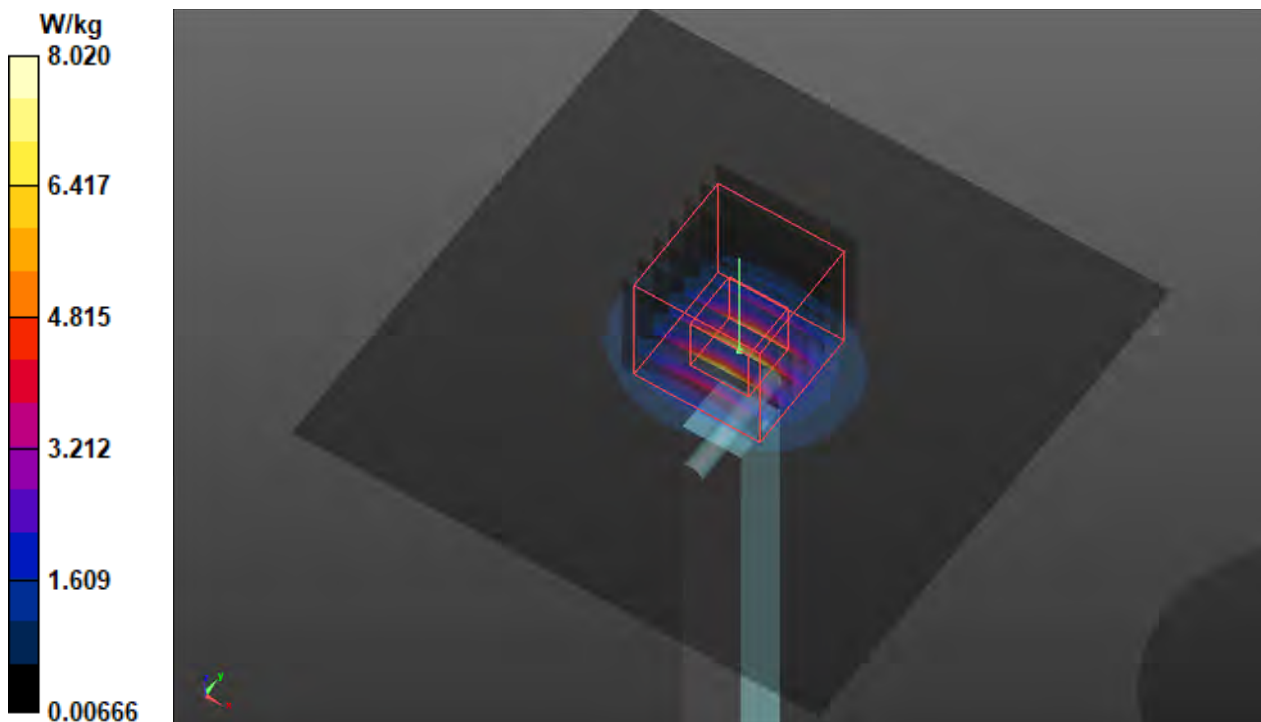

## System Check\_H5600\_201027

**DUT: Dipole 5 GHz; Type: D5GHzV2; SN: 1019**

Communication System: UID 0, CW; Frequency: 5600 MHz; Duty Cycle: 1:1

Medium: H34T60N1\_1027 Medium parameters used:  $f = 5600$  MHz;  $\sigma = 5.17$  S/m;  $\epsilon_r = 34.876$ ;  $\rho = 1000$  kg/m<sup>3</sup>

Ambient Temperature : 23.7 °C; Liquid Temperature : 23.2 °C

DASY5 Configuration:

- Probe: EX3DV4 - SN7537; ConvF(4.7, 4.7, 4.7) @ 5600 MHz; Calibrated: 2020/05/29
- Sensor-Surface: 1.4mm (Mechanical Surface Detection)
- Electronics: DAE4 Sn1277; Calibrated: 2020/01/24
- Phantom: Twin-SAM V8.0\_1988; Type: QD 000 P41 AA;
- Measurement SW: DASY52, Version 52.10 (4); SEMCAD X Version 14.6.14 (7483)

**Pin=50mW/Area Scan (91x91x1):** Interpolated grid: dx=1.000 mm, dy=1.000 mm  
Maximum value of SAR (interpolated) = 9.08 W/kg

**Pin=50mW/Zoom Scan (7x7x7)/Cube 0:** Measurement grid: dx=4mm, dy=4mm, dz=1.4mm  
Reference Value = 47.04 V/m; Power Drift = -0.03 dB

Peak SAR (extrapolated) = 15.7 W/kg

**SAR(1 g) = 3.8 W/kg; SAR(10 g) = 1.11 W/kg** (SAR corrected for target medium)

Maximum value of SAR (measured) = 9.74 W/kg

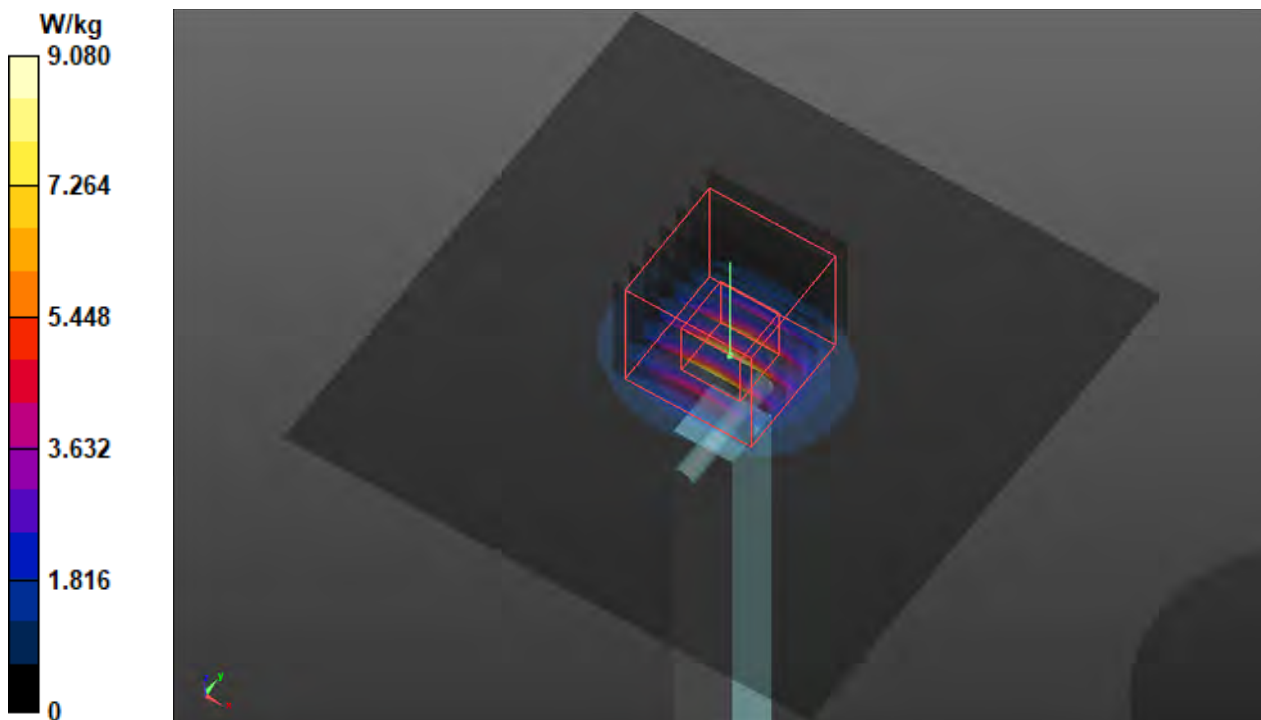

## System Check\_H5750\_201026

**DUT: Dipole 5 GHz; Type: D5GHzV2; SN: 1019**

Communication System: UID 0, CW; Frequency: 5750 MHz; Duty Cycle: 1:1

Medium: H34T60N1\_1026 Medium parameters used:  $f = 5750$  MHz;  $\sigma = 5.249$  S/m;  $\epsilon_r = 36.271$ ;  $\rho = 1000$  kg/m<sup>3</sup>

Ambient Temperature : 23.8 °C; Liquid Temperature : 23.3 °C

DASY5 Configuration:

- Probe: EX3DV4 - SN7537; ConvF(4.95, 4.95, 4.95) @ 5750 MHz; Calibrated: 2020/05/29
- Sensor-Surface: 1.4mm (Mechanical Surface Detection)
- Electronics: DAE4 Sn1277; Calibrated: 2020/01/24
- Phantom: Twin-SAM V8.0\_1988; Type: QD 000 P41 AA;
- Measurement SW: DASY52, Version 52.10 (4); SEMCAD X Version 14.6.14 (7483)

**Pin=50mW/Area Scan (91x91x1):** Interpolated grid: dx=1.000 mm, dy=1.000 mm

Maximum value of SAR (interpolated) = 7.62 W/kg

**Pin=50mW/Zoom Scan (7x7x7)/Cube 0:** Measurement grid: dx=4mm, dy=4mm, dz=1.4mm

Reference Value = 41.74 V/m; Power Drift = -0.16 dB

Peak SAR (extrapolated) = 13.3 W/kg

**SAR(1 g) = 3.63 W/kg; SAR(10 g) = 1.05 W/kg** (SAR corrected for target medium)

Maximum value of SAR (measured) = 7.92 W/kg

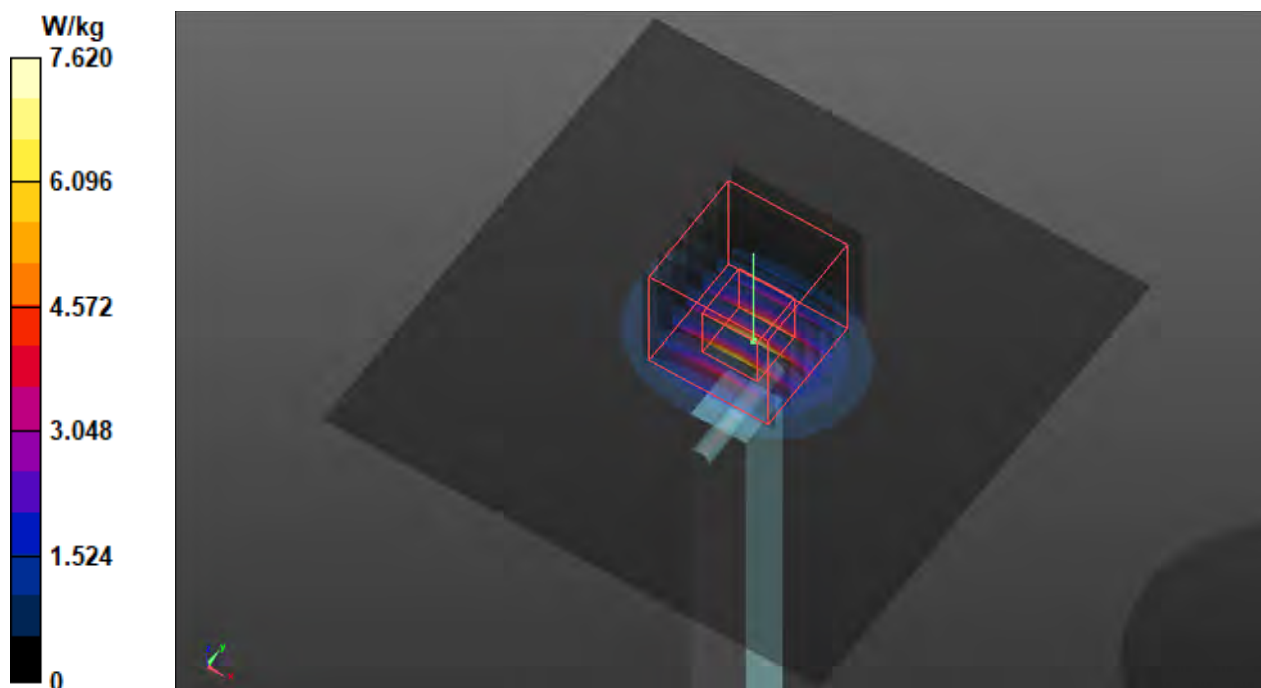

## System Check\_H2450\_201024

**DUT: Dipole 2450 MHz; Type: D2450V2; SN: 737**

Communication System: UID 0, CW; Frequency: 2450 MHz; Duty Cycle: 1:1

Medium: H19T27N1\_1024 Medium parameters used (interpolated):  $f = 2450$  MHz;  $\sigma = 1.873$  S/m;  $\epsilon_r = 38.311$ ;  $\rho = 1000$  kg/m<sup>3</sup>

Ambient Temperature : 23.5°C; Liquid Temperature : 23.1°C

DASY5 Configuration:

- Probe: EX3DV4 - SN7537; ConvF(7.4, 7.4, 7.4) @ 2450 MHz; Calibrated: 2020/05/29
- Sensor-Surface: 1.4mm (Mechanical Surface Detection)
- Electronics: DAE4 Sn1277; Calibrated: 2020/01/24
- Phantom: Twin-SAM V8.0\_1988; Type: QD 000 P41 AA;
- Measurement SW: DASY52, Version 52.10 (4); SEMCAD X Version 14.6.14 (7483)

**Pin=50mW/Area Scan (81x81x1):** Interpolated grid: dx=1.200 mm, dy=1.200 mm  
Maximum value of SAR (interpolated) = 3.94 W/kg

**Pin=50mW/Zoom Scan (7x7x7)/Cube 0:** Measurement grid: dx=5mm, dy=5mm, dz=5mm

Reference Value = 47.17 V/m; Power Drift = -0.16 dB

Peak SAR (extrapolated) = 4.79 W/kg

**SAR(1 g) = 2.33 W/kg; SAR(10 g) = 1.12 W/kg** (SAR corrected for target medium)

Maximum value of SAR (measured) = 3.91 W/kg

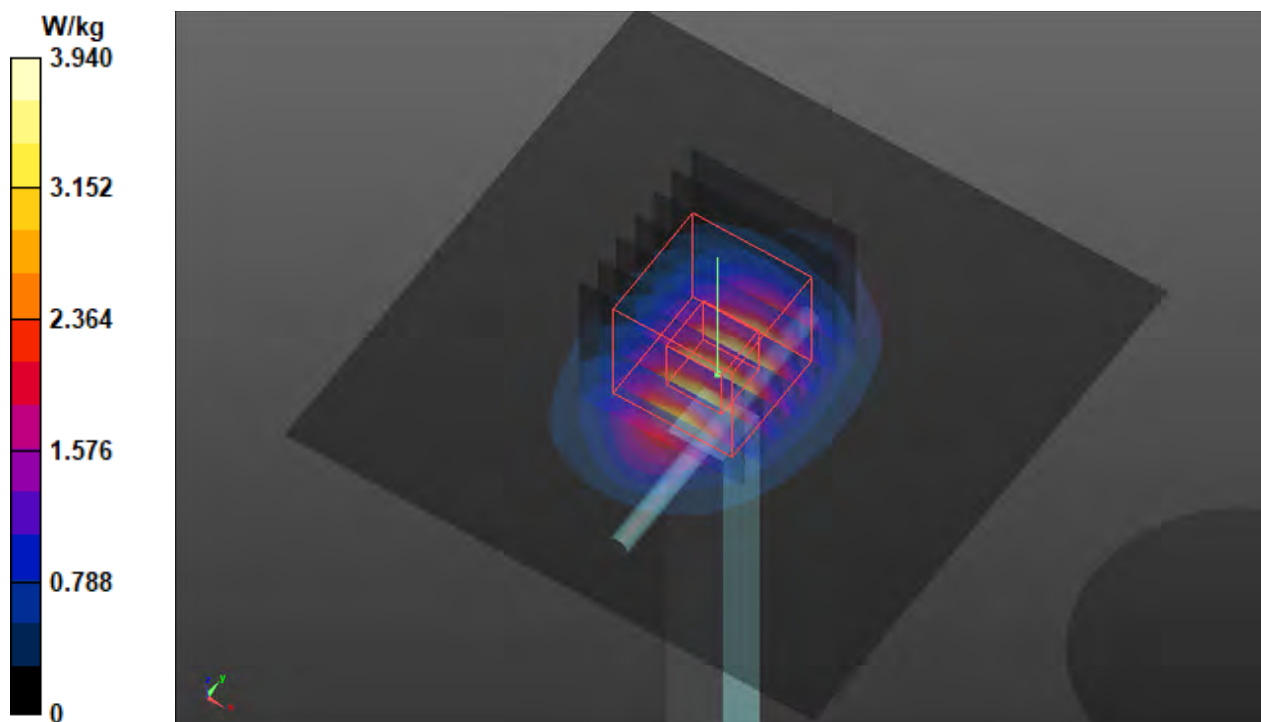



## System Check\_H5250\_201029

**DUT: Dipole 5 GHz; Type: D5GHzV2; SN: 1019**

Communication System: UID 0, CW; Frequency: 5250 MHz; Duty Cycle: 1:1

Medium: H34T60N1\_1029 Medium parameters used:  $f = 5250$  MHz;  $\sigma = 4.828$  S/m;  $\epsilon_r = 36.023$ ;  $\rho = 1000$  kg/m<sup>3</sup>

Ambient Temperature : 23.8 °C; Liquid Temperature : 23.3 °C

DASY5 Configuration:

- Probe: EX3DV4 - SN3820; ConvF(4.75, 4.75, 4.75) @ 5250 MHz; Calibrated: 2020/06/25
- Sensor-Surface: 1.4mm (Mechanical Surface Detection)
- Electronics: DAE4 Sn1431; Calibrated: 2020/03/18
- Phantom: Twin-SAM V8.0\_1988; Type: QD 000 P41 AA;
- Measurement SW: DASY52, Version 52.10 (4); SEMCAD X Version 14.6.14 (7483)

**Pin=50mW/Area Scan (91x91x1):** Interpolated grid: dx=1.000 mm, dy=1.000 mm

Maximum value of SAR (interpolated) = 8.80 W/kg

**Pin=50mW/Zoom Scan (7x7x7)/Cube 0:** Measurement grid: dx=4mm, dy=4mm, dz=1.4mm

Reference Value = 48.41 V/m; Power Drift = -0.00 dB

Peak SAR (extrapolated) = 15.4 W/kg

**SAR(1 g) = 3.78 W/kg; SAR(10 g) = 1.05 W/kg** (SAR corrected for target medium)

Maximum value of SAR (measured) = 9.59 W/kg

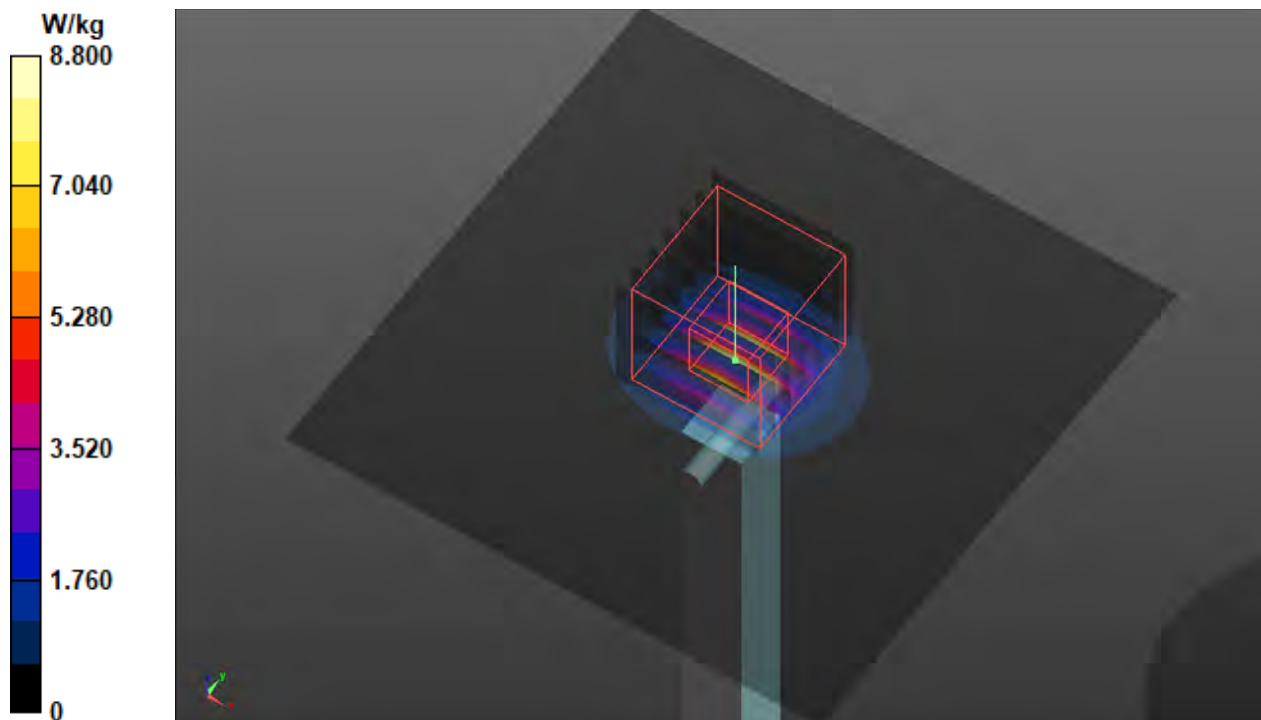

## System Check\_H5600\_201024

**DUT: Dipole 5 GHz; Type: D5GHzV2; SN: 1019**

Communication System: UID 0, CW; Frequency: 5600 MHz; Duty Cycle: 1:1

Medium: H34T60N1\_1024 Medium parameters used:  $f = 5600$  MHz;  $\sigma = 5.278$  S/m;  $\epsilon_r = 36.522$ ;  $\rho = 1000$  kg/m<sup>3</sup>

Ambient Temperature : 23.5°C; Liquid Temperature : 23.1°C

DASY5 Configuration:

- Probe: EX3DV4 - SN7537; ConvF(4.7, 4.7, 4.7) @ 5600 MHz; Calibrated: 2020/05/29
- Sensor-Surface: 1.4mm (Mechanical Surface Detection)
- Electronics: DAE4 Sn1277; Calibrated: 2020/01/24
- Phantom: Twin-SAM V8.0\_1988; Type: QD 000 P41 AA;
- Measurement SW: DASY52, Version 52.10 (4); SEMCAD X Version 14.6.14 (7483)

**Pin=50mW/Area Scan (91x91x1):** Interpolated grid: dx=1.000 mm, dy=1.000 mm  
Maximum value of SAR (interpolated) = 10.6 W/kg

**Pin=50mW/Zoom Scan (7x7x7)/Cube 0:** Measurement grid: dx=4mm, dy=4mm, dz=1.4mm  
Reference Value = 48.20 V/m; Power Drift = 0.02 dB

Peak SAR (extrapolated) = 19.8 W/kg

**SAR(1 g) = 4.56 W/kg; SAR(10 g) = 1.28 W/kg** (SAR corrected for target medium)

Maximum value of SAR (measured) = 11.0 W/kg

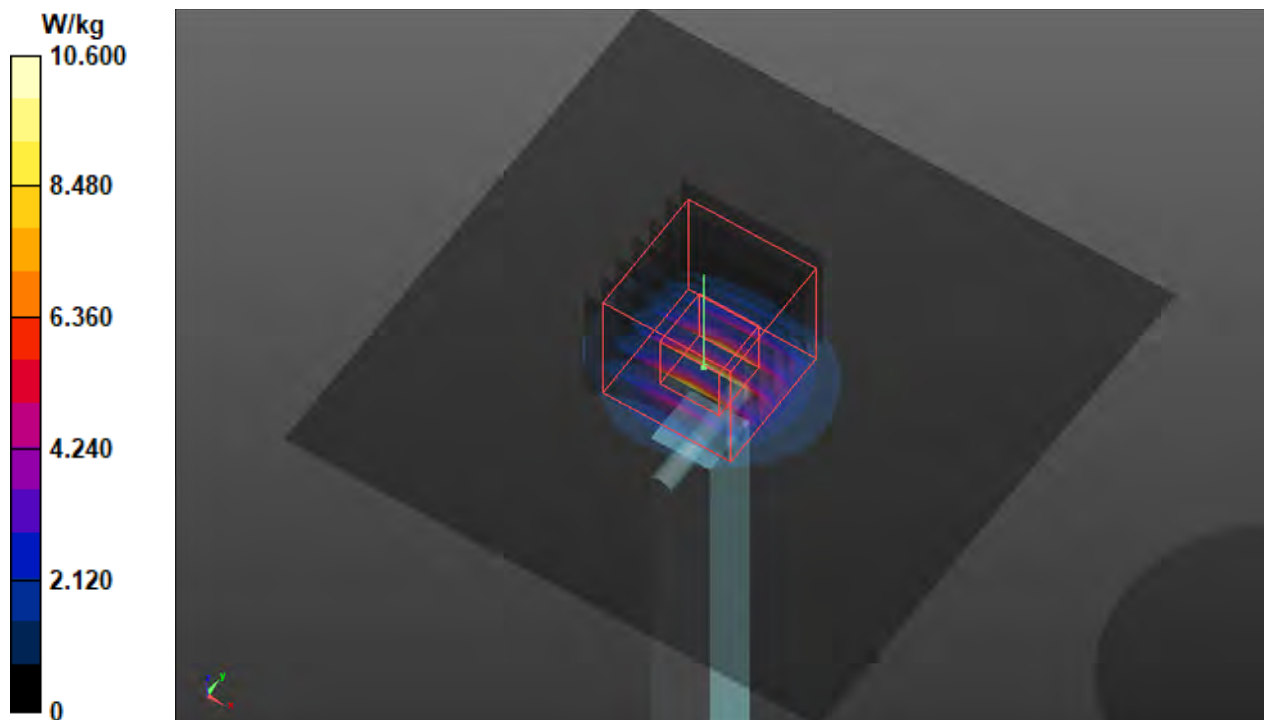

## System Check\_H5750\_201028

**DUT: Dipole 5 GHz; Type: D5GHzV2; SN: 1019**

Communication System: UID 0, CW; Frequency: 5750 MHz; Duty Cycle: 1:1

Medium: H34T60N1\_1028 Medium parameters used:  $f = 5750$  MHz;  $\sigma = 5.315$  S/m;  $\epsilon_r = 34.934$ ;  $\rho = 1000$  kg/m<sup>3</sup>

Ambient Temperature : 23.8 °C; Liquid Temperature : 23.3 °C

DASY5 Configuration:

- Probe: EX3DV4 - SN3820; ConvF(4.4, 4.4, 4.4) @ 5750 MHz; Calibrated: 2020/06/25
- Sensor-Surface: 1.4mm (Mechanical Surface Detection)
- Electronics: DAE4 Sn1431; Calibrated: 2020/03/18
- Phantom: Twin-SAM V8.0\_1988; Type: QD 000 P41 AA;
- Measurement SW: DASY52, Version 52.10 (4); SEMCAD X Version 14.6.14 (7483)

**Pin=50mW/Area Scan (91x91x1):** Interpolated grid: dx=1.000 mm, dy=1.000 mm  
Maximum value of SAR (interpolated) = 8.61 W/kg

**Pin=50mW/Zoom Scan (7x7x7)/Cube 0:** Measurement grid: dx=4mm, dy=4mm, dz=1.4mm  
Reference Value = 45.26 V/m; Power Drift = -0.01 dB

Peak SAR (extrapolated) = 16.5 W/kg

**SAR(1 g) = 3.63 W/kg; SAR(10 g) = 1.05 W/kg** (SAR corrected for target medium)

Maximum value of SAR (measured) = 9.44 W/kg

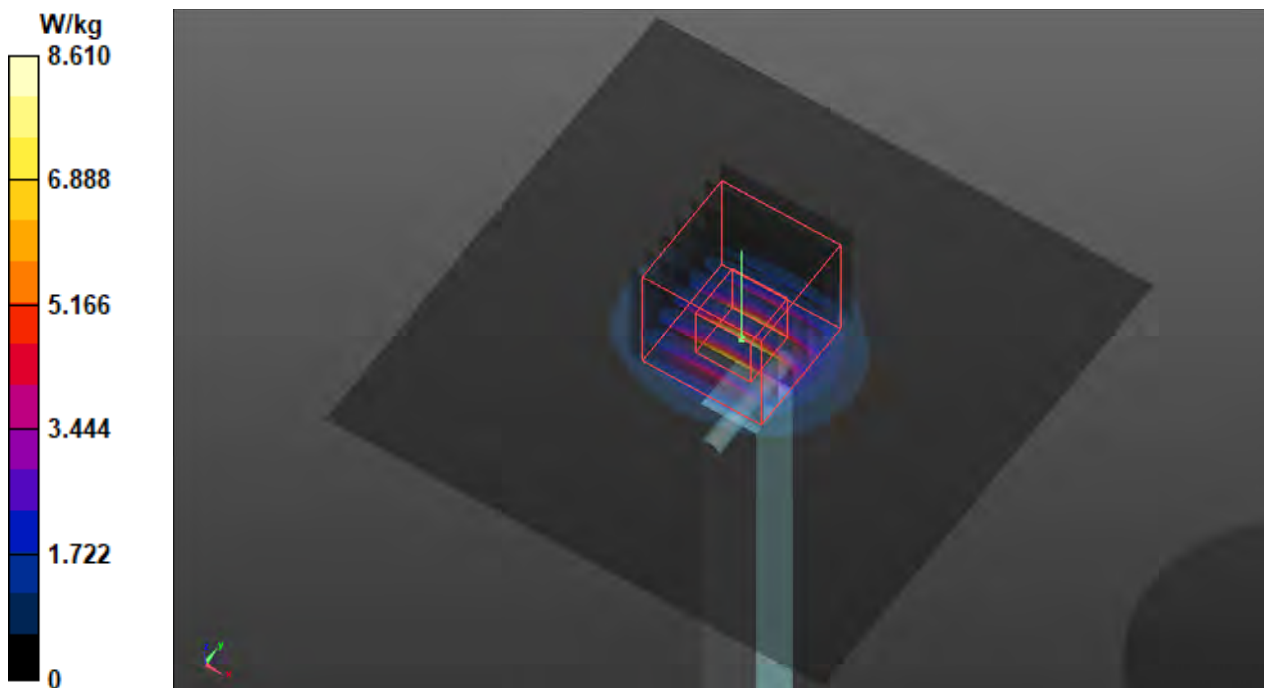

## Appendix B. SAR Plots of SAR Measurement

The SAR plots for highest measured SAR in each exposure configuration, wireless mode and frequency band combination, and measured SAR > 1.5 W/kg are shown as follows.

## P01 WLAN2.4G\_802.11b\_Right Tilted\_Ch6\_Ant 0+1\_Battery1

**DUT: 200825C05**

Communication System: UID 10012 - CAB, IEEE 802.11b WiFi 2.4 GHz (DSSS, 1 Mbps);  
Frequency: 2437 MHz; Duty Cycle: 1:1.01  
Medium: H19T27N1\_1025 Medium parameters used (interpolated):  $f = 2437$  MHz;  $\sigma = 1.849$  S/m;  
 $\epsilon_r = 39.22$ ;  $\rho = 1000$  kg/m<sup>3</sup>  
Ambient Temperature : 23.7 °C; Liquid Temperature : 23.1 °C

### DASY5 Configuration:

- Probe: EX3DV4 - SN7537; ConvF(7.4, 7.4, 7.4) @ 2437 MHz; Calibrated: 2020/05/29
- Sensor-Surface: 1.4mm (Mechanical Surface Detection)
- Electronics: DAE4 Sn1277; Calibrated: 2020/01/24
- Phantom: Twin-SAM V8.0\_1988; Type: QD 000 P41 AA;
- Measurement SW: DASY52, Version 52.10 (4); SEMCAD X Version 14.6.14 (7483)

**Area Scan (91x171x1):** Interpolated grid: dx=1.200 mm, dy=1.200 mm  
Maximum value of SAR (interpolated) = 0.749 W/kg

**Zoom Scan (7x7x7)/Cube 0:** Measurement grid: dx=5mm, dy=5mm, dz=5mm  
Reference Value = 21.18 V/m; Power Drift = -0.03 dB  
Peak SAR (extrapolated) = 0.898 W/kg  
**SAR(1 g) = 0.510 W/kg; SAR(10 g) = 0.270 W/kg** (SAR corrected for target medium)  
Smallest distance from peaks to all points 3 dB below = 11.7 mm  
Ratio of SAR at M2 to SAR at M1 = 58.6%  
Maximum value of SAR (measured) = 0.762 W/kg

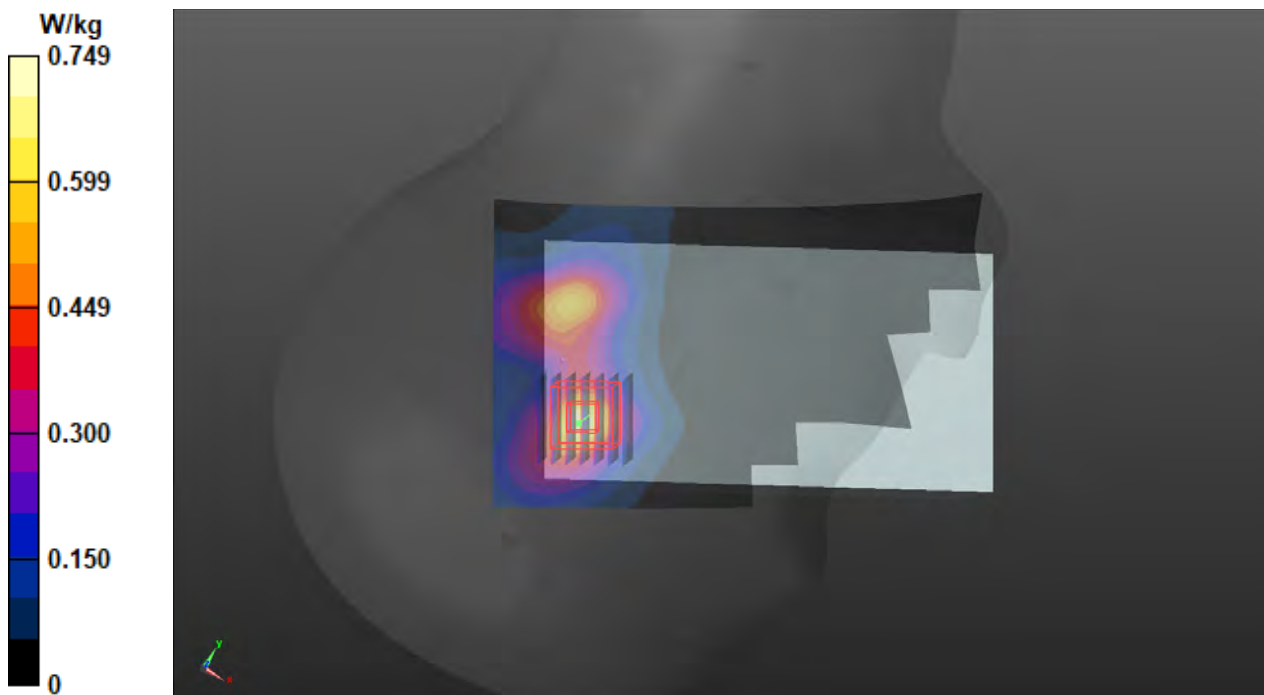

## P02 WLAN5.2G\_802.11n HT40\_Left Cheek\_Ch46\_Ant 0+1\_Battery1

**DUT: 200825C05**

Communication System: UID 10599 - AAC, IEEE 802.11n (HT Mixed, 40MHz, MCS0);

Frequency: 5230 MHz; Duty Cycle: 1:1.13

Medium: H34T60N1\_1024 Medium parameters used:  $f = 5230$  MHz;  $\sigma = 4.818$  S/m;  $\epsilon_r = 37.054$ ;  $\rho = 1000$  kg/m<sup>3</sup>

Ambient Temperature : 23.5°C; Liquid Temperature : 23.1°C

DASY5 Configuration:

- Probe: EX3DV4 - SN7537; ConvF(5.35, 5.35, 5.35) @ 5230 MHz; Calibrated: 2020/05/29
- Sensor-Surface: 1.4mm (Mechanical Surface Detection)
- Electronics: DAE4 Sn1277; Calibrated: 2020/01/24
- Phantom: Twin-SAM V8.0\_1988; Type: QD 000 P41 AA;
- Measurement SW: DASY52, Version 52.10 (4); SEMCAD X Version 14.6.14 (7483)

**Area Scan (111x201x1):** Interpolated grid: dx=1.000 mm, dy=1.000 mm

Maximum value of SAR (interpolated) = 1.46 W/kg

**Zoom Scan (7x7x7)/Cube 0:** Measurement grid: dx=4mm, dy=4mm, dz=1.4mm

Reference Value = 19.12 V/m; Power Drift = -0.12 dB

Peak SAR (extrapolated) = 2.31 W/kg

**SAR(1 g) = 0.784 W/kg; SAR(10 g) = 0.307 W/kg** (SAR corrected for target medium)

Smallest distance from peaks to all points 3 dB below = 8.5 mm

Ratio of SAR at M2 to SAR at M1 = 70.4%

Maximum value of SAR (measured) = 1.63 W/kg

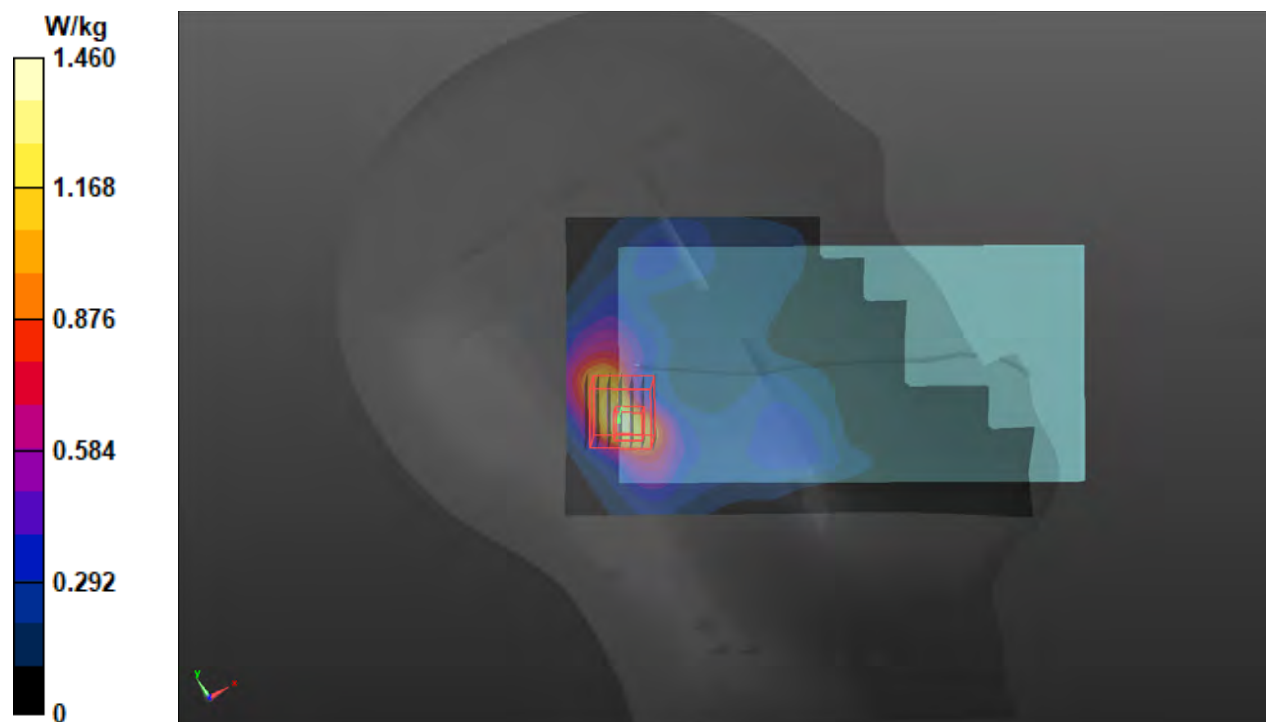

### P03 WLAN5.6G\_802.11n HT40\_Left Tilted\_Ch110\_Ant 0\_Battery1

**DUT: 200825C05**

Communication System: UID 10599 - AAC, IEEE 802.11n (HT Mixed, 40MHz, MCS0);  
Frequency: 5550 MHz; Duty Cycle: 1:1.14  
Medium: H34T60N1\_1025 Medium parameters used:  $f = 5550$  MHz;  $\sigma = 5.112$  S/m;  $\epsilon_r = 34.792$ ;  $\rho = 1000$  kg/m<sup>3</sup>  
Ambient Temperature : 23.7 °C; Liquid Temperature : 23.1 °C

**DASY5 Configuration:**

- Probe: EX3DV4 - SN7537; ConvF(4.7, 4.7, 4.7) @ 5550 MHz; Calibrated: 2020/05/29
- Sensor-Surface: 1.4mm (Mechanical Surface Detection)
- Electronics: DAE4 Sn1277; Calibrated: 2020/01/24
- Phantom: Twin-SAM V8.0\_1988; Type: QD 000 P41 AA;
- Measurement SW: DASY52, Version 52.10 (4); SEMCAD X Version 14.6.14 (7483)

**Area Scan (111x201x1):** Interpolated grid: dx=1.000 mm, dy=1.000 mm  
Maximum value of SAR (interpolated) = 1.92 W/kg

**Zoom Scan (7x7x7)/Cube 0:** Measurement grid: dx=4mm, dy=4mm, dz=1.4mm  
Reference Value = 16.01 V/m; Power Drift = 0.16 dB  
Peak SAR (extrapolated) = 3.30 W/kg  
**SAR(1 g) = 1.01 W/kg; SAR(10 g) = 0.381 W/kg** (SAR corrected for target medium)  
Smallest distance from peaks to all points 3 dB below = 9 mm  
Ratio of SAR at M2 to SAR at M1 = 69%  
Maximum value of SAR (measured) = 2.24 W/kg

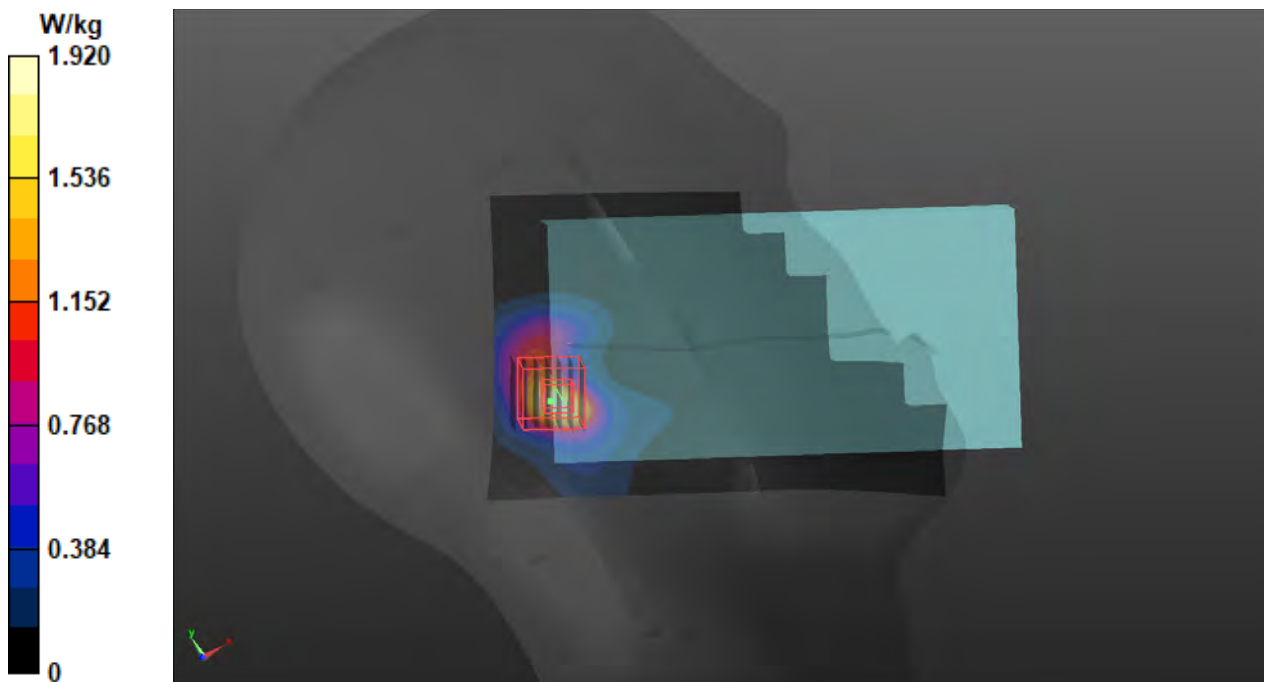



## P04 WLAN5.8G\_802.11ac VHT80\_Left Cheek\_Ch155\_Ant0\_Battery1

**DUT: 200825C05**

Communication System: UID 10544 - AAC, IEEE 802.11ac WiFi (80MHz, MCS0); Frequency: 5775 MHz; Duty Cycle: 1:1.19

Medium: H34T60N1\_1025 Medium parameters used:  $f = 5775$  MHz;  $\sigma = 5.354$  S/m;  $\epsilon_r = 34.336$ ;  $\rho = 1000$  kg/m<sup>3</sup>

Ambient Temperature : 23.7 °C; Liquid Temperature : 23.1 °C

DASY5 Configuration:

- Probe: EX3DV4 - SN7537; ConvF(4.95, 4.95, 4.95) @ 5775 MHz; Calibrated: 2020/05/29
- Sensor-Surface: 1.4mm (Mechanical Surface Detection)
- Electronics: DAE4 Sn1277; Calibrated: 2020/01/24
- Phantom: Twin-SAM V8.0\_1988; Type: QD 000 P41 AA;
- Measurement SW: DASY52, Version 52.10 (4); SEMCAD X Version 14.6.14 (7483)

**Area Scan (111x201x1):** Interpolated grid: dx=1.000 mm, dy=1.000 mm

Maximum value of SAR (interpolated) = 0.793 W/kg

**Zoom Scan (7x7x7)/Cube 0:** Measurement grid: dx=4mm, dy=4mm, dz=1.4mm

Reference Value = 9.591 V/m; Power Drift = 0.15 dB

Peak SAR (extrapolated) = 1.33 W/kg

**SAR(1 g) = 0.393 W/kg; SAR(10 g) = 0.141 W/kg** (SAR corrected for target medium)

Smallest distance from peaks to all points 3 dB below = 9 mm

Ratio of SAR at M2 to SAR at M1 = 67.9%

Maximum value of SAR (measured) = 0.862 W/kg

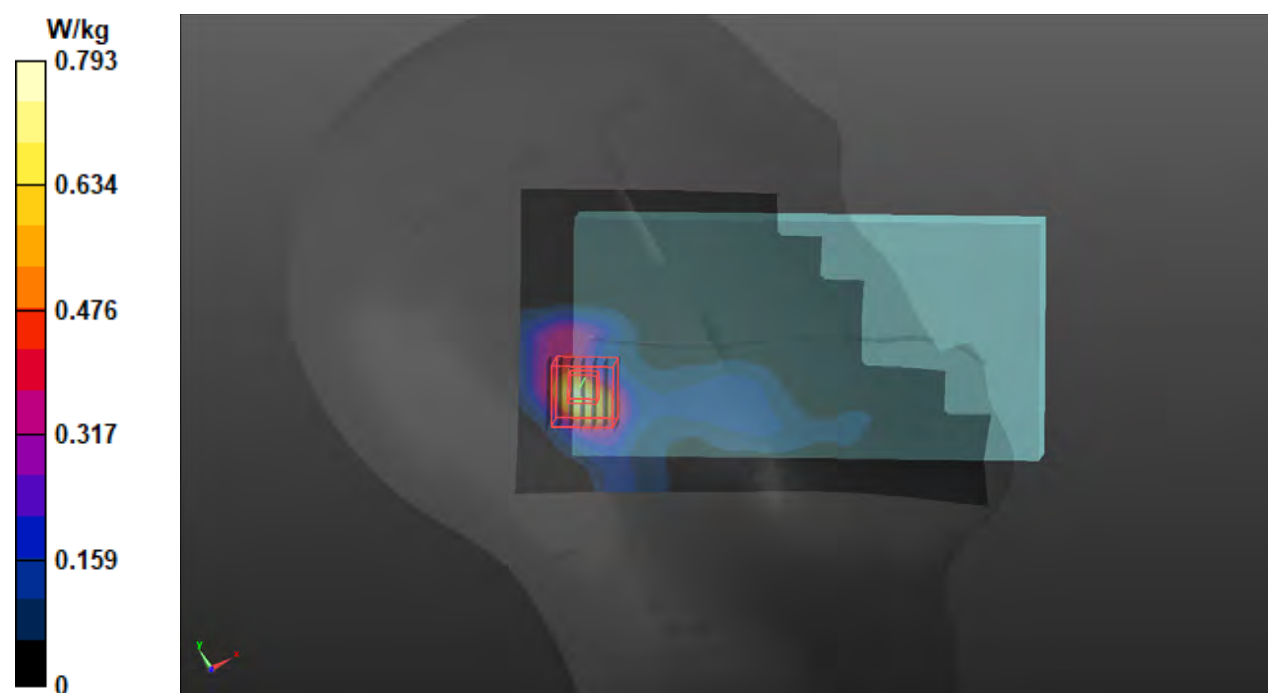

### P05 BT\_BR EDR\_Right Cheek\_Ch39\_Ant 0\_Battery1

**DUT: 200825C05**

Communication System: UID 10032 - CAA, IEEE 802.15.1 Bluetooth (GFSK, DH5); Frequency: 2441 MHz; Duty Cycle: 1:1.3  
Medium: H19T27N1\_1028 Medium parameters used (interpolated):  $f = 2441$  MHz;  $\sigma = 1.838$  S/m;  $\epsilon_r = 37.887$ ;  $\rho = 1000$  kg/m<sup>3</sup>  
Ambient Temperature : 23.8 °C; Liquid Temperature : 23.3 °C

**DASY5 Configuration:**

- Probe: EX3DV4 - SN3820; ConvF(6.85, 6.85, 6.85) @ 2441 MHz; Calibrated: 2020/06/25
- Sensor-Surface: 1.4mm (Mechanical Surface Detection)
- Electronics: DAE4 Sn1431; Calibrated: 2020/03/18
- Phantom: Twin-SAM V8.0\_1988; Type: QD 000 P41 AA;
- Measurement SW: DASY52, Version 52.10 (4); SEMCAD X Version 14.6.14 (7483)

**Area Scan (101x171x1):** Interpolated grid: dx=1.200 mm, dy=1.200 mm  
Maximum value of SAR (interpolated) = 0.00624 W/kg

**Zoom Scan (7x7x7)/Cube 0:** Measurement grid: dx=5mm, dy=5mm, dz=5mm  
Reference Value = 1.751 V/m; Power Drift = 0.13 dB  
Peak SAR (extrapolated) = 0.00837 W/kg  
**SAR(1 g) = 0.00491 W/kg; SAR(10 g) = 0.00225 W/kg** (SAR corrected for target medium)  
Smallest distance from peaks to all points 3 dB below: Larger than measurement grid  
Ratio of SAR at M2 to SAR at M1 = 66.8%  
Maximum value of SAR (measured) = 0.00762 W/kg

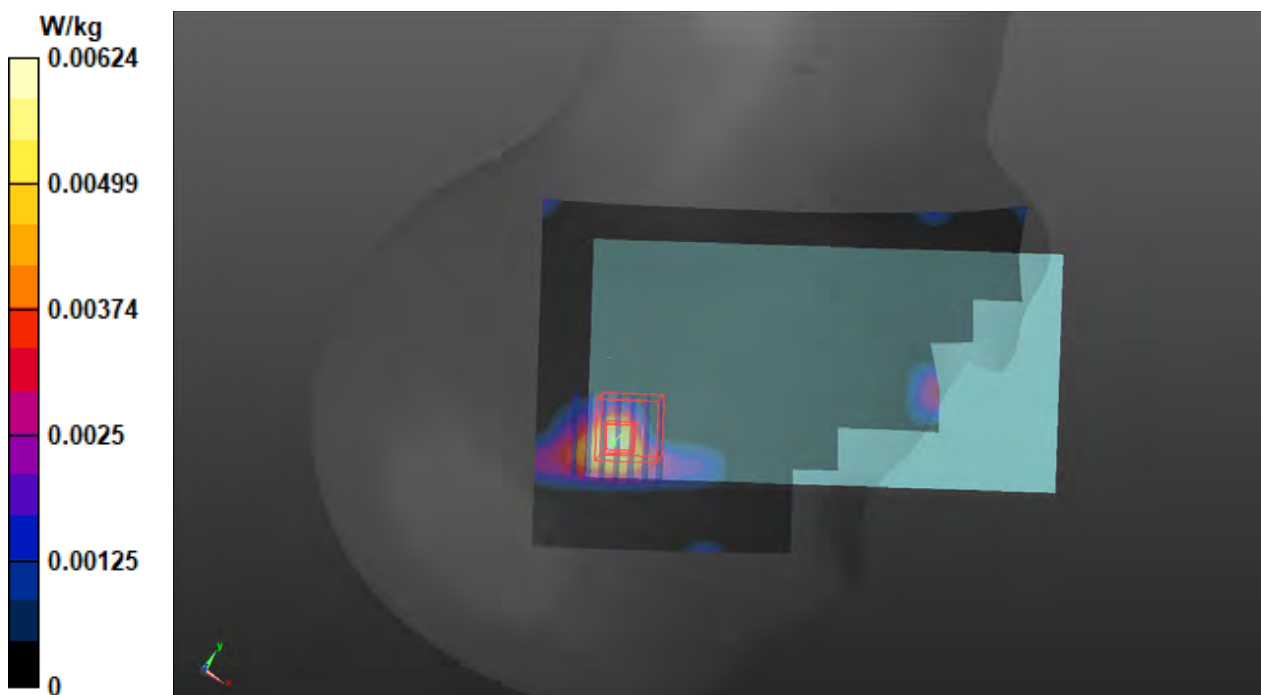

## P06 WLAN2.4G\_802.11b\_Front Face\_15mm\_Ch6\_Ant 0+1\_Battery1

**DUT: 200825C05**

Communication System: UID 10012 - CAB, IEEE 802.11b WiFi 2.4 GHz (DSSS, 1 Mbps);

Frequency: 2437 MHz; Duty Cycle: 1:1.01

Medium: H19T27N1\_1026 Medium parameters used (interpolated):  $f = 2437$  MHz;  $\sigma = 1.853$  S/m;

$\epsilon_r = 38.127$ ;  $\rho = 1000$  kg/m<sup>3</sup>

Ambient Temperature : 23.7 °C; Liquid Temperature : 23.2 °C

DASY5 Configuration:

- Probe: EX3DV4 - SN7537; ConvF(7.4, 7.4, 7.4) @ 2437 MHz; Calibrated: 2020/05/29

- Sensor-Surface: 1.4mm (Mechanical Surface Detection)

- Electronics: DAE4 Sn1277; Calibrated: 2020/01/24

- Phantom: Twin-SAM V8.0\_1988; Type: QD 000 P41 AA;

- Measurement SW: DASY52, Version 52.10 (4); SEMCAD X Version 14.6.14 (7483)

**Area Scan (101x181x1):** Interpolated grid: dx=1.200 mm, dy=1.200 mm

Maximum value of SAR (interpolated) = 0.299 W/kg

**Zoom Scan (7x7x7)/Cube 0:** Measurement grid: dx=5mm, dy=5mm, dz=5mm

Reference Value = 12.65 V/m; Power Drift = -0.08 dB

Peak SAR (extrapolated) = 0.337 W/kg

**SAR(1 g) = 0.192 W/kg; SAR(10 g) = 0.110 W/kg** (SAR corrected for target medium)

Smallest distance from peaks to all points 3 dB below = 15.2 mm

Ratio of SAR at M2 to SAR at M1 = 57.4%

Maximum value of SAR (measured) = 0.288 W/kg

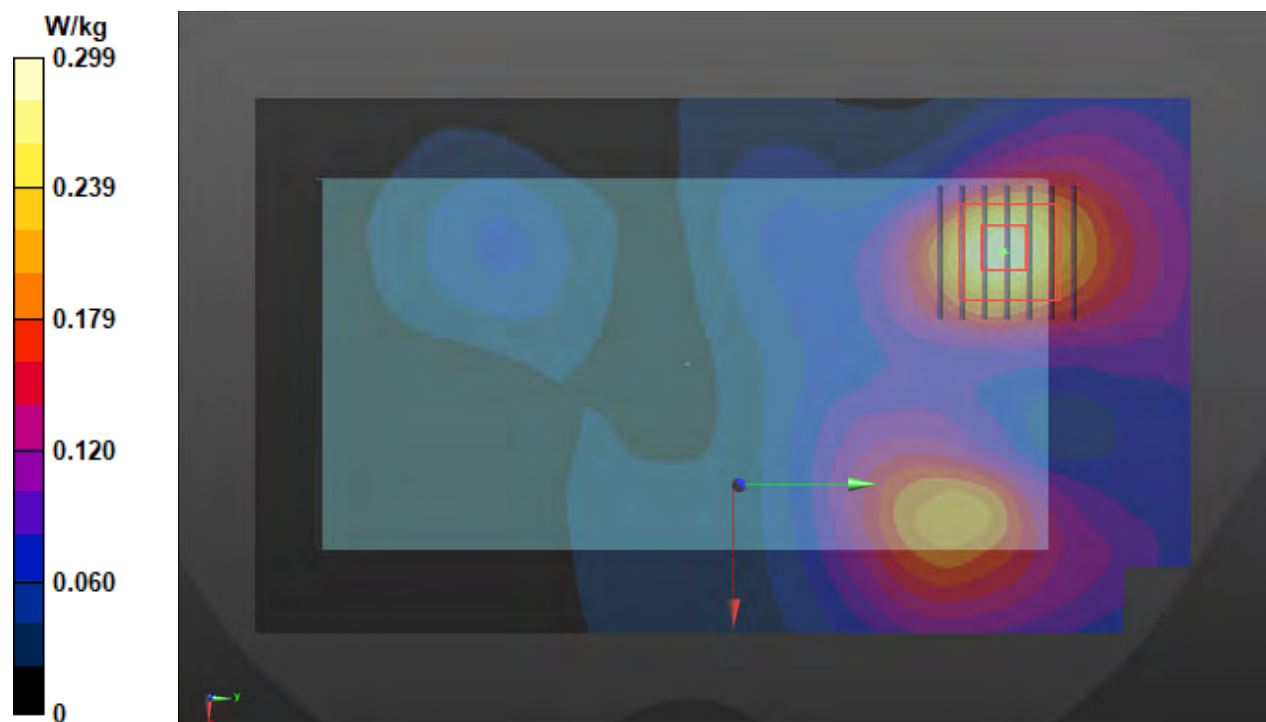

# P07 WLAN5.2G\_802.11n HT40\_Rear Face\_15mm\_Ch46\_Ant 0+1\_Battery1

**DUT: 200825C05**

Communication System: UID 10599 - AAC, IEEE 802.11n (HT Mixed, 40MHz, MCS0);  
Frequency: 5230 MHz; Duty Cycle: 1:1.13  
Medium: H34T60N1\_1026 Medium parameters used:  $f = 5230$  MHz;  $\sigma = 4.716$  S/m;  $\epsilon_r = 36.998$ ;  $\rho = 1000$  kg/m<sup>3</sup>  
Ambient Temperature : 23.7 °C; Liquid Temperature : 23.2 °C

### DASY5 Configuration:

- Probe: EX3DV4 - SN7537; ConvF(5.35, 5.35, 5.35) @ 5230 MHz; Calibrated: 2020/05/29
- Sensor-Surface: 1.4mm (Mechanical Surface Detection)
- Electronics: DAE4 Sn1277; Calibrated: 2020/01/24
- Phantom: Twin-SAM V8.0\_1988; Type: QD 000 P41 AA;
- Measurement SW: DASY52, Version 52.10 (4); SEMCAD X Version 14.6.14 (7483)

**Area Scan (121x211x1):** Interpolated grid: dx=1.000 mm, dy=1.000 mm  
Maximum value of SAR (interpolated) = 0.566 W/kg

**Zoom Scan (7x7x7)/Cube 0:** Measurement grid: dx=4mm, dy=4mm, dz=1.4mm

Reference Value = 11.71 V/m; Power Drift = -0.11 dB

Peak SAR (extrapolated) = 0.804 W/kg

**SAR(1 g) = 0.277 W/kg; SAR(10 g) = 0.128 W/kg** (SAR corrected for target medium)

Smallest distance from peaks to all points 3 dB below: Larger than measurement grid

Ratio of SAR at M2 to SAR at M1 = 69.6%

Maximum value of SAR (measured) = 0.557 W/kg

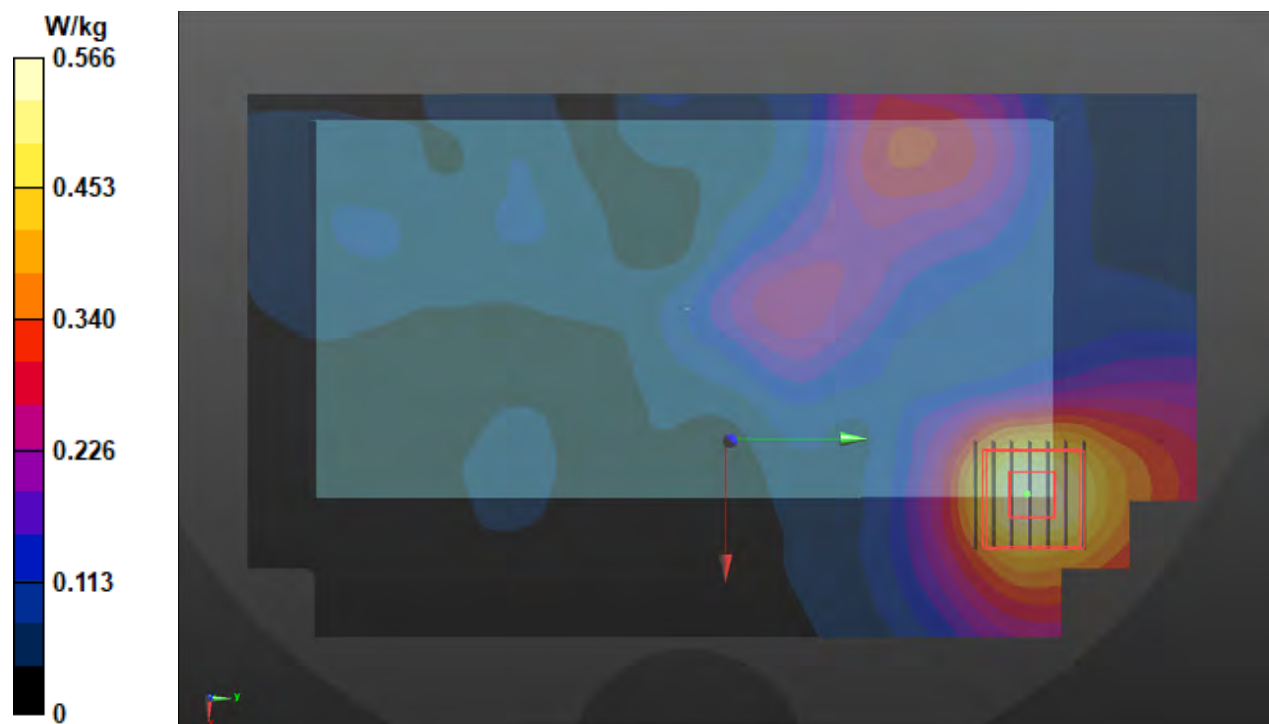

# P08 WLAN5.6G\_802.11n HT40\_Rear Face\_15mm\_Ch142\_Ant 1\_Battery1

**DUT: 200825C05**

Communication System: UID 10599 - AAC, IEEE 802.11n (HT Mixed, 40MHz, MCS0);  
Frequency: 5710 MHz; Duty Cycle: 1:1.15  
Medium: H34T60N1\_1026 Medium parameters used:  $f = 5710$  MHz;  $\sigma = 5.204$  S/m;  $\epsilon_r = 36.343$ ;  $\rho = 1000$  kg/m<sup>3</sup>  
Ambient Temperature : 23.7 °C; Liquid Temperature : 23.2 °C

### DASY5 Configuration:

- Probe: EX3DV4 - SN7537; ConvF(4.95, 4.95, 4.95) @ 5710 MHz; Calibrated: 2020/05/29
- Sensor-Surface: 1.4mm (Mechanical Surface Detection)
- Electronics: DAE4 Sn1277; Calibrated: 2020/01/24
- Phantom: Twin-SAM V8.0\_1988; Type: QD 000 P41 AA;
- Measurement SW: DASY52, Version 52.10 (4); SEMCAD X Version 14.6.14 (7483)

**Area Scan (121x211x1):** Interpolated grid: dx=1.000 mm, dy=1.000 mm  
Maximum value of SAR (interpolated) = 1.14 W/kg

**Zoom Scan (7x7x7)/Cube 0:** Measurement grid: dx=4mm, dy=4mm, dz=1.4mm  
Reference Value = 16.22 V/m; Power Drift = -0.05 dB

Peak SAR (extrapolated) = 1.79 W/kg

**SAR(1 g) = 0.534 W/kg; SAR(10 g) = 0.244 W/kg** (SAR corrected for target medium)

Smallest distance from peaks to all points 3 dB below: Larger than measurement grid

Ratio of SAR at M2 to SAR at M1 = 65%

Maximum value of SAR (measured) = 1.13 W/kg

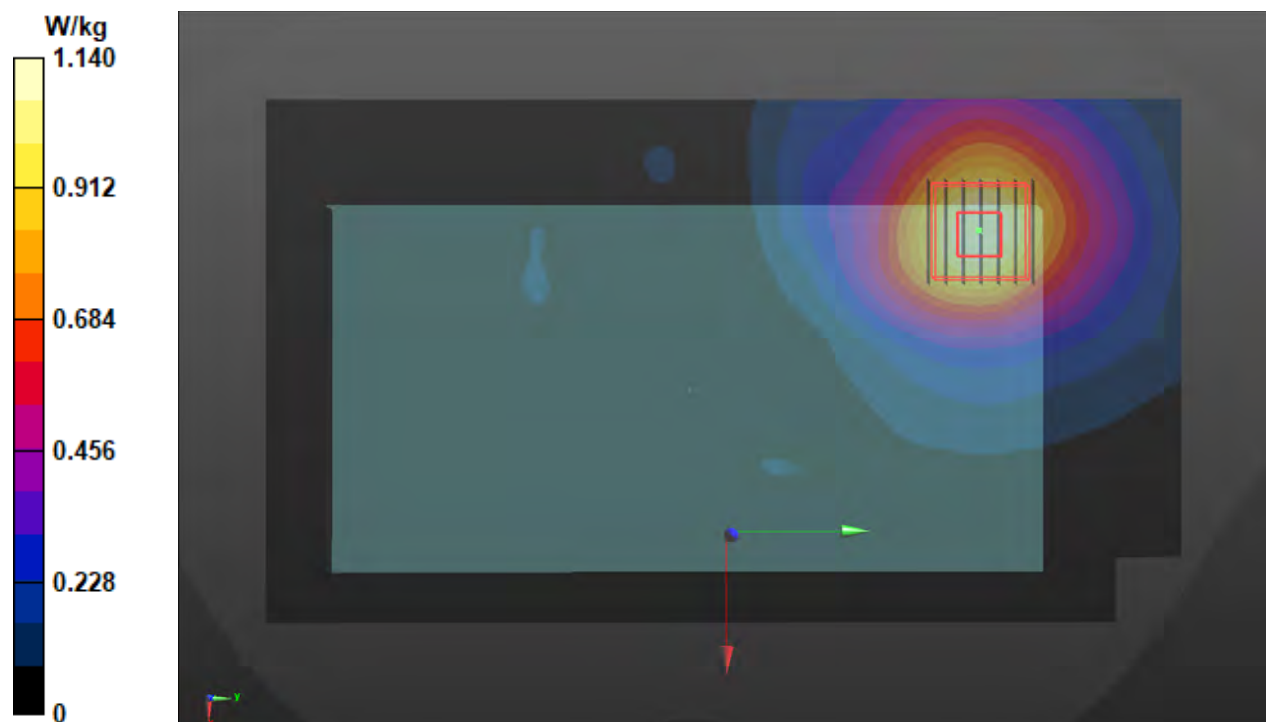

# P09 WLAN5.8G\_802.11ac VHT80\_Rear Face\_15mm\_Ch155\_Ant 0+1\_Battery1

**DUT: 200825C05**

Communication System: UID 10544 - AAC, IEEE 802.11ac WiFi (80MHz, MCS0); Frequency: 5775 MHz; Duty Cycle: 1:1.19

Medium: H34T60N1\_1026 Medium parameters used:  $f = 5775$  MHz;  $\sigma = 5.274$  S/m;  $\epsilon_r = 36.25$ ;  $\rho = 1000$  kg/m<sup>3</sup>

Ambient Temperature : 23.7 °C; Liquid Temperature : 23.2 °C

DASY5 Configuration:

- Probe: EX3DV4 - SN7537; ConvF(4.95, 4.95, 4.95) @ 5775 MHz; Calibrated: 2020/05/29
- Sensor-Surface: 1.4mm (Mechanical Surface Detection)
- Electronics: DAE4 Sn1277; Calibrated: 2020/01/24
- Phantom: Twin-SAM V8.0\_1988; Type: QD 000 P41 AA;
- Measurement SW: DASY52, Version 52.10 (4); SEMCAD X Version 14.6.14 (7483)

**Area Scan (121x211x1):** Interpolated grid: dx=1.000 mm, dy=1.000 mm

Maximum value of SAR (interpolated) = 0.579 W/kg

**Zoom Scan (7x7x7)/Cube 0:** Measurement grid: dx=4mm, dy=4mm, dz=1.4mm

Reference Value = 11.55 V/m; Power Drift = -0.11 dB

Peak SAR (extrapolated) = 0.934 W/kg

**SAR(1 g) = 0.272 W/kg; SAR(10 g) = 0.123 W/kg** (SAR corrected for target medium)

Smallest distance from peaks to all points 3 dB below: Larger than measurement grid

Ratio of SAR at M2 to SAR at M1 = 64.8%

Maximum value of SAR (measured) = 0.586 W/kg

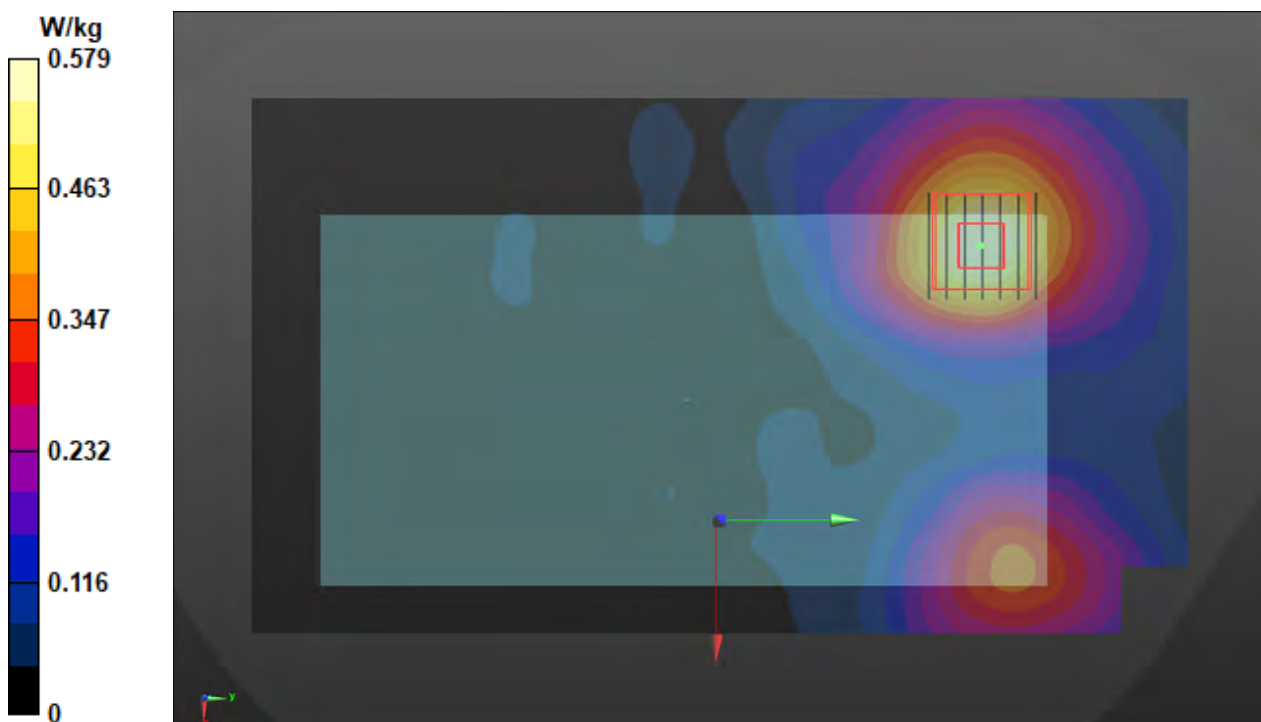



### P10 BT\_BR EDR\_Rear Face\_15mm\_Ch39\_Ant 0\_Battery1

**DUT: 200825C05**

Communication System: UID 10032 - CAA, IEEE 802.15.1 Bluetooth (GFSK, DH5); Frequency: 2441 MHz; Duty Cycle: 1:1.3

Medium: H19T27N1\_1028 Medium parameters used (interpolated):  $f = 2441$  MHz;  $\sigma = 1.838$  S/m;  $\epsilon_r = 37.887$ ;  $\rho = 1000$  kg/m<sup>3</sup>

Ambient Temperature : 23.8 °C; Liquid Temperature : 23.3 °C

DASY5 Configuration:

- Probe: EX3DV4 - SN3820; ConvF(6.85, 6.85, 6.85) @ 2441 MHz; Calibrated: 2020/06/25
- Sensor-Surface: 1.4mm (Mechanical Surface Detection)
- Electronics: DAE4 Sn1431; Calibrated: 2020/03/18
- Phantom: Twin-SAM V8.0\_1988; Type: QD 000 P41 AA;
- Measurement SW: DASY52, Version 52.10 (4); SEMCAD X Version 14.6.14 (7483)

**Area Scan (101x181x1):** Interpolated grid: dx=1.200 mm, dy=1.200 mm

Maximum value of SAR (interpolated) = 0.00494 W/kg

**Zoom Scan (7x7x7)/Cube 0:** Measurement grid: dx=5mm, dy=5mm, dz=5mm

Reference Value = 1.015 V/m; Power Drift = 0.10 dB

Peak SAR (extrapolated) = 0.00511 W/kg

**SAR(1 g) = 0.00218 W/kg; SAR(10 g) = 0.00123 W/kg** (SAR corrected for target medium)

Smallest distance from peaks to all points 3 dB below: Larger than measurement grid

Ratio of SAR at M2 to SAR at M1 = 65.9%

Maximum value of SAR (measured) = 0.00438 W/kg

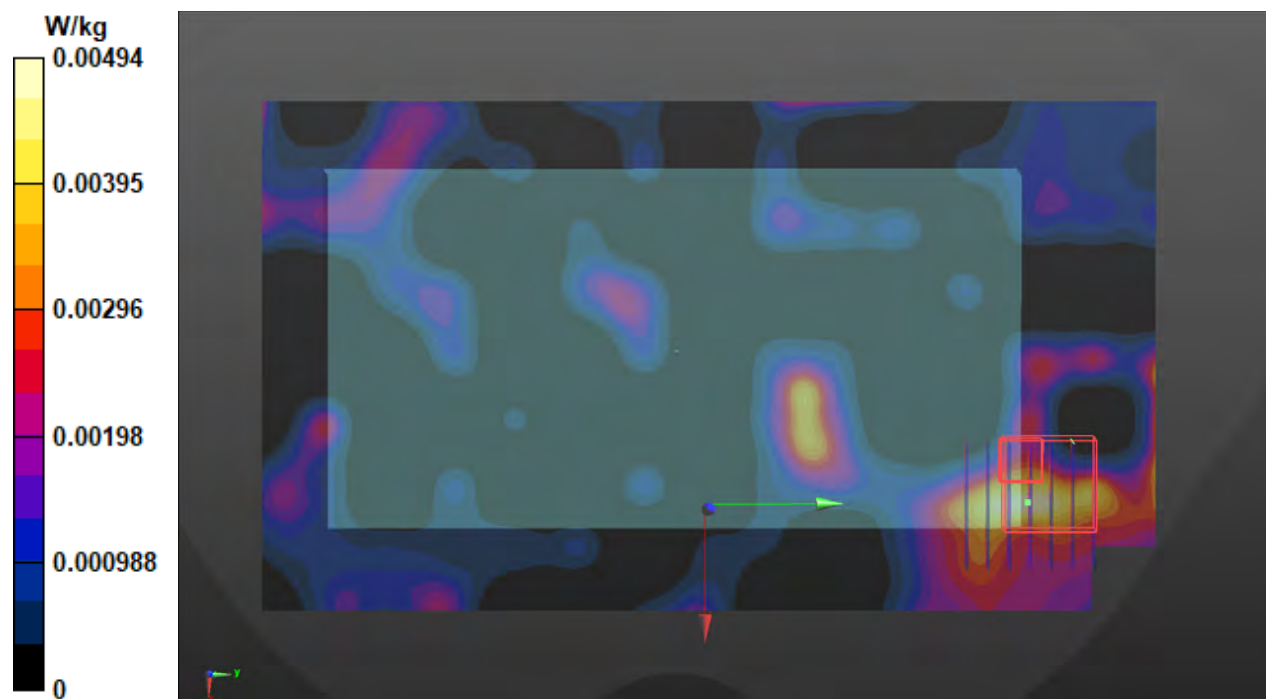



### P11 WLAN2.4G\_802.11b\_Right Side\_0mm\_Ch6\_Ant 0+1\_Battery1

**DUT: 200825C05**

Communication System: UID 10012 - CAB, IEEE 802.11b WiFi 2.4 GHz (DSSS, 1 Mbps);

Frequency: 2437 MHz; Duty Cycle: 1:1.01

Medium: H19T27N1\_1028 Medium parameters used:  $f = 2437$  MHz;  $\sigma = 1.833$  S/m;  $\epsilon_r = 37.906$ ;  $\rho = 1000$  kg/m<sup>3</sup>

Ambient Temperature : 23.8 °C; Liquid Temperature : 23.3 °C

DASY5 Configuration:

- Probe: EX3DV4 - SN3820; ConvF(6.85, 6.85, 6.85) @ 2437 MHz; Calibrated: 2020/06/25
- Sensor-Surface: 1.4mm (Mechanical Surface Detection)
- Electronics: DAE4 Sn1431; Calibrated: 2020/03/18
- Phantom: Twin-SAM V8.0\_1988; Type: QD 000 P41 AA;
- Measurement SW: DASY52, Version 52.10 (4); SEMCAD X Version 14.6.14 (7483)

**Area Scan (81x181x1):** Interpolated grid: dx=1.200 mm, dy=1.200 mm

Maximum value of SAR (interpolated) = 6.65 W/kg

**Zoom Scan (7x7x7)/Cube 0:** Measurement grid: dx=5mm, dy=5mm, dz=5mm

Reference Value = 44.05 V/m; Power Drift = -0.01 dB

Peak SAR (extrapolated) = 8.28 W/kg

**SAR(1 g) = 3.35 W/kg; SAR(10 g) = 1.38 W/kg** (SAR corrected for target medium)

Smallest distance from peaks to all points 3 dB below = 7.3 mm

Ratio of SAR at M2 to SAR at M1 = 44.2%

Maximum value of SAR (measured) = 6.22 W/kg

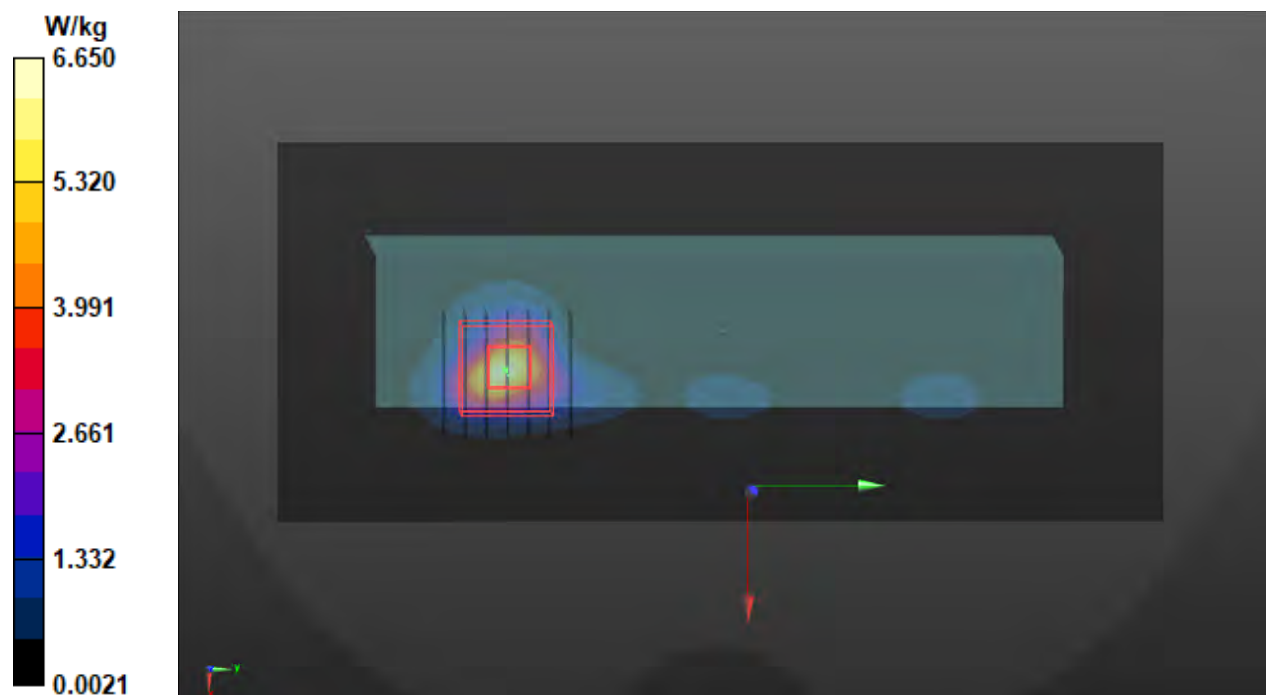

## P12 WLAN5.2G\_802.11n HT40\_Top Side\_0mm\_Ch46\_Ant 0+1\_Battery1

**DUT: 200825C05**

Communication System: UID 10599 - AAC, IEEE 802.11n (HT Mixed, 40MHz, MCS0);  
Frequency: 5230 MHz; Duty Cycle: 1:1.13  
Medium: H34T60N1\_1024 Medium parameters used:  $f = 5230$  MHz;  $\sigma = 4.818$  S/m;  $\epsilon_r = 37.054$ ;  $\rho = 1000$  kg/m<sup>3</sup>  
Ambient Temperature : 23.5°C; Liquid Temperature : 23.1°C

DASY5 Configuration:

- Probe: EX3DV4 - SN7537; ConvF(5.35, 5.35, 5.35) @ 5230 MHz; Calibrated: 2020/05/29
- Sensor-Surface: 1.4mm (Mechanical Surface Detection)
- Electronics: DAE4 Sn1277; Calibrated: 2020/01/24
- Phantom: Twin-SAM V8.0\_1988; Type: QD 000 P41 AA;
- Measurement SW: DASY52, Version 52.10 (4); SEMCAD X Version 14.6.14 (7483)

**Area Scan (81x121x1):** Interpolated grid: dx=1.000 mm, dy=1.000 mm  
Maximum value of SAR (interpolated) = 7.71 W/kg

**Zoom Scan (7x7x7)/Cube 0:** Measurement grid: dx=4mm, dy=4mm, dz=1.4mm  
Reference Value = 44.66 V/m; Power Drift = -0.11 dB  
Peak SAR (extrapolated) = 12.3 W/kg  
**SAR(1 g) = 3.18 W/kg; SAR(10 g) = 1 W/kg** (SAR corrected for target medium)  
Smallest distance from peaks to all points 3 dB below = 6.1 mm  
Ratio of SAR at M2 to SAR at M1 = 66.2%  
Maximum value of SAR (measured) = 7.78 W/kg

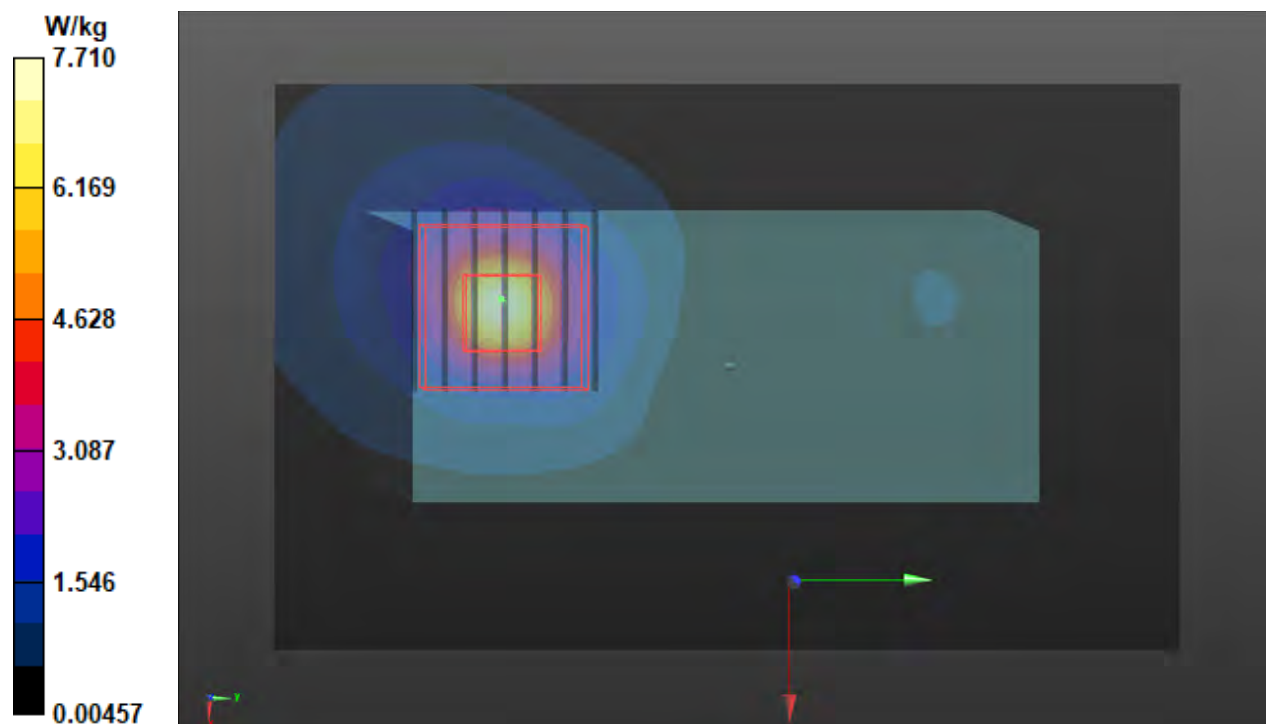

### P13 WLAN5.6G\_802.11n HT40\_Left Side\_0mm\_Ch142\_Ant 0\_Battery1

**DUT: 200825C05**

Communication System: UID 10599 - AAC, IEEE 802.11n (HT Mixed, 40MHz, MCS0);

Frequency: 5710 MHz; Duty Cycle: 1:1.14

Medium: H34T60N1\_1024 Medium parameters used:  $f = 5710$  MHz;  $\sigma = 5.388$  S/m;  $\epsilon_r = 36.328$ ;  $\rho = 1000$  kg/m<sup>3</sup>

Ambient Temperature : 23.5°C; Liquid Temperature : 23.1°C

DASY5 Configuration:

- Probe: EX3DV4 - SN7537; ConvF(4.95, 4.95, 4.95) @ 5710 MHz; Calibrated: 2020/05/29
- Sensor-Surface: 1.4mm (Mechanical Surface Detection)
- Electronics: DAE4 Sn1277; Calibrated: 2020/01/24
- Phantom: Twin-SAM V8.0\_1988; Type: QD 000 P41 AA;
- Measurement SW: DASY52, Version 52.10 (4); SEMCAD X Version 14.6.14 (7483)

**Area Scan (91x211x1):** Interpolated grid: dx=1.000 mm, dy=1.000 mm

Maximum value of SAR (interpolated) = 7.55 W/kg

**Zoom Scan (7x7x7)/Cube 0:** Measurement grid: dx=4mm, dy=4mm, dz=1.4mm

Reference Value = 32.81 V/m; Power Drift = -0.14 dB

Peak SAR (extrapolated) = 18.8 W/kg

**SAR(1 g) = 4.51 W/kg; SAR(10 g) = 1.4 W/kg** (SAR corrected for target medium)

Smallest distance from peaks to all points 3 dB below = 6.4 mm

Ratio of SAR at M2 to SAR at M1 = 64.1%

Maximum value of SAR (measured) = 10.9 W/kg

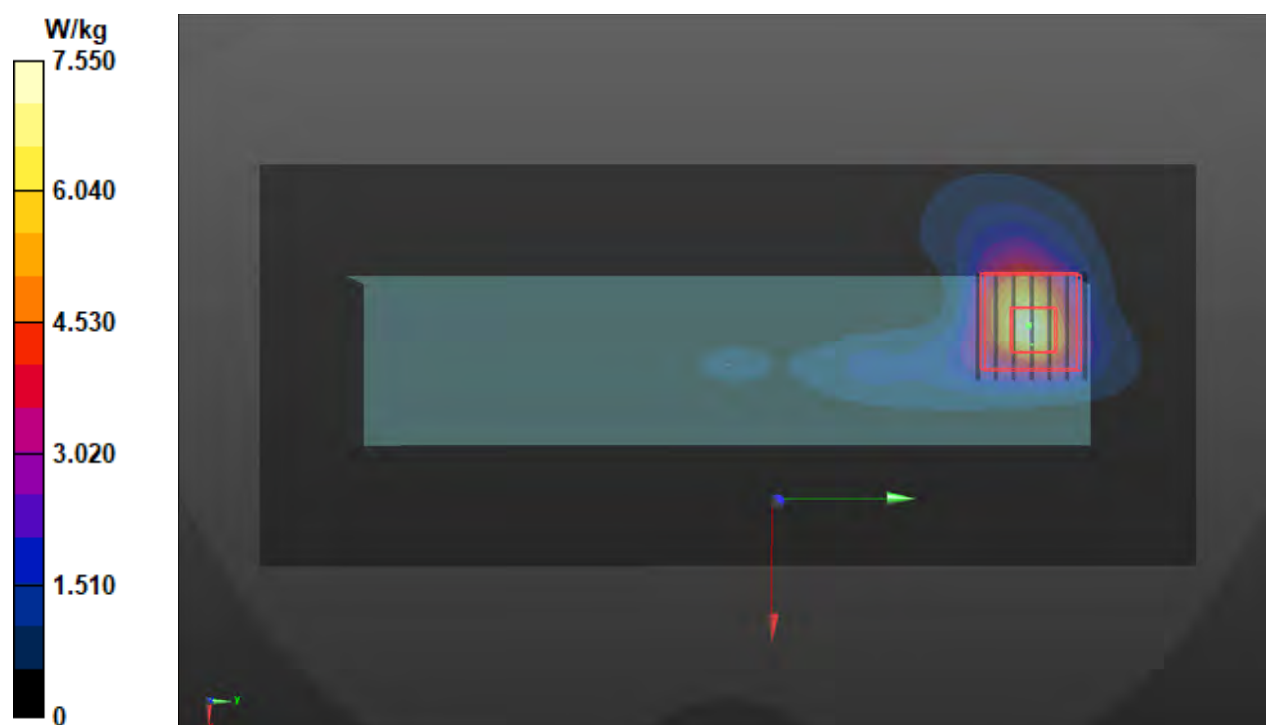

# P14 WLAN5.8G\_802.11ac VHT80\_Left Side\_0mm\_Ch155\_Ant 0+1\_Battery1

**DUT: 200825C05**

Communication System: UID 10544 - AAC, IEEE 802.11ac WiFi (80MHz, MCS0); Frequency: 5775 MHz; Duty Cycle: 1:1.19

Medium: H34T60N1\_1028 Medium parameters used:  $f = 5775$  MHz;  $\sigma = 5.339$  S/m;  $\epsilon_r = 34.891$ ;  $\rho = 1000$  kg/m<sup>3</sup>

Ambient Temperature : 23.8 °C; Liquid Temperature : 23.3 °C

DASY5 Configuration:

- Probe: EX3DV4 - SN3820; ConvF(4.4, 4.4, 4.4) @ 5775 MHz; Calibrated: 2020/06/25
- Sensor-Surface: 1.4mm (Mechanical Surface Detection)
- Electronics: DAE4 Sn1431; Calibrated: 2020/03/18
- Phantom: Twin-SAM V8.0\_1988; Type: QD 000 P41 AA;
- Measurement SW: DASY52, Version 52.10 (4); SEMCAD X Version 14.6.14 (7483)

**Area Scan (91x211x1):** Interpolated grid: dx=1.000 mm, dy=1.000 mm

Maximum value of SAR (interpolated) = 4.05 W/kg

**Zoom Scan (7x7x7)/Cube 0:** Measurement grid: dx=4mm, dy=4mm, dz=1.4mm

Reference Value = 30.04 V/m; Power Drift = -0.15 dB

Peak SAR (extrapolated) = 9.51 W/kg

**SAR(1 g) = 2.15 W/kg; SAR(10 g) = 0.681 W/kg** (SAR corrected for target medium)

Smallest distance from peaks to all points 3 dB below = 6.4 mm

Ratio of SAR at M2 to SAR at M1 = 61.6%

Maximum value of SAR (measured) = 5.31 W/kg



## P15 BT\_BR EDR\_Left Side\_0mm\_Ch39\_Ant 0\_Battery1

**DUT: 200825C05**

Communication System: UID 10032 - CAA, IEEE 802.15.1 Bluetooth (GFSK, DH5); Frequency: 2441 MHz; Duty Cycle: 1:1.3

Medium: H19T27N1\_1028 Medium parameters used (interpolated):  $f = 2441$  MHz;  $\sigma = 1.838$  S/m;  $\epsilon_r = 37.887$ ;  $\rho = 1000$  kg/m<sup>3</sup>

Ambient Temperature : 23.8 °C; Liquid Temperature : 23.3 °C

DASY5 Configuration:

- Probe: EX3DV4 - SN3820; ConvF(6.85, 6.85, 6.85) @ 2441 MHz; Calibrated: 2020/06/25
- Sensor-Surface: 1.4mm (Mechanical Surface Detection)
- Electronics: DAE4 Sn1431; Calibrated: 2020/03/18
- Phantom: Twin-SAM V8.0\_1988; Type: QD 000 P41 AA;
- Measurement SW: DASY52, Version 52.10 (4); SEMCAD X Version 14.6.14 (7483)

**Area Scan (81x181x1):** Interpolated grid: dx=1.200 mm, dy=1.200 mm

Maximum value of SAR (interpolated) = 0.0381 W/kg

**Zoom Scan (7x7x7)/Cube 0:** Measurement grid: dx=5mm, dy=5mm, dz=5mm

Reference Value = 4.624 V/m; Power Drift = -0.07 dB

Peak SAR (extrapolated) = 0.0580 W/kg

**SAR(1 g) = 0.026 W/kg; SAR(10 g) = 0.011 W/kg** (SAR corrected for target medium)

Smallest distance from peaks to all points 3 dB below: Larger than measurement grid

Ratio of SAR at M2 to SAR at M1 = 47.5%

Maximum value of SAR (measured) = 0.0449 W/kg



### Appendix C. Calibration Certificate for Probe and Dipole

The SPEAG calibration certificates are shown as follows.



Accreditation No.: **SCS 0108**

Accredited by the Swiss Accreditation Service (SAS)  
The Swiss Accreditation Service is one of the signatories to the EA  
Multilateral Agreement for the recognition of calibration certificates

Client **B.V. ADT (Auden)**

Certificate No: **D2450V2-737\_Aug20**

## CALIBRATION CERTIFICATE

Object **D2450V2 - SN:737**

Calibration procedure(s) **QA CAL-05.v11  
Calibration Procedure for SAR Validation Sources between 0.7-3 GHz**

Calibration date: **August 13, 2020**

This calibration certificate documents the traceability to national standards, which realize the physical units of measurements (SI).  
The measurements and the uncertainties with confidence probability are given on the following pages and are part of the certificate.

All calibrations have been conducted in the closed laboratory facility: environment temperature ( $22 \pm 3$ )°C and humidity < 70%.

Calibration Equipment used (M&TE critical for calibration)

Primary Standards	ID #	Cal Date (Certificate No.)	Scheduled Calibration
Power meter NRP	SN: 104778	01-Apr-20 (No. 217-03100/03101)	Apr-21
Power sensor NRP-Z91	SN: 103244	01-Apr-20 (No. 217-03100)	Apr-21
Power sensor NRP-Z91	SN: 103245	01-Apr-20 (No. 217-03101)	Apr-21
Reference 20 dB Attenuator	SN: BH9394 (20k)	31-Mar-20 (No. 217-03106)	Apr-21
Type-N mismatch combination	SN: 310982 / 06327	31-Mar-20 (No. 217-03104)	Apr-21
Reference Probe EX3DV4	SN: 7349	29-Jun-20 (No. EX3-7349_Jun20)	Jun-21
DAE4	SN: 601	27-Dec-19 (No. DAE4-601_Dec19)	Dec-20

Secondary Standards	ID #	Check Date (in house)	Scheduled Check
Power meter E4419B	SN: GB39512475	30-Oct-14 (in house check Feb-19)	In house check: Oct-20
Power sensor HP 8481A	SN: US37292783	07-Oct-15 (in house check Oct-18)	In house check: Oct-20
Power sensor HP 8481A	SN: MY41092317	07-Oct-15 (in house check Oct-18)	In house check: Oct-20
RF generator R&S SMT-06	SN: 100972	15-Jun-15 (in house check Oct-18)	In house check: Oct-20
Network Analyzer Agilent E8358A	SN: US41080477	31-Mar-14 (in house check Oct-19)	In house check: Oct-20

Calibrated by: **Jeffrey Katzman**      **Jeffrey Katzman**      **Laboratory Technician**      *J. Katzman*

Approved by: **Katja Pokovic**      **Katja Pokovic**      **Technical Manager**      *K. Pokovic*

Issued: August 14, 2020

This calibration certificate shall not be reproduced except in full without written approval of the laboratory.





Accredited by the Swiss Accreditation Service (SAS)

The Swiss Accreditation Service is one of the signatories to the EA  
Multilateral Agreement for the recognition of calibration certificates

### Glossary:

TSL	tissue simulating liquid
ConvF	sensitivity in TSL / NORM x,y,z
N/A	not applicable or not measured

### Calibration is Performed According to the Following Standards:

- IEEE Std 1528-2013, "IEEE Recommended Practice for Determining the Peak Spatial-Averaged Specific Absorption Rate (SAR) in the Human Head from Wireless Communications Devices: Measurement Techniques", June 2013
- IEC 62209-1, "Measurement procedure for the assessment of Specific Absorption Rate (SAR) from hand-held and body-mounted devices used next to the ear (frequency range of 300 MHz to 6 GHz)", July 2016
- IEC 62209-2, "Procedure to determine the Specific Absorption Rate (SAR) for wireless communication devices used in close proximity to the human body (frequency range of 30 MHz to 6 GHz)", March 2010
- KDB 865664, "SAR Measurement Requirements for 100 MHz to 6 GHz"

### Additional Documentation:

- DASY4/5 System Handbook

### Methods Applied and Interpretation of Parameters:

- Measurement Conditions:** Further details are available from the Validation Report at the end of the certificate. All figures stated in the certificate are valid at the frequency indicated.
- Antenna Parameters with TSL:** The dipole is mounted with the spacer to position its feed point exactly below the center marking of the flat phantom section, with the arms oriented parallel to the body axis.
- Feed Point Impedance and Return Loss:** These parameters are measured with the dipole positioned under the liquid filled phantom. The impedance stated is transformed from the measurement at the SMA connector to the feed point. The Return Loss ensures low reflected power. No uncertainty required.
- Electrical Delay:** One-way delay between the SMA connector and the antenna feed point. No uncertainty required.
- SAR measured:** SAR measured at the stated antenna input power.
- SAR normalized:** SAR as measured, normalized to an input power of 1 W at the antenna connector.
- SAR for nominal TSL parameters:** The measured TSL parameters are used to calculate the nominal SAR result.

The reported uncertainty of measurement is stated as the standard uncertainty of measurement multiplied by the coverage factor  $k=2$ , which for a normal distribution corresponds to a coverage probability of approximately 95%.

## Measurement Conditions

DASY system configuration, as far as not given on page 1.

<b>DASY Version</b>	DASY5	V52.10.4
<b>Extrapolation</b>	Advanced Extrapolation	
<b>Phantom</b>	Modular Flat Phantom	
<b>Distance Dipole Center - TSL</b>	10 mm	with Spacer
<b>Zoom Scan Resolution</b>	dx, dy, dz = 5 mm	
<b>Frequency</b>	2450 MHz $\pm$ 1 MHz	

## Head TSL parameters

The following parameters and calculations were applied.

	<b>Temperature</b>	<b>Permittivity</b>	<b>Conductivity</b>
<b>Nominal Head TSL parameters</b>	22.0 °C	39.2	1.80 mho/m
<b>Measured Head TSL parameters</b>	(22.0 $\pm$ 0.2) °C	38.9 $\pm$ 6 %	1.84 mho/m $\pm$ 6 %
<b>Head TSL temperature change during test</b>	< 0.5 °C	---	---

## SAR result with Head TSL

<b>SAR averaged over 1 cm<sup>3</sup> (1 g) of Head TSL</b>	Condition	
SAR measured	250 mW input power	13.1 W/kg
SAR for nominal Head TSL parameters	normalized to 1W	<b>51.6 W/kg <math>\pm</math> 17.0 % (k=2)</b>

<b>SAR averaged over 10 cm<sup>3</sup> (10 g) of Head TSL</b>	condition	
SAR measured	250 mW input power	6.12 W/kg
SAR for nominal Head TSL parameters	normalized to 1W	<b>24.3 W/kg <math>\pm</math> 16.5 % (k=2)</b>

## Appendix (Additional assessments outside the scope of SCS 0108)

### Antenna Parameters with Head TSL

Impedance, transformed to feed point	54.8 $\Omega$ + 4.7 j $\Omega$
Return Loss	- 23.9 dB

### General Antenna Parameters and Design

Electrical Delay (one direction)	1.162 ns
----------------------------------	----------

After long term use with 100W radiated power, only a slight warming of the dipole near the feedpoint can be measured.

The dipole is made of standard semirigid coaxial cable. The center conductor of the feeding line is directly connected to the second arm of the dipole. The antenna is therefore short-circuited for DC-signals. On some of the dipoles, small end caps are added to the dipole arms in order to improve matching when loaded according to the position as explained in the "Measurement Conditions" paragraph. The SAR data are not affected by this change. The overall dipole length is still according to the Standard.

No excessive force must be applied to the dipole arms, because they might bend or the soldered connections near the feedpoint may be damaged.

### Additional EUT Data

Manufactured by	SPEAG
-----------------	-------

# DASY5 Validation Report for Head TSL

Date: 13.08.2020

Test Laboratory: SPEAG, Zurich, Switzerland

**DUT: Dipole 2450 MHz; Type: D2450V2; Serial: D2450V2 - SN:737**

Communication System: UID 0 - CW; Frequency: 2450 MHz

Medium parameters used:  $f = 2450$  MHz;  $\sigma = 1.84$  S/m;  $\epsilon_r = 38.9$ ;  $\rho = 1000$  kg/m<sup>3</sup>

Phantom section: Flat Section

Measurement Standard: DASY5 (IEEE/IEC/ANSI C63.19-2011)

DASY52 Configuration:

- Probe: EX3DV4 - SN7349; ConvF(7.74, 7.74, 7.74) @ 2450 MHz; Calibrated: 29.06.2020
- Sensor-Surface: 1.4mm (Mechanical Surface Detection)
- Electronics: DAE4 Sn601; Calibrated: 27.12.2019
- Phantom: Flat Phantom 5.0 (front); Type: QD 000 P50 AA; Serial: 1001
- DASY52 52.10.4(1527); SEMCAD X 14.6.14(7483)

## Dipole Calibration for Head Tissue/Pin=250 mW, d=10mm/Zoom Scan (7x7x7)/Cube 0:

Measurement grid: dx=5mm, dy=5mm, dz=5mm

Reference Value = 114.4 V/m; Power Drift = -0.09 dB

Peak SAR (extrapolated) = 25.6 W/kg

**SAR(1 g) = 13.1 W/kg; SAR(10 g) = 6.12 W/kg**

Smallest distance from peaks to all points 3 dB below = 9 mm

Ratio of SAR at M2 to SAR at M1 = 51.2%

Maximum value of SAR (measured) = 21.2 W/kg

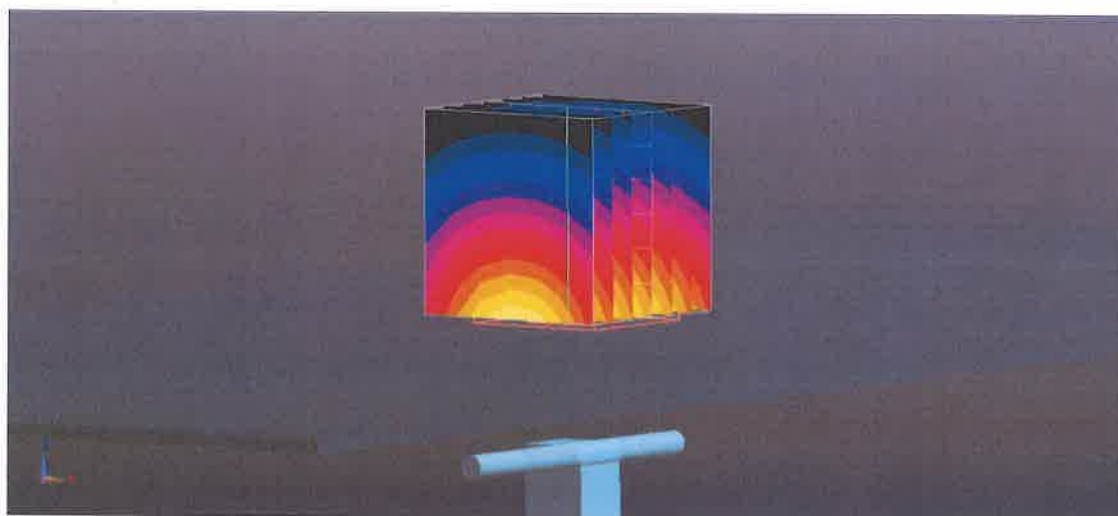
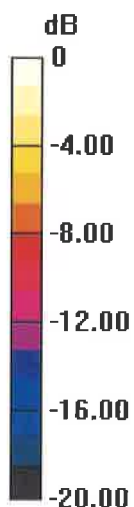

0 dB = 21.2 W/kg = 13.27 dBW/kg

# Impedance Measurement Plot for Head TSL

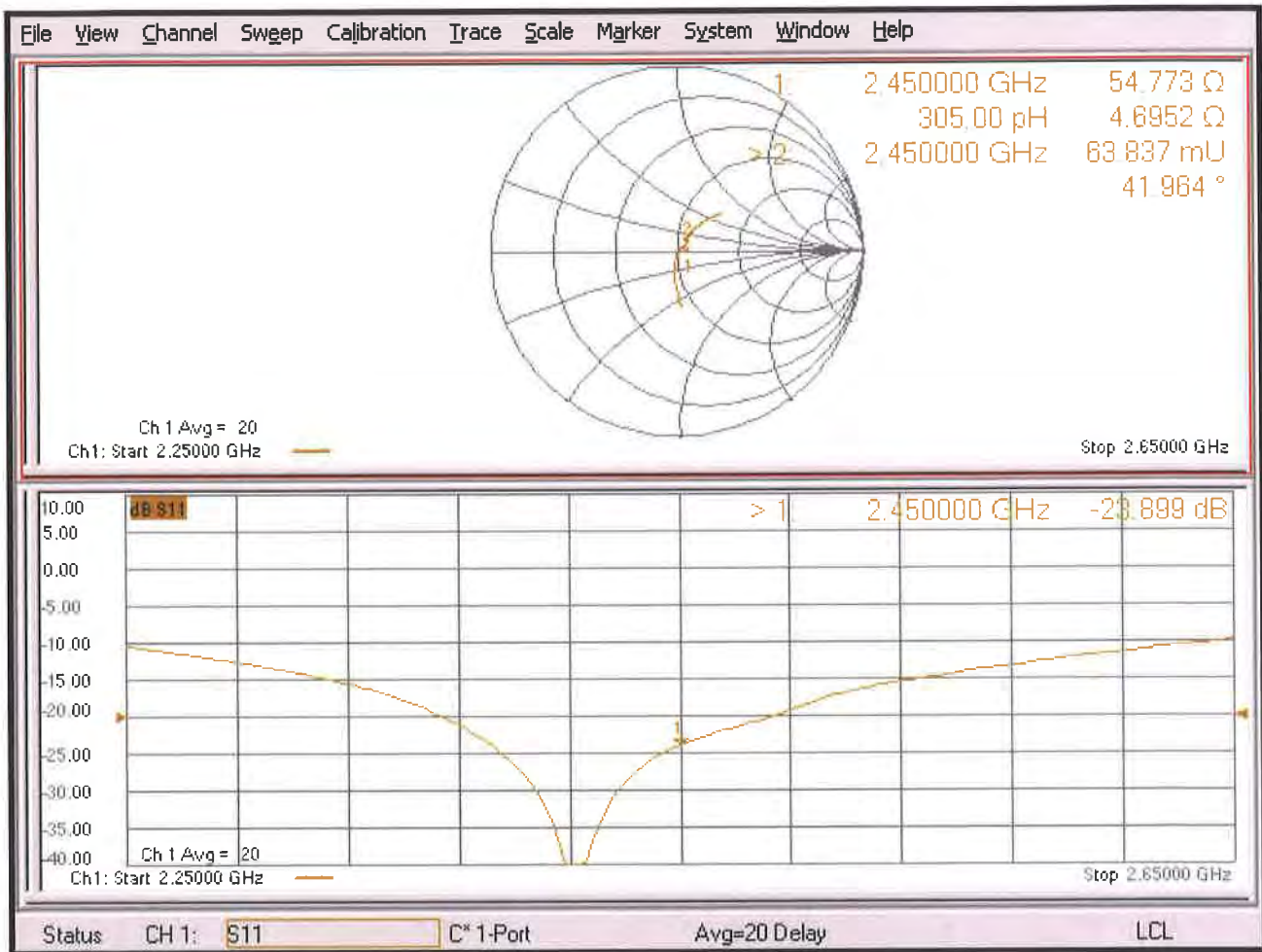



Accredited by the Swiss Accreditation Service (SAS)  
The Swiss Accreditation Service is one of the signatories to the EA  
Multilateral Agreement for the recognition of calibration certificates

Accreditation No.: **SCS 0108**

Client **B.V. ADT (Auden)**

Certificate No: **D5GHzV2-1019\_Mar20**

## CALIBRATION CERTIFICATE

Object **D5GHzV2 - SN:1019**

Calibration procedure(s) **QA CAL-22.v4  
Calibration Procedure for SAR Validation Sources between 3-6 GHz**

Calibration date: **March 13, 2020**

This calibration certificate documents the traceability to national standards, which realize the physical units of measurements (SI).  
The measurements and the uncertainties with confidence probability are given on the following pages and are part of the certificate.

All calibrations have been conducted in the closed laboratory facility: environment temperature ( $22 \pm 3$ )°C and humidity < 70%.

Calibration Equipment used (M&TE critical for calibration)

Primary Standards	ID #	Cal Date (Certificate No.)	Scheduled Calibration
Power meter NRP	SN: 104778	03-Apr-19 (No. 217-02892/02893)	Apr-20
Power sensor NRP-Z91	SN: 103244	03-Apr-19 (No. 217-02892)	Apr-20
Power sensor NRP-Z91	SN: 103245	03-Apr-19 (No. 217-02893)	Apr-20
Reference 20 dB Attenuator	SN: 5058 (20k)	04-Apr-19 (No. 217-02894)	Apr-20
Type-N mismatch combination	SN: 5047.2 / 06327	04-Apr-19 (No. 217-02895)	Apr-20
Reference Probe EX3DV4	SN: 3503	31-Dec-19 (No. EX3-3503_Dec19)	Dec-20
DAE4	SN: 601	27-Dec-19 (No. DAE4-601_Dec19)	Dec-20

Secondary Standards	ID #	Check Date (in house)	Scheduled Check
Power meter E4419B	SN: GB39512475	30-Oct-14 (in house check Feb-19)	In house check: Oct-20
Power sensor HP 8481A	SN: US37292783	07-Oct-15 (in house check Oct-18)	In house check: Oct-20
Power sensor HP 8481A	SN: MY41092317	07-Oct-15 (in house check Oct-18)	In house check: Oct-20
RF generator R&S SMT-06	SN: 100972	15-Jun-15 (in house check Oct-18)	In house check: Oct-20
Network Analyzer Agilent E8358A	SN: US41080477	31-Mar-14 (in house check Oct-19)	In house check: Oct-20

Calibrated by: **Jeton Kastrati**      **Function: Laboratory Technician**      **Signature:**

Approved by: **Katja Pokovic**      **Technical Manager**

Issued: March 13, 2020

This calibration certificate shall not be reproduced except in full without written approval of the laboratory.





Accredited by the Swiss Accreditation Service (SAS)

The Swiss Accreditation Service is one of the signatories to the EA  
Multilateral Agreement for the recognition of calibration certificates

### Glossary:

TSL	tissue simulating liquid
ConvF	sensitivity in TSL / NORM x,y,z
N/A	not applicable or not measured

### Calibration is Performed According to the Following Standards:

- IEEE Std 1528-2013, "IEEE Recommended Practice for Determining the Peak Spatial-Averaged Specific Absorption Rate (SAR) in the Human Head from Wireless Communications Devices: Measurement Techniques", June 2013
- IEC 62209-1, "Measurement procedure for the assessment of Specific Absorption Rate (SAR) from hand-held and body-mounted devices used next to the ear (frequency range of 300 MHz to 6 GHz)", July 2016
- IEC 62209-2, "Procedure to determine the Specific Absorption Rate (SAR) for wireless communication devices used in close proximity to the human body (frequency range of 30 MHz to 6 GHz)", March 2010
- KDB 865664, "SAR Measurement Requirements for 100 MHz to 6 GHz"

### Additional Documentation:

- DASY4/5 System Handbook

### Methods Applied and Interpretation of Parameters:

- Measurement Conditions:* Further details are available from the Validation Report at the end of the certificate. All figures stated in the certificate are valid at the frequency indicated.
- Antenna Parameters with TSL:* The dipole is mounted with the spacer to position its feed point exactly below the center marking of the flat phantom section, with the arms oriented parallel to the body axis.
- Feed Point Impedance and Return Loss:* These parameters are measured with the dipole positioned under the liquid filled phantom. The impedance stated is transformed from the measurement at the SMA connector to the feed point. The Return Loss ensures low reflected power. No uncertainty required.
- Electrical Delay:* One-way delay between the SMA connector and the antenna feed point. No uncertainty required.
- SAR measured:* SAR measured at the stated antenna input power.
- SAR normalized:* SAR as measured, normalized to an input power of 1 W at the antenna connector.
- SAR for nominal TSL parameters:* The measured TSL parameters are used to calculate the nominal SAR result.

The reported uncertainty of measurement is stated as the standard uncertainty of measurement multiplied by the coverage factor  $k=2$ , which for a normal distribution corresponds to a coverage probability of approximately 95%.



## Measurement Conditions

DASY system configuration, as far as not given on page 1.

<b>DASY Version</b>	DASY5	V52.10.4
<b>Extrapolation</b>	Advanced Extrapolation	
<b>Phantom</b>	Modular Flat Phantom V5.0	
<b>Distance Dipole Center - TSL</b>	10 mm	with Spacer
<b>Zoom Scan Resolution</b>	dx, dy = 4.0 mm, dz = 1.4 mm	Graded Ratio = 1.4 (Z direction)
<b>Frequency</b>	5250 MHz ± 1 MHz 5600 MHz ± 1 MHz 5750 MHz ± 1 MHz 5850 MHz ± 1 MHz	

## Head TSL parameters at 5250 MHz

The following parameters and calculations were applied.

	Temperature	Permittivity	Conductivity
<b>Nominal Head TSL parameters</b>	22.0 °C	35.9	4.71 mho/m
<b>Measured Head TSL parameters</b>	(22.0 ± 0.2) °C	34.9 ± 6 %	4.49 mho/m ± 6 %
<b>Head TSL temperature change during test</b>	< 0.5 °C	---	----

## SAR result with Head TSL at 5250 MHz

<b>SAR averaged over 1 cm<sup>3</sup> (1 g) of Head TSL</b>	Condition	
SAR measured	100 mW input power	8.03 W/kg
SAR for nominal Head TSL parameters	normalized to 1W	<b>79.7 W/kg ± 19.9 % (k=2)</b>

<b>SAR averaged over 10 cm<sup>3</sup> (10 g) of Head TSL</b>	condition	
SAR measured	100 mW input power	2.30 W/kg
SAR for nominal Head TSL parameters	normalized to 1W	<b>22.8 W/kg ± 19.5 % (k=2)</b>

### Head TSL parameters at 5600 MHz

The following parameters and calculations were applied.

	Temperature	Permittivity	Conductivity
Nominal Head TSL parameters	22.0 °C	35.5	5.07 mho/m
Measured Head TSL parameters	(22.0 ± 0.2) °C	34.4 ± 6 %	4.84 mho/m ± 6 %
Head TSL temperature change during test	< 0.5 °C	----	----

### SAR result with Head TSL at 5600 MHz

SAR averaged over 1 cm <sup>3</sup> (1 g) of Head TSL	Condition	
SAR measured	100 mW input power	8.45 W/kg
SAR for nominal Head TSL parameters	normalized to 1W	<b>83.8 W/kg ± 19.9 % (k=2)</b>

SAR averaged over 10 cm <sup>3</sup> (10 g) of Head TSL	condition	
SAR measured	100 mW input power	2.39 W/kg
SAR for nominal Head TSL parameters	normalized to 1W	<b>23.7 W/kg ± 19.5 % (k=2)</b>

### Head TSL parameters at 5750 MHz

The following parameters and calculations were applied.

	Temperature	Permittivity	Conductivity
Nominal Head TSL parameters	22.0 °C	35.4	5.22 mho/m
Measured Head TSL parameters	(22.0 ± 0.2) °C	34.2 ± 6 %	4.99 mho/m ± 6 %
Head TSL temperature change during test	< 0.5 °C	----	----

### SAR result with Head TSL at 5750 MHz

SAR averaged over 1 cm <sup>3</sup> (1 g) of Head TSL	Condition	
SAR measured	100 mW input power	8.11 W/kg
SAR for nominal Head TSL parameters	normalized to 1W	<b>80.4 W/kg ± 19.9 % (k=2)</b>

SAR averaged over 10 cm <sup>3</sup> (10 g) of Head TSL	condition	
SAR measured	100 mW input power	2.30 W/kg
SAR for nominal Head TSL parameters	normalized to 1W	<b>22.8 W/kg ± 19.5 % (k=2)</b>

## Head TSL parameters at 5850 MHz

The following parameters and calculations were applied.

	Temperature	Permittivity	Conductivity
<b>Nominal Head TSL parameters</b>	22.0 °C	35.2	5.32 mho/m
<b>Measured Head TSL parameters</b>	(22.0 ± 0.2) °C	34.1 ± 6 %	5.10 mho/m ± 6 %
<b>Head TSL temperature change during test</b>	< 0.5 °C	----	----

## SAR result with Head TSL at 5850 MHz

<b>SAR averaged over 1 cm<sup>3</sup> (1 g) of Head TSL</b>	Condition	
SAR measured	100 mW input power	8.24 W/kg
SAR for nominal Head TSL parameters	normalized to 1W	<b>81.7 W/kg ± 19.9 % (k=2)</b>

<b>SAR averaged over 10 cm<sup>3</sup> (10 g) of Head TSL</b>	condition	
SAR measured	100 mW input power	2.33 W/kg
SAR for nominal Head TSL parameters	normalized to 1W	<b>23.1 W/kg ± 19.5 % (k=2)</b>

## Appendix (Additional assessments outside the scope of SCS 0108)

### Antenna Parameters with Head TSL at 5250 MHz

Impedance, transformed to feed point	54.6 $\Omega$ - 5.1 j $\Omega$
Return Loss	- 23.7 dB

### Antenna Parameters with Head TSL at 5600 MHz

Impedance, transformed to feed point	58.1 $\Omega$ - 1.2 j $\Omega$
Return Loss	- 22.4 dB

### Antenna Parameters with Head TSL at 5750 MHz

Impedance, transformed to feed point	58.4 $\Omega$ + 3.9 j $\Omega$
Return Loss	- 21.3 dB

### Antenna Parameters with Head TSL at 5850 MHz

Impedance, transformed to feed point	55.8 $\Omega$ + 0.6 j $\Omega$
Return Loss	- 25.1 dB

### General Antenna Parameters and Design

Electrical Delay (one direction)	1.204 ns
----------------------------------	----------

After long term use with 100W radiated power, only a slight warming of the dipole near the feedpoint can be measured.

The dipole is made of standard semirigid coaxial cable. The center conductor of the feeding line is directly connected to the second arm of the dipole. The antenna is therefore short-circuited for DC-signals. On some of the dipoles, small end caps are added to the dipole arms in order to improve matching when loaded according to the position as explained in the "Measurement Conditions" paragraph. The SAR data are not affected by this change. The overall dipole length is still according to the Standard.

No excessive force must be applied to the dipole arms, because they might bend or the soldered connections near the feedpoint may be damaged.

### Additional EUT Data

Manufactured by	SPEAG
-----------------	-------

# DASY5 Validation Report for Head TSL

Date: 13.03.2020

Test Laboratory: SPEAG, Zurich, Switzerland

## DUT: Dipole D5GHzV2; Type: D5GHzV2; Serial: D5GHzV2 - SN:1019

Communication System: UID 0 - CW; Frequency: 5250 MHz, Frequency: 5600 MHz, Frequency: 5750 MHz, Frequency: 5850 MHz

Medium parameters used:  $f = 5250$  MHz;  $\sigma = 4.49$  S/m;  $\epsilon_r = 34.9$ ;  $\rho = 1000$  kg/m<sup>3</sup>,

Medium parameters used:  $f = 5600$  MHz;  $\sigma = 4.84$  S/m;  $\epsilon_r = 34.4$ ;  $\rho = 1000$  kg/m<sup>3</sup>,

Medium parameters used:  $f = 5750$  MHz;  $\sigma = 4.99$  S/m;  $\epsilon_r = 34.2$ ;  $\rho = 1000$  kg/m<sup>3</sup>,

Medium parameters used:  $f = 5850$  MHz;  $\sigma = 5.1$  S/m;  $\epsilon_r = 34.1$ ;  $\rho = 1000$  kg/m<sup>3</sup>

Phantom section: Flat Section

Measurement Standard: DASY5 (IEEE/IEC/ANSI C63.19-2011)

### DASY52 Configuration:

- Probe: EX3DV4 - SN3503; ConvF(5.5, 5.5, 5.5) @ 5250 MHz, ConvF(5.1, 5.1, 5.1) @ 5600 MHz, ConvF(5.08, 5.08, 5.08) @ 5750 MHz, ConvF(4.99, 4.99, 4.99) @ 5850 MHz; Calibrated: 31.12.2019
- Sensor-Surface: 1.4mm (Mechanical Surface Detection)
- Electronics: DAE4 Sn601; Calibrated: 27.12.2019
- Phantom: Flat Phantom 5.0 (front); Type: QD 000 P50 AA; Serial: 1001
- DASY52 52.10.4(1527); SEMCAD X 14.6.14(7483)

### Dipole Calibration for Head Tissue/Pin=100mW, dist=10mm, f=5250 MHz/Zoom Scan, dist=1.4mm

(8x8x8)/Cube 0: Measurement grid: dx=4mm, dy=4mm, dz=1.4mm

Reference Value = 77.45 V/m; Power Drift = -0.08 dB

Peak SAR (extrapolated) = 27.9 W/kg

**SAR(1 g) = 8.03 W/kg; SAR(10 g) = 2.30 W/kg**

Smallest distance from peaks to all points 3 dB below = 7.2 mm

Ratio of SAR at M2 to SAR at M1 = 69.7%

Maximum value of SAR (measured) = 17.9 W/kg

### Dipole Calibration for Head Tissue/Pin=100mW, dist=10mm, f=5600 MHz/Zoom Scan, dist=1.4mm

(8x8x8)/Cube 0: Measurement grid: dx=4mm, dy=4mm, dz=1.4mm

Reference Value = 77.30 V/m; Power Drift = -0.02 dB

Peak SAR (extrapolated) = 31.9 W/kg

**SAR(1 g) = 8.45 W/kg; SAR(10 g) = 2.39 W/kg**

Smallest distance from peaks to all points 3 dB below = 7.2 mm

Ratio of SAR at M2 to SAR at M1 = 67.1%

Maximum value of SAR (measured) = 19.4 W/kg

### Dipole Calibration for Head Tissue/Pin=100mW, dist=10mm, f=5750 MHz/Zoom Scan, dist=1.4mm

(8x8x8)/Cube 0: Measurement grid: dx=4mm, dy=4mm, dz=1.4mm

Reference Value = 75.26 V/m; Power Drift = -0.02 dB

Peak SAR (extrapolated) = 32.0 W/kg

**SAR(1 g) = 8.11 W/kg; SAR(10 g) = 2.30 W/kg**

Smallest distance from peaks to all points 3 dB below = 7.2 mm

Ratio of SAR at M2 to SAR at M1 = 65.4%

Maximum value of SAR (measured) = 19.0 W/kg

**Dipole Calibration for Head Tissue/Pin=100mW, dist=10mm, f=5850 MHz/Zoom Scan, dist=1.4mm (8x8x8)/Cube 0:** Measurement grid: dx=4mm, dy=4mm, dz=1.4mm  
Reference Value = 75.08 V/m; Power Drift = -0.09 dB  
Peak SAR (extrapolated) = 33.4 W/kg  
**SAR(1 g) = 8.24 W/kg; SAR(10 g) = 2.33 W/kg**  
Smallest distance from peaks to all points 3 dB below = 7.2 mm  
Ratio of SAR at M2 to SAR at M1 = 64.7%  
Maximum value of SAR (measured) = 19.4 W/kg

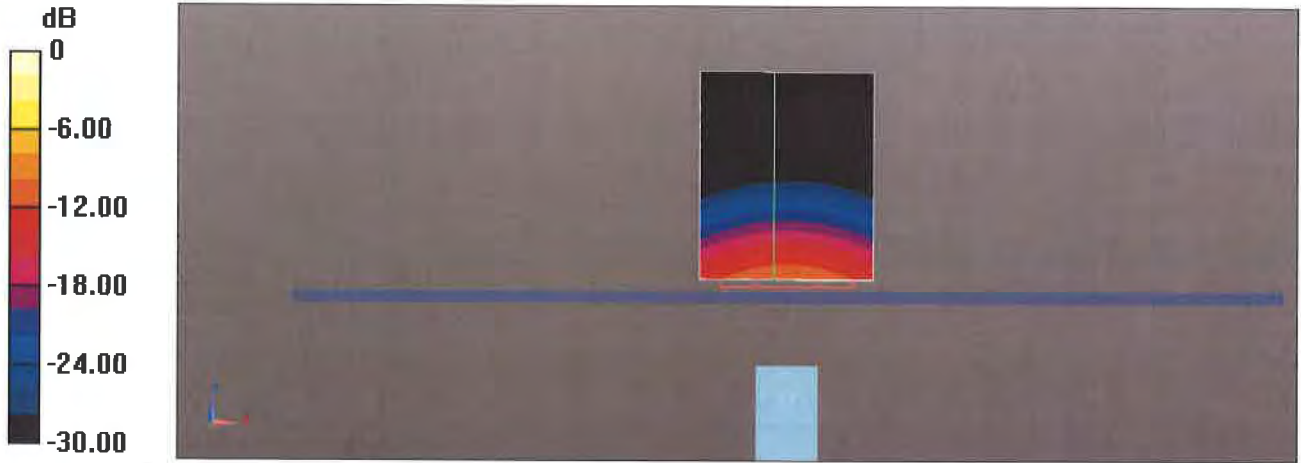

0 dB = 19.4 W/kg = 12.88 dBW/kg

# Impedance Measurement Plot for Head TSL

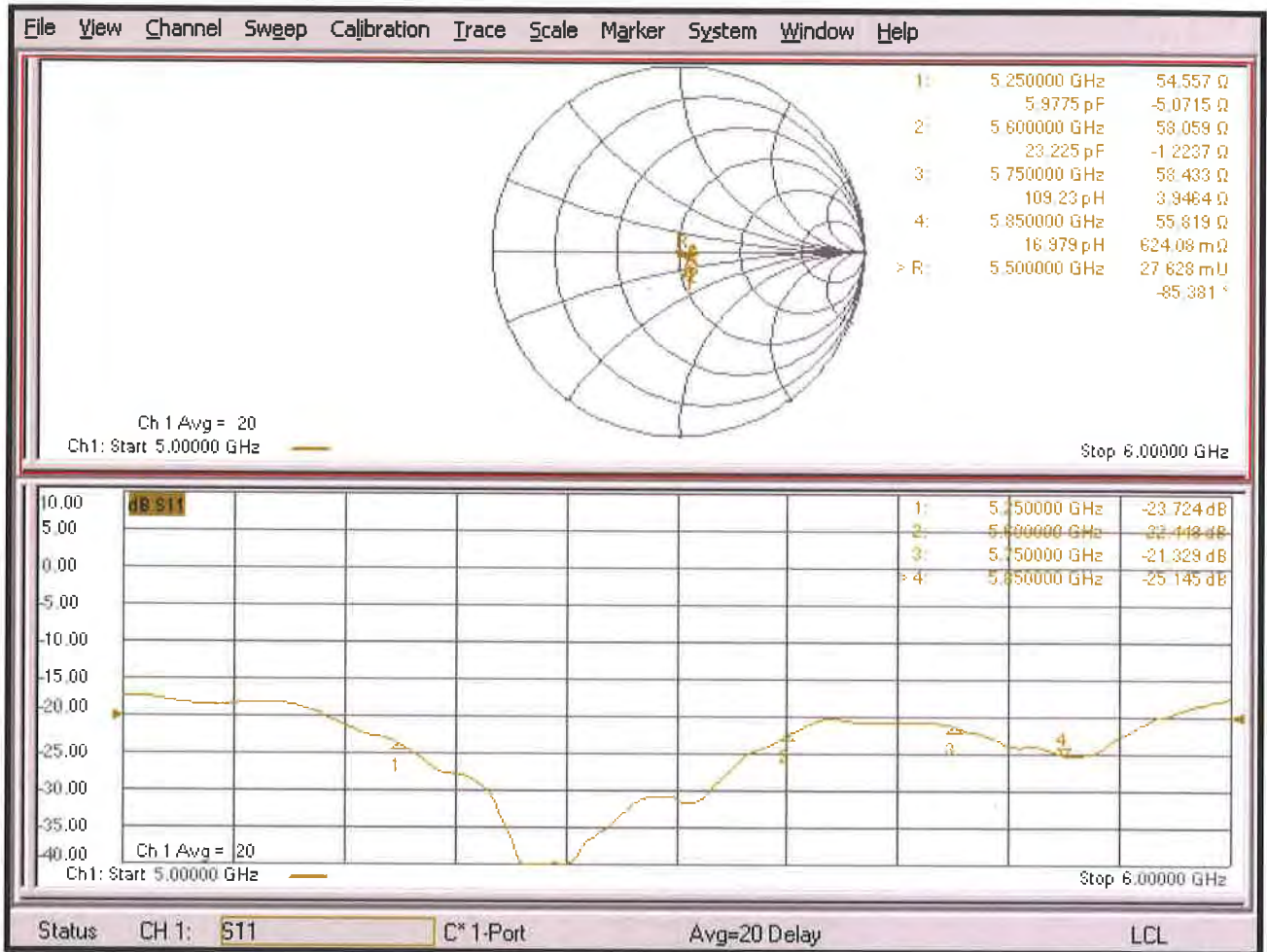





Accredited by the Swiss Accreditation Service (SAS)  
The Swiss Accreditation Service is one of the signatories to the EA  
Multilateral Agreement for the recognition of calibration certificates

Accreditation No.: **SCS 0108**

Client **B.V. ADT (Auden)**

Certificate No: **EX3-7537\_May20**

## CALIBRATION CERTIFICATE

Object **EX3DV4 - SN:7537**

Calibration procedure(s) **QA CAL-01.v9, QA CAL-14.v5, QA CAL-23.v5, QA CAL-25.v7  
Calibration procedure for dosimetric E-field probes**

Calibration date: **May 29, 2020**

This calibration certificate documents the traceability to national standards, which realize the physical units of measurements (SI).  
The measurements and the uncertainties with confidence probability are given on the following pages and are part of the certificate.

All calibrations have been conducted in the closed laboratory facility: environment temperature (22 ± 3)°C and humidity < 70%.

Calibration Equipment used (M&TE critical for calibration)

Primary Standards	ID	Cal Date (Certificate No.)	Scheduled Calibration
Power meter NRP	SN: 104778	01-Apr-20 (No. 217-03100/03101)	Apr-21
Power sensor NRP-Z91	SN: 103244	01-Apr-20 (No. 217-03100)	Apr-21
Power sensor NRP-Z91	SN: 103245	01-Apr-20 (No. 217-03101)	Apr-21
Reference 20 dB Attenuator	SN: CC2552 (20x)	31-Mar-20 (No. 217-03106)	Apr-21
DAE4	SN: 660	27-Dec-19 (No. DAE4-660_Dec19)	Dec-20
Reference Probe ES3DV2	SN: 3013	31-Dec-19 (No. ES3-3013_Dec19)	Dec-20
Secondary Standards	ID	Check Date (in house)	Scheduled Check
Power meter E4419B	SN: GB41293874	06-Apr-16 (in house check Jun-18)	In house check: Jun-20
Power sensor E4412A	SN: MY41498087	06-Apr-16 (in house check Jun-18)	In house check: Jun-20
Power sensor E4412A	SN: 000110210	06-Apr-16 (in house check Jun-18)	In house check: Jun-20
RF generator HP 8648C	SN: US3642U01700	04-Aug-99 (in house check Jun-18)	In house check: Jun-20
Network Analyzer E8358A	SN: US41080477	31-Mar-14 (in house check Oct-19)	In house check: Oct-20

	Name	Function	Signature
Calibrated by:	<b>Michael Weber</b>	<b>Laboratory Technician</b>	
Approved by:	<b>Katja Pokovic</b>	<b>Technical Manager</b>	
			Issued: June 1, 2020
This calibration certificate shall not be reproduced except in full without written approval of the laboratory.			



Accredited by the Swiss Accreditation Service (SAS)

Accreditation No.: **SCS 0108**

The Swiss Accreditation Service is one of the signatories to the EA Multilateral Agreement for the recognition of calibration certificates

### Glossary:

TSL	tissue simulating liquid
NORM <sub>x,y,z</sub>	sensitivity in free space
ConvF	sensitivity in TSL / NORM <sub>x,y,z</sub>
DCP	diode compression point
CF	crest factor (1/duty_cycle) of the RF signal
A, B, C, D	modulation dependent linearization parameters
Polarization $\varphi$	$\varphi$ rotation around probe axis
Polarization $\vartheta$	$\vartheta$ rotation around an axis that is in the plane normal to probe axis (at measurement center), i.e., $\vartheta = 0$ is normal to probe axis
Connector Angle	information used in DASY system to align probe sensor X to the robot coordinate system

### Calibration is Performed According to the Following Standards:

- IEEE Std 1528-2013, "IEEE Recommended Practice for Determining the Peak Spatial-Averaged Specific Absorption Rate (SAR) in the Human Head from Wireless Communications Devices: Measurement Techniques", June 2013
- IEC 62209-1, "Measurement procedure for the assessment of Specific Absorption Rate (SAR) from hand-held and body-mounted devices used next to the ear (frequency range of 300 MHz to 6 GHz)", July 2016
- IEC 62209-2, "Procedure to determine the Specific Absorption Rate (SAR) for wireless communication devices used in close proximity to the human body (frequency range of 30 MHz to 6 GHz)", March 2010
- KDB 865664, "SAR Measurement Requirements for 100 MHz to 6 GHz"

### Methods Applied and Interpretation of Parameters:

- NORM<sub>x,y,z</sub>**: Assessed for E-field polarization  $\vartheta = 0$  ( $f \leq 900$  MHz in TEM-cell;  $f > 1800$  MHz: R22 waveguide). NORM<sub>x,y,z</sub> are only intermediate values, i.e., the uncertainties of NORM<sub>x,y,z</sub> does not affect the E<sup>2</sup>-field uncertainty inside TSL (see below ConvF).
- NORM(f)<sub>x,y,z</sub> = NORM<sub>x,y,z</sub> \* frequency\_response** (see Frequency Response Chart). This linearization is implemented in DASY4 software versions later than 4.2. The uncertainty of the frequency response is included in the stated uncertainty of ConvF.
- DCP<sub>x,y,z</sub>**: DCP are numerical linearization parameters assessed based on the data of power sweep with CW signal (no uncertainty required). DCP does not depend on frequency nor media.
- PAR**: PAR is the Peak to Average Ratio that is not calibrated but determined based on the signal characteristics
- A<sub>x,y,z</sub>; B<sub>x,y,z</sub>; C<sub>x,y,z</sub>; D<sub>x,y,z</sub>; VR<sub>x,y,z</sub>**: A, B, C, D are numerical linearization parameters assessed based on the data of power sweep for specific modulation signal. The parameters do not depend on frequency nor media. VR is the maximum calibration range expressed in RMS voltage across the diode.
- ConvF and Boundary Effect Parameters**: Assessed in flat phantom using E-field (or Temperature Transfer Standard for  $f \leq 800$  MHz) and inside waveguide using analytical field distributions based on power measurements for  $f > 800$  MHz. The same setups are used for assessment of the parameters applied for boundary compensation (alpha, depth) of which typical uncertainty values are given. These parameters are used in DASY4 software to improve probe accuracy close to the boundary. The sensitivity in TSL corresponds to NORM<sub>x,y,z</sub> \* ConvF whereby the uncertainty corresponds to that given for ConvF. A frequency dependent ConvF is used in DASY version 4.4 and higher which allows extending the validity from  $\pm 50$  MHz to  $\pm 100$  MHz.
- Spherical isotropy (3D deviation from isotropy)**: in a field of low gradients realized using a flat phantom exposed by a patch antenna.
- Sensor Offset**: The sensor offset corresponds to the offset of virtual measurement center from the probe tip (on probe axis). No tolerance required.
- Connector Angle**: The angle is assessed using the information gained by determining the NORM<sub>x</sub> (no uncertainty required).

## DASY/EASY - Parameters of Probe: EX3DV4 - SN:7537

### Basic Calibration Parameters

	Sensor X	Sensor Y	Sensor Z	Unc (k=2)
Norm ( $\mu\text{V}/(\text{V}/\text{m})^2$ ) <sup>A</sup>	0.62	0.68	0.60	$\pm 10.1 \%$
DCP (mV) <sup>B</sup>	99.6	101.4	100.0	

### Calibration Results for Modulation Response

UID	Communication System Name		A dB	B dB/ $\mu\text{V}$	C	D dB	VR mV	Max dev.	Max Unc <sup>E</sup> (k=2)
0	CW	X	0.00	0.00	1.00	0.00	161.1	$\pm 3.5 \%$	$\pm 4.7 \%$
		Y	0.00	0.00	1.00		173.9		
		Z	0.00	0.00	1.00		155.9		
10352-AAA	Pulse Waveform (200Hz, 10%)	X	20.00	89.12	18.99	10.00	60.0	$\pm 4.2 \%$	$\pm 9.6 \%$
		Y	20.00	95.73	23.23		60.0		
		Z	20.00	89.82	19.50		60.0		
10353-AAA	Pulse Waveform (200Hz, 20%)	X	20.00	89.89	18.43	6.99	80.0	$\pm 2.8 \%$	$\pm 9.6 \%$
		Y	20.00	100.73	24.81		80.0		
		Z	20.00	91.13	19.20		80.0		
10354-AAA	Pulse Waveform (200Hz, 40%)	X	20.00	94.44	19.57	3.98	95.0	$\pm 1.4 \%$	$\pm 9.6 \%$
		Y	20.00	103.31	24.71		95.0		
		Z	20.00	96.20	20.50		95.0		
10355-AAA	Pulse Waveform (200Hz, 60%)	X	20.00	103.95	23.00	2.22	120.0	$\pm 1.2 \%$	$\pm 9.6 \%$
		Y	20.00	110.50	26.78		120.0		
		Z	20.00	99.60	21.04		120.0		
10387-AAA	QPSK Waveform, 1 MHz	X	1.82	66.71	15.70	1.00	150.0	$\pm 1.7 \%$	$\pm 9.6 \%$
		Y	1.79	65.65	15.04		150.0		
		Z	1.80	66.59	15.41		150.0		
10388-AAA	QPSK Waveform, 10 MHz	X	2.41	68.82	16.38	0.00	150.0	$\pm 1.2 \%$	$\pm 9.6 \%$
		Y	2.35	67.99	15.69		150.0		
		Z	2.39	68.72	16.12		150.0		
10396-AAA	64-QAM Waveform, 100 kHz	X	3.14	71.59	19.61	3.01	150.0	$\pm 0.9 \%$	$\pm 9.6 \%$
		Y	2.99	69.93	18.59		150.0		
		Z	2.84	69.66	18.37		150.0		
10399-AAA	64-QAM Waveform, 40 MHz	X	3.65	67.49	16.12	0.00	150.0	$\pm 0.9 \%$	$\pm 9.6 \%$
		Y	3.48	66.51	15.49		150.0		
		Z	3.51	66.94	15.72		150.0		
10414-AAA	WLAN CCDF, 64-QAM, 40MHz	X	5.01	65.86	15.76	0.00	150.0	$\pm 1.8 \%$	$\pm 9.6 \%$
		Y	4.89	65.20	15.31		150.0		
		Z	4.88	65.49	15.46		150.0		

Note: For details on UID parameters see Appendix

The reported uncertainty of measurement is stated as the standard uncertainty of measurement multiplied by the coverage factor  $k=2$ , which for a normal distribution corresponds to a coverage probability of approximately 95%.

<sup>A</sup> The uncertainties of Norm X,Y,Z do not affect the  $E^2$ -field uncertainty inside TSL (see Page 5).

<sup>B</sup> Numerical linearization parameter: uncertainty not required.

<sup>E</sup> Uncertainty is determined using the max. deviation from linear response applying rectangular distribution and is expressed for the square of the field value.

## DASY/EASY - Parameters of Probe: EX3DV4 - SN:7537

### Sensor Model Parameters

	C1 fF	C2 fF	$\alpha$ V <sup>-1</sup>	T1 ms.V <sup>-2</sup>	T2 ms.V <sup>-1</sup>	T3 ms	T4 V <sup>-2</sup>	T5 V <sup>-1</sup>	T6
X	49.4	370.28	35.89	14.18	0.00	5.01	1.43	0.21	1.01
Y	55.5	416.40	35.79	16.48	0.00	5.10	0.73	0.35	1.01
Z	48.8	361.84	35.16	14.43	0.00	5.03	0.67	0.31	1.00

### Other Probe Parameters

Sensor Arrangement	Triangular
Connector Angle (°)	-3.3
Mechanical Surface Detection Mode	enabled
Optical Surface Detection Mode	disabled
Probe Overall Length	337 mm
Probe Body Diameter	10 mm
Tip Length	9 mm
Tip Diameter	2.5 mm
Probe Tip to Sensor X Calibration Point	1 mm
Probe Tip to Sensor Y Calibration Point	1 mm
Probe Tip to Sensor Z Calibration Point	1 mm
Recommended Measurement Distance from Surface	1.4 mm

## DASY/EASY - Parameters of Probe: EX3DV4 - SN:7537

### Calibration Parameter Determined in Head Tissue Simulating Media

f (MHz) <sup>C</sup>	Relative Permittivity <sup>F</sup>	Conductivity (S/m) <sup>F</sup>	ConvF X	ConvF Y	ConvF Z	Alpha <sup>G</sup>	Depth <sup>G</sup> (mm)	Unc (k=2)
750	41.9	0.89	10.66	10.66	10.66	0.53	0.80	± 12.0 %
835	41.5	0.90	10.34	10.34	10.34	0.46	0.80	± 12.0 %
900	41.5	0.97	10.12	10.12	10.12	0.31	0.99	± 12.0 %
1450	40.5	1.20	8.64	8.64	8.64	0.44	0.80	± 12.0 %
1640	40.2	1.31	8.51	8.51	8.51	0.34	0.86	± 12.0 %
1750	40.1	1.37	8.47	8.47	8.47	0.36	0.86	± 12.0 %
1900	40.0	1.40	8.02	8.02	8.02	0.35	0.86	± 12.0 %
2000	40.0	1.40	7.99	7.99	7.99	0.31	0.86	± 12.0 %
2300	39.5	1.67	7.72	7.72	7.72	0.40	0.90	± 12.0 %
2450	39.2	1.80	7.40	7.40	7.40	0.38	0.90	± 12.0 %
2600	39.0	1.96	7.18	7.18	7.18	0.43	0.90	± 12.0 %
3300	38.2	2.71	6.67	6.67	6.67	0.35	1.30	± 13.1 %
3500	37.9	2.91	6.61	6.61	6.61	0.35	1.30	± 13.1 %
3700	37.7	3.12	6.53	6.53	6.53	0.35	1.30	± 13.1 %
3900	37.5	3.32	6.49	6.49	6.49	0.40	1.50	± 13.1 %
4100	37.2	3.53	6.20	6.20	6.20	0.40	1.50	± 13.1 %
4200	37.1	3.63	6.04	6.04	6.04	0.40	1.50	± 13.1 %
4400	36.9	3.84	5.94	5.94	5.94	0.40	1.70	± 13.1 %
4600	36.7	4.04	5.90	5.90	5.90	0.45	1.70	± 13.1 %
4800	36.4	4.25	5.68	5.68	5.68	0.40	1.80	± 13.1 %
4950	36.3	4.40	5.59	5.59	5.59	0.40	1.80	± 13.1 %
5250	35.9	4.71	5.35	5.35	5.35	0.40	1.80	± 13.1 %
5600	35.5	5.07	4.70	4.70	4.70	0.40	1.80	± 13.1 %
5750	35.4	5.22	4.95	4.95	4.95	0.40	1.80	± 13.1 %
5850	35.1	5.32	4.80	4.80	4.80	0.40	1.80	± 13.1 %

<sup>C</sup> Frequency validity above 300 MHz of ± 100 MHz only applies for DASY v4.4 and higher (see Page 2), else it is restricted to ± 50 MHz. The uncertainty is the RSS of the ConvF uncertainty at calibration frequency and the uncertainty for the indicated frequency band. Frequency validity below 300 MHz is ± 10, 25, 40, 50 and 70 MHz for ConvF assessments at 30, 64, 128, 150 and 220 MHz respectively. Validity of ConvF assessed at 6 MHz is 4-9 MHz, and ConvF assessed at 13 MHz is 9-19 MHz. Above 5 GHz frequency validity can be extended to ± 110 MHz.

<sup>F</sup> At frequencies below 3 GHz, the validity of tissue parameters ( $\epsilon$  and  $\sigma$ ) can be relaxed to ± 10% if liquid compensation formula is applied to measured SAR values. At frequencies above 3 GHz, the validity of tissue parameters ( $\epsilon$  and  $\sigma$ ) is restricted to ± 5%. The uncertainty is the RSS of the ConvF uncertainty for indicated target tissue parameters.

<sup>G</sup> Alpha/Depth are determined during calibration. SPEAG warrants that the remaining deviation due to the boundary effect after compensation is always less than ± 1% for frequencies below 3 GHz and below ± 2% for frequencies between 3-6 GHz at any distance larger than half the probe tip diameter from the boundary.

### Frequency Response of E-Field (TEM-Cell:ifi110 EXX, Waveguide: R22)

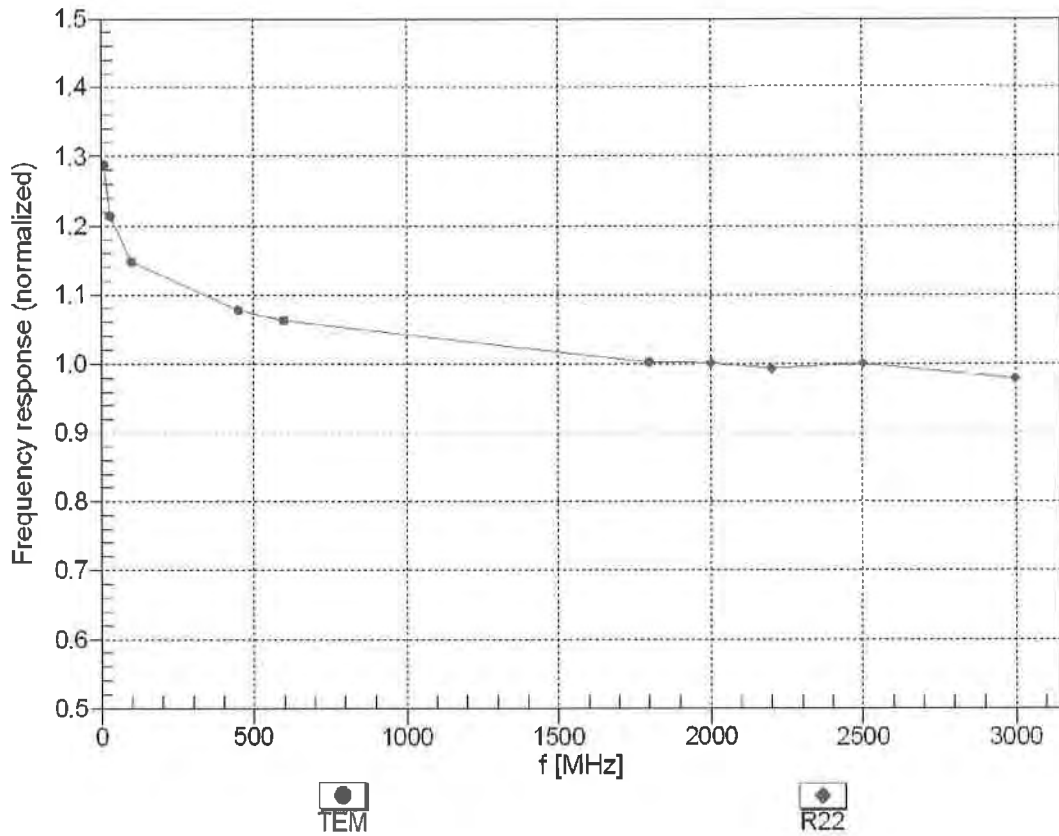

Uncertainty of Frequency Response of E-field:  $\pm 6.3\%$  (k=2)



## Receiving Pattern ( $\phi$ ), $\theta = 0^\circ$

f=600 MHz, TEM

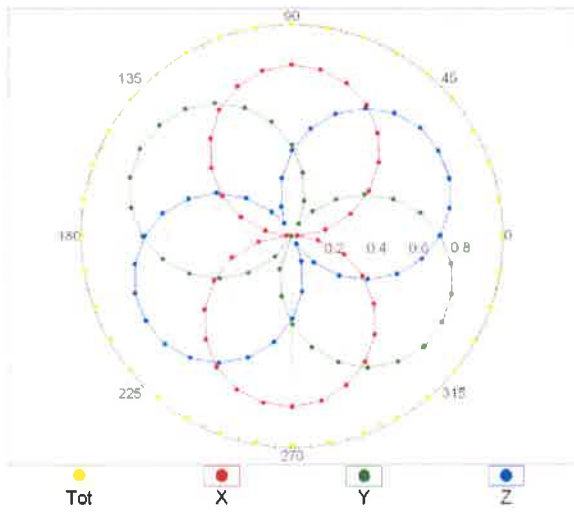

f=1800 MHz, R22

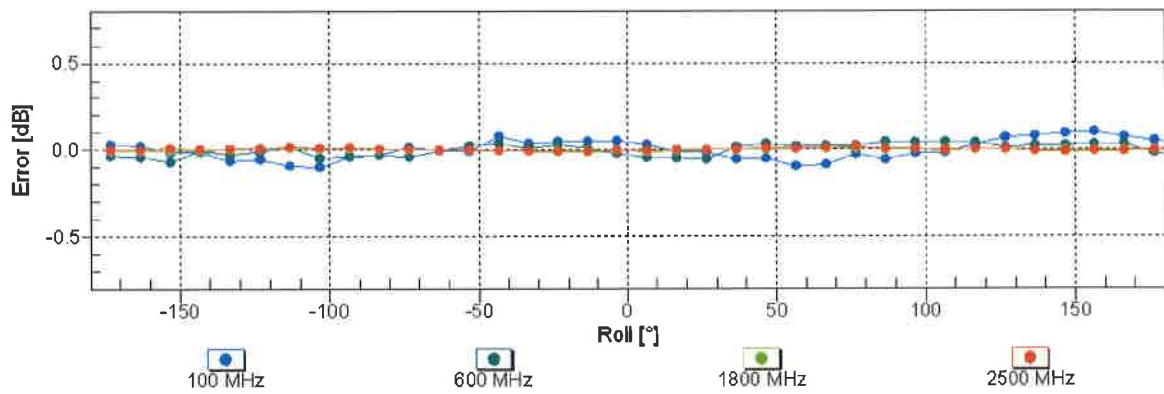
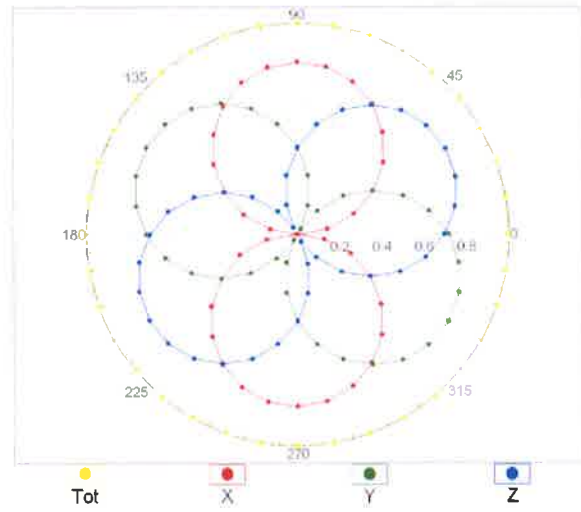

Uncertainty of Axial Isotropy Assessment:  $\pm 0.5\%$  (k=2)



### Dynamic Range f(SAR<sub>head</sub>) (TEM cell , f<sub>eval</sub>= 1900 MHz)

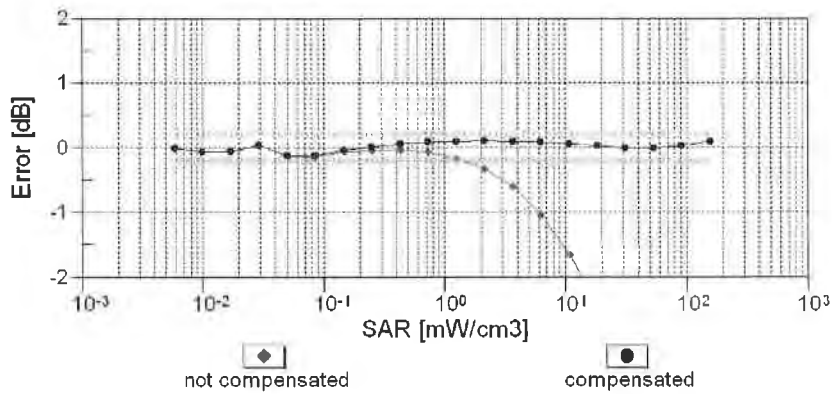
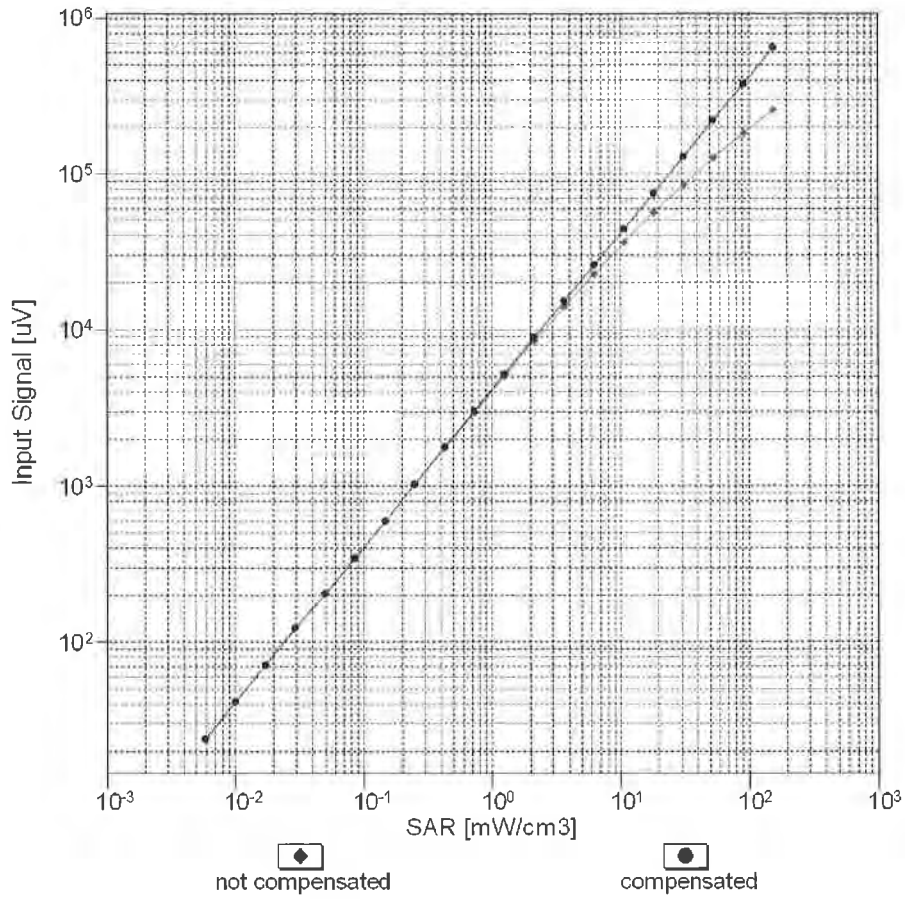

Uncertainty of Linearity Assessment: ± 0.6% (k=2)

## Conversion Factor Assessment

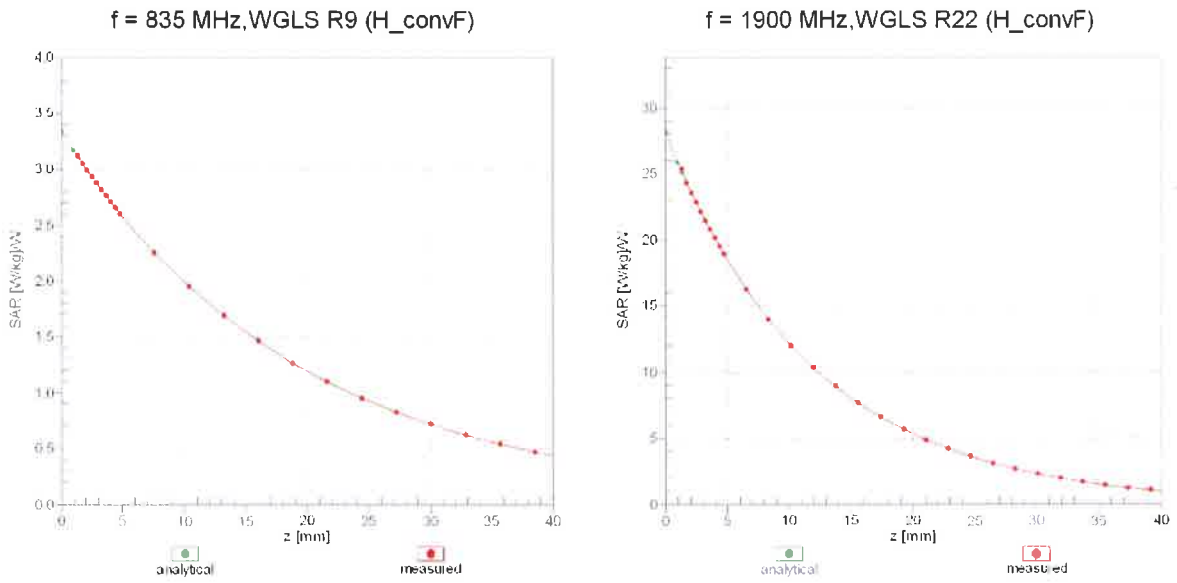

## Deviation from Isotropy in Liquid Error ( $\phi, \theta$ ), f = 900 MHz

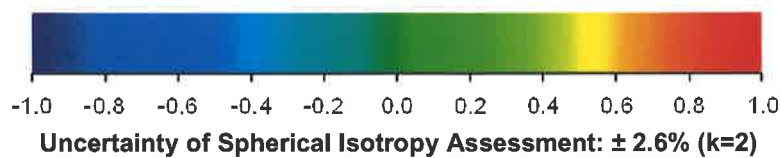
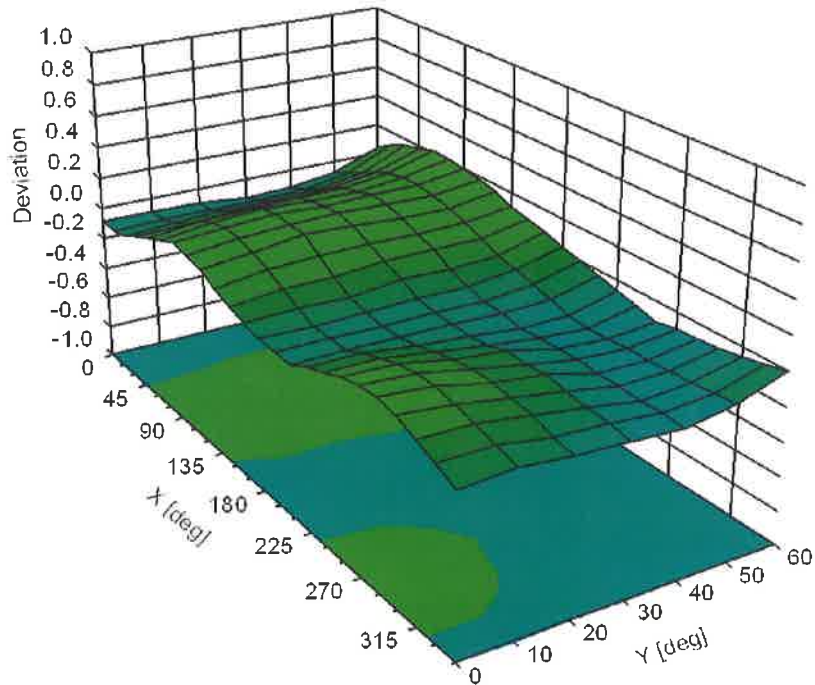

Uncertainty of Spherical Isotropy Assessment:  $\pm 2.6\%$  ( $k=2$ )

## Appendix: Modulation Calibration Parameters

UID	Rev	Communication System Name	Group	PAR (dB)	Unc <sup>E</sup> (k=2)
0		CW	CW	0.00	± 4.7 %
10010	CAA	SAR Validation (Square, 100ms, 10ms)	Test	10.00	± 9.6 %
10011	CAB	UMTS-FDD (WCDMA)	WCDMA	2.91	± 9.6 %
10012	CAB	IEEE 802.11b WiFi 2.4 GHz (DSSS, 1 Mbps)	WLAN	1.87	± 9.6 %
10013	CAB	IEEE 802.11g WiFi 2.4 GHz (DSSS-OFDM, 6 Mbps)	WLAN	9.46	± 9.6 %
10021	DAC	GSM-FDD (TDMA, GMSK)	GSM	9.39	± 9.6 %
10023	DAC	GPRS-FDD (TDMA, GMSK, TN 0)	GSM	9.57	± 9.6 %
10024	DAC	GPRS-FDD (TDMA, GMSK, TN 0-1)	GSM	6.56	± 9.6 %
10025	DAC	EDGE-FDD (TDMA, 8PSK, TN 0)	GSM	12.62	± 9.6 %
10026	DAC	EDGE-FDD (TDMA, 8PSK, TN 0-1)	GSM	9.55	± 9.6 %
10027	DAC	GPRS-FDD (TDMA, GMSK, TN 0-1-2)	GSM	4.80	± 9.6 %
10028	DAC	GPRS-FDD (TDMA, GMSK, TN 0-1-2-3)	GSM	3.55	± 9.6 %
10029	DAC	EDGE-FDD (TDMA, 8PSK, TN 0-1-2)	GSM	7.78	± 9.6 %
10030	CAA	IEEE 802.15.1 Bluetooth (GFSK, DH1)	Bluetooth	5.30	± 9.6 %
10031	CAA	IEEE 802.15.1 Bluetooth (GFSK, DH3)	Bluetooth	1.87	± 9.6 %
10032	CAA	IEEE 802.15.1 Bluetooth (GFSK, DH5)	Bluetooth	1.16	± 9.6 %
10033	CAA	IEEE 802.15.1 Bluetooth (PI/4-DQPSK, DH1)	Bluetooth	7.74	± 9.6 %
10034	CAA	IEEE 802.15.1 Bluetooth (PI/4-DQPSK, DH3)	Bluetooth	4.53	± 9.6 %
10035	CAA	IEEE 802.15.1 Bluetooth (PI/4-DQPSK, DH5)	Bluetooth	3.83	± 9.6 %
10036	CAA	IEEE 802.15.1 Bluetooth (8-DPSK, DH1)	Bluetooth	8.01	± 9.6 %
10037	CAA	IEEE 802.15.1 Bluetooth (8-DPSK, DH3)	Bluetooth	4.77	± 9.6 %
10038	CAA	IEEE 802.15.1 Bluetooth (8-DPSK, DH5)	Bluetooth	4.10	± 9.6 %
10039	CAB	CDMA2000 (1xRTT, RC1)	CDMA2000	4.57	± 9.6 %
10042	CAB	IS-54 / IS-136 FDD (TDMA/FDM, PI/4-DQPSK, Halfrate)	AMPS	7.78	± 9.6 %
10044	CAA	IS-91/EIA/TIA-553 FDD (FDMA, FM)	AMPS	0.00	± 9.6 %
10048	CAA	DECT (TDD, TDMA/FDM, GFSK, Full Slot, 24)	DECT	13.80	± 9.6 %
10049	CAA	DECT (TDD, TDMA/FDM, GFSK, Double Slot, 12)	DECT	10.79	± 9.6 %
10056	CAA	UMTS-TDD (TD-SCDMA, 1.28 Mcps)	TD-SCDMA	11.01	± 9.6 %
10058	DAC	EDGE-FDD (TDMA, 8PSK, TN 0-1-2-3)	GSM	6.52	± 9.6 %
10059	CAB	IEEE 802.11b WiFi 2.4 GHz (DSSS, 2 Mbps)	WLAN	2.12	± 9.6 %
10060	CAB	IEEE 802.11b WiFi 2.4 GHz (DSSS, 5.5 Mbps)	WLAN	2.83	± 9.6 %
10061	CAB	IEEE 802.11b WiFi 2.4 GHz (DSSS, 11 Mbps)	WLAN	3.60	± 9.6 %
10062	CAC	IEEE 802.11a/h WiFi 5 GHz (OFDM, 6 Mbps)	WLAN	8.68	± 9.6 %
10063	CAC	IEEE 802.11a/h WiFi 5 GHz (OFDM, 9 Mbps)	WLAN	8.63	± 9.6 %
10064	CAC	IEEE 802.11a/h WiFi 5 GHz (OFDM, 12 Mbps)	WLAN	9.09	± 9.6 %
10065	CAC	IEEE 802.11a/h WiFi 5 GHz (OFDM, 18 Mbps)	WLAN	9.00	± 9.6 %
10066	CAC	IEEE 802.11a/h WiFi 5 GHz (OFDM, 24 Mbps)	WLAN	9.38	± 9.6 %
10067	CAC	IEEE 802.11a/h WiFi 5 GHz (OFDM, 36 Mbps)	WLAN	10.12	± 9.6 %
10068	CAC	IEEE 802.11a/h WiFi 5 GHz (OFDM, 48 Mbps)	WLAN	10.24	± 9.6 %
10069	CAC	IEEE 802.11a/h WiFi 5 GHz (OFDM, 54 Mbps)	WLAN	10.56	± 9.6 %
10071	CAB	IEEE 802.11g WiFi 2.4 GHz (DSSS/OFDM, 9 Mbps)	WLAN	9.83	± 9.6 %
10072	CAB	IEEE 802.11g WiFi 2.4 GHz (DSSS/OFDM, 12 Mbps)	WLAN	9.62	± 9.6 %
10073	CAB	IEEE 802.11g WiFi 2.4 GHz (DSSS/OFDM, 18 Mbps)	WLAN	9.94	± 9.6 %
10074	CAB	IEEE 802.11g WiFi 2.4 GHz (DSSS/OFDM, 24 Mbps)	WLAN	10.30	± 9.6 %
10075	CAB	IEEE 802.11g WiFi 2.4 GHz (DSSS/OFDM, 36 Mbps)	WLAN	10.77	± 9.6 %
10076	CAB	IEEE 802.11g WiFi 2.4 GHz (DSSS/OFDM, 48 Mbps)	WLAN	10.94	± 9.6 %
10077	CAB	IEEE 802.11g WiFi 2.4 GHz (DSSS/OFDM, 54 Mbps)	WLAN	11.00	± 9.6 %
10081	CAB	CDMA2000 (1xRTT, RC3)	CDMA2000	3.97	± 9.6 %
10082	CAB	IS-54 / IS-136 FDD (TDMA/FDM, PI/4-DQPSK, Fullrate)	AMPS	4.77	± 9.6 %
10090	DAC	GPRS-FDD (TDMA, GMSK, TN 0-4)	GSM	6.56	± 9.6 %
10097	CAB	UMTS-FDD (HSDPA)	WCDMA	3.98	± 9.6 %
10098	CAB	UMTS-FDD (HSUPA, Subtest 2)	WCDMA	3.98	± 9.6 %
10099	DAC	EDGE-FDD (TDMA, 8PSK, TN 0-4)	GSM	9.55	± 9.6 %
10100	CAE	LTE-FDD (SC-FDMA, 100% RB, 20 MHz, QPSK)	LTE-FDD	5.67	± 9.6 %
10101	CAE	LTE-FDD (SC-FDMA, 100% RB, 20 MHz, 16-QAM)	LTE-FDD	6.42	± 9.6 %
10102	CAE	LTE-FDD (SC-FDMA, 100% RB, 20 MHz, 64-QAM)	LTE-FDD	6.60	± 9.6 %
10103	CAG	LTE-TDD (SC-FDMA, 100% RB, 20 MHz, QPSK)	LTE-TDD	9.29	± 9.6 %
10104	CAG	LTE-TDD (SC-FDMA, 100% RB, 20 MHz, 16-QAM)	LTE-TDD	9.97	± 9.6 %
10105	CAG	LTE-TDD (SC-FDMA, 100% RB, 20 MHz, 64-QAM)	LTE-TDD	10.01	± 9.6 %
10108	CAG	LTE-FDD (SC-FDMA, 100% RB, 10 MHz, QPSK)	LTE-FDD	5.80	± 9.6 %