

Partial FCC Test Report

(Spot Check)

Report No.: RF200428C03E-3

FCC ID: PZWBHTM80QW

Test Model: BHT-M80-QW

Received Date: Aug. 25, 2020

Test Date: Sep. 05 ~ Oct. 24, 2020

Issued Date: Oct. 27, 2020

Applicant: DENSO WAVE INCORPORATED

Address: 1 Yoshiike Kusagi Agui-cho, Chita-gun Aichi 470-2297, Japan

Issued By: Bureau Veritas Consumer Products Services (H.K.) Ltd., Taoyuan Branch
Lin Kou Laboratories

Lab Address: No. 47-2, 14th Ling, Chia Pau Vil., Lin Kou Dist., New Taipei City, Taiwan

Test Location: No. 19, Hwa Ya 2nd Rd., Wen Hwa Vil., Kwei Shan Dist., Taoyuan City
33383, TAIWAN

**FCC Registration /
Designation Number:** 788550 / TW0003



This report is for your exclusive use. Any copying or replication of this report to or for any other person or entity, or use of our name or trademark, is permitted only with our prior written permission. This report sets forth our findings solely with respect to the test samples identified herein. The results set forth in this report are not indicative or representative of the quality or characteristics of the lot from which a test sample was taken or any similar or identical product unless specifically and expressly noted. Our report includes all of the tests requested by you and the results thereof based upon the information that you provided to us. You have 60 days from date of issuance of this report to notify us of any material error or omission caused by our negligence, provided, however, that such notice shall be in writing and shall specifically address the issue you wish to raise. A failure to raise such issue within the prescribed time shall constitute your unqualified acceptance of the completeness of this report, the tests conducted and the correctness of the report contents. Unless specific mention, the uncertainty of measurement has been explicitly taken into account to declare the compliance or non-compliance to the specification.

Table of Contents

Release Control Record	3
1 Certificate of Conformity	4
2 Summary of Test Results	5
2.1 Measurement Uncertainty.....	5
2.2 Modification Record.....	5
3 General Information	6
3.1 General Description of EUT.....	6
3.2 Description of Test Modes.....	8
3.2.1 Test Mode Applicability and Tested Channel Detail.....	9
3.3 Duty Cycle of Test Signal.....	10
3.4 Description of Support Units.....	11
3.4.1 Configuration of System under Test.....	11
3.5 General Description of Applied Standards and References.....	11
4 Test Types and Results	13
4.1 Radiated Emission and Bandedge Measurement.....	13
4.1.1 Limits of Radiated Emission and Bandedge Measurement.....	13
4.1.2 Test Instruments.....	14
4.1.3 Test Procedures.....	15
4.1.4 Deviation from Test Standard.....	15
4.1.5 Test Setup.....	16
4.1.6 EUT Operating Conditions.....	17
4.1.7 Test Results.....	18
4.2 Conducted Emission Measurement.....	25
4.2.1 Limits of Conducted Emission Measurement.....	25
4.2.2 Test Instruments.....	25
4.2.3 Test Procedures.....	26
4.2.4 Deviation from Test Standard.....	26
4.2.5 Test Setup.....	26
4.2.6 EUT Operating Conditions.....	26
4.2.7 Test Results.....	27
4.3 Conducted Output Power Measurement.....	33
4.3.1 Limits of Conducted Output Power Measurement.....	33
4.3.2 Test Setup.....	33
4.3.3 Test Instruments.....	33
4.3.4 Test Procedures.....	33
4.3.5 Deviation from Test Standard.....	33
4.3.6 EUT Operating Conditions.....	33
4.3.7 Test Results.....	34
4.4 Power Spectral Density Measurement.....	35
4.4.1 Limits of Power Spectral Density Measurement.....	35
4.4.2 Test Setup.....	35
4.4.3 Test Instruments.....	35
4.4.4 Test Procedure.....	35
4.4.5 Deviation from Test Standard.....	35
4.4.6 EUT Operating Condition.....	35
4.4.7 Test Results.....	36
Annex A- Band Edge Measurement	38
5 Pictures of Test Arrangements	39
Appendix – Information of the Testing Laboratories	40

Release Control Record

Issue No.	Description	Date Issued
RF200428C03E-3	Original release	Oct. 27, 2020

1 Certificate of Conformity

Product: 2D Code Handy Terminal

Brand: DENSO

Test Model: BHT-M80-QW

Sample Status: Engineering sample

Applicant: DENSO WAVE INCORPORATED

Test Date: Sep. 05 ~ Oct. 24, 2020

Standards: 47 CFR FCC Part 15, Subpart C (Section 15.247)
ANSI C63.10:2013

The above equipment has been tested by **Bureau Veritas Consumer Products Services (H.K.) Ltd., Taoyuan Branch**, and found compliance with the requirement of the above standards. The test record, data evaluation & Equipment Under Test (EUT) configurations represented herein are true and accurate accounts of the measurements of the sample's RF characteristics under the conditions specified in this report.

Prepared by : , **Date:** Oct. 27, 2020
Polly Chien / Specialist

Approved by : , **Date:** Oct. 27, 2020
Bruce Chen / Senior Project Engineer

2 Summary of Test Results

47 CFR FCC Part 15, Subpart C (Section 15.247)			
FCC Clause	Test Item	Result	Remarks
15.207	AC Power Conducted Emission	Pass	Meet the requirement of limit. Minimum passing margin is -14.88dB at 0.40024MHz.
15.205 / 15.209 / 15.247(d)	Radiated Emissions and Band Edge Measurement	Pass	Meet the requirement of limit. Minimum passing margin is -1.0dB at 730.38MHz.
15.247(d)	Antenna Port Emission	N/A	Refer to note 1
15.247(a)(2)	6dB bandwidth	N/A	Refer to note 1
15.247(b)	Conducted power	Pass	Meet the requirement of limit.
15.247(e)	Power Spectral Density	Pass	Meet the requirement of limit.
15.203	Antenna Requirement	Pass	Antenna connector is spring not a standard connector.

Note:

1. This report is a partial report. Therefore, only Output Power, Power Spectral Density, AC Power Conducted Emission and Radiated Emissions were verified and recorded in this report. Other testing data please refer to the original BV CPS report no.: RF200428C03-7.
2. For 2.4G band compliance with rule 15.247(d) of the band-edge items, the test plots were recorded in Annex A. Test Procedures refer to report 4.1.3.
3. Determining compliance based on the results of the compliance measurement, not taking into account measurement instrumentation uncertainty.

2.1 Measurement Uncertainty

Where relevant, the following measurement uncertainty levels have been estimated for tests performed on the EUT as specified in CISPR 16-4-2:

Measurement	Frequency	Expanded Uncertainty (k=2) (\pm)
Conducted Emissions at mains ports	150kHz ~ 30MHz	2.79 dB
Radiated Emissions up to 1 GHz	9kHz ~ 30MHz	3.04 dB
	30MHz ~ 200MHz	3.59 dB
	200MHz ~ 1000MHz	3.60 dB
Radiated Emissions above 1 GHz	1GHz ~ 18GHz	2.29 dB
	18GHz ~ 40GHz	2.29 dB

2.2 Modification Record

There were no modifications required for compliance.

3 General Information

3.1 General Description of EUT

Product	2D Code Handy Terminal
Brand	DENSO
Test Model	BHT-M80-QW
Sample Status	Engineering sample
Power Supply Rating	3.85Vdc (Battery) 5.0Vdc / 9.0Vdc / 12.0Vdc (from adapter)
Modulation Type	GFSK
Transfer Rate	Bluetooth LE 4.0: 1Mbps Bluetooth LE 5.0: 2Mbps
Operating Frequency	2402 ~ 2480MHz
Number of Channel	40
Channel Spacing	2MHz
Output Power	Bluetooth LE 4.0: 1.276mW Bluetooth LE 5.0: 1.271mW
Antenna Type	Refer to note
Antenna Connector	Refer to note
Accessory Device	Refer to note
Cable Supplied	Refer to note

Note:

1. This report is a supplementary report to the original BV CPS report no.: RF200428C03-7. Exhibit prepared for FCC Spot Check Verification report, the format, test items and amount of spot-check test data are decided by applicant's engineering judgment, for more details please refer to declaration letter exhibit. Therefore, only Output Power, Power Spectral Density, AC Power Conducted Emission and Radiated Emissions were verified and recorded in this report. AC Power Conducted Emission and Radiated Emission tests according to original report radiated emission worst channel.
2. The EUT contains following accessory devices.

Battery 1	
Brand	DENSO
Model	BT1
Rating	3.85Vdc, 4020mAh, 15.47Wh

Battery 2	
Brand	DENSO
Model	BT1S
Rating	3.85Vdc, 2900mAh, 11.16Wh

Adapter	
Brand	CHANNEL WELL TECHNOLOGY
Model	2ACP0183C
Input Power	100-240Vac~0.5A , 50/60Hz
Output Power	5.0Vdc / 3.0A, 15.0W 9.0Vdc / 2.0A, 18.0W 12.0Vdc / 1.5A, 18.0W
Data Cable	1.45 m shielded USB cable without core

Cradle 1: QC3.0 charge single Cradle (Option)	
Brand	DENSO
Model	CU-M80UQ
Adapter	
Brand	CHANNEL WELL TECHNOLOGY
Model	2ACP0183C
Input Power	100-240Vac, 50/60Hz, 0.5A
Output Power	5.0Vdc / 3.0A, 15.0W 9.0Vdc / 2.0A, 18.0W 12.0Vdc / 1.5A, 18.0W
Data Cable	1.45 m shielded USB cable without core

Cradle 2: USB Cradle with spare battery charge (Option)	
Brand	DENSO
Model	CU-M80U
Adapter	
Brand	Sunny
Model	SYS1548-5012-T3
Input Power	100-240Vac, 1.5A MAX, 50-60Hz
Output Power	+12.0Vdc, 4.16A
Power cable	DC: 1.16m cable with one core AC: 1.71m non-shielded cable without core
Data Cable	1.45 m shielded USB cable without core

3. The EUT uses the following antennas.

Ant. Type	PIFA													
Ant. Connector	Spring													
Ant. 1 (WLAN)														
Frequency (MHz)	2412	2442	2484	5170	5180	5220	5320	5420	5520	5620	5720	5825	5835	
Peak Gain (dBi)	0.81	1.36	1.05	3.34	2.97	2.96	2.78	2.88	3.28	3.24	3.45	3.18	3.39	
Ant. 1 (BT)														
Frequency (MHz)	2402			2412			2442			2480				
Peak Gain (dBi)	-0.11			0.81			1.36			1.36				
Ant. 2 (WLAN)														
Frequency (MHz)	2412	2442	2484	5170	5180	5220	5320	5420	5520	5620	5720	5825	5835	
Peak Gain (dBi)	1.33	1.47	0.29	3.80	3.78	3.65	3.51	2.98	2.99	3.09	3.49	3.53	3.44	

* The max. gain was chosen for final tests.

*The above Antenna information is declared by manufacturer and for more detailed features description, please refer to the manufacturer's specifications, the laboratory shall not be held responsible.

3.2 Description of Test Modes

40 channels are provided to this EUT:

Channel	Freq. (MHz)	Channel	Freq. (MHz)	Channel	Freq. (MHz)	Channel	Freq. (MHz)
0	2402	10	2422	20	2442	30	2462
1	2404	11	2424	21	2444	31	2464
2	2406	12	2426	22	2446	32	2466
3	2408	13	2428	23	2448	33	2468
4	2410	14	2430	24	2450	34	2470
5	2412	15	2432	25	2452	35	2472
6	2414	16	2434	26	2454	36	2474
7	2416	17	2436	27	2456	37	2476
8	2418	18	2438	28	2458	38	2478
9	2420	19	2440	29	2460	39	2480

3.2.1 Test Mode Applicability and Tested Channel Detail

EUT Configure Mode	Applicable to				Description
	RE \geq 1G	RE<1G	PLC	APCM	
A	√	√	√	√	EUT with adapter
B	-	√	√	-	EUT with Cradle 1
C	-	√	√	-	EUT with Cradle 2

Where RE \geq 1G: Radiated Emission above 1GHz & Bandedge Measurement
 RE<1G: Radiated Emission below 1GHz
 PLC: Power Line Conducted Emission
 APCM: Antenna Port Conducted Measurement

- Note: The EUT had been pre-tested on the positioned of each 3 axis. The worst case was found when positioned on **X-plane** for mode A.
- "-" means no effect.

Radiated Emission Test (Above 1GHz):

- Pre-Scan has been conducted to determine the worst-case mode from all possible combinations between available modulations, data rates and antenna ports (if EUT with antenna diversity architecture).
- Following channel(s) was (were) selected for the final test as listed below.

EUT Configure Mode	Available Channel	Tested Channel	Modulation Type	Data Rate (Mbps)
A	0 to 39	39	GFSK	2

Radiated Emission Test (Below 1GHz):

- Pre-Scan has been conducted to determine the worst-case mode from all possible combinations between available modulations, data rates and antenna ports (if EUT with antenna diversity architecture).
- Following channel(s) was (were) selected for the final test as listed below.

EUT Configure Mode	Available Channel	Tested Channel	Modulation Type	Data Rate (Mbps)
A, B, C	0 to 39	39	GFSK	2

Power Line Conducted Emission Test:

- Pre-Scan has been conducted to determine the worst-case mode from all possible combinations between available modulations, data rates and antenna ports (if EUT with antenna diversity architecture).
- Following channel(s) was (were) selected for the final test as listed below.

EUT Configure Mode	Available Channel	Tested Channel	Modulation Type	Data Rate (Mbps)
A, B, C	0 to 39	39	GFSK	2

Antenna Port Conducted Measurement:

- This item includes all test value of each mode, but only includes spectrum plot of worst value of each mode.
- Pre-Scan has been conducted to determine the worst-case mode from all possible combinations between available modulations, data rates and antenna ports (if EUT with antenna diversity architecture).
- Following channel(s) was (were) selected for the final test as listed below.

EUT Configure Mode	Available Channel	Tested Channel	Modulation Type	Data Rate (Mbps)
A	0 to 39	0, 19, 39	GFSK	1, 2

Test Condition:

Applicable to	Environmental Conditions	Input Power	Tested by
RE≥1G	22 deg. C, 66% RH	120Vac, 60Hz	Greg Lin
RE<1G	22 deg. C, 66% RH 25 deg. C, 70% RH	120Vac, 60Hz	Greg Lin, Noah Chang
PLC	25 deg. C, 75% RH 26 deg. C, 69% RH	120Vac, 60Hz	Greg Lin, Willy Cheng
APCM	25 deg. C, 60% RH	120Vac, 60Hz	Ivan Tseng

3.3 Duty Cycle of Test Signal

Duty cycle of test signal is < 98%.

BT LE 4.0: Duty cycle = 0.388/0.628 = 0.618, Duty factor = 10 * log (1/0.618) = 2.09

BT LE 5.0: Duty cycle = 0.200/0.634 = 0.315, Duty factor = 10 * log (1/0.315) = 5.02

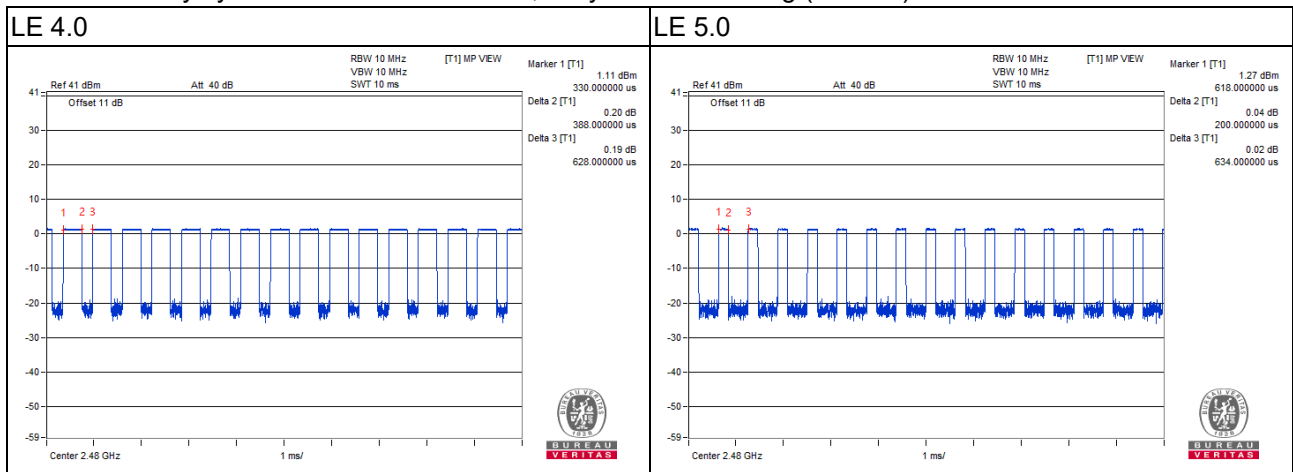

3.4 Description of Support Units

The EUT has been tested as an independent unit together with other necessary accessories or support units. The following support units or accessories were used to form a representative test configuration during the tests.

ID	Product	Brand	Model No.	Serial No.	FCC ID	Remarks
A.	Cradle 1	DENSO	CU-M80UQ	NA	NA	Provided by manufacturer
B.	Adapter	CHANNEL WELL TECHNOLOGY	2ACP0183C	NA	NA	Provided by manufacturer
C.	Cradle 2	DENSO	CU-M80U	NA	NA	Provided by manufacturer
D.	Adapter	Sunny	SYS1548-5012-T3	NA	NA	Provided by manufacturer

ID	Descriptions	Qty.	Length (m)	Shielding (Yes/No)	Cores (Qty.)	Remarks
1.	USB cable	1	1.45	Y	0	Accessory of EUT
2.	USB cable	1	1.45	Y	0	Provided by manufacturer
3.	USB cable	1	1.45	Y	0	Provided by manufacturer
4.	Power cable	1	1.16	-	1	Provided by manufacturer

Note: The core(s) is(are) originally attached to the cable(s).

3.4.1 Configuration of System under Test

Mode A

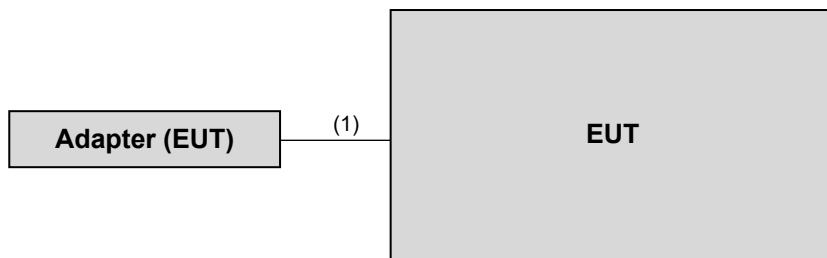

Mode B

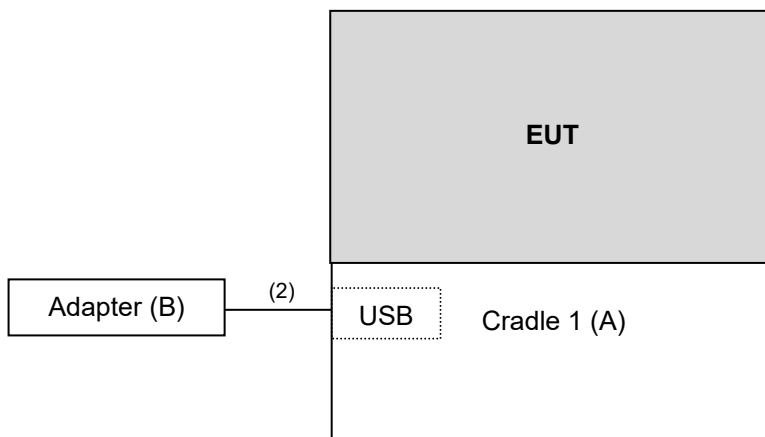

Mode C

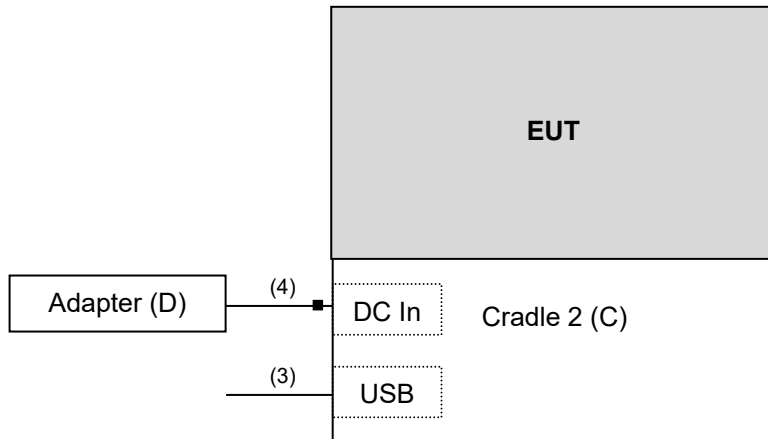

3.5 General Description of Applied Standards and References

The EUT is a RF Product. According to the specifications of the manufacturer, it must comply with the requirements of the following standards and references:

Test standard:

FCC Part 15, Subpart C (15.247)

ANSI C63.10:2013

All test items have been performed and recorded as per the above standards.

References Test Guidance:

KDB 558074 D01 15.247 Meas Guidance v05r02

All test items have been performed as a reference to the above KDB test guidance.

4 Test Types and Results

4.1 Radiated Emission and Bandedge Measurement

4.1.1 Limits of Radiated Emission and Bandedge Measurement

Radiated emissions which fall in the restricted bands must comply with the radiated emission limits specified as below table. Other emissions shall be at least 20dB below the highest level of the desired power:

Frequencies (MHz)	Field Strength (microvolts/meter)	Measurement Distance (meters)
0.009 ~ 0.490	2400/F(kHz)	300
0.490 ~ 1.705	24000/F(kHz)	30
1.705 ~ 30.0	30	30
30 ~ 88	100	3
88 ~ 216	150	3
216 ~ 960	200	3
Above 960	500	3

Note:

1. The lower limit shall apply at the transition frequencies.
2. Emission level (dBuV/m) = 20 log Emission level (uV/m).
3. For frequencies above 1000MHz, the field strength limits are based on average detector, however, the peak field strength of any emission shall not exceed the maximum permitted average limits, specified above by more than 20dB under any condition of modulation.

4.1.2 Test Instruments

Description & Manufacturer	Model No.	Serial No.	Cal. Date	Cal. Due
Test Receiver KEYSIGHT	N9038A	MY55420137	Apr. 16, 2020	Apr. 15, 2021
Spectrum Analyzer ROHDE & SCHWARZ	FSP40	100039	Jun. 12, 2020	Jun. 11, 2021
Spectrum Analyzer ROHDE & SCHWARZ	FSV40	100979	Mar. 18, 2020	Mar. 17, 2021
BILOG Antenna SCHWARZBECK	VULB9168	9168-160	Nov. 07, 2019	Nov. 06, 2020
HORN Antenna SCHWARZBECK	BBHA 9120 D	9120D-1169	Nov. 24, 2019	Nov. 23, 2020
HORN Antenna SCHWARZBECK	BBHA 9170	BBHA9170241	Nov. 24, 2019	Nov. 23, 2020
Loop Antenna TESEQ	HLA 6121	45745	Jul. 06, 2020	Jul. 05, 2021
Preamplifier Agilent (Below 1GHz)	8447D	2944A10638	Jun. 08, 2020	Jun. 07, 2021
Preamplifier Agilent (Above 1GHz)	8449B	3008A02367	Feb. 18, 2020	Feb. 17, 2021
RF signal cable HUBER+SUHNER&EMCI	SUCOFLEX 104 & EMC104-SM-SM800 0	CABLE-CH9-02 (248780+171006)	Jan. 18, 2020	Jan. 17, 2021
RF signal cable HUBER+SUHNER	SUCOFLEX 104	CABLE-CH9-(250795/ 4)	Jan. 18, 2020	Jan. 17, 2021
RF signal cable Woken	8D-FB	Cable-CH9-01	Jun. 08, 2020	Jun. 07, 2021
Software BV ADT	ADT_Radiated_ V7.6.15.9.5	NA	NA	NA
Antenna Tower EMCO	2070/2080	512.835.4684	NA	NA
Turn Table EMCO	2087-2.03	NA	NA	NA
Antenna Tower & Turn BV ADT	AT100	AT93021705	NA	NA
Turn Table BV ADT	TT100	TT93021705	NA	NA
Turn Table Controller BV ADT	SC100	SC93021705	NA	NA
Boresight Antenna Fixture	FBA-01	FBA-SIP01	NA	NA
USB Wideband Power Sensor KEYSIGHT	U2021XA	MY55050005/MY5519 0004/MY55190007/MY 55210005	Jul. 13, 2020	Jul. 12, 2021

Note: 1. The calibration interval of the above test instruments is 12 months and the calibrations are traceable to NML/ROC and NIST/USA.
2. The test was performed in HwaYa Chamber 9.

4.1.3 Test Procedures

For Radiated emission below 30MHz

- a. The EUT was placed on the top of a rotating table 0.8 meters above the ground at a 3 meter chamber room. The table was rotated 360 degrees to determine the position of the highest radiation.
- b. The EUT was set 3 meters away from the interference-receiving antenna, which was mounted on the top of a variable-height antenna tower.
- c. Parallel, perpendicular, and ground-parallel orientations of the antenna are set to make the measurement.
- d. For each suspected emission, the EUT was arranged to its worst case and the rotatable table was turned from 0 degrees to 360 degrees to find the maximum reading.
- e. The test-receiver system was set to Quasi-Peak Detect Function and Specified Bandwidth with Maximum Hold Mode.

Note:

1. The resolution bandwidth and video bandwidth of test receiver/spectrum analyzer is 9kHz at frequency below 30MHz.

For Radiated emission above 30MHz

- a. The EUT was placed on the top of a rotating table 0.8 meters (for 30MHz ~ 1GHz) / 1.5 meters (for above 1GHz) above the ground at 3 meter chamber room for test. The table was rotated 360 degrees to determine the position of the highest radiation.
- b. The EUT was set 3 meters away from the interference-receiving antenna, which was mounted on the top of a variable-height antenna tower.
- c. The height of antenna is varied from one meter to four meters above the ground to determine the maximum value of the field strength. Both horizontal and vertical polarizations of the antenna are set to make the measurement.
- d. For each suspected emission, the EUT was arranged to its worst case and then the antenna was tuned to heights from 1 meter to 4 meters and the rotatable table was turned from 0 degrees to 360 degrees to find the maximum reading.
- e. The test-receiver system was set to quasi-peak detect function and specified bandwidth with maximum hold mode when the test frequency is below 1 GHz.
- f. The test-receiver system was set to peak and average detect function and specified bandwidth with maximum hold mode when the test frequency is above 1 GHz. If the peak reading value also meets average limit, measurement with the average detector is unnecessary.

Note:

1. The resolution bandwidth and video bandwidth of test receiver/spectrum analyzer is 120kHz for Quasi-peak detection (QP) at frequency below 1GHz.
2. The resolution bandwidth of test receiver/spectrum analyzer is 1 MHz and the video bandwidth is 3 MHz for Peak detection (PK) at frequency above 1GHz.
3. The resolution bandwidth of test receiver/spectrum analyzer is 1MHz and the video bandwidth is $\geq 1/T$ (Duty cycle < 98%) or 10Hz (Duty cycle $\geq 98\%$) for Average detection (AV) at frequency above 1GHz. (BT LE 4.0: RBW = 1MHz, VBW = 3kHz, BT LE 5.0: RBW = 1MHz, VBW = 5kHz)
4. All modes of operation were investigated and the worst-case emissions are reported.

4.1.4 Deviation from Test Standard

No deviation.

4.1.5 Test Setup

For Radiated emission below 30MHz

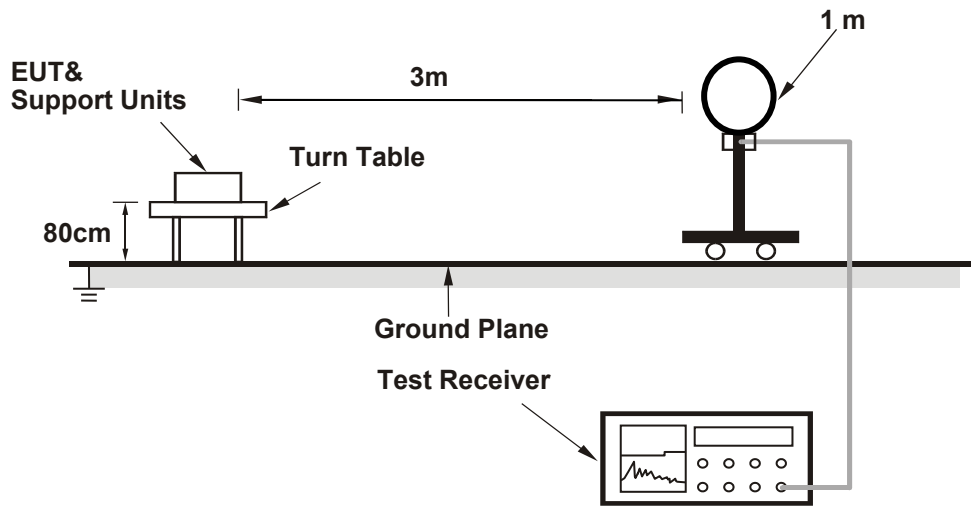

For Radiated emission 30MHz to 1GHz

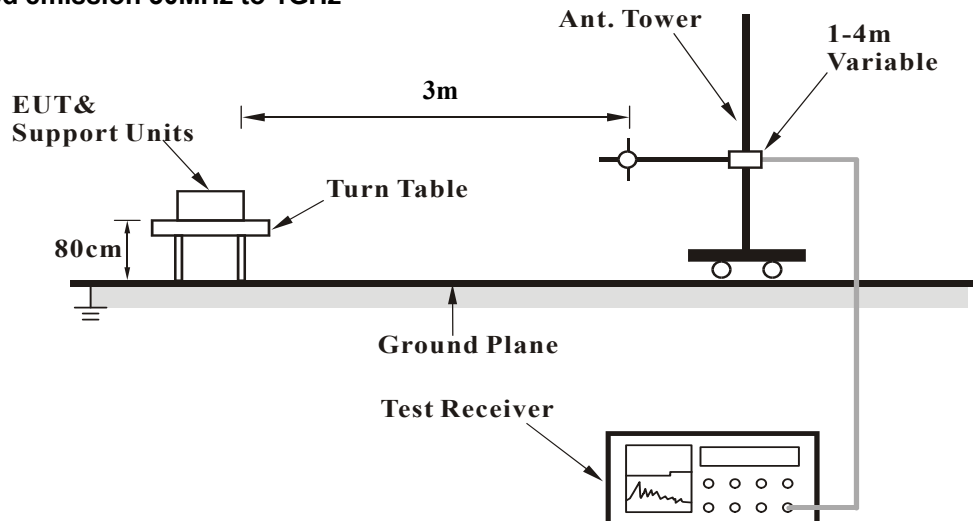

For Radiated emission above 1GHz

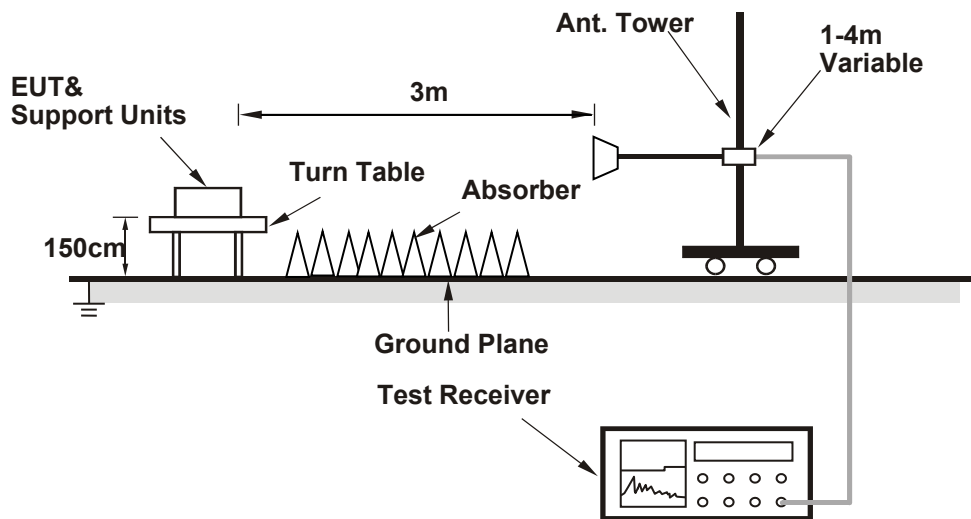

For the actual test configuration, please refer to the attached file (Test Setup Photo).

4.1.6 EUT Operating Conditions

- a. Placed the EUT on the testing table.
- b. The EUT under transmission condition continuously at specific channel frequency.

4.1.7 Test Results

Above 1 GHz Data:

LE 5.0

CHANNEL	TX Channel 39	DETECTOR FUNCTION	Peak (PK) Average (AV)
FREQUENCY RANGE	1GHz ~ 25GHz		

Antenna Polarity & Test Distance : Horizontal at 3 m								
No	Frequency (MHz)	Emission Level (dBuV/m)	Limit (dBuV/m)	Margin (dB)	Antenna Height (m)	Table Angle (Degree)	Raw Value (dBuV)	Correction Factor (dB/m)
1	*2480.00	91.8 PK			1.23 H	167	60.7	31.1
2	*2480.00	76.9 AV			1.23 H	167	45.8	31.1
3	2483.50	55.6 PK	74.0	-18.4	1.23 H	167	24.4	31.2
4	2483.50	43.4 AV	54.0	-10.6	1.23 H	167	12.2	31.2
5	4960.00	43.1 PK	74.0	-30.9	2.72 H	315	40.8	2.3
6	4960.00	30.2 AV	54.0	-23.8	2.72 H	315	27.9	2.3
Antenna Polarity & Test Distance : Vertical at 3m								
No	Frequency (MHz)	Emission Level (dBuV/m)	Limit (dBuV/m)	Margin (dB)	Antenna Height (m)	Table Angle (Degree)	Raw Value (dBuV)	Correction Factor (dB/m)
1	*2480.00	93.0 PK			2.07 V	15	61.9	31.1
2	*2480.00	78.7 AV			2.07 V	15	47.6	31.1
3	2483.50	56.3 PK	74.0	-17.7	2.07 V	15	25.1	31.2
4	2483.50	43.6 AV	54.0	-10.4	2.07 V	15	12.4	31.2
5	4960.00	44.4 PK	74.0	-29.6	2.83 V	121	42.1	2.3
6	4960.00	32.1 AV	54.0	-21.9	2.83 V	121	29.8	2.3

Remarks:

1. Emission Level(dBuV/m) = Raw Value(dBuV) + Correction Factor(dB/m).
2. Correction Factor(dB/m) = Antenna Factor(dB/m) + Cable Factor(dB) – Pre-Amplifier Factor(dB).
3. Margin value = Emission Level – Limit value.
4. The other emission levels were very low against the limit.
5. " * " : Fundamental frequency.

Below 1GHz worst-case data:

LE 5.0

CHANNEL	TX Channel 39	DETECTOR FUNCTION	Quasi-Peak (QP)
FREQUENCY RANGE	9kHz ~ 1GHz	TEST MODE	A

ANTENNA POLARITY & TEST DISTANCE: HORIZONTAL AT 3 M								
NO.	FREQ. (MHz)	EMISSION LEVEL (dBuV/m)	LIMIT (dBuV/m)	MARGIN (dB)	ANTENNA HEIGHT (m)	TABLE ANGLE (Degree)	RAW VALUE (dBuV)	CORRECTION FACTOR (dB/m)
1	70.74	31.6 QP	40.0	-8.4	1.25 H	290	42.7	-11.1
2	166.77	31.8 QP	43.5	-11.7	1.00 H	187	40.6	-8.8
3	298.69	28.2 QP	46.0	-17.8	1.25 H	174	35.3	-7.1
4	515.00	29.2 QP	46.0	-16.8	1.50 H	44	31.9	-2.7
5	767.20	32.9 QP	46.0	-13.1	1.00 H	358	30.4	2.5
6	920.46	35.4 QP	46.0	-10.6	1.00 H	281	30.3	5.1

Remarks:

1. Emission Level(dBuV/m) = Raw Value(dBuV) + Correction Factor(dB/m).
2. Correction Factor(dB/m) = Antenna Factor(dB/m) + Cable Factor(dB) – Pre-Amplifier Factor(dB).
3. The other emission levels were very low against the limit of frequency range 30MHz ~ 1000MHz.
4. Margin value = Emission Level – Limit value.
5. The emission levels were very low against the limit of frequency range 9kHz ~ 30MHz: the amplitude of spurious emissions attenuated more than 20 dB below the permissible value to be report.

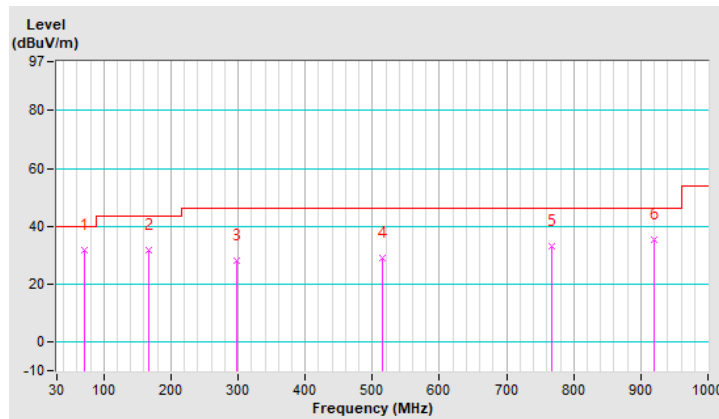

CHANNEL	TX Channel 39	DETECTOR FUNCTION	Quasi-Peak (QP)
FREQUENCY RANGE	9kHz ~ 1GHz	TEST MODE	A

ANTENNA POLARITY & TEST DISTANCE: VERTICAL AT 3 M								
NO.	FREQ. (MHz)	EMISSION LEVEL (dBuV/m)	LIMIT (dBuV/m)	MARGIN (dB)	ANTENNA HEIGHT (m)	TABLE ANGLE (Degree)	RAW VALUE (dBuV)	CORRECTION FACTOR (dB/m)
1	30.00	32.3 QP	40.0	-7.7	1.25 V	207	42.8	-10.5
2	63.95	29.6 QP	40.0	-10.4	1.00 V	166	39.5	-9.9
3	190.05	26.7 QP	43.5	-16.8	1.50 V	276	37.9	-11.2
4	267.65	40.1 QP	46.0	-5.9	1.00 V	128	48.2	-8.1
5	482.02	29.9 QP	46.0	-16.1	1.50 V	136	33.2	-3.3
6	844.80	35.3 QP	46.0	-10.7	1.00 V	252	31.8	3.5

Remarks:

1. Emission Level(dBuV/m) = Raw Value(dBuV) + Correction Factor(dB/m).
2. Correction Factor(dB/m) = Antenna Factor(dB/m) + Cable Factor(dB) – Pre-Amplifier Factor(dB).
3. The other emission levels were very low against the limit of frequency range 30MHz ~ 1000MHz.
4. Margin value = Emission Level – Limit value.
5. The emission levels were very low against the limit of frequency range 9kHz ~ 30MHz: the amplitude of spurious emissions attenuated more than 20 dB below the permissible value to be report.

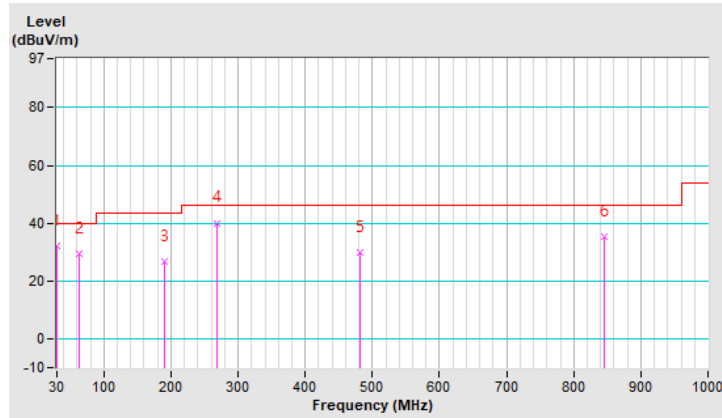

CHANNEL	TX Channel 39	DETECTOR FUNCTION	Quasi-Peak (QP)
FREQUENCY RANGE	9kHz ~ 1GHz	TEST MODE	B

ANTENNA POLARITY & TEST DISTANCE: HORIZONTAL AT 3 M								
NO.	FREQ. (MHz)	EMISSION LEVEL (dBuV/m)	LIMIT (dBuV/m)	MARGIN (dB)	ANTENNA HEIGHT (m)	TABLE ANGLE (Degree)	RAW VALUE (dBuV)	CORRECTION FACTOR (dB/m)
1	103.64	25.7 QP	43.5	-17.8	1.00 H	188	38.4	-12.7
2	144.38	28.0 QP	43.5	-15.5	1.00 H	109	36.9	-8.9
3	181.25	21.7 QP	43.5	-21.8	1.99 H	263	32.2	-10.5
4	720.68	37.0 QP	46.0	-9.0	1.49 H	284	35.4	1.6
5	788.60	32.3 QP	46.0	-13.7	1.99 H	308	28.4	3.9
6	955.47	39.2 QP	46.0	-6.8	1.00 H	202	31.8	7.4

Remarks:

1. Emission Level(dBuV/m) = Raw Value(dBuV) + Correction Factor(dB/m).
2. Correction Factor(dB/m) = Antenna Factor(dB/m) + Cable Factor(dB) – Pre-Amplifier Factor(dB).
3. The other emission levels were very low against the limit of frequency range 30MHz ~ 1000MHz.
4. Margin value = Emission Level – Limit value.
5. The emission levels were very low against the limit of frequency range 9kHz ~ 30MHz: the amplitude of spurious emissions attenuated more than 20 dB below the permissible value to be report.

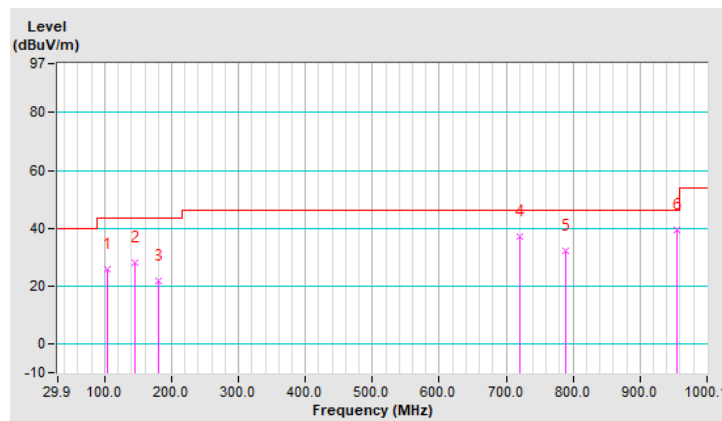

CHANNEL	TX Channel 39	DETECTOR FUNCTION	Quasi-Peak (QP)
FREQUENCY RANGE	9kHz ~ 1GHz	TEST MODE	B

ANTENNA POLARITY & TEST DISTANCE: VERTICAL AT 3 M								
NO.	FREQ. (MHz)	EMISSION LEVEL (dBuV/m)	LIMIT (dBuV/m)	MARGIN (dB)	ANTENNA HEIGHT (m)	TABLE ANGLE (Degree)	RAW VALUE (dBuV)	CORRECTION FACTOR (dB/m)
1	33.78	32.1 QP	40.0	-7.9	1.50 V	115	42.3	-10.2
2	49.30	25.2 QP	40.0	-14.8	1.01 V	136	33.9	-8.7
3	130.80	25.7 QP	43.5	-17.8	1.01 V	156	35.7	-10.0
4	646.95	27.9 QP	46.0	-18.1	1.50 V	13	28.0	-0.1
5	790.54	33.3 QP	46.0	-12.7	1.50 V	13	29.5	3.8
6	934.13	42.8 QP	46.0	-3.2	1.50 V	13	35.8	7.0

Remarks:

1. Emission Level(dBuV/m) = Raw Value(dBuV) + Correction Factor(dB/m).
2. Correction Factor(dB/m) = Antenna Factor(dB/m) + Cable Factor(dB) – Pre-Amplifier Factor(dB).
3. The other emission levels were very low against the limit of frequency range 30MHz ~ 1000MHz.
4. Margin value = Emission Level – Limit value.
5. The emission levels were very low against the limit of frequency range 9kHz ~ 30MHz: the amplitude of spurious emissions attenuated more than 20 dB below the permissible value to be report.

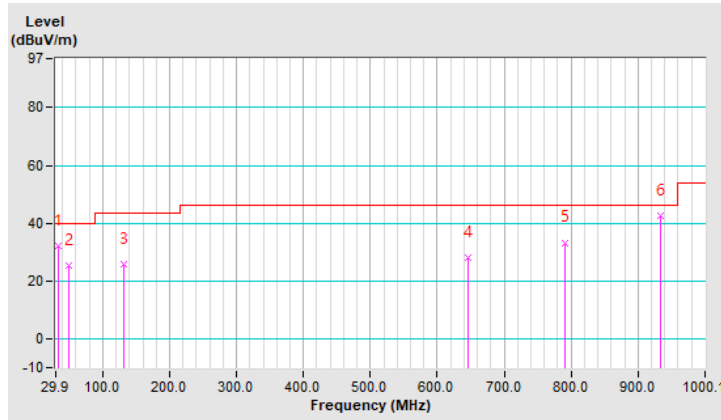

CHANNEL	TX Channel 39	DETECTOR FUNCTION	Quasi-Peak (QP)
FREQUENCY RANGE	9kHz ~ 1GHz	TEST MODE	C

ANTENNA POLARITY & TEST DISTANCE: HORIZONTAL AT 3 M								
NO.	FREQ. (MHz)	EMISSION LEVEL (dBuV/m)	LIMIT (dBuV/m)	MARGIN (dB)	ANTENNA HEIGHT (m)	TABLE ANGLE (Degree)	RAW VALUE (dBuV)	CORRECTION FACTOR (dB/m)
1	99.75	26.6 QP	43.5	-16.9	1.00 H	188	39.9	-13.3
2	144.38	28.0 QP	43.5	-15.5	1.00 H	109	36.9	-8.9
3	210.36	24.1 QP	43.5	-19.4	1.00 H	172	35.6	-11.5
4	295.73	25.3 QP	46.0	-20.7	1.00 H	148	33.0	-7.7
5	546.05	26.2 QP	46.0	-19.8	1.00 H	278	29.0	-2.8
6	939.95	42.1 QP	46.0	-3.9	1.99 H	156	34.9	7.2

Remarks:

1. Emission Level(dBuV/m) = Raw Value(dBuV) + Correction Factor(dB/m).
2. Correction Factor(dB/m) = Antenna Factor(dB/m) + Cable Factor(dB) – Pre-Amplifier Factor(dB).
3. The other emission levels were very low against the limit of frequency range 30MHz ~ 1000MHz.
4. Margin value = Emission Level – Limit value.
5. The emission levels were very low against the limit of frequency range 9kHz ~ 30MHz: the amplitude of spurious emissions attenuated more than 20 dB below the permissible value to be report.

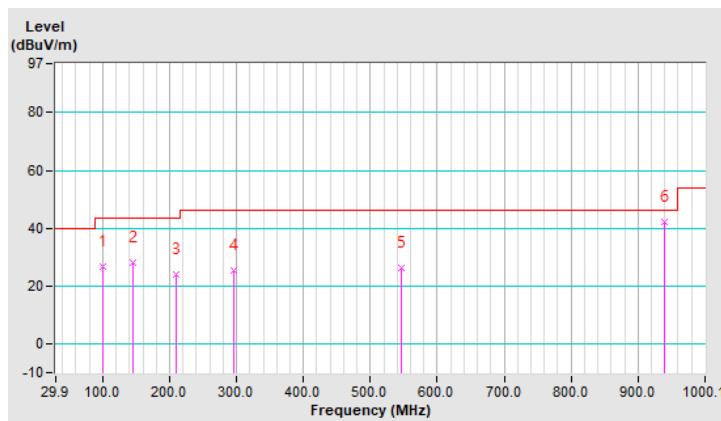

CHANNEL	TX Channel 39	DETECTOR FUNCTION	Quasi-Peak (QP)
FREQUENCY RANGE	9kHz ~ 1GHz	TEST MODE	C

ANTENNA POLARITY & TEST DISTANCE: VERTICAL AT 3 M								
NO.	FREQ. (MHz)	EMISSION LEVEL (dBuV/m)	LIMIT (dBuV/m)	MARGIN (dB)	ANTENNA HEIGHT (m)	TABLE ANGLE (Degree)	RAW VALUE (dBuV)	CORRECTION FACTOR (dB/m)
1	37.66	35.3 QP	40.0	-4.7	1.50 V	112	44.9	-9.6
2	130.80	25.7 QP	43.5	-17.8	1.01 V	156	35.7	-10.0
3	309.32	23.6 QP	46.0	-22.4	1.50 V	112	30.9	-7.3
4	449.03	26.5 QP	46.0	-19.5	2.00 V	336	31.3	-4.8
5	730.38	45.0 QP	46.0	-1.0	1.50 V	13	43.0	2.0
6	934.13	43.8 QP	46.0	-2.2	1.50 V	13	36.8	7.0

Remarks:

1. Emission Level(dBuV/m) = Raw Value(dBuV) + Correction Factor(dB/m).
2. Correction Factor(dB/m) = Antenna Factor(dB/m) + Cable Factor(dB) – Pre-Amplifier Factor(dB).
3. The other emission levels were very low against the limit of frequency range 30MHz ~ 1000MHz.
4. Margin value = Emission Level – Limit value.
5. The emission levels were very low against the limit of frequency range 9kHz ~ 30MHz: the amplitude of spurious emissions attenuated more than 20 dB below the permissible value to be report.

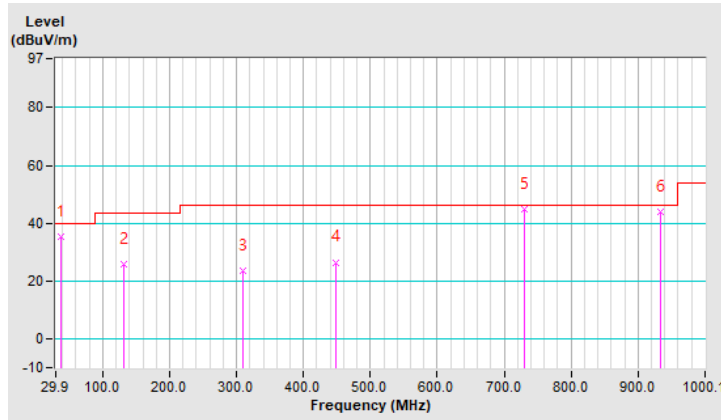

4.2 Conducted Emission Measurement

4.2.1 Limits of Conducted Emission Measurement

Frequency (MHz)	Conducted Limit (dBuV)	
	Quasi-peak	Average
0.15 - 0.5	66 - 56	56 - 46
0.50 - 5.0	56	46
5.0 - 30.0	60	50

Note: 1. The lower limit shall apply at the transition frequencies.
 2. The limit decreases in line with the logarithm of the frequency in the range of 0.15 to 0.50MHz.

4.2.2 Test Instruments

Tested date: Sep. 05 ~ Oct. 24, 2020

Description & Manufacturer	Model No.	Serial No.	Cal. Date	Cal. Due
Test Receiver ROHDE & SCHWARZ	ESCI	100613	Dec. 11, 2019	Dec. 10, 2020
RF signal cable Woken	5D-FB	Cable-cond1-01	Sep. 04, 2020	Sep. 03, 2021
LISN ROHDE & SCHWARZ (EUT)	ENV216	101826	Feb. 20, 2020	Feb. 19, 2021
V-LISN ROHDE & SCHWARZ (Peripheral)	NNBL 8226-2	8226-142	Jul. 31, 2020	Jul. 30, 2021
Software ADT	BV ADT_Cond_ V7.3.7.4	NA	NA	NA

Note: 1. The calibration interval of the above test instruments is 12 months and the calibrations are traceable to NML/ROC and NIST/USA.
 2. The test was performed in HwaYa Shielded Room 1 (Conduction 1).
 3. The VCCI Site Registration No. is C-12040.

4.2.3 Test Procedures

- The EUT was placed 0.4 meters from the conducting wall of the shielded room with EUT being connected to the power mains through a line impedance stabilization network (LISN). Other support units were connected to the power mains through another LISN. The two LISNs provide 50 ohm/ 50uH of coupling impedance for the measuring instrument.
- Both lines of the power mains connected to the EUT were checked for maximum conducted interference.
- The frequency range from 150kHz to 30MHz was searched. Emission levels under (Limit - 20dB) was not recorded.

Note: The resolution bandwidth and video bandwidth of test receiver is 9kHz for quasi-peak detection (QP) and average detection (AV) at frequency 0.15MHz-30MHz.

4.2.4 Deviation from Test Standard

No deviation.

4.2.5 Test Setup

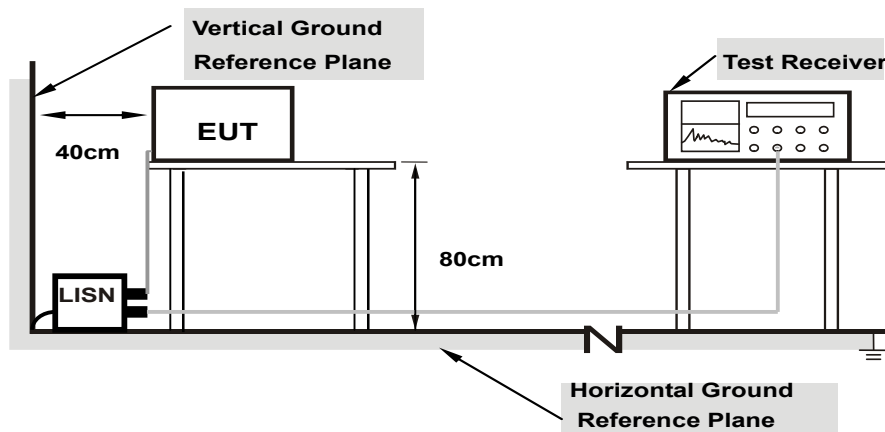

Note: 1.Support units were connected to second LISN.

For the actual test configuration, please refer to the attached file (Test Setup Photo).

4.2.6 EUT Operating Conditions

Same as 4.1.6.

4.2.7 Test Results

LE 5.0

Phase	Line (L)	Detector Function	Quasi-Peak (QP) / Average (AV)
Test Mode	A		

No	Freq. [MHz]	Corr. Factor (dB)	Reading Value [dB (uV)]		Emission Level [dB (uV)]		Limit [dB (uV)]		Margin (dB)	
			Q.P.	AV.	Q.P.	AV.	Q.P.	AV.	Q.P.	AV.
			1	0.16105	9.65	19.69	4.10	29.34	13.75	65.41
2	0.20600	9.66	15.42	5.33	25.08	14.99	63.37	53.37	-38.29	-38.38
3	0.27400	9.66	11.14	1.37	20.80	11.03	61.00	51.00	-40.20	-39.97
4	0.72200	9.67	12.38	1.80	22.05	11.47	56.00	46.00	-33.95	-34.53
5	0.91000	9.67	10.45	1.87	20.12	11.54	56.00	46.00	-35.88	-34.46
6	4.58200	9.74	12.42	2.96	22.16	12.70	56.00	46.00	-33.84	-33.30

Remarks:

1. Q.P. and AV. are abbreviations of quasi-peak and average individually.
2. The emission levels of other frequencies were very low against the limit.
3. Margin value = Emission level - Limit value
4. Correction factor = Insertion loss + Cable loss
5. Emission Level = Correction Factor + Reading Value.

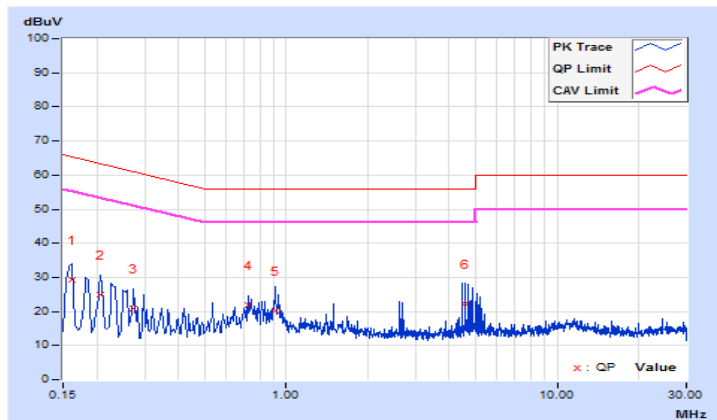

Phase	Neutral (N)	Detector Function	Quasi-Peak (QP) / Average (AV)
Test Mode	A		

No	Freq. [MHz]	Corr. Factor (dB)	Reading Value [dB (uV)]		Emission Level [dB (uV)]		Limit [dB (uV)]		Margin (dB)	
			Q.P.	AV.	Q.P.	AV.	Q.P.	AV.	Q.P.	AV.
			1	0.15400	9.68	19.52	4.05	29.20	13.73	65.78
2	0.17384	9.68	15.04	4.61	24.72	14.29	64.77	54.77	-40.05	-40.48
3	0.20095	9.68	15.36	4.29	25.04	13.97	63.57	53.57	-38.53	-39.60
4	0.31400	9.68	8.31	1.80	17.99	11.48	59.86	49.86	-41.87	-38.38
5	0.73800	9.69	7.39	1.94	17.08	11.63	56.00	46.00	-38.92	-34.37
6	4.57400	9.78	17.40	2.18	27.18	11.96	56.00	46.00	-28.82	-34.04

Remarks:

1. Q.P. and AV. are abbreviations of quasi-peak and average individually.
2. The emission levels of other frequencies were very low against the limit.
3. Margin value = Emission level - Limit value
4. Correction factor = Insertion loss + Cable loss
5. Emission Level = Correction Factor + Reading Value.

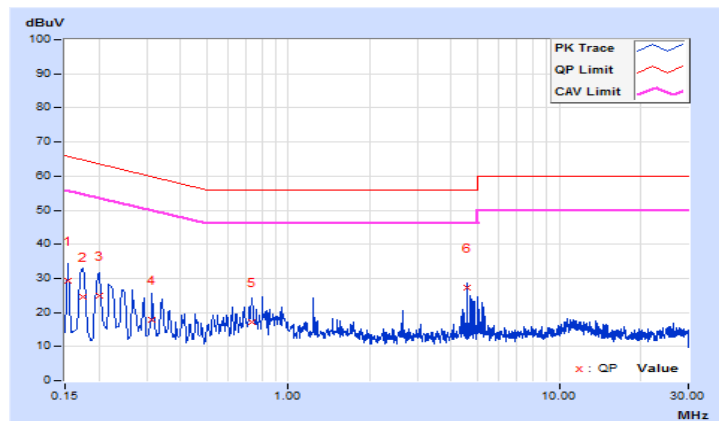

Phase	Line (L)	Detector Function	Quasi-Peak (QP) / Average (AV)
Test Mode	B		

No	Freq. [MHz]	Corr. Factor (dB)	Reading Value [dB (uV)]		Emission Level [dB (uV)]		Limit [dB (uV)]		Margin (dB)	
			Q.P.	AV.	Q.P.	AV.	Q.P.	AV.	Q.P.	AV.
			1	0.16955	9.65	25.23	12.11	34.88	21.76	64.98
2	0.63093	9.66	28.09	19.74	37.75	29.40	56.00	46.00	-18.25	-16.60
3	1.12359	9.67	16.59	9.14	26.26	18.81	56.00	46.00	-29.74	-27.19
4	4.65432	9.75	17.86	8.63	27.61	18.38	56.00	46.00	-28.39	-27.62
5	7.29748	9.77	11.79	4.49	21.56	14.26	60.00	50.00	-38.44	-35.74
6	10.04621	9.79	6.68	0.69	16.47	10.48	60.00	50.00	-43.53	-39.52

Remarks:

1. Q.P. and AV. are abbreviations of quasi-peak and average individually.
2. The emission levels of other frequencies were very low against the limit.
3. Margin value = Emission level - Limit value
4. Correction factor = Insertion loss + Cable loss
5. Emission Level = Correction Factor + Reading Value.

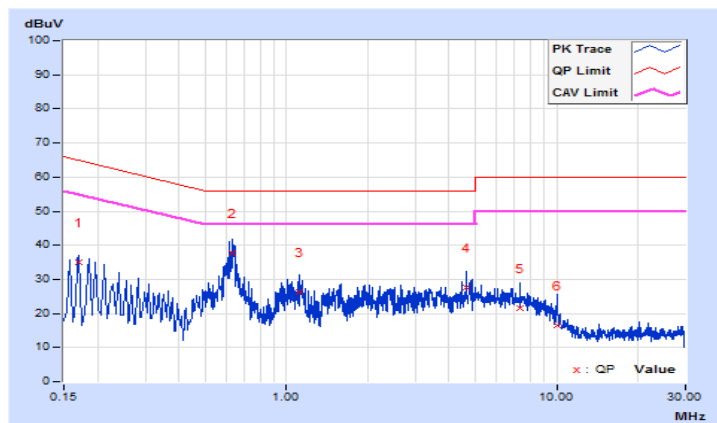

Phase	Neutral (N)	Detector Function	Quasi-Peak (QP) / Average (AV)
Test Mode	B		

No	Freq. [MHz]	Corr. Factor (dB)	Reading Value [dB (uV)]		Emission Level [dB (uV)]		Limit [dB (uV)]		Margin (dB)	
			Q.P.	AV.	Q.P.	AV.	Q.P.	AV.	Q.P.	AV.
			1	0.15782	9.68	26.76	11.51	36.44	21.19	65.58
2	0.63484	9.68	20.86	12.46	30.54	22.14	56.00	46.00	-25.46	-23.86
3	1.33473	9.70	3.81	1.12	13.51	10.82	56.00	46.00	-42.49	-35.18
4	1.97988	9.73	8.31	1.46	18.04	11.19	56.00	46.00	-37.96	-34.81
5	4.55266	9.78	19.64	5.46	29.42	15.24	56.00	46.00	-26.58	-30.76
6	5.81950	9.79	7.15	1.28	16.94	11.07	60.00	50.00	-43.06	-38.93

Remarks:

1. Q.P. and AV. are abbreviations of quasi-peak and average individually.
2. The emission levels of other frequencies were very low against the limit.
3. Margin value = Emission level - Limit value
4. Correction factor = Insertion loss + Cable loss
5. Emission Level = Correction Factor + Reading Value.

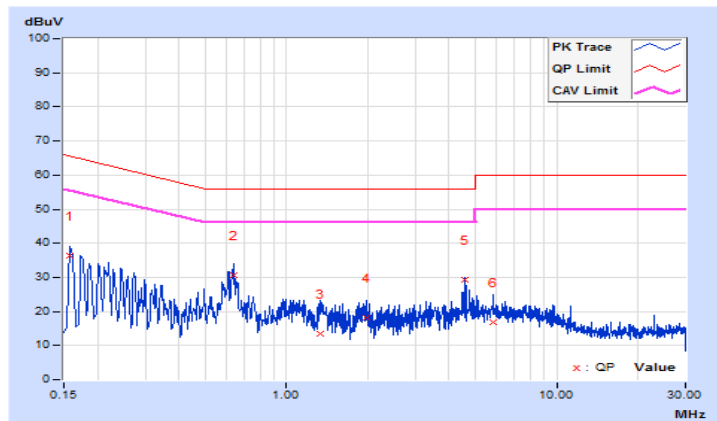

Phase	Line (L)	Detector Function	Quasi-Peak (QP) / Average (AV)
Test Mode	C		

No	Freq. [MHz]	Corr. Factor (dB)	Reading Value [dB (uV)]		Emission Level [dB (uV)]		Limit [dB (uV)]		Margin (dB)	
			Q.P.	AV.	Q.P.	AV.	Q.P.	AV.	Q.P.	AV.
			1	0.16564	9.58	29.30	13.21	38.88	22.79	65.18
2	0.17737	9.59	27.78	12.49	37.37	22.08	64.61	54.61	-27.24	-32.53
3	0.40024	9.58	27.92	23.39	37.50	32.97	57.85	47.85	-20.35	-14.88
4	1.20179	9.61	14.81	9.51	24.42	19.12	56.00	46.00	-31.58	-26.88
5	1.45203	9.61	12.88	8.17	22.49	17.78	56.00	46.00	-33.51	-28.22
6	20.75179	9.78	21.26	20.06	31.04	29.84	60.00	50.00	-28.96	-20.16

Remarks:

1. Q.P. and AV. are abbreviations of quasi-peak and average individually.
2. The emission levels of other frequencies were very low against the limit.
3. Margin value = Emission level - Limit value
4. Correction factor = Insertion loss + Cable loss
5. Emission Level = Correction Factor + Reading Value.

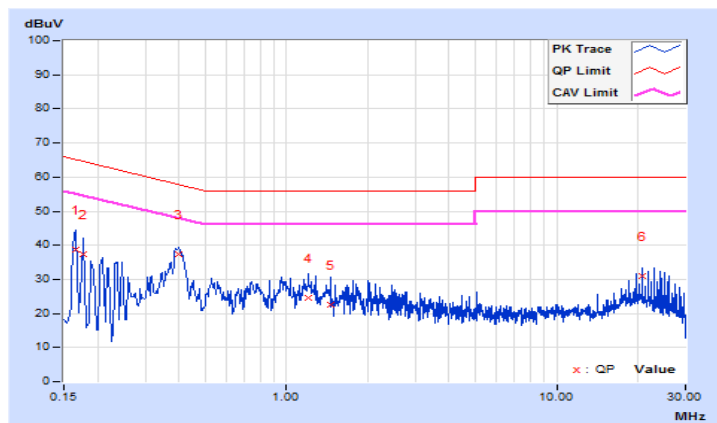

Phase	Neutral (N)	Detector Function	Quasi-Peak (QP) / Average (AV)
Test Mode	C		

No	Freq. [MHz]	Corr. Factor (dB)	Reading Value [dB (uV)]		Emission Level [dB (uV)]		Limit [dB (uV)]		Margin (dB)	
			Q.P.	AV.	Q.P.	AV.	Q.P.	AV.	Q.P.	AV.
			1	0.15391	9.56	32.79	18.23	42.35	27.79	65.79
2	0.16955	9.56	29.21	14.88	38.77	24.44	64.98	54.98	-26.21	-30.54
3	0.39426	9.56	27.87	22.88	37.43	32.44	57.97	47.97	-20.54	-15.53
4	1.94078	9.60	14.88	8.03	24.48	17.63	56.00	46.00	-31.52	-28.37
5	4.65041	9.66	17.91	5.90	27.57	15.56	56.00	46.00	-28.43	-30.44
6	20.75179	9.83	22.14	20.97	31.97	30.80	60.00	50.00	-28.03	-19.20

Remarks:

1. Q.P. and AV. are abbreviations of quasi-peak and average individually.
2. The emission levels of other frequencies were very low against the limit.
3. Margin value = Emission level - Limit value
4. Correction factor = Insertion loss + Cable loss
5. Emission Level = Correction Factor + Reading Value.

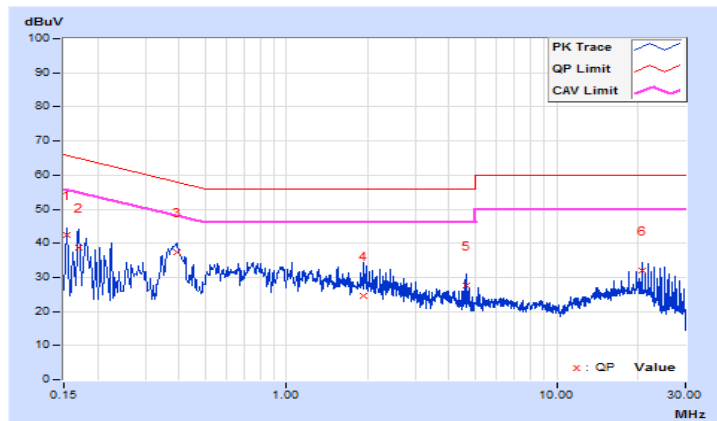

4.3 Conducted Output Power Measurement

4.3.1 Limits of Conducted Output Power Measurement

For systems using digital modulation in the 2400–2483.5 MHz bands: 1 Watt (30dBm)

4.3.2 Test Setup

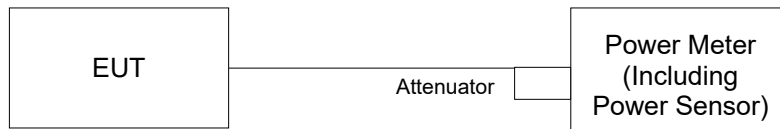

4.3.3 Test Instruments

Refer to section 4.1.2 to get information of above instrument.

4.3.4 Test Procedures

For Peak Power

A peak power sensor was used on the output port of the EUT. A power meter was used to read the response of the peak power sensor. Record the power level.

For Average Power

Average power sensor was used to perform output power measurement, trigger and gating function of wide band power meter is enabled to measure max output power of TX on burst. Duty factor is not added to measured value.

4.3.5 Deviation from Test Standard

No deviation.

4.3.6 EUT Operating Conditions

Same as item 4.3.6.

4.3.7 Test Results

Peak Power

LE 4.0

Channel	Frequency (MHz)	Peak Power (mW)	Peak Power (dBm)	Limit (dBm)	Pass/Fail
0	2402	1.107	0.44	30.00	Pass
19	2440	1.276	1.06	30.00	Pass
39	2480	1.159	0.64	30.00	Pass

LE 5.0

Channel	Frequency (MHz)	Peak Power (mW)	Peak Power (dBm)	Limit (dBm)	Pass/Fail
0	2402	1.151	0.61	30.00	Pass
19	2440	1.271	1.04	30.00	Pass
39	2480	1.216	0.85	30.00	Pass

Average Power

LE 4.0

Channel	Frequency (MHz)	Average Power (mW)	Average Power (dBm)
0	2402	1.069	0.29
19	2440	1.236	0.92
39	2480	1.122	0.50

LE 5.0

Channel	Frequency (MHz)	Average Power (mW)	Average Power (dBm)
0	2402	1.062	0.26
19	2440	1.208	0.82
39	2480	1.117	0.48

4.4 Power Spectral Density Measurement

4.4.1 Limits of Power Spectral Density Measurement

The Maximum of Power Spectral Density Measurement is 8dBm per 3kHz.

4.4.2 Test Setup

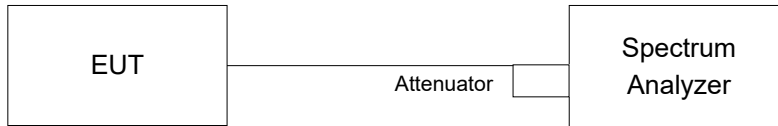

4.4.3 Test Instruments

Refer to section 4.1.2 to get information of above instrument.

4.4.4 Test Procedure

- a. Set analyzer center frequency to DTS channel center frequency.
- b. Set the span to 1.5 times the DTS bandwidth.
- c. Set the RBW to: $3 \text{ kHz} \leq \text{RBW} \leq 100 \text{ kHz}$.
- d. Set the VBW $\geq 3 \times \text{RBW}$.
- e. Detector = peak.
- f. Sweep time = auto couple.
- g. Trace mode = max hold.
- h. Allow trace to fully stabilize.
- i. Use the peak marker function to determine the maximum amplitude level within the RBW.

4.4.5 Deviation from Test Standard

No deviation.

4.4.6 EUT Operating Condition

Same as item 4.3.6

4.4.7 Test Results

LE 4.0

Channel	Freq. (MHz)	PSD (dBm/3kHz)	Limit (dBm/3kHz)	Pass / Fail
0	2402	-13.90	8.00	Pass
19	2440	-13.37	8.00	Pass
39	2480	-13.81	8.00	Pass

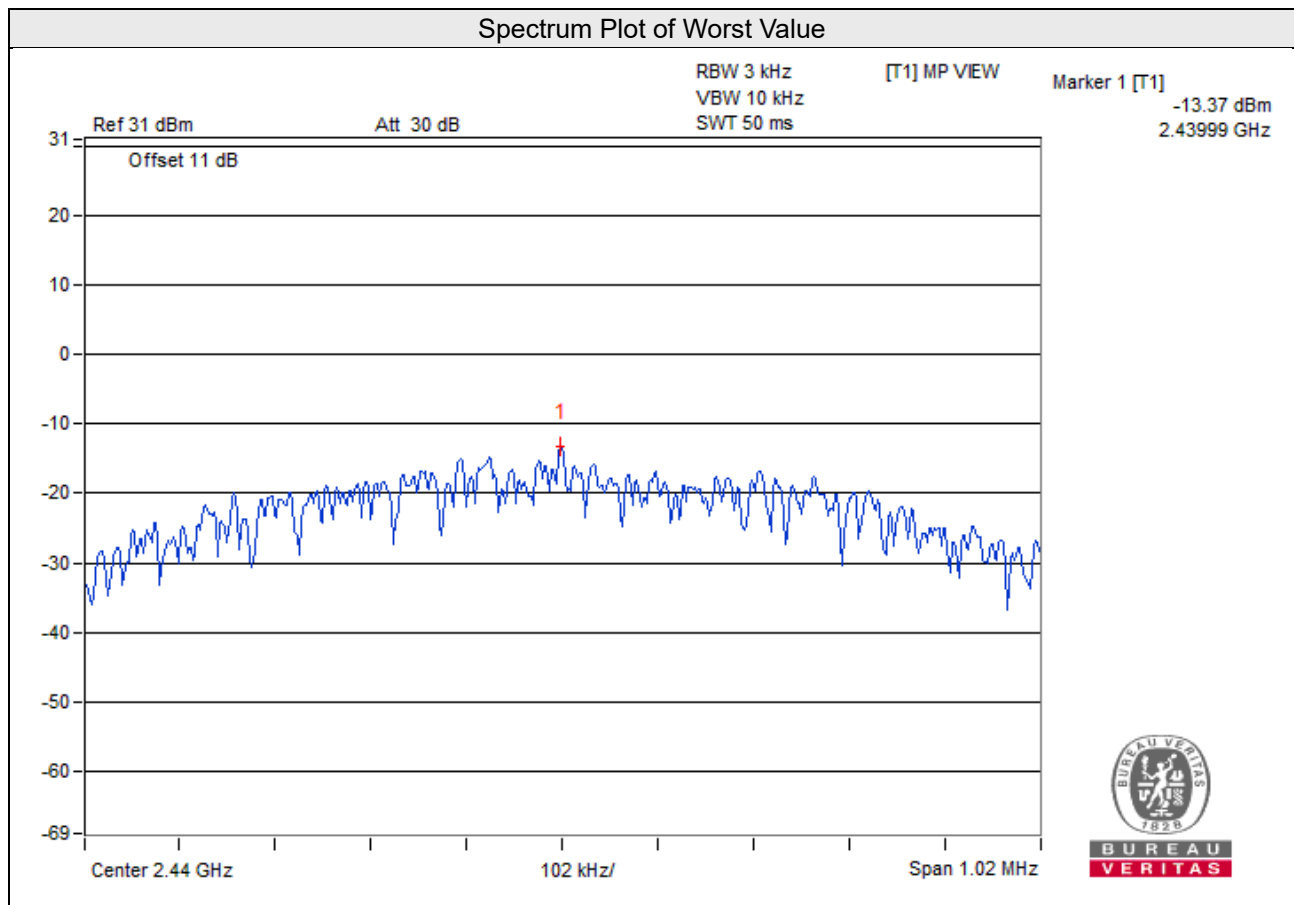

LE 5.0

Channel	Freq. (MHz)	PSD (dBm/3kHz)	Limit (dBm/3kHz)	Pass / Fail
0	2402	-17.56	8.00	Pass
19	2440	-17.10	8.00	Pass
39	2480	-17.57	8.00	Pass

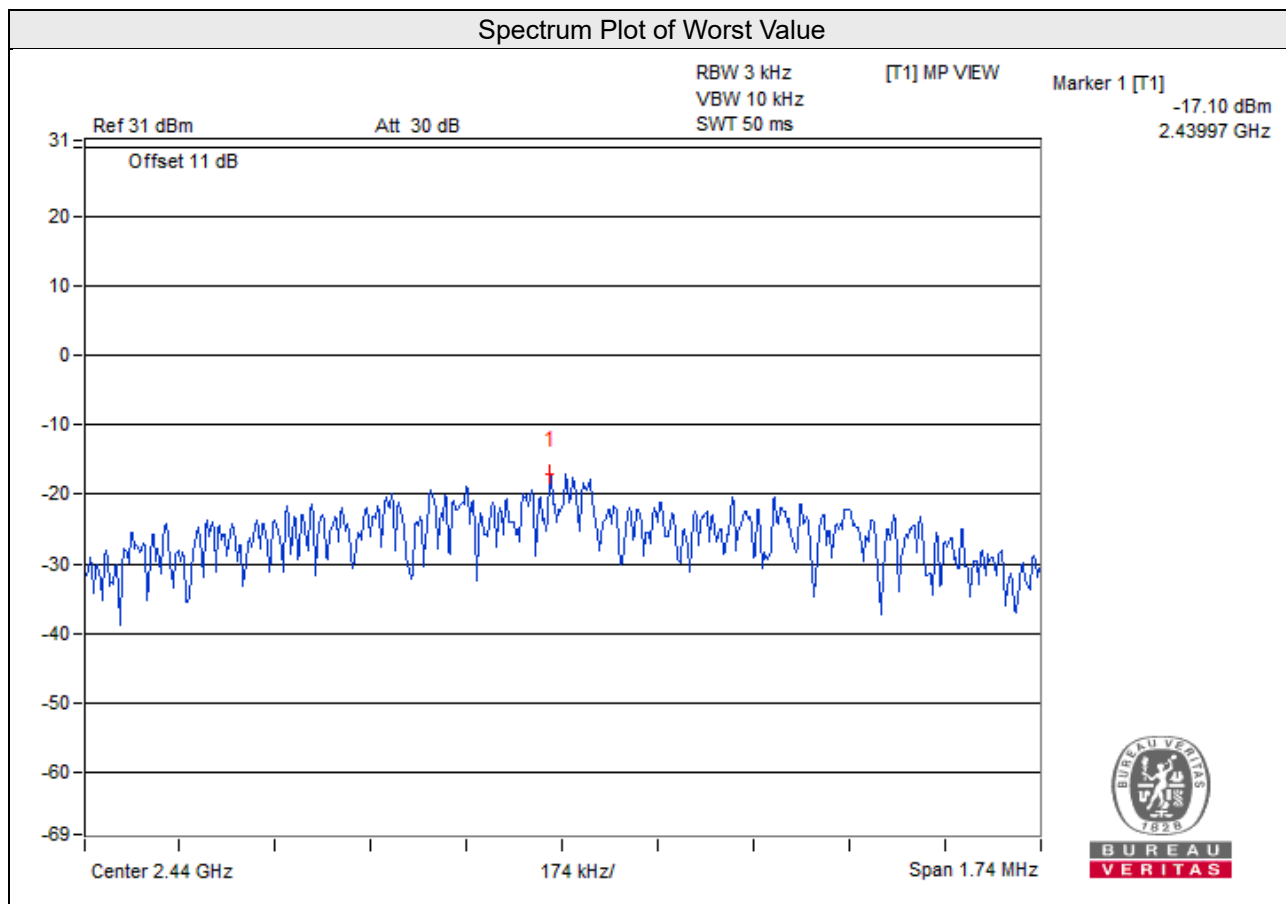

Annex A- Band Edge Measurement

LE 5.0

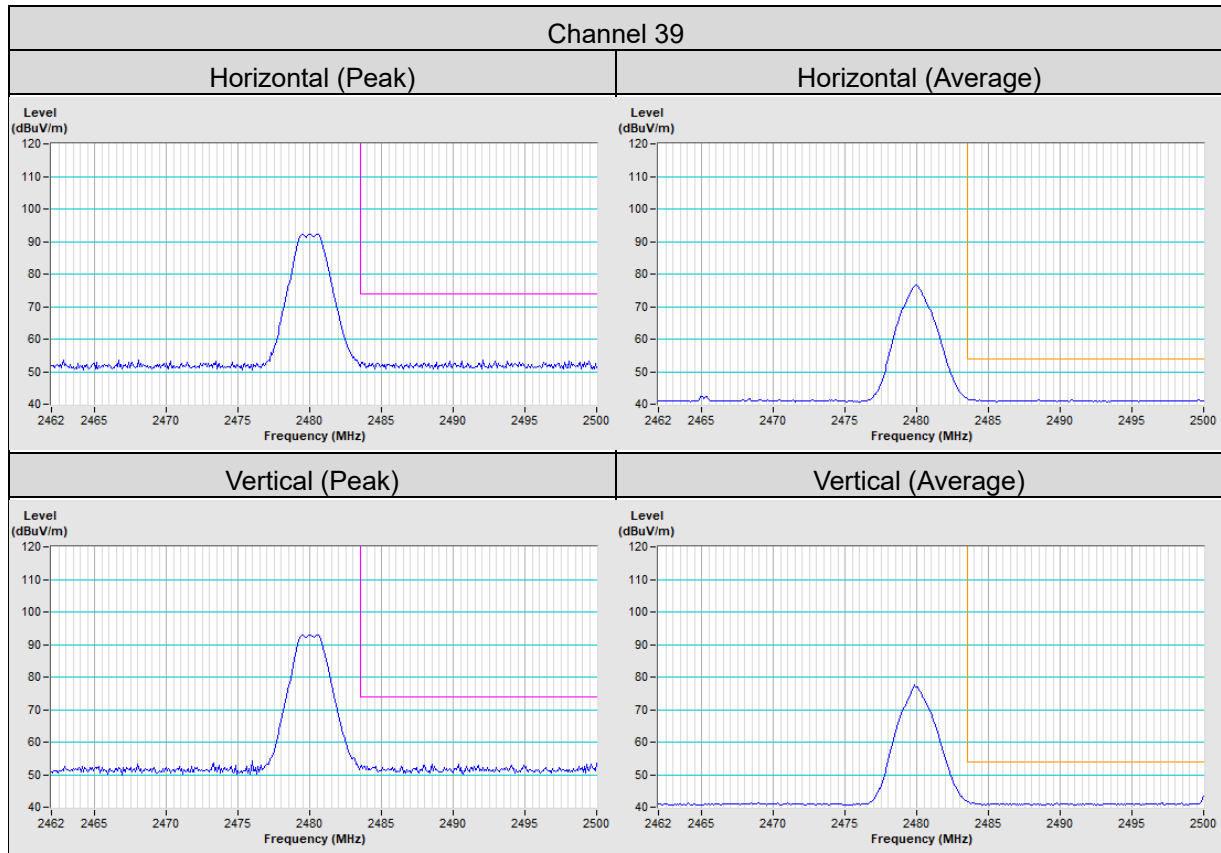

5 Pictures of Test Arrangements

Please refer to the attached file (Test Setup Photo).

Appendix – Information of the Testing Laboratories

We, Bureau Veritas Consumer Products Services (H.K.) Ltd., Taoyuan Branch, were founded in 1988 to provide our best service in EMC, Radio, Telecom and Safety consultation. Our laboratories are FCC recognized accredited test firms and accredited and approved according to ISO/IEC 17025.

If you have any comments, please feel free to contact us at the following:

Lin Kou EMC/RF Lab

Tel: 886-2-26052180

Fax: 886-2-26051924

Hsin Chu EMC/RF/Telecom Lab

Tel: 886-3-6668565

Fax: 886-3-6668323

Hwa Ya EMC/RF/Safety Lab

Tel: 886-3-3183232

Fax: 886-3-3270892

Email: service.adt@tw.bureauveritas.com

Web Site: www.bureauveritas-adt.com

The address and road map of all our labs can be found in our web site also.

--- END ---