

# DENSO

## BHT-M70 Series

### Operator's Guide

### 操作指南

### Handy Terminal

### 手持式終端機

BHT-M70-QW (WLAN model)

BHT-M70-QWG (WLAN + WWAN model)

---

Thank you for using the DENSO WAVE Handy Terminal.

Please read this manual thoroughly prior to operation to ensure full use of the product's functionality, and store safely in a convenient location for quick reference even after reading.

This manual contains only the basic details required for operation.

Please refer to the User's Manual for further details on general operation.

The User's Manual can be downloaded from the DENSO WAVE Web site.

<https://www.denso-wave.com/>

---

感謝您使用 DENSO WAVE 公司的手持式終端機。

為了讓您充分使用本產品的功能，請在開始操作前閱讀本說明書。並且，在閱讀後為了能夠在必要時隨時參考，請妥善保管本說明書。

本說明書僅記載了操作過程中所需要的基本內容。

關於所有操作的詳細內容，請參考操作說明書。

操作說明書可從本公司網站免費下載。

<http://www.denso-wave.com/>

---



496996 - 0930

# Chapter1 Please read me first

Please contact your nearest distributor, if using in other countries.

The latest precision manufacturing technology yields LCD panels with an effective resolution of 99.99% or higher. The downside, however, is that up to 0.01% of the pixels can remain permanently dark or lit on today's state-of-the-art panels.

Furthermore, please be aware that individual differences may occur in the screen color and brightness due to the characteristics of the white LEDs used in the LCD display backlight.

The Customer shall not modify, reverse compile, reverse engineer, reverse assemble, and or otherwise tamper with our BHT's firmware.

## 1.1 About This Manual

Due to changes and improvements, the content of this manual may be subject to change without prior notice.

The reproduction or duplication of the whole or part of this manual is strictly prohibited without prior consent.

Please contact DENSO WAVE if this manual is lost.

Every attempt has been made to ensure that the content of this manual is thorough and up to date, however, we kindly ask you to report any questionable descriptions, mistakes or omissions, if any, to DENSO WAVE.

## 1.2 Liability Limitations

DENSO WAVE INCORPORATED ("DENSO WAVE") does not assume any product liability (including damages for lost profits, interruption of operations, or the loss of business-related information) arising out of, or in connection with, the use of, or inability to use the BHT system software or related manuals.

DENSO WAVE takes reasonable precautions to ensure its products do not infringe upon any patents or other intellectual property rights of other(s), however, DENSO WAVE cannot be responsible for any patent or other intellectual property right infringement(s) or violation(s) arising from any of the following.

- (1) The use of DENSO WAVE's products in connection or in combination with other components, products, devices, data processing systems or software not supplied by DENSO WAVE.
- (2) The use of DENSO WAVE's products in a manner for which they were not intended nor designed.
- (3) The modification of DENSO WAVE's products by parties other than DENSO WAVE.

If it is judged by DENSO WAVE that malfunction of the product is due to the product having been dropped or subjected to impact, repairs will be made at a reasonable charge even within the warranty period.

- DENSO WAVE will not bear any responsibility for data which customers have recorded and are received by DENSO WAVE for repair and analysis.

## 1.3 Free/Open source software (FOSS)

This product contains Free / Open Source Software (FOSS.) DENSO WAVE is ready to provide compliant source codes. For details, please contact our dealer or contact the site below.

<https://www.denso-wave.com/>

## 1.4 Product Contents Check

Ensure you have all of the following items prior to use. In the event of missing or damaged item, please contact your dealer.

- Handy terminal ×1
- Operator's guide (this manual) ×1
- SAFETY PRECAUTIONS ×1
- Hand belt ×1
- Battery Included or not depends on the model.

Model	Product Number	Included battery
BHT-M70-QW	104969-465X	Not included
	104969-466X	BT3
	104969-468X	
	104969-470X	
BHT-M70-QWG	104969-477X	Not included
	104969-478X	BT3
	104969-480X	
	104969-482X	

X is a number between 0 and 9.

## 1.5 Customer Registration

To allow us to provide our customers with comprehensive service and support, we request that all customers complete a Member Registration Form. Registered members will be offered the following privileges.

- The latest upgrade information
- Free exhibition and event information for new products
- Free web-information service "QBdirect."

### QBdirect Service Contents

Information searching service (FAQ)	Offers detailed information on each product.
Download service	The latest OS systems for the BHT Series, repair software, and sample programs can be downloaded.
E-mail inquiries	Product related queries can be sent in by e-mail.

Please note that these privileges may be subject to change without prior notice.

### How to Register

Access the URL below and follow the instruction provided.  
<https://www.denso-wave.com/>

## 1.6 Secured Three-year Warranty

If you register the serial number of the product within one month after your purchase, the warranty of the registered product will be prolonged to three years from the one-year warranty.

Please access the URL below to register.  
<https://www.denso-wave.com/>

The serial number for registration is found under the QR Code on the name plate.

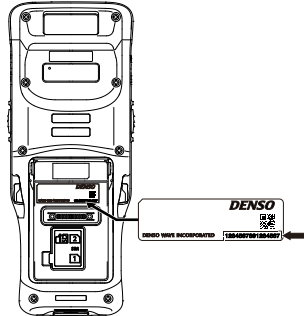

## 1.7 Usage Precautions

### 1.7.1 Usage environment restrictions

Do not use the BHT where it may be exposed to fire, high temperatures, or direct sunlight.  
(Failure to observe this may result in damage, overheating, explosion, or fire.)

When the BHT is stored in a high-temperature, high-humidity environment of 50 - 60°C, leave to sit in a location at room temperature and normal humidity for at least 1 day prior to use.

Failure to observe this may cause a reading failure or damage the BHT.

Do not use the BHT in places with extreme temperature variations.

(Failure to observe this may lead to BHT malfunction due to condensation.)

Leave the BHT for a short while prior to use when moved from a cold to a warm environment.

Do not use the BHT in places where it may be exposed to strong impact or significant static electricity.

### 1.7.2 Keep the BHT away from electromagnetic waves and metallic objects.

Wireless communication may not be possible in the following locations and using.

In the vicinity of the following devices operating on a 2.4 GHz waveband  
(Communication may not be possible due to electromagnetic interference.)

- Industrial, scientific, or medical equipment such as microwave ovens
- Wireless LAN devices
- Logistics systems in places such as plants or warehouses
- Wireless devices such as amateur radio stations

In the vicinity of household appliances emitting electromagnetic waves such as computers or televisions (Communication may not be possible due to electromagnetic noise.)

In the vicinity of metallic objects, in places with high levels of metallic dust, or in places surrounded by metal walls (Communication may not be possible due to the presence of metallic objects.)

Putting on any metallic objects around the antenna. Placing your hand over the antenna

## 1.8 Proper Care of the BHT

Make sure to turn OFF the BHT before cleaning.

### Cleaning the BHT and charging contacts

To keep clean BHT and charging contacts, periodically wipe them clean with a cotton swab and the like. Be sure not to scratch or deform the contacts while cleaning.

Never use organic solvents such as thinner or alcohol, as this may cause plating of the contacts to be peeled off.

### Cleaning the Housing

To keep the appearance of the BHT at its best, wipe it clean with a dry, soft cloth.

To best clean the BHT, wipe it clean with a cloth slightly dampened with diluted neutral detergent and dry with a soft, dry cloth.

Never use organic solvents such as thinner or alcohol, as this may cause the housing to be marred or paint to be peeled off.

### Cleaning the LCD screen

Never rub or hit the LCD screen with anything hard, as this may result in scratches on the screen or breakage.

### Cleaning the Reading window

Keep clean reading window; otherwise, reading performance may be adversely affected.

When using in dusty areas, check the clear plate of the reading window for the accumulation of the dust, on a regular basis. To keep clean device at its best, blow dust away with an airbrush and wipe it clean with a cotton swab and the like.

Hard particles such as sand can cause abrasive wear on the plate. Blow them away with an airbrush or brush them away with a soft brush.

## Important Notice of Disinfection and Maintenance for DENSO WAVE AUTO-ID Products.

As described in the care and maintenance of the Operator's Guide\* contained in the package of regular AUTO-ID products, the usage of thinner and alcohol for cleaning is prohibited.

In consideration of the currently widespread novel coronavirus infection, DENSO WAVE performed the wiping test under its own test standards using 70% ethanol or 10 ppm to 80 ppm hypochlorous acid water in expectation of a certain disinfection effect. As a result, we visually confirmed that there is no remarkable discoloration and color fading on the surface of the housing. Before using the solutions described below, please read and understand the following descriptions.

Test description: Wiping the outer surface of a product excluding the reading window, the dust-proof plate and cables with the robot arm 1,500 times

Solutions: 70% ethanol/ 10 ppm to 80 ppm hypochlorous acid water/ 70% isopropyl alcohol/ 3% hydrogen peroxide

Applicable models: AUTO-ID product models selected by material and posted on the DENSO WAVE's website.

### Note

- Do not apply any liquid on the reading window or the dust-proof plate. Never get any liquid into narrow spaces such as holes and slits.
- When wiping, be sure to use a soft cloth. If any liquid remains after operation, wipe it off with a dry and soft cloth.
- This description does not guarantee the product specifications. Product degradation such as housing degradation may become apparent depending on the operation environment.

## Chapter2 Component and Functions

### 2.1 BHT-M70

Upper side

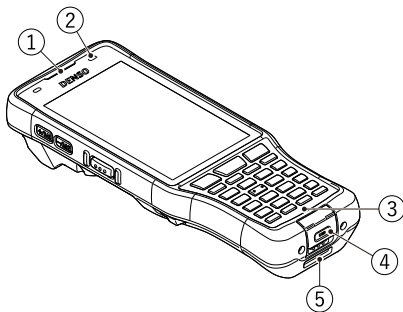

- ① Receiver,Speaker
- ② Status indicator
- ③ microphone
- ④ USB connector
- ⑤ Interface connector
- ⑥ Hand belt
- ⑦ Rear camera
- ⑧ Code reading window
- ⑨ Battery cover locks

Lower side

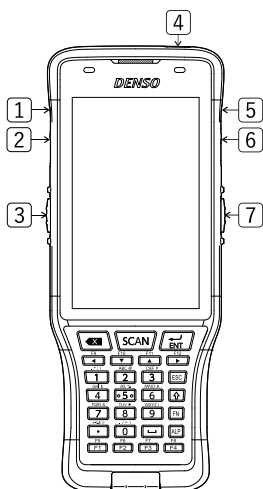
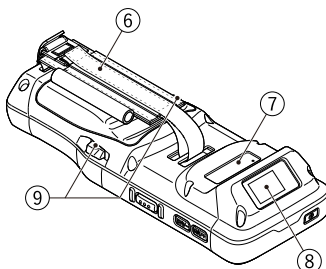

- ① M1 key
- ② M2 key
- ③ Left trigger key
- ④ Power key
- ⑤ M3 key
- ⑥ M4 key
- ⑦ Right trigger key

## Chapter3 Preparation before use

### 3.1 Mounting the hand belt

#### 3.1.1

Attach the hand belt to each of the two places as shown in the figure.

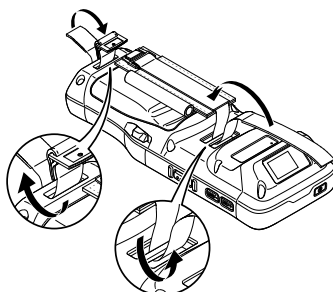

#### 3.1.2

Connect the hand belt.

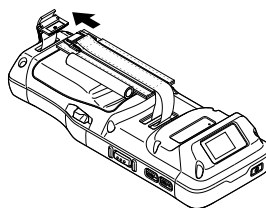

#### 3.1.3

Install the stylus as shown. Select the right or left side of the hand belt.

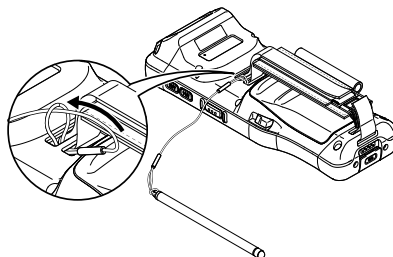

#### 3.1.4

It is also possible to store the stylus in the hand belt.

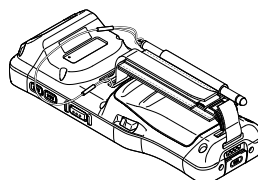

## 3.2 Inserting and removing the main battery

### 3.2.1

#### Inserting the battery

Insert the battery in the arrow direction.

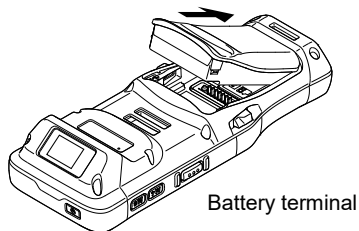

### 3.2.2

Push the battery in the arrow direction.

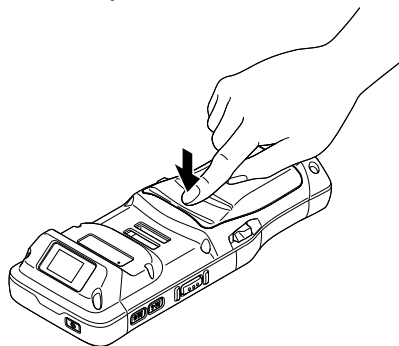

### 3.2.3

#### Removing the battery

Push the battery cover locks in the arrow direction.

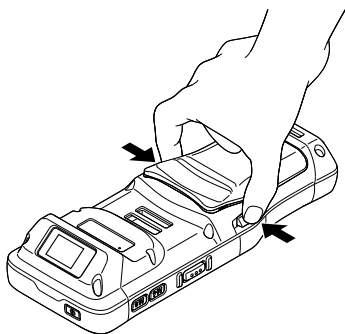

### 3.2.4

Pull out the battery with the battery tab held.

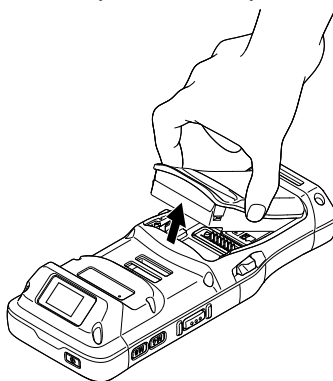



## 3.3 Charging the BHT

The main battery may not be fully charged for shipment. Please charge the main battery to full before using the handy terminal. You may use the Charging Cradle or USB cable to charge the handy terminal.

### 3.3.1 Charging Time

#### Main battery

The main battery powers the handy terminal to work. It takes approximately 2.1 hours to charge an empty 3050 mAh battery to full. The status indicator above the screen will light up in red while charging and will turn blue when charging is complete.

#### Sub-battery

The sub-battery is mounted on the circuit board and used for retaining data when the main battery is replaced or when it is removed.

It may take approximately ten minutes to fully charge an empty sub-battery after installing the main one. Do not remove the battery until the charge is completed so as to retain data properly.

### 3.3.2 Charging Temperature

Charging the battery at room temperature (18 - 25°C) is recommended in order to deliver optimal performance. Please note that battery charging stops when ambient temperature drops below 0°C or exceed 40°C. The temperature to stop charging may vary according to the practical operating environment.

### 3.3.3 Operation on Battery Power

When 802.11a/b/g/n/ac, GSM/GPRS/EDGE/WCDMA/UMTS/HSDPA/HSUPA/HSPA+/LTE, Bluetooth v5.1&v2.1+EDR and GPS are all enabled on battery power, the main battery level will drop down substantially. Prolonged use of the display and continued scanning of barcodes will also affect battery level.

In order to avoid the unexpected system shutting down when the battery level is low, we suggest that you keep a fresh battery for replacement at all times, or connect the BHT to an external power.

Remove the battery from the BHT or the Cradle then store in a cool and dry place if not using the BHT for an extended period of time.

Storing a fully charged or depleted (unable to turn on the BHT) battery for long periods time may deteriorate the performance and life of the battery.

For long-term storage, storing the battery at the 50% of the power level is recommended.

During long-term storage, charge the battery cartridge fully once a year in order to maintain the battery performance. When fully charge, allow the battery to discharge down to the recommended level before restoring.

The battery may swell over the years depending on usage environment. This is a characteristic of a lithium-ion battery and is not safety hazard.

### 3.3.4 Charging Status of the BHT

The Charge status of the BHT is shown on the status indicator above the display screen.

Status indicator	Indication	Description
Charging	Red, solid	Charging the BHT
	Red, blink	Charging error
	Green, solid	Charging complete

### 3.3.5 Using the USB Cable

- (1) Connect the USB Type-C connector to the connector at the bottom of the BHT.
- (2) Connect the USB Type-A connector to the USB power adapter.

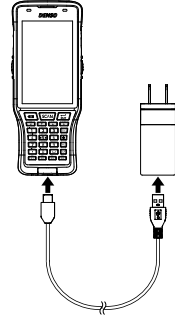

### 3.3.6 Using the Charging Cradle

#### Plugging in the cradle

Connect the dedicated power adapter, the USB cable and/or USB power adapter to the cradle. Plug in the AC plug or the AC adapter.

The right figure is for when the CU-M70U is plugged in using the power adapter.

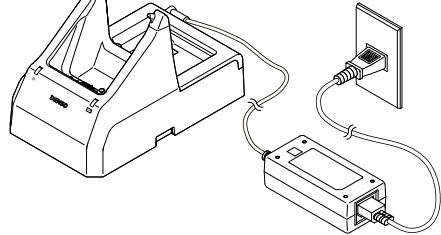

The right figure is for when the CU-M70UQ is connected using the USB cable and USB power adapter.

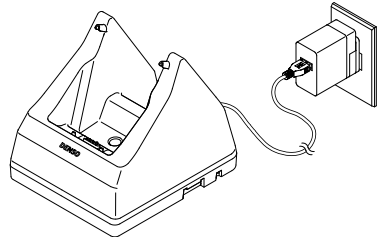

#### Power Supply for CU-M70U/L

Use ONLY a DNWA approved Nationally Recognized Test Laboratory (NRTL) Certified ITE (LPS/SELV) power supply with electrical ratings:  
Output 12 VDC, min 4.16 A, with a maximum ambient temperature of at least + 40°C. Use of alternative power supply will invalidate any approvals given to this unit and may be dangerous.

#### Power Supply for CU-M70UQ

Use ONLY a DNWA approved Nationally Recognized Test Laboratory (NRTL) Certified ITE (LPS/SELV) power supply with electrical ratings:  
Output 5 VDC, min 3 A, with a maximum ambient temperature of at least + 40°C. Use of alternative power supply will invalidate any approvals given to this unit and may be dangerous.

## Charging BHT

Set the BHT in the cradle upright and gently tilt it away from you.

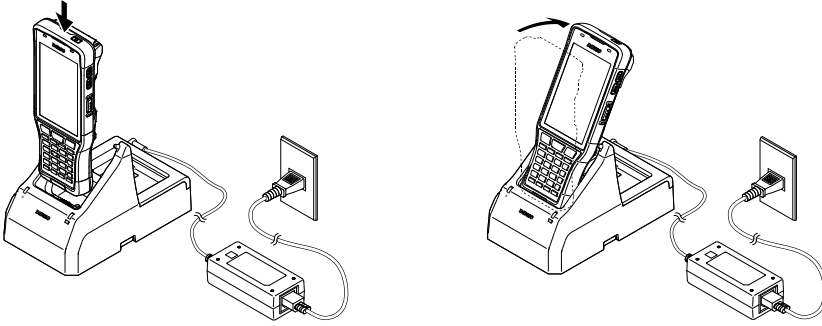

Note: When placing the BHT on the cradle, ensure there is no tangled strap between the device and the cradle. A specific part of the device may get warm while charging depending on operating environment and conditions. This is not malfunction.

## Removing the BHT from the Cradle

Tilt the BHT toward you and pull out perpendicularly

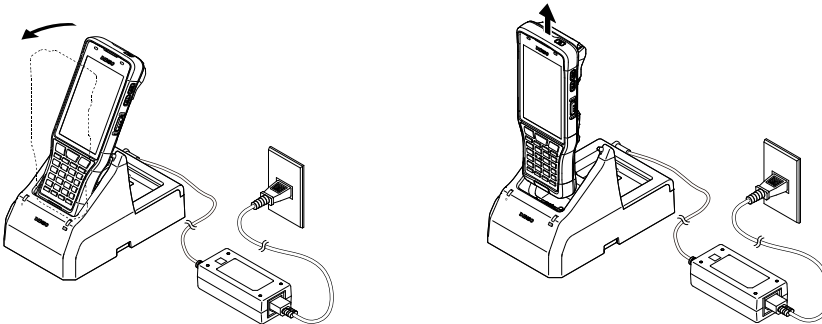

## Notice on the power connection of the charging cradle

As for CU-M70U with the USB interface, both power adapter and USB cable can be used. When only the USB cable is used, the charging time could be longer under the condition where the BHT is operated even during charging. This may cause the charging status error, and thus, use of the power adapter is recommended. Using a deteriorated battery may also cause a charging error. In this case, replace that battery with a new one.

# Chapter4 How to Use

## 4.1 Turning ON the Power

To turn on the BHT, press and hold the power button  located on the upper side of the device. The OS starts up and the lock screen is displayed. Swipe up from the bottom of the lock screen to display the home screen.

Note: Ensure the battery is seated properly; otherwise, the BHT is not turned on. If the device is used in low temperature environment such as a freezing room, it shall be turned on in the environment of ambient temperature prior to use. Cold environment can prevent the device from powering on. Operating the device in low temperature environment may result in delayed BHT operations, or considerably reduced operating time, due to the battery characteristics. Perform operation verification of the BHT against conditions of use before using.

## 4.2 Reading Codes

Follow the procedure below to read codes.

### 4.2.1

Press the power key to start up the BHT from the sleep mode.

### 4.2.2

Tap the Scan Settings.

Set the Enabled scan to ON, and tap the ★TEST★ on the menu bar.

Then the test scan form opens to display the scanned data.

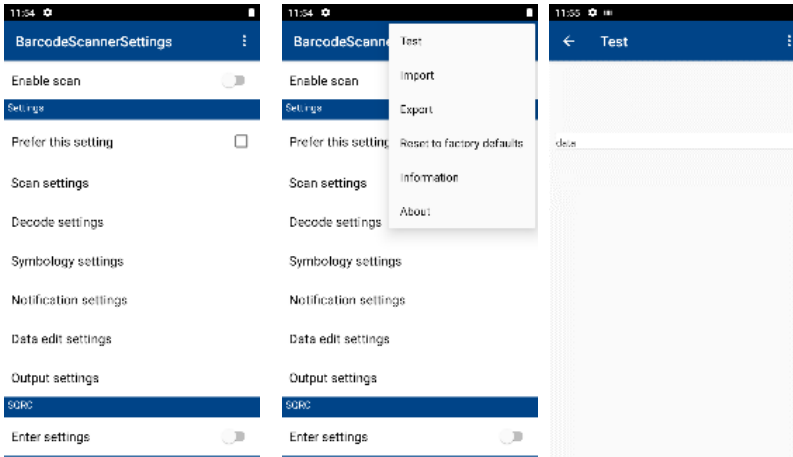

Illuminating in blue

### 4.2.3

Point the code reading window towards the barcode to scan and press a trigger key on the side of the scanner. Light for scanning is irradiated and the printed barcode is scanned.

When the data is successfully scanned and displayed, or the time has elapsed, the light for scanning disappears.

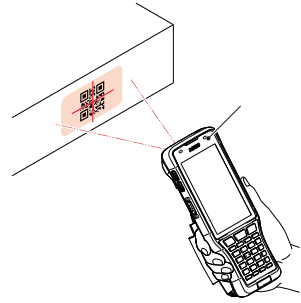





## 4.3 Turning OFF the Power

To power off the BHT, press and hold the power button , and tap the pop up ★Power off★ menu. Make sure that all user data and tasks are saved before tapping the ★Power off★ menu.

## 4.4 Battery Power Level Indicator

You can check the battery charge on the battery icon, on the top left corner of the screen. The battery indicator just shows the estimated battery remaining, so charge the device a little at a time, whenever you have a chance.

Refer to the Safety Precautions for proper handling and usage of the battery.

Battery icon	Status
 100%	100%
 76%	Slightly reduced
 15%	Dropping below 15%
	Charging

## 4.5 Using the BHT after Long Non-Use

Data stored in the BHT may be lost or damaged and the calendar clock may stop if the BHT is left unused for a long period.

- Keep a backup copy of important or critical information beforehand.
- Reset the calendar clock if it is stopped.
- The battery can also be served as a backup power source to fully charge the sub-battery. To successfully achieve this, keep the battery installed at least for 10 minutes.

Please refer to the User's Manual for more information on trouble shooting.

## Chapter5 When Unable to Successfully Read Codes

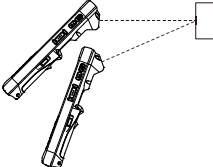
	Cause	Countermeasure
Specular reflection	Mounting the BHT perpendicular to a code may cause specular reflection. This may lead to no-read results.	Adjust the position of the BHT relative to the code and scan again. 
Distance from code	No-read results can occur if the BHT is positioned too close to or too far from a code within a possible read distance.	Gradually change the mounting position of the BHT relative to the code so as to find an appropriate focal distance.
Curved material's surface of barcodes	No-read results can occur if the material's surface of the barcode is excessively curved.	Ensure that the reading window is mounted at center relative to the code while scanning.
Missing barcodes by debris	Debris can obstructs barcode elements from the view of the BHT.	Remove any obstruction of the barcode and scan again.
Soiled reading window	No-read results can occur if the reading window has obstruction such as dust or debris.	Blow out any contaminants with an airbrush; gently wipe the window with a soft, dry cloth.
Reading in sunlight or inappropriate brightness	No-read results can be caused by code reading in sunlight or environment with inappropriate brightness.	In outdoor use, ensure to avoid environment where the BHT exposes to sunlight while scanning. In indoor use, ensure to scan barcodes in environment with appropriate brightness for decoding.

# Chapter6 Troubleshooting Guide

## 6.1 The BHT is not turned ON

- Make sure that the battery is properly inserted into the BHT.
- Check the battery power level and charge the battery if necessary.
- Wipe any dirt from the battery and BHT terminals.

## 6.2 The BHT cannot be charged

- Make sure that the dedicated battery charger is being used.
- Make sure that the battery is properly inserted into the BHT.
- Make sure that the BHT has been properly placed on the charger.  
The BHT status indicator will turn red when properly placed on the charger.
- Wipe any dirt from the battery and BHT contacts.
- If the battery in use has been repeatedly charged three hundred times or more or it has been more than one year since the battery started to be used, replace it with a new one to avoid any trouble caused by the deteriorated battery.

## 6.3 The BHT accidentally turns OFF

- Make sure that the battery has been fully charged. If not, charge the battery.
- Check whether auto power off is set. If auto power off is set, the power will be turned off automatically when the BHT is not used for the set time.

Auto power off setting can be changed only in the user program.

The BHT may be broken if the above measures are not adequate.

Notify the system administrator.

Refer to the User's Manual for appropriate measures if an error message is displayed on the BHT during the operation.

Data location	Data retention
Internal storage flash memory	Data retained
microSD card	Data retained
Data being edited	Data erased

- All rights reserved. No part of this publication may be reproduced in any form or by any means without permission in writing from the publisher. All products and company names mentioned are trademarks or registered trademarks of their respective holders.
- DENSO WAVE INCORPORATED does not assume any product liability arising out of, or in connection with, the application or use of any product, circuit, or application described herein.
- If it is judged by DENSO WAVE INCORPORATED that malfunction of the product is due to the product having been dropped or subjected to impact, repairs will be made at a reasonable charge even within the warranty period.
- Intellectual Property Precaution  
DENSO WAVE INCORPORATED ("DENSO WAVE") takes reasonable precautions to ensure its products do not infringe upon any patent or other intellectual property rights of other(s), but DENSO WAVE cannot be responsible for any patent or other intellectual property right infringement(s) or violation(s) which arise from (i) the use of DENSO WAVE's product(s) in connection or in combination with other component(s), product(s), data processing system(s) or equipment or software not supplied from DENSO WAVE; (ii) the use of DENSO WAVE's products in a manner for which the same were not intended nor designed; or (iii) any modification of DENSO WAVE's products by other(s) than DENSO WAVE.

Copyright © DENSO WAVE INCORPORATED, 2018

All rights reserved. No part of this publication may be reproduced in any form or by any means without permission in writing from the publisher.

All products and company names mentioned in this document are trademarks or registered trademarks of their respective holders.

QBDirect is a trademark of DENSO WAVE INCORPORATED. Android™ is a trademark of Google LLC.

Other products and company names mentioned in this document are trademarks or registered trademarks of their respective holders.

Specifications are subject to change without prior notice.

---

## DENSO WAVE INCORPORATED

1 Yoshiike Kusagi Agui-cho, Chita-gun, Aichi 470-2297, Japan

<https://www.denso-wave.com/>

This manual uses recycled paper.



# 第1章 使用須知

如需將本產品出口到國外，請事先向我公司營業點諮詢。

液晶屏採用高精度技術生產，屏幕上有可能存在個別暗點或亮點，但這不屬於故障。

此外，由於液晶屏背光源使用的白色LED的特性，每台產品的屏幕色彩或亮度存在差異。敬請諒解。  
對本產品的固件不能進行逆向工程、反編譯、反彙編、合併、更改或更換。

## 1.1 關於本手冊

- 因規格改良等原因，本手冊的內容可能會有不經事先通知而發生變更的情況。
- 未經許可，禁止轉載、複製本手冊的全部或部分內容。
- 如不慎丟失本手冊，請向我公司諮詢。
- 對於本手冊的內容，雖然我們盡力追求完美，但萬一發現有可疑之處、錯誤或遺漏，煩請與我公司聯繫。

## 1.2 責任範圍

- 對於因使用或無法使用BHT系統軟件、相關資料而造成的附帶或間接損害（包含因營業利潤損失、業務中斷、營業信息喪失等造成的損害），本公司不承擔任何責任。
- 為了防止產品侵害他人專利權，本公司採取了適當的措施，但對於因以下(1)~(3)項中任何一種原因引起的專利權侵害等事件，本公司將無法承擔責任，敬請諒解。
  - (1) 與非本公司提供的零件、產品、裝置、數據處理系統或軟件配套使用時
  - (2) 本公司產品被以預想不到的方法使用時
  - (3) 本公司產品被本公司以外的第三方改造時
- 如果本公司判斷是因掉落、衝擊造成的故障，即使在保質期內，也將是有償維修。
- 預存用戶的產品進行修理、解析等時，對於用戶保存在產品內的數據，本公司將無法承擔責任。

## 1.3 Free/Open source software (FOSS)

- 本產品中包含Free/Open Source Software(FOSS)。Denso Wave有提供對應源代碼的準備。詳細情況請諮詢本公司的銷售門店或者訪問以下網站。  
<https://www.denso-wave.com/>

## 1.4 附屬品的確認

使用前，請確認以下附屬品是否齊全。

如果發現有不齊或損壞等情況，請與銷售門店聯繫。

- BHT本體（1台）
- 操作指南（本手冊）
- 安全預防措施
- 手帶（1根）
  
- 電池  
包含電池或取決於型號。不包含

詳細信息請參見下圖。

型號	產品編號	電池類型
BHT-M70-QW	104969-465X	不包含
	104969-466X	BT3
	104969-468X	
	104969-470X	
BHT-M70-QWG	104969-477X	不包含
	104969-478X	BT3
	104969-480X	
	104969-482X	

X是介於0和9之間的數字。

## 1.5 用戶註冊

為了向選購本公司產品的用戶提供更充實的服務和幫助，本公司希望用戶配合進行“用戶註冊”。進行用戶註冊後可以享受以下特別服務。

- 發布版本升級通知
- 發布有關新產品、展覽會以及各種活動等的信息
- 免費使用網絡信息服務“QBdirect”

### QBdirect的服務內容

信息搜索服務（FAQ）	可以獲取各種產品的詳細信息。
下載服務	可以下載BHT系列的最新系統、軟件的修改模塊以及樣品程序。
產品諮詢	可以通過電子郵件對產品進行諮詢。

特別服務的內容會發生變化，敬請諒解。

註冊方法

請訪問以下網頁並按照嚮導進行註冊。

<https://www.denso-wave.com/>

## 1.6 有保證的三年保固

如果您在購買產品後一個月內註冊產品序號，註冊後的產品保固期將從一年延長到三年。

請至以下網址註冊。

<https://www.denso-wave.com/>

在銘板上的QR碼下可以找到註冊的序號。

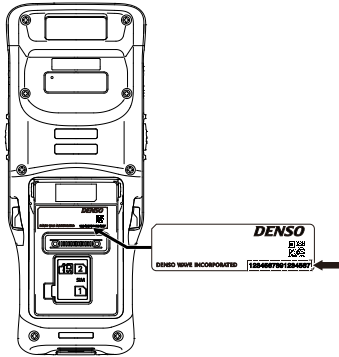

## 1.7 使用上的注意事項

### 1.7.1 不能使用的場所

- 火邊等高溫場所、受陽光直射的場所（有可能會造成故障、發熱、破裂、著火）。存放在溫度50 °C ~ 60 °C的高溫高濕場所時，請在常溫常濕的場所放置1天以上後再使用。如果在內部保持高溫的狀態下使用，有可能會造成無法讀取等設備故障。
- 溫度變化急劇的場所（結露會引起運行錯誤）  
從寒冷的地方移動到溫暖的地方時，請放置一段時間後再使用。
- 會受到強烈衝擊或有大量靜電產生的場所

### 1.7.2 遠離電波、電磁波、金屬

在以下場所或使用方法下，可能會出現無法進行無線通信的情況。

- 以下使用2.4 GHz頻段電波的設備的附近（因受電波干擾，會出現無法通信的情況。）
  - 微波爐等工業、科學、醫療用設備
  - 無線LAN設備
  - 工廠或倉庫等的物理管理系統
  - 業餘無線電站等的無線收發器
- 電腦、電視等產生電磁波的家電產品的附近（電磁噪聲會導致無法通信。）
- 金屬物的附近、金屬粉多的地方、被金屬壁包圍的房間（因受金屬的影響，會出現無法通信的情況。）
- 通信天線的周圍有金屬物或被用手遮擋。

### 1.7.3 電池的更換時期

當電池經過反覆充放電後接近使用壽命時，因容量下降，會導致BHT的運行時間變短。如果出現這種情況，請停止使用已到使用壽命的電池，並更換新電池。  
另外，因電池到達使用壽命後會發生膨脹，所以會出現難以插入BHT的情況。如果出現這種情況，說明電池壽命已到，請立即更換新電池。

## 1.8 日常保養

進行日常保養前，請務必關閉電源。

- BHT本體以及充電端子上的污垢

請定期用棉花棒等擦去BHT本體或充電端子上的污垢。  
但在擦拭時，請注意避免使端子變形。  
進行清潔時，請勿使用香蕉水、酒精等溶劑。  
否則有可能造成充電電極的鍍層脫落。

- 外殼的污垢

請用柔軟的干布擦除。  
污垢嚴重時，請將布浸入用水稀釋的中性清潔劑中，擰乾後擦拭，最後用乾布擦除水分。  
請勿使用香蕉水、酒精等溶劑。否則有可能造成外殼變質或塗料脫落。

- 液晶屏的污垢

液晶屏容易受傷，請勿用硬物刮劃或敲打。  
否則有可能造成表面受傷或破裂。

- 按鍵的污垢

擦拭按鍵表面的污垢時，請勿強力搓揉或拉拽按鍵。否則可能會造成按鍵損壞。

- 條碼讀取窗口的污垢

如果條碼讀取窗口的玻璃板上粘有灰塵或垃圾，會影響條碼的讀取。  
在灰塵多的地方使用時，請定期檢查讀取窗口的玻璃板上是否粘有灰塵，如果有灰塵，請用空氣刷將灰塵吹走後，用柔軟的棉花棒等輕輕擦拭乾淨。  
有沙粒等硬物粘附時，如果搓揉會造成讀取窗口的玻璃板受傷，所以請用空氣刷將沙粒吹走，或用毛尖柔軟的刷子將沙粒刷掉。

### DENSO WAVE AUTO-ID產品消毒與保養的重要通知。

如AUTO-ID一般產品包裝內的《操作指南》\*維護與保養一節所述，嚴禁使用稀釋劑和酒精進行清潔。

由於新型冠狀病毒目前正在爆發大流行，本公司按照自家測試標準，使用70%乙醇或10 ppm至80 ppm的次氯酸水進行擦拭試驗，期望能達到一定的消毒效果。就結果來說，我們肉眼看不出外殼表面上有任何明顯的變色及褪色。在使用下述的溶液之前，請詳閱並了解以下說明。

測試說明：用機器手臂擦拭產品的外表面1500次（讀取窗口、防塵板和電纜線除外）

溶液：70%乙醇/ 10 ppm至80 ppm的次氯酸水/ 70%異丙醇/ 3%過氧化氫

適用型號：按材料選擇並公佈在DENSO WAVE網站上的AUTO-ID產品型號。

#### 注意

- 請勿在讀取窗口或防塵板塗上任何液體。切勿讓任何液體流入孔和狹縫等狹小空間。
- 務必使用軟布擦拭。如果操作後仍有液體殘留，請用乾的軟布擦拭乾淨。
- 本說明未保證產品之規格。外殼劣化等的產品劣化情況可能會因操作環境變得更明顯。

## 第2章 元件

### 2.1 BHT-M70

上側面

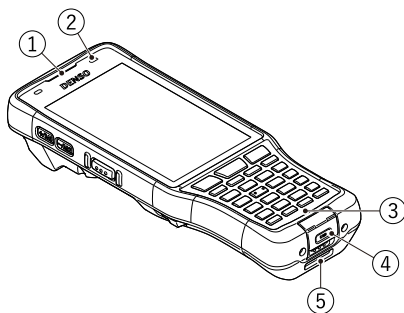

下側面

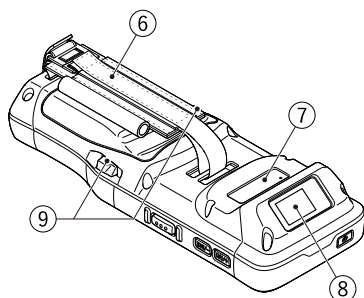

- ① 揚聲器、接收器
- ② 狀態指示燈
- ③ 麥克風
- ④ USB連接器
- ⑤ 介面連接器
- ⑥ 手帶
- ⑦ 後相機
- ⑧ 條碼讀取窗口
- ⑨ 電池蓋鎖

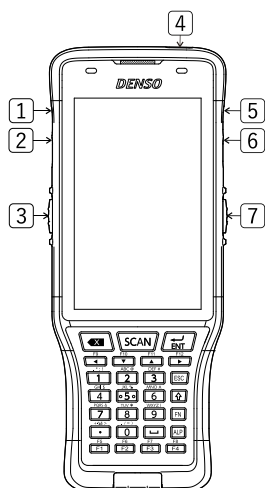

- ① M1鍵
- ② M2鍵
- ③ 左觸發鍵
- ④ 電源鍵
- ⑤ M3鍵
- ⑥ M4鍵
- ⑦ 右觸發鍵

## 第3章 使用前的準備工作

### 3.1 手帶安裝。

如圖所示，將手帶分別固定在兩個位置。

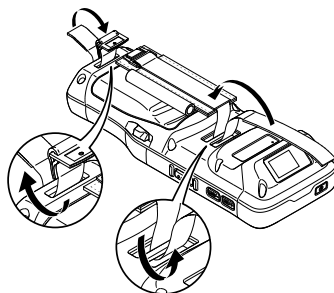

連接手帶。

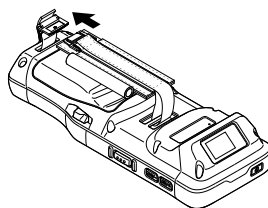

如圖所示安裝觸控筆。選擇手帶的右側或左側。

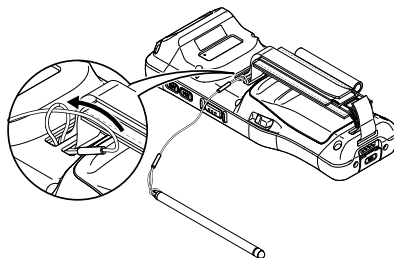

也可以將手寫筆存放在手帶中。

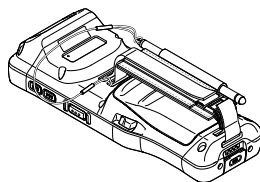

## 3.2 插入和取出主電池

### 3.2.1

#### 插入

按箭頭方向插入電池。

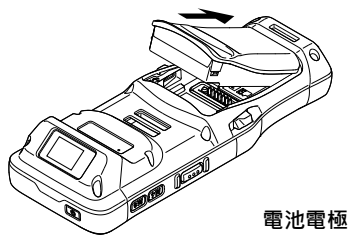

### 3.2.2

按箭頭方向壓下電池。

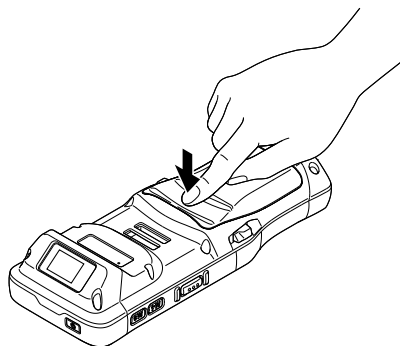

### 3.2.3

#### 移除

沿箭頭方向壓下電池蓋鎖。

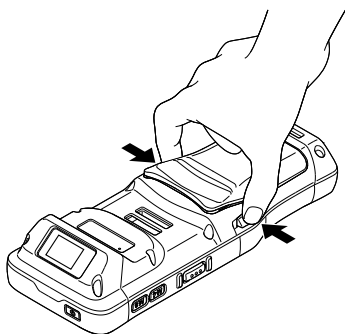

### 3.2.4

握住電池鎖片，拉出電池。

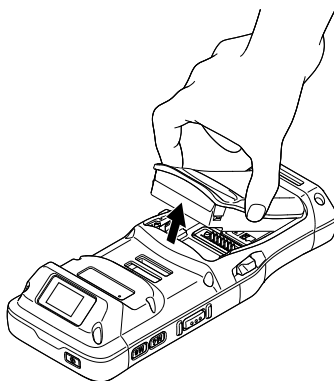

## 3.3 為BHT充電

主電池可能沒有充滿電就出貨。請將主電池充滿電後再使用手持式終端機。您可以使用充電座或USB線為手持式終端機充電。

### 3.3.1 充電時間

#### 主電池

手持式終端機是由主電池供電以維持其運轉。將空的主電池充滿電大約需要2.1個小時。充電時螢幕上方的狀態指示燈會亮起紅色，充電完成後會變成綠色。

#### 副電池

副電池安裝在主機板上，用途為在更換電池或取出電池時保留資料。

當副電池充滿電後，資料至少可保留5分鐘。

安裝完主電池後，可能需要大約十分鐘才能將空的副電池充滿電。請勿取出電池，以便妥善保留資料。

### 3.3.2 充電溫度

建議在室溫下（18°C 至 25°C）為電池充電，以達到最佳性能。請注意，當環境溫度降至 0°C 以下或超過 40°C 時，電池將停止充電。停止充電的溫度可能會因實際操作環境而有所不同。

### 3.3.3 電池供電的操作

當802.11a/b/g/n/ac、GSM/GPRS/EDGE/WCDMA/UMTS/HSDPA/HSUPA/HSPA+/LTE、v5.1及v2.1+EDR藍牙和GPS都啟用電池供電時，主電池電量將大幅下降。長時間使用螢幕和連續掃描條碼也會影響電池電量。

為了避免電池電量過低時系統意外關機，建議您隨時準備好新的電池進行更換，或是將BHT連接至外部電源。

如果長時間不使用BHT，請將電池從BHT或充電座中取出，再存放在陰涼乾燥的地方。長時間存放充滿電或電力耗盡（無法開啟BHT）的電池，可能會耗損電池的性能和壽命。如需長期存放，建議將電池電力保留在50%的電量。

在長期存放過程中，為了保持電池性能，每年應充滿一次電池盒。電池充滿後，先將電池放電至建議電量後再恢復存放。

根據使用環境的不同，電池可能會在幾年後膨脹。這是鋰離子電池的特性，不存在安全隱患。

### 3.3.4 BHT的充電狀態

BHT的充電狀態顯示在螢幕上方的狀態指示燈上。

狀態指示燈	指示	說明
充電	紅色，恆亮	為BHT充電
	紅色，閃爍	充電錯誤
	綠色，恆亮	充電完成
	沒有亮燈	充電錯誤（充電停止。）



### 3.3.5 使用USB線

- (3) 將USB Type-C連接器插入手持式終端機底部的連接器。
- (4) 將USB Type-A連接器插入USB電源供應器。

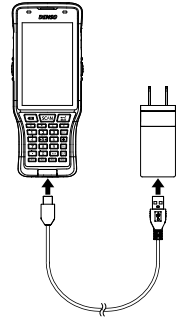

### 3.3.6 使用充電座

#### 將充電座上電源

使用專用電源供應器或USB線和USB電源供應器，將充電座上電源。  
將交流電插頭或交流電電源供應器插入電源插座。

使用電源供應器將CU-M70U接上電源

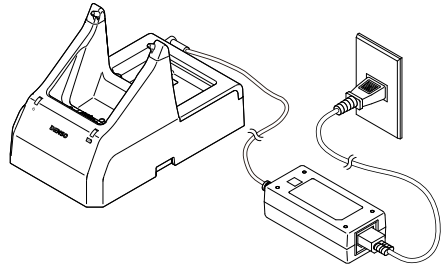

使用USB電源供應器將CU-M70UQ接上電源

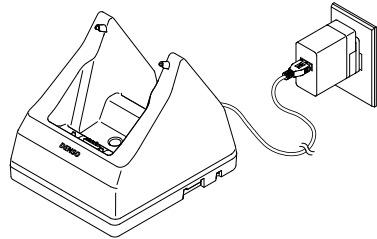

#### 電源供應器 CU-M70U/L

只能使用經電綜核准且通過國家認可測試實驗室 (NRTL) 認證的ITE (LPS / SELV) 電源供應器，其電氣額定值：輸出12 VDC,最低 4.16 A，最大環境溫度至少+ 40°C。使用替代的電源供應器會使此裝置的任何認證失效，並且可能產生危險。

#### 電源供應器 CU-M70UQ

只能使用經電綜核准且通過國家認可測試實驗室 (NRTL) 認證的ITE (LPS / SELV) 電源供應器，其電氣額定值：輸出5 VDC,最低 3 A，最大環境溫度至少+ 40°C。使用替代的電源供應器會使此裝置的任何認證失效，並且可能產生危險。

## 給BHT充電

將BHT直立，逐漸向後傾斜。

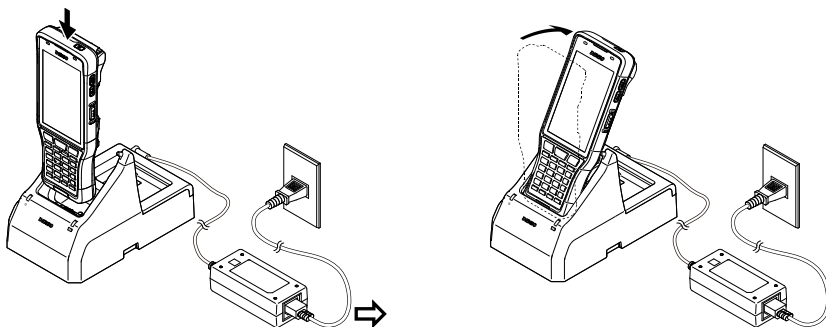

注意：將BHT放置在充電座上時，請注意不要讓掛繩纏繞在BHT和充電座之間。充電時，BHT的某個特定部位可能會因工作環境和條件的不同而發熱。這並非故障。

## 從充電座取下BHT

向前傾斜BHT，並將其拉出。

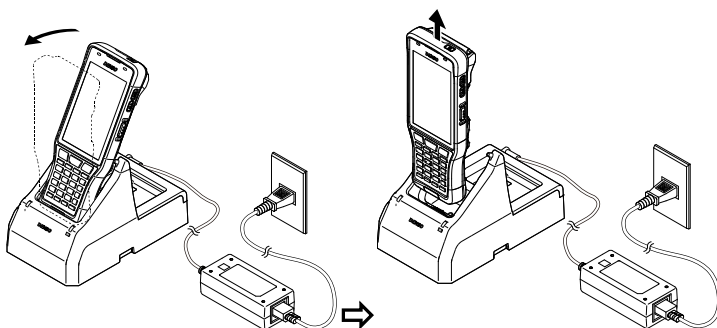

## 關於充電座電源連接的注意事項

對於帶有USB介面的CU-M70U，電源供應器和USB線皆可使用。

要為BHT和備用電池充電，可使用電源供應器。

使用USB線充電時，只能為BHT充電。在BHT中安裝大容量電池或在BHT處於工作狀態時充電等情況下，建議使用電源供應器；因為這些情況可能會導致長時間充電或充電錯誤。使用耗損的電池可能會導致充電錯誤。在這種情況下，要更換新的電池。

## 第4章 使用方法

### 4.1 開啟電源

#### 電源開啟

要開啟BHT的電源，請按住位於機器上側的電源鍵。OS啟動並顯示鎖定畫面。從下往上滑動鎖定畫面，即可顯示主畫面。

注意。為了方便手持式掃描器供電，必須將電池固定在正確位置上。在冷藏室等低溫環境下使用BHT時，請在正常環境溫度下開機，再將BHT帶到低溫環境中。在低溫下開啟BHT電源，可能無法成功啟動BHT。由於電池的特性使然，在低溫環境下操作BHT，可能會導致BHT延遲運行或大幅縮短工作時間。使用前請確認操作條件。

### 4.2 掃描條碼

按照以下步驟讀取條碼。

#### 4.2.1

按下電源鍵，從睡眠狀態啟動BHT。

#### 4.2.2

點選掃描設定。

打開讀取啟用，點選功能表列上的 **★測試★**。

接著測試掃描表格將會開啟，顯示掃描的資料。

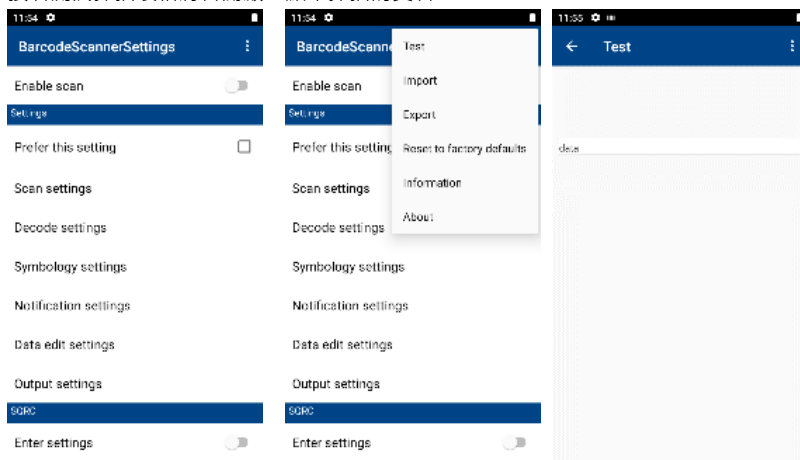

### 4.2.3

將條碼讀取窗口指向要掃描的條碼，並按下掃描器側面的觸發鍵。用掃描用的光線進行照射，對列印出來的條碼進行掃描。成功掃描並顯示資料後，或是經過一段時間後，掃描的燈光會消失。

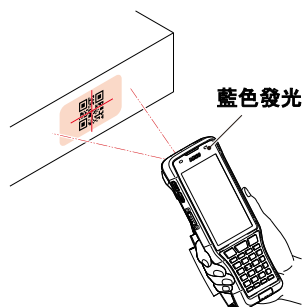

## 4.3 Turn OFF the Power





### Power OFF

要關閉BHT電源，按住電源按鈕，點選彈出的 ★電源關閉★功能表。在點選 ★關閉電源★ 功能表之前，請確認所有的用戶資料和工作都已儲存。

## 4.4 電池電量指示燈

可從液晶螢幕右上方顯示的電池圖示確認主電池的電量。由於指示燈顯示的只是主電池電量的粗略估計，並非準確的剩餘電量，所以請儘早充電。

主電池電量指示燈只顯示電池電量的粗略估計，並非準確的剩餘電量。請閱讀安全注意事項，確保已正確使用電池。

電池圖示	狀態
 100%	100%
 76%	略微減少
 15%	降至15%以下
	充電

## 4.5 長時間不使用BHT後再度使用

如果長時間不使用BHT，BHT中儲存的資料可能會消失或損壞，並且日曆時鐘可能會停止。

- 重要的或關鍵的資訊應事先做好備份。
- 如果日曆時鐘已停止，則重新設定之。
- 電池也作為備份電源使用。至少在副電池充電前的10分鐘內，勿從BHT上取下電池。欲瞭解更多的故障排除資訊，請參考使用手冊。

## 第5章 當無法成功讀取條碼時

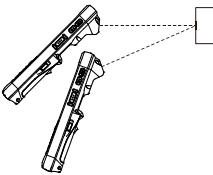
	原因	對策
鏡面反射	當光線從正上方聚焦在條碼的印刷表面時，BHT可能會因鏡面反射而無法讀取條碼。	改變BHT讀取角度，再試一次。 
與條碼之距離	如果條碼離BHT讀取窗口太近或太遠，即使條碼在讀取區域內，也可能無法讀取。	緩慢地將BHT移向或遠離條碼，然後再試一次。
條碼表面曲率	如果其表面極度彎曲，可能無法讀取條碼。	讀取位於條碼讀取窗口中心位置的條碼。
條碼表面的污垢	如果條碼表面有污垢，可能無法讀取。	抹除條碼上的污垢，再試一次。
條碼讀取窗口的污垢	如果條碼讀取窗口有污垢，可能無法讀取條碼。	用氣刷吹走所有灰塵，然後用棉籤或類似的軟物輕輕擦拭讀取窗口。
陽光直射、環境光線	陽光直射或周圍光線的亮度可能會對條碼讀取產生不利影響。	讀取條碼時要避開陽光直射。在室內讀取時，調整周圍光線的亮度。

## 第6章 故障排除指南

### 6.1 BHT電源沒有開啟

- 確認主電池已正確插入BHT中。
- 檢查電池電量，必要時為電池充電。
- 抹除主電池和BHT掃描器上的灰塵。

### 6.2 BHT無法充電。

- 確認已使用專用電源供應器。
- 確認主電池已正確插入BHT中。
- 確認BHT已被正確放置在充電座中。  
當正確放入充電座時，BHT狀態指示燈將變成紅色。
- 抹除主電池和BHT掃描器上的灰塵。
- 如果主電池充電次數超過300次，或使用時間超過一年，請更換新的電池，以避免因電池劣化而造成的任何問題。

### 6.3 BHT意外關閉。

- 確認電池已充飽電。如果沒有充飽，請為電池充電。
  - 檢查是否設定了自動關閉電源。如果設定了自動關閉電源，則在設定的時間內未使用BHT，電源將自動關閉。  
自動關閉電源設定只能透過用戶程式變更。
- 如果採取上述措施仍未解決，BHT可能已損壞。  
通知系統管理員。  
如果在操作過程中BHT上顯示錯誤訊息，請參考使用手冊以採取適當的措施。

## 第7章 關閉電源後的記憶體內容

資料位置	資料保留
內部儲存快閃記憶體	保留的資料
microSD卡	保留的資料
編輯中的資料	刪除的資料

- 保留所有權利。未經出版商書面許可，不得以任何形式或手段複製本出版物的任何部分。所有提及的產品和公司名稱均為其各自持有者所擁有的商標或註冊商標。
- DENSO WAVE INCORPORATED不承擔因應用或使用本文所述的任何產品、電路或應用程式而產生的或與之相關的任何產品責任。
- 如果DENSO WAVE INCORPORATED判斷是由於產品掉落或受到撞擊而導致的故障，即使在保固期內，也會收取合理的維修費用。
- 智慧財產權注意事項  
DENSO WAVE INCORPORATED (以下簡稱「DENSO WAVE」) 採取合理的預防措施，確保其產品不侵犯他人的任何專利或其他任何智慧財產權，但DENSO WAVE對以下狀況的任何專利或其他智慧財產權之侵權或違法行為概不負責：(i) 將DENSO WAVE的產品與非DENSO WAVE提供的其他元件、產品、資料處理系統或裝置或軟體連接或結合使用；(ii) 使用DENSO WAVE產品的方式不符合此產品的用途或設計；或是 (iii) 由DENSO WAVE以外的他者對 DENSO WAVE產品所進行的任何改裝。

版權所有 © DENSO WAVE INCORPORATED, 2018

保留所有權利。未經出版商書面許可，不得以任何形式或手段複製本出版物的任何部分。

本文件中所有提及的產品和公司名稱均為其各自持有者所擁有的商標或註冊商標。

QBdirect是DENSO WAVE INCORPORATED的商標。Android™是Google LLC的商標。本文件中提及的其他產品和公司名稱均為其各自持有者所擁有的商標或註冊商標。

規格如有變更，恕不另行通知。

---

## DENSO WAVE INCORPORATED

1 Yoshiike Kusagi Agui-cho, Chita-gun, Aichi 470-2297, Japan

<https://www.denso-wave.com/>

This manual uses recycled paper.