

FCC Test Report (BT-EDR)

Report No.: RF210105C01-2

FCC ID: PZWBHTM70QWG

Test Model: BHT-M70-QWG

Received Date: 2021/1/5

Test Date: 2021/1/17 ~ 2021/8/18

Issued Date: 2021/9/29

Applicant: DENSO WAVE INCORPORATED

Address: 1 Yoshiike Kusagi Agui-cho, Chita-gun Aichi 470-2297, Japan

Issued By: Bureau Veritas Consumer Products Services (H.K.) Ltd., Taoyuan Branch
Hsin Chu Laboratory

Lab Address: E-2, No.1, Li Hsin 1st Road, Hsinchu Science Park, Hsinchu City 300,
Taiwan

Test Location: E-2, No.1, Li Hsin 1st Road, Hsinchu Science Park, Hsinchu City 300,
Taiwan

**FCC Registration /
Designation Number:** 723255 / TW2022



This report is for your exclusive use. Any copying or replication of this report to or for any other person or entity, or use of our name or trademark, is permitted only with our prior written permission. This report sets forth our findings solely with respect to the test samples identified herein. The results set forth in this report are not indicative or representative of the quality or characteristics of the lot from which a test sample was taken or any similar or identical product unless specifically and expressly noted. Our report includes all of the tests requested by you and the results thereof based upon the information that you provided to us. You have 60 days from date of issuance of this report to notify us of any material error or omission caused by our negligence, provided, however, that such notice shall be in writing and shall specifically address the issue you wish to raise. A failure to raise such issue within the prescribed time shall constitute your unqualified acceptance of the completeness of this report, the tests conducted and the correctness of the report contents. Unless specific mention, the uncertainty of measurement has been explicitly taken into account to declare the compliance or non-compliance to the specification.

Table of Contents

Release Control Record	4
1 Certificate of Conformity	5
2 Summary of Test Results	6
2.1 Measurement Uncertainty	6
2.2 Modification Record	6
3 General Information	7
3.1 General Description of EUT (BT-EDR)	7
3.2 Description of Test Modes	9
3.2.1 Test Mode Applicability and Tested Channel Detail	10
3.3 Duty Cycle of Test Signal	12
3.4 Description of Support Units	13
3.4.1 Configuration of System under Test	14
3.5 General Description of Applied Standards and References	16
4 Test Types and Results	17
4.1 Radiated Emission and Bandedge Measurement	17
4.1.1 Limits of Radiated Emission and Bandedge Measurement	17
4.1.2 Test Instruments	18
4.1.3 Test Procedures	20
4.1.4 Deviation from Test Standard	20
4.1.5 Test Setup	21
4.1.6 EUT Operating Conditions	22
4.1.7 Test Results	23
4.2 Conducted Emission Measurement	31
4.2.1 Limits of Conducted Emission Measurement	31
4.2.2 Test Instruments	31
4.2.3 Test Procedures	32
4.2.4 Deviation from Test Standard	32
4.2.5 Test Setup	32
4.2.6 EUT Operating Condition	32
4.2.7 Test Results	33
4.3 Number of Hopping Frequency Used	35
4.3.1 Limits of Hopping Frequency Used Measurement	35
4.3.2 Test Setup	35
4.3.3 Test Instruments	35
4.3.4 Test Procedure	35
4.3.5 Deviation from Test Standard	35
4.3.6 Test Results	36
4.4 Dwell Time on Each Channel	37
4.4.1 Limits of Dwell Time on Each Channel Measurement	37
4.4.2 Test Setup	37
4.4.3 Test Instruments	37
4.4.4 Test Procedures	37
4.4.5 Deviation from Test Standard	37
4.4.6 Test Results	38
4.5 Channel Bandwidth	42
4.5.1 Limits of Channel Bandwidth Measurement	42
4.5.2 Test Setup	42
4.5.3 Test Instruments	42
4.5.4 Test Procedure	42
4.5.5 Deviation from Test Standard	42
4.5.6 EUT Operating Condition	42
4.5.7 Test Results	43
4.6 Hopping Channel Separation	44

4.6.1	Limits of Hopping Channel Separation Measurement.....	44
4.6.2	Test Setup.....	44
4.6.3	Test Instruments	44
4.6.4	Test Procedure	44
4.6.5	Deviation from Test Standard	44
4.6.6	Test Results	45
4.7	Maximum Output Power.....	46
4.7.1	Limits of Maximum Output Power Measurement	46
4.7.2	Test Setup.....	46
4.7.3	Test Instruments	46
4.7.4	Test Procedure	46
4.7.5	Deviation from Test Standard	46
4.7.6	EUT Operating Condition	46
4.7.7	Test Results	47
4.8	Conducted Out of Band Emission Measurement.....	48
4.8.1	Limits of Conducted Out of Band Emission Measurement.....	48
4.8.2	Test Instruments	48
4.8.3	Test Procedure	48
4.8.4	Deviation from Test Standard	48
4.8.5	EUT Operating Condition	48
4.8.6	Test Results	48
5	Pictures of Test Arrangements.....	51
	Annex A - Band-Edge Measurement.....	52
	Appendix – Information of the Testing Laboratories	54

Release Control Record

Issue No.	Description	Date Issued
RF210105C01-2	Original release.	2021/9/29

1 Certificate of Conformity

Product: 2D Code Handy Terminal

Brand: DENSO

Test Model: BHT-M70-QWG

Sample Status: Engineering sample

Applicant: DENSO WAVE INCORPORATED

Test Date: 2021/1/17 ~ 2021/8/18

Standards: 47 CFR FCC Part 15, Subpart C (Section 15.247)
ANSI C63.10: 2013

The above equipment has been tested by **Bureau Veritas Consumer Products Services (H.K.) Ltd., Taoyuan Branch**, and found compliance with the requirement of the above standards. The test record, data evaluation & Equipment Under Test (EUT) configurations represented herein are true and accurate accounts of the measurements of the sample's EMC characteristics under the conditions specified in this report.

Prepared by : Vivian Huang , **Date:** 2021/9/29
Vivian Huang / Specialist

Approved by : Clark Lin , **Date:** 2021/9/29
Clark Lin / Technical Manager

2 Summary of Test Results

47 CFR FCC Part 15, Subpart C (Section 15.247)			
FCC Clause	Test Item	Result	Remarks
15.207	AC Power Conducted Emission	PASS	Meet the requirement of limit. Minimum passing margin is -16.06 dB at 0.65781 MHz.
15.247(a)(1)(iii)	Number of Hopping Frequency Used	PASS	Meet the requirement of limit.
15.247(a)(1)(iii)	Dwell Time on Each Channel	PASS	Meet the requirement of limit.
15.247(a)(1)	1. Hopping Channel Separation 2. Spectrum Bandwidth of a Frequency Hopping Sequence Spread Spectrum System	PASS	Meet the requirement of limit.
15.247(b)	Maximum Peak Output Power	PASS	Meet the requirement of limit.
15.205 & 209 & 15.247(d)	Radiated Emissions & Band Edge Measurement	PASS	Meet the requirement of limit. Minimum passing margin is -10.3 dB at 2362.42 MHz.
15.247(d)	Antenna Port Emission	PASS	Meet the requirement of limit.
15.203	Antenna Requirement	PASS	No antenna connector is used.

Note:

- For 2.4GHz band compliance with rule 15.247(d) of the band-edge items, the test plots were recorded in Annex A. Test Procedures refer to report 4.1.3.
- If the Frequency Hopping System operating in 2400-2483.5MHz band and the output power less than 125mW. The hopping channel carrier frequencies separated by a minimum of 25kHz or two-thirds of the 20dB bandwidth of hopping channel whichever is greater.
- Determining compliance based on the results of the compliance measurement, not taking into account measurement instrumentation uncertainty.

2.1 Measurement Uncertainty

Where relevant, the following measurement uncertainty levels have been estimated for tests performed on the EUT as specified in CISPR 16-4-2:

Measurement	Frequency	Expanded Uncertainty (k=2) (\pm)
Conducted Emissions at mains ports	150kHz ~ 30MHz	1.9 dB
Conducted emissions	-	2.5 dB
Radiated Emissions up to 1 GHz	9kHz ~ 30MHz	3.1 dB
	30MHz ~ 1GHz	5.4 dB
Radiated Emissions above 1 GHz	1GHz ~ 18GHz	5.0 dB
	18GHz ~ 40GHz	5.3 dB

2.2 Modification Record

There were no modifications required for compliance.

3 General Information

3.1 General Description of EUT (BT-EDR)

Product	2D Code Handy Terminal
Brand	DENSO
Test Model	BHT-M70-QWG
Status of EUT	Engineering sample
Power Supply Rating	3.6 Vdc from battery; 5 Vdc from power adapter
Modulation Type	GFSK, $\pi/4$ -DQPSK, 8DPSK
Modulation Technology	FHSS
Transfer Rate	Up to 3 Mbps
Operating Frequency	2.402 ~ 2.480 GHz
Number of Channel	79
Output Power	12.764 mW
Antenna Type	Refer to Note
Antenna Connector	Refer to Note
Accessory Device	Battery x 1 Adapter x 1 (Option) Adapter x 1 (for Cradle) QC3.0 charge single Cradle x 1 (Option_Brand: DENSO, Model: CU-M70UQ) USB Cradle with spare battery charge x 1 (Option_Brand: DENSO, Model: CU-M70U) LAN Cradle with Spare battery charge x 1 (Option_Brand: DENSO, Model: CU-M70L)
Cable Supplied	USB Cable x 1 (Shielded, 1.45m, Option _Brand: NIEN-YI, Model: NYS3892-0)

Note:

1. The EUT has below radios as following table:

Radio 1	Radio 2	Radio 3	Radio 4
WLAN 2.4GHz	WLAN 5GHz	Bluetooth	WWAN (LTE + WCDMA + GSM)

2. Simultaneously transmission condition.

Condition	Technology	
1	WWAN	WLAN (2.4GHz)
2	WWAN	WLAN (5GHz)
3	WWAN	Bluetooth

Note: The emission of the simultaneous operation has been evaluated and no non-compliance was found.

3. The EUT must be supplied with a power adapter & battery and following below table:

Item	Brand	Model No.	Spec.
Battery	DENSO	BT3	DC Output: 3.6Vdc, 3050mAh, 10.98Wh
Adapter (Option)	CHANNEL WELL	2ACP0183C	AC Input: 100-240Vac~, 0.5A, 50/60Hz DC Output: 5.0Vdc / 3.0A 15.0W, 9.0Vdc / 2.0A 18.0W, 12.0Vdc / 1.5A 18.0W
For Cradle use			
Item	Brand	Model No.	Spec.
Adapter (Option)	Sunny	SYS1548-5012-T3	AC Input: 100-240Vac~1.5A MAX 50-60Hz AC Cable: Unshielded, 1.71m DC Output: +12.0Vdc / 4.16A DC Cable: Unshielded, 1.16m with one core

4. The antennas provided to the EUT, please refer to the following table:

Antenna No.	RF Chain No	Brand	Model	Antenna gain (dBi)	Frequency Range (MHz)	Antenna Type	Connector Type
1 (WiFi & BT)	Chain0	HONGBO	1415-01R8C00	3.26	2400-2500 (WiFi)	PIFA	Spring
				3.21	2400-2500 (BT)		
				3.63	5150-5250		
				3.65	5250-5350		
				3.45	5470-5725		
				3.52	5725-5850		
2 (WiFi)	Chain1	HONGBO	1415-01R8C00	0.68	2400-2500	PIFA	Spring
				2.63	5150-5250		
				2.6	5250-5350		
				2.93	5470-5725		
				2.4	5725-5850		

5. The EUT was pre-tested for conducted emission test under following test modes:

Pre-test Mode	Description
Mode A	Adapter Mode
Mode B	Laptop Mode
Mode C	Cradle with Type C port
Mode D	Cradle with RJ45 port
Mode E	QC3.0 charge single Cradle

From the above modes, the worst conducted emission test was found in **Mode A**. Therefore only the test data of the modes were recorded in this report.

6. The EUT was pre-tested for radiated emission test under following test modes:

Pre-test Mode	Description
Mode A	Battery Mode
Mode B	Adapter Mode
Mode C	Cradle with Type C port
Mode D	Cradle with RJ45 port
Mode E	QC3.0 charge single Cradle

The worst radiated emissions were found in **Mode D** for below 1GHz and found in **Mode B** for above 1GHz. Therefore only the test data of the modes were recorded in this report.

7. The above EUT information is declared by manufacturer and for more detailed features description, please refer to the manufacturer's specifications or user's manual.

8. The above Antenna information is declared by manufacturer and for more detailed features description, please refer to the manufacturer's specifications, the laboratory shall not be held responsible.

3.2 Description of Test Modes

79 channels are provided for BT-EDR mode:

Channel	Freq. (MHz)	Channel	Freq. (MHz)	Channel	Freq. (MHz)	Channel	Freq. (MHz)
0	2402	20	2422	40	2442	60	2462
1	2403	21	2423	41	2443	61	2463
2	2404	22	2424	42	2444	62	2464
3	2405	23	2425	43	2445	63	2465
4	2406	24	2426	44	2446	64	2466
5	2407	25	2427	45	2447	65	2467
6	2408	26	2428	46	2448	66	2468
7	2409	27	2429	47	2449	67	2469
8	2410	28	2430	48	2450	68	2470
9	2411	29	2431	49	2451	69	2471
10	2412	30	2432	50	2452	70	2472
11	2413	31	2433	51	2453	71	2473
12	2414	32	2434	52	2454	72	2474
13	2415	33	2435	53	2455	73	2475
14	2416	34	2436	54	2456	74	2476
15	2417	35	2437	55	2457	75	2477
16	2418	36	2438	56	2458	76	2478
17	2419	37	2439	57	2459	77	2479
18	2420	38	2440	58	2460	78	2480
19	2421	39	2441	59	2461		

3.2.1 Test Mode Applicability and Tested Channel Detail

EUT CONFIGURE MODE	APPLICABLE TO				DESCRIPTION
	RE≥1G	RE<1G	PLC	APCM	
-	√	√	√	√	-

Where **RE≥1G**: Radiated Emission above 1GHz **RE<1G**: Radiated Emission below 1GHz
PLC: Power Line Conducted Emission **APCM**: Antenna Port Conducted Measurement

Note: The EUT had been pre-tested on the positioned of each 3 axis. The worst case was found when positioned on X-plane

Radiated Emission Test (Above 1GHz):

- Pre-Scan has been conducted to determine the worst-case mode from all possible combinations between available modulations, data rates and antenna ports (if EUT with antenna diversity architecture).
- Following channel(s) was (were) selected for the final test as listed below.

AVAILABLE CHANNEL	TESTED CHANNEL	MODULATION TECHNOLOGY	MODULATION TYPE	PACKET TYPE
0 to 78	0, 39, 78	FHSS	GFSK	DH5
0 to 78	0, 39, 78	FHSS	8DPSK	3DH5

Radiated Emission Test (Below 1GHz):

- Pre-Scan has been conducted to determine the worst-case mode from all possible combinations between available modulations, data rates and antenna ports (if EUT with antenna diversity architecture).
- Following channel(s) was (were) selected for the final test as listed below.

AVAILABLE CHANNEL	TESTED CHANNEL	MODULATION TECHNOLOGY	MODULATION TYPE	PACKET TYPE
0 to 78	39	FHSS	GFSK	DH5

Power Line Conducted Emission Test:

- Pre-Scan has been conducted to determine the worst-case mode from all possible combinations between available modulations, data rates and antenna ports (if EUT with antenna diversity architecture).
- Following channel(s) was (were) selected for the final test as listed below.

AVAILABLE CHANNEL	TESTED CHANNEL	MODULATION TECHNOLOGY	MODULATION TYPE	PACKET TYPE
0 to 78	39	FHSS	GFSK	DH5

Antenna Port Conducted Measurement:

- This item includes all test value of each mode, but only includes spectrum plot of worst value of each mode.
- Pre-Scan has been conducted to determine the worst-case mode from all possible combinations between available modulations, data rates and antenna ports (if EUT with antenna diversity architecture).
- Following channel(s) was (were) selected for the final test as listed below.

AVAILABLE CHANNEL	TESTED CHANNEL	MODULATION TECHNOLOGY	MODULATION TYPE	PACKET TYPE
0 to 78	0, 39, 78	FHSS	GFSK	DH5
0 to 78	0, 39, 78	FHSS	8DPSK	3DH5

Test Condition:

APPLICABLE TO	ENVIRONMENTAL CONDITIONS	INPUT POWER	TESTED BY
RE \geq 1G	25deg. C, 75%RH	120Vac, 60Hz	Tom Yang
RE $<$ 1G	25deg. C, 65%RH	120Vac, 60Hz	Carter Lin
PLC	25deg. C, 66%RH	120Vac, 60Hz	Sampson Chen
APCM	25deg. C, 60%RH	120Vac, 60Hz	Eric Peng

3.3 Duty Cycle of Test Signal

Duty cycle of test signal is < 98 %, duty factor shall be considered.

GFSK: Duty cycle = 2.879 ms/3.755 ms = 0.767, Duty factor = $10 * \log (1/ \text{Duty cycle}) = 1.15\text{dB}$

8DPSK: Duty cycle = 2.883 ms/3.75 ms = 0.769, Duty factor = $10 * \log (1/ \text{Duty cycle}) = 1.14\text{dB}$

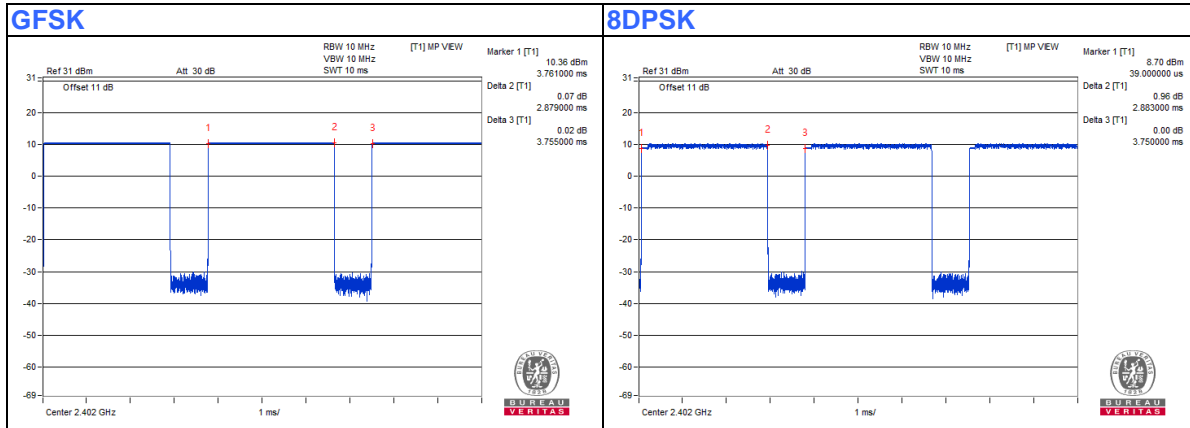

3.4 Description of Support Units

The EUT has been tested as an independent unit together with other necessary accessories or support units. The following support units or accessories were used to form a representative test configuration during the tests.

ID	Product	Brand	Model No.	Serial No.	FCC ID	Remarks
A.	Laptop	DELL	E5430	HYV4VY1	FCC DoC	Provided by Lab
B.	Cradle	Denso	CU-M70U	NA	NA	Supplied by client

Note:

1. All power cords of the above support units are non-shielded (1.8m).

ID	Descriptions	Qty.	Length (m)	Shielding (Yes/No)	Cores (Qty.)	Remarks
1.	USB Cable	1	1.45	No	0	Supplied by client
2.	RJ-45 Cable	1	10	Yes	0	Provided by Lab
3.	DC Cable	1	1.16	Yes	1	Supplied by client
4.	AC Cable	1	1.71	Yes	0	Supplied by client

Note: The core(s) is(are) originally attached to the cable(s).

3.4.1 Configuration of System under Test

For radiated emission (below 1GHz):

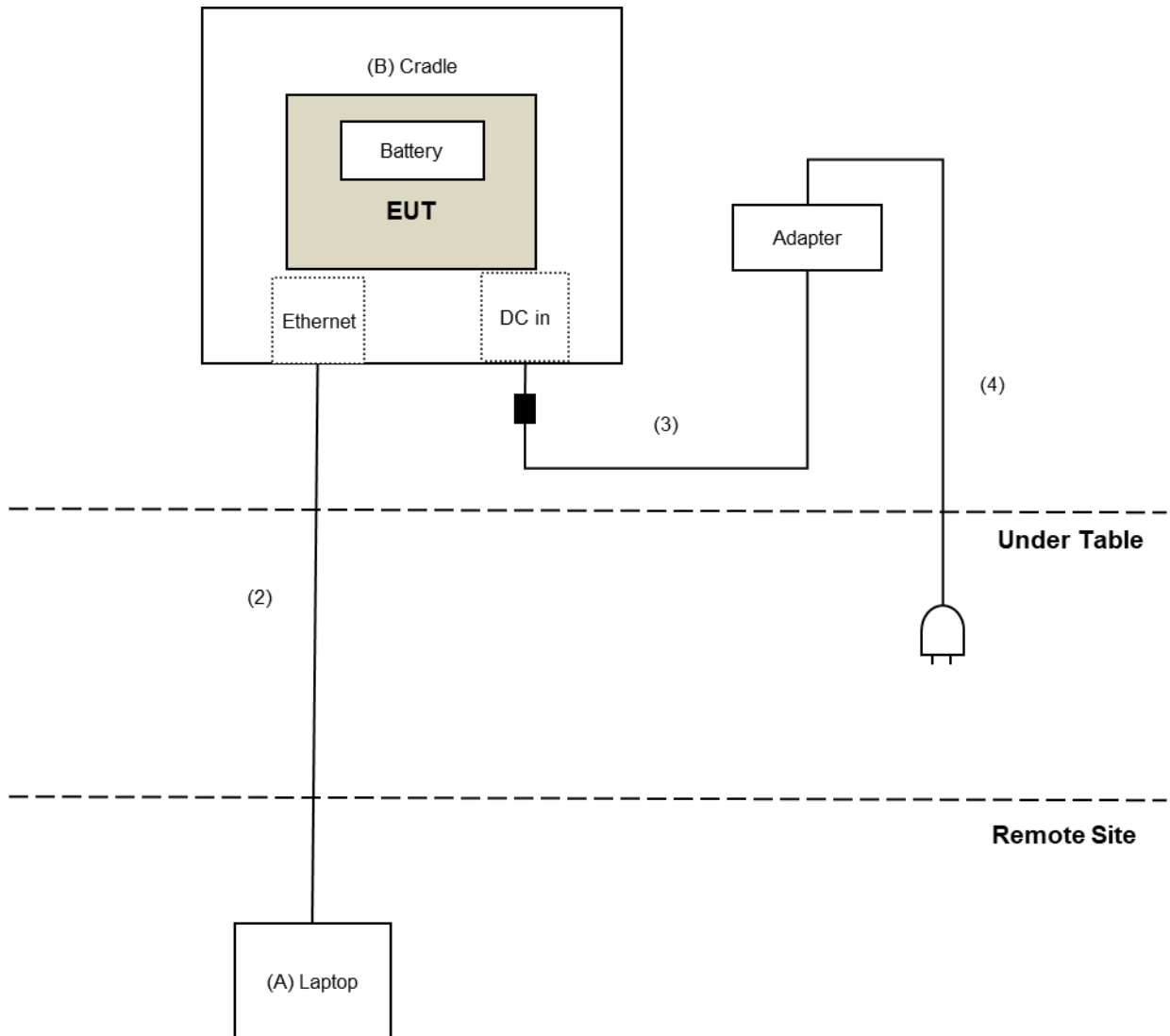

For conducted emission & radiated emission (above 1GHz):

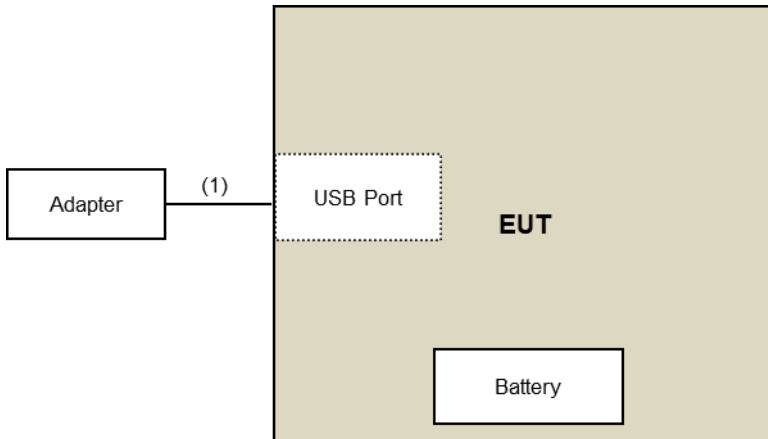

3.5 General Description of Applied Standards and References

The EUT is a RF Product. According to the specifications of the manufacturer, it must comply with the requirements of the following standards and references:

Test Standard:

FCC Part 15, Subpart C (15.247)

ANSI C63.10-2013

All test items have been performed and recorded as per the above standards.

References Test Guidance:

KDB 558074 D01 15.247 Meas Guidance v05r02

All test items have been performed as a reference to the above KDB test guidance.

4 Test Types and Results

4.1 Radiated Emission and Bandedge Measurement

4.1.1 Limits of Radiated Emission and Bandedge Measurement

Radiated emissions which fall in the restricted bands must comply with the radiated emission limits specified as below table. Other emissions shall be at least 20dB below the highest level of the desired power:

Frequencies (MHz)	Field Strength (microvolts/meter)	Measurement Distance (meters)
0.009 ~ 0.490	2400/F(kHz)	300
0.490 ~ 1.705	24000/F(kHz)	30
1.705 ~ 30.0	30	30
30 ~ 88	100	3
88 ~ 216	150	3
216 ~ 960	200	3
Above 960	500	3

Note:

1. The lower limit shall apply at the transition frequencies.
2. Emission level (dBuV/m) = 20 log Emission level (uV/m).
3. For frequencies above 1000MHz, the field strength limits are based on average detector, however, the peak field strength of any emission shall not exceed the maximum permitted average limits, specified above by more than 20dB under any condition of modulation.

4.1.2 Test Instruments

For Radiated Emission and Bandedge test:

DESCRIPTION & MANUFACTURER	MODEL NO.	SERIAL NO.	CALIBRATED DATE	CALIBRATED UNTIL
MXE EMI Receiver(20 Hz to 44 GHz) Keysight	N9038A	MY54450088	2020/7/6	2021/7/5
Software	ADT_Radiated_V8.7.08	NA	NA	NA
Antenna Tower & Turn Table Max-Full	MF-7802	MF780208406	NA	NA
Pre_Amplifier EMCI	EMC001340	980142	2020/5/25	2021/5/24
LOOP ANTENNA Electro-Metrics	EM-6879	264	2021/3/5	2022/3/4
RF Coaxial Cable JYEBO	5D-FB	LOOPCAB-001	2021/1/7	2022/1/6
RF Coaxial Cable JYEBO	5D-FB	LOOPCAB-002	2021/1/7	2022/1/6
Pre_Amplifier Mini-Circuits	ZFL-1000VH2	QA0838008	2020/10/20	2021/10/19
Trilog Broadband Antenna SCHWARZBECK	VULB 9168	9168-361	2020/11/5	2021/11/4
RF Coaxial Cable COMMATE/PEWC	8D	966-3-1	2020/3/17	2021/3/16
RF Coaxial Cable COMMATE/PEWC	8D	966-3-2	2020/3/17	2021/3/16
RF Coaxial Cable COMMATE/PEWC	8D	966-3-3	2020/3/17	2021/3/16
Fixed attenuator Mini-Circuits	UNAT-5+	PAD-3m-3-01	2020/9/24	2021/9/23
Horn Antenna Schwarzbeck	BBHA9120-D	9120D-406	2020/11/22	2021/11/21
Pre_Amplifier EMCI	EMC12630SE	980384	2021/1/11	2022/1/10
RF Coaxial Cable EMCI	EMC104-SM-SM-1500	180504	2021/4/26	2022/4/25
RF Coaxial Cable EMCI	EMC104-SM-SM-2000	180601	2020/6/9	2021/6/8
RF Coaxial Cable EMCI	EMC104-SM-SM-6000	210201	2021/5/13	2022/5/12
Fix tool for Boresight antenna tower LIOW GUU	FBA-01	FBA_SIP01	NA	NA
Spectrum Analyzer Keysight	N9030A	MY54490679	2020/7/13	2021/7/12
Pre_Amplifier EMCI	EMC184045SE	980387	2021/1/11	2022/1/10
SHF-EHF Horn Schwarzbeck	BBHA 9170	BBHA9170519	2020/11/22	2021/11/21
RF Cable-Frequency range: 1-40GHz EMCI	EMC102-KM-KM-1200	160924	2021/1/11	2022/1/10
RF cable (40GHz) EMCI	EMC-KM-KM-4000	200214	2020/3/11	2021/3/10

Note:

1. The calibration interval of the above test instruments is 12 months and the calibrations are traceable to NML/ROC and NIST/USA.
2. The test was performed in 966 Chamber No. 3.
3. Tested Date: 2021/1/17 ~ 2021/1/31

For other test items:

DESCRIPTION & MANUFACTURER	MODEL NO.	SERIAL NO.	CALIBRATED DATE	CALIBRATED UNTIL
Spectrum Analyzer R&S	FSV40	100964	2021/3/8	2022/3/7
Power meter Anritsu	ML2495A	1529002	2021/6/21	2022/6/20
Power sensor Anritsu	MA2411B	1339443	2021/5/31	2022/5/30
10dB Attenuator Woken	MDCS18N-10	MDCS18N-10-01	2021/4/13	2022/4/12
Software	ADT_RF Test Software V6.6.5.4	NA	NA	NA

- NOTE:**
1. The test was performed in Oven room 2.
 2. The calibration interval of the above test instruments is 12 months and the calibrations are traceable to NML/ROC and NIST/USA.
 3. Tested Date: 2021/8/18

4.1.3 Test Procedures

For Radiated emission below 30MHz

- a. The EUT was placed on the top of a rotating table 0.8 meters above the ground at a 3 meter chamber room. The table was rotated 360 degrees to determine the position of the highest radiation.
- b. The EUT was set 3 meters away from the interference-receiving antenna, which was mounted on the top of a variable-height antenna tower.
- c. Parallel, perpendicular, and ground-parallel orientations of the antenna are set to make the measurement.
- d. For each suspected emission, the EUT was arranged to its worst case and the rotatable table was turned from 0 degrees to 360 degrees to find the maximum reading.
- e. The test-receiver system was set to Quasi-Peak Detect Function and Specified Bandwidth with Maximum Hold Mode.

Note:

1. The resolution bandwidth and video bandwidth of test receiver/spectrum analyzer is 9kHz at frequency below 30MHz.

For Radiated emission above 30MHz

- a. The EUT was placed on the top of a rotating table 0.8 meters (for 30MHz ~ 1GHz) / 1.5 meters (for above 1GHz) above the ground at 3 meter chamber room for test. The table was rotated 360 degrees to determine the position of the highest radiation.
- b. The EUT was set 3 meters away from the interference-receiving antenna, which was mounted on the top of a variable-height antenna tower.
- c. The height of antenna is varied from one meter to four meters above the ground to determine the maximum value of the field strength. Both horizontal and vertical polarizations of the antenna are set to make the measurement.
- d. For each suspected emission, the EUT was arranged to its worst case and then the antenna was tuned to heights from 1 meter to 4 meters and the rotatable table was turned from 0 degrees to 360 degrees to find the maximum reading.
- e. The test-receiver system was set to quasi-peak detect function and specified bandwidth with maximum hold mode when the test frequency is below 1 GHz.
- f. The test-receiver system was set to peak and average detect function and specified bandwidth with maximum hold mode when the test frequency is above 1 GHz. If the peak reading value also meets average limit, measurement with the average detector is unnecessary.

Note:

1. The resolution bandwidth and video bandwidth of test receiver/spectrum analyzer is 120kHz for Quasi-peak detection (QP) at frequency below 1GHz.
2. The resolution bandwidth of test receiver/spectrum analyzer is 1 MHz and the video bandwidth is 3 MHz for Peak detection (PK) at frequency above 1GHz.
3. The resolution bandwidth of test receiver/spectrum analyzer is 1MHz and the video bandwidth is $\geq 1/T$ (Duty cycle < 98%) or 10Hz (Duty cycle $\geq 98\%$) for Average detection (AV) at frequency above 1GHz.
4. All modes of operation were investigated and the worst-case emissions are reported.

4.1.4 Deviation from Test Standard

No deviation.

4.1.5 Test Setup

For Radiated emission below 30MHz

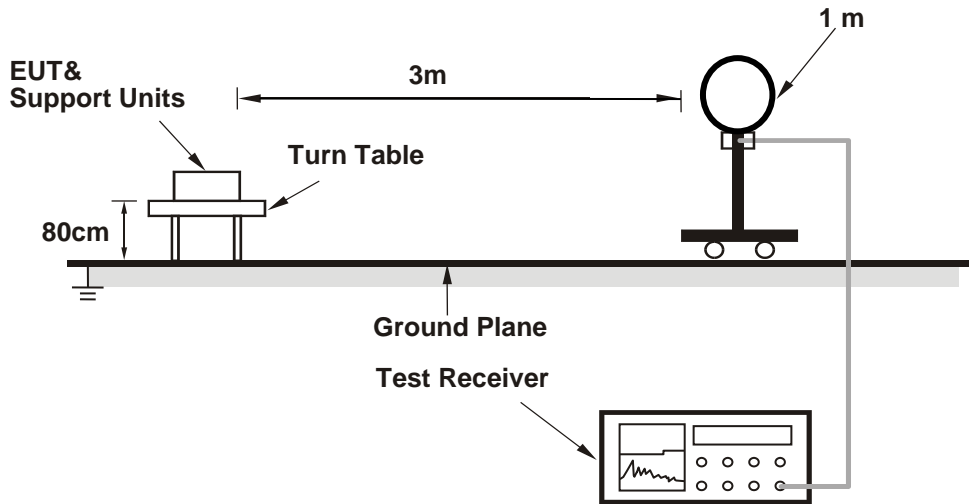

For Radiated emission 30MHz to 1GHz

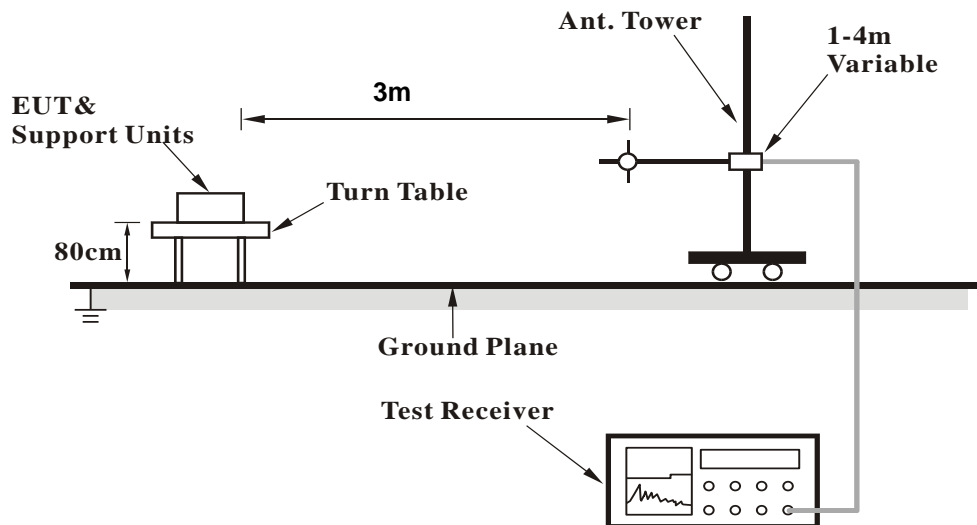

For Radiated emission above 1GHz

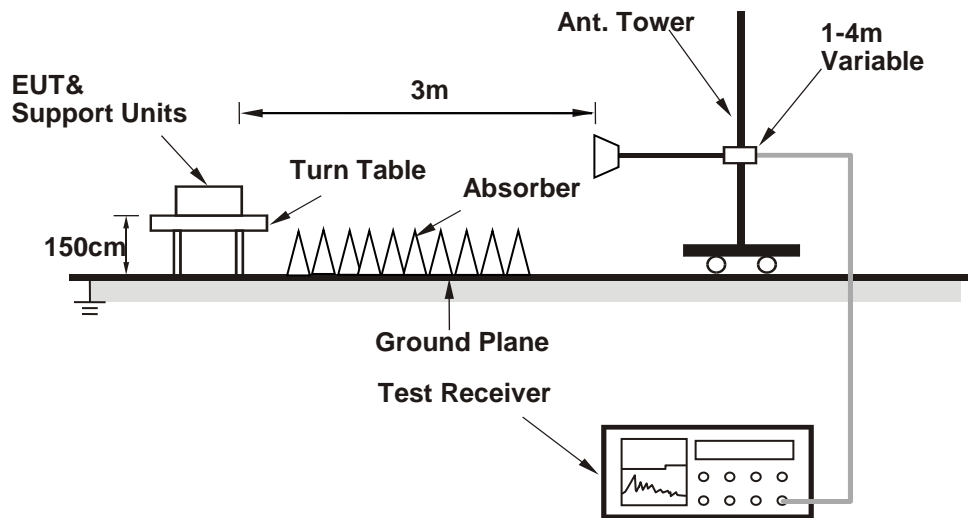

For the actual test configuration, please refer to the attached file (Test Setup Photo).

4.1.6 EUT Operating Conditions

- a. Placed the EUT on the testing table.
- b. Controlling software (Qualcomm Radio Control Toolkit v4.0 v4.0-00147) has been activated to set the EUT under transmission condition continuously at specific channel frequency.

4.1.7 Test Results

Above 1GHz Data:

RF Mode	TX BT_GFSK	Channel	CH 0 : 2402 MHz
Frequency Range	1GHz ~ 25GHz	Detector Function	Peak (PK) Average (AV)

Antenna Polarity & Test Distance : Horizontal at 3 m								
No	Frequency (MHz)	Emission Level (dBuV/m)	Limit (dBuV/m)	Margin (dB)	Antenna Height (m)	Table Angle (Degree)	Raw Value (dBuV)	Correction Factor (dB/m)
1	2362.42	54.8 PK	74.0	-19.2	1.48 H	356	55.6	-0.8
2	2362.42	43.7 AV	54.0	-10.3	1.48 H	356	44.5	-0.8
3	*2402.00	105.8 PK			1.48 H	356	106.7	-0.9
4	*2402.00	105.3 AV			1.48 H	356	106.2	-0.9
5	4804.00	39.5 PK	74.0	-34.5	2.24 H	310	35.4	4.1
6	4804.00	28.0 AV	54.0	-26.0	2.24 H	310	23.9	4.1
Antenna Polarity & Test Distance : Vertical at 3 m								
No	Frequency (MHz)	Emission Level (dBuV/m)	Limit (dBuV/m)	Margin (dB)	Antenna Height (m)	Table Angle (Degree)	Raw Value (dBuV)	Correction Factor (dB/m)
1	2326.40	56.0 PK	74.0	-18.0	1.01 V	310	56.7	-0.7
2	2326.40	43.3 AV	54.0	-10.7	1.01 V	310	44.0	-0.7
3	*2402.00	107.0 PK			1.01 V	310	107.9	-0.9
4	*2402.00	106.6 AV			1.01 V	310	107.5	-0.9
5	4804.00	39.2 PK	74.0	-34.8	1.97 V	200	35.1	4.1
6	4804.00	28.1 AV	54.0	-25.9	1.97 V	200	24.0	4.1

Remarks:

1. Emission Level(dBuV/m) = Raw Value(dBuV) + Correction Factor(dB/m)
2. Correction Factor(dB/m) = Antenna Factor(dB/m) + Cable Factor(dB) – Pre-Amplifier Factor(dB)
3. Margin value = Emission Level – Limit value
4. The other emission levels were very low against the limit.
5. " * ": Fundamental frequency.

RF Mode	TX BT_GFSK	Channel	CH 39 : 2441 MHz
Frequency Range	1GHz ~ 25GHz	Detector Function	Peak (PK) Average (AV)

Antenna Polarity & Test Distance : Horizontal at 3 m

No	Frequency (MHz)	Emission Level (dBuV/m)	Limit (dBuV/m)	Margin (dB)	Antenna Height (m)	Table Angle (Degree)	Raw Value (dBuV)	Correction Factor (dB/m)
1	*2441.00	105.5 PK			1.42 H	356	106.4	-0.9
2	*2441.00	105.1 AV			1.42 H	356	106.0	-0.9
3	4882.00	38.7 PK	74.0	-35.3	2.28 H	309	34.5	4.2
4	4882.00	27.5 AV	54.0	-26.5	2.28 H	309	23.3	4.2
5	7323.00	44.8 PK	74.0	-29.2	1.32 H	79	34.5	10.3
6	7323.00	32.7 AV	54.0	-21.3	1.32 H	79	22.4	10.3

Antenna Polarity & Test Distance : Vertical at 3 m

No	Frequency (MHz)	Emission Level (dBuV/m)	Limit (dBuV/m)	Margin (dB)	Antenna Height (m)	Table Angle (Degree)	Raw Value (dBuV)	Correction Factor (dB/m)
1	*2441.00	107.0 PK			1.19 V	308	107.9	-0.9
2	*2441.00	106.6 AV			1.19 V	308	107.5	-0.9
3	4882.00	39.0 PK	74.0	-35.0	1.96 V	198	34.8	4.2
4	4882.00	27.4 AV	54.0	-26.6	1.96 V	198	23.2	4.2
5	7323.00	44.5 PK	74.0	-29.5	1.65 V	161	34.2	10.3
6	7323.00	32.1 AV	54.0	-21.9	1.65 V	161	21.8	10.3

Remarks:

1. Emission Level(dBuV/m) = Raw Value(dBuV) + Correction Factor(dB/m)
2. Correction Factor(dB/m) = Antenna Factor(dB/m) + Cable Factor(dB) – Pre-Amplifier Factor(dB)
3. Margin value = Emission Level – Limit value
4. The other emission levels were very low against the limit.
5. " * ": Fundamental frequency.

RF Mode	TX BT_GFSK	Channel	CH 78 : 2480 MHz
Frequency Range	1GHz ~ 25GHz	Detector Function	Peak (PK) Average (AV)

Antenna Polarity & Test Distance : Horizontal at 3 m

No	Frequency (MHz)	Emission Level (dBuV/m)	Limit (dBuV/m)	Margin (dB)	Antenna Height (m)	Table Angle (Degree)	Raw Value (dBuV)	Correction Factor (dB/m)
1	*2480.00	105.5 PK			1.43 H	355	106.3	-0.8
2	*2480.00	105.3 AV			1.43 H	355	106.1	-0.8
3	2496.11	53.8 PK	74.0	-20.2	1.43 H	355	54.6	-0.8
4	2496.11	43.2 AV	54.0	-10.8	1.43 H	355	44.0	-0.8
5	4960.00	38.5 PK	74.0	-35.5	2.34 H	288	34.0	4.5
6	4960.00	27.2 AV	54.0	-26.8	2.34 H	288	22.7	4.5
7	7440.00	44.9 PK	74.0	-29.1	1.41 H	84	34.6	10.3
8	7440.00	32.4 AV	54.0	-21.6	1.41 H	84	22.1	10.3

Antenna Polarity & Test Distance : Vertical at 3 m

No	Frequency (MHz)	Emission Level (dBuV/m)	Limit (dBuV/m)	Margin (dB)	Antenna Height (m)	Table Angle (Degree)	Raw Value (dBuV)	Correction Factor (dB/m)
1	*2480.00	106.8 PK			1.18 V	313	107.6	-0.8
2	*2480.00	106.2 AV			1.18 V	313	107.0	-0.8
3	2487.56	55.2 PK	74.0	-18.8	1.18 V	313	56.0	-0.8
4	2487.56	43.3 AV	54.0	-10.7	1.18 V	313	44.1	-0.8
5	4960.00	39.5 PK	74.0	-34.5	1.92 V	207	35.0	4.5
6	4960.00	29.2 AV	54.0	-24.8	1.92 V	207	24.7	4.5
7	7440.00	44.6 PK	74.0	-29.4	1.67 V	146	34.3	10.3
8	7440.00	32.2 AV	54.0	-21.8	1.67 V	146	21.9	10.3

Remarks:

1. Emission Level(dBuV/m) = Raw Value(dBuV) + Correction Factor(dB/m)
2. Correction Factor(dB/m) = Antenna Factor(dB/m) + Cable Factor(dB) – Pre-Amplifier Factor(dB)
3. Margin value = Emission Level – Limit value
4. The other emission levels were very low against the limit.
5. " * ": Fundamental frequency.

RF Mode	TX BT_8DPSK	Channel	CH 0 : 2402 MHz
Frequency Range	1GHz ~ 25GHz	Detector Function	Peak (PK) Average (AV)

Antenna Polarity & Test Distance : Horizontal at 3 m

No	Frequency (MHz)	Emission Level (dBuV/m)	Limit (dBuV/m)	Margin (dB)	Antenna Height (m)	Table Angle (Degree)	Raw Value (dBuV)	Correction Factor (dB/m)
1	2365.57	55.7 PK	74.0	-18.3	1.47 H	356	56.5	-0.8
2	2365.57	43.4 AV	54.0	-10.6	1.47 H	356	44.2	-0.8
3	*2402.00	104.3 PK			1.47 H	356	105.2	-0.9
4	*2402.00	101.3 AV			1.47 H	356	102.2	-0.9
5	4804.00	39.5 PK	74.0	-34.5	2.34 H	291	35.4	4.1
6	4804.00	28.0 AV	54.0	-26.0	2.34 H	291	23.9	4.1

Antenna Polarity & Test Distance : Vertical at 3 m

No	Frequency (MHz)	Emission Level (dBuV/m)	Limit (dBuV/m)	Margin (dB)	Antenna Height (m)	Table Angle (Degree)	Raw Value (dBuV)	Correction Factor (dB/m)
1	2362.51	56.5 PK	74.0	-17.5	1.18 V	310	57.3	-0.8
2	2362.51	43.2 AV	54.0	-10.8	1.18 V	310	44.0	-0.8
3	*2402.00	105.8 PK			1.18 V	310	106.7	-0.9
4	*2402.00	102.2 AV			1.18 V	310	103.1	-0.9
5	4804.00	39.3 PK	74.0	-34.7	1.89 V	209	35.2	4.1
6	4804.00	27.7 AV	54.0	-26.3	1.89 V	209	23.6	4.1

Remarks:

1. Emission Level(dBuV/m) = Raw Value(dBuV) + Correction Factor(dB/m)
2. Correction Factor(dB/m) = Antenna Factor(dB/m) + Cable Factor(dB) – Pre-Amplifier Factor(dB)
3. Margin value = Emission Level – Limit value
4. The other emission levels were very low against the limit.
5. " * ": Fundamental frequency.

RF Mode	TX BT_8DPSK	Channel	CH 39 : 2441 MHz
Frequency Range	1GHz ~ 25GHz	Detector Function	Peak (PK) Average (AV)

Antenna Polarity & Test Distance : Horizontal at 3 m

No	Frequency (MHz)	Emission Level (dBuV/m)	Limit (dBuV/m)	Margin (dB)	Antenna Height (m)	Table Angle (Degree)	Raw Value (dBuV)	Correction Factor (dB/m)
1	*2441.00	104.9 PK			1.45 H	351	105.8	-0.9
2	*2441.00	101.1 AV			1.45 H	351	102.0	-0.9
3	4882.00	39.4 PK	74.0	-34.6	2.32 H	295	35.2	4.2
4	4882.00	28.1 AV	54.0	-25.9	2.32 H	295	23.9	4.2
5	7323.00	44.5 PK	74.0	-29.5	1.41 H	61	34.2	10.3
6	7323.00	32.1 AV	54.0	-21.9	1.41 H	61	21.8	10.3

Antenna Polarity & Test Distance : Vertical at 3 m

No	Frequency (MHz)	Emission Level (dBuV/m)	Limit (dBuV/m)	Margin (dB)	Antenna Height (m)	Table Angle (Degree)	Raw Value (dBuV)	Correction Factor (dB/m)
1	*2441.00	105.6 PK			1.08 V	317	106.5	-0.9
2	*2441.00	101.9 AV			1.08 V	317	102.8	-0.9
3	4882.00	39.3 PK	74.0	-34.7	1.94 V	201	35.1	4.2
4	4882.00	28.0 AV	54.0	-26.0	1.94 V	201	23.8	4.2
5	7323.00	44.0 PK	74.0	-30.0	1.70 V	140	33.7	10.3
6	7323.00	32.0 AV	54.0	-22.0	1.70 V	140	21.7	10.3

Remarks:

1. Emission Level(dBuV/m) = Raw Value(dBuV) + Correction Factor(dB/m)
2. Correction Factor(dB/m) = Antenna Factor(dB/m) + Cable Factor(dB) – Pre-Amplifier Factor(dB)
3. Margin value = Emission Level – Limit value
4. The other emission levels were very low against the limit.
5. " * ": Fundamental frequency.

RF Mode	TX BT_8DPSK	Channel	CH 78 : 2480 MHz
Frequency Range	1GHz ~ 25GHz	Detector Function	Peak (PK) Average (AV)

Antenna Polarity & Test Distance : Horizontal at 3 m

No	Frequency (MHz)	Emission Level (dBuV/m)	Limit (dBuV/m)	Margin (dB)	Antenna Height (m)	Table Angle (Degree)	Raw Value (dBuV)	Correction Factor (dB/m)
1	*2480.00	104.7 PK			1.40 H	356	105.5	-0.8
2	*2480.00	101.2 AV			1.40 H	356	102.0	-0.8
3	2489.38	54.6 PK	74.0	-19.4	1.40 H	356	55.4	-0.8
4	2489.38	43.6 AV	54.0	-10.4	1.40 H	356	44.4	-0.8
5	4960.00	38.8 PK	74.0	-35.2	2.32 H	296	34.3	4.5
6	4960.00	27.6 AV	54.0	-26.4	2.32 H	296	23.1	4.5
7	7440.00	44.7 PK	74.0	-29.3	1.40 H	75	34.4	10.3
8	7440.00	32.6 AV	54.0	-21.4	1.40 H	75	22.3	10.3

Antenna Polarity & Test Distance : Vertical at 3 m

No	Frequency (MHz)	Emission Level (dBuV/m)	Limit (dBuV/m)	Margin (dB)	Antenna Height (m)	Table Angle (Degree)	Raw Value (dBuV)	Correction Factor (dB/m)
1	*2480.00	105.4 PK			1.08 V	311	106.2	-0.8
2	*2480.00	101.7 AV			1.08 V	311	102.5	-0.8
3	2490.35	54.6 PK	74.0	-19.4	1.08 V	311	55.4	-0.8
4	2490.35	43.3 AV	54.0	-10.7	1.08 V	311	44.1	-0.8
5	4960.00	38.9 PK	74.0	-35.1	1.98 V	198	34.4	4.5
6	4960.00	27.8 AV	54.0	-26.2	1.98 V	198	23.3	4.5
7	7440.00	44.3 PK	74.0	-29.7	1.67 V	150	34.0	10.3
8	7440.00	32.2 AV	54.0	-21.8	1.67 V	150	21.9	10.3

Remarks:

1. Emission Level(dBuV/m) = Raw Value(dBuV) + Correction Factor(dB/m)
2. Correction Factor(dB/m) = Antenna Factor(dB/m) + Cable Factor(dB) – Pre-Amplifier Factor(dB)
3. Margin value = Emission Level – Limit value
4. The other emission levels were very low against the limit.
5. " * ": Fundamental frequency.

Below 1GHz Data:

RF Mode	TX BT_GFSK	Channel	CH 39 : 2441 MHz
Frequency Range	9kHz ~ 1GHz	Detector Function	Quasi-Peak (QP)

Antenna Polarity & Test Distance : Horizontal at 3 m								
No	Frequency (MHz)	Emission Level (dBuV/m)	Limit (dBuV/m)	Margin (dB)	Antenna Height (m)	Table Angle (Degree)	Raw Value (dBuV)	Correction Factor (dB/m)
1	75.57	22.0 QP	40.0	-18.0	2.00 H	0	33.8	-11.8
2	153.77	25.1 QP	43.5	-18.4	1.50 H	98	32.6	-7.5
3	377.87	25.3 QP	46.0	-20.7	1.50 H	360	29.7	-4.4
4	579.50	28.2 QP	46.0	-17.8	2.00 H	141	27.4	0.8
5	764.99	31.1 QP	46.0	-14.9	1.00 H	28	26.2	4.9
6	879.26	32.6 QP	46.0	-13.4	1.00 H	347	26.4	6.2

Remarks:

1. Emission Level(dBuV/m) = Raw Value(dBuV) + Correction Factor(dB/m)
2. Correction Factor(dB/m) = Antenna Factor(dB/m) + Cable Factor(dB) – Pre-Amplifier Factor(dB)
3. Margin value = Emission Level – Limit value
4. The other emission levels were very low against the limit of frequency range 30MHz~1000MHz.
5. The emission levels were very low against the limit of frequency range 9kHz~30MHz: the amplitude of spurious emissions attenuated more than 20 dB below the permissible value to be report.

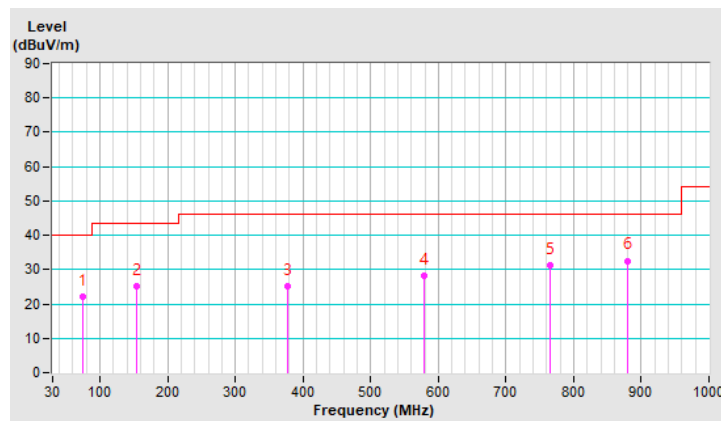

RF Mode	TX BT_GFSK	Channel	CH 39 : 2441 MHz
Frequency Range	9kHz ~ 1GHz	Detector Function	Quasi-Peak (QP)

Antenna Polarity & Test Distance : Vertical at 3 m

No	Frequency (MHz)	Emission Level (dBuV/m)	Limit (dBuV/m)	Margin (dB)	Antenna Height (m)	Table Angle (Degree)	Raw Value (dBuV)	Correction Factor (dB/m)
1	69.62	23.1 QP	40.0	-16.9	2.00 V	144	33.6	-10.5
2	142.76	25.1 QP	43.5	-18.4	2.50 V	287	32.9	-7.8
3	328.93	24.8 QP	46.0	-21.2	1.00 V	63	30.2	-5.4
4	476.90	27.5 QP	46.0	-18.5	2.00 V	16	29.1	-1.6
5	591.65	28.9 QP	46.0	-17.1	2.00 V	0	27.7	1.2
6	860.03	33.3 QP	46.0	-12.7	1.50 V	360	27.3	6.0

Remarks:

1. Emission Level(dBuV/m) = Raw Value(dBuV) + Correction Factor(dB/m)
2. Correction Factor(dB/m) = Antenna Factor(dB/m) + Cable Factor(dB) – Pre-Amplifier Factor(dB)
3. Margin value = Emission Level – Limit value
4. The other emission levels were very low against the limit of frequency range 30MHz~1000MHz.
5. The emission levels were very low against the limit of frequency range 9kHz~30MHz: the amplitude of spurious emissions attenuated more than 20 dB below the permissible value to be report.

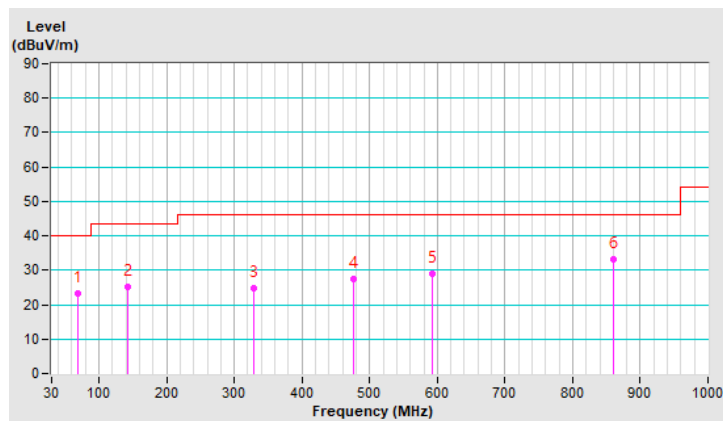

4.2 Conducted Emission Measurement

4.2.1 Limits of Conducted Emission Measurement

Frequency (MHz)	Conducted Limit (dBuV)	
	Quasi-peak	Average
0.15 - 0.5	66 - 56	56 - 46
0.50 - 5.0	56	46
5.0 - 30.0	60	50

Note: 1. The lower limit shall apply at the transition frequencies.

2. The limit decreases in line with the logarithm of the frequency in the range of 0.15 to 0.50MHz.

4.2.2 Test Instruments

DESCRIPTION & MANUFACTURER	MODEL NO.	SERIAL NO.	CALIBRATED DATE	CALIBRATED UNTIL
Test Receiver R&S	ESCS 30	847124/029	2020/10/20	2021/10/19
LISN R&S	ESH3-Z5	848773/004	2020/10/27	2021/10/26
LISN R & S	ESH3-Z5	835239/001	2020/3/19	2021/3/18
50 ohms Terminator	50	3	2020/10/26	2021/10/25
RF Coaxial Cable JYEBO	5D-FB	COCCAB-001	2020/9/26	2021/9/25
Fixed attenuator STI	STI02-2200-10	005	2020/8/29	2021/8/28
Software BVADT	BVADT_Cond_ V7.3.7.4	NA	NA	NA

Note:

1. The calibration interval of the above test instruments are 12 months and the calibrations are traceable to NML/ROC and NIST/USA.
2. The test was performed in Conduction 1.
3. Tested Date: 2021/2/1

4.2.3 Test Procedures

- The EUT was placed 0.4 meters from the conducting wall of the shielded room with EUT being connected to the power mains through a line impedance stabilization network (LISN). Other support units were connected to the power mains through another LISN. The two LISNs provide 50 ohm/ 50uH of coupling impedance for the measuring instrument.
- Both lines of the power mains connected to the EUT were checked for maximum conducted interference.
- The frequency range from 150kHz to 30MHz was searched. Emission levels under (Limit - 20dB) was not recorded.

Note: The resolution bandwidth and video bandwidth of test receiver is 9kHz for quasi-peak detection (QP) and average detection (AV) at frequency 0.15MHz-30MHz.

4.2.4 Deviation from Test Standard

No deviation.

4.2.5 Test Setup

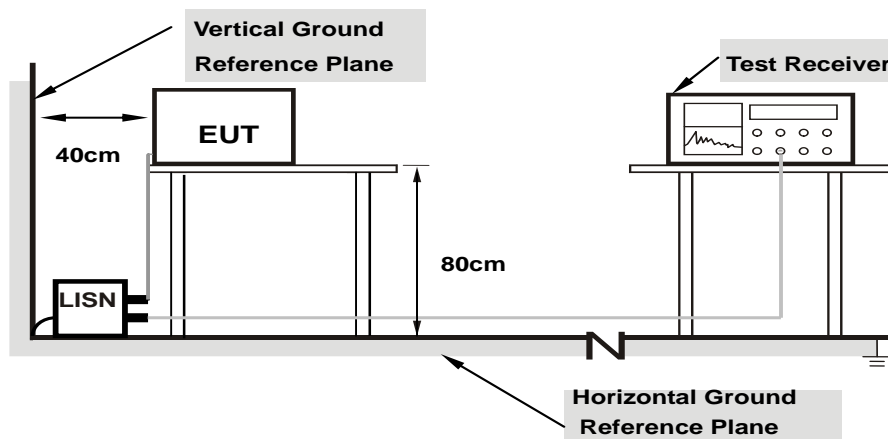

Note: 1.Support units were connected to second LISN.

For the actual test configuration, please refer to the attached file (Test Setup Photo).

4.2.6 EUT Operating Condition

Same as 4.1.6.

4.2.7 Test Results

RF Mode	TX BT_GFSK	Channel	CH 39 : 2441 MHz
Frequency Range	150kHz ~ 30MHz	Detector Function & Resolution Bandwidth	Quasi-Peak (QP) / Average (AV), 9kHz

Phase Of Power : Line (L)										
No	Frequency (MHz)	Correction Factor (dB)	Reading Value (dBuV)		Emission Level (dBuV)		Limit (dBuV)		Margin (dB)	
			Q.P.	AV.	Q.P.	AV.	Q.P.	AV.	Q.P.	AV.
1	0.15000	9.96	27.82	15.96	37.78	25.92	66.00	56.00	-28.22	-30.08
2	0.19687	9.99	25.87	15.58	35.86	25.57	63.74	53.74	-27.88	-28.17
3	0.66953	10.04	27.45	17.89	37.49	27.93	56.00	46.00	-18.51	-18.07
4	0.99766	10.06	22.52	12.94	32.58	23.00	56.00	46.00	-23.42	-23.00
5	3.25000	10.23	21.13	12.91	31.36	23.14	56.00	46.00	-24.64	-22.86
6	6.81250	10.49	20.18	12.19	30.67	22.68	60.00	50.00	-29.33	-27.32

Remarks:

1. Q.P. and AV. are abbreviations of quasi-peak and average individually.
2. The emission levels of other frequencies were very low against the limit.
3. Margin value = Emission level – Limit value
4. Correction factor = Insertion loss + Cable loss
5. Emission Level = Correction Factor + Reading Value

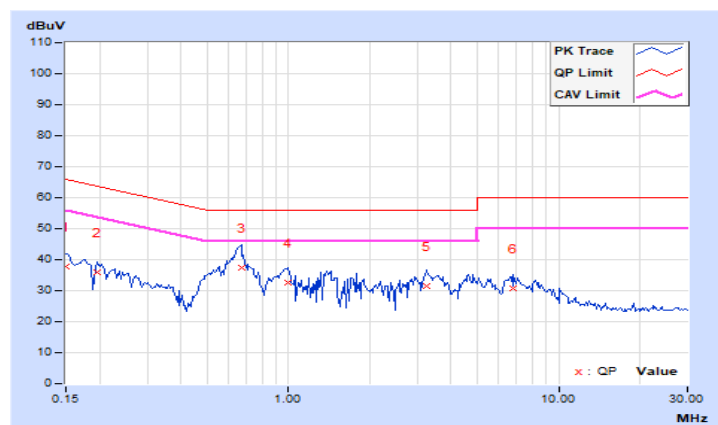

RF Mode	TX BT_GFSK	Channel	CH 39 : 2441 MHz
Frequency Range	150kHz ~ 30MHz	Detector Function & Resolution Bandwidth	Quasi-Peak (QP) / Average (AV), 9kHz

Phase Of Power : Neutral (N)										
No	Frequency (MHz)	Correction Factor (dB)	Reading Value (dBuV)		Emission Level (dBuV)		Limit (dBuV)		Margin (dB)	
			Q.P.	AV.	Q.P.	AV.	Q.P.	AV.	Q.P.	AV.
1	0.15391	9.94	32.16	20.61	42.10	30.55	65.79	55.79	-23.69	-25.24
2	0.20078	9.98	30.26	23.75	40.24	33.73	63.58	53.58	-23.34	-19.85
3	0.46250	10.02	22.50	12.84	32.52	22.86	56.65	46.65	-24.13	-23.79
4	0.65781	10.04	29.90	19.56	39.94	29.60	56.00	46.00	-16.06	-16.40
5	1.96484	10.14	23.84	13.96	33.98	24.10	56.00	46.00	-22.02	-21.90
6	4.14063	10.26	24.24	17.04	34.50	27.30	56.00	46.00	-21.50	-18.70

Remarks:

1. Q.P. and AV. are abbreviations of quasi-peak and average individually.
2. The emission levels of other frequencies were very low against the limit.
3. Margin value = Emission level – Limit value
4. Correction factor = Insertion loss + Cable loss
5. Emission Level = Correction Factor + Reading Value

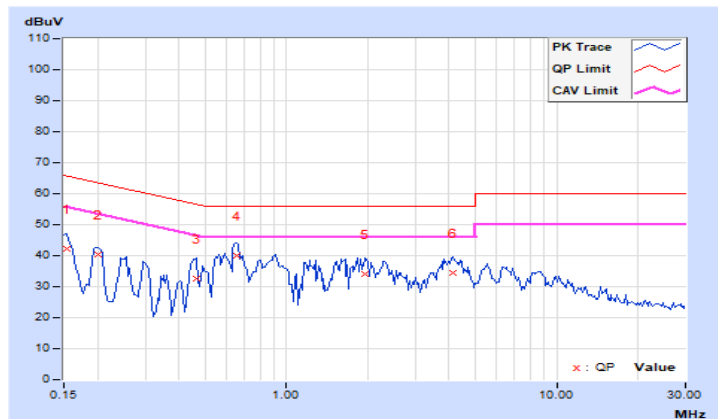

4.3 Number of Hopping Frequency Used

4.3.1 Limits of Hopping Frequency Used Measurement

At least 15 channels frequencies, and should be equally spaced.

4.3.2 Test Setup

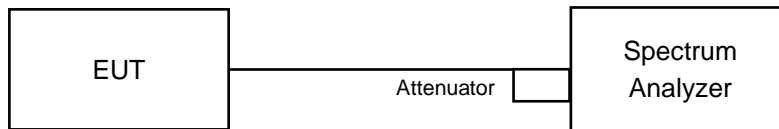

4.3.3 Test Instruments

Refer to section 4.1.2 to get information of above instrument.

4.3.4 Test Procedure

- a. Check the calibration of the measuring instrument (SA) using either an internal calibrator or a known signal from an external generator.
- b. Turn on the EUT and connect its antenna terminal to measurement via a low loss cable. Then set it to any one measured frequency within its operating range and make sure the instrument is operated in its linear range.
- c. Set the SA on MaxHold Mode, and then keep the EUT in hopping mode. Record all the signals from each channel until each one has been recorded.
- d. Set the SA on View mode and then plot the result on SA screen.
- e. Repeat above procedures until all frequencies measured were complete.

4.3.5 Deviation from Test Standard

No deviation.

4.3.6 Test Results

There are 79 hopping frequencies in the hopping mode. Please refer to next page for the test result. On the plots, it shows that the hopping frequencies are equally spaced.

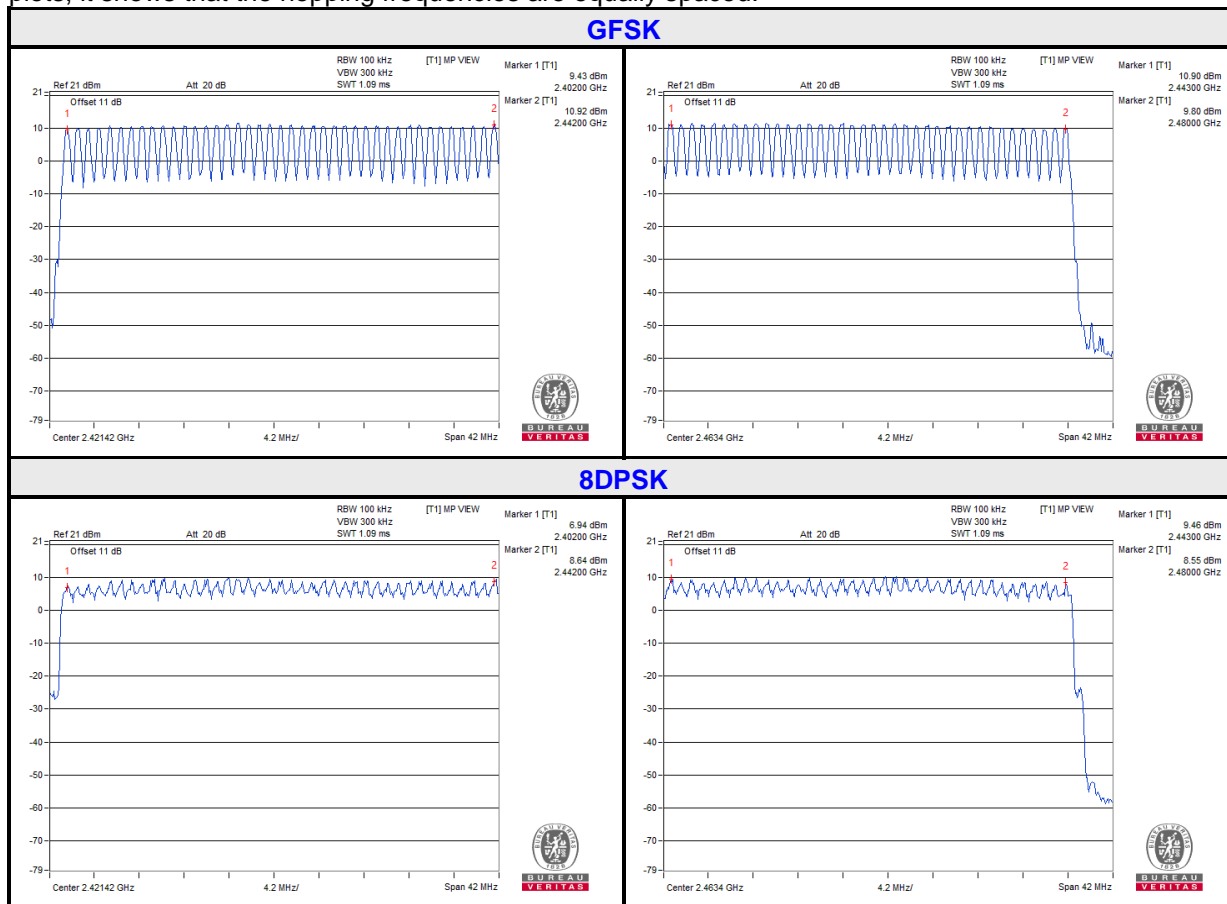

4.4 Dwell Time on Each Channel

4.4.1 Limits of Dwell Time on Each Channel Measurement

The average time of occupancy on any channel shall not be greater than 0.4 seconds within a period of 0.4 seconds multiplied by the number of hopping channels employed.

4.4.2 Test Setup

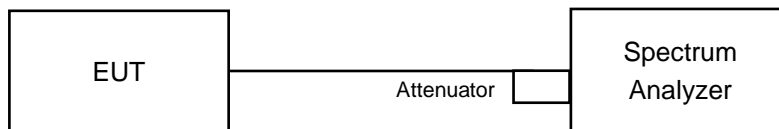

4.4.3 Test Instruments

Refer to section 4.1.2 to get information of above instrument.

4.4.4 Test Procedures

- a. Check the calibration of the measuring instrument (SA) using either an internal calibrator or a known signal from an external generator.
- b. Turn on the EUT and connect its antenna terminal to measurement via a low loss cable. Then set it to any one measured frequency within its operating range and make sure the instrument is operated in its linear range.
- c. Adjust the center frequency of SA on any frequency be measured and set SA to zero span mode. And then, set RBW and VBW of spectrum analyzer to proper value.
- d. Measure the time duration of one transmission on the measured frequency. And then plot the result with time difference of this time duration.
- e. Repeat above procedures until all different time-slot modes have been completed.

4.4.5 Deviation from Test Standard

No deviation.

4.4.6 Test Results

GFSK

Mode	Number of transmission in a 31.6 (79Hopping*0.4)	Length of transmission time (msec)	Result (msec)	Limit (msec)
DH1	50 (times / 5 sec) * 6.32 = 316 times	0.426	134.62	400
DH3	26 (times / 5 sec) * 6.32 = 165 times	1.7	280.5	400
DH5	16 (times / 5 sec) * 6.32 = 102 times	3.04	310.08	400

Note: Test plots of the transmitting time slot are shown on next page.

DH1

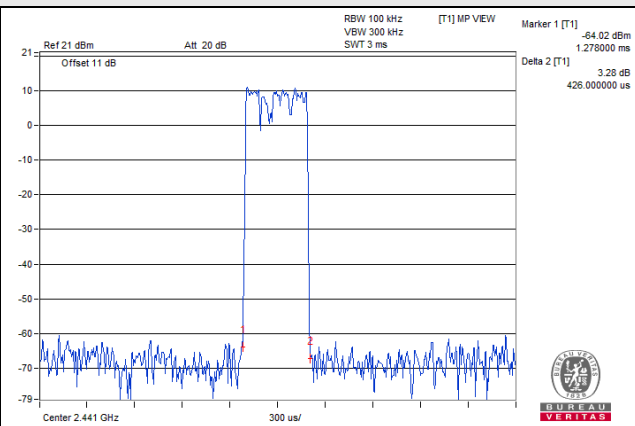
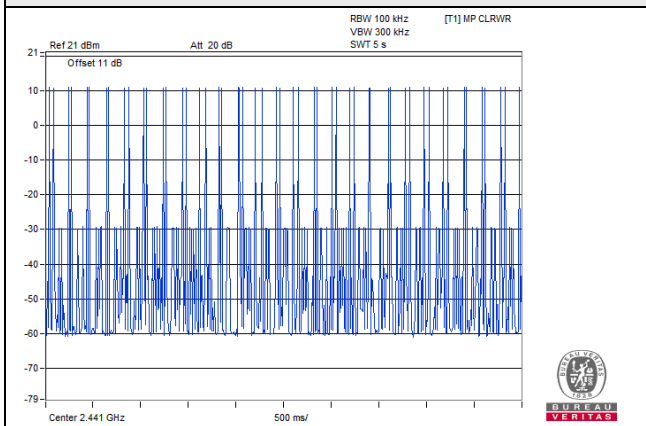

DH3

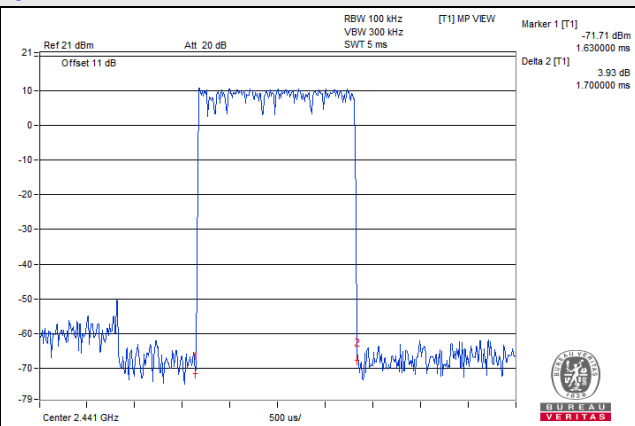
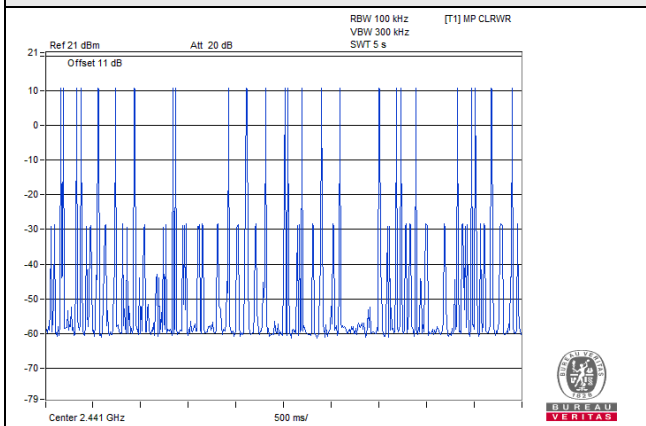

DH5

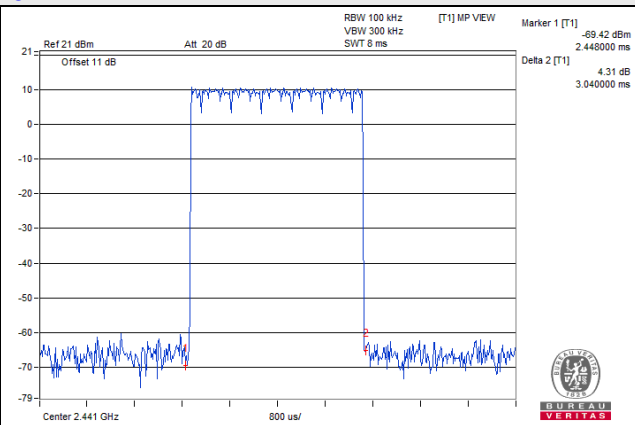
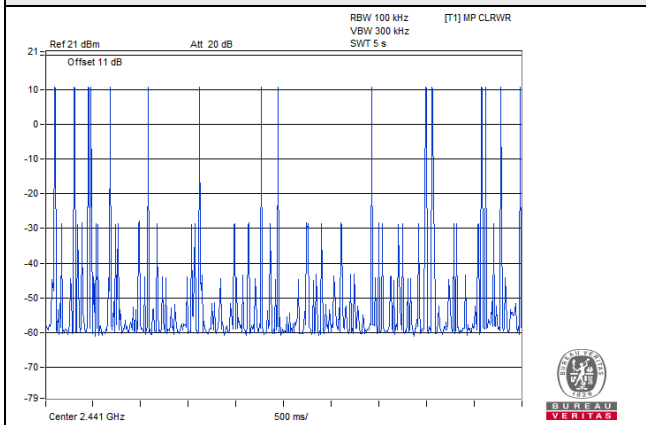

8DPSK

Mode	Number of transmission in a 31.6 (79Hopping*0.4)	Length of transmission time (msec)	Result (msec)	Limit (msec)
3DH1	51 (times / 5 sec) * 6.32 = 323 times	0.456	147.29	400
3DH3	27 (times / 5 sec) * 6.32 = 171 times	1.78	304.38	400
3DH5	16 (times / 5 sec) * 6.32 = 102 times	3.024	308.45	400

Note: Test plots of the transmitting time slot are shown on next page.

3DH1

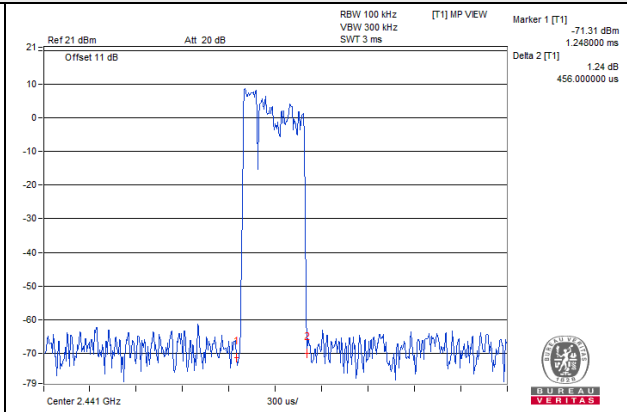
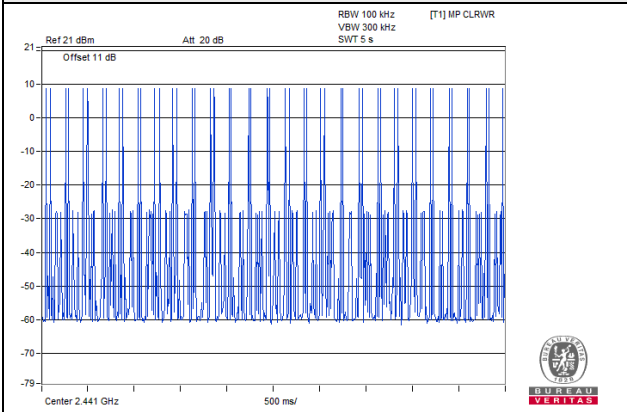

3DH3

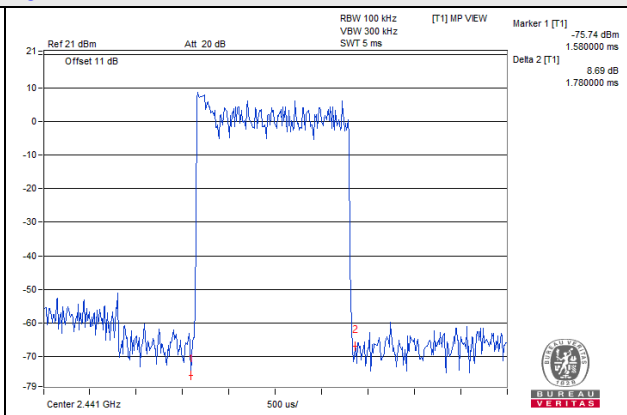
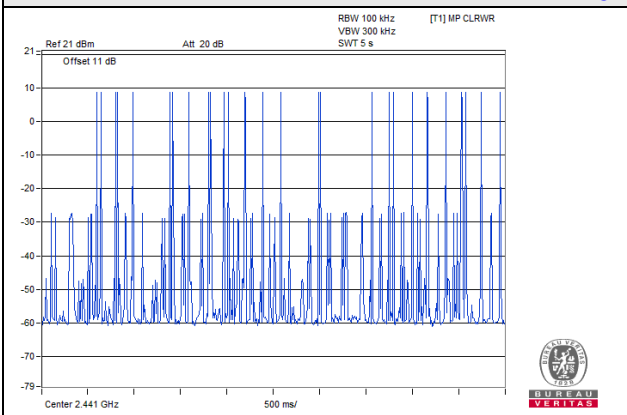

3DH5

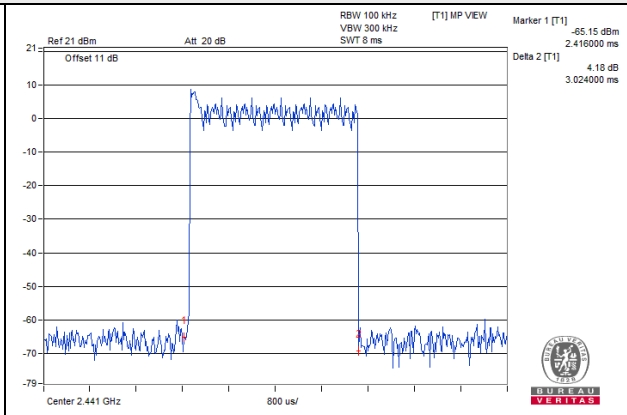
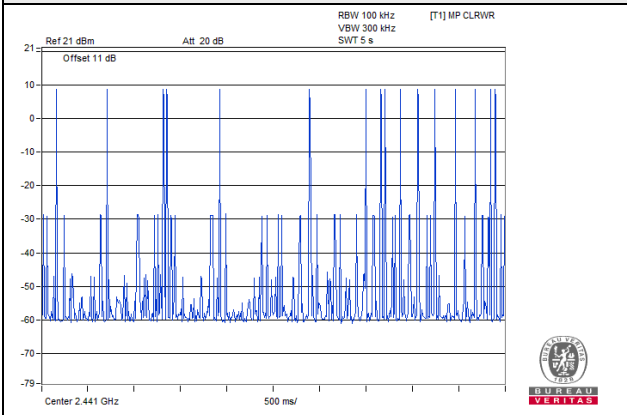

4.5 Channel Bandwidth

4.5.1 Limits of Channel Bandwidth Measurement

For frequency hopping system operating in the 2400-2483.5MHz, If the 20dB bandwidth of hopping channel is greater than 25kHz, two-thirds 20dB bandwidth of hopping channel shall be a minimum limit for the hopping channel separation.

4.5.2 Test Setup

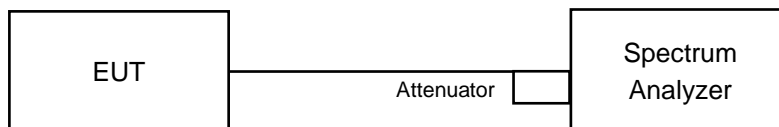

4.5.3 Test Instruments

Refer to section 4.1.2 to get information of above instrument.

4.5.4 Test Procedure

- a. Check the calibration of the measuring instrument using either an internal calibrator or a known signal from an external generator.
- b. Turn on the EUT and connect it to measurement instrument. Then set it to any one convenient frequency within its operating range. Set a reference level on the measuring instrument equal to the highest peak value.
- c. Measure the frequency difference of two frequencies that were attenuated 20dB from the reference level. Record the frequency difference as the emission bandwidth.
- d. Repeat above procedures until all frequencies measured were complete.

4.5.5 Deviation from Test Standard

No deviation.

4.5.6 EUT Operating Condition

The software provided by client enabled the EUT to transmit and receive data at lowest, middle and highest channel frequencies individually.

4.5.7 Test Results

Channel	Frequency (MHz)	20dB Bandwidth (MHz)	
		GFSK	8DPSK
0	2402	0.94	1.3
39	2441	0.94	1.3
78	2480	0.94	1.3

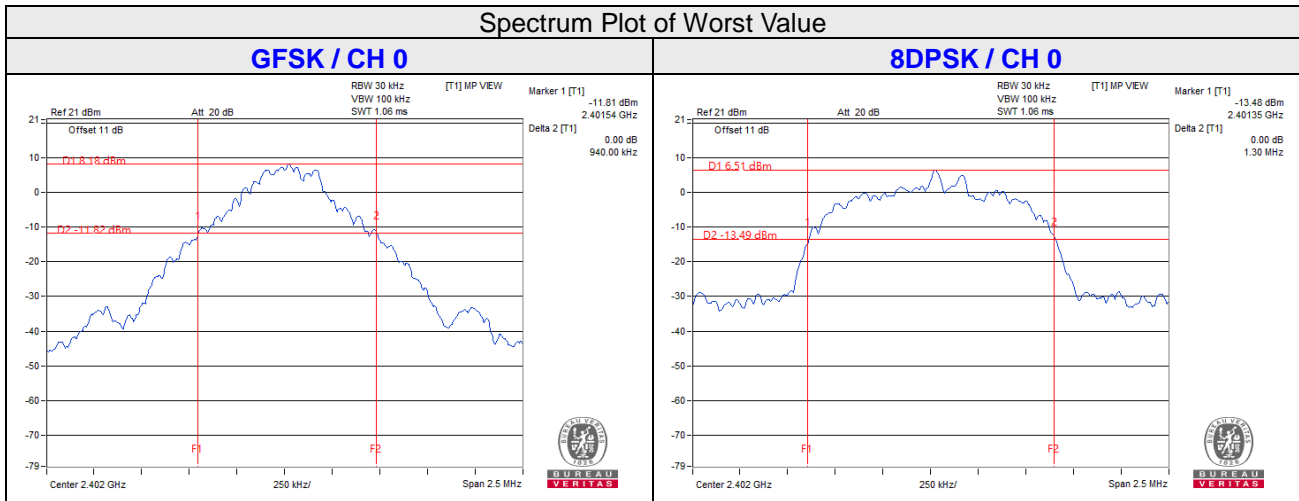

4.6 Hopping Channel Separation

4.6.1 Limits of Hopping Channel Separation Measurement

At least 25kHz or two-third of 20dB hopping channel bandwidth (whichever is greater).

4.6.2 Test Setup

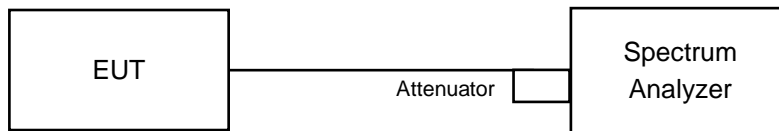

4.6.3 Test Instruments

Refer to section 4.1.2 to get information of above instrument.

4.6.4 Test Procedure

Measurement Procedure REF

- Check the calibration of the measuring instrument using either an internal calibrator or a known signal from an external generator.
- Turn on the EUT and connect it to measurement instrument. Then set it to any one convenient frequency within its operating range.
- By using the MaxHold function record the separation of two adjacent channels.
- Measure the frequency difference of these two adjacent channels by SA MARK function. And then plot the result on SA screen.
- Repeat above procedures until all frequencies measured were complete.

4.6.5 Deviation from Test Standard

No deviation.

4.6.6 Test Results

Channel	Frequency (MHz)	Adjacent Channel Separation (MHz)		20dB Bandwidth (MHz)		Minimum Limit (MHz)		Pass / Fail
		GFSK	8DPSK	GFSK	8DPSK	GFSK	8DPSK	
0	2402	1	1	0.94	1.3	0.63	0.87	Pass
39	2441	1	1	0.94	1.3	0.63	0.87	Pass
78	2480	1	1	0.94	1.3	0.63	0.87	Pass

Note: The minimum limit is two-third 20dB bandwidth.

Spectrum Plot of Worst Value

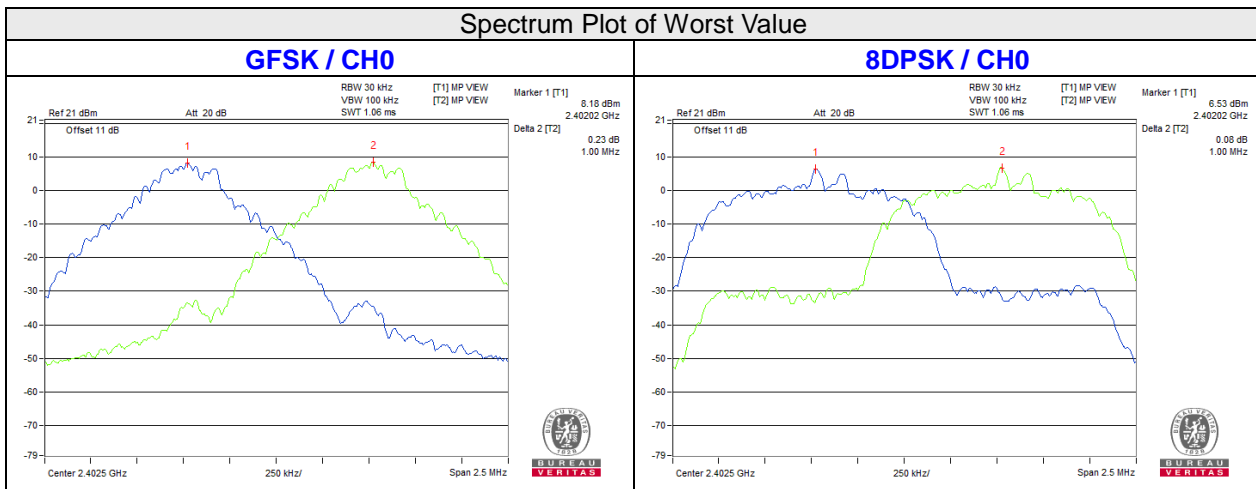

4.7 Maximum Output Power

4.7.1 Limits of Maximum Output Power Measurement

The Maximum Output Power Measurement is 125mW.

4.7.2 Test Setup

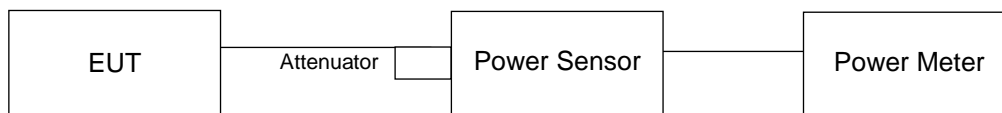

4.7.3 Test Instruments

Refer to section 4.1.2 to get information of above instrument.

4.7.4 Test Procedure

A peak power sensor was used on the output port of the EUT. A power meter was used to read the response of the peak power sensor. Record the power level.

Average power sensor was used to perform output power measurement, trigger and gating function of wide band power meter is enabled to measure max output power of TX on burst. Duty factor is not added to measured value.

4.7.5 Deviation from Test Standard

No deviation.

4.7.6 EUT Operating Condition

The software provided by client enabled the EUT to transmit and receive data at lowest, middle and highest channel frequencies individually.

4.7.7 Test Results

FOR PEAK POWER

GFSK

Channel	Frequency (MHz)	Peak Power (mW)	Peak Power (dBm)	Limit (dBm)	Pass/Fail
0	2402	11.776	10.71	21	Pass
39	2441	12.764	11.06	21	Pass
78	2480	10.74	10.31	21	Pass

Note: The max. gain is 3.21dBi < 6dBi, so the power limit shall not be reduced.

8DPSK

Channel	Frequency (MHz)	Peak Power (mW)	Peak Power (dBm)	Limit (dBm)	Pass/Fail
0	2402	9.727	9.88	21	Pass
39	2441	11.614	10.65	21	Pass
78	2480	9.795	9.91	21	Pass

Note: The max. gain is 3.21dBi < 6dBi, so the power limit shall not be reduced.

FOR AVERAGE POWER

GFSK

Channel	Frequency (MHz)	Average Power (mW)	Average Power (dBm)
0	2402	11.194	10.49
39	2441	12.134	10.84
78	2480	10.233	10.10

8DPSK

Channel	Frequency (MHz)	Average Power (mW)	Average Power (dBm)
0	2402	5.984	7.77
39	2441	6.339	8.02
78	2480	5.902	7.71

4.8 Conducted Out of Band Emission Measurement

4.8.1 Limits of Conducted Out of Band Emission Measurement

Below 20dB of the highest emission level of operating band (in 100kHz Resolution Bandwidth).

4.8.2 Test Instruments

Refer to section 4.1.2 to get information of above instrument.

4.8.3 Test Procedure

The transmitter output was connected to the spectrum analyzer via a low lose cable. Set both RBW and VBW of spectrum analyzer to 100 kHz and 300 kHz with suitable frequency span including 100 MHz bandwidth from band edge. The band edges was measured and recorded.

4.8.4 Deviation from Test Standard

No deviation.

4.8.5 EUT Operating Condition

The software provided by client enabled the EUT to transmit and receive data at lowest and highest channel frequencies individually.

4.8.6 Test Results

The spectrum plots are attached on the following images. D1 line indicates the highest level, D2 line indicates the 20dB offset below D1. It shows compliance with the requirement.

GFSK

Hopping disabled_Low Channel

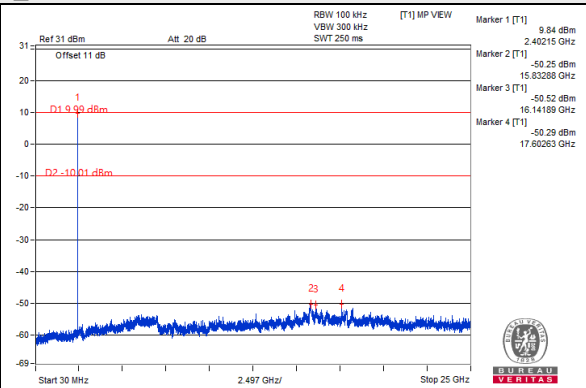
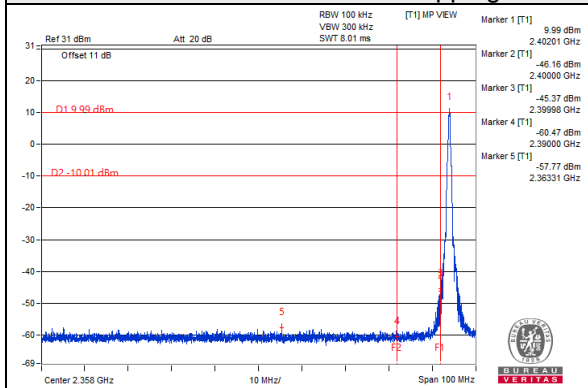

Hopping disabled_High Channel

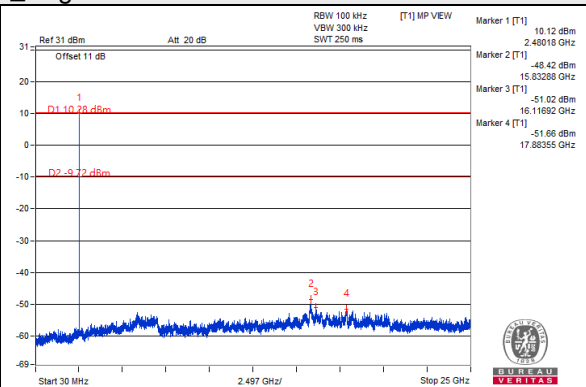
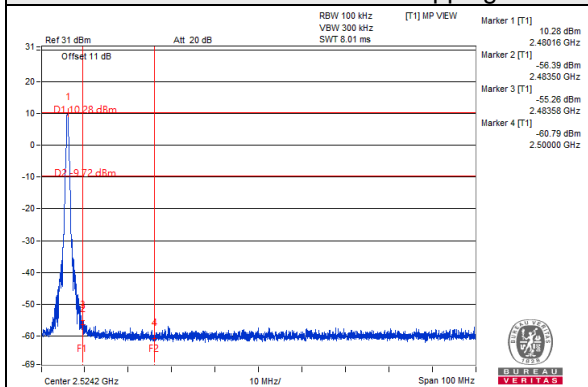

Hopping enabled_Low Channel

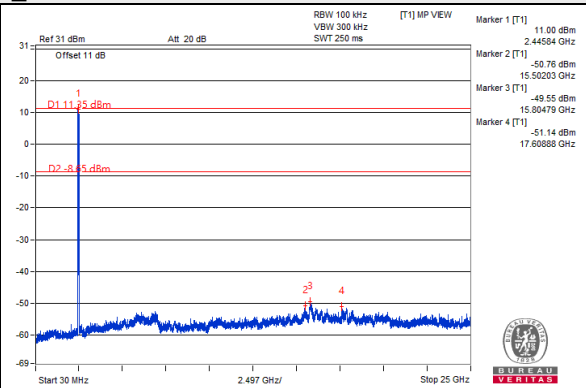
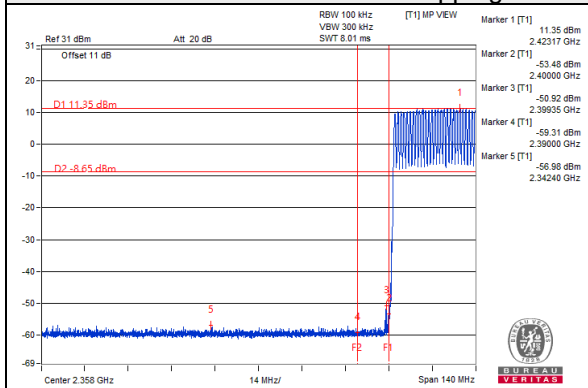

Hopping enabled_High Channel

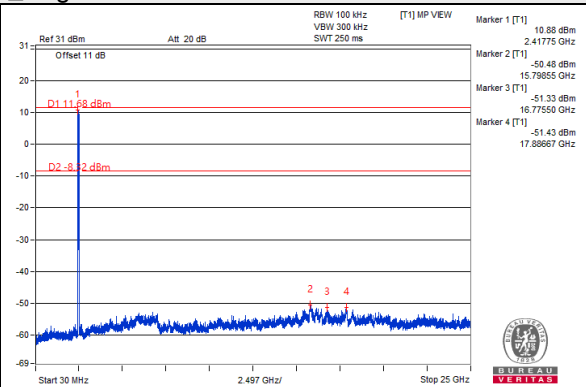
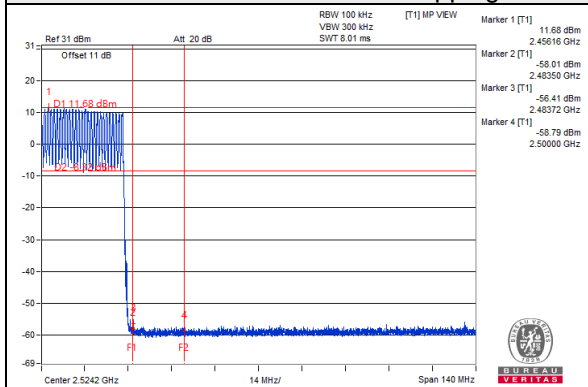

8DPSK

Hopping disabled_Low Channel

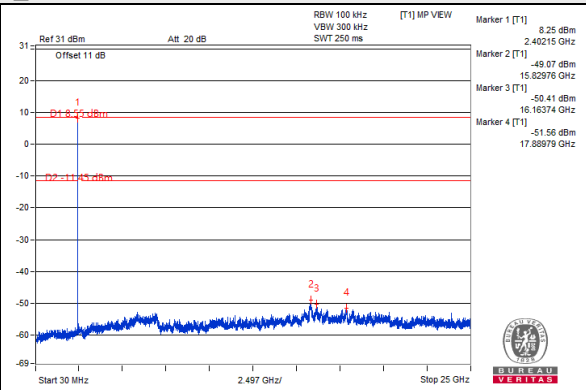
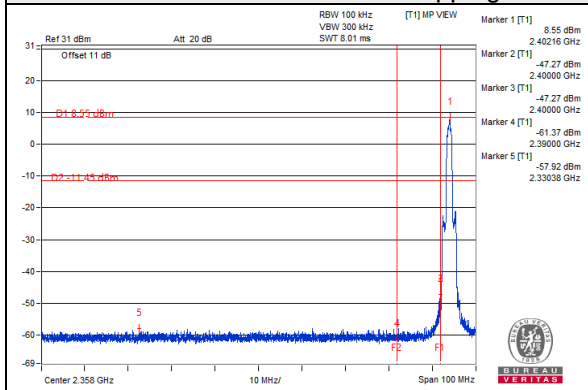

Hopping disabled_High Channel

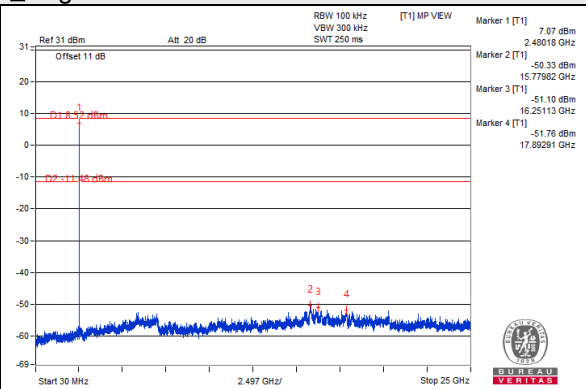
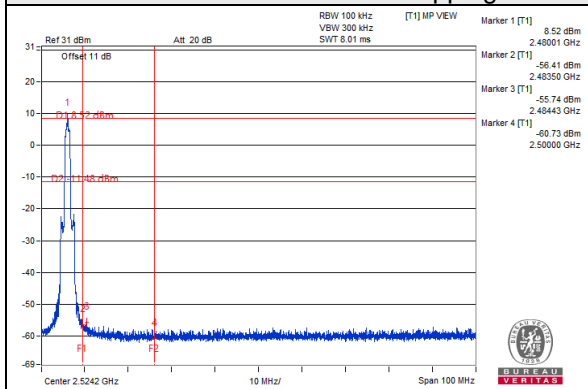

Hopping enabled_Low Channel

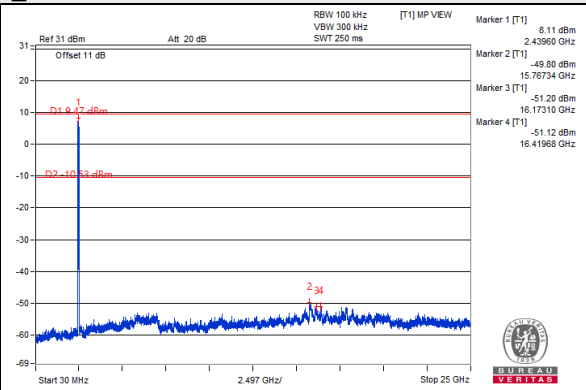
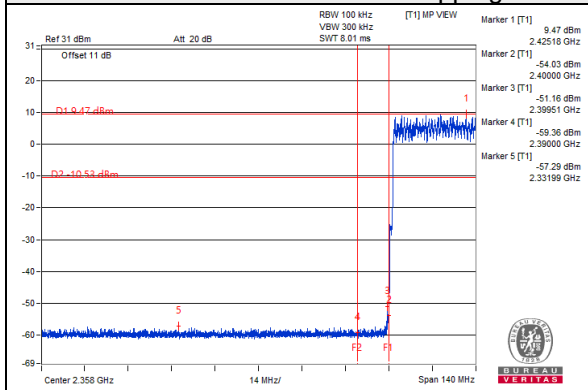

Hopping enabled_High Channel

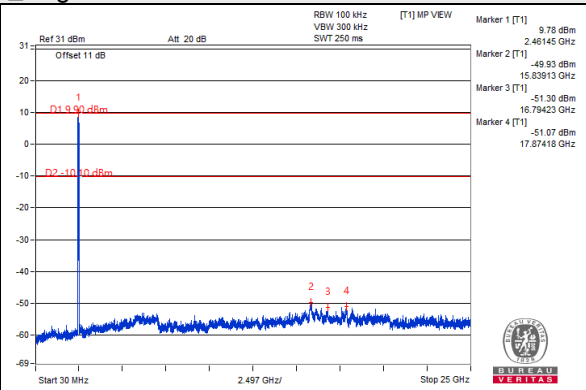
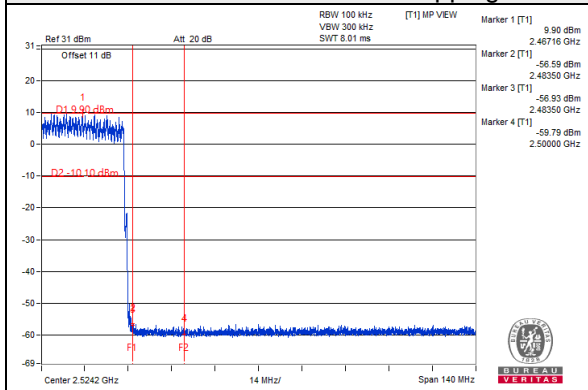

5 Pictures of Test Arrangements

Please refer to the attached file (Test Setup Photo).

Annex A - Band-Edge Measurement

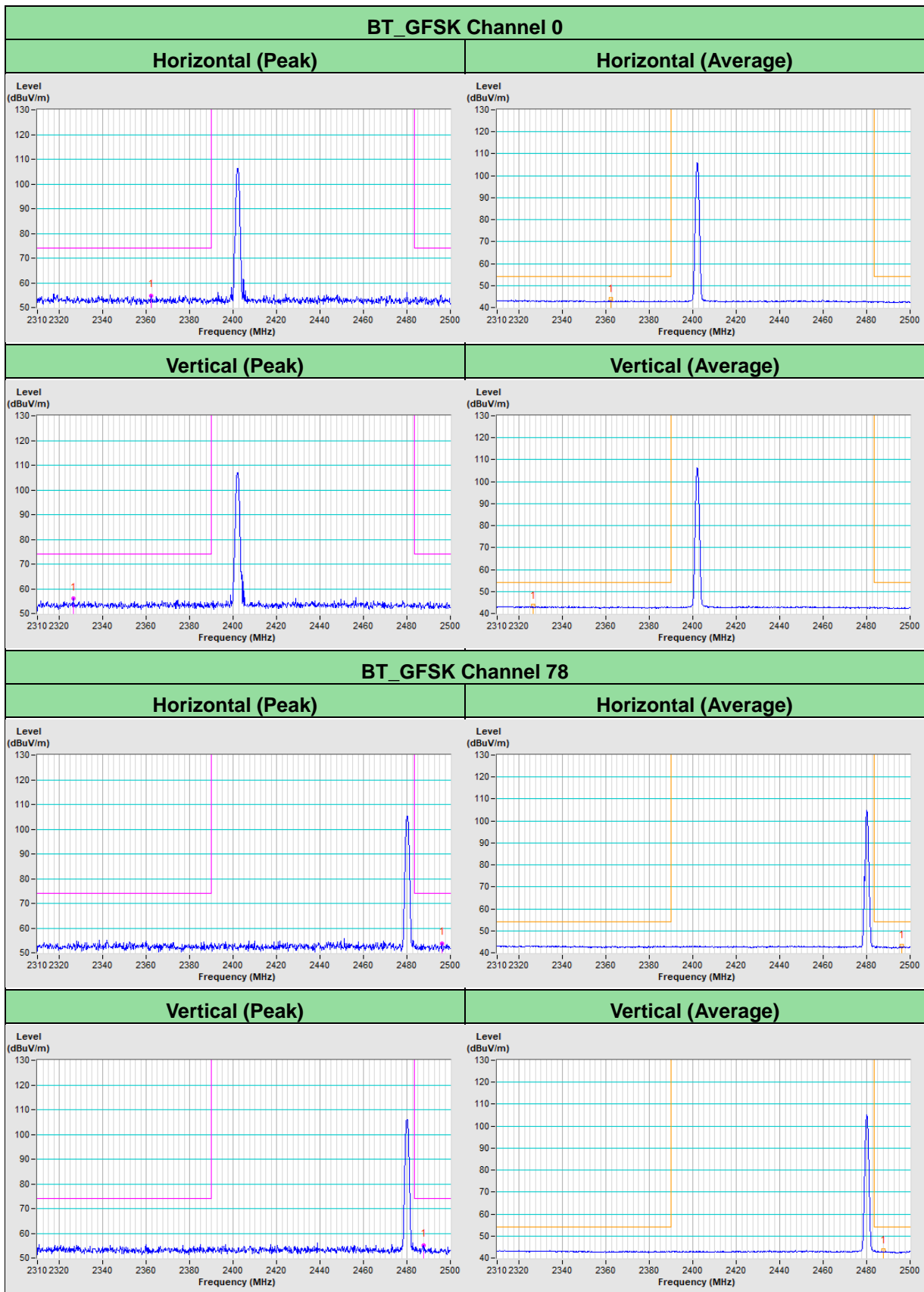

BT_8DPSK Channel 0

Horizontal (Peak)	Horizontal (Average)
-------------------	----------------------

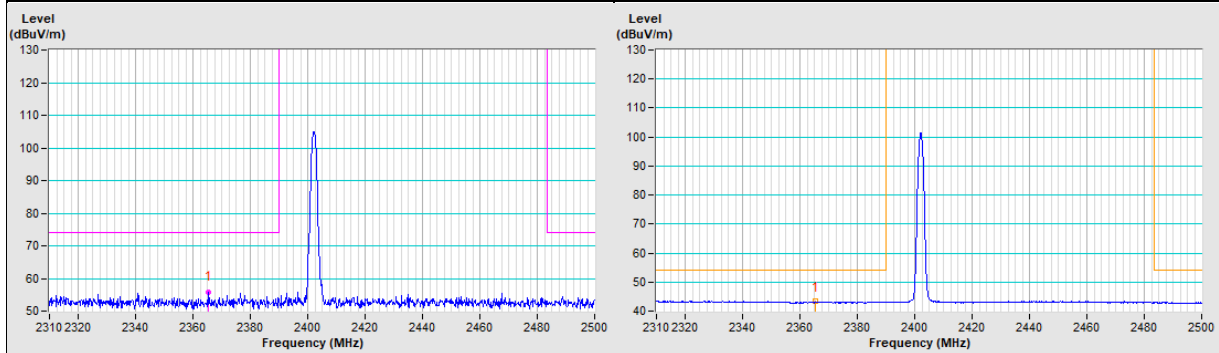

Vertical (Peak)	Vertical (Average)
-----------------	--------------------

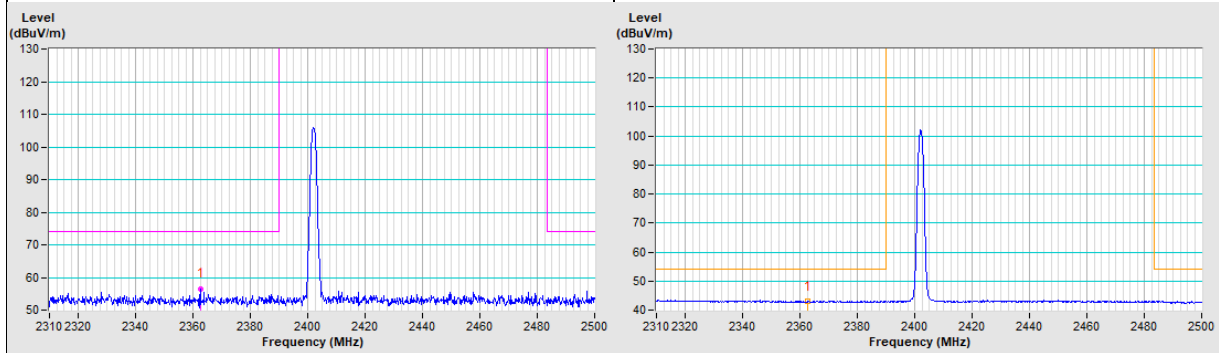

BT_8DPSK Channel 78

Horizontal (Peak)	Horizontal (Average)
-------------------	----------------------

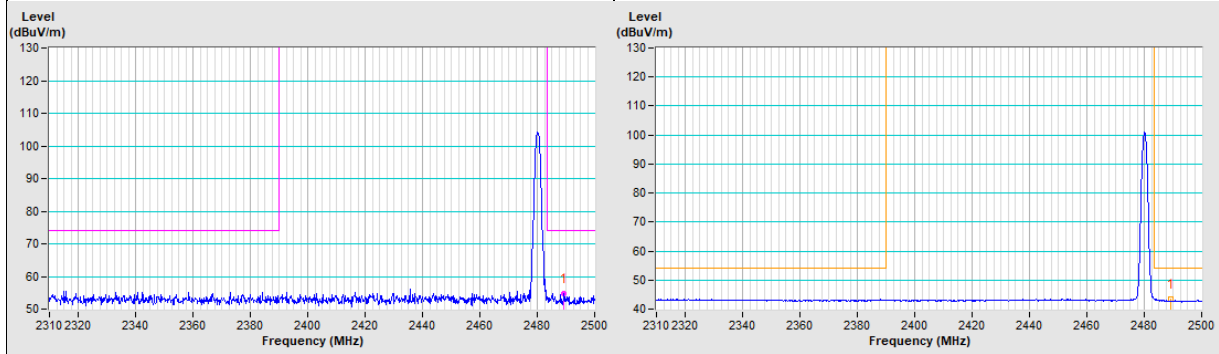

Vertical (Peak)	Vertical (Average)
-----------------	--------------------

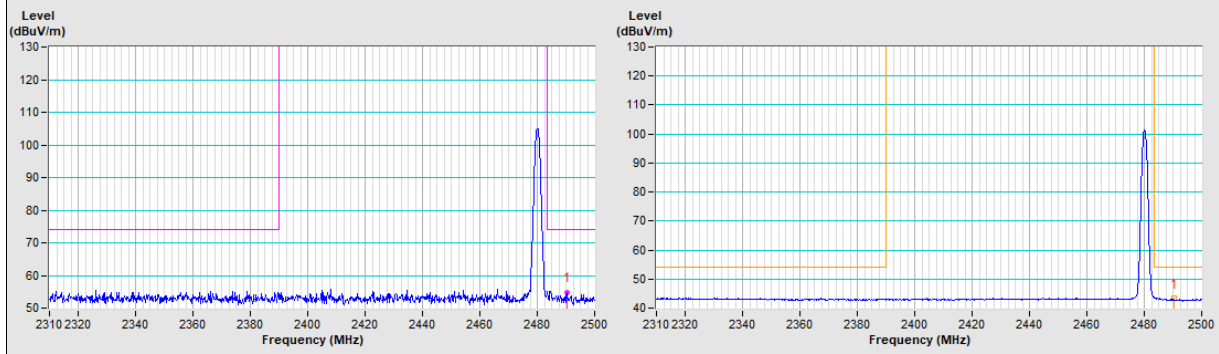

Appendix – Information of the Testing Laboratories

We, Bureau Veritas Consumer Products Services (H.K.) Ltd., Taoyuan Branch, were founded in 1988 to provide our best service in EMC, Radio, Telecom and Safety consultation. Our laboratories are FCC recognized accredited test firms and accredited according to ISO/IEC 17025.

If you have any comments, please feel free to contact us at the following:

Lin Kou EMC/RF Lab

Tel: 886-2-26052180

Fax: 886-2-26051924

Hsin Chu EMC/RF/Telecom Lab

Tel: 886-3-6668565

Fax: 886-3-6668323

Hwa Ya EMC/RF/Safety Lab

Tel: 886-3-3183232

Fax: 886-3-3270892

Email: service.adt@tw.bureauveritas.com

Web Site: www.bureauveritas-adt.com

The address and road map of all our labs can be found in our web site also.

--- END ---