

FCC Test Report (WLAN)

Report No.: RF210105C01-1

FCC ID: PZWBHTM70QWG

Test Model: BHT-M70-QWG

Received Date: 2021/1/5

Test Date: 2021/1/15 ~ 2021/8/18

Issued Date: 2021/09/29

Applicant: DENSO WAVE INCORPORATED

Address: 1 Yoshiike Kusagi Agui-cho, Chita-gun Aichi 470-2297, Japan

Issued By: Bureau Veritas Consumer Products Services (H.K.) Ltd., Taoyuan Branch
Hsin Chu Laboratory

Lab Address: E-2, No.1, Li Hsin 1st Road, Hsinchu Science Park, Hsinchu City 300,
Taiwan

Test Location: E-2, No.1, Li Hsin 1st Road, Hsinchu Science Park, Hsinchu City 300,
Taiwan

**FCC Registration /
Designation Number:** 723255 / TW2022



This report is for your exclusive use. Any copying or replication of this report to or for any other person or entity, or use of our name or trademark, is permitted only with our prior written permission. This report sets forth our findings solely with respect to the test samples identified herein. The results set forth in this report are not indicative or representative of the quality or characteristics of the lot from which a test sample was taken or any similar or identical product unless specifically and expressly noted. Our report includes all of the tests requested by you and the results thereof based upon the information that you provided to us. You have 60 days from date of issuance of this report to notify us of any material error or omission caused by our negligence, provided, however, that such notice shall be in writing and shall specifically address the issue you wish to raise. A failure to raise such issue within the prescribed time shall constitute your unqualified acceptance of the completeness of this report, the tests conducted and the correctness of the report contents. Unless specific mention, the uncertainty of measurement has been explicitly taken into account to declare the compliance or non-compliance to the specification.

Table of Contents

Release Control Record	4
1 Certificate of Conformity	5
2 Summary of Test Results	6
2.1 Measurement Uncertainty	6
2.2 Modification Record	6
3 General Information	7
3.1 General Description of EUT	7
3.2 Description of Test Modes	10
3.2.1 Test Mode Applicability and Tested Channel Detail	12
3.3 Duty Cycle of Test Signal	14
3.4 Description of Support Units	15
3.4.1 Configuration of System under Test	16
3.5 General Description of Applied Standard and References	18
4 Test Types and Results	19
4.1 Radiated Emission and Bandedge Measurement	19
4.1.1 Limits of Radiated Emission and Bandedge Measurement	19
4.1.2 Test Instruments	20
4.1.3 Test Procedure	22
4.1.4 Deviation from Test Standard	23
4.1.5 Test Setup	23
4.1.6 EUT Operating Condition	24
4.1.7 Test Results	25
4.2 Conducted Emission Measurement	69
4.2.1 Limits of Conducted Emission Measurement	69
4.2.2 Test Instruments	69
4.2.3 Test Procedure	70
4.2.4 Deviation from Test Standard	70
4.2.5 Test Setup	70
4.2.6 EUT Operating Condition	70
4.2.7 Test Results	71
4.3 Transmit Power Measurement	73
4.3.1 Limits of Transmit Power Measurement	73
4.3.2 Test Setup	73
4.3.3 Test Instruments	74
4.3.4 Test Procedure	74
4.3.5 Deviation from Test Standard	74
4.3.6 EUT Operating Condition	74
4.3.7 Test Results	75
4.4 Occupied Bandwidth Measurement	84
4.4.1 Test Setup	84
4.4.2 Test Instruments	84
4.4.3 Test Procedure	84
4.4.4 Test Results	85
4.5 Peak Power Spectral Density Measurement	91
4.5.1 Limits of Peak Power Spectral Density Measurement	91
4.5.2 Test Setup	91
4.5.3 Test Instruments	91
4.5.4 Test Procedure	91
4.5.5 Deviation from Test Standard	92
4.5.6 EUT Operating Condition	92
4.5.7 Test Results	93

4.6	Frequency Stability Measurement.....	99
4.6.1	Limits of Frequency Stability Measurement	99
4.6.2	Test Setup.....	99
4.6.3	Test Instruments	99
4.6.4	Test Procedure	99
4.6.5	Deviation from Test Standard	99
4.6.6	EUT Operating Condition	99
4.6.7	Test Results	100
4.7	6dB Bandwidth Measurement	101
4.7.1	Limits of 6dB Bandwidth Measurement.....	101
4.7.2	Test Setup.....	101
4.7.3	Test Instruments	101
4.7.4	Test Procedure	101
4.7.5	Deviation from Test Standard	101
4.7.6	EUT Operating Condition	101
4.7.7	Test Results	102
5	Pictures of Test Arrangements.....	104
	Annex A - Radiated Out of Band Emission (OOBE) Measurement (For U-NII-3 band)	105
	Annex B - Band-Edge Measurement (For U-NII-1, U-NII-2A, U-NII-2C band)	108
	Appendix – Information of the Testing Laboratories	116

Release Control Record

Issue No.	Description	Date Issued
RF210105C01-1	Original release.	2021/09/29

1 Certificate of Conformity

Product: 2D Code Handy Terminal

Brand: DENSO

Test Model: BHT-M70-QWG

Sample Status: Engineering sample

Applicant: DENSO WAVE INCORPORATED

Test Date: 2021/1/15 ~ 2021/8/18

Standard: 47 CFR FCC Part 15, Subpart E (Section 15.407)
ANSI C63.10: 2013

The above equipment has been tested by **Bureau Veritas Consumer Products Services (H.K.) Ltd., Taoyuan Branch**, and found compliance with the requirement of the above standards. The test record, data evaluation & Equipment Under Test (EUT) configurations represented herein are true and accurate accounts of the measurements of the sample's EMC characteristics under the conditions specified in this report.

Prepared by :  , **Date:** 2021/09/29
Claire Kuan / Specialist

Approved by :  , **Date:** 2021/09/29
Clark Lin / Technical Manager

2 Summary of Test Results

47 CFR FCC Part 15, Subpart E (Section 15.407)			
FCC Clause	Test Item	Result	Remarks
15.407(b)(6)	AC Power Conducted Emissions	Pass	Meet the requirement of limit. Minimum passing margin is -15.81dB at 0.65781 MHz.
15.407(b) (1/2/3/4(i/ii)/6)	Radiated Emissions & Band Edge Measurement*	Pass	Meet the requirement of limit. Minimum passing margin is -0.2 dB at 5150.00 MHz and 5460.00 MHz
15.407(a)(1/2/3)	Max Average Transmit Power	Pass	Meet the requirement of limit.
---	Occupied Bandwidth Measurement	-	Reference only.
15.407(a)(1/2/3)	Peak Power Spectral Density	Pass	Meet the requirement of limit.
15.407(e)	6dB bandwidth	Pass	Meet the requirement of limit. (U-NII-3 Band only)
15.407(g)	Frequency Stability	Pass	Meet the requirement of limit.
15.203	Antenna Requirement	Pass	Antenna connector is Spring not a standard connector.

Note:

- For U-NII-3 band compliance with rule part 15.407(b)(4)(i), the OBE test plots were recorded in Annex A.
- For U-NII-1, U-NII-2A, U-NII-2C band compliance with rule 15.407(b) of the band-edge items, the test plots were recorded in Annex B. Test Procedures refer to report 4.1.3.
- Determining compliance based on the results of the compliance measurement, not taking into account measurement instrumentation uncertainty.

2.1 Measurement Uncertainty

Where relevant, the following measurement uncertainty levels have been estimated for tests performed on the EUT as specified in CISPR 16-4-2:

Measurement	Frequency	Expanded Uncertainty (k=2) (\pm)
Conducted Emissions at mains ports	150kHz ~ 30MHz	1.9 dB
Radiated Emissions up to 1 GHz	9kHz ~ 30MHz	3.1 dB
	30MHz ~ 1GHz	5.4 dB
Radiated Emissions above 1 GHz	1GHz ~ 18GHz	5.0 dB
	18GHz ~ 40GHz	5.3 dB

2.2 Modification Record

There were no modifications required for compliance.

3 General Information

3.1 General Description of EUT

Product	2D Code Handy Terminal
Brand	DENSO
Test Model	BHT-M70-QWG
Status of EUT	Engineering sample
Power Supply Rating	3.6 Vdc from battery; 5 Vdc from power adapter
Modulation Type	64QAM, 16QAM, QPSK, BPSK for OFDM 256QAM for OFDM in 11ac mode
Modulation Technology	OFDM
Transfer Rate	802.11a: up to 54 Mbps 802.11n: up to 300 Mbps 802.11ac: up to 866.7 Mbps
Operating Frequency	5.18~5.32GHz, 5.50~5.72GHz, 5.745 ~ 5.825GHz
Number of Channel	802.11a, 802.11n (HT20), 802.11ac (VHT20): 25 802.11n (HT40), 802.11ac (VHT40): 12 802.11ac (VHT80): 6
Output Power	5.18 ~ 5.24 GHz: 160.801 mW 5.26 ~ 5.32GHz: 159.872 mW 5.5 ~ 5.72GHz: 158.608 mW 5.745 ~ 5.825 GHz: 202.086 mW
Antenna Type	Refer to Note
Antenna Connector	Refer to Note
Accessory Device	Battery x 1 Adapter x 1 (Option) Adapter x 1 (for Cradle) QC3.0 charge single Cradle x 1 (Option_Brand: DENSO, Model: CU-M70UQ) USB Cradle with spare battery charge x 1 (Option_Brand: DENSO, Model: CU-M70U) LAN Cradle with Spare battery charge x 1 (Option_Brand: DENSO, Model: CU-M70L)
Data Cable Supplied	USB Cable x 1 (Shielded, 1.45m, Option_Brand: NIEN-YI, Model: NYS3892-0)

Note:

1. The EUT has below radios as following table:

Radio 1	Radio 2	Radio 3	Radio 4
WLAN 2.4GHz	WLAN 5GHz	Bluetooth	WWAN (LTE + WCDMA + GSM)

2. Simultaneously transmission condition.

Condition	Technology	
1	WWAN	WLAN (2.4GHz)
2	WWAN	WLAN (5GHz)
3	WWAN	Bluetooth

Note: The emission of the simultaneous operation has been evaluated and no non-compliance was found.

3. The EUT must be supplied with a power adapter & battery and following below table:

Item	Brand	Model No.	Spec.
Battery	DENSO	BT3	DC Output: 3.6Vdc, 3050mAh, 10.98Wh
Adapter (Option)	CHANNEL WELL	2ACP0183C	AC Input: 100-240Vac~, 0.5A, 50/60Hz DC Output: 5.0Vdc / 3.0A 15.0W, 9.0Vdc / 2.0A 18.0W, 12.0Vdc / 1.5A 18.0W
For Cradle use			
Item	Brand	Model No.	Spec.
Adapter (Option)	Sunny	SYS1548-5012-T3	AC Input: 100-240Vac~1.5A MAX 50-60Hz AC Cable: Unshielded, 1.71m DC Output: +12.0Vdc / 4.16A DC Cable: Unshielded, 1.16m with one core

4. The antennas provided to the EUT, please refer to the following table:

Antenna No.	RF Chain No	Brand	Model	Antenna gain (dBi)	Frequency Range (MHz)	Antenna Type	Connector Type
1 (WiFi & BT)	Chain0	HONGBO	1415-01R8C00	3.26	2400-2500 (WiFi)	PIFA	Spring
				3.21	2400-2500 (BT)		
				3.63	5150-5250		
				3.65	5250-5350		
				3.45	5470-5725		
				3.52	5725-5850		
2 (WiFi)	Chain1	HONGBO	1415-01R8C00	0.68	2400-2500	PIFA	Spring
				2.63	5150-5250		
				2.6	5250-5350		
				2.93	5470-5725		
				2.4	5725-5850		

5. The EUT was pre-tested for conducted emission test under following test modes:

Pre-test Mode	Description
Mode A	Adapter Mode
Mode B	Laptop Mode
Mode C	Cradle with Type C port
Mode D	Cradle with RJ45 port
Mode E	QC3.0 charge single Cradle

From the above modes, the worst conducted emission test was found in **Mode A**. Therefore only the test data of the modes were recorded in this report.

6. The EUT was pre-tested for radiated emission test under following test modes:

Pre-test Mode	Description
Mode A	Battery Mode
Mode B	Adapter Mode
Mode C	Cradle with Type C port
Mode D	Cradle with RJ45 port
Mode E	QC3.0 charge single Cradle

From the above modes, the worst radiated emissions were found in **Mode D** for below 1GHz and found in **Mode B** for above 1GHz. Therefore only the test data of the modes were recorded in this report.

7. The EUT incorporates a MIMO function:

MODULATION MODE	TX & RX CONFIGURATION	
802.11a	2TX	2RX
802.11n (HT20)	2TX	2RX
802.11n (HT40)	2TX	2RX
802.11ac (VHT20)	2TX	2RX
802.11ac (VHT40)	2TX	2RX
802.11ac (VHT80)	2TX	2RX

Note: The EUT doesn't support beamforming function.

8. The above EUT information is declared by manufacturer and for more detailed features description, please refers to the manufacturer's specifications or user's manual.
9. The above Antenna information is declared by manufacturer and for more detailed features description, please refer to the manufacturer's specifications, the laboratory shall not be held responsible.

3.2 Description of Test Modes

FOR 5180 ~ 5320MHz

8 channels are provided for 802.11a, 802.11n (HT20), 802.11ac (VHT20):

Channel	Frequency	Channel	Frequency
36	5180 MHz	52	5260 MHz
40	5200 MHz	56	5280 MHz
44	5220 MHz	60	5300 MHz
48	5240 MHz	64	5320 MHz

4 channels are provided for 802.11n (HT40), 802.11ac (VHT40):

Channel	Frequency	Channel	Frequency
38	5190 MHz	54	5270 MHz
46	5230 MHz	62	5310 MHz

2 channel is provided for 802.11ac (VHT80):

Channel	Frequency	Channel	Frequency
42	5210 MHz	58	5290 MHz

FOR 5500 ~ 5720MHz

12 channels are provided for 802.11a, 802.11n (HT20), 802.11ac (VHT20):

Channel	Frequency	Channel	Frequency
100	5500 MHz	124	5620 MHz
104	5520 MHz	128	5640 MHz
108	5540 MHz	132	5660 MHz
112	5560 MHz	136	5680 MHz
116	5580 MHz	140	5700 MHz
120	5600 MHz	144	5720 MHz

6 channels are provided for 802.11n (HT40), 802.11ac (VHT40):

Channel	Frequency	Channel	Frequency
102	5510 MHz	126	5630 MHz
110	5550 MHz	134	5670 MHz
118	5590 MHz	142	5710 MHz

3 channels are provided for 802.11ac (VHT80):

Channel	Frequency	Channel	Frequency
106	5530 MHz	138	5690 MHz
122	5610 MHz		

FOR 5745 ~ 5825MHz:

5 channels are provided for 802.11a, 802.11n (HT20), 802.11ac (VHT20):

Channel	Frequency	Channel	Frequency
149	5745 MHz	161	5805 MHz
153	5765 MHz	165	5825 MHz
157	5785 MHz		

2 channels are provided for 802.11n (HT40), 802.11ac (VHT40):

Channel	Frequency	Channel	Frequency
151	5755 MHz	159	5795 MHz

1 channel is provided for 802.11ac (VHT80):

Channel	Frequency
155	5775 MHz

3.2.1 Test Mode Applicability and Tested Channel Detail

EUT Configure Mode	Applicable To				Description
	RE \geq 1G	RE<1G	PLC	APCM	
-	√	√	√	√	-

Where **RE \geq 1G**: Radiated Emission above 1GHz

RE<1G: Radiated Emission below 1GHz

PLC: Power Line Conducted Emission

APCM: Antenna Port Conducted Measurement

Note: The EUT had been pre-tested on the positioned of each 3 axis. The worst case was found when positioned on **X-place**.

Radiated Emission Test (Above 1GHz):

- Pre-Scan has been conducted to determine the worst-case mode from all possible combinations between available modulations, data rates and antenna ports (if EUT with antenna diversity architecture).
- Following channel(s) was (were) selected for the final test as listed below.

Mode	FREQ. Band (MHz)	Available Channel	Tested Channel	Modulation Technology	Modulation Type	Data Rate (Mbps)
802.11a	5180-5320	36 to 64	36, 40, 48, 52, 60, 64	OFDM	BPSK	6
802.11ac (VHT20)		36 to 64	36, 40, 48, 52, 60, 64	OFDM	BPSK	6.5
802.11ac (VHT40)		38 to 62	38, 46, 54, 62	OFDM	BPSK	13.5
802.11ac (VHT80)		42, 58	42, 58	OFDM	BPSK	29.3
802.11a	5500-5720	100 to 144	100, 116, 140, 144	OFDM	BPSK	6
802.11ac (VHT20)		100 to 144	100, 116, 140, 144	OFDM	BPSK	6.5
802.11ac (VHT40)		102 to 142	102, 110, 134, 142	OFDM	BPSK	13.5
802.11ac (VHT80)		106 to 138	106, 122, 138	OFDM	BPSK	29.3
802.11a	5745-5825	149 to 165	149, 157, 165	OFDM	BPSK	6
802.11ac (VHT20)		149 to 165	149, 157, 165	OFDM	BPSK	6.5
802.11ac (VHT40)		151 to 159	151, 159	OFDM	BPSK	13.5
802.11ac (VHT80)		155	155	OFDM	BPSK	29.3

Radiated Emission Test (Below 1GHz):

- Pre-Scan has been conducted to determine the worst-case mode from all possible combinations between available modulations, data rates and antenna ports (if EUT with antenna diversity architecture).
- Following channel(s) was (were) selected for the final test as listed below.

Mode	FREQ. Band (MHz)	Available Channel	Tested Channel	Modulation Technology	Modulation Type	Data Rate (Mbps)
802.11ac (VHT40)	5180-5320 5500-5720 5745-5825	38 to 62 102 to 142 151 to 159	151	OFDM	BPSK	13.5

Power Line Conducted Emission Test:

- Pre-Scan has been conducted to determine the worst-case mode from all possible combinations between available modulations, data rates and antenna ports (if EUT with antenna diversity architecture).
- Following channel(s) was (were) selected for the final test as listed below.

Mode	FREQ. Band (MHz)	Available Channel	Tested Channel	Modulation Technology	Modulation Type	Data Rate (Mbps)
802.11ac (VHT40)	5180-5320	38 to 62	151	OFDM	BPSK	13.5
	5500-5720	102 to 142				
	5745-5825	151 to 159				

Antenna Port Conducted Measurement:

- This item includes all test value of each mode, but only includes spectrum plot of worst value of each mode.
- Pre-Scan has been conducted to determine the worst-case mode from all possible combinations between available modulations, data rates and antenna ports (if EUT with antenna diversity architecture).
- Following channel(s) was (were) selected for the final test as listed below.

Mode	FREQ. Band (MHz)	Available Channel	Tested Channel	Modulation Technology	Modulation Type	Data Rate (Mbps)
802.11a	5180-5320	36 to 64	36, 40, 48, 52, 60, 64	OFDM	BPSK	6
802.11ac (VHT20)		36 to 64	36, 40, 48, 52, 60, 64	OFDM	BPSK	6.5
802.11ac (VHT40)		38 to 62	38, 46, 54, 62	OFDM	BPSK	13.5
802.11ac (VHT80)		42, 58	42, 58	OFDM	BPSK	29.3
802.11a	5500-5720	100 to 144	100, 116, 140, 144	OFDM	BPSK	6
802.11ac (VHT20)		100 to 144	100, 116, 140, 144	OFDM	BPSK	6.5
802.11ac (VHT40)		102 to 142	102, 110, 134, 142	OFDM	BPSK	13.5
802.11ac (VHT80)		106 to 138	106, 122, 138	OFDM	BPSK	29.3
802.11a	5745-5825	149 to 165	149, 157, 165	OFDM	BPSK	6
802.11ac (VHT20)		149 to 165	149, 157, 165	OFDM	BPSK	6.5
802.11ac (VHT40)		151 to 159	151, 159	OFDM	BPSK	13.5
802.11ac (VHT80)		155	155	OFDM	BPSK	29.3

Test Condition:

Applicable To	Environmental Conditions	Input Power	Tested By
RE \geq 1G	24deg. C, 68%RH 25deg. C, 65%RH 25deg. C, 75%RH	120Vac, 60Hz	Tom Yang
RE $<$ 1G	25deg. C, 65%RH	120Vac, 60Hz	Carter Lin
PLC	25deg. C, 66%RH	120Vac, 60Hz	Sampson Chen
APCM	25deg. C, 60%RH	120Vac, 60Hz	Eric Peng

3.3 Duty Cycle of Test Signal

Duty cycle of test signal is $\geq 98\%$, duty factor is not required.

802.11a: Duty cycle = $2.063 \text{ ms} / 2.102 \text{ ms} = 0.981$

802.11ac (VHT20): Duty cycle = $4.969 \text{ ms} / 5.013 \text{ ms} = 0.991$

802.11ac (VHT40): Duty cycle = $2.413 \text{ ms} / 2.452 \text{ ms} = 0.984$

802.11ac (VHT80): Duty cycle = $2.237 \text{ ms} / 2.275 \text{ ms} = 0.983$

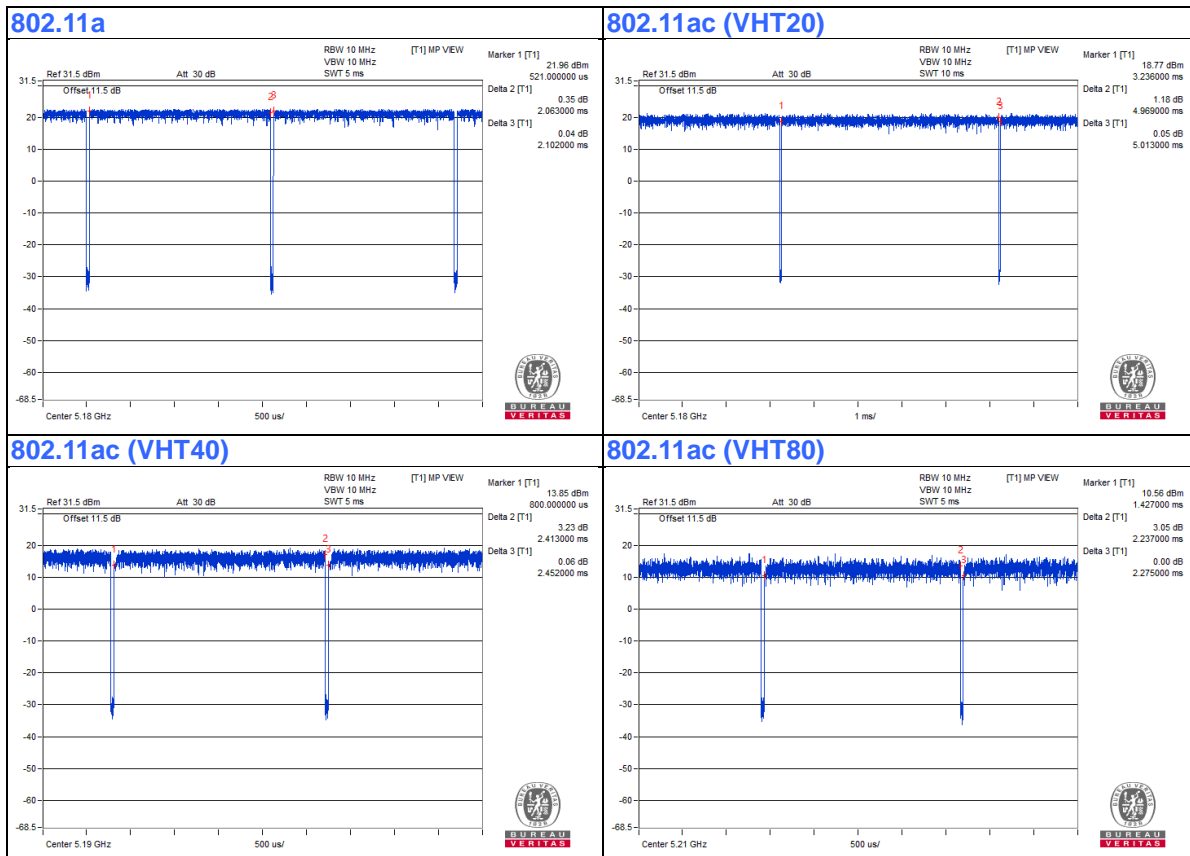

3.4 Description of Support Units

The EUT has been tested as an independent unit together with other necessary accessories or support units. The following support units or accessories were used to form a representative test configuration during the tests.

ID	Product	Brand	Model No.	Serial No.	FCC ID	Remarks
A.	Laptop	DELL	E5430	HYV4VY1	FCC DoC	Provided by Lab
B.	Cradle	Denso	CU-M70U	NA	NA	Supplied by client

Note:

1. All power cords of the above support units are non-shielded (1.8m).

ID	Descriptions	Qty.	Length (m)	Shielding (Yes/No)	Cores (Qty.)	Remarks
1.	USB Cable	1	1.45	No	0	Supplied by client
2.	RJ-45 Cable	1	10	Yes	0	Provided by Lab
3.	DC Cable	1	1.16	Yes	1	Supplied by client
4.	AC Cable	1	1.71	Yes	0	Supplied by client

Note: The core(s) is(are) originally attached to the cable(s).

3.4.1 Configuration of System under Test

For radiated emission (below 1GHz):

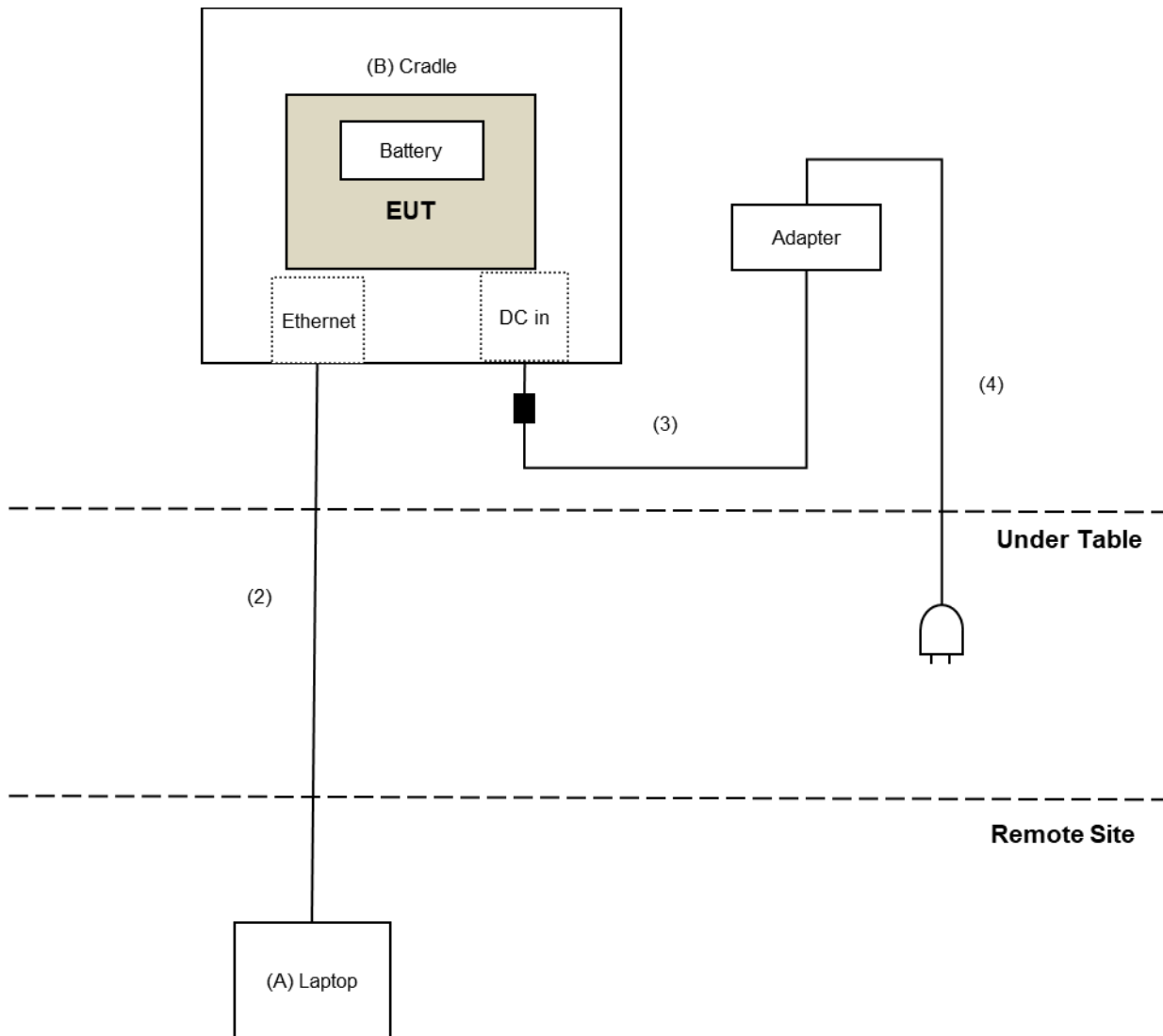

For conducted emission & radiated emission (above 1GHz):

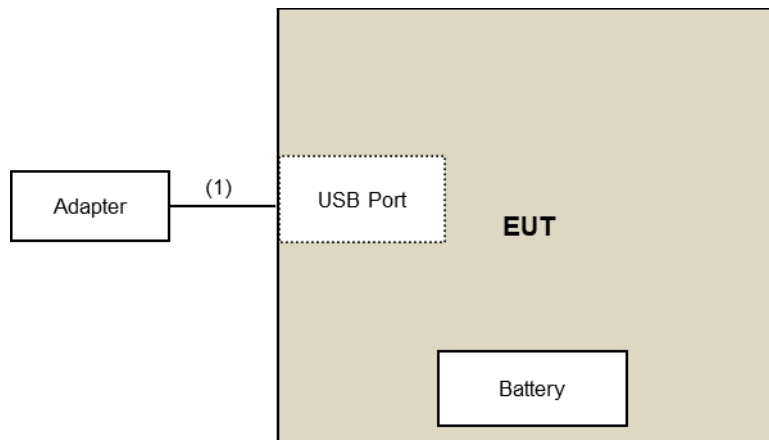

3.5 General Description of Applied Standard and References

The EUT is a RF Product. According to the specifications of the manufacturer, it must comply with the requirements of the following standards and references:

Test Standard:

FCC Part 15, Subpart E (15.407)

ANSI C63.10-2013

All test items have been performed and recorded as per the above standards.

References Test Guidance:

KDB 789033 D02 General UNII Test Procedure New Rules v02r01

KDB 662911 D01 Multiple Transmitter Output v02r01

All test items have been performed as a reference to the above KDB test guidance.

4 Test Types and Results

4.1 Radiated Emission and Bandedge Measurement

4.1.1 Limits of Radiated Emission and Bandedge Measurement

Radiated emissions which fall in the restricted bands must comply with the radiated emission limits specified as below table.

Frequencies (MHz)	Field Strength (microvolts/meter)	Measurement Distance (meters)
0.009 ~ 0.490	2400/F(kHz)	300
0.490 ~ 1.705	24000/F(kHz)	30
1.705 ~ 30.0	30	30
30 ~ 88	100	3
88 ~ 216	150	3
216 ~ 960	200	3
Above 960	500	3

NOTE:

1. The lower limit shall apply at the transition frequencies.
2. Emission level (dBuV/m) = 20 log Emission level (uV/m).
3. For frequencies above 1000MHz, the field strength limits are based on average detector, however, the peak field strength of any emission shall not exceed the maximum permitted average limits, specified above by more than 20dB under any condition of modulation.

Limits of unwanted emission out of the restricted bands

Applicable To		Limit	
789033 D02 General UNII Test Procedure New Rules v02r01		Field Strength at 3m	
		PK:74 (dBuV/m)	AV:54 (dBuV/m)
Frequency Band	Applicable To	EIRP Limit	Equivalent Field Strength at 3m
5150~5250 MHz	15.407(b)(1)	PK:-27 (dBm/MHz)	PK:68.2(dBuV/m)
5250~5350 MHz	15.407(b)(2)		
5470~5725 MHz	15.407(b)(3)		
5725~5850 MHz	15.407(b)(4)(i)	PK:-27 (dBm/MHz) ^{*1} PK:10 (dBm/MHz) ^{*2} PK:15.6 (dBm/MHz) ^{*3} PK:27 (dBm/MHz) ^{*4}	PK: 68.2(dBuV/m) ^{*1} PK:105.2 (dBuV/m) ^{*2} PK: 110.8(dBuV/m) ^{*3} PK:122.2 (dBuV/m) ^{*4}
*1 beyond 75 MHz or more above of the band edge.		*2 below the band edge increasing linearly to 10 dBm/MHz at 25 MHz above.	
*3 below the band edge increasing linearly to a level of 15.6 dBm/MHz at 5 MHz above.		*4 from 5 MHz above or below the band edge increasing linearly to a level of 27 dBm/MHz at the band edge.	

Note:

The following formula is used to convert the equipment isotropic radiated power (eirp) to field strength:

$$E = \frac{1000000\sqrt{30P}}{3} \mu\text{V/m, where P is the eirp (Watts).}$$

4.1.2 Test Instruments

For Radiated Emission and Band-Edge & OOB Test:

DESCRIPTION & MANUFACTURER	MODEL NO.	SERIAL NO.	CALIBRATED DATE	CALIBRATED UNTIL
Test Receiver Agilent	N9038A	MY50010156	2020/7/24	2021/7/23
Software	ADT_Radiated_V8.7.08	NA	NA	NA
Antenna Tower & Turn Table Max-Full	MF-7802	MF780208406	NA	NA
Pre_Amplifier EMCI	EMC001340	980142	2020/5/25	2021/5/24
LOOP ANTENNA Electro-Metrics	EM-6879	264	2020/2/18	2021/2/17
RF Coaxial Cable JYEBO	5D-FB	LOOPCAB-001	2021/1/7	2022/1/6
RF Coaxial Cable JYEBO	5D-FB	LOOPCAB-002	2021/1/7	2022/1/6
Pre_Amplifier Mini-Circuits	ZFL-1000VH2	QA0838008	2020/10/20	2021/10/19
Trilog Broadband Antenna SCHWARZBECK	VULB 9168	9168-361	2020/11/5	2021/11/4
RF Coaxial Cable COMMATE/PEWC	8D	966-3-1	2020/3/17	2021/3/16
RF Coaxial Cable COMMATE/PEWC	8D	966-3-2	2020/3/17	2021/3/16
RF Coaxial Cable COMMATE/PEWC	8D	966-3-3	2020/3/17	2021/3/16
Fixed attenuator Mini-Circuits	UNAT-5+	PAD-3m-3-01	2020/9/24	2021/9/23
Horn Antenna Schwarzbeck	BBHA9120-D	9120D-406	2020/11/22	2021/11/21
Pre_Amplifier EMCI	EMC12630SE	980384	2021/1/11	2022/1/10
RF Coaxial Cable EMCI	EMC104-SM-SM-1500	180504	2020/4/29	2021/4/28
RF Coaxial Cable EMCI	EMC104-SM-SM-2000	180601	2020/6/9	2021/6/8
RF Coaxial Cable EMCI	EMC104-SM-SM-6000	180602	2020/6/9	2021/6/8
Fix tool for Boresight antenna tower LIOW GUU	FBA-01	FBA_SIP01	NA	NA
Spectrum Analyzer Keysight	N9030A	MY54490679	2020/7/13	2021/7/12
Pre_Amplifier EMCI	EMC184045SE	980387	2021/1/11	2022/1/10
SHF-EHF Horn Schwarzbeck	BBHA 9170	BBHA9170519	2020/11/22	2021/11/21
RF Cable-Frequency range: 1-40GHz EMCI	EMC102-KM-KM-1200	160924	2021/1/11	2022/1/10
RF cable (40GHz) EMCI	EMC-KM-KM-4000	200214	2020/3/11	2021/3/10

Note:

1. The calibration interval of the above test instruments is 12 months and the calibrations are traceable to NML/ROC and NIST/USA.
2. The test was performed in 966 Chamber No. 3.
3. Tested Date: 2021/1/15 ~ 2021/1/31

For other test items:

DESCRIPTION & MANUFACTURER	MODEL NO.	SERIAL NO.	CALIBRATED DATE	CALIBRATED UNTIL
Spectrum Analyzer R&S	FSV40	101516	2021/3/8	2022/3/7
Power Meter Anritsu	ML2495A	1529002	2021/6/21	2022/6/20
Pulse Power Sensor Anritsu	MA2411B	1339443	2021/5/31	2022/5/30
Attenuator WOKEN	MDCS18N-10	MDCS18N-10-01	2021/4/13	2022/4/12
Software	ADT_RF Test Software V6.6.5.4	NA	NA	NA
DC POWER SUPPLY Topward	6603D	795558	NA	NA
Temperature & Humidity Chamber Giant Force	GTH-150-40-SP-AR	MAA0812-008	2021/1/14	2022/1/13
True RMS Clamp Meter Fluke	325	31130711WS	2021/6/2	2022/6/1

- NOTE:**
1. The test was performed in Oven room 2.
 2. The calibration interval of the above test instruments is 12 months and the calibrations are traceable to NML/ROC and NIST/USA.
 3. Tested Date: 2021/8/18

4.1.3 Test Procedure

For Radiated emission below 30MHz

- a. The EUT was placed on the top of a rotating table 0.8 meters above the ground at a 3 meter chamber room. The table was rotated 360 degrees to determine the position of the highest radiation.
- b. The EUT was set 3 meters away from the interference-receiving antenna, which was mounted on the top of a variable-height antenna tower.
- c. Parallel, perpendicular, and ground-parallel orientations of the antenna are set to make the measurement.
- d. For each suspected emission, the EUT was arranged to its worst case and the rotatable table was turned from 0 degrees to 360 degrees to find the maximum reading.
- e. The test-receiver system was set to Quasi-Peak Detect Function and Specified Bandwidth with Maximum Hold Mode.

Note:

1. The resolution bandwidth and video bandwidth of test receiver/spectrum analyzer is 9kHz at frequency below 30MHz.

For Radiated emission above 30MHz

- a. The EUT was placed on the top of a rotating table 0.8 meters (for 30MHz ~ 1GHz) / 1.5 meters (for above 1GHz) above the ground at 3 meter chamber room for test. The table was rotated 360 degrees to determine the position of the highest radiation.
- b. The EUT was set 3 meters away from the interference-receiving antenna, which was mounted on the top of a variable-height antenna tower.
- c. The height of antenna is varied from one meter to four meters above the ground to determine the maximum value of the field strength. Both horizontal and vertical polarizations of the antenna are set to make the measurement.
- d. For each suspected emission, the EUT was arranged to its worst case and then the antenna was tuned to heights from 1 meter to 4 meters and the rotatable table was turned from 0 degrees to 360 degrees to find the maximum reading.
- e. The test-receiver system was set to quasi-peak detect function and specified bandwidth with maximum hold mode when the test frequency is below 1 GHz.
- f. The test-receiver system was set to peak and average detects function and specified bandwidth with maximum hold mode when the test frequency is above 1 GHz. If the peak reading value also meets average limit, measurement with the average detector is unnecessary.

Note:

1. The resolution bandwidth and video bandwidth of test receiver/spectrum analyzer is 120kHz for Quasi-peak detection (QP) at frequency below 1GHz.
2. The resolution bandwidth of test receiver/spectrum analyzer is 1 MHz and the video bandwidth is 3 MHz for Peak detection (PK) at frequency above 1GHz.
3. The resolution bandwidth of test receiver/spectrum analyzer is 1MHz and the video bandwidth is $\geq 1/T$ (Duty cycle < 98%) or 10Hz (Duty cycle $\geq 98\%$) for Average detection (AV) at frequency above 1GHz.
4. All modes of operation were investigated and the worst-case emissions are reported.

4.1.4 Deviation from Test Standard

No deviation.

4.1.5 Test Setup

For Radiated emission below 30MHz

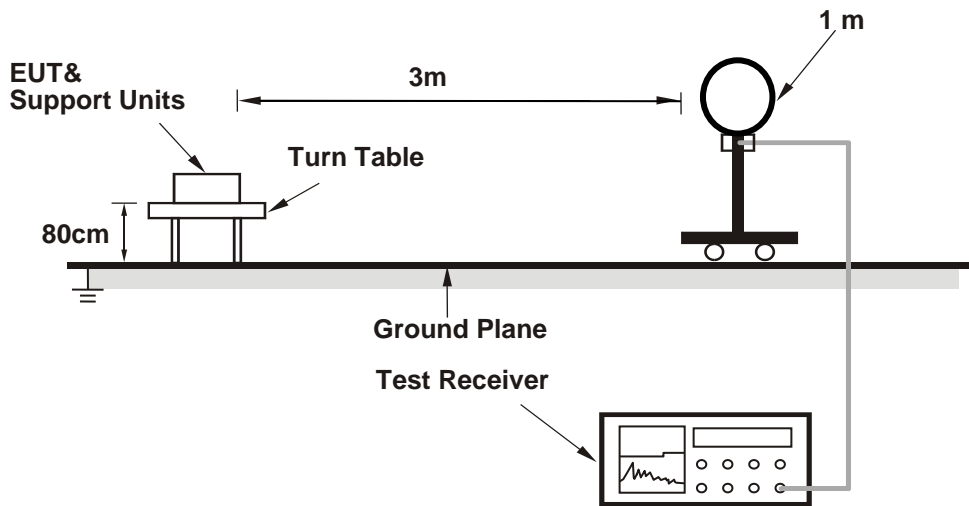

For Radiated emission 30MHz to 1GHz

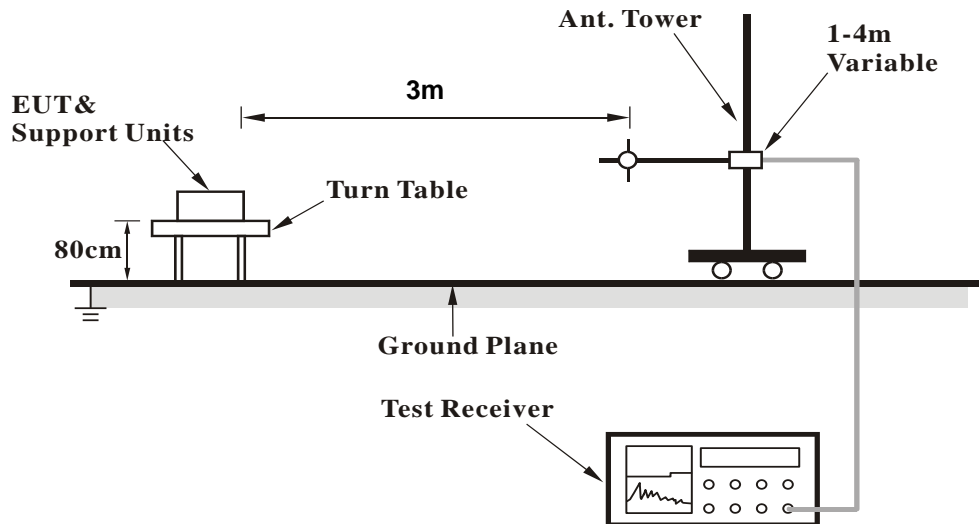

For Radiated emission above 1GHz

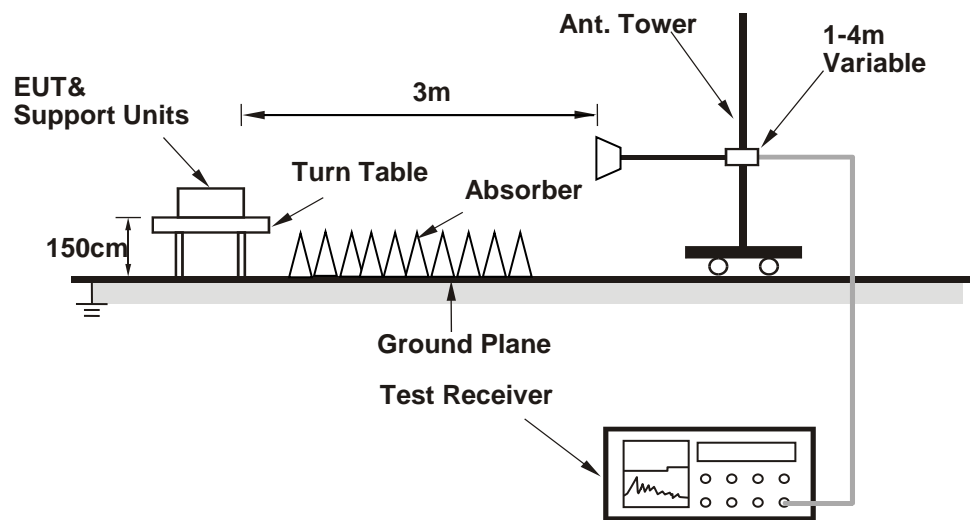

For the actual test configuration, please refer to the attached file (Test Setup Photo).

4.1.6 EUT Operating Condition

- Connected the EUT with the Laptop which is placed on the testing table.
- Controlling software (Qualcomm Radio Control Toolkit v4.0 v4.0-00147) has been activated to set the EUT under transmission condition continuously.

4.1.7 Test Results

Above 1GHz Data

RF Mode	TX 802.11a	Channel	CH 36 : 5180 MHz
Frequency Range	1GHz ~ 40GHz	Detector Function	Peak (PK) Average (AV)

Antenna Polarity & Test Distance : Horizontal at 3 m								
No	Frequency (MHz)	Emission Level (dBuV/m)	Limit (dBuV/m)	Margin (dB)	Antenna Height (m)	Table Angle (Degree)	Raw Value (dBuV)	Correction Factor (dB/m)
1	5150.00	63.1 PK	74.0	-10.9	1.03 H	260	57.9	5.2
2	5150.00	53.7 AV	54.0	-0.3	1.03 H	260	48.5	5.2
3	*5180.00	113.8 PK			1.03 H	260	108.8	5.0
4	*5180.00	103.2 AV			1.03 H	260	98.2	5.0
5	#10360.00	45.8 PK	68.2	-22.4	1.63 H	238	31.6	14.2
6	15540.00	46.3 PK	74.0	-27.7	2.13 H	116	31.4	14.9
7	15540.00	35.7 AV	54.0	-18.3	2.13 H	116	20.8	14.9
Antenna Polarity & Test Distance : Vertical at 3 m								
No	Frequency (MHz)	Emission Level (dBuV/m)	Limit (dBuV/m)	Margin (dB)	Antenna Height (m)	Table Angle (Degree)	Raw Value (dBuV)	Correction Factor (dB/m)
1	5150.00	63.1 PK	74.0	-10.9	1.04 V	246	57.9	5.2
2	5150.00	53.5 AV	54.0	-0.5	1.04 V	246	48.3	5.2
3	*5180.00	113.3 PK			1.04 V	246	108.3	5.0
4	*5180.00	103.0 AV			1.04 V	246	98.0	5.0
5	#10360.00	50.9 PK	68.2	-17.3	1.42 V	174	36.7	14.2
6	15540.00	45.2 PK	74.0	-28.8	1.44 V	139	30.3	14.9
7	15540.00	34.9 AV	54.0	-19.1	1.44 V	139	20.0	14.9

Remarks:

1. Emission Level(dBuV/m) = Raw Value(dBuV) + Correction Factor(dB/m)
2. Correction Factor(dB/m) = Antenna Factor(dB/m) + Cable Factor(dB) – Pre-Amplifier Factor(dB)
3. Margin value = Emission Level – Limit value
4. The other emission levels were very low against the limit.
5. " * ": Fundamental frequency.
6. " # ": The radiated frequency is out of the restricted band.

RF Mode	TX 802.11a	Channel	CH 40 : 5200 MHz
Frequency Range	1GHz ~ 40GHz	Detector Function	Peak (PK) Average (AV)

Antenna Polarity & Test Distance : Horizontal at 3 m

No	Frequency (MHz)	Emission Level (dBuV/m)	Limit (dBuV/m)	Margin (dB)	Antenna Height (m)	Table Angle (Degree)	Raw Value (dBuV)	Correction Factor (dB/m)
1	*5200.00	113.5 PK			1.06 H	273	108.7	4.8
2	*5200.00	103.2 AV			1.06 H	273	98.4	4.8
3	#10400.00	46.2 PK	68.2	-22.0	1.64 H	239	32.0	14.2
4	15600.00	45.7 PK	74.0	-28.3	2.13 H	106	30.7	15.0
5	15600.00	35.3 AV	54.0	-18.7	2.13 H	106	20.3	15.0

Antenna Polarity & Test Distance : Vertical at 3 m

No	Frequency (MHz)	Emission Level (dBuV/m)	Limit (dBuV/m)	Margin (dB)	Antenna Height (m)	Table Angle (Degree)	Raw Value (dBuV)	Correction Factor (dB/m)
1	*5200.00	113.4 PK			1.00 V	238	108.6	4.8
2	*5200.00	102.9 AV			1.00 V	238	98.1	4.8
3	#10400.00	51.2 PK	68.2	-17.0	1.38 V	160	37.0	14.2
4	15600.00	45.3 PK	74.0	-28.7	1.45 V	136	30.3	15.0
5	15600.00	35.2 AV	54.0	-18.8	1.45 V	136	20.2	15.0

Remarks:

1. Emission Level(dBuV/m) = Raw Value(dBuV) + Correction Factor(dB/m)
2. Correction Factor(dB/m) = Antenna Factor(dB/m) + Cable Factor(dB) – Pre-Amplifier Factor(dB)
3. Margin value = Emission Level – Limit value
4. The other emission levels were very low against the limit.
5. " * " : Fundamental frequency.
6. " # " : The radiated frequency is out of the restricted band.

RF Mode	TX 802.11a	Channel	CH 48 : 5240 MHz
Frequency Range	1GHz ~ 40GHz	Detector Function	Peak (PK) Average (AV)

Antenna Polarity & Test Distance : Horizontal at 3 m

No	Frequency (MHz)	Emission Level (dBuV/m)	Limit (dBuV/m)	Margin (dB)	Antenna Height (m)	Table Angle (Degree)	Raw Value (dBuV)	Correction Factor (dB/m)
1	*5240.00	112.3 PK			1.09 H	266	107.5	4.8
2	*5240.00	101.6 AV			1.09 H	266	96.8	4.8
3	5350.00	48.9 PK	74.0	-25.1	1.09 H	266	44.1	4.8
4	5350.00	37.2 AV	54.0	-16.8	1.09 H	266	32.4	4.8
5	#10480.00	46.0 PK	68.2	-22.2	1.58 H	235	31.9	14.1
6	15720.00	46.6 PK	74.0	-27.4	2.16 H	102	31.8	14.8
7	15720.00	36.0 AV	54.0	-18.0	2.16 H	102	21.2	14.8

Antenna Polarity & Test Distance : Vertical at 3 m

No	Frequency (MHz)	Emission Level (dBuV/m)	Limit (dBuV/m)	Margin (dB)	Antenna Height (m)	Table Angle (Degree)	Raw Value (dBuV)	Correction Factor (dB/m)
1	*5240.00	113.7 PK			1.07 V	244	108.9	4.8
2	*5240.00	104.5 AV			1.07 V	244	99.7	4.8
3	5350.00	50.3 PK	74.0	-23.7	1.07 V	244	45.5	4.8
4	5350.00	38.7 AV	54.0	-15.3	1.07 V	244	33.9	4.8
5	#10480.00	50.7 PK	68.2	-17.5	1.45 V	173	36.6	14.1
6	15720.00	45.2 PK	74.0	-28.8	1.40 V	140	30.4	14.8
7	15720.00	34.7 AV	54.0	-19.3	1.40 V	140	19.9	14.8

Remarks:

1. Emission Level(dBuV/m) = Raw Value(dBuV) + Correction Factor(dB/m)
2. Correction Factor(dB/m) = Antenna Factor(dB/m) + Cable Factor(dB) – Pre-Amplifier Factor(dB)
3. Margin value = Emission Level – Limit value
4. The other emission levels were very low against the limit.
5. " * ": Fundamental frequency.
6. " # ": The radiated frequency is out of the restricted band.

RF Mode	TX 802.11a	Channel	CH 52 : 5260 MHz
Frequency Range	1GHz ~ 40GHz	Detector Function	Peak (PK) Average (AV)

Antenna Polarity & Test Distance : Horizontal at 3 m

No	Frequency (MHz)	Emission Level (dBuV/m)	Limit (dBuV/m)	Margin (dB)	Antenna Height (m)	Table Angle (Degree)	Raw Value (dBuV)	Correction Factor (dB/m)
1	5150.00	48.7 PK	74.0	-25.3	1.09 H	262	43.5	5.2
2	5150.00	38.5 AV	54.0	-15.5	1.09 H	262	33.3	5.2
3	*5260.00	113.6 PK			1.09 H	262	108.8	4.8
4	*5260.00	103.1 AV			1.09 H	262	98.3	4.8
5	#10520.00	46.5 PK	68.2	-21.7	1.60 H	252	32.4	14.1
6	15780.00	46.4 PK	74.0	-27.6	2.13 H	107	31.9	14.5
7	15780.00	35.5 AV	54.0	-18.5	2.13 H	107	21.0	14.5

Antenna Polarity & Test Distance : Vertical at 3 m

No	Frequency (MHz)	Emission Level (dBuV/m)	Limit (dBuV/m)	Margin (dB)	Antenna Height (m)	Table Angle (Degree)	Raw Value (dBuV)	Correction Factor (dB/m)
1	5150.00	49.8 PK	74.0	-24.2	1.08 V	229	44.6	5.2
2	5150.00	38.2 AV	54.0	-15.8	1.08 V	229	33.0	5.2
3	*5260.00	113.7 PK			1.08 V	229	108.9	4.8
4	*5260.00	103.3 AV			1.08 V	229	98.5	4.8
5	#10520.00	51.2 PK	68.2	-17.0	1.38 V	171	37.1	14.1
6	15780.00	45.2 PK	74.0	-28.8	1.45 V	131	30.7	14.5
7	15780.00	34.7 AV	54.0	-19.3	1.45 V	131	20.2	14.5

Remarks:

1. Emission Level(dBuV/m) = Raw Value(dBuV) + Correction Factor(dB/m)
2. Correction Factor(dB/m) = Antenna Factor(dB/m) + Cable Factor(dB) – Pre-Amplifier Factor(dB)
3. Margin value = Emission Level – Limit value
4. The other emission levels were very low against the limit.
5. " * ": Fundamental frequency.
6. " # ": The radiated frequency is out of the restricted band.

RF Mode	TX 802.11a	Channel	CH 60 : 5300 MHz
Frequency Range	1GHz ~ 40GHz	Detector Function	Peak (PK) Average (AV)

Antenna Polarity & Test Distance : Horizontal at 3 m

No	Frequency (MHz)	Emission Level (dBuV/m)	Limit (dBuV/m)	Margin (dB)	Antenna Height (m)	Table Angle (Degree)	Raw Value (dBuV)	Correction Factor (dB/m)
1	*5300.00	113.2 PK			1.07 H	248	108.4	4.8
2	*5300.00	102.8 AV			1.07 H	248	98.0	4.8
3	10600.00	46.0 PK	74.0	-28.0	1.67 H	245	31.8	14.2
4	10600.00	35.5 AV	54.0	-18.5	1.67 H	245	21.3	14.2
5	15900.00	46.3 PK	74.0	-27.7	2.17 H	113	31.8	14.5
6	15900.00	35.4 AV	54.0	-18.6	2.17 H	113	20.9	14.5

Antenna Polarity & Test Distance : Vertical at 3 m

No	Frequency (MHz)	Emission Level (dBuV/m)	Limit (dBuV/m)	Margin (dB)	Antenna Height (m)	Table Angle (Degree)	Raw Value (dBuV)	Correction Factor (dB/m)
1	*5300.00	113.6 PK			1.03 V	223	108.8	4.8
2	*5300.00	103.0 AV			1.03 V	223	98.2	4.8
3	10600.00	45.2 PK	74.0	-28.8	1.57 V	222	31.0	14.2
4	10600.00	35.1 AV	54.0	-18.9	1.57 V	222	20.9	14.2
5	15900.00	46.4 PK	74.0	-27.6	2.17 V	109	31.9	14.5
6	15900.00	35.8 AV	54.0	-18.2	2.17 V	109	21.3	14.5

Remarks:

1. Emission Level(dBuV/m) = Raw Value(dBuV) + Correction Factor(dB/m)
2. Correction Factor(dB/m) = Antenna Factor(dB/m) + Cable Factor(dB) – Pre-Amplifier Factor(dB)
3. Margin value = Emission Level – Limit value
4. The other emission levels were very low against the limit.
5. " * ": Fundamental frequency.

RF Mode	TX 802.11a	Channel	CH 64 : 5320 MHz
Frequency Range	1GHz ~ 40GHz	Detector Function	Peak (PK) Average (AV)

Antenna Polarity & Test Distance : Horizontal at 3 m								
No	Frequency (MHz)	Emission Level (dBuV/m)	Limit (dBuV/m)	Margin (dB)	Antenna Height (m)	Table Angle (Degree)	Raw Value (dBuV)	Correction Factor (dB/m)
1	*5320.00	111.9 PK			1.02 H	265	107.1	4.8
2	*5320.00	102.6 AV			1.02 H	265	97.8	4.8
3	5350.00	64.2 PK	74.0	-9.8	1.02 H	265	59.4	4.8
4	5350.00	53.4 AV	54.0	-0.6	1.02 H	265	48.6	4.8
5	10640.00	45.4 PK	74.0	-28.6	1.57 H	224	31.1	14.3
6	10640.00	35.4 AV	54.0	-18.6	1.57 H	224	21.1	14.3
7	15960.00	46.5 PK	74.0	-27.5	2.22 H	116	31.8	14.7
8	15960.00	36.1 AV	54.0	-17.9	2.22 H	116	21.4	14.7

Antenna Polarity & Test Distance : Vertical at 3 m								
No	Frequency (MHz)	Emission Level (dBuV/m)	Limit (dBuV/m)	Margin (dB)	Antenna Height (m)	Table Angle (Degree)	Raw Value (dBuV)	Correction Factor (dB/m)
1	*5320.00	115.1 PK			1.02 V	248	110.3	4.8
2	*5320.00	105.3 AV			1.02 V	248	100.5	4.8
3	5350.00	66.2 PK	74.0	-7.8	1.02 V	248	61.4	4.8
4	5350.00	53.2 AV	54.0	-0.8	1.02 V	248	48.4	4.8
5	10640.00	45.7 PK	74.0	-28.3	1.57 V	210	31.4	14.3
6	10640.00	35.5 AV	54.0	-18.5	1.57 V	210	21.2	14.3
7	15960.00	46.7 PK	74.0	-27.3	2.22 V	98	32.0	14.7
8	15960.00	36.2 AV	54.0	-17.8	2.22 V	98	21.5	14.7

Remarks:

1. Emission Level(dBuV/m) = Raw Value(dBuV) + Correction Factor(dB/m)
2. Correction Factor(dB/m) = Antenna Factor(dB/m) + Cable Factor(dB) – Pre-Amplifier Factor(dB)
3. Margin value = Emission Level – Limit value
4. The other emission levels were very low against the limit.
5. " * ": Fundamental frequency.

RF Mode	TX 802.11a	Channel	CH 100 : 5500 MHz
Frequency Range	1GHz ~ 40GHz	Detector Function	Peak (PK) Average (AV)

Antenna Polarity & Test Distance : Horizontal at 3 m

No	Frequency (MHz)	Emission Level (dBuV/m)	Limit (dBuV/m)	Margin (dB)	Antenna Height (m)	Table Angle (Degree)	Raw Value (dBuV)	Correction Factor (dB/m)
1	5460.00	60.6 PK	74.0	-13.4	1.08 H	267	55.7	4.9
2	5460.00	48.7 AV	54.0	-5.3	1.08 H	267	43.8	4.9
3	#5470.00	67.5 PK	68.2	-0.7	1.08 H	267	62.5	5.0
4	*5500.00	111.1 PK			1.08 H	267	106.0	5.1
5	*5500.00	102.1 AV			1.08 H	267	97.0	5.1
6	11000.00	45.9 PK	74.0	-28.1	1.60 H	248	31.2	14.7
7	11000.00	35.7 AV	54.0	-18.3	1.60 H	248	21.0	14.7
8	#16500.00	46.4 PK	68.2	-21.8	2.16 H	88	29.9	16.5

Antenna Polarity & Test Distance : Vertical at 3 m

No	Frequency (MHz)	Emission Level (dBuV/m)	Limit (dBuV/m)	Margin (dB)	Antenna Height (m)	Table Angle (Degree)	Raw Value (dBuV)	Correction Factor (dB/m)
1	5460.00	58.4 PK	74.0	-15.6	1.11 V	241	53.5	4.9
2	5460.00	47.3 AV	54.0	-6.7	1.11 V	241	42.4	4.9
3	#5468.40	62.1 PK	68.2	-6.1	1.11 V	241	57.1	5.0
4	*5500.00	114.3 PK			1.11 V	241	109.2	5.1
5	*5500.00	104.6 AV			1.11 V	241	99.5	5.1
6	11000.00	46.1 PK	74.0	-27.9	1.57 V	220	31.4	14.7
7	11000.00	35.8 AV	54.0	-18.2	1.57 V	220	21.1	14.7
8	#16500.00	46.1 PK	68.2	-22.1	2.26 V	92	29.6	16.5

Remarks:

1. Emission Level(dBuV/m) = Raw Value(dBuV) + Correction Factor(dB/m)
2. Correction Factor(dB/m) = Antenna Factor(dB/m) + Cable Factor(dB) – Pre-Amplifier Factor(dB)
3. Margin value = Emission Level – Limit value
4. The other emission levels were very low against the limit.
5. " * ": Fundamental frequency.
6. " # ": The radiated frequency is out of the restricted band.

RF Mode	TX 802.11a	Channel	CH 116 : 5580 MHz
Frequency Range	1GHz ~ 40GHz	Detector Function	Peak (PK) Average (AV)

Antenna Polarity & Test Distance : Horizontal at 3 m

No	Frequency (MHz)	Emission Level (dBuV/m)	Limit (dBuV/m)	Margin (dB)	Antenna Height (m)	Table Angle (Degree)	Raw Value (dBuV)	Correction Factor (dB/m)
1	*5580.00	113.2 PK			1.06 H	241	108.2	5.0
2	*5580.00	102.7 AV			1.06 H	241	97.7	5.0
3	11160.00	45.9 PK	74.0	-28.1	1.63 H	246	31.3	14.6
4	11160.00	35.4 AV	54.0	-18.6	1.63 H	246	20.8	14.6
5	#16740.00	46.0 PK	68.2	-22.2	2.10 H	96	28.7	17.3

Antenna Polarity & Test Distance : Vertical at 3 m

No	Frequency (MHz)	Emission Level (dBuV/m)	Limit (dBuV/m)	Margin (dB)	Antenna Height (m)	Table Angle (Degree)	Raw Value (dBuV)	Correction Factor (dB/m)
1	*5580.00	113.5 PK			1.06 V	234	108.5	5.0
2	*5580.00	103.1 AV			1.06 V	234	98.1	5.0
3	11160.00	45.1 PK	74.0	-28.9	1.51 V	203	30.5	14.6
4	11160.00	35.2 AV	54.0	-18.8	1.51 V	203	20.6	14.6
5	#16740.00	46.5 PK	68.2	-21.7	2.17 V	98	29.2	17.3

Remarks:

1. Emission Level(dBuV/m) = Raw Value(dBuV) + Correction Factor(dB/m)
2. Correction Factor(dB/m) = Antenna Factor(dB/m) + Cable Factor(dB) – Pre-Amplifier Factor(dB)
3. Margin value = Emission Level – Limit value
4. The other emission levels were very low against the limit.
5. " * ": Fundamental frequency.
6. " # ": The radiated frequency is out of the restricted band.

RF Mode	TX 802.11a	Channel	CH 140 : 5700 MHz
Frequency Range	1GHz ~ 40GHz	Detector Function	Peak (PK) Average (AV)

Antenna Polarity & Test Distance : Horizontal at 3 m

No	Frequency (MHz)	Emission Level (dBuV/m)	Limit (dBuV/m)	Margin (dB)	Antenna Height (m)	Table Angle (Degree)	Raw Value (dBuV)	Correction Factor (dB/m)
1	*5700.00	111.9 PK			1.11 H	261	106.8	5.1
2	*5700.00	102.5 AV			1.11 H	261	97.4	5.1
3	#5725.00	67.6 PK	68.2	-0.6	1.11 H	261	62.4	5.2
4	11400.00	45.7 PK	74.0	-28.3	1.61 H	250	30.7	15.0
5	11400.00	35.5 AV	54.0	-18.5	1.61 H	250	20.5	15.0
6	#17100.00	46.2 PK	68.2	-22.0	2.11 H	96	27.7	18.5

Antenna Polarity & Test Distance : Vertical at 3 m

No	Frequency (MHz)	Emission Level (dBuV/m)	Limit (dBuV/m)	Margin (dB)	Antenna Height (m)	Table Angle (Degree)	Raw Value (dBuV)	Correction Factor (dB/m)
1	*5700.00	115.3 PK			1.01 V	246	110.2	5.1
2	*5700.00	105.8 AV			1.01 V	246	100.7	5.1
3	#5725.00	58.6 PK	68.2	-9.6	1.01 V	246	53.4	5.2
4	11400.00	45.5 PK	74.0	-28.5	1.59 V	214	30.5	15.0
5	11400.00	35.0 AV	54.0	-19.0	1.59 V	214	20.0	15.0
6	#17100.00	47.5 PK	68.2	-20.7	2.22 V	111	29.0	18.5
7	#17100.00	36.7 AV	54.0	-17.3	2.22 V	111	18.2	18.5

Remarks:

1. Emission Level(dBuV/m) = Raw Value(dBuV) + Correction Factor(dB/m)
2. Correction Factor(dB/m) = Antenna Factor(dB/m) + Cable Factor(dB) – Pre-Amplifier Factor(dB)
3. Margin value = Emission Level – Limit value
4. The other emission levels were very low against the limit.
5. " * ": Fundamental frequency.
6. " # ": The radiated frequency is out of the restricted band.

RF Mode	TX 802.11a	Channel	CH 144 : 5720 MHz
Frequency Range	1GHz ~ 40GHz	Detector Function	Peak (PK) Average (AV)

Antenna Polarity & Test Distance : Horizontal at 3 m

No	Frequency (MHz)	Emission Level (dBuV/m)	Limit (dBuV/m)	Margin (dB)	Antenna Height (m)	Table Angle (Degree)	Raw Value (dBuV)	Correction Factor (dB/m)
1	5460.00	49.2 PK	74.0	-24.8	1.09 H	264	44.3	4.9
2	5460.00	37.4 AV	54.0	-16.6	1.09 H	264	32.5	4.9
3	#5470.00	49.4 PK	68.2	-18.8	1.09 H	264	44.4	5.0
4	*5720.00	113.1 PK			1.09 H	264	107.9	5.2
5	*5720.00	103.4 AV			1.09 H	264	98.2	5.2
6	#5850.00	51.9 PK	68.2	-16.3	1.09 H	264	46.4	5.5
7	11440.00	45.7 PK	74.0	-28.3	1.67 H	240	30.6	15.1
8	11440.00	35.3 AV	54.0	-18.7	1.67 H	240	20.2	15.1
9	#17160.00	46.0 PK	68.2	-22.2	2.10 H	110	27.5	18.5

Antenna Polarity & Test Distance : Vertical at 3 m

No	Frequency (MHz)	Emission Level (dBuV/m)	Limit (dBuV/m)	Margin (dB)	Antenna Height (m)	Table Angle (Degree)	Raw Value (dBuV)	Correction Factor (dB/m)
1	5460.00	48.7 PK	74.0	-25.3	1.05 V	229	43.8	4.9
2	5460.00	37.0 AV	54.0	-17.0	1.05 V	229	32.1	4.9
3	#5470.00	49.2 PK	68.2	-19.0	1.05 V	229	44.2	5.0
4	*5720.00	113.7 PK			1.05 V	229	108.5	5.2
5	*5720.00	103.0 AV			1.05 V	229	97.8	5.2
6	#5850.00	51.5 PK	68.2	-16.7	1.05 V	229	46.0	5.5
7	11440.00	45.6 PK	74.0	-28.4	1.59 V	201	30.5	15.1
8	11440.00	35.3 AV	54.0	-18.7	1.59 V	201	20.2	15.1
9	#17160.00	46.2 PK	68.2	-22.0	2.16 V	88	27.7	18.5

Remarks:

1. Emission Level(dBuV/m) = Raw Value(dBuV) + Correction Factor(dB/m)
2. Correction Factor(dB/m) = Antenna Factor(dB/m) + Cable Factor(dB) – Pre-Amplifier Factor(dB)
3. Margin value = Emission Level – Limit value
4. The other emission levels were very low against the limit.
5. " * ": Fundamental frequency.
6. " # ": The radiated frequency is out of the restricted band.

RF Mode	TX 802.11a	Channel	CH 149 : 5745 MHz
Frequency Range	1GHz ~ 40GHz	Detector Function	Peak (PK) Average (AV)

Antenna Polarity & Test Distance : Horizontal at 3 m

No	Frequency (MHz)	Emission Level (dBuV/m)	Limit (dBuV/m)	Margin (dB)	Antenna Height (m)	Table Angle (Degree)	Raw Value (dBuV)	Correction Factor (dB/m)
1	#5616.05	52.1 PK	68.2	-16.1	1.03 H	271	47.1	5.0
2	*5745.00	115.3 PK			1.03 H	271	109.9	5.4
3	*5745.00	105.6 AV			1.03 H	271	100.2	5.4
4	#5938.31	52.8 PK	68.2	-15.4	1.03 H	271	47.2	5.6
5	11490.00	48.7 PK	74.0	-25.3	1.57 H	234	33.6	15.1
6	11490.00	36.4 AV	54.0	-17.6	1.57 H	234	21.3	15.1
7	#17235.00	52.4 PK	68.2	-15.8	2.16 H	85	33.8	18.6

Antenna Polarity & Test Distance : Vertical at 3 m

No	Frequency (MHz)	Emission Level (dBuV/m)	Limit (dBuV/m)	Margin (dB)	Antenna Height (m)	Table Angle (Degree)	Raw Value (dBuV)	Correction Factor (dB/m)
1	#5591.57	54.9 PK	68.2	-13.3	1.07 V	241	49.9	5.0
2	*5745.00	118.0 PK			1.07 V	241	112.6	5.4
3	*5745.00	108.5 AV			1.07 V	241	103.1	5.4
4	#5988.52	53.1 PK	68.2	-15.1	1.07 V	241	47.3	5.8
5	11490.00	49.1 PK	74.0	-24.9	1.38 V	166	34.0	15.1
6	11490.00	37.8 AV	54.0	-16.2	1.38 V	166	22.7	15.1
7	#17235.00	53.1 PK	68.2	-15.1	1.50 V	151	34.5	18.6

Remarks:

1. Emission Level(dBuV/m) = Raw Value(dBuV) + Correction Factor(dB/m)
2. Correction Factor(dB/m) = Antenna Factor(dB/m) + Cable Factor(dB) – Pre-Amplifier Factor(dB)
3. Margin value = Emission Level – Limit value
4. The other emission levels were very low against the limit.
5. " * ": Fundamental frequency.
6. " # ": The radiated frequency is out of the restricted band.

RF Mode	TX 802.11a	Channel	CH 157 : 5785 MHz
Frequency Range	1GHz ~ 40GHz	Detector Function	Peak (PK) Average (AV)

Antenna Polarity & Test Distance : Horizontal at 3 m

No	Frequency (MHz)	Emission Level (dBuV/m)	Limit (dBuV/m)	Margin (dB)	Antenna Height (m)	Table Angle (Degree)	Raw Value (dBuV)	Correction Factor (dB/m)
1	#5607.30	51.7 PK	68.2	-16.5	1.01 H	269	46.7	5.0
2	*5785.00	114.6 PK			1.01 H	269	109.1	5.5
3	*5785.00	105.4 AV			1.01 H	269	99.9	5.5
4	#5973.53	52.2 PK	68.2	-16.0	1.01 H	269	46.4	5.8
5	11570.00	48.9 PK	74.0	-25.1	1.59 H	247	34.0	14.9
6	11570.00	36.6 AV	54.0	-17.4	1.59 H	247	21.7	14.9
7	#17355.00	52.1 PK	68.2	-16.1	2.19 H	96	33.2	18.9

Antenna Polarity & Test Distance : Vertical at 3 m

No	Frequency (MHz)	Emission Level (dBuV/m)	Limit (dBuV/m)	Margin (dB)	Antenna Height (m)	Table Angle (Degree)	Raw Value (dBuV)	Correction Factor (dB/m)
1	#5569.05	53.6 PK	68.2	-14.6	1.06 V	238	48.5	5.1
2	*5785.00	117.4 PK			1.06 V	238	111.9	5.5
3	*5785.00	108.2 AV			1.06 V	238	102.7	5.5
4	#5940.26	53.6 PK	68.2	-14.6	1.06 V	238	48.0	5.6
5	11570.00	49.1 PK	74.0	-24.9	1.44 V	171	34.2	14.9
6	11570.00	37.9 AV	54.0	-16.1	1.44 V	171	23.0	14.9
7	#17355.00	52.5 PK	68.2	-15.7	1.47 V	150	33.6	18.9

Remarks:

1. Emission Level(dBuV/m) = Raw Value(dBuV) + Correction Factor(dB/m)
2. Correction Factor(dB/m) = Antenna Factor(dB/m) + Cable Factor(dB) – Pre-Amplifier Factor(dB)
3. Margin value = Emission Level – Limit value
4. The other emission levels were very low against the limit.
5. " * ": Fundamental frequency.
6. " # ": The radiated frequency is out of the restricted band.

RF Mode	TX 802.11a	Channel	CH 165 : 5825 MHz
Frequency Range	1GHz ~ 40GHz	Detector Function	Peak (PK) Average (AV)

Antenna Polarity & Test Distance : Horizontal at 3 m

No	Frequency (MHz)	Emission Level (dBuV/m)	Limit (dBuV/m)	Margin (dB)	Antenna Height (m)	Table Angle (Degree)	Raw Value (dBuV)	Correction Factor (dB/m)
1	#5591.04	52.2 PK	68.2	-16.0	1.03 H	270	47.2	5.0
2	*5825.00	114.0 PK			1.03 H	270	108.6	5.4
3	*5825.00	105.0 AV			1.03 H	270	99.6	5.4
4	#5929.90	51.8 PK	68.2	-16.4	1.03 H	270	46.2	5.6
5	11650.00	49.3 PK	74.0	-24.7	1.60 H	252	34.5	14.8
6	11650.00	37.1 AV	54.0	-16.9	1.60 H	252	22.3	14.8
7	#17475.00	52.1 PK	68.2	-16.1	2.21 H	94	32.4	19.7

Antenna Polarity & Test Distance : Vertical at 3 m

No	Frequency (MHz)	Emission Level (dBuV/m)	Limit (dBuV/m)	Margin (dB)	Antenna Height (m)	Table Angle (Degree)	Raw Value (dBuV)	Correction Factor (dB/m)
1	#5579.94	53.8 PK	68.2	-14.4	1.03 V	237	48.8	5.0
2	*5825.00	117.8 PK			1.03 V	237	112.4	5.4
3	*5825.00	108.5 AV			1.03 V	237	103.1	5.4
4	#5988.88	54.8 PK	68.2	-13.4	1.03 V	237	49.0	5.8
5	11650.00	49.0 PK	74.0	-25.0	1.43 V	185	34.2	14.8
6	11650.00	38.1 AV	54.0	-15.9	1.43 V	185	23.3	14.8
7	#17475.00	52.6 PK	68.2	-15.6	1.51 V	145	32.9	19.7

Remarks:

1. Emission Level(dBuV/m) = Raw Value(dBuV) + Correction Factor(dB/m)
2. Correction Factor(dB/m) = Antenna Factor(dB/m) + Cable Factor(dB) – Pre-Amplifier Factor(dB)
3. Margin value = Emission Level – Limit value
4. The other emission levels were very low against the limit.
5. " * ": Fundamental frequency.
6. " # ": The radiated frequency is out of the restricted band.

RF Mode	TX 802.11ac (VHT20)	Channel	CH 36 : 5180 MHz
Frequency Range	1GHz ~ 40GHz	Detector Function	Peak (PK) Average (AV)

Antenna Polarity & Test Distance : Horizontal at 3 m

No	Frequency (MHz)	Emission Level (dBuV/m)	Limit (dBuV/m)	Margin (dB)	Antenna Height (m)	Table Angle (Degree)	Raw Value (dBuV)	Correction Factor (dB/m)
1	5150.00	68.0 PK	74.0	-6.0	1.03 H	264	62.8	5.2
2	5150.00	53.7 AV	54.0	-0.3	1.03 H	264	48.5	5.2
3	*5180.00	113.7 PK			1.03 H	264	108.7	5.0
4	*5180.00	103.4 AV			1.03 H	264	98.4	5.0
5	#10360.00	46.3 PK	68.2	-21.9	1.63 H	227	32.1	14.2
6	15540.00	47.4 PK	74.0	-26.6	2.12 H	102	32.5	14.9
7	15540.00	36.5 AV	54.0	-17.5	2.12 H	102	21.6	14.9

Antenna Polarity & Test Distance : Vertical at 3 m

No	Frequency (MHz)	Emission Level (dBuV/m)	Limit (dBuV/m)	Margin (dB)	Antenna Height (m)	Table Angle (Degree)	Raw Value (dBuV)	Correction Factor (dB/m)
1	5150.00	64.0 PK	74.0	-10.0	1.00 V	238	58.8	5.2
2	5150.00	53.1 AV	54.0	-0.9	1.00 V	238	47.9	5.2
3	*5180.00	116.6 PK			1.00 V	238	111.6	5.0
4	*5180.00	106.8 AV			1.00 V	238	101.8	5.0
5	#10360.00	45.4 PK	68.2	-22.8	1.60 V	186	31.2	14.2
6	15540.00	46.3 PK	74.0	-27.7	2.15 V	100	31.4	14.9
7	15540.00	35.7 AV	54.0	-18.3	2.15 V	100	20.8	14.9

Remarks:

1. Emission Level(dBuV/m) = Raw Value(dBuV) + Correction Factor(dB/m)
2. Correction Factor(dB/m) = Antenna Factor(dB/m) + Cable Factor(dB) – Pre-Amplifier Factor(dB)
3. Margin value = Emission Level – Limit value
4. The other emission levels were very low against the limit.
5. " * ": Fundamental frequency.
6. " # ": The radiated frequency is out of the restricted band.

RF Mode	TX 802.11ac (VHT20)	Channel	CH 40 : 5200 MHz
Frequency Range	1GHz ~ 40GHz	Detector Function	Peak (PK) Average (AV)

Antenna Polarity & Test Distance : Horizontal at 3 m

No	Frequency (MHz)	Emission Level (dBuV/m)	Limit (dBuV/m)	Margin (dB)	Antenna Height (m)	Table Angle (Degree)	Raw Value (dBuV)	Correction Factor (dB/m)
1	*5200.00	114.1 PK			1.03 H	264	109.3	4.8
2	*5200.00	103.8 AV			1.03 H	264	99.0	4.8
3	#10400.00	46.0 PK	68.2	-22.2	1.57 H	233	31.8	14.2
4	15600.00	46.9 PK	74.0	-27.1	2.20 H	94	31.9	15.0
5	15600.00	36.1 AV	54.0	-17.9	2.20 H	94	21.1	15.0

Antenna Polarity & Test Distance : Vertical at 3 m

No	Frequency (MHz)	Emission Level (dBuV/m)	Limit (dBuV/m)	Margin (dB)	Antenna Height (m)	Table Angle (Degree)	Raw Value (dBuV)	Correction Factor (dB/m)
1	*5200.00	118.0 PK			1.12 V	263	113.2	4.8
2	*5200.00	107.6 AV			1.12 V	263	102.8	4.8
3	#10400.00	45.4 PK	68.2	-22.8	1.57 V	203	31.2	14.2
4	15600.00	45.7 PK	74.0	-28.3	2.11 V	73	30.7	15.0
5	15600.00	35.4 AV	54.0	-18.6	2.11 V	73	20.4	15.0

Remarks:

1. Emission Level(dBuV/m) = Raw Value(dBuV) + Correction Factor(dB/m)
2. Correction Factor(dB/m) = Antenna Factor(dB/m) + Cable Factor(dB) – Pre-Amplifier Factor(dB)
3. Margin value = Emission Level – Limit value
4. The other emission levels were very low against the limit.
5. " * ": Fundamental frequency.
6. " # ": The radiated frequency is out of the restricted band.

RF Mode	TX 802.11ac (VHT20)	Channel	CH 48 : 5240 MHz
Frequency Range	1GHz ~ 40GHz	Detector Function	Peak (PK) Average (AV)

Antenna Polarity & Test Distance : Horizontal at 3 m

No	Frequency (MHz)	Emission Level (dBuV/m)	Limit (dBuV/m)	Margin (dB)	Antenna Height (m)	Table Angle (Degree)	Raw Value (dBuV)	Correction Factor (dB/m)
1	*5240.00	112.7 PK			1.07 H	260	107.9	4.8
2	*5240.00	102.2 AV			1.07 H	260	97.4	4.8
3	5350.00	49.7 PK	74.0	-24.3	1.07 H	260	44.9	4.8
4	5350.00	38.4 AV	54.0	-15.6	1.07 H	260	33.6	4.8
5	#10480.00	45.7 PK	68.2	-22.5	1.57 H	227	31.6	14.1
6	15720.00	46.7 PK	74.0	-27.3	2.16 H	106	31.9	14.8
7	15720.00	36.0 AV	54.0	-18.0	2.16 H	106	21.2	14.8

Antenna Polarity & Test Distance : Vertical at 3 m

No	Frequency (MHz)	Emission Level (dBuV/m)	Limit (dBuV/m)	Margin (dB)	Antenna Height (m)	Table Angle (Degree)	Raw Value (dBuV)	Correction Factor (dB/m)
1	*5240.00	115.6 PK			1.10 V	261	110.8	4.8
2	*5240.00	105.4 AV			1.10 V	261	100.6	4.8
3	5350.00	49.5 PK	74.0	-24.5	1.10 V	261	44.7	4.8
4	5350.00	38.5 AV	54.0	-15.5	1.10 V	261	33.7	4.8
5	#10480.00	45.8 PK	68.2	-22.4	1.58 V	205	31.7	14.1
6	15720.00	46.0 PK	74.0	-28.0	2.20 V	102	31.2	14.8
7	15720.00	35.6 AV	54.0	-18.4	2.20 V	102	20.8	14.8

Remarks:

1. Emission Level(dBuV/m) = Raw Value(dBuV) + Correction Factor(dB/m)
2. Correction Factor(dB/m) = Antenna Factor(dB/m) + Cable Factor(dB) – Pre-Amplifier Factor(dB)
3. Margin value = Emission Level – Limit value
4. The other emission levels were very low against the limit.
5. " * ": Fundamental frequency.
6. " # ": The radiated frequency is out of the restricted band.

RF Mode	TX 802.11ac (VHT20)	Channel	CH 52 : 5260 MHz
Frequency Range	1GHz ~ 40GHz	Detector Function	Peak (PK) Average (AV)

Antenna Polarity & Test Distance : Horizontal at 3 m

No	Frequency (MHz)	Emission Level (dBuV/m)	Limit (dBuV/m)	Margin (dB)	Antenna Height (m)	Table Angle (Degree)	Raw Value (dBuV)	Correction Factor (dB/m)
1	5150.00	51.1 PK	74.0	-22.9	1.07 H	264	45.9	5.2
2	5150.00	39.3 AV	54.0	-14.7	1.07 H	264	34.1	5.2
3	*5260.00	114.0 PK			1.07 H	264	109.2	4.8
4	*5260.00	103.7 AV			1.07 H	264	98.9	4.8
5	#10520.00	45.5 PK	68.2	-22.7	1.54 H	232	31.4	14.1
6	15780.00	46.7 PK	74.0	-27.3	2.21 H	113	32.2	14.5
7	15780.00	36.2 AV	54.0	-17.8	2.21 H	113	21.7	14.5

Antenna Polarity & Test Distance : Vertical at 3 m

No	Frequency (MHz)	Emission Level (dBuV/m)	Limit (dBuV/m)	Margin (dB)	Antenna Height (m)	Table Angle (Degree)	Raw Value (dBuV)	Correction Factor (dB/m)
1	5150.00	51.2 PK	74.0	-22.8	1.09 V	249	46.0	5.2
2	5150.00	39.5 AV	54.0	-14.5	1.09 V	249	34.3	5.2
3	*5260.00	117.3 PK			1.09 V	249	112.5	4.8
4	*5260.00	107.1 AV			1.09 V	249	102.3	4.8
5	#10520.00	45.6 PK	68.2	-22.6	1.62 V	214	31.5	14.1
6	15780.00	46.7 PK	74.0	-27.3	2.16 V	97	32.2	14.5
7	15780.00	36.1 AV	54.0	-17.9	2.16 V	97	21.6	14.5

Remarks:

1. Emission Level(dBuV/m) = Raw Value(dBuV) + Correction Factor(dB/m)
2. Correction Factor(dB/m) = Antenna Factor(dB/m) + Cable Factor(dB) – Pre-Amplifier Factor(dB)
3. Margin value = Emission Level – Limit value
4. The other emission levels were very low against the limit.
5. " * ": Fundamental frequency.
6. " # ": The radiated frequency is out of the restricted band.

RF Mode	TX 802.11ac (VHT20)	Channel	CH 60 : 5300 MHz
Frequency Range	1GHz ~ 40GHz	Detector Function	Peak (PK) Average (AV)

Antenna Polarity & Test Distance : Horizontal at 3 m

No	Frequency (MHz)	Emission Level (dBuV/m)	Limit (dBuV/m)	Margin (dB)	Antenna Height (m)	Table Angle (Degree)	Raw Value (dBuV)	Correction Factor (dB/m)
1	*5300.00	113.7 PK			1.05 H	267	108.9	4.8
2	*5300.00	103.5 AV			1.05 H	267	98.7	4.8
3	10600.00	46.3 PK	74.0	-27.7	1.55 H	237	32.1	14.2
4	10600.00	35.8 AV	54.0	-18.2	1.55 H	237	21.6	14.2
5	15900.00	46.2 PK	74.0	-27.8	2.17 H	93	31.7	14.5
6	15900.00	35.8 AV	54.0	-18.2	2.17 H	93	21.3	14.5

Antenna Polarity & Test Distance : Vertical at 3 m

No	Frequency (MHz)	Emission Level (dBuV/m)	Limit (dBuV/m)	Margin (dB)	Antenna Height (m)	Table Angle (Degree)	Raw Value (dBuV)	Correction Factor (dB/m)
1	*5300.00	117.1 PK			1.04 V	238	112.3	4.8
2	*5300.00	106.8 AV			1.04 V	238	102.0	4.8
3	10600.00	45.7 PK	74.0	-28.3	1.61 V	202	31.5	14.2
4	10600.00	35.2 AV	54.0	-18.8	1.61 V	202	21.0	14.2
5	15900.00	46.3 PK	74.0	-27.7	2.21 V	91	31.8	14.5
6	15900.00	36.0 AV	54.0	-18.0	2.21 V	91	21.5	14.5

Remarks:

1. Emission Level(dBuV/m) = Raw Value(dBuV) + Correction Factor(dB/m)
2. Correction Factor(dB/m) = Antenna Factor(dB/m) + Cable Factor(dB) – Pre-Amplifier Factor(dB)
3. Margin value = Emission Level – Limit value
4. The other emission levels were very low against the limit.
5. " * ": Fundamental frequency.

RF Mode	TX 802.11ac (VHT20)	Channel	CH 64 : 5320 MHz
Frequency Range	1GHz ~ 40GHz	Detector Function	Peak (PK) Average (AV)

Antenna Polarity & Test Distance : Horizontal at 3 m								
No	Frequency (MHz)	Emission Level (dBuV/m)	Limit (dBuV/m)	Margin (dB)	Antenna Height (m)	Table Angle (Degree)	Raw Value (dBuV)	Correction Factor (dB/m)
1	*5320.00	112.9 PK			1.02 H	265	108.1	4.8
2	*5320.00	102.5 AV			1.02 H	265	97.7	4.8
3	5350.00	63.2 PK	74.0	-10.8	1.02 H	265	58.4	4.8
4	5350.00	53.5 AV	54.0	-0.5	1.02 H	265	48.7	4.8
5	10640.00	45.9 PK	74.0	-28.1	1.57 H	245	31.6	14.3
6	10640.00	35.6 AV	54.0	-18.4	1.57 H	245	21.3	14.3
7	15960.00	46.1 PK	74.0	-27.9	2.19 H	112	31.4	14.7
8	15960.00	35.8 AV	54.0	-18.2	2.19 H	112	21.1	14.7

Antenna Polarity & Test Distance : Vertical at 3 m								
No	Frequency (MHz)	Emission Level (dBuV/m)	Limit (dBuV/m)	Margin (dB)	Antenna Height (m)	Table Angle (Degree)	Raw Value (dBuV)	Correction Factor (dB/m)
1	*5320.00	116.1 PK			1.05 V	234	111.3	4.8
2	*5320.00	106.1 AV			1.05 V	234	101.3	4.8
3	5350.00	64.1 PK	74.0	-9.9	1.05 V	234	59.3	4.8
4	5350.00	53.2 AV	54.0	-0.8	1.05 V	234	48.4	4.8
5	10640.00	45.6 PK	74.0	-28.4	1.59 V	206	31.3	14.3
6	10640.00	34.9 AV	54.0	-19.1	1.59 V	206	20.6	14.3
7	15960.00	46.0 PK	74.0	-28.0	2.21 V	87	31.3	14.7
8	15960.00	35.5 AV	54.0	-18.5	2.21 V	87	20.8	14.7

Remarks:

1. Emission Level(dBuV/m) = Raw Value(dBuV) + Correction Factor(dB/m)
2. Correction Factor(dB/m) = Antenna Factor(dB/m) + Cable Factor(dB) – Pre-Amplifier Factor(dB)
3. Margin value = Emission Level – Limit value
4. The other emission levels were very low against the limit.
5. " * ": Fundamental frequency.

RF Mode	TX 802.11ac (VHT20)	Channel	CH 100 : 5500 MHz
Frequency Range	1GHz ~ 40GHz	Detector Function	Peak (PK) Average (AV)

Antenna Polarity & Test Distance : Horizontal at 3 m

No	Frequency (MHz)	Emission Level (dBuV/m)	Limit (dBuV/m)	Margin (dB)	Antenna Height (m)	Table Angle (Degree)	Raw Value (dBuV)	Correction Factor (dB/m)
1	5460.00	64.1 PK	74.0	-9.9	1.04 H	263	59.2	4.9
2	5460.00	51.6 AV	54.0	-2.4	1.04 H	263	46.7	4.9
3	#5470.00	67.5 PK	68.2	-0.7	1.04 H	263	62.5	5.0
4	*5500.00	112.3 PK			1.04 H	263	107.2	5.1
5	*5500.00	102.1 AV			1.04 H	263	97.0	5.1
6	11000.00	46.3 PK	74.0	-27.7	1.63 H	250	31.6	14.7
7	11000.00	35.8 AV	54.0	-18.2	1.63 H	250	21.1	14.7
8	#16500.00	46.9 PK	68.2	-21.3	2.20 H	110	30.4	16.5

Antenna Polarity & Test Distance : Vertical at 3 m

No	Frequency (MHz)	Emission Level (dBuV/m)	Limit (dBuV/m)	Margin (dB)	Antenna Height (m)	Table Angle (Degree)	Raw Value (dBuV)	Correction Factor (dB/m)
1	5460.00	58.8 PK	74.0	-15.2	1.06 V	227	53.9	4.9
2	5460.00	47.5 AV	54.0	-6.5	1.06 V	227	42.6	4.9
3	#5469.12	66.6 PK	68.2	-1.6	1.06 V	227	61.6	5.0
4	*5500.00	115.9 PK			1.06 V	227	110.8	5.1
5	*5500.00	105.8 AV			1.06 V	227	100.7	5.1
6	11000.00	44.8 PK	74.0	-29.2	1.62 V	199	30.1	14.7
7	11000.00	34.8 AV	54.0	-19.2	1.62 V	199	20.1	14.7
8	#16500.00	46.5 PK	68.2	-21.7	2.15 V	94	30.0	16.5

Remarks:

1. Emission Level(dBuV/m) = Raw Value(dBuV) + Correction Factor(dB/m)
2. Correction Factor(dB/m) = Antenna Factor(dB/m) + Cable Factor(dB) – Pre-Amplifier Factor(dB)
3. Margin value = Emission Level – Limit value
4. The other emission levels were very low against the limit.
5. " * ": Fundamental frequency.
6. " # ": The radiated frequency is out of the restricted band.

RF Mode	TX 802.11ac (VHT20)	Channel	CH 116 : 5580 MHz
Frequency Range	1GHz ~ 40GHz	Detector Function	Peak (PK) Average (AV)

Antenna Polarity & Test Distance : Horizontal at 3 m

No	Frequency (MHz)	Emission Level (dBuV/m)	Limit (dBuV/m)	Margin (dB)	Antenna Height (m)	Table Angle (Degree)	Raw Value (dBuV)	Correction Factor (dB/m)
1	*5580.00	113.6 PK			1.06 H	274	108.6	5.0
2	*5580.00	103.3 AV			1.06 H	274	98.3	5.0
3	11160.00	45.6 PK	74.0	-28.4	1.58 H	226	31.0	14.6
4	11160.00	35.2 AV	54.0	-18.8	1.58 H	226	20.6	14.6
5	#16740.00	46.8 PK	68.2	-21.4	2.21 H	102	29.5	17.3

Antenna Polarity & Test Distance : Vertical at 3 m

No	Frequency (MHz)	Emission Level (dBuV/m)	Limit (dBuV/m)	Margin (dB)	Antenna Height (m)	Table Angle (Degree)	Raw Value (dBuV)	Correction Factor (dB/m)
1	*5580.00	117.4 PK			1.09 V	235	112.4	5.0
2	*5580.00	107.1 AV			1.09 V	235	102.1	5.0
3	11160.00	45.9 PK	74.0	-28.1	1.60 V	209	31.3	14.6
4	11160.00	35.5 AV	54.0	-18.5	1.60 V	209	20.9	14.6
5	#16740.00	46.3 PK	68.2	-21.9	2.12 V	89	29.0	17.3

Remarks:

1. Emission Level(dBuV/m) = Raw Value(dBuV) + Correction Factor(dB/m)
2. Correction Factor(dB/m) = Antenna Factor(dB/m) + Cable Factor(dB) – Pre-Amplifier Factor(dB)
3. Margin value = Emission Level – Limit value
4. The other emission levels were very low against the limit.
5. " * ": Fundamental frequency.
6. " # ": The radiated frequency is out of the restricted band.

RF Mode	TX 802.11ac (VHT20)	Channel	CH 140 : 5700 MHz
Frequency Range	1GHz ~ 40GHz	Detector Function	Peak (PK) Average (AV)

Antenna Polarity & Test Distance : Horizontal at 3 m

No	Frequency (MHz)	Emission Level (dBuV/m)	Limit (dBuV/m)	Margin (dB)	Antenna Height (m)	Table Angle (Degree)	Raw Value (dBuV)	Correction Factor (dB/m)
1	*5700.00	112.7 PK			1.04 H	266	107.6	5.1
2	*5700.00	102.8 AV			1.04 H	266	97.7	5.1
3	#5725.00	67.4 PK	68.2	-0.8	1.04 H	266	62.2	5.2
4	11400.00	45.6 PK	74.0	-28.4	1.56 H	234	30.6	15.0
5	11400.00	35.1 AV	54.0	-18.9	1.56 H	234	20.1	15.0
6	#17100.00	46.4 PK	68.2	-21.8	2.14 H	97	27.9	18.5

Antenna Polarity & Test Distance : Vertical at 3 m

No	Frequency (MHz)	Emission Level (dBuV/m)	Limit (dBuV/m)	Margin (dB)	Antenna Height (m)	Table Angle (Degree)	Raw Value (dBuV)	Correction Factor (dB/m)
1	*5700.00	116.0 PK			1.07 V	237	110.9	5.1
2	*5700.00	106.1 AV			1.07 V	237	101.0	5.1
3	#5725.00	67.2 PK	68.2	-1.0	1.07 V	237	62.0	5.2
4	11400.00	45.7 PK	74.0	-28.3	1.59 V	198	30.7	15.0
5	11400.00	35.4 AV	54.0	-18.6	1.59 V	198	20.4	15.0
6	#17100.00	46.0 PK	68.2	-22.2	2.20 V	88	27.5	18.5

Remarks:

1. Emission Level(dBuV/m) = Raw Value(dBuV) + Correction Factor(dB/m)
2. Correction Factor(dB/m) = Antenna Factor(dB/m) + Cable Factor(dB) – Pre-Amplifier Factor(dB)
3. Margin value = Emission Level – Limit value
4. The other emission levels were very low against the limit.
5. " * ": Fundamental frequency.
6. " # ": The radiated frequency is out of the restricted band.

RF Mode	TX 802.11ac (VHT20)	Channel	CH 144 : 5720 MHz
Frequency Range	1GHz ~ 40GHz	Detector Function	Peak (PK) Average (AV)

Antenna Polarity & Test Distance : Horizontal at 3 m

No	Frequency (MHz)	Emission Level (dBuV/m)	Limit (dBuV/m)	Margin (dB)	Antenna Height (m)	Table Angle (Degree)	Raw Value (dBuV)	Correction Factor (dB/m)
1	5460.00	49.3 PK	74.0	-24.7	1.06 H	269	44.4	4.9
2	5460.00	36.9 AV	54.0	-17.1	1.06 H	269	32.0	4.9
3	#5470.00	48.9 PK	68.2	-19.3	1.06 H	269	43.9	5.0
4	*5720.00	113.8 PK			1.06 H	269	108.6	5.2
5	*5720.00	103.6 AV			1.06 H	269	98.4	5.2
6	#5850.00	51.4 PK	68.2	-16.8	1.06 H	269	45.9	5.5
7	11440.00	45.3 PK	74.0	-28.7	1.60 H	221	30.2	15.1
8	11440.00	35.1 AV	54.0	-18.9	1.60 H	221	20.0	15.1
9	#17160.00	46.5 PK	68.2	-21.7	2.19 H	93	28.0	18.5

Antenna Polarity & Test Distance : Vertical at 3 m

No	Frequency (MHz)	Emission Level (dBuV/m)	Limit (dBuV/m)	Margin (dB)	Antenna Height (m)	Table Angle (Degree)	Raw Value (dBuV)	Correction Factor (dB/m)
1	5460.00	49.5 PK	74.0	-24.5	1.09 V	229	44.6	4.9
2	5460.00	37.2 AV	54.0	-16.8	1.09 V	229	32.3	4.9
3	#5470.00	49.4 PK	68.2	-18.8	1.09 V	229	44.4	5.0
4	*5720.00	117.2 PK			1.09 V	229	112.0	5.2
5	*5720.00	106.8 AV			1.09 V	229	101.6	5.2
6	#5850.00	51.7 PK	68.2	-16.5	1.09 V	229	46.2	5.5
7	11440.00	45.4 PK	74.0	-28.6	1.60 V	211	30.3	15.1
8	11440.00	35.2 AV	54.0	-18.8	1.60 V	211	20.1	15.1
9	#17160.00	46.7 PK	68.2	-21.5	2.15 V	81	28.2	18.5

Remarks:

1. Emission Level(dBuV/m) = Raw Value(dBuV) + Correction Factor(dB/m)
2. Correction Factor(dB/m) = Antenna Factor(dB/m) + Cable Factor(dB) – Pre-Amplifier Factor(dB)
3. Margin value = Emission Level – Limit value
4. The other emission levels were very low against the limit.
5. " * ": Fundamental frequency.
6. " # ": The radiated frequency is out of the restricted band.

RF Mode	TX 802.11ac (VHT20)	Channel	CH 149 : 5745 MHz
Frequency Range	1GHz ~ 40GHz	Detector Function	Peak (PK) Average (AV)

Antenna Polarity & Test Distance : Horizontal at 3 m

No	Frequency (MHz)	Emission Level (dBuV/m)	Limit (dBuV/m)	Margin (dB)	Antenna Height (m)	Table Angle (Degree)	Raw Value (dBuV)	Correction Factor (dB/m)
1	#5594.98	52.0 PK	68.2	-16.2	1.04 H	270	47.0	5.0
2	*5745.00	114.3 PK			1.04 H	270	108.9	5.4
3	*5745.00	104.1 AV			1.04 H	270	98.7	5.4
4	#5992.57	51.4 PK	68.2	-16.8	1.04 H	270	45.6	5.8
5	11490.00	45.6 PK	74.0	-28.4	1.61 H	223	30.5	15.1
6	11490.00	35.3 AV	54.0	-18.7	1.61 H	223	20.2	15.1
7	#17235.00	46.7 PK	68.2	-21.5	2.22 H	91	28.1	18.6

Antenna Polarity & Test Distance : Vertical at 3 m

No	Frequency (MHz)	Emission Level (dBuV/m)	Limit (dBuV/m)	Margin (dB)	Antenna Height (m)	Table Angle (Degree)	Raw Value (dBuV)	Correction Factor (dB/m)
1	#5618.97	52.8 PK	68.2	-15.4	1.07 V	244	47.8	5.0
2	*5745.00	116.9 PK			1.07 V	244	111.5	5.4
3	*5745.00	106.6 AV			1.07 V	244	101.2	5.4
4	#5945.68	53.2 PK	68.2	-15.0	1.07 V	244	47.6	5.6
5	11490.00	45.5 PK	74.0	-28.5	1.61 V	205	30.4	15.1
6	11490.00	35.1 AV	54.0	-18.9	1.61 V	205	20.0	15.1
7	#17235.00	46.1 PK	68.2	-22.1	2.16 V	73	27.5	18.6

Remarks:

1. Emission Level(dBuV/m) = Raw Value(dBuV) + Correction Factor(dB/m)
2. Correction Factor(dB/m) = Antenna Factor(dB/m) + Cable Factor(dB) – Pre-Amplifier Factor(dB)
3. Margin value = Emission Level – Limit value
4. The other emission levels were very low against the limit.
5. " * ": Fundamental frequency.
6. " # ": The radiated frequency is out of the restricted band.

RF Mode	TX 802.11ac (VHT20)	Channel	CH 157 : 5785 MHz
Frequency Range	1GHz ~ 40GHz	Detector Function	Peak (PK) Average (AV)

Antenna Polarity & Test Distance : Horizontal at 3 m

No	Frequency (MHz)	Emission Level (dBuV/m)	Limit (dBuV/m)	Margin (dB)	Antenna Height (m)	Table Angle (Degree)	Raw Value (dBuV)	Correction Factor (dB/m)
1	#5618.14	50.9 PK	68.2	-17.3	1.03 H	269	45.9	5.0
2	*5785.00	114.1 PK			1.03 H	269	108.6	5.5
3	*5785.00	104.5 AV			1.03 H	269	99.0	5.5
4	#5987.84	51.6 PK	68.2	-16.6	1.03 H	269	45.8	5.8
5	11570.00	45.3 PK	74.0	-28.7	1.59 H	244	30.4	14.9
6	11570.00	35.1 AV	54.0	-18.9	1.59 H	244	20.2	14.9
7	#17355.00	46.1 PK	68.2	-22.1	2.14 H	101	27.2	18.9

Antenna Polarity & Test Distance : Vertical at 3 m

No	Frequency (MHz)	Emission Level (dBuV/m)	Limit (dBuV/m)	Margin (dB)	Antenna Height (m)	Table Angle (Degree)	Raw Value (dBuV)	Correction Factor (dB/m)
1	#5562.28	53.5 PK	68.2	-14.7	1.07 V	236	48.5	5.0
2	*5785.00	117.2 PK			1.07 V	236	111.7	5.5
3	*5785.00	107.0 AV			1.07 V	236	101.5	5.5
4	#6014.57	53.8 PK	68.2	-14.4	1.07 V	236	48.0	5.8
5	11570.00	46.1 PK	74.0	-27.9	1.60 V	215	31.2	14.9
6	11570.00	35.6 AV	54.0	-18.4	1.60 V	215	20.7	14.9
7	#17355.00	45.6 PK	68.2	-22.6	2.22 V	103	26.7	18.9

Remarks:

1. Emission Level(dBuV/m) = Raw Value(dBuV) + Correction Factor(dB/m)
2. Correction Factor(dB/m) = Antenna Factor(dB/m) + Cable Factor(dB) – Pre-Amplifier Factor(dB)
3. Margin value = Emission Level – Limit value
4. The other emission levels were very low against the limit.
5. " * ": Fundamental frequency.
6. " # ": The radiated frequency is out of the restricted band.

RF Mode	TX 802.11ac (VHT20)	Channel	CH 165 : 5825 MHz
Frequency Range	1GHz ~ 40GHz	Detector Function	Peak (PK) Average (AV)

Antenna Polarity & Test Distance : Horizontal at 3 m

No	Frequency (MHz)	Emission Level (dBuV/m)	Limit (dBuV/m)	Margin (dB)	Antenna Height (m)	Table Angle (Degree)	Raw Value (dBuV)	Correction Factor (dB/m)
1	#5567.17	52.6 PK	68.2	-15.6	1.00 H	271	47.5	5.1
2	*5825.00	114.0 PK			1.00 H	271	108.6	5.4
3	*5825.00	104.3 AV			1.00 H	271	98.9	5.4
4	#5927.23	51.4 PK	68.2	-16.8	1.00 H	271	45.8	5.6
5	11650.00	46.2 PK	74.0	-27.8	1.64 H	229	31.4	14.8
6	11650.00	35.9 AV	54.0	-18.1	1.64 H	229	21.1	14.8
7	#17475.00	47.1 PK	68.2	-21.1	2.18 H	109	27.4	19.7

Antenna Polarity & Test Distance : Vertical at 3 m

No	Frequency (MHz)	Emission Level (dBuV/m)	Limit (dBuV/m)	Margin (dB)	Antenna Height (m)	Table Angle (Degree)	Raw Value (dBuV)	Correction Factor (dB/m)
1	#5617.27	53.1 PK	68.2	-15.1	1.04 V	228	48.1	5.0
2	*5825.00	117.3 PK			1.04 V	228	111.9	5.4
3	*5825.00	106.7 AV			1.04 V	228	101.3	5.4
4	#5986.49	53.6 PK	68.2	-14.6	1.04 V	228	47.8	5.8
5	11650.00	46.0 PK	74.0	-28.0	1.61 V	210	31.2	14.8
6	11650.00	35.5 AV	54.0	-18.5	1.61 V	210	20.7	14.8
7	#17475.00	46.1 PK	68.2	-22.1	2.13 V	76	26.4	19.7

Remarks:

1. Emission Level(dBuV/m) = Raw Value(dBuV) + Correction Factor(dB/m)
2. Correction Factor(dB/m) = Antenna Factor(dB/m) + Cable Factor(dB) – Pre-Amplifier Factor(dB)
3. Margin value = Emission Level – Limit value
4. The other emission levels were very low against the limit.
5. " * ": Fundamental frequency.
6. " # ": The radiated frequency is out of the restricted band.

RF Mode	TX 802.11ac (VHT40)	Channel	CH 38 : 5190 MHz
Frequency Range	1GHz ~ 40GHz	Detector Function	Peak (PK) Average (AV)

Antenna Polarity & Test Distance : Horizontal at 3 m

No	Frequency (MHz)	Emission Level (dBuV/m)	Limit (dBuV/m)	Margin (dB)	Antenna Height (m)	Table Angle (Degree)	Raw Value (dBuV)	Correction Factor (dB/m)
1	5150.00	65.0 PK	74.0	-9.0	1.00 H	260	59.8	5.2
2	5150.00	53.8 AV	54.0	-0.2	1.00 H	260	48.6	5.2
3	*5190.00	108.7 PK			1.00 H	260	103.8	4.9
4	*5190.00	99.1 AV			1.00 H	260	94.2	4.9
5	#10380.00	45.6 PK	68.2	-22.6	1.57 H	243	31.5	14.1
6	15570.00	46.6 PK	74.0	-27.4	2.11 H	86	31.6	15.0
7	15570.00	36.0 AV	54.0	-18.0	2.11 H	86	21.0	15.0

Antenna Polarity & Test Distance : Vertical at 3 m

No	Frequency (MHz)	Emission Level (dBuV/m)	Limit (dBuV/m)	Margin (dB)	Antenna Height (m)	Table Angle (Degree)	Raw Value (dBuV)	Correction Factor (dB/m)
1	5150.00	66.4 PK	74.0	-7.6	1.08 V	223	61.2	5.2
2	5150.00	53.2 AV	54.0	-0.8	1.08 V	223	48.0	5.2
3	*5190.00	112.3 PK			1.08 V	223	107.4	4.9
4	*5190.00	102.0 AV			1.08 V	223	97.1	4.9
5	#10380.00	45.4 PK	68.2	-22.8	1.54 V	208	31.3	14.1
6	15570.00	46.6 PK	74.0	-27.4	2.19 V	81	31.6	15.0
7	15570.00	36.0 AV	54.0	-18.0	2.19 V	81	21.0	15.0

Remarks:

1. Emission Level(dBuV/m) = Raw Value(dBuV) + Correction Factor(dB/m)
2. Correction Factor(dB/m) = Antenna Factor(dB/m) + Cable Factor(dB) – Pre-Amplifier Factor(dB)
3. Margin value = Emission Level – Limit value
4. The other emission levels were very low against the limit.
5. " * ": Fundamental frequency.
6. " # ": The radiated frequency is out of the restricted band.

RF Mode	TX 802.11ac (VHT40)	Channel	CH 46 : 5230 MHz
Frequency Range	1GHz ~ 40GHz	Detector Function	Peak (PK) Average (AV)

Antenna Polarity & Test Distance : Horizontal at 3 m

No	Frequency (MHz)	Emission Level (dBuV/m)	Limit (dBuV/m)	Margin (dB)	Antenna Height (m)	Table Angle (Degree)	Raw Value (dBuV)	Correction Factor (dB/m)
1	*5230.00	109.7 PK			1.01 H	262	104.9	4.8
2	*5230.00	100.0 AV			1.01 H	262	95.2	4.8
3	5350.00	56.6 PK	74.0	-17.4	1.01 H	262	51.8	4.8
4	5350.00	47.3 AV	54.0	-6.7	1.01 H	262	42.5	4.8
5	#10460.00	45.3 PK	68.2	-22.9	1.63 H	233	31.2	14.1
6	15690.00	45.9 PK	74.0	-28.1	2.19 H	90	30.9	15.0
7	15690.00	35.6 AV	54.0	-18.4	2.19 H	90	20.6	15.0

Antenna Polarity & Test Distance : Vertical at 3 m

No	Frequency (MHz)	Emission Level (dBuV/m)	Limit (dBuV/m)	Margin (dB)	Antenna Height (m)	Table Angle (Degree)	Raw Value (dBuV)	Correction Factor (dB/m)
1	*5230.00	113.1 PK			1.04 V	221	108.3	4.8
2	*5230.00	103.2 AV			1.04 V	221	98.4	4.8
3	5350.00	56.4 PK	74.0	-17.6	1.04 V	221	51.6	4.8
4	5350.00	47.0 AV	54.0	-7.0	1.04 V	221	42.2	4.8
5	#10460.00	45.5 PK	68.2	-22.7	1.58 V	191	31.4	14.1
6	15690.00	46.0 PK	74.0	-28.0	2.18 V	98	31.0	15.0
7	15690.00	35.7 AV	54.0	-18.3	2.18 V	98	20.7	15.0

Remarks:

1. Emission Level(dBuV/m) = Raw Value(dBuV) + Correction Factor(dB/m)
2. Correction Factor(dB/m) = Antenna Factor(dB/m) + Cable Factor(dB) – Pre-Amplifier Factor(dB)
3. Margin value = Emission Level – Limit value
4. The other emission levels were very low against the limit.
5. " * ": Fundamental frequency.
6. " # ": The radiated frequency is out of the restricted band.

RF Mode	TX 802.11ac (VHT40)	Channel	CH 54 : 5270 MHz
Frequency Range	1GHz ~ 40GHz	Detector Function	Peak (PK) Average (AV)

Antenna Polarity & Test Distance : Horizontal at 3 m

No	Frequency (MHz)	Emission Level (dBuV/m)	Limit (dBuV/m)	Margin (dB)	Antenna Height (m)	Table Angle (Degree)	Raw Value (dBuV)	Correction Factor (dB/m)
1	5150.00	60.8 PK	74.0	-13.2	1.05 H	259	55.6	5.2
2	5150.00	51.1 AV	54.0	-2.9	1.05 H	259	45.9	5.2
3	*5270.00	111.9 PK			1.05 H	259	107.1	4.8
4	*5270.00	102.4 AV			1.05 H	259	97.6	4.8
5	#10540.00	45.9 PK	68.2	-22.3	1.63 H	244	31.7	14.2
6	15810.00	46.8 PK	74.0	-27.2	2.15 H	111	32.3	14.5
7	15810.00	36.3 AV	54.0	-17.7	2.15 H	111	21.8	14.5

Antenna Polarity & Test Distance : Vertical at 3 m

No	Frequency (MHz)	Emission Level (dBuV/m)	Limit (dBuV/m)	Margin (dB)	Antenna Height (m)	Table Angle (Degree)	Raw Value (dBuV)	Correction Factor (dB/m)
1	5150.00	60.7 PK	74.0	-13.3	1.09 V	209	55.5	5.2
2	5150.00	51.2 AV	54.0	-2.8	1.09 V	209	46.0	5.2
3	*5270.00	115.4 PK			1.09 V	209	110.6	4.8
4	*5270.00	105.5 AV			1.09 V	209	100.7	4.8
5	#10540.00	45.5 PK	68.2	-22.7	1.62 V	216	31.3	14.2
6	15810.00	46.1 PK	74.0	-27.9	2.12 V	104	31.6	14.5
7	15810.00	35.8 AV	54.0	-18.2	2.12 V	104	21.3	14.5

Remarks:

1. Emission Level(dBuV/m) = Raw Value(dBuV) + Correction Factor(dB/m)
2. Correction Factor(dB/m) = Antenna Factor(dB/m) + Cable Factor(dB) – Pre-Amplifier Factor(dB)
3. Margin value = Emission Level – Limit value
4. The other emission levels were very low against the limit.
5. " * ": Fundamental frequency.
6. " # ": The radiated frequency is out of the restricted band.

RF Mode	TX 802.11ac (VHT40)	Channel	CH 62 : 5310 MHz
Frequency Range	1GHz ~ 40GHz	Detector Function	Peak (PK) Average (AV)

Antenna Polarity & Test Distance : Horizontal at 3 m

No	Frequency (MHz)	Emission Level (dBuV/m)	Limit (dBuV/m)	Margin (dB)	Antenna Height (m)	Table Angle (Degree)	Raw Value (dBuV)	Correction Factor (dB/m)
1	*5310.00	108.8 PK			1.00 H	265	104.0	4.8
2	*5310.00	99.2 AV			1.00 H	265	94.4	4.8
3	5350.00	63.5 PK	74.0	-10.5	1.00 H	265	58.7	4.8
4	5350.00	53.5 AV	54.0	-0.5	1.00 H	265	48.7	4.8
5	10620.00	45.8 PK	74.0	-28.2	1.61 H	232	31.5	14.3
6	10620.00	35.4 AV	54.0	-18.6	1.61 H	232	21.1	14.3
7	15930.00	46.2 PK	74.0	-27.8	2.11 H	100	31.6	14.6
8	15930.00	35.7 AV	54.0	-18.3	2.11 H	100	21.1	14.6

Antenna Polarity & Test Distance : Vertical at 3 m

No	Frequency (MHz)	Emission Level (dBuV/m)	Limit (dBuV/m)	Margin (dB)	Antenna Height (m)	Table Angle (Degree)	Raw Value (dBuV)	Correction Factor (dB/m)
1	*5310.00	111.7 PK			1.12 V	236	106.9	4.8
2	*5310.00	101.4 AV			1.12 V	236	96.6	4.8
3	5357.23	64.7 PK	74.0	-9.3	1.12 V	236	59.8	4.9
4	5357.23	52.2 AV	54.0	-1.8	1.12 V	236	47.3	4.9
5	10620.00	45.2 PK	74.0	-28.8	1.55 V	198	30.9	14.3
6	10620.00	35.0 AV	54.0	-19.0	1.55 V	198	20.7	14.3
7	15930.00	46.0 PK	74.0	-28.0	2.19 V	84	31.4	14.6
8	15930.00	35.3 AV	54.0	-18.7	2.19 V	84	20.7	14.6

Remarks:

1. Emission Level(dBuV/m) = Raw Value(dBuV) + Correction Factor(dB/m)
2. Correction Factor(dB/m) = Antenna Factor(dB/m) + Cable Factor(dB) – Pre-Amplifier Factor(dB)
3. Margin value = Emission Level – Limit value
4. The other emission levels were very low against the limit.
5. " * ": Fundamental frequency.

RF Mode	TX 802.11ac (VHT40)	Channel	CH 102 : 5510 MHz
Frequency Range	1GHz ~ 40GHz	Detector Function	Peak (PK) Average (AV)

Antenna Polarity & Test Distance : Horizontal at 3 m

No	Frequency (MHz)	Emission Level (dBuV/m)	Limit (dBuV/m)	Margin (dB)	Antenna Height (m)	Table Angle (Degree)	Raw Value (dBuV)	Correction Factor (dB/m)
1	5452.60	60.3 PK	74.0	-13.7	1.02 H	266	55.4	4.9
2	5452.60	48.3 AV	54.0	-5.7	1.02 H	266	43.4	4.9
3	#5470.00	67.6 PK	68.2	-0.6	1.02 H	266	62.6	5.0
4	*5510.00	108.6 PK			1.02 H	266	103.5	5.1
5	*5510.00	99.0 AV			1.02 H	266	93.9	5.1
6	11020.00	45.5 PK	74.0	-28.5	1.55 H	248	30.9	14.6
7	11020.00	35.1 AV	54.0	-18.9	1.55 H	248	20.5	14.6
8	#16530.00	46.9 PK	68.2	-21.3	2.17 H	88	30.3	16.6

Antenna Polarity & Test Distance : Vertical at 3 m

No	Frequency (MHz)	Emission Level (dBuV/m)	Limit (dBuV/m)	Margin (dB)	Antenna Height (m)	Table Angle (Degree)	Raw Value (dBuV)	Correction Factor (dB/m)
1	5460.00	61.9 PK	74.0	-12.1	1.11 V	214	57.0	4.9
2	5460.00	49.0 AV	54.0	-5.0	1.11 V	214	44.1	4.9
3	#5462.46	62.9 PK	68.2	-5.3	1.11 V	214	58.0	4.9
4	*5510.00	112.0 PK			1.11 V	214	106.9	5.1
5	*5510.00	101.6 AV			1.11 V	214	96.5	5.1
6	11020.00	45.4 PK	74.0	-28.6	1.64 V	212	30.8	14.6
7	11020.00	34.9 AV	54.0	-19.1	1.64 V	212	20.3	14.6
8	#16530.00	46.5 PK	68.2	-21.7	2.19 V	83	29.9	16.6

Remarks:

1. Emission Level(dBuV/m) = Raw Value(dBuV) + Correction Factor(dB/m)
2. Correction Factor(dB/m) = Antenna Factor(dB/m) + Cable Factor(dB) – Pre-Amplifier Factor(dB)
3. Margin value = Emission Level – Limit value
4. The other emission levels were very low against the limit.
5. " * ": Fundamental frequency.
6. " # ": The radiated frequency is out of the restricted band.

RF Mode	TX 802.11ac (VHT40)	Channel	CH 110 : 5550 MHz
Frequency Range	1GHz ~ 40GHz	Detector Function	Peak (PK) Average (AV)

Antenna Polarity & Test Distance : Horizontal at 3 m

No	Frequency (MHz)	Emission Level (dBuV/m)	Limit (dBuV/m)	Margin (dB)	Antenna Height (m)	Table Angle (Degree)	Raw Value (dBuV)	Correction Factor (dB/m)
1	*5550.00	111.7 PK			1.09 H	266	106.7	5.0
2	*5550.00	102.4 AV			1.09 H	266	97.4	5.0
3	11100.00	46.0 PK	74.0	-28.0	1.62 H	238	31.7	14.3
4	11100.00	35.5 AV	54.0	-18.5	1.62 H	238	21.2	14.3
5	#16650.00	46.3 PK	68.2	-21.9	2.17 H	111	29.3	17.0

Antenna Polarity & Test Distance : Vertical at 3 m

No	Frequency (MHz)	Emission Level (dBuV/m)	Limit (dBuV/m)	Margin (dB)	Antenna Height (m)	Table Angle (Degree)	Raw Value (dBuV)	Correction Factor (dB/m)
1	*5550.00	115.4 PK			1.06 V	214	110.4	5.0
2	*5550.00	105.5 AV			1.06 V	214	100.5	5.0
3	11100.00	45.1 PK	74.0	-28.9	1.62 V	195	30.8	14.3
4	11100.00	34.8 AV	54.0	-19.2	1.62 V	195	20.5	14.3
5	#16650.00	46.0 PK	68.2	-22.2	2.19 V	73	29.0	17.0

Remarks:

1. Emission Level(dBuV/m) = Raw Value(dBuV) + Correction Factor(dB/m)
2. Correction Factor(dB/m) = Antenna Factor(dB/m) + Cable Factor(dB) – Pre-Amplifier Factor(dB)
3. Margin value = Emission Level – Limit value
4. The other emission levels were very low against the limit.
5. " * ": Fundamental frequency.
6. " # ": The radiated frequency is out of the restricted band.

RF Mode	TX 802.11ac (VHT40)	Channel	CH 134 : 5670 MHz
Frequency Range	1GHz ~ 40GHz	Detector Function	Peak (PK) Average (AV)

Antenna Polarity & Test Distance : Horizontal at 3 m

No	Frequency (MHz)	Emission Level (dBuV/m)	Limit (dBuV/m)	Margin (dB)	Antenna Height (m)	Table Angle (Degree)	Raw Value (dBuV)	Correction Factor (dB/m)
1	*5670.00	109.6 PK			1.04 H	263	104.5	5.1
2	*5670.00	100.1 AV			1.04 H	263	95.0	5.1
3	#5725.00	67.8 PK	68.2	-0.4	1.04 H	263	62.6	5.2
4	11340.00	46.6 PK	74.0	-27.4	1.54 H	234	31.5	15.1
5	11340.00	36.0 AV	54.0	-18.0	1.54 H	234	20.9	15.1
6	#17010.00	46.8 PK	68.2	-21.4	2.21 H	87	28.2	18.6

Antenna Polarity & Test Distance : Vertical at 3 m

No	Frequency (MHz)	Emission Level (dBuV/m)	Limit (dBuV/m)	Margin (dB)	Antenna Height (m)	Table Angle (Degree)	Raw Value (dBuV)	Correction Factor (dB/m)
1	*5670.00	112.9 PK			1.08 V	193	107.8	5.1
2	*5670.00	103.2 AV			1.08 V	193	98.1	5.1
3	#5725.00	66.3 PK	68.2	-1.9	1.08 V	193	61.1	5.2
4	11340.00	45.7 PK	74.0	-28.3	1.62 V	190	30.6	15.1
5	11340.00	35.2 AV	54.0	-18.8	1.62 V	190	20.1	15.1
6	#17010.00	45.9 PK	68.2	-22.3	2.13 V	89	27.3	18.6

Remarks:

1. Emission Level(dBuV/m) = Raw Value(dBuV) + Correction Factor(dB/m)
2. Correction Factor(dB/m) = Antenna Factor(dB/m) + Cable Factor(dB) – Pre-Amplifier Factor(dB)
3. Margin value = Emission Level – Limit value
4. The other emission levels were very low against the limit.
5. " * ": Fundamental frequency.
6. " # ": The radiated frequency is out of the restricted band.

RF Mode	TX 802.11ac (VHT40)	Channel	CH 142 : 5710 MHz
Frequency Range	1GHz ~ 40GHz	Detector Function	Peak (PK) Average (AV)

Antenna Polarity & Test Distance : Horizontal at 3 m

No	Frequency (MHz)	Emission Level (dBuV/m)	Limit (dBuV/m)	Margin (dB)	Antenna Height (m)	Table Angle (Degree)	Raw Value (dBuV)	Correction Factor (dB/m)
1	5460.00	50.0 PK	74.0	-24.0	1.02 H	265	45.1	4.9
2	5460.00	39.5 AV	54.0	-14.5	1.02 H	265	34.6	4.9
3	#5470.00	50.1 PK	68.2	-18.1	1.02 H	265	45.1	5.0
4	*5710.00	108.9 PK			1.02 H	265	103.7	5.2
5	*5710.00	99.3 AV			1.02 H	265	94.1	5.2
6	#5850.00	59.1 PK	68.2	-9.1	1.02 H	265	53.6	5.5
7	11420.00	46.2 PK	74.0	-27.8	1.57 H	219	31.2	15.0
8	11420.00	35.6 AV	54.0	-18.4	1.57 H	219	20.6	15.0
9	#17130.00	46.9 PK	68.2	-21.3	2.15 H	115	28.4	18.5

Antenna Polarity & Test Distance : Vertical at 3 m

No	Frequency (MHz)	Emission Level (dBuV/m)	Limit (dBuV/m)	Margin (dB)	Antenna Height (m)	Table Angle (Degree)	Raw Value (dBuV)	Correction Factor (dB/m)
1	5460.00	49.8 PK	74.0	-24.2	1.05 V	199	44.9	4.9
2	5460.00	39.4 AV	54.0	-14.6	1.05 V	199	34.5	4.9
3	#5470.00	50.2 PK	68.2	-18.0	1.05 V	199	45.2	5.0
4	*5710.00	115.4 PK			1.05 V	199	110.2	5.2
5	*5710.00	105.4 AV			1.05 V	199	100.2	5.2
6	#5850.00	59.0 PK	68.2	-9.2	1.05 V	199	53.5	5.5
7	11420.00	45.6 PK	74.0	-28.4	1.57 V	199	30.6	15.0
8	11420.00	35.4 AV	54.0	-18.6	1.57 V	199	20.4	15.0
9	#17130.00	46.2 PK	68.2	-22.0	2.16 V	101	27.7	18.5

Remarks:

1. Emission Level(dBuV/m) = Raw Value(dBuV) + Correction Factor(dB/m)
2. Correction Factor(dB/m) = Antenna Factor(dB/m) + Cable Factor(dB) – Pre-Amplifier Factor(dB)
3. Margin value = Emission Level – Limit value
4. The other emission levels were very low against the limit.
5. " * ": Fundamental frequency.
6. " # ": The radiated frequency is out of the restricted band.

RF Mode	TX 802.11ac (VHT40)	Channel	CH 151 : 5755 MHz
Frequency Range	1GHz ~ 40GHz	Detector Function	Peak (PK) Average (AV)

Antenna Polarity & Test Distance : Horizontal at 3 m

No	Frequency (MHz)	Emission Level (dBuV/m)	Limit (dBuV/m)	Margin (dB)	Antenna Height (m)	Table Angle (Degree)	Raw Value (dBuV)	Correction Factor (dB/m)
1	#5647.92	60.2 PK	68.2	-8.0	1.05 H	272	55.2	5.0
2	*5755.00	112.7 PK			1.05 H	272	107.3	5.4
3	*5755.00	102.2 AV			1.05 H	272	96.8	5.4
4	#6008.84	53.4 PK	68.2	-14.8	1.05 H	272	47.6	5.8
5	11510.00	45.8 PK	74.0	-28.2	1.52 H	236	30.7	15.1
6	11510.00	35.7 AV	54.0	-18.3	1.52 H	236	20.6	15.1
7	#17265.00	46.7 PK	68.2	-21.5	2.13 H	86	28.1	18.6

Antenna Polarity & Test Distance : Vertical at 3 m

No	Frequency (MHz)	Emission Level (dBuV/m)	Limit (dBuV/m)	Margin (dB)	Antenna Height (m)	Table Angle (Degree)	Raw Value (dBuV)	Correction Factor (dB/m)
1	#5644.39	60.7 PK	68.2	-7.5	1.04 V	241	55.7	5.0
2	*5755.00	115.6 PK			1.04 V	241	110.2	5.4
3	*5755.00	105.1 AV			1.04 V	241	99.7	5.4
4	#5985.06	56.1 PK	68.2	-12.1	1.04 V	241	50.3	5.8
5	11510.00	45.7 PK	74.0	-28.3	1.62 V	214	30.6	15.1
6	11510.00	35.7 AV	54.0	-18.3	1.62 V	214	20.6	15.1
7	#17265.00	46.7 PK	68.2	-21.5	2.20 V	108	28.1	18.6

Remarks:

1. Emission Level(dBuV/m) = Raw Value(dBuV) + Correction Factor(dB/m)
2. Correction Factor(dB/m) = Antenna Factor(dB/m) + Cable Factor(dB) – Pre-Amplifier Factor(dB)
3. Margin value = Emission Level – Limit value
4. The other emission levels were very low against the limit.
5. " * ": Fundamental frequency.
6. " # ": The radiated frequency is out of the restricted band.

RF Mode	TX 802.11ac (VHT40)	Channel	CH 159 : 5795 MHz
Frequency Range	1GHz ~ 40GHz	Detector Function	Peak (PK) Average (AV)

Antenna Polarity & Test Distance : Horizontal at 3 m

No	Frequency (MHz)	Emission Level (dBuV/m)	Limit (dBuV/m)	Margin (dB)	Antenna Height (m)	Table Angle (Degree)	Raw Value (dBuV)	Correction Factor (dB/m)
1	#5570.95	54.0 PK	68.2	-14.2	1.03 H	268	48.9	5.1
2	*5795.00	111.9 PK			1.03 H	268	106.4	5.5
3	*5795.00	101.6 AV			1.03 H	268	96.1	5.5
4	#5938.47	53.3 PK	68.2	-14.9	1.03 H	268	47.7	5.6
5	11590.00	46.1 PK	74.0	-27.9	1.59 H	230	31.3	14.8
6	11590.00	35.4 AV	54.0	-18.6	1.59 H	230	20.6	14.8
7	#17385.00	46.6 PK	68.2	-21.6	2.14 H	103	27.6	19.0

Antenna Polarity & Test Distance : Vertical at 3 m

No	Frequency (MHz)	Emission Level (dBuV/m)	Limit (dBuV/m)	Margin (dB)	Antenna Height (m)	Table Angle (Degree)	Raw Value (dBuV)	Correction Factor (dB/m)
1	#5572.18	56.6 PK	68.2	-11.6	1.06 V	225	51.5	5.1
2	*5795.00	116.1 PK			1.06 V	225	110.6	5.5
3	*5795.00	105.5 AV			1.06 V	225	100.0	5.5
4	#6022.26	57.8 PK	68.2	-10.4	1.06 V	225	52.0	5.8
5	11590.00	45.4 PK	74.0	-28.6	1.64 V	195	30.6	14.8
6	11590.00	34.9 AV	54.0	-19.1	1.64 V	195	20.1	14.8
7	#17385.00	45.4 PK	68.2	-22.8	2.14 V	77	26.4	19.0

Remarks:

1. Emission Level(dBuV/m) = Raw Value(dBuV) + Correction Factor(dB/m)
2. Correction Factor(dB/m) = Antenna Factor(dB/m) + Cable Factor(dB) – Pre-Amplifier Factor(dB)
3. Margin value = Emission Level – Limit value
4. The other emission levels were very low against the limit.
5. " * ": Fundamental frequency.
6. " # ": The radiated frequency is out of the restricted band.

RF Mode	TX 802.11ac (VHT80)	Channel	CH 42 : 5210 MHz
Frequency Range	1GHz ~ 40GHz	Detector Function	Peak (PK) Average (AV)

Antenna Polarity & Test Distance : Horizontal at 3 m

No	Frequency (MHz)	Emission Level (dBuV/m)	Limit (dBuV/m)	Margin (dB)	Antenna Height (m)	Table Angle (Degree)	Raw Value (dBuV)	Correction Factor (dB/m)
1	5147.30	63.4 PK	74.0	-10.6	1.02 H	265	58.1	5.3
2	5147.30	53.5 AV	54.0	-0.5	1.02 H	265	48.2	5.3
3	*5210.00	105.2 PK			1.02 H	265	100.4	4.8
4	*5210.00	95.4 AV			1.02 H	265	90.6	4.8
5	5350.00	52.2 PK	74.0	-21.8	1.02 H	265	47.4	4.8
6	5350.00	40.9 AV	54.0	-13.1	1.02 H	265	36.1	4.8
7	#10420.00	45.6 PK	68.2	-22.6	1.55 H	236	31.5	14.1
8	15630.00	46.8 PK	74.0	-27.2	2.17 H	88	31.8	15.0
9	15630.00	36.0 AV	54.0	-18.0	2.17 H	88	21.0	15.0

Antenna Polarity & Test Distance : Vertical at 3 m

No	Frequency (MHz)	Emission Level (dBuV/m)	Limit (dBuV/m)	Margin (dB)	Antenna Height (m)	Table Angle (Degree)	Raw Value (dBuV)	Correction Factor (dB/m)
1	5150.00	64.1 PK	74.0	-9.9	1.08 V	215	58.9	5.2
2	5150.00	52.3 AV	54.0	-1.7	1.08 V	215	47.1	5.2
3	*5210.00	108.2 PK			1.08 V	215	103.4	4.8
4	*5210.00	97.7 AV			1.08 V	215	92.9	4.8
5	5350.00	53.4 PK	74.0	-20.6	1.08 V	215	48.6	4.8
6	5350.00	42.8 AV	54.0	-11.2	1.08 V	215	38.0	4.8
7	#10420.00	45.4 PK	68.2	-22.8	1.59 V	217	31.3	14.1
8	15630.00	45.8 PK	74.0	-28.2	2.20 V	84	30.8	15.0
9	15630.00	35.6 AV	54.0	-18.4	2.20 V	84	20.6	15.0

Remarks:

1. Emission Level(dBuV/m) = Raw Value(dBuV) + Correction Factor(dB/m)
2. Correction Factor(dB/m) = Antenna Factor(dB/m) + Cable Factor(dB) – Pre-Amplifier Factor(dB)
3. Margin value = Emission Level – Limit value
4. The other emission levels were very low against the limit.
5. " * ": Fundamental frequency.
6. " # ": The radiated frequency is out of the restricted band.

RF Mode	TX 802.11ac (VHT80)	Channel	CH 58 : 5290 MHz
Frequency Range	1GHz ~ 40GHz	Detector Function	Peak (PK) Average (AV)

Antenna Polarity & Test Distance : Horizontal at 3 m

No	Frequency (MHz)	Emission Level (dBuV/m)	Limit (dBuV/m)	Margin (dB)	Antenna Height (m)	Table Angle (Degree)	Raw Value (dBuV)	Correction Factor (dB/m)
1	5054.50	52.8 PK	74.0	-21.2	1.00 H	262	47.7	5.1
2	5054.50	40.0 AV	54.0	-14.0	1.00 H	262	34.9	5.1
3	5112.00	50.6 PK	74.0	-23.4	1.00 H	262	45.1	5.5
4	5112.00	40.9 AV	54.0	-13.1	1.00 H	262	35.4	5.5
5	*5290.00	103.8 PK			1.00 H	262	99.0	4.8
6	*5290.00	93.3 AV			1.00 H	262	88.5	4.8
7	5350.00	63.4 PK	74.0	-10.6	1.00 H	262	58.6	4.8
8	5350.00	53.5 AV	54.0	-0.5	1.00 H	262	48.7	4.8
9	#10580.00	46.0 PK	68.2	-22.2	1.62 H	240	31.8	14.2
10	15870.00	46.9 PK	74.0	-27.1	2.20 H	88	32.4	14.5
11	15870.00	36.1 AV	54.0	-17.9	2.20 H	88	21.6	14.5

Antenna Polarity & Test Distance : Vertical at 3 m

No	Frequency (MHz)	Emission Level (dBuV/m)	Limit (dBuV/m)	Margin (dB)	Antenna Height (m)	Table Angle (Degree)	Raw Value (dBuV)	Correction Factor (dB/m)
1	5150.00	51.1 PK	74.0	-22.9	1.08 V	209	45.9	5.2
2	5150.00	41.3 AV	54.0	-12.7	1.08 V	209	36.1	5.2
3	*5290.00	106.2 PK			1.08 V	209	101.4	4.8
4	*5290.00	96.4 AV			1.08 V	209	91.6	4.8
5	5350.00	65.1 PK	74.0	-8.9	1.08 V	209	60.3	4.8
6	5350.00	53.2 AV	54.0	-0.8	1.08 V	209	48.4	4.8
7	#10580.00	45.2 PK	68.2	-23.0	1.58 V	196	31.0	14.2
8	15870.00	46.7 PK	74.0	-27.3	2.14 V	99	32.2	14.5
9	15870.00	36.2 AV	54.0	-17.8	2.14 V	99	21.7	14.5

Remarks:

1. Emission Level(dBuV/m) = Raw Value(dBuV) + Correction Factor(dB/m)
2. Correction Factor(dB/m) = Antenna Factor(dB/m) + Cable Factor(dB) – Pre-Amplifier Factor(dB)
3. Margin value = Emission Level – Limit value
4. The other emission levels were very low against the limit.
5. " * ": Fundamental frequency.
6. " # ": The radiated frequency is out of the restricted band.

RF Mode	TX 802.11ac (VHT80)	Channel	CH 106 : 5530 MHz
Frequency Range	1GHz ~ 40GHz	Detector Function	Peak (PK) Average (AV)

Antenna Polarity & Test Distance : Horizontal at 3 m

No	Frequency (MHz)	Emission Level (dBuV/m)	Limit (dBuV/m)	Margin (dB)	Antenna Height (m)	Table Angle (Degree)	Raw Value (dBuV)	Correction Factor (dB/m)
1	5460.00	66.1 PK	74.0	-7.9	1.08 H	268	61.2	4.9
2	5460.00	53.8 AV	54.0	-0.2	1.08 H	268	48.9	4.9
3	#5464.80	65.9 PK	68.2	-2.3	1.08 H	268	60.9	5.0
4	*5530.00	105.2 PK			1.08 H	268	100.1	5.1
5	*5530.00	95.1 AV			1.08 H	268	90.0	5.1
6	#5824.40	52.4 PK	68.2	-15.8	1.08 H	268	47.0	5.4
7	11060.00	45.7 PK	74.0	-28.3	1.61 H	239	31.2	14.5
8	11060.00	35.5 AV	54.0	-18.5	1.61 H	239	21.0	14.5
9	#16590.00	46.1 PK	68.2	-22.1	2.13 H	112	29.3	16.8

Antenna Polarity & Test Distance : Vertical at 3 m

No	Frequency (MHz)	Emission Level (dBuV/m)	Limit (dBuV/m)	Margin (dB)	Antenna Height (m)	Table Angle (Degree)	Raw Value (dBuV)	Correction Factor (dB/m)
1	5460.00	65.7 PK	74.0	-8.3	1.03 V	227	60.8	4.9
2	5460.00	52.4 AV	54.0	-1.6	1.03 V	227	47.5	4.9
3	#5464.41	65.1 PK	68.2	-3.1	1.03 V	227	60.1	5.0
4	*5530.00	107.7 PK			1.03 V	227	102.6	5.1
5	*5530.00	97.3 AV			1.03 V	227	92.2	5.1
6	#5758.29	54.5 PK	68.2	-13.7	1.03 V	227	49.1	5.4
7	11060.00	45.4 PK	74.0	-28.6	1.59 V	191	30.9	14.5
8	11060.00	35.0 AV	54.0	-19.0	1.59 V	191	20.5	14.5
9	#16590.00	46.0 PK	68.2	-22.2	2.21 V	98	29.2	16.8

Remarks:

1. Emission Level(dBuV/m) = Raw Value(dBuV) + Correction Factor(dB/m)
2. Correction Factor(dB/m) = Antenna Factor(dB/m) + Cable Factor(dB) – Pre-Amplifier Factor(dB)
3. Margin value = Emission Level – Limit value
4. The other emission levels were very low against the limit.
5. " * ": Fundamental frequency.
6. " # ": The radiated frequency is out of the restricted band.

RF Mode	TX 802.11ac (VHT80)	Channel	CH 122 : 5610 MHz
Frequency Range	1GHz ~ 40GHz	Detector Function	Peak (PK) Average (AV)

Antenna Polarity & Test Distance : Horizontal at 3 m

No	Frequency (MHz)	Emission Level (dBuV/m)	Limit (dBuV/m)	Margin (dB)	Antenna Height (m)	Table Angle (Degree)	Raw Value (dBuV)	Correction Factor (dB/m)
1	*5610.00	104.8 PK			1.03 H	267	99.8	5.0
2	*5610.00	95.4 AV			1.03 H	267	90.4	5.0
3	#5725.00	67.3 PK	68.2	-0.9	1.03 H	267	62.1	5.2
4	11220.00	45.8 PK	74.0	-28.2	1.62 H	244	30.8	15.0
5	11220.00	35.4 AV	54.0	-18.6	1.62 H	244	20.4	15.0
6	#16830.00	46.6 PK	68.2	-21.6	2.15 H	117	28.8	17.8

Antenna Polarity & Test Distance : Vertical at 3 m

No	Frequency (MHz)	Emission Level (dBuV/m)	Limit (dBuV/m)	Margin (dB)	Antenna Height (m)	Table Angle (Degree)	Raw Value (dBuV)	Correction Factor (dB/m)
1	*5610.00	108.2 PK			1.00 V	225	103.2	5.0
2	*5610.00	97.6 AV			1.00 V	225	92.6	5.0
3	#5725.00	66.9 PK	68.2	-1.3	1.00 V	225	61.7	5.2
4	11220.00	45.4 PK	74.0	-28.6	1.57 V	192	30.4	15.0
5	11220.00	35.2 AV	54.0	-18.8	1.57 V	192	20.2	15.0
6	#16830.00	46.6 PK	68.2	-21.6	2.21 V	92	28.8	17.8

Remarks:

1. Emission Level(dBuV/m) = Raw Value(dBuV) + Correction Factor(dB/m)
2. Correction Factor(dB/m) = Antenna Factor(dB/m) + Cable Factor(dB) – Pre-Amplifier Factor(dB)
3. Margin value = Emission Level – Limit value
4. The other emission levels were very low against the limit.
5. " * ": Fundamental frequency.
6. " # ": The radiated frequency is out of the restricted band.

RF Mode	TX 802.11ac (VHT80)	Channel	CH 138 : 5690 MHz
Frequency Range	1GHz ~ 40GHz	Detector Function	Peak (PK) Average (AV)

Antenna Polarity & Test Distance : Horizontal at 3 m

No	Frequency (MHz)	Emission Level (dBuV/m)	Limit (dBuV/m)	Margin (dB)	Antenna Height (m)	Table Angle (Degree)	Raw Value (dBuV)	Correction Factor (dB/m)
1	5460.00	49.5 PK	74.0	-24.5	1.00 H	266	44.6	4.9
2	5460.00	37.3 AV	54.0	-16.7	1.00 H	266	32.4	4.9
3	#5470.00	50.2 PK	68.2	-18.0	1.00 H	266	45.2	5.0
4	*5690.00	108.9 PK			1.00 H	266	103.8	5.1
5	*5690.00	99.3 AV			1.00 H	266	94.2	5.1
6	#5850.00	67.6 PK	68.2	-0.6	1.00 H	266	62.1	5.5
7	11380.00	46.2 PK	74.0	-27.8	1.61 H	249	31.1	15.1
8	11380.00	35.7 AV	54.0	-18.3	1.61 H	249	20.6	15.1
9	#17070.00	46.6 PK	68.2	-21.6	2.15 H	91	28.0	18.6

Antenna Polarity & Test Distance : Vertical at 3 m

No	Frequency (MHz)	Emission Level (dBuV/m)	Limit (dBuV/m)	Margin (dB)	Antenna Height (m)	Table Angle (Degree)	Raw Value (dBuV)	Correction Factor (dB/m)
1	5460.00	49.3 PK	74.0	-24.7	1.10 V	241	44.4	4.9
2	5460.00	36.9 AV	54.0	-17.1	1.10 V	241	32.0	4.9
3	#5470.00	50.2 PK	68.2	-18.0	1.10 V	241	45.2	5.0
4	*5690.00	113.2 PK			1.10 V	241	108.1	5.1
5	*5690.00	102.2 AV			1.10 V	241	97.1	5.1
6	#5850.00	67.5 PK	68.2	-0.7	1.10 V	241	62.0	5.5
7	11380.00	45.1 PK	74.0	-28.9	1.65 V	202	30.0	15.1
8	11380.00	35.0 AV	54.0	-19.0	1.65 V	202	19.9	15.1
9	#17070.00	46.5 PK	68.2	-21.7	2.21 V	87	27.9	18.6

Remarks:

1. Emission Level(dBuV/m) = Raw Value(dBuV) + Correction Factor(dB/m)
2. Correction Factor(dB/m) = Antenna Factor(dB/m) + Cable Factor(dB) – Pre-Amplifier Factor(dB)
3. Margin value = Emission Level – Limit value
4. The other emission levels were very low against the limit.
5. " * ": Fundamental frequency.
6. " # ": The radiated frequency is out of the restricted band.

RF Mode	TX 802.11ac (VHT80)	Channel	CH 155 : 5775 MHz
Frequency Range	1GHz ~ 40GHz	Detector Function	Peak (PK) Average (AV)

Antenna Polarity & Test Distance : Horizontal at 3 m

No	Frequency (MHz)	Emission Level (dBuV/m)	Limit (dBuV/m)	Margin (dB)	Antenna Height (m)	Table Angle (Degree)	Raw Value (dBuV)	Correction Factor (dB/m)
1	#5647.39	67.8 PK	68.2	-0.4	1.00 H	269	62.8	5.0
2	*5775.00	109.4 PK			1.00 H	269	103.9	5.5
3	*5775.00	99.6 AV			1.00 H	269	94.1	5.5
4	#5927.24	61.8 PK	68.2	-6.4	1.00 H	269	56.2	5.6
5	11550.00	45.5 PK	74.0	-28.5	1.60 H	249	30.5	15.0
6	11550.00	35.2 AV	54.0	-18.8	1.60 H	249	20.2	15.0
7	#17325.00	46.9 PK	68.2	-21.3	2.18 H	99	28.2	18.7

Antenna Polarity & Test Distance : Vertical at 3 m

No	Frequency (MHz)	Emission Level (dBuV/m)	Limit (dBuV/m)	Margin (dB)	Antenna Height (m)	Table Angle (Degree)	Raw Value (dBuV)	Correction Factor (dB/m)
1	#5646.90	66.6 PK	68.2	-1.6	1.12 V	236	61.6	5.0
2	*5775.00	112.7 PK			1.12 V	236	107.2	5.5
3	*5775.00	102.0 AV			1.12 V	236	96.5	5.5
4	#5931.44	58.8 PK	68.2	-9.4	1.12 V	236	53.2	5.6
5	11550.00	45.0 PK	74.0	-29.0	1.54 V	189	30.0	15.0
6	11550.00	34.9 AV	54.0	-19.1	1.54 V	189	19.9	15.0
7	#17325.00	46.2 PK	68.2	-22.0	2.12 V	79	27.5	18.7

Remarks:

1. Emission Level(dBuV/m) = Raw Value(dBuV) + Correction Factor(dB/m)
2. Correction Factor(dB/m) = Antenna Factor(dB/m) + Cable Factor(dB) – Pre-Amplifier Factor(dB)
3. Margin value = Emission Level – Limit value
4. The other emission levels were very low against the limit.
5. " * ": Fundamental frequency.
6. " # ": The radiated frequency is out of the restricted band.

Below 1GHz Data

RF Mode	TX 802.11ac (VHT40)	Channel	CH 151 : 5755 MHz
Frequency Range	9kHz ~ 1GHz	Detector Function	Quasi-Peak (QP)

Antenna Polarity & Test Distance : Horizontal at 3 m								
No	Frequency (MHz)	Emission Level (dBuV/m)	Limit (dBuV/m)	Margin (dB)	Antenna Height (m)	Table Angle (Degree)	Raw Value (dBuV)	Correction Factor (dB/m)
1	49.13	26.8 QP	40.0	-13.2	2.50 H	360	34.8	-8.0
2	135.37	23.5 QP	43.5	-20.0	2.00 H	96	31.8	-8.3
3	256.33	21.6 QP	46.0	-24.4	1.00 H	224	30.0	-8.4
4	418.78	25.8 QP	46.0	-20.2	2.00 H	155	28.8	-3.0
5	534.91	27.1 QP	46.0	-18.9	2.00 H	254	27.6	-0.5
6	798.29	31.7 QP	46.0	-14.3	2.50 H	4	26.7	5.0

Remarks:

1. Emission Level(dBuV/m) = Raw Value(dBuV) + Correction Factor(dB/m)
2. Correction Factor(dB/m) = Antenna Factor(dB/m) + Cable Factor(dB) – Pre-Amplifier Factor(dB)
3. Margin value = Emission Level – Limit value
4. The other emission levels were very low against the limit of frequency range 30MHz~1000MHz.
5. The emission levels were very low against the limit of frequency range 9kHz~30MHz: the amplitude of spurious emissions attenuated more than 20 dB below the permissible value to be report.

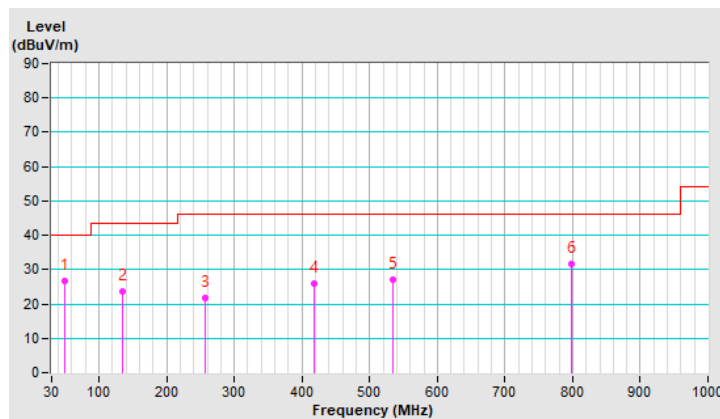

RF Mode	TX 802.11ac (VHT40)	Channel	CH 151 : 5755 MHz
Frequency Range	9kHz ~ 1GHz	Detector Function	Quasi-Peak (QP)

Antenna Polarity & Test Distance : Vertical at 3 m

No	Frequency (MHz)	Emission Level (dBUV/m)	Limit (dBUV/m)	Margin (dB)	Antenna Height (m)	Table Angle (Degree)	Raw Value (dBUV)	Correction Factor (dB/m)
1	114.41	22.9 QP	43.5	-20.6	2.00 V	0	33.1	-10.2
2	213.69	20.4 QP	43.5	-23.1	1.50 V	244	30.9	-10.5
3	377.87	25.3 QP	46.0	-20.7	1.50 V	360	29.7	-4.4
4	567.19	27.8 QP	46.0	-18.2	2.00 V	155	27.6	0.2
5	722.00	29.7 QP	46.0	-16.3	1.50 V	360	26.3	3.4
6	890.00	32.6 QP	46.0	-13.4	2.00 V	6	26.1	6.5

Remarks:

1. Emission Level(dBuV/m) = Raw Value(dBuV) + Correction Factor(dB/m)
2. Correction Factor(dB/m) = Antenna Factor(dB/m) + Cable Factor(dB) – Pre-Amplifier Factor(dB)
3. Margin value = Emission Level – Limit value
4. The other emission levels were very low against the limit of frequency range 30MHz~1000MHz.
5. The emission levels were very low against the limit of frequency range 9kHz~30MHz: the amplitude of spurious emissions attenuated more than 20 dB below the permissible value to be report.

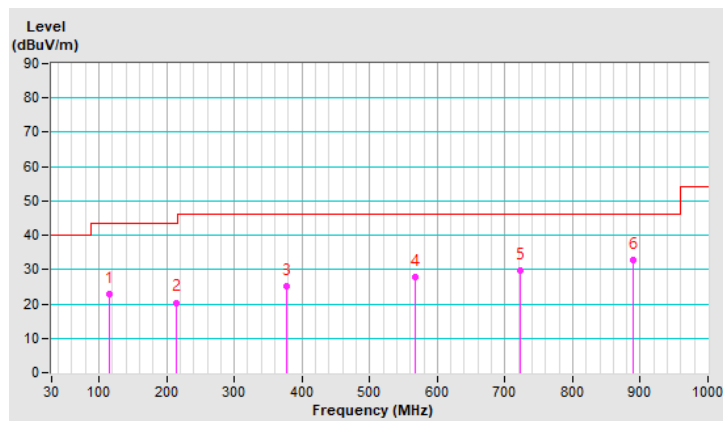

4.2 Conducted Emission Measurement

4.2.1 Limits of Conducted Emission Measurement

Frequency (MHz)	Conducted Limit (dBuV)	
	Quasi-peak	Average
0.15 - 0.5	66 - 56	56 - 46
0.50 - 5.0	56	46
5.0 - 30.0	60	50

Note: 1. The lower limit shall apply at the transition frequencies.

2. The limit decreases in line with the logarithm of the frequency in the range of 0.15 to 0.50MHz.

4.2.2 Test Instruments

DESCRIPTION & MANUFACTURER	MODEL NO.	SERIAL NO.	CALIBRATED DATE	CALIBRATED UNTIL
Test Receiver R&S	ESCS 30	847124/029	2020/10/20	2021/10/19
LISN R&S	ESH3-Z5	848773/004	2020/10/27	2021/10/26
LISN R & S	ESH3-Z5	835239/001	2020/3/19	2021/3/18
50 ohms Terminator	50	3	2020/10/26	2021/10/25
RF Coaxial Cable JYEBO	5D-FB	COCCAB-001	2020/9/26	2021/9/25
Fixed attenuator STI	STI02-2200-10	005	2020/8/29	2021/8/28
Software BVADT	BVADT_Cond_ V7.3.7.4	NA	NA	NA

Note:

1. The calibration interval of the above test instruments are 12 months and the calibrations are traceable to NML/ROC and NIST/USA.
2. The test was performed in Conduction 1.
3. Tested Date: 2021/2/1

4.2.3 Test Procedure

- a. The EUT was placed 0.4 meters from the conducting wall of the shielded room with EUT being connected to the power mains through a line impedance stabilization network (LISN). Other support units were connected to the power mains through another LISN. The two LISNs provide 50 ohm/ 50uH of coupling impedance for the measuring instrument.
- b. Both lines of the power mains connected to the EUT were checked for maximum conducted interference.
- c. The frequency range from 150kHz to 30MHz was searched. Emission levels under (Limit - 20dB) was not recorded.

Note: All modes of operation were investigated and the worst-case emissions are reported.

4.2.4 Deviation from Test Standard

No deviation.

4.2.5 Test Setup

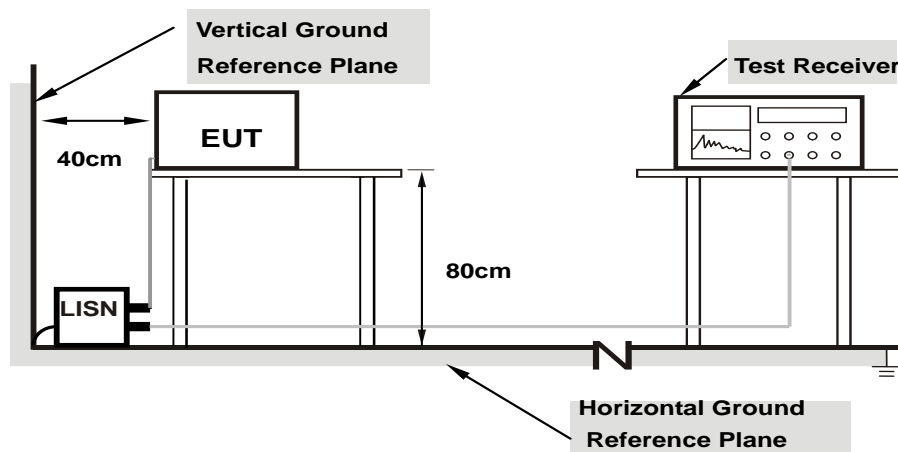

Note: 1.Support units were connected to second LISN.

For the actual test configuration, please refer to the attached file (Test Setup Photo).

4.2.6 EUT Operating Condition

Same as 4.1.6.

4.2.7 Test Results

RF Mode	TX 802.11ac (VHT40)	Channel	CH 151 : 5755 MHz
Frequency Range	150kHz ~ 30MHz	Detector Function & Resolution Bandwidth	Quasi-Peak (QP) / Average (AV), 9kHz

Phase Of Power : Line (L)										
No	Frequency (MHz)	Correction Factor (dB)	Reading Value (dBuV)		Emission Level (dBuV)		Limit (dBuV)		Margin (dB)	
			Q.P.	AV.	Q.P.	AV.	Q.P.	AV.	Q.P.	AV.
1	0.15000	9.96	27.72	15.50	37.68	25.46	66.00	56.00	-28.32	-30.54
2	0.22812	9.99	24.80	15.27	34.79	25.26	62.52	52.52	-27.73	-27.26
3	0.65781	10.04	30.02	20.15	40.06	30.19	56.00	46.00	-15.94	-15.81
4	1.49219	10.10	22.33	12.53	32.43	22.63	56.00	46.00	-23.57	-23.37
5	3.35938	10.24	20.40	11.89	30.64	22.13	56.00	46.00	-25.36	-23.87
6	4.66406	10.33	19.57	11.03	29.90	21.36	56.00	46.00	-26.10	-24.64

Remarks:

1. Q.P. and AV. are abbreviations of quasi-peak and average individually.
2. The emission levels of other frequencies were very low against the limit.
3. Margin value = Emission level – Limit value
4. Correction factor = Insertion loss + Cable loss
5. Emission Level = Correction Factor + Reading Value

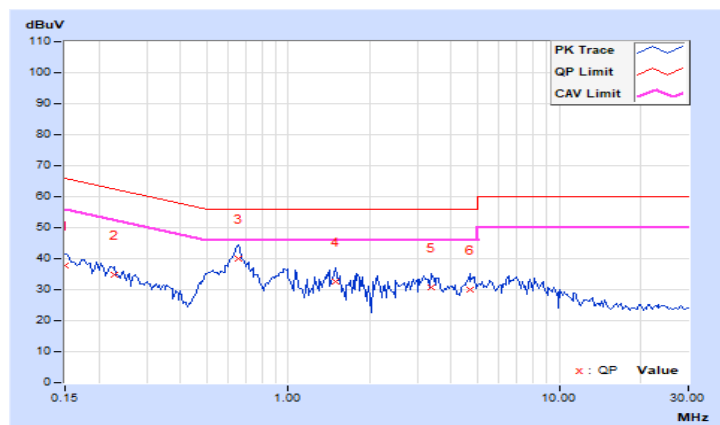

RF Mode	TX 802.11ac (VHT40)	Channel	CH 151 : 5755 MHz
Frequency Range	150kHz ~ 30MHz	Detector Function & Resolution Bandwidth	Quasi-Peak (QP) / Average (AV), 9kHz

Phase Of Power : Neutral (N)										
No	Frequency (MHz)	Correction Factor (dB)	Reading Value (dBuV)		Emission Level (dBuV)		Limit (dBuV)		Margin (dB)	
			Q.P.	AV.	Q.P.	AV.	Q.P.	AV.	Q.P.	AV.
1	0.15781	9.95	30.34	19.84	40.29	29.79	65.58	55.58	-25.29	-25.79
2	0.20469	9.98	30.64	20.17	40.62	30.15	63.42	53.42	-22.80	-23.27
3	0.68516	10.04	26.99	18.48	37.03	28.52	56.00	46.00	-18.97	-17.48
4	1.94531	10.14	25.64	15.11	35.78	25.25	56.00	46.00	-20.22	-20.75
5	4.06641	10.25	25.02	17.47	35.27	27.72	56.00	46.00	-20.73	-18.28
6	6.53516	10.41	19.84	13.40	30.25	23.81	60.00	50.00	-29.75	-26.19

Remarks:

1. Q.P. and AV. are abbreviations of quasi-peak and average individually.
2. The emission levels of other frequencies were very low against the limit.
3. Margin value = Emission level – Limit value
4. Correction factor = Insertion loss + Cable loss
5. Emission Level = Correction Factor + Reading Value

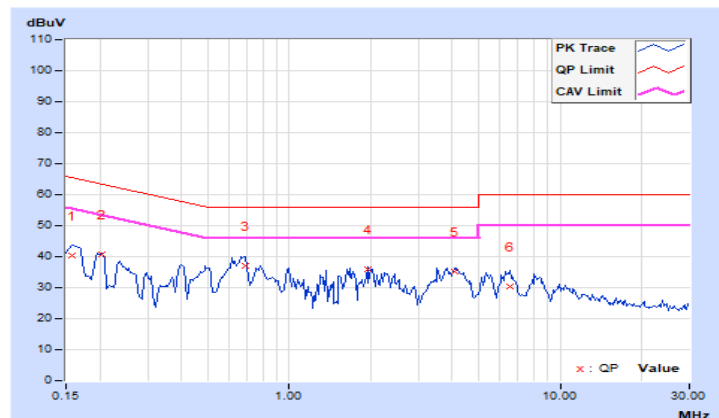

4.3 Transmit Power Measurement

4.3.1 Limits of Transmit Power Measurement

Operation Band	EUT Category		Limit
U-NII-1		Outdoor Access Point	1 Watt (30 dBm) (Max. e.i.r.p \leq 125mW(21 dBm) at any elevation angle above 30 degrees as measured from the horizon)
		Fixed point-to-point Access Point	1 Watt (30 dBm)
		Indoor Access Point	1 Watt (30 dBm)
	√	Client device	250mW (24 dBm)
U-NII-2A		√	250mW (24 dBm) or 11 dBm+10 log B*
U-NII-2C		√	250mW (24 dBm) or 11 dBm+10 log B*
U-NII-3		√	1 Watt (30 dBm)

*B is the 26 dB emission bandwidth in megahertz

Per KDB 662911 Method of conducted output power measurement on IEEE 802.11 devices,

Array Gain = 0 dB (i.e., no array gain) for $N_{ANT} \leq 4$;

Array Gain = 0 dB (i.e., no array gain) for channel widths ≥ 40 MHz for any N_{ANT} ;

Array Gain = $5 \log(N_{ANT}/N_{SS})$ dB or 3 dB, whichever is less for 20-MHz channel widths with $N_{ANT} \geq 5$.

For power measurements on all other devices: Array Gain = $10 \log(N_{ANT}/N_{SS})$ dB.

4.3.2 Test Setup

FOR POWER OUTPUT MEASUREMENT

For channel straddling 5725MHz:

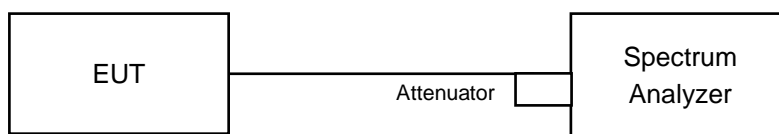

For other channels:

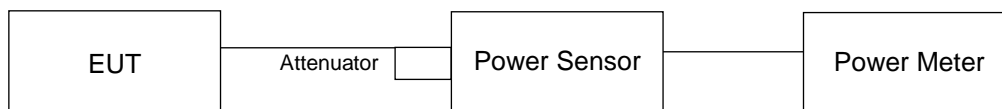

FOR 26dB OCCUPIED BANDWIDTH

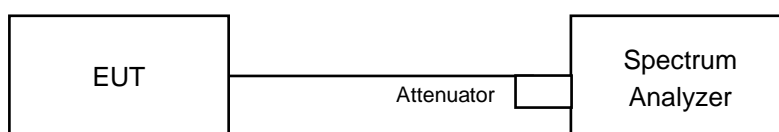

4.3.3 Test Instruments

Refer to section 4.1.2 to get information of above instrument.

4.3.4 Test Procedure

FOR POWER OUTPUT MEASUREMENT

For channel straddling 5725MHz:

Follow FCC KDB 789033 UNII test procedure:

Method SA-1

1. Set span to encompass the entire emission bandwidth (EBW) of the signal.
2. Set RBW = 1MHz.
3. Set the VBW $\geq 3 \times$ RBW.
4. Number of points in sweep ≥ 2 Span / RBW.
5. Sweep time = auto.
6. Set trigger to free run (duty cycle ≥ 98 percent)
7. Detector = RMS.
8. Trace average at least 100 traces in power averaging mode
9. Compute power by integrating the spectrum across the 26 dB EBW of the signal.

For other channels:

Method PM is used to perform output power measurement, trigger and gating function of wide band power meter is enabled to measure max output power of TX on burst. Duty factor is not added to measured value.

FOR 26dB OCCUPIED BANDWIDTH

1. Set RBW = approximately 1% of the emission bandwidth.
2. Set the VBW $>$ RBW.
3. Detector = Peak.
4. Trace mode = max hold.
5. Measure the maximum width of the emission that is 26 dB down from the peak of the emission. Compare this with the RBW setting of the analyzer. Readjust RBW and repeat measurement as needed until the RBW/EBW ratio is approximately 1%.

4.3.5 Deviation from Test Standard

No deviation.

4.3.6 EUT Operating Condition

The software provided by client to enable the EUT under transmission condition continuously at lowest, middle and highest channel frequencies individually.

4.3.7 Test Results

POWER OUTPUT
802.11a

Chan.	Chan. Freq. (MHz)	Average Power (dBm)		Total Power (mW)	Total Power (dBm)	Limit (dBm)	Pass / Fail
		Chain 0	Chain 1				
36	5180	19.05	18.94	158.696	22.01	24	Pass
40	5200	19.20	18.90	160.801	22.06	24	Pass
48	5240	18.06	17.51	120.337	20.80	24	Pass
52	5260	19.04	18.84	156.727	21.95	24	Pass
60	5300	19.17	18.88	159.872	22.04	24	Pass
64	5320	18.49	18.38	139.497	21.45	24	Pass
100	5500	18.44	18.57	141.768	21.52	24	Pass
116	5580	19.00	18.80	155.291	21.91	24	Pass
140	5700	18.45	18.50	140.779	21.49	24	Pass
*144 (U-NII-2C Band)	5720	18.86	18.62	149.691	21.75	24	Pass
*144 (U-NII-3 Band)	5720	12.76	11.86	34.226	15.34	30	Pass
149	5745	19.53	19.38	176.439	22.47	30	Pass
157	5785	19.46	18.95	166.832	22.22	30	Pass
165	5825	19.17	18.93	160.767	22.06	30	Pass

Note: * Test was performed in accordance with Measurement follow FCC KDB 789033 UNII test procedure Method SA-1 and use spectrum analyzer test.

Note: For U-NII-2A, U-NII-2C Band output power limitation is determined based on 26dBc bandwidth

Power Limit = 11dBm + 10logB < U-NII-2A, U-NII-2C >			
Channel Number	Freq.(MHz)	Min. B(MHz)	Determined Conducted Limit (dBm)
52	5260	24.47	24.88 > 24
60	5300	24.51	24.89 > 24
64	5320	23.67	24.74 > 24
100	5500	25.35	25.03 > 24
116	5580	28.55	25.55 > 24
140	5700	27.1	25.32 > 24
144 (U-NII-2C Band)	5720	21.6	24.34 > 24

802.11ac (VHT20)

Chan.	Chan. Freq. (MHz)	Average Power (dBm)		Total Power (mW)	Total Power (dBm)	Limit (dBm)	Pass / Fail
		Chain 0	Chain 1				
36	5180	18.67	18.39	142.645	21.54	24	Pass
40	5200	19.10	18.93	159.446	22.03	24	Pass
48	5240	17.83	17.44	116.136	20.65	24	Pass
52	5260	18.91	18.87	154.894	21.90	24	Pass
60	5300	19.05	18.86	157.266	21.97	24	Pass
64	5320	18.54	18.52	142.571	21.54	24	Pass
100	5500	18.48	18.69	144.43	21.60	24	Pass
116	5580	19.15	18.83	158.608	22.00	24	Pass
140	5700	18.61	18.68	146.401	21.66	24	Pass
*144 (U-NII-2C Band)	5720	19.07	17.88	142.1	21.53	23.98	Pass
*144 (U-NII-3 Band)	5720	13.27	11.96	36.936	15.67	30	Pass
149	5745	19.30	19.22	168.674	22.27	30	Pass
157	5785	19.27	19.00	163.961	22.15	30	Pass
165	5825	19.24	19.07	164.67	22.17	30	Pass

Note: * Test was performed in accordance with Measurement follow FCC KDB 789033 UNII test procedure Method SA-1 and use spectrum analyzer test.

Note: For U-NII-2A, U-NII-2C Band output power limitation is determined based on 26dBc bandwidth

Power Limit = 11dBm + 10logB < U-NII-2A, U-NII-2C >			
Channel Number	Freq.(MHz)	Min. B(MHz)	Determined Conducted Limit (dBm)
52	5260	25.21	25.01 > 24
60	5300	25.94	25.13 > 24
64	5320	25.5	25.06 > 24
100	5500	25.9	25.13 > 24
116	5580	28.8	25.59 > 24
140	5700	29.4	25.68 > 24
144 (U-NII-2C Band)	5720	19.88	23.98 < 24

802.11ac (VHT40)

Chan.	Chan. Freq. (MHz)	Average Power (dBm)		Total Power (mW)	Total Power (dBm)	Limit (dBm)	Pass / Fail
		Chain 0	Chain 1				
38	5190	16.82	16.52	92.958	19.68	24	Pass
46	5230	17.83	17.44	116.136	20.65	24	Pass
54	5270	18.94	18.67	151.964	21.82	24	Pass
62	5310	15.87	15.16	71.446	18.54	24	Pass
102	5510	16.25	16.25	84.339	19.26	24	Pass
110	5550	18.80	18.54	147.307	21.68	24	Pass
134	5670	16.28	16.22	84.341	19.26	24	Pass
*142 (U-NII-2C Band)	5710	18.86	18.04	140.593	21.48	24	Pass
*142 (U-NII-3 Band)	5710	8.13	8.71	13.931	11.44	30	Pass
151	5755	20.07	20.02	202.086	23.06	30	Pass
159	5795	20.01	20.01	200.461	23.02	30	Pass

Note: * Test was performed in accordance with Measurement follow FCC KDB 789033 UNII test procedure Method SA-1 and use spectrum analyzer test.

Note: For U-NII-2A, U-NII-2C Band output power limitation is determined based on 26dBc bandwidth

Power Limit = 11dBm + 10logB < U-NII-2A, U-NII-2C >			
Channel Number	Freq.(MHz)	Min. B(MHz)	Determined Conducted Limit (dBm)
54	5270	42.94	27.32 > 24
62	5310	42.38	27.27 > 24
102	5510	42.19	27.25 > 24
110	5550	52.33	28.18 > 24
134	5670	42.24	27.25 > 24
142 (U-NII-2C Band)	5710	41.44	27.17 > 24

802.11ac (VHT80)

Chan.	Chan. Freq. (MHz)	Average Power (dBm)		Total Power (mW)	Total Power (dBm)	Limit (dBm)	Pass / Fail
		Chain 0	Chain 1				
42	5210	16.36	15.94	82.516	19.17	24	Pass
58	5290	14.84	14.08	56.065	17.49	24	Pass
106	5530	16.18	15.88	80.221	19.04	24	Pass
122	5610	16.11	15.84	79.203	18.99	24	Pass
*138 (U-NII-2C Band)	5690	18.49	18.18	136.398	21.35	24	Pass
*138 (U-NII-3 Band)	5690	5.04	4.80	6.211	7.93	30	Pass
155	5775	19.30	19.02	164.913	22.17	30	Pass

Note: * Test was performed in accordance with Measurement follow FCC KDB 789033 UNII test procedure Method SA-1 and use spectrum analyzer test.

Note: For U-NII-2A, U-NII-2C Band output power limitation is determined based on 26dBc bandwidth

Power Limit = 11dBm + 10logB < U-NII-2A, U-NII-2C >			
Channel Number	Freq.(MHz)	Min. B(MHz)	Determined Conducted Limit (dBm)
58	5290	84.42	30.26 > 24
106	5530	84.66	30.27 > 24
122	5610	84.15	30.25 > 24
138 (U-NII-2C Band)	5690	84.08	30.24 > 24

For channel straddling 5725MHz of Power

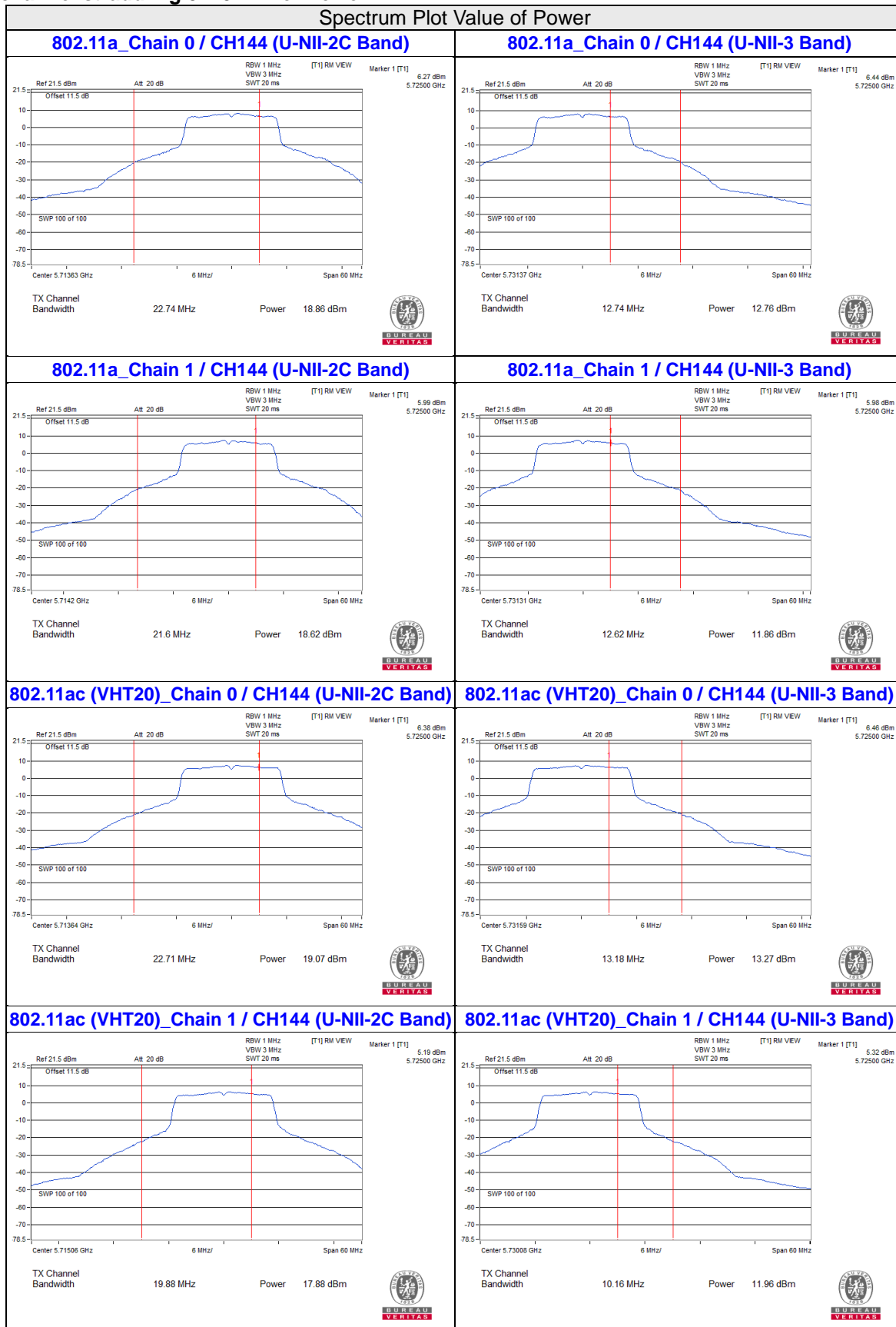

Spectrum Plot Value of Power

802.11ac (VHT40)_Chain 0 / CH142 (U-NII-2C Band) 802.11ac (VHT40)_Chain 0 / CH142 (U-NII-3 Band)

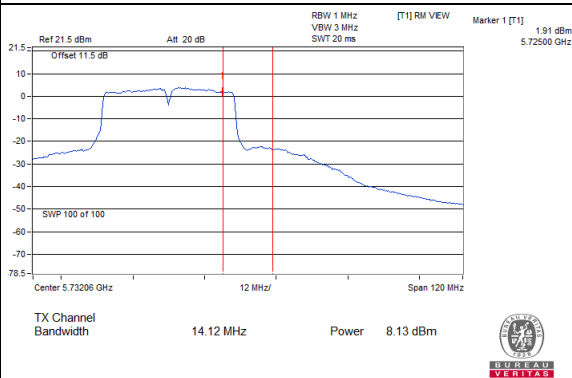
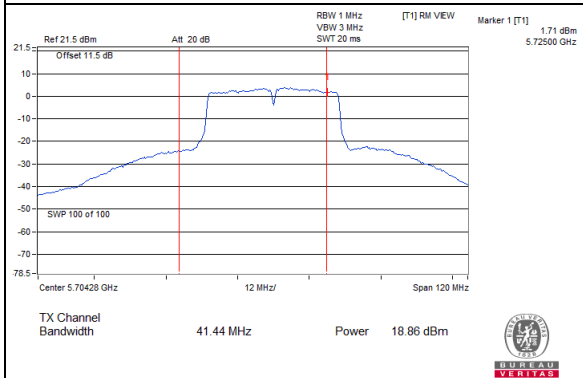

802.11ac (VHT40)_Chain 1 / CH142 (U-NII-2C Band) 802.11ac (VHT40)_Chain 1 / CH142 (U-NII-3 Band)

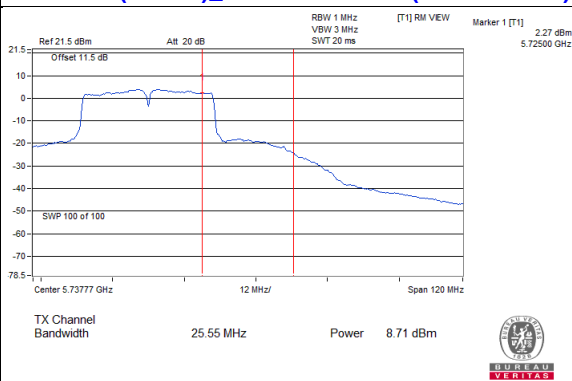
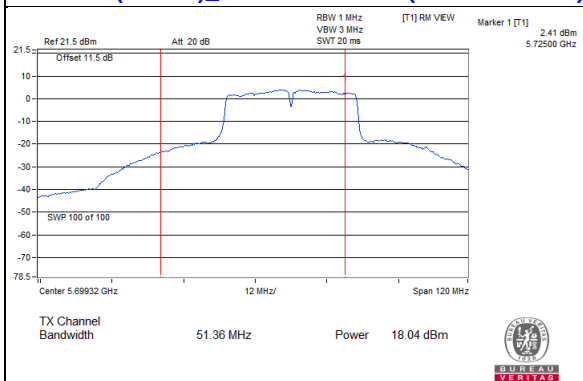

802.11ac (VHT80)_Chain 0 / CH138 (U-NII-2C Band) 802.11ac (VHT80)_Chain 0 / CH138 (U-NII-3 Band)

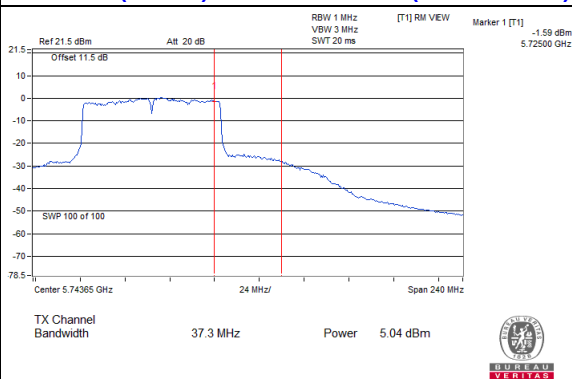
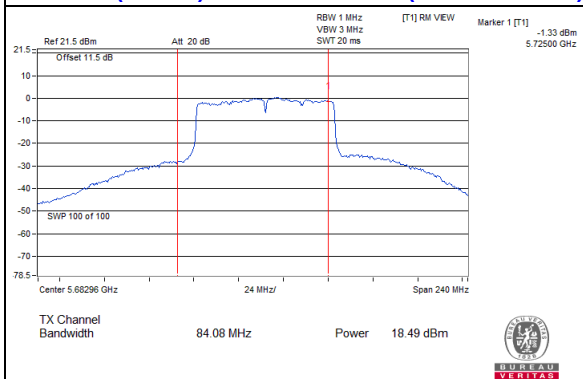

802.11ac (VHT80)_Chain 1 / CH138 (U-NII-2C Band) 802.11ac (VHT80)_Chain 1 / CH138 (U-NII-3 Band)

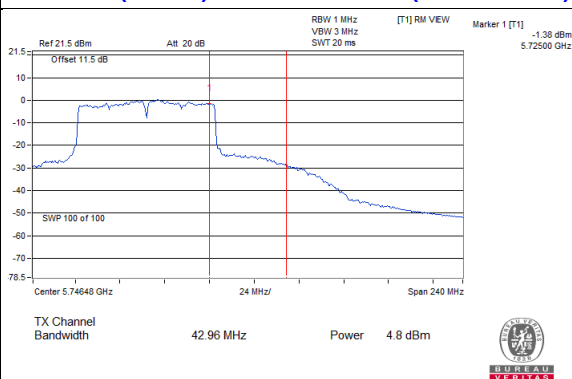
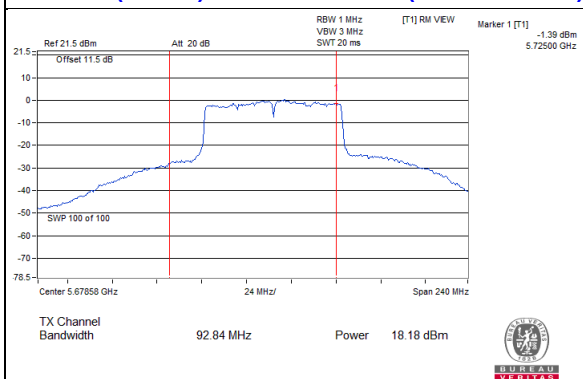

26dB OCCUPIED BANDWIDTH

802.11a

Channel	Frequency (MHz)	26dB Bandwidth (MHz)	
		Chain0	Chain1
36	5180	24.17	23.76
40	5200	23.71	22.9
48	5240	25.48	23.53
52	5260	41.51	24.47
60	5300	43.93	24.51
64	5320	41.62	23.67
100	5500	28.55	25.35
116	5580	36.21	28.55
140	5700	27.1	31.63
144 (U-NII-2C Band)	5720	22.74	21.6
144 (U-NII-3 Band)	5720	12.74	12.62
149	5745	25.59	24.29
157	5785	25.82	24.97
165	5825	26.15	25.35

802.11ac (VHT20)

Channel	Frequency (MHz)	26dB Bandwidth (MHz)	
		Chain0	Chain1
36	5180	24.93	24.59
40	5200	25.2	24.73
48	5240	26.5	25.26
52	5260	46.88	25.21
60	5300	46.02	25.94
64	5320	43.8	25.5
100	5500	28.93	25.9
116	5580	36.41	28.8
140	5700	29.4	29.54
144 (U-NII-2C Band)	5720	22.71	19.88
144 (U-NII-3 Band)	5720	13.18	10.16
149	5745	26.06	25.77
157	5785	26.55	26.28
165	5825	26.65	26.12

802.11ac (VHT40)

Channel	Frequency (MHz)	26dB Bandwidth (MHz)	
		Chain0	Chain1
38	5190	42.74	42.46
46	5230	46.06	42.6
54	5270	93.84	42.94
62	5310	42.42	42.38
102	5510	42.19	42.39
110	5550	91.04	52.33
134	5670	42.24	42.37
142 (U-NII-2C Band)	5710	41.44	51.36
142 (U-NII-3 Band)	5710	14.12	25.55
151	5755	42.69	42.62
159	5795	42.46	42.36

802.11ac (VHT80)

Channel	Frequency (MHz)	26dB Bandwidth (MHz)	
		Chain0	Chain1
42	5210	85.01	84.04
58	5290	84.47	84.42
106	5530	84.83	84.66
122	5610	85.03	84.15
138 (U-NII-2C Band)	5690	84.08	92.84
138 (U-NII-3 Band)	5690	37.3	42.96
155	5775	84.73	85.78

Spectrum Plot of Worst Value

802.11a_Chain 1 / CH144 (U-NII-3 Band)

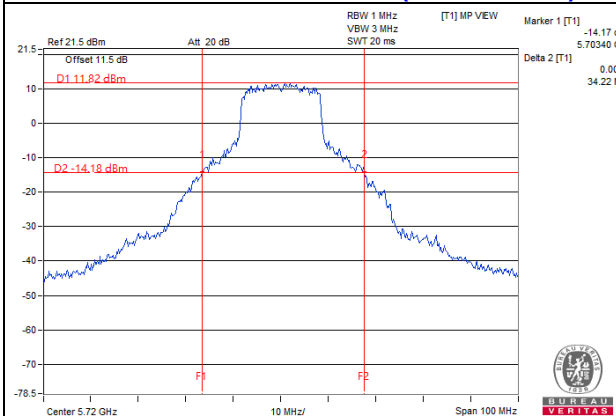

802.11ac (VHT20)_Chain 1 / CH144 (U-NII-3 Band)

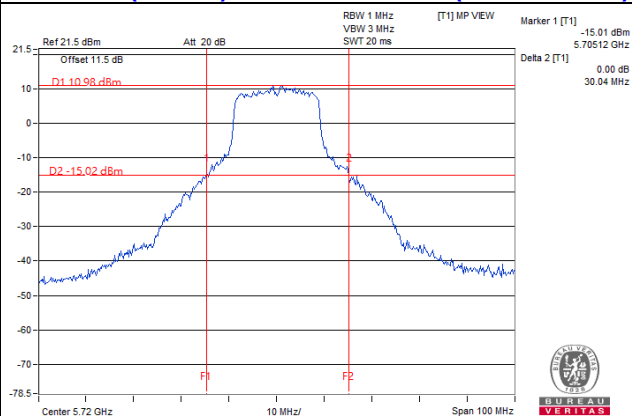

802.11ac (VHT40)_Chain 0 / CH142 (U-NII-3 Band)

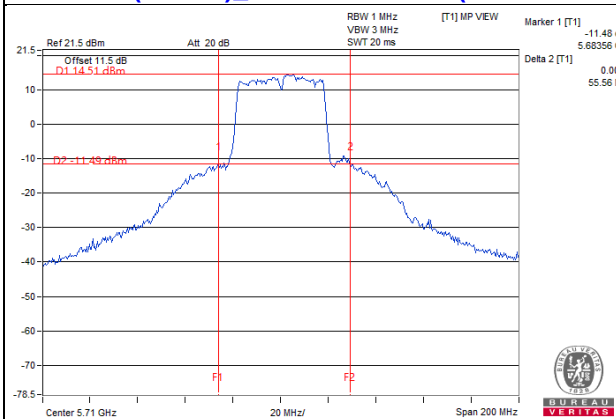

802.11ac (VHT80)_Chain 0 / CH138 (U-NII-3 Band)

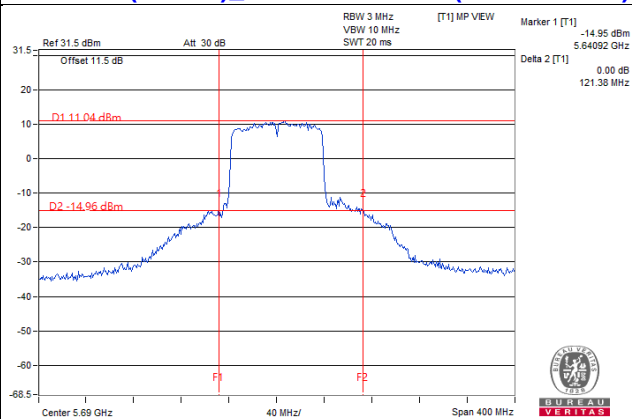

Note:

- For CH144 (U-NII-3) = Delta 2 - (5725MHz - Marker 1)
- For CH142 (U-NII-3) = Delta 2 - (5725MHz - Marker 1)
- For CH138 (U-NII-3) = Delta 2 - (5725MHz - Marker 1)

4.4 Occupied Bandwidth Measurement

4.4.1 Test Setup

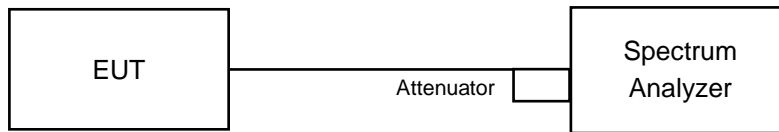

4.4.2 Test Instruments

Refer to section 4.1.2 to get information of above instrument.

4.4.3 Test Procedure

The transmitter output was connected to the spectrum analyzer through an attenuator. The bandwidth of the fundamental frequency was measured by spectrum analyzer with resolution bandwidth in the range of 1% to 5% of the anticipated emission bandwidth, and a video bandwidth at least 3x the resolution bandwidth and set the detector to SAMPLE. The width of a frequency band such that, below the lower and above the upper frequency limits, the mean powers emitted are each equal to a specified percentage 0.5% of the total mean power of a given emission.

4.4.4 Test Results

802.11a

Channel	Frequency (MHz)	Occupied Bandwidth (MHz)	
		Chain 0	Chain 1
36	5180	16.8	16.8
40	5200	16.8	16.8
48	5240	16.8	16.8
52	5260	35.04	16.8
60	5300	27.84	16.8
64	5320	26.16	16.68
100	5500	17.28	16.8
116	5580	20.76	17.04
140	5700	17.4	17.4
144 (U-NII-2C Band)	5720	15.68	14.72
144 (U-NII-3 Band)	5720	6.04	4.96
149	5745	16.8	16.8
157	5785	16.92	16.8
165	5825	17.04	16.8

802.11ac (VHT20)

Channel	Frequency (MHz)	Occupied Bandwidth (MHz)	
		Chain 0	Chain 1
36	5180	18	18
40	5200	17.88	17.88
48	5240	18	18
52	5260	39.6	18
60	5300	28.92	18
64	5320	25.68	17.88
100	5500	18.24	18
116	5580	20.16	18.24
140	5700	18.24	18.36
144 (U-NII-2C Band)	5720	15.44	14.24
144 (U-NII-3 Band)	5720	6.04	4.36
149	5745	18	18
157	5785	18	18
165	5825	18	18

802.11ac (VHT40)

Channel	Frequency (MHz)	Occupied Bandwidth (MHz)	
		Chain 0	Chain 1
38	5190	36.48	36.48
46	5230	36.96	36.72
54	5270	55.92	36.72
62	5310	36.48	36.48
102	5510	36.48	36.48
110	5550	51.6	36.96
134	5670	36.48	36.48
142 (U-NII-2C Band)	5710	33.48	33.96
142 (U-NII-3 Band)	5710	3.48	4.68
151	5755	36.48	36.72
159	5795	36.48	36.72

802.11ac (VHT80)

Channel	Frequency (MHz)	Occupied Bandwidth (MHz)	
		Chain 0	Chain 1
42	5210	75.84	75.84
58	5290	75.84	75.84
106	5530	75.84	75.84
122	5610	75.84	75.84
138 (U-NII-2C Band)	5690	73.4	73.4
138 (U-NII-3 Band)	5690	3.4	3.4
155	5775	75.84	75.84

Spectrum Plot of Max. Value

802.11a_Chain 0 / CH52

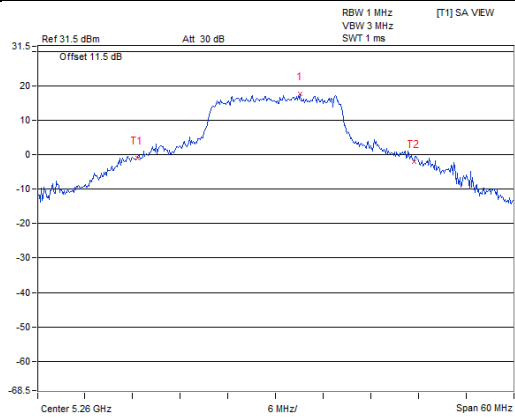

[T1] SA VIEW
 Marker 1 [T1]
 17.58 dBm
 5.26312 GHz
 35.04 MHz
 Temp 1 [T1 OBW]
 -0.98 dBm
 5.24248 GHz
 Temp 2 [T1 OBW]
 -2.11 dBm
 5.27752 GHz

802.11ac (VHT20)_Chain 0 / CH52

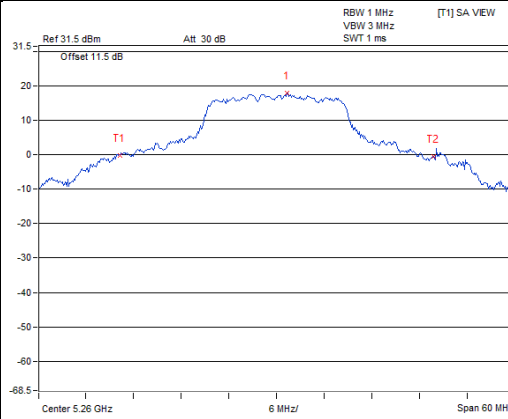

[T1] SA VIEW
 Marker 1 [T1]
 18.03 dBm
 5.26132 GHz
 39.60 MHz
 Temp 1 [T1 OBW]
 -0.11 dBm
 5.24020 GHz
 Temp 2 [T1 OBW]
 -0.58 dBm
 5.27980 GHz

802.11ac (VHT40)_Chain 0 / CH54

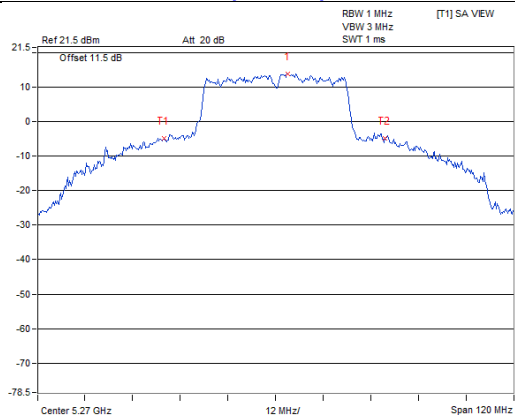

[T1] SA VIEW
 Marker 1 [T1]
 13.90 dBm
 5.27312 GHz
 55.92 MHz
 Temp 1 [T1 OBW]
 -4.95 dBm
 5.24168 GHz
 Temp 2 [T1 OBW]
 -4.71 dBm
 5.29760 GHz

802.11ac (VHT80)_Chain 0 / CH42

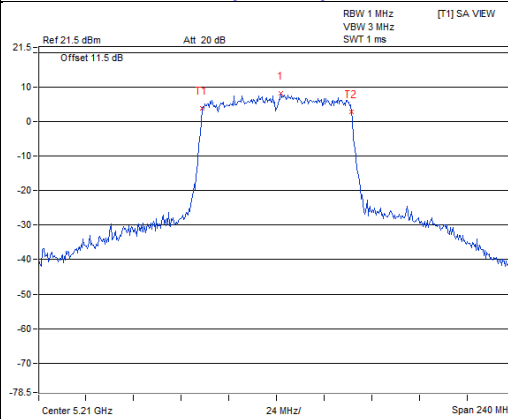

[T1] SA VIEW
 Marker 1 [T1]
 8.30 dBm
 5.21192 GHz
 75.84 MHz
 Temp 1 [T1 OBW]
 3.90 dBm
 5.17208 GHz
 Temp 2 [T1 OBW]
 2.86 dBm
 5.24792 GHz

For channel straddling 5725MHz of OCP99% BW

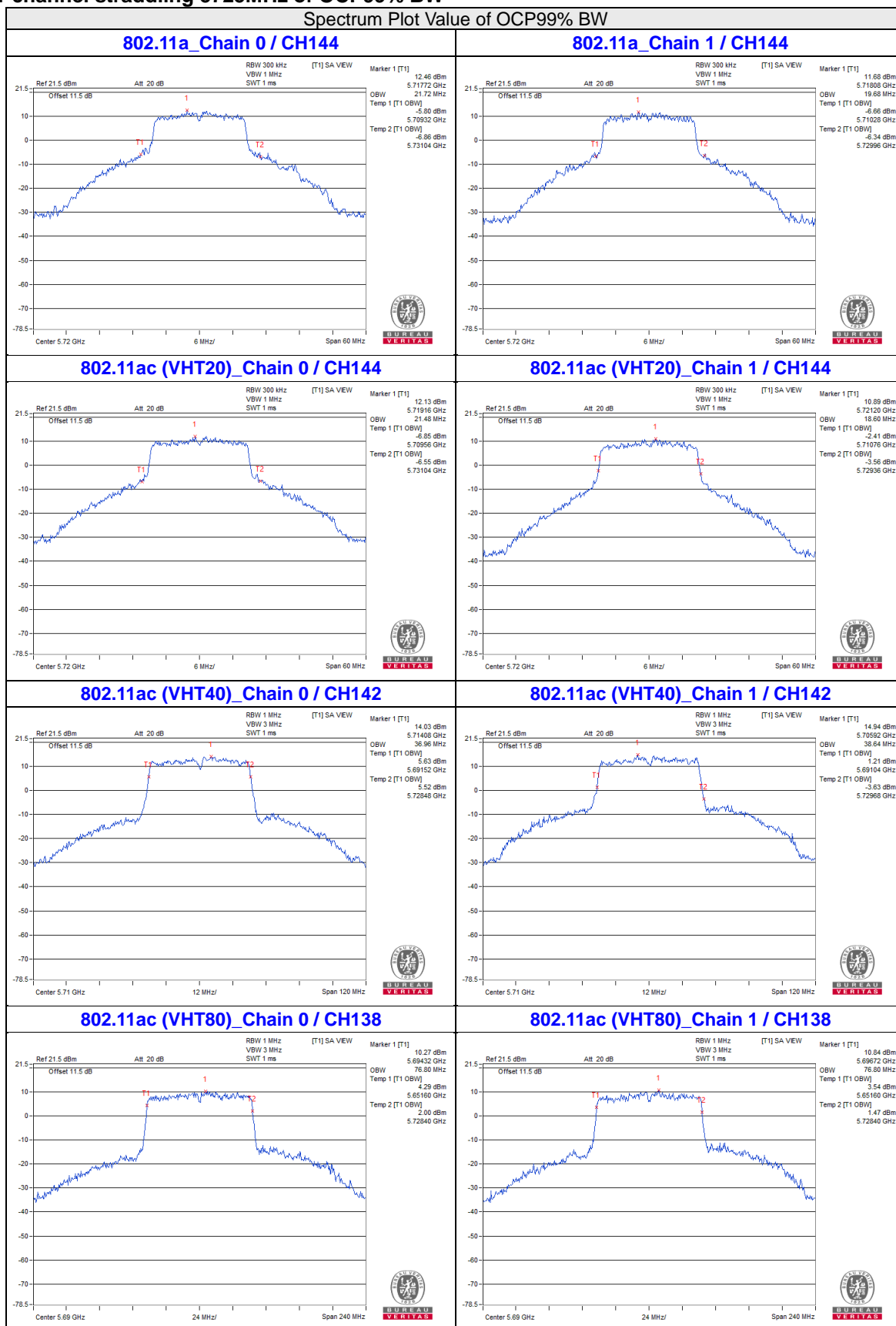

Spectrum Plot for near by DFS band
(DFS is required, if 99% OCP straddle into U-NII-2A band)

802.11a_Chain 0 / CH48

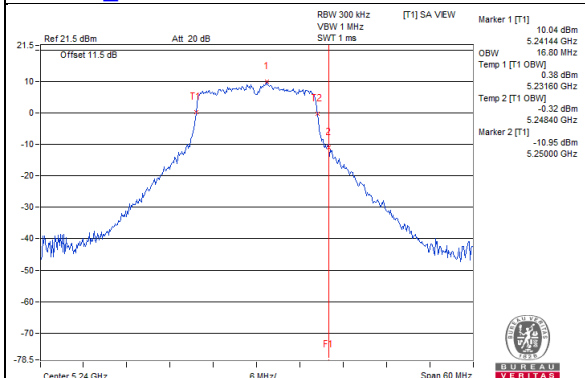

802.11a_Chain 1 / CH48

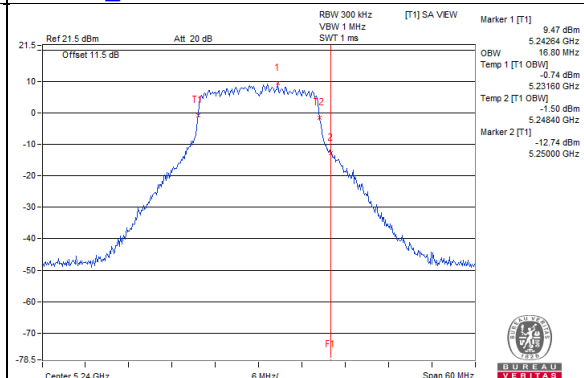

802.11ac (VHT20)_Chain 0 / CH48

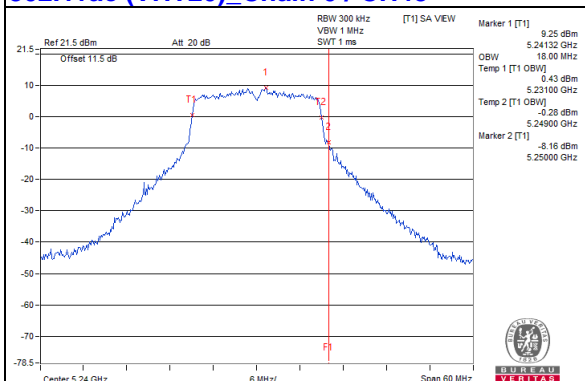

802.11ac (VHT20)_Chain 1 / CH48

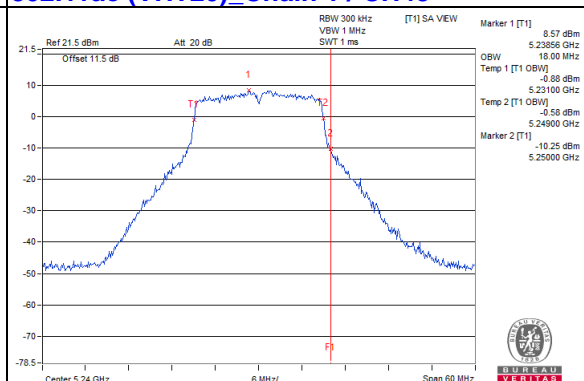

802.11ac (VHT40)_Chain 0 / CH46

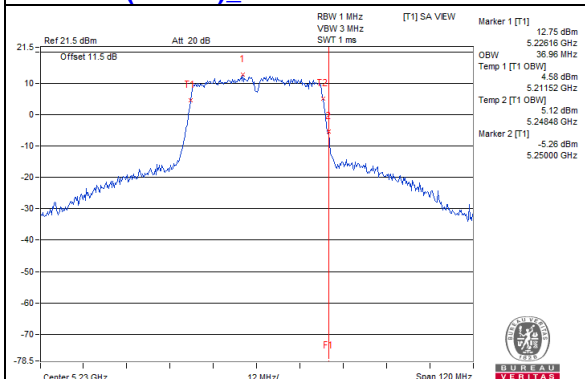

802.11ac (VHT40)_Chain 1 / CH46

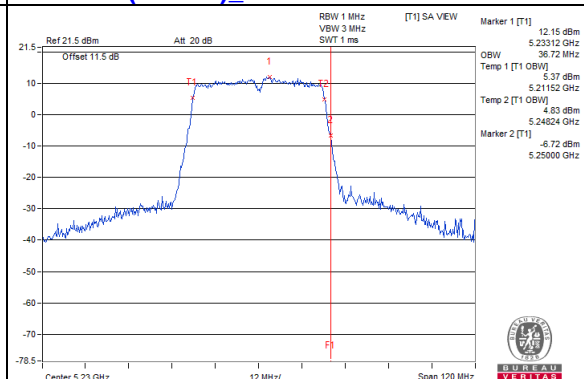

802.11ac (VHT80)_Chain 0 / CH42

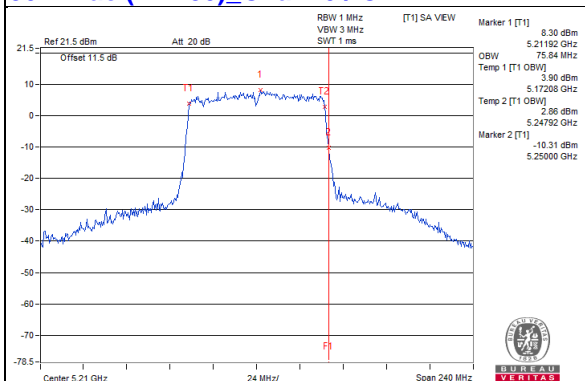

802.11ac (VHT80)_Chain 1 / CH42

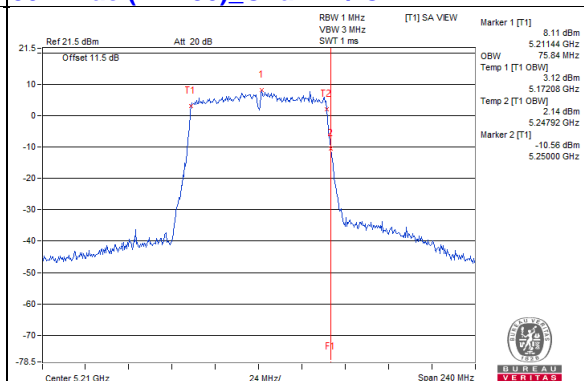

**Spectrum Plot for near by DFS band
(DFS is required, if 99% OCP straddle into U-NII-2C band)**

802.11a_Chain 0 / CH149

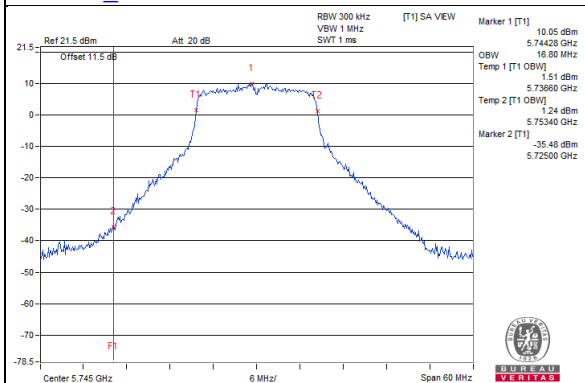

802.11a_Chain 1 / CH149

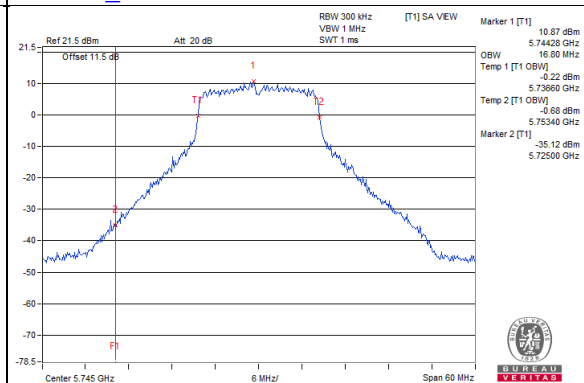

802.11ac (VHT20)_Chain 0 / CH149

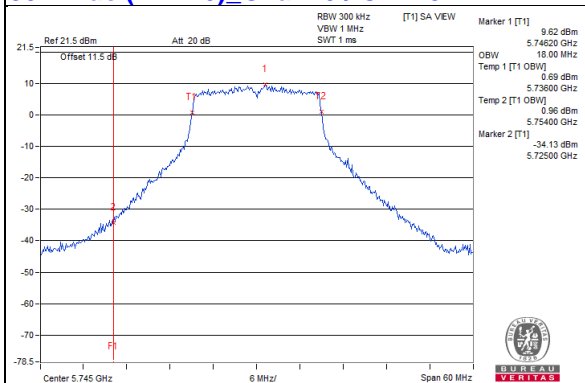

802.11ac (VHT20)_Chain 1 / CH149

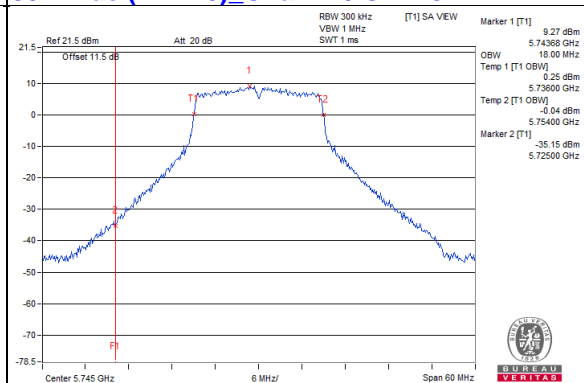

802.11ac (VHT40)_Chain 0 / CH151

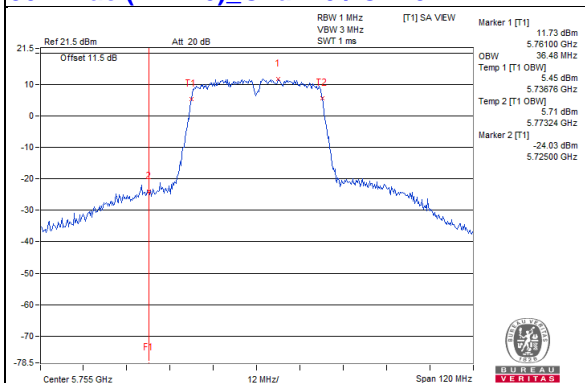

802.11ac (VHT40)_Chain 1 / CH151

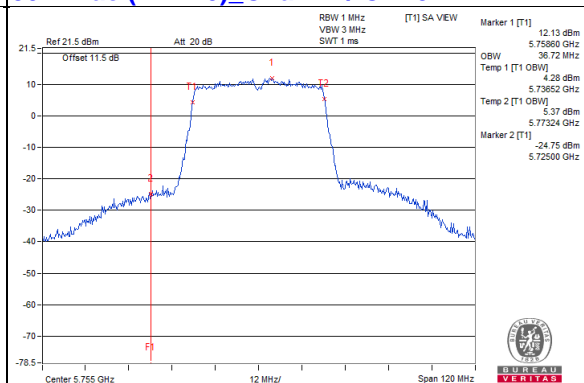

802.11ac (VHT80)_Chain 0 / CH155

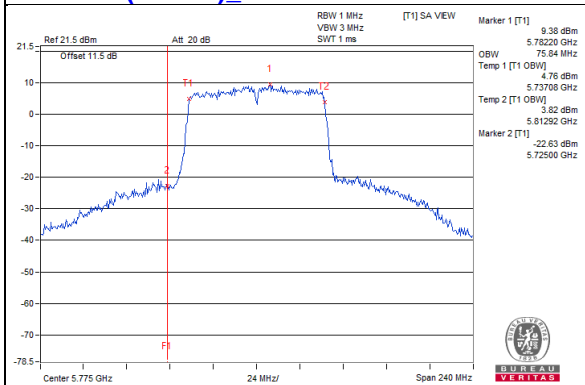

802.11ac (VHT80)_Chain 1 / CH155

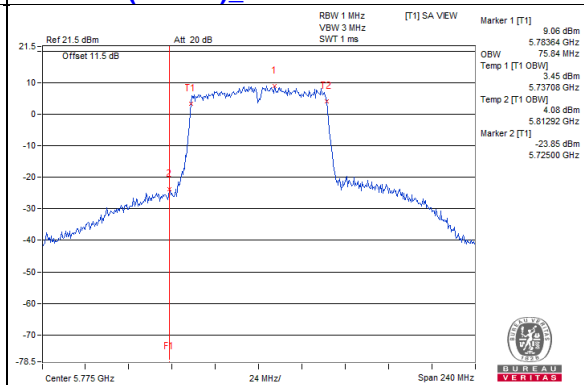

4.5 Peak Power Spectral Density Measurement

4.5.1 Limits of Peak Power Spectral Density Measurement

Operation Band	EUT Category		Limit
U-NII-1		Outdoor Access Point	17dBm/ MHz
		Fixed point-to-point Access Point	
		Indoor Access Point	
	√	Client device	11dBm/ MHz
U-NII-2A		√	11dBm/ MHz
U-NII-2C		√	11dBm/ MHz
U-NII-3		√	30dBm/ 500kHz

4.5.2 Test Setup

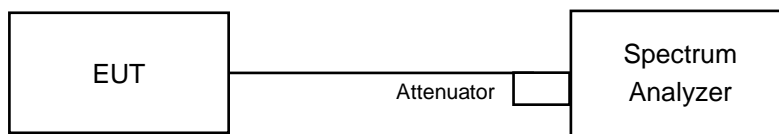

4.5.3 Test Instruments

Refer to section 4.1.2 to get information of above instrument.

4.5.4 Test Procedure

For U-NII-1, U-NII-2A, U-NII-2C band:

Using method SA-1

1. Set span to encompass the entire emission bandwidth (EBW) of the signal.
2. Set RBW = 1 MHz, Set VBW \geq 3 MHz, Detector = RMS
3. Sweep time = auto, trigger set to "free run".
4. Trace average at least 100 traces in power averaging mode.
5. Record the max value

For U-NII-3 band:

1. Set span to encompass the entire emission bandwidth (EBW) of the signal.
2. Set RBW = 300 kHz, Set VBW \geq 1 MHz, Detector = RMS
3. Use the peak marker function to determine the maximum power level in any 300 kHz band segment within the fundamental EBW.
4. Scale the observed power level to an equivalent value in 500 kHz by adjusting (increasing) the measured power by a bandwidth correction factor (BWCF) where $BWCF = 10\log(500\text{kHz}/300\text{kHz})$
5. Sweep time = auto, trigger set to "free run".
6. Trace average at least 100 traces in power averaging mode.
7. Record the max value

4.5.5 Deviation from Test Standard

No deviation.

4.5.6 EUT Operating Condition

Same as Item 4.3.6.

4.5.7 Test Results

For U-NII-1, U-NII-2A, U-NII-2C band:

802.11a

Chan.	Chan. Freq. (MHz)	PSD (dBm/MHz)		Total PSD (dBm/MHz)	Max. PSD Limit (dBm/MHz)	Pass / Fail
		Chain 0	Chain 1			
36	5180	4.61	4.65	7.64	10.85	Pass
40	5200	5.00	4.74	7.88	10.85	Pass
48	5240	5.03	4.72	7.89	10.85	Pass
52	5260	7.85	6.69	10.32	10.85	Pass
60	5300	6.65	6.72	9.70	10.85	Pass
64	5320	6.45	6.13	9.30	10.85	Pass
100	5500	6.65	6.12	9.40	10.80	Pass
116	5580	7.76	6.96	10.39	10.80	Pass
140	5700	7.25	6.68	9.98	10.80	Pass
144 (U-NII-2C Band)	5720	7.60	7.28	10.45	10.80	Pass

- Note: 1. Method a) of power density measurement of KDB 662911 is using for calculating total power density. Total power density is summing entire spectra across corresponding frequency bins on the various outputs by computer.
2. For UNII-1: Directional gain = $10 \log[(10^{G0/20} + 10^{G1/20})^2 / 2] = 6.15\text{dBi} > 6\text{dBi}$, so the power density limit shall be reduced to $11 - (6.15 - 6) = 10.85\text{dBm}$.
3. For UNII-2A: Directional gain = $10 \log[(10^{G0/20} + 10^{G1/20})^2 / 2] = 6.15\text{dBi} > 6\text{dBi}$, so the power density limit shall be reduced to $11 - (6.15 - 6) = 10.85\text{dBm}$.
4. For UNII-2C: Directional gain = $10 \log[(10^{G0/20} + 10^{G1/20})^2 / 2] = 6.2\text{dBi} > 6\text{dBi}$, so the power density limit shall be reduced to $11 - (6.2 - 6) = 10.8\text{dBm}$.

802.11ac (VHT20)

Chan.	Chan. Freq. (MHz)	PSD (dBm/MHz)		Total PSD (dBm/MHz)	Max. PSD Limit (dBm/MHz)	Pass / Fail
		Chain 0	Chain 1			
36	5180	4.65	4.14	7.41	10.85	Pass
40	5200	4.67	4.30	7.50	10.85	Pass
48	5240	4.63	4.41	7.53	10.85	Pass
52	5260	7.08	6.28	9.71	10.85	Pass
60	5300	6.22	6.25	9.25	10.85	Pass
64	5320	5.72	5.64	8.69	10.85	Pass
100	5500	5.93	5.83	8.89	10.80	Pass
116	5580	7.22	6.51	9.89	10.80	Pass
140	5700	6.59	6.33	9.47	10.80	Pass
144 (U-NII-2C Band)	5720	7.37	6.33	9.89	10.80	Pass

- Note: 1. Method a) of power density measurement of KDB 662911 is using for calculating total power density. Total power density is summing entire spectra across corresponding frequency bins on the various outputs by computer.
2. For UNII-1: Directional gain = $10 \log[(10^{G_{0/20}} + 10^{G_{1/20}})^2 / 2] = 6.15\text{dBi} > 6\text{dBi}$, so the power density limit shall be reduced to $11 - (6.15 - 6) = 10.85\text{dBm}$.
3. For UNII-2A: Directional gain = $10 \log[(10^{G_{0/20}} + 10^{G_{1/20}})^2 / 2] = 6.15\text{dBi} > 6\text{dBi}$, so the power density limit shall be reduced to $11 - (6.15 - 6) = 10.85\text{dBm}$.
4. For UNII-2C: Directional gain = $10 \log[(10^{G_{0/20}} + 10^{G_{1/20}})^2 / 2] = 6.2\text{dBi} > 6\text{dBi}$, so the power density limit shall be reduced to $11 - (6.2 - 6) = 10.8\text{dBm}$.

802.11ac (VHT40)

Chan.	Chan. Freq. (MHz)	PSD (dBm/MHz)		Total PSD (dBm/MHz)	Max. PSD Limit (dBm/MHz)	Pass / Fail
		Chain 0	Chain 1			
38	5190	1.59	1.32	4.47	10.85	Pass
46	5230	2.28	1.96	5.13	10.85	Pass
54	5270	3.18	3.18	6.19	10.85	Pass
62	5310	0.77	0.11	3.46	10.85	Pass
102	5510	1.41	0.69	4.08	10.80	Pass
110	5550	4.47	3.20	6.89	10.80	Pass
134	5670	1.67	1.09	4.40	10.80	Pass
142 (U-NII-2C Band)	5710	3.73	3.85	6.80	10.80	Pass

- Note: 1. Method a) of power density measurement of KDB 662911 is using for calculating total power density. Total power density is summing entire spectra across corresponding frequency bins on the various outputs by computer.
2. For UNII-1: Directional gain = $10 \log[(10^{G_{0/20}} + 10^{G_{1/20}})^2 / 2] = 6.15\text{dBi} > 6\text{dBi}$, so the power density limit shall be reduced to $11 - (6.15 - 6) = 10.85\text{dBm}$.
3. For UNII-2A: Directional gain = $10 \log[(10^{G_{0/20}} + 10^{G_{1/20}})^2 / 2] = 6.15\text{dBi} > 6\text{dBi}$, so the power density limit shall be reduced to $11 - (6.15 - 6) = 10.85\text{dBm}$.
4. For UNII-2C: Directional gain = $10 \log[(10^{G_{0/20}} + 10^{G_{1/20}})^2 / 2] = 6.2\text{dBi} > 6\text{dBi}$, so the power density limit shall be reduced to $11 - (6.2 - 6) = 10.8\text{dBm}$.

802.11ac (VHT80)

Chan.	Chan. Freq. (MHz)	PSD (dBm/MHz)		Total PSD (dBm/MHz)	Max. PSD Limit (dBm/MHz)	Pass / Fail
		Chain 0	Chain 1			
42	5210	-1.91	-2.58	0.78	10.85	Pass
58	5290	-3.38	-4.48	-0.89	10.85	Pass
106	5530	-2.26	-2.63	0.57	10.80	Pass
122	5610	-2.30	-2.15	0.79	10.80	Pass
138 (U-NII-2C Band)	5690	0.40	-0.02	3.21	10.80	Pass

- Note: 1. Method a) of power density measurement of KDB 662911 is using for calculating total power density. Total power density is summing entire spectra across corresponding frequency bins on the various outputs by computer.
2. For UNII-1: Directional gain = $10 \log[(10^{G0/20} + 10^{G1/20})^2 / 2] = 6.15\text{dBi} > 6\text{dBi}$, so the power density limit shall be reduced to $11-(6.15-6) = 10.85\text{dBm}$.
3. For UNII-2A: Directional gain = $10 \log[(10^{G0/20} + 10^{G1/20})^2 / 2] = 6.15\text{dBi} > 6\text{dBi}$, so the power density limit shall be reduced to $11-(6.15-6) = 10.85\text{dBm}$.
4. For UNII-2C: Directional gain = $10 \log[(10^{G0/20} + 10^{G1/20})^2 / 2] = 6.2\text{dBi} > 6\text{dBi}$, so the power density limit shall be reduced to $11-(6.2-6) = 10.8\text{dBm}$.

Spectrum Plot of Worst Value

802.11a_Chain 0 / CH52

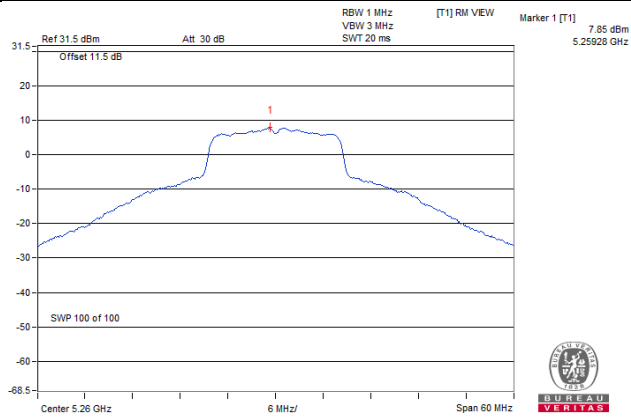

802.11ac (VHT20)_Chain 0 / CH144 (U-NII-2 Band)

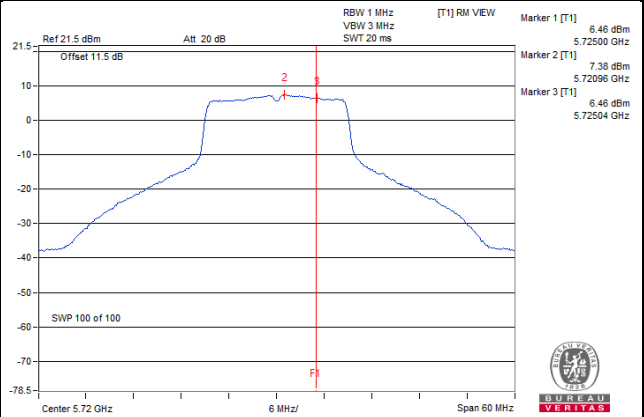

802.11ac (VHT40)_Chain 0 / CH110

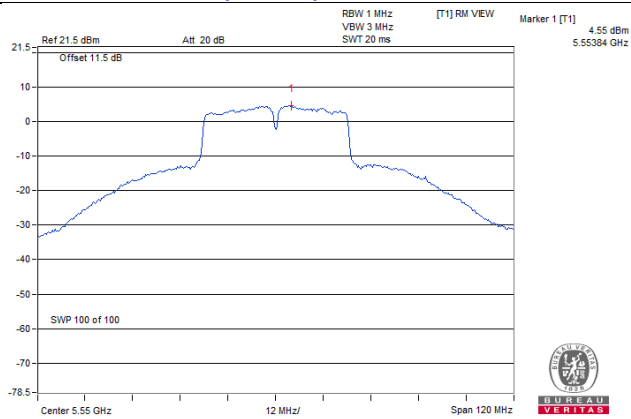

802.11ac (VHT80)_Chain 0 / CH138 (U-NII-2 Band)

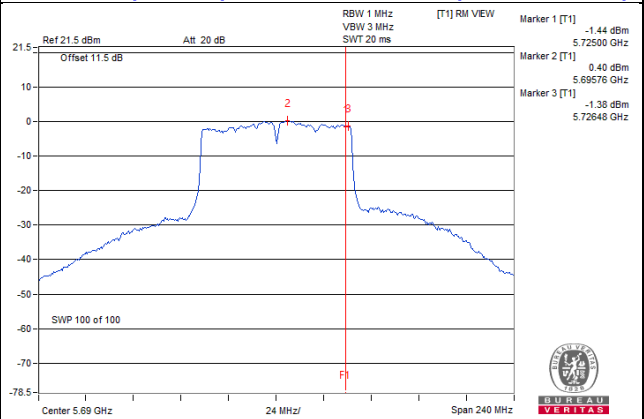

For U-NII-3 band:

802.11a

Chan.	Chan. Freq. (MHz)	PSD (dBm/300kHz)		Total PSD (dBm/300kHz)	Total PSD (dBm/500kHz)	PSD Limit (dBm/500kHz)	Pass / Fail
		Chain 0	Chain 1				
144 (U-NII-3 Band)	5720	-2.04	-2.89	0.57	2.79	30.00	Pass
149	5745	-2.56	-3.06	0.21	2.43	30.00	Pass
157	5785	-2.63	-2.92	0.24	2.46	30.00	Pass
165	5825	-3.05	-3.58	-0.30	1.92	30.00	Pass

- Note: 1. Method b) Measure and sum spectral maxima across the outputs of KDB 662911 is using for calculating total power density.
 2. Directional gain = $10 \log[(10^{G0/20} + 10^{G1/20})^2 / 2] = 5.99\text{dBi} < 6\text{dBi}$, so there is no need to reduce the power density limit.

802.11ac (VHT20)

Chan.	Chan. Freq. (MHz)	PSD (dBm/300kHz)		Total PSD (dBm/300kHz)	Total PSD (dBm/500kHz)	PSD Limit (dBm/500kHz)	Pass / Fail
		Chain 0	Chain 1				
144 (U-NII-3 Band)	5720	-2.12	-3.34	0.32	2.54	30.00	Pass
149	5745	-3.44	-3.26	-0.34	1.88	30.00	Pass
157	5785	-3.06	-3.41	-0.22	2.00	30.00	Pass
165	5825	-3.62	-3.24	-0.42	1.80	30.00	Pass

- Note: 1. Method b) Measure and sum spectral maxima across the outputs of KDB 662911 is using for calculating total power density.
 2. Directional gain = $10 \log[(10^{G0/20} + 10^{G1/20})^2 / 2] = 5.99\text{dBi} < 6\text{dBi}$, so there is no need to reduce the power density limit.

802.11ac (VHT40)

Chan.	Chan. Freq. (MHz)	PSD (dBm/300kHz)		Total PSD (dBm/300kHz)	Total PSD (dBm/500kHz)	PSD Limit (dBm/500kHz)	Pass / Fail
		Chain 0	Chain 1				
142 (U-NII-3 Band)	5710	-6.62	-6.41	-3.50	-1.28	30.00	Pass
151	5755	-7.36	-7.32	-4.33	-2.11	30.00	Pass
159	5795	-7.25	-7.16	-4.19	-1.97	30.00	Pass

- Note: 1. Method b) Measure and sum spectral maxima across the outputs of KDB 662911 is using for calculating total power density.
 2. Directional gain = $10 \log[(10^{G0/20} + 10^{G1/20})^2 / 2] = 5.99\text{dBi} < 6\text{dBi}$, so there is no need to reduce the power density limit.

802.11ac (VHT80)

Chan.	Chan. Freq. (MHz)	PSD (dBm/300kHz)		Total PSD (dBm/300kHz)	Total PSD (dBm/500kHz)	PSD Limit (dBm/500kHz)	Pass / Fail
		Chain 0	Chain 1				
138 (U-NII-3 Band)	5710	-10.37	-10.81	-7.57	-5.35	30.00	Pass
155	5755	-9.96	-10.22	-7.08	-4.86	30.00	Pass

- Note: 1. Method b) Measure and sum spectral maxima across the outputs of KDB 662911 is using for calculating total power density.
 2. Directional gain = $10 \log[(10^{G0/20} + 10^{G1/20})^2 / 2] = 5.99\text{dBi} < 6\text{dBi}$, so there is no need to reduce the power density limit.

Spectrum Plot of Worst Value

802.11a_Chain 0 / CH144 (U-NII-3 Band)

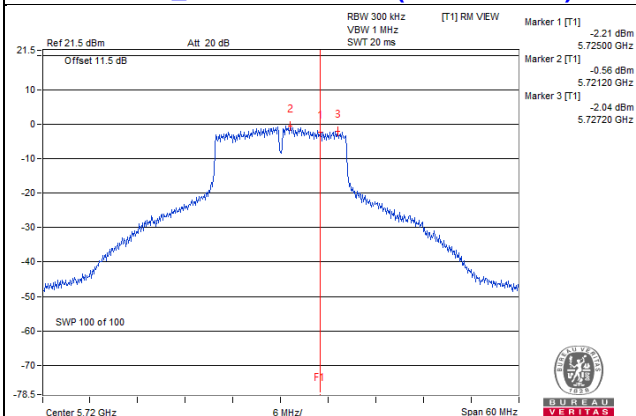

802.11ac (VHT20)_Chain 0 / CH144 (U-NII-3 Band)

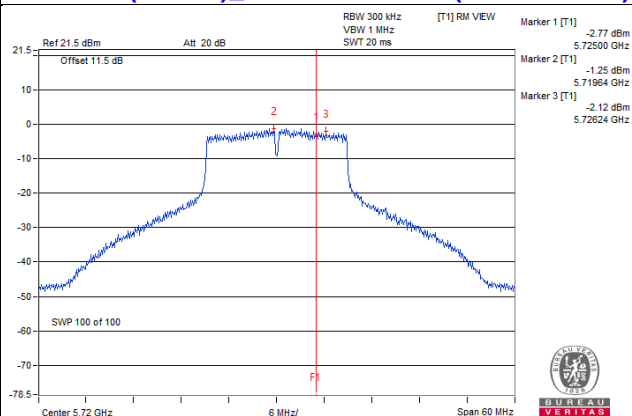

802.11ac (VHT40)_Chain 1 / CH142 (U-NII-3 Band)

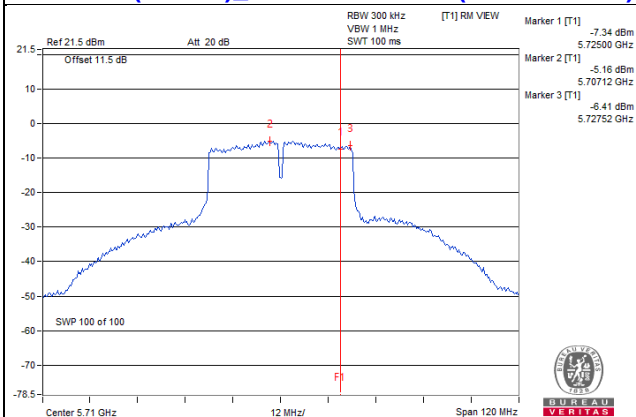

802.11ac (VHT80)_Chain 0 / CH155

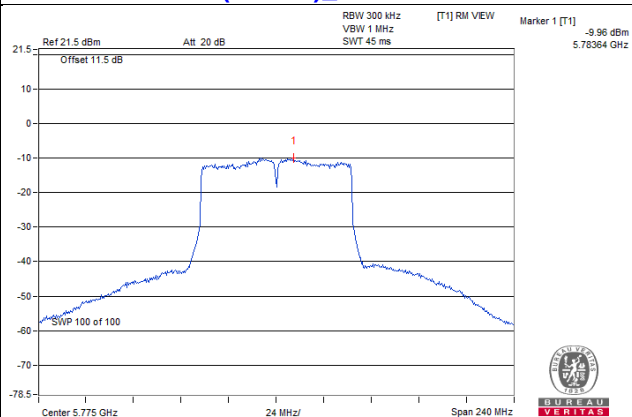

4.6 Frequency Stability Measurement

4.6.1 Limits of Frequency Stability Measurement

The frequency of the carrier signal shall be maintained within band of operation

4.6.2 Test Setup

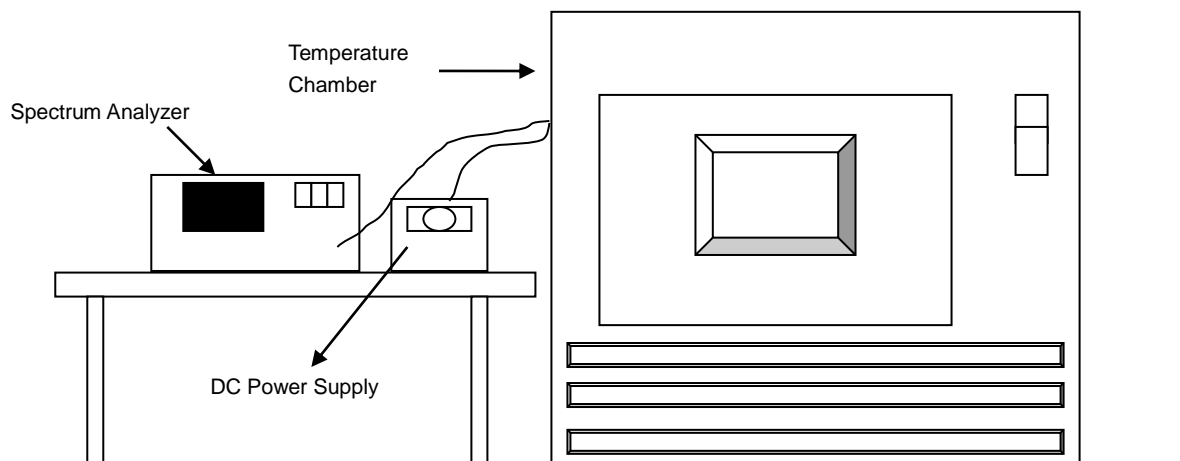

4.6.3 Test Instruments

Refer to section 4.1.2 to get information of above instrument.

4.6.4 Test Procedure

- The EUT was placed inside the environmental test chamber and powered by nominal AC voltage.
- Turn the EUT on and couple its output to a spectrum analyzer.
- Turn the EUT off and set the chamber to the highest temperature specified.
- Allow sufficient time (approximately 30 min) for the temperature of the chamber to stabilize, turn the EUT on and measure the operating frequency after 2, 5, and 10 Minutes.
- Repeat step (d) with the temperature chamber set to the next desired temperature until measurements down to the lowest specified temperature have been completed.
- The test chamber was allowed to stabilize at +20 degree C for a minimum of 30 Minutes. The supply voltage was then adjusted on the EUT from 85% to 115% and the frequency record.

4.6.5 Deviation from Test Standard

No deviation.

4.6.6 EUT Operating Condition

Set the EUT transmit at un-modulation mode to test frequency stability.

4.6.7 Test Results

Frequency Stability Versus Temp.									
Operating Frequency: 5180 MHz									
TEMP. (°C)	Power Supply (Vdc)	0 Minute		2 Minutes		5 Minutes		10 Minutes	
		Measured Frequency (MHz)	Pass/Fail	Measured Frequency (MHz)	Pass/Fail	Measured Frequency (MHz)	Pass/Fail	Measured Frequency (MHz)	Pass/Fail
50	3.6	5180.012	Pass	5180.012	Pass	5180.0081	Pass	5180.0096	Pass
40	3.6	5179.9961	Pass	5179.994	Pass	5179.9961	Pass	5179.9971	Pass
30	3.6	5179.9894	Pass	5179.9906	Pass	5179.9902	Pass	5179.9928	Pass
20	3.6	5180.0238	Pass	5180.0203	Pass	5180.0221	Pass	5180.0193	Pass
10	3.6	5180.0204	Pass	5180.0221	Pass	5180.0209	Pass	5180.0212	Pass
0	3.6	5179.9902	Pass	5179.9884	Pass	5179.9863	Pass	5179.9887	Pass
-10	3.6	5180.0072	Pass	5180.0093	Pass	5180.0087	Pass	5180.0053	Pass
-20	3.6	5179.996	Pass	5179.9948	Pass	5179.9983	Pass	5179.9953	Pass

Frequency Stability Versus Voltage									
Operating Frequency: 5180 MHz									
TEMP. (°C)	Power Supply (Vdc)	0 Minute		2 Minutes		5 Minutes		10 Minutes	
		Measured Frequency (MHz)	Pass/Fail	Measured Frequency (MHz)	Pass/Fail	Measured Frequency (MHz)	Pass/Fail	Measured Frequency (MHz)	Pass/Fail
20	4.14	5180.0245	Pass	5180.0205	Pass	5180.0228	Pass	5180.0198	Pass
	3.6	5180.0238	Pass	5180.0203	Pass	5180.0221	Pass	5180.0193	Pass
	3.06	5180.0238	Pass	5180.0209	Pass	5180.0211	Pass	5180.0197	Pass

4.7 6dB Bandwidth Measurement

4.7.1 Limits of 6dB Bandwidth Measurement

The minimum of 6dB Bandwidth Measurement is 0.5MHz.

4.7.2 Test Setup

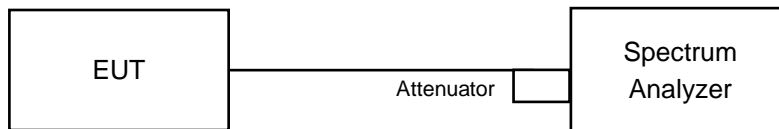

4.7.3 Test Instruments

Refer to section 4.1.2 to get information of above instrument.

4.7.4 Test Procedure

MEASUREMENT PROCEDURE REF

- Set resolution bandwidth (RBW) = 100kHz
- Set the video bandwidth (VBW) $\geq 3 \times$ RBW, Detector = Peak.
- Trace mode = max hold.
- Sweep = auto couple.
- Measure the maximum width of the emission that is constrained by the frequencies associated with the two amplitude points (upper and lower) that are attenuated by 6 dB relative to the maximum level measured in the fundamental emission

4.7.5 Deviation from Test Standard

No deviation.

4.7.6 EUT Operating Condition

The software provided by client to enable the EUT under transmission condition continuously at lowest, middle and highest channel frequencies individually.

4.7.7 Test Results

802.11a

Channel	Frequency (MHz)	6dB Bandwidth (MHz)		Limit (MHz)	Pass / Fail
		Chain 0	Chain 1		
144 (U-NII-3 Band)	5720	2.9	2.86	0.5	Pass
149	5745	15.21	16.06	0.5	Pass
157	5785	15.83	16.32	0.5	Pass
165	5825	16.06	16.08	0.5	Pass

802.11ac (VHT20)

Channel	Frequency (MHz)	6dB Bandwidth (MHz)		Limit (MHz)	Pass / Fail
		Chain 0	Chain 1		
144 (U-NII-3 Band)	5720	3.15	3.15	0.5	Pass
149	5745	16.52	15.78	0.5	Pass
157	5785	15.96	16.32	0.5	Pass
165	5825	16.92	16.03	0.5	Pass

802.11ac (VHT40)

Channel	Frequency (MHz)	6dB Bandwidth (MHz)		Limit (MHz)	Pass / Fail
		Chain 0	Chain 1		
142 (U-NII-3 Band)	5710	2.65	2.67	0.5	Pass
151	5755	35.53	35.84	0.5	Pass
159	5795	35.79	36.31	0.5	Pass

802.11ac (VHT80)

Channel	Frequency (MHz)	6dB Bandwidth (MHz)		Limit (MHz)	Pass / Fail
		Chain 0	Chain 1		
138 (U-NII-3 Band)	5690	2.73	2.7	0.5	Pass
155	5775	75.48	75.38	0.5	Pass

Spectrum Plot of Worst Value

802.11a_Chain 1 / CH144 (U-NII-3 Band)

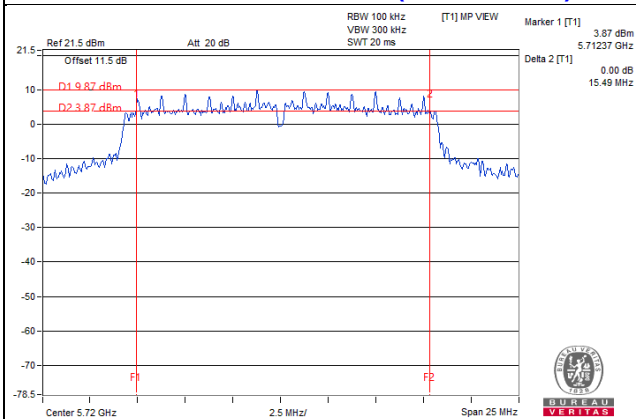

802.11ac (VHT20)_Chain 0 / CH144 (U-NII-3 Band)

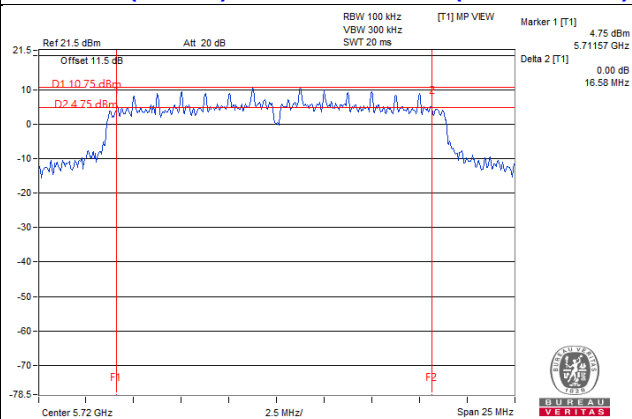

802.11ac (VHT40)_Chain 0 / CH142 (U-NII-3 Band)

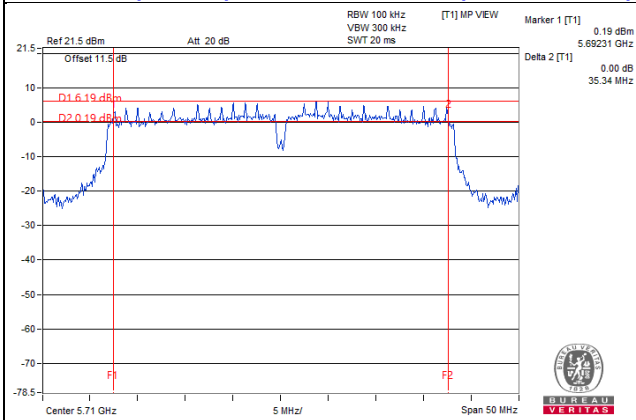

802.11ac (VHT80)_Chain 1 / CH138 (U-NII-3 Band)

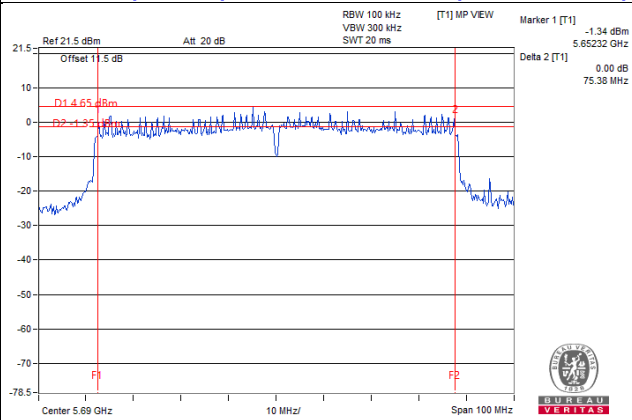

Note: The 6dB bandwidth above 5725MHz = Marker 1 + Delta 2 - 5725MHz

5 Pictures of Test Arrangements

Please refer to the attached file (Test Setup Photo).

Annex A - Radiated Out of Band Emission (OOBE) Measurement (For U-NII-3 band)

802.11a CH 149 : 5745 MHz

Horizontal

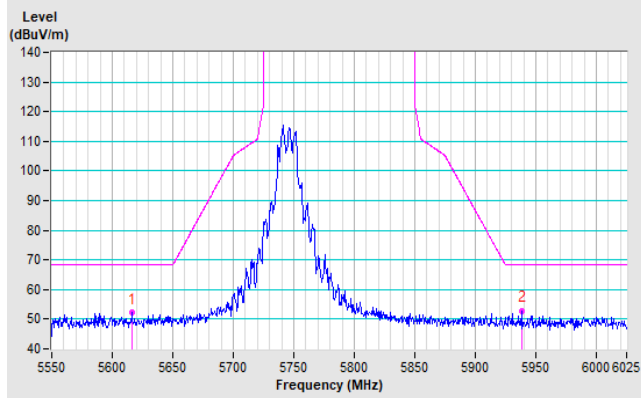

Vertical

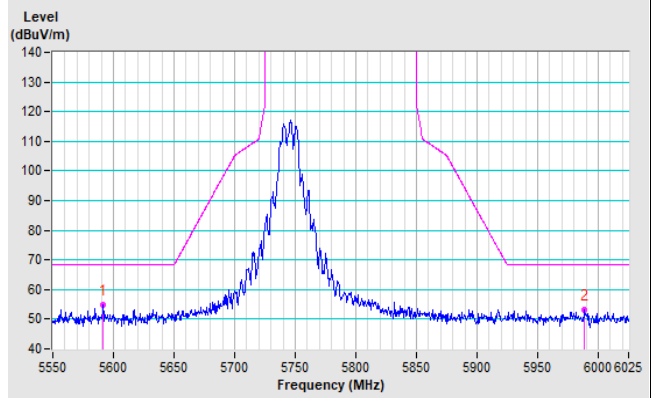

802.11a CH 157 : 5785 MHz

Horizontal

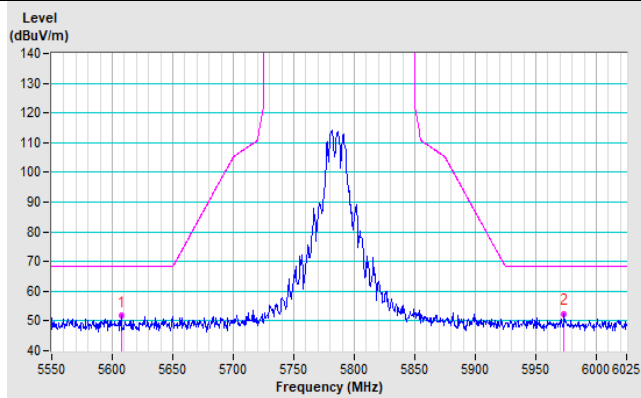

Vertical

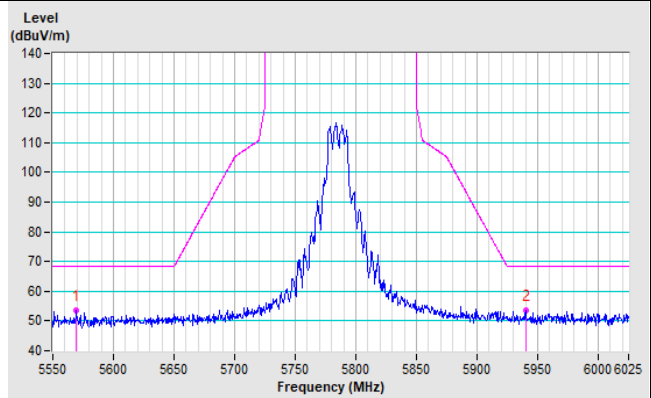

802.11a CH 165 : 5825 MHz

Horizontal

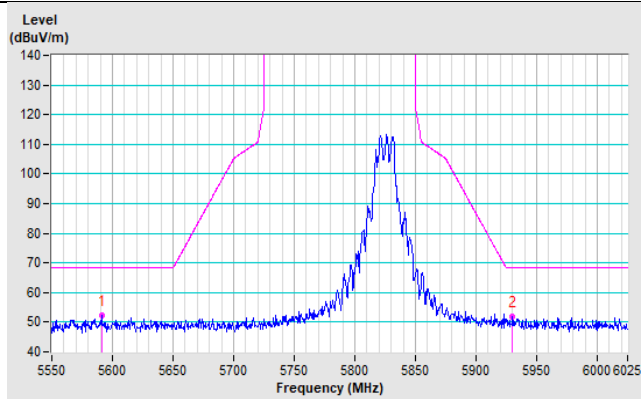

Vertical

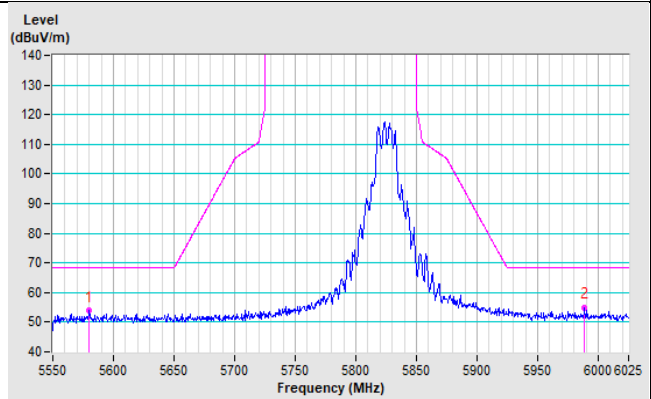

802.11ac (VHT20) CH 149 : 5745 MHz

Horizontal

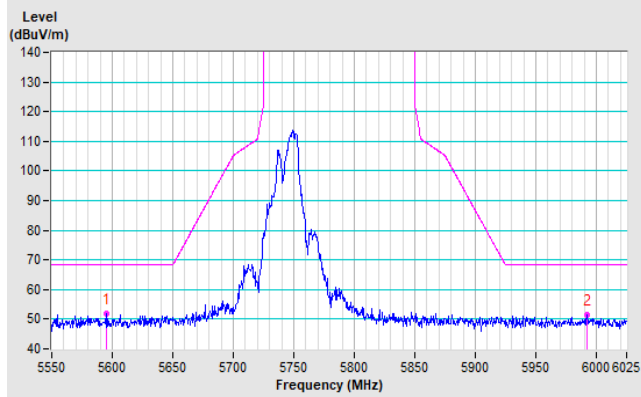

Vertical

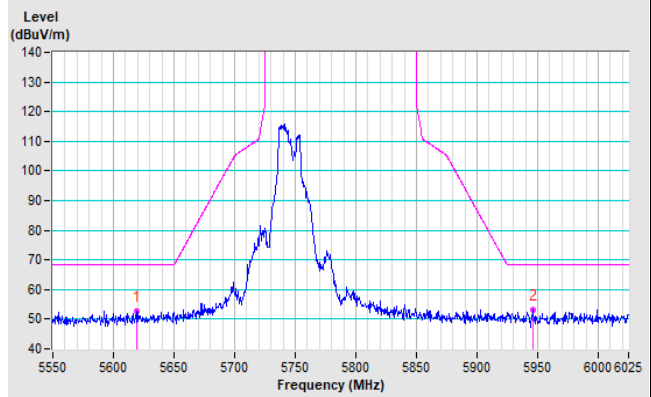

802.11ac (VHT20) CH 157 : 5785 MHz

Horizontal

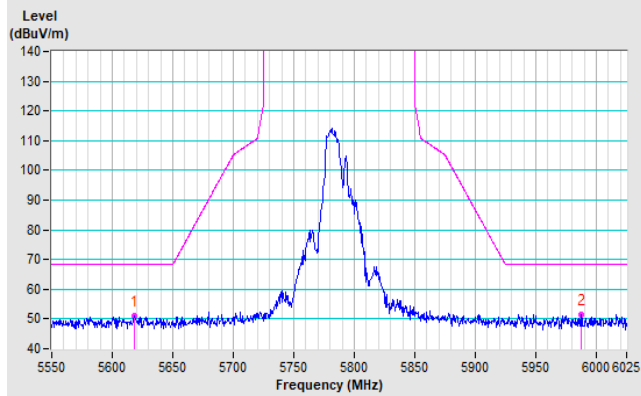

Vertical

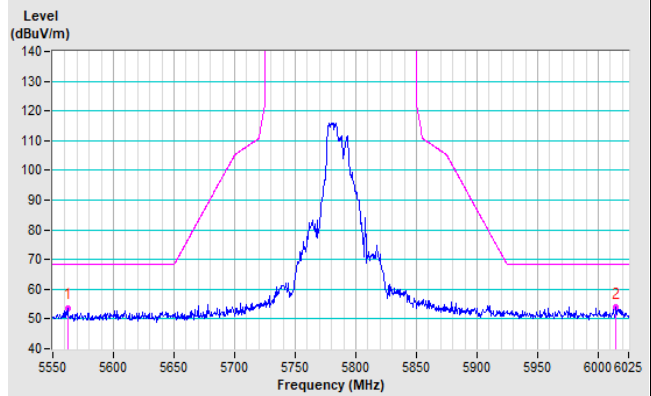

802.11ac (VHT20) CH 165 : 5825 MHz

Horizontal

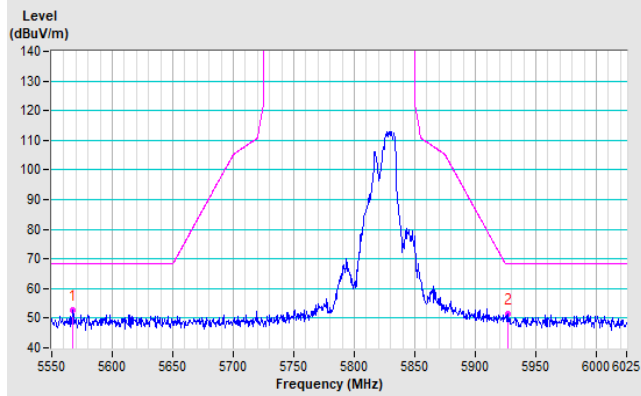

Vertical

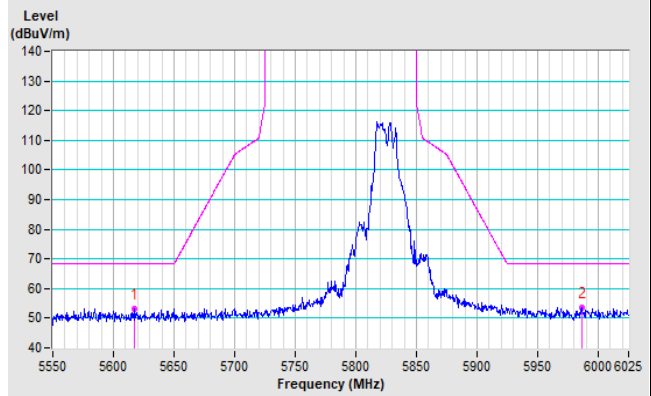

802.11ac (VHT40) CH 151 : 5755 MHz

Horizontal

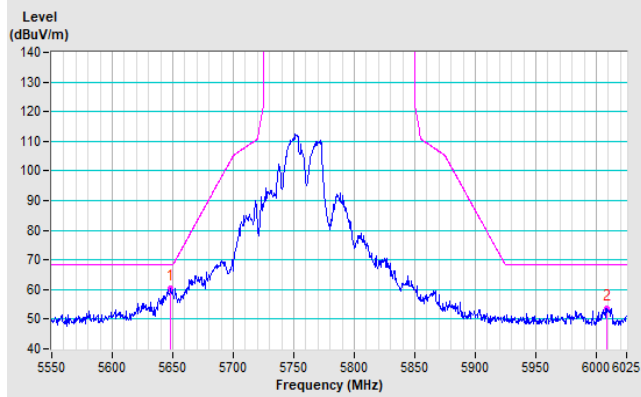

Vertical

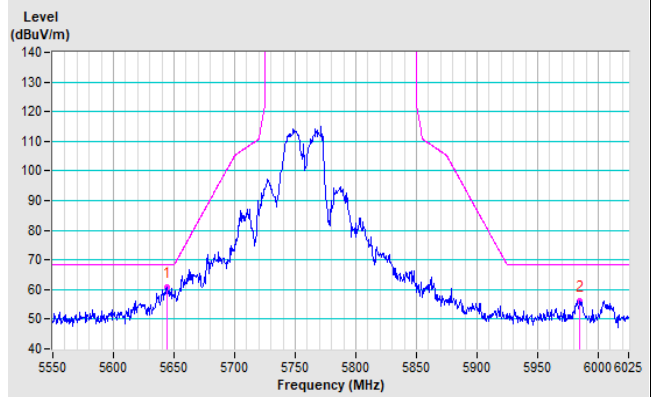

802.11ac (VHT40) CH 159 : 5795 MHz

Horizontal

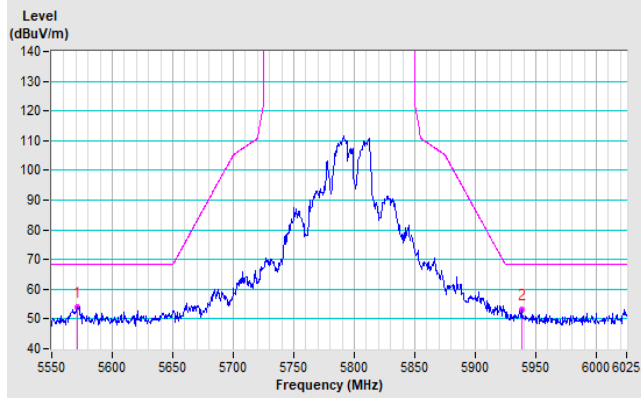

Vertical

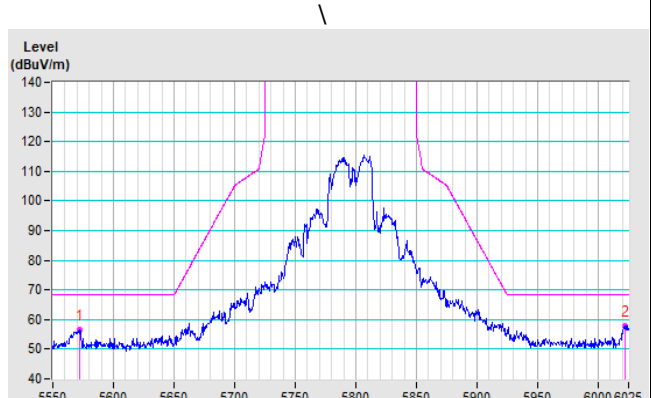

802.11ac (VHT80) CH 155 : 5775 MHz

Horizontal

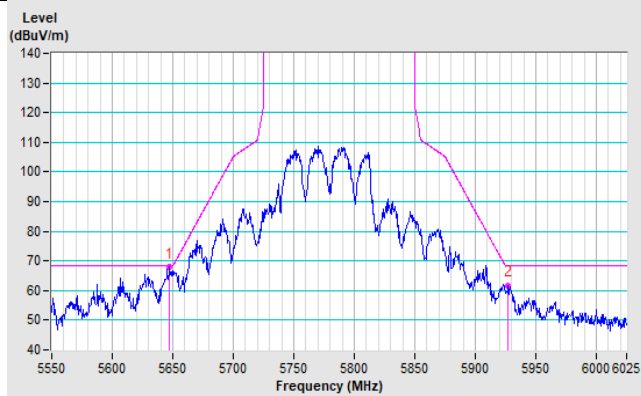

Vertical

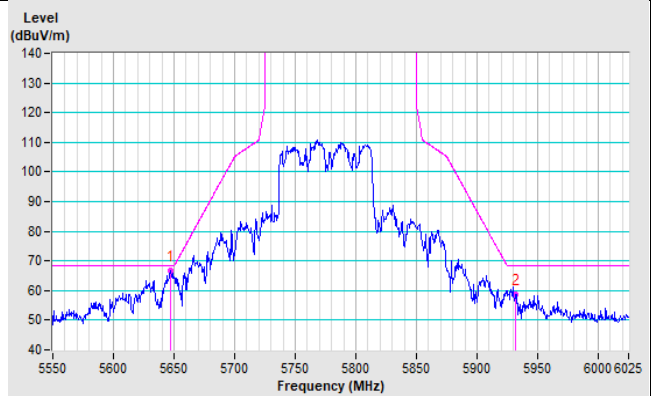

Annex B - Band-Edge Measurement (For U-NII-1, U-NII-2A, U-NII-2C band)

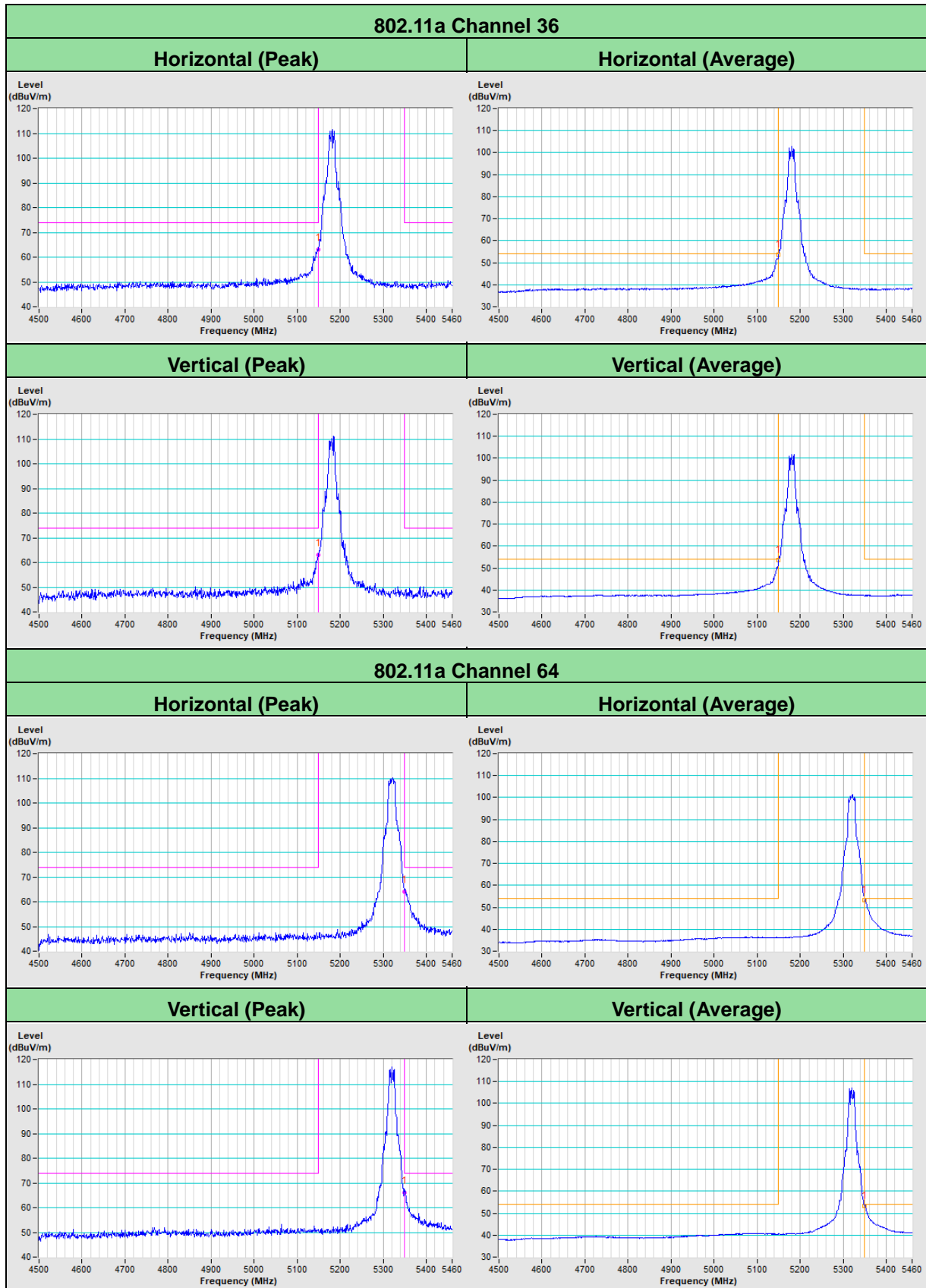

802.11a Channel 100

Horizontal (Peak)

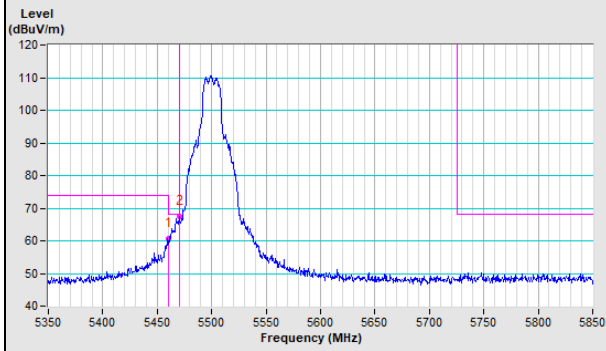

Horizontal (Average)

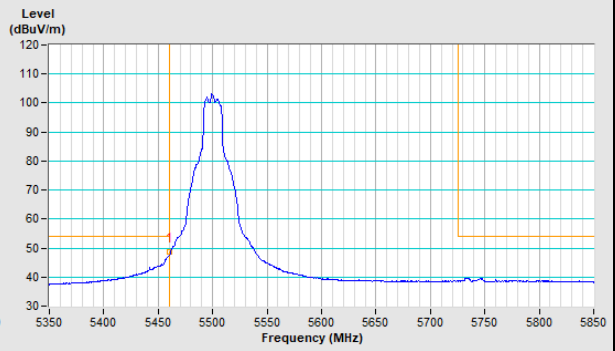

Vertical (Peak)

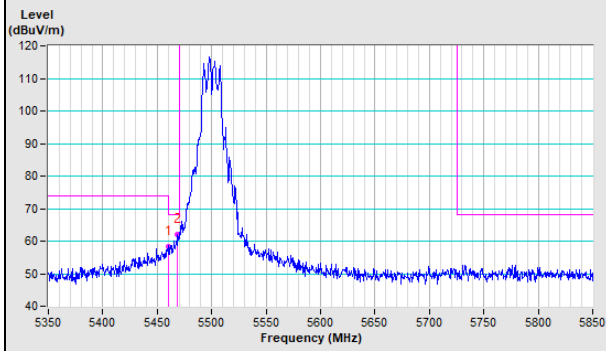

Vertical (Average)

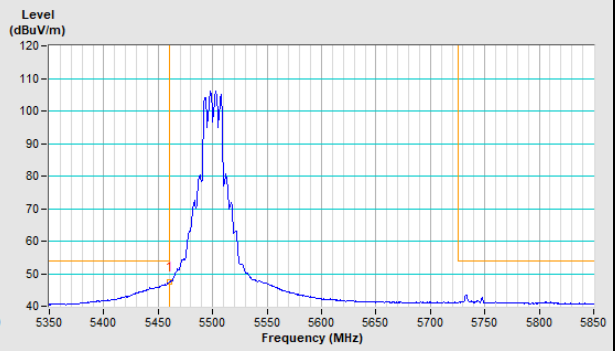

802.11ac (VHT20) Channel 36

Horizontal (Peak)	Horizontal (Average)
--------------------------	-----------------------------

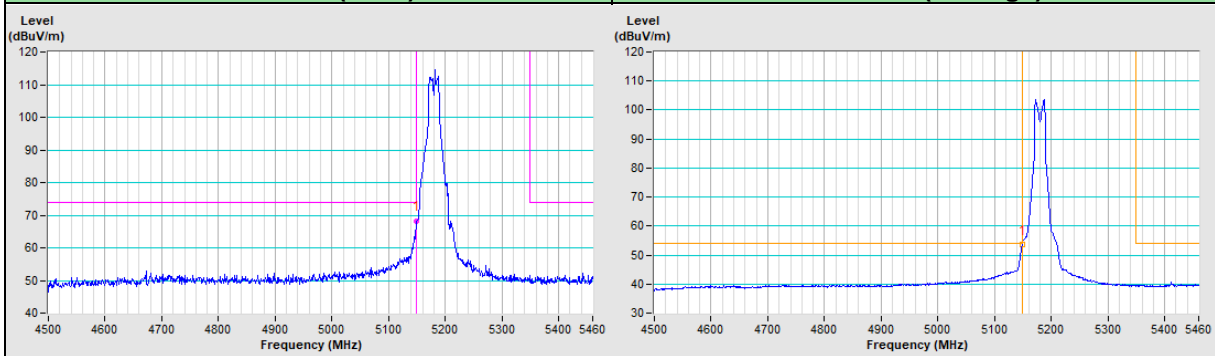

Vertical (Peak)	Vertical (Average)
------------------------	---------------------------

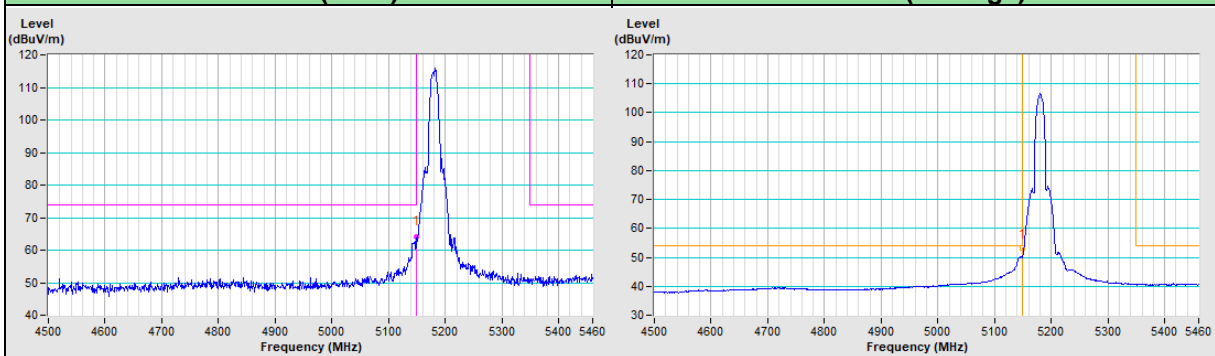

802.11ac (VHT20) Channel 64

Horizontal (Peak)	Horizontal (Average)
--------------------------	-----------------------------

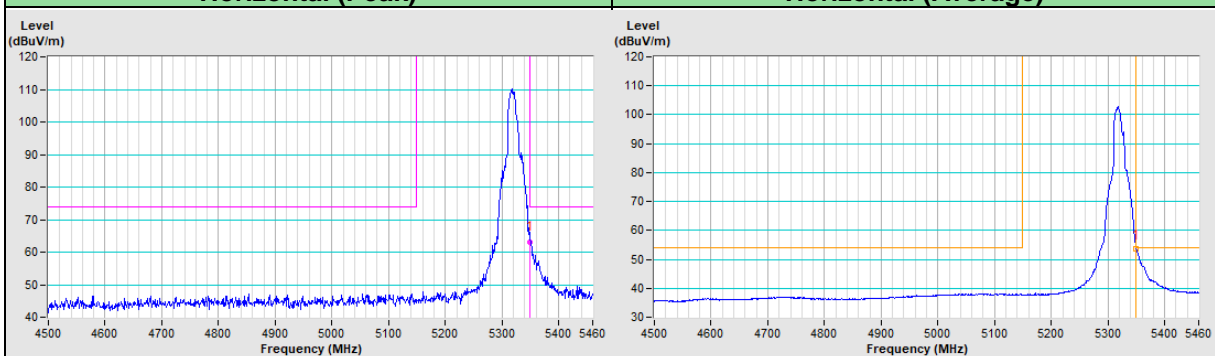

Vertical (Peak)	Vertical (Average)
------------------------	---------------------------

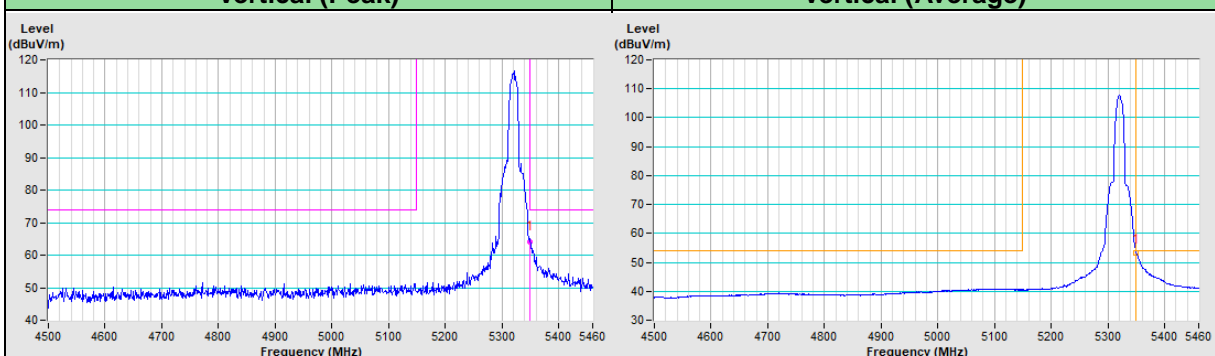

802.11ac (VHT20) Channel 100

Horizontal (Peak)

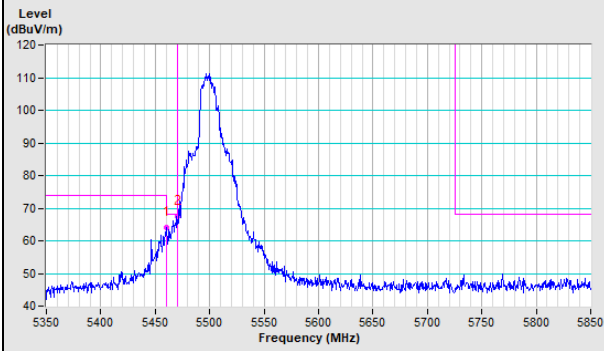

Horizontal (Average)

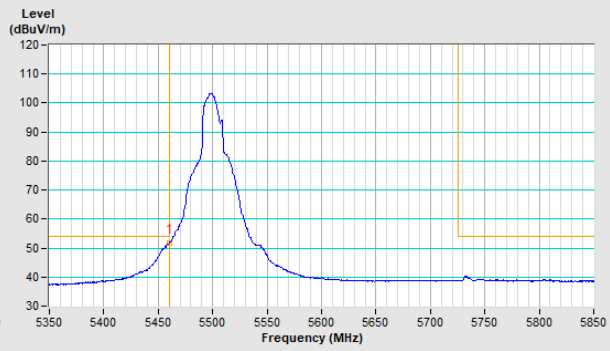

Vertical (Peak)

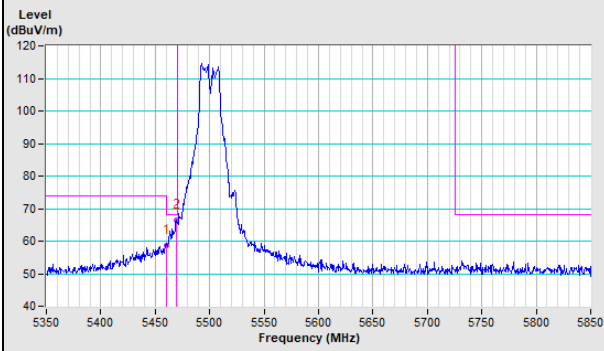

Vertical (Average)

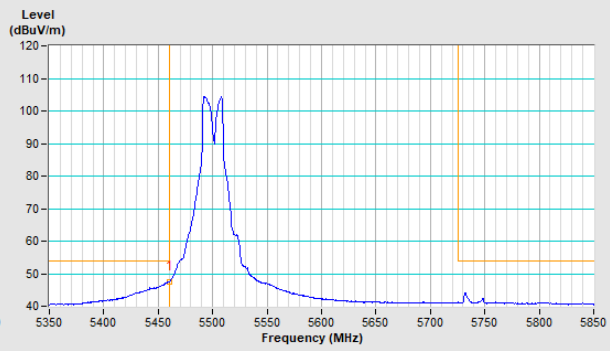

802.11ac (VHT40) Channel 38

Horizontal (Peak)

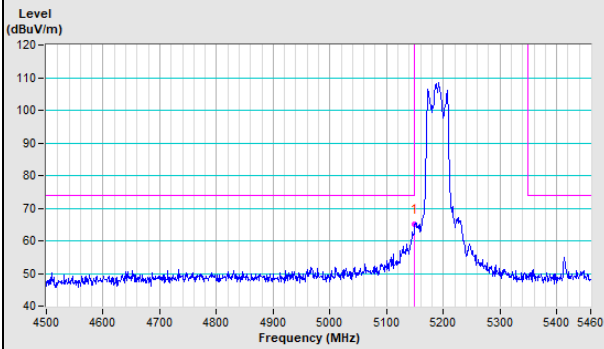

Horizontal (Average)

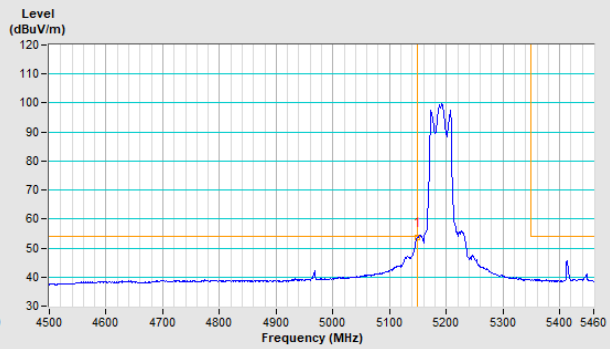

Vertical (Peak)

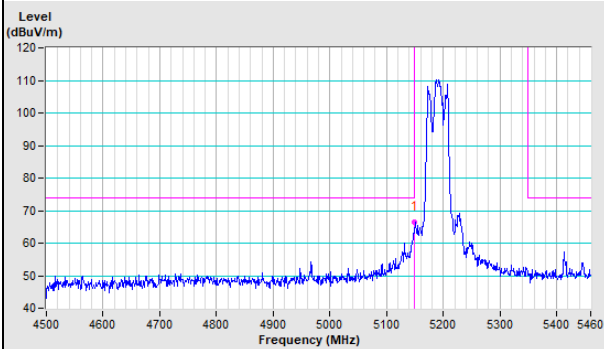

Vertical (Average)

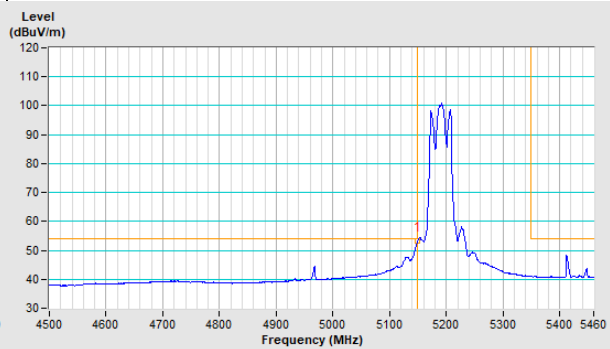

802.11ac (VHT40) Channel 62

Horizontal (Peak)

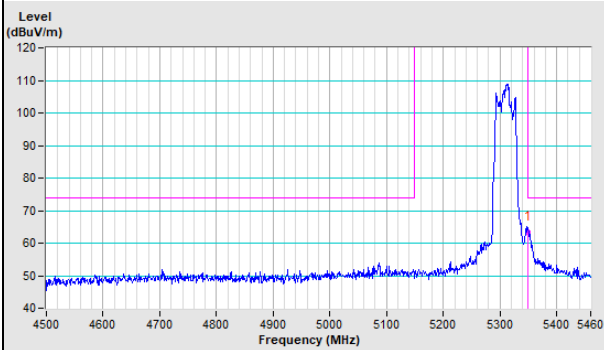

Horizontal (Average)

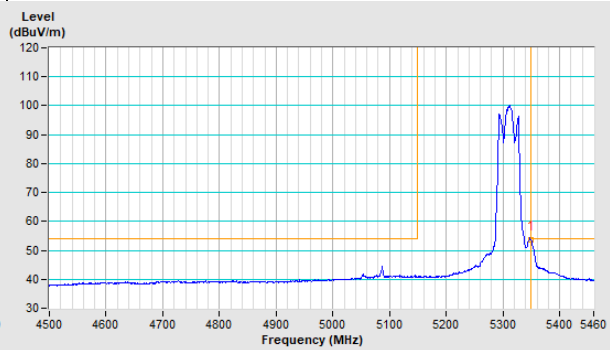

Vertical (Peak)

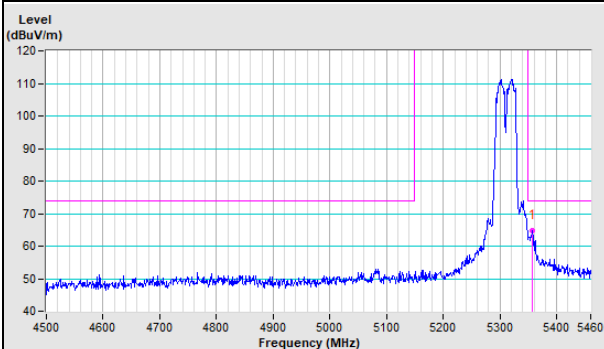

Vertical (Average)

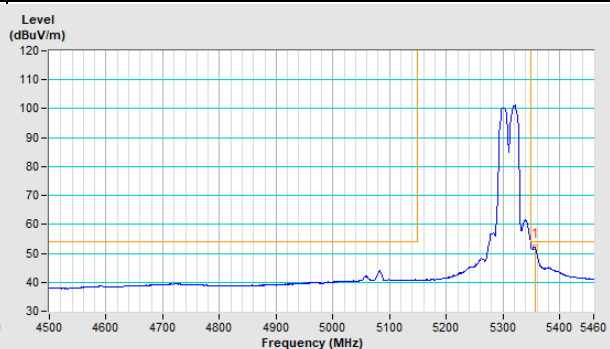

802.11ac (VHT40) Channel 102

Horizontal (Peak)

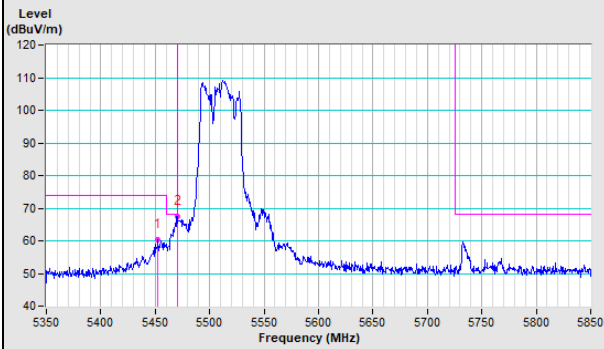

Horizontal (Average)

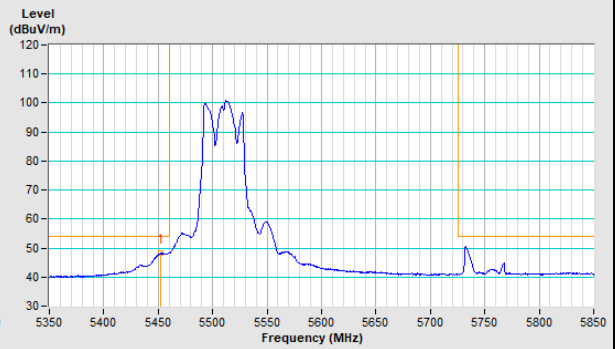

Vertical (Peak)

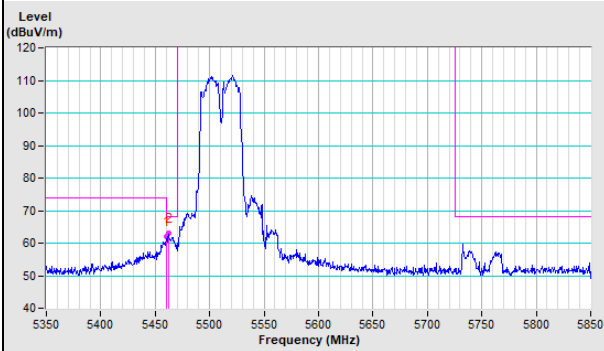

Vertical (Average)

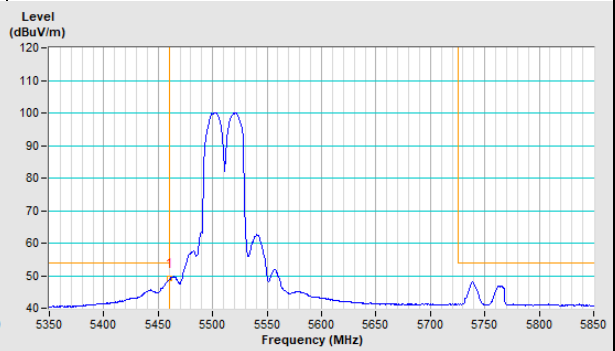

802.11ac (VHT80) Channel 42

Horizontal (Peak)	Horizontal (Average)
--------------------------	-----------------------------

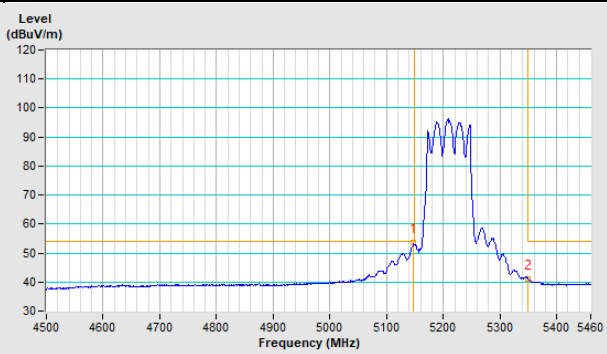
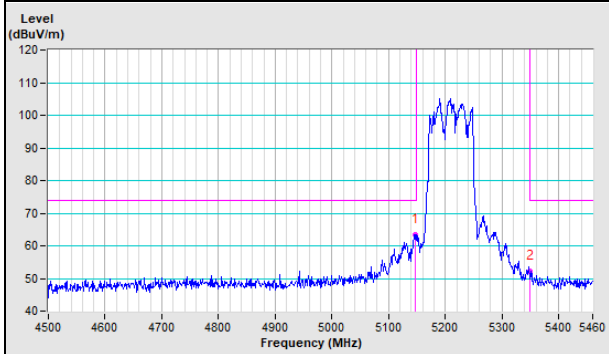

Vertical (Peak)	Vertical (Average)
------------------------	---------------------------

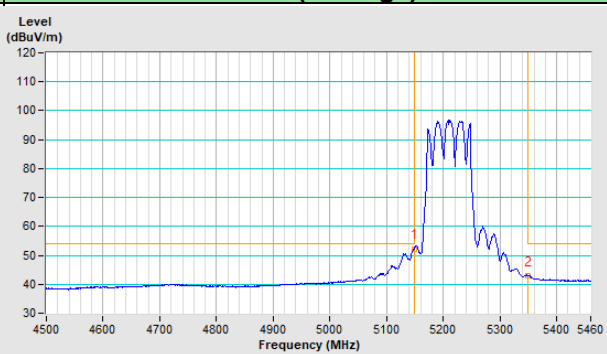
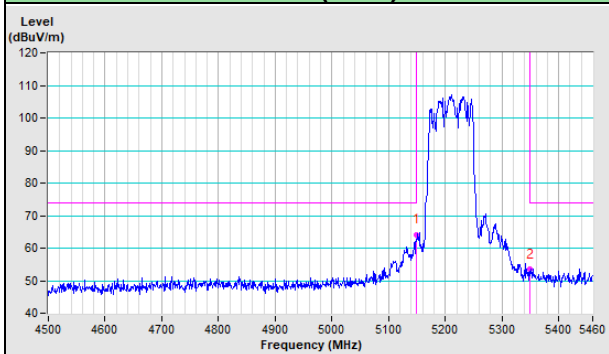

802.11ac (VHT80) Channel 58

Horizontal (Peak)	Horizontal (Average)
--------------------------	-----------------------------

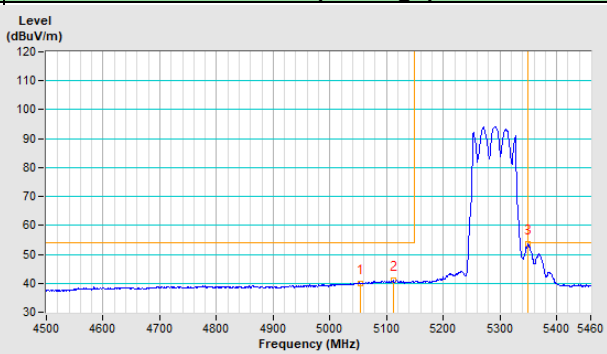
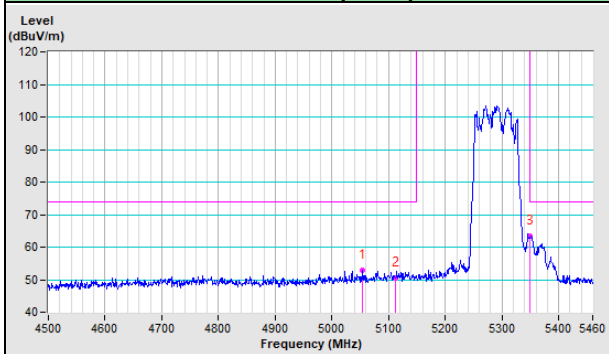

Vertical (Peak)	Vertical (Average)
------------------------	---------------------------

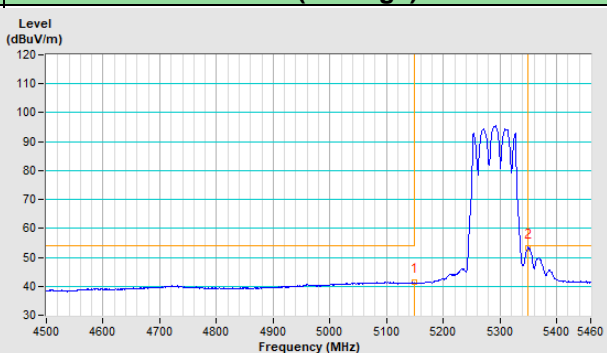
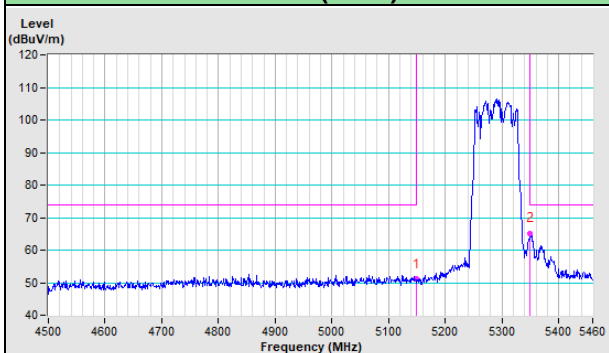

802.11ac (VHT80) Channel 106

Horizontal (Peak)

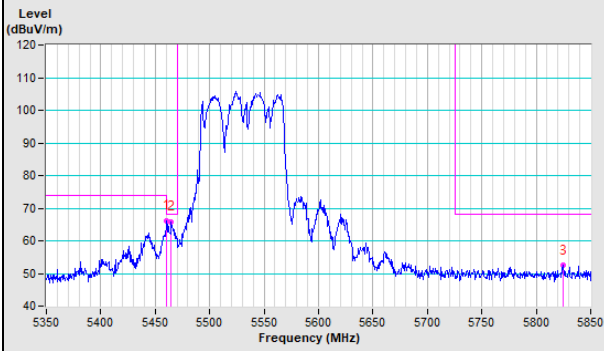

Horizontal (Average)

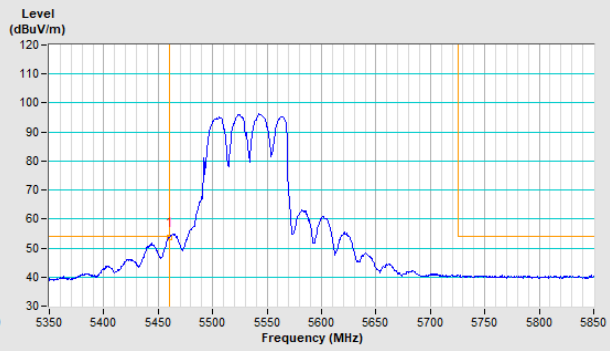

Vertical (Peak)

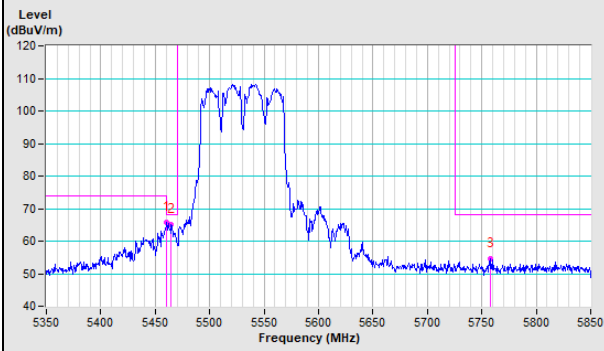

Vertical (Average)

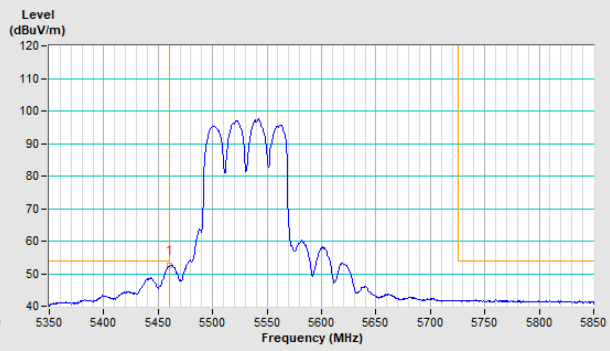

Appendix – Information of the Testing Laboratories

We, Bureau Veritas Consumer Products Services (H.K.) Ltd., Taoyuan Branch, were founded in 1988 to provide our best service in EMC, Radio, Telecom and Safety consultation. Our laboratories are FCC recognized accredited test firms and accredited according to ISO/IEC 17025.

If you have any comments, please feel free to contact us at the following:

Lin Kou EMC/RF Lab

Tel: 886-2-26052180

Fax: 886-2-26051924

Hsin Chu EMC/RF/Telecom Lab

Tel: 886-3-6668565

Fax: 886-3-6668323

Hwa Ya EMC/RF/Safety Lab

Tel: 886-3-3183232

Fax: 886-3-3270892

Email: service.adt@tw.bureauveritas.com

Web Site: www.bureauveritas-adt.com

The address and road map of all our labs can be found in our web site also.

--- END ---