

FCC Test Report (BT-LE)

Report No.: RF210105C01-3

FCC ID: PZWBHTM70QWG

Test Model: BHT-M70-QWG

Received Date: 2021/1/5

Test Date: 2021/1/17 ~ 2021/8/18

Issued Date: 2021/9/29

Applicant: DENSO WAVE INCORPORATED

Address: 1 Yoshiike Kusagi Agui-cho, Chita-gun Aichi 470-2297, Japan

Issued By: Bureau Veritas Consumer Products Services (H.K.) Ltd., Taoyuan Branch
Hsin Chu Laboratory

Lab Address: E-2, No.1, Li Hsin 1st Road, Hsinchu Science Park, Hsinchu City 300,
Taiwan

Test Location: E-2, No.1, Li Hsin 1st Road, Hsinchu Science Park, Hsinchu City 300,
Taiwan

**FCC Registration /
Designation Number:** 723255 / TW2022



This report is for your exclusive use. Any copying or replication of this report to or for any other person or entity, or use of our name or trademark, is permitted only with our prior written permission. This report sets forth our findings solely with respect to the test samples identified herein. The results set forth in this report are not indicative or representative of the quality or characteristics of the lot from which a test sample was taken or any similar or identical product unless specifically and expressly noted. Our report includes all of the tests requested by you and the results thereof based upon the information that you provided to us. You have 60 days from date of issuance of this report to notify us of any material error or omission caused by our negligence, provided, however, that such notice shall be in writing and shall specifically address the issue you wish to raise. A failure to raise such issue within the prescribed time shall constitute your unqualified acceptance of the completeness of this report, the tests conducted and the correctness of the report contents. Unless specific mention, the uncertainty of measurement has been explicitly taken into account to declare the compliance or non-compliance to the specification.

Table of Contents

Release Control Record	4
1 Certificate of Conformity	5
2 Summary of Test Results	6
2.1 Measurement Uncertainty	6
2.2 Modification Record	6
3 General Information	7
3.1 General Description of EUT (BT-LE)	7
3.2 Description of Test Modes	9
3.2.1 Test Mode Applicability and Tested Channel Detail	10
3.3 Duty Cycle of Test Signal	12
3.4 Description of Support Units	13
3.4.1 Configuration of System under Test	14
3.5 General Description of Applied Standards and References	16
4 Test Types and Results	17
4.1 Radiated Emission and Bandedge Measurement	17
4.1.1 Limits of Radiated Emission and Bandedge Measurement	17
4.1.2 Test Instruments	18
4.1.3 Test Procedures	20
4.1.4 Deviation from Test Standard	20
4.1.5 Test Setup	21
4.1.6 EUT Operating Conditions	22
4.1.7 Test Results	23
4.2 Conducted Emission Measurement	31
4.2.1 Limits of Conducted Emission Measurement	31
4.2.2 Test Instruments	31
4.2.3 Test Procedures	32
4.2.4 Deviation from Test Standard	32
4.2.5 Test Setup	32
4.2.6 EUT Operating Conditions	32
4.2.7 Test Results	33
4.3 6dB Bandwidth Measurement	35
4.3.1 Limits of 6dB Bandwidth Measurement	35
4.3.2 Test Setup	35
4.3.3 Test Instruments	35
4.3.4 Test Procedure	35
4.3.5 Deviation from Test Standard	35
4.3.6 EUT Operating Conditions	35
4.3.7 Test Results	36
4.4 Conducted Output Power Measurement	37
4.4.1 Limits of Conducted Output Power Measurement	37
4.4.2 Test Setup	37
4.4.3 Test Instruments	37
4.4.4 Test Procedures	37
4.4.5 Deviation from Test Standard	37
4.4.6 EUT Operating Conditions	37
4.4.7 Test Results	38
4.5 Power Spectral Density Measurement	39
4.5.1 Limits of Power Spectral Density Measurement	39
4.5.2 Test Setup	39
4.5.3 Test Instruments	39
4.5.4 Test Procedure	39
4.5.5 Deviation from Test Standard	39
4.5.6 EUT Operating Condition	39

4.5.7 Test Results	40
4.6 Conducted Out of Band Emission Measurement	41
4.6.1 Limits of Conducted Out of Band Emission Measurement.....	41
4.6.2 Test Setup.....	41
4.6.3 Test Instruments	41
4.6.4 Test Procedure	41
4.6.5 Deviation from Test Standard	41
4.6.6 EUT Operating Condition	41
4.6.7 Test Results	41
5 Pictures of Test Arrangements.....	44
Annex A - Band-Edge Measurement.....	45
Appendix – Information of the Testing Laboratories	47

Release Control Record

Issue No.	Description	Date Issued
RF210105C01-3	Original release.	2021/9/29

1 Certificate of Conformity

Product: 2D Code Handy Terminal

Brand: DENSO

Test Model: BHT-M70-QWG

Sample Status: Engineering sample

Applicant: DENSO WAVE INCORPORATED

Test Date: 2021/1/17 ~ 2021/8/18

Standards: 47 CFR FCC Part 15, Subpart C (Section 15.247)
ANSI C63.10: 2013

The above equipment has been tested by **Bureau Veritas Consumer Products Services (H.K.) Ltd., Taoyuan Branch**, and found compliance with the requirement of the above standards. The test record, data evaluation & Equipment Under Test (EUT) configurations represented herein are true and accurate accounts of the measurements of the sample's EMC characteristics under the conditions specified in this report.

Prepared by : Vivian Huang , **Date:** 2021/9/29
Vivian Huang / Specialist

Approved by : Clark Lin , **Date:** 2021/9/29
Clark Lin / Technical Manager

2 Summary of Test Results

47 CFR FCC Part 15, Subpart C (Section 15.247)			
FCC Clause	Test Item	Result	Remarks
15.207	AC Power Conducted Emission	PASS	Meet the requirement of limit. Minimum passing margin is -14.82 dB at 0.65391 MHz.
15.205 / 15.209 / 15.247(d)	Radiated Emissions and Band Edge Measurement	PASS	Meet the requirement of limit. Minimum passing margin is -9.3 dB at 2336.29 MHz.
15.247(d)	Antenna Port Emission	PASS	Meet the requirement of limit.
15.247(a)(2)	6dB bandwidth	PASS	Meet the requirement of limit.
15.247(b)	Conducted power	PASS	Meet the requirement of limit.
15.247(e)	Power Spectral Density	PASS	Meet the requirement of limit.
15.203	Antenna Requirement	PASS	Antenna connector is Spring not a standard connector.

Note:

- For 2.4 GHz band compliance with rule 15.247(d) of the band-edge items, the test plots were recorded in Annex A.
- Determining compliance based on the results of the compliance measurement, not taking into account measurement instrumentation uncertainty.

2.1 Measurement Uncertainty

Where relevant, the following measurement uncertainty levels have been estimated for tests performed on the EUT as specified in CISPR 16-4-2:

Measurement	Frequency	Expanded Uncertainty (k=2) (±)
Conducted Emissions at mains ports	150kHz ~ 30MHz	1.9 dB
Conducted emissions	-	2.5 dB
Radiated Emissions up to 1 GHz	9kHz ~ 30MHz	3.1 dB
	30MHz ~ 1GHz	5.4 dB
Radiated Emissions above 1 GHz	1GHz ~ 18GHz	5.0 dB
	18GHz ~ 40GHz	5.3 dB

2.2 Modification Record

There were no modifications required for compliance.

3 General Information

3.1 General Description of EUT (BT-LE)

Product	2D Code Handy Terminal
Brand	DENSO
Test Model	BHT-M70-QWG
Status of EUT	Engineering sample
Power Supply Rating	3.6 Vdc from battery; 5 Vdc from power adapter
Modulation Type	GFSK
Modulation Technology	DTS
Transfer Rate	Up to 2 Mbps
Operating Frequency	2.402 ~ 2.480 GHz
Number of Channel	40
Output Power	BT-LE 1M: 1.774 mW BT-LE 2M: 1.841 mW
Antenna Type	Refer to Note
Antenna Connector	Refer to Note
Accessory Device	Battery x 1 Adapter x 1 (Option) Adapter x 1 (for Cradle) QC3.0 charge single Cradle x 1 (Option_Brand: DENSO, Model: CU-M70UQ) USB Cradle with spare battery charge x 1 (Option_Brand: DENSO, Model: CU-M70U) LAN Cradle with Spare battery charge x 1 (Option_Brand: DENSO, Model: CU-M70L)
Data Cable Supplied	USB Cable x 1 (Shielded, 1.45m, Option _Brand: NIEN-YI, Model: NYS3892-0)

Note:

1. The EUT has below radios as following table:

Radio 1	Radio 2	Radio 3	Radio 4
WLAN 2.4GHz	WLAN 5GHz	Bluetooth	WWAN (LTE + WCDMA + GSM)

2. Simultaneously transmission condition.

Condition	Technology	
1	WWAN	WLAN (2.4GHz)
2	WWAN	WLAN (5GHz)
3	WWAN	Bluetooth

Note: The emission of the simultaneous operation has been evaluated and no non-compliance was found.

3. The EUT must be supplied with a power adapter & battery and following below table:

Item	Brand	Model No.	Spec.
Battery	DENSO	BT3	DC Output: 3.6Vdc, 3050mAh, 10.98Wh
Adapter (Option)	CHANNEL WELL	2ACP0183C	AC Input: 100-240Vac~, 0.5A, 50/60Hz DC Output: 5.0Vdc / 3.0A 15.0W, 9.0Vdc / 2.0A 18.0W, 12.0Vdc / 1.5A 18.0W
For Cradle use			
Item	Brand	Model No.	Spec.
Adapter (Option)	Sunny	SYS1548-5012-T3	AC Input: 100-240Vac~1.5A MAX 50-60Hz AC Cable: Unshielded, 1.71m DC Output: +12.0Vdc / 4.16A DC Cable: Unshielded, 1.16m with one core

4. The antennas provided to the EUT, please refer to the following table:

Antenna No.	RF Chain No	Brand	Model	Antenna gain (dBi)	Frequency Range (MHz)	Antenna Type	Connector Type
1 (WiFi & BT)	Chain0	HONGBO	1415-01R8C00	3.26	2400-2500 (WiFi)	PIFA	Spring
				3.21	2400-2500 (BT)		
				3.63	5150-5250		
				3.65	5250-5350		
				3.45	5470-5725		
				3.52	5725-5850		
2 (WiFi)	Chain1	HONGBO	1415-01R8C00	0.68	2400-2500	PIFA	Spring
				2.63	5150-5250		
				2.6	5250-5350		
				2.93	5470-5725		
				2.4	5725-5850		

5. The EUT was pre-tested for conducted emission test under following test modes:

Pre-test Mode	Description
Mode A	Adapter Mode
Mode B	Laptop Mode
Mode C	Cradle with Type C port
Mode D	Cradle with RJ45 port
Mode E	QC3.0 charge single Cradle

From the above modes, the worst conducted emission test was found in **Mode A**. Therefore only the test data of the modes were recorded in this report.

6. The EUT was pre-tested for radiated emission test under following test modes:

Pre-test Mode	Description
Mode A	Battery Mode
Mode B	Adapter Mode
Mode C	Cradle with Type C port
Mode D	Cradle with RJ45 port
Mode E	QC3.0 charge single Cradle

The worst radiated emissions were found in **Mode D** for below 1GHz and found in **Mode B** for above 1GHz. Therefore only the test data of the modes were recorded in this report.

7. The above EUT information is declared by manufacturer and for more detailed features description, please refers to the manufacturer's specifications or user's manual.

8. The above Antenna information is declared by manufacturer and for more detailed features description, please refer to the manufacturer's specifications, the laboratory shall not be held responsible.

3.2 Description of Test Modes

40 channels are provided to this EUT:

CHANNEL	FREQ. (MHz)	CHANNEL	FREQ. (MHz)	CHANNEL	FREQ. (MHz)	CHANNEL	FREQ. (MHz)
0	2402	10	2422	20	2442	30	2462
1	2404	11	2424	21	2444	31	2464
2	2406	12	2426	22	2446	32	2466
3	2408	13	2428	23	2448	33	2468
4	2410	14	2430	24	2450	34	2470
5	2412	15	2432	25	2452	35	2472
6	2414	16	2434	26	2454	36	2474
7	2416	17	2436	27	2456	37	2476
8	2418	18	2438	28	2458	38	2478
9	2420	19	2440	29	2460	39	2480

3.2.1 Test Mode Applicability and Tested Channel Detail

EUT CONFIGURE MODE	APPLICABLE TO				DESCRIPTION
	RE \geq 1G	RE $<$ 1G	PLC	APCM	
-	√	√	√	√	-

Where **RE \geq 1G**: Radiated Emission above 1GHz & Bandedge Measurement

RE $<$ 1G: Radiated Emission below 1GHz

PLC: Power Line Conducted Emission

APCM: Antenna Port Conducted Measurement

Note: The EUT had been pre-tested on the positioned of each 3 axis. The worst case was found when positioned on X-plane

Radiated Emission Test (Above 1GHz):

- Pre-Scan has been conducted to determine the worst-case mode from all possible combinations between available modulations, data rates and antenna ports (if EUT with antenna diversity architecture).

- Following channel(s) was (were) selected for the final test as listed below.

AVAILABLE CHANNEL	TESTED CHANNEL	MODULATION TYPE	DATA RATE (Mbps)
0 to 39	0, 19, 39	GFSK	1
0 to 39	0, 19, 39	GFSK	2

Radiated Emission Test (Below 1GHz):

- Pre-Scan has been conducted to determine the worst-case mode from all possible combinations between available modulations, data rates and antenna ports (if EUT with antenna diversity architecture).

- Following channel(s) was (were) selected for the final test as listed below.

AVAILABLE CHANNEL	TESTED CHANNEL	MODULATION TYPE	DATA RATE (Mbps)
0 to 39	39	GFSK	1

Power Line Conducted Emission Test:

- Pre-Scan has been conducted to determine the worst-case mode from all possible combinations between available modulations, data rates and antenna ports (if EUT with antenna diversity architecture).

- Following channel(s) was (were) selected for the final test as listed below.

AVAILABLE CHANNEL	TESTED CHANNEL	MODULATION TYPE	DATA RATE (Mbps)
0 to 39	39	GFSK	1

Antenna Port Conducted Measurement:

- This item includes all test value of each mode, but only includes spectrum plot of worst value of each mode.
- Pre-Scan has been conducted to determine the worst-case mode from all possible combinations between available modulations, data rates and antenna ports (if EUT with antenna diversity architecture).
- Following channel(s) was (were) selected for the final test as listed below.

AVAILABLE CHANNEL	TESTED CHANNEL	MODULATION TYPE	DATA RATE (Mbps)
0 to 39	0, 19, 39	GFSK	1
0 to 39	0, 19, 39	GFSK	2

Test Condition:

APPLICABLE TO	ENVIRONMENTAL CONDITIONS	INPUT POWER	TESTED BY
RE \geq 1G	25deg. C, 75%RH	120Vac, 60Hz	Tom Yang
RE<1G	25deg. C, 65%RH	120Vac, 60Hz	Carter Lin
PLC	25deg. C, 66%RH	120Vac, 60Hz	Sampson Chen
APCM	25deg. C, 60%RH	120Vac, 60Hz	Eric Peng

3.3 Duty Cycle of Test Signal

Duty cycle of test signal is < 98 %, duty factor shall be considered.

BT-LE 1M: Duty cycle = 0.388 ms/0.625 ms = 0.621, Duty factor = $10 * \log(1/\text{Duty cycle}) = 2.07 \text{ dB}$

BT-LE 2M: Duty cycle = 1.074ms/1.875 ms = 0.573, Duty factor = $10 * \log(1/\text{Duty cycle}) = 2.42 \text{ dB}$

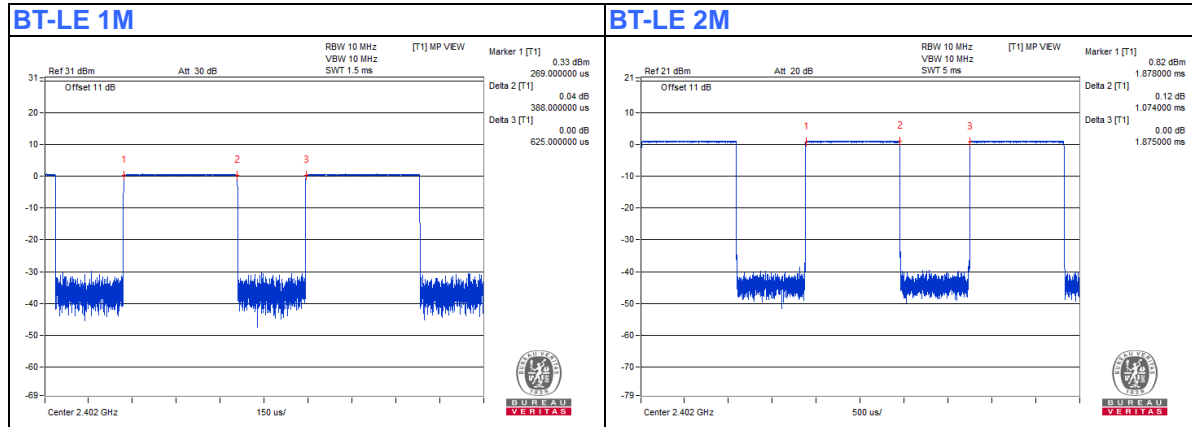

3.4 Description of Support Units

The EUT has been tested as an independent unit together with other necessary accessories or support units. The following support units or accessories were used to form a representative test configuration during the tests.

ID	Product	Brand	Model No.	Serial No.	FCC ID	Remarks
A.	Laptop	DELL	E5430	HYV4VY1	FCC DoC	Provided by Lab
B.	Cradle	Denso	CU-M70U	NA	NA	Supplied by client

Note:

1. All power cords of the above support units are non-shielded (1.8m).

ID	Descriptions	Qty.	Length (m)	Shielding (Yes/No)	Cores (Qty.)	Remarks
1.	USB Cable	1	1.45	No	0	Supplied by client
2.	RJ-45 Cable	1	10	Yes	0	Provided by Lab
3.	DC Cable	1	1.16	Yes	1	Supplied by client
4.	AC Cable	1	1.71	Yes	0	Supplied by client

Note: The core(s) is(are) originally attached to the cable(s).

3.4.1 Configuration of System under Test

For radiated emission (below 1GHz):

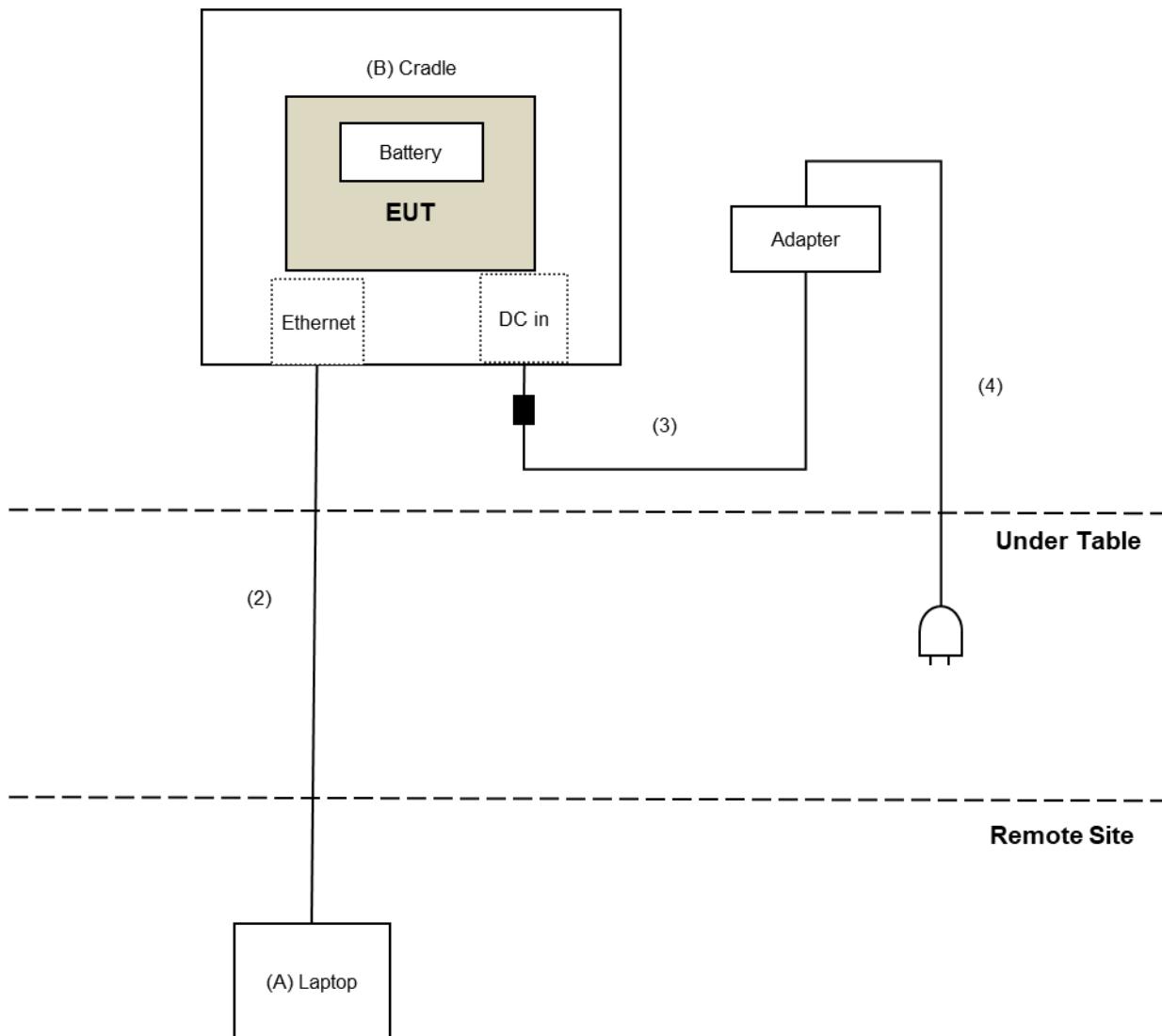

For conducted emission & radiated emission (above 1GHz):

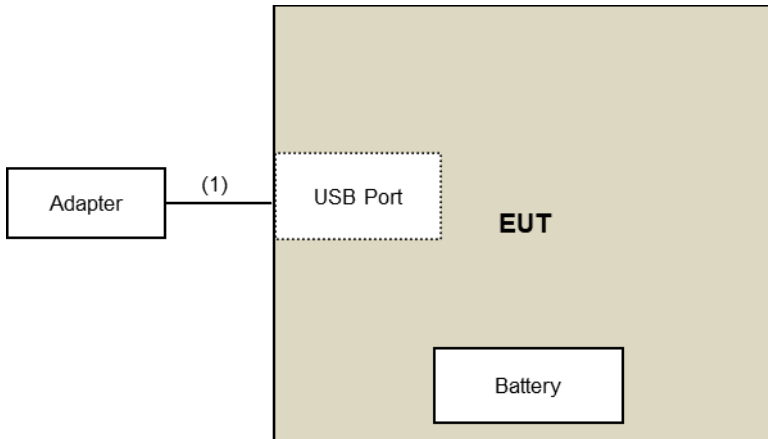

3.5 General Description of Applied Standards and References

The EUT is a RF Product. According to the specifications of the manufacturer, it must comply with the requirements of the following standards and references:

Test Standard:

FCC Part 15, Subpart C (15.247)

ANSI C63.10-2013

All test items have been performed and recorded as per the above standards.

References Test Guidance:

KDB 558074 D01 15.247 Meas Guidance v05r02

All test items have been performed as a reference to the above KDB test guidance.

4 Test Types and Results

4.1 Radiated Emission and Bandedge Measurement

4.1.1 Limits of Radiated Emission and Bandedge Measurement

Radiated emissions which fall in the restricted bands must comply with the radiated emission limits specified as below table. Other emissions shall be at least 20dB below the highest level of the desired power:

Frequencies (MHz)	Field Strength (microvolts/meter)	Measurement Distance (meters)
0.009 ~ 0.490	2400/F(kHz)	300
0.490 ~ 1.705	24000/F(kHz)	30
1.705 ~ 30.0	30	30
30 ~ 88	100	3
88 ~ 216	150	3
216 ~ 960	200	3
Above 960	500	3

Note:

1. The lower limit shall apply at the transition frequencies.
2. Emission level (dBuV/m) = 20 log Emission level (uV/m).
3. For frequencies above 1000MHz, the field strength limits are based on average detector, however, the peak field strength of any emission shall not exceed the maximum permitted average limits, specified above by more than 20dB under any condition of modulation.

4.1.2 Test Instruments

For Radiated Emission and Band-Edge Test:

DESCRIPTION & MANUFACTURER	MODEL NO.	SERIAL NO.	CALIBRATED DATE	CALIBRATED UNTIL
MXE EMI Receiver(20 Hz to 44 GHz) Keysight	N9038A	MY54450088	2020/7/6	2021/7/5
Software	ADT_Radiated_V8.7.08	NA	NA	NA
Antenna Tower & Turn Table Max-Full	MF-7802	MF780208406	NA	NA
Pre_Amplifier EMCI	EMC001340	980142	2020/5/25	2021/5/24
LOOP ANTENNA Electro-Metrics	EM-6879	264	2021/3/5	2022/3/4
RF Coaxial Cable JYEBO	5D-FB	LOOPCAB-001	2021/1/7	2022/1/6
RF Coaxial Cable JYEBO	5D-FB	LOOPCAB-002	2021/1/7	2022/1/6
Pre_Amplifier Mini-Circuits	ZFL-1000VH2	QA0838008	2020/10/20	2021/10/19
Trilog Broadband Antenna SCHWARZBECK	VULB 9168	9168-361	2020/11/5	2021/11/4
RF Coaxial Cable COMMATE/PEWC	8D	966-3-1	2020/3/17	2021/3/16
RF Coaxial Cable COMMATE/PEWC	8D	966-3-2	2020/3/17	2021/3/16
RF Coaxial Cable COMMATE/PEWC	8D	966-3-3	2020/3/17	2021/3/16
Fixed attenuator Mini-Circuits	UNAT-5+	PAD-3m-3-01	2020/9/24	2021/9/23
Horn Antenna Schwarzbeck	BBHA9120-D	9120D-406	2020/11/22	2021/11/21
Pre_Amplifier EMCI	EMC12630SE	980384	2021/1/11	2022/1/10
RF Coaxial Cable EMCI	EMC104-SM-SM-1500	180504	2021/4/26	2022/4/25
RF Coaxial Cable EMCI	EMC104-SM-SM-2000	180601	2020/6/9	2021/6/8
RF Coaxial Cable EMCI	EMC104-SM-SM-6000	210201	2021/5/13	2022/5/12
Fix tool for Boresight antenna tower LIOW GUU	FBA-01	FBA_SIP01	NA	NA
Spectrum Analyzer Keysight	N9030A	MY54490679	2020/7/13	2021/7/12
Pre_Amplifier EMCI	EMC184045SE	980387	2021/1/11	2022/1/10
SHF-EHF Horn Schwarzbeck	BBHA 9170	BBHA9170519	2020/11/22	2021/11/21
RF Cable-Frequency range: 1-40GHz EMCI	EMC102-KM-KM-1200	160924	2021/1/11	2022/1/10
RF cable (40GHz) EMCI	EMC-KM-KM-4000	200214	2020/3/11	2021/3/10

Note:

1. The calibration interval of the above test instruments is 12 months and the calibrations are traceable to NML/ROC and NIST/USA.
2. The test was performed in 966 Chamber No. 3.
3. Tested Date: 2021/1/17 ~ 2021/1/31

For other test items:

DESCRIPTION & MANUFACTURER	MODEL NO.	SERIAL NO.	CALIBRATED DATE	CALIBRATED UNTIL
Spectrum Analyzer R&S	FSV40	100964	2021/3/8	2022/3/7
Power meter Anritsu	ML2495A	1529002	2021/6/21	2022/6/20
Power sensor Anritsu	MA2411B	1339443	2021/5/31	2022/5/30
10dB Attenuator Woken	MDCS18N-10	MDCS18N-10-01	2021/4/13	2022/4/12
Software	ADT_RF Test Software V6.6.5.4	NA	NA	NA

- NOTE:**
1. The test was performed in Oven room 2.
 2. The calibration interval of the above test instruments is 12 months and the calibrations are traceable to NML/ROC and NIST/USA.
 3. Tested Date: 2021/8/18

4.1.3 Test Procedures

For Radiated emission below 30MHz

- a. The EUT was placed on the top of a rotating table 0.8 meters above the ground at a 3 meter chamber room. The table was rotated 360 degrees to determine the position of the highest radiation.
- b. The EUT was set 3 meters away from the interference-receiving antenna, which was mounted on the top of a variable-height antenna tower.
- c. Parallel, perpendicular, and ground-parallel orientations of the antenna are set to make the measurement.
- d. For each suspected emission, the EUT was arranged to its worst case and the rotatable table was turned from 0 degrees to 360 degrees to find the maximum reading.
- e. The test-receiver system was set to Quasi-Peak Detect Function and Specified Bandwidth with Maximum Hold Mode.

Note:

1. The resolution bandwidth and video bandwidth of test receiver/spectrum analyzer is 9kHz at frequency below 30MHz.

For Radiated emission above 30MHz

- a. The EUT was placed on the top of a rotating table 0.8 meters (for 30MHz ~ 1GHz) / 1.5 meters (for above 1GHz) above the ground at 3 meter chamber room for test. The table was rotated 360 degrees to determine the position of the highest radiation.
- b. The EUT was set 3 meters away from the interference-receiving antenna, which was mounted on the top of a variable-height antenna tower.
- c. The height of antenna is varied from one meter to four meters above the ground to determine the maximum value of the field strength. Both horizontal and vertical polarizations of the antenna are set to make the measurement.
- d. For each suspected emission, the EUT was arranged to its worst case and then the antenna was tuned to heights from 1 meter to 4 meters and the rotatable table was turned from 0 degrees to 360 degrees to find the maximum reading.
- e. The test-receiver system was set to quasi-peak detect function and specified bandwidth with maximum hold mode when the test frequency is below 1 GHz.
- f. The test-receiver system was set to peak and average detects function and specified bandwidth with maximum hold mode when the test frequency is above 1 GHz. If the peak reading value also meets average limit, measurement with the average detector is unnecessary.

Note:

1. The resolution bandwidth and video bandwidth of test receiver/spectrum analyzer is 120kHz for Quasi-peak detection (QP) at frequency below 1GHz.
2. The resolution bandwidth of test receiver/spectrum analyzer is 1 MHz and the video bandwidth is 3 MHz for Peak detection (PK) at frequency above 1GHz.
3. The resolution bandwidth of test receiver/spectrum analyzer is 1MHz and the video bandwidth is $\geq 1/T$ (Duty cycle < 98%) or 10Hz (Duty cycle $\geq 98\%$) for Average detection (AV) at frequency above 1GHz.
4. All modes of operation were investigated and the worst-case emissions are reported.

4.1.4 Deviation from Test Standard

No deviation.

4.1.5 Test Setup

For Radiated emission below 30MHz

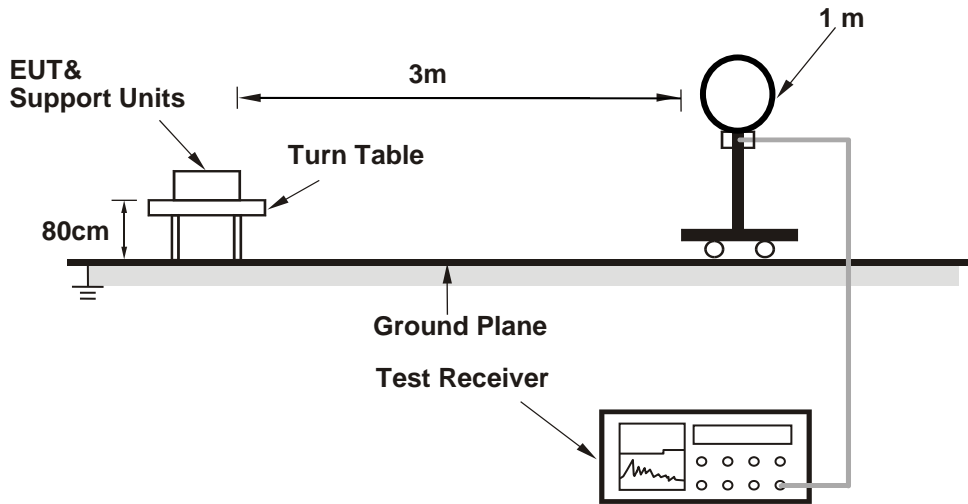

For Radiated emission 30MHz to 1GHz

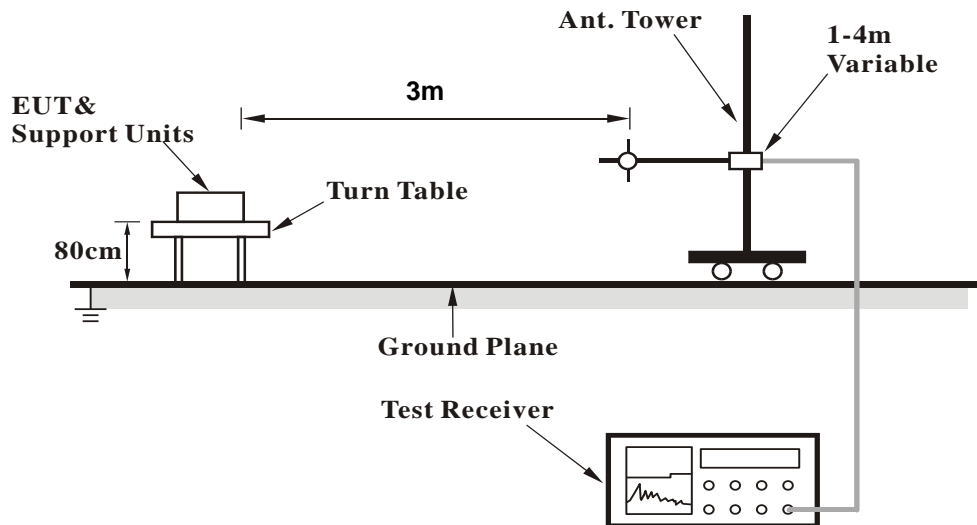

For Radiated emission above 1GHz

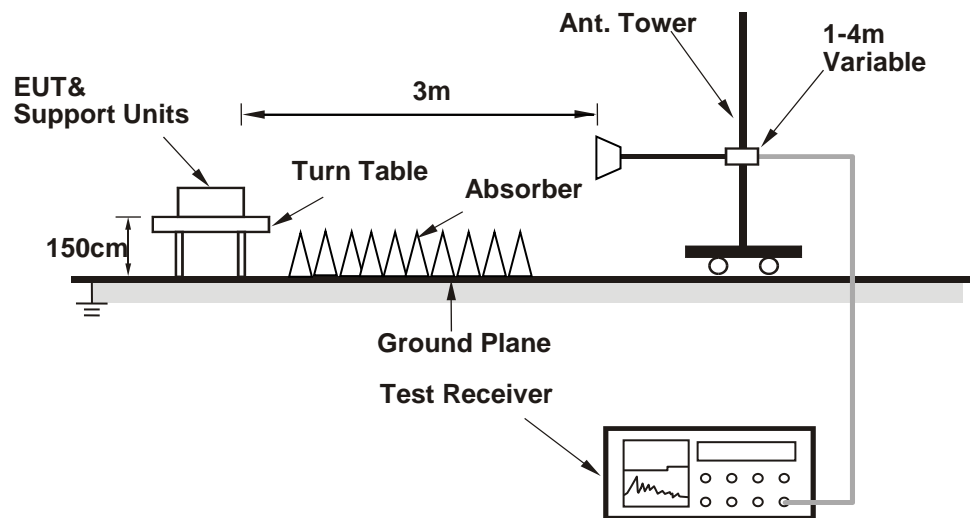

For the actual test configuration, please refer to the attached file (Test Setup Photo).

4.1.6 EUT Operating Conditions

- a. Placed the EUT on the testing table.
- b. Controlling software (Qualcomm Radio Control Toolkit v4.0 v4.0-00147) has been activated to set the EUT under transmission condition continuously at specific channel frequency.

4.1.7 Test Results

Above 1GHz Data:

RF Mode	TX BT_LE-1M	Channel	CH 0 : 2402 MHz
Frequency Range	1GHz ~ 25GHz	Detector Function	Peak (PK) Average (AV)

Antenna Polarity & Test Distance : Horizontal at 3 m								
No	Frequency (MHz)	Emission Level (dBuV/m)	Limit (dBuV/m)	Margin (dB)	Antenna Height (m)	Table Angle (Degree)	Raw Value (dBuV)	Correction Factor (dB/m)
1	2361.25	55.2 PK	74.0	-18.8	1.52 H	355	56.0	-0.8
2	2361.25	44.4 AV	54.0	-9.6	1.52 H	355	45.2	-0.8
3	*2402.00	95.7 PK			1.52 H	355	96.6	-0.9
4	*2402.00	94.6 AV			1.52 H	355	95.5	-0.9
5	4804.00	39.4 PK	74.0	-34.6	2.29 H	301	35.3	4.1
6	4804.00	28.0 AV	54.0	-26.0	2.29 H	301	23.9	4.1
Antenna Polarity & Test Distance : Vertical at 3 m								
No	Frequency (MHz)	Emission Level (dBuV/m)	Limit (dBuV/m)	Margin (dB)	Antenna Height (m)	Table Angle (Degree)	Raw Value (dBuV)	Correction Factor (dB/m)
1	2336.29	56.2 PK	74.0	-17.8	1.01 V	311	57.0	-0.8
2	2336.29	44.7 AV	54.0	-9.3	1.01 V	311	45.5	-0.8
3	*2402.00	96.6 PK			1.01 V	311	97.5	-0.9
4	*2402.00	95.5 AV			1.01 V	311	96.4	-0.9
5	4804.00	38.9 PK	74.0	-35.1	1.91 V	191	34.8	4.1
6	4804.00	27.7 AV	54.0	-26.3	1.91 V	191	23.6	4.1

Remarks:

1. Emission Level(dBuV/m) = Raw Value(dBuV) + Correction Factor(dB/m)
2. Correction Factor(dB/m) = Antenna Factor(dB/m) + Cable Factor(dB) – Pre-Amplifier Factor(dB)
3. Margin value = Emission Level – Limit value
4. The other emission levels were very low against the limit.
5. " * ": Fundamental frequency.

RF Mode	TX BT_LE-1M	Channel	CH 19 : 2440 MHz
Frequency Range	1GHz ~ 25GHz	Detector Function	Peak (PK) Average (AV)

Antenna Polarity & Test Distance : Horizontal at 3 m

No	Frequency (MHz)	Emission Level (dBuV/m)	Limit (dBuV/m)	Margin (dB)	Antenna Height (m)	Table Angle (Degree)	Raw Value (dBuV)	Correction Factor (dB/m)
1	*2440.00	95.9 PK			1.33 H	358	96.8	-0.9
2	*2440.00	94.9 AV			1.33 H	358	95.8	-0.9
3	4880.00	39.2 PK	74.0	-34.8	2.25 H	295	35.0	4.2
4	4880.00	27.5 AV	54.0	-26.5	2.25 H	295	23.3	4.2
5	7320.00	44.4 PK	74.0	-29.6	1.40 H	80	34.2	10.2
6	7320.00	32.4 AV	54.0	-21.6	1.40 H	80	22.2	10.2

Antenna Polarity & Test Distance : Vertical at 3 m

No	Frequency (MHz)	Emission Level (dBuV/m)	Limit (dBuV/m)	Margin (dB)	Antenna Height (m)	Table Angle (Degree)	Raw Value (dBuV)	Correction Factor (dB/m)
1	*2440.00	95.8 PK			1.27 V	310	96.7	-0.9
2	*2440.00	94.6 AV			1.27 V	310	95.5	-0.9
3	4880.00	39.6 PK	74.0	-34.4	1.94 V	192	35.4	4.2
4	4880.00	28.1 AV	54.0	-25.9	1.94 V	192	23.9	4.2
5	7320.00	44.6 PK	74.0	-29.4	1.71 V	146	34.4	10.2
6	7320.00	32.2 AV	54.0	-21.8	1.71 V	146	22.0	10.2

Remarks:

1. Emission Level(dBuV/m) = Raw Value(dBuV) + Correction Factor(dB/m)
2. Correction Factor(dB/m) = Antenna Factor(dB/m) + Cable Factor(dB) – Pre-Amplifier Factor(dB)
3. Margin value = Emission Level – Limit value
4. The other emission levels were very low against the limit.
5. " * ": Fundamental frequency.

RF Mode	TX BT_LE-1M	Channel	CH 39 : 2480 MHz
Frequency Range	1GHz ~ 25GHz	Detector Function	Peak (PK) Average (AV)

Antenna Polarity & Test Distance : Horizontal at 3 m

No	Frequency (MHz)	Emission Level (dBuV/m)	Limit (dBuV/m)	Margin (dB)	Antenna Height (m)	Table Angle (Degree)	Raw Value (dBuV)	Correction Factor (dB/m)
1	*2480.00	96.1 PK			1.38 H	355	96.9	-0.8
2	*2480.00	95.1 AV			1.38 H	355	95.9	-0.8
3	2493.62	54.8 PK	74.0	-19.2	1.38 H	355	55.6	-0.8
4	2493.62	44.2 AV	54.0	-9.8	1.38 H	355	45.0	-0.8
5	4960.00	39.1 PK	74.0	-34.9	2.35 H	309	34.6	4.5
6	4960.00	27.8 AV	54.0	-26.2	2.35 H	309	23.3	4.5
7	7440.00	44.5 PK	74.0	-29.5	1.43 H	74	34.2	10.3
8	7440.00	32.5 AV	54.0	-21.5	1.43 H	74	22.2	10.3

Antenna Polarity & Test Distance : Vertical at 3 m

No	Frequency (MHz)	Emission Level (dBuV/m)	Limit (dBuV/m)	Margin (dB)	Antenna Height (m)	Table Angle (Degree)	Raw Value (dBuV)	Correction Factor (dB/m)
1	*2480.00	96.1 PK			1.21 V	313	96.9	-0.8
2	*2480.00	95.0 AV			1.21 V	313	95.8	-0.8
3	2490.65	55.5 PK	74.0	-18.5	1.21 V	313	56.3	-0.8
4	2490.65	44.1 AV	54.0	-9.9	1.21 V	313	44.9	-0.8
5	4960.00	39.1 PK	74.0	-34.9	1.96 V	210	34.6	4.5
6	4960.00	27.7 AV	54.0	-26.3	1.96 V	210	23.2	4.5
7	7440.00	44.5 PK	74.0	-29.5	1.63 V	154	34.2	10.3
8	7440.00	32.3 AV	54.0	-21.7	1.63 V	154	22.0	10.3

Remarks:

1. Emission Level(dBuV/m) = Raw Value(dBuV) + Correction Factor(dB/m)
2. Correction Factor(dB/m) = Antenna Factor(dB/m) + Cable Factor(dB) – Pre-Amplifier Factor(dB)
3. Margin value = Emission Level – Limit value
4. The other emission levels were very low against the limit.
5. " * ": Fundamental frequency.

RF Mode	TX BT_LE-2M	Channel	CH 0 : 2402 MHz
Frequency Range	1GHz ~ 25GHz	Detector Function	Peak (PK) Average (AV)

Antenna Polarity & Test Distance : Horizontal at 3 m

No	Frequency (MHz)	Emission Level (dBuV/m)	Limit (dBuV/m)	Margin (dB)	Antenna Height (m)	Table Angle (Degree)	Raw Value (dBuV)	Correction Factor (dB/m)
1	2379.02	55.3 PK	74.0	-18.7	1.55 H	353	56.2	-0.9
2	2379.02	43.6 AV	54.0	-10.4	1.55 H	353	44.5	-0.9
3	*2402.00	95.7 PK			1.55 H	353	96.6	-0.9
4	*2402.00	92.7 AV			1.55 H	353	93.6	-0.9
5	4804.00	39.3 PK	74.0	-34.7	2.27 H	287	35.2	4.1
6	4804.00	27.8 AV	54.0	-26.2	2.27 H	287	23.7	4.1

Antenna Polarity & Test Distance : Vertical at 3 m

No	Frequency (MHz)	Emission Level (dBuV/m)	Limit (dBuV/m)	Margin (dB)	Antenna Height (m)	Table Angle (Degree)	Raw Value (dBuV)	Correction Factor (dB/m)
1	2370.35	55.1 PK	74.0	-18.9	1.01 V	311	56.0	-0.9
2	2370.35	43.9 AV	54.0	-10.1	1.01 V	311	44.8	-0.9
3	*2402.00	97.0 PK			1.01 V	311	97.9	-0.9
4	*2402.00	93.9 AV			1.01 V	311	94.8	-0.9
5	4804.00	38.5 PK	74.0	-35.5	1.95 V	206	34.4	4.1
6	4804.00	27.2 AV	54.0	-26.8	1.95 V	206	23.1	4.1

Remarks:

1. Emission Level(dBuV/m) = Raw Value(dBuV) + Correction Factor(dB/m)
2. Correction Factor(dB/m) = Antenna Factor(dB/m) + Cable Factor(dB) – Pre-Amplifier Factor(dB)
3. Margin value = Emission Level – Limit value
4. The other emission levels were very low against the limit.
5. " * ": Fundamental frequency.

RF Mode	TX BT_LE-2M	Channel	CH 19 : 2440 MHz
Frequency Range	1GHz ~ 25GHz	Detector Function	Peak (PK) Average (AV)

Antenna Polarity & Test Distance : Horizontal at 3 m

No	Frequency (MHz)	Emission Level (dBuV/m)	Limit (dBuV/m)	Margin (dB)	Antenna Height (m)	Table Angle (Degree)	Raw Value (dBuV)	Correction Factor (dB/m)
1	*2440.00	96.0 PK			1.38 H	357	96.9	-0.9
2	*2440.00	92.9 AV			1.38 H	357	93.8	-0.9
3	4880.00	39.1 PK	74.0	-34.9	2.33 H	307	34.9	4.2
4	4880.00	27.6 AV	54.0	-26.4	2.33 H	307	23.4	4.2
5	7320.00	43.8 PK	74.0	-30.2	1.37 H	66	33.6	10.2
6	7320.00	31.8 AV	54.0	-22.2	1.37 H	66	21.6	10.2

Antenna Polarity & Test Distance : Vertical at 3 m

No	Frequency (MHz)	Emission Level (dBuV/m)	Limit (dBuV/m)	Margin (dB)	Antenna Height (m)	Table Angle (Degree)	Raw Value (dBuV)	Correction Factor (dB/m)
1	*2440.00	97.3 PK			1.09 V	309	98.2	-0.9
2	*2440.00	93.6 AV			1.09 V	309	94.5	-0.9
3	4880.00	39.0 PK	74.0	-35.0	1.87 V	211	34.8	4.2
4	4880.00	27.6 AV	54.0	-26.4	1.87 V	211	23.4	4.2
5	7320.00	44.0 PK	74.0	-30.0	1.68 V	144	33.8	10.2
6	7320.00	32.0 AV	54.0	-22.0	1.68 V	144	21.8	10.2

Remarks:

1. Emission Level(dBuV/m) = Raw Value(dBuV) + Correction Factor(dB/m)
2. Correction Factor(dB/m) = Antenna Factor(dB/m) + Cable Factor(dB) – Pre-Amplifier Factor(dB)
3. Margin value = Emission Level – Limit value
4. The other emission levels were very low against the limit.
5. " * ": Fundamental frequency.

RF Mode	TX BT_LE-2M	Channel	CH 39 : 2480 MHz
Frequency Range	1GHz ~ 25GHz	Detector Function	Peak (PK) Average (AV)

Antenna Polarity & Test Distance : Horizontal at 3 m								
No	Frequency (MHz)	Emission Level (dBuV/m)	Limit (dBuV/m)	Margin (dB)	Antenna Height (m)	Table Angle (Degree)	Raw Value (dBuV)	Correction Factor (dB/m)
1	*2480.00	96.3 PK			1.40 H	355	97.1	-0.8
2	*2480.00	93.1 AV			1.40 H	355	93.9	-0.8
3	2498.42	54.6 PK	74.0	-19.4	1.40 H	355	55.4	-0.8
4	2498.42	43.3 AV	54.0	-10.7	1.40 H	355	44.1	-0.8
5	4960.00	39.2 PK	74.0	-34.8	2.29 H	299	34.7	4.5
6	4960.00	27.7 AV	54.0	-26.3	2.29 H	299	23.2	4.5
7	7440.00	44.6 PK	74.0	-29.4	1.38 H	67	34.3	10.3
8	7440.00	32.5 AV	54.0	-21.5	1.38 H	67	22.2	10.3

Antenna Polarity & Test Distance : Vertical at 3 m								
No	Frequency (MHz)	Emission Level (dBuV/m)	Limit (dBuV/m)	Margin (dB)	Antenna Height (m)	Table Angle (Degree)	Raw Value (dBuV)	Correction Factor (dB/m)
1	*2480.00	97.1 PK			1.12 V	312	97.9	-0.8
2	*2480.00	93.5 AV			1.12 V	312	94.3	-0.8
3	2485.45	55.2 PK	74.0	-18.8	1.12 V	312	56.0	-0.8
4	2485.45	43.4 AV	54.0	-10.6	1.12 V	312	44.2	-0.8
5	4960.00	39.4 PK	74.0	-34.6	1.96 V	208	34.9	4.5
6	4960.00	27.7 AV	54.0	-26.3	1.96 V	208	23.2	4.5
7	7440.00	44.0 PK	74.0	-30.0	1.72 V	156	33.7	10.3
8	7440.00	32.0 AV	54.0	-22.0	1.72 V	156	21.7	10.3

Remarks:

1. Emission Level(dBuV/m) = Raw Value(dBuV) + Correction Factor(dB/m)
2. Correction Factor(dB/m) = Antenna Factor(dB/m) + Cable Factor(dB) – Pre-Amplifier Factor(dB)
3. Margin value = Emission Level – Limit value
4. The other emission levels were very low against the limit.
5. " * ": Fundamental frequency.

Below 1GHz Data:

RF Mode	TX BT_LE-1M	Channel	CH 39 : 2480 MHz
Frequency Range	9kHz ~ 1GHz	Detector Function	Quasi-Peak (QP)

Antenna Polarity & Test Distance : Horizontal at 3 m								
No	Frequency (MHz)	Emission Level (dBuV/m)	Limit (dBuV/m)	Margin (dB)	Antenna Height (m)	Table Angle (Degree)	Raw Value (dBuV)	Correction Factor (dB/m)
1	52.46	26.1 QP	40.0	-13.9	2.50 H	272	34.2	-8.1
2	153.77	25.1 QP	43.5	-18.4	1.50 H	98	32.6	-7.5
3	266.61	22.2 QP	46.0	-23.8	1.00 H	268	30.0	-7.8
4	388.32	25.3 QP	46.0	-20.7	1.00 H	238	29.4	-4.1
5	520.48	27.9 QP	46.0	-18.1	1.50 H	288	28.4	-0.5
6	769.77	31.2 QP	46.0	-14.8	2.00 H	244	26.3	4.9

Remarks:

1. Emission Level(dBuV/m) = Raw Value(dBuV) + Correction Factor(dB/m)
2. Correction Factor(dB/m) = Antenna Factor(dB/m) + Cable Factor(dB) – Pre-Amplifier Factor(dB)
3. Margin value = Emission Level – Limit value
4. The other emission levels were very low against the limit of frequency range 30MHz~1000MHz.
5. The emission levels were very low against the limit of frequency range 9kHz~30MHz: the amplitude of spurious emissions attenuated more than 20 dB below the permissible value to be report.

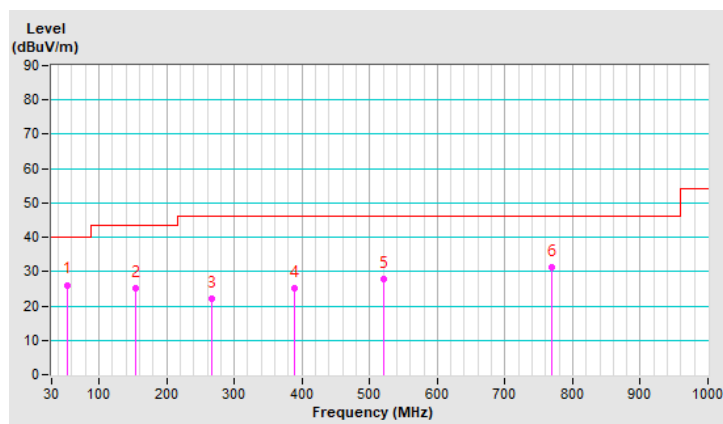

RF Mode	TX BT_LE-1M	Channel	CH 39 : 2480 MHz
Frequency Range	9kHz ~ 1GHz	Detector Function	Quasi-Peak (QP)

Antenna Polarity & Test Distance : Vertical at 3 m

No	Frequency (MHz)	Emission Level (dBuV/m)	Limit (dBuV/m)	Margin (dB)	Antenna Height (m)	Table Angle (Degree)	Raw Value (dBuV)	Correction Factor (dB/m)
1	104.01	20.9 QP	43.5	-22.6	1.50 V	288	32.3	-11.4
2	195.38	22.7 QP	43.5	-20.8	2.00 V	292	33.2	-10.5
3	368.65	25.2 QP	46.0	-20.8	2.50 V	352	29.8	-4.6
4	531.95	27.3 QP	46.0	-18.7	2.00 V	227	27.8	-0.5
5	718.82	29.5 QP	46.0	-16.5	1.00 V	100	26.1	3.4
6	898.03	33.7 QP	46.0	-12.3	1.50 V	138	27.1	6.6

Remarks:

1. Emission Level(dBuV/m) = Raw Value(dBuV) + Correction Factor(dB/m)
2. Correction Factor(dB/m) = Antenna Factor(dB/m) + Cable Factor(dB) – Pre-Amplifier Factor(dB)
3. Margin value = Emission Level – Limit value
4. The other emission levels were very low against the limit of frequency range 30MHz~1000MHz.
5. The emission levels were very low against the limit of frequency range 9kHz~30MHz: the amplitude of spurious emissions attenuated more than 20 dB below the permissible value to be report.

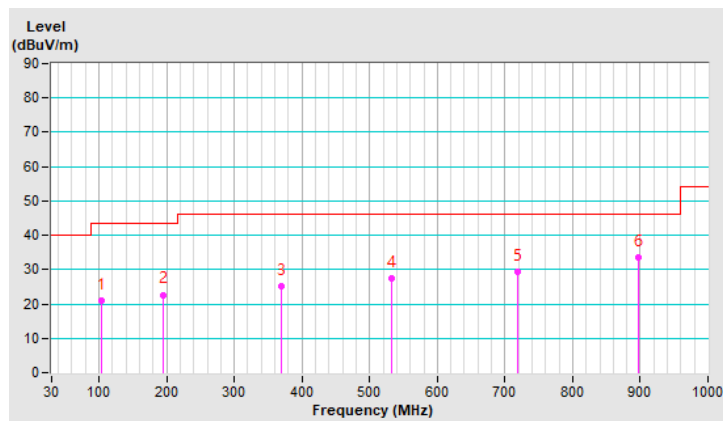

4.2 Conducted Emission Measurement

4.2.1 Limits of Conducted Emission Measurement

Frequency (MHz)	Conducted Limit (dBuV)	
	Quasi-peak	Average
0.15 - 0.5	66 - 56	56 - 46
0.50 - 5.0	56	46
5.0 - 30.0	60	50

Note: 1. The lower limit shall apply at the transition frequencies.

2. The limit decreases in line with the logarithm of the frequency in the range of 0.15 to 0.50MHz.

4.2.2 Test Instruments

DESCRIPTION & MANUFACTURER	MODEL NO.	SERIAL NO.	CALIBRATED DATE	CALIBRATED UNTIL
Test Receiver R&S	ESCS 30	847124/029	2020/10/20	2021/10/19
LISN R&S	ESH3-Z5	848773/004	2020/10/27	2021/10/26
LISN R & S	ESH3-Z5	835239/001	2020/3/19	2021/3/18
50 ohms Terminator	50	3	2020/10/26	2021/10/25
RF Coaxial Cable JYEBO	5D-FB	COCCAB-001	2020/9/26	2021/9/25
Fixed attenuator STI	STI02-2200-10	005	2020/8/29	2021/8/28
Software BVADT	BVADT_Cond_ V7.3.7.4	NA	NA	NA

Note:

1. The calibration interval of the above test instruments are 12 months and the calibrations are traceable to NML/ROC and NIST/USA.
2. The test was performed in Conduction 1.
3. Tested Date: 2021/2/1

4.2.3 Test Procedures

- The EUT was placed 0.4 meters from the conducting wall of the shielded room with EUT being connected to the power mains through a line impedance stabilization network (LISN). Other support units were connected to the power mains through another LISN. The two LISNs provide 50 ohm/ 50uH of coupling impedance for the measuring instrument.
- Both lines of the power mains connected to the EUT were checked for maximum conducted interference.
- The frequency range from 150kHz to 30MHz was searched. Emission levels under (Limit - 20dB) was not recorded.

Note: The resolution bandwidth and video bandwidth of test receiver is 9kHz for quasi-peak detection (QP) and average detection (AV) at frequency 0.15MHz-30MHz.

4.2.4 Deviation from Test Standard

No deviation.

4.2.5 Test Setup

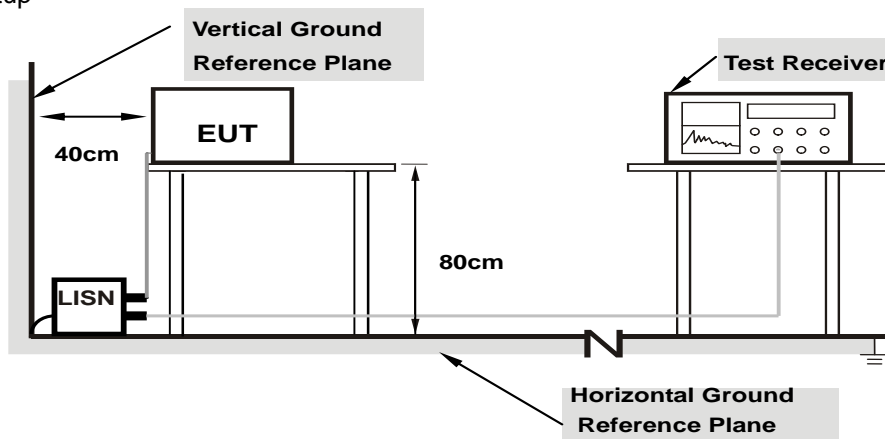

Note: 1.Support units were connected to second LISN.

For the actual test configuration, please refer to the attached file (Test Setup Photo).

4.2.6 EUT Operating Conditions

Same as 4.1.6.

4.2.7 Test Results

RF Mode	TX BT_LE-1M	Channel	CH 39 : 2480 MHz
Frequency Range	150kHz ~ 30MHz	Detector Function & Resolution Bandwidth	Quasi-Peak (QP) / Average (AV), 9kHz

Phase Of Power : Line (L)										
No	Frequency (MHz)	Correction Factor (dB)	Reading Value (dBuV)		Emission Level (dBuV)		Limit (dBuV)		Margin (dB)	
			Q.P.	AV.	Q.P.	AV.	Q.P.	AV.	Q.P.	AV.
1	0.15000	9.96	27.94	15.64	37.90	25.60	66.00	56.00	-28.10	-30.40
2	0.20469	9.99	25.95	16.06	35.94	26.05	63.42	53.42	-27.48	-27.37
3	0.66172	10.04	29.21	20.26	39.25	30.30	56.00	46.00	-16.75	-15.70
4	0.98984	10.06	22.69	12.86	32.75	22.92	56.00	46.00	-23.25	-23.08
5	1.51172	10.10	21.60	11.53	31.70	21.63	56.00	46.00	-24.30	-24.37
6	3.58594	10.25	21.38	12.95	31.63	23.20	56.00	46.00	-24.37	-22.80

Remarks:

1. Q.P. and AV. are abbreviations of quasi-peak and average individually.
2. The emission levels of other frequencies were very low against the limit.
3. Margin value = Emission level – Limit value
4. Correction factor = Insertion loss + Cable loss
5. Emission Level = Correction Factor + Reading Value

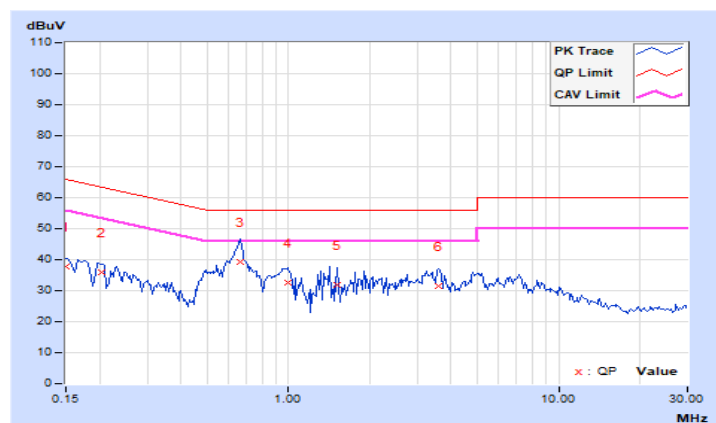

RF Mode	TX BT_LE-1M	Channel	CH 39 : 2480 MHz
Frequency Range	150kHz ~ 30MHz	Detector Function & Resolution Bandwidth	Quasi-Peak (QP) / Average (AV), 9kHz

Phase Of Power : Neutral (N)										
No	Frequency (MHz)	Correction Factor (dB)	Reading Value (dBuV)		Emission Level (dBuV)		Limit (dBuV)		Margin (dB)	
			Q.P.	AV.	Q.P.	AV.	Q.P.	AV.	Q.P.	AV.
1	0.15000	9.94	31.40	20.39	41.34	30.33	66.00	56.00	-24.66	-25.67
2	0.19687	9.98	30.30	19.61	40.28	29.59	63.74	53.74	-23.46	-24.15
3	0.65391	10.04	30.15	21.14	40.19	31.18	56.00	46.00	-15.81	-14.82
4	0.90781	10.06	25.09	12.81	35.15	22.87	56.00	46.00	-20.85	-23.13
5	4.07031	10.25	23.87	16.30	34.12	26.55	56.00	46.00	-21.88	-19.45
6	6.55078	10.41	21.97	15.63	32.38	26.04	60.00	50.00	-27.62	-23.96

Remarks:

1. Q.P. and AV. are abbreviations of quasi-peak and average individually.
2. The emission levels of other frequencies were very low against the limit.
3. Margin value = Emission level – Limit value
4. Correction factor = Insertion loss + Cable loss
5. Emission Level = Correction Factor + Reading Value

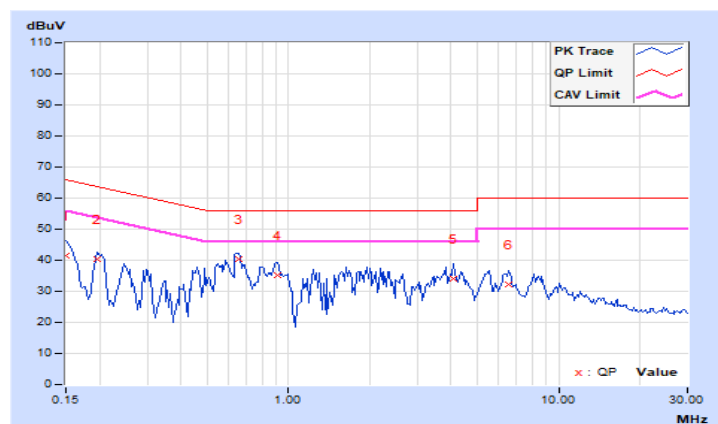

4.3 6dB Bandwidth Measurement

4.3.1 Limits of 6dB Bandwidth Measurement

The minimum of 6dB Bandwidth Measurement is 0.5 MHz.

4.3.2 Test Setup

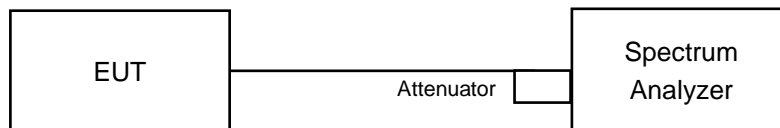

4.3.3 Test Instruments

Refer to section 4.1.2 to get information of above instrument.

4.3.4 Test Procedure

- a. Set resolution bandwidth (RBW) = 100kHz
- b. Set the video bandwidth (VBW) $\geq 3 \times$ RBW, Detector = Peak.
- c. Trace mode = max hold.
- d. Sweep = auto couple.
- e. Measure the maximum width of the emission that is constrained by the frequencies associated with the two amplitude points (upper and lower) that are attenuated by 6 dB relative to the maximum level measured in the fundamental emission

4.3.5 Deviation from Test Standard

No deviation.

4.3.6 EUT Operating Conditions

The software provided by client to enable the EUT under transmission condition continuously at lowest, middle and highest channel frequencies individually.

4.3.7 Test Results

BT-LE 1M

Channel	Frequency (MHz)	6dB Bandwidth (MHz)	Minimum Limit (MHz)	Pass / Fail
0	2402	0.69	0.5	Pass
19	2440	0.69	0.5	Pass
39	2480	0.69	0.5	Pass

BT-LE 2M

Channel	Frequency (MHz)	6dB Bandwidth (MHz)	Minimum Limit (MHz)	Pass / Fail
0	2402	1.16	0.5	Pass
19	2440	1.17	0.5	Pass
39	2480	1.17	0.5	Pass

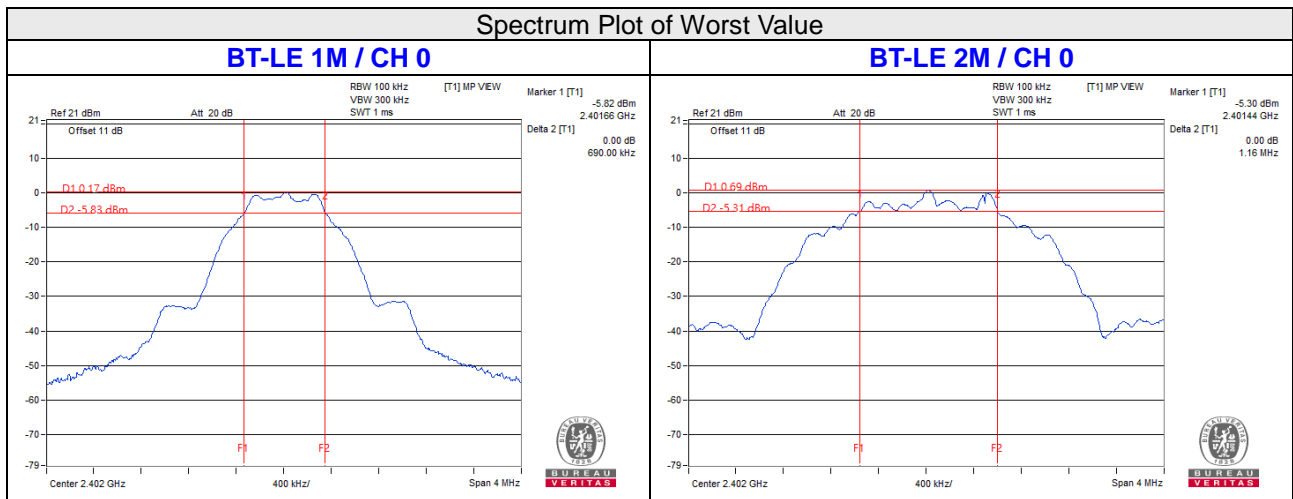

4.4 Conducted Output Power Measurement

4.4.1 Limits of Conducted Output Power Measurement

For systems using digital modulation in the 2400–2483.5 MHz bands: 1 Watt (30dBm)

4.4.2 Test Setup

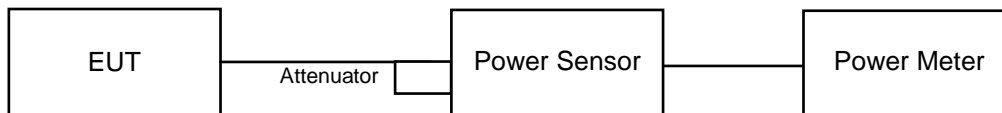

4.4.3 Test Instruments

Refer to section 4.1.2 to get information of above instrument.

4.4.4 Test Procedures

A peak power sensor was used on the output port of the EUT. A power meter was used to read the response of the peak power sensor. Record the power level.

Average power sensor was used to perform output power measurement, trigger and gating function of wide band power meter is enabled to measure max output power of TX on burst. Duty factor is not added to measured value.

4.4.5 Deviation from Test Standard

No deviation.

4.4.6 EUT Operating Conditions

Same as Item 4.3.6.

4.4.7 Test Results

FOR PEAK POWER BT-LE 1M

Channel	Frequency (MHz)	Peak Power (mW)	Peak Power (dBm)	Limit (dBm)	Pass/Fail
0	2402	1.766	2.47	30	Pass
19	2440	1.758	2.45	30	Pass
39	2480	1.774	2.49	30	Pass

Note: The max. gain is 3.21dBi < 6dBi, so the power limit shall not be reduced.

BT-LE 2M

Channel	Frequency (MHz)	Peak Power (mW)	Peak Power (dBm)	Limit (dBm)	Pass/Fail
0	2402	1.671	2.23	30	Pass
19	2440	1.774	2.49	30	Pass
39	2480	1.841	2.65	30	Pass

Note: The max. gain is 3.21dBi < 6dBi, so the power limit shall not be reduced.

FOR AVERAGE POWER BT-LE 1M

Channel	Frequency (MHz)	Average Power (mW)	Average Power (dBm)
0	2402	1.052	0.22
19	2440	1.159	0.64
39	2480	1.194	0.77

BT-LE 2M

Channel	Frequency (MHz)	Average Power (mW)	Average Power (dBm)
0	2402	1.045	0.19
19	2440	1.138	0.56
39	2480	1.186	0.74

4.5 Power Spectral Density Measurement

4.5.1 Limits of Power Spectral Density Measurement

The Maximum of Power Spectral Density Measurement is 8dBm in any 3 kHz.

4.5.2 Test Setup

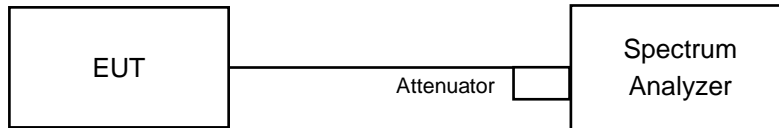

4.5.3 Test Instruments

Refer to section 4.1.2 to get information of above instrument.

4.5.4 Test Procedure

- a. Set analyzer center frequency to DTS channel center frequency.
- b. Set the span to 1.5 times the DTS bandwidth.
- c. Set the RBW to: $3 \text{ kHz} \leq \text{RBW} \leq 100 \text{ kHz}$.
- d. Set the VBW $\geq 3 \times \text{RBW}$.
- e. Detector = peak.
- f. Sweep time = auto couple.
- g. Trace mode = max hold.
- h. Allow trace to fully stabilize.
- i. Use the peak marker function to determine the maximum amplitude level within the RBW.

4.5.5 Deviation from Test Standard

No deviation.

4.5.6 EUT Operating Condition

Same as Item 4.3.6.

4.5.7 Test Results

BT-LE 1M

Channel	Freq. (MHz)	PSD (dBm/3kHz)	Limit (dBm/3kHz)	Pass /Fail
0	2402	-14.31	8	Pass
19	2440	-13.56	8	Pass
39	2480	-13.46	8	Pass

BT-LE 2M

Channel	Freq. (MHz)	PSD (dBm/3kHz)	Limit (dBm/3kHz)	Pass /Fail
0	2402	-17.75	8	Pass
19	2440	-17.11	8	Pass
39	2480	-16.94	8	Pass

Spectrum Plot of Worst Value

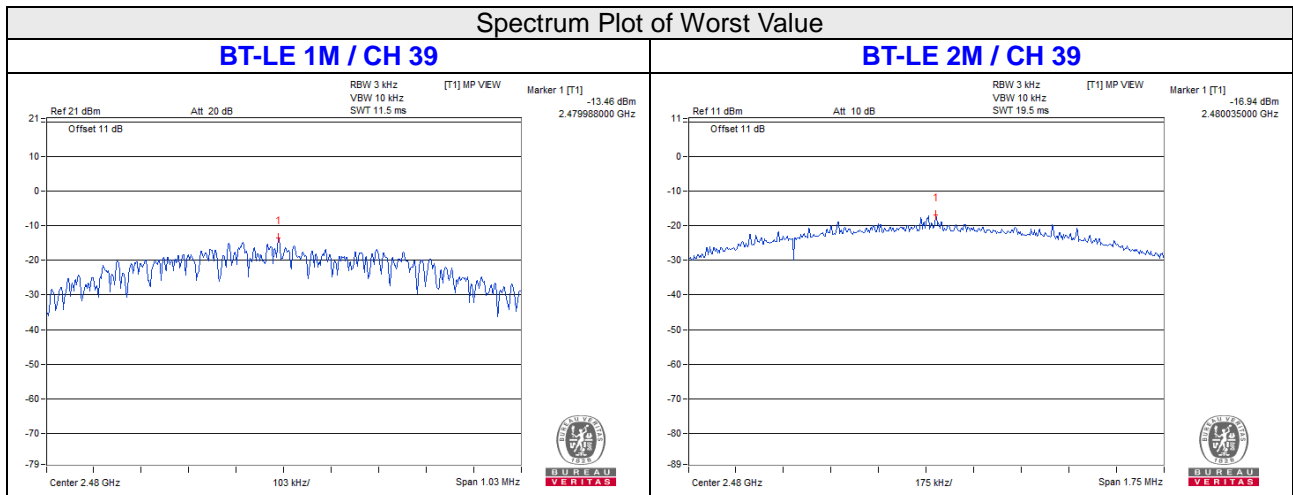

4.6 Conducted Out of Band Emission Measurement

4.6.1 Limits of Conducted Out of Band Emission Measurement

Below 20dB of the highest emission level of operating band (in 100kHz Resolution Bandwidth).

4.6.2 Test Setup

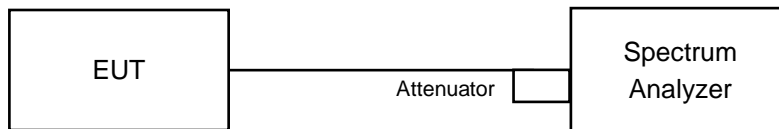

4.6.3 Test Instruments

Refer to section 4.1.2 to get information of above instrument.

4.6.4 Test Procedure

MEASUREMENT PROCEDURE REF

1. Set the RBW = 100 kHz.
2. Set the VBW \geq 300 kHz.
3. Detector = peak.
4. Sweep time = auto couple.
5. Trace mode = max hold.
6. Allow trace to fully stabilize.
7. Use the peak marker function to determine the maximum power level in any 100 kHz band segment within the fundamental EBW.

MEASUREMENT PROCEDURE OOBE

1. Set RBW = 100 kHz.
2. Set VBW \geq 300 kHz.
3. Detector = peak.
4. Sweep = auto couple.
5. Trace Mode = max hold.
6. Allow trace to fully stabilize.
7. Use the peak marker function to determine the maximum amplitude level.

4.6.5 Deviation from Test Standard

No deviation.

4.6.6 EUT Operating Condition

The software provided by client enabled the EUT to transmit and receive data at lowest and highest channel frequencies individually.

4.6.7 Test Results

The spectrum plots are attached on the following pages. D1 line indicates the highest level, and D2 line indicates the 20dB offset below D1. It shows compliance with the requirement.

BT-LE 1M

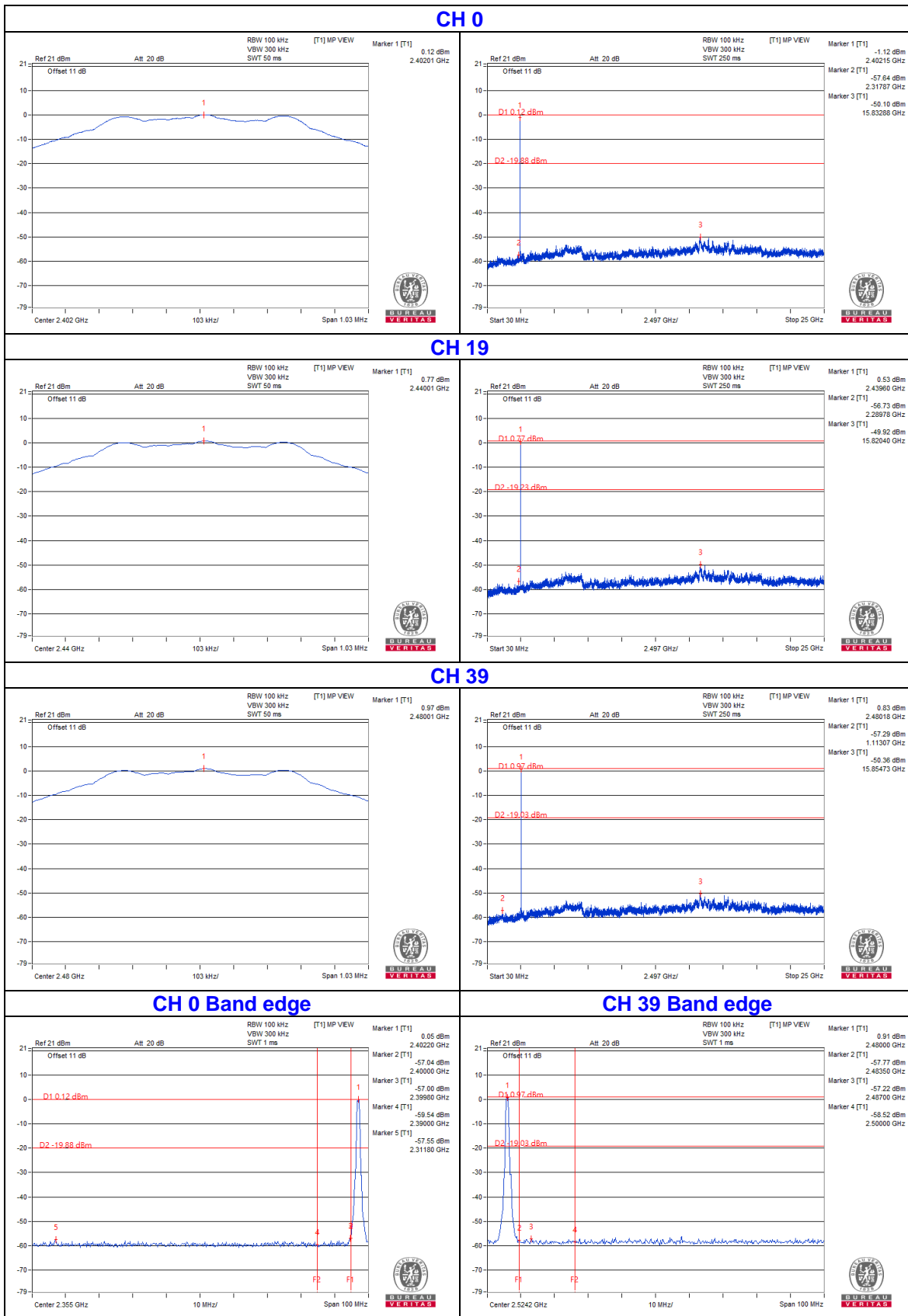

BT-LE 2M

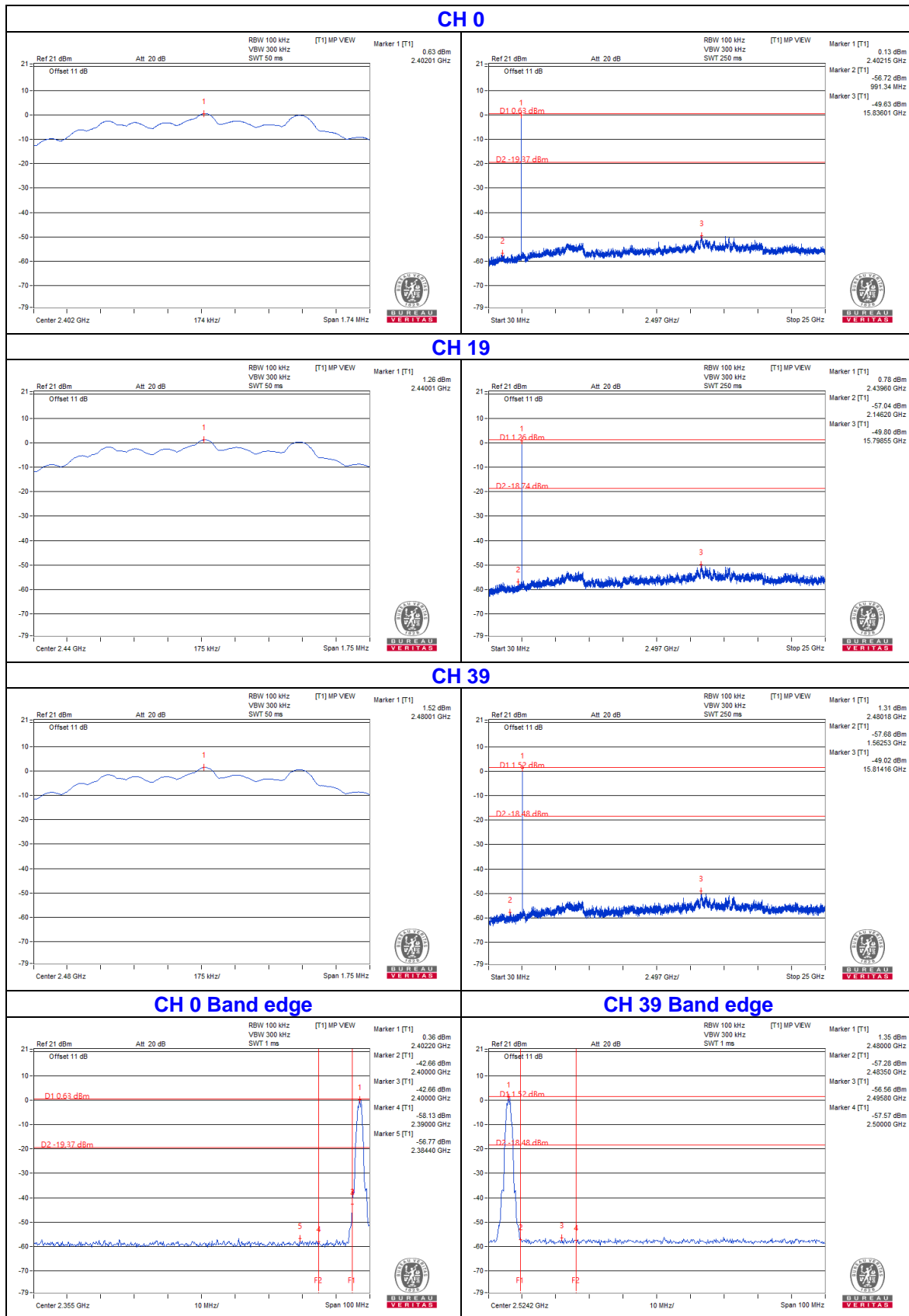

5 Pictures of Test Arrangements

Please refer to the attached file (Test Setup Photo).

Annex A - Band-Edge Measurement

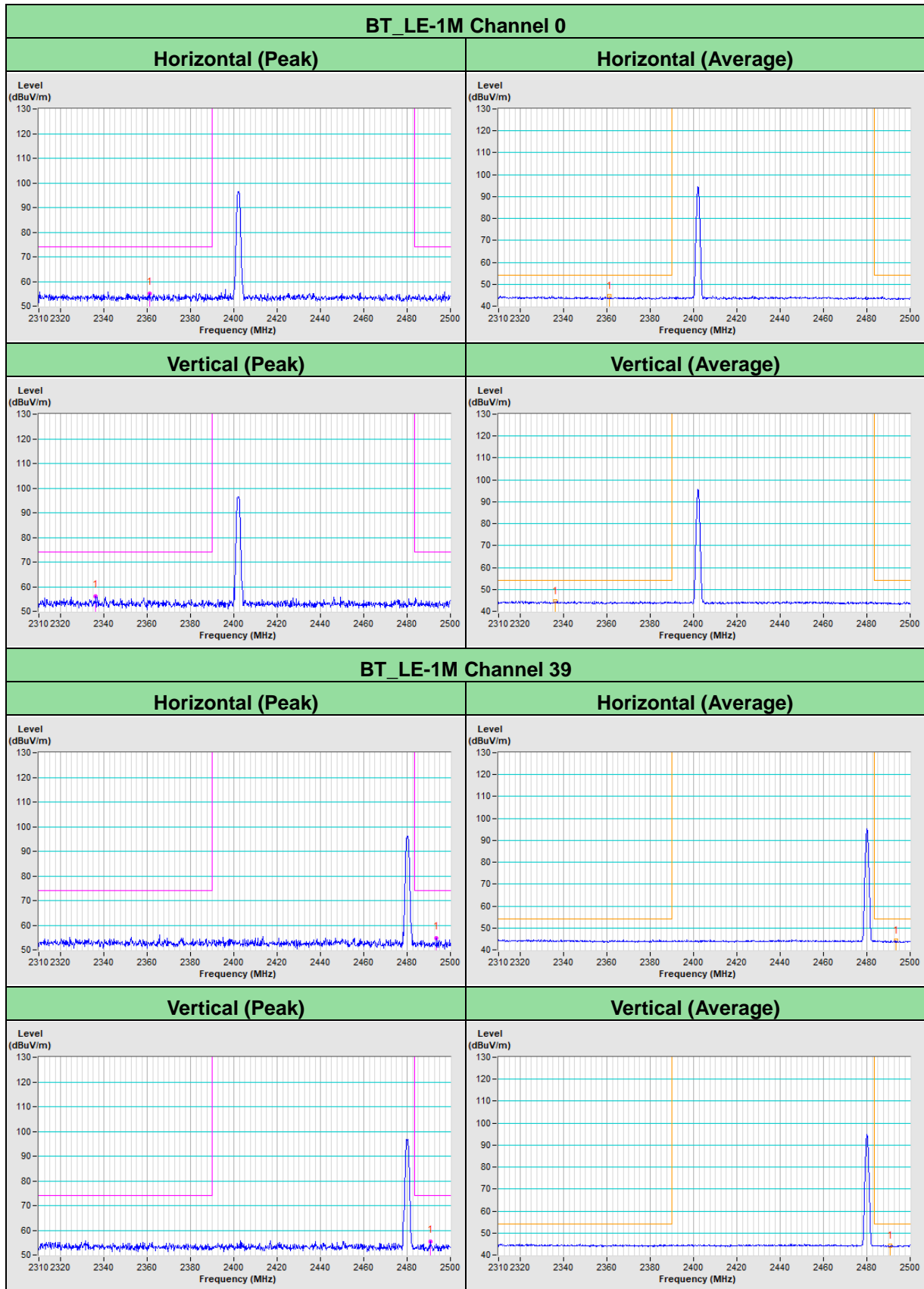

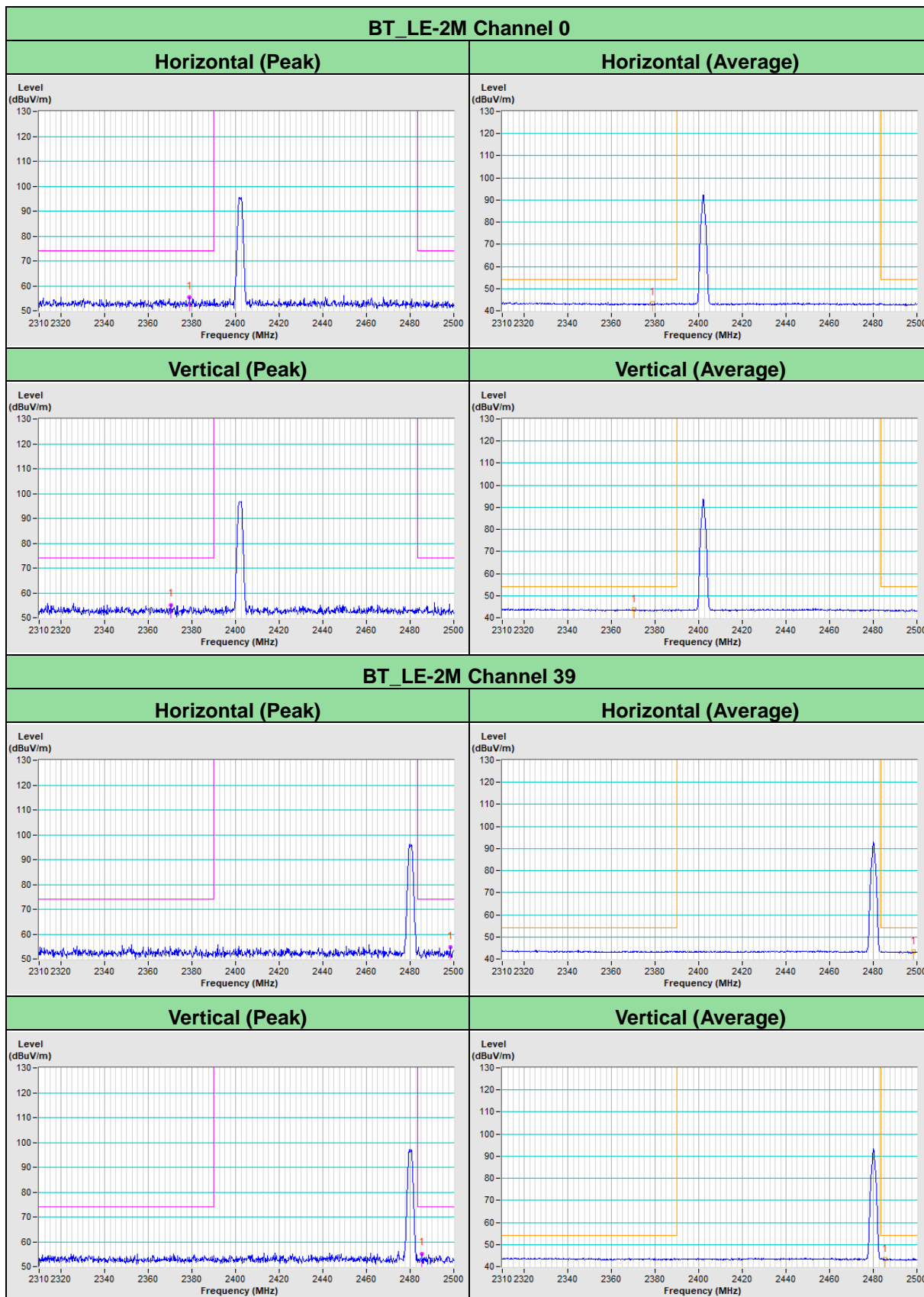

Appendix – Information of the Testing Laboratories

We, Bureau Veritas Consumer Products Services (H.K.) Ltd., Taoyuan Branch, were founded in 1988 to provide our best service in EMC, Radio, Telecom and Safety consultation. Our laboratories are FCC recognized accredited test firms and accredited according to ISO/IEC 17025.

If you have any comments, please feel free to contact us at the following:

Lin Kou EMC/RF Lab

Tel: 886-2-26052180

Fax: 886-2-26051924

Hsin Chu EMC/RF/Telecom Lab

Tel: 886-3-6668565

Fax: 886-3-6668323

Hwa Ya EMC/RF/Safety Lab

Tel: 886-3-3183232

Fax: 886-3-3270892

Email: service.adt@tw.bureauveritas.com

Web Site: www.bureauveritas-adt.com

The address and road map of all our labs can be found in our web site also.

--- END ---