

FCC Test Report

Report No.: RF180102C33C-8

FCC ID: PZWBHT1700BQL

Model: BHT-1700QWB-2

Series Model: BHT-1700QWB-1, BHT-1700BWB-1, BHT-1700QLWB-P
(Refer to item 3.1 for the more details)

Received Date: Jan. 02, 2018

Test Date: Jan. 22 ~ Jul. 18, 2018

Issued Date: Jul. 24, 2018

Applicant: DENSO WAVE INCORPORATED

Address: 1, Yoshiike, Kusagi, Agui-cho, Chita-gun, Aichi, 470-2297 Japan

Issued By: Bureau Veritas Consumer Products Services (H.K.) Ltd., Taoyuan Branch

Lab Address: No. 47-2, 14th Ling, Chia Pau Vil., Lin Kou Dist., New Taipei City, Taiwan
(R.O.C.)

Test Location: No. 19, Hwa Ya 2nd Rd., Wen Hwa Vil., Kwei Shan Dist., Taoyuan City
33383, TAIWAN (R.O.C.)

**FCC Registration/
Designation Number:** 788550 / TW0003



This report is for your exclusive use. Any copying or replication of this report to or for any other person or entity, or use of our name or trademark, is permitted only with our prior written permission. This report sets forth our findings solely with respect to the test samples identified herein. The results set forth in this report are not indicative or representative of the quality or characteristics of the lot from which a test sample was taken or any similar or identical product specifically and expressly noted. Our report includes all of the tests requested by you and the results thereof based upon the information that you provided to us. You have 60 days from date of issuance of this report to notify us of any material error or omission caused by our negligence, provided, however, that such notice shall be in writing and shall specifically address the issue you wish to raise. A failure to raise such issue within the prescribed time shall constitute your unqualified acceptance of the completeness of this report, the tests conducted and the correctness of the report contents. Unless specific mention, the uncertainty of measurement has been explicitly taken into account to declare the compliance or non-compliance to the specification. The report must not be used by the client to claim product certification, approval, or endorsement by TAF or any government agencies.

Table of Contents

Release Control Record	4
1 Certificate of Conformity	5
2 Summary of Test Results	6
2.1 Measurement Uncertainty	6
2.2 Modification Record	6
3 General Information	7
3.1 General Description of EUT	7
3.2 Description of Test Modes	10
3.2.1 Test Mode Applicability and Tested Channel Detail	12
3.3 Duty Cycle of Test Signal	14
3.4 Description of Support Units	15
3.4.1 Configuration of System under Test	15
3.5 General Description of Applied Standards	15
4 Test Types and Results	16
4.1 Radiated Emission and Bandedge Measurement.....	16
4.1.1 Limits of Radiated Emission and Bandedge Measurement	16
4.1.2 Test Instruments	17
4.1.3 Test Procedures.....	18
4.1.4 Deviation from Test Standard	19
4.1.5 Test Set Up	19
4.1.6 EUT Operating Conditions.....	20
4.1.7 Test Results	21
4.2 Conducted Emission Measurement	56
4.2.1 Limits of Conducted Emission Measurement	56
4.2.2 Test Instruments	56
4.2.3 Test Procedures.....	57
4.2.4 Deviation from Test Standard	57
4.2.5 Test Setup.....	57
4.2.6 EUT Operating Conditions.....	57
4.2.7 Test Results	58
4.3 Transmit Power Measurement	60
4.3.1 Limits of Transmit Power Measurement	60
4.3.2 Test Setup.....	60
4.3.3 Test Instruments	61
4.3.4 Test Procedure	61
4.3.5 Deviation from Test Standard	61
4.3.6 EUT Operating Conditions.....	61
4.3.7 Test Result.....	62
4.4 Occupied Bandwidth Measurement	67
4.4.1 Test Setup.....	67
4.4.2 Test Instruments	67
4.4.3 Test Procedure	67
4.4.4 Test Result.....	68
4.5 Peak Power Spectral Density Measurement	70
4.5.1 Limits of Peak Power Spectral Density Measurement	70
4.5.2 Test Setup.....	70
4.5.3 Test Instruments	70
4.5.4 Test Procedures.....	71
4.5.5 Deviation from Test Standard	71
4.5.6 EUT Operating Conditions.....	71
4.5.7 Test Results	72
4.6 Frequency Stability.....	76
4.6.1 Limits of Frequency Stability Measurement	76

4.6.2	Test Setup.....	76
4.6.3	Test Instruments	76
4.6.4	Test Procedure	76
4.6.5	Deviation from Test Standard	76
4.6.6	EUT Operating Condition	76
4.6.7	Test Results	77
4.7	6dB Bandwidth Measurement.....	78
4.7.1	Limits of 6dB Bandwidth Measurement.....	78
4.7.2	Test Setup.....	78
4.7.3	Test Instruments	78
4.7.4	Test Procedure	78
4.7.5	Deviation from Test Standard	78
4.7.6	EUT Operating Condition	78
4.7.7	Test Results	79
5	Pictures of Test Arrangements.....	81
	Annex A- Radiated Out of Band Emission (OOBE) Measurement (For U-NII-3 band).....	82
	Appendix – Information on the Testing Laboratories	85

Release Control Record

Issue No.	Description	Date Issued
RF180102C33C-8	Original release.	Jul. 24, 2018

1 Certificate of Conformity

Product: Barcode Handy Terminal, 2D Code Handy Terminal

Brand: DENSO

Model: BHT-1700QWB-2

Series Model: BHT-1700QWB-1, BHT-1700BWB-1, BHT-1700QLWB-P
(Refer to item 3.1 for the more details)

Sample Status: Engineering sample

Applicant: DENSO WAVE INCORPORATED

Test Date: Jan. 22 ~ Jul. 18, 2018

Standards: 47 CFR FCC Part 15, Subpart E (Section 15.407)
ANSI C63.10:2013

The above equipment has been tested by **Bureau Veritas Consumer Products Services (H.K.) Ltd., Taoyuan Branch**, and found compliance with the requirement of the above standards. The test record, data evaluation & Equipment Under Test (EUT) configurations represented herein are true and accurate accounts of the measurements of the sample's RF characteristics under the conditions specified in this report.

Prepared by : Pettie Chen , **Date:** Jul. 24, 2018
Pettie Chen / Senior Specialist

Approved by : Bruce Chen , **Date:** Jul. 24, 2018
Bruce Chen / Project Engineer

2 Summary of Test Results

47 CFR FCC Part 15, Subpart E (Section 15.407)			
FCC Clause	Test Item	Result	Remarks
15.407(b)(6)	AC Power Conducted Emissions	Pass	Meet the requirement of limit. Minimum passing margin is -12.31dB at 0.50000MHz.
15.407(b)(1/2/3/4(i/ii)/6)	Radiated Emissions & Band Edge Measurement	Pass	Meet the requirement of limit. Minimum passing margin is -1.0dB at 5350.00, 5470.00, 5725.00MHz.
15.407(a)(1/2/3)	Max Average Transmit Power	Pass	Meet the requirement of limit.
---	Occupied Bandwidth Measurement	Pass	Meet the requirement of limit.
15.407(a)(1/2/3)	Peak Power Spectral Density	Pass	Meet the requirement of limit. (U-NII-3 Band only)
15.407(e)	6dB bandwidth	Pass	Meet the requirement of limit.
15.407(g)	Frequency Stability	Pass	Meet the requirement of limit.
15.203	Antenna Requirement	Pass	Antenna connector is Metal shrapnel not a standard connector.

2.1 Measurement Uncertainty

Where relevant, the following measurement uncertainty levels have been estimated for tests performed on the EUT as specified in CISPR 16-4-2:

Measurement	Frequency	Expanded Uncertainty (k=2) (±)
Conducted Emissions at mains ports	150kHz ~ 30MHz	2.94 dB
Radiated Emissions	30MHz ~ 200MHz	3.63 dB
	200MHz ~ 1000MHz	3.64 dB
	1GHz ~ 18GHz	2.29 dB
	18GHz ~ 40GHz	2.29 dB

2.2 Modification Record

There were no modifications required for compliance.

3 General Information

3.1 General Description of EUT

Product	Barcode Handy Terminal, 2D Code Handy Terminal
Brand	DENSO
Model	BHT-1700QWB-2
Series Model	BHT-1700QWB-1, BHT-1700BWB-1, BHT-1700QLWB-P
Model Difference	Refer to Note
Sample Status	Engineering sample
Power Supply Rating	3.7Vdc (battery) 12Vdc (Cradle)
Modulation Type	16QAM, QPSK, BPSK
Modulation Technology	OFDM
Transfer Rate	802.11a: 54/48/36/24/18/12/9/6Mbps 802.11n: up to 150Mbps
Operating Frequency	5180~5240MHz, 5260~5320MHz, 5500~5700MHz, 5745~5825MHz
Number of Channel	5180~5240MHz: 802.11a, 802.11n (HT20): 4 802.11n (HT40): 2 5260~5320MHz: 802.11a, 802.11n (HT20): 4 802.11n (HT40): 2 5500~5700MHz: 802.11a, 802.11n (HT20): 11 802.11n (HT40): 5 5745~5825MHz: 802.11a, 802.11n (HT20): 5 802.11n (HT40): 2
Output Power	5180~5240MHz: 41.210mW 5260~5320MHz: 40.179mW 5500~5700MHz: 42.855mW 5745~5825MHz: 45.604mW
Antenna Type	Refer to note
Antenna Connector	Refer to note
Accessory Device	NA
Cable Supplied	NA

Note:

1. All models are listed as below.

Model Name	base module	CPU	Software	LCD	WLAN / NFC		Audio			
			OS	4"	WLAN	NFC	speaker	Main MIC	Sub MIC	Receiver
BHT-1700QWB-2	4inch WLAN/BT	APQ8009	Android	○	○	○	○	○	○	○
BHT-1700BWB-1	4inch WLAN/BT	APQ8009	Android	○	○		○			
BHT-1700QWB-1	4inch WLAN/BT	APQ8009	Android	○	○		○			
BHT-1700QLWB-P	4inch WLAN/BT	APQ8009	Android	○	○		○			

Model Name	Sensor	Reading			keyboard		Gun grip
	IR Reader	1D	2D	Camera (rear)	2D Long	10 Key	Trigger
BHT-1700QWB-2	○		○	○		○	
BHT-1700BWB-1		○				○	
BHT-1700QWB-1			○			○	
BHT-1700QLWB-P					○	○	○

*Model: BHT-1700QWB-2 was chosen for the final tests.

*NFC Limited module (Brand: DENSO, Model: DWI002, FCC ID: PZWDWI002) collocated in EUT (model: BHT-1700QWB-2).

2. The EUT provides 1 completed transmitter and 1 receiver.

Modulation Mode	TX Function
802.11a	1TX
802.11n (HT20)	1TX
802.11n (HT40)	1TX

3. The EUT with follow antennas gain is listed as table below.

Brand	Antenna Gain(dBi) Including cable loss	Frequency range (MHz to MHz)	Antenna Type	Connector Type	Cable Loss(dB) (External only)	Cable Length (External only)
WHAYU	2.27	2.4~2.4835GHz	PIFA	Metal shrapnel	1	30cm
	3.59	5.15~5.25GHz	PIFA	Metal shrapnel	1.7	30cm
	3.51	5.25~5.35GHz	PIFA	Metal shrapnel	1.7	30cm
	4.13	5.47~5.725GHz	PIFA	Metal shrapnel	1.7	30cm
	2.91	5.725~5.850GHz	PIFA	Metal shrapnel	1.7	30cm

4. The EUT consumes power from the following battery.

Battery 1 (For BHT-1700 Used)	
Brand	DENSO
Model	BT-110LA
Rating	2300mAh, 3.7Vdc,8.5Wh

Battery 2 (For BHT-1700 Used)	
Brand	DENSO
Model	BT-110L
Rating	3450mAh, 3.7Vdc,12.8Wh

*After pre-testing, battery 1 was the worst case for the final tests.

5. The client provides the following cradles for tests. (Support unit only)

LAN Cradle (For BHT-1700 Used) (Support unit)	
Brand	DENSO
Model	CU-BL-17
Output Power	12Vdc, 4.16A, 50W

USB Cradle (For BHT-1700 Used) (Support unit)	
Brand	DENSO
Model	CU-BU1-17
Output Power	12Vdc, 4.16A, 50W

Adapter for cradle (Support unit)	
Brand	FSP GROUP INC.
Model	FSP050-DBAE1
Input Power	100-240Vac, 1.5A, 50/60Hz
Output Power	12Vdc, 4.16A, 50W
Power Line	1.2m non-shielded DC cable with 1 core attached on adapter

*After pre-testing, USB cradle was the worst case for the final tests.

6. The above EUT information is declared by manufacturer and for more detailed features description, please refer to the manufacturer's specifications or user's manual.

3.2 Description of Test Modes

5180~5240MHz:

4 channels are provided for 802.11a, 802.11n (HT20):

Channel	Frequency	Channel	Frequency
36	5180 MHz	44	5220 MHz
40	5200 MHz	48	5240 MHz

2 channels are provided for 802.11n (HT40):

Channel	Frequency	Channel	Frequency
38	5190 MHz	46	5230 MHz

5260~5320MHz:

4 channels are provided for 802.11a, 802.11n (HT20):

Channel	Frequency	Channel	Frequency
52	5260 MHz	60	5300 MHz
56	5280 MHz	64	5320 MHz

2 channels are provided for 802.11n (HT40):

Channel	Frequency	Channel	Frequency
54	5270 MHz	62	5310 MHz

5500~5700MHz:

11 channels are provided for 802.11a, 802.11n (HT20):

Channel	Frequency	Channel	Frequency
100	5500 MHz	124	5620 MHz
104	5520 MHz	128	5640 MHz
108	5540 MHz	132	5660 MHz
112	5560 MHz	136	5680 MHz
116	5580 MHz	140	5700 MHz
120	5600 MHz		

5 channels are provided for 802.11n (HT40):

Channel	Frequency	Channel	Frequency
102	5510 MHz	126	5630 MHz
110	5550 MHz	134	5670 MHz
118	5590 MHz		

5745~5825MHz:

5 channels are provided for 802.11a, 802.11n (HT20):

Channel	Frequency	Channel	Frequency
149	5745 MHz	161	5805 MHz
153	5765 MHz	165	5825 MHz
157	5785 MHz		

2 channels are provided for 802.11n (HT40):

Channel	Frequency	Channel	Frequency
151	5755 MHz	159	5795 MHz

3.2.1 Test Mode Applicability and Tested Channel Detail

EUT Configure Mode	Applicable to				Description
	RE \geq 1G	RE $<$ 1G	PLC	APCM	
A	√	√	-	√	Power from battery
B	-	√	√	-	Power from Cradle

Where RE \geq 1G: Radiated Emission above 1GHz & Bandedge Measurement
 RE $<$ 1G: Radiated Emission below 1GHz
 PLC: Power Line Conducted Emission
 APCM: Antenna Port Conducted Measurement

Note:

1. The EUT had been pre-tested on the positioned of each 3 axis. The worst case was found when positioned on **Z-plane**.
2. "-" means no effect.

Radiated Emission Test (Above 1GHz):

- Pre-Scan has been conducted to determine the worst-case mode from all possible combinations between available modulations, data rates and antenna ports (if EUT with antenna diversity architecture).
- Following channel(s) was (were) selected for the final test as listed below.

EUT Configure Mode	Mode	Frequency Band (MHz)	Available Channel	Tested Channel	Modulation Technology	Data Rate (Mbps)
A	802.11a	5180-5240	36 to 48	36, 40, 48	OFDM	6.0
	802.11n (HT20)		36 to 48	36, 40, 48	OFDM	6.5
	802.11n (HT40)		38 to 46	38, 46	OFDM	13.5
A	802.11a	5260-5320	52 to 64	52, 60, 64	OFDM	6.0
	802.11n (HT20)		52 to 64	52, 60, 64	OFDM	6.5
	802.11n (HT40)		54 to 62	54, 62	OFDM	13.5
A	802.11a	5500-5700	100 to 140	100, 116, 140	OFDM	6.0
	802.11n (HT20)		100 to 140	100, 116, 140	OFDM	6.5
	802.11n (HT40)		102 to 134	102, 110, 134	OFDM	13.5
A	802.11a	5745-5825	149 to 165	149, 157, 165	OFDM	6.0
	802.11n (HT20)		149 to 165	149, 157, 165	OFDM	6.5
	802.11n (HT40)		151 to 159	151, 159	OFDM	13.5

Radiated Emission Test (Below 1GHz):

- Pre-Scan has been conducted to determine the worst-case mode from all possible combinations between available modulations, data rates and antenna ports (if EUT with antenna diversity architecture).
- Following channel(s) was (were) selected for the final test as listed below.

EUT Configure Mode	Mode	Frequency Band (MHz)	Available Channel	Tested Channel	Modulation Technology	Data Rate (Mbps)
A, B	802.11a	5180-5240	36 to 48	149	OFDM	6.0
		5260-5320	52 to 64		OFDM	6.0
		5500-5700	100 to 140		OFDM	6.0
		5745-5825	149 to 165		OFDM	6.0

Power Line Conducted Emission Test:

- Pre-Scan has been conducted to determine the worst-case mode from all possible combinations between available modulations, data rates and antenna ports (if EUT with antenna diversity architecture).
- Following channel(s) was (were) selected for the final test as listed below.

EUT Configure Mode	Mode	Frequency Band (MHz)	Available Channel	Tested Channel	Modulation Technology	Data Rate (Mbps)
B	802.11a	5180-5240	36 to 48	149	OFDM	6.0
		5260-5320	52 to 64		OFDM	6.0
		5500-5700	100 to 140		OFDM	6.0
		5745-5825	149 to 165		OFDM	6.0

Antenna Port Conducted Measurement:

- This item includes all test value of each mode, but only includes spectrum plot of worst value of each mode.
- Pre-Scan has been conducted to determine the worst-case mode from all possible combinations between available modulations, data rates and antenna ports (if EUT with antenna diversity architecture).
- Following channel(s) was (were) selected for the final test as listed below.

EUT Configure Mode	Mode	Frequency Band (MHz)	Available Channel	Tested Channel	Modulation Technology	Data Rate (Mbps)
A	802.11a	5180-5240	36 to 48	36, 40, 48	OFDM	6.0
	802.11n (HT20)		36 to 48	36, 40, 48	OFDM	6.5
	802.11n (HT40)		38 to 46	38, 46	OFDM	13.5
A	802.11a	5260-5320	52 to 64	52, 60, 64	OFDM	6.0
	802.11n (HT20)		52 to 64	52, 60, 64	OFDM	6.5
	802.11n (HT40)		54 to 62	54, 62	OFDM	13.5
A	802.11a	5500-5700	100 to 140	100, 116, 140	OFDM	6.0
	802.11n (HT20)		100 to 140	100, 116, 140	OFDM	6.5
	802.11n (HT40)		102 to 134	102, 110, 134	OFDM	13.5
A	802.11a	5745-5825	149 to 165	149, 157, 165	OFDM	6.0
	802.11n (HT20)		149 to 165	149, 157, 165	OFDM	6.5
	802.11n (HT40)		151 to 159	151, 159	OFDM	13.5

Test Condition:

Applicable to	Environmental Conditions	Input Power	Tested by
RE \geq 1G	25deg. C, 66%RH	120Vac, 60Hz	Matthew Yang
RE<1G	23deg. C, 66%RH 25deg. C, 70%RH	120Vac, 60Hz	Willy Cheng Luis Lee
PLC	23deg. C, 66%RH	120Vac, 60Hz	Willy Cheng
APCM	25deg. C, 60%RH	120Vac, 60Hz	Chris Lin

3.3 Duty Cycle of Test Signal

Duty cycle of test signal is $\geq 98\%$, duty factor is not required.

Duty cycle of test signal is $< 98\%$, duty factor shall be considered.

802.11a: Duty cycle = $1.348/1.584 = 0.851$, Duty factor = $10 * \log(1/0.851) = 0.70$

802.11n (HT20): Duty cycle = $1.276/1.476 = 0.864$, Duty factor = $10 * \log(1/0.864) = 0.63$

802.11n (HT40): Duty cycle = $0.628/0.828 = 0.758$, Duty factor = $10 * \log(1/0.758) = 1.20$



3.4 Description of Support Units

The EUT has been tested as an independent unit together with other necessary accessories or support units. The following support units or accessories were used to form a representative test configuration during the tests.

ID	Product	Brand	Model No.	Serial No.	FCC ID	Remarks
A.	Notebook	Lenovo	81A4	YD02TWF5	PPD-QCNFA435	-
B.	Cradle	DENSO	CU-BU1-17	NA	NA	Provided by manufacturer
C.	Adapter	FSP GROUP INC.	FSP050-DBAE1	NA	NA	Provided by manufacturer

Note: All power cords of the above support units are non-shielded (1.8m).

ID	Descriptions	Qty.	Length (m)	Shielding (Yes/No)	Cores (Qty.)	Remarks
1.	USB cable	1	0.5	Y	0	-
2.	DC cable	1	1.2	N	1	Provided by manufacturer

3.4.1 Configuration of System under Test

Test Mode A



Test Mode B

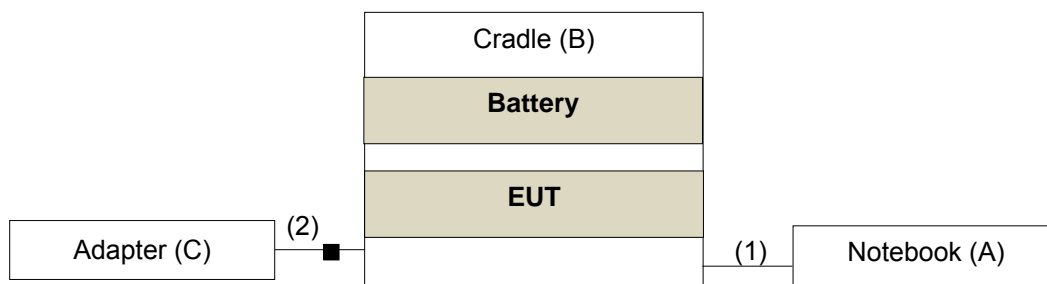

3.5 General Description of Applied Standards

The EUT is a RF Product. According to the specifications of the manufacturer, it must comply with the requirements of the following standards:

FCC Part 15, Subpart E (15.407)

KDB 789033 D02 General UNII Test Procedure New Rules v02r01

ANSI C63.10:2013

All test items have been performed and recorded as per the above standards.

4 Test Types and Results

4.1 Radiated Emission and Bandedge Measurement

4.1.1 Limits of Radiated Emission and Bandedge Measurement

Radiated emissions which fall in the restricted bands must comply with the radiated emission limits specified as below table.

Frequencies (MHz)	Field Strength (microvolts/meter)	Measurement Distance (meters)
0.009 ~ 0.490	2400/F(kHz)	300
0.490 ~ 1.705	24000/F(kHz)	30
1.705 ~ 30.0	30	30
30 ~ 88	100	3
88 ~ 216	150	3
216 ~ 960	200	3
Above 960	500	3

NOTE:

- The lower limit shall apply at the transition frequencies.
- Emission level (dBuV/m) = 20 log Emission level (uV/m).
- For frequencies above 1000MHz, the field strength limits are based on average detector, however, the peak field strength of any emission shall not exceed the maximum permitted average limits, specified above by more than 20dB under any condition of modulation.

Limits of unwanted emission out of the restricted bands

Applicable To		Limit	
789033 D02 General UNII Test Procedure New Rules v02r01		Field Strength at 3m	
		PK: 74 (dBµV/m)	AV: 54 (dBµV/m)
Frequency Band	Applicable To	EIRP Limit	Equivalent Field Strength at 3m
5150~5250 MHz	15.407(b)(1)	PK: -27 (dBm/MHz)	PK: 68.2(dBµV/m)
5250~5350 MHz	15.407(b)(2)		
5470~5725 MHz	15.407(b)(3)		
5725~5850 MHz	<input checked="" type="checkbox"/> 15.407(b)(4)(i)	PK: -27 (dBm/MHz) ^{*1} PK: 10 (dBm/MHz) ^{*2} PK: 15.6 (dBm/MHz) ^{*3} PK: 27 (dBm/MHz) ^{*4}	PK: 68.2(dBµV/m) ^{*1} PK: 105.2 (dBµV/m) ^{*2} PK: 110.8(dBµV/m) ^{*3} PK: 122.2 (dBµV/m) ^{*4}
	<input type="checkbox"/> 15.407(b)(4)(ii)	Emission limits in section 15.247(d)	
^{*1} beyond 75 MHz or more above of the band edge.		^{*2} below the band edge increasing linearly to 10 dBm/MHz at 25 MHz above.	
^{*3} below the band edge increasing linearly to a level of 15.6 dBm/MHz at 5 MHz above.		^{*4} from 5 MHz above or below the band edge increasing linearly to a level of 27 dBm/MHz at the band edge.	

Note: The following formula is used to convert the equipment isotropic radiated power (eirp) to field strength:

$$E = \frac{1000000 \sqrt{30P}}{3} \mu\text{V/m, where P is the eirp (Watts).}$$

4.1.2 Test Instruments

Description & Manufacturer	Model No.	Serial No.	Cal. Date	Cal. Due
Test Receiver ROHDE & SCHWARZ	ESCI	100424	Oct. 17, 2017	Oct. 16, 2018
Spectrum Analyzer ROHDE & SCHWARZ	FSP40	100040	Aug. 18, 2017	Aug. 17, 2018
BILOG Antenna SCHWARZBECK	VULB9168	9168-155	Dec. 11, 2017	Dec. 10, 2018
HORN Antenna SCHWARZBECK	BBHA 9120D	9120D-1170	Dec. 13, 2017	Dec. 12, 2018
HORN Antenna SCHWARZBECK	BBHA 9170	BBHA9170241	Dec. 01, 2017	Nov. 30, 2018
Loop Antenna EMCI	EM-6879	269	Aug. 11, 2017	Aug. 10, 2018
Preamplifier Agilent (Below 1GHz)	8447D	2944A10631	Aug. 08, 2017	Aug. 07, 2018
Preamplifier Agilent (Above 1GHz)	8449B	3008A01960	Aug. 08, 2017	Aug. 07, 2018
RF signal cable HUBER+SUHNER	SUCOFLEX 104	MY 13380+295012/04	Aug. 08, 2017	Aug. 07, 2018
RF signal cable HUBER+SUHNER	SUCOFLEX 104	Cable-CH4-03 (250724)	Aug. 08, 2017	Aug. 07, 2018
Software BV ADT	ADT_Radiated_ V7.6.15.9.5	NA	NA	NA
Antenna Tower inn-co GmbH	MA 4000	010303	NA	NA
Antenna Tower Controller BV ADT	AT100	AT93021703	NA	NA
Turn Table BV ADT	TT100	TT93021703	NA	NA
Turn Table Controller BV ADT	SC100	SC93021703	NA	NA
26GHz ~ 40GHz Amplifier Agilent	8449B	3008A1960	Aug. 08, 2017	Aug. 07, 2018
High Speed Peak Power Meter	ML2495A	0824012	Aug. 18, 2017	Aug. 17, 2018
Power Sensor	MA2411B	0738171	Aug. 18, 2017	Aug. 17, 2018

- Note: 1. The calibration interval of the above test instruments is 12 months and the calibrations are traceable to NML/ROC and NIST/USA.
2. The test was performed in HwaYa Chamber 4.
3. The FCC Designation Number is TW0003. The number will be varied with the Lab location and scope as attached.
4. The IC Site Registration No. is IC 7450F-4.

4.1.3 Test Procedures

For Radiated emission below 30MHz

- a. The EUT was placed on the top of a rotating table 0.8 meters above the ground at a 3 meter chamber room. The table was rotated 360 degrees to determine the position of the highest radiation.
- b. The EUT was set 3 meters away from the interference-receiving antenna, which was mounted on the top of a variable-height antenna tower.
- c. Parallel, perpendicular, and ground-parallel orientations of the antenna are set to make the measurement.
- d. For each suspected emission, the EUT was arranged to its worst case and the rotatable table was turned from 0 degrees to 360 degrees to find the maximum reading.
- e. The test-receiver system was set to Quasi-Peak Detect Function and Specified Bandwidth with Maximum Hold Mode.

Note:

1. The resolution bandwidth and video bandwidth of test receiver/spectrum analyzer is 9kHz at frequency below 30MHz.

For Radiated emission above 30MHz

- a. The EUT was placed on the top of a rotating table 0.8 meters (for 30MHz ~ 1GHz) / 1.5 meters (for above 1GHz) above the ground at 3 meter chamber room for test. The table was rotated 360 degrees to determine the position of the highest radiation.
- b. The EUT was set 3 meters away from the interference-receiving antenna, which was mounted on the top of a variable-height antenna tower.
- c. The height of antenna is varied from one meter to four meters above the ground to determine the maximum value of the field strength. Both horizontal and vertical polarizations of the antenna are set to make the measurement.
- d. For each suspected emission, the EUT was arranged to its worst case and then the antenna was tuned to heights from 1 meter to 4 meters and the rotatable table was turned from 0 degrees to 360 degrees to find the maximum reading.
- e. The test-receiver system was set to quasi-peak detect function and specified bandwidth with maximum hold mode when the test frequency is below 1 GHz.
- f. The test-receiver system was set to peak and average detect function and specified bandwidth with maximum hold mode when the test frequency is above 1 GHz. If the peak reading value also meets average limit, measurement with the average detector is unnecessary.

Note:

1. The resolution bandwidth and video bandwidth of test receiver/spectrum analyzer is 120kHz for Quasi-peak detection (QP) at frequency below 1GHz.
2. The resolution bandwidth of test receiver/spectrum analyzer is 1 MHz and the video bandwidth is 3 MHz for Peak detection (PK) at frequency above 1GHz.
3. The resolution bandwidth of test receiver/spectrum analyzer is 1MHz and the video bandwidth is $\geq 1/T$ (Duty cycle < 98%) or 10Hz (Duty cycle $\geq 98\%$) for Average detection (AV) at frequency above 1GHz.
4. All modes of operation were investigated and the worst-case emissions are reported.

4.1.4 Deviation from Test Standard

No deviation.

4.1.5 Test Set Up

For Radiated emission below 30MHz

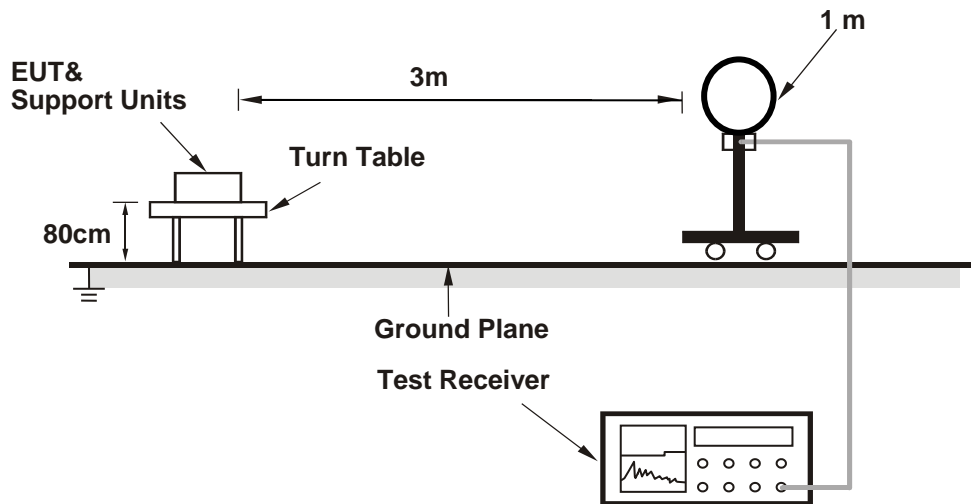

For Radiated emission 30MHz to 1GHz

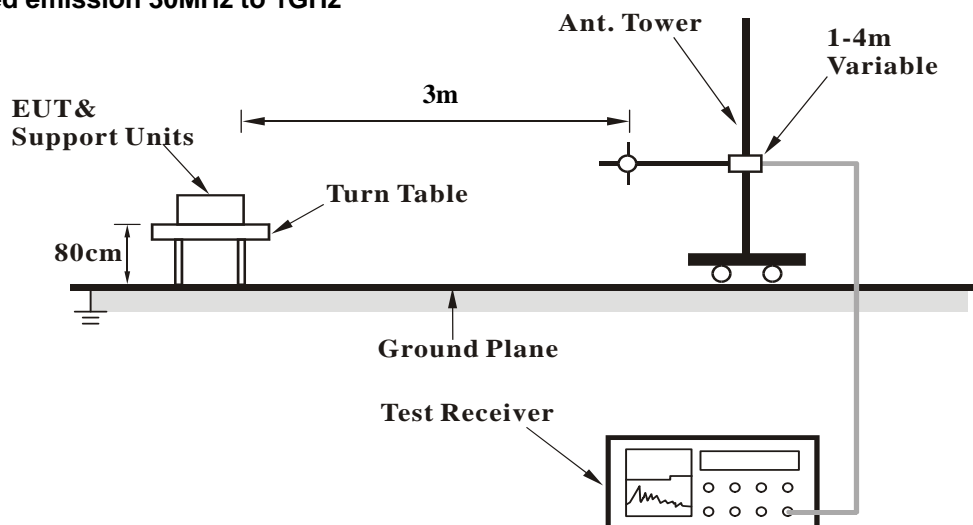

For Radiated emission above 1GHz

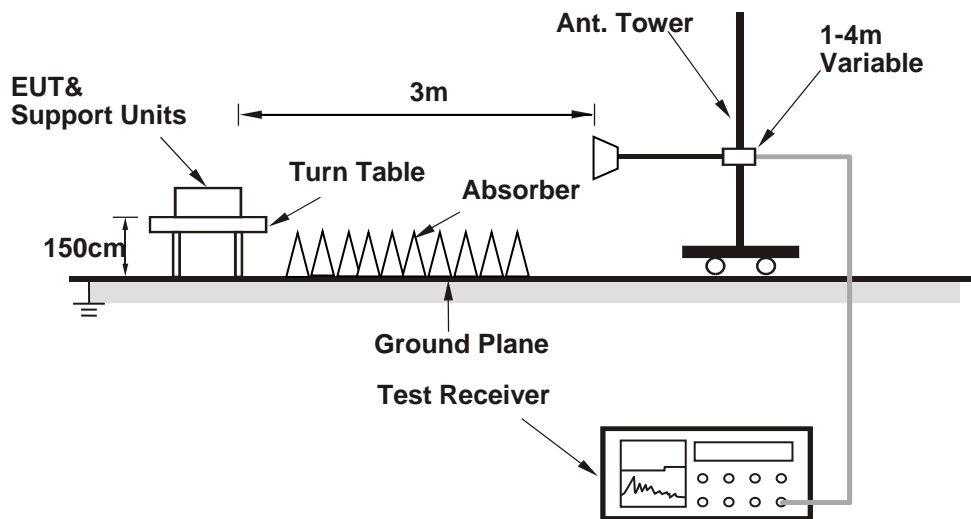

For the actual test configuration, please refer to the attached file (Test Setup Photo).

4.1.6 EUT Operating Conditions

Test Mode A

- a. Set the EUT under transmission condition continuously at specific channel frequency.

Test Mode B

- a. Set the EUT plugged in the cradle and connected with a notebook system via a USB cable and placed on a testing table.
- b. The notebook system ran a test program (provided by manufacturer) to enable EUT under transmission condition continuously at specific channel frequency.

4.1.7 Test Results

Above 1GHz data:

802.11a

CHANNEL	TX Channel 36	DETECTOR	Peak (PK)
FREQUENCY RANGE	1GHz ~ 40GHz	FUNCTION	Average (AV)

ANTENNA POLARITY & TEST DISTANCE: HORIZONTAL AT 3 M								
NO.	FREQ. (MHz)	EMISSION LEVEL (dBuV/m)	LIMIT (dBuV/m)	MARGIN (dB)	ANTENNA HEIGHT (m)	TABLE ANGLE (Degree)	RAW VALUE (dBuV)	CORRECTION FACTOR (dB/m)
1	5150.00	72.5 PK	74.0	-1.5	2.75 H	196	69.9	2.6
2	5150.00	50.6 AV	54.0	-3.4	2.75 H	196	48.0	2.6
3	*5180.00	109.9 PK			3.06 H	192	69.0	40.9
4	*5180.00	98.5 AV			3.06 H	192	57.6	40.9
5	#10360.00	59.6 PK	74.0	-14.4	1.46 H	285	44.8	14.8
6	#10360.00	46.6 AV	54.0	-7.4	1.46 H	285	31.8	14.8
ANTENNA POLARITY & TEST DISTANCE: VERTICAL AT 3 M								
NO.	FREQ. (MHz)	EMISSION LEVEL (dBuV/m)	LIMIT (dBuV/m)	MARGIN (dB)	ANTENNA HEIGHT (m)	TABLE ANGLE (Degree)	RAW VALUE (dBuV)	CORRECTION FACTOR (dB/m)
1	5150.00	70.9 PK	74.0	-3.1	1.04 V	201	68.3	2.6
2	5150.00	49.8 AV	54.0	-4.2	1.04 V	201	47.2	2.6
3	*5180.00	106.2 PK			1.01 V	197	65.3	40.9
4	*5180.00	96.0 AV			1.01 V	197	55.1	40.9
5	#10360.00	59.2 PK	74.0	-14.8	1.20 V	82	44.4	14.8
6	#10360.00	46.2 AV	54.0	-7.8	1.20 V	82	31.4	14.8

Remarks:

1. Emission Level(dBuV/m) = Raw Value(dBuV) + Correction Factor(dB/m)
2. Correction Factor(dB/m) = Antenna Factor(dB/m) + Cable Factor(dB) – Pre-Amplifier Factor(dB)
3. The other emission levels were very low against the limit.
4. Margin value = Emission Level – Limit value
5. " * ": Fundamental frequency.
6. " # ": The radiated frequency is out of the restricted band.

CHANNEL	TX Channel 40	DETECTOR	Peak (PK)
FREQUENCY RANGE	1GHz ~ 40GHz	FUNCTION	Average (AV)

ANTENNA POLARITY & TEST DISTANCE: HORIZONTAL AT 3 M

NO.	FREQ. (MHz)	EMISSION LEVEL (dBuV/m)	LIMIT (dBuV/m)	MARGIN (dB)	ANTENNA HEIGHT (m)	TABLE ANGLE (Degree)	RAW VALUE (dBuV)	CORRECTION FACTOR (dB/m)
1	*5200.00	110.9 PK			2.54 H	182	70.0	40.9
2	*5200.00	100.6 AV			2.54 H	182	59.7	40.9
3	#10400.00	59.8 PK	74.0	-14.2	1.59 H	291	44.9	14.9
4	#10400.00	47.0 AV	54.0	-7.0	1.59 H	291	32.1	14.9

ANTENNA POLARITY & TEST DISTANCE: VERTICAL AT 3 M

NO.	FREQ. (MHz)	EMISSION LEVEL (dBuV/m)	LIMIT (dBuV/m)	MARGIN (dB)	ANTENNA HEIGHT (m)	TABLE ANGLE (Degree)	RAW VALUE (dBuV)	CORRECTION FACTOR (dB/m)
1	*5200.00	108.0 PK			1.06 V	195	67.1	40.9
2	*5200.00	97.4 AV			1.06 V	195	56.5	40.9
3	#10400.00	59.4 PK	74.0	-14.6	1.24 V	87	44.5	14.9
4	#10400.00	46.4 AV	54.0	-7.6	1.24 V	87	31.5	14.9

Remarks:

1. Emission Level(dBuV/m) = Raw Value(dBuV) + Correction Factor(dB/m)
2. Correction Factor(dB/m) = Antenna Factor(dB/m) + Cable Factor(dB) – Pre-Amplifier Factor(dB)
3. The other emission levels were very low against the limit.
4. Margin value = Emission Level – Limit value
5. " * ": Fundamental frequency.
6. " # ": The radiated frequency is out of the restricted band.

CHANNEL	TX Channel 48	DETECTOR FUNCTION	Peak (PK)
FREQUENCY RANGE	1GHz ~ 40GHz		Average (AV)

ANTENNA POLARITY & TEST DISTANCE: HORIZONTAL AT 3 M

NO.	FREQ. (MHz)	EMISSION LEVEL (dBuV/m)	LIMIT (dBuV/m)	MARGIN (dB)	ANTENNA HEIGHT (m)	TABLE ANGLE (Degree)	RAW VALUE (dBuV)	CORRECTION FACTOR (dB/m)
1	*5240.00	110.2 PK			2.54 H	181	69.5	40.7
2	*5240.00	99.6 AV			2.54 H	181	58.9	40.7
3	5350.00	57.0 PK	74.0	-17.0	2.70 H	189	54.2	2.8
4	5350.00	43.5 AV	54.0	-10.5	2.70 H	189	40.7	2.8
5	#10480.00	59.4 PK	74.0	-14.6	1.61 H	288	44.7	14.7
6	#10480.00	46.6 AV	54.0	-7.4	1.61 H	288	31.9	14.7

ANTENNA POLARITY & TEST DISTANCE: VERTICAL AT 3 M

NO.	FREQ. (MHz)	EMISSION LEVEL (dBuV/m)	LIMIT (dBuV/m)	MARGIN (dB)	ANTENNA HEIGHT (m)	TABLE ANGLE (Degree)	RAW VALUE (dBuV)	CORRECTION FACTOR (dB/m)
1	*5240.00	107.6 PK			1.10 V	193	66.9	40.7
2	*5240.00	97.4 AV			1.10 V	193	56.7	40.7
3	5350.00	55.0 PK	74.0	-19.0	1.14 V	187	52.2	2.8
4	5350.00	43.0 AV	54.0	-11.0	1.14 V	187	40.2	2.8
5	#10480.00	58.9 PK	74.0	-15.1	1.27 V	80	44.2	14.7
6	#10480.00	46.3 AV	54.0	-7.7	1.27 V	80	31.6	14.7

Remarks:

1. Emission Level(dBuV/m) = Raw Value(dBuV) + Correction Factor(dB/m)
2. Correction Factor(dB/m) = Antenna Factor(dB/m) + Cable Factor(dB) – Pre-Amplifier Factor(dB)
3. The other emission levels were very low against the limit.
4. Margin value = Emission Level – Limit value
5. " * ": Fundamental frequency.
6. " # ": The radiated frequency is out of the restricted band.

CHANNEL	TX Channel 52	DETECTOR FUNCTION	Peak (PK)
FREQUENCY RANGE	1GHz ~ 40GHz		Average (AV)

ANTENNA POLARITY & TEST DISTANCE: HORIZONTAL AT 3 M

NO.	FREQ. (MHz)	EMISSION LEVEL (dBuV/m)	LIMIT (dBuV/m)	MARGIN (dB)	ANTENNA HEIGHT (m)	TABLE ANGLE (Degree)	RAW VALUE (dBuV)	CORRECTION FACTOR (dB/m)
1	5150.00	54.3 PK	74.0	-19.7	2.55 H	181	51.7	2.6
2	5150.00	43.1 AV	54.0	-10.9	2.55 H	181	40.5	2.6
3	*5260.00	112.4 PK			2.69 H	195	71.7	40.7
4	*5260.00	101.1 AV			2.69 H	195	60.4	40.7
5	#10520.00	58.8 PK	74.0	-15.2	1.52 H	336	44.0	14.8
6	#10520.00	45.9 AV	54.0	-8.1	1.52 H	336	31.1	14.8

ANTENNA POLARITY & TEST DISTANCE: VERTICAL AT 3 M

NO.	FREQ. (MHz)	EMISSION LEVEL (dBuV/m)	LIMIT (dBuV/m)	MARGIN (dB)	ANTENNA HEIGHT (m)	TABLE ANGLE (Degree)	RAW VALUE (dBuV)	CORRECTION FACTOR (dB/m)
1	5150.00	56.7 PK	74.0	-17.3	1.23 V	152	54.1	2.6
2	5150.00	43.4 AV	54.0	-10.6	1.23 V	152	40.8	2.6
3	*5260.00	109.7 PK			1.01 V	195	69.0	40.7
4	*5260.00	98.9 AV			1.01 V	195	58.2	40.7
5	#10520.00	59.7 PK	74.0	-14.3	1.66 V	35	44.9	14.8
6	#10520.00	46.1 AV	54.0	-7.9	1.66 V	35	31.3	14.8

Remarks:

1. Emission Level(dBuV/m) = Raw Value(dBuV) + Correction Factor(dB/m)
2. Correction Factor(dB/m) = Antenna Factor(dB/m) + Cable Factor(dB) – Pre-Amplifier Factor(dB)
3. The other emission levels were very low against the limit.
4. Margin value = Emission Level – Limit value
5. " * ": Fundamental frequency.
6. " # ": The radiated frequency is out of the restricted band.

CHANNEL	TX Channel 60	DETECTOR FUNCTION	Peak (PK)
FREQUENCY RANGE	1GHz ~ 40GHz		Average (AV)

ANTENNA POLARITY & TEST DISTANCE: HORIZONTAL AT 3 M								
NO.	FREQ. (MHz)	EMISSION LEVEL (dBuV/m)	LIMIT (dBuV/m)	MARGIN (dB)	ANTENNA HEIGHT (m)	TABLE ANGLE (Degree)	RAW VALUE (dBuV)	CORRECTION FACTOR (dB/m)
1	*5300.00	110.8 PK			2.44 H	186	70.2	40.6
2	*5300.00	99.6 AV			2.44 H	186	59.0	40.6
3	10600.00	60.5 PK	74.0	-13.5	2.33 H	156	45.3	15.2
4	10600.00	46.9 AV	54.0	-7.1	2.33 H	156	31.7	15.2
ANTENNA POLARITY & TEST DISTANCE: VERTICAL AT 3 M								
NO.	FREQ. (MHz)	EMISSION LEVEL (dBuV/m)	LIMIT (dBuV/m)	MARGIN (dB)	ANTENNA HEIGHT (m)	TABLE ANGLE (Degree)	RAW VALUE (dBuV)	CORRECTION FACTOR (dB/m)
1	*5300.00	107.6 PK			1.15 V	199	67.0	40.6
2	*5300.00	96.5 AV			1.15 V	199	55.9	40.6
3	10600.00	59.8 PK	74.0	-14.2	1.66 V	345	44.6	15.2
4	10600.00	46.7 AV	54.0	-7.3	1.66 V	345	31.5	15.2

Remarks:

1. Emission Level(dBuV/m) = Raw Value(dBuV) + Correction Factor(dB/m)
2. Correction Factor(dB/m) = Antenna Factor(dB/m) + Cable Factor(dB) – Pre-Amplifier Factor(dB)
3. The other emission levels were very low against the limit.
4. Margin value = Emission Level – Limit value
5. " * ": Fundamental frequency.
6. " # ": The radiated frequency is out of the restricted band.

CHANNEL	TX Channel 64	DETECTOR FUNCTION	Peak (PK)
FREQUENCY RANGE	1GHz ~ 40GHz		Average (AV)

ANTENNA POLARITY & TEST DISTANCE: HORIZONTAL AT 3 M

NO.	FREQ. (MHz)	EMISSION LEVEL (dBuV/m)	LIMIT (dBuV/m)	MARGIN (dB)	ANTENNA HEIGHT (m)	TABLE ANGLE (Degree)	RAW VALUE (dBuV)	CORRECTION FACTOR (dB/m)
1	*5320.00	109.3 PK			2.39 H	185	68.6	40.7
2	*5320.00	98.8 AV			2.39 H	185	58.1	40.7
3	5350.00	72.4 PK	74.0	-1.6	2.33 H	184	69.6	2.8
4	5350.00	53.0 AV	54.0	-1.0	2.33 H	184	50.2	2.8
5	10640.00	59.5 PK	74.0	-14.5	1.31 H	78	44.1	15.4
6	10640.00	47.0 AV	54.0	-7.0	1.31 H	78	31.6	15.4

ANTENNA POLARITY & TEST DISTANCE: VERTICAL AT 3 M

NO.	FREQ. (MHz)	EMISSION LEVEL (dBuV/m)	LIMIT (dBuV/m)	MARGIN (dB)	ANTENNA HEIGHT (m)	TABLE ANGLE (Degree)	RAW VALUE (dBuV)	CORRECTION FACTOR (dB/m)
1	*5320.00	106.2 PK			1.00 V	185	65.5	40.7
2	*5320.00	95.6 AV			1.00 V	185	54.9	40.7
3	5350.00	66.4 PK	74.0	-7.6	1.06 V	188	63.6	2.8
4	5350.00	49.5 AV	54.0	-4.5	1.06 V	188	46.7	2.8
5	10640.00	59.3 PK	74.0	-14.7	2.22 V	119	43.9	15.4
6	10640.00	46.8 AV	54.0	-7.2	2.22 V	119	31.4	15.4

Remarks:

1. Emission Level(dBuV/m) = Raw Value(dBuV) + Correction Factor(dB/m)
2. Correction Factor(dB/m) = Antenna Factor(dB/m) + Cable Factor(dB) – Pre-Amplifier Factor(dB)
3. The other emission levels were very low against the limit.
4. Margin value = Emission Level – Limit value
5. " * ": Fundamental frequency.
6. " # ": The radiated frequency is out of the restricted band.

CHANNEL	TX Channel 100	DETECTOR FUNCTION	Peak (PK)
FREQUENCY RANGE	1GHz ~ 40GHz		Average (AV)

ANTENNA POLARITY & TEST DISTANCE: HORIZONTAL AT 3 M

NO.	FREQ. (MHz)	EMISSION LEVEL (dBuV/m)	LIMIT (dBuV/m)	MARGIN (dB)	ANTENNA HEIGHT (m)	TABLE ANGLE (Degree)	RAW VALUE (dBuV)	CORRECTION FACTOR (dB/m)
1	5460.00	70.9 PK	74.0	-3.1	2.26 H	286	67.7	3.2
2	5460.00	50.5 AV	54.0	-3.5	2.26 H	286	47.3	3.2
3	#5470.00	73.0 PK	74.0	-1.0	2.33 H	296	69.8	3.2
4	#5470.00	52.6 AV	54.0	-1.4	2.33 H	296	49.4	3.2
5	*5500.00	109.7 PK			2.10 H	186	68.2	41.5
6	*5500.00	99.3 AV			2.10 H	186	57.8	41.5
7	11000.00	60.0 PK	74.0	-14.0	1.62 H	231	44.0	16.0
8	11000.00	47.3 AV	54.0	-6.7	1.62 H	231	31.3	16.0

ANTENNA POLARITY & TEST DISTANCE: VERTICAL AT 3 M

NO.	FREQ. (MHz)	EMISSION LEVEL (dBuV/m)	LIMIT (dBuV/m)	MARGIN (dB)	ANTENNA HEIGHT (m)	TABLE ANGLE (Degree)	RAW VALUE (dBuV)	CORRECTION FACTOR (dB/m)
1	5460.00	69.3 PK	74.0	-4.7	1.30 V	180	66.1	3.2
2	5460.00	48.0 AV	54.0	-6.0	1.30 V	180	44.8	3.2
3	#5470.00	70.2 PK	74.0	-3.8	1.33 V	189	67.0	3.2
4	#5470.00	48.9 AV	54.0	-5.1	1.33 V	189	45.7	3.2
5	*5500.00	107.2 PK			1.01 V	159	65.7	41.5
6	*5500.00	96.6 AV			1.01 V	159	55.1	41.5
7	11000.00	59.7 PK	74.0	-14.3	1.23 V	166	43.7	16.0
8	11000.00	46.9 AV	54.0	-7.1	1.23 V	166	30.9	16.0

Remarks:

1. Emission Level(dBuV/m) = Raw Value(dBuV) + Correction Factor(dB/m)
2. Correction Factor(dB/m) = Antenna Factor(dB/m) + Cable Factor(dB) – Pre-Amplifier Factor(dB)
3. The other emission levels were very low against the limit.
4. Margin value = Emission Level – Limit value
5. " * ": Fundamental frequency.
6. " # ": The radiated frequency is out of the restricted band.

CHANNEL	TX Channel 116	DETECTOR	Peak (PK)
FREQUENCY RANGE	1GHz ~ 40GHz	FUNCTION	Average (AV)

ANTENNA POLARITY & TEST DISTANCE: HORIZONTAL AT 3 M

NO.	FREQ. (MHz)	EMISSION LEVEL (dBuV/m)	LIMIT (dBuV/m)	MARGIN (dB)	ANTENNA HEIGHT (m)	TABLE ANGLE (Degree)	RAW VALUE (dBuV)	CORRECTION FACTOR (dB/m)
1	*5580.00	110.9 PK			2.06 H	188	69.0	41.9
2	*5580.00	100.3 AV			2.06 H	188	58.4	41.9
3	11160.00	59.9 PK	74.0	-14.1	2.36 H	332	44.2	15.7
4	11160.00	46.8 AV	54.0	-7.2	2.36 H	332	31.1	15.7

ANTENNA POLARITY & TEST DISTANCE: VERTICAL AT 3 M

NO.	FREQ. (MHz)	EMISSION LEVEL (dBuV/m)	LIMIT (dBuV/m)	MARGIN (dB)	ANTENNA HEIGHT (m)	TABLE ANGLE (Degree)	RAW VALUE (dBuV)	CORRECTION FACTOR (dB/m)
1	*5580.00	108.5 PK			1.02 V	158	66.6	41.9
2	*5580.00	97.8 AV			1.02 V	158	55.9	41.9
3	11160.00	60.1 PK	74.0	-13.9	1.52 V	335	44.4	15.7
4	11160.00	47.2 AV	54.0	-6.8	1.52 V	335	31.5	15.7

Remarks:

1. Emission Level(dBuV/m) = Raw Value(dBuV) + Correction Factor(dB/m)
2. Correction Factor(dB/m) = Antenna Factor(dB/m) + Cable Factor(dB) – Pre-Amplifier Factor(dB)
3. The other emission levels were very low against the limit.
4. Margin value = Emission Level – Limit value
5. " * ": Fundamental frequency.
6. " # ": The radiated frequency is out of the restricted band.

CHANNEL	TX Channel 140	DETECTOR FUNCTION	Peak (PK)
FREQUENCY RANGE	1GHz ~ 40GHz		Average (AV)

ANTENNA POLARITY & TEST DISTANCE: HORIZONTAL AT 3 M

NO.	FREQ. (MHz)	EMISSION LEVEL (dBuV/m)	LIMIT (dBuV/m)	MARGIN (dB)	ANTENNA HEIGHT (m)	TABLE ANGLE (Degree)	RAW VALUE (dBuV)	CORRECTION FACTOR (dB/m)
1	*5700.00	108.0 PK			2.41 H	209	65.9	42.1
2	*5700.00	97.5 AV			2.41 H	209	55.4	42.1
3	#5725.00	73.0 PK	74.0	-1.0	2.40 H	206	69.3	3.7
4	#5725.00	52.7 AV	54.0	-1.3	2.40 H	206	49.0	3.7
5	11400.00	60.1 PK	74.0	-13.9	3.33 H	256	44.1	16.0
6	11400.00	47.2 AV	54.0	-6.8	3.33 H	256	31.2	16.0

ANTENNA POLARITY & TEST DISTANCE: VERTICAL AT 3 M

NO.	FREQ. (MHz)	EMISSION LEVEL (dBuV/m)	LIMIT (dBuV/m)	MARGIN (dB)	ANTENNA HEIGHT (m)	TABLE ANGLE (Degree)	RAW VALUE (dBuV)	CORRECTION FACTOR (dB/m)
1	*5700.00	105.5 PK			1.03 V	159	63.4	42.1
2	*5700.00	95.5 AV			1.03 V	159	53.4	42.1
3	#5725.00	70.0 PK	74.0	-4.0	1.09 V	176	66.3	3.7
4	#5725.00	51.1 AV	54.0	-2.9	1.09 V	176	47.4	3.7
5	11400.00	59.8 PK	74.0	-14.2	3.65 V	36	43.8	16.0
6	11400.00	47.0 AV	54.0	-7.0	3.65 V	36	31.0	16.0

Remarks:

1. Emission Level(dBuV/m) = Raw Value(dBuV) + Correction Factor(dB/m)
2. Correction Factor(dB/m) = Antenna Factor(dB/m) + Cable Factor(dB) – Pre-Amplifier Factor(dB)
3. The other emission levels were very low against the limit.
4. Margin value = Emission Level – Limit value
5. " * ": Fundamental frequency.
6. " # ": The radiated frequency is out of the restricted band.

CHANNEL	TX Channel 149	DETECTOR FUNCTION	Peak (PK)
FREQUENCY RANGE	1GHz ~ 40GHz		Average (AV)

ANTENNA POLARITY & TEST DISTANCE: HORIZONTAL AT 3 M

NO.	FREQ. (MHz)	EMISSION LEVEL (dBuV/m)	LIMIT (dBuV/m)	MARGIN (dB)	ANTENNA HEIGHT (m)	TABLE ANGLE (Degree)	RAW VALUE (dBuV)	CORRECTION FACTOR (dB/m)
1	#5632.80	56.5 PK	68.2	-11.7	2.49 H	208	53.0	3.5
2	*5745.00	111.0 PK			2.49 H	208	68.8	42.2
3	*5745.00	100.4 AV			2.49 H	208	58.2	42.2
4	#5951.20	58.9 PK	68.2	-9.3	2.49 H	208	54.3	4.6
5	11490.00	60.7 PK	74.0	-13.3	1.85 H	47	44.5	16.2
6	11490.00	47.9 AV	54.0	-6.1	1.85 H	47	31.7	16.2

ANTENNA POLARITY & TEST DISTANCE: VERTICAL AT 3 M

NO.	FREQ. (MHz)	EMISSION LEVEL (dBuV/m)	LIMIT (dBuV/m)	MARGIN (dB)	ANTENNA HEIGHT (m)	TABLE ANGLE (Degree)	RAW VALUE (dBuV)	CORRECTION FACTOR (dB/m)
1	#5616.80	57.2 PK	68.2	-11.0	1.01 V	161	53.7	3.5
2	*5745.00	107.7 PK			1.01 V	161	65.5	42.2
3	*5745.00	97.5 AV			1.01 V	161	55.3	42.2
4	#5987.20	57.7 PK	68.2	-10.5	1.01 V	161	53.0	4.7
5	11490.00	60.3 PK	74.0	-13.7	1.36 V	287	44.1	16.2
6	11490.00	47.6 AV	54.0	-6.4	1.36 V	287	31.4	16.2

Remarks:

1. Emission Level(dBuV/m) = Raw Value(dBuV) + Correction Factor(dB/m)
2. Correction Factor(dB/m) = Antenna Factor(dB/m) + Cable Factor(dB) – Pre-Amplifier Factor(dB)
3. The other emission levels were very low against the limit.
4. Margin value = Emission Level – Limit value
5. " * ": Fundamental frequency.
6. " # ": The radiated frequency is out of the restricted band.

CHANNEL	TX Channel 157	DETECTOR FUNCTION	Peak (PK)
FREQUENCY RANGE	1GHz ~ 40GHz		Average (AV)

ANTENNA POLARITY & TEST DISTANCE: HORIZONTAL AT 3 M

NO.	FREQ. (MHz)	EMISSION LEVEL (dBuV/m)	LIMIT (dBuV/m)	MARGIN (dB)	ANTENNA HEIGHT (m)	TABLE ANGLE (Degree)	RAW VALUE (dBuV)	CORRECTION FACTOR (dB/m)
1	#5639.20	56.7 PK	68.2	-11.5	2.35 H	207	53.3	3.4
2	*5785.00	111.0 PK			2.35 H	207	68.6	42.4
3	*5785.00	100.0 AV			2.35 H	207	57.6	42.4
4	#5989.60	58.2 PK	68.2	-10.0	2.35 H	207	53.5	4.7
5	11570.00	60.6 PK	74.0	-13.4	1.88 H	50	44.6	16.0
6	11570.00	47.9 AV	54.0	-6.1	1.88 H	50	31.9	16.0

ANTENNA POLARITY & TEST DISTANCE: VERTICAL AT 3 M

NO.	FREQ. (MHz)	EMISSION LEVEL (dBuV/m)	LIMIT (dBuV/m)	MARGIN (dB)	ANTENNA HEIGHT (m)	TABLE ANGLE (Degree)	RAW VALUE (dBuV)	CORRECTION FACTOR (dB/m)
1	#5600.00	58.1 PK	68.2	-10.1	1.05 V	162	54.4	3.7
2	*5785.00	108.1 PK			1.05 V	162	65.7	42.4
3	*5785.00	97.4 AV			1.05 V	162	55.0	42.4
4	#5936.80	58.9 PK	68.2	-9.3	1.05 V	162	54.4	4.5
5	11570.00	60.2 PK	74.0	-13.8	1.33 V	296	44.2	16.0
6	11570.00	47.6 AV	54.0	-6.4	1.33 V	296	31.6	16.0

Remarks:

1. Emission Level(dBuV/m) = Raw Value(dBuV) + Correction Factor(dB/m)
2. Correction Factor(dB/m) = Antenna Factor(dB/m) + Cable Factor(dB) – Pre-Amplifier Factor(dB)
3. The other emission levels were very low against the limit.
4. Margin value = Emission Level – Limit value
5. " * ": Fundamental frequency.
6. " # ": The radiated frequency is out of the restricted band.

CHANNEL	TX Channel 165	DETECTOR FUNCTION	Peak (PK)
FREQUENCY RANGE	1GHz ~ 40GHz		Average (AV)

ANTENNA POLARITY & TEST DISTANCE: HORIZONTAL AT 3 M

NO.	FREQ. (MHz)	EMISSION LEVEL (dBuV/m)	LIMIT (dBuV/m)	MARGIN (dB)	ANTENNA HEIGHT (m)	TABLE ANGLE (Degree)	RAW VALUE (dBuV)	CORRECTION FACTOR (dB/m)
1	#5628.80	57.0 PK	68.2	-11.2	2.67 H	207	53.5	3.5
2	*5825.00	111.0 PK			2.67 H	207	68.2	42.8
3	*5825.00	100.1 AV			2.67 H	207	57.3	42.8
4	#5935.20	58.1 PK	68.2	-10.1	2.67 H	207	53.6	4.5
5	11650.00	60.5 PK	74.0	-13.5	1.79 H	42	45.1	15.4
6	11650.00	47.4 AV	54.0	-6.6	1.79 H	42	32.0	15.4

ANTENNA POLARITY & TEST DISTANCE: VERTICAL AT 3 M

NO.	FREQ. (MHz)	EMISSION LEVEL (dBuV/m)	LIMIT (dBuV/m)	MARGIN (dB)	ANTENNA HEIGHT (m)	TABLE ANGLE (Degree)	RAW VALUE (dBuV)	CORRECTION FACTOR (dB/m)
1	#5604.80	56.7 PK	68.2	-11.5	2.62 V	332	53.1	3.6
2	*5825.00	107.9 PK			2.62 V	332	65.1	42.8
3	*5825.00	97.5 AV			2.62 V	332	54.7	42.8
4	#5943.20	57.8 PK	68.2	-10.4	2.62 V	332	53.3	4.5
5	11650.00	60.1 PK	74.0	-13.9	1.30 V	301	44.7	15.4
6	11650.00	46.9 AV	54.0	-7.1	1.30 V	301	31.5	15.4

Remarks:

1. Emission Level(dBuV/m) = Raw Value(dBuV) + Correction Factor(dB/m)
2. Correction Factor(dB/m) = Antenna Factor(dB/m) + Cable Factor(dB) – Pre-Amplifier Factor(dB)
3. The other emission levels were very low against the limit.
4. Margin value = Emission Level – Limit value
5. " * ": Fundamental frequency.
6. " # ": The radiated frequency is out of the restricted band.

802.11n (HT20)

CHANNEL	TX Channel 36	DETECTOR	Peak (PK)
FREQUENCY RANGE	1GHz ~ 40GHz	FUNCTION	Average (AV)

ANTENNA POLARITY & TEST DISTANCE: HORIZONTAL AT 3 M								
NO.	FREQ. (MHz)	EMISSION LEVEL (dBuV/m)	LIMIT (dBuV/m)	MARGIN (dB)	ANTENNA HEIGHT (m)	TABLE ANGLE (Degree)	RAW VALUE (dBuV)	CORRECTION FACTOR (dB/m)
1	5150.00	72.6 PK	74.0	-1.4	2.46 H	190	70.0	2.6
2	5150.00	50.6 AV	54.0	-3.4	2.46 H	190	48.0	2.6
3	*5180.00	108.6 PK			2.40 H	187	67.7	40.9
4	*5180.00	97.6 AV			2.40 H	187	56.7	40.9
5	#10360.00	59.4 PK	74.0	-14.6	1.82 H	302	44.6	14.8
6	#10360.00	46.5 AV	54.0	-7.5	1.82 H	302	31.7	14.8
ANTENNA POLARITY & TEST DISTANCE: VERTICAL AT 3 M								
NO.	FREQ. (MHz)	EMISSION LEVEL (dBuV/m)	LIMIT (dBuV/m)	MARGIN (dB)	ANTENNA HEIGHT (m)	TABLE ANGLE (Degree)	RAW VALUE (dBuV)	CORRECTION FACTOR (dB/m)
1	5150.00	70.7 PK	74.0	-3.3	1.09 V	206	68.1	2.6
2	5150.00	49.6 AV	54.0	-4.4	1.09 V	206	47.0	2.6
3	*5180.00	105.8 PK			1.03 V	199	64.9	40.9
4	*5180.00	95.5 AV			1.03 V	199	54.6	40.9
5	#10360.00	59.0 PK	74.0	-15.0	1.28 V	102	44.2	14.8
6	#10360.00	46.3 AV	54.0	-7.7	1.28 V	102	31.5	14.8

Remarks:

1. Emission Level(dBuV/m) = Raw Value(dBuV) + Correction Factor(dB/m)
2. Correction Factor(dB/m) = Antenna Factor(dB/m) + Cable Factor(dB) – Pre-Amplifier Factor(dB)
3. The other emission levels were very low against the limit.
4. Margin value = Emission Level – Limit value
5. " * ": Fundamental frequency.
6. " # ": The radiated frequency is out of the restricted band.

CHANNEL	TX Channel 40	DETECTOR	Peak (PK)
FREQUENCY RANGE	1GHz ~ 40GHz	FUNCTION	Average (AV)

ANTENNA POLARITY & TEST DISTANCE: HORIZONTAL AT 3 M

NO.	FREQ. (MHz)	EMISSION LEVEL (dBuV/m)	LIMIT (dBuV/m)	MARGIN (dB)	ANTENNA HEIGHT (m)	TABLE ANGLE (Degree)	RAW VALUE (dBuV)	CORRECTION FACTOR (dB/m)
1	*5200.00	109.5 PK			2.55 H	191	68.6	40.9
2	*5200.00	98.7 AV			2.55 H	191	57.8	40.9
3	#10400.00	59.8 PK	74.0	-14.2	1.77 H	309	44.9	14.9
4	#10400.00	46.7 AV	54.0	-7.3	1.77 H	309	31.8	14.9

ANTENNA POLARITY & TEST DISTANCE: VERTICAL AT 3 M

NO.	FREQ. (MHz)	EMISSION LEVEL (dBuV/m)	LIMIT (dBuV/m)	MARGIN (dB)	ANTENNA HEIGHT (m)	TABLE ANGLE (Degree)	RAW VALUE (dBuV)	CORRECTION FACTOR (dB/m)
1	*5200.00	106.7 PK			1.11 V	184	65.8	40.9
2	*5200.00	96.4 AV			1.11 V	184	55.5	40.9
3	#10400.00	59.5 PK	74.0	-14.5	1.27 V	106	44.6	14.9
4	#10400.00	46.3 AV	54.0	-7.7	1.27 V	106	31.4	14.9

Remarks:

1. Emission Level(dBuV/m) = Raw Value(dBuV) + Correction Factor(dB/m)
2. Correction Factor(dB/m) = Antenna Factor(dB/m) + Cable Factor(dB) – Pre-Amplifier Factor(dB)
3. The other emission levels were very low against the limit.
4. Margin value = Emission Level – Limit value
5. " * ": Fundamental frequency.
6. " # ": The radiated frequency is out of the restricted band.

CHANNEL	TX Channel 48	DETECTOR	Peak (PK)
FREQUENCY RANGE	1GHz ~ 40GHz	FUNCTION	Average (AV)

ANTENNA POLARITY & TEST DISTANCE: HORIZONTAL AT 3 M

NO.	FREQ. (MHz)	EMISSION LEVEL (dBuV/m)	LIMIT (dBuV/m)	MARGIN (dB)	ANTENNA HEIGHT (m)	TABLE ANGLE (Degree)	RAW VALUE (dBuV)	CORRECTION FACTOR (dB/m)
1	*5240.00	108.8 PK			2.60 H	189	68.1	40.7
2	*5240.00	98.2 AV			2.60 H	189	57.5	40.7
3	5350.00	56.9 PK	74.0	-17.1	2.68 H	167	54.1	2.8
4	5350.00	43.6 AV	54.0	-10.4	2.68 H	167	40.8	2.8
5	#10480.00	59.4 PK	74.0	-14.6	1.80 H	322	44.7	14.7
6	#10480.00	46.2 AV	54.0	-7.8	1.80 H	322	31.5	14.7

ANTENNA POLARITY & TEST DISTANCE: VERTICAL AT 3 M

NO.	FREQ. (MHz)	EMISSION LEVEL (dBuV/m)	LIMIT (dBuV/m)	MARGIN (dB)	ANTENNA HEIGHT (m)	TABLE ANGLE (Degree)	RAW VALUE (dBuV)	CORRECTION FACTOR (dB/m)
1	*5240.00	106.3 PK			1.09 V	188	65.6	40.7
2	*5240.00	96.1 AV			1.09 V	188	55.4	40.7
3	5350.00	55.2 PK	74.0	-18.8	1.12 V	202	52.4	2.8
4	5350.00	43.1 AV	54.0	-10.9	1.12 V	202	40.3	2.8
5	#10480.00	59.1 PK	74.0	-14.9	1.33 V	100	44.4	14.7
6	#10480.00	46.2 AV	54.0	-7.8	1.33 V	100	31.5	14.7

Remarks:

1. Emission Level(dBuV/m) = Raw Value(dBuV) + Correction Factor(dB/m)
2. Correction Factor(dB/m) = Antenna Factor(dB/m) + Cable Factor(dB) – Pre-Amplifier Factor(dB)
3. The other emission levels were very low against the limit.
4. Margin value = Emission Level – Limit value
5. " * ": Fundamental frequency.
6. " # ": The radiated frequency is out of the restricted band.

CHANNEL	TX Channel 52	DETECTOR	Peak (PK)
FREQUENCY RANGE	1GHz ~ 40GHz	FUNCTION	Average (AV)

ANTENNA POLARITY & TEST DISTANCE: HORIZONTAL AT 3 M

NO.	FREQ. (MHz)	EMISSION LEVEL (dBuV/m)	LIMIT (dBuV/m)	MARGIN (dB)	ANTENNA HEIGHT (m)	TABLE ANGLE (Degree)	RAW VALUE (dBuV)	CORRECTION FACTOR (dB/m)
1	5150.00	56.7 PK	74.0	-17.3	2.62 H	185	54.1	2.6
2	5150.00	43.8 AV	54.0	-10.2	2.62 H	185	41.2	2.6
3	*5260.00	111.2 PK			2.52 H	190	70.5	40.7
4	*5260.00	100.7 AV			2.52 H	190	60.0	40.7
5	#10520.00	60.2 PK	74.0	-13.8	2.66 H	156	45.4	14.8
6	#10520.00	47.1 AV	54.0	-6.9	2.66 H	156	32.3	14.8

ANTENNA POLARITY & TEST DISTANCE: VERTICAL AT 3 M

NO.	FREQ. (MHz)	EMISSION LEVEL (dBuV/m)	LIMIT (dBuV/m)	MARGIN (dB)	ANTENNA HEIGHT (m)	TABLE ANGLE (Degree)	RAW VALUE (dBuV)	CORRECTION FACTOR (dB/m)
1	5150.00	46.5 PK	74.0	-27.5	1.33 V	206	43.9	2.6
2	5150.00	43.4 AV	54.0	-10.6	1.33 V	206	40.8	2.6
3	*5260.00	108.2 PK			1.17 V	197	67.5	40.7
4	*5260.00	97.6 AV			1.17 V	197	56.9	40.7
5	#10520.00	60.0 PK	74.0	-14.0	2.39 V	116	45.2	14.8
6	#10520.00	46.9 AV	54.0	-7.1	2.39 V	116	32.1	14.8

Remarks:

1. Emission Level(dBuV/m) = Raw Value(dBuV) + Correction Factor(dB/m)
2. Correction Factor(dB/m) = Antenna Factor(dB/m) + Cable Factor(dB) – Pre-Amplifier Factor(dB)
3. The other emission levels were very low against the limit.
4. Margin value = Emission Level – Limit value
5. " * ": Fundamental frequency.
6. " # ": The radiated frequency is out of the restricted band.

CHANNEL	TX Channel 60	DETECTOR	Peak (PK)
FREQUENCY RANGE	1GHz ~ 40GHz	FUNCTION	Average (AV)

ANTENNA POLARITY & TEST DISTANCE: HORIZONTAL AT 3 M

NO.	FREQ. (MHz)	EMISSION LEVEL (dBuV/m)	LIMIT (dBuV/m)	MARGIN (dB)	ANTENNA HEIGHT (m)	TABLE ANGLE (Degree)	RAW VALUE (dBuV)	CORRECTION FACTOR (dB/m)
1	*5300.00	109.5 PK			2.41 H	181	68.9	40.6
2	*5300.00	99.0 AV			2.41 H	181	58.4	40.6
3	10600.00	60.5 PK	74.0	-13.5	3.31 H	253	45.3	15.2
4	10600.00	46.9 AV	54.0	-7.1	3.31 H	253	31.7	15.2

ANTENNA POLARITY & TEST DISTANCE: VERTICAL AT 3 M

NO.	FREQ. (MHz)	EMISSION LEVEL (dBuV/m)	LIMIT (dBuV/m)	MARGIN (dB)	ANTENNA HEIGHT (m)	TABLE ANGLE (Degree)	RAW VALUE (dBuV)	CORRECTION FACTOR (dB/m)
1	*5300.00	107.3 PK			1.14 V	200	66.7	40.6
2	*5300.00	96.3 AV			1.14 V	200	55.7	40.6
3	10600.00	60.3 PK	74.0	-13.7	2.26 V	125	45.1	15.2
4	10600.00	46.8 AV	54.0	-7.2	2.26 V	125	31.6	15.2

Remarks:

1. Emission Level(dBuV/m) = Raw Value(dBuV) + Correction Factor(dB/m)
2. Correction Factor(dB/m) = Antenna Factor(dB/m) + Cable Factor(dB) – Pre-Amplifier Factor(dB)
3. The other emission levels were very low against the limit.
4. Margin value = Emission Level – Limit value
5. " * ": Fundamental frequency.
6. " # ": The radiated frequency is out of the restricted band.

CHANNEL	TX Channel 64	DETECTOR FUNCTION	Peak (PK)
FREQUENCY RANGE	1GHz ~ 40GHz		Average (AV)

ANTENNA POLARITY & TEST DISTANCE: HORIZONTAL AT 3 M

NO.	FREQ. (MHz)	EMISSION LEVEL (dBuV/m)	LIMIT (dBuV/m)	MARGIN (dB)	ANTENNA HEIGHT (m)	TABLE ANGLE (Degree)	RAW VALUE (dBuV)	CORRECTION FACTOR (dB/m)
1	*5320.00	108.9 PK			2.42 H	187	68.2	40.7
2	*5320.00	98.3 AV			2.42 H	187	57.6	40.7
3	5350.00	69.0 PK	74.0	-5.0	2.33 H	190	66.2	2.8
4	5350.00	52.5 AV	54.0	-1.5	2.33 H	190	49.7	2.8
5	10640.00	60.1 PK	74.0	-13.9	1.82 H	115	44.7	15.4
6	10640.00	47.1 AV	54.0	-6.9	1.82 H	115	31.7	15.4

ANTENNA POLARITY & TEST DISTANCE: VERTICAL AT 3 M

NO.	FREQ. (MHz)	EMISSION LEVEL (dBuV/m)	LIMIT (dBuV/m)	MARGIN (dB)	ANTENNA HEIGHT (m)	TABLE ANGLE (Degree)	RAW VALUE (dBuV)	CORRECTION FACTOR (dB/m)
1	*5320.00	105.1 PK			1.08 V	180	64.4	40.7
2	*5320.00	94.6 AV			1.08 V	180	53.9	40.7
3	5350.00	66.5 PK	74.0	-7.5	1.09 V	193	63.7	2.8
4	5350.00	48.7 AV	54.0	-5.3	1.09 V	193	45.9	2.8
5	10640.00	59.9 PK	74.0	-14.1	3.33 V	102	44.5	15.4
6	10640.00	46.7 AV	54.0	-7.3	3.33 V	102	31.3	15.4

Remarks:

1. Emission Level(dBuV/m) = Raw Value(dBuV) + Correction Factor(dB/m)
2. Correction Factor(dB/m) = Antenna Factor(dB/m) + Cable Factor(dB) – Pre-Amplifier Factor(dB)
3. The other emission levels were very low against the limit.
4. Margin value = Emission Level – Limit value
5. " * ": Fundamental frequency.
6. " # ": The radiated frequency is out of the restricted band.

CHANNEL	TX Channel 100	DETECTOR FUNCTION	Peak (PK)
FREQUENCY RANGE	1GHz ~ 40GHz		Average (AV)

ANTENNA POLARITY & TEST DISTANCE: HORIZONTAL AT 3 M

NO.	FREQ. (MHz)	EMISSION LEVEL (dBuV/m)	LIMIT (dBuV/m)	MARGIN (dB)	ANTENNA HEIGHT (m)	TABLE ANGLE (Degree)	RAW VALUE (dBuV)	CORRECTION FACTOR (dB/m)
1	5460.00	70.3 PK	74.0	-3.7	2.19 H	185	67.1	3.2
2	5460.00	49.5 AV	54.0	-4.5	2.19 H	185	46.3	3.2
3	#5470.00	73.0 PK	74.0	-1.0	2.15 H	193	69.8	3.2
4	#5470.00	52.1 AV	54.0	-1.9	2.15 H	193	48.9	3.2
5	*5500.00	108.7 PK			2.09 H	186	67.2	41.5
6	*5500.00	98.0 AV			2.09 H	186	56.5	41.5
7	11000.00	60.8 PK	74.0	-13.2	3.22 H	166	44.8	16.0
8	11000.00	47.2 AV	54.0	-6.8	3.22 H	166	31.2	16.0

ANTENNA POLARITY & TEST DISTANCE: VERTICAL AT 3 M

NO.	FREQ. (MHz)	EMISSION LEVEL (dBuV/m)	LIMIT (dBuV/m)	MARGIN (dB)	ANTENNA HEIGHT (m)	TABLE ANGLE (Degree)	RAW VALUE (dBuV)	CORRECTION FACTOR (dB/m)
1	5460.00	69.0 PK	74.0	-5.0	1.25 V	177	65.8	3.2
2	5460.00	46.7 AV	54.0	-7.3	1.25 V	177	43.5	3.2
3	#5470.00	71.4 PK	74.0	-2.6	1.16 V	166	68.2	3.2
4	#5470.00	49.8 AV	54.0	-4.2	1.16 V	166	46.6	3.2
5	*5500.00	107.3 PK			1.02 V	158	65.8	41.5
6	*5500.00	96.0 AV			1.02 V	158	54.5	41.5
7	11000.00	60.9 PK	74.0	-13.1	1.19 V	26	44.9	16.0
8	11000.00	47.2 AV	54.0	-6.8	1.19 V	26	31.2	16.0

Remarks:

1. Emission Level(dBuV/m) = Raw Value(dBuV) + Correction Factor(dB/m)
2. Correction Factor(dB/m) = Antenna Factor(dB/m) + Cable Factor(dB) – Pre-Amplifier Factor(dB)
3. The other emission levels were very low against the limit.
4. Margin value = Emission Level – Limit value
5. " * ": Fundamental frequency.
6. " # ": The radiated frequency is out of the restricted band.

CHANNEL	TX Channel 116	DETECTOR	Peak (PK)
FREQUENCY RANGE	1GHz ~ 40GHz	FUNCTION	Average (AV)

ANTENNA POLARITY & TEST DISTANCE: HORIZONTAL AT 3 M

NO.	FREQ. (MHz)	EMISSION LEVEL (dBuV/m)	LIMIT (dBuV/m)	MARGIN (dB)	ANTENNA HEIGHT (m)	TABLE ANGLE (Degree)	RAW VALUE (dBuV)	CORRECTION FACTOR (dB/m)
1	*5580.00	111.1 PK			2.05 H	195	69.2	41.9
2	*5580.00	100.1 AV			2.05 H	195	58.2	41.9
3	11160.00	60.0 PK	74.0	-14.0	3.12 H	155	44.3	15.7
4	11160.00	46.8 AV	54.0	-7.2	3.12 H	155	31.1	15.7

ANTENNA POLARITY & TEST DISTANCE: VERTICAL AT 3 M

NO.	FREQ. (MHz)	EMISSION LEVEL (dBuV/m)	LIMIT (dBuV/m)	MARGIN (dB)	ANTENNA HEIGHT (m)	TABLE ANGLE (Degree)	RAW VALUE (dBuV)	CORRECTION FACTOR (dB/m)
1	*5580.00	109.2 PK			1.08 V	160	67.3	41.9
2	*5580.00	98.5 AV			1.08 V	160	56.6	41.9
3	11160.00	59.7 PK	74.0	-14.3	1.65 V	322	44.0	15.7
4	11160.00	46.5 AV	54.0	-7.5	1.65 V	322	30.8	15.7

Remarks:

1. Emission Level(dBuV/m) = Raw Value(dBuV) + Correction Factor(dB/m)
2. Correction Factor(dB/m) = Antenna Factor(dB/m) + Cable Factor(dB) – Pre-Amplifier Factor(dB)
3. The other emission levels were very low against the limit.
4. Margin value = Emission Level – Limit value
5. " * ": Fundamental frequency.
6. " # ": The radiated frequency is out of the restricted band.

CHANNEL	TX Channel 140	DETECTOR FUNCTION	Peak (PK)
FREQUENCY RANGE	1GHz ~ 40GHz		Average (AV)

ANTENNA POLARITY & TEST DISTANCE: HORIZONTAL AT 3 M

NO.	FREQ. (MHz)	EMISSION LEVEL (dBuV/m)	LIMIT (dBuV/m)	MARGIN (dB)	ANTENNA HEIGHT (m)	TABLE ANGLE (Degree)	RAW VALUE (dBuV)	CORRECTION FACTOR (dB/m)
1	*5700.00	107.8 PK			2.41 H	205	65.7	42.1
2	*5700.00	96.5 AV			2.41 H	205	54.4	42.1
3	#5725.00	68.4 PK	74.0	-5.6	2.46 H	199	64.7	3.7
4	#5725.00	52.9 AV	54.0	-1.1	2.46 H	199	49.2	3.7
5	11400.00	60.9 PK	74.0	-13.1	2.26 H	51	44.9	16.0
6	11400.00	47.7 AV	54.0	-6.3	2.26 H	51	31.7	16.0

ANTENNA POLARITY & TEST DISTANCE: VERTICAL AT 3 M

NO.	FREQ. (MHz)	EMISSION LEVEL (dBuV/m)	LIMIT (dBuV/m)	MARGIN (dB)	ANTENNA HEIGHT (m)	TABLE ANGLE (Degree)	RAW VALUE (dBuV)	CORRECTION FACTOR (dB/m)
1	*5700.00	105.2 PK			1.03 V	159	63.1	42.1
2	*5700.00	93.7 AV			1.03 V	159	51.6	42.1
3	#5725.00	66.1 PK	74.0	-7.9	1.22 V	186	62.4	3.7
4	#5725.00	50.7 AV	54.0	-3.3	1.22 V	186	47.0	3.7
5	11400.00	60.7 PK	74.0	-13.3	1.25 V	22	44.7	16.0
6	11400.00	47.4 AV	54.0	-6.6	1.25 V	22	31.4	16.0

Remarks:

1. Emission Level(dBuV/m) = Raw Value(dBuV) + Correction Factor(dB/m)
2. Correction Factor(dB/m) = Antenna Factor(dB/m) + Cable Factor(dB) – Pre-Amplifier Factor(dB)
3. The other emission levels were very low against the limit.
4. Margin value = Emission Level – Limit value
5. " * ": Fundamental frequency.
6. " # ": The radiated frequency is out of the restricted band.

CHANNEL	TX Channel 149	DETECTOR FUNCTION	Peak (PK)
FREQUENCY RANGE	1GHz ~ 40GHz		Average (AV)

ANTENNA POLARITY & TEST DISTANCE: HORIZONTAL AT 3 M

NO.	FREQ. (MHz)	EMISSION LEVEL (dBuV/m)	LIMIT (dBuV/m)	MARGIN (dB)	ANTENNA HEIGHT (m)	TABLE ANGLE (Degree)	RAW VALUE (dBuV)	CORRECTION FACTOR (dB/m)
1	#5638.40	57.7 PK	68.2	-10.5	2.38 H	204	54.3	3.4
2	*5745.00	110.7 PK			2.38 H	204	68.5	42.2
3	*5745.00	99.5 AV			2.38 H	204	57.3	42.2
4	#5974.40	59.0 PK	68.2	-9.2	2.38 H	204	54.4	4.6
5	11490.00	61.4 PK	74.0	-12.6	1.91 H	29	45.2	16.2
6	11490.00	48.3 AV	54.0	-5.7	1.91 H	29	32.1	16.2

ANTENNA POLARITY & TEST DISTANCE: VERTICAL AT 3 M

NO.	FREQ. (MHz)	EMISSION LEVEL (dBuV/m)	LIMIT (dBuV/m)	MARGIN (dB)	ANTENNA HEIGHT (m)	TABLE ANGLE (Degree)	RAW VALUE (dBuV)	CORRECTION FACTOR (dB/m)
1	#5600.00	57.3 PK	68.2	-10.9	1.00 V	159	53.6	3.7
2	*5745.00	107.5 PK			1.00 V	159	65.3	42.2
3	*5745.00	97.0 AV			1.00 V	159	54.8	42.2
4	#5993.60	59.0 PK	68.2	-9.2	1.00 V	159	54.3	4.7
5	11490.00	60.9 PK	74.0	-13.1	1.42 V	225	44.7	16.2
6	11490.00	47.9 AV	54.0	-6.1	1.42 V	225	31.7	16.2

Remarks:

1. Emission Level(dBuV/m) = Raw Value(dBuV) + Correction Factor(dB/m)
2. Correction Factor(dB/m) = Antenna Factor(dB/m) + Cable Factor(dB) – Pre-Amplifier Factor(dB)
3. The other emission levels were very low against the limit.
4. Margin value = Emission Level – Limit value
5. " * ": Fundamental frequency.
6. " # ": The radiated frequency is out of the restricted band.

CHANNEL	TX Channel 157	DETECTOR FUNCTION	Peak (PK)
FREQUENCY RANGE	1GHz ~ 40GHz		Average (AV)

ANTENNA POLARITY & TEST DISTANCE: HORIZONTAL AT 3 M

NO.	FREQ. (MHz)	EMISSION LEVEL (dBuV/m)	LIMIT (dBuV/m)	MARGIN (dB)	ANTENNA HEIGHT (m)	TABLE ANGLE (Degree)	RAW VALUE (dBuV)	CORRECTION FACTOR (dB/m)
1	#5629.60	57.6 PK	68.2	-10.6	2.56 H	206	54.1	3.5
2	*5785.00	110.4 PK			2.56 H	206	68.0	42.4
3	*5785.00	99.6 AV			2.56 H	206	57.2	42.4
4	#5982.40	58.8 PK	68.2	-9.4	2.56 H	206	54.2	4.6
5	11570.00	61.4 PK	74.0	-12.6	1.94 H	34	45.4	16.0
6	11570.00	48.0 AV	54.0	-6.0	1.94 H	34	32.0	16.0

ANTENNA POLARITY & TEST DISTANCE: VERTICAL AT 3 M

NO.	FREQ. (MHz)	EMISSION LEVEL (dBuV/m)	LIMIT (dBuV/m)	MARGIN (dB)	ANTENNA HEIGHT (m)	TABLE ANGLE (Degree)	RAW VALUE (dBuV)	CORRECTION FACTOR (dB/m)
1	#5628.00	58.1 PK	68.2	-10.1	2.87 V	336	54.6	3.5
2	*5785.00	108.0 PK			2.87 V	336	65.6	42.4
3	*5785.00	97.1 AV			2.87 V	336	54.7	42.4
4	#5970.40	59.2 PK	68.2	-9.0	2.87 V	336	54.6	4.6
5	11570.00	61.0 PK	74.0	-13.0	1.44 V	231	45.0	16.0
6	11570.00	47.7 AV	54.0	-6.3	1.44 V	231	31.7	16.0

Remarks:

1. Emission Level(dBuV/m) = Raw Value(dBuV) + Correction Factor(dB/m)
2. Correction Factor(dB/m) = Antenna Factor(dB/m) + Cable Factor(dB) – Pre-Amplifier Factor(dB)
3. The other emission levels were very low against the limit.
4. Margin value = Emission Level – Limit value
5. " * ": Fundamental frequency.
6. " # ": The radiated frequency is out of the restricted band.

CHANNEL	TX Channel 165	DETECTOR FUNCTION	Peak (PK)
FREQUENCY RANGE	1GHz ~ 40GHz		Average (AV)

ANTENNA POLARITY & TEST DISTANCE: HORIZONTAL AT 3 M

NO.	FREQ. (MHz)	EMISSION LEVEL (dBuV/m)	LIMIT (dBuV/m)	MARGIN (dB)	ANTENNA HEIGHT (m)	TABLE ANGLE (Degree)	RAW VALUE (dBuV)	CORRECTION FACTOR (dB/m)
1	#5632.00	57.8 PK	68.2	-10.4	2.59 H	204	54.3	3.5
2	*5825.00	110.2 PK			2.59 H	204	67.4	42.8
3	*5825.00	99.6 AV			2.59 H	204	56.8	42.8
4	#5981.60	58.7 PK	68.2	-9.5	2.59 H	204	54.1	4.6
5	11650.00	60.4 PK	74.0	-13.6	1.99 H	35	45.0	15.4
6	11650.00	47.3 AV	54.0	-6.7	1.99 H	35	31.9	15.4

ANTENNA POLARITY & TEST DISTANCE: VERTICAL AT 3 M

NO.	FREQ. (MHz)	EMISSION LEVEL (dBuV/m)	LIMIT (dBuV/m)	MARGIN (dB)	ANTENNA HEIGHT (m)	TABLE ANGLE (Degree)	RAW VALUE (dBuV)	CORRECTION FACTOR (dB/m)
1	#5637.60	57.7 PK	68.2	-10.5	3.14 V	332	54.3	3.4
2	*5825.00	108.0 PK			3.14 V	332	65.2	42.8
3	*5825.00	97.7 AV			3.14 V	332	54.9	42.8
4	#5963.20	59.0 PK	68.2	-9.2	3.14 V	332	54.3	4.7
5	11650.00	60.2 PK	74.0	-13.8	1.34 V	212	44.8	15.4
6	11650.00	47.1 AV	54.0	-6.9	1.34 V	212	31.7	15.4

Remarks:

1. Emission Level(dBuV/m) = Raw Value(dBuV) + Correction Factor(dB/m)
2. Correction Factor(dB/m) = Antenna Factor(dB/m) + Cable Factor(dB) – Pre-Amplifier Factor(dB)
3. The other emission levels were very low against the limit.
4. Margin value = Emission Level – Limit value
5. " * ": Fundamental frequency.
6. " # ": The radiated frequency is out of the restricted band.

802.11n (HT40)

CHANNEL	TX Channel 38	DETECTOR	Peak (PK)
FREQUENCY RANGE	1GHz ~ 40GHz	FUNCTION	Average (AV)

ANTENNA POLARITY & TEST DISTANCE: HORIZONTAL AT 3 M								
NO.	FREQ. (MHz)	EMISSION LEVEL (dBuV/m)	LIMIT (dBuV/m)	MARGIN (dB)	ANTENNA HEIGHT (m)	TABLE ANGLE (Degree)	RAW VALUE (dBuV)	CORRECTION FACTOR (dB/m)
1	5150.00	71.1 PK	74.0	-2.9	3.04 H	197	68.5	2.6
2	5150.00	52.8 AV	54.0	-1.2	3.04 H	197	50.2	2.6
3	*5190.00	102.3 PK			3.09 H	187	61.4	40.9
4	*5190.00	91.1 AV			3.09 H	187	50.2	40.9
5	#10380.00	60.0 PK	74.0	-14.0	2.13 H	331	45.2	14.8
6	#10380.00	46.4 AV	54.0	-7.6	2.13 H	331	31.6	14.8
ANTENNA POLARITY & TEST DISTANCE: VERTICAL AT 3 M								
NO.	FREQ. (MHz)	EMISSION LEVEL (dBuV/m)	LIMIT (dBuV/m)	MARGIN (dB)	ANTENNA HEIGHT (m)	TABLE ANGLE (Degree)	RAW VALUE (dBuV)	CORRECTION FACTOR (dB/m)
1	5150.00	70.6 PK	74.0	-3.4	1.09 V	198	68.0	2.6
2	5150.00	52.6 AV	54.0	-1.4	1.09 V	198	50.0	2.6
3	*5190.00	100.9 PK			1.07 V	195	60.0	40.9
4	*5190.00	89.9 AV			1.07 V	195	49.0	40.9
5	#10380.00	59.7 PK	74.0	-14.3	1.47 V	56	44.9	14.8
6	#10380.00	46.3 AV	54.0	-7.7	1.47 V	56	31.5	14.8

Remarks:

1. Emission Level(dBuV/m) = Raw Value(dBuV) + Correction Factor(dB/m)
2. Correction Factor(dB/m) = Antenna Factor(dB/m) + Cable Factor(dB) – Pre-Amplifier Factor(dB)
3. The other emission levels were very low against the limit.
4. Margin value = Emission Level – Limit value
5. " * ": Fundamental frequency.
6. " # ": The radiated frequency is out of the restricted band.

CHANNEL	TX Channel 46	DETECTOR FUNCTION	Peak (PK)
FREQUENCY RANGE	1GHz ~ 40GHz		Average (AV)

ANTENNA POLARITY & TEST DISTANCE: HORIZONTAL AT 3 M

NO.	FREQ. (MHz)	EMISSION LEVEL (dBuV/m)	LIMIT (dBuV/m)	MARGIN (dB)	ANTENNA HEIGHT (m)	TABLE ANGLE (Degree)	RAW VALUE (dBuV)	CORRECTION FACTOR (dB/m)
1	*5230.00	106.3 PK			2.96 H	188	65.6	40.7
2	*5230.00	95.4 AV			2.96 H	188	54.7	40.7
3	5350.00	57.5 PK	74.0	-16.5	3.01 H	180	54.7	2.8
4	5350.00	44.1 AV	54.0	-9.9	3.01 H	180	41.3	2.8
5	#10460.00	60.2 PK	74.0	-13.8	2.20 H	345	45.4	14.8
6	#10460.00	46.7 AV	54.0	-7.3	2.20 H	345	31.9	14.8

ANTENNA POLARITY & TEST DISTANCE: VERTICAL AT 3 M

NO.	FREQ. (MHz)	EMISSION LEVEL (dBuV/m)	LIMIT (dBuV/m)	MARGIN (dB)	ANTENNA HEIGHT (m)	TABLE ANGLE (Degree)	RAW VALUE (dBuV)	CORRECTION FACTOR (dB/m)
1	*5230.00	105.0 PK			1.07 V	197	64.3	40.7
2	*5230.00	94.5 AV			1.07 V	197	53.8	40.7
3	5350.00	57.0 PK	74.0	-17.0	1.12 V	200	54.2	2.8
4	5350.00	43.7 AV	54.0	-10.3	1.12 V	200	40.9	2.8
5	#10460.00	59.8 PK	74.0	-14.2	1.50 V	63	45.0	14.8
6	#10460.00	46.5 AV	54.0	-7.5	1.50 V	63	31.7	14.8

Remarks:

1. Emission Level(dBuV/m) = Raw Value(dBuV) + Correction Factor(dB/m)
2. Correction Factor(dB/m) = Antenna Factor(dB/m) + Cable Factor(dB) – Pre-Amplifier Factor(dB)
3. The other emission levels were very low against the limit.
4. Margin value = Emission Level – Limit value
5. " * ": Fundamental frequency.
6. " # ": The radiated frequency is out of the restricted band.

CHANNEL	TX Channel 54	DETECTOR FUNCTION	Peak (PK)
FREQUENCY RANGE	1GHz ~ 40GHz		Average (AV)

ANTENNA POLARITY & TEST DISTANCE: HORIZONTAL AT 3 M

NO.	FREQ. (MHz)	EMISSION LEVEL (dBuV/m)	LIMIT (dBuV/m)	MARGIN (dB)	ANTENNA HEIGHT (m)	TABLE ANGLE (Degree)	RAW VALUE (dBuV)	CORRECTION FACTOR (dB/m)
1	5150.00	56.1 PK	74.0	-17.9	1.62 H	311	53.5	2.6
2	5150.00	43.6 AV	54.0	-10.4	1.62 H	311	41.0	2.6
3	*5270.00	108.2 PK			2.46 H	187	67.6	40.6
4	*5270.00	97.7 AV			2.46 H	187	57.1	40.6
5	#10540.00	59.9 PK	74.0	-14.1	1.33 H	319	45.0	14.9
6	#10540.00	46.8 AV	54.0	-7.2	1.33 H	319	31.9	14.9

ANTENNA POLARITY & TEST DISTANCE: VERTICAL AT 3 M

NO.	FREQ. (MHz)	EMISSION LEVEL (dBuV/m)	LIMIT (dBuV/m)	MARGIN (dB)	ANTENNA HEIGHT (m)	TABLE ANGLE (Degree)	RAW VALUE (dBuV)	CORRECTION FACTOR (dB/m)
1	5150.00	56.2 PK	74.0	-17.8	1.09 V	166	53.6	2.6
2	5150.00	43.5 AV	54.0	-10.5	1.09 V	166	40.9	2.6
3	*5270.00	105.0 PK			1.12 V	199	64.4	40.6
4	*5270.00	94.2 AV			1.12 V	199	53.6	40.6
5	#10540.00	59.4 PK	74.0	-14.6	2.63 V	112	44.5	14.9
6	#10540.00	46.1 AV	54.0	-7.9	2.63 V	112	31.2	14.9

Remarks:

1. Emission Level(dBuV/m) = Raw Value(dBuV) + Correction Factor(dB/m)
2. Correction Factor(dB/m) = Antenna Factor(dB/m) + Cable Factor(dB) – Pre-Amplifier Factor(dB)
3. The other emission levels were very low against the limit.
4. Margin value = Emission Level – Limit value
5. " * ": Fundamental frequency.
6. " # ": The radiated frequency is out of the restricted band.

CHANNEL	TX Channel 62	DETECTOR FUNCTION	Peak (PK)
FREQUENCY RANGE	1GHz ~ 40GHz		Average (AV)

ANTENNA POLARITY & TEST DISTANCE: HORIZONTAL AT 3 M

NO.	FREQ. (MHz)	EMISSION LEVEL (dBuV/m)	LIMIT (dBuV/m)	MARGIN (dB)	ANTENNA HEIGHT (m)	TABLE ANGLE (Degree)	RAW VALUE (dBuV)	CORRECTION FACTOR (dB/m)
1	*5310.00	103.4 PK			2.75 H	190	62.8	40.6
2	*5310.00	92.3 AV			2.75 H	190	51.7	40.6
3	5350.00	68.0 PK	74.0	-6.0	2.79 H	165	65.2	2.8
4	5350.00	52.7 AV	54.0	-1.3	2.79 H	165	49.9	2.8
5	10620.00	59.0 PK	74.0	-15.0	2.36 H	105	43.7	15.3
6	10620.00	45.7 AV	54.0	-8.3	2.36 H	105	30.4	15.3

ANTENNA POLARITY & TEST DISTANCE: VERTICAL AT 3 M

NO.	FREQ. (MHz)	EMISSION LEVEL (dBuV/m)	LIMIT (dBuV/m)	MARGIN (dB)	ANTENNA HEIGHT (m)	TABLE ANGLE (Degree)	RAW VALUE (dBuV)	CORRECTION FACTOR (dB/m)
1	*5310.00	100.6 PK			1.15 V	198	60.0	40.6
2	*5310.00	88.9 AV			1.15 V	198	48.3	40.6
3	5350.00	68.1 PK	74.0	-5.9	1.26 V	206	65.3	2.8
4	5350.00	49.4 AV	54.0	-4.6	1.26 V	206	46.6	2.8
5	10620.00	58.8 PK	74.0	-15.2	1.55 V	112	43.5	15.3
6	10620.00	45.4 AV	54.0	-8.6	1.55 V	112	30.1	15.3

Remarks:

1. Emission Level(dBuV/m) = Raw Value(dBuV) + Correction Factor(dB/m)
2. Correction Factor(dB/m) = Antenna Factor(dB/m) + Cable Factor(dB) – Pre-Amplifier Factor(dB)
3. The other emission levels were very low against the limit.
4. Margin value = Emission Level – Limit value
5. " * ": Fundamental frequency.
6. " # ": The radiated frequency is out of the restricted band.

CHANNEL	TX Channel 102	DETECTOR FUNCTION	Peak (PK)
FREQUENCY RANGE	1GHz ~ 40GHz		Average (AV)

ANTENNA POLARITY & TEST DISTANCE: HORIZONTAL AT 3 M

NO.	FREQ. (MHz)	EMISSION LEVEL (dBuV/m)	LIMIT (dBuV/m)	MARGIN (dB)	ANTENNA HEIGHT (m)	TABLE ANGLE (Degree)	RAW VALUE (dBuV)	CORRECTION FACTOR (dB/m)
1	5460.00	65.4 PK	74.0	-8.6	2.16 H	177	62.2	3.2
2	5460.00	50.0 AV	54.0	-4.0	2.16 H	177	46.8	3.2
3	#5470.00	67.4 PK	74.0	-6.6	2.13 H	185	64.2	3.2
4	#5470.00	52.2 AV	54.0	-1.8	2.13 H	185	49.0	3.2
5	*5510.00	100.1 PK			2.10 H	183	58.5	41.6
6	*5510.00	90.9 AV			2.10 H	183	49.3	41.6
7	11020.00	60.1 PK	74.0	-13.9	2.55 H	351	44.3	15.8
8	11020.00	47.1 AV	54.0	-6.9	2.55 H	351	31.3	15.8

ANTENNA POLARITY & TEST DISTANCE: VERTICAL AT 3 M

NO.	FREQ. (MHz)	EMISSION LEVEL (dBuV/m)	LIMIT (dBuV/m)	MARGIN (dB)	ANTENNA HEIGHT (m)	TABLE ANGLE (Degree)	RAW VALUE (dBuV)	CORRECTION FACTOR (dB/m)
1	5460.00	66.2 PK	74.0	-7.8	1.12 V	167	63.0	3.2
2	5460.00	46.4 AV	54.0	-7.6	1.12 V	167	43.2	3.2
3	#5470.00	68.3 PK	74.0	-5.7	1.09 V	166	65.1	3.2
4	#5470.00	48.6 AV	54.0	-5.4	1.09 V	166	45.4	3.2
5	*5510.00	97.1 PK			1.01 V	156	55.5	41.6
6	*5510.00	88.4 AV			1.01 V	156	46.8	41.6
7	11020.00	59.8 PK	74.0	-14.2	2.26 V	125	44.0	15.8
8	11020.00	47.0 AV	54.0	-7.0	2.26 V	125	31.2	15.8

Remarks:

1. Emission Level(dBuV/m) = Raw Value(dBuV) + Correction Factor(dB/m)
2. Correction Factor(dB/m) = Antenna Factor(dB/m) + Cable Factor(dB) – Pre-Amplifier Factor(dB)
3. The other emission levels were very low against the limit.
4. Margin value = Emission Level – Limit value
5. " * ": Fundamental frequency.
6. " # ": The radiated frequency is out of the restricted band.

CHANNEL	TX Channel 110	DETECTOR FUNCTION	Peak (PK)
FREQUENCY RANGE	1GHz ~ 40GHz		Average (AV)

ANTENNA POLARITY & TEST DISTANCE: HORIZONTAL AT 3 M

NO.	FREQ. (MHz)	EMISSION LEVEL (dBuV/m)	LIMIT (dBuV/m)	MARGIN (dB)	ANTENNA HEIGHT (m)	TABLE ANGLE (Degree)	RAW VALUE (dBuV)	CORRECTION FACTOR (dB/m)
1	#5470.00	65.9 PK	74.0	-8.1	2.06 H	179	62.7	3.2
2	#5470.00	48.3 AV	54.0	-5.7	2.06 H	179	45.1	3.2
3	*5550.00	108.2 PK			2.05 H	186	66.4	41.8
4	*5550.00	96.9 AV			2.05 H	186	55.1	41.8
5	11100.00	60.4 PK	74.0	-13.6	2.56 H	223	44.7	15.7
6	11100.00	47.2 AV	54.0	-6.8	2.56 H	223	31.5	15.7

ANTENNA POLARITY & TEST DISTANCE: VERTICAL AT 3 M

NO.	FREQ. (MHz)	EMISSION LEVEL (dBuV/m)	LIMIT (dBuV/m)	MARGIN (dB)	ANTENNA HEIGHT (m)	TABLE ANGLE (Degree)	RAW VALUE (dBuV)	CORRECTION FACTOR (dB/m)
1	#5470.00	63.3 PK	74.0	-10.7	1.06 V	162	60.1	3.2
2	#5470.00	46.2 AV	54.0	-7.8	1.06 V	162	43.0	3.2
3	*5550.00	105.3 PK			1.03 V	157	63.5	41.8
4	*5550.00	94.7 AV			1.03 V	157	52.9	41.8
5	11100.00	59.9 PK	74.0	-14.1	2.23 V	326	44.2	15.7
6	11100.00	46.6 AV	54.0	-7.4	2.23 V	326	30.9	15.7

Remarks:

1. Emission Level(dBuV/m) = Raw Value(dBuV) + Correction Factor(dB/m)
2. Correction Factor(dB/m) = Antenna Factor(dB/m) + Cable Factor(dB) – Pre-Amplifier Factor(dB)
3. The other emission levels were very low against the limit.
4. Margin value = Emission Level – Limit value
5. " * ": Fundamental frequency.
6. " # ": The radiated frequency is out of the restricted band.

CHANNEL	TX Channel 134	DETECTOR FUNCTION	Peak (PK)
FREQUENCY RANGE	1GHz ~ 40GHz		Average (AV)

ANTENNA POLARITY & TEST DISTANCE: HORIZONTAL AT 3 M

NO.	FREQ. (MHz)	EMISSION LEVEL (dBuV/m)	LIMIT (dBuV/m)	MARGIN (dB)	ANTENNA HEIGHT (m)	TABLE ANGLE (Degree)	RAW VALUE (dBuV)	CORRECTION FACTOR (dB/m)
1	*5670.00	106.2 PK			2.65 H	208	64.4	41.8
2	*5670.00	96.0 AV			2.65 H	208	54.2	41.8
3	#5725.00	72.2 PK	74.0	-1.8	2.75 H	209	68.5	3.7
4	#5725.00	52.9 AV	54.0	-1.1	2.75 H	209	49.2	3.7
5	11340.00	60.6 PK	74.0	-13.4	2.33 H	148	44.6	16.0
6	11340.00	47.3 AV	54.0	-6.7	2.33 H	148	31.3	16.0

ANTENNA POLARITY & TEST DISTANCE: VERTICAL AT 3 M

NO.	FREQ. (MHz)	EMISSION LEVEL (dBuV/m)	LIMIT (dBuV/m)	MARGIN (dB)	ANTENNA HEIGHT (m)	TABLE ANGLE (Degree)	RAW VALUE (dBuV)	CORRECTION FACTOR (dB/m)
1	*5670.00	104.4 PK			1.01 V	161	62.6	41.8
2	*5670.00	93.9 AV			1.01 V	161	52.1	41.8
3	#5725.00	66.7 PK	74.0	-7.3	1.06 V	175	63.0	3.7
4	#5725.00	50.2 AV	54.0	-3.8	1.06 V	175	46.5	3.7
5	11340.00	60.2 PK	74.0	-13.8	2.23 V	321	44.2	16.0
6	11340.00	46.9 AV	54.0	-7.1	2.23 V	321	30.9	16.0

Remarks:

1. Emission Level(dBuV/m) = Raw Value(dBuV) + Correction Factor(dB/m)
2. Correction Factor(dB/m) = Antenna Factor(dB/m) + Cable Factor(dB) – Pre-Amplifier Factor(dB)
3. The other emission levels were very low against the limit.
4. Margin value = Emission Level – Limit value
5. " * ": Fundamental frequency.
6. " # ": The radiated frequency is out of the restricted band.

CHANNEL	TX Channel 151	DETECTOR FUNCTION	Peak (PK)
FREQUENCY RANGE	1GHz ~ 40GHz		Average (AV)

ANTENNA POLARITY & TEST DISTANCE: HORIZONTAL AT 3 M

NO.	FREQ. (MHz)	EMISSION LEVEL (dBuV/m)	LIMIT (dBuV/m)	MARGIN (dB)	ANTENNA HEIGHT (m)	TABLE ANGLE (Degree)	RAW VALUE (dBuV)	CORRECTION FACTOR (dB/m)
1	#5648.00	61.1 PK	68.2	-7.1	2.47 H	207	57.7	3.4
2	*5755.00	107.2 PK			2.47 H	207	64.9	42.3
3	*5755.00	96.8 AV			2.47 H	207	54.5	42.3
4	#5961.60	59.1 PK	68.2	-9.1	2.47 H	207	54.4	4.7
5	11510.00	60.8 PK	74.0	-13.2	2.85 H	12	44.8	16.0
6	11510.00	47.7 AV	54.0	-6.3	2.85 H	12	31.7	16.0

ANTENNA POLARITY & TEST DISTANCE: VERTICAL AT 3 M

NO.	FREQ. (MHz)	EMISSION LEVEL (dBuV/m)	LIMIT (dBuV/m)	MARGIN (dB)	ANTENNA HEIGHT (m)	TABLE ANGLE (Degree)	RAW VALUE (dBuV)	CORRECTION FACTOR (dB/m)
1	#5646.40	59.4 PK	68.2	-8.8	1.04 V	160	56.0	3.4
2	*5755.00	104.4 PK			1.04 V	160	62.1	42.3
3	*5755.00	94.1 AV			1.04 V	160	51.8	42.3
4	#6000.00	59.0 PK	68.2	-9.2	1.04 V	160	54.3	4.7
5	11510.00	60.4 PK	74.0	-13.6	1.12 V	198	44.4	16.0
6	11510.00	47.3 AV	54.0	-6.7	1.12 V	198	31.3	16.0

Remarks:

1. Emission Level(dBuV/m) = Raw Value(dBuV) + Correction Factor(dB/m)
2. Correction Factor(dB/m) = Antenna Factor(dB/m) + Cable Factor(dB) – Pre-Amplifier Factor(dB)
3. The other emission levels were very low against the limit.
4. Margin value = Emission Level – Limit value
5. " * ": Fundamental frequency.
6. " # ": The radiated frequency is out of the restricted band.

CHANNEL	TX Channel 159	DETECTOR FUNCTION	Peak (PK)
FREQUENCY RANGE	1GHz ~ 40GHz		Average (AV)

ANTENNA POLARITY & TEST DISTANCE: HORIZONTAL AT 3 M

NO.	FREQ. (MHz)	EMISSION LEVEL (dBuV/m)	LIMIT (dBuV/m)	MARGIN (dB)	ANTENNA HEIGHT (m)	TABLE ANGLE (Degree)	RAW VALUE (dBuV)	CORRECTION FACTOR (dB/m)
1	#5649.60	58.1 PK	68.2	-10.1	2.44 H	206	54.7	3.4
2	*5795.00	106.9 PK			2.44 H	206	64.4	42.5
3	*5795.00	96.6 AV			2.44 H	206	54.1	42.5
4	#5995.20	59.6 PK	68.2	-8.6	2.44 H	206	54.9	4.7
5	11590.00	60.7 PK	74.0	-13.3	2.96 H	18	44.9	15.8
6	11590.00	47.6 AV	54.0	-6.4	2.96 H	18	31.8	15.8

ANTENNA POLARITY & TEST DISTANCE: VERTICAL AT 3 M

NO.	FREQ. (MHz)	EMISSION LEVEL (dBuV/m)	LIMIT (dBuV/m)	MARGIN (dB)	ANTENNA HEIGHT (m)	TABLE ANGLE (Degree)	RAW VALUE (dBuV)	CORRECTION FACTOR (dB/m)
1	#5602.40	58.1 PK	68.2	-10.1	1.00 V	162	54.5	3.6
2	*5795.00	104.3 PK			1.00 V	162	61.8	42.5
3	*5795.00	94.1 AV			1.00 V	162	51.6	42.5
4	#5940.80	58.7 PK	68.2	-9.5	1.00 V	162	54.2	4.5
5	11590.00	60.4 PK	74.0	-13.6	1.10 V	194	44.6	15.8
6	11590.00	47.3 AV	54.0	-6.7	1.10 V	194	31.5	15.8

Remarks:

1. Emission Level(dBuV/m) = Raw Value(dBuV) + Correction Factor(dB/m)
2. Correction Factor(dB/m) = Antenna Factor(dB/m) + Cable Factor(dB) – Pre-Amplifier Factor(dB)
3. The other emission levels were very low against the limit.
4. Margin value = Emission Level – Limit value
5. " * ": Fundamental frequency.
6. " # ": The radiated frequency is out of the restricted band.

Below 1GHz Worst-Case Data: 802.11a

CHANNEL	TX Channel 149	DETECTOR FUNCTION	Quasi-Peak (QP)
FREQUENCY RANGE	30MHz ~ 1GHz	TEST MODE	A

ANTENNA POLARITY & TEST DISTANCE: HORIZONTAL AT 3 M

NO.	FREQ. (MHz)	EMISSION LEVEL (dBuV/m)	LIMIT (dBuV/m)	MARGIN (dB)	ANTENNA HEIGHT (m)	TABLE ANGLE (Degree)	RAW VALUE (dBuV)	CORRECTION FACTOR (dB/m)
1	57.12	27.0 QP	40.0	-13.0	2.00 H	357	41.4	-14.4
2	70.73	24.6 QP	40.0	-15.4	2.00 H	357	40.8	-16.2
3	84.34	19.3 QP	40.0	-20.7	2.00 H	357	38.4	-19.1
4	313.77	16.9 QP	46.0	-29.1	1.00 H	187	29.3	-12.4
5	490.70	21.6 QP	46.0	-24.4	2.00 H	331	31.1	-9.5
6	652.07	23.6 QP	46.0	-22.4	1.00 H	67	30.2	-6.6

ANTENNA POLARITY & TEST DISTANCE: VERTICAL AT 3 M

NO.	FREQ. (MHz)	EMISSION LEVEL (dBuV/m)	LIMIT (dBuV/m)	MARGIN (dB)	ANTENNA HEIGHT (m)	TABLE ANGLE (Degree)	RAW VALUE (dBuV)	CORRECTION FACTOR (dB/m)
1	37.68	24.1 QP	40.0	-15.9	1.00 V	298	39.4	-15.3
2	55.18	22.1 QP	40.0	-17.9	1.50 V	61	36.4	-14.3
3	70.73	17.2 QP	40.0	-22.8	1.00 V	225	33.4	-16.2
4	129.06	19.4 QP	43.5	-24.1	1.00 V	114	34.9	-15.5
5	426.53	18.9 QP	46.0	-27.1	1.50 V	301	29.4	-10.5
6	669.57	23.8 QP	46.0	-22.2	1.00 V	87	30.2	-6.4

Remarks:

1. Emission Level(dBuV/m) = Raw Value(dBuV) + Correction Factor(dB/m)
2. Correction Factor(dB/m) = Antenna Factor(dB/m) + Cable Factor(dB) – Pre-Amplifier Factor(dB)
3. The other emission levels were very low against the limit.
4. Margin value = Emission Level – Limit value

CHANNEL	TX Channel 149	DETECTOR FUNCTION	Quasi-Peak (QP)
FREQUENCY RANGE	30MHz ~ 1GHz	TEST MODE	B

ANTENNA POLARITY & TEST DISTANCE: HORIZONTAL AT 3 M

NO.	FREQ. (MHz)	EMISSION LEVEL (dBuV/m)	LIMIT (dBuV/m)	MARGIN (dB)	ANTENNA HEIGHT (m)	TABLE ANGLE (Degree)	RAW VALUE (dBuV)	CORRECTION FACTOR (dB/m)
1	57.07	25.7 QP	40.0	-14.3	2.00 H	82	39.9	-14.2
2	276.33	42.1 QP	46.0	-3.9	1.00 H	180	54.9	-12.8
3	346.19	33.8 QP	46.0	-12.2	1.00 H	328	45.2	-11.4
4	734.27	31.9 QP	46.0	-14.1	2.00 H	344	35.0	-3.1
5	846.81	32.3 QP	46.0	-13.7	1.50 H	235	33.4	-1.1
6	891.44	39.0 QP	46.0	-7.0	1.00 H	188	39.5	-0.5

ANTENNA POLARITY & TEST DISTANCE: VERTICAL AT 3 M

NO.	FREQ. (MHz)	EMISSION LEVEL (dBuV/m)	LIMIT (dBuV/m)	MARGIN (dB)	ANTENNA HEIGHT (m)	TABLE ANGLE (Degree)	RAW VALUE (dBuV)	CORRECTION FACTOR (dB/m)
1	60.95	24.5 QP	40.0	-15.5	1.01 V	325	38.9	-14.4
2	88.11	16.6 QP	43.5	-26.9	1.01 V	142	35.9	-19.3
3	274.39	31.5 QP	46.0	-14.5	1.01 V	185	44.3	-12.8
4	336.48	28.1 QP	46.0	-17.9	1.01 V	202	39.4	-11.3
5	730.38	27.1 QP	46.0	-18.9	1.51 V	243	30.3	-3.2
6	936.07	36.0 QP	46.0	-10.0	1.01 V	10	35.6	0.4

Remarks:

1. Emission Level(dBuV/m) = Raw Value(dBuV) + Correction Factor(dB/m)
2. Correction Factor(dB/m) = Antenna Factor(dB/m) + Cable Factor(dB) – Pre-Amplifier Factor(dB)
3. The other emission levels were very low against the limit.
4. Margin value = Emission Level – Limit value

4.2 Conducted Emission Measurement

4.2.1 Limits of Conducted Emission Measurement

Frequency (MHz)	Conducted Limit (dBuV)	
	Quasi-peak	Average
0.15 - 0.5	66 - 56	56 - 46
0.50 - 5.0	56	46
5.0 - 30.0	60	50

Note: 1. The lower limit shall apply at the transition frequencies.

2. The limit decreases in line with the logarithm of the frequency in the range of 0.15 to 0.50MHz.

4.2.2 Test Instruments

Test Date: Jan. 24, 2018

Description & Manufacturer	Model No.	Serial No.	Cal. Date	Cal. Due
Test Receiver ROHDE & SCHWARZ	ESCI	100613	Nov. 23, 2017	Nov. 22, 2018
RF signal cable (with 10dB PAD) Woken	5D-FB	Cable-cond1-01	Sep. 05, 2017	Sep. 04, 2018
LISN ROHDE & SCHWARZ (EUT)	ESH3-Z5	835239/001	Mar. 10, 2017	Mar. 09, 2018
LISN ROHDE & SCHWARZ (Peripheral)	ESH3-Z5	100311	Aug. 15, 2017	Aug. 14, 2018
Software ADT	BV ADT_Cond_ V7.3.7.4	NA	NA	NA

Note: 1. The calibration interval of the above test instruments is 12 months and the calibrations are traceable to NML/ROC and NIST/USA.

2. The test was performed in HwaYa Shielded Room 1.

3. The VCCI Site Registration No. is C-2040.

4.2.3 Test Procedures

- The EUT was placed 0.4 meters from the conducting wall of the shielded room with EUT being connected to the power mains through a line impedance stabilization network (LISN). Other support units were connected to the power mains through another LISN. The two LISNs provide 50 ohm/ 50uH of coupling impedance for the measuring instrument.
- Both lines of the power mains connected to the EUT were checked for maximum conducted interference.
- The frequency range from 150kHz to 30MHz was searched. Emission levels under (Limit - 20dB) was not recorded.

NOTE: The resolution bandwidth and video bandwidth of test receiver is 9kHz for quasi-peak detection (QP) and average detection (AV) at frequency 0.15MHz-30MHz.

4.2.4 Deviation from Test Standard

No deviation.

4.2.5 Test Setup

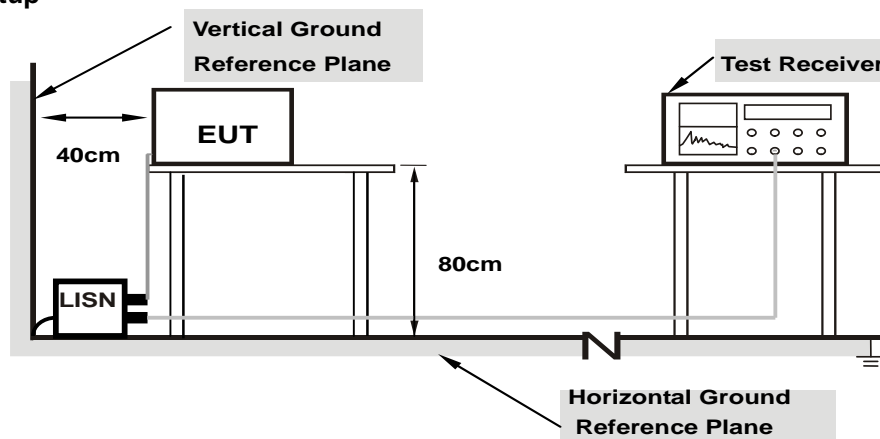

Note: 1.Support units were connected to second LISN.

For the actual test configuration, please refer to the attached file (Test Setup Photo).

4.2.6 EUT Operating Conditions

Same as 4.1.6.

4.2.7 Test Results

Phase	Line (L)	Detector Function	Quasi-Peak (QP) / Average (AV)
-------	----------	-------------------	--------------------------------

No	Freq. [MHz]	Corr. Factor (dB)	Reading Value [dB (uV)]		Emission Level [dB (uV)]		Limit [dB (uV)]		Margin (dB)	
			Q.P.	AV.	Q.P.	AV.	Q.P.	AV.	Q.P.	AV.
			1	0.15885	10.10	37.60	24.83	47.70	34.93	65.52
2	0.18903	10.10	33.09	19.82	43.19	29.92	64.08	54.08	-20.89	-24.16
3	0.20084	10.10	29.70	13.09	39.80	23.19	63.58	53.58	-23.78	-30.39
4	0.27120	10.11	17.00	6.52	27.11	16.63	61.08	51.08	-33.97	-34.45
5	0.50000	10.12	29.05	23.40	39.17	33.52	56.00	46.00	-16.83	-12.48
6	13.05300	10.80	19.12	13.41	29.92	24.21	60.00	50.00	-30.08	-25.79

REMARKS:

1. Q.P. and AV. are abbreviations of quasi-peak and average individually.
2. The emission levels of other frequencies were very low against the limit.
3. Margin value = Emission level - Limit value
4. Correction factor = Insertion loss + Cable loss
5. Emission Level = Correction Factor + Reading Value.

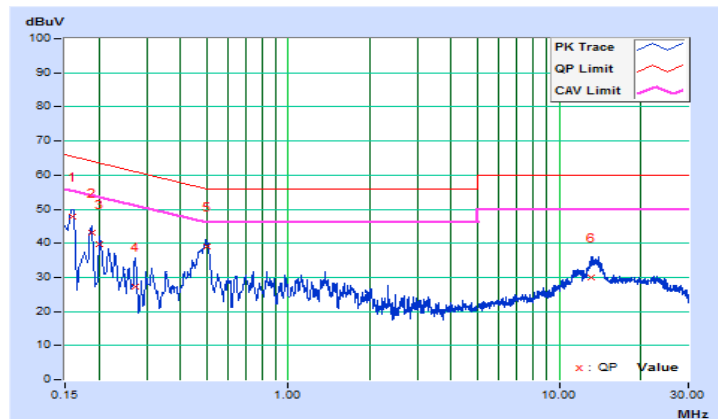

Phase	Neutral (N)	Detector Function	Quasi-Peak (QP) / Average (AV)
-------	-------------	-------------------	--------------------------------

No	Freq. [MHz]	Corr. Factor (dB)	Reading Value [dB (uV)]		Emission Level [dB (uV)]		Limit [dB (uV)]		Margin (dB)	
			Q.P.	AV.	Q.P.	AV.	Q.P.	AV.	Q.P.	AV.
			1	0.15719	10.10	37.74	26.08	47.84	36.18	65.61
2	0.18903	10.10	32.06	20.17	42.16	30.27	64.08	54.08	-21.92	-23.81
3	0.27512	10.11	19.14	7.78	29.25	17.89	60.96	50.96	-31.71	-33.07
4	0.50000	10.12	29.04	23.57	39.16	33.69	56.00	46.00	-16.84	-12.31
5	1.06463	10.13	17.81	12.25	27.94	22.38	56.00	46.00	-28.06	-23.62
6	11.40298	10.58	18.00	12.84	28.58	23.42	60.00	50.00	-31.42	-26.58

REMARKS:

1. Q.P. and AV. are abbreviations of quasi-peak and average individually.
2. The emission levels of other frequencies were very low against the limit.
3. Margin value = Emission level - Limit value
4. Correction factor = Insertion loss + Cable loss
5. Emission Level = Correction Factor + Reading Value.

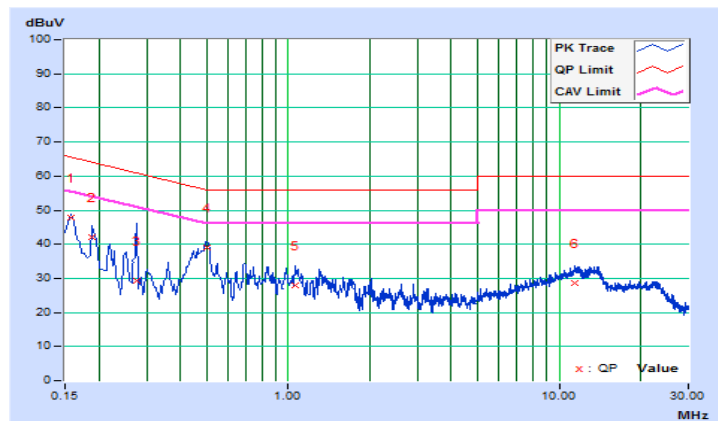

4.3 Transmit Power Measurement

4.3.1 Limits of Transmit Power Measurement

Operation Band	EUT Category		LIMIT
U-NII-1		Outdoor Access Point	1 Watt (30 dBm) (Max. e.i.r.p \leq 125mW(21 dBm) at any elevation angle above 30 degrees as measured from the horizon)
		Fixed point-to-point Access Point	1 Watt (30 dBm)
		Indoor Access Point	1 Watt (30 dBm)
	√	Mobile and Portable client device	250mW (24 dBm)
U-NII-2A		√	250mW (24 dBm) or 11 dBm+10 log B*
U-NII-2C		√	250mW (24 dBm) or 11 dBm+10 log B*
U-NII-3		√	1 Watt (30 dBm)

*B is the 26 dB emission bandwidth in megahertz

4.3.2 Test Setup

For Power Output
 802.11a, 802.11n (HT20), 802.11n (HT40)

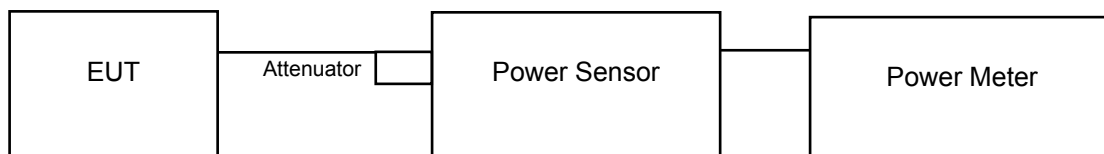

For 26dB and Occupied Bandwidth

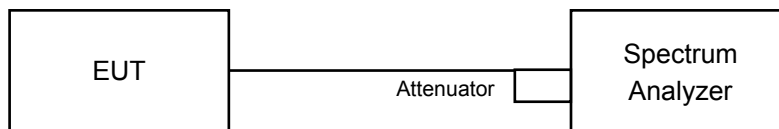

4.3.3 Test Instruments

Refer to section 4.1.2 to get information of above instrument.

4.3.4 Test Procedure

For Average Power Measurement

For 802.11a, 802.11n (HT20), 802.11n (HT40)

Method PM is used to perform output power measurement, trigger and gating function of wide band power meter is enabled to measure max output power of TX on burst. Duty factor is not added to measured value.

For 26dB Bandwidth

- a. Set RBW = approximately 1% of the emission bandwidth.
- b. Set the VBW > RBW.
- c. Detector = Peak.
- d. Trace mode = max hold.
- e. Measure the maximum width of the emission that is 26 dB down from the peak of the emission. Compare this with the RBW setting of the analyzer. Readjust RBW and repeat measurement as needed until the RBW/EBW ratio is approximately 1%.

For Occupied Bandwidth

The transmitter output was connected to the spectrum analyzer through an attenuator. The bandwidth of the fundamental frequency was measured by spectrum analyzer with resolution bandwidth in the range of 1% to 5% of the anticipated emission bandwidth, and a video bandwidth at least 3x the resolution bandwidth and set the detector to Sampling. The width of a frequency band such that, below the lower and above the upper frequency limits, the mean powers emitted are each equal to a specified percentage 0.5 % of the total mean power of a given emission.

4.3.5 Deviation from Test Standard

No deviation.

4.3.6 EUT Operating Conditions

The software provided by client to enable the EUT under transmission condition continuously at lowest, middle and highest channel frequencies individually.

4.3.7 Test Result

Power Output:

802.11a

Chan.	Freq. (MHz)	Conducted Power (mW)	Conducted Power (dBm)	Power Limit (dBm)	Pass / Fail
36	5180	41.210	16.15	24.00	Pass
40	5200	40.551	16.08	24.00	Pass
48	5240	39.537	15.97	24.00	Pass
52	5260	40.179	16.04	24.00	Pass
60	5300	39.902	16.01	24.00	Pass
64	5320	40.087	16.03	24.00	Pass
100	5500	42.170	16.25	24.00	Pass
116	5580	42.855	16.32	24.00	Pass
140	5700	33.651	15.27	24.00	Pass
149	5745	45.604	16.59	30.00	Pass
157	5785	43.752	16.41	30.00	Pass
165	5825	42.170	16.25	30.00	Pass

Note:

For U-NII-2A, U-NII-2C Band:

1. $11\text{dBm} + 10\log(40.37) = 27.06\text{ dBm} > 24\text{dBm}$
2. $11\text{dBm} + 10\log(41.33) = 27.16\text{ dBm} > 24\text{dBm}$
3. $11\text{dBm} + 10\log(43.10) = 27.34\text{ dBm} > 24\text{dBm}$
4. $11\text{dBm} + 10\log(41.02) = 27.13\text{ dBm} > 24\text{dBm}$
5. $11\text{dBm} + 10\log(42.77) = 27.31\text{ dBm} > 24\text{dBm}$
6. $11\text{dBm} + 10\log(41.85) = 27.22\text{ dBm} > 24\text{dBm}$

802.11n (HT20)

Chan.	Freq. (MHz)	Conducted Power (mW)	Conducted Power (dBm)	Power Limit (dBm)	Pass / Fail
36	5180	30.339	14.82	24.00	Pass
40	5200	30.974	14.91	24.00	Pass
48	5240	30.903	14.90	24.00	Pass
52	5260	32.434	15.11	24.00	Pass
60	5300	31.477	14.98	24.00	Pass
64	5320	30.974	14.91	24.00	Pass
100	5500	34.119	15.33	24.00	Pass
116	5580	34.435	15.37	24.00	Pass
140	5700	23.550	13.72	24.00	Pass
149	5745	34.356	15.36	30.00	Pass
157	5785	34.514	15.38	30.00	Pass
165	5825	31.842	15.03	30.00	Pass

Note:

For U-NII-2A, U-NII-2C Band:

1. $11\text{dBm} + 10\log(40.49) = 27.07\text{ dBm} > 24\text{dBm}$
2. $11\text{dBm} + 10\log(40.87) = 27.11\text{ dBm} > 24\text{dBm}$
3. $11\text{dBm} + 10\log(39.91) = 27.01\text{ dBm} > 24\text{dBm}$
4. $11\text{dBm} + 10\log(42.95) = 27.33\text{ dBm} > 24\text{dBm}$
5. $11\text{dBm} + 10\log(43.97) = 27.43\text{ dBm} > 24\text{dBm}$
6. $11\text{dBm} + 10\log(45.90) = 27.62\text{ dBm} > 24\text{dBm}$

802.11n (HT40)

Chan.	Freq. (MHz)	Conducted Power (mW)	Conducted Power (dBm)	Power Limit (dBm)	Pass / Fail
38	5190	25.942	14.14	24.00	Pass
46	5230	26.303	14.20	24.00	Pass
54	5270	26.242	14.19	24.00	Pass
62	5310	18.621	12.70	24.00	Pass
102	5510	15.596	11.93	24.00	Pass
110	5550	28.184	14.50	24.00	Pass
134	5670	28.249	14.51	24.00	Pass
151	5755	30.061	14.78	30.00	Pass
159	5795	28.840	14.60	30.00	Pass

Note:

For U-NII-2A, U-NII-2C Band:

1. $11\text{dBm} + 10\log(74.64) = 29.73\text{ dBm} > 24\text{dBm}$
2. $11\text{dBm} + 10\log(63.52) = 29.03\text{ dBm} > 24\text{dBm}$
3. $11\text{dBm} + 10\log(62.88) = 28.99\text{ dBm} > 24\text{dBm}$
4. $11\text{dBm} + 10\log(89.00) = 30.49\text{ dBm} > 24\text{dBm}$
5. $11\text{dBm} + 10\log(83.58) = 30.22\text{ dBm} > 24\text{dBm}$

26dB Bandwidth:

802.11a

Channel	Frequency (MHz)	26dBc Bandwidth (MHz)
36	5180	39.81
40	5200	40.65
48	5240	40.48
52	5260	40.37
60	5300	41.33
64	5320	43.10
100	5500	41.02
116	5580	42.77
140	5700	41.85

802.11n (HT20)

Channel	Frequency (MHz)	26dBc Bandwidth (MHz)
36	5180	39.67
40	5200	39.96
48	5240	43.25
52	5260	40.49
60	5300	40.87
64	5320	39.91
100	5500	42.95
116	5580	43.97
140	5700	45.90

802.11n (HT40)

Channel	Frequency (MHz)	26dBc Bandwidth (MHz)
38	5190	70.58
46	5230	70.54
54	5270	74.64
62	5310	63.52
102	5510	62.88
110	5550	89.00
134	5670	83.58

Spectrum Plot of Worst Value

802.11a

802.11n (HT20)

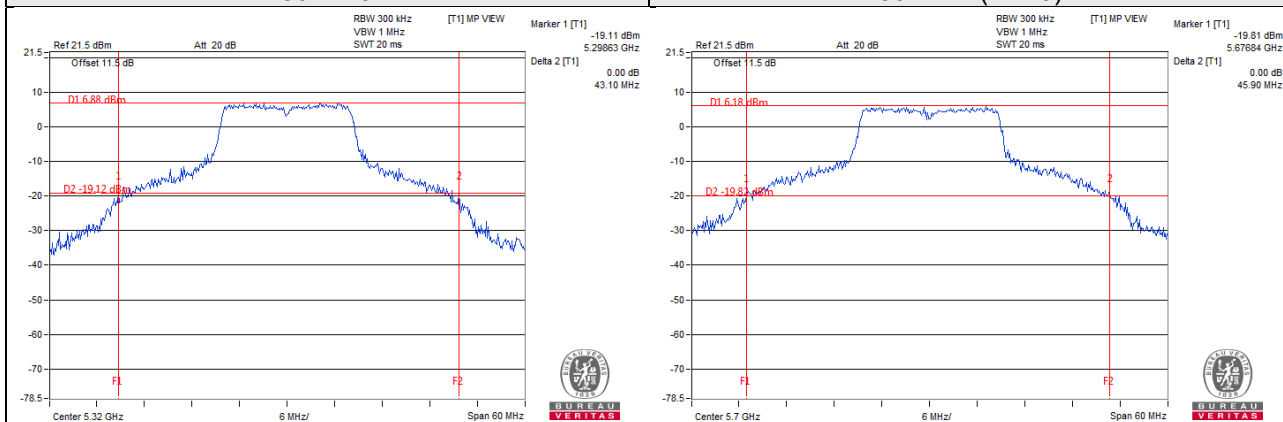

802.11n (HT40)

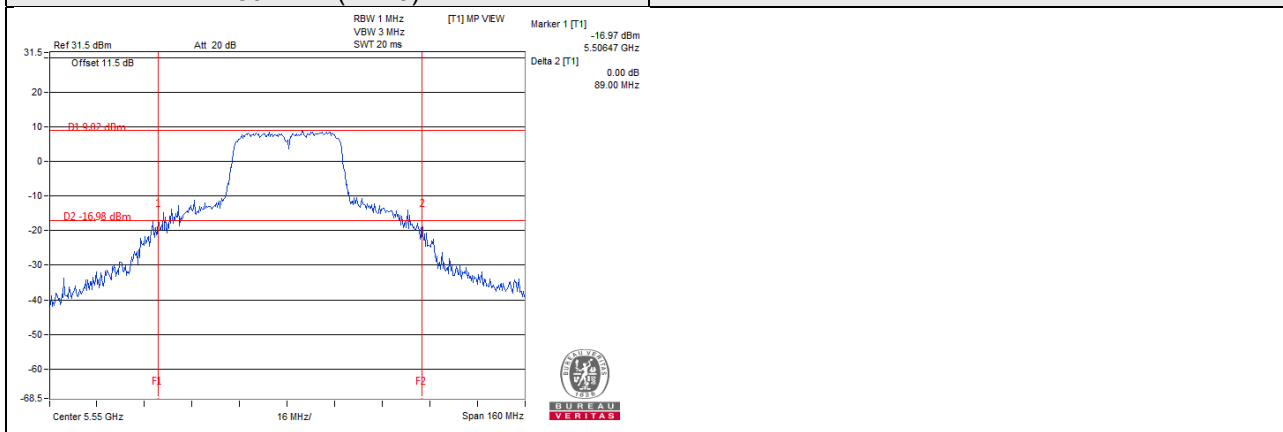

EUT Maximum Conducted Power

802.11a

Frequency Band (MHz)	Max. Power	
	Output Power (mW)	Output Power (dBm)
5250~5350	40.179	16.04
5470~5725	42.855	16.32

Note: Manufacturer provides Transmit Power Control description to meet this requirement.

802.11n (HT20)

Frequency Band (MHz)	Max. Power	
	Output Power (mW)	Output Power (dBm)
5250~5350	32.434	15.11
5470~5725	34.435	15.37

Note: Manufacturer provides Transmit Power Control description to meet this requirement.

802.11n (HT40)

Frequency Band (MHz)	Max. Power	
	Output Power (mW)	Output Power (dBm)
5250~5350	26.242	14.19
5470~5725	28.249	14.51

Note: Manufacturer provides Transmit Power Control description to meet this requirement.

4.4 Occupied Bandwidth Measurement

4.4.1 Test Setup

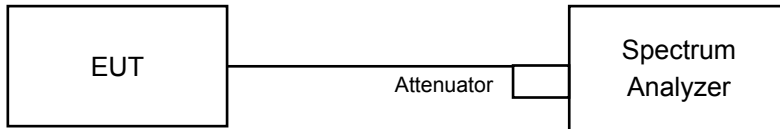

4.4.2 Test Instruments

Refer to section 4.1.2 to get information of above instrument.

4.4.3 Test Procedure

The transmitter output was connected to the spectrum analyzer through an attenuator. The bandwidth of the fundamental frequency was measured by spectrum analyzer with resolution bandwidth in the range of 1% to 5% of the anticipated emission bandwidth, and a video bandwidth at least 3x the resolution bandwidth and set the detector to sampling. The width of a frequency band such that, below the lower and above the upper frequency limits, the mean powers emitted are each equal to a specified percentage 0.5 %of the total mean power of a given emission.

4.4.4 Test Result

802.11a

Channel	Frequency (MHz)	Occupied Bandwidth (MHz)
36	5180	18.84
40	5200	19.20
48	5240	18.48
52	5260	19.56
60	5300	19.56
64	5320	19.56
100	5500	20.04
116	5580	22.20
140	5700	21.12
149	5745	26.88
157	5785	27.72
165	5825	28.08

802.11n (HT20)

Channel	Frequency (MHz)	Occupied Bandwidth (MHz)
36	5180	18.60
40	5200	18.60
48	5240	18.84
52	5260	18.72
60	5300	18.72
64	5320	18.84
100	5500	19.08
116	5580	20.76
140	5700	25.68
149	5745	22.08
157	5785	23.52
165	5825	24.24

802.11n (HT40)

Channel	Frequency (MHz)	Occupied Bandwidth (MHz)
38	5190	36.72
46	5230	36.84
54	5270	36.84
62	5310	36.60
102	5510	36.60
110	5550	37.20
134	5670	37.20
151	5755	37.08
159	5795	37.32

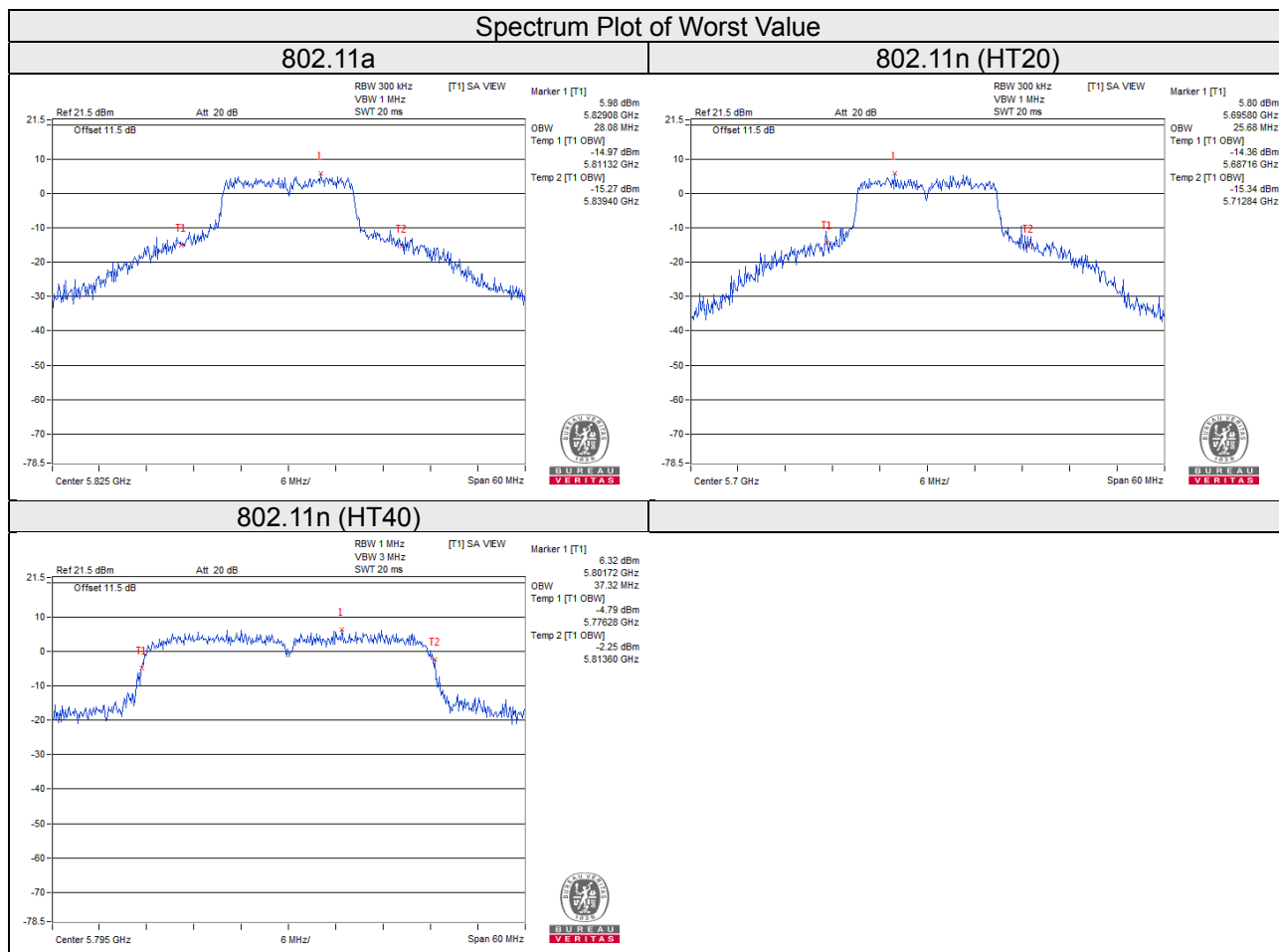

4.5 Peak Power Spectral Density Measurement

4.5.1 Limits of Peak Power Spectral Density Measurement

Operation Band	EUT Category		LIMIT
U-NII-1		Outdoor Access Point	17dBm/ MHz
		Fixed point-to-point Access Point	
		Indoor Access Point	
	√	Mobile and Portable client device	11dBm/ MHz
U-NII-2A		√	11dBm/ MHz
U-NII-2C		√	11dBm/ MHz
U-NII-3		√	30dBm/ 500kHz

4.5.2 Test Setup

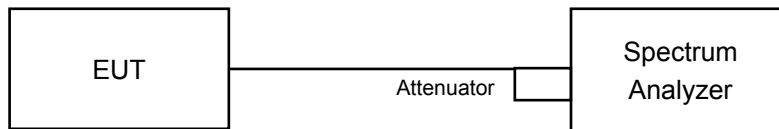

4.5.3 Test Instruments

Refer to section 4.1.2 to get information of above instrument.

4.5.4 Test Procedures

For U-NII-1, U-NII-2A, U-NII-2C band:

Duty cycle of test signal is $\geq 98\%$

Using method SA-1

- 1) Set span to encompass the entire emission bandwidth (EBW) of the signal.
- 2) Set RBW = 1MHz, Set VBW ≥ 3 MHz, Detector = RMS
- 3) Set Channel power measure = 1MHz
- 4) Sweep time = auto, trigger set to "free run".
- 5) Trace average at least 100 traces in power averaging mode.
- 6) Record the max value

Duty cycle of test signal is $< 98\%$

Using method SA-2

- 1) Set span to encompass the entire emission bandwidth (EBW) of the signal.
- 2) Set RBW = 1MHz, Set VBW ≥ 3 MHz, Detector = RMS
- 3) Set Channel power measure = 1MHz
- 4) Sweep time = auto, trigger set to "free run".
- 5) Trace average at least 100 traces in power averaging mode.
- 6) Record the max value and add $10 \log (1/\text{duty cycle})$

For U-NII-3 band:

Duty cycle of test signal is $\geq 98\%$

Using method SA-1

- 1) Set span to encompass the entire emission bandwidth (EBW) of the signal.
- 2) Set RBW = 300 kHz, Set VBW ≥ 1 MHz, Detector = RMS.
- 3) Use the peak marker function to determine the maximum power level in any 300 kHz band segment within the fundamental EBW.
- 4) Scale the observed power level to an equivalent value in 500 kHz by adjusting (reducing) the measured power by a bandwidth correction factor (BWCF) where $BWCF = 10\log(500 \text{ kHz} / 300 \text{ kHz})$.
- 5) Sweep time = auto, trigger set to "free run".
- 6) Trace average at least 100 traces in power averaging mode.
- 7) Record the max value.

Duty cycle of test signal is $< 98\%$

- 1) Set span to encompass the entire emission bandwidth (EBW) of the signal.
- 2) Set RBW = 300 kHz, Set VBW ≥ 1 MHz, Detector = RMS
- 3) Use the peak marker function to determine the maximum power level in any 300 kHz band segment within the fundamental EBW.
- 4) Scale the observed power level to an equivalent value in 500 kHz by adjusting (reducing) the measured power by a bandwidth correction factor (BWCF) where $BWCF = 10\log(500 \text{ kHz} / 300 \text{ kHz})$
- 5) Sweep time = auto, trigger set to "free run".
- 6) Trace average at least 100 traces in power averaging mode.
- 7) Record the max value and add $10 \log (1/\text{duty cycle})$

4.5.5 Deviation from Test Standard

No deviation.

4.5.6 EUT Operating Conditions

Same as 4.3.6.

4.5.7 Test Results

For U-NII-1, U-NII-2A, U-NII-2C band

802.11a

Chan.	Freq. (MHz)	PSD Without Duty Factor (dBm/MHz)	Duty Factor (dB)	Total PSD With Duty Factor (dBm/MHz)	Max. Limit (dBm/MHz)	Pass / Fail
36	5180	0.12	0.70	0.82	11	Pass
40	5200	0.18	0.70	0.88	11	Pass
48	5240	-0.02	0.70	0.68	11	Pass
52	5260	0.91	0.70	1.61	11	Pass
60	5300	0.86	0.70	1.56	11	Pass
64	5320	0.74	0.70	1.44	11	Pass
100	5500	0.56	0.70	1.26	11	Pass
116	5580	1.49	0.70	2.19	11	Pass
140	5700	-0.58	0.70	0.12	11	Pass

NOTE: Refer to section 3.1 for duty cycle spectrum plot.

802.11n (HT20)

Chan.	Freq. (MHz)	PSD Without Duty Factor (dBm/MHz)	Duty Factor (dB)	Total PSD With Duty Factor (dBm/MHz)	Max. Limit (dBm/MHz)	Pass / Fail
36	5180	-0.90	0.63	-0.27	11	Pass
40	5200	-0.93	0.63	-0.30	11	Pass
48	5240	-0.63	0.63	0.00	11	Pass
52	5260	-0.44	0.63	0.19	11	Pass
60	5300	-0.53	0.63	0.10	11	Pass
64	5320	-0.48	0.63	0.15	11	Pass
100	5500	-0.53	0.63	0.10	11	Pass
116	5580	0.59	0.63	1.22	11	Pass
140	5700	0.24	0.63	0.87	11	Pass

NOTE: Refer to section 3.1 for duty cycle spectrum plot.

802.11n (HT40)

Chan.	Freq. (MHz)	PSD Without Duty Factor (dBm/MHz)	Duty Factor (dB)	Total PSD With Duty Factor (dBm/MHz)	Max. Limit (dBm/MHz)	Pass / Fail
38	5190	-5.56	1.20	-4.36	11	Pass
46	5230	-4.51	1.20	-3.31	11	Pass
54	5270	-4.83	1.20	-3.63	11	Pass
62	5310	-5.62	1.20	-4.42	11	Pass
102	5510	-7.08	1.20	-5.88	11	Pass
110	5550	-3.56	1.20	-2.36	11	Pass
134	5670	-5.00	1.20	-3.80	11	Pass

NOTE: Refer to section 3.1 for duty cycle spectrum plot.

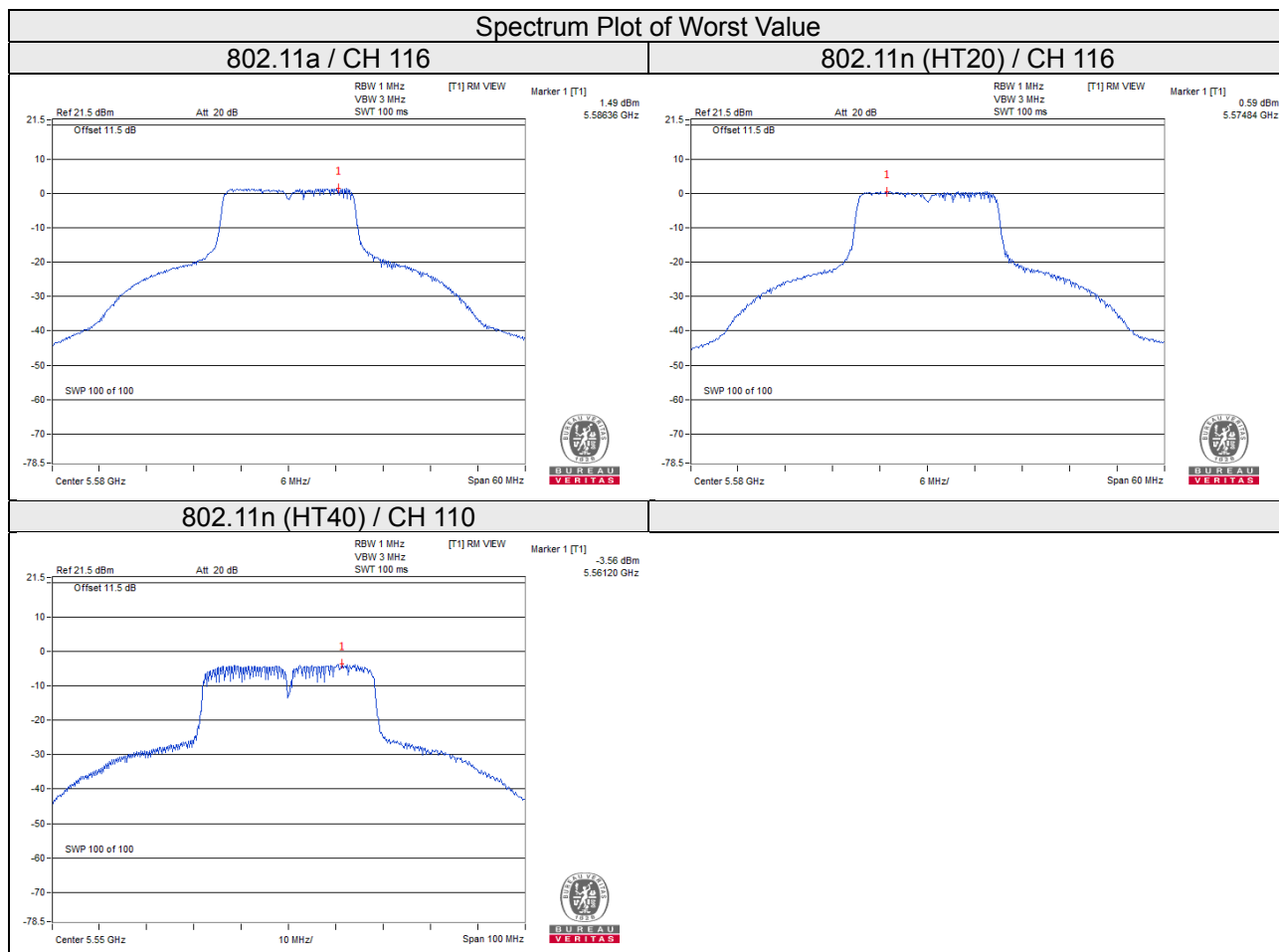

For U-NII-3 band:

802.11a

Chan.	Freq. (MHz)	PSD W/O Duty Factor		Duty factor	Total PSD (dBm/500kHz)	Limit (dBm/500kHz)	Pass / Fail
		(dBm/300kHz)	(dBm/500kHz)				
149	5745	-6.68	-4.46	0.70	-3.76	30.00	Pass
157	5785	-7.55	-5.33	0.70	-4.63	30.00	Pass
165	5825	-7.40	-5.18	0.70	-4.48	30.00	Pass

NOTE: Refer to section 3.1 for duty cycle spectrum plot.

802.11n (HT20)

Chan.	Freq. (MHz)	PSD W/O Duty Factor		Duty factor	Total PSD (dBm/500kHz)	Limit (dBm/500kHz)	Pass / Fail
		(dBm/300kHz)	(dBm/500kHz)				
149	5745	-8.20	-5.98	0.63	-5.35	30.00	Pass
157	5785	-8.58	-6.36	0.63	-5.73	30.00	Pass
165	5825	-8.76	-6.54	0.63	-5.91	30.00	Pass

NOTE: Refer to section 3.1 for duty cycle spectrum plot.

802.11n (HT40)

Chan.	Freq. (MHz)	PSD W/O Duty Factor		Duty factor	Total PSD (dBm/500kHz)	Limit (dBm/500kHz)	Pass / Fail
		(dBm/300kHz)	(dBm/500kHz)				
151	5755	-13.23	-11.01	1.20	-9.81	30.00	Pass
159	5795	-13.22	-11.00	1.20	-9.80	30.00	Pass

NOTE: Refer to section 3.1 for duty cycle spectrum plot.

Spectrum Plot of Worst Value

802.11a

802.11n (HT20)

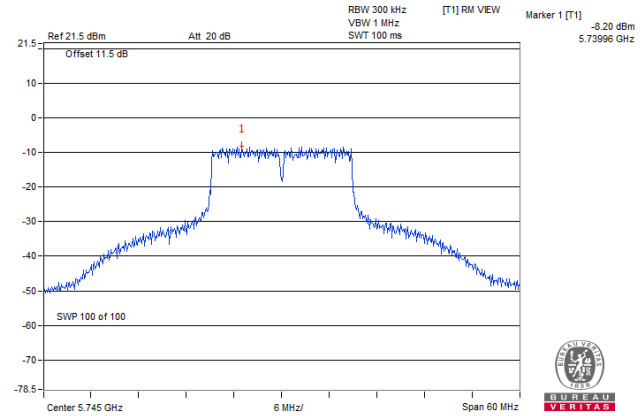
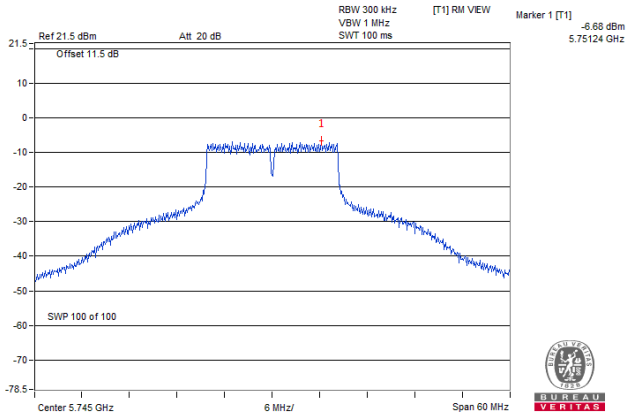

802.11n (HT40)

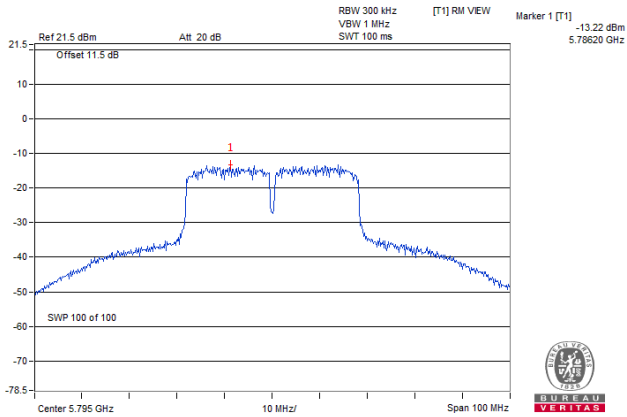

4.6 Frequency Stability

4.6.1 Limits of Frequency Stability Measurement

The frequency of the carrier signal shall be maintained within band of operation

4.6.2 Test Setup

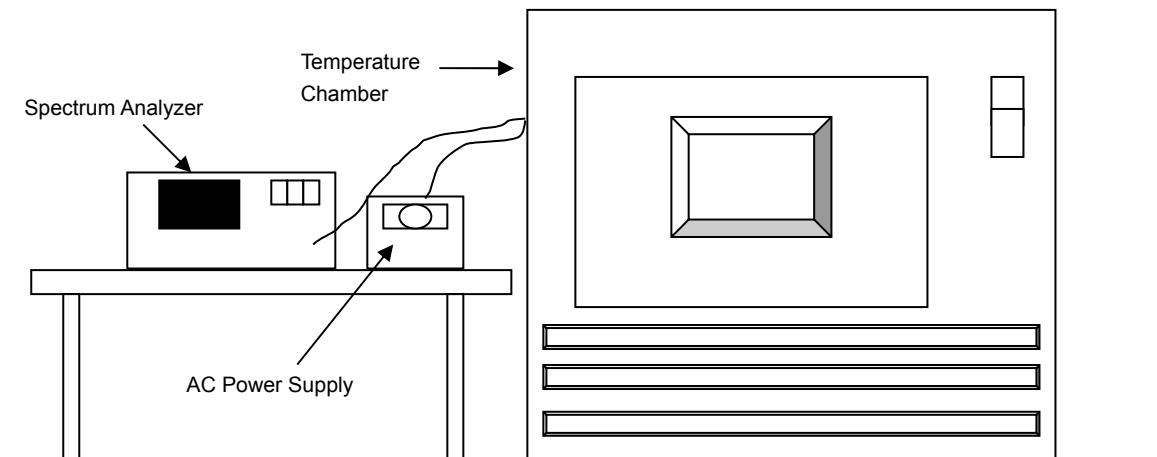

4.6.3 Test Instruments

Refer to section 4.1.2 to get information of above instrument.

4.6.4 Test Procedure

- The EUT was placed inside the environmental test chamber and powered by nominal AC voltage.
- Turn the EUT on and couple its output to a spectrum analyzer.
- Turn the EUT off and set the chamber to the highest temperature specified.
- Allow sufficient time (approximately 30 min) for the temperature of the chamber to stabilize, turn the EUT on and measure the operating frequency after 2, 5, and 10 minutes.
- Repeat step 2 and 3 with the temperature chamber set to the lowest temperature.
- The test chamber was allowed to stabilize at +20 degree C for a minimum of 30 minutes. The supply voltage was then adjusted on the EUT from 85% to 115% and the frequency record.

4.6.5 Deviation from Test Standard

No deviation.

4.6.6 EUT Operating Condition

Set the EUT transmit at un-modulation mode to test frequency stability.

4.6.7 Test Results

Frequency Stability Versus Temp.									
Operating Frequency: 5180MHz									
Temp. (°C)	Power Supply (Vac)	0 Minute		2 Minute		5 Minute		10 Minute	
		Measured Frequency (MHz)	Result	Measured Frequency (MHz)	Result	Measured Frequency (MHz)	Result	Measured Frequency (MHz)	Result
50	120	5179.9880	Pass	5179.9880	Pass	5179.9850	Pass	5179.9860	Pass
40	120	5179.9918	Pass	5179.9906	Pass	5179.9922	Pass	5179.9880	Pass
30	120	5179.9876	Pass	5179.9898	Pass	5179.9900	Pass	5179.9902	Pass
20	120	5180.0115	Pass	5180.0139	Pass	5180.0132	Pass	5180.0136	Pass
10	120	5179.9819	Pass	5179.9821	Pass	5179.9811	Pass	5179.9831	Pass
0	120	5179.9769	Pass	5179.9788	Pass	5179.9782	Pass	5179.9795	Pass
-10	120	5180.0095	Pass	5180.0081	Pass	5180.0059	Pass	5180.0068	Pass
-20	120	5179.9958	Pass	5179.9959	Pass	5179.9952	Pass	5179.9955	Pass
-30	120	5179.9802	Pass	5179.9810	Pass	5179.9836	Pass	5179.9804	Pass

Frequency Stability Versus Voltage									
Operating Frequency: 5180MHz									
Temp. (°C)	Power Supply (Vac)	0 Minute		2 Minute		5 Minute		10 Minute	
		Measured Frequency (MHz)	Result	Measured Frequency (MHz)	Result	Measured Frequency (MHz)	Result	Measured Frequency (MHz)	Result
20	138	5180.0111	Pass	5180.0136	Pass	5180.0132	Pass	5180.0144	Pass
	120	5180.0115	Pass	5180.0139	Pass	5180.0132	Pass	5180.0136	Pass
	102	5180.0113	Pass	5180.0137	Pass	5180.0132	Pass	5180.0131	Pass

4.7 6dB Bandwidth Measurement

4.7.1 Limits of 6dB Bandwidth Measurement

The minimum of 6dB Bandwidth Measurement is 0.5MHz.

4.7.2 Test Setup

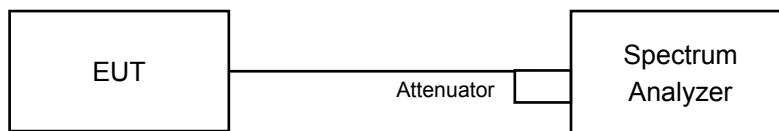

4.7.3 Test Instruments

Refer to section 4.1.2 to get information of above instrument.

4.7.4 Test Procedure

Measurement Procedure REF

- Set resolution bandwidth (RBW) = 100kHz
- Set the video bandwidth (VBW) $\geq 3 \times$ RBW, Detector = Peak.
- Trace mode = max hold.
- Sweep = auto couple.
- Measure the maximum width of the emission that is constrained by the frequencies associated with the two amplitude points (upper and lower) that are attenuated by 6 dB relative to the maximum level measured in the fundamental emission

4.7.5 Deviation from Test Standard

No deviation.

4.7.6 EUT Operating Condition

The software provided by client to enable the EUT under transmission condition continuously at lowest, middle and highest channel frequencies individually.

4.7.7 Test Results

802.11a

Channel	Frequency (MHz)	6dB Bandwidth (MHz)	Minimum Limit (MHz)	Pass / Fail
149	5745	16.43	0.5	Pass
157	5785	16.41	0.5	Pass
165	5825	16.40	0.5	Pass

802.11n (HT20)

Channel	Frequency (MHz)	6dB Bandwidth (MHz)	Minimum Limit (MHz)	Pass / Fail
149	5745	17.60	0.5	Pass
157	5785	17.64	0.5	Pass
165	5825	17.60	0.5	Pass

802.11n (HT40)

Channel	Frequency (MHz)	6dB Bandwidth (MHz)	Minimum Limit (MHz)	Pass / Fail
151	5755	35.34	0.5	Pass
159	5795	35.34	0.5	Pass

Spectrum Plot of Worst Value

802.11a

802.11n (HT20)

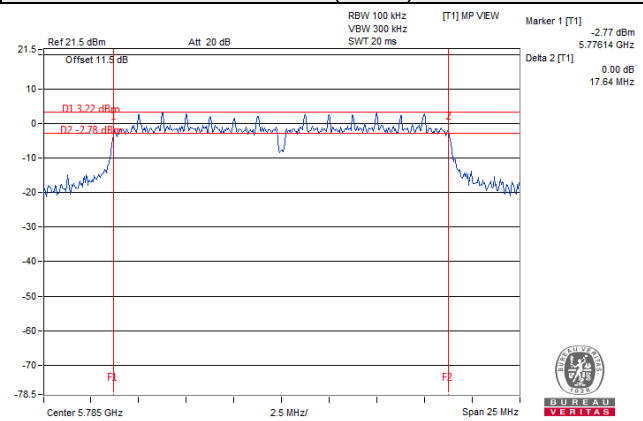
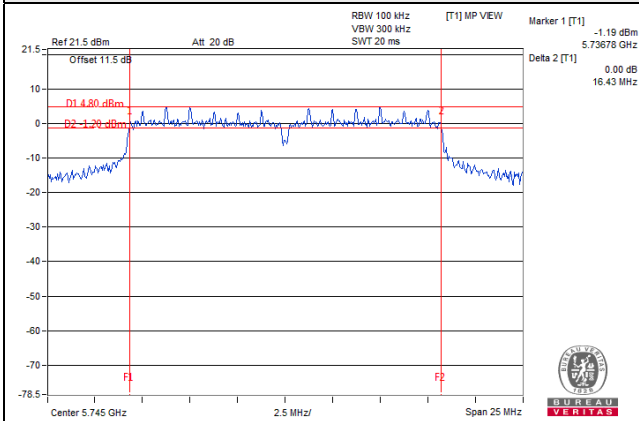

802.11n (HT40)

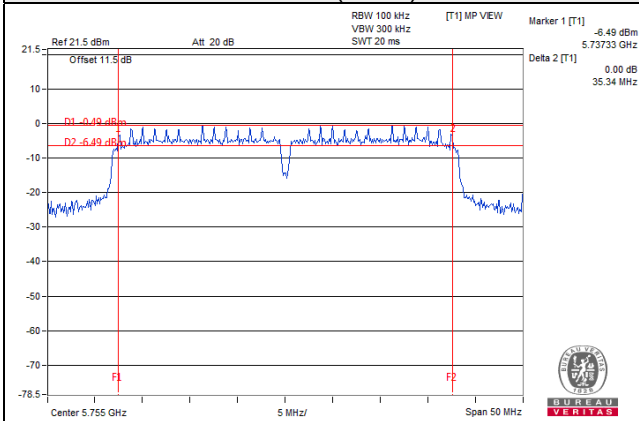

5 Pictures of Test Arrangements

Please refer to the attached file (Test Setup Photo).

Annex A- Radiated Out of Band Emission (OOBE) Measurement (For U-NII-3 band)

802.11a

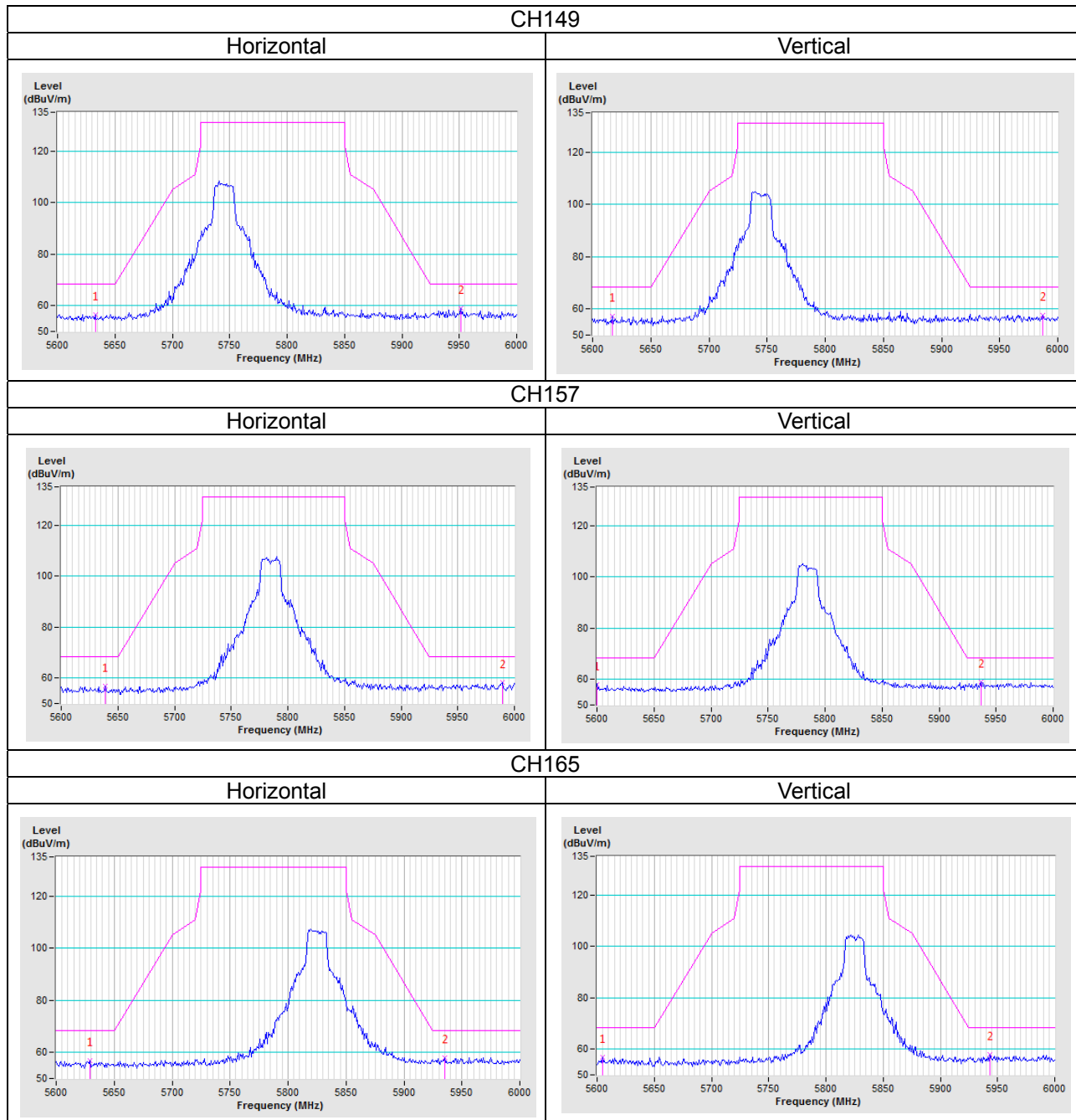

802.11n (HT20)

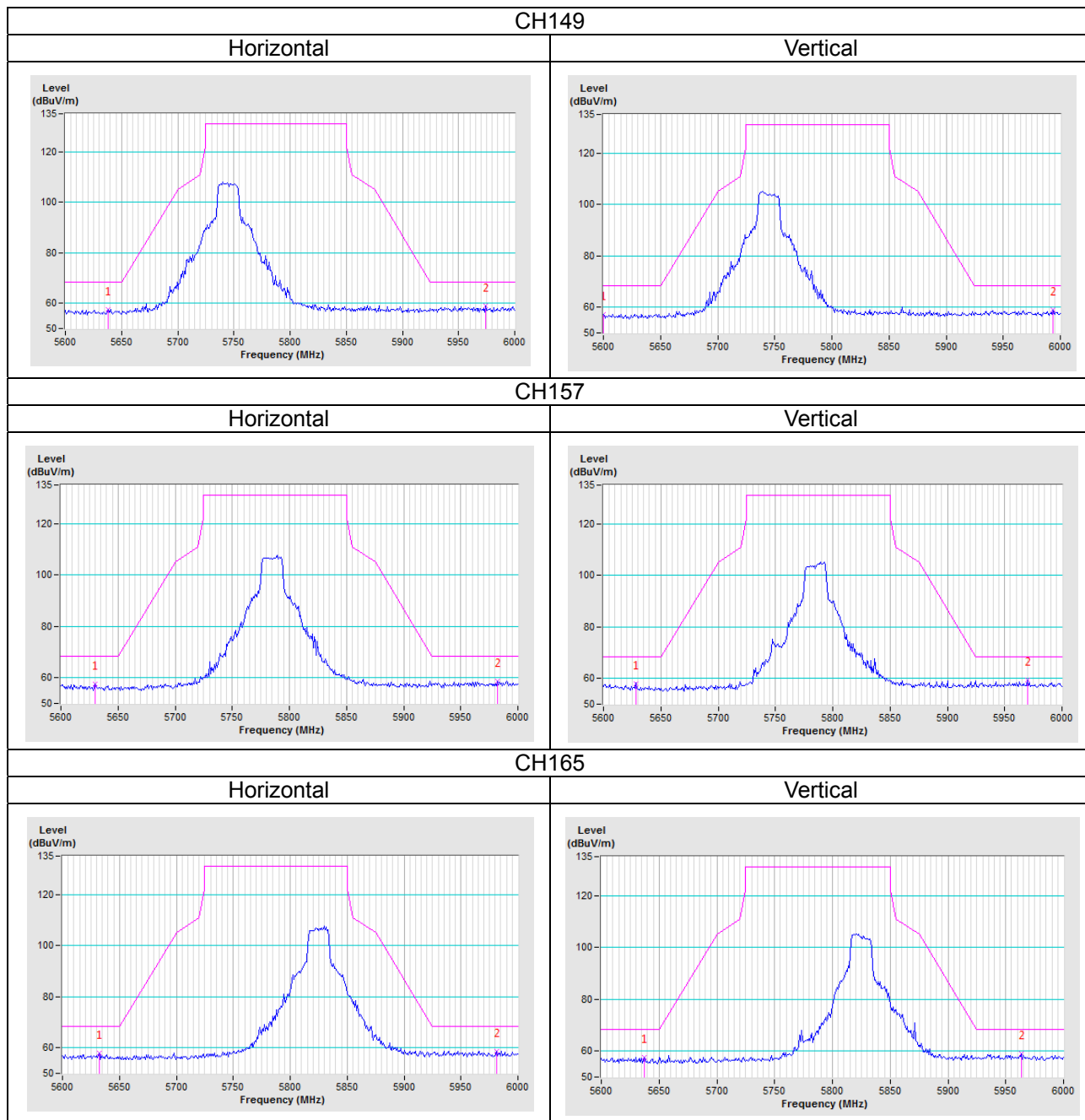

802.11n (HT40)

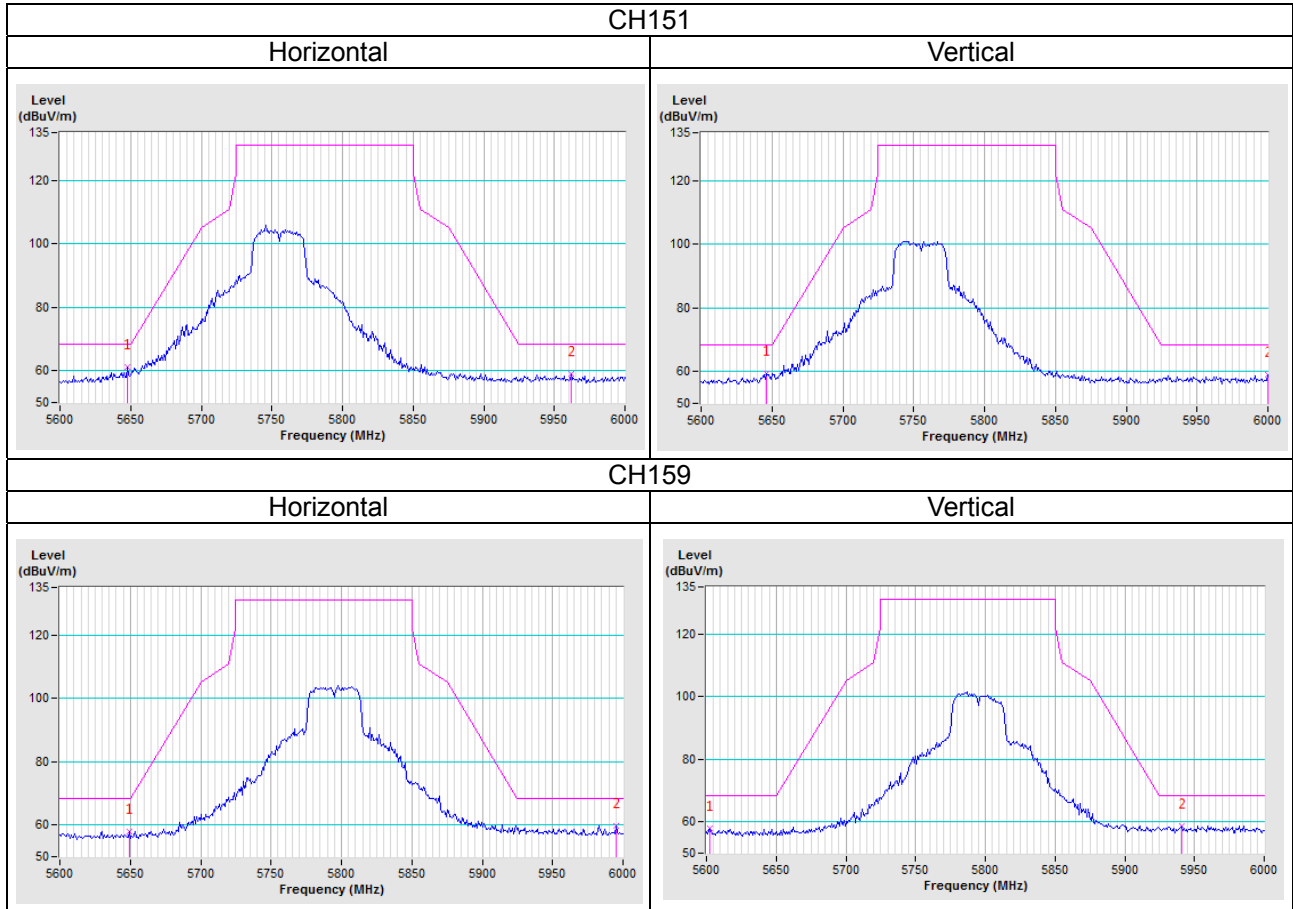

Appendix – Information on the Testing Laboratories

We, Bureau Veritas Consumer Products Services (H.K.) Ltd., Taoyuan Branch, were founded in 1988 to provide our best service in EMC, Radio, Telecom and Safety consultation. Our laboratories are accredited and approved according to ISO/IEC 17025.

If you have any comments, please feel free to contact us at the following:

Linko EMC/RF Lab

Tel: 886-2-26052180

Fax: 886-2-26051924

Hsin Chu EMC/RF/Telecom Lab

Tel: 886-3-6668565

Fax: 886-3-6668323

Hwa Ya EMC/RF/Safety

Tel: 886-3-3183232

Fax: 886-3-3270892

Email: service.adt@tw.bureauveritas.com

Web Site: www.bureauveritas-adt.com

The address and road map of all our labs can be found in our web site also.

--- END ---