

FCC Test Report

Report No.: RF150810C22A-1

FCC ID: PZWBHT1200QU

Test Model: BHT-1281QULWB-CE

Received Date: Aug. 04, 2015

Test Date: Aug. 04 ~ Aug. 24, 2015

Issued Date: Aug. 24, 2015

Applicant: DENSO WAVE INCORPORATED

Address: 1, Yoshiike, Kusagi, Agui-cho, Chita-gun, Aichi, 470-2297 Japan

Issued By: Bureau Veritas Consumer Products Services (H.K.) Ltd., Taoyuan Branch

Lab Address: No. 47-2, 14th Ling, Chia Pau Vil., Lin Kou Dist., New Taipei City, Taiwan
(R.O.C.)

Test Location: No.19, Hwa Ya 2nd Rd., Wen Hwa Vil., Kwei Shan Dist., Taoyuan City
33383, TAIWAN (R.O.C.)



This report is for your exclusive use. Any copying or replication of this report to or for any other person or entity, or use of our name or trademark, is permitted only with our prior written permission. This report sets forth our findings solely with respect to the test samples identified herein. The results set forth in this report are not indicative or representative of the quality or characteristics of the lot from which a test sample was taken or any similar or identical product unless specifically and expressly noted. Our report includes all of the tests requested by you and the results thereof based upon the information that you provided to us. You have 60 days from date of issuance of this report to notify us of any material error or omission caused by our negligence, provided, however, that such notice shall be in writing and shall specifically address the issue you wish to raise. A failure to raise such issue within the prescribed time shall constitute your unqualified acceptance of the completeness of this report, the tests conducted and the correctness of the report contents. Unless specific mention, the uncertainty of measurement has been explicitly taken into account to declare the compliance or non-compliance to the specification. The report must not be used by the client to claim product certification, approval, or endorsement by TAF or any government agencies.

Table of Contents

| | |
|---|-----------|
| Release Control Record | 4 |
| 1 Certificate of Conformity | 5 |
| 2 Summary of Test Results | 6 |
| 2.1 Measurement Uncertainty..... | 6 |
| 2.2 Modification Record..... | 6 |
| 3 General Information | 7 |
| 3.1 General Description of EUT..... | 7 |
| 3.2 Description of Test Modes..... | 8 |
| 3.2.1 Test Mode Applicability and Tested Channel Detail..... | 9 |
| 3.3 Description of Support Units..... | 11 |
| 3.3.1 Configuration of System under Test..... | 11 |
| 3.4 General Description of Applied Standards..... | 12 |
| 4 Test Types and Results | 13 |
| 4.1 Radiated Emission and Bandedge Measurement..... | 13 |
| 4.1.1 Limits of Radiated Emission and Bandedge Measurement..... | 13 |
| 4.1.2 Test Instruments..... | 14 |
| 4.1.3 Test Procedures..... | 15 |
| 4.1.4 Deviation from Test Standard..... | 15 |
| 4.1.5 Test Set Up..... | 16 |
| 4.1.6 EUT Operating Conditions..... | 16 |
| 4.1.7 Test Results..... | 17 |
| 4.2 Conducted Emission Measurement..... | 26 |
| 4.2.1 Limits of Conducted Emission Measurement..... | 26 |
| 4.2.2 Test Instruments..... | 26 |
| 4.2.3 Test Procedures..... | 27 |
| 4.2.4 Deviation From Test Standard..... | 27 |
| 4.2.5 Test Setup..... | 27 |
| 4.2.6 EUT Operating Condition..... | 27 |
| 4.2.7 Test Results..... | 28 |
| 4.3 Number of Hopping Frequency Used..... | 34 |
| 4.3.1 Limits of Hopping Frequency Used Measurement..... | 34 |
| 4.3.2 Test Setup..... | 34 |
| 4.3.3 Test Instruments..... | 34 |
| 4.3.4 Test Procedure..... | 34 |
| 4.3.5 Deviation from Test Standard..... | 34 |
| 4.3.6 Test Results..... | 35 |
| 4.4 Dwell Time on Each Channel..... | 36 |
| 4.4.1 Limits of Dwell Time on Each Channel Measurement..... | 36 |
| 4.4.2 Test Setup..... | 36 |
| 4.4.3 Test Instruments..... | 36 |
| 4.4.4 Test Procedures..... | 36 |
| 4.4.5 Deviation from Test Standard..... | 36 |
| 4.4.6 Test Results..... | 37 |
| 4.5 Channel Bandwidth..... | 38 |
| 4.5.1 Limits of Channel Bandwidth Measurement..... | 38 |
| 4.5.2 Test Setup..... | 38 |
| 4.5.3 Test Instruments..... | 38 |
| 4.5.4 Test Procedure..... | 38 |
| 4.5.5 Deviation from Test Standard..... | 38 |
| 4.5.6 EUT Operating Condition..... | 38 |
| 4.5.7 Test Results..... | 39 |
| 4.6 Hopping Channel Separation..... | 40 |
| 4.6.1 Limits of Hopping Channel Separation Measurement..... | 40 |



| | | |
|----------|---|-----------|
| 4.6.2 | Test Setup..... | 40 |
| 4.6.3 | Test Instruments | 40 |
| 4.6.4 | Test Procedure | 40 |
| 4.6.5 | Deviation From Test Standard..... | 40 |
| 4.6.6 | Test Results | 41 |
| 4.7 | Maximum Output Power..... | 42 |
| 4.7.1 | Limits of Maximum Output Power Measurement | 42 |
| 4.7.2 | Test Setup..... | 42 |
| 4.7.3 | Test Instruments | 42 |
| 4.7.4 | Test Procedure | 42 |
| 4.7.5 | Deviation fromTest Standard | 42 |
| 4.7.6 | EUT Operating Condition | 42 |
| 4.7.7 | Test Results | 43 |
| 4.8 | Conducted Out of Band Emission Measurement..... | 44 |
| 4.8.1 | Limits Of Conducted Out Of Band Emission Measurement..... | 44 |
| 4.8.2 | Test Instruments | 44 |
| 4.8.3 | Test Procedure | 44 |
| 4.8.4 | Deviation From Test Standard..... | 44 |
| 4.8.5 | EUT Operating Condition | 44 |
| 4.8.6 | Test Results | 44 |
| 5 | Pictures of Test Arrangements..... | 46 |
| | Appendix – Information on the Testing Laboratories | 47 |



A D T

Release Control Record

| Issue No. | Description | Date Issued |
|----------------|------------------|---------------|
| RF150810C22A-1 | Original release | Aug. 24, 2015 |



1 Certificate of Conformity

Product: 2D Code Handy Terminal

Brand: DENSO

Test Model: BHT-1281QULWB-CE

Sample Status: Mass Production

Applicant: DENSO WAVE INCORPORATED

Test Date: Aug. 04 ~ Aug. 24, 2015

Standards: 47 CFR FCC Part 15, Subpart C (Section 15.247)
ANSI C63.10: 2013

The above equipment has been tested by **Bureau Veritas Consumer Products Services (H.K.) Ltd., Taoyuan Branch**, and found compliance with the requirement of the above standards. The test record, data evaluation & Equipment Under Test (EUT) configurations represented herein are true and accurate accounts of the measurements of the sample's EMC characteristics under the conditions specified in this report.

Prepared by : Polly Chen , **Date:** Aug. 24, 2015
Polly Chen / Specialist

Approved by : Ken Liu , **Date:** Aug. 24, 2015
Ken Liu / Senior Manager

2 Summary of Test Results

| 47 CFR FCC Part 15, Subpart C (SECTION 15.247) | | | |
|--|---|--------|---|
| FCC Clause | Test Item | Result | Remarks |
| 15.207 | AC Power Conducted Emission | PASS | Meet the requirement of limit. Minimum passing margin is -7.33dB at 0.44557MHz. |
| 15.247(a)(1)(i) | Number of Hopping Frequency Used | PASS | Meet the requirement of limit. |
| 15.247(a)(1)(i) | Dwell Time on Each Channel | PASS | Meet the requirement of limit. |
| 15.247(a)(1) | 1. Hopping Channel Separation 2. Spectrum Bandwidth of a Frequency Hopping Sequence Spread Spectrum System | PASS | Meet the requirement of limit. |
| 15.247(b)(2) | Maximum Peak Output Power | PASS | Meet the requirement of limit. |
| 15.205 & 209 | Radiated Emissions | PASS | Meet the requirement of limit. Minimum passing margin is -2.7dB at 45.45MHz. |
| 15.247(d) | Band Edge Measurement | PASS | Meet the requirement of limit. Minimum passing margin is -34.3dB at 902.00MHz. |
| 15.247(d) | Antenna Port Emission | PASS | Meet the requirement of limit. |
| 15.203 | Antenna Requirement | PASS | No antenna connector is used. |

NOTE: If The Frequency Hopping System operating in 2400-2483.5MHz band and the output power less than 125mW. The hopping channel carrier frequencies separated by a minimum of 25kHz or two-thirds of the 20dB bandwidth of hopping channel whichever is greater.

2.1 Measurement Uncertainty

Where relevant, the following measurement uncertainty levels have been estimated for tests performed on the EUT as specified in CISPR 16-4-2:

| Measurement | Frequency | Expanded Uncertainty (k=2) (\pm) |
|------------------------------------|------------------|--------------------------------------|
| Conducted Emissions at mains ports | 150kHz ~ 30MHz | 2.44 dB |
| Radiated Emissions up to 1 GHz | 30MHz ~ 200MHz | 3.86 dB |
| | 200MHz ~ 1000MHz | 3.87 dB |
| Radiated Emissions above 1 GHz | 1GHz ~ 18GHz | 2.29 dB |
| | 18GHz ~ 40GHz | 2.29 dB |

2.2 Modification Record

There were no modifications required for compliance.

3 General Information

3.1 General Description of EUT

| | |
|---------------------|--|
| Product | 2D Code Handy Terminal |
| Brand | DENSO |
| Test Model | BHT-1281QULWB-CE |
| Status of EUT | Mass Production |
| Power Supply Rating | 3.7Vdc from battery 12Vdc from cradle |
| Modulation Type | PSK |
| Channel Spacing | 500kHz |
| Operating Frequency | 902.75~927.25 MHz |
| Number of Channel | 50 |
| Output Power | 510.505mW |
| Antenna Type | Inverted- F antenna with 4dBi gain |
| Antenna Connector | NA |
| Accessory Device | NA |
| Data Cable Supplied | NA |

Note:

1. The following devices are support units only.

| Device | Brand Name | Model No. | Remark |
|-----------------------|------------|--------------|--|
| Battery | DENSO | BT-110L | Rating: 3.7Vdc, 3450mAh, 12.8Wh |
| Cradle | DENSO | CU-1233 | 12Vdc, 1.8A |
| AC adapter for cradle | FSP | FSP050-DBAE1 | I/P: 100-240Vac, 1.5A, 50/60Hz O/P: 12.0Vdc, 4.16A MAX (50W Max) AC 1.7m power cable without core DC 1.2m power cable with 1 core |

2. The above EUT information is declared by manufacturer and for more detailed features description, please refer to the manufacturer's specifications or User's Manual.

3.2 Description of Test Modes

50 channels are provided to this EUT:

| Channel | Freq. (MHz) | Channel | Freq. (MHz) |
|---------|-------------|---------|-------------|
| 0 | 902.75 | 25 | 915.25 |
| 1 | 903.25 | 26 | 915.75 |
| 2 | 903.75 | 27 | 916.25 |
| 3 | 904.25 | 28 | 916.75 |
| 4 | 904.75 | 29 | 917.25 |
| 5 | 905.25 | 30 | 917.75 |
| 6 | 905.75 | 31 | 918.25 |
| 7 | 906.25 | 32 | 918.75 |
| 8 | 906.75 | 33 | 919.25 |
| 9 | 907.25 | 34 | 919.75 |
| 10 | 907.75 | 35 | 920.25 |
| 11 | 908.25 | 36 | 920.75 |
| 12 | 908.75 | 37 | 921.25 |
| 13 | 909.25 | 38 | 921.75 |
| 14 | 909.75 | 39 | 922.25 |
| 15 | 910.25 | 40 | 922.75 |
| 16 | 910.75 | 41 | 923.25 |
| 17 | 911.25 | 42 | 923.75 |
| 18 | 911.75 | 43 | 924.25 |
| 19 | 912.25 | 44 | 924.75 |
| 20 | 912.75 | 45 | 925.25 |
| 21 | 913.25 | 46 | 925.75 |
| 22 | 913.75 | 47 | 926.25 |
| 23 | 914.25 | 48 | 926.75 |
| 24 | 914.75 | 49 | 927.25 |

3.2.1 Test Mode Applicability and Tested Channel Detail

| EUT CONFIGURE MODE | APPLICABLE TO | | | | DESCRIPTION |
|--------------------|---------------|-------|-----|------|--------------------|
| | RE \geq 1G | RE<1G | PLC | APCM | |
| A | √ | √ | - | √ | EUT + Battery mode |
| B | - | √ | √ | - | EUT + Cradle mode |

Where **RE \geq 1G**: Radiated Emission above 1GHz **RE<1G**: Radiated Emission below 1GHz
PLC: Power Line Conducted Emission **APCM**: Antenna Port Conducted Measurement

NOTE:

1. The EUT had been pre-tested on the positioned of each 3 axis. The worst case was found when positioned on **X-plane**.
2. "-" means no effect.

Radiated Emission Test (Above 1GHz):

- Pre-Scan has been conducted to determine the worst-case mode from all possible combinations between available modulations, data rates and antenna ports (if EUT with antenna diversity architecture).
- Following channel(s) was (were) selected for the final test as listed below.

| EUT CONFIGURE MODE | AVAILABLE CHANNEL | TESTED CHANNEL | MODULATION TECHNOLOGY |
|--------------------|-------------------|----------------|-----------------------|
| A | 0 to 49 | 0, 24, 49 | PSK |

Radiated Emission Test (Below 1GHz):

- Pre-Scan has been conducted to determine the worst-case mode from all possible combinations between available modulations, data rates and antenna ports (if EUT with antenna diversity architecture).
- Following channel(s) was (were) selected for the final test as listed below.

| EUT CONFIGURE MODE | AVAILABLE CHANNEL | TESTED CHANNEL | MODULATION TECHNOLOGY |
|--------------------|-------------------|----------------|-----------------------|
| A, B | 0 to 49 | 0, 24, 49 | PSK |

Power Line Conducted Emission Test:

- Pre-Scan has been conducted to determine the worst-case mode from all possible combinations between available modulations, data rates and antenna ports (if EUT with antenna diversity architecture).
- Following channel(s) was (were) selected for the final test as listed below.

| EUT CONFIGURE MODE | AVAILABLE CHANNEL | TESTED CHANNEL | MODULATION TECHNOLOGY |
|--------------------|-------------------|----------------|-----------------------|
| B | 0 to 49 | 0, 24, 49 | PSK |

Antenna Port Conducted Measurement:

- This item includes all test value of each mode, but only includes spectrum plot of worst value of each mode.
- Pre-Scan has been conducted to determine the worst-case mode from all possible combinations between available modulations, data rates and antenna ports (if EUT with antenna diversity architecture).
- Following channel(s) was (were) selected for the final test as listed below.

| EUT CONFIGURE MODE | AVAILABLE CHANNEL | TESTED CHANNEL | MODULATION TECHNOLOGY |
|--------------------|-------------------|----------------|-----------------------|
| B | 0 to 49 | 0, 24, 49 | PSK |

Test Condition:

| APPLICABLE TO | ENVIRONMENTAL CONDITIONS | INPUT POWER | TESTED BY |
|---------------|--------------------------|---|-------------------------|
| RE≥1G | 18deg. C, 70%RH | 3.7Vdc (Battery) | Nick Hsu |
| RE<1G | 18deg. C, 70%RH | 120Vac, 60Hz (System) 3.7Vdc (Battery) | Nick Hsu |
| PLC | 24deg. C, 64%RH | 120Vac, 60Hz (System) | Jones Chang, Match Tsui |
| APCM | 25deg. C, 60%RH | 3.7Vdc (Battery) | Nick Hsu |

3.3 Description of Support Units

The EUT has been tested as an independent unit together with other necessary accessories or support units. The following support units or accessories were used to form a representative test configuration during the tests.

| ID | Product | Brand | Model No. | Serial No. | FCC ID | Remarks |
|----|-----------------------|-------|--------------|------------|--------|---------------------|
| A. | Cradle | DENSO | CU-1233 | NA | NA | Provided by client. |
| B. | AC adapter for cradle | FSP | FSP050-DBAE1 | NA | NA | Provided by client. |
| C. | Battery | DENSO | BT-110L | NA | NA | Provided by client. |

Note: All power cords of the above support units are non-shielded (1.8m).

| ID | Descriptions | Qty. | Length (m) | Shielding (Yes/No) | Cores (Qty.) | Remarks |
|----|----------------|------|------------|--------------------|--------------|---------------------|
| 1. | USB cable | 1 | 1.8 | Y | 0 | - |
| 2. | RS232 cable | 1 | 1.8 | Y | 0 | - |
| 3. | AC Power cable | 1 | 1.7 | - | 0 | Provided by client. |
| 4. | DC Power cable | 1 | 1.2 | - | 1 | Provided by client. |

Note: The core(s) is(are) originally attached to the cable(s).

3.3.1 Configuration of System under Test

Test mode A

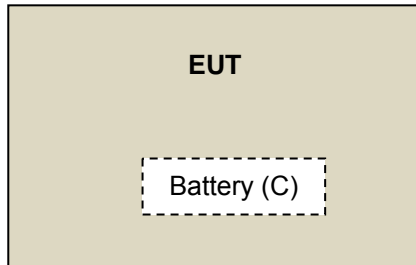

Test mode B

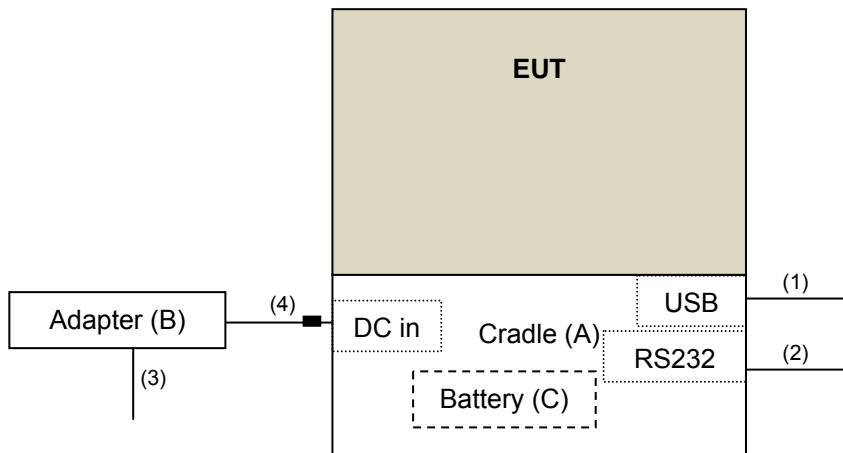

3.4 General Description of Applied Standards

The EUT is a RF Product. According to the specifications of the manufacturer, it must comply with the requirements of the following standards:

FCC Part 15, Subpart C (15.247)
ANSI C63.10-2013

All test items have been performed and recorded as per the above standards.

NOTE: The EUT has been verified to comply with the requirements of FCC Part 15, Subpart B, Class A (Verification). The test report has been issued separately.

4 Test Types and Results

4.1 Radiated Emission and Bandedge Measurement

4.1.1 Limits of Radiated Emission and Bandedge Measurement

Radiated emissions which fall in the restricted bands must comply with the radiated emission limits specified as below table. Other emissions shall be at least 20dB below the highest level of the desired power:

| Frequencies (MHz) | Field Strength (microvolts/meter) | Measurement Distance (meters) |
|-------------------|-----------------------------------|-------------------------------|
| 0.009 ~ 0.490 | 2400/F(kHz) | 300 |
| 0.490 ~ 1.705 | 24000/F(kHz) | 30 |
| 1.705 ~ 30.0 | 30 | 30 |
| 30 ~ 88 | 100 | 3 |
| 88 ~ 216 | 150 | 3 |
| 216 ~ 960 | 200 | 3 |
| Above 960 | 500 | 3 |

NOTE:

1. The lower limit shall apply at the transition frequencies.
2. Emission level (dBuV/m) = 20 log Emission level (uV/m).
3. For frequencies above 1000MHz, the field strength limits are based on average detector, however, the peak field strength of any emission shall not exceed the maximum permitted average limits, specified above by more than 20dB under any condition of modulation.



4.1.2 Test Instruments

| Description & Manufacturer | Model No. | Serial No. | Date Of Calibration | Due Date Of Calibration |
|--------------------------------------|------------------------------|----------------------|---------------------|-------------------------|
| Test Receiver ROHDE & SCHWARZ | ESIB7 | 100187 | Apr. 10, 2015 | Apr. 09, 2016 |
| Spectrum Analyzer ROHDE & SCHWARZ | FSP40 | 100041 | Aug. 29, 2014 | Aug. 28, 2015 |
| BILOG Antenna SCHWARZBECK | VULB9168 | 9168-160 | Feb. 05, 2015 | Feb. 04, 2016 |
| HORN Antenna SCHWARZBECK | 9120D | 209 | Feb. 09, 2015 | Feb. 08, 2016 |
| HORN Antenna SCHWARZBECK | BBHA 9170 | BBHA9170241 | Feb. 09, 2015 | Feb. 08, 2016 |
| Preamplifier Agilent | 8447D | 2944A10738 | Oct.18, 2014 | Oct. 17, 2015 |
| Preamplifier Agilent | 8449B | 3008A01964 | Aug. 22, 2014 | Aug. 21, 2015 |
| | | | Aug. 22, 2015 | Aug. 21, 2016 |
| RF signal cable HUBER+SUHNNER | SUCOFLEX 104 | 214378/4 | Aug. 22, 2014 | Aug. 21, 2015 |
| | | | Aug. 22, 2015 | Aug. 21, 2016 |
| RF signal cable HUBER+SUHNNER | SUCOFLEX 106 | 12738/6 +309224/4 | Aug. 22, 2014 | Aug. 21, 2015 |
| | | | Aug. 22, 2015 | Aug. 21, 2016 |
| Software BV ADT | ADT_Radiated_ V7.6.15.9.4 | NA | NA | NA |
| Antenna Tower inn-co GmbH | MA 4000 | 013303 | NA | NA |
| Antenna Tower Controller BV ADT | AT100 | AT93021702 | NA | NA |
| Turn Table BV ADT | TT100 | TT93021702 | NA | NA |
| Turn Table Controller BV ADT | SC100 | SC93021702 | NA | NA |
| High Speed Peak Power Meter | ML2495A | 0824011 | Jul. 09, 2015 | Jul. 08, 2016 |
| Power Sensor | MA2411B | 0738171 | Jul. 09, 2015 | Jul. 08, 2016 |

- NOTE:**
1. The calibration interval of the above test instruments is 12 months and the calibrations are traceable to NML/ROC and NIST/USA.
 2. The test was performed in HwaYa Chamber 4.
 3. The horn antenna and HP preamplifier (model: 8449B) are used only for the measurement of emission frequency above 1GHz if tested.
 4. The FCC Site Registration No. is 460141.
 5. The IC Site Registration No. is IC7450F-4.

4.1.3 Test Procedures

- a. The EUT was placed on the top of a rotating table 0.8 meters (for below 1GHz) / 1.5 meters (for above 1GHz) above the ground at 3 meter chamber room for test. The table was rotated 360 degrees to determine the position of the highest radiation.
- b. The EUT was set 3 meters away from the interference-receiving antenna, which was mounted on the top of a variable-height antenna tower.
- c. The height of antenna is varied from one meter to four meters above the ground to determine the maximum value of the field strength. Both horizontal and vertical polarizations of the antenna are set to make the measurement.
- d. For each suspected emission, the EUT was arranged to its worst case and then the antenna was tuned to heights from 1 meter to 4 meters and the rotatable table was turned from 0 degrees to 360 degrees to find the maximum reading.
- e. The test-receiver system was set to quasi-peak detect function and specified bandwidth with maximum hold mode when the test frequency is below 1 GHz.
- f. The test-receiver system was set to peak detect function and specified bandwidth with maximum hold mode when the test frequency is above 1 GHz.

Note:

1. The resolution bandwidth and video bandwidth of test receiver/spectrum analyzer is 120kHz for Quasi-peak detection (QP) at frequency below 1GHz.
2. The resolution bandwidth of test receiver/spectrum analyzer is 1 MHz and the video bandwidth is 3 MHz for Peak detection (PK) at frequency above 1GHz.
3. For Average measurement, due to the DH5 packet was the worse case duty cycle for a transmit dwell time on a channel, based upon bluetooth theory the transmitter is on $0.625 * 5$ per 296.25 ms per channel. Therefore, the duty cycle correlation factor be equal to: $20\log(3.125 / 100) = -30.1$ dB, therefore Average value = peak reading + $20\log(\text{duty cycle})$.
4. All modes of operation were investigated and the worst-case emissions are reported.

4.1.4 Deviation from Test Standard

No deviation.

4.1.5 Test Set Up

<Frequency Range below 1GHz>

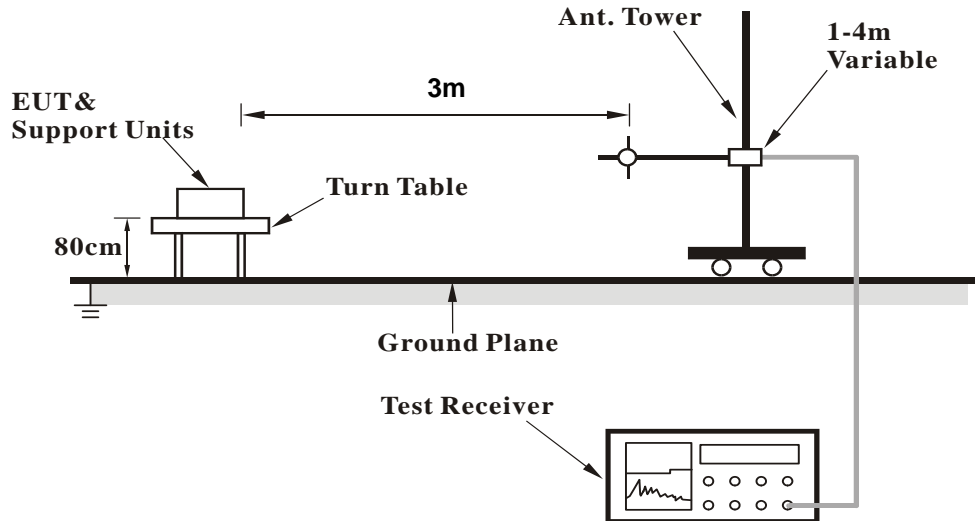

<Frequency Range above 1GHz>

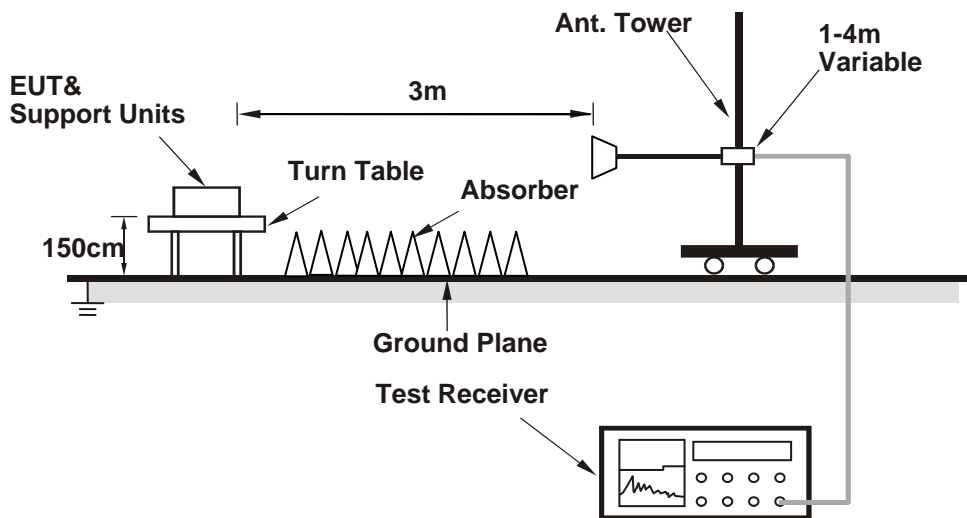

For the actual test configuration, please refer to the attached file (Test Setup Photo).

4.1.6 EUT Operating Conditions

Set the EUT under transmission condition continuously at specific channel frequency.

4.1.7 Test Results
ABOVE 1GHz DATA :

| | | | |
|-----------------|--------------|----------------------|---------------------------|
| CHANNEL | TX Channel 0 | DETECTOR FUNCTION | Peak (PK) Average (AV) |
| FREQUENCY RANGE | 1GHz ~ 25GHz | | |

| ANTENNA POLARITY & TEST DISTANCE: HORIZONTAL AT 3 M | | | | | | | | |
|---|----------------|-------------------------------|-------------------|----------------|--------------------------|----------------------------|------------------------|--------------------------------|
| NO. | FREQ. (MHz) | EMISSION LEVEL (dBuV/m) | LIMIT (dBuV/m) | MARGIN (dB) | ANTENNA HEIGHT (m) | TABLE ANGLE (Degree) | RAW VALUE (dBuV) | CORRECTION FACTOR (dB/m) |
| 1 | #902.00 | 66.2 PK | 102.5 | -36.3 | 1.46 H | 35 | 38.50 | 27.70 |
| 2 | #902.00 | 56.5 AV | 99.3 | -42.8 | 1.46 H | 35 | 28.80 | 27.70 |
| 3 | *902.75 | 122.5 PK | | | 1.53 H | 1 | 94.80 | 27.70 |
| 4 | *902.75 | 119.3 AV | | | 1.53 H | 1 | 91.60 | 27.70 |
| 5 | 2708.25 | 49.1 PK | 74.0 | -24.9 | 1.15 H | 184 | 50.30 | -1.20 |
| 6 | 2708.25 | 48.2 AV | 54.0 | -5.8 | 1.15 H | 184 | 49.40 | -1.20 |
| 7 | 3611.00 | 50.0 PK | 74.0 | -24.0 | 1.00 H | 285 | 49.00 | 1.00 |
| 8 | 3611.00 | 47.4 AV | 54.0 | -6.6 | 1.00 H | 285 | 46.40 | 1.00 |

| ANTENNA POLARITY & TEST DISTANCE: VERTICAL AT 3 M | | | | | | | | |
|---|----------------|-------------------------------|-------------------|----------------|--------------------------|----------------------------|------------------------|--------------------------------|
| NO. | FREQ. (MHz) | EMISSION LEVEL (dBuV/m) | LIMIT (dBuV/m) | MARGIN (dB) | ANTENNA HEIGHT (m) | TABLE ANGLE (Degree) | RAW VALUE (dBuV) | CORRECTION FACTOR (dB/m) |
| 1 | #902.00 | 65.1 PK | 103.7 | -38.6 | 1.13 V | 5 | 37.40 | 27.70 |
| 2 | #902.00 | 56.1 AV | 100.2 | -44.1 | 1.13 V | 5 | 28.40 | 27.70 |
| 3 | *902.75 | 123.7 PK | | | 1.20 V | 7 | 96.00 | 27.70 |
| 4 | *902.75 | 120.2 AV | | | 1.20 V | 7 | 92.50 | 27.70 |
| 5 | 2708.25 | 49.1 PK | 74.0 | -24.9 | 1.00 V | 216 | 50.30 | -1.20 |
| 6 | 2708.25 | 47.7 AV | 54.0 | -6.3 | 1.00 V | 216 | 48.90 | -1.20 |
| 7 | 3611.00 | 49.6 PK | 74.0 | -24.4 | 1.32 V | 215 | 48.60 | 1.00 |
| 8 | 3611.00 | 47.2 AV | 54.0 | -6.8 | 1.32 V | 215 | 46.20 | 1.00 |

REMARKS:

1. Emission Level(dBuV/m) = Raw Value(dBuV) + Correction Factor(dB/m)
2. Correction Factor(dB/m) = Antenna Factor(dB/m) + Cable Factor(dB)
– Pre-Amplifier Factor (dB)
3. The other emission levels were very low against the limit.
4. Margin value = Emission Level – Limit value
5. " * ": Fundamental frequency.
6. " # ": The radiated frequency is out of the restricted band.

| | | | |
|-----------------|---------------|----------------------|---------------------------|
| CHANNEL | TX Channel 24 | DETECTOR FUNCTION | Peak (PK) Average (AV) |
| FREQUENCY RANGE | 1GHz ~ 25GHz | | |

| ANTENNA POLARITY & TEST DISTANCE: HORIZONTAL AT 3 M | | | | | | | | |
|---|----------------|-------------------------------|-------------------|----------------|--------------------------|----------------------------|------------------------|--------------------------------|
| NO. | FREQ. (MHz) | EMISSION LEVEL (dBuV/m) | LIMIT (dBuV/m) | MARGIN (dB) | ANTENNA HEIGHT (m) | TABLE ANGLE (Degree) | RAW VALUE (dBuV) | CORRECTION FACTOR (dB/m) |
| 1 | *914.75 | 123.8 PK | | | 1.57 H | 7 | 95.80 | 28.00 |
| 2 | *914.75 | 120.0 AV | | | 1.57 H | 7 | 92.00 | 28.00 |
| 3 | 2744.25 | 48.7 PK | 74.0 | -25.3 | 1.08 H | 237 | 49.80 | -1.10 |
| 4 | 2744.25 | 46.0 AV | 54.0 | -8.0 | 1.08 H | 237 | 47.10 | -1.10 |
| 5 | 3659.00 | 52.9 PK | 74.0 | -21.1 | 1.00 H | 289 | 51.60 | 1.30 |
| 6 | 3659.00 | 50.2 AV | 54.0 | -3.8 | 1.00 H | 289 | 48.90 | 1.30 |
| ANTENNA POLARITY & TEST DISTANCE: VERTICAL AT 3 M | | | | | | | | |
| NO. | FREQ. (MHz) | EMISSION LEVEL (dBuV/m) | LIMIT (dBuV/m) | MARGIN (dB) | ANTENNA HEIGHT (m) | TABLE ANGLE (Degree) | RAW VALUE (dBuV) | CORRECTION FACTOR (dB/m) |
| 1 | *914.75 | 124.2 PK | | | 1.16 V | 9 | 96.20 | 28.00 |
| 2 | *914.75 | 121.0 AV | | | 1.16 V | 9 | 93.00 | 28.00 |
| 3 | 2744.25 | 48.1 PK | 74.0 | -25.9 | 1.00 V | 200 | 49.20 | -1.10 |
| 4 | 2744.25 | 46.8 AV | 54.0 | -7.2 | 1.00 V | 200 | 47.90 | -1.10 |
| 5 | 3659.00 | 50.2 PK | 74.0 | -23.8 | 1.00 V | 216 | 48.90 | 1.30 |
| 6 | 3659.00 | 47.7 AV | 54.0 | -6.3 | 1.00 V | 216 | 46.40 | 1.30 |

REMARKS:

1. Emission Level(dBuV/m) = Raw Value(dBuV) + Correction Factor(dB/m)
2. Correction Factor(dB/m) = Antenna Factor(dB/m) + Cable Factor(dB)
– Pre-Amplifier Factor (dB)
3. The other emission levels were very low against the limit.
4. Margin value = Emission Level – Limit value
5. " * ": Fundamental frequency.
6. " # ": The radiated frequency is out of the restricted band.

| | | | |
|-----------------|---------------|----------------------|---------------------------|
| CHANNEL | TX Channel 49 | DETECTOR FUNCTION | Peak (PK) Average (AV) |
| FREQUENCY RANGE | 1GHz ~ 25GHz | | |

| ANTENNA POLARITY & TEST DISTANCE: HORIZONTAL AT 3 M | | | | | | | | |
|---|----------------|-------------------------------|-------------------|----------------|--------------------------|----------------------------|------------------------|--------------------------------|
| NO. | FREQ. (MHz) | EMISSION LEVEL (dBuV/m) | LIMIT (dBuV/m) | MARGIN (dB) | ANTENNA HEIGHT (m) | TABLE ANGLE (Degree) | RAW VALUE (dBuV) | CORRECTION FACTOR (dB/m) |
| 1 | *927.25 | 122.7 PK | | | 1.51 H | 2 | 94.50 | 28.20 |
| 2 | *927.25 | 119.4 AV | | | 1.51 H | 2 | 91.20 | 28.20 |
| 3 | #928.00 | 63.7 PK | 102.7 | -39.0 | 1.10 H | 11 | 35.50 | 28.20 |
| 4 | #928.00 | 55.4 AV | 99.4 | -44.0 | 1.10 H | 11 | 27.20 | 28.20 |
| 5 | 2781.75 | 44.3 PK | 74.0 | -29.7 | 1.10 H | 178 | 45.30 | -1.00 |
| 6 | 2781.75 | 34.7 AV | 54.0 | -19.3 | 1.10 H | 178 | 35.70 | -1.00 |
| 7 | 3709.00 | 50.7 PK | 74.0 | -23.3 | 1.00 H | 287 | 49.20 | 1.50 |
| 8 | 3709.00 | 46.4 AV | 54.0 | -7.6 | 1.00 H | 287 | 44.90 | 1.50 |

| ANTENNA POLARITY & TEST DISTANCE: VERTICAL AT 3 M | | | | | | | | |
|---|----------------|-------------------------------|-------------------|----------------|--------------------------|----------------------------|------------------------|--------------------------------|
| NO. | FREQ. (MHz) | EMISSION LEVEL (dBuV/m) | LIMIT (dBuV/m) | MARGIN (dB) | ANTENNA HEIGHT (m) | TABLE ANGLE (Degree) | RAW VALUE (dBuV) | CORRECTION FACTOR (dB/m) |
| 1 | *927.25 | 124.1 PK | | | 1.18 V | 352 | 95.90 | 28.20 |
| 2 | *927.25 | 120.6 AV | | | 1.18 V | 352 | 92.40 | 28.20 |
| 3 | #928.00 | 67.2 PK | 104.1 | -36.9 | 1.21 V | 3 | 39.00 | 28.20 |
| 4 | #928.00 | 57.0 AV | 100.6 | -43.6 | 1.21 V | 3 | 28.80 | 28.20 |
| 5 | 2781.75 | 47.0 PK | 74.0 | -27.0 | 1.02 V | 200 | 48.00 | -1.00 |
| 6 | 2781.75 | 43.3 AV | 54.0 | -10.7 | 1.02 V | 200 | 44.30 | -1.00 |
| 7 | 3709.00 | 49.6 PK | 74.0 | -24.4 | 1.05 V | 173 | 48.10 | 1.50 |
| 8 | 3709.00 | 45.9 AV | 54.0 | -8.1 | 1.05 V | 173 | 44.40 | 1.50 |

REMARKS:

1. Emission Level(dBuV/m) = Raw Value(dBuV) + Correction Factor(dB/m)
2. Correction Factor(dB/m) = Antenna Factor(dB/m) + Cable Factor(dB)
– Pre-Amplifier Factor (dB)
3. The other emission levels were very low against the limit.
4. Margin value = Emission Level – Limit value
5. " * ": Fundamental frequency.
6. " # ": The radiated frequency is out of the restricted band.



A D T

BELOW 1GHz WORST-CASE DATA:

| | | | |
|-----------------|--------------|-------------------|-----------------|
| CHANNEL | TX Channel 0 | DETECTOR FUNCTION | Quasi-Peak (QP) |
| FREQUENCY RANGE | 30MHz ~ 1GHz | TEST MODE | A |

| ANTENNA POLARITY & TEST DISTANCE: HORIZONTAL AT 3 M | | | | | | | | |
|---|-------------|-------------------------|----------------|-------------|--------------------|----------------------|------------------|--------------------------|
| NO. | FREQ. (MHz) | EMISSION LEVEL (dBuV/m) | LIMIT (dBuV/m) | MARGIN (dB) | ANTENNA HEIGHT (m) | TABLE ANGLE (Degree) | RAW VALUE (dBuV) | CORRECTION FACTOR (dB/m) |
| 1 | 189.33 | 31.0 QP | 43.5 | -12.5 | 1.50 H | 59 | 47.00 | -16.00 |
| 2 | 276.82 | 34.3 QP | 46.0 | -11.7 | 1.01 H | 112 | 47.30 | -13.00 |
| 3 | 348.76 | 32.9 QP | 46.0 | -13.1 | 1.01 H | 271 | 44.50 | -11.60 |
| 4 | 444.03 | 36.7 QP | 46.0 | -9.3 | 2.00 H | 41 | 46.10 | -9.40 |
| 5 | 469.31 | 38.5 QP | 46.0 | -7.5 | 2.00 H | 47 | 47.40 | -8.90 |
| 6 | 817.34 | 33.2 QP | 46.0 | -12.8 | 1.01 H | 203 | 35.10 | -1.90 |

| ANTENNA POLARITY & TEST DISTANCE: VERTICAL AT 3 M | | | | | | | | |
|---|--------------|-------------------------|----------------|-------------|--------------------|----------------------|------------------|--------------------------|
| NO. | FREQ. (MHz) | EMISSION LEVEL (dBuV/m) | LIMIT (dBuV/m) | MARGIN (dB) | ANTENNA HEIGHT (m) | TABLE ANGLE (Degree) | RAW VALUE (dBuV) | CORRECTION FACTOR (dB/m) |
| 1 | 45.45 | 37.3 QP | 40.0 | -2.7 | 1.49 V | 9 | 52.10 | -14.80 |
| 2 | 195.16 | 24.4 QP | 43.5 | -19.1 | 1.00 V | 331 | 40.90 | -16.50 |
| 3 | 276.82 | 26.1 QP | 46.0 | -19.9 | 1.00 V | 195 | 39.10 | -13.00 |
| 4 | 348.76 | 25.0 QP | 46.0 | -21.0 | 1.00 V | 141 | 36.60 | -11.60 |
| 5 | 469.31 | 30.5 QP | 46.0 | -15.5 | 1.99 V | 177 | 39.40 | -8.90 |
| 6 | 930.11 | 35.3 QP | 46.0 | -10.7 | 1.49 V | 9 | 35.20 | 0.10 |

REMARKS:

1. Emission Level(dBuV/m) = Raw Value(dBuV) + Correction Factor(dB/m)
2. Correction Factor(dB/m) = Antenna Factor(dB/m) + Cable Factor(dB) – Pre-Amplifier Factor (dB)
3. The other emission levels were very low against the limit.
4. Margin value = Emission Level – Limit value

| | | | |
|-----------------|---------------|-------------------|-----------------|
| CHANNEL | TX Channel 24 | DETECTOR FUNCTION | Quasi-Peak (QP) |
| FREQUENCY RANGE | 30MHz ~ 1GHz | TEST MODE | A |

| ANTENNA POLARITY & TEST DISTANCE: HORIZONTAL AT 3 M | | | | | | | | |
|---|-------------|-------------------------|----------------|-------------|--------------------|----------------------|------------------|--------------------------|
| NO. | FREQ. (MHz) | EMISSION LEVEL (dBuV/m) | LIMIT (dBuV/m) | MARGIN (dB) | ANTENNA HEIGHT (m) | TABLE ANGLE (Degree) | RAW VALUE (dBuV) | CORRECTION FACTOR (dB/m) |
| 1 | 189.33 | 30.5 QP | 43.5 | -13.0 | 1.49 H | 64 | 46.50 | -16.00 |
| 2 | 276.82 | 34.8 QP | 46.0 | -11.2 | 1.00 H | 88 | 47.80 | -13.00 |
| 3 | 372.09 | 33.4 QP | 46.0 | -12.6 | 1.00 H | 35 | 44.40 | -11.00 |
| 4 | 444.03 | 36.5 QP | 46.0 | -9.5 | 1.99 H | 43 | 45.90 | -9.40 |
| 5 | 469.31 | 37.6 QP | 46.0 | -8.4 | 1.99 H | 43 | 46.50 | -8.90 |
| 6 | 897.05 | 36.5 QP | 46.0 | -9.5 | 1.49 H | 337 | 37.20 | -0.70 |
| ANTENNA POLARITY & TEST DISTANCE: VERTICAL AT 3 M | | | | | | | | |
| NO. | FREQ. (MHz) | EMISSION LEVEL (dBuV/m) | LIMIT (dBuV/m) | MARGIN (dB) | ANTENNA HEIGHT (m) | TABLE ANGLE (Degree) | RAW VALUE (dBuV) | CORRECTION FACTOR (dB/m) |
| 1 | 47.40 | 36.4 QP | 40.0 | -3.6 | 1.01 V | 14 | 51.00 | -14.60 |
| 2 | 59.06 | 31.1 QP | 40.0 | -8.9 | 1.01 V | 15 | 45.90 | -14.80 |
| 3 | 191.28 | 23.7 QP | 43.5 | -19.8 | 1.01 V | 148 | 39.90 | -16.20 |
| 4 | 276.82 | 26.1 QP | 46.0 | -19.9 | 1.01 V | 191 | 39.10 | -13.00 |
| 5 | 372.09 | 26.0 QP | 46.0 | -20.0 | 1.01 V | 165 | 37.00 | -11.00 |
| 6 | 469.31 | 30.4 QP | 46.0 | -15.6 | 2.00 V | 171 | 39.30 | -8.90 |

REMARKS:

1. Emission Level(dBuV/m) = Raw Value(dBuV) + Correction Factor(dB/m)
2. Correction Factor(dB/m) = Antenna Factor(dB/m) + Cable Factor(dB)
– Pre-Amplifier Factor (dB)
3. The other emission levels were very low against the limit.
4. Margin value = Emission Level – Limit value

| | | | |
|-----------------|---------------|-------------------|-----------------|
| CHANNEL | TX Channel 49 | DETECTOR FUNCTION | Quasi-Peak (QP) |
| FREQUENCY RANGE | 30MHz ~ 1GHz | TEST MODE | A |

| ANTENNA POLARITY & TEST DISTANCE: HORIZONTAL AT 3 M | | | | | | | | |
|---|-------------|-------------------------|----------------|-------------|--------------------|----------------------|------------------|--------------------------|
| NO. | FREQ. (MHz) | EMISSION LEVEL (dBuV/m) | LIMIT (dBuV/m) | MARGIN (dB) | ANTENNA HEIGHT (m) | TABLE ANGLE (Degree) | RAW VALUE (dBuV) | CORRECTION FACTOR (dB/m) |
| 1 | 45.45 | 26.7 QP | 40.0 | -13.3 | 1.51 H | 110 | 41.50 | -14.80 |
| 2 | 189.33 | 29.9 QP | 43.5 | -13.6 | 1.51 H | 66 | 45.90 | -16.00 |
| 3 | 276.82 | 34.4 QP | 46.0 | -11.6 | 1.01 H | 105 | 47.40 | -13.00 |
| 4 | 372.09 | 34.1 QP | 46.0 | -11.9 | 1.01 H | 37 | 45.10 | -11.00 |
| 5 | 469.31 | 37.5 QP | 46.0 | -8.5 | 2.00 H | 40 | 46.40 | -8.90 |
| 6 | 900.94 | 37.6 QP | 46.0 | -8.4 | 1.51 H | 14 | 38.20 | -0.60 |
| ANTENNA POLARITY & TEST DISTANCE: VERTICAL AT 3 M | | | | | | | | |
| NO. | FREQ. (MHz) | EMISSION LEVEL (dBuV/m) | LIMIT (dBuV/m) | MARGIN (dB) | ANTENNA HEIGHT (m) | TABLE ANGLE (Degree) | RAW VALUE (dBuV) | CORRECTION FACTOR (dB/m) |
| 1 | 47.40 | 36.6 QP | 40.0 | -3.4 | 1.50 V | 316 | 51.20 | -14.60 |
| 2 | 61.01 | 31.1 QP | 40.0 | -8.9 | 1.50 V | 8 | 46.30 | -15.20 |
| 3 | 195.16 | 23.1 QP | 43.5 | -20.4 | 1.00 V | 133 | 39.60 | -16.50 |
| 4 | 469.31 | 30.3 QP | 46.0 | -15.7 | 1.99 V | 173 | 39.20 | -8.90 |
| 5 | 729.84 | 28.3 QP | 46.0 | -17.7 | 1.00 V | 243 | 31.90 | -3.60 |
| 6 | 897.05 | 33.2 QP | 46.0 | -12.8 | 1.00 V | 10 | 33.90 | -0.70 |

REMARKS:

1. Emission Level(dBuV/m) = Raw Value(dBuV) + Correction Factor(dB/m)
2. Correction Factor(dB/m) = Antenna Factor(dB/m) + Cable Factor(dB)
– Pre-Amplifier Factor (dB)
3. The other emission levels were very low against the limit.
4. Margin value = Emission Level – Limit value

| | | | |
|-----------------|--------------|-------------------|-----------------|
| CHANNEL | TX Channel 0 | DETECTOR FUNCTION | Quasi-Peak (QP) |
| FREQUENCY RANGE | 30MHz ~ 1GHz | TEST MODE | B |

| ANTENNA POLARITY & TEST DISTANCE: HORIZONTAL AT 3 M | | | | | | | | |
|---|-------------|-------------------------|----------------|-------------|--------------------|----------------------|------------------|--------------------------|
| NO. | FREQ. (MHz) | EMISSION LEVEL (dBuV/m) | LIMIT (dBuV/m) | MARGIN (dB) | ANTENNA HEIGHT (m) | TABLE ANGLE (Degree) | RAW VALUE (dBuV) | CORRECTION FACTOR (dB/m) |
| 1 | 148.50 | 30.2 QP | 43.5 | -13.3 | 1.00 H | 116 | 44.20 | -14.00 |
| 2 | 189.33 | 34.6 QP | 43.5 | -8.9 | 1.50 H | 259 | 50.60 | -16.00 |
| 3 | 251.55 | 32.2 QP | 46.0 | -13.8 | 1.00 H | 258 | 46.50 | -14.30 |
| 4 | 348.76 | 32.2 QP | 46.0 | -13.8 | 1.00 H | 196 | 43.80 | -11.60 |
| 5 | 469.31 | 33.7 QP | 46.0 | -12.3 | 1.99 H | 50 | 42.60 | -8.90 |
| 6 | 673.46 | 33.6 QP | 46.0 | -12.4 | 1.00 H | 279 | 38.50 | -4.90 |
| ANTENNA POLARITY & TEST DISTANCE: VERTICAL AT 3 M | | | | | | | | |
| NO. | FREQ. (MHz) | EMISSION LEVEL (dBuV/m) | LIMIT (dBuV/m) | MARGIN (dB) | ANTENNA HEIGHT (m) | TABLE ANGLE (Degree) | RAW VALUE (dBuV) | CORRECTION FACTOR (dB/m) |
| 1 | 148.50 | 31.0 QP | 43.5 | -12.5 | 1.01 V | 257 | 45.00 | -14.00 |
| 2 | 195.16 | 28.9 QP | 43.5 | -14.6 | 1.50 V | 6 | 45.40 | -16.50 |
| 3 | 348.76 | 37.4 QP | 46.0 | -8.6 | 1.50 V | 270 | 49.00 | -11.60 |
| 4 | 372.09 | 35.7 QP | 46.0 | -10.3 | 1.50 V | 293 | 46.70 | -11.00 |
| 5 | 444.03 | 37.3 QP | 46.0 | -8.7 | 1.01 V | 248 | 46.70 | -9.40 |
| 6 | 469.31 | 37.3 QP | 46.0 | -8.7 | 1.01 V | 248 | 46.20 | -8.90 |

REMARKS:

1. Emission Level(dBuV/m) = Raw Value(dBuV) + Correction Factor(dB/m)
2. Correction Factor(dB/m) = Antenna Factor(dB/m) + Cable Factor(dB)
– Pre-Amplifier Factor (dB)
3. The other emission levels were very low against the limit.
4. Margin value = Emission Level – Limit value



| | | | |
|-----------------|---------------|-------------------|-----------------|
| CHANNEL | TX Channel 24 | DETECTOR FUNCTION | Quasi-Peak (QP) |
| FREQUENCY RANGE | 30MHz ~ 1GHz | TEST MODE | B |

| ANTENNA POLARITY & TEST DISTANCE: HORIZONTAL AT 3 M | | | | | | | | |
|---|-------------|-------------------------|----------------|-------------|--------------------|----------------------|------------------|--------------------------|
| NO. | FREQ. (MHz) | EMISSION LEVEL (dBuV/m) | LIMIT (dBuV/m) | MARGIN (dB) | ANTENNA HEIGHT (m) | TABLE ANGLE (Degree) | RAW VALUE (dBuV) | CORRECTION FACTOR (dB/m) |
| 1 | 167.94 | 28.7 QP | 43.5 | -14.8 | 1.50 H | 76 | 43.00 | -14.30 |
| 2 | 189.33 | 33.3 QP | 43.5 | -10.2 | 2.00 H | 268 | 49.30 | -16.00 |
| 3 | 251.55 | 31.1 QP | 46.0 | -14.9 | 1.01 H | 250 | 45.40 | -14.30 |
| 4 | 348.76 | 30.4 QP | 46.0 | -15.6 | 1.01 H | 201 | 42.00 | -11.60 |
| 5 | 469.31 | 30.7 QP | 46.0 | -15.3 | 1.50 H | 48 | 39.60 | -8.90 |
| 6 | 648.18 | 31.1 QP | 46.0 | -14.9 | 1.01 H | 261 | 36.30 | -5.20 |
| ANTENNA POLARITY & TEST DISTANCE: VERTICAL AT 3 M | | | | | | | | |
| NO. | FREQ. (MHz) | EMISSION LEVEL (dBuV/m) | LIMIT (dBuV/m) | MARGIN (dB) | ANTENNA HEIGHT (m) | TABLE ANGLE (Degree) | RAW VALUE (dBuV) | CORRECTION FACTOR (dB/m) |
| 1 | 142.67 | 30.3 QP | 43.5 | -13.2 | 1.00 V | 272 | 44.70 | -14.40 |
| 2 | 195.16 | 29.2 QP | 43.5 | -14.3 | 1.49 V | 15 | 45.70 | -16.50 |
| 3 | 348.76 | 37.0 QP | 46.0 | -9.0 | 1.49 V | 265 | 48.60 | -11.60 |
| 4 | 372.09 | 35.7 QP | 46.0 | -10.3 | 1.49 V | 268 | 46.70 | -11.00 |
| 5 | 444.03 | 36.6 QP | 46.0 | -9.4 | 1.00 V | 243 | 46.00 | -9.40 |
| 6 | 469.31 | 36.8 QP | 46.0 | -9.2 | 1.00 V | 238 | 45.70 | -8.90 |

REMARKS:

1. Emission Level(dBuV/m) = Raw Value(dBuV) + Correction Factor(dB/m)
2. Correction Factor(dB/m) = Antenna Factor(dB/m) + Cable Factor(dB)
– Pre-Amplifier Factor (dB)
3. The other emission levels were very low against the limit.
4. Margin value = Emission Level – Limit value

| | | | |
|-----------------|---------------|-------------------|-----------------|
| CHANNEL | TX Channel 49 | DETECTOR FUNCTION | Quasi-Peak (QP) |
| FREQUENCY RANGE | 30MHz ~ 1GHz | TEST MODE | B |

ANTENNA POLARITY & TEST DISTANCE: HORIZONTAL AT 3 M

| NO. | FREQ. (MHz) | EMISSION LEVEL (dBuV/m) | LIMIT (dBuV/m) | MARGIN (dB) | ANTENNA HEIGHT (m) | TABLE ANGLE (Degree) | RAW VALUE (dBuV) | CORRECTION FACTOR (dB/m) |
|-----|-------------|-------------------------|----------------|-------------|--------------------|----------------------|------------------|--------------------------|
| 1 | 189.33 | 32.4 QP | 43.5 | -11.1 | 1.50 H | 273 | 48.40 | -16.00 |
| 2 | 251.55 | 30.7 QP | 46.0 | -15.3 | 1.00 H | 234 | 45.00 | -14.30 |
| 3 | 348.76 | 31.0 QP | 46.0 | -15.0 | 1.00 H | 208 | 42.60 | -11.60 |
| 4 | 444.03 | 30.6 QP | 46.0 | -15.4 | 2.00 H | 58 | 40.00 | -9.40 |
| 5 | 648.18 | 30.1 QP | 46.0 | -15.9 | 1.00 H | 270 | 35.30 | -5.20 |
| 6 | 768.73 | 32.4 QP | 46.0 | -13.6 | 1.50 H | 285 | 35.20 | -2.80 |

ANTENNA POLARITY & TEST DISTANCE: VERTICAL AT 3 M

| NO. | FREQ. (MHz) | EMISSION LEVEL (dBuV/m) | LIMIT (dBuV/m) | MARGIN (dB) | ANTENNA HEIGHT (m) | TABLE ANGLE (Degree) | RAW VALUE (dBuV) | CORRECTION FACTOR (dB/m) |
|-----|-------------|-------------------------|----------------|-------------|--------------------|----------------------|------------------|--------------------------|
| 1 | 148.50 | 30.8 QP | 43.5 | -12.7 | 1.01 V | 284 | 44.80 | -14.00 |
| 2 | 276.82 | 30.3 QP | 46.0 | -15.7 | 1.50 V | 16 | 43.30 | -13.00 |
| 3 | 348.76 | 36.7 QP | 46.0 | -9.3 | 1.50 V | 79 | 48.30 | -11.60 |
| 4 | 372.09 | 35.1 QP | 46.0 | -10.9 | 1.50 V | 122 | 46.10 | -11.00 |
| 5 | 444.03 | 35.7 QP | 46.0 | -10.3 | 1.01 V | 236 | 45.10 | -9.40 |
| 6 | 469.31 | 35.6 QP | 46.0 | -10.4 | 1.01 V | 234 | 44.50 | -8.90 |

REMARKS:

1. Emission Level(dBuV/m) = Raw Value(dBuV) + Correction Factor(dB/m)
2. Correction Factor(dB/m) = Antenna Factor(dB/m) + Cable Factor(dB)
– Pre-Amplifier Factor (dB)
3. The other emission levels were very low against the limit.
4. Margin value = Emission Level – Limit value

4.2 Conducted Emission Measurement

4.2.1 Limits of Conducted Emission Measurement

| Frequency (MHz) | Conducted Limit (dBuV) | |
|-----------------|------------------------|---------|
| | Quasi-peak | Average |
| 0.15 - 0.5 | 66 - 56 | 56 - 46 |
| 0.50 - 5.0 | 56 | 46 |
| 5.0 - 30.0 | 60 | 50 |

Note: 1. The lower limit shall apply at the transition frequencies.

2. The limit decreases in line with the logarithm of the frequency in the range of 0.15 to 0.50MHz.

4.2.2 Test Instruments

| Description & Manufacturer | Model No. | Serial No. | Date Of Calibration | Due Date Of Calibration |
|---|--------------------------|----------------|---------------------|-------------------------|
| Test Receiver ROHDE & SCHWARZ | ESCI | 100613 | Nov. 11, 2014 | Nov. 10, 2015 |
| RF signal cable Woken | 5D-FB | Cable-HYC01-01 | Dec. 26, 2014 | Dec. 25, 2015 |
| LISN ROHDE & SCHWARZ (EUT) | ESH3-Z5 | 835239/001 | Feb. 26, 2015 | Feb. 25, 2016 |
| LISN ROHDE & SCHWARZ (Peripheral) | ESH3-Z5 | 100311 | Jul. 24, 2015 | Jul. 23, 2016 |
| Software ADT | BV ADT_Cond_ V7.3.7.3 | NA | NA | NA |

NOTE: 1. The calibration interval of the above test instruments is 12 months and the calibrations are traceable to NML/ROC and NIST/USA.

2. The test was performed in HwaYa Shielded Room 1.

3. The VCCI Site Registration No. is C-2040.

4.2.3 Test Procedures

- a. The EUT was placed 0.4 meters from the conducting wall of the shielded room with EUT being connected to the power mains through a line impedance stabilization network (LISN). Other support units were connected to the power mains through another LISN. The two LISNs provide 50 ohm/ 50uH of coupling impedance for the measuring instrument.
- b. Both lines of the power mains connected to the EUT were checked for maximum conducted interference.
- c. The frequency range from 150kHz to 30MHz was searched. Emission levels under (Limit - 20dB) was not recorded.

NOTE: The resolution bandwidth and video bandwidth of test receiver is 9kHz for quasi-peak detection (QP) and average detection (AV) at frequency 0.15MHz-30MHz.

4.2.4 Deviation From Test Standard

No deviation.

4.2.5 Test Setup

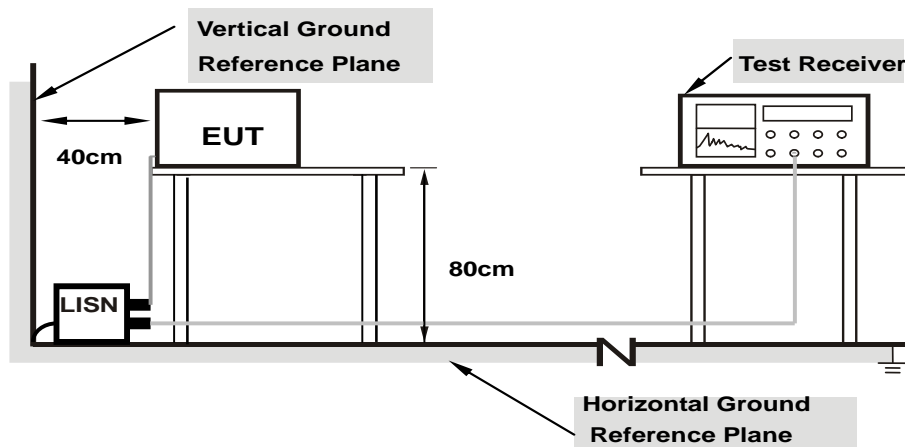

- Note:**
1. Support units were connected to second LISN.
 2. Both of LISNs (AMN) are 80 cm from EUT and at least 80 from other units and other metal planes

For the actual test configuration, please refer to the attached file (Test Setup Photo).

4.2.6 EUT Operating Condition

Same as 4.1.6.

4.2.7 Test Results

| | | | |
|---------|--------------|-------------------|--------------------------------|
| Phase | Line (L) | Detector Function | Quasi-Peak (QP) / Average (AV) |
| Channel | TX Channel 0 | | |

| No | Freq. [MHz] | Corr. Factor (dB) | Reading Value | | Emission Level | | Limit | | Margin | |
|----|----------------|-------------------------|---------------|-------|----------------|-------|-----------|-------|--------|--------|
| | | | [dB (uV)] | | [dB (uV)] | | [dB (uV)] | | (dB) | |
| | | | Q.P. | AV. | Q.P. | AV. | Q.P. | AV. | Q.P. | AV. |
| 1 | 0.17474 | 0.05 | 40.05 | 25.54 | 40.10 | 25.59 | 64.73 | 54.73 | -24.63 | -29.14 |
| 2 | 0.44552 | 0.06 | 43.28 | 36.57 | 43.34 | 36.63 | 56.96 | 46.96 | -13.62 | -10.33 |
| 3 | 0.48759 | 0.06 | 42.25 | 35.57 | 42.31 | 35.63 | 56.21 | 46.21 | -13.90 | -10.58 |
| 4 | 0.86238 | 0.08 | 33.89 | 25.61 | 33.97 | 25.69 | 56.00 | 46.00 | -22.03 | -20.31 |
| 5 | 1.06596 | 0.08 | 35.28 | 24.24 | 35.36 | 24.32 | 56.00 | 46.00 | -20.64 | -21.68 |
| 6 | 16.11147 | 0.73 | 34.69 | 28.74 | 35.42 | 29.47 | 60.00 | 50.00 | -24.58 | -20.53 |

REMARKS:

1. Q.P. and AV. are abbreviations of quasi-peak and average individually.
2. The emission levels of other frequencies were very low against the limit.
3. Margin value = Emission level - Limit value
4. Correction factor = Insertion loss + Cable loss
5. Emission Level = Correction Factor + Reading Value.

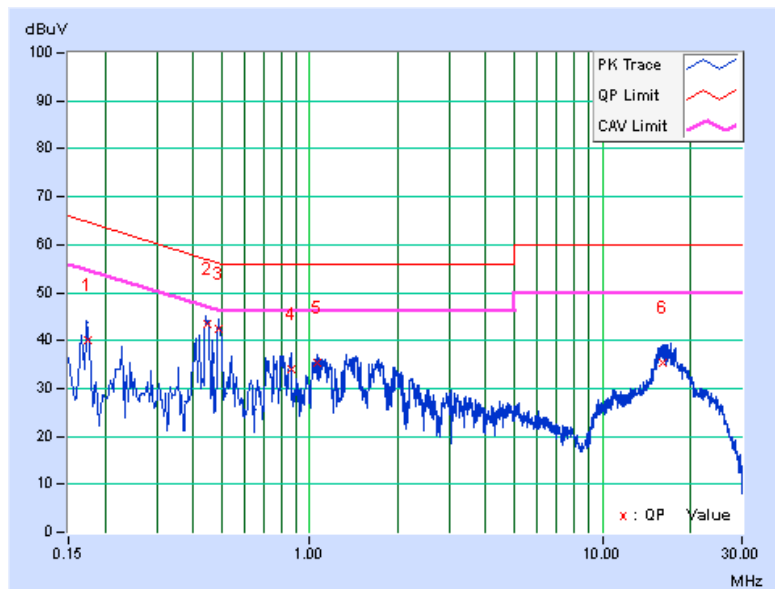

| | | | |
|---------|--------------|-------------------|--------------------------------|
| Phase | Neutral (N) | Detector Function | Quasi-Peak (QP) / Average (AV) |
| Channel | TX Channel 0 | | |

| No | Freq. [MHz] | Corr. Factor (dB) | Reading Value | | Emission Level | | Limit | | Margin | |
|----|----------------|-------------------------|---------------|-------|----------------|-------|-----------|-------|--------|--------|
| | | | [dB (uV)] | | [dB (uV)] | | [dB (uV)] | | (dB) | |
| | | | Q.P. | AV. | Q.P. | AV. | Q.P. | AV. | Q.P. | AV. |
| 1 | 0.18129 | 0.05 | 41.57 | 33.25 | 41.62 | 33.30 | 64.43 | 54.43 | -22.81 | -21.13 |
| 2 | 0.45285 | 0.06 | 43.38 | 38.51 | 43.44 | 38.57 | 56.82 | 46.82 | -13.38 | -8.25 |
| 3 | 0.50266 | 0.06 | 40.87 | 32.42 | 40.93 | 32.48 | 56.00 | 46.00 | -15.07 | -13.52 |
| 4 | 0.75308 | 0.07 | 35.47 | 29.29 | 35.54 | 29.36 | 56.00 | 46.00 | -20.46 | -16.64 |
| 5 | 1.07357 | 0.08 | 37.08 | 28.69 | 37.16 | 28.77 | 56.00 | 46.00 | -18.84 | -17.23 |
| 6 | 15.77358 | 0.60 | 33.45 | 27.06 | 34.05 | 27.66 | 60.00 | 50.00 | -25.95 | -22.34 |

REMARKS:

1. Q.P. and AV. are abbreviations of quasi-peak and average individually.
2. The emission levels of other frequencies were very low against the limit.
3. Margin value = Emission level - Limit value
4. Correction factor = Insertion loss + Cable loss
5. Emission Level = Correction Factor + Reading Value.

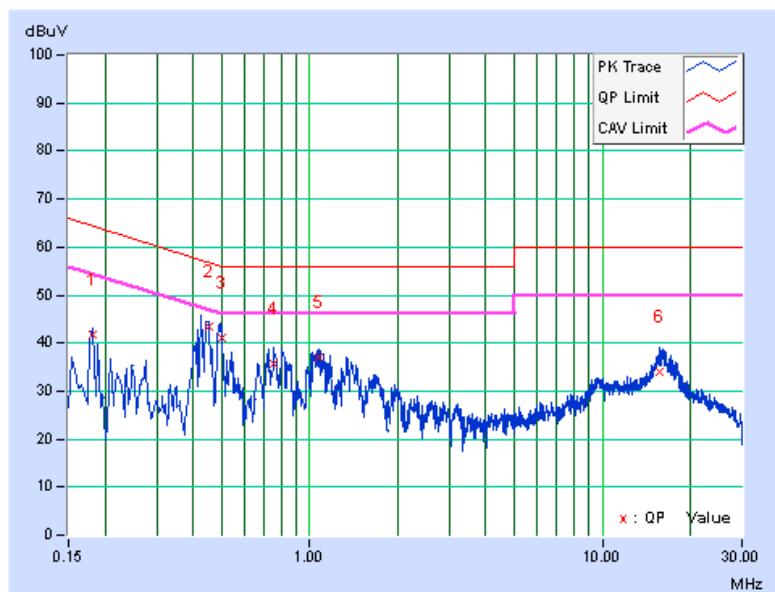

| | | | |
|---------|---------------|-------------------|--------------------------------|
| Phase | Line (L) | Detector Function | Quasi-Peak (QP) / Average (AV) |
| Channel | TX Channel 24 | | |

| No | Freq. [MHz] | Corr. Factor (dB) | Reading Value [dB (uV)] | | Emission Level [dB (uV)] | | Limit [dB (uV)] | | Margin (dB) | |
|----|----------------|----------------------|----------------------------|---------|-----------------------------|-------|--------------------|-------|----------------|--------|
| | | | Q.P. | AV. | Q.P. | AV. | Q.P. | AV. | Q.P. | AV. |
| | | | 1 | 0.17863 | 0.06 | 42.23 | 31.08 | 42.29 | 31.14 | 64.55 |
| 2 | 0.44458 | 0.06 | 44.05 | 38.25 | 44.11 | 38.31 | 56.98 | 46.98 | -12.86 | -8.66 |
| 3 | 0.49163 | 0.06 | 42.98 | 36.87 | 43.04 | 36.93 | 56.14 | 46.14 | -13.10 | -9.21 |
| 4 | 0.70987 | 0.07 | 36.72 | 27.08 | 36.79 | 27.15 | 56.00 | 46.00 | -19.21 | -18.85 |
| 5 | 1.07752 | 0.08 | 34.58 | 26.88 | 34.66 | 26.96 | 56.00 | 46.00 | -21.34 | -19.04 |
| 6 | 16.39226 | 0.74 | 33.60 | 28.74 | 34.34 | 29.48 | 60.00 | 50.00 | -25.66 | -20.52 |

REMARKS:

1. Q.P. and AV. are abbreviations of quasi-peak and average individually.
2. The emission levels of other frequencies were very low against the limit.
3. Margin value = Emission level - Limit value
4. Correction factor = Insertion loss + Cable loss
5. Emission Level = Correction Factor + Reading Value.

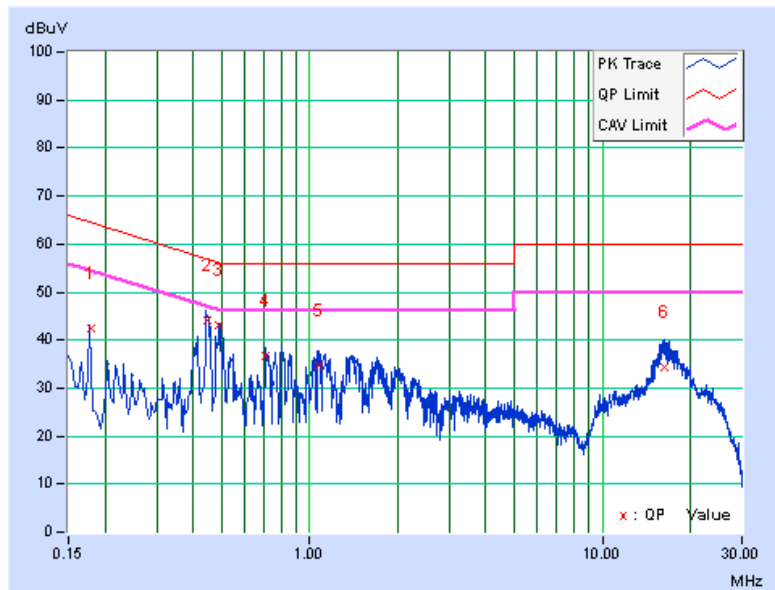

| | | | |
|---------|---------------|-------------------|--------------------------------|
| Phase | Neutral (N) | Detector Function | Quasi-Peak (QP) / Average (AV) |
| Channel | TX Channel 24 | | |

| No | Freq. [MHz] | Corr. Factor (dB) | Reading Value [dB (uV)] | | Emission Level [dB (uV)] | | Limit [dB (uV)] | | Margin (dB) | |
|----------|----------------|----------------------|----------------------------|--------------|-----------------------------|--------------|--------------------|--------------|----------------|--------------|
| | | | Q.P. | AV. | Q.P. | AV. | Q.P. | AV. | Q.P. | AV. |
| | | | 1 | 0.15000 | 0.05 | 35.24 | 23.87 | 35.29 | 23.92 | 66.00 |
| 2 | 0.44557 | 0.06 | 45.08 | 39.57 | 45.14 | 39.63 | 56.96 | 46.96 | -11.82 | -7.33 |
| 3 | 0.48752 | 0.06 | 44.26 | 37.85 | 44.32 | 37.91 | 56.21 | 46.21 | -11.89 | -8.30 |
| 4 | 0.79899 | 0.07 | 36.05 | 28.41 | 36.12 | 28.48 | 56.00 | 46.00 | -19.88 | -17.52 |
| 5 | 1.08352 | 0.08 | 37.14 | 28.28 | 37.22 | 28.36 | 56.00 | 46.00 | -18.78 | -17.64 |
| 6 | 15.99867 | 0.61 | 31.27 | 25.64 | 31.88 | 26.25 | 60.00 | 50.00 | -28.12 | -23.75 |

REMARKS:

1. Q.P. and AV. are abbreviations of quasi-peak and average individually.
2. The emission levels of other frequencies were very low against the limit.
3. Margin value = Emission level - Limit value
4. Correction factor = Insertion loss + Cable loss
5. Emission Level = Correction Factor + Reading Value.

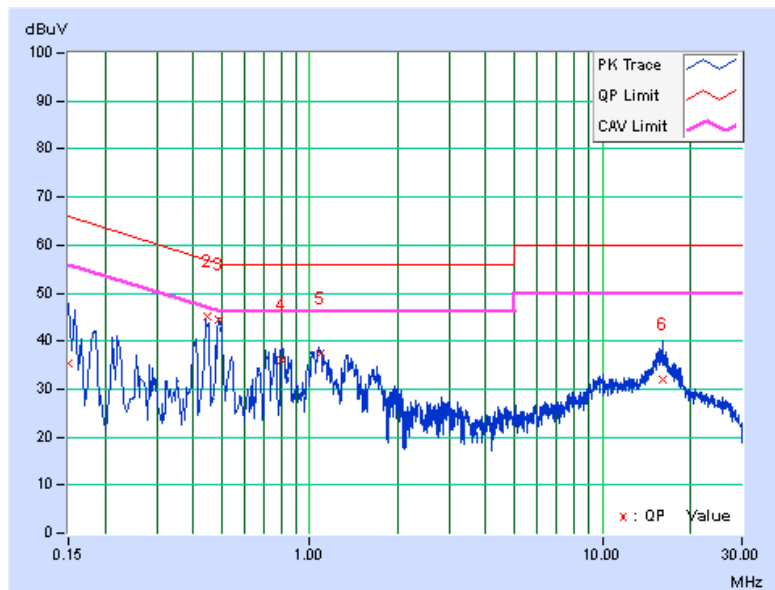

| | | | |
|---------|---------------|-------------------|--------------------------------|
| Phase | Line (L) | Detector Function | Quasi-Peak (QP) / Average (AV) |
| Channel | TX Channel 49 | | |

| No | Freq. [MHz] | Corr. Factor (dB) | Reading Value [dB (uV)] | | Emission Level [dB (uV)] | | Limit [dB (uV)] | | Margin (dB) | |
|----|----------------|----------------------|----------------------------|---------|-----------------------------|-------|--------------------|-------|----------------|--------|
| | | | Q.P. | AV. | Q.P. | AV. | Q.P. | AV. | Q.P. | AV. |
| | | | 1 | 0.17886 | 0.06 | 40.53 | 29.75 | 40.59 | 29.81 | 64.54 |
| 2 | 0.44652 | 0.06 | 43.25 | 36.87 | 43.31 | 36.93 | 56.94 | 46.94 | -13.63 | -10.01 |
| 3 | 0.49351 | 0.06 | 43.01 | 37.08 | 43.07 | 37.14 | 56.11 | 46.11 | -13.04 | -8.97 |
| 4 | 0.70985 | 0.07 | 36.54 | 29.72 | 36.61 | 29.79 | 56.00 | 46.00 | -19.39 | -16.21 |
| 5 | 1.07785 | 0.08 | 36.28 | 28.04 | 36.36 | 28.12 | 56.00 | 46.00 | -19.64 | -17.88 |
| 6 | 16.39856 | 0.74 | 33.01 | 26.87 | 33.75 | 27.61 | 60.00 | 50.00 | -26.25 | -22.39 |

REMARKS:

1. Q.P. and AV. are abbreviations of quasi-peak and average individually.
2. The emission levels of other frequencies were very low against the limit.
3. Margin value = Emission level - Limit value
4. Correction factor = Insertion loss + Cable loss
5. Emission Level = Correction Factor + Reading Value.

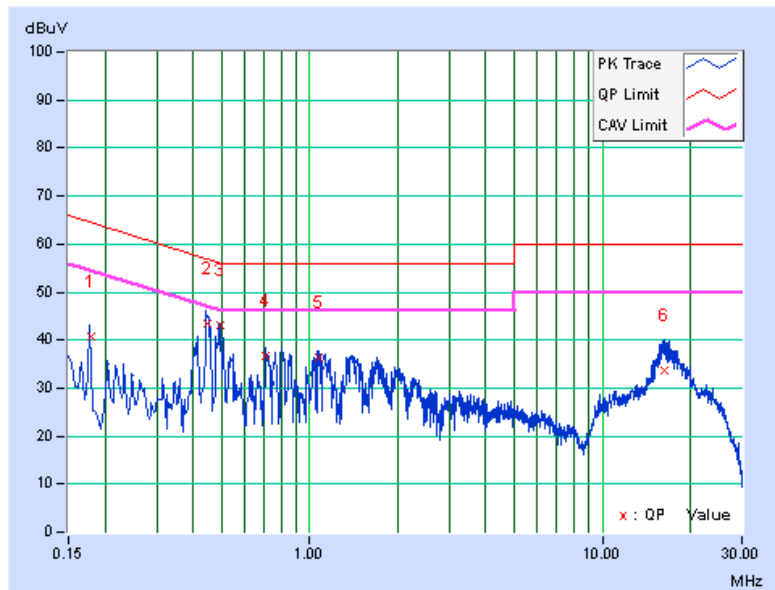

| | | | |
|---------|---------------|-------------------|--------------------------------|
| Phase | Neutral (N) | Detector Function | Quasi-Peak (QP) / Average (AV) |
| Channel | TX Channel 49 | | |

| No | Freq. [MHz] | Corr. Factor (dB) | Reading Value [dB (uV)] | | Emission Level [dB (uV)] | | Limit [dB (uV)] | | Margin (dB) | |
|----|----------------|-------------------------|----------------------------|---------|-----------------------------|-------|--------------------|-------|----------------|--------|
| | | | Q.P. | AV. | Q.P. | AV. | Q.P. | AV. | Q.P. | AV. |
| | | | 1 | 0.15006 | 0.05 | 34.87 | 23.85 | 34.92 | 23.90 | 66.00 |
| 2 | 0.44456 | 0.06 | 43.08 | 38.54 | 43.14 | 38.60 | 56.98 | 46.98 | -13.83 | -8.37 |
| 3 | 0.48675 | 0.06 | 42.96 | 37.85 | 43.02 | 37.91 | 56.22 | 46.22 | -13.20 | -8.31 |
| 4 | 0.79968 | 0.07 | 36.08 | 28.17 | 36.15 | 28.24 | 56.00 | 46.00 | -19.85 | -17.76 |
| 5 | 1.08153 | 0.08 | 37.05 | 28.44 | 37.13 | 28.52 | 56.00 | 46.00 | -18.87 | -17.48 |
| 6 | 15.99811 | 0.61 | 32.62 | 25.67 | 33.23 | 26.28 | 60.00 | 50.00 | -26.77 | -23.72 |

REMARKS:

1. Q.P. and AV. are abbreviations of quasi-peak and average individually.
2. The emission levels of other frequencies were very low against the limit.
3. Margin value = Emission level - Limit value
4. Correction factor = Insertion loss + Cable loss
5. Emission Level = Correction Factor + Reading Value.

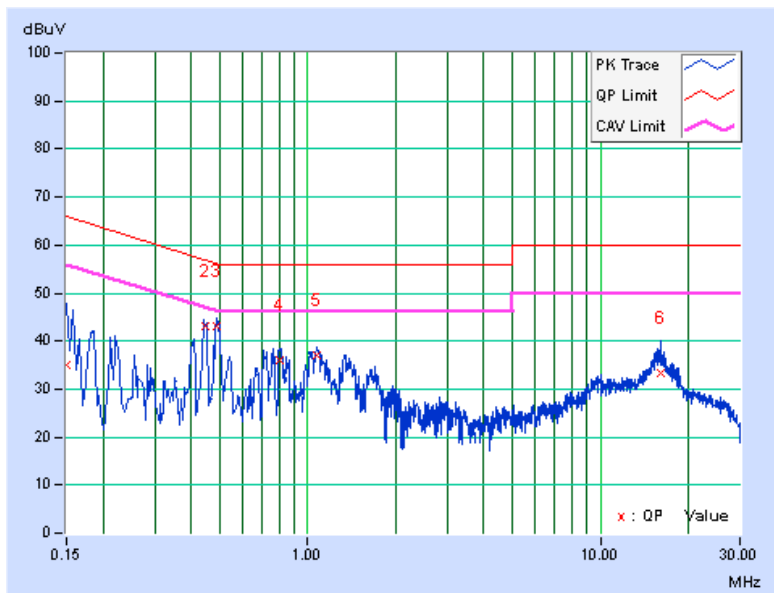

4.3 Number of Hopping Frequency Used

4.3.1 Limits of Hopping Frequency Used Measurement

At least 50 channels frequencies, and should be equally spaced.

4.3.2 Test Setup

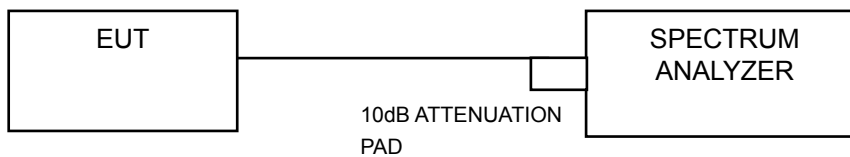

4.3.3 Test Instruments

Refer to section 4.1.2 to get information of above instrument.

4.3.4 Test Procedure

- a. Check the calibration of the measuring instrument (SA) using either an internal calibrator or a known signal from an external generator.
- b. Turn on the EUT and connect its antenna terminal to measurement via a low loss cable. Then set it to any one measured frequency within its operating range and make sure the instrument is operated in its linear range.
- c. Set the SA on MaxHold Mode, and then keep the EUT in hopping mode. Record all the signals from each channel until each one has been recorded.
- d. Set the SA on View mode and then plot the result on SA screen.
- e. Repeat above procedures until all frequencies measured were complete.

4.3.5 Deviation from Test Standard

No deviation.

4.3.6 Test Results

There are 50 hopping frequencies in the hopping mode. On the plots, it shows that the hopping frequencies are equally spaced.

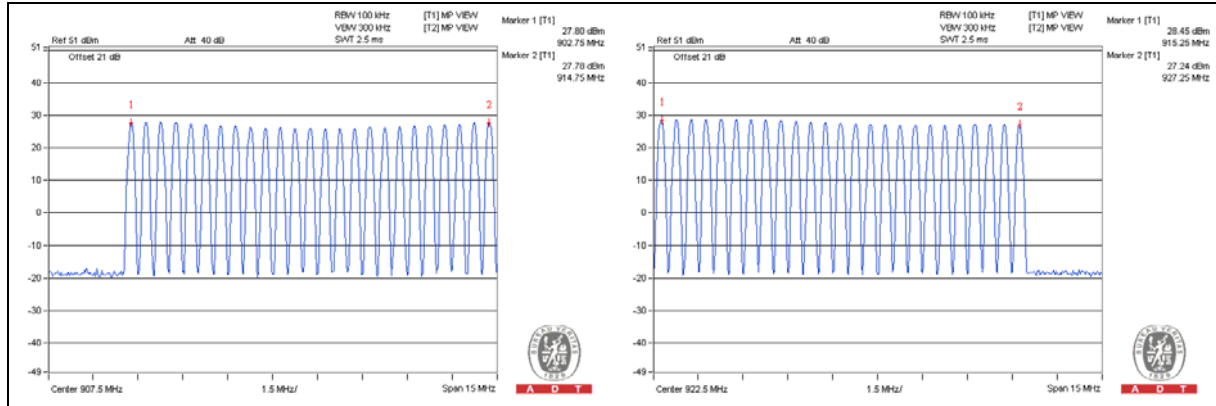

4.4 Dwell Time on Each Channel

4.4.1 Limits of Dwell Time on Each Channel Measurement

The average time of occupancy on any frequency shall not be greater than 0.4 seconds within a 20 second period.

4.4.2 Test Setup



4.4.3 Test Instruments

Refer to section 4.1.2 to get information of above instrument.

4.4.4 Test Procedures

- a. Check the calibration of the measuring instrument (SA) using either an internal calibrator or a known signal from an external generator.
- b. Turn on the EUT and connect its antenna terminal to measurement via a low loss cable. Then set it to any one measured frequency within its operating range and make sure the instrument is operated in its linear range.
- c. Adjust the center frequency of SA on any frequency be measured and set SA to zero span mode. And then, set RBW and VBW of spectrum analyzer to proper value.
- d. Measure the time duration of one transmission on the measured frequency. And then plot the result with time difference of this time duration.
- e. Repeat above procedures until all different time-slot modes have been completed.

4.4.5 Deviation from Test Standard

No deviation.

4.4.6 Test Results

| Number of transmission in a 20 (50Hopping*0.4) | Length of transmission time (msec) | Result (msec) | Limit (msec) |
|--|------------------------------------|---------------|--------------|
| 2 (times / 10 sec) * 2 = 4 times | 22 | 88 | 400 |

NOTE: Test plots of the transmitting time slot are shown on following.

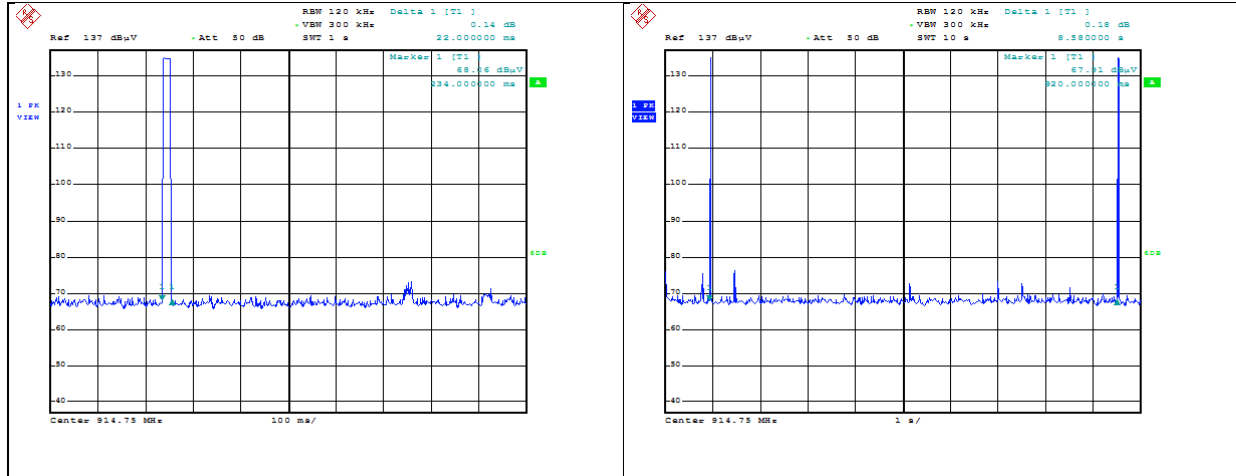

4.5 Channel Bandwidth

4.5.1 Limits of Channel Bandwidth Measurement

The 20 dB bandwidth of the hopping channel shall be less than 250 kHz.

4.5.2 Test Setup



4.5.3 Test Instruments

Refer to section 4.1.2 to get information of above instrument.

4.5.4 Test Procedure

- Check the calibration of the measuring instrument using either an internal calibrator or a known signal from an external generator.
- Turn on the EUT and connect it to measurement instrument. Then set it to any one convenient frequency within its operating range. Set a reference level on the measuring instrument equal to the highest peak value.
- Measure the frequency difference of two frequencies that were attenuated 20dB from the reference level. Record the frequency difference as the emission bandwidth.
- Repeat above procedures until all frequencies measured were complete.

4.5.5 Deviation from Test Standard

No deviation.

4.5.6 EUT Operating Condition

The software provided by client enabled the EUT to transmit and receive data at lowest, middle and highest channel frequencies individually.

4.5.7 Test Results

| Channel | Frequency (MHz) | 20dB Bandwidth (MHz) | Limit (MHz) |
|---------|-----------------|----------------------|-------------|
| 0 | 902.75 | 0.084902 | 0.25 |
| 24 | 914.75 | 0.084398 | 0.25 |
| 49 | 927.25 | 0.085142 | 0.25 |

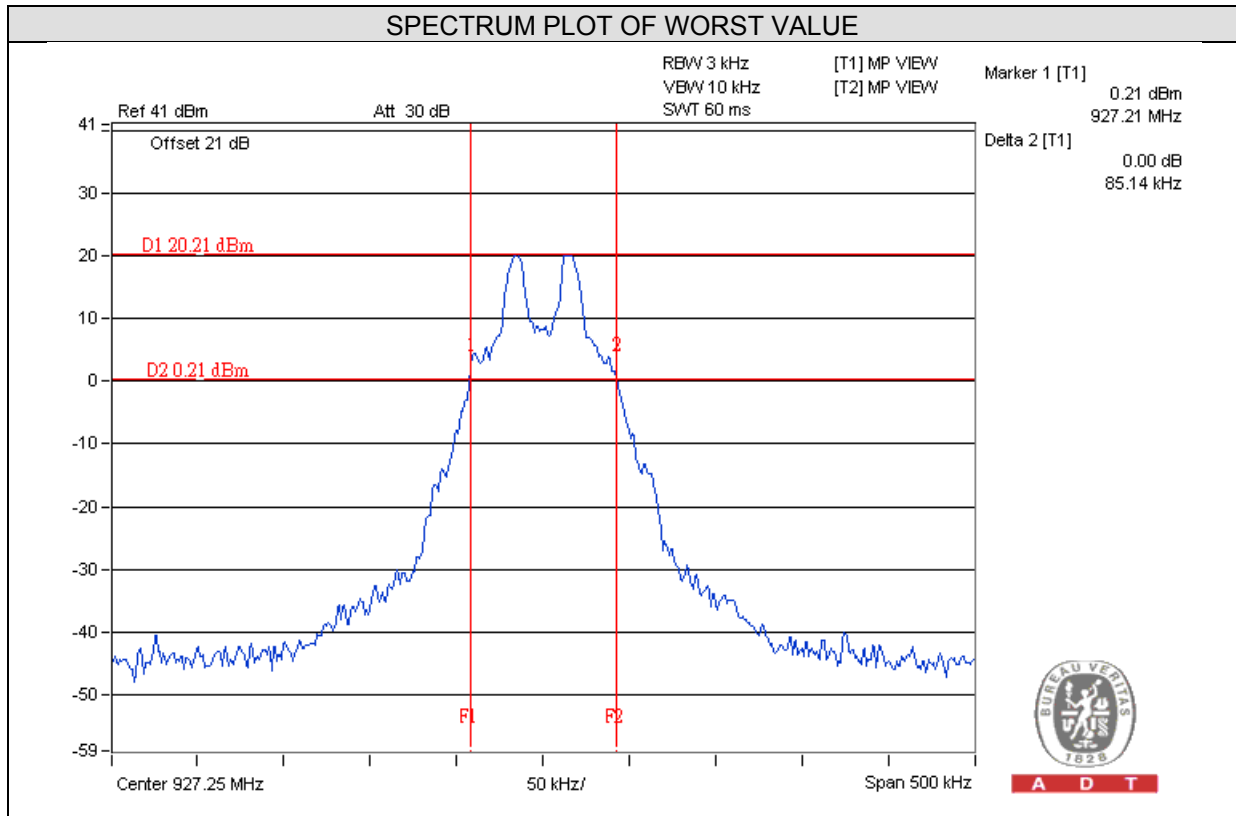

4.6 Hopping Channel Separation

4.6.1 Limits of Hopping Channel Separation Measurement

At least 25kHz or two-third of 20dB hopping channel bandwidth (whichever is greater).

4.6.2 Test Setup

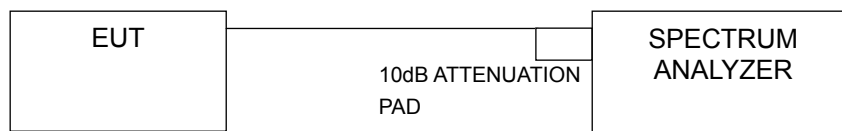

4.6.3 Test Instruments

Refer to section 4.1.2 to get information of above instrument.

4.6.4 Test Procedure

- a. Check the calibration of the measuring instrument using either an internal calibrator or a known signal from an external generator.
- b. Turn on the EUT and connect it to measurement instrument. Then set it to any one convenient frequency within its operating range.
- c. By using the MaxHold function record the separation of two adjacent channels.
- d. Measure the frequency difference of these two adjacent channels by SA MARK function. And then plot the result on SA screen.
- e. Repeat above procedures until all frequencies measured were complete.

4.6.5 Deviation From Test Standard

No deviation.

4.6.6 Test Results

| Channel | Frequency (MHz) | Adjacent Channel Separation (MHz) | Minimum Limit (MHz) | Pass / Fail |
|---------|-----------------|-----------------------------------|---------------------|-------------|
| 0 | 902.75 | 0.505 | 0.084902 | PASS |
| 24 | 914.75 | 0.506 | 0.084398 | PASS |
| 49 | 927.25 | 0.507 | 0.085142 | PASS |

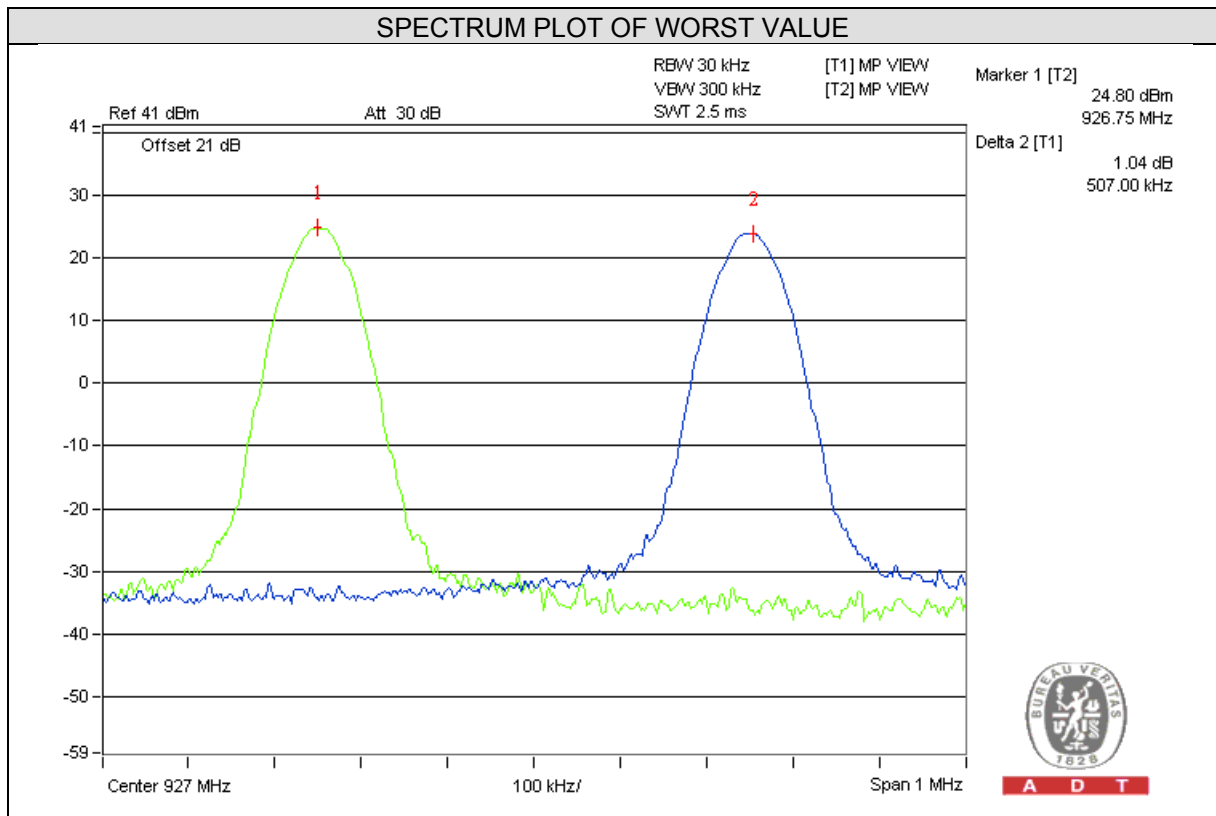

4.7 Maximum Output Power

4.7.1 Limits of Maximum Output Power Measurement

The Maximum Output Power Measurement is 30dBm.

4.7.2 Test Setup

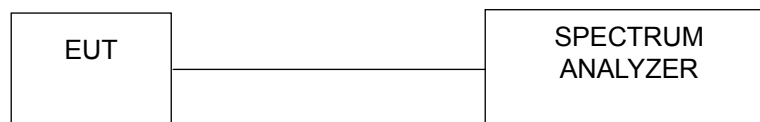

4.7.3 Test Instruments

Refer to section 4.1.2 to get information of above instrument.

4.7.4 Test Procedure

- a. Check the calibration of the measuring instrument using either an internal calibrator or a known signal from an external generator.
- b. Turn on the EUT and connect it to measurement instrument. Then set it to any one convenient frequency within its operating range. Set a reference level on the measuring instrument equal to the highest peak value.
- c. The center frequency of the spectrum analyzer is set to the fundamental frequency and using 3MHz RBW and 10 MHz VBW.
- d. Measure the captured power within the band and recording the plot.
- e. Repeat above procedures until all frequencies required were complete.

4.7.5 Deviation from Test Standard

No deviation.

4.7.6 EUT Operating Condition

The software provided by client enabled the EUT to transmit and receive data at lowest, middle and highest channel frequencies individually.

4.7.7 Test Results

| Channel | Frequency (MHz) | Output Power (mW) | Output Power (dBm) | Power Limit (dBm) | Pass / Fail |
|---------|-----------------|-------------------|--------------------|-------------------|-------------|
| 0 | 902.75 | 459.198 | 26.62 | 30 | PASS |
| 24 | 914.75 | 510.505 | 27.08 | 30 | PASS |
| 49 | 927.25 | 380.189 | 25.80 | 30 | PASS |

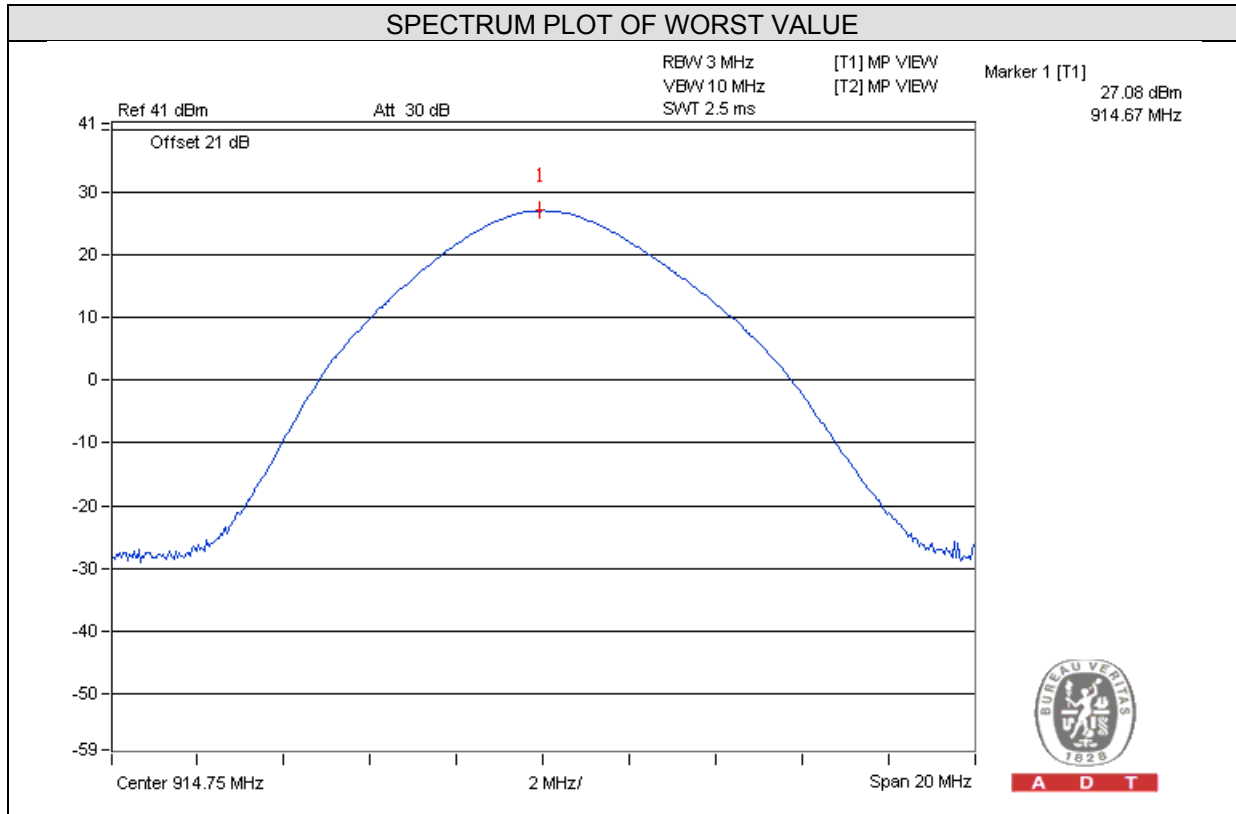

4.8 Conducted Out of Band Emission Measurement

4.8.1 Limits Of Conducted Out Of Band Emission Measurement

Below -20 dB of the highest emission level of operating band (in 100kHz RBW).

4.8.2 Test Instruments

Refer to section 4.1.2 to get information of above instrument.

4.8.3 Test Procedure

The transmitter output was connected to the spectrum analyzer via a low lose cable. Set both RBW and VBW of spectrum analyzer to 100 kHz and 300 kHz with suitable frequency span including 100 MHz bandwidth from band edge. The band edges was measured and recorded.

4.8.4 Deviation From Test Standard

No deviation.

4.8.5 EUT Operating Condition

The software provided by client enabled the EUT to transmit and receive data at lowest, middle and highest channel frequencies individually.

4.8.6 Test Results

The spectrum plots are attached on the following images. D1 line indicates the highest level, D2 line indicates the 20dB offset below D1. It shows compliance with the requirement.

Hopping disabled Low Channel

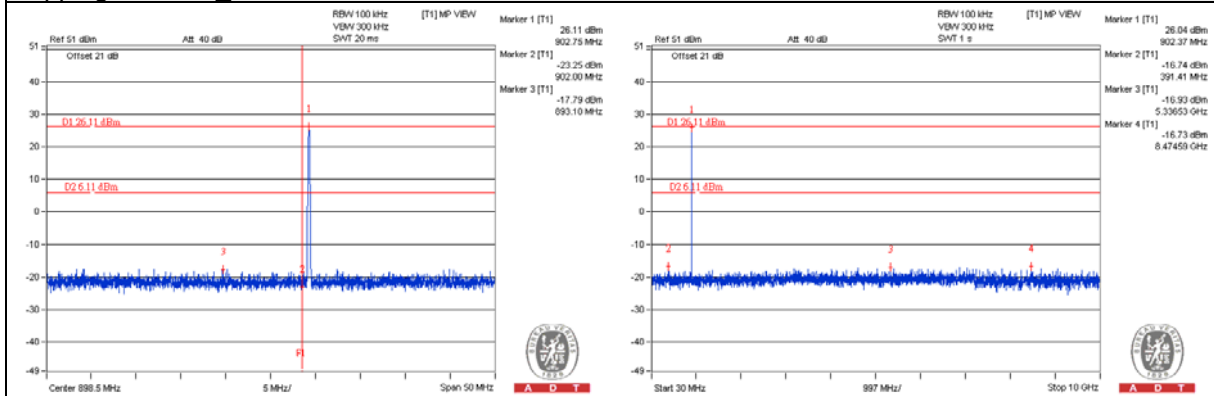

Hopping disabled High Channel

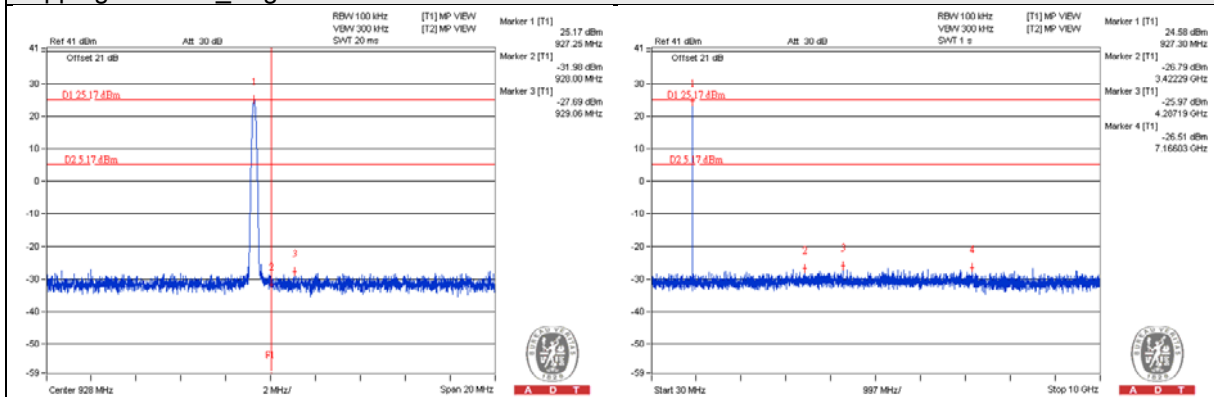

Hopping enabled

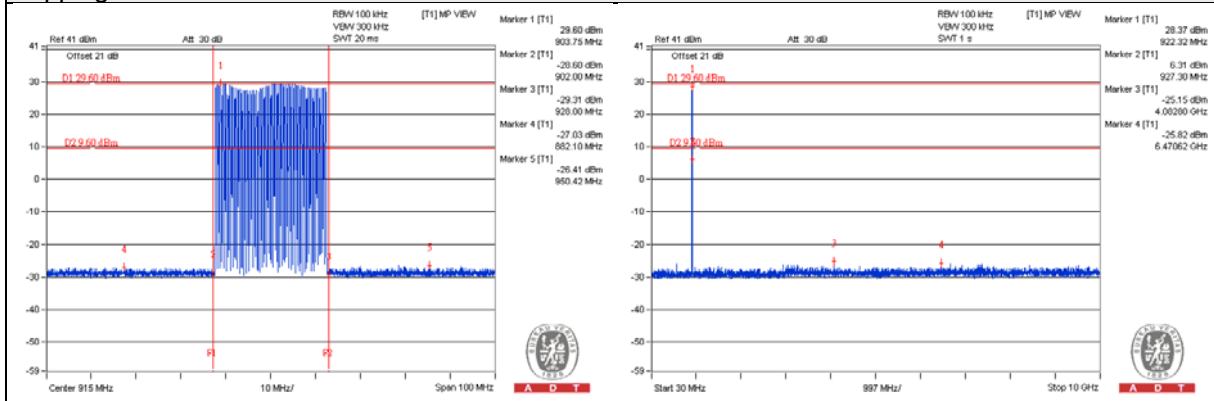

5 Pictures of Test Arrangements

Please refer to the attached file (Test Setup Photo).

Appendix – Information on the Testing Laboratories

We, Bureau Veritas Consumer Products Services (H.K.) Ltd., Taoyuan Branch, were founded in 1988 to provide our best service in EMC, Radio, Telecom and Safety consultation. Our laboratories are accredited and approved according to ISO/IEC 17025.

If you have any comments, please feel free to contact us at the following:

Linko EMC/RF Lab

Tel: 886-2-26052180

Fax: 886-2-26051924

Hsin Chu EMC/RF Lab/Telecom Lab

Tel: 886-3-5935343

Fax: 886-3-5935342

Hwa Ya EMC/RF/Safety

Tel: 886-3-3183232

Fax: 886-3-3270892

Email: service.adt@tw.bureauveritas.com

Web Site: www.bureauveritas-adt.com

The address and road map of all our labs can be found in our web site also.

--- END ---