

If you experience a problem that is not noted in this manual, please do not return the product to the store. Our Customer Service Department may have a simple solution to your problem. Please contact us at 1-800-268-6237 or email us at summerinfant.com/contact.

FCC Information

This device complies with part 15 of the FCC Rules. Operation is subject to the following two conditions: (1) This device may not cause harmful interference, and (2) this device must accept any interference received, including interference that may cause undesired operation.

CAUTION: Changes or modifications not expressly approved by Summer Infant may void the users authority to operate this equipment.

NOTE: This equipment has been tested and found to comply with the limits for a Class B digital device, pursuant to part 15 of the FCC Rules. These limits are designed to provide reasonable protection against harmful interference in a residential installation. This equipment generates, uses and can radiate radio frequency energy and, if not installed and used in accordance with the instructions, may cause harmful interference to radio communications. However, there is no guarantee that interference will not occur in a particular installation. If this equipment does cause harmful interference to radio or television reception, which can be determined by turning the equipment off and on, the user is encouraged to try to correct the interference by one or more of the following measures:

- Reorient or relocate the receiver
- Increase the separation between the equipment and the receiver
- Connect the equipment into an outlet on a circuit different from that to which the receiver is connected.
- Consult the dealer or an experienced radio/TV technician for help

CAUTION: 1. To comply with FCC/IC RF exposure compliance requirements a separation distance of at least 20 cm must be maintained between the antenna of this device and all persons. 2. This transmitter must not be co-located or operating in conjunction with any other antenna or transmitter.

IC caution:

This device complies with Industry Canada licence-exempt RSS standard(s). Operation is subject to the following two conditions: (1) this device may not cause interference, and (2) this device must accept any interference, including interference that may cause undesired operation of the device.

Le présent appareil est conforme aux CNR d'Industrie Canada applicables aux appareils radio exempts de licence.

L'exploitation est autorisée aux deux conditions suivantes:

- (1) l'appareil ne doit pas produire de brouillage, et
- (2) l'utilisateur de l'appareil doit accepter tout brouillage radioélectrique subi, même si le brouillage est susceptible d'en compromettre le fonctionnement.

Under Industry Canada regulations, this radio transmitter may only operate using an antenna of a type and maximum (or lesser) gain approved for the transmitter by Industry Canada. To reduce potential radio interference to other users, the antenna type and its gain should be so chosen that the equivalent isotropically radiated power (e.i.r.p.) is not more than that necessary for successful communication.

Conformément à la réglementation d'Industrie Canada, le présent émetteur radio peut fonctionner avec une antenne d'un type et d'un gain maximal (ou inférieur) approuvé pour l'émetteur par Industrie Canada. Dans le but de réduire les risques de brouillage radioélectrique à l'intention des autres utilisateurs, il faut choisir le type d'antenne et son gain de sorte que la puissance isotrope rayonnée équivalente (p.i.r.e.) ne dépasse pas l'intensité nécessaire à l'établissement d'une communication satisfaisante.

Summer Infant, Inc.
1275 Park East Drive
Woonsocket, RI 02895 USA
1-800-268-6237

Summer Infant Europe, Ltd.
First Floor North Wing, Focus 31
Cleveland Road, Hemel Hempstead
HP2 7BW UK
+44 (0) 144 250 5000



29000

Please read the following instructions and warnings carefully.
Tools required for wall mount:
Screwdriver and drill (not included)

Keep this instruction manual for future reference.

For technical support see back page.

For adult use only.

! WARNING:
Adult assembly required.
Keep small parts away from children when assembling.



INSTRUCTION MANUAL

WIDEVIEW™ DIGITAL COLOR VIDEO MONITOR

! WARNING:
STRANGULATION HAZARD - Children have STRANGLED in cords. Keep this cord out of reach of children (more than 3 feet (0.9 m) away from the crib). Use enclosed Security Clips to help secure cord away from baby's reach. Never use extension cords with AC Adapters. Only use the AC Adapters provided.



WARNING:

THIS PRODUCT CANNOT REPLACE RESPONSIBLE ADULT SUPERVISION.

- **STRANGULATION HAZARD** - Children have **STRANGLED** in cords. Keep this cord out of reach of children (more than 3 feet (0.9 m) away from the crib). Use enclosed Security Clips to help secure cord away from baby's reach. Never use extension cords with AC Adapters. Only use the AC Adapters provided.
- When an AC Adapter is plugged into an electrical outlet, do not touch the exposed end.
- Test monitor before first use, periodically, and when changing location of the Camera.
- Do not use monitor near water (such as bathtub, sink, etc.).
- Keep monitor away from heat sources (such as stoves, radiators, etc.).
- Make sure there is proper ventilation around all monitor components. Do not place on sofas, cushions, beds, etc. which may block ventilation.
- This product is not a toy. Do not allow children to play with it.
- This product contains small parts. Adult assembly required. Exercise care when unpacking and assembling the product.

BATTERY WARNING:

- Use only the original rechargeable battery provided. Please contact Summer Infant, Inc. for replacement battery. Contact information can be found on page 8 of these instructions or on the battery itself.
- Clean battery and product contacts prior to battery installation.
- Do not short-circuit supply terminals.
- Only the recommended battery or equivalent are to be used, volts and size.
- Remove battery when product is stored for long periods of time or when battery is exhausted.
- Dispose of exhausted battery properly.
- Keep all batteries away from children.



IMPORTANT SAFETY INSTRUCTIONS

- 1) Read Instructions - All the safety and operating instructions should be read before the product is operated.
- 2) Retain Instructions - The safety and operating instructions should be retained for future reference.
- 3) Heed Warnings - All warnings on the product and in the operating instructions should be adhered to.
- 4) Follow Instructions - All operating and use instructions should be followed.
- 5) Cleaning - Unplug this product from the wall outlet before cleaning. Do not use liquid cleaners or aerosol cleaners. Use a damp cloth for cleaning.
- 6) Attachments - Do not use attachments not recommended by the product manufacturer as they may cause hazards.
- 7) Water and Moisture - Do not use this product near water - for example, near a bath tub, wash bowl, kitchen sink, or laundry tub; in a wet basement; or near a swimming pool; and the like.
- 8) Accessories - Do not place this product on an unstable cart, stand, tripod, bracket, or table. The product may fall, causing serious injury to a child or adult, and serious damage to the product. Use only with a cart, stand, tripod, bracket, or table recommended by the manufacturer, or sold with the product. Any mounting of the product should follow the manufacturer's instructions, and should use a mounting accessory recommended by the manufacturer.
- 9) Ventilation - Slots and openings in the cabinet are provided for ventilation and to ensure reliable operation of the product and to protect it from overheating, and these openings must not be blocked or covered. The openings should never be blocked by placing the product on a bed, sofa, rug, or other similar surfaces. This product should not be placed in a built-in installation such as a bookcase or rack unless proper ventilation is provided or the manufacturer's instructions have been adhered to.
- 10) Power Sources - This product should be operated only from the type of power source indicated on the marking label. If you are not sure of the type of power supply to your home, consult your product dealer or local power company. For products intended to operate from battery power, or other sources, refer to the operating instructions.
- 11) Power-Cord Protection - Power-supply cords should be routed so that they are not likely to be walked on or pinched by items placed upon or against them, paying particular attention to cords at plugs, convenience receptacles, and the point where they exit from the product.
- 12) Power Lines - An outside antenna system should not be located in the vicinity of overhead power lines or other electric light or power circuits, or where it can fall into such power lines or circuits. When installing an outside antenna system, extreme care should be taken to keep from touching such power lines or circuits as contact with them might be fatal.
- 13) Overloading - Do not overload wall outlets, extension cords, or integral convenience receptacles as this can result in a risk of fire or electric shock.
- 14) Object and Liquid Entry - Never push objects of any kind into this product through openings as they may touch dangerous voltage points or short-out parts that could result in a fire or electric shock. Never spill liquid of any kind on the product.
- 15) Servicing - Do not attempt to service this product yourself as opening or removing covers may expose you to dangerous voltage or other hazards. Refer all servicing to qualified service personnel.
- 16) Damage Requiring Service - Unplug this product from the wall outlet and refer servicing to qualified service personnel under the following conditions:
 - a) When the power-supply cord or plug is damaged,
 - b) If liquid has been spilled, or objects have fallen into the product,
 - c) If the product has been exposed to rain or water,
 - d) If the product does not operate normally by following the operating instructions. Adjusting only those controls that are covered by the operating instructions as an improper adjustment of other controls may result in damage and will often require extensive work by a qualified technician to restore the product to its normal operation,
 - e) If the product has been dropped or damaged in any way, and
 - f) When the product exhibits a distinct change in performance - this indicated a need for service.
- 17) Replacement Parts - When replacement parts are required, be sure the service technician has used replacement parts specified by the manufacturer or have the same characteristics as the original part. Unauthorized substitutions may result in fire, electric shock, or other hazards.
- 18) Safety Check - Upon completion of any service or repairs to this product, ask the service technician to perform safety checks to determine that the product is in proper operating condition.
- 19) Wall or Ceiling Mounting - The product should be mounted to a wall or ceiling only as recommended by the manufacturer.
- 20) Heat - The product should be situated away from heat sources such as radiators, heat registers, stoves, or other products (including amplifiers) that produce heat.

SPECIAL FEATURES:

- **Wide angle lens technology:** Innovative wide angle lens technology delivers a view with 4-times more of the room visible. This technology enables parents to monitor more of the baby's environment and is especially beneficial for parents monitoring babies and toddlers as they start move around in either their crib or the bedroom.
- **Digital zoom:** The zoom option enables you to get a closer view on screen. Pressing the zoom button once will move the image on the monitor screen to 2x normal view. Pressing the button again returns the image to normal view.
- **Two-way communication:** Calm baby with the sound of your voice or use as a convenient way to remind each other of something needed from the nursery. By speaking into the handheld monitor, you can give comfort and reassurance, or gentle reminders, from another room. Press and hold the (🗨️) button on the left side of the monitor to activate two-way communication.
- **Night Vision:** The camera's infrared LED's enable automatic black and white night vision for monitoring in low-light and dark rooms. Parents have peace of mind knowing they can see and hear their baby, day and night.
- **Adjustable volume & brightness:** Volume adjustments allow higher volume settings for parents who want to hear every little sound from baby, like cooing, and lower volume settings to monitor louder sounds and cries from baby. Easily adjust the volume based on your preferences and the level of other sounds in the home. Brightness can be adjusted, as well, to accommodate the level of light in the room. Using the brightness control feature enables lighter or darker video, depending on room viewing conditions. Use the up and down arrows to adjust the brightness.
- **Sound Lights:** The 5 sound activated LED lights illuminate based on the level of baby's sounds. If baby is just cooing, green to amber lights will illuminate and if baby is crying, amber to red lights will illuminate. This feature is particularly helpful for parents if they are in crowded or noisy rooms.
- **Power-Save Mode:** While operating on battery power, the video screen will go to sleep, to conserve battery power. Audio and sound lights continue to function normally. Video sleep mode is not available when using AC adapter.
- **Video On-Off Button:** This button turns the video mode on from video sleep mode. It is ideal for a quick view of baby in the middle of the night. To monitor in audio only mode, simply press the quick view button again to turn the video screen off.
- **Kick Stand:** The monitor has a built-in kick-stand for tabletop convenience. Simply flip out the kick-stand and place the monitor on a stable, level surface.

PROBLEM SOLVING:

No picture or sound

- Make sure the camera and handheld monitor unit are paired (see page 5)
- Make sure the camera and handheld monitor unit are turned on
- Make sure the AC adapters are plugged in
- Make sure the outlets are working

Sound but no picture

- Press the Quick View/Video On-Off Button once to turn on video mode
- Check to make sure nothing is blocking the camera
- Test reception by moving the handheld unit and/or camera to different locations
- Make sure the camera and handheld monitor unit are paired (see page 5)

Picture but no sound

- Power the handheld completely off, remove and re-insert the battery, then turn handheld back on.
- Turn up the volume using Volume Control
- Make sure the camera and handheld monitor unit are paired (see page 5)

Picture not clear

- Position the handheld unit closer to the camera
- Move the handheld unit away from other electronic devices, cordless phones, etc.
- Adjust the brightness using the Brightness Control
- Test reception by moving the handheld unit and/or camera to different locations

Squealing sound coming from speaker on Handheld Unit

- Move the handheld unit and camera further away from each other
- Turn the volume down using Volume Control
- Power the handheld completely off, remove and re-insert the battery, then turn handheld back on.

REPLACEMENT PARTS AND PRODUCT REGISTRATION

If you need to order a replacement part or want to order an Extra Camera, you can contact our Customer Relations Department at **1-800-268-6237** or via email at www.summerinfant.com/contact

- Extra Camera: #29180
- Rechargeable Ni-MH 3.6V 800mAh battery: #29030-10
- Camera AC Adapter: #02000-05
- Handheld AC Adapter: #28450-13

To register your product, visit:

www.summerinfant.com/product-registration/product-registration-form

FEATURES & COMPONENTS

MONITOR (Front View):

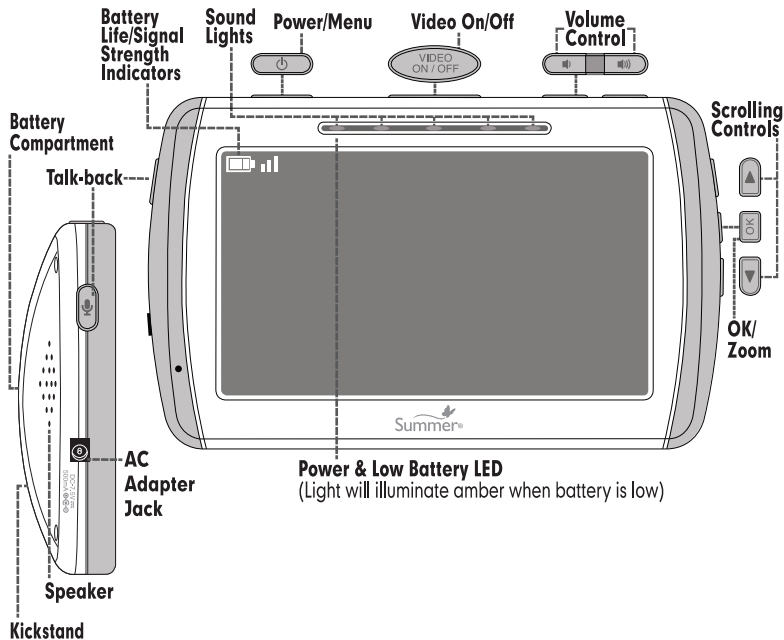

CAMERA:

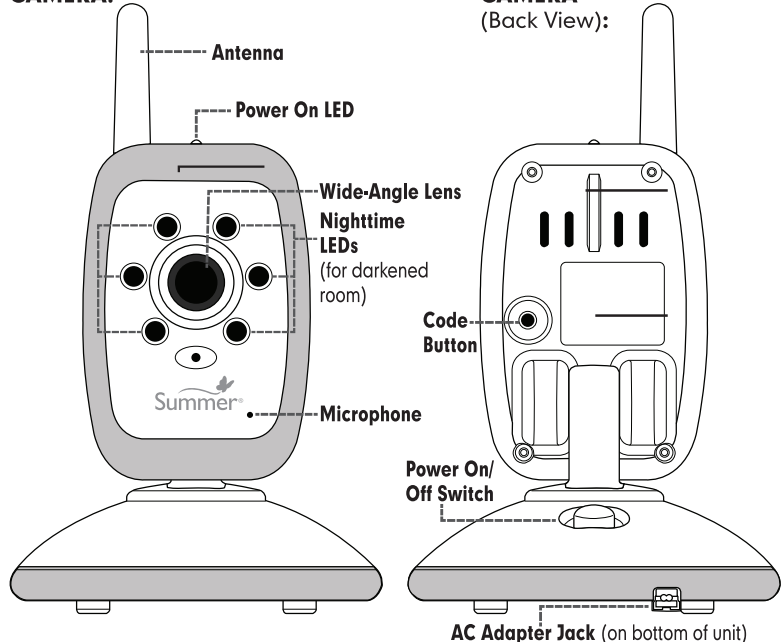

Adapters and Hardware:

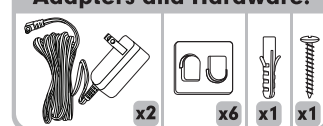

SETUP & USE:

WARNING:
STRANGULATION HAZARD - Children have STRANGLED in cords. Keep this cord out of reach of children (more than 3 feet (0.9 m) away from the crib). Use enclosed Security Clips to help secure cord away from baby's reach. Never use extension cords with AC Adapters. Only use the AC Adapters provided.



Testing Initial Setup:

Before using the monitor, charge the battery for 4-5 hours. To set up the system, you will need two adults. One adult should view the picture on the monitor while the other is in the nursery to adjust the camera. Often the quality of the reception can be improved by slightly repositioning the camera or the monitor. It may help to place an object in the crib to simulate the position and size of your baby.

Step 1: To test reception, determine a location for the camera that will provide the best view of your baby in the crib (note: do not mount camera in permanent location until initial set up test completed). Plug AC adapter into wall outlet and turn camera power on.

Step 2: Press and hold POWER/MENU button on handheld unit for 5-seconds until the Summer logo appears on screen. Video should immediately appear on screen. If video does not appear, go to "Pairing Monitor & Camera" section on page 5. If video appears, the initial set up test is complete and you can install camera, instructions below.

Installing Camera:

Place the camera on a flat surface, such as a bureau or shelf (Fig A) or mount the camera on a wall. Place the camera or cords within 3-feet of the crib. Secure the cord to the wall using the 6 security clips included to keep the cord away from baby's reach.

To Wall-Mount:

Step 1: Pre-drill a hole in the wall, a 3/16" (4.8mm) drill bit (Fig C)

Step 2: Insert the wall anchor (included) into the hole and with a hammer, tap gently on the end until the wall anchor is flush with the wall.

Step 3: Insert the screw (included) into the wall anchor and tighten screw until only 1/4" (6.2mm) of the screw is exposed.

Step 4: Insert camera AC adapter into the camera's AC adapter jack.

Step 5: Slide the back of the camera down onto the screw until the camera is secure to the wall.

Step 6: Plug the AC adapter into a standard electrical outlet.

Step 7: Secure the cord to the wall using the 6 security clips included to keep cord away from baby's reach. (Figures B & D)

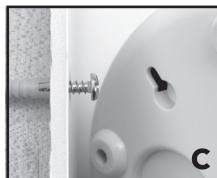
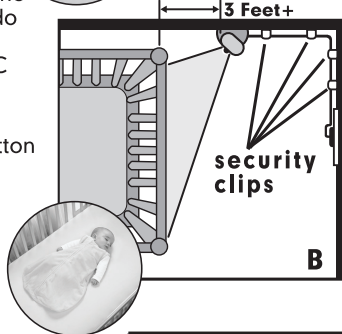
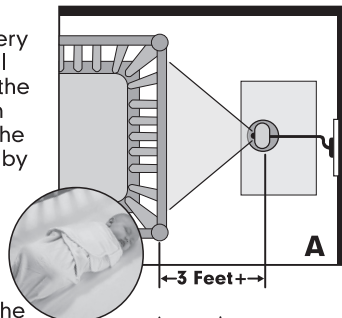

SETUP & USE (continued):

To use plugged-in:

Step 1: Place the monitors in the rooms from which you want to monitor your baby (ie., bedroom or living room). Plug the monitor AC adapters into the AC adapter jacks and other ends into standard electrical outlets.

Step 2: Press and hold POWER/MENU button for 5-seconds to power up until the Summer logo or video appears on screen.

Step 3: For audio and no video, press the VIDEO ON/OFF button top of the unit.

Step 4: To turn the monitor off completely, press and hold the POWER/MENU button for 5-seconds.

To use in portable/battery mode:

Step 1: Before using the monitor in portable mode (battery), charge the battery for 4-5 hours.

Step 2: To charge the battery, plug the monitor adapter into the monitor AC adapter jack (as shown on page 3). Plug the other end into a standard electrical outlet.

Step 3: After initial 4-5 hour charge, to achieve optimal battery life, charge the battery overnight and use in battery-mode during daytime monitoring, for up to 6-hours of continuous use.

Note: Only charge the battery when the battery life indicator is low. Constant recharging of your battery before the low battery indicator light comes on will decrease the life of your batteries.

When battery is low, the Power-On LED will also illuminate amber indicating that the battery needs to be charged.

- Remove battery during long periods of non-use.
- If battery is exhausted, remove immediately from the monitor.
- Properly dispose of exhausted battery.

Pairing Monitor and Camera:

The handheld unit and the camera are paired at the factory for privacy reasons. If the handheld and camera are not paired with each other for any reason, follow steps to pair:

Step 1: Move the handheld unit to the same area as the camera.

Step 2: With both the handheld unit and camera powered on. Press the "POWER/MENU" button.

Step 3: Using the up arrow on the right side of the monitor highlight "ADD CAM" (+CAM) and press the "OK/ZOOM" button to enter the ADD CAM menu. The next available camera will automatically be highlighted (CAM 2 3 4). Press the OK/ZOOM button again to begin pairing.

Step 4: Within 20-seconds, press the CODE button once on the back of the camera. The green power LED will begin to flash.

Step 5: Once successfully paired, the green power LED will stop flashing and video will appear on the monitor screen.

If this is unsuccessful, you should repeat steps above making sure the camera and monitor are close enough to each other for pairing.

ADDING ADDITIONAL CAMERA:

Note: This product accepts up to 4 cameras and operates on audio and video auto-scan to view each camera on an 8-second rotation. To order an additional camera (item #29180), please contact our Consumer Relations Team by phone at: 1-800-268-6237 or via email at: www.summerinfant.com/contact for details.

Please note: the SCAN, DEL, ADD, VIEW CAM menu options are only used with additional cameras.