**CETECOM™****CETECOM ICT Services**
consulting - testing - certification >>>**TEST REPORT**

Test Report No.: 1-9303/15-02-02-A

Deutsche
Akkreditierungsstelle
D-PL-12076-01-00**Testing Laboratory****CETECOM ICT Services GmbH**Untertürkheimer Straße 6 – 10
66117 Saarbrücken/Germany
Phone: + 49 681 5 98 - 0
Fax: + 49 681 5 98 - 9075
Internet: <http://www.cetecom.com>
e-mail: ict@cetecom.com**Accredited Test Laboratory:**

The testing laboratory (area of testing) is accredited according to DIN EN ISO/IEC 17025 (2005) by the Deutsche Akkreditierungsstelle GmbH (DAKkS). The accreditation is valid for the scope of testing procedures as stated in the accreditation certificate with the registration number: D-PL-12076-01-00

Applicant**Microsoft Mobile Oy**Keilalahdentie 2-4
02150 Espoo/FINLANDContact: Juha Paukku
e-mail: Juha.Paukku@microsoft.com
Phone: +358 7 18 00 80 00
Fax: +358 7 18 04 68 80**Manufacturer****Microsoft Mobile Oy**Keilalahdentie 2-4
02150 Espoo/FINLAND**Test Standard/s**

IEEE 1528-2003

Recommended Practice for Determining the Peak Spatial-Average Specific Absorption Rate (SAR) in the Human Head from Wireless Communications Devices: Measurement Techniques
Radio Frequency Exposure Compliance of Radiocommunication Apparatus (All Frequency Bands)

RSS-102 Issue 5

For further applied test standards please refer to section 3 of this test report.

Test ItemKind of test item: Smartphone
Device type: portable device
Model name: **RM-1154**
S/N serial number: B50000CAU / B506BBEAU / B509B92AU / B52C4AFU / B50B459AU / B541DBCAU / B5043FFAU
FCC-ID: PYARM-1154
IC: 661X-RM1154
IMEI-Number: 004402743285805 / 004402743285847 / 004402743285227 / 004402743285284 / 004402743285425 / 004402743289344 / 004402743285706
Hardware status: 1.5.6.0
Software status: 10c56.00006.0001
Firmware status: 01078.00017.15461.48000
Frequency: see technical details
Antenna: integrated antenna
Battery option: BV-T3G Li-ion battery 3.8V 2000mAh
Accessories: stereo headset WH-108
Test sample status: identical prototype
Exposure category: general population / uncontrolled environment

This test report is electronically signed and valid without handwriting signature. For verification of the electronic signatures, the public keys can be requested at the testing laboratory.

Test Report authorised:Thomas Vogler
Lab Manager
Radio Communications & EMC**Test performed:**Marco Scigliano
Testing Manager
Radio Communications & EMC

1 Table of contents

1	Table of contents	2
2	General information	4
2.1	Notes and disclaimer	4
2.2	Application details	4
2.3	Statement of compliance	4
2.4	Technical details	5
2.5	Transmitter and Antenna Operating Configurations	7
3	Test standards/ procedures references	8
3.1	RF exposure limits	10
4	Summary of Measurement Results	11
4.1	Maximum measured and reported SAR values for Head configuration	11
4.2	Maximum measured and reported SAR values for body worn configuration	12
4.3	Maximum measured and reported SAR values for hotspot configuration	13
4.4	SAR measurement variability and measurement uncertainty analysis	14
5	Test Environment	14
6	Test Set-up	15
6.1	Measurement system	15
6.1.1	System Description	15
6.1.2	Test environment	16
6.1.3	Probe description	16
6.1.4	Phantom description	17
6.1.5	Device holder description	18
6.1.6	Scanning procedure	19
6.1.7	Spatial Peak SAR Evaluation	20
6.1.8	Data Storage and Evaluation	21
6.1.9	Tissue simulating liquids: dielectric properties	23
6.1.10	Tissue simulating liquids: parameters	24
6.1.11	Measurement uncertainty evaluation for SAR test	28
6.1.12	Measurement uncertainty evaluation for System Check	31
6.1.13	System check	32
6.1.14	System check procedure	33
6.1.15	System validation	34
7	Detailed Test Results	35
7.1	Conducted power measurements	35
7.1.1	Conducted power measurements GSM 850 MHz	36
7.1.2	Conducted power measurements GSM 1900 MHz	36
7.1.3	Conducted power measurements WCDMA FDD V (850 MHz)	37
7.1.4	Conducted power measurements WCDMA FDD IV (1700 MHz)	38
7.1.5	Conducted power measurements WCDMA FDD II (1900 MHz)	39
7.1.6	Test-set-up information for WCDMA / HSPDA / HSUPA	40
7.1.7	Conducted power measurements LTE FDD 2 1900 MHz	44
7.1.8	Conducted power measurements LTE FDD 4 1700 MHz	47
7.1.9	Conducted power measurements LTE FDD 4 1700 MHz (PR)	50
7.1.10	Conducted power measurements LTE FDD 5 850 MHz	53
7.1.11	Conducted power measurements LTE FDD 7 2600 MHz	55
7.1.12	Conducted power measurements LTE TDD 38 2600 MHz	57
7.1.13	Justification of SAR measurements in LTE mode	59
7.1.14	MPR information in LTE mode	59
7.1.15	LTE TDD test configuration	60
7.1.16	Conducted power measurements WLAN 2450 MHz	62
7.1.17	Standalone SAR Test Exclusion	65
7.1.18	Hotspot mode SAR measurement positions	66
7.2	SAR test results	67

7.2.1	General description of test procedures.....	67
7.2.2	Results overview.....	68
7.2.3	Multiple Transmitter Information	90
7.2.4	SAR peak location separation	99
8	Test equipment and ancillaries used for tests	105
9	Observations.....	105
Annex A:	System performance check.....	106
Annex B:	DASY5 measurement results	129
Annex B.1:	GSM850.....	129
Annex B.2:	GSM1900.....	133
Annex B.3:	UMTS FDD II	136
Annex B.4:	UMTS FDD IV.....	139
Annex B.5:	UMTS FDD V.....	142
Annex B.6:	LTE FDD 2.....	145
Annex B.7:	LTE FDD 4.....	149
Annex B.8:	LTE FDD 5.....	152
Annex B.9:	LTE FDD 7.....	155
Annex B.10:	LTE TDD 38.....	158
Annex B.11:	WLAN 2450MHz	162
Annex B.12:	Combined Fast SAR	166
Annex B.13:	Liquid depth	167
Annex C:	Photo documentation.....	171
Annex D:	Calibration parameters.....	171
Annex E:	RF Technical Brief Cover Sheet acc. to RSS-102 Annex A	172
Annex E.1:	Declaration of RF Exposure Compliance Annex B	173
Annex F:	Document History	174
Annex G:	Further Information	174

2 General information

2.1 Notes and disclaimer

The test results of this test report relate exclusively to the test item specified in this test report. CETECOM ICT Services GmbH does not assume responsibility for any conclusions and generalisations drawn from the test results with regard to other specimens or samples of the type of the equipment represented by the test item. The test report may only be reproduced or published in full. Reproduction or publication of extracts from the report requires the prior written approval of CETECOM ICT Services GmbH.

This test report is electronically signed and valid without handwriting signature. For verification of the electronic signatures, the public keys can be requested at the testing laboratory.

The testing service provided by CETECOM ICT Services GmbH has been rendered under the current "General Terms and Conditions for CETECOM ICT Services GmbH".

CETECOM ICT Services GmbH will not be liable for any loss or damage resulting from false, inaccurate, inappropriate or incomplete product information provided by the customer.

Under no circumstances does the CETECOM ICT Services GmbH test report include any endorsement or warranty regarding the functionality, quality or performance of any other product or service provided.

Under no circumstances does the CETECOM ICT Services GmbH test report include or imply any product or service warranties from CETECOM ICT Services GmbH, including, without limitation, any implied warranties of merchantability, fitness for purpose, or non-infringement, all of which are expressly disclaimed by CETECOM ICT Services GmbH.

All rights and remedies regarding vendor's products and services for which CETECOM ICT Services GmbH has prepared this test report shall be provided by the party offering such products or services and not by CETECOM ICT Services GmbH.

In no case this test report can be considered as a Letter of Approval.

2.2 Application details

Date of receipt of order:	2015-12-16
Date of receipt of test item:	2015-12-08
Start of test:	2015-12-10
End of test:	2015-12-30
Person(s) present during the test:	

2.3 Statement of compliance

The SAR values found for the RM-1154 Smartphone are below the maximum recommended levels of 1.6 W/Kg as averaged over any 1 g tissue according to the FCC rule §2.1093, the ANSI/IEEE C 95.1:1992, the NCRP Report Number 86 for uncontrolled environment, according to the Health Canada's Safety Code 6 and the Industry Canada Radio Standards Specification RSS-102 for General Population/Uncontrolled exposure.

For body worn operation, this device has been tested and meets FCC RF exposure guidelines when used with any accessory that contains no metal and that positions the handset a minimum of 15 mm from the body. Use of other accessories may not ensure compliance with FCC RF exposure guidelines.

According to KDB pub 941225 D06 this device has been tested with 10 mm distance to the phantom for operation in WLAN hot spot mode.

2.4 Technical details

Band tested for this test report	Technology	Lowest transmit frequency/MHz	Highest transmit frequency/MHz	Lowest receive Frequency/MHz	Highest receive Frequency/MHz	Kind of modulation	Power Class	Tested power control level	GPRS/EGPRS mobile station class	GPRS/EGPRS multislotted class	(E)GPRS voice mode or DTM	Test channel low	Test channel middle	Test channel high	Maximum output power/dBm)*
<input type="checkbox"/>	GSM	880.2	914.8	925.2	959.8	GMSK 8-PSK	4 E2	5	A	33	11	975	37	124	32.5
<input type="checkbox"/>	GSM DCS	1710.2	1784.8	1805.2	1879.8	GMSK 8-PSK	1 E2	0	A	33	11	512	698	885	29.5
<input checked="" type="checkbox"/>	GSM cellular	824.2	848.8	869.2	893.8	GMSK 8-PSK	4 E2	5	A	33	11	128	190	251	32.6
<input checked="" type="checkbox"/>	GSM PCS	1850.2	1909.8	1930.2	1989.8	GMSK 8-PSK	1 E2	0	A	33	11	512	661	810	29.4

)*: measured slotted peak power for GSM

Band tested for this test report	Technology	Lowest transmit frequency/MHz	Highest transmit frequency/MHz	Lowest receive Frequency/MHz	Highest receive Frequency/MHz	Kind of modulation	Power Class	Tested power control level	Test channel low	Test channel middle	Test channel high	Maximum output power(dBm) *
<input type="checkbox"/>	UMTS FDD I	1922.4	1977.6	2112.4	2167.6	QPSK	3	max	9612	9750	9888	23.5
<input checked="" type="checkbox"/>	UMTS FDD II	1852.4	1907.6	1932.4	1987.6	QPSK	3	max	9262	9400	9538	23.2
<input checked="" type="checkbox"/>	UMTS FDD IV	1712.4	1752.6	2112.4	2152.6	QPSK	3	max	1312	1412	1513	23.3
<input checked="" type="checkbox"/>	UMTS FDD V	826.4	846.6	871.4	891.6	QPSK	3	max	4132	4182	4233	23.4
<input type="checkbox"/>	UMTS FDD VIII	882.4	912.6	927.4	957.6	QPSK	3	max	2712	2788	2863	23.0
<input type="checkbox"/>	LTE FDD 1	1920	1980	2110	2170	QPSK	3	max	18100	18300	18500	23.8
<input checked="" type="checkbox"/>	LTE FDD 2	1850	1910	1930	1990	QPSK	3	max	18700	18900	19100	23.1
<input type="checkbox"/>	LTE FDD 3	1710	1785	1805	1880	QPSK	3	max	19300	19575	19850	23.9
<input checked="" type="checkbox"/>	LTE FDD 4	1710	1755	2110	2155	QPSK	3	max	20050	20175	20300	23.4
<input checked="" type="checkbox"/>	LTE FDD 5	824	849	869	894	QPSK	3	max	20450	20525	20600	23.4
<input checked="" type="checkbox"/>	LTE FDD 7	2500	2570	2620	2690	QPSK	3	max	20850	21100	21350	23.4
<input type="checkbox"/>	LTE FDD 8	880	915	925	960	QPSK	3	max	21500	21625	21750	23.7
<input type="checkbox"/>	LTE FDD 20	832	862	791	821	QPSK	3	max	24250	24300	24350	23.4
<input type="checkbox"/>	LTE FDD 28	703	748	758	803	QPSK	3	max	27310	27435	27560	23.6
<input checked="" type="checkbox"/>	LTE TDD 38	2570	2620	2570	2620	QPSK	3	max	37850	38000	38150	23.5
<input type="checkbox"/>	LTE TDD 39	1880	1920	1880	1920	QPSK	3	max	38350	38450	38550	23.5
<input type="checkbox"/>	LTE TDD 40	2300	2400	2300	2400	QPSK	3	max	38750	39150	39550	23.7
<input type="checkbox"/>	LTE TDD 41	2496	2690	2496	2690	QPSK	3	max	40340	40740	41140	23.4
<input type="checkbox"/>	WLAN	2412	2472	2412	2472	CCK OFDM	--	max	1	7	13	17.6
<input checked="" type="checkbox"/>	WLAN US	2412	2462	2412	2462	CCK OFDM	--	max	1	6	11	17.8
<input type="checkbox"/>	BT	2402	2480	2402	2480	GFSK	3	max	0	39	78	1.5

)*: measured averaged max. RMS power for UMTS, LTE, WLAN and BT.

HSDPA/HSUPA 3GPP UE release version 8

LTE: Category 4

2.5 Transmitter and Antenna Operating Configurations

Simultaneous transmission conditions
GSM / GPRS / EDGE / DTM + BT/BLE ¹
GSM / GPRS / EDGE / DTM + WLAN 2.4GHz
UMTS / HSPA + BT/BLE
UMTS / HSPA + WLAN 2.4GHz
LTE + BT/BLE
LTE + WLAN 2.4GHz

Table 1: Simultaneous transmission conditions

Note: BT and WLAN can be active at the same time, but only with interleaving of packages switched on board level. That means that they don't transmit at the same time.

BLE¹ - Bluetooth low energy

3 Test standards/ procedures references

Test Standard	Version	Test Standard Description
IEEE 1528-2003	2003-04	Recommended Practice for Determining the Peak Spatial-Average Specific Absorption Rate (SAR) in the Human Head from Wireless Communications Devices: Measurement Techniques
IEEE 1528-2013	2013-06	Recommended Practice for Determining the Peak Spatial-Average Specific Absorption Rate (SAR) in the Human Head from Wireless Communications Devices: Measurement Techniques
RSS-102 Issue 5	2015-03	Radio Frequency Exposure Compliance of Radiocommunication Apparatus (All Frequency Bands)
Canada's Safety Code No. 6	2015-06	Limits of Human Exposure to Radiofrequency Electromagnetic Fields in the Frequency Range from 3 kHz to 300 GHz
IEEE Std. C95-3	2002	IEEE Recommended Practice for the Measurement of Potentially Hazardous Electromagnetic Fields – RF and Microwave
IEEE Std. C95-1	2005	IEEE Standard for Safety Levels with Respect to Human Exposure to Radio Frequency Electromagnetic Fields, 3 kHz to 300 GHz.
IEC 62209-2	2010	Human exposure to radio frequency fields from hand-held and bodymounted wireless communication devices. Human models, instrumentation, and procedures. Procedure to determine the specific absorption rate (SAR) for wireless communication devices used in close proximity to the human body (frequency range of 30 MHz to 6 GHz)

FCC KDBs:

KDB 865664D01v01	August 7, 2015	FCC OET SAR measurement requirements 100 MHz to 6 GHz
KDB 865664D02v01	October 23, 2015	RF Exposure Compliance Reporting and Documentation Considerations
KDB 447498D01v06	October 23, 2015	Mobile and Portable Devices RF Exposure Procedures and Equipment Authorization Policies
KDB 648474D04v01	October 23, 2015	SAR Evaluation Considerations for Wireless Handsets
KDB 941225D01v03	October 23, 2015	SAR Measurements Procedures for 3G Devices
KDB 941225D05v02	October 23, 2015	SAR for LTE Devices
KDB 941225D05Av01	October 23, 2015	LTE Rel. 10 KDB Inquiry Sheet
KDB 941225D06v02	October 23, 2015	SAR Evaluation Procedures for Portable Devices with Wireless Router Capabilities
KDB 248227D01v02	October 23, 2015	SAR Measurement Procedures for 802.11 a/b/g Transmitters

3.1 RF exposure limits

Human Exposure	Uncontrolled Environment General Population	Controlled Environment Occupational
Spatial Peak SAR* (Brain and Trunk)	1.60 mW/g	8.00 mW/g
Spatial Average SAR** (Whole Body)	0.08 mW/g	0.40 mW/g
Spatial Peak SAR*** (Hands/Feet/Ankle/Wrist)	4.00 mW/g	20.00 mW/g

Table 2: RF exposure limits

The limit applied in this test report is shown in bold letters

Notes:

- * The Spatial Peak value of the SAR averaged over any 1 gram of tissue (defined as a tissue volume in the shape of a cube) and over the appropriate averaging time
- ** The Spatial Average value of the SAR averaged over the whole body.
- *** The Spatial Peak value of the SAR averaged over any 10 grams of tissue (defined as a tissue volume in the shape of a cube) and over the appropriate averaging time.

Uncontrolled Environments are defined as locations where there is the exposure of individuals who have no knowledge or control of their exposure.

Controlled Environments are defined as locations where there is exposure that may be incurred by persons who are aware of the potential for exposure, (i.e. as a result of employment or occupation).

4 Summary of Measurement Results

<input checked="" type="checkbox"/>	No deviations from the technical specifications ascertained		
<input type="checkbox"/>	Deviations from the technical specifications ascertained		
Maximum SAR value reported for 1g (W/kg)			
	PCE	DTS	UNII
head	1.170	0.874	---
body worn 15 mm distance	0.823	0.218	---
hotspot operation 10 mm distance	1.300	0.851	---
collocated situations	ΣSAR evaluation	1.529	
	SPLSR_i ≤ 0.04	0.03	

4.1 Maximum measured and reported SAR values for Head configuration

HEAD	SAR_{1g} results(W/kg)		SAR_{10g} results(W/kg)	
	Measured	Extrapolated	Measured	Extrapolated
GSM 850	0.574	0.587	0.365	0.374
GSM 1900	0.380	0.407	0.229	0.245
UMTS FDD II	0.513	0.537	0.303	0.317
UMTS FDD IV	0.509	0.521	0.276	0.282
UMTS FDD V	0.518	0.595	0.333	0.380
LTE FDD 2	0.596	0.660	0.357	0.391
LTE FDD 4	0.554	0.580	0.305	0.319
LTE FDD 5	0.478	0.489	0.304	0.311
LTE FDD 7	1.170	1.170	0.618	0.618
LTE TDD 38	0.531	0.779	0.277	0.402
WLAN 2450	0.744	0.874	0.349	0.410

reported Combined SAR WWAN and WLAN 2.4GHz evaluation		
Frequency band	Position	Combined fast SAR_{1g}
GSM 850	left tilted 15°	0.930
GSM 1900	left tilted 15°	0.979
UMTS FDD II	left tilted 15°	0.990
UMTS FDD IV	left tilted 15°	0.963
UMTS FDD V	left tilted 15°	0.917
LTE FDD 2	left tilted 15°	0.970
LTE FDD 4	left tilted 15°	0.955
LTE FDD 5	left tilted 15°	0.902
LTE FDD 7	left cheek	1.110
LTE TDD 38	left tilted 15°	0.912

4.2 Maximum measured and reported SAR values for body worn configuration

body worn 15mm	SAR _{1g} results(W/kg)		SAR _{10g} results(W/kg)	
	Measured	Extrapolated	Measured	Extrapolated
GSM 850	0.564	0.650	0.417	0.484
GSM 1900	0.284	0.304	0.171	0.183
UMTS FDD II	0.433	0.453	0.251	0.263
UMTS FDD IV	0.684	0.785	0.426	0.489
UMTS FDD V	0.519	0.596	0.378	0.434
LTE FDD 2	0.458	0.502	0.269	0.295
LTE FDD 4	0.604	0.618	0.358	0.366
LTE FDD 5	0.489	0.512	0.354	0.371
LTE FDD 7	0.823	0.823	0.453	0.453
LTE TDD 38	0.321	0.453	0.173	0.244
WLAN 2450	0.166	0.218	0.089	0.115

reported Combined SAR WWAN and WLAN 2.4GHz evaluation		
Frequency band	Position	Combined fast SAR _{1g}
GSM 850	rear 15mm	0.621
GSM 1900	front 15mm	0.371
UMTS FDD II	front 15mm	0.436
UMTS FDD IV	front 15mm	0.635
UMTS FDD V	front 15mm	0.562
LTE FDD 2	front 15mm	0.483
LTE FDD 4	front 15mm	0.592
LTE FDD 5	rear 15mm	0.502
LTE FDD 7	front 15mm	0.811
LTE TDD 38	front 15mm	0.434

4.3 Maximum measured and reported SAR values for hotspot configuration

hotspot 10mm	SAR _{1g} results(W/kg)		SAR _{10g} results(W/kg)	
	Measured	Extrapolated	Measured	Extrapolated
GSM 850	0.991	1.014	0.565	0.658
GSM 1900	0.615	0.659	0.351	0.376
UMTS FDD II	1.220	1.277	0.642	0.672
UMTS FDD IV	1.020	1.198	0.533	0.612
UMTS FDD V	0.777	0.892	0.515	0.578
LTE FDD 2	0.949	1.041	0.530	0.581
LTE FDD 4	1.140	1.222	0.592	0.634
LTE FDD 5	0.730	0.747	0.431	0.441
LTE FDD 7	1.300	1.300	0.695	0.695
LTE TDD 38	0.576	0.814	0.311	0.439
WLAN 2450	0.724	0.851	0.328	0.385

reported Combined SAR WWAN and WLAN 2.4GHz evaluation		
Frequency band	Position	Combined fast SAR _{1g}
GSM 850	front 10mm	1.050
GSM 1900	top 10mm	0.851
UMTS FDD II	front 10mm	1.280
UMTS FDD IV	front 10mm	1.160
UMTS FDD V	front 10mm	0.901
LTE FDD 2	rear 10mm	0.970
LTE FDD 4	front 10mm	1.150
LTE FDD 5	top 10mm	0.851
LTE FDD 7	front 10mm	1.210
LTE TDD 38	top 10mm	0.851

4.4 SAR measurement variability and measurement uncertainty analysis

This analysis is required for worst case results larger than 0.8 W/kg.

frequency band	highest original measurement result at worst case position (W/kg)	repeated measurement result at worst case position (W/kg)	ratio <1.2
GSM 835	0.991	0.940	1.05
UMTS FDD II	1.220	1.170	1.04
UMTS FDD IV hotspot ant1	0.800	0.828	1.04
UMTS FDD IV hotspot ant2	1.020	0.999	1.02
LTE FDD 2	0.944	0.949	1.01
LTE FDD 4 hotspot ant1	0.827	0.773	1.07
LTE FDD 4 hotspot ant2	1.020	1.140	1.12
LTE FDD 7 head	1.150	1.170	1.02
LTE FDD 7 hotspot	1.300	1.190	1.09
LTE FDD 7 body	0.823	0.742	1.11
WLAN2450	0.744	0.689	1.08

5 Test Environment

Ambient temperature:	20 – 24 °C
Tissue Simulating liquid:	20 – 24 °C
Relative humidity content:	40 – 50 %
Air pressure:	not relevant for this kind of testing
Power supply:	230 V / 50 Hz

Exact temperature values for each test are shown in the table(s) under 7.1 and/or on the measurement plots.

6 Test Set-up

6.1 Measurement system

6.1.1 System Description

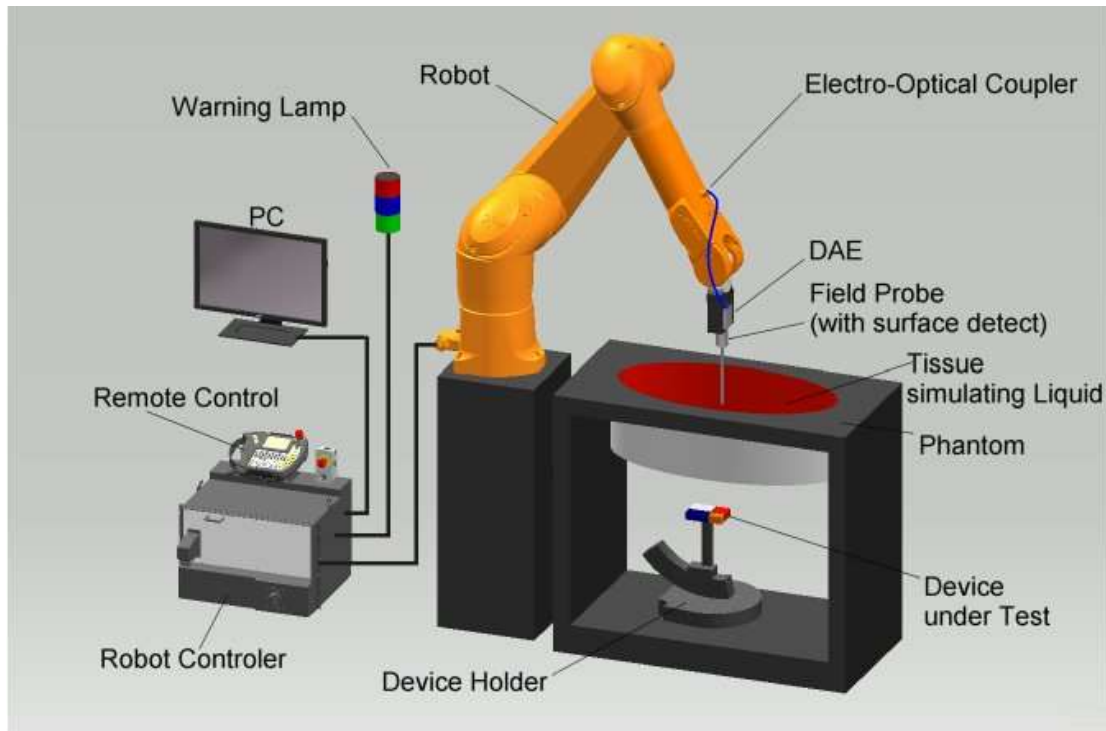

- The DASYS system for performing compliance tests consists of the following items:
- A standard high precision 6-axis robot (Stäubli RX/TX family) with controller and software. An arm extension for accommodating the data acquisition electronics (DAE).
- A dosimetric probe, i.e. an isotropic E-field probe optimized and calibrated for usage in tissue simulating liquid.
- A data acquisition electronic (DAE) which performs the signal amplification, signal multiplexing, AD-conversion, offset measurements, mechanical surface detection, collision detection, etc. The unit is battery powered with standard or rechargeable batteries. The signal is optically transmitted to the EOC.
- The Electro-Optical Coupler (EOC) performs the conversion from the optical into a digital electric signal of the DAE. The EOC is connected to the DASYS measurement server.
- The DASYS measurement server, which performs all real-time data evaluation for field measurements and surface detection, controls robot movements and handles safety operation. A computer operating Windows 7.
- DASYS software and SEMCAD data evaluation software.
- Remote control with teach panel and additional circuitry for robot safety such as warning lamps, etc.
- The generic twin phantom enabling the testing of left-hand and right-hand usage.
- The triple flat and eli phantom for the testing of handheld and body-mounted wireless devices.
- The device holder for handheld mobile phones and mounting device adaptor for laptops
- Tissue simulating liquid mixed according to the given recipes.
- System check dipoles allowing to validate the proper functioning of the system.

6.1.2 Test environment

The DASY measurement system is placed in a laboratory room within an environment which avoids influence on SAR measurements by ambient electromagnetic fields and any reflection from the environment. The pictures at the beginning of the photo documentation show a complete view of the test environment. The system allows the measurement of SAR values larger than 0.005 mW/g.

6.1.3 Probe description

Isotropic E-Field Probe ES3DV3 for Dosimetric Measurements	
Technical data according to manufacturer information	
Construction	Symmetrical design with triangular core Interleaved sensors Built-in shielding against static charges PEEK enclosure material (resistant to organic solvents, e.g., butyl diglycol)
Calibration	Calibration certificate in Appendix D
Frequency	10 MHz to 3 GHz (dosimetry); Linearity: ± 0.2 dB (30 MHz to 3 GHz)
Directivity	± 0.2 dB in HSL (rotation around probe axis) ± 0.3 dB in HSL (rotation normal to probe axis)
Dynamic range	5 μ W/g to > 100 mW/g; Linearity: ± 0.2 dB
Dimensions	Overall length: 330 mm Tip length: 20 mm Body diameter: 12 mm Tip diameter: 3.9 mm Distance from probe tip to dipole centers: 2.0 mm
Application	General dosimetry up to 3 GHz Compliance tests of mobile phones Fast automatic scanning in arbitrary phantoms (ES3DV3)

Isotropic E-Field Probe EX3DV4 for Dosimetric Measurements	
Technical data according to manufacturer information	
Construction	Symmetrical design with triangular core Interleaved sensors Built-in shielding against static charges PEEK enclosure material (resistant to organic solvents, e.g., DGBE)
Calibration	ISO/IEC 17025 calibration service available.
Frequency	10 MHz to >6 GHz (dosimetry); Linearity: ± 0.2 dB (30 MHz to 6 GHz)
Directivity	± 0.3 dB in HSL (rotation around probe axis) ± 0.5 dB in tissue material (rotation normal to probe axis)
Dynamic range	10 μ W/g to > 100 mW/g; Linearity: ± 0.2 dB (noise: typically <1 μ W/g)
Dimensions	Overall length: 337 mm (Tip: 20mm) Tip length: 2.5 mm (Body: 12mm) Typical distance from probe tip to dipole centers: 1mm
Application	High precision dosimetric measurements in any exposure scenario (e.g., very strong gradient fields). Only probe which enables compliance testing for frequencies up to 6 GHz with precision of better 30%.

6.1.4 Phantom description

The used SAM Phantom meets the requirements specified in FCC KDB865664 D01 for Specific Absorption Rate (SAR) measurements.

The phantom consists of a fibreglass shell integrated in a wooden table. It allows left-hand and right-hand head as well as body-worn measurements with a maximum liquid depth of 18 cm in head position and 22 cm in planar position (body measurements). The thickness of the Phantom shell is 2 mm +/- 0.1 mm.

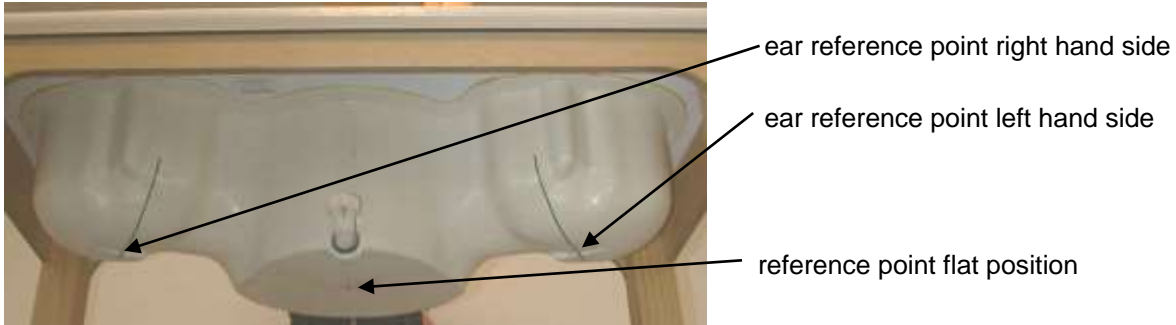

Triple Modular Phantom consists of three identical modules which can be installed and removed separately without emptying the liquid. It includes three reference points for phantom installation. Covers prevent evaporation of the liquid. Phantom material is resistant to DGBE based tissue simulating liquids.

6.1.5 Device holder description

The DASY device holder has two scales for device rotation (with respect to the body axis) and the device inclination (with respect to the line between the ear openings). The plane between the ear openings and the mouth tip has a rotation angle of 65°. The bottom plate contains three pair of bolts for locking the device holder. The device holder positions are adjusted to the standard measurement positions in the three sections. This device holder is used for standard mobile phones or PDA's only. If necessary an additional support of polystyrene material is used.



Larger DUT's (e.g. notebooks) cannot be tested using this device holder. Instead a support of bigger polystyrene cubes and thin polystyrene plates is used to position the DUT in all relevant positions to find and measure spots with maximum SAR values.

Therefore those devices are normally only tested at the flat part of the SAM.

6.1.6 Scanning procedure

- The DASY installation includes predefined files with recommended procedures for measurements and system check. They are read-only document files and destined as fully defined but unmeasured masks. All test positions (head or body-worn) are tested with the same configuration of test steps differing only in the grid definition for the different test positions.
- The „reference“ and „drift“ measurements are located at the beginning and end of the batch process. They measure the field drift at one single point in the liquid over the complete procedure. The indicated drift is mainly the variation of the DUT's output power and should vary max. +/- 5 %.
- The highest integrated SAR value is the main concern in compliance test applications. These values can mostly be found at the inner surface of the phantom and cannot be measured directly due to the sensor offset in the probe. To extrapolate the surface values, the measurement distances to the surface must be known accurately. A distance error of 0.5mm could produce SAR errors of 6% at 1800 MHz. Using predefined locations for measurements is not accurate enough. Any shift of the phantom (e.g., slight deformations after filling it with liquid) would produce high uncertainties. For an automatic and accurate detection of the phantom surface, the DASY5 system uses the mechanical surface detection. The detection is always at touch, but the probe will move backward from the surface the indicated distance before starting the measurement.
- The „area scan“ measures the SAR above the DUT or verification dipole on a parallel plane to the surface. It is used to locate the approximate location of the peak SAR with 2D spline interpolation. The robot performs a stepped movement along one grid axis while the local electrical field strength is measured by the probe. The probe is touching the surface of the SAM during acquisition of measurement values. The scan uses different grid spacings for different frequency measurements. Standard grid spacing for head measurements in frequency ranges ≤ 2 GHz is 15 mm in x- and y-dimension. For higher frequencies a finer resolution is needed, thus for the grid spacing is reduced according the following table:

Area scan grid spacing for different frequency ranges	
Frequency range	Grid spacing
≤ 2 GHz	≤ 15 mm
2 – 4 GHz	≤ 12 mm
4 – 6 GHz	≤ 10 mm

Grid spacing and orientation have no influence on the SAR result. For special applications where the standard scan method does not find the peak SAR within the grid, e.g. mobile phones with flip cover, the grid can be adapted in orientation. Results of this coarse scan are shown in annex B.

- A „zoom scan“ measures the field in a volume around the 2D peak SAR value acquired in the previous „coarse“ scan. It uses a fine meshed grid where the robot moves the probe in steps along all the 3 axis (x, y and z-axis) starting at the bottom of the Phantom. The grid spacing for the cube measurement is varied according to the measured frequency range, the dimensions are given in the following table:

Zoom scan grid spacing and volume for different frequency ranges			
Frequency range	Grid spacing for x, y axis	Grid spacing for z axis	Minimum zoom scan volume
≤ 2 GHz	≤ 8 mm	≤ 5 mm	≥ 30 mm
2 – 3 GHz	≤ 5 mm*	≤ 5 mm	≥ 28 mm
3 – 4 GHz	≤ 5 mm*	≤ 4 mm	≥ 28 mm
4 – 5 GHz	≤ 4 mm*	≤ 3 mm	≥ 25 mm
5 – 6 GHz	≤ 4 mm*	≤ 2 mm	≥ 22 mm

* When zoom scan is required and the reported SAR from the area scan based 1-g SAR estimation procedures of KDB Publication 447498 is ≤ 1.4 W/kg, ≤ 8 mm, ≤ 7 mm and ≤ 5 mm zoom scan resolution may be applied, respectively, for 2 GHz to 3 GHz, 3 GHz to 4 GHz and 4 GHz to 6 GHz.

DASY is also able to perform repeated zoom scans if more than 1 peak is found during area scan. In this document, the evaluated peak 1g and 10g averaged SAR values are shown in the 2D-graphics in annex B. Test results relevant for the specified standard (see section 3) are shown in table form in section 7.

6.1.7 Spatial Peak SAR Evaluation

The spatial peak SAR - value for 1 and 10 g is evaluated after the Cube measurements have been done. The basis of the evaluation are the SAR values measured at the points of the fine cube grid consisting of all points in the three directions x, y and z. The algorithm that finds the maximal averaged volume is separated into three different stages.

- The data between the dipole center of the probe and the surface of the phantom are extrapolated. This data cannot be measured since the center of the dipole is 1 to 2.7 mm away from the tip of the probe and the distance between the surface and the lowest measuring point is about 1 mm (see probe calibration sheet). The extrapolated data from a cube measurement can be visualized by selecting 'Graph Evaluated'.
- The maximum interpolated value is searched with a straight-forward algorithm. Around this maximum the SAR - values averaged over the spatial volumes (1g or 10 g) are computed using the 3d-spline interpolation algorithm. If the volume cannot be evaluated (i.e., if a part of the grid was cut off by the boundary of the measurement area) the evaluation will be started on the corners of the bottom plane of the cube.
- All neighbouring volumes are evaluated until no neighbouring volume with a higher average value is found.

Extrapolation

The extrapolation is based on a least square algorithm [W. Gander, Computermathematik, p.168-180]. Through the points in the first 3 cm along the z-axis, polynomials of order four are calculated. These polynomials are then used to evaluate the points between the surface and the probe tip. The points, calculated from the surface, have a distance of 1 mm from each other.

Interpolation

The interpolation of the points is done with a 3d-Spline. The 3d-Spline is composed of three one-dimensional splines with the "Not a knot"-condition [W. Gander, Computermathematik, p.141-150] (x, y and z -direction) [Numerical Recipes in C, Second Edition, p.123ff].

Volume Averaging

At First the size of the cube is calculated. Then the volume is integrated with the trapezoidal algorithm. 8000 points (20x20x20) are interpolated to calculate the average.

Advanced Extrapolation

DASY uses the advanced extrapolation option which is able to compensate boundary effects on E-field probes.

6.1.8 Data Storage and Evaluation

Data Storage

The DASY software stores the acquired data from the data acquisition electronics as raw data (in microvolt readings from the probe sensors), together with all necessary software parameters for the data evaluation (probe calibration data, liquid parameters and device frequency and modulation data) in measurement files with the extension ".DA4", ".DA5x". The software evaluates the desired unit and format for output each time the data is visualized or exported. This allows verification of the complete software setup even after the measurement and allows correction of incorrect parameter settings. For example, if a measurement has been performed with a wrong crest factor parameter in the device setup, the parameter can be corrected afterwards and the data can be re-evaluated.

The measured data can be visualized or exported in different units or formats, depending on the selected probe type ([V/m], [A/m], [°C], [mW/g], [mW/cm²], [dBrel], etc.). Some of these units are not available in certain situations or show meaningless results, e.g., a SAR output in a lossless media will always be zero. Raw data can also be exported to perform the evaluation with other software packages.

Data Evaluation by SEMCAD

The SEMCAD software automatically executes the following procedures to calculate the field units from the microvolt readings at the probe connector. The parameters used in the evaluation are stored in the configuration modules of the software:

Probe parameters:	- Sensitivity	Norm _i , a _{i0} , a _{i1} , a _{i2}
	- Conversion factor	ConvF _i
	- Diode compression point	Dcpi
Device parameters:	- Frequency	f
	- Crest factor	cf
Media parameters:	- Conductivity	σ
	- Density	ρ

These parameters must be set correctly in the software. They can be found in the component documents or they can be imported into the software from the configuration files issued for the DASY components. In the direct measuring mode of the multimeter option, the parameters of the actual system setup are used. In the scan visualization and export modes, the parameters stored in the corresponding document files are used.

The first step of the evaluation is a linearization of the filtered input signal to account for the compression characteristics of the detector diode. The compensation depends on the input signal, the diode type and the DC-transmission factor from the diode to the evaluation electronics.

If the exciting field is pulsed, the crest factor of the signal must be known to correctly compensate for peak power. The formula for each channel can be given as:

$$V_i = U_i + U_i^2 \cdot cf/dcp_i$$

with V_i = compensated signal of channel i (i = x, y, z)
 U_i = input signal of channel i (i = x, y, z)
 cf = crest factor of exciting field (DASY parameter)
 dcp_i = diode compression point (DASY parameter)

From the compensated input signals the primary field data for each channel can be evaluated:

E-field probes: $E_i = (V_i / Norm_i \cdot ConvF)^{1/2}$

H-field probes: $H_i = (V_i)^{1/2} \cdot (a_{i0} + a_{i1}f + a_{i2}f^2)/f$

with V_i = compensated signal of channel i (i = x, y, z)
 $Norm_i$ = sensor sensitivity of channel i (i = x, y, z)
 [mV/(V/m)²] for E-field Probes
 $ConvF$ = sensitivity enhancement in solution
 a_{ij} = sensor sensitivity factors for H-field probes
 f = carrier frequency [GHz]
 E_i = electric field strength of channel i in V/m
 H_i = magnetic field strength of channel i in A/m

The RSS value of the field components gives the total field strength (Hermitian magnitude):

$$E_{tot} = (E_x^2 + E_y^2 + E_z^2)^{1/2}$$

The primary field data are used to calculate the derived field units.

$$SAR = (E_{tot}^2 \cdot \sigma) / (\rho \cdot 1000)$$

with SAR = local specific absorption rate in mW/g
 E_{tot} = total field strength in V/m
 σ = conductivity in [mho/m] or [Siemens/m]
 ρ = equivalent tissue density in g/cm³

Note that the density is normally set to 1 (or 1.06), to account for actual brain density rather than the density of the simulation liquid. The power flow density is calculated assuming the excitation field to be a free space field.

$$P_{pwe} = E_{tot}^2 / 3770 \quad \text{or} \quad P_{pwe} = H_{tot}^2 \cdot 37.7$$

with P_{pwe} = equivalent power density of a plane wave in mW/cm²
 E_{tot} = total electric field strength in V/m
 H_{tot} = total magnetic field strength in A/m

6.1.9 Tissue simulating liquids: dielectric properties

The following materials are used for producing the tissue-equivalent materials.

(Liquids used for tests described in section 7. are marked with ☒):

Ingredients (% of weight)	Frequency (MHz)								
	<input type="checkbox"/> 450	<input type="checkbox"/> 750	<input checked="" type="checkbox"/> 835	<input type="checkbox"/> 900	<input type="checkbox"/> 1450	<input checked="" type="checkbox"/> 1750	<input checked="" type="checkbox"/> 1900	<input checked="" type="checkbox"/> 2450	<input type="checkbox"/> 5000
frequency band									
Water	38.56	41.1	41.45	40.92	54.37	55.35	55.19	54.7	64 - 78
Salt (NaCl)	3.95	1.4	1.45	1.48	0.63	0.38	0.19	0.0	2 - 3
Sugar	56.32	57.0	56.0	56.5	0.0	0.0	0.0	0.0	0.0
HEC	0.98	0.2	1.0	1.0	0.0	0.0	0.0	0.0	0.0
Bactericide	0.19	0.2	0.1	0.1	0.1	0.1	0.1	0.1	0.0
Tween 20	0.0	0.0	0.0	0.0	44.90	44.17	44.52	45.2	0.0
Emulsifiers	0.0	0.0	0.0	0.0	0.0	0.0	0.0	0.0	9 - 15
Mineral Oil	0.0	0.0	0.0	0.0	0.0	0.0	0.0	0.0	11 - 18

Table 3: Head tissue dielectric properties

Ingredients (% of weight)	Frequency (MHz)								
	<input type="checkbox"/> 450	<input type="checkbox"/> 750	<input checked="" type="checkbox"/> 835	<input type="checkbox"/> 900	<input type="checkbox"/> 1450	<input checked="" type="checkbox"/> 1750	<input checked="" type="checkbox"/> 1900	<input checked="" type="checkbox"/> 2450	<input type="checkbox"/> 5000
frequency band									
Water	51.16	51.7	52.4	56.0	71.40	71.45	71.56	71.65	64 - 78
Salt (NaCl)	1.49	0.9	1.40	0.76	0.55	0.5	0.39	0.3	2 - 3
Sugar	46.78	47.2	45.0	41.76	0.0	0.0	0.0	0.0	0.0
HEC	0.52	0.0	1.0	1.21	0.0	0.0	0.0	0.0	0.0
Bactericide	0.05	0.1	0.1	0.27	0.1	0.1	0.1	0.1	0.0
Tween 20	0.0	0.0	0.0	0.0	27.95	27.95	27.95	27.95	0.0
Emulsifiers	0.0	0.0	0.0	0.0	0.0	0.0	0.0	0.0	9 - 15
Mineral Oil	0.0	0.0	0.0	0.0	0.0	0.0	0.0	0.0	11 - 18

Table 4: Body tissue dielectric properties

Salt: 99+% Pure Sodium Chloride

Water: De-ionized, 16MΩ+ resistivity

Sugar: 98+% Pure Sucrose

HEC: Hydroxyethyl Cellulose

Tween 20: Polyoxyethylene (20) sorbitan monolaurate

6.1.10 Tissue simulating liquids: parameters

Liquid HSL	Freq. (MHz)	Target head tissue		Measurement head tissue					Measurement date
		Permittivity	Conductivity (S/m)	Permittivity	Dev. %	Conductivity		Dev. %	
						ϵ''	(S/m)		
850/900	824	41.56	0.90	42.7	2.7%	19.89	0.91	1.4%	2015-12-11
	835	41.50	0.90	42.5	2.5%	19.85	0.92	2.4%	
	837	41.50	0.90	42.5	2.5%	19.86	0.92	2.5%	
	849	41.50	0.92	42.4	2.1%	19.81	0.94	2.2%	
850/900	824	41.56	0.90	42.7	2.7%	19.89	0.91	1.4%	2015-12-12
	829	41.50	0.90	42.6	2.7%	19.87	0.92	1.8%	
	835	41.50	0.90	42.5	2.5%	19.85	0.92	2.4%	
	837	41.50	0.90	42.5	2.5%	19.86	0.92	2.5%	
	844	41.50	0.91	42.4	2.2%	19.84	0.93	2.4%	
	849	41.50	0.92	42.4	2.1%	19.81	0.94	2.2%	
850/900	826	41.55	0.90	41.7	0.4%	19.66	0.90	0.4%	2015-12-16
	835	41.50	0.90	41.6	0.1%	19.64	0.91	1.4%	
	836	41.50	0.90	41.5	0.0%	19.67	0.91	1.5%	
	847	41.50	0.91	41.4	-0.3%	19.62	0.92	1.3%	
1750	1712	40.13	1.35	39.3	-2.0%	13.71	1.31	-3.3%	2015-12-15
	1732	40.10	1.36	39.3	-2.1%	13.73	1.32	-2.8%	
	1750	40.07	1.37	39.2	-2.2%	13.76	1.34	-2.3%	
	1752	40.07	1.37	39.2	-2.2%	13.76	1.34	-2.3%	
1750	1720	40.11	1.35	38.9	-3.1%	13.67	1.31	-3.4%	2015-12-17
	1732	40.10	1.36	38.8	-3.2%	13.68	1.32	-3.2%	
	1745	40.08	1.37	38.8	-3.3%	13.71	1.33	-2.8%	
	1750	40.07	1.37	38.8	-3.3%	13.71	1.33	-2.7%	
1900	1860	40.00	1.40	39.6	-0.9%	13.04	1.35	-3.6%	2015-12-11
	1880	40.00	1.40	39.6	-1.0%	13.06	1.37	-2.4%	
	1900	40.00	1.40	39.5	-1.2%	13.21	1.40	-0.3%	
1900	1850	40.00	1.40	38.9	-2.7%	13.05	1.34	-4.1%	2015-12-14
	1880	40.00	1.40	38.8	-3.0%	13.14	1.37	-1.8%	
	1900	40.00	1.40	38.7	-3.2%	13.18	1.39	-0.5%	
	1910	40.00	1.40	38.7	-3.3%	13.19	1.40	0.1%	

Liquid HSL	Freq. (MHz)	Target head tissue		Measurement head tissue					Measurement date
		Permittivity	Conductivity (S/m)	Permittivity	Dev. %	Conductivity		Dev. %	
						ϵ''	(S/m)		
1900	1852	40.00	1.40	38.6	-3.6%	12.92	1.33	-4.9%	2015-12-15
	1880	40.00	1.40	38.5	-3.8%	12.99	1.36	-3.0%	
	1900	40.00	1.40	38.4	-4.1%	13.05	1.38	-1.5%	
	1908	40.00	1.40	38.4	-4.1%	13.05	1.39	-1.1%	
2450	2412	39.27	1.77	39.0	-0.6%	12.85	1.72	-2.4%	2015-12-21
	2437	39.22	1.79	38.9	-0.8%	12.94	1.75	-1.9%	
	2450	39.20	1.80	38.9	-0.8%	12.94	1.76	-2.0%	
	2462	39.18	1.81	38.9	-0.8%	12.96	1.77	-2.1%	
2450 / 2600	2510	39.12	1.87	38.4	-1.9%	13.40	1.87	0.3%	2015-12-22
	2535	39.09	1.89	38.3	-2.1%	13.44	1.90	0.1%	
	2560	39.06	1.92	38.2	-2.2%	13.51	1.92	0.2%	
	2600	39.01	1.96	38.1	-2.4%	13.60	1.97	0.2%	
2600	2580	39.03	1.94	37.5	-4.0%	13.38	1.92	-1.1%	2015-12-28
	2595	39.02	1.96	37.4	-4.1%	13.39	1.93	-1.3%	
	2600	39.01	1.96	37.4	-4.2%	13.40	1.94	-1.3%	
	2610	39.00	1.97	37.4	-4.2%	13.43	1.95	-1.3%	

Table 5: Parameter of the head tissue simulating liquid

Liquid MSL	Freq. (MHz)	Target body tissue		Measurement body tissue					Measurement date
		Permittivity	Conductivity (S/m)	Permittivity	Dev. %	Conductivity		Dev. %	
						ε"	(S/m)		
850/900	829	55.22	0.97	54.8	-0.8%	21.59	1.00	2.7%	2015-12-19
	835	55.20	0.97	54.7	-0.9%	21.57	1.00	3.3%	
	837	55.19	0.97	54.7	-0.9%	21.57	1.00	3.3%	
	844	55.17	0.98	54.6	-1.0%	21.52	1.01	3.0%	
850/900	826	55.24	0.97	53.5	-3.1%	21.03	0.97	-0.3%	2015-12-22
	835	55.20	0.97	53.4	-3.3%	20.98	0.97	0.5%	
	836	55.20	0.97	53.4	-3.3%	20.98	0.98	0.6%	
	847	55.16	0.98	53.3	-3.4%	20.92	0.99	0.1%	
850/900	824	55.24	0.97	53.6	-3.0%	21.06	0.97	-0.4%	2015-12-23
	835	55.20	0.97	53.5	-3.2%	21.00	0.98	0.6%	
	837	55.19	0.97	53.5	-3.2%	21.02	0.98	0.6%	
	849	55.16	0.99	53.3	-3.3%	20.96	0.99	0.3%	
1750	1720	53.51	1.47	52.4	-2.1%	15.40	1.47	0.3%	2015-12-22
	1732	53.48	1.48	52.4	-2.1%	15.40	1.48	0.4%	
	1745	53.44	1.49	52.3	-2.1%	15.40	1.49	0.6%	
	1750	53.43	1.49	52.3	-2.1%	15.41	1.50	0.8%	
1750	1720	53.51	1.47	51.7	-3.4%	15.39	1.47	0.2%	2015-12-23
	1732	53.48	1.48	51.7	-3.3%	15.39	1.48	0.4%	
	1745	53.44	1.49	51.8	-3.2%	15.42	1.50	0.8%	
	1750	53.43	1.49	51.8	-3.1%	15.41	1.50	0.8%	
1750	1712	53.53	1.46	52.1	-2.7%	15.72	1.50	2.2%	2015-12-29
	1732	53.48	1.48	52.1	-2.7%	15.70	1.51	2.4%	
	1750	53.43	1.49	52.0	-2.7%	15.72	1.53	2.8%	
	1753	53.42	1.49	52.0	-2.7%	15.72	1.53	2.9%	
1900	1860	53.30	1.52	54.6	2.4%	14.04	1.45	-4.4%	2015-12-17
	1880	53.30	1.52	54.7	2.6%	14.16	1.48	-2.6%	
	1900	53.30	1.52	54.5	2.2%	14.21	1.50	-1.2%	
1900	1850	53.30	1.52	54.0	1.3%	14.11	1.45	-4.5%	2015-12-18
	1852	53.30	1.52	54.0	1.3%	14.10	1.45	-4.4%	
	1880	53.30	1.52	53.9	1.2%	14.14	1.48	-2.7%	
	1900	53.30	1.52	53.9	1.1%	14.15	1.50	-1.6%	
	1908	53.30	1.52	53.8	1.0%	14.17	1.50	-1.1%	
	1910	53.30	1.52	53.8	1.0%	14.15	1.50	-1.1%	
	1910	53.30	1.52	53.8	1.0%	14.15	1.50	-1.1%	
1900	1850	53.30	1.52	54.0	1.3%	14.30	1.47	-3.2%	2015-12-19
	1880	53.30	1.52	54.1	1.4%	14.34	1.50	-1.3%	
	1900	53.30	1.52	53.8	1.0%	14.41	1.52	0.2%	
	1910	53.30	1.52	53.8	1.0%	14.29	1.52	-0.1%	
2450	2412	52.75	1.91	51.7	-2.0%	14.64	1.96	2.6%	2015-12-24
	2437	52.72	1.94	51.6	-2.0%	14.67	1.99	2.6%	
	2450	52.70	1.95	51.6	-2.1%	14.72	2.01	2.9%	
	2462	52.68	1.97	51.6	-2.1%	14.76	2.02	2.8%	

Liquid MSL	Freq. (MHz)	Target body tissue		Measurement body tissue					Measurement date
		Permittivity	Conductivity (S/m)	Permittivity	Dev. %	Conductivity		Dev. %	
						ϵ''	(S/m)		
2600	2580	52.53	2.13	50.4	-4.1%	15.04	2.16	1.1%	2015-12-29
	2595	52.52	2.16	50.4	-4.1%	15.14	2.19	1.4%	
	2600	52.51	2.16	50.3	-4.2%	15.16	2.19	1.4%	
	2610	52.50	2.18	50.3	-4.2%	15.22	2.21	1.5%	
2600	2510	52.62	2.04	50.6	-3.9%	15.03	2.10	3.1%	2015-12-30
	2535	52.59	2.07	50.6	-3.8%	15.15	2.14	3.2%	
	2560	52.56	2.11	50.4	-4.2%	15.16	2.16	2.5%	
	2600	52.51	2.16	50.3	-4.2%	15.16	2.19	1.4%	

Table 6: Parameter of the body tissue simulating liquid

Note: The dielectric properties have been measured using the contact probe method at 22°C.

6.1.11 Measurement uncertainty evaluation for SAR test

DASY5 Uncertainty Budget								
According to IEEE 1528/2003 and IEC 62209-1 for the 300 MHz - 3 GHz range								
Source of uncertainty	Uncertainty Value ± %	Probability Distribution	Divisor	c _i (1g)	c _i (10g)	Standard Uncertainty		v _i ² or v _{eff}
						± %, (1g)	± %, (10g)	
Measurement System								
Probe calibration	± 6.0 %	Normal	1	1	1	± 6.0 %	± 6.0 %	∞
Axial isotropy	± 4.7 %	Rectangular	√ 3	0.7	0.7	± 1.9 %	± 1.9 %	∞
Hemispherical isotropy	± 9.6 %	Rectangular	√ 3	0.7	0.7	± 3.9 %	± 3.9 %	∞
Boundary effects	± 1.0 %	Rectangular	√ 3	1	1	± 0.6 %	± 0.6 %	∞
Probe linearity	± 4.7 %	Rectangular	√ 3	1	1	± 2.7 %	± 2.7 %	∞
System detection limits	± 1.0 %	Rectangular	√ 3	1	1	± 0.6 %	± 0.6 %	∞
Readout electronics	± 0.3 %	Normal	1	1	1	± 0.3 %	± 0.3 %	∞
Response time	± 0.8 %	Rectangular	√ 3	1	1	± 0.5 %	± 0.5 %	∞
Integration time	± 2.6 %	Rectangular	√ 3	1	1	± 1.5 %	± 1.5 %	∞
RF ambient noise	± 3.0 %	Rectangular	√ 3	1	1	± 1.7 %	± 1.7 %	∞
RF ambient reflections	± 3.0 %	Rectangular	√ 3	1	1	± 1.7 %	± 1.7 %	∞
Probe positioner	± 0.4 %	Rectangular	√ 3	1	1	± 0.2 %	± 0.2 %	∞
Probe positioning	± 2.9 %	Rectangular	√ 3	1	1	± 1.7 %	± 1.7 %	∞
Max.SAR evaluation	± 1.0 %	Rectangular	√ 3	1	1	± 0.6 %	± 0.6 %	∞
Test Sample Related								
Device positioning	± 2.9 %	Normal	1	1	1	± 2.9 %	± 2.9 %	145
Device holder uncertainty	± 3.6 %	Normal	1	1	1	± 3.6 %	± 3.6 %	5
Power drift	± 5.0 %	Rectangular	√ 3	1	1	± 2.9 %	± 2.9 %	∞
Phantom and Set-up								
Phantom uncertainty	± 4.0 %	Rectangular	√ 3	1	1	± 2.3 %	± 2.3 %	∞
Liquid conductivity (target)	± 5.0 %	Rectangular	√ 3	0.64	0.43	± 1.8 %	± 1.2 %	∞
Liquid conductivity (meas.)	± 5.0 %	Rectangular	√ 3	0.64	0.43	± 1.8 %	± 1.2 %	∞
Liquid permittivity (target)	± 5.0 %	Rectangular	√ 3	0.6	0.49	± 1.7 %	± 1.4 %	∞
Liquid permittivity (meas.)	± 5.0 %	Rectangular	√ 3	0.6	0.49	± 1.7 %	± 1.4 %	∞
Combined Std.						± 11.1 %	± 10.8 %	387
Expanded Std.						± 22.1 %	± 21.6 %	

Table 7: Measurement uncertainties

Worst-Case uncertainty budget for DASY5 assessed according to IEEE 1528/2003.

The budget is valid for 2G and 3G communication signals and frequency range 300MHz - 3 GHz.

For these conditions it represents a worst-case analysis. For specific tests and configurations, the uncertainty could be considerable smaller.

Relative DASY5 Uncertainty Budget for SAR Tests								
According to IEEE 1528/2013 and IEC62209/2011 for the 0.3 - 3GHz range								
Error Description	Uncertainty Value ± %	Probability Distribution	Divisor	c _i (1g)	c _i (10g)	Standard Uncertainty		v _i ² or v _{eff}
						± %, (1g)	± %, (10g)	
Measurement System								
Probe calibration	± 6.0 %	Normal	1	1	1	± 6.0 %	± 6.0 %	∞
Axial isotropy	± 4.7 %	Rectangular	√ 3	0.7	0.7	± 1.9 %	± 1.9 %	∞
Hemispherical isotropy	± 9.6 %	Rectangular	√ 3	0.7	0.7	± 3.9 %	± 3.9 %	∞
Boundary effects	± 1.0 %	Rectangular	√ 3	1	1	± 0.6 %	± 0.6 %	∞
Probe linearity	± 4.7 %	Rectangular	√ 3	1	1	± 2.7 %	± 2.7 %	∞
System detection limits	± 1.0 %	Rectangular	√ 3	1	1	± 0.6 %	± 0.6 %	∞
Modulation Response	± 2.4 %	Rectangular	√ 3	1	1	± 1.4 %	± 1.4 %	∞
Readout electronics	± 0.3 %	Normal	1	1	1	± 0.3 %	± 0.3 %	∞
Response time	± 0.8 %	Rectangular	√ 3	1	1	± 0.5 %	± 0.5 %	∞
Integration time	± 2.6 %	Rectangular	√ 3	1	1	± 1.5 %	± 1.5 %	∞
RF ambient noise	± 3.0 %	Rectangular	√ 3	1	1	± 1.7 %	± 1.7 %	∞
RF ambient reflections	± 3.0 %	Rectangular	√ 3	1	1	± 1.7 %	± 1.7 %	∞
Probe positioner	± 0.4 %	Rectangular	√ 3	1	1	± 0.2 %	± 0.2 %	∞
Probe positioning	± 2.9 %	Rectangular	√ 3	1	1	± 1.7 %	± 1.7 %	∞
Max. SAR evaluation	± 2.0 %	Rectangular	√ 3	1	1	± 1.2 %	± 1.2 %	∞
Test Sample Related								
Device positioning	± 2.9 %	Normal	1	1	1	± 2.9 %	± 2.9 %	145
Device holder uncertainty	± 3.6 %	Normal	1	1	1	± 3.6 %	± 3.6 %	5
Power drift	± 5.0 %	Rectangular	√ 3	1	1	± 2.9 %	± 2.9 %	∞
Phantom and Set-up								
Phantom uncertainty	± 6.1 %	Rectangular	√ 3	1	1	± 3.5 %	± 3.5 %	∞
SAR correction	± 1.9 %	Rectangular	√ 3	1	0.84	± 1.1 %	± 0.9 %	∞
Liquid conductivity (meas.)	± 5.0 %	Rectangular	√ 3	0.78	0.71	± 2.3 %	± 2.0 %	∞
Liquid permittivity (meas.)	± 5.0 %	Rectangular	√ 3	0.26	0.26	± 0.8 %	± 0.8 %	∞
Temp. Unc. - Conductivity	± 3.4 %	Rectangular	√ 3	0.78	0.71	± 1.5 %	± 1.4 %	∞
Temp. Unc. - Permittivity	± 0.4 %	Rectangular	√ 3	0.23	0.26	± 0.1 %	± 0.1 %	∞
Combined Uncertainty						± 11.3 %	± 11.3 %	330
Expanded Std. Uncertainty						± 22.7 %	± 22.5 %	

Table 8: Measurement uncertainties
 Worst-Case uncertainty budget for DASY5 assessed according to IEEE 1528/2013 and IEC 62209-1/2011 standards. The budget is valid for the frequency range 300MHz -3 GHz and represents a worst-case analysis. For specific tests and configurations, the uncertainty could be considerable smaller.

DASY5 Uncertainty Budget									
According to IEC 62209-2/2010 for the 300 MHz - 6 GHz range									
Source of uncertainty	Uncertainty Value	Probability Distribution	Divisor	c _i (1g)	c _i (10g)	Standard Uncertainty		v _i ² or v _{eff}	
						± %, (1g)	± %, (10g)		
Measurement System									
Probe calibration	± 6.6 %	Normal	1	1	1	± 6.6 %	± 6.6 %	∞	
Axial isotropy	± 4.7 %	Rectangular	√ 3	0.7	0.7	± 1.9 %	± 1.9 %	∞	
Hemispherical isotropy	± 9.6 %	Rectangular	√ 3	0.7	0.7	± 3.9 %	± 3.9 %	∞	
Boundary effects	± 2.0 %	Rectangular	√ 3	1	1	± 1.2 %	± 1.2 %	∞	
Probe linearity	± 4.7 %	Rectangular	√ 3	1	1	± 2.7 %	± 2.7 %	∞	
System detection limits	± 1.0 %	Rectangular	√ 3	1	1	± 0.6 %	± 0.6 %	∞	
Modulation Response	± 2.4 %	Rectangular	√ 3	1	1	± 1.4 %	± 1.4 %	∞	
Readout electronics	± 0.3 %	Normal	1	1	1	± 0.3 %	± 0.3 %	∞	
Response time	± 0.8 %	Rectangular	√ 3	1	1	± 0.5 %	± 0.5 %	∞	
Integration time	± 2.6 %	Rectangular	√ 3	1	1	± 1.5 %	± 1.5 %	∞	
RF ambient noise	± 3.0 %	Rectangular	√ 3	1	1	± 1.7 %	± 1.7 %	∞	
RF ambient reflections	± 3.0 %	Rectangular	√ 3	1	1	± 1.7 %	± 1.7 %	∞	
Probe positioner	± 0.8 %	Rectangular	√ 3	1	1	± 0.5 %	± 0.5 %	∞	
Probe positioning	± 6.7 %	Rectangular	√ 3	1	1	± 3.9 %	± 3.9 %	∞	
Post-processing	± 4.0 %	Rectangular	√ 3	1	1	± 2.3 %	± 2.3 %	∞	
Test Sample Related									
Device positioning	± 2.9 %	Normal	1	1	1	± 2.9 %	± 2.9 %	145	
Device holder uncertainty	± 3.6 %	Normal	1	1	1	± 3.6 %	± 3.6 %	5	
Power drift	± 5.0 %	Rectangular	√ 3	1	1	± 2.9 %	± 2.9 %	∞	
Phantom and Set-up									
Phantom uncertainty	± 7.9 %	Rectangular	√ 3	1	1	± 4.6 %	± 4.6 %	∞	
SAR correction	± 1.9 %	Rectangular	√ 3	1	0.84	± 1.1 %	± 0.9 %	∞	
Liquid conductivity (meas.)	± 5.0 %	Rectangular	√ 3	0.78	0.71	± 2.3 %	± 2.0 %	∞	
Liquid permittivity (meas.)	± 5.0 %	Rectangular	√ 3	0.26	0.26	± 0.8 %	± 0.8 %	∞	
Temp. Unc. - Conductivity	± 3.4 %	Rectangular	√ 3	0.78	0.71	± 1.5 %	± 1.4 %	∞	
Temp. Unc. - Permittivity	± 0.4 %	Rectangular	√ 3	0.23	0.26	± 0.1 %	± 0.1 %	∞	
Combined Uncertainty						± 12.7 %	± 12.6 %	330	
Expanded Std. Uncertainty						± 25.4 %	± 25.3 %		

Table 9: Measurement uncertainties.

Worst-Case uncertainty budget for DASY5 assessed according to according to IEC 62209-2/2010 standard. The budget is valid for the frequency range 300MHz - 6 GHz and represents a worst-case analysis. For specific tests and configurations, the uncertainty could be considerable smaller.

6.1.12 Measurement uncertainty evaluation for System Check

Uncertainty of a System Performance Check with DASY5 System for the 0.3 - 3 GHz range								
Source of uncertainty	Uncertainty Value	Probability Distribution	Divisor	c_i	c_i	Standard Uncertainty		v_i^2 or
				(1g)	(10g)	± %, (1g)	± %, (10g)	v_{eff}
Measurement System								
Probe calibration	± 6.0 %	Normal	1	1	1	± 6.0 %	± 6.0 %	∞
Axial isotropy	± 4.7 %	Rectangular	√ 3	0.7	0.7	± 1.9 %	± 1.9 %	∞
Hemispherical isotropy	± 0.0 %	Rectangular	√ 3	0.7	0.7	± 0.0 %	± 0.0 %	∞
Boundary effects	± 1.0 %	Rectangular	√ 3	1	1	± 0.6 %	± 0.6 %	∞
Probe linearity	± 4.7 %	Rectangular	√ 3	1	1	± 2.7 %	± 2.7 %	∞
System detection limits	± 1.0 %	Rectangular	√ 3	1	1	± 0.6 %	± 0.6 %	∞
Readout electronics	± 0.3 %	Normal	1	1	1	± 0.3 %	± 0.3 %	∞
Response time	± 0.0 %	Rectangular	√ 3	1	1	± 0.0 %	± 0.0 %	∞
Integration time	± 0.0 %	Rectangular	√ 3	1	1	± 0.0 %	± 0.0 %	∞
RF ambient conditions	± 3.0 %	Rectangular	√ 3	1	1	± 1.7 %	± 1.7 %	∞
Probe positioner	± 0.4 %	Rectangular	√ 3	1	1	± 0.2 %	± 0.2 %	∞
Probe positioning	± 2.9 %	Rectangular	√ 3	1	1	± 1.7 %	± 1.7 %	∞
Max. SAR evaluation	± 1.0 %	Rectangular	√ 3	1	1	± 0.6 %	± 0.6 %	∞
Test Sample Related								
Dev. of experimental dipole	± 0.0 %	Rectangular	√ 3	1	1	± 0.0 %	± 0.0 %	∞
Source to liquid distance	± 2.0 %	Rectangular	√ 3	1	1	± 1.2 %	± 1.2 %	∞
Power drift	± 3.4 %	Rectangular	√ 3	1	1	± 2.0 %	± 2.0 %	∞
Phantom and Set-up								
Phantom uncertainty	± 4.0 %	Rectangular	√ 3	1	1	± 2.3 %	± 2.3 %	∞
SAR correction	± 1.9 %	Rectangular	√ 3	1	0.84	± 1.1 %	± 0.9 %	∞
Liquid conductivity (meas.)	± 5.0 %	Normal	1	0.78	0.71	± 3.9 %	± 3.6 %	∞
Liquid permittivity (meas.)	± 5.0 %	Normal	1	0.26	0.26	± 1.3 %	± 1.3 %	∞
Temp. unc. - Conductivity	± 1.7 %	Rectangular	√ 3	0.78	0.71	± 0.8 %	± 0.7 %	∞
Temp. unc. - Permittivity	± 0.3 %	Rectangular	√ 3	0.23	0.26	± 0.0 %	± 0.0 %	∞
Combined Uncertainty						± 9.1 %	± 8.9 %	330
Expanded Std. Uncertainty						± 18.2 %	± 17.9 %	

Table 10: Measurement uncertainties of the System Check with DASY5 (0.3-3GHz)

Note: Worst case probe calibration uncertainty has been applied for all probes used during the measurements.

6.1.13 System check

The system check is performed for verifying the accuracy of the complete measurement system and performance of the software. The system check is performed with tissue equivalent material according to IEEE 1528. The following table shows system check results for all frequency bands and tissue liquids used during the tests (plot(s) see annex A).

System performance check (1000 mW)									
System validation Kit	Probe	Frequency	Target SAR _{1g} /mW/g (+/- 10%)	Target SAR _{10g} /mW/g (+/- 10%)	Measured SAR _{1g} /mW/g	SAR _{1g} dev.	Measured SAR _{10g} /mW/g	SAR _{10g} dev.	Measured date
D835V2 S/N: 4d153	ES3DV3 S/N: 3320	835 MHz head	9.08	5.93	9.74	7.3%	6.38	7.6%	2015-12-11
D835V2 S/N: 4d153	ES3DV3 S/N: 3320	835 MHz head	9.08	5.93	9.81	8.0%	6.45	8.8%	2015-12-12
D835V2 S/N: 4d153	ES3DV3 S/N: 3320	835 MHz head	9.08	5.93	9.51	4.7%	6.23	5.1%	2015-12-16
D835V2 S/N: 4d153	ES3DV3 S/N: 3320	835 MHz body	9.30	6.16	9.72	4.5%	6.42	4.2%	2015-12-19
D835V2 S/N: 4d153	ES3DV3 S/N: 3320	835 MHz body	9.30	6.16	9.51	2.3%	6.30	2.3%	2015-12-22
D835V2 S/N: 4d153	ES3DV3 S/N: 3320	835 MHz body	9.30	6.16	9.90	6.5%	6.53	6.0%	2015-12-23
D1750V2 S/N: 1093	ES3DV3 S/N: 3326	1750 MHz head	37.20	19.90	37.30	0.3%	19.80	-0.5%	2015-12-15
D1750V2 S/N: 1093	ES3DV3 S/N: 3326	1750 MHz head	36.60	19.30	36.50	-0.3%	19.40	0.5%	2015-12-17
D1750V2 S/N: 1093	ES3DV3 S/N: 3326	1750 MHz body	37.90	20.30	39.20	3.4%	20.90	3.0%	2015-12-22
D1750V2 S/N: 1093	ES3DV3 S/N: 3326	1750 MHz body	37.90	20.30	40.00	5.5%	21.30	4.9%	2015-12-23
D1750V2 S/N: 1093	ES3DV3 S/N: 3320	1750 MHz body	37.90	20.30	39.10	3.2%	20.90	3.0%	2015-12-29
D1900V2 S/N: 5d009	EX3DV4 S/N: 3944	1900 MHz head	41.10	21.40	40.40	-1.7%	21.10	-1.4%	2015-12-11
D1900V2 S/N: 5d009	EX3DV4 S/N: 3944	1900 MHz head	41.10	21.40	41.30	0.5%	21.60	0.9%	2015-12-14
D1900V2 S/N: 5d009	EX3DV4 S/N: 3944	1900 MHz head	41.10	21.40	39.90	-2.9%	20.80	-2.8%	2015-12-15
D1900V2 S/N: 5d009	EX3DV4 S/N: 3944	1900 MHz body	40.50	21.50	39.80	-1.7%	21.10	-1.9%	2015-12-17
D1900V2 S/N: 5d009	EX3DV4 S/N: 3944	1900 MHz body	40.50	21.50	40.30	-0.5%	21.40	-0.5%	2015-12-18
D1900V2 S/N: 5d009	EX3DV4 S/N: 3944	1900 MHz body	40.50	21.50	39.90	-1.5%	21.20	-1.4%	2015-12-19
D2450V2 S/N: 710	EX3DV4 S/N: 3944	2450 MHz head	52.10	24.00	53.80	3.3%	25.10	4.6%	2015-12-21
D2450V2 S/N: 710	ES3DV3 S/N: 3320	2450 MHz body	51.00	23.80	54.10	6.1%	24.90	4.6%	2015-12-24
D2600V2 S/N: 1040	EX3DV4 S/N: 3944	2600 MHz head	56.90	25.90	56.30	-1.1%	25.00	-3.5%	2015-12-22
D2600V2 S/N: 1040	EX3DV4 S/N: 3944	2600 MHz head	56.90	25.90	58.90	3.5%	26.30	1.5%	2015-12-28
D2600V2 S/N: 1040	EX3DV4 S/N: 3944	2600 MHz body	56.80	25.90	56.30	-0.9%	24.80	-4.2%	2015-12-29
D2600V2 S/N: 1040	EX3DV4 S/N: 3944	2600 MHz body	56.80	25.90	55.30	-2.6%	24.60	-5.0%	2015-12-30

Table 11: Results system check

6.1.14 System check procedure

The system check is performed by using a validation dipole which is positioned parallel to the planar part of the SAM phantom at the reference point. The distance of the dipole to the SAM phantom is determined by a plexiglass spacer. The dipole is connected to the signal source consisting of signal generator and amplifier via a directional coupler, N-connector cable and adaption to SMA. It is fed with a power of 1000 mW for frequencies below 2 GHz or 100 mW for frequencies above 2 GHz. To adjust this power a power meter is used. The power sensor is connected to the cable before the system check to measure the power at this point and do adjustments at the signal generator. At the outputs of the directional coupler both return loss as well as forward power are controlled during the validation to make sure that emitted power at the dipole is kept constant. This can also be checked by the power drift measurement after the test (result on plot).

System check results have to be equal or near the values determined during dipole calibration (target SAR in table above) with the relevant liquids and test system.

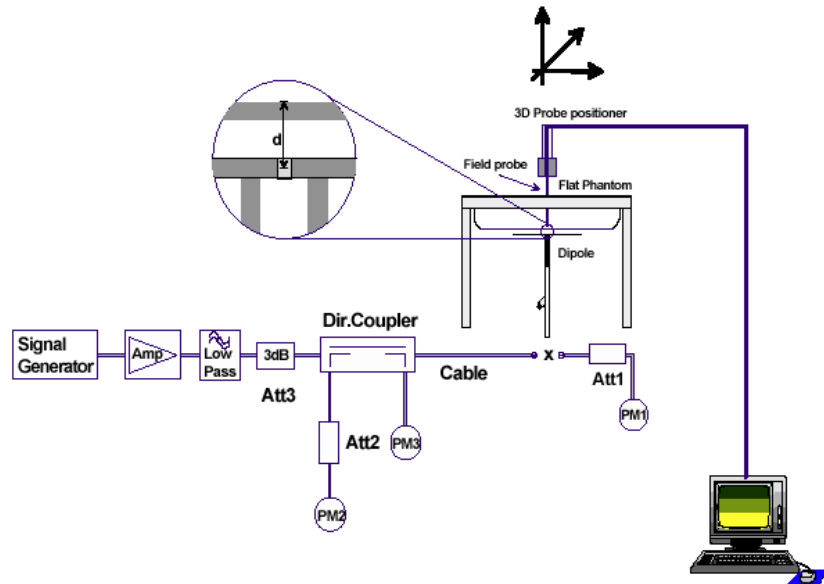

6.1.15 System validation

The system validation is performed in a similar way as a system check. It needs to be performed once a SAR measurement system has been established and allows an evaluation of the system accuracy with all components used together with the specified system. It has to be repeated at least once a year or when new system components are used (DAE, probe, phantom, dipole, liquid type).

In addition to the procedure used during system check a system validation also includes checks of probe isotropy, probe modulation factor and RF signal.

The following table lists the system validations relevant for this test report:

Frequency (MHz)	Test System	DASY SW	Dipole Type /SN	Probe Type / SN	Calibrated signal type(s)	DAE unit Type / SN	head validation	body validation
835	Saarbrücken / SAR-2	V52.8.7	D835V2 / 4d153	ES3DV3 / 3320	CW	DAE3 / 413	2015-03-13	2015-04-30
1750	Saarbrücken / SAR-2	V52.8.7	D1750V2 / 1093	ES3DV3 / 3320	CW	DAE3 / 413	2015-07-22	2015-07-23
2450	Saarbrücken / SAR-2	V52.8.7	D2450V2 / 710	ES3DV3 / 3320	CW	DAE3 / 413	2015-07-25	2015-07-25
1750	Saarbrücken / SAR-3	V52.8.7	D1750V2 / 1093	ES3DV3 / 3326	CW	DAE4/ 1387	2015-09-09	2015-11-25
1900	Saarbrücken / SAR-1	V52.8.7	D1900V2 / 5d009	EX3DV4 / 3944	CW	DAE3/ 477	2015-11-23	2015-11-25
2450	Saarbrücken / SAR-1	V52.8.7	D2450V2 / 710	EX3DV4 / 3944	CW	DAE3/ 477	2015-11-21	2015-11-21
2600	Saarbrücken / SAR-1	V52.8.7	D2600V2 / 1040	EX3DV4 / 3944	CW	DAE3/ 477	2015-11-20	2015-11-20

7 Detailed Test Results

7.1 Conducted power measurements

For the measurements the Rohde & Schwarz Radio Communication Tester CMU 200 and CMW500 were used. The output power was measured using an integrated RF connector and attached RF cable. The conducted output power was also checked before and after each SAR measurement. The resulting power values were within a 0.2 dB tolerance of the values shown below.

Note: CMU200 measures GSM peak and average output power for active timeslots.

For SAR the time based average power is relevant. The difference in-between depends on the duty cycle of the TDMA signal:

No. of timeslots	1	2	3	4
Duty Cycle	1 : 8	1 : 4	1 : 2.66	1 : 2
time based avg. power compared to slotted avg. power	- 9.03 dB	- 6.02 dB	- 4.26 dB	- 3.01 dB

The signalling modes differ as follows:

mode	coding scheme	modulation
GPRS	CS1 to CS4	GMSK
EGPRS (EDGE)	MCS1 to MCS4	GMSK
EGPRS (EDGE)	MCS5 to MCS9	8PSK

Apart from modulation change (GMSK/8PSK) coding schemes differ in code rate without influence on the RF signal. Therefore one coding scheme per mode was selected for conducted power measurements.

7.1.1 Conducted power measurements GSM 850 MHz

Conducted output power GSM 850 MHz (dBm)								
SN: 004402743285805			Slotted avg. power			Time based avg. power		
TS	mod.	upper limit	CH 128	CH 190	CH 251	CH 128	CH 190	CH 251
			824.2 MHz	836.6 MHz	848.8 MHz	824.2 MHz	836.6 MHz	848.8 MHz
1	GMSK	32.9	32.2	32.3	32.6	23.2	23.3	23.6
2	GMSK	31.4	30.5	30.6	31.2	24.5	24.6	25.2
3	GMSK	29.6	29.0	29.1	29.4	24.7	24.8	25.1
4	GMSK	28.4	27.7	27.9	28.3	24.7	24.9	25.3
1	8PSK	27.4	26.7	26.6	26.7	17.7	17.6	17.7
2	8PSK	26.4	26.3	26.2	26.3	20.3	20.2	20.3
3	8PSK	24.6	24.2	24.3	24.2	19.9	20.0	19.9
4	8PSK	23.4	22.7	22.7	22.7	19.7	19.7	19.7

Table 12: Test results conducted power measurement GSM 850 MHz

RESULTS PROVIDED BY CUSTOMER

7.1.2 Conducted power measurements GSM 1900 MHz

Conducted output power GSM 1900 MHz (dBm)								
SN: 004402743285284			Slotted avg. power			Time based avg. power		
TS	mod.	upper limit	CH 512	CH 661	CH 810	CH 512	CH 661	CH 810
			1850.2 MHz	1880.0 MHz	1909.8 MHz	1850.2 MHz	1880.0 MHz	1909.8 MHz
1	GMSK	29.9	29.3	29.4	29.4	20.3	20.4	20.4
2	GMSK	29.4	29.2	29.1	29.2	23.2	23.1	23.2
3	GMSK	26.6	26.3	26.3	26.5	22.0	22.0	22.2
4	GMSK	25.4	25.0	25.1	25.3	22.0	22.1	22.3
1	8PSK	25.9	25.4	25.2	25.9	16.4	16.2	16.9
2	8PSK	25.9	25.0	25.2	25.6	19.0	19.2	19.6
3	8PSK	24.6	24.0	24.3	24.4	19.7	20.0	20.1
4	8PSK	23.4	23.0	23.1	23.2	20.0	20.1	20.2

Table 13: Test results conducted power measurement GSM 1900 MHz

RESULTS PROVIDED BY CUSTOMER

7.1.3 Conducted power measurements WCDMA FDD V (850 MHz)

Max. RMS output power 850 MHz (FDD V) / dBm				
mode	upper limit	CH 4132 / 826.4 MHz	CH 4182 / 836.4 MHz	CH 4233 / 846.6 MHz
RMC 12.2 kbit/s	23.9	23.3	23.3	23.4
DC-HSDPA Sub test 1	22.9	21.7	22.0	22.1
DC-HSDPA Sub test 2	20.9	21.1	21.4	20.9
DC-HSDPA Sub test 3	21.9	20.6	21.0	21.3
DC-HSDPA Sub test 4	20.9	21.9	21.9	21.8
HSUPA Sub test 1	22.9	22.5	22.4	22.4
HSUPA Sub test 2	22.9	22.3	22.5	22.5
HSUPA Sub test 3	22.9	22.5	22.5	22.4
HSUPA Sub test 4	22.4	22.0	22.0	22.0
HSUPA Sub test 5	22.4	22.0	22.0	22.0
SN: 004402743285805				

Table 14: Test results conducted power measurement UMTS FDD V 850MHz

RESULTS PROVIDED BY CUSTOMER

7.1.4 Conducted power measurements WCDMA FDD IV (1700 MHz)

Max. RMS output power FDD IV (1700MHz) / dBm				
mode	upper limit	CH 1312 / 1712.4 MHz	CH 1412 / 1732.4 MHz	CH 1513 / 1752.6 MHz
RMC 12.2 kbit/s	23.4	23.2	23.3	23.1
DC-HSDPA Sub test 1	22.4	21.7	21.7	21.8
DC-HSDPA Sub test 2	20.4	21.0	21.3	21.0
DC-HSDPA Sub test 3	21.4	20.5	21.1	20.7
DC-HSDPA Sub test 4	20.4	21.9	21.8	21.4
HSUPA Sub test 1	22.4	22.4	22.4	22.2
HSUPA Sub test 2	22.4	22.3	22.3	22.2
HSUPA Sub test 3	22.4	22.5	22.3	22.1
HSUPA Sub test 4	21.9	21.9	21.9	21.6
HSUPA Sub test 5	21.9	21.9	21.9	21.7
SN: 004402743285227				

Table 15: Test results conducted power measurement UMTS FDD IV 1700MHz

Max. RMS output power FDD IV (1700MHz) / dBm with power reduction				
mode	upper limit	CH 1312 / 1712.4 MHz	CH 1412 / 1732.4 MHz	CH 1513 / 1752.6 MHz
RMC 12.2 kbit/s	22.4	21.7	21.8	21.8
DC-HSDPA Sub test 1	21.4	20.8	20.5	20.5
DC-HSDPA Sub test 2	19.4	19.4	20.0	19.4
DC-HSDPA Sub test 3	20.4	20.0	19.6	19.2
DC-HSDPA Sub test 4	19.4	20.4	20.6	20.3
HSUPA Sub test 1	21.4	21.0	21.0	21.0
HSUPA Sub test 2	21.4	20.9	21.0	20.9
HSUPA Sub test 3	21.4	20.9	21.0	20.9
HSUPA Sub test 4	20.9	20.5	20.5	20.4
HSUPA Sub test 5	20.9	20.4	20.5	20.4
SN: 004402743285706				

Table 16: Test results conducted power measurement UMTS FDD IV 1700MHz with power reduction

RESULTS PROVIDED BY CUSTOMER

7.1.5 Conducted power measurements WCDMA FDD II (1900 MHz)

mode	Max. RMS output power 1900 MHz (FDD II) / dBm			
	upper limit	CH 9262 / 1852.4 MHz	CH 9400 / 1880.0 MHz	CH 9538 / 1907.6 MHz
RMC 12.2 kbit/s	23.4	23.2	23.2	23.0
DC-HSDPA Sub test 1	22.9	21.9	21.7	22.0
DC-HSDPA Sub test 2	20.9	21.3	20.8	20.8
DC-HSDPA Sub test 3	21.9	20.9	20.6	21.3
DC-HSDPA Sub test 4	20.9	21.8	21.8	21.7
HSUPA Sub test 1	22.9	22.4	22.4	22.3
HSUPA Sub test 2	22.9	22.3	22.3	22.3
HSUPA Sub test 3	22.9	22.4	22.3	22.3
HSUPA Sub test 4	22.4	22.0	21.9	21.8
HSUPA Sub test 5	22.4	22.0	21.9	21.8

SN: 004402743285284

Table 17: Test results conducted power measurement UMTS FDD II 1900MHz

RESULTS PROVIDED BY CUSTOMER

Remark: None of the HSDPA/HSUPA settings leads to conducted power values exceeding the conducted power in RMC mode by more than 0.25 dB.

Therefore no additional SAR measurements were performed in HSDPA/HSUPA mode.

7.1.6 Test-set-up information for WCDMA / HSPDA / HSUPA

a) WCDMA RMC

In RMC (reference measurement channel) mode the conducted power at 4 different bit rates was measured. They correspond with the used spreading factors as follows:

Bit rate	12.2 kbit/s	64 kbit/s	144 kbit/s	384 kbit/s
Spreading factor (SF)	64	16	8	4

In RMC mode only DPCCH and DPDCH are active. As bit rate changes do not influence the relative power of any code channel the measured RMS output power remains on the same level which is set to maximum by TPC (Transmit power control) pattern type 'All 1'.

b) DC-HSDPA (3GPP Release 8)

Dual Cell – HSDPA has been signaled using the following settings for connection setup:

Parameter During Connection Setup	Value
P-CPICH_Ec/lor	-10 dB
P-CCPCH	-12
SCH_Ec/lor	-12
PICH_Ec/lor	-15
HS-PDSCH	off
HS-SCCH_1	off
DPCH_Ec/lor	-5
OCNS_Ec/lor	-3.1

Table 18: Downlink Physical Channels according to 3GPP 34.121 Table E.5.0

The fixed reference channel has been set to H-set 12 according to 3GPP TS 34.121 Table C.8.1.12:

Parameter	Unit	Value
Nominal Average Inf. Bit Rate	kbit/s	60
Inter-TTI Distance	TTI's	1
Information Bit Payload (N _{INF})	Bits	120
Number Code Blocks	Blocks	1
Binary Channel Bits Per TTI	Bits	960
Total Available SML's in UE	SML's	19200
Number of SML's per HARQ Process	SML's	3200
Coding Rate		0.15
Number of Physical Channel Codecs	Codecs	1
Modulation		QPSK
Note 1: The RMC is intended to be used for DC-HSDPA mode and both cells shall transmit with identical parameters as listed in the table. Note 2: Maximum number of transmission is limited to 1, i.e., retransmission is not allowed. The redundancy and constellation version 0 shall be used.		

Table 19: H-Set 12 QPSK configuration

The same Sub-test settings as for Release 5 HSDPA were used for the tests.

c) HSUPA

In HSUPA mode additional code channels (E-DPCCH, E-DPDCHn) are added for data transfer in uplink at higher bit rates.

5 sub-tests are defined by 3GPP 34.121 according to the following table :

Sub-test	β_c	β_d	β_d (SF)	β_c/β_d	$\beta_{hs}^{(1)}$	β_{ec}	β_{ed}	β_{ec} (SF)	β_{ed} (code)	CM ⁽²⁾ (dB)	MPR (dB)	AG ⁽⁴⁾ Index	E-TFCI
1	11/15 ⁽³⁾	15/15 ⁽³⁾	64	11/15 ⁽³⁾	22/15	209/225	1039/225	4	1	1.0	0.0	20	75
2	6/15	15/15	64	6/15	12/15	12/15	94/75	4	1	3.0	2.0	12	67
3	15/15	9/15	64	15/9	30/15	30/15	$\beta_{ed1}:47/15$ $\beta_{ed2}:47/15$	4	2	2.0	1.0	15	92
4	2/15	15/15	64	2/15	4/15	2/15	56/75	4	1	3.0	2.0	17	71
5	15/15 ⁽⁴⁾	15/15 ⁽⁴⁾	64	15/15 ⁽⁴⁾	30/15	24/15	134/15	4	1	1.0	0.0	21	81

Note 1: $\Delta_{ACK}, \Delta_{NACK}, \Delta_{CQI} = 8 \iff A_{hs} = \beta_{hs}/\beta_c = 30/15 \iff \beta_{hs} = 30/15 * \beta_c$
 Note 2 : CM = 1 for $\beta_c/\beta_d = 12/15, \beta_{hs}/\beta_c = 24/15$. For all other combinations of DPDCH, DPCCH, HS-DPCCH, E-DPDCH and E-DPCCH the MPR is based on the relative CM difference
 Note 3 : For subtest 1 the β_c/β_d ratio of 11/15 for the TFC during the measurement period (TF1, TF0) is achieved by setting the signalled gain factors for the reference TFC (TF1,TF1) to $\beta_c = 10/15$ and $\beta_d = 15/15$
 Note 4 : For subtest 5 the β_c/β_d ratio of 15/15 for the TFC during the measurement period (TF1, TF0) is achieved by setting the signalled gain factors for the reference TFC (TF1,TF1) to $\beta_c = 14/15$ and $\beta_d = 15/15$
 Note 5 : Testing UE using E-DPDCH Physical Layer category 1 Sub-test 3 is not required according to TS 25.306 Table 5.1g
 Note 6 : β_{ed} can not be set directly; it is set by Absolute Grant Value

Table 20: Subtests for UMTS Release 6 HSUPA

To achieve the settings above some additional procedures were defined by 3GPP 34.121. Those have been included in an application note for the CMU200 and were exactly followed :

- Test mode connection (BS signal tab) :
- RMC 12.2 kbit/s + HSPA 34.108 with loop mode 1
- HS-DSCH settings (BS signal tab):
- FRC with H-set 1 QPSK
- ACK-NACK repetition factor = 3
- CQI feedback cycle = 4ms
- CQI repetition factor = 2
- HSUPA-specific signalling settings (UE signal tab) :
- E-TFCI table index = 0
- E-DCH minimum set E-TFCI = 9
- Puncturing limit non-max = 0.84
- max. number of channelisation codes = 2x SF4
- Initial Serving Grant Value = Off
- HSDPA and HSUPA Gain factors (UE signal tab)

Sub-test	β_c	β_d	$\Delta_{ACK}, \Delta_{NACK}, \Delta_{CQI}$	$\Delta E-DPCCH$)*
1	10	15	8	6
2	6	15	8	8
3	15	9	8	8
4	2	15	8	5
5	14	15	8	7

)* : β_{ec} and β_{ed} ratios (relative to β_c and β_d) are set by $\Delta E-DPCCH$

- HSUPA Reference E-TFCIs (UE signal tab > HSUPA gain factors) :

Sub-test	1, 2, 4, 5				
Number of E-TFCIs	5				
Reference E-TFCI	11	67	71	75	81
Reference E-TFCI power offset	4	18	23	26	27

Sub-test	3	
Number of E-TFCIs	2	
Reference E-TFCI	11	92
Reference E-TFCI power offset	4	18

- HSUPA-specific generator parameters (BS Signal tab > HSUPA > E-AGCH > AG Pattern)

Sub-test	Absolute Grant Value (AG Index)
1	20
2	12
3	15
4	17
5	21

- Power Level settings (BS Signal tab > Node B-settings):

- Level reference : Output Channel Power (Ior)
- Output Channel Power (Ior) : -86 dBm

- Downlink Physical Channel Settings (BS signal tab)

- P-CPICH : -10 dB
- S-CPICH : Off
- P-SCH : -15 dB
- S-SCH : -15 dB
- P-CCPCH : -12 dB
- S-CCPCH : -12 dB
- PICH : -15 dB
- AICH : -12 dB
- DPDCH : -10 dB
- HS-SCCH : -8 dB
- HS-PDSCH : -3 dB
- E-AGCH : -20 dB
- E-RGCH/E-HICH - 20 dB
- E-RGCH Active : Off

The settings above were stored once for each sub-test and recalled before the measurement.

HSUPA test procedure :

To reach maximum output power in HSUPA mode the following procedures were followed:

3 different TPC patterns were defined :

Set 1 : Closed loop with target power 10 dBm

Set 2 : Single Pattern+Alternating with binary pattern '11111' for 1 dB steps 'up'

Set 3 : Single Pattern+Alternating with binary pattern '00000' for 1 dB steps 'down'

After recalling a certain HSUPA sub-test the HSUPA E-AGCH graph with E-TFCI event counter is displayed. After starting with the closed loop command the power is increased in 1 dB steps by activating pattern set 2 until the UE decreases the transmitted E-TFCI. At this point set 3 is activated once to reduce the output power to the value at which the original E-TFCI, which is required for the sub-test, appears again.

For conducted power measurements the same steps are repeated in the power menu to read out the corresponding maximum RMS output power with the target E-TFCI.

For SAR measurements it is useful to switch to Code Domain Power vs. Time display.

Here the CMU200 shows relative power values (max. and min.) of each code channel which should roughly correspond to the numerators of the gain factors e.g. :

Sub-test	β_c	β_d	β_{hs}	β_{ec}	β_{ed}
5	15	15	30	24	134

By this way a surveillance of signalling conditions is possible to make sure that HSUPA code channels are active during the complete SAR measurement.

7.1.7 Conducted power measurements LTE FDD 2 1900 MHz

Bandwidth (MHz)	Channel / Frequency (MHz)	Resource block allocation	P _{avg} (dBm)			
			QPSK		16-QAM	
			upper limit	meas.	upper limit	meas.
1.4	18607 / 1850.7	1 RB low	23.4	22.9	22.4	22.1
		1 RB mid	23.4	23.0	22.4	22.5
		1 RB high	23.4	22.9	22.4	22.2
		50% RB low	23.4	22.8	22.4	22.2
		50% RB mid	23.4	23.0	22.4	22.1
		50% RB high	23.4	23.0	22.4	22.1
	100% RB	22.4	22.0	21.4	20.8	
	18900 / 1880.0	1 RB low	23.4	22.6	22.4	21.9
		1 RB mid	23.4	22.8	22.4	21.8
		1 RB high	23.4	22.7	22.4	21.5
		50% RB low	23.4	22.8	22.4	21.6
		50% RB mid	23.4	22.9	22.4	21.7
		50% RB high	23.4	22.8	22.4	21.5
	100% RB	22.4	21.9	21.4	20.4	
	19193 / 1909.3	1 RB low	23.4	22.7	22.4	22.2
		1 RB mid	23.4	22.6	22.4	22.4
		1 RB high	23.4	22.6	22.4	22.2
		50% RB low	23.4	22.6	22.4	22.0
50% RB mid		23.4	22.8	22.4	22.0	
50% RB high		23.4	22.7	22.4	21.9	
100% RB	22.4	21.7	21.4	20.5		
3.0	18615 / 1851.5	1 RB low	23.4	23.0	22.4	22.5
		1 RB mid	23.4	23.0	22.4	22.5
		1 RB high	23.4	23.0	22.4	22.4
		50% RB low	22.4	22.1	21.4	21.1
		50% RB mid	22.4	22.1	21.4	21.1
		50% RB high	22.4	22.1	21.4	21.1
	100% RB	22.4	22.0	21.4	21.0	
	18900 / 1880.0	1 RB low	23.4	22.8	22.4	21.9
		1 RB mid	23.4	22.7	22.4	21.8
		1 RB high	23.4	22.8	22.4	21.4
		50% RB low	22.4	21.9	21.4	20.6
		50% RB mid	22.4	21.9	21.4	20.6
		50% RB high	22.4	21.9	21.4	20.7
	100% RB	22.4	21.9	21.4	20.6	
	19185 / 1908.5	1 RB low	23.4	22.9	22.4	22.1
		1 RB mid	23.4	22.7	22.4	21.8
		1 RB high	23.4	22.9	22.4	21.8
		50% RB low	22.4	21.9	21.4	20.7
50% RB mid		22.4	22.0	21.4	21.1	
50% RB high		22.4	21.9	21.4	20.8	
100% RB	22.4	21.9	21.4	21.1		

Bandwidth (MHz)	Channel / Frequency (MHz)	Resource block allocation	P _{avg} (dBm)			
			QPSK		16-QAM	
			upper limit	meas.	upper limit	meas.
5.0	18625 / 1852.5	1 RB low	23.4	23.0	22.4	22.3
		1 RB mid	23.4	22.9	22.4	22.1
		1 RB high	23.4	22.8	22.4	22.0
		50% RB low	22.4	22.1	21.4	21.1
		50% RB mid	22.4	22.0	21.4	20.9
		50% RB high	22.4	22.0	21.4	20.9
		100% RB	22.4	22.0	21.4	21.2
	18900 / 1880.0	1 RB low	23.4	22.5	22.4	22.0
		1 RB mid	23.4	22.7	22.4	21.9
		1 RB high	23.4	22.6	22.4	21.8
		50% RB low	22.4	21.8	21.4	20.8
		50% RB mid	22.4	21.8	21.4	20.8
		50% RB high	22.4	21.8	21.4	20.8
	19175 / 1907.5	100% RB	22.4	21.9	21.4	20.9
		1 RB low	23.4	22.7	22.4	22.1
		1 RB mid	23.4	22.9	22.4	21.9
		1 RB high	23.4	22.8	22.4	22.1
		50% RB low	22.4	21.8	21.4	20.7
50% RB mid		22.4	21.9	21.4	20.8	
50% RB high		22.4	21.8	21.4	20.7	
10.0	18650 / 1855	100% RB	22.4	21.8	21.4	20.9
		1 RB low	23.4	23.1	22.4	22.1
		1 RB mid	23.4	23.0	22.4	21.9
		1 RB high	23.4	23.1	22.4	22.1
		50% RB low	22.4	22.0	21.4	21.1
		50% RB mid	22.4	22.0	21.4	21.1
		50% RB high	22.4	22.0	21.4	21.0
	18900 / 1880	100% RB	22.4	22.1	21.4	21.0
		1 RB low	23.4	23.0	22.4	22.1
		1 RB mid	23.4	22.8	22.4	22.0
		1 RB high	23.4	22.8	22.4	22.0
		50% RB low	22.4	21.9	21.4	20.9
		50% RB mid	22.4	21.9	21.4	20.8
		50% RB high	22.4	21.8	21.4	20.8
	19150 / 1905	100% RB	22.4	21.8	21.4	20.9
		1 RB low	23.4	22.7	22.4	22.0
		1 RB mid	23.4	22.7	22.4	22.1
		1 RB high	23.4	22.7	22.4	22.1
50% RB low		22.4	21.9	21.4	20.7	
50% RB mid		22.4	21.8	21.4	21.0	
50% RB high		22.4	21.8	21.4	20.8	
100% RB	22.4	21.7	21.4	20.7		

Bandwidth (MHz)	Channel / Frequency (MHz)	Resource block allocation	P _{avg} (dBm)			
			QPSK		16-QAM	
			upper limit	meas.	upper limit	meas.
15.0	18675 / 1857.5	1 RB low	23.4	23.1	22.4	22.4
		1 RB mid	23.4	22.8	22.4	22.2
		1 RB high	23.4	22.9	22.4	22.2
		50% RB low	22.4	22.1	21.4	21.0
		50% RB mid	22.4	21.9	21.4	21.0
		50% RB high	22.4	22.0	21.4	20.9
	100% RB	22.4	21.9	21.4	20.8	
	18900 / 1880.0	1 RB low	23.4	23.0	22.4	22.3
		1 RB mid	23.4	22.8	22.4	22.0
		1 RB high	23.4	22.6	22.4	22.0
		50% RB low	22.4	21.9	21.4	20.9
		50% RB mid	22.4	21.9	21.4	20.9
		50% RB high	22.4	21.9	21.4	20.8
	100% RB	22.4	21.9	21.4	20.8	
	19125 / 1902.5	1 RB low	23.4	23.1	22.4	22.3
		1 RB mid	23.4	22.8	22.4	22.1
		1 RB high	23.4	22.8	22.4	22.2
		50% RB low	22.4	22.0	21.4	21.0
50% RB mid		22.4	21.8	21.4	20.8	
50% RB high		22.4	21.8	21.4	20.9	
100% RB	22.4	21.8	21.4	20.8		
20.0	18700 / 1860	1 RB low	23.4	23.0	22.4	22.1
		1 RB mid	23.4	22.9	22.4	22.0
		1 RB high	23.4	22.8	22.4	21.6
		50% RB low	22.4	21.8	21.4	20.8
		50% RB mid	22.4	21.8	21.4	20.7
		50% RB high	22.4	21.9	21.4	20.8
	100% RB	22.4	21.9	21.4	20.9	
	18900 / 1880	1 RB low	23.4	23.0	22.4	22.1
		1 RB mid	23.4	22.7	22.4	21.9
		1 RB high	23.4	22.7	22.4	22.4
		50% RB low	22.4	22.0	21.4	20.9
		50% RB mid	22.4	21.9	21.4	20.9
		50% RB high	22.4	21.8	21.4	20.8
	100% RB	22.4	21.9	21.4	20.8	
	19100 / 1900	1 RB low	23.4	22.7	22.4	21.9
		1 RB mid	23.4	22.5	22.4	22.0
		1 RB high	23.4	22.5	22.4	21.7
		50% RB low	22.4	21.7	21.4	20.9
50% RB mid		22.4	21.7	21.4	20.7	
50% RB high		22.4	21.6	21.4	20.6	
100% RB	22.4	21.7	21.4	20.6		

Table 21: Test results conducted power measurement LTE FDD 2 1900 MHz.
SN: 004402743285284

RESULTS PROVIDED BY CUSTOMER

7.1.8 Conducted power measurements LTE FDD 4 1700 MHz

Bandwidth (MHz)	Channel / Frequency (MHz)	Resource block allocation	P _{avg} (dBm)			
			QPSK		16-QAM	
			upper limit	meas.	upper limit	meas.
1.4	19957 / 1710.7	1 RB low	23.4	23.2	22.4	22.5
		1 RB mid	23.4	23.3	22.4	22.6
		1 RB high	23.4	23.2	22.4	22.5
		50% RB low	23.4	23.2	22.4	22.3
		50% RB mid	23.4	23.3	22.4	22.3
		50% RB high	23.4	23.3	22.4	22.3
	100% RB	22.4	22.1	21.4	21.2	
	20175 / 1732.5	1 RB low	23.4	23.0	22.4	22.4
		1 RB mid	23.4	23.2	22.4	22.5
		1 RB high	23.4	22.9	22.4	21.8
		50% RB low	23.4	23.1	22.4	22.0
		50% RB mid	23.4	23.1	22.4	22.2
		50% RB high	23.4	23.2	22.4	22.4
	100% RB	22.4	22.2	21.4	20.9	
	20393 / 1754.3	1 RB low	23.4	23.1	22.4	22.5
		1 RB mid	23.4	23.1	22.4	22.5
		1 RB high	23.4	23.1	22.4	22.6
		50% RB low	23.4	23.1	22.4	22.4
50% RB mid		23.4	23.2	22.4	22.4	
50% RB high		23.4	23.2	22.4	22.5	
100% RB	22.4	22.2	21.4	21.1		
3	19965 / 1711.5	1 RB low	23.4	23.4	22.4	22.5
		1 RB mid	23.4	23.3	22.4	22.4
		1 RB high	23.4	23.2	22.4	22.6
		50% RB low	22.4	22.3	21.4	21.5
		50% RB mid	22.4	22.4	21.4	21.5
		50% RB high	22.4	22.3	21.4	21.5
	100% RB	22.4	22.4	21.4	21.4	
	20175 / 1732.5	1 RB low	23.4	23.0	22.4	22.4
		1 RB mid	23.4	22.9	22.4	22.4
		1 RB high	23.4	22.9	22.4	22.4
		50% RB low	22.4	22.1	21.4	21.3
		50% RB mid	22.4	22.1	21.4	21.3
		50% RB high	22.4	22.0	21.4	21.0
	100% RB	22.4	22.1	21.4	20.9	
	20385 / 1753.5	1 RB low	23.4	23.2	22.4	22.4
		1 RB mid	23.4	23.1	22.4	22.4
		1 RB high	23.4	23.1	22.4	22.4
		50% RB low	22.4	22.2	21.4	21.3
50% RB mid		22.4	22.2	21.4	21.0	
50% RB high		22.4	22.2	21.4	21.2	
100% RB	22.4	22.0	21.4	20.8		

Bandwidth (MHz)	Channel / Frequency (MHz)	Resource block allocation	P _{avg} (dBm)			
			QPSK		16-QAM	
			upper limit	meas.	upper limit	meas.
5	19975 / 1712.5	1 RB low	23.4	23.0	22.4	22.2
		1 RB mid	23.4	23.3	22.4	22.8
		1 RB high	23.4	22.9	22.4	21.9
		50% RB low	22.4	22.4	21.4	21.1
		50% RB mid	22.4	22.4	21.4	21.2
		50% RB high	22.4	22.3	21.4	21.1
	20175 / 1732.5	100% RB	22.4	22.3	21.4	21.4
		1 RB low	23.4	23.0	22.4	22.5
		1 RB mid	23.4	23.0	22.4	22.6
		1 RB high	23.4	23.0	22.4	22.4
		50% RB low	22.4	22.0	21.4	21.1
		50% RB mid	22.4	22.1	21.4	21.2
	20375 / 1752.5	50% RB high	22.4	22.1	21.4	20.9
		100% RB	22.4	22.1	21.4	21.0
		1 RB low	23.4	23.0	22.4	22.4
		1 RB mid	23.4	23.1	22.4	22.5
		1 RB high	23.4	23.1	22.4	22.5
		50% RB low	22.4	22.2	21.4	21.1
10	20000 / 1715.0	50% RB mid	22.4	22.2	21.4	21.1
		50% RB high	22.4	22.1	21.4	21.0
		100% RB	22.4	22.1	21.4	21.0
		1 RB low	23.4	23.4	22.4	22.7
		1 RB mid	23.4	23.0	22.4	22.6
		1 RB high	23.4	23.2	22.4	22.8
	20175 / 1732.5	50% RB low	22.4	22.4	21.4	21.3
		50% RB mid	22.4	22.3	21.4	21.1
		50% RB high	22.4	22.2	21.4	21.2
		100% RB	22.4	22.4	21.4	21.3
		1 RB low	23.4	23.3	22.4	22.8
		1 RB mid	23.4	23.0	22.4	22.8
	20350 / 1750.0	1 RB high	23.4	23.1	22.4	22.7
		50% RB low	22.4	22.1	21.4	21.4
		50% RB mid	22.4	22.2	21.4	21.1
		50% RB high	22.4	22.1	21.4	21.2
		100% RB	22.4	22.1	21.4	21.1
		1 RB low	23.4	23.0	22.4	22.3
	1 RB mid	23.4	23.3	22.4	22.6	
	1 RB high	23.4	23.1	22.4	22.4	
	50% RB low	22.4	22.2	21.4	21.1	
	50% RB mid	22.4	22.3	21.4	21.4	
	50% RB high	22.4	22.4	21.4	21.6	
	100% RB	22.4	22.3	21.4	21.3	

Bandwidth (MHz)	Channel / Frequency (MHz)	Resource block allocation	P _{avg} (dBm)			
			QPSK		16-QAM	
			upper limit	meas.	upper limit	meas.
15	20025 / 1717.5	1 RB low	23.4	23.4	22.4	23.0
		1 RB mid	23.4	23.4	22.4	22.8
		1 RB high	23.4	23.2	22.4	22.3
		50% RB low	22.4	22.4	21.4	21.3
		50% RB mid	22.4	22.3	21.4	21.3
		50% RB high	22.4	22.2	21.4	21.3
	100% RB	22.4	22.3	21.4	21.2	
	20175 / 1732.5	1 RB low	23.4	23.2	22.4	22.8
		1 RB mid	23.4	23.0	22.4	22.5
		1 RB high	23.4	23.0	22.4	22.4
		50% RB low	22.4	22.1	21.4	21.1
		50% RB mid	22.4	22.1	21.4	21.3
		50% RB high	22.4	22.1	21.4	21.2
	100% RB	22.4	22.1	21.4	21.1	
	20325 / 1747.5	1 RB low	23.4	23.1	22.4	22.3
		1 RB mid	23.4	23.1	22.4	22.3
		1 RB high	23.4	23.3	22.4	22.7
		50% RB low	22.4	22.3	21.4	21.0
50% RB mid		22.4	22.3	21.4	21.4	
50% RB high		22.4	22.4	21.4	21.3	
100% RB	22.4	22.4	21.4	21.1		
20	20050 / 1720.0	1 RB low	23.4	23.1	22.4	22.7
		1 RB mid	23.4	23.2	22.4	22.5
		1 RB high	23.4	23.0	22.4	22.5
		50% RB low	22.4	22.4	21.4	21.1
		50% RB mid	22.4	22.1	21.4	21.1
		50% RB high	22.4	22.2	21.4	21.0
	100% RB	22.4	22.2	21.4	21.0	
	20175 / 1732.5	1 RB low	23.4	23.3	22.4	22.4
		1 RB mid	23.4	23.0	22.4	22.4
		1 RB high	23.4	23.0	22.4	22.4
		50% RB low	22.4	22.3	21.4	21.2
		50% RB mid	22.4	22.1	21.4	21.1
		50% RB high	22.4	22.2	21.4	21.1
	100% RB	22.4	22.3	21.4	21.2	
	20300 / 1745.0	1 RB low	23.4	23.2	22.4	22.4
		1 RB mid	23.4	23.0	22.4	22.6
		1 RB high	23.4	23.1	22.4	22.2
		50% RB low	22.4	22.1	21.4	21.0
50% RB mid		22.4	22.2	21.4	21.2	
50% RB high		22.4	22.4	21.4	21.3	
100% RB	22.4	22.2	21.4	21.2		

Table 22: Test results conducted power measurement LTE FDD 4 1700 MHz.
SN: 004402743285227

RESULTS PROVIDED BY CUSTOMER

7.1.9 Conducted power measurements LTE FDD 4 1700 MHz (PR)

with power reduction

Bandwidth (MHz)	Channel / Frequency (MHz)	Resource block allocation	P _{avg} (dBm)			
			QPSK		16-QAM	
			upper limit	meas.	upper limit	meas.
1.4	19957 / 1710.7	1 RB low	22.4	21.5	21.4	20.9
		1 RB mid	22.4	21.5	21.4	20.9
		1 RB high	22.4	21.6	21.4	20.9
		50% RB low	22.4	21.5	21.4	20.8
		50% RB mid	22.4	21.5	21.4	20.8
		50% RB high	22.4	21.5	21.4	20.8
	20175 / 1732.5	100% RB	21.4	20.5	20.4	19.5
		1 RB low	22.4	21.9	21.4	21.2
		1 RB mid	22.4	22.0	21.4	21.2
		1 RB high	22.4	21.9	21.4	21.2
		50% RB low	22.4	21.9	21.4	21.3
		50% RB mid	22.4	21.9	21.4	21.3
	20393 / 1754.3	50% RB high	22.4	21.8	21.4	21.2
		100% RB	21.4	20.9	20.4	19.7
		1 RB low	22.4	21.6	21.4	21.0
		1 RB mid	22.4	21.7	21.4	21.0
		1 RB high	22.4	21.7	21.4	21.0
		50% RB low	22.4	21.6	21.4	21.1
3	19965 / 1711.5	50% RB mid	22.4	21.7	21.4	21.0
		50% RB high	22.4	21.7	21.4	21.1
		100% RB	21.4	20.7	20.4	19.7
		1 RB low	22.4	21.9	21.4	21.2
		1 RB mid	22.4	21.8	21.4	21.0
		1 RB high	22.4	21.7	21.4	21.1
	20175 / 1732.5	50% RB low	21.4	20.8	20.4	19.9
		50% RB mid	21.4	20.8	20.4	19.8
		50% RB high	21.4	20.8	20.4	19.8
		100% RB	21.4	20.6	20.4	19.9
		1 RB low	22.4	22.0	21.4	21.4
		1 RB mid	22.4	22.0	21.4	21.3
	20385 / 1753.5	1 RB high	22.4	22.0	21.4	21.4
		50% RB low	21.4	21.1	20.4	20.2
		50% RB mid	21.4	20.9	20.4	20.2
		50% RB high	21.4	21.0	20.4	20.1
		100% RB	21.4	20.9	20.4	20.0
		1 RB low	22.4	21.7	21.4	21.1
		1 RB mid	22.4	21.6	21.4	20.9
		1 RB high	22.4	21.7	21.4	21.1
		50% RB low	21.4	20.7	20.4	19.9
		50% RB mid	21.4	20.7	20.4	19.6
		50% RB high	21.4	20.7	20.4	19.8
		100% RB	21.4	20.7	20.4	19.4

Bandwidth (MHz)	Channel / Frequency (MHz)	Resource block allocation	P _{avg} (dBm)			
			QPSK		16-QAM	
			upper limit	meas.	upper limit	meas.
5	19975 / 1712.5	1 RB low	22.4	21.7	21.4	21.1
		1 RB mid	22.4	21.7	21.4	21.1
		1 RB high	22.4	21.6	21.4	21.1
		50% RB low	21.4	20.8	20.4	19.7
		50% RB mid	21.4	20.8	20.4	19.7
		50% RB high	21.4	20.8	20.4	19.6
	100% RB	21.4	20.7	20.4	19.7	
	20175 / 1732.5	1 RB low	22.4	21.9	21.4	21.3
		1 RB mid	22.4	21.9	21.4	21.3
		1 RB high	22.4	21.9	21.4	21.4
		50% RB low	21.4	20.9	20.4	19.9
		50% RB mid	21.4	21.0	20.4	19.9
		50% RB high	21.4	20.9	20.4	19.7
	100% RB	21.4	21.0	20.4	19.8	
	20375 / 1752.5	1 RB low	22.4	21.7	21.4	21.2
		1 RB mid	22.4	21.8	21.4	21.2
		1 RB high	22.4	21.7	21.4	21.2
		50% RB low	21.4	20.8	20.4	19.7
50% RB mid		21.4	20.8	20.4	19.7	
50% RB high		21.4	20.8	20.4	19.7	
100% RB	21.4	20.8	20.4	19.7		
10	20000 / 1715.0	1 RB low	22.4	22.1	21.4	21.5
		1 RB mid	22.4	22.0	21.4	21.5
		1 RB high	22.4	21.9	21.4	21.2
		50% RB low	21.4	21.0	20.4	20.0
		50% RB mid	21.4	20.9	20.4	19.8
		50% RB high	21.4	20.9	20.4	19.9
	100% RB	21.4	20.9	20.4	19.9	
	20175 / 1732.5	1 RB low	22.4	21.9	21.4	21.5
		1 RB mid	22.4	22.0	21.4	21.4
		1 RB high	22.4	21.8	21.4	21.3
		50% RB low	21.4	21.0	20.4	20.1
		50% RB mid	21.4	21.0	20.4	19.9
		50% RB high	21.4	21.0	20.4	19.9
	100% RB	21.4	21.0	20.4	19.9	
	20350 / 1750.0	1 RB low	22.4	21.9	21.4	21.4
		1 RB mid	22.4	22.0	21.4	21.5
		1 RB high	22.4	21.8	21.4	21.4
		50% RB low	21.4	21.0	20.4	20.0
50% RB mid		21.4	21.0	20.4	19.9	
50% RB high		21.4	21.0	20.4	20.1	
100% RB	21.4	21.0	20.4	20.0		

Bandwidth (MHz)	Channel / Frequency (MHz)	Resource block allocation	P _{avg} (dBm)			
			QPSK		16-QAM	
			upper limit	meas.	upper limit	meas.
15	20025 / 1717.5	1 RB low	22.4	21.9	21.4	21.5
		1 RB mid	22.4	21.8	21.4	20.9
		1 RB high	22.4	22.0	21.4	21.5
		50% RB low	21.4	21.0	20.4	19.9
		50% RB mid	21.4	20.9	20.4	19.9
		50% RB high	21.4	20.8	20.4	19.8
	20175 / 1732.5	100% RB	21.4	20.9	20.4	19.9
		1 RB low	22.4	22.2	21.4	21.5
		1 RB mid	22.4	22.0	21.4	21.3
		1 RB high	22.4	21.8	21.4	21.3
		50% RB low	21.4	21.0	20.4	19.9
		50% RB mid	21.4	21.0	20.4	20.0
	20325 / 1747.5	50% RB high	21.4	21.0	20.4	19.9
		100% RB	21.4	21.0	20.4	20.0
		1 RB low	22.4	21.8	21.4	21.0
		1 RB mid	22.4	21.7	21.4	21.0
		1 RB high	22.4	21.7	21.4	21.0
		50% RB low	21.4	20.8	20.4	19.8
20	20050 / 1720.0	50% RB mid	21.4	20.9	20.4	19.8
		50% RB high	21.4	20.8	20.4	19.7
		100% RB	21.4	20.8	20.4	19.7
		1 RB low	22.4	21.9	21.4	21.1
		1 RB mid	22.4	21.7	21.4	20.9
		1 RB high	22.4	21.7	21.4	20.9
	20175 / 1732.5	50% RB low	21.4	20.9	20.4	19.7
		50% RB mid	21.4	20.8	20.4	19.7
		50% RB high	21.4	20.8	20.4	19.8
		100% RB	21.4	20.8	20.4	19.7
		1 RB low	22.4	22.1	21.4	21.5
		1 RB mid	22.4	22.0	21.4	21.2
	20300 / 1745.0	1 RB high	22.4	21.8	21.4	21.0
		50% RB low	21.4	21.0	20.4	19.9
		50% RB mid	21.4	21.0	20.4	19.8
		50% RB high	21.4	20.9	20.4	19.9
		100% RB	21.4	21.0	20.4	19.9
		1 RB low	22.4	21.9	21.4	21.1
		1 RB mid	22.4	21.8	21.4	21.0
		1 RB high	22.4	21.8	21.4	21.0
		50% RB low	21.4	20.9	20.4	19.9
		50% RB mid	21.4	20.8	20.4	19.8
		50% RB high	21.4	20.9	20.4	19.8
		100% RB	21.4	20.9	20.4	19.8

Table 23: Test results conducted power measurement LTE FDD 4 1700 MHz with power reduction SN: 004402743285706

RESULTS PROVIDED BY CUSTOMER

7.1.10 Conducted power measurements LTE FDD 5 850 MHz

Bandwidth (MHz)	Channel / Frequency (MHz)	Resource block allocation	P _{avg} (dBm)			
			QPSK		16-QAM	
			upper limit	meas.	upper limit	meas.
1.4	20407 / 824.7	1 RB low	23.4	23.3	22.4	22.7
		1 RB mid	23.4	23.4	22.4	22.9
		1 RB high	23.4	23.4	22.4	22.8
		50% RB low	23.4	23.2	22.4	22.4
		50% RB mid	23.4	23.4	22.4	22.4
		50% RB high	23.4	23.3	22.4	22.5
	100% RB	22.4	22.4	21.4	21.5	
	20525 / 836.5	1 RB low	23.4	23.1	22.4	22.4
		1 RB mid	23.4	23.3	22.4	22.9
		1 RB high	23.4	23.1	22.4	22.4
		50% RB low	23.4	23.1	22.4	22.5
		50% RB mid	23.4	23.2	22.4	22.6
		50% RB high	23.4	23.2	22.4	22.6
	100% RB	22.4	22.2	21.4	21.2	
	20643 / 848.3	1 RB low	23.4	23.1	22.4	22.5
		1 RB mid	23.4	23.3	22.4	22.6
		1 RB high	23.4	23.2	22.4	22.5
		50% RB low	23.4	23.4	22.4	22.7
50% RB mid		23.4	23.3	22.4	22.6	
50% RB high		23.4	23.3	22.4	22.5	
100% RB	22.4	22.3	21.4	21.2		
3.0	20415 / 825.5	1 RB low	23.4	23.2	22.4	22.4
		1 RB mid	23.4	23.3	22.4	22.9
		1 RB high	23.4	23.2	22.4	22.7
		50% RB low	22.4	22.3	21.4	21.5
		50% RB mid	22.4	22.2	21.4	21.6
		50% RB high	22.4	22.4	21.4	21.5
	100% RB	22.4	22.3	21.4	21.6	
	20525 / 836.5	1 RB low	23.4	23.0	22.4	22.4
		1 RB mid	23.4	23.2	22.4	22.4
		1 RB high	23.4	23.0	22.4	22.5
		50% RB low	22.4	22.2	21.4	21.5
		50% RB mid	22.4	22.1	21.4	21.4
		50% RB high	22.4	22.4	21.4	21.5
	100% RB	22.4	22.1	21.4	21.2	
	20635 / 847.5	1 RB low	23.4	23.1	22.4	22.7
		1 RB mid	23.4	23.1	22.4	22.5
		1 RB high	23.4	23.3	22.4	22.6
		50% RB low	22.4	22.3	21.4	21.4
50% RB mid		22.4	22.3	21.4	21.6	
50% RB high		22.4	22.4	21.4	21.7	
100% RB	22.4	22.3	21.4	21.4		

Bandwidth (MHz)	Channel / Frequency (MHz)	Resource block allocation	P _{avg} (dBm)			
			QPSK		16-QAM	
			upper limit	meas.	upper limit	meas.
5.0	20425 / 826.5	1 RB low	23.4	23.0	22.4	22.2
		1 RB mid	23.4	23.2	22.4	22.4
		1 RB high	23.4	23.0	22.4	22.1
		50% RB low	22.4	22.3	21.4	21.5
		50% RB mid	22.4	22.3	21.4	21.6
		50% RB high	22.4	22.2	21.4	21.4
	100% RB	22.4	22.3	21.4	21.3	
	20525 / 836.5	1 RB low	23.4	23.3	22.4	22.4
		1 RB mid	23.4	23.1	22.4	22.4
		1 RB high	23.4	23.2	22.4	22.3
		50% RB low	22.4	22.2	21.4	21.4
		50% RB mid	22.4	22.2	21.4	21.2
		50% RB high	22.4	22.1	21.4	21.3
	100% RB	22.4	22.2	21.4	21.2	
	20625 / 846.5	1 RB low	23.4	23.2	22.4	22.4
		1 RB mid	23.4	23.3	22.4	22.8
		1 RB high	23.4	23.2	22.4	22.5
		50% RB low	22.4	22.4	21.4	21.4
50% RB mid		22.4	22.3	21.4	21.3	
50% RB high		22.4	22.2	21.4	21.5	
100% RB	22.4	22.4	21.4	21.4		
10.0	20450 / 829	1 RB low	23.4	23.2	22.4	22.4
		1 RB mid	23.4	23.2	22.4	22.6
		1 RB high	23.4	23.0	22.4	22.2
		50% RB low	22.4	22.2	21.4	21.4
		50% RB mid	22.4	22.3	21.4	21.5
		50% RB high	22.4	22.2	21.4	21.2
	100% RB	22.4	22.3	21.4	21.3	
	20525 / 836.5	1 RB low	23.4	23.2	22.4	22.6
		1 RB mid	23.4	23.2	22.4	22.5
		1 RB high	23.4	23.1	22.4	22.4
		50% RB low	22.4	22.2	21.4	21.6
		50% RB mid	22.4	22.2	21.4	21.4
		50% RB high	22.4	22.1	21.4	21.2
	100% RB	22.4	22.2	21.4	21.3	
	20600 / 844	1 RB low	23.4	23.2	22.4	22.8
		1 RB mid	23.4	23.3	22.4	22.7
		1 RB high	23.4	23.2	22.4	22.7
		50% RB low	22.4	22.4	21.4	21.4
50% RB mid		22.4	22.2	21.4	21.3	
50% RB high		22.4	22.4	21.4	21.5	
100% RB	22.4	22.3	21.4	21.4		

Table 24: Test results conducted power measurement LTE FDD 5 850 MHz. SN: 004402743285805

RESULTS PROVIDED BY CUSTOMER

7.1.11 Conducted power measurements LTE FDD 7 2600 MHz

Bandwidth (MHz)	Channel / Frequency (MHz)	Resource block allocation	P _{avg} (dBm)			
			QPSK		16-QAM	
			upper limit	meas.	upper limit	meas.
5.0	20775 / 2502.5	1 RB low	23.4	23.2	22.4	22.8
		1 RB mid	23.4	23.1	22.4	22.8
		1 RB high	23.4	23.2	22.4	22.7
		50% RB low	22.4	22.1	21.4	21.2
		50% RB mid	22.4	22.1	21.4	21.3
		50% RB high	22.4	22.1	21.4	21.2
	21100 / 2535	100% RB	22.4	22.1	21.4	21.2
		1 RB low	23.4	23.0	22.4	22.7
		1 RB mid	23.4	23.2	22.4	22.8
		1 RB high	23.4	23.3	22.4	22.8
		50% RB low	22.4	22.3	21.4	21.2
		50% RB mid	22.4	22.3	21.4	21.2
	21425 / 2567.5	50% RB high	22.4	22.3	21.4	21.2
		100% RB	22.4	22.3	21.4	21.5
		1 RB low	23.4	23.3	22.4	22.3
		1 RB mid	23.4	23.3	22.4	22.8
		1 RB high	23.4	23.2	22.4	22.8
		50% RB low	22.4	22.2	21.4	21.1
10.0	20800 / 2505	50% RB mid	22.4	22.2	21.4	21.2
		50% RB high	22.4	22.3	21.4	21.2
		100% RB	22.4	22.3	21.4	21.3
		1 RB low	23.4	23.3	22.4	22.8
		1 RB mid	23.4	23.2	22.4	23.0
		1 RB high	23.4	23.4	22.4	22.9
	21100 / 2535	50% RB low	22.4	22.3	21.4	21.4
		50% RB mid	22.4	22.2	21.4	21.5
		50% RB high	22.4	22.4	21.4	21.5
		100% RB	22.4	22.2	21.4	21.4
		1 RB low	23.4	23.2	22.4	22.6
		1 RB mid	23.4	23.4	22.4	22.8
	21400 / 2565	1 RB high	23.4	23.4	22.4	22.7
		50% RB low	22.4	22.4	21.4	21.5
		50% RB mid	22.4	22.4	21.4	21.3
		50% RB high	22.4	22.4	21.4	21.3
		100% RB	22.4	22.3	21.4	21.4
		1 RB low	23.4	23.2	22.4	22.5
	21400 / 2565	1 RB mid	23.4	23.1	22.4	22.5
		1 RB high	23.4	23.3	22.4	22.7
		50% RB low	22.4	22.2	21.4	21.2
		50% RB mid	22.4	22.2	21.4	21.4
		50% RB high	22.4	22.4	21.4	21.4
		100% RB	22.4	22.3	21.4	21.1

Bandwidth (MHz)	Channel / Frequency (MHz)	Resource block allocation	P _{avg} (dBm)			
			QPSK		16-QAM	
			upper limit	meas.	upper limit	meas.
15.0	20825 / 2507.5	1 RB low	23.4	23.4	22.4	22.9
		1 RB mid	23.4	23.3	22.4	22.7
		1 RB high	23.4	23.4	22.4	22.7
		50% RB low	22.4	22.3	21.4	21.2
		50% RB mid	22.4	22.3	21.4	21.3
		50% RB high	22.4	22.4	21.4	21.4
	21100 / 2535	100% RB	22.4	22.3	21.4	21.3
		1 RB low	23.4	23.3	22.4	22.8
		1 RB mid	23.4	23.3	22.4	22.7
		1 RB high	23.4	23.4	22.4	22.8
		50% RB low	22.4	22.3	21.4	21.3
		50% RB mid	22.4	22.3	21.4	21.2
	21375 / 2562.5	50% RB high	22.4	22.4	21.4	21.3
		100% RB	22.4	22.4	21.4	21.3
		1 RB low	23.4	23.1	22.4	22.4
		1 RB mid	23.4	23.0	22.4	22.3
		1 RB high	23.4	23.2	22.4	22.5
		50% RB low	22.4	22.1	21.4	21.0
20.0	20850 / 2510	50% RB mid	22.4	22.0	21.4	20.9
		50% RB high	22.4	22.2	21.4	21.0
		100% RB	22.4	22.1	21.4	21.0
		1 RB low	23.4	23.3	22.4	22.6
		1 RB mid	23.4	23.4	22.4	22.5
		1 RB high	23.4	23.3	22.4	22.5
	21100 / 2535	50% RB low	22.4	22.4	21.4	21.2
		50% RB mid	22.4	22.4	21.4	21.4
		50% RB high	22.4	22.3	21.4	21.4
		100% RB	22.4	22.3	21.4	21.3
		1 RB low	23.4	23.4	22.4	22.6
		1 RB mid	23.4	23.3	22.4	22.7
	21350 / 2560	1 RB high	23.4	23.2	22.4	22.4
		50% RB low	22.4	22.3	21.4	21.3
		50% RB mid	22.4	22.3	21.4	21.4
		50% RB high	22.4	22.3	21.4	21.3
		100% RB	22.4	22.3	21.4	21.4
		1 RB low	23.4	23.4	22.4	22.2
	1 RB mid	23.4	23.2	22.4	22.3	
	1 RB high	23.4	23.3	22.4	22.7	
	50% RB low	22.4	22.2	21.4	21.1	
	50% RB mid	22.4	22.2	21.4	21.1	
	50% RB high	22.4	22.2	21.4	21.2	
	100% RB	22.4	22.2	21.4	21.2	

Table 25: Test results conducted power measurement LTE FDD 7 2600 MHz.
SN: 004402743285425

RESULTS PROVIDED BY CUSTOMER

7.1.12 Conducted power measurements LTE TDD 38 2600 MHz

Bandwidth (MHz)	Channel / Frequency (MHz)	Resource block allocation	P _{avg} (dBm)			
			QPSK		16-QAM	
			upper limit	meas.	upper limit	meas.
5.0	37775 / 2572.5	1 RB low	25.0	23.1	24.0	22.4
		1 RB mid	25.0	23.1	24.0	22.3
		1 RB high	25.0	23.1	24.0	22.3
		50% RB low	24.0	22.1	23.0	21.1
		50% RB mid	24.0	22.1	23.0	21.1
		50% RB high	24.0	22.1	23.0	21.1
	100% RB	24.0	22.0	23.0	21.1	
	38000 / 2595	1 RB low	25.0	23.1	24.0	22.2
		1 RB mid	25.0	23.1	24.0	21.9
		1 RB high	25.0	23.0	24.0	22.2
		50% RB low	24.0	22.2	23.0	21.2
		50% RB mid	24.0	22.1	23.0	21.2
		50% RB high	24.0	22.2	23.0	21.2
	100% RB	24.0	22.0	23.0	21.4	
	38225 / 2617.5	1 RB low	25.0	23.0	24.0	22.1
		1 RB mid	25.0	23.0	24.0	22.0
		1 RB high	25.0	23.1	24.0	22.2
		50% RB low	24.0	22.1	23.0	20.9
50% RB mid		24.0	22.2	23.0	21.2	
50% RB high		24.0	22.2	23.0	20.9	
100% RB	24.0	22.4	23.0	21.4		
10.0	37800 / 2575	1 RB low	25.0	23.2	24.0	22.3
		1 RB mid	25.0	23.2	24.0	22.7
		1 RB high	25.0	23.2	24.0	22.2
		50% RB low	24.0	22.2	23.0	21.2
		50% RB mid	24.0	22.2	23.0	21.2
		50% RB high	24.0	22.2	23.0	21.5
	100% RB	24.0	22.2	23.0	21.1	
	38000 / 2595	1 RB low	25.0	23.4	24.0	22.6
		1 RB mid	25.0	23.3	24.0	22.6
		1 RB high	25.0	23.0	24.0	22.2
		50% RB low	24.0	22.3	23.0	21.5
		50% RB mid	24.0	22.2	23.0	21.4
		50% RB high	24.0	22.2	23.0	21.4
	100% RB	24.0	22.2	23.0	21.2	
	38200 / 2615	1 RB low	25.0	23.0	24.0	22.0
		1 RB mid	25.0	23.2	24.0	22.2
		1 RB high	25.0	23.1	24.0	22.4
		50% RB low	24.0	22.2	23.0	21.2
50% RB mid		24.0	22.3	23.0	21.1	
50% RB high		24.0	22.4	23.0	21.2	
100% RB	24.0	22.3	23.0	21.1		

Bandwidth (MHz)	Channel / Frequency (MHz)	Resource block allocation	P _{avg} (dBm)			
			QPSK		16-QAM	
			upper limit	meas.	upper limit	meas.
15.0	37825 / 2577.5	1 RB low	25.0	23.3	24.0	22.6
		1 RB mid	25.0	23.1	24.0	22.5
		1 RB high	25.0	23.3	24.0	22.7
		50% RB low	24.0	22.2	23.0	21.2
		50% RB mid	24.0	22.3	23.0	21.3
		50% RB high	24.0	22.2	23.0	21.3
		100% RB	24.0	22.2	23.0	21.3
	38000 / 2595	1 RB low	25.0	23.5	24.0	22.8
		1 RB mid	25.0	23.2	24.0	22.5
		1 RB high	25.0	23.3	24.0	22.7
		50% RB low	24.0	22.3	23.0	21.2
		50% RB mid	24.0	22.2	23.0	21.2
		50% RB high	24.0	22.1	23.0	21.1
	38175 / 2612.5	100% RB	24.0	22.2	23.0	21.2
		1 RB low	25.0	23.3	24.0	22.4
		1 RB mid	25.0	23.2	24.0	22.2
		1 RB high	25.0	23.3	24.0	22.3
		50% RB low	24.0	22.2	23.0	20.9
50% RB mid		24.0	22.2	23.0	21.0	
50% RB high		24.0	22.2	23.0	21.2	
20.0	37850 / 2580	100% RB	24.0	22.3	23.0	21.2
		1 RB low	25.0	23.2	24.0	22.4
		1 RB mid	25.0	23.3	24.0	22.5
		1 RB high	25.0	23.3	24.0	22.4
		50% RB low	24.0	22.3	23.0	21.3
		50% RB mid	24.0	22.4	23.0	21.3
		50% RB high	24.0	22.3	23.0	21.3
	38000 / 2595	100% RB	24.0	22.2	23.0	21.3
		1 RB low	25.0	23.5	24.0	22.6
		1 RB mid	25.0	23.2	24.0	22.4
		1 RB high	25.0	23.0	24.0	22.2
		50% RB low	24.0	22.3	23.0	21.3
		50% RB mid	24.0	22.3	23.0	21.2
	38150 / 2610	50% RB high	24.0	22.1	23.0	21.2
		100% RB	24.0	22.3	23.0	21.2
		1 RB low	25.0	23.1	24.0	22.2
		1 RB mid	25.0	23.1	24.0	22.3
		1 RB high	25.0	23.2	24.0	22.3
50% RB low		24.0	22.2	23.0	21.2	
50% RB mid		24.0	22.3	23.0	21.3	
50% RB high	24.0	22.3	23.0	21.2		
100% RB	24.0	22.3	23.0	21.2		

Table 26: Test results conducted power measurement LTE TDD 38 2600 MHz.
SN: 004402743285425

RESULTS PROVIDED BY CUSTOMER

7.1.13 Justification of SAR measurements in LTE mode

According to Chapter 5 'SAR test procedures for LTE devices of FCC KDB Publication 941225 D05 the following test configurations for standalone measurements of the largest channel bandwidth (chapter 5.2) had to be taken into consideration:

5.2.1. QPSK with 1 RB allocation

Start with the largest channel bandwidth and measure SAR for QPSK with 1 RB allocation, using the RB offset and *required test channel* combination with the highest maximum output power for RB offsets at the upper edge, middle and lower edge of each *required test channel*. When the *reported SAR* is ≤ 0.8 W/kg, testing of the remaining RB offset configurations and *required test channels* is not required for 1 RB allocation; otherwise, SAR is required for the remaining *required test channels* and only for the RB offset configuration with the highest output power for that channel. When the *reported SAR* of a *required test channel* is > 1.45 W/kg, SAR is required for all three RB offset configurations for that *required test channel*.

5.2.2. QPSK with 50% RB allocation

The procedures required for 1 RB allocation in 5.2.1 are applied to measure the SAR for QPSK with 50% RB allocation.

5.2.3. QPSK with 100% RB allocation

For QPSK with 100% RB allocation, SAR is not required when the highest maximum output power for 100 % RB allocation is less than the highest maximum output power in 50% and 1 RB allocations and the highest *reported SAR* for 1 RB and 50% RB allocation in 5.2.1 and 5.2.2 are ≤ 0.8 W/kg. Otherwise, SAR is measured for the highest output power channel and if the *reported SAR* is > 1.45 W/kg, the remaining *required test channels* must also be tested.

5.2.4. Higher order modulations

For each modulation besides QPSK; e.g., 16-QAM, 64-QAM, apply the QPSK procedures in sections 5.2.1, 5.2.2 and 5.2.3 to determine the QAM configurations that may need SAR measurement. For each configuration identified as required for testing, SAR is required only when the highest maximum output power for the configuration in the higher order modulation is $> \frac{1}{2}$ dB higher than the same configuration in QPSK or when the *reported SAR* for the QPSK configuration is > 1.45 W/kg.

Testing of other channel bandwidths was not necessary because the output power of equivalent channel configurations was less than $\frac{1}{2}$ dB larger compared to the largest channel bandwidth and reported SAR was < 1.45 W/kg.

Conducted and radiated measurements were performed with the maximum number of bundled TTIs supported by the DUT (see section 2.4 for details).

7.1.14 MPR information in LTE mode

There is a permanently applied MPR implemented by the manufacturer. MPR is enabled for this device according to 3GPP TS36.101.

Modulation	Channel bandwidth / resource block configuration						Target MPR	3 GPP MPR
	1.4 MHz	3 MHz	5 MHz	10 MHz	15 MHz	20 MHz		
QPSK	> 5	> 4	> 8	> 12	> 16	> 18	1	≤ 1
16QAM	≤ 5	≤ 4	≤ 8	≤ 12	≤ 16	≤ 18	1	≤ 1
16QAM	> 5	> 4	> 8	> 12	> 16	> 18	2	≤ 2

Therefore there is no power reduction at 1.4 MHz bandwidth with 50% RB allocation (3 RBs).

Additional differences in conducted power are not caused by implemented MPR but depend on measurement uncertainty and allowable tolerances per 3GPP or tune-up. A-MPR was disabled for all SAR tests.

7.1.15 LTE TDD test configuration

LTE Devices using Time-Division Duplex (TDD) Systems must be tested using a fixed periodic duty factor according the highest transmission duty factor implemented for the device and supported by the Defined 3GPP LTE TDD configurations. (FCC KDB 941225 D05 SAR for LTE Devices v02r03)

TDD LTE Band 38 support Type 2 Frame Structure as described in the following tables from the 3GPP TS 36.211 section 4.2.

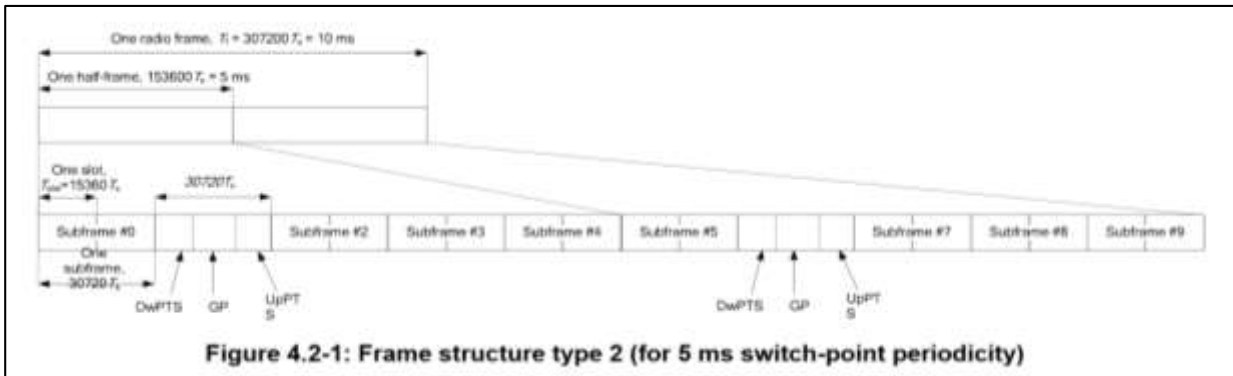

Table 4.2-1: Configuration of special subframe (lengths of DwPTS/GP/UpPTS)

Special subframe configuration	Normal cyclic prefix in downlink			Extended cyclic prefix in downlink		
	DwPTS	UpPTS		DwPTS	UpPTS	
		Normal cyclic prefix in uplink	Extended cyclic prefix in uplink		Normal cyclic prefix in uplink	Extended cyclic prefix in uplink
0	$6592 \cdot T_s$	$2192 \cdot T_s$	$2560 \cdot T_s$	$7680 \cdot T_s$	$2192 \cdot T_s$	$2560 \cdot T_s$
1	$19760 \cdot T_s$			$20480 \cdot T_s$		
2	$21952 \cdot T_s$			$23040 \cdot T_s$		
3	$24144 \cdot T_s$			$25600 \cdot T_s$		
4	$26336 \cdot T_s$	$4384 \cdot T_s$	$5120 \cdot T_s$	$7680 \cdot T_s$	$4384 \cdot T_s$	$5120 \cdot T_s$
5	$6592 \cdot T_s$			$20480 \cdot T_s$		
6	$19760 \cdot T_s$			$23040 \cdot T_s$		
7	$21952 \cdot T_s$			$12800 \cdot T_s$		
8	$24144 \cdot T_s$	-	-	-	-	-
9	$13168 \cdot T_s$	-	-	-	-	-

Table 4.2-2: Uplink-downlink configurations

Uplink-downlink configuration	Downlink-to-Uplink Switch-point periodicity	Subframe number									
		0	1	2	3	4	5	6	7	8	9
0	5 ms	D	S	U	U	U	D	S	U	U	U
1	5 ms	D	S	U	U	D	D	S	U	U	D
2	5 ms	D	S	U	D	D	D	S	U	D	D
3	10 ms	D	S	U	U	U	D	D	D	D	D
4	10 ms	D	S	U	U	D	D	D	D	D	D
5	10 ms	D	S	U	D	D	D	D	D	D	D
6	5 ms	D	S	U	U	U	D	S	U	U	D

Figure 4.2-1 shows that a radio frame is divided in ten subframes that consist of Uplink- / Downlink- and Special-subframes. The Duty Cycle for LTE TDD should be calculated on Uplink-subframes and Special-subframes as both contain Uplink transmissions. The following formula is used for the calculation of the Duty Cycle. (With Uplink-subframes counted according the table 4.2-2)

$$\text{Duty Cycle} = (30720\text{Ts} \times \text{Ups} + \text{Uplink Component} \times \text{Specials}) / (30720\text{Ts})$$

According to table 4.2-1 the Uplink component of the Special-subframes is:

$$\text{Uplink Component} = \text{UpPTS}$$

This results in the following formula:

$$\text{Duty Cycle} = [30720\text{Ts} \times \text{Ups} + \text{UpPTS} \times \text{Specials}] / (30720\text{Ts})$$

The measured configuration of the device, which results in the highest output, was derived from the following table:

Uplink-downlink configuration	Subframe number			Configuration of special subframe							
				Normal cyclic prefix in downlink				Extended cyclic prefix in downlink			
	D S U			Normal cyclic prefix in uplink		Extended cyclic prefix in uplink		Normal cyclic prefix in uplink		Extended cyclic prefix in uplink	
				configuration 0 ~ 4	configuration 5 ~ 9	configuration 0 ~ 4	configuration 5 ~ 9	configuration 0 ~ 3	configuration 4 ~ 7	configuration 0 ~ 3	configuration 4 ~ 7
0	2	2	6	61.43%	62.85%	61.67%	63.33%	61.43%	62.85%	61.67%	63.33%
1	4	2	4	41.43%	42.85%	41.67%	43.33%	41.43%	42.85%	41.67%	43.33%
2	6	2	2	21.43%	22.85%	21.67%	23.33%	21.43%	22.85%	21.67%	23.33%
3	6	1	3	30.71%	31.43%	30.83%	31.67%	30.71%	31.43%	30.83%	31.67%
4	7	1	2	20.71%	21.43%	20.83%	21.67%	20.71%	21.43%	20.83%	21.67%
5	8	1	1	10.71%	11.43%	10.83%	11.67%	10.71%	11.43%	10.83%	11.67%
6	3	2	1	51.43%	52.85%	51.67%	53.33%	51.43%	52.85%	51.67%	53.33%

Therefore SAR for LTE TDD should be tested with the highest transmission duty factor (63.33%) using Uplink-downlink configuration 0 and Special-subframe configuration 7 (Frame structure type 2).

7.1.16 Conducted power measurements WLAN 2450 MHz

802.11b		maximum average conducted output power [dBm]				upper limit	earpiece*
Band	Ch	1Mbps	2Mbps	5.5Mbps	11Mbps		
2450MHz	1	17.5	17.5	17.5	17.5	18.5	OFF
	6	17.3	17.3	17.3	17.3		
	11	17.8	17.8	17.9	17.8		
2450MHz	1	13.2	13.1	13.1	13.1	14.5	ON
	6	13.3	13.2	13.2	13.2		
	11	13.8	13.8	13.8	13.8		

Table 27: Test results conducted power measurement 802.11b
SN: 00402743285706

*) Earpiece on activates power reduction

RESULTS PROVIDED BY CUSTOMER

802.11g		maximum average conducted output power [dBm]							
earpiece off*									
Band	Ch	6Mbps	9Mbps	12Mbps	18Mbps	24Mbps	36Mbps	48Mbps	54Mbps
2450MHz	1	12.2	12.2	12.3	12.4	12.4	12.4	12.5	12.5
	6	17.2	17.3	17.3	17.4	17.5	17.2	16.1	15.7
	11	12.9	12.6	12.6	12.7	12.7	12.8	12.8	12.8
earpiece on**									
2450MHz	1	11.1	11.1	11.2	11.3	11.3	11.3	11.5	11.4
	6	11.1	11.1	11.2	11.3	11.4	11.1	11.1	11.1
	11	11.7	11.8	11.9	11.9	11.9	12.0	12.1	12.1

Table 28: Test results conducted power measurement 802.11g
SN: 00402743285706

*) Earpiece off (no power reduction) - upper Limits:

Standard	Modulation	Data rate [MBPS]	CH 1	CH 6	CH 11
802.11g	BPSK	6	13.5	18.5	13.5
802.11g	BPSK	9	13.5	18.5	13.5
802.11g	QPSK	12	13.5	18.5	13.5
802.11g	QPSK	18	13.5	18.5	13.5
802.11g	16QAM	24	13.5	18.5	13.5
802.11g	16QAM	36	13.5	18.0	13.5
802.11g	64QAM	48	13.5	17.0	13.5
802.11g	64QAM	54	13.5	16.5	13.5

**) Earpiece on activates power reduction - upper limit: 12.5dBm

RESULTS PROVIDED BY CUSTOMER

802.11n HT-20		maximum average conducted output power [dBm]							
Band	Ch	MCS-0 6.5Mbps	MCS-1 13Mbps	MCS-2 19.5Mbps	MCS-3 26Mbps	MCS-4 39Mbps	MCS-5 52Mbps	MCS-6 58.5Mbps	MCS-7 65Mbps
earpiece off*									
2450MHz	1	12.4	12.3	12.4	12.5	12.5	12.5	12.5	12.5
	6	16.4	16.5	16.6	16.6	15.7	15.3	14.8	13.5
	11	12.7	12.7	12.7	12.8	12.9	13.0	13.0	12.9
earpiece on**									
2450MHz	1	11.2	11.3	11.4	11.4	11.4	11.4	11.5	11.5
	6	11.3	11.3	11.4	11.4	11.2	11.3	11.2	11.3
	11	11.9	11.9	12.0	12.1	11.8	12.1	11.8	11.8

Table 29: Test results conducted power measurement 802.11n HT-20
SN: 00402743285706

*) Earpiece off (no power reduction) - upper Limits:

Standard	MCS index	Spatial streams	Modulation	Data rate [MBPS]	CH 1	CH 6	CH 11
802.11n	0	1	BPSK	6.5 / 7.2	13.5	17.5	13.5
802.11n	1	1	QPSK	13.0 / 14.4	13.5	17.5	13.5
802.11n	2	1	QPSK	19.5 / 21.7	13.5	17.5	13.5
802.11n	3	1	16QAM	26.0 / 28.9	13.5	17.5	13.5
802.11n	4	1	16QAM	39.0 / 43.3	13.5	16.5	13.5
802.11n	5	1	64QAM	52.0 / 57.8	13.5	16	13.5
802.11n	6	1	64QAM	58.5 / 65.0	13.5	15.5	13.5
802.11n	7	1	64QAM	65.0 / 72.2	13.5	14.5	13.5

***) Earpiece on activates power reduction - upper limit: **12.5**dBm

RESULTS PROVIDED BY CUSTOMER

802.11n HT-40		maximum average conducted output power [dBm]							
Band	Ch	MCS-0 13.5Mbps	MCS-1 27Mbps	MCS-2 40.5Mbps	MCS-3 54Mbps	MCS-4 81Mbps	MCS-5 108Mbps	MCS-6 121.5Mbps	MCS-7 135Mbps
earpiece off*									
2450MHz	3	11.2	11.4	11.4	11.5	11.5	11.7	11.5	11.6
	6	15.2	15.4	15.5	15.5	14.5	14.0	13.3	12.3
	11	11.0	11.2	11.3	11.3	11.3	11.4	11.4	11.5
earpiece on**									
2450MHz	3	11.1	11.3	11.4	11.4	11.4	11.6	11.5	11.6
	6	11.0	10.9	11.0	11.0	11.1	11.1	11.1	11.1
	11	11.3	11.4	11.2	11.2	11.3	11.4	11.4	11.4

Table 30: Test results conducted power measurement 802.11n HT-40
SN: 00402743285706

*) Earpiece off (no power reduction) - upper Limits:

Standard	MCS index	Spatial streams	Modulation	Data rate [MBPS]	CH 1	CH 6	CH 11
802.11n	0	1	BPSK	6.5 / 7.2	12.5	16.5	12.5
802.11n	1	1	QPSK	13.0 / 14.4	12.5	16.5	12.5
802.11n	2	1	QPSK	19.5 / 21.7	12.5	16.5	12.5
802.11n	3	1	16QAM	26.0 / 28.9	12.5	16.5	12.5
802.11n	4	1	16QAM	39.0 / 43.3	12.5	15.5	12.5
802.11n	5	1	64QAM	52.0 / 57.8	12.5	15.0	12.5
802.11n	6	1	64QAM	58.5 / 65.0	12.5	14.5	12.5
802.11n	7	1	64QAM	65.0 / 72.2	12.5	13.5	12.5

) Earpiece on activates power reduction - upper limit: **12.5dBm

RESULTS PROVIDED BY CUSTOMER

7.1.17 Standalone SAR Test Exclusion

Standalone SAR test exclusion considerations for Head position						
Communication system	freq. (MHz)	P _{avg} * (dBm)	P _{avg} * (mW)	threshold _{1-g} comparison value	SAR test exclusion	
Bluetooth 2450	2450	1.5	1.4	0.4	yes	

Table 31: Standalone SAR test exclusion considerations in **head position**

Standalone SAR test exclusion considerations for Hot spot mode position						
Communication system	freq. (MHz)	distance (mm)	P _{avg} * (dBm)	P _{avg} * (mW)	threshold _{1-g} comparison value	SAR test exclusion
Bluetooth 2450	2450	10	1.5	1.4	0.2	yes

Table 32: Standalone SAR test exclusion considerations in **hotspot mode position**

P_{avg}* - maximum possible output power declared by manufacturer

The **1-g SAR test exclusion thresholds** for 100 MHz to 6 GHz at *test separation distances* ≤ 50 mm are determined by:

$[(\text{max. power of channel, including tune-up tolerance, mW}) / (\text{min. test separation distance, mm})] \cdot [\sqrt{f(\text{GHz})}] \leq 3.0$ for 1-g SAR, where:

- f(GHz) is the RF channel transmit frequency in GHz
- Power and distance are rounded to the nearest mW and mm before calculation
- The result is rounded to one decimal place for comparison

When the minimum test separation distance is < 5 mm, a distance of 5 mm is applied to determine SAR test exclusion

Standalone SAR test exclusion considerations for Body worn position						
Communication system	freq. (MHz)	distance (mm)	P _{avg} * (dBm)	P _{avg} * (mW)	threshold _{1-g} comparison value	SAR test exclusion
Bluetooth 2450	2450	15	1.5	1.4	0.1	yes

Table 33: Standalone SAR test exclusion considerations in **body position**

P_{avg}* - maximum possible output power declared by manufacturer

The **1-g SAR test exclusion thresholds** for 100 MHz to 6 GHz at *test separation distances* ≤ 50 mm are determined by:

$[(\text{max. power of channel, including tune-up tolerance, mW}) / (\text{min. test separation distance, mm})] \cdot [\sqrt{f(\text{GHz})}] \leq 3.0$ for 1-g SAR, where:

- f(GHz) is the RF channel transmit frequency in GHz
- Power and distance are rounded to the nearest mW and mm before calculation
- The result is rounded to one decimal place for comparison
- When the minimum test separation distance is < 5 mm, a distance of 5 mm is applied to determine SAR test exclusion

7.1.18 Hotspot mode SAR measurement positions

Hotspot mode SAR measurement positions						
mode	front	rear	left edge	right edge	top edge	bottom edge
GSM 850	yes	yes	yes	yes	no	yes
GSM 1900	yes	yes	yes	yes	no	yes
WCDMA FDD II	yes	yes	yes	yes	no	yes
WCDMA FDD IV	yes	yes	yes	yes	no	yes
WCDMA FDD V	yes	yes	yes	yes	no	yes
CDMA BC0 850	yes	yes	yes	yes	no	yes
CDMA BC1 1900	yes	yes	yes	yes	no	yes
LTE FDD 2 1900	yes	yes	yes	yes	no	yes
LTE FDD 4 1750	yes	yes	yes	yes	no	yes
LTE FDD 5 850	yes	yes	yes	yes	no	yes
LTE FDD 17 750	yes	yes	yes	yes	no	yes
WLAN 2450	yes	yes	yes	yes	yes	no

The edges with less than 2.5 cm distance to the TX antennas need to be tested for hotspot SAR.

For antenna dimensions and separation distances **see annex C photo documentation.**

7.2 SAR test results

7.2.1 General description of test procedures

- The DUT is tested using CMU 200 and CMW 500 communications testers as controller unit to set test channels and maximum output power to the DUT, as well as for measuring the conducted peak power.
- Test positions as described in the tables above are in accordance with the specified test standard.
- Tests in body position were performed in that configuration, which generates the highest time based averaged output power (see conducted power results).
- Tests in head position with GSM were performed in voice mode with 1 timeslot unless GPRS/EGPRS/DTM function allows parallel voice and data traffic on 2 or more timeslots (see section 2.4 for details).
- UMTS was tested in RMC mode with 12.2 kbit/s and TPC bits set to 'all 1'.
- Required WLAN test channels were selected according to KDB 248227
- For body worn operation, this device has been tested and meets FCC RF exposure guidelines when used with any accessory that contains no metal and that positions the handset a minimum of 15 mm from the body. Use of other accessories may not ensure compliance with FCC RF exposure guidelines.
- According to FCC KDB pub 941225 D06 this device has been tested with 10 mm distance to the phantom for operation in WLAN hot spot mode.
- Per FCC KDB pub 941225 D06 the edges with antennas within 2.5 cm are required to be evaluated for SAR to cover WLAN hot spot function.
- For SAR measurements test samples with fixed **power back off** have been used in **LTE FDD 4** and **UMTS FDD IV** mode for all configurations that require power back off during normal operation **in hot spot mode**.
- According to IEEE 1528 the SAR test shall be performed at middle channel. Testing of top and bottom channel is optional.
- According to KDB 447498 D01 testing of other required channels within the operating mode of a frequency band is not required when the reported 1-g or 10-g SAR for the mid-band or highest output power channel is:
 - ≤ 0.8 W/kg or 2.0 W/kg, for 1-g or 10-g respectively, when the transmission band is ≤ 100 MHz
 - ≤ 0.6 W/kg or 1.5 W/kg, for 1-g or 10-g respectively, when the transmission band is between 100 MHz and 200 MHz
 - ≤ 0.4 W/kg or 1.0 W/kg, for 1-g or 10-g respectively, when the transmission band is ≥ 200 MHz
- IEEE 1528-2003 requires the middle channel to be tested first. This generally applies to wireless devices that are designed to operate in technologies with tight tolerances for maximum output power variations across channels in the band. When the maximum output power variation across the required test channels is $> \frac{1}{2}$ dB, instead of the middle channel, the highest output power channel must be used.

7.2.2 Results overview

measured / extrapolated SAR numbers - Head - GSM 850 MHz											
Ch.	Freq. (MHz)	time slots	Position	cond. P _{max} (dBm)		SAR _{1g} (W/kg)		SAR _{10g} (W/kg)		power drift (dB)	liquid (°C)
				declared**	measured	meas.	extrap.	meas.	extrap.		
Antenna 1											
190	836.6	4	left cheek	28.4	27.9	0.262	0.294	0.208	0.233	0.06	22.1
190	836.6	4	left tilted 15°	28.4	27.9	0.094	0.106	0.076	0.085	0.12	22.1
128	824.2	4	right cheek	28.4	27.7	0.412	0.484	0.260	0.305	0.08	22.1
190	836.6	4	right cheek	28.4	27.9	0.478	0.536	0.301	0.338	0.01	22.1
251	848.8	4	right cheek	28.4	28.3	0.574	0.587	0.365	0.374	-0.03	22.1
190	836.6	4	right tilted 15°	28.4	27.9	0.108	0.121	0.087	0.098	0.11	22.1
8-PSK											
251	848.8	2	right cheek	26.4	26.3	0.157	0.161	0.102	0.104	-0.14	22.1
Antenna 2											
128	824.2	4	left cheek	28.4	27.7	0.417	0.490	0.291	0.342	0.03	22.1
190	836.6	4	left cheek	28.4	27.9	0.395	0.443	0.295	0.331	0.06	22.1
251	848.8	4	left cheek	28.4	28.3	0.413	0.423	0.309	0.316	0.03	22.1
190	836.6	4	left tilted 15°	28.4	27.9	0.166	0.186	0.134	0.150	0.05	22.1
190	836.6	4	right cheek	28.4	27.9	0.362	0.406	0.288	0.323	0.03	22.1
190	836.6	4	right tilted 15°	28.4	27.9	0.167	0.187	0.135	0.151	0.04	22.1

Table 34: Test results head SAR GSM 850MHz (see max. SAR plots in Annex B.1: GSM850 page 129)

measured / extrapolated SAR numbers - hotspot mode - GSM 850 MHz												
Ch.	Freq. (MHz)	time slots	Position	cond. P _{max} (dBm)		SAR _{1g} (W/kg)		SAR _{10g} (W/kg)		power drift (dB)	liquid (°C)	dist. (mm)
				declared**	meas.	meas.	extrap.	meas.	extrap.			
Antenna 1												
128	824.2	4	front	28.4	27.7	0.819	0.962	0.463	0.544	0.00	22.7	10
190	836.6	4	front	28.4	27.9	0.901	1.011	0.512	0.574	-0.01	22.7	10
251	848.8	4	front	28.4	28.3	0.991	1.014	0.565	0.578	-0.01	22.7	10
190	836.6	4	rear	28.4	27.9	0.732	0.821	0.503	0.564	0.05	22.7	10
190	836.6	4	left edge	28.4	27.9	0.518	0.581	0.275	0.309	0.03	22.7	10
190	836.6	4	right edge	28.4	27.9	0.248	0.278	0.171	0.192	0.00	22.7	10
190	836.6	4	bottom edge	28.4	27.9	0.473	0.531	0.285	0.320	-0.14	22.7	10
251	848.8	4	front*	28.4	28.3	0.940	0.962	0.544	0.557	0.04	22.7	10
Antenna 2												
190	836.6	4	front	28.4	27.9	0.728	0.817	0.537	0.603	-0.06	22.7	10
128	824.2	4	rear	28.4	27.7	0.745	0.875	0.560	0.658	0.02	22.7	10
190	836.6	4	rear	28.4	27.9	0.736	0.826	0.548	0.615	-0.01	22.7	10
251	848.8	4	rear	28.4	28.3	0.724	0.741	0.540	0.553	0.04	22.7	10
190	836.6	4	left edge	28.4	27.9	0.283	0.318	0.195	0.219	0.00	22.7	10
190	836.6	4	right edge	28.4	27.9	0.389	0.436	0.204	0.229	-0.01	22.7	10
190	836.6	4	bottom edge	28.4	27.9	0.256	0.287	0.159	0.178	-0.05	22.7	10

Table 35: Test results hotspot mode SAR GSM 850 MHz (see max. SAR plots in Annex B.1: GSM850 page 129)

Top edge position for hotspot mode is not required since the distance from the main antenna to the edge is greater than 2.5 cm.

* - repeated at the highest SAR measurement according to the FCC KDB 865664

** - maximum possible output power declared by manufacturer.

measured / extrapolated SAR numbers - Body worn - GSM 850 MHz												
Ch.	Freq. (MHz)	time slots	Position	cond. P _{max} (dBm)		SAR _{1g} (W/kg)		SAR _{10g} (W/kg)		power drift (dB)	liquid (°C)	dist. (mm)
				declared**	meas.	meas.	extrap.	meas.	extrap.			
Antenna 1												
128	824.2	4	front	28.4	27.7	0.416	0.489	0.303	0.356	0.01	22.7	15
190	836.6	4	front	28.4	27.9	0.504	0.565	0.367	0.412	0.01	22.7	15
251	848.8	4	front	28.4	28.3	0.564	0.577	0.412	0.422	-0.03	22.7	15
190	836.6	4	rear	28.4	27.9	0.463	0.519	0.338	0.379	0.01	22.7	15
Antenna 2												
190	836.6	4	front	28.4	27.9	0.496	0.557	0.372	0.417	0.00	22.7	15
128	824.2	4	rear	28.4	27.7	0.553	0.650	0.412	0.484	-0.08	22.7	15
190	836.6	4	rear	28.4	27.9	0.561	0.629	0.417	0.468	0.01	22.7	15
251	848.8	4	rear	28.4	28.3	0.543	0.556	0.404	0.413	0.08	22.7	15

Table 36: Test results body worn SAR GSM 850 MHz (see max. SAR plots in Annex B.1: GSM850 page 129)

measured / extrapolated SAR numbers - Head - GSM 1900 MHz												
Ch.	Freq. (MHz)	time slots	Position	cond. P _{max} (dBm)		SAR _{1g} (W/kg)		SAR _{10g} (W/kg)		power drift (dB)	liquid (°C)	
				declared**	measured	meas.	extrap.	meas.	extrap.			
Antenna 1												
661	1880.0	2	left cheek	29.4	29.1	0.185	0.198	0.118	0.126	-0.04	21.4	
661	1880.0	2	left tilted 15°	29.4	29.1	0.129	0.138	0.077	0.083	0.06	21.4	
512	1850.2	2	right cheek	29.4	29.2	0.358	0.375	0.217	0.227	0.00	21.4	
661	1880.0	2	right cheek	29.4	29.1	0.380	0.407	0.229	0.245	-0.05	21.4	
810	1909.8	2	right cheek	29.4	29.2	0.373	0.391	0.223	0.234	-0.01	21.4	
661	1880.0	2	right tilted 15°	29.4	29.1	0.166	0.178	0.102	0.109	-0.04	21.4	
Antenna 1 - EGPRS												
810	1909.8	4	right cheek	23.4	23.2	0.178	0.186	0.104	0.109	-0.12	21.4	
Antenna 2												
512	1850.2	2	left cheek	29.4	29.2	0.257	0.269	0.150	0.157	-0.05	21.4	
661	1880.0	2	left cheek	29.4	29.1	0.250	0.268	0.147	0.158	-0.09	21.4	
810	1909.8	2	left cheek	29.4	29.2	0.261	0.273	0.151	0.158	0.00	21.4	
661	1880.0	2	left tilted 15°	29.4	29.1	0.064	0.069	0.041	0.044	-0.08	21.4	
661	1880.0	2	right cheek	29.4	29.1	0.107	0.115	0.067	0.072	-0.05	21.4	
661	1880.0	2	right tilted 15°	29.4	29.1	0.060	0.064	0.036	0.039	-0.04	21.4	

Table 37: Test results head SAR GSM 1900MHz (see max. SAR plots in Annex B.2: GSM1900 page 133)

measured / extrapolated SAR numbers - hotspot mode - GSM 1900 MHz												
Ch.	Freq. (MHz)	time slots	Position	cond. P _{max} (dBm)		SAR _{1g} (W/kg)		SAR _{10g} (W/kg)		power drift (dB)	liquid (°C)	dist. (mm)
				declared**	meas.	meas.	extrap.	meas.	extrap.			
Antenna 1												
512	1850.2	2	front	29.4	29.2	0.525	0.550	0.295	0.309	-0.05	21.4	10
661	1880.0	2	front	29.4	29.1	0.615	0.659	0.351	0.376	-0.04	21.4	10
810	1909.8	2	front	29.4	29.2	0.530	0.555	0.301	0.315	-0.07	21.4	10
661	1880.0	2	rear	29.4	29.1	0.535	0.573	0.319	0.342	-0.04	21.4	10
661	1880.0	2	left edge	29.4	29.1	0.126	0.135	0.078	0.083	-0.10	21.4	10
661	1880.0	2	right edge	29.4	29.1	0.403	0.432	0.204	0.219	-0.07	21.4	10
661	1880.0	2	bottom edge	29.4	29.1	0.595	0.638	0.327	0.350	0.03	21.4	10
Antenna 2												
512	1850.2	2	front	29.4	29.2	0.430	0.450	0.230	0.241	-0.07	21.4	10
661	1880.0	2	front	29.4	29.1	0.469	0.503	0.254	0.272	-0.03	21.4	10
810	1909.8	2	front	29.4	29.2	0.383	0.401	0.204	0.214	-0.02	21.4	10
661	1880.0	2	rear	29.4	29.1	0.374	0.401	0.236	0.253	-0.01	21.4	10
661	1880.0	2	left edge	29.4	29.1	0.213	0.228	0.105	0.113	-0.03	21.4	10
661	1880.0	2	right edge	29.4	29.1	0.049	0.052	0.029	0.031	-0.19	21.4	10
661	1880.0	2	bottom edge	29.4	29.1	0.381	0.408	0.214	0.229	-0.09	21.4	10

Table 38: Test results hotspot mode SAR GSM 1900 MHz (see max. SAR plots in Annex B.2: GSM1900 page 133)

Top edge position for hotspot mode is not required since the distance from the main antenna to the edge is greater than 2.5 cm.

measured / extrapolated SAR numbers - Body worn - GSM 1900 MHz												
Ch.	Freq. (MHz)	time slots	Position	cond. P _{max} (dBm)		SAR _{1g} (W/kg)		SAR _{10g} (W/kg)		power drift (dB)	liquid (°C)	dist. (mm)
				declared**	meas.	meas.	extrap.	meas.	extrap.			
Antenna 1												
512	1850.2	2	front	29.4	29.2	0.252	0.264	0.150	0.157	-0.01	21.4	15
661	1880.0	2	front	29.4	29.1	0.284	0.304	0.170	0.182	-0.04	21.4	15
810	1909.8	2	front	29.4	29.2	0.261	0.273	0.154	0.161	-0.02	21.4	15
661	1880.0	2	rear	29.4	29.1	0.271	0.290	0.168	0.180	0.00	21.4	15
Antenna 2												
661	1880.0	2	front	29.4	29.1	0.207	0.222	0.120	0.129	-0.06	21.4	15
661	1880.0	2	rear	29.4	29.1	0.267	0.280	0.140	0.179	-0.10	21.4	15
661	1880.0	2	rear	29.4	29.1	0.219	0.235	0.140	0.150	-0.06	21.4	15
661	1880.0	2	rear	29.4	29.1	0.188	0.201	0.171	0.183	-0.06	21.4	15

Table 39: Test results body worn SAR GSM 1900 MHz (see max. SAR plots in Annex B.2: GSM1900 page 133)

** - maximum possible output power declared by manufacturer

measured / extrapolated SAR numbers - Head - UMTS FDD II 1880 MHz											
Ch.	Freq. (MHz)	test cond.	Position	cond. P _{max} (dBm)		SAR _{1g} (W/kg)		SAR _{10g} (W/kg)		power drift (dB)	liquid (°C)
				declared**	measured	meas.	extrap.	meas.	extrap.		
Antenna 1											
9400	1880.0	RMC	left cheek	23.4	23.2	0.206	0.216	0.132	0.138	0.01	21.9
9400	1880.0	RMC	left tilted 15°	23.4	23.2	0.140	0.147	0.084	0.088	-0.02	21.9
9262	1852.4	RMC	right cheek	23.4	23.2	0.449	0.470	0.274	0.287	-0.03	21.9
9400	1880.0	RMC	right cheek	23.4	23.2	0.444	0.465	0.268	0.281	-0.01	21.9
9538	1907.6	RMC	right cheek	23.4	23.0	0.457	0.501	0.276	0.303	0.00	21.9
9400	1880.0	RMC	right tilted 15°	23.4	23.2	0.194	0.203	0.118	0.124	-0.03	21.9
Antenna 2											
9262	1852.4	RMC	left cheek	23.4	23.2	0.511	0.535	0.303	0.317	0.00	21.9
9400	1880.0	RMC	left cheek	23.4	23.2	0.513	0.537	0.302	0.316	-0.05	21.9
9538	1907.6	RMC	left cheek	23.4	23.0	0.488	0.535	0.289	0.317	-0.09	21.9
9400	1880.0	RMC	left tilted 15°	23.4	23.2	0.137	0.143	0.092	0.096	0.06	21.9
9400	1880.0	RMC	right cheek	23.4	23.2	0.217	0.227	0.139	0.146	0.00	21.9
9400	1880.0	RMC	right tilted 15°	23.4	23.2	0.124	0.130	0.078	0.082	0.02	21.9

Table 40: Test results head SAR UMTS FDD II 1880 MHz (see max. SAR plots in Annex B.3: UMTS FDD II page 133)

measured / extrapolated SAR numbers - hotspot mode - UMTS FDD II 1880 MHz												
Ch.	Freq. (MHz)	test cond.	Position	cond. P _{max} (dBm)		SAR _{1g} (W/kg)		SAR _{10g} (W/kg)		power drift (dB)	liquid (°C)	dist. (mm)
				declared**	meas.	meas.	extrap.	meas.	extrap.			
Antenna 1												
9400	1880.0	RMC	front	23.4	23.2	0.710	0.743	0.393	0.412	-0.01	22.2	10
9262	1852.4	RMC	rear	23.4	23.2	0.677	0.709	0.418	0.438	0.01	22.2	10
9400	1880.0	RMC	rear	23.4	23.2	0.737	0.772	0.449	0.470	0.02	22.2	10
9538	1907.6	RMC	rear	23.4	23.0	0.552	0.605	0.338	0.371	0.00	22.2	10
9400	1880.0	RMC	left edge	23.4	23.2	0.141	0.148	0.082	0.086	-0.09	22.2	10
9400	1880.0	RMC	right edge	23.4	23.2	0.310	0.325	0.172	0.180	-0.06	22.2	10
9400	1880.0	RMC	bottom edge	23.4	23.2	0.720	0.754	0.409	0.428	-0.02	22.2	10
Antenna 2												
9262	1852.4	RMC	front	23.4	23.2	1.220	1.277	0.642	0.672	0.13	22.2	10
9400	1880.0	RMC	front	23.4	23.2	1.120	1.173	0.593	0.621	0.04	22.2	10
9538	1907.6	RMC	front	23.4	23.0	1.070	1.173	0.562	0.616	-0.09	22.2	10
9262	1852.4	RMC	rear	23.4	23.2	0.940	0.984	0.521	0.546	0.01	22.2	10
9400	1880.0	RMC	rear	23.4	23.2	0.878	0.919	0.467	0.489	-0.06	22.2	10
9538	1907.6	RMC	rear	23.4	23.0	0.784	0.860	0.411	0.451	-0.04	22.2	10
9400	1880.0	RMC	left edge	23.4	23.2	0.419	0.439	0.219	0.229	-0.15	22.2	10
9400	1880.0	RMC	right edge	23.4	23.2	0.149	0.156	0.087	0.091	-0.09	22.2	10
9262	1852.4	RMC	bottom edge	23.4	23.2	0.831	0.870	0.458	0.480	0.04	22.2	10
9400	1880.0	RMC	bottom edge	23.4	23.2	0.798	0.836	0.433	0.453	-0.01	22.2	10
9538	1907.6	RMC	bottom edge	23.4	23.0	0.692	0.759	0.372	0.408	0.01	22.2	10
9262	1852.4	HSDPA	front	23.4	23.2	0.897	0.939	0.492	0.515	0.03	22.2	10
9262	1852.4	HSUPA	front	23.4	23.2	0.691	0.724	0.372	0.390	0.05	22.2	10
9262	1852.4	DC-HSDPA	front	23.4	23.2	0.796	0.834	0.441	0.462	0.04	22.2	10
9262	1852.4	RMC	front*	23.4	23.2	1.170	1.225	0.610	0.639	-0.07	22.2	10

Table 41: Test results hotspot mode SAR UMTS FDD II 1880 MHz (see max. SAR plots in Annex B.3: UMTS FDD II)

* - repeated at the highest SAR measurement according to the FCC KDB 865664

** - maximum possible output power declared by manufacturer

Top edge position for hotspot is not required since the distance from the main antenna to the edge is greater than 2.5 cm.

measured / extrapolated SAR numbers - Body worn - UMTS FDD II 1880 MHz												
Ch.	Freq. (MHz)	test cond.	Position	cond. P _{max} (dBm)		SAR _{1g} (W/kg)		SAR _{10g} (W/kg)		power drift (dB)	liquid (°C)	dist. (mm)
				declared**	meas.	meas.	extrap.	meas.	extrap.			
Antenna 1												
9400	1880.0	RMC	front	23.4	23.2	0.316	0.331	0.187	0.196	0.00	22.2	15
9262	1852.4	RMC	rear	23.4	23.2	0.363	0.380	0.230	0.241	0.10	22.2	15
9400	1880.0	RMC	rear	23.4	23.2	0.357	0.374	0.227	0.238	0.00	22.2	15
9538	1907.6	RMC	rear	23.4	23.0	0.304	0.333	0.195	0.214	-0.02	22.2	15
Antenna 2												
9262	1852.4	RMC	front	23.4	23.2	0.412	0.431	0.243	0.254	-0.01	22.2	15
9400	1880.0	RMC	front	23.4	23.2	0.433	0.453	0.251	0.263	0.03	22.2	15
9538	1907.6	RMC	front	23.4	23.0	0.338	0.371	0.196	0.215	-0.06	22.2	15
9400	1880.0	RMC	rear	23.4	23.2	0.363	0.380	0.236	0.247	-0.06	22.2	15

Table 42: Test results body worn SAR UMTS FDD II 1880MHz (see SAR_{max} plots in Annex B.3: UMTS FDD II)

measured / extrapolated SAR numbers - Head - UMTS FDD IV 1700 MHz												
Ch.	Freq. (MHz)	test cond.	Position	cond. P _{max} (dBm)		SAR _{1g} (W/kg)		SAR _{10g} (W/kg)		power drift (dB)	liquid (°C)	
				declared**	measured	meas.	extrap.	meas.	extrap.			
Antenna 1												
1413	1732.4	RMC	left cheek	23.4	23.3	0.136	0.139	0.087	0.089	-0.09	21.0	
1413	1732.4	RMC	left tilted 15°	23.4	23.3	0.108	0.111	0.064	0.065	0.08	21.0	
1312	1712.4	RMC	right cheek	23.4	23.2	0.420	0.440	0.243	0.254	-0.16	21.0	
1413	1732.4	RMC	right cheek	23.4	23.3	0.377	0.386	0.216	0.221	0.18	21.0	
1513	1752.6	RMC	right cheek	23.4	23.1	0.345	0.370	0.196	0.210	0.11	21.0	
1413	1732.4	RMC	right tilted 15°	23.4	23.3	0.107	0.109	0.070	0.071	0.03	21.0	
Antenna 2												
1312	1712.4	RMC	left cheek	23.4	23.2	0.469	0.491	0.254	0.266	0.02	21.0	
1413	1732.4	RMC	left cheek	23.4	23.3	0.509	0.521	0.276	0.282	-0.09	21.0	
1513	1752.6	RMC	left cheek	23.4	23.1	0.480	0.514	0.261	0.280	0.02	21.0	
1413	1732.4	RMC	left tilted 15°	23.4	23.3	0.119	0.122	0.071	0.073	0.11	21.0	
1413	1732.4	RMC	right cheek	23.4	23.3	0.192	0.196	0.120	0.123	0.09	21.0	
1413	1732.4	RMC	right tilted 15°	23.4	23.3	0.098	0.100	0.057	0.058	-0.07	21.0	

Table 43: Test results head SAR UMTS FDD IV 1700 MHz (see max. SAR plots in Annex B.4: UMTS FDD IV page 139)

measured / extrapolated SAR numbers - hotspot mode - UMTS FDD IV 1700 MHz												
Ch.	Freq. (MHz)	test cond.	Position	cond. P _{max} (dBm)		SAR _{1g} (W/kg)		SAR _{10g} (W/kg)		power drift (dB)	liquid (°C)	dist. (mm)
				declared**	meas.	meas.	extrap.	meas.	extrap.			
Antenna 1												
1412	1732.4	RMC	front	22.4	21.8	0.667	0.766	0.400	0.459	-0.11	22.2	10
1312	1712.4	RMC	rear	22.4	21.7	0.800	0.940	0.492	0.578	0.05	22.2	10
1412	1732.4	RMC	rear	22.4	21.8	0.745	0.855	0.456	0.524	0.04	22.2	10
1513	1752.6	RMC	rear	22.4	21.8	0.702	0.806	0.427	0.490	0.04	22.2	10
1412	1732.4	RMC	left edge	22.4	21.8	0.115	0.132	0.066	0.076	0.03	22.2	10
1412	1732.4	RMC	right edge	22.4	21.8	0.300	0.344	0.158	0.181	0.02	22.2	10
1412	1732.4	RMC	bottom edge	22.4	21.8	0.546	0.627	0.293	0.336	0.09	22.2	10
1312	1712.4	RMC	rear*	22.4	21.7	0.828	0.973	0.512	0.602	-0.13	22.2	10
Antenna 2												
1312	1712.4	RMC	front	22.4	21.7	1.020	1.198	0.521	0.612	0.04	22.2	10
1412	1732.4	RMC	front	22.4	21.8	1.010	1.160	0.517	0.594	0.05	22.2	10
1513	1752.6	RMC	front	22.4	21.8	0.925	1.062	0.474	0.544	0.04	22.2	10
1312	1712.4	RMC	rear	22.4	21.7	0.941	1.106	0.502	0.590	0.11	22.2	10
1412	1732.4	RMC	rear	22.4	21.8	0.890	1.022	0.533	0.612	0.06	22.2	10
1513	1752.6	RMC	rear	22.4	21.8	0.873	1.002	0.523	0.600	0.10	22.2	10
1312	1712.4	RMC	left edge	22.4	21.7	0.731	0.859	0.338	0.397	-0.05	22.2	10
1412	1732.4	RMC	left edge	22.4	21.8	0.697	0.800	0.324	0.372	-0.05	22.2	10
1513	1752.6	RMC	left edge	22.4	21.8	0.587	0.674	0.273	0.313	0.02	22.2	10
1412	1732.4	RMC	right edge	22.4	21.8	0.114	0.131	0.070	0.081	0.03	22.2	10
1412	1732.4	RMC	bottom edge	22.4	21.8	0.687	0.789	0.368	0.423	-0.13	22.2	10
1312	1712.4	RMC	front*	22.4	21.7	0.999	1.174	0.515	0.605	0.05	22.2	10

Table 44: Test results hotspot mode SAR UMTS FDD IV 1700 MHz (see max. SAR plots in Annex B.4: UMTS FDD IV page 139)

* - repeated at the highest SAR measurement according to the FCC KDB 865664

Top edge position for hotspot is not required since the distance from the main antenna to the edge is greater than 2.5 cm.

measured / extrapolated SAR numbers - Body worn - UMTS FDD IV 1700 MHz												
Ch.	Freq. (MHz)	test cond.	Position	cond. P _{max} (dBm)		SAR _{1g} (W/kg)		SAR _{10g} (W/kg)		power drift (dB)	liquid (°C)	dist. (mm)
				declared**	meas.	meas.	extrap.	meas.	extrap.			
Antenna 1												
1413	1732.4	RMC	front	22.4	21.8	0.512	0.588	0.324	0.372	-0.10	22.8	15
1312	1712.4	RMC	rear	22.4	21.7	0.652	0.766	0.412	0.484	-0.09	22.8	15
1413	1732.4	RMC	rear	22.4	21.8	0.684	0.785	0.426	0.489	0.09	22.8	15
1513	1752.6	RMC	rear	22.4	21.8	0.505	0.580	0.315	0.362	0.04	22.8	15
Antenna 2												
1413	1732.4	RMC	front	22.4	21.8	0.598	0.687	0.323	0.371	-0.01	22.8	15
1312	1712.4	RMC	rear	22.4	21.7	0.613	0.720	0.377	0.443	-0.01	22.8	15
1413	1732.4	RMC	rear	22.4	21.8	0.622	0.714	0.383	0.440	0.05	22.8	15
1513	1752.6	RMC	rear	22.4	21.8	0.597	0.685	0.369	0.424	0.01	22.8	15

Table 45: Test results body worn SAR UMTS FDD IV 1700 MHz (see max. SAR plots in Annex B.4: UMTS FDD IV page 139)

** - maximum possible output power declared by manufacturer

measured / extrapolated SAR numbers - Head - UMTS FDD V 850 MHz											
Ch.	Freq. (MHz)	test cond.	Position	cond. P _{max} (dBm)		SAR _{1g} (W/kg)		SAR _{10g} (W/kg)		power drift (dB)	liquid (°C)
				declared**	measured	meas.	extrap.	meas.	extrap.		
Antenna 1											
4182	836.4	RMC	left cheek	23.9	23.3	0.282	0.324	0.223	0.256	0.01	22.1
4182	836.4	RMC	left tilted 15°	23.9	23.3	0.098	0.112	0.078	0.090	0.03	22.1
4132	826.4	RMC	right cheek	23.9	23.3	0.496	0.569	0.316	0.363	-0.02	22.1
4182	836.4	RMC	right cheek	23.9	23.3	0.518	0.595	0.331	0.380	-0.02	22.1
4233	846.6	RMC	right cheek	23.9	23.4	0.517	0.580	0.333	0.374	0.00	22.1
4182	836.4	RMC	right tilted 15°	23.9	23.3	0.124	0.142	0.100	0.115	0.02	22.1
Antenna 2											
4132	826.4	RMC	left cheek	23.9	23.3	0.385	0.442	0.251	0.288	-0.12	22.1
4182	836.4	RMC	left cheek	23.9	23.3	0.377	0.433	0.257	0.295	-0.05	22.1
4233	846.6	RMC	left cheek	23.9	23.4	0.367	0.412	0.257	0.288	-0.12	22.1
4182	836.4	RMC	left tilted 15°	23.9	23.3	0.111	0.127	0.089	0.102	0.18	22.1
4182	836.4	RMC	right cheek	23.9	23.3	0.228	0.262	0.180	0.207	-0.10	22.1
4182	836.4	RMC	right tilted 15°	23.9	23.3	0.082	0.094	0.066	0.076	-0.03	22.1

Table 46: Test results head SAR UMTS FDD V 850 MHz (see max. SAR plots in Annex B.5: UMTS FDD V page 142)

measured / extrapolated SAR numbers - hotspot mode - UMTS FDD V 850 MHz												
Ch.	Freq. (MHz)	test cond.	Position	cond. P _{max} (dBm)		SAR _{1g} (W/kg)		SAR _{10g} (W/kg)		power drift (dB)	liquid (°C)	dist. (mm)
				declared**	meas.	meas.	extrap.	meas.	extrap.			
Antenna 1												
4132	826.4	RMC	front	23.9	23.3	0.704	0.808	0.423	0.486	-0.03	22.5	10
4182	836.4	RMC	front	23.9	23.3	0.745	0.855	0.436	0.501	-0.04	22.5	10
4233	846.6	RMC	front	23.9	23.4	0.677	0.760	0.491	0.551	-0.01	22.5	10
4132	826.4	RMC	rear	23.9	23.3	0.777	0.892	0.459	0.527	-0.09	22.5	10
4182	836.4	RMC	rear	23.9	23.3	0.748	0.859	0.441	0.506	0.01	22.5	10
4233	846.6	RMC	rear	23.9	23.4	0.725	0.813	0.515	0.578	0.00	22.5	10
4182	836.4	RMC	left edge	23.9	23.3	0.583	0.669	0.306	0.351	-0.03	22.5	10
4182	836.4	RMC	right edge	23.9	23.3	0.262	0.301	0.180	0.207	-0.03	22.5	10
4182	836.4	RMC	bottom edge	23.9	23.3	0.409	0.470	0.246	0.282	-0.15	22.5	10
Antenna 2												
4182	836.4	RMC	front	23.9	23.3	0.470	0.540	0.345	0.396	-0.13	22.5	10
4132	826.4	RMC	rear	23.9	23.3	0.516	0.592	0.382	0.439	0.12	22.5	10
4182	836.4	RMC	rear	23.9	23.3	0.497	0.571	0.369	0.424	-0.01	22.5	10
4233	846.6	RMC	rear	23.9	23.4	0.497	0.558	0.371	0.416	-0.02	22.5	10
4182	836.4	RMC	left edge	23.9	23.3	0.187	0.215	0.129	0.148	0.02	22.5	10
4182	836.4	RMC	right edge	23.9	23.3	0.269	0.309	0.138	0.158	0.01	22.5	10
4182	836.4	RMC	bottom edge	23.9	23.3	0.175	0.201	0.109	0.125	0.10	22.5	10

Table 47: Test results hotspot mode SAR UMTS FDD V 850 MHz (see max. SAR plots in Annex B.5: UMTS FDD V page 142)

* - repeated at the highest SAR measurement according to the FCC KDB 865664

** - maximum possible output power declared by manufacturer

Top edge position for hotspot is not required since the distance from the main antenna to the edge is greater than 2.5 cm.

measured / extrapolated SAR numbers - Body worn - UMTS FDD V 850 MHz												
Ch.	Freq. (MHz)	test cond.	Position	cond. P _{max} (dBm)		SAR _{1g} (W/kg)		SAR _{10g} (W/kg)		power drift (dB)	liquid (°C)	dist. (mm)
				declared**	meas.	meas.	extrap.	meas.	extrap.			
Antenna 1												
4132	826.4	RMC	front	23.9	23.3	0.502	0.576	0.368	0.423	-0.02	22.5	15
4182	836.4	RMC	front	23.9	23.3	0.519	0.596	0.378	0.434	0.06	22.5	15
4233	846.6	RMC	front	23.9	23.4	0.486	0.545	0.356	0.399	0.01	22.5	15
4182	836.4	RMC	rear	23.9	23.3	0.477	0.548	0.348	0.400	0.01	22.5	15
Antenna 2												
4182	836.4	RMC	front	23.9	23.3	0.321	0.369	0.240	0.276	0.01	22.5	15
4132	826.4	RMC	rear	23.9	23.3	0.359	0.412	0.266	0.305	-0.06	22.5	15
4182	836.4	RMC	rear	23.9	23.3	0.345	0.396	0.256	0.294	-0.01	22.5	15
4233	846.6	RMC	rear	23.9	23.4	0.330	0.370	0.246	0.276	-0.12	22.5	15

Table 48: Test results body worn SAR UMTS FDD V 850 MHz (see max. SAR plots in Annex B.5: UMTS FDD V page 142)

measured / extrapolated SAR numbers - Head - LTE FDD 2 1900 MHz												
Ch.	Freq. (MHz)	RB offset	Position	cond. P _{max} (dBm)		SAR _{1g} (W/kg)		SAR _{10g} (W/kg)		power drift (dB)	liquid (°C)	
				declared**	measured	meas.	extrap.	meas.	extrap.			
20MHz BW/1RB/QPSK / Antenna 1												
18900	1880	0	left cheek	23.4	23.0	0.223	0.245	0.143	0.157	-0.11	21.0	
18900	1880	0	left tilted 15°	23.4	23.0	0.129	0.141	0.080	0.087	0.04	21.0	
18700	1860	0	right cheek	23.4	23.0	0.293	0.321	0.173	0.190	-0.11	21.0	
18900	1880	0	right cheek	23.4	23.0	0.290	0.318	0.173	0.190	-0.02	21.0	
19100	1900	0	right cheek	23.4	22.7	0.310	0.364	0.182	0.214	0.00	21.0	
18900	1880	0	right tilted 15°	23.4	23.0	0.185	0.203	0.112	0.123	-0.04	21.0	
20MHz BW/50RB/QPSK / Antenna 1												
18900	1880	0	left cheek	22.4	22.0	0.172	0.189	0.111	0.122	0.06	21.0	
18900	1880	0	left tilted 15°	22.4	22.0	0.097	0.107	0.060	0.065	-0.04	21.0	
18900	1880	0	right cheek	22.4	22.0	0.224	0.246	0.134	0.147	-0.09	21.0	
18900	1880	0	right tilted 15°	22.4	22.0	0.135	0.148	0.081	0.088	0.03	21.0	
20MHz BW/1RB/QPSK / Antenna 2												
18700	1860	0	left cheek	23.4	23.0	0.546	0.599	0.327	0.359	0.19	21.0	
18900	1880	0	left cheek	23.4	23.0	0.596	0.654	0.357	0.391	0.01	21.0	
19100	1900	0	left cheek	23.4	22.7	0.562	0.660	0.333	0.391	-0.02	21.0	
18900	1880	0	left tilted 15°	23.4	23.0	0.113	0.124	0.069	0.075	0.02	21.0	
18900	1880	0	right cheek	23.4	23.0	0.245	0.269	0.157	0.172	0.00	21.0	
18900	1880	0	right tilted 15°	23.4	23.0	0.106	0.116	0.065	0.072	-0.03	21.0	
20MHz BW/50RB/QPSK / Antenna 2												
18900	1880	0	left cheek	22.4	22.0	0.445	0.488	0.267	0.293	-0.05	21.0	
18900	1880	0	left tilted 15°	22.4	22.0	0.088	0.097	0.053	0.058	0.03	21.0	
18900	1880	0	right cheek	22.4	22.0	0.195	0.214	0.126	0.138	0.05	21.0	
18900	1880	0	right tilted 15°	22.4	22.0	0.084	0.092	0.051	0.056	0.12	21.0	

Table 49: Test results head SAR LTE FDD 2 1900 MHz (see max. SAR plots in Annex B.6: LTE FDD 2 page 142)

measured / extrapolated SAR numbers - hotspot mode - LTE FDD 2 1900 MHz												
Ch.	Freq. (MHz)	RB offset	Position	cond. P _{max} (dBm)		SAR _{1g} (W/kg)		SAR _{10g} (W/kg)		power drift (dB)	liquid (°C)	dist. (mm)
				declared**	meas.	meas.	extrap.	meas.	extrap.			
20MHz BW/1RB/QPSK Antenna 1												
18700	1860	0	front	23.4	23.0	0.624	0.684	0.339	0.372	-0.06	22.3	10
18900	1880	0	front	23.4	23.0	0.662	0.726	0.357	0.391	-0.01	22.3	10
19100	1900	0	front	23.4	22.7	0.616	0.724	0.336	0.395	-0.03	22.3	10
18900	1880	0	rear	23.4	23.0	0.614	0.673	0.385	0.422	0.03	22.3	10
18900	1880	0	left edge	23.4	23.0	0.136	0.149	0.080	0.088	-0.07	22.3	10
18900	1880	0	right edge	23.4	23.0	0.299	0.328	0.150	0.164	-0.02	22.3	10
18900	1880	0	bottom edge	23.4	23.0	0.620	0.680	0.363	0.398	0.07	22.3	10
20MHz BW/50RB/QPSK Antenna 1												
18900	1880	0	front	22.4	22.0	0.503	0.552	0.271	0.297	0.03	22.3	10
18900	1880	0	rear	22.4	22.0	0.474	0.520	0.293	0.321	0.03	22.3	10
18900	1880	0	left edge	22.4	22.0	0.104	0.114	0.063	0.069	-0.03	22.3	10
18900	1880	0	right edge	22.4	22.0	0.222	0.243	0.113	0.124	0.04	22.3	10
18900	1880	0	bottom edge	22.4	22.0	0.505	0.554	0.290	0.318	-0.05	22.3	10
20MHz BW/1RB/QPSK Antenna 2												
18700	1860	0	front	23.4	23.0	0.943	1.034	0.511	0.560	-0.03	22.3	10
18900	1880	0	front	23.4	23.0	0.908	0.996	0.490	0.537	-0.17	22.3	10
19100	1900	0	front	23.4	22.7	0.748	0.879	0.395	0.464	-0.01	22.3	10
18700	1860	0	rear	23.4	23.0	0.944	1.035	0.528	0.579	0.13	22.3	10
18900	1880	0	rear	23.4	23.0	0.919	1.008	0.509	0.558	-0.08	22.3	10
19100	1900	0	rear	23.4	22.7	0.724	0.851	0.394	0.463	0.04	22.3	10
18900	1880	0	left edge	23.4	23.0	0.441	0.484	0.233	0.255	-0.01	22.3	10
18900	1880	0	right edge	23.4	23.0	0.083	0.091	0.048	0.053	0.04	22.3	10
18900	1880	0	bottom edge	23.4	23.0	0.701	0.769	0.378	0.414	0.09	22.3	10
18700	1860	0	rear*	23.4	23.0	0.949	1.041	0.530	0.581	0.12	22.3	10
20MHz BW/50RB/QPSK Antenna 2												
18900	1880	0	front	22.4	22.0	0.675	0.740	0.360	0.395	-0.04	22.3	10
18900	1880	0	rear	22.4	22.0	0.665	0.729	0.368	0.404	0.10	22.3	10
18900	1880	0	left edge	22.4	22.0	0.365	0.400	0.196	0.215	-0.07	22.3	10
18900	1880	0	right edge	22.4	22.0	0.056	0.062	0.033	0.036	-0.03	22.3	10
18900	1880	0	bottom edge	22.4	22.0	0.528	0.579	0.279	0.306	0.10	22.3	10
20MHz BW/100RB/QPSK Antenna 2												
18900	1880	0	front	22.4	21.9	0.649	0.728	0.347	0.389	-0.04	22.3	10
18900	1880	0	rear	22.4	21.9	0.646	0.725	0.357	0.401	0.02	22.3	10
18900	1880	0	left edge	22.4	21.9	0.358	0.402	0.190	0.213	-0.04	22.3	10
18900	1880	0	right edge	22.4	21.9	0.049	0.055	0.028	0.031	-0.03	22.3	10
18900	1880	0	bottom edge	22.4	21.9	0.477	0.535	0.246	0.276	0.10	22.3	10

Table 50: Test results hotspot mode SAR LTE FDD 2 1900MHz (see max. SAR plots in Annex B.6: LTE FDD 2)

* - repeated at the highest SAR measurement according to the FCC KDB 865664

** - maximum possible output power declared by manufacturer

Top edge position for hotspot mode is not required since the distance from the main antenna to the edge is greater than 2.5 cm.

measured / extrapolated SAR numbers - Body worn - LTE FDD 2 1900 MHz												
Ch.	Freq. (MHz)	RB offset	Position	cond. P _{max} (dBm)		SAR _{1g} (W/kg)		SAR _{10g} (W/kg)		power drift (dB)	liquid (°C)	dist. (mm)
				declared**	meas.	meas.	extrap.	meas.	extrap.			
20MHz BW/1RB/QPSK Antenna 1												
18900	1880	0	front	23.4	23.0	0.266	0.292	0.174	0.191	-0.03	22.3	15
18700	1860	0	rear	23.4	23.0	0.325	0.356	0.208	0.228	0.16	22.3	15
18900	1880	0	rear	23.4	23.0	0.324	0.355	0.211	0.231	0.04	22.3	15
19100	1900	0	rear	23.4	22.7	0.293	0.344	0.188	0.221	0.16	22.3	15
20MHz BW/50RB/QPSK Antenna 1												
18900	1880	0	front	22.4	22.0	0.209	0.229	0.136	0.149	0.03	22.3	15
18900	1880	0	rear	22.4	22.0	0.250	0.274	0.160	0.175	0.07	22.3	15
20MHz BW/1RB/QPSK Antenna 2												
18700	1860	0	front	23.4	23.0	0.458	0.502	0.269	0.295	-0.19	22.3	15
18900	1880	0	front	23.4	23.0	0.400	0.439	0.235	0.258	-0.03	22.3	15
19100	1900	0	front	23.4	22.7	0.342	0.402	0.219	0.257	0.05	22.3	15
18900	1880	0	rear	23.4	23.0	0.359	0.394	0.230	0.252	-0.07	22.3	15
20MHz BW/50RB/QPSK Antenna 2												
18900	1880	0	front	22.4	22.0	0.307	0.337	0.180	0.197	-0.02	22.3	15
18900	1880	0	rear	22.4	22.0	0.278	0.305	0.179	0.196	-0.08	22.3	15

Table 51: Test results body worn SAR LTE FDD 2 1900 MHz (see max. SAR plots in Annex B.6: LTE FDD 2)

measured / extrapolated SAR numbers - Head - LTE FDD 4 1750 MHz												
Ch.	Freq. (MHz)	RB offset	Position	cond. P _{max} (dBm)		SAR _{1g} (W/kg)		SAR _{10g} (W/kg)		power drift (dB)	liquid (°C)	
				declared**	meas.	meas.	extrap.	meas.	extrap.			
20MHz BW/1RB/QPSK / Antenna 1												
20175	1732.5	0	left cheek	23.4	23.3	0.117	0.120	0.075	0.077	0.17	22.5	
20175	1732.5	0	left tilted 15°	23.4	23.3	0.096	0.098	0.057	0.058	-0.08	22.5	
20050	1720.0	49	right cheek	23.4	23.2	0.499	0.523	0.283	0.296	-0.10	22.5	
20175	1732.5	0	right cheek	23.4	23.3	0.480	0.491	0.270	0.276	0.04	22.5	
20300	1745.0	0	right cheek	23.4	23.2	0.423	0.443	0.237	0.248	-0.05	22.5	
20175	1732.5	0	right tilted 15°	23.4	23.3	0.090	0.092	0.054	0.056	-0.02	22.5	
20MHz BW/50RB/QPSK / Antenna 1												
20050	1720.0	0	left cheek	22.4	22.4	0.104	0.104	0.067	0.067	0.14	22.5	
20050	1720.0	0	left tilted 15°	22.4	22.4	0.085	0.085	0.049	0.049	0.11	22.5	
20050	1720.0	0	right cheek	22.4	22.4	0.396	0.396	0.227	0.227	-0.09	22.5	
20050	1720.0	0	right tilted 15°	22.4	22.4	0.067	0.067	0.044	0.044	0.10	22.5	
20MHz BW/1RB/QPSK / Antenna 2												
20050	1720.0	49	left cheek	23.4	23.2	0.531	0.556	0.296	0.310	-0.10	22.5	
20175	1732.5	0	left cheek	23.4	23.3	0.537	0.550	0.293	0.300	-0.10	22.5	
20300	1745.0	0	left cheek	23.4	23.2	0.554	0.580	0.305	0.319	-0.11	22.5	
20175	1732.5	0	left tilted 15°	23.4	23.3	0.111	0.114	0.065	0.066	0.08	22.5	
20175	1732.5	0	right cheek	23.4	23.3	0.252	0.258	0.159	0.163	0.02	22.5	
20175	1732.5	0	right tilted 15°	23.4	23.3	0.084	0.085	0.046	0.047	0.04	22.5	
20MHz BW/50RB/QPSK / Antenna 2												
20050	1720.0	0	left cheek	22.4	22.4	0.399	0.399	0.220	0.220	-0.04	22.5	
20050	1720.0	0	left tilted 15°	22.4	22.4	0.082	0.082	0.047	0.047	0.18	22.5	
20050	1720.0	0	right cheek	22.4	22.4	0.195	0.195	0.122	0.122	0.13	22.5	
20050	1720.0	0	right tilted 15°	22.4	22.4	0.071	0.071	0.040	0.040	-0.09	22.5	

Table 52: Test results head SAR LTE FDD 4 1750 MHz (see max. SAR plots in Annex B.7: LTE FDD 4 page 149)

measured / extrapolated SAR numbers - hotspot mode - LTE FDD 4 1750 MHz												
Ch.	Freq. (MHz)	RB offset	Position	cond. P _{max} (dBm)		SAR _{1g} (W/kg)		SAR _{10g} (W/kg)		power drift (dB)	liquid (°C)	dist. (mm)
				declared**	meas.	meas.	extrap.	meas.	extrap.			
20MHz BW/1RB/QPSK/Antenna 1												
20175	1732.5	0	front	22.4	22.1	0.719	0.770	0.447	0.479	0.01	22.6	10
20050	1720.0	0	rear	22.4	21.9	0.767	0.861	0.473	0.531	-0.06	22.6	10
20175	1732.5	0	rear	22.4	22.1	0.827	0.886	0.472	0.506	0.10	22.6	10
20300	1745.0	0	rear	22.4	21.9	0.640	0.718	0.405	0.454	0.10	22.6	10
20175	1732.5	0	left edge	22.4	22.1	0.103	0.110	0.055	0.059	-0.11	22.6	10
20175	1732.5	0	right edge	22.4	22.1	0.350	0.375	0.181	0.194	0.08	22.6	10
20175	1732.5	0	bottom edge	22.4	22.1	0.473	0.507	0.238	0.255	-0.05	22.6	10
20175	1732.5	0	rear*	22.4	22.1	0.773	0.828	0.469	0.503	0.10	22.6	10
20MHz BW/50RB/QPSK/Antenna 1												
20175	1732.5	0	front	21.4	21.0	0.486	0.533	0.290	0.318	-0.10	22.6	10
20175	1732.5	0	rear	21.4	21.0	0.718	0.787	0.386	0.423	0.00	22.6	10
20175	1732.5	0	left edge	21.4	21.0	0.066	0.073	0.035	0.038	-0.01	22.6	10
20175	1732.5	0	right edge	21.4	21.0	0.251	0.275	0.130	0.143	0.05	22.6	10
20175	1732.5	0	bottom edge	21.4	21.0	0.325	0.356	0.161	0.177	0.09	22.6	10
20MHz BW/100RB/QPSK/Antenna 1												
20175	1732.5	0	front	21.4	21.0	0.532	0.583	0.312	0.342	-0.08	22.6	10
20175	1732.5	0	rear	21.4	21.0	0.673	0.738	0.364	0.399	0.01	22.6	10
20175	1732.5	0	left edge	21.4	21.0	0.056	0.061	0.030	0.033	0.06	22.6	10
20175	1732.5	0	right edge	21.4	21.0	0.242	0.265	0.125	0.137	0.17	22.6	10
20175	1732.5	0	bottom edge	21.4	21.0	0.316	0.346	0.156	0.171	0.16	22.6	10
20MHz BW/1RB/QPSK/Antenna 2												
20050	1720.0	0	front	22.4	21.9	0.978	1.097	0.510	0.572	0.14	22.6	10
20175	1732.5	0	front	22.4	22.1	1.020	1.093	0.532	0.570	-0.14	22.6	10
20300	1745.0	0	front	22.4	21.9	0.900	1.010	0.475	0.533	-0.08	22.6	10
20050	1720.0	0	rear	22.4	21.9	0.870	0.976	0.471	0.528	0.13	22.6	10
20175	1732.5	0	rear	22.4	22.1	0.903	0.968	0.489	0.524	0.12	22.6	10
20300	1745.0	0	rear	22.4	21.9	0.811	0.910	0.443	0.497	0.16	22.6	10
20175	1732.5	0	left edge	22.4	22.1	0.570	0.611	0.279	0.299	-0.14	22.6	10
20175	1732.5	0	right edge	22.4	22.1	0.127	0.136	0.074	0.079	0.00	22.6	10
20050	1720.0	0	bottom edge	22.4	21.9	0.687	0.771	0.385	0.432	-0.17	22.6	10
20175	1732.5	0	bottom edge	22.4	22.1	0.795	0.852	0.449	0.481	-0.17	22.6	10
20300	1745.0	0	bottom edge	22.4	21.9	0.727	0.816	0.414	0.465	-0.03	22.6	10
20175	1732.5	0	front*	22.4	22.1	1.140	1.222	0.592	0.634	0.17	22.6	10
20MHz BW/50RB/QPSK/Antenna 2												
20050	1720.0	0	front	21.4	20.9	0.755	0.847	0.392	0.440	0.00	22.6	10
20175	1732.5	0	front	21.4	21.0	0.761	0.834	0.394	0.432	0.02	22.6	10
20300	1745.0	0	front	21.4	20.9	0.724	0.812	0.376	0.422	0.02	22.6	10
20175	1732.5	0	rear	21.4	21.0	0.661	0.708	0.358	0.384	0.14	22.6	10
20175	1732.5	0	left edge	21.4	21.0	0.429	0.470	0.209	0.229	0.04	22.6	10
20175	1732.5	0	right edge	21.4	21.0	0.099	0.108	0.058	0.064	0.01	22.6	10
20175	1732.5	0	bottom edge	21.4	21.0	0.590	0.647	0.334	0.366	-0.08	22.6	10

measured / extrapolated SAR numbers - hotspot mode - LTE FDD 4 1750 MHz												
Ch.	Freq. (MHz)	RB offset	Position	cond. P _{max} (dBm)		SAR _{1g} (W/kg)		SAR _{10g} (W/kg)		power drift (dB)	liquid (°C)	dist. (mm)
				declared**	meas.	meas.	extrap.	meas.	extrap.			
20MHz BW/100RB/QPSK/Antenna 2												
20050	1720.0	0	front	21.4	20.8	0.743	0.853	0.385	0.442	0.02	22.6	10
20175	1732.5	0	front	21.4	21.0	0.752	0.825	0.390	0.428	0.02	22.6	10
20300	1745.0	0	front	21.4	20.9	0.702	0.788	0.365	0.410	0.02	22.6	10
20050	1720.0	0	rear	21.4	20.8	0.743	0.853	0.399	0.458	-0.17	22.6	10
20175	1732.5	0	rear	21.4	21.0	0.742	0.814	0.400	0.439	-0.06	22.6	10
20300	1745.0	0	rear	21.4	20.9	0.682	0.765	0.370	0.415	-0.10	22.6	10
20175	1732.5	0	left edge	21.4	21.0	0.411	0.451	0.200	0.219	0.02	22.6	10
20175	1732.5	0	right edge	21.4	21.0	0.096	0.105	0.057	0.062	0.05	22.6	10
20175	1732.5	0	bottom edge	21.4	21.0	0.579	0.635	0.327	0.359	-0.10	22.6	10

Table 53: Test results hotspot mode SAR LTE FDD 4 1750MHz (see max. SAR plots in Annex B.7: LTE FDD 4)

Top edge position for hotspot mode is not required since the distance from the main antenna to the edge is greater than 2.5 cm.

measured / extrapolated SAR numbers - Body worn - LTE FDD 4 1750 MHz												
Ch.	Freq. (MHz)	RB offset	Position	cond. P _{max} (dBm)		SAR _{1g} (W/kg)		SAR _{10g} (W/kg)		power drift (dB)	liquid (°C)	dist. (mm)
				declared**	meas.	meas.	extrap.	meas.	extrap.			
20MHz BW/1RB/QPSK/Antenna 1												
20175	1732.5	0	front	23.4	23.3	0.452	0.463	0.285	0.292	0.01	22.2	15
20050	1720.0	49	rear	23.4	23.2	0.518	0.542	0.325	0.340	-0.14	22.2	15
20175	1732.5	0	rear	23.4	23.3	0.489	0.500	0.307	0.314	0.03	22.2	15
20300	1745.0	0	rear	23.4	23.2	0.462	0.484	0.291	0.305	0.14	22.2	15
20MHz BW/50RB/QPSK/Antenna 1												
20175	1732.5	0	front	22.4	22.4	0.329	0.329	0.207	0.207	0.00	22.2	15
20175	1732.5	0	rear	22.4	22.4	0.360	0.360	0.227	0.227	-0.05	22.2	15
20MHz BW/1RB/QPSK/Antenna 2												
20050	1720.0	49	front	23.4	23.2	0.585	0.613	0.328	0.343	0.17	22.2	15
20175	1732.5	0	front	23.4	23.3	0.604	0.618	0.337	0.345	-0.04	22.2	15
20300	1745.0	0	front	23.4	23.2	0.548	0.574	0.311	0.326	0.15	22.2	15
20175	1732.5	0	rear	23.4	23.3	0.579	0.592	0.358	0.366	-0.11	22.2	15
20MHz BW/50RB/QPSK/Antenna 2												
20175	1732.5	0	front	23.4	23.3	0.439	0.449	0.246	0.252	0.07	22.2	15
20175	1732.5	0	rear	22.4	22.4	0.419	0.419	0.259	0.259	0.08	22.2	15

Table 54: Test results body worn SAR LTE FDD 4 1750 MHz (see max. SAR plots in Annex B.7: LTE FDD 4)

* - repeated at the highest SAR measurement according to the FCC KDB 865664

** - maximum possible output power declared by manufacturer

measured / extrapolated SAR numbers - Head - LTE FDD 5 850 MHz											
Ch.	Freq. (MHz)	RB offset	Position	cond. P _{max} (dBm)		SAR _{1g} (W/kg)		SAR _{10g} (W/kg)		power drift (dB)	liquid (°C)
				declared**	meas.	meas.	extrap.	meas.	extrap.		
10MHz BW/1RB/QPSK Antenna 1											
20600	844.0	24	left cheek	23.4	23.3	0.277	0.283	0.220	0.225	0.05	21.7
20600	844.0	24	left tilted 15°	23.4	23.3	0.104	0.106	0.083	0.085	0.12	21.7
20450	829.0	24	right cheek	23.4	23.2	0.363	0.380	0.233	0.244	-0.15	21.7
20525	836.5	24	right cheek	23.4	23.2	0.439	0.460	0.277	0.290	0.14	21.7
20600	844.0	24	right cheek	23.4	23.3	0.478	0.489	0.304	0.311	-0.03	21.7
20600	844.0	24	right tilted 15°	23.4	23.3	0.114	0.117	0.091	0.093	0.17	21.7
10MHz BW/25RB/QPSK Antenna 1											
20600	844.0	0	left cheek	22.4	22.4	0.213	0.213	0.170	0.170	0.03	21.7
20600	844.0	0	left tilted 15°	22.4	22.4	0.083	0.083	0.066	0.066	0.09	21.7
20600	844.0	0	right cheek	22.4	22.4	0.376	0.376	0.238	0.238	0.05	21.7
20600	844.0	0	right tilted 15°	22.4	22.4	0.092	0.092	0.073	0.073	0.04	21.7
10MHz BW/1RB/QPSK Antenna 2											
20450	829.0	24	left cheek	23.4	23.2	0.253	0.265	0.192	0.201	0.00	21.7
20525	836.5	24	left cheek	23.4	23.2	0.264	0.276	0.201	0.210	-0.08	21.7
20600	844.0	24	left cheek	23.4	23.3	0.222	0.227	0.170	0.174	0.05	21.7
20600	844.0	24	left tilted 15°	23.4	23.3	0.086	0.088	0.069	0.070	-0.11	21.7
20600	844.0	24	right cheek	23.4	23.3	0.209	0.214	0.166	0.170	0.06	21.7
20600	844.0	24	right tilted 15°	23.4	23.3	0.083	0.085	0.066	0.068	-0.06	21.7
10MHz BW/25RB/QPSK Antenna 2											
20600	844.0	0	left cheek	22.4	22.4	0.182	0.182	0.140	0.140	0.04	21.7
20600	844.0	0	left tilted 15°	22.4	22.4	0.071	0.071	0.057	0.057	0.12	21.7
20600	844.0	0	right cheek	22.4	22.4	0.178	0.178	0.142	0.142	0.03	21.7
20600	844.0	0	right tilted 15°	22.4	22.4	0.069	0.069	0.055	0.055	0.11	21.7

Table 55: Test results head SAR LTE FDD 5 850 MHz (see max. SAR plots in Annex B.8: LTE FDD 5 page 152)

measured / extrapolated SAR numbers - hotspot mode - LTE FDD 5 850 MHz												
Ch.	Freq. (MHz)	RB offset	Position	cond. Pmax (dBm)		SAR1g (W/kg)		SAR10g (W/kg)		power drift (dB)	liquid (°C)	dist. (mm)
				declared**	meas.	meas.	extrap.	meas.	extrap.			
10MHz BW/1RB/QPSK Antenna 1												
20450	829.0	24	front	23.4	23.2	0.701	0.734	0.418	0.438	-0.13	22.5	10
20525	836.5	24	front	23.4	23.2	0.665	0.696	0.395	0.414	-0.02	22.5	10
20600	844.0	24	front	23.4	23.3	0.730	0.747	0.431	0.441	-0.17	22.3	10
20600	844.0	24	rear	23.4	23.3	0.702	0.718	0.464	0.475	-0.16	22.3	10
20600	844.0	24	left edge	23.4	23.3	0.225	0.230	0.148	0.151	0.08	22.5	10
20600	844.0	24	right edge	23.4	23.3	0.520	0.532	0.288	0.295	-0.12	22.5	10
20600	844.0	24	bottom edge	23.4	23.3	0.460	0.471	0.269	0.275	-0.17	22.5	10
10MHz BW/25RB/QPSK Antenna 1												
20600	844.0	0	front	22.4	22.4	0.599	0.599	0.346	0.346	-0.01	22.3	10
20600	844.0	0	rear	22.4	22.4	0.574	0.574	0.376	0.376	-0.03	22.3	10
20600	844.0	0	left edge	22.4	22.4	0.174	0.174	0.113	0.113	-0.03	22.5	10
20600	844.0	0	right edge	22.4	22.4	0.419	0.419	0.233	0.233	-0.10	22.5	10
20600	844.0	0	bottom edge	22.4	22.4	0.363	0.363	0.215	0.215	0.02	22.5	10
10MHz BW/1RB/QPSK Antenna 2												
20600	844.0	24	front	22.4	22.4	0.396	0.396	0.294	0.294	-0.09	22.3	10
20450	829.0	24	rear	22.4	22.4	0.472	0.472	0.362	0.362	0.01	22.5	10
20525	836.5	24	rear	22.4	22.4	0.468	0.468	0.353	0.353	-0.02	22.5	10
20600	844.0	24	rear	22.4	22.4	0.478	0.478	0.358	0.358	0.14	22.3	10
20600	844.0	24	left edge	22.4	22.4	0.199	0.199	0.099	0.099	0.12	22.5	10
20600	844.0	24	right edge	22.4	22.4	0.088	0.088	0.060	0.060	-0.02	22.5	10
20600	844.0	24	bottom edge	22.4	22.4	0.086	0.086	0.050	0.050	-0.10	22.5	10
10MHz BW/25RB/QPSK Antenna 2												
20600	844.0	0	front	22.4	22.4	0.336	0.336	0.250	0.250	0.00	22.3	10
20600	844.0	0	rear	22.4	22.4	0.397	0.397	0.300	0.300	0.02	22.3	10
20600	844.0	0	left edge	22.4	22.4	0.172	0.172	0.086	0.086	-0.02	22.5	10
20600	844.0	0	right edge	22.4	22.4	0.103	0.103	0.071	0.071	-0.08	22.5	10
20600	844.0	0	bottom edge	22.4	22.4	0.068	0.068	0.040	0.040	0.14	22.5	10

Table 56: Test results hotspot mode SAR LTE FDD 5 850 MHz (see max. SAR plots in Annex B.8: LTE FDD 5)

Top edge position for hotspot mode is not required since the distance from the main antenna to the edge is greater than 2.5 cm.

* - repeated at the highest SAR measurement according to the FCC KDB 865664

** - maximum possible output power declared by manufacturer

measured / extrapolated SAR numbers - Body worn - LTE FDD 5 850 MHz												
Ch.	Freq. (MHz)	RB offset	Position	cond. P _{max} (dBm)		SAR _{1g} (W/kg)		SAR _{10g} (W/kg)		power drift (dB)	liquid (°C)	dist. (mm)
				declared**	meas.	meas.	extrap.	meas.	extrap.			
10MHz BW/1RB/QPSK Antenna 1												
20600	844.0	24	front	23.4	23.3	0.432	0.442	0.314	0.321	0.11	22.3	15
20450	829.0	24	rear	23.4	23.2	0.489	0.512	0.354	0.371	0.13	22.3	15
20525	836.5	24	rear	23.4	23.2	0.447	0.468	0.329	0.345	0.11	22.3	15
20600	844.0	24	rear	23.4	23.3	0.462	0.473	0.336	0.344	-0.01	22.3	15
10MHz BW/25RB/QPSK Antenna 1												
20600	844.0	0	front	23.4	23.3	0.365	0.374	0.265	0.271	0.02	22.3	15
20600	844.0	0	rear	22.4	22.4	0.375	0.375	0.272	0.272	0.00	22.3	15
10MHz BW/1RB/QPSK Antenna 2												
20600	844.0	24	front	23.4	23.3	0.298	0.305	0.224	0.229	0.13	22.3	15
20450	829.0	24	rear	23.4	23.2	0.261	0.273	0.196	0.205	-0.06	22.3	15
20525	836.5	24	rear	23.4	23.2	0.330	0.346	0.249	0.261	-0.04	22.3	15
20600	844.0	24	rear	23.4	23.3	0.326	0.334	0.245	0.251	0.17	22.3	15
10MHz BW/25RB/QPSK Antenna 2												
20600	844.0	0	front	22.4	22.4	0.246	0.246	0.187	0.187	-0.02	22.3	15
20600	844.0	0	rear	22.4	22.4	0.274	0.274	0.206	0.206	-0.04	22.3	15

Table 57: Test results body worn SAR LTE FDD 5 850 MHz (see max. SAR plots in Annex B.8: LTE FDD 5)

measured / extrapolated SAR numbers - Head - LTE FDD 7 2600 MHz											
Ch.	Freq. (MHz)	RB offset	Position	cond. P _{max} (dBm)		SAR _{1g} (W/kg)		SAR _{10g} (W/kg)		power drift (dB)	liquid (°C)
				declared**	meas.	meas.	extrap.	meas.	extrap.		
20MHz BW/1RB/QPSK Antenna 1											
21100	2535	0	left cheek	23.4	23.4	0.283	0.283	0.142	0.142	-0.03	21.4
21100	2535	0	left tilted 15°	23.4	23.4	0.178	0.178	0.093	0.093	-0.02	21.4
20850	2510	49	right cheek	23.4	23.4	0.495	0.495	0.262	0.262	0.08	21.4
21100	2535	0	right cheek	23.4	23.4	0.521	0.521	0.277	0.277	0.07	21.4
21350	2560	0	right cheek	23.4	23.4	0.555	0.555	0.292	0.292	0.03	21.4
21100	2535	0	right tilted 15°	23.4	23.4	0.158	0.158	0.079	0.079	-0.14	21.4
20MHz BW/50RB/QPSK Antenna 1											
20850	2510	0	left cheek	22.4	22.4	0.230	0.230	0.115	0.115	-0.03	21.4
20850	2510	0	left tilted 15°	22.4	22.4	0.149	0.149	0.078	0.078	-0.04	21.4
20850	2510	0	right cheek	22.4	22.4	0.377	0.377	0.200	0.200	0.13	21.4
20850	2510	0	right tilted 15°	22.4	22.4	0.122	0.122	0.059	0.059	0.00	21.4
20MHz BW/1RB/QPSK Antenna 2											
20850	2510	49	left cheek	23.4	23.4	0.990	0.990	0.526	0.526	-0.09	21.4
21100	2535	0	left cheek	23.4	23.4	1.150	1.150	0.601	0.601	0.03	21.4
21350	2560	0	left cheek	23.4	23.4	0.969	0.969	0.513	0.513	0.06	21.4
21100	2535	0	left tilted 15°	23.4	23.4	0.263	0.263	0.138	0.138	0.01	21.4
21100	2535	0	left cheek*	23.4	23.4	1.170	1.170	0.618	0.618	-0.02	21.4
21100	2535	0	right cheek	23.4	23.4	0.468	0.468	0.257	0.257	0.05	21.4
21100	2535	0	right tilted 15°	23.4	23.4	0.488	0.488	0.237	0.237	0.00	21.4
20MHz BW/50RB/QPSK Antenna 2											
20850	2510	0	left cheek	22.4	22.4	0.822	0.822	0.436	0.436	-0.15	21.4
21100	2535	0	left cheek	22.4	22.3	0.926	0.948	0.489	0.500	0.17	21.4
21350	2560	0	left cheek	22.4	22.2	0.829	0.868	0.436	0.457	0.11	21.4
20850	2510	0	left tilted 15°	22.4	22.4	0.181	0.181	0.097	0.097	0.00	21.4
20850	2510	0	right cheek	22.4	22.4	0.352	0.352	0.193	0.193	0.03	21.4
20850	2510	0	right tilted 15°	22.4	22.4	0.309	0.309	0.147	0.147	0.07	21.4
20MHz BW/100RB/QPSK Antenna 2											
20850	2510	0	left cheek	22.4	22.3	0.721	0.738	0.383	0.392	-0.04	21.4
21100	2535	0	left cheek	22.4	22.3	0.815	0.834	0.429	0.439	-0.13	21.4
21350	2560	0	left cheek	22.4	22.2	0.760	0.796	0.400	0.419	0.14	21.4
21100	2535	0	left tilted 15°	22.4	22.3	0.203	0.208	0.107	0.109	0.09	21.4
21100	2535	0	right cheek	22.4	22.3	0.486	0.497	0.271	0.277	-0.08	21.4
21100	2535	0	right tilted 15°	22.4	22.3	0.370	0.379	0.172	0.176	-0.11	21.4

Table 58: Test results head SAR LTE FDD 7 2600 MHz (see max. SAR plots in Annex B.9: LTE FDD 7 page 155)

* - repeated at the highest SAR measurement according to the FCC KDB 865664

** - maximum possible output power declared by manufacturer

measured / extrapolated SAR numbers - hotspot mode - LTE FDD 7 2600 MHz												
Ch.	Freq. (MHz)	RB offset	Position	cond. P _{max} (dBm)		SAR _{1g} (W/kg)		SAR _{10g} (W/kg)		power drift (dB)	liquid (°C)	dist. (mm)
				declared**	measured	meas.	extrap.	meas.	extrap.			
20MHz BW/1RB/QPSK Antenna 1												
21100	2535	0	front	23.4	23.4	0.799	0.799	0.409	0.409	-0.03	21.4	10
20850	2510	49	rear	23.4	23.4	0.743	0.743	0.387	0.387	-0.19	21.4	10
21100	2535	0	rear	23.4	23.4	0.807	0.807	0.409	0.409	0.07	21.4	10
21350	2560	0	rear	23.4	23.4	0.757	0.757	0.383	0.383	-0.04	21.4	10
21100	2535	0	left edge	23.4	23.4	0.139	0.139	0.075	0.075	-0.10	21.4	10
21100	2535	0	right edge	23.4	23.4	0.328	0.328	0.165	0.165	0.00	21.4	10
20850	2510	49	bottom edge	23.4	23.4	0.790	0.790	0.421	0.421	-0.06	21.4	10
21100	2535	0	bottom edge	23.4	23.4	0.845	0.845	0.442	0.442	0.01	21.4	10
21350	2560	0	bottom edge	23.4	23.4	0.882	0.882	0.463	0.463	-0.05	21.4	10
20MHz BW/50RB/QPSK Antenna 1												
20850	2510	0	front	22.4	22.4	0.554	0.554	0.286	0.286	-0.05	21.4	10
20850	2510	0	rear	22.4	22.4	0.546	0.546	0.283	0.283	0.05	21.4	10
20850	2510	0	left edge	22.4	22.4	0.101	0.101	0.054	0.054	0.00	21.4	10
20850	2510	0	right edge	22.4	22.4	0.232	0.232	0.117	0.117	-0.02	21.4	10
20850	2510	0	bottom edge	22.4	22.4	0.635	0.635	0.336	0.336	0.02	21.4	10
20MHz BW/100RB/QPSK Antenna 1												
21100	2535	0	front	22.4	22.3	0.724	0.741	0.370	0.379	-0.04	21.4	10
21100	2535	0	rear	22.4	22.3	0.672	0.688	0.338	0.346	0.04	21.4	10
21100	2535	0	left edge	22.4	22.3	0.108	0.111	0.058	0.059	-0.06	21.4	10
21100	2535	0	right edge	22.4	22.3	0.274	0.280	0.138	0.141	-0.11	21.4	10
21100	2535	0	bottom edge	22.4	22.3	0.708	0.724	0.372	0.381	-0.03	21.4	10
20MHz BW/1RB/QPSK Antenna 2												
20850	2510	49	front	23.4	23.4	1.120	1.120	0.610	0.610	0.01	21.4	10
21100	2535	0	front	23.4	23.4	1.250	1.250	0.678	0.678	0.07	21.4	10
21350	2560	0	front	23.4	23.4	1.190	1.190	0.648	0.648	0.06	21.4	10
20850	2510	49	rear	23.4	23.4	1.160	1.160	0.629	0.629	0.12	21.4	10
21100	2535	0	rear	23.4	23.4	1.300	1.300	0.695	0.695	0.07	21.4	10
21350	2560	0	rear	23.4	23.4	1.290	1.290	0.689	0.689	0.02	21.4	10
21100	2535	0	left edge	23.4	23.4	0.557	0.557	0.286	0.286	-0.10	21.4	10
21100	2535	0	right edge	23.4	23.4	0.027	0.027	0.015	0.015	-0.03	21.4	10
21100	2535	0	bottom edge	23.4	23.4	0.188	0.188	0.102	0.102	-0.13	21.4	10
21100	2535	0	rear*	23.4	23.4	1.190	1.190	0.637	0.637	-0.10	21.4	10
20MHz BW/50RB/QPSK Antenna 2												
20850	2510	0	front	22.4	22.4	0.788	0.788	0.433	0.433	-0.04	21.4	10
21100	2535	0	front	22.4	22.3	0.914	0.935	0.498	0.510	-0.01	21.4	10
21350	2560	0	front	22.4	22.2	1.020	1.068	0.551	0.577	-0.03	21.4	10
20850	2510	0	rear	22.4	22.4	0.894	0.894	0.481	0.481	0.00	21.4	10
21100	2535	0	rear	22.4	22.3	1.070	1.095	0.574	0.587	-0.01	21.4	10
21350	2560	0	rear	22.4	22.2	1.050	1.099	0.555	0.581	-0.14	21.4	10
20850	2510	0	left edge	22.4	22.4	0.380	0.380	0.195	0.195	-0.04	21.4	10
20850	2510	0	right edge	22.4	22.4	0.024	0.024	0.013	0.013	-0.06	21.4	10
20850	2510	0	bottom edge	22.4	22.4	0.131	0.131	0.067	0.067	-0.13	21.4	10

measured / extrapolated SAR numbers - hotspot mode - LTE FDD 7 2600 MHz												
Ch.	Freq. (MHz)	RB offset	Position	cond. P _{max} (dBm)		SAR _{1g} (W/kg)		SAR _{10g} (W/kg)		power drift (dB)	liquid (°C)	dist. (mm)
				declared**	measured	meas.	extrap.	meas.	extrap.			
20MHz BW/100RB/QPSK Antenna 2												
20850	2510	0	front	22.4	22.3	0.829	0.848	0.452	0.463	-0.07	21.4	10
21100	2535	0	front	22.4	22.3	0.937	0.959	0.509	0.521	-0.17	21.4	10
21350	2560	0	front	22.4	22.2	0.931	0.975	0.500	0.524	-0.04	21.4	10
21100	2535	0	rear	22.4	22.3	0.672	0.688	0.338	0.346	0.04	21.4	10
21100	2535	0	left edge	22.4	22.3	0.384	0.393	0.199	0.204	0.00	21.4	10
21100	2535	0	right edge	22.4	22.3	0.015	0.015	0.006	0.007	-0.01	21.4	10
21100	2535	0	bottom edge	22.4	22.3	0.113	0.116	0.062	0.064	-0.06	21.4	10

Table 59: Test results hotspot mode SAR LTE FDD 7 2600MHz (see max. SAR plots in Annex B.9: LTE FDD 7)

Top edge position for hotspot mode is not required since the distance from the main antenna to the edge is greater than 2.5 cm.

measured / extrapolated SAR numbers - Body worn - LTE FDD 7 2600 MHz												
Ch.	Freq. (MHz)	RB offset	Position	cond. P _{max} (dBm)		SAR _{1g} (W/kg)		SAR _{10g} (W/kg)		power drift (dB)	liquid (°C)	dist. (mm)
				declared**	measured	meas.	extrap.	meas.	extrap.			
20MHz BW/1RB/QPSK Antenna 1												
20850	2510	49	front	23.4	23.4	0.389	0.389	0.212	0.212	-0.20	21.4	15
21100	2535	0	front	23.4	23.4	0.442	0.442	0.240	0.240	-0.06	21.4	15
21350	2560	0	front	23.4	23.4	0.443	0.443	0.237	0.237	-0.04	21.4	15
21100	2535	0	rear	23.4	23.4	0.382	0.382	0.209	0.209	-0.03	21.4	15
20MHz BW/50RB/QPSK Antenna 1												
20850	2510	0	front	22.4	22.4	0.303	0.303	0.174	0.174	-0.01	21.4	15
20850	2510	0	rear	22.4	22.4	0.289	0.289	0.162	0.162	-0.10	21.4	15
20MHz BW/1RB/QPSK Antenna 2												
20850	2510	49	front	23.4	23.4	0.771	0.771	0.425	0.425	0.00	21.4	15
21100	2535	0	front	23.4	23.4	0.809	0.809	0.448	0.448	-0.06	21.4	15
21350	2560	0	front	23.4	23.4	0.823	0.823	0.453	0.453	-0.06	21.4	15
21100	2535	0	rear	23.4	23.4	0.732	0.732	0.406	0.406	-0.01	21.4	15
21350	2560	0	front*	23.4	23.4	0.742	0.742	0.403	0.403	-0.03	21.4	15
20MHz BW/50RB/QPSK Antenna 2												
20850	2510	0	front	22.4	22.4	0.574	0.574	0.319	0.319	-0.16	21.4	15
20850	2510	0	rear	22.4	22.4	0.504	0.504	0.276	0.276	-0.02	21.4	15
20MHz BW/100RB/QPSK Antenna 2												
21100	2535	0	front	22.4	22.3	0.542	0.555	0.297	0.304	0.04	21.4	15
21100	2535	0	rear	22.4	22.3	0.594	0.608	0.323	0.331	-0.04	21.4	15

Table 60: Test results body worn SAR LTE FDD 7 2600 MHz (see max. SAR plots in Annex B.9: LTE FDD 7)

** - maximum possible output power declared by manufacturer

measured / extrapolated SAR numbers - Head - LTE TDD 38 2600 MHz											
Ch.	Freq. (MHz)	RB offset	Position	cond. Pmax (dBm)		SAR1g (W/kg)		SAR10g (W/kg)		power drift (dB)	liquid (°C)
				declared**	meas.	meas.	extrap.	meas.	extrap.		
20MHz BW - 1RB - QPSK - Antenna 1											
38000	2595	0	left cheek	25.0	23.5	0.127	0.179	0.064	0.091	0.07	22.2
38000	2595	0	left tilted 15°	25.0	23.5	0.100	0.141	0.051	0.072	-0.08	22.2
37850	2580	99	right cheek	25.0	23.3	0.188	0.278	0.099	0.146	-0.12	22.2
38000	2595	0	right cheek	25.0	23.5	0.207	0.292	0.109	0.154	-0.13	22.2
38150	2610	99	right cheek	25.0	23.2	0.190	0.288	0.099	0.149	-0.19	22.2
38000	2595	0	right tilted 15°	25.0	23.5	0.062	0.088	0.028	0.040	-0.06	22.2
20MHz BW - 50RB - QPSK - Antenna 1											
37850	2580	24	left cheek	24.0	22.4	0.087	0.125	0.043	0.063	-0.01	22.2
37850	2580	24	left tilted 15°	24.0	22.4	0.075	0.108	0.038	0.055	-0.18	22.2
37850	2580	24	right cheek	24.0	22.4	0.156	0.225	0.082	0.119	-0.07	22.2
37850	2580	24	right tilted 15°	24.0	22.4	0.041	0.059	0.017	0.025	-0.04	22.2
20MHz BW - 1RB - QPSK - Antenna 2											
37850	2580	99	left cheek	25.0	23.3	0.527	0.779	0.272	0.402	-0.15	22.2
38000	2595	0	left cheek	25.0	23.5	0.531	0.750	0.277	0.391	-0.04	22.2
38150	2610	99	left cheek	25.0	23.2	0.458	0.693	0.238	0.360	0.02	22.2
38000	2595	0	left tilted 15°	25.0	23.5	0.113	0.160	0.056	0.079	-0.10	22.2
38000	2595	0	right cheek	25.0	23.5	0.203	0.287	0.108	0.153	0.02	22.2
38000	2595	0	right tilted 15°	25.0	23.5	0.209	0.295	0.094	0.133	0.15	22.2
20MHz BW - 50RB - QPSK - Antenna 2											
37850	2580	24	left cheek	24.0	22.4	0.400	0.578	0.208	0.301	-0.05	22.2
37850	2580	24	left tilted 15°	24.0	22.4	0.109	0.158	0.053	0.076	0.00	22.2
37850	2580	24	right cheek	24.0	22.4	0.142	0.205	0.078	0.112	0.09	22.2
37850	2580	24	right tilted 15°	24.0	22.4	0.143	0.207	0.064	0.093	-0.01	22.2

Table 61: Test results head SAR LTE TDD 38 2600 MHz (see max. SAR plots in Annex B.10: LTE TDD 38 page 158)

measured / extrapolated SAR numbers - hotspot mode - LTE TDD 38 2600 MHz												
Ch.	Freq. (MHz)	RB offset	Position	cond. Pmax (dBm)		SAR1g (W/kg)		SAR10g (W/kg)		power drift (dB)	liquid (°C)	dist. (mm)
				declared**	meas.	meas.	extrap.	meas.	extrap.			
20MHz BW - 1RB - QPSK - Antenna 1												
38000	2595	0	front	25.0	23.5	0.378	0.534	0.194	0.274	-0.14	21.9	10
38000	2595	0	rear	25.0	23.5	0.362	0.511	0.177	0.250	0.01	21.9	10
38000	2595	0	left edge	25.0	23.5	0.059	0.083	0.030	0.043	-0.11	21.9	10
38000	2595	0	right edge	25.0	23.5	0.181	0.256	0.089	0.126	-0.02	21.9	10
37850	2580	99	bottom edge	25.0	23.3	0.360	0.532	0.190	0.281	0.01	21.9	10
38000	2595	0	bottom edge	25.0	23.5	0.397	0.561	0.206	0.291	0.05	21.9	10
38150	2610	99	bottom edge	25.0	23.2	0.352	0.533	0.184	0.278	-0.04	21.9	10
20MHz BW - 50RB - QPSK - Antenna 1												
37850	2580	24	front	24.0	22.4	0.269	0.389	0.138	0.199	-0.04	21.9	10
37850	2580	24	rear	24.0	22.4	0.272	0.393	0.133	0.192	-0.02	21.9	10
37850	2580	24	left edge	24.0	22.3	0.044	0.065	0.022	0.033	-0.20	21.9	10
37850	2580	24	right edge	24.0	22.3	0.138	0.204	0.067	0.099	0.10	21.9	10
37850	2580	24	bottom edge	24.0	22.3	0.296	0.438	0.153	0.226	0.04	21.9	10
20MHz BW - 1RB - QPSK - Antenna 2												
37850	2580	99	front	25.0	23.3	0.549	0.812	0.294	0.435	-0.04	21.9	10
38000	2595	0	front	25.0	23.5	0.576	0.814	0.311	0.439	0.02	21.9	10
38150	2610	99	front	25.0	23.2	0.526	0.796	0.281	0.425	0.07	21.9	10
38000	2595	0	rear	25.0	23.5	0.554	0.783	0.293	0.414	-0.01	21.9	10
38000	2595	0	left edge	25.0	23.5	0.275	0.388	0.138	0.195	0.17	21.9	10
38000	2595	0	right edge	25.0	23.5	0.005	0.008	0.002	0.003	-0.07	21.9	10
38000	2595	0	bottom edge	25.0	23.5	0.096	0.135	0.052	0.073	-0.06	21.9	10
20MHz BW - 50RB - QPSK - Antenna 2												
37850	2580	24	front	24.0	22.4	0.375	0.542	0.203	0.293	-0.03	21.9	10
38000	2595	24	rear	24.0	22.3	0.413	0.611	0.217	0.321	-0.05	21.9	10
37850	2580	24	left edge	24.0	22.3	0.197	0.291	0.099	0.147	-0.03	21.9	10
37850	2580	24	right edge	24.0	22.3	0.008	0.011	0.003	0.005	-0.15	21.9	10
37850	2580	24	bottom edge	24.0	22.3	0.067	0.100	0.037	0.054	0.00	21.9	10
20MHz BW - 100RB - QPSK - Antenna 2												
38000	2595	0	front	24.0	22.3	0.440	0.651	0.234	0.346	-0.03	21.9	10
38000	2595	0	rear	24.0	22.3	0.421	0.623	0.222	0.328	-0.05	21.9	10
38000	2595	0	left edge	24.0	22.3	0.189	0.280	0.094	0.139	0.13	21.9	10
38000	2595	0	right edge	24.0	22.3	0.005	0.008	0.002	0.003	-0.01	21.9	10
38000	2595	0	bottom edge	24.0	22.3	0.076	0.113	0.041	0.061	-0.08	21.9	10

Table 62: Test results hotspot mode SAR LTE TDD 38 2600 MHz (see max. SAR plots in Annex B.10: LTE TDD 38)

Top edge position for hotspot mode is not required since the distance from the main antenna to the edge is greater than 2.5 cm.

measured / extrapolated SAR numbers - Body worn - LTE TDD 38 2600 MHz												
Ch.	Freq. (MHz)	RB offset	Position	cond. Pmax (dBm)		SAR1g (W/kg)		SAR10g (W/kg)		power drift (dB)	liquid (°C)	dist. (mm)
				declared**	meas.	meas.	extrap.	meas.	extrap.			
20MHz BW - 1RB - QPSK - Antenna 1												
37850	2580	99	front	25.0	23.3	0.188	0.278	0.102	0.151	-0.15	21.9	15
38000	2595	0	front	25.0	23.5	0.188	0.266	0.103	0.145	-0.01	21.9	15
38150	2610	99	front	25.0	23.2	0.182	0.275	0.098	0.148	0.13	21.9	15
38000	2595	0	rear	25.0	23.5	0.179	0.253	0.095	0.134	0.01	21.9	15
20MHz BW - 50RB - QPSK - Antenna 1												
37850	2580	24	front	24.0	22.4	0.140	0.202	0.076	0.110	0.12	21.9	15
37850	2580	24	rear	24.0	22.4	0.129	0.186	0.068	0.098	-0.09	21.9	15
20MHz BW - 1RB - QPSK - Antenna 2												
38000	2595	0	front	25.0	23.5	0.316	0.446	0.171	0.242	0.14	21.9	15
37850	2580	99	rear	25.0	23.3	0.299	0.442	0.160	0.237	0.04	21.9	15
38000	2595	0	rear	25.0	23.5	0.321	0.453	0.173	0.244	0.17	21.9	15
38150	2610	99	rear	25.0	23.2	0.283	0.428	0.150	0.227	-0.03	21.9	15
20MHz BW - 50RB - QPSK - Antenna 2												
37850	2580	24	front	24.0	22.4	0.213	0.308	0.116	0.168	0.01	21.9	15
37850	2580	24	rear	24.0	22.4	0.224	0.324	0.120	0.173	-0.13	21.9	15

Table 63: Test results body worn SAR LTE TDD 38 2600 MHz (see max. SAR plots in Annex B.10: LTE TDD 38)

** - maximum possible output power declared by manufacturer

measured / extrapolated SAR numbers - Head - WLAN 2450 MHz												
Ch.	Freq. (MHz)	test cond.	Position	cond. P _{max} (dBm)		SAR _{1g} (W/kg)		SAR _{10g} (W/kg)		power drift (dB)	liquid (°C)	
				declared**	meas.	meas.	extrap.	meas.	extrap.			
11	2462	1Mbit/s	left cheek	14.5	13.8	0.638	0.750	0.307	0.361	0.00	22.6	
1	2412	1Mbit/s	left tilted 15°	14.5	13.2	0.524	0.707	0.236	0.318	0.00	22.6	
2	2417	1Mbit/s	left tilted 15°	14.5	13.7	0.676	0.813	0.313	0.376	0.00	22.6	
6	2437	1Mbit/s	left tilted 15°	14.5	13.3	0.527	0.695	0.243	0.320	0.05	22.6	
11	2462	1Mbit/s	left tilted 15°	14.5	13.8	0.744	0.874	0.349	0.410	0.03	22.6	
11	2462	1Mbit/s	right cheek	14.5	13.8	0.631	0.741	0.285	0.335	0.03	22.6	
11	2462	1Mbit/s	right tilted 15°	14.5	13.8	0.629	0.739	0.285	0.335	0.02	22.6	
11	2462	1Mbit/s	left tilted*	14.5	13.8	0.689	0.810	0.321	0.377	0.02	22.6	

Table 64: Test results head SAR WLAN 2450 MHz (see max. SAR plots in Annex B.11: WLAN 2450MHz page 162)

measured / extrapolated SAR numbers - hotspot mode - WLAN 2450 MHz												
Ch.	Freq. (MHz)	test cond.	Position	cond. P _{max} (dBm)		SAR _{1g} (W/kg)		SAR _{10g} (W/kg)		power drift (dB)	liquid (°C)	dist. (mm)
				declared**	meas.	meas.	extrap.	meas.	extrap.			
11	2462	1Mbit/s	front	18.5	17.8	0.343	0.403	0.174	0.204	0.00	22.4	10
11	2462	1Mbit/s	rear	18.5	17.8	0.342	0.402	0.168	0.197	-0.02	22.4	10
11	2462	1Mbit/s	left edge	18.5	17.8	0.032	0.037	0.016	0.019	0.01	22.4	10
11	2462	1Mbit/s	right edge	18.5	17.8	0.036	0.042	0.021	0.025	0.09	22.4	10
1	2412	1Mbit/s	top edge	18.5	17.5	0.639	0.804	0.283	0.356	0.00	22.4	10
6	2437	1Mbit/s	top edge	18.5	17.3	0.640	0.844	0.288	0.380	-0.01	22.4	10
11	2462	1Mbit/s	top edge	18.5	17.8	0.724	0.851	0.328	0.385	-0.02	22.4	10

Table 65: Test results hotspot mode SAR WLAN 2450 MHz (see max. SAR plots in Annex B.11: WLAN 2450MHz)

Bottom side edge positions for hotspot mode are not required since the distance from the WLAN antenna to the edge is greater than 2.5cm.

measured / extrapolated SAR numbers - Body worn - WLAN 2450 MHz												
Ch.	Freq. (MHz)	test cond.	Position	cond. P _{max} (dBm)		SAR _{1g} (W/kg)		SAR _{10g} (W/kg)		power drift (dB)	liquid (°C)	dist. (mm)
				declared**	meas.	meas.	extrap.	meas.	extrap.			
1	2412	1Mbit/s	front	18.5	17.5	0.149	0.188	0.078	0.098	0.01	22.4	15
6	2437	1Mbit/s	front	18.5	17.3	0.165	0.218	0.087	0.115	0.04	22.4	15
11	2462	1Mbit/s	front	18.5	17.8	0.166	0.195	0.089	0.105	0.01	22.4	15
11	2462	1Mbit/s	rear	18.5	17.8	0.166	0.195	0.087	0.103	-0.01	22.4	15

Table 66: Test results body worn SAR WLAN 2450 MHz (see max. SAR plots in Annex B.11: WLAN 2450MHz)

* - repeated at the highest SAR measurement according to the FCC KDB 865664

** - maximum possible output power declared by manufacturer

Estimated stand alone SAR.					
Communication system	freq. (GHz)	distance (mm)	P _{avg} (dBm)	P _{avg} (mW)	estimated _{1-g} (W/kg)
Bluetooth 2450 head	2.45	5	1.5	1.4	0.059
Bluetooth 2450 hotspot	2.45	10	1.5	1.4	0.029
Bluetooth 2450 body worn	2.45	15	1.5	1.4	0.020

Table 67: Estimated stand alone SAR_{max} for Bluetooth 2450MHz head and body

7.2.3 Multiple Transmitter Information

The following tables list information which is relevant for the decision if a simultaneous transmit evaluation is necessary according to FCC KDB 447498D01 General RF Exposure Guidance v05.

reported SAR WWAN and WLAN 2.4GHz , ΣSAR evaluation, SPLSRI						
Frequency band	Position	SAR _{max} /W/kg		ΣSAR <1.6W/kg	distance Ri, mm	ratio ≤ 0.04
		WWAN	WLAN			
GSM 850	left cheek	0.490	0.750	1.240		
	left tilted 15°	0.186	0.874	1.060		
	right cheek	0.587	0.741	1.328		
	right tilted 15°	0.187	0.739	0.926		
	front 10mm	1.014	0.403	1.417		
	rear 10mm	0.875	0.402	1.277		
	left 10mm	0.581	0.037	0.618		
	right 10mm	0.436	0.042	0.478		
	top 10mm	0.000	0.851	0.851		
	bottom 10mm	0.531	0.000	0.531		
	front 15mm	0.650	0.218	0.868		
	rear 15mm	0.484	0.195	0.679		
GSM 1900	left cheek	0.273	0.750	1.023		
	left tilted 15°	0.138	0.874	1.012		
	right cheek	0.407	0.741	1.148		
	right tilted 15°	0.178	0.739	0.917		
	front 10mm	0.659	0.403	1.062		
	rear 10mm	0.573	0.402	0.975		
	left 10mm	0.228	0.037	0.265		
	right 10mm	0.432	0.042	0.474		
	top 10mm	0.000	0.851	0.851		
	bottom 10mm	0.638	0.000	0.638		
	front 15mm	0.304	0.218	0.522		
	rear 15mm	0.290	0.195	0.485		
UMTS FDD II	left cheek	0.537	0.750	1.287		
	left tilted 15°	0.147	0.874	1.021		
	right cheek	0.501	0.741	1.242		
	right tilted 15°	0.203	0.739	0.942		
	front 10mm	1.277	0.403	1.680	145.1	0.02
	rear 10mm	0.984	0.402	1.386		
	left 10mm	0.439	0.037	0.476		
	right 10mm	0.325	0.042	0.367		
	top 10mm	0.000	0.851	0.851		
	bottom 10mm	0.870	0.000	0.870		
	front 15mm	0.453	0.218	0.671		
	rear 15mm	0.380	0.195	0.575		

reported SAR WWAN and WLAN 2.4GHz, ΣSAR evaluation, SPLSRI						
Frequency band	Position	SAR _{max} /W/kg		ΣSAR <1.6W/kg	distance Ri, mm	ratio ≤ 0.04
		WWAN	WLAN			
UMTS FDD IV	left cheek	0.521	0.750	1.271		
	left tilted 15°	0.122	0.874	0.996		
	right cheek	0.440	0.741	1.181		
	right tilted 15°	0.109	0.739	0.848		
	front 10mm	1.198	0.403	1.601	143.7	0.01
	rear 10mm	1.106	0.402	1.508		
	left 10mm	0.859	0.037	0.896		
	right 10mm	0.344	0.042	0.386		
	top 10mm	0.000	0.851	0.851		
	bottom 10mm	0.789	0.000	0.789		
	front 15mm	0.687	0.218	0.905		
	rear 15mm	0.785	0.195	0.980		
WCDMA FDD V	left cheek	0.442	0.750	1.192		
	left tilted 15°	0.127	0.874	1.001		
	right cheek	0.595	0.741	1.336		
	right tilted 15°	0.142	0.739	0.881		
	front 10mm	0.855	0.403	1.258		
	rear 10mm	0.892	0.402	1.294		
	left 10mm	0.669	0.037	0.706		
	right 10mm	0.309	0.042	0.351		
	top 10mm	0.000	0.851	0.851		
	bottom 10mm	0.471	0.000	0.471		
	front 15mm	0.596	0.218	0.814		
	rear 15mm	0.548	0.195	0.743		
LTE FDD 2	left cheek	0.660	0.750	1.410		
	left tilted 15°	0.141	0.874	1.015		
	right cheek	0.364	0.741	1.105		
	right tilted 15°	0.203	0.739	0.942		
	front 10mm	1.034	0.403	1.437		
	rear 10mm	1.041	0.402	1.443		
	left 10mm	0.484	0.037	0.521		
	right 10mm	0.328	0.042	0.370		
	top 10mm	0.000	0.851	0.851		
	bottom 10mm	0.769	0.000	0.769		
	front 15mm	0.502	0.218	0.720		
	rear 15mm	0.394	0.195	0.589		
LTE FDD 4	left cheek	0.580	0.750	1.330		
	left tilted 15°	0.114	0.874	0.988		
	right cheek	0.523	0.741	1.264		
	right tilted 15°	0.092	0.739	0.831		
	front 10mm	1.222	0.403	1.625	145.5	0.01
	rear 10mm	0.976	0.402	1.378		
	left 10mm	0.611	0.037	0.648		
	right 10mm	0.375	0.042	0.417		
	top 10mm	0.000	0.851	0.851		
	bottom 10mm	0.647	0.000	0.647		
	front 15mm	0.618	0.218	0.836		
	rear 15mm	0.592	0.195	0.787		

reported SAR WWAN and WLAN 2.4GHz , Σ SAR evaluation, SPLSR_i						
Frequency band	Position	SAR _{max} /W/kg		Σ SAR <1.6W/kg	distance R _i , mm	ratio ≤ 0.04
		WWAN	WLAN			
LTE FDD 5	left cheek	0.283	0.750	1.033		
	left tilted 15°	0.106	0.874	0.980		
	right cheek	0.489	0.741	1.230		
	right tilted 15°	0.117	0.739	0.856		
	front 10mm	0.747	0.403	1.150		
	rear 10mm	0.718	0.402	1.120		
	left 10mm	0.230	0.037	0.267		
	right 10mm	0.532	0.042	0.574		
	top 10mm	0.000	0.851	0.851		
	bottom 10mm	0.460	0.000	0.460		
	front 15mm	0.442	0.218	0.660		
	rear 15mm	0.512	0.195	0.707		
LTE FDD 7	left cheek	1.170	0.750	1.920	82.3	0.03
	left tilted 15°	0.263	0.874	1.137		
	right cheek	0.555	0.741	1.296		
	right tilted 15°	0.488	0.739	1.227		
	front 10mm	1.250	0.403	1.653	122.7	0.02
	rear 10mm	1.300	0.402	1.702	128.7	0.02
	left 10mm	0.557	0.037	0.594		
	right 10mm	0.328	0.042	0.370		
	top 10mm	0.000	0.851	0.851		
	bottom 10mm	0.882	0.000	0.882		
	front 15mm	0.823	0.218	1.041		
	rear 15mm	0.732	0.195	0.927		
LTE TDD 38	left cheek	0.779	0.750	1.529		
	left tilted 15°	0.160	0.874	1.034		
	right cheek	0.292	0.741	1.033		
	right tilted 15°	0.295	0.739	1.034		
	front 10mm	0.814	0.403	1.217		
	rear 10mm	0.783	0.402	1.185		
	left 10mm	0.388	0.037	0.425		
	right 10mm	0.256	0.042	0.298		
	top 10mm	0.000	0.851	0.851		
	bottom 10mm	0.561	0.000	0.561		
	front 15mm	0.446	0.218	0.664		
	rear 15mm	0.453	0.195	0.648		

Table 68: SAR_{max} WWAN and **WLAN 2.4GHz**, Σ SAR evaluation, **SPLSR_i**

reported SAR WWAN and WLAN 2.4GHz , Combined fast SAR _{1g}				
Frequency band	Position	SAR _{max} /W/kg		Combined fast SAR _{1g}
		WWAN	WLAN	
GSM 850	left cheek	0.490	0.750	0.797
	left tilted 15°	0.186	0.874	0.930
	right cheek	0.587	0.741	0.808
	right tilted 15°	0.187	0.739	0.802
	front 10mm	1.014	0.403	1.050
	rear 10mm	0.875	0.402	0.838
	left 10mm	0.581	0.037	0.568
	right 10mm	0.436	0.042	0.400
	top 10mm	0.000	0.851	0.851
	bottom 10mm	0.531	0.000	0.531
	front 15mm	0.650	0.218	0.563
	rear 15mm	0.484	0.195	0.621
	GSM 1900	left cheek	0.273	0.750
left tilted 15°		0.138	0.874	0.979
right cheek		0.407	0.741	0.811
right tilted 15°		0.178	0.739	0.852
front 10mm		0.659	0.403	0.672
rear 10mm		0.573	0.402	0.567
left 10mm		0.228	0.037	0.216
right 10mm		0.432	0.042	0.407
top 10mm		0.000	0.851	0.851
bottom 10mm		0.638	0.000	0.638
front 15mm		0.304	0.218	0.371
rear 15mm		0.290	0.195	0.305
UMTS FDD II		left cheek	0.537	0.750
	left tilted 15°	0.147	0.874	0.990
	right cheek	0.501	0.741	0.821
	right tilted 15°	0.203	0.739	0.848
	front 10mm	1.277	0.403	1.280
	rear 10mm	0.984	0.402	0.872
	left 10mm	0.439	0.037	0.356
	right 10mm	0.325	0.042	0.322
	top 10mm	0.000	0.851	0.851
	bottom 10mm	0.870	0.000	0.870
	front 15mm	0.453	0.218	0.436
	rear 15mm	0.380	0.195	0.372
	UMTS FDD IV	left cheek	0.521	0.750
left tilted 15°		0.122	0.874	0.963
right cheek		0.440	0.741	0.804
right tilted 15°		0.109	0.739	0.818
front 10mm		1.198	0.403	1.160
rear 10mm		1.106	0.402	1.050
left 10mm		0.859	0.037	0.770
right 10mm		0.344	0.042	0.354
top 10mm		0.000	0.851	0.851
bottom 10mm		0.789	0.000	0.789
front 15mm		0.687	0.218	0.635
rear 15mm		0.785	0.195	0.568

reported SAR WWAN and WLAN 2.4GHz , Combined fast SAR _{1g}				
Frequency band	Position	SAR _{max} /W/kg		Combined fast SAR _{1g}
		WWAN	WLAN	
WCDMA FDD V	left cheek	0.442	0.750	0.788
	left tilted 15°	0.127	0.874	0.917
	right cheek	0.595	0.741	0.801
	right tilted 15°	0.142	0.739	0.774
	front 10mm	0.855	0.403	0.901
	rear 10mm	0.892	0.402	0.890
	left 10mm	0.669	0.037	0.642
	right 10mm	0.309	0.042	0.282
	top 10mm	0.000	0.851	0.851
	bottom 10mm	0.471	0.000	0.471
	front 15mm	0.596	0.218	0.562
	rear 15mm	0.548	0.195	0.531
	LTE FDD 2	left cheek	0.660	0.750
left tilted 15°		0.141	0.874	0.970
right cheek		0.364	0.741	0.801
right tilted 15°		0.203	0.739	0.820
front 10mm		1.034	0.403	0.965
rear 10mm		1.041	0.402	0.970
left 10mm		0.484	0.037	0.473
right 10mm		0.328	0.042	0.291
top 10mm		0.000	0.851	0.851
bottom 10mm		0.769	0.000	0.769
front 15mm		0.502	0.218	0.483
rear 15mm		0.394	0.195	0.376
LTE FDD 4		left cheek	0.580	0.750
	left tilted 15°	0.114	0.874	0.955
	right cheek	0.523	0.741	0.805
	right tilted 15°	0.092	0.739	0.822
	front 10mm	1.222	0.403	1.150
	rear 10mm	0.976	0.402	0.870
	left 10mm	0.611	0.037	0.628
	right 10mm	0.375	0.042	0.364
	top 10mm	0.000	0.851	0.851
	bottom 10mm	0.647	0.000	0.647
	front 15mm	0.618	0.218	0.592
	rear 15mm	0.592	0.195	0.578
	LTE FDD 5	left cheek	0.283	0.750
left tilted 15°		0.106	0.874	0.902
right cheek		0.489	0.741	0.805
right tilted 15°		0.117	0.739	0.776
front 10mm		0.747	0.403	0.773
rear 10mm		0.718	0.402	0.764
left 10mm		0.230	0.037	0.230
right 10mm		0.532	0.042	0.530
top 10mm		0.000	0.851	0.851
bottom 10mm		0.460	0.000	0.460
front 15mm		0.442	0.218	0.448
rear 15mm		0.512	0.195	0.502

reported SAR WWAN and WLAN 2.4GHz , Combined fast SAR _{1g}				
Frequency band	Position	SAR _{max} /W/kg		Combined fast SAR _{1g}
		WWAN	WLAN	
LTE FDD 7	left cheek	1.170	0.750	1.110
	left tilted 15°	0.263	0.874	0.965
	right cheek	0.555	0.741	0.835
	right tilted 15°	0.488	0.739	0.851
	front 10mm	1.250	0.403	1.210
	rear 10mm	1.300	0.402	1.190
	left 10mm	0.557	0.037	0.545
	right 10mm	0.328	0.042	0.336
	top 10mm	0.000	0.851	0.851
	bottom 10mm	0.882	0.000	0.882
	front 15mm	0.823	0.218	0.811
	rear 15mm	0.732	0.195	0.712
	LTE TDD 38	left cheek	0.779	0.750
left tilted 15°		0.160	0.874	0.912
right cheek		0.292	0.741	0.800
right tilted 15°		0.295	0.739	0.773
front 10mm		0.814	0.403	0.783
rear 10mm		0.783	0.402	0.745
left 10mm		0.388	0.037	0.388
right 10mm		0.256	0.042	0.268
top 10mm		0.000	0.851	0.851
bottom 10mm		0.561	0.000	0.561
front 15mm		0.446	0.218	0.434
rear 15mm		0.453	0.195	0.432

Table 69: SAR_{max} WWAN and **WLAN 2.4GHz**, Combined SAR evaluation (worst case see in Annex B.12: Combined Fast SAR page 166)

reported SAR WWAN and BT 2.4GHz , ΣSAR evaluation				
Frequency band	Position	SAR _{max} /W/kg		ΣSAR <1.6W/kg
		WWAN	BT	
GSM 850	left cheek	0.490	0.059	0.549
	left tilted 15°	0.186	0.059	0.245
	right cheek	0.587	0.059	0.646
	right tilted 15°	0.187	0.059	0.246
	front 10mm	1.014	0.029	1.043
	rear 10mm	0.875	0.029	0.904
	left 10mm	0.581	0.029	0.610
	right 10mm	0.436	0.029	0.465
	top 10mm	0.000	0.029	0.029
	bottom 10mm	0.531	0.029	0.560
	front 15mm	0.650	0.020	0.670
	rear 15mm	0.484	0.020	0.504
GSM 1900	left cheek	0.273	0.059	0.332
	left tilted 15°	0.138	0.059	0.197
	right cheek	0.407	0.059	0.466
	right tilted 15°	0.178	0.059	0.237
	front 10mm	0.659	0.029	0.688
	rear 10mm	0.573	0.029	0.602
	left 10mm	0.228	0.029	0.257
	right 10mm	0.432	0.029	0.461
	top 10mm	0.000	0.029	0.029
	bottom 10mm	0.638	0.029	0.667
	front 15mm	0.304	0.020	0.324
	rear 15mm	0.290	0.020	0.310
UMTS FDD II	left cheek	0.537	0.059	0.596
	left tilted 15°	0.147	0.059	0.206
	right cheek	0.501	0.059	0.560
	right tilted 15°	0.203	0.059	0.262
	front 10mm	1.277	0.029	1.306
	rear 10mm	0.984	0.029	1.013
	left 10mm	0.439	0.029	0.468
	right 10mm	0.325	0.029	0.354
	top 10mm	0.000	0.029	0.029
	bottom 10mm	0.870	0.029	0.899
	front 15mm	0.453	0.020	0.473
	rear 15mm	0.380	0.020	0.400
UMTS FDD IV	left cheek	0.521	0.059	0.580
	left tilted 15°	0.122	0.059	0.181
	right cheek	0.440	0.059	0.499
	right tilted 15°	0.109	0.059	0.168
	front 10mm	1.198	0.029	1.227
	rear 10mm	1.106	0.029	1.135
	left 10mm	0.859	0.029	0.888
	right 10mm	0.344	0.029	0.373
	top 10mm	0.000	0.029	0.029
	bottom 10mm	0.789	0.029	0.818
	front 15mm	0.687	0.020	0.707
	rear 15mm	0.785	0.020	0.805

reported SAR WWAN and BT 2.4GHZ , ΣSAR evaluation				
Frequency band	Position	SAR _{max} /W/kg		ΣSAR <1.6W/kg
		WWAN	BT	
WCDMA FDD V	left cheek	0.442	0.059	0.501
	left tilted 15°	0.127	0.059	0.186
	right cheek	0.595	0.059	0.654
	right tilted 15°	0.142	0.059	0.201
	front 10mm	0.855	0.029	0.884
	rear 10mm	0.892	0.029	0.921
	left 10mm	0.669	0.029	0.698
	right 10mm	0.309	0.029	0.338
	top 10mm	0.000	0.029	0.029
	bottom 10mm	0.471	0.029	0.500
	front 15mm	0.596	0.020	0.616
	rear 15mm	0.548	0.020	0.568
LTE FDD 2	left cheek	0.660	0.059	0.719
	left tilted 15°	0.141	0.059	0.200
	right cheek	0.364	0.059	0.423
	right tilted 15°	0.203	0.059	0.262
	front 10mm	1.034	0.029	1.063
	rear 10mm	1.041	0.029	1.070
	left 10mm	0.484	0.029	0.513
	right 10mm	0.328	0.029	0.357
	top 10mm	0.000	0.029	0.029
	bottom 10mm	0.769	0.029	0.798
	front 15mm	0.502	0.020	0.522
	rear 15mm	0.394	0.020	0.414
LTE FDD 4	left cheek	0.580	0.059	0.639
	left tilted 15°	0.114	0.059	0.173
	right cheek	0.523	0.059	0.582
	right tilted 15°	0.092	0.059	0.151
	front 10mm	1.222	0.029	1.251
	rear 10mm	0.976	0.029	1.005
	left 10mm	0.611	0.029	0.640
	right 10mm	0.375	0.029	0.404
	top 10mm	0.000	0.029	0.029
	bottom 10mm	0.647	0.029	0.676
	front 15mm	0.618	0.020	0.638
	rear 15mm	0.592	0.020	0.612
LTE FDD 5	left cheek	0.283	0.059	0.342
	left tilted 15°	0.106	0.059	0.165
	right cheek	0.489	0.059	0.548
	right tilted 15°	0.117	0.059	0.176
	front 10mm	0.747	0.029	0.776
	rear 10mm	0.718	0.029	0.747
	left 10mm	0.230	0.029	0.259
	right 10mm	0.532	0.029	0.561
	top 10mm	0.000	0.029	0.029
	bottom 10mm	0.460	0.029	0.489
	front 15mm	0.442	0.020	0.462
	rear 15mm	0.512	0.020	0.532

reported SAR WWAN and BT 2.4GHz , Σ SAR evaluation				
Frequency band	Position	SAR _{max} /W/kg		Σ SAR <1.6W/kg
		WWAN	BT	
LTE FDD 7	left cheek	1.170	0.059	1.229
	left tilted 15°	0.263	0.059	0.322
	right cheek	0.555	0.059	0.614
	right tilted 15°	0.488	0.059	0.547
	front 10mm	1.250	0.029	1.279
	rear 10mm	1.300	0.029	1.329
	left 10mm	0.557	0.029	0.586
	right 10mm	0.328	0.029	0.357
	top 10mm	0.000	0.029	0.029
	bottom 10mm	0.882	0.029	0.911
	front 15mm	0.823	0.020	0.843
	rear 15mm	0.732	0.020	0.752
LTE TDD 38	left cheek	0.779	0.059	0.838
	left tilted 15°	0.160	0.059	0.219
	right cheek	0.292	0.059	0.351
	right tilted 15°	0.295	0.059	0.354
	front 10mm	0.814	0.029	0.843
	rear 10mm	0.783	0.029	0.812
	left 10mm	0.388	0.029	0.417
	right 10mm	0.256	0.029	0.285
	top 10mm	0.000	0.029	0.029
	bottom 10mm	0.561	0.029	0.590
	front 15mm	0.446	0.020	0.466
	rear 15mm	0.453	0.020	0.473

Table 70: SAR_{max} WWAN and **Bluetooth 2450MHz**, Σ SAR evaluation

Minimum antenna separation distance between 1st MAIN antenna and Bluetooth antenna – **80 mm**
 2nd MAIN antenna and Bluetooth antenna – **92 mm**

Conclusion:

Σ SAR > 1.6 W/kg, but SAR-to-(peak-locations spacing) **ratio (SPLSR_i)** is less than **0.04** therefore simultaneous transmissions SAR measurement with the enlarged zoom scan measurement and volume scan post-processing procedures is **not** required.

7.2.4 SAR peak location separation

UMTS FDD II + WLAN2450 front 10mm hotspot:

Find distance of maxima	
<input type="checkbox"/> Maxima and position w.r.t. Grid Reference Point	associated 1g averages
<input type="checkbox"/> Zoom Scan (D:\Projekte2015\1-9303-2-2\2450\FCC-WLAN2450 hotspot.da52:0/Front High 10mm)	
Max. 1 at (6.85, -0.75, 0.44) cm	0.34 W/kg
<input type="checkbox"/> Zoom Scan (W:\Projekte2015\1-9303-2-2\GSM1900\FCC-UMTS FDD II hotspot.da52:1/Front Low 10mm)	
Max. 2 at (-7.30, 2.45, 0.62) cm	1.22 W/kg
<input type="checkbox"/> Distances and Separation Ratios	
Max. 1 - Max. 2	Distance [cm]: 14.51 / Separation ratio [W/kg/cm]: 0.11

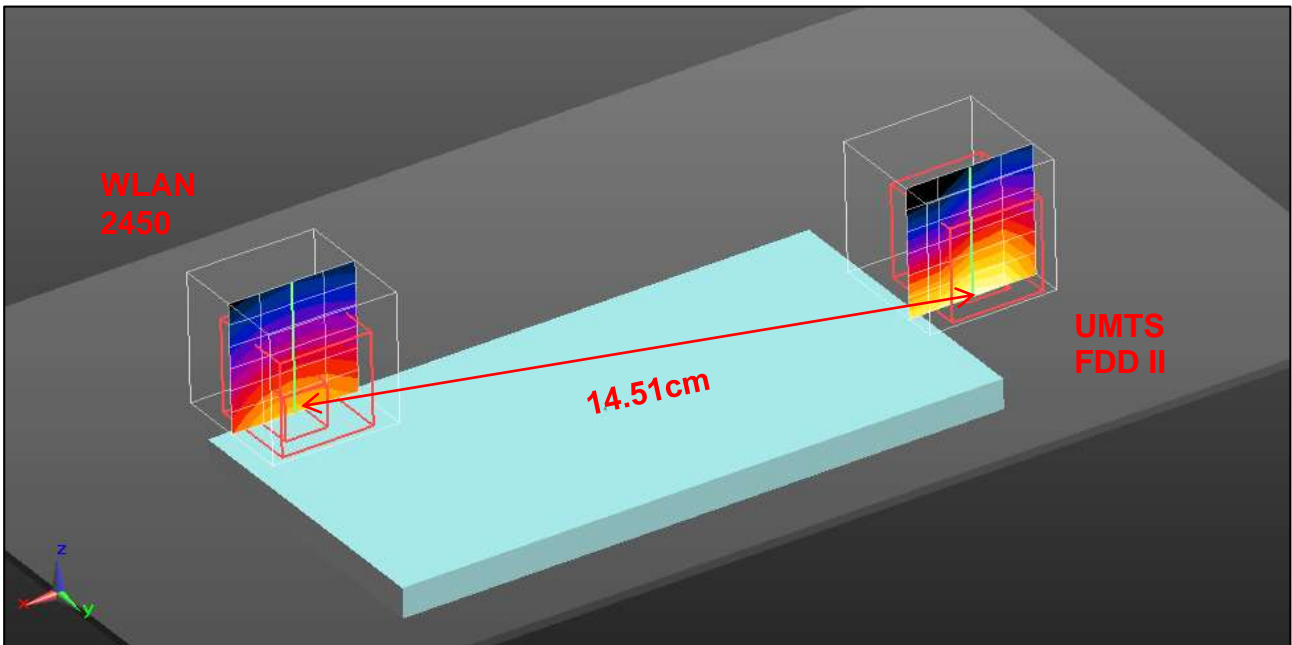

UMTS FDD IV + WLAN2450 front 10mm hotspot:

Find distance of maxima	
<input type="checkbox"/> Maxima and position w.r.t. Grid Reference Point	associated 1g averages
<input type="checkbox"/> Zoom Scan (D:\Projekte2015\1-9303-2-2\1750\FCC-UMTS FDD IV hotspot.da52:1/Front Low 10mm)	
Max. 1 at (-7.00, 3.05, 0.63) cm	1.02 W/kg
<input type="checkbox"/> Zoom Scan (D:\Projekte2015\1-9303-2-2\2450\FCC-WLAN2450 hotspot.da52:0/Front High 10mm)	
Max. 2 at (6.85, -0.75, 0.44) cm	0.34 W/kg
<input type="checkbox"/> Distances and Separation Ratios	
Max. 1 - Max. 2	Distance [cm]: 14.37 / Separation ratio [W/kg/cm]: 0.09

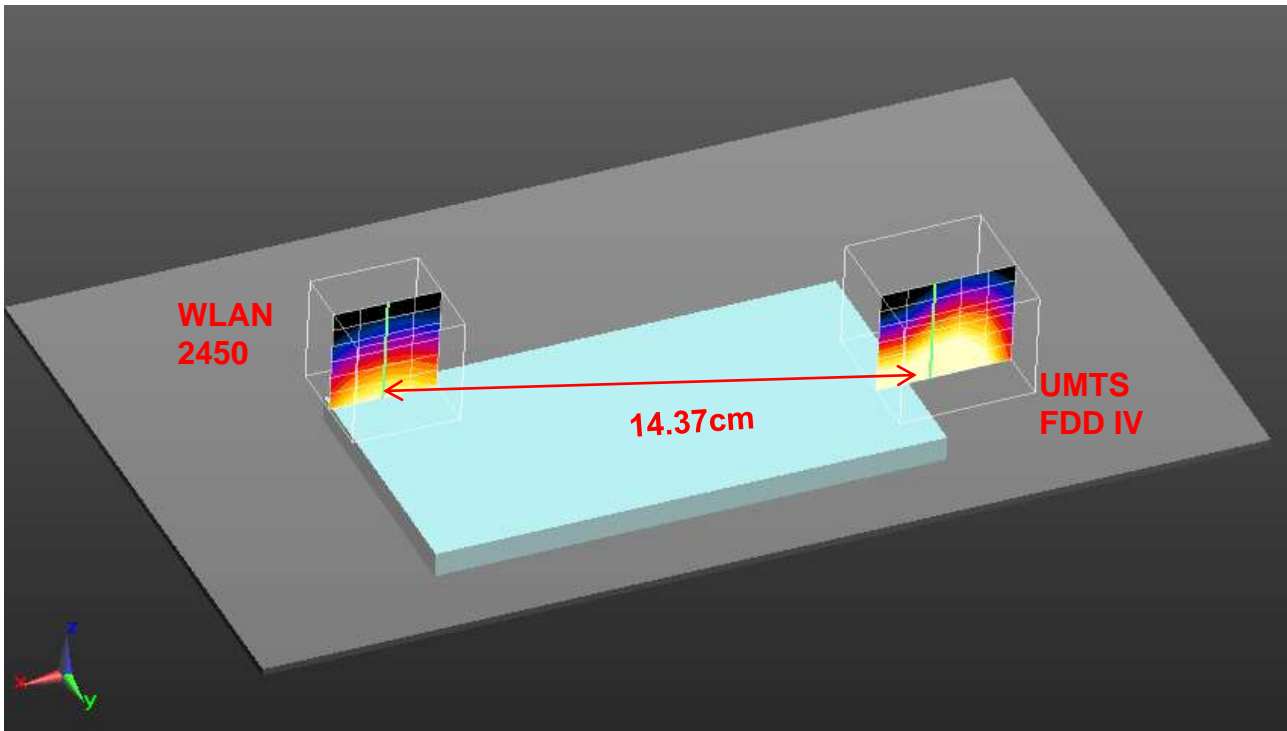

LTE FDD 4 + WLAN2450 front 10mm hotspot:

Find distance of maxima	
<input type="checkbox"/> Maxima and position w.r.t. Grid Reference Point associated 1g averages	
<input type="checkbox"/> Zoom Scan (D:\Projekte2015\1-9303-2-2\2450\FCC-WLAN2450 hotspot.da52:0/Front High 10mm)	
Max. 1 at (6.85, -0.75, 0.44) cm	0.34 W/kg
<input type="checkbox"/> Zoom Scan (X:\SAR-3\Projekte2015\1-9303-2-2\FCC-LTE FDD 4 hotspot.da52:3/Front Middle 10mm - 0 RB offset WC)	
Max. 2 at (-7.30, 2.60, 0.62) cm	1.14 W/kg
<input type="checkbox"/> Distances and Separation Ratios	
Max. 1 - Max. 2	Distance [cm]: 14.55 / Separation ratio [W/kg/cm]: 0.10

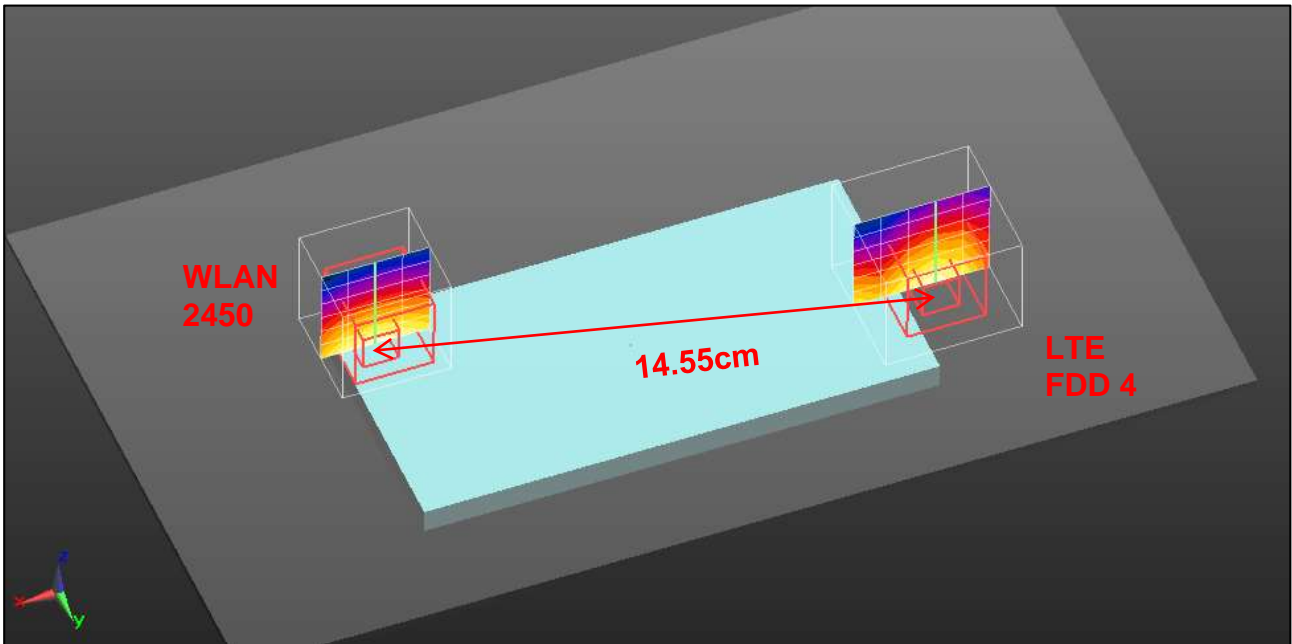

LTE FDD 7 + WLAN2450 left cheek:

Find distance of maxima	
<input type="checkbox"/> Maxima and position w.r.t. Grid Reference Point associated 1g averages	
<input type="checkbox"/> Zoom Scan (W:\Projekte2015\1-9303-2-2\2450 - 2600\IEEE1528-WLAN2450 head.da53:0/Touch Position - High)	
Max. 1 at (-0.31, 0.29, 0.01) cm	0.64 W/kg
<input type="checkbox"/> Zoom Scan (W:\Projekte2015\1-9303-2-2\2450 - 2600\IEEE1528-EN62209-LTE FDD 7 head.da53:4/Touch Position - Middle - ORB offset worst case)	
Max. 2 at (4.65, -6.28, -0.16) cm	1.17 W/kg
<input type="checkbox"/> Distances and Separation Ratios	
Max. 1 - Max. 2	Distance [cm]: 8.23 / Separation ratio [W/kg/cm]: 0.22

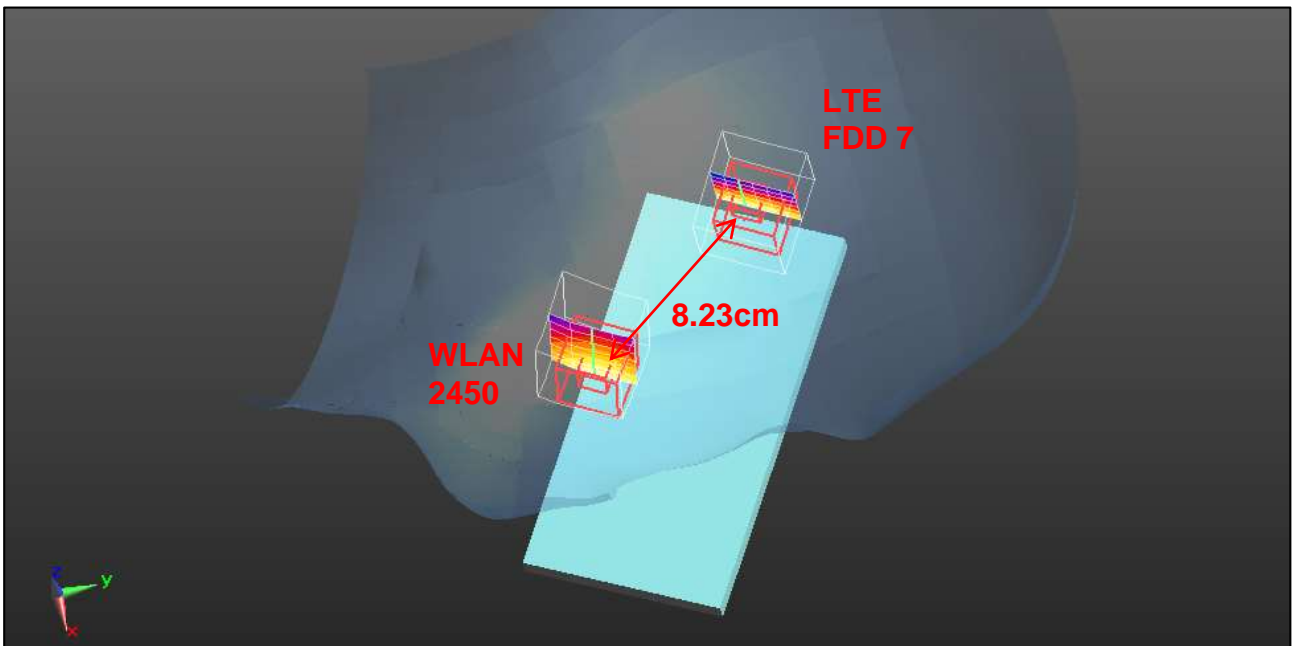

LTE FDD 7 + WLAN2450 front 10mm hotspot:

Find distance of maxima	
<input type="checkbox"/> Maxima and position w.r.t. Grid Reference Point	associated 1g averages
<input type="checkbox"/> Zoom Scan (D:\Projekte2015\1-9303-2-2\2450 - 2600\FCC-LTE FDD 7 hotspot.da52:3\Front Middle 10mm - ORB offset)	
Max. 1 at (-5.10, 2.05, 0.59) cm	1.25 W/kg
<input type="checkbox"/> Zoom Scan (D:\Projekte2015\1-9303-2-2\2450\FCC-WLAN2450 hotspot.da52:0\Front High 10mm)	
Max. 2 at (6.85, -0.75, 0.44) cm	0.34 W/kg
<input type="checkbox"/> Distances and Separation Ratios	
Max. 1 - Max. 2	Distance [cm]: 12.27 / Separation ratio [W/kg/cm]: 0.13

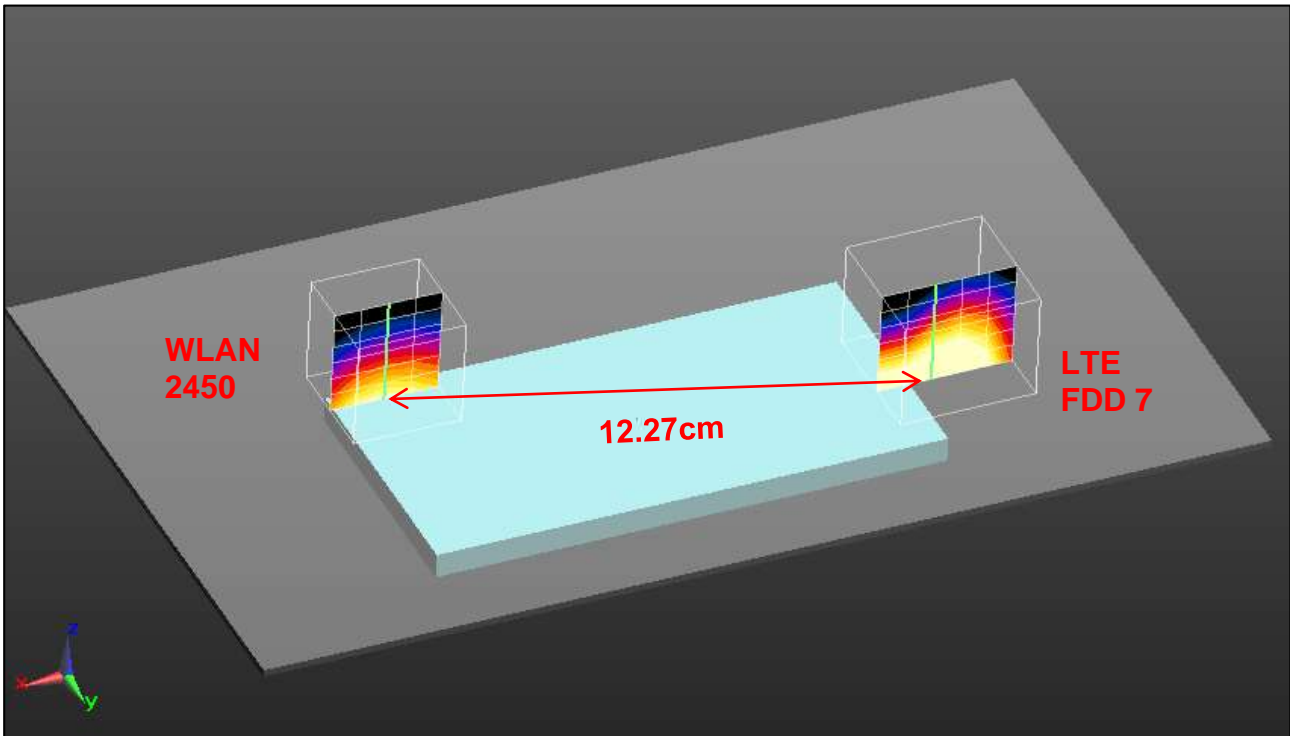

LTE FDD 7 + WLAN2450 rear 10mm hotspot:

Find distance of maxima	
<input type="checkbox"/> Maxima and position w.r.t. Grid Reference Point associated 1g averages	
<input type="checkbox"/> Zoom Scan (D:\Projekte2015\1-9303-2-2\2450\FCC-WLAN2450 hotspot.da52:0/Rear High 10mm)	
Max. 1 at (7.35, 0.75, 0.44) cm	0.34 W/kg
<input type="checkbox"/> Zoom Scan (D:\Projekte2015\1-9303-2-2\2450 - 2600\FCC-LTE FDD 7 hotspot.da52:3/Rear Middle 10mm - ORB offset)	
Max. 2 at (-5.15, -2.30, 0.59) cm	1.30 W/kg
<input type="checkbox"/> Distances and Separation Ratios	
Max. 1 - Max. 2	Distance [cm]: 12.87 / Separation ratio [W/kg/cm]: 0.13

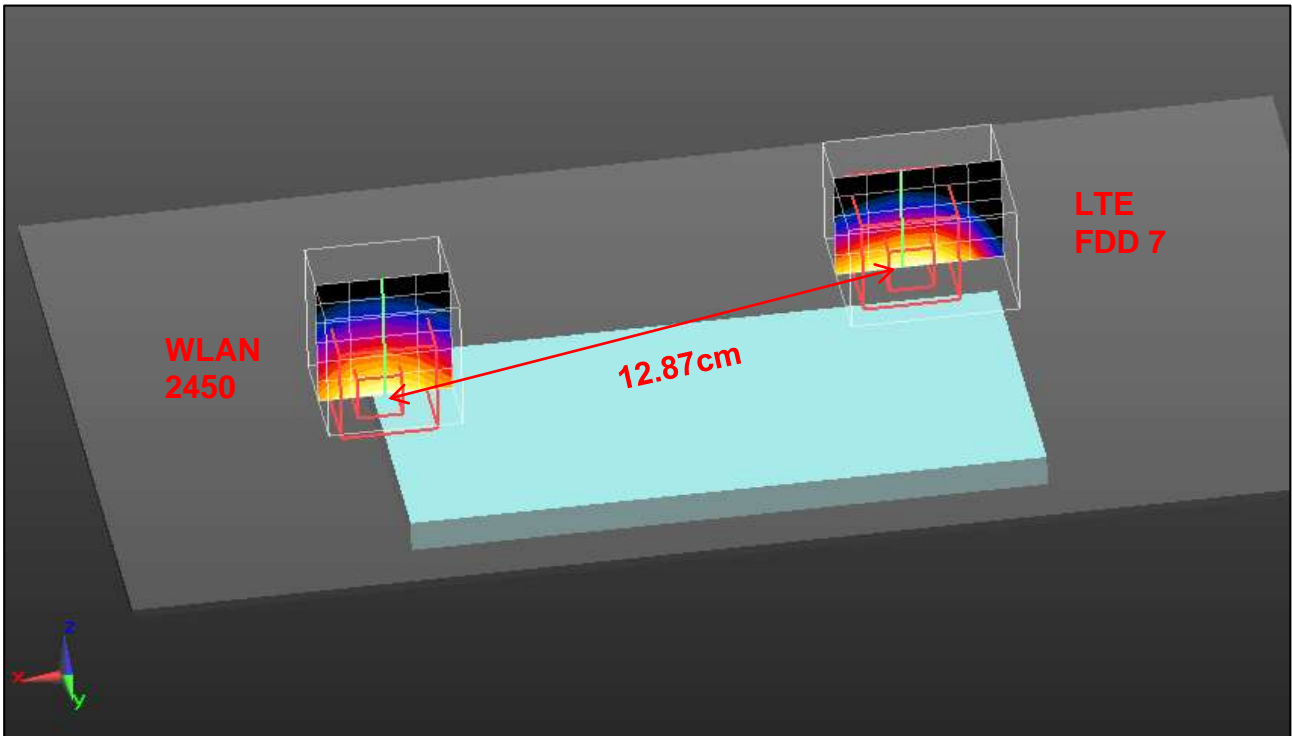

8 Test equipment and ancillaries used for tests

To simplify the identification of the test equipment and/or ancillaries which were used, the reporting of the relevant test cases only refer to the test item number as specified in the table below.

Equipment	Type	Manufacturer	Serial No.	Last Calibration	Frequency (months)
Dosimetric E-Field Probe	ES3DV3	Schmid & Partner Engineering AG	3320	February 25, 2015	12
Dosimetric E-Field Probe	ES3DV3	Schmid & Partner Engineering AG	3326	August 12, 2015	12
Dosimetric E-Field Probe	EX3DV4	Schmid & Partner Engineering AG	3944	August 14, 2015	12
835 MHz System Validation Dipole	D835V2	Schmid & Partner Engineering AG	4d153	May 12, 2015	24
1750 MHz System Validation Dipole	D1750V2	Schmid & Partner Engineering AG	1093	May 13, 2015	24
1900 MHz System Validation Dipole	D1900V2	Schmid & Partner Engineering AG	5d009	May 13, 2015	24
2450 MHz System Validation Dipole	D2450V2	Schmid & Partner Engineering AG	710	August 11, 2014	24
2600 MHz System Validation Dipole	D2600V2	Schmid & Partner Engineering AG	1040	August 11, 2015	24
Data acquisition electronics	DAE3V1	Schmid & Partner Engineering AG	413	January 15, 2015	12
Data acquisition electronics	DAE3V1	Schmid & Partner Engineering AG	477	May 22, 2015	12
Data acquisition electronics	DAE4	Schmid & Partner Engineering AG	1387	August 12, 2015	12
Software	DASY52 52.8.7	Schmid & Partner Engineering AG	---	N/A	--
Triple Modular Flat Phantom V5.1	QD 000 P51 C	Schmid & Partner Engineering AG	1154	N/A	--
SAM Twin Phantom V5.0	QD 000 P40 C	Schmid & Partner Engineering AG	1813	N/A	--
Universal Radio Communication Tester	CMU 200	Rohde & Schwarz	106826	February 11, 2015	24
Universal Radio Communication Tester	CMW500	Rohde & Schwarz	102375	January 28, 2015	24
Network Analyser 300 kHz to 6 GHz	8753ES	Hewlett Packard)*	US39174436	January 29, 2015	24
Dielectric Probe Kit	85070C	Hewlett Packard	US99360146	N/A	12
Signal Generator	8671B	Hewlett Packard	2823A00656	January 29, 2015	24
Amplifier	25S1G4 (25 Watt)	Amplifier Reasearch	20452	N/A	--
Power Meter	NRP	Rohde & Schwarz	101367	January 21, 2015	24
Power Meter Sensor	NRP Z22	Rohde & Schwarz	100227	January 21, 2015	12
Power Meter Sensor	NRP Z22	Rohde & Schwarz	100234	January 21, 2015	12
Directional Coupler	778D	Hewlett Packard	19171	January 21, 2015	12

)* : Network analyzer probe calibration against air, distilled water and a shorting block performed before measuring liquid parameters.

9 Observations

No observations exceeding those reported with the single test cases have been made.

Annex A: System performance check

Date/Time: 11.12.2015 11:23:08

SystemPerformanceCheck-D835 head 2015-12-11

DUT: Dipole 835 MHz; Type: D835V2; Serial: 4d153

Communication System: UID 0, CW (0); Communication System Band: D835 (835.0 MHz); Frequency: 835 MHz; Communication System PAR: 0 dB; PMF: 1

Medium parameters used: $f = 835$ MHz; $\sigma = 0.922$ S/m; $\epsilon_r = 42.534$; $\rho = 1000$ kg/m³

Phantom section: Flat Section

Measurement Standard: DASY5

DASY5 Configuration:

- Probe: ES3DV3 - SN3320; ConvF(6.14, 6.14, 6.14); Calibrated: 25.02.2015;
- Sensor-Surface: 3mm (Mechanical Surface Detection), $z = 2.0, 32.0$
- Electronics: DAE3 Sn413; Calibrated: 15.01.2015
- Phantom: SAM front; Type: QD000P40CC; Serial: TP-1041
- DASY52 52.8.7(1137); SEMCAD X 14.6.10(7164)

HSL835/d=15mm, Pin=100 mW, dist=3.0mm/Area Scan (51x51x1): Interpolated grid:

$dx=1.500$ mm, $dy=1.500$ mm

Maximum value of SAR (interpolated) = 1.11 W/kg

HSL835/d=15mm, Pin=100 mW, dist=3.0mm/Zoom Scan (7x7x7)/Cube 0:

Measurement grid: $dx=5$ mm, $dy=5$ mm, $dz=5$ mm

Reference Value = 36.288 V/m; Power Drift = -0.04 dB

Peak SAR (extrapolated) = 1.44 W/kg

SAR(1 g) = 0.974 W/kg; SAR(10 g) = 0.638 W/kg

Maximum value of SAR (measured) = 1.14 W/kg

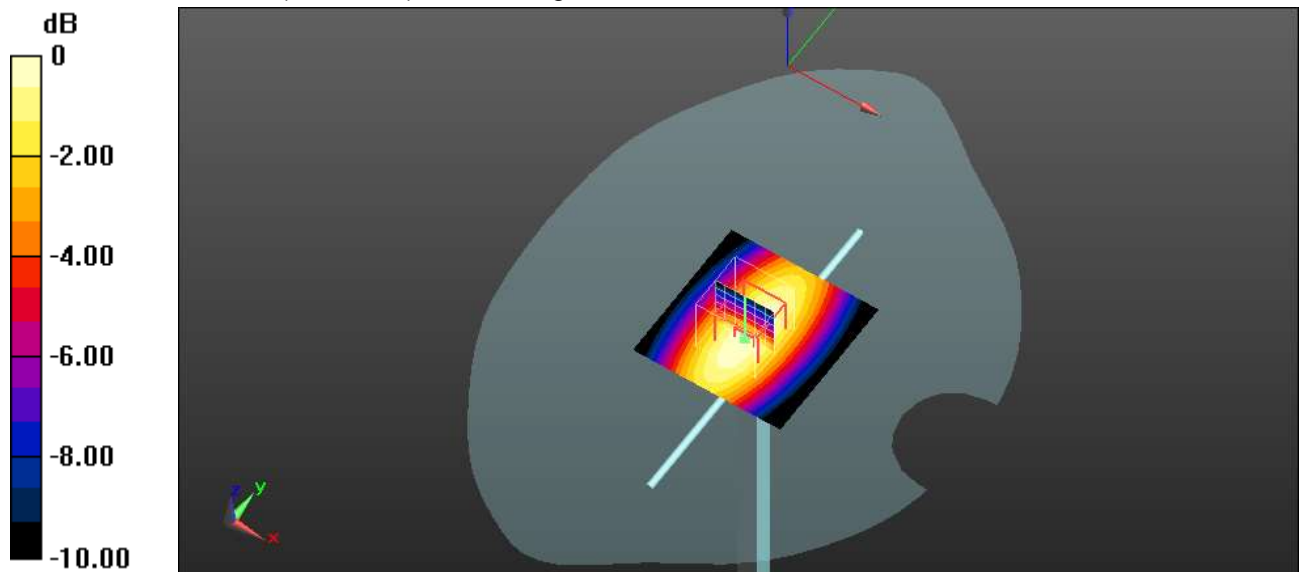

0 dB = 1.14 W/kg = 0.57 dBW/kg

Additional information:

ambient temperature: 22.9°C; liquid temperature: 22.1°C

Date/Time: 12.12.2015 10:01:42

SystemPerformanceCheck-D835 head 2015-12-12

DUT: Dipole 835 MHz; Type: D835V2; Serial: 4d153

Communication System: UID 0, CW (0); Communication System Band: D835 (835.0 MHz); Frequency: 835 MHz; Communication System PAR: 0 dB; PMF: 1

Medium parameters used: $f = 835$ MHz; $\sigma = 0.922$ S/m; $\epsilon_r = 42.534$; $\rho = 1000$ kg/m³

Phantom section: Flat Section

Measurement Standard: DASY5

DASY5 Configuration:

- Probe: ES3DV3 - SN3320; ConvF(6.14, 6.14, 6.14); Calibrated: 25.02.2015;
- Sensor-Surface: 3mm (Mechanical Surface Detection), $z = 2.0, 32.0$
- Electronics: DAE3 Sn413; Calibrated: 15.01.2015
- Phantom: SAM front; Type: QD000P40CC; Serial: TP-1041
- DASY52 52.8.7(1137); SEMCAD X 14.6.10(7164)

HSL835/d=15mm, Pin=100 mW, dist=3.0mm/Area Scan (51x51x1): Interpolated grid:

$dx=1.500$ mm, $dy=1.500$ mm

Maximum value of SAR (interpolated) = 1.14 W/kg

HSL835/d=15mm, Pin=100 mW, dist=3.0mm/Zoom Scan (7x7x7)/Cube 0:

Measurement grid: $dx=5$ mm, $dy=5$ mm, $dz=5$ mm

Reference Value = 37.256 V/m; Power Drift = -0.17 dB

Peak SAR (extrapolated) = 1.45 W/kg

SAR(1 g) = 0.981 W/kg; SAR(10 g) = 0.645 W/kg

Maximum value of SAR (measured) = 1.15 W/kg

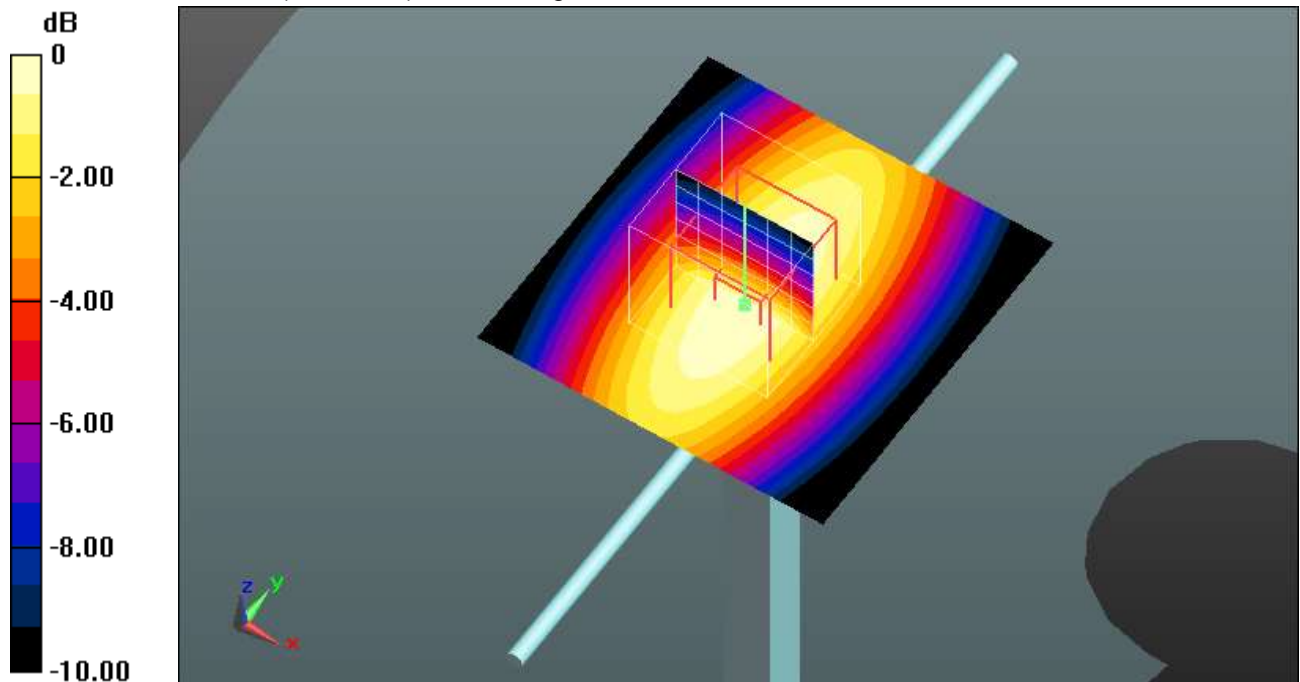

0 dB = 1.15 W/kg = 0.61 dBW/kg

Additional information:

ambient temperature: 22.4°C; liquid temperature: 21.7°C

SystemPerformanceCheck-D835 head 2015-12-16

DUT: Dipole 835 MHz; Type: D835V2; Serial: 4d153

Communication System: UID 0, CW (0); Communication System Band: D835 (835.0 MHz); Frequency: 835 MHz; Communication System PAR: 0 dB; PMF: 1

Medium parameters used: $f = 835$ MHz; $\sigma = 0.912$ S/m; $\epsilon_r = 41.554$; $\rho = 1000$ kg/m³

Phantom section: Flat Section

Measurement Standard: DASYS

DASY5 Configuration:

- Probe: ES3DV3 - SN3320; ConvF(6.14, 6.14, 6.14); Calibrated: 25.02.2015;
- Sensor-Surface: 3mm (Mechanical Surface Detection), $z = 2.0, 32.0$
- Electronics: DAE3 Sn413; Calibrated: 15.01.2015
- Phantom: SAM front; Type: QD000P40CC; Serial: TP-1041
- DASY52 52.8.7(1137); SEMCAD X 14.6.10(7164)

HSL835/d=15mm, Pin=100 mW, dist=3.0mm/Area Scan (51x51x1): Interpolated grid:

$dx=1.500$ mm, $dy=1.500$ mm

Maximum value of SAR (interpolated) = 1.19 W/kg

HSL835/d=15mm, Pin=100 mW, dist=3.0mm/Zoom Scan (7x7x7)/Cube 0:

Measurement grid: $dx=5$ mm, $dy=5$ mm, $dz=5$ mm

Reference Value = 36.999 V/m; Power Drift = -0.12 dB

Peak SAR (extrapolated) = 1.41 W/kg

SAR(1 g) = 0.951 W/kg; SAR(10 g) = 0.623 W/kg

Maximum value of SAR (measured) = 1.11 W/kg

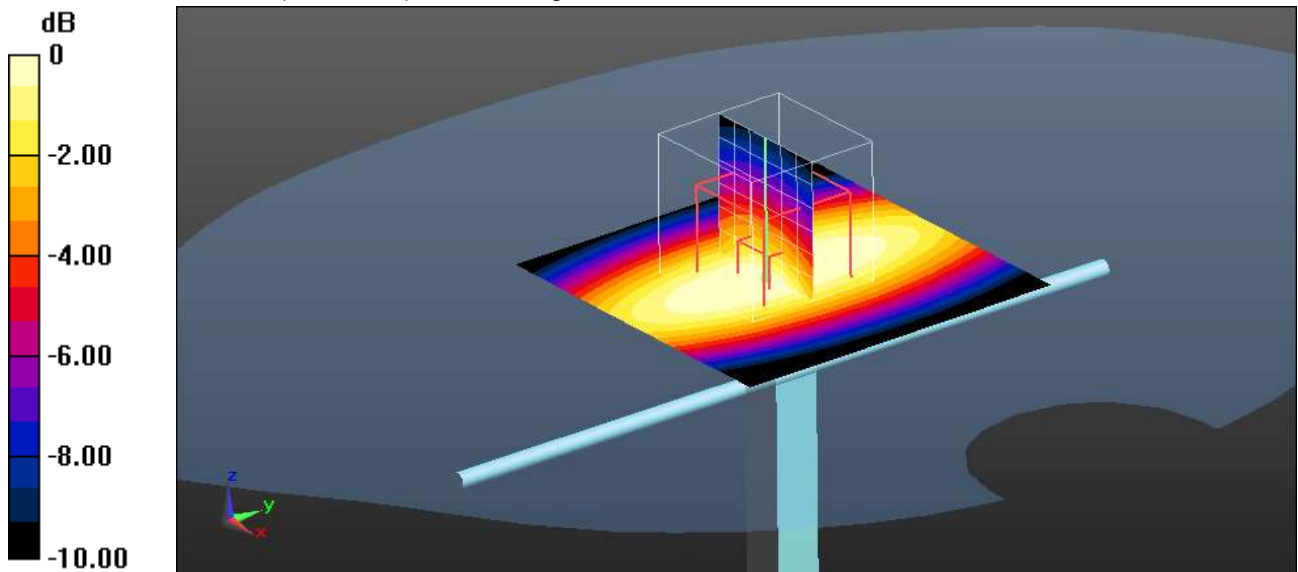

0 dB = 1.11 W/kg = 0.45 dBW/kg

Additional information:

ambient temperature: 22.9°C; liquid temperature: 22.1°C

Date/Time: 19.12.2015 08:35:09

SystemPerformanceCheck-D835 body 2015-12-19

DUT: Dipole 835 MHz; Type: D835V2; Serial: 4d153

Communication System: UID 0, CW (0); Communication System Band: D835 (835.0 MHz); Frequency: 835 MHz; Communication System PAR: 0 dB; PMF: 1

Medium parameters used: $f = 835$ MHz; $\sigma = 1.002$ S/m; $\epsilon_r = 54.705$; $\rho = 1000$ kg/m³

Phantom section: Center Section

Measurement Standard: DASY5

DASY5 Configuration:

- Probe: ES3DV3 - SN3320; ConvF(6.11, 6.11, 6.11); Calibrated: 25.02.2015;
- Sensor-Surface: 3mm (Mechanical Surface Detection (Locations From Previous Scan Used)), Sensor-Surface: 3mm (Mechanical Surface Detection), $z = 2.0, 32.0$
- Electronics: DAE3 Sn413; Calibrated: 15.01.2015
- Phantom: Triple Flat Phantom 5.1C; Type: QD 000 P51 CA; Serial: 1154
- DASY52 52.8.7(1137); SEMCAD X 14.6.10(7164)

MSL835/d=15mm, Pin=100 mW, dist=3.0mm/Area Scan (51x51x1): Interpolated
grid: $dx=1.500$ mm, $dy=1.500$ mm
Maximum value of SAR (interpolated) = 1.11 W/kg

MSL835/d=15mm, Pin=100 mW, dist=3.0mm/Zoom Scan (7x7x7)/Cube 0:

Measurement grid: $dx=5$ mm, $dy=5$ mm, $dz=5$ mm

Reference Value = 32.612 V/m; Power Drift = 0.05 dB

Peak SAR (extrapolated) = 1.41 W/kg

SAR(1 g) = 0.972 W/kg; SAR(10 g) = 0.642 W/kg

Maximum value of SAR (measured) = 1.13 W/kg

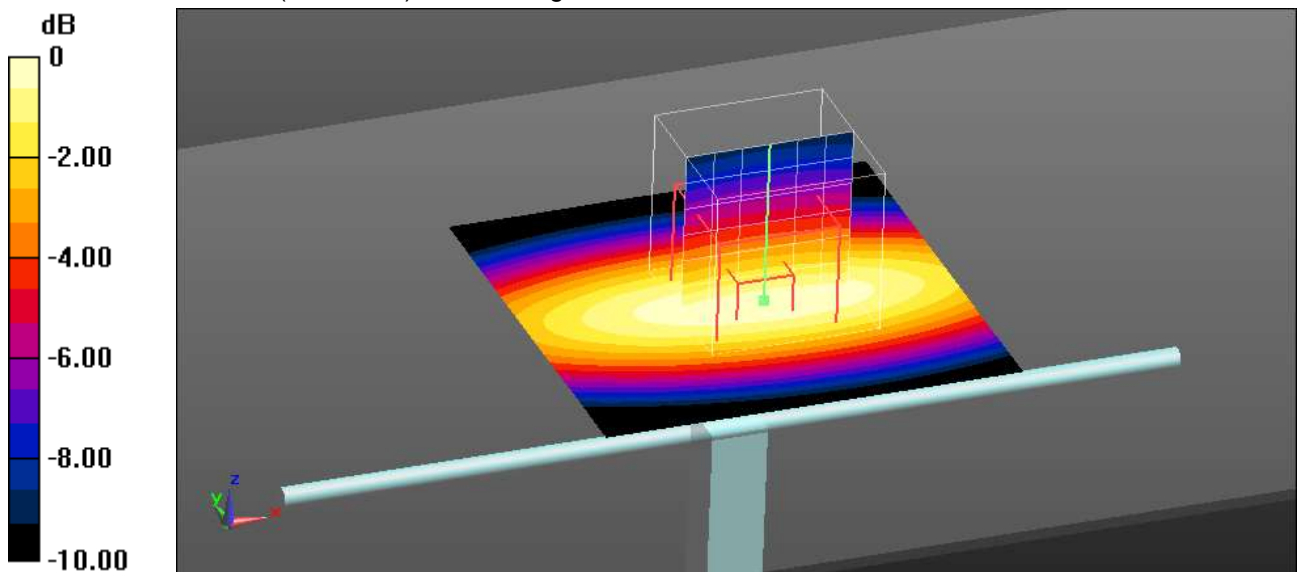

0 dB = 1.13 W/kg = 0.53 dBW/kg

Additional information:

ambient temperature: 23.9°C; liquid temperature: 22.3°C

SystemPerformanceCheck-D835 body 2015-12-22

DUT: Dipole 835 MHz; Type: D835V2; Serial: 4d153

Communication System: UID 0, CW (0); Communication System Band: D835 (835.0 MHz); Frequency: 835 MHz; Communication System PAR: 0 dB; PMF: 1

Medium parameters used (extrapolated): $f = 835$ MHz; $\sigma = 0.967$ S/m; $\epsilon_r = 38.859$; $\rho = 1000$ kg/m³

Phantom section: Center Section

Measurement Standard: DASy5

DASy5 Configuration:

- Probe: ES3DV3 - SN3320; ConvF(6.14, 6.14, 6.14); Calibrated: 25.02.2015;
- Sensor-Surface: 3mm (Mechanical Surface Detection), $z = 2.0, 32.0$
- Electronics: DAE3 Sn413; Calibrated: 15.01.2015
- Phantom: Triple Flat Phantom 5.1C; Type: QD 000 P51 CA; Serial: 1154
- DASy52 52.8.7(1137); SEMCAD X 14.6.10(7164)

MSL835/d=15mm, Pin=100 mW, dist=3.0mm/Area Scan (51x51x1): Interpolated

grid: $dx=1.500$ mm, $dy=1.500$ mm

Maximum value of SAR (interpolated) = 1.11 W/kg

MSL835/d=15mm, Pin=100 mW, dist=3.0mm/Zoom Scan (7x7x7)/Cube 0:

Measurement grid: $dx=5$ mm, $dy=5$ mm, $dz=5$ mm

Reference Value = 33.307 V/m; Power Drift = -0.10 dB

Peak SAR (extrapolated) = 1.38 W/kg

SAR(1 g) = 0.951 W/kg; SAR(10 g) = 0.630 W/kg

Maximum value of SAR (measured) = 1.10 W/kg

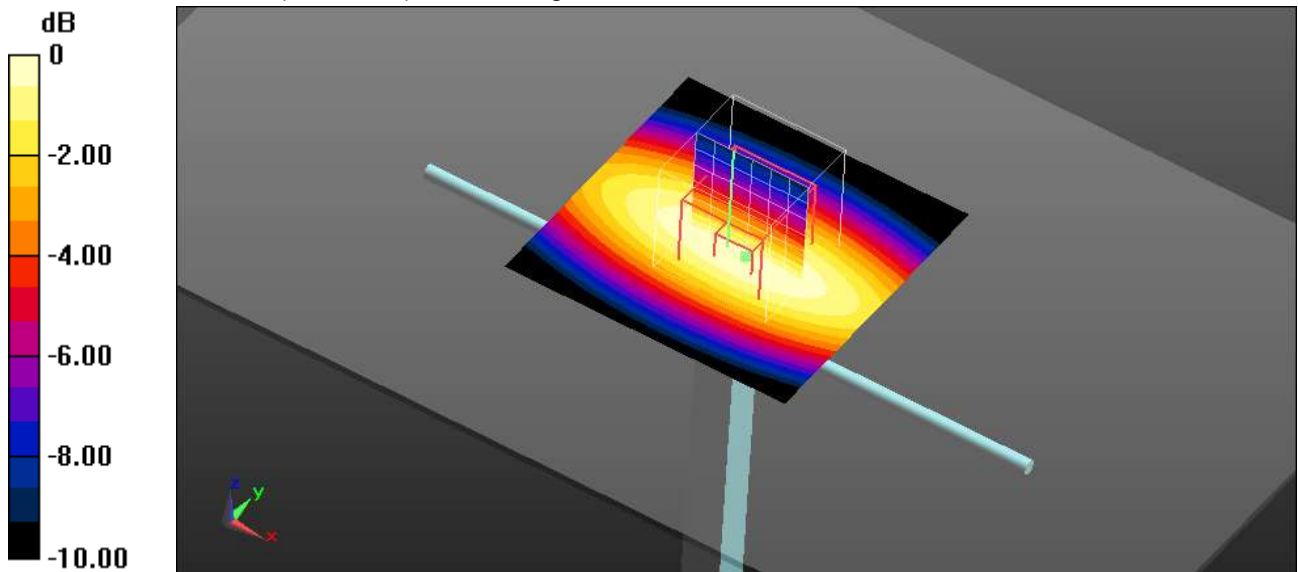

0 dB = 1.10 W/kg = 0.41 dBW/kg

Additional information:

ambient temperature: 23.0°C; liquid temperature: 22.5°C

SystemPerformanceCheck-D835 body 2015-12-23

DUT: Dipole 835 MHz; Type: D835V2; Serial: 4d153

Communication System: UID 0, CW (0); Communication System Band: D835 (835.0 MHz); Frequency: 835 MHz; Communication System PAR: 0 dB; PMF: 1

Medium parameters used: $f = 835$ MHz; $\sigma = 0.976$ S/m; $\epsilon_r = 53.461$; $\rho = 1000$ kg/m³

Phantom section: Center Section

Measurement Standard: DASY5

DASY5 Configuration:

- Probe: ES3DV3 - SN3320; ConvF(6.11, 6.11, 6.11); Calibrated: 25.02.2015;
- Sensor-Surface: 3mm (Mechanical Surface Detection), $z = 2.0, 32.0$
- Electronics: DAE3 Sn413; Calibrated: 15.01.2015
- Phantom: Triple Flat Phantom 5.1C; Type: QD 000 P51 CA; Serial: 1154
- DASY52 52.8.7(1137); SEMCAD X 14.6.10(7164)

MSL835/d=15mm, Pin=100 mW, dist=3.0mm/Area Scan (51x51x1): Interpolated

grid: $dx=1.500$ mm, $dy=1.500$ mm

Maximum value of SAR (interpolated) = 1.13 W/kg

MSL835/d=15mm, Pin=100 mW, dist=3.0mm/Zoom Scan (7x7x7)/Cube 0:

Measurement grid: $dx=5$ mm, $dy=5$ mm, $dz=5$ mm

Reference Value = 33.689 V/m; Power Drift = -0.04 dB

Peak SAR (extrapolated) = 1.45 W/kg

SAR(1 g) = 0.990 W/kg; SAR(10 g) = 0.653 W/kg

Maximum value of SAR (measured) = 1.16 W/kg

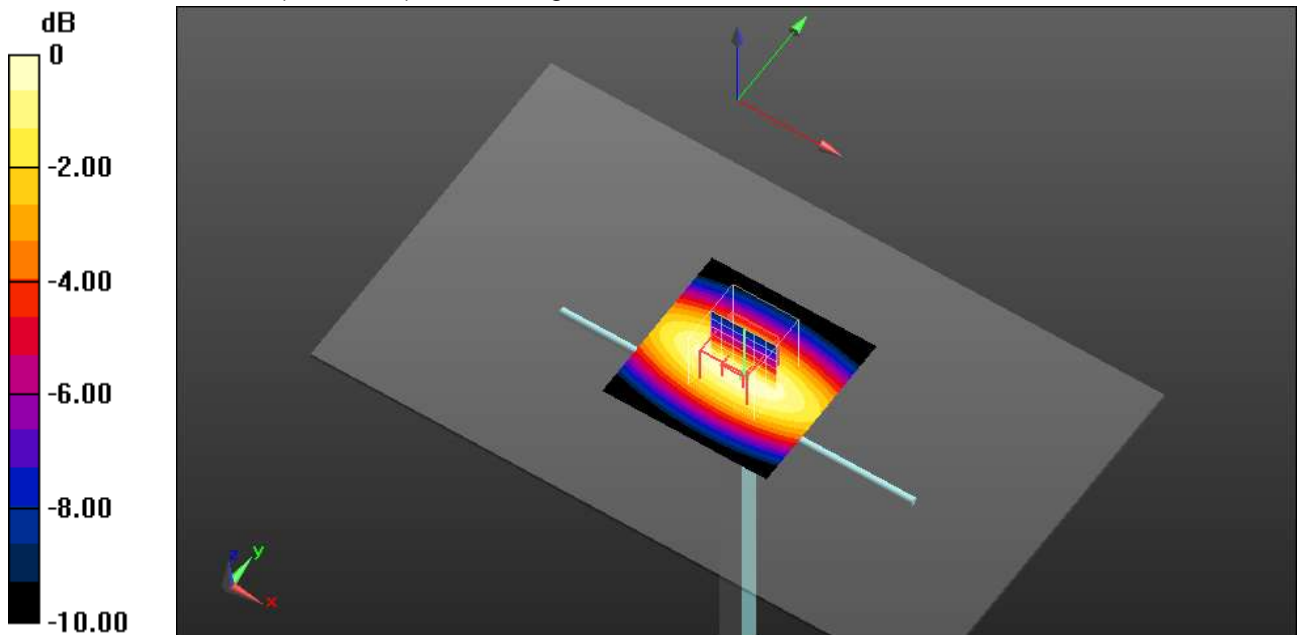

0 dB = 1.16 W/kg = 0.64 dBW/kg

Additional information:

ambient temperature: 23.5°C; liquid temperature: 22.7°C

SystemPerformanceCheck-D1750 2015-12-15

DUT: Dipole 1750 MHz; Type: D1750V2; Serial: 1093

Communication System: UID 0, CW (0); Communication System Band: D1750 (1750.0 MHz); Frequency: 1750 MHz; Communication System PAR: 0 dB; PMF: 1

Medium parameters used: $f = 1750$ MHz; $\sigma = 1.339$ S/m; $\epsilon_r = 39.19$; $\rho = 1000$ kg/m³

Phantom section: Flat Section

Measurement Standard: DASYS

DASY5 Configuration:

- Probe: ES3DV3 - SN3326; ConvF(5.18, 5.18, 5.18); Calibrated: 8/12/2015;
- Sensor-Surface: 3mm (Mechanical Surface Detection), $z = 2.0, 32.0$
- Electronics: DAE4 Sn1387; Calibrated: 8/12/2015
- Phantom: SAM front; Type: QD000P40CC; Serial: TP:1041
- DASY52 52.8.8(1222); SEMCAD X 14.6.10(7331)

HSL1750/d=15mm, Pin=100 mW, dist=3.0mm/Area Scan (51x51x1): Interpolated

grid: $dx=1.500$ mm, $dy=1.500$ mm

Maximum value of SAR (interpolated) = 5.12 W/kg

HSL1750/d=15mm, Pin=100 mW, dist=3.0mm/Zoom Scan (7x7x7)/Cube 0:

Measurement grid: $dx=5$ mm, $dy=5$ mm, $dz=5$ mm

Reference Value = 61.86 V/m; Power Drift = -0.12 dB

Peak SAR (extrapolated) = 6.73 W/kg

SAR(1 g) = 3.73 W/kg; SAR(10 g) = 1.98 W/kg

Maximum value of SAR (measured) = 4.72 W/kg

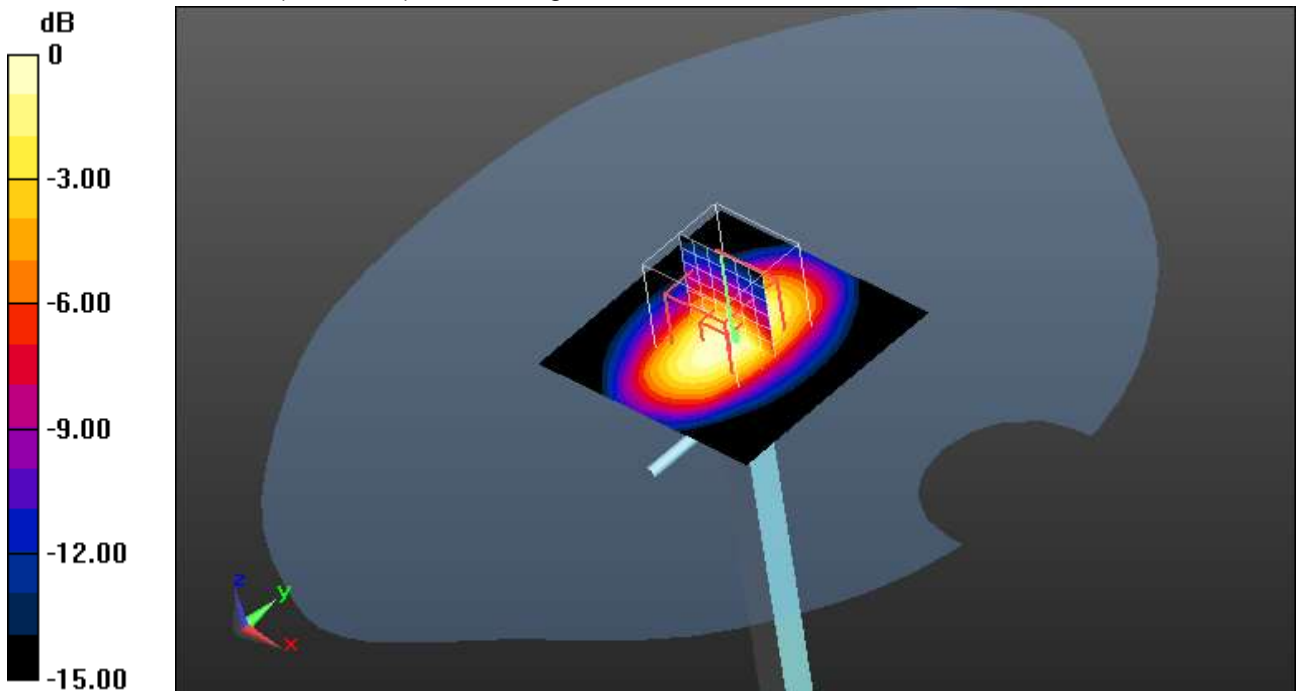

0 dB = 4.72 W/kg = 6.74 dBW/kg

Additional information:

ambient temperature: 22.2°C; liquid temperature: 21.7°C

SystemPerformanceCheck-D1750 2015-12-17

DUT: Dipole 1750 MHz; Type: D1750V2; Serial: 1093

Communication System: UID 0, CW (0); Communication System Band: D1750 (1750.0 MHz); Frequency: 1750 MHz; Communication System PAR: 0 dB; PMF: 1

Medium parameters used: $f = 1750$ MHz; $\sigma = 1.335$ S/m; $\epsilon_r = 38.751$; $\rho = 1000$ kg/m³

Phantom section: Flat Section

Measurement Standard: DASy5

DASy5 Configuration:

- Probe: ES3DV3 - SN3326; ConvF(5.18, 5.18, 5.18); Calibrated: 8/12/2015;
- Sensor-Surface: 3mm (Mechanical Surface Detection), $z = 2.0, 32.0$
- Electronics: DAE4 Sn1387; Calibrated: 8/12/2015
- Phantom: SAM front; Type: QD000P40CC; Serial: TP:1041
- DASy52 52.8.8(1222); SEMCAD X 14.6.10(7331)

HSL1750/d=15mm, Pin=100 mW, dist=3.0mm/Area Scan (51x51x1): Interpolated

grid: $dx=1.500$ mm, $dy=1.500$ mm

Maximum value of SAR (interpolated) = 5.02 W/kg

HSL1750/d=15mm, Pin=100 mW, dist=3.0mm/Zoom Scan (7x7x7)/Cube 0:

Measurement grid: $dx=5$ mm, $dy=5$ mm, $dz=5$ mm

Reference Value = 61.22 V/m; Power Drift = -0.10 dB

Peak SAR (extrapolated) = 6.58 W/kg

SAR(1 g) = 3.65 W/kg; SAR(10 g) = 1.94 W/kg

Maximum value of SAR (measured) = 4.63 W/kg

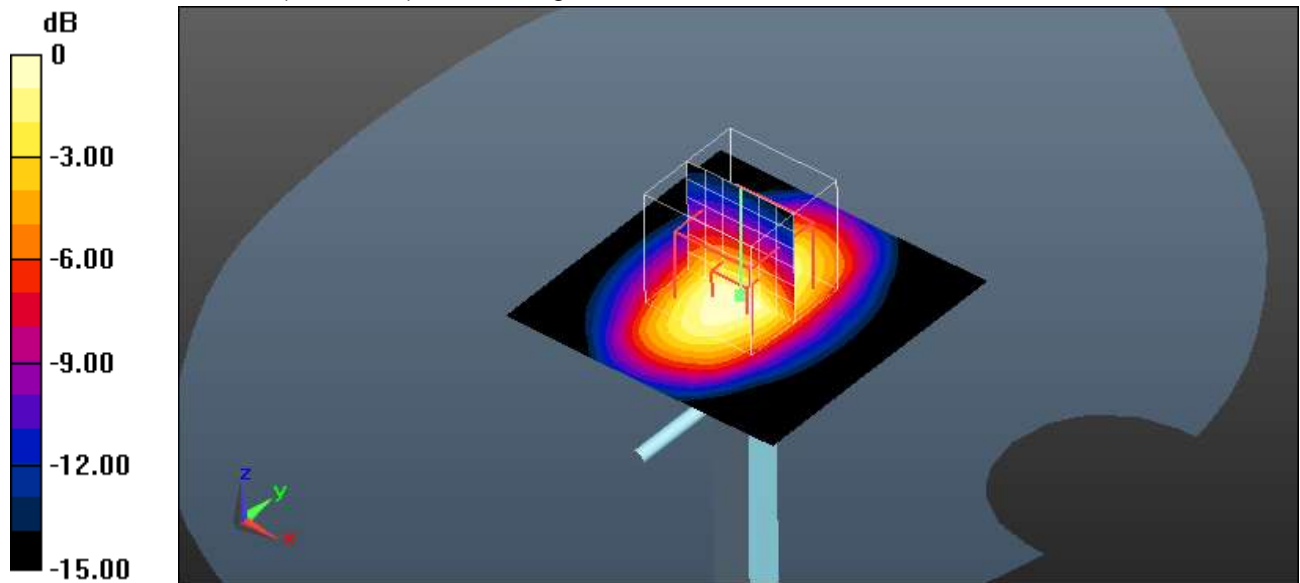

0 dB = 4.63 W/kg = 6.66 dBW/kg

Additional information:

ambient temperature: 22.9°C; liquid temperature: 22.5°C

Date/Time: 12/22/2015 5:48:30 AM

SystemPerformanceCheck-D1750 2015-12-22

DUT: Dipole 1750 MHz; Type: D1750V2; Serial: 1093

Communication System: UID 0, CW (0); Communication System Band: D1750 (1750.0 MHz); Frequency: 1750 MHz; Communication System PAR: 0 dB; PMF: 1

Medium parameters used: $f = 1750$ MHz; $\sigma = 1.5$ S/m; $\epsilon_r = 52.304$; $\rho = 1000$ kg/m³

Phantom section: Center Section

Measurement Standard: DASYS

DASY5 Configuration:

- Probe: ES3DV3 - SN3326; ConvF(4.85, 4.85, 4.85); Calibrated: 8/12/2015;
- Sensor-Surface: 3mm (Mechanical Surface Detection), $z = 2.0, 32.0$
- Electronics: DAE4 Sn1387; Calibrated: 8/12/2015
- Phantom: Triple Flat Phantom 5.1C; Type: QD 000 P51 CA; Serial: 1154
- DASY52 52.8.8(1222); SEMCAD X 14.6.10(7331)

HSL1750/d=15mm, Pin=100 mW, dist=3.0mm/Area Scan (51x51x1): Interpolated

grid: $dx=1.500$ mm, $dy=1.500$ mm

Maximum value of SAR (interpolated) = 5.46 W/kg

HSL1750/d=15mm, Pin=100 mW, dist=3.0mm/Zoom Scan (7x7x7)/Cube 0:

Measurement grid: $dx=5$ mm, $dy=5$ mm, $dz=5$ mm

Reference Value = 60.16 V/m; Power Drift = -0.09 dB

Peak SAR (extrapolated) = 6.85 W/kg

SAR(1 g) = 3.92 W/kg; SAR(10 g) = 2.09 W/kg

Maximum value of SAR (measured) = 4.94 W/kg

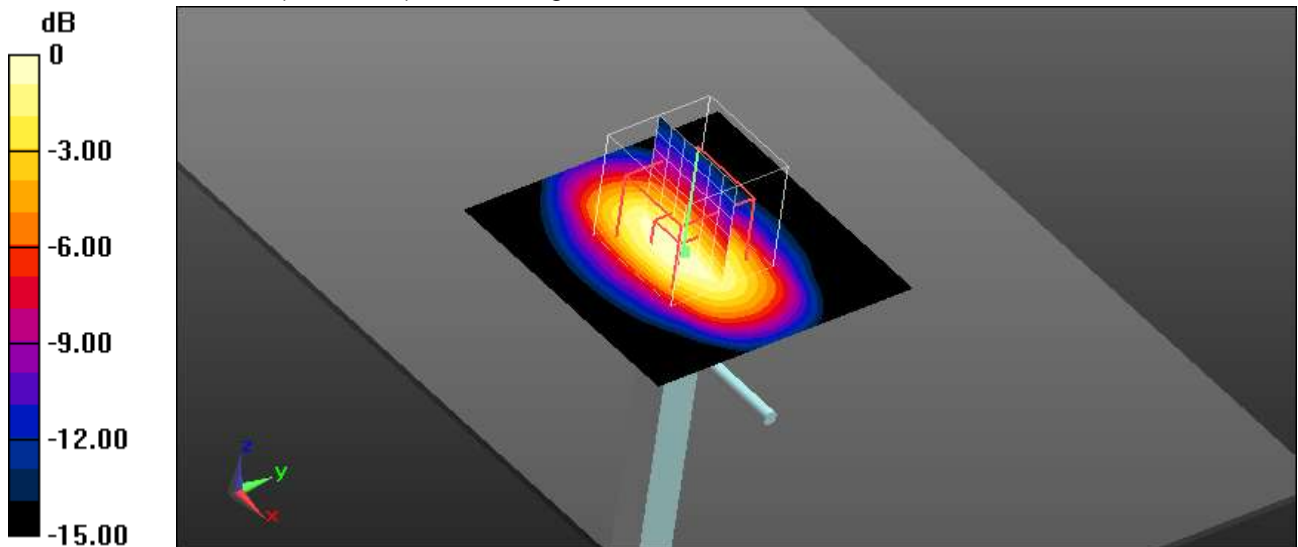

0 dB = 4.94 W/kg = 6.94 dBW/kg

Additional information:

ambient temperature: 22.8°C; liquid temperature: 22.6°C

SystemPerformanceCheck-D1750 2015-12-23

DUT: Dipole 1750 MHz; Type: D1750V2; Serial: 1093

Communication System: UID 0, CW (0); Communication System Band: D1750 (1750.0 MHz); Frequency: 1750 MHz; Communication System PAR: 0 dB; PMF: 1

Medium parameters used: $f = 1750$ MHz; $\sigma = 1.5$ S/m; $\epsilon_r = 51.767$; $\rho = 1000$ kg/m³

Phantom section: Center Section

Measurement Standard: DASYS

DASY5 Configuration:

- Probe: ES3DV3 - SN3326; ConvF(4.85, 4.85, 4.85); Calibrated: 8/12/2015;
- Sensor-Surface: 3mm (Mechanical Surface Detection), $z = 2.0, 32.0$
- Electronics: DAE4 Sn1387; Calibrated: 8/12/2015
- Phantom: Triple Flat Phantom 5.1C; Type: QD 000 P51 CA; Serial: 1154
- DASY52 52.8.8(1222); SEMCAD X 14.6.10(7331)

MSL1750/d=15mm, Pin=100 mW, dist=3.0mm/Area Scan (51x51x1): Interpolated

grid: $dx=1.500$ mm, $dy=1.500$ mm

Maximum value of SAR (interpolated) = 5.52 W/kg

MSL1750/d=15mm, Pin=100 mW, dist=3.0mm/Zoom Scan (7x7x7)/Cube 0:

Measurement grid: $dx=5$ mm, $dy=5$ mm, $dz=5$ mm

Reference Value = 60.63 V/m; Power Drift = -0.09 dB

Peak SAR (extrapolated) = 6.99 W/kg

SAR(1 g) = 4 W/kg; SAR(10 g) = 2.13 W/kg

Maximum value of SAR (measured) = 5.05 W/kg

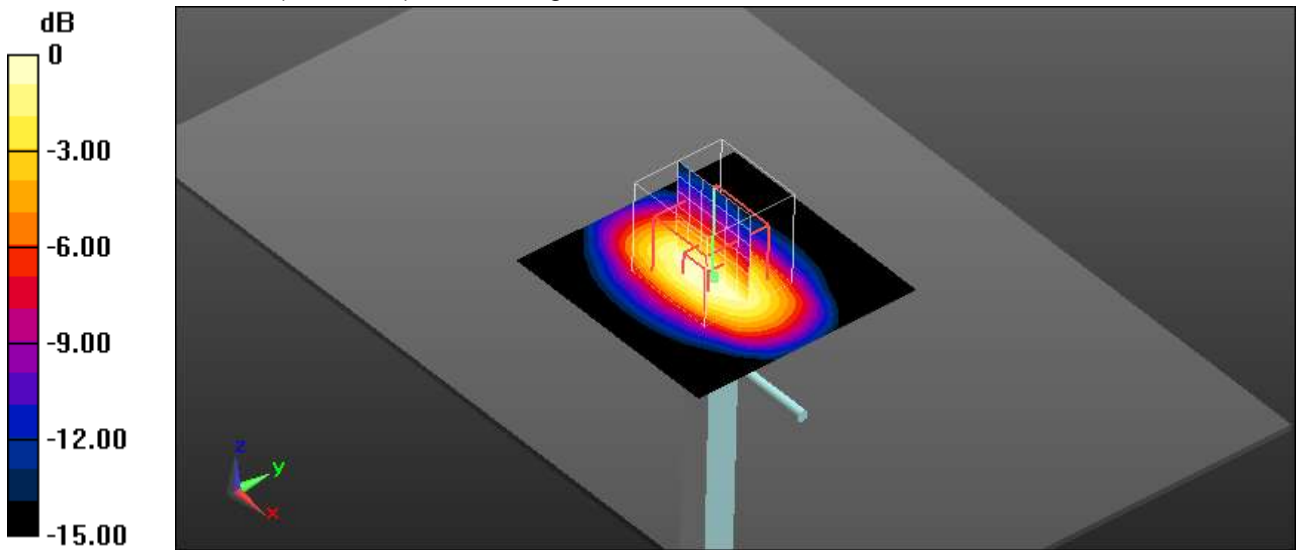

0 dB = 5.05 W/kg = 7.03 dBW/kg

Additional information:

ambient temperature: 22.0°C; liquid temperature: 22.2°C

SystemPerformanceCheck-D1750 body 2015-12-29

DUT: Dipole 1750 MHz; Type: D1750V2; Serial: 1093

Communication System: UID 0, CW (0); Communication System Band: D1750 (1750.0 MHz); Frequency: 1750 MHz; Communication System PAR: 0 dB; PMF: 1

Medium parameters used: $f = 1750$ MHz; $\sigma = 1.53$ S/m; $\epsilon_r = 51.999$; $\rho = 1000$ kg/m³

Phantom section: Center Section

Measurement Standard: DASY5

DASY5 Configuration:

- Probe: ES3DV3 - SN3320; ConvF(4.73, 4.73, 4.73); Calibrated: 25.02.2015;
- Sensor-Surface: 3mm (Mechanical Surface Detection), $z = 2.0, 32.0$
- Electronics: DAE3 Sn413; Calibrated: 15.01.2015
- Phantom: Triple Flat Phantom 5.1C; Type: QD 000 P51 CA; Serial: 1154
- DASY52 52.8.7(1137); SEMCAD X 14.6.10(7164)

MSL1750/d=10mm, Pin=100 mW, dist=3.0mm/Area Scan (51x51x1): Interpolated

grid: $dx=1.500$ mm, $dy=1.500$ mm

Maximum value of SAR (interpolated) = 5.98 W/kg

MSL1750/d=10mm, Pin=100 mW, dist=3.0mm/Zoom Scan (7x7x7)/Cube 0:

Measurement grid: $dx=5$ mm, $dy=5$ mm, $dz=5$ mm

Reference Value = 59.735 V/m; Power Drift = -0.10 dB

Peak SAR (extrapolated) = 6.87 W/kg

SAR(1 g) = 3.91 W/kg; SAR(10 g) = 2.09 W/kg

Maximum value of SAR (measured) = 4.95 W/kg

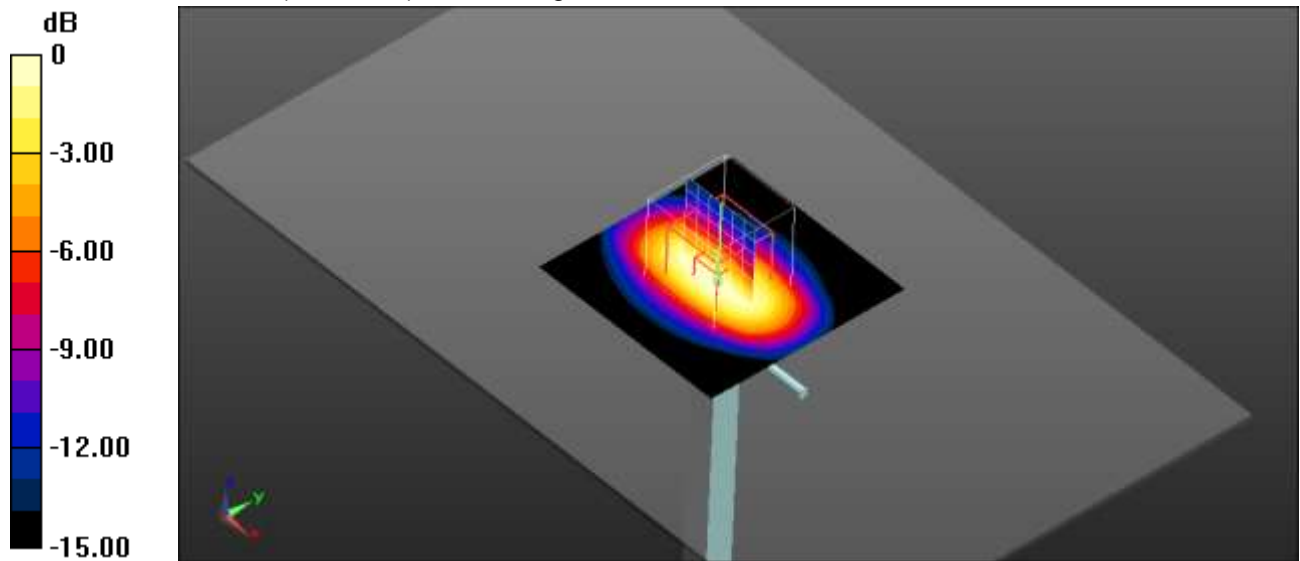

0 dB = 4.95 W/kg = 6.95 dBW/kg

Additional information:

ambient temperature: 23.3°C; liquid temperature: 22.8°C

Date/Time: 11.12.2015 09:07:48

SystemPerformanceCheck-D1900 HSL 2015-12-11

DUT: Dipole 1900 MHz; Type: D1900V2; Serial: 5d009

Communication System: UID 0, CW (0); Communication System Band: D1900 (1900.0 MHz); Frequency: 1900 MHz; Communication System PAR: 0 dB; PMF: 1

Medium parameters used: $f = 1900$ MHz; $\sigma = 1.396$ S/m; $\epsilon_r = 39.529$; $\rho = 1000$ kg/m³

Phantom section: Flat Section

Measurement Standard: DASY5

DASY5 Configuration:

- Probe: EX3DV4 - SN3944; ConvF(8.19, 8.19, 8.19); Calibrated: 14.08.2015;
- Sensor-Surface: 2mm (Mechanical Surface Detection), $z = 1.0, 31.0$
- Electronics: DAE3 Sn477; Calibrated: 22.05.2015
- Phantom: SAM; Type: SAM; Serial: 1043
- DASY52 52.8.7(1137); SEMCAD X 14.6.10(7164)

HSL1900/d=10mm, Pin=100 mW, dist=2.0mm/Area Scan (51x51x1): Interpolated

grid: $dx=1.500$ mm, $dy=1.500$ mm

Maximum value of SAR (interpolated) = 6.78 W/kg

HSL1900/d=10mm, Pin=100 mW, dist=2.0mm/Zoom Scan (7x7x7)/Cube 0:

Measurement grid: $dx=5$ mm, $dy=5$ mm, $dz=5$ mm

Reference Value = 65.499 V/m; Power Drift = 0.00 dB

Peak SAR (extrapolated) = 7.44 W/kg

SAR(1 g) = 4.04 W/kg; SAR(10 g) = 2.11 W/kg

Maximum value of SAR (measured) = 5.82 W/kg

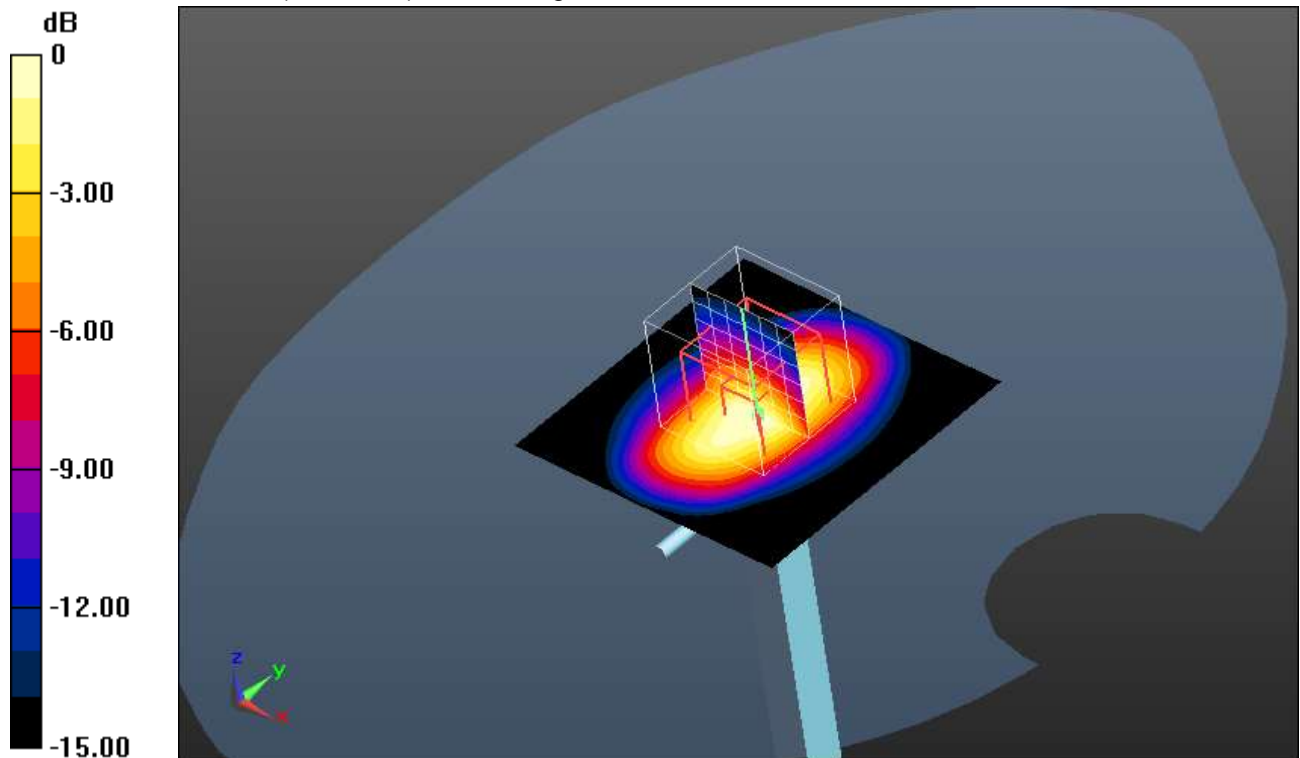

0 dB = 5.82 W/kg = 7.65 dBW/kg

Additional information:

ambient temperature: 22.2°C; liquid temperature: 21.0°C

Date/Time: 14.12.2015 08:31:18

SystemPerformanceCheck-D1900 HSL 2015-12-14

DUT: Dipole 1900 MHz; Type: D1900V2; Serial: 5d009

Communication System: UID 0, CW (0); Communication System Band: D1900 (1900.0 MHz); Frequency: 1900 MHz; Communication System PAR: 0 dB; PMF: 1

Medium parameters used: $f = 1900$ MHz; $\sigma = 1.393$ S/m; $\epsilon_r = 38.738$; $\rho = 1000$ kg/m³

Phantom section: Flat Section

Measurement Standard: DASY5

DASY5 Configuration:

- Probe: EX3DV4 - SN3944; ConvF(8.19, 8.19, 8.19); Calibrated: 14.08.2015;
- Sensor-Surface: 2mm (Mechanical Surface Detection), $z = 1.0, 31.0$
- Electronics: DAE3 Sn477; Calibrated: 22.05.2015
- Phantom: SAM; Type: SAM; Serial: 1043
- DASY52 52.8.7(1137); SEMCAD X 14.6.10(7164)

HSL1900/d=10mm, Pin=100 mW, dist=2.0mm/Area Scan (51x51x1): Interpolated

grid: $dx=1.500$ mm, $dy=1.500$ mm

Maximum value of SAR (interpolated) = 6.92 W/kg

HSL1900/d=10mm, Pin=100 mW, dist=2.0mm/Zoom Scan (7x7x7)/Cube 0:

Measurement grid: $dx=5$ mm, $dy=5$ mm, $dz=5$ mm

Reference Value = 66.760 V/m; Power Drift = -0.09 dB

Peak SAR (extrapolated) = 7.55 W/kg

SAR(1 g) = 4.13 W/kg; SAR(10 g) = 2.16 W/kg

Maximum value of SAR (measured) = 5.95 W/kg

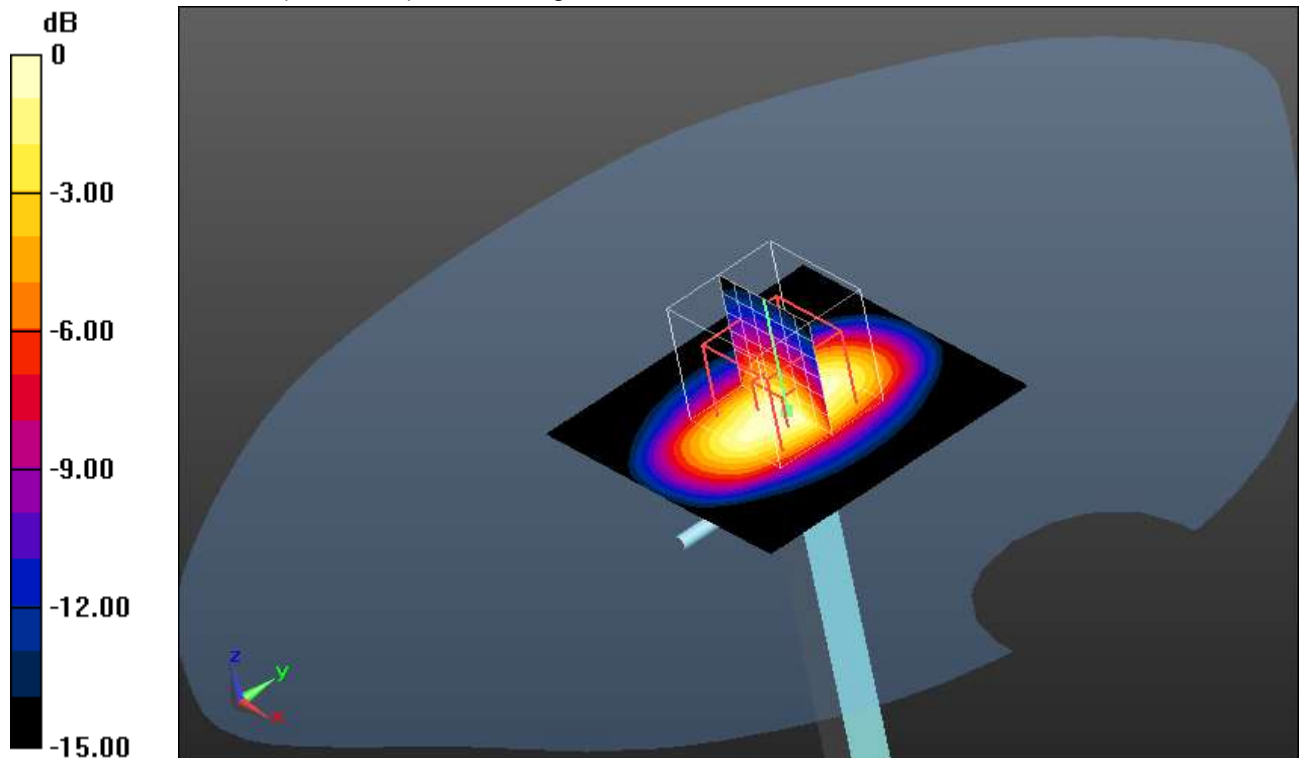

0 dB = 5.95 W/kg = 7.75 dBW/kg

Additional information:

ambient temperature: 22.4°C; liquid temperature: 21.4°C

Date/Time: 15.12.2015 13:15:09

SystemPerformanceCheck-D1900 HSL 2015-12-15

DUT: Dipole 1900 MHz; Type: D1900V2; Serial: 5d009

Communication System: UID 0, CW (0); Communication System Band: D1900 (1900.0 MHz); Frequency: 1900 MHz; Communication System PAR: 0 dB; PMF: 1

Medium parameters used: $f = 1900$ MHz; $\sigma = 1.379$ S/m; $\epsilon_r = 38.38$; $\rho = 1000$ kg/m³

Phantom section: Flat Section

Measurement Standard: DASY5

DASY5 Configuration:

- Probe: EX3DV4 - SN3944; ConvF(8.19, 8.19, 8.19); Calibrated: 14.08.2015;
- Sensor-Surface: 2mm (Mechanical Surface Detection), $z = 1.0, 31.0$
- Electronics: DAE3 Sn477; Calibrated: 22.05.2015
- Phantom: SAM; Type: SAM; Serial: 1043
- DASY52 52.8.7(1137); SEMCAD X 14.6.10(7164)

HSL1900/d=10mm, Pin=100 mW, dist=2.0mm/Area Scan (51x51x1): Interpolated

grid: $dx=1.500$ mm, $dy=1.500$ mm

Maximum value of SAR (interpolated) = 6.43 W/kg

HSL1900/d=10mm, Pin=100 mW, dist=2.0mm/Zoom Scan (7x7x7)/Cube 0:

Measurement grid: $dx=5$ mm, $dy=5$ mm, $dz=5$ mm

Reference Value = 64.606 V/m; Power Drift = 0.01 dB

Peak SAR (extrapolated) = 7.32 W/kg

SAR(1 g) = 3.99 W/kg; SAR(10 g) = 2.08 W/kg

Maximum value of SAR (measured) = 5.67 W/kg

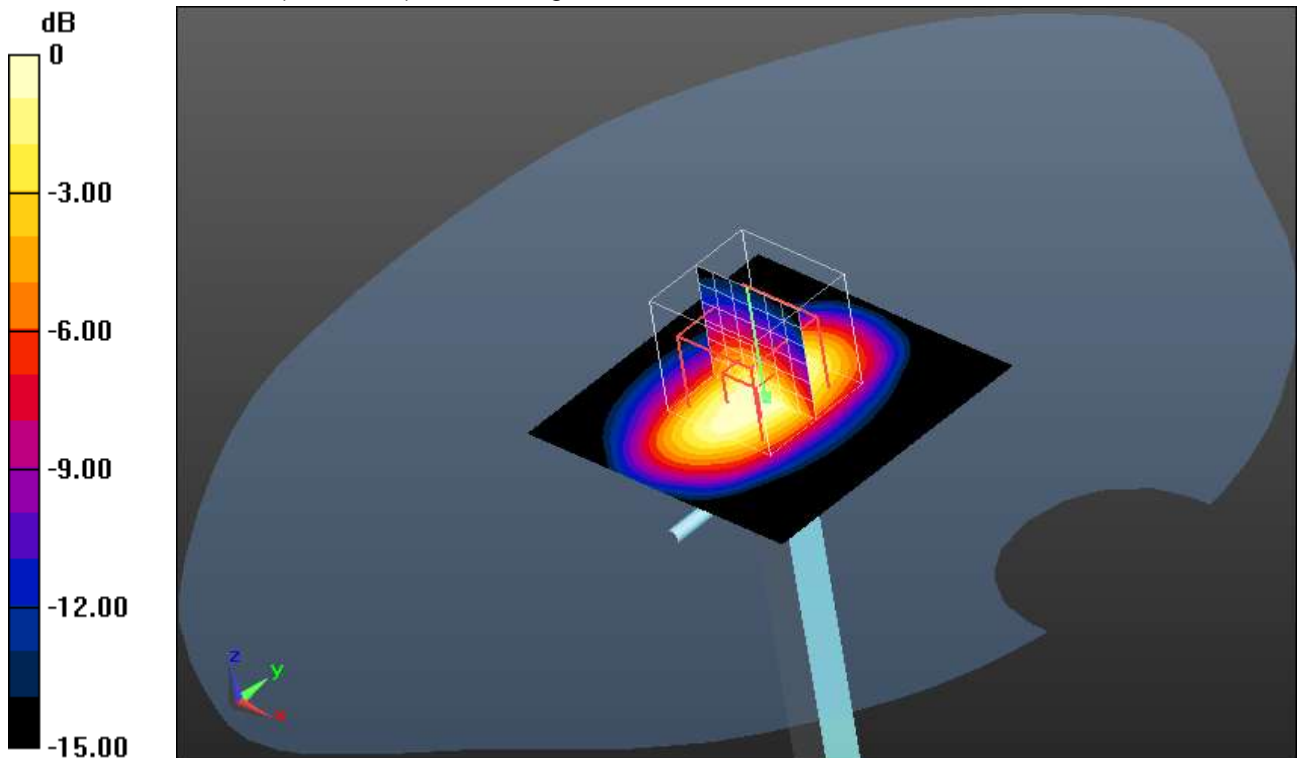

0 dB = 5.67 W/kg = 7.54 dBW/kg

Additional information:

ambient temperature: 22.6°C; liquid temperature: 21.9°C

SystemPerformanceCheck-D1900 MSL 2015-12-17

DUT: Dipole 1900 MHz; Type: D1900V2; Serial: 5d009

Communication System: UID 0, CW (0); Communication System Band: D1900 (1900.0 MHz); Frequency: 1900 MHz; Communication System PAR: 0 dB; PMF: 1

Medium parameters used: $f = 1900$ MHz; $\sigma = 1.502$ S/m; $\epsilon_r = 54.462$; $\rho = 1000$ kg/m³

Phantom section: Center Section

Measurement Standard: DASYS

DASY5 Configuration:

- Probe: EX3DV4 - SN3944; ConvF(7.91, 7.91, 7.91); Calibrated: 14.08.2015;
- Sensor-Surface: 2mm (Mechanical Surface Detection), $z = 1.0, 31.0$
- Electronics: DAE3 Sn477; Calibrated: 22.05.2015
- Phantom: Triple Flat Phantom 5.1C; Type: QD 000 P51 CA; Serial: 1154
- DASY52 52.8.7(1137); SEMCAD X 14.6.10(7164)

MSL1900/d=10mm, Pin=100 mW, dist=2.0mm/Area Scan (51x51x1): Interpolated
grid: $dx=1.500$ mm, $dy=1.500$ mm

Maximum value of SAR (interpolated) = 6.26 W/kg

MSL1900/d=10mm, Pin=100 mW, dist=2.0mm/Zoom Scan (7x7x7)/Cube 0:

Measurement grid: $dx=5$ mm, $dy=5$ mm, $dz=5$ mm

Reference Value = 60.792 V/m; Power Drift = 0.05 dB

Peak SAR (extrapolated) = 7.03 W/kg

SAR(1 g) = 3.98 W/kg; SAR(10 g) = 2.11 W/kg

Maximum value of SAR (measured) = 5.65 W/kg

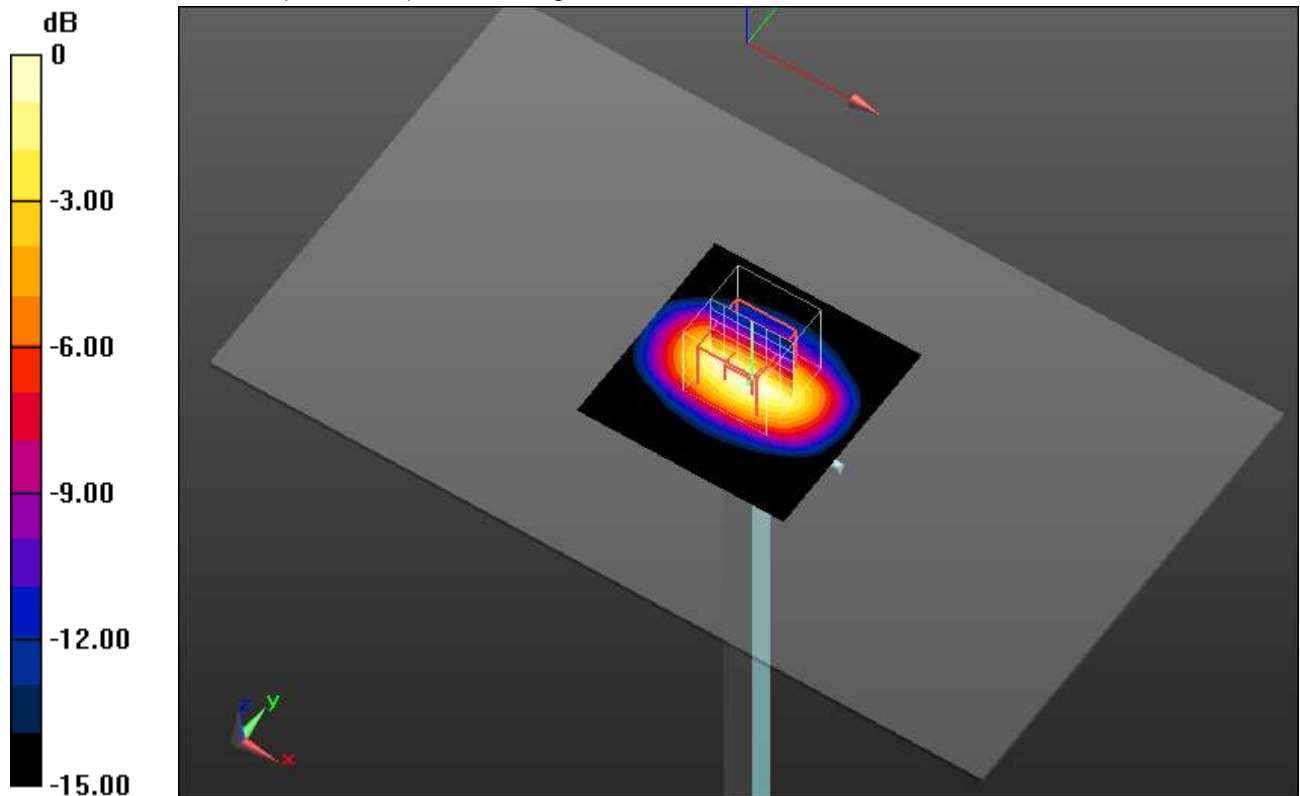

0 dB = 5.65 W/kg = 7.52 dBW/kg

Additional information:

ambient temperature: 23.6°C; liquid temperature: 22.3°C

Date/Time: 18.12.2015 07:59:00

SystemPerformanceCheck-D1900 MSL 2015-12-18

DUT: Dipole 1900 MHz; Type: D1900V2; Serial: 5d009

Communication System: UID 0, CW (0); Communication System Band: D1900 (1900.0 MHz); Frequency: 1900 MHz; Communication System PAR: 0 dB; PMF: 1

Medium parameters used: $f = 1900$ MHz; $\sigma = 1.495$ S/m; $\epsilon_r = 53.859$; $\rho = 1000$ kg/m³

Phantom section: Center Section

Measurement Standard: DASYS

DASY5 Configuration:

- Probe: EX3DV4 - SN3944; ConvF(7.91, 7.91, 7.91); Calibrated: 14.08.2015;
- Sensor-Surface: 2mm (Mechanical Surface Detection), $z = 1.0, 31.0$
- Electronics: DAE3 Sn477; Calibrated: 22.05.2015
- Phantom: Triple Flat Phantom 5.1C; Type: QD 000 P51 CA; Serial: 1154
- DASY52 52.8.7(1137); SEMCAD X 14.6.10(7164)

MSL1900/d=10mm, Pin=100 mW, dist=2.0mm/Area Scan (51x51x1): Interpolated
grid: $dx=1.500$ mm, $dy=1.500$ mm

Maximum value of SAR (interpolated) = 6.65 W/kg

MSL1900/d=10mm, Pin=100 mW, dist=2.0mm/Zoom Scan (7x7x7)/Cube 0:

Measurement grid: $dx=5$ mm, $dy=5$ mm, $dz=5$ mm

Reference Value = 61.780 V/m; Power Drift = 0.00 dB

Peak SAR (extrapolated) = 7.05 W/kg

SAR(1 g) = 4.03 W/kg; SAR(10 g) = 2.14 W/kg

Maximum value of SAR (measured) = 5.67 W/kg

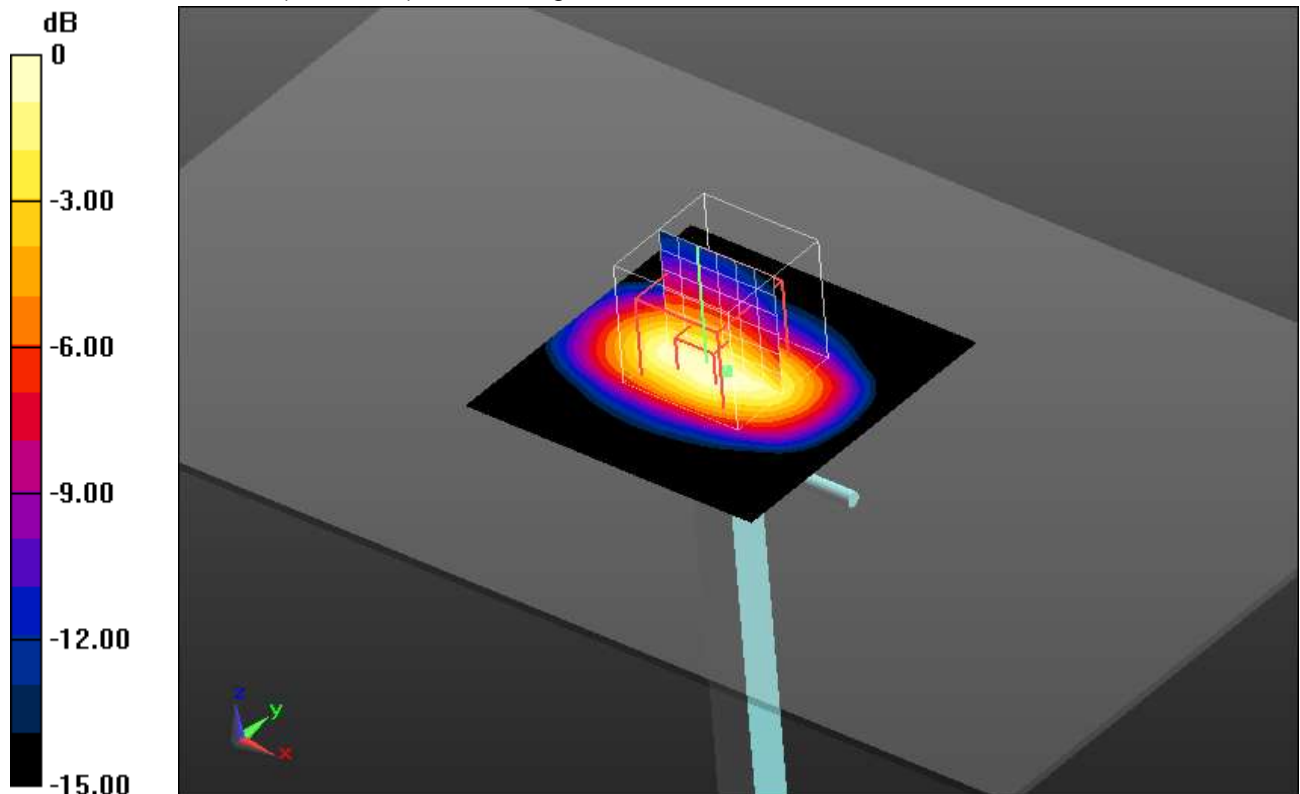

0 dB = 5.67 W/kg = 7.54 dBW/kg

Additional information:

ambient temperature: 23.3°C; liquid temperature: 22.2°C

SystemPerformanceCheck-D1900 MSL 2015-12-19

DUT: Dipole 1900 MHz; Type: D1900V2; Serial: 5d009

Communication System: UID 0, CW (0); Communication System Band: D1900 (1900.0 MHz); Frequency: 1900 MHz; Communication System PAR: 0 dB; PMF: 1

Medium parameters used: $f = 1900$ MHz; $\sigma = 1.523$ S/m; $\epsilon_r = 53.838$; $\rho = 1000$ kg/m³

Phantom section: Center Section

Measurement Standard: DASYS

DASY5 Configuration:

- Probe: EX3DV4 - SN3944; ConvF(7.91, 7.91, 7.91); Calibrated: 14.08.2015;
- Sensor-Surface: 2mm (Mechanical Surface Detection), $z = 1.0, 31.0$
- Electronics: DAE3 Sn477; Calibrated: 22.05.2015
- Phantom: Triple Flat Phantom 5.1C; Type: QD 000 P51 CA; Serial: 1154
- DASY52 52.8.7(1137); SEMCAD X 14.6.10(7164)

MSL1900/d=10mm, Pin=100 mW, dist=2.0mm/Area Scan (51x51x1): Interpolated

grid: $dx=1.500$ mm, $dy=1.500$ mm

Maximum value of SAR (interpolated) = 6.56 W/kg

MSL1900/d=10mm, Pin=100 mW, dist=2.0mm/Zoom Scan (7x7x7)/Cube 0:

Measurement grid: $dx=5$ mm, $dy=5$ mm, $dz=5$ mm

Reference Value = 61.269 V/m; Power Drift = 0.04 dB

Peak SAR (extrapolated) = 6.98 W/kg

SAR(1 g) = 3.99 W/kg; SAR(10 g) = 2.12 W/kg

Maximum value of SAR (measured) = 5.59 W/kg

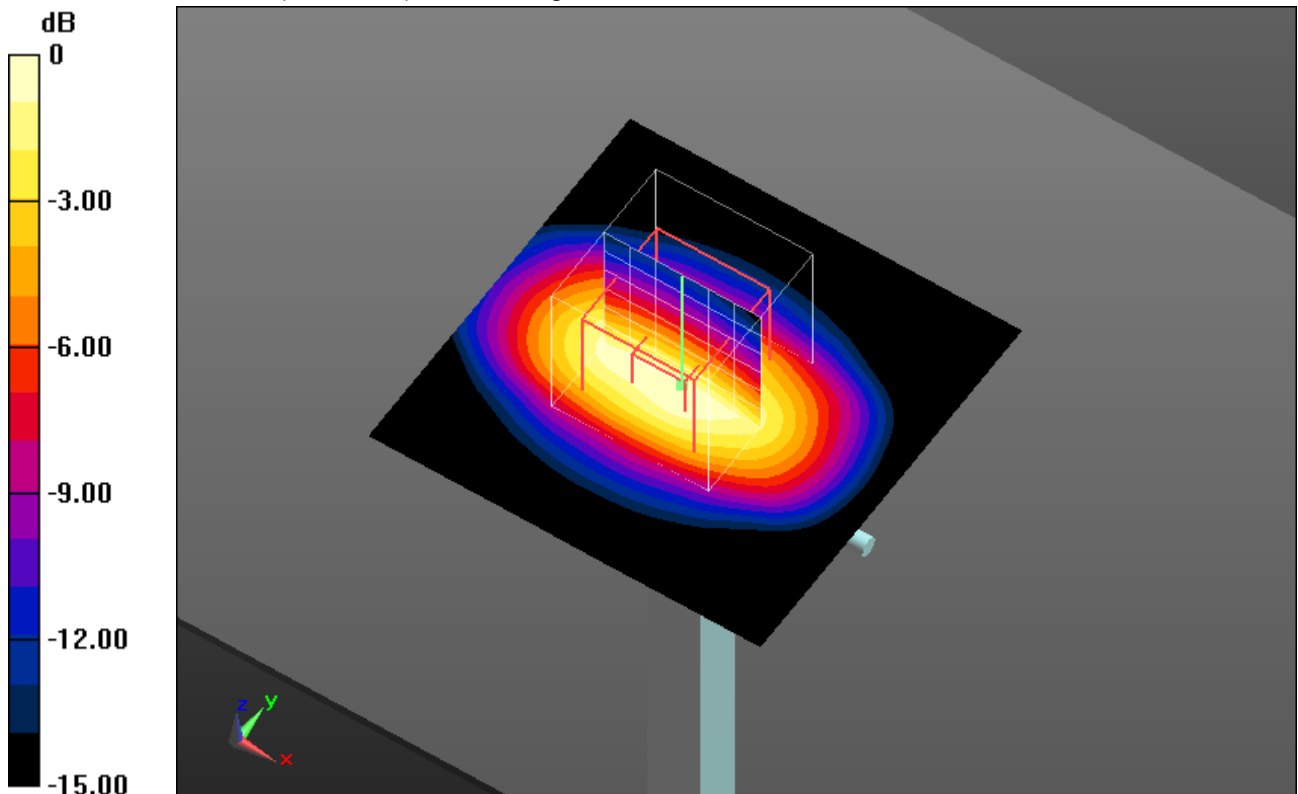

0 dB = 5.59 W/kg = 7.47 dBW/kg

Additional information:

ambient temperature: 22.5°C; liquid temperature: 21.4°C

SystemPerformanceCheck-D2450 HSL 2015-12-21

DUT: Dipole 2450 MHz; Type: D2450V2; Serial: 710

Communication System: UID 0, CW (0); Communication System Band: D2450 (2450.0 MHz); Frequency: 2450 MHz; Communication System PAR: 0 dB; PMF: 1

Medium parameters used: $f = 2450$ MHz; $\sigma = 1.763$ S/m; $\epsilon_r = 38.875$; $\rho = 1000$ kg/m³

Phantom section: Flat Section

Measurement Standard: DASY5

DASY5 Configuration:

- Probe: EX3DV4 - SN3944; ConvF(7.28, 7.28, 7.28); Calibrated: 14.08.2015;
- Sensor-Surface: 2mm (Mechanical Surface Detection), $z = 1.0, 31.0$
- Electronics: DAE3 Sn477; Calibrated: 22.05.2015
- Phantom: SAM; Type: SAM; Serial: 1043
- DASY52 52.8.7(1137); SEMCAD X 14.6.10(7164)

HSL2450/d=10mm, Pin=100 mW, dist=2.0mm/Area Scan (81x81x1): Interpolated

grid: $dx=1.000$ mm, $dy=1.000$ mm

Maximum value of SAR (interpolated) = 8.24 W/kg

HSL2450/d=10mm, Pin=100 mW, dist=2.0mm/Zoom Scan (7x7x7)/Cube 0:

Measurement grid: $dx=5$ mm, $dy=5$ mm, $dz=5$ mm

Reference Value = 69.149 V/m; Power Drift = -0.10 dB

Peak SAR (extrapolated) = 11.1 W/kg

SAR(1 g) = 5.38 W/kg; SAR(10 g) = 2.51 W/kg

Maximum value of SAR (measured) = 8.25 W/kg

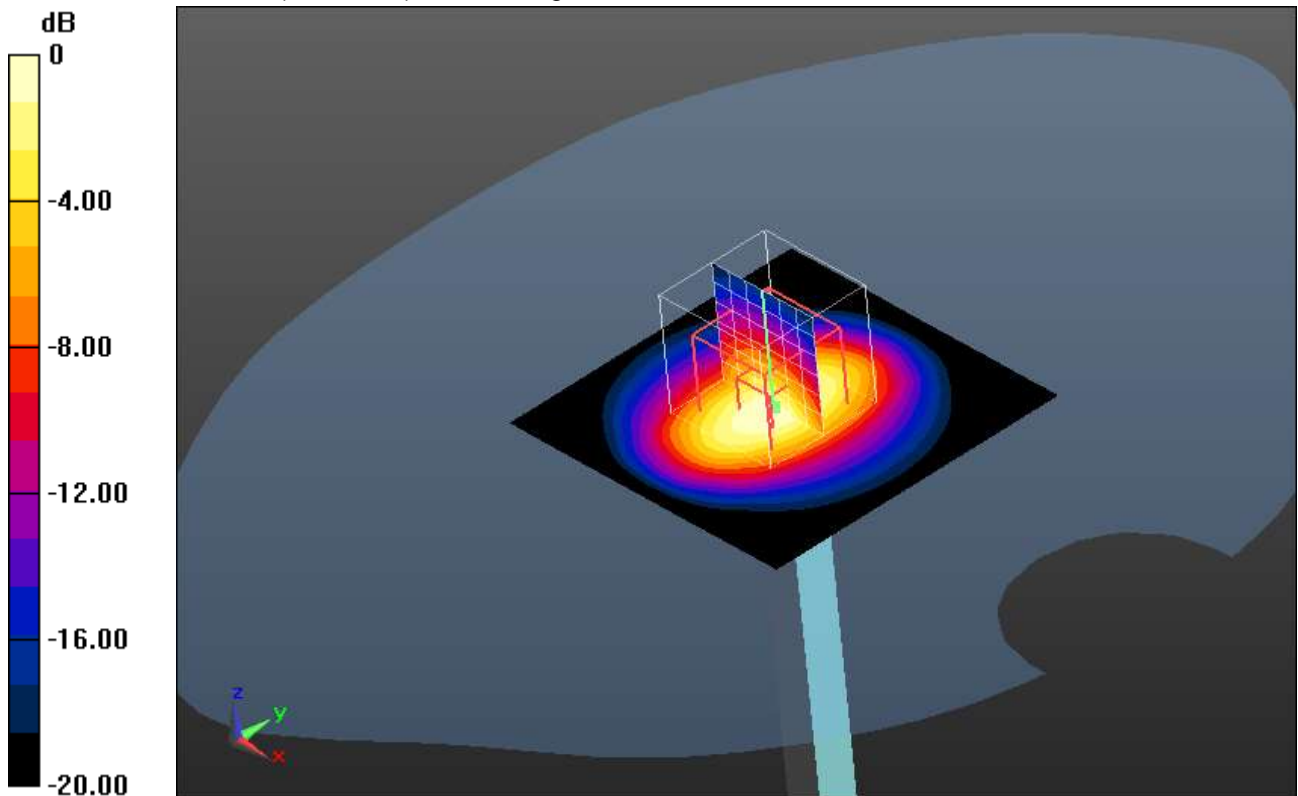

0 dB = 8.25 W/kg = 9.16 dBW/kg

Additional information:

ambient temperature: 23.1°C; liquid temperature: 22.6°C

Date/Time: 24.12.2015 14:35:51

SystemPerformanceCheck-D2450 body 2015-12-24

DUT: Dipole 2450 MHz; Type: D2450V2; Serial: 710

Communication System: UID 0, CW (0); Communication System Band: D2450 (2450.0 MHz); Frequency: 2450 MHz; Communication System PAR: 0 dB; PMF: 1

Medium parameters used: $f = 2450$ MHz; $\sigma = 2.007$ S/m; $\epsilon_r = 51.605$; $\rho = 1000$ kg/m³

Phantom section: Center Section

Measurement Standard: DASY5

DASY5 Configuration:

- Probe: ES3DV3 - SN3320; ConvF(4.16, 4.16, 4.16); Calibrated: 25.02.2015;
- Sensor-Surface: 3mm (Mechanical Surface Detection (Locations From Previous Scan Used)), Sensor-Surface: 3mm (Mechanical Surface Detection), $z = 2.0, 32.0$
- Electronics: DAE3 Sn413; Calibrated: 15.01.2015
- Phantom: Triple Flat Phantom 5.1C; Type: QD 000 P51 CA; Serial: 1154
- DASY52 52.8.7(1137); SEMCAD X 14.6.10(7164)

MSL2450/d=10mm, Pin=100 mW, dist=3.0mm/Area Scan (51x51x1): Interpolated

grid: $dx=1.500$ mm, $dy=1.500$ mm

Maximum value of SAR (interpolated) = 8.79 W/kg

MSL2450/d=10mm, Pin=100 mW, dist=3.0mm/Zoom Scan (7x7x7)/Cube 0:

Measurement grid: $dx=5$ mm, $dy=5$ mm, $dz=5$ mm

Reference Value = 60.924 V/m; Power Drift = 0.03 dB

Peak SAR (extrapolated) = 11.6 W/kg

SAR(1 g) = 5.41 W/kg; SAR(10 g) = 2.49 W/kg

Maximum value of SAR (measured) = 7.14 W/kg

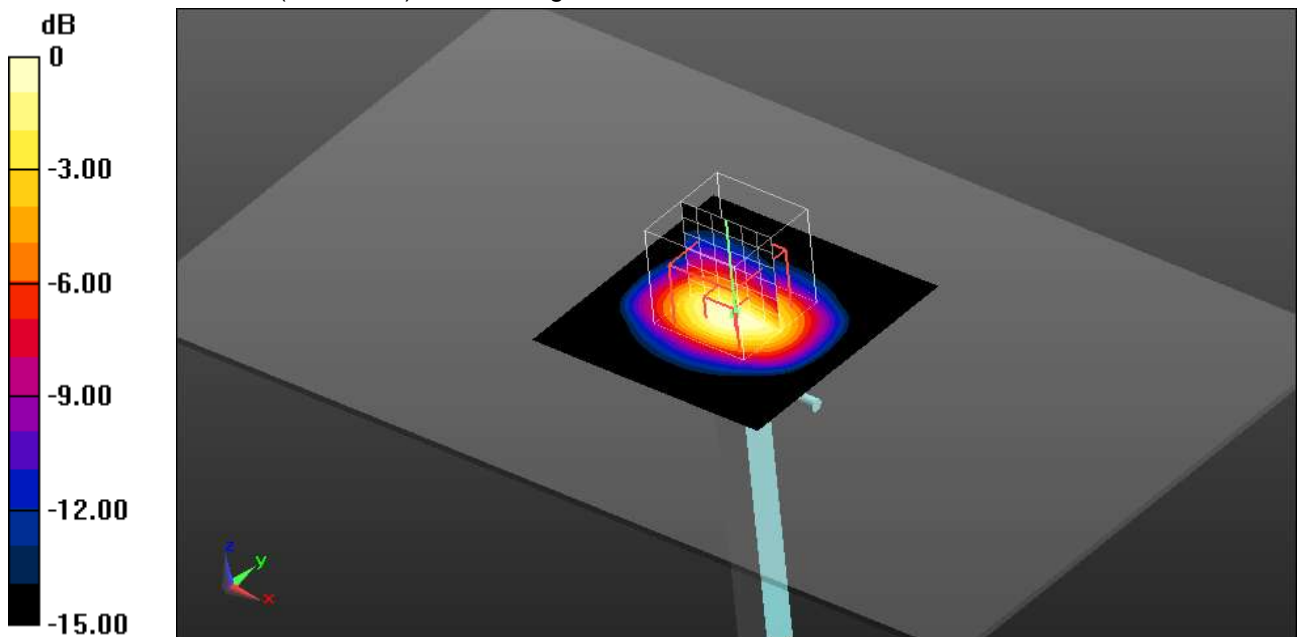

0 dB = 7.14 W/kg = 8.54 dBW/kg

Additional information:

ambient temperature: 23.4°C; liquid temperature: 22.4°C

SystemPerformanceCheck-D2600 HSL 2015-12-22

DUT: Dipole 2600 MHz; Type: D2600V2; Serial: 1040

Communication System: UID 0, CW (0); Communication System Band: D2600 (2600.0 MHz); Frequency: 2600 MHz; Communication System PAR: 0 dB; PMF: 1

Medium parameters used: $f = 2600$ MHz; $\sigma = 1.968$ S/m; $\epsilon_r = 38.07$; $\rho = 1000$ kg/m³

Phantom section: Flat Section

Measurement Standard: DASY5

DASY5 Configuration:

- Probe: EX3DV4 - SN3944; ConvF(7.15, 7.15, 7.15); Calibrated: 14.08.2015;
- Sensor-Surface: 2mm (Mechanical Surface Detection), $z = 1.0, 31.0$
- Electronics: DAE3 Sn477; Calibrated: 22.05.2015
- Phantom: SAM; Type: SAM; Serial: 1043
- DASY52 52.8.7(1137); SEMCAD X 14.6.10(7164)

HSL2450-2600/d=10mm, Pin=100 mW, dist=2.0mm/Area Scan (81x81x1):

Interpolated grid: $dx=1.000$ mm, $dy=1.000$ mm

Maximum value of SAR (interpolated) = 8.80 W/kg

HSL2450-2600/d=10mm, Pin=100 mW, dist=2.0mm/Zoom Scan (7x7x7)/Cube

0: Measurement grid: $dx=5$ mm, $dy=5$ mm, $dz=5$ mm

Reference Value = 68.283 V/m; Power Drift = -0.04 dB

Peak SAR (extrapolated) = 12.1 W/kg

SAR(1 g) = 5.63 W/kg; SAR(10 g) = 2.5 W/kg

Maximum value of SAR (measured) = 8.78 W/kg

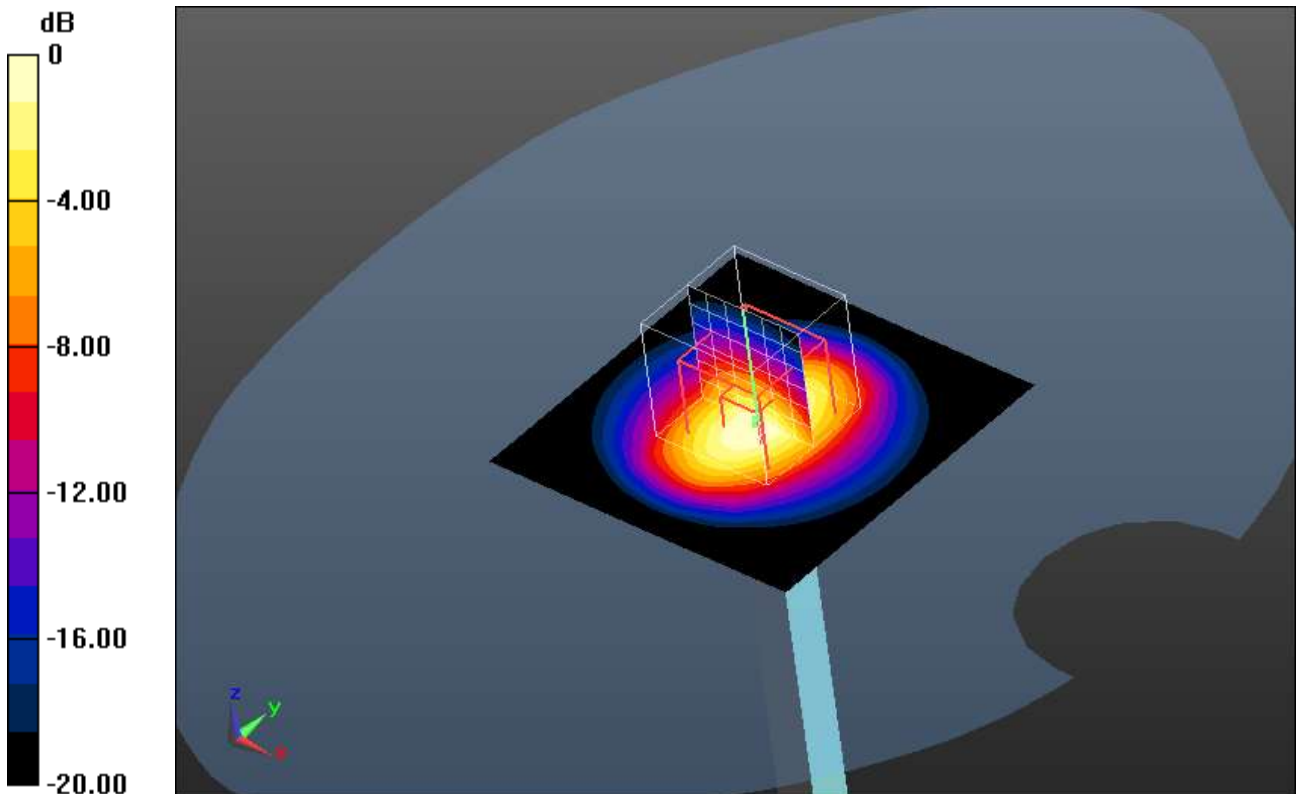

0 dB = 8.78 W/kg = 9.43 dBW/kg

Additional information:

ambient temperature: 22.6°C; liquid temperature: 21.4°C

SystemPerformanceCheck-D2600 HSL 2015-12-28

DUT: Dipole 2600 MHz; Type: D2600V2; Serial: 1040

Communication System: UID 0, CW (0); Communication System Band: D2600 (2600.0 MHz); Frequency: 2600 MHz; Communication System PAR: 0 dB; PMF: 1

Medium parameters used: $f = 2600$ MHz; $\sigma = 1.938$ S/m; $\epsilon_r = 37.382$; $\rho = 1000$ kg/m³

Phantom section: Flat Section

Measurement Standard: DASY5

DASY5 Configuration:

- Probe: EX3DV4 - SN3944; ConvF(7.15, 7.15, 7.15); Calibrated: 14.08.2015;
- Sensor-Surface: 2mm (Mechanical Surface Detection), $z = 1.0, 31.0$
- Electronics: DAE3 Sn477; Calibrated: 22.05.2015
- Phantom: SAM; Type: SAM; Serial: 1043
- DASY52 52.8.7(1137); SEMCAD X 14.6.10(7164)

HSL2450-2600/d=10mm, Pin=100 mW, dist=2.0mm/Area Scan (71x71x1):

Interpolated grid: $dx=1.000$ mm, $dy=1.000$ mm

Maximum value of SAR (interpolated) = 9.37 W/kg

HSL2450-2600/d=10mm, Pin=100 mW, dist=2.0mm/Zoom Scan (7x7x7)/Cube

0: Measurement grid: $dx=5$ mm, $dy=5$ mm, $dz=5$ mm

Reference Value = 70.017 V/m; Power Drift = 0.01 dB

Peak SAR (extrapolated) = 12.4 W/kg

SAR(1 g) = 5.89 W/kg; SAR(10 g) = 2.63 W/kg

Maximum value of SAR (measured) = 9.16 W/kg

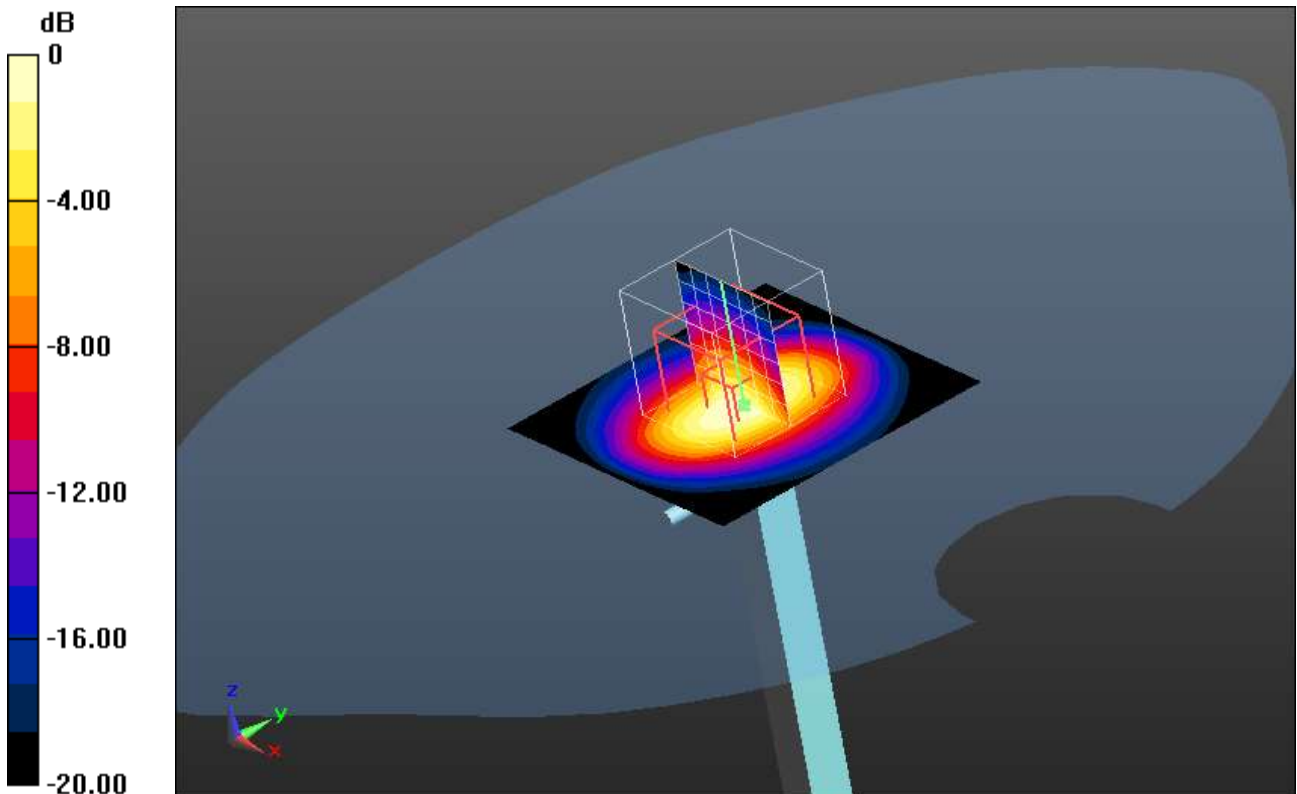

0 dB = 9.16 W/kg = 9.62 dBW/kg

Additional information:

ambient temperature: 22.4°C; liquid temperature: 22.2°C

Date/Time: 29.12.2015 15:11:42

SystemPerformanceCheck-D2600 MSL 2015-12-29

DUT: Dipole 2600 MHz; Type: D2600V2; Serial: 1040

Communication System: UID 0, CW (0); Communication System Band: D2600 (2600.0 MHz); Frequency: 2600 MHz; Communication System PAR: 0 dB; PMF: 1

Medium parameters used: $f = 2600$ MHz; $\sigma = 2.193$ S/m; $\epsilon_r = 50.31$; $\rho = 1000$ kg/m³

Phantom section: Center Section

Measurement Standard: DASY5

DASY5 Configuration:

- Probe: EX3DV4 - SN3944; ConvF(7.37, 7.37, 7.37); Calibrated: 14.08.2015;
- Sensor-Surface: 2mm (Mechanical Surface Detection), $z = 1.0, 31.0$
- Electronics: DAE3 Sn477; Calibrated: 22.05.2015
- Phantom: Triple Flat Phantom 5.1C; Type: QD 000 P51 CA; Serial: 1154
- DASY52 52.8.7(1137); SEMCAD X 14.6.10(7164)

MSL2450-2600/d=10mm, Pin=100 mW, dist=2.0mm/Area Scan (71x71x1):

Interpolated grid: $dx=1.000$ mm, $dy=1.000$ mm

Maximum value of SAR (interpolated) = 8.98 W/kg

MSL2450-2600/d=10mm, Pin=100 mW, dist=2.0mm/Zoom Scan (7x7x7)/Cube

0: Measurement grid: $dx=5$ mm, $dy=5$ mm, $dz=5$ mm

Reference Value = 63.540 V/m; Power Drift = 0.04 dB

Peak SAR (extrapolated) = 12.1 W/kg

SAR(1 g) = 5.63 W/kg; SAR(10 g) = 2.48 W/kg

Maximum value of SAR (measured) = 8.85 W/kg

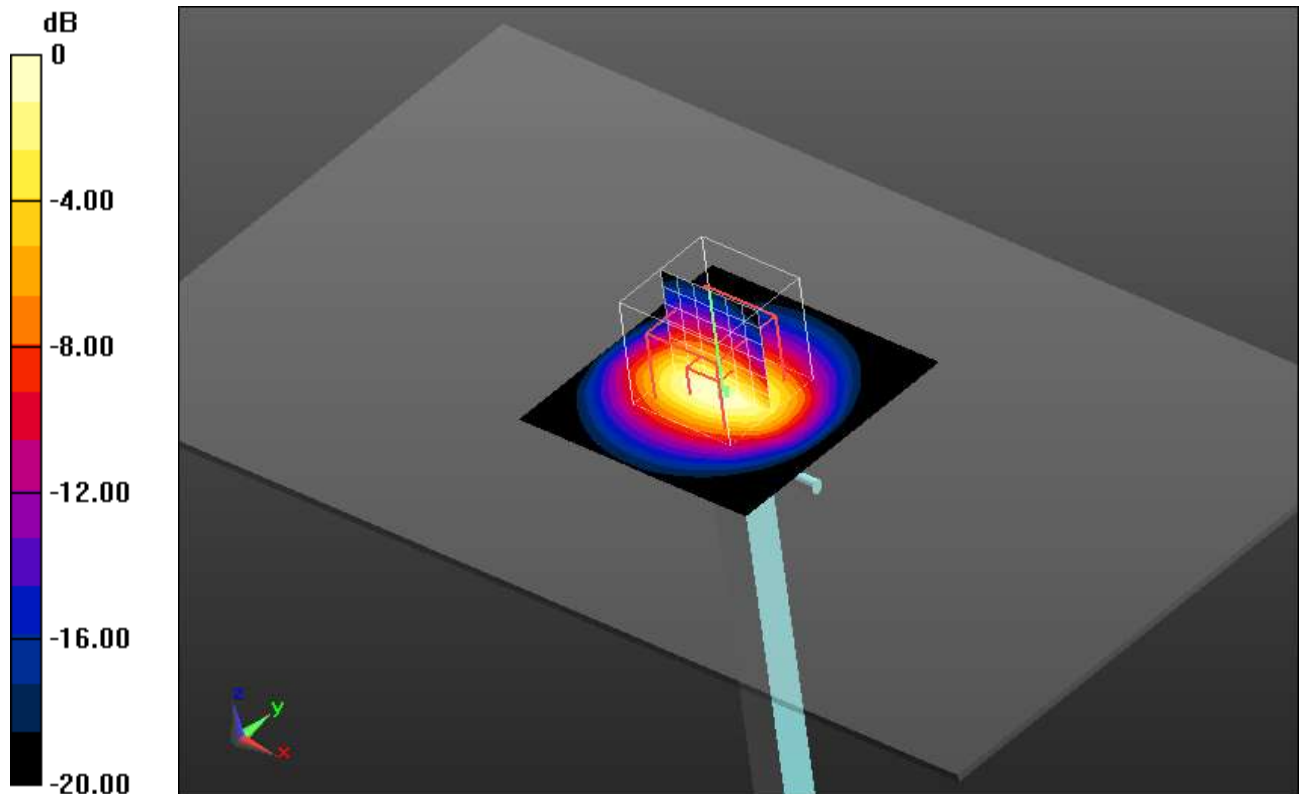

0 dB = 8.85 W/kg = 9.47 dBW/kg

Additional information:

ambient temperature: 23.0°C; liquid temperature: 21.9°C

Date/Time: 30.12.2015 08:29:30

SystemPerformanceCheck-D2600 MSL 2015-12-30

DUT: Dipole 2600 MHz; Type: D2600V2; Serial: 1040

Communication System: UID 0, CW (0); Communication System Band: D2600 (2600.0 MHz); Frequency: 2600 MHz; Communication System PAR: 0 dB; PMF: 1

Medium parameters used: $f = 2600$ MHz; $\sigma = 2.193$ S/m; $\epsilon_r = 50.31$; $\rho = 1000$ kg/m³

Phantom section: Center Section

Measurement Standard: DASY5

DASY5 Configuration:

- Probe: EX3DV4 - SN3944; ConvF(7.37, 7.37, 7.37); Calibrated: 14.08.2015;
- Sensor-Surface: 2mm (Mechanical Surface Detection), $z = 1.0, 31.0$
- Electronics: DAE3 Sn477; Calibrated: 22.05.2015
- Phantom: Triple Flat Phantom 5.1C; Type: QD 000 P51 CA; Serial: 1154
- DASY52 52.8.7(1137); SEMCAD X 14.6.10(7164)

MSL2450-2600/d=10mm, Pin=100 mW, dist=2.0mm/Area Scan (71x71x1):

Interpolated grid: $dx=1.000$ mm, $dy=1.000$ mm

Maximum value of SAR (interpolated) = 8.79 W/kg

MSL2450-2600/d=10mm, Pin=100 mW, dist=2.0mm/Zoom Scan (7x7x7)/Cube

0: Measurement grid: $dx=5$ mm, $dy=5$ mm, $dz=5$ mm

Reference Value = 63.482 V/m; Power Drift = 0.02 dB

Peak SAR (extrapolated) = 11.7 W/kg

SAR(1 g) = 5.53 W/kg; SAR(10 g) = 2.46 W/kg

Maximum value of SAR (measured) = 8.64 W/kg

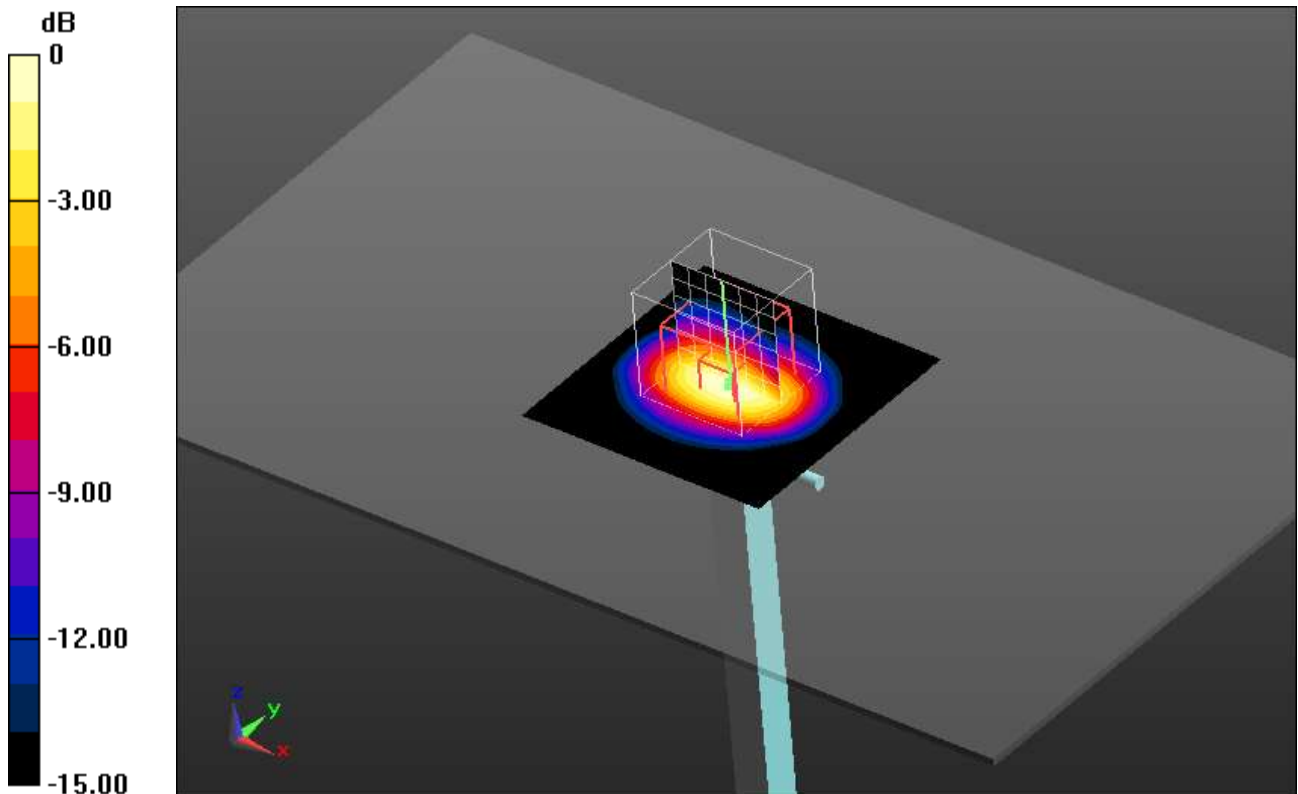

0 dB = 8.64 W/kg = 9.37 dBW/kg

Additional information:

ambient temperature: 22.3°C; liquid temperature: 21.4°C

Annex B: DASY5 measurement results

Annex 1.1.1 SAR plots for the highest measured SAR in each exposure configuration, wireless mode and frequency band combination according to FCC KDB 865664 D02

Annex B.1: GSM850

Date/Time: 11.12.2015 12:05:20

IEEE1528-GSM850 head

DUT: Microsoft; Type: RM-1154; Serial: 004402743285805

Communication System: UID 0, GSM/GPRS 4TS (0); Communication System Band: GSM 850; Frequency: 848.8 MHz; Communication System PAR: 3.01 dB; PMF: 1.41416

Medium parameters used: $f = 849$ MHz; $\sigma = 0.936$ S/m; $\epsilon_r = 42.369$; $\rho = 1000$ kg/m³

Phantom section: Right Section

Measurement Standard: DASY5

DASY5 Configuration:

- Probe: ES3DV3 - SN3320; ConvF(6.14, 6.14, 6.14); Calibrated: 25.02.2015;
- Sensor-Surface: 3mm (Mechanical Surface Detection (Locations From Previous Scan Used)), Sensor-Surface: 3mm (Mechanical Surface Detection), $z = 2.0, 32.0$
- Electronics: DAE3 Sn413; Calibrated: 15.01.2015
- Phantom: SAM front; Type: QD000P40CC; Serial: TP-1041
- DASY52 52.8.7(1137); SEMCAD X 14.6.10(7164)

Right-Hand-Side HSL - ANT 1/Touch Position - Hi/Area Scan (71x121x1):

Interpolated grid: $dx=1.500$ mm, $dy=1.500$ mm

Maximum value of SAR (interpolated) = 0.730 W/kg

Right-Hand-Side HSL - ANT 1/Touch Position - Hi/Zoom Scan (6x5x7)/Cube 0:

Measurement grid: $dx=7.5$ mm, $dy=7.5$ mm, $dz=5$ mm

Reference Value = 28.048 V/m; Power Drift = -0.03 dB

Peak SAR (extrapolated) = 0.956 W/kg

SAR(1 g) = 0.574 W/kg; SAR(10 g) = 0.365 W/kg

Maximum value of SAR (measured) = 0.696 W/kg

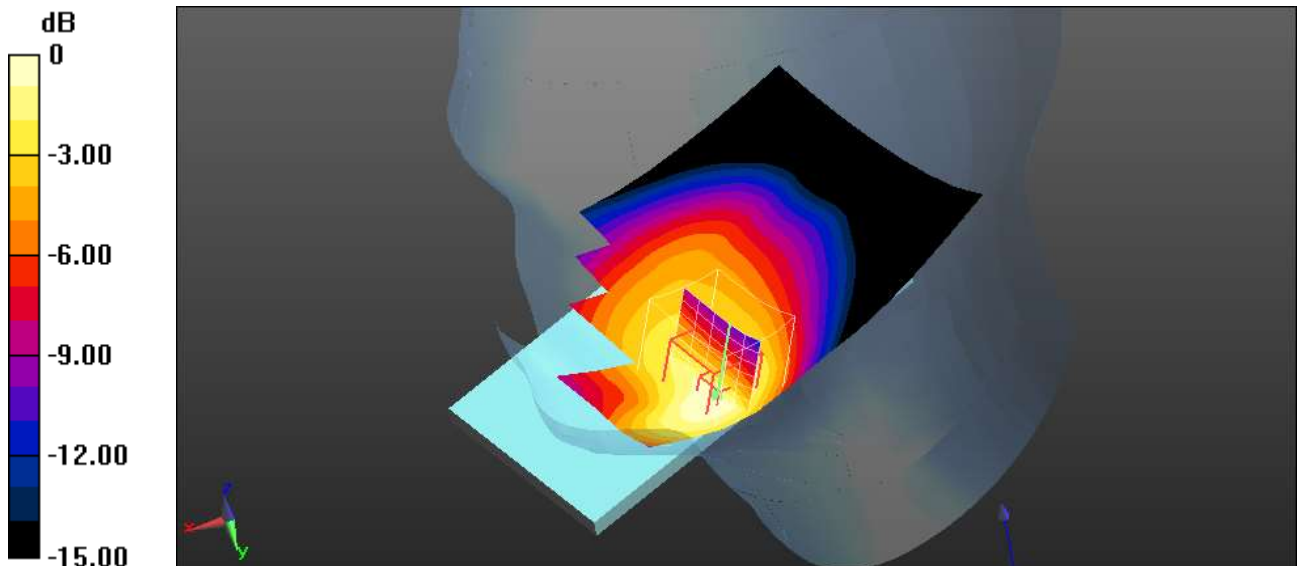

0 dB = 0.696 W/kg = -1.57 dBW/kg

Additional information:

ambient temperature: 22.9°C; liquid temperature: 22.1°C

FCC-GSM850 hotspot

DUT: Microsoft; Type: RM-1154; Serial: 004402743285805

Communication System: UID 0, GSM/GPRS 4TS (0); Communication System Band: GSM 850; Frequency: 848.8 MHz; Communication System PAR: 3.01 dB; PMF: 1.41416

Medium parameters used: $f = 849$ MHz; $\sigma = 0.99$ S/m; $\epsilon_r = 53.308$; $\rho = 1000$ kg/m³

Phantom section: Center Section

Measurement Standard: DASY5

DASY5 Configuration:

- Probe: ES3DV3 - SN3320; ConvF(6.11, 6.11, 6.11); Calibrated: 25.02.2015;
- Sensor-Surface: 3mm (Mechanical Surface Detection (Locations From Previous Scan Used)), Sensor-Surface: 3mm (Mechanical Surface Detection), $z = 2.0, 32.0$
- Electronics: DAE3 Sn413; Calibrated: 15.01.2015
- Phantom: Triple Flat Phantom 5.1C; Type: QD 000 P51 CA; Serial: 1154
- DASY52 52.8.7(1137); SEMCAD X 14.6.10(7164)

MSL835 - ANT 1/Front High 10mm/Area Scan (71x131x1): Interpolated grid: $dx=1.500$ mm, $dy=1.500$ mm

Maximum value of SAR (interpolated) = 1.23 W/kg

MSL835 - ANT 1/Front High 10mm/Zoom Scan (5x5x7)/Cube 0: Measurement grid:

$dx=7.5$ mm, $dy=7.5$ mm, $dz=5$ mm

Reference Value = 36.640 V/m; Power Drift = -0.01 dB

Peak SAR (extrapolated) = 1.75 W/kg

SAR(1 g) = 0.991 W/kg; SAR(10 g) = 0.565 W/kg

Maximum value of SAR (measured) = 1.22 W/kg

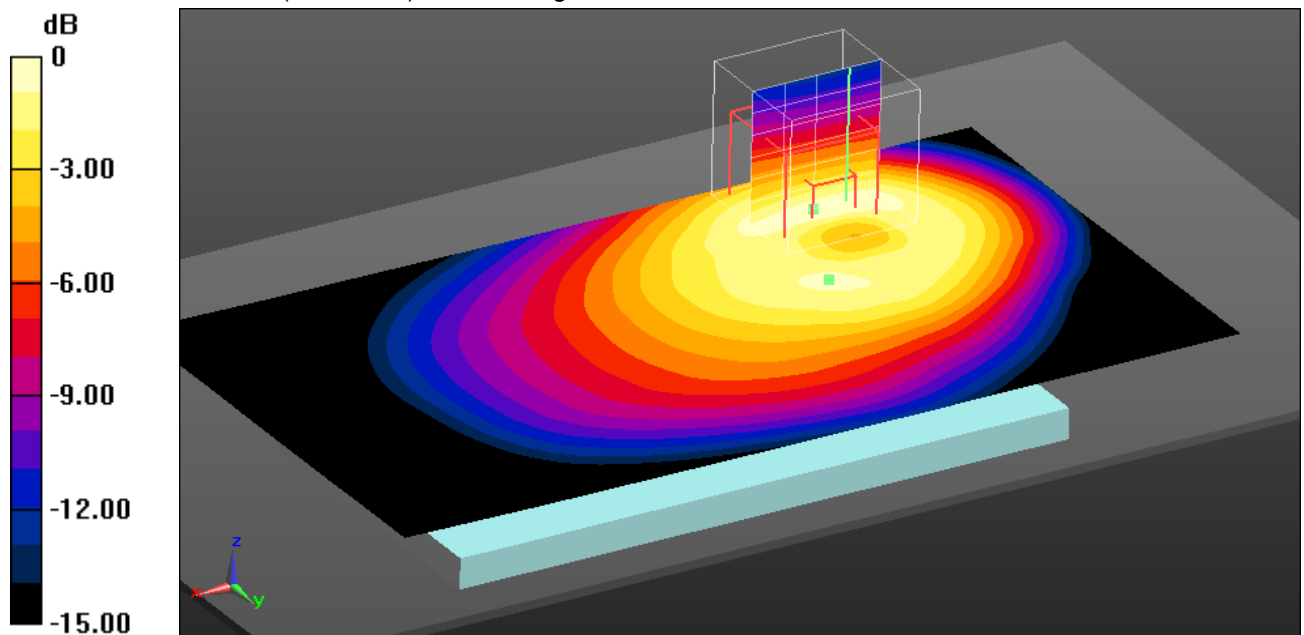

0 dB = 1.22 W/kg = 0.86 dBW/kg

Additional information:

position or distance of DUT to the phantom: 10 mm

ambient temperature: 23.5°C; liquid temperature: 22.7°C

Date/Time: 23.12.2015 10:42:24

FCC-GSM850 body worn

DUT: Microsoft; Type: RM-1154; Serial: 004402743285805

Communication System: UID 0, GSM/GPRS 4TS (0); Communication System Band: GSM 850; Frequency: 848.8 MHz; Communication System PAR: 3.01 dB; PMF: 1.41416

Medium parameters used: $f = 849$ MHz; $\sigma = 0.99$ S/m; $\epsilon_r = 53.308$; $\rho = 1000$ kg/m³

Phantom section: Center Section

Measurement Standard: DASY5

DASY5 Configuration:

- Probe: ES3DV3 - SN3320; ConvF(6.11, 6.11, 6.11); Calibrated: 25.02.2015;
- Sensor-Surface: 3mm (Mechanical Surface Detection (Locations From Previous Scan Used)), Sensor-Surface: 3mm (Mechanical Surface Detection), $z = 2.0, 32.0$
- Electronics: DAE3 Sn413; Calibrated: 15.01.2015
- Phantom: Triple Flat Phantom 5.1C; Type: QD 000 P51 CA; Serial: 1154
- DASY52 52.8.7(1137); SEMCAD X 14.6.10(7164)

MSL835 - ANT 1/Front High 15mm/Area Scan (71x131x1): Interpolated grid: $dx=1.500$ mm, $dy=1.500$ mm

Maximum value of SAR (interpolated) = 0.632 W/kg

MSL835 - ANT 1/Front High 15mm/Zoom Scan (5x5x7)/Cube 0: Measurement grid:

$dx=7.5$ mm, $dy=7.5$ mm, $dz=5$ mm

Reference Value = 26.016 V/m; Power Drift = -0.03 dB

Peak SAR (extrapolated) = 0.726 W/kg

SAR(1 g) = 0.564 W/kg; SAR(10 g) = 0.412 W/kg

Maximum value of SAR (measured) = 0.628 W/kg

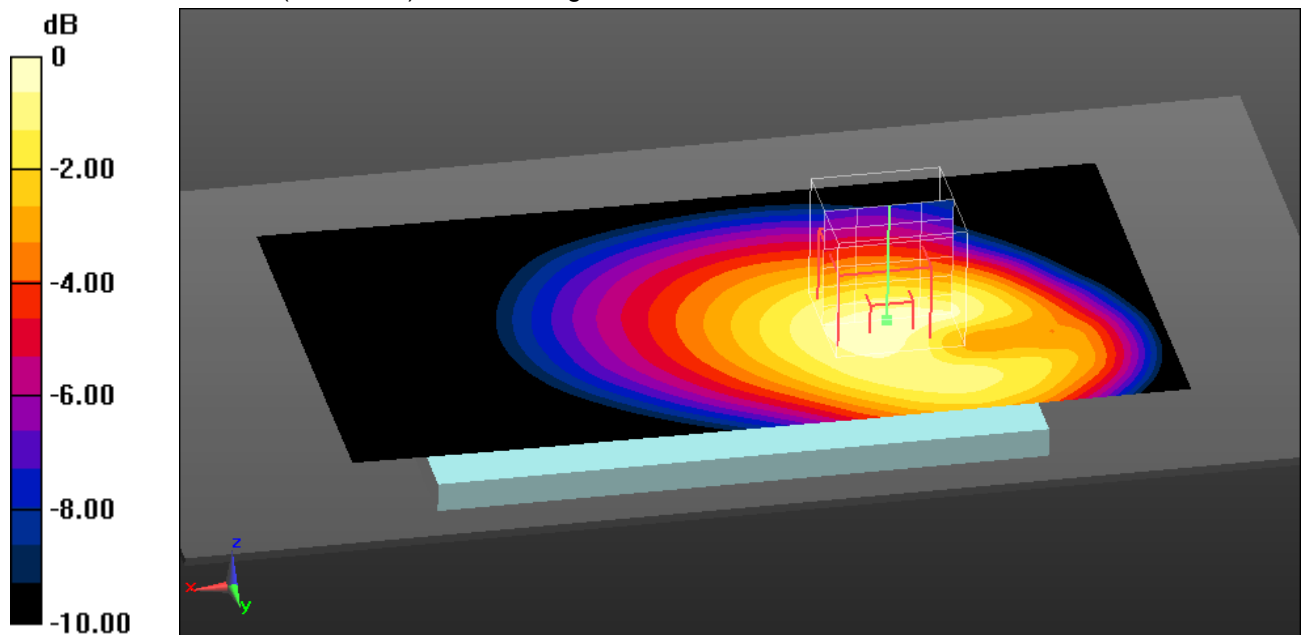

0 dB = 0.628 W/kg = -2.02 dBW/kg

Additional information:

position or distance of DUT to the phantom: 15 mm

ambient temperature: 23.5°C; liquid temperature: 22.7°C

FCC-GSM850 body worn

DUT: Microsoft; Type: RM-1154; Serial: 004402743285805

Communication System: UID 0, GSM/GPRS 4TS (0); Communication System Band: GSM 850; Frequency: 824.2 MHz; Communication System PAR: 3.01 dB; PMF: 1.41416

Medium parameters used (interpolated): $f = 824.2$ MHz; $\sigma = 0.966$ S/m; $\epsilon_r = 53.595$; $\rho = 1000$ kg/m³

Phantom section: Center Section

Measurement Standard: DASYS

DASY5 Configuration:

- Probe: ES3DV3 - SN3320; ConvF(6.11, 6.11, 6.11); Calibrated: 25.02.2015;
- Sensor-Surface: 3mm (Mechanical Surface Detection (Locations From Previous Scan Used)), Sensor-Surface: 3mm (Mechanical Surface Detection), $z = 2.0, 32.0$
- Electronics: DAE3 Sn413; Calibrated: 15.01.2015
- Phantom: Triple Flat Phantom 5.1C; Type: QD 000 P51 CA; Serial: 1154
- DASY52 52.8.7(1137); SEMCAD X 14.6.10(7164)

MSL835 - ANT 2/Rear Low 15mm/Area Scan (71x131x1): Interpolated grid: $dx=1.500$ mm, $dy=1.500$ mm

Maximum value of SAR (interpolated) = 0.603 W/kg

MSL835 - ANT 2/Rear Low 15mm/Zoom Scan (5x5x7)/Cube 0: Measurement grid:

$dx=7.5$ mm, $dy=7.5$ mm, $dz=5$ mm

Reference Value = 25.644 V/m; Power Drift = -0.08 dB

Peak SAR (extrapolated) = 0.697 W/kg

SAR(1 g) = 0.553 W/kg; SAR(10 g) = 0.412 W/kg

Maximum value of SAR (measured) = 0.605 W/kg

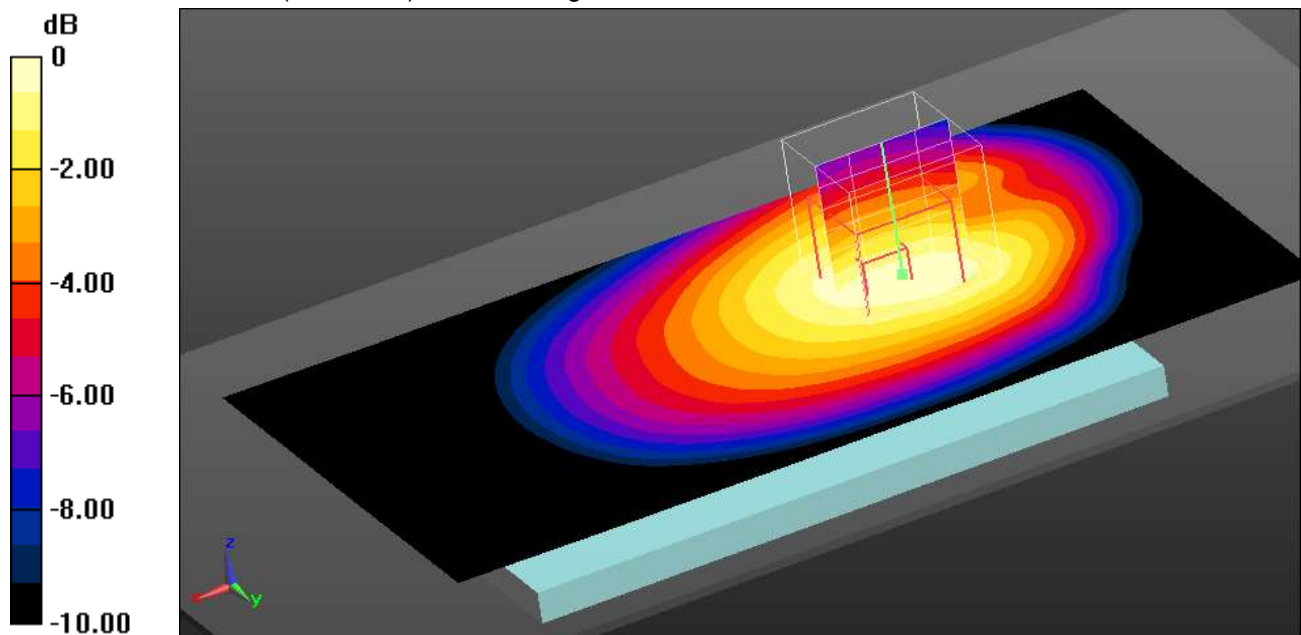

0 dB = 0.605 W/kg = -2.18 dBW/kg

Additional information:

position or distance of DUT to the phantom: 15 mm

ambient temperature: 23.5°C; liquid temperature: 22.7°C

Annex B.2: GSM1900

Date/Time: 14.12.2015 11:04:10

IEEE1528-GSM1900 head

DUT: Microsoft; Type: RM-1154; Serial: 004402743285284

Communication System: UID 0, GSM/GPRS 2TS (0); Communication System Band: GSM 1900; Frequency: 1880 MHz; Communication System PAR: 6.021 dB; PMF: 2.00009

Medium parameters used: $f = 1880$ MHz; $\sigma = 1.374$ S/m; $\epsilon_r = 38.796$; $\rho = 1000$ kg/m³

Phantom section: Right Section

Measurement Standard: DASY5

DASY5 Configuration:

- Probe: EX3DV4 - SN3944; ConvF(8.19, 8.19, 8.19); Calibrated: 14.08.2015;
- Sensor-Surface: 2mm (Mechanical Surface Detection (Locations From Previous Scan Used)), Sensor-Surface: 2mm (Mechanical Surface Detection), $z = 1.0, 31.0$
- Electronics: DAE3 Sn477; Calibrated: 22.05.2015
- Phantom: SAM; Type: SAM; Serial: 1043
- DASY52 52.8.7(1137); SEMCAD X 14.6.10(7164)

Right-Hand-Side HSL - ANT 1/Touch Position - Mid/Area Scan (71x121x1):

Interpolated grid: $dx=1.500$ mm, $dy=1.500$ mm

Maximum value of SAR (interpolated) = 0.526 W/kg

Right-Hand-Side HSL - ANT 1/Touch Position - Mid/Zoom Scan (5x5x7)/Cube

0: Measurement grid: $dx=7.5$ mm, $dy=7.5$ mm, $dz=5$ mm

Reference Value = 19.519 V/m; Power Drift = -0.05 dB

Peak SAR (extrapolated) = 0.601 W/kg

SAR(1 g) = 0.380 W/kg; SAR(10 g) = 0.229 W/kg

Maximum value of SAR (measured) = 0.502 W/kg

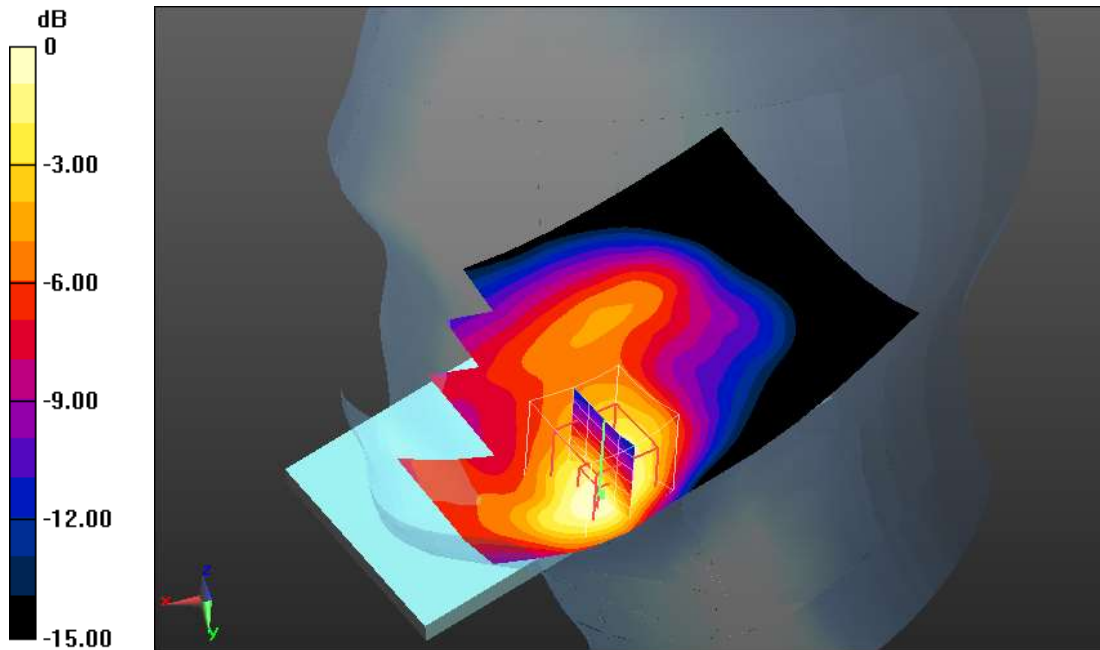

0 dB = 0.502 W/kg = -2.99 dBW/kg

Additional information:

ambient temperature: 22.4°C; liquid temperature: 21.4°C

Date/Time: 19.12.2015 09:14:59

FCC-GSM 1900 hotspot

DUT: Microsoft; Type: RM-1154; Serial: 004402743285284

Communication System: UID 0, GSM/GPRS 2TS (0); Communication System Band: GSM 1900; Frequency: 1880 MHz; Communication System PAR: 6.021 dB; PMF: 2.00009

Medium parameters used: $f = 1880$ MHz; $\sigma = 1.5$ S/m; $\epsilon_r = 54.049$; $\rho = 1000$ kg/m³

Phantom section: Center Section

Measurement Standard: DASY5

DASY5 Configuration:

- Probe: EX3DV4 - SN3944; ConvF(7.91, 7.91, 7.91); Calibrated: 14.08.2015;
- Sensor-Surface: 2mm (Mechanical Surface Detection (Locations From Previous Scan Used)), Sensor-Surface: 2mm (Mechanical Surface Detection), $z = 1.0, 31.0$
- Electronics: DAE3 Sn477; Calibrated: 22.05.2015
- Phantom: Triple Flat Phantom 5.1C; Type: QD 000 P51 CA; Serial: 1154
- DASY52 52.8.7(1137); SEMCAD X 14.6.10(7164)

MSL1900 - ANT 1/Front Middle 10mm/Area Scan (71x131x1): Interpolated grid:

$dx=1.500$ mm, $dy=1.500$ mm

Maximum value of SAR (interpolated) = 0.838 W/kg

MSL1900 - ANT 1/Front Middle 10mm/Zoom Scan (6x6x7)/Cube 0: Measurement

grid: $dx=7.5$ mm, $dy=7.5$ mm, $dz=5$ mm

Reference Value = 23.943 V/m; Power Drift = -0.04 dB

Peak SAR (extrapolated) = 1.01 W/kg

SAR(1 g) = 0.615 W/kg; SAR(10 g) = 0.351 W/kg

Maximum value of SAR (measured) = 0.783 W/kg

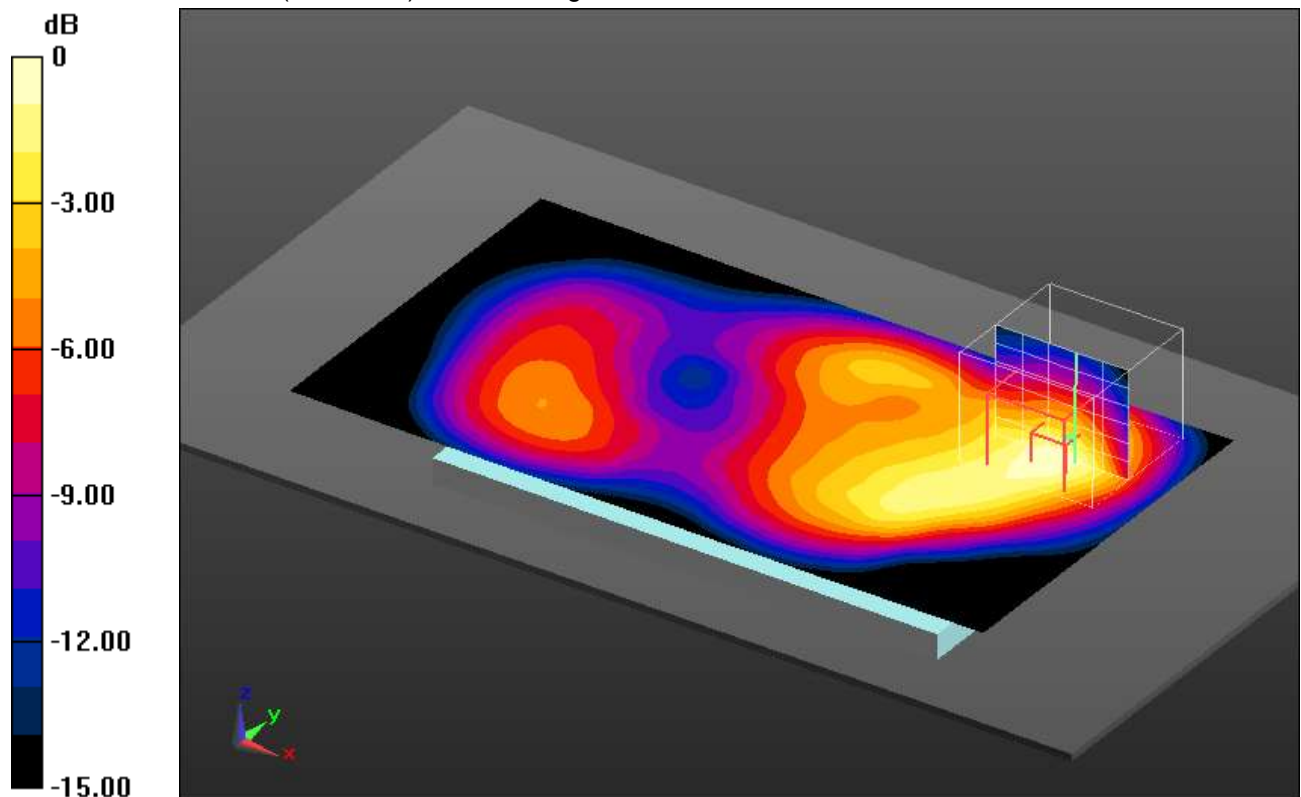

0 dB = 0.783 W/kg = -1.06 dBW/kg

Additional information:

position or distance of DUT to SAM: 10 mm

ambient temperature: 22.5°C; liquid temperature: 21.4°C

FCC-GSM 1900 body worn

DUT: Microsoft; Type: RM-1154; Serial: 004402743285284

Communication System: UID 0, GSM/GPRS 2TS (0); Communication System Band: GSM 1900; Frequency: 1880 MHz; Communication System PAR: 6.021 dB; PMF: 2.00009

Medium parameters used: $f = 1880$ MHz; $\sigma = 1.5$ S/m; $\epsilon_r = 54.049$; $\rho = 1000$ kg/m³

Phantom section: Center Section

Measurement Standard: DASY5

DASY5 Configuration:

- Probe: EX3DV4 - SN3944; ConvF(7.91, 7.91, 7.91); Calibrated: 14.08.2015;
- Sensor-Surface: 2mm (Mechanical Surface Detection (Locations From Previous Scan Used)), Sensor-Surface: 2mm (Mechanical Surface Detection), $z = 1.0, 31.0$
- Electronics: DAE3 Sn477; Calibrated: 22.05.2015
- Phantom: Triple Flat Phantom 5.1C; Type: QD 000 P51 CA; Serial: 1154
- DASY52 52.8.7(1137); SEMCAD X 14.6.10(7164)

MSL1900 - ANT 1/Front Middle 15mm/Area Scan (71x131x1): Interpolated grid:

$dx=1.500$ mm, $dy=1.500$ mm

Maximum value of SAR (interpolated) = 0.359 W/kg

MSL1900 - ANT 1/Front Middle 15mm/Zoom Scan (6x6x7)/Cube 0: Measurement

grid: $dx=7.5$ mm, $dy=7.5$ mm, $dz=5$ mm

Reference Value = 16.006 V/m; Power Drift = -0.04 dB

Peak SAR (extrapolated) = 0.443 W/kg

SAR(1 g) = 0.284 W/kg; SAR(10 g) = 0.170 W/kg

Maximum value of SAR (measured) = 0.362 W/kg

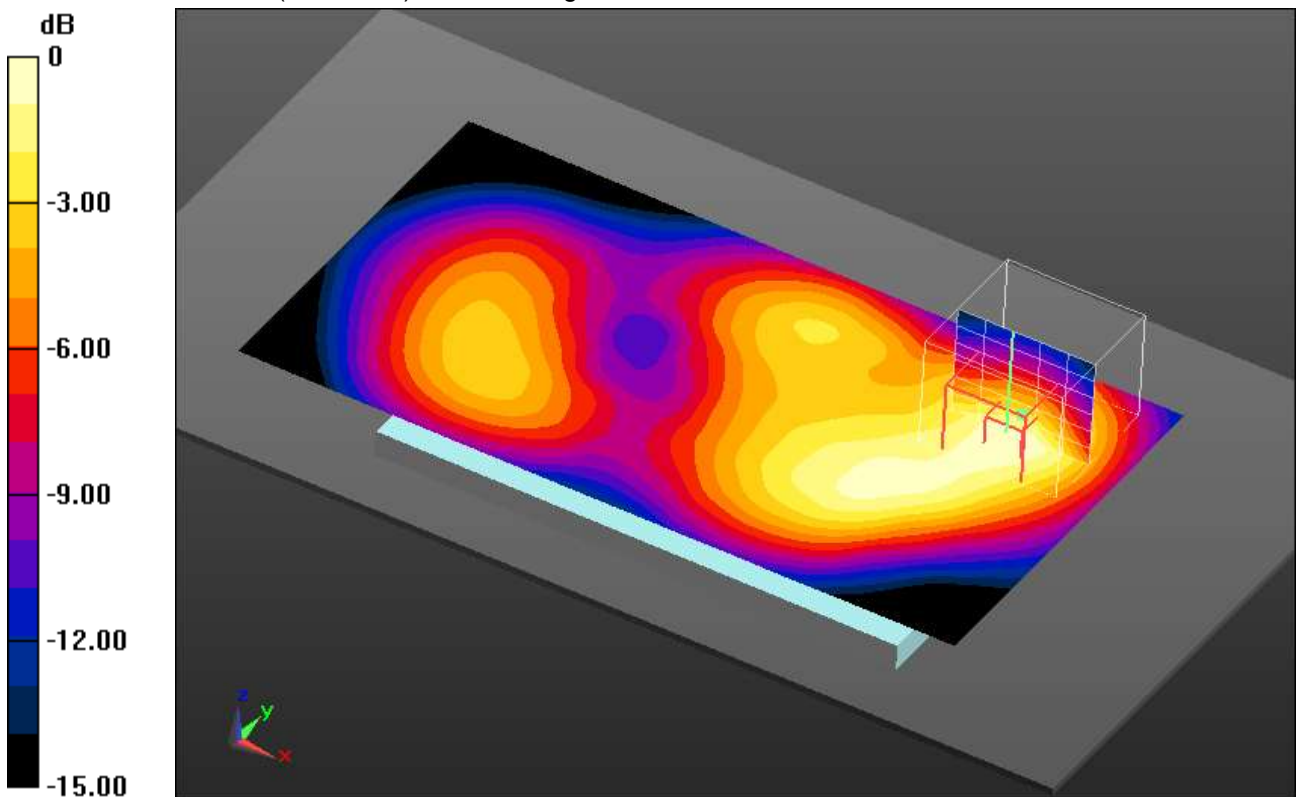

0 dB = 0.362 W/kg = -4.41 dBW/kg

Additional information:

position or distance of DUT to SAM: 15 mm

ambient temperature: 22.5°C; liquid temperature: 21.4°C

Annex B.3: UMTS FDD II

Date/Time: 15.12.2015 10:02:47

IEEE1528-UMTS FDD II head

DUT: Microsoft; Type: RM-1154; Serial: 004402743285284

Communication System: UID 0, UMTS FDD (0); Communication System Band: UMTS FDD II; Frequency: 1880 MHz; Communication System PAR: 0 dB; PMF: 1

Medium parameters used: $f = 1880$ MHz; $\sigma = 1.358$ S/m; $\epsilon_r = 38.471$; $\rho = 1000$ kg/m³

Phantom section: Left Section

Measurement Standard: DASY5

DASY5 Configuration:

- Probe: EX3DV4 - SN3944; ConvF(8.19, 8.19, 8.19); Calibrated: 14.08.2015;
- Sensor-Surface: 2mm (Mechanical Surface Detection (Locations From Previous Scan Used)), Sensor-Surface: 2mm (Mechanical Surface Detection), $z = 1.0, 31.0$
- Electronics: DAE3 Sn477; Calibrated: 22.05.2015
- Phantom: SAM; Type: SAM; Serial: 1043
- DASY52 52.8.7(1137); SEMCAD X 14.6.10(7164)

Left-Hand-Side HSL - ANT 2/Touch Position - Mid/Area Scan (71x121x1):

Interpolated grid: $dx=1.500$ mm, $dy=1.500$ mm

Maximum value of SAR (interpolated) = 0.689 W/kg

Left-Hand-Side HSL - ANT 2/Touch Position - Mid/Zoom Scan (6x6x7)/Cube 0:

Measurement grid: $dx=7.5$ mm, $dy=7.5$ mm, $dz=5$ mm

Reference Value = 22.203 V/m; Power Drift = -0.05 dB

Peak SAR (extrapolated) = 0.824 W/kg

SAR(1 g) = 0.513 W/kg; SAR(10 g) = 0.302 W/kg

Maximum value of SAR (measured) = 0.674 W/kg

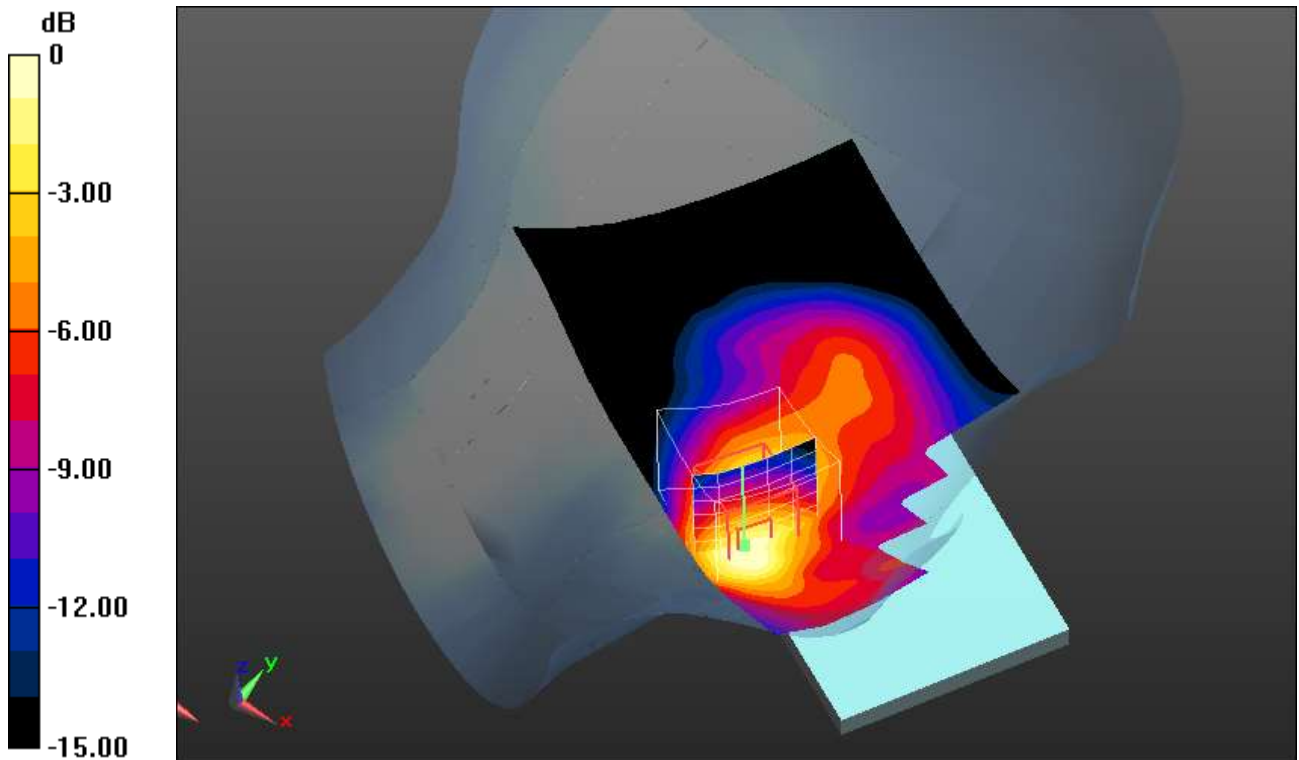

0 dB = 0.674 W/kg = -1.71 dBW/kg

Additional information:

ambient temperature: 22.6°C; liquid temperature: 21.9°C

Date/Time: 18.12.2015 11:12:42

FCC-UMTS FDD II hotspot

DUT: Microsoft; Type: RM-1154; Serial: 004402743285284

Communication System: UID 0, UMTS FDD (0); Communication System Band: UMTS FDD II; Frequency: 1852.4 MHz; Communication System PAR: 0 dB; PMF: 1

Medium parameters used (interpolated): $f = 1852.4$ MHz; $\sigma = 1.452$ S/m; $\epsilon_r = 53.984$; $\rho = 1000$ kg/m³

Phantom section: Center Section

Measurement Standard: DASY5

DASY5 Configuration:

- Probe: EX3DV4 - SN3944; ConvF(7.91, 7.91, 7.91); Calibrated: 14.08.2015;
- Sensor-Surface: 2mm (Mechanical Surface Detection (Locations From Previous Scan Used)), Sensor-Surface: 2mm (Mechanical Surface Detection), $z = 1.0, 31.0$
- Electronics: DAE3 Sn477; Calibrated: 22.05.2015
- Phantom: Triple Flat Phantom 5.1C; Type: QD 000 P51 CA; Serial: 1154
- DASY52 52.8.7(1137); SEMCAD X 14.6.10(7164)

MSL1900 - ANT 2/Front Low 10mm/Area Scan (71x131x1): Interpolated grid: $dx=1.500$ mm, $dy=1.500$ mm

Maximum value of SAR (interpolated) = 1.84 W/kg

MSL1900 - ANT 2/Front Low 10mm/Zoom Scan (5x5x7)/Cube 0: Measurement grid:

$dx=7.5$ mm, $dy=7.5$ mm, $dz=5$ mm

Reference Value = 34.692 V/m; Power Drift = 0.13 dB

Peak SAR (extrapolated) = 2.14 W/kg

SAR(1 g) = 1.22 W/kg; SAR(10 g) = 0.642 W/kg

Maximum value of SAR (measured) = 1.60 W/kg

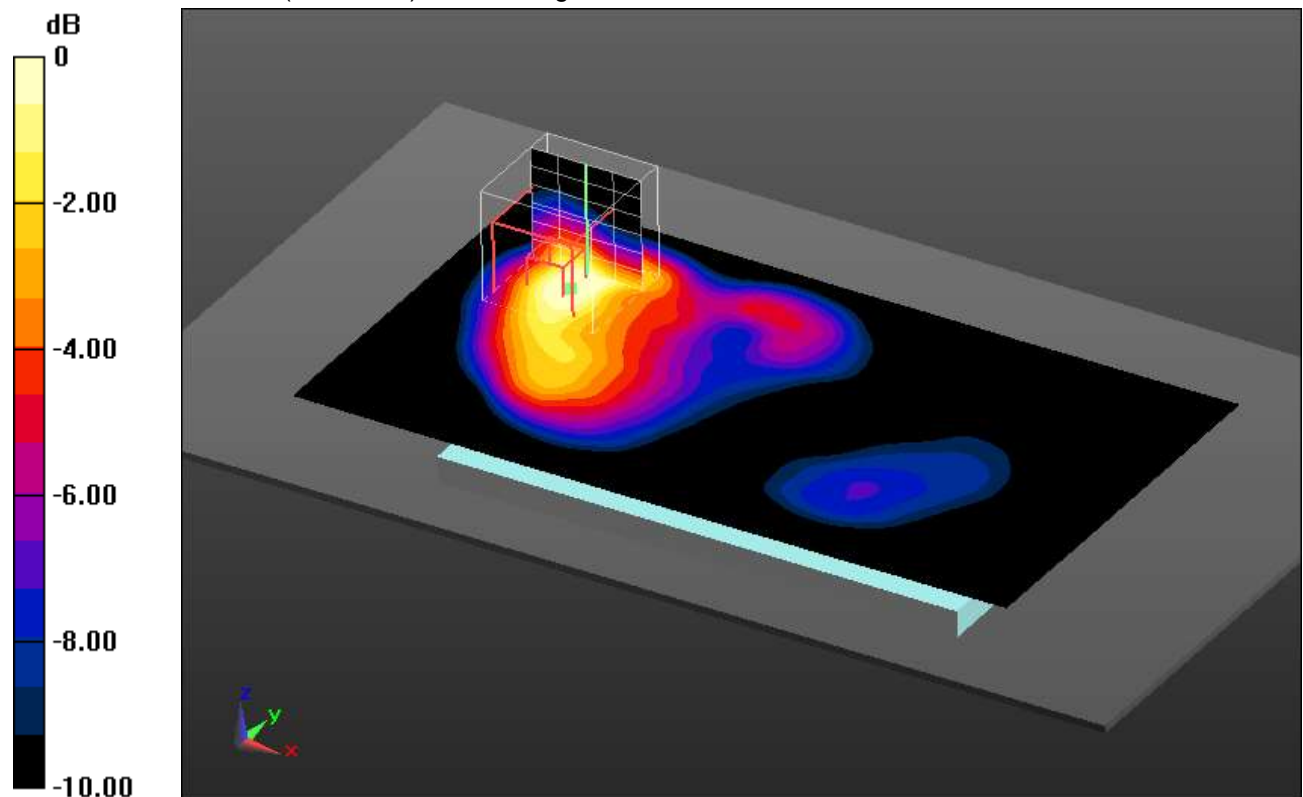

0 dB = 1.60 W/kg = 2.04 dBW/kg

Additional information:

position or distance of DUT to SAM: 10 mm

ambient temperature: 23.3°C; liquid temperature: 22.2°C

FCC-UMTS FDD II body worn

DUT: Microsoft; Type: RM-1154; Serial: 004402743285284

Communication System: UID 0, UMTS FDD (0); Communication System Band: UMTS FDD II; Frequency: 1880 MHz; Communication System PAR: 0 dB; PMF: 1

Medium parameters used: $f = 1880$ MHz; $\sigma = 1.479$ S/m; $\epsilon_r = 53.922$; $\rho = 1000$ kg/m³

Phantom section: Center Section

Measurement Standard: DASY5

DASY5 Configuration:

- Probe: EX3DV4 - SN3944; ConvF(7.91, 7.91, 7.91); Calibrated: 14.08.2015;
- Sensor-Surface: 2mm (Mechanical Surface Detection (Locations From Previous Scan Used)), Sensor-Surface: 2mm (Mechanical Surface Detection), $z = 1.0, 31.0$
- Electronics: DAE3 Sn477; Calibrated: 22.05.2015
- Phantom: Triple Flat Phantom 5.1C; Type: QD 000 P51 CA; Serial: 1154
- DASY52 52.8.7(1137); SEMCAD X 14.6.10(7164)

MSL1900 - ANT 2/Front Middle 15mm/Area Scan (71x131x1): Interpolated grid:

$dx=1.500$ mm, $dy=1.500$ mm

Maximum value of SAR (interpolated) = 0.564 W/kg

MSL1900 - ANT 2/Front Middle 15mm/Zoom Scan (6x5x7)/Cube 0: Measurement

grid: $dx=7.5$ mm, $dy=7.5$ mm, $dz=5$ mm

Reference Value = 19.181 V/m; Power Drift = 0.03 dB

Peak SAR (extrapolated) = 0.702 W/kg

SAR(1 g) = 0.433 W/kg; SAR(10 g) = 0.251 W/kg

Maximum value of SAR (measured) = 0.559 W/kg

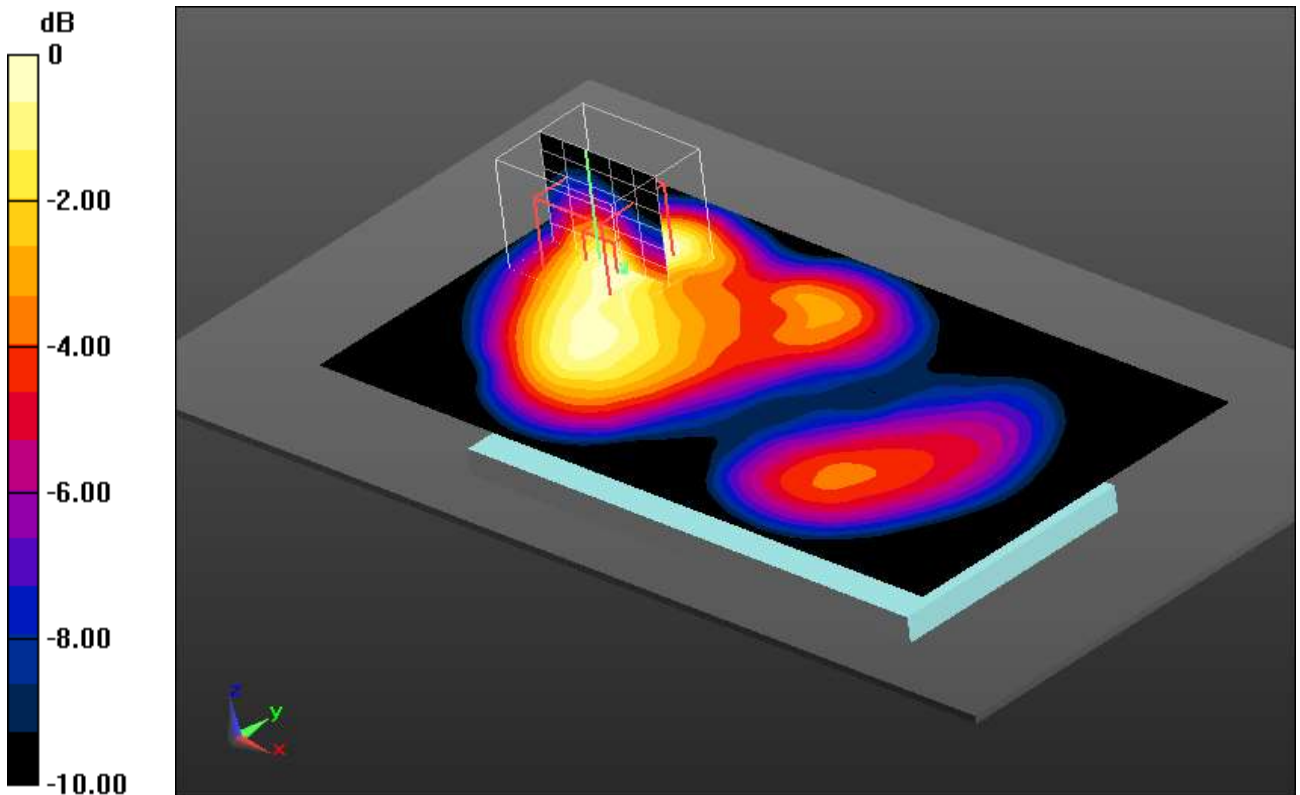

0 dB = 0.559 W/kg = -2.53 dBW/kg

Additional information:

position or distance of DUT to SAM: 15 mm

ambient temperature: 23.3°C; liquid temperature: 22.2°C

Annex B.4: UMTS FDD IV

Date/Time: 12/15/2015 11:15:19 PM

IEEE1528-UMTS FDD IV head

DUT: Microsoft; Type: RM-1154; Serial: 004402743285227

Communication System: UID 0, UMTS FDD (0); Communication System Band: UMTS FDD IV; Frequency: 1732.4 MHz; Communication System PAR: 0 dB; PMF: 1

Medium parameters used (interpolated): $f = 1732.4$ MHz; $\sigma = 1.323$ S/m; $\epsilon_r = 39.246$; $\rho = 1000$ kg/m³

Phantom section: Left Section

Measurement Standard: DASY5

DASY5 Configuration:

- Probe: ES3DV3 - SN3326; ConvF(5.18, 5.18, 5.18); Calibrated: 8/12/2015;
- Sensor-Surface: 3mm (Mechanical Surface Detection (Locations From Previous Scan Used)), Sensor-Surface: 3mm (Mechanical Surface Detection), $z = 2.0, 32.0$
- Electronics: DAE4 Sn1387; Calibrated: 8/12/2015
- Phantom: SAM front; Type: QD000P40CC; Serial: TP:1041
- DASY52 52.8.8(1222); SEMCAD X 14.6.10(7331)

Left-Hand side - ANT 2/Touch Position - Mid/Area Scan (71x121x1): Interpolated grid: $dx=1.500$ mm, $dy=1.500$ mm

Maximum value of SAR (interpolated) = 0.626 W/kg

Left-Hand side - ANT 2/Touch Position - Mid/Zoom Scan (8x6x7)/Cube 0:

Measurement grid: $dx=7.5$ mm, $dy=7.5$ mm, $dz=5$ mm

Reference Value = 21.74 V/m; Power Drift = -0.09 dB

Peak SAR (extrapolated) = 0.874 W/kg

SAR(1 g) = 0.509 W/kg; SAR(10 g) = 0.276 W/kg

Maximum value of SAR (measured) = 0.646 W/kg

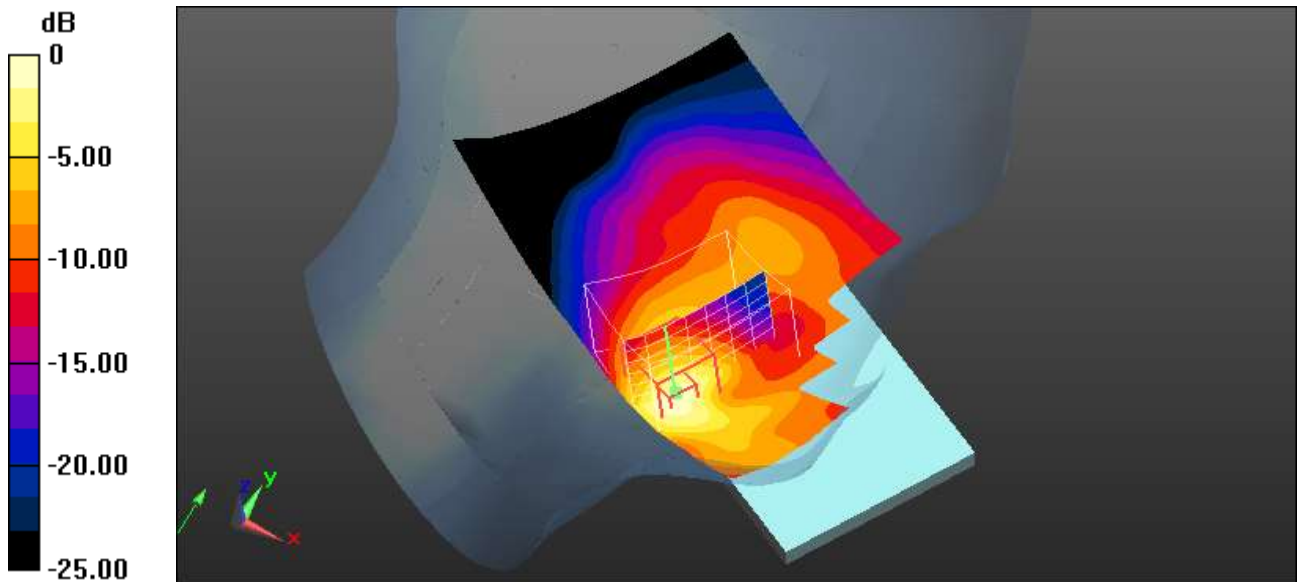

0 dB = 0.646 W/kg = -1.90 dBW/kg

Additional information:

ambient temperature: 22.2°C; liquid temperature: 21.7°C

FCC-UMTS FDD IV hotspot

DUT: Microsoft; Type: RM-1154; Serial: 004402743285706

Communication System: UID 0, UMTS FDD (0); Communication System Band: UMTS FDD IV; Frequency: 1712.4 MHz; Communication System PAR: 0 dB; PMF: 1

Medium parameters used (interpolated): $f = 1712.4$ MHz; $\sigma = 1.465$ S/m; $\epsilon_r = 51.673$; $\rho = 1000$ kg/m³

Phantom section: Center Section

Measurement Standard: DASy5

DASy5 Configuration:

- Probe: ES3DV3 - SN3326; ConvF(4.85, 4.85, 4.85); Calibrated: 8/12/2015;
- Sensor-Surface: 3mm (Mechanical Surface Detection (Locations From Previous Scan Used)), Sensor-Surface: 3mm (Mechanical Surface Detection), $z = 2.0, 32.0$
- Electronics: DAE4 Sn1387; Calibrated: 8/12/2015
- Phantom: Triple Flat Phantom 5.1C; Type: QD 000 P51 CA; Serial: 1154
- DASy52 52.8.8(1222); SEMCAD X 14.6.10(7331)

MSL1750 - ANT 2/Front Low 10mm/Area Scan (71x131x1): Interpolated grid: $dx=1.500$ mm, $dy=1.500$ mm

Maximum value of SAR (interpolated) = 1.24 W/kg

MSL1750 - ANT 2/Front Low 10mm/Zoom Scan (6x6x7)/Cube 0: Measurement grid:

$dx=7.5$ mm, $dy=7.5$ mm, $dz=5$ mm

Reference Value = 29.61 V/m; Power Drift = 0.04 dB

Peak SAR (extrapolated) = 1.83 W/kg

SAR(1 g) = 1.02 W/kg; SAR(10 g) = 0.521 W/kg

Maximum value of SAR (measured) = 1.20 W/kg

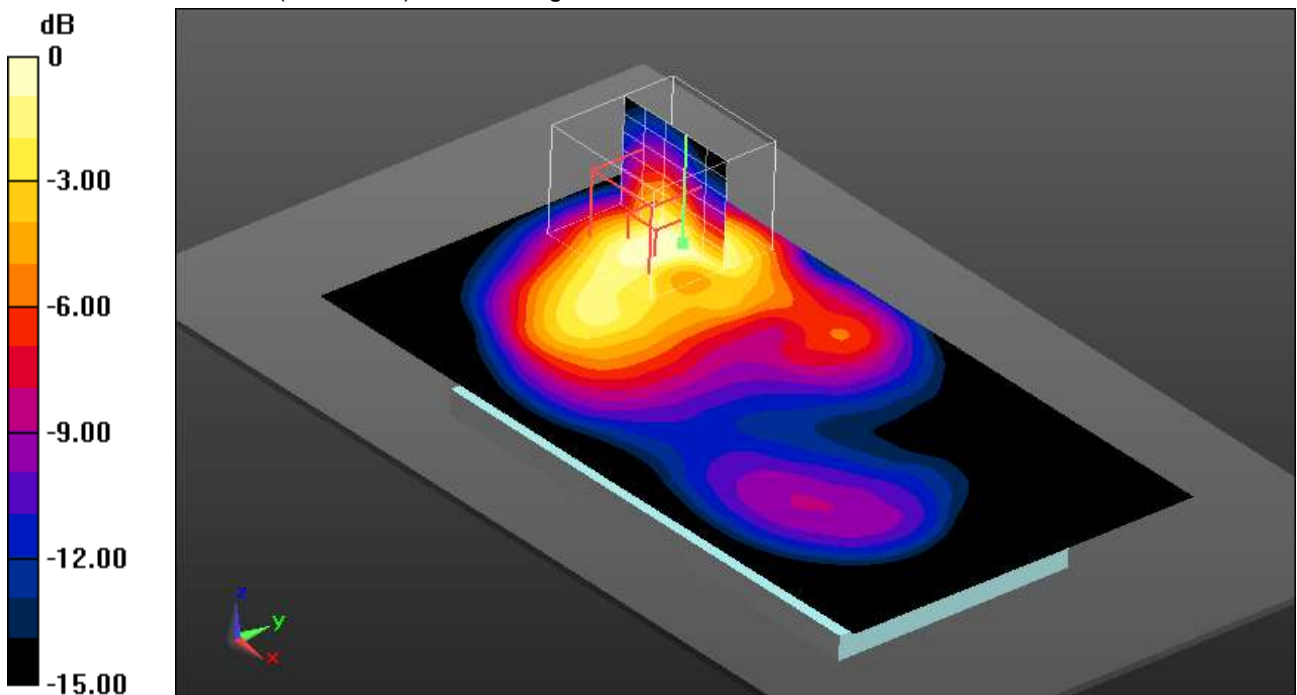

0 dB = 1.20 W/kg = 0.79 dBW/kg

Additional information:

position or distance of DUT to the phantom: 10 mm

ambient temperature: 22.0°C; liquid temperature: 22.2°C

Date/Time: 29.12.2015 10:44:02

FCC-UMTS FDD IV body worn

DUT: Microsoft; Type: RM-1154; Serial: 004402743285227

Communication System: UID 0, UMTS FDD (0); Communication System Band: UMTS FDD IV; Frequency: 1732.4 MHz; Communication System PAR: 0 dB; PMF: 1

Medium parameters used (interpolated): $f = 1732.4$ MHz; $\sigma = 1.514$ S/m; $\epsilon_r = 52.043$; $\rho = 1000$ kg/m³

Phantom section: Center Section

Measurement Standard: DASy5

DASy5 Configuration:

- Probe: ES3DV3 - SN3320; ConvF(4.73, 4.73, 4.73); Calibrated: 25.02.2015;
- Sensor-Surface: 3mm (Mechanical Surface Detection (Locations From Previous Scan Used)), Sensor-Surface: 3mm (Mechanical Surface Detection), $z = 2.0, 32.0$
- Electronics: DAE3 Sn413; Calibrated: 15.01.2015
- Phantom: Triple Flat Phantom 5.1C; Type: QD 000 P51 CA; Serial: 1154
- DASy52 52.8.7(1137); SEMCAD X 14.6.10(7164)

MSL1750 - ANT 1/Rear Middle 15mm/Area Scan (71x131x1): Interpolated grid:

$dx=1.500$ mm, $dy=1.500$ mm

Maximum value of SAR (interpolated) = 0.601 W/kg

MSL1750 - ANT 1/Rear Middle 15mm/Zoom Scan (5x5x7)/Cube 0: Measurement

grid: $dx=7.5$ mm, $dy=7.5$ mm, $dz=5$ mm

Reference Value = 19.836 V/m; Power Drift = 0.09 dB

Peak SAR (extrapolated) = 1.06 W/kg

SAR(1 g) = 0.684 W/kg; SAR(10 g) = 0.426 W/kg

Maximum value of SAR (measured) = 0.809 W/kg

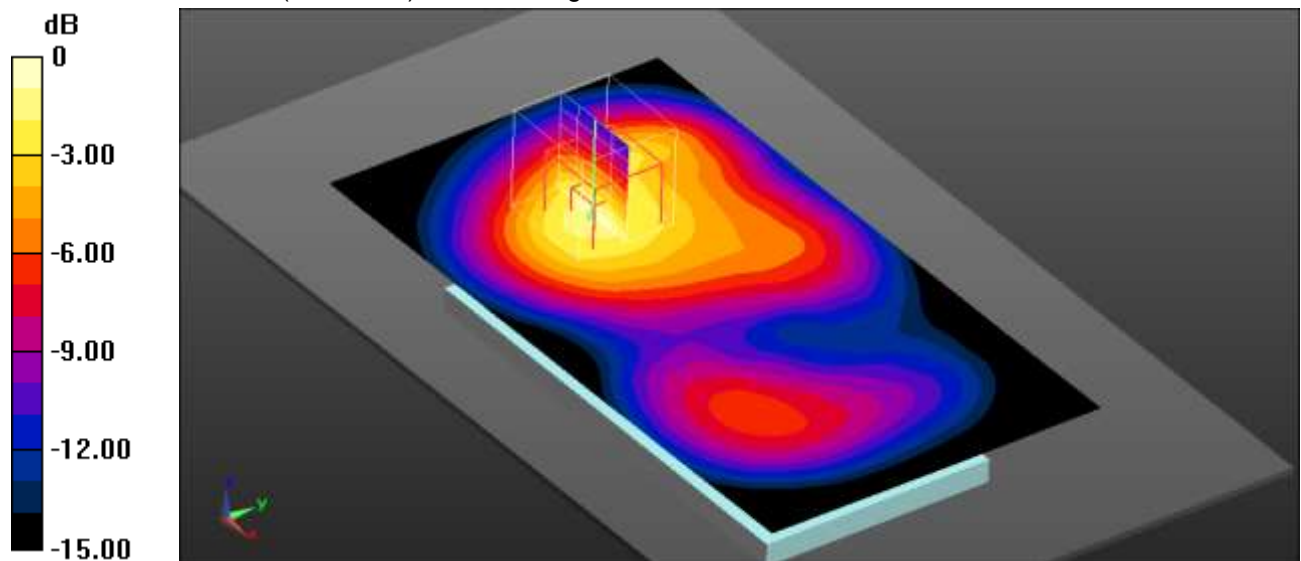

0 dB = 0.809 W/kg = -0.92 dBW/kg

Additional information:

position or distance of DUT to the phantom: 15 mm

ambient temperature: 23.3°C; liquid temperature: 22.8°C

Annex B.5: UMTS FDD V

Date/Time: 16.12.2015 15:14:42

IEEE1528-UMTS FDD V head

DUT: Microsoft; Type: RM-1154; Serial: 004402743285805

Communication System: UID 0, UMTS FDD (0); Communication System Band: UMTS FDD V; Frequency: 836.4 MHz; Communication System PAR: 0 dB; PMF: 1

Medium parameters used (interpolated): $f = 836.4$ MHz; $\sigma = 0.915$ S/m; $\epsilon_r = 41.521$; $\rho = 1000$ kg/m³

Phantom section: Right Section

Measurement Standard: DASYS5

DASY5 Configuration:

- Probe: ES3DV3 - SN3320; ConvF(6.14, 6.14, 6.14); Calibrated: 25.02.2015;
- Sensor-Surface: 3mm (Mechanical Surface Detection), $z = 2.0, 32.0$
- Electronics: DAE3 Sn413; Calibrated: 15.01.2015
- Phantom: SAM front; Type: QD000P40CC; Serial: TP-1041
- DASY52 52.8.7(1137); SEMCAD X 14.6.10(7164)

Right-Hand-Side HSL - ANT 1/Touch Position - Mid/Area Scan (71x121x1):

Interpolated grid: $dx=1.500$ mm, $dy=1.500$ mm

Maximum value of SAR (interpolated) = 0.645 W/kg

Right-Hand-Side HSL - ANT 1/Touch Position - Mid/Zoom Scan (5x5x7)/Cube

0: Measurement grid: $dx=7.5$ mm, $dy=7.5$ mm, $dz=5$ mm

Reference Value = 26.883 V/m; Power Drift = -0.02 dB

Peak SAR (extrapolated) = 0.851 W/kg

SAR(1 g) = 0.518 W/kg; SAR(10 g) = 0.331 W/kg

Maximum value of SAR (measured) = 0.625 W/kg

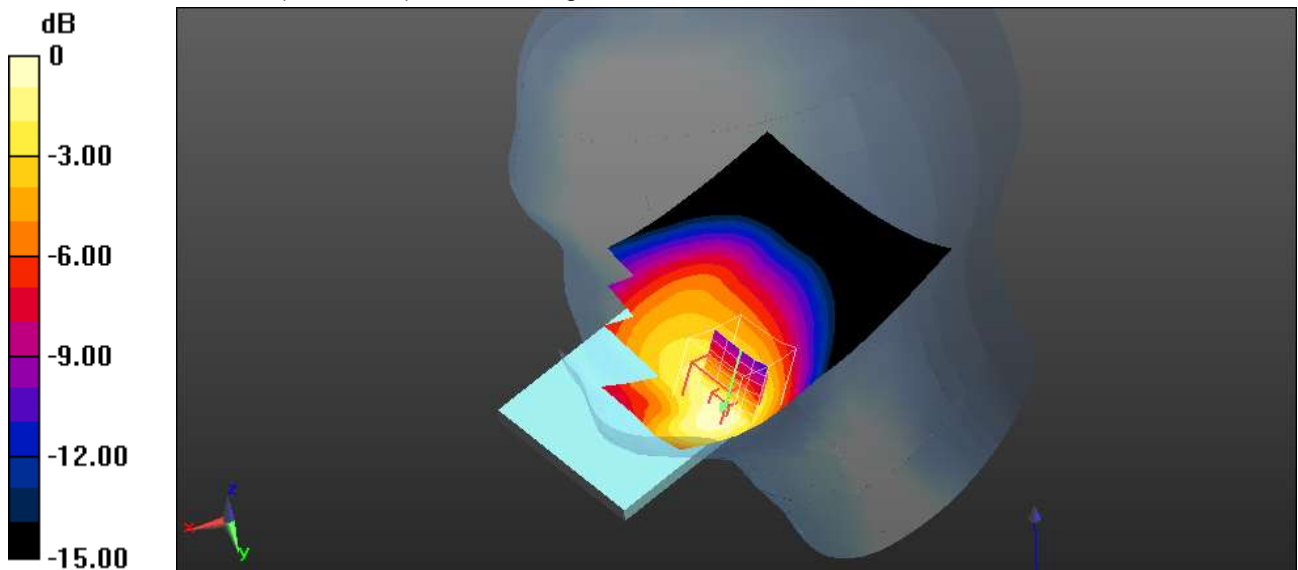

0 dB = 0.625 W/kg = -2.04 dBW/kg

Additional information:

ambient temperature: 22.9°C; liquid temperature: 22.1°C

FCC-UMTS FDD V hotspot

DUT: Microsoft; Type: RM-1154; Serial: 004402743285805

Communication System: UID 0, UMTS FDD (0); Communication System Band: UMTS FDD V; Frequency: 826.4 MHz; Communication System PAR: 0 dB; PMF: 1

Medium parameters used (extrapolated): $f = 826.4$ MHz; $\sigma = 0.959$ S/m; $\epsilon_r = 38.973$; $\rho = 1000$ kg/m³

Phantom section: Center Section

Measurement Standard: DASY5

DASY5 Configuration:

- Probe: ES3DV3 - SN3320; ConvF(6.14, 6.14, 6.14); Calibrated: 25.02.2015;
- Sensor-Surface: 3mm (Mechanical Surface Detection (Locations From Previous Scan Used)), Sensor-Surface: 3mm (Mechanical Surface Detection), $z = 2.0, 32.0$
- Electronics: DAE3 Sn413; Calibrated: 15.01.2015
- Phantom: Triple Flat Phantom 5.1C; Type: QD 000 P51 CA; Serial: 1154
- DASY52 52.8.7(1137); SEMCAD X 14.6.10(7164)

MSL835 - ANT 1/Rear Low 10mm/Area Scan (71x131x1): Interpolated grid: $dx=1.500$ mm, $dy=1.500$ mm

Maximum value of SAR (interpolated) = 0.892 W/kg

MSL835 - ANT 1/Rear Low 10mm/Zoom Scan (9x6x7)/Cube 0: Measurement grid:

$dx=7.5$ mm, $dy=7.5$ mm, $dz=5$ mm

Reference Value = 31.449 V/m; Power Drift = -0.09 dB

Peak SAR (extrapolated) = 1.35 W/kg

SAR(1 g) = 0.777 W/kg; SAR(10 g) = 0.459 W/kg

Maximum value of SAR (measured) = 0.952 W/kg

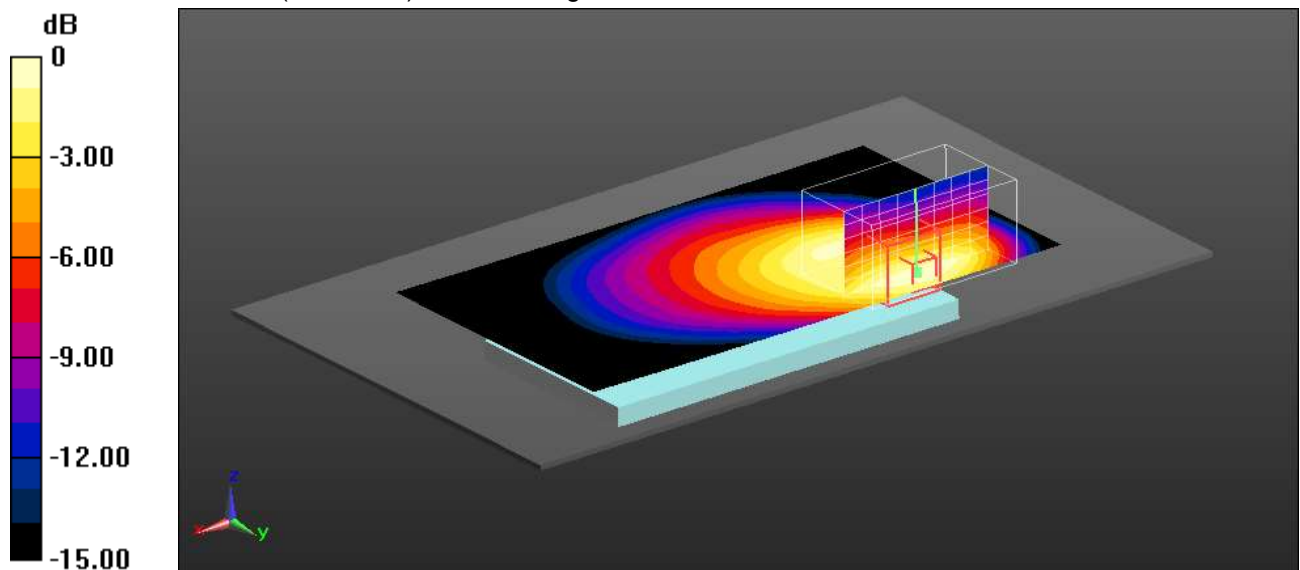

0 dB = 0.952 W/kg = -0.21 dBW/kg

Additional information:

position or distance of DUT to the phantom: 10 mm

ambient temperature: 23.0°C; liquid temperature: 22.5°C

Date/Time: 22.12.2015 10:17:22

FCC-UMTS FDD V body worn

DUT: Microsoft; Type: RM-1154; Serial: 004402743285805

Communication System: UID 0, UMTS FDD (0); Communication System Band: UMTS FDD V; Frequency: 836.4 MHz; Communication System PAR: 0 dB; PMF: 1

Medium parameters used (extrapolated): $f = 836.4$ MHz; $\sigma = 0.968$ S/m; $\epsilon_r = 38.84$; $\rho = 1000$ kg/m³

Phantom section: Center Section

Measurement Standard: DASYS

DASY5 Configuration:

- Probe: ES3DV3 - SN3320; ConvF(6.14, 6.14, 6.14); Calibrated: 25.02.2015;
- Sensor-Surface: 3mm (Mechanical Surface Detection), $z = 2.0, 32.0$
- Electronics: DAE3 Sn413; Calibrated: 15.01.2015
- Phantom: Triple Flat Phantom 5.1C; Type: QD 000 P51 CA; Serial: 1154
- DASY52 52.8.7(1137); SEMCAD X 14.6.10(7164)

MSL835 - ANT 1/Front Middle 15mm/Area Scan (71x131x1): Interpolated grid:

$dx=1.500$ mm, $dy=1.500$ mm

Maximum value of SAR (interpolated) = 0.557 W/kg

MSL835 - ANT 1/Front Middle 15mm/Zoom Scan (7x6x7)/Cube 0: Measurement grid:

$dx=7.5$ mm, $dy=7.5$ mm, $dz=5$ mm

Reference Value = 24.573 V/m; Power Drift = 0.06 dB

Peak SAR (extrapolated) = 0.663 W/kg

SAR(1 g) = 0.519 W/kg; SAR(10 g) = 0.378 W/kg

Maximum value of SAR (measured) = 0.575 W/kg

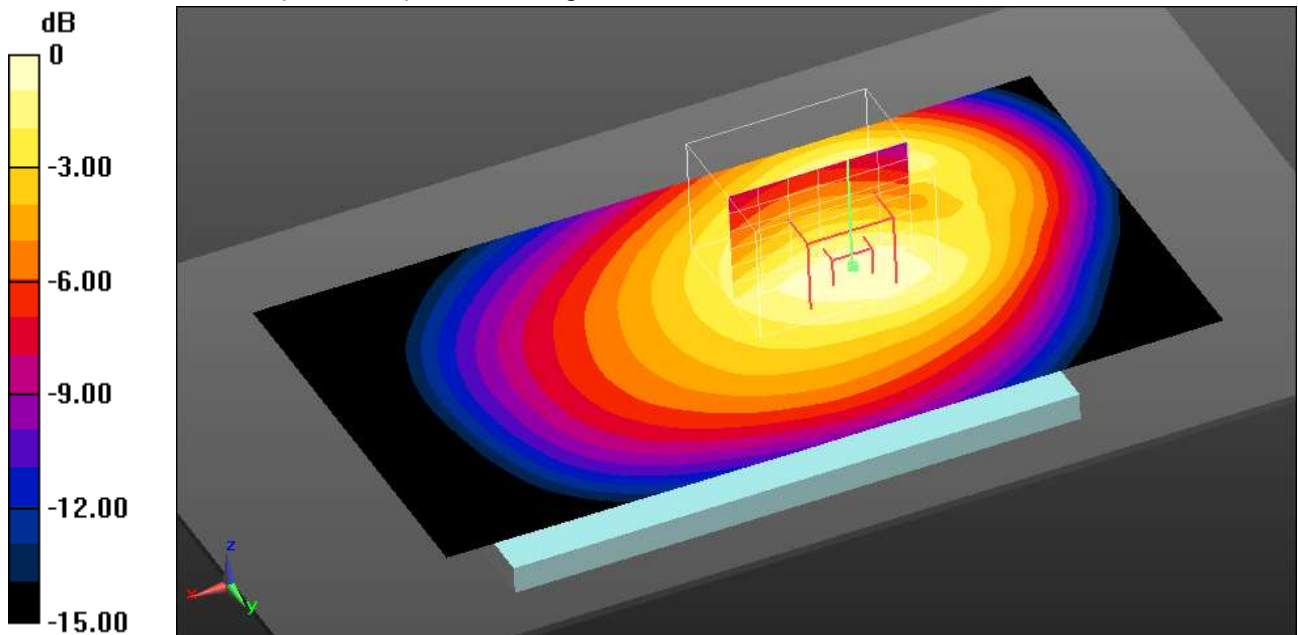

0 dB = 0.575 W/kg = -2.40 dBW/kg

Additional information:

position or distance of DUT to the phantom: 15 mm

ambient temperature: 23.0°C; liquid temperature: 22.5°C

Annex B.6: LTE FDD 2

Date/Time: 11.12.2015 15:43:11

IEEE1528-LTE FDD 2 head

DUT: Microsoft; Type: RM-1154; Serial: 004402743285284

Communication System: UID 0, LTE FDD (0); Communication System Band: LTE 2 (1900MHz); Frequency: 1880 MHz; Communication System PAR: 0 dB; PMF: 1

Medium parameters used: $f = 1880$ MHz; $\sigma = 1.366$ S/m; $\epsilon_r = 39.606$; $\rho = 1000$ kg/m³

Phantom section: Left Section

Measurement Standard: DASY5

DASY5 Configuration:

- Probe: EX3DV4 - SN3944; ConvF(8.19, 8.19, 8.19); Calibrated: 14.08.2015;
- Sensor-Surface: 2mm (Mechanical Surface Detection (Locations From Previous Scan Used)), Sensor-Surface: 2mm (Mechanical Surface Detection), $z = 1.0, 31.0$
- Electronics: DAE3 Sn477; Calibrated: 22.05.2015
- Phantom: SAM; Type: SAM; Serial: 1043
- DASY52 52.8.7(1137); SEMCAD X 14.6.10(7164)

Left-Hand-Side HSL - ANT 2 - 20MHz BW - QPSK - 1RB - 0RB offset/Touch Position - Middle/Area Scan (71x121x1):

Interpolated grid: $dx=1.500$ mm, $dy=1.500$ mm

Maximum value of SAR (interpolated) = 0.804 W/kg

Left-Hand-Side HSL - ANT 2 - 20MHz BW - QPSK - 1RB - 0RB offset/Touch Position - Middle/Zoom Scan (6x6x7)/Cube 0:

Measurement grid: $dx=7.5$ mm, $dy=7.5$ mm,

$dz=5$ mm

Reference Value = 24.223 V/m; Power Drift = -0.01 dB

Peak SAR (extrapolated) = 0.936 W/kg

SAR(1 g) = 0.596 W/kg; SAR(10 g) = 0.357 W/kg

Maximum value of SAR (measured) = 0.770 W/kg

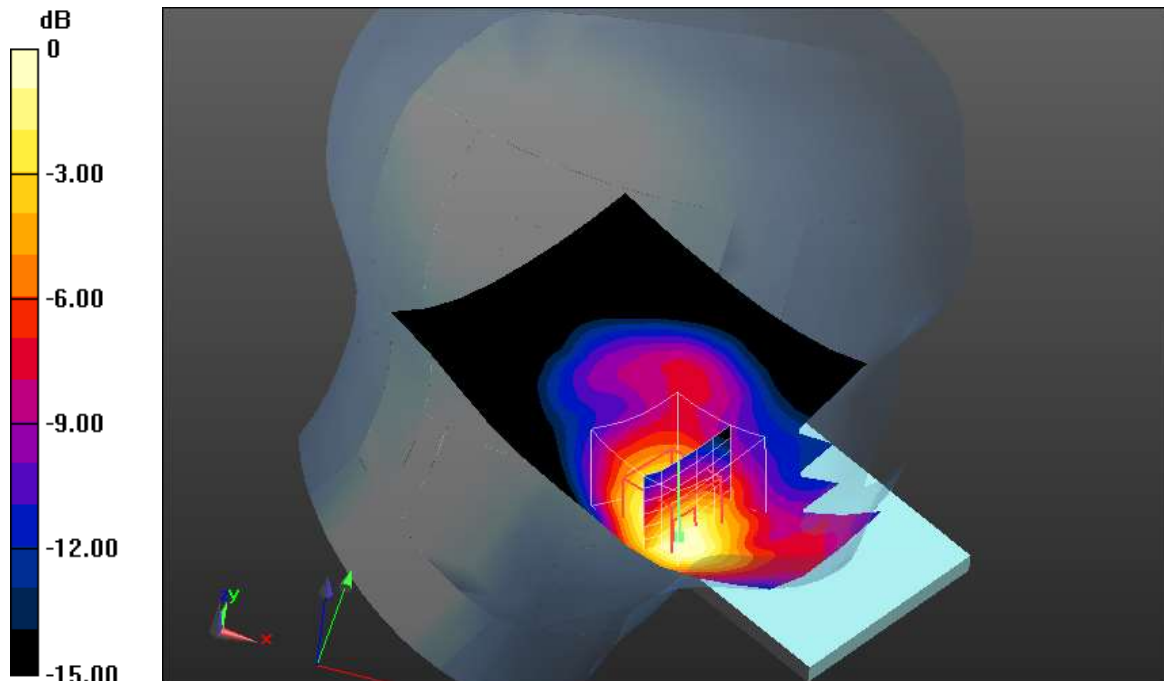

0 dB = 0.770 W/kg = -1.14 dBW/kg

Additional information:

ambient temperature: 22.2°C; liquid temperature: 21.0°C

IEEE1528-LTE FDD 2 head

DUT: Microsoft; Type: RM-1154; Serial: 004402743285284

Communication System: UID 0, LTE FDD (0); Communication System Band: LTE 2 (1900MHz); Frequency: 1900 MHz; Communication System PAR: 0 dB; PMF: 1

Medium parameters used: $f = 1900$ MHz; $\sigma = 1.396$ S/m; $\epsilon_r = 39.529$; $\rho = 1000$ kg/m³

Phantom section: Left Section

Measurement Standard: DASY5

DASY5 Configuration:

- Probe: EX3DV4 - SN3944; ConvF(8.19, 8.19, 8.19); Calibrated: 14.08.2015;
- Sensor-Surface: 2mm (Mechanical Surface Detection (Locations From Previous Scan Used)), Sensor-Surface: 2mm (Mechanical Surface Detection), $z = 1.0, 31.0$
- Electronics: DAE3 Sn477; Calibrated: 22.05.2015
- Phantom: SAM; Type: SAM; Serial: 1043
- DASY52 52.8.7(1137); SEMCAD X 14.6.10(7164)

Left-Hand-Side HSL - ANT 2 - 20MHz BW - QPSK - 1RB - 0RB offset/Touch

Position - Hi/Area Scan (71x121x1): Interpolated grid: $dx=1.500$ mm, $dy=1.500$ mm

Maximum value of SAR (interpolated) = 0.748 W/kg

Left-Hand-Side HSL - ANT 2 - 20MHz BW - QPSK - 1RB - 0RB offset/Touch

Position - Hi/Zoom Scan (6x6x7)/Cube 0: Measurement grid: $dx=7.5$ mm, $dy=7.5$ mm, $dz=5$ mm

Reference Value = 23.257 V/m; Power Drift = -0.02 dB

Peak SAR (extrapolated) = 0.894 W/kg

SAR(1 g) = 0.562 W/kg; SAR(10 g) = 0.333 W/kg

Maximum value of SAR (measured) = 0.722 W/kg

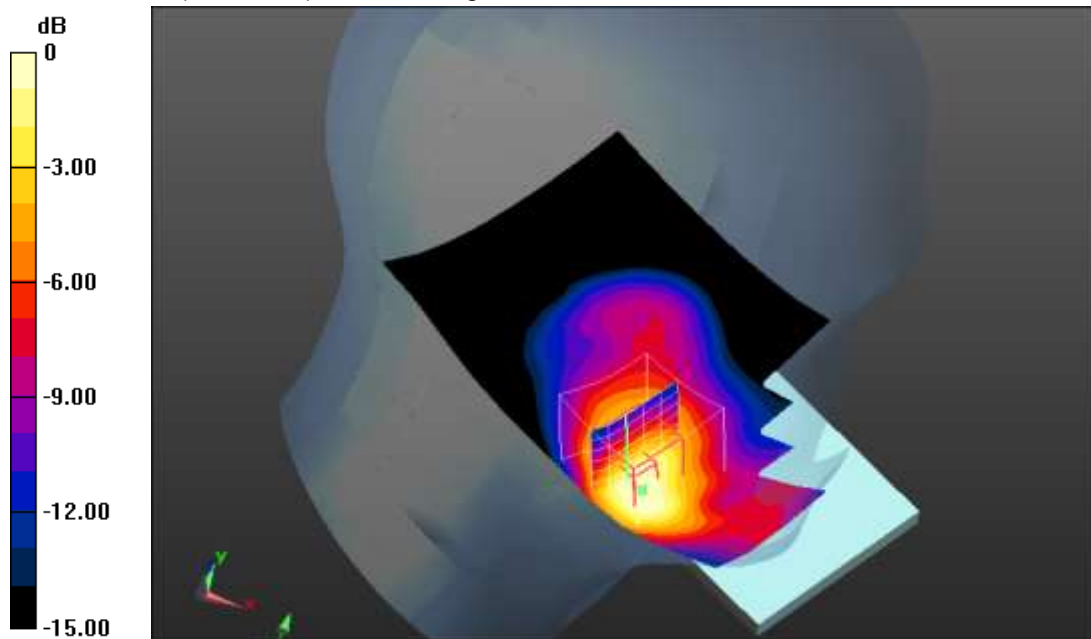

0 dB = 0.722 W/kg = -1.41 dBW/kg

Additional information:

ambient temperature: 22.2°C; liquid temperature: 21.0°C

Date/Time: 17.12.2015 19:29:57

FCC-LTE FDD 2 hotspot

DUT: Microsoft; Type: RM-1154; Serial: 004402743285284

Communication System: UID 0, LTE FDD (0); Communication System Band: LTE 2 (1900MHz); Frequency: 1860 MHz; Communication System PAR: 0 dB; PMF: 1

Medium parameters used: $f = 1860$ MHz; $\sigma = 1.453$ S/m; $\epsilon_r = 54.587$; $\rho = 1000$ kg/m³

Phantom section: Center Section

Measurement Standard: DASY5

DASY5 Configuration:

- Probe: EX3DV4 - SN3944; ConvF(7.91, 7.91, 7.91); Calibrated: 14.08.2015;
- Sensor-Surface: 2mm (Mechanical Surface Detection (Locations From Previous Scan Used)), Sensor-Surface: 2mm (Mechanical Surface Detection), $z = 1.0, 31.0$
- Electronics: DAE3 Sn477; Calibrated: 22.05.2015
- Phantom: Triple Flat Phantom 5.1C; Type: QD 000 P51 CA; Serial: 1154
- DASY52 52.8.7(1137); SEMCAD X 14.6.10(7164)

MSL1900 - ANT 2 - 20MHz BW - QPSK - 1RB - 0RB offset/Rear Low 10mm

wc/Area Scan (71x131x1): Interpolated grid: $dx=1.500$ mm, $dy=1.500$ mm

Maximum value of SAR (interpolated) = 1.32 W/kg

MSL1900 - ANT 2 - 20MHz BW - QPSK - 1RB - 0RB offset/Rear Low 10mm

wc/Zoom Scan (5x5x7)/Cube 0: Measurement grid: $dx=7.5$ mm, $dy=7.5$ mm, $dz=5$ mm

Reference Value = 29.883 V/m; Power Drift = 0.12 dB

Peak SAR (extrapolated) = 1.58 W/kg

SAR(1 g) = 0.949 W/kg; SAR(10 g) = 0.530 W/kg

Maximum value of SAR (measured) = 1.21 W/kg

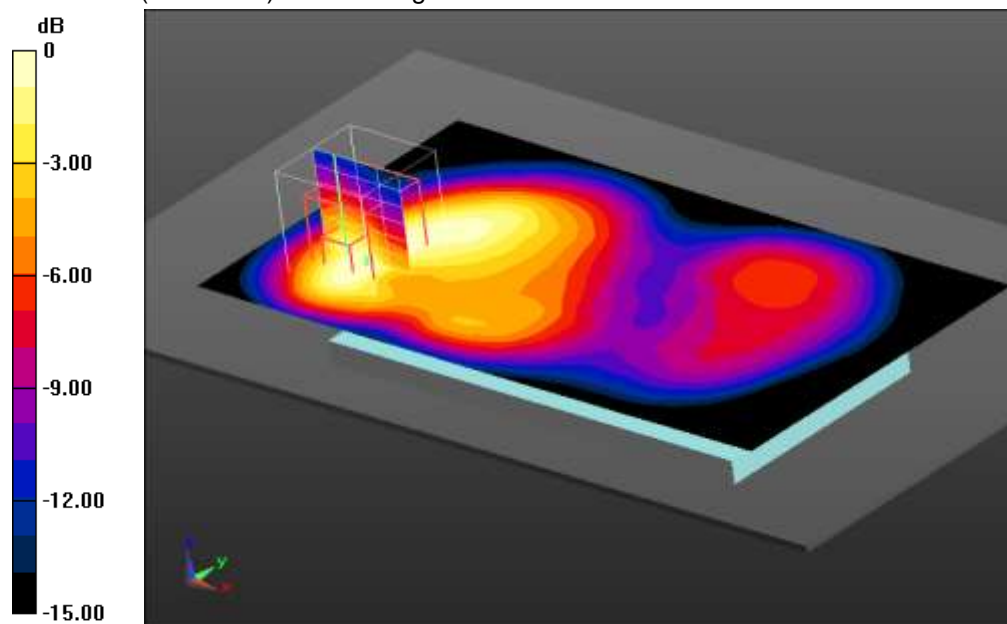

0 dB = 1.21 W/kg = 0.83 dBW/kg

Additional information:

position or distance of DUT to SAM: 10 mm

ambient temperature: 23.6°C; liquid temperature: 22.3°C

Date/Time: 17.12.2015 19:50:08

FCC-LTE FDD 2 body worn

DUT: Microsoft; Type: RM-1154; Serial: 004402743285284

Communication System: UID 0, LTE FDD (0); Communication System Band: LTE 2 (1900MHz); Frequency: 1860 MHz; Communication System PAR: 0 dB; PMF: 1

Medium parameters used: $f = 1860$ MHz; $\sigma = 1.453$ S/m; $\epsilon_r = 54.587$; $\rho = 1000$ kg/m³

Phantom section: Center Section

Measurement Standard: DASY5

DASY5 Configuration:

- Probe: EX3DV4 - SN3944; ConvF(7.91, 7.91, 7.91); Calibrated: 14.08.2015;
- Sensor-Surface: 2mm (Mechanical Surface Detection (Locations From Previous Scan Used)), Sensor-Surface: 2mm (Mechanical Surface Detection), $z = 1.0, 31.0$
- Electronics: DAE3 Sn477; Calibrated: 22.05.2015
- Phantom: Triple Flat Phantom 5.1C; Type: QD 000 P51 CA; Serial: 1154
- DASY52 52.8.7(1137); SEMCAD X 14.6.10(7164)

MSL1900 - ANT 2 - 20MHz BW - QPSK - 1RB - 0RB offset/Front Low

15mm/Area Scan (71x131x1): Interpolated grid: $dx=1.500$ mm, $dy=1.500$ mm

Maximum value of SAR (interpolated) = 0.603 W/kg

MSL1900 - ANT 2 - 20MHz BW - QPSK - 1RB - 0RB offset/Front Low

15mm/Zoom Scan (5x5x7)/Cube 0: Measurement grid: $dx=7.5$ mm, $dy=7.5$ mm, $dz=5$ mm

Reference Value = 20.050 V/m; Power Drift = -0.19 dB

Peak SAR (extrapolated) = 0.727 W/kg

SAR(1 g) = 0.458 W/kg; SAR(10 g) = 0.269 W/kg

Maximum value of SAR (measured) = 0.582 W/kg

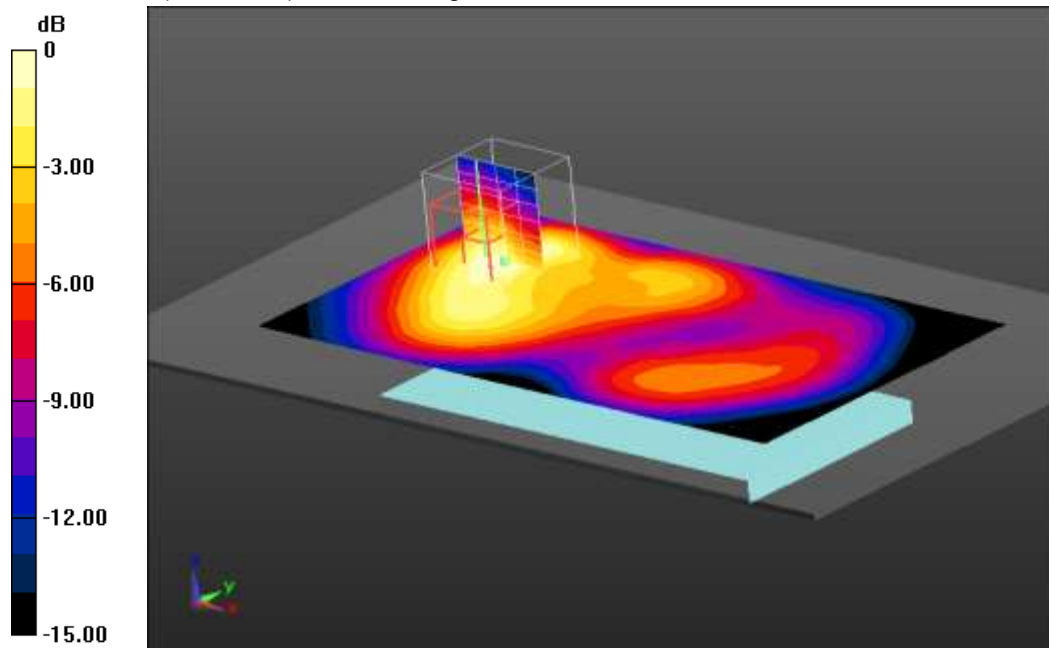

0 dB = 0.582 W/kg = -2.35 dBW/kg

Additional information:

position or distance of DUT to SAM: 15 mm

ambient temperature: 23.6°C; liquid temperature: 22.3°C

Annex B.7: LTE FDD 4

Date/Time: 12/17/2015 5:23:52 PM

IEEE1528-LTE FDD 4 head**DUT: Microsoft; Type: RM-1154; Serial: 004402743285227**

Communication System: UID 0, LTE FDD (0); Communication System Band: LTE 4 (1700MHz); Frequency: 1745 MHz; Communication System PAR: 0 dB; PMF: 1

Medium parameters used: $f = 1745$ MHz; $\sigma = 1.331$ S/m; $\epsilon_r = 38.77$; $\rho = 1000$ kg/m³

Phantom section: Left Section

Measurement Standard: DASYS5

DASY5 Configuration:

- Probe: ES3DV3 - SN3326; ConvF(5.18, 5.18, 5.18); Calibrated: 8/12/2015;
- Sensor-Surface: 3mm (Mechanical Surface Detection (Locations From Previous Scan Used)), Sensor-Surface: 3mm (Mechanical Surface Detection), $z = 2.0, 32.0$
- Electronics: DAE4 Sn1387; Calibrated: 8/12/2015
- Phantom: SAM front; Type: QD000P40CC; Serial: TP:1041
- DASY52 52.8.8(1222); SEMCAD X 14.6.10(7331)

Left-Hand side - ANT 2 - 20 MHz BW - QPSK - 1 RB/Touch Position - High - 0**RB offset/Area Scan (71x121x1):** Interpolated grid: $dx=1.500$ mm, $dy=1.500$ mm

Maximum value of SAR (interpolated) = 0.640 W/kg

Left-Hand side - ANT 2 - 20 MHz BW - QPSK - 1 RB/Touch Position - High - 0**RB offset/Zoom Scan (5x5x7)/Cube 0:** Measurement grid: $dx=7.5$ mm, $dy=7.5$ mm, $dz=5$ mm

Reference Value = 21.40 V/m; Power Drift = -0.11 dB

Peak SAR (extrapolated) = 0.941 W/kg

SAR(1 g) = 0.554 W/kg; SAR(10 g) = 0.305 W/kg

Maximum value of SAR (measured) = 0.684 W/kg

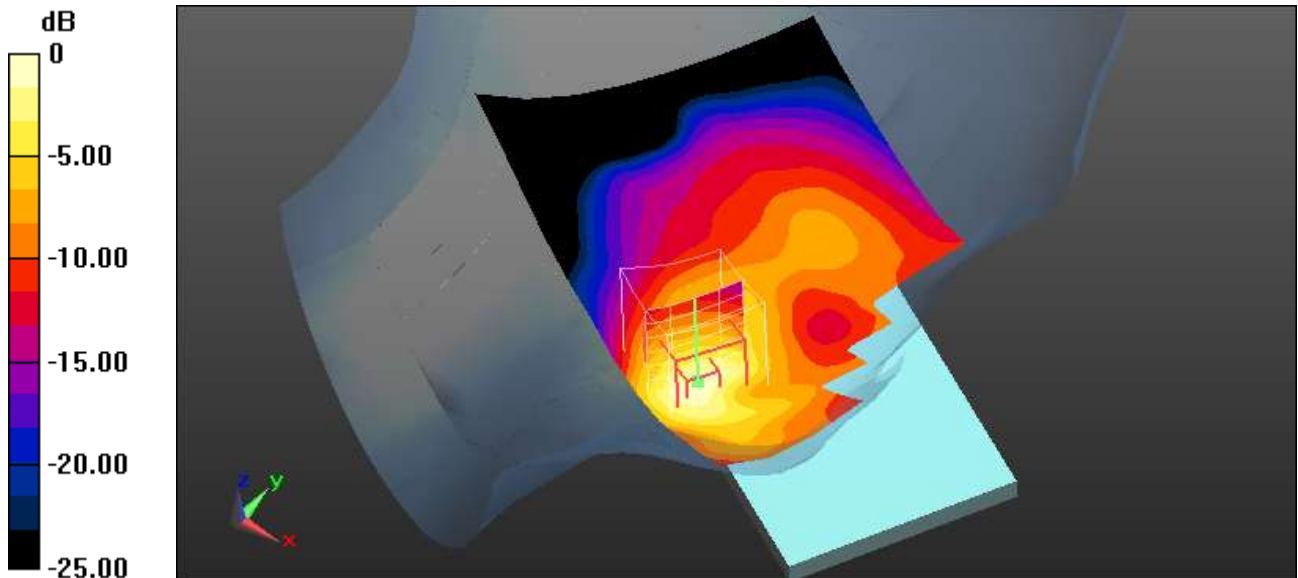

0 dB = 0.684 W/kg = -1.65 dBW/kg

Additional information:

ambient temperature: 22.9°C; liquid temperature: 22.5°C

Date/Time: 12/22/2015 11:12:52 PM

FCC-LTE FDD 4 hotspot

DUT: Microsoft; Type: RM-1154; Serial: 004402743285706

Communication System: UID 0, LTE FDD (0); Communication System Band: LTE 4 (1700MHz); Frequency: 1732.5 MHz; Communication System PAR: 0 dB; PMF: 1

Medium parameters used (interpolated): $f = 1732.5$ MHz; $\sigma = 1.485$ S/m; $\epsilon_r = 52.359$; $\rho = 1000$ kg/m³

Phantom section: Center Section

Measurement Standard: DASy5

DASy5 Configuration:

- Probe: ES3DV3 - SN3326; ConvF(4.85, 4.85, 4.85); Calibrated: 8/12/2015;
- Sensor-Surface: 3mm (Mechanical Surface Detection (Locations From Previous Scan Used)), Sensor-Surface: 3mm (Mechanical Surface Detection), $z = 2.0, 32.0$
- Electronics: DAE4 Sn1387; Calibrated: 8/12/2015
- Phantom: Triple Flat Phantom 5.1C; Type: QD 000 P51 CA; Serial: 1154
- DASy52 52.8.8(1222); SEMCAD X 14.6.10(7331)

MSL1750 - ANT 2 - 20MHz BW - QPSK - 1RB/Front Middle 10mm - 0 RB offset

WC/Area Scan (71x131x1): Interpolated grid: $dx=1.500$ mm, $dy=1.500$ mm

Maximum value of SAR (interpolated) = 1.32 W/kg

MSL1750 - ANT 2 - 20MHz BW - QPSK - 1RB/Front Middle 10mm - 0 RB offset

WC/Zoom Scan (6x6x7)/Cube 0: Measurement grid: $dx=7.5$ mm, $dy=7.5$ mm, $dz=5$ mm

Reference Value = 30.88 V/m; Power Drift = 0.17 dB

Peak SAR (extrapolated) = 2.03 W/kg

SAR(1 g) = 1.14 W/kg; SAR(10 g) = 0.592 W/kg

Maximum value of SAR (measured) = 1.45 W/kg

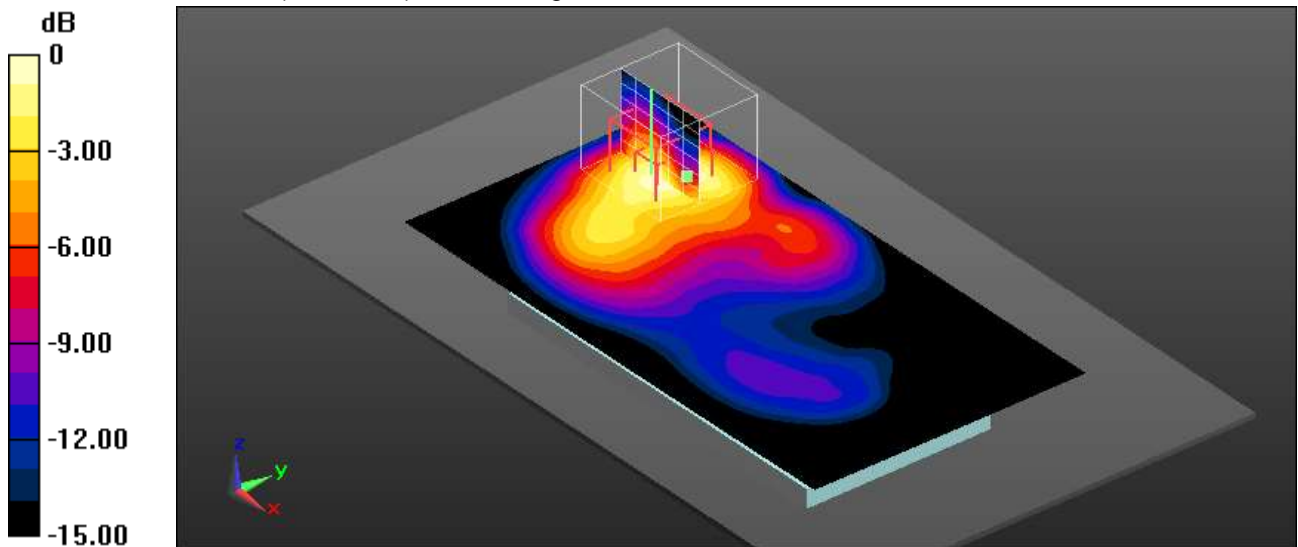

0 dB = 1.45 W/kg = 1.61 dBW/kg

Additional information:

position or distance of DUT to the phantom: 10 mm

ambient temperature: 22.8°C; liquid temperature: 22.6°C

FCC-LTE FDD 4 body worn

DUT: Microsoft; Type: RM-1154; Serial: 004402743285227

Communication System: UID 0, LTE FDD (0); Communication System Band: LTE 4 (1700MHz); Frequency: 1732.5 MHz; Communication System PAR: 0 dB; PMF: 1

Medium parameters used (interpolated): $f = 1732.5$ MHz; $\sigma = 1.484$ S/m; $\epsilon_r = 51.726$; $\rho = 1000$ kg/m³

Phantom section: Center Section

Measurement Standard: DASy5

DASy5 Configuration:

- Probe: ES3DV3 - SN3326; ConvF(4.85, 4.85, 4.85); Calibrated: 8/12/2015;
- Sensor-Surface: 3mm (Mechanical Surface Detection (Locations From Previous Scan Used)), Sensor-Surface: 3mm (Mechanical Surface Detection), $z = 2.0, 32.0$
- Electronics: DAE4 Sn1387; Calibrated: 8/12/2015
- Phantom: Triple Flat Phantom 5.1C; Type: QD 000 P51 CA; Serial: 1154
- DASy52 52.8.8(1222); SEMCAD X 14.6.10(7331)

MSL1750 - ANT 2 - 20MHz BW - QPSK - 1RB/Front Middle 15mm - 0 RB

offset/Area Scan (71x131x1): Interpolated grid: $dx=1.500$ mm, $dy=1.500$ mm

Maximum value of SAR (interpolated) = 0.706 W/kg

MSL1750 - ANT 2 - 20MHz BW - QPSK - 1RB/Front Middle 15mm - 0 RB

offset/Zoom Scan (6x6x7)/Cube 0: Measurement grid: $dx=7.5$ mm, $dy=7.5$ mm, $dz=5$ mm

Reference Value = 22.21 V/m; Power Drift = -0.04 dB

Peak SAR (extrapolated) = 0.999 W/kg

SAR(1 g) = 0.604 W/kg; SAR(10 g) = 0.337 W/kg

Maximum value of SAR (measured) = 0.721 W/kg

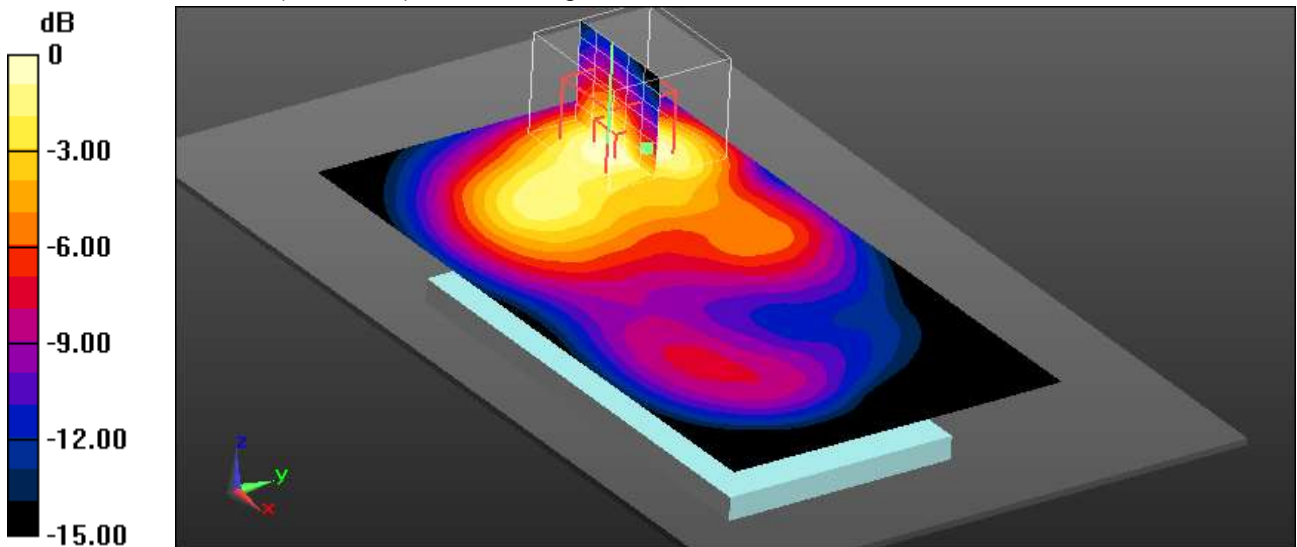

0 dB = 0.721 W/kg = -1.42 dBW/kg

Additional information:

position or distance of DUT to the phantom: 15 mm

ambient temperature: 22.0°C; liquid temperature: 22.2°C

Annex B.8: LTE FDD 5

Date/Time: 12.12.2015 12:04:47

IEEE1528-LTE FDD 5 head**DUT: Microsoft; Type: RM-1154; Serial: 004402743285805**

Communication System: UID 0, LTE FDD (0); Communication System Band: LTE 5 (850MHz); Frequency: 844 MHz; Communication System PAR: 0 dB; PMF: 1

Medium parameters used: $f = 844$ MHz; $\sigma = 0.931$ S/m; $\epsilon_r = 42.428$; $\rho = 1000$ kg/m³

Phantom section: Right Section

Measurement Standard: DASYS5

DASY5 Configuration:

- Probe: ES3DV3 - SN3320; ConvF(6.14, 6.14, 6.14); Calibrated: 25.02.2015;
- Sensor-Surface: 3mm (Mechanical Surface Detection (Locations From Previous Scan Used)), Sensor-Surface: 3mm (Mechanical Surface Detection), $z = 2.0, 32.0$
- Electronics: DAE3 Sn413; Calibrated: 15.01.2015
- Phantom: SAM front; Type: QD000P40CC; Serial: TP-1041
- DASY52 52.8.7(1137); SEMCAD X 14.6.10(7164)

Right-Hand-Side HSL - ANT 1 - 10MHz BW - 1RB - QPSK/Touch Position - High 24RB offset/Area Scan (71x121x1): Interpolated grid: $dx=1.500$ mm, $dy=1.500$ mm

Maximum value of SAR (interpolated) = 0.603 W/kg

Right-Hand-Side HSL - ANT 1 - 10MHz BW - 1RB - QPSK/Touch Position - High 24RB offset/Zoom Scan (5x5x7)/Cube 0: Measurement grid: $dx=7.5$ mm, $dy=7.5$ mm, $dz=5$ mm

Reference Value = 25.573 V/m; Power Drift = -0.03 dB

Peak SAR (extrapolated) = 0.772 W/kg

SAR(1 g) = 0.478 W/kg; SAR(10 g) = 0.304 W/kg

Maximum value of SAR (measured) = 0.560 W/kg

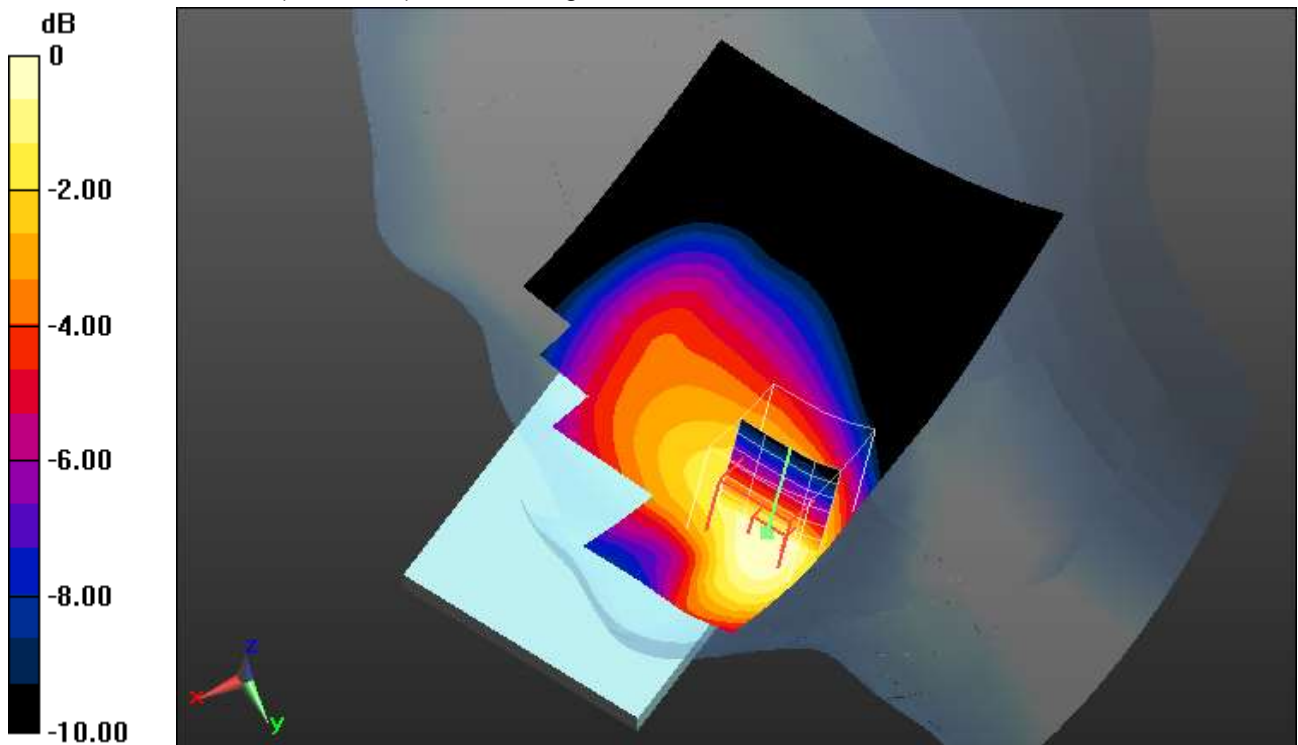

0 dB = 0.560 W/kg = -2.52 dBW/kg

Additional information:

ambient temperature: 22.4°C; liquid temperature: 21.7°C

FCC-LTE FDD 5 hotspot

DUT: Microsoft; Type: RM-1154; Serial: 004402743285805

Communication System: UID 0, LTE FDD (0); Communication System Band: LTE 5 (850MHz); Frequency: 844 MHz; Communication System PAR: 0 dB; PMF: 1

Medium parameters used: $f = 844$ MHz; $\sigma = 1.01$ S/m; $\epsilon_r = 54.627$; $\rho = 1000$ kg/m³

Phantom section: Center Section

Measurement Standard: DASy5

DASy5 Configuration:

- Probe: ES3DV3 - SN3320; ConvF(6.11, 6.11, 6.11); Calibrated: 25.02.2015;
- Sensor-Surface: 3mm (Mechanical Surface Detection), $z = 2.0, 32.0$
- Electronics: DAE3 Sn413; Calibrated: 15.01.2015
- Phantom: Triple Flat Phantom 5.1C; Type: QD 000 P51 CA; Serial: 1154
- DASy52 52.8.7(1137); SEMCAD X 14.6.10(7164)

MSL850 - ANT 1 - 10MHz BW - QPSK - 1RB - 24RB offset/Front High

10mm/Area Scan (71x131x1): Interpolated grid: $dx=1.500$ mm, $dy=1.500$ mm

Maximum value of SAR (interpolated) = 0.883 W/kg

MSL850 - ANT 1 - 10MHz BW - QPSK - 1RB - 24RB offset/Front High

10mm/Zoom Scan (7x6x7)/Cube 0: Measurement grid: $dx=7.5$ mm, $dy=7.5$ mm, $dz=5$ mm

Reference Value = 30.942 V/m; Power Drift = -0.17 dB

Peak SAR (extrapolated) = 1.26 W/kg

SAR(1 g) = 0.730 W/kg; SAR(10 g) = 0.431 W/kg

Maximum value of SAR (measured) = 0.866 W/kg

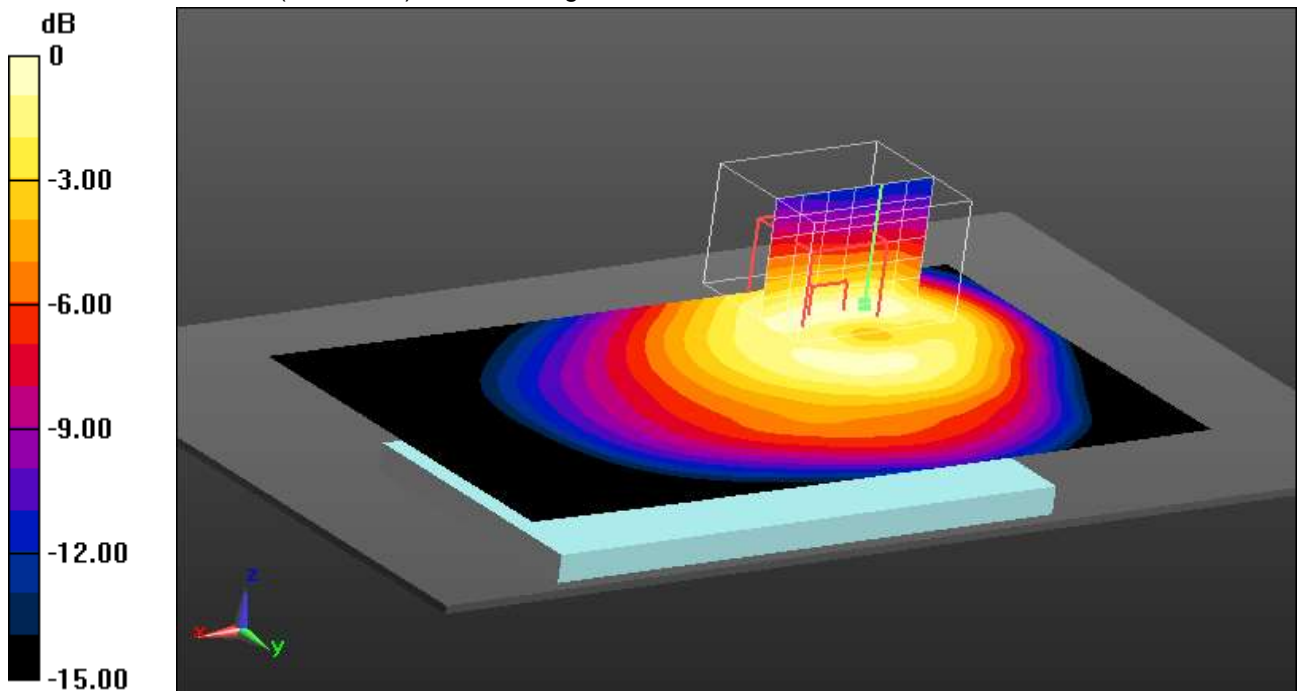

0 dB = 0.866 W/kg = -0.62 dBW/kg

Additional information:

position or distance of DUT to the phantom: 10 mm

ambient temperature: 23.9 °C; liquid temperature: 22.3 °C

Date/Time: 19.12.2015 15:55:17

FCC-LTE FDD 5 body worn

DUT: Microsoft; Type: RM-1154; Serial: 004402743285805

Communication System: UID 0, LTE FDD (0); Communication System Band: LTE 5 (850MHz); Frequency: 829 MHz; Communication System PAR: 0 dB; PMF: 1

Medium parameters used: $f = 829$ MHz; $\sigma = 0.995$ S/m; $\epsilon_r = 54.78$; $\rho = 1000$ kg/m³

Phantom section: Center Section

Measurement Standard: DASY5

DASY5 Configuration:

- Probe: ES3DV3 - SN3320; ConvF(6.11, 6.11, 6.11); Calibrated: 25.02.2015;
- Sensor-Surface: 3mm (Mechanical Surface Detection (Locations From Previous Scan Used)), Sensor-Surface: 3mm (Mechanical Surface Detection), $z = 2.0, 32.0$
- Electronics: DAE3 Sn413; Calibrated: 15.01.2015
- Phantom: Triple Flat Phantom 5.1C; Type: QD 000 P51 CA; Serial: 1154
- DASY52 52.8.7(1137); SEMCAD X 14.6.10(7164)

MSL835 - ANT 1 - 10MHz BW - QPSK - 1RB - 24RB offset/Rear Low

15mm/Area Scan (71x131x1): Interpolated grid: $dx=1.500$ mm, $dy=1.500$ mm

Maximum value of SAR (interpolated) = 0.562 W/kg

MSL835 - ANT 1 - 10MHz BW - QPSK - 1RB - 24RB offset/Rear Low

15mm/Zoom Scan (6x5x7)/Cube 0: Measurement grid: $dx=7.5$ mm, $dy=7.5$ mm, $dz=5$ mm

Reference Value = 23.590 V/m; Power Drift = 0.13 dB

Peak SAR (extrapolated) = 0.646 W/kg

SAR(1 g) = 0.489 W/kg; SAR(10 g) = 0.354 W/kg

Maximum value of SAR (measured) = 0.553 W/kg

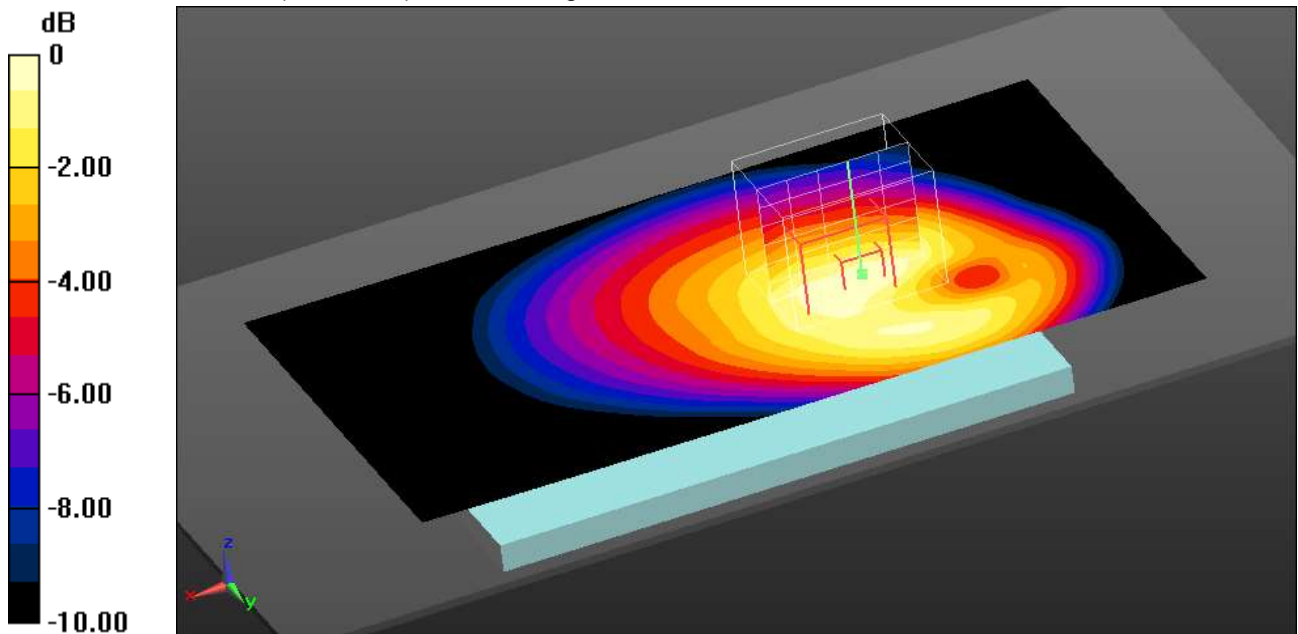

0 dB = 0.553 W/kg = -2.57 dBW/kg

Additional information:

position or distance of DUT to the phantom: 15 mm

ambient temperature: 23.9 °C; liquid temperature: 22.3 °C

Annex B.9: LTE FDD 7

Date/Time: 22.12.2015 13:51:33

IEEE1528-EN62209-LTE FDD 7 head

DUT: Microsoft; Type: RM-1154; Serial: 004402743285425

Communication System: UID 0, LTE FDD (0); Communication System Band: LTE 7 (2600MHz); Frequency: 2535 MHz; Communication System PAR: 0 dB; PMF: 1

Medium parameters used: $f = 2535$ MHz; $\sigma = 1.896$ S/m; $\epsilon_r = 38.274$; $\rho = 1000$ kg/m³

Phantom section: Left Section

Measurement Standard: DASYS5

DASY5 Configuration:

- Probe: EX3DV4 - SN3944; ConvF(7.15, 7.15, 7.15); Calibrated: 14.08.2015;
- Sensor-Surface: 2mm (Mechanical Surface Detection (Locations From Previous Scan Used)), Sensor-Surface: 2mm (Mechanical Surface Detection), $z = 1.0, 31.0$
- Electronics: DAE3 Sn477; Calibrated: 22.05.2015
- Phantom: SAM; Type: SAM; Serial: 1043
- DASY52 52.8.7(1137); SEMCAD X 14.6.10(7164)

Left-Hand-Side 20MHz BW - QPSK - 1RB Antenna 2/Touch Position - Middle - 0RB offset worst case/Area Scan (111x161x1): Interpolated grid: $dx=1.000$ mm, $dy=1.000$ mm

Maximum value of SAR (interpolated) = 1.70 W/kg

Left-Hand-Side 20MHz BW - QPSK - 1RB Antenna 2/Touch Position - Middle - 0RB offset worst case/Zoom Scan (5x5x7)/Cube 0: Measurement grid: $dx=7.5$ mm, $dy=7.5$ mm, $dz=5$ mm

Reference Value = 29.184 V/m; Power Drift = -0.02 dB

Peak SAR (extrapolated) = 2.06 W/kg

SAR(1 g) = 1.17 W/kg; SAR(10 g) = 0.618 W/kg

Maximum value of SAR (measured) = 1.64 W/kg

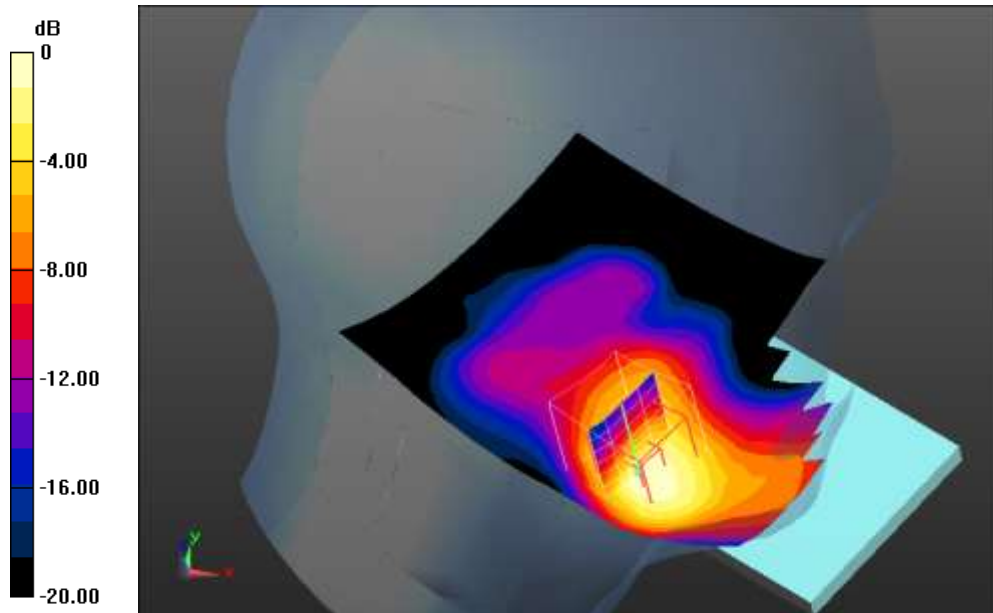

0 dB = 1.64 W/kg = 2.15 dBW/kg

Additional information:

ambient temperature: 22.6°C; liquid temperature: 21.4°C

FCC-LTE FDD 7 hotspot

DUT: Microsoft; Type: RM-1154; Serial: 004402743285425

Communication System: UID 0, LTE FDD (0); Communication System Band: LTE 7 (2600MHz); Frequency: 2535 MHz; Communication System PAR: 0 dB; PMF: 1

Medium parameters used: $f = 2535$ MHz; $\sigma = 2.137$ S/m; $\epsilon_r = 50.602$; $\rho = 1000$ kg/m³

Phantom section: Center Section

Measurement Standard: DASY5

DASY5 Configuration:

- Probe: EX3DV4 - SN3944; ConvF(7.37, 7.37, 7.37); Calibrated: 14.08.2015;
- Sensor-Surface: 2mm (Mechanical Surface Detection (Locations From Previous Scan Used)), Sensor-Surface: 2mm (Mechanical Surface Detection), $z = 1.0, 26.0$
- Electronics: DAE3 Sn477; Calibrated: 22.05.2015
- Phantom: Triple Flat Phantom 5.1C; Type: QD 000 P51 CA; Serial: 1154
- DASY52 52.8.7(1137); SEMCAD X 14.6.10(7164)

MSL2450-2600 - ANT 2 - 20MHz BW - QPSK - 1RB/Rear Middle 10mm - 0RB offset/Area Scan (111x191x1): Interpolated grid: $dx=1.000$ mm, $dy=1.000$ mm

Maximum value of SAR (interpolated) = 1.73 W/kg

MSL2450-2600 - ANT 2 - 20MHz BW - QPSK - 1RB/Rear Middle 10mm - 0RB offset/Zoom Scan (6x6x7)/Cube 0: Measurement grid: $dx=7.5$ mm, $dy=7.5$ mm, $dz=5$ mm

Reference Value = 28.858 V/m; Power Drift = 0.07 dB

Peak SAR (extrapolated) = 2.28 W/kg

SAR(1 g) = 1.3 W/kg; SAR(10 g) = 0.695 W/kg

Maximum value of SAR (measured) = 1.78 W/kg

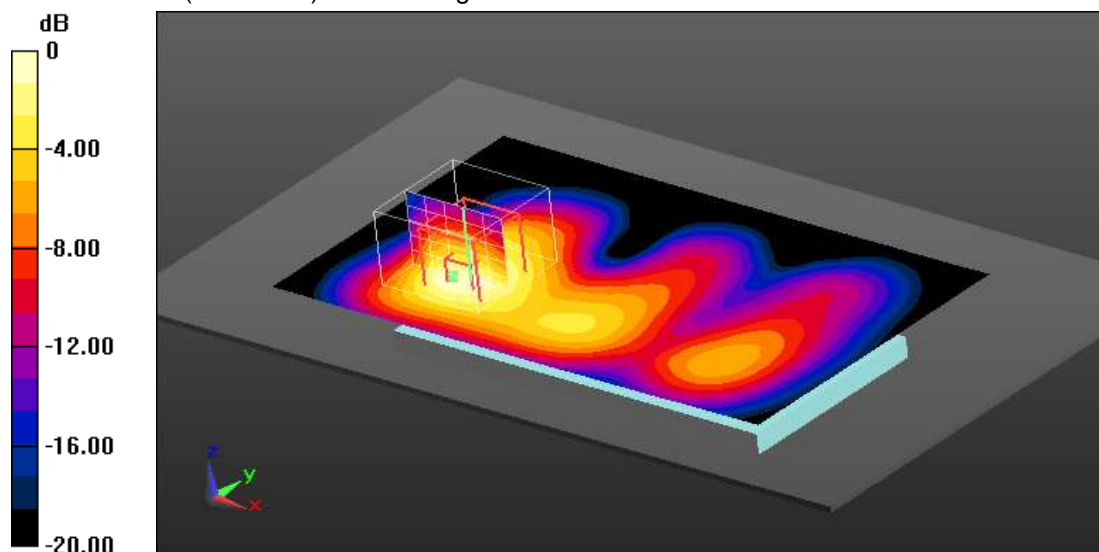

0 dB = 1.78 W/kg = 2.50 dBW/kg

Additional information:

position or distance of DUT to SAM: 10 mm

ambient temperature: 22.3°C; liquid temperature: 21.4°C

FCC-LTE FDD 7 body worn

DUT: Microsoft; Type: RM-1154; Serial: 004402743285425

Communication System: UID 0, LTE FDD (0); Communication System Band: LTE 7 (2600MHz); Frequency: 2560 MHz; Communication System PAR: 0 dB; PMF: 1

Medium parameters used: $f = 2560$ MHz; $\sigma = 2.159$ S/m; $\epsilon_r = 50.358$; $\rho = 1000$ kg/m³

Phantom section: Center Section

Measurement Standard: DASYS

DASY5 Configuration:

- Probe: EX3DV4 - SN3944; ConvF(7.37, 7.37, 7.37); Calibrated: 14.08.2015;
- Sensor-Surface: 2mm (Mechanical Surface Detection (Locations From Previous Scan Used)), Sensor-Surface: 2mm (Mechanical Surface Detection), $z = 1.0, 26.0$
- Electronics: DAE3 Sn477; Calibrated: 22.05.2015
- Phantom: Triple Flat Phantom 5.1C; Type: QD 000 P51 CA; Serial: 1154
- DASY52 52.8.7(1137); SEMCAD X 14.6.10(7164)

MSL2450-2600 - ANT 2 - 20MHz BW - QPSK - 1RB/Front High 15mm - 0RB

offset/Area Scan (111x191x1): Interpolated grid: $dx=1.000$ mm, $dy=1.000$ mm

Maximum value of SAR (interpolated) = 1.15 W/kg

MSL2450-2600 - ANT 2 - 20MHz BW - QPSK - 1RB/Front High 15mm - 0RB

offset/Zoom Scan (6x5x7)/Cube 0: Measurement grid: $dx=7.5$ mm, $dy=7.5$ mm, $dz=5$ mm

Reference Value = 22.905 V/m; Power Drift = -0.06 dB

Peak SAR (extrapolated) = 1.45 W/kg

SAR(1 g) = 0.823 W/kg; SAR(10 g) = 0.453 W/kg

Maximum value of SAR (measured) = 1.12 W/kg

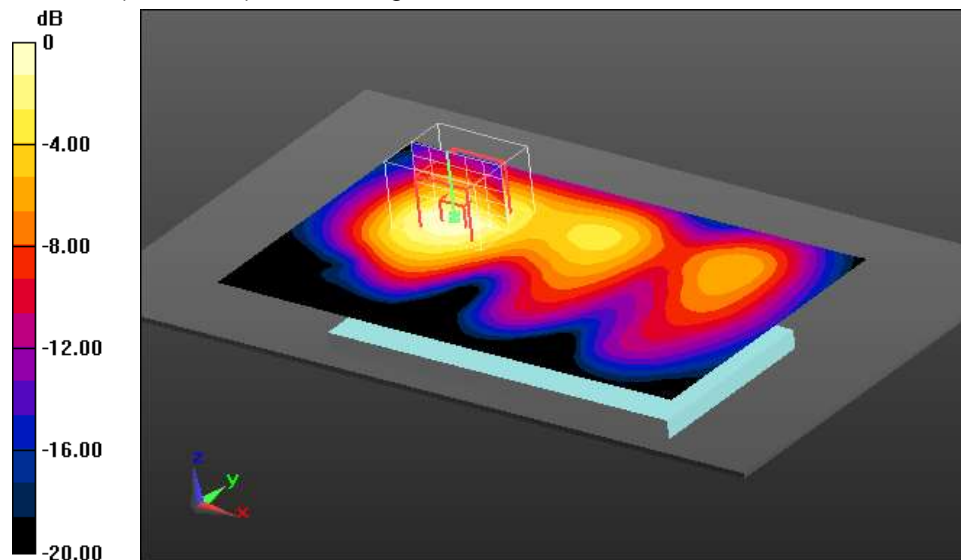

0 dB = 1.12 W/kg = 0.49 dBW/kg

Additional information:

position or distance of DUT to SAM: 15 mm

ambient temperature: 22.3°C; liquid temperature: 21.4°C

Annex B.10: LTE TDD 38

Date/Time: 28.12.2015 20:25:46

IEEE1528-EN62209-LTE TDD 38 head

DUT: Microsoft; Type: RM-1154; Serial: 004402743285425

Communication System: UID 0, LTE TDD (0); Communication System Band: LTE TDD 38; Frequency: 2580 MHz; Communication System PAR: 1.984 dB; PMF: 1

Medium parameters used: $f = 2580$ MHz; $\sigma = 1.921$ S/m; $\epsilon_r = 37.461$; $\rho = 1000$ kg/m³

Phantom section: Left Section

Measurement Standard: DASY5

DASY5 Configuration:

- Probe: EX3DV4 - SN3944; ConvF(7.15, 7.15, 7.15); Calibrated: 14.08.2015;
- Sensor-Surface: 2mm (Mechanical Surface Detection (Locations From Previous Scan Used)), Sensor-Surface: 2mm (Mechanical Surface Detection), $z = 1.0, 31.0$
- Electronics: DAE3 Sn477; Calibrated: 22.05.2015
- Phantom: SAM; Type: SAM; Serial: 1043
- DASY52 52.8.7(1137); SEMCAD X 14.6.10(7164)

Left-Hand-Side 20MHz BW - QPSK - 1RB Antenna 2/Touch Position - Low - 99RB offset/Area Scan (111x161x1):

Interpolated grid: $dx=1.000$ mm, $dy=1.000$ mm

Maximum value of SAR (interpolated) = 0.749 W/kg

Left-Hand-Side 20MHz BW - QPSK - 1RB Antenna 2/Touch Position - Low - 99RB offset/Zoom Scan (5x5x7)/Cube 0:

Measurement grid: $dx=7.5$ mm, $dy=7.5$ mm, $dz=5$ mm

Reference Value = 19.032 V/m; Power Drift = -0.15 dB

Peak SAR (extrapolated) = 0.948 W/kg

SAR(1 g) = 0.527 W/kg; SAR(10 g) = 0.272 W/kg

Maximum value of SAR (measured) = 0.745 W/kg

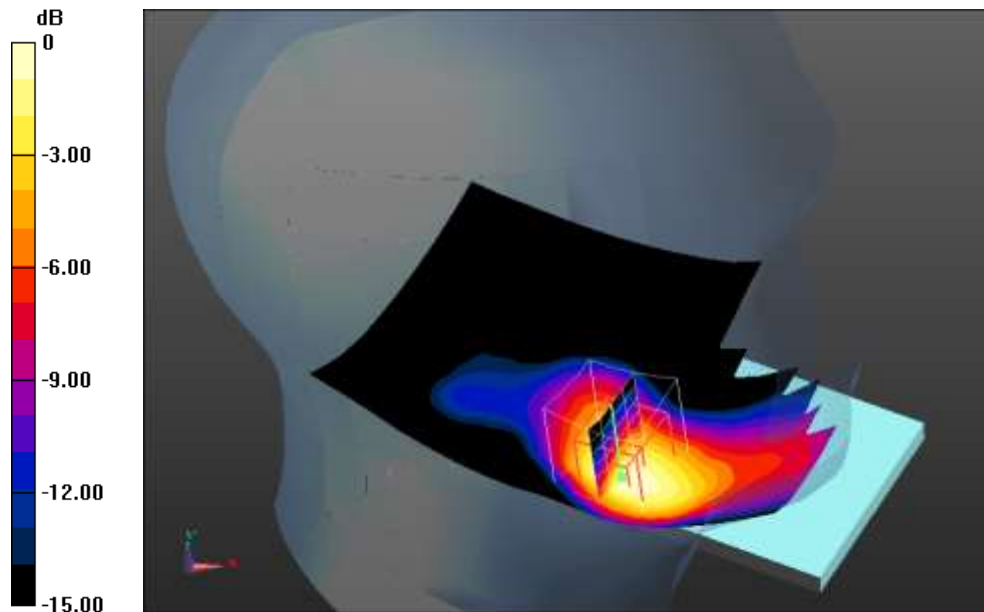

0 dB = 0.745 W/kg = -1.28 dBW/kg

Additional information:

ambient temperature: 22.7°C; liquid temperature: 22.2°C

IEEE1528-EN62209-LTE TDD 38 head

DUT: Microsoft; Type: RM-1154; Serial: 004402743285425

Communication System: UID 0, LTE TDD (0); Communication System Band: LTE TDD 38; Frequency: 2595 MHz; Communication System PAR: 1.984 dB; PMF: 1

Medium parameters used: $f = 2595$ MHz; $\sigma = 1.934$ S/m; $\epsilon_r = 37.401$; $\rho = 1000$ kg/m³

Phantom section: Left Section

Measurement Standard: DASY5

DASY5 Configuration:

- Probe: EX3DV4 - SN3944; ConvF(7.15, 7.15, 7.15); Calibrated: 14.08.2015;
- Sensor-Surface: 2mm (Mechanical Surface Detection (Locations From Previous Scan Used)), Sensor-Surface: 2mm (Mechanical Surface Detection), $z = 1.0, 31.0$
- Electronics: DAE3 Sn477; Calibrated: 22.05.2015
- Phantom: SAM; Type: SAM; Serial: 1043
- DASY52 52.8.7(1137); SEMCAD X 14.6.10(7164)

Left-Hand-Side 20MHz BW - QPSK - 1RB Antenna 2/Touch Position - Middle - 0RB offset/Area Scan (111x161x1): Interpolated grid: dx=1.000 mm, dy=1.000 mm

Maximum value of SAR (interpolated) = 0.760 W/kg

Left-Hand-Side 20MHz BW - QPSK - 1RB Antenna 2/Touch Position - Middle - 0RB offset/Zoom Scan (5x5x7)/Cube 0: Measurement grid: dx=7.5mm, dy=7.5mm, dz=5mm

Reference Value = 19.385 V/m; Power Drift = -0.04 dB

Peak SAR (extrapolated) = 0.952 W/kg

SAR(1 g) = 0.531 W/kg; SAR(10 g) = 0.277 W/kg

Maximum value of SAR (measured) = 0.749 W/kg

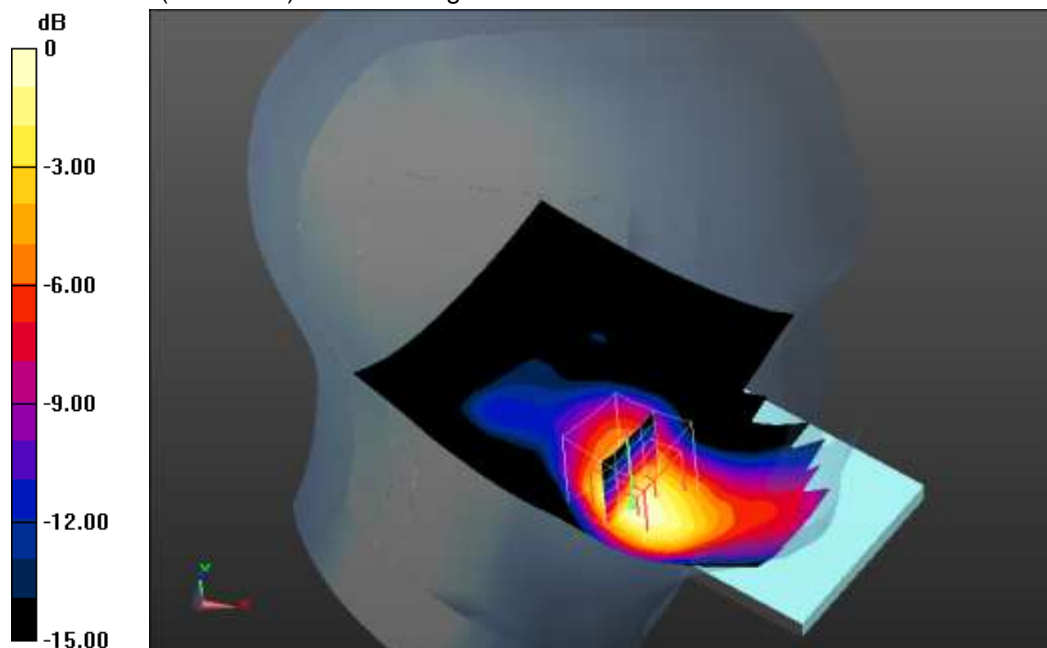

0 dB = 0.749 W/kg = -1.26 dBW/kg

Additional information:

ambient temperature: 22.7°C; liquid temperature: 22.2°C

FCC-LTE TDD 38 hotspot

DUT: Microsoft; Type: RM-1154; Serial: 004402743285425

Communication System: UID 0, LTE TDD (0); Communication System Band: LTE TDD 38; Frequency: 2595 MHz; Communication System PAR: 1.984 dB; PMF: 1

Medium parameters used: $f = 2595$ MHz; $\sigma = 2.186$ S/m; $\epsilon_r = 50.37$; $\rho = 1000$ kg/m³

Phantom section: Center Section

Measurement Standard: DASY5

DASY5 Configuration:

- Probe: EX3DV4 - SN3944; ConvF(7.37, 7.37, 7.37); Calibrated: 14.08.2015;
- Sensor-Surface: 2mm (Mechanical Surface Detection (Locations From Previous Scan Used)), Sensor-Surface: 2mm (Mechanical Surface Detection), $z = 1.0, 31.0$
- Electronics: DAE3 Sn477; Calibrated: 22.05.2015
- Phantom: Triple Flat Phantom 5.1C; Type: QD 000 P51 CA; Serial: 1154
- DASY52 52.8.7(1137); SEMCAD X 14.6.10(7164)

MSL2450-2600 - ANT 2 - 20MHz BW - QPSK - 1RB/Front Middle 10mm - 0RB offset/Area Scan (111x191x1):

Interpolated grid: $dx=1.000$ mm, $dy=1.000$ mm

Maximum value of SAR (interpolated) = 0.775 W/kg

MSL2450-2600 - ANT 2 - 20MHz BW - QPSK - 1RB/Front Middle 10mm - 0RB offset/Zoom Scan (5x5x7)/Cube 0:

Measurement grid: $dx=7.5$ mm, $dy=7.5$ mm, $dz=5$ mm

Reference Value = 19.260 V/m; Power Drift = 0.02 dB

Peak SAR (extrapolated) = 1.00 W/kg

SAR(1 g) = 0.576 W/kg; SAR(10 g) = 0.311 W/kg

Maximum value of SAR (measured) = 0.779 W/kg

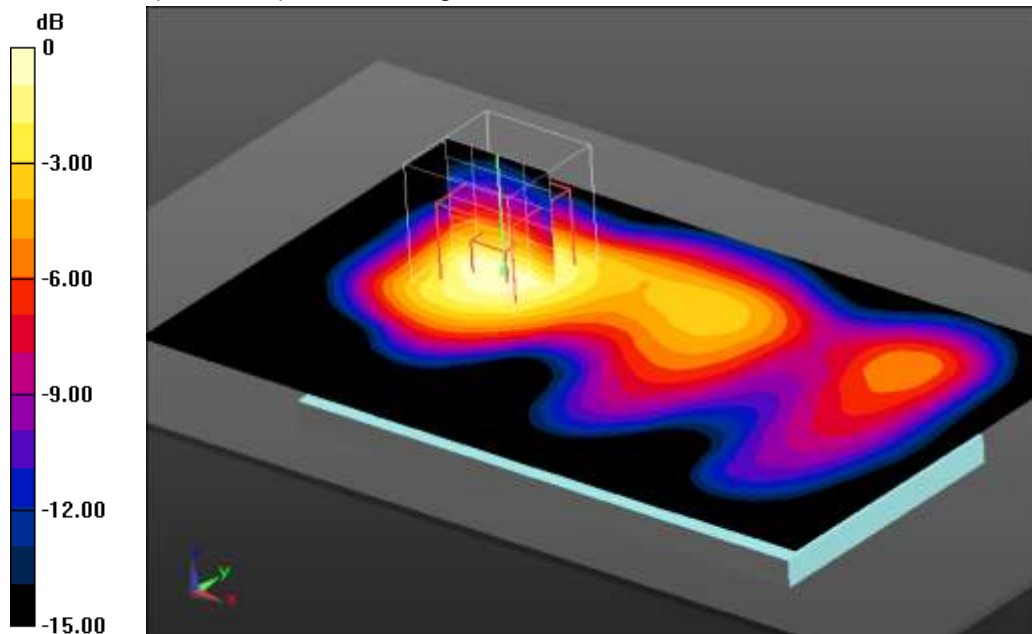

0 dB = 0.779 W/kg = -1.08 dBW/kg

Additional information:

position or distance of DUT to SAM: 10 mm

ambient temperature: 23.0°C; liquid temperature: 21.9°C

Date/Time: 29.12.2015 11:02:42

FCC-LTE TDD 38 body worn

DUT: Microsoft; Type: RM-1154; Serial: 004402743285425

Communication System: UID 0, LTE TDD (0); Communication System Band: LTE TDD 38; Frequency: 2595 MHz; Communication System PAR: 1.984 dB; PMF: 1

Medium parameters used: $f = 2595$ MHz; $\sigma = 2.186$ S/m; $\epsilon_r = 50.37$; $\rho = 1000$ kg/m³

Phantom section: Center Section

Measurement Standard: DASY5

DASY5 Configuration:

- Probe: EX3DV4 - SN3944; ConvF(7.37, 7.37, 7.37); Calibrated: 14.08.2015;
- Sensor-Surface: 2mm (Mechanical Surface Detection (Locations From Previous Scan Used)), Sensor-Surface: 2mm (Mechanical Surface Detection), $z = 1.0, 31.0$
- Electronics: DAE3 Sn477; Calibrated: 22.05.2015
- Phantom: Triple Flat Phantom 5.1C; Type: QD 000 P51 CA; Serial: 1154
- DASY52 52.8.7(1137); SEMCAD X 14.6.10(7164)

MSL2450-2600 - ANT 2 - 20MHz BW - QPSK - 1RB/Rear Middle 15mm - 0RB offset/Area Scan (111x191x1):

Interpolated grid: $dx=1.000$ mm, $dy=1.000$ mm

Maximum value of SAR (interpolated) = 0.433 W/kg

MSL2450-2600 - ANT 2 - 20MHz BW - QPSK - 1RB/Rear Middle 15mm - 0RB offset/Zoom Scan (5x5x7)/Cube 0:

Measurement grid: $dx=7.5$ mm, $dy=7.5$ mm, $dz=5$ mm

Reference Value = 14.004 V/m; Power Drift = 0.17 dB

Peak SAR (extrapolated) = 0.585 W/kg

SAR(1 g) = 0.321 W/kg; SAR(10 g) = 0.173 W/kg

Maximum value of SAR (measured) = 0.450 W/kg

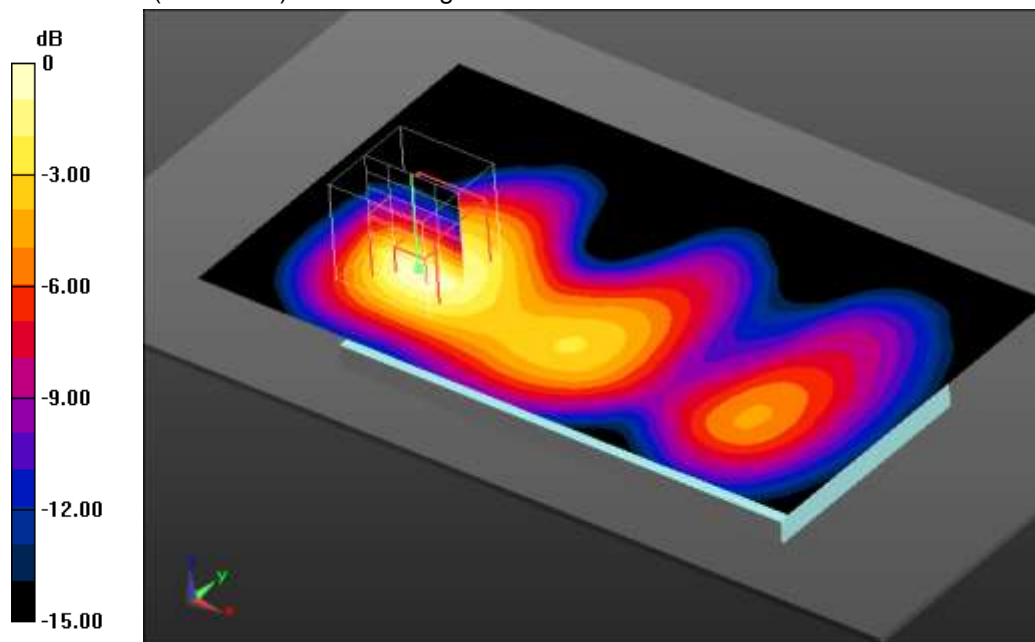

0 dB = 0.450 W/kg = -3.47 dBW/kg

Additional information:

position or distance of DUT to SAM: 15 mm

ambient temperature: 23.0°C; liquid temperature: 21.9°C

Annex B.11: WLAN 2450MHz

Date/Time: 21.12.2015 18:12:57

IEEE1528-WLAN2450 head

DUT: Microsoft; Type: RM-1154; Serial: 004402743289344

Communication System: UID 0, WLAN 2450 (0); Communication System Band: 2.4 GHz; Frequency: 2462 MHz; Communication System PAR: 0 dB; PMF: 1

Medium parameters used: $f = 2462$ MHz; $\sigma = 1.776$ S/m; $\epsilon_r = 38.87$; $\rho = 1000$ kg/m³

Phantom section: Left Section

Measurement Standard: DASY5

DASY5 Configuration:

- Probe: EX3DV4 - SN3944; ConvF(7.28, 7.28, 7.28); Calibrated: 14.08.2015;
- Sensor-Surface: 2mm (Mechanical Surface Detection (Locations From Previous Scan Used)), Sensor-Surface: 2mm (Mechanical Surface Detection), $z = 1.0, 26.0$
- Electronics: DAE3 Sn477; Calibrated: 22.05.2015
- Phantom: SAM; Type: SAM; Serial: 1043
- DASY52 52.8.7(1137); SEMCAD X 14.6.10(7164)

Left-Hand-Side HSL - Earpiece ON/Tilt Position - High/Area Scan

(111x161x1): Interpolated grid: $dx=1.000$ mm, $dy=1.000$ mm

Maximum value of SAR (interpolated) = 1.25 W/kg

Left-Hand-Side HSL - Earpiece ON/Tilt Position - High/Zoom Scan

(7x7x7)/Cube 0: Measurement grid: $dx=5$ mm, $dy=5$ mm, $dz=5$ mm

Reference Value = 24.183 V/m; Power Drift = 0.03 dB

Peak SAR (extrapolated) = 1.68 W/kg

SAR(1 g) = 0.744 W/kg; SAR(10 g) = 0.349 W/kg

Maximum value of SAR (measured) = 1.18 W/kg

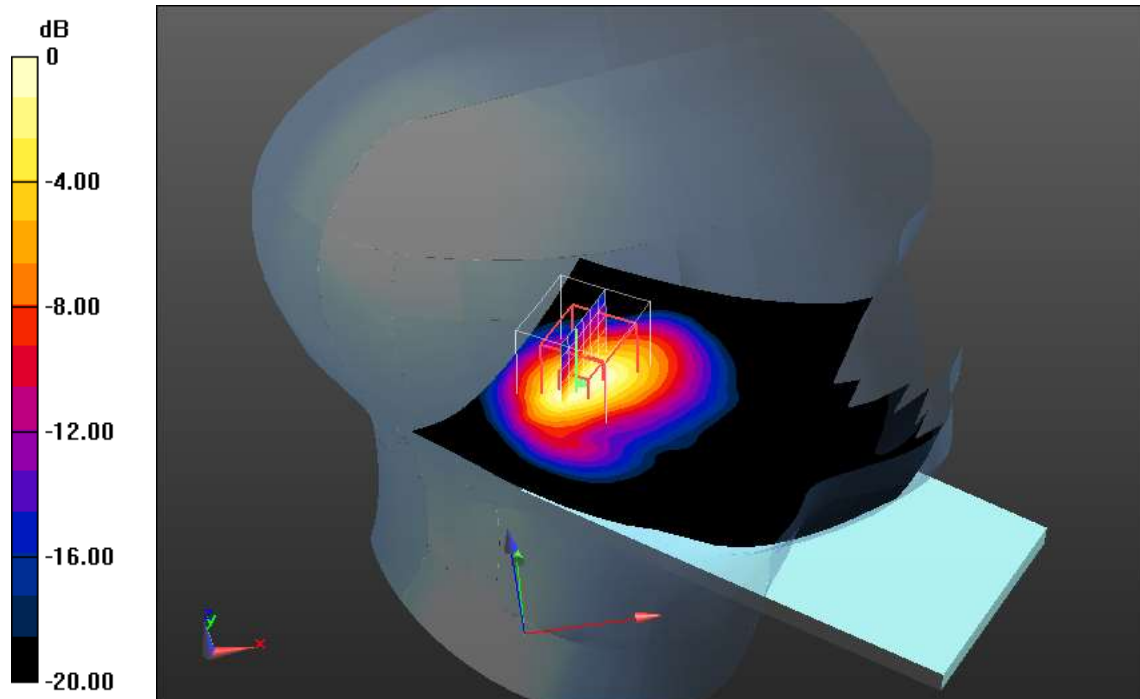

0 dB = 1.18 W/kg = 0.72 dBW/kg

Additional information:

ambient temperature: 23.1°C; liquid temperature: 22.6°C

FCC-WLAN2450 hotspot

DUT: Microsoft; Type: RM-1154; Serial: 004402743289344

Communication System: UID 0, WLAN 2450 (0); Communication System Band: 2.4 GHz; Frequency: 2462 MHz; Communication System PAR: 0 dB; PMF: 1

Medium parameters used: $f = 2462$ MHz; $\sigma = 2.022$ S/m; $\epsilon_r = 51.597$; $\rho = 1000$ kg/m³

Phantom section: Center Section

Measurement Standard: DASY5

DASY5 Configuration:

- Probe: ES3DV3 - SN3320; ConvF(4.16, 4.16, 4.16); Calibrated: 25.02.2015;
- Sensor-Surface: 3mm (Mechanical Surface Detection (Locations From Previous Scan Used)), Sensor-Surface: 3mm (Mechanical Surface Detection), $z = 2.0, 32.0$
- Electronics: DAE3 Sn413; Calibrated: 15.01.2015
- Phantom: Triple Flat Phantom 5.1C; Type: QD 000 P51 CA; Serial: 1154
- DASY52 52.8.7(1137); SEMCAD X 14.6.10(7164)

MSL2450/Top edge High 10mm/Area Scan (111x191x1): Interpolated grid: $dx=1.000$ mm, $dy=1.000$ mm

Maximum value of SAR (interpolated) = 0.986 W/kg

MSL2450/Top edge High 10mm/Zoom Scan (5x5x7)/Cube 0: Measurement grid:

$dx=7.5$ mm, $dy=7.5$ mm, $dz=5$ mm

Reference Value = 22.294 V/m; Power Drift = -0.02 dB

Peak SAR (extrapolated) = 1.56 W/kg

SAR(1 g) = 0.724 W/kg; SAR(10 g) = 0.328 W/kg

Maximum value of SAR (measured) = 0.970 W/kg

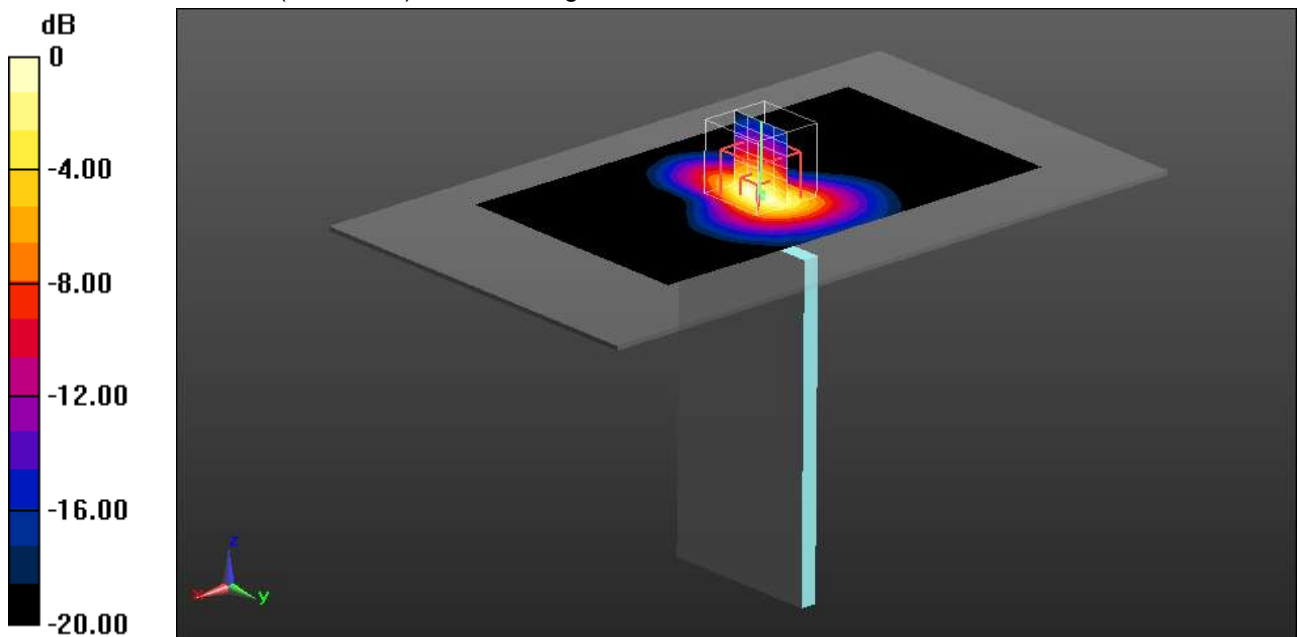

0 dB = 0.970 W/kg = -0.13 dBW/kg

Additional information:

position or distance of DUT to the phantom: 10 mm

ambient temperature: 23.4°C; liquid temperature: 22.4°C

FCC-WLAN2450 body worn

DUT: Microsoft; Type: RM-1154; Serial: 004402743289344

Communication System: UID 0, WLAN 2450 (0); Communication System Band: 2.4 GHz; Frequency: 2437 MHz; Communication System PAR: 0 dB; PMF: 1

Medium parameters used: $f = 2437$ MHz; $\sigma = 1.989$ S/m; $\epsilon_r = 51.635$; $\rho = 1000$ kg/m³

Phantom section: Center Section

Measurement Standard: DASY5

DASY5 Configuration:

- Probe: ES3DV3 - SN3320; ConvF(4.16, 4.16, 4.16); Calibrated: 25.02.2015;
- Sensor-Surface: 3mm (Mechanical Surface Detection (Locations From Previous Scan Used)), Sensor-Surface: 3mm (Mechanical Surface Detection), $z = 2.0, 32.0$
- Electronics: DAE3 Sn413; Calibrated: 15.01.2015
- Phantom: Triple Flat Phantom 5.1C; Type: QD 000 P51 CA; Serial: 1154
- DASY52 52.8.7(1137); SEMCAD X 14.6.10(7164)

MSL2450/Front Middle 15mm/Area Scan (111x191x1): Interpolated grid: $dx=1.000$ mm, $dy=1.000$ mm

Maximum value of SAR (interpolated) = 0.212 W/kg

MSL2450/Front Middle 15mm/Zoom Scan (5x5x7)/Cube 0: Measurement grid:

$dx=7.5$ mm, $dy=7.5$ mm, $dz=5$ mm

Reference Value = 10.106 V/m; Power Drift = 0.04 dB

Peak SAR (extrapolated) = 0.321 W/kg

SAR(1 g) = 0.165 W/kg; SAR(10 g) = 0.087 W/kg

Maximum value of SAR (measured) = 0.207 W/kg

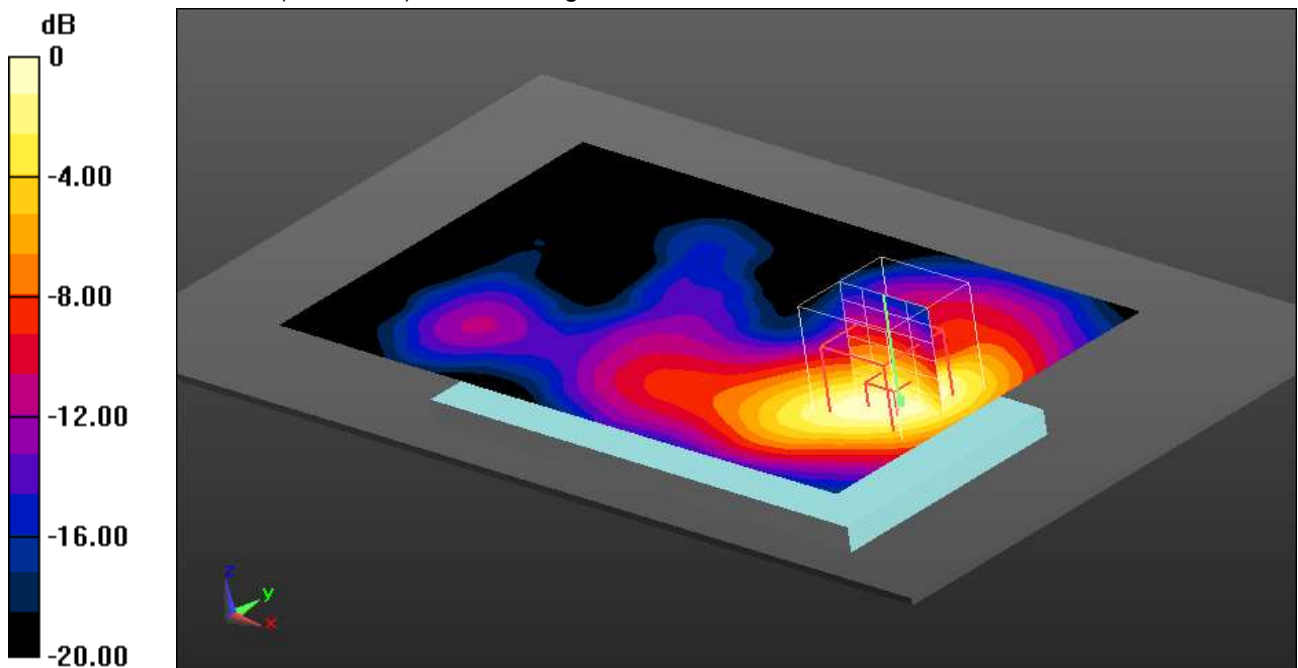

0 dB = 0.207 W/kg = -6.84 dBW/kg

Additional information:

position or distance of DUT to the phantom: 15 mm

ambient temperature: 23.4°C; liquid temperature: 22.4°C

Date/Time: 24.12.2015 11:39:07

FCC-WLAN2450 body worn

DUT: Microsoft; Type: RM-1154; Serial: 004402743289344

Communication System: UID 0, WLAN 2450 (0); Communication System Band: 2.4 GHz; Frequency: 2462 MHz; Communication System PAR: 0 dB; PMF: 1

Medium parameters used: $f = 2462$ MHz; $\sigma = 2.022$ S/m; $\epsilon_r = 51.597$; $\rho = 1000$ kg/m³

Phantom section: Center Section

Measurement Standard: DASYS

DASY5 Configuration:

- Probe: ES3DV3 - SN3320; ConvF(4.16, 4.16, 4.16); Calibrated: 25.02.2015;
- Sensor-Surface: 3mm (Mechanical Surface Detection (Locations From Previous Scan Used)), Sensor-Surface: 3mm (Mechanical Surface Detection), $z = 2.0, 32.0$
- Electronics: DAE3 Sn413; Calibrated: 15.01.2015
- Phantom: Triple Flat Phantom 5.1C; Type: QD 000 P51 CA; Serial: 1154
- DASY52 52.8.7(1137); SEMCAD X 14.6.10(7164)

MSL2450/Front High 15mm/Area Scan (111x191x1): Interpolated grid: $dx=1.000$ mm, $dy=1.000$ mm

Maximum value of SAR (interpolated) = 0.211 W/kg

MSL2450/Front High 15mm/Zoom Scan (5x5x7)/Cube 0: Measurement grid: $dx=7.5$ mm, $dy=7.5$ mm, $dz=5$ mm

Reference Value = 10.224 V/m; Power Drift = 0.01 dB

Peak SAR (extrapolated) = 0.322 W/kg

SAR(1 g) = 0.166 W/kg; SAR(10 g) = 0.089 W/kg

Maximum value of SAR (measured) = 0.206 W/kg

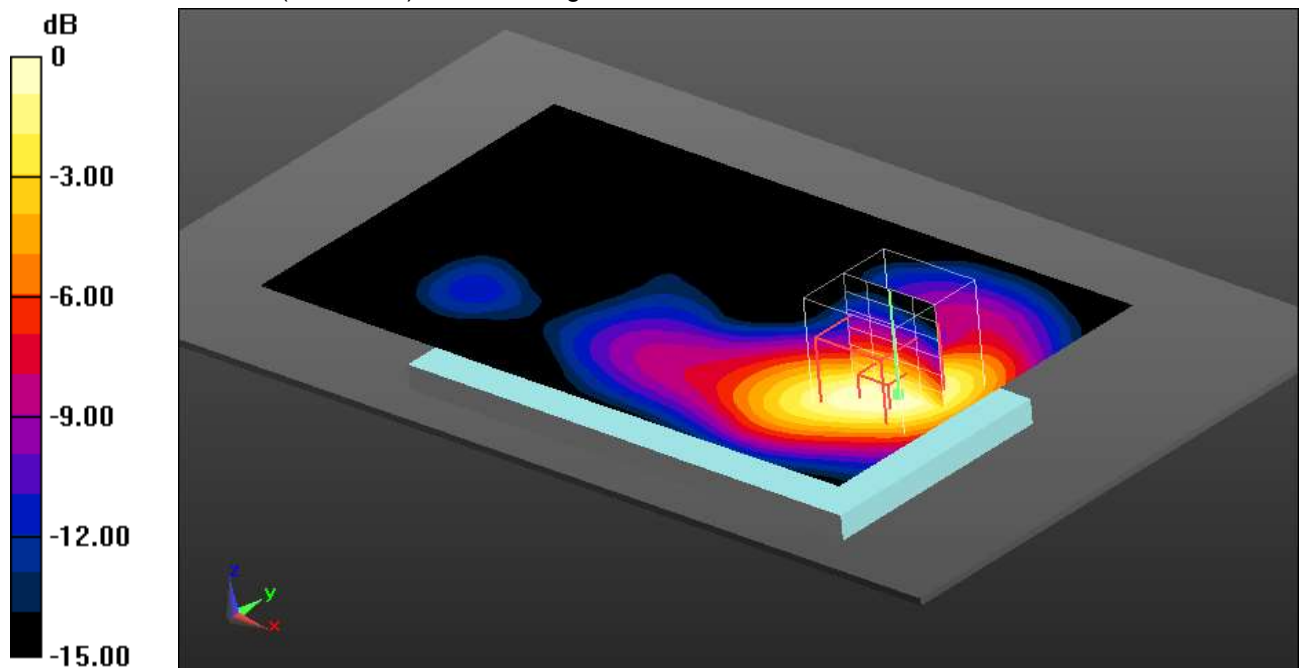

0 dB = 0.206 W/kg = -6.86 dBW/kg

Additional information:

position or distance of DUT to the phantom: 15 mm

ambient temperature: 23.4°C; liquid temperature: 22.4°C

Annex B.12: Combined Fast SAR

Multi-Band Fast SAR-UMTS FDD II front - 10mm

Multi-Band Configurations:

DASY Configuration for MSL2450/Front High 10mm/Area Scan:

Date/Time: 24.12.2015 10:31:53

Test Laboratory: Cetecom ICT Services GmbH

File Name: [FCC-WLAN2450 hotspot.da52:0](#)

DUT: Microsoft; Type: RM-1154; Serial: 004402743289344

Communication System: UID 0, WLAN 2450 (0); Frequency: 2462 MHz; Duty Cycle: 1:1; PMF: 1

Medium: MSL2450 Medium parameters used: $f = 2462$ MHz; $\sigma = 2.022$ S/m; $\epsilon_r = 51.597$; $\rho = 1000$ kg/m³

Phantom section: Center Section

Probe: ES3DV3 - SN3320; ConvF(4.16, 4.16, 4.16); Calibrated: 25.02.2015;

- Sensor-Surface: 3mm (Mechanical Surface Detection)
- Electronics: DAE3 Sn413; Calibrated: 15.01.2015
- Phantom: Triple Flat Phantom 5.1C; Type: QD 000 P51 CA; Serial: 1154
- Measurement SW: DASY52, Version 52.8 (7)

DASY Configuration for MSL1900 - ANT 2/Front Low 10mm/Area Scan:

Date/Time: 18.12.2015 11:12:42

Test Laboratory: CETECOM ICT Services

File Name: [FCC-UMTS FDD II hotspot.da52:1](#)

DUT: Microsoft; Type: RM-1154; Serial: 004402743285284

Communication System: UID 0, UMTS FDD (0); Frequency: 1852.4 MHz; Duty Cycle: 1:1; PMF: 1

Medium: MSL1900 Medium parameters used (interpolated): $f = 1852.4$ MHz; $\sigma = 1.452$ S/m; $\epsilon_r = 53.984$; $\rho = 1000$ kg/m³

Phantom section: Center Section

Probe: EX3DV4 - SN3944; ConvF(7.91, 7.91, 7.91); Calibrated: 14.08.2015;

- Sensor-Surface: 2mm (Mechanical Surface Detection (Locations From Previous Scan Used))
- Electronics: DAE3 Sn477; Calibrated: 22.05.2015
- Phantom: Triple Flat Phantom 5.1C; Type: QD 000 P51 CA; Serial: 1154
- Measurement SW: DASY52, Version 52.8 (7)

Fast SAR of Combined Scans: SAR(1 g) = 1.28 W/kg; SAR(10 g) = 0.679 W/kg

Maximum value of SAR (interpolated) = 1.80 W/kg

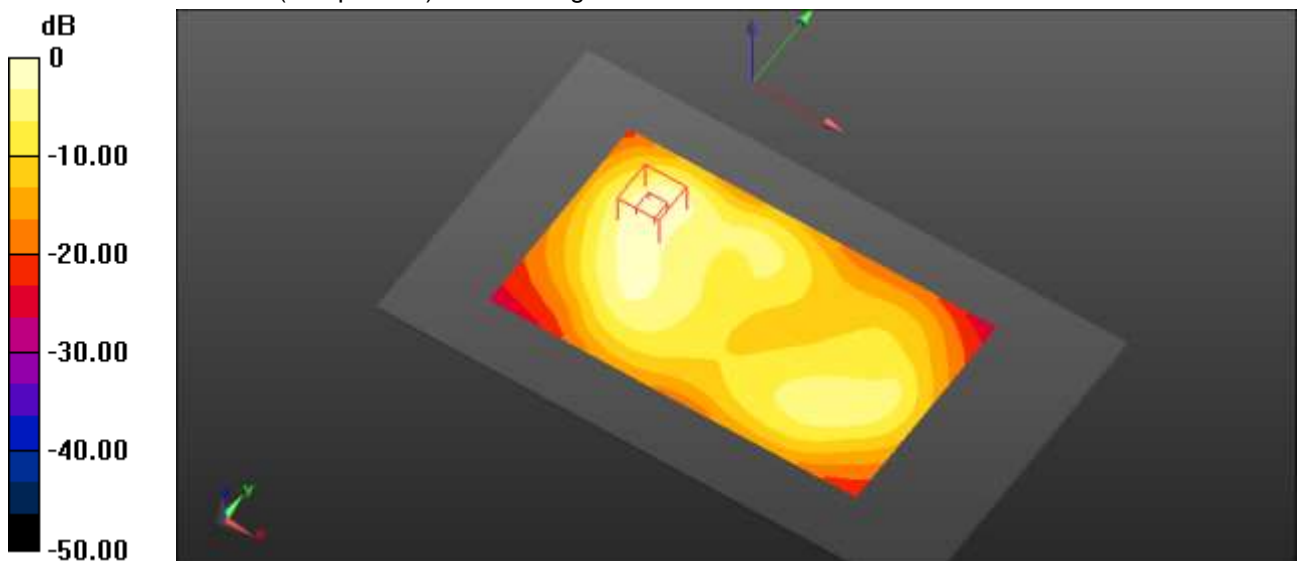

0 dB = 1.80 W/kg = 2.55 dBW/kg

Annex B.13: Liquid depth

Photo 1: Liquid depth 850 MHz head simulating liquid

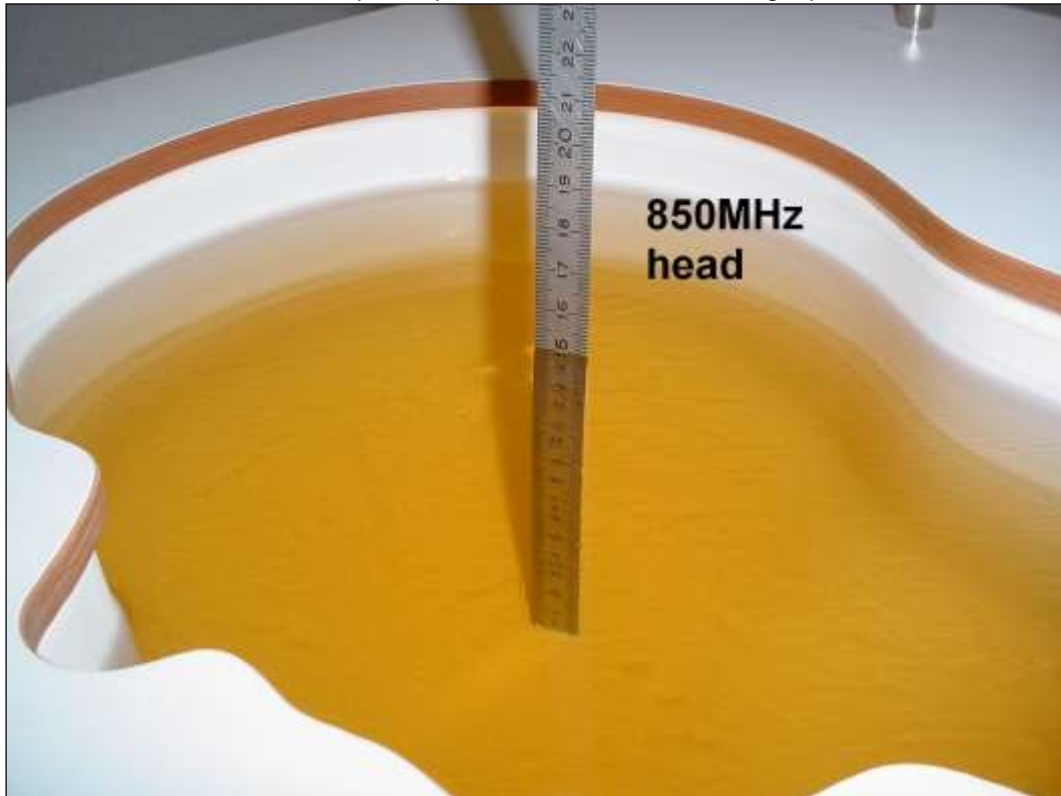

Photo 2: Liquid depth 850 MHz body simulating liquid



Photo 3: Liquid depth 1750MHz head simulating liquid



Photo 4: Liquid depth 1750 MHz body simulating liquid

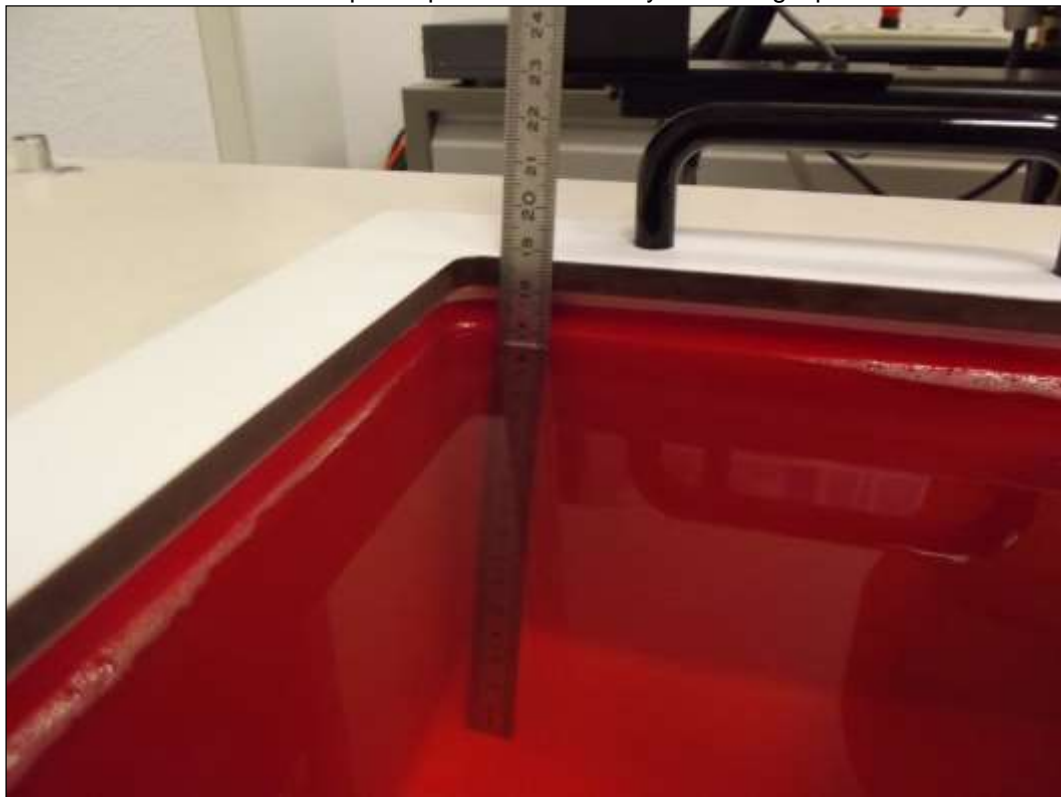

Photo 5: Liquid depth 1900MHz head simulating liquid

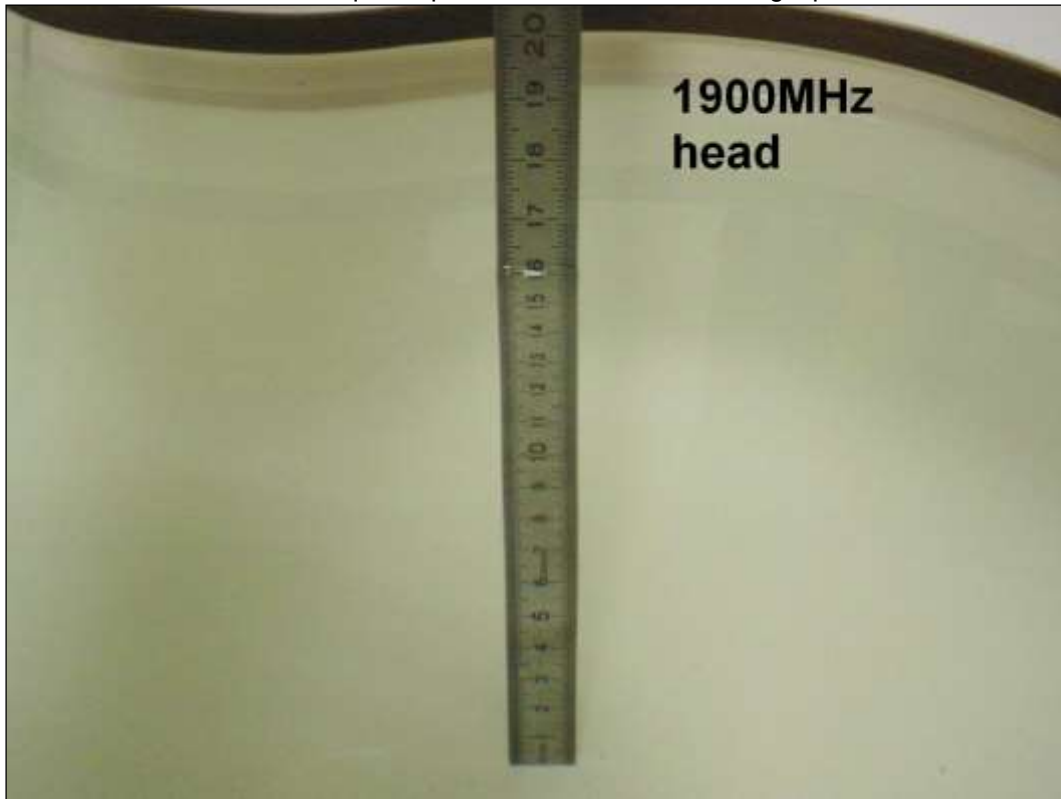

Photo 6: Liquid depth 1900 MHz body simulating liquid

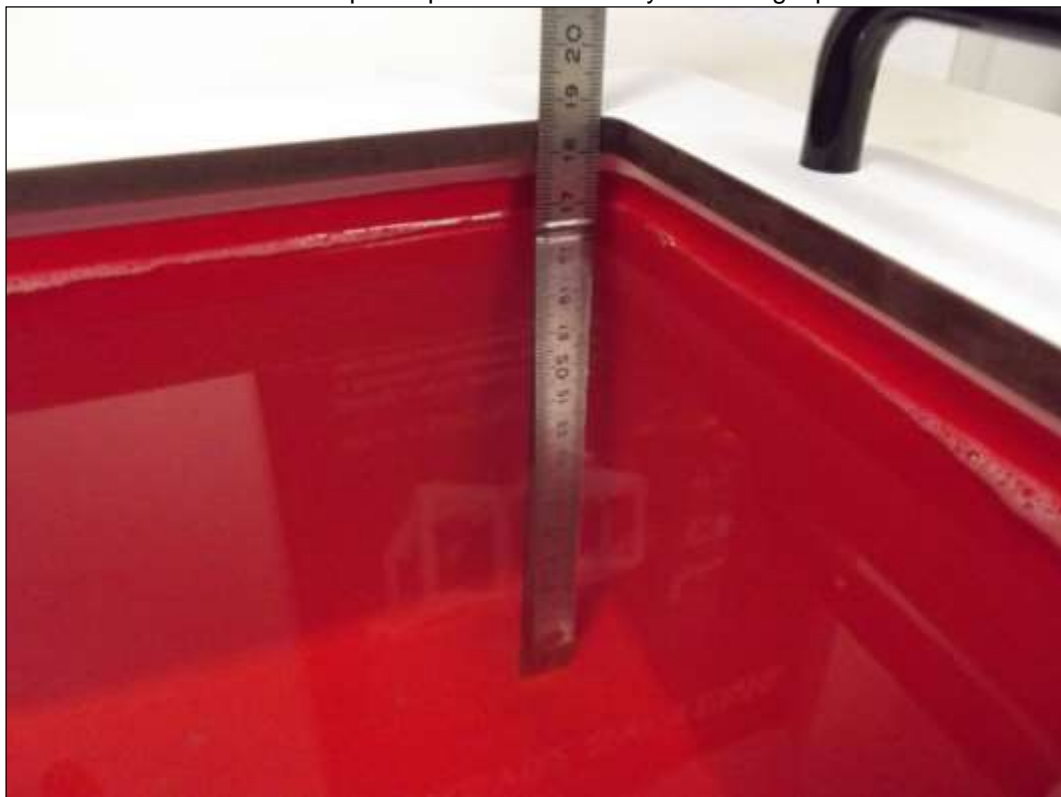

Photo 7: Liquid depth 2450MHz head simulating liquid

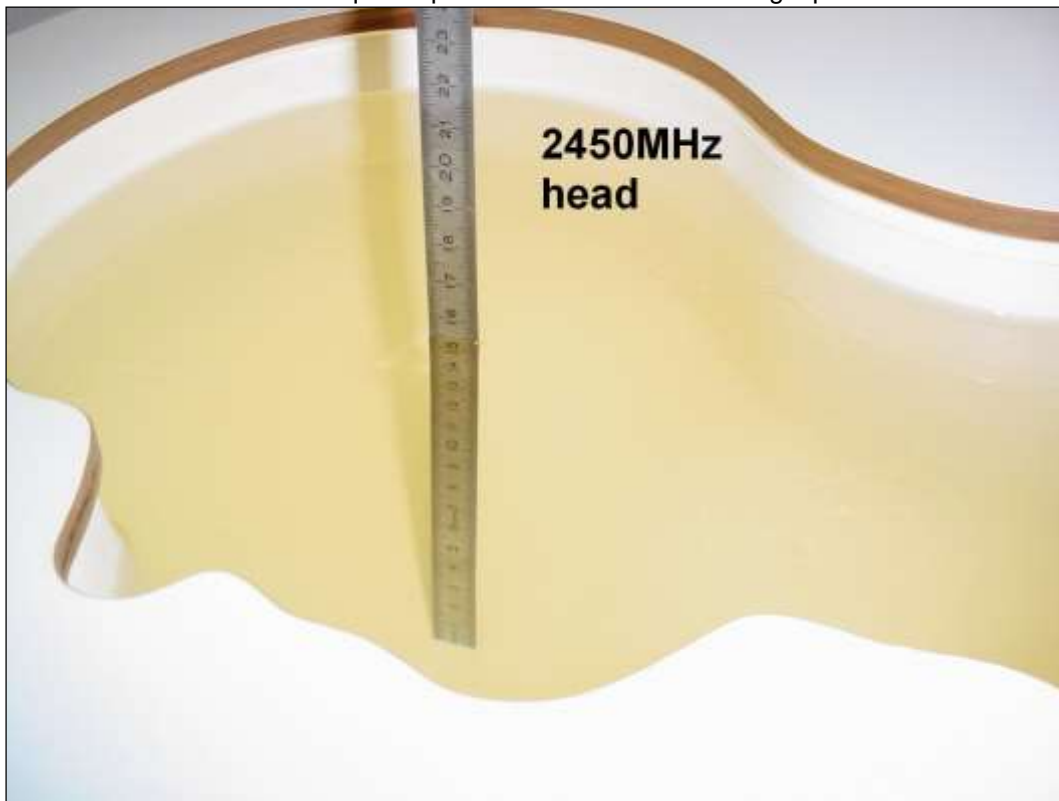
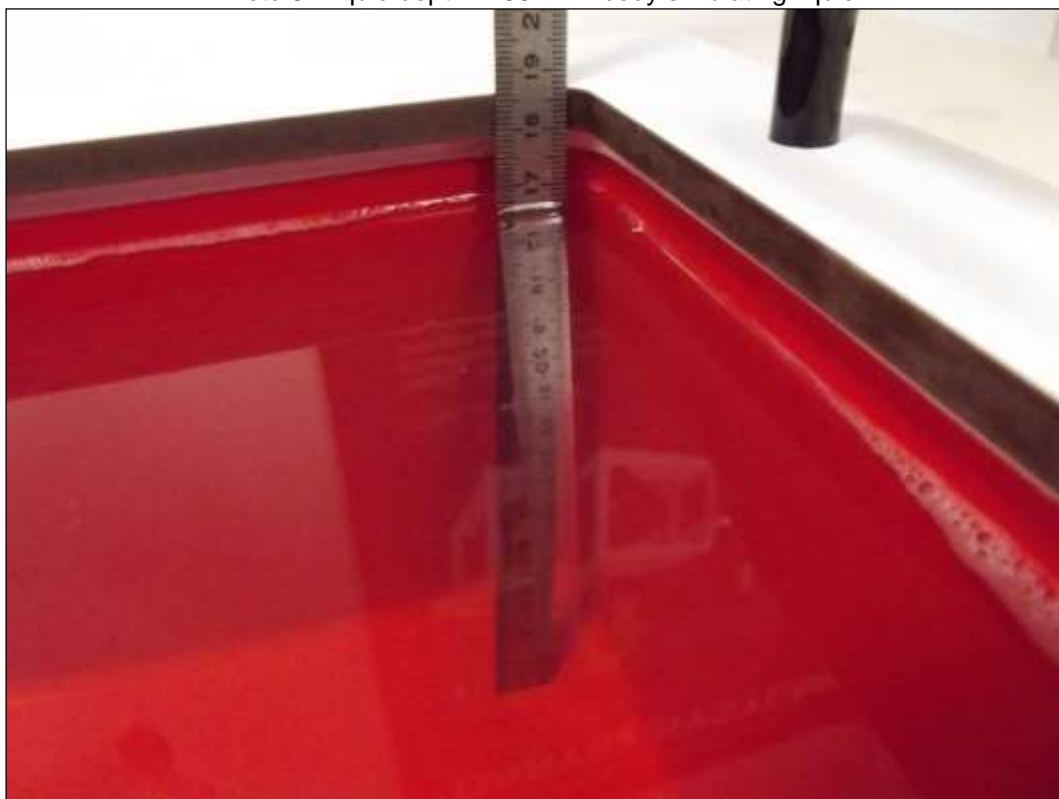

Photo 8: Liquid depth 2450 MHz body simulating liquid



Annex C: Photo documentation

Photo documentation is described in the additional document:

Appendix to test report no. 1-9303/15-02-02-A Photo documentation

Annex D: Calibration parameters

Calibration parameters are described in the additional document:

**Appendix to test report no. 1-9303/15-02-02-A
Calibration data, Phantom certificate
and detail information of the DASY5 System**

Annex E: RF Technical Brief Cover Sheet acc. to RSS-102 Annex A

- 1. COMPANY NUMBER: 661X
- 2. PRODUCT MARKETING NAME (PNM): RM-1154
- 3. HARDWARE VERSION IDENTIFICATION NO. (HVIN): RM-1154
- 4. FIRMWARE VERSION IDENTIFICATION NO. (FVIN): CORE_01078.00017.15461.48000
- 5. HOST MARKETING NAME (HMN): N/A
- 6. IC CERTIFICATION NUMBER: 661X-RM1154
- 7. APPLICANT: **Microsoft Mobile Oy**
- 8. SAR/RF EXPOSURE TEST LABORATORY: **CETECOM ICT Services GmbH**

9. TYPE OF EVALUATION:

(a) SAR Evaluation: **Device Used in the Vicinity of the Human Head**

- Multiple transmitters: Yes No
- Evaluated against exposure limits: General Public Use Controlled Use
- Duty cycle used in evaluation: 100 %
- Standards used for evaluation:

RSS-102 Issue 5	(2015-03)	IEEE C95-3	(2002)
IEEE 1528-2013	(2014-06)	IEEE C95-1	(2005)
Safety Code No.6	(2015-06)		

KDBs and further information follow in separate table below.

- SAR value: **1.170 W/kg**. Measured Computed Calculated

(b) SAR Evaluation: **Body-Worn Device**

- Multiple transmitters: Yes No
- Evaluated against exposure limits: General Public Use Controlled Use
- Duty cycle used in evaluation: 100 %
- Standard used for evaluation:

RSS-102 Issue 5	(2015-03)	IEEE C95-3	(2002)
IEEE 1528-2013	(2014-06)	IEEE C95-1	(2005)
Safety Code No.6	(2015-06)	IEC 62209-2	(2010)

KDBs and further information follow in separate table below.

- SAR value: **0.823 W/kg**. Measured Computed Calculated

(c) SAR Evaluation for **Limb-Worn Device**: not tested

Annex E.1: Declaration of RF Exposure Compliance Annex B

ATTESTATION: I attest that the information provided in Annex E: is correct; that a Technical Brief was prepared and the information it contains is correct; that the device evaluation was performed or supervised by me; that applicable measurement methods and evaluation methodologies have been followed and that the device meets the SAR and/or RF exposure limits of RSS-102.

Signature:

NAME : **Thomas Vogler**

TITLE : Dipl.-Ing. (FH)

COMPANY : CETECOM ICT Services GmbH

PRODUCT MARKETING NAME (PMN): RM-1154

HARDWARE VERSION IDENTIFICATION NO. (HVIN): RM-1154

FIRMWARE VERSION IDENTIFICATION NO. (FVIN):

HOST MARKETING NAME (HMN): N/A

IC CERTIFICATION NUMBER: 661X-RM1154

Test Standard	Version	FCC KDBs	Version
IEEE 1528-2003	2003-04	KDB 865664D01v01r03	February 7, 2014
IEEE 1528-2013	2014-06	KDB 447498D01v05r02	February 7, 2014
RSS-102 Issue 5	2015-04	KDB 447498D02v02	November 13, 2009
Canada's Safety Code No. 6	2015-03	KDB 648474D04v01r02	December 4, 2013
IEEE Std. C95-3	2002	KDB 941225D01v03	October 16, 2014
IEEE Std. C95-1	2005	KDB 941225D05v02r03	December 5, 2013
IEC 62209-2	2010	KDB 941225D06v02	October 16, 2014
		KDB 941225D07v01	May 28, 2013
		KDB 248227D01v02r01	June 8, 2015

Annex F: Document History

Version	Applied Changes	Date of Release
	Initial Release	2016-01-08
-A	Tune Up Declaration in 7.1.8 LTE4 corrected. Section 4.4 corrected.	2016-01-26

Annex G: Further Information**Glossary**

BW	-	Bandwidth
DTS	-	Distributed Transmission System
DUT	-	Device under Test
EUT	-	Equipment under Test
FCC	-	Federal Communication Commission
FCC ID	-	Company Identifier at FCC
HW	-	Hardware
IC	-	Industry Canada
Inv. No.	-	Inventory number
LTE	-	Long Term Evolution
N/A	-	not applicable
PCE	-	Personal Consumption Expenditure
OET	-	Office of Engineering and Technology
RB	-	resource block(s)
SAR	-	Specific Absorption Rate
S/N	-	Serial Number
SPLSR _i	-	SAR-to-(peak-locations spacing) ratio
SW	-	Software
UNII	-	Unlicensed National Information Infrastructure