

HAC RF Emissions Test Report

Test report no.:	RF_RM-1154_01	Date of report:	2015-02-02
Template version:	13.0	Number of pages:	14
Testing laboratory:	TCC Microsoft Salo Laboratory P.O.Box 303 Joensuunkatu 7E FIN-24101 SALO, FINLAND Tel. +358 71 800 8000 Fax. +358 71 80 44122	Client:	Microsoft P.O. Box 68 Sinitaival 5 FIN-33721 TAMPERE, FINLAND Tel. +358 (0) 7180 08000 Fax. +358 (0) 7180 46880
Responsible test engineer:	Janne Hirsimäki	Product contact person:	Juha Paukku
Measurements made by:	Janne Hirsimäki		
Tested devices:	RM-1154, HW: 1560		
FCC ID:	PYARM-1154	IC:	661X-RM1154
Supplement reports:	T-Coil_RM-1154_02, HAC_Photo_RM-1154_03		
Testing has been carried out in accordance with:	<p>ANSI C63.19-2011 American National Standard for Methods of Measurement of Compatibility between Wireless Communications Devices and Hearing Aids</p> <p>CTIA Test Plan for Hearing Aid Compatibility, Revision 3.0, November 2013</p>		
Documentation:	The documentation of the testing performed on the tested devices is archived for 15 years at TCC Microsoft.		
Test results:	<p>The tested device complies with the requirements in respect of all parameters subject to the test. The test results and statements relate only to the items tested. The test report shall not be reproduced except in full, without written approval of the laboratory.</p>		

Date and signatures:

For the contents:

CONTENTS

1. SUMMARY OF HAC RF EMISSION TEST REPORT 3

1.1 TEST DETAILS.....3

1.2 MAXIMUM RESULTS3

 1.2.1 *Electric field measurements*3

 1.2.2 *Overall RF emissions category of the tested device*.....3

 1.2.3 *Maximum Drift*3

 1.2.4 *Measurement Uncertainty*.....3

2. DESCRIPTION OF THE DEVICE UNDER TEST 4

2.1 PICTURE OF DEVICE5

3. TEST CONDITIONS..... 5

3.1 TEMPERATURE AND HUMIDITY.....5

3.2 TEST SIGNAL, FREQUENCIES, AND OUTPUT POWER5

4. DESCRIPTION OF THE TEST EQUIPMENT 6

4.1 MEASUREMENT SYSTEM AND COMPONENTS6

 4.1.1 *Isotropic E-field probe ER3DV6*.....7

 4.1.2 *Device Holder*7

4.2 VALIDATION OF THE SYSTEM.....8

5. DESCRIPTION OF THE TEST PROCEDURE 9

5.1 TEST ARCH AND DEVICE HOLDER.....9

5.2 TEST POSITIONS.....9

 5.2.1 *Scan area centered at the acoustic output*9

5.3 SCAN PROCEDURES.....10

5.4 MODULATION INTERFERENCE FACTOR.....10

5.5 SUB-GRID EXCLUSION.....11

5.6 CATEGORY LIMITS.....11

6. LOW-POWER EXEMPTION.....12

7. MEASUREMENT UNCERTAINTY.....13

8. RESULTS14

APPENDIX A: SYSTEM VALIDATION SCANS

APPENDIX B: MEASUREMENT SCANS

APPENDIX C: RELEVANT PAGES FROM PROBE CALIBRATION REPORT(S)

APPENDIX D: RELEVANT PAGES FROM DIPOLE VALIDATION KIT REPORT(S)

1. SUMMARY OF HAC RF EMISSION TEST REPORT

1.1 Test Details

Period of test	2015-12-17
HW and SW numbers of tested device	RM-1154, HW: 1560, SW: 01078.00017.15461.48000
Batteries used in testing	BV-T3G
Other accessories used in testing	-
State of sample	Prototype unit
Notes	-

1.2 Maximum Results

The maximum measured HAC RF emissions values and categories for electric and magnetic fields are given in section 1.2.1 and 1.2.2 respectively.

1.2.1 Electric field measurements

Mode	Limit of E-field max. value in category M3 [dB V/m]	Maximum E-field value after exclusion [dB V/m]	Category
GSM850	40 - 45	33.05	M4
GSM1900	30 - 35	29.83	M4

1.2.2 Overall RF emissions category of the tested device

Mode	E-field Category	Pass / Fail
GSM850	M4	Pass
GSM1900	M4	Pass
Final Category	M4	Pass

1.2.3 Maximum Drift

Maximum drift during measurements	≤ 0.2 dB
-----------------------------------	----------

1.2.4 Measurement Uncertainty

Extended Uncertainty (k=2) 95%, E-field	16.3 %
-----------------------------------------	--------

2. DESCRIPTION OF THE DEVICE UNDER TEST

Air-interface	Band (MHz)	Type	C63.19/ tested	Simultaneous Transmissions	Reduced power	Voice Over Digital Transport OTT Capability	HAC report number
GSM	850	VO	Yes	Yes BT, WLAN	N/A	NA	RF_RM-1154_01
	1900				N/A	NA	RF_RM-1154_01
	GPRS/EDGE	DT	N/A	Yes BT, WLAN	N/A	YES*	-
WCDMA	850 (Band 5) 1700/2100 (Band 4) 1900 (Band 2)	V/D	Yes**	Yes BT, WLAN	N/A	YES	RF_RM-1154_01
FDD- LTE	850 (Band 5) 1700/2100 (Band 4) 1900 (Band 2) 2500 (Band 7)	V/D	Yes***	Yes BT, WLAN	N/A	YES	RF_RM-1154_01
TDD-LTE	2600 (Band 38)	V/D	No****	Yes BT, WLAN	N/A	YES	RF_RM-1154_01
BT	2450	DT	N/A	Yes GSM, GPRS/EDGE, WCDMA, LTE	N/A	YES*	-
WLAN	2450	DT	N/A	Yes GSM, GPRS/EDGE, WCDMA, LTE	N/A	YES*	-

VO Voice CMRS/PSTN Service Only

V/D Voice CMRS/PSTN and Data Service

DT Digital Transport

*supports only non CMRS voice (OTT).

**RF Emission testing was not required for WCDMA air-interface because of Low-power exemption.

***No LTE Associated T-Coil measurement has been made in accordance with 285076 D02 T-Coil testing for CMRS IP.

****HAC RF measurement not required since no Associated T-Coil measurement has been made in accordance with 285076 D02 T-Coil testing for CMRS IP.

HAC rating was evaluated for voice mode only in GSM air interface in this report.

Outside of USA the transmitter of the device is capable of operating also in 700MHz, 900MHz, 1800MHz, 2100MHz and 2300MHz bands, which are not part of this filing.

Two antennas are used for transmission of some of the cellular bands in diversity-Tx mode. In this mode the antennas can not transmit at the same time. See table below for applicable antennas in each transmission band and mode. A separate single antenna is used for WLAN. All antennas are fully and separately HAC RF tested for individual transmission.

	Tx Antennas	
	Antenna 1	Antenna 2
GSM850	✓	✓
WCDMA850 (Band 5)	✓	✓
LTE850 (Band 5)	✓	✓
WCDMA1700/2100 (Band 4)	✓	✓
LTE1700/2100 (Band 4)	✓	✓
GSM1900	✓	✓
WCDMA1900 (Band 2)	✓	✓
LTE1900 (Band 2)	✓	✓
LTE2500 (Band 7)	✓	✓
LTE2600 (Band 38)	✓	✓
WLAN2450	✓	-

2.1 Picture of Device

See separate report HAC_Photo_RM-1154_03.

3. TEST CONDITIONS

3.1 Temperature and Humidity

Ambient temperature [°C]:	20.5 – 22.5
Ambient humidity [RH %]:	35 – 55

3.2 Test Signal, Frequencies, and Output Power

The transmitter of the device was put into operation by using a call tester. Communications between the device and the call tester were established by air link.

The device output power was set to maximum power level for all tests; a fully charged battery was used for every test sequence.

The measurements were performed on lowest, middle and highest channels.

The conducted output power of the device was measured by a separate test laboratory on the same unit as used for HAC testing. The results are given in the HAC result tables.

4. DESCRIPTION OF THE TEST EQUIPMENT

4.1 Measurement system and components

The measurements were performed using an automated near-field scanning system, DASY5, manufactured by Schmid & Partner Engineering AG (SPEAG) in Switzerland.

The following table lists calibration dates of SPEAG components:

Test Equipment	Serial Number	Calibration interval	Calibration expiry
DAE 4	1332	12 months	2016-01
E-field Probe ER3DV6	2367	12 months	2016-04
Dipole Validation Kit, CD835V3	1064	24 months	2017-04
Dipole Validation Kit, CD1880V3	1052	24 months	2017-04
DASY52 software	Version 52.8	-	-

Additional test equipment used in testing and validation:

Test Equipment	Model	Serial Number	Calibration interval	Calibration expiry
Signal Generator	SME 06	836407/007	12 months	2016-04
Amplifier	ZHL-42	854105	-	-
Power Meter	NRVD	840297/032	12 months	2016-04
Power Sensor	NRV-Z53	848532/001	12 months	2016-04
Call Tester	CMU-200	101111	-	-

4.1.1 Isotropic E-field probe ER3DV6

Construction	One dipole parallel, two dipoles normal to probe axis Built-in shielding against static charges PEEK enclosure material
Frequency	In air 100 MHz to >6 GHz; Linearity: ± 0.2 dB (100 MHz to 3 GHz)
Directivity	± 0.2 dB in air (rotation around probe axis) ± 0.4 dB in air (rotation normal to probe axis)
Dynamic Range	2 V/m to > 1000 V/m; Linearity: ± 0.2 dB
Dimensions	Overall length: 330 mm Tip length: 16 mm Body diameter: 12 mm Tip diameter: 8 mm Distance from probe tip to nearest point of dipole: 1.25 mm
Application	General near-field measurements up to 6 GHz Field component measurements Fast automatic scanning in phantoms

4.1.2 Device Holder

The Device Holder and Test Arch are manufactured by Speag (www.speag.com). Test arch is used for all tests i.e. for both validation testing and device testing. The holder and test arch conforms to the requirements of ANSI C63.19.

The SPEAG device holder (see Section 5.1) was used to position the test device in all tests.

4.2 Validation of the System

The manufacturer calibrates the probes annually. Validation measurements are made regularly using the dipole validation kit. The power level used by manufacturer in dipole calibration is supplied to the dipole antenna. The antenna is scanned at 15mm distance between top surface of the dipole and calibration point of the probe.

System Validation, E-field

f [MHz]	Dipole SN	Description	E-field [V/m]
835	1064	Reference result ± 10% window	104.2 93.8 – 114.6
		2015-12-16	104.9
1880	1052	Reference result ± 10% window	89.8 80.8 – 98.8
		2015-12-16	90.87

Plots of the system validation scans are given in Appendix A.

5. DESCRIPTION OF THE TEST PROCEDURE

5.1 Test Arch and Device Holder

The test device was placed in the Device Holder (illustrated below) that is supplied by SPEAG. Using this positioner the tested device is positioned under Test Arch.



Device holder and Test Arch supplied by SPEAG

5.2 Test Positions

5.2.1 Scan area centered at the acoustic output

The device was positioned such that Device Reference plane was touching the bottom of the Test Arch. The scan is centered at the acoustic output by aligning the acoustic output with the intersection of the Test Arch's middle bar and dielectric wire.

5.3 Scan Procedures

Near field scans of 5cm x 5cm were used for determination of the field distribution. Measurement plane distance from WD reference plane is 15mm. Scans were performed for E-field using appropriate probe. DASY software divides detected values into 3 x 3 sub grids as described in the C63.19 standard.

5.4 Modulation Interference Factor

The HAC Standard ANSI C63.19-2011 defines a new scaling using the Modulation Interference Factor (MIF) which replaces the need for the Articulation Weighting Factor (AWF) during the evaluation and is applicable to any modulation scheme.

The Modulation Interference Factor (MIF, in dB) is added to the measured average E-field (in dBV/m) and converts it to the RF Audio Interference Potential (RFAIP, in dBV/m). This level considers the audible amplitude modulation components in the RF E-field. CW fields without amplitude modulation are assumed to not interfere with the hearing aid electronics. Modulations without time slots and low fluctuations at low frequencies have low MIF values, TDMA modulations with narrow transmission slots and repetition rates of few 100 Hz have high MIF values and give similar classification as ANSI C63.19-2007.

DASY52 is using the indirect measurement method according to ANSI C63.19-2011 and near field probe read the averaged E-field. Especially for the new high peak-to-average (PAR) signal types, the probes shall be linearized by PMR calibration in order to not overestimate the field reading.

DASY52 uses well-defined signals for PMR calibration. The MIF of these signals has been determined numerically. It allows a precise scaling and is therefore automatically applied. The following table lists the MIF values evaluated by SPEAG and the detailed parameters for E-field probe can be found in the probe calibration report in the appendix C.

UID	UID Version Date	Communication system	MIF (dB)
10021-DAB	2015-02-06	GSM-FDD (TDMA, GMSK)	3.63
10011-CAB	2015-02-06	UMTS-FDD (WCDMA)	-27.23
10170-CAB	2015-02-06	LTE-FDD (SC-FDMA, 1 RB, 20 MHz, 16-QAM)	-9.76
10173-CAB	2015-02-06	LTE-TDD (SC-FDMA, 1 RB, 20 MHz, 16-QAM)	-1.44

The MIF measurement uncertainty is estimated by SPEAG:

MIF (dB)	MIF Measurement Uncertainty (dB)
-7 to +5	0.2
-13 to +11	0.5
> -20	1.0

5.5 Sub-grid Exclusion

The measurement grid defined in C63.19 consists of 9 evenly sized blocks, which are used to define permissible exclusion areas. For E-field measurements three contiguous blocks may be excluded from the measurements except the center block may never be excluded.

5.6 Category Limits

From remaining maximum values after exclusion process, Hearing Aid M-category is defined according to the category limits of C63.19 – 2011.

Category	Limits for E-Field Emissions	
	E-field <960 MHz [dB V/m]	E-field >960 MHz [dB V/m]
M1	50 – 55	40 – 45
M2	45 – 50	35 – 40
M3	40 – 45	30 – 35
M4	< 40	< 30

6. LOW-POWER EXEMPTION

An RF air interface technology of a device can be exempt from testing when its average antenna input power added to its MIF is ≤ 17 dBm.

Air-interface	Power Tuning Target (dBm)	Upper limit of Power Tuning Tolerance (dBm)	MIF (dB)	Upper limit of Power Tuning Tolerance + MIF (dBm)	HAC tested
GSM850	32.5	32.9	3.63	36.53	Yes
WCDMA850 (Band 5)	23.5	23.9	-27.23	-3.33	No
LTE850 (Band 5)*	23.0	23.4	-9.76	13.64	No
WCDMA1700/2100 (Band 4)	23.0	23.4	-27.23	-3.83	No
LTE1700/2100 (Band 4)*	23.0	23.4	-9.76	13.64	No
GSM1900	29.5	29.9	3.63	33.53	Yes
WCDMA1900 (Band 2)	23.0	23.4	-27.23	-3.83	No
LTE1900 (Band 2)*	23.0	23.4	-9.76	13.64	No
LTE2500 (Band 7)*	23.0	23.4	-9.76	13.64	No
LTE2600 (Band 38)**	23.0	23.4	-1.44	21.96	No

* No Associated T-Coil measurement has been made in accordance with 285076 D02 T-Coil testing for CMRS IP.

**HAC RF measurement not required since no Associated T-Coil measurement has been made in accordance with 285076 D02 T-Coil testing for CMRS IP.

LTE low-power exemption calculations are based on 1RB 16-QAM MIF which is worst case for the LTE-FDD and LTE-TDD.

7. MEASUREMENT UNCERTAINTY

Source of Uncertainty	Tolerance ±%	Prob. Dist.	Div.	ci E	ci H	Standard Uncertainty ±%, E
MEASUREMENT SYSTEM						
Probe Calibration	5.1	N	1	1	1	5.1
Axial Isotropy	4.7	R	√3	1	1	2.7
Sensor Displacement	16.5	R	√3	1	0.145	9.5
Boundary Effects	2.4	R	√3	1	1	1.4
Phantom Boundary Effect	7.2	R	√3	1	0	4.1
Linearity	4.7	R	√3	1	1	2.7
Scaling with PMR calibration	10.0	R	√3	1	1	5.8
System Detection Limit	1.0	R	√3	1	1	0.6
Readout Electronics	0.3	N	1	1	1	0.3
Response Time	0.8	R	√3	1	1	0.5
Integration Time	2.6	R	√3	1	1	1.5
RF Ambient Conditions	3.0	R	√3	1	1	1.7
RF Reflections	12.0	R	√3	1	1	6.9
Probe Positioner	1.2	R	√3	1	0.67	0.7
Probe Positioning	4.7	R	√3	1	0.67	2.7
Extrapolation and Interpolation	1.0	R	√3	1	1	0.6
TEST SAMPLE RELATED						
Device Positioning Vertical	4.7	R	√3	1	0.67	2.7
Device Positioning Lateral	1.0	R	√3	1	1	0.6
Device Holder and Phantom	2.4	R	√3	1	1	1.4
Power Drift	5.0	R	√3	1	1	2.9
PHANTOM AND SETUP RELATED						
Phantom Thickness	2.4	R	√3	1	0.67	1.4
Combined Standard Uncertainty						16.3
Expanded Uncertainty on Power						32.6
Expanded Uncertainty on Field						16.3

8. RESULTS

The calculated maximum field values for the test device are tabulated below:

GSM850, RF emissions results – Antenna 1

Mode	Test configuration	Ch 128 824.2 MHz	Ch 190 836.6 MHz	Ch 251 848.8 MHz
GSM850	Conducted Power	32.6 dBm	32.4 dBm	32.5 dBm
	E-field [dB V/m]	32.76	30.92	33.05
	Category	M4	M4	M4

GSM850, RF emissions results – Antenna 2

Mode	Test configuration	Ch 128 824.2 MHz	Ch 190 836.6 MHz	Ch 251 848.8 MHz
GSM850	Conducted Power	32.6 dBm	32.4 dBm	32.5 dBm
	E-field [dB V/m]	32.63	32.69	32.39
	Category	M4	M4	M4

GSM1900, RF emissions results – Antenna 1

Mode	Test configuration	Ch 512 1850.2MHz	Ch 661 1880.0MHz	Ch 810 1909.8MHz
GSM1900	Conducted Power	29.5 dBm	29.5 dBm	29.9 dBm
	E-field [dB V/m]	28.19	29.03	29.83
	Category	M4	M4	M4

GSM1900, RF emissions results – Antenna 2

Mode	Test configuration	Ch 512 1850.2MHz	Ch 661 1880.0MHz	Ch 810 1909.8MHz
GSM1900	Conducted Power	29.5 dBm	29.5 dBm	29.9 dBm
	E-field [dB V/m]	26.91	27.27	27.06
	Category	M4	M4	M4

Plots of the measurement scans are shown in **Appendix B**. Excluded cells are colored orange.



APPENDIX A: SYSTEM VALIDATION SCANS

Test Laboratory: TCC Microsoft
Type: **CD835V3**; Serial: **1064**

Communication System: CW
Frequency: 835 MHz; Duty Cycle: 1:1
Medium: Air
Medium parameters used: $\sigma = 0$ S/m, $\epsilon_r = 1$; $\rho = 0$ kg/m³
Phantom section: RF Section

DASY Configuration:
- Probe: ER3DV6 - SN2367
- ConvF(1, 1, 1); Calibrated: 2015-04-29;
- Sensor-Surface: (Fix Surface)
- Electronics: DAE4 Sn1332; Calibrated: 2015-01-13
- Phantom: HAC Test Arch with AMCC; Type: SD HAC P01 BA
- Measurement SW: DASY52, Version 52.8 (8); SEMCAD X Version 14.6.10 (7331)

Dipole E-Field measurement 835MHz/E Scan - measurement distance from the probe sensor center to CD835 Dipole = 15mm/Hearing Aid Compatibility Test (41x361x1):

Interpolated grid: dx=0.5000 mm, dy=0.5000 mm
Device Reference Point: 0, 0, -6.3 mm
Reference Value = 101.2 V/m; Power Drift = -0.02 dB
PMR not calibrated. PMF = 1.000 is applied.
E-field emissions = 104.9 V/m

Grid 1 M4 103.7 V/m	Grid 2 M4 104.9 V/m	Grid 3 M4 102.0 V/m
Grid 4 M4 62.85 V/m	Grid 5 M4 63.44 V/m	Grid 6 M4 61.98 V/m
Grid 7 M4 100.9 V/m	Grid 8 M4 102.6 V/m	Grid 9 M4 101.1 V/m

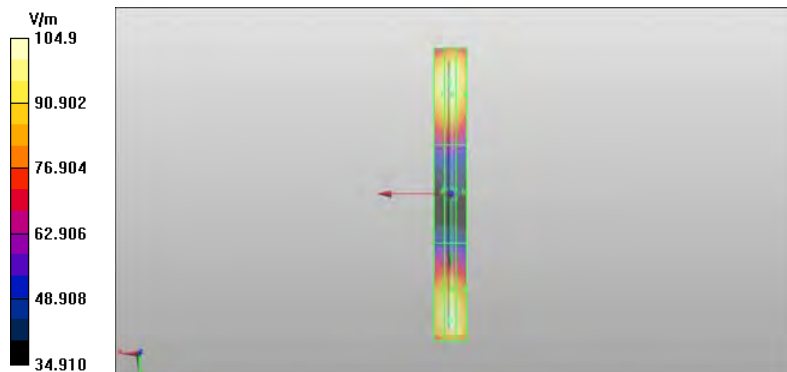

Test Laboratory: TCC Microsoft
Type: CD1880V3; Serial: 1052

Communication System: CW
Frequency: 1880 MHz; Duty Cycle: 1:1
Medium: Air
Medium parameters used: $\sigma = 0$ S/m, $\epsilon_r = 1$; $\rho = 0$ kg/m³
Phantom section: RF Section

DASY Configuration:

- Probe: ER3DV6 - SN2367
- ConvF(1, 1, 1); Calibrated: 2015-04-29;
- Sensor-Surface: (Fix Surface)
- Electronics: DAE4 Sn1332; Calibrated: 2015-01-13
- Phantom: HAC Test Arch with AMCC; Type: SD HAC P01 BA
- Measurement SW: DASY52, Version 52.8 (8); SEMCAD X Version 14.6.10 (7331)

Dipole E-Field measurement 1880MHz/E Scan - measurement distance from the probe sensor center to CD1880 Dipole = 15mm/Hearing Aid Compatibility Test (41x181x1): Interpolated grid: dx=0.5000 mm, dy=0.5000 mm

Device Reference Point: 0, 0, -6.3 mm
Reference Value = 151.9 V/m; Power Drift = -0.02 dB
PMR not calibrated. PMF = 1.000 is applied.
E-field emissions = 90.87 V/m

Grid 1 M3 89.32 V/m	Grid 2 M3 90.87 V/m	Grid 3 M3 89.10 V/m
Grid 4 M3 71.66 V/m	Grid 5 M3 72.30 V/m	Grid 6 M3 70.90 V/m
Grid 7 M3 83.44 V/m	Grid 8 M3 85.40 V/m	Grid 9 M3 84.59 V/m

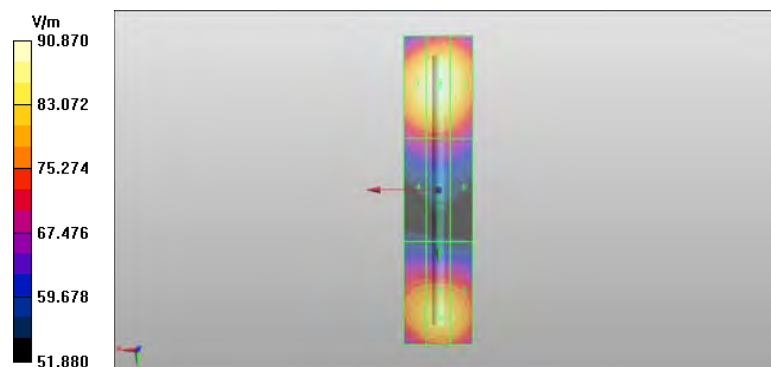



APPENDIX B: MEASUREMENT SCANS

Test Laboratory: TCC Microsoft

Type: RM-1150, HW:1520; Serial: 004402/74/328524/3

Communication System: UID 10021 - DAB, GSM-FDD (TDMA, GMSK)

Frequency: 824.2 MHz; Duty Cycle: 1:8.6896

Medium: Air;

Medium parameters used: $\sigma = 0 \text{ S/m}$, $\epsilon_r = 1$; $\rho = 0 \text{ kg/m}^3$

Phantom section: RF Section

DASY Configuration:

- Probe: ER3DV6 - SN2367
- ConvF(1, 1, 1); Calibrated: 2015-04-29;
- Sensor-Surface: (Fix Surface)
- Electronics: DAE4 Sn1332; Calibrated: 2015-01-13
- Phantom: HAC Test Arch with AMCC; Type: SD HAC P01 BA;
- Measurement SW: DASY52, Version 52.8 (8); SEMCAD X Version 14.6.10 (7331)

E Scan/GSM850 - Low - Ant 1/Hearing Aid Compatibility Test (101x101x1):

Interpolated grid: dx=0.5000 mm, dy=0.5000 mm

Device Reference Point: 0, 0, -6.3 mm

Reference Value = 32.89 V/m; Power Drift = -0.00 dB

Applied MIF = 3.63 dB

RF audio interference level = 32.76 dBV/m

Emission category: M4

Grid 1 M4 34.31 dBV/m	Grid 2 M4 34.39 dBV/m	Grid 3 M4 33.05 dBV/m
Grid 4 M4 32.58 dBV/m	Grid 5 M4 32.76 dBV/m	Grid 6 M4 31.87 dBV/m
Grid 7 M4 30.26 dBV/m	Grid 8 M4 30.72 dBV/m	Grid 9 M4 30.09 dBV/m

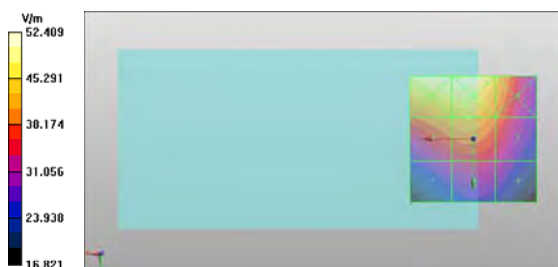

Test Laboratory: TCC Microsoft

Type: RM-1150, HW:1520; Serial: 004402/74/328524/3

Communication System: UID 10021 - DAB, GSM-FDD (TDMA, GMSK)

Frequency: 836.6 MHz; Duty Cycle: 1:8.6896

Medium: Air;

Medium parameters used: $\sigma = 0 \text{ S/m}$, $\epsilon_r = 1$; $\rho = 0 \text{ kg/m}^3$

Phantom section: RF Section

DASY Configuration:

- Probe: ER3DV6 - SN2367
- ConvF(1, 1, 1); Calibrated: 2015-04-29;
- Sensor-Surface: (Fix Surface)
- Electronics: DAE4 Sn1332; Calibrated: 2015-01-13
- Phantom: HAC Test Arch with AMCC; Type: SD HAC P01 BA;
- Measurement SW: DASY52, Version 52.8 (8); SEMCAD X Version 14.6.10 (7331)

E Scan/GSM850 - Middle - Ant 1/Hearing Aid Compatibility Test (101x101x1):

Interpolated grid: dx=0.5000 mm, dy=0.5000 mm

Device Reference Point: 0, 0, -6.3 mm

Reference Value = 24.52 V/m; Power Drift = 0.03 dB

Applied MIF = 3.63 dB

RF audio interference level = 30.92 dBV/m

Emission category: M4

Grid 1 M4 32.62 dBV/m	Grid 2 M4 32.98 dBV/m	Grid 3 M4 31.32 dBV/m
Grid 4 M4 30.44 dBV/m	Grid 5 M4 30.92 dBV/m	Grid 6 M4 30 dBV/m
Grid 7 M4 27.57 dBV/m	Grid 8 M4 28.17 dBV/m	Grid 9 M4 28.07 dBV/m

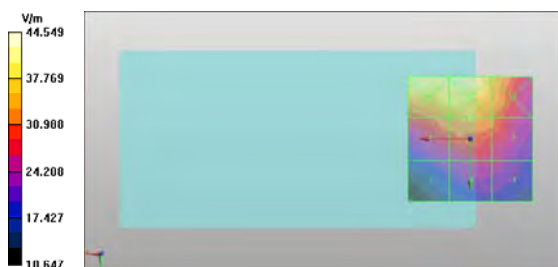

Test Laboratory: TCC Microsoft

Type: RM-1150, HW:1520; Serial: 004402/74/328524/3

Communication System: UID 10021 - DAB, GSM-FDD (TDMA, GMSK)

Frequency: 848.8 MHz; Duty Cycle: 1:8.6896

Medium: Air;

Medium parameters used: $\sigma = 0 \text{ S/m}$, $\epsilon_r = 1$; $\rho = 0 \text{ kg/m}^3$

Phantom section: RF Section

DASY Configuration:

- Probe: ER3DV6 - SN2367
- ConvF(1, 1, 1); Calibrated: 2015-04-29;
- Sensor-Surface: (Fix Surface)
- Electronics: DAE4 Sn1332; Calibrated: 2015-01-13
- Phantom: HAC Test Arch with AMCC; Type: SD HAC P01 BA;
- Measurement SW: DASY52, Version 52.8 (8); SEMCAD X Version 14.6.10 (7331)

E Scan/GSM850 - High - Ant 1/Hearing Aid Compatibility Test (101x101x1):

Interpolated grid: dx=0.5000 mm, dy=0.5000 mm

Device Reference Point: 0, 0, -6.3 mm

Reference Value = 33.69 V/m; Power Drift = -0.02 dB

Applied MIF = 3.63 dB

RF audio interference level = 33.05 dBV/m

Emission category: M4

Grid 1 M4 34.68 dBV/m	Grid 2 M4 34.73 dBV/m	Grid 3 M4 33.49 dBV/m
Grid 4 M4 32.81 dBV/m	Grid 5 M4 33.05 dBV/m	Grid 6 M4 32.22 dBV/m
Grid 7 M4 30.28 dBV/m	Grid 8 M4 30.83 dBV/m	Grid 9 M4 30.26 dBV/m

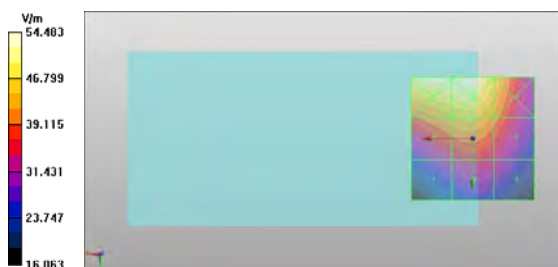

Test Laboratory: TCC Microsoft

Type: RM-1150, HW:1520; Serial: 004402/74/328524/3

Communication System: UID 10021 - DAB, GSM-FDD (TDMA, GMSK)

Frequency: 824.2 MHz; Duty Cycle: 1:8.6896

Medium: Air;

Medium parameters used: $\sigma = 0$ S/m, $\epsilon_r = 1$; $\rho = 0$ kg/m³

Phantom section: RF Section

DASY Configuration:

- Probe: ER3DV6 - SN2367
- ConvF(1, 1, 1); Calibrated: 2015-04-29;
- Sensor-Surface: (Fix Surface)
- Electronics: DAE4 Sn1332; Calibrated: 2015-01-13
- Phantom: HAC Test Arch with AMCC; Type: SD HAC P01 BA;
- Measurement SW: DASY52, Version 52.8 (8); SEMCAD X Version 14.6.10 (7331)

E Scan/GSM850 - Low - Ant 2/Hearing Aid Compatibility Test (101x101x1):

Interpolated grid: dx=0.5000 mm, dy=0.5000 mm

Device Reference Point: 0, 0, -6.3 mm

Reference Value = 33.54 V/m; Power Drift = -0.03 dB

Applied MIF = 3.63 dB

RF audio interference level = 32.63 dBV/m

Emission category: M4

Grid 1 M4 30.09 dBV/m	Grid 2 M4 30.82 dBV/m	Grid 3 M4 30.43 dBV/m
Grid 4 M4 32.14 dBV/m	Grid 5 M4 32.63 dBV/m	Grid 6 M4 32.05 dBV/m
Grid 7 M4 33.57 dBV/m	Grid 8 M4 33.81 dBV/m	Grid 9 M4 32.89 dBV/m

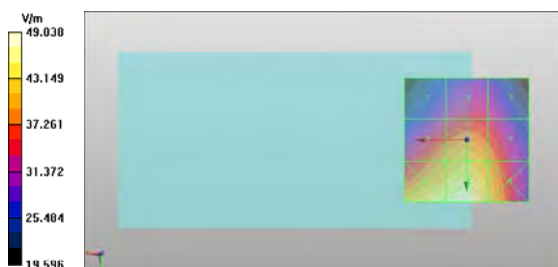

Test Laboratory: TCC Microsoft

Type: RM-1150, HW:1520; Serial: 004402/74/328524/3

Communication System: UID 10021 - DAB, GSM-FDD (TDMA, GMSK)

Frequency: 836.6 MHz; Duty Cycle: 1:8.6896

Medium: Air;

Medium parameters used: $\sigma = 0$ S/m, $\epsilon_r = 1$; $\rho = 0$ kg/m³

Phantom section: RF Section

DASY Configuration:

- Probe: ER3DV6 - SN2367
- ConvF(1, 1, 1); Calibrated: 2015-04-29;
- Sensor-Surface: (Fix Surface)
- Electronics: DAE4 Sn1332; Calibrated: 2015-01-13
- Phantom: HAC Test Arch with AMCC; Type: SD HAC P01 BA;
- Measurement SW: DASY52, Version 52.8 (8); SEMCAD X Version 14.6.10 (7331)

E Scan/GSM850 - Middle - Ant 2/Hearing Aid Compatibility Test (101x101x1):

Interpolated grid: dx=0.5000 mm, dy=0.5000 mm

Device Reference Point: 0, 0, -6.3 mm

Reference Value = 32.99 V/m; Power Drift = -0.06 dB

Applied MIF = 3.63 dB

RF audio interference level = 32.69 dBV/m

Emission category: M4

Grid 1 M4 29.31 dBV/m	Grid 2 M4 30.39 dBV/m	Grid 3 M4 30.06 dBV/m
Grid 4 M4 32.09 dBV/m	Grid 5 M4 32.69 dBV/m	Grid 6 M4 32.17 dBV/m
Grid 7 M4 34.05 dBV/m	Grid 8 M4 34.28 dBV/m	Grid 9 M4 33.42 dBV/m

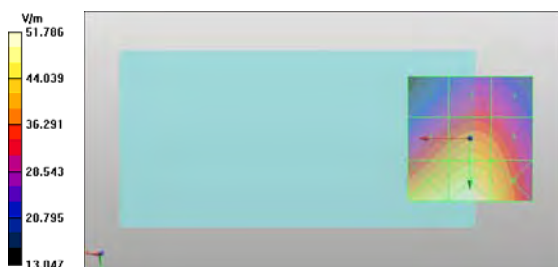

Test Laboratory: TCC Microsoft

Type: RM-1150, HW:1520; Serial: 004402/74/328524/3

Communication System: UID 10021 - DAB, GSM-FDD (TDMA, GMSK)

Frequency: 848.8 MHz; Duty Cycle: 1:8.6896

Medium: Air;

Medium parameters used: $\sigma = 0$ S/m, $\epsilon_r = 1$; $\rho = 0$ kg/m³

Phantom section: RF Section

DASY Configuration:

- Probe: ER3DV6 - SN2367
- ConvF(1, 1, 1); Calibrated: 2015-04-29;
- Sensor-Surface: (Fix Surface)
- Electronics: DAE4 Sn1332; Calibrated: 2015-01-13
- Phantom: HAC Test Arch with AMCC; Type: SD HAC P01 BA;
- Measurement SW: DASY52, Version 52.8 (8); SEMCAD X Version 14.6.10 (7331)

E Scan/GSM850 - High - Ant 2/Hearing Aid Compatibility Test (101x101x1):

Interpolated grid: dx=0.5000 mm, dy=0.5000 mm

Device Reference Point: 0, 0, -6.3 mm

Reference Value = 32.65 V/m; Power Drift = 0.02 dB

Applied MIF = 3.63 dB

RF audio interference level = 32.39 dBV/m

Emission category: M4

Grid 1 M4 29.65 dBV/m	Grid 2 M4 30.54 dBV/m	Grid 3 M4 30.18 dBV/m
Grid 4 M4 31.84 dBV/m	Grid 5 M4 32.39 dBV/m	Grid 6 M4 31.88 dBV/m
Grid 7 M4 33.35 dBV/m	Grid 8 M4 33.64 dBV/m	Grid 9 M4 32.78 dBV/m

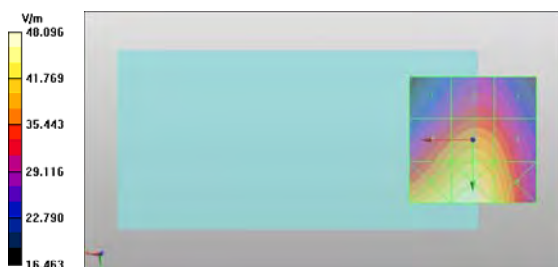

Test Laboratory: TCC Microsoft

Type: RM-1150, HW:1520; Serial: 004402/74/328524/3

Communication System: UID 10021 - DAB, GSM-FDD (TDMA, GMSK)

Frequency: 1850.2 MHz; Duty Cycle: 1:8.6896

Medium: Air;

Medium parameters used: $\sigma = 0 \text{ S/m}$, $\epsilon_r = 1$; $\rho = 0 \text{ kg/m}^3$

Phantom section: RF Section

DASY Configuration:

- Probe: ER3DV6 - SN2367
- ConvF(1, 1, 1); Calibrated: 2015-04-29;
- Sensor-Surface: (Fix Surface)
- Electronics: DAE4 Sn1332; Calibrated: 2015-01-13
- Phantom: HAC Test Arch with AMCC; Type: SD HAC P01 BA;
- Measurement SW: DASY52, Version 52.8 (8); SEMCAD X Version 14.6.10 (7331)

E Scan/GSM1900 - Low - Ant 1/Hearing Aid Compatibility Test (101x101x1):

Interpolated grid: dx=0.5000 mm, dy=0.5000 mm

Device Reference Point: 0, 0, -6.3 mm

Reference Value = 15.98 V/m; Power Drift = -0.02 dB

Applied MIF = 3.63 dB

RF audio interference level = 28.19 dBV/m

Emission category: M4

Grid 1 M4 29.03 dBV/m	Grid 2 M3 30.64 dBV/m	Grid 3 M3 30.29 dBV/m
Grid 4 M4 25.29 dBV/m	Grid 5 M4 28.19 dBV/m	Grid 6 M4 28.14 dBV/m
Grid 7 M4 27.28 dBV/m	Grid 8 M4 27.18 dBV/m	Grid 9 M4 26.64 dBV/m

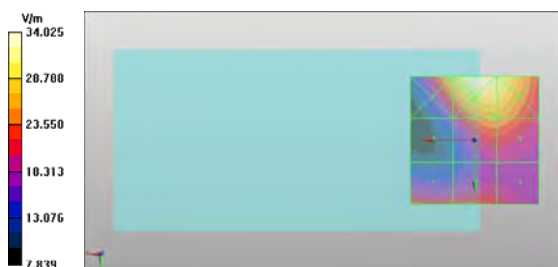

Test Laboratory: TCC Microsoft

Type: RM-1150, HW:1520; Serial: 004402/74/328524/3

Communication System: UID 10021 - DAB, GSM-FDD (TDMA, GMSK)

Frequency: 1880 MHz; Duty Cycle: 1:8.6896

Medium: Air;

Medium parameters used: $\sigma = 0$ S/m, $\epsilon_r = 1$; $\rho = 0$ kg/m³

Phantom section: RF Section

DASY Configuration:

- Probe: ER3DV6 - SN2367
- ConvF(1, 1, 1); Calibrated: 2015-04-29;
- Sensor-Surface: (Fix Surface)
- Electronics: DAE4 Sn1332; Calibrated: 2015-01-13
- Phantom: HAC Test Arch with AMCC; Type: SD HAC P01 BA;
- Measurement SW: DASY52, Version 52.8 (8); SEMCAD X Version 14.6.10 (7331)

E Scan/GSM1900 - Middle - Ant 1/Hearing Aid Compatibility Test (101x101x1):

Interpolated grid: dx=0.5000 mm, dy=0.5000 mm

Device Reference Point: 0, 0, -6.3 mm

Reference Value = 16.96 V/m; Power Drift = -0.06 dB

Applied MIF = 3.63 dB

RF audio interference level = 29.03 dBV/m

Emission category: M4

Grid 1 M4 29.65 dBV/m	Grid 2 M3 31.44 dBV/m	Grid 3 M3 31.1 dBV/m
Grid 4 M4 25.75 dBV/m	Grid 5 M4 29.03 dBV/m	Grid 6 M4 29 dBV/m
Grid 7 M4 28.2 dBV/m	Grid 8 M4 27.33 dBV/m	Grid 9 M4 26.74 dBV/m

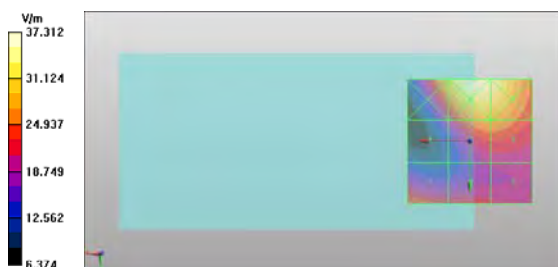

Test Laboratory: TCC Microsoft

Type: RM-1150, HW:1520; Serial: 004402/74/328524/3

Communication System: UID 10021 - DAB, GSM-FDD (TDMA, GMSK)

Frequency: 1909.8 MHz; Duty Cycle: 1:8.6896

Medium: Air;

Medium parameters used: $\sigma = 0 \text{ S/m}$, $\epsilon_r = 1$; $\rho = 0 \text{ kg/m}^3$

Phantom section: RF Section

DASY Configuration:

- Probe: ER3DV6 - SN2367
- ConvF(1, 1, 1); Calibrated: 2015-04-29;
- Sensor-Surface: (Fix Surface)
- Electronics: DAE4 Sn1332; Calibrated: 2015-01-13
- Phantom: HAC Test Arch with AMCC; Type: SD HAC P01 BA;
- Measurement SW: DASY52, Version 52.8 (8); SEMCAD X Version 14.6.10 (7331)

E Scan/GSM1900 - High - Ant 1/Hearing Aid Compatibility Test (101x101x1):

Interpolated grid: $dx=0.5000 \text{ mm}$, $dy=0.5000 \text{ mm}$

Device Reference Point: 0, 0, -6.3 mm

Reference Value = 18.64 V/m; Power Drift = -0.01 dB

Applied MIF = 3.63 dB

RF audio interference level = 29.83 dBV/m

Emission category: M4

Grid 1 M3 30.46 dBV/m	Grid 2 M3 32.26 dBV/m	Grid 3 M3 31.88 dBV/m
Grid 4 M4 26.76 dBV/m	Grid 5 M4 29.83 dBV/m	Grid 6 M4 29.76 dBV/m
Grid 7 M4 28.32 dBV/m	Grid 8 M4 27.51 dBV/m	Grid 9 M4 26.71 dBV/m

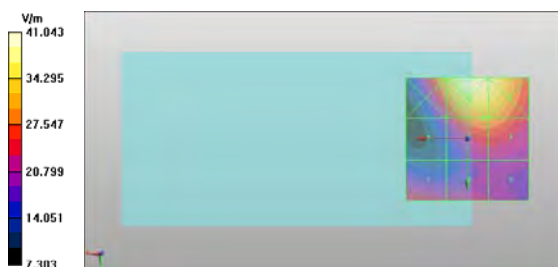

Test Laboratory: TCC Microsoft

Type: RM-1150, HW:1520; Serial: 004402/74/328524/3

Communication System: UID 10021 - DAB, GSM-FDD (TDMA, GMSK)

Frequency: 1850.2 MHz; Duty Cycle: 1:8.6896

Medium: Air;

Medium parameters used: $\sigma = 0$ S/m, $\epsilon_r = 1$; $\rho = 0$ kg/m³

Phantom section: RF Section

DASY Configuration:

- Probe: ER3DV6 - SN2367
- ConvF(1, 1, 1); Calibrated: 2015-04-29;
- Sensor-Surface: (Fix Surface)
- Electronics: DAE4 Sn1332; Calibrated: 2015-01-13
- Phantom: HAC Test Arch with AMCC; Type: SD HAC P01 BA;
- Measurement SW: DASY52, Version 52.8 (8); SEMCAD X Version 14.6.10 (7331)

E Scan/GSM1900 - Low - Ant 2/Hearing Aid Compatibility Test (101x101x1):

Interpolated grid: dx=0.5000 mm, dy=0.5000 mm

Device Reference Point: 0, 0, -6.3 mm

Reference Value = 15.53 V/m; Power Drift = -0.00 dB

Applied MIF = 3.63 dB

RF audio interference level = 26.91 dBV/m

Emission category: M4

Grid 1 M4 26.11 dBV/m	Grid 2 M4 26.43 dBV/m	Grid 3 M4 25.13 dBV/m
Grid 4 M4 24.67 dBV/m	Grid 5 M4 26.91 dBV/m	Grid 6 M4 26.8 dBV/m
Grid 7 M4 26.68 dBV/m	Grid 8 M4 28.49 dBV/m	Grid 9 M4 28.25 dBV/m

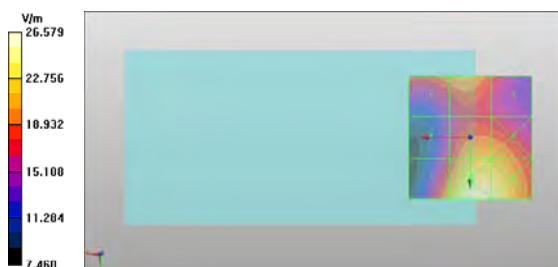

Test Laboratory: TCC Microsoft

Type: RM-1150, HW:1520; Serial: 004402/74/328524/3

Communication System: UID 10021 - DAB, GSM-FDD (TDMA, GMSK)

Frequency: 1880 MHz; Duty Cycle: 1:8.6896

Medium: Air;

Medium parameters used: $\sigma = 0 \text{ S/m}$, $\epsilon_r = 1$; $\rho = 0 \text{ kg/m}^3$

Phantom section: RF Section

DASY Configuration:

- Probe: ER3DV6 - SN2367
- ConvF(1, 1, 1); Calibrated: 2015-04-29;
- Sensor-Surface: (Fix Surface)
- Electronics: DAE4 Sn1332; Calibrated: 2015-01-13
- Phantom: HAC Test Arch with AMCC; Type: SD HAC P01 BA;
- Measurement SW: DASY52, Version 52.8 (8); SEMCAD X Version 14.6.10 (7331)

E Scan/GSM1900 - Middle - Ant 2/Hearing Aid Compatibility Test (101x101x1):

Interpolated grid: dx=0.5000 mm, dy=0.5000 mm

Device Reference Point: 0, 0, -6.3 mm

Reference Value = 16.27 V/m; Power Drift = -0.01 dB

Applied MIF = 3.63 dB

RF audio interference level = 27.27 dBV/m

Emission category: M4

Grid 1 M4 25.55 dBV/m	Grid 2 M4 25.81 dBV/m	Grid 3 M4 25.24 dBV/m
Grid 4 M4 24.56 dBV/m	Grid 5 M4 27.27 dBV/m	Grid 6 M4 27.18 dBV/m
Grid 7 M4 26.47 dBV/m	Grid 8 M4 28.6 dBV/m	Grid 9 M4 28.43 dBV/m

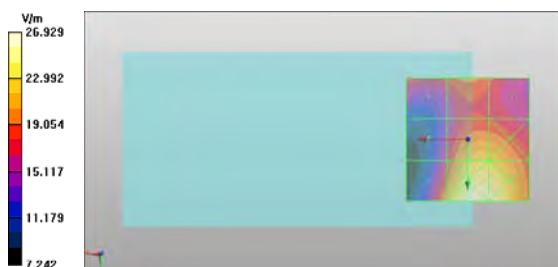

Test Laboratory: TCC Microsoft

Type: RM-1150, HW:1520; Serial: 004402/74/328524/3

Communication System: UID 10021 - DAB, GSM-FDD (TDMA, GMSK)

Frequency: 1909.8 MHz; Duty Cycle: 1:8.6896

Medium: Air;

Medium parameters used: $\sigma = 0$ S/m, $\epsilon_r = 1$; $\rho = 0$ kg/m³

Phantom section: RF Section

DASY Configuration:

- Probe: ER3DV6 - SN2367
- ConvF(1, 1, 1); Calibrated: 2015-04-29;
- Sensor-Surface: (Fix Surface)
- Electronics: DAE4 Sn1332; Calibrated: 2015-01-13
- Phantom: HAC Test Arch with AMCC; Type: SD HAC P01 BA;
- Measurement SW: DASY52, Version 52.8 (8); SEMCAD X Version 14.6.10 (7331)

E Scan/GSM1900 - High - Ant 2/Hearing Aid Compatibility Test (101x101x1):

Interpolated grid: dx=0.5000 mm, dy=0.5000 mm

Device Reference Point: 0, 0, -6.3 mm

Reference Value = 16.22 V/m; Power Drift = -0.02 dB

Applied MIF = 3.63 dB

RF audio interference level = 27.06 dBV/m

Emission category: M4

Grid 1 M4 25.71 dBV/m	Grid 2 M4 26.01 dBV/m	Grid 3 M4 25.56 dBV/m
Grid 4 M4 23.64 dBV/m	Grid 5 M4 27.06 dBV/m	Grid 6 M4 26.99 dBV/m
Grid 7 M4 25.62 dBV/m	Grid 8 M4 28.28 dBV/m	Grid 9 M4 28.14 dBV/m

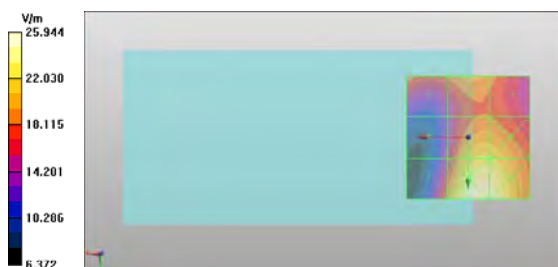



APPENDIX C: RELEVANT PAGES FROM PROBE CALIBRATION REPORT(S)



Accredited by the Swiss Accreditation Service (SAS)
The Swiss Accreditation Service is one of the signatories to the EA
Multilateral Agreement for the recognition of calibration certificates

Accreditation No.: SCS 0108

Client **TCC Microsoft**

Certificate No: **ER3-2367_Apr15**

CALIBRATION CERTIFICATE

Object: **ER3DV6 - SN:2367**

Calibration procedure(s): **QA CAL-02.v8, QA CAL-25.v6**
Calibration procedure for E-field probes optimized for close near field evaluations in air

Calibration date: **April 29, 2015**

This calibration certificate documents the traceability to national standards, which realize the physical units of measurements (SI).
The measurements and the uncertainties with confidence probability are given on the following pages and are part of the certificate.

All calibrations have been conducted in the closed laboratory facility: environment temperature (22 ± 3)°C and humidity < 70%.

Calibration Equipment used (M&TE critical for calibration)

Primary Standards	ID	Cal Date (Certificate No.)	Scheduled Calibration
Power meter E4419B	GB41293874	01-Apr-15 (No. 217-02128)	Mar-16
Power sensor E4412A	MY41498087	01-Apr-15 (No. 217-02128)	Mar-16
Reference 3 dB Attenuator	SN: S5054 (3c)	01-Apr-15 (No. 217-02129)	Mar-16
Reference 20 dB Attenuator	SN: S5277 (20x)	01-Apr-15 (No. 217-02132)	Mar-16
Reference 30 dB Attenuator	SN: S5129 (30b)	01-Apr-15 (No. 217-02133)	Mar-16
Reference Probe ER3DV6	SN: 2328	08-Oct-14 (No. ER3-2328_Oct14)	Oct-15
DAE4	SN: 789	16-Mar-15 (No. DAE4-789_Mar15)	Mar-16
Secondary Standards	ID	Check Date (in house)	Scheduled Check
RF generator HP 8648C	US3642U01700	4-Aug-99 (in house check Apr-13)	In house check: Apr-16
Network Analyzer HP 8753E	US37390585	18-Oct-01 (in house check Oct-14)	In house check: Oct-15

Calibrated by:	Name Michael Weber	Function Laboratory Technician	Signature
Approved by:	Name Katja Pokovic	Function Technical Manager	

Issued: April 29, 2015

This calibration certificate shall not be reproduced except in full without written approval of the laboratory.

DASY/EASY - Parameters of Probe: ER3DV6 - SN:2367

Basic Calibration Parameters

	Sensor X	Sensor Y	Sensor Z	Unc (k=2)
Norm ($\mu\text{V}/(\text{V}/\text{m})^2$)	1.76	1.66	1.79	$\pm 10.1\%$
DCP (mV) ^B	99.4	98.8	100.7	

Modulation Calibration Parameters

UID	Communication System Name		A dB	B dB $\sqrt{\mu\text{V}}$	C	D dB	VR mV	Unc ^E (k=2)
0	CW	X	0.0	0.0	1.0	0.00	172.3	$\pm 3.0\%$
		Y	0.0	0.0	1.0		200.0	
		Z	0.0	0.0	1.0		188.0	
10011-CAB	UMTS-FDD (WCDMA)	X	3.32	67.3	19.2	2.91	139.8	$\pm 0.5\%$
		Y	3.22	66.5	18.6		122.0	
		Z	3.10	65.8	18.0		109.7	
10012-CAB	IEEE 802.11b WiFi 2.4 GHz (DSSS, 1 Mbps)	X	2.81	67.8	18.7	1.87	142.7	$\pm 0.5\%$
		Y	2.66	66.8	18.1		123.9	
		Z	3.04	68.6	18.6		112.6	
10013-CAB	IEEE 802.11g WiFi 2.4 GHz (DSSS-OFDM, 6 Mbps)	X	12.70	75.1	26.7	9.46	145.2	$\pm 3.8\%$
		Y	11.38	71.8	24.6		117.5	
		Z	11.31	70.7	23.4		107.6	
10021-DAB	GSM-FDD (TDMA, GMSK)	X	18.62	99.3	28.8	9.39	100.7	$\pm 1.4\%$
		Y	15.76	99.4	28.9		109.5	
		Z	27.08	99.5	28.7		145.6	
10039-CAB	CDMA2000 (1xRTT, RC1)	X	5.09	68.1	20.2	4.57	144.7	$\pm 0.9\%$
		Y	4.68	66.2	19.0		119.7	
		Z	4.60	65.8	18.5		111.2	
10059-CAB	IEEE 802.11b WiFi 2.4 GHz (DSSS, 2 Mbps)	X	3.37	70.9	20.4	2.12	140.6	$\pm 0.5\%$
		Y	2.71	66.9	18.2		118.0	
		Z	3.41	69.8	19.1		111.1	
10060-CAB	IEEE 802.11b WiFi 2.4 GHz (DSSS, 5.5 Mbps)	X	11.18	96.8	30.1	2.83	128.4	$\pm 0.5\%$
		Y	6.92	88.6	27.4		149.1	
		Z	12.03	92.9	27.4		143.5	
10061-CAB	IEEE 802.11b WiFi 2.4 GHz (DSSS, 11 Mbps)	X	10.83	91.6	28.7	3.60	131.2	$\pm 0.7\%$
		Y	6.91	84.0	26.1		149.2	
		Z	8.58	82.7	24.2		104.8	
10071-CAB	IEEE 802.11g WiFi 2.4 GHz (DSSS/OFDM, 9 Mbps)	X	13.03	75.9	27.5	9.83	141.3	$\pm 1.7\%$
		Y	11.41	71.7	24.8		110.0	
		Z	11.83	71.8	24.3		110.7	
10072-CAB	IEEE 802.11g WiFi 2.4 GHz (DSSS/OFDM, 12 Mbps)	X	12.74	76.1	27.5	9.62	138.2	$\pm 4.1\%$
		Y	11.06	71.8	24.8		110.8	
		Z	11.25	71.0	23.7		103.4	

10073-CAB	IEEE 802.11g WiFi 2.4 GHz (DSSS/OFDM, 18 Mbps)	X	13.01	76.9	28.2	9.94	134.5	±4.1 %
		Y	11.14	72.1	25.3		107.6	
		Z	11.54	71.8	24.4		102.2	
10074-CAB	IEEE 802.11g WiFi 2.4 GHz (DSSS/OFDM, 24 Mbps)	X	13.33	77.8	29.1	10.30	131.2	±2.2 %
		Y	11.24	72.4	25.7		105.0	
		Z	11.80	72.3	25.0		100.2	
10075-CAB	IEEE 802.11g WiFi 2.4 GHz (DSSS/OFDM, 36 Mbps)	X	13.82	79.2	30.3	10.77	128.7	±2.5 %
		Y	11.47	73.1	26.6		102.0	
		Z	12.10	72.9	25.7		98.4	
10076-CAB	IEEE 802.11g WiFi 2.4 GHz (DSSS/OFDM, 48 Mbps)	X	13.95	79.6	30.7	10.94	126.7	±2.2 %
		Y	12.98	77.9	29.8		149.8	
		Z	12.27	73.3	26.0		97.4	
10077-CAB	IEEE 802.11g WiFi 2.4 GHz (DSSS/OFDM, 54 Mbps)	X	13.91	79.5	30.7	11.00	125.7	±2.2 %
		Y	12.93	77.8	29.8		148.4	
		Z	12.31	73.5	26.1		96.8	
10081-CAB	CDMA2000 (1xRTT, RC3)	X	4.04	66.6	19.2	3.97	138.5	±0.7 %
		Y	3.88	65.8	18.7		120.2	
		Z	4.08	66.8	19.0		149.6	
10103-CAB	LTE-TDD (SC-FDMA, 100% RB, 20 MHz, QPSK)	X	10.26	76.4	27.3	9.29	100.0	±2.2 %
		Y	9.64	75.3	26.9		118.9	
		Z	11.53	77.5	26.9		119.0	
10104-CAB	LTE-TDD (SC-FDMA, 100% RB, 20 MHz, 16-QAM)	X	11.22	76.1	27.9	9.97	109.0	±3.0 %
		Y	10.63	75.2	27.5		129.6	
		Z	12.58	77.6	27.7		131.8	
10105-CAB	LTE-TDD (SC-FDMA, 100% RB, 20 MHz, 64-QAM)	X	11.46	76.5	28.2	10.01	111.1	±3.3 %
		Y	10.78	75.3	27.6		131.6	
		Z	12.82	77.9	27.9		134.1	
10151-CAB	LTE-TDD (SC-FDMA, 50% RB, 20 MHz, QPSK)	X	12.67	84.2	31.8	9.28	144.3	±2.5 %
		Y	9.02	74.3	26.5		115.2	
		Z	10.71	76.3	26.5		114.6	
10152-CAB	LTE-TDD (SC-FDMA, 50% RB, 20 MHz, 16-QAM)	X	10.77	75.9	28.0	9.92	104.6	±3.0 %
		Y	9.97	74.3	27.1		123.6	
		Z	11.89	77.0	27.5		124.3	
10153-CAB	LTE-TDD (SC-FDMA, 50% RB, 20 MHz, 64-QAM)	X	10.90	75.7	27.9	10.05	106.0	±3.0 %
		Y	10.20	74.4	27.2		125.3	
		Z	12.24	77.5	27.8		127.1	
10169-CAB	LTE-FDD (SC-FDMA, 1 RB, 20 MHz, QPSK)	X	5.40	68.0	20.9	5.73	135.5	±1.2 %
		Y	5.08	66.8	20.1		116.5	
		Z	5.37	67.5	20.2		147.4	
10170-CAB	LTE-FDD (SC-FDMA, 1 RB, 20 MHz, 16-QAM)	X	6.39	69.6	22.0	6.52	136.7	±1.4 %
		Y	5.81	67.6	20.8		112.2	
		Z	6.36	69.0	21.3		147.6	
10171-AAB	LTE-FDD (SC-FDMA, 1 RB, 20 MHz, 64-QAM)	X	6.42	69.8	22.1	6.49	137.2	±1.4 %
		Y	5.82	67.8	20.9		111.9	
		Z	6.34	69.0	21.2		147.3	

10172-CAB	LTE-TDD (SC-FDMA, 1 RB, 20 MHz, QPSK)	X	8.72	79.2	29.6	9.21	111.6	±2.7 %
		Y	7.56	76.2	28.0		122.5	
		Z	12.44	86.1	31.3		135.1	
10173-CAB	LTE-TDD (SC-FDMA, 1 RB, 20 MHz, 16-QAM)	X	8.73	78.2	28.9	9.48	107.2	±2.7 %
		Y	8.07	77.5	28.7		123.2	
		Z	13.52	87.9	32.1		137.4	
10174-CAB	LTE-TDD (SC-FDMA, 1 RB, 20 MHz, 64-QAM)	X	9.29	78.0	29.6	10.25	108.0	±3.3 %
		Y	8.64	77.3	29.4		124.2	
		Z	13.49	87.0	32.8		138.3	
10175-CAC	LTE-FDD (SC-FDMA, 1 RB, 10 MHz, QPSK)	X	5.39	67.9	20.8	5.72	131.2	±1.2 %
		Y	4.99	66.4	19.9		111.8	
		Z	5.35	67.5	20.1		146.4	
10176-CAC	LTE-FDD (SC-FDMA, 1 RB, 10 MHz, 16-QAM)	X	6.41	69.7	22.1	6.52	135.0	±1.4 %
		Y	5.79	67.5	20.8		112.2	
		Z	6.34	69.0	21.2		146.6	
10177-CAE	LTE-FDD (SC-FDMA, 1 RB, 5 MHz, QPSK)	X	5.36	67.7	20.7	5.73	132.0	±0.9 %
		Y	4.97	66.3	19.7		111.5	
		Z	5.37	67.5	20.1		145.4	
10178-CAC	LTE-FDD (SC-FDMA, 1 RB, 5 MHz, 16-QAM)	X	6.32	69.2	21.8	6.52	134.3	±1.4 %
		Y	5.83	67.7	20.9		111.6	
		Z	6.33	69.0	21.2		146.7	
10179-CAC	LTE-FDD (SC-FDMA, 1 RB, 10 MHz, 64-QAM)	X	6.40	69.7	22.1	6.50	133.8	±1.4 %
		Y	5.84	67.8	20.8		111.6	
		Z	6.36	69.1	21.2		146.9	
10180-CAC	LTE-FDD (SC-FDMA, 1 RB, 5 MHz, 64-QAM)	X	6.42	69.7	22.1	6.50	133.4	±1.4 %
		Y	5.83	67.8	20.9		111.6	
		Z	6.37	69.1	21.3		147.3	
10181-CAB	LTE-FDD (SC-FDMA, 1 RB, 15 MHz, QPSK)	X	5.41	68.1	20.9	5.72	131.9	±0.9 %
		Y	4.98	66.3	19.8		111.4	
		Z	5.35	67.4	20.1		145.8	
10182-CAB	LTE-FDD (SC-FDMA, 1 RB, 15 MHz, 16-QAM)	X	6.38	69.5	22.0	6.52	133.8	±1.4 %
		Y	5.87	67.9	21.0		111.4	
		Z	6.33	68.9	21.2		146.6	
10183-AAA	LTE-FDD (SC-FDMA, 1 RB, 15 MHz, 64-QAM)	X	6.37	69.5	21.9	6.50	133.6	±1.4 %
		Y	5.78	67.5	20.7		111.4	
		Z	6.34	69.0	21.2		146.4	
10184-CAC	LTE-FDD (SC-FDMA, 1 RB, 3 MHz, QPSK)	X	5.43	68.1	21.0	5.73	131.7	±1.2 %
		Y	5.03	66.5	19.9		111.5	
		Z	5.35	67.4	20.1		144.9	
10185-CAC	LTE-FDD (SC-FDMA, 1 RB, 3 MHz, 16-QAM)	X	6.41	69.7	22.1	6.51	133.5	±1.4 %
		Y	5.81	67.6	20.8		111.6	
		Z	6.36	69.0	21.3		146.2	
10186-AAC	LTE-FDD (SC-FDMA, 1 RB, 3 MHz, 64-QAM)	X	6.38	69.6	22.0	6.50	133.3	±1.4 %
		Y	5.85	67.9	20.9		111.4	
		Z	6.36	69.1	21.2		146.5	

10187-CAC	LTE-FDD (SC-FDMA, 1 RB, 1.4 MHz, QPSK)	X	5.41	68.0	20.9	5.73	131.6	±1.2 %
		Y	5.06	66.7	20.1		111.5	
		Z	5.35	67.4	20.1		145.0	
10188-CAC	LTE-FDD (SC-FDMA, 1 RB, 1.4 MHz, 16-QAM)	X	6.35	69.4	21.9	6.52	133.8	±1.4 %
		Y	5.87	67.9	21.0		111.5	
		Z	6.32	68.9	21.2		146.4	
10189-AAC	LTE-FDD (SC-FDMA, 1 RB, 1.4 MHz, 64-QAM)	X	6.37	69.4	21.9	6.50	134.7	±1.4 %
		Y	5.87	67.9	21.0		111.6	
		Z	6.37	69.0	21.2		146.4	
10226-CAA	LTE-TDD (SC-FDMA, 1 RB, 1.4 MHz, 16-QAM)	X	8.76	78.3	28.9	9.49	108.3	±2.7 %
		Y	7.92	76.8	28.4		121.8	
		Z	13.21	87.2	31.9		135.5	
10227-CAA	LTE-TDD (SC-FDMA, 1 RB, 1.4 MHz, 64-QAM)	X	9.35	78.3	29.9	10.26	108.4	±3.5 %
		Y	8.49	76.6	29.0		123.3	
		Z	13.19	86.3	32.5		136.3	
10228-CAA	LTE-TDD (SC-FDMA, 1 RB, 1.4 MHz, QPSK)	X	8.56	78.6	29.2	9.22	108.7	±2.7 %
		Y	7.62	76.5	28.2		122.3	
		Z	12.25	85.6	31.1		134.4	
10229-CAB	LTE-TDD (SC-FDMA, 1 RB, 3 MHz, 16-QAM)	X	8.71	78.1	28.9	9.48	108.9	±2.7 %
		Y	8.03	77.3	28.6		122.5	
		Z	13.21	87.1	31.8		136.2	
10230-CAB	LTE-TDD (SC-FDMA, 1 RB, 3 MHz, 64-QAM)	X	9.49	78.9	30.2	10.25	110.7	±3.3 %
		Y	8.55	76.9	29.2		123.7	
		Z	13.33	86.6	32.6		136.7	
10231-CAB	LTE-TDD (SC-FDMA, 1 RB, 3 MHz, QPSK)	X	8.67	79.1	29.4	9.19	111.1	±3.0 %
		Y	7.49	76.0	27.9		122.2	
		Z	12.20	85.5	31.0		134.4	
10232-CAB	LTE-TDD (SC-FDMA, 1 RB, 5 MHz, 16-QAM)	X	8.91	79.0	29.4	9.48	109.4	±2.7 %
		Y	7.99	77.3	28.6		122.5	
		Z	13.22	87.3	31.9		135.5	
10233-CAB	LTE-TDD (SC-FDMA, 1 RB, 5 MHz, 64-QAM)	X	9.53	79.0	30.3	10.25	111.1	±3.3 %
		Y	8.49	76.7	29.1		123.3	
		Z	13.24	86.4	32.5		136.7	
10234-CAB	LTE-TDD (SC-FDMA, 1 RB, 5 MHz, QPSK)	X	8.66	79.0	29.4	9.21	111.1	±3.0 %
		Y	7.49	75.9	27.8		122.4	
		Z	12.33	85.9	31.2		134.8	
10235-CAB	LTE-TDD (SC-FDMA, 1 RB, 10 MHz, 16-QAM)	X	8.73	78.3	28.9	9.48	109.2	±2.7 %
		Y	7.88	76.7	28.3		122.8	
		Z	13.05	86.9	31.7		135.4	
10236-CAB	LTE-TDD (SC-FDMA, 1 RB, 10 MHz, 64-QAM)	X	9.43	78.8	30.1	10.25	110.1	±3.3 %
		Y	8.57	77.0	29.3		123.6	
		Z	13.33	86.7	32.6		136.7	
10237-CAB	LTE-TDD (SC-FDMA, 1 RB, 10 MHz, QPSK)	X	8.35	77.9	28.8	9.21	108.1	±2.7 %
		Y	7.51	76.0	27.9		121.9	
		Z	12.63	86.6	31.5		134.4	

10238-CAB	LTE-TDD (SC-FDMA, 1 RB, 15 MHz, 16-QAM)	X	8.77	78.5	29.1	9.48	108.9	±2.7 %
		Y	7.96	77.1	28.5		122.6	
		Z	12.91	86.5	31.5		135.8	
10239-CAB	LTE-TDD (SC-FDMA, 1 RB, 15 MHz, 64-QAM)	X	9.46	78.8	30.2	10.25	110.8	±3.3 %
		Y	8.58	77.0	29.3		123.9	
		Z	13.42	86.9	32.7		137.0	
10240-CAB	LTE-TDD (SC-FDMA, 1 RB, 15 MHz, QPSK)	X	8.62	78.9	29.4	9.21	109.6	±3.0 %
		Y	7.63	76.5	28.2		122.7	
		Z	12.41	86.1	31.3		134.8	
10241-CAA	LTE-TDD (SC-FDMA, 50% RB, 1.4 MHz, 16-QAM)	X	9.71	78.4	29.5	9.82	118.3	±3.3 %
		Y	8.96	77.2	29.0		133.7	
		Z	13.75	86.4	32.1		149.1	
10242-CAA	LTE-TDD (SC-FDMA, 50% RB, 1.4 MHz, 64-QAM)	X	9.88	78.8	29.8	9.86	119.3	±3.3 %
		Y	8.97	77.0	28.9		134.6	
		Z	9.35	74.6	26.2		98.2	
10243-CAA	LTE-TDD (SC-FDMA, 50% RB, 1.4 MHz, QPSK)	X	9.31	78.8	29.7	9.46	115.7	±3.3 %
		Y	8.25	76.1	28.3		130.8	
		Z	12.89	85.5	31.5		144.5	
10244-CAB	LTE-TDD (SC-FDMA, 50% RB, 3 MHz, 16-QAM)	X	11.31	80.6	31.0	10.06	131.6	±2.5 %
		Y	10.05	77.7	29.5		148.0	
		Z	10.25	75.0	26.6		106.4	
10245-CAB	LTE-TDD (SC-FDMA, 50% RB, 3 MHz, 64-QAM)	X	11.25	80.2	30.7	10.06	133.2	±3.8 %
		Y	10.15	77.9	29.6		149.1	
		Z	10.50	75.6	26.9		107.7	
10246-CAB	LTE-TDD (SC-FDMA, 50% RB, 3 MHz, QPSK)	X	10.09	79.8	29.9	9.30	126.1	±3.5 %
		Y	8.86	76.9	28.5		140.0	
		Z	9.30	74.7	26.0		101.8	
10247-CAB	LTE-TDD (SC-FDMA, 50% RB, 5 MHz, 16-QAM)	X	11.26	80.0	30.5	9.91	135.2	±1.9 %
		Y	8.69	72.1	25.9		106.5	
		Z	10.40	75.1	26.5		109.7	
10248-CAB	LTE-TDD (SC-FDMA, 50% RB, 5 MHz, 64-QAM)	X	11.76	81.1	31.4	10.09	138.4	±2.5 %
		Y	8.85	72.1	26.0		106.8	
		Z	10.63	75.4	26.9		110.3	
10249-CAB	LTE-TDD (SC-FDMA, 50% RB, 5 MHz, QPSK)	X	10.33	80.1	30.1	9.29	127.4	±3.8 %
		Y	9.13	77.4	28.8		142.8	
		Z	9.42	74.7	25.9		103.5	
10250-CAB	LTE-TDD (SC-FDMA, 50% RB, 10 MHz, 16-QAM)	X	12.01	81.3	31.1	9.81	142.4	±2.7 %
		Y	9.02	72.4	25.9		110.8	
		Z	10.97	75.8	26.8		115.8	
10251-CAB	LTE-TDD (SC-FDMA, 50% RB, 10 MHz, 64-QAM)	X	12.54	81.8	31.8	10.17	145.3	±2.7 %
		Y	9.56	73.1	26.6		113.5	
		Z	11.32	75.9	27.2		117.5	
10252-CAB	LTE-TDD (SC-FDMA, 50% RB, 10 MHz, QPSK)	X	11.01	81.2	30.4	9.24	131.4	±3.5 %
		Y	9.72	78.3	29.0		149.7	
		Z	9.78	74.9	25.9		107.3	

10253-CAB	LTE-TDD (SC-FDMA, 50% RB, 15 MHz, 16-QAM)	X	10.37	74.6	27.1	9.90	101.8	±2.7 %
		Y	9.65	73.1	26.3		117.6	
		Z	11.60	76.3	27.1		122.8	
10254-CAB	LTE-TDD (SC-FDMA, 50% RB, 15 MHz, 64-QAM)	X	10.82	75.3	27.8	10.14	102.9	±3.5 %
		Y	10.01	73.4	26.7		119.6	
		Z	11.91	76.5	27.4		124.5	
10255-CAB	LTE-TDD (SC-FDMA, 50% RB, 15 MHz, QPSK)	X	11.84	82.2	30.7	9.20	139.1	±3.8 %
		Y	8.57	72.7	25.5		109.6	
		Z	10.47	75.8	26.2		113.1	
10256-CAA	LTE-TDD (SC-FDMA, 100% RB, 1.4 MHz, 16-QAM)	X	10.46	78.6	29.7	9.96	125.9	±3.5 %
		Y	9.68	77.3	29.1		144.5	
		Z	9.89	74.6	26.3		104.3	
10257-CAA	LTE-TDD (SC-FDMA, 100% RB, 1.4 MHz, 64-QAM)	X	10.65	78.8	29.9	10.08	127.5	±3.5 %
		Y	9.75	77.1	29.1		145.0	
		Z	10.09	74.9	26.6		104.3	
10258-CAA	LTE-TDD (SC-FDMA, 100% RB, 1.4 MHz, QPSK)	X	9.59	78.4	29.2	9.34	121.6	±3.3 %
		Y	8.63	76.3	28.2		137.5	
		Z	8.96	73.8	25.5		99.4	
10259-CAB	LTE-TDD (SC-FDMA, 100% RB, 3 MHz, 16-QAM)	X	11.65	80.7	31.0	9.98	137.8	±2.2 %
		Y	8.89	72.2	26.0		107.4	
		Z	10.62	75.4	26.8		110.8	
10260-CAB	LTE-TDD (SC-FDMA, 100% RB, 3 MHz, 64-QAM)	X	11.89	81.3	31.3	9.97	140.0	±3.0 %
		Y	8.96	72.3	26.0		108.4	
		Z	10.72	75.4	26.8		112.2	
10261-CAB	LTE-TDD (SC-FDMA, 100% RB, 3 MHz, QPSK)	X	10.46	80.2	30.0	9.24	128.9	±3.8 %
		Y	9.22	77.2	28.5		144.9	
		Z	9.49	74.6	25.8		104.7	
10262-CAB	LTE-TDD (SC-FDMA, 100% RB, 5 MHz, 16-QAM)	X	11.82	80.7	30.8	9.83	141.3	±2.5 %
		Y	9.04	72.4	25.9		111.1	
		Z	10.88	75.6	26.7		114.7	
10263-CAB	LTE-TDD (SC-FDMA, 100% RB, 5 MHz, 64-QAM)	X	12.40	81.4	31.5	10.16	144.3	±2.7 %
		Y	9.48	72.8	26.4		112.9	
		Z	11.30	75.9	27.2		117.1	
10264-CAB	LTE-TDD (SC-FDMA, 100% RB, 5 MHz, QPSK)	X	10.81	80.6	30.1	9.23	130.0	±3.5 %
		Y	9.63	78.0	28.9		149.4	
		Z	9.82	75.0	26.0		107.6	
10265-CAB	LTE-TDD (SC-FDMA, 100% RB, 10 MHz, 16-QAM)	X	12.76	82.0	31.4	9.92	149.7	±2.5 %
		Y	9.70	73.3	26.5		116.8	
		Z	11.59	76.2	27.0		122.4	
10266-CAB	LTE-TDD (SC-FDMA, 100% RB, 10 MHz, 64-QAM)	X	10.53	74.5	27.2	10.07	101.5	±3.0 %
		Y	9.94	73.5	26.7		118.9	
		Z	11.91	76.6	27.4		124.5	
10267-CAB	LTE-TDD (SC-FDMA, 100% RB, 10 MHz, QPSK)	X	11.63	81.5	30.4	9.30	137.1	±3.8 %
		Y	8.68	73.0	25.8		109.2	
		Z	10.60	76.0	26.3		113.1	

10268-CAB	LTE-TDD (SC-FDMA, 100% RB, 15 MHz, 16-QAM)	X	11.10	75.4	27.5	10.06	106.0	±3.3 %
		Y	10.48	74.3	27.0		124.1	
		Z	12.67	77.6	27.8		132.2	
10269-CAB	LTE-TDD (SC-FDMA, 100% RB, 15 MHz, 64-QAM)	X	11.59	76.4	28.2	10.13	110.7	±3.5 %
		Y	10.61	74.1	26.9		125.9	
		Z	12.82	77.6	27.8		134.3	
10270-CAB	LTE-TDD (SC-FDMA, 100% RB, 15 MHz, QPSK)	X	10.46	76.1	27.5	9.58	100.5	±2.7 %
		Y	9.59	74.1	26.4		115.4	
		Z	11.59	77.0	27.0		120.0	
10290-AAB	CDMA2000, RC1, SO55, Full Rate	X	4.54	67.9	19.6	3.91	140.0	±0.7 %
		Y	4.16	66.2	18.6		119.3	
		Z	4.10	65.8	18.2		109.8	
10291-AAB	CDMA2000, RC3, SO55, Full Rate	X	3.78	67.4	19.4	3.46	136.4	±0.7 %
		Y	3.49	65.8	18.4		115.2	
		Z	3.72	67.0	18.8		146.5	
10292-AAB	CDMA2000, RC3, SO32, Full Rate	X	3.63	67.0	19.2	3.39	136.3	±0.7 %
		Y	3.41	65.7	18.3		114.9	
		Z	3.63	66.9	18.7		145.8	
10293-AAB	CDMA2000, RC3, SO3, Full Rate	X	3.74	67.1	19.2	3.50	134.4	±0.7 %
		Y	3.49	65.6	18.3		114.4	
		Z	3.73	66.9	18.8		146.1	
10295-AAB	CDMA2000, RC1, SO3, 1/8th Rate 25 fr.	X	16.08	98.6	40.1	12.49	130.9	±3.0 %
		Y	12.68	95.1	40.0		96.0	
		Z	20.08	99.3	38.4		120.1	
10315-AAB	IEEE 802.11b WiFi 2.4 GHz (DSSS, 1 Mbps, 96pc duty cycle)	X	2.52	66.6	18.2	1.71	137.2	±0.5 %
		Y	2.46	66.0	17.7		117.9	
		Z	2.66	67.2	18.1		108.8	
10403-AAB	CDMA2000 (1xEV-DO, Rev. 0)	X	4.72	67.2	18.7	3.76	147.9	±0.5 %
		Y	4.66	67.4	18.6		123.7	
		Z	4.57	66.7	18.1		112.8	
10404-AAB	CDMA2000 (1xEV-DO, Rev. A)	X	4.68	67.3	18.8	3.77	146.5	±0.7 %
		Y	4.58	67.5	18.7		121.9	
		Z	4.48	66.6	18.1		112.0	

The reported uncertainty of measurement is stated as the standard uncertainty of measurement multiplied by the coverage factor $k=2$, which for a normal distribution corresponds to a coverage probability of approximately 95%.

^D Numerical linearization parameter: uncertainty not required.

^E Uncertainty is determined using the max. deviation from linear response applying rectangular distribution and is expressed for the square of the field value.



APPENDIX D: RELEVANT PAGES FROM DIPOLE VALIDATION KIT REPORT(S)



Accredited by the Swiss Accreditation Service (SAS)
The Swiss Accreditation Service is one of the signatories to the EA
Multilateral Agreement for the recognition of calibration certificates

Accreditation No.: **SCS 0108**

Client **TCC Microsoft**

Certificate No: **CD835V3-1064_Apr15**

CALIBRATION CERTIFICATE

Object **CD835V3 - SN: 1064**

Calibration procedure(s) **QA CAL-20.v6
Calibration procedure for dipoles in air**

Calibration date: **April 17, 2015**

This calibration certificate documents the traceability to national standards, which realize the physical units of measurements (SI).
The measurements and the uncertainties with confidence probability are given on the following pages and are part of the certificate.

All calibrations have been conducted in the closed laboratory facility: environment temperature $(22 \pm 3)^\circ\text{C}$ and humidity $< 70\%$.

Calibration Equipment used (M&TE critical for calibration)

Primary Standards	ID #	Cal Date (Certificate No.)	Scheduled Calibration
Power meter EPM-442A	GB37480704	07-Oct-14 (No. 217-02020)	Oct-15
Power sensor HP 8481A	US37292783	07-Oct-14 (No. 217-02020)	Oct-15
Power sensor HP 8481A	MY41092317	07-Oct-14 (No. 217-02021)	Oct-15
Reference 10 dB Attenuator	SN: 5047.2 / 06327	01-Apr-15 (No. 217-02130)	Mar-16
Probe ER3DV6	SN: 2336	31-Dec-14 (No. ER3-2336_Dec14)	Dec-15
Probe H3DV6	SN: 6065	31-Dec-14 (No. H3-6065_Dec14)	Dec-15
DAE4	SN: 781	12-Sep-14 (No. DAE4-781_Sep14)	Sep-15
Secondary Standards	ID #	Check Date (in house)	Scheduled Check
Power meter Agilent 4419B	SN: GB42420191	09-Oct-09 (in house check Sep-14)	In house check: Sep-16
Power sensor HP E4412A	SN: US38485102	05-Jan-10 (in house check Sep-14)	In house check: Sep-16
Power sensor HP 8482A	SN: US37295597	09-Oct-09 (in house check Sep-14)	In house check: Sep-16
Network Analyzer HP 8753E	US37390585	18-Oct-01 (in house check Oct-14)	In house check: Oct-15
RF generator R&S SMT-06	SN: 832283/011	27-Aug-12 (in house check Oct-13)	In house check: Oct-16

Calibrated by: **Claudio Laubler** Name: Claudio Laubler Function: Laboratory Technician

Approved by: **Fin Bornholt** Name: Fin Bornholt Function: Deputy Technical Manager

Signature

Issued: April 17, 2015

This calibration certificate shall not be reproduced except in full without written approval of the laboratory.



Accredited by the Swiss Accreditation Service (SAS)
The Swiss Accreditation Service is one of the signatories to the EA
Multilateral Agreement for the recognition of calibration certificates

Accreditation No.: **SCS 0108**

References

- [1] ANSI-C63.19-2011
American National Standard, Methods of Measurement of Compatibility between Wireless Communications Devices and Hearing Aids.

Methods Applied and Interpretation of Parameters:

- **Coordinate System:** y-axis is in the direction of the dipole arms, z-axis is from the basis of the antenna (mounted on the table) towards its feed point between the two dipole arms. x-axis is normal to the other axes. In coincidence with the standards [1], the measurement planes (probe sensor center) are selected to be at a distance of 15 mm above the top metal edge of the dipole arms.
- **Measurement Conditions:** Further details are available from the hardcopies at the end of the certificate. All figures stated in the certificate are valid at the frequency indicated. The forward power to the dipole connector is set with a calibrated power meter connected and monitored with an auxiliary power meter connected to a directional coupler. While the dipole under test is connected, the forward power is adjusted to the same level.
- **Antenna Positioning:** The dipole is mounted on a HAC Test Arch phantom using the matching dipole positioner with the arms horizontal and the feeding cable coming from the floor. The measurements are performed in a shielded room with absorbers around the setup to reduce the reflections. It is verified before the mounting of the dipole under the Test Arch phantom, that its arms are perfectly in a line. It is installed on the HAC dipole positioner with its arms parallel below the dielectric reference wire and able to move elastically in vertical direction without changing its relative position to the top center of the Test Arch phantom. The vertical distance to the probe is adjusted after dipole mounting with a DASY5 Surface Check job. Before the measurement, the distance between phantom surface and probe tip is verified. The proper measurement distance is selected by choosing the matching section of the HAC Test Arch phantom with the proper device reference point (upper surface of the dipole) and the matching grid reference point (tip of the probe) considering the probe sensor offset. The vertical distance to the probe is essential for the accuracy.
- **Feed Point Impedance and Return Loss:** These parameters are measured using a HP 8753E Vector Network Analyzer. The impedance is specified at the SMA connector of the dipole. The influence of reflections was eliminated by applying the averaging function while moving the dipole in the air, at least 70cm away from any obstacles.
- **E-field distribution:** E field is measured in the x-y-plane with an isotropic ER3D-field probe with 100 mW forward power to the antenna feed point. In accordance with [1], the scan area is 20mm wide, its length exceeds the dipole arm length (180 or 90mm). The sensor center is 15 mm (in z) above the metal top of the dipole arms. Two 3D maxima are available near the end of the dipole arms. Assuming the dipole arms are perfectly in one line, the average of these two maxima (in subgrid 2 and subgrid 8) is determined to compensate for any non-parallelity to the measurement plane as well as the sensor displacement. The E-field value stated as calibration value represents the maximum of the interpolated 3D-E-field, in the plane above the dipole surface.

The reported uncertainty of measurement is stated as the standard uncertainty of measurement multiplied by the coverage factor $k=2$, which for a normal distribution corresponds to a coverage probability of approximately 95%.

Measurement Conditions

DASY system configuration, as far as not given on page 1.

DASY Version	DASY5	V52.8.8
Phantom	HAC Test Arch	
Distance Dipole Top - Probe Center	15 mm	
Scan resolution	dx, dy = 5 mm	
Frequency	835 MHz \pm 1 MHz	
Input power drift	< 0.05 dB	

Maximum Field values at 835 MHz

E-field 15 mm above dipole surface	condition	Interpolated maximum
Maximum measured above high end	100mW input power	104.2V/m = 40.36 dBV/m
Maximum measured above low end	100mW input power	102.2V/m = 40.19 dBV/m
Averaged maximum above arm	100mW input power	103.2V/m \pm 12.8 % (k=2)

Appendix (Additional assessments outside the scope of SCS 0108)

Antenna Parameters

Frequency	Return Loss	Impedance
800 MHz	16.5 dB	42.7 Ω - 11.9 j Ω
835 MHz	24.9 dB	50.4 Ω + 5.7 j Ω
900 MHz	17.2 dB	56.9 Ω - 13.2 j Ω
950 MHz	22.1 dB	48.4 Ω + 7.6 j Ω
960 MHz	16.0 dB	52.9 Ω + 16.3 j Ω

3.2 Antenna Design and Handling

The calibration dipole has a symmetric geometry with a built-in two stub matching network, which leads to the enhanced bandwidth.

The dipole is built of standard semirigid coaxial cable. The internal matching line is open ended. The antenna is therefore open for DC signals.

Do not apply force to dipole arms, as they are liable to bend. The soldered connections near the feedpoint may be damaged. After excessive mechanical stress or overheating, check the impedance characteristics to ensure that the internal matching network is not affected.

After long term use with 40W radiated power, only a slight warming of the dipole near the feedpoint can be measured.

Impedance Measurement Plot

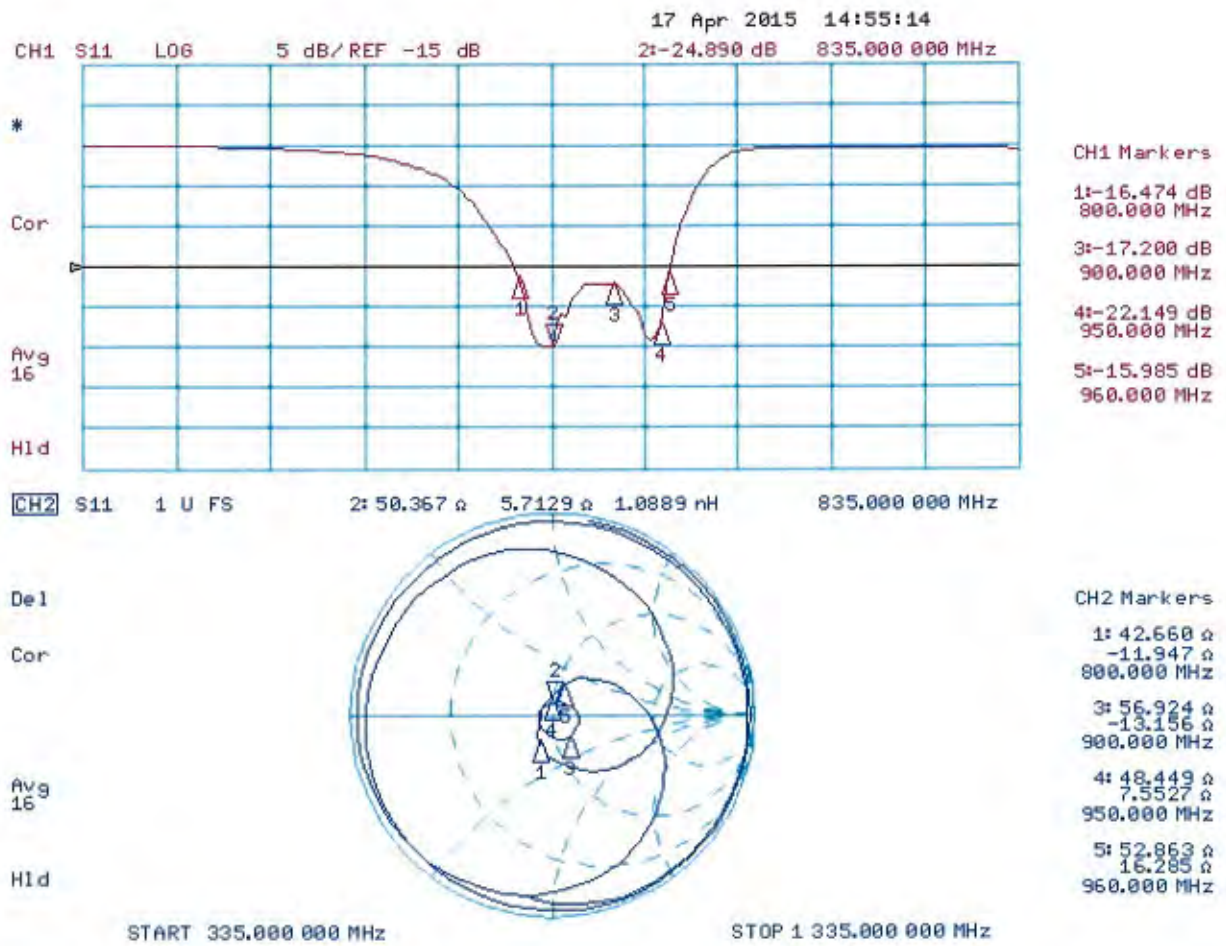

DASY5 E-field Result

Date: 17.04.2015

Test Laboratory: SPEAG Lab2

DUT: HAC-Dipole 835 MHz; Type: CD835V3; Serial: CD835V3 - SN: 1064

Communication System: UID 0 - CW; Frequency: 835 MHz
Medium parameters used: $\sigma = 0$ S/m, $\epsilon_r = 1$; $\rho = 1000$ kg/m³
Phantom section: RF Section
Measurement Standard: DASY5 (IEEE/IEC/ANSI C63.19-2011)

DASY52 Configuration:

- Probe: ER3DV6 - SN2336; ConvF(1, 1, 1); Calibrated: 31.12.2014;
- Sensor-Surface: (Fix Surface)
- Electronics: DAE4 Sn781; Calibrated: 12.09.2014
- Phantom: HAC Test Arch with AMCC; Type: SD HAC P01 BA; Serial: 1070
- DASY52 52.8.8(1222); SEMCAD X 14.6.10(7331)

Dipole E-Field measurement @ 835MHz/E-Scan - 835MHz d=15mm/Hearing Aid Compatibility Test (41x361x1):

Interpolated grid: dx=0.5000 mm, dy=0.5000 mm
Device Reference Point: 0, 0, -6.3 mm
Reference Value = 117.7 V/m; Power Drift = -0.02 dB
Applied MIF = 0.00 dB
RF audio interference level = 40.36 dBV/m
Emission category: M3

MIF scaled E-field

Grid 1 M3 40.11 dBV/m	Grid 2 M3 40.36 dBV/m	Grid 3 M3 40.24 dBV/m
Grid 4 M4 35.56 dBV/m	Grid 5 M4 35.85 dBV/m	Grid 6 M4 35.84 dBV/m
Grid 7 M4 39.89 dBV/m	Grid 8 M3 40.19 dBV/m	Grid 9 M3 40.14 dBV/m

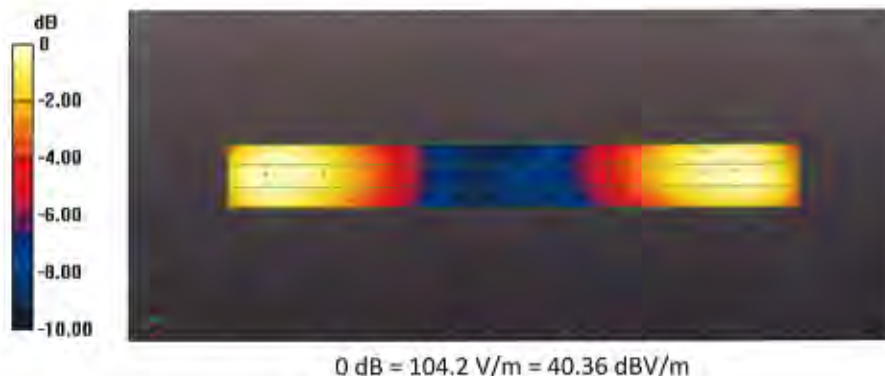



Accredited by the Swiss Accreditation Service (SAS)
The Swiss Accreditation Service is one of the signatories to the EA
Multilateral Agreement for the recognition of calibration certificates

Accreditation No.: **SCS 0108**

Client **TCC Microsoft**

Certificate No: **CD1880V3-1052_Apr15**

CALIBRATION CERTIFICATE

Object **CD1880V3 - SN: 1052**

Calibration procedure(s) **QA CAL-20.v6
Calibration procedure for dipoles in air**

Calibration date: **April 17, 2015**

This calibration certificate documents the traceability to national standards, which realize the physical units of measurements (SI).
The measurements and the uncertainties with confidence probability are given on the following pages and are part of the certificate.

All calibrations have been conducted in the closed laboratory facility: environment temperature (22 ± 3)°C and humidity < 70%.

Calibration Equipment used (M&TE critical for calibration)

Primary Standards	ID #	Cal Date (Certificate No.)	Scheduled Calibration
Power meter EPM-442A	GB37480704	07-Oct-14 (No. 217-02020)	Oct-15
Power sensor HP 8481A	US37292783	07-Oct-14 (No. 217-02020)	Oct-15
Power sensor HP 8481A	MY41092317	07-Oct-14 (No. 217-02021)	Oct-15
Reference 10 dB Attenuator	SN: 5047.2 / 06327	01-Apr-15 (No. 217-02130)	Mar-16
Probe ER3DV6	SN: 2336	31-Dec-14 (No. ER3-2336_Dec14)	Dec-15
Probe H3DV6	SN: 6065	31-Dec-14 (No. H3-6065_Dec14)	Dec-15
DAE4	SN: 781	12-Sep-14 (No. DAE4-781_Sep14)	Sep-15
Secondary Standards	ID #	Check Date (in house)	Scheduled Check
Power meter Agilent 4419B	SN: GB42420191	09-Oct-09 (in house check Sep-14)	In house check: Sep-16
Power sensor HP E4412A	SN: US38485102	05-Jan-10 (in house check Sep-14)	In house check: Sep-16
Power sensor HP 8482A	SN: US37295597	09-Oct-09 (in house check Sep-14)	In house check: Sep-16
Network Analyzer HP 8753E	US37390585	18-Oct-01 (in house check Oct-14)	In house check: Oct-15
RF generator R&S SMT-06	SN: 832283/011	27-Aug-12 (in house check Oct-13)	In house check: Oct-16

Calibrated by: **Claudio Leubler** Name: Claudio Leubler Function: Laboratory Technician

Approved by: **Fin Bornholt** Name: Fin Bornholt Function: Deputy Technical Manager

Signature

Issued: April 17, 2015

This calibration certificate shall not be reproduced except in full without written approval of the laboratory.



Accredited by the Swiss Accreditation Service (SAS)
The Swiss Accreditation Service is one of the signatories to the EA
Multilateral Agreement for the recognition of calibration certificates

Accreditation No.: **SCS 0108**

References

- [1] ANSI-C63.19-2011
American National Standard, Methods of Measurement of Compatibility between Wireless Communications Devices and Hearing Aids.

Methods Applied and Interpretation of Parameters:

- **Coordinate System:** y-axis is in the direction of the dipole arms. z-axis is from the basis of the antenna (mounted on the table) towards its feed point between the two dipole arms. x-axis is normal to the other axes. In coincidence with the standards [1], the measurement planes (probe sensor center) are selected to be at a distance of 15 mm above the top metal edge of the dipole arms.
- **Measurement Conditions:** Further details are available from the hardcopies at the end of the certificate. All figures stated in the certificate are valid at the frequency indicated. The forward power to the dipole connector is set with a calibrated power meter connected and monitored with an auxiliary power meter connected to a directional coupler. While the dipole under test is connected, the forward power is adjusted to the same level.
- **Antenna Positioning:** The dipole is mounted on a HAC Test Arch phantom using the matching dipole positioner with the arms horizontal and the feeding cable coming from the floor. The measurements are performed in a shielded room with absorbers around the setup to reduce the reflections. It is verified before the mounting of the dipole under the Test Arch phantom, that its arms are perfectly in a line. It is installed on the HAC dipole positioner with its arms parallel below the dielectric reference wire and able to move elastically in vertical direction without changing its relative position to the top center of the Test Arch phantom. The vertical distance to the probe is adjusted after dipole mounting with a DASY5 Surface Check job. Before the measurement, the distance between phantom surface and probe tip is verified. The proper measurement distance is selected by choosing the matching section of the HAC Test Arch phantom with the proper device reference point (upper surface of the dipole) and the matching grid reference point (tip of the probe) considering the probe sensor offset. The vertical distance to the probe is essential for the accuracy.
- **Feed Point Impedance and Return Loss:** These parameters are measured using a HP 8753E Vector Network Analyzer. The impedance is specified at the SMA connector of the dipole. The influence of reflections was eliminated by applying the averaging function while moving the dipole in the air, at least 70cm away from any obstacles.
- **E-field distribution:** E field is measured in the x-y-plane with an isotropic ER3D-field probe with 100 mW forward power to the antenna feed point. In accordance with [1], the scan area is 20mm wide, its length exceeds the dipole arm length (180 or 90mm). The sensor center is 15 mm (in z) above the metal top of the dipole arms. Two 3D maxima are available near the end of the dipole arms. Assuming the dipole arms are perfectly in one line, the average of these two maxima (in subgrid 2 and subgrid 8) is determined to compensate for any non-parallelity to the measurement plane as well as the sensor displacement. The E-field value stated as calibration value represents the maximum of the interpolated 3D-E-field, in the plane above the dipole surface.

The reported uncertainty of measurement is stated as the standard uncertainty of measurement multiplied by the coverage factor $k=2$, which for a normal distribution corresponds to a coverage probability of approximately 95%.

Measurement Conditions

DASY system configuration, as far as not given on page 1.

DASY Version	DASY5	V52.8.8
Phantom	HAC Test Arch	
Distance Dipole Top - Probe Center	15 mm	
Scan resolution	dx, dy = 5 mm	
Frequency	1880 MHz \pm 1 MHz	
Input power drift	< 0.05 dB	

Maximum Field values at 1880 MHz

E-field 15 mm above dipole surface	condition	Interpolated maximum
Maximum measured above high end	100mW input power	89.8V/m = 39.07 dBV/m
Maximum measured above low end	100mW input power	89.0V/m = 38.99 dBV/m
Averaged maximum above arm	100mW input power	89.4V/m \pm 12.8 % (k=2)

Appendix (Additional assessments outside the scope of SCS 0108)

Antenna Parameters

Frequency	Return Loss	Impedance
1730 MHz	22.0 dB	48.6 Ω + 7.7 j Ω
1880 MHz	20.5 dB	51.4 Ω + 9.5 j Ω
1900 MHz	20.8 dB	54.4 Ω + 8.5 j Ω
1950 MHz	26.5 dB	54.8 Ω - 1.1 j Ω
2000 MHz	21.4 dB	42.2 Ω - 0.4 j Ω

3.2 Antenna Design and Handling

The calibration dipole has a symmetric geometry with a built-in two stub matching network, which leads to the enhanced bandwidth.

The dipole is built of standard semirigid coaxial cable. The internal matching line is open ended. The antenna is therefore open for DC signals.

Do not apply force to dipole arms, as they are liable to bend. The soldered connections near the feedpoint may be damaged. After excessive mechanical stress or overheating, check the impedance characteristics to ensure that the internal matching network is not affected.

After long term use with 40W radiated power, only a slight warming of the dipole near the feedpoint can be measured.

Impedance Measurement Plot

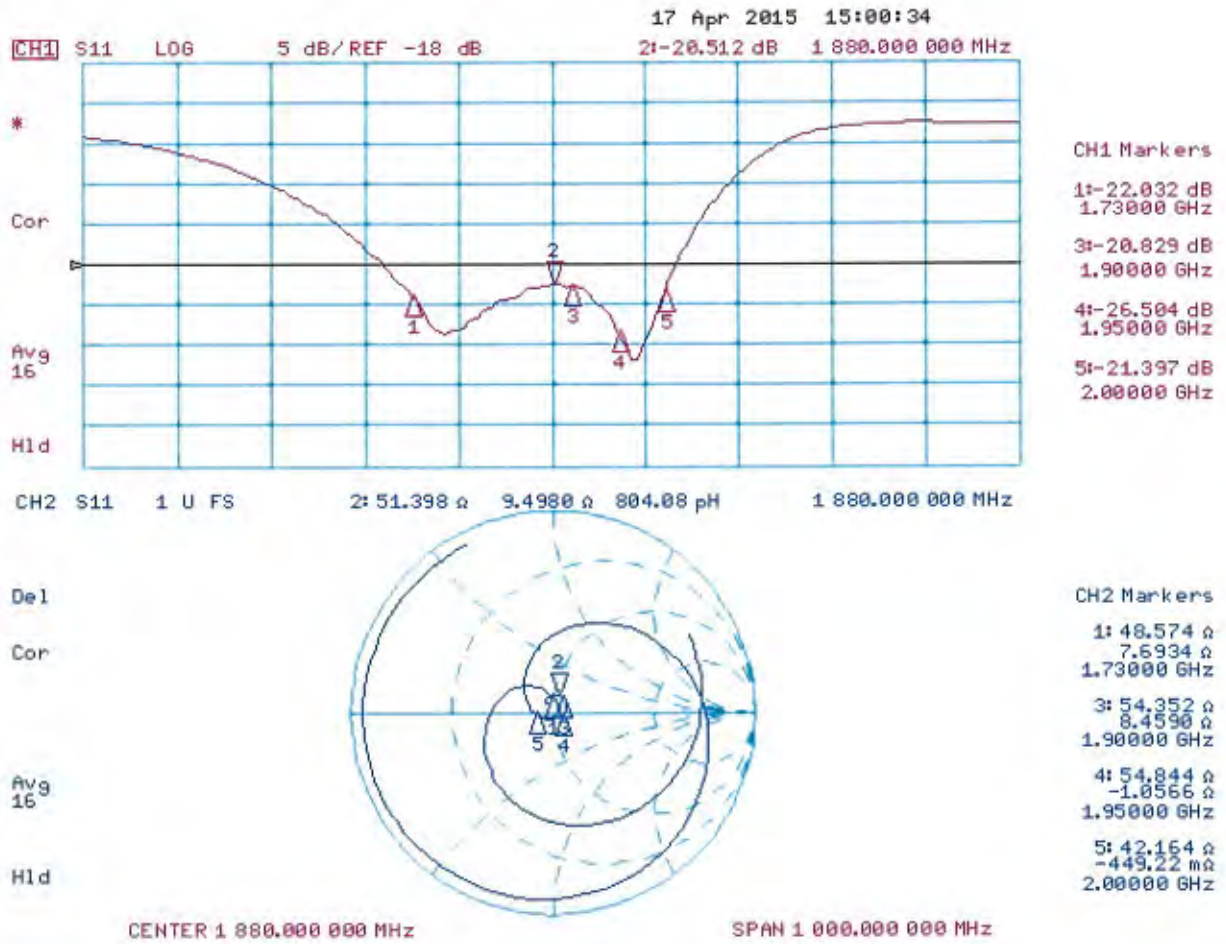

DASY5 E-field Result

Date: 17.04.2015

Test Laboratory: SPEAG Lab2

DUT: HAC Dipole 1880 MHz; Type: CD1880V3; Serial: CD1880V3 - SN: 1052

Communication System: UID 0 - CW; Frequency: 1880 MHz

Medium parameters used: $\sigma = 0$ S/m, $\epsilon_r = 1$; $\rho = 1000$ kg/m³

Phantom section: RF Section

Measurement Standard: DASY5 (IEEE/IEC/ANSI C63.19-2011)

DASY52 Configuration:

- Probe: ER3DV6 - SN2336; ConvF(1, 1, 1); Calibrated: 31.12.2014;
- Sensor-Surface: (Fix Surface)
- Electronics: DAE4 Sn781; Calibrated: 12.09.2014
- Phantom: HAC Test Arch with AMCC; Type: SD HAC P01 BA; Serial: 1070
- DASY52 52.8.8(1222); SEMCAD X 14.6.10(7331)

Dipole E-Field measurement @ 1880MHz/E-Scan - 1880MHz d=15mm/Hearing Aid Compatibility Test (41x181x1):

Interpolated grid; dx=0.5000 mm, dy=0.5000 mm

Device Reference Point: 0, 0, -6.3 mm

Reference Value = 136.7 V/m; Power Drift = -0.04 dB

Applied MIF = 0.00 dB

RF audio interference level = 38.99 dBV/m

Emission category: M2

MIF scaled E-field

Grid 1 M2 38.77 dBV/m	Grid 2 M2 38.99 dBV/m	Grid 3 M2 38.87 dBV/m
Grid 4 M2 36.57 dBV/m	Grid 5 M2 36.75 dBV/m	Grid 6 M2 36.69 dBV/m
Grid 7 M2 38.74 dBV/m	Grid 8 M2 38.91 dBV/m	Grid 9 M2 38.79 dBV/m

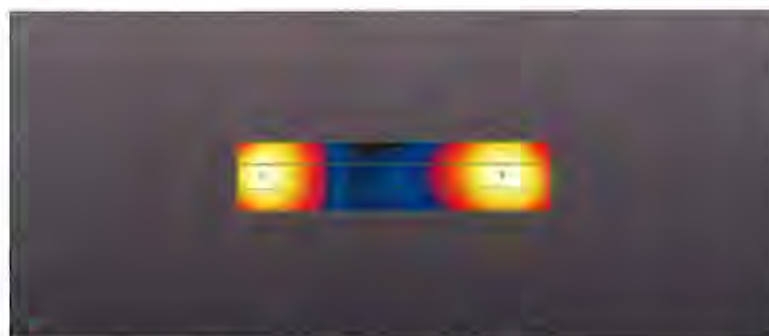
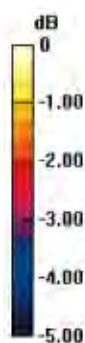

0 dB = 89.02 V/m = 38.99 dBV/m