

TEST REPORT

Test Report No.: 1-5831/13-03-02-B



Testing Laboratory

CETECOM ICT Services GmbH
 Untertürkheimer Straße 6 – 10
 66117 Saarbrücken/Germany
 Phone: + 49 681 5 98 - 0
 Fax: + 49 681 5 98 - 9075
 Internet: <http://www.cetecom.com>
 e-mail: ict@cetecom.com

Accredited Test Laboratory:

The testing laboratory (area of testing) is accredited according to DIN EN ISO/IEC 17025 (2005) by the Deutsche Akkreditierungsstelle GmbH (DAkkS)
 The accreditation is valid for the scope of testing procedures as stated in the accreditation certificate with the registration number: D-PL-12076-01-01

Applicant

Sony Mobile Communications AB
 Nya Vattentornet
 22188 Lund/SWEDEN

Phone: +46 46 19 30 00

Contact: Fredrik Björk
 e-mail: Fredrik.Bjork@sonymobile.com
 Phone: +46 1 08 01 46 75
 Fax: +46 1 08 00 24 41

Manufacturer

Sony Mobile Communications AB
 Nya Vattentornet
 22188 Lund/SWEDEN

Test Standard/s

IEEE 1528-2003	Recommended Practice for Determining the Peak Spatial-Average Specific Absorption Rate (SAR) in the Human Head from Wireless Communications Devices: Measurement Techniques
OET Bulletin 65 Supplement C	Evaluating Compliance with FCC Guidelines for Human Exposure to Radiofrequency Electromagnetic Fields
RSS-102 Issue 4	Radio Frequency Exposure Compliance of Radiocommunication Apparatus (All Frequency Bands)

For further applied test standards please refer to section 3 of this test report.

Test Item

Kind of test item:	Tablet PC
Device type:	portable device
Model name:	SGP321
S/N serial number:	CB5A1NY05N / CB5A1NY05H
FCC-ID:	PY7 TM-0030
IC:	4170B-TM0030
IMEI-Number:	00440245-081820-2 / 00440245-081865-7
Hardware status:	AP1
Software status:	10.1.1.A.1.11
Frequency:	see technical details
Antenna:	integrated antenna
Battery option:	Integrated battery
Accessories:	Stereo headset MH-EX300AP SN: 1238SSP00000735
Test sample status:	identical prototype
Exposure category:	general population / uncontrolled environment

Test Report authorised:

2013-04-13 Thomas Vogler
 Senior Testing Manager

Test performed:

2013-04-13 Oleksandr Hnatovskiy
 Testing Manager

1 Table of contents

1	Table of contents.....	2
2	General information	4
2.1	Notes and disclaimer	4
2.2	Application details	4
2.3	Statement of compliance.....	4
2.4	Technical details.....	5
2.5	Transmitter and Antenna Operating Configurations	6
3	Test standards/ procedures references.....	7
3.1	RF exposure limits	8
4	Summary of Measurement Results	9
4.1	SAR measurement variability and measurement uncertainty analysis.....	9
5	Test Environment	9
6	Test Set-up.....	10
6.1	Measurement system.....	10
6.1.1	System Description.....	10
6.1.2	Test environment.....	11
6.1.3	Probe description.....	11
6.1.4	Phantom description.....	12
6.1.5	Device holder description	12
6.1.6	Laptop Extension Kit for Device holder	12
6.1.7	Scanning procedure	13
6.1.8	Spatial Peak SAR Evaluation	14
6.1.9	Data Storage and Evaluation.....	15
6.1.10	Tissue simulating liquids: dielectric properties	17
6.1.11	Tissue simulating liquids: parameters	18
6.1.12	Measurement uncertainty evaluation for SAR test.....	19
6.1.13	Measurement uncertainty evaluation for System Check.....	23
6.1.14	System check	25
6.1.15	System check procedure	26
7	Detailed Test Results	27
7.1	G Sensor controlled power back off	27
7.1.1	Description.....	27
7.1.2	Verification.....	27
7.2	Conducted power measurements.....	28
7.2.1	Conducted power measurements GSM 850 MHz.....	29
7.2.2	Conducted power measurements GSM 1900 MHz.....	30
7.2.3	Justification of SAR measurements in GSM mode	30
7.2.4	Conducted power measurements UMTS FDD V (850 MHz)	31
7.2.5	Test-set-up information for WCDMA / HSPDA / HSUPA	32
7.2.6	Conducted power measurements LTE FDD 5 850 MHz.....	37
7.2.7	Conducted power measurements LTE FDD 7 2600 MHz.....	40
7.2.8	Justification of SAR measurements in LTE mode.....	43
7.2.9	MPR information in LTE mode	43
7.2.10	Conducted power measurements WLAN 2.4 GHz.....	44
7.2.11	Conducted power measurements WLAN 5 GHz.....	44
7.2.12	Standalone SAR Test Exclusion	45
7.2.13	Multiple Transmitter Information	46
7.2.14	SAR measurement positions	48
7.3	SAR test results.....	49

7.3.1	Results overview	49
7.3.2	General description of test procedures	54
8	Test equipment and ancillaries used for tests	55
9	Observations	55
Annex A:	System performance check.....	56
Annex B:	DASY5 measurement results.....	67
Annex B.1:	GSM 850MHz	67
Annex B.2:	GSM 1900MHz	73
Annex B.3:	UMTS FDD V.....	80
Annex B.4:	LTE FDD 5	86
Annex B.5:	LTE FDD 7	110
Annex B.6:	WLAN 2450MHz	123
Annex B.7:	WLAN 5GHz.....	128
Annex B.8:	Z-axis scan.....	138
Annex B.9:	Liquid depth.....	140
Annex C:	Photo documentation.....	142
Annex D:	RF Technical Brief Cover Sheet acc. to RSS-102 Annex A	143
Annex D.1:	Declaration of RF Exposure Compliance.....	143
Annex E:	Calibration parameters.....	144
Annex F:	Document History	144
Annex G:	Further Information	144

2 General information

2.1 Notes and disclaimer

The test results of this test report relate exclusively to the test item specified in this test report. CETECOM ICT Services GmbH does not assume responsibility for any conclusions and generalisations drawn from the test results with regard to other specimens or samples of the type of the equipment represented by the test item. The test report may only be reproduced or published in full. Reproduction or publication of extracts from the report requires the prior written approval of CETECOM ICT Services GmbH.

This test report is electronically signed and valid without handwriting signature. For verification of the electronic signatures, the public keys can be requested at the testing laboratory.

The testing service provided by CETECOM ICT Services GmbH has been rendered under the current "General Terms and Conditions for CETECOM ICT Services GmbH".

CETECOM ICT Services GmbH will not be liable for any loss or damage resulting from false, inaccurate, inappropriate or incomplete product information provided by the customer.

Under no circumstances does the CETECOM ICT Services GmbH test report include any endorsement or warranty regarding the functionality, quality or performance of any other product or service provided.

Under no circumstances does the CETECOM ICT Services GmbH test report include or imply any product or service warranties from CETECOM ICT Services GmbH, including, without limitation, any implied warranties of merchantability, fitness for purpose, or non-infringement, all of which are expressly disclaimed by CETECOM ICT Services GmbH.

All rights and remedies regarding vendor's products and services for which CETECOM ICT Services GmbH has prepared this test report shall be provided by the party offering such products or services and not by CETECOM ICT Services GmbH.

In no case this test report can be considered as a Letter of Approval.

2.2 Application details

Date of receipt of order:	2013-01-10
Date of receipt of test item:	2013-03-07
Start of test:	2013-03-11
End of test:	2013-03-28
Person(s) present during the test:	

2.3 Statement of compliance

The SAR values found for the SGP321 Tablet PC are below the maximum recommended levels of 1.6 W/Kg as averaged over any 1 g tissue according to the FCC rule §2.1093, the ANSI/IEEE C 95.1:1992, the NCRP Report Number 86 for uncontrolled environment, according to the Health Canada's Safety Code 6 and the Industry Canada Radio Standards Specification RSS-102 for General Population/Uncontrolled exposure.

2.4 Technical details

Band tested for this test report	Technology	Lowest transmit frequency/MHz	Highest transmit frequency/MHz	Lowest receive Frequency/MHz	Highest receive Frequency/MHz	Kind of modulation	Power Class	Tested power control level	GPRS/EGPRS mobile station class	GPRS/EGPRS multislots class	(E)GPRS voice mode or DTM	Test channel low	Test channel middle	Test channel high	Maximum output power(dBm)*		
															Full power	Power back off	
<input type="checkbox"/>	GSM	880.2	914.8	925.2	959.8	GMSK 8-PSK	4 E2	5	B	10	no	975	37	124	33.5	---	
<input type="checkbox"/>	GSM DCS	1710.2	1784.8	1805.2	1879.8	GMSK 8-PSK	1 E2	0	B	10	no	512	698	885	30.3	---	
<input checked="" type="checkbox"/>	GSM cellular	824.2	848.8	869.2	893.8	GMSK 8-PSK	4 E2	5	B	10	no	128	190	251	33.0	29.0	
<input checked="" type="checkbox"/>	GSM PCS	1850.2	1909.8	1930.2	1989.8	GMSK 8-PSK	1 E2	0	B	10	no	512	661	810	30.1	26.6	
<input type="checkbox"/>	UMTS FDD I	1922.4	1977.6	2112.4	2167.6	QPSK	3	max	--	--	--	9612	9750	9888	23.8	---	
<input checked="" type="checkbox"/>	UMTS FDD V	826.4	846.6	871.4	891.6	QPSK	3	max	--	--	--	4132	4182	4233	23.8	18.8	
<input type="checkbox"/>	UMTS FDD VIII	882.4	912.6	927.4	957.6	QPSK	3	max	--	--	--	2712	2787	2863	23.7	---	
<input type="checkbox"/>	LTE FDD 1	1920	1980	2110	2170	OFDM QPSK 16QAM	3	max	--	--	--	18100	18300	18500	23.5	---	
<input type="checkbox"/>	LTE FDD 3	1710	1785	1805	1880		3	max	--	--	--	19300	19575	19850	23.6	---	
<input checked="" type="checkbox"/>	LTE FDD 5	824	849	869	894		3	max	--	--	--	20450	20525	20600	23.4	19.2	
<input checked="" type="checkbox"/>	LTE FDD 7	2500	2570	2620	2690		3	max	--	--	--	20850	21100	21350	22.5	10.6	
<input type="checkbox"/>	LTE FDD 8	880	915	925	960		3	max	--	--	--	21500	21625	21750	23.5	---	
<input type="checkbox"/>	LTE FDD 20	832	862	791	821		3	max	--	--	--	24250	24300	24350	23.6	---	
<input checked="" type="checkbox"/>	WLAN	2412	2472	2412	2472	CCK OFDM	--	max	--	--	--	1	7	13	11.0	---	
<input checked="" type="checkbox"/>	WLAN US	2412	2462	2412	2462		--	max	--	--	--	1	6	11	11.0	---	
<input checked="" type="checkbox"/>	WLAN	5180	5240	5180	5240	OFDM	--	max	--	--	--	--	40	--	8.5	---	
<input checked="" type="checkbox"/>	WLAN	5260	5320	5260	5320	OFDM	--	max	--	--	--	--	56	--	8.3	---	
<input checked="" type="checkbox"/>	WLAN	5500	5700	5500	5700	OFDM	--	max	--	--	--	--	140	--	8.1	---	
<input checked="" type="checkbox"/>	WLAN	5745	5825	5745	5825	OFDM	--	max	--	--	--	149	--	--	11.4	---	
<input type="checkbox"/>	BT	2402	2480	2402	2480	GFSK	3	max	--	--	--	0	39	78			
supported UMTS features				category			remarks										
Release 8 HSDPA				24			QPSK, 16QAM, 64-QAM Dual-Cell 42.2 Mbit/s										
Release 6 HSUPA				6			no 16QAM , no MIMO, 5.76 Mbit/s										

)*: slotted peak power for GSM, averaged max. RMS power for UMTS, WLAN and BT.

2.5 Transmitter and Antenna Operating Configurations

Simultaneous transmission conditions	
GSM / GPRS / EDGE	+ BT/BLE
GSM / GPRS / EDGE	+ WLAN 2.4GHz
GSM / GPRS / EDGE	+ WLAN 5GHz
UMTS / HSPA	+ BT/BLE
UMTS / HSPA	+ WLAN 2.4GHz
UMTS / HSPA	+ WLAN 5GHz
LTE	+ BT/BLE
LTE	+ WLAN 2.4GHz
LTE	+ WLAN 5GHz

Table 1: Simultaneous transmission conditions

Note: BT and WLAN can be active at the same time, but only with interleaving of packages switched on board level. That means that they don't transmit at the same time.

3 Test standards/ procedures references

Test Standard	Version	Test Standard Description
IEEE 1528-2003	2003-04	Recommended Practice for Determining the Peak Spatial-Average Specific Absorption Rate (SAR) in the Human Head from Wireless Communications Devices: Measurement Techniques
OET Bulletin 65 Supplement C	1997-01 2001-01	Evaluating Compliance with FCC Guidelines for Human Exposure to Radiofrequency Electromagnetic Fields
RSS-102 Issue 4	2010-03	Radio Frequency Exposure Compliance of Radiocommunication Apparatus (All Frequency Bands)
Canada's Safety Code No. 6	99-EHD-237	Limits of Human Exposure to Radiofrequency Electromagnetic Fields in the Frequency Range from 3 kHz to 300 GHz
IEEE Std. C95-3	2002	IEEE Recommended Practice for the Measurement of Potentially Hazardous Electromagnetic Fields – RF and Microwave
IEEE Std. C95-1	1992	IEEE Standard for Safety Levels with Respect to Human Exposure to Radio Frequency Electromagnetic Fields, 3 kHz to 300 GHz.
IEC 62209-2	2010	Human exposure to radio frequency fields from hand-held and bodymounted wireless communication devices. Human models, instrumentation, and procedures. Procedure to determine the specific absorption rate (SAR) for wireless communication devices used in close proximity to the human body (frequency range of 30 MHz to 6 GHz)
FCC KDBs:		
KDB 865664D01v01	October 24, 2012	FCC OET SAR measurement requirements 100 MHz to 6 GHz
KDB 865664D02v01	October 24, 2012	RF Exposure Compliance Reporting and Documentation Considerations
KDB 447498D01v05	October 24, 2012	Mobile and Portable Devices RF Exposure Procedures and Equipment Authorization Policies
KDB 648474D04v01	October 24, 2012	SAR Evaluation Considerations for Handsets with Multiple Transmitters & Antennas
KDB 941225D01v02	April 10, 2007	SAR Measurements Procedures for 3G Devices
KDB 941225D02v01	December 14, 2009	3GPP R6 HSPA and R7 HSPA+ SAR Guidance
KDB 941225D03v01	December, 2008	SAR Test Reduction Procedure for GSM/GPRS/EDGE
KDB 248227D01v01	May, 2007	SAR Measurement Procedures for 802.11 a/b/g Transmitters
KDB 450824D01v01	January, 2007	SAR Probe Calibration and System Verification considerations for measurements from 150 MHz to 3 GHz
KDB 450824D01v01	March 4, 2012	Dipole Requirements for SAR System Validation and Verification
KDB 616217D03v01	November13, 2009	SAR Evaluation Considerations for Laptop Computers with Antennas Built-in on Display Screens
KDB 941225D05v02	October 24, 2012	SAR for LTE Devices

Additional KDB inquiry:

Individual FCC KDB guidance regarding to proper consideration of the G-sensor controlled power back-off feature of the device has been applied which requires using the standard SAR measurement procedures for tablet computers. Section 7.1 describes the G-sensor control depending on device orientation and conducted power with and without back-off is listed in section 7.2.

3.1 RF exposure limits

Human Exposure	Uncontrolled Environment General Population	Controlled Environment Occupational
Spatial Peak SAR* (Brain and Trunk)	1.60 mW/g	8.00 mW/g
Spatial Average SAR** (Whole Body)	0.08 mW/g	0.40 mW/g
Spatial Peak SAR*** (Hands/Feet/Ankle/Wrist)	4.00 mW/g	20.00 mW/g

Table 2: RF exposure limits

The limit applied in this test report is shown in bold letters

Notes:

- * The Spatial Peak value of the SAR averaged over any 1 gram of tissue (defined as a tissue volume in the shape of a cube) and over the appropriate averaging time
- ** The Spatial Average value of the SAR averaged over the whole body.
- *** The Spatial Peak value of the SAR averaged over any 10 grams of tissue (defined as a tissue volume in the shape of a cube) and over the appropriate averaging time.

Uncontrolled Environments are defined as locations where there is the exposure of individuals who have no knowledge or control of their exposure.

Controlled Environments are defined as locations where there is exposure that may be incurred by persons who are aware of the potential for exposure, (i.e. as a result of employment or occupation).

4 Summary of Measurement Results

<input checked="" type="checkbox"/>	No deviations from the technical specifications ascertained		
<input type="checkbox"/>	Deviations from the technical specifications ascertained		
Maximum SAR value reported for 1g (W/kg)			
	PCE	DTS	UNII
body 0 mm distance	1.101	1.194	0.930
collocated situations	ΣSAR evaluation	2.295	
	SPLSR_i ≤ 0.040	0.015	

4.1 SAR measurement variability and measurement uncertainty analysis

This analysis is required for worst case results larger than 0.8 W/kg.

frequency band	highest measurement result at worst case position (W/kg)	second measurement result at worst case position (W/kg)	ratio <1.2
GSM 835	0.961	0.981	1.02
GSM 1900	0.952	0.933	1.02
UMTS FDD V	0.948	0.957	1.01
LTE FDD 5	0.980	0.982	1.00
LTE FDD 7	0.768		
WLAN 2.4 GHz	1.140	1.050	1.09
WLAN 5 GHz	0.756		

5 Test Environment

Ambient temperature:	20 – 24 °C
Tissue Simulating liquid:	20 – 24 °C
Relative humidity content:	40 – 50 %
Air pressure:	not relevant for this kind of testing
Power supply:	230 V / 50 Hz

Exact temperature values for each test are shown in the table(s) under 7.1 and/or on the measurement plots.

6 Test Set-up

6.1 Measurement system

6.1.1 System Description

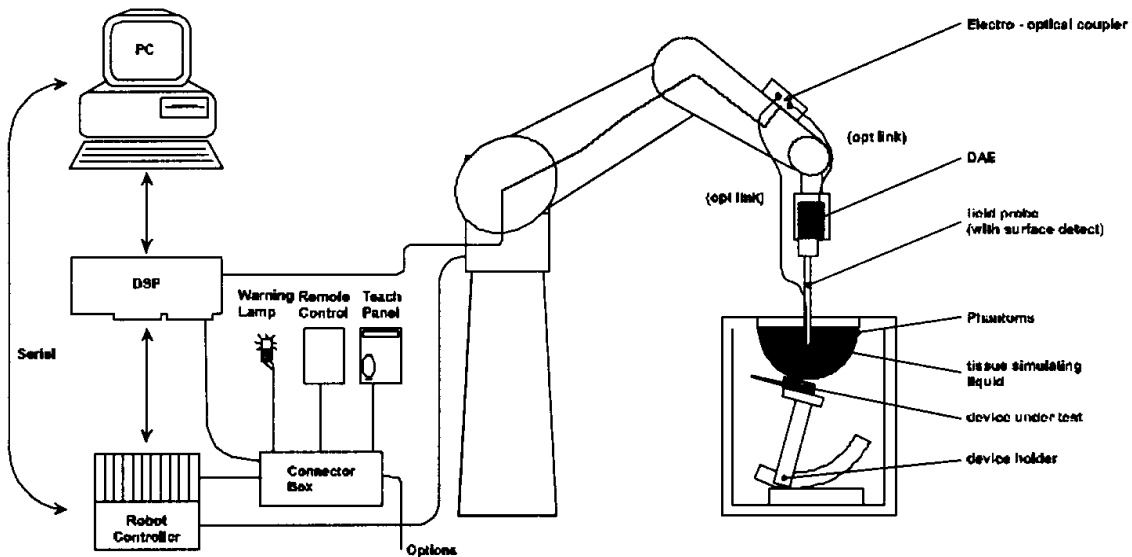

- The DAS system for performing compliance tests consists of the following items:
- A standard high precision 6-axis robot (Stäubli RX family) with controller and software. An arm extension for accommodating the data acquisition electronics (DAE).
- A dosimetric probe, i.e. an isotropic E-field probe optimized and calibrated for usage in tissue simulating liquid. The probe is equipped with an optical surface detector system.
- A data acquisition electronic (DAE) which performs the signal amplification, signal multiplexing, AD-conversion, offset measurements, mechanical surface detection, collision detection, etc. The unit is battery powered with standard or rechargeable batteries. The signal is optically transmitted to the EOC.
- A unit to operate the optical surface detector which is connected to the EOC.
- The Electro-Optical Coupler (EOC) performs the conversion from the optical into a digital electric signal of the DAE. The EOC is connected to the DAS measurement server.
- The DAS measurement server, which performs all real-time data evaluation for field measurements and surface detection, controls robot movements and handles safety operation. A computer operating Windows XP or Windows 7.
- DAS software and SEMCAD data evaluation software.
- Remote control with teach panel and additional circuitry for robot safety such as warning lamps, etc.
- The generic twin phantom enabling the testing of left-hand and right-hand usage.
- The device holder for handheld mobile phones.
- Tissue simulating liquid mixed according to the given recipes.
- System check dipoles allowing to validate the proper functioning of the system.

6.1.2 Test environment

The DASY measurement system is placed at the head end of a room with dimensions: 5 x 2.5 x 3 m³, the SAM phantom is placed in a distance of 75 cm from the side walls and 1.1m from the rear wall. Above the test system a 1.5 x 1.5 m² array of pyramid absorbers is installed to reduce reflections from the ceiling.

Picture 1 of the photo documentation shows a complete view of the test environment.

The system allows the measurement of SAR values larger than 0.005 mW/g.

6.1.3 Probe description

Isotropic E-Field Probe ET3DV6 for Dosimetric Measurements

Technical data according to manufacturer information	
Construction	Symmetrical design with triangular core Built-in optical fiber for surface detection system Built-in shielding against static charges PEEK enclosure material (resistant to organic solvents, e.g., glycoether)
Calibration	In air from 10 MHz to 2.5 GHz In head tissue simulating liquid (HSL) at 900 (800-1000) MHz and 1.8 GHz (1700-1910 MHz) (accuracy $\pm 9.5\%$; k=2) Calibration for other liquids and frequencies upon request
Frequency	10 MHz to 3 GHz (dosimetry); Linearity: ± 0.2 dB (30 MHz to 3 GHz)
Directivity	± 0.2 dB in HSL (rotation around probe axis) ± 0.4 dB in HSL (rotation normal to probe axis)
Dynamic range	5 μ W/g to > 100 mW/g; Linearity: ± 0.2 dB
Optical Surface Detection	± 0.2 mm repeatability in air and clear liquids over diffuse reflecting surfaces (ET3DV6 only)
Dimensions	Overall length: 330 mm Tip length: 16 mm Body diameter: 12 mm Tip diameter: 6.8 mm Distance from probe tip to dipole centers: 2.7 mm
Application	General dosimetry up to 3 GHz Compliance tests of mobile phones Fast automatic scanning in arbitrary phantoms (ET3DV6)

6.1.4 Phantom description

The used ELI4 Phantom meets the requirements specified in Edition 01-01 of Supplement C to OET Bulletin 65 for Specific Absorption Rate (SAR) measurements. The phantom consists of a fibreglass shell integrated in a wooden table.



The ELI4 phantom is intended for compliance testing of handheld and body-mounted wireless devices in the frequency range of 30MHz to 6 GHz. ELI4 is fully compatible with the standard IEC 62209-2 and all known tissue simulating liquids.

6.1.5 Device holder description



The DASY device holder has two scales for device rotation (with respect to the body axis) and the device inclination (with respect to the line between the ear openings). The plane between the ear openings and the mouth tip has a rotation angle of 65°. The bottom plate contains three pair of bolts for locking the device holder. The device holder positions are adjusted to the standard measurement positions in the three sections. This device holder is used for standard mobile phones or PDA's only. If necessary an additional support of polystyrene material is used.

Larger DUT's (e.g. notebooks) cannot be tested using the device holder without the extension kit described below.

6.1.6 Laptop Extension Kit for Device holder

SPEAG released a simple but effective extension for their Mounting Device that facilitates the testing of larger devices according to IEC 62209-2 (e.g., laptops, cameras, etc).

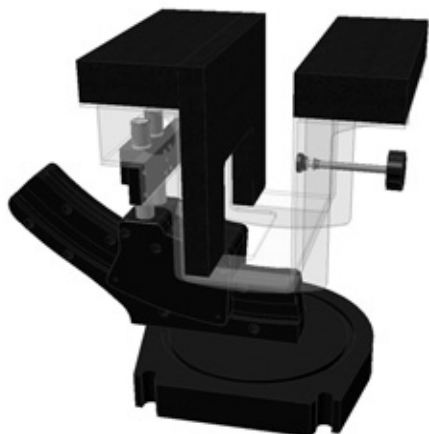

The extension is lightweight and made of POM, PET-G acrylic glass and foam. It fits easily on the upper part of the Mounting Device in place of the phone positioner.

6.1.7 Scanning procedure

- The DASY installation includes predefined files with recommended procedures for measurements and system check. They are read-only document files and destined as fully defined but unmeasured masks. All test positions (head or body-worn) are tested with the same configuration of test steps differing only in the grid definition for the different test positions.
- The „reference“ and „drift“ measurements are located at the beginning and end of the batch process. They measure the field drift at one single point in the liquid over the complete procedure. The indicated drift is mainly the variation of the DUT's output power and should vary max. +/- 5 %.
- The „surface check“ measurement tests the optical surface detection system of the DASY system by repeatedly detecting the surface with the optical and mechanical surface detector and comparing the results. The output gives the detecting heights of both systems, the difference between the two systems and the standard deviation of the detection repeatability. Air bubbles or refraction in the liquid due to separation of the sugar-water mixture gives poor repeatability (above $\pm 0.1\text{mm}$). To prevent wrong results tests are only executed when the liquid is free of air bubbles. The difference between the optical surface detection and the actual surface depends on the probe and is specified with each probe. (It does not depend on the surface reflectivity or the probe angle to the surface within $\pm 30^\circ$.)
- The „area scan“ measures the SAR above the DUT or verification dipole on a parallel plane to the surface. It is used to locate the approximate location of the peak SAR with 2D spline interpolation. The robot performs a stepped movement along one grid axis while the local electrical field strength is measured by the probe. The probe is touching the surface of the SAM during acquisition of measurement values. The standard scan uses large grid spacing for faster measurement. Standard grid spacing for head measurements is 15 mm in x- and y- dimension. If a finer resolution is needed, the grid spacing can be reduced. Grid spacing and orientation have no influence on the SAR result. For special applications where the standard scan method does not find the peak SAR within the grid, e.g. mobile phones with flip cover, the grid can be adapted in orientation. Results of this coarse scan are shown in annex 2.
- A „7x7x7 zoom scan“ measures the field in a volume around the 2D peak SAR value acquired in the previous „coarse“ scan. This is a fine 7x7 grid where the robot additionally moves the probe in 7 steps along the z-axis away from the bottom of the Phantom. Grid spacing for the cube measurement is 5 mm / 4 mm in x and y-direction and 5 mm / 2 mm in z-direction. DASY is also able to perform repeated zoom scans if more than 1 peak is found during area scan. In this document, the evaluated peak 1g and 10g averaged SAR values are shown in the 2D-graphics in annex 2. Test results relevant for the specified standard (see section 3) are shown in table form in section 7.
- A Z-axis scan measures the total SAR value at the x-and y-position of the maximum SAR value found during the cube 7x7x7 scan. The probe is moved away in z-direction from the bottom of the SAM phantom in 2mm steps. This measurement shows the continuity of the liquid and can - depending in the field strength – also show the liquid depth. A z-axis scan of the measurement with maximum SAR value is shown in annex 2.

6.1.8 Spatial Peak SAR Evaluation

The spatial peak SAR - value for 1 and 10 g is evaluated after the Cube measurements have been done. The basis of the evaluation are the SAR values measured at the points of the fine cube grid consisting of 7 x 7 x 7 points. The algorithm that finds the maximal averaged volume is separated into three different stages.

- The data between the dipole center of the probe and the surface of the phantom are extrapolated. This data cannot be measured since the center of the dipole is 2.7 mm away from the tip of the probe and the distance between the surface and the lowest measuring point is about 1 mm (see probe calibration sheet). The extrapolated data from a cube measurement can be visualized by selecting 'Graph Evaluated'.
- The maximum interpolated value is searched with a straight-forward algorithm. Around this maximum the SAR - values averaged over the spatial volumes (1g or 10 g) are computed using the 3d-spline interpolation algorithm. If the volume cannot be evaluated (i.e., if a part of the grid was cut off by the boundary of the measurement area) the evaluation will be started on the corners of the bottom plane of the cube.
- All neighbouring volumes are evaluated until no neighbouring volume with a higher average value is found.

Extrapolation

The extrapolation is based on a least square algorithm [W. Gander, Computermathematik, p.168-180]. Through the points in the first 3 cm along the z-axis, polynomials of order four are calculated. These polynomials are then used to evaluate the points between the surface and the probe tip. The points, calculated from the surface, have a distance of 1 mm from each other.

Interpolation

The interpolation of the points is done with a 3d-Spline. The 3d-Spline is composed of three one-dimensional splines with the "Not a knot"-condition [W. Gander, Computermathematik, p.141-150] (x, y and z -direction) [Numerical Recipes in C, Second Edition, p.123ff].

Volume Averaging

At First the size of the cube is calculated. Then the volume is integrated with the trapezoidal algorithm. 8000 points (20x20x20) are interpolated to calculate the average.

Advanced Extrapolation

DASY uses the advanced extrapolation option which is able to compensate boundary effects on E-field probes.

6.1.9 Data Storage and Evaluation

Data Storage

The DASY software stores the acquired data from the data acquisition electronics as raw data (in microvolt readings from the probe sensors), together with all necessary software parameters for the data evaluation (probe calibration data, liquid parameters and device frequency and modulation data) in measurement files with the extension ".DA4", ".DA5x". The software evaluates the desired unit and format for output each time the data is visualized or exported. This allows verification of the complete software setup even after the measurement and allows correction of incorrect parameter settings. For example, if a measurement has been performed with a wrong crest factor parameter in the device setup, the parameter can be corrected afterwards and the data can be re-evaluated.

The measured data can be visualized or exported in different units or formats, depending on the selected probe type ([V/m], [A/m], [°C], [mW/g], [mW/cm²], [dBrel], etc.). Some of these units are not available in certain situations or show meaningless results, e.g., a SAR output in a lossless media will always be zero. Raw data can also be exported to perform the evaluation with other software packages.

Data Evaluation by SEMCAD

The SEMCAD software automatically executes the following procedures to calculate the field units from the microvolt readings at the probe connector. The parameters used in the evaluation are stored in the configuration modules of the software:

Probe parameters:	- Sensitivity	$\text{Norm}_i, a_{i0}, a_{i1}, a_{i2}$
	- Conversion factor	ConvF_i
	- Diode compression point	D_{cpi}
Device parameters:	- Frequency	f
	- Crest factor	cf
Media parameters:	- Conductivity	σ
	- Density	ρ

These parameters must be set correctly in the software. They can be found in the component documents or they can be imported into the software from the configuration files issued for the DASY components. In the direct measuring mode of the multimeter option, the parameters of the actual system setup are used. In the scan visualization and export modes, the parameters stored in the corresponding document files are used.

The first step of the evaluation is a linearization of the filtered input signal to account for the compression characteristics of the detector diode. The compensation depends on the input signal, the diode type and the DC-transmission factor from the diode to the evaluation electronics.

If the exciting field is pulsed, the crest factor of the signal must be known to correctly compensate for peak power. The formula for each channel can be given as:

$$V_i = U_i + U_i^2 \cdot cf/dcp_i$$

with V_i = compensated signal of channel i (i = x, y, z)
 U_i = input signal of channel i (i = x, y, z)
 cf = crest factor of exciting field (DASY parameter)
 dcp_i = diode compression point (DASY parameter)

From the compensated input signals the primary field data for each channel can be evaluated:

E-field probes: $E_i = (V_i / Norm_i \cdot ConvF)^{1/2}$

H-field probes: $H_i = (V_i)^{1/2} \cdot (a_{i0} + a_{i1}f + a_{i2}f^2)/f$

with V_i = compensated signal of channel i (i = x, y, z)
 $Norm_i$ = sensor sensitivity of channel i (i = x, y, z)
 [mV/(V/m)²] for E-field Probes
 $ConvF$ = sensitivity enhancement in solution
 a_{ij} = sensor sensitivity factors for H-field probes
 f = carrier frequency [GHz]
 E_i = electric field strength of channel i in V/m
 H_i = magnetic field strength of channel i in A/m

The RSS value of the field components gives the total field strength (Hermitian magnitude):

$$E_{tot} = (E_x^2 + E_y^2 + E_z^2)^{1/2}$$

The primary field data are used to calculate the derived field units.

$$SAR = (E_{tot}^2 \cdot \sigma) / (\rho \cdot 1000)$$

with SAR = local specific absorption rate in mW/g
 E_{tot} = total field strength in V/m
 σ = conductivity in [mho/m] or [Siemens/m]
 ρ = equivalent tissue density in g/cm³

Note that the density is normally set to 1 (or 1.06), to account for actual brain density rather than the density of the simulation liquid. The power flow density is calculated assuming the excitation field to be a free space field.

$$P_{pwe} = E_{tot}^2 / 3770 \quad \text{or} \quad P_{pwe} = H_{tot}^2 \cdot 37.7$$

with P_{pwe} = equivalent power density of a plane wave in mW/cm²
 E_{tot} = total electric field strength in V/m
 H_{tot} = total magnetic field strength in A/m

6.1.10 Tissue simulating liquids: dielectric properties

The following materials are used for producing the tissue-equivalent materials.

(Liquids used for tests described in section 7. are marked with ☒) :

Ingredients (% of weight)	Frequency (MHz)								
	<input type="checkbox"/> 450	<input type="checkbox"/> 750	<input checked="" type="checkbox"/> 835	<input type="checkbox"/> 900	<input type="checkbox"/> 1450	<input type="checkbox"/> 1800	<input checked="" type="checkbox"/> 1900	<input checked="" type="checkbox"/> 2450	<input checked="" type="checkbox"/> 5000
frequency band									
Tissue Type	Body	Body	Body	Body	Body	Body	Body	Body	Body
Water	51.16	51.7	52.4	56.0	70.97	69.91	69.91	73.2	64 - 78
Salt (NaCl)	1.49	0.9	1.40	0.76	0.43	0.13	0.13	0.04	2 - 3
Sugar	46.78	47.2	45.0	41.76	0.0	0.0	0.0	0.0	0.0
HEC	0.52	0.0	1.0	1.21	0.0	0.0	0.0	0.0	0.0
Bactericide	0.05	0.1	0.1	0.27	0.0	0.0	0.0	0.0	0.0
Triton X-100	0.0	0.0	0.0	0.0	0.0	0.0	0.0	0.0	0.0
DGBE	0.0	0.0	0.0	0.0	28.60	29.96	29.96	26.7	0.0
Emulsifiers	0.0	0.0	0.0	0.0	0.0	0.0	0.0	0.0	9 - 15
Mineral Oil	0.0	0.0	0.0	0.0	0.0	0.0	0.0	0.0	11 - 18

Table 3: Body tissue dielectric properties

Salt: 99+% Pure Sodium Chloride

Water: De-ionized, 16MΩ+ resistivity

Sugar: 98+% Pure Sucrose

HEC: Hydroxyethyl Cellulose

DGBE: 99+% Di(ethylene glycol) butyl ether, [2-(2-butoxyethoxy)ethanol]

Triton X-100(ultra pure): Polyethylene glycol mono [4-(1,1,3,3-tetramethylbutyl)phenyl]ether

Note: Due to their availability body tissue simulating liquids as defined by FCC OET Bulletin 65 Supplement C are generally used for body worn SAR testing according to European standards.

6.1.11 Tissue simulating liquids: parameters

Liquid MSL	Freq. (MHz)	Target body tissue		Measurement body tissue				Measurement date
		Permittivity	Conductivity [S/m]	Permittivity	Dev. %	Conductivity [S/m]	Dev. %	
850/900	824	55.2	0.97	55.1	-0.2%	0.96	-1.0%	2013-03-16
	829	55.2	0.97	55.0	-0.4%	0.97	0.0%	2031-03-16
	837	55.2	0.97	54.9	-0.5%	0.97	0.0%	2031-03-16
	844	55.2	0.97	54.8	-0.7%	0.98	1.0%	2031-03-16
	849	55.2	0.97	54.8	-0.7%	0.98	1.0%	2031-03-16
	900	55.0	1.05	54.4	-1.1%	1.04	-1.0%	2031-03-16
850/900	829	55.2	0.97	55.9	1.2%	0.96	-1.0%	2013-05-02
	844	55.2	0.97	55.7	1.0%	0.97	0.0%	2013-05-02
	900	55.0	1.05	54.2	-1.5%	1.03	-1.9%	2013-05-02
1900	1850	53.3	1.52	52.8	-0.9%	1.47	-3.3%	2013-03-11
	1880	53.3	1.52	52.7	-1.1%	1.50	-1.3%	2013-03-11
	1900	53.3	1.52	52.6	-1.3%	1.52	0.0%	2013-03-11
	1910	53.3	1.52	52.6	-1.3%	1.54	1.3%	2013-03-11
2450 /2600	2412	52.7	1.95	52.2	-0.9%	1.96	0.5%	2013-03-22
	2437	52.7	1.95	52.1	-1.1%	1.98	1.5%	2013-03-22
	2450	52.7	1.95	52.1	-1.1%	2.00	2.6%	2013-03-22
	2462	52.7	1.95	52.0	-1.3%	2.02	3.6%	2013-03-22
	2510	52.5	2.16	51.8	-1.3%	2.09	-3.2%	2013-03-27
	2535	52.5	2.16	51.7	-1.5%	2.12	-1.9%	2013-03-27
	2560	52.5	2.16	51.6	-1.7%	2.16	0.0%	2013-03-27
	2600	52.5	2.16	51.5	-1.9%	2.22	2.8%	2013-03-27
2450 /2600	2535	52.5	2.16	51.7	-1.5%	2.12	-1.9%	2013-05-03
	2600	52.5	2.16	50.2	-4.4%	2.22	2.8%	2013-05-03
5GHz	5200	49.0	5.30	48.0	-2.0%	5.34	0.8%	2013-01-05
	5220	49.0	5.30	48.0	-2.0%	5.38	1.5%	2013-01-05
	5260	48.9	5.40	47.9	-2.0%	5.41	0.2%	2013-01-05
	5300	48.9	5.40	47.8	-2.2%	5.46	1.1%	2013-01-05
	5320	48.9	5.40	47.8	-2.2%	5.53	2.4%	2013-01-05
	5500	48.6	5.65	47.3	-2.7%	5.71	1.1%	2013-01-05
	5600	48.6	5.65	47.1	-3.1%	5.83	3.2%	2013-01-05
	5700	48.2	6.00	46.9	-2.7%	5.97	-0.5%	2013-01-05
	5785	48.2	6.00	46.7	-3.1%	6.08	1.3%	2013-01-05
	5800	48.2	6.00	46.7	-3.1%	6.10	1.7%	2013-01-05

Table 4: Parameter of the body tissue simulating liquid

Note: The dielectric properties have been measured using the contact probe method at 22°C.

6.1.12 Measurement uncertainty evaluation for SAR test

Relative DASY5 Uncertainty Budget for SAR Tests								
According to IEEE 1528/2011 and IEC62209-1/2011 (0.3-3GHz range)								
Error Description	Uncertainty Value	Probability Distribution	Divisor	c_i	c_i	Standard Uncertainty		v_i^2 or v_{eff}
				(1g)	(10g)	± %, (1g)	± %, (10g)	
Measurement System								
Probe calibration	± 6.0 %	Normal	1	1	1	± 6.0 %	± 6.0 %	∞
Axial isotropy	± 4.7 %	Rectangular	√ 3	0.7	0.7	± 1.9 %	± 1.9 %	∞
Hemispherical isotropy	± 9.6 %	Rectangular	√ 3	0.7	0.7	± 3.9 %	± 3.9 %	∞
Boundary effects	± 1.0 %	Rectangular	√ 3	1	1	± 0.6 %	± 0.6 %	∞
Probe linearity	± 4.7 %	Rectangular	√ 3	1	1	± 2.7 %	± 2.7 %	∞
System detection limits	± 1.0 %	Rectangular	√ 3	1	1	± 0.6 %	± 0.6 %	∞
Modulation Response	± 2.4 %	Rectangular	√ 3	1	1	± 1.4 %	± 1.4 %	∞
Readout electronics	± 0.3 %	Normal	1	1	1	± 0.3 %	± 0.3 %	∞
Response time	± 0.8 %	Rectangular	√ 3	1	1	± 0.5 %	± 0.5 %	∞
Integration time	± 2.6 %	Rectangular	√ 3	1	1	± 1.5 %	± 1.5 %	∞
RF ambient noise	± 3.0 %	Rectangular	√ 3	1	1	± 1.7 %	± 1.7 %	∞
RF ambient reflections	± 3.0 %	Rectangular	√ 3	1	1	± 1.7 %	± 1.7 %	∞
Probe positioner	± 0.4 %	Rectangular	√ 3	1	1	± 0.2 %	± 0.2 %	∞
Probe positioning	± 2.9 %	Rectangular	√ 3	1	1	± 1.7 %	± 1.7 %	∞
Max. SAR evaluation	± 2.0 %	Rectangular	√ 3	1	1	± 1.2 %	± 1.2 %	∞
Test Sample Related								
Device positioning	± 2.9 %	Normal	1	1	1	± 2.9 %	± 2.9 %	145
Device holder uncertainty	± 3.6 %	Normal	1	1	1	± 3.6 %	± 3.6 %	5
Power drift	± 5.0 %	Rectangular	√ 3	1	1	± 2.9 %	± 2.9 %	∞
Phantom and Set-up								
Phantom uncertainty	± 6.1 %	Rectangular	√ 3	1	1	± 3.5 %	± 3.5 %	∞
SAR correction	± 1.9 %	Rectangular	√ 3	1	0.84	± 1.1 %	± 0.9 %	∞
Liquid conductivity (meas.)	± 5.0 %	Rectangular	√ 3	0.78	0.71	± 2.3 %	± 2.0 %	∞
Liquid permittivity (meas.)	± 5.0 %	Rectangular	√ 3	0.26	0.26	± 0.8 %	± 0.8 %	∞
Temp. Unc. - Conductivity	± 3.4 %	Rectangular	√ 3	0.78	0.71	± 1.5 %	± 1.4 %	∞
Temp. Unc. - Permittivity	± 0.4 %	Rectangular	√ 3	0.23	0.26	± 0.1 %	± 0.1 %	∞
Combined Uncertainty						± 11.3 %	± 11.3 %	330
Expanded Std. Uncertainty						± 22.7 %	± 22.5 %	

Table 5: Measurement uncertainties

Worst-Case uncertainty budget for DASY5 assessed according to IEEE 1528/2011 and IEC 62209-1/2011 draft standards. The budget is valid for the frequency range 300MHz -3 GHz and represents a worst-case analysis. For specific tests and configurations, the uncertainty could be considerable smaller.

Relative DASY5 Uncertainty Budget for SAR Tests								
According to IEC62209-2/2010 (30 MHz - 6 GHz range)								
Error Description	Uncertainty Value	Probability Distribution	Divisor	c_i	c_i	Standard Uncertainty		v_i^2 or v_{eff}
				(1g)	(10g)	± %, (1g)	± %, (10g)	
Measurement System								
Probe calibration	± 6.6 %	Normal	1	1	1	± 6.6 %	± 6.6 %	∞
Axial isotropy	± 4.7 %	Rectangular	√ 3	0.7	0.7	± 1.9 %	± 1.9 %	∞
Hemispherical isotropy	± 9.6 %	Rectangular	√ 3	0.7	0.7	± 3.9 %	± 3.9 %	∞
Boundary effects	± 2.0 %	Rectangular	√ 3	1	1	± 1.2 %	± 1.2 %	∞
Probe linearity	± 4.7 %	Rectangular	√ 3	1	1	± 2.7 %	± 2.7 %	∞
System detection limits	± 1.0 %	Rectangular	√ 3	1	1	± 0.6 %	± 0.6 %	∞
Modulation Response	± 2.4 %	Rectangular	√ 3	1	1	± 1.4 %	± 1.4 %	∞
Readout electronics	± 0.3 %	Normal	1	1	1	± 0.3 %	± 0.3 %	∞
Response time	± 0.8 %	Rectangular	√ 3	1	1	± 0.5 %	± 0.5 %	∞
Integration time	± 2.6 %	Rectangular	√ 3	1	1	± 1.5 %	± 1.5 %	∞
RF ambient noise	± 3.0 %	Rectangular	√ 3	1	1	± 1.7 %	± 1.7 %	∞
RF ambient reflections	± 3.0 %	Rectangular	√ 3	1	1	± 1.7 %	± 1.7 %	∞
Probe positioner	± 0.8 %	Rectangular	√ 3	1	1	± 0.5 %	± 0.5 %	∞
Probe positioning	± 6.7 %	Rectangular	√ 3	1	1	± 3.9 %	± 3.9 %	∞
Post-processing	± 4.0 %	Rectangular	√ 3	1	1	± 2.3 %	± 2.3 %	∞
Test Sample Related								
Device positioning	± 2.9 %	Normal	1	1	1	± 2.9 %	± 2.9 %	145
Device holder uncertainty	± 3.6 %	Normal	1	1	1	± 3.6 %	± 3.6 %	5
Power drift	± 5.0 %	Rectangular	√ 3	1	1	± 2.9 %	± 2.9 %	∞
Phantom and Set-up								
Phantom uncertainty	± 7.9 %	Rectangular	√ 3	1	1	± 4.6 %	± 4.6 %	∞
SAR correction	± 1.9 %	Rectangular	√ 3	1	0.84	± 1.1 %	± 0.9 %	∞
Liquid conductivity (meas.)	± 5.0 %	Rectangular	√ 3	0.78	0.71	± 2.3 %	± 2.0 %	∞
Liquid permittivity (meas.)	± 5.0 %	Rectangular	√ 3	0.26	0.26	± 0.8 %	± 0.8 %	∞
Temp. Unc. - Conductivity	± 3.4 %	Rectangular	√ 3	0.78	0.71	± 1.5 %	± 1.4 %	∞
Temp. Unc. - Permittivity	± 0.4 %	Rectangular	√ 3	0.23	0.26	± 0.1 %	± 0.1 %	∞
Combined Uncertainty						± 12.7 %	± 12.6 %	330
Expanded Std. Uncertainty						± 25.4 %	± 25.3 %	

Table 6: Measurement uncertainties. Worst-Case uncertainty budget for DASY5 assessed according to according to IEC 62209-2/2010 standard. The budget is valid for the frequency range 30MHz - 6 GHz and represents a worst-case analysis. For specific tests and configurations, the uncertainty could be considerable smaller.

Relative DASY5 Uncertainty Budget for SAR Tests								
According to IEEE 1528-2003, IEC 62209-1 for the 3-6 GHz range								
Error Description	Uncertainty Value	Probability Distribution	Divisor	c _i	c _i	Standard Uncertainty		v _i ² or
				(1g)	(10g)	± %, (1g)	± %, (10g)	v _{eff}
Measurement System								
Probe calibration	± 6.6 %	Normal	1	1	1	± 6.6 %	± 6.6 %	∞
Axial isotropy	± 4.7 %	Rectangular	√ 3	0.7	0.7	± 1.9 %	± 1.9 %	∞
Hemispherical isotropy	± 9.6 %	Rectangular	√ 3	0.7	0.7	± 3.9 %	± 3.9 %	∞
Boundary effects	± 2.0 %	Rectangular	√ 3	1	1	± 1.2 %	± 1.2 %	∞
Probe linearity	± 4.7 %	Rectangular	√ 3	1	1	± 2.7 %	± 2.7 %	∞
System detection limits	± 1.0 %	Rectangular	√ 3	1	1	± 0.6 %	± 0.6 %	∞
Readout electronics	± 0.3 %	Normal	1	1	1	± 0.3 %	± 0.3 %	∞
Response time	± 0.8 %	Rectangular	√ 3	1	1	± 0.5 %	± 0.5 %	∞
Integration time	± 2.6 %	Rectangular	√ 3	1	1	± 1.5 %	± 1.5 %	∞
RF ambient noise	± 3.0 %	Rectangular	√ 3	1	1	± 1.7 %	± 1.7 %	∞
RF ambient reflections	± 3.0 %	Rectangular	√ 3	1	1	± 1.7 %	± 1.7 %	∞
Probe positioner	± 0.8 %	Rectangular	√ 3	1	1	± 0.5 %	± 0.5 %	∞
Probe positioning	± 6.7 %	Rectangular	√ 3	1	1	± 3.9 %	± 3.9 %	∞
Max. SAR evaluation	± 4.0 %	Rectangular	√ 3	1	1	± 2.3 %	± 2.3 %	∞
Test Sample Related								
Device positioning	± 2.9 %	Normal	1	1	1	± 2.9 %	± 2.9 %	145
Device holder uncertainty	± 3.6 %	Normal	1	1	1	± 3.6 %	± 3.6 %	5
Power drift	± 5.0 %	Rectangular	√ 3	1	1	± 2.9 %	± 2.9 %	∞
Phantom and Set-up								
Phantom uncertainty	± 4.0 %	Rectangular	√ 3	1	1	± 2.3 %	± 2.3 %	∞
Liquid conductivity (target)	± 5.0 %	Rectangular	√ 3	0.64	0.43	± 1.8 %	± 1.2 %	∞
Liquid conductivity (meas.)	± 5.0 %	Rectangular	√ 3	0.64	0.43	± 1.8 %	± 1.2 %	∞
Liquid permittivity (target)	± 5.0 %	Rectangular	√ 3	0.6	0.49	± 1.7 %	± 1.4 %	∞
Liquid permittivity (meas.)	± 5.0 %	Rectangular	√ 3	0.6	0.49	± 1.7 %	± 1.4 %	∞
Combined Uncertainty						± 12.1 %	± 11.9 %	330
Expanded Std. Uncertainty						± 24.3 %	± 23.8 %	

Table 7: Measurement uncertainties

Worst-Case uncertainty budget for DASY5 valid for 3G communication signals and frequency range 3 - 6 GHz. Probe calibration error reflects uncertainty of the EX3D probe. For specific tests and configurations, the uncertainty could be considerable smaller.

Relative DASY5 Uncertainty Budget for SAR Tests								
According to IEEE 1528/2011 and IEC62209-1/2011 (3-6GHz range)								
Error Description	Uncertainty Value	Probability Distribution	Divisor	c_i	c_i	Standard Uncertainty		v_i^2 or v_{eff}
				(1g)	(10g)	± %, (1g)	± %, (10g)	
Measurement System								
Probe calibration	± 6.6 %	Normal	1	1	1	± 6.6 %	± 6.6 %	∞
Axial isotropy	± 4.7 %	Rectangular	√ 3	0.7	0.7	± 1.9 %	± 1.9 %	∞
Hemispherical isotropy	± 9.6 %	Rectangular	√ 3	0.7	0.7	± 3.9 %	± 3.9 %	∞
Boundary effects	± 2.0 %	Rectangular	√ 3	1	1	± 1.2 %	± 1.2 %	∞
Probe linearity	± 4.7 %	Rectangular	√ 3	1	1	± 2.7 %	± 2.7 %	∞
System detection limits	± 1.0 %	Rectangular	√ 3	1	1	± 0.6 %	± 0.6 %	∞
Modulation Response	± 2.4 %	Rectangular	√ 3	1	1	± 1.4 %	± 1.4 %	∞
Readout electronics	± 0.3 %	Normal	1	1	1	± 0.3 %	± 0.3 %	∞
Response time	± 0.8 %	Rectangular	√ 3	1	1	± 0.5 %	± 0.5 %	∞
Integration time	± 2.6 %	Rectangular	√ 3	1	1	± 1.5 %	± 1.5 %	∞
RF ambient noise	± 3.0 %	Rectangular	√ 3	1	1	± 1.7 %	± 1.7 %	∞
RF ambient reflections	± 3.0 %	Rectangular	√ 3	1	1	± 1.7 %	± 1.7 %	∞
Probe positioner	± 0.8 %	Rectangular	√ 3	1	1	± 0.5 %	± 0.5 %	∞
Probe positioning	± 6.7 %	Rectangular	√ 3	1	1	± 3.9 %	± 3.9 %	∞
Max. SAR evaluation	± 4.0 %	Rectangular	√ 3	1	1	± 2.3 %	± 2.3 %	∞
Test Sample Related								
Device positioning	± 2.9 %	Normal	1	1	1	± 2.9 %	± 2.9 %	145
Device holder uncertainty	± 3.6 %	Normal	1	1	1	± 3.6 %	± 3.6 %	5
Power drift	± 5.0 %	Rectangular	√ 3	1	1	± 2.9 %	± 2.9 %	∞
Phantom and Set-up								
Phantom uncertainty	± 6.6 %	Rectangular	√ 3	1	1	± 3.8 %	± 3.8 %	∞
SAR correction	± 1.9 %	Rectangular	√ 3	1	0.84	± 1.1 %	± 0.9 %	∞
Liquid conductivity (meas.)	± 5.0 %	Rectangular	√ 3	0.78	0.71	± 2.3 %	± 2.0 %	∞
Liquid permittivity (meas.)	± 5.0 %	Rectangular	√ 3	0.26	0.26	± 0.8 %	± 0.8 %	∞
Temp. Unc. - Conductivity	± 3.4 %	Rectangular	√ 3	0.78	0.71	± 1.5 %	± 1.4 %	∞
Temp. Unc. - Permittivity	± 0.4 %	Rectangular	√ 3	0.23	0.26	± 0.1 %	± 0.1 %	∞
Combined Uncertainty						± 12.4 %	± 12.4 %	330
Expanded Std. Uncertainty						± 24.9 %	± 24.8 %	

Table 8: Measurement uncertainties

Worst-Case uncertainty budget for DASY5 assessed according to IEEE 1528/2011 and IEC 62209-1/2011 draft standards. The budget is valid for the frequency range 3GHz -6GHz and represents a worst-case analysis. For specific tests and configurations, the uncertainty could be considerable smaller.

6.1.13 Measurement uncertainty evaluation for System Check

Uncertainty of a System Performance Check with DASY5 System for the 0.3 - 3 GHz range								
Source of uncertainty	Uncertainty Value	Probability Distribution	Divisor	c_i	c_i	Standard Uncertainty		v_i^2 or
				(1g)	(10g)	± %, (1g)	± %, (10g)	v_{eff}
Measurement System								
Probe calibration	± 6.0 %	Normal	1	1	1	± 6.0 %	± 6.0 %	∞
Axial isotropy	± 4.7 %	Rectangular	√ 3	0.7	0.7	± 1.9 %	± 1.9 %	∞
Hemispherical isotropy	± 0.0 %	Rectangular	√ 3	0.7	0.7	± 0.0 %	± 0.0 %	∞
Boundary effects	± 1.0 %	Rectangular	√ 3	1	1	± 0.6 %	± 0.6 %	∞
Probe linearity	± 4.7 %	Rectangular	√ 3	1	1	± 2.7 %	± 2.7 %	∞
System detection limits	± 1.0 %	Rectangular	√ 3	1	1	± 0.6 %	± 0.6 %	∞
Readout electronics	± 0.3 %	Normal	1	1	1	± 0.3 %	± 0.3 %	∞
Response time	± 0.0 %	Rectangular	√ 3	1	1	± 0.0 %	± 0.0 %	∞
Integration time	± 0.0 %	Rectangular	√ 3	1	1	± 0.0 %	± 0.0 %	∞
RF ambient conditions	± 3.0 %	Rectangular	√ 3	1	1	± 1.7 %	± 1.7 %	∞
Probe positioner	± 0.4 %	Rectangular	√ 3	1	1	± 0.2 %	± 0.2 %	∞
Probe positioning	± 2.9 %	Rectangular	√ 3	1	1	± 1.7 %	± 1.7 %	∞
Max. SAR evaluation	± 1.0 %	Rectangular	√ 3	1	1	± 0.6 %	± 0.6 %	∞
Test Sample Related								
Dev. of experimental dipole	± 0.0 %	Rectangular	√ 3	1	1	± 0.0 %	± 0.0 %	∞
Source to liquid distance	± 2.0 %	Rectangular	√ 3	1	1	± 1.2 %	± 1.2 %	∞
Power drift	± 3.4 %	Rectangular	√ 3	1	1	± 2.0 %	± 2.0 %	∞
Phantom and Set-up								
Phantom uncertainty	± 4.0 %	Rectangular	√ 3	1	1	± 2.3 %	± 2.3 %	∞
SAR correction	± 1.9 %	Rectangular	√ 3	1	0.84	± 1.1 %	± 0.9 %	∞
Liquid conductivity (meas.)	± 5.0 %	Normal	1	0.78	0.71	± 3.9 %	± 3.6 %	∞
Liquid permittivity (meas.)	± 5.0 %	Normal	1	0.26	0.26	± 1.3 %	± 1.3 %	∞
Temp. unc. - Conductivity	± 1.7 %	Rectangular	√ 3	0.78	0.71	± 0.8 %	± 0.7 %	∞
Temp. unc. - Permittivity	± 0.3 %	Rectangular	√ 3	0.23	0.26	± 0.0 %	± 0.0 %	∞
Combined Uncertainty						± 9.1 %	± 8.9 %	330
Expanded Std. Uncertainty						± 18.2 %	± 17.9 %	

Table 9: Measurement uncertainties of the System Check with DASY5 (0.3-3GHz)

Uncertainty of a System Performance Check with DASY5 System for the 3 - 6 GHz range								
Source of uncertainty	Uncertainty Value	Probability Distribution	Divisor	c _i	c _i	Standard Uncertainty		v _i ² or v _{eff}
				(1g)	(10g)	± %, (1g)	± %, (10g)	
Measurement System								
Probe calibration	± 6.6 %	Normal	1	1	1	± 6.6 %	± 6.6 %	∞
Axial isotropy	± 4.7 %	Rectangular	√ 3	0.7	0.7	± 1.9 %	± 1.9 %	∞
Hemispherical isotropy	± 0.0 %	Rectangular	√ 3	0.7	0.7	± 0.0 %	± 0.0 %	∞
Boundary effects	± 1.0 %	Rectangular	√ 3	1	1	± 0.6 %	± 0.6 %	∞
Probe linearity	± 4.7 %	Rectangular	√ 3	1	1	± 2.7 %	± 2.7 %	∞
System detection limits	± 1.0 %	Rectangular	√ 3	1	1	± 0.6 %	± 0.6 %	∞
Readout electronics	± 0.3 %	Normal	1	1	1	± 0.3 %	± 0.3 %	∞
Response time	± 0.0 %	Rectangular	√ 3	1	1	± 0.0 %	± 0.0 %	∞
Integration time	± 0.0 %	Rectangular	√ 3	1	1	± 0.0 %	± 0.0 %	∞
RF ambient conditions	± 3.0 %	Rectangular	√ 3	1	1	± 1.7 %	± 1.7 %	∞
Probe positioner	± 0.8 %	Rectangular	√ 3	1	1	± 0.5 %	± 0.5 %	∞
Probe positioning	± 6.7 %	Rectangular	√ 3	1	1	± 3.9 %	± 3.9 %	∞
Max. SAR evaluation	± 1.0 %	Rectangular	√ 3	1	1	± 0.6 %	± 0.6 %	∞
Test Sample Related								
Dev. of experimental dipole	± 0.0 %	Rectangular	√ 3	1	1	± 0.0 %	± 0.0 %	∞
Source to liquid distance	± 2.0 %	Rectangular	√ 3	1	1	± 1.2 %	± 1.2 %	∞
Power drift	± 3.4 %	Rectangular	√ 3	1	1	± 2.0 %	± 2.0 %	∞
Phantom and Set-up								
Phantom uncertainty	± 4.0 %	Rectangular	√ 3	1	1	± 2.3 %	± 2.3 %	∞
SAR correction	± 1.9 %	Rectangular	√ 3	1	0.84	± 1.1 %	± 0.9 %	∞
Liquid conductivity (meas.)	± 5.0 %	Normal	1	0.78	0.71	± 3.9 %	± 3.6 %	∞
Liquid permittivity (meas.)	± 5.0 %	Normal	1	0.26	0.26	± 1.3 %	± 1.3 %	∞
Temp. unc. - Conductivity	± 1.7 %	Rectangular	√ 3	0.78	0.71	± 0.8 %	± 0.7 %	∞
Temp. unc. - Permittivity	± 0.3 %	Rectangular	√ 3	0.23	0.26	± 0.0 %	± 0.0 %	∞
Combined Uncertainty						± 10.1 %	± 10.0 %	330
Expanded Std. Uncertainty						± 20.2 %	± 19.9 %	

Table 10: Measurement uncertainties of the System Check with DASY5 (3-6GHz)

Note: Worst case probe calibration uncertainty has been applied for all probes used during the measurements.

6.1.14 System check

The system check is performed for verifying the accuracy of the complete measurement system and performance of the software. The system check is performed with tissue equivalent material according to IEEE 1528. The following table shows system check results for all frequency bands and tissue liquids used during the tests (plot(s) see annex A).

System performance check (1000 mW)								
System validation Kit	Frequency	Target SAR _{1g} (+/- 10%)	Target SAR _{10g} (+/- 10%)	Measured SAR _{1g} mW/g	SAR _{1g} dev. %	Measured SAR _{10g} mW/g	SAR _{10g} dev. %	Measured date
D900V2 S/N: 102	900 MHz body	11.2	7.2	11.2	0.0%	7.28	0.6%	2013-03-16
D900V2 S/N: 102	900 MHz body	11.2	7.2	10.9	-2.7%	7.08	-2.2%	2013-03-18
D900V2 S/N: 102	900 MHz body	11.2	7.2	10.8	-3.6%	7.05	-2.6%	2013-05-02
D1900V2 S/N:	1900 MHz body	40.9	21.5	41.5	1.5%	22.40	4.2%	2013-03-11
D2450V2 S/N: 710	2450 MHz body	51.2	23.9	52.9	3.3%	23.30	-2.5%	2013-03-22
D2600V2 S/N: 1040	2600 MHz body	56.6	25.4	55.5	-1.9%	24.30	-4.3%	2013-03-27
D2600V2 S/N: 1040	2600 MHz body	56.6	25.4	55.3	-2.3%	24.00	-5.5%	2013-03-28
D2600V2 S/N: 1040	2600 MHz body	56.6	25.4	56.2	-0.7%	24.60	-3.1%	2013-05-03
D5GHzV2 S/N: 1055	5200 MHz body	73.4	20.7	72.1	-1.8%	20.30	-1.9%	2013-03-21
D5GHzV2 S/N: 1055	5500 MHz body	78.4	21.7	73.0	-6.9%	20.50	-5.5%	2013-03-21
D5GHzV2 S/N: 1055	5800 MHz body	74.0	20.4	71.1	-3.9%	19.90	-2.5%	2013-03-21

Table 11: Results system check

6.1.15 System check procedure

The system check is performed by using a validation dipole which is positioned parallel to the planar part of the SAM phantom at the reference point. The distance of the dipole to the SAM phantom is determined by a plexiglass spacer. The dipole is connected to the signal source consisting of signal generator and amplifier via a directional coupler, N-connector cable and adaption to SMA. It is fed with a power of 1000 mW for frequencies below 2 GHz or 100 mW for frequencies above 2 GHz. To adjust this power a power meter is used. The power sensor is connected to the cable before the system check to measure the power at this point and do adjustments at the signal generator. At the outputs of the directional coupler both return loss as well as forward power are controlled during the validation to make sure that emitted power at the dipole is kept constant. This can also be checked by the power drift measurement after the test (result on plot). System check results have to be equal or near the values determined during dipole calibration (target SAR in table above) with the relevant liquids and test system.

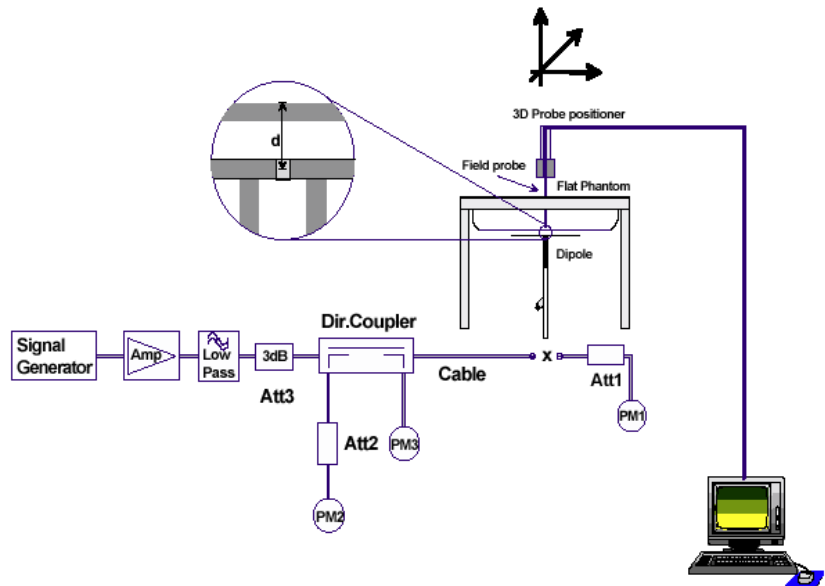

7 Detailed Test Results

7.1 G Sensor controlled power back off

7.1.1 Description

The implemented acceleration sensor (G Sensor) in the device is used to determine how the relative position of the device towards the ground is. Through the triaxial coordinate values from the sensor the device is able to align the screen depending on the direction the device is held, for example switching between portrait and landscape modes.

An accelerometer in earth's gravitational shows $1G(=9.8m/s^2)$ acceleration towards center of the Earth. The direction towards the center of the Earth is known as downward.

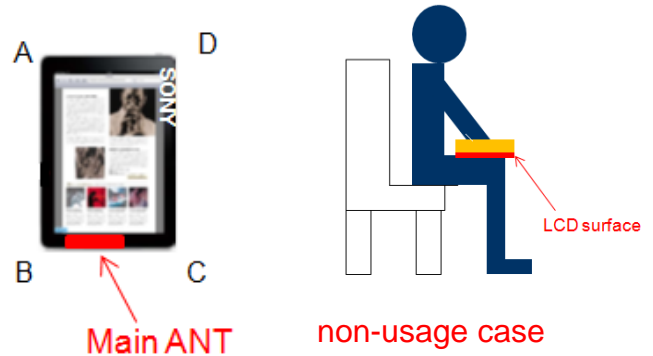

The acceleration sensor is used to trigger the power back off to meet SAR regulation.

The power back off is activated almost all the time. Only the non-usage case that the display is facing the ground will deactivate the power back off. If the device is tilted more than 5° degrees from the horizontal direction the power back off will be activated. The following picture describes the detection of the acceleration sensor for the power back off.

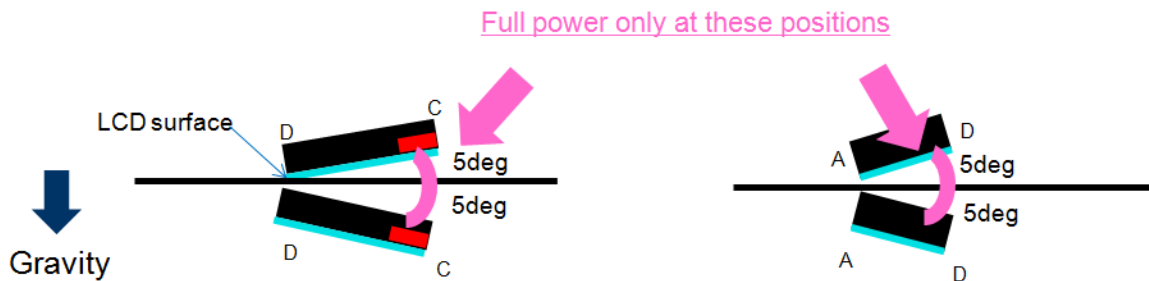

7.1.2 Verification

The functionality of the sensor and back off system were verified during the conducted measurements. The DUT was positioned face down on a holder which was tilted from 0° to 5° degrees while the RF Power was monitored. All possible directions were checked. Once the tilt level arrived 5° degrees regardless of the direction the back off function was activated and the Tx power was reduced. All positions above 5° degrees as well as all positions with the display turned upwards resulted with the same constant power reduction.

The picture shows the setup for the verification.

Device cradle for conducted measurements
 DASY device holder for notebooks
 Inclinometer with 0.1° resolution

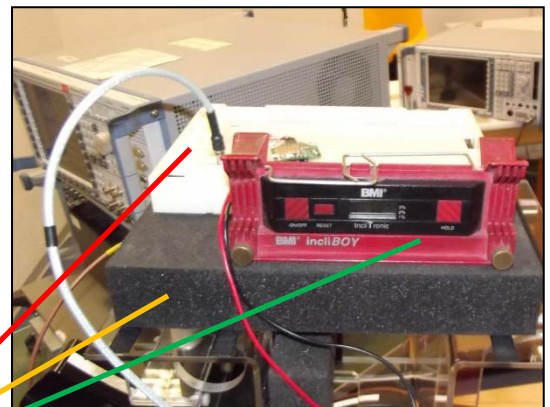

7.2 Conducted power measurements

For the measurements a Rohde & Schwarz Radio Communication Tester CMU 200 was used. The output power was measured using an integrated RF connector and attached RF cable. The conducted output power was also checked before and after each SAR measurement. The resulting power values were within a 0.2 dB tolerance of the values shown below.

Note: CMU200 measures GSM peak and average output power for active timeslots.

For SAR the time based average power is relevant. The difference in-between depends on the duty cycle of the TDMA signal:

No. of timeslots	1	2	3	4
Duty Cycle	1 : 8	1 : 4	1 : 2.66	1 : 2
time based avg. power compared to slotted avg. power	- 9 dB	- 6 dB	- 4.25 dB	- 3 dB

The signalling modes differ as follows :

mode	coding scheme	modulation
GPRS	CS1 to CS4	GMSK
EGPRS (EDGE)	MCS1 to MCS4	GMSK
EGPRS (EDGE)	MCS5 to MCS9	8PSK

Apart from modulation change (GMSK/8PSK) coding schemes differ in code rate without influence on the RF signal. Therefore one coding scheme per mode was selected for conducted power measurements.

7.2.1 Conducted power measurements GSM 850 MHz

Channel / frequency	modulation	timeslots	slotted avg. Power (dBm)			calculated time based avg. Power (dBm)	
			full	back off	diff.	full	back off
128 / 824.2 MHz	GMSK	1	33.0	29.0	4.0	24.0	20.0
190 / 836.6 MHz	GMSK	1	32.8	28.8	4.0	23.8	19.8
251 / 848.0 MHz	GMSK	1	32.9	28.9	4.0	23.9	19.9
128 / 824.2 MHz	GMSK	2	30.7	26.2	4.5	24.7	20.2
190 / 836.6 MHz	GMSK	2	30.4	26.2	4.2	24.4	20.2
251 / 848.0 MHz	GMSK	2	30.5	25.9	4.6	24.5	19.9
128 / 824.2 MHz	GMSK	3	28.5	24.7	3.8	24.25	20.45
190 / 836.6 MHz	GMSK	3	28.2	24.4	3.8	23.95	20.15
251 / 848.0 MHz	GMSK	3	28.3	24.4	3.9	24.05	20.15
128 / 824.2 MHz	GMSK	4	27.6	23.6	4.0	24.6	20.6
190 / 836.6 MHz	GMSK	4	27.3	23.3	4.0	24.3	20.3
251 / 848.0 MHz	GMSK	4	27.4	23.3	4.1	24.4	20.3
128 / 824.2 MHz	8PSK	1	27.0	27.1	-0.1	18.0	18.1
190 / 836.6 MHz	8PSK	1	26.8	27.0	-0.2	17.8	18.0
251 / 848.0 MHz	8PSK	1	26.8	27.0	-0.2	17.8	18.0
128 / 824.2 MHz	8PSK	2	25.1	25.1	0.0	19.1	19.1
190 / 836.6 MHz	8PSK	2	25.0	25.0	0.0	19.0	19.0
251 / 848.0 MHz	8PSK	2	25.0	25.0	0.0	19.0	19.0
128 / 824.2 MHz	8PSK	3	24.4	24.3	0.1	20.15	20.05
190 / 836.6 MHz	8PSK	3	24.2	24.3	-0.1	19.95	20.05
251 / 848.0 MHz	8PSK	3	24.2	24.2	0.0	19.95	19.95
128 / 824.2 MHz	8PSK	4	22.3	22.4	-0.1	19.3	19.4
190 / 836.6 MHz	8PSK	4	22.2	22.2	0.0	19.2	19.2
251 / 848.0 MHz	8PSK	4	22.2	22.3	-0.1	19.2	19.3

Table 12: Test results conducted power measurement GSM 850 MHz

7.2.2 Conducted power measurements GSM 1900 MHz

Channel / frequency	modulation	timeslots	slotted avg. Power (dBm)			calculated time based avg. Power (dBm)	
			full	back off	diff.	full	back off
512 / 1850.2 MHz	GMSK	1	30.1	26.6	3.5	21.1	17.6
661 / 1880.0 MHz	GMSK	1	30.1	26.5	3.6	21.1	17.5
810 / 1909.8 MHz	GMSK	1	30.0	26.6	3.4	21.0	17.6
512 / 1850.2 MHz	GMSK	2	27.2	23.6	3.6	21.2	17.6
661 / 1880.0 MHz	GMSK	2	27.2	23.7	3.5	21.2	17.7
810 / 1909.8 MHz	GMSK	2	27.2	23.6	3.6	21.2	17.6
512 / 1850.2 MHz	GMSK	3	26.2	21.9	4.3	21.95	17.65
661 / 1880.0 MHz	GMSK	3	26.4	22.0	4.4	22.15	17.75
810 / 1909.8 MHz	GMSK	3	26.3	21.9	4.4	22.05	17.65
512 / 1850.2 MHz	GMSK	4	25.2	20.8	4.4	22.2	17.8
661 / 1880.0 MHz	GMSK	4	25.3	20.8	4.5	22.3	17.8
810 / 1909.8 MHz	GMSK	4	25.2	20.7	4.5	22.2	17.7
512 / 1850.2 MHz	8PSK	1	26.2	26.1	0.1	17.2	17.1
661 / 1880.0 MHz	8PSK	1	26.3	26.2	0.1	17.3	17.2
810 / 1909.8 MHz	8PSK	1	26.2	26.2	0.0	17.2	17.2
512 / 1850.2 MHz	8PSK	2	24.3	23.7	0.6	18.3	17.7
661 / 1880.0 MHz	8PSK	2	24.3	23.7	0.6	18.3	17.7
810 / 1909.8 MHz	8PSK	2	24.3	23.7	0.6	18.3	17.7
512 / 1850.2 MHz	8PSK	3	23.3	22.1	1.2	19.05	17.85
661 / 1880.0 MHz	8PSK	3	23.3	22.1	1.2	19.05	17.85
810 / 1909.8 MHz	8PSK	3	23.3	22.1	1.2	19.05	17.85
512 / 1850.2 MHz	8PSK	4	22.3	20.9	1.4	19.3	17.9
661 / 1880.0 MHz	8PSK	4	22.2	20.8	1.4	19.2	17.8
810 / 1909.8 MHz	8PSK	4	22.3	20.8	1.5	19.3	17.8

Table 13: Test results conducted power measurement GSM 1900 MHz

7.2.3 Justification of SAR measurements in GSM mode

SAR measurements were performed in the configuration with highest calculated time based averaged output power.

For comparison an additional delta measurement was performed with 1 timeslot in speech mode. In EDGE mode no delta measurement was performed.

7.2.4 Conducted power measurements UMTS FDD V (850 MHz)

Max. RMS output power UMTS 850 MHz (FDD V) / dBm									
mode	Channel / frequency								
	4132 / 826.4 MHz			4182 / 836.4 MHz			4233 / 846.6 MHz		
	full	back off	diff.	full	back off	diff.	full	back off	diff.
RMC 12.2 kbit/s	23.7	18.8	4.9	23.7	18.7	5.0	23.8	18.8	5.0
RMC 64 kbit/s	23.6	18.7	4.9	23.5	18.7	4.8	23.8	18.8	5.0
RMC 144 kbit/s	23.7	18.7	5.0	23.7	18.7	5.0	23.8	18.9	4.9
RMC 384 kbit/s	23.6	18.7	4.9	23.6	18.7	4.9	23.8	18.9	4.9
HSDPA Sub test 1	23.7	18.8	4.9	23.6	18.7	4.9	23.8	18.9	4.9
HSDPA Sub test 2	22.3	17.2	5.1	22.1	17.1	5.0	22.2	17.3	4.9
HSDPA Sub test 3	21.1	15.5	5.6	20.9	15.5	5.4	21.0	16.2	4.8
HSDPA Sub test 4	20.5	15.7	4.8	20.9	15.7	5.2	20.8	16.0	4.8
DC-HSDPA Sub test 1	23.6	18.8	4.9	23.6	18.8	4.9	23.5	18.8	4.9
DC-HSDPA Sub test 2	23.6	18.8	5.1	23.6	18.7	5.0	23.5	18.8	4.9
DC-HSDPA Sub test 3	23.1	18.7	5.6	23.1	18.7	5.4	23.0	18.8	4.8
DC-HSDPA Sub test 4	23.1	18.7	4.8	23.1	18.7	5.2	23.0	18.8	4.8
HSUPA Sub test 1	23.3	18.4	4.9	23.1	18.3	4.8	23.2	17.6	5.6
HSUPA Sub test 2	22.1	17.1	5.0	22.1	17.0	5.1	22.2	17.2	5.0
HSUPA Sub test 3	22.3	17.7	4.6	22.2	17.4	4.8	22.7	17.6	5.1
HSUPA Sub test 4	22.1	17.2	4.9	22.1	17.2	4.9	22.2	17.4	4.8
HSUPA Sub test 5	23.3	18.5	4.8	23.3	18.4	4.9	23.2	18.5	4.7

Table 14: Test results conducted power measurement UMTS FDD V 850MHz

Remark: None of the HSDPA/HSUPA settings leads to conducted power values exceeding the conducted power in RMC mode by more than 0.25 dB.

7.2.5 Test-set-up information for WCDMA / HSPDA / HSUPA

a) WCDMA RMC

In RMC (reference measurement channel) mode the conducted power at 4 different bit rates was measured. They correspond with the used spreading factors as follows:

Bit rate	12.2 kbit/s	64 kbit/s	144 kbit/s	384 kbit/s
Spreading factor (SF)	64	16	8	4

In RMC mode only DPCCH and DPDCH are active. As bit rate changes do not influence the relative power of any code channel the measured RMS output power remains on the same level which is set to maximum by TPC (Transmit power control) pattern type 'All 1'.

b) HSDPA

HSDPA adds the HS-DPCCH in uplink as a control channel for high speed data transfer in downlink. In HSDPA mode 4 sub-tests are defined by 3GPP 34.121 according to the following table:

Sub-test	β_c	β_d	β_d (SF)	β_c/β_d	$\beta_{hs}^{(1)}$	CM(dB) ⁽²⁾
1	2/15	15/15	64	2/15	4/15	0.0
2	12/15 ⁽³⁾	15/15 ⁽³⁾	64	12/15 ⁽³⁾	24/15	1.0
3	15/15	8/15	64	15/8	30/15	1.5
4	15/15	4/15	64	15/4	30/15	1.5

Note 1: $\Delta_{ACK}, \Delta_{NACK}, \Delta_{CQI} = 8 \iff A_{hs} = \beta_{hs}/\beta_c = 30/15 \iff \beta_{hs} = 30/15 * \beta_c$

Note 2 : CM = 1 for $\beta_c/\beta_d = 12/15$, $\beta_{hs}/\beta_c = 24/15$

Note 3 : For subtest 2 the β_c/β_d ratio of 12/15 for the TFC during the measurement period (TF1, TF0) is achieved by setting the signalled gain factors for the reference TFC (TF1,TF1) to $\beta_c = 11/15$ and $\beta_d = 15/15$

Table 15: Sub-tests for UMTS Release 5 HSDPA

The β_c and β_d gain factors for DPCCH and DPDCH were set according to the values in the above table, β_{hs} for HS-DPCCH is set automatically to the correct value when $\Delta_{ACK}, \Delta_{NACK}, \Delta_{CQI} = 8$. The variation of the β_c/β_d ratio causes a power reduction at sub-tests 2 - 4.

The measurements were performed with a Fixed Reference Channel (FRC) and H-Set 1 QPSK.

Parameter	Value
Nominal average inf. bit rate	534 kbit/s
Inter-TTI Distance	3 TTI's
Number of HARQ Processes	2 Processes
Information Bit Payload	3202 Bits
MAC-d PDU size	336 Bits
Number Code Blocks	1 Block
Binary Channel Bits Per TTI	4800 Bits
Total Available SMLs in UE	19200 SMLs
Number of SMLs per HARQ Process	9600 SMLs
Coding Rate	0.67
Number of Physical Channel Codes	5

Table 16: settings of required H-Set 1 QPSK acc. to 3GPP 34.121

c) DC-HSDPA (3GPP Release 8)

Dual Cell – HSDPA has been signaled using the following settings for connection setup:

Parameter	Value
During Connection Setup	
P-CPICH_Ec/Ior	-10 dB
P-CCPCH	-12
SCH_Ec/Ior	-12
PICH_Ec/Ior	-15
HS-PDSCH	off
HS-SCCH_1	off
DPCH_Ec/Ior	-5
OCNS_Ec/Ior	-3.1

Table 17: Downlink Physical Channels according to 3GPP 34.121 Table E.5.0

The fixed reference channel has been set to H-set 12 according to 3GPP TS 34.121 Table C.8.1.12:

Parameter	Unit	Value
Nominal Average Inf. Bit Rate	kbit/s	60
Inter-TTI Distance	TTI's	1
Information Bit Payload (N_{INF})	Bits	120
Number Code Blocks	Blocks	1
Binary Channel Bits Per TTI	Bits	960
Total Available SML's in UE	SML's	19200
Number of SML's per HARQ Process	SML's	3200
Coding Rate		0.15
Number of Physical Channel Codecs	Codecs	1
Modulation		QPSK
Note 1: The RMC is intended to be used for DC-HSDPA mode and both cells shall transmit with identical parameters as listed in the table. Note 2: Maximum number of transmission is limited to 1, i.e., retransmission is not allowed. The redundancy and constellation version 0 shall be used.		

Table 18: H-Set 12 QPSK configuration

The same Sub-test settings as for Release 5 HSDPA were used for the tests.

d) HSUPA

In HSUPA mode additional code channels (E-DPCCH, E-DPDCHn) are added for data transfer in uplink at higher bit rates.

5 sub-tests are defined by 3GPP 34.121 according to the following table :

Sub-test	β_c	β_d	β_d (SF)	β_c/β_d	$\beta_{hs}^{(1)}$	β_{ec}	β_{ed}	β_{ec} (SF)	β_{ed} (code)	CM ⁽²⁾ (dB)	MPR (dB)	AG ⁽⁴⁾ Index	E-TFCI
1	11/15 ⁽³⁾	15/15 ⁽³⁾	64	11/15 ⁽³⁾	22/15	209/225	1039/225	4	1	1.0	0.0	20	75
2	6/15	15/15	64	6/15	12/15	12/15	94/75	4	1	3.0	2.0	12	67
3	15/15	9/15	64	15/9	30/15	30/15	$\beta_{ed1}:47/15$ $\beta_{ed2}:47/15$	4	2	2.0	1.0	15	92
4	2/15	15/15	64	2/15	4/15	2/15	56/75	4	1	3.0	2.0	17	71
5	15/15 ⁽⁴⁾	15/15 ⁽⁴⁾	64	15/15 ⁽⁴⁾	30/15	24/15	134/15	4	1	1.0	0.0	21	81

Note 1 : $\Delta_{ACK}, \Delta_{NACK}, \Delta_{CQI} = 8 \iff A_{hs} = \beta_{hs}/\beta_c = 30/15 \iff \beta_{hs} = 30/15 * \beta_c$
 Note 2 : CM = 1 for $\beta_c/\beta_d = 12/15, \beta_{hs}/\beta_c = 24/15$. For all other combinations of DPDCH, DPCCH, HS-DPCCH, E-DPDCH and E-DPCCH the MPR is based on the relative CM difference
 Note 3 : For subtest 1 the β_c/β_d ratio of 11/15 for the TFC during the measurement period (TF1, TF0) is achieved by setting the signalled gain factors for the reference TFC (TF1,TF1) to $\beta_c = 10/15$ and $\beta_d = 15/15$
 Note 4 : For subtest 5 the β_c/β_d ratio of 15/15 for the TFC during the measurement period (TF1, TF0) is achieved by setting the signalled gain factors for the reference TFC (TF1,TF1) to $\beta_c = 14/15$ and $\beta_d = 15/15$
 Note 5 : Testing UE using E-DPDCH Physical Layer category 1 Sub-test 3 is not required according to TS 25.306 Table 5.1g
 Note 6 : β_{ed} can not be set directly; it is set by Absolute Grant Value

Table 19: Subtests for UMTS Release 6 HSUPA

To achieve the settings above some additional procedures were defined by 3GPP 34.121. Those have been included in an application note for the CMU200 and were exactly followed :

- Test mode connection (BS signal tab) :
- RMC 12.2 kbit/s + HSPA 34.108 with loop mode 1
- HS-DSCH settings (BS signal tab):
- FRC with H-set 1 QPSK
- ACK-NACK repetition factor = 3
- CQI feedback cycle = 4ms
- CQI repetition factor = 2
- HSUPA-specific signalling settings (UE signal tab) :
- E-TFCI table index = 0
- E-DCH minimum set E-TFCI = 9
- Puncturing limit non-max = 0.84
- max. number of channelisation codes = 2x SF4
- Initial Serving Grant Value = Off
- HSDPA and HSUPA Gain factors (UE signal tab)

Sub-test	β_c	β_d	$\Delta_{ACK}, \Delta_{NACK}, \Delta_{CQI}$	$\Delta E-DPCCH$)*
1	10	15	8	6
2	6	15	8	8
3	15	9	8	8
4	2	15	8	5
5	14	15	8	7

)* : β_{ec} and β_{ed} ratios (relative to β_c and β_d) are set by $\Delta E-DPCCH$

- HSUPA Reference E-TFCIs (UE signal tab > HSUPA gain factors) :

Sub-test	1, 2, 4, 5				
Number of E-TFCIs	5				
Reference E-TFCI	11	67	71	75	81
Reference E-TFCI power offset	4	18	23	26	27

Sub-test	3	
Number of E-TFCIs	2	
Reference E-TFCI	11	92
Reference E-TFCI power offset	4	18

- HSUPA-specific generator parameters (BS Signal tab > HSUPA > E-AGCH > AG Pattern)

Sub-test	Absolute Grant Value (AG Index)
1	20
2	12
3	15
4	17
5	21

- Power Level settings (BS Signal tab > Node B-settings):

- Level reference : Output Channel Power (Ior)
- Output Channel Power (Ior) : -86 dBm

- Downlink Physical Channel Settings (BS signal tab)

- P-CPICH : -10 dB
- S-CPICH : Off
- P-SCH : -15 dB
- S-SCH : -15 dB
- P-CCPCH : -12 dB
- S-CCPCH : -12 dB
- PICH : -15 dB
- AICH : -12 dB
- DPDCH : -10 dB
- HS-SCCH : -8 dB
- HS-PDSCH : -3 dB
- E-AGCH : -20 dB
- E-RGCH/E-HICH - 20 dB
- E-RGCH Active : Off

The settings above were stored once for each sub-test and recalled before the measurement.

HSUPA test procedure :

To reach maximum output power in HSUPA mode the following procedures were followed:

3 different TPC patterns were defined :

Set 1 : Closed loop with target power 10 dBm

Set 2 : Single Pattern+Alternating with binary pattern '11111' for 1 dB steps 'up'

Set 3 : Single Pattern+Alternating with binary pattern '00000' for 1 dB steps 'down'

After recalling a certain HSUPA sub-test the HSUPA E-AGCH graph with E-TFCI event counter is displayed. After starting with the closed loop command the power is increased in 1 dB steps by activating pattern set 2 until the UE decreases the transmitted E-TFCI.

At this point set 3 is activated once to reduce the output power to the value at which the original E-TFCI, which is required for the sub-test, appears again.

For conducted power measurements the same steps are repeated in the power menu to read out the corresponding maximum RMS output power with the target E-TFCI.

For SAR measurements it is useful to switch to Code Domain Power vs. Time display.

Here the CMU200 shows relative power values (max. and min.) of each code channel which should roughly correspond to the numerators of the gain factors e.g. :

Sub-test	β_c	β_d	β_{hs}	β_{ec}	β_{ed}
5	15	15	30	24	134

By this way a surveillance of signalling conditions is possible to make sure that HSUPA code channels are active during the complete SAR measurement.

7.2.6 Conducted power measurements LTE FDD 5 850 MHz

	Channel / frequency	BW	RB Size	RB offset	Modulation	Conducted power / dBm		
						full	back off	diff.
Low Channel	20407 / 824.7MHz	1.4	1	0	QPSK	23.2	19.0	4.2
			1	3	QPSK	23.3	19.1	4.2
			1	5	QPSK	23.2	19.0	4.2
			3	0	QPSK	23.1	18.8	4.3
			3	2	QPSK	23.1	18.9	4.2
			3	3	QPSK	23.1	18.9	4.2
			6	0	QPSK	22.2	18.8	3.4
			1	0	16-QAM	21.6	18.3	3.3
			1	3	16-QAM	21.7	18.3	3.4
			1	5	16-QAM	21.5	18.3	3.2
			3	0	16-QAM	22.4	19.1	3.3
			3	2	16-QAM	22.4	19.1	3.3
			3	3	16-QAM	22.2	19.0	3.2
			6	0	16-QAM	21.2	18.8	2.4
			20415 / 825.5MHz	3	1	0	QPSK	23.1
	1	7			QPSK	23.1	18.9	4.2
	1	14			QPSK	23.1	19.0	4.1
	8	0			QPSK	22.0	18.8	3.2
	8	4			QPSK	22.1	18.9	3.2
	8	8			QPSK	22.1	18.9	3.2
	15	0			QPSK	22.2	18.9	3.3
	1	0			16-QAM	21.5	18.2	3.3
	1	7			16-QAM	21.5	18.2	3.3
	1	14			16-QAM	21.6	18.4	3.2
	8	0			16-QAM	21.2	19.0	2.2
	8	4			16-QAM	21.2	18.9	2.3
	8	8			16-QAM	21.3	19.0	2.3
	15	0			16-QAM	21.1	18.9	2.2
	20425 / 826.5MHz	5			1	0	QPSK	23.3
			1	12	QPSK	23.3	19.1	4.2
			1	24	QPSK	23.3	19.1	4.2
			12	0	QPSK	22.2	18.8	3.4
			12	6	QPSK	22.2	18.9	3.3
			12	12	QPSK	22.2	18.9	3.3
			25	0	QPSK	22.1	18.9	3.2
			1	0	16-QAM	21.8	18.6	3.2
			1	12	16-QAM	21.9	18.6	3.3
			1	24	16-QAM	21.9	18.6	3.3
			12	0	16-QAM	21.1	18.8	2.3
			12	6	16-QAM	21.1	18.8	2.3
			12	12	16-QAM	21.0	18.7	2.3
			25	0	16-QAM	21.2	18.8	2.4
			20450 / 829MHz	10	1	0	QPSK	23.3
	1	25			QPSK	23.4	19.2	4.2
	1	49			QPSK	23.4	19.2	4.2
25	0	QPSK			22.1	19.0	3.1	
25	12	QPSK			22.2	19.0	3.2	
25	25	QPSK			22.2	19.1	3.1	
50	0	QPSK			22.1	18.9	3.2	
1	0	16-QAM			22.0	18.7	3.3	
1	25	16-QAM			22.0	18.7	3.3	
1	49	16-QAM			22.0	18.7	3.3	
25	0	16-QAM			21.2	19.0	2.2	
25	12	16-QAM			21.2	19.0	2.2	
25	25	16-QAM			21.0	18.9	2.1	
50	0	16-QAM			21.1	18.9	2.2	

	Channel / frequency	BW	RB Size	RB offset	Modulation	Conducted power / dBm		
						full	back off	diff.
Middle Channel	20525 / 836.5MHz	1.4	1	0	QPSK	23.1	18.9	4.2
			1	3	QPSK	23.1	18.9	4.2
			1	5	QPSK	23.2	19.0	4.2
			3	0	QPSK	23.1	18.9	4.2
			3	2	QPSK	23.2	18.9	4.3
			3	3	QPSK	23.2	18.9	4.3
			6	0	QPSK	22.2	19.0	3.2
			1	0	16-QAM	22.2	18.9	3.3
			1	3	16-QAM	22.3	19.0	3.3
			1	5	16-QAM	22.2	19.0	3.2
			3	0	16-QAM	22.1	18.9	3.2
			3	2	16-QAM	22.2	18.9	3.3
		3	3	16-QAM	22.2	18.9	3.3	
		6	0	16-QAM	21.1	18.8	2.3	
		3	1	0	QPSK	23.3	19.1	4.2
			1	7	QPSK	23.2	19.0	4.2
			1	14	QPSK	23.1	18.9	4.2
			8	0	QPSK	22.2	18.8	3.4
			8	4	QPSK	22.3	18.9	3.4
			8	8	QPSK	22.3	19.0	3.3
			15	0	QPSK	22.1	18.9	3.2
			1	0	16-QAM	21.8	18.6	3.2
			1	7	16-QAM	21.8	18.6	3.2
			1	14	16-QAM	21.7	18.4	3.3
			8	0	16-QAM	21.2	19.1	2.1
			8	4	16-QAM	21.2	19.1	2.1
		8	8	16-QAM	21.2	19.0	2.2	
		15	0	16-QAM	21.3	19.0	2.3	
		5	1	0	QPSK	23.3	19.1	4.2
			1	12	QPSK	23.2	19.0	4.2
			1	24	QPSK	23.1	18.9	4.2
			12	0	QPSK	22.2	19.0	3.2
			12	6	QPSK	22.3	19.0	3.3
			12	12	QPSK	22.3	19.0	3.3
			25	0	QPSK	22.0	18.9	3.1
			1	0	16-QAM	21.8	18.5	3.3
			1	12	16-QAM	21.7	18.4	3.3
			1	24	16-QAM	21.5	18.3	3.2
			12	0	16-QAM	21.3	19.0	2.3
			12	6	16-QAM	21.3	19.0	2.3
		12	12	16-QAM	21.3	19.0	2.3	
		25	0	16-QAM	21.0	18.8	2.2	
		10	1	0	QPSK	23.1	19.0	4.1
			1	25	QPSK	23.1	18.9	4.2
			1	49	QPSK	23.1	18.9	4.2
			25	0	QPSK	22.0	18.9	3.1
			25	12	QPSK	22.1	18.9	3.2
			25	25	QPSK	22.1	18.7	3.4
			50	0	QPSK	22.0	18.9	3.1
			1	0	16-QAM	21.6	18.4	3.2
1	25		16-QAM	21.5	18.3	3.2		
1	49		16-QAM	21.5	18.3	3.2		
25	0		16-QAM	21.1	18.9	2.2		
25	12		16-QAM	21.1	18.9	2.2		
25	25	16-QAM	21.1	18.9	2.2			
50	0	16-QAM	21.0	18.8	2.2			

	Channel / frequency	BW	RB Size	RB offset	Modulation	Conducted power / dBm		
						full	back off	diff.
High Channel	20643 / 848.3MHz	1.4	1	0	QPSK	23.1	18.9	4.2
			1	3	QPSK	23.1	18.8	4.3
			1	5	QPSK	23.0	18.8	4.2
			3	0	QPSK	23.2	19.1	4.1
			3	2	QPSK	23.2	19.0	4.2
			3	3	QPSK	23.2	19.0	4.2
			6	0	QPSK	22.2	18.9	3.3
			1	0	16-QAM	22.2	18.9	3.3
			1	3	16-QAM	22.2	18.9	3.3
			1	5	16-QAM	22.1	18.8	3.3
			3	0	16-QAM	22.3	19.0	3.3
			3	2	16-QAM	22.4	19.1	3.3
	3	3	16-QAM	22.3	19.1	3.2		
	6	0	16-QAM	21.2	19.0	2.2		
	1	0	QPSK	23.3	19.1	4.2		
	1	7	QPSK	23.4	19.1	4.3		
	1	14	QPSK	23.2	19.0	4.2		
	8	0	QPSK	22.3	19.0	3.3		
	8	4	QPSK	22.3	19.0	3.3		
	8	8	QPSK	22.3	19.0	3.3		
	15	0	QPSK	22.3	19.0	3.3		
	1	0	16-QAM	22.0	18.8	3.2		
	1	7	16-QAM	22.0	18.8	3.2		
	1	14	16-QAM	21.9	18.6	3.3		
	8	0	16-QAM	21.3	19.1	2.2		
	8	4	16-QAM	21.5	19.2	2.3		
	8	8	16-QAM	21.4	19.1	2.3		
	15	0	16-QAM	21.2	19.0	2.2		
	1	0	QPSK	23.4	19.2	4.2		
	1	12	QPSK	23.3	19.1	4.2		
	1	24	QPSK	23.1	19.0	4.1		
	12	0	QPSK	22.3	19.0	3.3		
	12	6	QPSK	22.3	19.0	3.3		
	12	12	QPSK	22.2	19.0	3.2		
	25	0	QPSK	22.1	19.0	3.1		
	1	0	16-QAM	21.9	18.7	3.2		
	1	12	16-QAM	21.9	18.7	3.2		
	1	24	16-QAM	21.7	18.5	3.2		
	12	0	16-QAM	21.2	19.0	2.2		
	12	6	16-QAM	21.2	19.0	2.2		
	12	12	16-QAM	21.1	19.0	2.1		
	25	0	16-QAM	21.1	18.9	2.2		
	1	0	QPSK	23.2	19.1	4.1		
	1	25	QPSK	23.4	19.2	4.2		
	1	49	QPSK	23.3	19.1	4.2		
25	0	QPSK	22.1	18.9	3.2			
25	12	QPSK	22.2	19.0	3.2			
25	25	QPSK	22.1	18.9	3.2			
50	0	QPSK	22.1	18.9	3.2			
1	0	16-QAM	21.8	18.6	3.2			
1	25	16-QAM	22.0	18.8	3.2			
1	49	16-QAM	21.8	18.6	3.2			
25	0	16-QAM	21.0	18.9	2.1			
25	12	16-QAM	21.0	18.9	2.1			
25	25	16-QAM	21.0	18.9	2.1			
50	0	16-QAM	20.9	18.7	2.2			

Table 20: Test results conducted power measurement LTE FDD 5 850 MHz

7.2.7 Conducted power measurements LTE FDD 7 2600 MHz

	Channel / frequency	BW	RB Size	RB offset	Modulation	Conducted power / dBm		
						full	back off	diff.
Low Channel	20775 / 2502.5MHz	5	1	0	QPSK	22.4	10.2	12.2
			1	12	QPSK	22.6	10.5	12.1
			1	24	QPSK	22.6	10.2	12.4
			12	0	QPSK	21.3	9.9	11.4
			12	6	QPSK	21.4	10.1	11.3
			12	12	QPSK	21.5	10.3	11.2
			25	0	QPSK	21.3	10.3	11.0
			1	0	16-QAM	20.2	9.7	10.5
			1	12	16-QAM	20.3	9.8	10.5
			1	24	16-QAM	20.3	9.8	10.5
			12	0	16-QAM	20.3	9.8	10.5
			12	6	16-QAM	20.4	9.9	10.5
			12	12	16-QAM	20.4	9.8	10.6
			25	0	16-QAM	20.3	9.6	10.7
	20800 / 2505MHz	10	1	0	QPSK	22.4	9.0	13.4
			1	25	QPSK	22.4	10.0	12.4
			1	49	QPSK	22.1	9.9	12.2
			25	0	QPSK	21.3	9.9	11.4
			25	12	QPSK	21.2	10.1	11.1
			25	25	QPSK	21.0	10.3	10.7
			50	0	QPSK	21.2	9.8	11.4
			1	0	16-QAM	21.2	9.5	11.7
			1	25	16-QAM	21.2	9.7	11.5
			1	49	16-QAM	20.4	9.8	10.6
			25	0	16-QAM	20.3	9.9	10.4
			25	12	16-QAM	20.2	9.8	10.4
			25	25	16-QAM	20.2	9.9	10.3
			50	0	16-QAM	20.2	9.8	10.4
	20825 / 2507.5MHz	15	1	0	QPSK	22.5	10.1	12.4
			1	37	QPSK	22.3	9.9	12.4
			1	74	QPSK	22.3	10.1	12.2
			36	0	QPSK	21.2	9.8	11.4
			36	20	QPSK	20.8	10.1	10.7
			36	36	QPSK	20.9	10.3	10.6
			75	0	QPSK	21.0	9.6	11.4
			1	0	16-QAM	21.3	9.7	11.6
			1	37	16-QAM	21.1	9.5	11.6
			1	74	16-QAM	21.1	9.7	11.4
			36	0	16-QAM	21.0	9.7	11.3
			36	20	16-QAM	21.0	9.6	11.4
			36	36	16-QAM	20.9	9.6	11.3
			75	0	16-QAM	21.0	9.8	11.2
	20850 / 2510MHz	20	1	0	QPSK	22.4	9.9	12.5
			1	49	QPSK	22.1	9.7	12.4
			1	99	QPSK	22.0	9.7	12.3
			50	0	QPSK	21.1	9.7	11.4
			50	25	QPSK	21.0	9.7	11.3
			50	50	QPSK	20.9	10.0	10.9
100			0	QPSK	21.1	9.9	11.2	
1			0	16-QAM	21.7	10.0	11.7	
1			49	16-QAM	21.5	10.1	11.4	
1			99	16-QAM	21.4	9.8	11.6	
50			0	16-QAM	20.3	10.0	10.3	
50			25	16-QAM	20.2	9.8	10.4	
50			50	16-QAM	20.2	9.9	10.3	
100			0	16-QAM	20.1	9.9	10.2	

	Channel / frequency	BW	RB Size	RB offset	Modulation	Conducted power / dBm		
						full	back off	diff.
Middle Channel	21100 / 2535.0MHz	5	1	0	QPSK	22.3	10.1	12.2
			1	12	QPSK	22.3	10.2	12.1
			1	24	QPSK	22.3	9.8	12.5
			12	0	QPSK	21.3	10.3	11.0
			12	6	QPSK	21.2	10.2	11.0
			12	12	QPSK	21.1	10.1	11.0
			25	0	QPSK	21.2	10.4	10.8
			1	0	16-QAM	21.1	10.3	10.8
			1	12	16-QAM	21.0	9.7	11.3
			1	24	16-QAM	21.0	9.4	11.6
			12	0	16-QAM	20.0	10.2	9.8
			12	6	16-QAM	20.0	10.1	9.9
		12	12	16-QAM	20.0	10.2	9.8	
		25	0	16-QAM	20.1	10.2	9.9	
		1	0	QPSK	22.4	9.9	12.5	
		1	25	QPSK	22.3	10.0	12.3	
		1	49	QPSK	22.3	10.5	11.8	
		25	0	QPSK	21.2	10.4	10.8	
		25	12	QPSK	21.0	10.2	10.8	
		25	25	QPSK	21.0	10.2	10.8	
		50	0	QPSK	21.2	10.4	10.8	
		1	0	16-QAM	21.0	10.2	10.8	
		1	25	16-QAM	21.0	9.9	11.1	
		1	49	16-QAM	21.0	10.6	10.4	
		25	0	16-QAM	21.0	10.1	10.9	
		25	12	16-QAM	20.9	10.2	10.7	
		25	25	16-QAM	21.0	10.1	10.9	
		50	0	16-QAM	20.2	10.2	10.0	
		1	0	QPSK	22.3	10.3	12.0	
		1	37	QPSK	22.3	10.2	12.1	
		1	74	QPSK	22.5	9.9	12.6	
		36	0	QPSK	21.2	10.5	10.7	
		36	20	QPSK	21.1	10.2	10.9	
		36	36	QPSK	21.1	10.1	11.0	
		75	0	QPSK	21.1	10.3	10.8	
		1	0	16-QAM	21.2	9.8	11.4	
		1	37	16-QAM	21.1	9.9	11.2	
		1	74	16-QAM	21.0	9.6	11.4	
		36	0	16-QAM	20.5	10.6	9.9	
		36	20	16-QAM	20.4	10.6	9.8	
		36	36	16-QAM	20.5	10.6	9.9	
		75	0	16-QAM	20.3	10.5	9.8	
		1	0	QPSK	22.3	10.6	11.7	
		1	49	QPSK	22.3	10.2	12.1	
		1	99	QPSK	22.6	10.4	12.2	
		50	0	QPSK	21.2	10.5	10.7	
		50	25	QPSK	21.1	9.9	11.2	
		50	50	QPSK	21.1	9.8	11.3	
		100	0	QPSK	21.2	10.6	10.6	
		1	0	16-QAM	21.4	10.6	10.8	
1	49	16-QAM	21.3	10.0	11.3			
1	99	16-QAM	21.8	10.4	11.4			
50	0	16-QAM	20.4	10.2	10.2			
50	25	16-QAM	20.3	10.2	10.1			
50	50	16-QAM	20.4	10.2	10.2			
100	0	16-QAM	20.2	10.2	10.0			

	Channel / frequency	BW	RB Size	RB offset	Modulation	Conducted power / dBm		
						full	back off	diff.
High Channel	21425 / 2567.5MHz	5	1	0	QPSK	22.7	9.8	12.9
			1	12	QPSK	22.7	10.2	12.5
			1	24	QPSK	22.9	10.5	12.4
			12	0	QPSK	21.5	10.5	11.0
			12	6	QPSK	21.5	10.5	11.0
			12	12	QPSK	21.7	10.5	11.2
			25	0	QPSK	21.6	10.4	11.2
			1	0	16-QAM	21.4	9.7	11.7
			1	12	16-QAM	21.5	9.8	11.7
			1	24	16-QAM	21.6	9.7	11.9
			12	0	16-QAM	21.6	10.1	11.5
			12	6	16-QAM	21.6	10.1	11.5
			12	12	16-QAM	21.5	10.1	11.4
			25	0	16-QAM	20.5	10.1	10.4
			21400 / 2565MHz	10	1	0	QPSK	22.5
	1	25	QPSK		22.5	10.2	12.3	
	1	49	QPSK		22.7	10.5	12.2	
	25	0	QPSK		21.5	10.3	11.2	
	25	12	QPSK		21.5	10.5	11.0	
	25	25	QPSK		21.4	10.5	10.9	
	50	0	QPSK		21.3	10.4	10.9	
	1	0	16-QAM		21.2	9.8	11.4	
	1	25	16-QAM		21.2	9.5	11.7	
	1	49	16-QAM		21.3	10.1	11.2	
	25	0	16-QAM		20.6	10.4	10.2	
	25	12	16-QAM		20.6	10.3	10.3	
	25	25	16-QAM		20.5	10.2	10.3	
	50	0	16-QAM		20.4	10.2	10.2	
	21375 / 2562.5MHz	15	1		0	QPSK	22.3	9.6
	1		37	QPSK	22.7	9.8	12.9	
	1		74	QPSK	22.8	9.9	12.9	
	36		0	QPSK	21.2	9.8	11.4	
	36		20	QPSK	21.3	10.5	10.8	
	36		36	QPSK	21.4	10.4	11.0	
	75		0	QPSK	21.3	10.2	11.1	
	1		0	16-QAM	21.1	9.6	11.5	
	1		37	16-QAM	21.5	9.8	11.7	
	1		74	16-QAM	21.5	10.0	11.5	
	36		0	16-QAM	21.3	9.9	11.4	
	36		20	16-QAM	21.2	9.8	11.4	
	36		36	16-QAM	21.2	9.9	11.3	
	75		0	16-QAM	20.3	9.8	10.5	
	21350 / 2560MHz		20	1	0	QPSK	22.4	9.8
	1	49		QPSK	22.4	10.0	12.4	
	1	99		QPSK	22.7	10.6	12.1	
50	0	QPSK		21.1	9.8	11.3		
50	25	QPSK		21.3	10.5	10.8		
50	50	QPSK		21.4	10.6	10.8		
100	0	QPSK		21.2	10.1	11.1		
1	0	16-QAM		21.5	9.8	11.7		
1	49	16-QAM		21.6	9.8	11.8		
1	99	16-QAM		21.8	10.4	11.4		
50	0	16-QAM		20.7	10.2	10.5		
50	25	16-QAM		20.8	10.4	10.4		
50	50	16-QAM		20.7	10.3	10.4		
100	0	16-QAM		20.4	9.8	10.6		

Table 21: Test results conducted power measurement LTE FDD 7 2600 MHz

7.2.8 Justification of SAR measurements in LTE mode

According to Chapter 5 'SAR test procedures for LTE devices of FCC KDB Publication 941225 D05 the following test configurations for standalone measurements of the largest channel bandwidth (chapter 5.2) had to be taken into consideration:

5.2.1. QPSK with 1 RB allocation

Start with the largest channel bandwidth and measure SAR for QPSK with 1 RB allocation, using the RB offset and *required test channel* combination with the highest maximum output power for RB offsets at the upper edge, middle and lower edge of each *required test channel*. When the *reported SAR* is ≤ 0.8 W/kg, testing of the remaining RB offset configurations and *required test channels* is not required for 1 RB allocation; otherwise, SAR is required for the remaining *required test channels* and only for the RB offset configuration with the highest output power for that channel.6 When the *reported SAR* of a *required test channel* is > 1.45 W/kg, SAR is required for all three RB offset configurations for that *required test channel*.

5.2.2. QPSK with 50% RB allocation

The procedures required for 1 RB allocation in 5.2.1 are applied to measure the SAR for QPSK with 50% RB allocation.

5.2.3. QPSK with 100% RB allocation

For QPSK with 100% RB allocation, SAR is not required when the highest maximum output power for 100 % RB allocation is less than the highest maximum output power in 50% and 1 RB allocations and the highest *reported SAR* for 1 RB and 50% RB allocation in 5.2.1 and 5.2.2 are ≤ 0.8 W/kg. Otherwise, SAR is measured for the highest output power channel and if the *reported SAR* is > 1.45 W/kg, the remaining *required test channels* must also be tested.

5.2.4. Higher order modulations

For each modulation besides QPSK; e.g., 16-QAM, 64-QAM, apply the QPSK procedures in sections 5.2.1, 5.2.2 and 5.2.3 to determine the QAM configurations that may need SAR measurement. For each configuration identified as required for testing, SAR is required only when the highest maximum output power for the configuration in the higher order modulation is $> \frac{1}{2}$ dB higher than the same configuration in QPSK or when the *reported SAR* for the QPSK configuration is > 1.45 W/kg.

Testing of other channel bandwidths was not necessary because the output power of equivalent channel configurations was less than $\frac{1}{2}$ dB larger compared to the largest channel bandwidth and reported SAR was < 1.45 W/kg

7.2.9 MPR information in LTE mode

There is a permanently applied MPR implemented by the manufacturer. MPR is enabled for this device according to 3GPP TS36.101.

Modulation	Channel bandwidth / resource block configuration						Target MPR	3 GPP MPR
	1.4 MHz	3 MHz	5 MHz	10 MHz	15 MHz	20 MHz		
QPSK	> 5	> 4	> 8	> 12	> 16	> 18	1	≤ 1
16QAM	≤ 5	≤ 4	≤ 8	≤ 12	≤ 16	≤ 18	1	≤ 1
16QAM	> 5	> 4	> 8	> 12	> 16	> 18	2	≤ 2

Therefore there is no power reduction at 1.4 MHz bandwidth with 50% RB allocation (3 RBs).

Additional differences in conducted power are not caused by implemented MPR but depend on measurement uncertainty and allowable tolerances per 3GPP or tune-up. A-MPR was disabled for all SAR tests.

7.2.10 Conducted power measurements WLAN 2.4 GHz

Channel / frequency	modulation	bit rate	time based avg. power
1 / 2412 MHz	CCK	1 MBit/s	10.9dBm
6 / 2437 MHz	CCK	1 MBit/s	10.5dBm
11 / 2462 MHz	CCK	1 MBit/s	11.0dBm
13 / 2472 MHz	CCK	1 MBit/s	10.9dBm
1 / 2412 MHz	OFDM	6 MBit/s	10.6dBm
6 / 2437 MHz	OFDM	6 MBit/s	10.2dBm
11 / 2462 MHz	OFDM	6 MBit/s	10.4dBm
13 / 2472 MHz	OFDM	6 MBit/s	10.4dBm
1 / 2412 MHz	OFDM	6.5 MBit/s	9.6dBm
6 / 2437 MHz	OFDM	6.5 MBit/s	10.2dBm
11 / 2462 MHz	OFDM	6.5 MBit/s	10.4dBm
13 / 2472 MHz	OFDM	6.5 MBit/s	10.4dBm

Table 22: Test results conducted power measurement WLAN 2.4 GHz

7.2.11 Conducted power measurements WLAN 5 GHz

Conducted time based avg. power measurement WLAN 5 GHz (dBm)					
Channel	Frequency (MHz)	modulation	6 MBit/s	6.5 MBit/s	13.5 MBit/s
36	5180	OFDM	7.8	8.1	8.3
40	5200	OFDM	8.0	7.8	
44	5220	OFDM	8.5	8.0	7.2
48	5240	OFDM	7.9	8.0	
52	5260	OFDM	7.6	7.5	6.6
56	5280	OFDM	7.6	7.6	
60	5300	OFDM	8.3	8.3	8.1
64	5320	OFDM	8.0	8.3	
100	5500	OFDM	7.1	7.4	8.0
104	5520	OFDM	6.8	6.8	
108	5540	OFDM	7.8	7.1	8.0
112	5560	OFDM	8.0	7.4	
116	5580	OFDM	7.5	7.9	8.0
120	5600	OFDM	8.0	8.0	
124	5620	OFDM	8.0	8.0	7.9
128	5640	OFDM	7.6	8.0	
132	5660	OFDM	8.0	7.3	8.0
136	5680	OFDM	8.0	8.0	
140	5700	OFDM	7.0	7.1	---
149	5745	OFDM	10.4	9.8	9.6
153	5765	OFDM	10.9	10.7	
157	5785	OFDM	11.4	9.7	10.6
161	5805	OFDM	11.2	11.2	
165	5825	OFDM	11.0	9.6	---

Table 23: Test results conducted time based avg. power measurement WLAN 5 GHz

7.2.12 Standalone SAR Test Exclusion

Standalone SAR test exclusion considerations					
Communication system	freq. (MHz)	P_{avg}^* (dBm)	P_{avg}^* (mW)	threshold _{1-g} comparison value	SAR test exclusion
GSM 850	835	21.1	128.8	23.5	no
GSM 1900	1880	18.1	64.6	17.7	no
FDD V 850	835	19.0	79.4	14.5	no
LTE FDD 5	835	19.5	89.1	16.3	no
LTE FDD 7	2550	11.0	12.6	4.0	no
WLAN 2450	2450	11.5	14.1	4.4	no
WLAN 5.2 GHz	5200	9.3	8.5	3.9	no
WLAN 5.3 GHz	5300	9.3	8.5	3.9	no
WLAN 5.6 GHz	5600	7.5	5.6	2.7	yes
WLAN 5.8 GHz	5800	9.5	8.9	4.3	no
Bluetooth 2450	2450	9.80	9.5	3.0	yes

Table 24: Standalone SAR test exclusion considerations

The **1-g SAR test exclusion thresholds** for 100 MHz to 6 GHz at *test separation distances* ≤ 50 mm are determined by:

$[(\text{max. power of channel, including tune-up tolerance, mW}) / (\text{min. test separation distance, mm})] \cdot [\sqrt{f(\text{GHz})}] \leq 3.0$ for 1-g SAR, where:

- $f(\text{GHz})$ is the RF channel transmit frequency in GHz
- Power and distance are rounded to the nearest mW and mm before calculation
- The result is rounded to one decimal place for comparison
- When the minimum test separation distance is < 5 mm, a distance of 5 mm is applied to determine SAR test exclusion

* - maximum possible output power declared by manufacturer

7.2.13 Multiple Transmitter Information

The following tables list information which is relevant for the decision if a simultaneous transmit evaluation is necessary according to FCC KDB 447498D01 General RF Exposure Guidance v05.

Minimum antenna separation distance between Main antenna and WLAN – **228.765 mm**

reported SAR WWAN and WLAN 2.4GHz , Σ SAR evaluation, SPLSR_i						
Frequency band	Position	reported SAR /W/kg		Σ SAR	distance	ratio
		WWAN	WLAN	<1.6W/kg	R _i , mm	≤ 0.040
GSM 850	rear	1.101	1.194	2.295	228.8	0.015
GSM 1900	rear	1.020	1.194	2.214	228.8	0.014
WCDMA FDD V	rear	1.002	1.194	2.196	228.8	0.014
LTE FDD 5	rear	1.085	1.194	2.279	228.8	0.015
LTE FDD 7	rear	0.844	1.194	2.038	228.8	0.013

Table 25: SAR_{max} WWAN and **WLAN 2.4GHz**, Σ SAR evaluation, **SPLSR_i**;

reported SAR WWAN and WLAN 5GHz , Σ SAR evaluation, SPLSR_i						
Frequency band	Position	reported SAR /W/kg		Σ SAR	distance	ratio
		WWAN	WLAN	<1.6W/kg	R _i , mm	≤ 0.040
GSM 850	rear	1.101	0.930	2.031	228.8	0.013
GSM 1900	rear	1.020	0.930	1.950	228.8	0.012
WCDMA FDD V	rear	1.002	0.930	1.932	228.8	0.012
LTE FDD 5	rear	1.085	0.930	2.015	228.8	0.013
LTE FDD 7	rear	0.844	0.930	1.774	228.8	0.010

Table 26: SAR_{max} WWAN and **WLAN 5GHz**, Σ SAR evaluation, **SPLSR_i**;

reported SAR WWAN and Bluetooth 2.4GHz , Σ SAR evaluation, SPLSR_i						
Frequency band	Position	reported SAR /W/kg		Σ SAR	distance*	ratio
		WWAN	BT*	<1.6W/kg	R _i , mm	≤ 0.040
GSM 850	rear	1.101	0.399	1.500	228.8	0.008
GSM 1900	rear	1.020	0.399	1.419	228.8	0.007
WCDMA FDD V	rear	1.002	0.399	1.401	228.8	0.007
LTE FDD 5	rear	1.085	0.399	1.484	228.8	0.008
LTE FDD 7	rear	0.844	0.399	1.243	228.8	0.006

Table 27: SAR_{max} WWAN and **Bluetooth 2450MHz**, Σ SAR evaluation, **SPLSR_i**;

BT* - estimated SAR (see the table below)

distance* - the closest physical separation of the antennas – **228.765 mm**

When the sum of SAR is larger than the limit, SAR test exclusion is determined by the SAR to peak location separation ratio. The simultaneous transmitting antennas in each operating mode and exposure condition combination must be considered one pair at a time to determine the SAR to peak location separation ratio to qualify for test exclusion. The **ratio** is determined by $(SAR_1 + SAR_2)^{1.5}/R_i$, rounded to two decimal digits, and must be ≤ 0.04 for all antenna pairs in the configuration to qualify for 1 -g SAR test exclusion. **SAR₁** and **SAR₂** are the highest **reported** SAR for each antenna in the pair, and **R_i** is the separation distance between the peak SAR locations for the antenna pair in mm.

Estimated SAR					
Communication system	freq. (GHz)	distance (mm)	P _{avg} * (dBm)	P _{avg} * (mW)	estimated _{1-g} (W/kg)
Bluetooth 2450 body	2.45	5	9.8	9.5	0.399

Table 28: Calculated SAR_{max} for **Bluetooth 2450MHz** head and body

* - maximum possible output power declared by manufacturer

When standalone SAR test exclusion applies to an antenna that transmits simultaneously with other antennas, the standalone SAR must be estimated according to following to determine simultaneous transmission SAR test exclusion:

$(\text{max. power of channel, including tune-up tolerance, mW}) / (\text{min. test separation distance, mm}) \cdot [\sqrt{f(\text{GHz})} / x]$
W/kg for test separation distances ≤ 50 mm;

where $x = 7.5$ for 1-g SAR.

When the minimum test separation distance is < 5 mm, a distance of 5 mm is applied to determine SAR test exclusion

Conclusion:

$\Sigma\text{SAR} > 1.6$ W/kg, but SAR-to-(peak-locations spacing) **ratio** (**SPLSR_i**) is less than **0.04** therefore simultaneous transmissions SAR with Volume Scans is **not** required.

7.2.14 SAR measurement positions

SAR measurement positions						
mode	front	rear	left edge	right edge	top edge	bottom edge
GSM 850	no	yes	no	yes	yes	no
GSM 1900	no	yes	no	yes	yes	no
WCDMA FDD V 850	no	yes	no	yes	yes	no
LTE FDD 5	no	yes	no	yes	yes	no
LTE FDD 7	no	yes	no	yes	yes	no
WLAN 2450	no	yes	yes	no	no	no
WLAN 5.2GHz	no	yes	yes	no	no	no
WLAN 5.3GHz	no	yes	yes	no	no	no
WLAN 5.6GHz	no	yes	yes	no	no	no
WLAN 2450	no	yes	yes	no	no	no

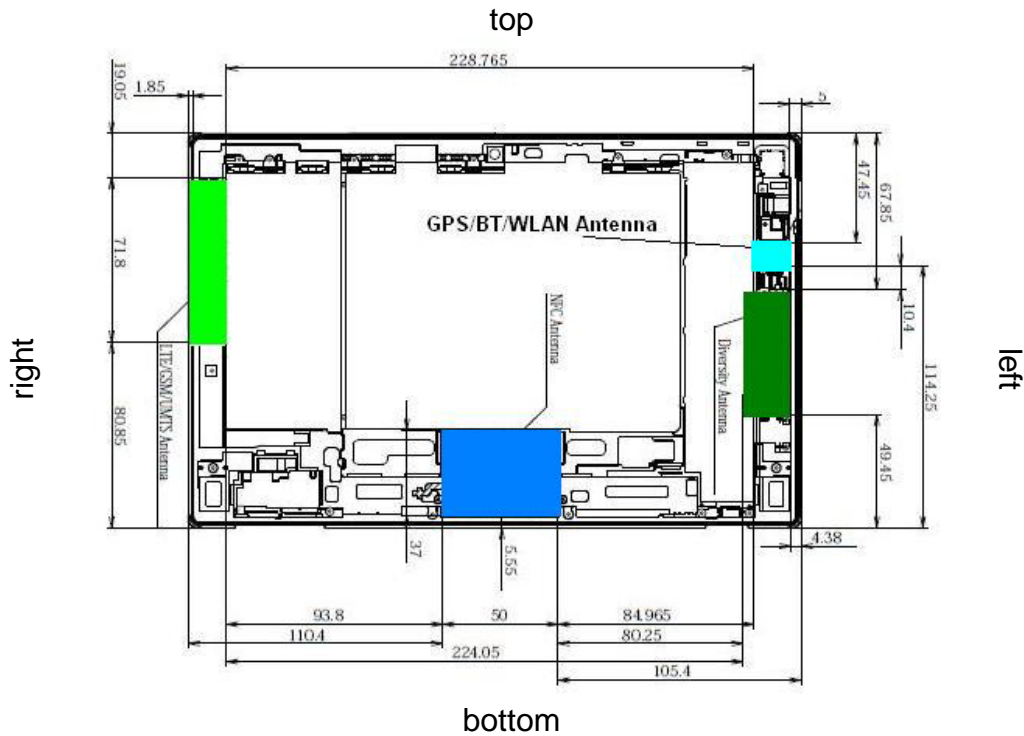

Note:

With 80.85 mm distance of the LTE/GSM/UMTS antenna to the bottom edge and min. 47.45 mm distance of the GPS/WLAN/BT antenna to all adjacent edges SAR test exclusion for adjacent edges is possible according to KDB 447498 D01v05 chapter 4.3.1 2) or Appendix A/B.

Adjacent edge SAR test exclusion considerations						
Communication system	freq. (MHz)	P _{avg} * (dBm)	P _{avg} * (mW)	distance (mm)	exclusion threshold _{1g} (mW)	SAR test exclusion
GSM 850	835	21.1	128.8	19.1	62.5	no
GSM 1900	1880	18.1	64.6	19.1	41.7	no
UMTS FDD V	835	19.0	79.4	19.1	62.7	no
LTE FDD 5	835	19.5	89.1	19.1	62.5	no
LTE FDD 7	2535	11.0	12.6	19.1	35.9	yes
GSM 850	835	21.1	128.8	80.9	265.4	yes
GSM 1900	1880	18.1	64.6	80.9	176.9	yes
UMTS FDD V	835	19.0	79.4	80.9	265.4	yes
LTE FDD 5	835	19.5	89.1	80.9	265.4	yes
LTE FDD 7	2535	11.0	12.6	80.9	152.3	yes
WLAN 2450	2450	11.5	14.1	47.5	90.9	yes
WLAN 5.2 GHz	5200	9.3	8.5	47.5	62.4	yes
WLAN 5.3 GHz	5300	9.3	8.5	47.5	61.8	yes
WLAN 5.6 GHz	5600	7.5	5.6	47.5	60.2	yes
WLAN 5.8 GHz	5800	9.5	8.9	47.5	59.1	yes
Bluetooth 2450	2450	9.80	9.5	47.5	91.0	yes

Table 29: Adjacent edge SAR test exclusion considerations

7.3 SAR test results

7.3.1 Results overview

measured / extrapolated SAR numbers - Body - GSM 850 MHz									
Ch.	freq. (MHz)	time slots	distance (mm)	Position	cond. output power (dBm)		SAR _{1g} results(W/kg)		liquid temp. (°C)
					declared**	measured	measured	extrapolated	
Body GPRS 4TS, GMSK									
128	824.2	4	0	rear	24.1	23.6	0.961	1.078	21.7
190	836.6	4	0	rear	24.1	23.3	0.797	0.958	21.7
251	848.8	4	0	rear	24.1	23.3	0.768	0.923	21.7
190	836.6	4	0	right edge	24.1	23.3	0.503	0.605	21.7
190	836.6	4	0	top edge	24.1	23.3	0.087	0.105	21.7
128	824.2	4	0	rear*	24.1	23.6	0.981	1.101	21.7

Table 30: Test results body SAR GSM 850 MHz

measured / extrapolated SAR numbers - Body - GSM 1900 MHz									
Ch.	freq. (MHz)	time slots	distance (mm)	Position	cond. output power (dBm)		SAR _{1g} results(W/kg)		liquid temp. (°C)
					declared**	measured	measured	extrapolated	
Body GPRS 4TS, GMSK									
512	1850.2	4	0	rear	21.1	20.8	0.819	0.878	21.1
661	1880.0	4	0	rear	21.1	20.8	0.675	0.723	21.1
810	1909.8	4	0	rear	21.1	20.7	0.688	0.754	21.1
661	1880.0	4	0	right edge	21.1	20.8	0.398	0.426	21.1
661	1880.0	4	0	top edge	21.1	20.8	0.079	0.085	21.1
Body EGPRS 4TS, 8PSK									
661	1880.0	4	0	rear	21.1	20.8	0.952	1.020	21.1
661	1880.0	4	0	rear*	21.1	20.8	0.933	1.000	21.1

Table 31: Test results body SAR GSM 1900 MHz

* - repeated at the highest SAR measurement according to the FCC KDB 865664

** - maximum possible output power declared by manufacturer (including power back-off)

Note: EGRPS was additionally tested because conducted power was at similar level as GPRS.

measured / extrapolated SAR numbers - Body - WCDMA FDD V 850 MHz									
Ch.	freq. (MHz)	test condition	distance (mm)	Position	cond. output power (dBm)		SAR _{1g} results(W/kg)		liquid temp. (°C)
					declared**	measured	measured	extrapolated	
4132	826.4	RMC	0	rear	19.0	18.8	0.831	0.870	21.7
4182	836.4	RMC	0	rear	19.0	18.7	0.864	0.926	21.7
4233	846.6	RMC	0	rear	19.0	18.8	0.948	0.993	21.7
4182	836.4	RMC	0	right edge	19.0	18.7	0.449	0.481	21.7
4182	836.4	RMC	0	top edge	19.0	18.7	0.086	0.092	21.7
4233	846.6	RMC	0	rear*	19.0	18.8	0.957	1.002	21.7

Table 32: Test results body SAR UMTS FDD V 850 MHz

* - repeated at the highest SAR measurement according to the FCC KDB 865664

** - maximum possible output power declared by manufacturer (including power back-off)

measured / extrapolated SAR numbers - Body - LTE FDD 5 850MHz / 10MHz BW								
Ch.	freq. (MHz)	test condition	Position	cond. output power (dBm)		SAR _{1g} results(W/kg)		liquid temp. (°C)
				declared**	measured	measured	extrapolated	
20450	829	1RB/25RB offset/QPSK	rear	19.5	19.2	0.790	0.847	21.7
20525	836.5	1RB/0RB offset/QPSK	rear	19.5	19.0	0.873	0.980	21.7
20600	844	1RB/25RB offset/QPSK	rear	19.5	19.2	0.735	0.788	21.7
20525	836.5	1RB/0RB offset/QPSK	right edge	19.5	19.0	0.493	0.553	21.7
20525	836.5	1RB/0RB offset/QPSK	top edge	19.5	19.0	0.077	0.086	21.7
20525	836.5	1RB/25RB offset/QPSK	rear	19.5	18.9	0.739	0.848	21.7
20525	836.5	1RB/49RB offset/QPSK	rear	19.5	18.9	0.633	0.727	21.7
20525	836.5	1RB/0RB offset/QPSK	rear*	19.5	19.0	0.875	0.982	21.7
20525	836.5	25RB/0RB offset/QPSK	rear	19.5	18.9	0.800	0.919	21.7
20525	836.5	25RB/0RB offset/QPSK	right edge	19.5	18.9	0.455	0.522	21.7
20525	836.5	25RB/0RB offset/QPSK	top edge	19.5	18.9	0.078	0.089	21.7
20525	836.5	50RB/0RB offset/QPSK	rear	19.5	18.9	0.841	0.966	21.7
20450	829	1RB/25RB offset/QPSK	right edge	19.5	19.2	0.540	0.579	21.9
20600	844	1RB/25RB offset/QPSK	right edge	19.5	19.2	0.545	0.584	21.9
20450	829	1RB/25RB offset/QPSK	top edge	19.5	19.2	0.084	0.090	21.9
20600	844	1RB/25RB offset/QPSK	top edge	19.5	19.2	0.081	0.087	21.9
20450	829	1RB/0RB offset/QPSK	rear	19.5	19.1	0.603	0.661	21.9
20450	829	1RB/49RB offset/QPSK	rear	19.5	19.2	0.733	0.785	21.9
20450	829	25RB/25RB offset/QPSK	rear	19.5	19.1	0.713	0.782	21.9
20600	844	25RB/12RB offset/QPSK	rear	19.5	19.0	0.552	0.619	21.9
20450	829	25RB/25RB offset/QPSK	right edge	19.5	19.1	0.491	0.538	21.9
20450	829	25RB/25RB offset/QPSK	top edge	19.5	19.1	0.077	0.084	21.9
20450	829	50RB/0RB offset/QPSK	rear	19.5	18.9	0.945	1.085	21.9
20600	844	50RB/0RB offset/QPSK	rear	19.5	18.9	0.803	0.922	21.9

Table 33: Test results body SAR LTE FDD 5 850MHz / 10MHz BW

* - repeated at the highest SAR measurement according to the FCC KDB 865664

** - maximum possible output power declared by manufacturer (including power back-off)

measured / extrapolated SAR numbers - Body - LTE FDD 7 2600 MHz / 20MHz BW								
Ch.	freq. (MHz)	test condition	Position	cond. output power (dBm)		SAR _{1g} results(W/kg)		liquid temp. (°C)
				declared**	measured	measured	extrapolated	
20850	2510	1RB/49RB offset/16QAM	rear	11.0	10.1	0.600	0.738	20.9
21100	2535	1RB/0RB offset/QPSK	rear	11.0	10.6	0.768	0.842	20.9
21350	2560	1RB/99RB offset/QPSK	rear	11.0	10.6	0.634	0.695	20.9
21100	2535	1RB/0RB offset/QPSK	right edge	11.0	10.6	0.529	0.580	20.9
21100	2535	1RB/0RB offset/QPSK	top edge	11.0	10.6	0.000	0.000	20.9
21100	2535	1RB/49RB offset/QPSK	rear	11.0	10.2	0.702	0.844	20.9
21100	2535	1RB/99RB offset/QPSK	rear	11.0	10.4	0.364	0.418	20.9
20850	2510	50RB/50RB offset/QPSK	rear	11.0	10.0	0.666	0.838	20.9
21100	2535	50RB/0RB offset/QPSK	rear	11.0	10.5	0.702	0.788	20.9
21350	2560	50RB/50RB offset/QPSK	rear	11.0	10.6	0.495	0.543	20.9
21100	2535	50RB/0RB offset/QPSK	right edge	11.0	10.5	0.470	0.527	20.9
21100	2535	50RB/0RB offset/QPSK	top edge	11.0	10.5	0.000	0.000	20.9
20850	2510	1RB/0RB offset/QPSK	rear	11.0	9.9	0.625	0.805	22.1

Table 34: Test results body SAR LTE FDD 7 2600 MHz

* - repeated at the highest SAR measurement according to the FCC KDB 865664

** - maximum possible output power declared by manufacturer (including power back-off)

measured / extrapolated SAR numbers - Body - WLAN 2450 MHz									
Ch.	freq. (MHz)	Test condition	distance (mm)	Position	cond. output power (dBm)		SAR _{1g} results(W/kg)		liquid temp.(°C)
					declared**	measured	measured	extrapolated	
1	2412	1Mbit/s	0	rear	11.2	10.9	0.971	1.040	21.4
6	2437	1Mbit/s	0	rear	11.2	10.5	1.010	1.187	21.4
11	2462	1Mbit/s	0	rear	11.2	11.0	1.140	1.194	21.4
11	2462	1Mbit/s	0	left edge	11.2	11.0	0.173	0.181	21.4
11	2462	1Mbit/s	0	rear*	11.2	11.0	1.050	1.099	21.4

Table 35: Test results body SAR WLAN 2450 MHz

* - repeated at the highest SAR measurement according to the FCC KDB 865664

** - maximum possible output power declared by manufacturer

measured / extrapolated SAR numbers - Body - WLAN 5GHz									
Ch.	frequency (MHz)	distance	Position	cond. output power (dBm)		SAR _{1g} results(W/kg)		liquid temp. (°C)	
				declared**	measured	measured	extrapolated		
44	5220	0	rear	8.9	8.5	0.521	0.571	21.5	
52	5260	0	rear	8.9	7.6	0.318	0.429	21.5	
60	5300	0	rear	8.9	8.3	0.704	0.808	21.5	
64	5320	0	rear	8.9	8.0	0.756	0.930	21.5	
120	5600	0	rear	8.0	8.0	0.471	0.471	21.5	
157	5785	0	rear	11.5	11.4	0.272	0.278	21.5	
44	5220	0	left edge	9.3	8.5	0.027	0.032	21.5	
60	5300	0	left edge	9.3	8.3	0.054	0.068	21.5	
120	5600	0	left edge	8.0	8.0	0.095	0.095	21.5	
157	5785	0	left edge	11.5	11.4	0.033	0.034	21.5	

Table 36: Test results body SAR WLAN 5GHz

* - repeated at the highest SAR measurement according to the FCC KDB 865664

** - maximum possible output power declared by manufacturer

Estimated SAR					
Communication system	freq. (GHz)	distance (mm)	P _{avg} * (dBm)	P _{avg} * (mW)	estimated _{1-g} (W/kg)
Bluetooth 2450 body	2.45	5	9.8	9.5	0.399

Table 37: Calculated SAR_{max} for **Bluetooth 2450MHz** head and body

* - maximum possible output power declared by manufacturer

When standalone SAR test exclusion applies to an antenna that transmits simultaneously with other antennas, the standalone SAR must be estimated according to following to determine simultaneous transmission SAR test exclusion:

$(\text{max. power of channel, including tune-up tolerance, mW}) / (\text{min. test separation distance, mm}) \cdot [\sqrt{f(\text{GHz})} / x]$
W/kg for test separation distances ≤ 50 mm;

where $x = 7.5$ for 1-g SAR.

When the minimum test separation distance is < 5 mm, a distance of 5 mm is applied to determine SAR test exclusion

7.3.2 General description of test procedures

- The DUT is tested using CMU 200 and CMW 500 communications testers as controller unit to set test channels and maximum output power to the DUT, as well as for measuring the conducted peak power.
- SAR tests in **GSM**, **UMTS** and **LTE** modes were performed with **power back off** as is described in chapter 7.1
- Test positions as described in the tables above are in accordance with the specified test standard.
- According to IEEE 1528 the SAR test shall be performed at middle channel. Testing of top and bottom channel is optional.
- Required WLAN test channels were selected according to KDB 248227
- According to KDB 447498 D01 testing of other required channels within the operating mode of a frequency band is not required when the reported 1-g or 10-g SAR for the mid-band or highest output power channel is:
 - ≤ 0.8 W/kg or 2.0 W/kg, for 1-g or 10-g respectively, when the transmission band is ≤ 100 MHz
 - ≤ 0.6 W/kg or 1.5 W/kg, for 1-g or 10-g respectively, when the transmission band is between 100 MHz and 200 MHz
 - ≤ 0.4 W/kg or 1.0 W/kg, for 1-g or 10-g respectively, when the transmission band is ≥ 200 MHz
- The tests were performed in that configuration, which generates the highest time based averaged output power (see conducted power results).
- UMTS was tested in RMC mode with 12.2 kbit/s and TPC bits set to 'all 1'.
- WLAN was tested in 802.11b mode with 1 MBit/s and in 802.11a mode with 6 MBit/s. According to KDB 248227 the SAR testing for 802.11g/n is not required since the maximum power of 802.11g/n is less ¼ dB higher than maximum power of 802.11a/b.
- Tests in body position were performed with 0 mm air gap between DUT and SAM.

8 Test equipment and ancillaries used for tests

To simplify the identification of the test equipment and/or ancillaries which were used, the reporting of the relevant test cases only refer to the test item number as specified in the table below.

Equipment	Type	Manufacturer	Serial No.	Last Calibration	Frequency (months)
Dosimetric E-Field Probe	ET3DV6	Schmid & Partner Engineering AG	1558	August 24, 2012	12
Dosimetric E-Field Probe	EX3DV4	Schmid & Partner Engineering AG	3566	August 23, 2012	12
900 MHz System Validation Dipole	D900V2	Schmid & Partner Engineering AG	102	August 15, 2011	24
1900 MHz System Validation Dipole	D1900V2	Schmid & Partner Engineering AG	5d009	August 17, 2011	24
2450 MHz System Validation Dipole	D2450V2	Schmid & Partner Engineering AG	710	August 13, 2012	24
2600 MHz System Validation Dipole	D2600V2	Schmid & Partner Engineering AG	1040	19.08.2011	24
5 GHz System Validation Dipole	D5GHZV2	Schmid & Partner Engineering AG	1055	August 22, 2011	24
Data acquisition electronics	DAE3V1	Schmid & Partner Engineering AG	477	May 09, 2012	12
Software	DASY52 52.8.5	Schmid & Partner Engineering AG	---	N/A	--
Phantom ELI 4.0	QDOVA0 01BA	Schmid & Partner Engineering AG	1046	N/A	--
Universal Radio Communication Tester	CMU 200	Rohde & Schwarz	106826	January 16, 2013	24
Universal Radio Communication Tester	CMW500	Rohde & Schwarz	102375	January 16, 2013	24
Network Analyser 300 kHz to 6 GHz	8753ES	Hewlett Packard)*	US39174436	February 24, 2012	24
Dielectric Probe Kit	85070C	Hewlett Packard	US99360146	N/A	12
Signal Generator	8671B	Hewlett Packard	2823A00656	January 15, 2013	24
Amplifier	25S1G4 (25 Watt)	Amplifier Reasearch	20452	N/A	--
Power Meter	NRP	Rohde & Schwarz	101367	January 15, 2013	24
Power Meter Sensor	NRP Z22	Rohde & Schwarz	100227	January 14, 2013	12
Power Meter Sensor	NRP Z22	Rohde & Schwarz	100234	January 14, 2013	12
Directional Coupler	778D	Hewlett Packard	19171	January 14, 2013	12

)* : Network analyzer probe calibration against air, distilled water and a shorting block performed before measuring liquid parameters.

9 Observations

No observations exceeding those reported with the single test cases have been made.

Annex A: System performance check

Date/Time: 16.03.2013 10:01:06

SystemPerformanceCheck-D900 body 2013-03-16

DUT: Dipole 900 MHz; Type: D900V2; Serial: 102

Communication System: CW; Communication System Band: D900 (900.0 MHz); Frequency: 900 MHz;

Communication System PAR: 0 dB; PMF: 1

Medium parameters used: $f = 900 \text{ MHz}$; $\sigma = 1.04 \text{ S/m}$; $\epsilon_r = 54.4$; $\rho = 1000 \text{ kg/m}^3$

Phantom section: Flat Section

Measurement Standard: DASYS

DASY5 Configuration:

- Probe: ET3DV6 - SN1558; ConvF(5.92, 5.92, 5.92); Calibrated: 24.08.2012;
- Modulation Compensation:
- Sensor-Surface: 4mm (Mechanical Surface Detection), $z = 2.7, 32.7$
- Electronics: DAE3 Sn477; Calibrated: 09.05.2012
- Phantom: ELI 4.0; Type: QDOVA001BA; Serial: 1046
- DASY52 52.8.5(1059); SEMCAD X 14.6.8(7028)

System Performance Check/d=15mm, Pin=1000 mW, dist=4.0mm/Area

Scan (51x51x1): Interpolated grid: $dx=1.500 \text{ mm}$, $dy=1.500 \text{ mm}$

Maximum value of SAR (interpolated) = 12.2 W/kg

System Performance Check/d=15mm, Pin=1000 mW, dist=4.0mm/Zoom

Scan (7x7x7) (7x7x7)/Cube 0: Measurement grid: $dx=5\text{mm}$, $dy=5\text{mm}$, $dz=5\text{mm}$

Reference Value = 107.9 V/m; Power Drift = 0.02 dB

Peak SAR (extrapolated) = 16.3 W/kg

SAR(1 g) = 11.2 W/kg; SAR(10 g) = 7.28 W/kg

Maximum value of SAR (measured) = 12.2 W/kg

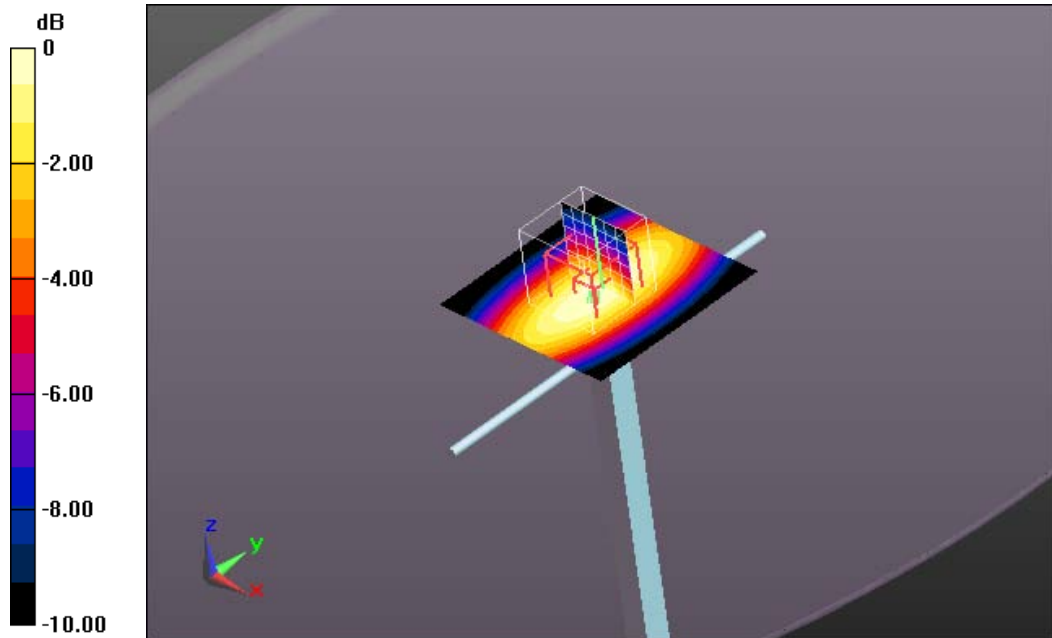

0 dB = 11.2 W/kg = 10.49 dBW/kg

Additional information:

ambient temperature: 22.2°C; liquid temperature: 21.9°C

Date/Time: 18.03.2013 08:23:14

SystemPerformanceCheck-D900 body 2013-03-18

DUT: Dipole 900 MHz; Type: D900V2; Serial: 102

Communication System: CW; Communication System Band: D900 (900.0 MHz); Frequency: 900 MHz;

Communication System PAR: 0 dB; PMF: 1

Medium parameters used: $f = 900 \text{ MHz}$; $\sigma = 1.04 \text{ S/m}$; $\epsilon_r = 54.4$; $\rho = 1000 \text{ kg/m}^3$

Phantom section: Flat Section

Measurement Standard: DASYS5

DASY5 Configuration:

- Probe: ET3DV6 - SN1558; ConvF(5.92, 5.92, 5.92); Calibrated: 24.08.2012;
- Sensor-Surface: 4mm (Mechanical Surface Detection), $z = 2.7, 32.7$
- Electronics: DAE3 Sn477; Calibrated: 09.05.2012
- Phantom: ELI 4.0; Type: QDOVA001BA; Serial: 1046
- DASYS52 52.8.5(1059); SEMCAD X 14.6.8(7028)

System Performance Check/d=15mm, Pin=1000 mW, dist=4.0mm/Area

Scan (51x51x1): Interpolated grid: $dx=1.500 \text{ mm}$, $dy=1.500 \text{ mm}$

Maximum value of SAR (interpolated) = 11.9 W/kg

System Performance Check/d=15mm, Pin=1000 mW, dist=4.0mm/Zoom

Scan (7x7x7) (7x7x7)/Cube 0: Measurement grid: $dx=5\text{mm}$, $dy=5\text{mm}$, $dz=5\text{mm}$

Reference Value = 111.3 V/m; Power Drift = -0.16 dB

Peak SAR (extrapolated) = 16.0 W/kg

SAR(1 g) = 10.9 W/kg; SAR(10 g) = 7.08 W/kg

Maximum value of SAR (measured) = 11.9 W/kg

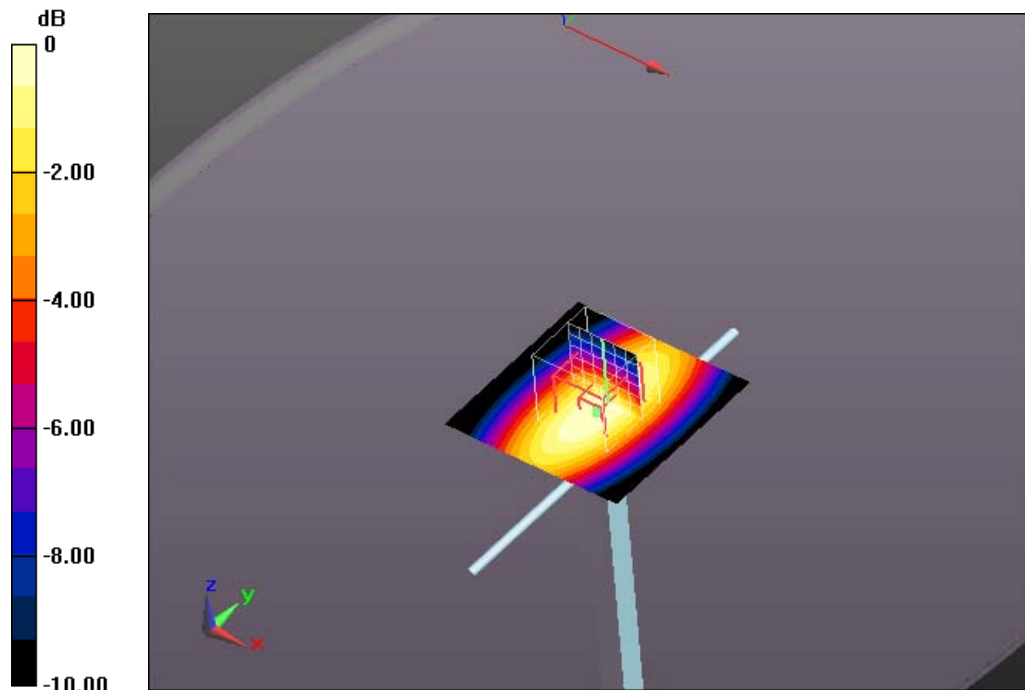

0 dB = 11.9 W/kg = 10.76 dBW/kg

Additional information:

ambient temperature: 23.5°C; liquid temperature: 21.7°C

Date/Time: 02.05.2013 19:54:43

SystemPerformanceCheck-D900 body 2013-05-02

DUT: Dipole 900 MHz; Type: D900V2; Serial: 102

Communication System: CW; Communication System Band: D900 (900.0 MHz); Frequency: 900 MHz;

Communication System PAR: 0 dB; PMF: 1

Medium parameters used: $f = 900$ MHz; $\sigma = 1.03$ S/m; $\epsilon_r = 54.2$; $\rho = 1000$ kg/m³

Phantom section: Flat Section

Measurement Standard: DASYS5

DASY5 Configuration:

- Probe: ET3DV6 - SN1558; ConvF(5.92, 5.92, 5.92); Calibrated: 24.08.2012;
- Modulation Compensation:
- Sensor-Surface: 4mm (Mechanical Surface Detection), $z = 2.7, 32.7$
- Electronics: DAE3 Sn477; Calibrated: 09.05.2012
- Phantom: ELI 4.0; Type: QDOVA001BA; Serial: 1046
- DASY52 52.8.5(1059); SEMCAD X 14.6.8(7028)

System Performance Check/d=15mm, Pin=1000 mW, dist=4.0mm/Area

Scan (51x51x1): Interpolated grid: $dx=1.500$ mm, $dy=1.500$ mm

Maximum value of SAR (interpolated) = 11.6 W/kg

System Performance Check/d=15mm, Pin=1000 mW, dist=4.0mm/Zoom

Scan (7x7x7)/Cube 0: Measurement grid: $dx=5$ mm, $dy=5$ mm, $dz=5$ mm

Reference Value = 111.1 V/m; Power Drift = -0.05 dB

Peak SAR (extrapolated) = 15.7 W/kg

SAR(1 g) = 10.8 W/kg; SAR(10 g) = 7.05 W/kg

Maximum value of SAR (measured) = 11.6 W/kg

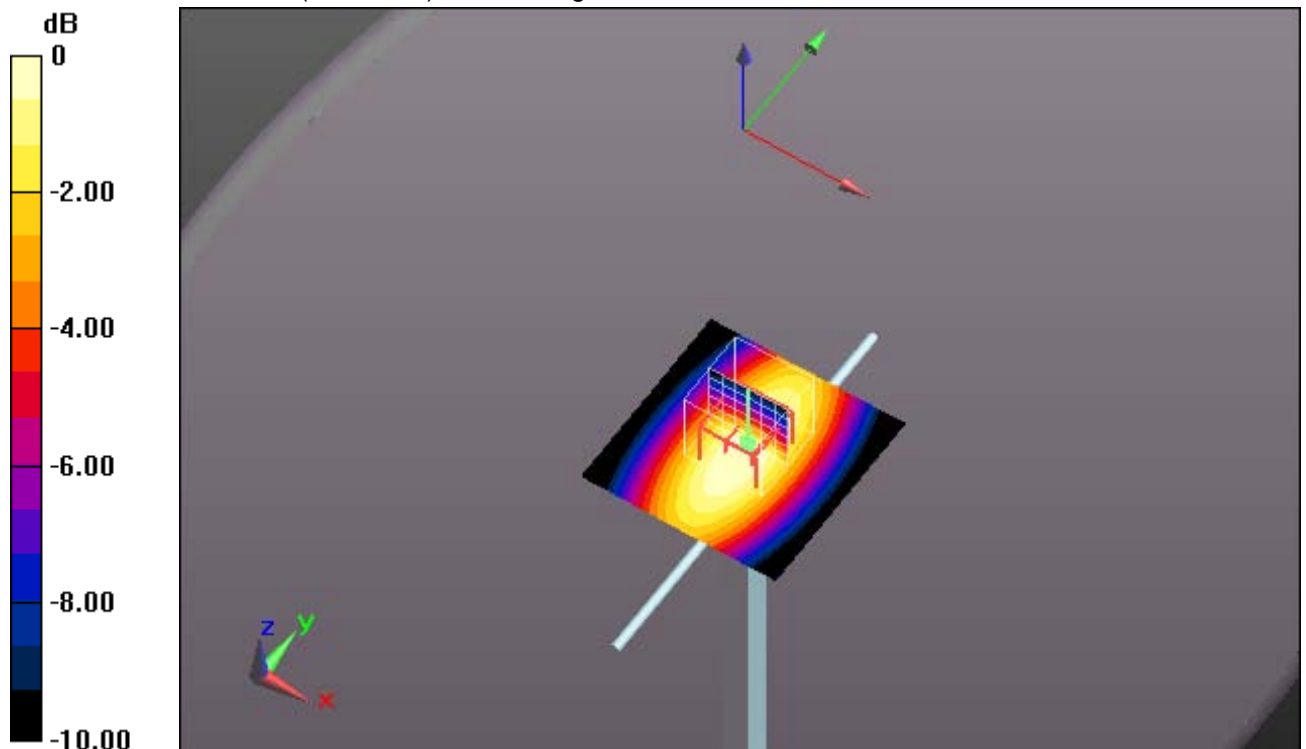

0 dB = 11.6 W/kg = 10.64 dBW/kg

Additional information:

ambient temperature: 22.2°C; liquid temperature: 21.9°C

Date/Time: 11.03.2013 09:46:22

SystemPerformanceCheck-D1900 body 2013-03-11

DUT: Dipole 1900 MHz; Type: D1900V2; Serial: 5d009

Communication System: CW; Communication System Band: D1900 (1900.0 MHz); Frequency: 1900 MHz;

Communication System PAR: 0 dB; PMF: 1

Medium parameters used: $f = 1900$ MHz; $\sigma = 1.52$ S/m; $\epsilon_r = 52.6$; $\rho = 1000$ kg/m³

Phantom section: Flat Section

Measurement Standard: DASYS

DASY5 Configuration:

- Probe: ET3DV6 - SN1558; ConvF(4.2, 4.2, 4.2); Calibrated: 24.08.2012;
- Sensor-Surface: 4mm (Mechanical Surface Detection), $z = 2.7, 32.7$
- Electronics: DAE3 Sn477; Calibrated: 09.05.2012
- Phantom: ELI 4.0; Type: QDOVA001BA; Serial: 1046
- DASY52 52.8.5(1059); SEMCAD X 14.6.8(7028)

System Performance Check/d=10mm, Pin=1000 mW, dist=4.0mm/Area

Scan (51x51x1): Interpolated grid: $dx=1.500$ mm, $dy=1.500$ mm

Maximum value of SAR (interpolated) = 58.5 W/kg

System Performance Check/d=10mm, Pin=1000 mW, dist=4.0mm/Zoom

Scan (7x7x7) (7x7x7)/Cube 0: Measurement grid: $dx=5$ mm, $dy=5$ mm, $dz=5$ mm

Reference Value = 189.6 V/m; Power Drift = -0.00 dB

Peak SAR (extrapolated) = 68.0 W/kg

SAR(1 g) = 41.5 W/kg; SAR(10 g) = 22.4 W/kg

Maximum value of SAR (measured) = 47.4 W/kg

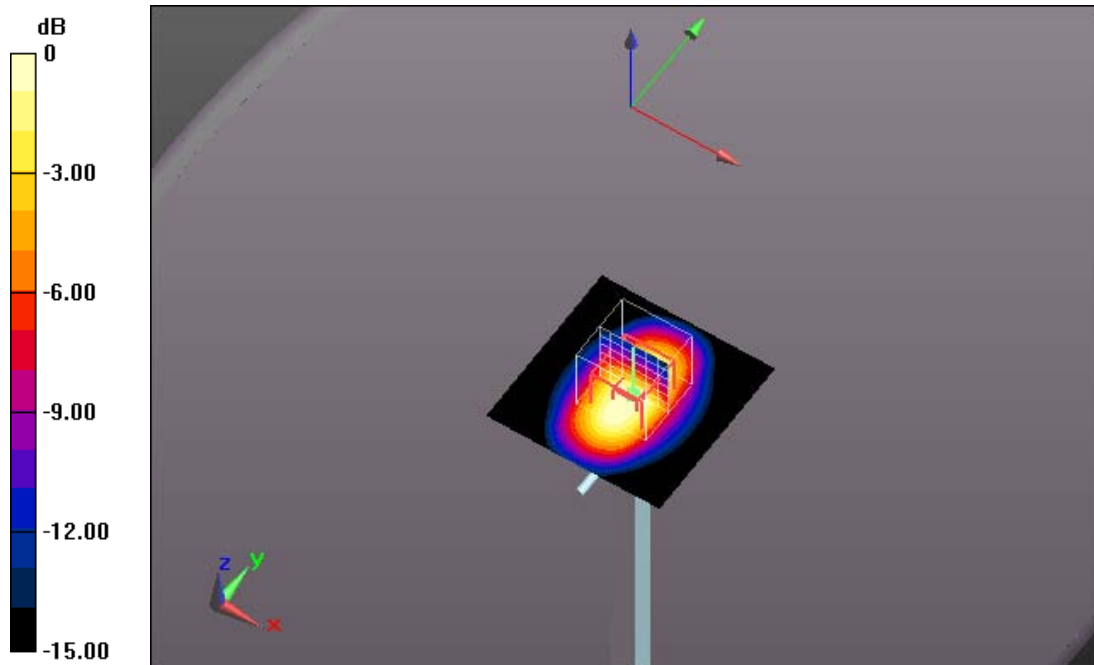

0 dB = 47.4 W/kg = 16.76 dBW/kg

Additional information:

ambient temperature: 22.3°C; liquid temperature: 21.1°C

Date/Time: 22.03.2013 20:05:14

SystemPerformanceCheck-D2450 body 2013-03-22

DUT: Dipole 2450 MHz; Type: D2450V2; Serial: 710

Communication System: CW; Communication System Band: D2450 (2450.0 MHz); Frequency: 2450 MHz;

Communication System PAR: 0 dB; PMF: 1

Medium parameters used: $f = 2450$ MHz; $\sigma = 2$ S/m; $\epsilon_r = 52.1$; $\rho = 1000$ kg/m³

Phantom section: Flat Section

Measurement Standard: DASYS

DASY5 Configuration:

- Probe: ET3DV6 - SN1558; ConvF(4.06, 4.06, 4.06); Calibrated: 24.08.2012;
- Sensor-Surface: 4mm (Mechanical Surface Detection), $z = 2.7, 32.7$
- Electronics: DAE3 Sn477; Calibrated: 09.05.2012
- Phantom: ELI 4.0; Type: QDOVA001BA; Serial: 1046
- DASY52 52.8.5(1059); SEMCAD X 14.6.8(7028)

System Performance Check/d=10mm, Pin=100 mW, dist=4.0mm/Area Scan

(51x51x1): Interpolated grid: $dx=1.500$ mm, $dy=1.500$ mm

Maximum value of SAR (interpolated) = 7.23 W/kg

System Performance Check/d=10mm, Pin=100 mW, dist=4.0mm/Zoom

Scan (7x7x7) (7x7x7)/Cube 0: Measurement grid: $dx=5$ mm, $dy=5$ mm, $dz=5$ mm

Reference Value = 53.168 V/m; Power Drift = -0.03 dB

Peak SAR (extrapolated) = 14.4 W/kg

SAR(1 g) = 5.29 W/kg; SAR(10 g) = 2.33 W/kg

Maximum value of SAR (measured) = 5.69 W/kg

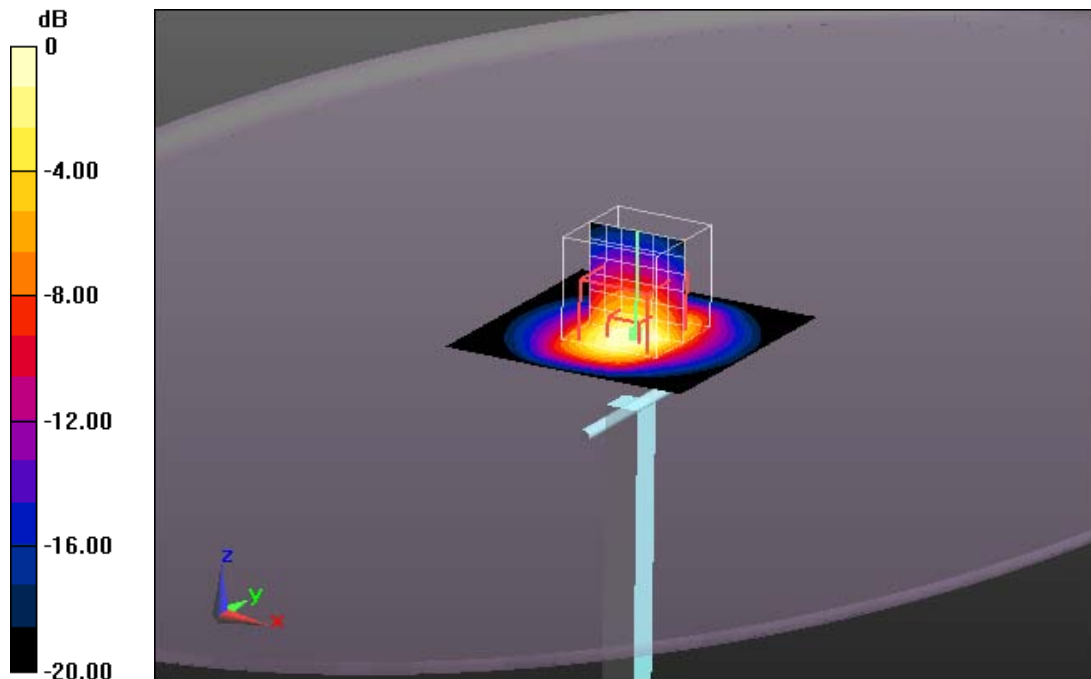

0 dB = 5.69 W/kg = 7.55 dBW/kg

Additional information:

ambient temperature: 22.2°C; liquid temperature: 21.4°C

Date/Time: 27.03.2013 13:19:27

SystemPerformanceCheck-D2600 body 2013-03-27

DUT: Dipole 2600 MHz; Type: D2600V2; Serial: 1040

Communication System: CW; Communication System Band: D2600 (2600.0 MHz); Frequency: 2600 MHz;

Communication System PAR: 0 dB; PMF: 1

Medium parameters used: $f = 2600$ MHz; $\sigma = 2.22$ S/m; $\epsilon_r = 51.5$; $\rho = 1000$ kg/m³

Phantom section: Flat Section

Measurement Standard: DASYS

DASY5 Configuration:

- Probe: EX3DV4 - SN3566; ConvF(6.06, 6.06, 6.06); Calibrated: 23.08.2012;
- Modulation Compensation:
- Sensor-Surface: 2mm (Mechanical Surface Detection), Sensor-Surface: 4mm (Mechanical Surface Detection), $z = 1.0, 31.0$
- Electronics: DAE3 Sn477; Calibrated: 09.05.2012
- Phantom: ELI 4.0; Type: QDOVA001BA; Serial: 1046
- DASYS2 52.8.5(1059); SEMCAD X 14.6.8(7028)

MSL/d=10mm, Pin=100 mW, dist=2.0mm/Area Scan (51x51x1): Interpolated grid:

$dx=1.500$ mm, $dy=1.500$ mm

Maximum value of SAR (interpolated) = 10.8 W/kg

MSL/d=10mm, Pin=100 mW, dist=2.0mm/Zoom Scan (7x7x7) (7x7x7)/Cube

0: Measurement grid: $dx=5$ mm, $dy=5$ mm, $dz=5$ mm

Reference Value = 63.695 V/m; Power Drift = -0.05 dB

Peak SAR (extrapolated) = 12.1 W/kg

SAR(1 g) = 5.55 W/kg; SAR(10 g) = 2.43 W/kg

Maximum value of SAR (measured) = 6.36 W/kg

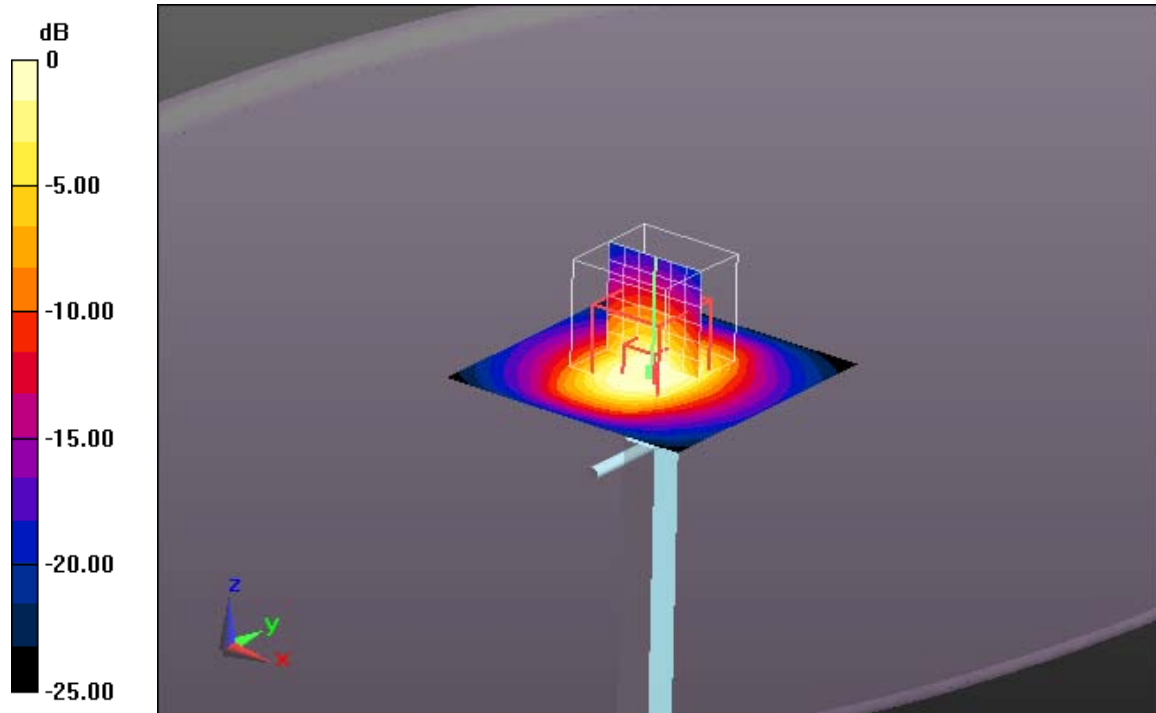

0 dB = 6.36 W/kg = 8.03 dBW/kg

Additional information:

ambient temperature: 21.0°C; liquid temperature: 20.5°C

Date/Time: 28.03.2013 20:42:07

SystemPerformanceCheck-D2600 body 2013-03-28

DUT: Dipole 2600 MHz; Type: D2600V2; Serial: 1040

Communication System: CW; Communication System Band: D2600 (2600.0 MHz); Frequency: 2600 MHz;

Communication System PAR: 0 dB; PMF: 1

Medium parameters used: $f = 2600$ MHz; $\sigma = 2.22$ S/m; $\epsilon_r = 51.5$; $\rho = 1000$ kg/m³

Phantom section: Flat Section

Measurement Standard: DASYS5

DASY5 Configuration:

- Probe: EX3DV4 - SN3566; ConvF(6.06, 6.06, 6.06); Calibrated: 23.08.2012;

- Modulation Compensation:

- Sensor-Surface: 2mm (Mechanical Surface Detection), Sensor-Surface: 4mm (Mechanical Surface Detection), $z = 1.0, 31.0$

- Electronics: DAE3 Sn477; Calibrated: 09.05.2012

- Phantom: ELI 4.0; Type: QDOVA001BA; Serial: 1046

- DASYS52 52.8.5(1059); SEMCAD X 14.6.8(7028)

MSL/d=10mm, Pin=100 mW, dist=2.0mm/Area Scan (51x51x1): Interpolated grid:

$dx=1.500$ mm, $dy=1.500$ mm

Maximum value of SAR (interpolated) = 10.8 W/kg

MSL/d=10mm, Pin=100 mW, dist=2.0mm/Zoom Scan (7x7x7) (7x7x7)/Cube

0: Measurement grid: $dx=5$ mm, $dy=5$ mm, $dz=5$ mm

Reference Value = 63.084 V/m; Power Drift = 0.01 dB

Peak SAR (extrapolated) = 12.3 W/kg

SAR(1 g) = 5.53 W/kg; SAR(10 g) = 2.4 W/kg

Maximum value of SAR (measured) = 6.41 W/kg

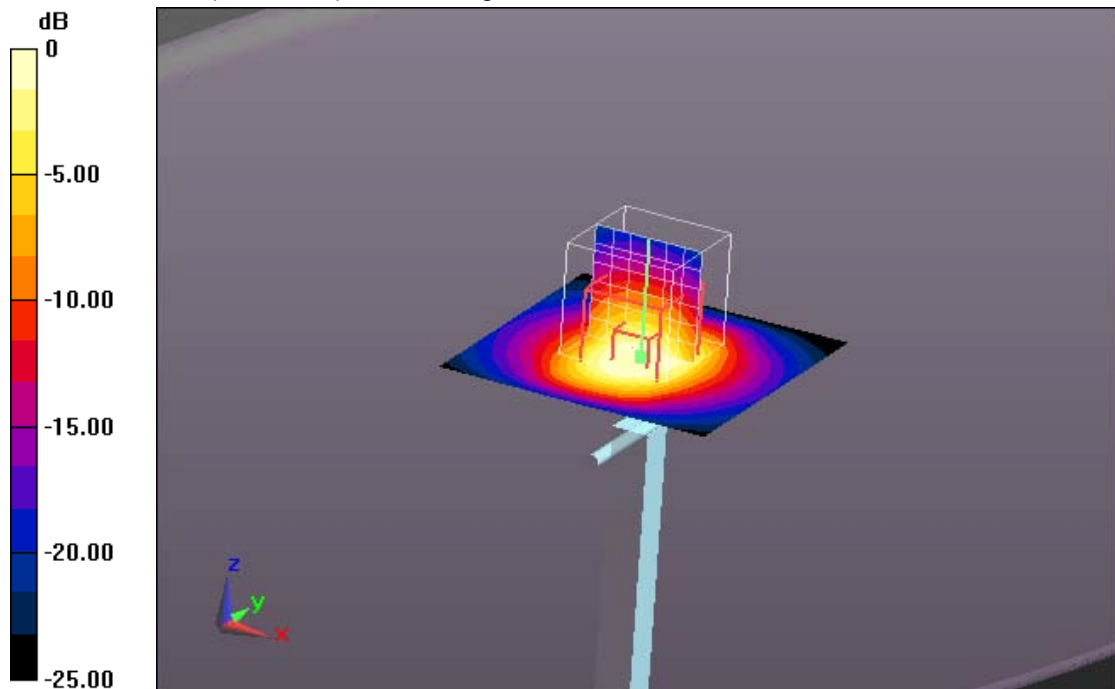

0 dB = 6.41 W/kg = 8.07 dBW/kg

Additional information:

ambient temperature: 21.5°C; liquid temperature: 20.9°C

Date/Time: 03.05.2013 12:37:12

SystemPerformanceCheck-D2600 body 2013-05-03

DUT: Dipole 2600 MHz; Type: D2600V2; Serial: 1040

Communication System: CW; Communication System Band: D2600 (2600.0 MHz); Frequency: 2600 MHz;

Communication System PAR: 0 dB; PMF: 1

Medium parameters used: $f = 2600$ MHz; $\sigma = 2.22$ S/m; $\epsilon_r = 50.2$; $\rho = 1000$ kg/m³

Phantom section: Flat Section

Measurement Standard: DASYS

DASY5 Configuration:

- Probe: EX3DV4 - SN3566; ConvF(6.06, 6.06, 6.06); Calibrated: 23.08.2012;
- Modulation Compensation:
- Sensor-Surface: 2mm (Mechanical Surface Detection), Sensor-Surface: 4mm (Mechanical Surface Detection), $z = 1.0, 31.0$
- Electronics: DAE3 Sn477; Calibrated: 09.05.2012
- Phantom: ELI 4.0; Type: QDOVA001BA; Serial: 1046
- DASYS2 52.8.5(1059); SEMCAD X 14.6.8(7028)

MSL/d=10mm, Pin=100 mW, dist=2.0mm/Area Scan (51x51x1): Interpolated grid:

$dx=1.500$ mm, $dy=1.500$ mm

Maximum value of SAR (interpolated) = 10.7 W/kg

MSL/d=10mm, Pin=100 mW, dist=2.0mm/Zoom Scan (7x7x7) (7x7x7)/Cube

0: Measurement grid: $dx=5$ mm, $dy=5$ mm, $dz=5$ mm

Reference Value = 63.677 V/m; Power Drift = 0.04 dB

Peak SAR (extrapolated) = 12.2 W/kg

SAR(1 g) = 5.62 W/kg; SAR(10 g) = 2.46 W/kg

Maximum value of SAR (measured) = 6.47 W/kg

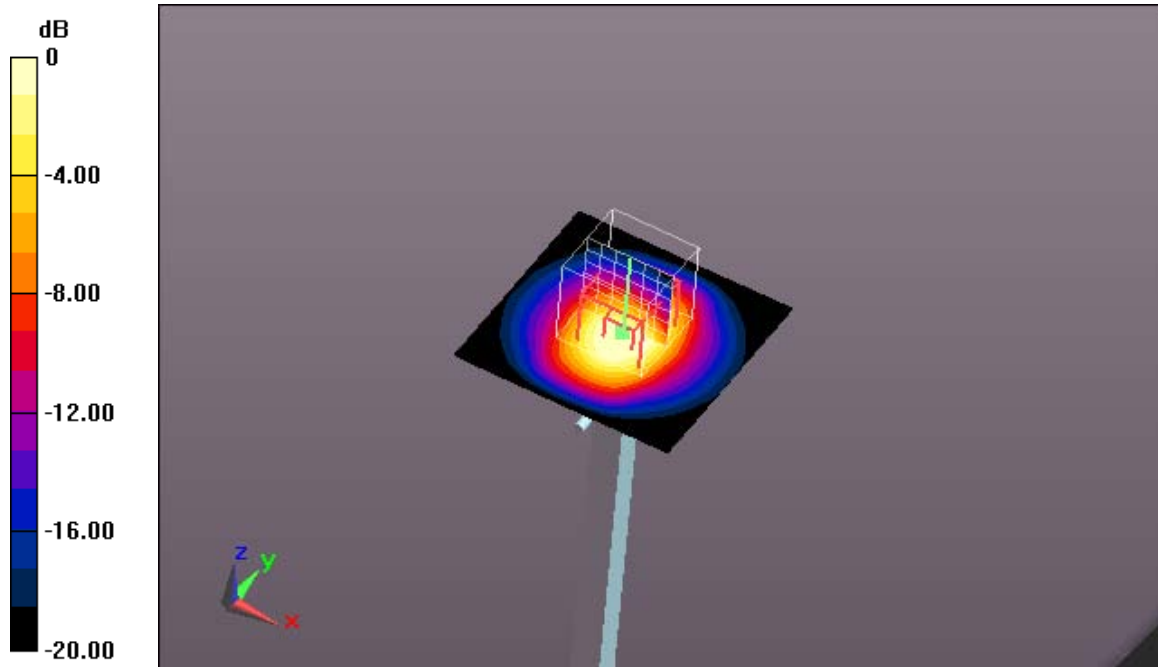

0 dB = 6.47 W/kg = 8.11 dBW/kg

Additional information:

ambient temperature: 23.3°C; liquid temperature: 22.1°C

Date/Time: 21.03.2013 13:10:38

SystemPerformanceCheck-D5GHz-body 2013-03-21

DUT: Dipole 5 GHz; Type: D5GHzV2; Serial: 1055

Communication System: CW; Frequency: 5200 MHz; Communication System PAR: 0 dB; PMF: 1

Medium parameters used: $f = 5200$ MHz; $\sigma = 5.34$ S/m; $\epsilon_r = 48.02$; $\rho = 1000$ kg/m³

Phantom section: Flat Section

Measurement Standard: DASY5

DASY5 Configuration:

- Probe: EX3DV4 - SN3566; ConvF(3.5, 3.5, 3.5); Calibrated: 23.08.2012;
- Sensor-Surface: 4mm (Mechanical Surface Detection), Sensor-Surface: 2mm (Mechanical Surface Detection), $z = 1.0, 22.0$
- Electronics: DAE3 Sn477; Calibrated: 09.05.2012
- Phantom: ELI 4.0; Type: QDOVA001BA; Serial: 1046
- DASY52 52.8.5(1059); SEMCAD X 14.6.8(7028)

MSL/d=10mm, Pin=100mW 5.2GHz/Area Scan (91x91x1): Interpolated grid:

$dx=1.000$ mm, $dy=1.000$ mm

Maximum value of SAR (interpolated) = 8.69 W/kg

MSL/d=10mm, Pin=100mW 5.2GHz/Zoom Scan (8x8x8) (8x8x8)/Cube 0:

Measurement grid: $dx=4.3$ mm, $dy=4.3$ mm, $dz=3$ mm

Reference Value = 41.033 V/m; Power Drift = 0.04 dB

Peak SAR (extrapolated) = 26.4 W/kg

SAR(1 g) = 7.21 W/kg; SAR(10 g) = 2.03 W/kg

Maximum value of SAR (measured) = 13.9 W/kg

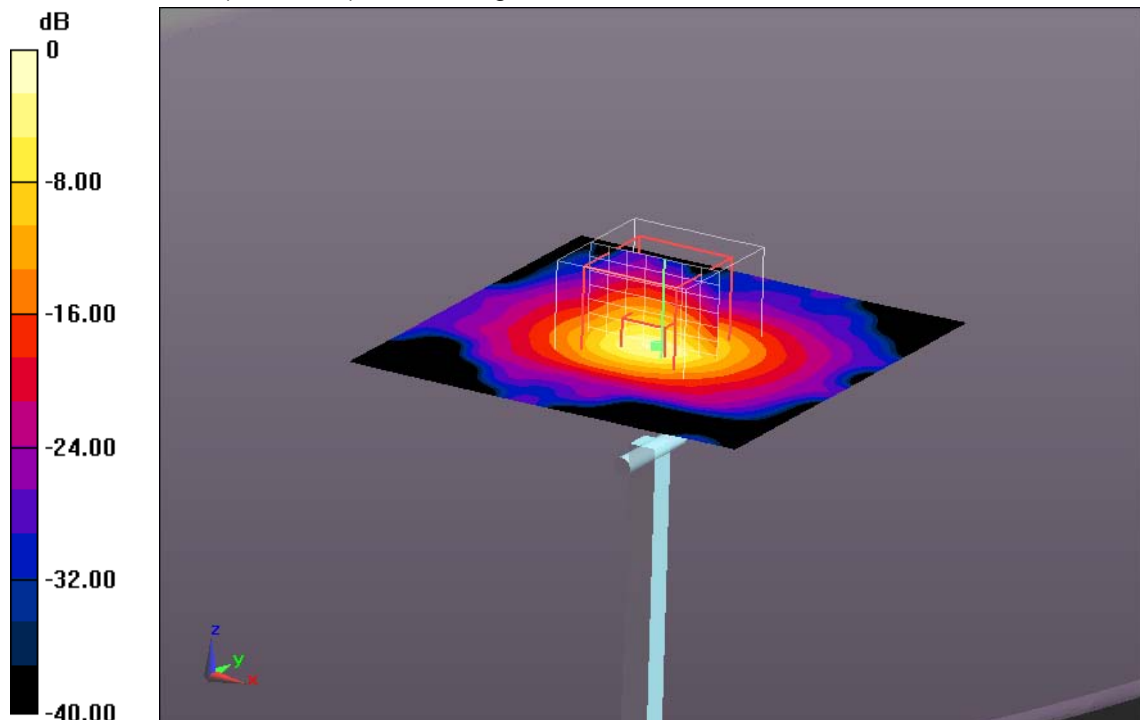

0 dB = 13.9 W/kg = 11.43 dBW/kg

Additional information:

ambient temperature: 22.2°C; liquid temperature: 21.1°C

Date/Time: 21.03.2013 12:40:21

SystemPerformanceCheck-D5GHz-body 2013-03-21

DUT: Dipole 5 GHz; Type: D5GHzV2; Serial: 1055

Communication System: CW; Frequency: 5500 MHz; Communication System PAR: 0 dB; PMF: 1

Medium parameters used: $f = 5500$ MHz; $\sigma = 5.71$ S/m; $\epsilon_r = 47.27$; $\rho = 1000$ kg/m³

Phantom section: Flat Section

Measurement Standard: DASY5

DASY5 Configuration:

- Probe: EX3DV4 - SN3566; ConvF(3.1, 3.1, 3.1); Calibrated: 23.08.2012;
- Sensor-Surface: 4mm (Mechanical Surface Detection), Sensor-Surface: 2mm (Mechanical Surface Detection), $z = 1.0, 22.0$
- Electronics: DAE3 Sn477; Calibrated: 09.05.2012
- Phantom: ELI 4.0; Type: QDOVA001BA; Serial: 1046
- DASY52 52.8.5(1059); SEMCAD X 14.6.8(7028)

MSL/d=10mm, Pin=100mW 5.5GHz/Area Scan (91x91x1): Interpolated grid:

$dx=1.000$ mm, $dy=1.000$ mm

Maximum value of SAR (interpolated) = 8.78 W/kg

MSL/d=10mm, Pin=100mW 5.5GHz/Zoom Scan (8x8x8) (8x8x8)/Cube 0:

Measurement grid: $dx=4.3$ mm, $dy=4.3$ mm, $dz=3$ mm

Reference Value = 40.209 V/m; Power Drift = 0.03 dB

Peak SAR (extrapolated) = 27.7 W/kg

SAR(1 g) = 7.3 W/kg; SAR(10 g) = 2.05 W/kg

Maximum value of SAR (measured) = 14.5 W/kg

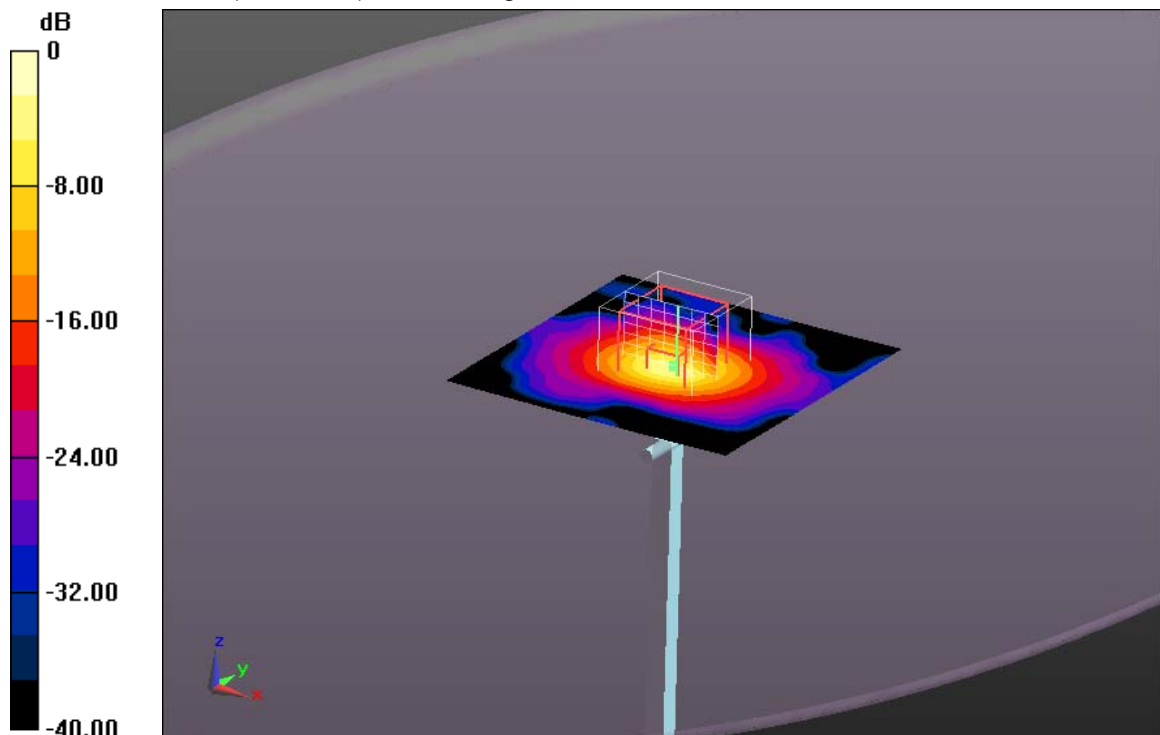

0 dB = 14.5 W/kg = 11.61 dBW/kg

Additional information:

ambient temperature: 22.2°C; liquid temperature: 21.1°C

Date/Time: 21.03.2013 11:49:28

SystemPerformanceCheck-D5GHz-body 2013-03-21

DUT: Dipole 5 GHz; Type: D5GHzV2; Serial: 1055

Communication System: CW; Frequency: 5800 MHz; Communication System PAR: 0 dB; PMF: 1

Medium parameters used: $f = 5800$ MHz; $\sigma = 6.1$ S/m; $\epsilon_r = 46.69$; $\rho = 1000$ kg/m³

Phantom section: Flat Section

Measurement Standard: DASYS5

DASY5 Configuration:

- Probe: EX3DV4 - SN3566; ConvF(3.12, 3.12, 3.12); Calibrated: 23.08.2012;
- Sensor-Surface: 4mm (Mechanical Surface Detection), Sensor-Surface: 2mm (Mechanical Surface Detection), $z = 1.0, 22.0$
- Electronics: DAE3 Sn477; Calibrated: 09.05.2012
- Phantom: ELI 4.0; Type: QDOVA001BA; Serial: 1046
- DASYS52 52.8.5(1059); SEMCAD X 14.6.8(7028)

MSL/d=10mm, Pin=100mW 5.8GHz/Area Scan (91x91x1): Interpolated grid:

$dx=1.000$ mm, $dy=1.000$ mm

Maximum value of SAR (interpolated) = 7.99 W/kg

MSL/d=10mm, Pin=100mW 5.8GHz/Zoom Scan (8x8x8) (8x8x8)/Cube 0:

Measurement grid: $dx=4.3$ mm, $dy=4.3$ mm, $dz=3$ mm

Reference Value = 37.965 V/m; Power Drift = -0.02 dB

Peak SAR (extrapolated) = 28.2 W/kg

SAR(1 g) = 7.11 W/kg; SAR(10 g) = 1.99 W/kg

Maximum value of SAR (measured) = 14.1 W/kg

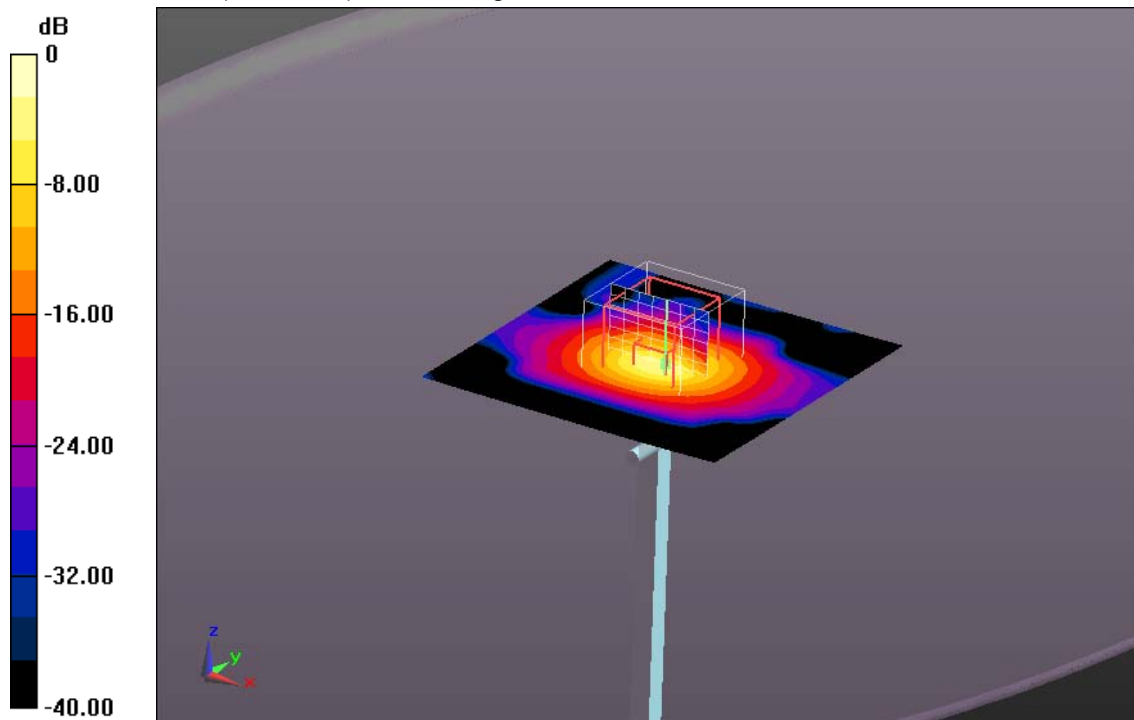

0 dB = 14.1 W/kg = 11.49 dBW/kg

Additional information:

ambient temperature: 22.2°C; liquid temperature: 21.1°C

Annex B: DASY5 measurement results

Annex B.1: GSM 850MHz

Date/Time: 16.03.2013 11:59:42

OET65-GSM 850

DUT: Sony; Type: SGP321; Serial: CB5A1NY05N

Communication System: GPRS-FDD (TDMA, GMSK, TN 0-1-2-3); Communication System Band: GSM 850 (824.0 - 849.0 MHz); Frequency: 824.2 MHz; Communication System PAR: 3.55 dB; PMF: 1.50487

Medium parameters used (interpolated): $f = 824.2$ MHz; $\sigma = 0.96$ S/m; $\epsilon_r = 55.097$; $\rho = 1000$ kg/m³

Phantom section: Flat Section

Measurement Standard: DASY5

DASY5 Configuration:

- Probe: ET3DV6 - SN1558; ConvF(6, 6, 6); Calibrated: 24.08.2012;
- Modulation Compensation: PMR (X: a=40.6 dB, b=99.4 dB√μV, c=23.0, d=3.6 dB / Y: a=33.7 dB, b=99.5 dB√μV, c=23.1, d=3.6 dB / Z: a=31.5 dB, b=99.5 dB√μV, c=23.6, d=3.6 dB); Calibrated: 24.08.2012
- Sensor-Surface: 4mm (Mechanical Surface Detection (Locations From Previous Scan Used)), Sensor-Surface: 4mm (Mechanical Surface Detection), z = 2.7, 32.7
- Electronics: DAE3 Sn477; Calibrated: 09.05.2012
- Phantom: ELI 4.0; Type: QDOVA001BA; Serial: 1046
- DASY52 52.8.5(1059); SEMCAD X 14.6.8(7028)

Body MSL/Rear Position - Low/Area Scan (141x211x1): Interpolated grid: dx=1.500 mm, dy=1.500 mm

Maximum value of SAR (interpolated) = 0.937 W/kg

Body MSL/Rear Position - Low/Zoom Scan (8x8x7)/Cube 0: Measurement grid: dx=5mm, dy=5mm, dz=5mm

Reference Value = 31.156 V/m; Power Drift = -0.05 dB

Peak SAR (extrapolated) = 1.86 W/kg

SAR(1 g) = 0.961 W/kg; SAR(10 g) = 0.524 W/kg

Maximum value of SAR (measured) = 1.04 W/kg

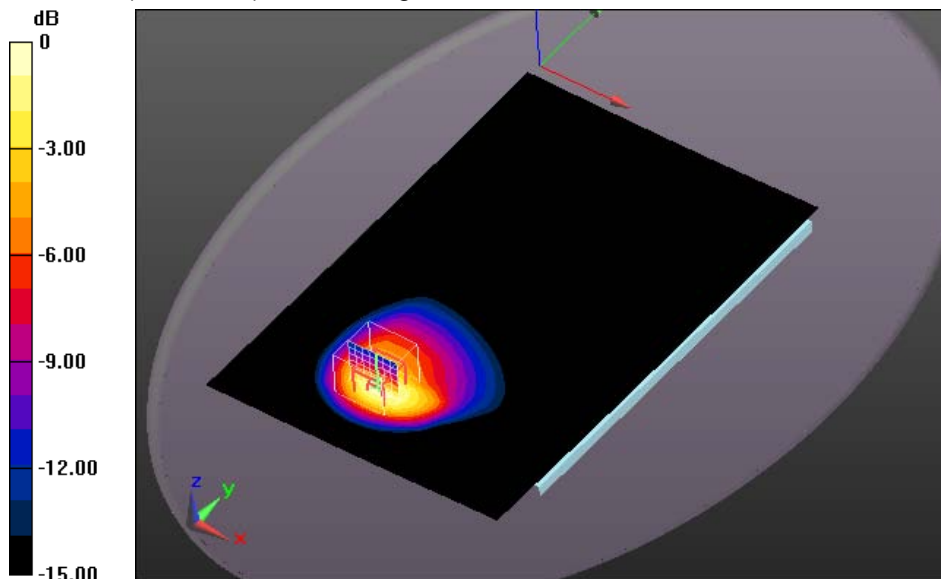

0 dB = 1.04 W/kg = 0.17 dBW/kg

Additional information:

position or distance of DUT to SAM: 0 mm

ambient temperature: 22.6°C; liquid temperature: 21.7°C

Date/Time: 16.03.2013 11:16:41

OET65-GSM 850

DUT: Sony; Type: SGP321; Serial: CB5A1NY05N

Communication System: GPRS-FDD (TDMA, GMSK, TN 0-1-2-3); Communication System Band: GSM 850 (824.0 - 849.0 MHz); Frequency: 836.6 MHz; Communication System PAR: 3.55 dB; PMF: 1.50487
 Medium parameters used (interpolated): $f = 836.6$ MHz; $\sigma = 0.97$ S/m; $\epsilon_r = 54.899$; $\rho = 1000$ kg/m³

Phantom section: Flat Section

Measurement Standard: DASYS

DASY5 Configuration:

- Probe: ET3DV6 - SN1558; ConvF(6, 6, 6); Calibrated: 24.08.2012;
- Modulation Compensation: PMR (X: a=40.6 dB, b=99.4 dB $\sqrt{\mu}$ V, c=23.0, d=3.6 dB / Y: a=33.7 dB, b=99.5 dB $\sqrt{\mu}$ V, c=23.1, d=3.6 dB / Z: a=31.5 dB, b=99.5 dB $\sqrt{\mu}$ V, c=23.6, d=3.6 dB); Calibrated: 24.08.2012
- Sensor-Surface: 4mm (Mechanical Surface Detection), z = 2.7, 32.7
- Electronics: DAE3 Sn477; Calibrated: 09.05.2012
- Phantom: ELI 4.0; Type: QDOVA001BA; Serial: 1046
- DASY52 52.8.5(1059); SEMCAD X 14.6.8(7028)

Body MSL/Rear Position - Mid/Area Scan (141x211x1): Interpolated grid: dx=1.500 mm, dy=1.500 mm
 Maximum value of SAR (interpolated) = 0.775 W/kg

Body MSL/Rear Position - Mid/Zoom Scan (8x8x7)/Cube 0: Measurement grid: dx=5mm, dy=5mm, dz=5mm

Reference Value = 28.090 V/m; Power Drift = -0.04 dB

Peak SAR (extrapolated) = 1.53 W/kg

SAR(1 g) = 0.797 W/kg; SAR(10 g) = 0.432 W/kg

Maximum value of SAR (measured) = 0.883 W/kg

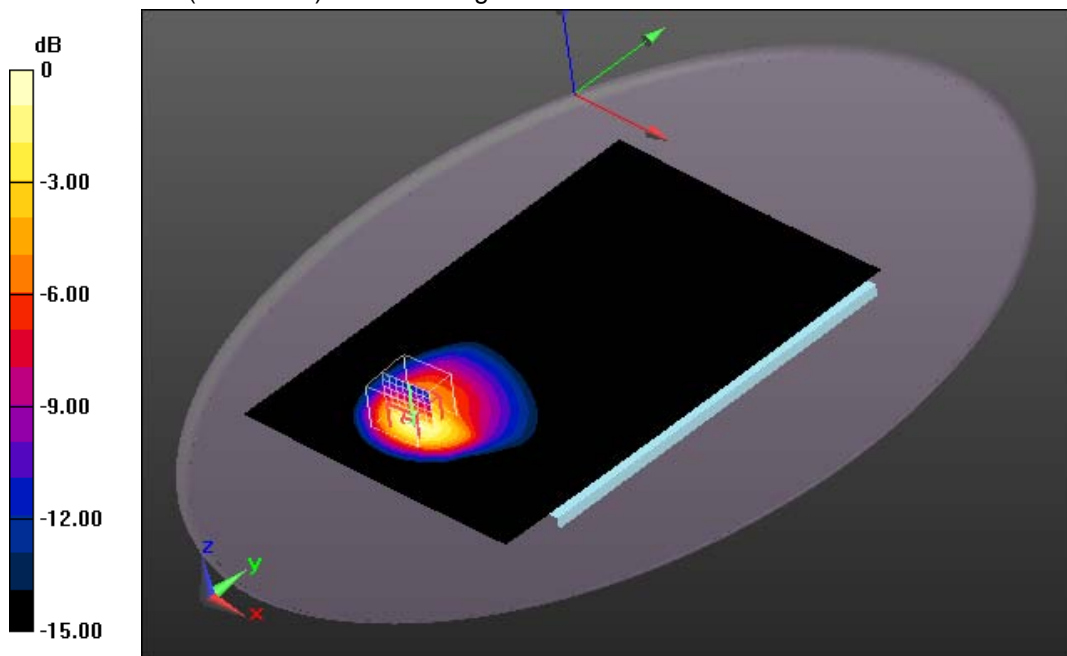

0 dB = 0.883 W/kg = -0.54 dBW/kg

Additional information:

position or distance of DUT to SAM: 0 mm

ambient temperature: 22.6°C; liquid temperature: 21.7°C

Date/Time: 16.03.2013 12:28:54

OET65-GSM 850

DUT: Sony; Type: SGP321; Serial: CB5A1NY05N

Communication System: GPRS-FDD (TDMA, GMSK, TN 0-1-2-3); Communication System Band: GSM 850 (824.0 - 849.0 MHz); Frequency: 848.6 MHz; Communication System PAR: 3.55 dB; PMF: 1.50487
 Medium parameters used (interpolated): $f = 848.6$ MHz; $\sigma = 0.979$ S/m; $\epsilon_r = 54.81$; $\rho = 1000$ kg/m³

Phantom section: Flat Section

Measurement Standard: DASYS

DASY5 Configuration:

- Probe: ET3DV6 - SN1558; ConvF(6, 6, 6); Calibrated: 24.08.2012;
- Modulation Compensation: PMR (X: a=40.6 dB, b=99.4 dB√μV, c=23.0, d=3.6 dB / Y: a=33.7 dB, b=99.5 dB√μV, c=23.1, d=3.6 dB / Z: a=31.5 dB, b=99.5 dB√μV, c=23.6, d=3.6 dB); Calibrated: 24.08.2012
- Sensor-Surface: 4mm (Mechanical Surface Detection (Locations From Previous Scan Used)), Sensor-Surface: 4mm (Mechanical Surface Detection), z = 2.7, 32.7
- Electronics: DAE3 Sn477; Calibrated: 09.05.2012
- Phantom: ELI 4.0; Type: QDOVA001BA; Serial: 1046
- DASY52 52.8.5(1059); SEMCAD X 14.6.8(7028)

Body MSL/Rear Position - Hi/Area Scan (141x211x1): Interpolated grid: dx=1.500 mm, dy=1.500 mm

Maximum value of SAR (interpolated) = 0.743 W/kg

Body MSL/Rear Position - Hi/Zoom Scan (8x8x7)/Cube 0: Measurement grid:

dx=5mm, dy=5mm, dz=5mm

Reference Value = 27.199 V/m; Power Drift = -0.02 dB

Peak SAR (extrapolated) = 1.49 W/kg

SAR(1 g) = 0.768 W/kg; SAR(10 g) = 0.414 W/kg

Maximum value of SAR (measured) = 0.860 W/kg

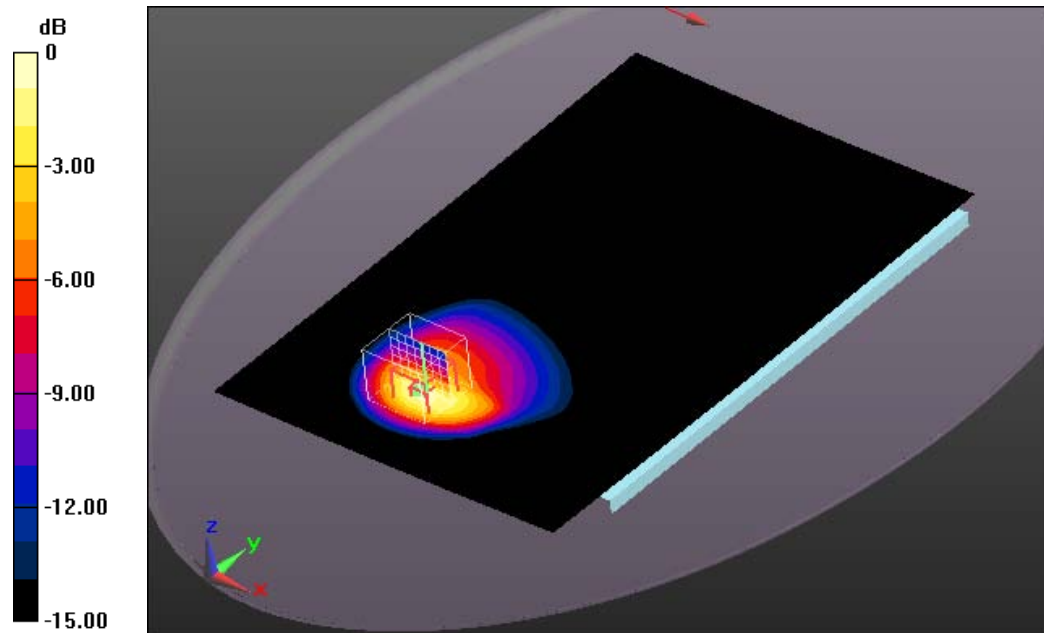

0 dB = 0.860 W/kg = -0.66 dBW/kg

Additional information:

position or distance of DUT to SAM: 0 mm

ambient temperature: 22.6°C; liquid temperature: 21.7°C

Date/Time: 16.03.2013 10:52:17

OET65-GSM 850

DUT: Sony; Type: SGP321; Serial: CB5A1NY05N

Communication System: GPRS-FDD (TDMA, GSMK, TN 0-1-2-3); Communication System Band: GSM 850 (824.0 - 849.0 MHz); Frequency: 836.6 MHz; Communication System PAR: 3.55 dB; PMF: 1.50487
 Medium parameters used (interpolated): $f = 836.6$ MHz; $\sigma = 0.97$ S/m; $\epsilon_r = 54.899$; $\rho = 1000$ kg/m³

Phantom section: Flat Section

Measurement Standard: DASYS

DASY5 Configuration:

- Probe: ET3DV6 - SN1558; ConvF(6, 6, 6); Calibrated: 24.08.2012;
- Modulation Compensation: PMR (X: a=40.6 dB, b=99.4 dB√μV, c=23.0, d=3.6 dB / Y: a=33.7 dB, b=99.5 dB√μV, c=23.1, d=3.6 dB / Z: a=31.5 dB, b=99.5 dB√μV, c=23.6, d=3.6 dB); Calibrated: 24.08.2012
- Sensor-Surface: 4mm (Mechanical Surface Detection), z = 2.7, 32.7
- Electronics: DAE3 Sn477; Calibrated: 09.05.2012
- Phantom: ELI 4.0; Type: QDOVA001BA; Serial: 1046
- DASY52 52.8.5(1059); SEMCAD X 14.6.8(7028)

Body MSL/Right Side Position - Middle 0mm/Area Scan (71x131x1):

Interpolated grid: dx=1.500 mm, dy=1.500 mm

Maximum value of SAR (interpolated) = 0.463 W/kg

Body MSL/Right Side Position - Middle 0mm/Zoom Scan (7x7x7)/Cube 0:

Measurement grid: dx=5mm, dy=5mm, dz=5mm

Reference Value = 20.937 V/m; Power Drift = -0.01 dB

Peak SAR (extrapolated) = 1.44 W/kg

SAR(1 g) = 0.503 W/kg; SAR(10 g) = 0.241 W/kg

Maximum value of SAR (measured) = 0.543 W/kg

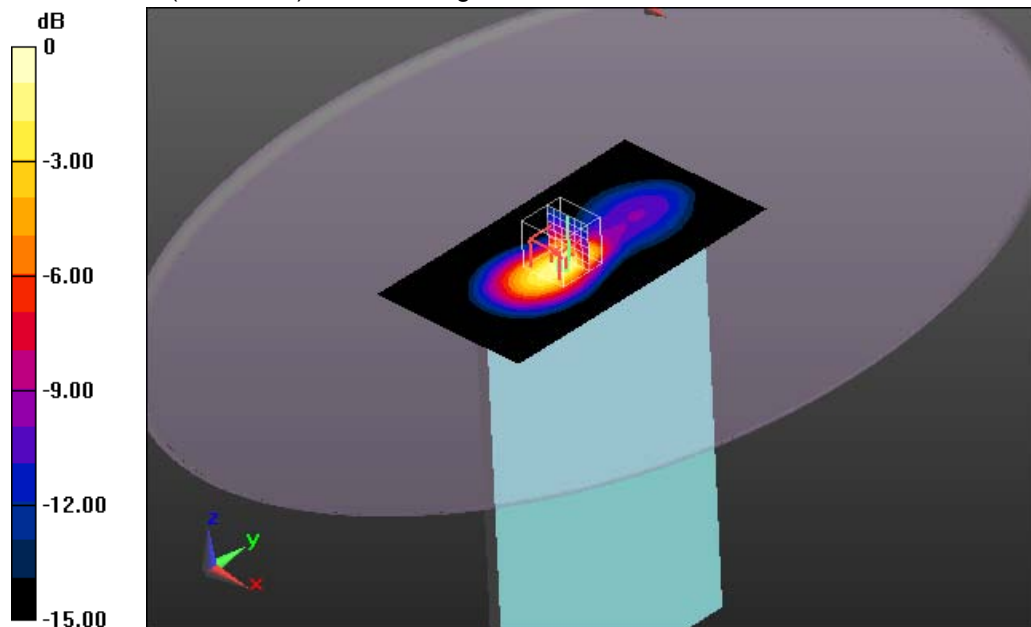

0 dB = 0.543 W/kg = -2.65 dBW/kg

Additional information:

position or distance of DUT to SAM: 0 mm

ambient temperature: 22.6°C; liquid temperature: 21.7°C

Date/Time: 16.03.2013 10:23:15

OET65-GSM 850

DUT: Sony; Type: SGP321; Serial: CB5A1NY05N

Communication System: GPRS-FDD (TDMA, GMSK, TN 0-1-2-3); Communication System Band: GSM 850 (824.0 - 849.0 MHz); Frequency: 836.6 MHz; Communication System PAR: 3.55 dB; PMF: 1.50487
 Medium parameters used (interpolated): $f = 836.6$ MHz; $\sigma = 0.97$ S/m; $\epsilon_r = 54.899$; $\rho = 1000$ kg/m³

Phantom section: Flat Section

Measurement Standard: DASYS

DASY5 Configuration:

- Probe: ET3DV6 - SN1558; ConvF(6, 6, 6); Calibrated: 24.08.2012;
- Modulation Compensation: PMR (X: a=40.6 dB, b=99.4 dB√μV, c=23.0, d=3.6 dB / Y: a=33.7 dB, b=99.5 dB√μV, c=23.1, d=3.6 dB / Z: a=31.5 dB, b=99.5 dB√μV, c=23.6, d=3.6 dB); Calibrated: 24.08.2012
- Sensor-Surface: 4mm (Mechanical Surface Detection), z = 2.7, 32.7
- Electronics: DAE3 Sn477; Calibrated: 09.05.2012
- Phantom: ELI 4.0; Type: QDOVA001BA; Serial: 1046
- DASY52 52.8.5(1059); SEMCAD X 14.6.8(7028)

Body MSL/Top Position - Middle/Area Scan (81x201x1): Interpolated grid: dx=1.500 mm, dy=1.500 mm
 Maximum value of SAR (interpolated) = 0.0950 W/kg

Body MSL/Top Position - Middle/Zoom Scan (7x7x7)/Cube 0: Measurement grid: dx=5mm, dy=5mm, dz=5mm

Reference Value = 10.157 V/m; Power Drift = -0.04 dB

Peak SAR (extrapolated) = 0.126 W/kg

SAR(1 g) = 0.087 W/kg; SAR(10 g) = 0.059 W/kg

Maximum value of SAR (measured) = 0.0934 W/kg

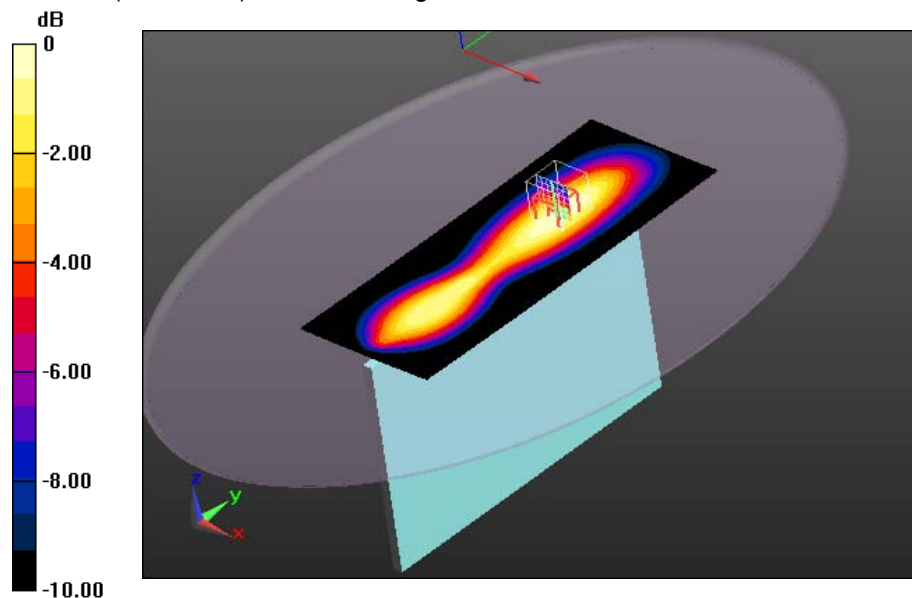

0 dB = 0.0934 W/kg = -10.30 dBW/kg

Additional information:

position or distance of DUT to SAM: 0 mm

ambient temperature: 22.6°C; liquid temperature: 21.7°C

Date/Time: 16.03.2013 13:09:43

OET65-GSM 850

DUT: Sony; Type: SGP321; Serial: CB5A1NY05N

Communication System: GPRS-FDD (TDMA, GMSK, TN 0-1-2-3); Communication System Band: GSM 850 (824.0 - 849.0 MHz); Frequency: 824.2 MHz; Communication System PAR: 3.55 dB; PMF: 1.50487
 Medium parameters used (interpolated): $f = 824.2 \text{ MHz}$; $\sigma = 0.96 \text{ S/m}$; $\epsilon_r = 55.097$; $\rho = 1000 \text{ kg/m}^3$

Phantom section: Flat Section

Measurement Standard: DASYS5

DASY5 Configuration:

- Probe: ET3DV6 - SN1558; ConvF(6, 6, 6); Calibrated: 24.08.2012;
- Modulation Compensation: PMR (X: $a=40.6 \text{ dB}$, $b=99.4 \text{ dB}\sqrt{\mu\text{V}}$, $c=23.0$, $d=3.6 \text{ dB}$ / Y: $a=33.7 \text{ dB}$, $b=99.5 \text{ dB}\sqrt{\mu\text{V}}$, $c=23.1$, $d=3.6 \text{ dB}$ / Z: $a=31.5 \text{ dB}$, $b=99.5 \text{ dB}\sqrt{\mu\text{V}}$, $c=23.6$, $d=3.6 \text{ dB}$); Calibrated: 24.08.2012
- Sensor-Surface: 4mm (Mechanical Surface Detection (Locations From Previous Scan Used)), Sensor-Surface: 4mm (Mechanical Surface Detection), $z = 2.7, 32.7$
- Electronics: DAE3 Sn477; Calibrated: 09.05.2012
- Phantom: ELI 4.0; Type: QDOVA001BA; Serial: 1046
- DASYS52 52.8.5(1059); SEMCAD X 14.6.8(7028)

Body MSL/Rear Position - Low wc/Area Scan (141x211x1): Interpolated grid:

$dx=1.500 \text{ mm}$, $dy=1.500 \text{ mm}$

Maximum value of SAR (interpolated) = 0.953 W/kg

Body MSL/Rear Position - Low wc/Zoom Scan (8x8x7)/Cube 0: Measurement

grid: $dx=5\text{mm}$, $dy=5\text{mm}$, $dz=5\text{mm}$

Reference Value = 31.705 V/m; Power Drift = -0.03 dB

Peak SAR (extrapolated) = 1.89 W/kg

SAR(1 g) = 0.981 W/kg; SAR(10 g) = 0.536 W/kg

Maximum value of SAR (measured) = 1.06 W/kg

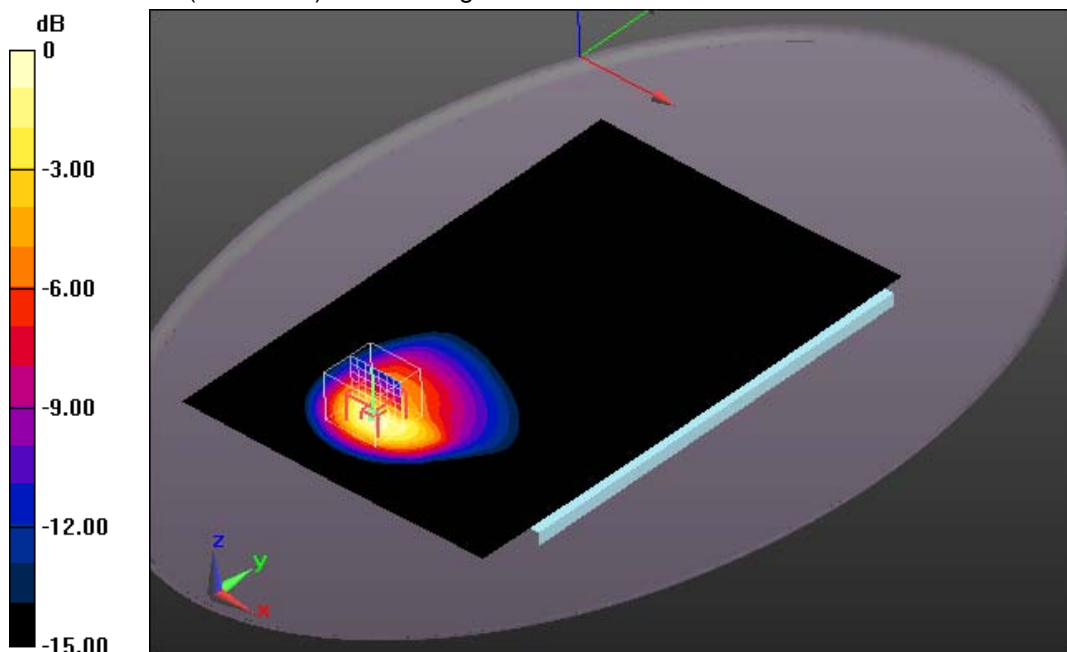

0 dB = 1.06 W/kg = 0.25 dBW/kg

Additional information:

position or distance of DUT to SAM: 0 mm

ambient temperature: 22.6°C; liquid temperature: 21.7°C

Annex B.2: GSM 1900MHz

Date/Time: 11.03.2013 08:51:32

OET65-GSM1900-body

DUT: Sony; Type: SGP321; Serial: CB5A1NY05N

Communication System: GPRS-FDD (TDMA, GMSK, TN 0-1-2-3); Communication System Band: PCS 1900 (1850.0 - 1910.0 MHz); Frequency: 1850.2 MHz; Communication System PAR: 3.55 dB; PMF: 1.50487
 Medium parameters used: $f = 1850.2 \text{ MHz}$; $\sigma = 1.47 \text{ S/m}$; $\epsilon_r = 52.8$; $\rho = 1000 \text{ kg/m}^3$

Phantom section: Flat Section

Measurement Standard: DASYS

DASY5 Configuration:

- Probe: ET3DV6 - SN1558; ConvF(4.2, 4.2, 4.2); Calibrated: 24.08.2012;
- Modulation Compensation: PMR (X: $a=40.6 \text{ dB}$, $b=99.4 \text{ dB}\sqrt{\mu\text{V}}$, $c=23.0$, $d=3.6 \text{ dB}$ / Y: $a=33.7 \text{ dB}$, $b=99.5 \text{ dB}\sqrt{\mu\text{V}}$, $c=23.1$, $d=3.6 \text{ dB}$ / Z: $a=31.5 \text{ dB}$, $b=99.5 \text{ dB}\sqrt{\mu\text{V}}$, $c=23.6$, $d=3.6 \text{ dB}$); Calibrated: 24.08.2012
- Sensor-Surface: 4mm (Mechanical Surface Detection (Locations From Previous Scan Used)), Sensor-Surface: 4mm (Mechanical Surface Detection), $z = 2.7, 32.7$
- Electronics: DAE3 Sn477; Calibrated: 09.05.2012
- Phantom: ELI 4.0; Type: QDOVA001BA; Serial: 1046
- DASYS2 52.8.5(1059); SEMCAD X 14.6.8(7028)

Body MSL/Rear Position - Low/Area Scan (141x221x1): Interpolated grid: $dx=1.500 \text{ mm}$, $dy=1.500 \text{ mm}$

Maximum value of SAR (interpolated) = 0.989 W/kg

Body MSL/Rear Position - Low/Zoom Scan (7x7x7)/Cube 0: Measurement grid:

$dx=5\text{mm}$, $dy=5\text{mm}$, $dz=5\text{mm}$

Reference Value = 22.122 V/m; Power Drift = -0.12 dB

Peak SAR (extrapolated) = 2.08 W/kg

SAR(1 g) = 0.819 W/kg; SAR(10 g) = 0.389 W/kg

Maximum value of SAR (measured) = 0.918 W/kg

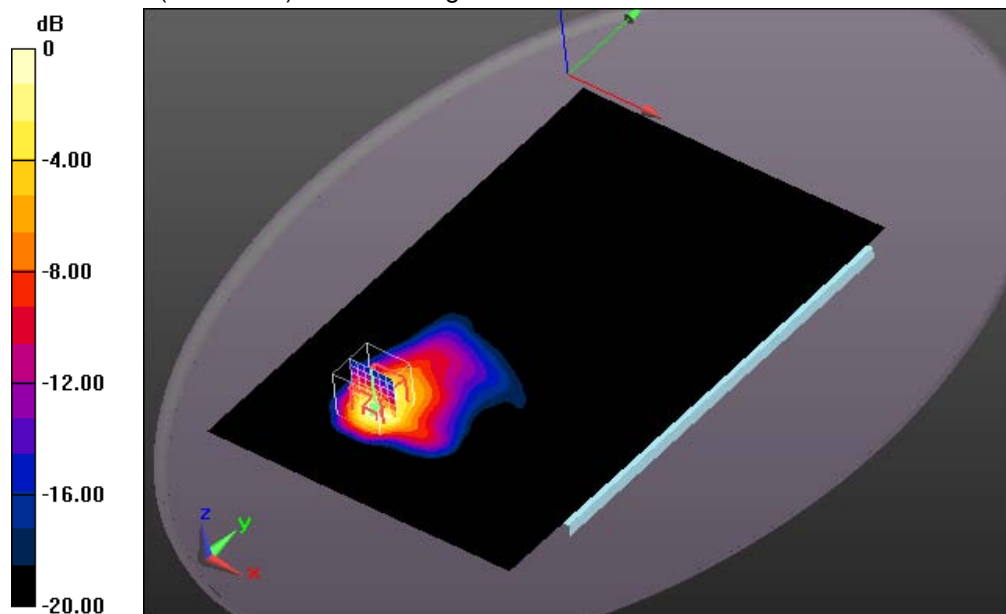

0 dB = 0.918 W/kg = -0.37 dBW/kg

Additional information:

position or distance of DUT to SAM: 0 mm

ambient temperature: 22.3°C; liquid temperature: 21.1°C

Date/Time: 11.03.2013 08:10:58

OET65-GSM1900-body

DUT: Sony; Type: SGP321; Serial: CB5A1NY05N

Communication System: GPRS-FDD (TDMA, GMSK, TN 0-1-2-3); Communication System Band: PCS 1900 (1850.0 - 1910.0 MHz); Frequency: 1880 MHz; Communication System PAR: 3.55 dB; PMF: 1.50487

Medium parameters used: $f = 1880$ MHz; $\sigma = 1.5$ S/m; $\epsilon_r = 52.7$; $\rho = 1000$ kg/m³

Phantom section: Flat Section

Measurement Standard: DASYS

DASY5 Configuration:

- Probe: ET3DV6 - SN1558; ConvF(4.2, 4.2, 4.2); Calibrated: 24.08.2012;
- Modulation Compensation: PMR (X: a=40.6 dB, b=99.4 dB $\sqrt{\mu}$ V, c=23.0, d=3.6 dB / Y: a=33.7 dB, b=99.5 dB $\sqrt{\mu}$ V, c=23.1, d=3.6 dB / Z: a=31.5 dB, b=99.5 dB $\sqrt{\mu}$ V, c=23.6, d=3.6 dB); Calibrated: 24.08.2012
- Sensor-Surface: 4mm (Mechanical Surface Detection), z = 2.7, 32.7
- Electronics: DAE3 Sn477; Calibrated: 09.05.2012
- Phantom: ELI 4.0; Type: QDOVA001BA; Serial: 1046
- DASY52 52.8.5(1059); SEMCAD X 14.6.8(7028)

Body MSL/Rear Position - Middle/Area Scan (141x221x1): Interpolated grid:

dx=1.500 mm, dy=1.500 mm

Maximum value of SAR (interpolated) = 0.791 W/kg

Body MSL/Rear Position - Middle/Zoom Scan (7x7x7)/Cube 0: Measurement grid:

dx=5mm, dy=5mm, dz=5mm

Reference Value = 21.713 V/m; Power Drift = -0.16 dB

Peak SAR (extrapolated) = 1.54 W/kg

SAR(1 g) = 0.675 W/kg; SAR(10 g) = 0.334 W/kg

Maximum value of SAR (measured) = 0.775 W/kg

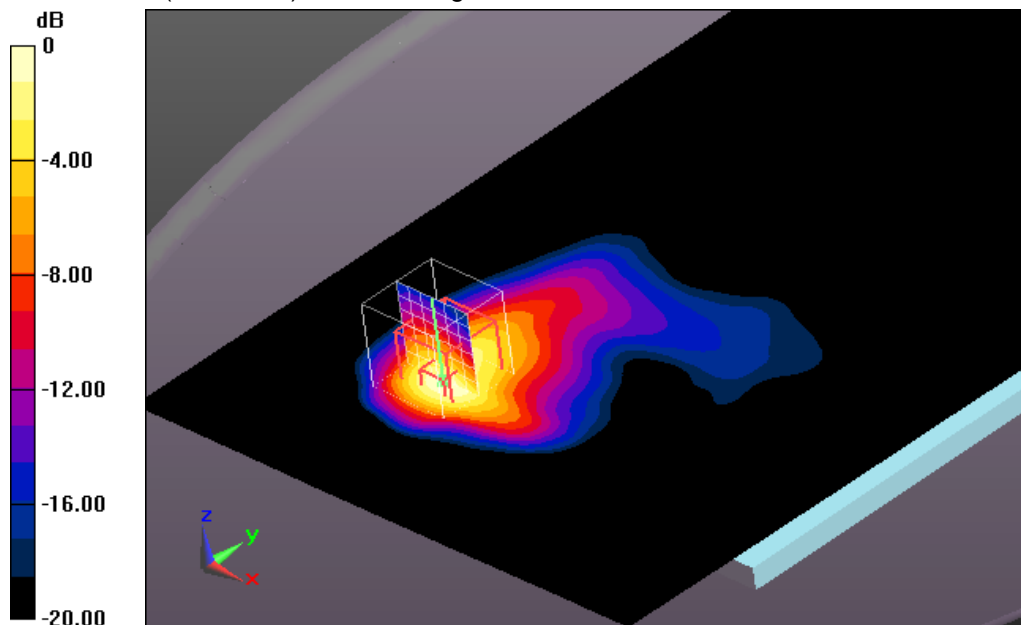

0 dB = 0.775 W/kg = -1.11 dBW/kg

Additional information:

position or distance of DUT to SAM: 0 mm

ambient temperature: 22.3°C; liquid temperature: 21.1°C

Date/Time: 11.03.2013 09:16:13

OET65-GSM1900-body

DUT: Sony; Type: SGP321; Serial: CB5A1NY05N

Communication System: GPRS-FDD (TDMA, GMSK, TN 0-1-2-3); Communication System Band: PCS 1900 (1850.0 - 1910.0 MHz); Frequency: 1909.8 MHz; Communication System PAR: 3.55 dB; PMF: 1.50487
 Medium parameters used: $f = 1909.8 \text{ MHz}$; $\sigma = 1.54 \text{ S/m}$; $\epsilon_r = 52.6$; $\rho = 1000 \text{ kg/m}^3$

Phantom section: Flat Section

Measurement Standard: DASYS5

DASY5 Configuration:

- Probe: ET3DV6 - SN1558; ConvF(4.2, 4.2, 4.2); Calibrated: 24.08.2012;
- Modulation Compensation: PMR (X: a=40.6 dB, b=99.4 dB $\sqrt{\mu\text{V}}$, c=23.0, d=3.6 dB / Y: a=33.7 dB, b=99.5 dB $\sqrt{\mu\text{V}}$, c=23.1, d=3.6 dB / Z: a=31.5 dB, b=99.5 dB $\sqrt{\mu\text{V}}$, c=23.6, d=3.6 dB); Calibrated: 24.08.2012
- Sensor-Surface: 4mm (Mechanical Surface Detection (Locations From Previous Scan Used)), Sensor-Surface: 4mm (Mechanical Surface Detection), z = 2.7, 32.7
- Electronics: DAE3 Sn477; Calibrated: 09.05.2012
- Phantom: ELI 4.0; Type: QDOVA001BA; Serial: 1046
- DASY52 52.8.5(1059); SEMCAD X 14.6.8(7028)

Body MSL/Rear Position - Hi/Area Scan (141x221x1): Interpolated grid: dx=1.500 mm, dy=1.500 mm

Maximum value of SAR (interpolated) = 0.804 W/kg

Body MSL/Rear Position - Hi/Zoom Scan (7x7x7)/Cube 0: Measurement grid:

dx=5mm, dy=5mm, dz=5mm

Reference Value = 22.691 V/m; Power Drift = -0.10 dB

Peak SAR (extrapolated) = 1.52 W/kg

SAR(1 g) = 0.688 W/kg; SAR(10 g) = 0.337 W/kg

Maximum value of SAR (measured) = 0.792 W/kg

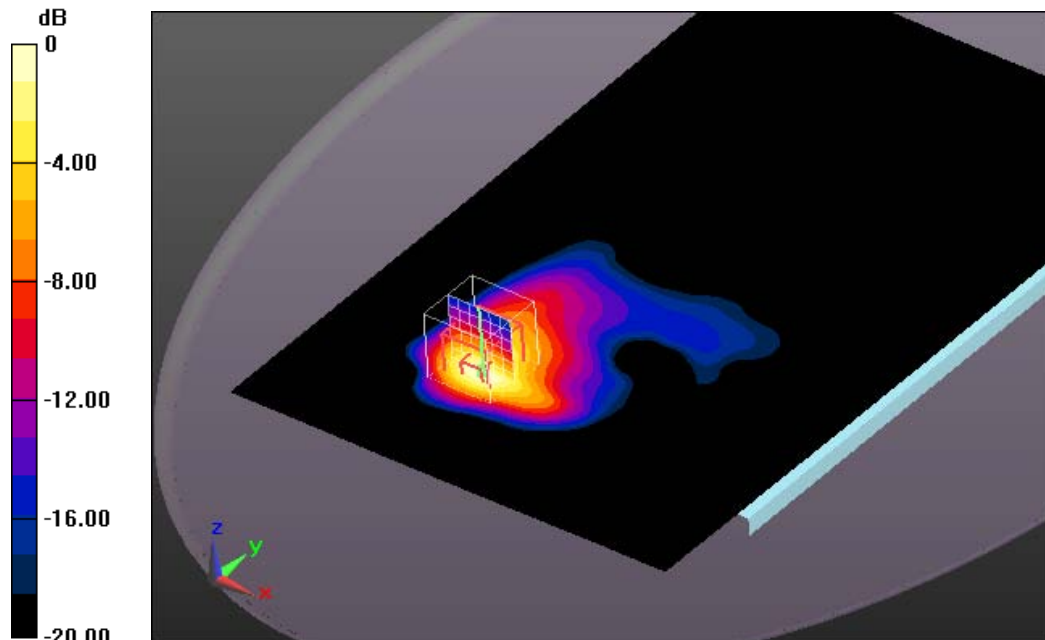

0 dB = 0.792 W/kg = -1.01 dBW/kg

Additional information:

position or distance of DUT to SAM: 0 mm

ambient temperature: 22.3°C; liquid temperature: 21.1°C

Date/Time: 11.03.2013 07:05:17

OET65-GSM1900-body

DUT: Sony; Type: SGP321; Serial: CB5A1NY05N

Communication System: GPRS-FDD (TDMA, GMSK, TN 0-1-2-3); Communication System Band: PCS 1900 (1850.0 - 1910.0 MHz); Frequency: 1880 MHz; Communication System PAR: 3.55 dB; PMF: 1.50487

Medium parameters used: $f = 1880$ MHz; $\sigma = 1.5$ S/m; $\epsilon_r = 52.7$; $\rho = 1000$ kg/m³

Phantom section: Flat Section

Measurement Standard: DASYS

DASY5 Configuration:

- Probe: ET3DV6 - SN1558; ConvF(4.2, 4.2, 4.2); Calibrated: 24.08.2012;
- Modulation Compensation: PMR (X: a=40.6 dB, b=99.4 dB $\sqrt{\mu}$ V, c=23.0, d=3.6 dB / Y: a=33.7 dB, b=99.5 dB $\sqrt{\mu}$ V, c=23.1, d=3.6 dB / Z: a=31.5 dB, b=99.5 dB $\sqrt{\mu}$ V, c=23.6, d=3.6 dB); Calibrated: 24.08.2012
- Sensor-Surface: 4mm (Mechanical Surface Detection), z = 2.7, 32.7
- Electronics: DAE3 Sn477; Calibrated: 09.05.2012
- Phantom: ELI 4.0; Type: QDOVA001BA; Serial: 1046
- DASY52 52.8.5(1059); SEMCAD X 14.6.8(7028)

Body MSL/Right Side Position - Mid/Area Scan (81x151x1): Interpolated grid:

dx=1.500 mm, dy=1.500 mm

Maximum value of SAR (interpolated) = 0.448 W/kg

Body MSL/Right Side Position - Mid/Zoom Scan (7x7x7)/Cube 0: Measurement

grid: dx=5mm, dy=5mm, dz=5mm

Reference Value = 18.024 V/m; Power Drift = -0.11 dB

Peak SAR (extrapolated) = 0.950 W/kg

SAR(1 g) = 0.398 W/kg; SAR(10 g) = 0.175 W/kg

Maximum value of SAR (measured) = 0.465 W/kg

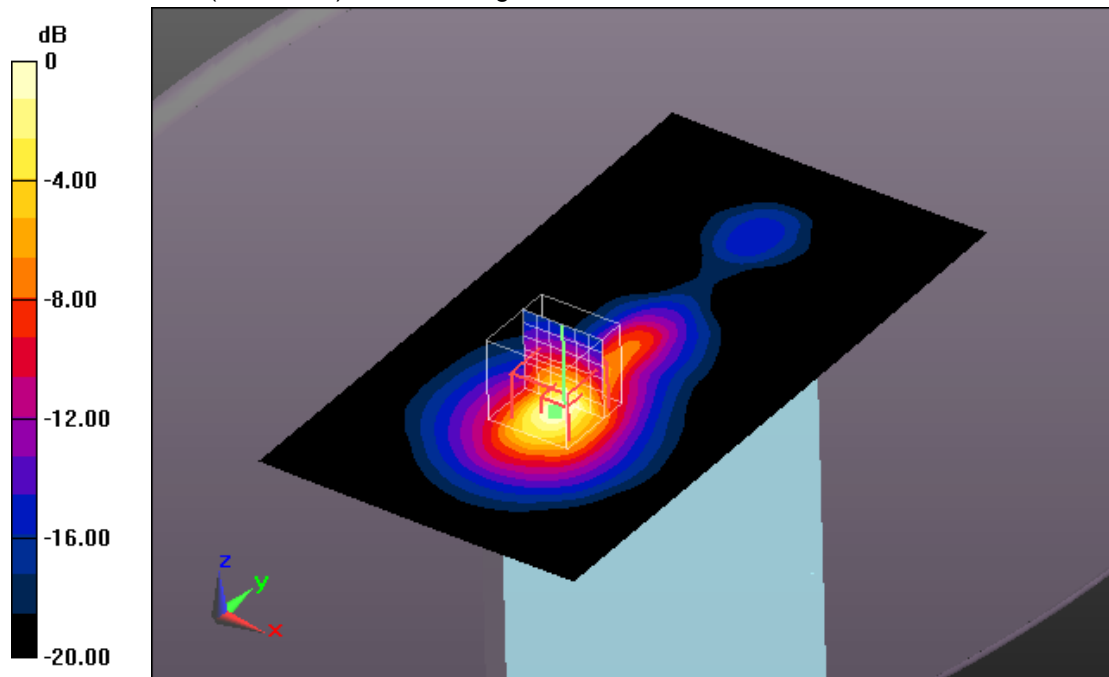

0 dB = 0.465 W/kg = -3.33 dBW/kg

Additional information:

position or distance of DUT to SAM: 0 mm

ambient temperature: 22.3°C; liquid temperature: 21.1°C

Date/Time: 11.03.2013 07:30:43

OET65-GSM1900-body

DUT: Sony; Type: SGP321; Serial: CB5A1NY05N

Communication System: GPRS-FDD (TDMA, GMSK, TN 0-1-2-3); Communication System Band: PCS 1900 (1850.0 - 1910.0 MHz); Frequency: 1880 MHz; Communication System PAR: 3.55 dB; PMF: 1.50487

Medium parameters used: $f = 1880$ MHz; $\sigma = 1.5$ S/m; $\epsilon_r = 52.7$; $\rho = 1000$ kg/m³

Phantom section: Flat Section

Measurement Standard: DASYS5

DASY5 Configuration:

- Probe: ET3DV6 - SN1558; ConvF(4.2, 4.2, 4.2); Calibrated: 24.08.2012;
- Modulation Compensation: PMR (X: a=40.6 dB, b=99.4 dB $\sqrt{\mu}$ V, c=23.0, d=3.6 dB / Y: a=33.7 dB, b=99.5 dB $\sqrt{\mu}$ V, c=23.1, d=3.6 dB / Z: a=31.5 dB, b=99.5 dB $\sqrt{\mu}$ V, c=23.6, d=3.6 dB); Calibrated: 24.08.2012
- Sensor-Surface: 4mm (Mechanical Surface Detection), z = 2.7, 32.7
- Electronics: DAE3 Sn477; Calibrated: 09.05.2012
- Phantom: ELI 4.0; Type: QDOVA001BA; Serial: 1046
- DASY52 52.8.5(1059); SEMCAD X 14.6.8(7028)

Body MSL/Top Position - Middle/Area Scan (81x201x1): Interpolated grid: dx=1.500 mm, dy=1.500 mm

Maximum value of SAR (interpolated) = 0.0900 W/kg

Body MSL/Top Position - Middle/Zoom Scan (7x7x7)/Cube 0: Measurement grid:

dx=5mm, dy=5mm, dz=5mm

Reference Value = 8.200 V/m; Power Drift = -0.01 dB

Peak SAR (extrapolated) = 0.132 W/kg

SAR(1 g) = 0.079 W/kg; SAR(10 g) = 0.043 W/kg

Maximum value of SAR (measured) = 0.0893 W/kg

Body MSL/Top Position - Middle/Zoom Scan 2 (7x7x7)/Cube 0: Measurement grid: dx=5mm, dy=5mm, dz=5mm

Reference Value = 8.200 V/m; Power Drift = -0.01 dB

Peak SAR (extrapolated) = 0.104 W/kg

SAR(1 g) = 0.066 W/kg; SAR(10 g) = 0.040 W/kg

Maximum value of SAR (measured) = 0.0724 W/kg

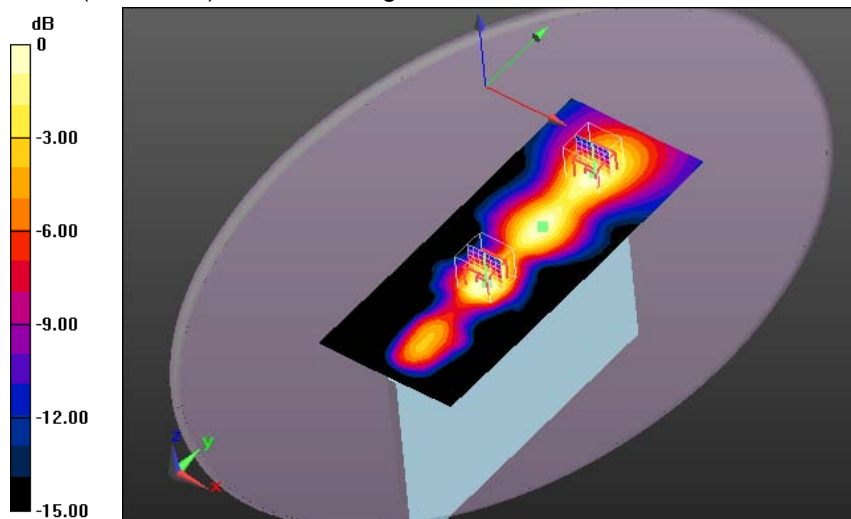

0 dB = 0.0724 W/kg = -11.40 dBW/kg

Additional information:

position or distance of DUT to SAM: 0 mm

ambient temperature: 22.3°C; liquid temperature: 21.1°C

Date/Time: 11.03.2013 10:14:24

OET65-GSM1900-body

DUT: Sony; Type: SGP321; Serial: CB5A1NY05N

Communication System: EDGE (8PSK, TN 0-1-2-3); Communication System Band: PCS 1900; Frequency: 1850.2 MHz; Communication System PAR: 6.53 dB; PMF: 1.79267

Medium parameters used: $f = 1850.2$ MHz; $\sigma = 1.47$ S/m; $\epsilon_r = 52.8$; $\rho = 1000$ kg/m³

Phantom section: Flat Section

Measurement Standard: DASYS5

DASY5 Configuration:

- Probe: ET3DV6 - SN1558; ConvF(4.2, 4.2, 4.2); Calibrated: 24.08.2012;
- Sensor-Surface: 4mm (Mechanical Surface Detection (Locations From Previous Scan Used)), Sensor-Surface: 4mm (Mechanical Surface Detection), $z = 2.7, 32.7$
- Electronics: DAE3 Sn477; Calibrated: 09.05.2012
- Phantom: ELI 4.0; Type: QDOVA001BA; Serial: 1046
- DASYS52 52.8.5(1059); SEMCAD X 14.6.8(7028)

Body MSL/Rear Position - Low 8PSK/Area Scan (141x221x1): Interpolated grid:

$dx=1.500$ mm, $dy=1.500$ mm

Maximum value of SAR (interpolated) = 1.03 W/kg

Body MSL/Rear Position - Low 8PSK/Zoom Scan (7x7x7)/Cube 0: Measurement

grid: $dx=5$ mm, $dy=5$ mm, $dz=5$ mm

Reference Value = 27.157 V/m; Power Drift = -0.01 dB

Peak SAR (extrapolated) = 2.48 W/kg

SAR(1 g) = 0.952 W/kg; SAR(10 g) = 0.428 W/kg

Maximum value of SAR (measured) = 1.11 W/kg

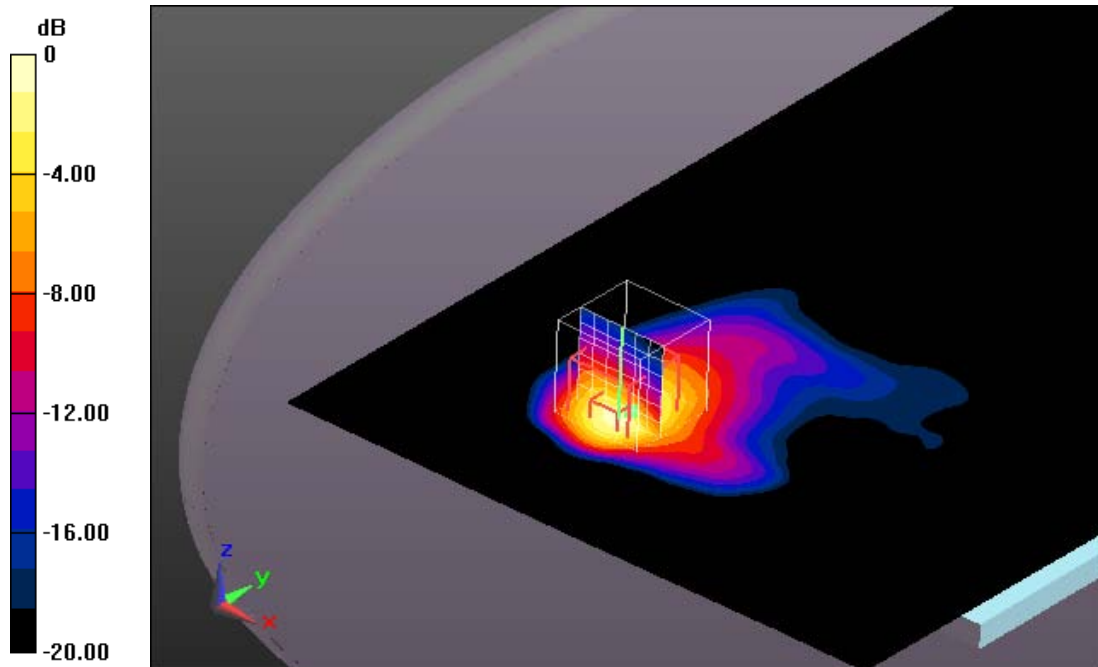

0 dB = 1.11 W/kg = 0.45 dBW/kg

Additional information:

position or distance of DUT to SAM: 0 mm

ambient temperature: 22.3°C; liquid temperature: 21.1°C

Date/Time: 11.03.2013 10:40:46

OET65-GSM1900-body

DUT: Sony; Type: SGP321; Serial: CB5A1NY05N

Communication System: EDGE (8PSK, TN 0-1-2-3); Communication System Band: PCS 1900; Frequency: 1850.2 MHz; Communication System PAR: 6.53 dB; PMF: 1.79267

Medium parameters used: $f = 1850.2$ MHz; $\sigma = 1.47$ S/m; $\epsilon_r = 52.8$; $\rho = 1000$ kg/m³

Phantom section: Flat Section

Measurement Standard: DASYS

DASY5 Configuration:

- Probe: ET3DV6 - SN1558; ConvF(4.2, 4.2, 4.2); Calibrated: 24.08.2012;
- Sensor-Surface: 4mm (Mechanical Surface Detection (Locations From Previous Scan Used)), Sensor-Surface: 4mm (Mechanical Surface Detection), $z = 2.7, 32.7$
- Electronics: DAE3 Sn477; Calibrated: 09.05.2012
- Phantom: ELI 4.0; Type: QDOVA001BA; Serial: 1046
- DASYS52 52.8.5(1059); SEMCAD X 14.6.8(7028)

Body MSL/Rear Position - Low 8PSK WC/Area Scan (141x221x1): Interpolated

grid: $dx=1.500$ mm, $dy=1.500$ mm

Maximum value of SAR (interpolated) = 1.05 W/kg

Body MSL/Rear Position - Low 8PSK WC/Zoom Scan (7x7x7)/Cube 0:

Measurement grid: $dx=5$ mm, $dy=5$ mm, $dz=5$ mm

Reference Value = 26.046 V/m; Power Drift = -0.06 dB

Peak SAR (extrapolated) = 2.36 W/kg

SAR(1 g) = 0.933 W/kg; SAR(10 g) = 0.441 W/kg

Maximum value of SAR (measured) = 1.08 W/kg

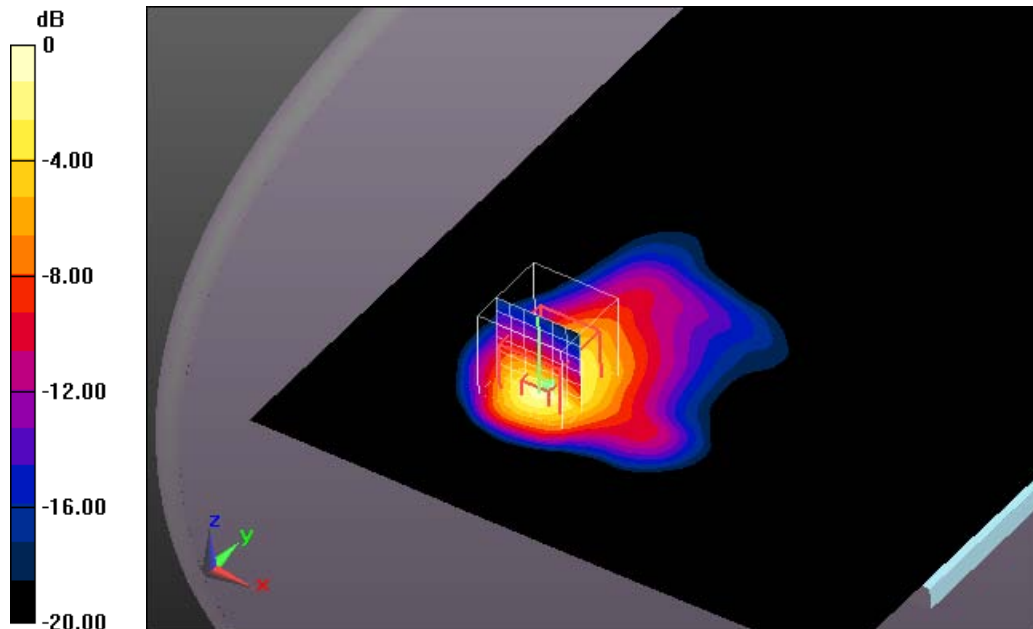

0 dB = 1.08 W/kg = 0.33 dBW/kg

Additional information:

position or distance of DUT to SAM: 0 mm

ambient temperature: 22.3°C; liquid temperature: 21.1°C

Annex B.3: UMTS FDD V

Date/Time: 16.03.2013 14:17:10

OET65-UMTS FDD-V

DUT: Sony; Type: SGP321; Serial: CB5A1NY05N

Communication System: UMTS-FDD (WCDMA); Communication System Band: Band 5, UTRA/FDD (824.0 - 849.0 MHz); Frequency: 826.4 MHz; Communication System PAR: 2.91 dB; PMF: 1.00231

Medium parameters used (interpolated): $f = 826.4$ MHz; $\sigma = 0.962$ S/m; $\epsilon_r = 55.057$; $\rho = 1000$ kg/m³

Phantom section: Flat Section

Measurement Standard: DASYS

DASY5 Configuration:

- Probe: ET3DV6 - SN1558; ConvF(6, 6, 6); Calibrated: 24.08.2012;

- Modulation Compensation: PMR (X: $a=3.22$ dB, $b=66.3$ dB $\sqrt{\mu}$ V, $c=18.5$, $d=2.9$ dB / Y: $a=3.10$ dB, $b=65.6$ dB $\sqrt{\mu}$ V, $c=18.0$, $d=2.9$ dB / Z: $a=3.31$ dB, $b=66.5$ dB $\sqrt{\mu}$ V, $c=18.4$, $d=2.9$ dB); Calibrated: 24.08.2012

- Sensor-Surface: 4mm (Mechanical Surface Detection (Locations From Previous Scan Used)), Sensor-Surface: 4mm (Mechanical Surface Detection), $z = 2.7, 32.7$

- Electronics: DAE3 Sn477; Calibrated: 09.05.2012

- Phantom: ELI 4.0; Type: QDOVA001BA; Serial: 1046

- DASYS2 52.8.5(1059); SEMCAD X 14.6.8(7028)

Body MSL/Rear Position - Low/Area Scan (141x211x1): Interpolated grid: $dx=1.500$ mm, $dy=1.500$ mm

Maximum value of SAR (interpolated) = 0.799 W/kg

Body MSL/Rear Position - Low/Zoom Scan (7x7x7)/Cube 0: Measurement grid:

$dx=5$ mm, $dy=5$ mm, $dz=5$ mm

Reference Value = 29.077 V/m; Power Drift = -0.00 dB

Peak SAR (extrapolated) = 1.61 W/kg

SAR(1 g) = 0.831 W/kg; SAR(10 g) = 0.452 W/kg

Maximum value of SAR (measured) = 0.897 W/kg

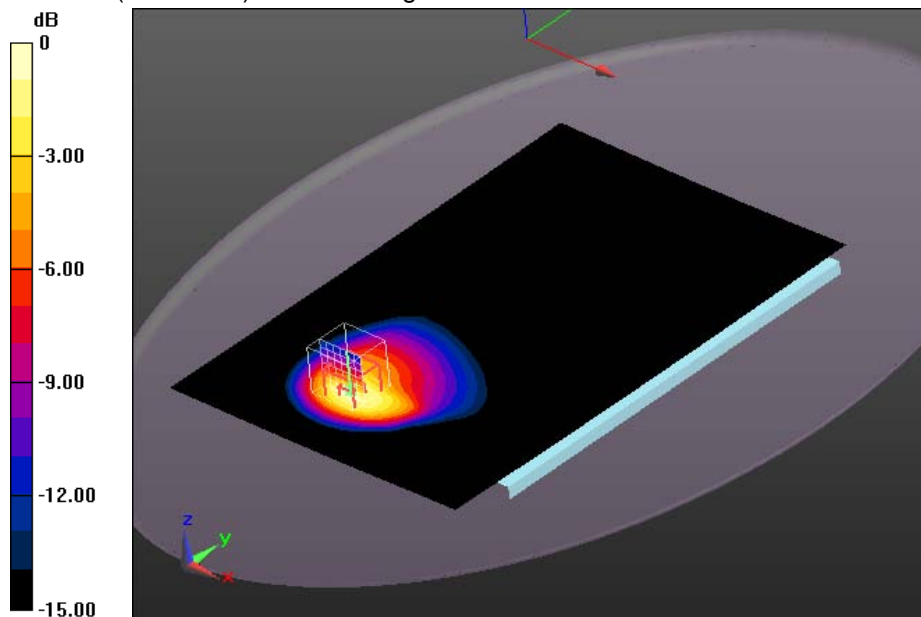

0 dB = 0.897 W/kg = -0.47 dBW/kg

Additional information:

position or distance of DUT to SAM: 0 mm

ambient temperature: 22.6°C; liquid temperature: 21.7°C

Date/Time: 16.03.2013 13:39:53

OET65-UMTS FDD-V

DUT: Sony; Type: SGP321; Serial: CB5A1NY05N

Communication System: UMTS-FDD (WCDMA); Communication System Band: Band 5, UTRA/FDD (824.0 - 849.0 MHz); Frequency: 836.4 MHz; Communication System PAR: 2.91 dB; PMF: 1.00231

Medium parameters used: $f = 836.41$ MHz; $\sigma = 0.97$ S/m; $\epsilon_r = 54.9$; $\rho = 1000$ kg/m³

Phantom section: Flat Section

Measurement Standard: DASYS

DASY5 Configuration:

- Probe: ET3DV6 - SN1558; ConvF(6, 6, 6); Calibrated: 24.08.2012;
- Modulation Compensation: PMR (X: a=3.22 dB, b=66.3 dB $\sqrt{\mu}$ V, c=18.5, d=2.9 dB / Y: a=3.10 dB, b=65.6 dB $\sqrt{\mu}$ V, c=18.0, d=2.9 dB / Z: a=3.31 dB, b=66.5 dB $\sqrt{\mu}$ V, c=18.4, d=2.9 dB); Calibrated: 24.08.2012
- Sensor-Surface: 4mm (Mechanical Surface Detection (Locations From Previous Scan Used)), Sensor-Surface: 4mm (Mechanical Surface Detection), z = 2.7, 32.7
- Electronics: DAE3 Sn477; Calibrated: 09.05.2012
- Phantom: ELI 4.0; Type: QDOVA001BA; Serial: 1046
- DASYS52 52.8.5(1059); SEMCAD X 14.6.8(7028)

Body MSL/Rear Position - Middle/Area Scan (141x211x1): Interpolated grid:

dx=1.500 mm, dy=1.500 mm

Maximum value of SAR (interpolated) = 0.837 W/kg

Body MSL/Rear Position - Middle/Zoom Scan (8x8x7)/Cube 0: Measurement grid:

dx=5mm, dy=5mm, dz=5mm

Reference Value = 29.508 V/m; Power Drift = -0.03 dB

Peak SAR (extrapolated) = 1.67 W/kg

SAR(1 g) = 0.864 W/kg; SAR(10 g) = 0.471 W/kg

Maximum value of SAR (measured) = 0.943 W/kg

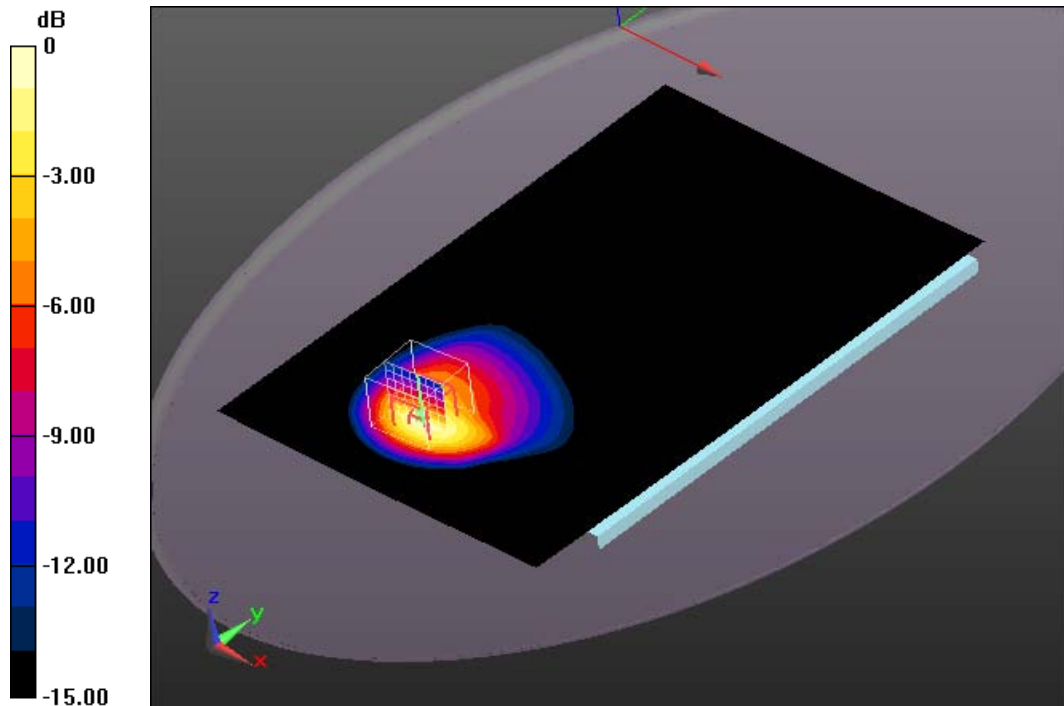

0 dB = 0.943 W/kg = -0.25 dBW/kg

Additional information:

position or distance of DUT to SAM: 0 mm

ambient temperature: 22.6°C; liquid temperature: 21.7°C

Date/Time: 16.03.2013 14:41:05

OET65-UMTS FDD-V

DUT: Sony; Type: SGP321; Serial: CB5A1NY05N

Communication System: UMTS-FDD (WCDMA); Communication System Band: Band 5, UTRA/FDD (824.0 - 849.0 MHz); Frequency: 846.6 MHz; Communication System PAR: 2.91 dB; PMF: 1.00231

Medium parameters used (interpolated): $f = 846.6$ MHz; $\sigma = 0.978$ S/m; $\epsilon_r = 54.825$; $\rho = 1000$ kg/m³

Phantom section: Flat Section

Measurement Standard: DASYS

DASY5 Configuration:

- Probe: ET3DV6 - SN1558; ConvF(6, 6, 6); Calibrated: 24.08.2012;
- Modulation Compensation: PMR (X: a=3.22 dB, b=66.3 dB $\sqrt{\mu}$ V, c=18.5, d=2.9 dB / Y: a=3.10 dB, b=65.6 dB $\sqrt{\mu}$ V, c=18.0, d=2.9 dB / Z: a=3.31 dB, b=66.5 dB $\sqrt{\mu}$ V, c=18.4, d=2.9 dB); Calibrated: 24.08.2012
- Sensor-Surface: 4mm (Mechanical Surface Detection (Locations From Previous Scan Used)), Sensor-Surface: 4mm (Mechanical Surface Detection), z = 2.7, 32.7
- Electronics: DAE3 Sn477; Calibrated: 09.05.2012
- Phantom: ELI 4.0; Type: QDOVA001BA; Serial: 1046
- DASY52 52.8.5(1059); SEMCAD X 14.6.8(7028)

Body MSL/Rear Position - Hi/Area Scan (141x211x1): Interpolated grid: dx=1.500 mm, dy=1.500 mm

Maximum value of SAR (interpolated) = 0.900 W/kg

Body MSL/Rear Position - Hi/Zoom Scan (8x8x7)/Cube 0: Measurement grid:

dx=5mm, dy=5mm, dz=5mm

Reference Value = 30.437 V/m; Power Drift = 0.01 dB

Peak SAR (extrapolated) = 1.87 W/kg

SAR(1 g) = 0.948 W/kg; SAR(10 g) = 0.509 W/kg

Maximum value of SAR (measured) = 1.04 W/kg

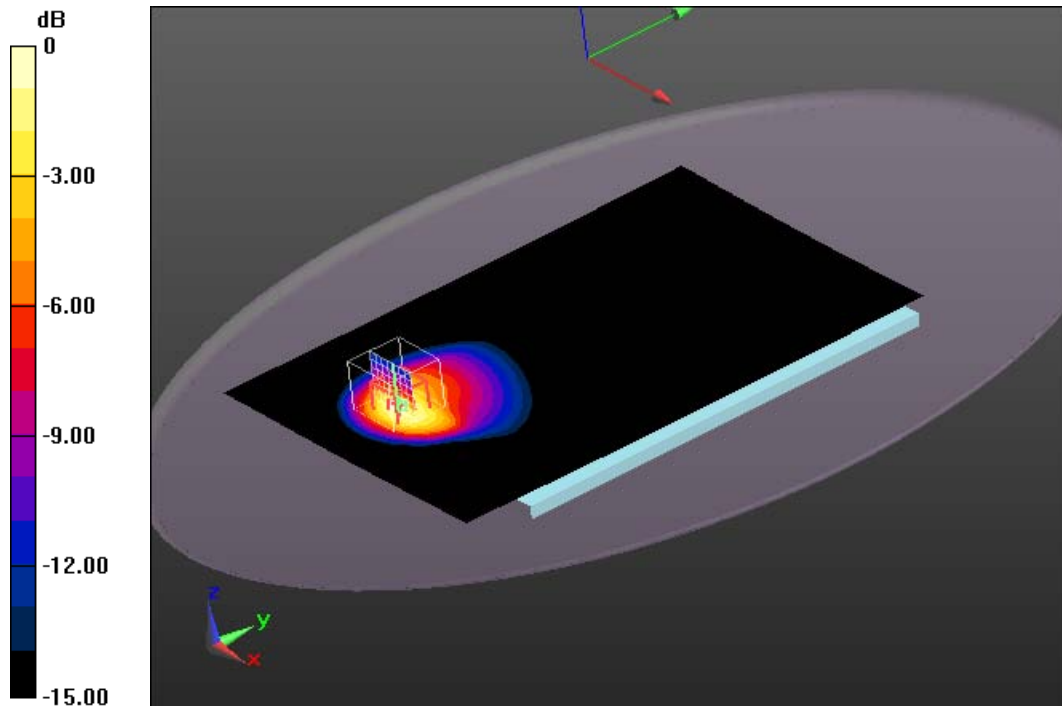

Additional information:

position or distance of DUT to SAM: 0 mm

ambient temperature: 22.6°C; liquid temperature: 21.7°C

Date/Time: 16.03.2013 15:41:29

OET65-UMTS FDD-V

DUT: Sony; Type: SGP321; Serial: CB5A1NY05N

Communication System: UMTS-FDD (WCDMA); Communication System Band: Band 5, UTRA/FDD (824.0 - 849.0 MHz); Frequency: 836.4 MHz; Communication System PAR: 2.91 dB; PMF: 1.00231

Medium parameters used: $f = 836.41$ MHz; $\sigma = 0.97$ S/m; $\epsilon_r = 54.9$; $\rho = 1000$ kg/m³

Phantom section: Flat Section

Measurement Standard: DASYS

DASY5 Configuration:

- Probe: ET3DV6 - SN1558; ConvF(6, 6, 6); Calibrated: 24.08.2012;
- Modulation Compensation: PMR (X: a=3.22 dB, b=66.3 dB $\sqrt{\mu}$ V, c=18.5, d=2.9 dB / Y: a=3.10 dB, b=65.6 dB $\sqrt{\mu}$ V, c=18.0, d=2.9 dB / Z: a=3.31 dB, b=66.5 dB $\sqrt{\mu}$ V, c=18.4, d=2.9 dB); Calibrated: 24.08.2012
- Sensor-Surface: 4mm (Mechanical Surface Detection (Locations From Previous Scan Used)), Sensor-Surface: 4mm (Mechanical Surface Detection), z = 2.7, 32.7
- Electronics: DAE3 Sn477; Calibrated: 09.05.2012
- Phantom: ELI 4.0; Type: QDOVA001BA; Serial: 1046
- DASY52 52.8.5(1059); SEMCAD X 14.6.8(7028)

Body MSL/Right Side Position - Middle/Area Scan (71x131x1): Interpolated grid:

dx=1.500 mm, dy=1.500 mm

Maximum value of SAR (interpolated) = 0.398 W/kg

Body MSL/Right Side Position - Middle/Zoom Scan (7x7x7)/Cube 0:

Measurement grid: dx=5mm, dy=5mm, dz=5mm

Reference Value = 19.747 V/m; Power Drift = -0.07 dB

Peak SAR (extrapolated) = 1.34 W/kg

SAR(1 g) = 0.449 W/kg; SAR(10 g) = 0.219 W/kg

Maximum value of SAR (measured) = 0.509 W/kg

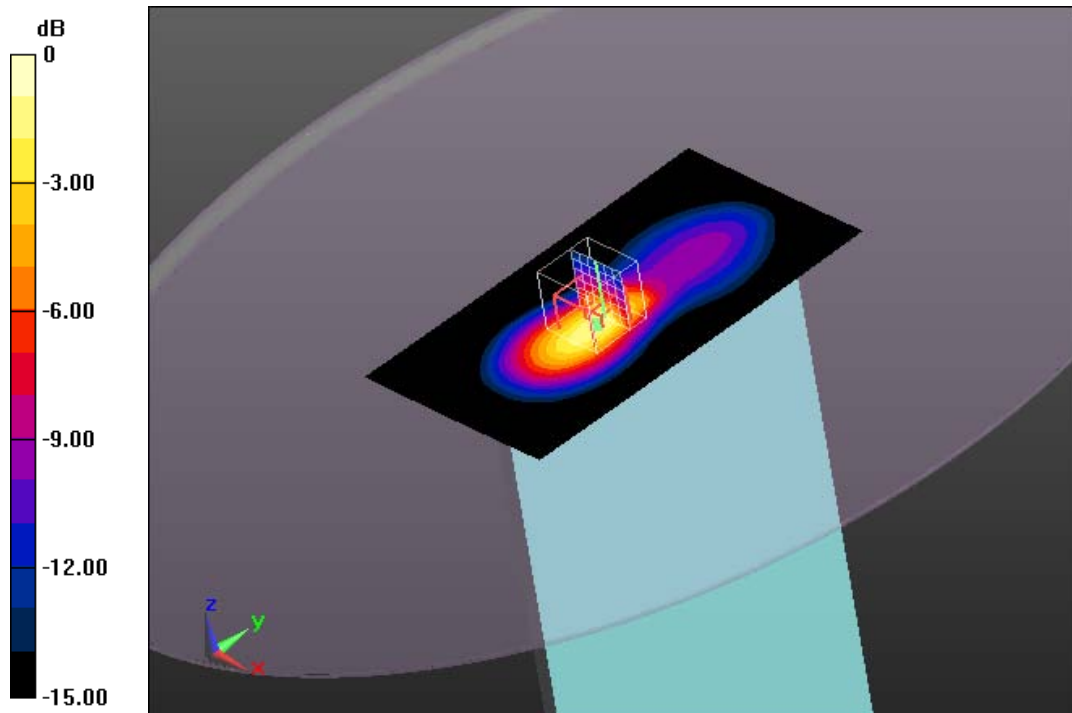

0 dB = 0.509 W/kg = -2.93 dBW/kg

Additional information:

position or distance of DUT to SAM: 0 mm

ambient temperature: 22.6°C; liquid temperature: 21.7°C

Date/Time: 16.03.2013 16:07:13

OET65-UMTS FDD-V

DUT: Sony; Type: SGP321; Serial: CB5A1NY05N

Communication System: UMTS-FDD (WCDMA); Communication System Band: Band 5, UTRA/FDD (824.0 - 849.0 MHz); Frequency: 836.4 MHz; Communication System PAR: 2.91 dB; PMF: 1.00231

Medium parameters used: $f = 836.41$ MHz; $\sigma = 0.97$ S/m; $\epsilon_r = 54.9$; $\rho = 1000$ kg/m³

Phantom section: Flat Section

Measurement Standard: DASYS

DASY5 Configuration:

- Probe: ET3DV6 - SN1558; ConvF(6, 6, 6); Calibrated: 24.08.2012;
- Modulation Compensation: PMR (X: a=3.22 dB, b=66.3 dB $\sqrt{\mu}$ V, c=18.5, d=2.9 dB / Y: a=3.10 dB, b=65.6 dB $\sqrt{\mu}$ V, c=18.0, d=2.9 dB / Z: a=3.31 dB, b=66.5 dB $\sqrt{\mu}$ V, c=18.4, d=2.9 dB); Calibrated: 24.08.2012
- Sensor-Surface: 4mm (Mechanical Surface Detection (Locations From Previous Scan Used)), Sensor-Surface: 4mm (Mechanical Surface Detection), z = 2.7, 32.7
- Electronics: DAE3 Sn477; Calibrated: 09.05.2012
- Phantom: ELI 4.0; Type: QDOVA001BA; Serial: 1046
- DASY52 52.8.5(1059); SEMCAD X 14.6.8(7028)

Body MSL/Top Position - Middle/Area Scan (81x201x1): Interpolated grid: dx=1.500 mm, dy=1.500 mm

Maximum value of SAR (interpolated) = 0.0900 W/kg

Body MSL/Top Position - Middle/Zoom Scan (7x7x7)/Cube 0: Measurement grid:

dx=5mm, dy=5mm, dz=5mm

Reference Value = 10.111 V/m; Power Drift = -0.02 dB

Peak SAR (extrapolated) = 0.124 W/kg

SAR(1 g) = 0.086 W/kg; SAR(10 g) = 0.059 W/kg

Maximum value of SAR (measured) = 0.0928 W/kg

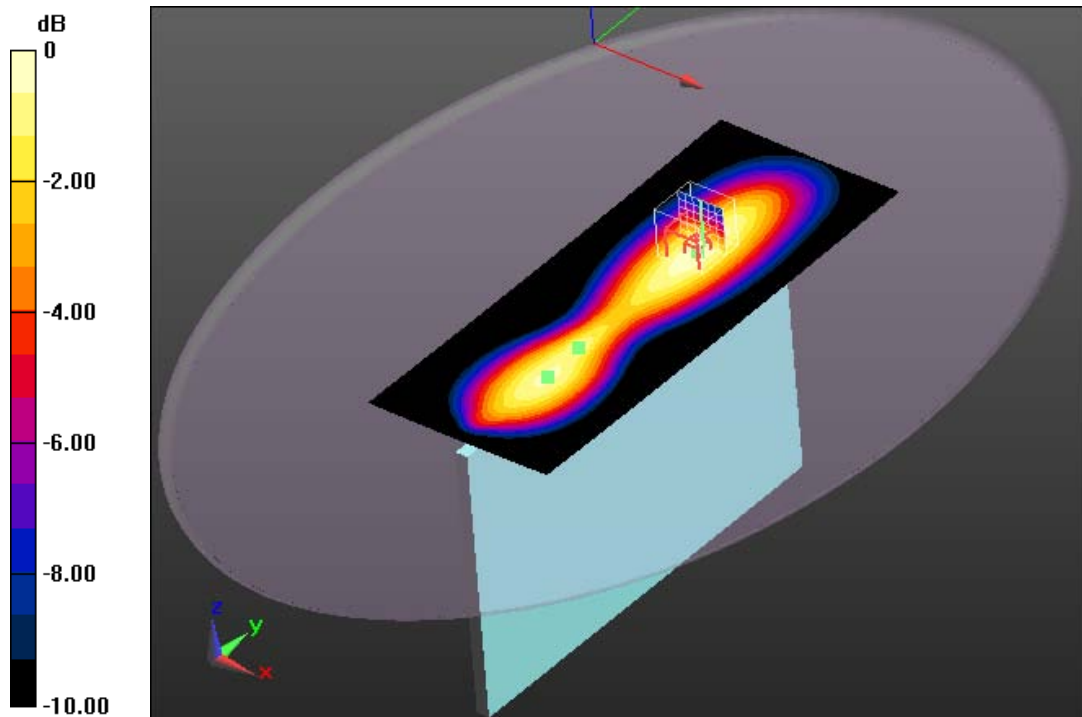

0 dB = 0.0928 W/kg = -10.32 dBW/kg

Additional information:

position or distance of DUT to SAM: 0 mm

ambient temperature: 22.6°C; liquid temperature: 21.7°C

Date/Time: 16.03.2013 15:09:45

OET65-UMTS FDD-V

DUT: Sony; Type: SGP321; Serial: CB5A1NY05N

Communication System: UMTS-FDD (WCDMA); Communication System Band: Band 5, UTRA/FDD (824.0 - 849.0 MHz); Frequency: 846.6 MHz; Communication System PAR: 2.91 dB; PMF: 1.00231

Medium parameters used (interpolated): $f = 846.6$ MHz; $\sigma = 0.978$ S/m; $\epsilon_r = 54.825$; $\rho = 1000$ kg/m³

Phantom section: Flat Section

Measurement Standard: DASYS

DASY5 Configuration:

- Probe: ET3DV6 - SN1558; ConvF(6, 6, 6); Calibrated: 24.08.2012;
- Modulation Compensation: PMR (X: a=3.22 dB, b=66.3 dB $\sqrt{\mu}$ V, c=18.5, d=2.9 dB / Y: a=3.10 dB, b=65.6 dB $\sqrt{\mu}$ V, c=18.0, d=2.9 dB / Z: a=3.31 dB, b=66.5 dB $\sqrt{\mu}$ V, c=18.4, d=2.9 dB); Calibrated: 24.08.2012
- Sensor-Surface: 4mm (Mechanical Surface Detection (Locations From Previous Scan Used)), Sensor-Surface: 4mm (Mechanical Surface Detection), z = 2.7, 32.7
- Electronics: DAE3 Sn477; Calibrated: 09.05.2012
- Phantom: ELI 4.0; Type: QDOVA001BA; Serial: 1046
- DASY52 52.8.5(1059); SEMCAD X 14.6.8(7028)

Body MSL/Rear Position - High wc/Area Scan (141x211x1): Interpolated grid:

dx=1.500 mm, dy=1.500 mm

Maximum value of SAR (interpolated) = 0.943 W/kg

Body MSL/Rear Position - High wc/Zoom Scan (8x8x7)/Cube 0: Measurement

grid: dx=5mm, dy=5mm, dz=5mm

Reference Value = 31.105 V/m; Power Drift = -0.02 dB

Peak SAR (extrapolated) = 1.86 W/kg

SAR(1 g) = 0.957 W/kg; SAR(10 g) = 0.518 W/kg

Maximum value of SAR (measured) = 1.04 W/kg

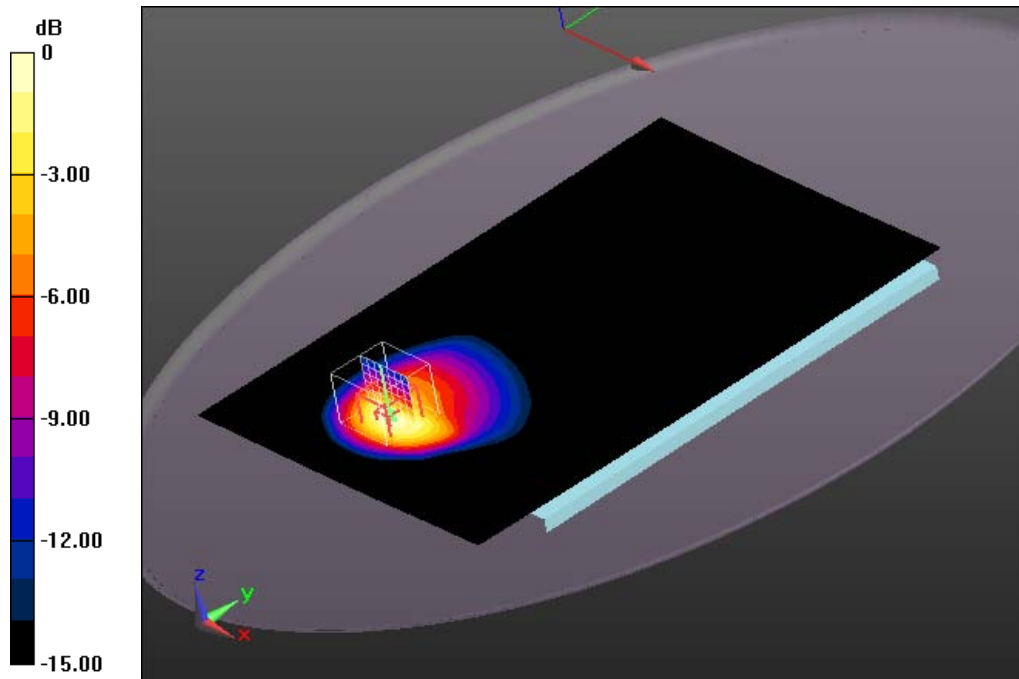

0 dB = 1.04 W/kg = 0.17 dBW/kg

Additional information:

position or distance of DUT to SAM: 0 mm

ambient temperature: 22.6°C; liquid temperature: 21.7°C

Annex B.4: LTE FDD 5

Date/Time: 18.03.2013 12:02:50

OET65-LTE FDD 5

DUT: Sony; Type: SGP321; Serial: CB5A1NY05N

Communication System: LTE-FDD (SC-FDMA, 1 RB, 10 MHz, QPSK); Communication System Band: Band 5, E-UTRA/FDD (824.0 - 849.0 MHz); Frequency: 829 MHz; Communication System PAR: 5.73 dB; PMF: 1.13894

Medium parameters used (interpolated): $f = 829$ MHz; $\sigma = 0.965$ S/m; $\epsilon_r = 55.009$; $\rho = 1000$ kg/m³

Phantom section: Flat Section

Measurement Standard: DASYS

DASY5 Configuration:

- Probe: ET3DV6 - SN1558; ConvF(6, 6, 6); Calibrated: 24.08.2012;
- Modulation Compensation: PMR (X: a=5.20 dB, b=66.8 dB√μV, c=20.1, d=5.7 dB / Y: a=4.96 dB, b=65.8 dB√μV, c=19.4, d=5.7 dB / Z: a=5.31 dB, b=67.1 dB√μV, c=20.2, d=5.7 dB); Calibrated: 24.08.2012
- Sensor-Surface: 4mm (Mechanical Surface Detection (Locations From Previous Scan Used)), Sensor-Surface: 4mm (Mechanical Surface Detection), z = 2.7, 32.7
- Electronics: DAE3 Sn477; Calibrated: 09.05.2012
- Phantom: ELI 4.0; Type: QDOVA001BA; Serial: 1046
- DASY52 52.8.5(1059); SEMCAD X 14.6.8(7028)

Body MSL/Rear Position - Low/Area Scan (141x211x1): Interpolated grid: dx=1.500 mm, dy=1.500 mm

Maximum value of SAR (interpolated) = 0.870 W/kg

Body MSL/Rear Position - Low/Zoom Scan (7x7x7)/Cube 0: Measurement grid:

dx=5mm, dy=5mm, dz=5mm

Reference Value = 31.212 V/m; Power Drift = -0.03 dB

Peak SAR (extrapolated) = 1.50 W/kg

SAR(1 g) = 0.790 W/kg; SAR(10 g) = 0.437 W/kg

Maximum value of SAR (measured) = 0.891 W/kg

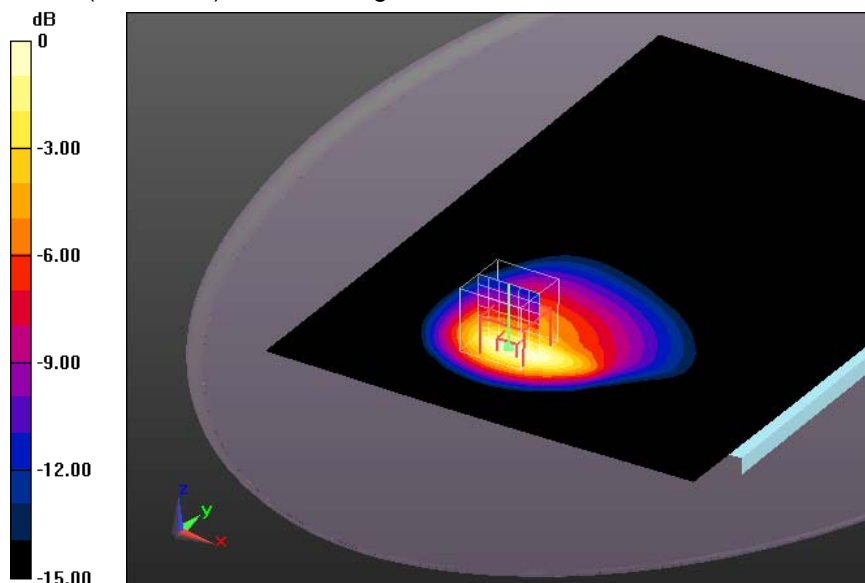

0 dB = 0.891 W/kg = -0.50 dBW/kg

Additional information:

position or distance of DUT to SAM: 0mm

ambient temperature: 23.5°C; liquid temperature: 21.7°C

Date/Time: 18.03.2013 11:36:24

OET65-LTE FDD 5

DUT: Sony; Type: SGP321; Serial: CB5A1NY05N

Communication System: LTE-FDD (SC-FDMA, 1 RB, 10 MHz, QPSK); Communication System Band: Band 5, E-UTRA/FDD (824.0 - 849.0 MHz); Frequency: 836.5 MHz; Communication System PAR: 5.73 dB; PMF: 1.13894

Medium parameters used (interpolated): $f = 836.5$ MHz; $\sigma = 0.97$ S/m; $\epsilon_r = 54.899$; $\rho = 1000$ kg/m³

Phantom section: Flat Section

Measurement Standard: DASY5

DASY5 Configuration:

- Probe: ET3DV6 - SN1558; ConvF(6, 6, 6); Calibrated: 24.08.2012;
- Modulation Compensation: PMR (X: a=5.20 dB, b=66.8 dB $\sqrt{\mu}$ V, c=20.1, d=5.7 dB / Y: a=4.96 dB, b=65.8 dB $\sqrt{\mu}$ V, c=19.4, d=5.7 dB / Z: a=5.31 dB, b=67.1 dB $\sqrt{\mu}$ V, c=20.2, d=5.7 dB); Calibrated: 24.08.2012
- Sensor-Surface: 4mm (Mechanical Surface Detection (Locations From Previous Scan Used)), Sensor-Surface: 4mm (Mechanical Surface Detection), z = 2.7, 32.7
- Electronics: DAE3 Sn477; Calibrated: 09.05.2012
- Phantom: ELI 4.0; Type: QDOVA001BA; Serial: 1046
- DASY52 52.8.5(1059); SEMCAD X 14.6.8(7028)

Body MSL/Rear Position - Mid ORB offset/Area Scan (141x211x1): Interpolated

grid: dx=1.500 mm, dy=1.500 mm

Maximum value of SAR (interpolated) = 0.955 W/kg

Body MSL/Rear Position - Mid ORB offset/Zoom Scan (7x7x7)/Cube 0:

Measurement grid: dx=5mm, dy=5mm, dz=5mm

Reference Value = 32.446 V/m; Power Drift = -0.01 dB

Peak SAR (extrapolated) = 1.67 W/kg

SAR(1 g) = 0.873 W/kg; SAR(10 g) = 0.479 W/kg

Maximum value of SAR (measured) = 0.967 W/kg

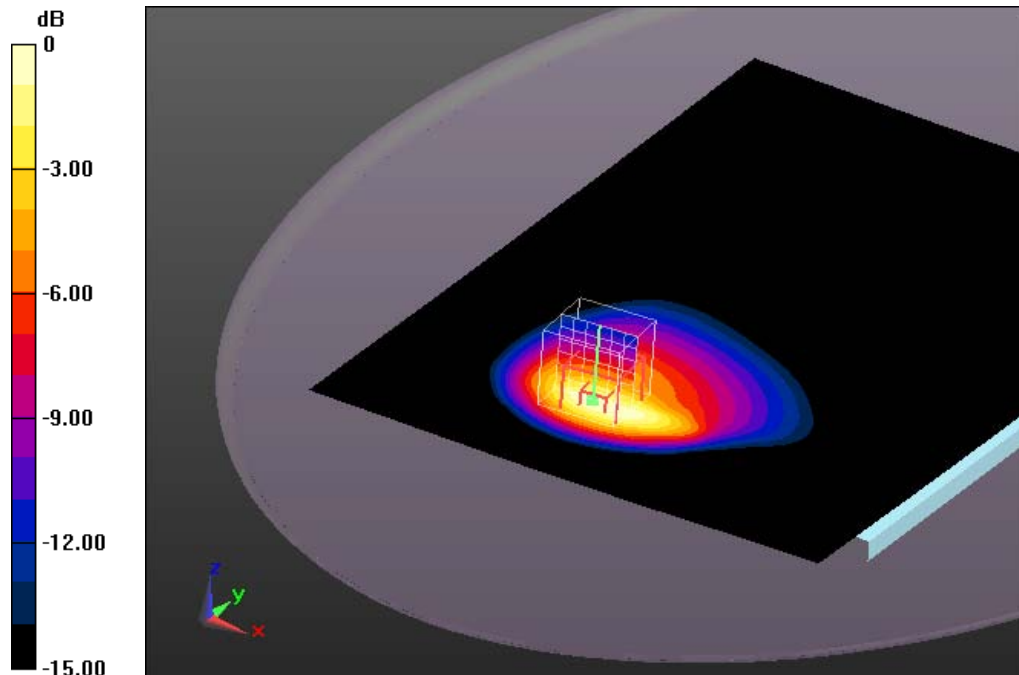

0 dB = 0.967 W/kg = -0.15 dBW/kg

Additional information:

position or distance of DUT to SAM: 0mm

ambient temperature: 23.5°C; liquid temperature: 21.7°C

Date/Time: 18.03.2013 12:28:22

OET65-LTE FDD 5

DUT: Sony; Type: SGP321; Serial: CB5A1NY05N

Communication System: LTE-FDD (SC-FDMA, 1 RB, 10 MHz, QPSK); Communication System Band: Band 5, E-UTRA/FDD (824.0 - 849.0 MHz); Frequency: 844 MHz; Communication System PAR: 5.73 dB; PMF: 1.13894

Medium parameters used (interpolated): $f = 844$ MHz; $\sigma = 0.976$ S/m; $\epsilon_r = 54.844$; $\rho = 1000$ kg/m³

Phantom section: Flat Section

Measurement Standard: DASYS

DASY5 Configuration:

- Probe: ET3DV6 - SN1558; ConvF(6, 6, 6); Calibrated: 24.08.2012;
- Modulation Compensation: PMR (X: a=5.20 dB, b=66.8 dB $\sqrt{\mu}$ V, c=20.1, d=5.7 dB / Y: a=4.96 dB, b=65.8 dB $\sqrt{\mu}$ V, c=19.4, d=5.7 dB / Z: a=5.31 dB, b=67.1 dB $\sqrt{\mu}$ V, c=20.2, d=5.7 dB); Calibrated: 24.08.2012
- Sensor-Surface: 4mm (Mechanical Surface Detection (Locations From Previous Scan Used)), Sensor-Surface: 4mm (Mechanical Surface Detection), z = 2.7, 32.7
- Electronics: DAE3 Sn477; Calibrated: 09.05.2012
- Phantom: ELI 4.0; Type: QDOVA001BA; Serial: 1046
- DASYS 52.8.5(1059); SEMCAD X 14.6.8(7028)

Body MSL/Rear Position - Hi/Area Scan (141x211x1): Interpolated grid: dx=1.500 mm, dy=1.500 mm

Maximum value of SAR (interpolated) = 0.799 W/kg

Body MSL/Rear Position - Hi/Zoom Scan (7x7x7)/Cube 0: Measurement grid:

dx=5mm, dy=5mm, dz=5mm

Reference Value = 29.640 V/m; Power Drift = -0.02 dB

Peak SAR (extrapolated) = 1.41 W/kg

SAR(1 g) = 0.735 W/kg; SAR(10 g) = 0.401 W/kg

Maximum value of SAR (measured) = 0.814 W/kg

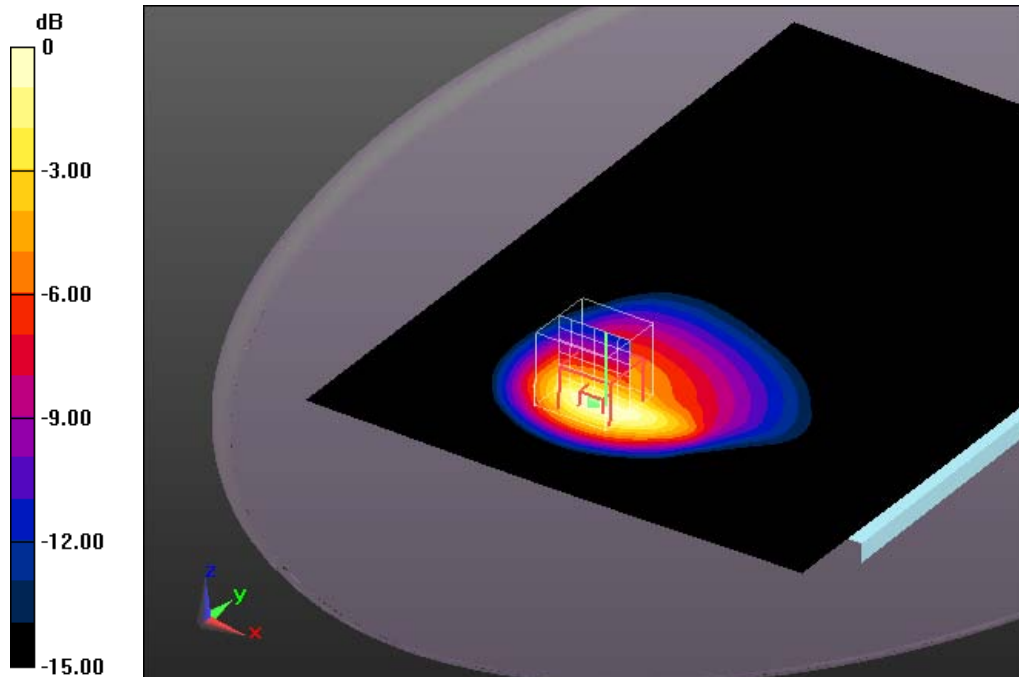

0 dB = 0.814 W/kg = -0.89 dBW/kg

Additional information:

position or distance of DUT to SAM: 0mm

ambient temperature: 23.5°C; liquid temperature: 21.7°C

Date/Time: 18.03.2013 09:31:52

OET65-LTE FDD 5

DUT: Sony; Type: SGP321; Serial: CB5A1NY05N

Communication System: LTE-FDD (SC-FDMA, 1 RB, 10 MHz, QPSK); Communication System Band: Band 5, E-UTRA/FDD (824.0 - 849.0 MHz); Frequency: 836.5 MHz; Communication System PAR: 5.73 dB; PMF: 1.13894

Medium parameters used (interpolated): $f = 836.5$ MHz; $\sigma = 0.97$ S/m; $\epsilon_r = 54.899$; $\rho = 1000$ kg/m³

Phantom section: Flat Section

Measurement Standard: DASY5

DASY5 Configuration:

- Probe: ET3DV6 - SN1558; ConvF(6, 6, 6); Calibrated: 24.08.2012;
- Modulation Compensation: PMR (X: a=5.20 dB, b=66.8 dB $\sqrt{\mu}$ V, c=20.1, d=5.7 dB / Y: a=4.96 dB, b=65.8 dB $\sqrt{\mu}$ V, c=19.4, d=5.7 dB / Z: a=5.31 dB, b=67.1 dB $\sqrt{\mu}$ V, c=20.2, d=5.7 dB); Calibrated: 24.08.2012
- Sensor-Surface: 4mm (Mechanical Surface Detection (Locations From Previous Scan Used)), Sensor-Surface: 4mm (Mechanical Surface Detection), z = 2.7, 32.7
- Electronics: DAE3 Sn477; Calibrated: 09.05.2012
- Phantom: ELI 4.0; Type: QDOVA001BA; Serial: 1046
- DASY52 52.8.5(1059); SEMCAD X 14.6.8(7028)

Body MSL/Right Side Position - Middle/Area Scan (71x131x1): Interpolated grid:

dx=1.500 mm, dy=1.500 mm

Maximum value of SAR (interpolated) = 0.429 W/kg

Body MSL/Right Side Position - Middle/Zoom Scan (7x7x7)/Cube 0:

Measurement grid: dx=5mm, dy=5mm, dz=5mm

Reference Value = 19.191 V/m; Power Drift = 0.05 dB

Peak SAR (extrapolated) = 1.47 W/kg

SAR(1 g) = 0.493 W/kg; SAR(10 g) = 0.237 W/kg

Maximum value of SAR (measured) = 0.579 W/kg

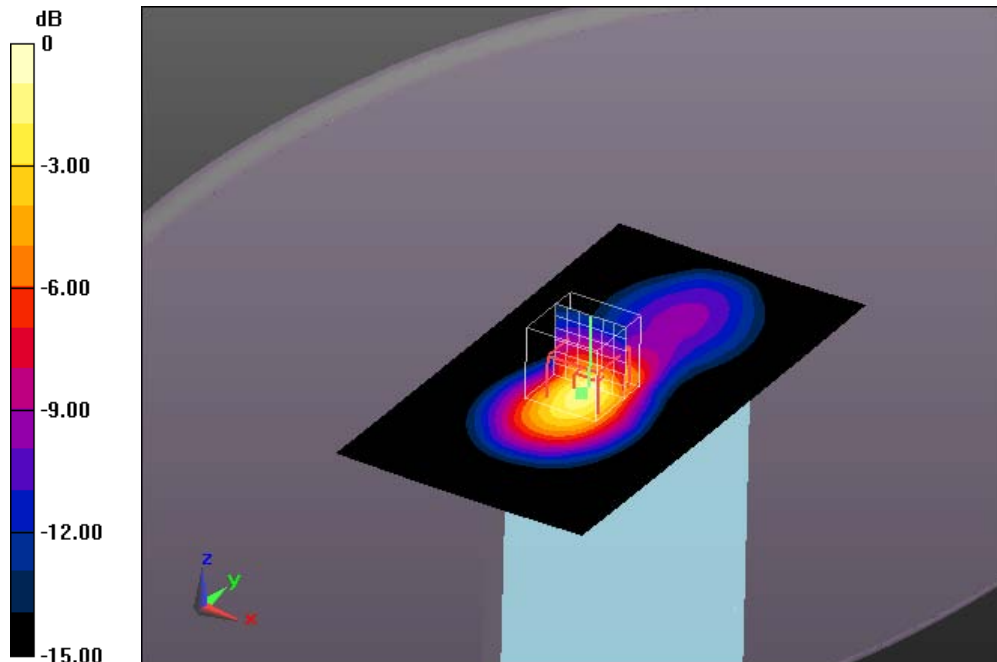

0 dB = 0.579 W/kg = -2.37 dBW/kg

Additional information:

position or distance of DUT to SAM: 0mm

ambient temperature: 23.5°C; liquid temperature: 21.7°C

Date/Time: 18.03.2013 10:03:39

OET65-LTE FDD 5

DUT: Sony; Type: SGP321; Serial: CB5A1NY05N

Communication System: LTE-FDD (SC-FDMA, 1 RB, 10 MHz, QPSK); Communication System Band: Band 5, E-UTRA/FDD (824.0 - 849.0 MHz); Frequency: 836.5 MHz; Communication System PAR: 5.73 dB; PMF: 1.13894

Medium parameters used (interpolated): $f = 836.5$ MHz; $\sigma = 0.97$ S/m; $\epsilon_r = 54.899$; $\rho = 1000$ kg/m³

Phantom section: Flat Section

Measurement Standard: DASYS

DASY5 Configuration:

- Probe: ET3DV6 - SN1558; ConvF(6, 6, 6); Calibrated: 24.08.2012;
- Modulation Compensation: PMR (X: a=5.20 dB, b=66.8 dB/μV, c=20.1, d=5.7 dB / Y: a=4.96 dB, b=65.8 dB/μV, c=19.4, d=5.7 dB / Z: a=5.31 dB, b=67.1 dB/μV, c=20.2, d=5.7 dB); Calibrated: 24.08.2012
- Sensor-Surface: 4mm (Mechanical Surface Detection), z = 2.7, 32.7
- Electronics: DAE3 Sn477; Calibrated: 09.05.2012
- Phantom: ELI 4.0; Type: QDOVA001BA; Serial: 1046
- DASY52 52.8.5(1059); SEMCAD X 14.6.8(7028)

Body MSL/Top Position - Middle/Area Scan (81x201x1): Interpolated grid: dx=1.500 mm, dy=1.500 mm

Maximum value of SAR (interpolated) = 0.0838 W/kg

Body MSL/Top Position - Middle/Zoom Scan (7x8x7)/Cube 0: Measurement grid:

dx=5mm, dy=5mm, dz=5mm

Reference Value = 9.475 V/m; Power Drift = -0.03 dB

Peak SAR (extrapolated) = 0.110 W/kg

SAR(1 g) = 0.077 W/kg; SAR(10 g) = 0.052 W/kg

Maximum value of SAR (measured) = 0.0824 W/kg

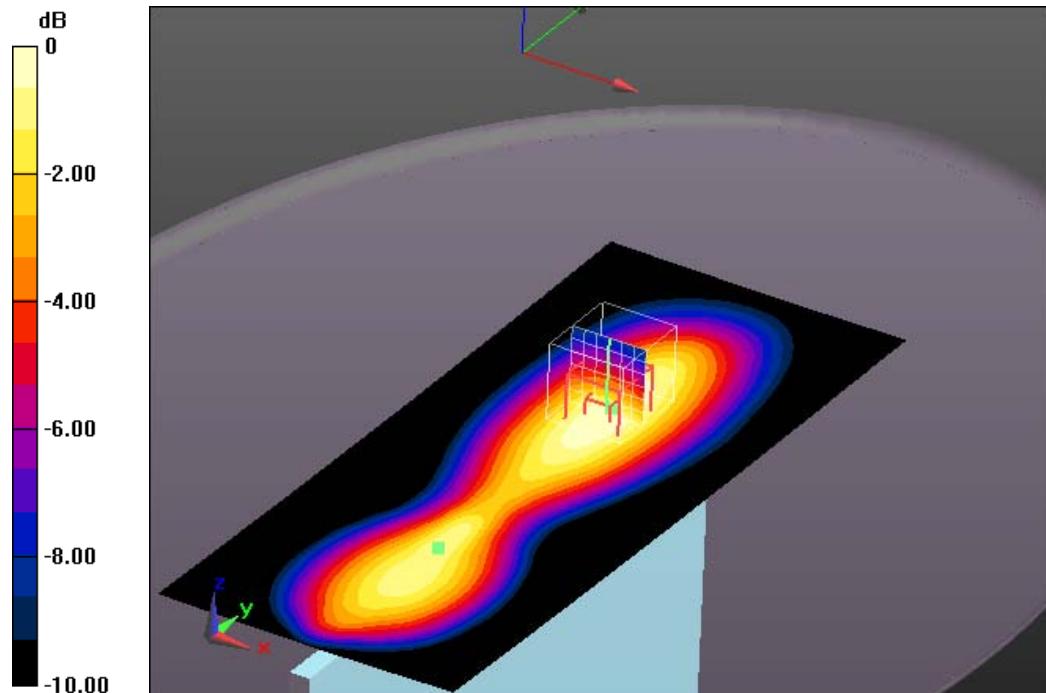

0 dB = 0.0824 W/kg = -10.84 dBW/kg

Additional information:

position or distance of DUT to SAM: 0mm

ambient temperature: 23.5°C; liquid temperature: 21.7°C

Date/Time: 18.03.2013 13:52:45

OET65-LTE FDD 5

DUT: Sony; Type: SGP321; Serial: CB5A1NY05N

Communication System: LTE-FDD (SC-FDMA, 1 RB, 10 MHz, QPSK); Communication System Band: Band 5, E-UTRA/FDD (824.0 - 849.0 MHz); Frequency: 836.5 MHz; Communication System PAR: 5.73 dB; PMF: 1.13894

Medium parameters used (interpolated): $f = 836.5$ MHz; $\sigma = 0.97$ S/m; $\epsilon_r = 54.899$; $\rho = 1000$ kg/m³

Phantom section: Flat Section

Measurement Standard: DASY5

DASY5 Configuration:

- Probe: ET3DV6 - SN1558; ConvF(6, 6, 6); Calibrated: 24.08.2012;
- Modulation Compensation: PMR (X: a=5.20 dB, b=66.8 dB $\sqrt{\mu}$ V, c=20.1, d=5.7 dB / Y: a=4.96 dB, b=65.8 dB $\sqrt{\mu}$ V, c=19.4, d=5.7 dB / Z: a=5.31 dB, b=67.1 dB $\sqrt{\mu}$ V, c=20.2, d=5.7 dB); Calibrated: 24.08.2012
- Sensor-Surface: 4mm (Mechanical Surface Detection (Locations From Previous Scan Used)), Sensor-Surface: 4mm (Mechanical Surface Detection), z = 2.7, 32.7
- Electronics: DAE3 Sn477; Calibrated: 09.05.2012
- Phantom: ELI 4.0; Type: QDOVA001BA; Serial: 1046
- DASY52 52.8.5(1059); SEMCAD X 14.6.8(7028)

Body MSL/Rear Position - Mid 25RB offset/Area Scan (141x211x1): Interpolated grid: dx=1.500 mm, dy=1.500 mm

Maximum value of SAR (interpolated) = 0.810 W/kg

Body MSL/Rear Position - Mid 25RB offset/Zoom Scan (7x7x7)/Cube 0:

Measurement grid: dx=5mm, dy=5mm, dz=5mm

Reference Value = 29.938 V/m; Power Drift = -0.03 dB

Peak SAR (extrapolated) = 1.40 W/kg

SAR(1 g) = 0.739 W/kg; SAR(10 g) = 0.406 W/kg

Maximum value of SAR (measured) = 0.815 W/kg

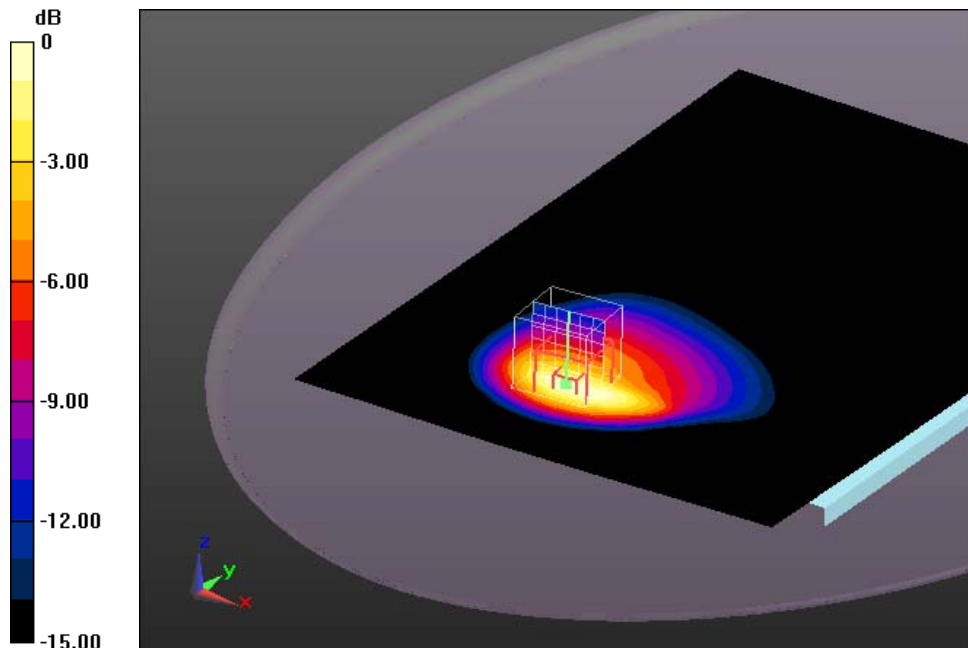

0 dB = 0.815 W/kg = -0.89 dBW/kg

Additional information:

position or distance of DUT to SAM: 0mm

ambient temperature: 23.5°C; liquid temperature: 21.7°C

Date/Time: 18.03.2013 14:18:39

OET65-LTE FDD 5

DUT: Sony; Type: SGP321; Serial: CB5A1NY05N

Communication System: LTE-FDD (SC-FDMA, 1 RB, 10 MHz, QPSK); Communication System Band: Band 5, E-UTRA/FDD (824.0 - 849.0 MHz); Frequency: 836.5 MHz; Communication System PAR: 5.73 dB; PMF: 1.13894

Medium parameters used (interpolated): $f = 836.5$ MHz; $\sigma = 0.97$ S/m; $\epsilon_r = 54.899$; $\rho = 1000$ kg/m³

Phantom section: Flat Section

Measurement Standard: DASYS

DASY5 Configuration:

- Probe: ET3DV6 - SN1558; ConvF(6, 6, 6); Calibrated: 24.08.2012;
- Modulation Compensation: PMR (X: a=5.20 dB, b=66.8 dB $\sqrt{\mu}$ V, c=20.1, d=5.7 dB / Y: a=4.96 dB, b=65.8 dB $\sqrt{\mu}$ V, c=19.4, d=5.7 dB / Z: a=5.31 dB, b=67.1 dB $\sqrt{\mu}$ V, c=20.2, d=5.7 dB); Calibrated: 24.08.2012
- Sensor-Surface: 4mm (Mechanical Surface Detection (Locations From Previous Scan Used)), Sensor-Surface: 4mm (Mechanical Surface Detection), z = 2.7, 32.7
- Electronics: DAE3 Sn477; Calibrated: 09.05.2012
- Phantom: ELI 4.0; Type: QDOVA001BA; Serial: 1046
- DASY52 52.8.5(1059); SEMCAD X 14.6.8(7028)

Body MSL/Rear Position - Mid 49RB offset/Area Scan (141x211x1): Interpolated

grid: dx=1.500 mm, dy=1.500 mm

Maximum value of SAR (interpolated) = 0.693 W/kg

Body MSL/Rear Position - Mid 49RB offset/Zoom Scan (7x7x7)/Cube 0:

Measurement grid: dx=5mm, dy=5mm, dz=5mm

Reference Value = 27.613 V/m; Power Drift = -0.06 dB

Peak SAR (extrapolated) = 1.20 W/kg

SAR(1 g) = 0.633 W/kg; SAR(10 g) = 0.347 W/kg

Maximum value of SAR (measured) = 0.694 W/kg

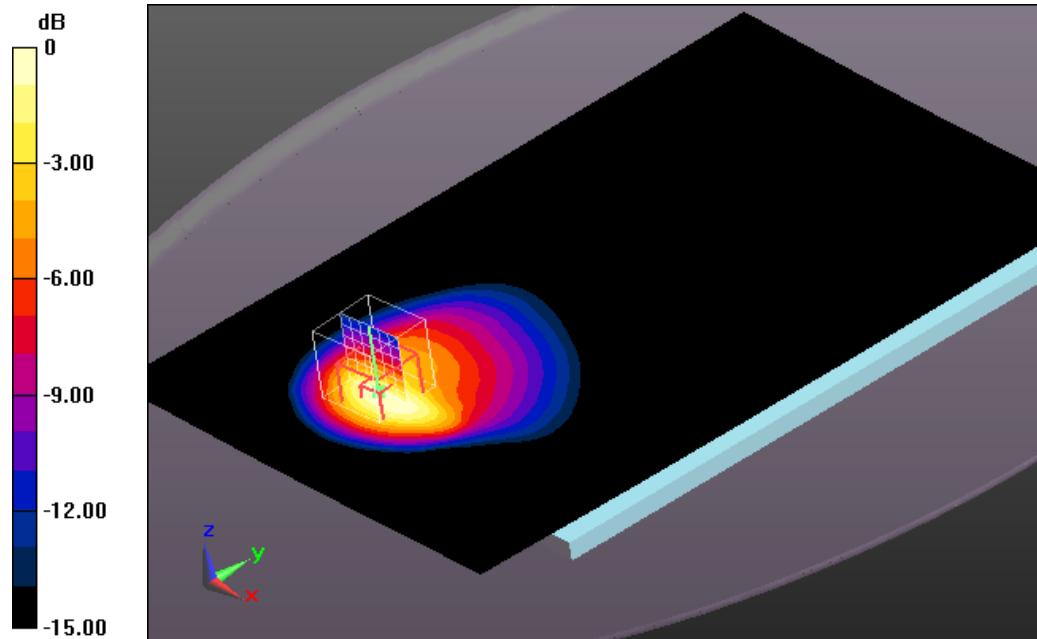

0 dB = 0.694 W/kg = -1.59 dBW/kg

Additional information:

position or distance of DUT to SAM: 0mm

ambient temperature: 23.5°C; liquid temperature: 21.7°C

Date/Time: 18.03.2013 14:43:25

OET65-LTE FDD 5

DUT: Sony; Type: SGP321; Serial: CB5A1NY05N

Communication System: LTE-FDD (SC-FDMA, 1 RB, 10 MHz, QPSK); Communication System Band: Band 5, E-UTRA/FDD (824.0 - 849.0 MHz); Frequency: 836.5 MHz; Communication System PAR: 5.73 dB; PMF: 1.13894

Medium parameters used (interpolated): $f = 836.5$ MHz; $\sigma = 0.97$ S/m; $\epsilon_r = 54.899$; $\rho = 1000$ kg/m³

Phantom section: Flat Section

Measurement Standard: DASYS

DASY5 Configuration:

- Probe: ET3DV6 - SN1558; ConvF(6, 6, 6); Calibrated: 24.08.2012;
- Modulation Compensation: PMR (X: a=5.20 dB, b=66.8 dB $\sqrt{\mu}$ V, c=20.1, d=5.7 dB / Y: a=4.96 dB, b=65.8 dB $\sqrt{\mu}$ V, c=19.4, d=5.7 dB / Z: a=5.31 dB, b=67.1 dB $\sqrt{\mu}$ V, c=20.2, d=5.7 dB); Calibrated: 24.08.2012
- Sensor-Surface: 4mm (Mechanical Surface Detection (Locations From Previous Scan Used)), Sensor-Surface: 4mm (Mechanical Surface Detection), z = 2.7, 32.7
- Electronics: DAE3 Sn477; Calibrated: 09.05.2012
- Phantom: ELI 4.0; Type: QDOVA001BA; Serial: 1046
- DASY52 52.8.5(1059); SEMCAD X 14.6.8(7028)

Body MSL/Rear Position - Mid ORB offset WC/Area Scan (141x211x1):

Interpolated grid: dx=1.500 mm, dy=1.500 mm

Maximum value of SAR (interpolated) = 0.954 W/kg

Body MSL/Rear Position - Mid ORB offset WC/Zoom Scan (8x8x7)/Cube 0:

Measurement grid: dx=5mm, dy=5mm, dz=5mm

Reference Value = 32.396 V/m; Power Drift = 0.00 dB

Peak SAR (extrapolated) = 1.67 W/kg

SAR(1 g) = 0.875 W/kg; SAR(10 g) = 0.479 W/kg

Maximum value of SAR (measured) = 0.964 W/kg

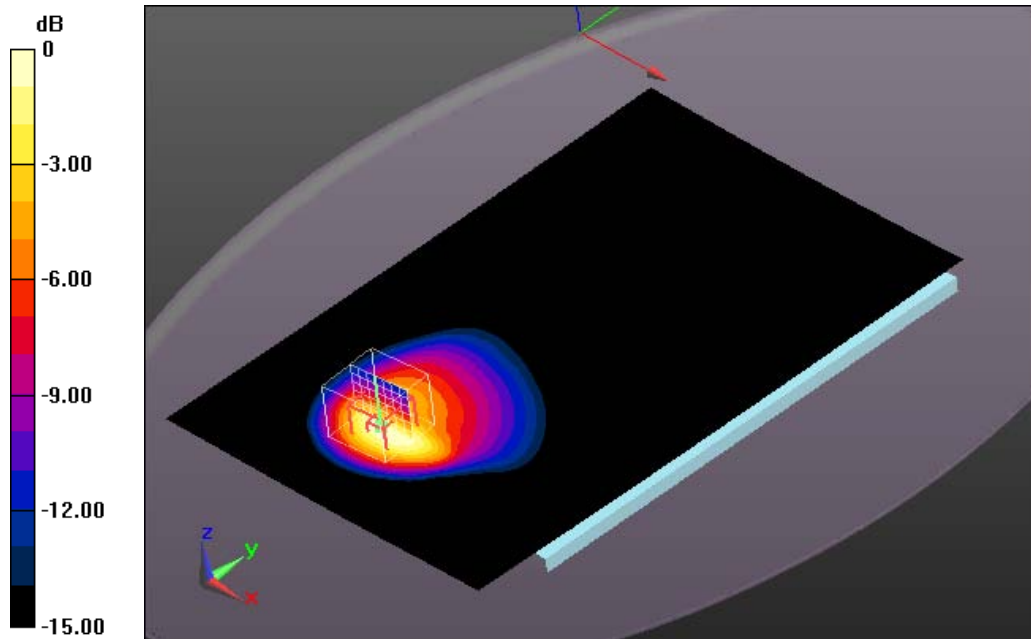

0 dB = 0.964 W/kg = -0.16 dBW/kg

Additional information:

position or distance of DUT to SAM: 0 mm

ambient temperature: 23.5°C; liquid temperature: 21.7°C

Date/Time: 18.03.2013 10:56:48

OET65-LTE FDD 5

DUT: Sony; Type: SGP321; Serial: CB5A1NY05N

Communication System: LTE-FDD (SC-FDMA, 50% RB, 10 MHz, QPSK); Communication System Band: Band 5, E-UTRA/FDD (824.0 - 849.0 MHz); Frequency: 836.5 MHz; Communication System PAR: 5.76 dB; PMF: 1.01391

Medium parameters used (interpolated): $f = 836.5$ MHz; $\sigma = 0.97$ S/m; $\epsilon_r = 54.899$; $\rho = 1000$ kg/m³

Phantom section: Flat Section

Measurement Standard: DASY5

DASY5 Configuration:

- Probe: ET3DV6 - SN1558; ConvF(6, 6, 6); Calibrated: 24.08.2012;
- Modulation Compensation: PMR (X: $a=6.31$ dB, $b=67.8$ dB $\sqrt{\mu}$ V, $c=20.5$, $d=5.8$ dB / Y: $a=5.91$ dB, $b=66.1$ dB $\sqrt{\mu}$ V, $c=19.3$, $d=5.8$ dB / Z: $a=5.98$ dB, $b=66.2$ dB $\sqrt{\mu}$ V, $c=19.4$, $d=5.8$ dB); Calibrated: 24.08.2012
- Sensor-Surface: 4mm (Mechanical Surface Detection), $z = 2.7, 32.7$
- Electronics: DAE3 Sn477; Calibrated: 09.05.2012
- Phantom: ELI 4.0; Type: QDOVA001BA; Serial: 1046
- DASY52 52.8.5(1059); SEMCAD X 14.6.8(7028)

Body MSL/Rear Position - Mid 25RB/ 0RB offset/Area Scan (141x211x1):

Interpolated grid: $dx=1.500$ mm, $dy=1.500$ mm

Maximum value of SAR (interpolated) = 0.870 W/kg

Body MSL/Rear Position - Mid 25RB/ 0RB offset/Zoom Scan (7x7x7)/Cube

0: Measurement grid: $dx=5$ mm, $dy=5$ mm, $dz=5$ mm

Reference Value = 30.798 V/m; Power Drift = -0.02 dB

Peak SAR (extrapolated) = 1.53 W/kg

SAR(1 g) = 0.800 W/kg; SAR(10 g) = 0.437 W/kg

Maximum value of SAR (measured) = 0.883 W/kg

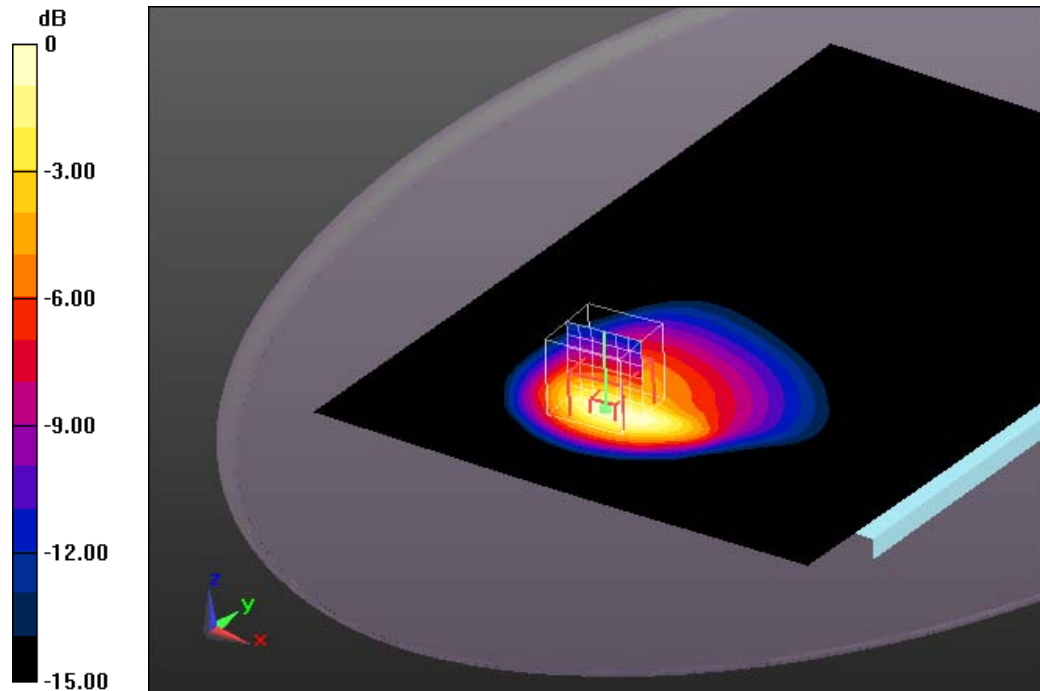

0 dB = 0.883 W/kg = -0.54 dBW/kg

Additional information:

position or distance of DUT to SAM: 0mm

ambient temperature: 23.5°C; liquid temperature: 21.7°C

Date/Time: 18.03.2013 09:05:02

OET65-LTE FDD 5

DUT: Sony; Type: SGP321; Serial: CB5A1NY05N

Communication System: LTE-FDD (SC-FDMA, 50% RB, 10 MHz, QPSK); Communication System Band: Band 5, E-UTRA/FDD (824.0 - 849.0 MHz); Frequency: 836.5 MHz; Communication System PAR: 5.76 dB; PMF: 1.01391

Medium parameters used (interpolated): $f = 836.5$ MHz; $\sigma = 0.97$ S/m; $\epsilon_r = 54.899$; $\rho = 1000$ kg/m³

Phantom section: Flat Section

Measurement Standard: DASYS

DASY5 Configuration:

- Probe: ET3DV6 - SN1558; ConvF(6, 6, 6); Calibrated: 24.08.2012;
- Modulation Compensation: PMR (X: $a=6.31$ dB, $b=67.8$ dB $\sqrt{\mu V}$, $c=20.5$, $d=5.8$ dB / Y: $a=5.91$ dB, $b=66.1$ dB $\sqrt{\mu V}$, $c=19.3$, $d=5.8$ dB / Z: $a=5.98$ dB, $b=66.2$ dB $\sqrt{\mu V}$, $c=19.4$, $d=5.8$ dB); Calibrated: 24.08.2012
- Sensor-Surface: 4mm (Mechanical Surface Detection), $z = 2.7, 32.7$
- Electronics: DAE3 Sn477; Calibrated: 09.05.2012
- Phantom: ELI 4.0; Type: QDOVA001BA; Serial: 1046
- DASY52 52.8.5(1059); SEMCAD X 14.6.8(7028)

Body MSL/Right Side Position - Middle 25RB/ 0RB offset/Area Scan

(71x131x1): Interpolated grid: $dx=1.500$ mm, $dy=1.500$ mm

Maximum value of SAR (interpolated) = 0.391 W/kg

Body MSL/Right Side Position - Middle 25RB/ 0RB offset/Zoom Scan

(7x7x7)/Cube 0: Measurement grid: $dx=5$ mm, $dy=5$ mm, $dz=5$ mm

Reference Value = 18.217 V/m; Power Drift = 0.07 dB

Peak SAR (extrapolated) = 1.41 W/kg

SAR(1 g) = 0.455 W/kg; SAR(10 g) = 0.215 W/kg

Maximum value of SAR (measured) = 0.532 W/kg

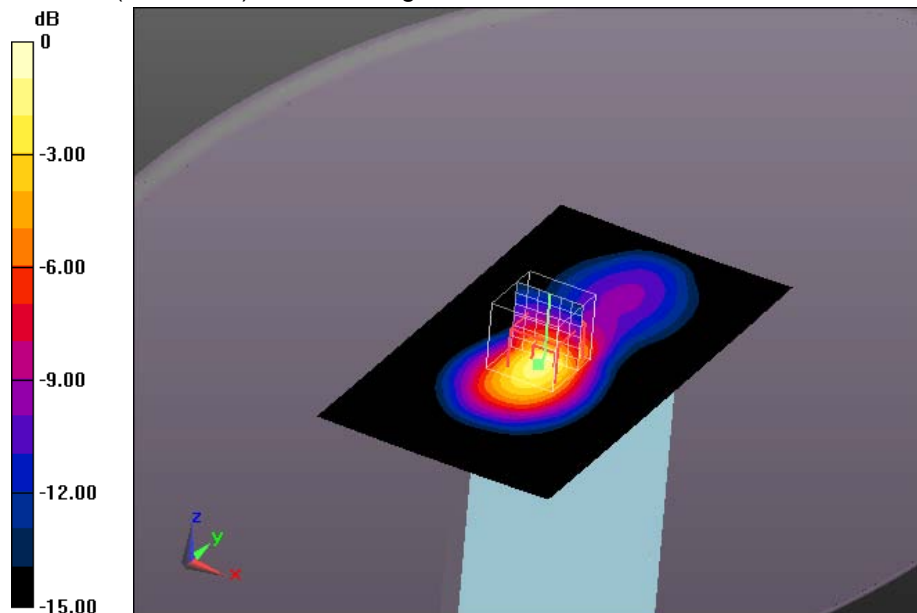

0 dB = 0.532 W/kg = -2.74 dBW/kg

Additional information:

position or distance of DUT to SAM: 0mm

ambient temperature: 23.5°C; liquid temperature: 21.7°C

Date/Time: 18.03.2013 10:33:43

OET65-LTE FDD 5

DUT: Sony; Type: SGP321; Serial: CB5A1NY05N

Communication System: LTE-FDD (SC-FDMA, 50% RB, 10 MHz, QPSK); Communication System Band: Band 5, E-UTRA/FDD (824.0 - 849.0 MHz); Frequency: 836.5 MHz; Communication System PAR: 5.76 dB; PMF: 1.01391

Medium parameters used (interpolated): $f = 836.5$ MHz; $\sigma = 0.97$ S/m; $\epsilon_r = 54.899$; $\rho = 1000$ kg/m³

Phantom section: Flat Section

Measurement Standard: DASY5

DASY5 Configuration:

- Probe: ET3DV6 - SN1558; ConvF(6, 6, 6); Calibrated: 24.08.2012;
- Modulation Compensation: PMR (X: $a=6.31$ dB, $b=67.8$ dB $\sqrt{\mu}$ V, $c=20.5$, $d=5.8$ dB / Y: $a=5.91$ dB, $b=66.1$ dB $\sqrt{\mu}$ V, $c=19.3$, $d=5.8$ dB / Z: $a=5.98$ dB, $b=66.2$ dB $\sqrt{\mu}$ V, $c=19.4$, $d=5.8$ dB); Calibrated: 24.08.2012
- Sensor-Surface: 4mm (Mechanical Surface Detection (Locations From Previous Scan Used)), Sensor-Surface: 4mm (Mechanical Surface Detection), $z = 2.7, 32.7$
- Electronics: DAE3 Sn477; Calibrated: 09.05.2012
- Phantom: ELI 4.0; Type: QDOVA001BA; Serial: 1046
- DASY52 52.8.5(1059); SEMCAD X 14.6.8(7028)

Body MSL/Top Position - Middle 25RB/ 0RB offset/Area Scan (81x201x1):

Interpolated grid: $dx=1.500$ mm, $dy=1.500$ mm

Maximum value of SAR (interpolated) = 0.0834 W/kg

Body MSL/Top Position - Middle 25RB/ 0RB offset/Zoom Scan

(7x7x7)/Cube 0: Measurement grid: $dx=5$ mm, $dy=5$ mm, $dz=5$ mm

Reference Value = 9.629 V/m; Power Drift = 0.00 dB

Peak SAR (extrapolated) = 0.111 W/kg

SAR(1 g) = 0.078 W/kg; SAR(10 g) = 0.053 W/kg

Maximum value of SAR (measured) = 0.0829 W/kg

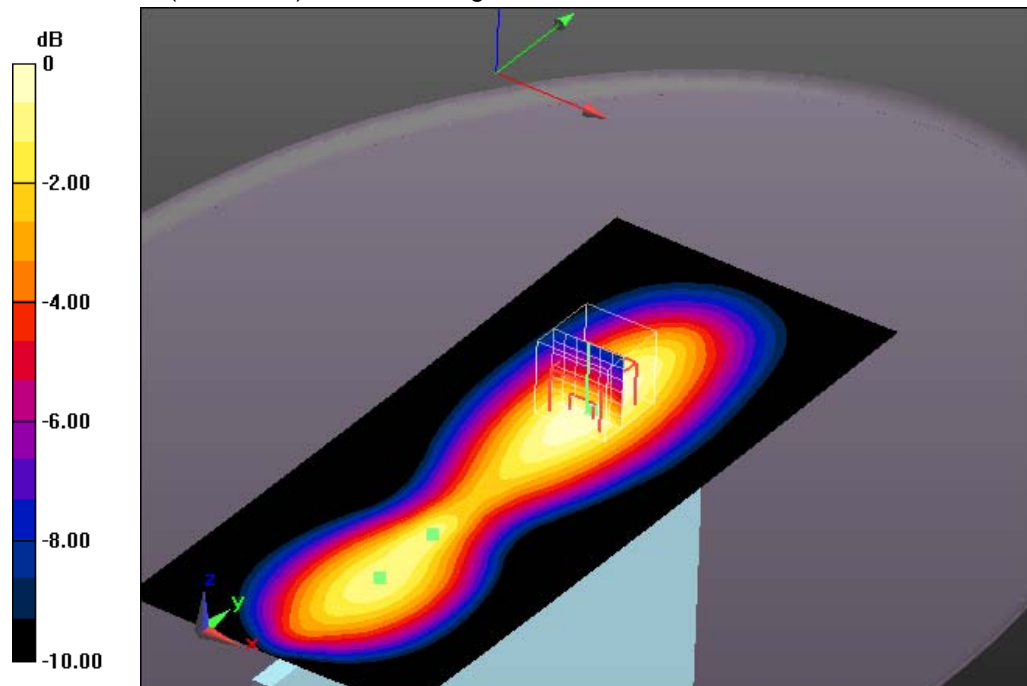

0 dB = 0.0829 W/kg = -10.81 dBW/kg

Additional information:

position or distance of DUT to SAM: 0mm

ambient temperature: 23.5°C; liquid temperature: 21.7°C

Date/Time: 18.03.2013 13:23:58

OET65-LTE FDD 5

DUT: Sony; Type: SGP321; Serial: CB5A1NY05N

Communication System: LTE-FDD (100%RB, 10 MHz, QPSK); Communication System Band: FDD 5;

Frequency: 836.5 MHz; Communication System PAR: 5.8 dB; PMF: 1.00577

Medium parameters used (interpolated): $f = 836.5$ MHz; $\sigma = 0.97$ S/m; $\epsilon_r = 54.899$; $\rho = 1000$ kg/m³

Phantom section: Flat Section

Measurement Standard: DASYS

DASY5 Configuration:

- Probe: ET3DV6 - SN1558; ConvF(6, 6, 6); Calibrated: 24.08.2012;
- Sensor-Surface: 4mm (Mechanical Surface Detection (Locations From Previous Scan Used)), Sensor-Surface: 4mm (Mechanical Surface Detection), $z = 2.7, 32.7$
- Electronics: DAE3 Sn477; Calibrated: 09.05.2012
- Phantom: ELI 4.0; Type: QDOVA001BA; Serial: 1046
- DASY52 52.8.5(1059); SEMCAD X 14.6.8(7028)

Body MSL/Rear Position - Mid 50RB/Area Scan (141x211x1): Interpolated grid:

$dx=1.500$ mm, $dy=1.500$ mm

Maximum value of SAR (interpolated) = 0.922 W/kg

Body MSL/Rear Position - Mid 50RB/Zoom Scan (7x7x7)/Cube 0: Measurement

grid: $dx=5$ mm, $dy=5$ mm, $dz=5$ mm

Reference Value = 32.156 V/m; Power Drift = -0.01 dB

Peak SAR (extrapolated) = 1.73 W/kg

SAR(1 g) = 0.841 W/kg; SAR(10 g) = 0.446 W/kg

Maximum value of SAR (measured) = 0.920 W/kg

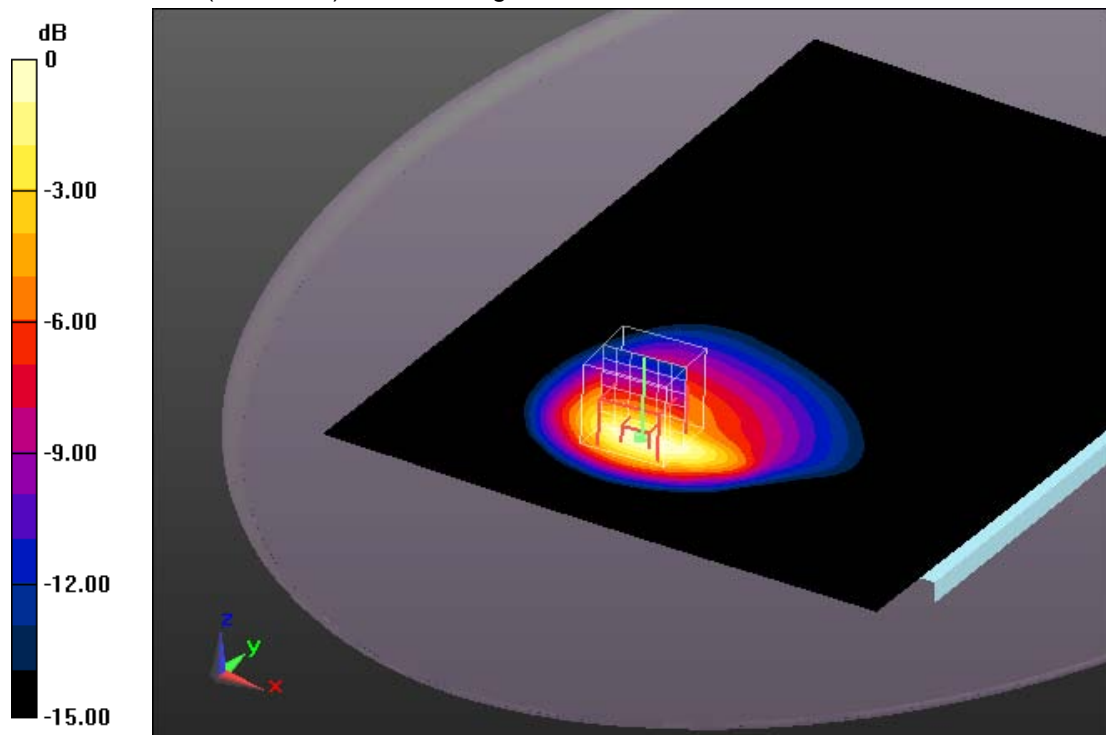

0 dB = 0.920 W/kg = -0.36 dBW/kg

Additional information:

position or distance of DUT to SAM: 0mm

ambient temperature: 23.5°C; liquid temperature: 21.7°C

Date/Time: 02.05.2013 11:54:57

OET65-LTE FDD-5

DUT: Sony; Type: SGP321; Serial: CB5A1NY05N

Communication System: LTE-FDD (SC-FDMA, 1 RB, 10 MHz, QPSK); Communication System Band: Band 5, E-UTRA/FDD (824.0 - 849.0 MHz); Frequency: 829 MHz; Communication System PAR: 5.73 dB; PMF: 1.13894

Medium parameters used (interpolated): $f = 829$ MHz; $\sigma = 0.955$ S/m; $\epsilon_r = 55.855$; $\rho = 1000$ kg/m³

Phantom section: Flat Section

Measurement Standard: DASYS

DASY5 Configuration:

- Probe: ET3DV6 - SN1558; ConvF(6, 6, 6); Calibrated: 24.08.2012;
- Modulation Compensation: PMR (X: $a=5.20$ dB, $b=66.8$ dB $\sqrt{\mu V}$, $c=20.1$, $d=5.7$ dB / Y: $a=4.96$ dB, $b=65.8$ dB $\sqrt{\mu V}$, $c=19.4$, $d=5.7$ dB / Z: $a=5.31$ dB, $b=67.1$ dB $\sqrt{\mu V}$, $c=20.2$, $d=5.7$ dB); Calibrated: 24.08.2012
- Sensor-Surface: 4mm (Mechanical Surface Detection), $z = 2.7, 32.7$
- Electronics: DAE3 Sn477; Calibrated: 09.05.2012
- Phantom: ELI 4.0; Type: QDOVA001BA; Serial: 1046
- DASYS52 52.8.5(1059); SEMCAD X 14.6.8(7028)

Body MSL/Right Side Position - Low 25RB offset/Area Scan (71x131x1):

Interpolated grid: $dx=1.500$ mm, $dy=1.500$ mm

Maximum value of SAR (interpolated) = 0.482 W/kg

Body MSL/Right Side Position - Low 25RB offset/Zoom Scan (7x7x7)/Cube

0: Measurement grid: $dx=5$ mm, $dy=5$ mm, $dz=5$ mm

Reference Value = 20.704 V/m; Power Drift = 0.05 dB

Peak SAR (extrapolated) = 1.55 W/kg

SAR(1 g) = 0.540 W/kg; SAR(10 g) = 0.265 W/kg

Maximum value of SAR (measured) = 0.602 W/kg

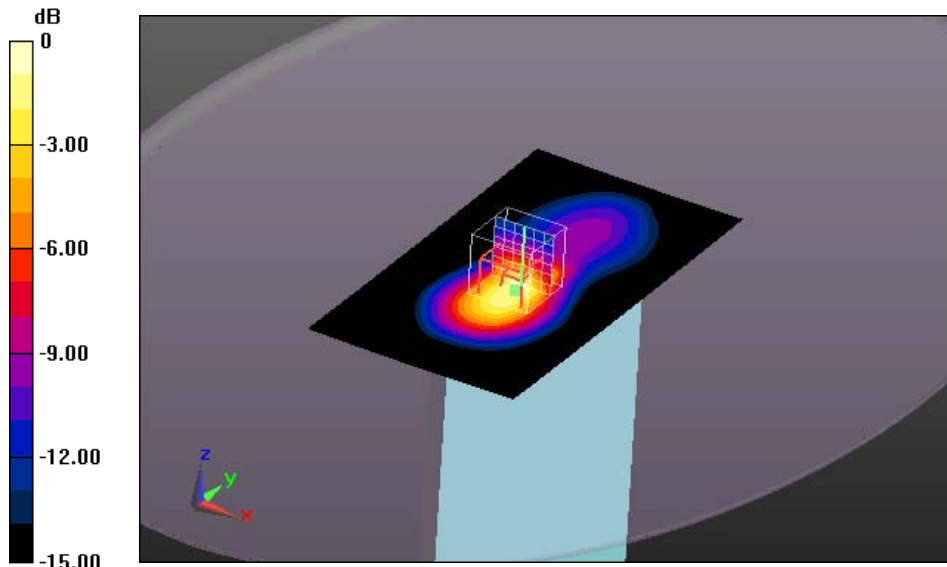

0 dB = 0.602 W/kg = -2.20 dBW/kg

Additional information:

position or distance of DUT to SAM: 0 mm

ambient temperature: 22.2 °C; liquid temperature: 21.9 °C

Date/Time: 02.05.2013 12:17:29

OET65-LTE FDD-5

DUT: Sony; Type: SGP321; Serial: CB5A1NY05N

Communication System: LTE-FDD (SC-FDMA, 1 RB, 10 MHz, QPSK); Communication System Band: Band 5, E-UTRA/FDD (824.0 - 849.0 MHz); Frequency: 844 MHz; Communication System PAR: 5.73 dB; PMF: 1.13894

Medium parameters used (interpolated): $f = 844$ MHz; $\sigma = 0.971$ S/m; $\epsilon_r = 55.744$; $\rho = 1000$ kg/m³

Phantom section: Flat Section

Measurement Standard: DASYS

DASY5 Configuration:

- Probe: ET3DV6 - SN1558; ConvF(6, 6, 6); Calibrated: 24.08.2012;
- Modulation Compensation: PMR (X: a=5.20 dB, b=66.8 dB $\sqrt{\mu}$ V, c=20.1, d=5.7 dB / Y: a=4.96 dB, b=65.8 dB $\sqrt{\mu}$ V, c=19.4, d=5.7 dB / Z: a=5.31 dB, b=67.1 dB $\sqrt{\mu}$ V, c=20.2, d=5.7 dB); Calibrated: 24.08.2012
- Sensor-Surface: 4mm (Mechanical Surface Detection (Locations From Previous Scan Used)), Sensor-Surface: 4mm (Mechanical Surface Detection), z = 2.7, 32.7
- Electronics: DAE3 Sn477; Calibrated: 09.05.2012
- Phantom: ELI 4.0; Type: QDOVA001BA; Serial: 1046
- DASY52 52.8.5(1059); SEMCAD X 14.6.8(7028)

Body MSL/Right Side Position - High 25RB offset/Area Scan (71x131x1):

Interpolated grid: dx=1.500 mm, dy=1.500 mm

Maximum value of SAR (interpolated) = 0.486 W/kg

Body MSL/Right Side Position - High 25RB offset/Zoom Scan (7x7x7)/Cube

0: Measurement grid: dx=5mm, dy=5mm, dz=5mm

Reference Value = 20.947 V/m; Power Drift = -0.02 dB

Peak SAR (extrapolated) = 1.54 W/kg

SAR(1 g) = 0.545 W/kg; SAR(10 g) = 0.263 W/kg

Maximum value of SAR (measured) = 0.610 W/kg

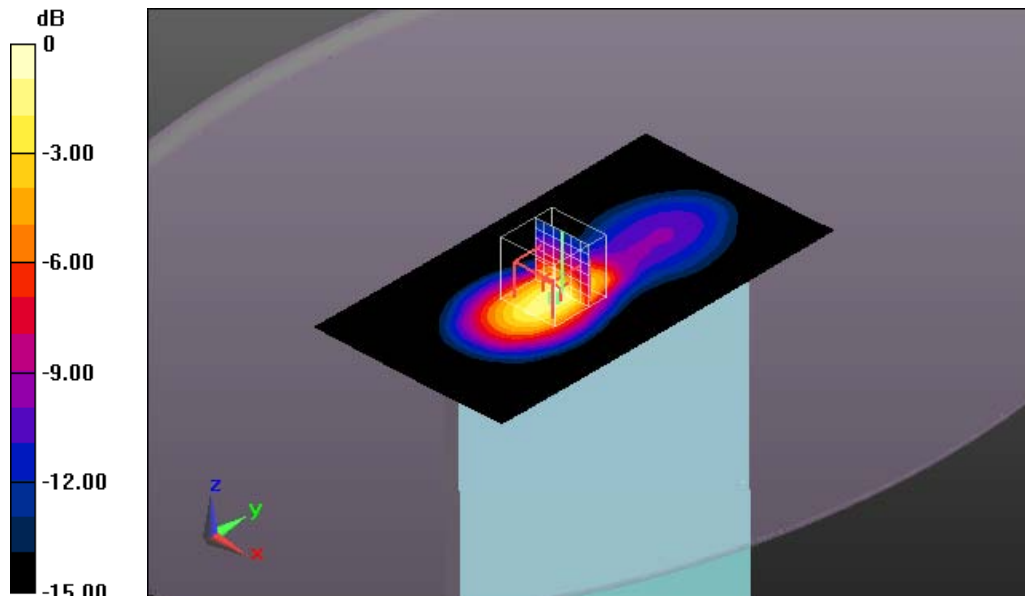

0 dB = 0.610 W/kg = -2.15 dBW/kg

Additional information:

position or distance of DUT to SAM: 0 mm

ambient temperature: 22.2 °C; liquid temperature: 21.9 °C

Date/Time: 02.05.2013 12:41:27

OET65-LTE FDD-5

DUT: Sony; Type: SGP321; Serial: CB5A1NY05N

Communication System: LTE-FDD (SC-FDMA, 1 RB, 10 MHz, QPSK); Communication System Band: Band 5, E-UTRA/FDD (824.0 - 849.0 MHz); Frequency: 829 MHz; Communication System PAR: 5.73 dB; PMF: 1.13894

Medium parameters used (interpolated): $f = 829$ MHz; $\sigma = 0.955$ S/m; $\epsilon_r = 55.855$; $\rho = 1000$ kg/m³

Phantom section: Flat Section

Measurement Standard: DASYS

DASY5 Configuration:

- Probe: ET3DV6 - SN1558; ConvF(6, 6, 6); Calibrated: 24.08.2012;
- Modulation Compensation: PMR (X: a=5.20 dB, b=66.8 dB $\sqrt{\mu}$ V, c=20.1, d=5.7 dB / Y: a=4.96 dB, b=65.8 dB $\sqrt{\mu}$ V, c=19.4, d=5.7 dB / Z: a=5.31 dB, b=67.1 dB $\sqrt{\mu}$ V, c=20.2, d=5.7 dB); Calibrated: 24.08.2012
- Sensor-Surface: 4mm (Mechanical Surface Detection), z = 2.7, 32.7
- Electronics: DAE3 Sn477; Calibrated: 09.05.2012
- Phantom: ELI 4.0; Type: QDOVA001BA; Serial: 1046
- DASYS2 52.8.5(1059); SEMCAD X 14.6.8(7028)

Body MSL/Top Position - Low 25RB offset/Area Scan (81x201x1): Interpolated

grid: dx=1.500 mm, dy=1.500 mm

Maximum value of SAR (interpolated) = 0.0903 W/kg

Body MSL/Top Position - Low 25RB offset/Zoom Scan (7x7x7)/Cube 0:

Measurement grid: dx=5mm, dy=5mm, dz=5mm

Reference Value = 10.024 V/m; Power Drift = 0.04 dB

Peak SAR (extrapolated) = 0.121 W/kg

SAR(1 g) = 0.084 W/kg; SAR(10 g) = 0.057 W/kg

Maximum value of SAR (measured) = 0.0895 W/kg

Body MSL/Top Position - Low 25RB offset/Zoom Scan 2 (8x11x7)/Cube 0:

Measurement grid: dx=5mm, dy=5mm, dz=5mm

Reference Value = 10.024 V/m; Power Drift = 0.04 dB

Peak SAR (extrapolated) = 0.146 W/kg

SAR(1 g) = 0.075 W/kg; SAR(10 g) = 0.052 W/kg

Maximum value of SAR (measured) = 0.0816 W/kg

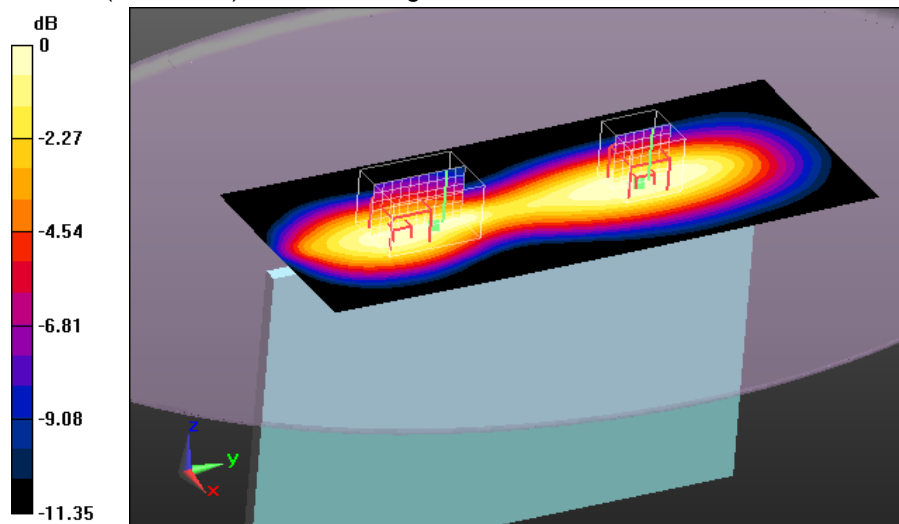

0 dB = 0.0816 W/kg = -10.88 dBW/kg

Additional information:

position or distance of DUT to SAM: 0 mm

ambient temperature: 22.2 °C; liquid temperature: 21.9 °C

Date/Time: 02.05.2013 13:31:44

OET65-LTE FDD-5

DUT: Sony; Type: SGP321; Serial: CB5A1NY05N

Communication System: LTE-FDD (SC-FDMA, 1 RB, 10 MHz, QPSK); Communication System Band: Band 5, E-UTRA/FDD (824.0 - 849.0 MHz); Frequency: 844 MHz; Communication System PAR: 5.73 dB; PMF: 1.13894

Medium parameters used (interpolated): $f = 844$ MHz; $\sigma = 0.971$ S/m; $\epsilon_r = 55.744$; $\rho = 1000$ kg/m³

Phantom section: Flat Section

Measurement Standard: DASYS

DASY5 Configuration:

- Probe: ET3DV6 - SN1558; ConvF(6, 6, 6); Calibrated: 24.08.2012;
- Modulation Compensation: PMR (X: $a=5.20$ dB, $b=66.8$ dB $\sqrt{\mu V}$, $c=20.1$, $d=5.7$ dB / Y: $a=4.96$ dB, $b=65.8$ dB $\sqrt{\mu V}$, $c=19.4$, $d=5.7$ dB / Z: $a=5.31$ dB, $b=67.1$ dB $\sqrt{\mu V}$, $c=20.2$, $d=5.7$ dB); Calibrated: 24.08.2012
- Sensor-Surface: 4mm (Mechanical Surface Detection (Locations From Previous Scan Used)), Sensor-Surface: 4mm (Mechanical Surface Detection), $z = 2.7, 32.7$
- Electronics: DAE3 Sn477; Calibrated: 09.05.2012
- Phantom: ELI 4.0; Type: QDOVA001BA; Serial: 1046
- DASY52 52.8.5(1059); SEMCAD X 14.6.8(7028)

Body MSL/Top Position - High 25RB offset/Area Scan (81x201x1): Interpolated grid: $dx=1.500$ mm, $dy=1.500$ mm

Maximum value of SAR (interpolated) = 0.0881 W/kg

Body MSL/Top Position - High 25RB offset/Zoom Scan (7x7x7)/Cube 0:

Measurement grid: $dx=5$ mm, $dy=5$ mm, $dz=5$ mm

Reference Value = 9.854 V/m; Power Drift = -0.01 dB

Peak SAR (extrapolated) = 0.117 W/kg

SAR(1 g) = 0.081 W/kg; SAR(10 g) = 0.055 W/kg

Maximum value of SAR (measured) = 0.0872 W/kg

Body MSL/Top Position - High 25RB offset/Zoom Scan 2 (8x12x7)/Cube 0:

Measurement grid: $dx=5$ mm, $dy=5$ mm, $dz=5$ mm

Reference Value = 9.854 V/m; Power Drift = -0.01 dB

Peak SAR (extrapolated) = 0.157 W/kg

SAR(1 g) = 0.072 W/kg; SAR(10 g) = 0.050 W/kg

Maximum value of SAR (measured) = 0.0800 W/kg

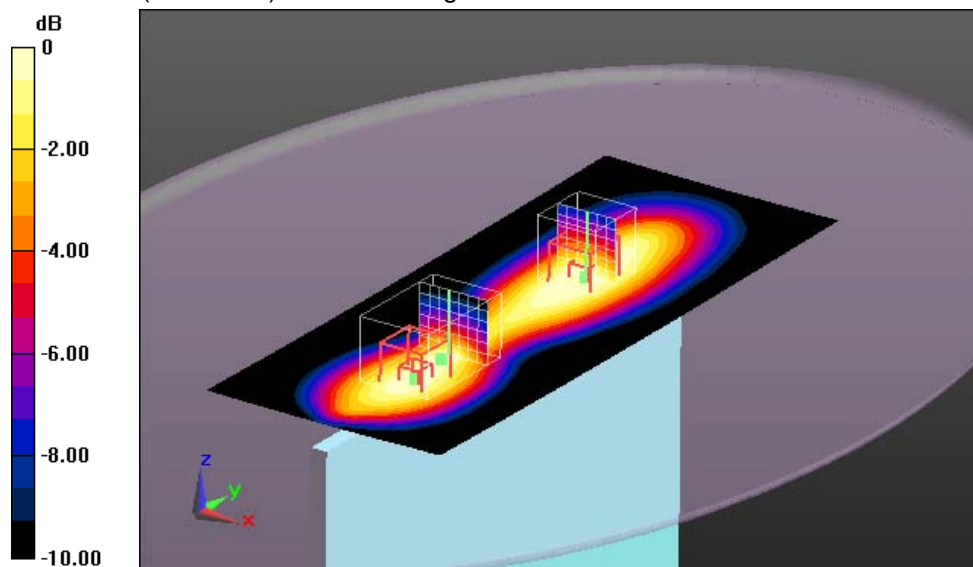

0 dB = 0.0800 W/kg = -10.97 dBW/kg

Additional information:

position or distance of DUT to SAM: 0 mm

ambient temperature: 22.2 °C; liquid temperature: 21.9 °C

Date/Time: 02.05.2013 15:36:21

OET65-LTE FDD-5

DUT: Sony; Type: SGP321; Serial: CB5A1NY05N

Communication System: LTE-FDD (SC-FDMA, 1 RB, 10 MHz, QPSK); Communication System Band: Band 5, E-UTRA/FDD (824.0 - 849.0 MHz); Frequency: 829 MHz; Communication System PAR: 5.73 dB; PMF: 1.13894

Medium parameters used (interpolated): $f = 829$ MHz; $\sigma = 0.955$ S/m; $\epsilon_r = 55.855$; $\rho = 1000$ kg/m³

Phantom section: Flat Section

Measurement Standard: DASYS

DASY5 Configuration:

- Probe: ET3DV6 - SN1558; ConvF(6, 6, 6); Calibrated: 24.08.2012;
- Modulation Compensation: PMR (X: a=5.20 dB, b=66.8 dB $\sqrt{\mu}$ V, c=20.1, d=5.7 dB / Y: a=4.96 dB, b=65.8 dB $\sqrt{\mu}$ V, c=19.4, d=5.7 dB / Z: a=5.31 dB, b=67.1 dB $\sqrt{\mu}$ V, c=20.2, d=5.7 dB); Calibrated: 24.08.2012
- Sensor-Surface: 4mm (Mechanical Surface Detection), z = 2.7, 32.7
- Electronics: DAE3 Sn477; Calibrated: 09.05.2012
- Phantom: ELI 4.0; Type: QDOVA001BA; Serial: 1046
- DASY52 52.8.5(1059); SEMCAD X 14.6.8(7028)

Body MSL/Rear Position - Low 0RB offset/Area Scan (121x121x1): Interpolated

grid: dx=1.500 mm, dy=1.500 mm

Maximum value of SAR (interpolated) = 0.600 W/kg

Body MSL/Rear Position - Low 0RB offset/Zoom Scan (8x8x7)/Cube 0:

Measurement grid: dx=5mm, dy=5mm, dz=5mm

Reference Value = 25.355 V/m; Power Drift = 0.01 dB

Peak SAR (extrapolated) = 1.12 W/kg

SAR(1 g) = 0.603 W/kg; SAR(10 g) = 0.337 W/kg

Maximum value of SAR (measured) = 0.663 W/kg

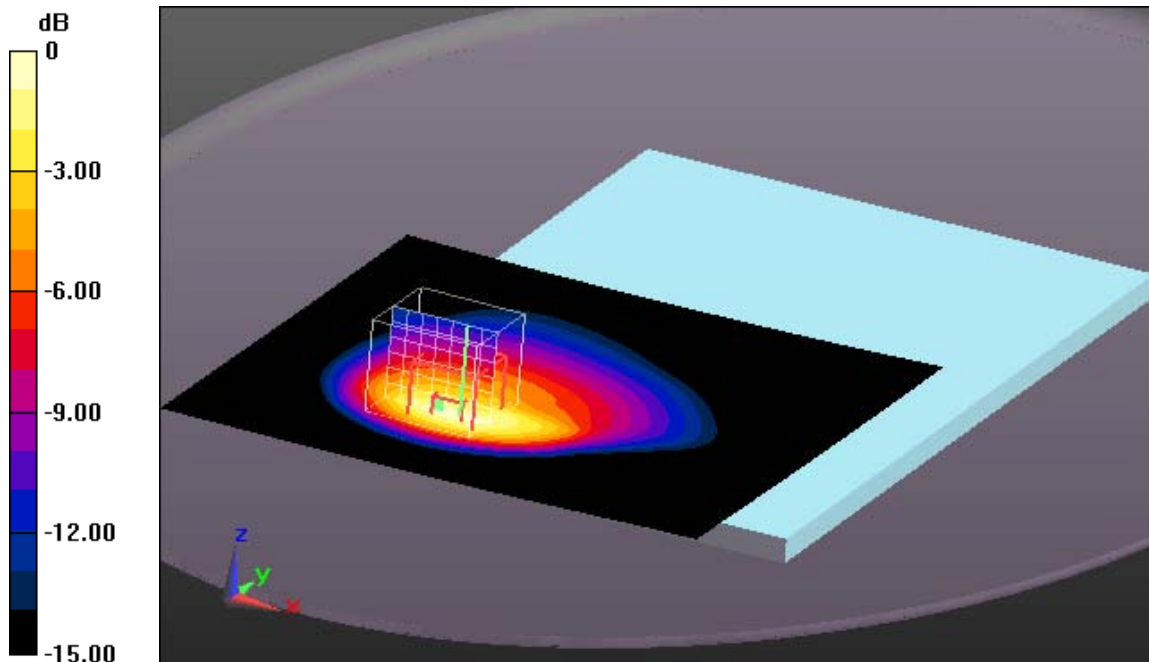

0 dB = 0.663 W/kg = -1.78 dBW/kg

Additional information:

position or distance of DUT to SAM: 0 mm

ambient temperature: 22.2 °C; liquid temperature: 21.9 °C

Date/Time: 02.05.2013 16:06:07

OET65-LTE FDD-5

DUT: Sony; Type: SGP321; Serial: CB5A1NY05N

Communication System: LTE-FDD (SC-FDMA, 1 RB, 10 MHz, QPSK); Communication System Band: Band 5, E-UTRA/FDD (824.0 - 849.0 MHz); Frequency: 829 MHz; Communication System PAR: 5.73 dB; PMF: 1.13894

Medium parameters used (interpolated): $f = 829$ MHz; $\sigma = 0.955$ S/m; $\epsilon_r = 55.855$; $\rho = 1000$ kg/m³

Phantom section: Flat Section

Measurement Standard: DASYS5

DASY5 Configuration:

- Probe: ET3DV6 - SN1558; ConvF(6, 6, 6); Calibrated: 24.08.2012;
- Modulation Compensation: PMR (X: a=5.20 dB, b=66.8 dB $\sqrt{\mu}$ V, c=20.1, d=5.7 dB / Y: a=4.96 dB, b=65.8 dB $\sqrt{\mu}$ V, c=19.4, d=5.7 dB / Z: a=5.31 dB, b=67.1 dB $\sqrt{\mu}$ V, c=20.2, d=5.7 dB); Calibrated: 24.08.2012
- Sensor-Surface: 4mm (Mechanical Surface Detection (Locations From Previous Scan Used)), Sensor-Surface: 4mm (Mechanical Surface Detection), z = 2.7, 32.7
- Electronics: DAE3 Sn477; Calibrated: 09.05.2012
- Phantom: ELI 4.0; Type: QDOVA001BA; Serial: 1046
- DASYS5 52.8.5(1059); SEMCAD X 14.6.8(7028)

Body MSL/Rear Position - Low 49RB offset/Area Scan (121x121x1):

Interpolated grid: dx=1.500 mm, dy=1.500 mm

Maximum value of SAR (interpolated) = 0.728 W/kg

Body MSL/Rear Position - Low 49RB offset/Zoom Scan (8x8x7)/Cube 0:

Measurement grid: dx=5mm, dy=5mm, dz=5mm

Reference Value = 27.809 V/m; Power Drift = 0.05 dB

Peak SAR (extrapolated) = 1.36 W/kg

SAR(1 g) = 0.733 W/kg; SAR(10 g) = 0.407 W/kg

Maximum value of SAR (measured) = 0.812 W/kg

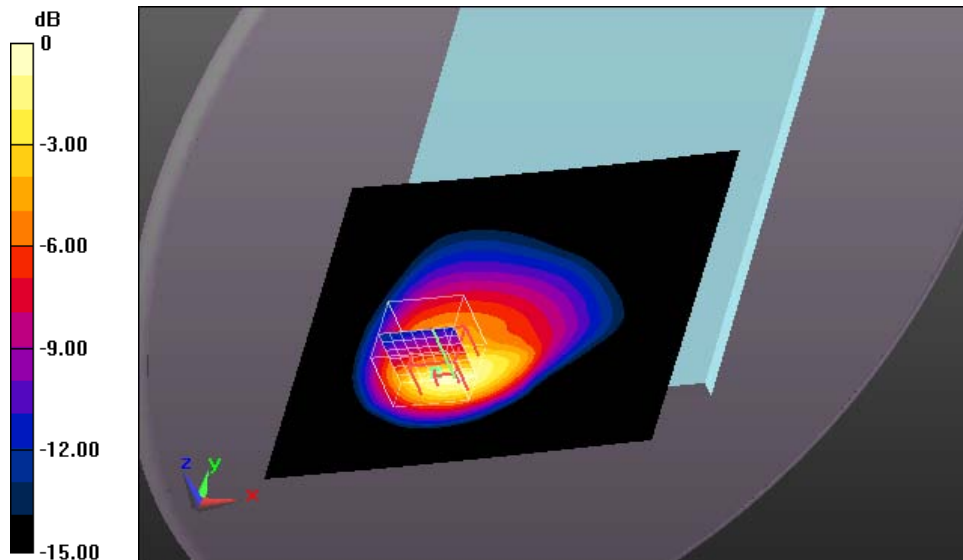

0 dB = 0.812 W/kg = -0.90 dBW/kg

Additional information:

position or distance of DUT to SAM: 0 mm

ambient temperature: 22.2 °C; liquid temperature: 21.9 °C

Date/Time: 02.05.2013 16:28:39

OET65-LTE FDD-5

DUT: Sony; Type: SGP321; Serial: CB5A1NY05N

Communication System: LTE-FDD (SC-FDMA, 50% RB, 10 MHz, QPSK); Communication System Band: Band 5, E-UTRA/FDD (824.0 - 849.0 MHz); Frequency: 829 MHz; Communication System PAR: 5.76 dB; PMF: 1.01391

Medium parameters used (interpolated): $f = 829$ MHz; $\sigma = 0.955$ S/m; $\epsilon_r = 55.855$; $\rho = 1000$ kg/m³

Phantom section: Flat Section

Measurement Standard: DASY5

DASY5 Configuration:

- Probe: ET3DV6 - SN1558; ConvF(6, 6, 6); Calibrated: 24.08.2012;
- Modulation Compensation: PMR (X: a=6.31 dB, b=67.8 dB $\sqrt{\mu}$ V, c=20.5, d=5.8 dB / Y: a=5.91 dB, b=66.1 dB $\sqrt{\mu}$ V, c=19.3, d=5.8 dB / Z: a=5.98 dB, b=66.2 dB $\sqrt{\mu}$ V, c=19.4, d=5.8 dB); Calibrated: 24.08.2012
- Sensor-Surface: 4mm (Mechanical Surface Detection (Locations From Previous Scan Used)), Sensor-Surface: 4mm (Mechanical Surface Detection), z = 2.7, 32.7
- Electronics: DAE3 Sn477; Calibrated: 09.05.2012
- Phantom: ELI 4.0; Type: QDOVA001BA; Serial: 1046
- DASY52 52.8.5(1059); SEMCAD X 14.6.8(7028)

Body MSL/Rear Position - Low 25RB/ 25RB offset/Area Scan (121x121x1):

Interpolated grid: dx=1.500 mm, dy=1.500 mm

Maximum value of SAR (interpolated) = 0.705 W/kg

Body MSL/Rear Position - Low 25RB/ 25RB offset/Zoom Scan (8x8x7)/Cube

0: Measurement grid: dx=5mm, dy=5mm, dz=5mm

Reference Value = 27.475 V/m; Power Drift = 0.00 dB

Peak SAR (extrapolated) = 1.32 W/kg

SAR(1 g) = 0.713 W/kg; SAR(10 g) = 0.397 W/kg

Maximum value of SAR (measured) = 0.791 W/kg

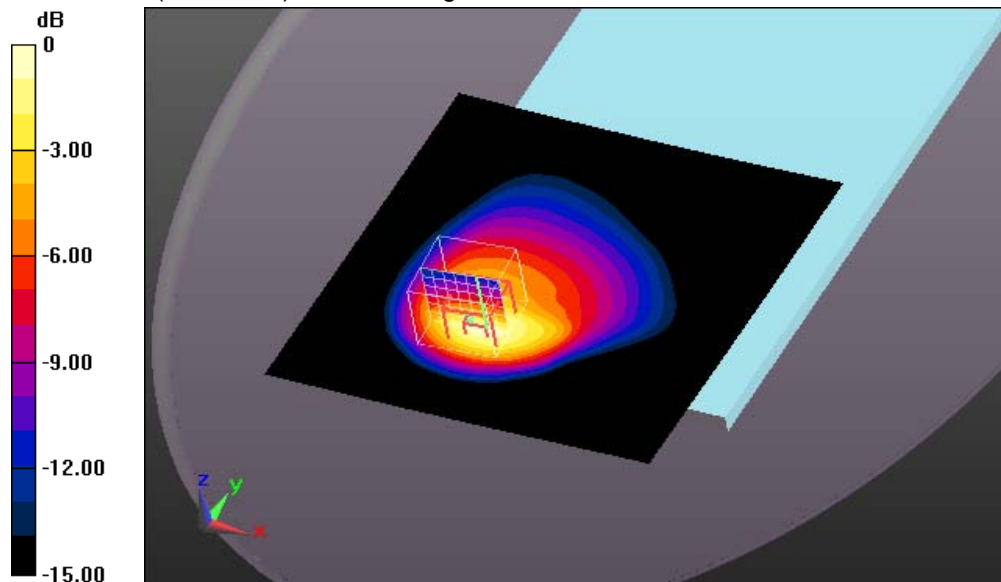

0 dB = 0.791 W/kg = -1.02 dBW/kg

Additional information:

position or distance of DUT to SAM: 0 mm

ambient temperature: 22.2 °C; liquid temperature: 21.9 °C

Date/Time: 02.05.2013 16:57:52

OET65-LTE FDD-5

DUT: Sony; Type: SGP321; Serial: CB5A1NY05N

Communication System: LTE-FDD (SC-FDMA, 50% RB, 10 MHz, QPSK); Communication System Band: Band 5, E-UTRA/FDD (824.0 - 849.0 MHz); Frequency: 844 MHz; Communication System PAR: 5.76 dB; PMF: 1.01391

Medium parameters used (interpolated): $f = 844$ MHz; $\sigma = 0.971$ S/m; $\epsilon_r = 55.744$; $\rho = 1000$ kg/m³

Phantom section: Flat Section

Measurement Standard: DASYS

DASY5 Configuration:

- Probe: ET3DV6 - SN1558; ConvF(6, 6, 6); Calibrated: 24.08.2012;
- Modulation Compensation: PMR (X: a=6.31 dB, b=67.8 dB $\sqrt{\mu}$ V, c=20.5, d=5.8 dB / Y: a=5.91 dB, b=66.1 dB $\sqrt{\mu}$ V, c=19.3, d=5.8 dB / Z: a=5.98 dB, b=66.2 dB $\sqrt{\mu}$ V, c=19.4, d=5.8 dB); Calibrated: 24.08.2012
- Sensor-Surface: 4mm (Mechanical Surface Detection (Locations From Previous Scan Used)), Sensor-Surface: 4mm (Mechanical Surface Detection), z = 2.7, 32.7
- Electronics: DAE3 Sn477; Calibrated: 09.05.2012
- Phantom: ELI 4.0; Type: QDOVA001BA; Serial: 1046
- DASY52 52.8.5(1059); SEMCAD X 14.6.8(7028)

Body MSL/Rear Position - High 25RB/ 12RB offset/Area Scan (121x121x1):

Interpolated grid: dx=1.500 mm, dy=1.500 mm

Maximum value of SAR (interpolated) = 0.542 W/kg

Body MSL/Rear Position - High 25RB/ 12RB offset/Zoom Scan

(8x8x7)/Cube 0: Measurement grid: dx=5mm, dy=5mm, dz=5mm

Reference Value = 24.216 V/m; Power Drift = -0.01 dB

Peak SAR (extrapolated) = 1.03 W/kg

SAR(1 g) = 0.552 W/kg; SAR(10 g) = 0.308 W/kg

Maximum value of SAR (measured) = 0.607 W/kg

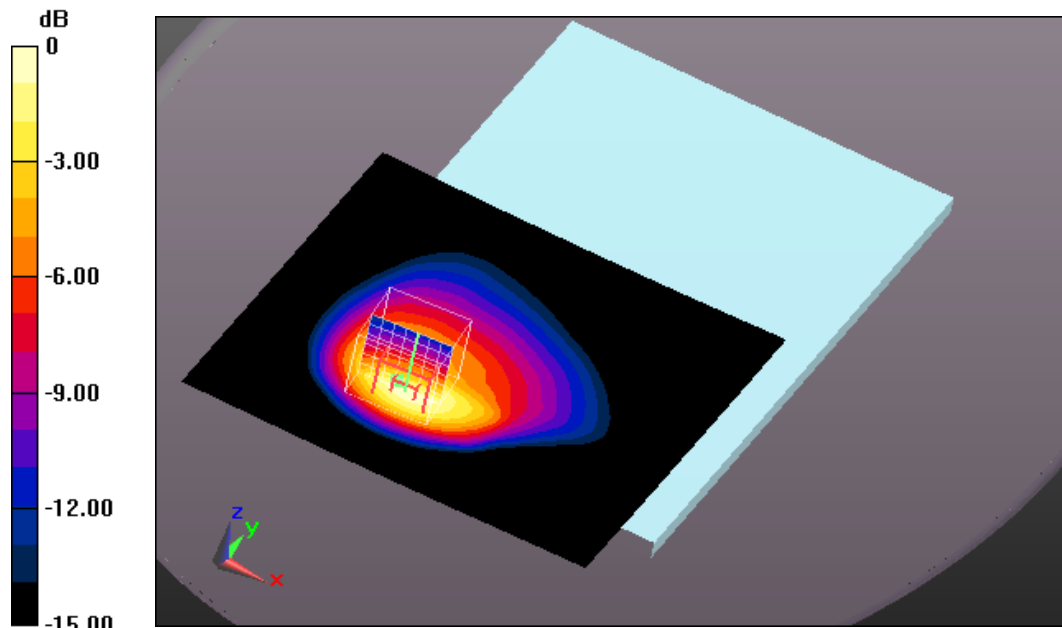

0 dB = 0.607 W/kg = -2.17 dBW/kg

Additional information:

position or distance of DUT to SAM: 0 mm

ambient temperature: 22.2 °C; liquid temperature: 21.9 °C

Date/Time: 02.05.2013 15:04:46

OET65-LTE FDD-5

DUT: Sony; Type: SGP321; Serial: CB5A1NY05N

Communication System: LTE-FDD (SC-FDMA, 50% RB, 10 MHz, QPSK); Communication System Band: Band 5, E-UTRA/FDD (824.0 - 849.0 MHz); Frequency: 829 MHz; Communication System PAR: 5.76 dB; PMF: 1.01391

Medium parameters used (interpolated): $f = 829$ MHz; $\sigma = 0.955$ S/m; $\epsilon_r = 55.855$; $\rho = 1000$ kg/m³

Phantom section: Flat Section

Measurement Standard: DASYS

DASY5 Configuration:

- Probe: ET3DV6 - SN1558; ConvF(6, 6, 6); Calibrated: 24.08.2012;
- Modulation Compensation: PMR (X: a=6.31 dB, b=67.8 dB $\sqrt{\mu}$ V, c=20.5, d=5.8 dB / Y: a=5.91 dB, b=66.1 dB $\sqrt{\mu}$ V, c=19.3, d=5.8 dB / Z: a=5.98 dB, b=66.2 dB $\sqrt{\mu}$ V, c=19.4, d=5.8 dB); Calibrated: 24.08.2012
- Sensor-Surface: 4mm (Mechanical Surface Detection (Locations From Previous Scan Used)), Sensor-Surface: 4mm (Mechanical Surface Detection), z = 2.7, 32.7
- Electronics: DAE3 Sn477; Calibrated: 09.05.2012
- Phantom: ELI 4.0; Type: QDOVA001BA; Serial: 1046
- DASY52 52.8.5(1059); SEMCAD X 14.6.8(7028)

Body MSL/Right Side Position - Low 25RB offset 25RB/Area Scan

(71x131x1): Interpolated grid: dx=1.500 mm, dy=1.500 mm

Maximum value of SAR (interpolated) = 0.502 W/kg

Body MSL/Right Side Position - Low 25RB offset 25RB/Zoom Scan

(7x7x7)/Cube 0: Measurement grid: dx=5mm, dy=5mm, dz=5mm

Reference Value = 23.796 V/m; Power Drift = 0.10 dB

Peak SAR (extrapolated) = 1.35 W/kg

SAR(1 g) = 0.491 W/kg; SAR(10 g) = 0.240 W/kg

Maximum value of SAR (measured) = 0.569 W/kg

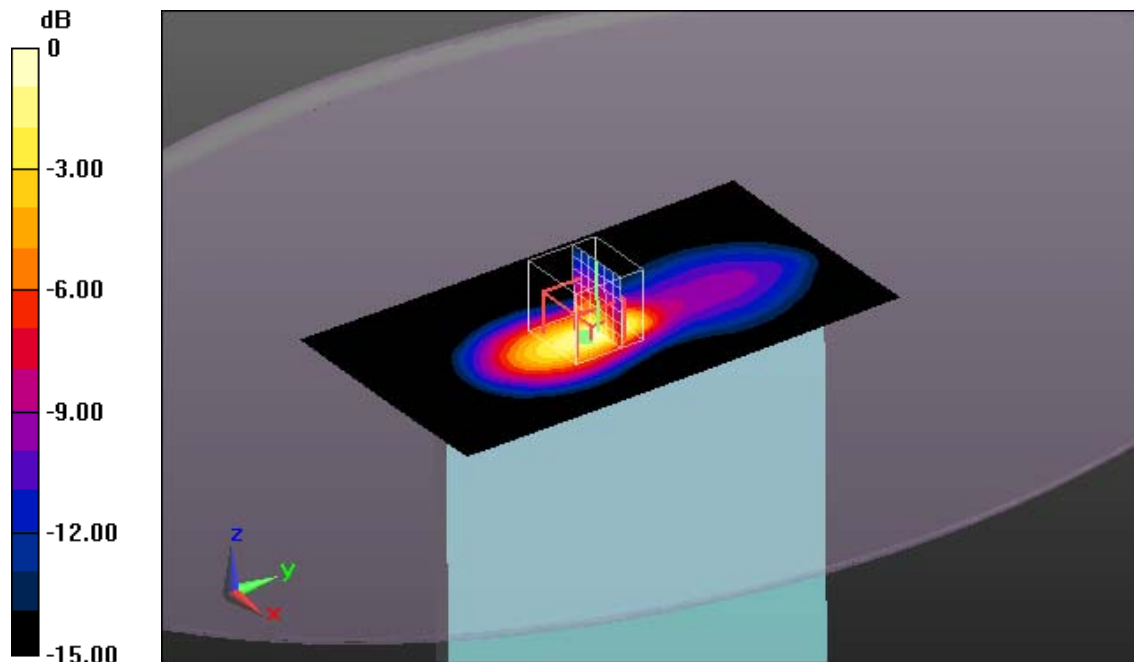

0 dB = 0.569 W/kg = -2.45 dBW/kg

Additional information:

position or distance of DUT to SAM: 0 mm

ambient temperature: 22.2 °C; liquid temperature: 21.9 °C

Date/Time: 02.05.2013 14:19:55

OET65-LTE FDD-5

DUT: Sony; Type: SGP321; Serial: CB5A1NY05N

Communication System: LTE-FDD (SC-FDMA, 50% RB, 10 MHz, QPSK); Communication System Band: Band 5, E-UTRA/FDD (824.0 - 849.0 MHz); Frequency: 829 MHz; Communication System PAR: 5.76 dB; PMF: 1.01391

Medium parameters used (interpolated): $f = 829$ MHz; $\sigma = 0.955$ S/m; $\epsilon_r = 55.855$; $\rho = 1000$ kg/m³

Phantom section: Flat Section

Measurement Standard: DASYS

DASY5 Configuration:

- Probe: ET3DV6 - SN1558; ConvF(6, 6, 6); Calibrated: 24.08.2012;
- Modulation Compensation: PMR (X: a=6.31 dB, b=67.8 dB $\sqrt{\mu}$ V, c=20.5, d=5.8 dB / Y: a=5.91 dB, b=66.1 dB $\sqrt{\mu}$ V, c=19.3, d=5.8 dB / Z: a=5.98 dB, b=66.2 dB $\sqrt{\mu}$ V, c=19.4, d=5.8 dB); Calibrated: 24.08.2012
- Sensor-Surface: 4mm (Mechanical Surface Detection (Locations From Previous Scan Used)), Sensor-Surface: 4mm (Mechanical Surface Detection), z = 2.7, 32.7
- Electronics: DAE3 Sn477; Calibrated: 09.05.2012
- Phantom: ELI 4.0; Type: QDOVA001BA; Serial: 1046
- DASY52 52.8.5(1059); SEMCAD X 14.6.8(7028)

Body MSL/Top Position - Low 25RB offset 25RB/Area Scan (81x201x1):

Interpolated grid: dx=1.500 mm, dy=1.500 mm

Maximum value of SAR (interpolated) = 0.0844 W/kg

Body MSL/Top Position - Low 25RB offset 25RB/Zoom Scan (7x7x7)/Cube

0: Measurement grid: dx=5mm, dy=5mm, dz=5mm

Reference Value = 9.703 V/m; Power Drift = -0.01 dB

Peak SAR (extrapolated) = 0.112 W/kg

SAR(1 g) = 0.077 W/kg; SAR(10 g) = 0.053 W/kg

Maximum value of SAR (measured) = 0.0836 W/kg

Body MSL/Top Position - Low 25RB offset 25RB/Zoom Scan 2

(7x11x7)/Cube 0: Measurement grid: dx=5mm, dy=5mm, dz=5mm

Reference Value = 9.703 V/m; Power Drift = -0.01 dB

Peak SAR (extrapolated) = 0.142 W/kg

SAR(1 g) = 0.070 W/kg; SAR(10 g) = 0.049 W/kg

Maximum value of SAR (measured) = 0.0780 W/kg

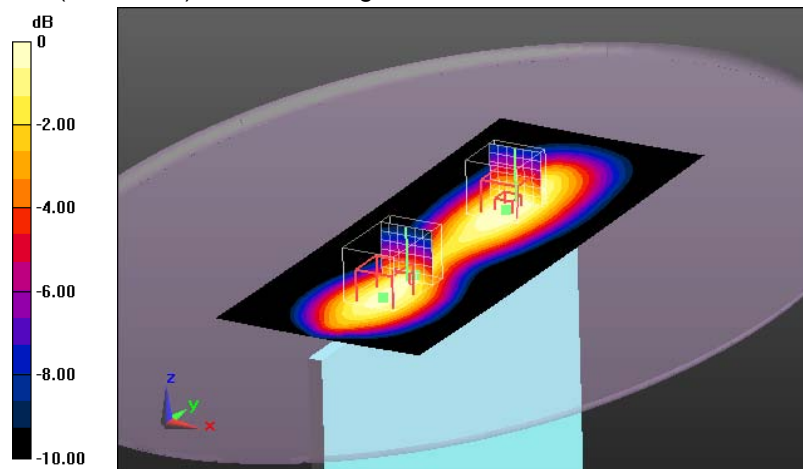

0 dB = 0.0780 W/kg = -11.08 dBW/kg

Additional information:

position or distance of DUT to SAM: 0 mm

ambient temperature: 22.2 °C; liquid temperature: 21.9 °C

Date/Time: 02.05.2013 18:16:39

OET65-LTE FDD-5

DUT: Sony; Type: SGP321; Serial: CB5A1NY05N

Communication System: LTE-FDD (100%RB, 10 MHz, QPSK); Communication System Band: FDD 5;

Frequency: 829 MHz; Communication System PAR: 5.8 dB; PMF: 1.00577

Medium parameters used (interpolated): $f = 829$ MHz; $\sigma = 0.955$ S/m; $\epsilon_r = 55.855$; $\rho = 1000$ kg/m³

Phantom section: Flat Section

Measurement Standard: DASYS

DASY5 Configuration:

- Probe: ET3DV6 - SN1558; ConvF(6, 6, 6); Calibrated: 24.08.2012;
- Sensor-Surface: 4mm (Mechanical Surface Detection), $z = 2.7, 32.7$
- Electronics: DAE3 Sn477; Calibrated: 09.05.2012
- Phantom: ELI 4.0; Type: QDOVA001BA; Serial: 1046
- DASYS2 52.8.5(1059); SEMCAD X 14.6.8(7028)

Body MSL/Rear Position - Low 50RB/Area Scan (131x121x1): Interpolated grid:

$dx=1.500$ mm, $dy=1.500$ mm

Maximum value of SAR (interpolated) = 0.889 W/kg

Body MSL/Rear Position - Low 50RB/Zoom Scan (9x8x7)/Cube 0: Measurement

grid: $dx=5$ mm, $dy=5$ mm, $dz=5$ mm

Reference Value = 30.512 V/m; Power Drift = -0.109 dB

Peak SAR (extrapolated) = 2.73 W/kg

SAR(1 g) = 0.945 W/kg; SAR(10 g) = 0.455 W/kg

Maximum value of SAR (measured) = 1.01 W/kg

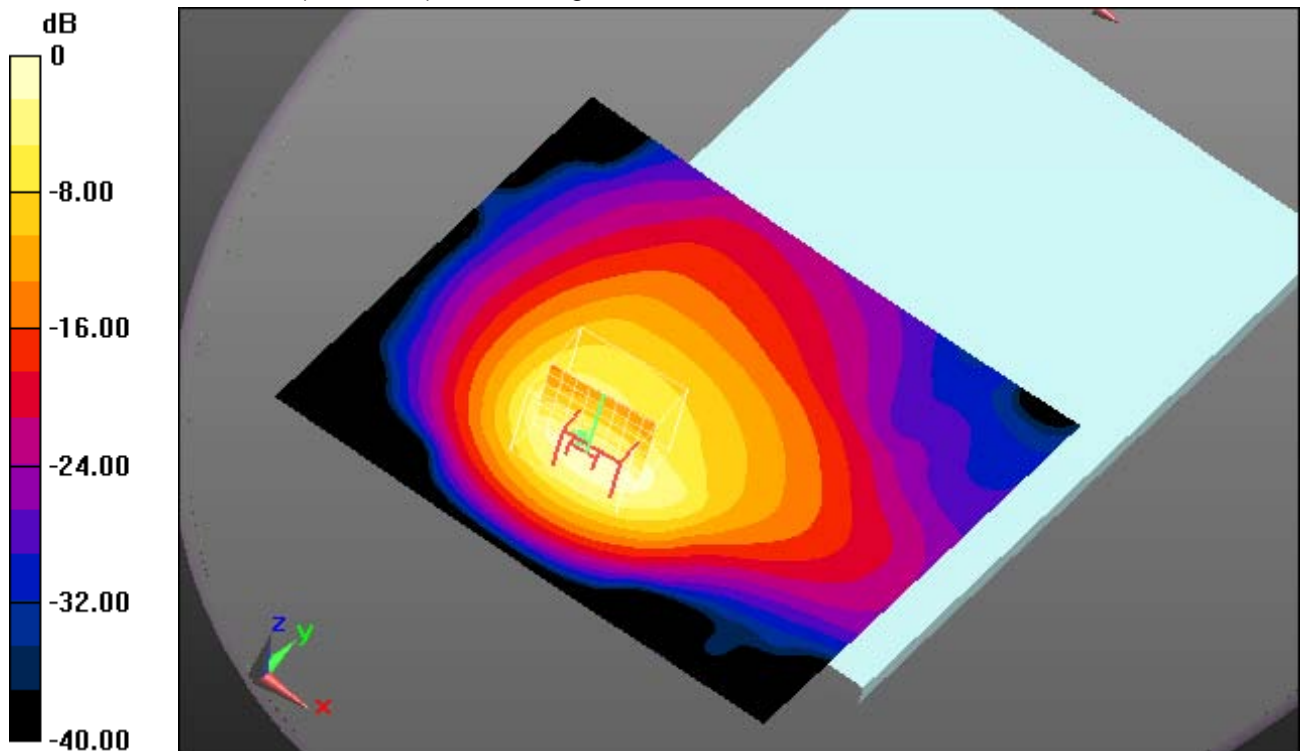

0 dB = 1.01 W/kg = 0.04 dBW/kg

Additional information:

position or distance of DUT to SAM: 0 mm

ambient temperature: 22.2 °C; liquid temperature: 21.9 °C

Date/Time: 02.05.2013 18:51:04

OET65-LTE FDD-5

DUT: Sony; Type: SGP321; Serial: CB5A1NY05N

Communication System: LTE-FDD (100%RB, 10 MHz, QPSK); Communication System Band: FDD 5;

Frequency: 844 MHz; Communication System PAR: 5.8 dB; PMF: 1.00577

Medium parameters used (interpolated): $f = 844$ MHz; $\sigma = 0.971$ S/m; $\epsilon_r = 55.744$; $\rho = 1000$ kg/m³

Phantom section: Flat Section

Measurement Standard: DASYS

DASY5 Configuration:

- Probe: ET3DV6 - SN1558; ConvF(6, 6, 6); Calibrated: 24.08.2012;
- Sensor-Surface: 4mm (Mechanical Surface Detection (Locations From Previous Scan Used)), Sensor-Surface: 4mm (Mechanical Surface Detection), $z = 2.7, 32.7$
- Electronics: DAE3 Sn477; Calibrated: 09.05.2012
- Phantom: ELI 4.0; Type: QDOVA001BA; Serial: 1046
- DASYS2 52.8.5(1059); SEMCAD X 14.6.8(7028)

Body MSL/Rear Position - High 50RB/Area Scan (131x121x1): Interpolated grid:

$dx=1.500$ mm, $dy=1.500$ mm

Maximum value of SAR (interpolated) = 0.804 W/kg

Body MSL/Rear Position - High 50RB/Zoom Scan (8x8x7)/Cube 0: Measurement

grid: $dx=5$ mm, $dy=5$ mm, $dz=5$ mm

Reference Value = 28.357 V/m; Power Drift = -0.02 dB

Peak SAR (extrapolated) = 1.64 W/kg

SAR(1 g) = 0.803 W/kg; SAR(10 g) = 0.425 W/kg

Maximum value of SAR (measured) = 0.892 W/kg

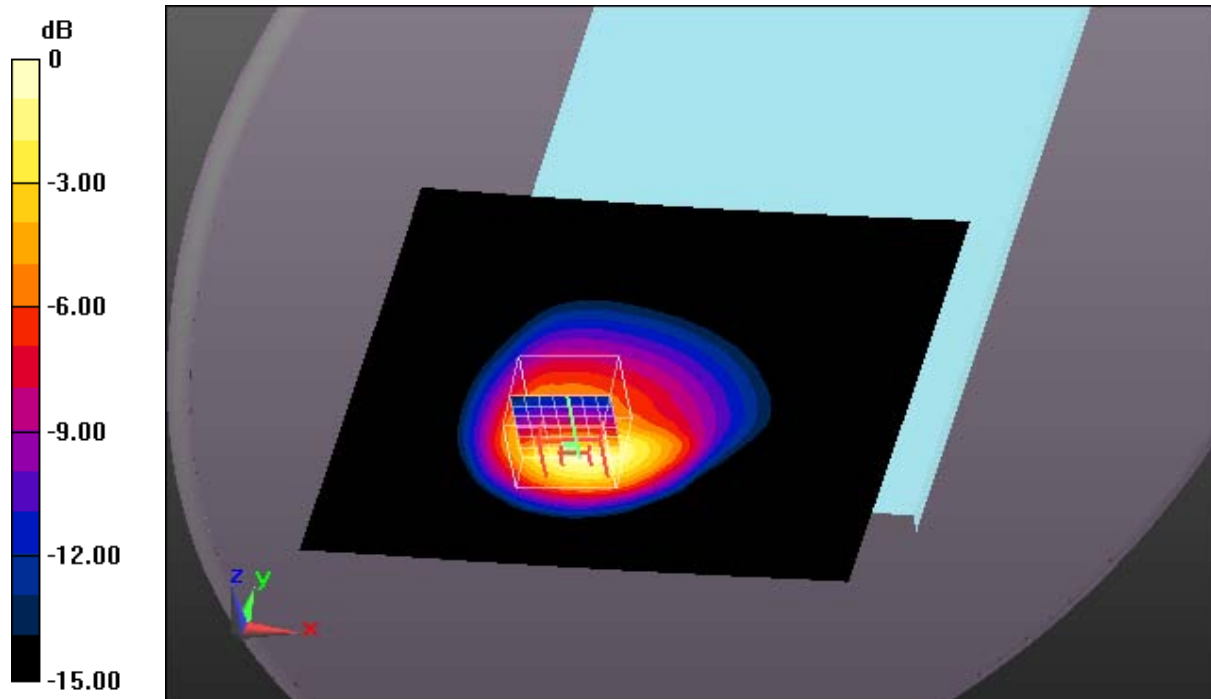

0 dB = 0.892 W/kg = -0.50 dBW/kg

Additional information:

position or distance of DUT to SAM: 0 mm

ambient temperature: 22.2 °C; liquid temperature: 21.9 °C

Annex B.5: LTE FDD 7

Date/Time: 27.03.2013 20:35:24

OET65_EN62209-2-Body-LTE 7_power backoff

DUT: Sony; Type: SGP321; Serial: CB5A1NY07E

Communication System: LTE-FDD (SC-FDMA, 1 RB, 20 MHz, QPSK); Communication System Band: Band 7, E-UTRA/FDD (2500.0 - 2570.0 MHz); Frequency: 2535 MHz; Communication System PAR: 5.73 dB; PMF: 1.13894

Medium parameters used: $f = 2535$ MHz; $\sigma = 2.12$ S/m; $\epsilon_r = 51.7$; $\rho = 1000$ kg/m³

Phantom section: Flat Section

Measurement Standard: DASYS5

DASY5 Configuration:

- Probe: EX3DV4 - SN3566; ConvF(6.06, 6.06, 6.06); Calibrated: 23.08.2012;
- Modulation Compensation: PMR (X: a=4.39 dB, b=64.6 dB $\sqrt{\mu}$ V, c=18.5, d=5.7 dB / Y: a=4.72 dB, b=66.1 dB $\sqrt{\mu}$ V, c=19.4, d=5.7 dB / Z: a=4.77 dB, b=67.0 dB $\sqrt{\mu}$ V, c=20.2, d=5.7 dB); Calibrated: 23.08.2012
- Sensor-Surface: 2mm (Mechanical Surface Detection (Locations From Previous Scan Used)), Sensor-Surface: 2mm (Mechanical Surface Detection), z = 1.0, 31.0
- Electronics: DAE3 Sn477; Calibrated: 09.05.2012
- Phantom: ELI 4.0; Type: QDOVA001BA; Serial: 1046
- DASY52 52.8.5(1059); SEMCAD X 14.6.8(7028)

MSL/Rear position - Low 49 Offset 16-QAM/Area Scan (191x281x1):

Interpolated grid: dx=1.000 mm, dy=1.000 mm

Maximum value of SAR (interpolated) = 1.12 W/kg

MSL/Rear position - Low 49 Offset 16-QAM/Zoom Scan (7x7x7)/Cube 0:

Measurement grid: dx=5mm, dy=5mm, dz=5mm

Reference Value = 20.478 V/m; Power Drift = -0.02 dB

Peak SAR (extrapolated) = 1.47 W/kg

SAR(1 g) = 0.600 W/kg; SAR(10 g) = 0.215 W/kg

Maximum value of SAR (measured) = 1.03 W/kg

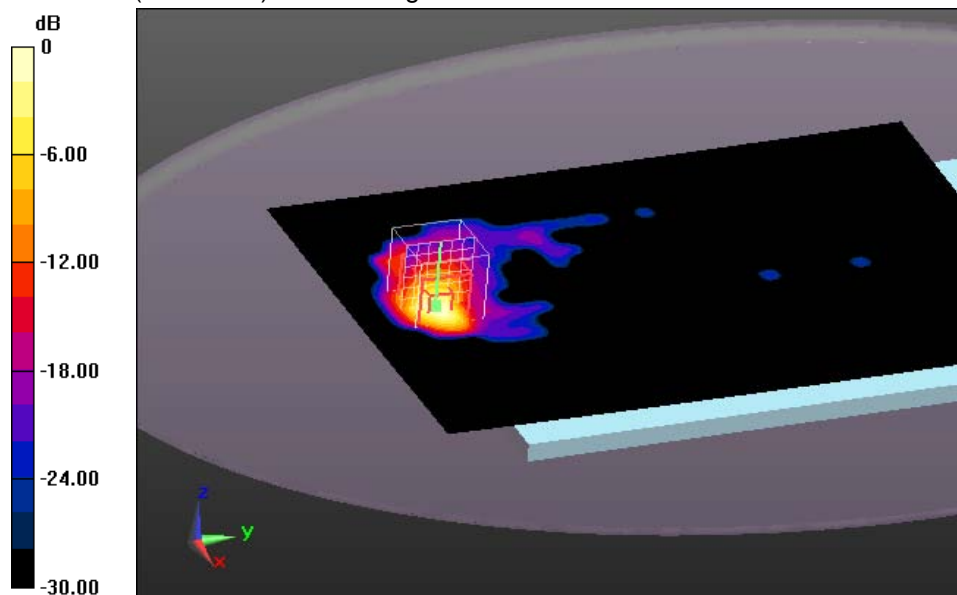

0 dB = 1.03 W/kg = 0.13 dBW/kg

Additional information:

position or distance of DUT to SAM: 0mm

ambient temperature: 21.5°C; liquid temperature: 20.9°C

Date/Time: 27.03.2013 18:39:04

OET65_EN62209-2-Body-LTE 7_power backoff

DUT: Sony; Type: SGP321; Serial: CB5A1NY07E

Communication System: LTE-FDD (SC-FDMA, 1 RB, 20 MHz, QPSK); Communication System Band: Band 7, E-UTRA/FDD (2500.0 - 2570.0 MHz); Frequency: 2535 MHz; Communication System PAR: 5.73 dB; PMF: 1.13894

Medium parameters used: $f = 2535 \text{ MHz}$; $\sigma = 2.12 \text{ S/m}$; $\epsilon_r = 51.7$; $\rho = 1000 \text{ kg/m}^3$

Phantom section: Flat Section

Measurement Standard: DASY5

DASY5 Configuration:

- Probe: EX3DV4 - SN3566; ConvF(6.06, 6.06, 6.06); Calibrated: 23.08.2012;
- Modulation Compensation: PMR (X: $a=4.39 \text{ dB}$, $b=64.6 \text{ dB}\sqrt{\mu\text{V}}$, $c=18.5$, $d=5.7 \text{ dB}$ / Y: $a=4.72 \text{ dB}$, $b=66.1 \text{ dB}\sqrt{\mu\text{V}}$, $c=19.4$, $d=5.7 \text{ dB}$ / Z: $a=4.77 \text{ dB}$, $b=67.0 \text{ dB}\sqrt{\mu\text{V}}$, $c=20.2$, $d=5.7 \text{ dB}$); Calibrated: 23.08.2012
- Sensor-Surface: 2mm (Mechanical Surface Detection), $z = 1.0, 31.0$
- Electronics: DAE3 Sn477; Calibrated: 09.05.2012
- Phantom: ELI 4.0; Type: QDOVA001BA; Serial: 1046
- DASY52 52.8.5(1059); SEMCAD X 14.6.8(7028)

MSL/Rear position - Middle offset 0/Area Scan (191x281x1): Interpolated grid:

$dx=1.000 \text{ mm}$, $dy=1.000 \text{ mm}$

Maximum value of SAR (interpolated) = 1.45 W/kg

MSL/Rear position - Middle offset 0/Zoom Scan (7x7x7)/Cube 0: Measurement

grid: $dx=5\text{mm}$, $dy=5\text{mm}$, $dz=5\text{mm}$

Reference Value = 23.108 V/m; Power Drift = -0.03 dB

Peak SAR (extrapolated) = 1.90 W/kg

SAR(1 g) = 0.768 W/kg; SAR(10 g) = 0.273 W/kg

Maximum value of SAR (measured) = 1.32 W/kg

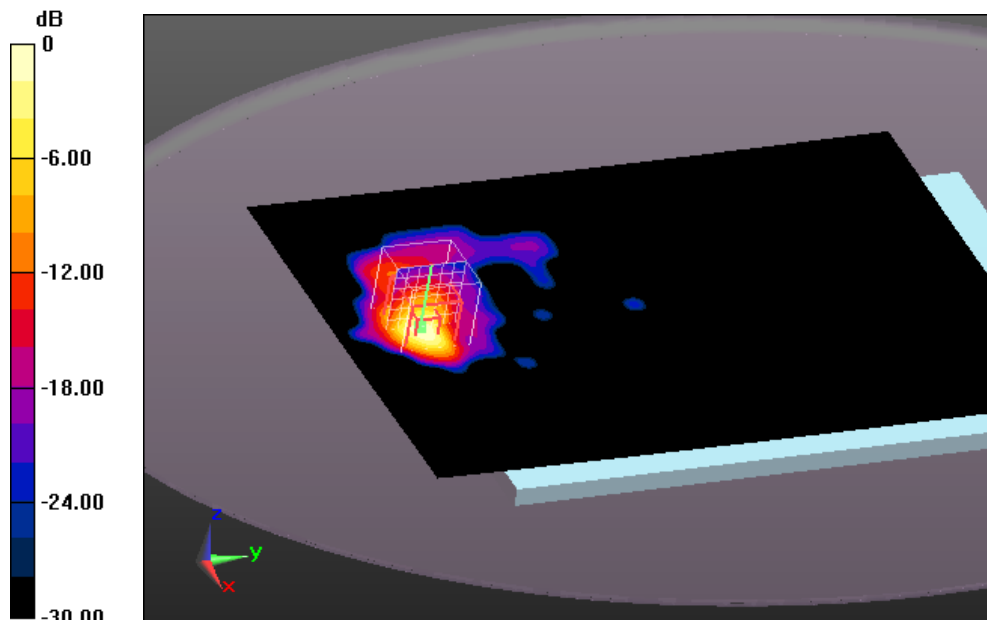

0 dB = 1.32 W/kg = 1.21 dBW/kg

Additional information:

position or distance of DUT to SAM: 0mm

ambient temperature: 21.5°C; liquid temperature: 20.9°C

Date/Time: 28.03.2013 08:02:20

OET65_EN62209-2-Body-LTE 7_power backoff

DUT: Sony; Type: SGP321; Serial: CB5A1NY07E

Communication System: LTE-FDD (SC-FDMA, 1 RB, 20 MHz, QPSK); Communication System Band: Band 7, E-UTRA/FDD (2500.0 - 2570.0 MHz); Frequency: 2560 MHz; Communication System PAR: 5.73 dB; PMF: 1.13894

Medium parameters used (interpolated): $f = 2560$ MHz; $\sigma = 2.162$ S/m; $\epsilon_r = 51.617$; $\rho = 1000$ kg/m³

Phantom section: Flat Section

Measurement Standard: DASYS

DASY5 Configuration:

- Probe: EX3DV4 - SN3566; ConvF(6.06, 6.06, 6.06); Calibrated: 23.08.2012;
- Modulation Compensation: PMR (X: a=4.39 dB, b=64.6 dB $\sqrt{\mu}$ V, c=18.5, d=5.7 dB / Y: a=4.72 dB, b=66.1 dB $\sqrt{\mu}$ V, c=19.4, d=5.7 dB / Z: a=4.77 dB, b=67.0 dB $\sqrt{\mu}$ V, c=20.2, d=5.7 dB); Calibrated: 23.08.2012
- Sensor-Surface: 2mm (Mechanical Surface Detection), z = 1.0, 31.0
- Electronics: DAE3 Sn477; Calibrated: 09.05.2012
- Phantom: ELI 4.0; Type: QDOVA001BA; Serial: 1046
- DASY52 52.8.5(1059); SEMCAD X 14.6.8(7028)

MSL/Rear position - High offset 99 QPSK/Area Scan (151x121x1): Interpolated

grid: dx=1.000 mm, dy=1.000 mm

Maximum value of SAR (interpolated) = 1.08 W/kg

MSL/Rear position - High offset 99 QPSK/Zoom Scan (7x7x7)/Cube 0:

Measurement grid: dx=5mm, dy=5mm, dz=5mm

Reference Value = 20.132 V/m; Power Drift = -0.02 dB

Peak SAR (extrapolated) = 1.57 W/kg

SAR(1 g) = 0.634 W/kg; SAR(10 g) = 0.225 W/kg

Maximum value of SAR (measured) = 1.09 W/kg

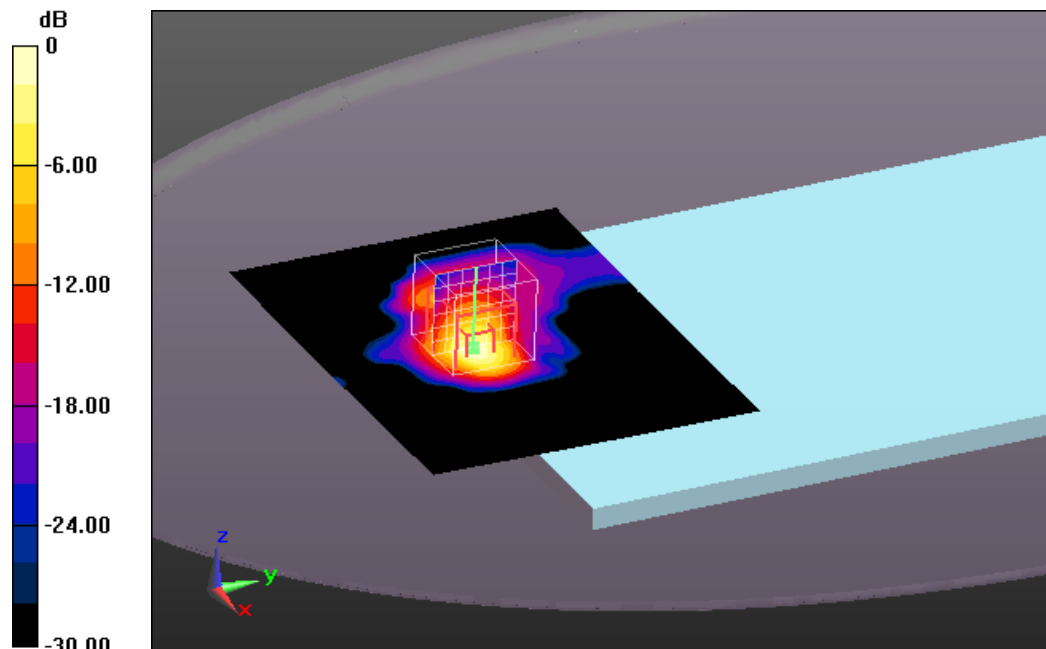

0 dB = 1.09 W/kg = 0.37 dBW/kg

Additional information:

position or distance of DUT to SAM: 0mm

ambient temperature: 21.5°C; liquid temperature: 20.9°C

Date/Time: 27.03.2013 15:17:40

OET65_EN62209-2-Body-LTE 7_power backoff

DUT: Sony; Type: SGP321; Serial: CB5A1NY07E

Communication System: LTE-FDD (SC-FDMA, 1 RB, 20 MHz, QPSK); Communication System Band: Band 7, E-UTRA/FDD (2500.0 - 2570.0 MHz); Frequency: 2535 MHz; Communication System PAR: 5.73 dB; PMF: 1.13894

Medium parameters used: $f = 2535$ MHz; $\sigma = 2.12$ S/m; $\epsilon_r = 51.7$; $\rho = 1000$ kg/m³

Phantom section: Flat Section

Measurement Standard: DASYS

DASY5 Configuration:

- Probe: EX3DV4 - SN3566; ConvF(6.06, 6.06, 6.06); Calibrated: 23.08.2012;
- Modulation Compensation: PMR (X: a=4.39 dB, b=64.6 dB/μV, c=18.5, d=5.7 dB / Y: a=4.72 dB, b=66.1 dB/μV, c=19.4, d=5.7 dB / Z: a=4.77 dB, b=67.0 dB/μV, c=20.2, d=5.7 dB); Calibrated: 23.08.2012
- Sensor-Surface: 2mm (Mechanical Surface Detection (Locations From Previous Scan Used)), Sensor-Surface: 2mm (Mechanical Surface Detection), z = 1.0, 31.0
- Electronics: DAE3 Sn477; Calibrated: 09.05.2012
- Phantom: ELI 4.0; Type: QDOVA001BA; Serial: 1046
- DASY52 52.8.5(1059); SEMCAD X 14.6.8(7028)

MSL/Right Side Position - Mid 0mm/Area Scan (101x211x1): Interpolated grid:

dx=1.000 mm, dy=1.000 mm

Maximum value of SAR (interpolated) = 1.03 W/kg

MSL/Right Side Position - Mid 0mm/Zoom Scan (7x7x7)/Cube 0: Measurement

grid: dx=5mm, dy=5mm, dz=5mm

Reference Value = 18.480 V/m; Power Drift = -0.01 dB

Peak SAR (extrapolated) = 1.25 W/kg

SAR(1 g) = 0.529 W/kg; SAR(10 g) = 0.183 W/kg

Maximum value of SAR (measured) = 0.923 W/kg

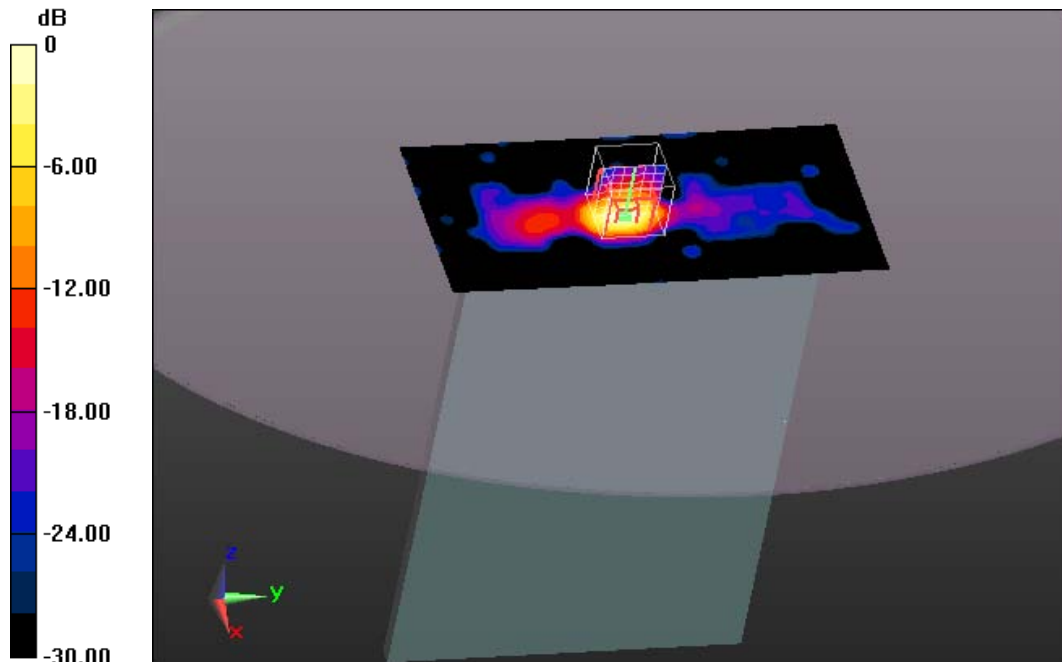

0 dB = 0.923 W/kg = -0.35 dBW/kg

Additional information:

position or distance of DUT to SAM: 0mm

ambient temperature: 21.5°C; liquid temperature: 20.9°C

Date/Time: 27.03.2013 17:21:52

OET65_EN62209-2-Body-LTE 7_power backoff

DUT: Sony; Type: SGP321; Serial: CB5A1NY07E

Communication System: LTE-FDD (SC-FDMA, 1 RB, 20 MHz, QPSK); Communication System Band: Band 7, E-UTRA/FDD (2500.0 - 2570.0 MHz); Frequency: 2535 MHz; Communication System PAR: 5.73 dB; PMF: 1.13894

Medium parameters used: $f = 2535$ MHz; $\sigma = 2.12$ S/m; $\epsilon_r = 51.7$; $\rho = 1000$ kg/m³

Phantom section: Flat Section

Measurement Standard: DASYS5

DASY5 Configuration:

- Probe: EX3DV4 - SN3566; ConvF(6.06, 6.06, 6.06); Calibrated: 23.08.2012;
- Modulation Compensation: PMR (X: a=4.39 dB, b=64.6 dB/μV, c=18.5, d=5.7 dB / Y: a=4.72 dB, b=66.1 dB/μV, c=19.4, d=5.7 dB / Z: a=4.77 dB, b=67.0 dB/μV, c=20.2, d=5.7 dB); Calibrated: 23.08.2012
- Sensor-Surface: 2mm (Mechanical Surface Detection (Locations From Previous Scan Used)), Sensor-Surface: 2mm (Mechanical Surface Detection), z = 1.0, 31.0
- Electronics: DAE3 Sn477; Calibrated: 09.05.2012
- Phantom: ELI 4.0; Type: QDOVA001BA; Serial: 1046
- DASY52 52.8.5(1059); SEMCAD X 14.6.8(7028)

MSL/Top Position - Middle/Area Scan (111x301x1): Interpolated grid: dx=1.000 mm, dy=1.000 mm

Maximum value of SAR (interpolated) = 0.00493 W/kg

MSL/Top Position - Middle/Zoom Scan (9x8x7)/Cube 0: Measurement grid: dx=5mm, dy=5mm, dz=5mm

Reference Value = 0.850 V/m; Power Drift = 0.145 dB

Peak SAR (extrapolated) = 0.00532 W/kg

SAR(1 g) = 8.01e-005 W/kg; SAR(10 g) = 1.07e-005 W/kg

Maximum value of SAR (measured) = 0.00550 W/kg

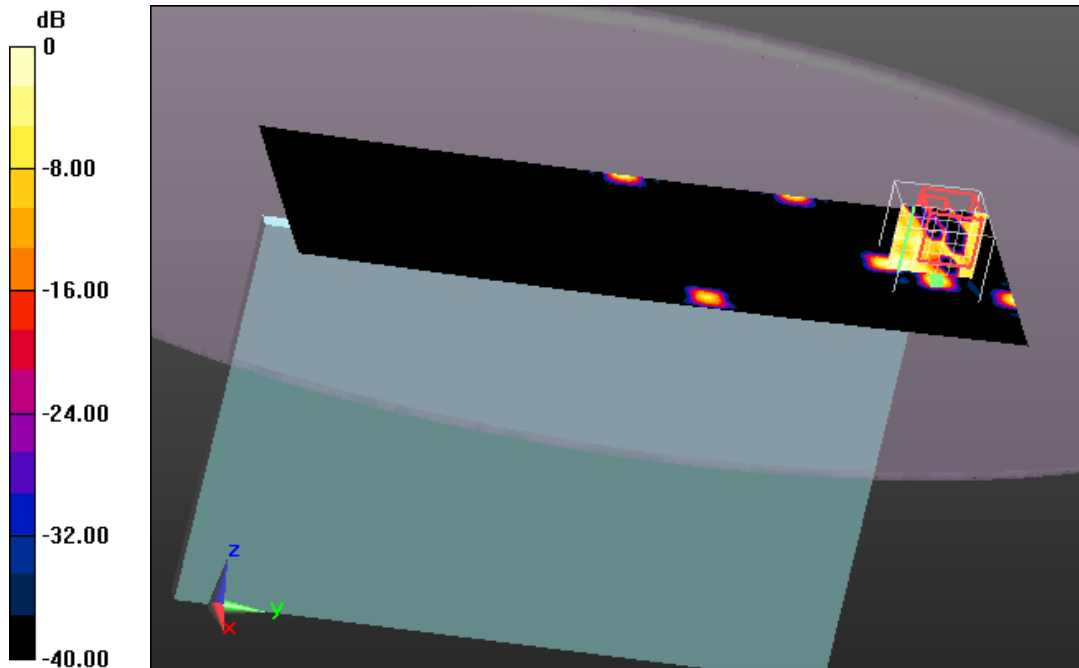

0 dB = 0.00550 W/kg = -22.60 dBW/kg

Additional information:

position or distance of DUT to SAM: 0mm

ambient temperature: 21.5°C; liquid temperature: 20.9°C

Date/Time: 28.03.2013 08:40:45

OET65_EN62209-2-Body-LTE 7_power backoff

DUT: Sony; Type: SGP321; Serial: CB5A1NY07E

Communication System: LTE-FDD (SC-FDMA, 1 RB, 20 MHz, QPSK); Communication System Band: Band 7, E-UTRA/FDD (2500.0 - 2570.0 MHz); Frequency: 2535 MHz; Communication System PAR: 5.73 dB; PMF: 1.13894

Medium parameters used: $f = 2535 \text{ MHz}$; $\sigma = 2.12 \text{ S/m}$; $\epsilon_r = 51.7$; $\rho = 1000 \text{ kg/m}^3$

Phantom section: Flat Section

Measurement Standard: DASYS5

DASY5 Configuration:

- Probe: EX3DV4 - SN3566; ConvF(6.06, 6.06, 6.06); Calibrated: 23.08.2012;
- Modulation Compensation: PMR (X: $a=4.39 \text{ dB}$, $b=64.6 \text{ dB}\sqrt{\mu\text{V}}$, $c=18.5$, $d=5.7 \text{ dB}$ / Y: $a=4.72 \text{ dB}$, $b=66.1 \text{ dB}\sqrt{\mu\text{V}}$, $c=19.4$, $d=5.7 \text{ dB}$ / Z: $a=4.77 \text{ dB}$, $b=67.0 \text{ dB}\sqrt{\mu\text{V}}$, $c=20.2$, $d=5.7 \text{ dB}$); Calibrated: 23.08.2012
- Sensor-Surface: 2mm (Mechanical Surface Detection (Locations From Previous Scan Used)), Sensor-Surface: 2mm (Mechanical Surface Detection), $z = 1.0, 31.0$
- Electronics: DAE3 Sn477; Calibrated: 09.05.2012
- Phantom: ELI 4.0; Type: QDOVA001BA; Serial: 1046
- DASY52 52.8.5(1059); SEMCAD X 14.6.8(7028)

MSL/Rear position - Middle offset 49/Area Scan (151x121x1): Interpolated grid:

$dx=1.000 \text{ mm}$, $dy=1.000 \text{ mm}$

Maximum value of SAR (interpolated) = 1.18 W/kg

MSL/Rear position - Middle offset 49/Zoom Scan (7x7x7)/Cube 0: Measurement

grid: $dx=5\text{mm}$, $dy=5\text{mm}$, $dz=5\text{mm}$

Reference Value = 21.403 V/m; Power Drift = 0.03 dB

Peak SAR (extrapolated) = 1.72 W/kg

SAR(1 g) = 0.702 W/kg; SAR(10 g) = 0.249 W/kg

Maximum value of SAR (measured) = 1.20 W/kg

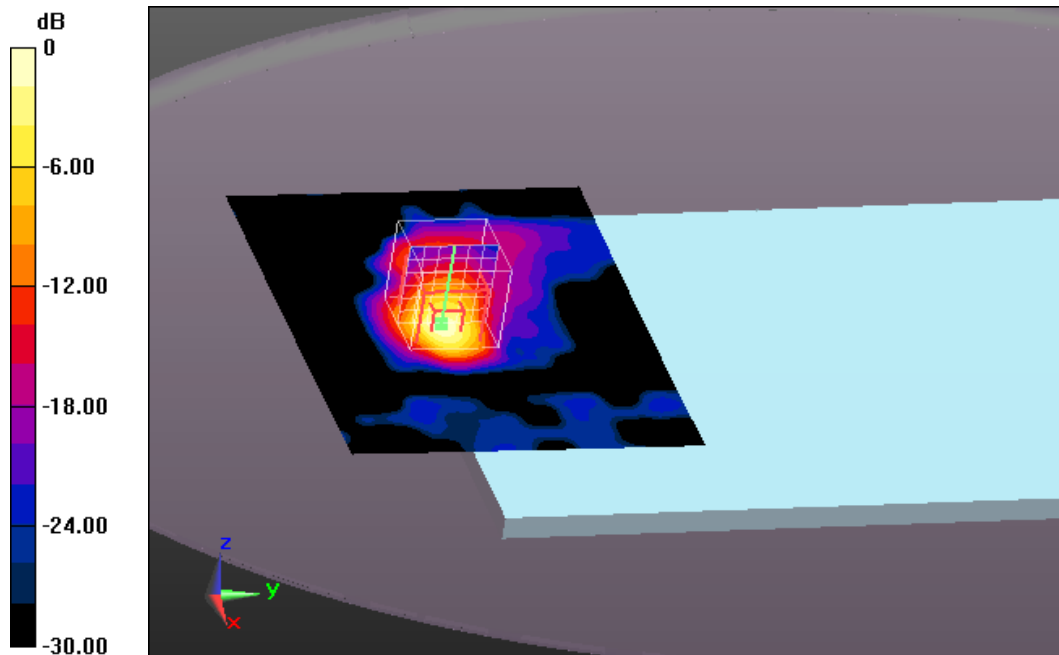

0 dB = 1.20 W/kg = 0.79 dBW/kg

Additional information:

position or distance of DUT to SAM: 0mm

ambient temperature: 21.5°C; liquid temperature: 20.9°C

Date/Time: 28.03.2013 09:01:27

OET65_EN62209-2-Body-LTE 7_power backoff

DUT: Sony; Type: SGP321; Serial: CB5A1NY07E

Communication System: LTE-FDD (SC-FDMA, 1 RB, 20 MHz, QPSK); Communication System Band: Band 7, E-UTRA/FDD (2500.0 - 2570.0 MHz); Frequency: 2535 MHz; Communication System PAR: 5.73 dB; PMF: 1.13894

Medium parameters used: $f = 2535$ MHz; $\sigma = 2.12$ S/m; $\epsilon_r = 51.7$; $\rho = 1000$ kg/m³

Phantom section: Flat Section

Measurement Standard: DASY5

DASY5 Configuration:

- Probe: EX3DV4 - SN3566; ConvF(6.06, 6.06, 6.06); Calibrated: 23.08.2012;
- Modulation Compensation: PMR (X: a=4.39 dB, b=64.6 dB $\sqrt{\mu}$ V, c=18.5, d=5.7 dB / Y: a=4.72 dB, b=66.1 dB $\sqrt{\mu}$ V, c=19.4, d=5.7 dB / Z: a=4.77 dB, b=67.0 dB $\sqrt{\mu}$ V, c=20.2, d=5.7 dB); Calibrated: 23.08.2012
- Sensor-Surface: 2mm (Mechanical Surface Detection (Locations From Previous Scan Used)), Sensor-Surface: 2mm (Mechanical Surface Detection), z = 1.0, 31.0
- Electronics: DAE3 Sn477; Calibrated: 09.05.2012
- Phantom: ELI 4.0; Type: QDOVA001BA; Serial: 1046
- DASY52 52.8.5(1059); SEMCAD X 14.6.8(7028)

MSL/Rear position - Middle offset 99/Area Scan (151x121x1): Interpolated grid:

dx=1.000 mm, dy=1.000 mm

Maximum value of SAR (interpolated) = 0.604 W/kg

MSL/Rear position - Middle offset 99/Zoom Scan (7x7x7)/Cube 0: Measurement

grid: dx=5mm, dy=5mm, dz=5mm

Reference Value = 15.515 V/m; Power Drift = 0.07 dB

Peak SAR (extrapolated) = 0.910 W/kg

SAR(1 g) = 0.364 W/kg; SAR(10 g) = 0.128 W/kg

Maximum value of SAR (measured) = 0.615 W/kg

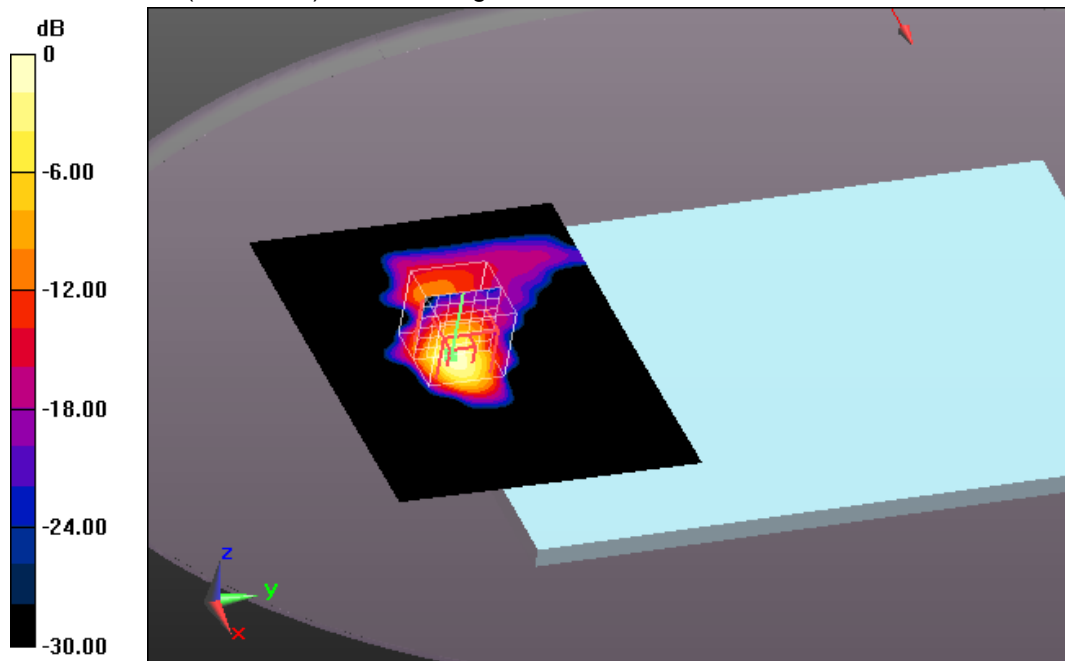

0 dB = 0.615 W/kg = -2.11 dBW/kg

Additional information:

position or distance of DUT to SAM: 0mm

ambient temperature: 21.5°C; liquid temperature: 20.9°C

Date/Time: 27.03.2013 21:09:08

OET65_EN62209-2-Body-LTE 7_power backoff

DUT: Sony; Type: SGP321; Serial: CB5A1NY07E

Communication System: LTE-FDD (SC-FDMA, 50% RB, 20 MHz, QPSK); Communication System Band: Band 7, E-UTRA/FDD (2500.0 - 2570.0 MHz); Frequency: 2535 MHz; Communication System PAR: 5.84 dB; PMF: 1.03753

Medium parameters used: $f = 2535$ MHz; $\sigma = 2.12$ S/m; $\epsilon_r = 51.7$; $\rho = 1000$ kg/m³

Phantom section: Flat Section

Measurement Standard: DASYS

DASY5 Configuration:

- Probe: EX3DV4 - SN3566; ConvF(6.06, 6.06, 6.06); Calibrated: 23.08.2012;
- Modulation Compensation: PMR (X: a=6.35 dB, b=66.5 dB/μV, c=19.1, d=5.8 dB / Y: a=6.25 dB, b=66.2 dB/μV, c=19.1, d=5.8 dB / Z: a=6.30 dB, b=66.8 dB/μV, c=19.6, d=5.8 dB); Calibrated: 23.08.2012
- Sensor-Surface: 2mm (Mechanical Surface Detection (Locations From Previous Scan Used)), Sensor-Surface: 2mm (Mechanical Surface Detection), z = 1.0, 31.0
- Electronics: DAE3 Sn477; Calibrated: 09.05.2012
- Phantom: ELI 4.0; Type: QDOVA001BA; Serial: 1046
- DASY52 52.8.5(1059); SEMCAD X 14.6.8(7028)

MSL/Rear position - Low 50% offset 50 QPSK/Area Scan (191x281x1):

Interpolated grid: dx=1.000 mm, dy=1.000 mm

Maximum value of SAR (interpolated) = 1.24 W/kg

MSL/Rear position - Low 50% offset 50 QPSK/Zoom Scan (7x7x7)/Cube 0:

Measurement grid: dx=5mm, dy=5mm, dz=5mm

Reference Value = 21.725 V/m; Power Drift = -0.03 dB

Peak SAR (extrapolated) = 1.64 W/kg

SAR(1 g) = 0.666 W/kg; SAR(10 g) = 0.238 W/kg

Maximum value of SAR (measured) = 1.14 W/kg

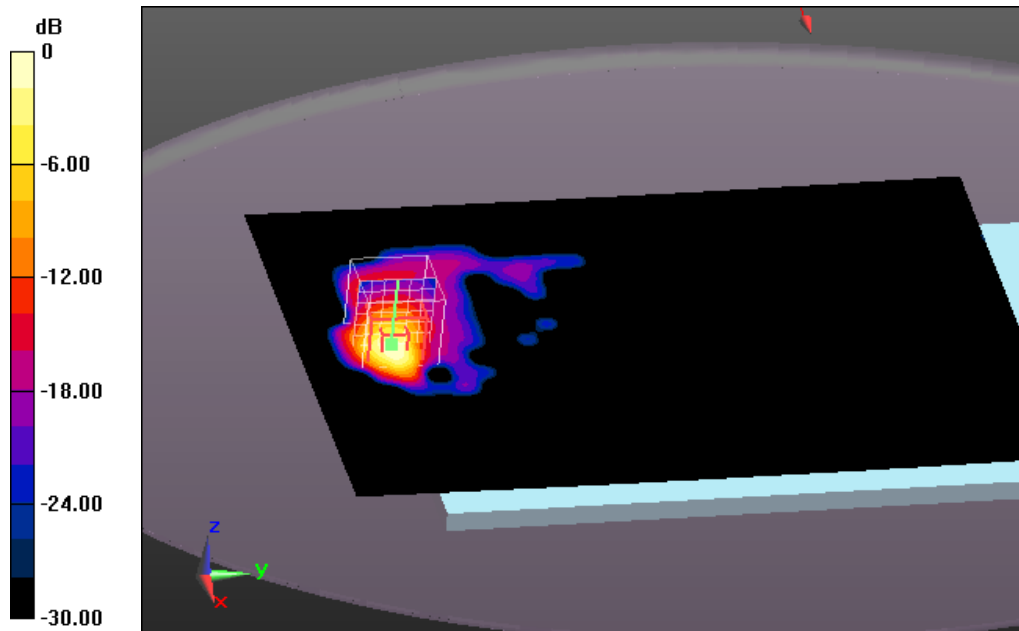

0 dB = 1.14 W/kg = 0.57 dBW/kg

Additional information:

position or distance of DUT to SAM: 0mm

ambient temperature: 21.5°C; liquid temperature: 20.9°C

Date/Time: 27.03.2013 19:59:05

OET65_EN62209-2-Body-LTE 7_power backoff

DUT: Sony; Type: SGP321; Serial: CB5A1NY07E

Communication System: LTE-FDD (SC-FDMA, 50% RB, 20 MHz, QPSK); Communication System Band: Band 7, E-UTRA/FDD (2500.0 - 2570.0 MHz); Frequency: 2535 MHz; Communication System PAR: 5.84 dB; PMF: 1.03753

Medium parameters used: $f = 2535$ MHz; $\sigma = 2.12$ S/m; $\epsilon_r = 51.7$; $\rho = 1000$ kg/m³

Phantom section: Flat Section

Measurement Standard: DASYS5

DASY5 Configuration:

- Probe: EX3DV4 - SN3566; ConvF(6.06, 6.06, 6.06); Calibrated: 23.08.2012;
- Modulation Compensation: PMR (X: a=6.35 dB, b=66.5 dB $\sqrt{\mu}$ V, c=19.1, d=5.8 dB / Y: a=6.25 dB, b=66.2 dB $\sqrt{\mu}$ V, c=19.1, d=5.8 dB / Z: a=6.30 dB, b=66.8 dB $\sqrt{\mu}$ V, c=19.6, d=5.8 dB); Calibrated: 23.08.2012
- Sensor-Surface: 2mm (Mechanical Surface Detection (Locations From Previous Scan Used)), Sensor-Surface: 2mm (Mechanical Surface Detection), z = 1.0, 31.0
- Electronics: DAE3 Sn477; Calibrated: 09.05.2012
- Phantom: ELI 4.0; Type: QDOVA001BA; Serial: 1046
- DASY52 52.8.5(1059); SEMCAD X 14.6.8(7028)

MSL/Rear position - Middle 50%/Area Scan (191x281x1): Interpolated grid: dx=1.000 mm, dy=1.000 mm

Maximum value of SAR (interpolated) = 1.32 W/kg

MSL/Rear position - Middle 50%/Zoom Scan (7x7x7)/Cube 0: Measurement grid:

dx=5mm, dy=5mm, dz=5mm

Reference Value = 22.122 V/m; Power Drift = -0.01 dB

Peak SAR (extrapolated) = 1.74 W/kg

SAR(1 g) = 0.702 W/kg; SAR(10 g) = 0.249 W/kg

Maximum value of SAR (measured) = 1.21 W/kg

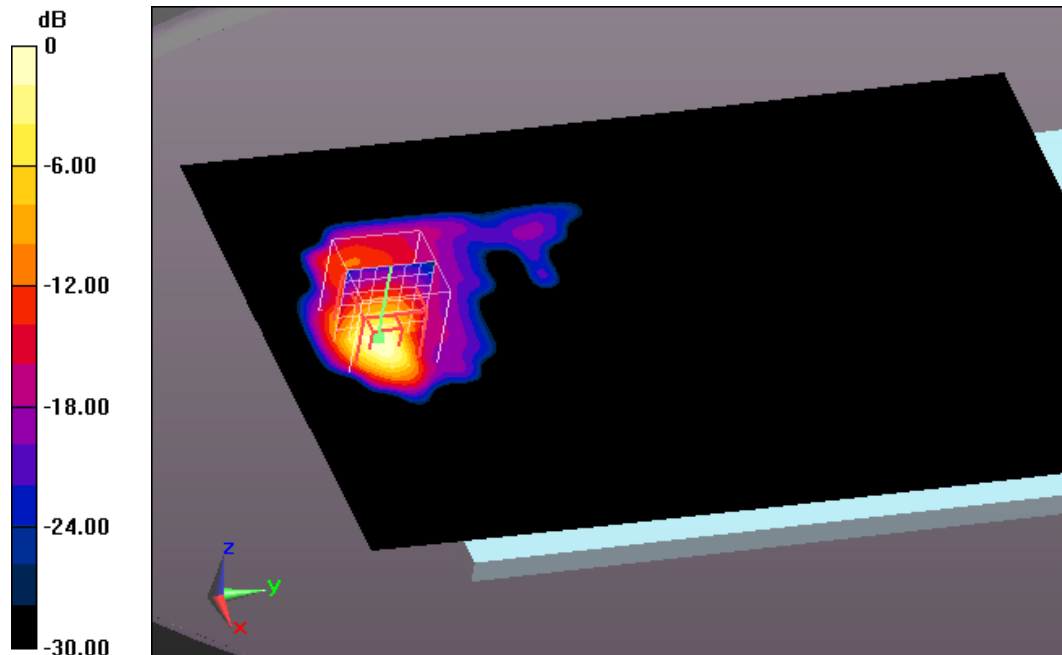

0 dB = 1.21 W/kg = 0.83 dBW/kg

Additional information:

position or distance of DUT to SAM: 0mm

ambient temperature: 21.5°C; liquid temperature: 20.9°C

Date/Time: 27.03.2013 21:50:21

OET65_EN62209-2-Body-LTE 7_power backoff

DUT: Sony; Type: SGP321; Serial: CB5A1NY07E

Communication System: LTE-FDD (SC-FDMA, 50% RB, 20 MHz, QPSK); Communication System Band: Band 7, E-UTRA/FDD (2500.0 - 2570.0 MHz); Frequency: 2560 MHz; Communication System PAR: 5.84 dB; PMF: 1.03753

Medium parameters used (interpolated): $f = 2560$ MHz; $\sigma = 2.162$ S/m; $\epsilon_r = 51.617$; $\rho = 1000$ kg/m³

Phantom section: Flat Section

Measurement Standard: DASY5

DASY5 Configuration:

- Probe: EX3DV4 - SN3566; ConvF(6.06, 6.06, 6.06); Calibrated: 23.08.2012;
- Modulation Compensation: PMR (X: a=6.35 dB, b=66.5 dB $\sqrt{\mu}$ V, c=19.1, d=5.8 dB / Y: a=6.25 dB, b=66.2 dB $\sqrt{\mu}$ V, c=19.1, d=5.8 dB / Z: a=6.30 dB, b=66.8 dB $\sqrt{\mu}$ V, c=19.6, d=5.8 dB); Calibrated: 23.08.2012
- Sensor-Surface: 2mm (Mechanical Surface Detection (Locations From Previous Scan Used)), Sensor-Surface: 2mm (Mechanical Surface Detection), z = 1.0, 31.0
- Electronics: DAE3 Sn477; Calibrated: 09.05.2012
- Phantom: ELI 4.0; Type: QDOVA001BA; Serial: 1046
- DASY52 52.8.5(1059); SEMCAD X 14.6.8(7028)

MSL/Rear position - High 50% offset 50 QPSK/Area Scan (191x281x1):

Interpolated grid: dx=1.000 mm, dy=1.000 mm

Maximum value of SAR (interpolated) = 0.926 W/kg

MSL/Rear position - High 50% offset 50 QPSK/Zoom Scan (7x7x7)/Cube 0:

Measurement grid: dx=5mm, dy=5mm, dz=5mm

Reference Value = 18.901 V/m; Power Drift = -0.04 dB

Peak SAR (extrapolated) = 1.24 W/kg

SAR(1 g) = 0.495 W/kg; SAR(10 g) = 0.173 W/kg

Maximum value of SAR (measured) = 0.853 W/kg

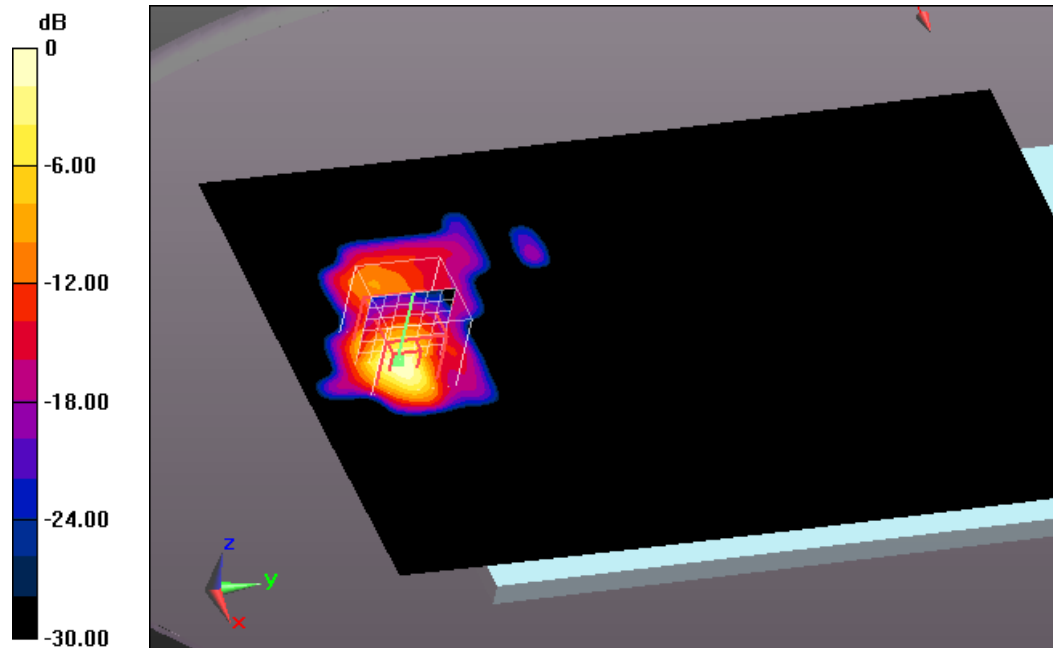

0 dB = 0.853 W/kg = -0.69 dBW/kg

Additional information:

position or distance of DUT to SAM: 0mm

ambient temperature: 21.5°C; liquid temperature: 20.9°C

Date/Time: 27.03.2013 15:40:31

OET65_EN62209-2-Body-LTE 7_power backoff

DUT: Sony; Type: SGP321; Serial: CB5A1NY07E

Communication System: LTE-FDD (SC-FDMA, 50% RB, 20 MHz, QPSK); Communication System Band: Band 7, E-UTRA/FDD (2500.0 - 2570.0 MHz); Frequency: 2535 MHz; Communication System PAR: 5.84 dB; PMF: 1.03753

Medium parameters used: $f = 2535$ MHz; $\sigma = 2.12$ S/m; $\epsilon_r = 51.7$; $\rho = 1000$ kg/m³

Phantom section: Flat Section

Measurement Standard: DASYS

DASY5 Configuration:

- Probe: EX3DV4 - SN3566; ConvF(6.06, 6.06, 6.06); Calibrated: 23.08.2012;
- Modulation Compensation: PMR (X: a=6.35 dB, b=66.5 dB $\sqrt{\mu}$ V, c=19.1, d=5.8 dB / Y: a=6.25 dB, b=66.2 dB $\sqrt{\mu}$ V, c=19.1, d=5.8 dB / Z: a=6.30 dB, b=66.8 dB $\sqrt{\mu}$ V, c=19.6, d=5.8 dB); Calibrated: 23.08.2012
- Sensor-Surface: 2mm (Mechanical Surface Detection (Locations From Previous Scan Used)), Sensor-Surface: 2mm (Mechanical Surface Detection), z = 1.0, 31.0
- Electronics: DAE3 Sn477; Calibrated: 09.05.2012
- Phantom: ELI 4.0; Type: QDOVA001BA; Serial: 1046
- DASY52 52.8.5(1059); SEMCAD X 14.6.8(7028)

MSL/Right Side Position - Mid 50%/Area Scan (101x211x1): Interpolated grid:

dx=1.000 mm, dy=1.000 mm

Maximum value of SAR (interpolated) = 1.27 W/kg

MSL/Right Side Position - Mid 50%/Zoom Scan (7x7x7)/Cube 0: Measurement

grid: dx=5mm, dy=5mm, dz=5mm

Reference Value = 16.537 V/m; Power Drift = -0.10 dB

Peak SAR (extrapolated) = 1.30 W/kg

SAR(1 g) = 0.470 W/kg; SAR(10 g) = 0.159 W/kg

Maximum value of SAR (measured) = 0.882 W/kg

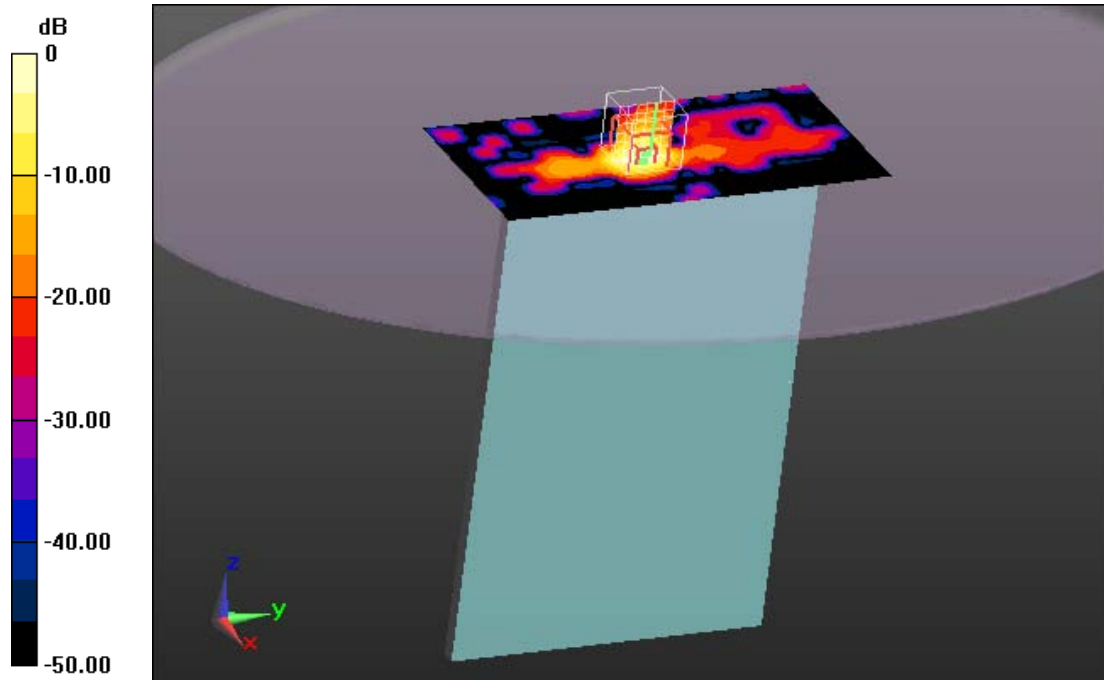

0 dB = 0.882 W/kg = -0.55 dBW/kg

Additional information:

position or distance of DUT to SAM: 0mm

ambient temperature: 21.5°C; liquid temperature: 20.9°C

Date/Time: 27.03.2013 17:52:45

OET65_EN62209-2-Body-LTE 7_power backoff

DUT: Sony; Type: SGP321; Serial: CB5A1NY07E

Communication System: LTE-FDD (SC-FDMA, 50% RB, 20 MHz, QPSK); Communication System Band: Band 7, E-UTRA/FDD (2500.0 - 2570.0 MHz); Frequency: 2535 MHz; Communication System PAR: 5.84 dB; PMF: 1.03753

Medium parameters used: $f = 2535$ MHz; $\sigma = 2.12$ S/m; $\epsilon_r = 51.7$; $\rho = 1000$ kg/m³

Phantom section: Flat Section

Measurement Standard: DASYS

DASY5 Configuration:

- Probe: EX3DV4 - SN3566; ConvF(6.06, 6.06, 6.06); Calibrated: 23.08.2012;
- Modulation Compensation: PMR (X: a=6.35 dB, b=66.5 dB $\sqrt{\mu}$ V, c=19.1, d=5.8 dB / Y: a=6.25 dB, b=66.2 dB $\sqrt{\mu}$ V, c=19.1, d=5.8 dB / Z: a=6.30 dB, b=66.8 dB $\sqrt{\mu}$ V, c=19.6, d=5.8 dB); Calibrated: 23.08.2012
- Sensor-Surface: 2mm (Mechanical Surface Detection (Locations From Previous Scan Used)), Sensor-Surface: 2mm (Mechanical Surface Detection), z = 1.0, 31.0
- Electronics: DAE3 Sn477; Calibrated: 09.05.2012
- Phantom: ELI 4.0; Type: QDOVA001BA; Serial: 1046
- DASY52 52.8.5(1059); SEMCAD X 14.6.8(7028)

MSL/Top Position - Middle 50% 0mm/Area Scan (111x301x1): Interpolated grid:

dx=1.000 mm, dy=1.000 mm

Maximum value of SAR (interpolated) = 0.00696 W/kg

MSL/Top Position - Middle 50% 0mm/Zoom Scan (8x8x7)/Cube 0: Measurement

grid: dx=5mm, dy=5mm, dz=5mm

Reference Value = 0 V/m; Power Drift = 0.173 dB

Peak SAR (extrapolated) = 0.000923 W/kg

SAR(1 g) = 1.34e-005 W/kg; SAR(10 g) = 1.89e-006 W/kg

Maximum value of SAR (measured) = 0.00379 W/kg

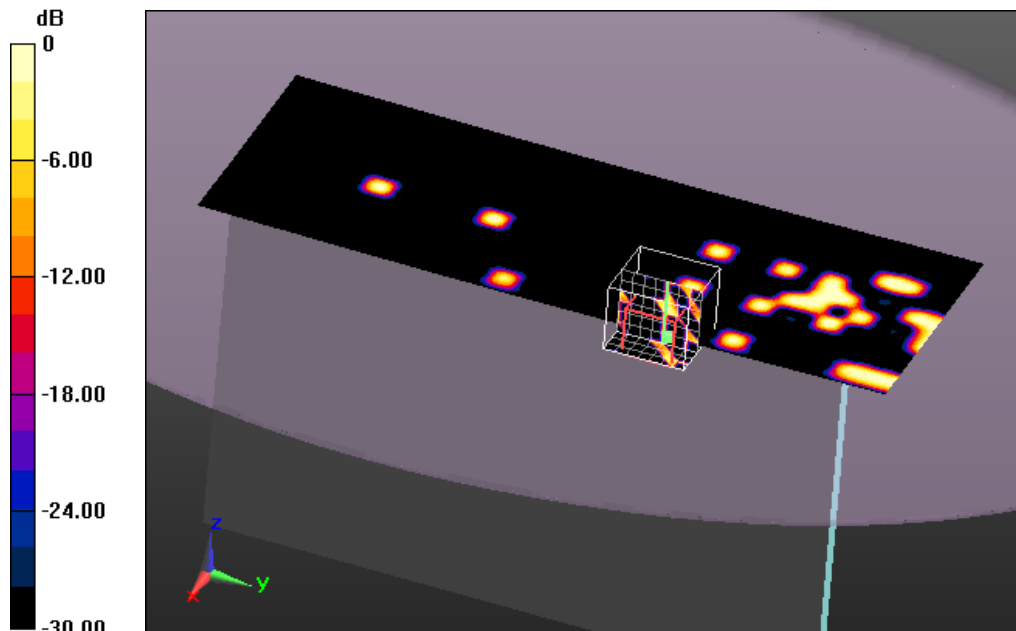

0 dB = 0.00379 W/kg = -24.21 dBW/kg

Additional information:

position or distance of DUT to SAM: 0mm

ambient temperature: 21.5°C; liquid temperature: 20.9°C

Date/Time: 03.05.2013 11:44:11

OET65_EN62209-2-Body-LTE 7_power backoff

DUT: Sony; Type: SGP321; Serial: CB5A1NY07E

Communication System: LTE-FDD (SC-FDMA, 1 RB, 20 MHz, QPSK); Communication System Band: Band 7, E-UTRA/FDD (2500.0 - 2570.0 MHz); Frequency: 2510 MHz; Communication System PAR: 5.73 dB; PMF: 1.13894

Medium parameters used: $f = 2510$ MHz; $\sigma = 2.09$ S/m; $\epsilon_r = 50.5$; $\rho = 1000$ kg/m³

Phantom section: Flat Section

Measurement Standard: DASYS5

DASY5 Configuration:

- Probe: EX3DV4 - SN3566; ConvF(6.06, 6.06, 6.06); Calibrated: 23.08.2012;
- Modulation Compensation: PMR (X: a=4.39 dB, b=64.6 dB $\sqrt{\mu}$ V, c=18.5, d=5.7 dB / Y: a=4.72 dB, b=66.1 dB $\sqrt{\mu}$ V, c=19.4, d=5.7 dB / Z: a=4.77 dB, b=67.0 dB $\sqrt{\mu}$ V, c=20.2, d=5.7 dB); Calibrated: 23.08.2012
- Sensor-Surface: 2mm (Mechanical Surface Detection), z = 1.0, 31.0
- Electronics: DAE3 Sn477; Calibrated: 09.05.2012
- Phantom: ELI 4.0; Type: QDOVA001BA; Serial: 1046
- DASYS52 52.8.5(1059); SEMCAD X 14.6.8(7028)

MSL/Rear position - Low 0 Offset/Area Scan (181x181x1): Interpolated grid:

dx=1.000 mm, dy=1.000 mm

Maximum value of SAR (interpolated) = 1.17 W/kg

MSL/Rear position - Low 0 Offset/Zoom Scan (7x7x7)/Cube 0: Measurement grid:

dx=5mm, dy=5mm, dz=5mm

Reference Value = 17.848 V/m; Power Drift = 0.00 dB

Peak SAR (extrapolated) = 1.50 W/kg

SAR(1 g) = 0.625 W/kg; SAR(10 g) = 0.229 W/kg

Maximum value of SAR (measured) = 1.06 W/kg

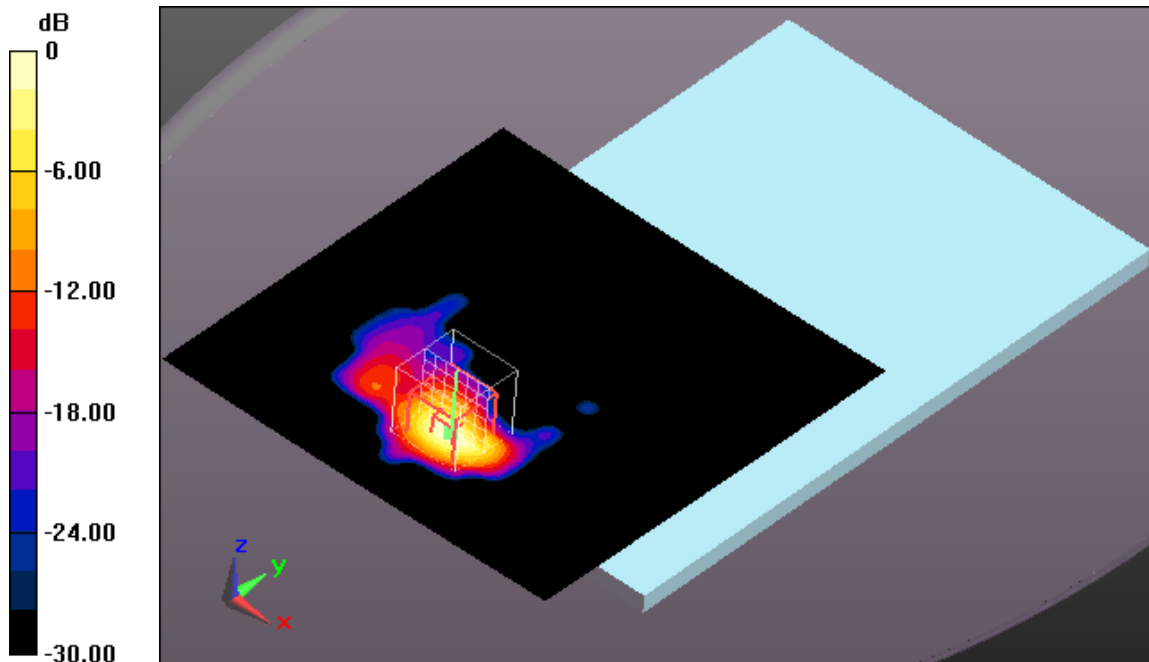

0 dB = 1.06 W/kg = 0.25 dBW/kg

Additional information:

position or distance of DUT to SAM: 0 mm

ambient temperature: 23.3°C; liquid temperature: 22.1°C

Annex B.6: WLAN 2450MHz

Date/Time: 22.03.2013 16:28:39

OET65-WLAN2450-body

DUT: Sony; Type: SGP321; Serial: CB5A1NY05H

Communication System: IEEE 802.11b WiFi 2.4 GHz (DSSS, 1 Mbps); Communication System Band: ISM 2.4 GHz Band (2400.0 - 2483.5 MHz); Frequency: 2412 MHz; Communication System PAR: 1.87 dB; PMF: 1.04833

Medium parameters used: $f = 2412$ MHz; $\sigma = 1.96$ S/m; $\epsilon_r = 52.2$; $\rho = 1000$ kg/m³

Phantom section: Flat Section

Measurement Standard: DASYS5

DASY5 Configuration:

- Probe: ET3DV6 - SN1558; ConvF(4.06, 4.06, 4.06); Calibrated: 24.08.2012;
- Modulation Compensation: PMR (X: a=2.76 dB, b=67.0 dB√μV, c=18.1, d=1.9 dB / Y: a=2.60 dB, b=66.5 dB√μV, c=17.9, d=1.9 dB / Z: a=2.38 dB, b=64.1 dB√μV, c=16.5, d=1.9 dB); Calibrated: 24.08.2012
- Sensor-Surface: 4mm (Mechanical Surface Detection (Locations From Previous Scan Used)), Sensor-Surface: 4mm (Mechanical Surface Detection), z = 2.7, 32.7
- Electronics: DAE3 Sn477; Calibrated: 09.05.2012
- Phantom: ELI 4.0; Type: QDOVA001BA; Serial: 1046
- DASY52 52.8.5(1059); SEMCAD X 14.6.8(7028)

Body MSL/Rear Position - Low/Area Scan (201x301x1): Interpolated grid: dx=1.000 mm, dy=1.000 mm

Maximum value of SAR (interpolated) = 1.21 W/kg

Body MSL/Rear Position - Low/Zoom Scan (7x7x7)/Cube 0: Measurement grid:

dx=5mm, dy=5mm, dz=5mm

Reference Value = 22.220 V/m; Power Drift = -0.09 dB

Peak SAR (extrapolated) = 2.91 W/kg

SAR(1 g) = 0.971 W/kg; SAR(10 g) = 0.370 W/kg

Maximum value of SAR (measured) = 1.04 W/kg

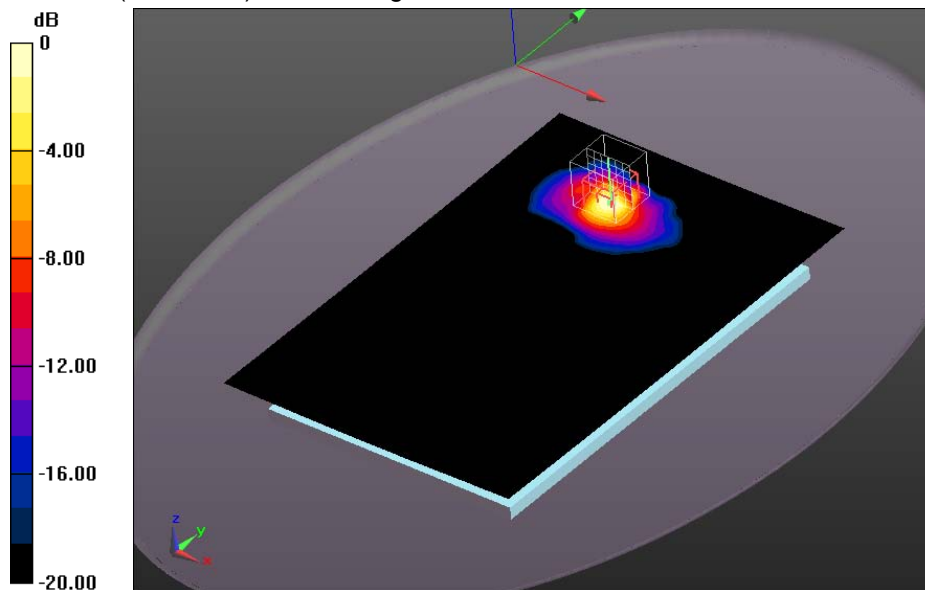

0 dB = 1.04 W/kg = 0.17 dBW/kg

Additional information:

position or distance of DUT to SAM: 0 mm

ambient temperature: 22.2°C; liquid temperature: 21.4°C

Date/Time: 22.03.2013 15:50:08

OET65-WLAN2450-body

DUT: Sony; Type: SGP321; Serial: CB5A1NY05H

Communication System: IEEE 802.11b WiFi 2.4 GHz (DSSS, 1 Mbps); Communication System Band: ISM 2.4 GHz Band, World but Japan (2401.5 - 2482.5 MHz); Frequency: 2437 MHz; Communication System PAR: 1.87 dB; PMF: 1.04833

Medium parameters used: $f = 2437$ MHz; $\sigma = 1.98$ S/m; $\epsilon_r = 52.1$; $\rho = 1000$ kg/m³

Phantom section: Flat Section

Measurement Standard: DASYS

DASY5 Configuration:

- Probe: ET3DV6 - SN1558; ConvF(4.06, 4.06, 4.06); Calibrated: 24.08.2012;
- Modulation Compensation: PMR (X: $a=2.76$ dB, $b=67.0$ dB $\sqrt{\mu}$ V, $c=18.1$, $d=1.9$ dB / Y: $a=2.60$ dB, $b=66.5$ dB $\sqrt{\mu}$ V, $c=17.9$, $d=1.9$ dB / Z: $a=2.38$ dB, $b=64.1$ dB $\sqrt{\mu}$ V, $c=16.5$, $d=1.9$ dB); Calibrated: 24.08.2012
- Sensor-Surface: 4mm (Mechanical Surface Detection (Locations From Previous Scan Used)), Sensor-Surface: 4mm (Mechanical Surface Detection), $z = 2.7, 32.7$
- Electronics: DAE3 Sn477; Calibrated: 09.05.2012
- Phantom: ELI 4.0; Type: QDOVA001BA; Serial: 1046
- DASY52 52.8.5(1059); SEMCAD X 14.6.8(7028)

Body MSL/Rear Position - Middle/Area Scan (201x301x1): Interpolated grid:

$dx=1.000$ mm, $dy=1.000$ mm

Maximum value of SAR (interpolated) = 1.26 W/kg

Body MSL/Rear Position - Middle/Zoom Scan (7x7x7)/Cube 0: Measurement grid:

$dx=5$ mm, $dy=5$ mm, $dz=5$ mm

Reference Value = 22.630 V/m; Power Drift = -0.07 dB

Peak SAR (extrapolated) = 2.99 W/kg

SAR(1 g) = 1.01 W/kg; SAR(10 g) = 0.383 W/kg

Maximum value of SAR (measured) = 1.08 W/kg

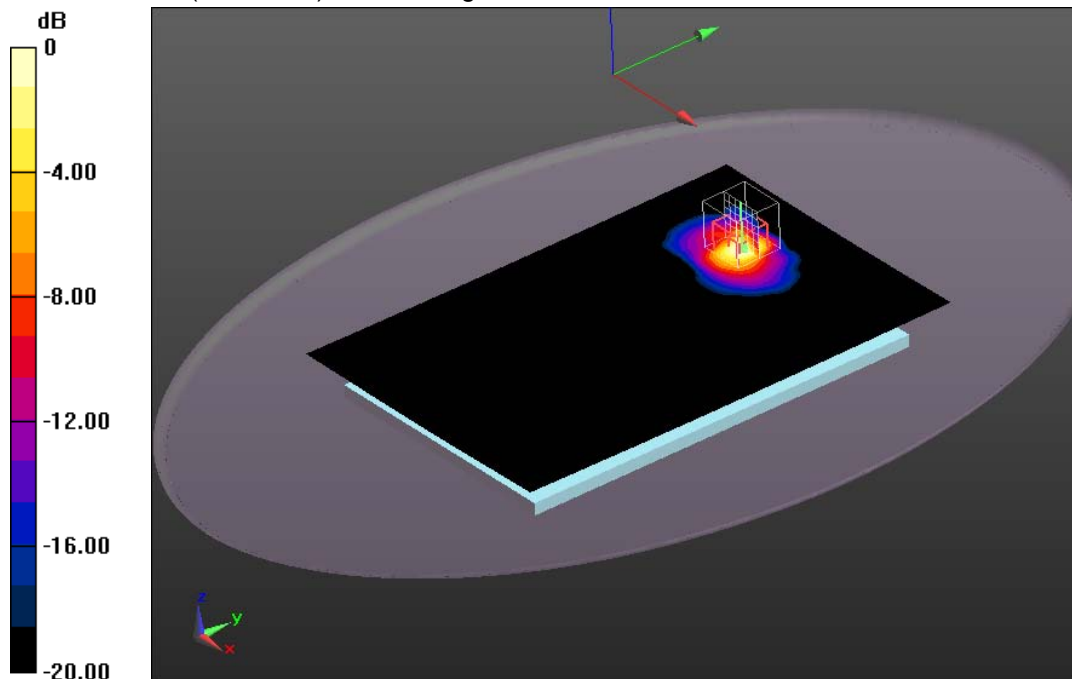

0 dB = 1.08 W/kg = 0.33 dBW/kg

Additional information:

position or distance of DUT to SAM: 0 mm

ambient temperature: 22.2°C; liquid temperature: 21.4°C

Date/Time: 22.03.2013 14:19:26

OET65-WLAN2450-body

DUT: Sony; Type: SGP321; Serial: CB5A1NY05H

Communication System: IEEE 802.11b WiFi 2.4 GHz (DSSS, 1 Mbps); Communication System Band: ISM 2.4 GHz Band, World but Japan (2401.5 - 2482.5 MHz); Frequency: 2462 MHz; Communication System PAR: 1.87 dB; PMF: 1.04833

Medium parameters used: $f = 2462$ MHz; $\sigma = 2.02$ S/m; $\epsilon_r = 52$; $\rho = 1000$ kg/m³

Phantom section: Flat Section

Measurement Standard: DASYS

DASY5 Configuration:

- Probe: ET3DV6 - SN1558; ConvF(4.06, 4.06, 4.06); Calibrated: 24.08.2012;
- Modulation Compensation: PMR (X: $a=2.76$ dB, $b=67.0$ dB $\sqrt{\mu}$ V, $c=18.1$, $d=1.9$ dB / Y: $a=2.60$ dB, $b=66.5$ dB $\sqrt{\mu}$ V, $c=17.9$, $d=1.9$ dB / Z: $a=2.38$ dB, $b=64.1$ dB $\sqrt{\mu}$ V, $c=16.5$, $d=1.9$ dB); Calibrated: 24.08.2012
- Sensor-Surface: 4mm (Mechanical Surface Detection), $z = 2.7, 32.7$
- Electronics: DAE3 Sn477; Calibrated: 09.05.2012
- Phantom: ELI 4.0; Type: QDOVA001BA; Serial: 1046
- DASYS52 52.8.5(1059); SEMCAD X 14.6.8(7028)

Body MSL/Rear Position - Hi/Area Scan (201x301x1): Interpolated grid: $dx=1.000$ mm, $dy=1.000$ mm

Maximum value of SAR (interpolated) = 1.42 W/kg

Body MSL/Rear Position - Hi/Zoom Scan (7x7x7)/Cube 0: Measurement grid:

$dx=5$ mm, $dy=5$ mm, $dz=5$ mm

Reference Value = 23.844 V/m; Power Drift = -0.09 dB

Peak SAR (extrapolated) = 3.47 W/kg

SAR(1 g) = 1.14 W/kg; SAR(10 g) = 0.430 W/kg

Maximum value of SAR (measured) = 1.22 W/kg

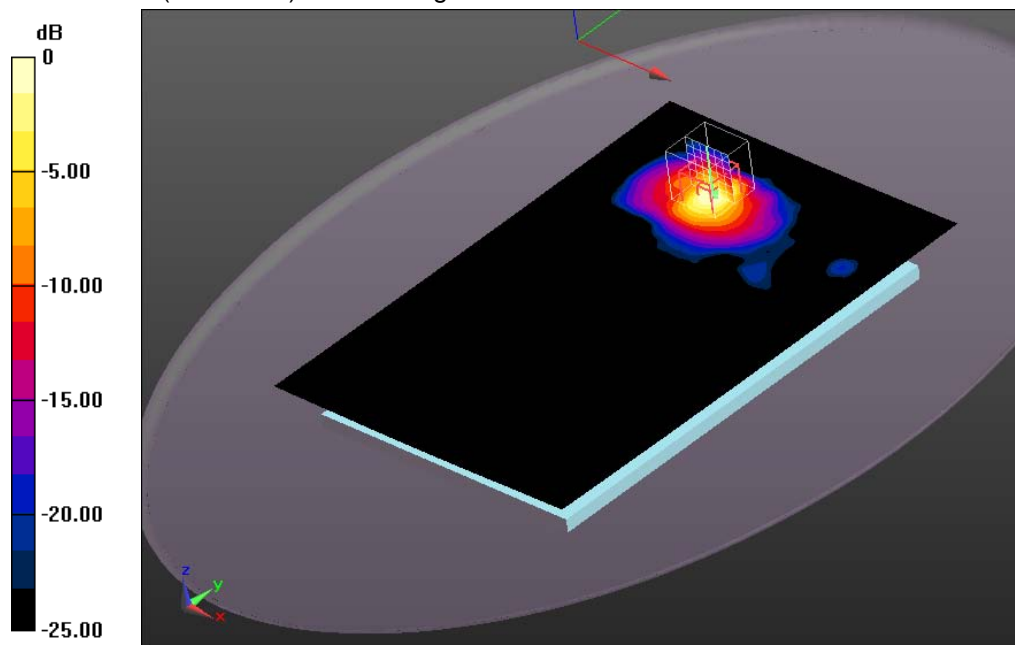

0 dB = 1.22 W/kg = 0.86 dBW/kg

Additional information:

position or distance of DUT to SAM: 0 mm

ambient temperature: 22.2°C; liquid temperature: 21.4°C

Date/Time: 22.03.2013 13:21:34

OET65-WLAN2450-body

DUT: Sony; Type: SGP321; Serial: CB5A1NY05H

Communication System: IEEE 802.11b WiFi 2.4 GHz (DSSS, 1 Mbps); Communication System Band: ISM 2.4 GHz Band, World but Japan (2401.5 - 2482.5 MHz); Frequency: 2462 MHz; Communication System PAR: 1.87 dB; PMF: 1.04833

Medium parameters used: $f = 2462$ MHz; $\sigma = 2.02$ S/m; $\epsilon_r = 52$; $\rho = 1000$ kg/m³

Phantom section: Flat Section

Measurement Standard: DASY5

DASY5 Configuration:

- Probe: ET3DV6 - SN1558; ConvF(4.06, 4.06, 4.06); Calibrated: 24.08.2012;
- Modulation Compensation: PMR (X: $a=2.76$ dB, $b=67.0$ dB $\sqrt{\mu}$ V, $c=18.1$, $d=1.9$ dB / Y: $a=2.60$ dB, $b=66.5$ dB $\sqrt{\mu}$ V, $c=17.9$, $d=1.9$ dB / Z: $a=2.38$ dB, $b=64.1$ dB $\sqrt{\mu}$ V, $c=16.5$, $d=1.9$ dB); Calibrated: 24.08.2012
- Sensor-Surface: 4mm (Mechanical Surface Detection), $z = 2.7, 32.7$
- Electronics: DAE3 Sn477; Calibrated: 09.05.2012
- Phantom: ELI 4.0; Type: QDOVA001BA; Serial: 1046
- DASY52 52.8.5(1059); SEMCAD X 14.6.8(7028)

Body MSL/Left Side Position - Hi/Area Scan (111x201x1): Interpolated grid:

$dx=1.000$ mm, $dy=1.000$ mm

Maximum value of SAR (interpolated) = 0.190 W/kg

Body MSL/Left Side Position - Hi/Zoom Scan (7x7x7)/Cube 0: Measurement grid:

$dx=5$ mm, $dy=5$ mm, $dz=5$ mm

Reference Value = 8.973 V/m; Power Drift = 0.02 dB

Peak SAR (extrapolated) = 0.458 W/kg

SAR(1 g) = 0.173 W/kg; SAR(10 g) = 0.080 W/kg

Maximum value of SAR (measured) = 0.188 W/kg

Body MSL/Left Side Position - Hi/Zoom Scan (7x7x7)/Cube 1: Measurement grid:

$dx=5$ mm, $dy=5$ mm, $dz=5$ mm

Reference Value = 8.973 V/m; Power Drift = 0.02 dB

Peak SAR (extrapolated) = 0.429 W/kg

SAR(1 g) = 0.160 W/kg; SAR(10 g) = 0.071 W/kg

Maximum value of SAR (measured) = 0.175 W/kg

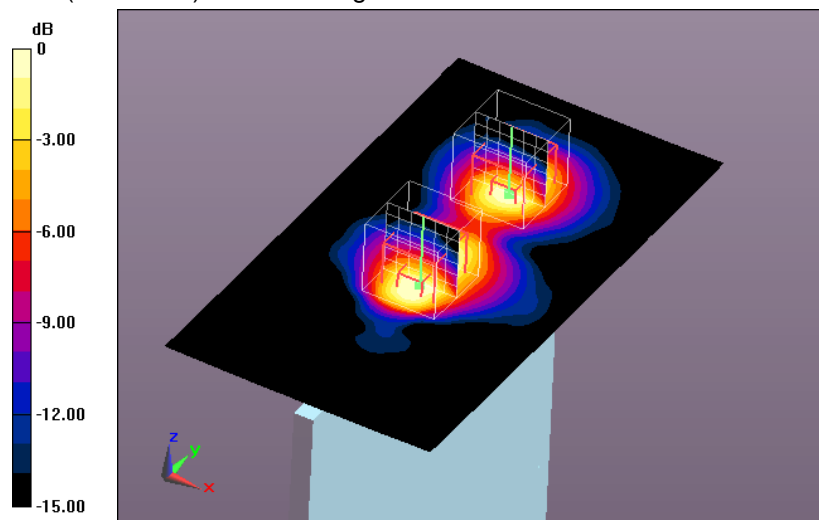

0 dB = 0.175 W/kg = -7.57 dBW/kg

Additional information:

position or distance of DUT to SAM: 0mm

ambient temperature: 22.2°C; liquid temperature: 21.4°C

Date/Time: 22.03.2013 19:31:37

OET65-WLAN2450-body

DUT: Sony; Type: SGP321; Serial: CB5A1NY05H

Communication System: IEEE 802.11b WiFi 2.4 GHz (DSSS, 1 Mbps); Communication System Band: ISM 2.4 GHz Band, World but Japan (2401.5 - 2482.5 MHz); Frequency: 2462 MHz; Communication System PAR: 1.87 dB; PMF: 1.04833

Medium parameters used: $f = 2462$ MHz; $\sigma = 2.02$ S/m; $\epsilon_r = 52$; $\rho = 1000$ kg/m³

Phantom section: Flat Section

Measurement Standard: DASY5

DASY5 Configuration:

- Probe: ET3DV6 - SN1558; ConvF(4.06, 4.06, 4.06); Calibrated: 24.08.2012;
- Modulation Compensation: PMR (X: a=2.76 dB, b=67.0 dB/μV, c=18.1, d=1.9 dB / Y: a=2.60 dB, b=66.5 dB/μV, c=17.9, d=1.9 dB / Z: a=2.38 dB, b=64.1 dB/μV, c=16.5, d=1.9 dB); Calibrated: 24.08.2012
- Sensor-Surface: 4mm (Mechanical Surface Detection), z = 2.7, 32.7
- Electronics: DAE3 Sn477; Calibrated: 09.05.2012
- Phantom: ELI 4.0; Type: QDOVA001BA; Serial: 1046
- DASY52 52.8.5(1059); SEMCAD X 14.6.8(7028)

Body MSL/Rear Position - Hi WC/Area Scan (201x301x1): Interpolated grid:

dx=1.000 mm, dy=1.000 mm

Maximum value of SAR (interpolated) = 1.29 W/kg

Body MSL/Rear Position - Hi WC/Zoom Scan (7x7x7)/Cube 0: Measurement grid:

dx=5mm, dy=5mm, dz=5mm

Reference Value = 22.873 V/m; Power Drift = -0.06 dB

Peak SAR (extrapolated) = 3.19 W/kg

SAR(1 g) = 1.05 W/kg; SAR(10 g) = 0.400 W/kg

Maximum value of SAR (measured) = 1.13 W/kg

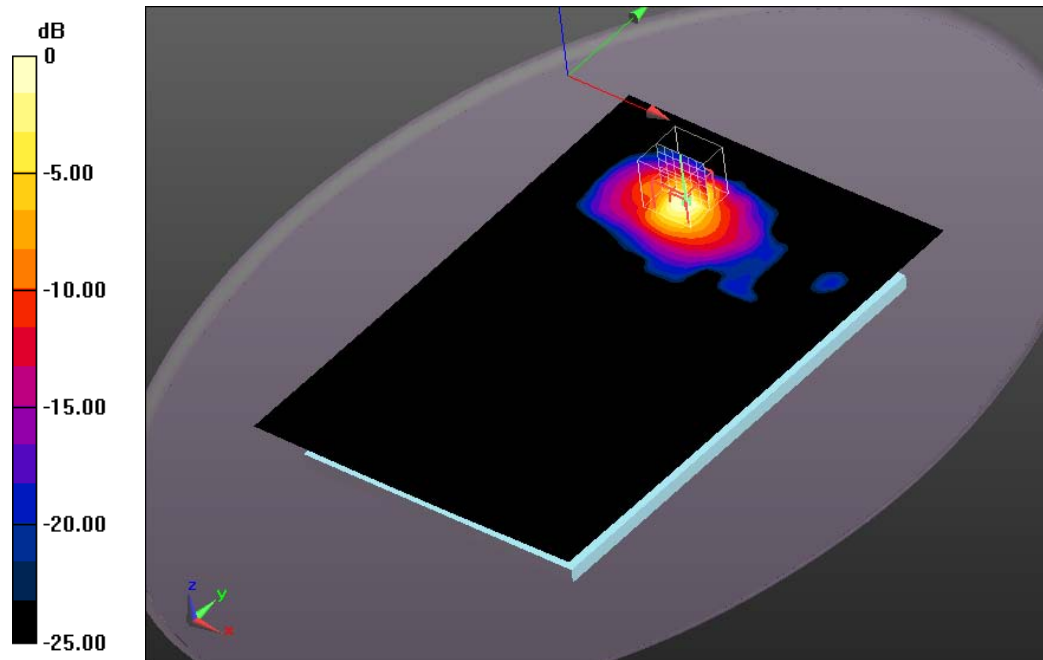

0 dB = 1.13 W/kg = 0.53 dBW/kg

Additional information:

position or distance of DUT to SAM: 0 mm

ambient temperature: 22.2°C; liquid temperature: 21.4°C

Annex B.7: WLAN 5GHz

Date/Time: 21.03.2013 08:48:12

OET65_EN62209-2-Body-WLAN 5GHz

DUT: Sony; Type: SGP321; Serial: CB5A1NY05H

Communication System: IEEE 802.11a/h WiFi 5 GHz (OFDM, 6 Mbps); Communication System Band: 5 GHz Band (5030.0 - 5825.0 MHz); Frequency: 5220 MHz; Communication System PAR: 8.68 dB; PMF: 1.07895

Medium parameters used (interpolated): $f = 5220$ MHz; $\sigma = 5.375$ S/m; $\epsilon_r = 47.96$; $\rho = 1000$ kg/m³

Phantom section: Flat Section

Measurement Standard: DASYS

DASY5 Configuration:

- Probe: EX3DV4 - SN3566; ConvF(3.5, 3.5, 3.5); Calibrated: 23.08.2012;
- Modulation Compensation: PMR (X: a=10.1 dB, b=68.5 dB $\sqrt{\mu}$ V, c=21.4, d=8.7 dB / Y: a=9.85 dB, b=67.7 dB $\sqrt{\mu}$ V, c=21.0, d=8.7 dB / Z: a=9.78 dB, b=67.8 dB $\sqrt{\mu}$ V, c=21.2, d=8.7 dB); Calibrated: 23.08.2012
- Sensor-Surface: 2mm (Mechanical Surface Detection), z = 1.0, 23.0
- Electronics: DAE3 Sn477; Calibrated: 09.05.2012
- Phantom: ELI 4.0; Type: QDOVA001BA; Serial: 1046
- DASY52 52.8.5(1059); SEMCAD X 14.6.8(7028)

MSL-5GHz/Rear position - Channel 44/Area Scan (201x291x1): Interpolated grid:

dx=1.000 mm, dy=1.000 mm

Maximum value of SAR (interpolated) = 1.62 W/kg

MSL-5GHz/Rear position - Channel 44/Zoom Scan (8x8x12)/Cube 0:

Measurement grid: dx=4mm, dy=4mm, dz=2mm

Reference Value = 13.630 V/m; Power Drift = -0.120 dB

Peak SAR (extrapolated) = 2.69 W/kg

SAR(1 g) = 0.521 W/kg; SAR(10 g) = 0.114 W/kg

Maximum value of SAR (measured) = 1.34 W/kg

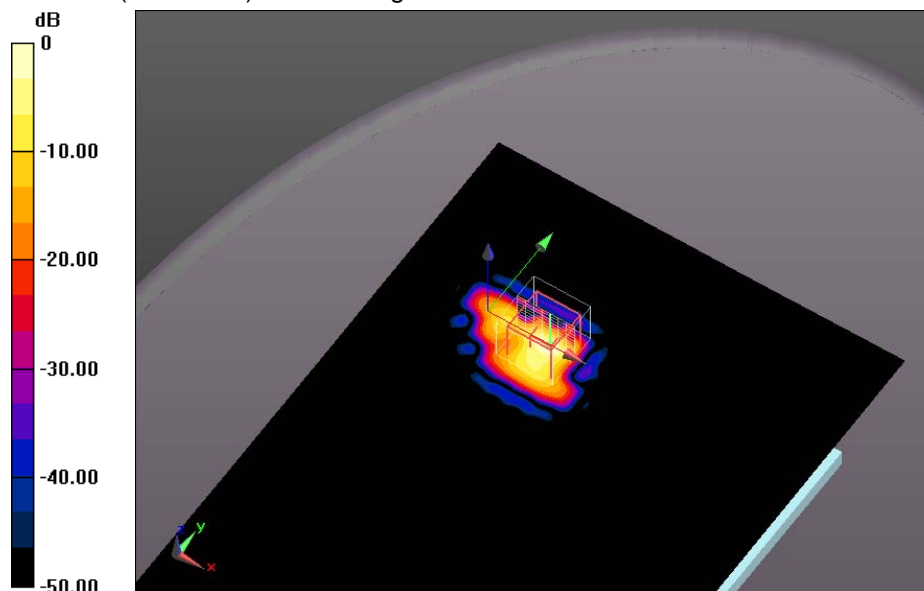

0 dB = 1.34 W/kg = 1.27 dBW/kg

Additional information:

position or distance of DUT to SAM: 0 mm

ambient temperature: 22.3°C; liquid temperature: 21.5°C

Date/Time: 22.03.2013 09:39:52

OET65_EN62209-2-Body-WLAN 5GHz

DUT: Sony; Type: SGP321; Serial: CB5A1NY05H

Communication System: IEEE 802.11a/h WiFi 5 GHz (OFDM, 6 Mbps); Communication System Band: 5 GHz Band (5030.0 - 5825.0 MHz); Frequency: 5260 MHz; Communication System PAR: 8.68 dB; PMF: 1.07895

Medium parameters used: $f = 5260$ MHz; $\sigma = 5.41$ S/m; $\epsilon_r = 47.9$; $\rho = 1000$ kg/m³

Phantom section: Flat Section

Measurement Standard: DASYS5

DASY5 Configuration:

- Probe: EX3DV4 - SN3566; ConvF(3.35, 3.35, 3.35); Calibrated: 23.08.2012;
- Modulation Compensation: PMR (X: $a=10.1$ dB, $b=68.5$ dB $\sqrt{\mu V}$, $c=21.4$, $d=8.7$ dB / Y: $a=9.85$ dB, $b=67.7$ dB $\sqrt{\mu V}$, $c=21.0$, $d=8.7$ dB / Z: $a=9.78$ dB, $b=67.8$ dB $\sqrt{\mu V}$, $c=21.2$, $d=8.7$ dB); Calibrated: 23.08.2012
- Sensor-Surface: 2mm (Mechanical Surface Detection), $z = 1.0, 23.0$
- Electronics: DAE3 Sn477; Calibrated: 09.05.2012
- Phantom: ELI 4.0; Type: QDOVA001BA; Serial: 1046
- DASYS52 52.8.5(1059); SEMCAD X 14.6.8(7028)

MSL-5GHz/Rear position - Channel 52/Area Scan (171x171x1): Interpolated grid:

$dx=1.000$ mm, $dy=1.000$ mm

Maximum value of SAR (interpolated) = 1.05 W/kg

MSL-5GHz/Rear position - Channel 52/Zoom Scan (8x8x12)/Cube 0:

Measurement grid: $dx=4$ mm, $dy=4$ mm, $dz=2$ mm

Reference Value = 11.455 V/m; Power Drift = -0.04 dB

Peak SAR (extrapolated) = 1.35 W/kg

SAR(1 g) = 0.318 W/kg; SAR(10 g) = 0.076 W/kg

Maximum value of SAR (measured) = 0.741 W/kg

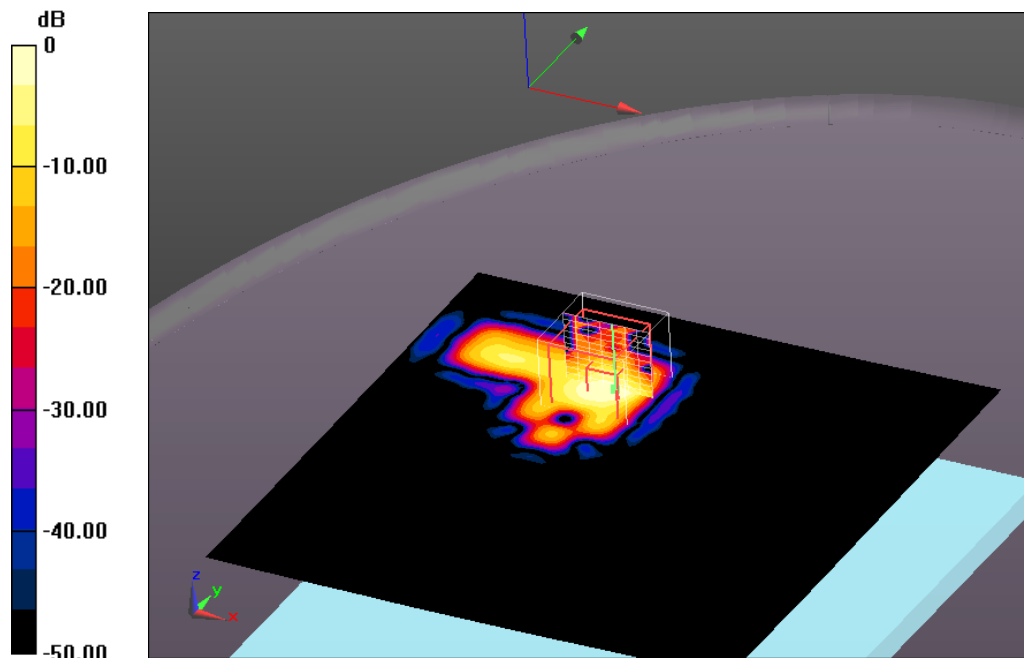

0 dB = 0.741 W/kg = -1.30 dBW/kg

Additional information:

position or distance of DUT to SAM: 0mm

ambient temperature: 22.3°C; liquid temperature: 21.5°C

Date/Time: 21.03.2013 10:25:00

OET65_EN62209-2-Body-WLAN 5GHz

DUT: Sony; Type: SGP321; Serial: CB5A1NY05H

Communication System: IEEE 802.11a/h WiFi 5 GHz (OFDM, 6 Mbps); Communication System Band: 5 GHz Band (5030.0 - 5825.0 MHz); Frequency: 5300 MHz; Communication System PAR: 8.68 dB; PMF: 1.07895

Medium parameters used: $f = 5300$ MHz; $\sigma = 5.46$ S/m; $\epsilon_r = 47.79$; $\rho = 1000$ kg/m³

Phantom section: Flat Section

Measurement Standard: DASYS

DASY5 Configuration:

- Probe: EX3DV4 - SN3566; ConvF(3.35, 3.35, 3.35); Calibrated: 23.08.2012;
- Modulation Compensation: PMR (X: $a=10.1$ dB, $b=68.5$ dB $\sqrt{\mu}$ V, $c=21.4$, $d=8.7$ dB / Y: $a=9.85$ dB, $b=67.7$ dB $\sqrt{\mu}$ V, $c=21.0$, $d=8.7$ dB / Z: $a=9.78$ dB, $b=67.8$ dB $\sqrt{\mu}$ V, $c=21.2$, $d=8.7$ dB); Calibrated: 23.08.2012
- Sensor-Surface: 2mm (Mechanical Surface Detection (Locations From Previous Scan Used)), Sensor-Surface: 2mm (Mechanical Surface Detection), $z = 1.0, 23.0$
- Electronics: DAE3 Sn477; Calibrated: 09.05.2012
- Phantom: ELI 4.0; Type: QDOVA001BA; Serial: 1046
- DASY52 52.8.5(1059); SEMCAD X 14.6.8(7028)

MSL-5GHz/Rear position - Channel 60/Area Scan (201x291x1): Interpolated grid:

$dx=1.000$ mm, $dy=1.000$ mm

Maximum value of SAR (interpolated) = 2.32 W/kg

MSL-5GHz/Rear position - Channel 60/Zoom Scan (9x9x12)/Cube 0:

Measurement grid: $dx=4$ mm, $dy=4$ mm, $dz=2$ mm

Reference Value = 18.149 V/m; Power Drift = -0.071 dB

Peak SAR (extrapolated) = 4.69 W/kg

SAR(1 g) = 0.704 W/kg; SAR(10 g) = 0.195 W/kg

Maximum value of SAR (measured) = 2.34 W/kg

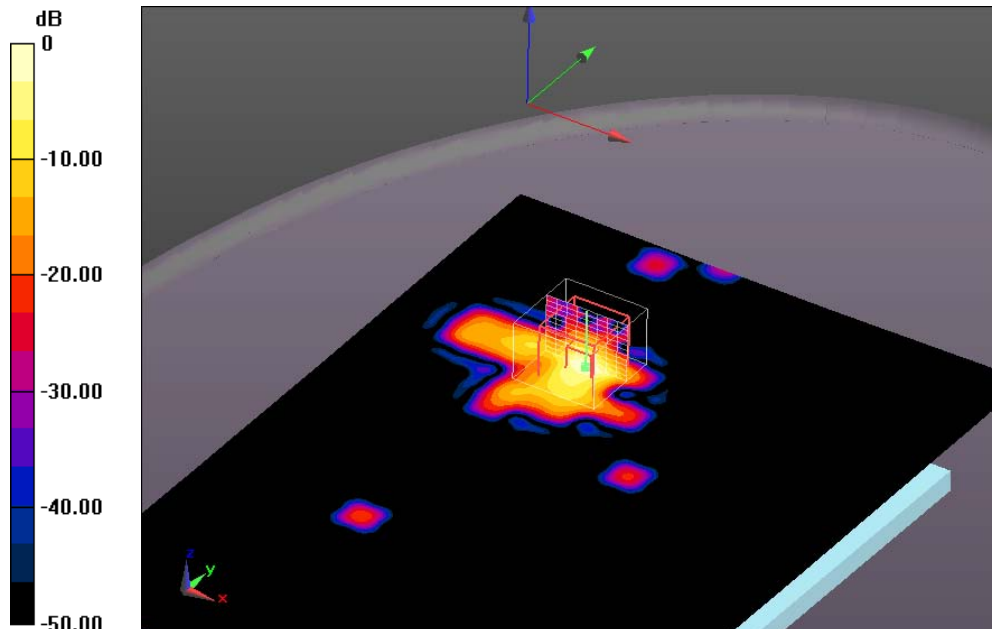

0 dB = 2.34 W/kg = 3.69 dBW/kg

Additional information:

position or distance of DUT to SAM: 0mm

ambient temperature: 22.3°C; liquid temperature: 21.5°C

Date/Time: 21.03.2013 11:10:04

OET65_EN62209-2-Body-WLAN 5GHz

DUT: Sony; Type: SGP321; Serial: CB5A1NY05H

Communication System: IEEE 802.11a/h WiFi 5 GHz (OFDM, 6 Mbps); Communication System Band: 5 GHz Band (5030.0 - 5825.0 MHz); Frequency: 5320 MHz; Communication System PAR: 8.68 dB; PMF: 1.07895

Medium parameters used: $f = 5320$ MHz; $\sigma = 5.53$ S/m; $\epsilon_r = 47.79$; $\rho = 1000$ kg/m³

Phantom section: Flat Section

Measurement Standard: DASYS

DASY5 Configuration:

- Probe: EX3DV4 - SN3566; ConvF(3.35, 3.35, 3.35); Calibrated: 23.08.2012;
- Modulation Compensation: PMR (X: $a=10.1$ dB, $b=68.5$ dB $\sqrt{\mu V}$, $c=21.4$, $d=8.7$ dB / Y: $a=9.85$ dB, $b=67.7$ dB $\sqrt{\mu V}$, $c=21.0$, $d=8.7$ dB / Z: $a=9.78$ dB, $b=67.8$ dB $\sqrt{\mu V}$, $c=21.2$, $d=8.7$ dB); Calibrated: 23.08.2012
- Sensor-Surface: 2mm (Mechanical Surface Detection (Locations From Previous Scan Used)), Sensor-Surface: 2mm (Mechanical Surface Detection), $z = 1.0, 23.0$
- Electronics: DAE3 Sn477; Calibrated: 09.05.2012
- Phantom: ELI 4.0; Type: QDOVA001BA; Serial: 1046
- DASY52 52.8.5(1059); SEMCAD X 14.6.8(7028)

MSL-5GHz/Rear position - Channel 64/Area Scan (171x171x1): Interpolated grid:

$dx=1.000$ mm, $dy=1.000$ mm

Maximum value of SAR (interpolated) = 2.16 W/kg

MSL-5GHz/Rear position - Channel 64/Zoom Scan (8x8x12)/Cube 0:

Measurement grid: $dx=4$ mm, $dy=4$ mm, $dz=2$ mm

Reference Value = 20.615 V/m; Power Drift = -0.025 dB

Peak SAR (extrapolated) = 4.02 W/kg

SAR(1 g) = 0.756 W/kg; SAR(10 g) = 0.168 W/kg

Maximum value of SAR (measured) = 1.82 W/kg

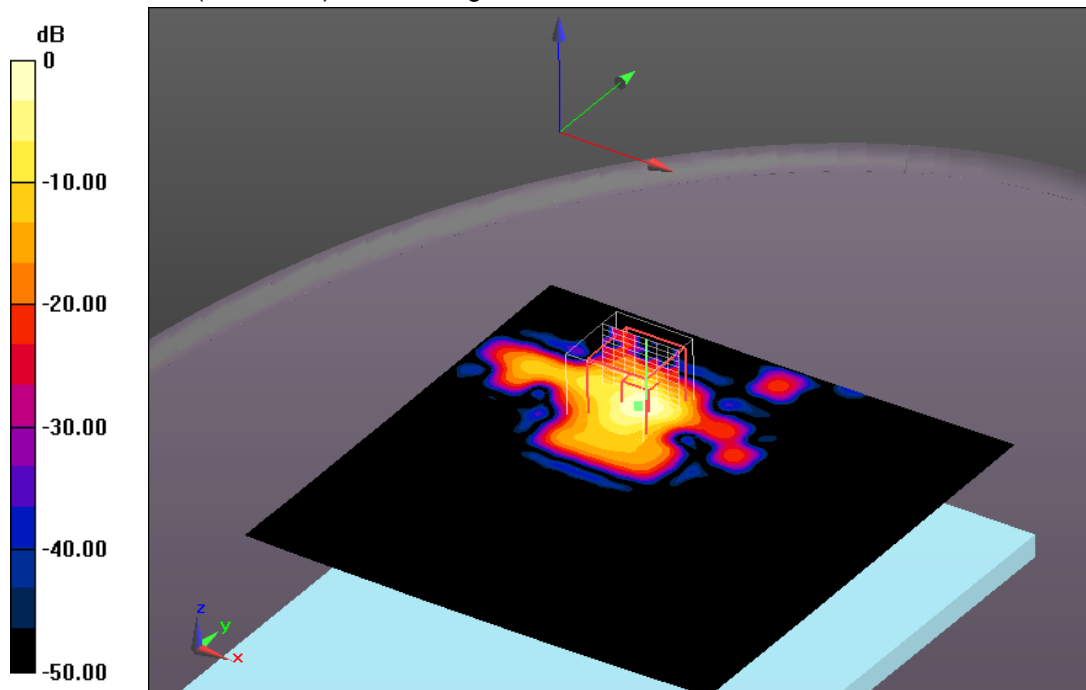

0 dB = 1.82 W/kg = 2.60 dBW/kg

Additional information:

position or distance of DUT to SAM: 0mm

ambient temperature: 22.3°C; liquid temperature: 21.5°C

Date/Time: 21.03.2013 11:45:16

OET65_EN62209-2-Body-WLAN 5GHz

DUT: Sony; Type: SGP321; Serial: CB5A1NY05H

Communication System: IEEE 802.11a/h WiFi 5 GHz (OFDM, 6 Mbps); Communication System Band: 5 GHz Band (5030.0 - 5825.0 MHz); Frequency: 5600 MHz; Communication System PAR: 8.68 dB; PMF: 1.07895

Medium parameters used: $f = 5600$ MHz; $\sigma = 5.83$ S/m; $\epsilon_r = 47.05$; $\rho = 1000$ kg/m³

Phantom section: Flat Section

Measurement Standard: DASYS

DASY5 Configuration:

- Probe: EX3DV4 - SN3566; ConvF(3.1, 3.1, 3.1); Calibrated: 23.08.2012;
- Modulation Compensation: PMR (X: $a=10.1$ dB, $b=68.5$ dB $\sqrt{\mu V}$, $c=21.4$, $d=8.7$ dB / Y: $a=9.85$ dB, $b=67.7$ dB $\sqrt{\mu V}$, $c=21.0$, $d=8.7$ dB / Z: $a=9.78$ dB, $b=67.8$ dB $\sqrt{\mu V}$, $c=21.2$, $d=8.7$ dB); Calibrated: 23.08.2012
- Sensor-Surface: 2mm (Mechanical Surface Detection (Locations From Previous Scan Used)), Sensor-Surface: 2mm (Mechanical Surface Detection), $z = 1.0, 23.0$
- Electronics: DAE3 Sn477; Calibrated: 09.05.2012
- Phantom: ELI 4.0; Type: QDOVA001BA; Serial: 1046
- DASY52 52.8.5(1059); SEMCAD X 14.6.8(7028)

MSL-5GHz/Rear position - Channel 120/Area Scan (171x201x1): Interpolated grid:

$dx=1.000$ mm, $dy=1.000$ mm

Maximum value of SAR (interpolated) = 1.87 W/kg

MSL-5GHz/Rear position - Channel 120/Zoom Scan (8x8x12)/Cube 0:

Measurement grid: $dx=4$ mm, $dy=4$ mm, $dz=2$ mm

Reference Value = 15.416 V/m; Power Drift = 0.19 dB

Peak SAR (extrapolated) = 2.29 W/kg

SAR(1 g) = 0.471 W/kg; SAR(10 g) = 0.101 W/kg

Maximum value of SAR (measured) = 1.30 W/kg

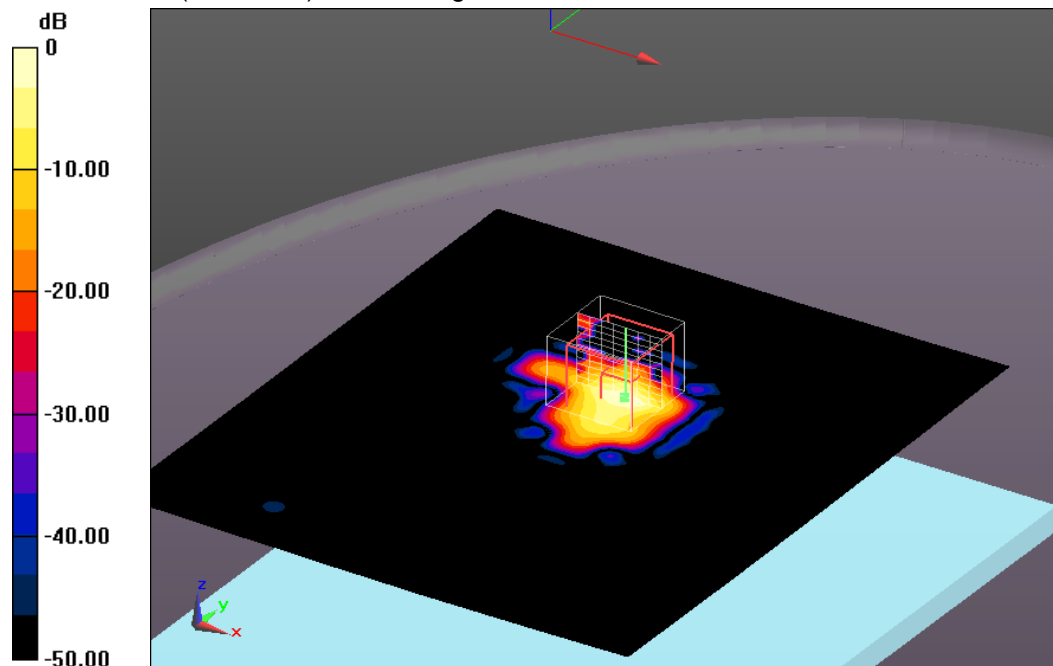

0 dB = 1.30 W/kg = 1.14 dBW/kg

Additional information:

position or distance of DUT to SAM: 0mm

ambient temperature: 22.3°C; liquid temperature: 21.5°C

Date/Time: 21.03.2013 12:23:26

OET65_EN62209-2-Body-WLAN 5GHz

DUT: Sony; Type: SGP321; Serial: CB5A1NY05H

Communication System: IEEE 802.11a/h WiFi 5 GHz (OFDM, 6 Mbps); Communication System Band: 5 GHz Band (5030.0 - 5825.0 MHz); Frequency: 5785 MHz; Communication System PAR: 8.68 dB; PMF: 1.07895

Medium parameters used: $f = 5785 \text{ MHz}$; $\sigma = 6.08 \text{ S/m}$; $\epsilon_r = 46.71$; $\rho = 1000 \text{ kg/m}^3$

Phantom section: Flat Section

Measurement Standard: DASY5

DASY5 Configuration:

- Probe: EX3DV4 - SN3566; ConvF(3.12, 3.12, 3.12); Calibrated: 23.08.2012;
- Modulation Compensation: PMR (X: $a=10.1 \text{ dB}$, $b=68.5 \text{ dB}\sqrt{\mu\text{V}}$, $c=21.4$, $d=8.7 \text{ dB}$ / Y: $a=9.85 \text{ dB}$, $b=67.7 \text{ dB}\sqrt{\mu\text{V}}$, $c=21.0$, $d=8.7 \text{ dB}$ / Z: $a=9.78 \text{ dB}$, $b=67.8 \text{ dB}\sqrt{\mu\text{V}}$, $c=21.2$, $d=8.7 \text{ dB}$); Calibrated: 23.08.2012
- Sensor-Surface: 2mm (Mechanical Surface Detection (Locations From Previous Scan Used)), Sensor-Surface: 2mm (Mechanical Surface Detection), $z = 1.0, 23.0$
- Electronics: DAE3 Sn477; Calibrated: 09.05.2012
- Phantom: ELI 4.0; Type: QDOVA001BA; Serial: 1046
- DASY52 52.8.5(1059); SEMCAD X 14.6.8(7028)

MSL-5GHz/Rear position - Channel 157/Area Scan (171x201x1): Interpolated grid:

$dx=1.000 \text{ mm}$, $dy=1.000 \text{ mm}$

Maximum value of SAR (interpolated) = 1.26 W/kg

MSL-5GHz/Rear position - Channel 157/Zoom Scan (9x8x12)/Cube 0:

Measurement grid: $dx=4\text{mm}$, $dy=4\text{mm}$, $dz=2\text{mm}$

Reference Value = 11.649 V/m; Power Drift = 0.120 dB

Peak SAR (extrapolated) = 1.27 W/kg

SAR(1 g) = 0.272 W/kg; SAR(10 g) = 0.055 W/kg

Maximum value of SAR (measured) = 0.728 W/kg

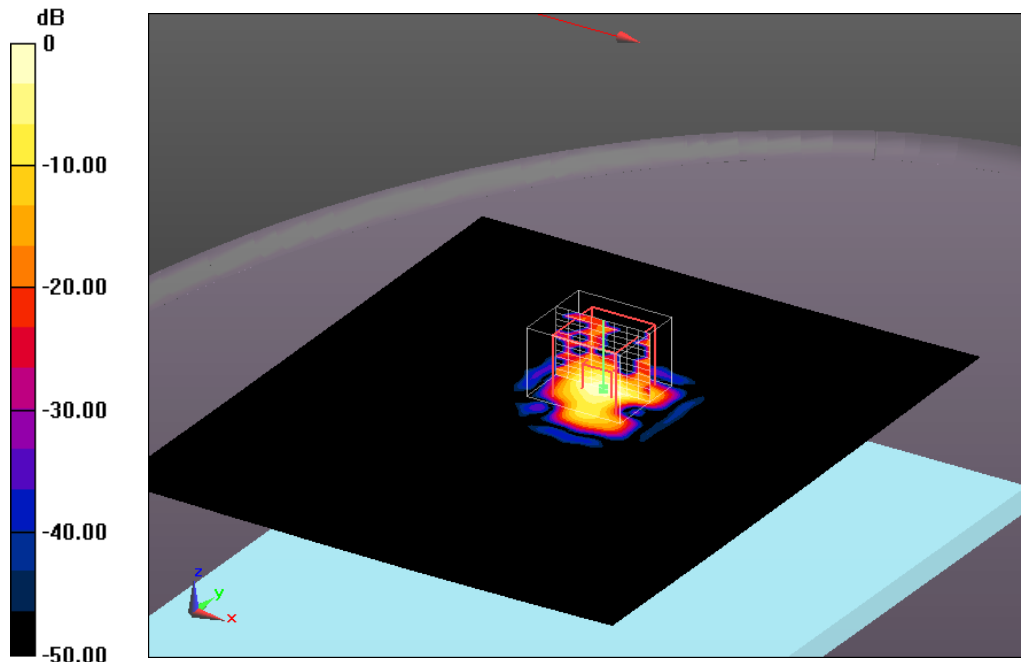

0 dB = 0.728 W/kg = -1.38 dBW/kg

Additional information:

position or distance of DUT to SAM: 0mm

ambient temperature: 22.3°C; liquid temperature: 21.5°C

Date/Time: 21.03.2013 13:04:27

OET65_EN62209-2-Body-WLAN 5GHz

DUT: Sony; Type: SGP321; Serial: CB5A1NY05H

Communication System: IEEE 802.11a/h WiFi 5 GHz (OFDM, 6 Mbps); Communication System Band: 5 GHz Band (5030.0 - 5825.0 MHz); Frequency: 5220 MHz; Communication System PAR: 8.69 dB; PMF: 1.07895

Medium parameters used (interpolated): $f = 5220$ MHz; $\sigma = 5.375$ S/m; $\epsilon_r = 47.96$; $\rho = 1000$ kg/m³

Phantom section: Flat Section

Measurement Standard: DASYS5

DASY5 Configuration:

- Probe: EX3DV4 - SN3566; ConvF(3.5, 3.5, 3.5); Calibrated: 23.08.2012;
- Modulation Compensation: PMR (X: $a=10.1$ dB, $b=68.5$ dB $\sqrt{\mu}$ V, $c=21.4$, $d=8.7$ dB / Y: $a=9.85$ dB, $b=67.7$ dB $\sqrt{\mu}$ V, $c=21.0$, $d=8.7$ dB / Z: $a=9.78$ dB, $b=67.8$ dB $\sqrt{\mu}$ V, $c=21.2$, $d=8.7$ dB); Calibrated: 23.08.2012
- Sensor-Surface: 2mm (Mechanical Surface Detection), $z = 1.0, 23.0$
- Electronics: DAE3 Sn477; Calibrated: 09.05.2012
- Phantom: ELI 4.0; Type: QDOVA001BA; Serial: 1046
- DASY52 52.8.5(1059); SEMCAD X 14.6.8(7028)

MSL-5GHz/Left Side Position - Channel 44/Area Scan (121x221x1): Interpolated grid: $dx=1.000$ mm, $dy=1.000$ mm

Maximum value of SAR (interpolated) = 0.0900 W/kg

MSL-5GHz/Left Side Position - Channel 44/Zoom Scan (8x12x12)/Cube 0:

Measurement grid: $dx=4$ mm, $dy=4$ mm, $dz=2$ mm

Reference Value = 0 V/m; Power Drift = 0.00 dB

Peak SAR (extrapolated) = 0.332 W/kg

SAR(1 g) = 0.027 W/kg; SAR(10 g) = 0.00618 W/kg

Maximum value of SAR (measured) = 0.0565 W/kg

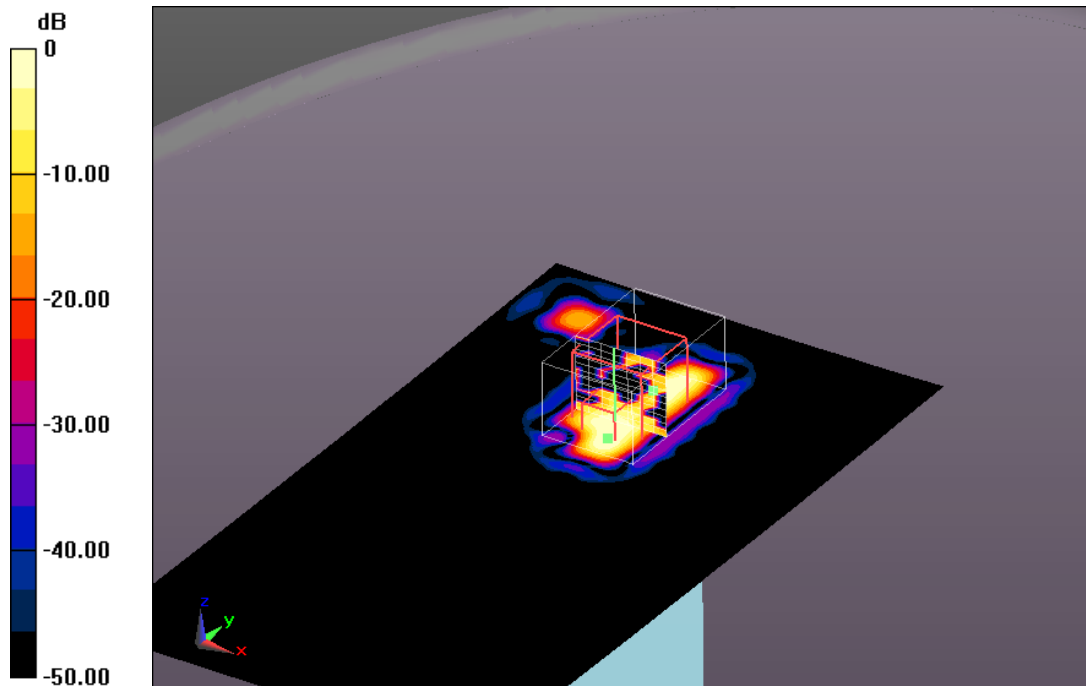

0 dB = 0.0565 W/kg = -12.48 dBW/kg

Additional information:

position or distance of DUT to SAM: 0mm

ambient temperature: 22.3°C; liquid temperature: 21.5°C

Date/Time: 21.03.2013 13:47:10

OET65_EN62209-2-Body-WLAN 5GHz

DUT: Sony; Type: SGP321; Serial: CB5A1NY05H

Communication System: IEEE 802.11a/h WiFi 5 GHz (OFDM, 6 Mbps); Communication System Band: 5 GHz Band (5030.0 - 5825.0 MHz); Frequency: 5300 MHz; Communication System PAR: 8.69 dB; PMF: 1.07895

Medium parameters used: $f = 5300$ MHz; $\sigma = 5.46$ S/m; $\epsilon_r = 47.79$; $\rho = 1000$ kg/m³

Phantom section: Flat Section

Measurement Standard: DASYS

DASY5 Configuration:

- Probe: EX3DV4 - SN3566; ConvF(3.35, 3.35, 3.35); Calibrated: 23.08.2012;
- Modulation Compensation: PMR (X: $a=10.1$ dB, $b=68.5$ dB $\sqrt{\mu}$ V, $c=21.4$, $d=8.7$ dB / Y: $a=9.85$ dB, $b=67.7$ dB $\sqrt{\mu}$ V, $c=21.0$, $d=8.7$ dB / Z: $a=9.78$ dB, $b=67.8$ dB $\sqrt{\mu}$ V, $c=21.2$, $d=8.7$ dB); Calibrated: 23.08.2012
- Sensor-Surface: 2mm (Mechanical Surface Detection (Locations From Previous Scan Used)), Sensor-Surface: 2mm (Mechanical Surface Detection), $z = 1.0, 23.0$
- Electronics: DAE3 Sn477; Calibrated: 09.05.2012
- Phantom: ELI 4.0; Type: QDOVA001BA; Serial: 1046
- DASYS2 52.8.5(1059); SEMCAD X 14.6.8(7028)

MSL-5GHz/Left Side Position - Channel 60/Area Scan (121x221x1): Interpolated

grid: $dx=1.000$ mm, $dy=1.000$ mm

Maximum value of SAR (interpolated) = 0.300 W/kg

MSL-5GHz/Left Side Position - Channel 60/Zoom Scan (8x12x12)/Cube 0:

Measurement grid: $dx=4$ mm, $dy=4$ mm, $dz=2$ mm

Reference Value = 3.397 V/m; Power Drift = -0.064 dB

Peak SAR (extrapolated) = 0.269 W/kg

SAR(1 g) = 0.054 W/kg; SAR(10 g) = 0.015 W/kg

Maximum value of SAR (measured) = 0.135 W/kg

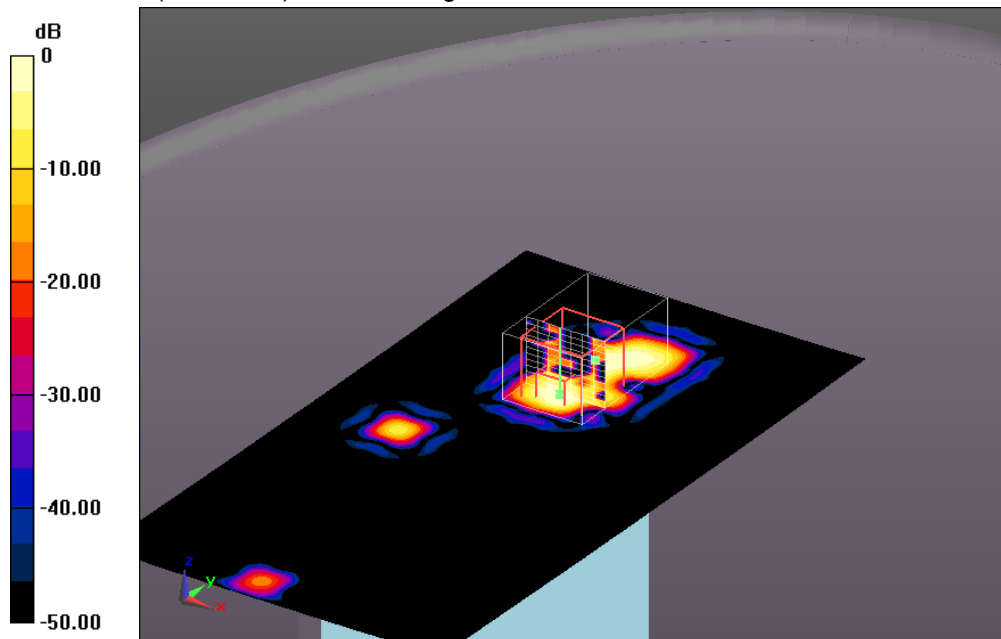

0 dB = 0.135 W/kg = -8.70 dBW/kg

Additional information:

position or distance of DUT to SAM: 0mm

ambient temperature: 22.3°C; liquid temperature: 21.5°C

Date/Time: 21.03.2013 14:28:19

OET65_EN62209-2-Body-WLAN 5GHz

DUT: Sony; Type: SGP321; Serial: CB5A1NY05H

Communication System: IEEE 802.11a/h WiFi 5 GHz (OFDM, 6 Mbps); Communication System Band: 5 GHz Band (5030.0 - 5825.0 MHz); Frequency: 5600 MHz; Communication System PAR: 8.68 dB; PMF: 1.07895

Medium parameters used: $f = 5600$ MHz; $\sigma = 5.83$ S/m; $\epsilon_r = 47.05$; $\rho = 1000$ kg/m³

Phantom section: Flat Section

Measurement Standard: DASYS

DASY5 Configuration:

- Probe: EX3DV4 - SN3566; ConvF(3.1, 3.1, 3.1); Calibrated: 23.08.2012;
- Modulation Compensation: PMR (X: $a=10.1$ dB, $b=68.5$ dB $\sqrt{\mu V}$, $c=21.4$, $d=8.7$ dB / Y: $a=9.85$ dB, $b=67.7$ dB $\sqrt{\mu V}$, $c=21.0$, $d=8.7$ dB / Z: $a=9.78$ dB, $b=67.8$ dB $\sqrt{\mu V}$, $c=21.2$, $d=8.7$ dB); Calibrated: 23.08.2012
- Sensor-Surface: 2mm (Mechanical Surface Detection (Locations From Previous Scan Used)), Sensor-Surface: 2mm (Mechanical Surface Detection), $z = 1.0, 23.0$
- Electronics: DAE3 Sn477; Calibrated: 09.05.2012
- Phantom: ELI 4.0; Type: QDOVA001BA; Serial: 1046
- DASYS 52.8.5(1059); SEMCAD X 14.6.8(7028)

MSL-5GHz/Left Side Position - Channel 120/Area Scan (121x221x1):

Interpolated grid: $dx=1.000$ mm, $dy=1.000$ mm

Maximum value of SAR (interpolated) = 0.414 W/kg

MSL-5GHz/Left Side Position - Channel 120/Zoom Scan (9x11x12)/Cube 0:

Measurement grid: $dx=4$ mm, $dy=4$ mm, $dz=2$ mm

Reference Value = 3.978 V/m; Power Drift = 0.054 dB

Peak SAR (extrapolated) = 0.574 W/kg

SAR(1 g) = 0.095 W/kg; SAR(10 g) = 0.023 W/kg

Maximum value of SAR (measured) = 0.228 W/kg

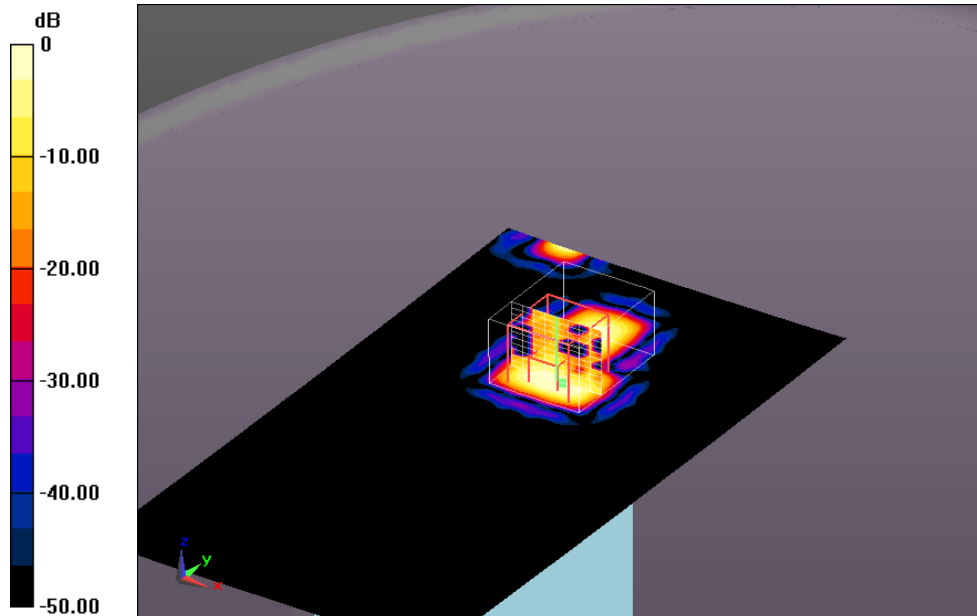

0 dB = 0.228 W/kg = -6.42 dBW/kg

Additional information:

position or distance of DUT to SAM: 0mm

ambient temperature: 22.3°C; liquid temperature: 21.5°C

Date/Time: 21.03.2013 15:13:56

OET65_EN62209-2-Body-WLAN 5GHz

DUT: Sony; Type: SGP321; Serial: CB5A1NY05H

Communication System: IEEE 802.11a/h WiFi 5 GHz (OFDM, 6 Mbps); Communication System Band: 5 GHz Band (5030.0 - 5825.0 MHz); Frequency: 5785 MHz; Communication System PAR: 8.68 dB; PMF: 1.07895

Medium parameters used: $f = 5785$ MHz; $\sigma = 6.08$ S/m; $\epsilon_r = 46.71$; $\rho = 1000$ kg/m³

Phantom section: Flat Section

Measurement Standard: DASYS

DASY5 Configuration:

- Probe: EX3DV4 - SN3566; ConvF(3.12, 3.12, 3.12); Calibrated: 23.08.2012;
- Modulation Compensation: PMR (X: $a=10.1$ dB, $b=68.5$ dB $\sqrt{\mu V}$, $c=21.4$, $d=8.7$ dB / Y: $a=9.85$ dB, $b=67.7$ dB $\sqrt{\mu V}$, $c=21.0$, $d=8.7$ dB / Z: $a=9.78$ dB, $b=67.8$ dB $\sqrt{\mu V}$, $c=21.2$, $d=8.7$ dB); Calibrated: 23.08.2012
- Sensor-Surface: 2mm (Mechanical Surface Detection (Locations From Previous Scan Used)), Sensor-Surface: 2mm (Mechanical Surface Detection), $z = 1.0, 23.0$
- Electronics: DAE3 Sn477; Calibrated: 09.05.2012
- Phantom: ELI 4.0; Type: QDOVA001BA; Serial: 1046
- DASY52 52.8.5(1059); SEMCAD X 14.6.8(7028)

MSL-5GHz/Left Side Position - Channel 157/Area Scan (121x221x1):

Interpolated grid: $dx=1.000$ mm, $dy=1.000$ mm

Maximum value of SAR (interpolated) = 0.147 W/kg

MSL-5GHz/Left Side Position - Channel 157/Zoom Scan (8x9x12)/Cube 0:

Measurement grid: $dx=4$ mm, $dy=4$ mm, $dz=2$ mm

Reference Value = 2.537 V/m; Power Drift = 0.00 dB

Peak SAR (extrapolated) = 0.359 W/kg

SAR(1 g) = 0.033 W/kg; SAR(10 g) = 0.00626 W/kg

Maximum value of SAR (measured) = 0.0865 W/kg

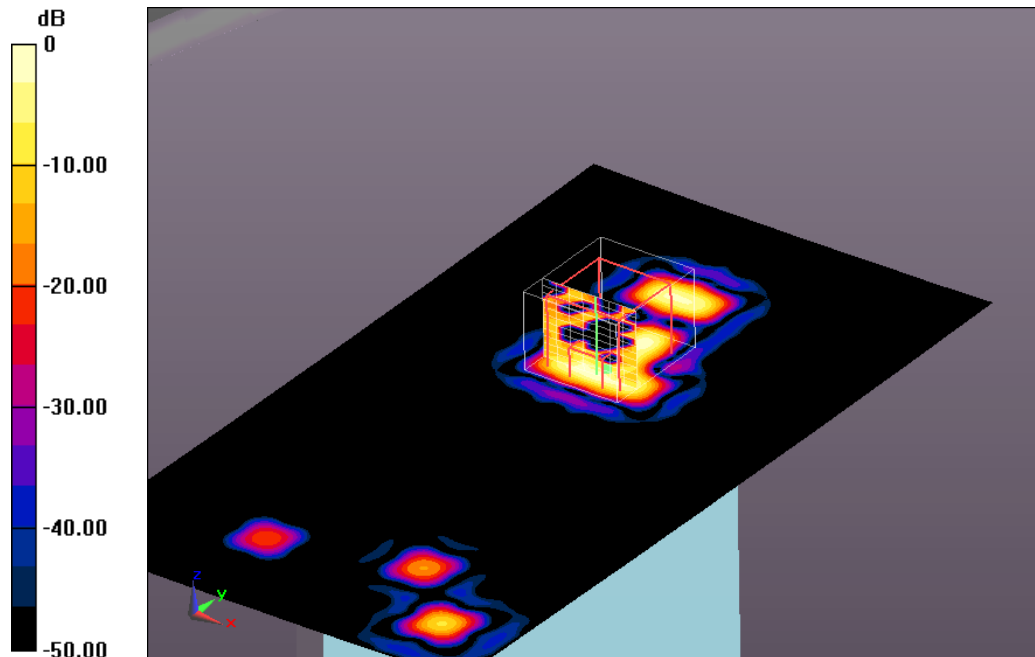

0 dB = 0.0865 W/kg = -10.63 dBW/kg

Additional information:

position or distance of DUT to SAM: 0mm

ambient temperature: 22.3°C; liquid temperature: 21.5°C

Annex B.8: Z-axis scan

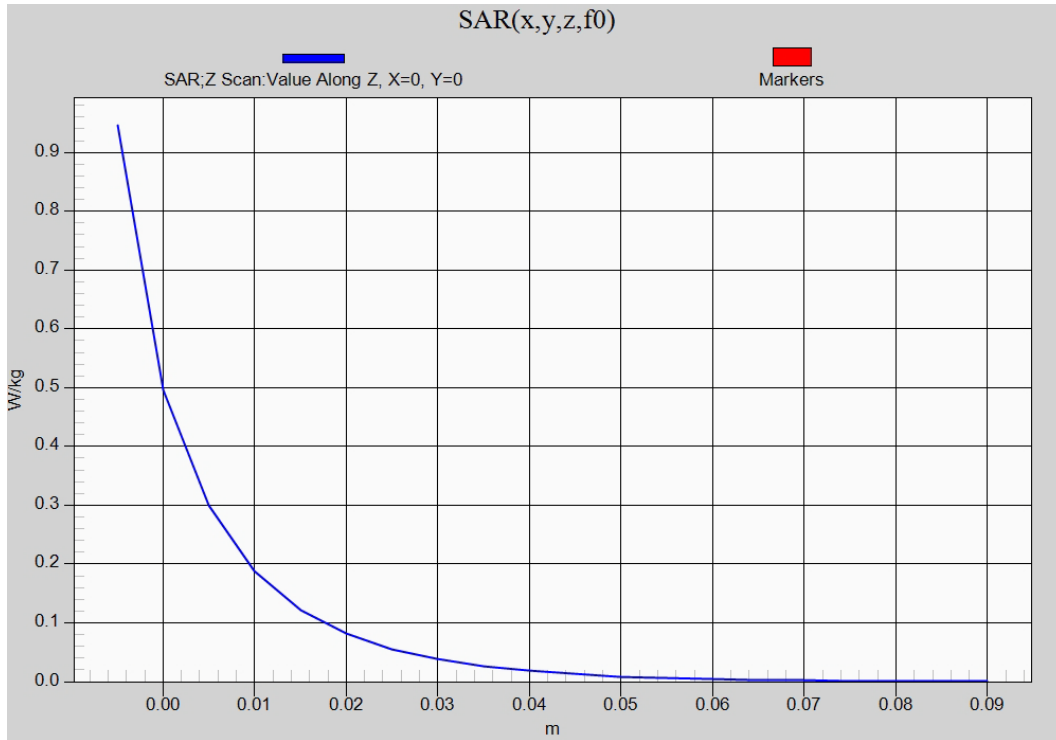

850 body

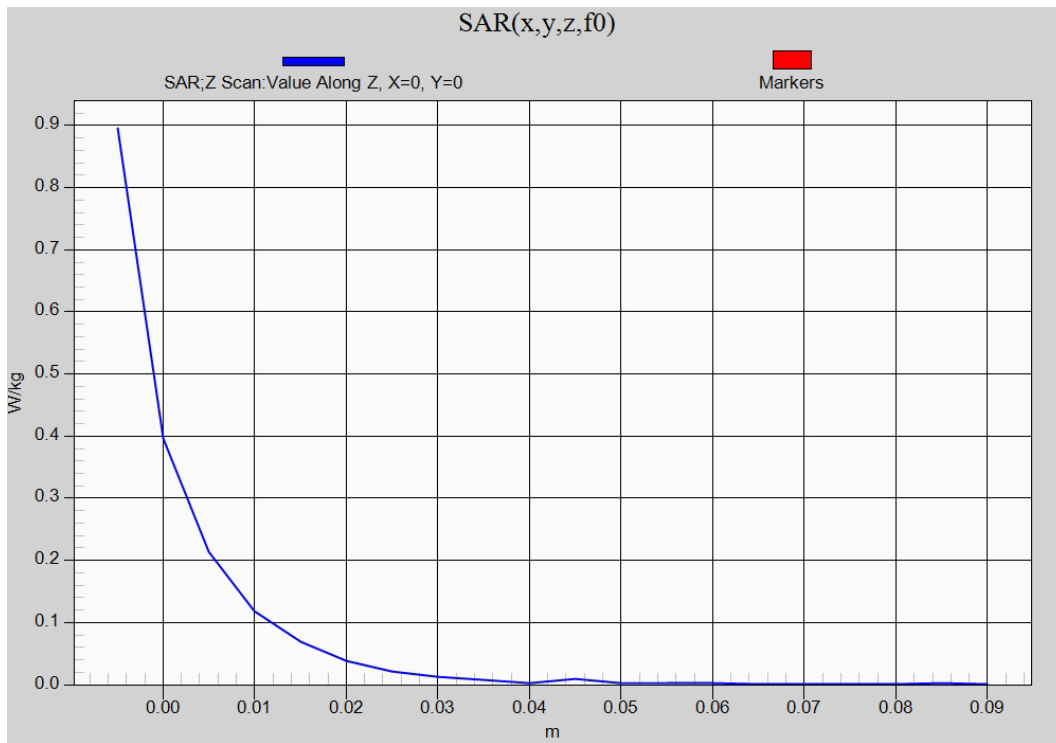

1900 body

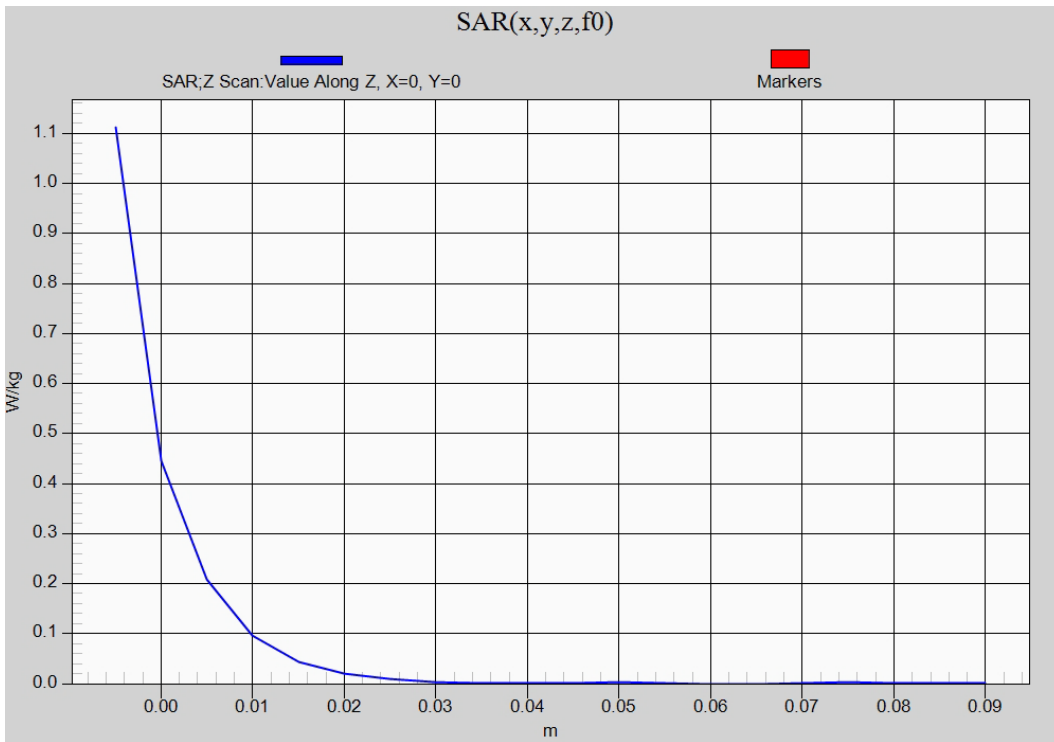

2450 body

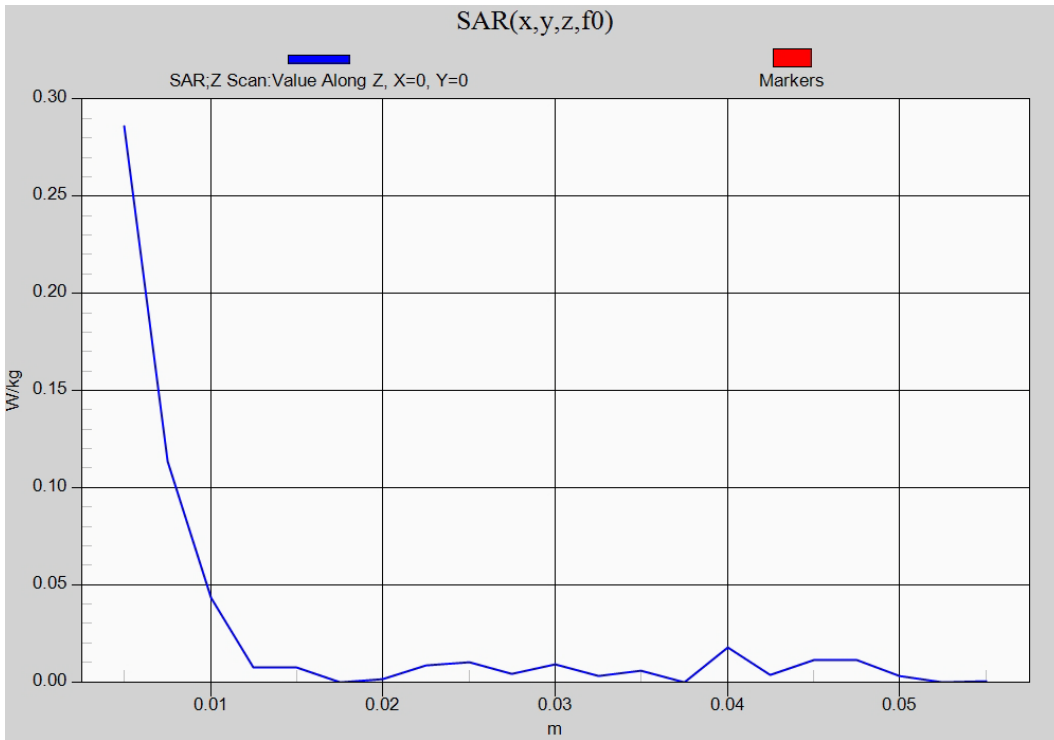

5GHz body

Annex B.9: Liquid depth

Photo 1: Liquid depth 850 MHz body simulating liquid



Photo 2: Liquid depth 1900 MHz body simulating liquid

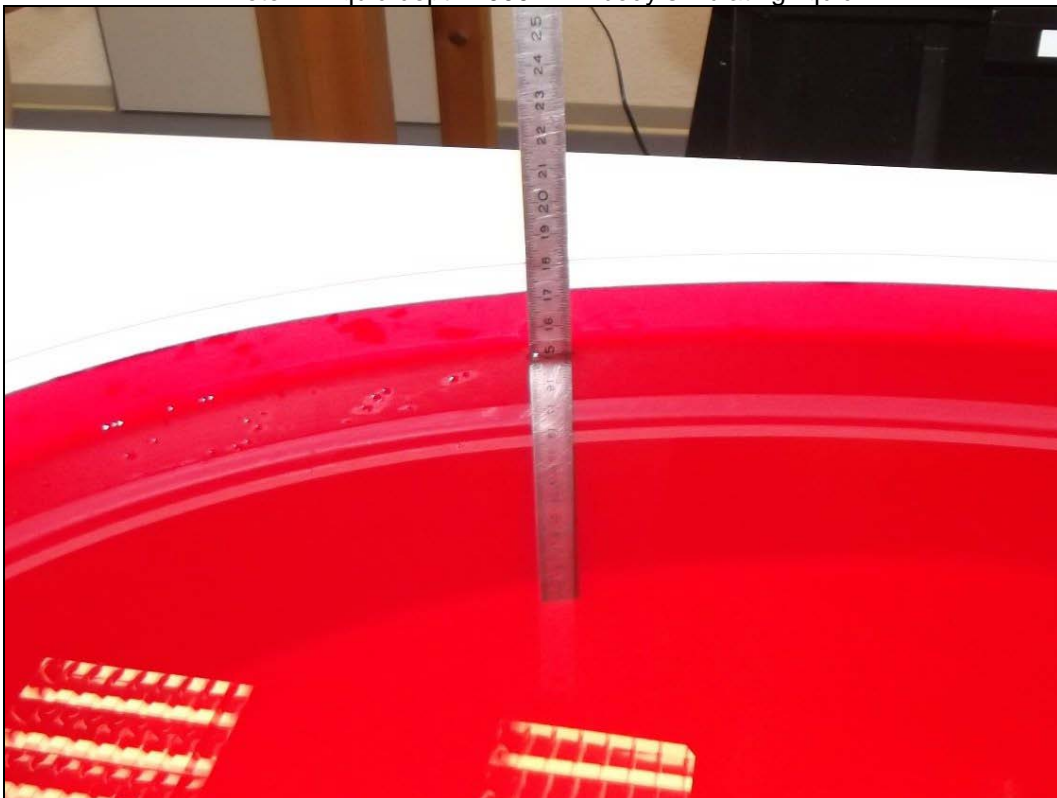

Photo 3: Liquid depth 2450 MHz body simulating liquid

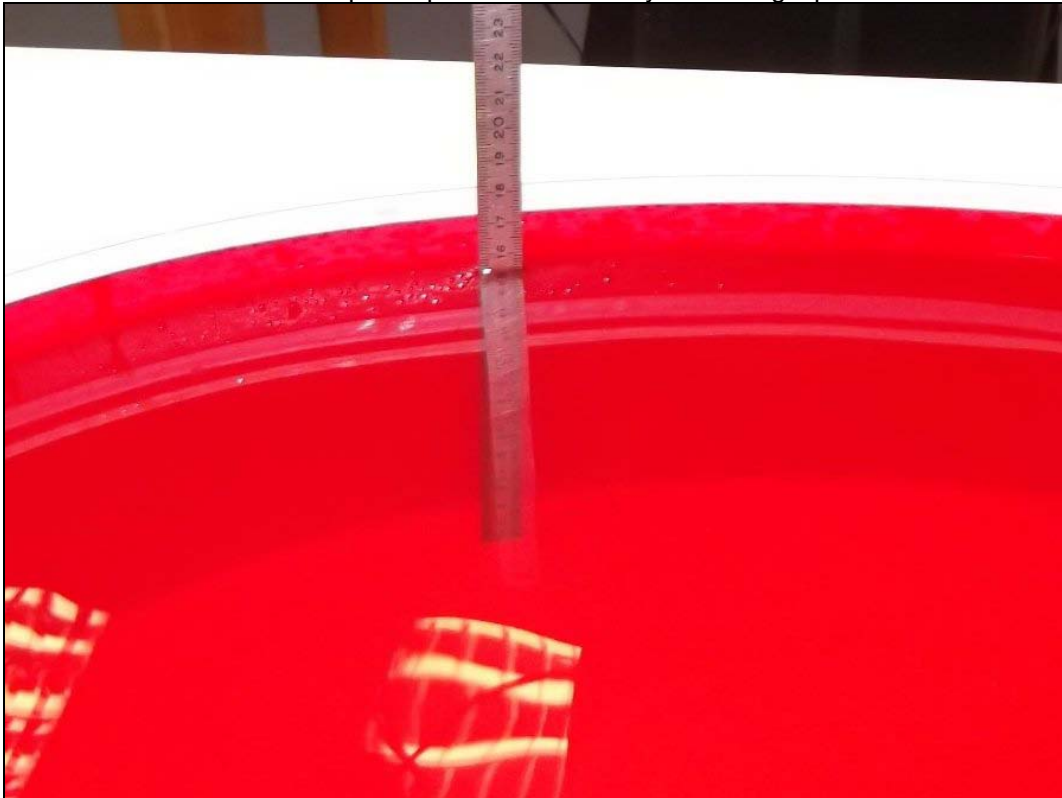
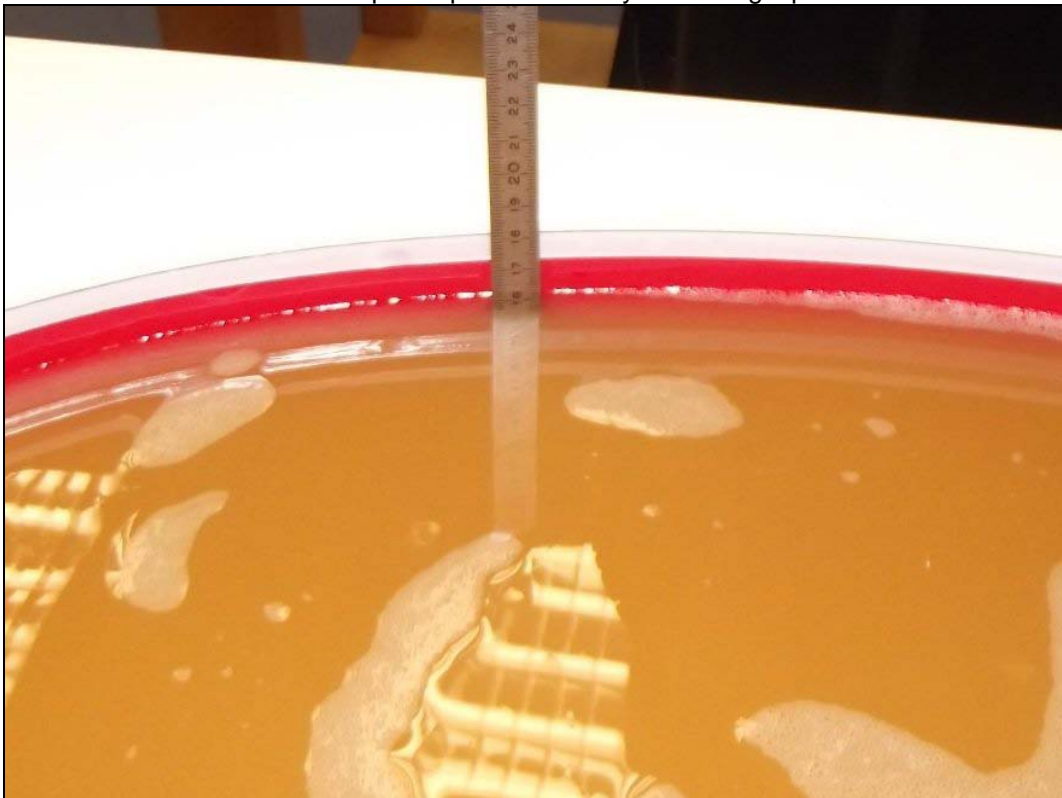

Photo 4: Liquid depth 5 GHz body simulating liquid



Annex C: Photo documentation

Photo documentation is described in the additional document:

Appendix to test report no. 1-5831/13-03-02-B Photo documentation

Annex D: RF Technical Brief Cover Sheet acc. to RSS-102 Annex A

1. COMPANY NUMBER: **4170B**
2. MODEL NUMBER: **SGP321**
3. MANUFACTURER: **Sony Mobile Communications AB**
4. TYPE OF EVALUATION:

SAR Evaluation: Body-worn Device

- Multiple transmitters: Yes No
- Evaluated against exposure limits: General Public Use Controlled Use
- Duty cycle used in evaluation: 100 %
- Standard used for evaluation: RSS-102 Issue 4 (2010-03)
- SAR value: **1.194 W/kg.** Measured Computed Calculated

Annex D.1: Declaration of RF Exposure Compliance

ATTESTATION: I attest that the information provided in Annex D: is correct; that a Technical Brief was prepared and the information it contains is correct; that the device evaluation was performed or supervised by me; that applicable measurement methods and evaluation methodologies have been followed and that the device meets the SAR and/or RF exposure limits of RSS-102.

Signature:



Date: **2013-04-13**

NAME : **Thomas Vogler**

TITLE : Dipl.-Ing. (FH)

COMPANY : CETECOM ICT Services GmbH

Annex E: Calibration parameters

Calibration parameters are described in the additional document :

Appendix to test report no. 1-5831/13-03-02-B Calibration data, Phantom certificate and detail information of the DASY System

Annex F: Document History

Version	Applied Changes	Date of Release
	Initial Release	2013-04-13
-A	Corrected chapter 7.2.8	2013-04-17
-B	Completed LTE measurements Table 33 / Table 34 / Table 4 / Table 11 Corrected Table 25 / Table 26 / Table 27	2013-05-03

Annex G: Further Information

Glossary

BW	-	Bandwidth
DTS	-	Distributed Transmission System
DUT	-	Device under Test
EUT	-	Equipment under Test
FCC	-	Federal Communication Commission
FCC ID	-	Company Identifier at FCC
HW	-	Hardware
IC	-	Industry Canada
Inv. No.	-	Inventory number
LTE	-	Long Term Evolution
N/A	-	not applicable
PCE	-	Personal Consumption Expenditure
OET	-	Office of Engineering and Technology
RB	-	resource block(s)
SAR	-	Specific Absorption Rate
S/N	-	Serial Number
SPLSR _i	-	SAR-to-(peak-locations spacing) ratio
SW	-	Software
UNII	-	Unlicensed National Information Infrastructure