



# TEST REPORT

**Test Report No. :** UL-RPT-RP10295122JD01M V4.0

**Manufacturer** : Sony Mobile Communications Inc.  
**FCC ID** : PY7PM-0801  
**Technology** : WLAN  
**Test Standard(s)** : FCC Part 15.407(h)(2)

1. This test report shall not be reproduced in full or partial, without the written approval of UL VS LTD.
2. The results in this report apply only to the sample(s) tested.
3. The sample tested is in compliance with the above standard(s).
4. The test results in this report are traceable to the national or international standards.
5. Version 4.0 supersedes all previous versions

**Date of Issue:** 31 July 2014

**Checked by:**

Sarah Williams  
Engineer, Radio Performance

**Issued by :**

pp

John Newell  
Group Quality Manager  
Basingstoke,  
UL VS LTD



This laboratory is accredited by UKAS.  
The tests reported herein have been  
performed in accordance with its' terms  
of accreditation.

---

## UL VS LTD

Pavilion A, Ashwood Park, Ashwood Way, Basingstoke, Hampshire, RG23 8BG, UK  
Telephone: +44 (0)1256 312000  
Facsimile: +44 (0)1256 312001

This page has been left intentionally blank.

---

**Table of Contents**

<b>1. Customer Information.....</b>	<b>4</b>
<b>2. Summary of Testing.....</b>	<b>5</b>
2.1. General Information	5
2.2. Summary of Test Results	5
2.3. Methods and Procedures	5
2.4. Deviations from the Test Specification	5
<b>3. Equipment Under Test (EUT) .....</b>	<b>6</b>
3.1. Identification of Equipment Under Test (EUT)	6
3.2. Description of EUT	6
3.3. Modifications Incorporated in the EUT	6
3.4. Additional Information Related to Testing	6
3.5. Support Equipment	7
<b>4. Operation and Monitoring of the EUT during Testing .....</b>	<b>8</b>
4.1. Operating Modes	8
4.2. Configuration and Peripherals	8
<b>5. Measurements, Examinations and Derived Results .....</b>	<b>12</b>
5.1. General Comments	12
5.2. Test Results	13
5.2.1. Channel Closing Transmission Time and Channel Move Time	13
<b>6. Measurement Uncertainty .....</b>	<b>16</b>
<b>7. Report Revision History .....</b>	<b>17</b>
<b>Appendix 1. Radar Calibration .....</b>	<b>18</b>
<b>Appendix 2. Aeroflex Test Platform Approval email.....</b>	<b>19</b>
<b>Appendix 3. System Noise Floor Reference Plots.....</b>	<b>20</b>
<b>Appendix 4. Channel Loading.....</b>	<b>21</b>

### **1. Customer Information**



<b>Company Name:</b>	Sony Mobile Communications Inc.
<b>Address:</b>	Nya Vattentornet Mobilvägen 10 Lund 22188 Sweden

## **2. Summary of Testing**

### **2.1. General Information**

<b>Specification Reference:</b>	47CFR15.407
<b>Specification Title:</b>	Code of Federal Regulations Volume 47 (Telecommunications): Part 15 Subpart E (Unlicensed National Information Infrastructure Devices) - Section 15.407
<b>Site Registration:</b>	209735
<b>Location of Testing:</b>	UL VS LTD, Unit 3 Horizon, Wade Road, Kingsland Business Park, Basingstoke, Hampshire, RG24 8AH, United Kingdom
<b>Test Date:</b>	09 June 2014

### **2.2. Summary of Test Results**

<b>FCC Reference (47CFR)</b>	<b>Measurement</b>	<b>Result</b>
Part 15.407(h)(2)(iii)	Channel Closing Transmission Time and Channel Move Time	
<b>Key to Results</b>		
 = Complied  = Did not comply		

#### **Note(s):**

1. The Manufacturer confirms that information regarding the parameters of the radar waveforms is not available to the end user.

### **2.3. Methods and Procedures**

<b>Reference:</b>	FCC KDB 905462 D02 UNII DFS Compliance Procedures v01 (June 2, 2014)
<b>Title:</b>	Compliance Measurement Procedures for Unlicensed-National Information Infrastructure Devices Operating in the 5250-5350 MHz and 5470-5725 MHz Bands Incorporating Dynamic Frequency Selection

### **2.4. Deviations from the Test Specification**

For the measurements contained within this test report, there were no deviations from, additions to, or exclusions from the test specification identified above.

### **3. Equipment Under Test (EUT)**

#### **3.1. Identification of Equipment Under Test (EUT)**

<b>Brand Name:</b>	Sony
<b>IMEI:</b>	004402452752656
<b>Serial Number:</b>	CB5A1Z1RY2
<b>Hardware Version Number:</b>	A
<b>Software Version Number:</b>	23.0.A.0.204
<b>FCC ID:</b>	PY7PM-0801

#### **3.2. Description of EUT**

The equipment under test (EUT) was a GSM/WCDMA/LTE Phone + Bluetooth, DTS/UNII a/b/g/n/ac + NFC & ANT+.

The EUT supports DFS as a Client without Radar Detection only. Wi-Fi hotspot/tethering mode is not operational in the 5 GHz bands.

#### **3.3. Modifications Incorporated in the EUT**

No modifications were applied to the EUT during testing.

#### **3.4. Additional Information Related to Testing**

<b>Technology Tested:</b>	Unlicensed National Information Infrastructure Devices (U-NII)	
<b>Type of Unit:</b>	Transceiver	
<b>Modulation:</b>	BPSK, QPSK, 16QAM, 64QAM & 256QAM	
<b>Data Rates:</b>	IEEE 802.11a	6, 9, 12, 18, 24, 36, 48 & 54 Mbps
	IEEE 802.11n HT20	MCS0 to MCS7 (1 spatial stream)
	IEEE 802.11n HT40	MCS0 to MCS7 (1 spatial stream)
	IEEE 802.11ac VHT20	MCS0 to MCS8 (1 spatial stream)
	IEEE 802.11ac VHT40	MCS0 to MCS9 (1 spatial stream)
	IEEE 802.11ac VHT80	MCS0 to MCS9 (1 spatial stream)
<b>Power Supply Requirement(s):</b>	Nominal	3.8 VDC
	Minimum	3.42 VDC
	Maximum	4.18 VDC
<b>Transmit / Receive Frequency Range:</b>	5150 to 5350 MHz 5470 to 5850 MHz	
<b>Transmit / Receive Channels Tested at 40 MHz Bandwidth setting:</b>	<b>Channel ID</b>	<b>Channel Centre Frequency (MHz)</b>
	102	5510

### **3.5. Support Equipment**

The following support equipment was used to exercise the EUT during testing:

<b>Description:</b>	Wireless Dual Band Router (DFS Master)
<b>Brand Name:</b>	Netgear
<b>Model Name or Number:</b>	N600
<b>FCC ID:</b>	PY311100155
<b>Serial Number:</b>	2P021C7W00226

<b>Description:</b>	Laptop Computer
<b>Brand Name:</b>	Dell
<b>Model Name or Number:</b>	Lattitude D610
<b>Serial Number:</b>	GN20Q1J

<b>Brand Name:</b>	Sony
<b>Description:</b>	AC Charger
<b>Model Name or Number:</b>	EP880

## **4. Operation and Monitoring of the EUT during Testing**

### **4.1. Operating Modes**

The EUT was tested in the following operating modes, unless otherwise stated:

- Operating on the channel selected by the Master device in either UNII Band 2a or UNII Band 2c.
- The Master device controls the channel bandwidth and modulation of the EUT. The Master device was set to 802.11n / MCS0 with 40 MHz channel bandwidth.
- KDB 905462 D02 *UNII DFS Compliance Procedures* states in Table 2 the EUT should be tested at maximum channel bandwidth (80 MHz for 802.11ac mode). However, the exception for 802.11ac client devices in KDB 905462 D03 *U-NII Client Devices Without Radar Detection Capability* was used to test the client device at 40 MHz channel bandwidth due to limited availability of FCC approved DFS-capable 802.11ac routers.
- For the required channel loading of >17% in KDB 905642 D02 7.7 c), a data transfer was performed between a test computer and the EUT. This gave a channel loading (duty cycle) of 19.3% at the modulation scheme and bandwidth above. See Appendix 4 *Channel Loading* for further details.

### **4.2. Configuration and Peripherals**

The EUT was tested in the following configuration(s):

- The EUT is a DFS Client without Radar Detection capability. It was tested in combination with an FCC approved Netgear DFS enabled router (FCC ID: PY311100155) being used as the Master. A Radar Type 0 was injected to the Master to test the Clients Channel Move Time and Channel Closing Transmission Time after receiving the channel shutdown command from the Master.
- All measurements were made using a conducted link. The EUT has one external antenna port fitted for test purposes. System losses for the interconnecting hardware were measured and taken into consideration.
- The Radar test platform used was the Aeroflex DFS Radar 110105 Simulator and Analyser which has been verified and accepted by Andrew Leimer of the FCC/NTIA on the 23<sup>rd</sup> of September 2011. Refer to Appendix 2 of this Test Report for the original confirmation email.
- The DFS detection threshold of -57.5 dBm (-62 + 1 dB + 3.5 dBi) was used at the Master device antenna port. Note this is not dependent on the EUT EIRP, Spectral Density or EUT Antenna Gain, only the antenna gain of the master device, as the EUT does not have radar detection.
- The Master device used for test was set to 17 dBm / 50 mW with TPC enabled.
- Plots and data were captured using a Rohde and Schwarz FSV 30 Test Receiver in spectrum analyser mode. The number of data points was increased to maximum and the trace data exported so it could be analysed in far greater detail than available on the built-in display.
- The Channel Move Time was the time taken from the end of the radar waveform to the time the Client ceased transmissions. The Channel Closing Transmission Time was calculated to the nearest sample from any additional pulses occurring >200 ms after the end of the radar.



## Setup diagram for test of DFS Client without Radar Detection.

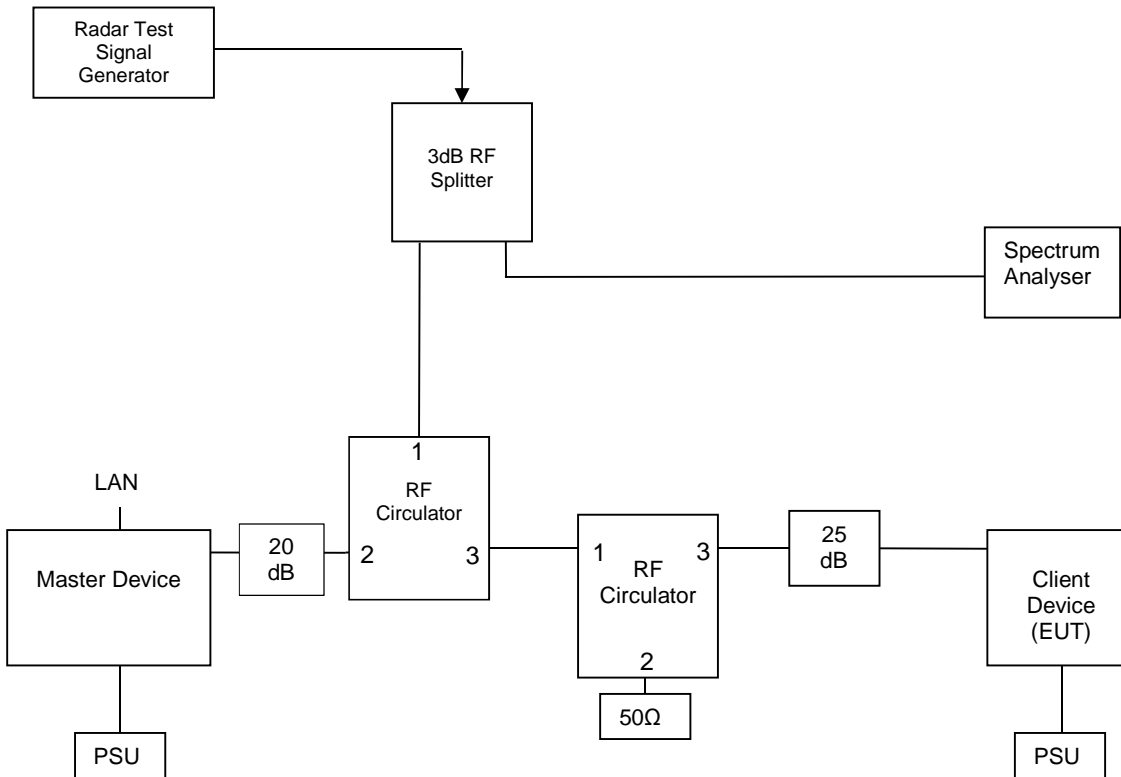

### Rationale

The setup shown above ensures the waveforms indicated on the spectrum analyser are in order of magnitude. The circulators have typically 18 dB attenuation in the reverse direction. The left-hand circulator directs the radar towards the master, ensuring there is not an overly large radar pulse into the client (EUT) even though there is the same attenuation between the client and the radar generator. The radar signal should be approximately 56 dB smaller at the client antenna port than at the master. The right-hand circulator is to give the same path loss between master and client in both directions of the 802.11 communications link.

The Radar signal is most predominant on the spectrum analyser, coming straight through a 3 dB splitter. The client is 2<sup>nd</sup> largest, being attenuated by the 25 dB, and the (typically 18 dB) isolation from the directional splitter. The smallest signal is the master, being attenuated by 20 dB from the attenuator and approximately 18 dB from the left-hand circulator and 18 dB across the splitter.

The RF path from the radar generator to the DFS Master crosses no isolated ports of any splitters or circulators and any change of impedance in load between calibration and test is isolated from any circulators by 50  $\Omega$  attenuators which further minimises mismatch. This setup therefore meets the requirements of KDB 905462 D02 clause 7.2 points (A) and (B) whilst providing greater radar generator amplitude headroom and lower radar signal at the client.

**Applicability of DFS requirements prior to use of a channel**

Requirement	Operational Mode		
	Master	Client Without Radar Detection	Client With Radar Detection
<i>Non-Occupancy Period</i>	Yes	Not required	Yes
<i>DFS Detection Threshold</i>	Yes	Not required	Yes
<i>Channel Availability Check Time</i>	Yes	Not required	Not required
<i>Uniform Spreading</i>	Yes	Not required	Yes

**Applicability of DFS requirements during normal operation**

Requirement	Operational Mode	
	Master Device or Client with Radar Detection	Client Without Radar Detection
<i>DFS Detection Threshold</i>	Yes	Not required
<i>Channel Closing Transmission Time</i>	Yes	Yes
<i>Channel Move Time</i>	Yes	Yes
<i>U-NII Detection Bandwidth</i>	Yes	Not required

Additional requirements for devices with multiple bandwidth modes	Master Device or Client with Radar Detection	Client Without Radar Detection
<i>U-NII Detection Bandwidth and Statistical Performance Check</i>	All BW modes must be tested	Not required
<i>Channel Move Time and Channel Closing Transmission Time</i>	Test using widest BW mode available	<b>Test using the widest BW mode available for the link</b>
<i>All other tests</i>	Any single BW mode	Not required

**Note:** Frequencies selected for statistical performance check (Section 7.8.4) should include several frequencies within the radar detection bandwidth and frequencies near the edge of the radar detection bandwidth. For 802.11 devices it is suggested to select frequencies in all 20 MHz channel blocks and a null frequencies between the bonded 20 MHz channel blocks.

**Interference Threshold values, Master or Client incorporating In-Service Monitoring**

Maximum Transmit Power	Value (see note)
EIRP $\geq$ 200 milliwatt	-64 dBm
EIRP < 200 milliwatt and power spectral density < 10 dBm/MHz	-62 dBm

**Note 1:** This is the level at the input of the receiver assuming a 0 dBi receive antenna **Note 2:** Throughout these test procedures an additional 1dB has been added to the amplitude of the test transmission waveforms to account for variations in measurement equipment. This will ensure that the test signal is at or above the detection threshold level to trigger a DFS response. **Note 3:** EIRP is based on the highest antenna gain. For MIMO devices refer to KDB Publication 662911 D01.

**DFS Response requirement values**

Parameter	Value
<i>Non-occupancy period</i>	Minimum 30 minutes
<i>Channel Availability Check Time</i>	60 seconds
<i>Channel Move Time</i>	10 seconds See Note 1.
<i>Channel Closing Transmission Time</i>	200 milliseconds + an aggregate of 60 milliseconds over remaining 10 second period. See Notes 1 and 2.
<i>U-NII Detection Bandwidth</i>	Minimum 100% of the U-NII 99% transmission power bandwidth. See Note 3.

**Note 1:** *Channel Move Time* and the *Channel Closing Transmission Time* should be performed with Radar Type 0. The measurement timing begins at the end of the Radar Type 0 burst. **Note 2:** The *Channel Closing Transmission Time* is comprised of 200 milliseconds starting at the beginning of the *Channel Move Time* plus any additional intermittent control signals required to facilitate a *Channel* move (an aggregate of 60 milliseconds) during the remainder of the 10 second period. The aggregate duration of control signals will not count quiet periods in between transmissions. **Note 3:** During the *U-NII Detection Bandwidth* detection test, radar type 0 should be used. For each frequency step the minimum percentage of detection is 90 percent. Measurements are performed with no data traffic.

**Short Pulse Radar Test Waveforms**

Radar Type	Pulse Width (Microseconds)	PRI (Microseconds)	Pulses	Minimum Percentage of Successful Detection	Minimum Trials
<b>0</b>	<b>1</b>	<b>1428</b>	<b>18</b>	See Note 1	See Note 1

**Note 1:** should be used for the detection bandwidth test, channel move time and channel closing time tests.

## **5. Measurements, Examinations and Derived Results**

### **5.1. General Comments**

Measurement uncertainties are evaluated in accordance with current best practice. Our reported expanded uncertainties are based on standard uncertainties, which are multiplied by an appropriate coverage factor to provide a statistical confidence level of approximately 95%. Please refer to *Section 6 Measurement Uncertainty* for details.

In accordance with UKAS requirements all the measurement equipment is on a calibration schedule. All equipment was within the calibration period on the date of testing.

**5.2. Test Results****5.2.1. Channel Closing Transmission Time and Channel Move Time****Test Summary:**

<b>Test Engineer:</b>	Philip Harrison	<b>Test Date:</b>	09 June 2014
<b>Test Sample IMEI:</b>	004402452752656		

<b>FCC Reference:</b>	Part 15.407(h)(2)(iii)
<b>Test Method Used:</b>	KDB 905462 D02 Section 7.8.3

**Environmental Conditions:**

<b>Temperature (°C):</b>	25
<b>Relative Humidity (%):</b>	47

**Note(s):**

1. The channel move time is the time taken from the end of the radar burst to the ceasing of transmissions of the EUT.
2. The Total Aggregate Channel Closing Transmission Time shown in the table below was measured from 200 ms after the end of the radar burst and compared to the 60 ms limit.
3. The smaller transmissions seen in the plot that are less than -52 dBm, come from the Master device and not from the Client, these transmissions can be ignored for the below results.

**Results:**

<b>Radar #</b>	<b>Channel Frequency (MHz)</b>	<b>Channel Move Time (ms)</b>	<b>Total Aggregate Channel Closing Time after first 200 ms (ms)</b>	<b>Limit (ms)</b>	<b>Margin (ms)</b>	<b>Status</b>
1	5510	129.75	-	10000	9870.25	Complied
1	5510	-	0	60	60	Complied

Radar burst type 0 was detected and channel move occurred.

**Channel Closing Transmission Time and Channel Move Time (continued)**

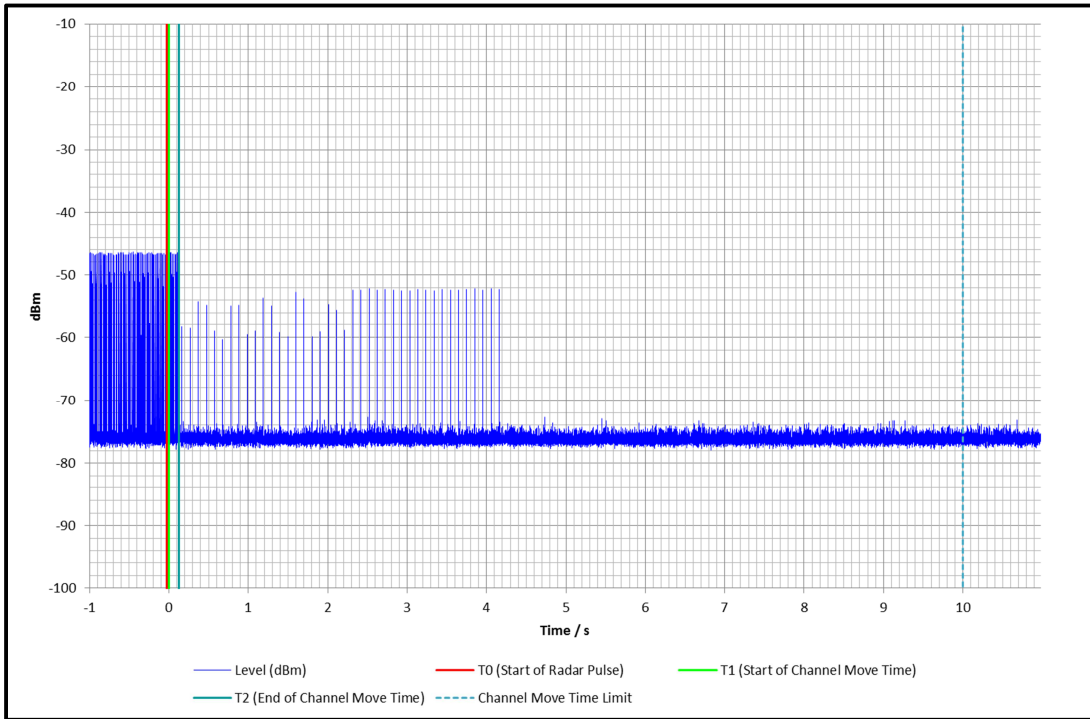

**Channel Move Time 5510 MHz – Short Radar (Type 0) - Full 10 seconds**

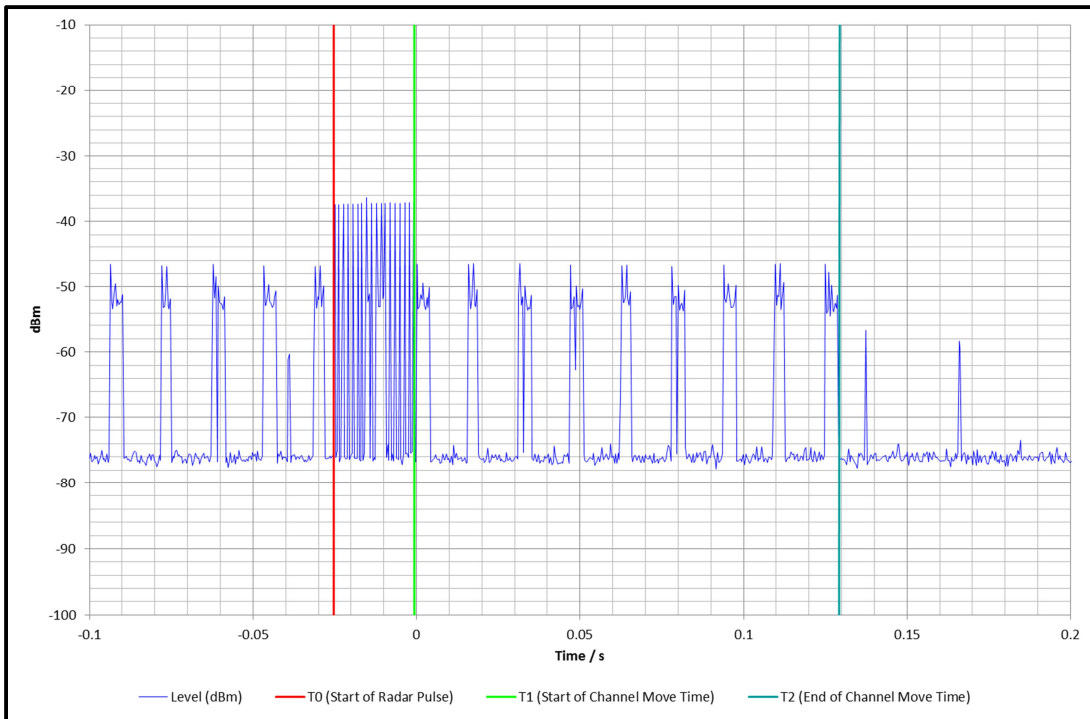

**Channel Move Time 5510 MHz – Short Radar (Type 0) – Zoomed Plot**

**Channel Closing Transmission Time and Channel Move Time (continued)****Test Equipment Used:**

<b>Asset No.</b>	<b>Instrument</b>	<b>Manufacturer</b>	<b>Type No.</b>	<b>Serial No.</b>	<b>Date Calibration Due</b>	<b>Cal. Interval (Months)</b>
M1631	DFS Test System	Aeroflex	PXI 3000	300110/291	11 Jun 2015	24
M1873	Spectrum Analyser	Rohde & Schwarz	FSV30	103074	15 May 2015	12
A030	Step Attenuator	Narda	445-69	01544	Calibrated before use	-
A090	Step Attenuator	Narda	743-80	01057	Calibrated before use	-
A2179	Coaxial Circulator 4-18GHz	AtlanTecRF	ACC-20130-SF-SF-SF	120409230	Calibrated before use	-
A2182	Coaxial Circulator 4-18GHz	AtlanTecRF	ACC-20130-SF-SF-SF	120409231	Calibrated before use	-
A2121	Splitter	Mini-Circuits	ZN2PD-63-S+	S UU12701203	Calibrated before use	-
M1657	Thermohygrometer	JM Handelspunkt	30.5015.13	None stated	14 Mar 2015	12

## **6. Measurement Uncertainty**

No measurement or test can ever be perfect and the imperfections give rise to error of measurement in the results. Consequently the result of a measurement is only an approximation to the value of the measurand (the specific quantity subject to measurement) and is only complete when accompanied by a statement of the uncertainty of the approximation.

The expression of uncertainty of a measurement result allows realistic comparison of results with reference values and limits given in specifications and standards.

The uncertainty of the result may need to be taken into account when interpreting the measurement results.

The reported expanded uncertainties below are based on a standard uncertainty multiplied by an appropriate coverage factor such that a confidence level of approximately 95% is maintained. For the purposes of this document “approximately” is interpreted as meaning “effectively” or “for most practical purposes”.

<b>Measurement Type</b>	<b>Range</b>	<b>Confidence Level (%)</b>	<b>Calculated Uncertainty</b>
DFS Radar Amplitude	5.15 GHz to 5.825 GHz	95%	±2.17 dB
Channel Shutdown Timing	5.15 GHz to 5.825 GHz	95%	±0.45 ms

The methods used to calculate the above uncertainties are in line with those recommended within the various measurement specifications. Where measurement specifications do not include guidelines for the evaluation of measurement uncertainty the published guidance of the appropriate accreditation body is followed.



## **7. Report Revision History**

<b>Version Number</b>	<b>Revision Details</b>		
	<b>Page No(s)</b>	<b>Clause</b>	<b>Details</b>
1.0	-	-	Initial Version
2.0	-	-	Removal of photographs from report
3.0	10 & 11	-	Additional information added
4.0	-	-	EUT Description update

## Appendix 1. Radar Calibration

### Radar calibration procedure.

The system was configured as shown in section 4.2, but with the spectrum analyser port terminated into a 50Ω load, and a spectrum analyser connected to the master port. The radar was then replayed by the Aeroflex DFS test system, the waveform captured, and the amplitude adjusted until correct.

The accuracy of the radars pulses themselves and the software which creates them has already been approved by the FCC and NTIA. See Appendix 3 for details.

Due to the difficulty of measuring the 1 μs burst accurately across the duration of a radar pulse sequence the output of the Radar generator with both CW and test Radars has been correlated. The test network loss is then calibrated using a CW signal from the radar generator, and an offset put into the radar generation software. All radars are then generated at the correct level at the Master device antenna port.

Below is an example plot of the type 0 radar burst at the DFS master port of the attenuation network. The Aeroflex signal generator was set to -57.5 dBm output and the correct path loss offset applied.

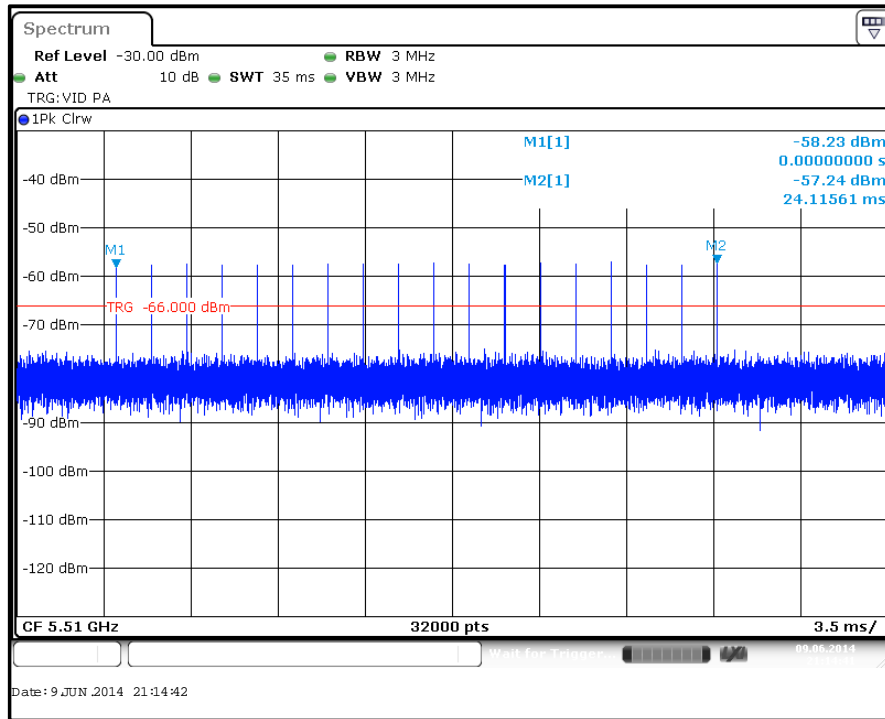

Type 0 Radar

**Appendix 2. Aeroflex Test Platform Approval email**

From: Andrew Leimer [<mailto:Andrew.Leimer@fcc.gov>]  
Sent: Friday, September 23, 2011 4:24 PM  
To: Chisham, Steve  
Cc: Carey, Tim; Hack, Barry; Rashmi Doshi; Joe Dichoso  
Subject: RE: Certification for Aeroflex DFS solution

Hello Steve,

The Aeroflex "DXI based DFS test solution" system used for DFS alternative radar signal generation has been approved by the FCC and NTIA.

This approval permits the system to be used by labs in the testing of DFS devices for equipment authorization Certification. It is recommended that applicants that use your system for testing include a statement in the Test Report or a Letter Exhibit stating that the system has FCC and NTIA approval. This E-mail is your record of this approval.

Note that the appropriate term for your system is Approved as the term Certification is reserved for devices gaining equipment authorization through the FCC or a TCB.

Regards,

Andy Leimer

FCC/OET/EACB

### Appendix 3. System Noise Floor Reference Plots

As required by Section 8.3.4(iii) of KDB 905462 D02, the following plot shows the reference noise floor of the system used during measurement. It also shows compliance with Section 8.3.7 of KDB 905462 D02 when the path loss of the coupling network shown in Section 4.2 *Configuration and Peripherals* is added to the noise floor.

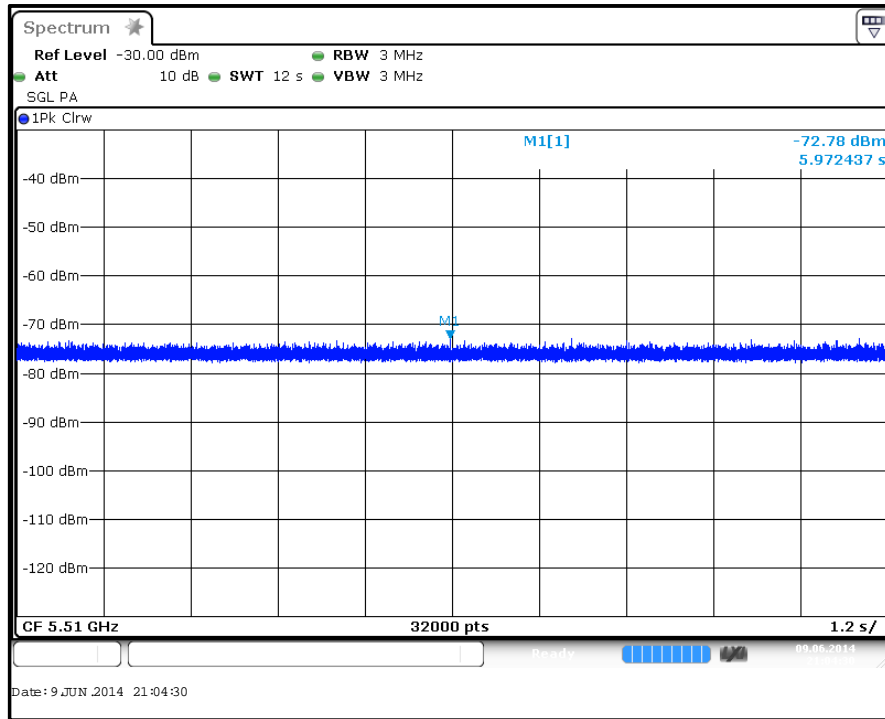

**Noise Floor of Spectrum Analyser**

### Appendix 4. Channel Loading

As required by Section 8.3. 3 f) of KDB 605642 D02, the following plot and calculations shows the duty cycle of the channel used during testing.

Streaming representative file types as defined in Section 7.7 a) of KDB 605642 D02, were found not to produce a high enough duty cycle of >17%, as required by 7.7 c), on a 40 MHz channel bandwidth. This included lowest data rate with modulation coding scheme MCS0, maximum video size (1080p) and the minimum video compression ratio during encoding. Therefore alternative pseudo-random data transfer as per 7.7 b) was streamed to simulate data transfer. A suitable duty cycle was obtained with the link limited to MCS0 and a data transfer of 2 Mbps.

The duty cycle was calculated over 200 milliseconds. This was captured on a spectrum analyser in the time domain using a 0 Hz span and 32000 sweep points to ensure accuracy to 6.25 µs sample size.

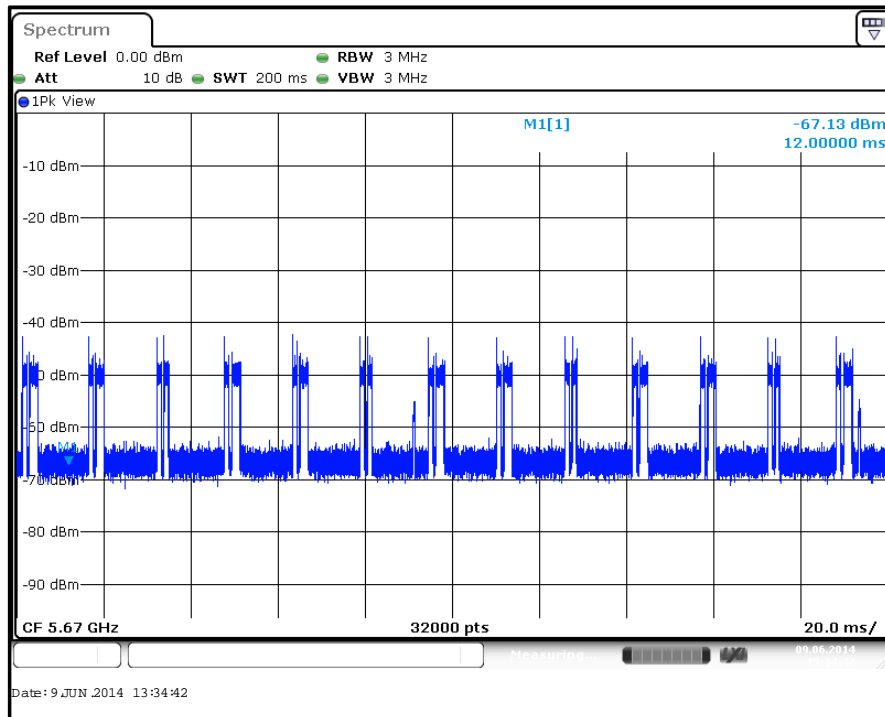

The number of samples greater than -60 dBm was compared to the total number of samples to calculate the duty cycle. The EUT and test router were found to be transmitting above this threshold for 6166 of the 25834 seconds, resulting in a channel loading of 19.27 %, and hence meeting the requirement of greater than 17 %.

--- END OF REPORT ---