**CETECOM™****CETECOM ICT Services**  
consulting - testing - certification >>>

## TEST REPORT

Test Report No.: 1-6965/13-19-02



### Testing Laboratory

**CETECOM ICT Services GmbH**Untertürkheimer Straße 6 – 10  
66117 Saarbrücken/Germany  
Phone: + 49 681 5 98 - 0  
Fax: + 49 681 5 98 - 9075  
Internet: <http://www.cetecom.com>  
e-mail: [ict@cetecom.com](mailto:ict@cetecom.com)**Accredited Test Laboratory:**

The testing laboratory (area of testing) is accredited according to DIN EN ISO/IEC 17025 (2005) by the Deutsche Akkreditierungsstelle GmbH (DAkkS) The accreditation is valid for the scope of testing procedures as stated in the accreditation certificate with the registration number: D-PL-12076-01-01

### Applicant

**Sony Mobile Communications AB**Nya Vattentorget  
22188 Lund/SWEDEN

Phone: +46 46 19 30 00

Contact: Mikael Nilsson  
e-mail: [Micke.nilsson@sonymobile.com](mailto:Micke.nilsson@sonymobile.com)  
Phone: +46 7 03 22 75 03  
Fax: -/-

### Manufacturer

**Sony Mobile Communications AB**Nya Vattentorget  
22188 Lund/SWEDEN

### Test Standard/s

IEEE 1528-2003

Recommended Practice for Determining the Peak Spatial-Average Specific Absorption Rate (SAR) in the Human Head from Wireless Communications Devices: Measurement Techniques

RSS-102 Issue 4

Radio Frequency Exposure Compliance of Radiocommunication Apparatus (All Frequency Bands)

For further applied test standards please refer to section 3 of this test report.

### Test Item

Kind of test item: Smart Phone  
Device type: portable device  
**Model name:** **PY7PM-0751-BV**  
S/N serial number: CB5126Z4PZ / CB5126Z4RE / CB5126Z4R3 / CB5126Z4RN/ CB5126Z4MR  
FCC-ID: PY7PM-0751  
IMEI-Number: 004402452659109 / 004402452659026 / 004402452658952 / 004402452659018  
Hardware status: AP1.0  
Software status: 17.1.1A.0.348  
Frequency: see technical details  
Antenna: integrated antenna  
Battery option: Embedded battery  
Accessories: ---  
Test sample status: identical prototype  
Exposure category: general population / uncontrolled environment

This test report is electronically signed and valid without handwriting signature. For verification of the electronic signatures, the public keys can be requested at the testing laboratory.

**Test Report authorised:****Test performed:**Oleksandr Hnatovskiy  
Testing ManagerMarco Scigliano  
Expert

<b>1</b>	<b>Table of contents</b>	<b>2</b>
1	Table of contents.....	2
2	General information .....	4
2.1	Notes and disclaimer .....	4
2.2	Application details .....	4
2.3	Statement of compliance .....	4
2.4	Technical details.....	5
2.5	Transmitter and Antenna Operating Configurations .....	6
3	Test standards/ procedures references .....	7
3.1	RF exposure limits .....	8
4	Summary of Measurement Results .....	9
4.1	SAR measurement variability and measurement uncertainty analysis.....	10
5	Test Environment .....	10
6	Test Set-up.....	11
6.1	Measurement system.....	11
6.1.1	System Description.....	11
6.1.2	Test environment.....	12
6.1.3	Probe description.....	12
6.1.4	Phantom description.....	13
6.1.5	Device holder description .....	14
6.1.6	Scanning procedure .....	15
6.1.7	Spatial Peak SAR Evaluation .....	16
6.1.8	Data Storage and Evaluation.....	17
6.1.9	Tissue simulating liquids: dielectric properties .....	19
6.1.10	Tissue simulating liquids: parameters .....	20
6.1.11	Measurement uncertainty evaluation for SAR test.....	22
6.1.12	Measurement uncertainty evaluation for System Check.....	26
6.1.13	System check .....	28
6.1.14	System check procedure .....	29
6.1.15	System validation .....	30
7	Detailed Test Results .....	31
7.1	Conducted power measurements.....	31
7.1.1	Conducted power measurements GSM 850 MHz.....	32
7.1.2	Conducted power measurements GSM 1900 MHz.....	33
7.1.3	Justification of SAR measurements in GSM mode .....	33
7.1.4	Conducted power measurements WCDMA FDD V (850 MHz).....	34
7.1.5	Conducted power measurements WCDMA FDD II (1900 MHz) .....	35
7.1.6	Test-set-up information for WCDMA / HSPDA / HSUPA .....	36
7.1.7	Conducted power measurements LTE FDD 2 1900 MHz.....	41
7.1.8	Conducted power measurements LTE FDD 5 850 MHz.....	44
7.1.9	Justification of SAR measurements in LTE mode .....	48
7.1.10	MPR information in LTE mode .....	48
7.1.11	Conducted power measurements WLAN 2.4 GHz.....	49
7.1.12	Conducted power measurements WLAN 5 GHz.....	50
7.1.13	Standalone SAR Test Exclusion .....	52
7.1.14	Hotspot mode SAR measurement positions .....	53
7.2	SAR test results.....	54
7.2.1	Results overview .....	54
7.2.2	General description of test procedures .....	68
7.2.3	Multiple Transmitter Information.....	69

<b>8</b>	<b>Test equipment and ancillaries used for tests .....</b>	<b>73</b>
<b>9</b>	<b>Observations .....</b>	<b>73</b>
<b>Annex A:</b>	<b>System performance check .....</b>	<b>74</b>
<b>Annex B:</b>	<b>DASY5 measurement results .....</b>	<b>95</b>
	<b>Annex B.1: GSM 850 .....</b>	<b>95</b>
	<b>Annex B.2: GSM 1900 .....</b>	<b>98</b>
	<b>Annex B.3: UMTS FDD II .....</b>	<b>101</b>
	<b>Annex B.4: UMTS FDD V .....</b>	<b>104</b>
	<b>Annex B.5: LTE FDD 2 .....</b>	<b>107</b>
	<b>Annex B.6: LTE FDD 5 .....</b>	<b>111</b>
	<b>Annex B.7: LTE FDD 7 .....</b>	<b>114</b>
	<b>Annex B.8: WLAN 2450MHz .....</b>	<b>117</b>
	<b>Annex B.9: WLAN 5GHz .....</b>	<b>120</b>
	<b>Annex B.10: Liquid depth .....</b>	<b>122</b>
<b>Annex C:</b>	<b>Photo documentation .....</b>	<b>126</b>
<b>Annex D:</b>	<b>Calibration parameters .....</b>	<b>126</b>
<b>Annex E:</b>	<b>Document History .....</b>	<b>127</b>
<b>Annex F:</b>	<b>Further Information .....</b>	<b>127</b>

## 2 General information

### 2.1 Notes and disclaimer

The test results of this test report relate exclusively to the test item specified in this test report. CETECOM ICT Services GmbH does not assume responsibility for any conclusions and generalisations drawn from the test results with regard to other specimens or samples of the type of the equipment represented by the test item. The test report may only be reproduced or published in full. Reproduction or publication of extracts from the report requires the prior written approval of CETECOM ICT Services GmbH.

This test report is electronically signed and valid without handwriting signature. For verification of the electronic signatures, the public keys can be requested at the testing laboratory.

The testing service provided by CETECOM ICT Services GmbH has been rendered under the current "General Terms and Conditions for CETECOM ICT Services GmbH".

CETECOM ICT Services GmbH will not be liable for any loss or damage resulting from false, inaccurate, inappropriate or incomplete product information provided by the customer.

Under no circumstances does the CETECOM ICT Services GmbH test report include any endorsement or warranty regarding the functionality, quality or performance of any other product or service provided.

Under no circumstances does the CETECOM ICT Services GmbH test report include or imply any product or service warranties from CETECOM ICT Services GmbH, including, without limitation, any implied warranties of merchantability, fitness for purpose, or non-infringement, all of which are expressly disclaimed by CETECOM ICT Services GmbH.

All rights and remedies regarding vendor's products and services for which CETECOM ICT Services GmbH has prepared this test report shall be provided by the party offering such products or services and not by CETECOM ICT Services GmbH.

In no case this test report can be considered as a Letter of Approval.

### 2.2 Application details

Date of receipt of order:	2014-04-14
Date of receipt of test item:	2014-04-28
Start of test:	2014-05-06
End of test:	2014-05-22
Person(s) present during the test:	

### 2.3 Statement of compliance

The SAR values found for the PY7PM-0751-BV Smart Phone are below the maximum recommended levels of 1.6 W/Kg as averaged over any 1 g tissue according to the FCC rule §2.1093, the ANSI/IEEE C 95.1:1992, the NCRP Report Number 86 for uncontrolled environment, according to the Health Canada's Safety Code 6 and the Industry Canada Radio Standards Specification RSS-102 for General Population/Uncontrolled exposure.

For body worn operation, this device has been tested and meets FCC RF exposure guidelines when used with any accessory that contains no metal and that positions the handset a minimum of 15 mm from the body. Use of other accessories may not ensure compliance with FCC RF exposure guidelines.

According to KDB pub 941225 D06 this device has been tested with 10 mm distance to the phantom for operation in WLAN hot spot mode.

## 2.4 Technical details

Band tested for this test report	Technology	Lowest transmit frequency/MHz	Highest transmit frequency/MHz	Lowest receive Frequency/MHz	Highest receive Frequency/MHz	Kind of modulation	Power Class	Tested power control level	GPRS/EGPRS mobile station class	GPRS/EGPRS multislots class	(E)GPRS voice mode or DTM	Test channel low	Test channel middle	Test channel high	Maximum output power/dBm )*
<input type="checkbox"/>	GSM	880.2	914.8	925.2	959.8	GMSK 8-PSK	4 E2	5	A	33	yes	975	37	124	33.4
<input type="checkbox"/>	GSM DCS	1710.2	1784.8	1805.2	1879.8	GMSK 8-PSK	1 E2	0	A	33	yes	512	698	885	30.5
<input checked="" type="checkbox"/>	GSM cellular	824.2	848.8	869.2	893.8	GMSK 8-PSK	4 E2	5	A	33	yes	128	190	251	33.1
<input checked="" type="checkbox"/>	GSM PCS	1850.2	1909.8	1930.2	1989.8	GMSK 8-PSK	1 E2	0	A	33	yes	512	661	810	30.5
<input type="checkbox"/>	UMTS FDD I	1922.4	1977.6	2112.4	2167.6	QPSK	3	max	--	--	--	9612	9750	9888	24.3
<input checked="" type="checkbox"/>	UMTS FDD II	1852.4	1907.6	1932.4	1987.6	QPSK	3	max	--	--	--	9262	9400	9538	22.9
<input checked="" type="checkbox"/>	UMTS FDD V	826.4	846.6	871.4	891.6	QPSK	3	max	--	--	--	4132	4182	4233	23.9
<input type="checkbox"/>	UMTS FDD VIII	882.4	912.6	927.4	957.6	QPSK	3	max	--	--	--	2712	2788	2863	24.5
<input type="checkbox"/>	LTE FDD 1	1920	1980	2110	2170	QPSK	3	max	--	--	--	18100	18300	18500	23.7
<input checked="" type="checkbox"/>	LTE FDD 2	1850	1910	1930	1990	QPSK	3	max	--	--	--	18700	18900	19100	22.6
<input type="checkbox"/>	LTE FDD 3	1710	1785	1805	1880	QPSK	3	max	--	--	--	19300	19575	19850	23.6
<input checked="" type="checkbox"/>	LTE FDD 5	824	849	869	894	QPSK	3	max	--	--	--	20450	20525	20600	23.5
<input checked="" type="checkbox"/>	LTE FDD 7	2500	2570	2620	2690	QPSK	3	max	--	--	--	20850	21100	21350	22.7
<input type="checkbox"/>	LTE FDD 8	880	915	925	960	QPSK	3	max	--	--	--	21500	21625	21750	23.4
<input type="checkbox"/>	LTE FDD 28	703	748	758	803	QPSK	3	max	--	--	--	27310	27435	27560	23.5
<input type="checkbox"/>	WLAN	2412	2472	2412	2472	CCK OFDM	--	max	--	--	--	1	7	13	16.5
<input checked="" type="checkbox"/>	WLAN US	2412	2462	2412	2462	CCK OFDM	--	max	--	--	--	1	6	11	16.4
<input checked="" type="checkbox"/>	WLAN	5180	5240	5180	5240	OFDM	--	max	--	--	--	--	--	48	14.5
<input checked="" type="checkbox"/>	WLAN	5260	5320	5260	5320	OFDM	--	max	--	--	--	52	--	--	14.6
<input checked="" type="checkbox"/>	WLAN	5500	5700	5500	5700	OFDM	--	max	--	--	--	--	112	--	14.8
<input checked="" type="checkbox"/>	WLAN	5745	5825	5745	5825	OFDM	--	max	--	--	--	149	--	--	14.6
<input type="checkbox"/>	BT	2402	2480	2402	2480	GFSK	3	max	--	--	--	0	39	78	<10

)\*: measured slotted peak power for GSM, averaged max. RMS power for UMTS, LTE, WLAN and BT.

**Features:**

GSM bands 2.5	(GPRS, EDGE) class A, Multislot class 33 (max 4 TS uplink, max 5 TS downlink, max. 6 TS active) DTM class 11 (max 3 TS uplink, max 4 TS downlink, max 5 TS active)
Rel 9 HSDPA UE	cat 10 bands 2, 5 (QPSK, 16QAM, 64QAM, Dual-Cell, 42.2 Mbps)
Rel 9 HSPA UE	cat: 6 bands 2, 5 (QPSK, no 16QAM, 5.76 Mbps)
Rel 10 LTE UE	cat: 4 bands 2, 5, 7 (QPSK, 16QAM, no MIMO, 50Mbps uplink)
LTE FDD	RX Diversity antenna
WLAN	WiFi Hotspot – Auto RF power reduction
BT BR / BT LE	
ANT+	
RFID 13.56 MHz	

## 2.5 Transmitter and Antenna Operating Configurations

Simultaneous transmission conditions	
GSM / GPRS / EDGE / DTM	+ BT/BLE <sup>1</sup>
GSM / GPRS / EDGE / DTM	+ WLAN 2.4GHz
GSM / GPRS / EDGE / DTM	+ WLAN 5GHz
UMTS / HSPA	+ BT/BLE
UMTS / HSPA	+ WLAN 2.4GHz
UMTS / HSPA	+ WLAN 5GHz
LTE	+ BT/BLE
LTE	+ WLAN 2.4GHz
LTE	+ WLAN 5GHz
GSM / GPRS / EDGE / DTM	+ BT + WLAN 5GHz
UMTS / HSPA	+ BT + WLAN 5GHz
LTE	+ BT + WLAN 5GHz

Table 1: Simultaneous transmission conditions

Note: BT and WLAN can be active at the same time, but only with interleaving of packages switched on board level. That means that they don't transmit at the same time.

BLE<sup>1</sup> - Bluetooth low energy

### 3 Test standards/ procedures references

Test Standard	Version	Test Standard Description
IEEE 1528-2003	2003-04	Recommended Practice for Determining the Peak Spatial-Average Specific Absorption Rate (SAR) in the Human Head from Wireless Communications Devices: Measurement Techniques
IEEE 1528-2013	2014-06	Recommended Practice for Determining the Peak Spatial-Average Specific Absorption Rate (SAR) in the Human Head from Wireless Communications Devices: Measurement Techniques
RSS-102 Issue 4	2010-03	Radio Frequency Exposure Compliance of Radiocommunication Apparatus (All Frequency Bands)
IEEE Std. C95-3	2002	IEEE Recommended Practice for the Measurement of Potentially Hazardous Electromagnetic Fields – RF and Microwave
IEEE Std. C95-1	1992	IEEE Standard for Safety Levels with Respect to Human Exposure to Radio Frequency Electromagnetic Fields, 3 kHz to 300 GHz.
IEC 62209-2	2010	Human exposure to radio frequency fields from hand-held and bodymounted wireless communication devices. Human models, instrumentation, and procedures. Procedure to determine the specific absorption rate (SAR) for wireless communication devices used in close proximity to the human body (frequency range of 30 MHz to 6 GHz)
FCC KDBs:		
KDB 865664D01v01	May 28, 2013	FCC OET SAR measurement requirements 100 MHz to 6 GHz
KDB 865664D02v01	May 28, 2013	RF Exposure Compliance Reporting and Documentation Considerations
KDB 447498D01v05	February 7, 2014	Mobile and Portable Devices RF Exposure Procedures and Equipment Authorization Policies
KDB 648474D04v01	May 28, 2013	SAR Evaluation Considerations for Wireless Handsets
KDB 941225D01v02	April 10, 2007	SAR Measurements Procedures for 3G Devices
KDB 941225D02v01	December 14, 2009	3GPP R6 HSPA and R7 HSPA+ SAR Guidance
KDB 941225D02v02	May 28, 2013	SAR Guidance for HSPA, HSPA+, DC-HSDPA and 1x-Advanced
KDB 941225D05v02	May 28, 2013	SAR for LTE Devices
KDB 941225D03v01	December, 2008	SAR Test Reduction Procedure for GSM/GPRS/EDGE
KDB 941225D06v01	May 28, 2013	SAR Evaluation Procedures for Portable Devices with Wireless Router Capabilities
KDB 248227D01v01	May, 2007	SAR Measurement Procedures for 802.11 a/b/g Transmitters
KDB 450824D01v01	January, 2007	SAR Probe Calibration and System Verification considerations for measurements from 150 MHz to 3 GHz
KDB 450824D01v01	March 4, 2012	Dipole Requirements for SAR System Validation and Verification

### 3.1 RF exposure limits

Human Exposure	Uncontrolled Environment General Population	Controlled Environment Occupational
Spatial Peak SAR* (Brain and Trunk)	<b>1.60 mW/g</b>	8.00 mW/g
Spatial Average SAR** (Whole Body)	0.08 mW/g	0.40 mW/g
Spatial Peak SAR*** (Hands/Feet/Ankle/Wrist)	4.00 mW/g	20.00 mW/g

Table 2: RF exposure limits

The limit applied in this test report is shown in bold letters

Notes:

- \* The Spatial Peak value of the SAR averaged over any 1 gram of tissue (defined as a tissue volume in the shape of a cube) and over the appropriate averaging time
- \*\* The Spatial Average value of the SAR averaged over the whole body.
- \*\*\* The Spatial Peak value of the SAR averaged over any 10 grams of tissue (defined as a tissue volume in the shape of a cube) and over the appropriate averaging time.

Uncontrolled Environments are defined as locations where there is the exposure of individuals who have no knowledge or control of their exposure.

Controlled Environments are defined as locations where there is exposure that may be incurred by persons who are aware of the potential for exposure, (i.e. as a result of employment or occupation).



#### 4 Summary of Measurement Results

<input checked="" type="checkbox"/>	No deviations from the technical specifications ascertained		
<input type="checkbox"/>	Deviations from the technical specifications ascertained		
<b>Maximum SAR value reported for 1g (W/kg)</b>			
	<b>PCE</b>	<b>DTS</b>	<b>UNII</b>
<b>head</b>	<b>0.605</b>	<b>0.369</b>	<b>0.207</b>
<b>body worn 15 mm distance</b>	<b>1.236</b>	<b>0.135</b>	<b>0.234</b>
<b>hotspot operation 10 mm distance</b>	<b>1.206</b>	<b>0.262</b>	not supported
<b>collocated situations</b>	<b>ΣSAR evaluation</b>	<b>1.591</b>	

HEAD	SAR <sub>1g</sub> results(W/kg)		SAR <sub>10g</sub> (W/kg)	
	Measured	Extrapolated	Meas.	Extrap.
GSM 850	<b>0.605</b>	<b>0.605</b>	<b>0.464</b>	<b>0.464</b>
GSM 1900	0.331	0.339	0.205	0.210
UMTS FDD II	0.445	0.455	0.277	0.283
UMTS FDD V	0.506	0.518	0.388	0.397
LTE FDD 2	0.368	0.453	0.232	0.285
LTE FDD 5	0.395	0.454	0.305	0.350
LTE FDD 7	0.198	0.207	0.105	0.110
WLAN 2450	0.300	0.369	0.142	0.175
WLAN 5 GHz	0.180	0.207	0.060	0.069
Bluetooth 2450	not tested	not tested	not tested	not tested

HOTSPOT	SAR <sub>1g</sub> results(W/kg)		SAR <sub>10g</sub> (W/kg)	
	Measured	Extrapolated	Meas.	Extrap.
GSM 850	0.751	0.768	0.570	0.583
GSM 1900	0.797	0.797	0.443	0.443
UMTS FDD II	<b>1.120</b>	1.146	<b>0.603</b>	0.617
UMTS FDD V	0.620	0.649	0.470	0.492
LTE FDD 2	1.040	1.194	0.555	<b>0.637</b>
LTE FDD 5	0.561	0.644	0.428	0.491
LTE FDD 7	1.100	<b>1.206</b>	0.511	0.560
WLAN 2450	0.213	0.262	0.104	0.128
Bluetooth 2450	not tested	not tested	not tested	not tested

BODY WORN	SAR <sub>1g</sub> results(W/kg)		SAR <sub>10g</sub> (W/kg)	
	Measured	Extrapolated	Meas.	Extrap.
GSM 850	0.569	0.582	0.431	0.441
GSM 1900	0.463	0.463	0.273	0.273
UMTS FDD II	0.547	0.560	0.322	0.330
UMTS FDD V	0.428	0.438	0.323	0.331
LTE FDD 2	0.521	0.609	0.307	0.363
LTE FDD 5	0.449	0.516	0.343	0.394
LTE FDD 7	<b>1.180</b>	<b>1.236</b>	<b>0.605</b>	<b>0.634</b>
WLAN 2450	0.110	0.135	0.056	0.069
WLAN 5 GHz	0.204	0.234	0.075	0.086
Bluetooth 2450	not tested	not tested	not tested	not tested

#### 4.1 SAR measurement variability and measurement uncertainty analysis

This analysis is required for worst case results larger than 0.8 W/kg.

frequency band	highest original measurement result at worst case position (W/kg)	repeated measurement result at worst case position (W/kg)	ratio <1.2
UMTS FDD II	1.120	1.030	1.09
LTE FDD 2	1.040	0.925	1.12
LTE FDD 7	1.180	1.130	1.04

#### 5 Test Environment

Ambient temperature:	20 – 24 °C
Tissue Simulating liquid:	20 – 24 °C
Relative humidity content:	40 – 50 %
Air pressure:	not relevant for this kind of testing
Power supply:	230 V / 50 Hz

Exact temperature values for each test are shown in the table(s) under 7.1 and/or on the measurement plots.

## 6 Test Set-up

### 6.1 Measurement system

#### 6.1.1 System Description

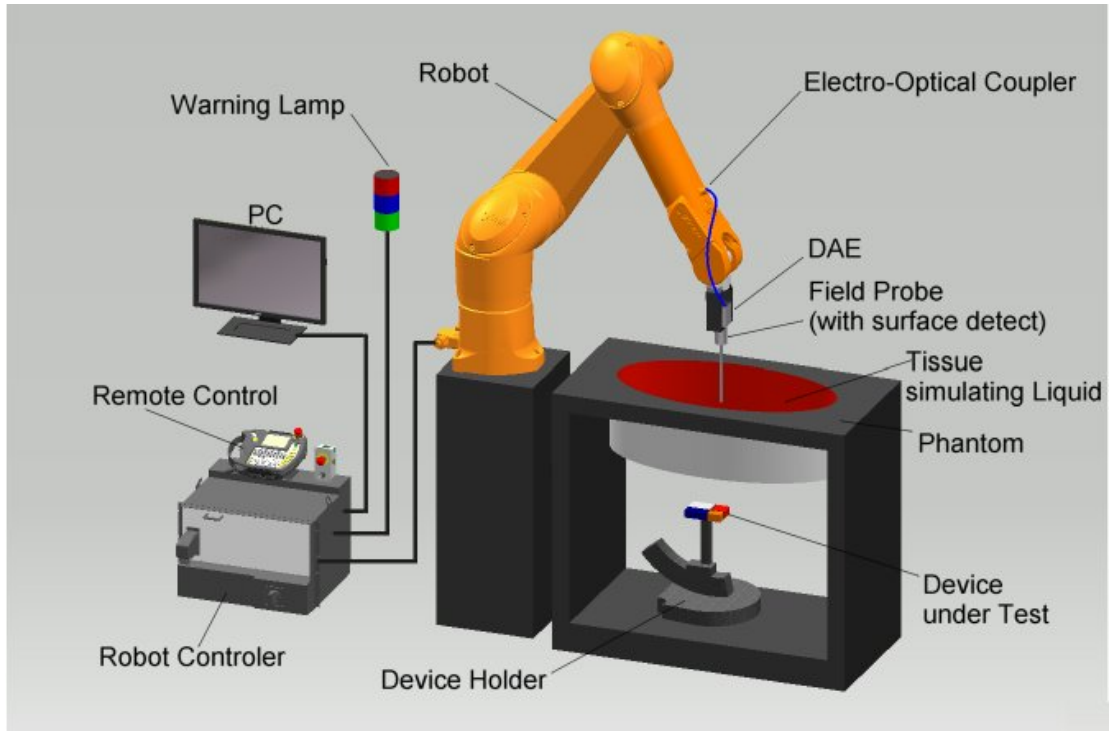

- The DAS system for performing compliance tests consists of the following items:
- A standard high precision 6-axis robot (Stäubli RX/TX family) with controller and software. An arm extension for accommodating the data acquisition electronics (DAE).
- A dosimetric probe, i.e. an isotropic E-field probe optimized and calibrated for usage in tissue simulating liquid.
- A data acquisition electronic (DAE) which performs the signal amplification, signal multiplexing, AD-conversion, offset measurements, mechanical surface detection, collision detection, etc. The unit is battery powered with standard or rechargeable batteries. The signal is optically transmitted to the EOC.
- The Electro-Optical Coupler (EOC) performs the conversion from the optical into a digital electric signal of the DAE. The EOC is connected to the DAS measurement server.
- The DAS measurement server, which performs all real-time data evaluation for field measurements and surface detection, controls robot movements and handles safety operation. A computer operating Windows 7.
- DAS software and SEMCAD data evaluation software.
- Remote control with teach panel and additional circuitry for robot safety such as warning lamps, etc.
- The generic twin phantom enabling the testing of left-hand and right-hand usage.
- The triple flat and eli phantom for the testing of handheld and body-mounted wireless devices.
- The device holder for handheld mobile phones and mounting device adaptor for laptops
- Tissue simulating liquid mixed according to the given recipes.
- System check dipoles allowing to validate the proper functioning of the system.

## 6.1.2 Test environment

The DASY measurement system is placed in a laboratory room within an environment which avoids influence on SAR measurements by ambient electromagnetic fields and any reflection from the environment. The pictures at the beginning of the photo documentation show a complete view of the test environment. The system allows the measurement of SAR values larger than 0.005 mW/g.

## 6.1.3 Probe description

Isotropic E-Field Probe ET3DV6 for Dosimetric Measurements

<b>Technical data according to manufacturer information</b>	
Construction	Symmetrical design with triangular core Built-in optical fiber for surface detection system Built-in shielding against static charges PEEK enclosure material (resistant to organic solvents, e.g., glycoether)
Calibration	In air from 10 MHz to 2.5 GHz In head tissue simulating liquid (HSL) at 900 (800-1000) MHz and 1.8 GHz (1700-1910 MHz) (accuracy $\pm 9.5\%$ ; $k=2$ ) Calibration for other liquids and frequencies upon request
Frequency	10 MHz to 3 GHz (dosimetry); Linearity: $\pm 0.2$ dB (30 MHz to 3 GHz)
Directivity	$\pm 0.2$ dB in HSL (rotation around probe axis) $\pm 0.4$ dB in HSL (rotation normal to probe axis)
Dynamic range	5 $\mu$ W/g to > 100 mW/g; Linearity: $\pm 0.2$ dB
Optical Surface Detection	$\pm 0.2$ mm repeatability in air and clear liquids over diffuse reflecting surfaces (ET3DV6 only)
Dimensions	Overall length: 330 mm Tip length: 16 mm Body diameter: 12 mm Tip diameter: 6.8 mm Distance from probe tip to dipole centers: 2.7 mm
Application	General dosimetry up to 3 GHz Compliance tests of mobile phones Fast automatic scanning in arbitrary phantoms (ET3DV6)

#### 6.1.4 Phantom description

The used SAM Phantom meets the requirements specified in FCC KDB865664 D01 for Specific Absorption Rate (SAR) measurements.

The phantom consists of a fibreglass shell integrated in a wooden table. It allows left-hand and right-hand head as well as body-worn measurements with a maximum liquid depth of 18 cm in head position and 22 cm in planar position (body measurements). The thickness of the Phantom shell is 2 mm +/- 0.1 mm.

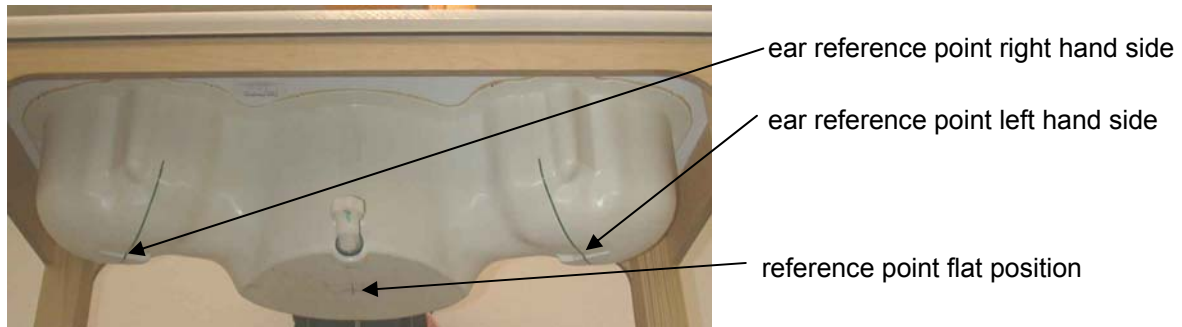

Triple Modular Phantom consists of three identical modules which can be installed and removed separately without emptying the liquid. It includes three reference points for phantom installation. Covers prevent evaporation of the liquid. Phantom material is resistant to DGBE based tissue simulating liquids.

### 6.1.5 Device holder description

The DASY device holder has two scales for device rotation (with respect to the body axis) and the device inclination (with respect to the line between the ear openings). The plane between the ear openings and the mouth tip has a rotation angle of 65°. The bottom plate contains three pair of bolts for locking the device holder. The device holder positions are adjusted to the standard measurement positions in the three sections. This device holder is used for standard mobile phones or PDA's only. If necessary an additional support of polystyrene material is used.



Larger DUT's (e.g. notebooks) cannot be tested using this device holder. Instead a support of bigger polystyrene cubes and thin polystyrene plates is used to position the DUT in all relevant positions to find and measure spots with maximum SAR values. Therefore those devices are normally only tested at the flat part of the SAM.

### 6.1.6 Scanning procedure

- The DASY installation includes predefined files with recommended procedures for measurements and system check. They are read-only document files and destined as fully defined but unmeasured masks. All test positions (head or body-worn) are tested with the same configuration of test steps differing only in the grid definition for the different test positions.
- The „reference“ and „drift“ measurements are located at the beginning and end of the batch process. They measure the field drift at one single point in the liquid over the complete procedure. The indicated drift is mainly the variation of the DUT's output power and should vary max. +/- 5 %.
- The highest integrated SAR value is the main concern in compliance test applications. These values can mostly be found at the inner surface of the phantom and cannot be measured directly due to the sensor offset in the probe. To extrapolate the surface values, the measurement distances to the surface must be known accurately. A distance error of 0.5mm could produce SAR errors of 6% at 1800 MHz. Using predefined locations for measurements is not accurate enough. Any shift of the phantom (e.g., slight deformations after filling it with liquid) would produce high uncertainties. For an automatic and accurate detection of the phantom surface, the DASY5 system uses the mechanical surface detection. The detection is always at touch, but the probe will move backward from the surface the indicated distance before starting the measurement.
- The „area scan“ measures the SAR above the DUT or verification dipole on a parallel plane to the surface. It is used to locate the approximate location of the peak SAR with 2D spline interpolation. The robot performs a stepped movement along one grid axis while the local electrical field strength is measured by the probe. The probe is touching the surface of the SAM during acquisition of measurement values. The scan uses different grid spacings for different frequency measurements. Standard grid spacing for head measurements in frequency ranges  $\leq 2$  GHz is 15 mm in x- and y-dimension. For higher frequencies a finer resolution is needed, thus for the grid spacing is reduced according the following table:

Area scan grid spacing for different frequency ranges	
Frequency range	Grid spacing
$\leq 2$ GHz	$\leq 15$ mm
2 – 4 GHz	$\leq 12$ mm
4 – 6 GHz	$\leq 10$ mm

Grid spacing and orientation have no influence on the SAR result. For special applications where the standard scan method does not find the peak SAR within the grid, e.g. mobile phones with flip cover, the grid can be adapted in orientation. Results of this coarse scan are shown in annex B.

- A „zoom scan“ measures the field in a volume around the 2D peak SAR value acquired in the previous „coarse“ scan. It uses a fine meshed grid where the robot moves the probe in steps along all the 3 axis (x,y and z-axis) starting at the bottom of the Phantom. The grid spacing for the cube measurement is varied according to the measured frequency range, the dimensions are given in the following table:

Zoom scan grid spacing and volume for different frequency ranges			
Frequency range	Grid spacing for x, y axis	Grid spacing for z axis	Minimum zoom scan volume
$\leq 2$ GHz	$\leq 8$ mm	$\leq 5$ mm	$\geq 30$ mm
2 – 3 GHz	$\leq 5$ mm	$\leq 5$ mm	$\geq 28$ mm
3 – 4 GHz	$\leq 5$ mm	$\leq 4$ mm	$\geq 28$ mm
4 – 5 GHz	$\leq 4$ mm	$\leq 3$ mm	$\geq 25$ mm
5 – 6 GHz	$\leq 4$ mm	$\leq 2$ mm	$\geq 22$ mm

DASY is also able to perform repeated zoom scans if more than 1 peak is found during area scan. In this document, the evaluated peak 1g and 10g averaged SAR values are shown in the 2D-graphics in annex B. Test results relevant for the specified standard (see section 3) are shown in table form in section 7.

## 6.1.7 Spatial Peak SAR Evaluation

The spatial peak SAR - value for 1 and 10 g is evaluated after the Cube measurements have been done. The basis of the evaluation are the SAR values measured at the points of the fine cube grid consisting of all points in the three directions x, y and z. The algorithm that finds the maximal averaged volume is separated into three different stages.

- The data between the dipole center of the probe and the surface of the phantom are extrapolated. This data cannot be measured since the center of the dipole is 1 to 2.7 mm away from the tip of the probe and the distance between the surface and the lowest measuring point is about 1 mm (see probe calibration sheet). The extrapolated data from a cube measurement can be visualized by selecting 'Graph Evaluated'.
- The maximum interpolated value is searched with a straight-forward algorithm. Around this maximum the SAR - values averaged over the spatial volumes (1g or 10 g) are computed using the 3d-spline interpolation algorithm. If the volume cannot be evaluated (i.e., if a part of the grid was cut off by the boundary of the measurement area) the evaluation will be started on the corners of the bottom plane of the cube.
- All neighbouring volumes are evaluated until no neighbouring volume with a higher average value is found.

### Extrapolation

The extrapolation is based on a least square algorithm [W. Gander, Computermathematik, p.168-180]. Through the points in the first 3 cm along the z-axis, polynomials of order four are calculated. These polynomials are then used to evaluate the points between the surface and the probe tip. The points, calculated from the surface, have a distance of 1 mm from each other.

### Interpolation

The interpolation of the points is done with a 3d-Spline. The 3d-Spline is composed of three one-dimensional splines with the "Not a knot"-condition [W. Gander, Computermathematik, p.141-150] (x, y and z -direction) [Numerical Recipes in C, Second Edition, p.123ff ].

### Volume Averaging

At First the size of the cube is calculated. Then the volume is integrated with the trapezoidal algorithm. 8000 points (20x20x20) are interpolated to calculate the average.

### Advanced Extrapolation

DASY uses the advanced extrapolation option which is able to compensate boundary effects on E-field probes.



## 6.1.8 Data Storage and Evaluation

### Data Storage

The DASY software stores the acquired data from the data acquisition electronics as raw data (in microvolt readings from the probe sensors), together with all necessary software parameters for the data evaluation (probe calibration data, liquid parameters and device frequency and modulation data) in measurement files with the extension ".DA4", ".DA5x". The software evaluates the desired unit and format for output each time the data is visualized or exported. This allows verification of the complete software setup even after the measurement and allows correction of incorrect parameter settings. For example, if a measurement has been performed with a wrong crest factor parameter in the device setup, the parameter can be corrected afterwards and the data can be re-evaluated.

The measured data can be visualized or exported in different units or formats, depending on the selected probe type ([V/m], [A/m], [°C], [mW/g], [mW/cm<sup>2</sup>], [dBrel], etc.). Some of these units are not available in certain situations or show meaningless results, e.g., a SAR output in a lossless media will always be zero. Raw data can also be exported to perform the evaluation with other software packages.

### Data Evaluation by SEMCAD

The SEMCAD software automatically executes the following procedures to calculate the field units from the microvolt readings at the probe connector. The parameters used in the evaluation are stored in the configuration modules of the software:

Probe parameters:	- Sensitivity	$\text{Norm}_i, a_{i0}, a_{i1}, a_{i2}$
	- Conversion factor	$\text{ConvF}_i$
	- Diode compression point	$D_{\text{cpi}}$
Device parameters:	- Frequency	$f$
	- Crest factor	$cf$
Media parameters:	- Conductivity	$\sigma$
	- Density	$\rho$

These parameters must be set correctly in the software. They can be found in the component documents or they can be imported into the software from the configuration files issued for the DASY components. In the direct measuring mode of the multimeter option, the parameters of the actual system setup are used. In the scan visualization and export modes, the parameters stored in the corresponding document files are used.

The first step of the evaluation is a linearization of the filtered input signal to account for the compression characteristics of the detector diode. The compensation depends on the input signal, the diode type and the DC-transmission factor from the diode to the evaluation electronics.

If the exciting field is pulsed, the crest factor of the signal must be known to correctly compensate for peak power. The formula for each channel can be given as:

$$V_i = U_i + U_i^2 \cdot cf/dcp_i$$

with  $V_i$  = compensated signal of channel i (i = x, y, z)  
 $U_i$  = input signal of channel i (i = x, y, z)  
 cf = crest factor of exciting field (DASY parameter)  
 $dcp_i$  = diode compression point (DASY parameter)

From the compensated input signals the primary field data for each channel can be evaluated:

E-field probes:  $E_i = (V_i / Norm_i \cdot ConvF)^{1/2}$

H-field probes:  $H_i = (V_i)^{1/2} \cdot (a_{i0} + a_{i1}f + a_{i2}f^2)/f$

with  $V_i$  = compensated signal of channel i (i = x, y, z)  
 $Norm_i$  = sensor sensitivity of channel i (i = x, y, z)  
 [mV/(V/m)<sup>2</sup>] for E-field Probes  
 $ConvF$  = sensitivity enhancement in solution  
 $a_{ij}$  = sensor sensitivity factors for H-field probes  
 $f$  = carrier frequency [GHz]  
 $E_i$  = electric field strength of channel i in V/m  
 $H_i$  = magnetic field strength of channel i in A/m

The RSS value of the field components gives the total field strength (Hermitian magnitude):

$$E_{tot} = (E_x^2 + E_y^2 + E_z^2)^{1/2}$$

The primary field data are used to calculate the derived field units.

$$SAR = (E_{tot}^2 \cdot \sigma) / (\rho \cdot 1000)$$

with SAR = local specific absorption rate in mW/g  
 $E_{tot}$  = total field strength in V/m  
 $\sigma$  = conductivity in [mho/m] or [Siemens/m]  
 $\rho$  = equivalent tissue density in g/cm<sup>3</sup>

Note that the density is normally set to 1 (or 1.06), to account for actual brain density rather than the density of the simulation liquid. The power flow density is calculated assuming the excitation field to be a free space field.

$$P_{pwe} = E_{tot}^2 / 3770 \quad \text{or} \quad P_{pwe} = H_{tot}^2 \cdot 37.7$$

with  $P_{pwe}$  = equivalent power density of a plane wave in mW/cm<sup>2</sup>  
 $E_{tot}$  = total electric field strength in V/m  
 $H_{tot}$  = total magnetic field strength in A/m

### 6.1.9 Tissue simulating liquids: dielectric properties

The following materials are used for producing the tissue-equivalent materials.

(Liquids used for tests described in section 7. are marked with ☒):

Ingredients (% of weight)	Frequency (MHz)								
	<input type="checkbox"/> 450	<input type="checkbox"/> 750	<input checked="" type="checkbox"/> 835	<input type="checkbox"/> 900	<input type="checkbox"/> 1450	<input type="checkbox"/> 1750	<input checked="" type="checkbox"/> 1900	<input checked="" type="checkbox"/> 2450	<input checked="" type="checkbox"/> 5000
frequency band									
Tissue Type	Head	Head	Head	Head	Head	Head	Head	Head	Head
Water	38.56	41.1	41.45	40.92	52.64	52.64	54.9	62.7	64 - 78
Salt (NaCl)	3.95	1.4	1.45	1.48	0.61	0.36	0.18	0.5	2 - 3
Sugar	56.32	57.0	56.0	56.5	0.0	0.0	0.0	0.0	0.0
HEC	0.98	0.2	1.0	1.0	0.0	0.0	0.0	0.0	0.0
Bactericide	0.19	0.2	0.1	0.1	0.0	0.0	0.0	0.0	0.0
Triton X-100	0.0	0.0	0.0	0.0	0.0	0.0	0.0	36.8	0.0
DGBE	0.0	0.0	0.0	0.0	46.75	47.0	44.92	0.0	0.0
Emulsifiers	0.0	0.0	0.0	0.0	0.0	0.0	0.0	0.0	9 - 15
Mineral Oil	0.0	0.0	0.0	0.0	0.0	0.0	0.0	0.0	11 - 18

Table 3: Head tissue dielectric properties

Ingredients (% of weight)	Frequency (MHz)								
	<input type="checkbox"/> 450	<input type="checkbox"/> 750	<input checked="" type="checkbox"/> 835	<input type="checkbox"/> 900	<input type="checkbox"/> 1450	<input type="checkbox"/> 1750	<input checked="" type="checkbox"/> 1900	<input checked="" type="checkbox"/> 2450	<input checked="" type="checkbox"/> 5000
frequency band									
Tissue Type	Body	Body	Body	Body	Body	Body	Body	Body	Body
Water	51.16	51.7	52.4	56.0	70.97	69.91	69.91	73.2	64 - 78
Salt (NaCl)	1.49	0.9	1.40	0.76	0.43	0.13	0.13	0.04	2 - 3
Sugar	46.78	47.2	45.0	41.76	0.0	0.0	0.0	0.0	0.0
HEC	0.52	0.0	1.0	1.21	0.0	0.0	0.0	0.0	0.0
Bactericide	0.05	0.1	0.1	0.27	0.0	0.0	0.0	0.0	0.0
Triton X-100	0.0	0.0	0.0	0.0	0.0	0.0	0.0	0.0	0.0
DGBE	0.0	0.0	0.0	0.0	28.60	29.96	29.96	26.7	0.0
Emulsifiers	0.0	0.0	0.0	0.0	0.0	0.0	0.0	0.0	9 - 15
Mineral Oil	0.0	0.0	0.0	0.0	0.0	0.0	0.0	0.0	11 - 18

Table 4: Body tissue dielectric properties

Salt: 99+% Pure Sodium Chloride

Water: De-ionized, 16MΩ+ resistivity

Sugar: 98+% Pure Sucrose

HEC: Hydroxyethyl Cellulose

DGBE: 99+% Di(ethylene glycol) butyl ether, [2-(2-butoxyethoxy)ethanol]

Triton X-100(ultra pure): Polyethylene glycol mono [4-(1,1,3,3-tetramethylbutyl)phenyl]ether

**6.1.10 Tissue simulating liquids: parameters**

Liquid HSL	Freq. (MHz)	Target head tissue		Measurement head tissue					Measurement date
		Permittivity	Conductivity [S/m]	Permittivity	Dev. %	Conductivity		Dev. %	
						$\epsilon''$	[S/m]		
850/900	824	41.56	0.90	41.7	0.3%	19.55	0.90	-0.3%	2014-05-07
	825	41.55	0.90	41.7	0.3%	19.56	0.90	-0.2%	
	829	41.53	0.90	41.6	0.1%	19.59	0.90	0.4%	
	835	41.50	0.90	41.4	-0.2%	19.62	0.91	1.3%	
	837	41.50	0.90	41.4	-0.3%	19.60	0.91	1.2%	
	844	41.50	0.91	41.3	-0.5%	19.53	0.92	0.8%	
	847	41.50	0.91	41.3	-0.5%	19.47	0.92	0.5%	
	849	41.50	0.92	41.3	-0.6%	19.44	0.92	0.3%	
1900	1850	40.00	1.40	39.9	-0.3%	12.96	1.33	-4.7%	2014-05-09
	1852	40.00	1.40	39.9	-0.3%	12.97	1.34	-4.6%	
	1860	40.00	1.40	39.8	-0.5%	12.95	1.34	-4.3%	
	1880	40.00	1.40	39.8	-0.6%	12.90	1.35	-3.6%	
	1900	40.00	1.40	39.6	-1.1%	13.02	1.38	-1.7%	
	1908	40.00	1.40	39.4	-1.4%	13.00	1.38	-1.4%	
	1910	40.00	1.40	39.4	-1.4%	13.00	1.38	-1.3%	
2450  2600	2412	39.27	1.77	39.1	-0.5%	12.73	1.71	-3.3%	2014-05-16
	2437	39.22	1.79	38.9	-0.9%	12.92	1.75	-2.1%	
	2462	39.18	1.81	38.9	-0.9%	13.16	1.80	-0.6%	
	2510	39.12	1.87	38.8	-0.8%	13.16	1.84	-1.5%	
	2535	39.09	1.89	38.6	-1.3%	13.14	1.85	-2.1%	
	2560	39.06	1.92	38.4	-1.7%	13.27	1.89	-1.5%	
5GHz	5200	35.99	4.66	36.3	1.0%	15.46	4.47	-3.9%	2014-05-15
	5240	35.94	4.70	36.3	0.9%	15.34	4.47	-4.8%	
	5260	35.92	4.72	36.1	0.5%	15.52	4.54	-3.7%	
	5500	35.64	4.96	35.8	0.4%	15.76	4.82	-2.9%	
	5560	35.57	5.02	35.9	1.0%	15.87	4.91	-2.3%	
	5745	35.36	5.21	35.5	0.3%	15.78	5.04	-3.3%	

Table 5: Parameter of the head tissue simulating liquid

Liquid MSL	Freq. (MHz)	Target <b>body</b> tissue		Measurement <b>body</b> tissue					Measurement date
		Permittivity	Conductivity [S/m]	Permittivity	Dev. %	Conductivity		Dev. %	
						$\epsilon''$	[S/m]		
850/900	824	55.24	0.97	55.0	-0.4%	21.72	1.00	2.7%	2014-05-08
	825	55.24	0.97	55.0	-0.5%	21.72	1.00	2.8%	
	829	55.22	0.97	54.9	-0.6%	21.71	1.00	3.3%	
	837	55.19	0.97	54.8	-0.7%	21.70	1.01	3.9%	
	844	55.17	0.98	54.7	-0.8%	21.61	1.01	3.4%	
	847	55.16	0.98	54.7	-0.8%	21.58	1.02	3.3%	
	849	55.16	0.99	54.7	-0.9%	21.55	1.02	3.1%	
1900	1850	53.30	1.52	53.5	0.3%	14.36	1.48	-2.8%	2014-05-08
	1852	53.30	1.52	53.5	0.3%	14.38	1.48	-2.5%	
	1860	53.30	1.52	53.5	0.5%	14.46	1.50	-1.5%	
	1880	53.30	1.52	54.1	1.5%	14.91	1.56	2.6%	
	1900	53.30	1.52	54.1	1.4%	15.08	1.59	4.8%	
	1908	53.30	1.52	54.0	1.3%	14.87	1.58	3.9%	
	1910	53.30	1.52	54.0	1.3%	14.81	1.57	3.5%	
2450  2600	2412	52.75	1.91	51.6	-2.2%	14.54	1.95	2.0%	2014-05-16
	2437	52.72	1.94	51.3	-2.7%	14.64	1.98	2.4%	
	2462	52.68	1.97	51.0	-3.1%	14.78	2.02	2.9%	
	2510	52.62	2.04	51.2	-2.7%	14.85	2.07	1.9%	
	2535	52.59	2.07	51.1	-2.8%	14.86	2.09	1.2%	
	2560	52.56	2.11	50.8	-3.3%	14.93	2.13	0.9%	
5GHz	5200	49.01	5.30	48.4	-1.3%	18.04	5.22	-1.6%	2014-05-21
	5240	48.96	5.35	48.1	-1.7%	18.05	5.26	-1.6%	
	5260	48.93	5.37	48.0	-2.0%	18.06	5.28	-1.6%	
	5500	48.61	5.65	47.6	-2.0%	18.32	5.61	-0.8%	
	5560	48.53	5.72	47.6	-1.9%	18.34	5.67	-0.8%	
	5745	48.27	5.94	47.3	-2.1%	18.53	5.92	-0.3%	

Table 6: Parameter of the body tissue simulating liquid

Note: The dielectric properties have been measured using the contact probe method at 22°C.

### 6.1.11 Measurement uncertainty evaluation for SAR test

Relative DASY5 Uncertainty Budget for SAR Tests								
According to IEEE 1528/2011 and IEC62209-1/2011 (0.3-3GHz range)								
Error Description	Uncertainty Value	Probability Distribution	Divisor	$C_i$	$C_i$	Standard Uncertainty		$v_i^2$ or $v_{eff}$
				(1g)	(10g)	± %, (1g)	± %, (10g)	
<b>Measurement System</b>								
Probe calibration	± 6.0 %	Normal	1	1	1	± 6.0 %	± 6.0 %	∞
Axial isotropy	± 4.7 %	Rectangular	√ 3	0.7	0.7	± 1.9 %	± 1.9 %	∞
Hemispherical isotropy	± 9.6 %	Rectangular	√ 3	0.7	0.7	± 3.9 %	± 3.9 %	∞
Boundary effects	± 1.0 %	Rectangular	√ 3	1	1	± 0.6 %	± 0.6 %	∞
Probe linearity	± 4.7 %	Rectangular	√ 3	1	1	± 2.7 %	± 2.7 %	∞
System detection limits	± 1.0 %	Rectangular	√ 3	1	1	± 0.6 %	± 0.6 %	∞
Modulation Response	± 2.4 %	Rectangular	√ 3	1	1	± 1.4 %	± 1.4 %	∞
Readout electronics	± 0.3 %	Normal	1	1	1	± 0.3 %	± 0.3 %	∞
Response time	± 0.8 %	Rectangular	√ 3	1	1	± 0.5 %	± 0.5 %	∞
Integration time	± 2.6 %	Rectangular	√ 3	1	1	± 1.5 %	± 1.5 %	∞
RF ambient noise	± 3.0 %	Rectangular	√ 3	1	1	± 1.7 %	± 1.7 %	∞
RF ambient reflections	± 3.0 %	Rectangular	√ 3	1	1	± 1.7 %	± 1.7 %	∞
Probe positioner	± 0.4 %	Rectangular	√ 3	1	1	± 0.2 %	± 0.2 %	∞
Probe positioning	± 2.9 %	Rectangular	√ 3	1	1	± 1.7 %	± 1.7 %	∞
Max. SAR evaluation	± 2.0 %	Rectangular	√ 3	1	1	± 1.2 %	± 1.2 %	∞
<b>Test Sample Related</b>								
Device positioning	± 2.9 %	Normal	1	1	1	± 2.9 %	± 2.9 %	145
Device holder uncertainty	± 3.6 %	Normal	1	1	1	± 3.6 %	± 3.6 %	5
Power drift	± 5.0 %	Rectangular	√ 3	1	1	± 2.9 %	± 2.9 %	∞
<b>Phantom and Set-up</b>								
Phantom uncertainty	± 6.1 %	Rectangular	√ 3	1	1	± 3.5 %	± 3.5 %	∞
SAR correction	± 1.9 %	Rectangular	√ 3	1	0.84	± 1.1 %	± 0.9 %	∞
Liquid conductivity (meas.)	± 5.0 %	Rectangular	√ 3	0.78	0.71	± 2.3 %	± 2.0 %	∞
Liquid permittivity (meas.)	± 5.0 %	Rectangular	√ 3	0.26	0.26	± 0.8 %	± 0.8 %	∞
Temp. Unc. - Conductivity	± 3.4 %	Rectangular	√ 3	0.78	0.71	± 1.5 %	± 1.4 %	∞
Temp. Unc. - Permittivity	± 0.4 %	Rectangular	√ 3	0.23	0.26	± 0.1 %	± 0.1 %	∞
<b>Combined Uncertainty</b>						± 11.3 %	± 11.3 %	330
<b>Expanded Std. Uncertainty</b>						± 22.7 %	± 22.5 %	

Table 7: Measurement uncertainties

Worst-Case uncertainty budget for DASY5 assessed according to IEEE 1528/2011 and IEC 62209-1/2011 draft standards. The budget is valid for the frequency range 300MHz -3 GHz and represents a worst-case analysis. For specific tests and configurations, the uncertainty could be considerable smaller.

Relative DASY5 Uncertainty Budget for SAR Tests								
According to IEC62209-2/2010 (30 MHz - 6 GHz range)								
Error Description	Uncertainty Value	Probability Distribution	Divisor	$c_i$	$c_i$	Standard Uncertainty		$v_i^2$ or $v_{eff}$
				(1g)	(10g)	± %, (1g)	± %, (10g)	
<b>Measurement System</b>								
Probe calibration	± 6.6 %	Normal	1	1	1	± 6.6 %	± 6.6 %	∞
Axial isotropy	± 4.7 %	Rectangular	√ 3	0.7	0.7	± 1.9 %	± 1.9 %	∞
Hemispherical isotropy	± 9.6 %	Rectangular	√ 3	0.7	0.7	± 3.9 %	± 3.9 %	∞
Boundary effects	± 2.0 %	Rectangular	√ 3	1	1	± 1.2 %	± 1.2 %	∞
Probe linearity	± 4.7 %	Rectangular	√ 3	1	1	± 2.7 %	± 2.7 %	∞
System detection limits	± 1.0 %	Rectangular	√ 3	1	1	± 0.6 %	± 0.6 %	∞
Modulation Response	± 2.4 %	Rectangular	√ 3	1	1	± 1.4 %	± 1.4 %	∞
Readout electronics	± 0.3 %	Normal	1	1	1	± 0.3 %	± 0.3 %	∞
Response time	± 0.8 %	Rectangular	√ 3	1	1	± 0.5 %	± 0.5 %	∞
Integration time	± 2.6 %	Rectangular	√ 3	1	1	± 1.5 %	± 1.5 %	∞
RF ambient noise	± 3.0 %	Rectangular	√ 3	1	1	± 1.7 %	± 1.7 %	∞
RF ambient reflections	± 3.0 %	Rectangular	√ 3	1	1	± 1.7 %	± 1.7 %	∞
Probe positioner	± 0.8 %	Rectangular	√ 3	1	1	± 0.5 %	± 0.5 %	∞
Probe positioning	± 6.7 %	Rectangular	√ 3	1	1	± 3.9 %	± 3.9 %	∞
Post-processing	± 4.0 %	Rectangular	√ 3	1	1	± 2.3 %	± 2.3 %	∞
<b>Test Sample Related</b>								
Device positioning	± 2.9 %	Normal	1	1	1	± 2.9 %	± 2.9 %	145
Device holder uncertainty	± 3.6 %	Normal	1	1	1	± 3.6 %	± 3.6 %	5
Power drift	± 5.0 %	Rectangular	√ 3	1	1	± 2.9 %	± 2.9 %	∞
<b>Phantom and Set-up</b>								
Phantom uncertainty	± 7.9 %	Rectangular	√ 3	1	1	± 4.6 %	± 4.6 %	∞
SAR correction	± 1.9 %	Rectangular	√ 3	1	0.84	± 1.1 %	± 0.9 %	∞
Liquid conductivity (meas.)	± 5.0 %	Rectangular	√ 3	0.78	0.71	± 2.3 %	± 2.0 %	∞
Liquid permittivity (meas.)	± 5.0 %	Rectangular	√ 3	0.26	0.26	± 0.8 %	± 0.8 %	∞
Temp. Unc. - Conductivity	± 3.4 %	Rectangular	√ 3	0.78	0.71	± 1.5 %	± 1.4 %	∞
Temp. Unc. - Permittivity	± 0.4 %	Rectangular	√ 3	0.23	0.26	± 0.1 %	± 0.1 %	∞
<b>Combined Uncertainty</b>						± 12.7 %	± 12.6 %	330
<b>Expanded Std. Uncertainty</b>						± 25.4 %	± 25.3 %	

Table 8: Measurement uncertainties. Worst-Case uncertainty budget for DASY5 assessed according to according to IEC 62209-2/2010 standard. The budget is valid for the frequency range 30MHz - 6 GHz and represents a worst-case analysis. For specific tests and configurations, the uncertainty could be considerable smaller.

Relative DASY5 Uncertainty Budget for SAR Tests								
According to IEEE 1528-2003, IEC 62209-1 for the 3-6 GHz range								
Error Description	Uncertainty Value	Probability Distribution	Divisor	c <sub>i</sub>	c <sub>i</sub>	Standard Uncertainty		v <sub>i</sub> <sup>2</sup> or v <sub>eff</sub>
				(1g)	(10g)	± %, (1g)	± %, (10g)	
<b>Measurement System</b>								
Probe calibration	± 6.6 %	Normal	1	1	1	± 6.6 %	± 6.6 %	∞
Axial isotropy	± 4.7 %	Rectangular	√ 3	0.7	0.7	± 1.9 %	± 1.9 %	∞
Hemispherical isotropy	± 9.6 %	Rectangular	√ 3	0.7	0.7	± 3.9 %	± 3.9 %	∞
Boundary effects	± 2.0 %	Rectangular	√ 3	1	1	± 1.2 %	± 1.2 %	∞
Probe linearity	± 4.7 %	Rectangular	√ 3	1	1	± 2.7 %	± 2.7 %	∞
System detection limits	± 1.0 %	Rectangular	√ 3	1	1	± 0.6 %	± 0.6 %	∞
Readout electronics	± 0.3 %	Normal	1	1	1	± 0.3 %	± 0.3 %	∞
Response time	± 0.8 %	Rectangular	√ 3	1	1	± 0.5 %	± 0.5 %	∞
Integration time	± 2.6 %	Rectangular	√ 3	1	1	± 1.5 %	± 1.5 %	∞
RF ambient noise	± 3.0 %	Rectangular	√ 3	1	1	± 1.7 %	± 1.7 %	∞
RF ambient reflections	± 3.0 %	Rectangular	√ 3	1	1	± 1.7 %	± 1.7 %	∞
Probe positioner	± 0.8 %	Rectangular	√ 3	1	1	± 0.5 %	± 0.5 %	∞
Probe positioning	± 6.7 %	Rectangular	√ 3	1	1	± 3.9 %	± 3.9 %	∞
Max. SAR evaluation	± 4.0 %	Rectangular	√ 3	1	1	± 2.3 %	± 2.3 %	∞
<b>Test Sample Related</b>								
Device positioning	± 2.9 %	Normal	1	1	1	± 2.9 %	± 2.9 %	145
Device holder uncertainty	± 3.6 %	Normal	1	1	1	± 3.6 %	± 3.6 %	5
Power drift	± 5.0 %	Rectangular	√ 3	1	1	± 2.9 %	± 2.9 %	∞
<b>Phantom and Set-up</b>								
Phantom uncertainty	± 4.0 %	Rectangular	√ 3	1	1	± 2.3 %	± 2.3 %	∞
Liquid conductivity (target)	± 5.0 %	Rectangular	√ 3	0.64	0.43	± 1.8 %	± 1.2 %	∞
Liquid conductivity (meas.)	± 5.0 %	Rectangular	√ 3	0.64	0.43	± 1.8 %	± 1.2 %	∞
Liquid permittivity (target)	± 5.0 %	Rectangular	√ 3	0.6	0.49	± 1.7 %	± 1.4 %	∞
Liquid permittivity (meas.)	± 5.0 %	Rectangular	√ 3	0.6	0.49	± 1.7 %	± 1.4 %	∞
<b>Combined Uncertainty</b>						± 12.1 %	± 11.9 %	330
<b>Expanded Std. Uncertainty</b>						± 24.3 %	± 23.8 %	

Table 9: Measurement uncertainties

Worst-Case uncertainty budget for DASY5 valid for 3G communication signals and frequency range 3 - 6 GHz. Probe calibration error reflects uncertainty of the EX3D probe. For specific tests and configurations, the uncertainty could be considerable smaller.



Relative DASY5 Uncertainty Budget for SAR Tests								
According to IEEE 1528/2011 and IEC62209-1/2011 (3-6GHz range)								
Error Description	Uncertainty Value	Probability Distribution	Divisor	$c_i$	$c_i$	Standard Uncertainty		$v_i^2$ or $v_{eff}$
				(1g)	(10g)	± %, (1g)	± %, (10g)	
<b>Measurement System</b>								
Probe calibration	± 6.6 %	Normal	1	1	1	± 6.6 %	± 6.6 %	∞
Axial isotropy	± 4.7 %	Rectangular	√ 3	0.7	0.7	± 1.9 %	± 1.9 %	∞
Hemispherical isotropy	± 9.6 %	Rectangular	√ 3	0.7	0.7	± 3.9 %	± 3.9 %	∞
Boundary effects	± 2.0 %	Rectangular	√ 3	1	1	± 1.2 %	± 1.2 %	∞
Probe linearity	± 4.7 %	Rectangular	√ 3	1	1	± 2.7 %	± 2.7 %	∞
System detection limits	± 1.0 %	Rectangular	√ 3	1	1	± 0.6 %	± 0.6 %	∞
Modulation Response	± 2.4 %	Rectangular	√ 3	1	1	± 1.4 %	± 1.4 %	∞
Readout electronics	± 0.3 %	Normal	1	1	1	± 0.3 %	± 0.3 %	∞
Response time	± 0.8 %	Rectangular	√ 3	1	1	± 0.5 %	± 0.5 %	∞
Integration time	± 2.6 %	Rectangular	√ 3	1	1	± 1.5 %	± 1.5 %	∞
RF ambient noise	± 3.0 %	Rectangular	√ 3	1	1	± 1.7 %	± 1.7 %	∞
RF ambient reflections	± 3.0 %	Rectangular	√ 3	1	1	± 1.7 %	± 1.7 %	∞
Probe positioner	± 0.8 %	Rectangular	√ 3	1	1	± 0.5 %	± 0.5 %	∞
Probe positioning	± 6.7 %	Rectangular	√ 3	1	1	± 3.9 %	± 3.9 %	∞
Max. SAR evaluation	± 4.0 %	Rectangular	√ 3	1	1	± 2.3 %	± 2.3 %	∞
<b>Test Sample Related</b>								
Device positioning	± 2.9 %	Normal	1	1	1	± 2.9 %	± 2.9 %	145
Device holder uncertainty	± 3.6 %	Normal	1	1	1	± 3.6 %	± 3.6 %	5
Power drift	± 5.0 %	Rectangular	√ 3	1	1	± 2.9 %	± 2.9 %	∞
<b>Phantom and Set-up</b>								
Phantom uncertainty	± 6.6 %	Rectangular	√ 3	1	1	± 3.8 %	± 3.8 %	∞
SAR correction	± 1.9 %	Rectangular	√ 3	1	0.84	± 1.1 %	± 0.9 %	∞
Liquid conductivity (meas.)	± 5.0 %	Rectangular	√ 3	0.78	0.71	± 2.3 %	± 2.0 %	∞
Liquid permittivity (meas.)	± 5.0 %	Rectangular	√ 3	0.26	0.26	± 0.8 %	± 0.8 %	∞
Temp. Unc. - Conductivity	± 3.4 %	Rectangular	√ 3	0.78	0.71	± 1.5 %	± 1.4 %	∞
Temp. Unc. - Permittivity	± 0.4 %	Rectangular	√ 3	0.23	0.26	± 0.1 %	± 0.1 %	∞
<b>Combined Uncertainty</b>						± 12.4 %	± 12.4 %	330
<b>Expanded Std. Uncertainty</b>						± 24.9 %	± 24.8 %	

Table 10: Measurement uncertainties

Worst-Case uncertainty budget for DASY5 assessed according to IEEE 1528/2011 and IEC 62209-1/2011 draft standards. The budget is valid for the frequency range 3GHz -6GHz and represents a worst-case analysis. For specific tests and configurations, the uncertainty could be considerable smaller.

### 6.1.12 Measurement uncertainty evaluation for System Check

Uncertainty of a System Performance Check with DASY5 System for the 0.3 - 3 GHz range								
Source of uncertainty	Uncertainty Value	Probability Distribution	Divisor	$c_i$	$c_i$	Standard Uncertainty		$v_i^2$ or $v_{eff}$
				(1g)	(10g)	± %, (1g)	± %, (10g)	
<b>Measurement System</b>								
Probe calibration	± 6.0 %	Normal	1	1	1	± 6.0 %	± 6.0 %	∞
Axial isotropy	± 4.7 %	Rectangular	√ 3	0.7	0.7	± 1.9 %	± 1.9 %	∞
Hemispherical isotropy	± 0.0 %	Rectangular	√ 3	0.7	0.7	± 0.0 %	± 0.0 %	∞
Boundary effects	± 1.0 %	Rectangular	√ 3	1	1	± 0.6 %	± 0.6 %	∞
Probe linearity	± 4.7 %	Rectangular	√ 3	1	1	± 2.7 %	± 2.7 %	∞
System detection limits	± 1.0 %	Rectangular	√ 3	1	1	± 0.6 %	± 0.6 %	∞
Readout electronics	± 0.3 %	Normal	1	1	1	± 0.3 %	± 0.3 %	∞
Response time	± 0.0 %	Rectangular	√ 3	1	1	± 0.0 %	± 0.0 %	∞
Integration time	± 0.0 %	Rectangular	√ 3	1	1	± 0.0 %	± 0.0 %	∞
RF ambient conditions	± 3.0 %	Rectangular	√ 3	1	1	± 1.7 %	± 1.7 %	∞
Probe positioner	± 0.4 %	Rectangular	√ 3	1	1	± 0.2 %	± 0.2 %	∞
Probe positioning	± 2.9 %	Rectangular	√ 3	1	1	± 1.7 %	± 1.7 %	∞
Max. SAR evaluation	± 1.0 %	Rectangular	√ 3	1	1	± 0.6 %	± 0.6 %	∞
<b>Test Sample Related</b>								
Dev. of experimental dipole	± 0.0 %	Rectangular	√ 3	1	1	± 0.0 %	± 0.0 %	∞
Source to liquid distance	± 2.0 %	Rectangular	√ 3	1	1	± 1.2 %	± 1.2 %	∞
Power drift	± 3.4 %	Rectangular	√ 3	1	1	± 2.0 %	± 2.0 %	∞
<b>Phantom and Set-up</b>								
Phantom uncertainty	± 4.0 %	Rectangular	√ 3	1	1	± 2.3 %	± 2.3 %	∞
SAR correction	± 1.9 %	Rectangular	√ 3	1	0.84	± 1.1 %	± 0.9 %	∞
Liquid conductivity (meas.)	± 5.0 %	Normal	1	0.78	0.71	± 3.9 %	± 3.6 %	∞
Liquid permittivity (meas.)	± 5.0 %	Normal	1	0.26	0.26	± 1.3 %	± 1.3 %	∞
Temp. unc. - Conductivity	± 1.7 %	Rectangular	√ 3	0.78	0.71	± 0.8 %	± 0.7 %	∞
Temp. unc. - Permittivity	± 0.3 %	Rectangular	√ 3	0.23	0.26	± 0.0 %	± 0.0 %	∞
<b>Combined Uncertainty</b>						± 9.1 %	± 8.9 %	330
<b>Expanded Std. Uncertainty</b>						± 18.2 %	± 17.9 %	

Table 11: Measurement uncertainties of the System Check with DASY5 (0.3-3GHz)

Uncertainty of a System Performance Check with DASY5 System for the 3 - 6 GHz range								
Source of uncertainty	Uncertainty Value	Probability Distribution	Divisor	$c_i$	$c_i$	Standard Uncertainty		$v_i^2$ or $v_{eff}$
				(1g)	(10g)	± %, (1g)	± %, (10g)	
<b>Measurement System</b>								
Probe calibration	± 6.6 %	Normal	1	1	1	± 6.6 %	± 6.6 %	∞
Axial isotropy	± 4.7 %	Rectangular	√ 3	0.7	0.7	± 1.9 %	± 1.9 %	∞
Hemispherical isotropy	± 0.0 %	Rectangular	√ 3	0.7	0.7	± 0.0 %	± 0.0 %	∞
Boundary effects	± 1.0 %	Rectangular	√ 3	1	1	± 0.6 %	± 0.6 %	∞
Probe linearity	± 4.7 %	Rectangular	√ 3	1	1	± 2.7 %	± 2.7 %	∞
System detection limits	± 1.0 %	Rectangular	√ 3	1	1	± 0.6 %	± 0.6 %	∞
Readout electronics	± 0.3 %	Normal	1	1	1	± 0.3 %	± 0.3 %	∞
Response time	± 0.0 %	Rectangular	√ 3	1	1	± 0.0 %	± 0.0 %	∞
Integration time	± 0.0 %	Rectangular	√ 3	1	1	± 0.0 %	± 0.0 %	∞
RF ambient conditions	± 3.0 %	Rectangular	√ 3	1	1	± 1.7 %	± 1.7 %	∞
Probe positioner	± 0.8 %	Rectangular	√ 3	1	1	± 0.5 %	± 0.5 %	∞
Probe positioning	± 6.7 %	Rectangular	√ 3	1	1	± 3.9 %	± 3.9 %	∞
Max. SAR evaluation	± 1.0 %	Rectangular	√ 3	1	1	± 0.6 %	± 0.6 %	∞
<b>Test Sample Related</b>								
Dev. of experimental dipole	± 0.0 %	Rectangular	√ 3	1	1	± 0.0 %	± 0.0 %	∞
Source to liquid distance	± 2.0 %	Rectangular	√ 3	1	1	± 1.2 %	± 1.2 %	∞
Power drift	± 3.4 %	Rectangular	√ 3	1	1	± 2.0 %	± 2.0 %	∞
<b>Phantom and Set-up</b>								
Phantom uncertainty	± 4.0 %	Rectangular	√ 3	1	1	± 2.3 %	± 2.3 %	∞
SAR correction	± 1.9 %	Rectangular	√ 3	1	0.84	± 1.1 %	± 0.9 %	∞
Liquid conductivity (meas.)	± 5.0 %	Normal	1	0.78	0.71	± 3.9 %	± 3.6 %	∞
Liquid permittivity (meas.)	± 5.0 %	Normal	1	0.26	0.26	± 1.3 %	± 1.3 %	∞
Temp. unc. - Conductivity	± 1.7 %	Rectangular	√ 3	0.78	0.71	± 0.8 %	± 0.7 %	∞
Temp. unc. - Permittivity	± 0.3 %	Rectangular	√ 3	0.23	0.26	± 0.0 %	± 0.0 %	∞
<b>Combined Uncertainty</b>						± 10.1 %	± 10.0 %	330
<b>Expanded Std. Uncertainty</b>						± 20.2 %	± 19.9 %	

Table 12: Measurement uncertainties of the System Check with DASY5 (3-6GHz)

Note: Worst case probe calibration uncertainty has been applied for all probes used during the measurements.

### 6.1.13 System check

The system check is performed for verifying the accuracy of the complete measurement system and performance of the software. The system check is performed with tissue equivalent material according to IEEE 1528. The following table shows system check results for all frequency bands and tissue liquids used during the tests (plot(s) see annex A).

System performance check (1000 mW)								
System validation Kit	Frequency	Target SAR <sub>1g</sub> /mW/g(+/- 10%)	Target SAR <sub>10g</sub> /mW/g(+/- 10%)	Measured SAR <sub>1g</sub> mW/g	SAR <sub>1g</sub> dev. %	Measured SAR <sub>10g</sub> mW/g	SAR <sub>10g</sub> dev. %	Measured date
D835V2 S/N: 4d153	835 MHz head	9.58	6.21	10.20	6.5%	6.69	7.7%	2014-05-07
D835V2 S/N: 4d153	835 MHz head	9.58	6.21	9.42	-1.7%	6.23	0.3%	2014-05-14
D835V2 S/N: 4d153	835 MHz body	9.40	6.12	9.61	2.2%	6.38	4.2%	2014-05-08
D835V2 S/N: 4d153	835 MHz body	9.40	6.12	9.66	2.8%	6.40	4.6%	2014-05-15
D835V2 S/N: 4d153	835 MHz body	9.40	6.12	9.72	3.4%	6.45	5.4%	2014-05-16
D1900V2 S/N: 5d009	1900 MHz head	40.10	21.00	41.20	2.7%	22.00	4.8%	2014-05-09
D1900V2 S/N: 5d009	1900 MHz head	40.10	21.00	41.10	2.5%	22.00	4.8%	2014-05-13
D1900V2 S/N: 5d009	1900 MHz body	40.90	21.70	39.00	-4.6%	21.10	-2.8%	2014-05-08
D1900V2 S/N: 5d009	1900 MHz body	40.90	21.70	41.10	0.5%	21.80	0.5%	2014-05-21
D1900V2 S/N: 5d009	1900 MHz body	40.90	21.70	42.20	3.2%	22.40	3.2%	2014-05-22
D2450V2 S/N: 710	2450 MHz head	51.50	24.00	53.60	4.1%	25.00	4.2%	2014-05-16
D2450V2 S/N: 710	2450 MHz body	51.20	23.90	53.40	4.3%	24.40	2.1%	2014-05-16
D2600V2 S/N: 1040	2600 MHz head	58.00	26.10	55.20	-4.8%	24.72	-5.3%	2014-05-16
D2600V2 S/N: 1040	2600 MHz body	56.80	25.40	54.50	-4.0%	24.20	-4.7%	2014-05-19
D2600V2 S/N: 1040	2600 MHz body	56.80	25.40	56.90	0.2%	25.50	0.4%	2014-05-20
D5GHzV2 S/N: 1055	5200 MHz head	80.40	23.00	75.20	-6.5%	21.52	-6.4%	2014-05-15
D5GHzV2 S/N: 1055	5500 MHz head	84.90	24.30	88.60	4.4%	24.90	2.5%	2014-05-15
D5GHzV2 S/N: 1055	5800 MHz head	80.10	22.70	83.40	4.1%	23.30	2.6%	2014-05-15
D5GHzV2 S/N: 1055	5200 MHz body	74.20	20.80	71.80	-3.2%	20.50	-1.4%	2014-05-21
D5GHzV2 S/N: 1055	5500 MHz body	77.90	21.70	80.20	3.0%	22.60	4.1%	2014-05-21
D5GHzV2 S/N: 1055	5800 MHz body	73.30	20.20	77.00	5.0%	21.40	5.9%	2014-05-21

Table 13: Results system check

### 6.1.14 System check procedure

The system check is performed by using a validation dipole which is positioned parallel to the planar part of the SAM phantom at the reference point. The distance of the dipole to the SAM phantom is determined by a plexiglass spacer. The dipole is connected to the signal source consisting of signal generator and amplifier via a directional coupler, N-connector cable and adaption to SMA. It is fed with a power of 1000 mW for frequencies below 2 GHz or 100 mW for frequencies above 2 GHz. To adjust this power a power meter is used. The power sensor is connected to the cable before the system check to measure the power at this point and do adjustments at the signal generator. At the outputs of the directional coupler both return loss as well as forward power are controlled during the validation to make sure that emitted power at the dipole is kept constant. This can also be checked by the power drift measurement after the test (result on plot). System check results have to be equal or near the values determined during dipole calibration (target SAR in table above) with the relevant liquids and test system.

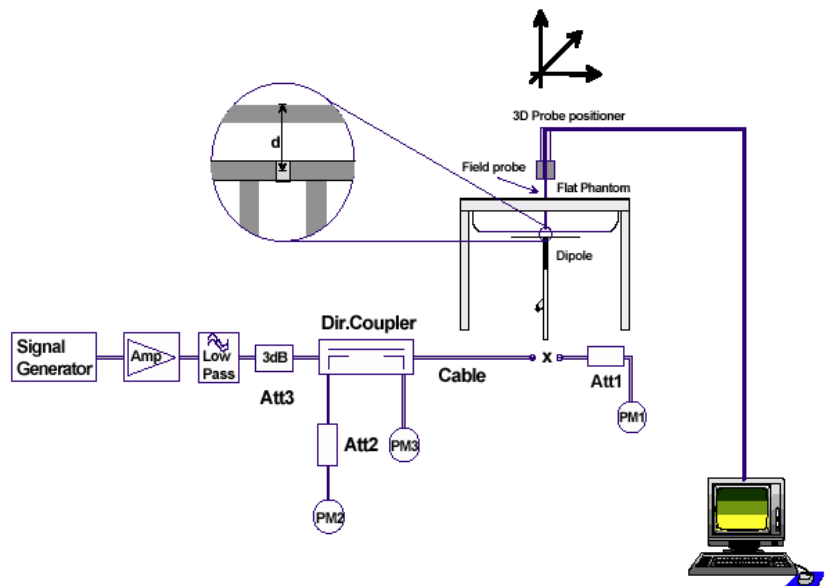

### 6.1.15 System validation

The system validation is performed in a similar way as a system check. It needs to be performed once a SAR measurement system has been established and allows an evaluation of the system accuracy with all components used together with the specified system. It has to be repeated at least once a year or when new system components are used (DAE, probe, phantom, dipole, liquid type).

In addition to the procedure used during system check a system validation also includes checks of probe isotropy, probe modulation factor and RF signal.

The following table lists the system validations relevant for this test report:

Probe Calibration Point f / MHz	Test System	DASY SW	Dipole Type / SN	Probe Type / SN	Calibrated signal type(s)	DAE unit Type / SN	Validation done	
							Head tissue simulant	Body tissue simulant
835	Saarbrücken / SAR-2	V52.8.7	D835V2 / 4d153	ET3DV6 / 1558	CW	DAE3/ 408	2013-10-11	2013-10-10
1900	Saarbrücken / SAR-2	V52.8.7	D1900V2 / 5d009	ET3DV6 / 1558	CW	DAE3/ 408	2013-10-15	2013-10-16
2450	Saarbrücken / SAR-2	V52.8.7	D2450V2 / 710	ET3DV6 / 1558	CW	DAE3/ 408	2013-11-13	2014-05-16
5200	Saarbrücken / SAR-2	V52.8.7	D5GHzV2 / 1055	EX3DV4 / 3944	CW	DAE3/ 408	2013-11-19	2013-11-21
5500	Saarbrücken / SAR-2	V52.8.7	D5GHzV2 / 1055	EX3DV4 / 3944	CW	DAE3/ 408	2013-11-19	2013-11-21
5800	Saarbrücken / SAR-2	V52.8.7	D5GHzV2 / 1055	EX3DV4 / 3944	CW	DAE3/ 408	2013-11-19	2013-11-21
5200	Saarbrücken / SAR-2	V52.8.7	D5GHzV2 / 1055	EX3DV4 / 3944	CW	DAE3/ 477	2014-05-15	2014-05-21
5500	Saarbrücken / SAR-2	V52.8.7	D5GHzV2 / 1055	EX3DV4 / 3944	CW	DAE3/ 477	2014-05-15	2014-05-21
5800	Saarbrücken / SAR-2	V52.8.7	D5GHzV2 / 1055	EX3DV4 / 3944	CW	DAE3/ 477	2014-05-15	2014-05-21
835	Saarbrücken / SAR-3	V52.8.7	D835V2 / 4d153	ES3DV3 / 3326	CW	DAE4/ 1387	2013-09-26	2013-10-07
1900	Saarbrücken / SAR-3	V52.8.7	D1900V2 / 5d009	ES3DV3 / 3326	CW	DAE4/ 1387	2013-09-30	2013-10-07

## 7 Detailed Test Results

### 7.1 Conducted power measurements

For the measurements a Rohde & Schwarz Radio Communication Tester CMU 200 was used. The output power was measured using an integrated RF connector and attached RF cable. The conducted output power was also checked before and after each SAR measurement. The resulting power values were within a 0.2 dB tolerance of the values shown below.

Note: CMU200 measures GSM peak and average output power for active timeslots.

For SAR the time based average power is relevant. The difference in-between depends on the duty cycle of the TDMA signal:

<b>No. of timeslots</b>	<b>1</b>	<b>2</b>	<b>3</b>	<b>4</b>
Duty Cycle	1 : 8	1: 4	1 : 2.66	1 : 2
time based avg. power compared to slotted avg. power	- 9 dB	- 6 dB	- 4.25 dB	- 3 dB

The signalling modes differ as follows :

<b>mode</b>	<b>coding scheme</b>	<b>modulation</b>
GPRS	CS1 to CS4	GMSK
EGPRS (EDGE)	MCS1 to MCS4	GMSK
EGPRS (EDGE)	MCS5 to MCS9	8PSK

Apart from modulation change (GMSK/8PSK) coding schemes differ in code rate without influence on the RF signal. Therefore one coding scheme per mode was selected for conducted power measurements.

### 7.1.1 Conducted power measurements GSM 850 MHz

Channel / frequency	modulation	timeslots	slotted avg. power	time based avg. Power (calculated)
128 / 824.2 MHz	GMSK	1	33.0 dBm	24.0 dBm
190 / 836.6 MHz	GMSK	1	33.1 dBm	24.1 dBm
251 / 848.8 MHz	GMSK	1	33.1 dBm	24.1 dBm
128 / 824.2 MHz	GMSK	2	30.8 dBm	24.8 dBm
190 / 836.6 MHz	GMSK	2	30.8 dBm	24.8 dBm
251 / 848.8 MHz	GMSK	2	30.9 dBm	24.9 dBm
128 / 824.2 MHz	GMSK	3	28.8 dBm	24.55 dBm
190 / 836.6 MHz	GMSK	3	28.8 dBm	24.55 dBm
251 / 848.8 MHz	GMSK	3	28.8 dBm	24.55 dBm
128 / 824.2 MHz	GMSK	<b>4</b>	<b>27.9 dBm</b>	<b>24.9 dBm</b>
190 / 836.6 MHz	GMSK	<b>4</b>	<b>27.9 dBm</b>	<b>24.9 dBm</b>
251 / 848.8 MHz	GMSK	<b>4</b>	<b>27.9 dBm</b>	<b>24.9 dBm</b>
128 / 824.2 MHz	8PSK	1	27.6 dBm	18.6 dBm
190 / 836.6 MHz	8PSK	1	27.6 dBm	18.6 dBm
251 / 848.8 MHz	8PSK	1	27.7 dBm	18.7 dBm
128 / 824.2 MHz	8PSK	2	25.4 dBm	19.4 dBm
190 / 836.6 MHz	8PSK	2	25.5 dBm	19.5 dBm
251 / 848.8 MHz	8PSK	2	25.5 dBm	19.5 dBm
128 / 824.2 MHz	8PSK	3	24.5 dBm	20.25 dBm
190 / 836.6 MHz	8PSK	3	24.5 dBm	20.25 dBm
251 / 848.8 MHz	8PSK	3	24.5 dBm	20.25 dBm
128 / 824.2 MHz	8PSK	4	22.4 dBm	19.4 dBm
190 / 836.6 MHz	8PSK	4	22.4 dBm	19.4 dBm
251 / 848.8 MHz	8PSK	4	22.5 dBm	19.5 dBm
GSM 850MHz DTM				
Channel / frequency	modulation		slotted avg. power	time based avg. Power (calculated)
128 / 824.2 MHz	GMSK + 1 GMSK		30.6 dBm	24.6 dBm
190 / 836.6 MHz	GMSK + 1 GMSK		30.6 dBm	24.6 dBm
251 / 848.8 MHz	GMSK + 1 GMSK		30.7 dBm	24.7 dBm
128 / 824.2 MHz	<b>GMSK + 2 GMSK</b>		<b>28.9 dBm</b>	<b>24.7 dBm</b>
190 / 836.6 MHz	<b>GMSK + 2 GMSK</b>		<b>28.9 dBm</b>	<b>24.7 dBm</b>
251 / 848.8 MHz	<b>GMSK + 2 GMSK</b>		<b>29.0 dBm</b>	<b>24.8 dBm</b>
128 / 824.2 MHz	GMSK + 1 8PSK		25.7 dBm	19.7 dBm
190 / 836.6 MHz	GMSK + 1 8PSK		25.8 dBm	19.8 dBm
251 / 848.8 MHz	GMSK + 1 8PSK		25.8 dBm	19.8 dBm
128 / 824.2 MHz	GMSK + 2 8PSK		25.5 dBm	21.3 dBm
190 / 836.6 MHz	GMSK + 2 8PSK		25.6 dBm	21.4 dBm
251 / 848.8 MHz	GMSK + 2 8PSK		25.7 dBm	21.5 dBm

Table 14: Test results conducted power measurement GSM 850 MHz



### 7.1.2 Conducted power measurements GSM 1900 MHz

Channel / frequency	modulation	timeslots	slotted avg. power	time based avg. Power (calculated)
512 / 1850.2 MHz	GMSK	1	30.5 dBm	21.5 dBm
661 / 1880.0 MHz	GMSK	1	30.5 dBm	21.5 dBm
810 / 1909.8 MHz	GMSK	1	30.4 dBm	21.4 dBm
512 / 1850.2 MHz	GMSK	2	27.9 dBm	21.9 dBm
661 / 1880.0 MHz	GMSK	2	28.0 dBm	22.0 dBm
810 / 1909.8 MHz	GMSK	2	27.9 dBm	21.9 dBm
512 / 1850.2 MHz	GMSK	3	26.5 dBm	22.25 dBm
661 / 1880.0 MHz	GMSK	3	26.5 dBm	22.25 dBm
810 / 1909.8 MHz	GMSK	3	26.4 dBm	22.15 dBm
512 / 1850.2 MHz	GMSK	<b>4</b>	<b>25.5 dBm</b>	<b>22.5 dBm</b>
661 / 1880.0 MHz	GMSK	<b>4</b>	<b>25.5 dBm</b>	<b>22.5 dBm</b>
810 / 1909.8 MHz	GMSK	<b>4</b>	<b>25.5 dBm</b>	<b>22.5 dBm</b>
512 / 1850.2 MHz	8PSK	1	26.7 dBm	17.7 dBm
661 / 1880.0 MHz	8PSK	1	26.7 dBm	17.7 dBm
810 / 1909.8 MHz	8PSK	1	26.7 dBm	17.7 dBm
512 / 1850.2 MHz	8PSK	2	24.7 dBm	18.7 dBm
661 / 1880.0 MHz	8PSK	2	24.8 dBm	18.8 dBm
810 / 1909.8 MHz	8PSK	2	24.7 dBm	18.7 dBm
512 / 1850.2 MHz	8PSK	3	23.9 dBm	19.65 dBm
661 / 1880.0 MHz	8PSK	3	24.0 dBm	19.75 dBm
810 / 1909.8 MHz	8PSK	3	23.8 dBm	19.55 dBm
512 / 1850.2 MHz	8PSK	4	22.8 dBm	19.8 dBm
661 / 1880.0 MHz	8PSK	4	22.9 dBm	19.9 dBm
810 / 1909.8 MHz	8PSK	4	22.7 dBm	19.7 dBm

GSM 1900MHz DTM				
Channel / frequency	modulation	slotted avg.	time based avg.	
512 / 1850.2 MHz	GMSK + 1 GMSK	28.0 dBm	22.0 dBm	
661 / 1880.0 MHz	GMSK + 1 GMSK	28.0 dBm	22.0 dBm	
810 / 1909.8 MHz	GMSK + 1 GMSK	27.9 dBm	21.9 dBm	
512 / 1850.2 MHz	<b>GMSK + 2 GMSK</b>	<b>26.6 dBm</b>	<b>22.35 dBm</b>	
661 / 1880.0 MHz	<b>GMSK + 2 GMSK</b>	<b>26.6 dBm</b>	<b>22.35 dBm</b>	
810 / 1909.8 MHz	<b>GMSK + 2 GMSK</b>	<b>26.5 dBm</b>	<b>22.25 dBm</b>	
512 / 1850.2 MHz	GMSK + 1 8PSK	24.9 dBm	18.9 dBm	
661 / 1880.0 MHz	GMSK + 1 8PSK	25.0 dBm	19.0 dBm	
810 / 1909.8 MHz	GMSK + 1 8PSK	24.9 dBm	18.9 dBm	
512 / 1850.2 MHz	GMSK + 2 8PSK	24.6 dBm	20.35 dBm	
661 / 1880.0 MHz	GMSK + 2 8PSK	24.7 dBm	20.45 dBm	
810 / 1909.8 MHz	GMSK + 2 8PSK	24.6 dBm	20.35 dBm	

Table 15: Test results conducted power measurement GSM 1900 MHz

### 7.1.3 Justification of SAR measurements in GSM mode

SAR measurements were performed in the configuration with highest calculated time based averaged output power.

#### 7.1.4 Conducted power measurements WCDMA FDD V (850 MHz)

mode	Max. RMS output power 850 MHz (FDD V) / dBm		
	Channel / frequency		
	4132 / 826.4 MHz	4182 / 836.6 MHz	4233 / 846.6 MHz
<b>RMC 12.2 kbit/s</b>	<b>23.8</b>	<b>23.8</b>	<b>23.9</b>
RMC 64 kbit/s	23.8	23.8	23.9
RMC 144 kbit/s	23.8	23.8	23.9
RMC 384 kbit/s	23.8	23.8	23.9
AMR 4.75 kbit/s	23.8	23.7	23.9
AMR 5.15 kbit/s	23.7	23.7	23.8
AMR 5.9 kbit/s	23.7	23.7	23.8
AMR 6.7 kbit/s	23.8	23.7	23.9
AMR 7.4 kbit/s	23.8	23.7	23.8
AMR 7.95 kbit/s	23.8	23.7	23.9
AMR 10.2 kbit/s	23.8	23.7	23.9
AMR 12.2 kbit/s	23.8	23.7	23.9
<b>HSDPA Sub test 1</b>	<b>23.3</b>	<b>23.2</b>	<b>23.4</b>
HSDPA Sub test 2	22.0	22.1	22.0
HSDPA Sub test 3	21.3	21.2	21.3
HSDPA Sub test 4	21.0	20.9	21.2
<b>DC-HSDPA Sub test 1</b>	<b>23.2</b>	<b>23.1</b>	<b>23.1</b>
DC-HSDPA Sub test 2	23.2	23.1	23.2
DC-HSDPA Sub test 3	22.8	22.9	22.8
DC-HSDPA Sub test 4	22.8	22.8	22.8
HSUPA Sub test 1	23.3	23.3	23.5
HSUPA Sub test 2	21.5	21.7	22.0
HSUPA Sub test 3	22.4	22.4	22.5
HSUPA Sub test 4	21.8	21.8	21.9
<b>HSUPA Sub test 5</b>	<b>22.8</b>	<b>22.9</b>	<b>23.1</b>

Table 16: Test results conducted power measurement UMTS FDD V 850MHz

### 7.1.5 Conducted power measurements WCDMA FDD II (1900 MHz)

mode	Max. RMS output power 1900 MHz (FDD II) / dBm		
	9262 / 1852.4 MHz	9400 / 1880.0 MHz	9538 / 1907.6 MHz
<b>RMC 12.2 kbit/s</b>	<b>22.9</b>	<b>22.8</b>	<b>22.9</b>
RMC 64 kbit/s	22.8	22.8	22.9
RMC 144 kbit/s	22.8	22.8	22.9
RMC 384 kbit/s	22.8	22.8	22.9
AMR 4.75 kbit/s	22.8	22.7	22.8
AMR 5.15 kbit/s	22.8	22.7	22.8
AMR 5.9 kbit/s	22.8	22.7	22.8
AMR 6.7 kbit/s	22.8	22.7	22.8
AMR 7.4 kbit/s	22.8	22.8	22.8
AMR 7.95 kbit/s	22.8	22.7	22.9
AMR 10.2 kbit/s	22.8	22.7	22.8
AMR 12.2 kbit/s	22.8	22.8	22.8
<b>HSDPA Sub test 1</b>	<b>22.6</b>	<b>22.6</b>	<b>22.6</b>
HSDPA Sub test 2	21.3	21.2	21.2
HSDPA Sub test 3	20.1	20.1	20.0
HSDPA Sub test 4	19.9	19.7	19.7
<b>DC-HSDPA Sub test 1</b>	<b>22.5</b>	<b>22.5</b>	<b>22.5</b>
DC-HSDPA Sub test 2	22.5	22.4	22.5
DC-HSDPA Sub test 3	22.1	22.1	22.1
DC-HSDPA Sub test 4	22.0	22.0	22.0
HSUPA Sub test 1	22.3	22.3	22.0
HSUPA Sub test 2	20.7	20.7	20.4
HSUPA Sub test 3	21.6	21.6	21.3
HSUPA Sub test 4	21.1	21.2	21.0
<b>HSUPA Sub test 5</b>	<b>22.0</b>	<b>22.7</b>	<b>21.9</b>

Table 17: Test results conducted power measurement UMTS FDD II 1900MHz

Remark: None of the HSDPA/HSUPA settings leads to conducted power values exceeding the conducted power in RMC mode by more than 0.25 dB.

Therefore no additional SAR measurements were performed in HSDPA/HSUPA mode.

## 7.1.6 Test-set-up information for WCDMA / HSPDA / HSUPA

### a) WCDMA RMC

In RMC (reference measurement channel) mode the conducted power at 4 different bit rates was measured. They correspond with the used spreading factors as follows:

Bit rate	12.2 kbit/s	64 kbit/s	144 kbit/s	384 kbit/s
Spreading factor (SF)	64	16	8	4

In RMC mode only DPCCH and DPDCH are active. As bit rate changes do not influence the relative power of any code channel the measured RMS output power remains on the same level which is set to maximum by TPC (Transmit power control) pattern type 'All 1'.

### b) HSDPA

HSDPA adds the HS-DPCCH in uplink as a control channel for high speed data transfer in downlink. In HSDPA mode 4 sub-tests are defined by 3GPP 34.121 according to the following table:

Sub-test	$\beta_c$	$\beta_d$	$\beta_d$ (SF)	$\beta_c/\beta_d$	$\beta_{hs}^{(1)}$	CM(dB) <sup>(2)</sup>
1	2/15	15/15	64	2/15	4/15	0.0
2	12/15 <sup>(3)</sup>	15/15 <sup>(3)</sup>	64	12/15 <sup>(3)</sup>	24/15	1.0
3	15/15	8/15	64	15/8	30/15	1.5
4	15/15	4/15	64	15/4	30/15	1.5

Note 1:  $\Delta_{ACK}, \Delta_{NACK}, \Delta_{CQI} = 8 \iff A_{hs} = \beta_{hs}/\beta_c = 30/15 \iff \beta_{hs} = 30/15 * \beta_c$

Note 2 : CM = 1 for  $\beta_c/\beta_d = 12/15, \beta_{hs}/\beta_c = 24/15$

Note 3 : For subtest 2 the  $\beta_c/\beta_d$  ratio of 12/15 for the TFC during the measurement period (TF1, TF0) is achieved by setting the signalled gain factors for the reference TFC (TF1, TF1) to  $\beta_c = 11/15$  and  $\beta_d = 15/15$

Table 18: Sub-tests for UMTS Release 5 HSDPA

The  $\beta_c$  and  $\beta_d$  gain factors for DPCCH and DPDCH were set according to the values in the above table,  $\beta_{hs}$  for HS-DPCCH is set automatically to the correct value when  $\Delta_{ACK}, \Delta_{NACK}, \Delta_{CQI} = 8$ . The variation of the  $\beta_c/\beta_d$  ratio causes a power reduction at sub-tests 2 - 4.

The measurements were performed with a Fixed Reference Channel (FRC) and H-Set 1 QPSK.

Parameter	Value
Nominal average inf. bit rate	534 kbit/s
Inter-TTI Distance	3 TTI's
Number of HARQ Processes	2 Processes
Information Bit Payload	3202 Bits
MAC-d PDU size	336 Bits
Number Code Blocks	1 Block
Binary Channel Bits Per TTI	4800 Bits
Total Available SMLs in UE	19200 SMLs
Number of SMLs per HARQ Process	9600 SMLs
Coding Rate	0.67
Number of Physical Channel Codes	5

Table 19: settings of required H-Set 1 QPSK acc. to 3GPP 34.121

## c) DC-HSDPA (3GPP Release 8)

Dual Cell – HSDPA has been signaled using the following settings for connection setup:

Parameter	Value
During Connection Setup	
P-CPICH_Ec/Ior	-10 dB
P-CCPCH	-12
SCH_Ec/Ior	-12
PICH_Ec/Ior	-15
HS-PDSCH	off
HS-SCCH_1	off
DPCH_Ec/Ior	-5
OCNS_Ec/Ior	-3.1

Table 20: Downlink Physical Channels according to 3GPP 34.121 Table E.5.0

The fixed reference channel has been set to H-set 12 according to 3GPP TS 34.121 Table C.8.1.12:

Parameter	Unit	Value
Nominal Average Inf. Bit Rate	kbit/s	60
Inter-TTI Distance	TTI's	1
Information Bit Payload ( $N_{INF}$ )	Bits	120
Number Code Blocks	Blocks	1
Binary Channel Bits Per TTI	Bits	960
Total Available SML's in UE	SML's	19200
Number of SML's per HARQ Process	SML's	3200
Coding Rate		0.15
Number of Physical Channel Codecs	Codecs	1
Modulation		QPSK
Note 1: The RMC is intended to be used for DC-HSDPA mode and both cells shall transmit with identical parameters as listed in the table. Note 2: Maximum number of transmission is limited to 1, i.e., retransmission is not allowed. The redundancy and constellation version 0 shall be used.		

Table 21: H-Set 12 QPSK configuration

The same Sub-test settings as for Release 5 HSDPA were used for the tests.

d) HSUPA

In HSUPA mode additional code channels (E-DPCCH, E-DPDCHn) are added for data transfer in uplink at higher bit rates.

5 sub-tests are defined by 3GPP 34.121 according to the following table :

Sub-test	$\beta_c$	$\beta_d$	$\beta_d$ (SF)	$\beta_c/\beta_d$	$\beta_{hs}^{(1)}$	$\beta_{ec}$	$\beta_{ed}$	$\beta_{ec}$ (SF)	$\beta_{ed}$ (code)	CM <sup>(2)</sup> (dB)	MPR (dB)	AG <sup>(4)</sup> Index	E-TFCI
1	11/15 <sup>(3)</sup>	15/15 <sup>(3)</sup>	64	11/15 <sup>(3)</sup>	22/15	209/225	1039/225	4	1	1.0	0.0	20	75
2	6/15	15/15	64	6/15	12/15	12/15	94/75	4	1	3.0	2.0	12	67
3	15/15	9/15	64	15/9	30/15	30/15	$\beta_{ed1}:47/15$ $\beta_{ed2}:47/15$	4	2	2.0	1.0	15	92
4	2/15	15/15	64	2/15	4/15	2/15	56/75	4	1	3.0	2.0	17	71
5	15/15 <sup>(4)</sup>	15/15 <sup>(4)</sup>	64	15/15 <sup>(4)</sup>	30/15	24/15	134/15	4	1	1.0	0.0	21	81

Note 1 :  $\Delta_{ACK}, \Delta_{NACK}, \Delta_{CQI} = 8 \iff A_{hs} = \beta_{hs}/\beta_c = 30/15 \iff \beta_{hs} = 30/15 * \beta_c$   
 Note 2 : CM = 1 for  $\beta_c/\beta_d = 12/15, \beta_{hs}/\beta_c = 24/15$ . For all other combinations of DPDCH, DPCCH, HS-DPCCH, E-DPDCH and E-DPCCH the MPR is based on the relative CM difference  
 Note 3 : For subtest 1 the  $\beta_c/\beta_d$  ratio of 11/15 for the TFC during the measurement period (TF1, TF0) is achieved by setting the signalled gain factors for the reference TFC (TF1, TF1) to  $\beta_c = 10/15$  and  $\beta_d = 15/15$   
 Note 4 : For subtest 5 the  $\beta_c/\beta_d$  ratio of 15/15 for the TFC during the measurement period (TF1, TF0) is achieved by setting the signalled gain factors for the reference TFC (TF1, TF1) to  $\beta_c = 14/15$  and  $\beta_d = 15/15$   
 Note 5 : Testing UE using E-DPDCH Physical Layer category 1 Sub-test 3 is not required according to TS 25.306 Table 5.1g  
 Note 6 :  $\beta_{ed}$  can not be set directly; it is set by Absolute Grant Value

Table 22: Subtests for UMTS Release 6 HSUPA

To achieve the settings above some additional procedures were defined by 3GPP 34.121. Those have been included in an application note for the CMU200 and were exactly followed :

- Test mode connection (BS signal tab) :
- RMC 12.2 kbit/s + HSPA 34.108 with loop mode 1
- HS-DSCH settings (BS signal tab):
- FRC with H-set 1 QPSK
- ACK-NACK repetition factor = 3
- CQI feedback cycle = 4ms
- CQI repetition factor = 2
- HSUPA-specific signalling settings (UE signal tab) :
- E-TFCI table index = 0
- E-DCH minimum set E-TFCI = 9
- Puncturing limit non-max = 0.84
- max. number of channelisation codes = 2x SF4
- Initial Serving Grant Value = Off
- HSDPA and HSUPA Gain factors (UE signal tab)

Sub-test	$\beta_c$	$\beta_d$	$\Delta_{ACK}, \Delta_{NACK}, \Delta_{CQI}$	$\Delta E-DPCCH$ )*
1	10	15	8	6
2	6	15	8	8
3	15	9	8	8
4	2	15	8	5
5	14	15	8	7

)\* :  $\beta_{ec}$  and  $\beta_{ed}$  ratios (relative to  $\beta_c$  and  $\beta_d$ ) are set by  $\Delta E-DPCCH$

- HSUPA Reference E-TFCIs (UE signal tab > HSUPA gain factors) :

<b>Sub-test</b>	<b>1, 2, 4, 5</b>				
Number of E-TFCIs	5				
Reference E-TFCI	11	67	71	75	81
Reference E-TFCI power offset	4	18	23	26	27

<b>Sub-test</b>	<b>3</b>	
Number of E-TFCIs	2	
Reference E-TFCI	11	92
Reference E-TFCI power offset	4	18

- HSUPA-specific generator parameters (BS Signal tab > HSUPA > E-AGCH > AG Pattern)

<b>Sub-test</b>	<b>Absolute Grant Value (AG Index)</b>
1	20
2	12
3	15
4	17
5	21

- Power Level settings (BS Signal tab > Node B-settings):

- Level reference : Output Channel Power (Ior)

- Output Channel Power (Ior) : -86 dBm

- Downlink Physical Channel Settings (BS signal tab)

- P-CPICH : -10 dB

- S-CPICH : Off

- P-SCH : -15 dB

- S-SCH : -15 dB

- P-CCPCH : -12 dB

- S-CCPCH : -12 dB

- PICH : -15 dB

- AICH : -12 dB

- DPDCH : -10 dB

- HS-SCCH : -8 dB

- HS-PDSCH : -3 dB

- E-AGCH : -20 dB

- E-RGCH/E-HICH - 20 dB

- E-RGCH Active : Off

The settings above were stored once for each sub-test and recalled before the measurement.

HSUPA test procedure :

To reach maximum output power in HSUPA mode the following procedures were followed:

3 different TPC patterns were defined :

Set 1 : Closed loop with target power 10 dBm

Set 2 : Single Pattern+Alternating with binary pattern '11111' for 1 dB steps 'up'

Set 3 : Single Pattern+Alternating with binary pattern '00000' for 1 dB steps 'down'

After recalling a certain HSUPA sub-test the HSUPA E-AGCH graph with E-TFCI event counter is displayed. After starting with the closed loop command the power is increased in 1 dB steps by activating pattern set 2 until the UE decreases the transmitted E-TFCI.

At this point set 3 is activated once to reduce the output power to the value at which the original E-TFCI, which is required for the sub-test, appears again.

For conducted power measurements the same steps are repeated in the power menu to read out the corresponding maximum RMS output power with the target E-TFCI.

For SAR measurements it is useful to switch to Code Domain Power vs. Time display.

Here the CMU200 shows relative power values (max. and min.) of each code channel which should roughly correspond to the numerators of the gain factors e.g. :

Sub-test	$\beta_c$	$\beta_d$	$\beta_{hs}$	$\beta_{ec}$	$\beta_{ed}$
5	15	15	30	24	134

By this way a surveillance of signalling conditions is possible to make sure that HSUPA code channels are active during the complete SAR measurement.



**7.1.7 Conducted power measurements LTE FDD 2 1900 MHz**

Bandwidth (MHz)	Channel / Frequency (MHz)	Resource block allocation	P <sub>avg</sub> (dBm)	
			QPSK	16-QAM
1.4	18607 / 1850.7	1 RB low	22.4	21.6
		1 RB mid	22.3	21.5
		1 RB high	22.4	21.5
		50% RB low	22.4	21.3
		50% RB mid	22.4	21.3
		50% RB high	22.4	21.2
	18900 / 1880.0	100% RB	21.3	20.2
		1 RB low	22.2	21.1
		1 RB mid	22.3	21.1
		1 RB high	22.3	21.1
		50% RB low	22.3	21.4
		50% RB mid	22.2	21.4
	19193 / 1909.3	50% RB high	22.2	21.3
		100% RB	21.3	20.3
		1 RB low	22.5	21.6
		1 RB mid	22.4	21.5
		1 RB high	22.5	21.6
		50% RB low	22.4	21.5
3.0	18615 / 1851.5	50% RB mid	22.5	21.4
		50% RB high	22.5	21.5
		100% RB	21.5	20.5
		1 RB low	22.4	21.4
		1 RB mid	22.4	21.5
		1 RB high	22.4	21.5
	18900 / 1880.0	50% RB low	21.3	20.1
		50% RB mid	21.3	20.1
		50% RB high	21.3	20.1
		100% RB	21.3	20.3
		1 RB low	22.3	21.1
		1 RB mid	22.2	21.0
	19185 / 1908.5	1 RB high	22.2	21.0
		50% RB low	21.2	20.3
		50% RB mid	21.2	20.3
		50% RB high	21.2	20.2
		100% RB	21.2	20.1
		1 RB low	22.5	21.3
19185 / 1908.5	1 RB mid	22.5	21.2	
	1 RB high	22.6	21.3	
	50% RB low	21.4	20.5	
	50% RB mid	21.5	20.4	
	50% RB high	21.4	20.4	
	100% RB	21.5	20.4	

Bandwidth (MHz)	Channel / Frequency (MHz)	Resource block allocation	P <sub>avg</sub> (dBm)	
			QPSK	16-QAM
5.0	18625 / 1852.5	1 RB low	22.4	21.3
		1 RB mid	22.4	21.3
		1 RB high	22.4	21.2
		50% RB low	21.3	20.3
		50% RB mid	21.3	20.4
		50% RB high	21.3	20.4
		100% RB	21.3	20.3
	18900 / 1880.0	1 RB low	22.2	21.6
		1 RB mid	22.2	21.6
		1 RB high	22.2	21.6
		50% RB low	21.2	20.2
		50% RB mid	21.2	20.1
		50% RB high	21.2	20.2
		100% RB	21.2	20.2
	19175 / 1907.5	1 RB low	22.4	21.1
		1 RB mid	22.5	21.2
		1 RB high	22.6	21.3
		50% RB low	21.5	20.5
50% RB mid		21.5	20.5	
50% RB high		21.5	20.5	
100% RB		21.5	20.5	
10.0	18650 / 1855	1 RB low	22.4	21.4
		1 RB mid	22.3	21.4
		1 RB high	22.3	21.4
		50% RB low	21.3	20.4
		50% RB mid	21.3	20.4
		50% RB high	21.3	20.4
		100% RB	21.3	20.2
	18900 / 1880	1 RB low	22.3	21.1
		1 RB mid	22.2	21.1
		1 RB high	22.3	21.0
		50% RB low	21.3	20.3
		50% RB mid	21.2	20.3
		50% RB high	21.3	20.2
		100% RB	21.3	20.2
	19150 / 1905	1 RB low	22.2	21.0
		1 RB mid	22.4	21.1
		1 RB high	22.6	21.3
		50% RB low	21.3	20.2
50% RB mid		21.4	20.4	
50% RB high		21.5	20.4	
100% RB		21.4	20.4	

Bandwidth (MHz)	Channel / Frequency (MHz)	Resource block allocation	P <sub>avg</sub> (dBm)	
			QPSK	16-QAM
15.0	18675 / 1857.5	1 RB low	22.4	21.5
		1 RB mid	22.3	21.4
		1 RB high	22.4	21.5
		50% RB low	21.4	20.5
		50% RB mid	21.3	20.4
		50% RB high	21.2	20.3
	18900 / 1880.0	100% RB	21.4	20.4
		1 RB low	22.3	21.6
		1 RB mid	22.2	21.6
		1 RB high	22.2	21.6
		50% RB low	21.2	20.2
		50% RB mid	21.3	20.2
	19125 / 1902.5	50% RB high	21.2	20.2
		100% RB	21.3	20.2
		1 RB low	22.2	21.0
		1 RB mid	22.4	21.1
		1 RB high	22.5	21.3
		50% RB low	21.2	20.1
20.0	18700 / 1860	50% RB mid	21.3	20.2
		50% RB high	21.3	20.3
		100% RB	<b>21.3</b>	20.4
		1 RB low	<b>22.4</b>	21.3
		1 RB mid	22.3	21.3
		1 RB high	22.2	21.3
	18900 / 1880	50% RB low	21.3	20.3
		50% RB mid	21.3	20.3
		50% RB high	21.3	20.3
		100% RB	21.2	20.2
		1 RB low	<b>22.1</b>	21.3
		1 RB mid	22.1	21.3
	19100 / 1900	1 RB high	22.0	21.3
		50% RB low	21.3	20.2
		50% RB mid	21.2	20.2
		50% RB high	21.2	20.2
		100% RB	21.2	20.2
		1 RB low	22.1	21.3
	19100 / 1900	1 RB mid	21.9	21.2
		1 RB high	<b>22.4</b>	21.6
		50% RB low	21.3	20.2
		50% RB mid	21.2	20.2
		50% RB high	<b>21.4</b>	20.4
		100% RB	21.3	20.3

Table 23: Test results conducted power measurement LTE FDD 2 1900 MHz.

### 7.1.8 Conducted power measurements LTE FDD 5 850 MHz

Bandwidth (MHz)	Channel / Frequency (MHz)	Resource block allocation	P <sub>avg</sub> (dBm)	
			QPSK	16-QAM
1.4	20407 / 824.7	1 RB low	23.2	22.5
		1 RB mid	23.2	22.4
		1 RB high	23.3	22.5
		50% RB low	23.3	22.3
		50% RB mid	23.2	22.3
		50% RB high	23.3	22.2
		100% RB	22.3	21.2
	20525 / 836.5	1 RB low	23.4	22.2
		1 RB mid	23.4	22.2
		1 RB high	23.4	22.3
		50% RB low	23.3	22.5
		50% RB mid	23.4	22.5
		50% RB high	23.4	22.6
	20643 / 848.3	100% RB	22.4	21.5
		1 RB low	23.1	22.4
		1 RB mid	23.1	22.3
		1 RB high	23.2	22.3
		50% RB low	23.2	22.2
50% RB mid		23.1	22.1	
3.0	20415 / 825.5	50% RB high	23.2	22.2
		100% RB	22.2	21.3
		1 RB low	23.3	22.4
		1 RB mid	23.2	22.4
		1 RB high	23.3	22.4
		50% RB low	22.3	21.1
		50% RB mid	22.3	21.1
	20525 / 836.5	50% RB high	22.3	21.1
		100% RB	22.3	21.3
		1 RB low	23.5	22.3
		1 RB mid	23.3	22.1
		1 RB high	23.4	22.2
		50% RB low	22.5	21.6
	20635 / 847.5	50% RB mid	22.4	21.5
		50% RB high	22.4	21.4
		100% RB	22.5	21.4
		1 RB low	23.5	22.3
		1 RB mid	23.3	22.0
1 RB high		23.3	22.0	
50% RB low		22.4	21.4	
50% RB mid	22.3	21.3		
50% RB high	22.2	21.2		
100% RB	22.3	21.3		

Bandwidth (MHz)	Channel / Frequency (MHz)	Resource block allocation	P <sub>avg</sub> (dBm)	
			QPSK	16-QAM
5.0	20425 / 826.5	1 RB low	23.3	22.3
		1 RB mid	23.2	22.2
		1 RB high	23.4	22.4
		50% RB low	22.3	21.3
		50% RB mid	22.2	21.3
		50% RB high	22.3	21.3
	20525 / 836.5	100% RB	22.3	21.3
		1 RB low	23.3	22.7
		1 RB mid	23.3	22.7
		1 RB high	23.3	22.7
		50% RB low	22.5	21.5
		50% RB mid	22.4	21.5
	20625 / 846.5	50% RB high	22.4	21.3
		100% RB	22.5	21.4
		1 RB low	23.4	22.1
		1 RB mid	23.3	22.1
		1 RB high	23.2	22.0
		50% RB low	22.4	21.4
10.0	20450 / 829	50% RB mid	22.4	21.4
		50% RB high	22.2	21.2
		100% RB	22.2	21.3
		1 RB low	23.2	22.4
		1 RB mid	23.3	22.5
		1 RB high	<b>23.3</b>	22.5
	20525 / 836.5	50% RB low	22.2	21.3
		50% RB mid	22.2	21.2
		50% RB high	<b>22.3</b>	21.4
		1 RB low	23.3	22.1
		1 RB mid	23.3	22.1
		1 RB high	<b>23.4</b>	22.2
	20600 / 844	50% RB low	22.4	21.5
		50% RB mid	<b>22.5</b>	21.5
		50% RB high	22.4	21.5
		100% RB	<b>22.4</b>	21.4
		1 RB low	<b>23.4</b>	22.2
		1 RB mid	23.4	22.2
20600 / 844	1 RB high	23.2	22.0	
	50% RB low	22.4	21.3	
	50% RB mid	<b>22.4</b>	21.4	
	50% RB high	22.4	21.3	
	100% RB	22.4	21.4	

Table 24: Test results conducted power measurement LTE FDD 5 850 MHz.

Bandwidth (MHz)	Channel / Frequency (MHz)	Resource block allocation	P <sub>avg</sub> (dBm)	P <sub>avg</sub> (dBm) back off	dev. dB	P <sub>avg</sub> (dBm)	P <sub>avg</sub> (dBm) back off	dev. dB
			QPSK	QPSK		16-QAM	16-QAM	
5.0	20775 / 2502.5	1 RB low	22.5	18.1	4.4	21.6	18.1	3.5
		1 RB mid	22.5	18.0	4.5	21.5	17.9	3.6
		1 RB high	22.6	18.0	4.6	21.6	18.0	3.6
		50% RB low	21.7	18.1	3.6	20.7	18.2	2.5
		50% RB mid	21.5	18.0	3.5	20.5	18.1	2.4
		50% RB high	21.6	18.1	3.5	20.6	18.1	2.5
		100% RB	21.5	18.0	3.5	20.5	18.0	2.5
	21100 / 2535	1 RB low	22.5	18.0	4.5	21.5	18.3	3.2
		1 RB mid	22.5	17.9	4.6	21.6	18.2	3.4
		1 RB high	22.6	18.0	4.6	21.7	18.4	3.3
		50% RB low	21.6	18.0	3.6	20.5	18.0	2.5
		50% RB mid	21.5	18.1	3.4	20.5	18.0	2.5
		50% RB high	21.5	18.1	3.4	20.5	18.1	2.4
		100% RB	21.5	18.0	3.5	20.4	18.0	2.4
	21425 / 2567.5	1 RB low	22.7	18.1	4.6	21.5	17.8	3.7
		1 RB mid	22.7	18.1	4.6	21.5	17.9	3.6
		1 RB high	22.7	18.1	4.6	21.5	17.9	3.6
		50% RB low	21.7	18.1	3.6	20.7	18.2	2.5
		50% RB mid	21.7	18.1	3.6	20.7	18.1	2.6
		50% RB high	21.7	18.1	3.6	20.7	18.1	2.6
		100% RB	21.7	18.1	3.6	20.7	18.2	2.5
10.0	20800 / 2505	1 RB low	22.6	18.1	4.5	21.7	18.3	3.4
		1 RB mid	22.6	18.0	4.6	21.7	18.2	3.5
		1 RB high	22.7	18.1	4.6	21.7	18.3	3.4
		50% RB low	21.6	18.0	3.6	20.6	18.0	2.6
		50% RB mid	21.6	18.0	3.6	20.6	18.1	2.5
		50% RB high	21.5	17.9	3.6	20.6	18.0	2.6
		100% RB	21.7	18.1	3.6	20.6	18.0	2.6
	21100 / 2535	1 RB low	22.5	18.0	4.5	21.2	17.8	3.4
		1 RB mid	22.6	17.9	4.7	21.3	17.7	3.6
		1 RB high	22.7	18.1	4.6	21.4	17.8	3.6
		50% RB low	21.6	18.0	3.6	20.7	18.0	2.7
		50% RB mid	21.5	17.9	3.6	20.6	18.0	2.6
		50% RB high	21.6	18.0	3.6	20.7	18.1	2.6
		100% RB	21.6	17.9	3.7	20.6	17.9	2.7
	21400 / 2565	1 RB low	22.7	18.1	4.6	21.5	17.8	3.7
		1 RB mid	22.7	18.1	4.6	21.5	17.8	3.7
		1 RB high	22.7	18.1	4.6	21.5	17.9	3.6
		50% RB low	21.6	17.9	3.7	20.5	18.0	2.5
		50% RB mid	21.7	18.1	3.6	20.6	18.1	2.5
		50% RB high	21.7	18.1	3.6	20.7	18.1	2.6
		100% RB	21.7	18.1	3.6	20.6	18.0	2.6

Bandwidth (MHz)	Channel / Frequency (MHz)	Resource block allocation	P <sub>avg</sub> (dBm) QPSK	P <sub>avg</sub> * (dBm) reduced QPSK	dev. dB	P <sub>avg</sub> (dBm) 16-QAM	P <sub>avg</sub> * (dBm) reduced 16-QAM	dev. dB
15.0	20825 / 2507.5	1 RB low	22.6	18.1	4.5	21.7	18.3	3.4
		1 RB mid	22.6	18.0	4.6	21.7	18.2	3.5
		1 RB high	22.7	18.1	4.6	21.7	18.4	3.3
		50% RB low	21.6	18.0	3.6	20.7	18.1	2.6
		50% RB mid	21.5	18.0	3.5	20.6	18.1	2.5
		50% RB high	21.6	18.1	3.5	20.7	18.2	2.5
	21100 / 2535	100% RB	21.6	18.0	3.6	20.6	18.1	2.5
		1 RB low	22.6	18.0	4.6	21.7	18.4	3.3
		1 RB mid	22.5	18.0	4.5	21.7	18.4	3.3
		1 RB high	22.6	18.1	4.5	21.7	18.4	3.3
		50% RB low	21.6	18.1	3.5	20.5	18.0	2.5
		50% RB mid	21.5	18.0	3.5	20.5	18.0	2.5
	21375 / 2562.5	50% RB high	21.6	18.1	3.5	20.6	18.0	2.6
		100% RB	21.5	18.0	3.5	20.6	18.1	2.5
		1 RB low	22.7	18.1	4.6	21.5	17.9	3.6
		1 RB mid	22.6	18.0	4.6	21.3	17.8	3.5
		1 RB high	22.7	18.2	4.5	21.6	18.0	3.6
		50% RB low	21.7	18.0	3.7	20.7	18.1	2.6
20.0	20850 / 2510	50% RB mid	21.6	18.0	3.6	20.6	18.0	2.6
		50% RB high	21.7	18.2	3.5	20.7	18.2	2.5
		100% RB	21.7	18.1	3.6	20.6	18.1	2.5
		1 RB low	22.6	18.0	4.6	21.7	18.3	3.4
		1 RB mid	22.6	18.0	4.6	21.7	18.1	3.6
		1 RB high	22.6	18.1	4.5	21.6	18.2	3.4
	21100 / 2535	50% RB low	21.7	18.2	3.5	20.7	18.2	2.5
		50% RB mid	21.7	18.1	3.6	20.7	18.1	2.6
		50% RB high	21.7	18.2	3.5	20.7	18.1	2.6
		100% RB	21.6	18.1	3.5	20.7	18.1	2.6
		1 RB low	22.5	18.0	4.5	21.7	18.3	3.4
		1 RB mid	22.4	17.9	4.5	21.7	18.2	3.5
	21350 / 2560	1 RB high	22.5	18.0	4.5	21.7	18.3	3.4
		50% RB low	21.5	18.0	3.5	20.5	18.0	2.5
		50% RB mid	21.5	18.1	3.4	20.5	18.0	2.5
		50% RB high	21.6	18.1	3.5	20.6	18.1	2.5
		100% RB	21.6	18.1	3.5	20.6	18.1	2.5
		1 RB low	22.6	18.0	4.6	21.7	18.3	3.4
21350 / 2560	1 RB mid	22.5	17.9	4.6	21.7	18.1	3.6	
	1 RB high	22.7	18.1	4.6	21.7	18.3	3.4	
	50% RB low	21.6	17.9	3.7	20.7	18.0	2.7	
	50% RB mid	21.7	18.0	3.7	20.7	18.1	2.6	
	50% RB high	21.7	18.1	3.6	20.7	18.1	2.6	
	100% RB	21.7	18.1	3.6	20.7	18.1	2.6	

Table 25: Test results conducted power measurement LTE FDD 7 2600 MHz.

\*-Power Reduction when hotspot (Wifi Tethering) is activated

## 7.1.9 Justification of SAR measurements in LTE mode

According to Chapter 5 'SAR test procedures for LTE devices of FCC KDB Publication 941225 D05 the following test configurations for standalone measurements of the largest channel bandwidth (chapter 5.2) had to be taken into consideration:

### 5.2.1. QPSK with 1 RB allocation

Start with the largest channel bandwidth and measure SAR for QPSK with 1 RB allocation, using the RB offset and *required test channel* combination with the highest maximum output power for RB offsets at the upper edge, middle and lower edge of each *required test channel*. When the *reported SAR* is  $\leq 0.8$  W/kg, testing of the remaining RB offset configurations and *required test channels* is not required for 1 RB allocation; otherwise, SAR is required for the remaining *required test channels* and only for the RB offset configuration with the highest output power for that channel.6 When the *reported SAR* of a *required test channel* is  $> 1.45$  W/kg, SAR is required for all three RB offset configurations for that *required test channel*.

### 5.2.2. QPSK with 50% RB allocation

The procedures required for 1 RB allocation in 5.2.1 are applied to measure the SAR for QPSK with 50% RB allocation.

### 5.2.3. QPSK with 100% RB allocation

For QPSK with 100% RB allocation, SAR is not required when the highest maximum output power for 100 % RB allocation is less than the highest maximum output power in 50% and 1 RB allocations and the highest *reported SAR* for 1 RB and 50% RB allocation in 5.2.1 and 5.2.2 are  $\leq 0.8$  W/kg. Otherwise, SAR is measured for the highest output power channel and if the *reported SAR* is  $> 1.45$  W/kg, the remaining *required test channels* must also be tested.

### 5.2.4. Higher order modulations

For each modulation besides QPSK; e.g., 16-QAM, 64-QAM, apply the QPSK procedures in sections 5.2.1, 5.2.2 and 5.2.3 to determine the QAM configurations that may need SAR measurement. For each configuration identified as required for testing, SAR is required only when the highest maximum output power for the configuration in the higher order modulation is  $> \frac{1}{2}$  dB higher than the same configuration in QPSK or when the *reported SAR* for the QPSK configuration is  $> 1.45$  W/kg.

Testing of other channel bandwidths was not necessary because the output power of equivalent channel configurations was less than  $\frac{1}{2}$  dB larger compared to the largest channel bandwidth and reported SAR was  $< 1.45$  W/kg.

Conducted and radiated measurements were performed with the maximum number of bundled TTIs supported by the DUT (see section 2.4 for details).

## 7.1.10 MPR information in LTE mode

There is a permanently applied MPR implemented by the manufacturer. MPR is enabled for this device according to 3GPP TS36.101.

Modulation	Channel bandwidth / resource block configuration						Target MPR	3 GPP MPR
	1.4 MHz	3 MHz	5 MHz	10 MHz	15 MHz	20 MHz		
QPSK	$> 5$	$> 4$	$> 8$	$> 12$	$> 16$	$> 18$	1	$\leq 1$
16QAM	$\leq 5$	$\leq 4$	$\leq 8$	$\leq 12$	$\leq 16$	$\leq 18$	1	$\leq 1$
16QAM	$> 5$	$> 4$	$> 8$	$> 12$	$> 16$	$> 18$	2	$\leq 2$

Therefore there is no power reduction at 1.4 MHz bandwidth with 50% RB allocation (3 RBs).

Additional differences in conducted power are not caused by implemented MPR but depend on measurement uncertainty and allowable tolerances per 3GPP or tune-up. A-MPR was disabled for all SAR tests.



### 7.1.11 Conducted power measurements WLAN 2.4 GHz

802.11b		maximum average conducted output power [dBm]
Band	Ch	1Mbps
2450MHz	1	14.5
	6	<b>16.4</b>
	11	14.1

Table 26: Test results conducted power measurement 802.11b\*

802.11g		maximum average conducted output power [dBm]
Band	Ch	6Mbps
2450MHz	1	12.5
	6	14.3
	11	12.4

Table 27: Test results conducted power measurement 802.11g\*

802.11n HT-20		maximum average conducted output power [dBm]
Band	Ch	MCS-0 6.5Mbps
2450MHz	1	12.2
	6	14.0
	11	11.7

Table 28: Test results conducted power measurement 802.11n HT-20\*

\*- Average Conducted output power has only been measured with the lowest data rate. According to Manufacturer Declaration "Statement on measured data rate for WLAN", the average conducted output power for W-LAN is highest always for the lowest data rate. Therefore the measurement of the conducted output power for W-LAN has only been carried with the lowest data rate.

### 7.1.12 Conducted power measurements WLAN 5 GHz

802.11a		maximum average conducted output power [dBm]	
Band	Ch	6Mbps	6.5Mbps
5200	36	14.3	14.5
	40	14.4	14.6
	44	14.4	14.5
	48	<b>14.5</b>	14.6
5300	52	<b>14.6</b>	14.5
	56	14.2	14.4
	60	14.2	14.6
	64	14.5	14.6
5600	100	14.5	14.7
	104	14.5	14.8
	108	14.6	14.8
	112	<b>14.8</b>	14.7
	116	14.7	14.7
	120	14.8	15.0
	124	14.7	14.6
	128	14.5	14.7
	132	14.7	14.7
	136	14.5	14.6
	140	14.8	14.7
	5800	149	<b>14.6</b>
153		14.6	14.6
157		14.5	14.7
161		14.4	14.4
165		14.4	14.4

Table 29: Test results conducted power measurement 802.11a\*

\*- Average Conducted output power has only been measured with the lowest data rate. According to Manufacturer Declaration "Statement on measured data rate for WLAN", the average conducted output power for W-LAN is highest always for the lowest data rate. Therefore the measurement of the conducted output power for W-LAN has only been carried with the lowest data rate.

802.11n HT-40 / 802.11ac VHT-40		
maximum average conducted output power [dBm]		
Band [MHz]	Ch	MCS-0 13.5Mbps
5200	38	9.7
	46	10.2
5300	54	9.8
	62	10
5600	102	10.2
	110	10.5
	118	10.4
	126	10.3
5800	134	10
	151	9.9
	159	10.1

Table 30: Test results conducted power measurement 802.11n HT-40 / 802.11ac VHT-40\*

802.11ac VHT-80		
maximum average conducted output power [dBm]		
Band	Ch	MCS-0 29.3Mbps
5200	42	10
5300	58	9.9
5600	106	10.1
	122	10.1
5800	155	10.2

Table 31: Test results conducted power measurement 802.11ac VHT-80\*

\*- Average Conducted output power has only been measured with the lowest data rate. According to Manufacturer Declaration "Statement on measured data rate for WLAN", the average conducted output power for W-LAN is highest always for the lowest data rate. Therefore the measurement of the conducted output power for W-LAN has only been carried with the lowest data rate.

### 7.1.13 Standalone SAR Test Exclusion

Standalone SAR test exclusion considerations for <b>Head</b> position					
Communication system	freq. (MHz)	P <sub>avg</sub> * (dBm)	P <sub>avg</sub> * (mW)	threshold <sub>1-g</sub> comparison value	SAR test exclusion
GSM 850	835	24.8	298.5	54.6	no
GSM 1900	1900	22.4	171.8	47.4	no
UMTS FDD II	1900	23.0	199.5	55.0	no
UMTS FDD V	835	24.0	251.2	45.9	no
LTE FDD 2	1880	23.0	199.5	54.7	no
LTE FDD 5	835	24.0	251.2	45.9	no
LTE FDD 7	2535	22.7	186.2	59.3	no
WLAN 2450	2450	17.3	53.7	16.8	no
WLAN 5.2 GHz	5200	15.2	33.1	15.1	no
WLAN 5.3 GHz	5300	15.2	33.1	15.2	no
WLAN 5.6 GHz	5600	15.2	33.1	15.7	no
WLAN 5.8 GHz	5800	15.2	33.1	15.9	no
Bluetooth 2450	2450	9.4	8.7	2.7	yes

Table 32: Standalone SAR test exclusion considerations in **head position**

Standalone SAR test exclusion considerations for <b>Hot spot mode</b> position						
Communication system	freq. (MHz)	distance (mm)	P <sub>avg</sub> * (dBm)	P <sub>avg</sub> * (mW)	threshold <sub>1-g</sub> comparison value	SAR test exclusion
GSM 850	835	10	25.0	316.2	28.9	no
GSM 1900	1900	10	22.5	177.8	24.5	no
UMTS FDD II	1900	10	23.0	199.5	27.5	no
UMTS FDD V	835	10	24.0	251.2	23.0	no
LTE FDD 2	1880	10	23.0	199.5	27.4	no
LTE FDD 5	835	10	24.0	251.2	23.0	no
LTE FDD 7	2535	10	18.5	70.8	11.3	no
WLAN 2450	2450	10	17.3	53.7	8.4	no
Bluetooth 2450	2450	10	9.4	8.7	1.4	yes

Table 33: Standalone SAR test exclusion considerations in **hotspot mode position**

P<sub>avg</sub>\* - maximum possible output power declared by manufacturer

The **1-g SAR test exclusion thresholds** for 100 MHz to 6 GHz at *test separation distances* ≤ 50 mm are determined by:

$$\left[ \frac{(\text{max. power of channel, including tune-up tolerance, mW})}{(\text{min. test separation distance, mm})} \cdot \sqrt{f(\text{GHz})} \right] \leq 3.0$$
 for 1-g SAR, where:

- f(GHz) is the RF channel transmit frequency in GHz
- Power and distance are rounded to the nearest mW and mm before calculation
- The result is rounded to one decimal place for comparison

When the minimum test separation distance is < 5 mm, a distance of 5 mm is applied to determine SAR test exclusion

Standalone SAR test exclusion considerations for <b>Body worn</b> position						
Communication system	freq. (MHz)	distance (mm)	P <sub>avg</sub> * (dBm)	P <sub>avg</sub> * (mW)	threshold <sub>1-g</sub> comparison value	SAR test exclusion
GSM 850	835	15	25.0	316.2	19.3	no
GSM 1900	1900	15	22.5	177.8	16.3	no
UMTS FDD II	1900	15	23.0	199.5	18.3	no
UMTS FDD V	835	15	24.0	251.2	15.3	no
LTE FDD 2	1880	15	23.0	199.5	18.2	no
LTE FDD 5	835	15	24.0	251.2	15.3	no
LTE FDD 7	2535	15	22.7	186.2	19.8	no
WLAN 2450	2450	15	17.3	53.7	5.6	no
WLAN 5.2 GHz	5200	15	15.2	33.1	5.0	no
WLAN 5.3 GHz	5300	15	15.2	33.1	5.1	no
WLAN 5.6 GHz	5600	15	15.2	33.1	5.2	no
WLAN 5.8 GHz	5800	15	15.2	33.1	5.3	no
Bluetooth 2450	2450	15	9.4	8.7	0.9	yes

Table 34: Standalone SAR test exclusion considerations in **body position**

P<sub>avg</sub>\* - maximum possible output power declared by manufacturer

The **1-g SAR test exclusion thresholds** for 100 MHz to 6 GHz at *test separation distances* ≤ 50 mm are determined by:

$$\left[ \frac{(\text{max. power of channel, including tune-up tolerance, mW})}{(\text{min. test separation distance, mm})} \right] \cdot \sqrt{f(\text{GHz})} \leq 3.0 \text{ for 1-g SAR, where:}$$

- f(GHz) is the RF channel transmit frequency in GHz
- Power and distance are rounded to the nearest mW and mm before calculation
- The result is rounded to one decimal place for comparison
- When the minimum test separation distance is < 5 mm, a distance of 5 mm is applied to determine SAR test exclusion
- 

### 7.1.14 Hotspot mode SAR measurement positions

Hotspot mode SAR measurement positions						
mode	front	rear	left edge	right edge	top edge	bottom edge
GSM 850	yes	yes	yes	yes	no	yes
GSM 1900	yes	yes	yes	yes	no	yes
WCDMA FDD II	yes	yes	yes	yes	no	yes
WCDMA FDD V	yes	yes	yes	yes	no	yes
LTE FDD 2 1900	yes	yes	yes	yes	no	yes
LTE FDD 5 850	yes	yes	yes	yes	no	yes
LTE FDD 7 2600	yes	yes	yes	yes	no	yes
WLAN 2450	yes	yes	yes	yes	yes	no

The edges with less than 2.5 cm distance to the TX antennas need to be tested for hotspot SAR.

Antenna dimensions and separation distances see in photo documentation

## 7.2 SAR test results

### 7.2.1 Results overview

measured / extrapolated SAR numbers - Head - GSM 850 MHz DTM										
Ch.	Freq. (MHz)	time slots	Position	cond. P <sub>max</sub> (dBm)		SAR <sub>1g</sub> results(W/kg)		SAR <sub>10g</sub> (W/kg)		liquid (°C)
				declared**	measured	measured	extrapolated	meas.	extrap.	
190	836.6	3	left cheek	29.0	28.9	0.482	0.493	0.371	0.380	22.3
190	836.6	3	left tilted 15°	29.0	28.9	0.239	0.245	0.189	0.193	22.3
128	824.2	3	right cheek	29.0	28.9	0.382	0.391	0.295	0.302	22.3
190	836.6	3	right cheek	29.0	28.9	0.498	0.510	0.385	0.394	22.3
251	848.8	3	right cheek	29.0	29.0	<b>0.605</b>	<b>0.605</b>	<b>0.464</b>	<b>0.464</b>	22.3
190	836.6	3	right tilted 15°	29.0	28.9	0.267	0.273	0.211	0.216	22.3

Table 35: Test results head SAR GSM 850MHz GMSK **3TS** in uplink (see max. SAR plot in Annex B.1: GSM 850 page 95)

Note: The device supports DTM class 11 with max. 3 timeslots in uplink. SAR measurements were performed in the configuration with highest calculated time based averaged output power (see section 7.1.1). Therefore 3 timeslots in uplink were used for test.

measured / extrapolated SAR numbers - hotspot mode - GSM 850 MHz											
Ch.	Freq. (MHz)	time slots	dist. (mm)	Position	cond. P <sub>max</sub> (dBm)		SAR <sub>1g</sub> results(W/kg)		SAR <sub>10g</sub> (W/kg)		liquid (°C)
					declared**	measured	measured	extrapolated	meas.	extrap.	
190	836.6	4	10	front	28.0	27.9	0.565	0.578	0.436	0.446	22.3
128	824.2	4	10	rear	28.0	27.9	0.537	0.550	0.407	0.416	22.3
190	836.6	4	10	rear	28.0	27.9	0.633	0.648	0.483	0.494	22.3
251	848.8	4	10	rear	28.0	27.9	<b>0.751</b>	<b>0.768</b>	<b>0.570</b>	<b>0.583</b>	22.3
190	836.6	4	10	left edge	28.0	27.9	0.312	0.319	0.221	0.226	22.3
190	836.6	4	10	right edge	28.0	27.9	0.353	0.361	0.248	0.254	22.3
190	836.6	4	10	bottom edge	28.0	27.9	0.202	0.207	0.132	0.135	22.3

Table 36: Test results hotspot mode SAR GSM 850 MHz (see max. SAR plot in Annex B.1: GSM 850 page 95)

Top edge position for hotspot mode is not required since the distance from the main antenna to the edge is greater than 2.5 cm.

measured / extrapolated SAR numbers - Body worn - GSM 850 MHz											
Ch.	Freq. (MHz)	time slots	dist. (mm)	Position	cond. P <sub>max</sub> (dBm)		SAR <sub>1g</sub> results(W/kg)		SAR <sub>10g</sub> (W/kg)		liquid (°C)
					declared**	measured	measured	extrapolated	meas.	extrap.	
190	836.6	4	15	front	28.0	27.9	0.461	0.472	0.353	0.361	22.3
128	824.2	4	15	rear	28.0	27.9	0.403	0.412	0.305	0.312	22.3
190	836.6	4	15	rear	28.0	27.9	0.470	0.481	0.356	0.364	22.3
251	848.8	4	15	rear	28.0	27.9	<b>0.569</b>	<b>0.582</b>	<b>0.431</b>	<b>0.441</b>	22.3

Table 37: Test results body worn SAR GSM 850 MHz (see max. SAR plot in Annex B.1: GSM 850 page 95)

\*\* - maximum possible output power declared by manufacturer

measured / extrapolated SAR numbers - Head - GSM 1900 MHz / DTM-MODE										
Ch.	Freq. (MHz)	time slots	Position	cond. P <sub>max</sub> (dBm)		SAR <sub>1g</sub> results(W/kg)		SAR <sub>10g</sub> (W/kg)		liquid (°C)
				declared**	measured	measured	extrapolated	meas.	extrap.	
512	1850.2	3	left cheek	26.6	26.6	0.318	0.318	0.202	0.202	22.2
661	1880.0	3	left cheek	26.6	26.6	0.309	0.309	0.192	0.192	22.2
810	1909.8	3	left cheek	26.6	26.5	<b>0.331</b>	<b>0.339</b>	<b>0.205</b>	<b>0.210</b>	22.2
661	1880.0	3	left tilted 15°	26.6	26.6	0.091	0.091	0.057	0.057	22.2
661	1880.0	3	right cheek	26.6	26.6	0.222	0.222	0.145	0.145	22.2
661	1880.0	3	right tilted 15°	26.6	26.6	0.090	0.090	0.054	0.054	22.2

Table 38: Test results head SAR GSM 1900MHz GMSK **3TS** in uplink (see max. SAR plot in Annex B.2: GSM 1900 page 98)

Note: The device supports DTM class 11 with max. 3 timeslots in uplink. SAR measurements were performed in the configuration with highest calculated time based averaged output power (see section 7.1.2). Therefore 3 timeslots in uplink were used for test.

measured / extrapolated SAR numbers - hotspot mode - GSM 1900 MHz												
Ch.	Freq. (MHz)	time slots	dist. (mm)	modul.	Position	cond. P <sub>max</sub> (dBm)		SAR <sub>1g</sub> results(W/kg)		SAR <sub>10g</sub> (W/kg)		liquid (°C)
						declared**	measured	measured	extrapolated	meas.	extrap.	
661	1880.0	4	10	GMSK	front	25.5	25.5	0.729	0.729	0.402	0.402	22.5
512	1850	4	10	GMSK	rear	25.5	25.5	0.736	0.736	0.421	0.421	22.5
661	1880.0	4	10	GMSK	rear	25.5	25.5	0.768	0.768	0.426	0.426	22.5
810	1910	4	10	GMSK	rear	25.5	25.5	<b>0.797</b>	<b>0.797</b>	<b>0.443</b>	<b>0.443</b>	22.5
661	1880.0	4	10	GMSK	left edge	25.5	25.5	0.177	0.177	0.108	0.108	22.5
661	1880.0	4	10	GMSK	right edge	25.5	25.5	0.127	0.127	0.079	0.079	22.5
661	1880.0	4	10	GMSK	bottom edge	25.5	25.5	0.759	0.759	0.409	0.409	22.5

Table 39: Test results hotspot mode SAR GSM 1900 MHz (see max. SAR plot in Annex B.2: GSM 1900 page 98)

Top edge position for hotspot mode is not required since the distance from the main antenna to the edge is greater than 2.5 cm.

measured / extrapolated SAR numbers - Body worn - GSM 1900 MHz												
Ch.	Freq. (MHz)	time slots	dist. (mm)	modul.	Position	cond. P <sub>max</sub> (dBm)		SAR <sub>1g</sub> results(W/kg)		SAR <sub>10g</sub> (W/kg)		liquid (°C)
						declared**	measured	measured	extrapolated	meas.	extrap.	
661	1880.0	4	15	GMSK	front	25.5	25.5	0.381	0.381	0.227	0.227	22.5
512	1850.2	4	15	GMSK	rear	25.5	25.5	0.434	0.434	0.263	0.263	22.5
661	1880.0	4	15	GMSK	rear	25.5	25.5	0.446	0.446	0.266	0.266	22.5
810	1909.8	4	15	GMSK	rear	25.5	25.5	<b>0.463</b>	<b>0.463</b>	<b>0.273</b>	<b>0.273</b>	22.5

Table 40: Test results body worn SAR GSM 1900 MHz (see max. SAR plot in Annex B.2: GSM 1900 page 98)

\*\* - maximum possible output power declared by manufacturer

measured / extrapolated SAR numbers - Head - UMTS FDD II 1880 MHz									
Ch.	Freq. (MHz)	Position	cond. P <sub>max</sub> (dBm)		SAR <sub>1g</sub> results(W/kg)		SAR <sub>10g</sub> (W/kg)		liquid (°C)
			declared**	measured	measured	extrapolated	meas.	extrap.	
9262	1852.4	left cheek	23.0	22.9	0.408	0.418	0.260	0.266	22.2
9400	1880.0	left cheek	23.0	22.8	0.402	0.421	0.256	0.268	22.2
9538	1907.6	left cheek	23.0	22.9	<b>0.445</b>	<b>0.455</b>	<b>0.277</b>	<b>0.283</b>	22.2
9400	1880.0	left tilted 15°	23.0	22.8	0.111	0.116	0.070	0.073	22.2
9400	1880.0	right cheek	23.0	22.8	0.280	0.293	0.183	0.192	22.2
9400	1880.0	right tilted 15°	23.0	22.8	0.107	0.112	0.064	0.067	22.2

Table 41: Test results head SAR UMTS FDD II 1880 MHz (see max. SAR plot in Annex B.3:UMTS FDD II page 101)

measured / extrapolated SAR numbers - hotspot mode - UMTS FDD II 1880 MHz											
Ch.	Freq. (MHz)	test condition	dist. (mm)	Position	cond. P <sub>max</sub> (dBm)		SAR <sub>1g</sub> results(W/kg)		SAR <sub>10g</sub> (W/kg)		liquid (°C)
					declared**	measured	measured	extrapolated	meas.	extrap.	
9262	1852.4	RMC	10	front	23.0	22.9	0.959	0.981	0.525	0.537	22.5
9400	1880.0	RMC	10	front	23.0	22.8	1.080	1.131	0.587	0.615	22.5
9538	1907.6	RMC	10	front	23.0	22.9	<b>1.120</b>	<b>1.146</b>	<b>0.603</b>	<b>0.617</b>	22.5
9262	1852.4	RMC	10	rear	23.0	22.9	0.737	0.754	0.423	0.433	22.5
9400	1880.0	RMC	10	rear	23.0	22.8	0.860	0.901	0.487	0.510	22.5
9538	1907.6	RMC	10	rear	23.0	22.9	0.944	0.966	0.522	0.534	22.5
9400	1880.0	RMC	10	left edge	23.0	22.8	0.207	0.217	0.127	0.133	22.5
9400	1880.0	RMC	10	right edge	23.0	22.8	0.134	0.140	0.085	0.089	22.5
9262	1852.4	RMC	10	bottom edge	23.0	22.9	0.892	0.913	0.474	0.485	22.5
9400	1880.0	RMC	10	bottom edge	23.0	22.8	1.050	1.099	0.557	0.583	22.5
9538	1907.6	RMC	10	bottom edge	23.0	22.9	1.120	1.146	0.583	0.597	22.5
9538	1907.6	RMC	10	front	23.0	22.9	1.030	1.054	0.558	0.571	22.5

Test results hotspot mode SAR UMTS FDD II 1880 MHz (see max. SAR plot in Annex B.3:UMTS FDD II page 101)

Top edge position for MHS is not required since the distance from the main antenna to the edge is greater than 2.5 cm.

measured / extrapolated SAR numbers - Body worn - UMTS FDD II 1880 MHz											
Ch.	Freq. (MHz)	test condition	dist. (mm)	Position	cond. P <sub>max</sub> (dBm)		SAR <sub>1g</sub> results(W/kg)		SAR <sub>10g</sub> (W/kg)		liquid (°C)
					declared**	measured	measured	extrapolated	meas.	extrap.	
9262	1852.4	RMC	15	front	23.0	22.9	0.470	0.481	0.281	0.288	22.5
9400	1880.0	RMC	15	front	23.0	22.8	0.534	0.559	0.314	0.329	22.5
9538	1907.6	RMC	15	front	23.0	22.9	<b>0.547</b>	<b>0.560</b>	<b>0.322</b>	<b>0.330</b>	22.5
9400	1880.0	RMC	15	rear	23.0	22.8	0.501	0.525	0.300	0.314	22.5

Table 42: Test results body worn SAR UMTS FDD II 1880 MHz (see max. SAR plot in Annex B.3:UMTS FDD II page 101)

\* - repeated at the highest SAR measurement according to the FCC KDB 865664

\*\* - maximum possible output power declared by manufacturer



measured / extrapolated SAR numbers - Head - UMTS FDD V 850 MHz									
Ch.	Freq. (MHz)	Position	cond. P <sub>max</sub> (dBm)		SAR <sub>1g</sub> results(W/kg)		SAR <sub>10g</sub> (W/kg)		liquid (°C)
			declared**	measured	measured	extrapolated	meas.	extrap.	
4182	836.4	left cheek	24.0	23.8	0.438	0.459	0.338	0.354	22.3
4182	836.4	left tilted 15°	24.0	23.8	0.228	0.239	0.180	0.188	22.3
4132	826.4	right cheek	24.0	23.8	0.413	0.432	0.318	0.333	22.3
4182	836.4	right cheek	24.0	23.8	0.464	0.486	0.357	0.374	22.3
4233	846.6	right cheek	24.0	23.9	<b>0.506</b>	<b>0.518</b>	<b>0.388</b>	<b>0.397</b>	22.3
4182	836.4	right tilted 15°	24.0	23.8	0.232	0.243	0.184	0.193	22.3

Table 43: Test results head SAR UMTS FDD V 850 MHz (see max. SAR plot in Annex B.4: UMTS FDD V page 104)

measured / extrapolated SAR numbers - hotspot mode - UMTS FDD V 850 MHz											
Ch.	Freq. (MHz)	test condition	dist. (mm)	Position	cond. P <sub>max</sub> (dBm)		SAR <sub>1g</sub> results(W/kg)		SAR <sub>10g</sub> (W/kg)		liquid (°C)
					declared**	measured	measured	extrapolated	meas.	extrap.	
4182	836.4	RMC	10	front	24.0	23.8	0.544	0.570	0.422	0.442	23.6
4132	826.4	RMC	10	rear	24.0	23.8	0.512	0.536	0.389	0.407	23.6
4182	836.4	RMC	10	rear	24.0	23.8	<b>0.620</b>	<b>0.649</b>	<b>0.470</b>	<b>0.492</b>	23.6
4233	846.6	RMC	10	rear	24.0	23.9	0.561	0.574	0.427	0.437	23.6
4182	836.4	RMC	10	left edge	24.0	23.8	0.325	0.340	0.229	0.240	23.6
4182	836.4	RMC	10	right edge	24.0	23.8	0.300	0.314	0.211	0.221	23.6
4182	836.4	RMC	10	bottom edge	24.0	23.8	0.165	0.173	0.109	0.114	23.6

Table 44: Test results hotspot mode SAR UMTS FDD V 850 MHz (see max. SAR plot in Annex B.4: UMTS FDD V page 104)

Top edge position for MHS is not required since the distance from the main antenna to the edge is greater than 2.5 cm.

measured / extrapolated SAR numbers - Body worn - UMTS FDD V 850 MHz											
Ch.	Freq. (MHz)	test condition	dist. (mm)	Position	cond. P <sub>max</sub> (dBm)		SAR <sub>1g</sub> results(W/kg)		SAR <sub>10g</sub> (W/kg)		liquid (°C)
					declared**	measured	measured	extrapolated	meas.	extrap.	
4182	836.4	RMC	15	front	24.0	23.8	0.339	0.355	0.306	0.320	22.3
4132	826.4	RMC	15	rear	24.0	23.8	0.392	0.410	0.297	0.311	22.3
4182	836.4	RMC	15	rear	24.0	23.8	0.404	0.423	0.305	0.319	22.3
4233	846.6	RMC	15	rear	24.0	23.9	<b>0.428</b>	<b>0.438</b>	<b>0.323</b>	<b>0.331</b>	22.3

Table 45: Test results body worn SAR UMTS FDD V 850 MHz (see max. SAR plot in Annex B.4: UMTS FDD V page 104)

\*\* - maximum possible output power declared by manufacturer

measured / extrapolated SAR numbers - Head - LTE FDD 2 1900 MHz										
Ch.	Freq. (MHz)	RB Offset	Position	cond. P <sub>max</sub> (dBm)		SAR <sub>1g</sub> results(W/kg)		SAR <sub>10g</sub> (W/kg)		liquid (°C)
				declared**	measured	measured	extrapolated	meas.	extrap.	
<b>20MHz BW/1RB/QPSK</b>										
18700	1860	0	left cheek	23.0	22.4	0.356	0.409	0.225	0.258	22.9
18900	1880	0	left cheek	23.0	22.1	<b>0.368</b>	<b>0.453</b>	<b>0.232</b>	<b>0.285</b>	22.9
19100	1900	99	left cheek	23.0	22.4	0.353	0.405	0.220	0.253	22.9
18700	1860	0	left tilted 15°	23.0	22.4	0.126	0.145	0.080	0.092	22.9
18700	1860	0	right cheek	23.0	22.4	0.236	0.271	0.157	0.180	22.9
18700	1860	0	right tilted 15°	23.0	22.4	0.105	0.121	0.064	0.074	22.9
<b>20MHz BW/50RB/QPSK</b>										
19100	1900	50	left cheek	22.0	21.4	0.275	0.316	0.171	0.196	22.9
19100	1900	50	left tilted 15°	22.0	21.4	0.078	0.090	0.047	0.054	22.9
19100	1900	50	right cheek	22.0	21.4	0.178	0.204	0.116	0.133	22.9
19100	1900	50	right tilted 15°	22.0	21.4	0.073	0.084	0.043	0.050	22.9

Table 46: Test results head SAR LTE FDD 2 1900 MHz (see max. SAR plot in Annex B.5: LTE FDD 2 page 107)

measured / extrapolated SAR numbers - hotspot mode - LTE FDD 2 1900 MHz											
Ch.	Freq. (MHz)	RB offset	dist. (mm)	Position	cond. P <sub>max</sub> (dBm)		SAR <sub>1g</sub> results(W/kg)		SAR <sub>10g</sub> (W/kg)		liquid (°C)
					declared**	measured	measured	extrapolated	meas.	extrap.	
<b>20MHz BW/1RB/QPSK</b>											
18700	1860	0	10	front	23.0	22.4	0.792	0.909	0.434	0.498	23.1
18900	1880	0	10	front	23.0	22.1	0.908	1.117	0.510	0.627	23.1
19100	1900	99	10	front	23.0	22.4	0.949	1.090	0.524	0.602	23.1
18700	1860	0	10	rear	23.0	22.4	0.722	0.829	0.421	0.483	23.1
18900	1880	0	10	rear	23.0	22.1	0.751	0.924	0.440	0.541	23.1
19100	1900	99	10	rear	23.0	22.4	0.803	0.922	0.464	0.533	23.1
18700	1860	0	10	left edge	23.0	22.4	0.194	0.223	0.119	0.137	23.1
18700	1860	0	10	right edge	23.0	22.4	0.101	0.116	0.065	0.075	23.1
18700	1860	0	10	bottom edge	23.0	22.4	0.775	0.890	0.414	0.475	23.1
18900	1880	0	10	bottom edge	23.0	22.1	0.958	1.179	0.511	0.629	23.1
19100	1900	99	10	bottom edge	23.0	22.4	<b>1.040</b>	<b>1.194</b>	<b>0.555</b>	<b>0.637</b>	23.1
19100	1900	99	10	bottom edge	23.0	22.4	0.925	1.062	0.488	0.560	23.1
<b>20MHz BW/50RB/QPSK</b>											
18700	1860	0	10	front	22.0	21.3	0.680	0.799	0.383	0.450	23.1
18900	1880	0	10	front	22.0	21.3	0.543	0.638	0.253	0.297	23.1
19100	1900	50	10	front	22.0	21.4	0.840	0.964	0.453	0.520	23.1
19100	1900	50	10	rear	22.0	21.4	0.572	0.657	0.329	0.378	23.1
19100	1900	50	10	left edge	22.0	21.4	0.157	0.180	0.095	0.110	23.1
19100	1900	50	10	right edge	22.0	21.4	0.088	0.101	0.051	0.059	23.1
18700	1860	0	10	bottom edge	22.0	21.3	0.670	0.787	0.360	0.423	23.1
18900	1880	0	10	bottom edge	22.0	21.3	0.725	0.852	0.388	0.456	23.1
19100	1900	50	10	bottom edge	22.0	21.4	0.821	0.943	0.436	0.501	23.1
<b>20MHz BW/100RB/QPSK</b>											
18700	1860	0	10	front	22.0	21.3	0.656	0.771	0.370	0.435	23.1
18700	1860	0	10	rear	22.0	21.3	0.516	0.606	0.309	0.363	23.1
18700	1860	0	10	left edge	22.0	21.3	0.151	0.177	0.093	0.109	23.1
18700	1860	0	10	right edge	22.0	21.3	0.080	0.094	0.051	0.059	23.1
18700	1860	0	10	bottom edge	22.0	21.3	0.710	0.834	0.380	0.446	23.1
18900	1880	0	10	bottom edge	22.0	21.2	0.726	0.873	0.388	0.466	23.1
19100	1900	0	10	bottom edge	22.0	21.3	0.772	0.907	0.413	0.485	23.1

Table 47: Test results hotspot mode SAR LTE FDD 2 1900 MHz (see max. SAR plot in Annex B.5: LTE FDD 2 page 107)

Top edge position for hotspot mode is not required since the distance from the main antenna to the edge is greater than 2.5 cm.

\* - repeated at the highest SAR measurement according to the FCC KDB 865664

measured / extrapolated SAR numbers - Body worn - LTE FDD 2 1900 MHz											
Ch.	Freq. (MHz)	RB offset	dist. (mm)	Position	cond. P <sub>max</sub> (dBm)		SAR <sub>1g</sub> results(W/kg)		SAR <sub>10g</sub> (W/kg)		liquid (°C)
					declared**	measured	measured	extrapolated	meas.	extrap.	
<b>20MHz BW/1RB/QPSK</b>											
18700	1860	0	15	front	23.0	22.4	0.475	0.545	0.283	0.325	22.2
18900	1880	0	15	front	23.0	22.1	0.495	<b>0.609</b>	0.295	<b>0.363</b>	22.2
19100	1900	99	15	front	23.0	22.4	<b>0.521</b>	0.598	<b>0.307</b>	0.352	22.2
18700	1860	0	15	rear	23.0	22.4	0.427	0.490	0.263	0.302	22.2
<b>20MHz BW/50RB/QPSK</b>											
19100	1900	50	15	front	22.0	21.4	0.403	0.463	0.237	0.272	22.2
19100	1900	50	15	rear	22.0	21.4	0.368	0.423	0.221	0.254	22.2

Table 48: Test results body worn SAR LTE FDD 2 1900 MHz (see max. SAR plot in Annex B.5: LTE FDD 2 page 107)

\*\* - maximum possible output power declared by manufacturer

measured / extrapolated SAR numbers - Head - LTE FDD 5 850 MHz											
Ch.	Freq. (MHz)	RB offset	Position	cond. P <sub>max</sub> (dBm)		SAR <sub>1g</sub> results(W/kg)		SAR <sub>10g</sub> (W/kg)		liquid (°C)	
				declared**	measured	measured	extrapolated	meas.	extrap.		
<b>10MHz BW/1RB/QPSK</b>											
20450	829.0	49	left cheek	24.0	23.3	0.343	0.403	0.265	0.311	22.3	
20525	836.5	49	left cheek	24.0	23.4	<b>0.395</b>	<b>0.454</b>	<b>0.305</b>	<b>0.350</b>	22.3	
20600	844.0	0	left cheek	24.0	23.4	0.363	0.417	0.281	0.323	22.3	
20525	836.5	49	left tilted 15°	24.0	23.4	0.193	0.222	0.151	0.173	22.3	
20525	836.5	49	right cheek	24.0	23.4	0.386	0.443	0.296	0.340	22.3	
20525	836.5	49	right tilted 15°	24.0	23.4	0.191	0.219	0.151	0.173	22.3	
<b>10MHz BW/25RB/QPSK</b>											
20525	836.5	12	left cheek	23.0	22.5	0.300	0.337	0.232	0.260	22.3	
20525	836.5	12	left tilted 15°	23.0	22.5	0.148	0.166	0.116	0.130	22.3	
20525	836.5	12	right cheek	23.0	22.5	0.296	0.332	0.226	0.254	22.3	
20525	836.5	12	right tilted 15°	23.0	22.5	0.146	0.164	0.116	0.130	22.3	

Table 49: Test results head SAR LTE FDD 5 850 MHz (see max. SAR plot in Annex B.6: LTE FDD 5 page 111)

measured / extrapolated SAR numbers - hotspot mode - LTE FDD 5 850 MHz											
Ch.	Freq. (MHz)	RB offset	dist. (mm)	Position	cond. P <sub>max</sub> (dBm)		SAR <sub>1g</sub> results(W/kg)		SAR <sub>10g</sub> (W/kg)		liquid (°C)
					declared**	measured	measured	extrapolated	meas.	extrap.	
<b>10MHz BW/1RB/QPSK</b>											
20525	836.5	49	10	front	24.0	23.4	0.490	0.563	0.380	0.436	22.7
20450	829.0	49	10	rear	24.0	23.3	0.527	0.619	0.402	0.472	22.7
20525	836.5	49	10	rear	24.0	23.4	<b>0.561</b>	<b>0.644</b>	<b>0.428</b>	<b>0.491</b>	22.7
20600	844.0	0	10	rear	24.0	23.4	0.517	0.594	0.394	0.452	22.7
20525	836.5	49	10	left edge	24.0	23.4	0.257	0.295	0.182	0.209	22.7
20525	836.5	49	10	right edge	24.0	23.4	0.311	0.357	0.219	0.251	22.7
20525	836.5	49	10	bottom edge	24.0	23.4	0.171	0.196	0.110	0.126	22.7
<b>10MHz BW/25RB/QPSK</b>											
20525	836.5	12	10	front	23.0	22.5	0.401	0.450	0.313	0.351	22.7
20525	836.5	12	10	rear	23.0	22.5	0.446	0.500	0.340	0.381	22.7
20525	836.5	12	10	left edge	23.0	22.5	0.212	0.238	0.149	0.167	22.7
20525	836.5	12	10	right edge	23.0	22.5	0.240	0.269	0.168	0.188	22.7
20525	836.5	12	10	bottom edge	23.0	22.5	0.125	0.140	0.082	0.092	22.7

Table 50: Test results hotspot mode SAR LTE FDD 5 850 MHz (see max. SAR plot in Annex B.6: LTE FDD 5 page 111)

Top edge position for hotspot mode is not required since the distance from the main antenna to the edge is greater than 2.5 cm.

measured / extrapolated SAR numbers - Body worn - LTE FDD 5 850 MHz											
Ch.	Freq. (MHz)	RB offset	dist. (mm)	Position	cond. P <sub>max</sub> (dBm)		SAR <sub>1g</sub> results(W/kg)		SAR <sub>10g</sub> (W/kg)		liquid (°C)
					declared**	measured	measured	extrapolated	meas.	extrap.	
<b>10MHz BW/1RB/QPSK</b>											
20525	836.5	49	15	front	24.0	23.4	0.447	0.513	<b>0.343</b>	<b>0.394</b>	22.6
20450	829.0	49	15	rear	24.0	23.3	0.406	0.477	0.308	0.362	22.6
20525	836.5	49	15	rear	24.0	23.4	<b>0.449</b>	<b>0.516</b>	0.340	0.390	22.6
20600	844.0	0	15	rear	24.0	23.4	0.435	0.499	0.329	0.378	22.6
<b>10MHz BW/25RB/QPSK</b>											
20525	836.5	12	15	front	23.0	22.5	0.349	0.392	0.268	0.301	22.6
20525	836.5	12	15	rear	23.0	22.5	0.347	0.389	0.263	0.295	22.6

Table 51: Test results body worn SAR LTE FDD 5 850 MHz (see max. SAR plot in Annex B.6: LTE FDD 5 page 111)

\* - repeated at the highest SAR measurement according to the FCC KDB 865664

\*\* - maximum possible output power declared by manufacturer

For QPSK with 100% RB allocation, SAR is required when the highest reported SAR for 1 RB or 50% RB allocation are > 0.8 W/kg

measured / extrapolated SAR numbers - Head - LTE FDD 7 2600 MHz										
Ch.	Freq. (MHz)	RB offset	Position	cond. P <sub>max</sub> (dBm)		SAR <sub>1g</sub> results(W/kg)		SAR <sub>10g</sub> (W/kg)		liquid (°C)
				declared**	measured	meas.	extrapolated	meas.	extrap.	
<b>20MHz BW/1RB/QPSK</b>										
20850	2510	50	left cheek	22.7	22.7	0.193	0.193	0.103	0.103	21.5
21100	2535	99	left cheek	22.7	22.5	<b>0.198</b>	<b>0.207</b>	<b>0.105</b>	<b>0.110</b>	21.5
21350	2560	99	left cheek	22.7	22.7	0.172	0.172	0.091	0.091	21.5
20850	2510	50	left tilted 15°	22.7	22.7	0.039	0.039	0.025	0.025	21.5
20850	2510	50	right cheek	22.7	22.7	0.121	0.121	0.071	0.071	21.5
20850	2510	50	right tilted 15°	22.7	22.7	0.057	0.057	0.030	0.030	21.5
<b>20MHz BW/50RB/QPSK</b>										
20850	2510	50	left cheek	21.7	21.7	0.148	0.148	0.078	0.078	21.5
20850	2510	50	left tilted 15°	21.7	21.7	0.030	0.030	0.020	0.020	21.5
20850	2510	50	right cheek	21.7	21.7	0.096	0.096	0.055	0.055	21.5
20850	2510	50	right tilted 15°	21.7	21.7	0.043	0.043	0.023	0.023	21.5

Table 52: Test results head SAR LTE FDD 7 2600 MHz (see max. SAR plot in Annex B.7: LTE FDD 7 page 114)

measured / extrapolated SAR numbers - hotspot mode - LTE FDD 7 2600 MHz Power Reduction when hotspot (Wifi Tethering) is activated											
Ch.	Freq. (MHz)	RB offset	dist. (mm)	Position	cond. P <sub>max</sub> (dBm)		SAR <sub>1g</sub> results(W/kg)		SAR <sub>10g</sub> (W/kg)		liquid (°C)
					declared**	measured	measured	extrapolated	meas.	extrap.	
<b>20MHz BW/1RB/QPSK</b>											
20850	2510	99	10	front	18.5	18.1	0.549	0.602	0.255	0.280	22.3
20850	2510	99	10	rear	18.5	18.1	0.662	0.726	0.320	0.351	22.3
20850	2510	99	10	left edge	18.5	18.1	0.072	0.079	0.041	0.045	22.3
20850	2510	99	10	right edge	18.5	18.1	0.022	0.024	0.013	0.015	22.3
20850	2510	99	10	bottom edge	18.5	18.1	0.994	1.090	0.462	0.507	22.3
21100	2535	99	10	bottom edge	18.5	18.1	<b>1.100</b>	<b>1.206</b>	<b>0.511</b>	<b>0.560</b>	22.3
21350	2560	99	10	bottom edge	18.5	18.1	1.030	1.129	0.476	0.522	22.3
<b>20MHz BW/50RB/QPSK</b>											
20850	2510	50	10	front	18.5	18.2	0.432	0.463	0.202	0.216	22.3
20850	2510	50	10	rear	18.5	18.2	0.667	0.715	0.318	0.341	22.3
20850	2510	50	10	left edge	18.5	18.2	0.070	0.075	0.040	0.043	22.3
20850	2510	50	10	right edge	18.5	18.2	0.019	0.021	0.011	0.012	22.3
20850	2510	50	10	bottom edge	18.5	18.2	0.928	0.994	0.434	0.465	22.3
21100	2535	50	10	bottom edge	18.5	18.1	1.090	1.195	0.509	0.558	22.3
21350	2560	50	10	bottom edge	18.5	18.1	1.090	1.195	0.498	0.546	22.3
<b>20MHz BW/100RB/QPSK</b>											
21100	2535	0	10	front	18.5	18.1	0.553	0.606	0.257	0.282	22.3
20850	2510	0	10	rear	18.5	18.1	0.734	0.805	0.350	0.384	22.3
21100	2535	0	10	rear	18.5	18.1	0.795	0.872	0.378	0.414	22.3
21350	2560	0	10	rear	18.5	18.1	0.753	0.826	0.357	0.391	22.3
21100	2535	0	10	left edge	18.5	18.1	0.059	0.064	0.035	0.038	22.3
21100	2535	0	10	right edge	18.5	18.1	0.021	0.023	0.013	0.014	22.3
20850	2510	0	10	bottom edge	18.5	18.1	0.927	1.016	0.436	0.478	22.3
21100	2535	0	10	bottom edge	18.5	18.1	1.050	1.151	0.489	0.536	22.3
21350	2560	0	10	bottom edge	18.5	18.1	1.040	1.140	0.481	0.527	22.3

Table 53: Test results hotspot mode SAR LTE FDD 7 2600 MHz (see max. SAR plot in Annex B.7: LTE FDD 7 page 114)

Top edge position for hotspot mode is not required since the distance from the main antenna to the edge is greater than 2.5 cm.

measured / extrapolated SAR numbers - Body worn - LTE FDD 7 2600 MHz												
Ch.	Freq. (MHz)	RB offset	dist. (mm)	Position	cond. P <sub>max</sub> (dBm)		SAR <sub>1g</sub> results(W/kg)		SAR <sub>10g</sub> (W/kg)		liquid (°C)	
					declared**	measured	measured	extrapolated	meas.	extrap.		
<b>20MHz BW/1RB/QPSK</b>												
20850	2510	50	15	front	22.7	22.7	0.717	0.717	0.364	0.364	22.8	
20850	2510	50	15	rear	22.7	22.7	1.020	1.020	0.529	0.529	22.8	
21100	2535	99	15	rear	22.7	22.5	<b>1.180</b>	<b>1.236</b>	<b>0.605</b>	<b>0.634</b>	22.8	
21350	2560	99	15	rear	22.7	22.7	1.030	1.030	0.528	0.528	22.8	
21100	2535	99	15	rear*	22.7	22.5	1.130	1.183	0.588	0.616	22.3	
<b>20MHz BW/50RB/QPSK</b>												
20850	2510	50	15	front	21.7	21.7	0.574	0.574	0.290	0.290	22.8	
20850	2510	50	15	rear	21.7	21.7	0.811	0.811	0.417	0.417	22.8	
21100	2535	50	15	rear	21.7	21.6	0.941	0.963	0.483	0.494	22.8	
21350	2560	50	15	rear	21.7	21.7	0.825	0.825	0.424	0.424	22.8	
<b>20MHz BW/100RB/QPSK</b>												
21350	2560	0	15	front	21.7	21.7	0.472	0.472	0.240	0.240	22.3	
21350	2560	0	15	rear	21.7	21.7	0.761	0.761	0.391	0.391	22.3	

Table 54: Test results body worn SAR LTE FDD 7 2600 MHz (see max. SAR plot in Annex B.7: LTE FDD 7 page 114)

\* - repeated at the highest SAR measurement according to the FCC KDB 865664

\*\* - maximum possible output power declared by manufacturer



measured / extrapolated SAR numbers - Head - WLAN 2450 MHz									
Ch.	Freq. (MHz)	Position	cond. P <sub>max</sub> (dBm)		SAR <sub>1g</sub> results(W/kg)		SAR <sub>10g</sub> (W/kg)		liquid (°C)
			declared**	measured	measured	extrapolated	meas.	extrap.	
1	2412	left cheek	15.3	14.5	0.212	0.255	0.102	0.123	21.5
6	2437	left cheek	17.3	16.4	<b>0.300</b>	<b>0.369</b>	<b>0.142</b>	<b>0.175</b>	21.5
11	2462	left cheek	15.3	14.1	0.196	0.258	0.091	0.120	21.5
13	2472	left cheek	17.3	16.5	0.283	0.340	0.135	0.162	21.5
6	2437	left tilted 15°	17.3	16.4	0.090	0.111	0.048	0.059	21.5
6	2437	right cheek	17.3	16.4	0.152	0.187	0.079	0.097	21.5
6	2437	right tilted 15°	17.3	16.4	0.077	0.095	0.041	0.050	21.5

Table 55: Test results head SAR WLAN 2450 MHz (see max. SAR plot in Annex B.8: WLAN 2450MHz page 117)

measured / extrapolated SAR numbers - hotspot mode - WLAN 2450 MHz											
Ch.	Freq. (MHz)	Test condition	dist. (mm)	Position	cond. P <sub>max</sub> (dBm)		SAR <sub>1g</sub> results(W/kg)		SAR <sub>10g</sub> (W/kg)		liquid (°C)
					declared**	measured	measured	extrapolated	meas.	extrap.	
6	2437	1Mbit/s	10	front	17.3	16.4	0.111	0.137	0.056	0.069	22.7
1	2412	1Mbit/s	10	rear	15.3	14.5	0.136	0.164	0.067	0.081	22.7
6	2437	1Mbit/s	10	rear	17.3	16.4	<b>0.213</b>	<b>0.262</b>	<b>0.104</b>	<b>0.128</b>	22.7
11	2462	1Mbit/s	10	rear	15.3	14.1	0.131	0.173	0.063	0.083	22.7
6	2437	1Mbit/s	10	left edge	17.3	16.4	0.006	0.007	0.003	0.003	22.7
6	2437	1Mbit/s	10	right edge	17.3	16.4	0.144	0.177	0.068	0.084	22.7
6	2437	1Mbit/s	10	top	17.3	16.4	0.023	0.028	0.013	0.016	22.7

Table 56: Test results hotspot mode SAR WLAN 2450 MHz (see max. SAR plot in Annex B.8: WLAN 2450MHz page 117)

Bottom side edge positions for hotspot mode are not required since the distance from the WLAN antenna to the edge is greater than 2.5cm.

measured / extrapolated SAR numbers - Body worn - WLAN 2450 MHz											
Ch.	Freq. (MHz)	Test condition	dist. (mm)	Position	cond. P <sub>max</sub> (dBm)		SAR <sub>1g</sub> results(W/kg)		SAR <sub>10g</sub> (W/kg)		liquid (°C)
					declared**	measured	measured	extrapolated	meas.	extrap.	
6	2437	1Mbit/s	15	front	17.3	16.4	0.063	0.077	0.033	0.041	22.7
1	2412	1Mbit/s	15	rear	15.3	14.5	0.061	0.073	0.032	0.039	22.7
6	2437	1Mbit/s	15	rear	17.3	16.4	<b>0.110</b>	<b>0.135</b>	<b>0.056</b>	<b>0.069</b>	22.7
11	2462	1Mbit/s	15	rear	15.3	14.1	0.063	0.083	0.032	0.043	22.7
13	2472	1Mbit/s	15	rear	17.3	16.5	0.097	0.117	0.049	0.059	22.7

Table 57: Test results body worn SAR WLAN 2450 MHz (see max. SAR plot in Annex B.8: WLAN 2450MHz page 117)

\*\* - maximum possible output power declared by manufacturer

measured / extrapolated SAR numbers - Head - WLAN 5 GHz									
Ch.	Freq. (MHz)	Position	cond. P <sub>max</sub> (dBm)		SAR <sub>1g</sub> results(W/kg)		SAR <sub>10g</sub> (W/kg)		liquid (°C)
			declared**	measured	measured	extrapolated	meas.	extrap.	
48	5240	left cheek	15.2	14.5	0.140	0.164	0.051	0.060	21.9
52	5260	left cheek	15.2	14.6	<b>0.180</b>	<b>0.207</b>	<b>0.060</b>	<b>0.069</b>	21.9
112	5560	left cheek	15.2	14.8	0.064	0.070	0.024	0.027	21.9
149	5745	left cheek	15.2	14.6	0.037	0.042	0.015	0.018	21.9
48	5240	left tilted 15°	15.2	14.5	0.070	0.082	0.025	0.030	21.9
52	5260	left tilted 15°	15.2	14.6	0.057	0.065	0.024	0.028	21.9
112	5560	left tilted 15°	15.2	14.8	0.034	0.037	0.014	0.015	21.9
149	5745	left tilted 15°	15.2	14.6	0.034	0.039	0.014	0.016	21.9
48	5240	right cheek	15.2	14.5	0.050	0.059	0.019	0.023	21.9
52	5260	right cheek	15.2	14.6	0.058	0.066	0.022	0.025	21.9
112	5560	right cheek	15.2	14.8	0.025	0.027	0.011	0.012	21.9
149	5745	right cheek	15.2	14.6	0.022	0.026	0.009	0.010	21.9
48	5240	right tilted 15°	15.2	14.5	0.027	0.031	0.011	0.012	21.9
52	5260	right tilted 15°	15.2	14.6	0.030	0.034	0.014	0.016	21.9
112	5560	right tilted 15°	15.2	14.8	0.016	0.018	0.008	0.009	21.9
149	5745	right tilted 15°	15.2	14.6	0.021	0.024	0.008	0.010	21.9

Table 58: Test results head SAR WLAN 5 GHz (see max. SAR plot in Annex B.9: WLAN 5GHz page 120)

measured / extrapolated SAR numbers - Body worn - WLAN 5 GHz											
Ch.	Freq. (MHz)	Test condition	dist. (mm)	Position	cond. P <sub>max</sub> (dBm)		SAR <sub>1g</sub> results(W/kg)		SAR <sub>10g</sub> (W/kg)		liquid (°C)
					declared**	measured	measured	extrapolated	meas.	extrap.	
48	5240	6Mbit/s	15	front	15.2	14.5	0.024	0.028	0.009	0.010	22.2
52	5260	6Mbit/s	15	front	15.2	14.6	0.028	0.032	0.009	0.010	22.2
112	5560	6Mbit/s	15	front	15.2	14.8	0.013	0.014	0.004	0.004	22.2
149	5745	6Mbit/s	15	front	15.2	14.6	0.011	0.013	0.004	0.005	22.2
48	5240	6Mbit/s	15	rear	15.2	14.5	0.181	0.213	0.066	0.078	22.2
52	5260	6Mbit/s	15	rear	15.2	14.6	<b>0.204</b>	<b>0.234</b>	<b>0.075</b>	<b>0.086</b>	22.2
112	5560	6Mbit/s	15	rear	15.2	14.8	0.090	0.099	0.033	0.036	22.2
149	5745	6Mbit/s	15	rear	15.2	14.6	0.077	0.088	0.028	0.032	22.2

Table 59: Test results body worn SAR WLAN 5 GHz (see max. SAR plot in Annex B.9: WLAN 5GHz page 120)

\*\* - maximum possible output power declared by manufacturer

Estimated stand alone SAR.					
Communication system	freq. (GHz)	distance (mm)	P <sub>avg</sub> (dBm)	P <sub>avg</sub> (mW)	estimated <sub>1-g</sub> (W/kg)
Bluetooth 2450 head	2.45	5	9.4	8.7	0.364
Bluetooth 2450 hotspot	2.45	10	9.4	8.7	0.182
Bluetooth 2450 body worn	2.45	15	9.4	8.7	0.121

Table 60: Estimated stand alone SAR<sub>max</sub> for **Bluetooth 2450MHz** hotspot mode and body worn

When standalone SAR test exclusion applies to an antenna that transmits simultaneously with other antennas, the standalone SAR must be estimated according to following to determine simultaneous transmission SAR test exclusion:

(max. power of channel, including tune-up tolerance, mW)/(min. test separation distance, mm)]·[√f(GHz)/x]  
W/kg for test separation distances ≤ 50 mm;  
where x = 7.5 for 1-g SAR.

When the minimum test separation distance is < 5 mm, a distance of 5 mm is applied to determine SAR test exclusion

## 7.2.2 General description of test procedures

- The DUT is tested using CMU 200 and CMW 500 communications testers as controller unit to set test channels and maximum output power to the DUT, as well as for measuring the conducted peak power.
- Test positions as described in the tables above are in accordance with the specified test standard.
- Tests in body position were performed in that configuration, which generates the highest time based averaged output power (see conducted power results).
- Tests in head position with GSM were performed in voice mode with 1 timeslot unless GPRS/EGPRS/DTM function allows parallel voice and data traffic on 2 or more timeslots (see section 2.4 for details).
- UMTS was tested in RMC mode with 12.2 kbit/s and TPC bits set to 'all 1'.
- WLAN was tested in 802.11a/b mode with 1 MBit/s and 6 MBit/s. According to KDB 248227 the SAR testing for 802.11g/n is not required since the maximum power of 802.11g/n is less ¼ dB higher than maximum power of 802.11a/b.
- Required WLAN test channels were selected according to KDB 248227
- For body worn operation, this device has been tested and meets FCC RF exposure guidelines when used with any accessory that contains no metal and that positions the handset a minimum of 15 mm from the body. Use of other accessories may not ensure compliance with FCC RF exposure guidelines.
- According to FCC KDB pub 941225 D06 this device has been tested with 10 mm distance to the phantom for operation in WLAN hot spot mode.
- Per FCC KDB pub 941225 D06 the edges with antennas within 2.5 cm are required to be evaluated for SAR to cover WLAN hot spot function.
- According to IEEE 1528 the SAR test shall be performed at middle channel. Testing of top and bottom channel is optional.
- According to KDB 447498 D01 testing of other required channels within the operating mode of a frequency band is not required when the reported 1-g or 10-g SAR for the mid-band or highest output power channel is:
  - $\leq 0.8$  W/kg or 2.0 W/kg, for 1-g or 10-g respectively, when the transmission band is  $\leq 100$  MHz
  - $\leq 0.6$  W/kg or 1.5 W/kg, for 1-g or 10-g respectively, when the transmission band is between 100 MHz and 200 MHz
  - $\leq 0.4$  W/kg or 1.0 W/kg, for 1-g or 10-g respectively, when the transmission band is  $\geq 200$  MHz
- IEEE 1528-2003 require the middle channel to be tested first. This generally applies to wireless devices that are designed to operate in technologies with tight tolerances for maximum output power variations across channels in the band. When the maximum output power variation across the required test channels is  $> \frac{1}{2}$  dB, instead of the middle channel, the highest output power channel must be used.
- LTE FDD 7 Power Reduction when hotspot (Wifi Tethering) is activated

### 7.2.3 Multiple Transmitter Information

The following tables list information which is relevant for the decision if a simultaneous transmit evaluation is necessary according to FCC KDB 447498D01 General RF Exposure Guidance v05.

reported SAR <b>WWAN</b> and <b>WLAN 2.4GHz</b> , $\Sigma$ SAR evaluation, <b>SPLSR<sub>i</sub></b>						
Frequency band	Position	SAR <sub>max</sub> W/kg		$\Sigma$ SAR <1.6W/kg	distance R <sub>i</sub> mm	ratio ≤ 0.040
		WWAN	WLAN			
GSM 850	left cheek	0.493	0.369	0.862		
	left tilted 15°	0.245	0.111	0.356		
	right cheek	0.605	0.187	0.792		
	right tilted 15°	0.273	0.095	0.368		
	front 10mm	0.578	0.137	0.715		
	rear 10mm	0.768	0.262	1.030		
	front 15mm	0.472	0.077	0.549		
	rear 15mm	0.582	0.135	0.717		
GSM 1900	left cheek	0.339	0.369	0.708		
	left tilted 15°	0.091	0.111	0.202		
	right cheek	0.222	0.187	0.409		
	right tilted 15°	0.090	0.095	0.185		
	front 10mm	0.729	0.137	0.866		
	rear 10mm	0.797	0.262	1.059		
	front 15mm	0.381	0.077	0.458		
	rear 15mm	0.463	0.135	0.598		
UMTS FDD II	left cheek	0.455	0.369	0.824		
	left tilted 15°	0.116	0.111	0.227		
	right cheek	0.293	0.187	0.480		
	right tilted 15°	0.112	0.095	0.207		
	front 10mm	1.146	0.137	1.283		
	rear 10mm	0.966	0.262	1.228		
	front 15mm	0.560	0.077	0.637		
	rear 15mm	0.525	0.135	0.660		
WCDMA FDD V	left cheek	0.459	0.369	0.828		
	left tilted 15°	0.239	0.111	0.350		
	right cheek	0.518	0.187	0.705		
	right tilted 15°	0.243	0.095	0.338		
	front 10mm	0.570	0.137	0.707		
	rear 10mm	0.649	0.262	0.911		
	front 15mm	0.355	0.077	0.432		
	rear 15mm	0.438	0.135	0.573		
LTE FDD 2	left cheek	0.453	0.369	0.822		
	left tilted 15°	0.145	0.111	0.256		
	right cheek	0.271	0.187	0.458		
	right tilted 15°	0.121	0.095	0.216		
	front 10mm	1.117	0.137	1.254		
	rear 10mm	0.924	0.262	1.186		
	front 15mm	0.609	0.077	0.686		
	rear 15mm	0.490	0.135	0.625		
LTE FDD 5	left cheek	0.454	0.369	0.823		
	left tilted 15°	0.222	0.111	0.333		
	right cheek	0.443	0.187	0.630		
	right tilted 15°	0.219	0.095	0.314		
	front 10mm	0.563	0.137	0.700		
	rear 10mm	0.644	0.262	0.906		
	front 15mm	0.513	0.077	0.590		
	rear 15mm	0.516	0.135	0.651		
LTE FDD 7	left cheek	0.207	0.369	0.576		
	left tilted 15°	0.039	0.111	0.150		
	right cheek	0.121	0.187	0.308		
	right tilted 15°	0.057	0.095	0.152		
	front 10mm	0.602	0.137	0.739		
	rear 10mm	0.726	0.262	0.988		
	front 15mm	0.717	0.077	0.794		
	rear 15mm	1.236	0.135	1.371		

Table 61: SAR<sub>max</sub> WWAN and **WLAN 2.4GHz**,  $\Sigma$ SAR evaluation, **SPLSR<sub>i</sub>**

reported SAR WWAN and WLAN 5GHz, ΣSAR evaluation, SPLSRi						
Frequency band	Position	SAR <sub>max</sub> /W/kg		ΣSAR <1.6W/kg	distance R <sub>i</sub> , mm	ratio ≤ 0.040
		WWAN	WLAN			
GSM 850	left cheek	0.493	0.207	0.700		
	left tilted 15°	0.245	0.082	0.327		
	right cheek	0.605	0.066	0.671		
	right tilted 15°	0.273	0.034	0.307		
	front 15mm	0.472	0.032	0.504		
	rear 15mm	0.582	0.234	0.816		
GSM 1900	left cheek	0.339	0.207	0.546		
	left tilted 15°	0.091	0.082	0.173		
	right cheek	0.222	0.066	0.288		
	right tilted 15°	0.090	0.034	0.124		
	front 15mm	0.381	0.032	0.413		
	rear 15mm	0.463	0.234	0.697		
UMTS FDD II	left cheek	0.455	0.207	0.662		
	left tilted 15°	0.116	0.082	0.198		
	right cheek	0.293	0.066	0.359		
	right tilted 15°	0.112	0.034	0.146		
	front 15mm	0.560	0.032	0.592		
	rear 15mm	0.525	0.234	0.759		
WCDMA FDD V	left cheek	0.459	0.207	0.666		
	left tilted 15°	0.239	0.082	0.321		
	right cheek	0.518	0.066	0.584		
	right tilted 15°	0.243	0.034	0.277		
	front 15mm	0.355	0.032	0.387		
	rear 15mm	0.438	0.234	0.672		
LTE FDD 2	left cheek	0.453	0.207	0.660		
	left tilted 15°	0.145	0.082	0.227		
	right cheek	0.271	0.066	0.337		
	right tilted 15°	0.121	0.034	0.155		
	front 15mm	0.609	0.032	0.641		
	rear 15mm	0.490	0.234	0.724		
LTE FDD 5	left cheek	0.454	0.207	0.661		
	left tilted 15°	0.222	0.082	0.304		
	right cheek	0.443	0.066	0.509		
	right tilted 15°	0.219	0.034	0.253		
	front 15mm	0.513	0.032	0.545		
	rear 15mm	0.516	0.234	0.750		
LTE FDD 7	left cheek	0.207	0.207	0.414		
	left tilted 15°	0.039	0.082	0.121		
	right cheek	0.121	0.066	0.187		
	right tilted 15°	0.057	0.034	0.091		
	front 15mm	0.717	0.032	0.749		
	rear 15mm	1.236	0.234	<b>1.470</b>		

Table 62: SAR<sub>max</sub> WWAN and WLAN 5GHz, ΣSAR evaluation, SPLSR<sub>i</sub>

reported SAR WWAN and Bluetooth 2.4GHz ΣSAR evaluation SPLSRi						
Frequency band	Position	SAR <sub>max</sub> /W/kg		ΣSAR <1.6W/kg	distance Ri. mm	ratio ≤ 0.040
		WWAN	Bluetooth			
GSM 850	left cheek	0.493	0.364	0.857		
	left tilted 15°	0.245	0.364	0.609		
	right cheek	0.605	0.364	0.969		
	right tilted 15°	0.273	0.364	0.637		
	front 10mm	0.578	0.182	0.760		
	rear 10mm	0.768	0.182	0.950		
	front 15mm	0.472	0.121	0.593		
	rear 15mm	0.582	0.121	0.703		
GSM 1900	left cheek	0.339	0.364	0.703		
	left tilted 15°	0.091	0.364	0.455		
	right cheek	0.222	0.364	0.586		
	right tilted 15°	0.090	0.364	0.454		
	front 10mm	0.729	0.182	0.911		
	rear 10mm	0.797	0.182	0.979		
	front 15mm	0.381	0.121	0.502		
	rear 15mm	0.463	0.121	0.584		
UMTS FDD II	left cheek	0.455	0.364	0.819		
	left tilted 15°	0.116	0.364	0.480		
	right cheek	0.293	0.364	0.657		
	right tilted 15°	0.112	0.364	0.476		
	front 10mm	1.146	0.182	1.328		
	rear 10mm	0.966	0.182	1.148		
	front 15mm	0.560	0.121	0.681		
	rear 15mm	0.525	0.121	0.646		
WCDMA FDD V	left cheek	0.459	0.364	0.823		
	left tilted 15°	0.239	0.364	0.603		
	right cheek	0.518	0.364	0.882		
	right tilted 15°	0.243	0.364	0.607		
	front 10mm	0.570	0.182	0.752		
	rear 10mm	0.649	0.182	0.831		
	front 15mm	0.355	0.121	0.476		
	rear 15mm	0.438	0.121	0.559		
LTE FDD 2	left cheek	0.453	0.364	0.817		
	left tilted 15°	0.145	0.364	0.509		
	right cheek	0.271	0.364	0.635		
	right tilted 15°	0.121	0.364	0.485		
	front 10mm	1.117	0.182	1.299		
	rear 10mm	0.924	0.182	1.106		
	front 15mm	0.609	0.121	0.730		
	rear 15mm	0.490	0.121	0.611		
LTE FDD 5	left cheek	0.454	0.364	0.818		
	left tilted 15°	0.222	0.364	0.586		
	right cheek	0.443	0.364	0.807		
	right tilted 15°	0.219	0.364	0.583		
	front 10mm	0.563	0.182	0.745		
	rear 10mm	0.644	0.182	0.826		
	front 15mm	0.513	0.121	0.634		
	rear 15mm	0.516	0.121	0.637		
LTE FDD 7	left cheek	0.207	0.364	0.571		
	left tilted 15°	0.039	0.364	0.403		
	right cheek	0.121	0.364	0.485		
	right tilted 15°	0.057	0.364	0.421		
	front 10mm	0.602	0.182	0.784		
	rear 10mm	0.726	0.182	0.908		
	front 15mm	0.717	0.121	0.838		
	rear 15mm	1.236	0.121	1.357		

Table 63: SAR<sub>max</sub> WWAN and Bluetooth 2450MHz, ΣSAR evaluation

reported SAR WWAN and WLAN 5GHz, $\Sigma$ SAR evaluation, SPLSRi							
Frequency band	Position	SARmax /W/kg			$\Sigma$ SAR <1.6W/kg	distance Ri, mm	ratio $\leq 0.040$
		WWAN	BT	WLAN			
GSM 850	left cheek	0.493	0.364	0.207	1.064		
	left tilted 15°	0.245	0.364	0.082	0.691		
	right cheek	0.605	0.364	0.066	1.035		
	right tilted 15°	0.273	0.364	0.034	0.671		
	front 15mm	0.472	0.121	0.032	0.625		
	rear 15mm	0.582	0.121	0.234	0.937		
GSM 1900	left cheek	0.339	0.364	0.207	0.910		
	left tilted 15°	0.091	0.364	0.082	0.537		
	right cheek	0.222	0.364	0.066	0.652		
	right tilted 15°	0.090	0.364	0.034	0.488		
	front 15mm	0.381	0.121	0.032	0.534		
	rear 15mm	0.463	0.121	0.234	0.818		
UMTS FDD II	left cheek	0.455	0.364	0.207	1.026		
	left tilted 15°	0.116	0.364	0.082	0.562		
	right cheek	0.293	0.364	0.066	0.723		
	right tilted 15°	0.112	0.364	0.034	0.510		
	front 15mm	0.560	0.121	0.032	0.713		
	rear 15mm	0.525	0.121	0.234	0.880		
WCDMA FDD V	left cheek	0.459	0.364	0.207	1.030		
	left tilted 15°	0.239	0.364	0.082	0.685		
	right cheek	0.518	0.364	0.066	0.948		
	right tilted 15°	0.243	0.364	0.034	0.641		
	front 15mm	0.355	0.121	0.032	0.508		
	rear 15mm	0.438	0.121	0.234	0.793		
LTE FDD 2	left cheek	0.453	0.364	0.207	1.024		
	left tilted 15°	0.145	0.364	0.082	0.591		
	right cheek	0.271	0.364	0.066	0.701		
	right tilted 15°	0.121	0.364	0.034	0.519		
	front 15mm	0.609	0.121	0.032	0.762		
	rear 15mm	0.490	0.121	0.234	0.845		
LTE FDD 5	left cheek	0.454	0.364	0.207	1.025		
	left tilted 15°	0.222	0.364	0.082	0.668		
	right cheek	0.443	0.364	0.066	0.873		
	right tilted 15°	0.219	0.364	0.034	0.617		
	front 15mm	0.513	0.121	0.032	0.666		
	rear 15mm	0.516	0.121	0.234	0.871		
LTE FDD 7	left cheek	0.207	0.364	0.207	0.778		
	left tilted 15°	0.039	0.364	0.082	0.485		
	right cheek	0.121	0.364	0.066	0.551		
	right tilted 15°	0.057	0.364	0.034	0.455		
	front 15mm	0.717	0.121	0.032	0.870		
	rear 15mm	1.236	0.121	0.234	<b>1.591</b>		

Table 64: SAR<sub>max</sub> WWAN, WLAN5GHz and Bluetooth 2450MHz,  $\Sigma$ SAR evaluation

### Conclusion:

$\Sigma$ SAR < 1.6 W/kg therefore simultaneous transmissions SAR measurement with the enlarged zoom scan measurement and volume scan post-processing procedures is **not** required.



## 8 Test equipment and ancillaries used for tests

To simplify the identification of the test equipment and/or ancillaries which were used, the reporting of the relevant test cases only refer to the test item number as specified in the table below.

Equipment	Type	Manufacturer	Serial No.	Last Calibration	Frequency (months)
Dosimetric E-Field Probe	ET3DV6	Schmid & Partner Engineering AG	1558	August 22, 2013	12
Dosimetric E-Field Probe	ET3DV6	Schmid & Partner Engineering AG	1559	January 20, 2014	12
Dosimetric E-Field Probe	ES3DV3	Schmid & Partner Engineering AG	3326	September 02, 2013	12
Dosimetric E-Field Probe	EX3DV4	Schmid & Partner Engineering AG	3944	August 02, 2013	12
835 MHz System Validation Dipole	D835V2	Schmid & Partner Engineering AG	4d153	June 06, 2013	24
1750 MHz System Validation Dipole	D1750V2	Schmid & Partner Engineering AG	1093	June 06, 2013	24
1900 MHz System Validation Dipole	D1900V2	Schmid & Partner Engineering AG	5d009	May 15, 2013	24
2450 MHz System Validation Dipole	D2450V2	Schmid & Partner Engineering AG	710	August 13, 2012	24
2600 MHz System Validation Dipole	D2600V2	Schmid & Partner Engineering AG	1040	August 15, 2013	24
5 GHz System Validation Dipole	D5GHV2	Schmid & Partner Engineering AG	1055	August 19, 2013	24
Data acquisition electronics	DAE3V1	Schmid & Partner Engineering AG	408	September 30, 2013	12
Data acquisition electronics	DAE3V1	Schmid & Partner Engineering AG	477	May 14, 2014	12
Data acquisition electronics	DAE4	Schmid & Partner Engineering AG	1387	August 28, 2013	12
Software	DASY52 52.8.7	Schmid & Partner Engineering AG	---	N/A	--
Triple Modular Flat Phantom V5.1	QD 000 P51 C	Schmid & Partner Engineering AG	1154	N/A	--
SAM Twin Phantom V5.0	QD 000 P40 C	Schmid & Partner Engineering AG	1813	N/A	--
Universal Radio Communication Tester	CMU 200	Rohde & Schwarz	106826	January 27, 2014	24
Universal Radio Communication Tester	CMW500	Rohde & Schwarz	102375	January 16, 2013	24
Network Analyser 300 kHz to 6 GHz	8753ES	Hewlett Packard)*	US39174436	January 28, 2014	24
Dielectric Probe Kit	85070C	Hewlett Packard	US99360146	N/A	12
Signal Generator	8671B	Hewlett Packard	2823A00656	January 22, 2014	24
Amplifier	25S1G4 (25 Watt)	Amplifier Research	20452	N/A	--
Power Meter	NRP	Rohde & Schwarz	101367	January 21, 2014	24
Power Meter Sensor	NRP Z22	Rohde & Schwarz	100227	January 21, 2014	12
Power Meter Sensor	NRP Z22	Rohde & Schwarz	100234	January 21, 2014	12
Directional Coupler	778D	Hewlett Packard	19171	January 21, 2014	12

)\* : Network analyzer probe calibration against air, distilled water and a shorting block performed before measuring liquid parameters.

## 9 Observations

No observations exceeding those reported with the single test cases have been made.

## Annex A: System performance check

Date/Time: 07.05.2014 11:39:38

### SystemPerformanceCheck-D835 head 2014-05-07

**DUT: Dipole 835 MHz; Type: D835V2; Serial: 4d153**

Communication System: UID 0, CW (0); Communication System Band: D835 (835.0 MHz); Frequency: 835 MHz; Communication System PAR: 0 dB; PMF: 1

Medium parameters used:  $f = 835$  MHz;  $\sigma = 0.912$  S/m;  $\epsilon_r = 41.42$ ;  $\rho = 1000$  kg/m<sup>3</sup>

Phantom section: Flat Section

Measurement Standard: DASYS

DASY5 Configuration:

- Probe: ET3DV6 - SN1558; ConvF(5.89, 5.89, 5.89); Calibrated: 22.08.2013;
- Sensor-Surface: 4mm (Mechanical Surface Detection),  $z = 2.7, 32.7$
- Electronics: DAE3 Sn408; Calibrated: 30.09.2013
- Phantom: SAM front; Type: QD000P40CC; Serial: TP-1042
- DASY52 52.8.7(1137); SEMCAD X 14.6.10(7164)

### HSL835/d=15mm, Pin=100 mW, dist=4.0mm/Area Scan (51x51x1): Interpolated

grid:  $dx=1.500$  mm,  $dy=1.500$  mm

Maximum value of SAR (interpolated) = 10.9 W/kg

### HSL835/d=15mm, Pin=100 mW, dist=4.0mm/Zoom Scan (7x7x7)/Cube 0:

Measurement grid:  $dx=5$ mm,  $dy=5$ mm,  $dz=5$ mm

Reference Value = 114.8 V/m; Power Drift = -0.09 dB

Peak SAR (extrapolated) = 14.8 W/kg

**SAR(1 g) = 10.2 W/kg; SAR(10 g) = 6.69 W/kg**

Maximum value of SAR (measured) = 10.9 W/kg

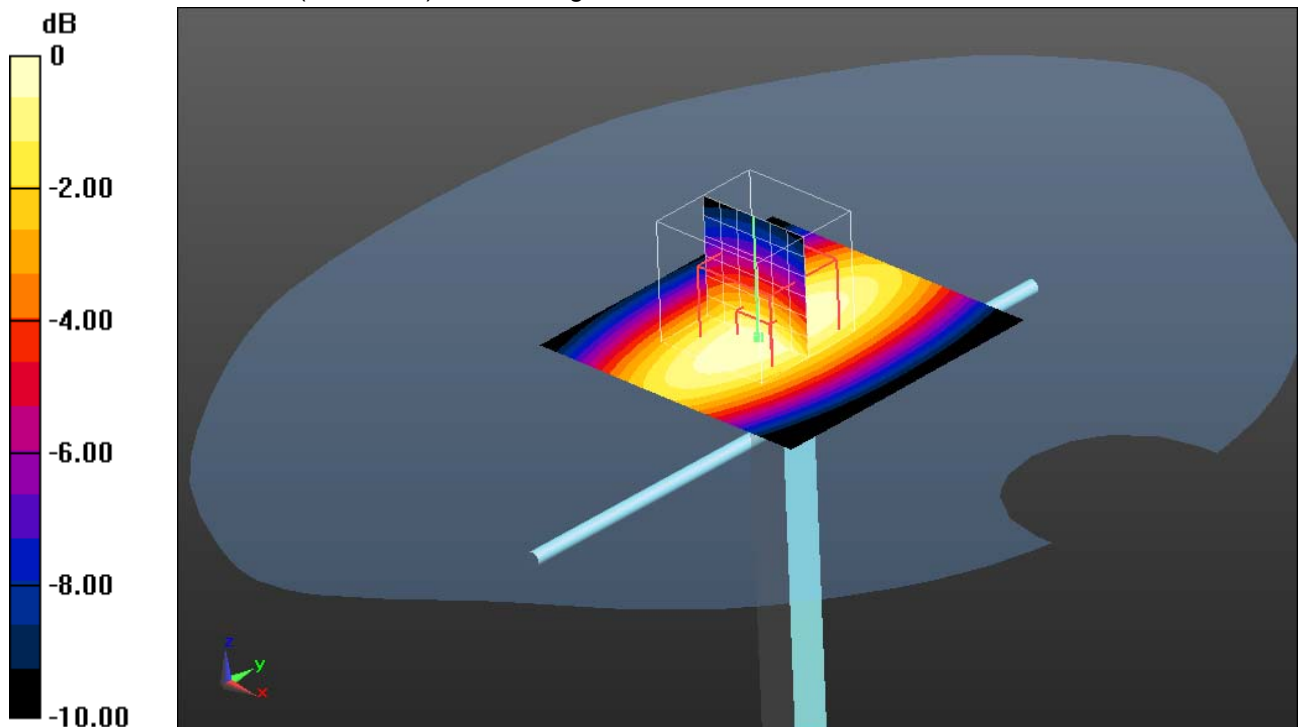

0 dB = 10.9 W/kg = 10.37 dBW/kg

#### Additional information:

ambient temperature: 23.4°C; liquid temperature: 22.3°C

Date/Time: 5/14/2014 1:28:06 PM

### SystemPerformanceCheck-D835 head 2014-05-14

**DUT: Dipole 835 MHz; Type: D835V2; Serial: 4d153**

Communication System: UID 0, CW (0); Communication System Band: D835 (835.0 MHz); Frequency: 835 MHz; Communication System PAR: 0 dB; PMF: 1

Medium parameters used:  $f = 835 \text{ MHz}$ ;  $\sigma = 0.912 \text{ S/m}$ ;  $\epsilon_r = 41.42$ ;  $\rho = 1000 \text{ kg/m}^3$

Phantom section: Flat Section

Measurement Standard: DASYS5

DASY5 Configuration:

- Probe: ES3DV3 - SN3326; ConvF(6.25, 6.25, 6.25); Calibrated: 9/2/2013;
- Sensor-Surface: 4mm (Mechanical Surface Detection),  $z = 2.0, 27.0$
- Electronics: DAE4 Sn1387; Calibrated: 8/28/2013
- Phantom: SAM front; Type: QD000P40CC; Serial: TP:1041
- DASY52 52.8.7(1137); SEMCAD X 14.6.10(7164)

**HSL835/d=15mm, Pin=1000mW/Area Scan (51x51x1):** Interpolated grid:  $dx=1.500 \text{ mm}$ ,  $dy=1.500 \text{ mm}$

Maximum value of SAR (interpolated) = 10.1 W/kg

**HSL835/d=15mm, Pin=1000mW/Zoom Scan (7x7x6)/Cube 0:** Measurement grid:  $dx=5\text{mm}$ ,  $dy=5\text{mm}$ ,  $dz=5\text{mm}$

Reference Value = 108.2 V/m; Power Drift = -0.02 dB

Peak SAR (extrapolated) = 13.6 W/kg

**SAR(1 g) = 9.42 W/kg; SAR(10 g) = 6.23 W/kg**

Maximum value of SAR (measured) = 10.2 W/kg

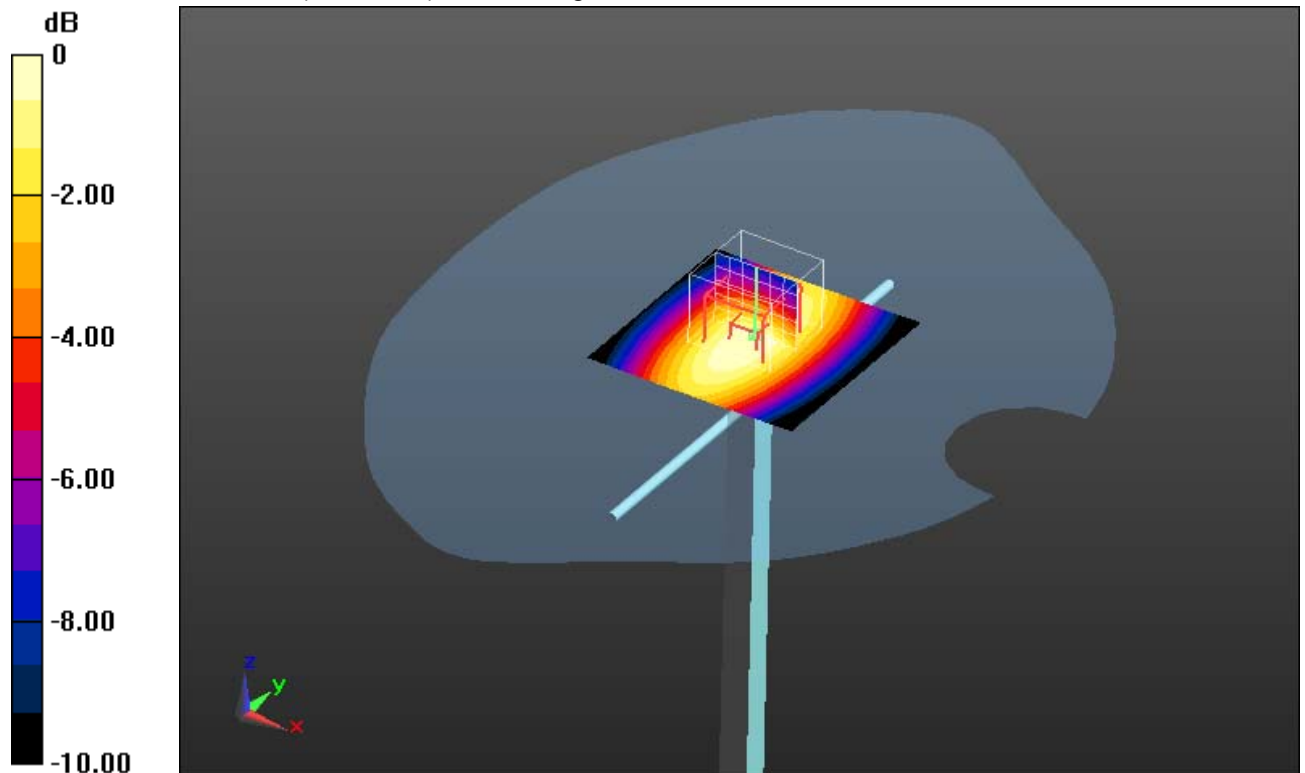

0 dB = 10.2 W/kg = 10.09 dBW/kg

**Additional information:**

ambient temperature: 23.1°C; liquid temperature: 22.3°C

Date/Time: 5/9/2014 2:53:03 PM

### SystemPerformanceCheck-D835 body 2014-05-08

**DUT: Dipole 835 MHz; Type: D835V2; Serial: 4d153**

Communication System: UID 0, CW (0); Communication System Band: D835 (835.0 MHz); Frequency: 835 MHz; Communication System PAR: 0 dB; PMF: 1

Medium parameters used:  $f = 835$  MHz;  $\sigma = 1.008$  S/m;  $\epsilon_r = 54.832$ ;  $\rho = 1000$  kg/m<sup>3</sup>

Phantom section: Center Section

Measurement Standard: DASYS

DASY5 Configuration:

- Probe: ES3DV3 - SN3326; ConvF(6.04, 6.04, 6.04); Calibrated: 9/2/2013;
- Sensor-Surface: 4mm (Mechanical Surface Detection),  $z = 2.0, 32.0$
- Electronics: DAE4 Sn1387; Calibrated: 8/28/2013
- Phantom: Triple Flat Phantom 5.1C; Type: QD 000 P51 CA; Serial: xxxx
- DASY52 52.8.7(1137); SEMCAD X 14.6.10(7164)

### MSL835/d=15mm, Pin=1000 mW, dist=4.0mm/Area Scan (51x51x1):

Interpolated grid:  $dx=1.500$  mm,  $dy=1.500$  mm

Maximum value of SAR (interpolated) = 10.3 W/kg

### MSL835/d=15mm, Pin=1000 mW, dist=4.0mm/Zoom Scan (7x7x7)/Cube 0:

Measurement grid:  $dx=5$ mm,  $dy=5$ mm,  $dz=5$ mm

Reference Value = 103.3 V/m; Power Drift = -0.01 dB

Peak SAR (extrapolated) = 13.8 W/kg

**SAR(1 g) = 9.61 W/kg; SAR(10 g) = 6.38 W/kg**

Maximum value of SAR (measured) = 10.4 W/kg

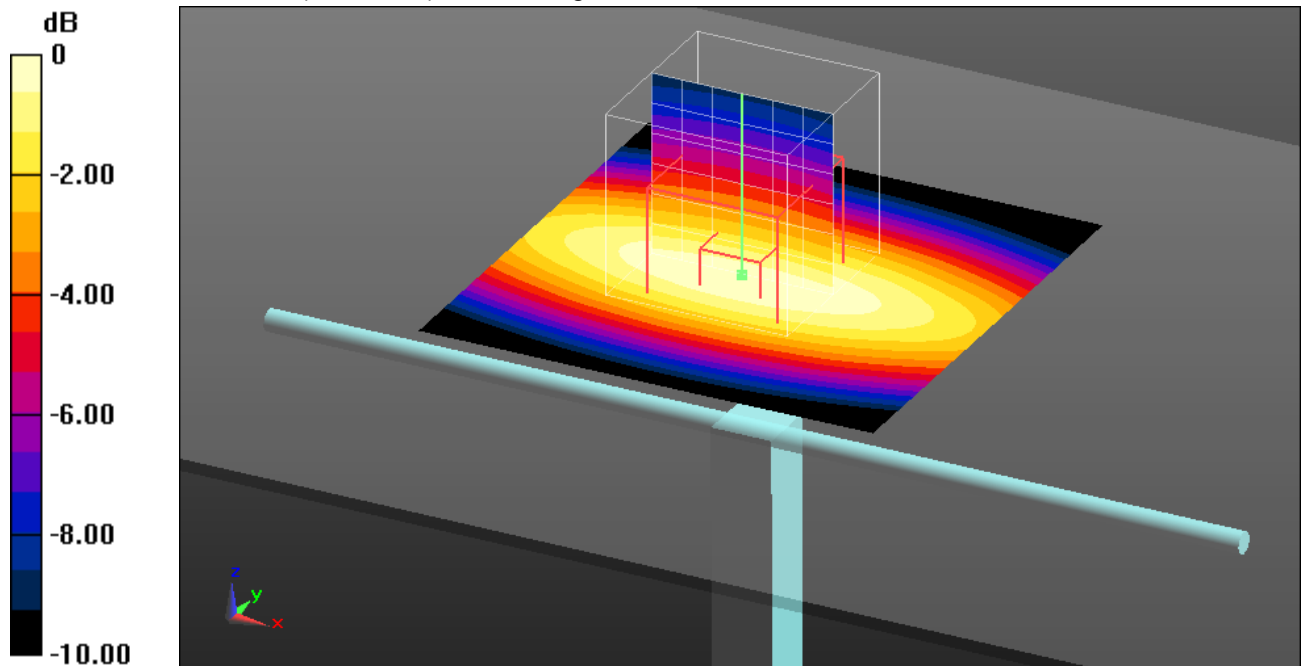

0 dB = 10.4 W/kg = 10.17 dBW/kg

#### Additional information:

ambient temperature: 23.3°C; liquid temperature: 22.3°C

Date/Time: 5/15/2014 10:05:44 AM

### SystemPerformanceCheck-D835 body 2014-05-15

**DUT: Dipole 835 MHz; Type: D835V2; Serial: 4d153**

Communication System: UID 0, CW (0); Communication System Band: D835 (835.0 MHz); Frequency: 835 MHz; Communication System PAR: 0 dB; PMF: 1

Medium parameters used:  $f = 835 \text{ MHz}$ ;  $\sigma = 1.008 \text{ S/m}$ ;  $\epsilon_r = 54.832$ ;  $\rho = 1000 \text{ kg/m}^3$

Phantom section: Center Section

Measurement Standard: DASY5

DASY5 Configuration:

- Probe: ES3DV3 - SN3326; ConvF(6.04, 6.04, 6.04); Calibrated: 9/2/2013;
- Sensor-Surface: 4mm (Mechanical Surface Detection),  $z = 2.0, 32.0$
- Electronics: DAE4 Sn1387; Calibrated: 8/28/2013
- Phantom: Triple Flat Phantom 5.1C; Type: QD 000 P51 CA; Serial: 5411
- DASY52 52.8.7(1137); SEMCAD X 14.6.10(7164)

**HSL835/d=15mm, Pin=1000 mW, dist=4.0mm/Area Scan (51x51x1):** Interpolated grid:  $dx=1.500 \text{ mm}$ ,  $dy=1.500 \text{ mm}$

Maximum value of SAR (interpolated) = 10.3 W/kg

**HSL835/d=15mm, Pin=1000 mW, dist=4.0mm/Zoom Scan (7x7x7)/Cube 0:**

Measurement grid:  $dx=5\text{mm}$ ,  $dy=5\text{mm}$ ,  $dz=5\text{mm}$

Reference Value = 103.0 V/m; Power Drift = 0.02 dB

Peak SAR (extrapolated) = 13.9 W/kg

**SAR(1 g) = 9.66 W/kg; SAR(10 g) = 6.4 W/kg**

Maximum value of SAR (measured) = 10.4 W/kg

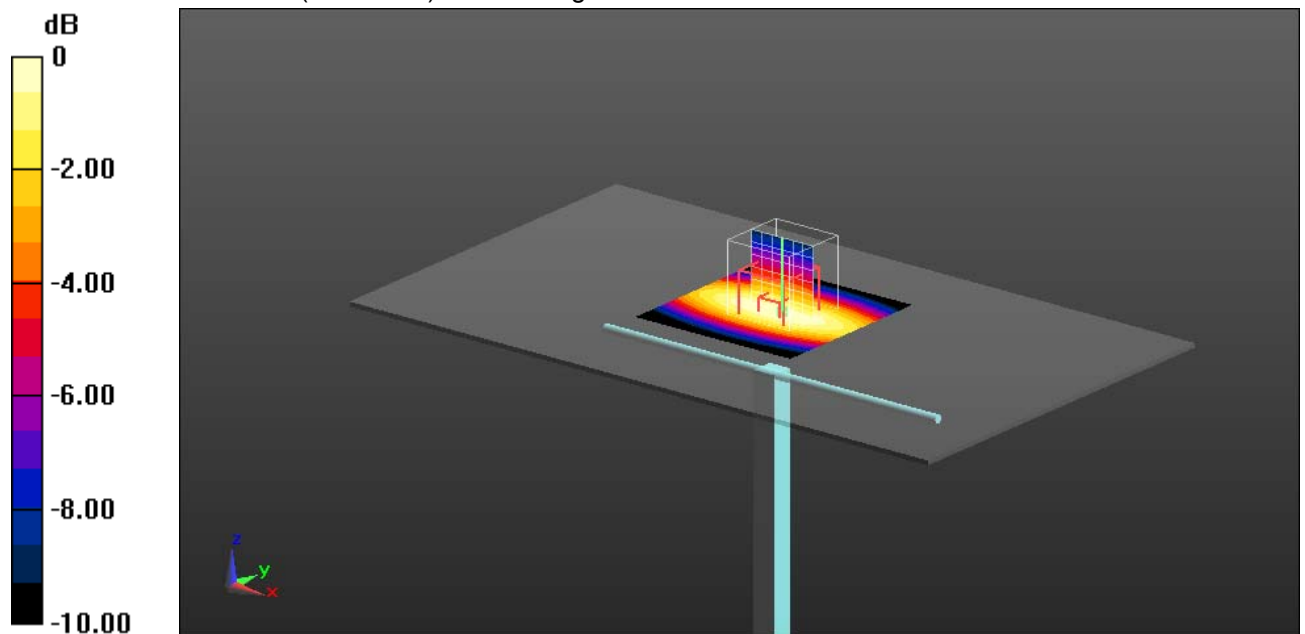

0 dB = 10.4 W/kg = 10.17 dBW/kg

**Additional information:**

ambient temperature: 23.3°C; liquid temperature: 22.7°C

Date/Time: 16.05.2014 09:21:44

### SystemPerformanceCheck-D835 body 2014-05-16

**DUT: Dipole 835 MHz; Type: D835V2; Serial: 4d153**

Communication System: UID 0, CW (0); Communication System Band: D835 (835.0 MHz); Frequency: 835 MHz; Communication System PAR: 0 dB; PMF: 1

Medium parameters used:  $f = 835$  MHz;  $\sigma = 1.008$  S/m;  $\epsilon_r = 54.832$ ;  $\rho = 1000$  kg/m<sup>3</sup>

Phantom section: Center Section

Measurement Standard: DASY5

DASY5 Configuration:

- Probe: ES3DV3 - SN3326; ConvF(6.04, 6.04, 6.04); Calibrated: 02.09.2013;
- Sensor-Surface: 4mm (Mechanical Surface Detection),  $z = 2.0, 32.0$
- Electronics: DAE4 Sn1387; Calibrated: 28.08.2013
- Phantom: Triple Flat Phantom 5.1C; Type: QD 000 P51 CA; Serial: xxxx
- DASY52 52.8.7(1137); SEMCAD X 14.6.10(7164)

**HSL835/d=15mm, Pin=1000 mW, dist=4.0mm/Area Scan (51x51x1):** Interpolated grid:  $dx=1.500$  mm,  $dy=1.500$  mm

Maximum value of SAR (interpolated) = 10.4 W/kg

**HSL835/d=15mm, Pin=1000 mW, dist=4.0mm/Zoom Scan (7x7x7)/Cube 0:**

Measurement grid:  $dx=5$ mm,  $dy=5$ mm,  $dz=5$ mm

Reference Value = 103.8 V/m; Power Drift = -0.02 dB

Peak SAR (extrapolated) = 14.0 W/kg

**SAR(1 g) = 9.72 W/kg; SAR(10 g) = 6.45 W/kg**

Maximum value of SAR (measured) = 10.5 W/kg

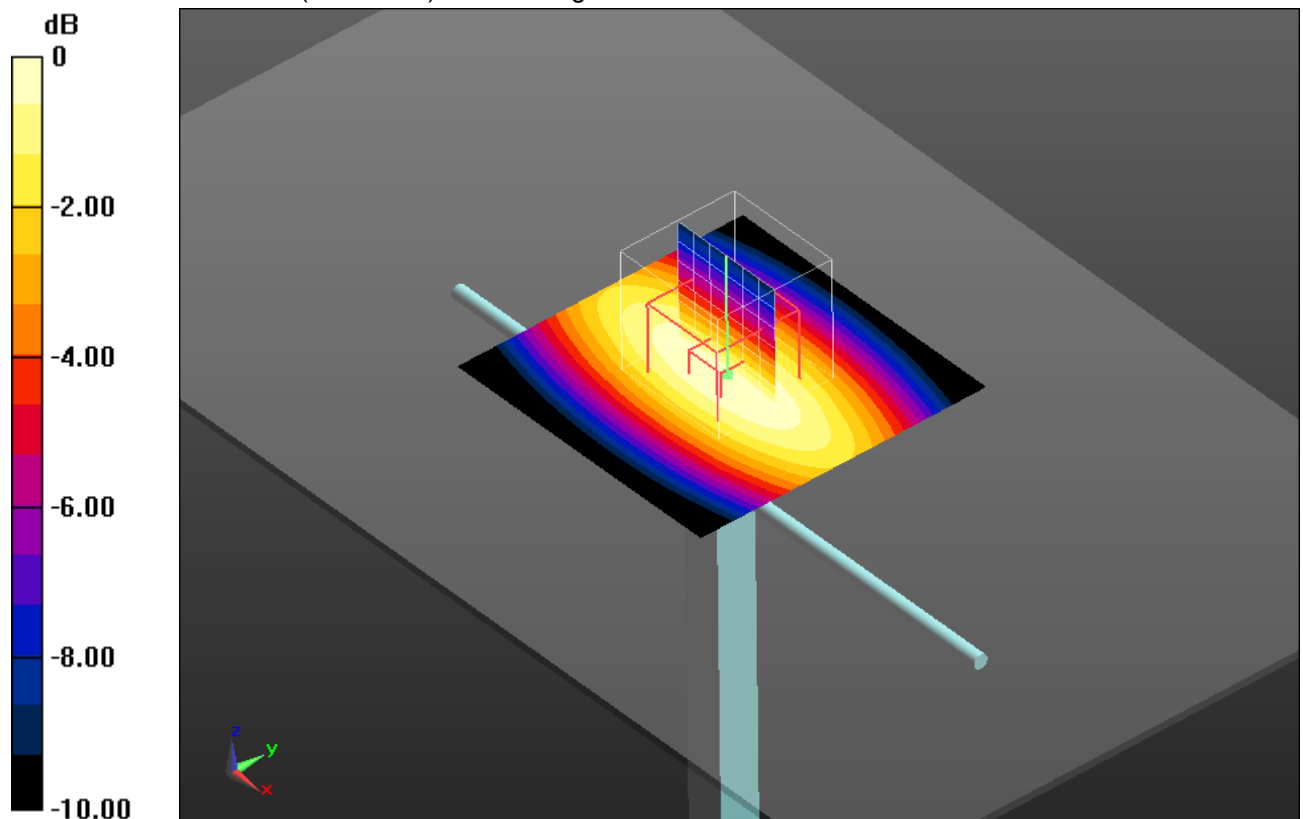

0 dB = 10.5 W/kg = 10.21 dBW/kg

**Additional information:**

ambient temperature: 23.3°C; liquid temperature: 22.6°C

Date/Time: 09.05.2014 08:59:28

### SystemPerformanceCheck-D1900 head 2014-05-09

**DUT: Dipole 1900 MHz; Type: D1900V2; Serial: 5d009**

Communication System: UID 0, CW (0); Communication System Band: D1900 (1900.0 MHz); Frequency: 1900 MHz; Communication System PAR: 0 dB; PMF: 1

Medium parameters used:  $f = 1900$  MHz;  $\sigma = 1.376$  S/m;  $\epsilon_r = 39.582$ ;  $\rho = 1000$  kg/m<sup>3</sup>

Phantom section: Flat Section

Measurement Standard: DASYS

DASY5 Configuration:

- Probe: ET3DV6 - SN1558; ConvF(4.75, 4.75, 4.75); Calibrated: 22.08.2013;
- Sensor-Surface: 4mm (Mechanical Surface Detection), z = 2.7, 32.7
- Electronics: DAE3 Sn408; Calibrated: 30.09.2013
- Phantom: SAM front; Type: QD000P40CC; Serial: TP-1042
- DASY52 52.8.7(1137); SEMCAD X 14.6.10(7164)

### HSL1900/d=10mm, Pin=1000 mW, dist=4.0mm/Area Scan (51x51x1):

Interpolated grid: dx=1.500 mm, dy=1.500 mm

Maximum value of SAR (interpolated) = 51.7 W/kg

### HSL1900/d=10mm, Pin=1000 mW, dist=4.0mm/Zoom Scan (7x7x7)/Cube 0:

Measurement grid: dx=5mm, dy=5mm, dz=5mm

Reference Value = 185.2 V/m; Power Drift = 0.12 dB

Peak SAR (extrapolated) = 70.6 W/kg

**SAR(1 g) = 41.2 W/kg; SAR(10 g) = 22 W/kg**

Maximum value of SAR (measured) = 46.4 W/kg

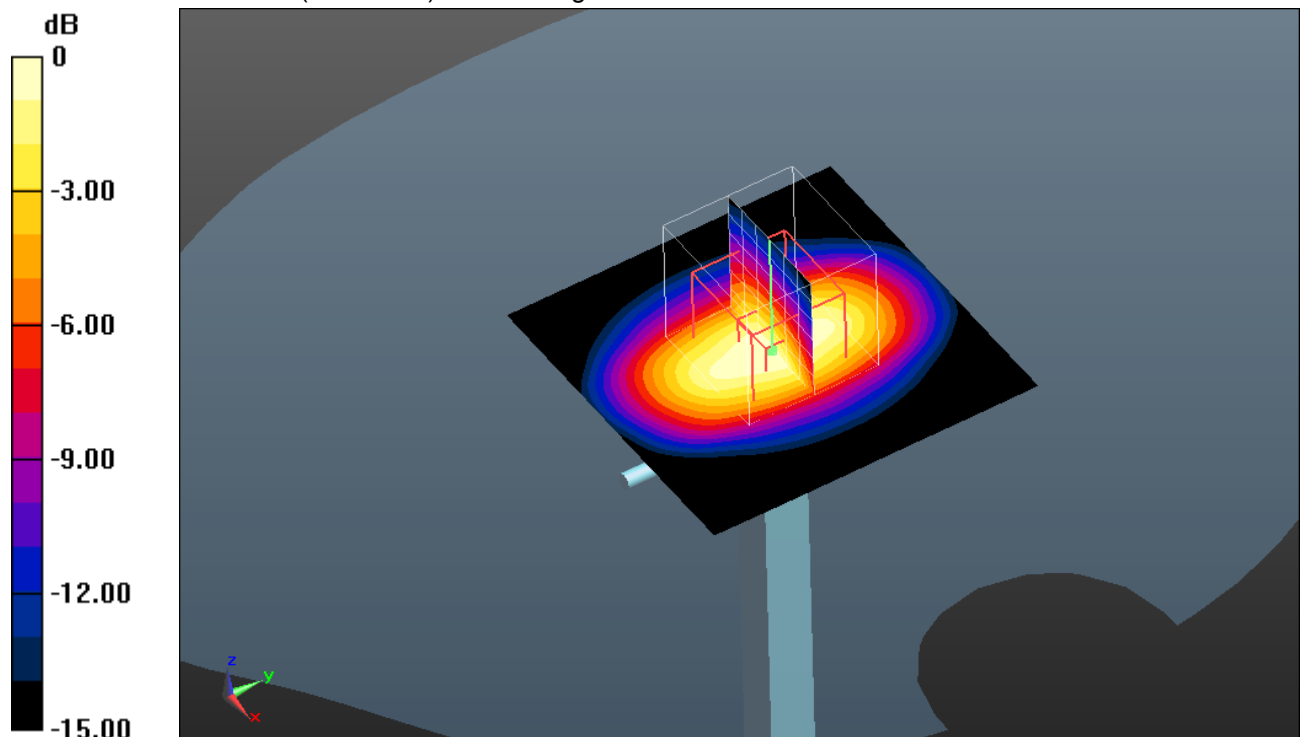

0 dB = 46.4 W/kg = 16.67 dBW/kg

#### Additional information:

ambient temperature: 22.9°C; liquid temperature: 22.2°C

Date/Time: 13.05.2014 12:59:41

### SystemPerformanceCheck-D1900 head 2014-05-13

**DUT: Dipole 1900 MHz; Type: D1900V2; Serial: 5d009**

Communication System: UID 0, CW (0); Communication System Band: D1900 (1900.0 MHz); Frequency: 1900 MHz; Communication System PAR: 0 dB; PMF: 1

Medium parameters used:  $f = 1900$  MHz;  $\sigma = 1.376$  S/m;  $\epsilon_r = 39.582$ ;  $\rho = 1000$  kg/m<sup>3</sup>

Phantom section: Flat Section

Measurement Standard: DASYS

DASY5 Configuration:

- Probe: ET3DV6 - SN1558; ConvF(4.75, 4.75, 4.75); Calibrated: 22.08.2013;
- Sensor-Surface: 4mm (Mechanical Surface Detection),  $z = 2.7, 32.7$
- Electronics: DAE3 Sn408; Calibrated: 30.09.2013
- Phantom: SAM front; Type: QD000P40CC; Serial: TP-1042
- DASY52 52.8.7(1137); SEMCAD X 14.6.10(7164)

### HSL1900/d=10mm, Pin=1000 mW, dist=4.0mm/Area Scan (51x51x1):

Interpolated grid:  $dx=1.500$  mm,  $dy=1.500$  mm

Maximum value of SAR (interpolated) = 54.2 W/kg

### HSL1900/d=10mm, Pin=1000 mW, dist=4.0mm/Zoom Scan (7x7x7)/Cube 0:

Measurement grid:  $dx=5$ mm,  $dy=5$ mm,  $dz=5$ mm

Reference Value = 190.8 V/m; Power Drift = 0.24 dB

Peak SAR (extrapolated) = 70.6 W/kg

**SAR(1 g) = 41.1 W/kg; SAR(10 g) = 22 W/kg**

Maximum value of SAR (measured) = 47.1 W/kg

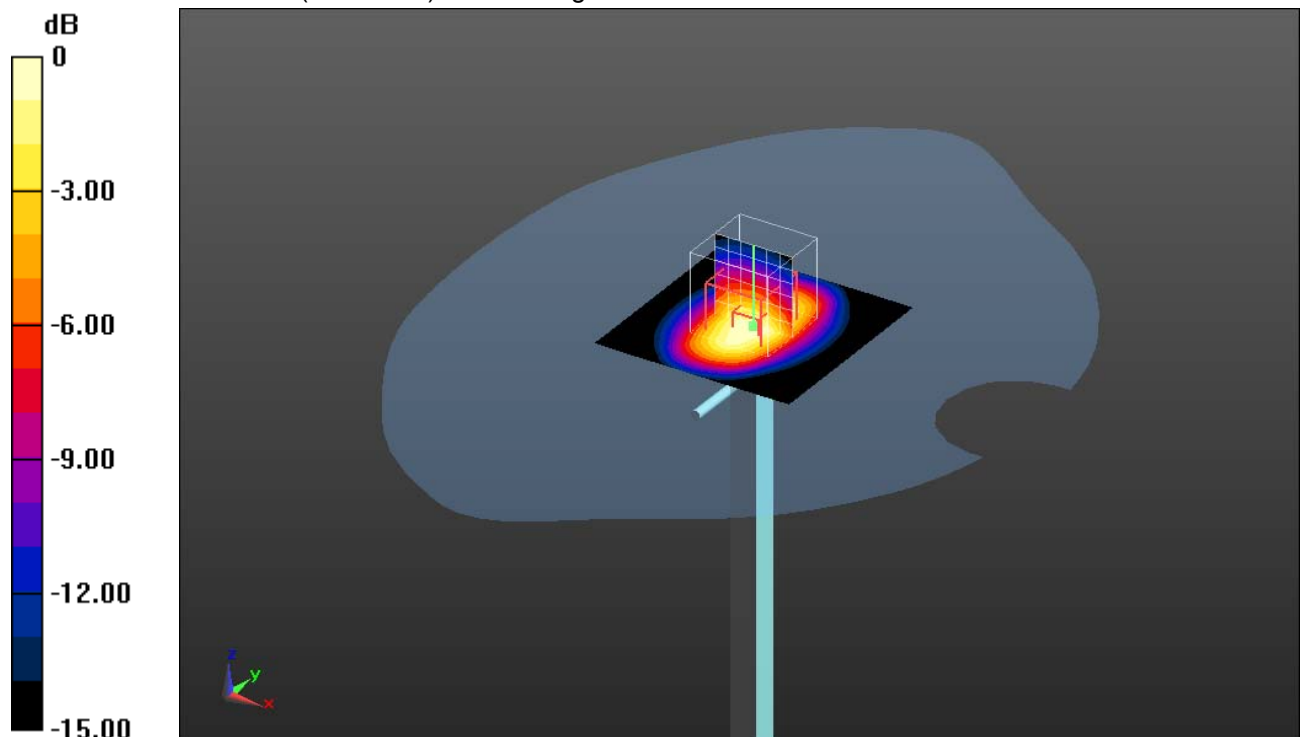

0 dB = 47.1 W/kg = 16.73 dBW/kg

#### Additional information:

ambient temperature: 23.3°C; liquid temperature: 22.9°C



Date/Time: 08.05.2014 14:17:04

### SystemPerformanceCheck-D1900 body 2014-05-08

**DUT: Dipole 1900 MHz; Type: D1900V2; Serial: 5d009**

Communication System: UID 0, CW (0); Communication System Band: D1900 (1900.0 MHz); Frequency: 1900 MHz; Communication System PAR: 0 dB; PMF: 1

Medium parameters used:  $f = 1900$  MHz;  $\sigma = 1.594$  S/m;  $\epsilon_r = 54.063$ ;  $\rho = 1000$  kg/m<sup>3</sup>

Phantom section: Center Section

Measurement Standard: DASY5

DASY5 Configuration:

- Probe: ET3DV6 - SN1558; ConvF(4.21, 4.21, 4.21); Calibrated: 22.08.2013;
- Sensor-Surface: 4mm (Mechanical Surface Detection),  $z = 2.7, 32.7$
- Electronics: DAE3 Sn408; Calibrated: 30.09.2013
- Phantom: Triple Flat Phantom 5.1C; Type: QD 000 P51 CA; Serial: 1154
- DASY52 52.8.7(1137); SEMCAD X 14.6.10(7164)

### MSL1900/d=10mm, Pin=1000 mW, dist=4.0mm/Area Scan (51x51x1):

Interpolated grid:  $dx=1.500$  mm,  $dy=1.500$  mm

Maximum value of SAR (interpolated) = 56.3 W/kg

### MSL1900/d=10mm, Pin=1000 mW, dist=4.0mm/Zoom Scan (7x7x7)/Cube 0:

Measurement grid:  $dx=5$ mm,  $dy=5$ mm,  $dz=5$ mm

Reference Value = 179.5 V/m; Power Drift = -0.02 dB

Peak SAR (extrapolated) = 64.5 W/kg

**SAR(1 g) = 39 W/kg; SAR(10 g) = 21.1 W/kg**

Maximum value of SAR (measured) = 44.2 W/kg

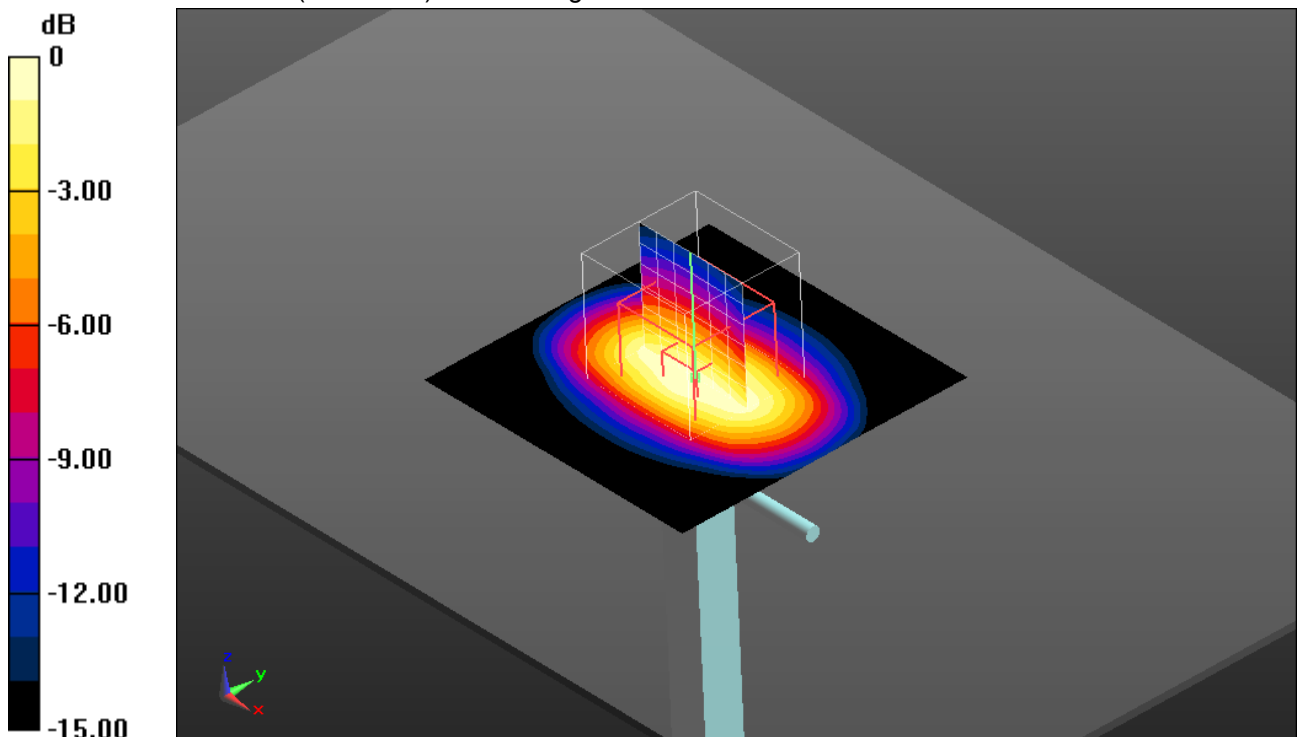

0 dB = 44.2 W/kg = 16.45 dBW/kg

#### Additional information:

ambient temperature: 23.4°C; liquid temperature: 22.5°C

Date/Time: 5/21/2014 7:32:17 AM

### SystemPerformanceCheck-D1900 body 2014-05-21

**DUT: Dipole 1900 MHz; Type: D1900V2; Serial: 5d009**

Communication System: UID 0, CW (0); Communication System Band: D1900 (1900.0 MHz); Frequency: 1900 MHz; Communication System PAR: 0 dB; PMF: 1

Medium parameters used:  $f = 1900$  MHz;  $\sigma = 1.594$  S/m;  $\epsilon_r = 54.063$ ;  $\rho = 1000$  kg/m<sup>3</sup>

Phantom section: Center Section

Measurement Standard: DASYS5

DASY5 Configuration:

- Probe: ES3DV3 - SN3326; ConvF(4.65, 4.65, 4.65); Calibrated: 9/2/2013;
- Sensor-Surface: 4mm (Mechanical Surface Detection), z = 2.0, 32.0
- Electronics: DAE4 Sn1387; Calibrated: 8/28/2013
- Phantom: Triple Flat Phantom 5.1C; Type: QD 000 P51 CA; Serial: xxxx
- DASYS52 52.8.7(1137); SEMCAD X 14.6.10(7164)

### MSL1900/d=10mm, Pin=1000 mW, dist=4.0mm/Area Scan (51x51x1):

Interpolated grid: dx=1.500 mm, dy=1.500 mm

Maximum value of SAR (interpolated) = 53.6 W/kg

### MSL1900/d=10mm, Pin=1000 mW, dist=4.0mm/Zoom Scan (7x7x7)/Cube 0:

Measurement grid: dx=5mm, dy=5mm, dz=5mm

Reference Value = 175.3 V/m; Power Drift = -0.06 dB

Peak SAR (extrapolated) = 72.3 W/kg

**SAR(1 g) = 41.1 W/kg; SAR(10 g) = 21.8 W/kg**

Maximum value of SAR (measured) = 46.6 W/kg

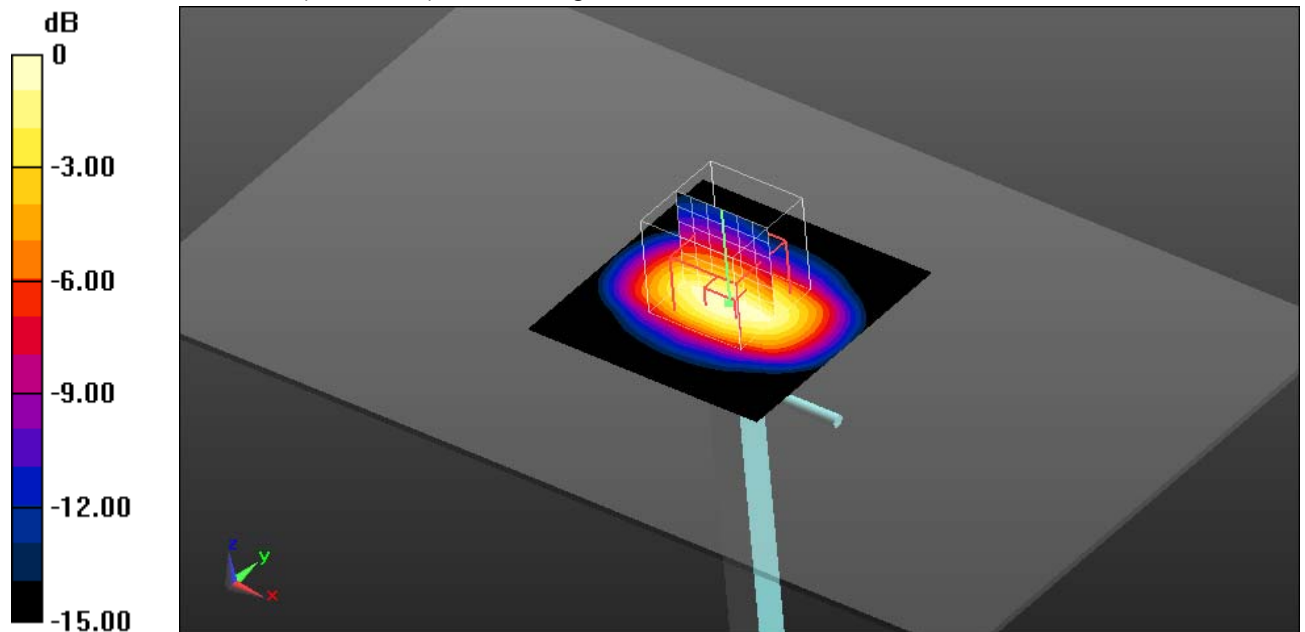

0 dB = 46.6 W/kg = 16.68 dBW/kg

#### Additional information:

ambient temperature: 23.8°C; liquid temperature: 23.1°C

Date/Time: 5/22/2014 4:42:33 PM

### SystemPerformanceCheck-D1900 body 2014-05-22

**DUT: Dipole 1900 MHz; Type: D1900V2; Serial: 5d009**

Communication System: UID 0, CW (0); Communication System Band: D1900 (1900.0 MHz); Frequency: 1900 MHz; Communication System PAR: 0 dB; PMF: 1

Medium parameters used:  $f = 1900$  MHz;  $\sigma = 1.594$  S/m;  $\epsilon_r = 54.063$ ;  $\rho = 1000$  kg/m<sup>3</sup>

Phantom section: Center Section

Measurement Standard: DASY5

DASY5 Configuration:

- Probe: ES3DV3 - SN3326; ConvF(4.65, 4.65, 4.65); Calibrated: 9/2/2013;
- Sensor-Surface: 4mm (Mechanical Surface Detection), z = 2.0, 32.0
- Electronics: DAE4 Sn1387; Calibrated: 8/28/2013
- Phantom: Triple Flat Phantom 5.1C; Type: QD 000 P51 CA; Serial: xxxx
- DASY52 52.8.7(1137); SEMCAD X 14.6.10(7164)

### MSL1900/d=10mm, Pin=1000 mW, dist=4.0mm/Area Scan (51x51x1):

Interpolated grid: dx=1.500 mm, dy=1.500 mm

Maximum value of SAR (interpolated) = 52.6 W/kg

### MSL1900/d=10mm, Pin=1000 mW, dist=4.0mm/Zoom Scan (7x7x7)/Cube 0:

Measurement grid: dx=5mm, dy=5mm, dz=5mm

Reference Value = 176.5 V/m; Power Drift = -0.09 dB

Peak SAR (extrapolated) = 74.2 W/kg

**SAR(1 g) = 42.2 W/kg; SAR(10 g) = 22.4 W/kg**

Maximum value of SAR (measured) = 47.2 W/kg

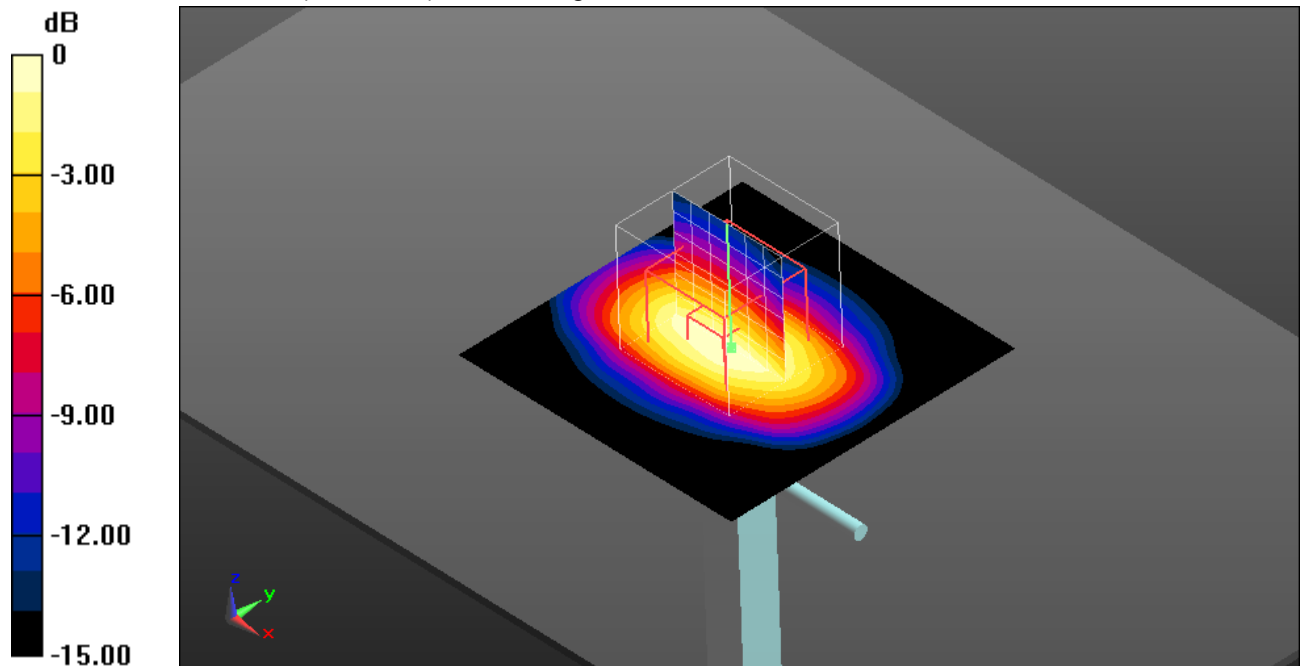

0 dB = 47.2 W/kg = 16.74 dBW/kg

#### Additional information:

ambient temperature: 22.8°C; liquid temperature: 22.2°C

Date/Time: 16.05.2014 13:03:34

### SystemPerformanceCheck-D2450 head 2014-05-16

**DUT: Dipole 2450 MHz; Type: D2450V2; Serial: 710**

Communication System: UID 0, CW (0); Communication System Band: D2450 (2450.0 MHz); Frequency: 2450 MHz; Communication System PAR: 0 dB; PMF: 1

Medium parameters used:  $f = 2450$  MHz;  $\sigma = 1.779$  S/m;  $\epsilon_r = 38.829$ ;  $\rho = 1000$  kg/m<sup>3</sup>

Phantom section: Flat Section

Measurement Standard: DASYS5

DASY5 Configuration:

- Probe: ET3DV6 - SN1558; ConvF(4.18, 4.18, 4.18); Calibrated: 22.08.2013;
- Sensor-Surface: 4mm (Mechanical Surface Detection),  $z = 2.7, 32.7$
- Electronics: DAE3 Sn408; Calibrated: 30.09.2013
- Phantom: SAM; Type: QD000P40C; Serial: TP1150
- DASY52 52.8.7(1137); SEMCAD X 14.6.10(7164)

### HSL2450/d=10mm, Pin=250 mW, dist=4.0mm/Area Scan (81x81x1): Interpolated

grid:  $dx=1.000$  mm,  $dy=1.000$  mm

Maximum value of SAR (interpolated) = 15.1 W/kg

### HSL2450/d=10mm, Pin=250 mW, dist=4.0mm/Zoom Scan (7x7x7)/Cube 0:

Measurement grid:  $dx=5$ mm,  $dy=5$ mm,  $dz=5$ mm

Reference Value = 97.391 V/m; Power Drift = -0.13 dB

Peak SAR (extrapolated) = 29.2 W/kg

**SAR(1 g) = 13.4 W/kg; SAR(10 g) = 6.25 W/kg**

Maximum value of SAR (measured) = 15.1 W/kg

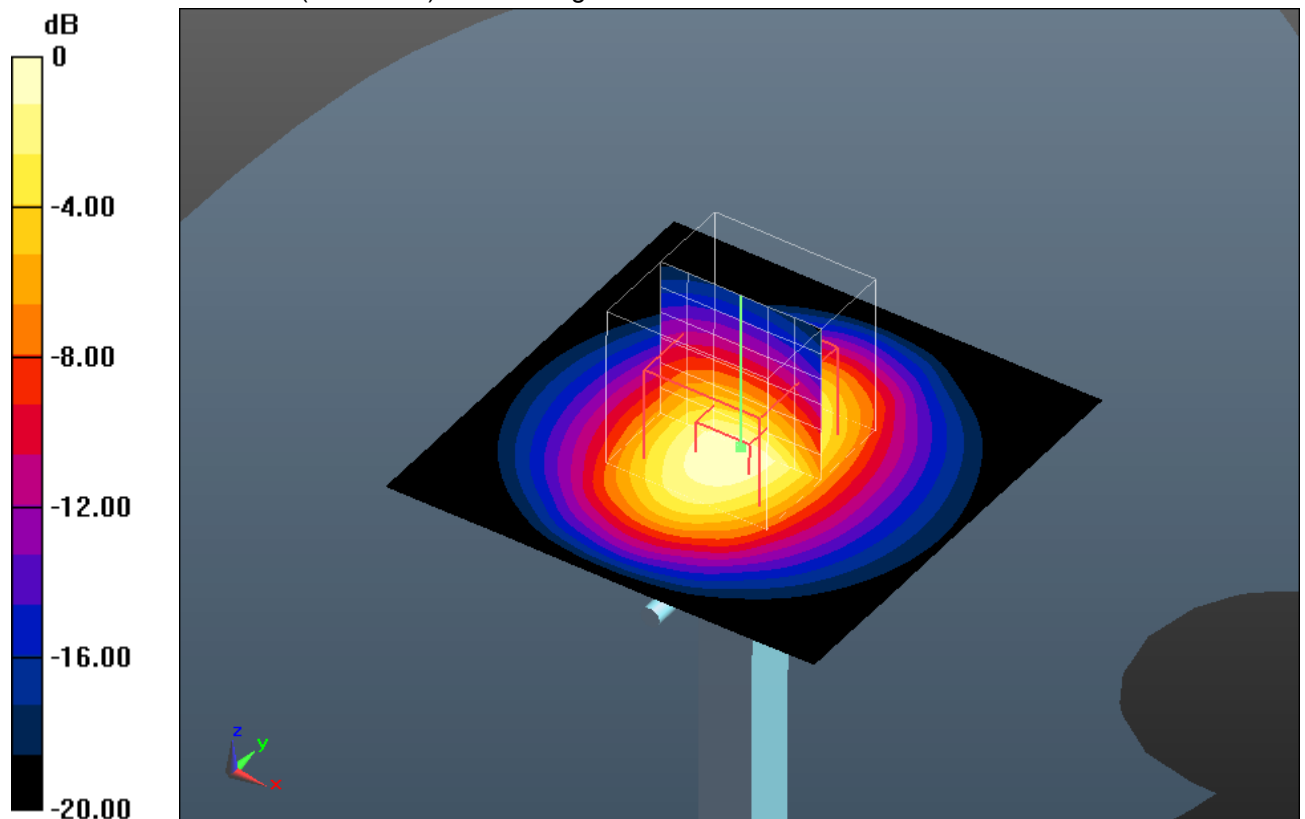

0 dB = 15.1 W/kg = 11.79 dBW/kg

**Additional information:**

ambient temperature: 21.8°C; liquid temperature: 21.5°C

Date/Time: 16.05.2014 12:40:04

### SystemPerformanceCheck-D2450 body 2014-05-16

**DUT: Dipole 2450 MHz; Type: D2450V2; Serial: 710**

Communication System: UID 0, CW (0); Communication System Band: D2450 (2450.0 MHz); Frequency: 2450 MHz; Communication System PAR: 0 dB; PMF: 1

Medium parameters used:  $f = 2450$  MHz;  $\sigma = 2.006$  S/m;  $\epsilon_r = 51.133$ ;  $\rho = 1000$  kg/m<sup>3</sup>

Phantom section: Center Section

Measurement Standard: DASYS5

DASY5 Configuration:

- Probe: ET3DV6 - SN1559; ConvF(3.97, 3.97, 3.97); Calibrated: 20.01.2014;
- Sensor-Surface: 4mm (Mechanical Surface Detection (Locations From Previous Scan Used)), Sensor-Surface: 4mm (Mechanical Surface Detection),  $z = 2.7, 32.7$
- Electronics: DAE3 Sn477; Calibrated: 14.05.2014
- Phantom: Triple Flat Phantom 5.1C; Type: QD 000 P51 CA; Serial: 1154
- DASY52 52.8.7(1137); SEMCAD X 14.6.10(7164)

### MSL2450/d=10mm, Pin=1000 mW, dist=4.0mm/Area Scan (81x81x1):

Interpolated grid:  $dx=1.000$  mm,  $dy=1.000$  mm

Maximum value of SAR (interpolated) = 57.6 W/kg

### MSL2450/d=10mm, Pin=1000 mW, dist=4.0mm/Zoom Scan (7x7x7)/Cube 0:

Measurement grid:  $dx=5$ mm,  $dy=5$ mm,  $dz=5$ mm

Reference Value = 172.0 V/m; Power Drift = -0.01 dB

Peak SAR (extrapolated) = 133 W/kg

**SAR(1 g) = 53.4 W/kg; SAR(10 g) = 24.4 W/kg**

Maximum value of SAR (measured) = 58.2 W/kg

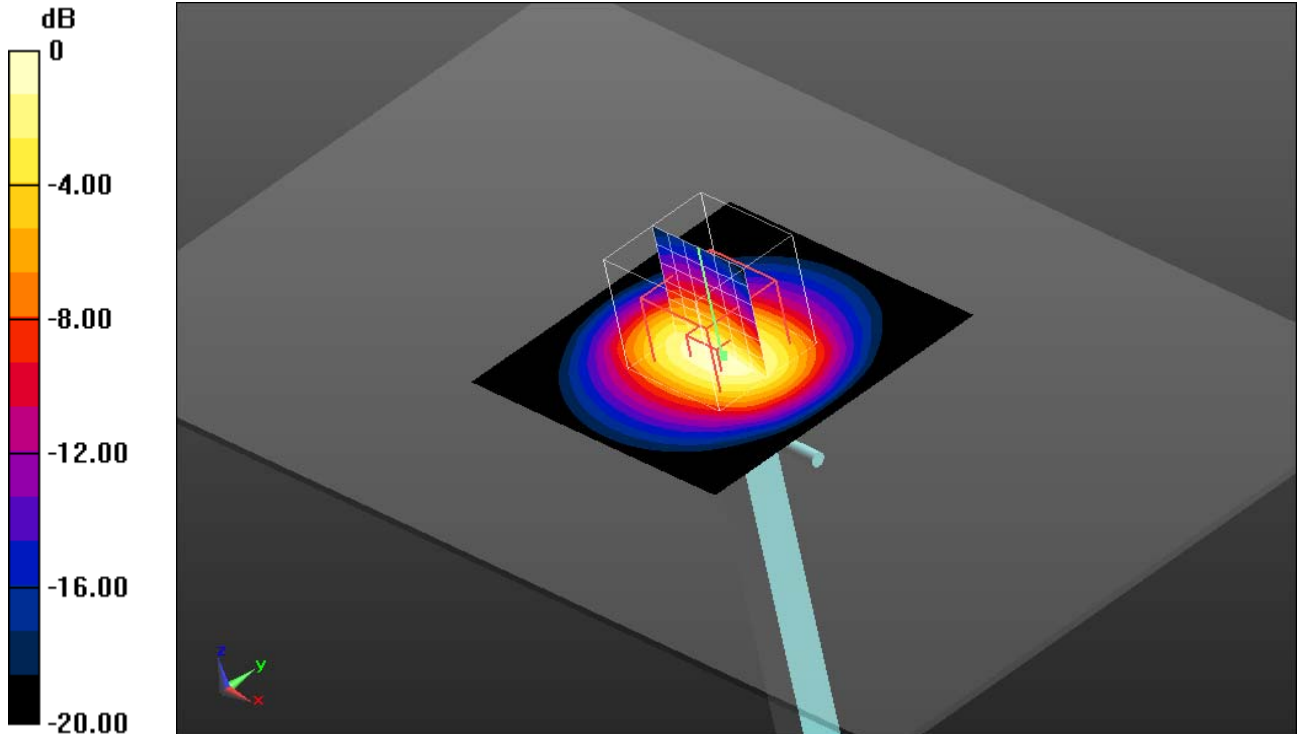

0 dB = 58.2 W/kg = 17.65 dBW/kg

#### Additional information:

ambient temperature: 23.1°C; liquid temperature: 22.7°C

Date/Time: 16.05.2014 13:32:23

### SystemPerformanceCheck-D2600 head 2014-05-16

**DUT: Dipole 2600 MHz; Type: D2600V2; Serial: 1040**

Communication System: UID 0, CW (0); Communication System Band: D2600 (2600.0 MHz); Frequency: 2600 MHz; Communication System PAR: 0 dB; PMF: 1

Medium parameters used:  $f = 2600$  MHz;  $\sigma = 1.954$  S/m;  $\epsilon_r = 38.378$ ;  $\rho = 1000$  kg/m<sup>3</sup>

Phantom section: Flat Section

Measurement Standard: DASYS5

DASY5 Configuration:

- Probe: EX3DV4 - SN3944; ConvF(7.43, 7.43, 7.43); Calibrated: 02.08.2013;
- Sensor-Surface: 2mm (Mechanical Surface Detection),  $z = 1.0, 31.0$
- Electronics: DAE3 Sn408; Calibrated: 30.09.2013
- Phantom: SAM; Type: QD000P40C; Serial: TP1150
- DASY52 52.8.7(1137); SEMCAD X 14.6.10(7164)

### HSL2450\_2600/d=10mm, Pin=250 mW, dist=2.0mm/Area Scan (81x81x1):

Interpolated grid:  $dx=1.000$  mm,  $dy=1.000$  mm

Maximum value of SAR (interpolated) = 21.9 W/kg

### HSL2450\_2600/d=10mm, Pin=250 mW, dist=2.0mm/Zoom Scan

**(7x7x7)/Cube 0:** Measurement grid:  $dx=5$ mm,  $dy=5$ mm,  $dz=5$ mm

Reference Value = 107.6 V/m; Power Drift = -0.04 dB

Peak SAR (extrapolated) = 29.9 W/kg

**SAR(1 g) = 13.8 W/kg; SAR(10 g) = 6.18 W/kg**

Maximum value of SAR (measured) = 21.8 W/kg

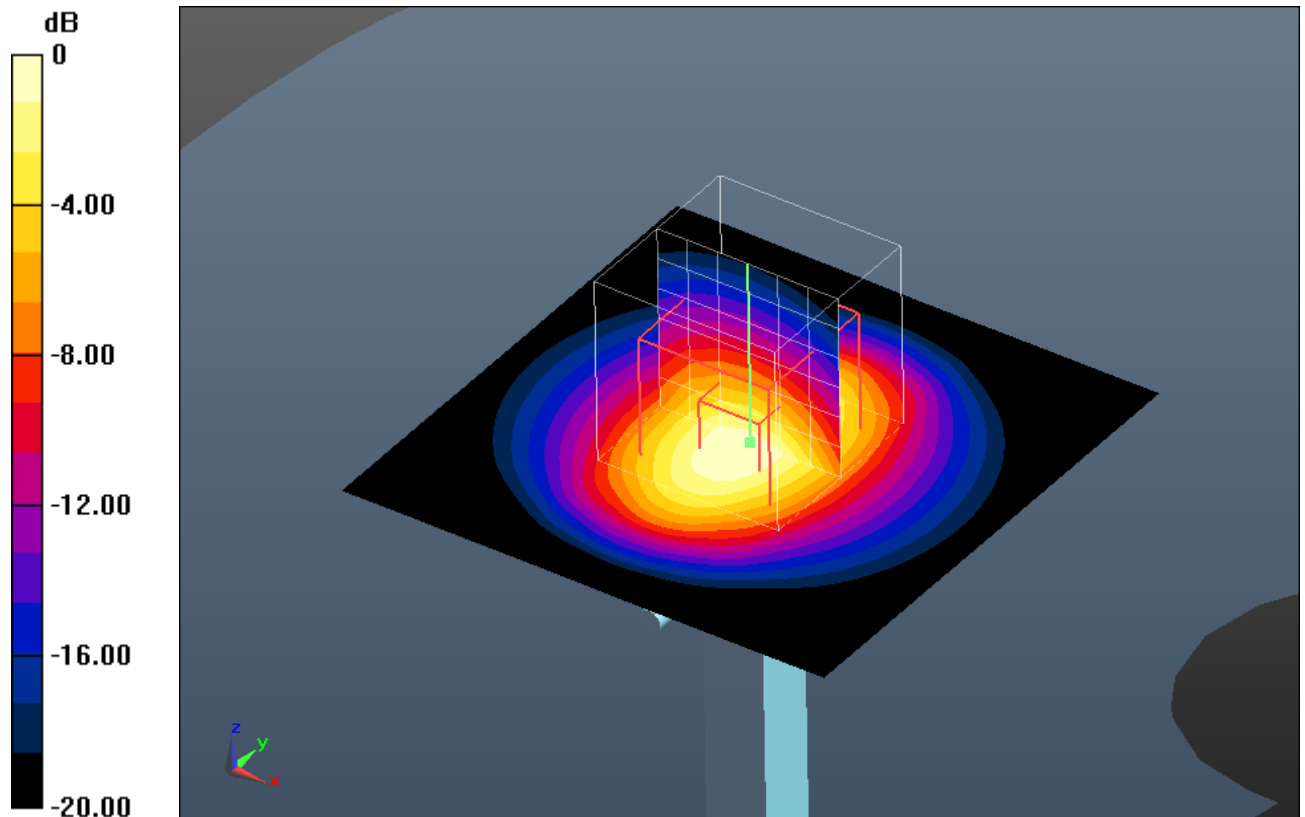

0 dB = 21.8 W/kg = 13.38 dBW/kg

**Additional information:**

ambient temperature: 21.8°C; liquid temperature: 21.5°C

Date/Time: 19.05.2014 13:06:37

### SystemPerformanceCheck-D2600 body 2014-05-19

**DUT: Dipole 2600 MHz; Type: D2600V2; Serial: 1040**

Communication System: UID 0, CW (0); Communication System Band: D2600 (2600.0 MHz); Frequency: 2600 MHz; Communication System PAR: 0 dB; PMF: 1

Medium parameters used:  $f = 2600$  MHz;  $\sigma = 2.179$  S/m;  $\epsilon_r = 50.652$ ;  $\rho = 1000$  kg/m<sup>3</sup>

Phantom section: Center Section

Measurement Standard: DASYS

DASY5 Configuration:

- Probe: EX3DV4 - SN3944; ConvF(7.27, 7.27, 7.27); Calibrated: 02.08.2013;
- Sensor-Surface: 2mm (Mechanical Surface Detection),  $z = 1.0, 31.0$
- Electronics: DAE3 Sn477; Calibrated: 14.05.2014
- Phantom: Triple Flat Phantom 5.1C; Type: QD 000 P51 CA; Serial: 1154
- DASY52 52.8.7(1137); SEMCAD X 14.6.10(7164)

### MSL2450/d=10mm, Pin=1000 mW, dist=2.0mm/Area Scan (81x81x1):

Interpolated grid:  $dx=1.000$  mm,  $dy=1.000$  mm

Maximum value of SAR (interpolated) = 85.5 W/kg

### MSL2450/d=10mm, Pin=1000 mW, dist=2.0mm/Zoom Scan (7x7x7)/Cube 0:

Measurement grid:  $dx=5$ mm,  $dy=5$ mm,  $dz=5$ mm

Reference Value = 198.6 V/m; Power Drift = -0.05 dB

Peak SAR (extrapolated) = 118 W/kg

**SAR(1 g) = 54.5 W/kg; SAR(10 g) = 24.2 W/kg**

Maximum value of SAR (measured) = 85.0 W/kg

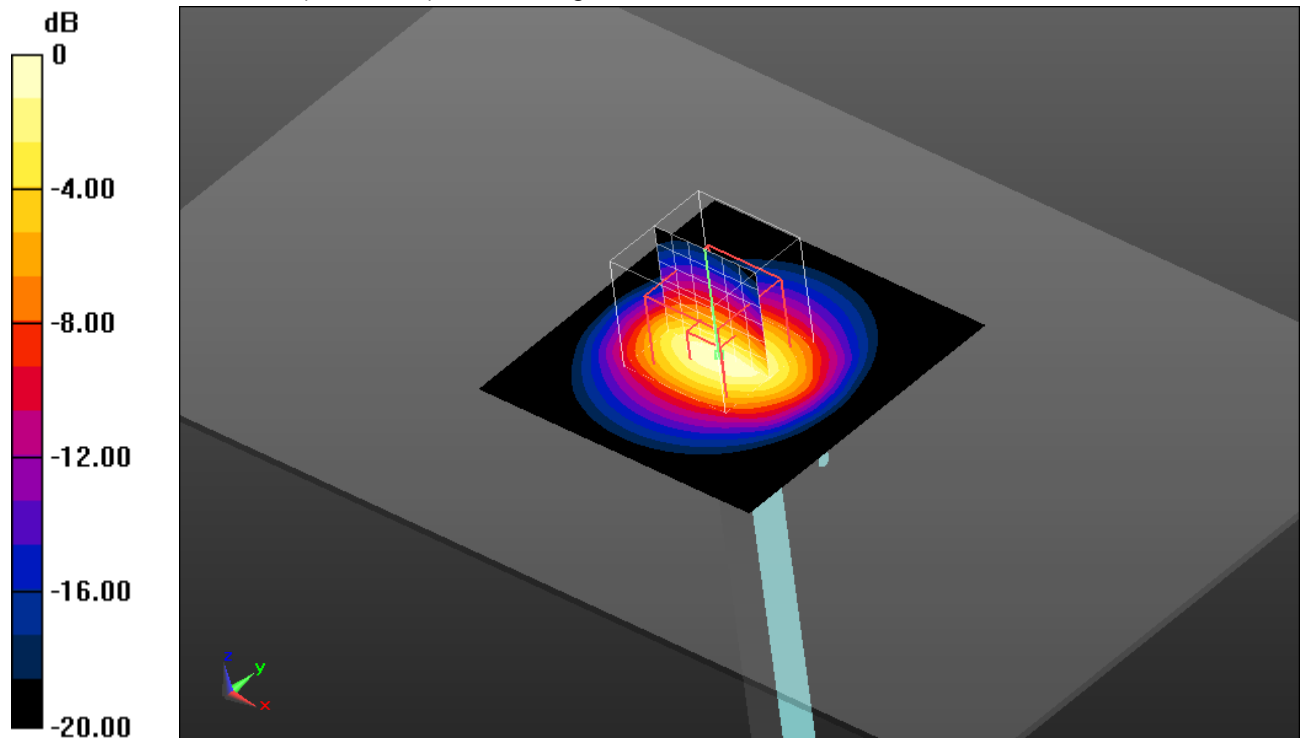

0 dB = 85.0 W/kg = 19.29 dBW/kg

#### Additional information:

ambient temperature: 23.5°C; liquid temperature: 22.8°C

Date/Time: 20.05.2014 07:05:35

### SystemPerformanceCheck-D2600 body 2014-05-20

**DUT: Dipole 2600 MHz; Type: D2600V2; Serial: 1040**

Communication System: UID 0, CW (0); Communication System Band: D2600 (2600.0 MHz); Frequency: 2600 MHz; Communication System PAR: 0 dB; PMF: 1

Medium parameters used:  $f = 2600$  MHz;  $\sigma = 2.179$  S/m;  $\epsilon_r = 50.652$ ;  $\rho = 1000$  kg/m<sup>3</sup>

Phantom section: Center Section

Measurement Standard: DASY5

DASY5 Configuration:

- Probe: EX3DV4 - SN3944; ConvF(7.27, 7.27, 7.27); Calibrated: 02.08.2013;
- Sensor-Surface: 2mm (Mechanical Surface Detection),  $z = 1.0, 31.0$
- Electronics: DAE3 Sn477; Calibrated: 14.05.2014
- Phantom: Triple Flat Phantom 5.1C; Type: QD 000 P51 CA; Serial: 1154
- DASY52 52.8.7(1137); SEMCAD X 14.6.10(7164)

### MSL2450/d=10mm, Pin=1000 mW, dist=2.0mm/Area Scan (81x81x1):

Interpolated grid:  $dx=1.000$  mm,  $dy=1.000$  mm

Maximum value of SAR (interpolated) = 88.7 W/kg

### MSL2450/d=10mm, Pin=1000 mW, dist=2.0mm/Zoom Scan (7x7x7)/Cube 0:

Measurement grid:  $dx=5$ mm,  $dy=5$ mm,  $dz=5$ mm

Reference Value = 202.9 V/m; Power Drift = 0.06 dB

Peak SAR (extrapolated) = 122 W/kg

**SAR(1 g) = 56.9 W/kg; SAR(10 g) = 25.5 W/kg**

Maximum value of SAR (measured) = 88.2 W/kg

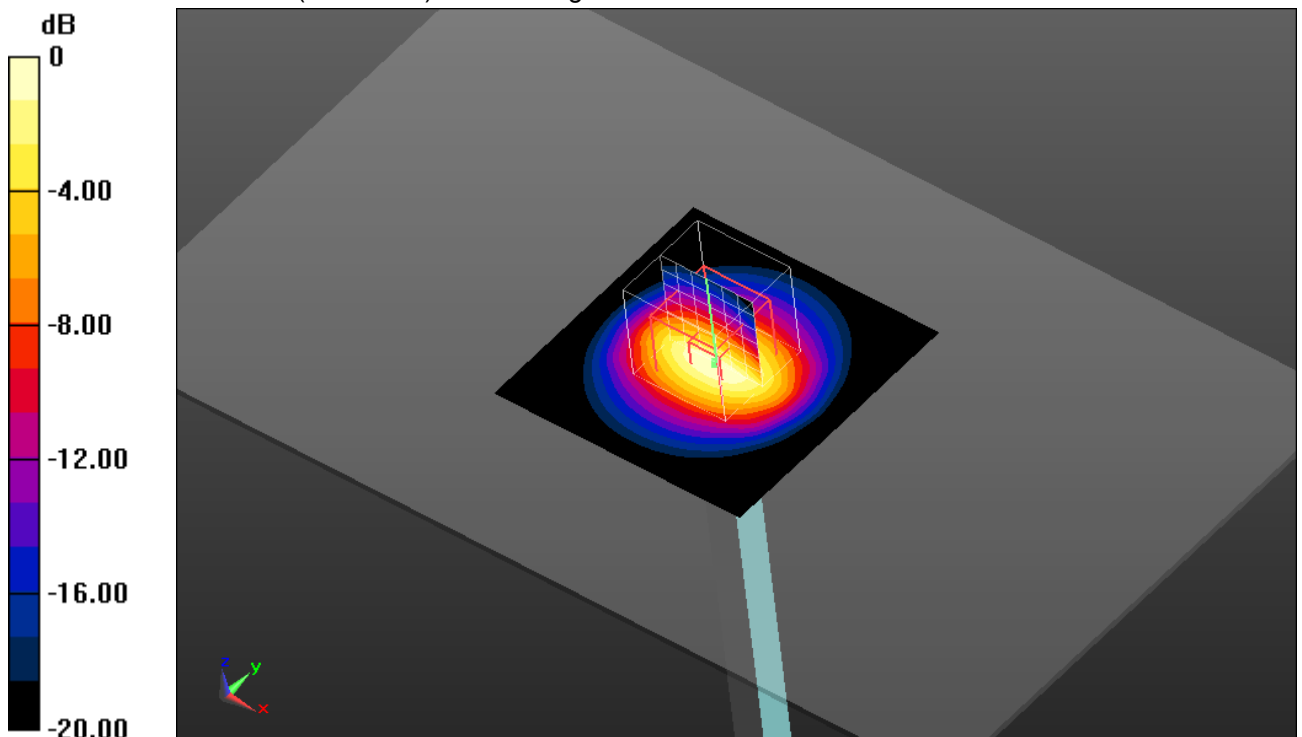

0 dB = 88.2 W/kg = 19.45 dBW/kg

#### Additional information:

ambient temperature: 23.1°C; liquid temperature: 22.3°C



Date/Time: 15.05.2014 15:02:27

### SystemPerformanceCheck-D5GHz head 2014-05-15

**DUT: Dipole 5 GHz; Type: D5GHzV2; Serial: 1055**

Communication System: UID 0, CW (0); Communication System Band: D5GHz (5000.0 - 6000.0 MHz);

Frequency: 5200 MHz; Communication System PAR: 0 dB; PMF: 1

Medium parameters used:  $f = 5200$  MHz;  $\sigma = 4.473$  S/m;  $\epsilon_r = 36.336$ ;  $\rho = 1000$  kg/m<sup>3</sup>

Phantom section: Flat Section

Measurement Standard: DASYS5

DASY5 Configuration:

- Probe: EX3DV4 - SN3944; ConvF(5.37, 5.37, 5.37); Calibrated: 02.08.2013;
- Sensor-Surface: 2mm (Mechanical Surface Detection),  $z = 1.0, 23.0$
- Electronics: DAE3 Sn408; Calibrated: 30.09.2013
- Phantom: SAM; Type: QD000P40C; Serial: TP1150
- DASY52 52.8.7(1137); SEMCAD X 14.6.10(7164)

### HSL 5GHz/d=10mm, Pin=250mW 5.2GHz/Area Scan (61x61x1): Interpolated grid:

$dx=1.000$  mm,  $dy=1.000$  mm

Maximum value of SAR (interpolated) = 36.9 W/kg

### HSL 5GHz/d=10mm, Pin=250mW 5.2GHz/Zoom Scan (7x7x12)/Cube 0:

Measurement grid:  $dx=4$ mm,  $dy=4$ mm,  $dz=2$ mm

Reference Value = 100.2 V/m; Power Drift = -0.03 dB

Peak SAR (extrapolated) = 80.4 W/kg

**SAR(1 g) = 18.8 W/kg; SAR(10 g) = 5.38 W/kg**

Maximum value of SAR (measured) = 38.9 W/kg

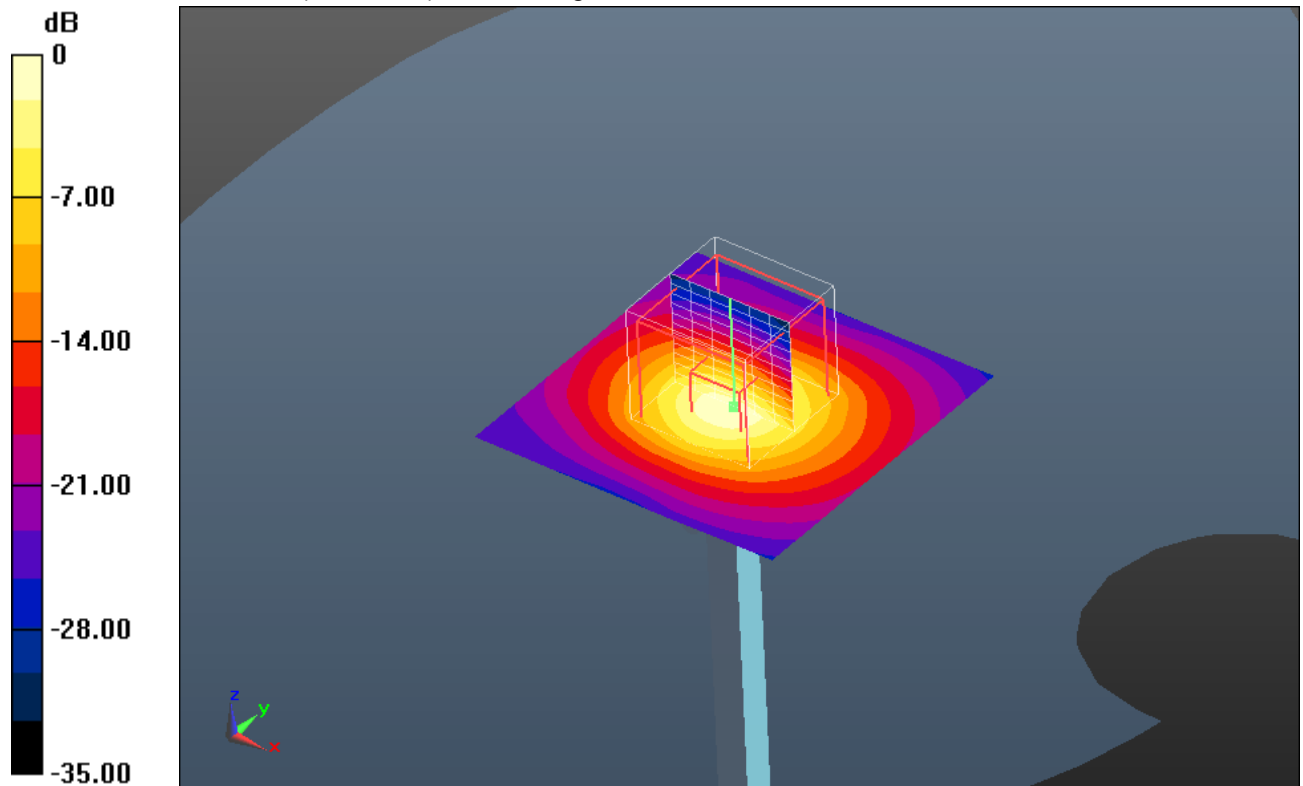

0 dB = 38.9 W/kg = 15.90 dBW/kg

#### Additional information:

ambient temperature: 22.2°C; liquid temperature: 21.9°C

Date/Time: 15.05.2014 16:45:49

### SystemPerformanceCheck-D5GHz head 2014-05-15

**DUT: Dipole 5 GHz; Type: D5GHzV2; Serial: 1055**

Communication System: UID 0, CW (0); Communication System Band: D5GHz (5000.0 - 6000.0 MHz);

Frequency: 5500 MHz; Communication System PAR: 0 dB; PMF: 1

Medium parameters used:  $f = 5500$  MHz;  $\sigma = 4.822$  S/m;  $\epsilon_r = 35.774$ ;  $\rho = 1000$  kg/m<sup>3</sup>

Phantom section: Flat Section

Measurement Standard: DASYS5

DASY5 Configuration:

- Probe: EX3DV4 - SN3944; ConvF(5, 5, 5); Calibrated: 02.08.2013;
- Sensor-Surface: 2mm (Mechanical Surface Detection (Locations From Previous Scan Used)), Sensor-Surface: 2mm (Mechanical Surface Detection),  $z = 1.0, 23.0$
- Electronics: DAE3 Sn408; Calibrated: 30.09.2013
- Phantom: SAM; Type: QD000P40C; Serial: TP1150
- DASYS52 52.8.7(1137); SEMCAD X 14.6.10(7164)

### HSL 5GHz/d=10mm, Pin=100mW 5.5GHz/Area Scan (61x61x1): Interpolated grid:

$dx=1.000$  mm,  $dy=1.000$  mm

Maximum value of SAR (interpolated) = 16.9 W/kg

### HSL 5GHz/d=10mm, Pin=100mW 5.5GHz/Zoom Scan (8x8x12)/Cube 0:

Measurement grid:  $dx=4$ mm,  $dy=4$ mm,  $dz=2$ mm

Reference Value = 59.944 V/m; Power Drift = 0.12 dB

Peak SAR (extrapolated) = 40.8 W/kg

**SAR(1 g) = 8.86 W/kg; SAR(10 g) = 2.49 W/kg**

Maximum value of SAR (measured) = 18.9 W/kg

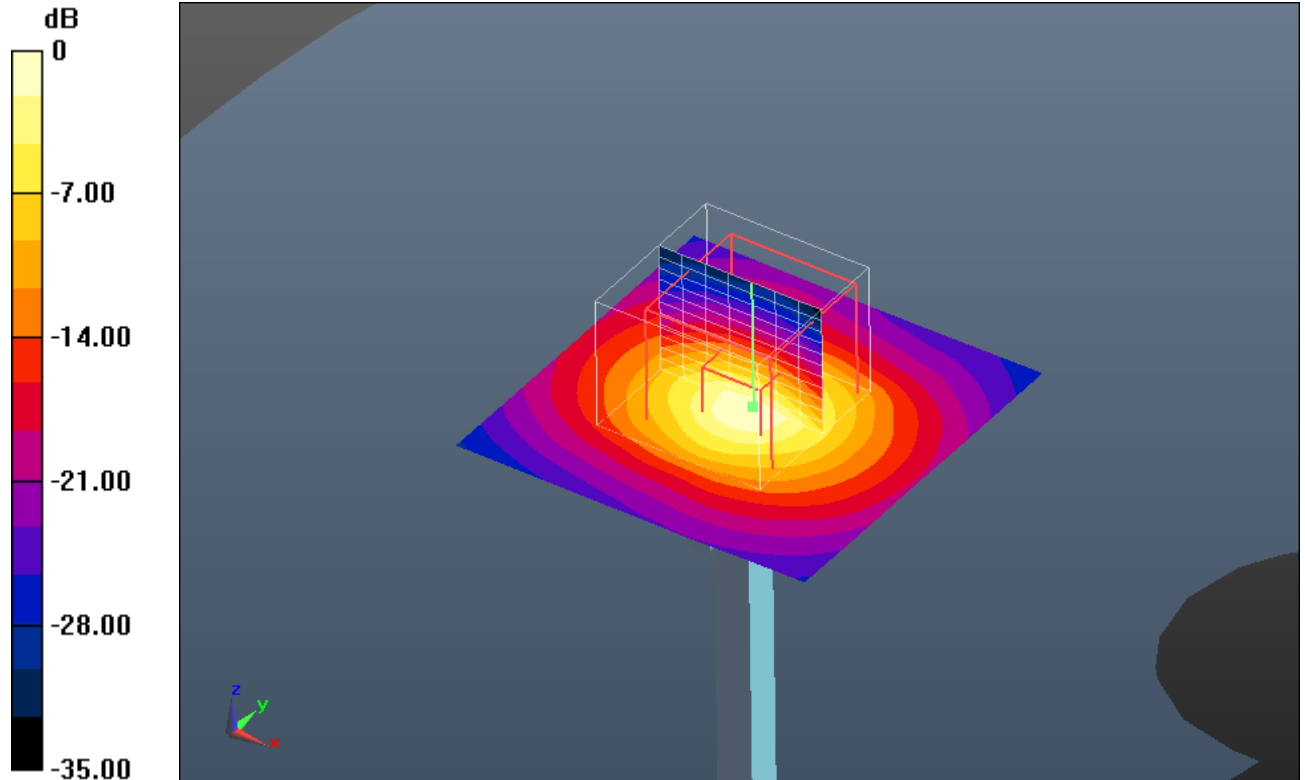

0 dB = 18.9 W/kg = 12.76 dBW/kg

#### Additional information:

ambient temperature: 22.2°C; liquid temperature: 21.9°C

Date/Time: 15.05.2014 17:56:39

### SystemPerformanceCheck-D5GHz head 2014-05-15

**DUT: Dipole 5 GHz; Type: D5GHzV2; Serial: 1055**

Communication System: UID 0, CW (0); Communication System Band: D5GHz (5000.0 - 6000.0 MHz);

Frequency: 5800 MHz; Communication System PAR: 0 dB; PMF: 1

Medium parameters used:  $f = 5800$  MHz;  $\sigma = 5.114$  S/m;  $\epsilon_r = 35.361$ ;  $\rho = 1000$  kg/m<sup>3</sup>

Phantom section: Flat Section

Measurement Standard: DASYS

DASY5 Configuration:

- Probe: EX3DV4 - SN3944; ConvF(4.75, 4.75, 4.75); Calibrated: 02.08.2013;
- Sensor-Surface: 2mm (Mechanical Surface Detection (Locations From Previous Scan Used)), Sensor-Surface: 2mm (Mechanical Surface Detection),  $z = 1.0, 23.0$
- Electronics: DAE3 Sn408; Calibrated: 30.09.2013
- Phantom: SAM; Type: QD000P40C; Serial: TP1150
- DASY52 52.8.7(1137); SEMCAD X 14.6.10(7164)

### HSL 5GHz/d=10mm, Pin=100mW 5.8GHz/Area Scan (61x61x1): Interpolated grid:

$dx=1.000$  mm,  $dy=1.000$  mm

Maximum value of SAR (interpolated) = 17.7 W/kg

### HSL 5GHz/d=10mm, Pin=100mW 5.8GHz/Zoom Scan (7x7x12)/Cube 0:

Measurement grid:  $dx=4$ mm,  $dy=4$ mm,  $dz=2$ mm

Reference Value = 62.744 V/m; Power Drift = -0.02 dB

Peak SAR (extrapolated) = 39.2 W/kg

**SAR(1 g) = 8.34 W/kg; SAR(10 g) = 2.33 W/kg**

Maximum value of SAR (measured) = 17.7 W/kg

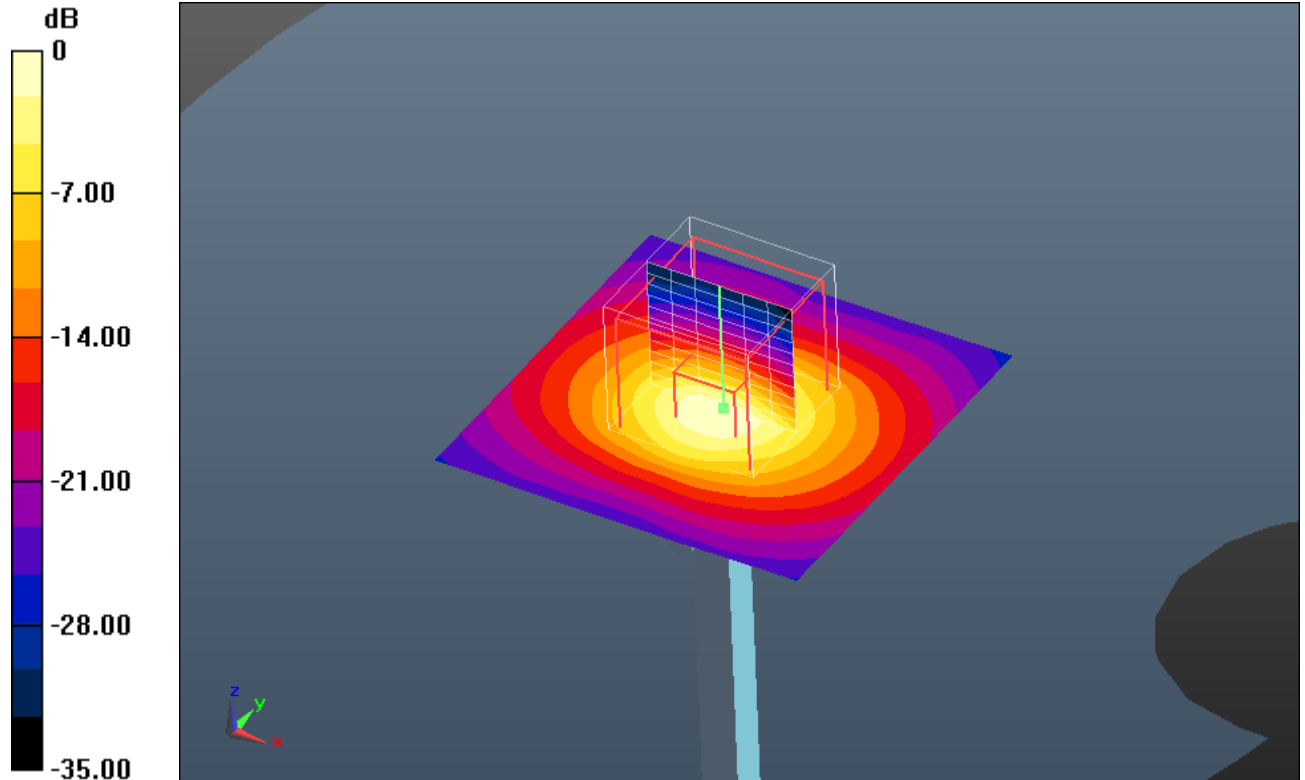

0 dB = 17.7 W/kg = 12.48 dBW/kg

#### Additional information:

ambient temperature: 22.2°C; liquid temperature: 21.9°C

Date/Time: 21.05.2014 11:13:37

### SystemPerformanceCheck-D5GHz body 2013-05-21

**DUT: Dipole 5 GHz; Type: D5GHzV2; Serial: 1055**

Communication System: UID 0, CW (0); Communication System Band: ITD5500 (5000.0 - 5900.0 MHz);

Frequency: 5200 MHz; Communication System PAR: 0 dB; PMF: 1

Medium parameters used:  $f = 5200$  MHz;  $\sigma = 5.217$  S/m;  $\epsilon_r = 48.385$ ;  $\rho = 1000$  kg/m<sup>3</sup>

Phantom section: Center Section

Measurement Standard: DASYS5

DASY5 Configuration:

- Probe: EX3DV4 - SN3944; ConvF(4.47, 4.47, 4.47); Calibrated: 02.08.2013;
- Sensor-Surface: 2mm (Mechanical Surface Detection (Locations From Previous Scan Used)), Sensor-Surface: 2mm (Mechanical Surface Detection),  $z = 1.0, 23.0$
- Electronics: DAE3 Sn477; Calibrated: 14.05.2014
- Phantom: Triple Flat Phantom 5.1C; Type: QD 000 P51 CA; Serial: 1154
- DASY52 52.8.7(1137); SEMCAD X 14.6.10(7164)

### MSL 5GHz/d=10mm, Pin=100mW 5.2GHz/Area Scan (61x61x1): Interpolated grid:

$dx=1.000$  mm,  $dy=1.000$  mm

Maximum value of SAR (interpolated) = 14.9 W/kg

### MSL 5GHz/d=10mm, Pin=100mW 5.2GHz/Zoom Scan (7x7x12)/Cube 0:

Measurement grid:  $dx=4$ mm,  $dy=4$ mm,  $dz=2$ mm

Reference Value = 54.434 V/m; Power Drift = -0.08 dB

Peak SAR (extrapolated) = 28.0 W/kg

**SAR(1 g) = 7.18 W/kg; SAR(10 g) = 2.05 W/kg**

Maximum value of SAR (measured) = 14.8 W/kg

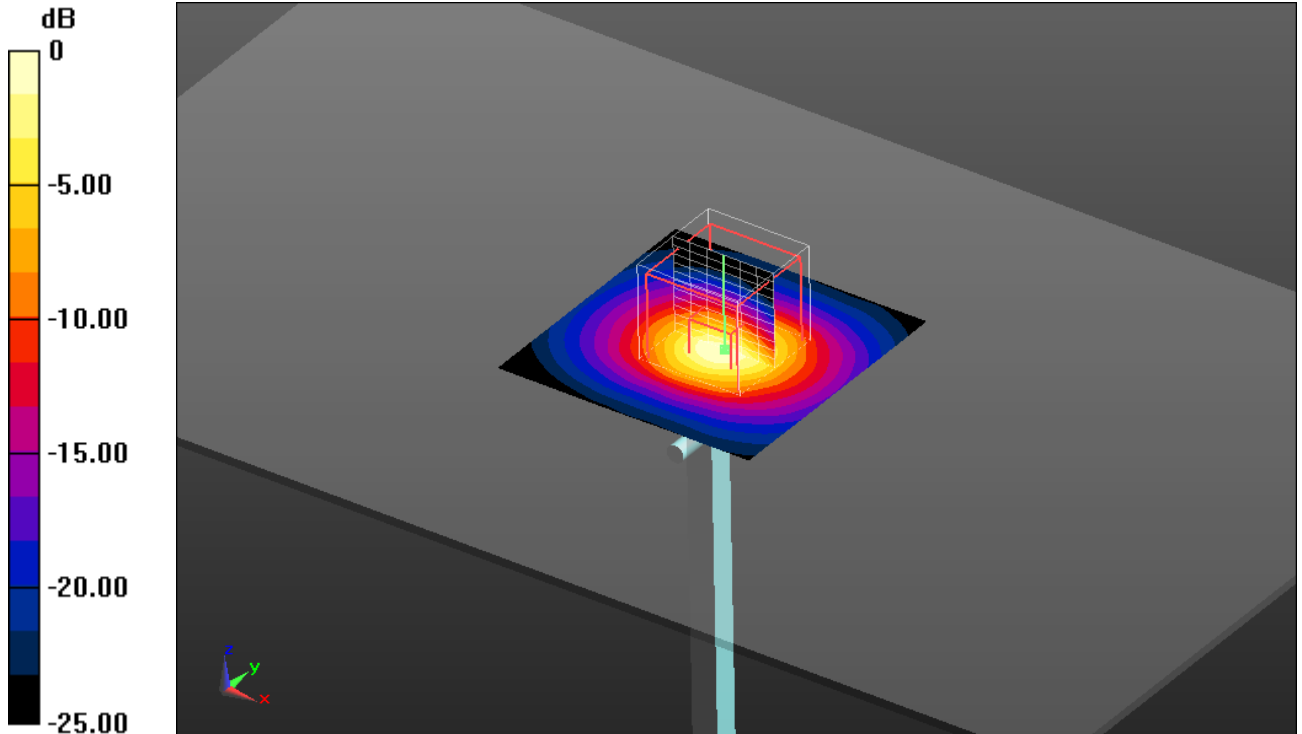

0 dB = 14.8 W/kg = 11.70 dBW/kg

#### Additional information:

ambient temperature: 23.4°C; liquid temperature: 22.2°C

Date/Time: 21.05.2014 11:43:48

### SystemPerformanceCheck-D5GHz body 2013-05-21

**DUT: Dipole 5 GHz; Type: D5GHzV2; Serial: 1055**

Communication System: UID 0, CW (0); Communication System Band: D5GHz (5000.0 - 6000.0 MHz);

Frequency: 5500 MHz; Communication System PAR: 0 dB; PMF: 1

Medium parameters used:  $f = 5500$  MHz;  $\sigma = 5.606$  S/m;  $\epsilon_r = 47.627$ ;  $\rho = 1000$  kg/m<sup>3</sup>

Phantom section: Center Section

Measurement Standard: DASYS5

DASY5 Configuration:

- Probe: EX3DV4 - SN3944; ConvF(4.09, 4.09, 4.09); Calibrated: 02.08.2013;
- Sensor-Surface: 2mm (Mechanical Surface Detection (Locations From Previous Scan Used)), Sensor-Surface: 2mm (Mechanical Surface Detection),  $z = 1.0, 23.0$
- Electronics: DAE3 Sn477; Calibrated: 14.05.2014
- Phantom: Triple Flat Phantom 5.1C; Type: QD 000 P51 CA; Serial: 1154
- DASY52 52.8.7(1137); SEMCAD X 14.6.10(7164)

### MSL 5GHz/d=10mm, Pin=100mW 5.5GHz/Area Scan (61x61x1): Interpolated grid:

$dx=1.000$  mm,  $dy=1.000$  mm

Maximum value of SAR (interpolated) = 17.3 W/kg

### MSL 5GHz/d=10mm, Pin=100mW 5.5GHz/Zoom Scan (8x8x12)/Cube 0:

Measurement grid:  $dx=4$ mm,  $dy=4$ mm,  $dz=2$ mm

Reference Value = 55.558 V/m; Power Drift = -0.07 dB

Peak SAR (extrapolated) = 32.8 W/kg

**SAR(1 g) = 8.02 W/kg; SAR(10 g) = 2.26 W/kg**

Maximum value of SAR (measured) = 16.7 W/kg

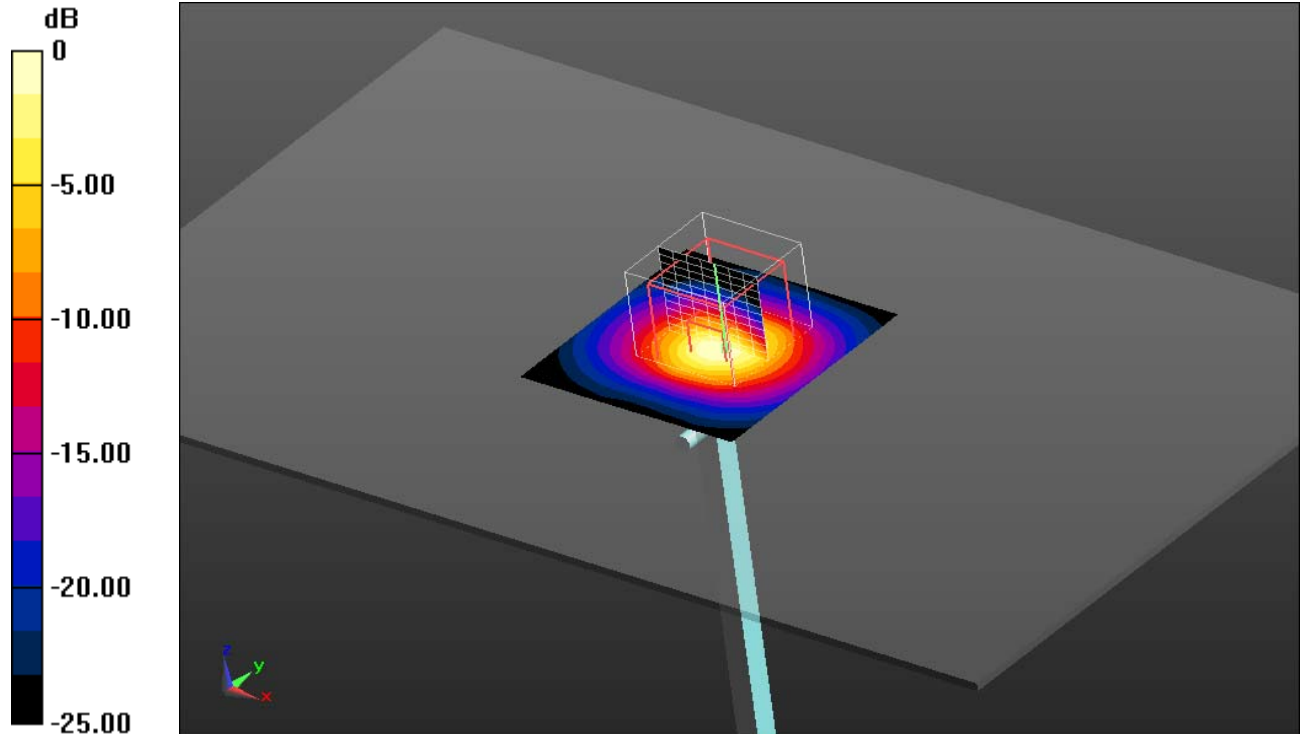

0 dB = 16.7 W/kg = 12.23 dBW/kg

#### Additional information:

ambient temperature: 23.4°C; liquid temperature: 22.2°C

Date/Time: 21.05.2014 12:21:53

### SystemPerformanceCheck-D5GHz body 2013-05-21

**DUT: Dipole 5 GHz; Type: D5GHzV2; Serial: 1055**

Communication System: UID 0, CW (0); Communication System Band: D5GHz (5000.0 - 6000.0 MHz);

Frequency: 5800 MHz; Communication System PAR: 0 dB; PMF: 1

Medium parameters used:  $f = 5800$  MHz;  $\sigma = 5.962$  S/m;  $\epsilon_r = 47.058$ ;  $\rho = 1000$  kg/m<sup>3</sup>

Phantom section: Center Section

Measurement Standard: DASYS5

DASY5 Configuration:

- Probe: EX3DV4 - SN3944; ConvF(4.2, 4.2, 4.2); Calibrated: 02.08.2013;
- Sensor-Surface: 2mm (Mechanical Surface Detection (Locations From Previous Scan Used)), Sensor-Surface: 2mm (Mechanical Surface Detection),  $z = 1.0, 23.0$
- Electronics: DAE3 Sn477; Calibrated: 14.05.2014
- Phantom: Triple Flat Phantom 5.1C; Type: QD 000 P51 CA; Serial: 1154
- DASY52 52.8.7(1137); SEMCAD X 14.6.10(7164)

### MSL 5GHz/d=10mm, Pin=100mW 5.8GHz/Area Scan (61x61x1): Interpolated grid:

$dx=1.000$  mm,  $dy=1.000$  mm

Maximum value of SAR (interpolated) = 16.1 W/kg

### MSL 5GHz/d=10mm, Pin=100mW 5.8GHz/Zoom Scan (7x7x12)/Cube 0:

Measurement grid:  $dx=4$ mm,  $dy=4$ mm,  $dz=2$ mm

Reference Value = 50.744 V/m; Power Drift = -0.01 dB

Peak SAR (extrapolated) = 34.1 W/kg

**SAR(1 g) = 7.7 W/kg; SAR(10 g) = 2.14 W/kg**

Maximum value of SAR (measured) = 16.8 W/kg

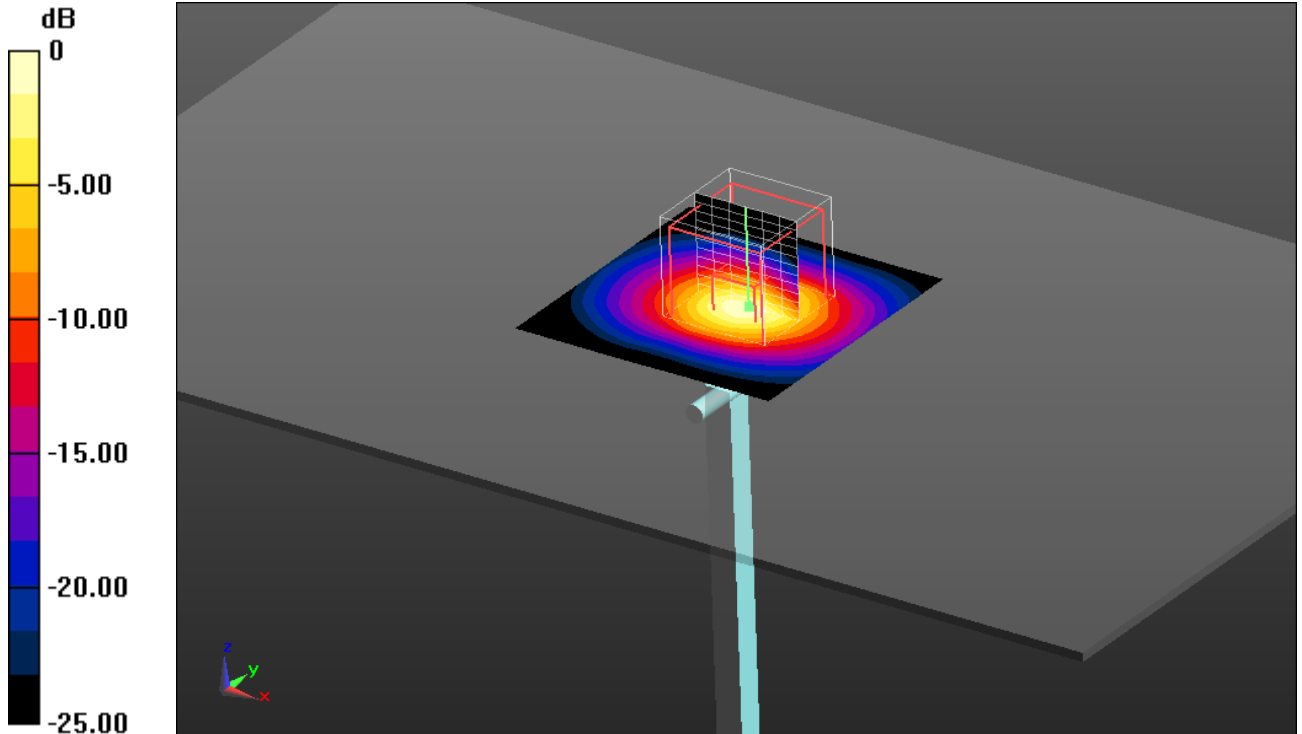

0 dB = 16.8 W/kg = 12.25 dBW/kg

#### Additional information:

ambient temperature: 23.4°C; liquid temperature: 22.2°C

## Annex B: DASY5 measurement results

SAR plots for **the highest measured SAR** in each exposure configuration, wireless mode and frequency band combination according to FCC KDB 865664 D02

### Annex B.1: GSM 850

Date/Time: 07.05.2014 17:40:06

#### IEEE1528-GSM850 head - DTM

**DUT: Sony; Type: PY7PM-0751; Serial: CB5126Z4PZ**

Communication System: UID 0, GSM/GPRS 3TS (0); Communication System Band: GSM 850; Frequency: 848.8 MHz; Communication System PAR: 4.314 dB; PMF: 1.64324

Medium parameters used:  $f = 849$  MHz;  $\sigma = 0.918$  S/m;  $\epsilon_r = 41.258$ ;  $\rho = 1000$  kg/m<sup>3</sup>

Phantom section: Right Section

Measurement Standard: DASY5

DASY5 Configuration:

- Probe: ET3DV6 - SN1558; ConvF(5.89, 5.89, 5.89); Calibrated: 22.08.2013;
- Sensor-Surface: 4mm (Mechanical Surface Detection (Locations From Previous Scan Used)), Sensor-Surface: 4mm (Mechanical Surface Detection),  $z = 2.7, 32.7$
- Electronics: DAE3 Sn408; Calibrated: 30.09.2013
- Phantom: SAM front; Type: QD000P40CC; Serial: TP-1042
- DASY52 52.8.7(1137); SEMCAD X 14.6.10(7164)

#### Right-Hand-Side HSL/Touch Position - Hi/Area Scan (71x121x1): Interpolated

grid:  $dx=1.500$  mm,  $dy=1.500$  mm

Maximum value of SAR (interpolated) = 0.645 W/kg

#### Right-Hand-Side HSL/Touch Position - Hi/Zoom Scan (6x5x7)/Cube 0:

Measurement grid:  $dx=7.5$ mm,  $dy=7.5$ mm,  $dz=5$ mm

Reference Value = 27.150 V/m; Power Drift = 0.04 dB

Peak SAR (extrapolated) = 0.766 W/kg

**SAR(1 g) = 0.605 W/kg; SAR(10 g) = 0.464 W/kg**

Maximum value of SAR (measured) = 0.633 W/kg

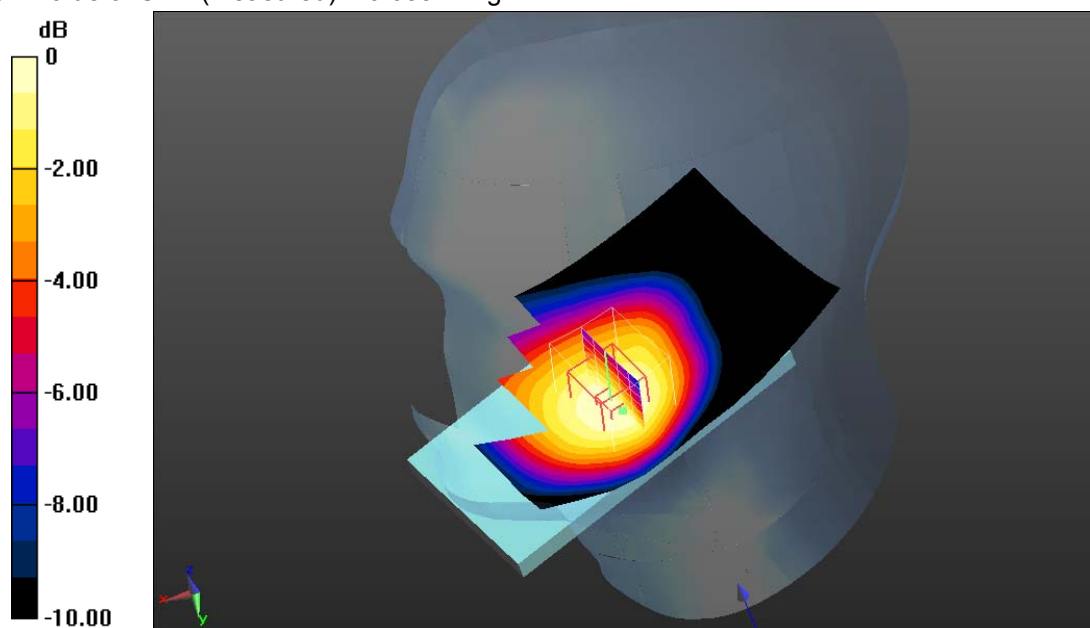

0 dB = 0.633 W/kg = -1.99 dBW/kg

#### Additional information:

ambient temperature: 23.4°C; liquid temperature: 22.3°C

Date/Time: 5/8/2014 4:05:47 PM

### FCC\_EN62209-2 GSM850 hotspot

**DUT: Sony; Type: PY7PM-0751; Serial: CB5126Z4PZ**

Communication System: UID 0, GSM/GPRS 4TS (0); Communication System Band: GSM 850; Frequency: 848.8 MHz; Communication System PAR: 3.01 dB; PMF: 1.41416

Medium parameters used:  $f = 849$  MHz;  $\sigma = 1.018$  S/m;  $\epsilon_r = 54.687$ ;  $\rho = 1000$  kg/m<sup>3</sup>

Phantom section: Center Section

Measurement Standard: DASYS

DASY5 Configuration:

- Probe: ES3DV3 - SN3326; ConvF(6.04, 6.04, 6.04); Calibrated: 9/2/2013;
- Sensor-Surface: 4mm (Mechanical Surface Detection (Locations From Previous Scan Used)), Sensor-Surface: 4mm (Mechanical Surface Detection),  $z = 2.0, 32.0$
- Electronics: DAE4 Sn1387; Calibrated: 8/28/2013
- Phantom: Triple Flat Phantom 5.1C; Type: QD 000 P51 CA; Serial: xxxx
- DASY52 52.8.7(1137); SEMCAD X 14.6.10(7164)

**MSL835 - 10mm/Rear High/Area Scan (131x71x1):** Interpolated grid:  $dx=1.500$  mm,  $dy=1.500$  mm

Maximum value of SAR (interpolated) = 0.781 W/kg

**MSL835 - 10mm/Rear High/Zoom Scan (5x5x7)/Cube 0:** Measurement grid:

$dx=7.5$ mm,  $dy=7.5$ mm,  $dz=5$ mm

Reference Value = 27.973 V/m; Power Drift = -0.00 dB

Peak SAR (extrapolated) = 0.923 W/kg

**SAR(1 g) = 0.751 W/kg; SAR(10 g) = 0.570 W/kg**

Maximum value of SAR (measured) = 0.787 W/kg

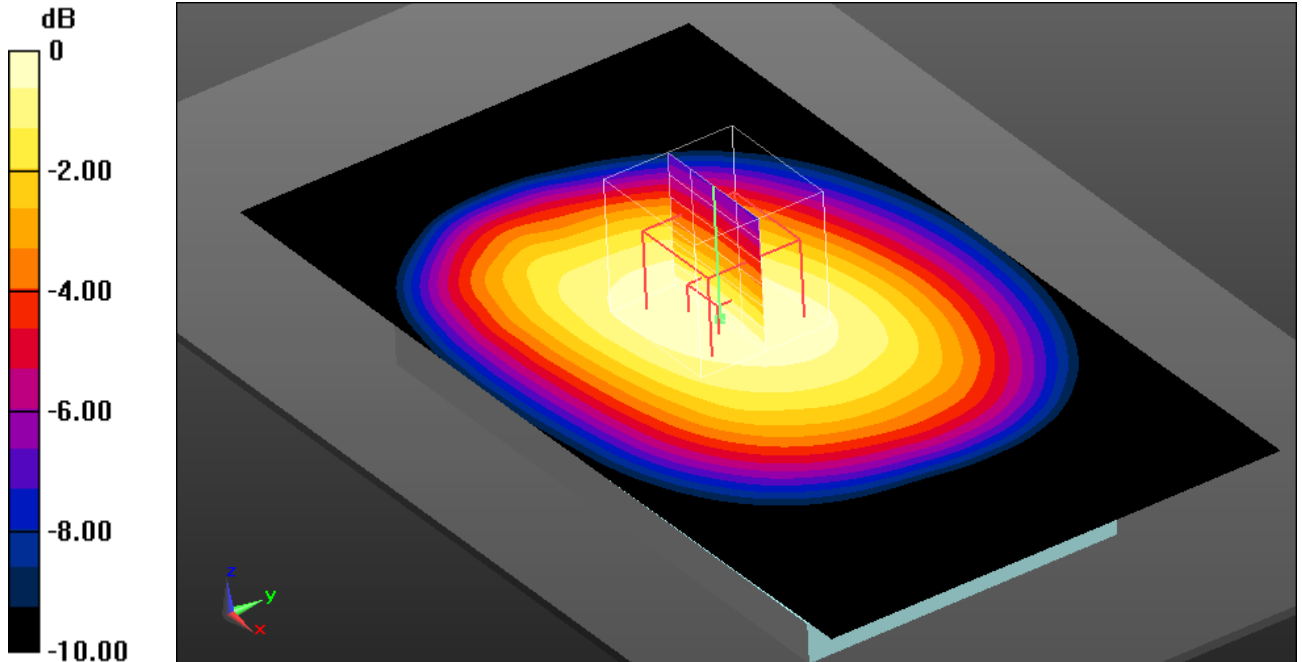

0 dB = 0.787 W/kg = -1.04 dBW/kg

**Additional information:**

position or distance of DUT to SAM: 10mm

ambient temperature: 23.3°C; liquid temperature: 22.3°C



Date/Time: 5/8/2014 10:41:11 AM

**FCC\_EN62209-2 GSM850 body worn**

**DUT: Sony; Type: PY7PM-0751; Serial: CB5126Z4PZ**

Communication System: UID 0, GSM/GPRS 4TS (0); Communication System Band: GSM 850; Frequency: 848.8 MHz; Communication System PAR: 3.01 dB; PMF: 1.41416

Medium parameters used:  $f = 849$  MHz;  $\sigma = 1.018$  S/m;  $\epsilon_r = 54.687$ ;  $\rho = 1000$  kg/m<sup>3</sup>

Phantom section: Center Section

Measurement Standard: DASYS5

DASY5 Configuration:

- Probe: ES3DV3 - SN3326; ConvF(6.04, 6.04, 6.04); Calibrated: 9/2/2013;
- Sensor-Surface: 4mm (Mechanical Surface Detection (Locations From Previous Scan Used)), Sensor-Surface: 4mm (Mechanical Surface Detection),  $z = 2.0, 32.0$
- Electronics: DAE4 Sn1387; Calibrated: 8/28/2013
- Phantom: Triple Flat Phantom 5.1C; Type: QD 000 P51 CA; Serial: xxxx
- DASYS52 52.8.7(1137); SEMCAD X 14.6.10(7164)

**MSL835 - 15mm/Rear High/Area Scan (131x71x1):** Interpolated grid:  $dx=1.500$  mm,  $dy=1.500$  mm

Maximum value of SAR (interpolated) = 0.600 W/kg

**MSL835 - 15mm/Rear High/Zoom Scan (5x5x7)/Cube 0:** Measurement grid:

$dx=7.5$ mm,  $dy=7.5$ mm,  $dz=5$ mm

Reference Value = 24.251 V/m; Power Drift = 0.08 dB

Peak SAR (extrapolated) = 0.706 W/kg

**SAR(1 g) = 0.569 W/kg; SAR(10 g) = 0.431 W/kg**

Maximum value of SAR (measured) = 0.597 W/kg

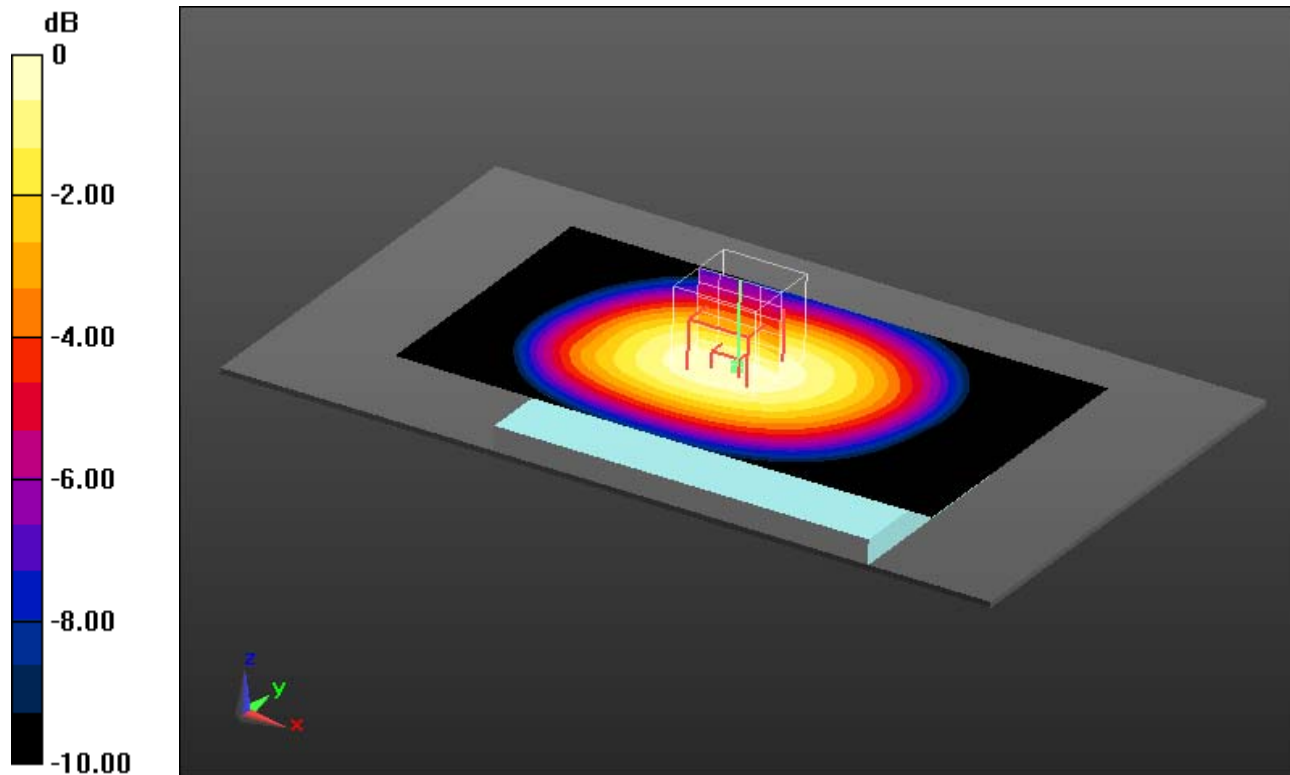

0 dB = 0.597 W/kg = -2.24 dBW/kg

**Additional information:**

position or distance of DUT to SAM: 15mm

ambient temperature: 23.3°C; liquid temperature: 22.3°C

**Annex B.2: GSM 1900**

Date/Time: 09.05.2014 16:25:38

**IEEE1528-GSM1900 head - DTM**

**DUT: Sony; Type: PY7PM-0751; Serial: CB5126Z4PZ**

Communication System: UID 0, GSM/GPRS 3TS (0); Communication System Band: GSM 1900; Frequency: 1909.8 MHz; Communication System PAR: 4.314 dB; PMF: 1.64324

Medium parameters used:  $f = 1910$  MHz;  $\sigma = 1.381$  S/m;  $\epsilon_r = 39.43$ ;  $\rho = 1000$  kg/m<sup>3</sup>

Phantom section: Left Section

Measurement Standard: DASYS

DASY5 Configuration:

- Probe: ET3DV6 - SN1558; ConvF(4.75, 4.75, 4.75); Calibrated: 22.08.2013;
- Sensor-Surface: 4mm (Mechanical Surface Detection (Locations From Previous Scan Used)), Sensor-Surface: 4mm (Mechanical Surface Detection),  $z = 2.7, 32.7$
- Electronics: DAE3 Sn408; Calibrated: 30.09.2013
- Phantom: SAM front; Type: QD000P40CC; Serial: TP-1042
- DASY52 52.8.7(1137); SEMCAD X 14.6.10(7164)

**Left-Hand-Side HSL/Touch Position - Hi/Area Scan (71x121x1):** Interpolated grid:

$dx=1.500$  mm,  $dy=1.500$  mm

Maximum value of SAR (interpolated) = 0.374 W/kg

**Left-Hand-Side HSL/Touch Position - Hi/Zoom Scan (5x6x7)/Cube 0:**

Measurement grid:  $dx=7.5$ mm,  $dy=7.5$ mm,  $dz=5$ mm

Reference Value = 16.905 V/m; Power Drift = -0.03 dB

Peak SAR (extrapolated) = 0.492 W/kg

**SAR(1 g) = 0.331 W/kg; SAR(10 g) = 0.205 W/kg**

Maximum value of SAR (measured) = 0.360 W/kg

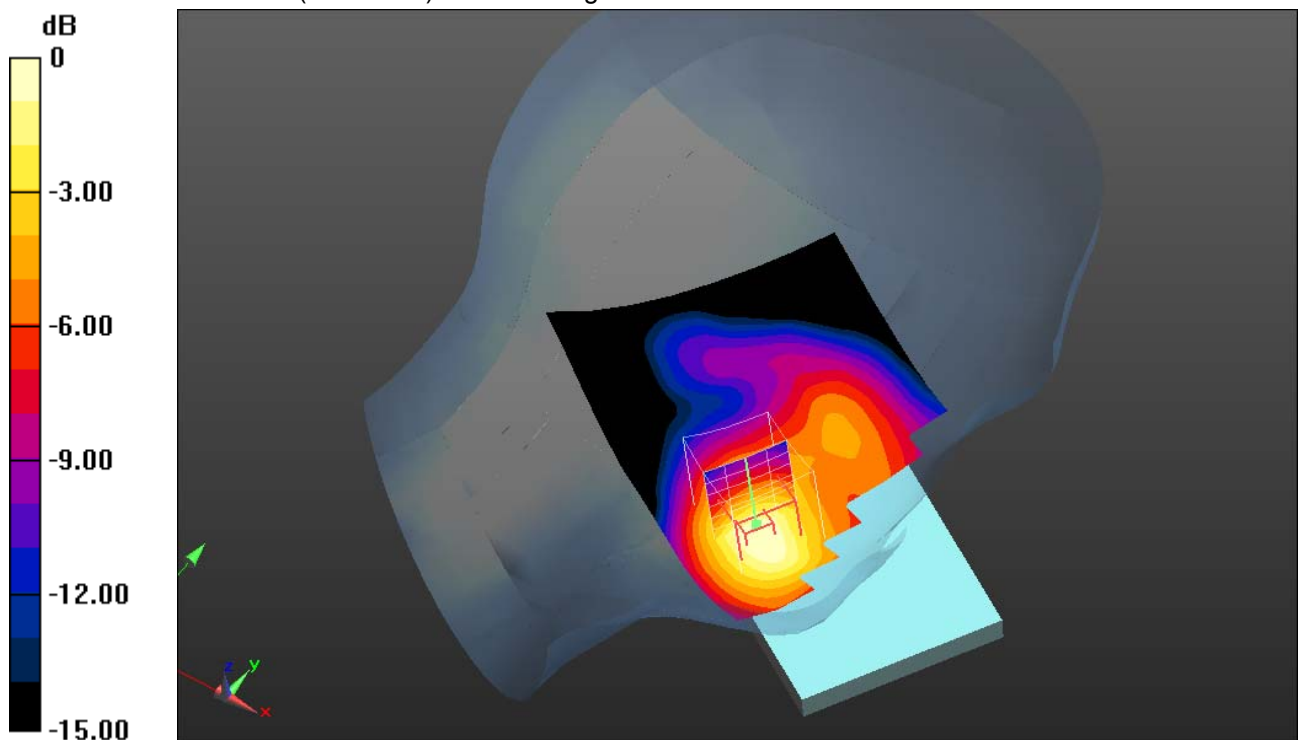

0 dB = 0.360 W/kg = -4.44 dBW/kg

**Additional information:**

ambient temperature: 22.9°C; liquid temperature: 22.2°C

Date/Time: 08.05.2014 13:16:30

### FCC\_EN62209-2 GSM1900 hotspot

**DUT: Sony; Type: PY7PM-0751; Serial: CB5126Z4PZ**

Communication System: UID 0, GSM/GPRS 4TS (0); Communication System Band: GSM 1900; Frequency: 1909.8 MHz; Communication System PAR: 3.01 dB; PMF: 1.41416

Medium parameters used:  $f = 1910$  MHz;  $\sigma = 1.574$  S/m;  $\epsilon_r = 53.981$ ;  $\rho = 1000$  kg/m<sup>3</sup>

Phantom section: Center Section

Measurement Standard: DASYS5

DASY5 Configuration:

- Probe: ET3DV6 - SN1558; ConvF(4.21, 4.21, 4.21); Calibrated: 22.08.2013;
- Sensor-Surface: 4mm (Mechanical Surface Detection (Locations From Previous Scan Used)), Sensor-Surface: 4mm (Mechanical Surface Detection),  $z = 2.7, 32.7$
- Electronics: DAE3 Sn408; Calibrated: 30.09.2013
- Phantom: Triple Flat Phantom 5.1C; Type: QD 000 P51 CA; Serial: 1154
- DASY52 52.8.7(1137); SEMCAD X 14.6.10(7164)

### MSL1900 - 4TS - 10mm/Rear High/Area Scan (131x71x1): Interpolated grid:

$dx=1.500$  mm,  $dy=1.500$  mm

Maximum value of SAR (interpolated) = 0.886 W/kg

### MSL1900 - 4TS - 10mm/Rear High/Zoom Scan (5x5x7)/Cube 0: Measurement grid:

$dx=7.5$ mm,  $dy=7.5$ mm,  $dz=5$ mm

Reference Value = 24.904 V/m; Power Drift = 0.13 dB

Peak SAR (extrapolated) = 1.31 W/kg

**SAR(1 g) = 0.797 W/kg; SAR(10 g) = 0.443 W/kg**

Maximum value of SAR (measured) = 0.849 W/kg

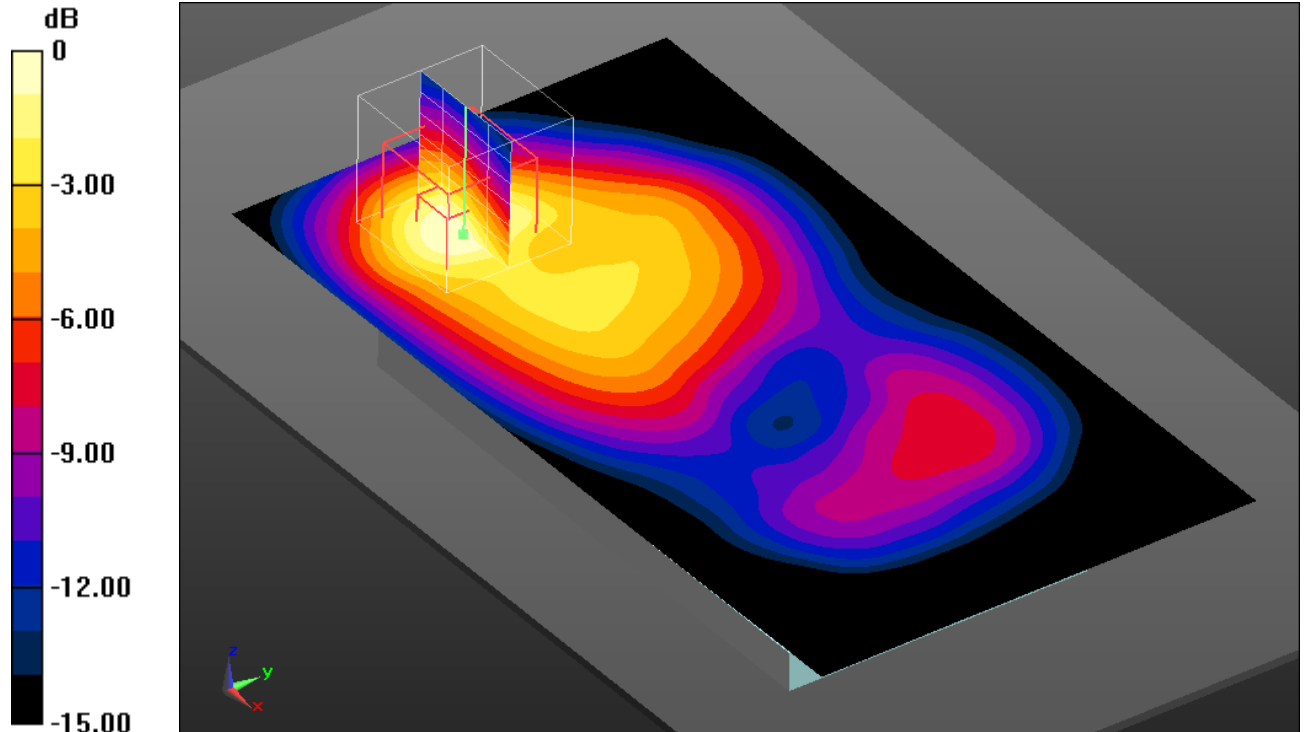

0 dB = 0.849 W/kg = -0.71 dBW/kg

#### Additional information:

position or distance of DUT to SAM: 10mm

ambient temperature: 23.4°C; liquid temperature: 22.5°C

Date/Time: 08.05.2014 12:36:27

**FCC\_EN62209-2 GSM1900 body worn**

**DUT: Sony; Type: PY7PM-0751; Serial: CB5126Z4PZ**

Communication System: UID 0, GSM/GPRS 4TS (0); Communication System Band: GSM 1900; Frequency: 1909.8 MHz; Communication System PAR: 3.01 dB; PMF: 1.41416

Medium parameters used:  $f = 1910$  MHz;  $\sigma = 1.574$  S/m;  $\epsilon_r = 53.981$ ;  $\rho = 1000$  kg/m<sup>3</sup>

Phantom section: Center Section

Measurement Standard: DASYS5

DASY5 Configuration:

- Probe: ET3DV6 - SN1558; ConvF(4.21, 4.21, 4.21); Calibrated: 22.08.2013;
- Sensor-Surface: 4mm (Mechanical Surface Detection (Locations From Previous Scan Used)), Sensor-Surface: 4mm (Mechanical Surface Detection),  $z = 2.7, 32.7$
- Electronics: DAE3 Sn408; Calibrated: 30.09.2013
- Phantom: Triple Flat Phantom 5.1C; Type: QD 000 P51 CA; Serial: 1154
- DASY52 52.8.7(1137); SEMCAD X 14.6.10(7164)

**MSL1900 - 4TS - 15mm/Rear High/Area Scan (131x71x1):** Interpolated grid:

$dx=1.500$  mm,  $dy=1.500$  mm

Maximum value of SAR (interpolated) = 0.518 W/kg

**MSL1900 - 4TS - 15mm/Rear High/Zoom Scan (5x5x7)/Cube 0:** Measurement grid:

$dx=7.5$ mm,  $dy=7.5$ mm,  $dz=5$ mm

Reference Value = 19.122 V/m; Power Drift = 0.02 dB

Peak SAR (extrapolated) = 0.718 W/kg

**SAR(1 g) = 0.463 W/kg; SAR(10 g) = 0.273 W/kg**

Maximum value of SAR (measured) = 0.502 W/kg

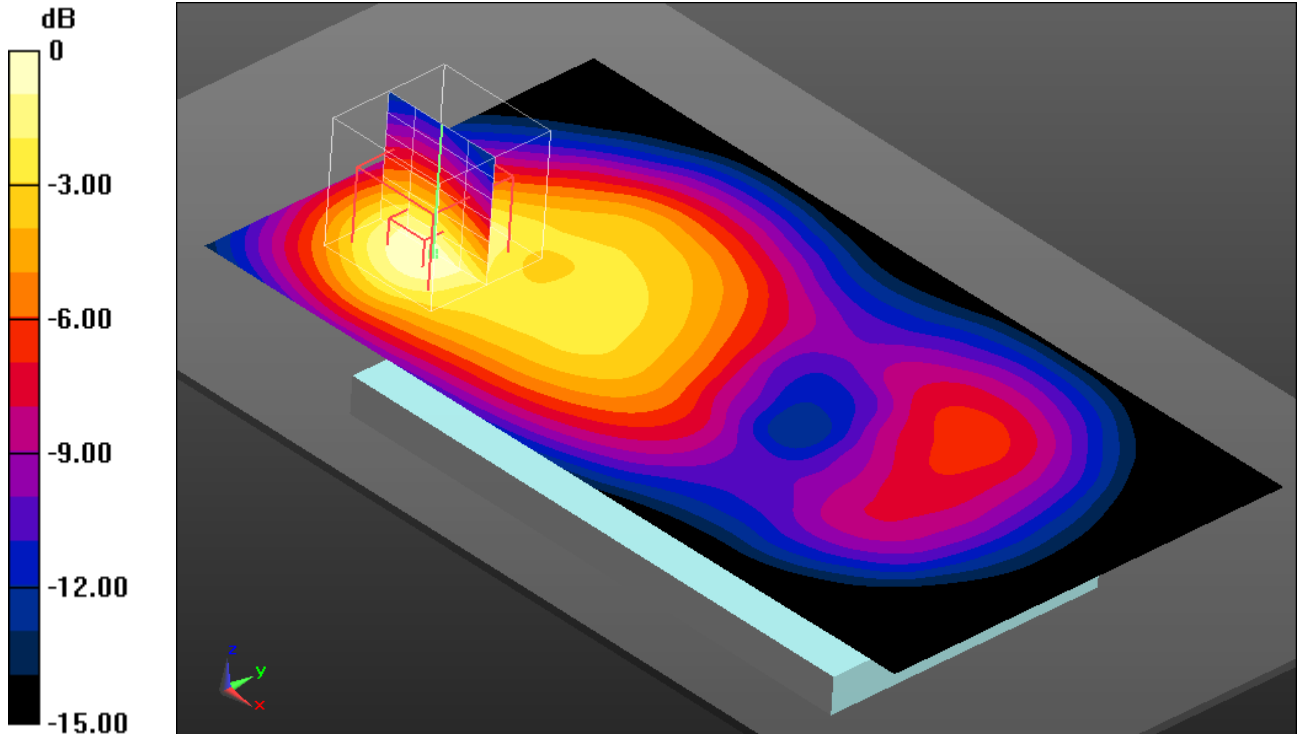

0 dB = 0.502 W/kg = -2.99 dBW/kg

**Additional information:**

position or distance of DUT to SAM: 15mm

ambient temperature: 23.4°C; liquid temperature: 22.5°C

## Annex B.3: UMTS FDD II

Date/Time: 09.05.2014 17:47:42

### IEEE1528-UMTS FDD II head

**DUT: Sony; Type: PY7PM-0751; Serial: CB5126Z4PZ**

Communication System: UID 0, UMTS FDD (0); Communication System Band: UMTS FDD II; Frequency: 1907.6 MHz; Communication System PAR: 0 dB; PMF: 1

Medium parameters used:  $f = 1908$  MHz;  $\sigma = 1.381$  S/m;  $\epsilon_r = 39.437$ ;  $\rho = 1000$  kg/m<sup>3</sup>

Phantom section: Left Section

Measurement Standard: DASYS

DASY5 Configuration:

- Probe: ET3DV6 - SN1558; ConvF(4.75, 4.75, 4.75); Calibrated: 22.08.2013;
- Sensor-Surface: 4mm (Mechanical Surface Detection (Locations From Previous Scan Used)), Sensor-Surface: 4mm (Mechanical Surface Detection),  $z = 2.7, 32.7$
- Electronics: DAE3 Sn408; Calibrated: 30.09.2013
- Phantom: SAM front; Type: QD000P40CC; Serial: TP-1042
- DASY52 52.8.7(1137); SEMCAD X 14.6.10(7164)

### Left-Hand-Side HSL/Touch Position - Hi/Area Scan (71x121x1): Interpolated grid:

$dx=1.500$  mm,  $dy=1.500$  mm

Maximum value of SAR (interpolated) = 0.505 W/kg

### Left-Hand-Side HSL/Touch Position - Hi/Zoom Scan (5x5x7)/Cube 0:

Measurement grid:  $dx=7.5$ mm,  $dy=7.5$ mm,  $dz=5$ mm

Reference Value = 19.706 V/m; Power Drift = 0.03 dB

Peak SAR (extrapolated) = 0.655 W/kg

**SAR(1 g) = 0.445 W/kg; SAR(10 g) = 0.277 W/kg**

Maximum value of SAR (measured) = 0.482 W/kg

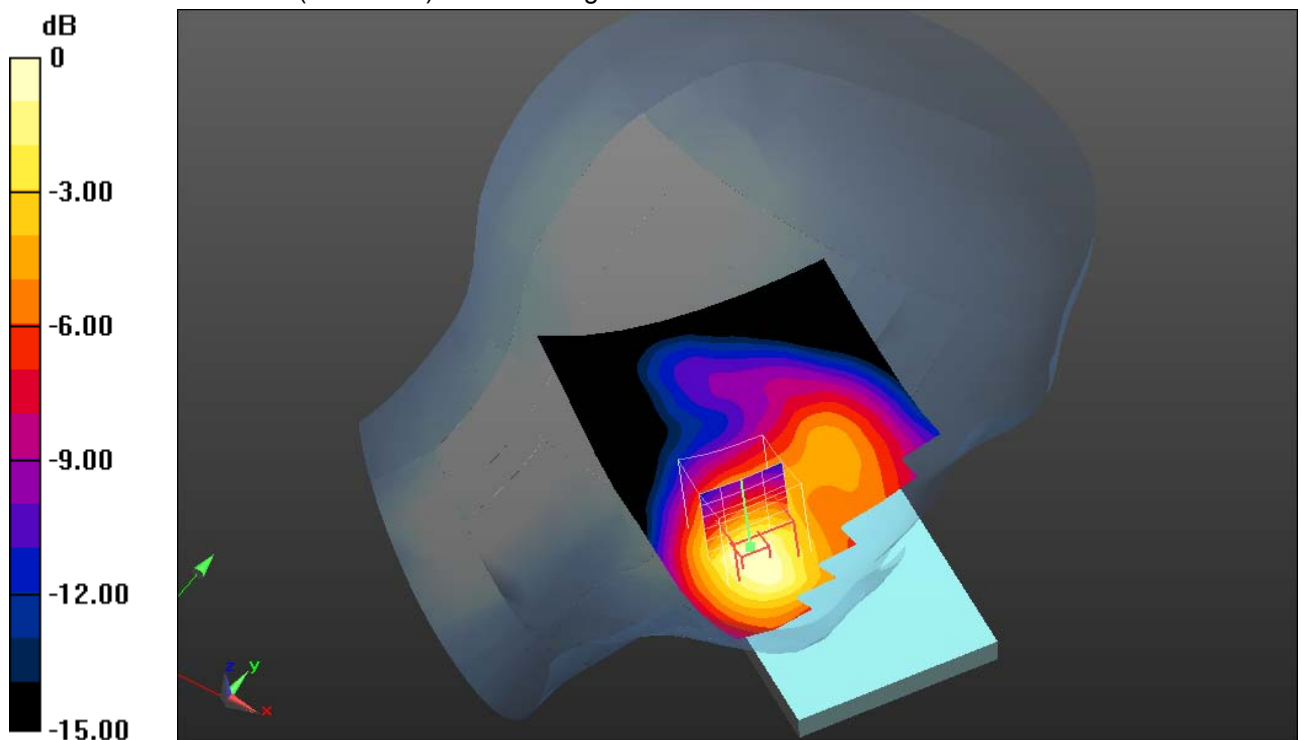

0 dB = 0.482 W/kg = -3.17 dBW/kg

#### Additional information:

ambient temperature: 22.9°C; liquid temperature: 22.2°C

Date/Time: 08.05.2014 15:39:45

**FCC\_EN62209-2 UMTS FDD II hotspot**

**DUT: Sony; Type: PY7PM-0751; Serial: CB5126Z4RE**

Communication System: UID 0, UMTS FDD (0); Communication System Band: UMTS FDD II; Frequency: 1907.6 MHz; Communication System PAR: 0 dB; PMF: 1

Medium parameters used:  $f = 1908 \text{ MHz}$ ;  $\sigma = 1.579 \text{ S/m}$ ;  $\epsilon_r = 54.002$ ;  $\rho = 1000 \text{ kg/m}^3$

Phantom section: Center Section

Measurement Standard: DASY5

DASY5 Configuration:

- Probe: ET3DV6 - SN1558; ConvF(4.21, 4.21, 4.21); Calibrated: 22.08.2013;
- Sensor-Surface: 4mm (Mechanical Surface Detection (Locations From Previous Scan Used)), Sensor-Surface: 4mm (Mechanical Surface Detection),  $z = 2.7, 32.7$
- Electronics: DAE3 Sn408; Calibrated: 30.09.2013
- Phantom: Triple Flat Phantom 5.1C; Type: QD 000 P51 CA; Serial: 1154
- DASY52 52.8.7(1137); SEMCAD X 14.6.10(7164)

**MSL1900 - 10mm/Front High/Area Scan (131x71x1):** Interpolated grid:  $dx=1.500 \text{ mm}$ ,  $dy=1.500 \text{ mm}$

Maximum value of SAR (interpolated) = 1.25 W/kg

**MSL1900 - 10mm/Front High/Zoom Scan (5x5x7)/Cube 0:** Measurement grid:

$dx=7.5\text{mm}$ ,  $dy=7.5\text{mm}$ ,  $dz=5\text{mm}$

Reference Value = 30.523 V/m; Power Drift = -0.02 dB

Peak SAR (extrapolated) = 1.95 W/kg

**SAR(1 g) = 1.12 W/kg; SAR(10 g) = 0.603 W/kg**

Maximum value of SAR (measured) = 1.24 W/kg

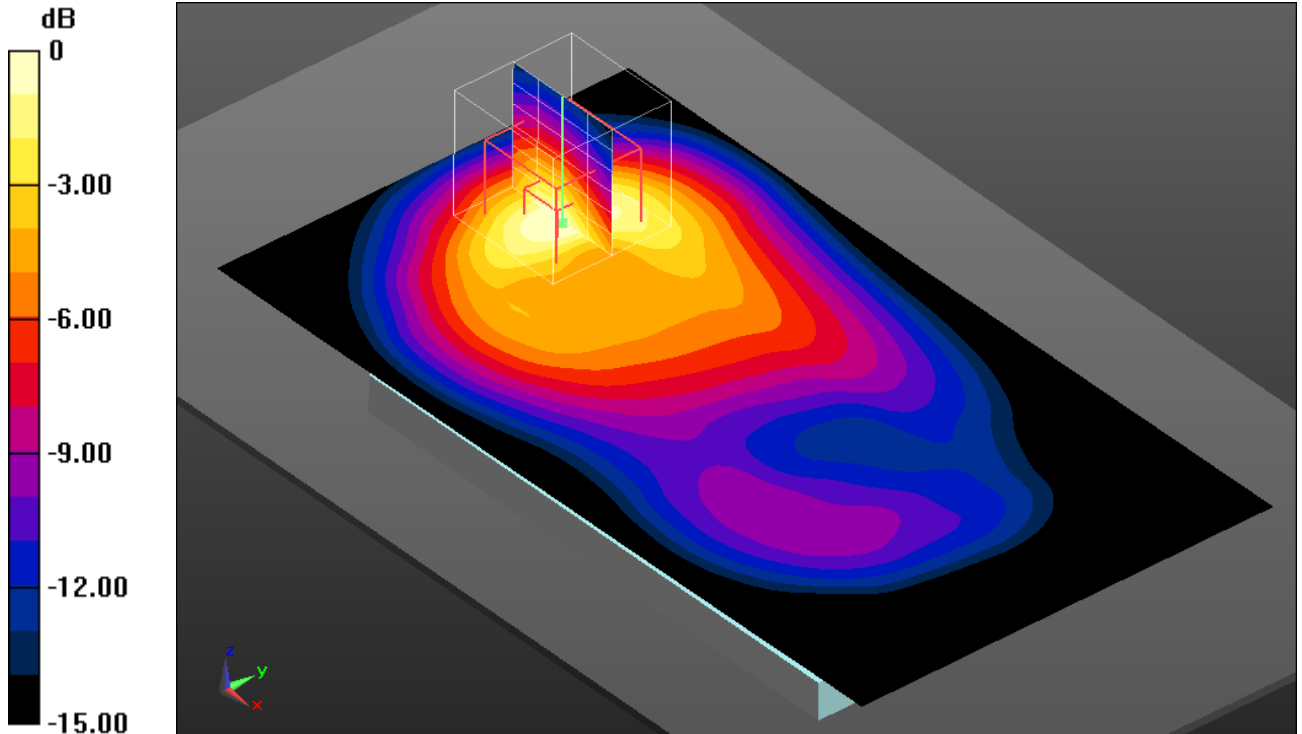

0 dB = 1.24 W/kg = 0.93 dBW/kg

**Additional information:**

position or distance of DUT to SAM: 10mm

ambient temperature: 23.4°C; liquid temperature: 22.5°C

Date/Time: 08.05.2014 18:56:47

**FCC\_EN62209-2 UMTS FDD II body worn**

**DUT: Sony; Type: PY7PM-0751; Serial: CB5126Z4RE**

Communication System: UID 0, UMTS FDD (0); Communication System Band: UMTS FDD II; Frequency: 1907.6 MHz; Communication System PAR: 0 dB; PMF: 1

Medium parameters used:  $f = 1908$  MHz;  $\sigma = 1.579$  S/m;  $\epsilon_r = 54.002$ ;  $\rho = 1000$  kg/m<sup>3</sup>

Phantom section: Center Section

Measurement Standard: DASYS5

DASY5 Configuration:

- Probe: ET3DV6 - SN1558; ConvF(4.21, 4.21, 4.21); Calibrated: 22.08.2013;
- Sensor-Surface: 4mm (Mechanical Surface Detection),  $z = 2.7, 32.7$
- Electronics: DAE3 Sn408; Calibrated: 30.09.2013
- Phantom: Triple Flat Phantom 5.1C; Type: QD 000 P51 CA; Serial: 1154
- DASY52 52.8.7(1137); SEMCAD X 14.6.10(7164)

**MSL1900 - 15mm/Front High/Area Scan (131x71x1):** Interpolated grid:  $dx=1.500$  mm,  $dy=1.500$  mm

Maximum value of SAR (interpolated) = 0.598 W/kg

**MSL1900 - 15mm/Front High/Zoom Scan (5x5x7)/Cube 0:** Measurement grid:

$dx=7.5$ mm,  $dy=7.5$ mm,  $dz=5$ mm

Reference Value = 20.369 V/m; Power Drift = -0.00 dB

Peak SAR (extrapolated) = 0.889 W/kg

**SAR(1 g) = 0.547 W/kg; SAR(10 g) = 0.322 W/kg**

Maximum value of SAR (measured) = 0.591 W/kg

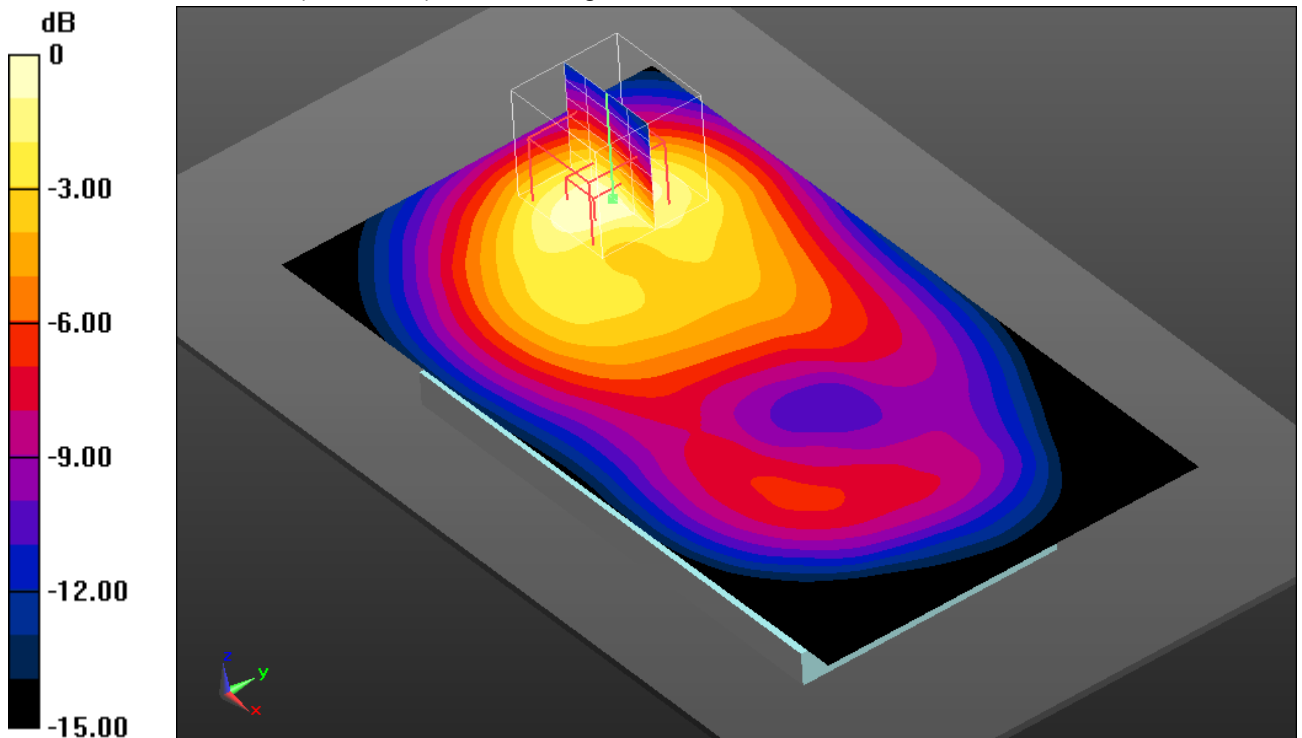

0 dB = 0.591 W/kg = -2.28 dBW/kg

**Additional information:**

position or distance of DUT to SAM: 15mm

ambient temperature: 23.4°C; liquid temperature: 22.5°C

## Annex B.4: UMTS FDD V

Date/Time: 07.05.2014 16:05:02

### IEEE1528-UMTS FDDV head

**DUT: Sony; Type: PY7PM-0751; Serial: CB5126Z4RE**

Communication System: UID 0, UMTS FDD (0); Communication System Band: UMTS FDD V; Frequency: 846.6 MHz; Communication System PAR: 0 dB; PMF: 1

Medium parameters used:  $f = 847$  MHz;  $\sigma = 0.918$  S/m;  $\epsilon_r = 41.279$ ;  $\rho = 1000$  kg/m<sup>3</sup>

Phantom section: Right Section

Measurement Standard: DASYS

DASY5 Configuration:

- Probe: ET3DV6 - SN1558; ConvF(5.89, 5.89, 5.89); Calibrated: 22.08.2013;
- Sensor-Surface: 4mm (Mechanical Surface Detection (Locations From Previous Scan Used)), Sensor-Surface: 4mm (Mechanical Surface Detection),  $z = 2.7, 32.7$
- Electronics: DAE3 Sn408; Calibrated: 30.09.2013
- Phantom: SAM front; Type: QD000P40CC; Serial: TP-1042
- DASY52 52.8.7(1137); SEMCAD X 14.6.10(7164)

**Right-Hand-Side HSL/Touch Position - Hi/Area Scan (71x121x1):** Interpolated  
grid:  $dx=1.500$  mm,  $dy=1.500$  mm

Maximum value of SAR (interpolated) = 0.538 W/kg

**Right-Hand-Side HSL/Touch Position - Hi/Zoom Scan (6x5x7)/Cube 0:**

Measurement grid:  $dx=7.5$ mm,  $dy=7.5$ mm,  $dz=5$ mm

Reference Value = 24.744 V/m; Power Drift = 0.00 dB

Peak SAR (extrapolated) = 0.633 W/kg

**SAR(1 g) = 0.506 W/kg; SAR(10 g) = 0.388 W/kg**

Maximum value of SAR (measured) = 0.530 W/kg

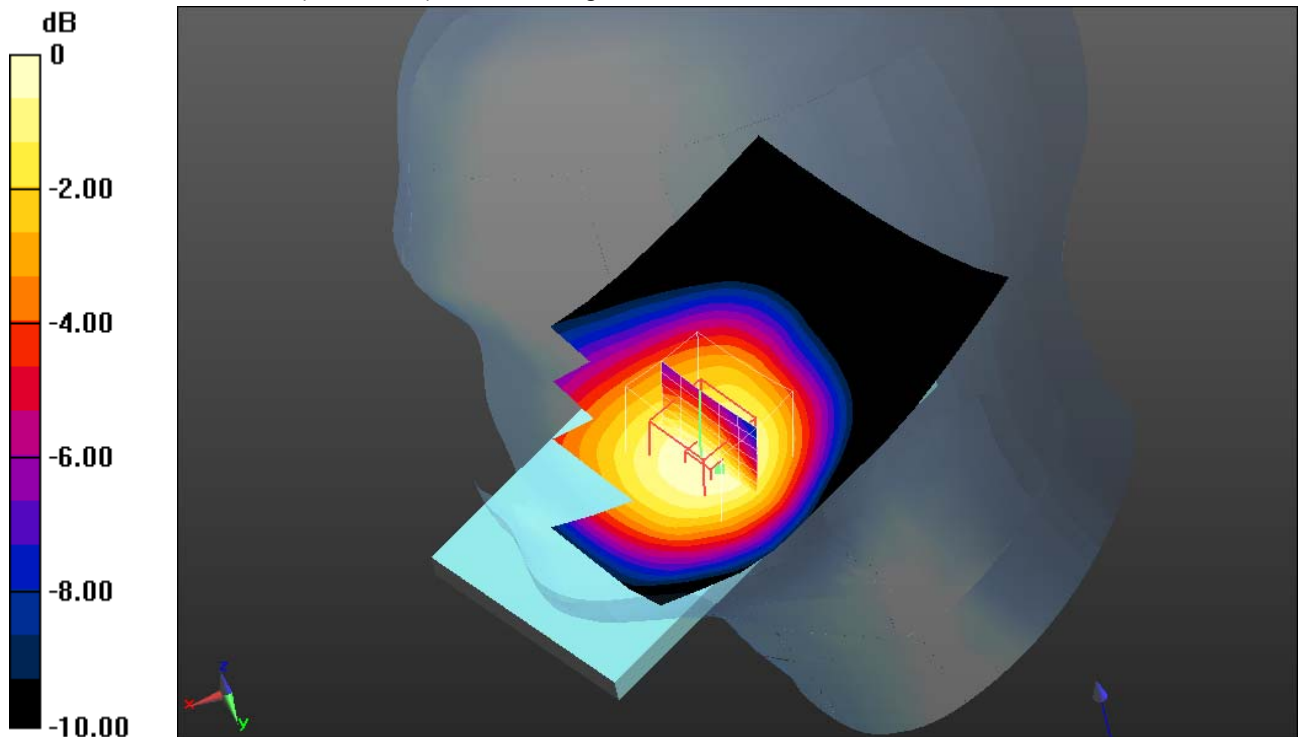

0 dB = 0.530 W/kg = -2.76 dBW/kg

#### Additional information:

ambient temperature: 23.4°C; liquid temperature: 22.3°C



Date/Time: 5/8/2014 12:31:34 PM

**FCC\_EN62209-2 UMTS FDD V hotspot**

**DUT: Sony; Type: PY7PM-0751; Serial: CB5126Z4RE**

Communication System: UID 0, UMTS FDD (0); Communication System Band: UMTS FDD V; Frequency: 836.4 MHz; Communication System PAR: 0 dB; PMF: 1

Medium parameters used (interpolated):  $f = 836.4$  MHz;  $\sigma = 1.01$  S/m;  $\epsilon_r = 54.829$ ;  $\rho = 1000$  kg/m<sup>3</sup>

Phantom section: Center Section

Measurement Standard: DASYS5

DASY5 Configuration:

- Probe: ES3DV3 - SN3326; ConvF(6.04, 6.04, 6.04); Calibrated: 9/2/2013;
- Sensor-Surface: 4mm (Mechanical Surface Detection (Locations From Previous Scan Used)), Sensor-Surface: 4mm (Mechanical Surface Detection),  $z = 2.0, 32.0$
- Electronics: DAE4 Sn1387; Calibrated: 8/28/2013
- Phantom: Triple Flat Phantom 5.1C; Type: QD 000 P51 CA; Serial: xxxx
- DASYS52 52.8.7(1137); SEMCAD X 14.6.10(7164)

**MSL835 - 10mm/Rear Middle/Area Scan (131x71x1):** Interpolated grid:  $dx=1.500$  mm,  $dy=1.500$  mm

Maximum value of SAR (interpolated) = 0.654 W/kg

**MSL835 - 10mm/Rear Middle/Zoom Scan (5x5x7)/Cube 0:** Measurement grid:

$dx=7.5$ mm,  $dy=7.5$ mm,  $dz=5$ mm

Reference Value = 25.816 V/m; Power Drift = 0.01 dB

Peak SAR (extrapolated) = 0.789 W/kg

**SAR(1 g) = 0.620 W/kg; SAR(10 g) = 0.470 W/kg**

Maximum value of SAR (measured) = 0.651 W/kg

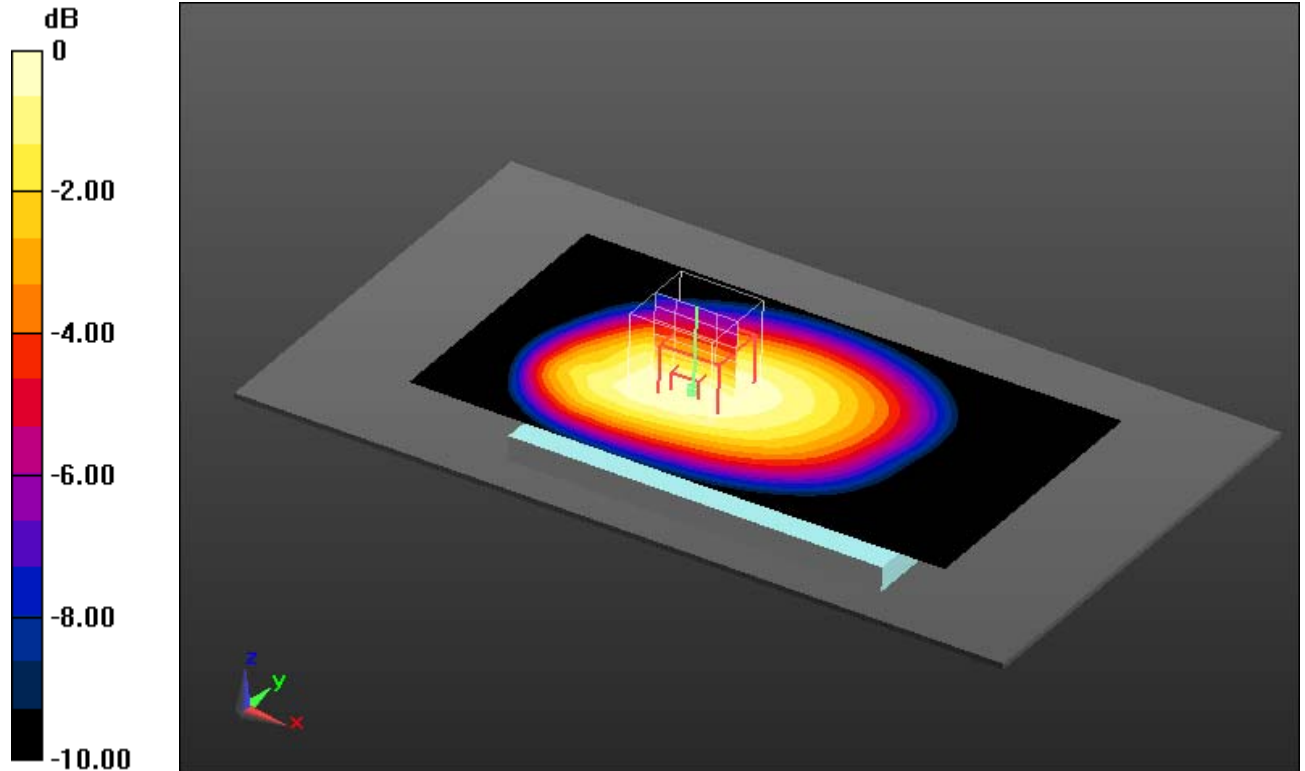

0 dB = 0.651 W/kg = -1.86 dBW/kg

**Additional information:**

position or distance of DUT to SAM: 10

ambient temperature: 23.4°C; liquid temperature: 22.3°C

Date/Time: 5/8/2014 1:58:20 PM

**FCC\_EN62209-2 UMTS FDD V body worn**

**DUT: Sony; Type: PY7PM-0751; Serial: CB5126Z4RE**

Communication System: UID 0, UMTS FDD (0); Communication System Band: UMTS FDD V; Frequency: 846.6 MHz; Communication System PAR: 0 dB; PMF: 1

Medium parameters used:  $f = 847 \text{ MHz}$ ;  $\sigma = 1.017 \text{ S/m}$ ;  $\epsilon_r = 54.721$ ;  $\rho = 1000 \text{ kg/m}^3$

Phantom section: Center Section

Measurement Standard: DASYS5

DASY5 Configuration:

- Probe: ES3DV3 - SN3326; ConvF(6.04, 6.04, 6.04); Calibrated: 9/2/2013;
- Sensor-Surface: 4mm (Mechanical Surface Detection (Locations From Previous Scan Used)), Sensor-Surface: 4mm (Mechanical Surface Detection),  $z = 2.0, 32.0$
- Electronics: DAE4 Sn1387; Calibrated: 8/28/2013
- Phantom: Triple Flat Phantom 5.1C; Type: QD 000 P51 CA; Serial: xxxx
- DASYS52 52.8.7(1137); SEMCAD X 14.6.10(7164)

**MSL835 - 15mm/Rear High/Area Scan (131x71x1):** Interpolated grid:  $dx=1.500 \text{ mm}$ ,  $dy=1.500 \text{ mm}$

Maximum value of SAR (interpolated) = 0.453 W/kg

**MSL835 - 15mm/Rear High/Zoom Scan (5x5x7)/Cube 0:** Measurement grid:

$dx=7.5\text{mm}$ ,  $dy=7.5\text{mm}$ ,  $dz=5\text{mm}$

Reference Value = 21.105 V/m; Power Drift = 0.02 dB

Peak SAR (extrapolated) = 0.530 W/kg

**SAR(1 g) = 0.428 W/kg; SAR(10 g) = 0.323 W/kg**

Maximum value of SAR (measured) = 0.450 W/kg

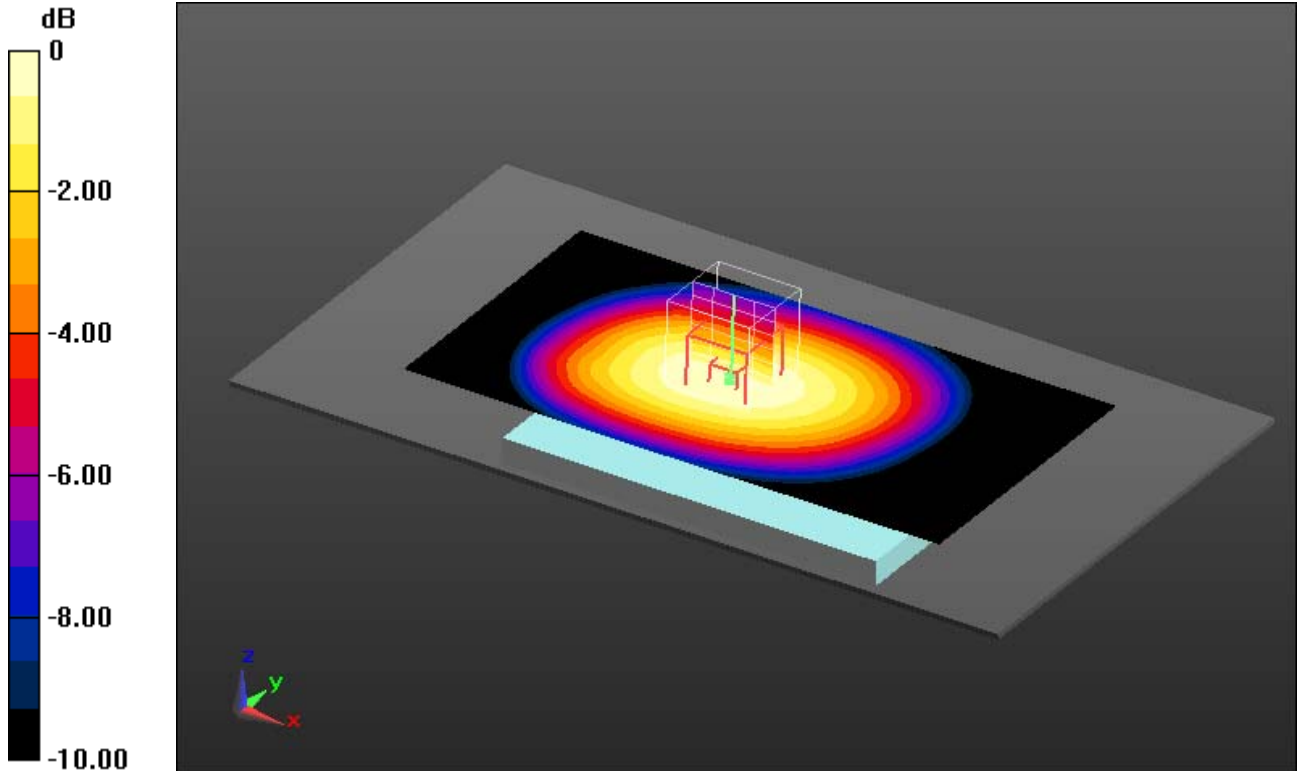

0 dB = 0.450 W/kg = -3.47 dBW/kg

**Additional information:**

position or distance of DUT to SAM: 15mm

ambient temperature: 23.3°C; liquid temperature: 22.3°C

## Annex B.5: LTE FDD 2

Date/Time: 13.05.2014 15:55:54

### IEEE1528-LTE FDD2 head

**DUT: Sony; Type: PY7PM-0751; Serial: CB5126Z4RN**

Communication System: UID 0, LTE FDD (0); Communication System Band: LTE 2 (1900MHz); Frequency: 1880 MHz; Communication System PAR: 0 dB; PMF: 1

Medium parameters used:  $f = 1880$  MHz;  $\sigma = 1.35$  S/m;  $\epsilon_r = 39.776$ ;  $\rho = 1000$  kg/m<sup>3</sup>

Phantom section: Left Section

Measurement Standard: DASYS5

DASY5 Configuration:

- Probe: ET3DV6 - SN1558; ConvF(4.75, 4.75, 4.75); Calibrated: 22.08.2013;
- Sensor-Surface: 4mm (Mechanical Surface Detection (Locations From Previous Scan Used)), Sensor-Surface: 4mm (Mechanical Surface Detection),  $z = 2.7, 32.7$
- Electronics: DAE3 Sn408; Calibrated: 30.09.2013
- Phantom: SAM front; Type: QD000P40CC; Serial: TP-1042
- DASY52 52.8.7(1137); SEMCAD X 14.6.10(7164)

### Left-Hand-Side HSL - QPSK - 20MHz BW - 1RB/Touch Position - Mid 0RB offset/Area Scan (71x121x1):

Interpolated grid:  $dx=1.500$  mm,  $dy=1.500$  mm

Maximum value of SAR (interpolated) = 0.405 W/kg

### Left-Hand-Side HSL - QPSK - 20MHz BW - 1RB/Touch Position - Mid 0RB offset/Zoom Scan (5x6x7)/Cube 0:

Measurement grid:  $dx=7.5$ mm,  $dy=7.5$ mm,  $dz=5$ mm

Reference Value = 17.645 V/m; Power Drift = 0.06 dB

Peak SAR (extrapolated) = 0.544 W/kg

**SAR(1 g) = 0.368 W/kg; SAR(10 g) = 0.232 W/kg**

Maximum value of SAR (measured) = 0.400 W/kg

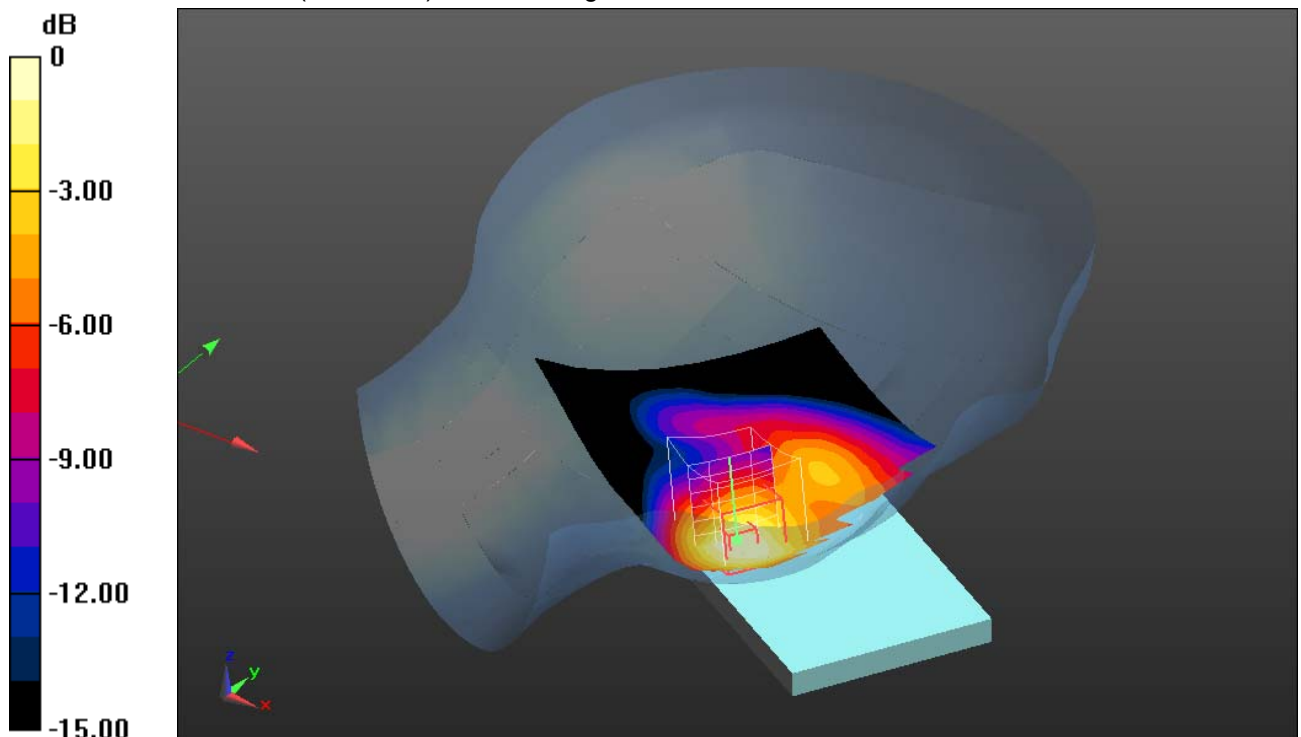

0 dB = 0.400 W/kg = -3.98 dBW/kg

#### Additional information:

ambient temperature: 23.3°C; liquid temperature: 22.9°C

Date/Time: 5/21/2014 1:47:18 PM

### FCC\_EN62209-2 LTE FDD 2 hotspot

**DUT: Sony; Type: PY7PM-0751; Serial: CB5126Z4R3**

Communication System: UID 0, LTE FDD (0); Communication System Band: LTE 2 (1900MHz); Frequency: 1900 MHz; Communication System PAR: 0 dB; PMF: 1

Medium parameters used:  $f = 1900$  MHz;  $\sigma = 1.594$  S/m;  $\epsilon_r = 54.063$ ;  $\rho = 1000$  kg/m<sup>3</sup>

Phantom section: Center Section

Measurement Standard: DASYS5

DASY5 Configuration:

- Probe: ES3DV3 - SN3326; ConvF(4.65, 4.65, 4.65); Calibrated: 9/2/2013;
- Sensor-Surface: 4mm (Mechanical Surface Detection (Locations From Previous Scan Used)), Sensor-Surface: 4mm (Mechanical Surface Detection),  $z = 2.0, 32.0$
- Electronics: DAE4 Sn1387; Calibrated: 8/28/2013
- Phantom: Triple Flat Phantom 5.1C; Type: QD 000 P51 CA
- DASY52 52.8.7(1137); SEMCAD X 14.6.10(7164)

### MSL1900 - 10mm - QPSK - 20MHz BW - 1RB/Bottom High 99RB offset/Area

**Scan (71x71x1):** Interpolated grid:  $dx=1.500$  mm,  $dy=1.500$  mm

Maximum value of SAR (interpolated) = 1.06 W/kg

### MSL1900 - 10mm - QPSK - 20MHz BW - 1RB/Bottom High 99RB

**offset/Zoom Scan (5x5x7)/Cube 0:** Measurement grid:  $dx=7.5$ mm,  $dy=7.5$ mm,  $dz=5$ mm

Reference Value = 23.745 V/m; Power Drift = -0.07 dB

Peak SAR (extrapolated) = 1.79 W/kg

**SAR(1 g) = 1.04 W/kg; SAR(10 g) = 0.555 W/kg**

Maximum value of SAR (measured) = 1.19 W/kg

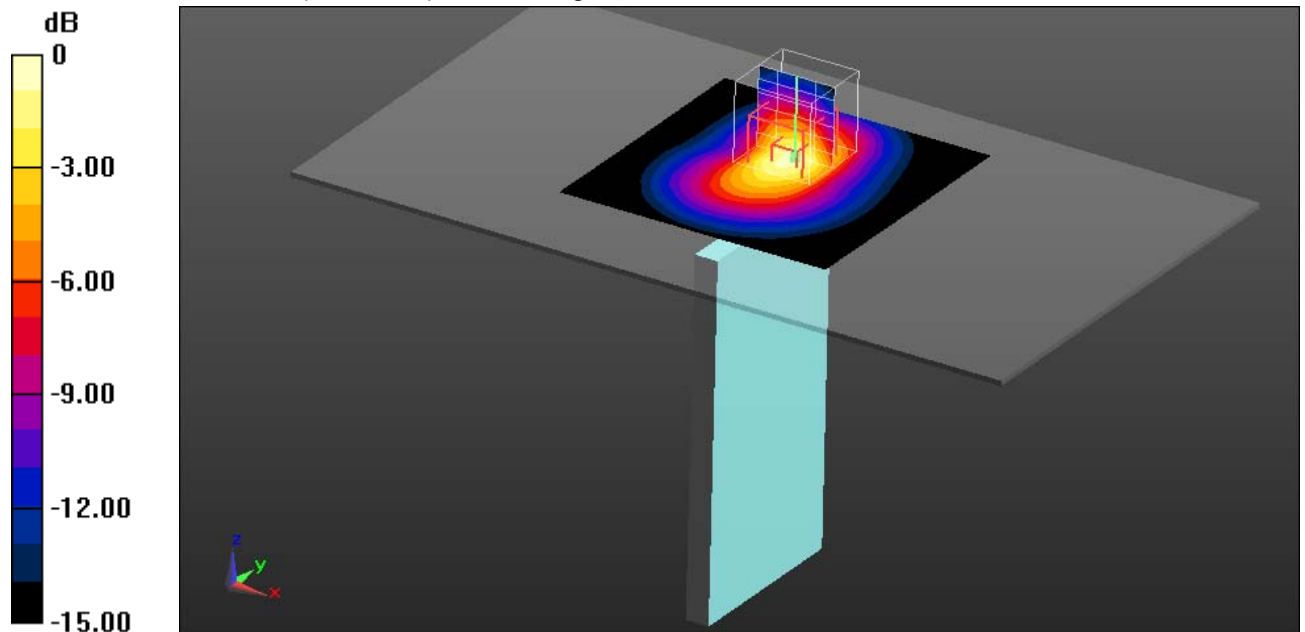

0 dB = 1.19 W/kg = 0.76 dBW/kg

**Additional information:**

position or distance of DUT to SAM: 10mm

ambient temperature: 23.8°C; liquid temperature: 23.1°C

Date/Time: 5/22/2014 2:42:20 PM

## FCC\_EN62209-2 LTE FDD 2 body worn

**DUT: Sony; Type: PY7PM-0751; Serial: CB5126Z4R3**

Communication System: UID 0, LTE FDD (0); Communication System Band: LTE 2 (1900MHz); Frequency: 1880 MHz; Communication System PAR: 0 dB; PMF: 1

Medium parameters used:  $f = 1880$  MHz;  $\sigma = 1.559$  S/m;  $\epsilon_r = 54.079$ ;  $\rho = 1000$  kg/m<sup>3</sup>

Phantom section: Center Section

Measurement Standard: DASYS5

DASY5 Configuration:

- Probe: ES3DV3 - SN3326; ConvF(4.65, 4.65, 4.65); Calibrated: 9/2/2013;
- Sensor-Surface: 4mm (Mechanical Surface Detection (Locations From Previous Scan Used)), Sensor-Surface: 4mm (Mechanical Surface Detection),  $z = 2.0, 32.0$
- Electronics: DAE4 Sn1387; Calibrated: 8/28/2013
- Phantom: Triple Flat Phantom 5.1C; Type: QD 000 P51 CA
- DASY52 52.8.7(1137); SEMCAD X 14.6.10(7164)

## MSL1900 - 15mm - QPSK - 20MHz BW - 1RB/Front Middle 0RB offset/Area

**Scan (131x71x1):** Interpolated grid:  $dx=1.500$  mm,  $dy=1.500$  mm

Maximum value of SAR (interpolated) = 0.558 W/kg

## MSL1900 - 15mm - QPSK - 20MHz BW - 1RB/Front Middle 0RB offset/Zoom

**Scan (5x5x7)/Cube 0:** Measurement grid:  $dx=7.5$ mm,  $dy=7.5$ mm,  $dz=5$ mm

Reference Value = 19.127 V/m; Power Drift = 0.04 dB

Peak SAR (extrapolated) = 0.775 W/kg

**SAR(1 g) = 0.495 W/kg; SAR(10 g) = 0.295 W/kg**

Maximum value of SAR (measured) = 0.546 W/kg

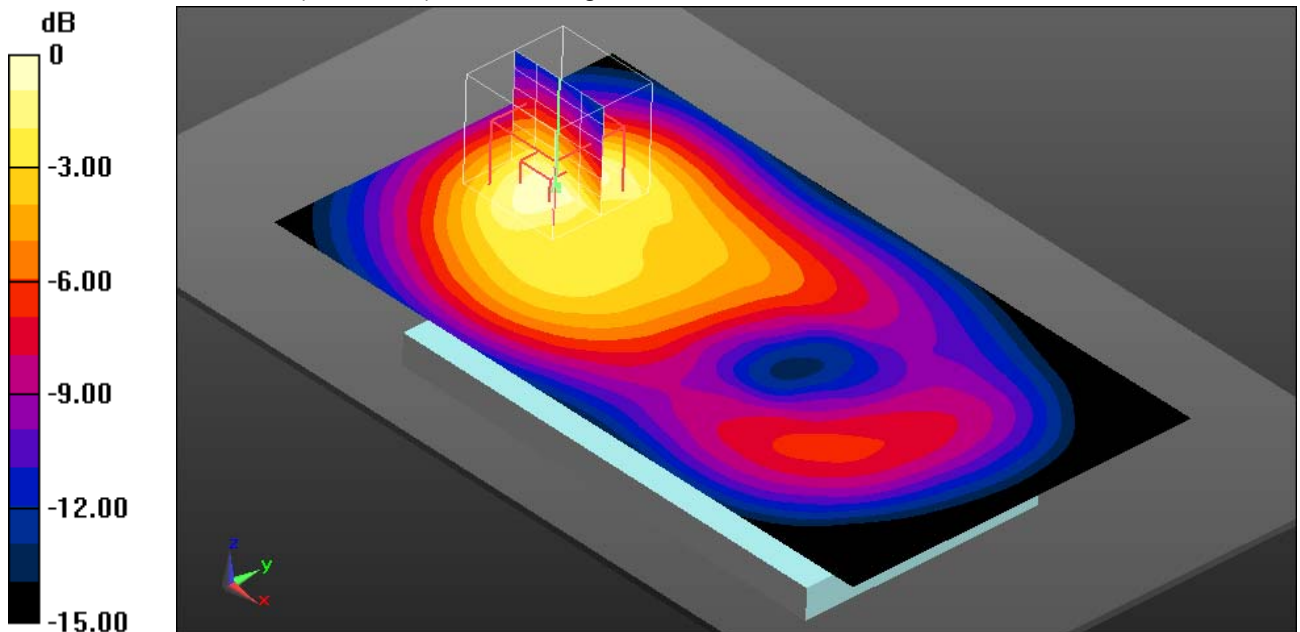

0 dB = 0.546 W/kg = -2.63 dBW/kg

### Additional information:

position or distance of DUT to SAM: 15mm

ambient temperature: 22.8°C; liquid temperature: 22.2°C

Date/Time: 5/22/2014 2:59:11 PM

**FCC\_EN62209-2 LTE FDD 2 body worn**

**DUT: Sony; Type: PY7PM-0751; Serial: CB5126Z4R3**

Communication System: UID 0, LTE FDD (0); Communication System Band: LTE 2 (1900MHz); Frequency: 1900 MHz; Communication System PAR: 0 dB; PMF: 1

Medium parameters used:  $f = 1900$  MHz;  $\sigma = 1.594$  S/m;  $\epsilon_r = 54.063$ ;  $\rho = 1000$  kg/m<sup>3</sup>

Phantom section: Center Section

Measurement Standard: DASYS5

DASY5 Configuration:

- Probe: ES3DV3 - SN3326; ConvF(4.65, 4.65, 4.65); Calibrated: 9/2/2013;
- Sensor-Surface: 4mm (Mechanical Surface Detection (Locations From Previous Scan Used)), Sensor-Surface: 4mm (Mechanical Surface Detection),  $z = 2.0, 32.0$
- Electronics: DAE4 Sn1387; Calibrated: 8/28/2013
- Phantom: Triple Flat Phantom 5.1C; Type: QD 000 P51 CA; Serial: xxxx
- DASY52 52.8.7(1137); SEMCAD X 14.6.10(7164)

**MSL1900 - 15mm - QPSK - 20MHz BW - 1RB/Front High 99RB offset/Area**

**Scan (131x71x1):** Interpolated grid:  $dx=1.500$  mm,  $dy=1.500$  mm

Maximum value of SAR (interpolated) = 0.590 W/kg

**MSL1900 - 15mm - QPSK - 20MHz BW - 1RB/Front High 99RB offset/Zoom**

**Scan (5x5x7)/Cube 0:** Measurement grid:  $dx=7.5$ mm,  $dy=7.5$ mm,  $dz=5$ mm

Reference Value = 19.453 V/m; Power Drift = 0.04 dB

Peak SAR (extrapolated) = 0.829 W/kg

**SAR(1 g) = 0.521 W/kg; SAR(10 g) = 0.307 W/kg**

Maximum value of SAR (measured) = 0.573 W/kg

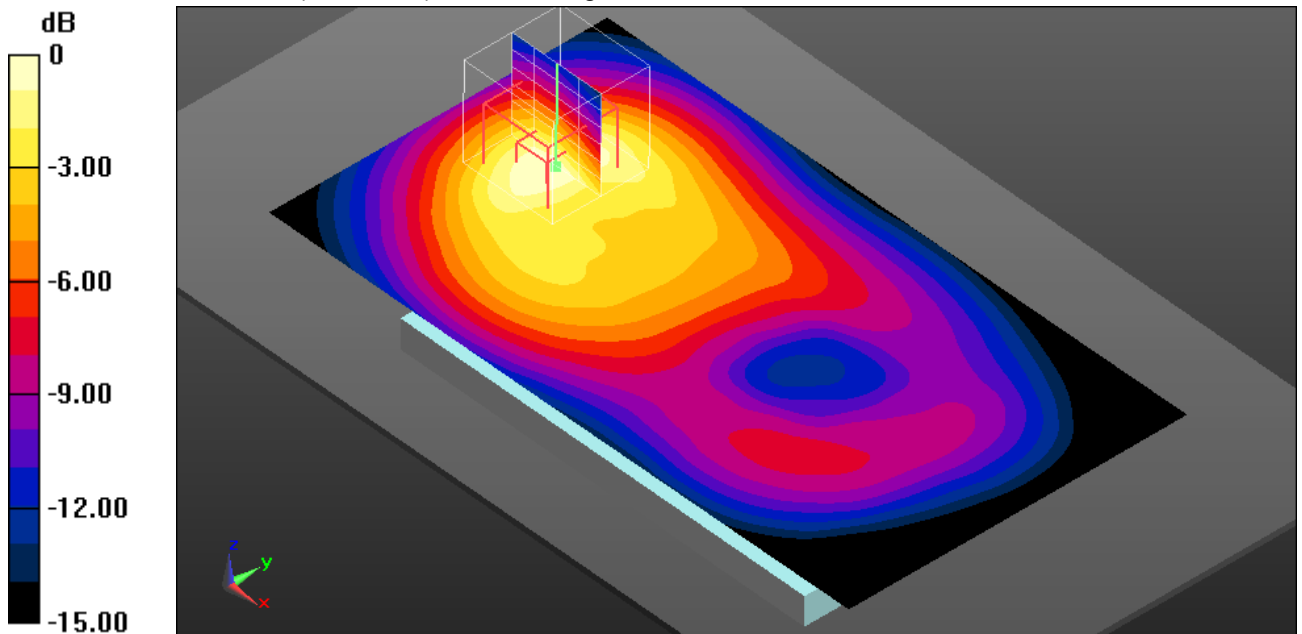

0 dB = 0.573 W/kg = -2.42 dBW/kg

**Additional information:**

position or distance of DUT to SAM: 15mm

ambient temperature: 22.8°C; liquid temperature: 22.2°C

**Annex B.6: LTE FDD 5**

Date/Time: 5/14/2014 2:24:44 PM

**IEEE1528-LTE FDD5 head**

**DUT: Sony; Type: PY7PM-0751; Serial: CB5126Z4RN**

Communication System: UID 0, LTE FDD (0); Communication System Band: LTE 5 (850MHz); Frequency: 836.5 MHz; Communication System PAR: 0 dB; PMF: 1

Medium parameters used (interpolated):  $f = 836.5 \text{ MHz}$ ;  $\sigma = 0.912 \text{ S/m}$ ;  $\epsilon_r = 41.388$ ;  $\rho = 1000 \text{ kg/m}^3$

Phantom section: Left Section

Measurement Standard: DASYS

DASY5 Configuration:

- Probe: ES3DV3 - SN3326; ConvF(6.25, 6.25, 6.25); Calibrated: 9/2/2013;
- Sensor-Surface: 4mm (Mechanical Surface Detection (Locations From Previous Scan Used)), Sensor-Surface: 4mm (Mechanical Surface Detection),  $z = 2.0, 32.0$
- Electronics: DAE4 Sn1387; Calibrated: 8/28/2013
- Phantom: SAM front; Type: QD000P40CC; Serial: TP:1041
- DASY52 52.8.7(1137); SEMCAD X 14.6.10(7164)

**Left-Hand-Side HSL - 10MHz BW - QPSK - 1RB/Touch Position - Mid 49RB offset/Area Scan (71x121x1):** Interpolated grid:  $dx=1.500 \text{ mm}$ ,  $dy=1.500 \text{ mm}$

Maximum value of SAR (interpolated) = 0.422 W/kg

**Left-Hand-Side HSL - 10MHz BW - QPSK - 1RB/Touch Position - Mid 49RB offset/Zoom Scan (5x5x7)/Cube 0:** Measurement grid:  $dx=7.5\text{mm}$ ,  $dy=7.5\text{mm}$ ,  $dz=5\text{mm}$

Reference Value = 21.355 V/m; Power Drift = 0.01 dB

Peak SAR (extrapolated) = 0.480 W/kg

**SAR(1 g) = 0.395 W/kg; SAR(10 g) = 0.305 W/kg**

Maximum value of SAR (measured) = 0.414 W/kg

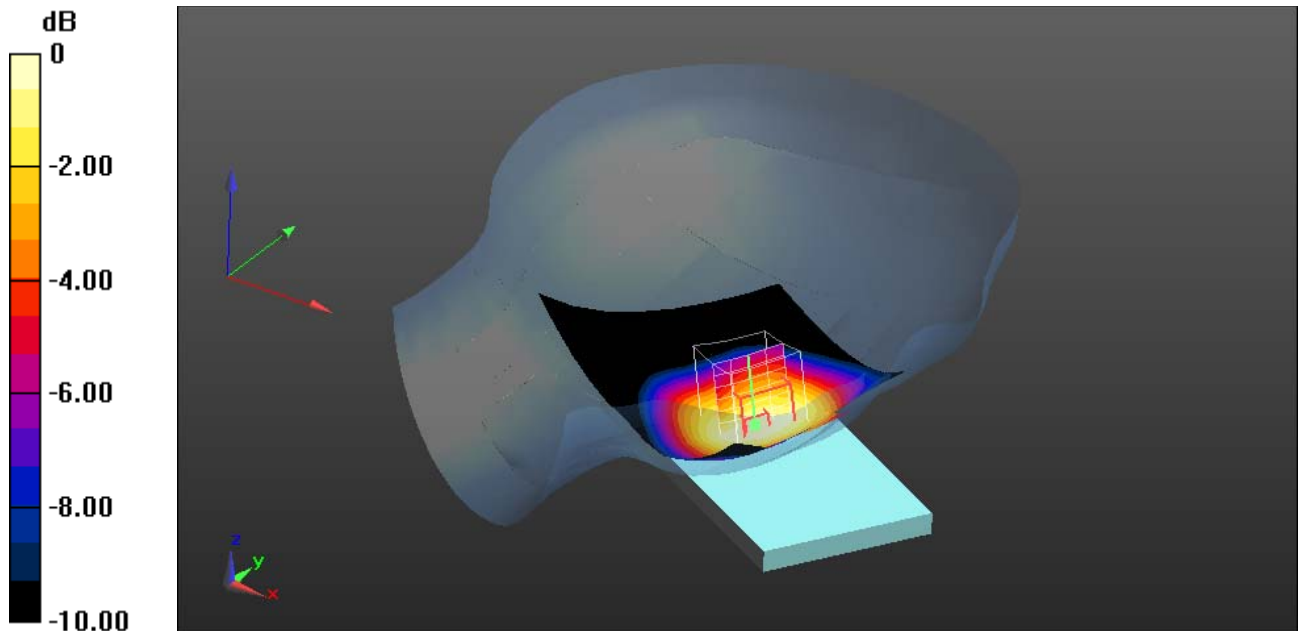

0 dB = 0.414 W/kg = -3.83 dBW/kg

**Additional information:**

ambient temperature: 23.1°C; liquid temperature: 22.3°C

Date/Time: 5/15/2014 11:00:07 AM

### FCC\_EN62209-2 LTE FDD 5 hotspot

**DUT: Sony; Type: PY7PM-0751; Serial: CB5126Z4RN**

Communication System: UID 0, LTE FDD (0); Communication System Band: LTE 5 (850MHz); Frequency: 836.5 MHz; Communication System PAR: 0 dB; PMF: 1

Medium parameters used (interpolated):  $f = 836.5$  MHz;  $\sigma = 0.967$  S/m;  $\epsilon_r = 53.411$ ;  $\rho = 1000$  kg/m<sup>3</sup>

Phantom section: Center Section

Measurement Standard: DASYS5

DASY5 Configuration:

- Probe: ES3DV3 - SN3326; ConvF(6.04, 6.04, 6.04); Calibrated: 9/2/2013;
- Sensor-Surface: 4mm (Mechanical Surface Detection (Locations From Previous Scan Used)), Sensor-Surface: 4mm (Mechanical Surface Detection),  $z = 2.0, 32.0$
- Electronics: DAE4 Sn1387; Calibrated: 8/28/2013
- Phantom: Triple Flat Phantom 5.1C; Type: QD 000 P51 CA; Serial: 5411
- DASY52 52.8.7(1137); SEMCAD X 14.6.10(7164)

### MSL850-10mm - QPSK - 10MHz BW - 1RB/Rear Middle 49RB offset/Area

**Scan (131x71x1):** Interpolated grid:  $dx=1.500$  mm,  $dy=1.500$  mm

Maximum value of SAR (interpolated) = 0.590 W/kg

### MSL850-10mm - QPSK - 10MHz BW - 1RB/Rear Middle 49RB offset/Zoom

**Scan (5x5x7)/Cube 0:** Measurement grid:  $dx=7.5$ mm,  $dy=7.5$ mm,  $dz=5$ mm

Reference Value = 24.877 V/m; Power Drift = 0.04 dB

Peak SAR (extrapolated) = 0.687 W/kg

**SAR(1 g) = 0.561 W/kg; SAR(10 g) = 0.428 W/kg**

Maximum value of SAR (measured) = 0.589 W/kg

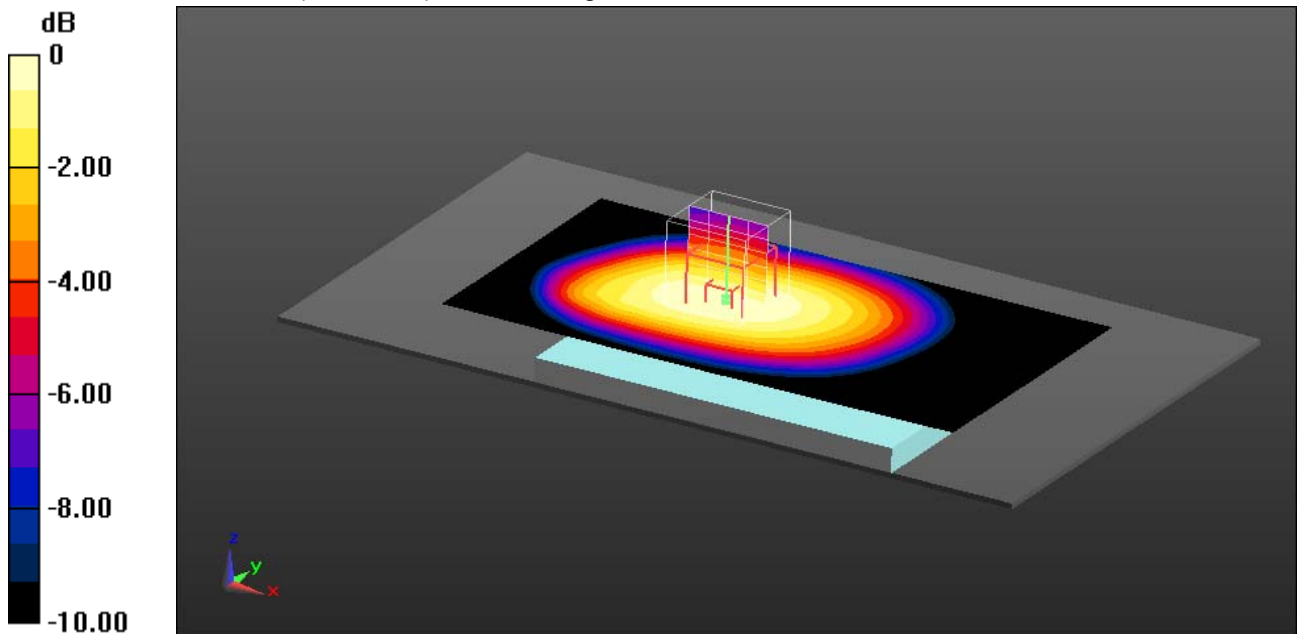

0 dB = 0.589 W/kg = -2.30 dBW/kg

**Additional information:**

position or distance of DUT to SAM: 10mm

ambient temperature: 23.3°C; liquid temperature: 22.7°C



Date/Time: 5/16/2014 10:37:54 AM

### FCC-LTE FDD 5 body worn

**DUT: Sony; Type: PY7PM-0751; Serial: CB5126Z4RN**

Communication System: UID 0, LTE FDD (0); Communication System Band: LTE 5 (850MHz); Frequency: 836.5 MHz; Communication System PAR: 0 dB; PMF: 1

Medium parameters used (interpolated):  $f = 836.5$  MHz;  $\sigma = 1.01$  S/m;  $\epsilon_r = 54.827$ ;  $\rho = 1000$  kg/m<sup>3</sup>

Phantom section: Center Section

Measurement Standard: DASY5

DASY5 Configuration:

- Probe: ES3DV3 - SN3326; ConvF(6.04, 6.04, 6.04); Calibrated: 9/2/2013;
- Sensor-Surface: 4mm (Mechanical Surface Detection (Locations From Previous Scan Used)), Sensor-Surface: 4mm (Mechanical Surface Detection),  $z = 2.0, 32.0$
- Electronics: DAE4 Sn1387; Calibrated: 8/28/2013
- Phantom: Triple Flat Phantom 5.1C; Type: QD 000 P51 CA; Serial: 5411
- DASY52 52.8.7(1137); SEMCAD X 14.6.10(7164)

### MSL850-15mm - QPSK - 10MHz BW - 1RB/Rear Middle 49RB offset/Area

**Scan (131x71x1):** Interpolated grid:  $dx=1.500$  mm,  $dy=1.500$  mm

Maximum value of SAR (interpolated) = 0.473 W/kg

### MSL850-15mm - QPSK - 10MHz BW - 1RB/Rear Middle 49RB offset/Zoom

**Scan (5x5x7)/Cube 0:** Measurement grid:  $dx=7.5$ mm,  $dy=7.5$ mm,  $dz=5$ mm

Reference Value = 21.604 V/m; Power Drift = 0.03 dB

Peak SAR (extrapolated) = 0.553 W/kg

**SAR(1 g) = 0.449 W/kg; SAR(10 g) = 0.340 W/kg**

Maximum value of SAR (measured) = 0.472 W/kg

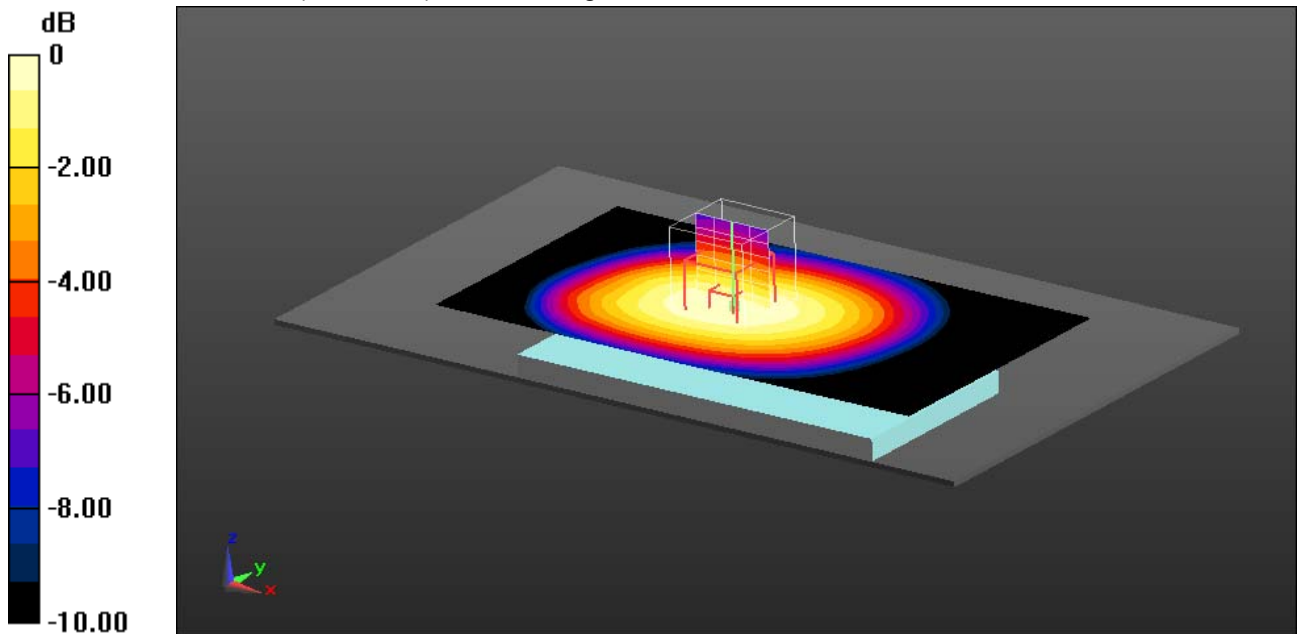

0 dB = 0.472 W/kg = -3.26 dBW/kg

**Additional information:**

position or distance of DUT to SAM: 15mm

ambient temperature: 23.3°C; liquid temperature: 22.6°C

## Annex B.7: LTE FDD 7

Date/Time: 16.05.2014 19:49:45

### IEEE1528\_EN62209-LTE FDD 7 head

**DUT: Sony; Type: PY7PM-0751; Serial: CB5126Z4RN**

Communication System: UID 0, LTE FDD (0); Communication System Band: LTE 7 (2600MHz); Frequency: 2535 MHz; Communication System PAR: 0 dB; PMF: 1

Medium parameters used:  $f = 2535$  MHz;  $\sigma = 1.853$  S/m;  $\epsilon_r = 38.568$ ;  $\rho = 1000$  kg/m<sup>3</sup>

Phantom section: Left Section

Measurement Standard: DASYS5

DASY5 Configuration:

- Probe: EX3DV4 - SN3944; ConvF(7.43, 7.43, 7.43); Calibrated: 02.08.2013;
- Sensor-Surface: 2mm (Mechanical Surface Detection),  $z = 1.0, 31.0$
- Electronics: DAE3 Sn408; Calibrated: 30.09.2013
- Phantom: SAM; Type: QD000P40C; Serial: TP1150
- DASY52 52.8.7(1137); SEMCAD X 14.6.10(7164)

**Left-Hand-Side HSL QPSK - 20MHz BW - 1RB/Touch Position - Middle - 99RB offset/Area Scan (111x171x1):** Interpolated grid:  $dx=1.000$  mm,  $dy=1.000$  mm  
Maximum value of SAR (interpolated) = 0.294 W/kg

**Left-Hand-Side HSL QPSK - 20MHz BW - 1RB/Touch Position - Middle - 99RB offset/Zoom Scan (7x7x7)/Cube 0:** Measurement grid:  $dx=5$ mm,  $dy=5$ mm,  $dz=5$ mm  
Reference Value = 12.356 V/m; Power Drift = 0.12 dB  
Peak SAR (extrapolated) = 0.364 W/kg  
**SAR(1 g) = 0.198 W/kg; SAR(10 g) = 0.105 W/kg**  
Maximum value of SAR (measured) = 0.276 W/kg

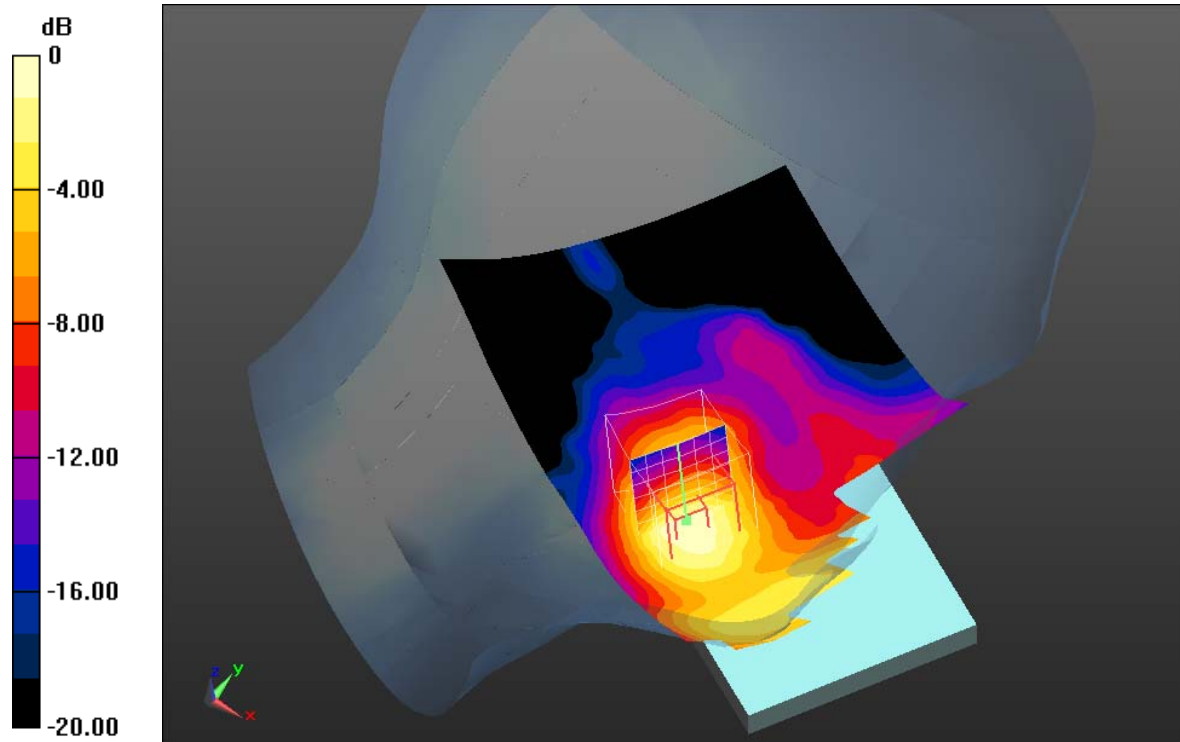

0 dB = 0.276 W/kg = -5.59 dBW/kg

#### Additional information:

ambient temperature: 22.8°C; liquid temperature: 21.5°C

Date/Time: 20.05.2014 13:53:28

## FCC\_EN62209-2 LTE7 hotspot mode

**DUT: Sony; Type: PY7PM-0751; Serial: CB5126Z4RN**

Communication System: UID 0, LTE FDD (0); Communication System Band: LTE 7 (2600MHz); Frequency: 2535 MHz; Communication System PAR: 0 dB; PMF: 1

Medium parameters used:  $f = 2535$  MHz;  $\sigma = 2.095$  S/m;  $\epsilon_r = 51.126$ ;  $\rho = 1000$  kg/m<sup>3</sup>

Phantom section: Center Section

Measurement Standard: DASYS5

DASY5 Configuration:

- Probe: EX3DV4 - SN3944; ConvF(7.27, 7.27, 7.27); Calibrated: 02.08.2013;
- Sensor-Surface: 4mm (Mechanical Surface Detection (Locations From Previous Scan Used)), Sensor-Surface: 2mm (Mechanical Surface Detection),  $z = 1.0, 31.0$
- Electronics: DAE3 Sn477; Calibrated: 14.05.2014
- Phantom: Triple Flat Phantom 5.1C; Type: QD 000 P51 CA; Serial: 1154
- DASY52 52.8.7(1137); SEMCAD X 14.6.10(7164)

## MSL2450 - 20MHz BW - QPSK - 1RB - 10mm - power reduced/Bottom Side

**Mid - 99RB offset/Area Scan (131x131x1):** Interpolated grid:  $dx=1.000$  mm,  $dy=1.000$  mm

Maximum value of SAR (interpolated) = 1.27 W/kg

## MSL2450 - 20MHz BW - QPSK - 1RB - 10mm - power reduced/Bottom Side

**Mid - 99RB offset/Zoom Scan (7x7x7)/Cube 0:** Measurement grid:  $dx=5$ mm,  $dy=5$ mm,  $dz=5$ mm

Reference Value = 28.586 V/m; Power Drift = -0.08 dB

Peak SAR (extrapolated) = 2.22 W/kg

**SAR(1 g) = 1.1 W/kg; SAR(10 g) = 0.511 W/kg**

Maximum value of SAR (measured) = 1.66 W/kg

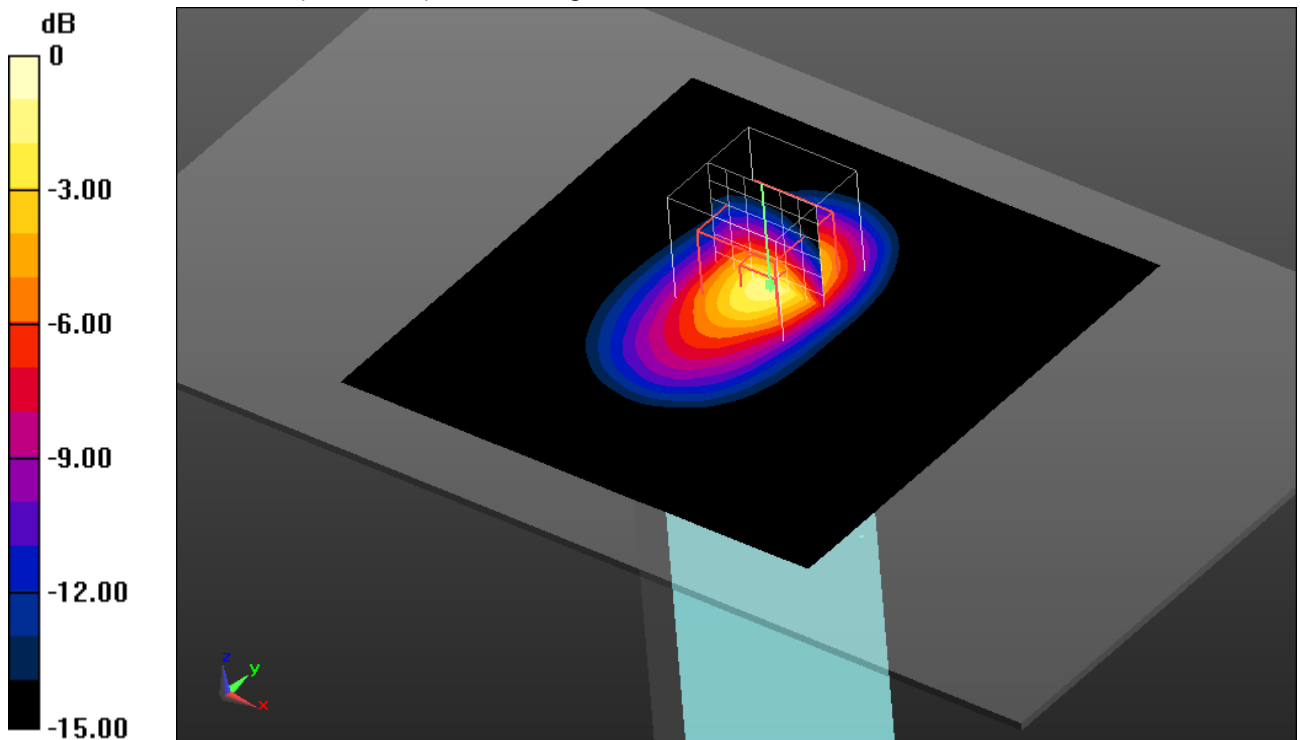

0 dB = 1.66 W/kg = 2.20 dBW/kg

### Additional information:

position or distance of DUT to SAM: 10 mm

ambient temperature: 23.2°C; liquid temperature: 22.3°C

Date/Time: 19.05.2014 16:54:35

### FCC\_EN62209-2 LTE7 body worn

**DUT: Sony; Type: PY7PM-0751; Serial: CB5126Z4RN**

Communication System: UID 0, LTE FDD (0); Communication System Band: LTE 7 (2600MHz); Frequency: 2535 MHz; Communication System PAR: 0 dB; PMF: 1

Medium parameters used:  $f = 2535$  MHz;  $\sigma = 2.095$  S/m;  $\epsilon_r = 51.126$ ;  $\rho = 1000$  kg/m<sup>3</sup>

Phantom section: Center Section

Measurement Standard: DASYS5

DASY5 Configuration:

- Probe: EX3DV4 - SN3944; ConvF(7.27, 7.27, 7.27); Calibrated: 02.08.2013;
- Sensor-Surface: 2mm (Mechanical Surface Detection (Locations From Previous Scan Used)), Sensor-Surface: 2mm (Mechanical Surface Detection),  $z = 1.0, 31.0$
- Electronics: DAE3 Sn477; Calibrated: 14.05.2014
- Phantom: Triple Flat Phantom 5.1C; Type: QD 000 P51 CA; Serial: 1154
- DASY52 52.8.7(1137); SEMCAD X 14.6.10(7164)

### MSL2450 - 20MHz BW - QPSK - 1RB - 15mm/Rear Middle - 99RB offset/Area Scan (111x181x1):

Interpolated grid:  $dx=1.000$  mm,  $dy=1.000$  mm

Maximum value of SAR (interpolated) = 1.70 W/kg

### MSL2450 - 20MHz BW - QPSK - 1RB - 15mm/Rear Middle - 99RB offset/Zoom Scan (7x7x7)/Cube 0:

Measurement grid:  $dx=5$ mm,  $dy=5$ mm,  $dz=5$ mm

Reference Value = 28.466 V/m; Power Drift = -0.03 dB

Peak SAR (extrapolated) = 2.26 W/kg

**SAR(1 g) = 1.18 W/kg; SAR(10 g) = 0.605 W/kg**

Maximum value of SAR (measured) = 1.69 W/kg

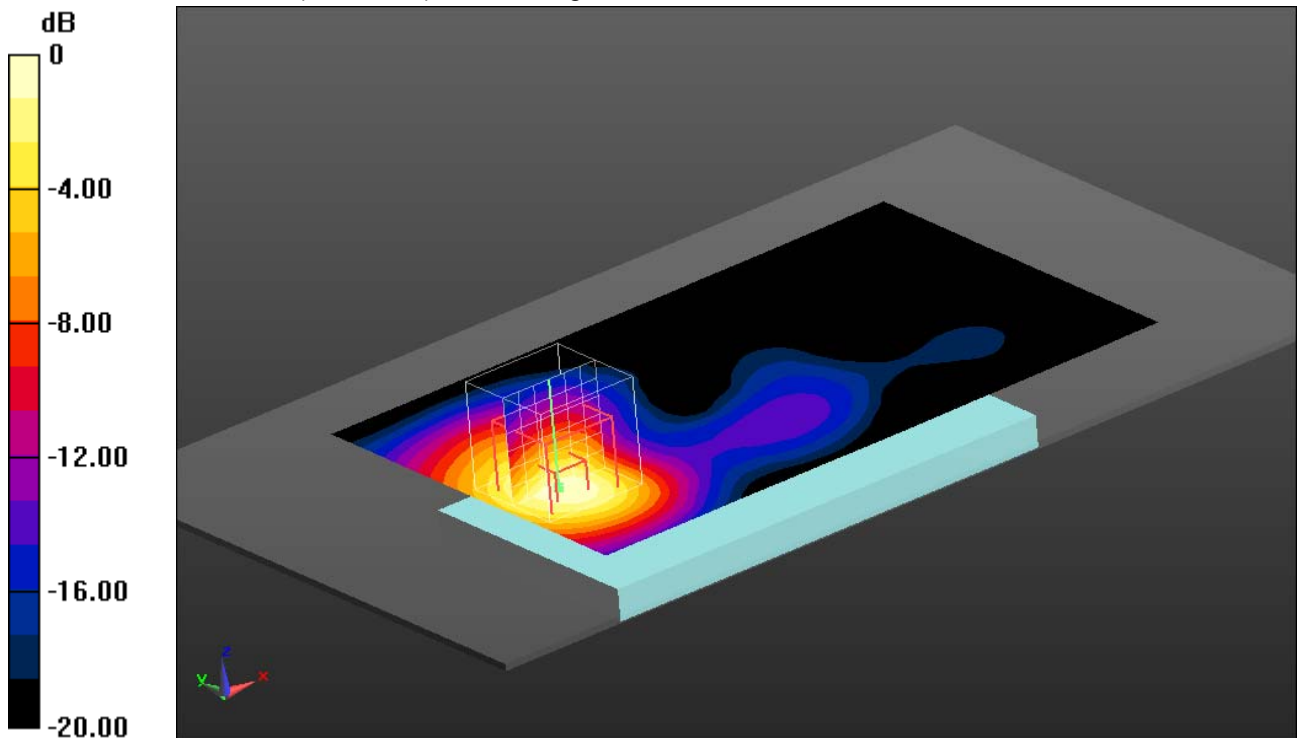

0 dB = 1.69 W/kg = 2.28 dBW/kg

#### Additional information:

position or distance of DUT to SAM: 15mm

ambient temperature: 23.5°C; liquid temperature: 22.8°C

## Annex B.8: WLAN 2450MHz

Date/Time: 16.05.2014 09:32:42

### IEEE1528\_EN62209-WLAN2450 head

DUT: Sony; Type: PY7PM-0751; Serial: CB5126Z4MR

Communication System: UID 0, WLAN 2450 (0); Communication System Band: 2.4 GHz; Frequency: 2437 MHz; Communication System PAR: 0 dB; PMF: 1

Medium parameters used:  $f = 2437$  MHz;  $\sigma = 1.751$  S/m;  $\epsilon_r = 38.855$ ;  $\rho = 1000$  kg/m<sup>3</sup>

Phantom section: Left Section

Measurement Standard: DASYS

DASY5 Configuration:

- Probe: ET3DV6 - SN1558; ConvF(4.18, 4.18, 4.18); Calibrated: 22.08.2013;
- Sensor-Surface: 4mm (Mechanical Surface Detection),  $z = 2.7, 32.7$
- Electronics: DAE3 Sn408; Calibrated: 30.09.2013
- Phantom: SAM; Type: QD000P40C; Serial: TP1150
- DASY52 52.8.7(1137); SEMCAD X 14.6.10(7164)

### Left-Hand-Side HSL/Touch Position - Ch 6/Area Scan (111x171x1): Interpolated

grid:  $dx=1.000$  mm,  $dy=1.000$  mm

Maximum value of SAR (interpolated) = 0.317 W/kg

### Left-Hand-Side HSL/Touch Position - Ch 6/Zoom Scan (7x7x7)/Cube 0:

Measurement grid:  $dx=5$ mm,  $dy=5$ mm,  $dz=5$ mm

Reference Value = 13.257 V/m; Power Drift = -0.12 dB

Peak SAR (extrapolated) = 0.729 W/kg

**SAR(1 g) = 0.300 W/kg; SAR(10 g) = 0.142 W/kg**

Maximum value of SAR (measured) = 0.322 W/kg

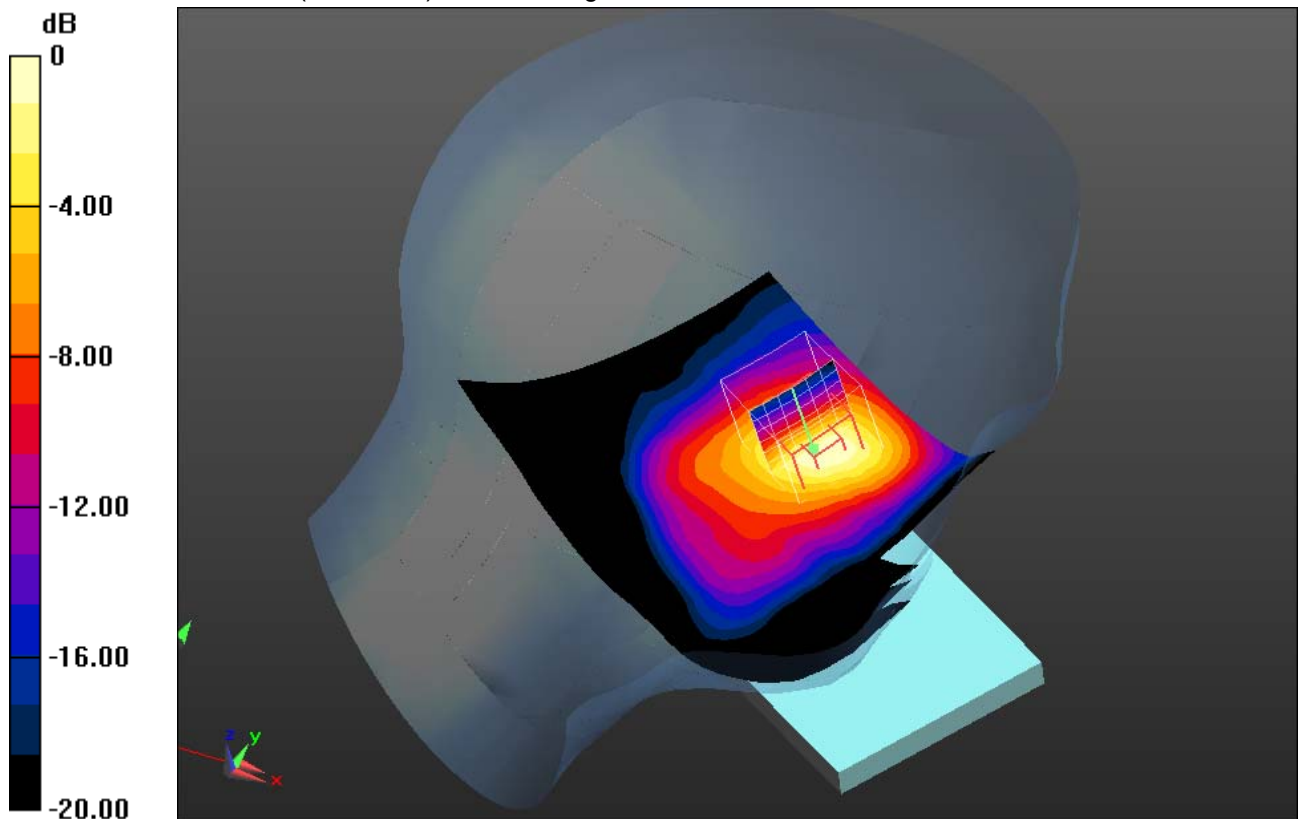

0 dB = 0.322 W/kg = -4.92 dBW/kg

#### Additional information:

ambient temperature: 21.8°C; liquid temperature: 21.5°C

Date/Time: 16.05.2014 16:06:56

### FCC\_EN62209-2 WLAN2450 hotspot

**DUT: Sony; Type: PY7PM-0751; Serial: CB5126Z4MR**

Communication System: UID 0, WLAN 2450 (0); Communication System Band: 2.4 GHz; Frequency: 2437 MHz; Communication System PAR: 0 dB; PMF: 1

Medium parameters used:  $f = 2437$  MHz;  $\sigma = 1.985$  S/m;  $\epsilon_r = 51.282$ ;  $\rho = 1000$  kg/m<sup>3</sup>

Phantom section: Center Section

Measurement Standard: DASYS5

DASY5 Configuration:

- Probe: ET3DV6 - SN1559; ConvF(3.97, 3.97, 3.97); Calibrated: 20.01.2014;
- Sensor-Surface: 4mm (Mechanical Surface Detection (Locations From Previous Scan Used)), Sensor-Surface: 4mm (Mechanical Surface Detection),  $z = 2.7, 32.7$
- Electronics: DAE3 Sn477; Calibrated: 14.05.2014
- Phantom: Triple Flat Phantom 5.1C; Type: QD 000 P51 CA; Serial: 1154
- DASY52 52.8.7(1137); SEMCAD X 14.6.10(7164)

**MSL2450-10mm/Rear Middle/Area Scan (111x181x1):** Interpolated grid:  $dx=1.000$  mm,  $dy=1.000$  mm

Maximum value of SAR (interpolated) = 0.240 W/kg

**MSL2450-10mm/Rear Middle/Zoom Scan (7x7x7)/Cube 0:** Measurement grid:

$dx=5$ mm,  $dy=5$ mm,  $dz=5$ mm

Reference Value = 10.170 V/m; Power Drift = 0.02 dB

Peak SAR (extrapolated) = 0.569 W/kg

**SAR(1 g) = 0.213 W/kg; SAR(10 g) = 0.104 W/kg**

Maximum value of SAR (measured) = 0.228 W/kg

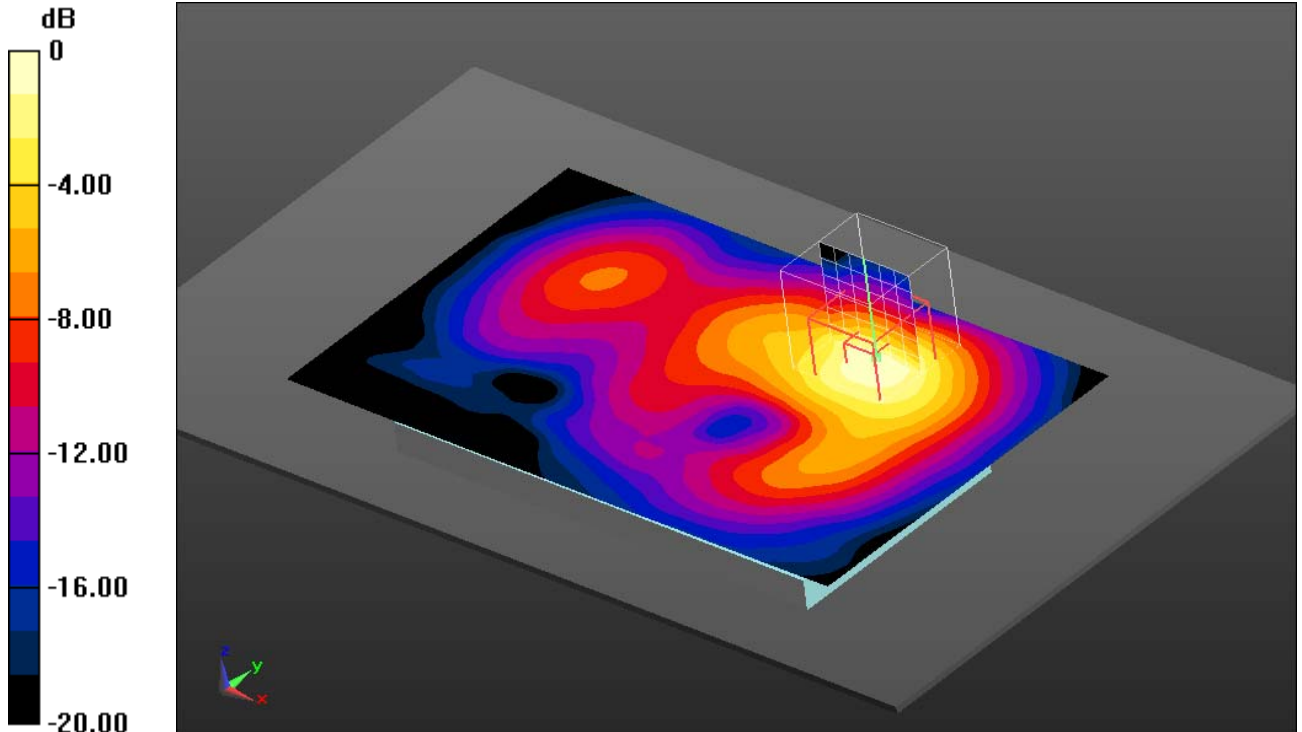

0 dB = 0.228 W/kg = -6.42 dBW/kg

**Additional information:**

position or distance of DUT to SAM: 10 mm

ambient temperature: 23.1°C; liquid temperature: 22.7°C

Date/Time: 16.05.2014 15:46:32

### FCC\_EN62209-2 WLAN2450 body worn

**DUT: Sony; Type: PY7PM-0751; Serial: CB5126Z4MR**

Communication System: UID 0, WLAN 2450 (0); Communication System Band: 2.4 GHz; Frequency: 2437 MHz; Communication System PAR: 0 dB; PMF: 1

Medium parameters used:  $f = 2437$  MHz;  $\sigma = 1.985$  S/m;  $\epsilon_r = 51.282$ ;  $\rho = 1000$  kg/m<sup>3</sup>

Phantom section: Center Section

Measurement Standard: DASYS5

DASY5 Configuration:

- Probe: ET3DV6 - SN1559; ConvF(3.97, 3.97, 3.97); Calibrated: 20.01.2014;
- Sensor-Surface: 4mm (Mechanical Surface Detection (Locations From Previous Scan Used)), Sensor-Surface: 4mm (Mechanical Surface Detection),  $z = 2.7, 32.7$
- Electronics: DAE3 Sn477; Calibrated: 14.05.2014
- Phantom: Triple Flat Phantom 5.1C; Type: QD 000 P51 CA; Serial: 1154
- DASY52 52.8.7(1137); SEMCAD X 14.6.10(7164)

**MSL2450-15mm/Rear Middle/Area Scan (111x181x1):** Interpolated grid:  $dx=1.000$  mm,  $dy=1.000$  mm

Maximum value of SAR (interpolated) = 0.117 W/kg

**MSL2450-15mm/Rear Middle/Zoom Scan (7x7x7)/Cube 0:** Measurement grid:

$dx=5$ mm,  $dy=5$ mm,  $dz=5$ mm

Reference Value = 7.545 V/m; Power Drift = -0.03 dB

Peak SAR (extrapolated) = 0.264 W/kg

**SAR(1 g) = 0.110 W/kg; SAR(10 g) = 0.056 W/kg**

Maximum value of SAR (measured) = 0.116 W/kg

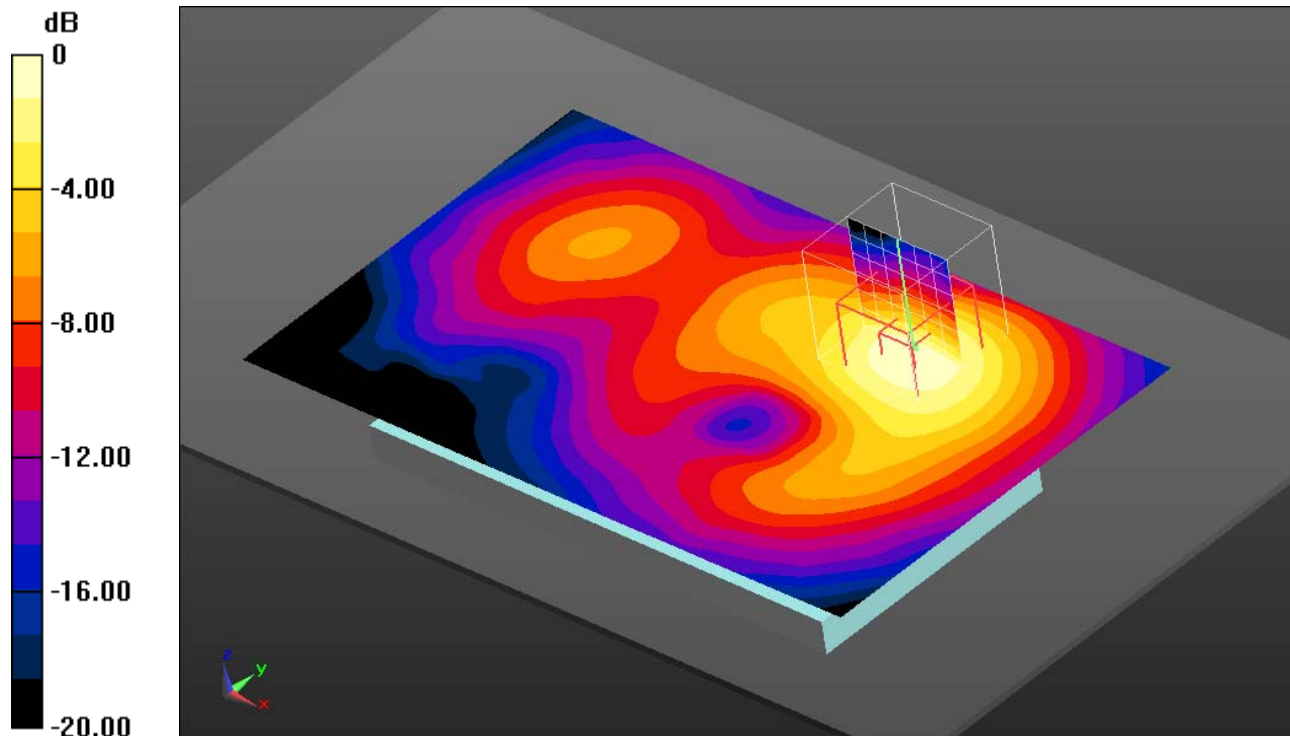

0 dB = 0.116 W/kg = -9.36 dBW/kg

**Additional information:**

position or distance of DUT to SAM: 15 mm

ambient temperature: 23.1°C; liquid temperature: 22.7°C

**Annex B.9: WLAN 5GHz**

Date/Time: 15.05.2014 10:03:25

**IEEE1528\_EN62209-WLAN5GHz head**

**DUT: Sony; Type: PY7PM-0751; Serial: CB5126Z4MR**

Communication System: UID 0, WLAN 5GHz (0); Communication System Band: 5 GHz Band; Frequency: 5260 MHz; Communication System PAR: 0 dB; PMF: 1

Medium parameters used:  $f = 5260$  MHz;  $\sigma = 4.542$  S/m;  $\epsilon_r = 36.112$ ;  $\rho = 1000$  kg/m<sup>3</sup>

Phantom section: Left Section

Measurement Standard: DASYS

DASY5 Configuration:

- Probe: EX3DV4 - SN3944; ConvF(5.22, 5.22, 5.22); Calibrated: 02.08.2013;
- Sensor-Surface: 2mm (Mechanical Surface Detection (Locations From Previous Scan Used)), Sensor-Surface: 2mm (Mechanical Surface Detection),  $z = 1.0, 23.0$
- Electronics: DAE3 Sn408; Calibrated: 30.09.2013
- Phantom: SAM; Type: QD000P40C; Serial: TP1150
- DASY52 52.8.7(1137); SEMCAD X 14.6.10(7164)

**Left-Hand-Side HSL/Touch Position - Ch52/Area Scan (111x171x1):**

Interpolated grid:  $dx=1.000$  mm,  $dy=1.000$  mm

Maximum value of SAR (interpolated) = 0.357 W/kg

**Left-Hand-Side HSL/Touch Position - Ch52/Zoom Scan (8x8x12)/Cube 0:**

Measurement grid:  $dx=4$ mm,  $dy=4$ mm,  $dz=2$ mm

Reference Value = 8.903 V/m; Power Drift = -0.06 dB

Peak SAR (extrapolated) = 0.772 W/kg

**SAR(1 g) = 0.180 W/kg; SAR(10 g) = 0.060 W/kg**

Maximum value of SAR (measured) = 0.342 W/kg

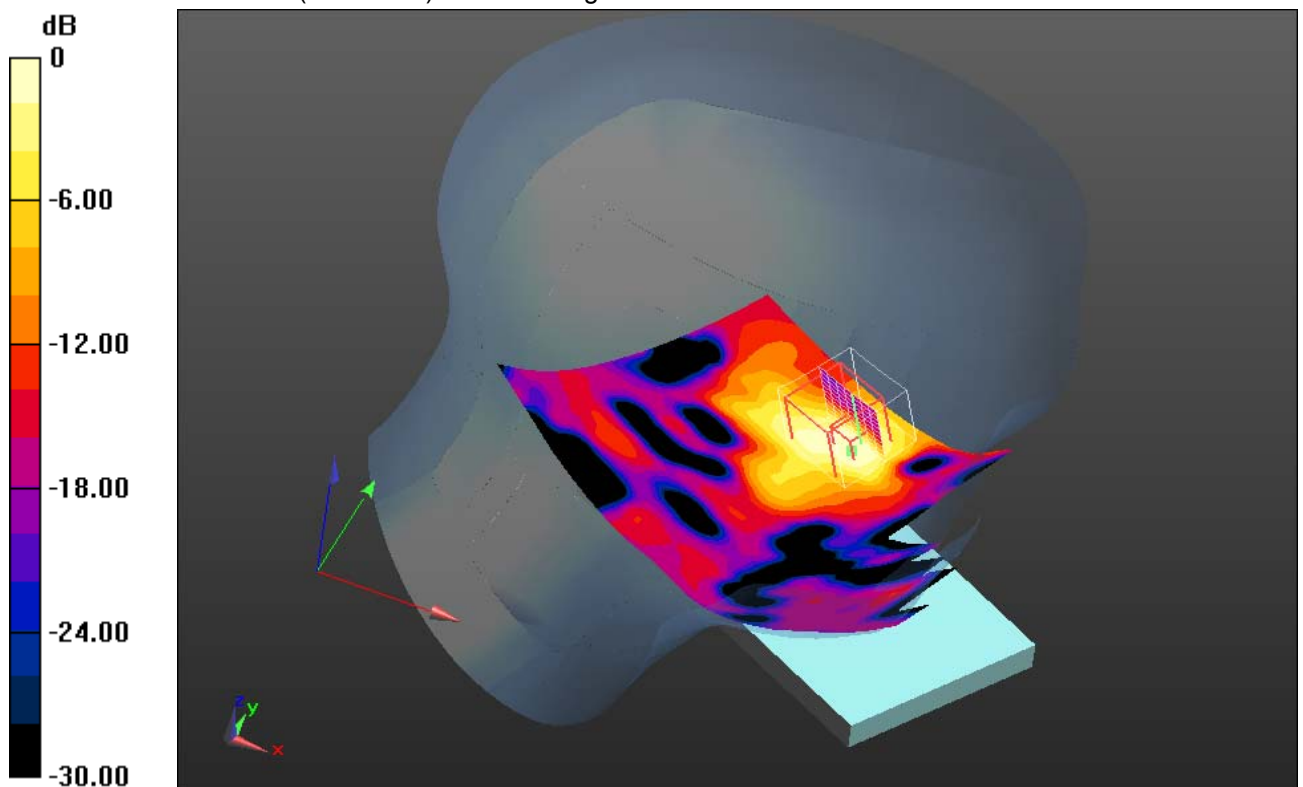

0 dB = 0.342 W/kg = -4.66 dBW/kg

**Additional information:**

ambient temperature: 22.2°C; liquid temperature: 21.9°C



Date/Time: 21.05.2014 16:07:35

### FCC\_EN62209-2 WLAN5GHz body worn

**DUT: Sony; Type: PY7PM-0751; Serial: CB5126Z4MR**

Communication System: UID 0, WLAN 5GHz (0); Communication System Band: 5 GHz Band; Frequency: 5260 MHz; Communication System PAR: 0 dB; PMF: 1

Medium parameters used:  $f = 5260$  MHz;  $\sigma = 5.285$  S/m;  $\epsilon_r = 47.962$ ;  $\rho = 1000$  kg/m<sup>3</sup>

Phantom section: Center Section

Measurement Standard: DASY5

DASY5 Configuration:

- Probe: EX3DV4 - SN3944; ConvF(4.3, 4.3, 4.3); Calibrated: 02.08.2013;
- Sensor-Surface: 2mm (Mechanical Surface Detection (Locations From Previous Scan Used)), Sensor-Surface: 2mm (Mechanical Surface Detection),  $z = 1.0, 23.0$
- Electronics: DAE3 Sn477; Calibrated: 14.05.2014
- Phantom: Triple Flat Phantom 5.1C; Type: QD 000 P51 CA; Serial: 1154
- DASY52 52.8.7(1137); SEMCAD X 14.6.10(7164)

**MSL - 15mm/RearCh52/Area Scan (191x121x1):** Interpolated grid:  $dx=1.000$  mm,  $dy=1.000$  mm

Maximum value of SAR (interpolated) = 0.368 W/kg

**MSL - 15mm/RearCh52/Zoom Scan (8x8x12)/Cube 0:** Measurement grid:  $dx=4$ mm,  $dy=4$ mm,  $dz=2$ mm

Reference Value = 8.668 V/m; Power Drift = -0.10 dB

Peak SAR (extrapolated) = 0.719 W/kg

**SAR(1 g) = 0.204 W/kg; SAR(10 g) = 0.075 W/kg**

Maximum value of SAR (measured) = 0.379 W/kg

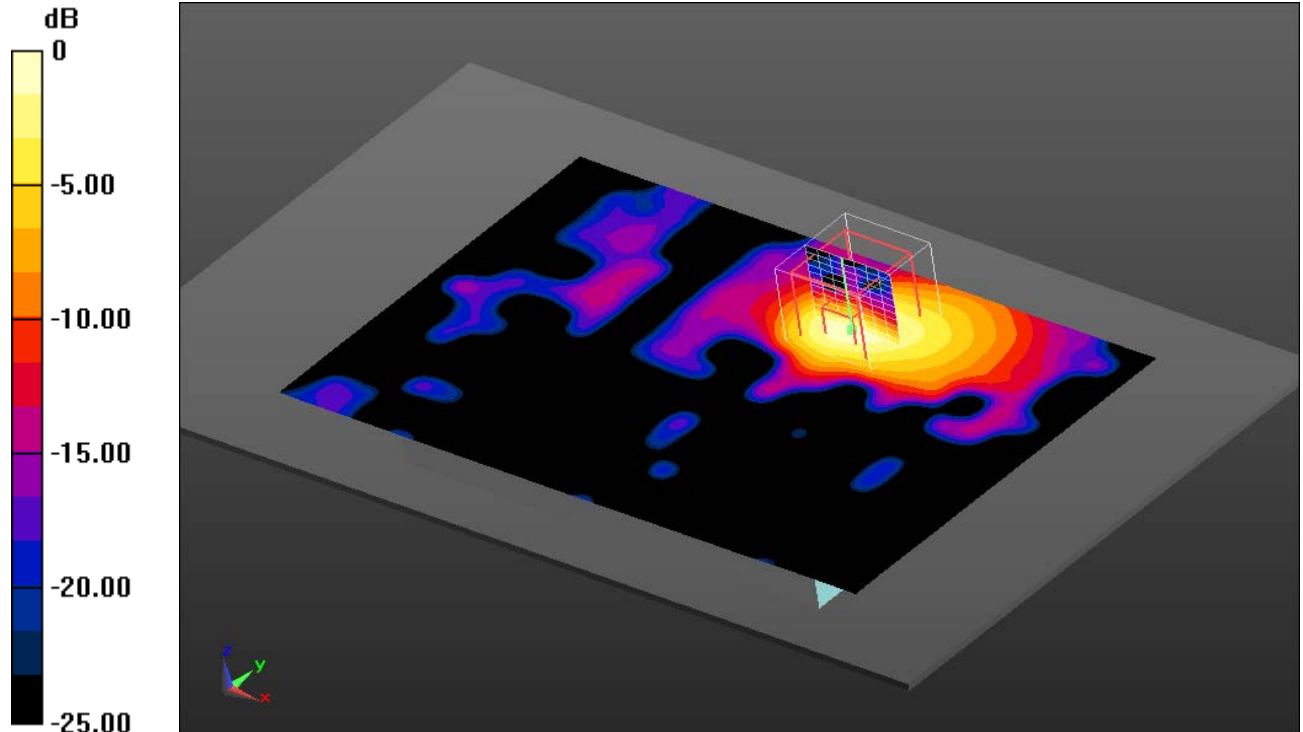

0 dB = 0.379 W/kg = -4.21 dBW/kg

**Additional information:**

position or distance of DUT to SAM: 15 mm

ambient temperature: 23.4°C; liquid temperature: 22.2°C

**Annex B.10: Liquid depth**

Photo 1: Liquid depth 850 MHz head simulating liquid

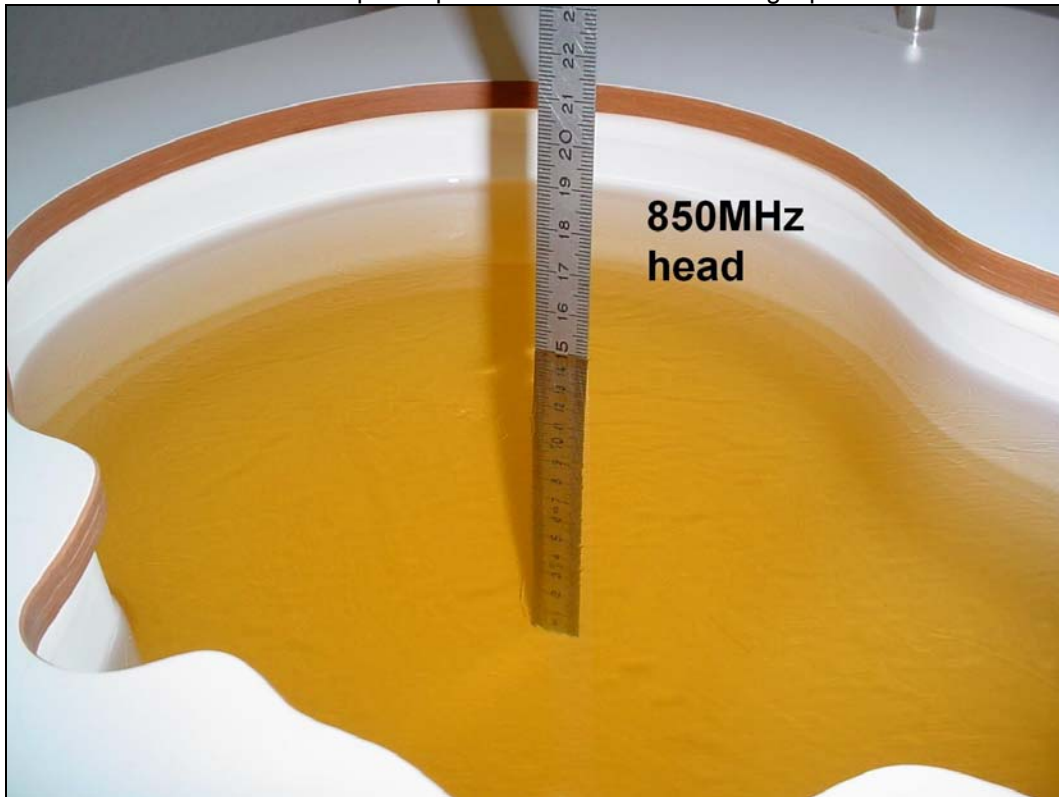

Photo 2: Liquid depth 850 MHz body simulating liquid



Photo 3: Liquid depth 1900MHz head simulating liquid

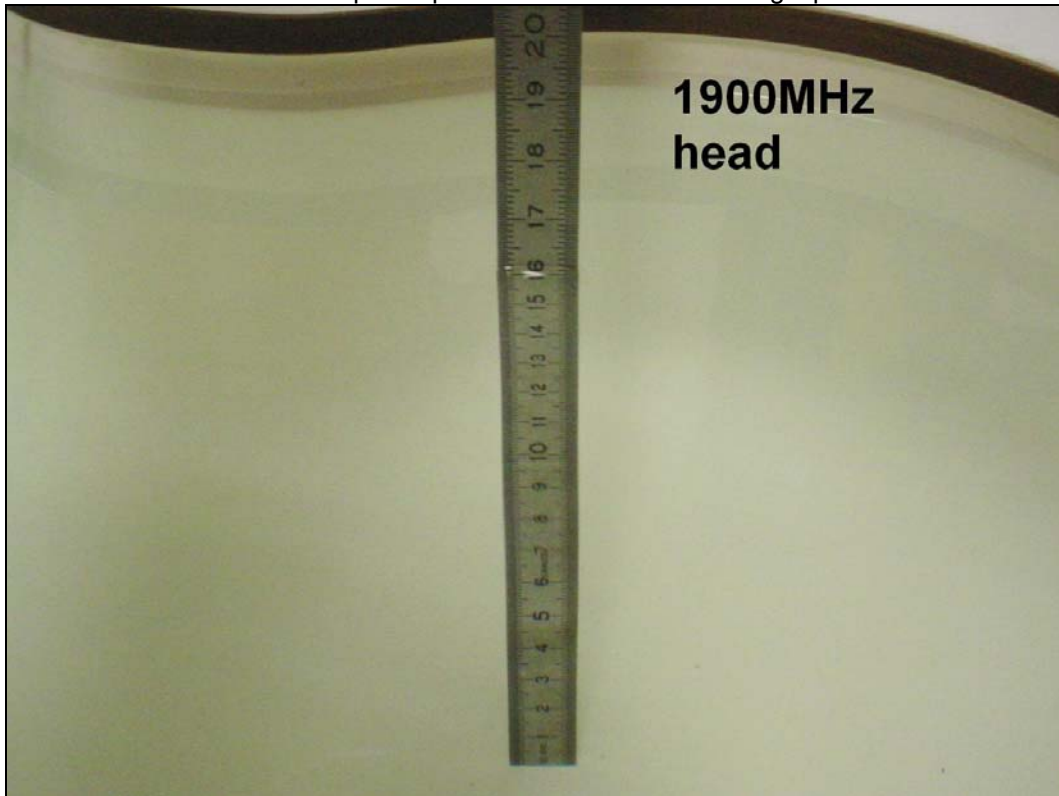

Photo 4: Liquid depth 1900 MHz body simulating liquid

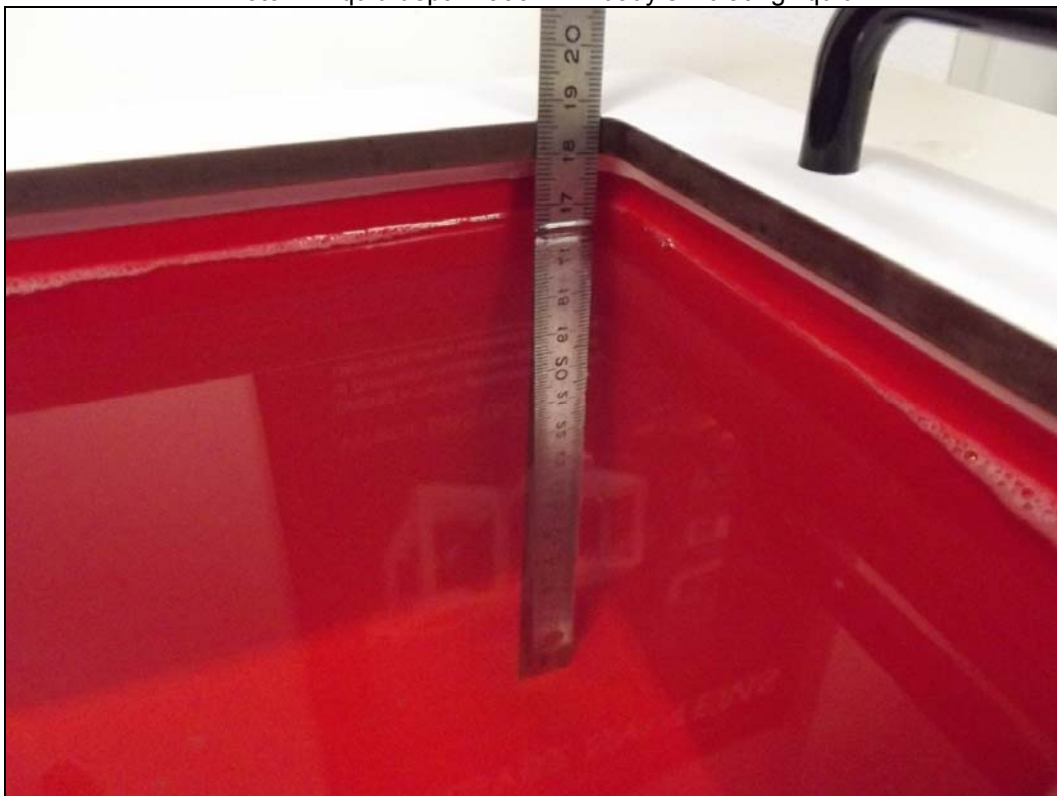

Photo 5: Liquid depth 2450MHz head simulating liquid

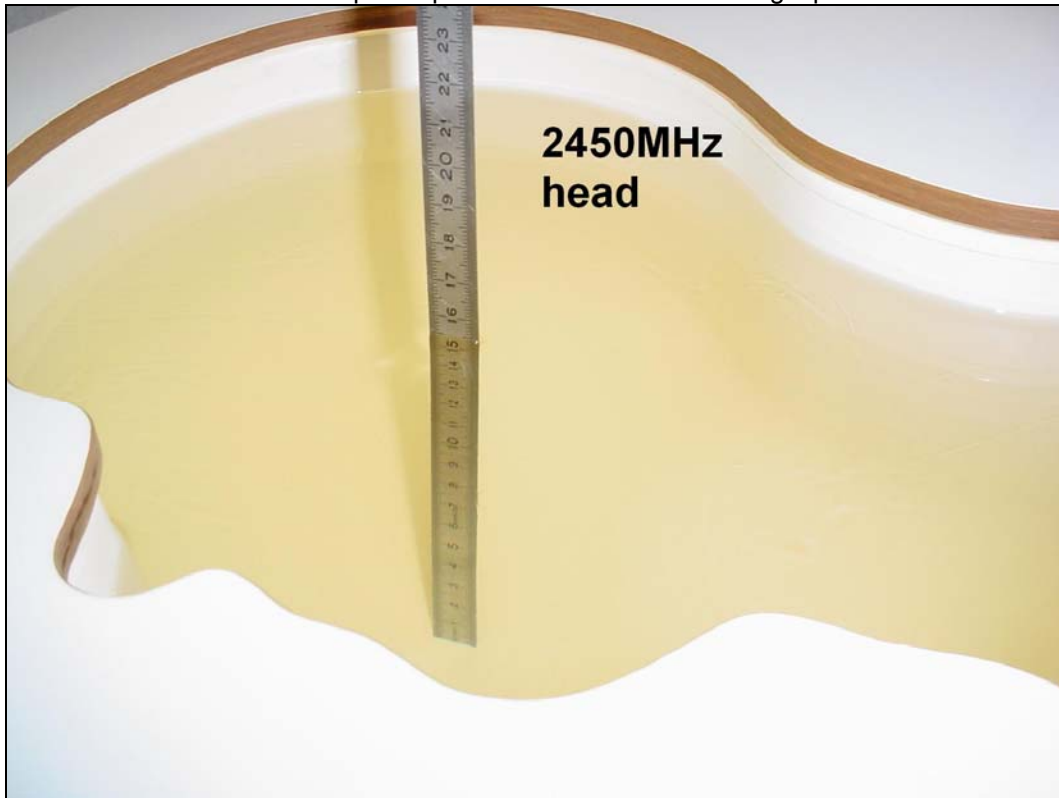

Photo 6: Liquid depth 2450 MHz body simulating liquid

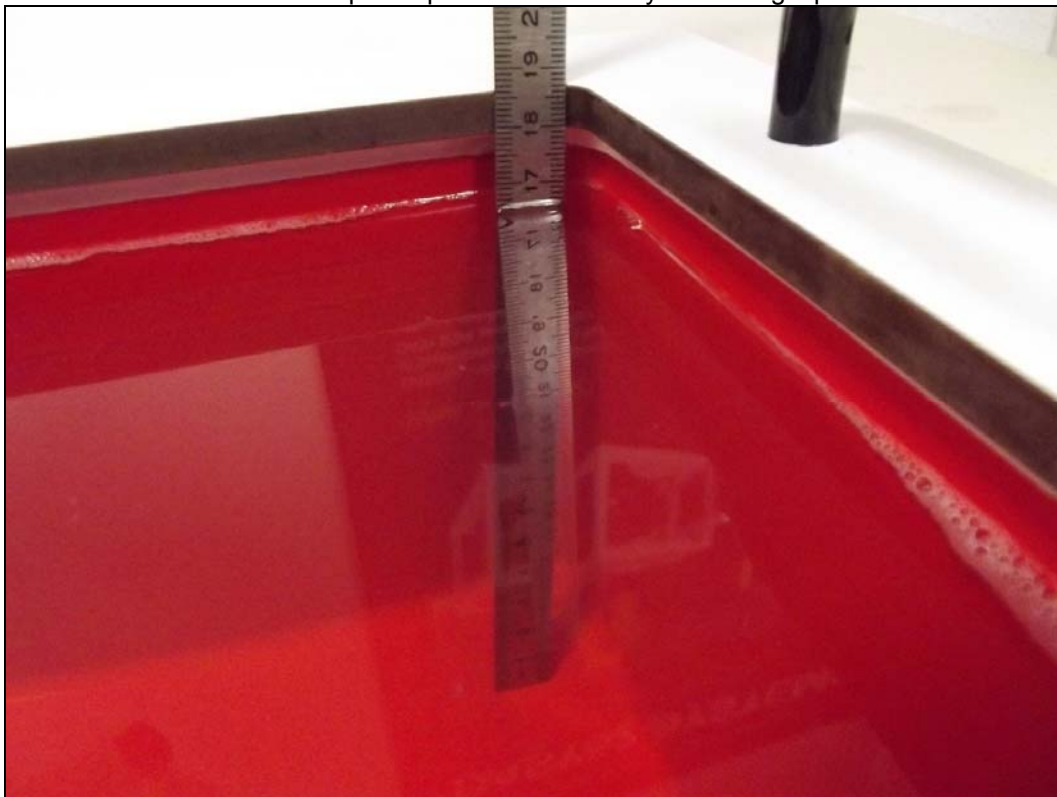
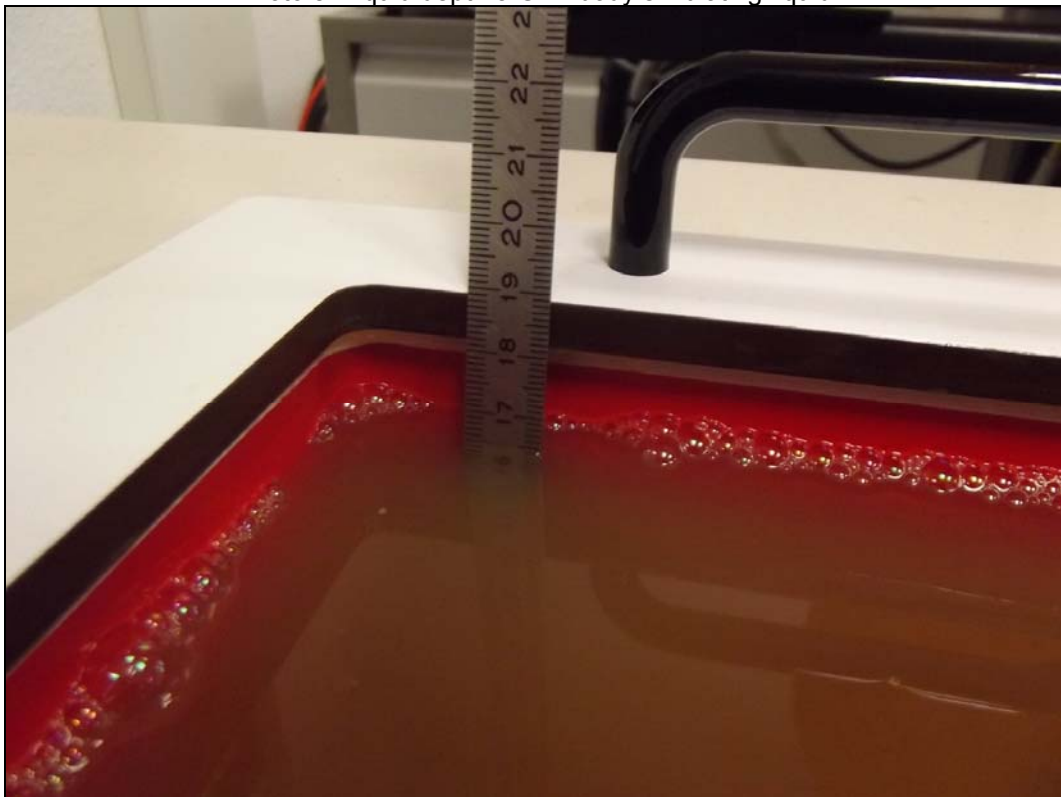

Photo 7: Liquid depth 5 GHz head simulating liquid



Photo 8: Liquid depth 5 GHz body simulating liquid



## **Annex C: Photo documentation**

Photo documentation is described in the additional document:

### **Appendix to test report no. 1-6965/13-19-02 Photo documentation**

## **Annex D: Calibration parameters**

Calibration parameters are described in the additional document:

### **Appendix to test report no. 1-6965/13-19-02 Calibration data, Phantom certificate and detail information of the DASY5 System**

## Annex E: Document History

Version	Applied Changes	Date of Release
	Initial Release	2014-06-02

## Annex F: Further Information

### Glossary

BW	-	Bandwidth
DTS	-	Distributed Transmission System
DUT	-	Device under Test
EUT	-	Equipment under Test
FCC	-	Federal Communication Commission
FCC ID	-	Company Identifier at FCC
HW	-	Hardware
IC	-	Industry Canada
Inv. No.	-	Inventory number
LTE	-	Long Term Evolution
N/A	-	not applicable
PCE	-	Personal Consumption Expenditure
OET	-	Office of Engineering and Technology
RB	-	resource block(s)
SAR	-	Specific Absorption Rate
S/N	-	Serial Number
SPLSR <sub>i</sub>	-	SAR-to-(peak-locations spacing) ratio
SW	-	Software
UNII	-	Unlicensed National Information Infrastructure