



TEST REPORT

Test report no.: 1-6965/13-19-07



Deutsche
Akkreditierungsstelle
D-PL-12076-01-01

Testing laboratory

CETECOM ICT Services GmbH

Untertuerkheimer Strasse 6 – 10

66117 Saarbruecken / Germany

Phone: + 49 681 5 98 - 0

Fax: + 49 681 5 98 - 9075

Internet: <http://www.cetecom.com>

e-mail: ict@cetecom.com

Accredited Testing Laboratory:

The testing laboratory (area of testing) is accredited according to DIN EN ISO/IEC 17025 (2005) by the Deutsche Akkreditierungsstelle GmbH (DAkkS)

The accreditation is valid for the scope of testing procedures as stated in the accreditation certificate with the registration number: D-PL-12076-01-01

Area of Testing:

Radio Communications & EMC (RCE)

Applicant

Sony Mobile Communications AB

Nya Vattentorget

22188 Lund / SWEDEN

Phone: +46 46 19 30 00

Fax: -/-

Contact: Mikael Nilsson

e-mail: Micke.nilsson@sonymobile.com

Phone: +46 7 03 22 75 03

Manufacturer

Sony Mobile Communications AB

Nya Vattentorget

22188 Lund / SWEDEN

Test standard/s

47 CFR Part 22

Title 47 of the Code of Federal Regulations; Chapter I; Part 22 - Public mobile services

For further applied test standards please refer to section 3 of this test report.

Test Item

Kind of test item:

Smart Phone GPRS/EGPRS 850/900/1800/1900; UMTS HSPA FDD/III/V/VIII; LTE FDD1/2/3/5/7/8/28; WLAN b/g/n/a/ac; BT 4.0; RFID; A-GPS

FCC ID:

PY7PM-0751

Frequency:

LTE FDD 5: 824 MHz – 849 MHz

Technology tested:

LTE FDD 5

Antenna:

Integrated antenna

Power supply:

3.7V DC by Li - polymer battery

Temperature range:

-30°C to +60°C

This test report is electronically signed and valid without handwriting signature. For verification of the electronic signatures, the public keys can be requested at the testing laboratory.

Test report authorised:

Stefan Bös
Senior Testing Manager

Test performed:

Andreas Luckenbill
Expert

1 Table of contents

1 Table of contents2

2 General information3

 2.1 Notes and disclaimer3

 2.2 Application details.....3

3 Test standard/s3

4 Test environment.....4

5 Test item4

 5.1 Additional information4

6 Test laboratories sub-contracted4

7 Summary of measurement results5

 7.1 LTE band V5

8 RF measurements6

 8.1 Description of test setup6

 8.1.1 Radiated measurements.....6

 8.1.2 Conducted measurements.....7

 8.2 Results LTE band V8

 8.2.1 RF output power8

 8.2.2 Frequency stability11

 8.2.3 Spurious emissions radiated13

 8.2.4 Spurious emissions conducted18

 8.2.5 Block edge compliance39

 8.2.6 Occupied bandwidth48

9 Test equipment and ancillaries used for tests58

10 Observations58

Annex A Document history59

Annex B Further information.....59

Annex C Accreditation Certificate60

2 General information

2.1 Notes and disclaimer

The test results of this test report relate exclusively to the test item specified in this test report. CETECOM ICT Services GmbH does not assume responsibility for any conclusions and generalizations drawn from the test results with regard to other specimens or samples of the type of the equipment represented by the test item.

The test report may only be reproduced or published in full. Reproduction or publication of extracts from the report requires the prior written approval of CETECOM ICT Services GmbH.

The testing service provided by CETECOM ICT Services GmbH has been rendered under the current "General Terms and Conditions for CETECOM ICT Services GmbH".

CETECOM ICT Services GmbH will not be liable for any loss or damage resulting from false, inaccurate, inappropriate or incomplete product information provided by the customer.

Under no circumstances does the CETECOM ICT Services GmbH test report include any endorsement or warranty regarding the functionality, quality or performance of any other product or service provided.

Under no circumstances does the CETECOM ICT Services GmbH test report include or imply any product or service warranties from CETECOM ICT Services GmbH, including, without limitation, any implied warranties of merchantability, fitness for purpose, or non-infringement, all of which are expressly disclaimed by CETECOM ICT Services GmbH.

All rights and remedies regarding vendor's products and services for which CETECOM ICT Services GmbH has prepared this test report shall be provided by the party offering such products or services and not by CETECOM ICT Services GmbH.

In no case this test report can be considered as a Letter of Approval.

This test report is electronically signed and valid without handwritten signature. For verification of the electronic signatures, the public keys can be requested at the testing laboratory.

2.2 Application details

Date of receipt of order:	2014-04-14
Date of receipt of test item:	2014-05-07
Start of test:	2014-05-07
End of test:	2014-05-15
Person(s) present during the test:	-/-

3 Test standard/s

Test standard	Date	Test standard description
47 CFR Part 22	-/-	Title 47 of the Code of Federal Regulations; Chapter I; Part 22 - Public mobile services

4 Test environment

Temperature:	T_{nom}	+22 °C during room temperature tests
	T_{max}	+60 °C during high temperature tests
	T_{min}	-30 °C during low temperature tests
Relative humidity content:		40 %
Barometric pressure:		not relevant for this kind of testing
Power supply:	V_{nom}	3.7 V DC by Li - polymer battery
	V_{max}	4.4 V
	V_{min}	3.3 V

5 Test item

Kind of test item	:	Smart Phone GPRS/EGPRS 850/900/1800/1900; UMTS HSPA FDD/III/V/VIII; LTE FDD1/2/3/5/7/8/28; WLAN b/g/n/a/ac; BT 4.0; RFID; A-GPS
Type identification	:	PY7PM-0751
S/N serial number	:	Rad. CB5126Z4S3, CB5126Z4R8 Cond. CB5126Z728, CB5126Z753
HW hardware status	:	AP1.0
SW software status	:	17.1.1.A.0.348
Frequency band [MHz]	:	LTE FDD 5: 824 MHz – 849 MHz
Type of modulation	:	QPSK, 16-QAM
Antenna	:	Integrated antenna
Power supply	:	3.7 V DC by Li - polymer battery
Temperature range	:	-30°C to +60 °C

5.1 Additional information

Test setup- and EUT-photos are included in test report: 1-6965/13-19-01_AnnexA
1-6965/13-19-01_AnnexB
1-6965/13-19-01_AnnexC

6 Test laboratories sub-contracted

None

7 Summary of measurement results

- No deviations from the technical specifications were ascertained
 There were deviations from the technical specifications ascertained

TC identifier	Description	verdict	date	Remark
RF-Testing	CFR Part 22	passed	2014-05-19	-/-

7.1 LTE band V

Test Case	temperature conditions	power source voltages	Pass	Fail	NA	NP	Remark
RF Output Power	Nominal	Nominal	<input checked="" type="checkbox"/>	<input type="checkbox"/>	<input type="checkbox"/>	<input type="checkbox"/>	-/-
Frequency Stability	Nominal	Nominal	<input checked="" type="checkbox"/>	<input type="checkbox"/>	<input type="checkbox"/>	<input type="checkbox"/>	-/-
Spurious Emissions Radiated	Nominal	Nominal	<input checked="" type="checkbox"/>	<input type="checkbox"/>	<input type="checkbox"/>	<input type="checkbox"/>	-/-
Spurious Emissions Conducted	Nominal	Nominal	<input checked="" type="checkbox"/>	<input type="checkbox"/>	<input type="checkbox"/>	<input type="checkbox"/>	-/-
Block Edge Compliance	Nominal	Nominal	<input checked="" type="checkbox"/>	<input type="checkbox"/>	<input type="checkbox"/>	<input type="checkbox"/>	-/-
Occupied Bandwidth	Nominal	Nominal	<input checked="" type="checkbox"/>	<input type="checkbox"/>	<input type="checkbox"/>	<input type="checkbox"/>	-/-

Note: NA = Not applicable; NP = Not performed

8 RF measurements

8.1 Description of test setup

For the spurious measurements we use the substitution method according TIA/EIA 603.

8.1.1 Radiated measurements

The radiated emissions from the EUT are performed in a semi anechoic chamber. The EUT is placed on a conductive turntable and powered with nominal voltage. The signalling is performed either from outside the chamber with a signalling unit (AP or other) by air link using a signalling antenna or directly by special test software from the customer.

Semi anechoic chamber

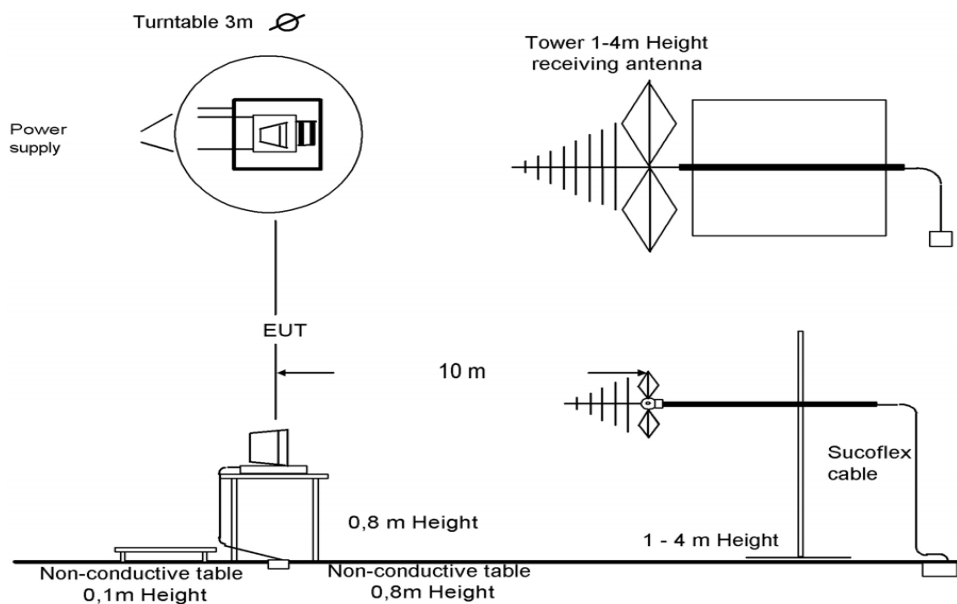

Picture 1: Diagram radiated measurements

9 kHz - 30 MHz:	active loop antenna
30 MHz – 1 GHz:	tri-log antenna
> 1 GHz:	horn antenna

Frequency being measured f	Measuring receiver bandwidth 6 dB	Spectrum analyser bandwidth 3dB
$f < 150 \text{ kHz}$	200 Hz or	300 Hz
$150 \text{ kHz} \leq f < 25 \text{ MHz}$	9 kHz or	10 kHz
$25 \text{ MHz} \leq f < 1000 \text{ MHz}$	120 kHz or	100 kHz
$1000 \text{ MHz} \leq f$		1 MHz
NOTE: Specific requirements in CEPT/ERC/Recommendation 70-03 [2] shall be applied where applicable.		

8.1.2 Conducted measurements

The EUT's RF signal is coupled out by the antenna connector which is supplied by the manufacturer. The signal is first 10dB attenuated before it is power divided (~6dB loss per branch). One of the signal paths is connected to the signalling unit (AP or other), the other one is connected to the spectrum analyzer. The specific losses for both signal paths are first checked within a calibration. The measurement readings on the signalling unit/spectrum analyzer are corrected by the specific test set-up loss. The attenuator, power divider, signalling unit and the spectrum analyzer are impedance matched on 50 Ohm. If special software is used, there is no power divider necessary.

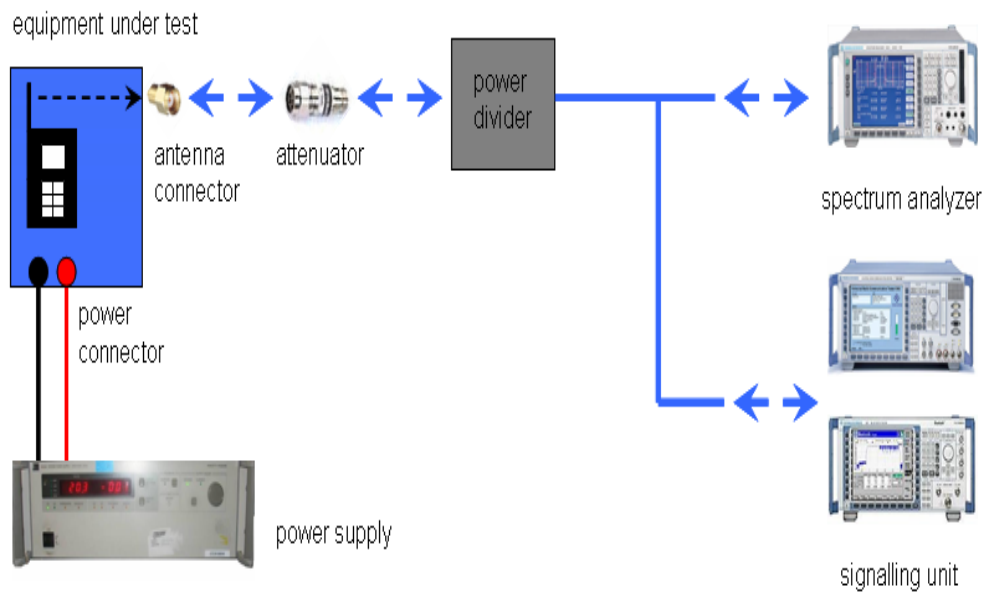

Picture 2: Diagram conducted measurements

The term measuring receiver refers to either a selective voltmeter or a spectrum analyser.

Frequency being measured f	Measuring receiver bandwidth 6 dB	Spectrum analyser bandwidth 3dB
$f < 150 \text{ kHz}$	200 Hz or	300 Hz
$150 \text{ kHz} \leq f < 25 \text{ MHz}$	9 kHz or	10 kHz
$25 \text{ MHz} \leq f < 1000 \text{ MHz}$	120 kHz or	100 kHz
$1000 \text{ MHz} \leq f$		1 MHz
NOTE: Specific requirements in CEPT/ERC/Recommendation 70-03 [2] shall be applied where applicable.		

8.2 Results LTE band V

The EUT was set to transmit the maximum power.

8.2.1 RF output power

Description:

This paragraph contains average power, peak output power and ERP measurements for the mobile station. In all cases, the peak output power is within the required mask (this mask is specified in the JTC standards, TIA PN3389 Vol. 1 Chap 7, and is no FCC requirement).

Measurement:

The mobile was set up for the maximum output power with pseudo random data modulation.

To determine the Peak-To-Average Power Ratio (PAPR) the measurement was performed with the Power Complementary Cumulative Distribution Function (CCDF).

Measurement parameters
Measured with CMW500

Limits:

FCC
CFR Part 22.913 CFR Part 2.1046
Nominal Peak Output Power
+38.45 dBm In measuring transmissions in this band using an average power technique, the peak-to-average ratio (PAR) of the transmission may not exceed 13 dB.

Results:

Output Power (conducted)						
Bandwidth (MHz)	Frequency (MHz)	Resource block allocation	Average Output Power (dBm) QPSK	Peak to Average Ratio (dB)	Average Output Power (dBm) 16-QAM	Peak to Average Ratio (dB)
1.4	824.7	1 RB low	23.2	4.7	22.5	5.3
		1 RB high	23.3	4.7	22.5	5.3
		50% RB mid	23.2	4.8	22.3	5.6
		100% RB	22.3	5.4	21.2	6.4
	836.5	1 RB low	23.4	5.9	22.2	4.9
		1 RB high	23.4	5.8	22.3	4.9
		50% RB mid	23.4	5.8	22.5	5.0
		100% RB	22.4	6.3	21.5	5.8
	848.3	1 RB low	23.1	4.6	22.4	5.9
		1 RB high	23.2	4.7	22.3	5.8
		50% RB mid	23.1	5.0	22.1	6.0
		100% RB	22.2	6.0	21.3	6.4
3	825.5	1 RB low	23.3	5.3	22.4	4.7
		1 RB high	23.3	5.3	22.4	4.7
		50% RB mid	22.3	5.8	21.1	4.8
		100% RB	22.3	6.2	21.3	5.6
	836.5	1 RB low	23.5	4.9	22.3	5.8
		1 RB high	23.4	4.8	22.2	5.8
		50% RB mid	22.4	5.0	21.5	5.8
		100% RB	22.5	6.1	21.4	6.8
	847.5	1 RB low	23.5	5.9	22.3	4.8
		1 RB high	23.3	6.0	22.0	4.9
		50% RB mid	22.3	5.8	21.3	5.0
		100% RB	22.3	6.6	21.3	5.8
5	826.5	1 RB low	23.3	4.7	22.3	5.5
		1 RB high	23.4	4.7	22.4	5.5
		50% RB mid	22.2	4.9	21.3	5.8
		100% RB	22.3	5.8	21.3	6.7
	836.5	1 RB low	23.3	5.3	22.7	5.0
		1 RB high	23.3	5.0	22.7	4.8
		50% RB mid	22.4	6.1	21.5	5.2
		100% RB	22.5	7.0	21.4	5.7
	846.5	1 RB low	23.4	4.8	22.1	5.8
		1 RB high	23.2	5.0	22.0	5.9
		50% RB mid	22.4	5.1	21.4	6.0
		100% RB	22.3	5.7	21.4	6.7

10	829	1 RB low	23.2	5.1	22.4	4.5
		1 RB high	23.3	5.4	22.5	4.7
		50% RB mid	22.2	5.9	21.2	5.0
		100% RB	22.2	6.7	21.3	6.1
	836.5	1 RB low	23.3	4.6	22.1	5.6
		1 RB high	23.4	4.6	22.2	5.5
		50% RB mid	22.5	5.2	21.5	6.0
		100% RB	22.4	5.4	21.4	6.1
	844	1 RB low	23.4	5.6	22.2	4.5
		1 RB high	23.2	5.8	22.0	4.7
		50% RB mid	22.4	6.0	21.4	5.1
		100% RB	22.4	6.8	21.4	5.8
Measurement uncertainty		± 0.5 dB				

Maximum radiated output power. Measured in the maximum conducted output power mode.

Output Power (radiated)			
Bandwidth (MHz)	Frequency (MHz)	Average Output Power (dBm)	Average Output Power (dBm)
		QPSK	16-QAM
1.4	824.7	19.5	18.7
	836.5	22.0	21.1
	848.3	22.4	21.6
3	825.5	19.5	18.6
	836.5	22.1	20.9
	847.5	22.7	21.5
5	826.5	19.6	18.6
	836.5	21.9	21.3
	846.5	22.6	21.3
10	829.0	19.5	18.7
	836.5	22.0	20.8
	844.0	22.6	21.4
Measurement uncertainty		± 3.0 dB	

Result: Passed

8.2.2 Frequency stability

Description:

In order to measure the carrier frequency under the condition of AFC lock, it is necessary to make measurements with the mobile station in a "call mode". This is accomplished with the use of a R&S CMW500 DIGITAL RADIOCOMMUNICATION TESTER.

1. Measure the carrier frequency at room temperature.
2. Subject the mobile station to overnight soak at -30 C.
3. With the mobile station, powered with V_{nom} , connected to the CMW500 and in a simulated call on channel 4180 (centre channel), measure the carrier frequency. These measurements should be made within two minutes of powering up the mobile station, to prevent significant self warming.
4. Repeat the above measurements at 10°C increments from -30°C to +60°C. Allow at least 1.5 hours at each temperature, unpowered, before making measurements.
5. Remeasure carrier frequency at room temperature with V_{nom} . Vary supply voltage from V_{min} to V_{max} , in 0.1 Volt steps remeasuring carrier frequency at each voltage. Pause at V_{nom} for 1.5 hours unpowered, to allow any self heating to stabilize, before continuing.
6. At all temperature levels hold the temperature to +/- 0.5°C during the measurement procedure.

Measurement:

Measurement parameters	
Detector:	Measured with CMW500
Sweep time:	
Video bandwidth:	
Resolution bandwidth:	
Span:	
Trace-Mode:	

Limits:

FCC
CFR Part 22.355 CFR Part 2.1055
Frequency Stability
± 0.1 ppm

Results:**AFC FREQ ERROR versus VOLTAGE**

Voltage (V)	Frequency Error (Hz)	Frequency Error (%)	Frequency Error (ppm)
3.3	-7	-0.00000084	-0.0084
3.4	-10	-0.00000120	-0.0120
3.5	2	0.00000024	0.0024
3.6	-4	-0.00000048	-0.0048
3.7	-8	-0.00000096	-0.0096
3.8	-7	-0.00000084	-0.0084
3.9	9	0.00000108	0.0108
4.0	1	0.00000012	0.0012
4.1	8	0.00000096	0.0096
4.2	-9	-0.00000108	-0.0108
4.3	-10	-0.00000120	-0.0120
4.4	5	0.00000060	0.0060

AFC FREQ ERROR versus TEMPERATURE

Temperature (°C)	Frequency Error (Hz)	Frequency Error (%)	Frequency Error (ppm)
-30	-9	-0.00000108	-0.0108
-20	9	0.00000108	0.0108
-10	-2	-0.00000024	-0.0024
± 0	3	0.00000036	0.0036
10	-9	-0.00000108	-0.0108
20	10	0.00000120	0.0120
30	1	0.00000012	0.0012
40	-9	-0.00000108	-0.0108
50	3	0.00000036	0.0036
60	-9	-0.00000108	-0.0108

Result: **Passed**

8.2.3 Spurious emissions radiated

Description:

The following steps outline the procedure used to measure the radiated emissions from the mobile station. The site is constructed in accordance with ANSI C63.4:2009 requirements and is recognized by the FCC to be in compliance for a 3 and a 10 meter site. The spectrum was scanned from 30 MHz to the 10th harmonic of the highest frequency generated within the equipment, which is the transmitted carrier that can be as high as 846.6 MHz. Measured up to 12.75 GHz. The resolution bandwidth is set as outlined in Part 22.917. The spectrum was scanned with the mobile station transmitting at carrier frequencies that pertain to low, mid and high channels of the LTE band V.

The final open field emission (here 10m semi-anechoic chamber listed by FCC) test procedure is as follows:

- a) The test item was placed on a 0.8 meter high non-conductive stand at a 3 meter test distance from the receive antenna.
- b) The antenna output was terminated in a 50 ohm load (if possible).
- c) A double ridged wave guide antenna was placed on an adjustable height antenna mast 3 meters from the test item for emission measurements.
- d) Detected emissions were maximized at each frequency by rotating the test item and adjusting the receive antenna height and polarization. The maximum meter reading was recorded. The radiated emission measurements of the harmonics of the transmit frequency through the 10th harmonic were measured with peak detector and 1 MHz bandwidth. If the harmonic could not be detected above the noise floor, the ambient level was recorded. The equivalent power into a dipole antenna was calculated from the field intensity levels measured at 3 meters.
- e) Now each detected emissions were substituted by the substitution method, in accordance with the TIA/EIA 603.

Measurement:

Measurement parameters	
Detector:	Peak
Sweep time:	2 sec.
Video bandwidth:	Below 1 GHz: 100 kHz Above 1 GHz: 1 MHz
Resolution bandwidth:	Below 1 GHz: 100 kHz Above 1 GHz: 1 MHz
Span:	100 MHz Steps
Trace-Mode:	Max Hold

Limits:

FCC
CFR Part 22.917 CFR Part 2.1053
Spurious Emissions Radiated
Attenuation $\geq 43 + 10\log(P)$ (P, Power in Watts)
-13 dBm

Results:

Radiated emissions measurements were made only at the center carrier frequency of the LTE band V (836.5 MHz). It was decided that measurements at this carrier frequency would be sufficient to demonstrate compliance with emissions limits because it was seen that all the significant spurs occur well outside the band and no radiation was seen from a carrier in one block of the LTE band V into any of the other blocks. The equipment must still, however, meet emissions requirements with the carrier at all frequencies over which it is capable of operating and it is the manufacturer's responsibility to verify this.

The final open field radiated levels are presented on the next pages. All measurements were done in horizontal and vertical polarization; the plots show the worst case. The plots show only the middle channel. If spurious were detected, the lowest and highest channel were checked too. The found values are stated in the table below.

As can be seen from this data, the emissions from the test item were within the specification limit.

QPSK:

Spurious Emission Level (dBm)								
Harmonic	Lowest channel Freq. (MHz)	Level [dBm]	Harmonic	Middle channel Freq. (MHz)	Level [dBm]	Harmonic	Highest channel Freq. (MHz)	Level [dBm]
2	1658.0	-	2	1673.0	-	2	1688.0	-
3	2487.0	-	3	2509.5	-	3	2532.0	-
4	3316.0	-	4	3346.0	-	4	3376.0	-
5	4145.0	-	5	4182.5	-	5	4220.0	-
6	4974.0	-	6	5019.0	-	6	5064.0	-
7	5803.0	-	7	5855.5	-	7	5908.0	-
8	6632.0	-	8	6692.0	-	8	6752.0	-
9	7461.0	-	9	7528.5	-	9	7596.0	-
10	8290.0	-	10	8365.0	-	10	8440.0	-
Measurement uncertainty					± 3dB			

16-QAM:

Spurious Emission Level (dBm)								
Harmonic	Lowest channel Freq. (MHz)	Level [dBm]	Harmonic	Middle channel Freq. (MHz)	Level [dBm]	Harmonic	Highest channel Freq. (MHz)	Level [dBm]
2	1658.0	-	2	1673.0	-	2	1688.0	-
3	2487.0	-	3	2509.5	-	3	2532.0	-
4	3316.0	-	4	3346.0	-	4	3376.0	-
5	4145.0	-	5	4182.5	-	5	4220.0	-
6	4974.0	-	6	5019.0	-	6	5064.0	-
7	5803.0	-	7	5855.5	-	7	5908.0	-
8	6632.0	-	8	6692.0	-	8	6752.0	-
9	7461.0	-	9	7528.5	-	9	7596.0	-
10	8290.0	-	10	8365.0	-	10	8440.0	-
Measurement uncertainty					± 3dB			

Result: Passed

QPSK with 10 MHz channel bandwidth

Plot 1: Channel 20525 (Traffic mode up to 30 MHz)

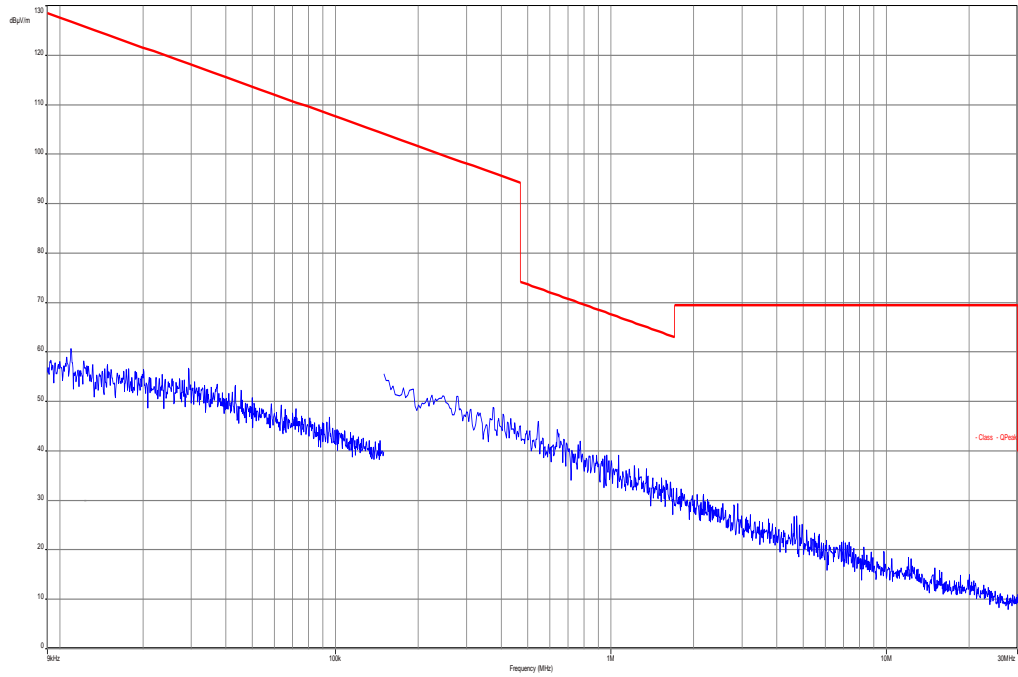

Plot 2: Channel 20525 (30 MHz – 12.75 GHz)

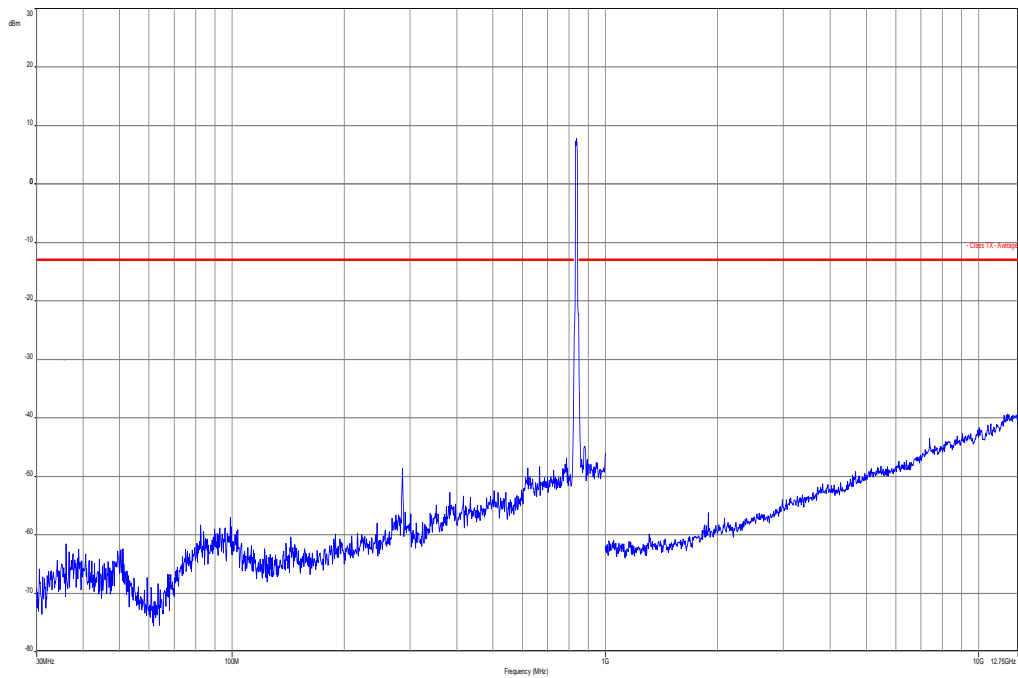

16-QAM with 10 MHz channel bandwidth

Plot 3: Channel 20525 (Traffic mode up to 30 MHz)

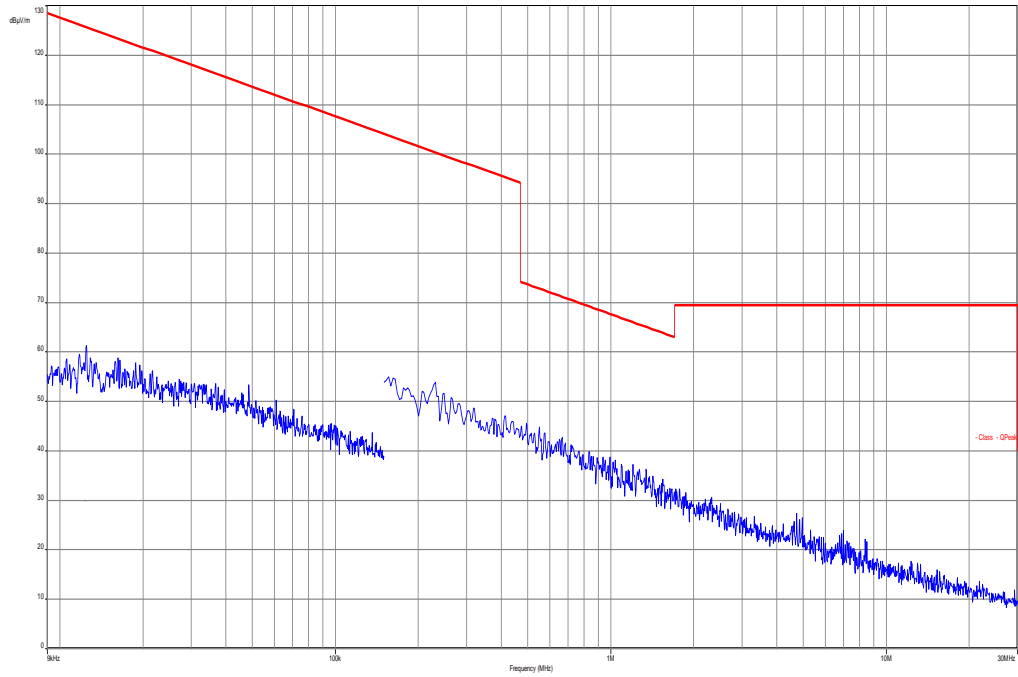

Plot 4: Channel 20525 (30 MHz – 12.75 GHz)

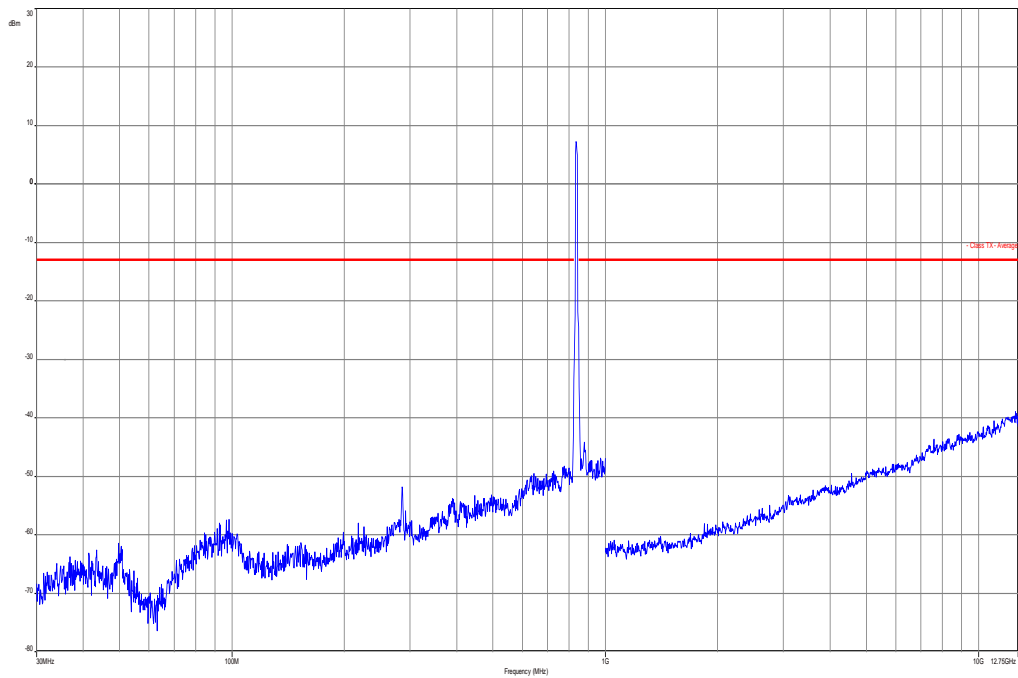

8.2.4 Spurious emissions conducted

Description:

The following steps outline the procedure used to measure the conducted emissions from the mobile station.

1. Determine frequency range for measurements: From CFR 2.1057 the spectrum should be investigated from the lowest radio frequency generated in the equipment up to at least the 10th harmonic of the carrier frequency. For the mobile station equipment tested, this equates to a frequency range of 13 MHz to 9 GHz, data taken from 10 MHz to 26 GHz.
2. Determine mobile station transmits frequencies: below outlines the band edge frequencies pertinent to conducted emissions testing.

Measurement:

Measurement parameters	
Detector:	Peak
Sweep time:	Auto
Video bandwidth:	Pre-measurement with 1 MHz On spurious detection re-measurement below 1 GHz with 100 kHz Above 1 GHz with 1 MHz
Resolution bandwidth:	Pre-measurement with 1 MHz On spurious detection re-measurement below 1 GHz with 100 kHz Above 1 GHz with 1 MHz
Span:	10 MHz – 26 GHz
Trace-Mode:	Max Hold

Limits:

FCC
CFR Part 22.917 CFR Part 2.1051
Spurious Emissions Conducted
Attenuation $\geq 43 + 10\log(P)$ (P, Power in Watts)
-13 dBm

Results: for 1.4 MHz channel bandwidth**QPSK**

Spurious Emission Level (dBm)								
Harmonic	Lowest channel Freq. (MHz)	Level [dBm]	Harmonic	Middle channel Freq. (MHz)	Level [dBm]	Harmonic	Highest channel Freq. (MHz)	Level [dBm]
2	1649.4	-	2	1673.0	-	2	1696,6	-
3	2474.1	-	3	2509.5	-	3	2544,9	-
4	3298.8	-	4	3346.0	-	4	3393,2	-
5	4123.5	-	5	4182.5	-	5	4241,5	-
6	4948.2	-	6	5019.0	-	6	5089,8	-
7	5772.9	-	7	5855.5	-	7	5938,1	-
8	6597.6	-	8	6692.0	-	8	6786,4	-
9	7422.3	-	9	7258.5	-	9	7634,7	-
10	8247.0	-	10	8365.0	-	10	8483	-
Measurement uncertainty					± 0.5dB			

16-QAM

Spurious Emission Level (dBm)								
Harmonic	Lowest channel Freq. (MHz)	Level [dBm]	Harmonic	Middle channel Freq. (MHz)	Level [dBm]	Harmonic	Highest channel Freq. (MHz)	Level [dBm]
2	1649.4	-	2	1673.0	-	2	1696.6	-
3	2474.1	-	3	2509.5	-	3	2544.9	-
4	3298.8	-	4	3346.0	-	4	3393.2	-
5	4123.5	-	5	4182.5	-	5	4241.5	-
6	4948.2	-	6	5019.0	-	6	5089.8	-
7	5772.9	-	7	5855.5	-	7	5938.1	-
8	6597.6	-	8	6692.0	-	8	6786.4	-
9	7422.3	-	9	7258.5	-	9	7634.7	-
10	8247.0	-	10	8365.0	-	10	8483.0	-
Measurement uncertainty					± 0.5dB			

Results: for 3 MHz channel bandwidth**QPSK**

Spurious Emission Level (dBm)								
Harmonic	Lowest channel Freq. (MHz)	Level [dBm]	Harmonic	Middle channel Freq. (MHz)	Level [dBm]	Harmonic	Highest channel Freq. (MHz)	Level [dBm]
2	1651.0	-	2	1673.0	-	2	1695.0	-
3	2476.5	-	3	2509.5	-	3	2542.5	-
4	3302.0	-	4	3346.0	-	4	3390.0	-
5	4127.5	-	5	4182.5	-	5	4237.5	-
6	4953.0	-	6	5019.0	-	6	5085.0	-
7	5778.5	-	7	5855.5	-	7	5932.5	-
8	6604.0	-	8	6692.0	-	8	6780.0	-
9	7429.5	-	9	7258.5	-	9	7627.5	-
10	8255.0	-	10	8365.0	-	10	8475.0	-
Measurement uncertainty					± 0.5dB			

16-QAM

Spurious Emission Level (dBm)								
Harmonic	Lowest channel Freq. (MHz)	Level [dBm]	Harmonic	Middle channel Freq. (MHz)	Level [dBm]	Harmonic	Highest channel Freq. (MHz)	Level [dBm]
2	1651.0	-	2	1673.0	-	2	1695.0	-
3	2476.5	-	3	2509.5	-	3	2542.5	-
4	3302.0	-	4	3346.0	-	4	3390.0	-
5	4127.5	-	5	4182.5	-	5	4237.5	-
6	4953.0	-	6	5019.0	-	6	5085.0	-
7	5778.5	-	7	5855.5	-	7	5932.5	-
8	6604.0	-	8	6692.0	-	8	6780.0	-
9	7429.5	-	9	7258.5	-	9	7627.5	-
10	8255.0	-	10	8365.0	-	10	8475.0	-
Measurement uncertainty					± 0.5dB			

Results: for 5 MHz channel bandwidth

QPSK

Spurious Emission Level (dBm)								
Harmonic	Lowest channel Freq. (MHz)	Level [dBm]	Harmonic	Middle channel Freq. (MHz)	Level [dBm]	Harmonic	Highest channel Freq. (MHz)	Level [dBm]
2	1653.0	-	2	1673.0	-	2	1693.0	-
3	2479.5	-	3	2509.5	-	3	2539.5	-
4	3306.0	-	4	3346.0	-	4	3386.0	-
5	4132.5	-	5	4182.5	-	5	4232.5	-
6	4959.0	-	6	5019.0	-	6	5079.0	-
7	5785.5	-	7	5855.5	-	7	5925.5	-
8	6612.0	-	8	6692.0	-	8	6772.0	-
9	7438.5	-	9	7528.5	-	9	7618.5	-
10	8265.0	-	10	8365.0	-	10	8465.0	-
Measurement uncertainty					± 0.5dB			

16-QAM

Spurious Emission Level (dBm)								
Harmonic	Lowest channel Freq. (MHz)	Level [dBm]	Harmonic	Middle channel Freq. (MHz)	Level [dBm]	Harmonic	Highest channel Freq. (MHz)	Level [dBm]
2	1653.0	-	2	1673.0	-	2	1693.0	-
3	2479.5	-	3	2509.5	-	3	2539.5	-
4	3306.0	-	4	3346.0	-	4	3386.0	-
5	4132.5	-	5	4182.5	-	5	4232.5	-
6	4959.0	-	6	5019.0	-	6	5079.0	-
7	5785.5	-	7	5855.5	-	7	5925.5	-
8	6612.0	-	8	6692.0	-	8	6772.0	-
9	7438.5	-	9	7528.5	-	9	7618.5	-
10	8265.0	-	10	8365.0	-	10	8465.0	-
Measurement uncertainty					± 0.5dB			

Results: for 10 MHz channel bandwidth

QPSK

Spurious Emission Level (dBm)								
Harmonic	Lowest channel Freq. (MHz)	Level [dBm]	Harmonic	Middle channel Freq. (MHz)	Level [dBm]	Harmonic	Highest channel Freq. (MHz)	Level [dBm]
2	1658.0	-	2	1673.0	-	2	1688.0	-
3	2487.0	-	3	2509.5	-	3	2532.0	-
4	3316.0	-	4	3346.0	-	4	3376.0	-
5	4145.0	-	5	4182.5	-	5	4220.0	-
6	4974.0	-	6	5019.0	-	6	5064.0	-
7	5803.0	-	7	5855.5	-	7	5908.0	-
8	6632.0	-	8	6692.0	-	8	6752.0	-
9	7461.0	-	9	7528.5	-	9	7596.0	-
10	8290.0	-	10	8365.0	-	10	8440.0	-
Measurement uncertainty					± 0.5dB			

16-QAM

Spurious Emission Level (dBm)								
Harmonic	Lowest channel Freq. (MHz)	Level [dBm]	Harmonic	Middle channel Freq. (MHz)	Level [dBm]	Harmonic	Highest channel Freq. (MHz)	Level [dBm]
2	1658.0	-	2	1673.0	-	2	1688.0	-
3	2487.0	-	3	2509.5	-	3	2532.0	-
4	3316.0	-	4	3346.0	-	4	3376.0	-
5	4145.0	-	5	4182.5	-	5	4220.0	-
6	4974.0	-	6	5019.0	-	6	5064.0	-
7	5803.0	-	7	5855.5	-	7	5908.0	-
8	6632.0	-	8	6692.0	-	8	6752.0	-
9	7461.0	-	9	7528.5	-	9	7596.0	-
10	8290.0	-	10	8365.0	-	10	8440.0	-
Measurement uncertainty					± 0.5dB			

Result: Passed

Plots: QPSK with 1.4 MHz channel bandwidth

Plot 1: Lowest Channel (10 MHz - 25 GHz)

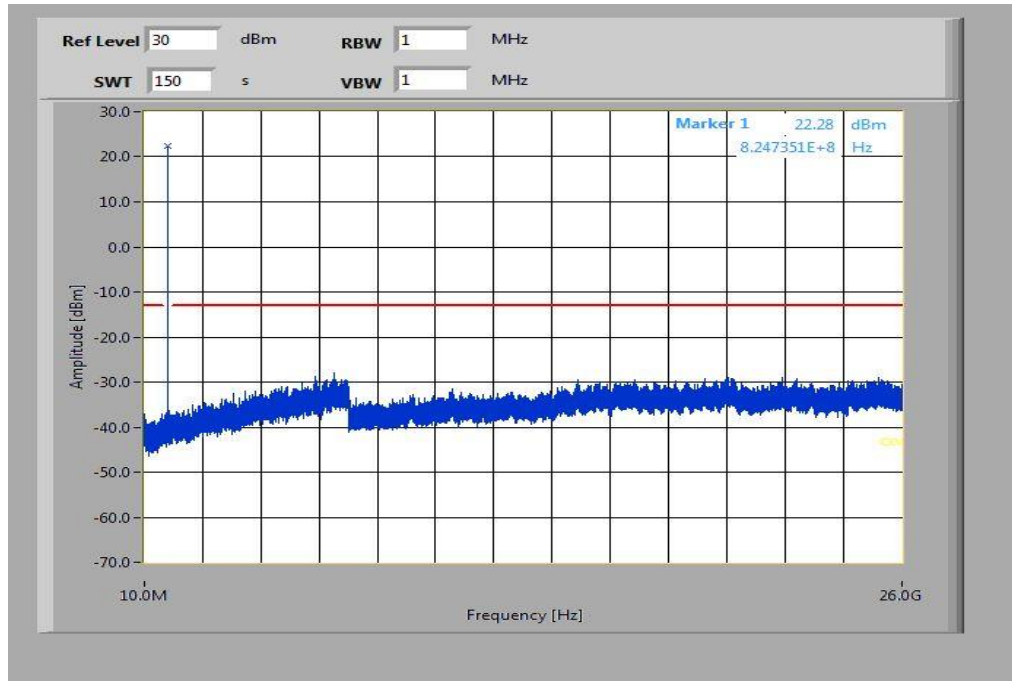

Plot 2: Middle Channel (10 MHz - 25 GHz)

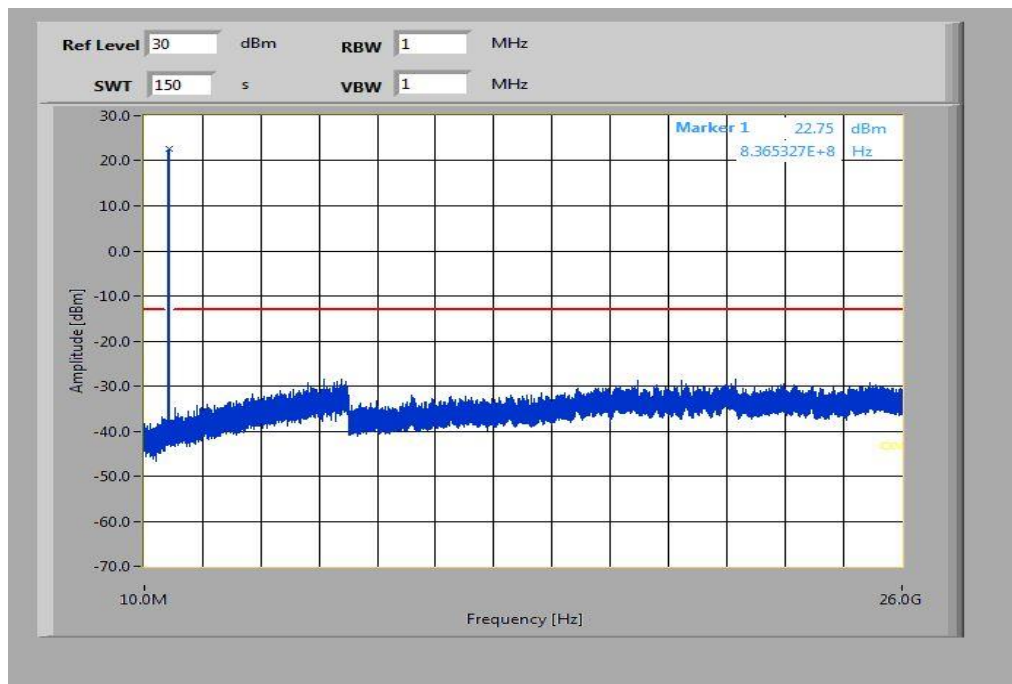

Plot 3: Highest Channel (10 MHz - 25 GHz)

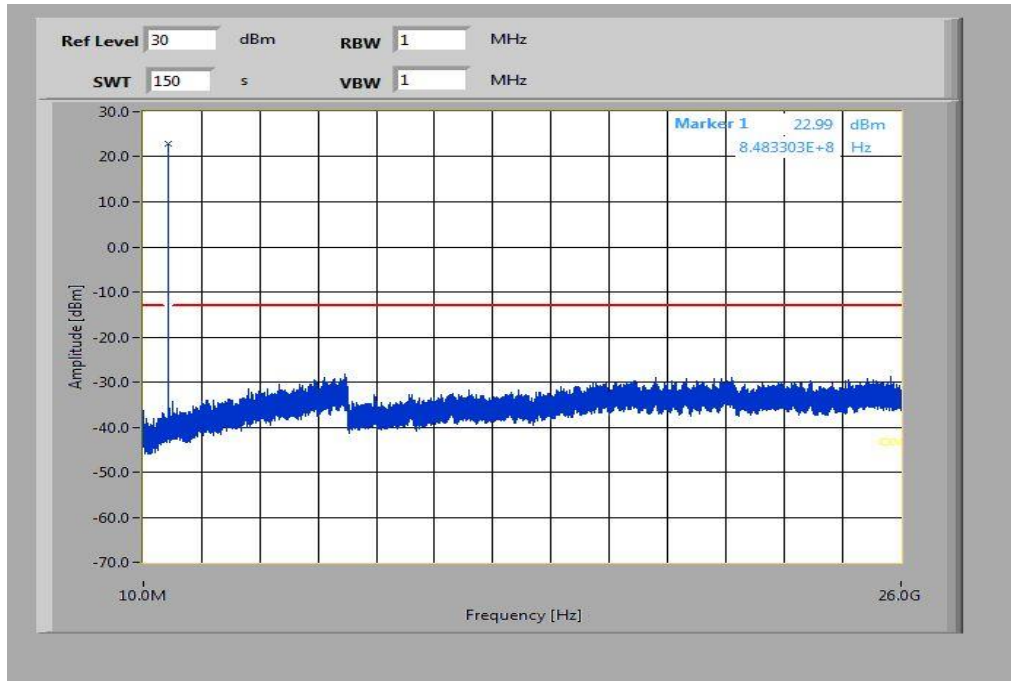

Plots: 16-QAM with 1.4 MHz channel bandwidth

Plot 1: Lowest Channel (10 MHz - 25 GHz)

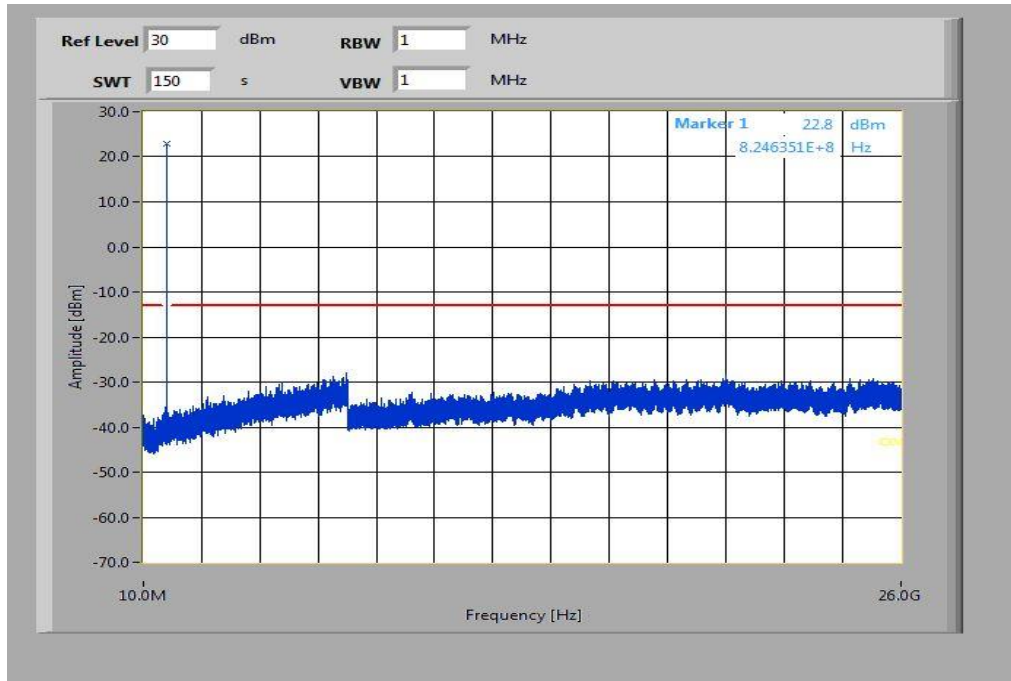

Plot 2: Middle Channel (10 MHz - 25 GHz)

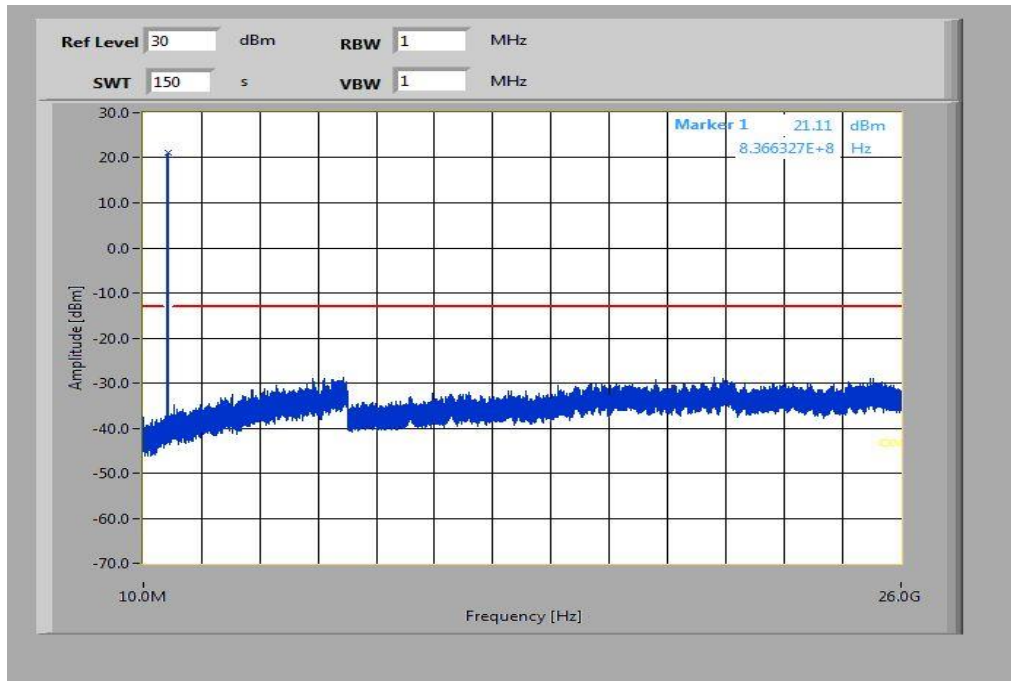

Plot 3: Highest Channel (10 MHz - 25 GHz)

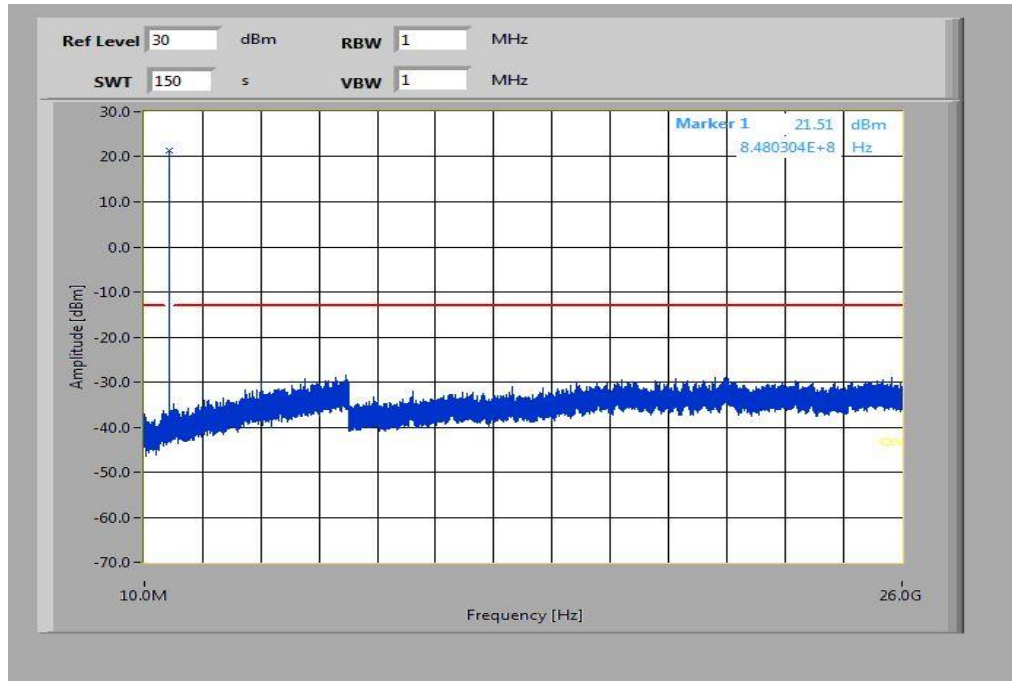

Plots: QPSK with 3 MHz channel bandwidth

Plot 4: Lowest Channel (10 MHz - 25 GHz)

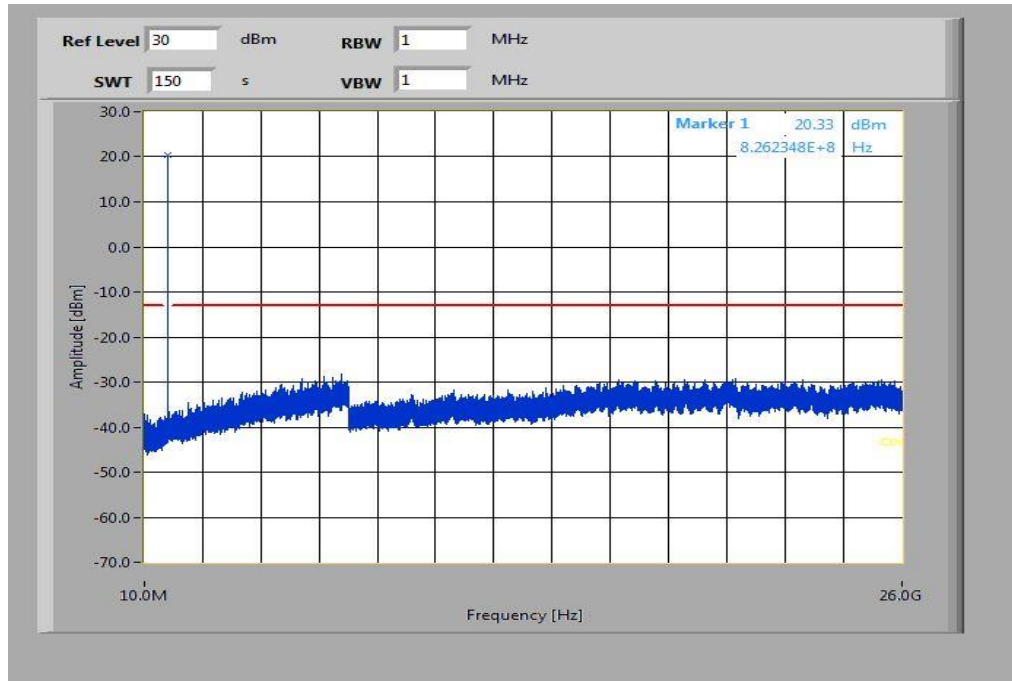

Plot 5: Middle Channel (10 MHz - 25 GHz)

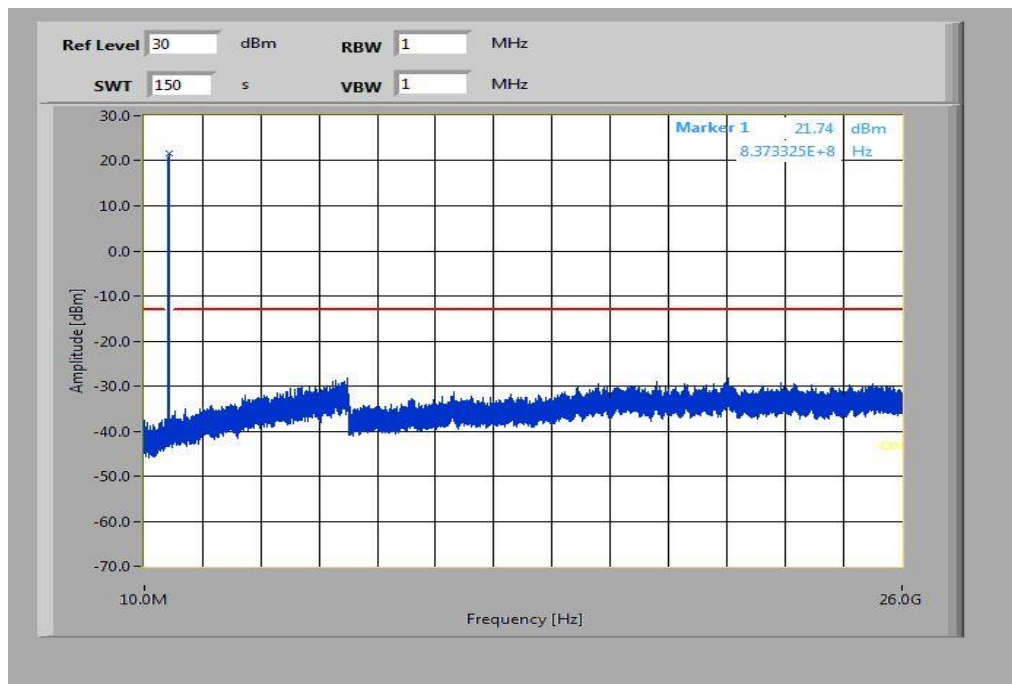

Plot 6: Highest Channel (10 MHz - 25 GHz)

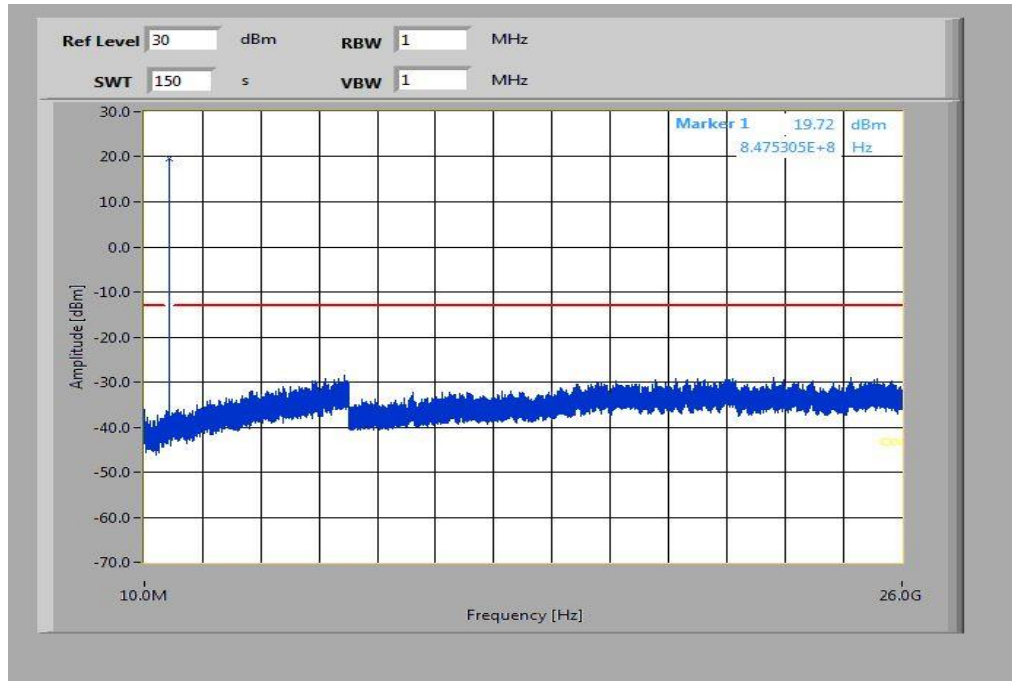

Plots: 16-QAM with 3 MHz channel bandwidth

Plot 4: Lowest Channel (10 MHz - 25 GHz)

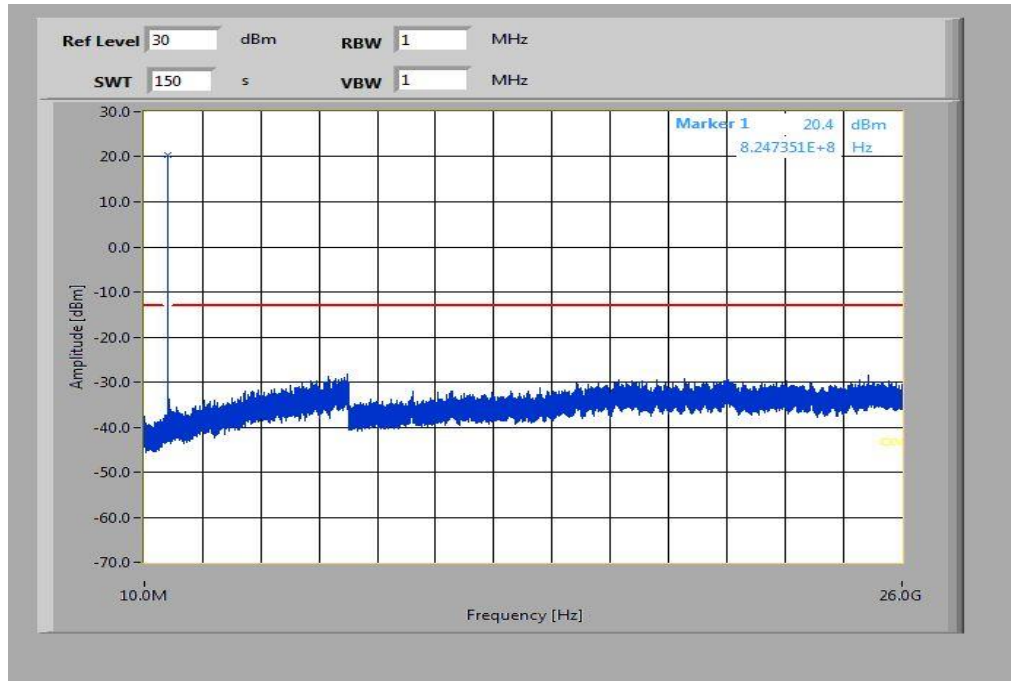

Plot 5: Middle Channel (10 MHz - 25 GHz)

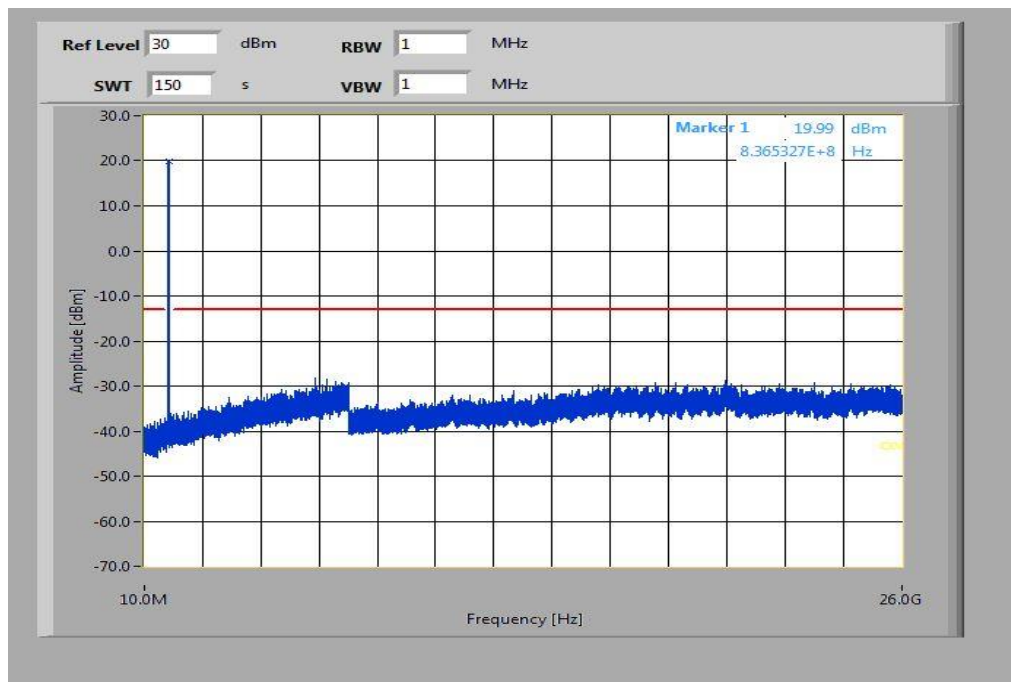

Plot 6: Highest Channel (10 MHz - 25 GHz)

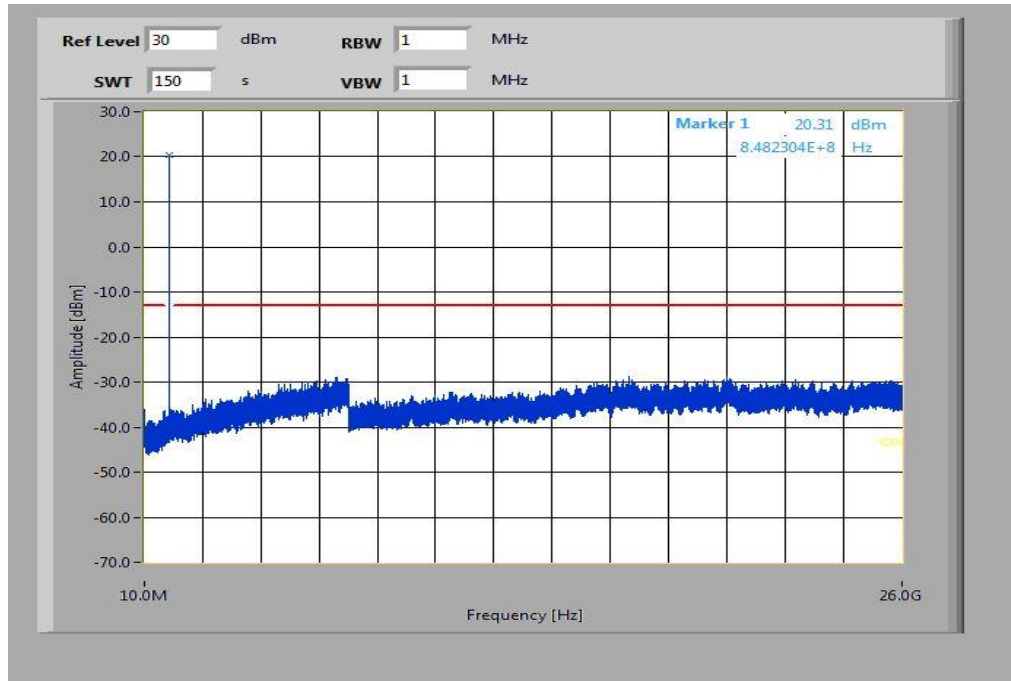

Plots: QPSK with 5 MHz channel bandwidth

Plot 1: Lowest Channel (10 MHz - 25 GHz)

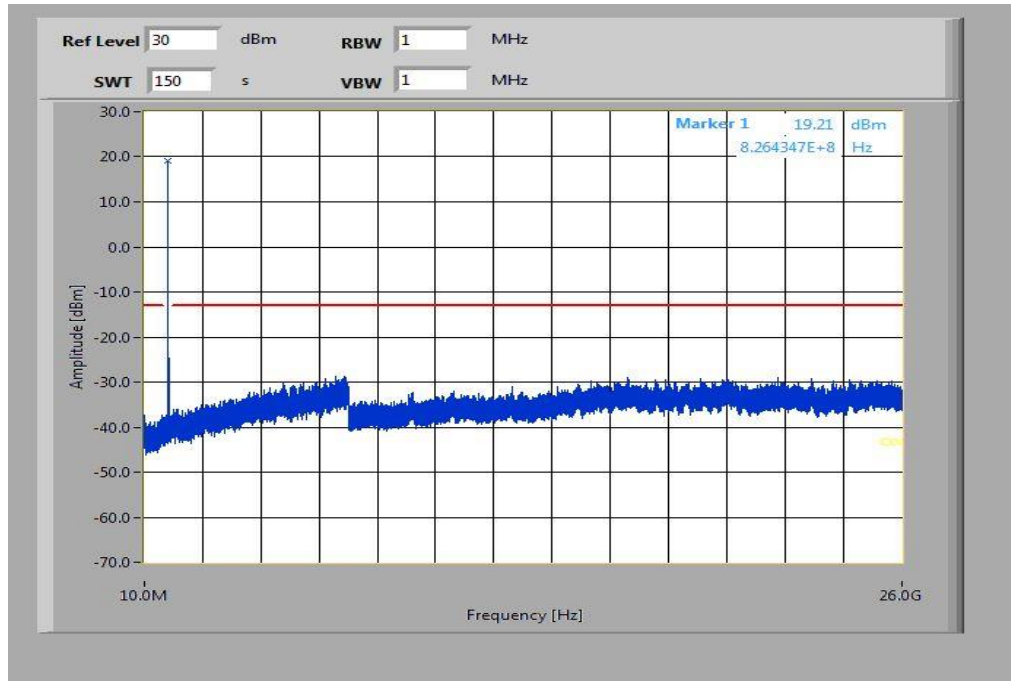

Plot 2: Middle Channel (10 MHz - 25 GHz)

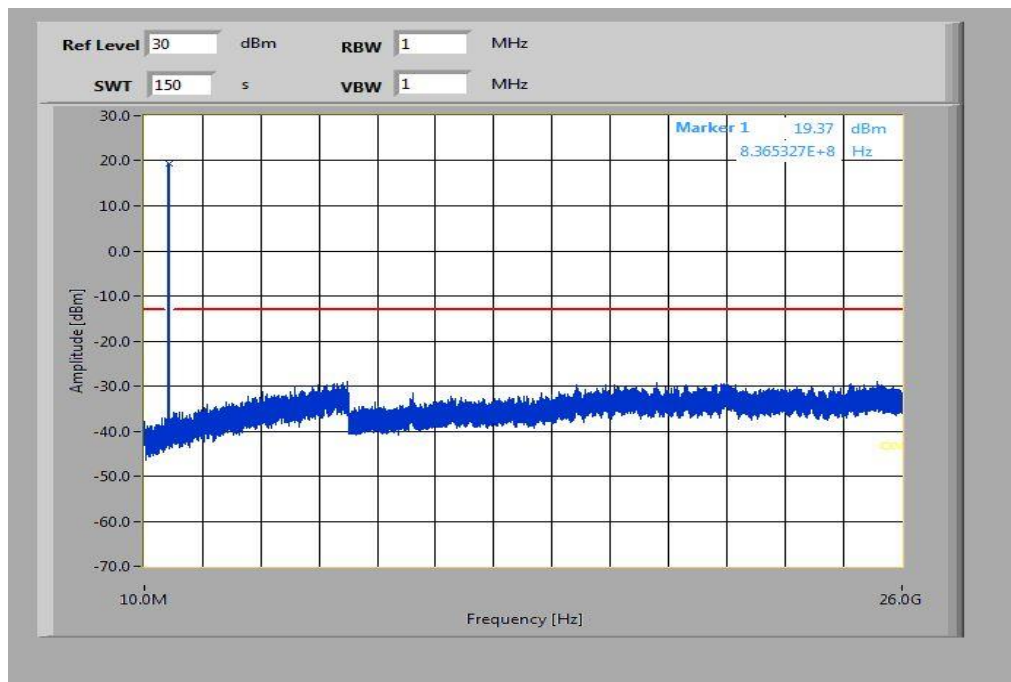

Plot 3: Highest Channel (10 MHz - 25 GHz)

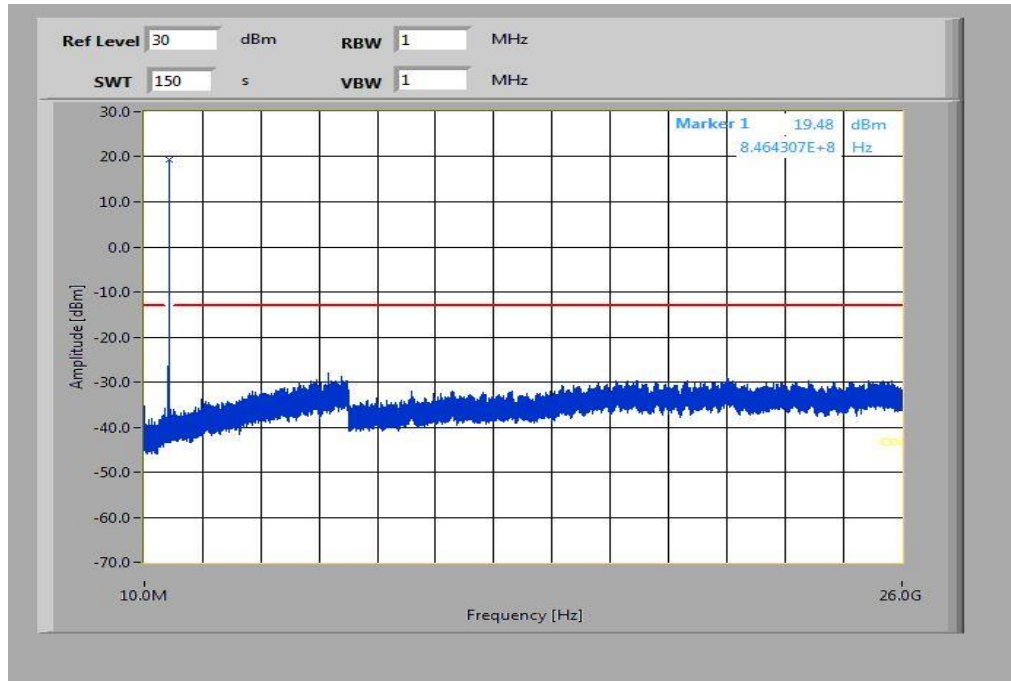

Plots: 16-QAM with 5 MHz channel bandwidth

Plot 4: Lowest Channel (10 MHz - 25 GHz)

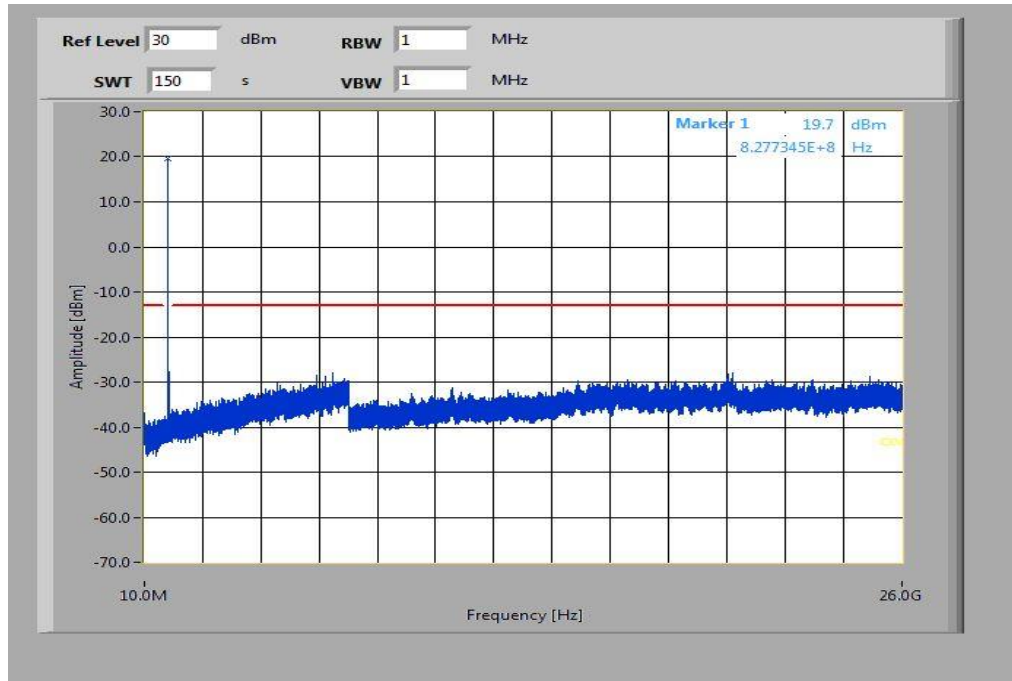

Plot 5: Middle Channel (10 MHz - 25 GHz)

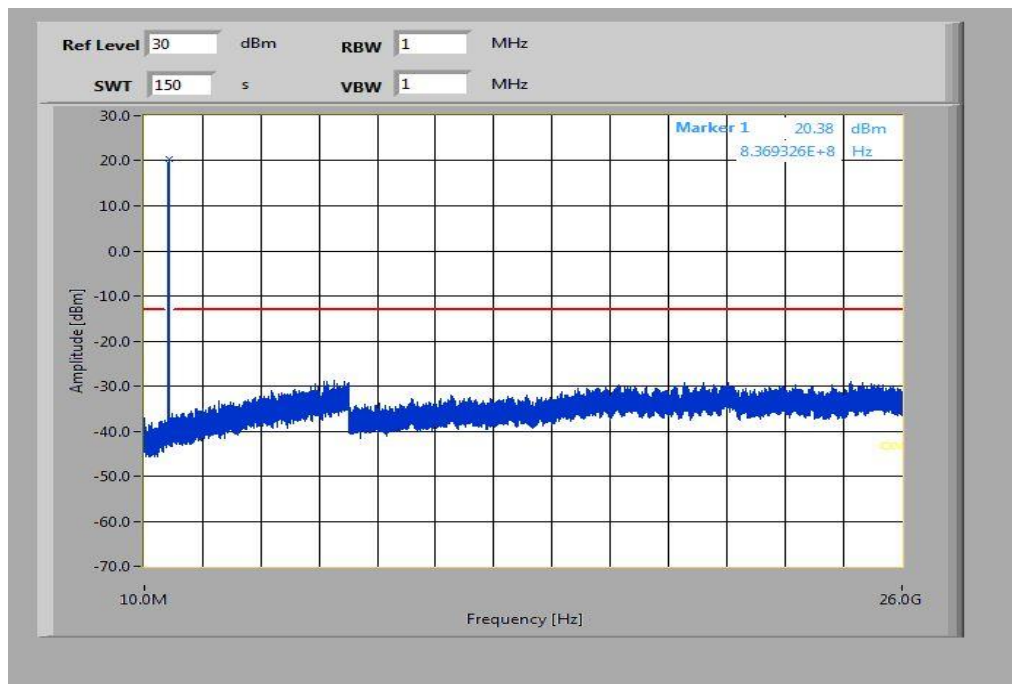

Plot 6: Highest Channel (10 MHz - 25 GHz)

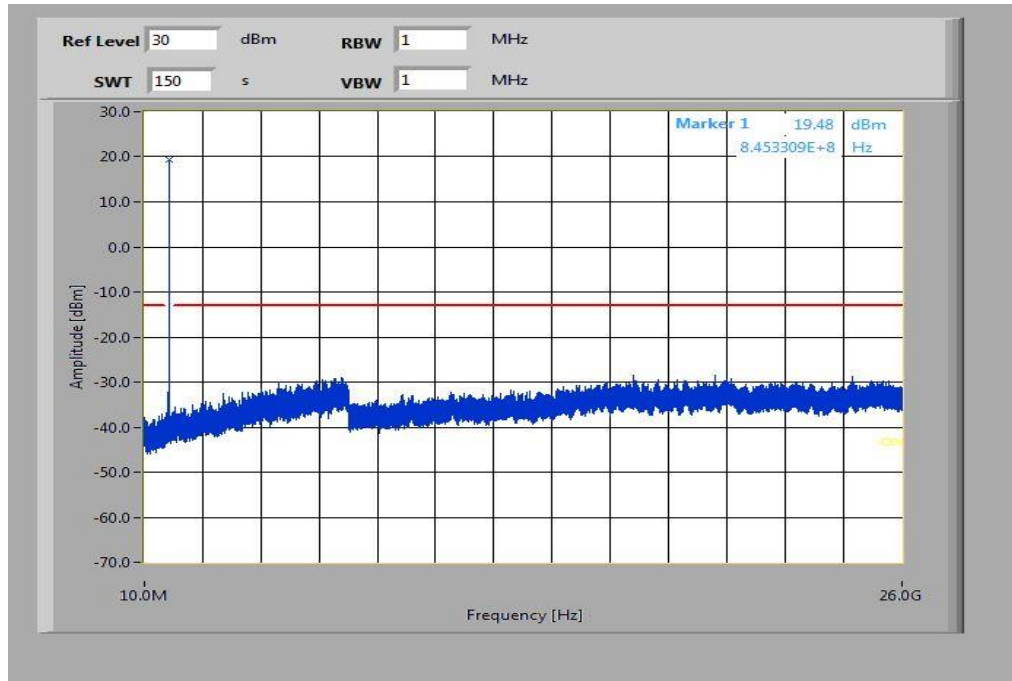

Plots: QPSK with 10 MHz channel bandwidth

Plot 1: Lowest Channel (10 MHz - 25 GHz)

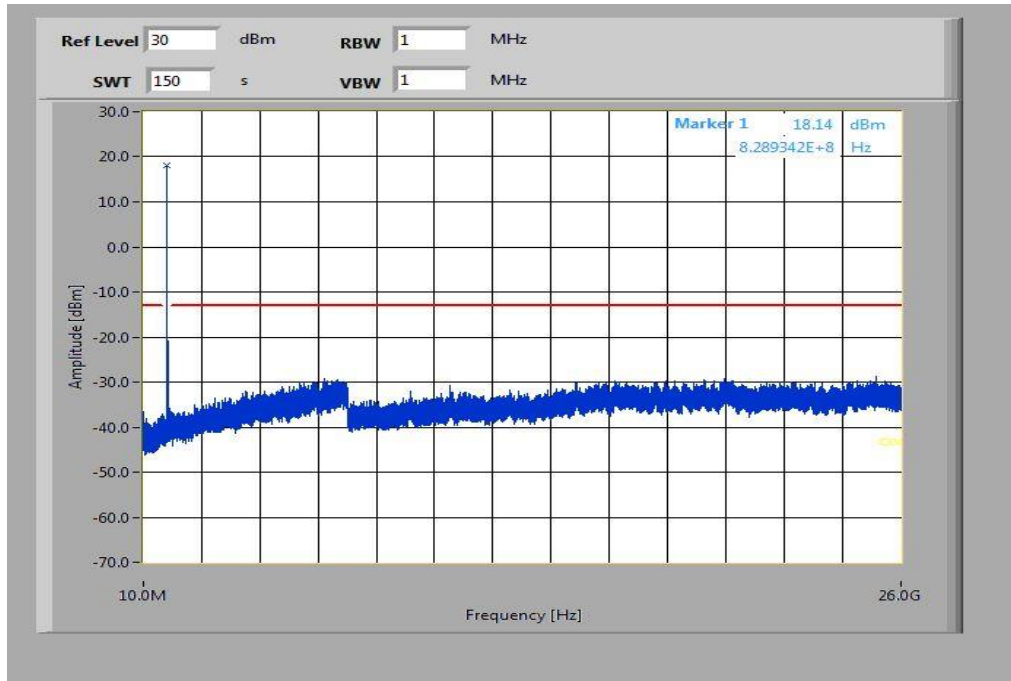

Plot 2: Middle Channel (10 MHz - 25 GHz)

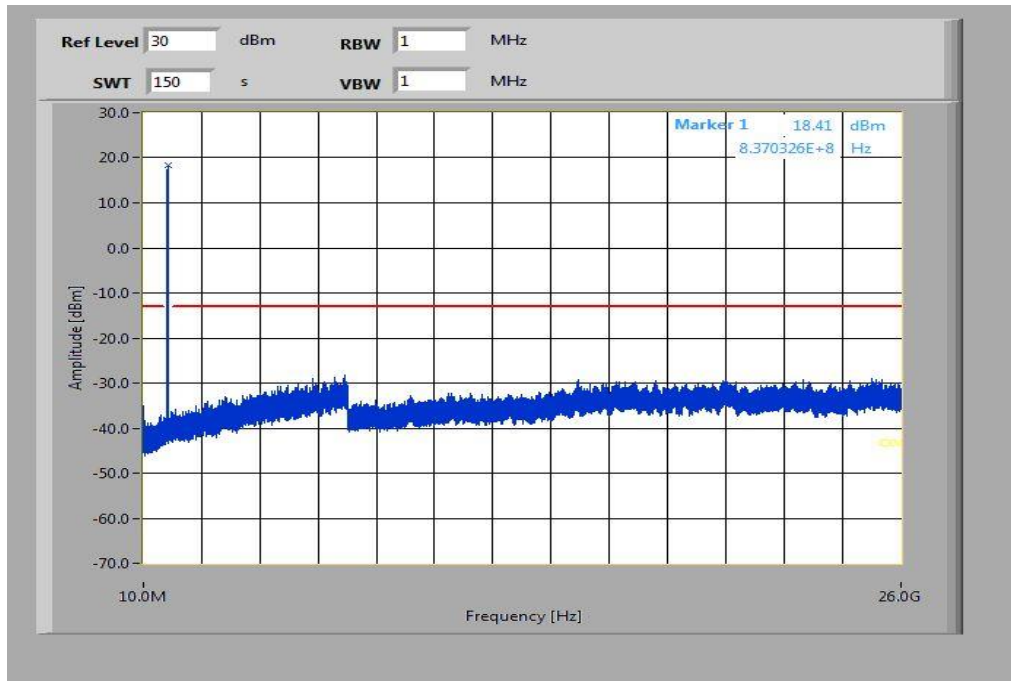

Plot 3: Highest Channel (10 MHz - 25 GHz)

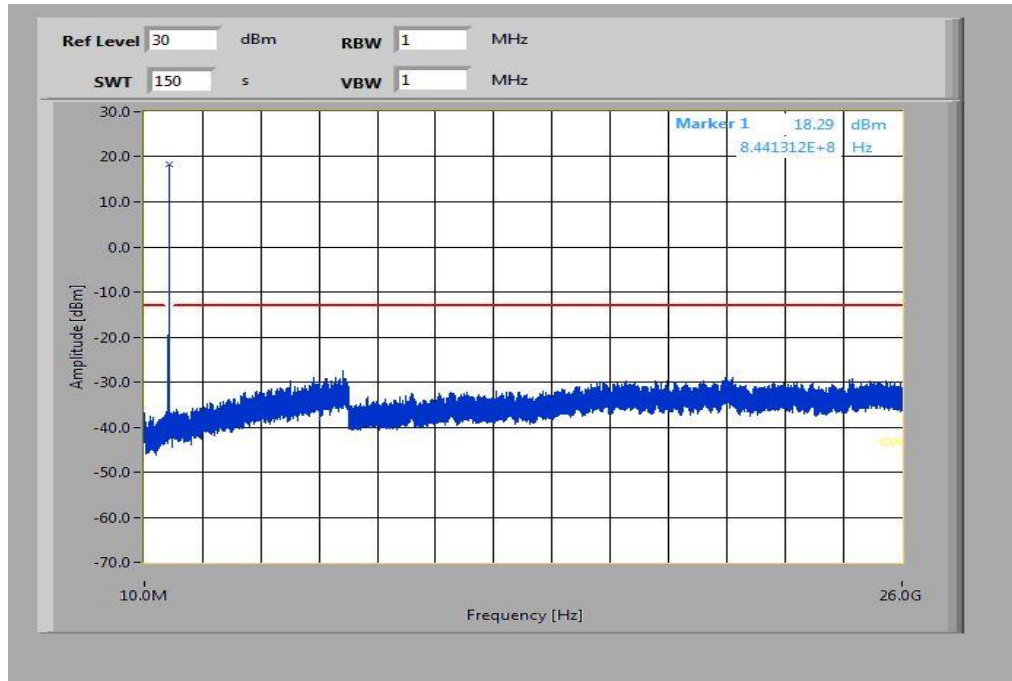

Plots: 16-QAM with 10 MHz channel bandwidth

Plot 4: Lowest Channel (10 MHz - 25 GHz)

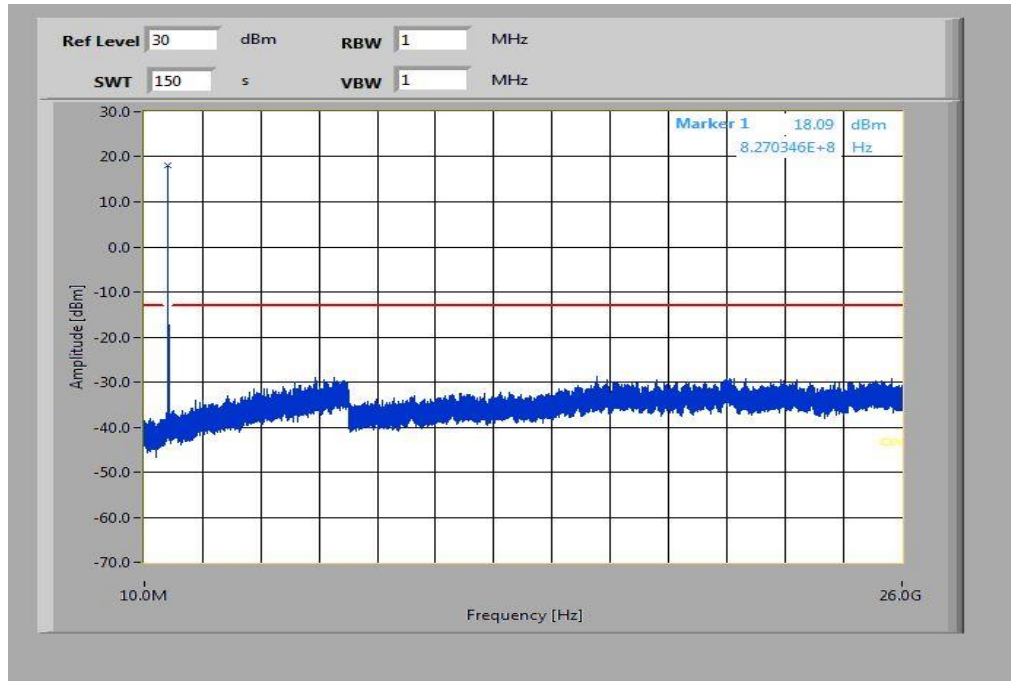

Plot 5: Middle Channel (10 MHz - 25 GHz)

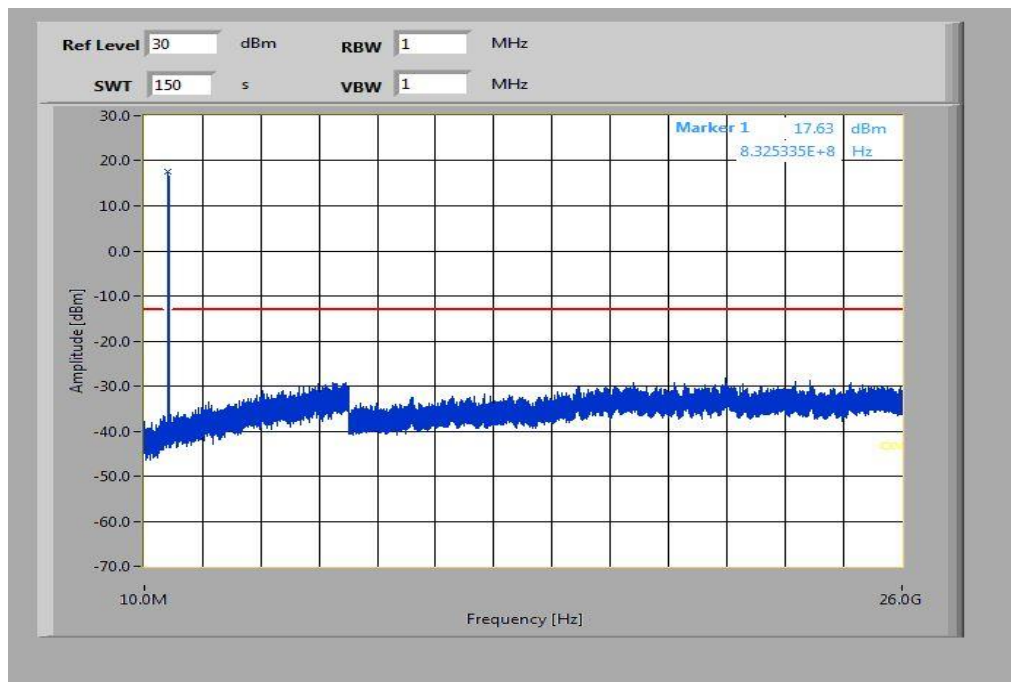

Plot 6: Highest Channel (10 MHz - 25 GHz)

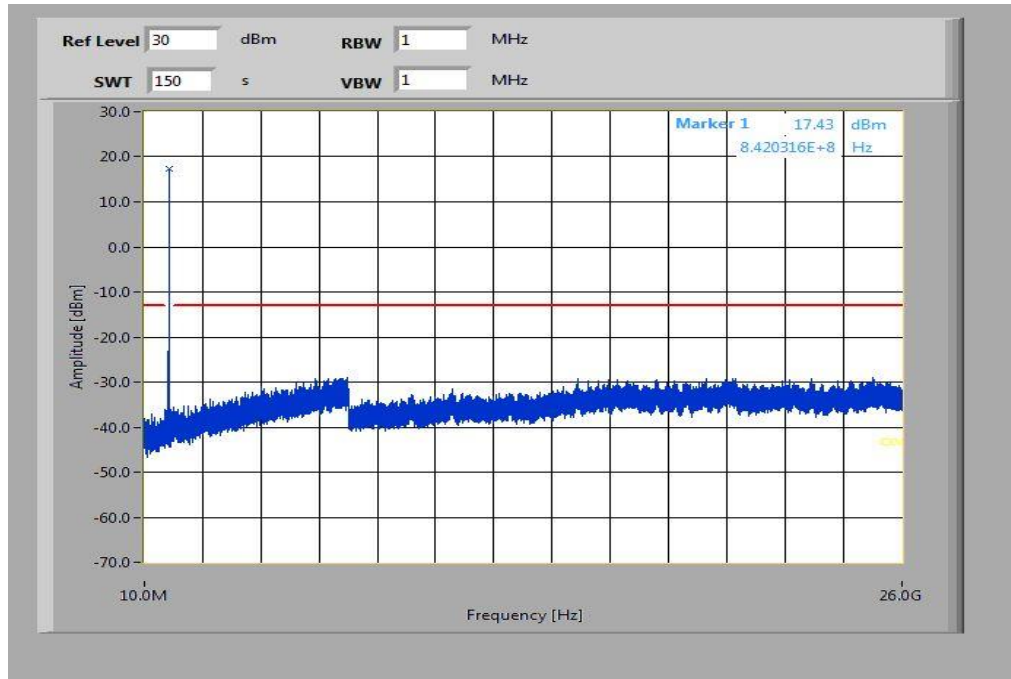

8.2.5 Block edge compliance

Description:

The spectrum at the band edges must comply with the spurious emissions limits.

Measurement:

Measurement parameters	
Detector:	RMS
Sweep time:	60 s
Video bandwidth:	30 kHz
Resolution bandwidth:	30 kHz
Span:	1 MHz
Trace-Mode:	Max Hold

Limits:

FCC
CFR Part 22.917 CFR Part 2.1051
Block Edge Compliance
<p>Part 22.917 specifies that “the power of any emission outside of the authorized operating frequency ranges must be attenuated below the transmitting power (P) by a factor of at least $43 + 10 \log(P)$ dB.”</p> <p>However, in publication number 890810, The FCC Office of Engineering and Technology specified the following correction to the limits when a resolution bandwidth smaller than 1% of the emission bandwidth is used:</p> <p>“An alternative is to add an additional correction factor of $10 \log(RBW1/RBW2)$ to the $43 + 10 \log(P)$ limit. RBW1 is the narrower measurement resolution bandwidth and RBW2 is either the 1% emissions bandwidth or 1 MHz.”</p> <p>When using a 30 kHz bandwidth, this yields a -5.23 adjustment to the limit [$10 \log(30\text{kHz}/100\text{kHz}) = -5.23$]. When this adjustment is applied to the limit, the limit becomes -18.23 dBm.</p>
-18.23 dBm

Results: 1.4 MHz channel bandwidth

Plot 1: Lowest channel – QPSK

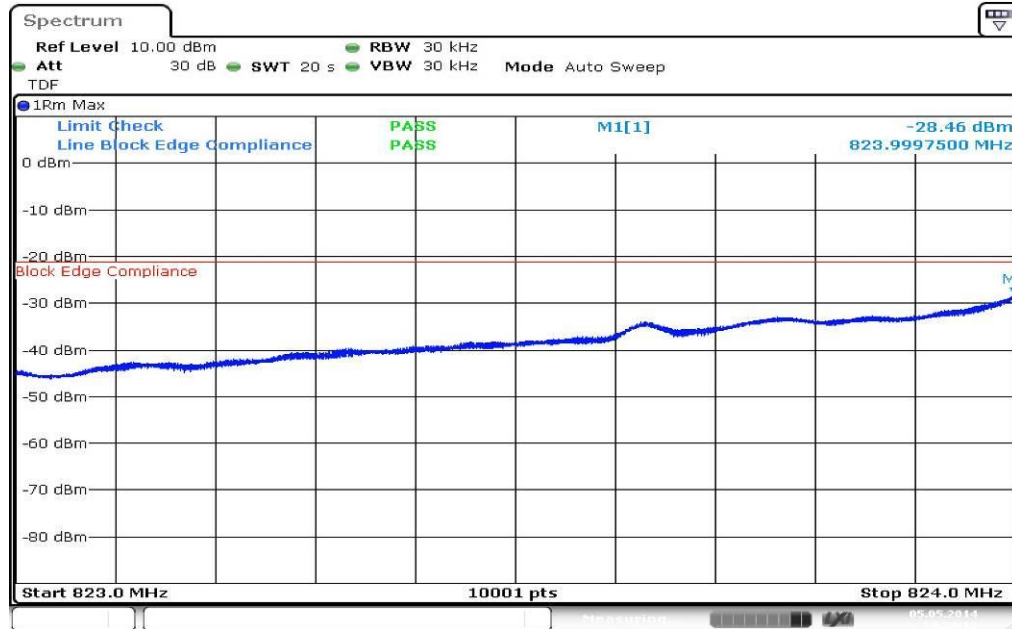

Plot 2: Highest channel – QPSK

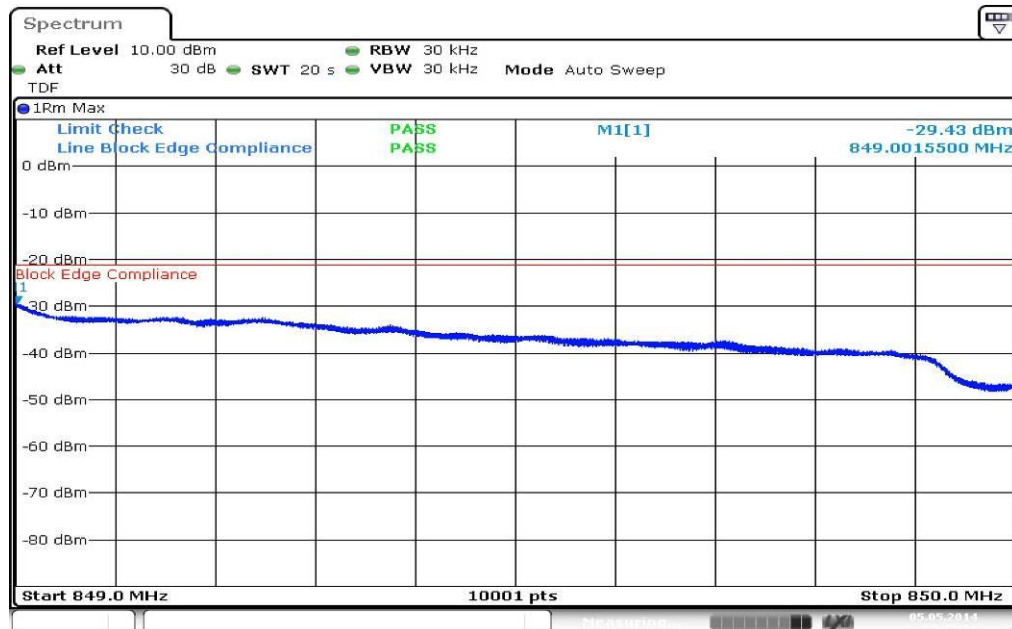

Plot 3: Lowest channel – 16-QAM

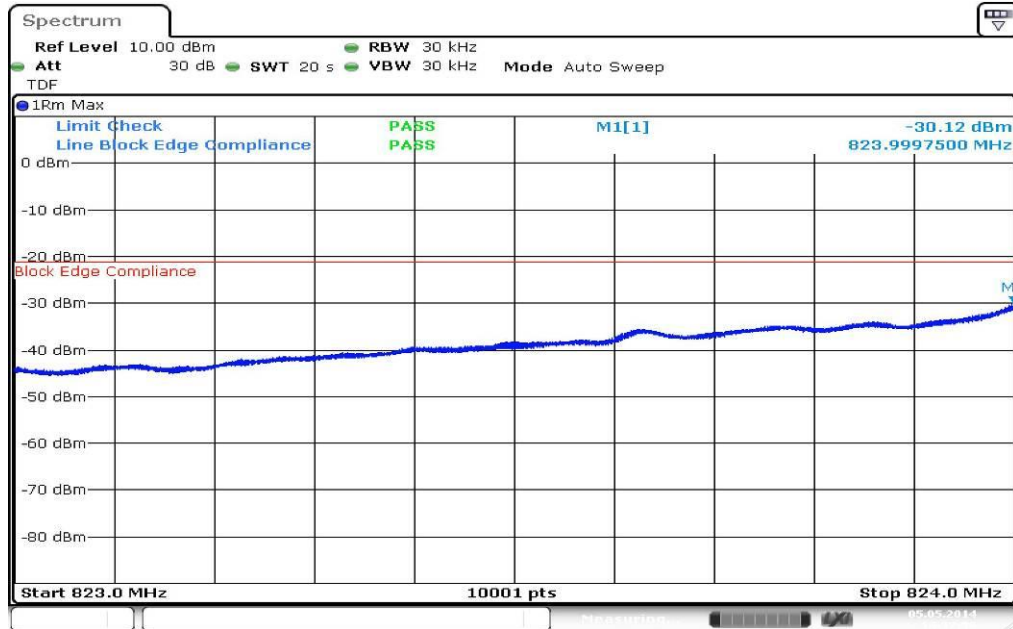

Plot 4: Highest channel – 16-QAM

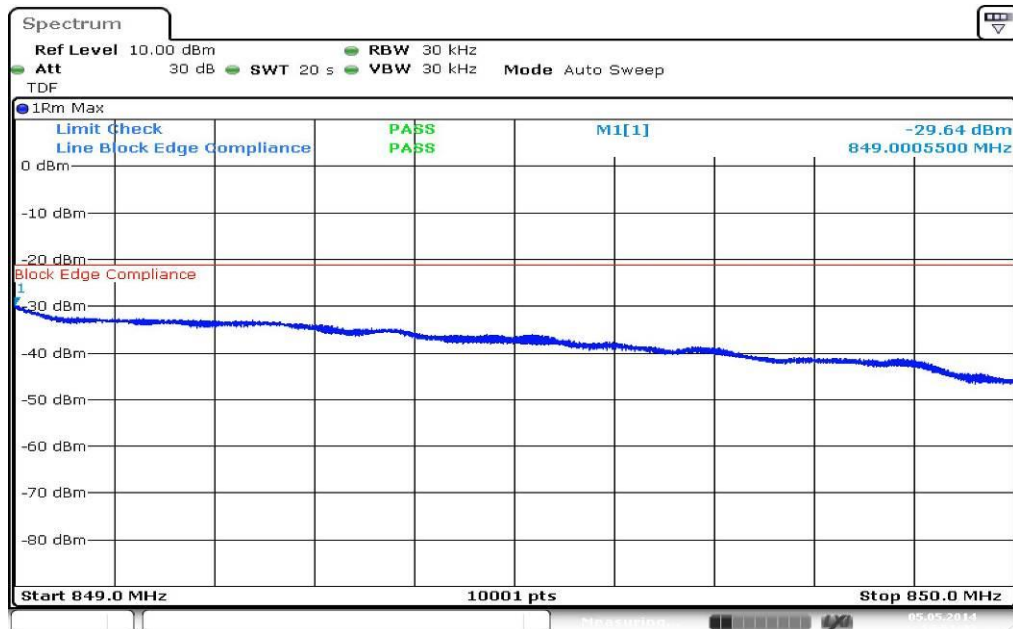

Results: 3 MHz channel bandwidth

Plot 1: Lowest channel – QPSK

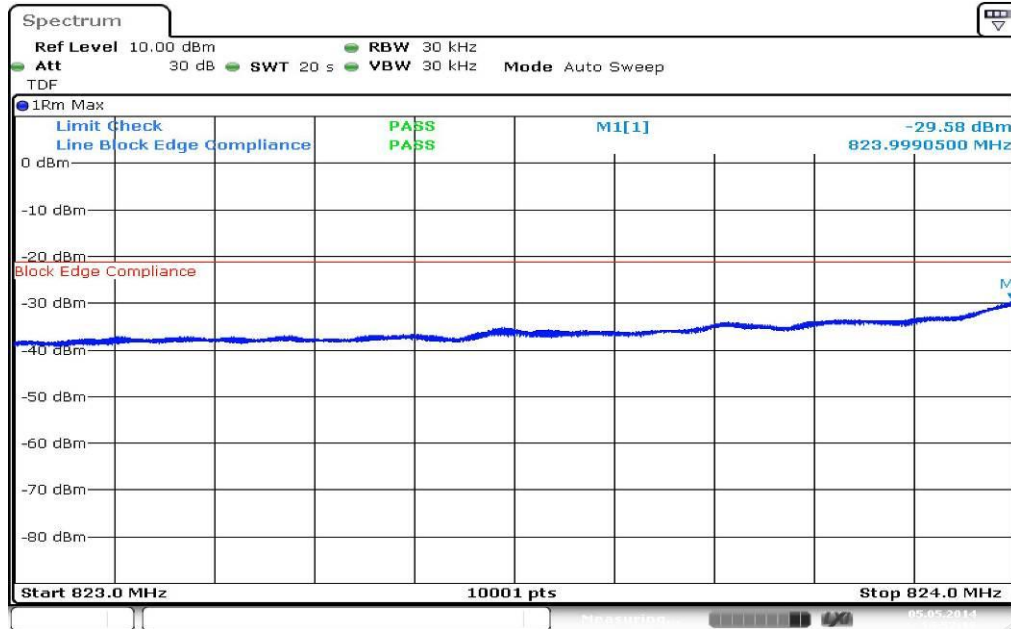

Plot 2: Highest channel – QPSK

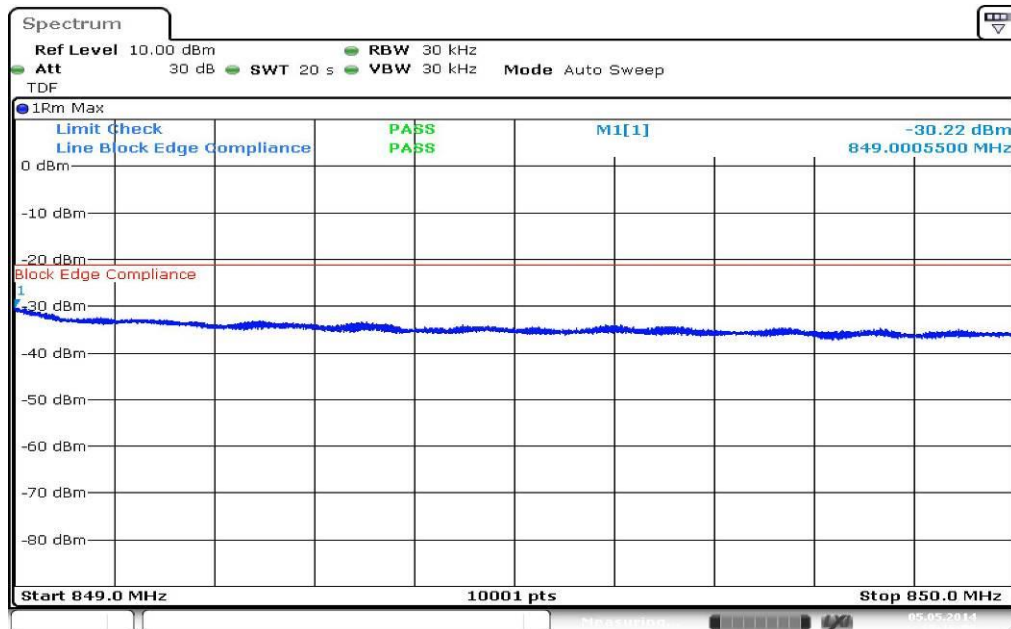

Plot 3: Lowest channel – 16-QAM

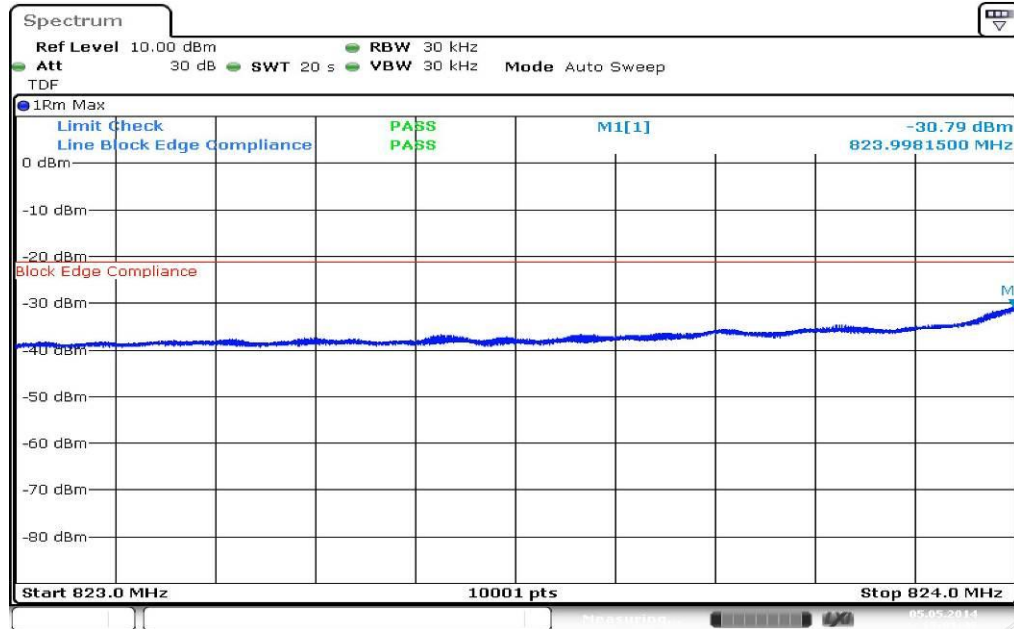

Plot 4: Highest channel – 16-QAM

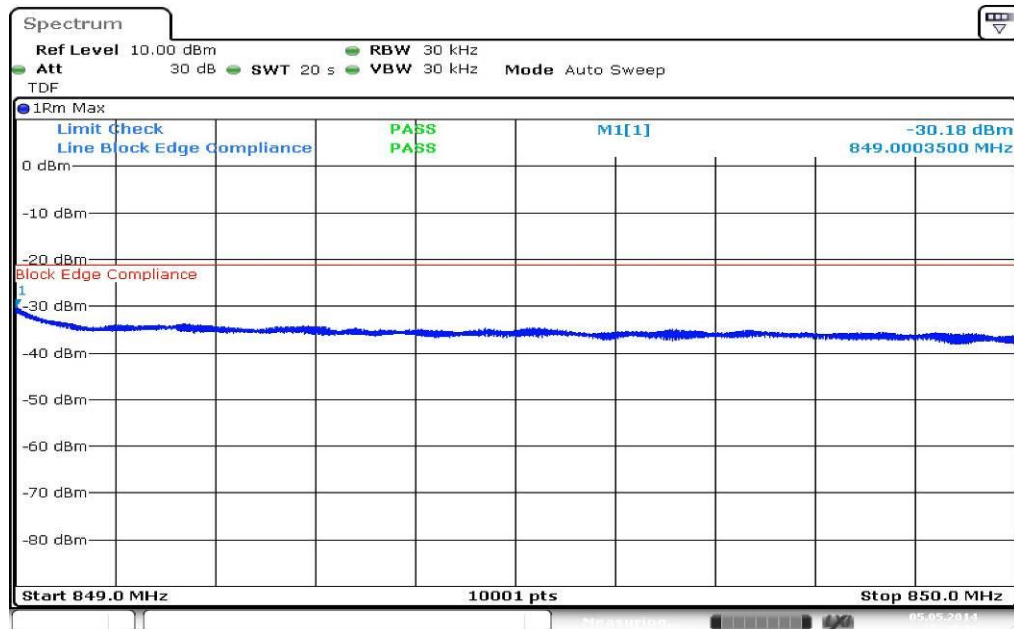

Results: 5 MHz channel bandwidth

Plot 1: Lowest channel – QPSK

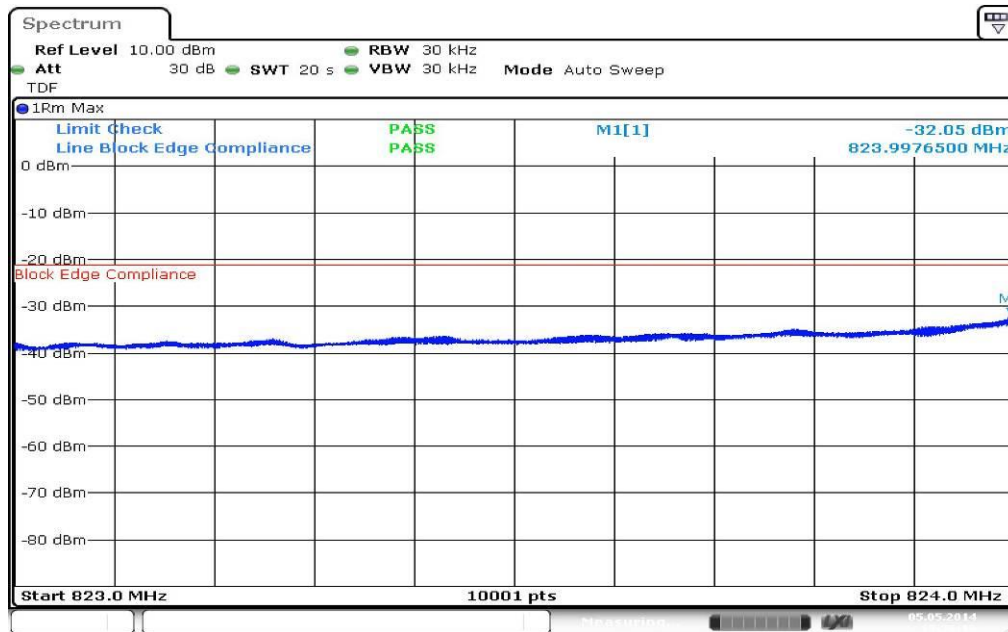

Plot 2: Highest channel – QPSK

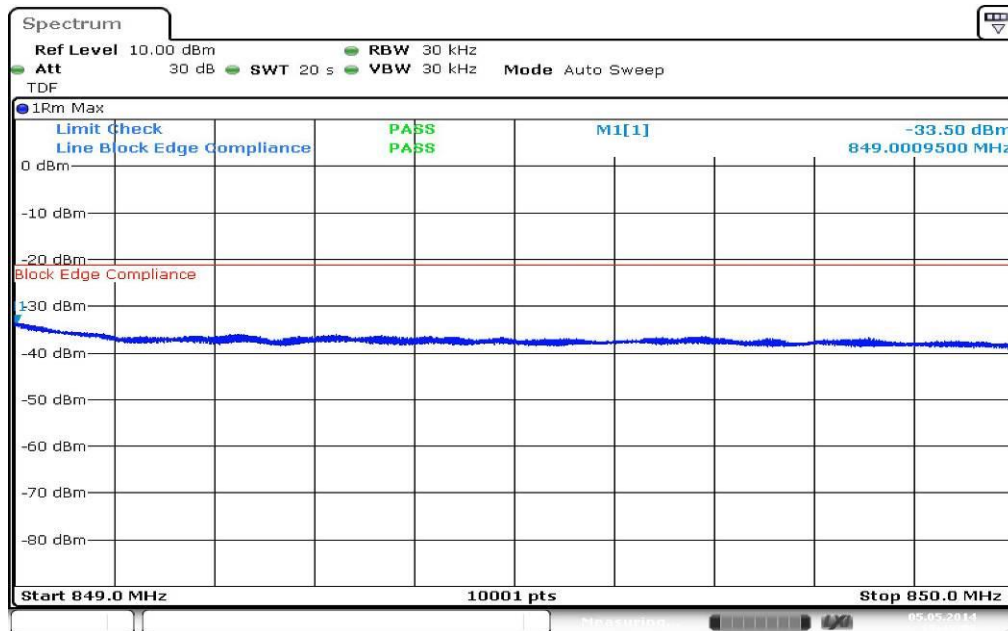

Plot 3: Lowest channel – 16-QAM

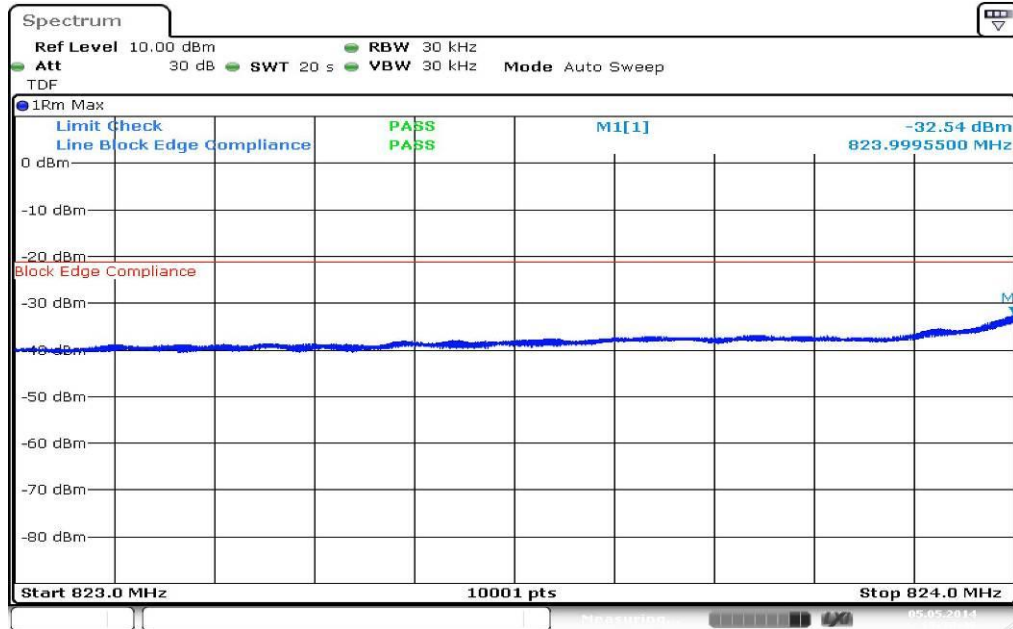

Date: 5.MAY.2014 15:30:48

Plot 4: Highest channel – 16-QAM

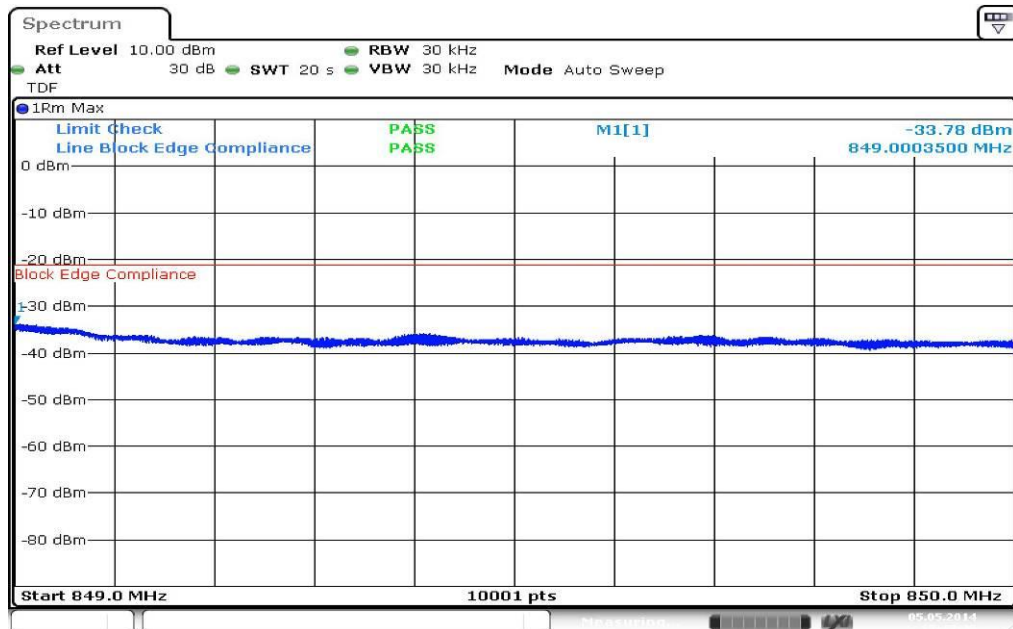

Date: 5.MAY.2014 15:49:40

Results: 10 MHz channel bandwidth

Plot 1: Lowest channel – QPSK

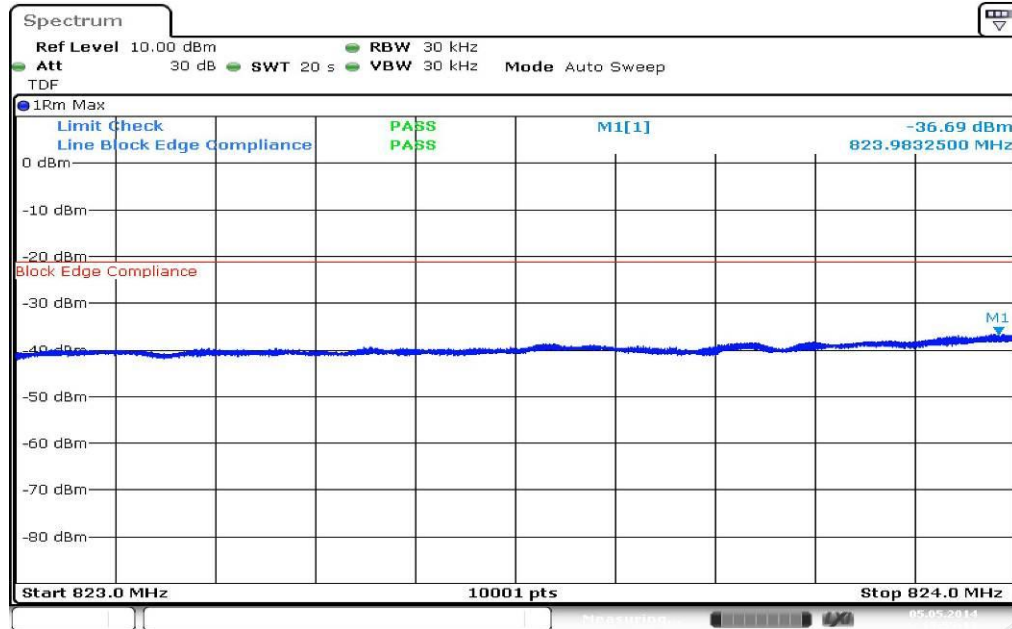

Date: 5.MAY.2014 15:55:13

Plot 2: Highest channel – QPSK

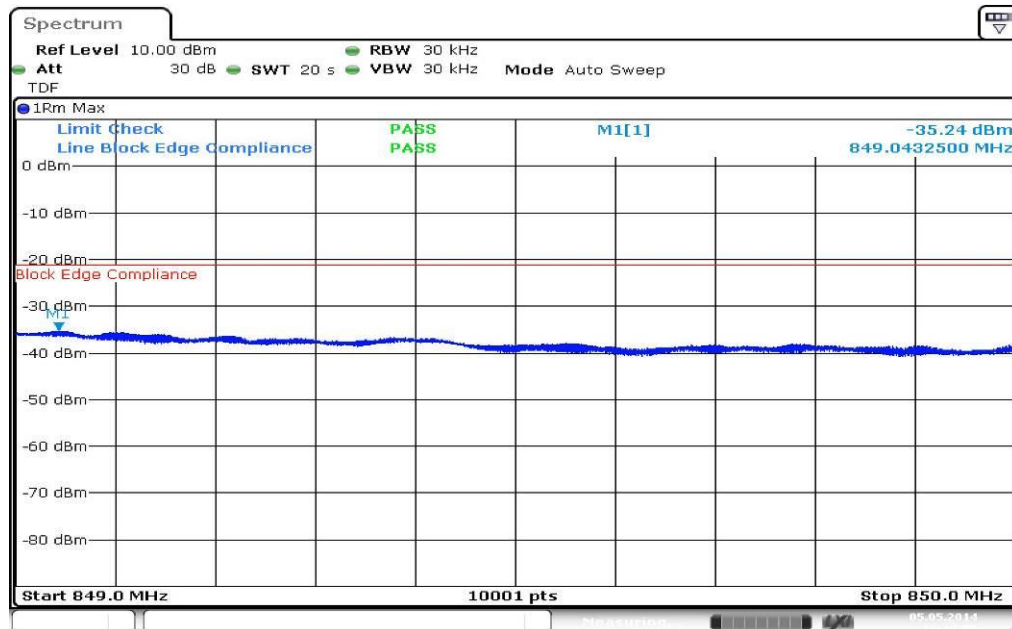

Date: 5.MAY.2014 16:14:06

Plot 3: Lowest channel – 16-QAM

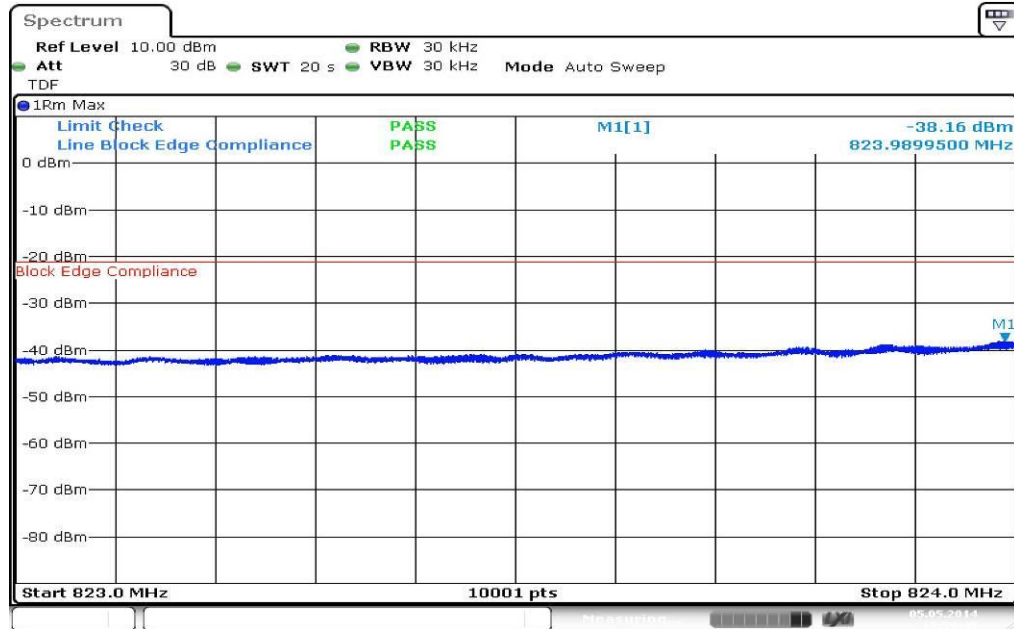

Plot 4: Highest channel – 16-QAM

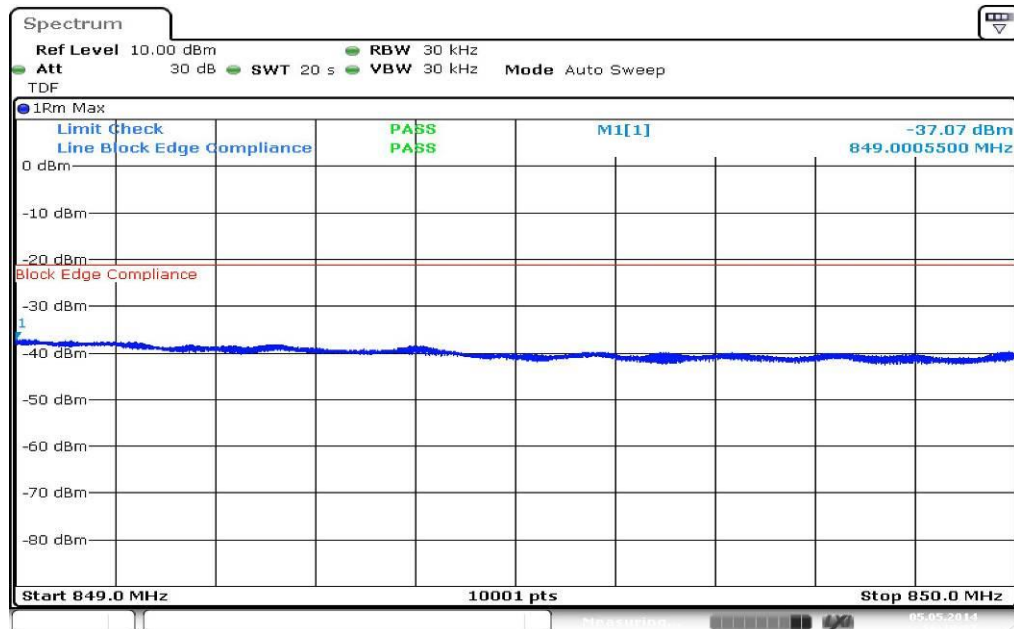

Result: **Passed**

8.2.6 Occupied bandwidth

Description:

Measurement of the occupied bandwidth of the transmitted signal.

Measurement:

Similar to conducted emissions, occupied bandwidth measurements are only provided for selected frequencies in order to reduce the amount of submitted data. Data were taken at the extreme and mid frequencies of the LTE band V. The table below lists the measured 99% power and -26dBc occupied bandwidths. Spectrum analyzer plots are included on the following pages.

Measurement parameters	
Detector:	Peak
Sweep time:	Auto
Video bandwidth:	10 kHz
Resolution bandwidth:	10 kHz
Span:	2 x nominal BW
Trace-Mode:	Max Hold

Limits:

FCC
CFR Part 22.917 CFR Part 2.1049
Occupied Bandwidth
Spectrum must fall completely in the specified band

Results:

Occupied Bandwidth – QPSK		
Bandwidth (MHz)	99% OBW (kHz)	-26 dBc BW (kHz)
1.4	1090	1293
3.0	2727	3043
5.0	4494	4981
10.0	9055	10133
Measurement uncertainty	± RBW	

Occupied Bandwidth – 16-QAM		
Bandwidth (MHz)	99% OBW (kHz)	-26 dBc BW (kHz)
1.4	1095	1294
3.0	2723	3052
5.0	4507	5015
10.0	9053	10051
Measurement uncertainty	± RBW	

Result: **Passed**

Plots: QPSK

Plot 1: 1.4 MHz (99% - OBW)

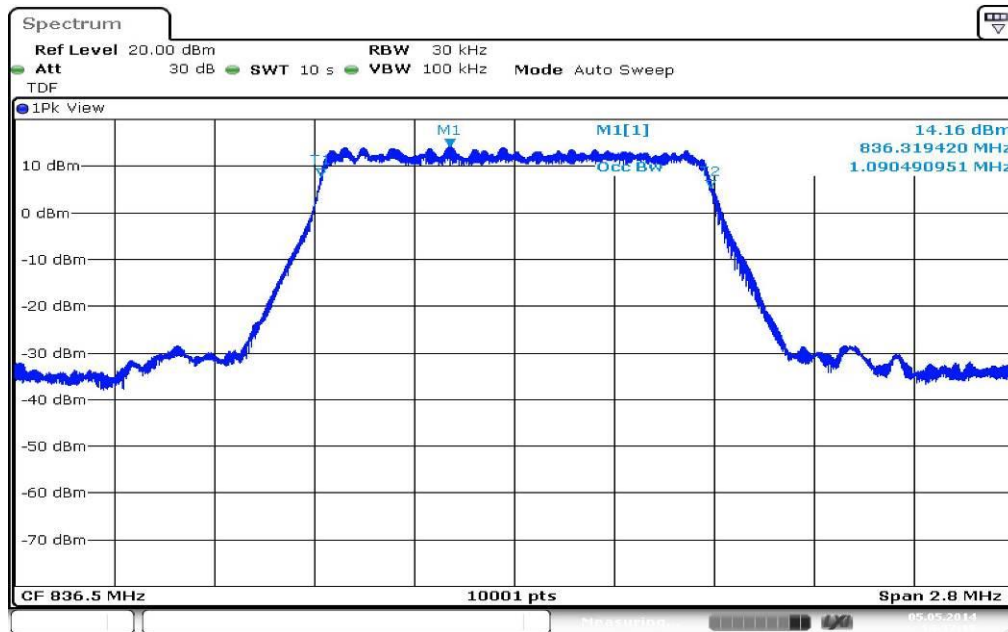

Date: 5.MAY.2014 14:37:15

Plot 2: 1.4 MHz (-26 dBc BW)

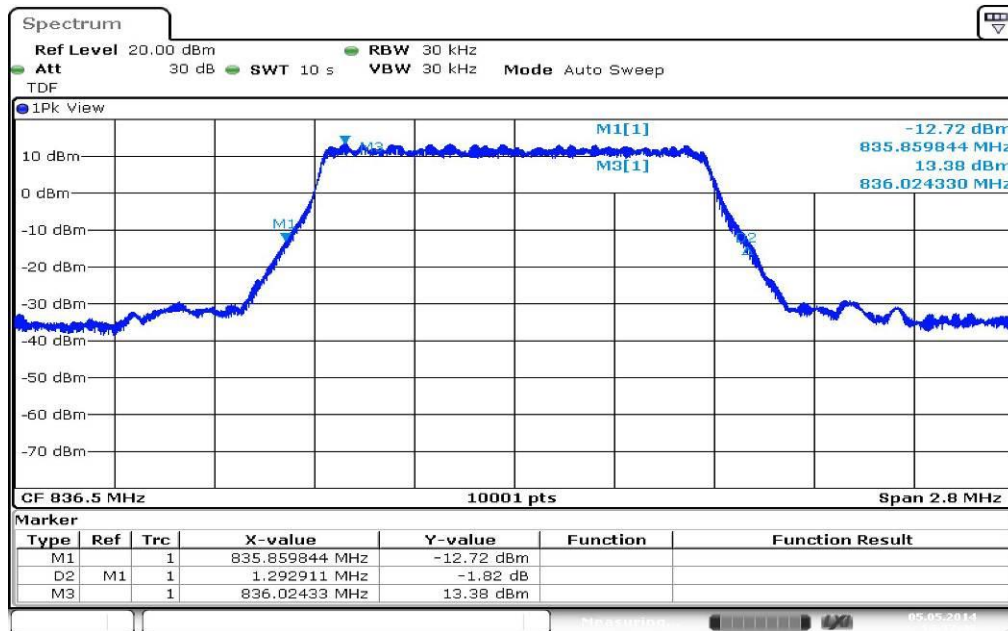

Date: 5.MAY.2014 14:37:48

Plot 3: 3 MHz (99% - OBW)

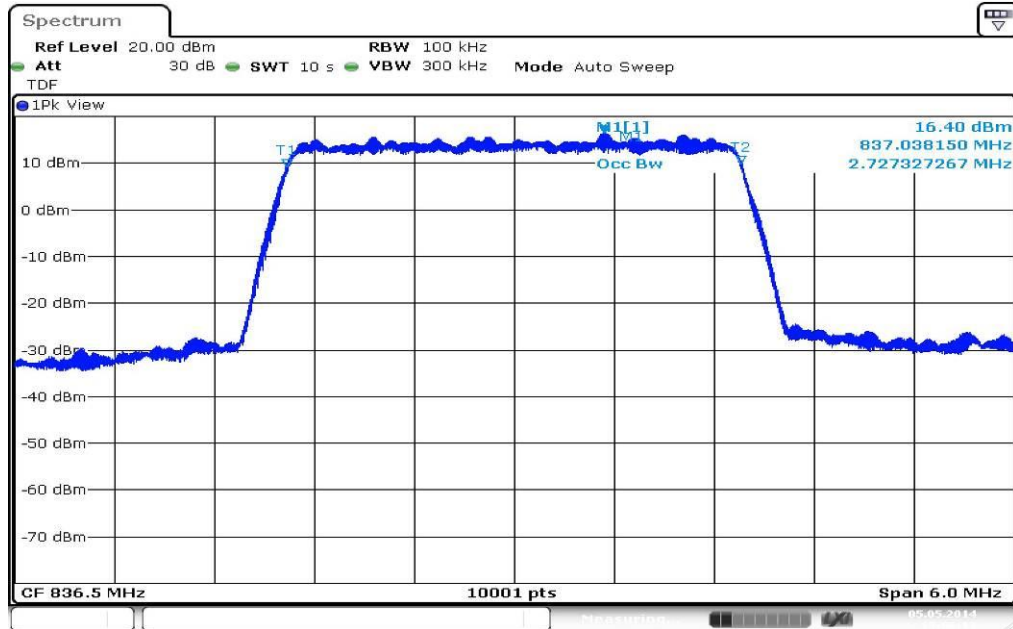

Plot 4: 3 MHz (-26 dBc BW)

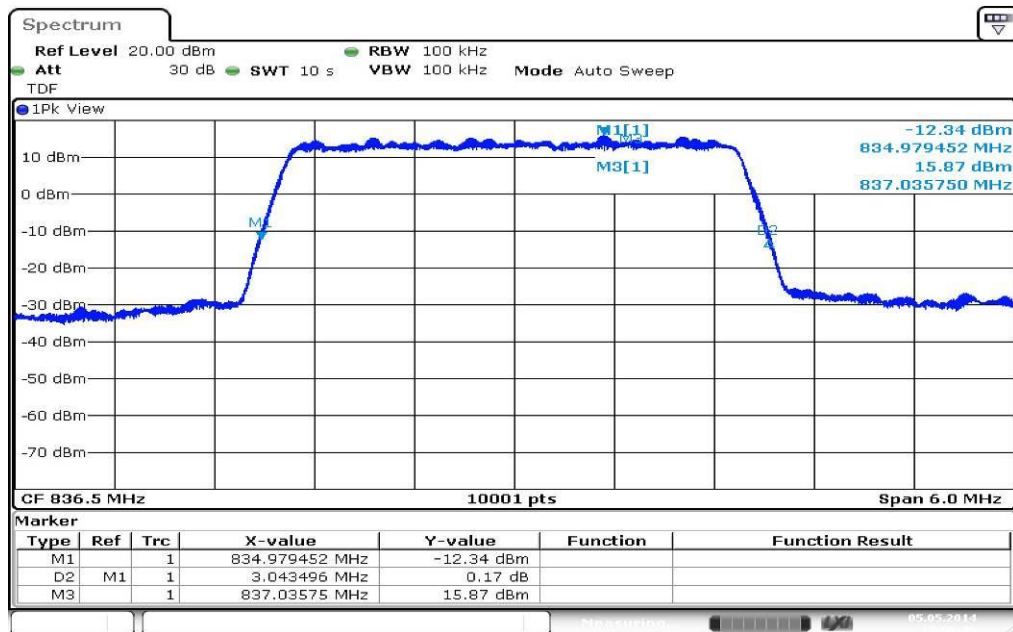

Plot 5: 5 MHz (99% - OBW)

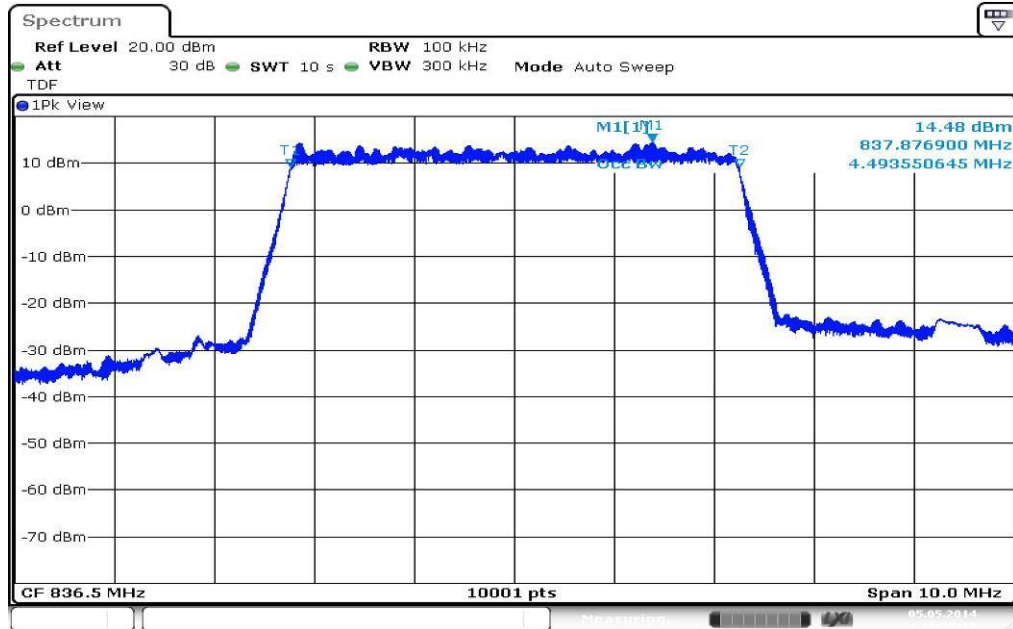

Plot 6: 5 MHz (-26 dBc BW)

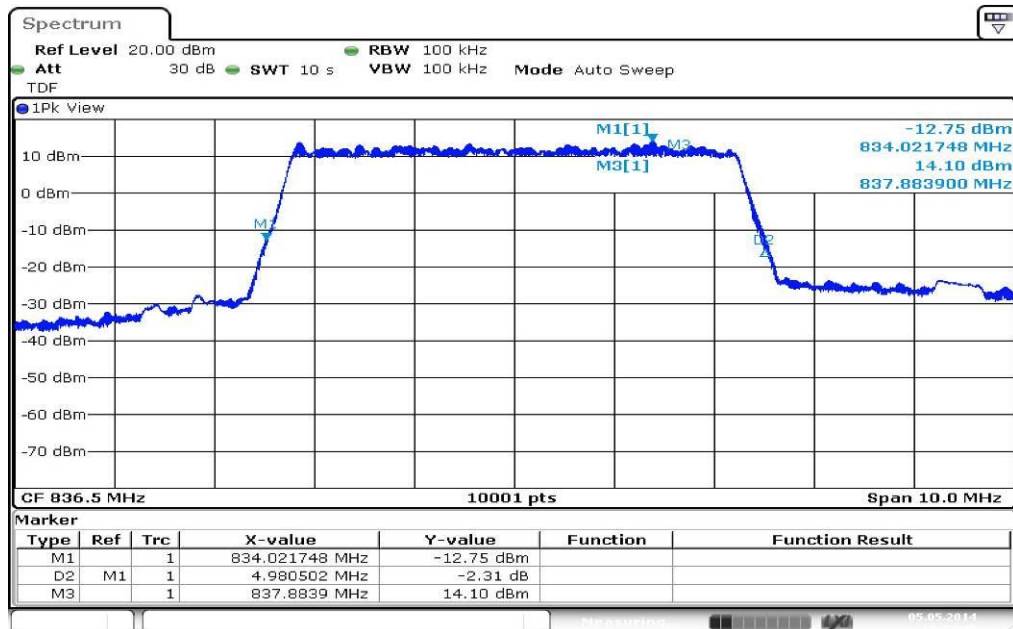

Plot 7: 10 MHz (99% - OBW)

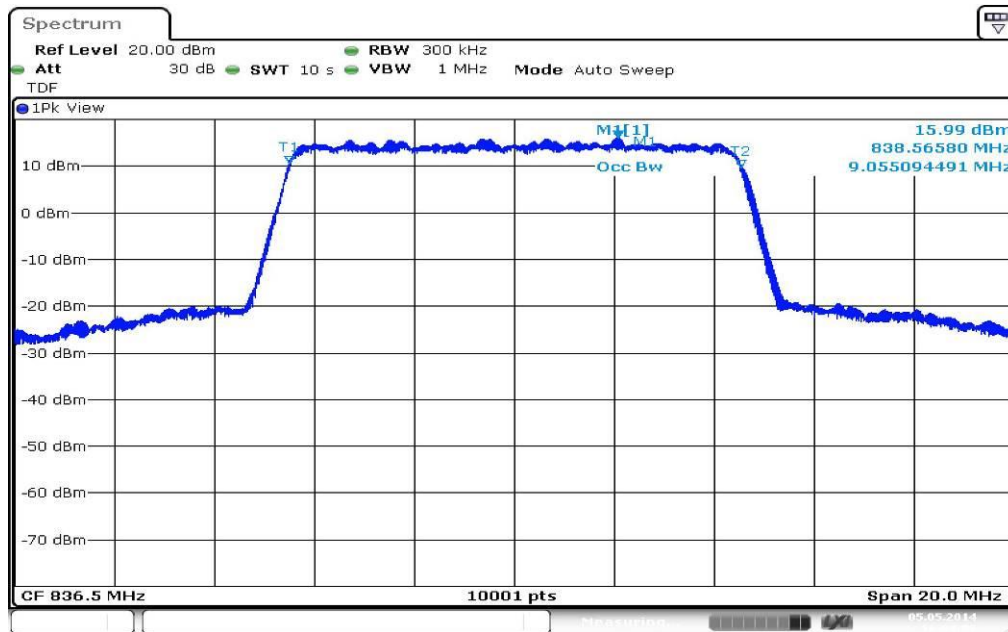

Date: 5.MAY.2014 16:04:09

Plot 8: 10 MHz (-26 dBc BW)

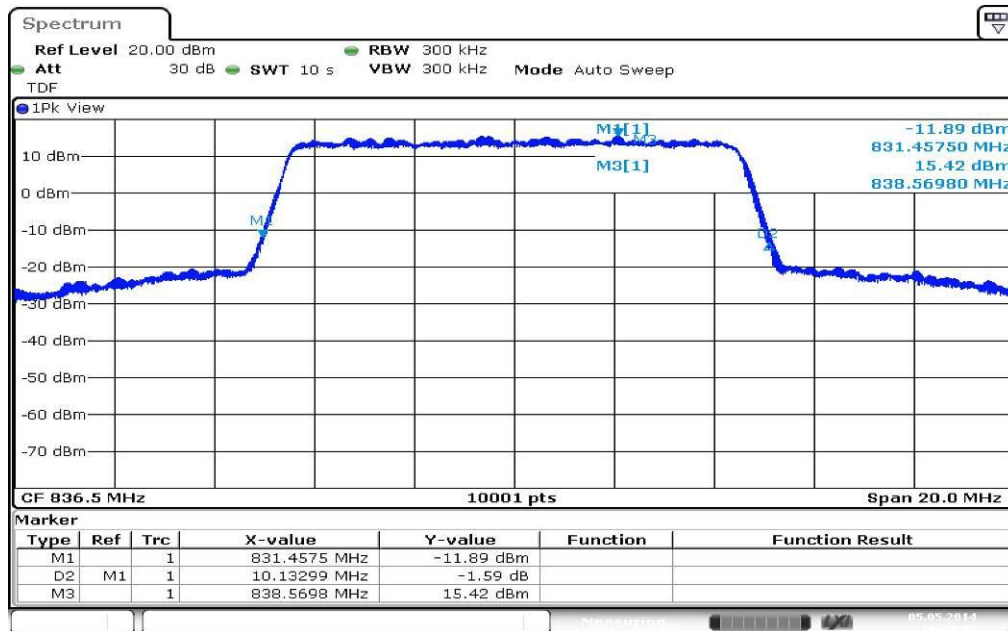

Date: 5.MAY.2014 16:04:42

Plots: 16-QAM

Plot 1: 1.4 MHz (99% - OBW)

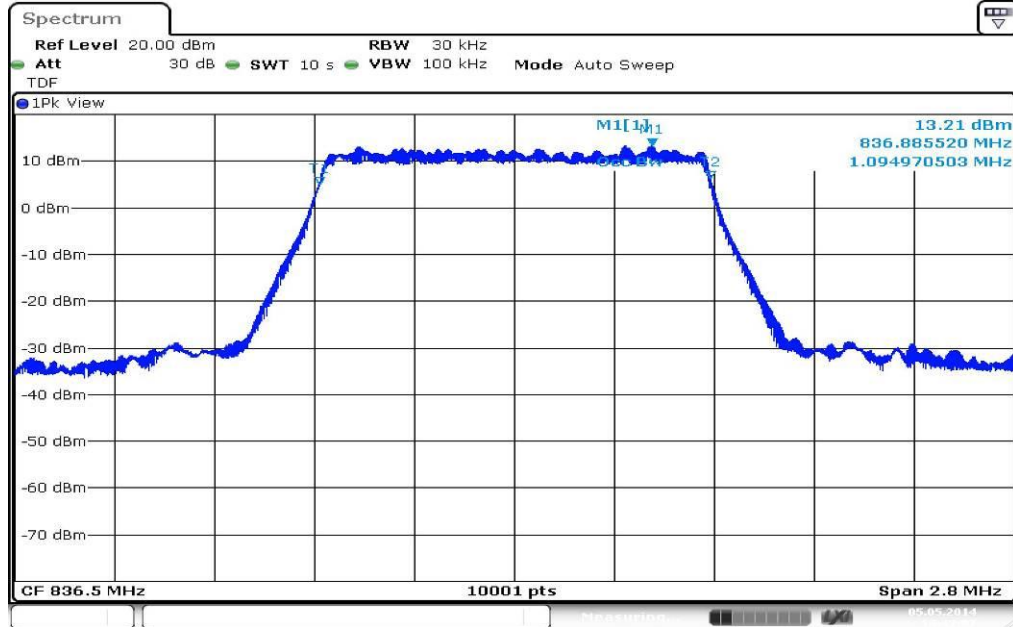

Date: 5.MAY.2014 14:42:07

Plot 2: 1.4 MHz (-26 dBc BW)

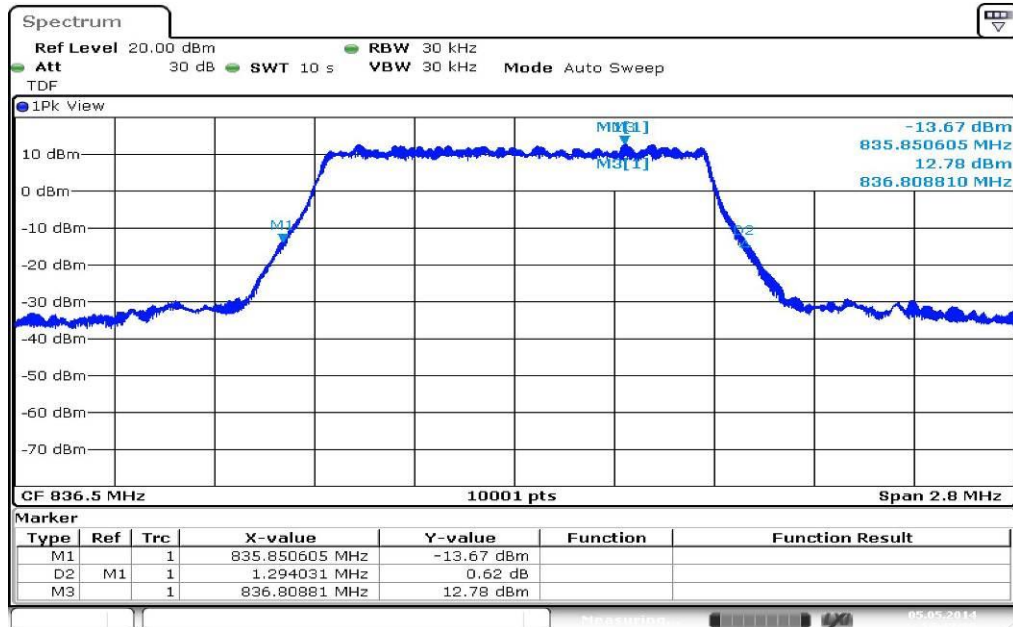

Date: 5.MAY.2014 14:42:40

Plot 3: 3 MHz (99% - OBW)

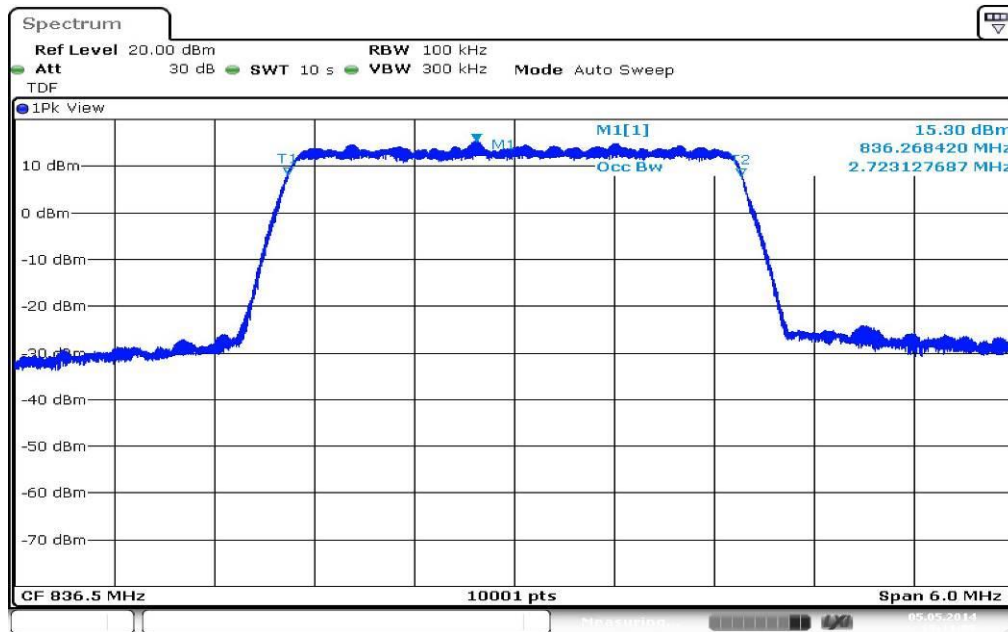

Date: 5.MAY.2014 15:11:05

Plot 4: 3 MHz (-26 dBc BW)

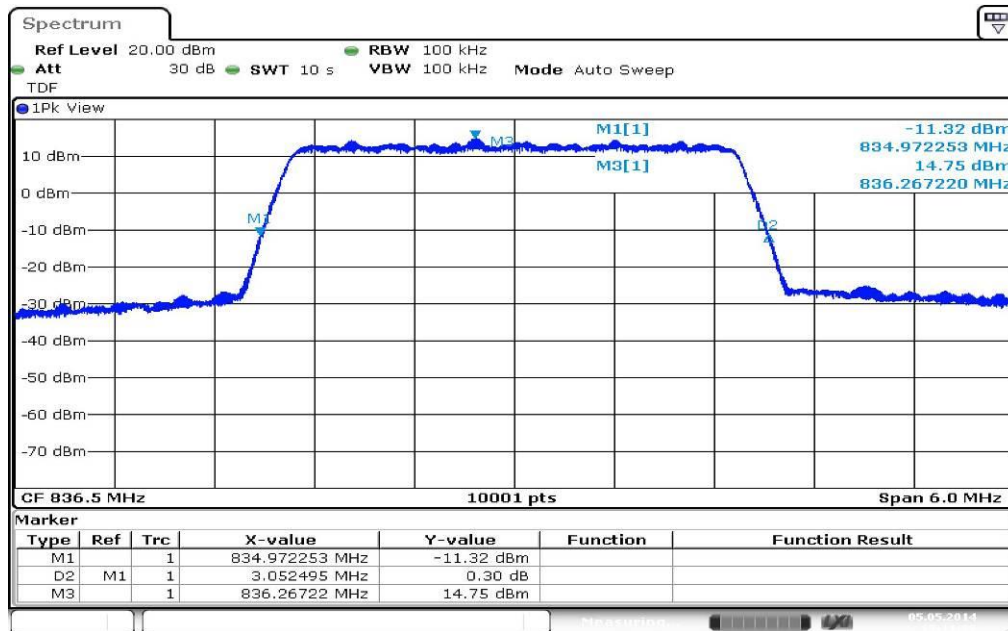

Date: 5.MAY.2014 15:11:38

Plot 5: 5 MHz (99% - OBW)

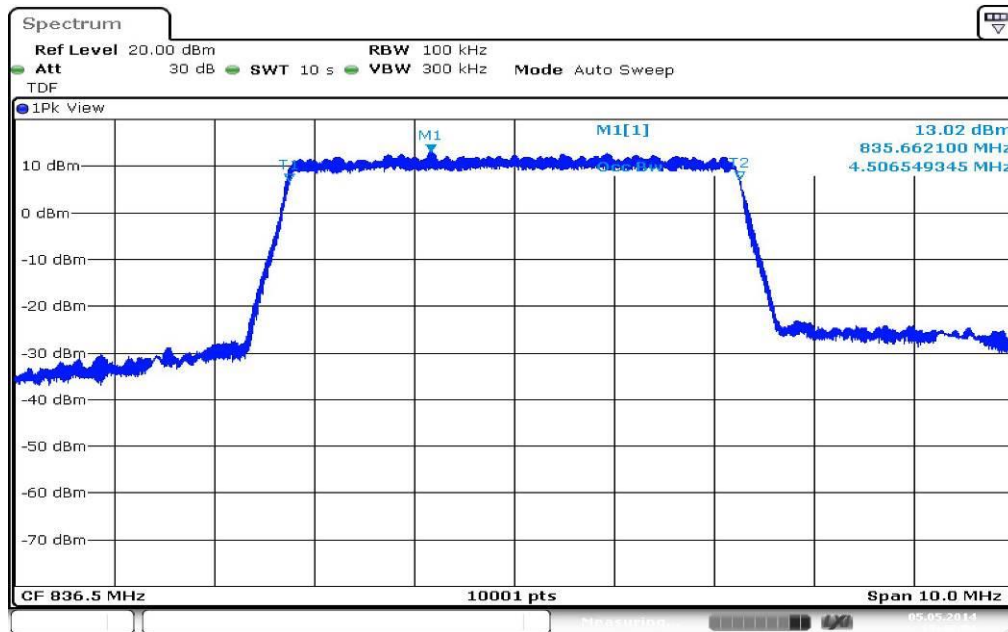

Plot 6: 5 MHz (-26 dBc BW)

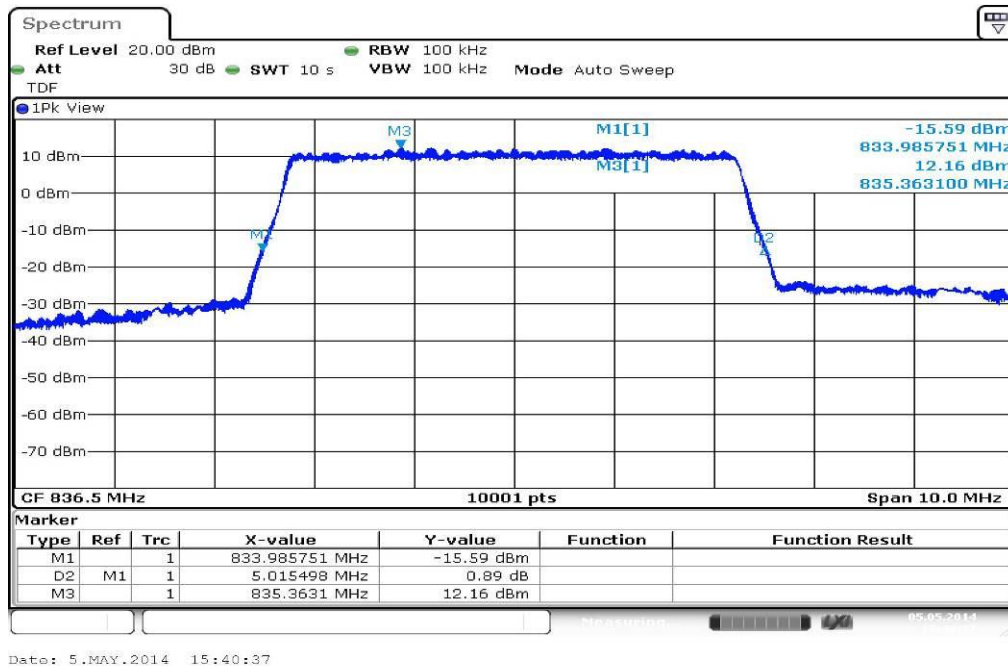

Plot 7: 10 MHz (99% - OBW)

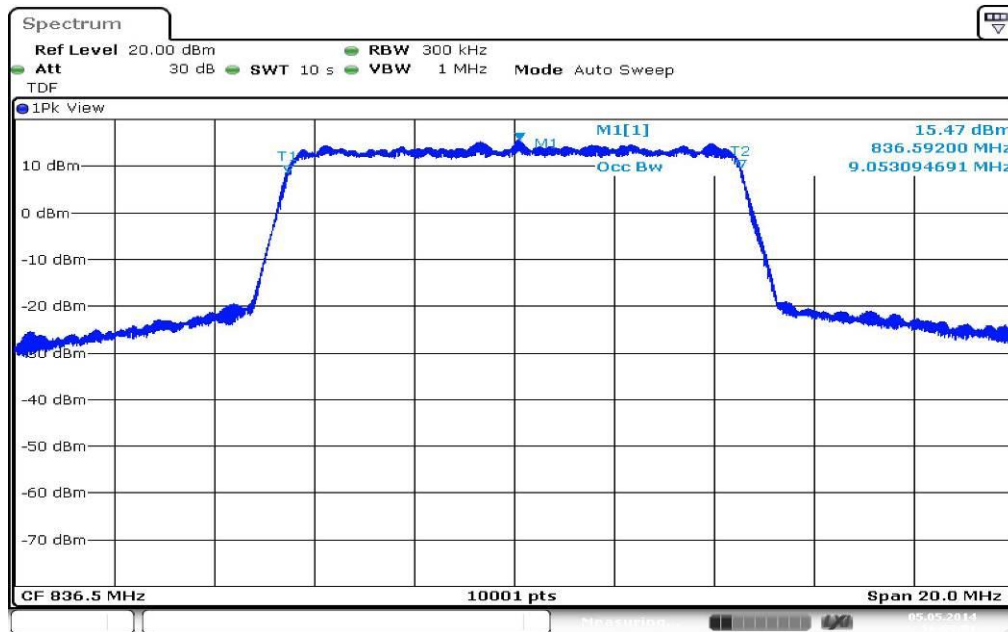

Date: 5.MAY.2014 16:09:01

Plot 8: 10 MHz (-26 dBc BW)

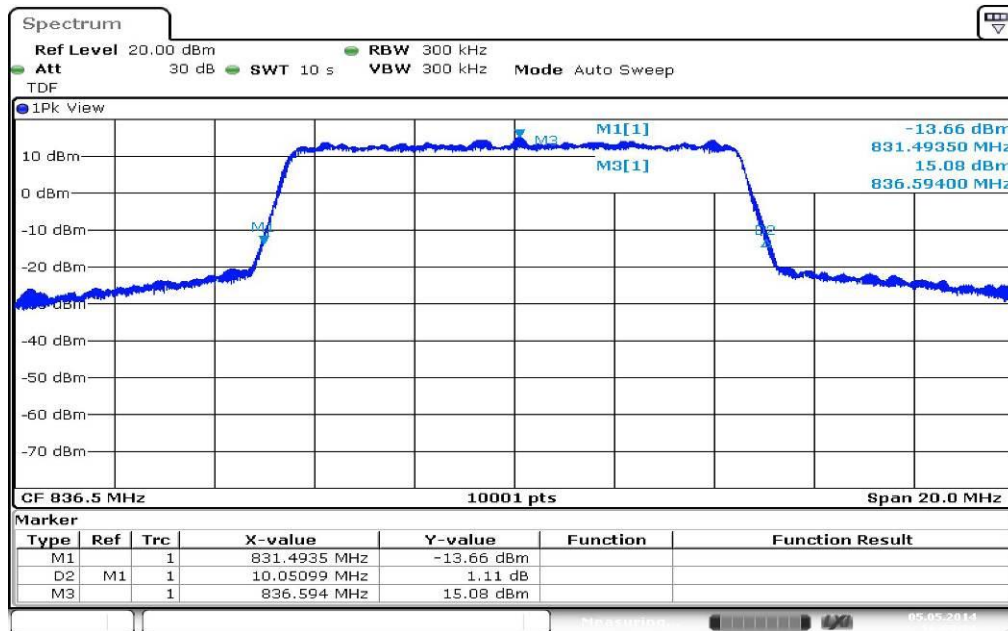

Date: 5.MAY.2014 16:09:34

9 Test equipment and ancillaries used for tests

Typically, the calibrations of the test apparatus are commissioned to and performed by an accredited calibration laboratory. The calibration intervals are determined in accordance with the DIN EN ISO/IEC 17025. In addition to the external calibrations, the laboratory executes comparison measurements with other calibrated test systems or effective verifications. Weekly chamber inspections and range calibrations are performed. Where possible, rf-generating and signalling equipment as well as measuring receivers and analyzers are connected to an external high-precision 10 MHz reference (GPS-based or rubidium frequency standard).

In order to simplify the identification of the equipment used at some special tests, some items of test equipment and ancillaries can be provided with an identifier or number in the equipment list below (Lab/Item).

No.	Lab / Item	Equipment	Type	Manufact.	Serial No.	INV. No Cetecom	Kind of Calibration	Last Calibration	Next Calibration
1	n. a.	Double-Ridged Waveguide Horn Antenna 1-18.0GHz	3115	EMCO	8812-3088	300001032	vKI!	08.05.2013	08.05.2015
2	n. a.	Anechoic chamber	FAC 3/5m	MWB / TDK	87400/02	300000996	ev		
3	n. a.	Switch / Control Unit	3488A	HP Meßtechnik	*	300000199	ne		
4	90	Active Loop Antenna 10 kHz to 30 MHz	6502	Kontron Psychotech	8905-2342	300000256	k	13.06.2013	13.06.2015
5	n. a.	Amplifier	js42-00502650-28-5a	Parzich GMBH	928979	300003143	ne		
6	n. a.	TRILOG Broadband Test-Antenna 30 MHz - 3 GHz	VULB9163	Schwarzbeck	371	300003854	vKI!	14.10.2011	14.10.2014
7	n. a.	MXE EMI Receiver 20 Hz bis 26,5 GHz	N9038A	Agilent Technologies	MY51210197	300004405	k	13.03.2014	13.03.2015
8	n. a.	4U RF Switch Platform	L4491A	Agilent Technologies	MY50000037	300004509	ne		
9	n. a.	Wideband Radio Communication Tester	CMW500	R&S	102375	300004187_0	k	13.03.2014	13.03.2016
10	n. a.	Signal Analyzer 40 GHz	FSV40	R&S	101042	300004517	k	21.01.2014	21.01.2015

Agenda: Kind of Calibration

k	calibration / calibrated	EK	limited calibration
ne	not required (k, ev, izw, zw not required)	zw	cyclical maintenance (external cyclical maintenance)
ev	periodic self verification	izw	internal cyclical maintenance
Ve	long-term stability recognized	g	blocked for accredited testing
vKI!	Attention: extended calibration interval	*)	next calibration ordered / currently in progress
NK!	Attention: not calibrated		

10 Observations

No observations exceeding those reported with the single test cases have been made.

Annex A Document history

Version	Applied changes	Date of release
	Initial release	2014-05-19

Annex B Further information**Glossary**

AVG	-	Average
DUT	-	Device under test
EMC	-	Electromagnetic Compatibility
EN	-	European Standard
EUT	-	Equipment under test
ETSI	-	European Telecommunications Standard Institute
FCC	-	Federal Communication Commission
FCC ID	-	Company Identifier at FCC
HW	-	Hardware
IC	-	Industry Canada
Inv. No.	-	Inventory number
N/A	-	Not applicable
PP	-	Positive peak
QP	-	Quasi peak
S/N	-	Serial number
SW	-	Software

