

TEST REPORT

Test report no.: 1-6965/13-19-04



Deutsche
Akkreditierungsstelle
D-PL-12076-01-01

Testing laboratory

CETECOM ICT Services GmbH
Untertuerkheimer Strasse 6 – 10
66117 Saarbruecken / Germany
Phone: + 49 681 5 98 - 0
Fax: + 49 681 5 98 - 9075
Internet: <http://www.cetecom.com>
e-mail: ict@cetecom.com

Accredited Testing Laboratory:

The testing laboratory (area of testing) is accredited according to DIN EN ISO/IEC 17025 (2005) by the Deutsche Akkreditierungsstelle GmbH (DAkkS). The accreditation is valid for the scope of testing procedures as stated in the accreditation certificate with the registration number: D-PL-12076-01-01
Area of Testing:
Radio Communications & EMC (RCE)

Applicant

Sony Mobile Communications AB
Nya Vattentorget
22188 Lund / SWEDEN
Phone: +46 46 19 30 00
Fax: -/-
Contact: Mikael Nilsson
e-mail: Micke.nilsson@sonymobile.com
Phone: +46 7 03 22 75 03

Manufacturer

Sony Mobile Communications AB
Nya Vattentorget
22188 Lund / SWEDEN

Test standard/s

47 CFR Part 22	Title 47 of the Code of Federal Regulations; Chapter I; Part 22 - Public mobile services
47 CFR Part 24	Title 47 of the Code of Federal Regulations; Chapter I; Part 24 - Personal communications services

For further applied test standards please refer to section 3 of this test report.

Test Item

Kind of test item:	Smart Phone GPRS/EGPRS 850/900/1800/1900; UMTS HSPA FDD/II/V/VIII; LTE FDD/1/2/3/5/7/8/28; WLAN b/g/n/a/ac; BT 4.0; RFID; A-GPS
FCC ID:	PY7PM-0751
Frequency:	GSM: 824.2 – 848.8 MHz, 1850.2 – 1909.8 MHz UMTS: 826.4 – 846.6 MHz, 1852.4 – 1907.6 MHz
Technology tested:	GSM/EDGE, UMTS
Antenna:	Integrated antenna
Power supply:	3.7V DC by Li - polymer battery
Temperature range:	-30°C to +60°C

This test report is electronically signed and valid without handwriting signature. For verification of the electronic signatures, the public keys can be requested at the testing laboratory.

Test report authorised:

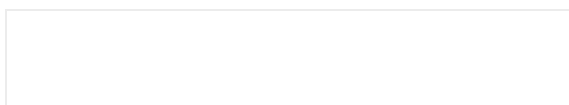

Stefan Bös
Senior Testing Manager

Test performed:

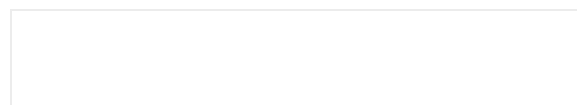

Andreas Luckenbill
Expert

1 Table of contents

1	Table of contents	2
2	General information	4
2.1	Notes and disclaimer	4
2.2	Application details.....	4
3	Test standard/s	4
4	Test environment.....	5
5	Test item	5
5.1	Additional information	5
6	Test laboratories sub-contracted	5
7	Summary of measurement results	6
7.1	GSM 850.....	6
7.2	PCS 1900	6
7.3	UMTS band II.....	7
7.4	UMTS band V.....	7
8	RF measurements	8
8.1	Description of test setup	8
8.1.1	Radiated measurements.....	8
8.1.2	Conducted measurements.....	9
8.2	Results GSM 850	10
8.2.1	RF output power	10
8.2.2	Frequency stability.....	12
8.2.3	Spurious emissions radiated	14
8.2.4	Spurious emissions conducted.....	17
8.2.5	Block edge compliance.....	21
8.2.6	Occupied bandwidth	24
8.3	Results PCS 1900	32
8.3.1	RF output power	32
8.3.2	Frequency stability.....	34
8.3.3	Spurious emissions radiated	36
8.3.4	Spurious emissions conducted.....	40
8.3.5	Block edge compliance.....	44
8.3.6	Occupied bandwidth	47
8.4	Results UMTS band II.....	55
8.4.1	RF output power	55
8.4.2	Frequency stability.....	57
8.4.3	Spurious emissions radiated	59
8.4.4	Spurious emissions conducted.....	63
8.4.5	Block edge compliance.....	67
8.4.6	Occupied bandwidth	69
8.5	Results UMTS band V	73
8.5.1	RF output power	73
8.5.2	Frequency stability.....	75
8.5.3	Spurious emissions radiated	77
8.5.4	Spurious emissions conducted.....	80
8.5.5	Block edge compliance.....	84
8.5.6	Occupied bandwidth	86
9	Test equipment and ancillaries used for tests	91
10	Observations	91
Annex A	Document history	92

Annex B	Further information.....	92
Annex C	Accreditation Certificate	93

2 General information

2.1 Notes and disclaimer

The test results of this test report relate exclusively to the test item specified in this test report. CETECOM ICT Services GmbH does not assume responsibility for any conclusions and generalizations drawn from the test results with regard to other specimens or samples of the type of the equipment represented by the test item.

The test report may only be reproduced or published in full. Reproduction or publication of extracts from the report requires the prior written approval of CETECOM ICT Services GmbH.

The testing service provided by CETECOM ICT Services GmbH has been rendered under the current "General Terms and Conditions for CETECOM ICT Services GmbH".

CETECOM ICT Services GmbH will not be liable for any loss or damage resulting from false, inaccurate, inappropriate or incomplete product information provided by the customer.

Under no circumstances does the CETECOM ICT Services GmbH test report include any endorsement or warranty regarding the functionality, quality or performance of any other product or service provided.

Under no circumstances does the CETECOM ICT Services GmbH test report include or imply any product or service warranties from CETECOM ICT Services GmbH, including, without limitation, any implied warranties of merchantability, fitness for purpose, or non-infringement, all of which are expressly disclaimed by CETECOM ICT Services GmbH.

All rights and remedies regarding vendor's products and services for which CETECOM ICT Services GmbH has prepared this test report shall be provided by the party offering such products or services and not by CETECOM ICT Services GmbH.

In no case this test report can be considered as a Letter of Approval.

This test report is electronically signed and valid without handwritten signature. For verification of the electronic signatures, the public keys can be requested at the testing laboratory.

2.2 Application details

Date of receipt of order:	2014-04-14
Date of receipt of test item:	2014-05-07
Start of test:	2014-05-07
End of test:	2014-05-14
Person(s) present during the test:	-/-

3 Test standard/s

Test standard	Date	Test standard description
47 CFR Part 22	-/-	Title 47 of the Code of Federal Regulations; Chapter I; Part 22 - Public mobile services
47 CFR Part 24	-/-	Title 47 of the Code of Federal Regulations; Chapter I; Part 24 - Personal communications services

4 Test environment

Temperature:	T_{nom}	+22 °C during room temperature tests
	T_{max}	+60 °C during high temperature tests
	T_{min}	-30 °C during low temperature tests
Relative humidity content:		46 %
Barometric pressure:		not relevant for this kind of testing
Power supply:	V_{nom}	3.7 V DC by Li - polymer battery
	V_{max}	4.4 V
	V_{min}	3.3 V

5 Test item

Kind of test item	:	Smart Phone GPRS/EGPRS 850/900/1800/1900; UMTS HSPA FDDI/II/V/VIII; LTE FDD1/2/3/5/7/8/28; WLAN b/g/n/a/ac; BT 4.0; RFID; A-GPS
S/N serial number	:	Rad. CB5126Z4S3, CB5126Z4R8 Cond. CB5126Z728, CB5126Z753
HW hardware status	:	AP1.0
SW software status	:	17.1.1.A.0.348
Frequency band [MHz]	:	GSM: 824.2 – 848.8 MHz, 1850.2 – 1909.8 MHz UMTS: 826.4 – 846.6 MHz, 1852.4 – 1907.6 MHz
Type of modulation	:	GMSK, 8-PSK, QPSK
Antenna	:	Integrated antenna
Power supply	:	3.7 V DC by Li - polymer battery
Temperature range	:	-30°C to +60°C

5.1 Additional information

Test setup- and EUT-photos are included in test report: 1-6965/13-19-01_AnnexA
1-6965/13-19-01_AnnexB
1-6965/13-19-01_AnnexC

6 Test laboratories sub-contracted

None

7 Summary of measurement results

- No deviations from the technical specifications were ascertained
- There were deviations from the technical specifications ascertained

TC identifier	Description	verdict	date	Remark
RF-Testing	CFR Part 22, 24	passed	2014-05-15	-/-

7.1 GSM 850

Test Case	temperature conditions	power source voltages	Pass	Fail	NA	NP	Remark
RF Output Power	Nominal	Nominal	<input checked="" type="checkbox"/>	<input type="checkbox"/>	<input type="checkbox"/>	<input type="checkbox"/>	-/-
Frequency Stability	Nominal	Nominal	<input checked="" type="checkbox"/>	<input type="checkbox"/>	<input type="checkbox"/>	<input type="checkbox"/>	-/-
Spurious Emissions Radiated	Nominal	Nominal	<input checked="" type="checkbox"/>	<input type="checkbox"/>	<input type="checkbox"/>	<input type="checkbox"/>	-/-
Spurious Emissions Conducted	Nominal	Nominal	<input checked="" type="checkbox"/>	<input type="checkbox"/>	<input type="checkbox"/>	<input type="checkbox"/>	-/-
Block Edge Compliance	Nominal	Nominal	<input checked="" type="checkbox"/>	<input type="checkbox"/>	<input type="checkbox"/>	<input type="checkbox"/>	-/-
Occupied Bandwidth	Nominal	Nominal	<input checked="" type="checkbox"/>	<input type="checkbox"/>	<input type="checkbox"/>	<input type="checkbox"/>	-/-

Note: NA = Not applicable; NP = Not performed

7.2 PCS 1900

Test Case	temperature conditions	power source voltages	Pass	Fail	NA	NP	Remark
RF Output Power	Nominal	Nominal	<input checked="" type="checkbox"/>	<input type="checkbox"/>	<input type="checkbox"/>	<input type="checkbox"/>	-/-
Frequency Stability	Nominal	Nominal	<input checked="" type="checkbox"/>	<input type="checkbox"/>	<input type="checkbox"/>	<input type="checkbox"/>	-/-
Spurious Emissions Radiated	Nominal	Nominal	<input checked="" type="checkbox"/>	<input type="checkbox"/>	<input type="checkbox"/>	<input type="checkbox"/>	-/-
Spurious Emissions Conducted	Nominal	Nominal	<input checked="" type="checkbox"/>	<input type="checkbox"/>	<input type="checkbox"/>	<input type="checkbox"/>	-/-
Block Edge Compliance	Nominal	Nominal	<input checked="" type="checkbox"/>	<input type="checkbox"/>	<input type="checkbox"/>	<input type="checkbox"/>	-/-
Occupied Bandwidth	Nominal	Nominal	<input checked="" type="checkbox"/>	<input type="checkbox"/>	<input type="checkbox"/>	<input type="checkbox"/>	-/-

Note: NA = Not applicable; NP = Not performed

7.3 UMTS band II

Test Case	temperature conditions	power source voltages	Pass	Fail	NA	NP	Remark
RF Output Power	Nominal	Nominal	<input checked="" type="checkbox"/>	<input type="checkbox"/>	<input type="checkbox"/>	<input type="checkbox"/>	-/-
Frequency Stability	Nominal	Nominal	<input checked="" type="checkbox"/>	<input type="checkbox"/>	<input type="checkbox"/>	<input type="checkbox"/>	-/-
Spurious Emissions Radiated	Nominal	Nominal	<input checked="" type="checkbox"/>	<input type="checkbox"/>	<input type="checkbox"/>	<input type="checkbox"/>	-/-
Spurious Emissions Conducted	Nominal	Nominal	<input checked="" type="checkbox"/>	<input type="checkbox"/>	<input type="checkbox"/>	<input type="checkbox"/>	-/-
Block Edge Compliance	Nominal	Nominal	<input checked="" type="checkbox"/>	<input type="checkbox"/>	<input type="checkbox"/>	<input type="checkbox"/>	-/-
Occupied Bandwidth	Nominal	Nominal	<input checked="" type="checkbox"/>	<input type="checkbox"/>	<input type="checkbox"/>	<input type="checkbox"/>	-/-

Note: NA = Not applicable; NP = Not performed

7.4 UMTS band V

Test Case	temperature conditions	power source voltages	Pass	Fail	NA	NP	Remark
RF Output Power	Nominal	Nominal	<input checked="" type="checkbox"/>	<input type="checkbox"/>	<input type="checkbox"/>	<input type="checkbox"/>	-/-
Frequency Stability	Nominal	Nominal	<input checked="" type="checkbox"/>	<input type="checkbox"/>	<input type="checkbox"/>	<input type="checkbox"/>	-/-
Spurious Emissions Radiated	Nominal	Nominal	<input checked="" type="checkbox"/>	<input type="checkbox"/>	<input type="checkbox"/>	<input type="checkbox"/>	-/-
Spurious Emissions Conducted	Nominal	Nominal	<input checked="" type="checkbox"/>	<input type="checkbox"/>	<input type="checkbox"/>	<input type="checkbox"/>	-/-
Block Edge Compliance	Nominal	Nominal	<input checked="" type="checkbox"/>	<input type="checkbox"/>	<input type="checkbox"/>	<input type="checkbox"/>	-/-
Occupied Bandwidth	Nominal	Nominal	<input checked="" type="checkbox"/>	<input type="checkbox"/>	<input type="checkbox"/>	<input type="checkbox"/>	-/-

Note: NA = Not applicable; NP = Not performed

8 RF measurements

8.1 Description of test setup

For the spurious measurements we use the substitution method according TIA/EIA 603.

8.1.1 Radiated measurements

The radiated emissions from the EUT are performed in a semi anechoic chamber. The EUT is placed on a conductive turntable and powered with nominal voltage. The signalling is performed either from outside the chamber with a signalling unit (AP or other) by air link using a signalling antenna or directly by special test software from the customer.

Semi anechoic chamber

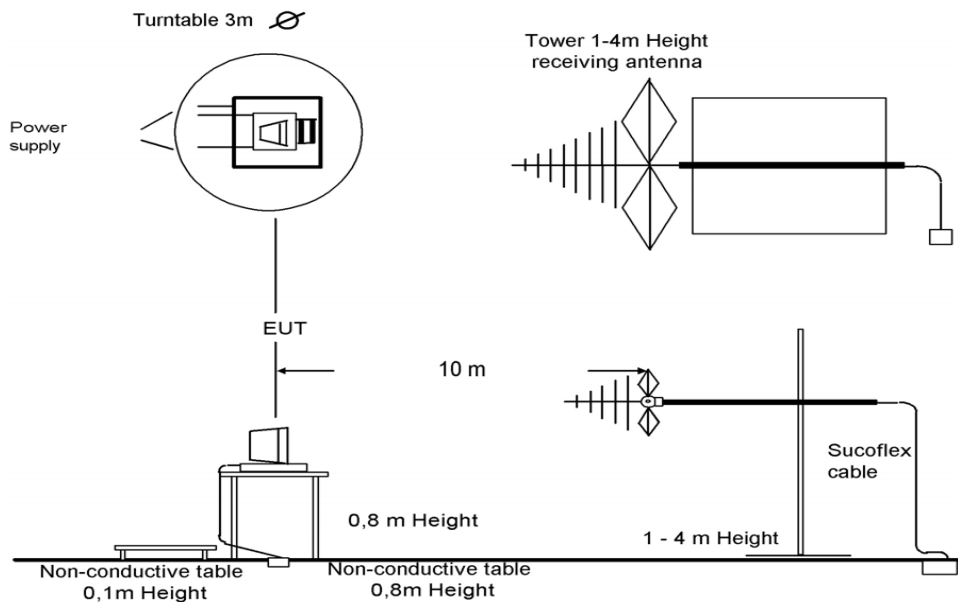

Picture 1: Diagram radiated measurements

- 9 kHz - 30 MHz: active loop antenna
- 30 MHz – 1 GHz: tri-log antenna
- > 1 GHz: horn antenna

Frequency being measured f	Measuring receiver bandwidth 6 dB	Spectrum analyser bandwidth 3dB
$f < 150 \text{ kHz}$	200 Hz or	300 Hz
$150 \text{ kHz} \leq f < 25 \text{ MHz}$	9 kHz or	10 kHz
$25 \text{ MHz} \leq f < 1000 \text{ MHz}$	120 kHz or	100 kHz
$1000 \text{ MHz} \leq f$		1 MHz
NOTE: Specific requirements in CEPT/ERC/Recommendation 70-03 [2] shall be applied where applicable.		

8.1.2 Conducted measurements

The EUT's RF signal is coupled out by the antenna connector which is supplied by the manufacturer. The signal is first 10dB attenuated before it is power divided (~6dB loss per branch). One of the signal paths is connected to the signalling unit (AP or other), the other one is connected to the spectrum analyzer. The specific losses for both signal paths are first checked within a calibration. The measurement readings on the signalling unit/spectrum analyzer are corrected by the specific test set-up loss. The attenuator, power divider, signalling unit and the spectrum analyzer are impedance matched on 50 Ohm. If special software is used, there is no power divider necessary.

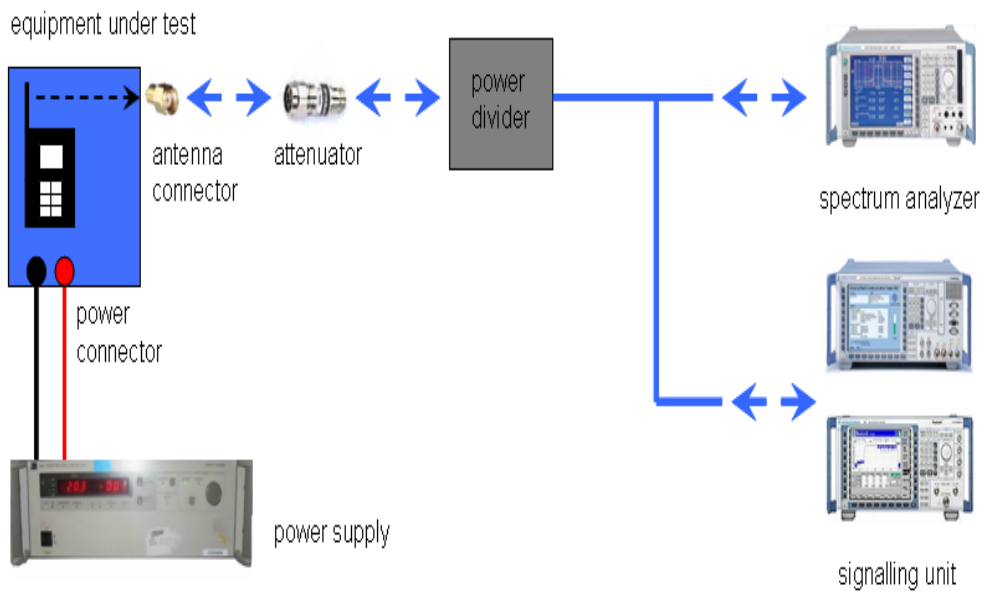

Picture 2: Diagram conducted measurements

The term measuring receiver refers to either a selective voltmeter or a spectrum analyser.

Frequency being measured f	Measuring receiver bandwidth 6 dB	Spectrum analyser bandwidth 3dB
$f < 150 \text{ kHz}$	200 Hz or	300 Hz
$150 \text{ kHz} \leq f < 25 \text{ MHz}$	9 kHz or	10 kHz
$25 \text{ MHz} \leq f < 1000 \text{ MHz}$	120 kHz or	100 kHz
$1000 \text{ MHz} \leq f$		1 MHz
NOTE: Specific requirements in CEPT/ERC/Recommendation 70-03 [2] shall be applied where applicable.		

8.2 Results GSM 850

All GSM-band measurements are done in GSM mode only (circuit switched).

All relevant tests have been repeated using 8-PSK modulation if EDGE mode is supported. All tests were performed with one timeslot in uplink activated and one timeslot in downlink activated. For each mode the highest output power was determined and used.

8.2.1 RF output power

Description:

This paragraph contains average power, peak output power and ERP measurements for the mobile station. In all cases, the peak output power is within the required mask (this mask is specified in the JTC standards, TIA PN3389 Vol. 1 Chap 7, and is no FCC requirement).

Measurement:

The mobile was set up for the maximum output power with pseudo random data modulation.

Measurement parameters	
Detector:	Peak and RMS (Power in Burst)
Sweep time:	Auto
Video bandwidth:	1 MHz
Resolution bandwidth:	1 MHz
Span:	Zero Span
Trace-Mode:	Max Hold

Limits:

FCC
CFR Part 22.913 CFR Part 2.1046
Nominal Peak Output Power
+38.45 dBm In measuring transmissions in this band using an average power technique, the peak-to-average ratio (PAR) of the transmission may not exceed 13 dB.

Results:

Output Power (conducted) GMSK mode		
Frequency (MHz)	Average Output Power (dBm)	Peak to Average Ratio (dB)
824.2	31.4	0.23
836.4	31.4	0.24
848.8	31.3	0.24
Measurement uncertainty	± 0.5 dB	

Output Power (conducted) 8-PSK mode		
Frequency (MHz)	Average Output Power (dBm)	Peak to Average Ratio (dB)
824.2	26.7	3.24
836.4	26.6	3.34
848.8	26.7	3.25
Measurement uncertainty	± 0.5 dB	

Output Power (radiated) GMSK mode	
Frequency (MHz)	Average Output Power (dBm) - ERP
824.2	27.6
836.4	30.0
848.8	30.5
Measurement uncertainty	± 2.0 dB

Output Power (radiated) 8-PSK mode	
Frequency (MHz)	Average Output Power (dBm) - ERP
824.2	22.9
836.4	25.2
848.8	25.9
Measurement uncertainty	± 2.0 dB

Result: Passed

8.2.2 Frequency stability

Description:

In order to measure the carrier frequency under the condition of AFC lock, it is necessary to make measurements with the mobile station in a “call mode”. This is accomplished with the use of a R&S CMU200 DIGITAL RADIOCOMMUNICATION TESTER.

1. Measure the carrier frequency at room temperature.
2. Subject the mobile station to overnight soak at -30 C.
3. With the mobile station, powered with V_{nom} , connected to the CMU200 and in a simulated call on channel 189 (centre channel), measure the carrier frequency. These measurements should be made within two minutes of powering up the mobile station, to prevent significant self warming.
4. Repeat the above measurements at 10°C increments from -30°C to +60°C. Allow at least 1.5 hours at each temperature, unpowered, before making measurements.
5. Remeasure carrier frequency at room temperature with V_{nom} . Vary supply voltage from V_{min} to V_{max} , in 0.1 Volt steps remeasuring carrier frequency at each voltage. Pause at V_{nom} for 1.5 hours unpowered, to allow any self heating to stabilize, before continuing.
6. At all temperature levels hold the temperature to +/- 0.5°C during the measurement procedure.

Measurement:

Measurement parameters	
Detector:	Measured with CMU200
Sweep time:	
Video bandwidth:	
Resolution bandwidth:	
Span:	
Trace-Mode:	

Limits:

FCC
CFR Part 22.355 CFR Part 2.1055
Frequency Stability
± 2.5 ppm

Results:**AFC FREQ ERROR versus VOLTAGE**

Voltage (V)	Frequency Error (Hz)	Frequency Error (%)	Frequency Error (ppm)
3.3	13	0.00000155	0.0155
3.4	11	0.00000132	0.0132
3.5	13	0.00000155	0.0155
3.6	14	0.00000167	0.0167
3.7	14	0.00000167	0.0167
3.8	8	0.00000096	0.0096
3.9	13	0.00000155	0.0155
4.0	13	0.00000155	0.0155
4.1	12	0.00000143	0.0143
4.2	14	0.00000167	0.0167
4.3	13	0.00000155	0.0155
4.4	16	0.00000191	0.0191

AFC FREQ ERROR versus TEMPERATURE

Temperature (°C)	Frequency Error (Hz)	Frequency Error (%)	Frequency Error (ppm)
-30	10	0.00000120	0.0120
-20	8	0.00000096	0.0096
-10	10	0.00000120	0.0120
± 0	15	0.00000179	0.0179
10	13	0.00000155	0.0155
20	15	0.00000179	0.0179
30	14	0.00000167	0.0167
40	14	0.00000167	0.0167
50	10	0.00000120	0.0120
60	9	0.00000108	0.0108

Result: **Passed**

8.2.3 Spurious emissions radiated

Description:

The following steps outline the procedure used to measure the radiated emissions from the mobile station. The site is constructed in accordance with ANSI C63.4:2009 requirements and is recognized by the FCC to be in compliance for a 3 and a 10 meter site. The spectrum was scanned from 30 MHz to the 10th harmonic of the highest frequency generated within the equipment, which is the transmitted carrier that can be as high as 848.8 MHz. This was rounded up to 12 GHz. The resolution bandwidth is set as outlined in Part 22.917. The spectrum was scanned with the mobile station transmitting at carrier frequencies that pertain to low, mid and high channels of the GSM-850 band.

The final open field emission (here 10m semi-anechoic chamber listed by FCC) test procedure is as follows:

- a) The test item was placed on a 0.8 meter high non-conductive stand at a 3 meter test distance from the receive antenna.
- b) The antenna output was terminated in a 50 ohm load (if possible).
- c) A double ridged wave guide antenna was placed on an adjustable height antenna mast 3 meters from the test item for emission measurements.
- d) Detected emissions were maximized at each frequency by rotating the test item and adjusting the receive antenna height and polarization. The maximum meter reading was recorded. The radiated emission measurements of the harmonics of the transmit frequency through the 10th harmonic were measured with peak detector and 1 MHz bandwidth. If the harmonic could not be detected above the noise floor, the ambient level was recorded. The equivalent power into a dipole antenna was calculated from the field intensity levels measured at 3 meters.
- e) Now each detected emissions were substituted by the substitution method, in accordance with the TIA/EIA 603.

Measurement:

Measurement parameters	
Detector:	Peak
Sweep time:	2 sec.
Video bandwidth:	Below 1 GHz: 100 kHz Above 1 GHz: 1 MHz
Resolution bandwidth:	Below 1 GHz: 100 kHz Above 1 GHz: 1 MHz
Span:	100 MHz Steps
Trace-Mode:	Max Hold

Limits:

FCC
CFR Part 22.917 CFR Part 2.1053
Spurious Emissions Radiated
Attenuation $\geq 43 + 10\log(P)$ (P, Power in Watts)
-13 dBm

Results:

Radiated emissions measurements were made only at the upper, center, and lower carrier frequencies of the GSM-850 band (824.2 MHz, 836.4 MHz and 848.8 MHz). It was decided that measurements at these three carrier frequencies would be sufficient to demonstrate compliance with emissions limits because it was seen that all the significant spurs occur well outside the band and no radiation was seen from a carrier in one block of the GSM-850 band into any of the other blocks. The equipment must still, however, meet emissions requirements with the carrier at all frequencies over which it is capable of operating and it is the manufacturer's responsibility to verify this.

The final open field radiated levels are presented on the next pages. All measurements were done in horizontal and vertical polarization; the plots show the worst case. The plots show only the middle channel. If spurious were detected, the lowest and highest channel were checked too. The found values are stated in the table below.

As can be seen from this data, the emissions from the test item were within the specification limit.

SPURIOUS EMISSION LEVEL (dBm)								
Harmonic	Ch. 128 Freq. (MHz)	Level [dBm]	Harmonic	Ch. 189 Freq. (MHz)	Level [dBm]	Harmonic	Ch. 251 Freq. (MHz)	Level [dBm]
2	1648.4	-	2	1672.8	-	2	1697.6	-
3	2472.6	-	3	2509.2	-	3	2546.4	-
4	3296.8	-	4	3345.6	-	4	3395.2	-
5	4121.0	-	5	4182.0	-	5	4244.0	-
6	4945.2	-	6	5018.4	-	6	5092.8	-
7	5769.4	-	7	5854.8	-	7	5941.6	-
8	6593.6	-	8	6691.2	-	8	6790.4	-
9	7417.8	-	9	7527.6	-	9	7639.2	-
10	8242.0	-	10	8364.0	-	10	8488.0	-
Measurement uncertainty					± 3dB			

Result: Passed

Plots:

Plot 1: Channel 189 (Traffic mode up to 30 MHz)

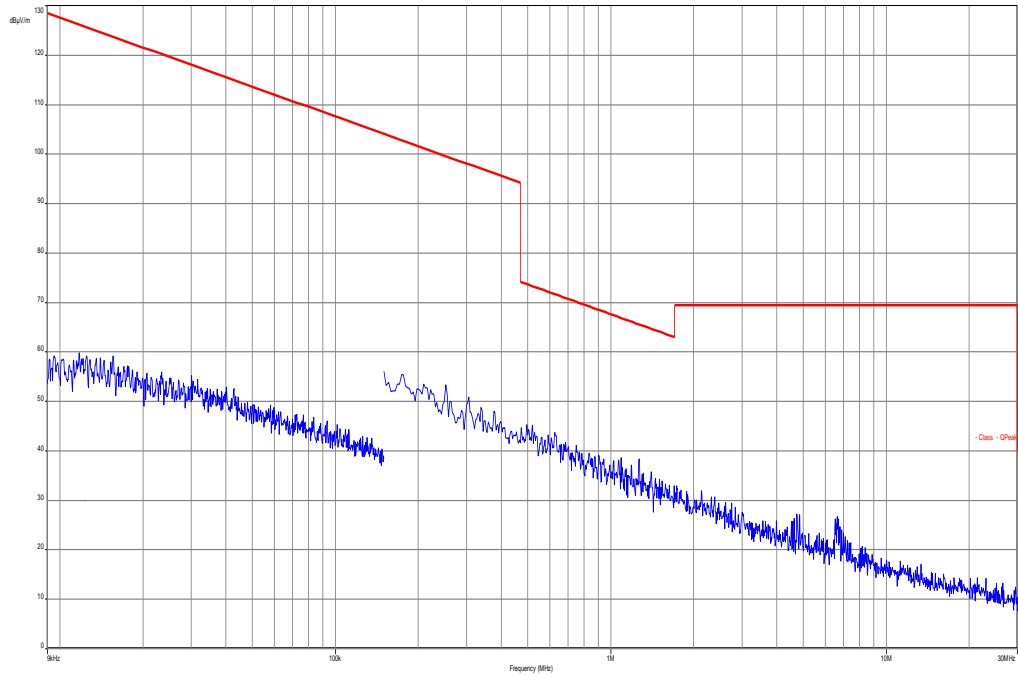

Plot 2: Channel 189 (30 MHz – 12.75 GHz)

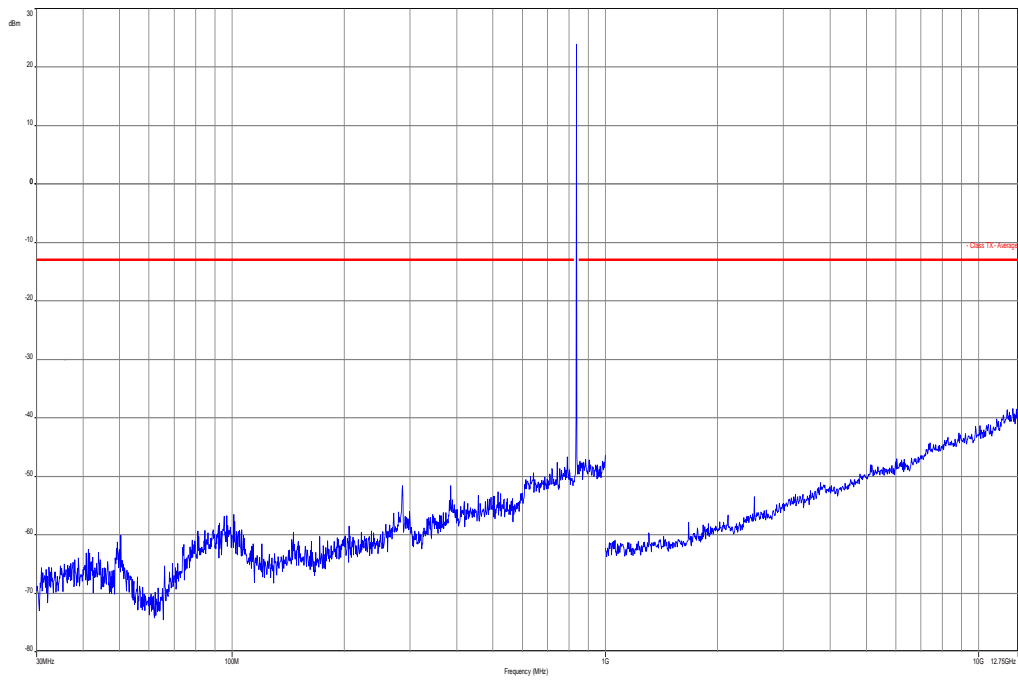

8.2.4 Spurious emissions conducted

Description:

The following steps outline the procedure used to measure the conducted emissions from the mobile station.

1. Determine frequency range for measurements: From CFR 2.1057 the spectrum should be investigated from the lowest radio frequency generated in the equipment up to at least the 10th harmonic of the carrier frequency. For the mobile station equipment tested, this equates to a frequency range of 13 MHz to 9 GHz, data taken from 10 MHz to 25 GHz.
2. Determine mobile station transmits frequencies: below outlines the band edge frequencies pertinent to conducted emissions testing.

GSM-850 Transmitter Channel Frequency

128 824.2 MHz

189 836.4 MHz

251 848.8 MHz

Measurement:

Measurement parameters	
Detector:	Peak
Sweep time:	Auto
Video bandwidth:	Pre-measurement with 1 MHz On spurious detection re-measurement below 1 GHz with 100 kHz Above 1 GHz with 1 MHz
Resolution bandwidth:	Pre-measurement with 1 MHz On spurious detection re-measurement below 1 GHz with 100 kHz Above 1 GHz with 1 MHz
Span:	10 MHz – 25 GHz
Trace-Mode:	Max Hold

Limits:

FCC
CFR Part 22.917 CFR Part 2.1051
Spurious Emissions Conducted
Attenuation $\geq 43 + 10\log(P)$ (P, Power in Watts)
-13 dBm

Results:

SPURIOUS EMISSION LEVEL (dBm)								
Harmonic	Ch. 128 Freq. (MHz)	Level [dBm]	Harmonic	Ch. 189 Freq. (MHz)	Level [dBm]	Harmonic	Ch. 251 Freq. (MHz)	Level [dBm]
2	1648.4	-	2	1672.8	-	2	1697.6	-
3	2472.6	-	3	2509.2	-	3	2546.4	-
4	3296.8	-	4	3345.6	-	4	3395.2	-
5	4121.0	-	5	4182.0	-	5	4244.0	-
6	4945.2	-	6	5018.4	-	6	5092.8	-
7	5769.4	-	7	5854.8	-	7	5941.6	-
8	6593.6	-	8	6691.2	-	8	6790.4	-
9	7417.8	-	9	7527.6	-	9	7639.2	-
10	8242.0	-	10	8364.0	-	10	8488.0	-
Measurement uncertainty					± 3dB			

Result: **Passed**

Plots:

Plot 1: Channel 128 (10 MHz - 25 GHz)

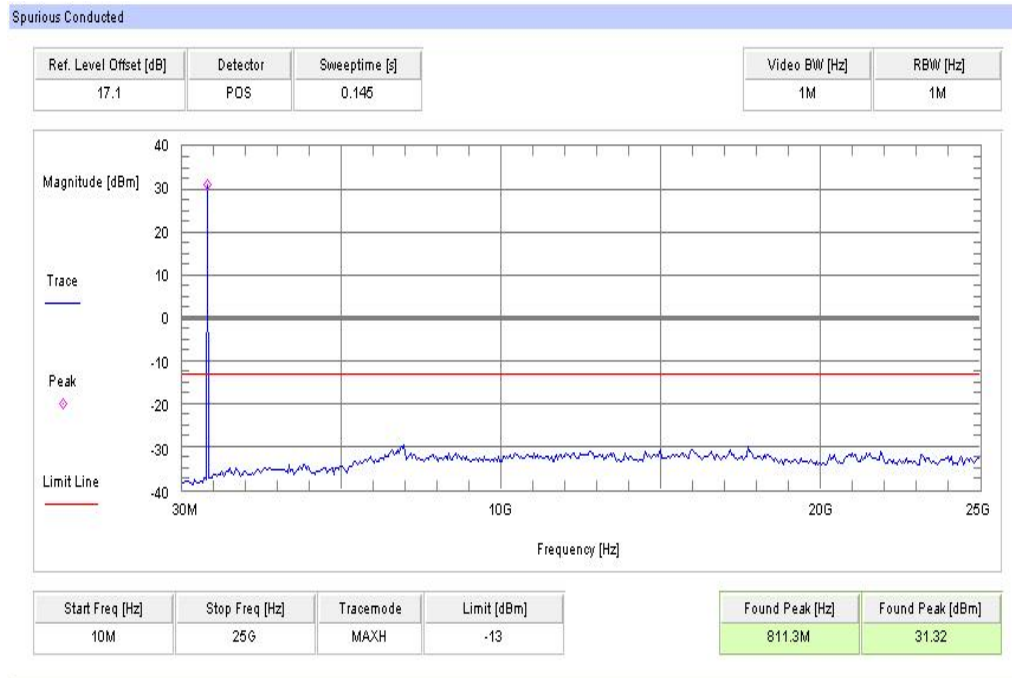

Plot 2: Channel 189 (10 MHz - 25 GHz)

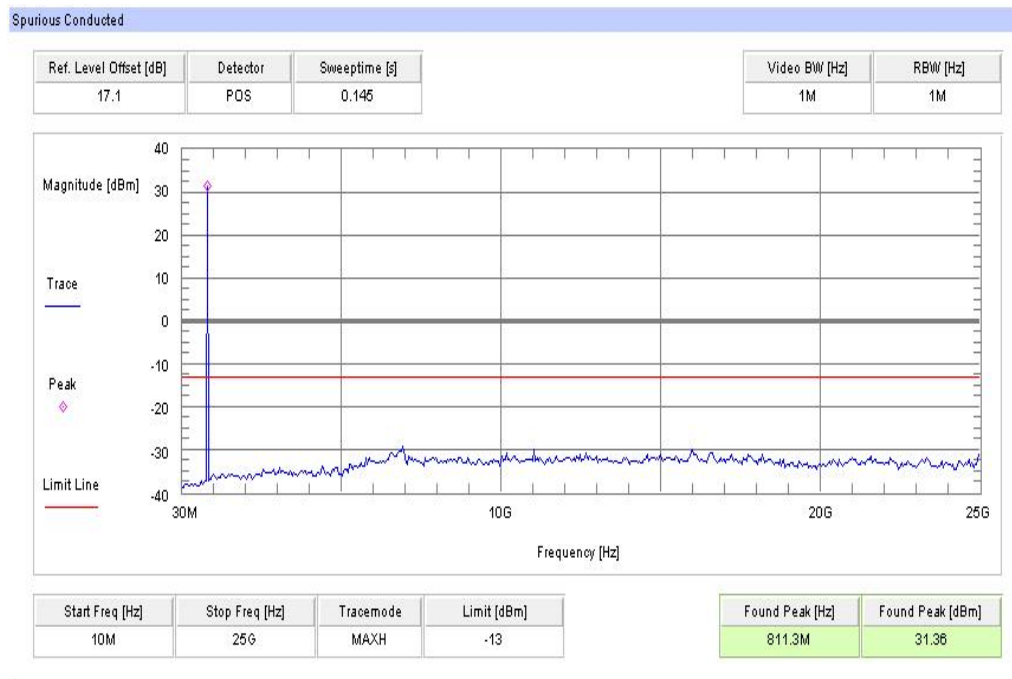

Plot 3: Channel 251 (10 MHz - 25 GHz)

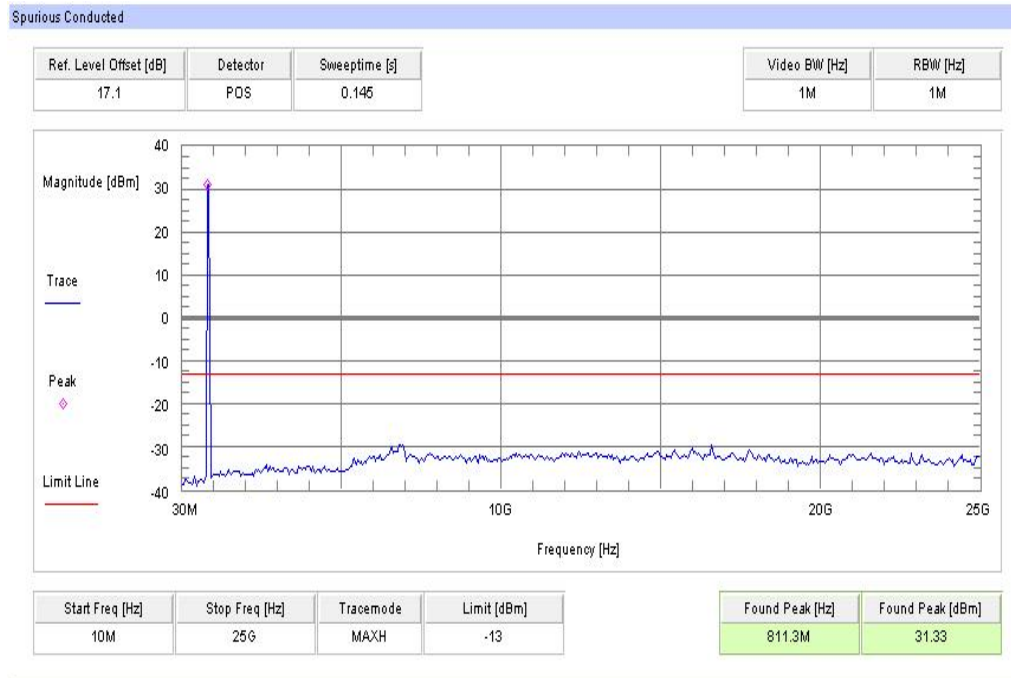

8.2.5 Block edge compliance

Description:

The spectrum at the band edges must comply with the spurious emissions limits.

Measurement:

Measurement parameters	
Detector:	RMS
Sweep time:	Auto
Video bandwidth:	3 kHz
Resolution bandwidth:	3 kHz
Span:	1 MHz
Trace-Mode:	Max Hold

Limits:

FCC
CFR Part 22.917 CFR Part 2.1051
Block Edge Compliance
Attenuation $\geq 43 + 10\log(P)$ (P, Power in Watts)
-13 dBm

Plots:

Plot 1: Channel 128 (GSM-mode)

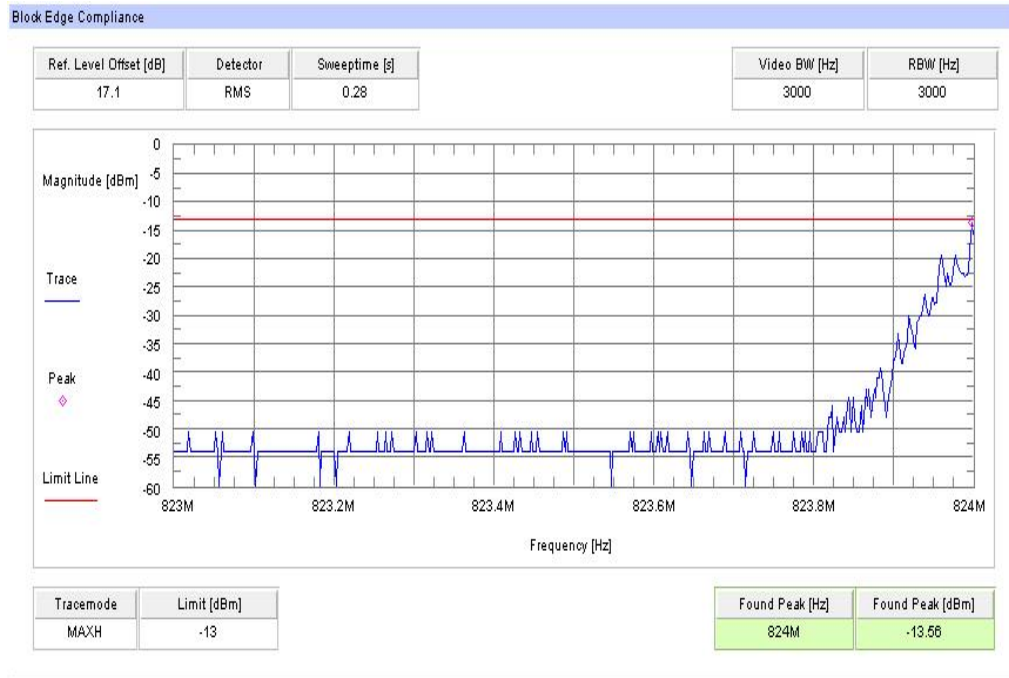

Plot 2: Channel 251 (GSM-mode)



Plot 3: Channel 128 (EDGE-mode)



Plot 4: Channel 251 (EDGE-mode)



Result: Passed

8.2.6 Occupied bandwidth

Description:

Measurement of the occupied bandwidth of the transmitted signal.

Measurement:

Similar to conducted emissions, occupied bandwidth measurements are only provided for selected frequencies in order to reduce the amount of submitted data. Data were taken at the extreme and mid frequencies of the GSM-850 frequency band. The table below lists the measured 99% power and -26dBc occupied bandwidths. Spectrum analyzer plots are included on the following pages.

Part 22.917 requires a measurement bandwidth of at least 1% of the occupied bandwidth. For ca. 300 kHz, this equates to a resolution bandwidth of at least 3 kHz. For this testing, a resolution bandwidth 10 kHz was used.

Measurement parameters	
Detector:	Peak
Sweep time:	Auto
Video bandwidth:	30 kHz
Resolution bandwidth:	10 kHz
Span:	1 MHz
Trace-Mode:	Max Hold

Limits:

FCC
CFR Part 22.917 CFR Part 2.1049
Occupied Bandwidth
Spectrum must fall completely in the specified band

Results:

Occupied Bandwidth - GMSK mode		
Frequency (MHz)	99% OBW (kHz)	-26 dBc BW (kHz)
824.2	265	301
836.4	263	307
848.8	267	307
Measurement uncertainty	± 3 kHz	

Occupied Bandwidth – 8-PSK mode		
Frequency (MHz)	99% OBW (kHz)	-26 dBc BW (kHz)
824.2	283	313
836.4	275	305
848.8	277	319
Measurement uncertainty	± 3 kHz	

Result: Passed

Plots:

Plot 1: Channel 128 (99% - OBW)



Plot 2: Channel 128 (-26 dBc BW)

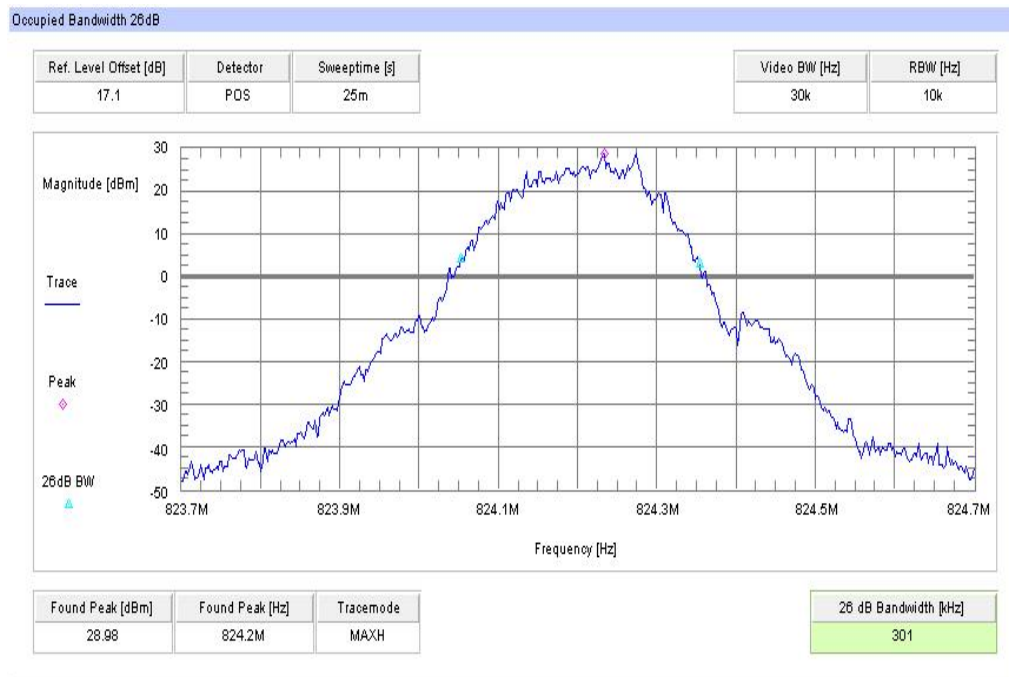

Plot 3: Channel 189 (99% - OBW)

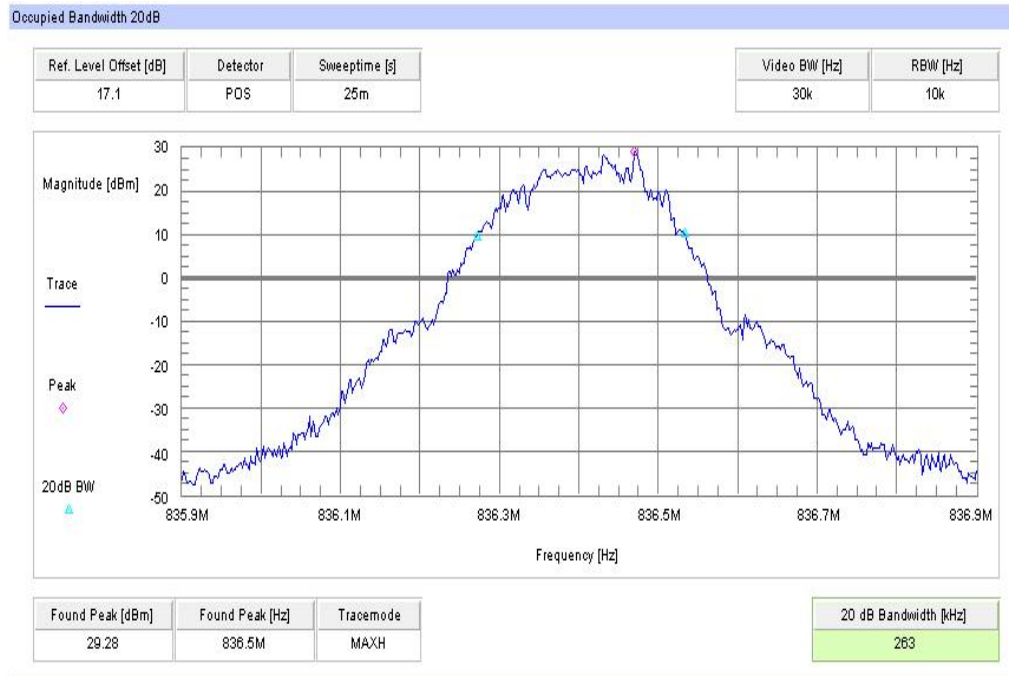

Plot 4: Channel 189 (-26 dBc BW)

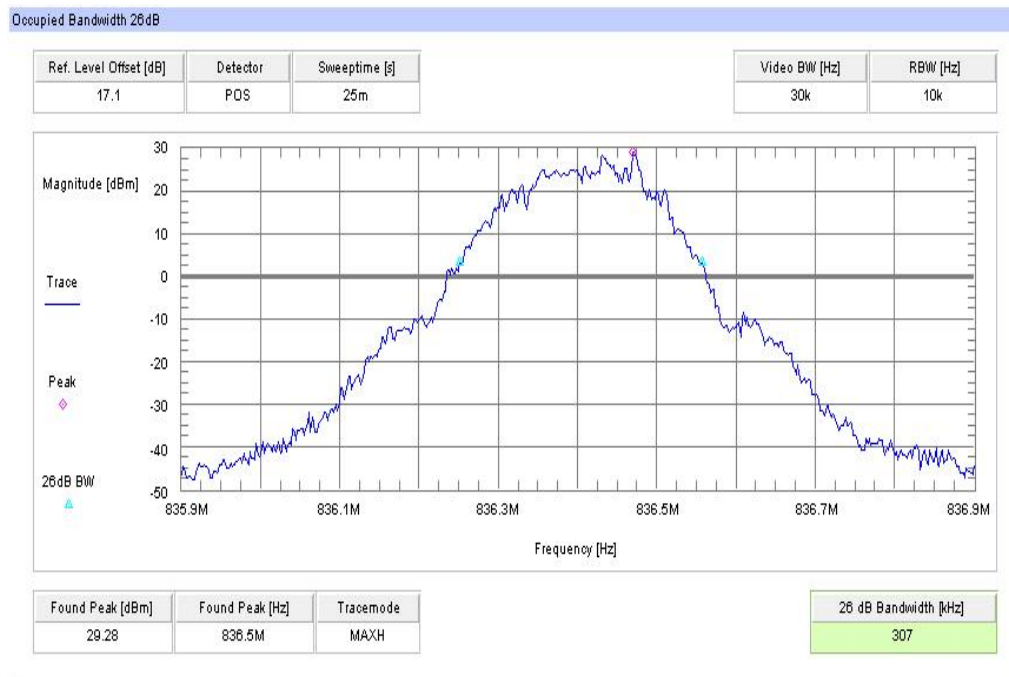

Plot 5: Channel 251 (99% - OBW)

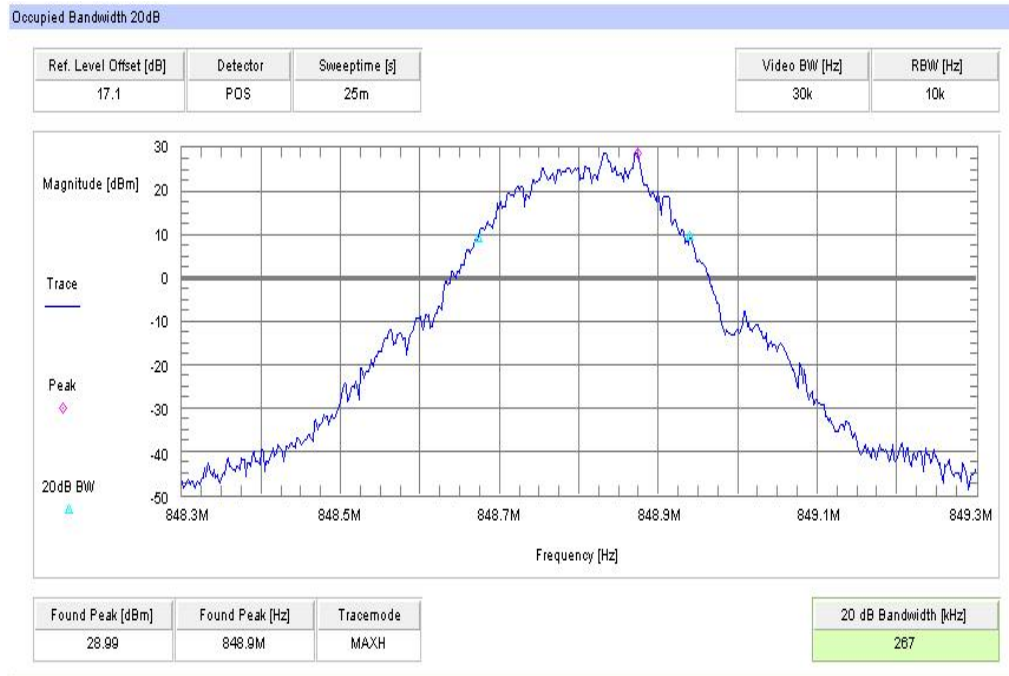

Plot 6: Channel 251 (-26 dBc BW)

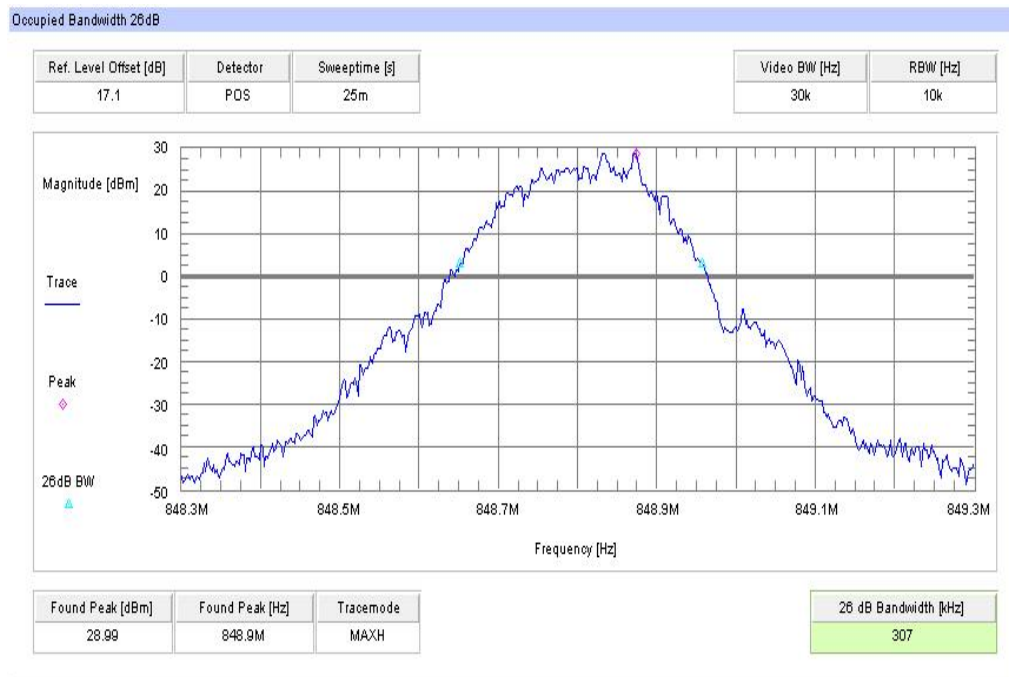

Plot 7: Channel 128 (99% - OBW) – 8-PSK



Plot 8: Channel 128 (-26 dBc BW) - 8-PSK

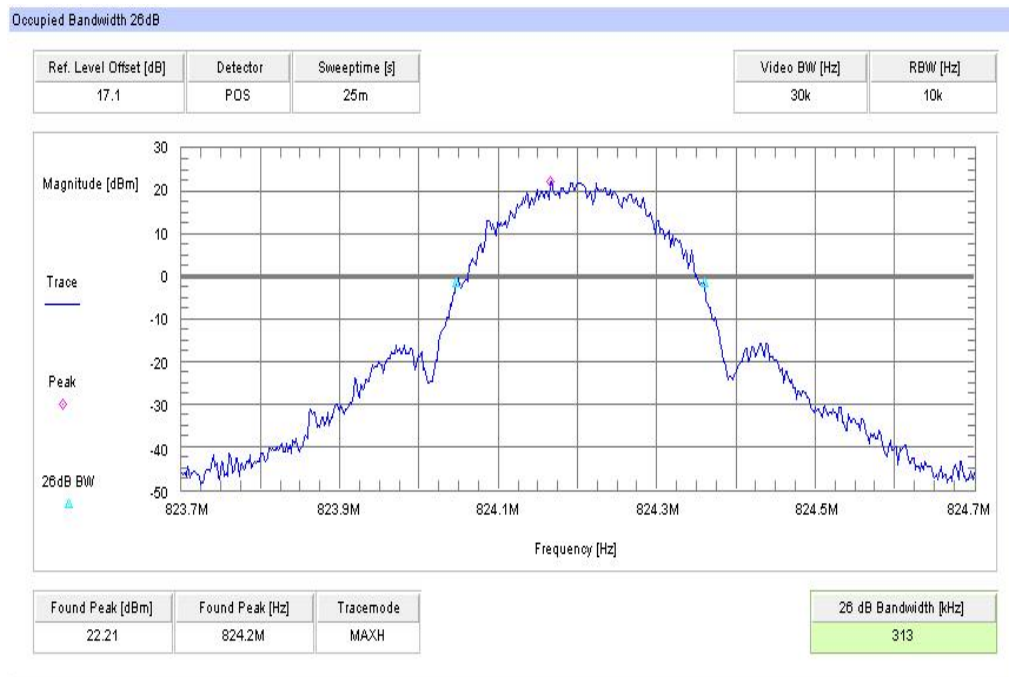

Plot 9: Channel 189 (99% - OBW) - 8-PSK

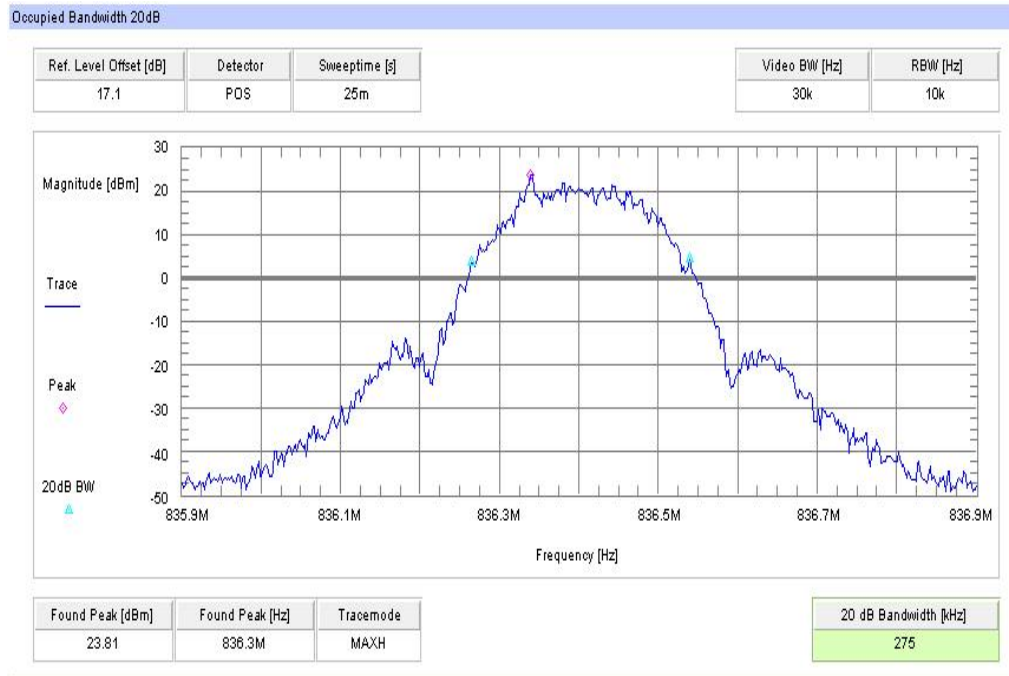

Plot 10: Channel 189 (-26 dBc BW) - 8-PSK

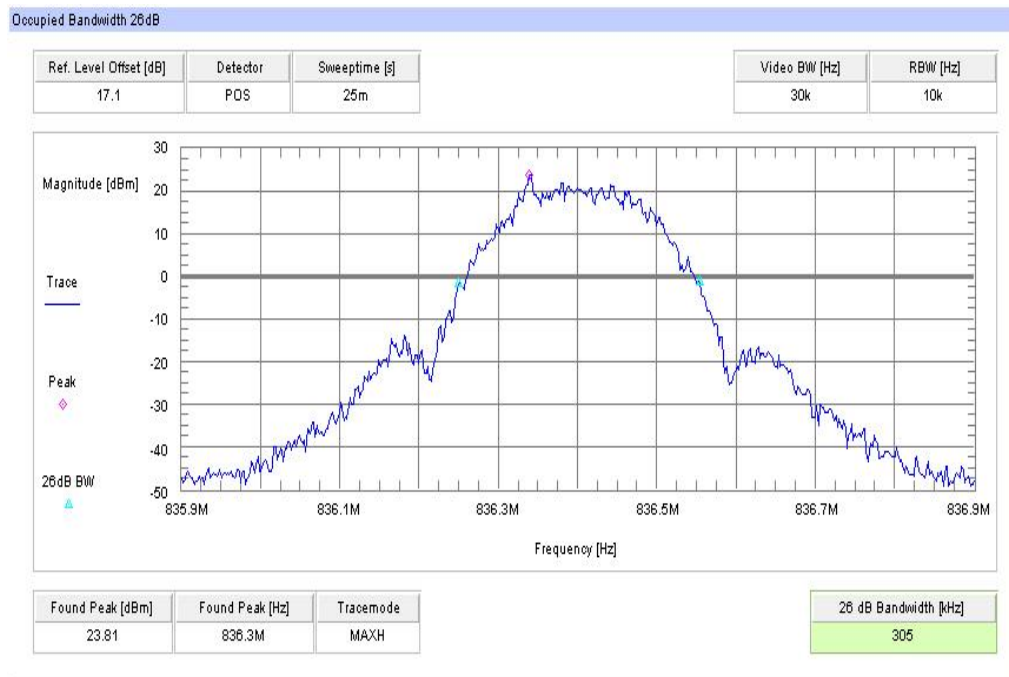

Plot 11: Channel 251 (99% - OBW) - 8-PSK

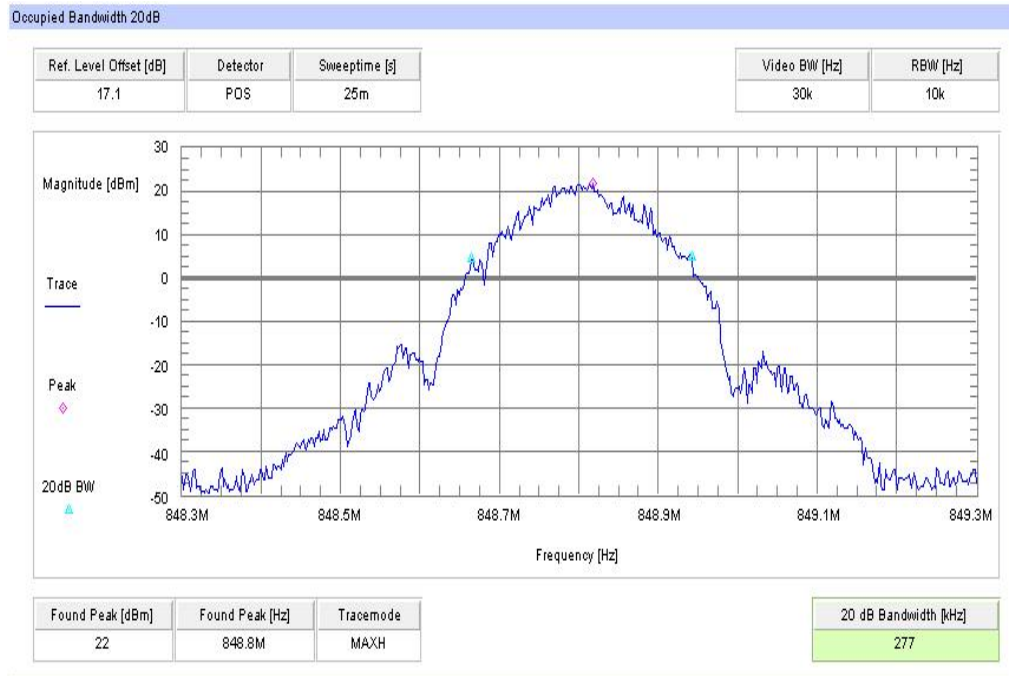

Plot 12: Channel 251 (-26 dBc BW) - 8-PSK

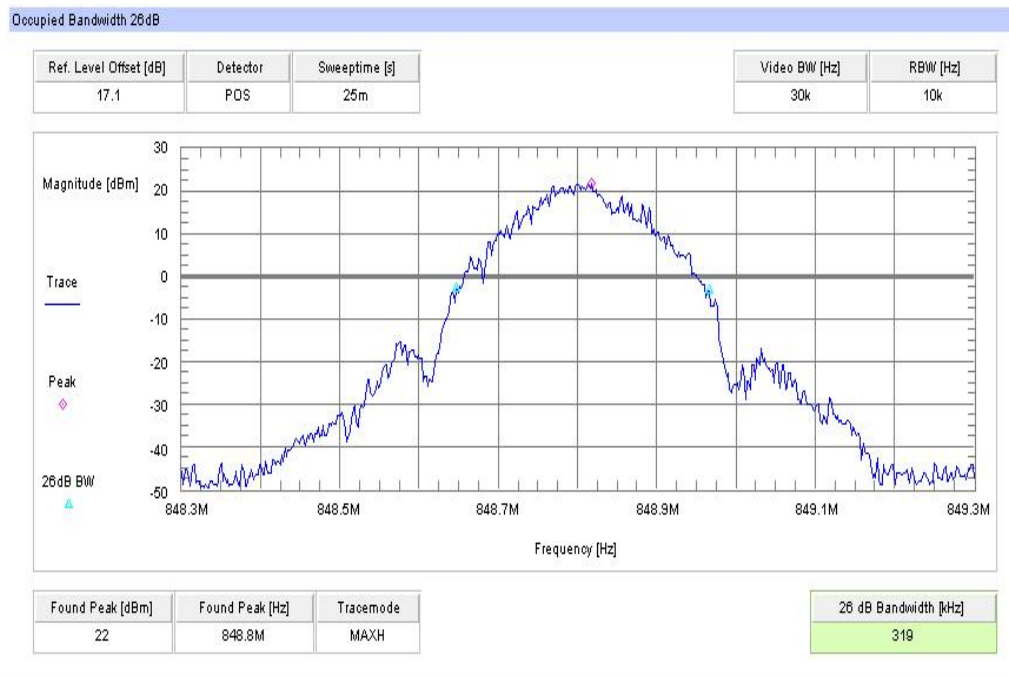

8.3 Results PCS 1900

All GSM-band measurements are done in GSM mode only (circuit switched). All relevant tests have been repeated using 8-PSK modulation if EDGE mode is supported. All tests were performed with one timeslot in uplink activated and one timeslot in downlink activated. For each mode the highest output power was determined and used.

8.3.1 RF output power

Description:

This paragraph contains average power, peak output power and EIRP measurements for the mobile station. In all cases, the peak output power is within the required mask (this mask is specified in the JTC standards, TIA PN3389 Vol. 1 Chap 7, and is no FCC requirement).

Measurement:

The mobile was set up for the maximum output power with pseudo random data modulation.

Measurement parameters	
Detector:	Peak and RMS (Power in Burst)
Sweep time:	Auto
Video bandwidth:	1 MHz
Resolution bandwidth:	1 MHz
Span:	Zero Span
Trace-Mode:	Max Hold

Limits:

FCC
CFR Part 24.232 CFR Part 2.1046
Nominal Peak Output Power
+33.00 dBm In measuring transmissions in this band using an average power technique, the peak-to-average ratio (PAR) of the transmission may not exceed 13 dB.

Results:

Output Power (conducted) GMSK mode		
Frequency (MHz)	Average Output Power (dBm)	Peak to Average Ratio (dB)
1850.2	29.6	0.14
1880.0	29.6	0.14
1909.8	29.8	0.12
Measurement uncertainty	± 0.5 dB	

Output Power (conducted) 8-PSK mode		
Frequency (MHz)	Average Output Power (dBm)	Peak to Average Ratio (dB)
1850.2	26.0	3.30
1880.0	26.2	3.36
1909.8	26.1	3.21
Measurement uncertainty	± 0.5 dB	

Output Power (radiated) GMSK mode	
Frequency (MHz)	Average Output Power (dBm) - EIRP
1850.2	32.3
1880.0	32.3
1909.8	32.4
Measurement uncertainty	± 2.0 dB

Output Power (radiated) 8-PSK mode	
Frequency (MHz)	Average Output Power (dBm) - EIRP
1850.2	28.7
1880.0	28.9
1909.8	28.7
Measurement uncertainty	± 2.0 dB

Result: Passed

8.3.2 Frequency stability

Description:

In order to measure the carrier frequency under the condition of AFC lock, it is necessary to make measurements with the mobile station in a “call mode”. This is accomplished with the use of a R&S CMU200 DIGITAL RADIOCOMMUNICATION TESTER.

1. Measure the carrier frequency at room temperature.
2. Subject the mobile station to overnight soak at -30 C.
3. With the mobile station, powered with V_{nom} , connected to the CMU200 and in a simulated call on channel 661 (centre channel), measure the carrier frequency. These measurements should be made within two minutes of powering up the mobile station, to prevent significant self warming.
4. Repeat the above measurements at 10°C increments from -30°C to +60°C. Allow at least 1.5 hours at each temperature, unpowered, before making measurements.
5. Remeasure carrier frequency at room temperature with V_{nom} . Vary supply voltage from V_{min} to V_{max} , in 0.1 Volt steps remeasuring carrier frequency at each voltage. Pause at V_{nom} for 1.5 hours unpowered, to allow any self heating to stabilize, before continuing.
6. At all temperature levels hold the temperature to +/- 0.5°C during the measurement procedure.

Measurement:

Measurement parameters	
Detector:	Measured with CMU200
Sweep time:	
Video bandwidth:	
Resolution bandwidth:	
Span:	
Trace-Mode:	

Limits:

FCC
CFR Part 24.235 CFR Part 2.1055
Frequency Stability
The frequency stability shall be sufficient to ensure that the fundamental emission stays within the authorized frequency block.

Results:**AFC FREQ ERROR versus VOLTAGE**

Voltage (V)	Frequency Error (Hz)	Frequency Error (%)	Frequency Error (ppm)
3.3	57	0.00000303	0.0303
3.4	56	0.00000298	0.0298
3.5	57	0.00000303	0.0303
3.6	55	0.00000293	0.0293
3.7	60	0.00000319	0.0319
3.8	57	0.00000303	0.0303
3.9	59	0.00000314	0.0314
4.0	62	0.00000330	0.0330
4.1	55	0.00000293	0.0293
4.2	57	0.00000303	0.0303
4.3	56	0.00000298	0.0298
4.4	57	0.00000303	0.0303

AFC FREQ ERROR versus TEMPERATURE

Temperature (°C)	Frequency Error (Hz)	Frequency Error (%)	Frequency Error (ppm)
-30	47	0.00000250	0.0250
-20	43	0.00000229	0.0229
-10	52	0.00000277	0.0277
± 0	57	0.00000303	0.0303
10	60	0.00000319	0.0319
20	56	0.00000298	0.0298
30	48	0.00000255	0.0255
40	54	0.00000287	0.0287
50	47	0.00000250	0.0250
60	53	0.00000282	0.0282

Result: **Passed**

8.3.3 Spurious emissions radiated

Description:

The following steps outline the procedure used to measure the radiated emissions from the mobile station. The site is constructed in accordance with ANSI C63.4:2009 requirements and is recognized by the FCC to be in compliance for a 3 and a 10 meter site. The spectrum was scanned from 30 MHz to the 10th harmonic of the highest frequency generated within the equipment, which is the transmitted carrier that can be as high as 1910 MHz. Measurement made up to 25 GHz. The resolution bandwidth is set as outlined in Part 24.238. The spectrum was scanned with the mobile station transmitting at carrier frequencies that pertain to low, mid and high channels of the PCS1900 band.

The final open field emission (here 10m semi-anechoic chamber listed by FCC) test procedure is as follows:

- a) The test item was placed on a 0.8 meter high non-conductive stand at a 3 meter test distance from the receive antenna.
- b) The antenna output was terminated in a 50 ohm load (if possible).
- c) A double ridged wave guide antenna was placed on an adjustable height antenna mast 3 meters from the test item for emission measurements.
- d) Detected emissions were maximized at each frequency by rotating the test item and adjusting the receive antenna height and polarization. The maximum meter reading was recorded. The radiated emission measurements of the harmonics of the transmit frequency through the 10th harmonic were measured with peak detector and 1 MHz bandwidth. If the harmonic could not be detected above the noise floor, the ambient level was recorded. The equivalent power into a dipole antenna was calculated from the field intensity levels measured at 3 meters.
- e) Now each detected emissions were substituted by the substitution method, in accordance with the TIA/EIA 603.

Measurement:

Measurement parameters	
Detector:	Peak
Sweep time:	2 sec.
Video bandwidth:	Below 1 GHz: 100 kHz Above 1 GHz: 1 MHz
Resolution bandwidth:	Below 1 GHz: 100 kHz Above 1 GHz: 1 MHz
Span:	100 MHz Steps
Trace-Mode:	Max Hold

Limits:

FCC
CFR Part 24.238 CFR Part 2.1053
Spurious Emissions Radiated
Attenuation $\geq 43 + 10\log(P)$ (P, Power in Watts)
-13 dBm

Results:

Radiated emissions measurements were made only at the upper, center, and lower carrier frequencies of the PCS1900 band (1850.2 MHz, 1880.0 MHz and 1909.8 MHz). It was decided that measurements at these three carrier frequencies would be sufficient to demonstrate compliance with emissions limits because it was seen that all the significant spurs occur well outside the band and no radiation was seen from a carrier in one block of the PCS1900 band into any of the other blocks. The equipment must still, however, meet emissions requirements with the carrier at all frequencies over which it is capable of operating and it is the manufacturer's responsibility to verify this.

The final open field radiated levels are presented on the next pages. All measurements were done in horizontal and vertical polarization; the plots show the worst case. The plots show only the middle channel. If spurious were detected, the lowest and highest channel were checked too. The found values are stated in the table below.

As can be seen from this data, the emissions from the test item were within the specification limit.

SPURIOUS EMISSION LEVEL (dBm)								
Harmonic	Ch. 512 Freq. (MHz)	Level [dBm]	Harmonic	Ch. 661 Freq. (MHz)	Level [dBm]	Harmonic	Ch. 810 Freq. (MHz)	Level [dBm]
2	3700.4	-	2	3760.0	-	2	3819.6	-
3	5550.6	-	3	5640.0	-	3	5729.4	-
4	7400.8	-	4	7520.0	-	4	7639.2	-
5	9251.0	-	5	9400.0	-	5	9549.0	-
6	11101.2	-	6	11280.0	-	6	11458.8	-
7	12951.4	-	7	13160.0	-	7	13368.6	-
8	14801.6	-	8	15040.0	-	8	15278.4	-
9	16651.8	-	9	16920.0	-	9	17188.2	-
10	18502.0	-	10	18800.0	-	10	19098.0	-
Measurement uncertainty					± 3dB			

Result: Passed

Plots:

Plot 1: Channel 661 (Traffic mode up to 30 MHz)

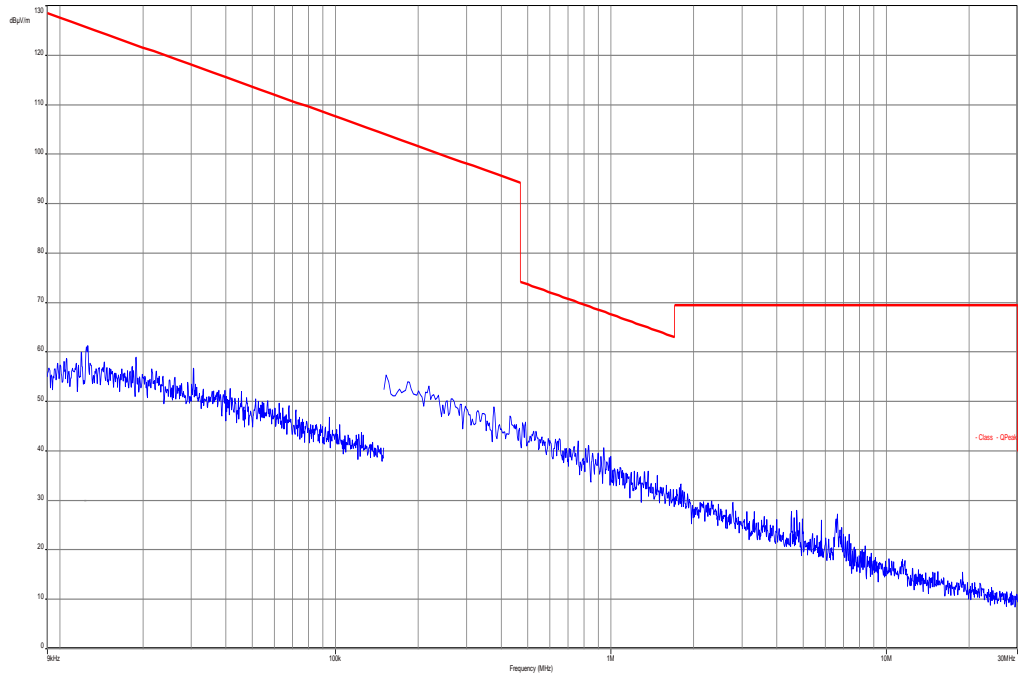

Plot 2: Channel 661 (30 MHz – 12.75 GHz)

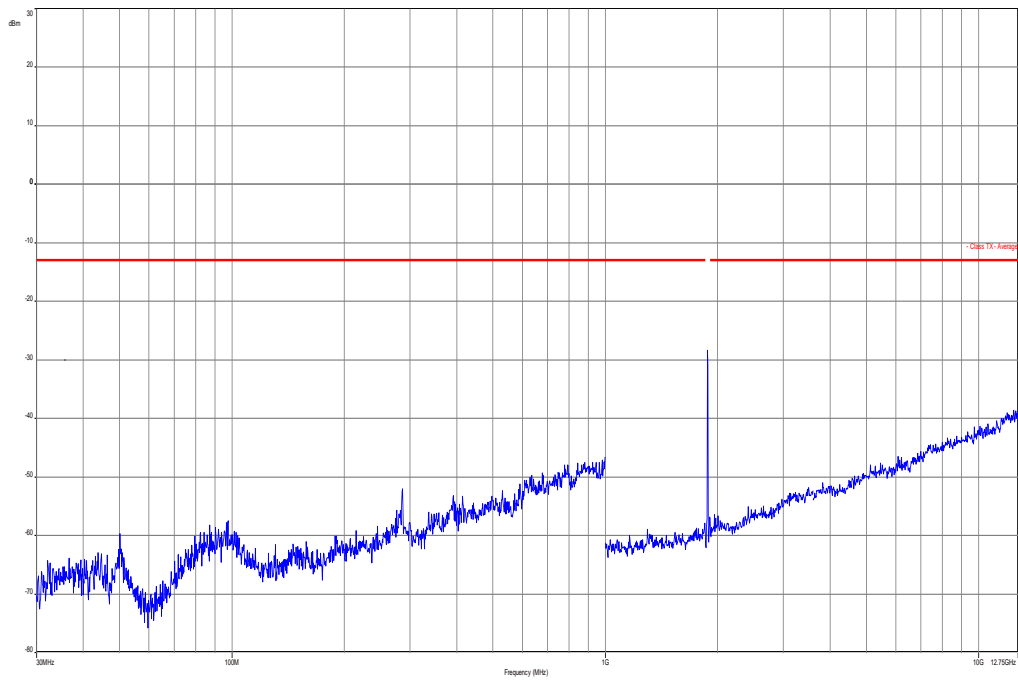

Carrier notched with 1.9 GHz rejection filter

Plot 3: Channel 661 (12 GHz - 25 GHz)

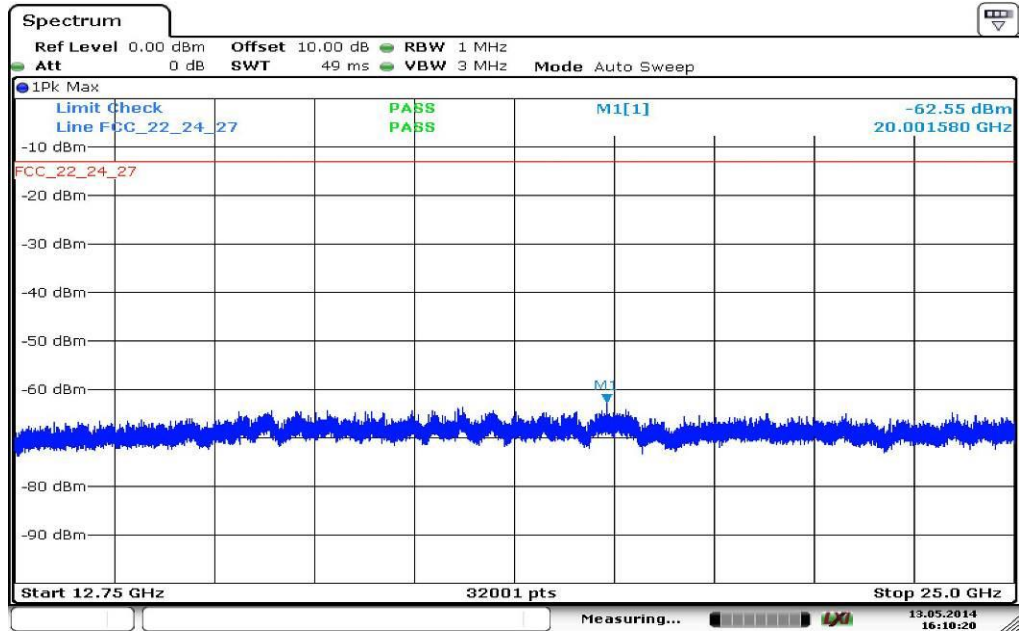

Date: 13.MAY.2014 16:10:20

8.3.4 Spurious emissions conducted

Description:

The following steps outline the procedure used to measure the conducted emissions from the mobile station.

1. Determine frequency range for measurements: From CFR 2.1057 the spectrum should be investigated from the lowest radio frequency generated in the equipment up to at least the 10th harmonic of the carrier frequency. For the mobile station equipment tested, this equates to a frequency range of 13 MHz to 19.1 GHz, data taken from 10 MHz to 25 GHz.
2. Determine mobile station transmits frequencies: below outlines the band edge frequencies pertinent to conducted emissions testing.

PCS1900 Transmitter Channel Frequency

- 512 1850.2 MHz
- 661 1880.0 MHz
- 810 1909.8 MHz

Measurement:

Measurement parameters	
Detector:	Peak
Sweep time:	Auto
Video bandwidth:	Pre-measurement with 1 MHz On spurious detection re-measurement below 1 GHz with 100 kHz Above 1 GHz with 1 MHz
Resolution bandwidth:	Pre-measurement with 1 MHz On spurious detection re-measurement below 1 GHz with 100 kHz Above 1 GHz with 1 MHz
Span:	10 MHz – 25 GHz
Trace-Mode:	Max Hold

Limits:

FCC
CFR Part 24.238 CFR Part 2.1051
Spurious Emissions Conducted
Attenuation $\geq 43 + 10\log(P)$ (P, Power in Watts)
-13 dBm

Results:

SPURIOUS EMISSION LEVEL (dBm)								
Harmonic	Ch. 512 Freq. (MHz)	Level [dBm]	Harmonic	Ch. 661 Freq. (MHz)	Level [dBm]	Harmonic	Ch. 810 Freq. (MHz)	Level [dBm]
2	3700.4	-	2	3760.0	-	2	3819.6	-
3	5550.6	-	3	5640.0	-	3	5729.4	-
4	7400.8	-	4	7520.0	-	4	7639.2	-
5	9251.0	-	5	9400.0	-	5	9549.0	-
6	11101.2	-	6	11280.0	-	6	11458.8	-
7	12951.4	-	7	13160.0	-	7	13368.6	-
8	14801.6	-	8	15040.0	-	8	15278.4	-
9	16651.8	-	9	16920.0	-	9	17188.2	-
10	18502.0	-	10	18800.0	-	10	19098.0	-
Measurement uncertainty					± 3dB			

Result: Passed

Plots:

Plot 1: Channel 512 (10 MHz - 25 GHz)

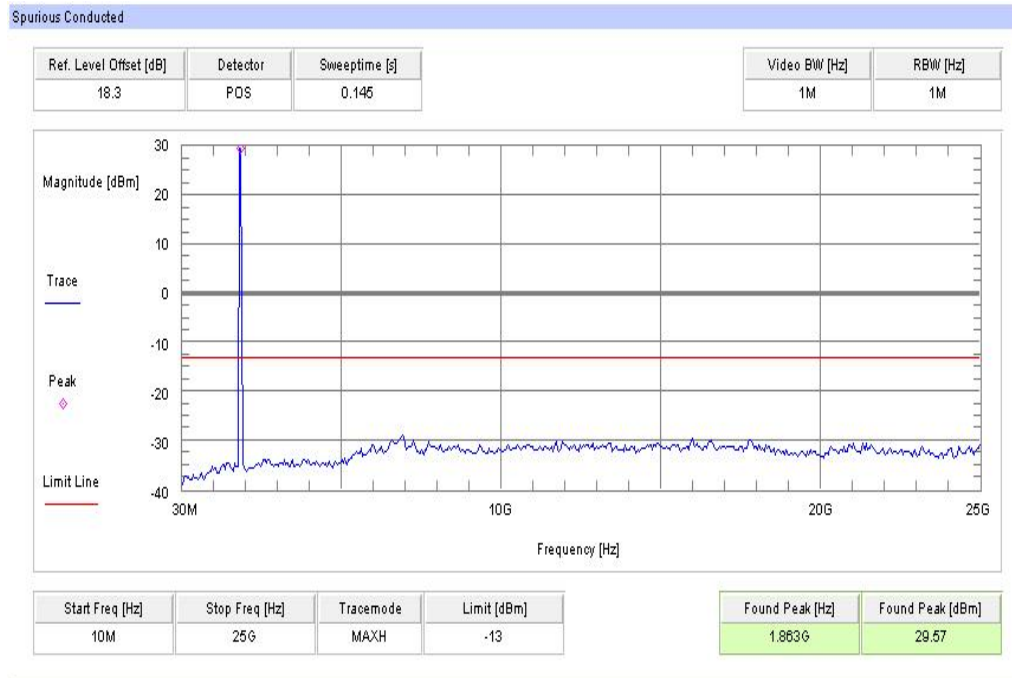

Plot 2: Channel 661 (10 MHz - 25 GHz)

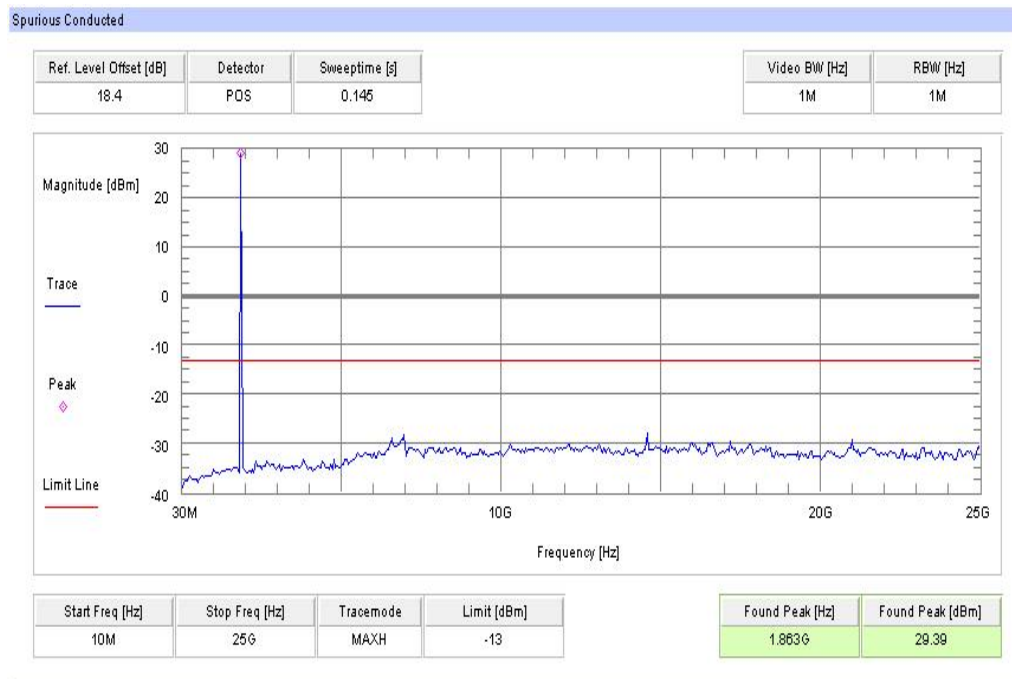

Plot 3: Channel 810 (10 MHz - 25 GHz)

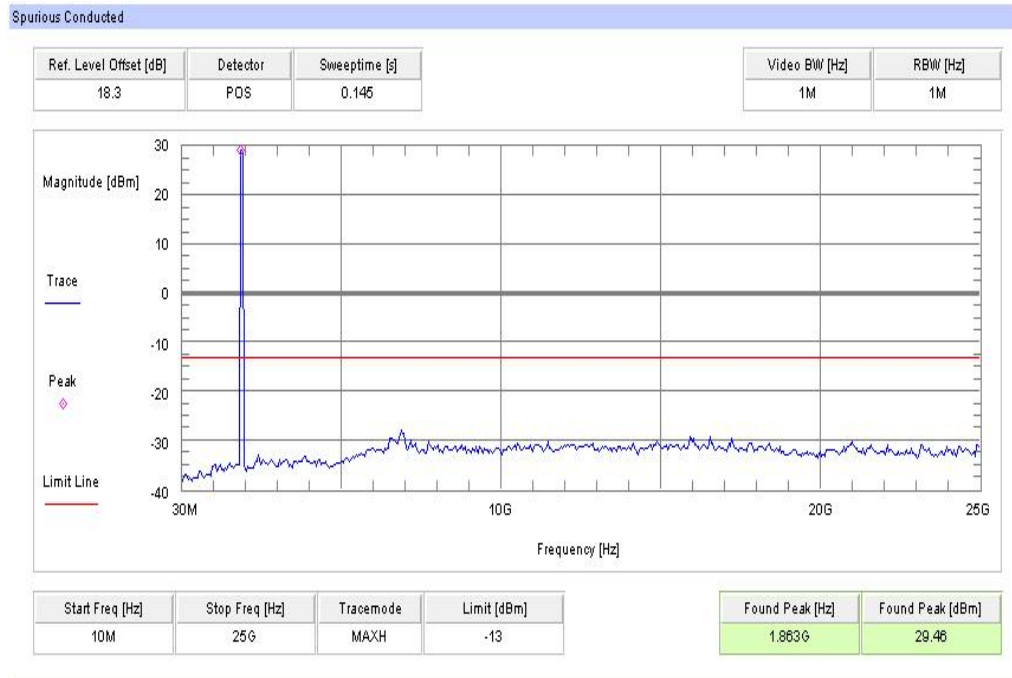

8.3.5 Block edge compliance

Description:

The spectrum at the band edges must comply with the spurious emissions limits.

Measurement:

Measurement parameters	
Detector:	RMS
Sweep time:	Auto
Video bandwidth:	3 kHz
Resolution bandwidth:	3 kHz
Span:	1 MHz
Trace-Mode:	Max Hold

Limits:

FCC
CFR Part 24.238 CFR Part 2.1051
Block Edge Compliance
Attenuation $\geq 43 + 10\log(P)$ (P, Power in Watts)
-13 dBm

Plots:

Plot 1: Channel 512 (GSM-mode)

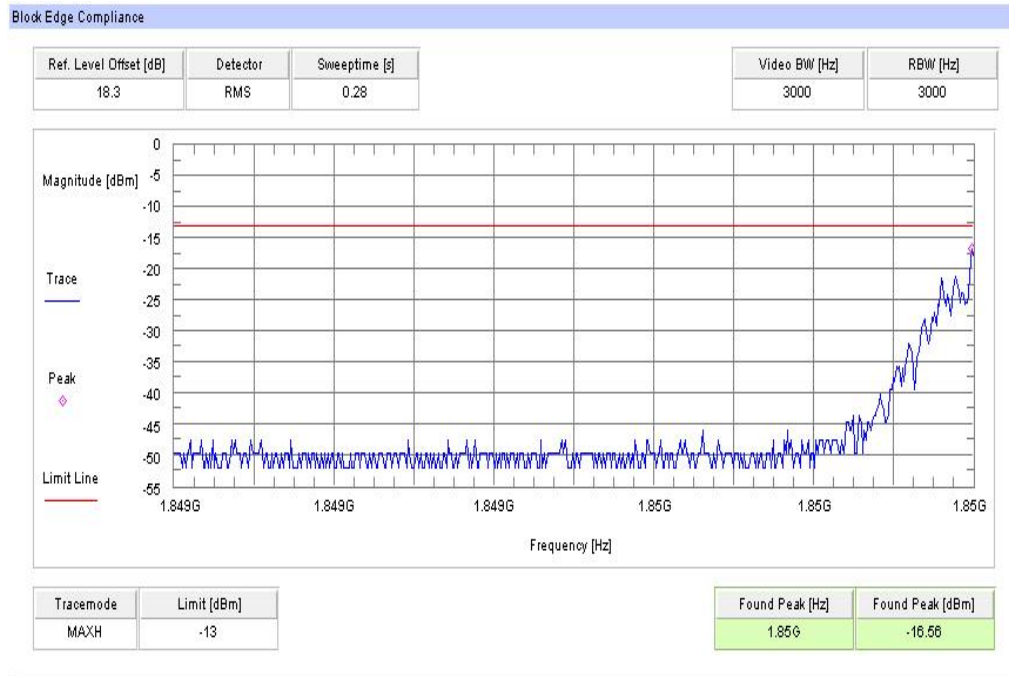

Plot 2: Channel 810 (GSM-mode)

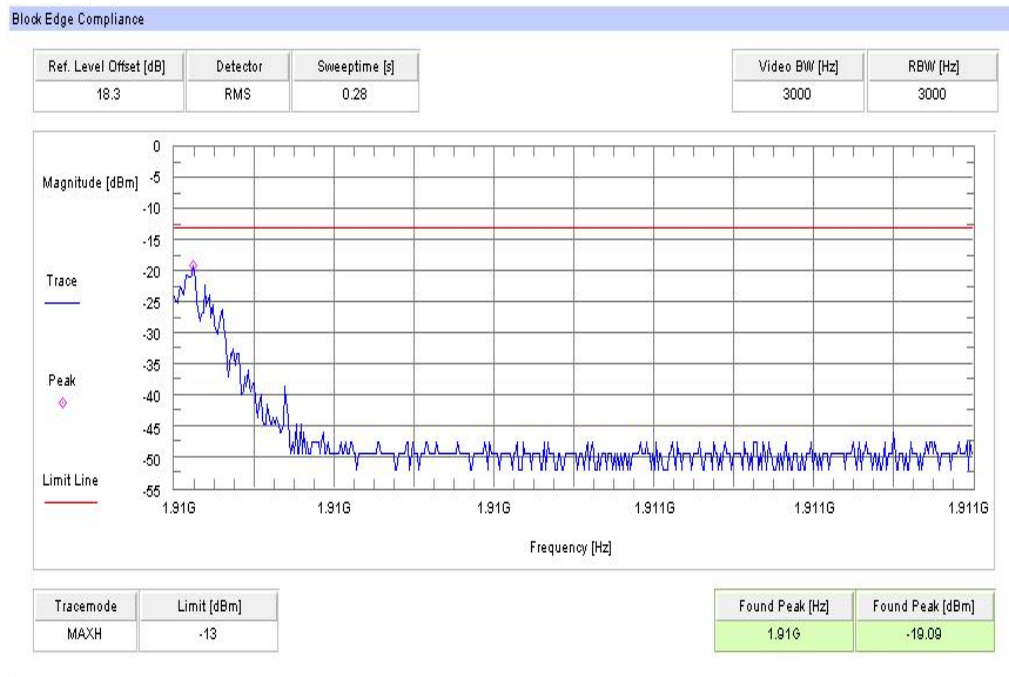

Plot 3: Channel 512 (EDGE-mode)

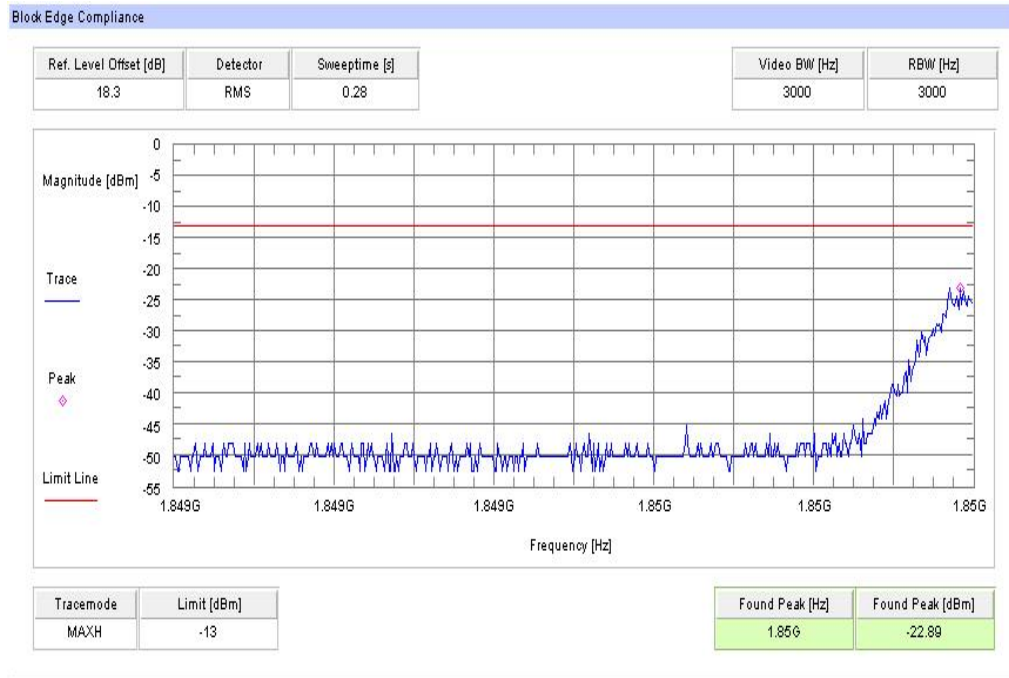

Plot 4: Channel 810 (EDGE-mode)

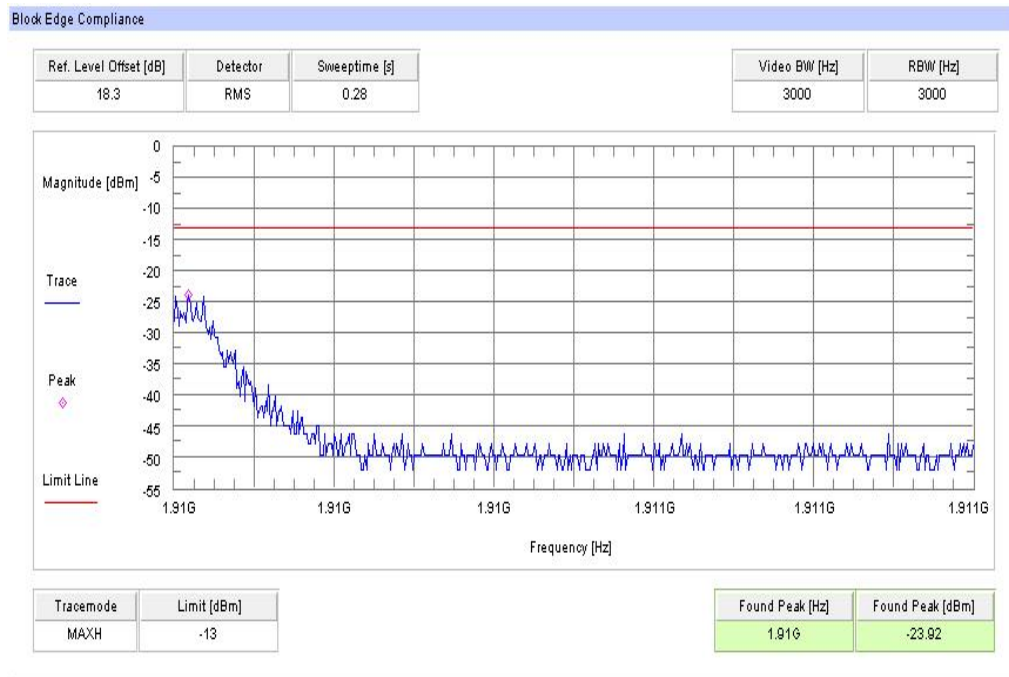

Result: Passed

8.3.6 Occupied bandwidth

Description:

Measurement of the occupied bandwidth of the transmitted signal.

Measurement:

Similar to conducted emissions, occupied bandwidth measurements are only provided for selected frequencies in order to reduce the amount of submitted data. Data were taken at the extreme and mid frequencies of the PCS1900 frequency band. The table below lists the measured 99% power and -26dBc occupied bandwidths. Spectrum analyzer plots are included on the following pages.

Part 24.238 requires a measurement bandwidth of at least 1% of the occupied bandwidth. For ca. 300 kHz, this equates to a resolution bandwidth of at least 3.0 kHz. For this testing, a resolution bandwidth 10 kHz was used.

Measurement parameters	
Detector:	Peak
Sweep time:	Auto
Video bandwidth:	30 kHz
Resolution bandwidth:	10 kHz
Span:	1 MHz
Trace-Mode:	Max Hold

Limits:

FCC
CFR Part 24.238 CFR Part 2.1049
Occupied Bandwidth
Spectrum must fall completely in the specified band

Results:

Occupied Bandwidth - GMSK mode		
Frequency (MHz)	99% OBW (kHz)	-26 dBc BW (kHz)
1850.2	263	303
1880.0	267	303
1909.8	265	297
Measurement uncertainty	± 3 kHz	

Occupied Bandwidth - EDGE mode		
Frequency (MHz)	99% OBW (kHz)	-26 dBc BW (kHz)
1850.2	269	311
1880.0	275	311
1909.8	289	309
Measurement uncertainty	± 3 kHz	

Result: Passed

Plots:

Plot 1: Channel 512 (99% - OBW)

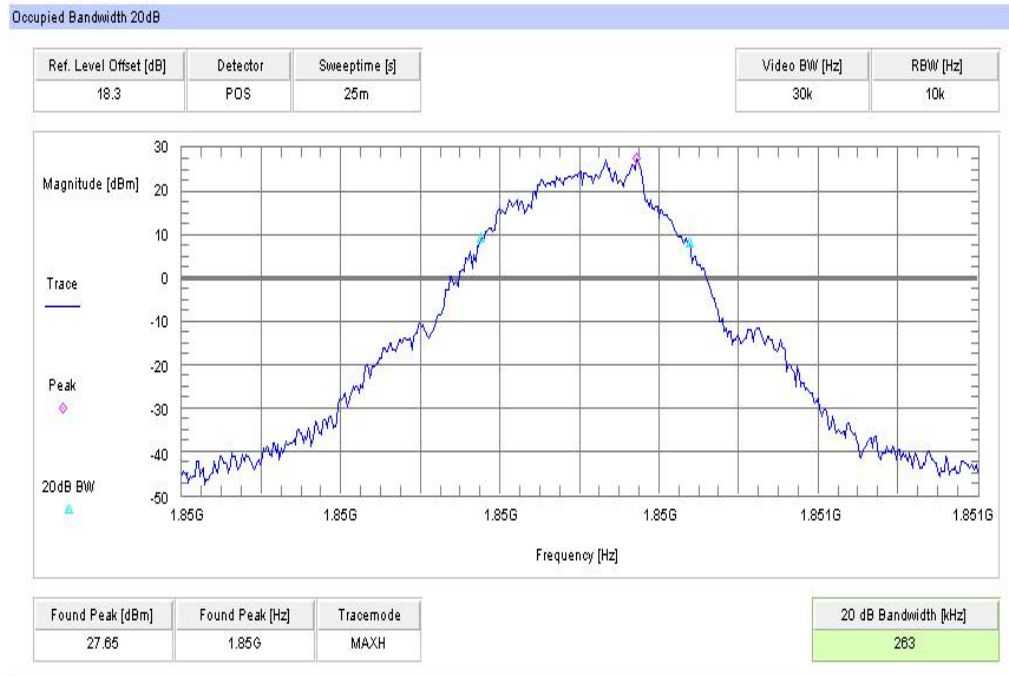

Plot 2: Channel 512 (-26 dBc BW)

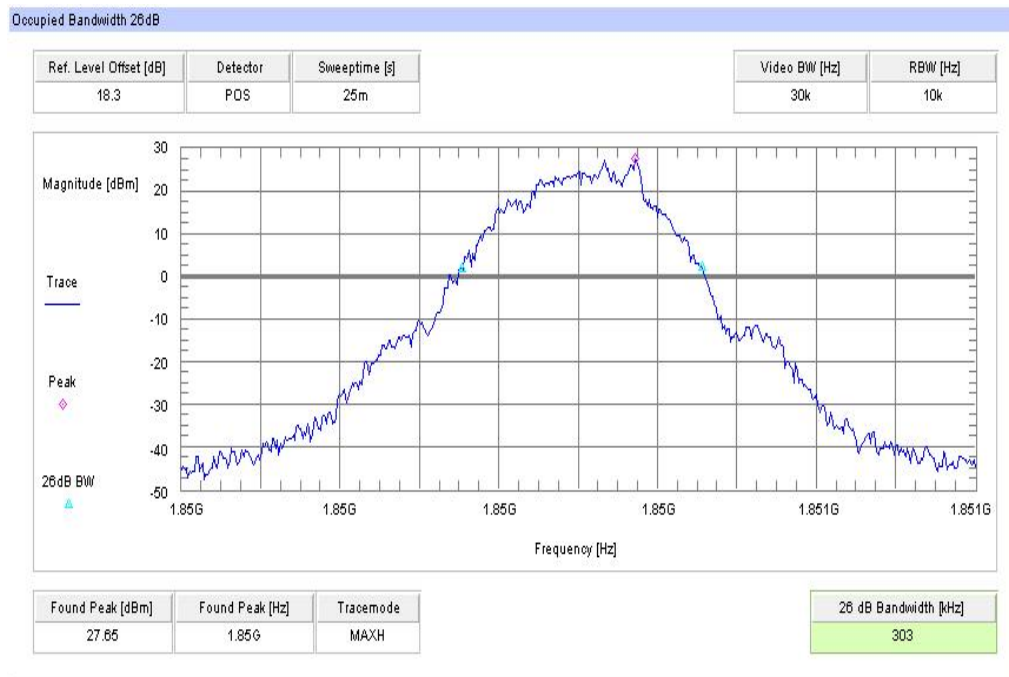

Plot 3: Channel 661 (99% - OBW)

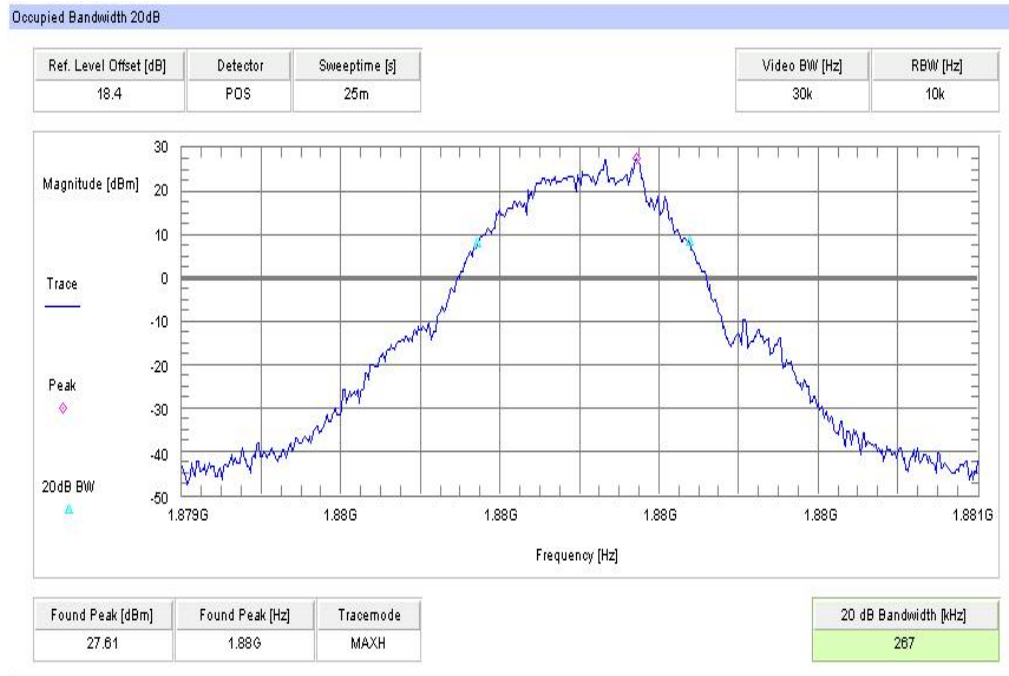

Plot 4: Channel 661 (-26 dBc BW)

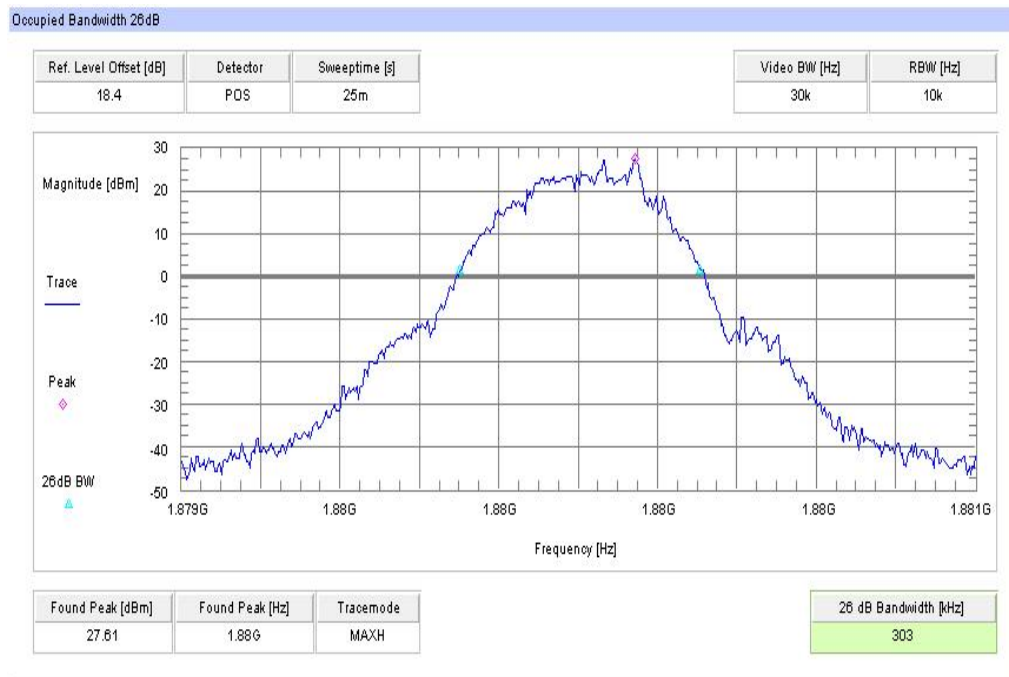

Plot 5: Channel 810 (99% - OBW)



Plot 6: Channel 810 (-26 dBc BW)

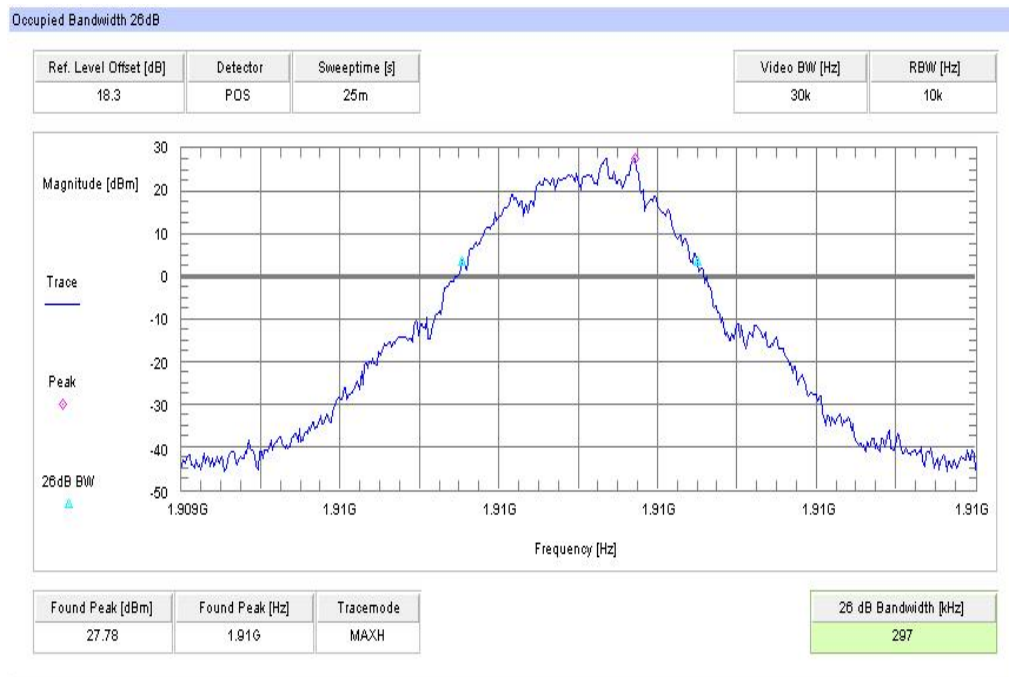

Plot 7: Channel 512 (99% - OBW) - EDGE

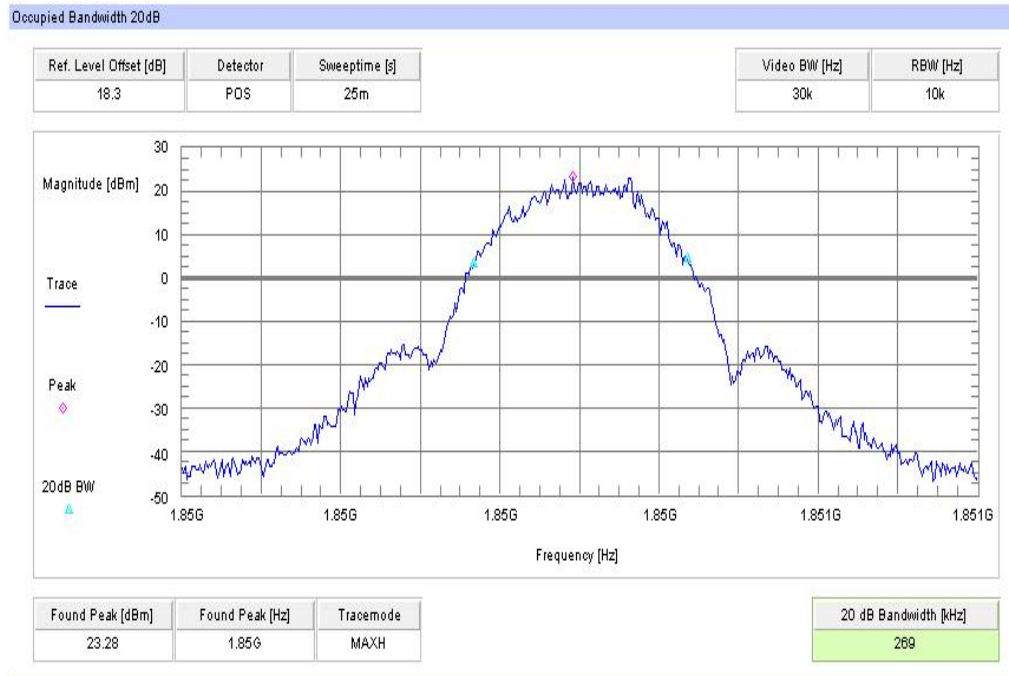

Plot 8: Channel 512 (-26 dBc BW) - EDGE

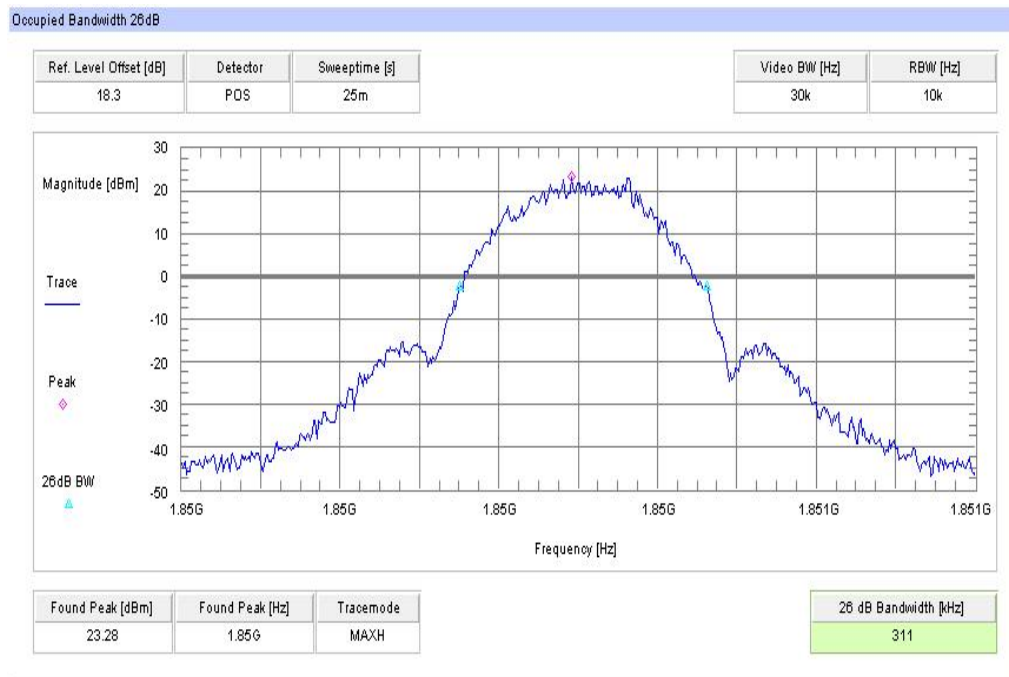

Plot 9: Channel 661 (99% - OBW) - EDGE

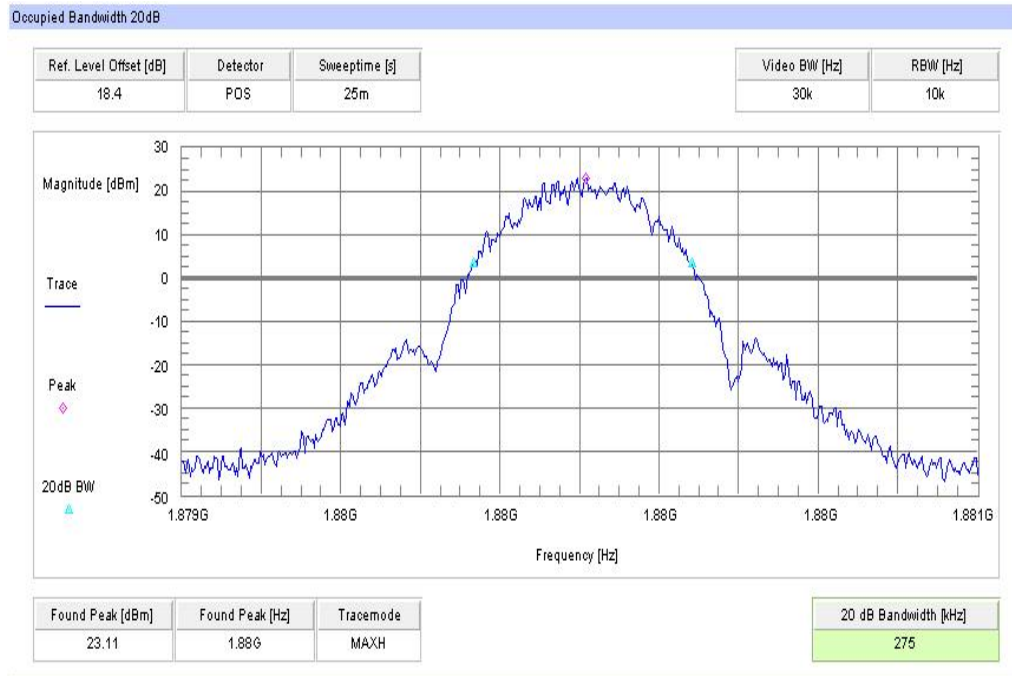

Plot 10: Channel 661 (-26 dBc BW) - EDGE

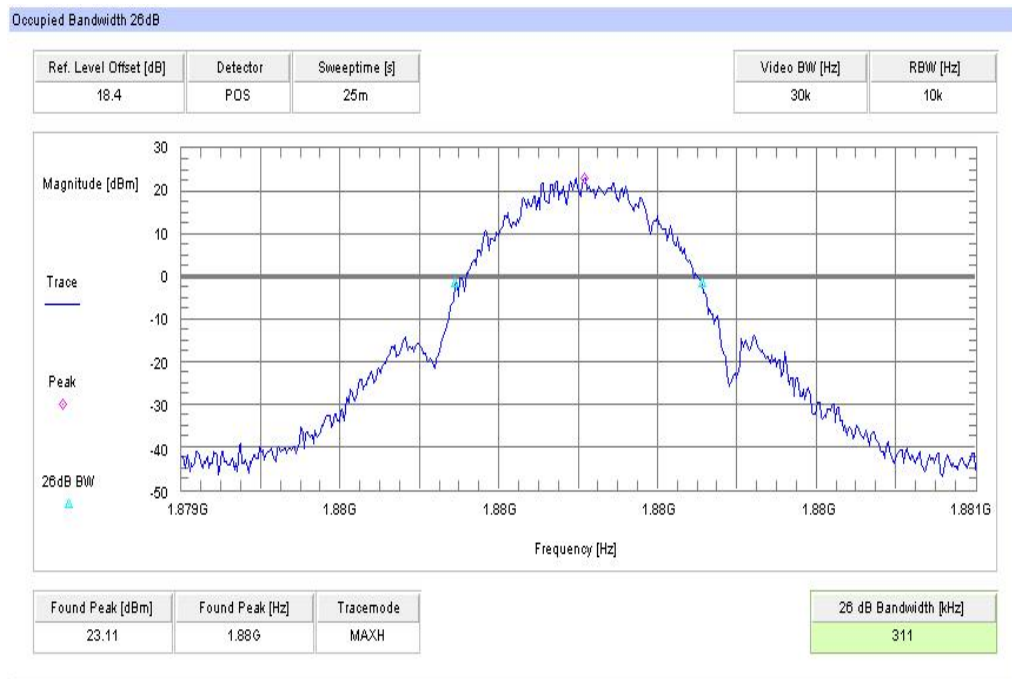

Plot 11: Channel 810 (99% - OBW) - EDGE



Plot 12: Channel 810 (-26 dBc BW) - EDGE

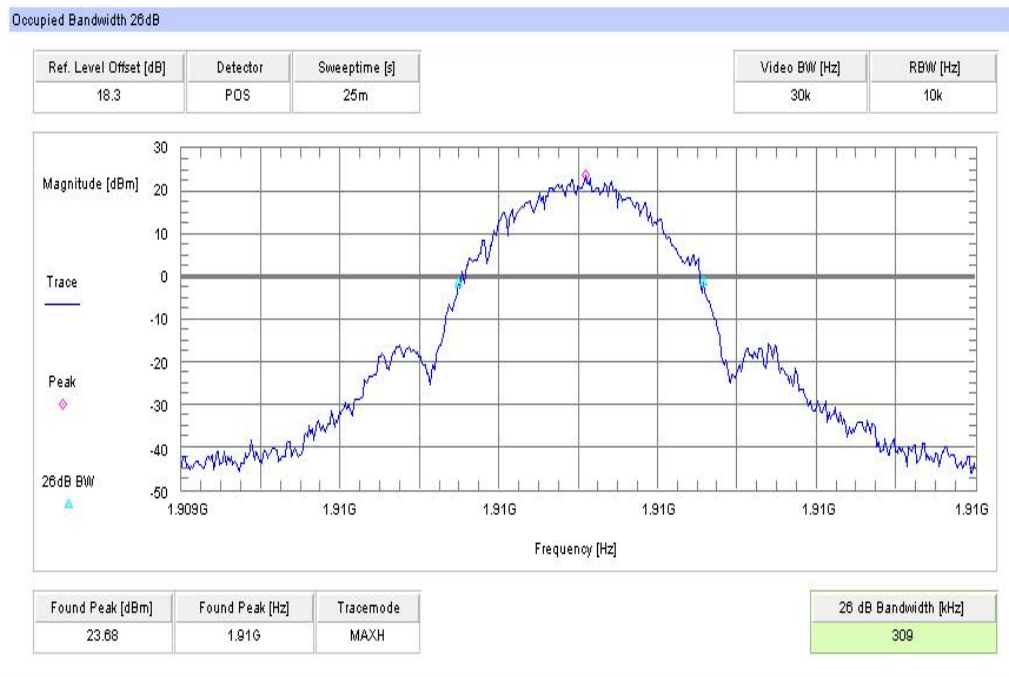

8.4 Results UMTS band II

All UMTS-band measurements are done in WCDMA mode only.
 The connection was established with the following setup: WCDMA CS-RMC, Max Power (All Bit up)

8.4.1 RF output power

Description:

This paragraph contains average power, peak output power and EIRP measurements for the mobile station. In all cases, the peak output power is within the required mask (this mask is specified in the JTC standards, TIA PN3389 Vol. 1 Chap 7, and is no FCC requirement).

Measurement:

The mobile was set up for the maximum output power with pseudo random data modulation.

To determine the Peak-To-Average Power Ratio (PAPR) the measurement was performed with the Power Complementary Cumulative Distribution Function (CCDF).

Measurement parameters	
Detector:	Peak and RMS (Power in Burst)
Sweep time:	Auto
Video bandwidth:	10 MHz
Resolution bandwidth:	10 MHz
Span:	Zero Span
Trace-Mode:	Max Hold

Limits:

FCC
CFR Part 24.232 CFR Part 2.1046
Nominal Peak Output Power
+33.00 dBm In measuring transmissions in this band using an average power technique, the peak-to-average ratio (PAR) of the transmission may not exceed 13 dB.

Results:

Output Power (conducted) WCDMA mode		
Frequency (MHz)	Average Output Power (dBm)	Peak to Average Ratio (dB)
1852.4	22.3	3.35
1880.0	22.6	3.37
1907.6	22.8	3.34
Measurement uncertainty	± 0.5 dB	

Output Power (radiated) WCDMA mode	
Frequency (MHz)	Average Output Power (dBm) - EIRP
1852.4	25.0
1880.0	25.3
1907.6	25.4
Measurement uncertainty	± 2.0 dB

Result: **Passed**

8.4.2 Frequency stability

Description:

In order to measure the carrier frequency under the condition of AFC lock, it is necessary to make measurements with the mobile station in a “call mode”. This is accomplished with the use of a R&S CMU200 DIGITAL RADIOCOMMUNICATION TESTER.

1. Measure the carrier frequency at room temperature.
2. Subject the mobile station to overnight soak at -30 C.
3. With the mobile station, powered with V_{nom} , connected to the CMU200 and in a simulated call on channel 9400 (centre channel), measure the carrier frequency. These measurements should be made within two minutes of powering up the mobile station, to prevent significant self warming.
4. Repeat the above measurements at 10°C increments from -30°C to +60°C. Allow at least 1.5 hours at each temperature, unpowered, before making measurements.
5. Remeasure carrier frequency at room temperature with V_{nom} . Vary supply voltage from V_{min} to V_{max} , in 0.1 Volt steps remeasuring carrier frequency at each voltage. Pause at V_{nom} for 1.5 hours unpowered, to allow any self heating to stabilize, before continuing.
6. At all temperature levels hold the temperature to +/- 0.5°C during the measurement procedure.

Measurement:

Measurement parameters	
Detector:	Measured with CMU200
Sweep time:	
Video bandwidth:	
Resolution bandwidth:	
Span:	
Trace-Mode:	

Limits:

FCC
CFR Part 24.235 CFR Part 2.1055
Frequency Stability
The frequency stability shall be sufficient to ensure that the fundamental emission stays within the authorized frequency block.

Results:**AFC FREQ ERROR versus VOLTAGE**

Voltage (V)	Frequency Error (Hz)	Frequency Error (%)	Frequency Error (ppm)
3.3	6	0.00000032	0.0032
3.4	6	0.00000032	0.0032
3.5	4	0.00000021	0.0021
3.6	7	0.00000037	0.0037
3.7	5	0.00000027	0.0027
3.8	6	0.00000032	0.0032
3.9	6	0.00000032	0.0032
4.0	4	0.00000021	0.0021
4.1	7	0.00000037	0.0037
4.2	6	0.00000032	0.0032
4.3	5	0.00000027	0.0027
4.4	8	0.00000043	0.0043

AFC FREQ ERROR versus TEMPERATURE

Temperature (°C)	Frequency Error (Hz)	Frequency Error (%)	Frequency Error (ppm)
-30	6	0.00000032	0.0032
-20	6	0.00000032	0.0032
-10	6	0.00000032	0.0032
± 0	6	0.00000032	0.0032
10	5	0.00000027	0.0027
20	4	0.00000021	0.0021
30	5	0.00000027	0.0027
40	7	0.00000037	0.0037
50	6	0.00000032	0.0032
60	3	0.00000016	0.0016

Result: Passed

8.4.3 Spurious emissions radiated

Description:

The following steps outline the procedure used to measure the radiated emissions from the mobile station. The site is constructed in accordance with ANSI C63.4:2009 requirements and is recognized by the FCC to be in compliance for a 3 and a 10 meter site. The spectrum was scanned from 30 MHz to the 10th harmonic of the highest frequency generated within the equipment, which is the transmitted carrier that can be as high as 1910 MHz. Measurement made up to 25 GHz. The resolution bandwidth is set as outlined in Part 24.238. The spectrum was scanned with the mobile station transmitting at carrier frequencies that pertain to low, mid and high channels of the UMTS band II.

The final open field emission (here 10m semi-anechoic chamber listed by FCC) test procedure is as follows:

- a) The test item was placed on a 0.8 meter high non-conductive stand at a 3 meter test distance from the receive antenna.
- b) The antenna output was terminated in a 50 ohm load (if possible).
- c) A double ridged wave guide antenna was placed on an adjustable height antenna mast 3 meters from the test item for emission measurements.
- d) Detected emissions were maximized at each frequency by rotating the test item and adjusting the receive antenna height and polarization. The maximum meter reading was recorded. The radiated emission measurements of the harmonics of the transmit frequency through the 10th harmonic were measured with peak detector and 1 MHz bandwidth. If the harmonic could not be detected above the noise floor, the ambient level was recorded. The equivalent power into a dipole antenna was calculated from the field intensity levels measured at 3 meters.
- e) Now each detected emissions were substituted by the substitution method, in accordance with the TIA/EIA 603.

Measurement:

Measurement parameters	
Detector:	Peak
Sweep time:	2 sec.
Video bandwidth:	Below 1 GHz: 100 kHz Above 1 GHz: 1 MHz
Resolution bandwidth:	Below 1 GHz: 100 kHz Above 1 GHz: 1 MHz
Span:	100 MHz Steps
Trace-Mode:	Max Hold

Limits:

FCC
CFR Part 24.238 CFR Part 2.1053
Spurious Emissions Radiated
Attenuation $\geq 43 + 10\log(P)$ (P, Power in Watts)
-13 dBm

Results:

Radiated emissions measurements were made only at the upper, center, and lower carrier frequencies of the UMTS band II (1852.4 MHz, 1880.0 MHz and 1907.6 MHz). It was decided that measurements at these three carrier frequencies would be sufficient to demonstrate compliance with emissions limits because it was seen that all the significant spurs occur well outside the band and no radiation was seen from a carrier in one block of the UMTS band II into any of the other blocks. The equipment must still, however, meet emissions requirements with the carrier at all frequencies over which it is capable of operating and it is the manufacturer's responsibility to verify this.

The final open field radiated levels are presented on the next pages.

All measurements were done in horizontal and vertical polarization; the plots show the worst case.

The plots show only the middle channel. If spurious were detected, the lowest and highest channel were checked too. The found values are stated in the table below.

As can be seen from this data, the emissions from the test item were within the specification limit.

SPURIOUS EMISSION LEVEL (dBm)								
Harmonic	Ch. 9262 Freq. (MHz)	Level [dBm]	Harmonic	Ch. 9400 Freq. (MHz)	Level [dBm]	Harmonic	Ch. 9538 Freq. (MHz)	Level [dBm]
2	3704.8	-	2	3760.0	-	2	3815.2	-
3	5557.2	-	3	5640.0	-	3	5722.8	-
4	7409.6	-	4	7520.0	-	4	7630.4	-
5	9262.0	-	5	9400.0	-	5	9538.0	-
6	11114.4	-	6	11280.0	-	6	11445.6	-
7	12966.8	-	7	13160.0	-	7	13353.2	-
8	14819.2	-	8	15040.0	-	8	15260.8	-
9	16671.6	-	9	16920.0	-	9	17168.4	-
10	18524.0	-	10	18800.0	-	10	19076.0	-
Measurement uncertainty					± 3dB			

Result: Passed

Plots:

Plot 1: Channel 9400 (Traffic mode up to 30 MHz)

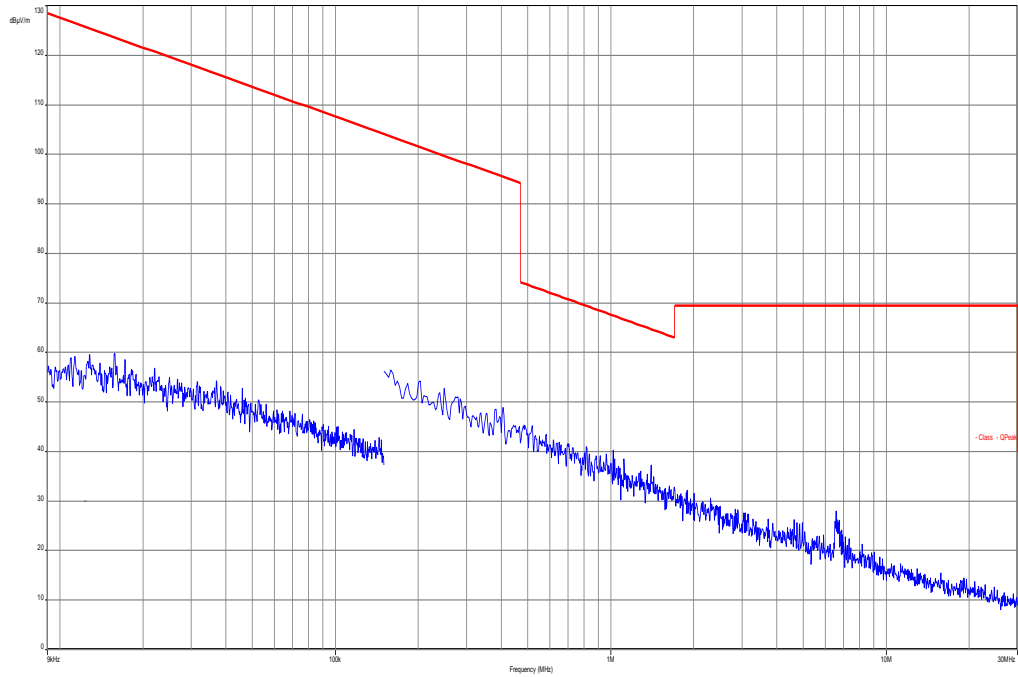

Plot 2: Channel 9400 (30 MHz – 12.75 GHz)

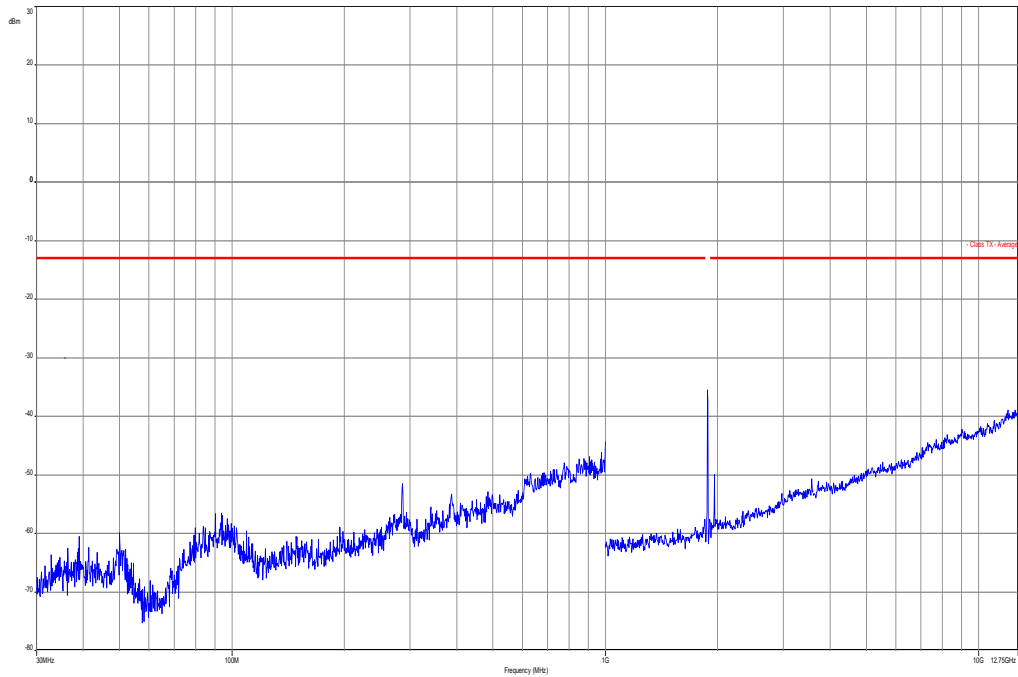

Carrier notched with 1.9 GHz rejection filter

Plot 3: Channel 9400 (12 GHz - 25 GHz)

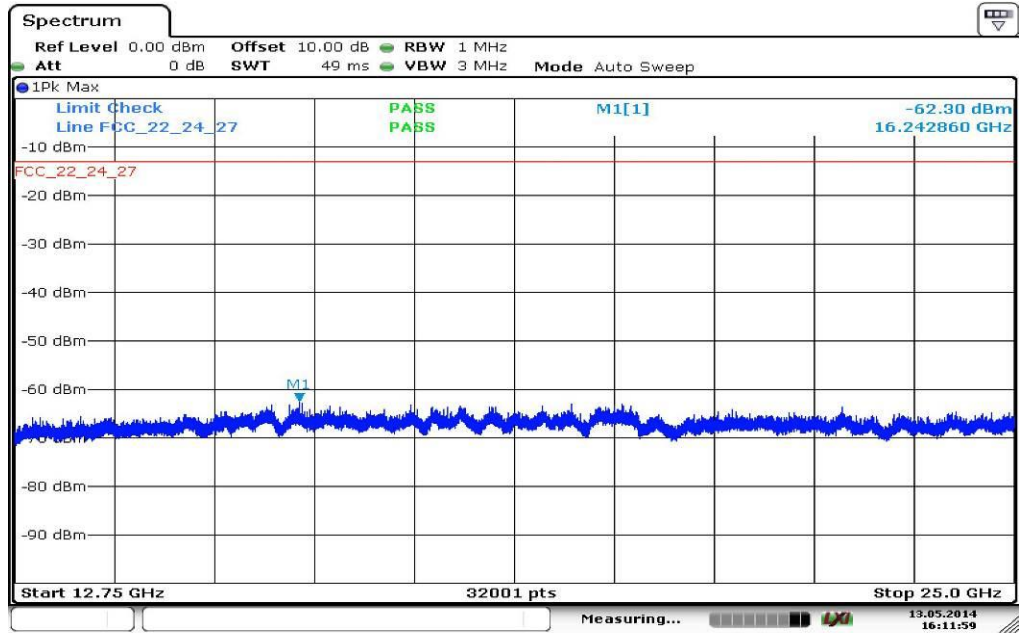

8.4.4 Spurious emissions conducted

Description:

The following steps outline the procedure used to measure the conducted emissions from the mobile station.

1. Determine frequency range for measurements: From CFR 2.1057 the spectrum should be investigated from the lowest radio frequency generated in the equipment up to at least the 10th harmonic of the carrier frequency. For the mobile station equipment tested, this equates to a frequency range of 13 MHz to 19.1 GHz, data taken from 10 MHz to 25 GHz.
2. Determine mobile station transmits frequencies: below outlines the band edge frequencies pertinent to conducted emissions testing.

UMTS band II Transmitter Channel Frequency

9262 1852.4 MHz

9400 1880.0 MHz

9538 1907.6 MHz

Measurement:

Measurement parameters	
Detector:	Peak
Sweep time:	Auto
Video bandwidth:	Pre-measurement with 1 MHz On spurious detection re-measurement below 1 GHz with 100 kHz Above 1 GHz with 1 MHz
Resolution bandwidth:	Pre-measurement with 1 MHz On spurious detection re-measurement below 1 GHz with 100 kHz Above 1 GHz with 1 MHz
Span:	10 MHz – 25 GHz
Trace-Mode:	Max Hold

Limits:

FCC
CFR Part 24.238 CFR Part 2.1051
Spurious Emissions Conducted
Attenuation $\geq 43 + 10\log(P)$ (P, Power in Watts)
-13 dBm

Results:

SPURIOUS EMISSION LEVEL (dBm)								
Harmonic	Ch. 9262 Freq. (MHz)	Level [dBm]	Harmonic	Ch. 9400 Freq. (MHz)	Level [dBm]	Harmonic	Ch. 9538 Freq. (MHz)	Level [dBm]
2	3704.8	-	2	3760.0	-	2	3815.2	-
3	5557.2	-	3	5640.0	-	3	5722.8	-
4	7409.6	-	4	7520.0	-	4	7630.4	-
5	9262.0	-	5	9400.0	-	5	9538.0	-
6	11114.4	-	6	11280.0	-	6	11445.6	-
7	12966.8	-	7	13160.0	-	7	13353.2	-
8	14819.2	-	8	15040.0	-	8	15260.8	-
9	16671.6	-	9	16920.0	-	9	17168.4	-
10	18524.0	-	10	18800.0	-	10	19076.0	-
Measurement uncertainty					± 3dB			

Result: Passed

Plots:

Plot 1: Channel 9262 (10 MHz - 25 GHz)

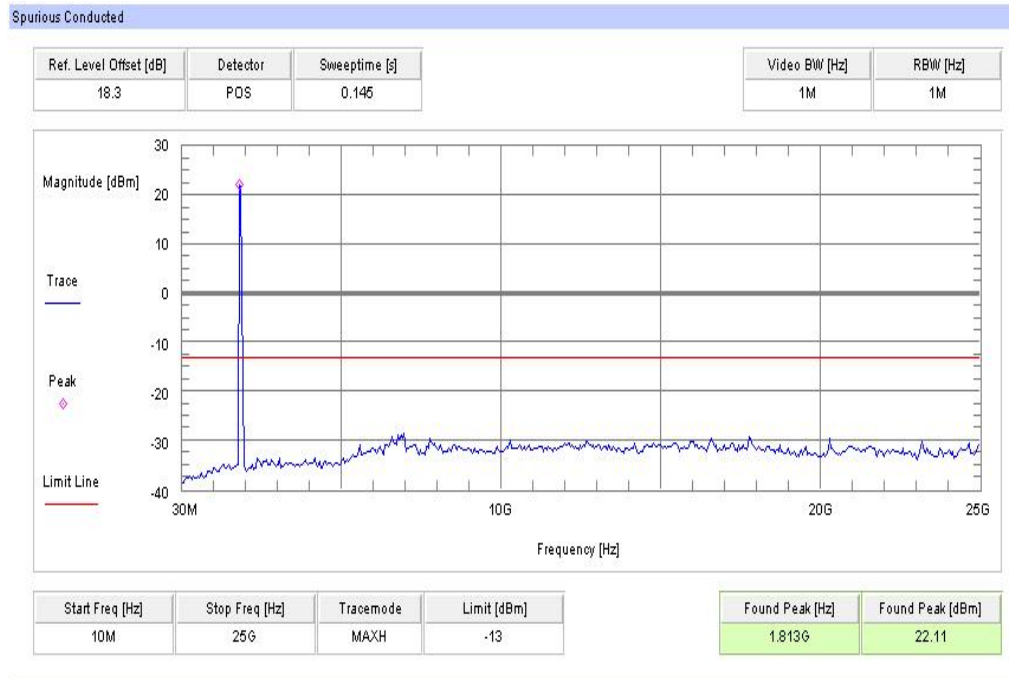

Plot 2: Channel 9400 (10 MHz - 25 GHz)

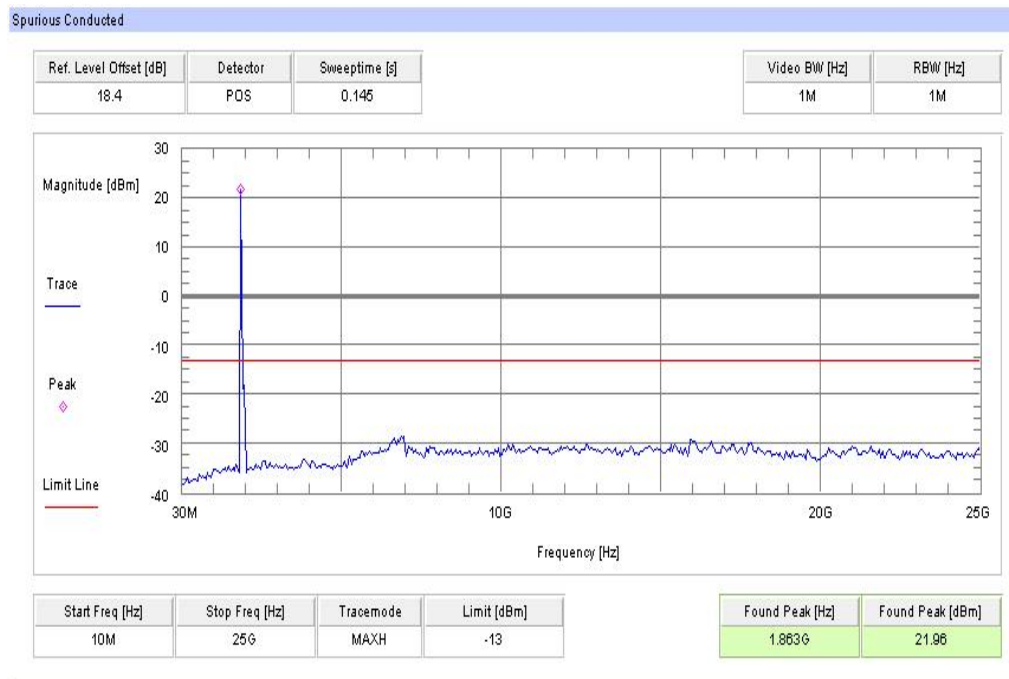

Plot 3: Channel 9538 (10 MHz - 25 GHz)

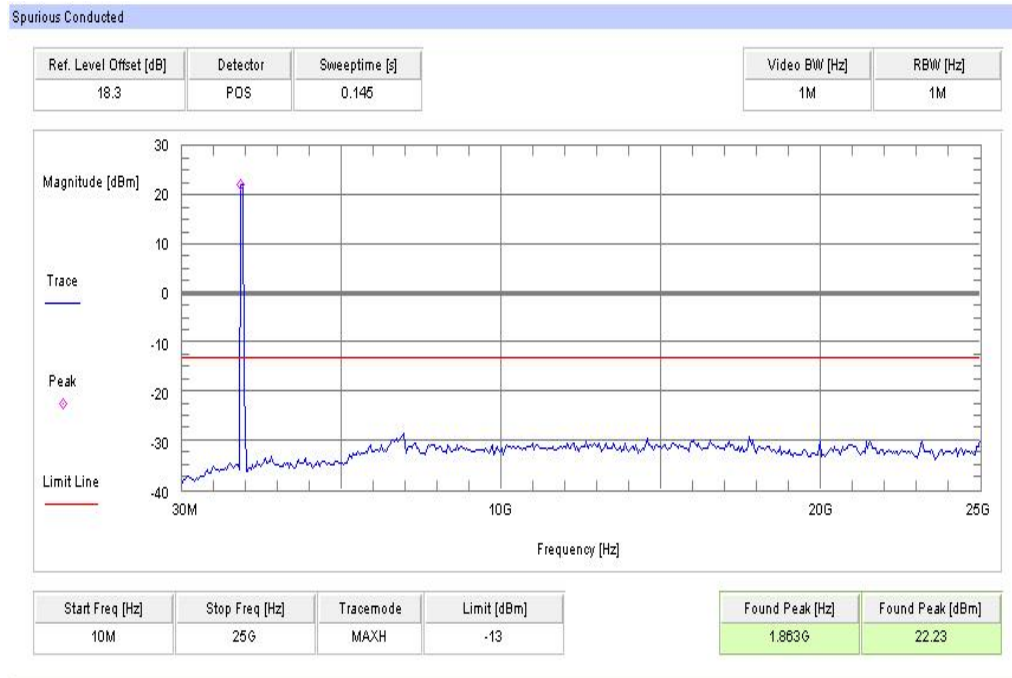

8.4.5 Block edge compliance

Description:

The spectrum at the band edges must comply with the spurious emissions limits.

Measurement:

Measurement parameters	
Detector:	RMS
Sweep time:	20 sec.
Video bandwidth:	30 kHz
Resolution bandwidth:	30 kHz
Span:	1 MHz
Trace-Mode:	Max Hold

Limits:

FCC
CFR Part 24.238 CFR Part 2.1051
Block Edge Compliance
<p>Part 24.238 specifies that “the power of any emission outside of the authorized operating frequency ranges must be attenuated below the transmitting power (P) by a factor of at least $43 + 10 \log(P)$ dB.”</p> <p>However, in publication number 890810, The FCC Office of Engineering and Technology specified the following correction to the limits when a resolution bandwidth smaller than 1% of the emission bandwidth is used:</p> <p>“An alternative is to add an additional correction factor of $10 \log(RBW1/ RBW2)$ to the $43 + 10 \log(P)$ limit. RBW1 is the narrower measurement resolution bandwidth and RBW2 is either the 1% emissions bandwidth or 1 MHz.”</p> <p>When using a 30 kHz bandwidth, this yields a -2.2185 adjustment to the limit [$10 \log(30 \text{kHz}/50 \text{kHz}) = -2.2185$]. When this adjustment is applied to the limit, the limit becomes -15.2185.</p>
-15.22 dBm

Plots:

Plot 1: Channel 9262

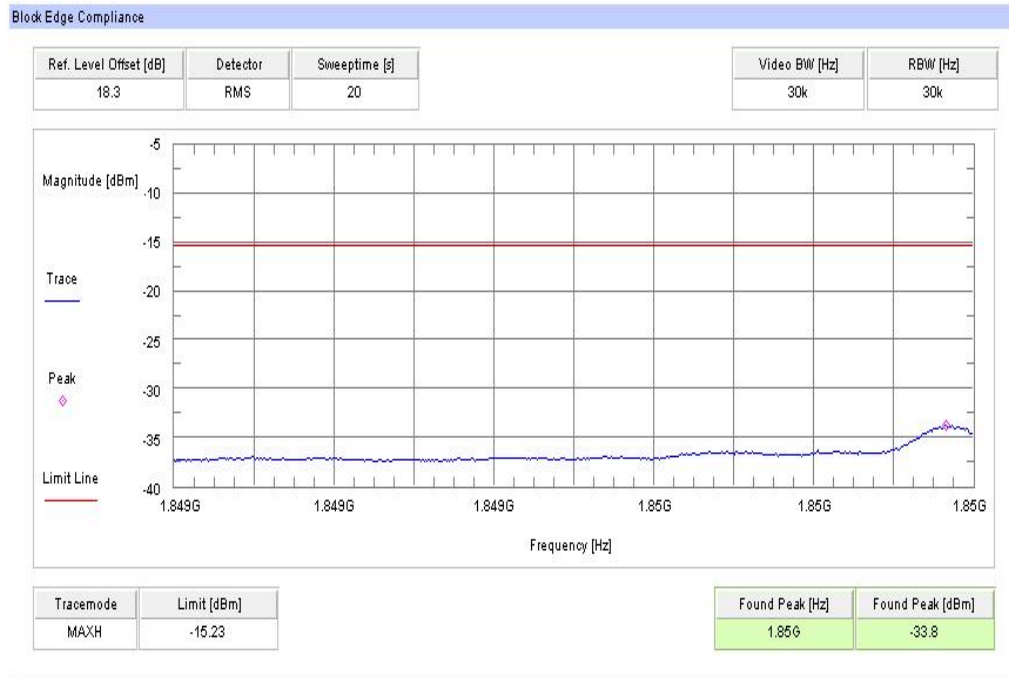

Plot 2: Channel 9538

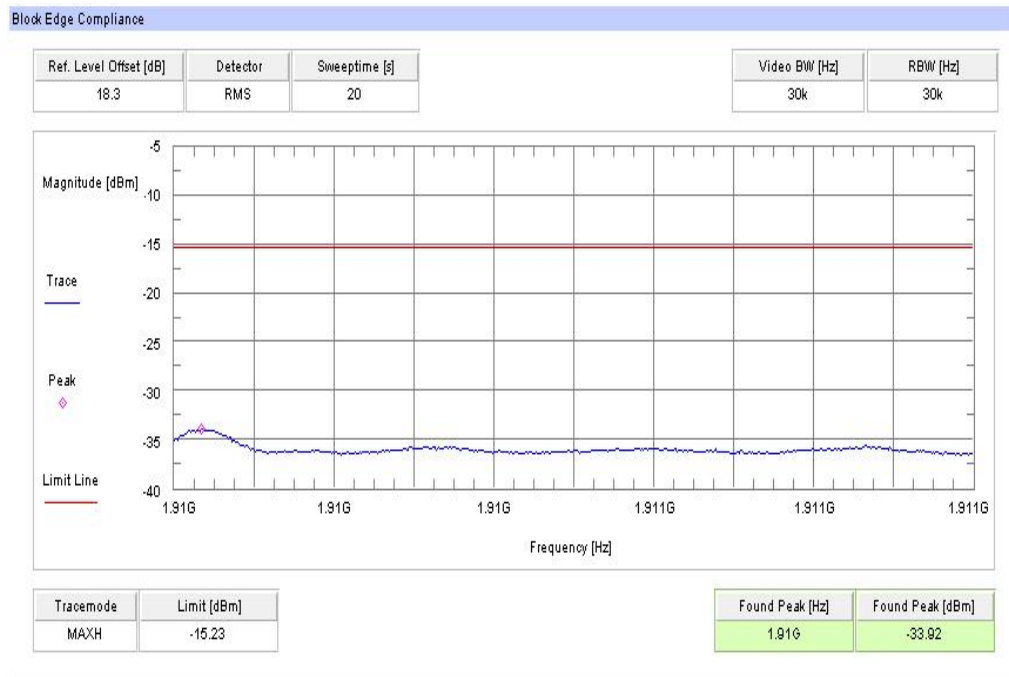

Result: Passed

8.4.6 Occupied bandwidth

Description:

Measurement of the occupied bandwidth of the transmitted signal.

Measurement:

Similar to conducted emissions, occupied bandwidth measurements are only provided for selected frequencies in order to reduce the amount of submitted data. Data were taken at the extreme and mid frequencies of the UMTS band II frequency band. The table below lists the measured 99% power and -26dBc occupied bandwidths. Spectrum analyzer plots are included on the following pages.

Part 24.238 requires a measurement bandwidth of at least 1% of the occupied bandwidth. For ca. 4700 kHz, this equates to a resolution bandwidth of at least 50 kHz. For this testing, a resolution bandwidth 100 kHz was used.

Measurement parameters	
Detector:	Peak
Sweep time:	Auto
Video bandwidth:	300 kHz
Resolution bandwidth:	100 kHz
Span:	6 MHz
Trace-Mode:	Max Hold

Limits:

FCC
CFR Part 24.238 CFR Part 2.1049
Occupied Bandwidth
Spectrum must fall completely in the specified band

Results:

Occupied Bandwidth		
Frequency (MHz)	99% OBW (kHz)	-26 dBc BW (kHz)
1852.4	4569	4677
1880.0	4569	4653
1907.6	4569	4689
Measurement uncertainty	± 100 kHz	

Result: Passed

Plots:

Plot 1: Channel 9262 (99% - OBW)



Plot 2: Channel 9262 (-26 dBc BW)

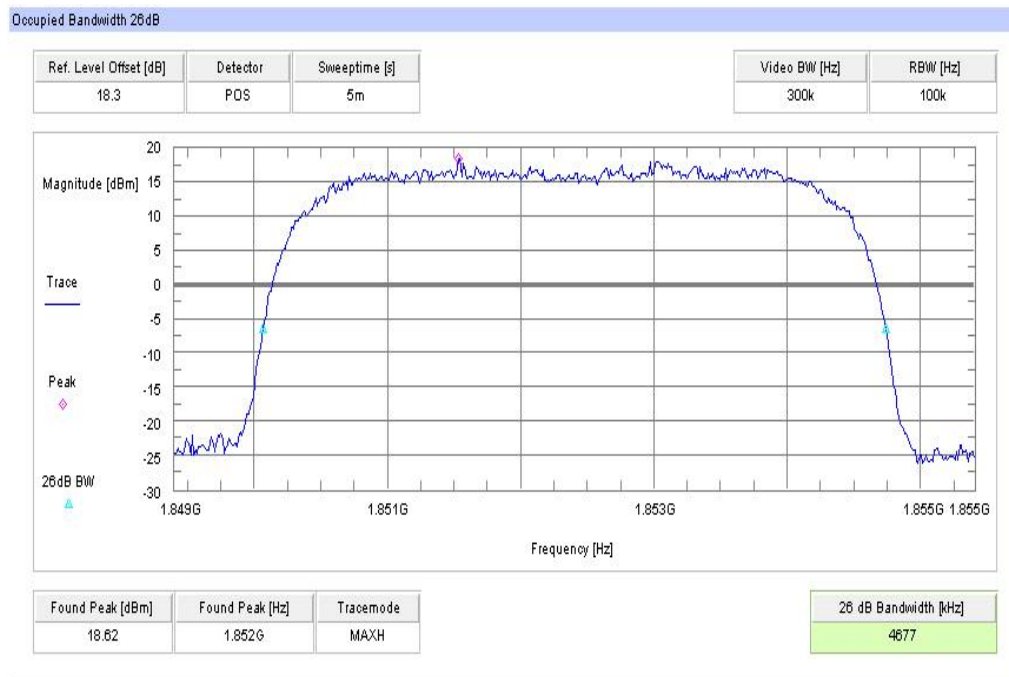

Plot 3: Channel 9400 (99% - OBW)

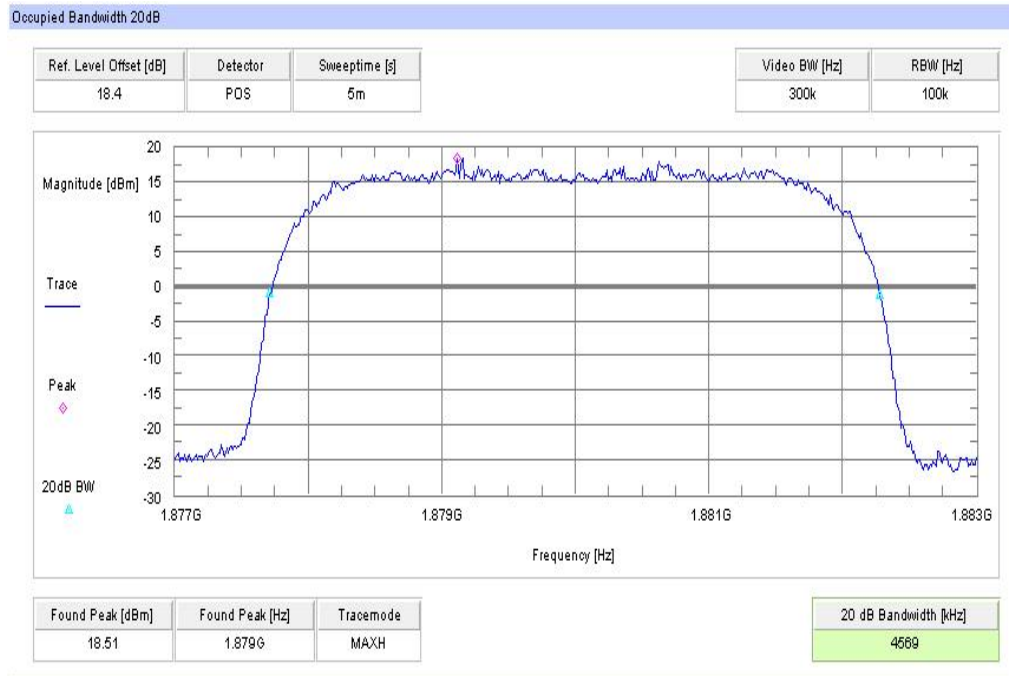

Plot 4: Channel 9400 (-26 dBc BW)

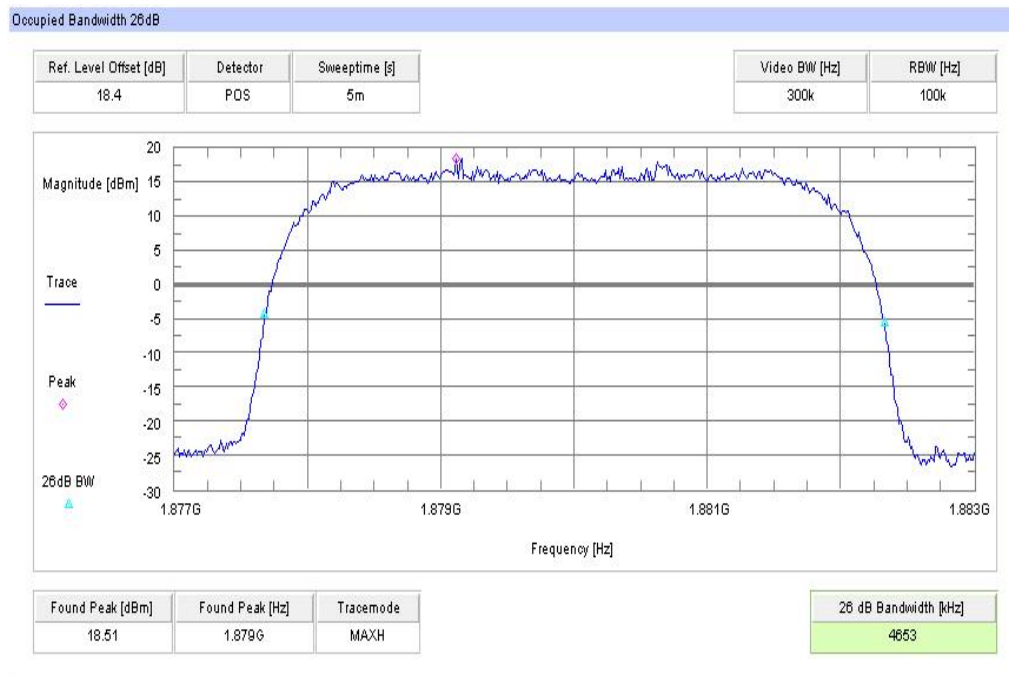

Plot 5: Channel 9538 (99% - OBW)

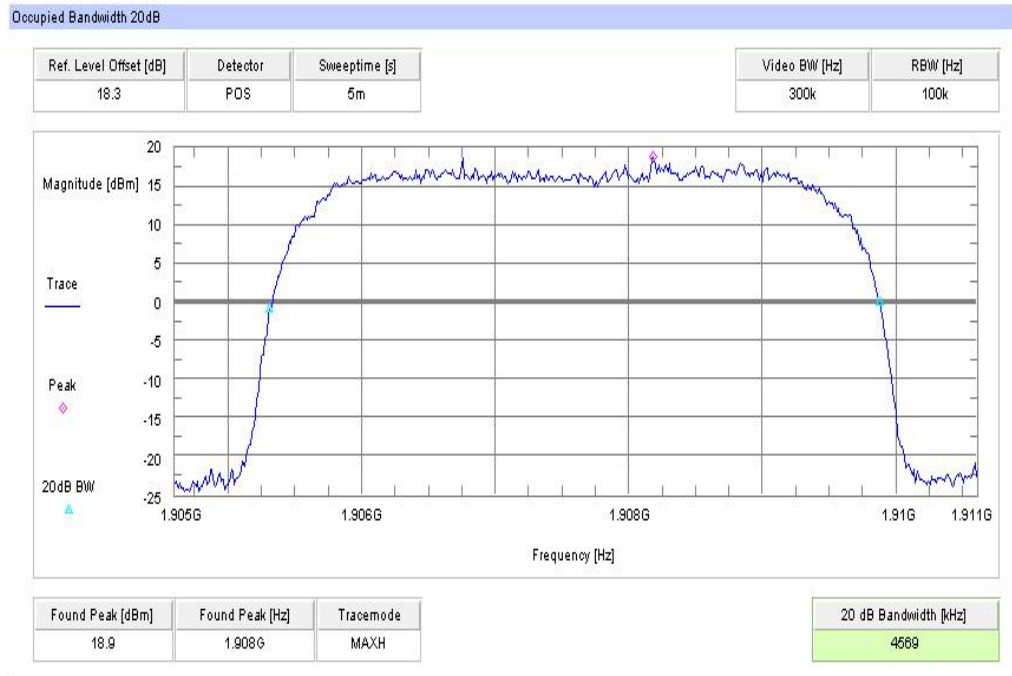

Plot 6: Channel 9538 (-26 dBc BW)

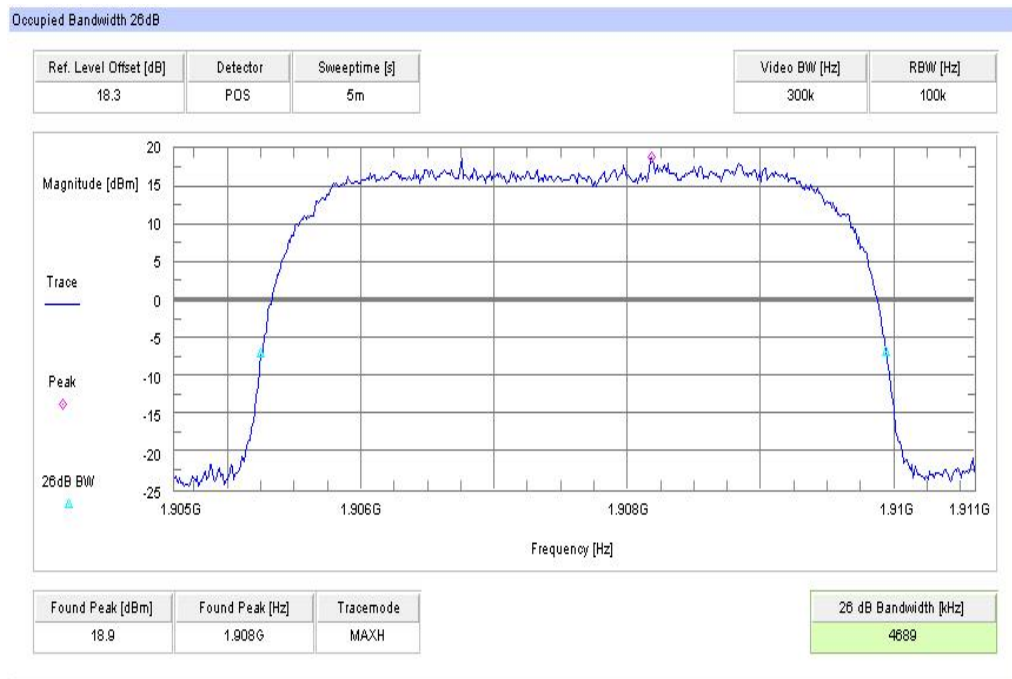

8.5 Results UMTS band V

All UMTS-band measurements are done in WCDMA mode only.

The connection was established with the following setup: WCDMA CS-RMC, Max Power (All Bit up)

8.5.1 RF output power

Description:

This paragraph contains average power, peak output power and ERP measurements for the mobile station. In all cases, the peak output power is within the required mask (this mask is specified in the JTC standards, TIA PN3389 Vol. 1 Chap 7, and is no FCC requirement).

Measurement:

The mobile was set up for the maximum output power with pseudo random data modulation.

To determine the Peak-To-Average Power Ratio (PAPR) the measurement was performed with the Power Complementary Cumulative Distribution Function (CCDF).

Measurement parameters	
Detector:	Peak and RMS (Power in Burst)
Sweep time:	Auto
Video bandwidth:	10 MHz
Resolution bandwidth:	10 MHz
Span:	Zero Span
Trace-Mode:	Max Hold

Limits:

FCC
CFR Part 22.913 CFR Part 2.1046
Nominal Peak Output Power
+38.45 dBm In measuring transmissions in this band using an average power technique, the peak-to-average ratio (PAR) of the transmission may not exceed 13 dB.

Results:

Output Power (conducted) WCDMA mode		
Frequency (MHz)	Average Output Power (dBm)	Peak to Average Ratio (dB)
826.4	23.6	3.22
836.0	23.5	3.28
846.6	23.5	3.38
Measurement uncertainty	± 0.5 dB	

Output Power (radiated) WCDMA mode	
Frequency (MHz)	Average Output Power (dBm) - ERP
826.4	19.8
836.0	22.1
846.6	22.7
Measurement uncertainty	± 2.0 dB

Result: Passed

8.5.2 Frequency stability

Description:

In order to measure the carrier frequency under the condition of AFC lock, it is necessary to make measurements with the mobile station in a “call mode”. This is accomplished with the use of a R&S CMU200 DIGITAL RADIOCOMMUNICATION TESTER.

1. Measure the carrier frequency at room temperature.
2. Subject the mobile station to overnight soak at -30 C.
3. With the mobile station, powered with V_{nom} , connected to the CMU200 and in a simulated call on channel 4180 (centre channel), measure the carrier frequency. These measurements should be made within two minutes of powering up the mobile station, to prevent significant self warming.
4. Repeat the above measurements at 10°C increments from -30°C to +60°C. Allow at least 1.5 hours at each temperature, unpowered, before making measurements.
5. Remeasure carrier frequency at room temperature with V_{nom} . Vary supply voltage from V_{min} to V_{max} , in 0.1 Volt steps remeasuring carrier frequency at each voltage. Pause at V_{nom} for 1.5 hours unpowered, to allow any self heating to stabilize, before continuing.
6. At all temperature levels hold the temperature to +/- 0.5°C during the measurement procedure.

Measurement:

Measurement parameters	
Detector:	Measured with CMU200
Sweep time:	
Video bandwidth:	
Resolution bandwidth:	
Span:	
Trace-Mode:	

Limits:

FCC
CFR Part 22.355 CFR Part 2.1055
Frequency Stability
± 0.1 ppm

Results:**AFC FREQ ERROR versus VOLTAGE**

Voltage (V)	Frequency Error (Hz)	Frequency Error (%)	Frequency Error (ppm)
3.3	-2	-0.00000024	-0.0024
3.4	3	0.00000036	0.0036
3.5	-2	-0.00000024	-0.0024
3.6	-2	-0.00000024	-0.0024
3.7	-4	-0.00000048	-0.0048
3.8	-2	-0.00000024	-0.0024
3.9	2	0.00000024	0.0024
4.0	2	0.00000024	0.0024
4.1	-3	-0.00000036	-0.0036
4.2	-2	-0.00000024	-0.0024
4.3	-2	-0.00000024	-0.0024
4.4	-4	-0.00000048	-0.0048

AFC FREQ ERROR versus TEMPERATURE

Temperature (°C)	Frequency Error (Hz)	Frequency Error (%)	Frequency Error (ppm)
-30	2	0.00000024	0.0024
-20	3	0.00000036	0.0036
-10	3	0.00000036	0.0036
± 0	-2	-0.00000024	-0.0024
10	-2	-0.00000024	-0.0024
20	-3	-0.00000036	-0.0036
30	-3	-0.00000036	-0.0036
40	2	0.00000024	0.0024
50	-4	-0.00000048	-0.0048
60	-3	-0.00000036	-0.0036

Result: **Passed**

8.5.3 Spurious emissions radiated

Description:

The following steps outline the procedure used to measure the radiated emissions from the mobile station. The site is constructed in accordance with ANSI C63.4:2009 requirements and is recognized by the FCC to be in compliance for a 3 and a 10 meter site. The spectrum was scanned at least up to the 10th harmonic of the highest frequency generated within the equipment, which is the transmitted carrier that can be as high as 846.6 MHz. Measurement made up to 12.75 GHz. The resolution bandwidth is set as outlined in Part 22.917. The spectrum was scanned with the mobile station transmitting at carrier frequencies that pertain to low, mid and high channels of the UMTS band V.

The final open field emission (here 10m semi-anechoic chamber listed by FCC) test procedure is as follows:

- a) The test item was placed on a 0.8 meter high non-conductive stand at a 3 meter test distance from the receive antenna.
- b) The antenna output was terminated in a 50 ohm load (if possible).
- c) A double ridged wave guide antenna was placed on an adjustable height antenna mast 3 meters from the test item for emission measurements.
- d) Detected emissions were maximized at each frequency by rotating the test item and adjusting the receive antenna height and polarization. The maximum meter reading was recorded. The radiated emission measurements of the harmonics of the transmit frequency through the 10th harmonic were measured with peak detector and 1 MHz bandwidth. If the harmonic could not be detected above the noise floor, the ambient level was recorded. The equivalent power into a dipole antenna was calculated from the field intensity levels measured at 3 meters.
- e) Now each detected emissions were substituted by the substitution method, in accordance with the TIA/EIA 603.

Measurement:

Measurement parameters	
Detector:	Peak
Sweep time:	2 sec.
Video bandwidth:	Below 1 GHz: 100 kHz Above 1 GHz: 1 MHz
Resolution bandwidth:	Below 1 GHz: 100 kHz Above 1 GHz: 1 MHz
Span:	100 MHz Steps
Trace-Mode:	Max Hold

Limits:

FCC
CFR Part 22.917 CFR Part 2.1053
Spurious Emissions Radiated
Attenuation $\geq 43 + 10\log(P)$ (P, Power in Watts)
-13 dBm

Results:

Radiated emissions measurements were made only at the upper, center, and lower carrier frequencies of the UMTS band V (826.4 MHz, 836.0 MHz and 846.6 MHz). It was decided that measurements at these three carrier frequencies would be sufficient to demonstrate compliance with emissions limits because it was seen that all the significant spurs occur well outside the band and no radiation was seen from a carrier in one block of the UMTS band V into any of the other blocks. The equipment must still, however, meet emissions requirements with the carrier at all frequencies over which it is capable of operating and it is the manufacturer's responsibility to verify this.

The final open field radiated levels are presented on the next pages.

All measurements were done in horizontal and vertical polarization; the plots show the worst case.

The plots show only the middle channel. If spurious were detected, the lowest and highest channel were checked too. The found values are stated in the table below.

As can be seen from this data, the emissions from the test item were within the specification limit.

SPURIOUS EMISSION LEVEL (dBm)								
Harmonic	Ch. 4132 Freq. (MHz)	Level [dBm]	Harmonic	Ch. 4180 Freq. (MHz)	Level [dBm]	Harmonic	Ch. 4233 Freq. (MHz)	Level [dBm]
2	1652.8	-	2	1672.0	-53.5	2	1693.2	-
3	2479.2	-	3	2508.0	-52.6	3	2539.8	-
4	3305.6	-	4	3344.0	-	4	3386.4	-
5	4132.0	-	5	4180.0	-	5	4233.0	-
6	4958.4	-	6	5016.0	-	6	5079.6	-
7	5784.8	-	7	5852.0	-	7	5926.2	-
8	6611.2	-	8	6688.0	-	8	6772.8	-
9	7437.6	-	9	7524.0	-	9	7619.4	-
10	8264.0	-	10	8360.0	-	10	8466.0	-
Measurement uncertainty					± 3dB			

Result: Passed

Plots:

Plot 1: Channel 4180 (Traffic mode up to 30 MHz)

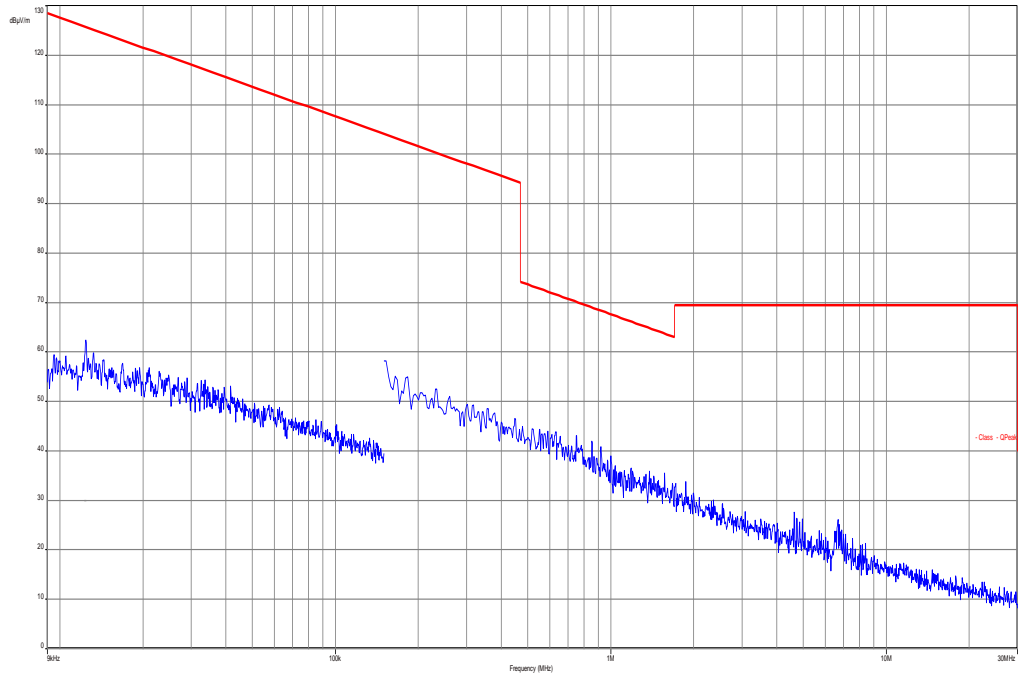

Plot 2: Channel 4180 (30 MHz – 12.75 GHz)

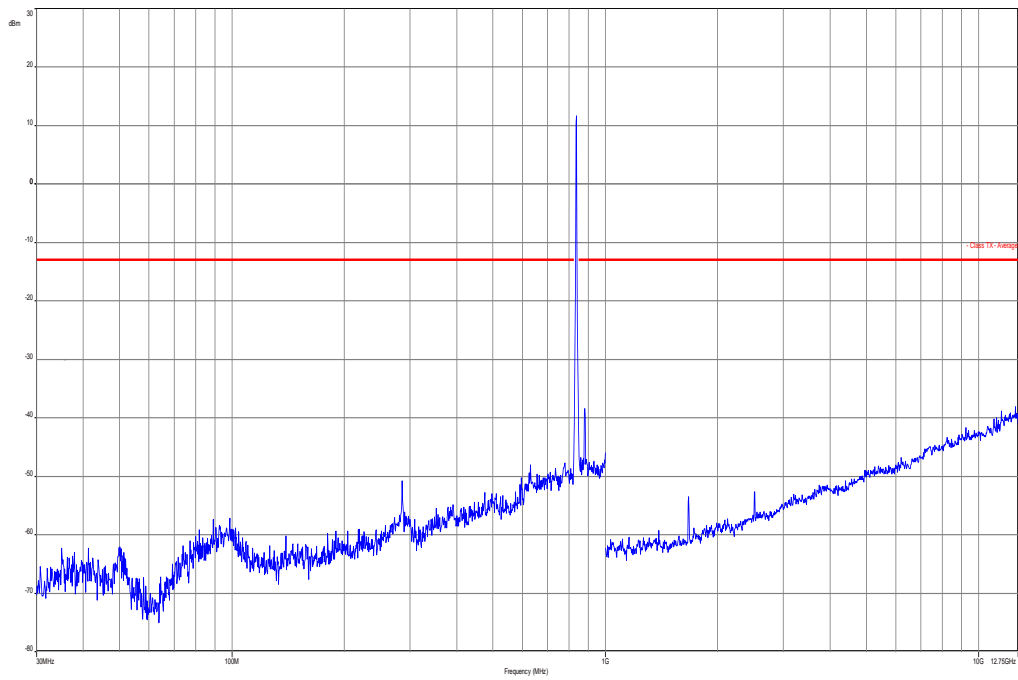

8.5.4 Spurious emissions conducted

Description:

The following steps outline the procedure used to measure the conducted emissions from the mobile station.

1. Determine frequency range for measurements: From CFR 2.1057 the spectrum should be investigated from the lowest radio frequency generated in the equipment up to at least the 10th harmonic of the carrier frequency. For the mobile station equipment tested, this equates to a frequency range of 13 MHz to 9 GHz, data taken from 10 MHz to 25 GHz.
2. Determine mobile station transmits frequencies: below outlines the band edge frequencies pertinent to conducted emissions testing.

UMTS band V Transmitter Channel Frequency

- 4132 826.4 MHz
- 4180 836.0 MHz
- 4233 846.6 MHz

Measurement:

Measurement parameters	
Detector:	Peak
Sweep time:	Auto
Video bandwidth:	Pre-measurement with 1 MHz On spurious detection re-measurement below 1 GHz with 100 kHz Above 1 GHz with 1 MHz
Resolution bandwidth:	Pre-measurement with 1 MHz On spurious detection re-measurement below 1 GHz with 100 kHz Above 1 GHz with 1 MHz
Span:	30 MHz – 25 GHz
Trace-Mode:	Max Hold

Limits:

FCC
CFR Part 22.917 CFR Part 2.1051
Spurious Emissions Conducted
Attenuation $\geq 43 + 10\log(P)$ (P, Power in Watts)
-13 dBm

Results:

SPURIOUS EMISSION LEVEL (dBm)								
Harmonic	Ch. 4132 Freq. (MHz)	Level [dBm]	Harmonic	Ch. 4180 Freq. (MHz)	Level [dBm]	Harmonic	Ch. 4233 Freq. (MHz)	Level [dBm]
2	1652.8	-	2	1672.0	-	2	1693.2	-
3	2479.2	-	3	2508.0	-	3	2539.8	-
4	3305.6	-	4	3344.0	-	4	3386.4	-
5	4132.0	-	5	4180.0	-	5	4233.0	-
6	4958.4	-	6	5016.0	-	6	5079.6	-
7	5784.8	-	7	5852.0	-	7	5926.2	-
8	6611.2	-	8	6688.0	-	8	6772.8	-
9	7437.6	-	9	7524.0	-	9	7619.4	-
10	8264.0	-	10	8360.0	-	10	8466.0	-
Measurement uncertainty					± 3dB			

Result: Passed

Plots:

Plot 1: Channel 4132 (10 MHz - 25 GHz)

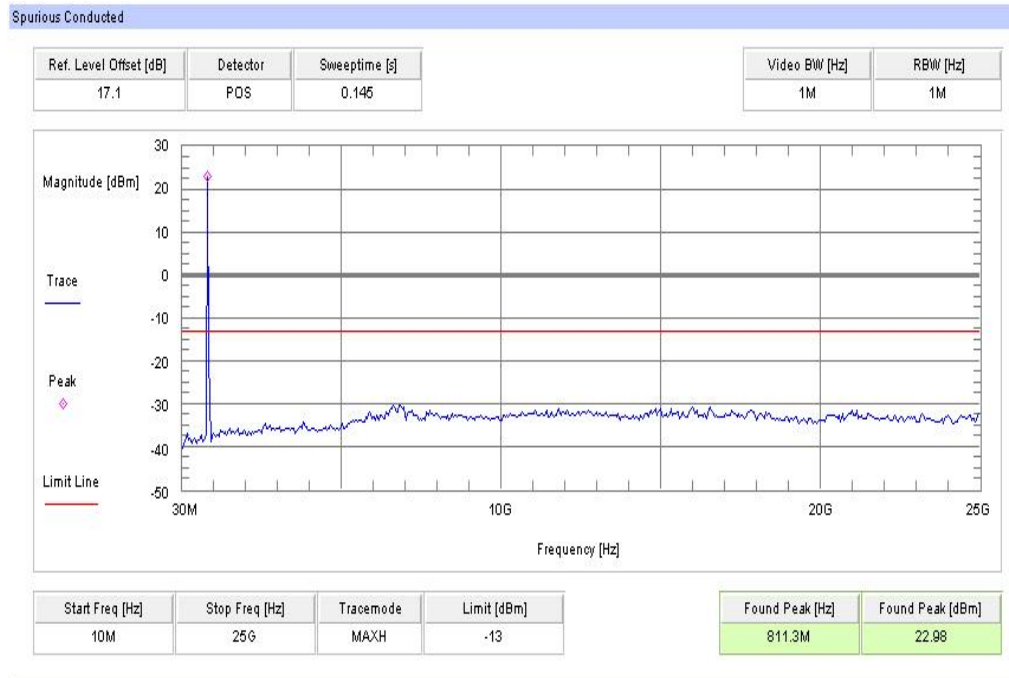

Plot 2: Channel 4180 (10 MHz - 25 GHz)

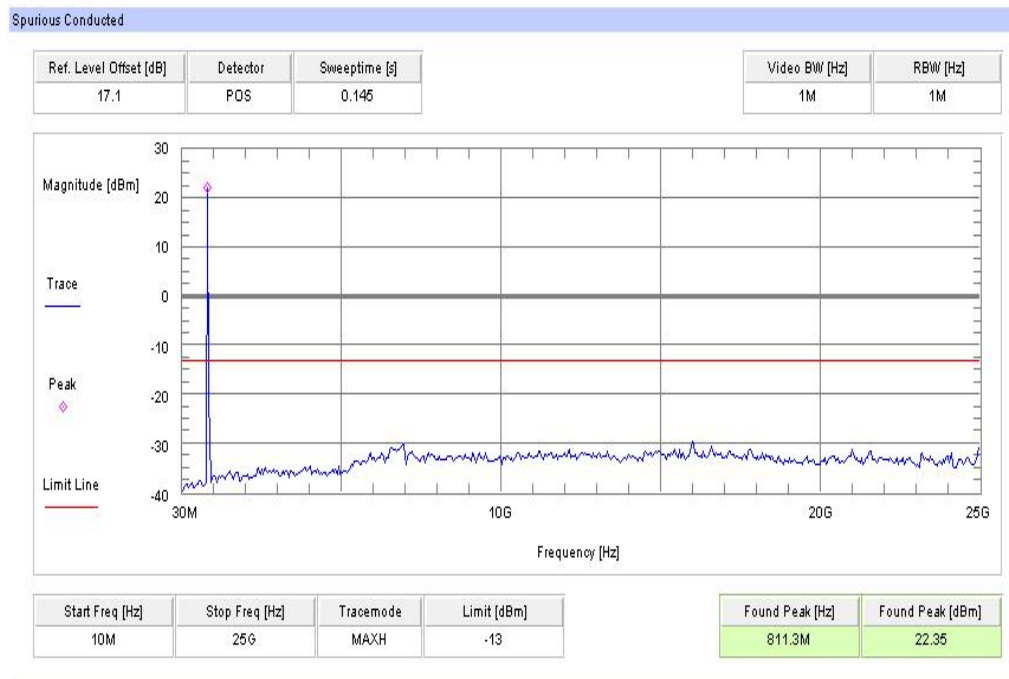

Plot 3: Channel 4233 (10 MHz - 25 GHz)

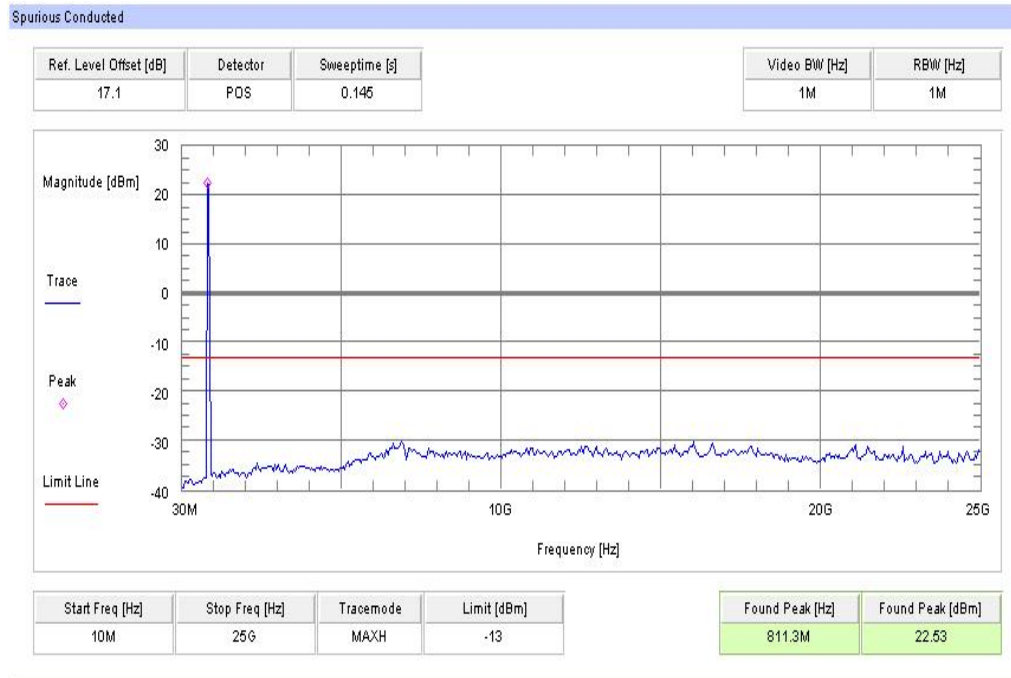

8.5.5 Block edge compliance

Description:

The spectrum at the band edges must comply with the spurious emissions limits.

Measurement:

Measurement parameters	
Detector:	RMS
Sweep time:	20 sec.
Video bandwidth:	30 kHz
Resolution bandwidth:	30 kHz
Span:	1 MHz
Trace-Mode:	Max Hold

Limits:

FCC
CFR Part 22.917 CFR Part 2.1051
Block Edge Compliance
<p>Part 22.917 specifies that “the power of any emission outside of the authorized operating frequency ranges must be attenuated below the transmitting power (P) by a factor of at least $43 + 10 \log(P)$ dB.”</p> <p>However, in publication number 890810, The FCC Office of Engineering and Technology specified the following correction to the limits when a resolution bandwidth smaller than 1% of the emission bandwidth is used:</p> <p>“An alternative is to add an additional correction factor of $10 \log(RBW1/ RBW2)$ to the $43 + 10 \log(P)$ limit. RBW1 is the narrower measurement resolution bandwidth and RBW2 is either the 1% emissions bandwidth or 1 MHz.”</p> <p>When using a 30 kHz bandwidth, this yields a -2.2185 adjustment to the limit [$10 \log(30kHz/50kHz) = -2.2185$]. When this adjustment is applied to the limit, the limit becomes -15.2185.</p>
-15.22 dBm

Plots:

Plot 1: Channel 4132

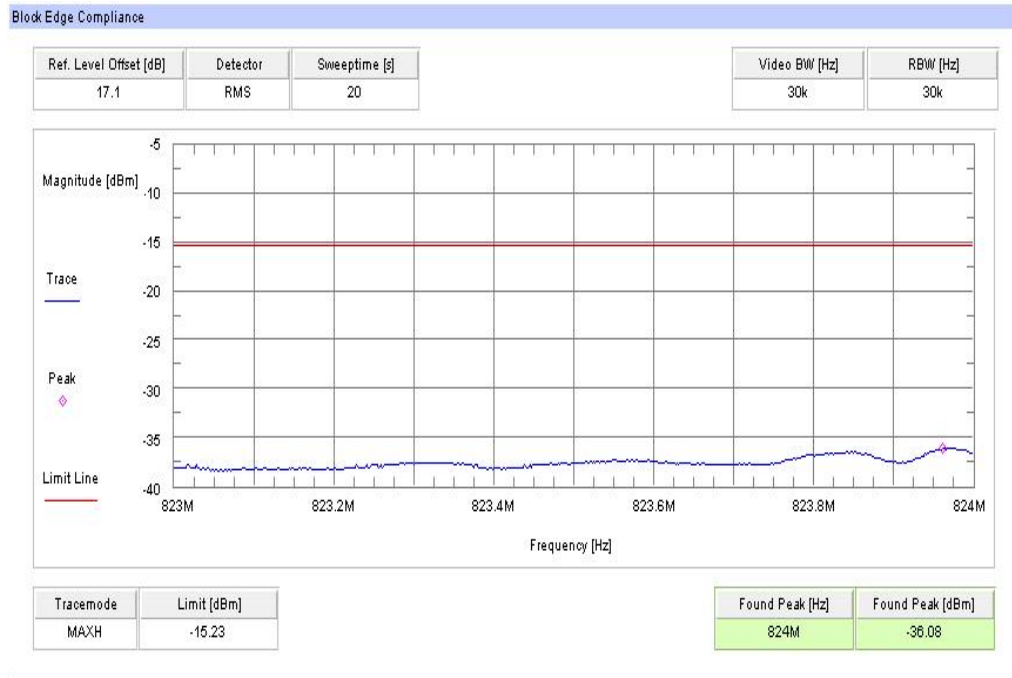

Plot 2: Channel 4233

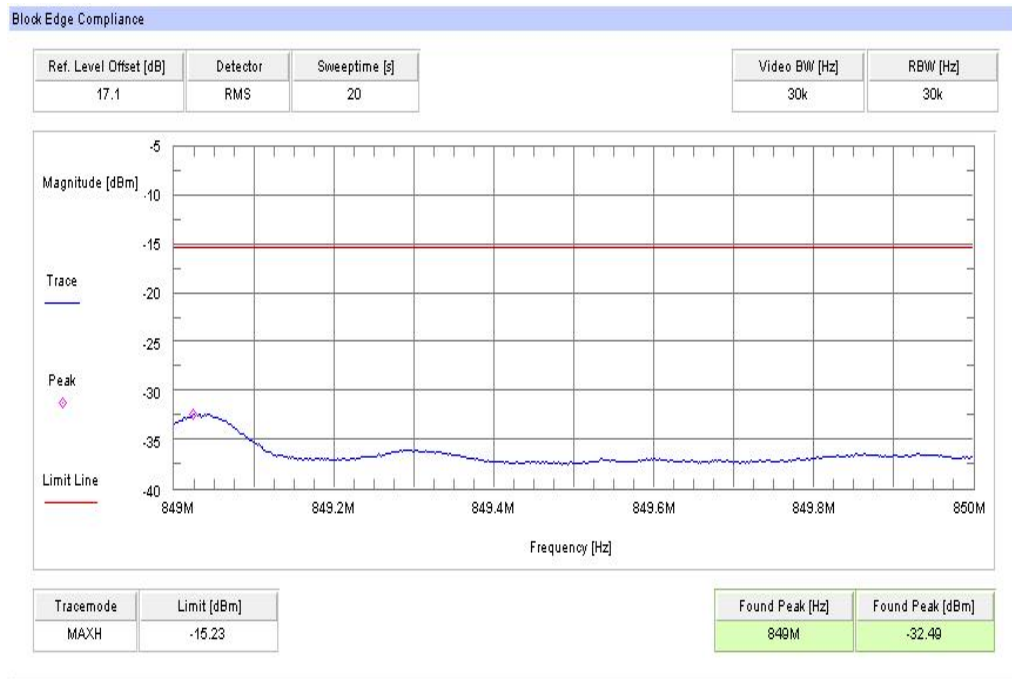

Result: Passed

8.5.6 Occupied bandwidth

Description:

Measurement of the occupied bandwidth of the transmitted signal.

Measurement:

Similar to conducted emissions, occupied bandwidth measurements are only provided for selected frequencies in order to reduce the amount of submitted data. Data were taken at the extreme and mid frequencies of the UMTS band V. The table below lists the measured 99% power and -26dBc occupied bandwidths. Spectrum analyzer plots are included on the following pages.

Part 22.917 requires a measurement bandwidth of at least 1% of the occupied bandwidth. For ca. 4700 kHz, this equates to a resolution bandwidth of at least 50 kHz. For this testing, a resolution bandwidth 100 kHz was used.

Measurement parameters	
Detector:	Peak
Sweep time:	Auto
Video bandwidth:	300 kHz
Resolution bandwidth:	100 kHz
Span:	6 MHz
Trace-Mode:	Max Hold

Limits:

FCC
CFR Part 22.917 CFR Part 2.1049
Occupied Bandwidth
Spectrum must fall completely in the specified band

Results:

Occupied Bandwidth		
Frequency (MHz)	99% OBW (kHz)	-26 dBc BW (kHz)
826.4	4557	4665
836.0	4569	4677
846.6	4569	4677
Measurement uncertainty	± 100 kHz	

Result: **Passed**

Plots:

Plot 1: Channel 4132 (99% - OBW)

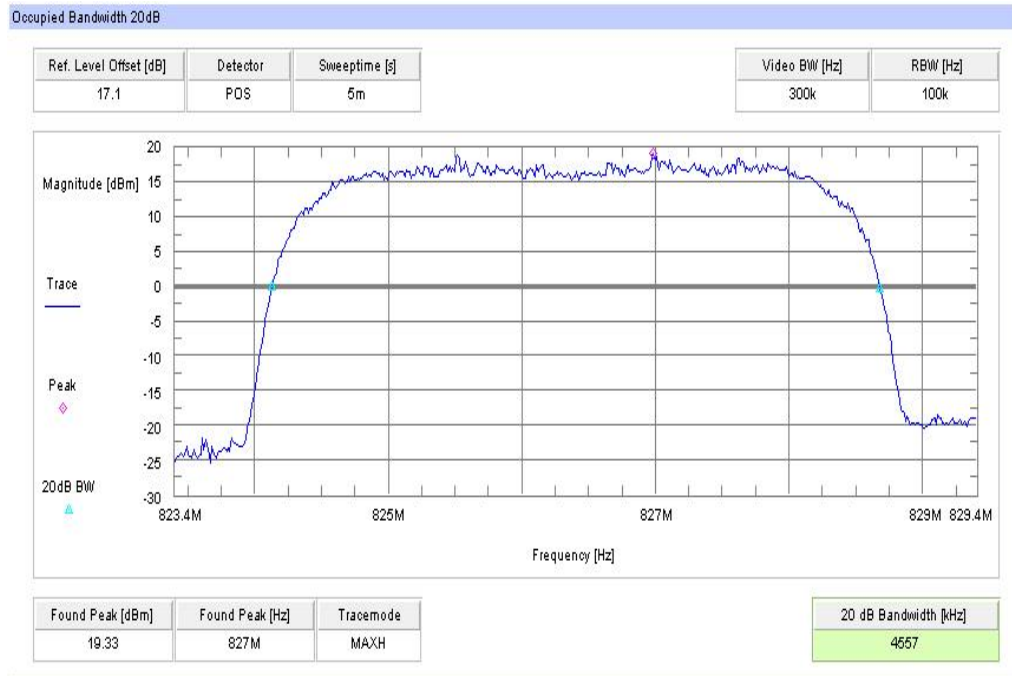

Plot 2: Channel 4132 (-26 dBc BW)

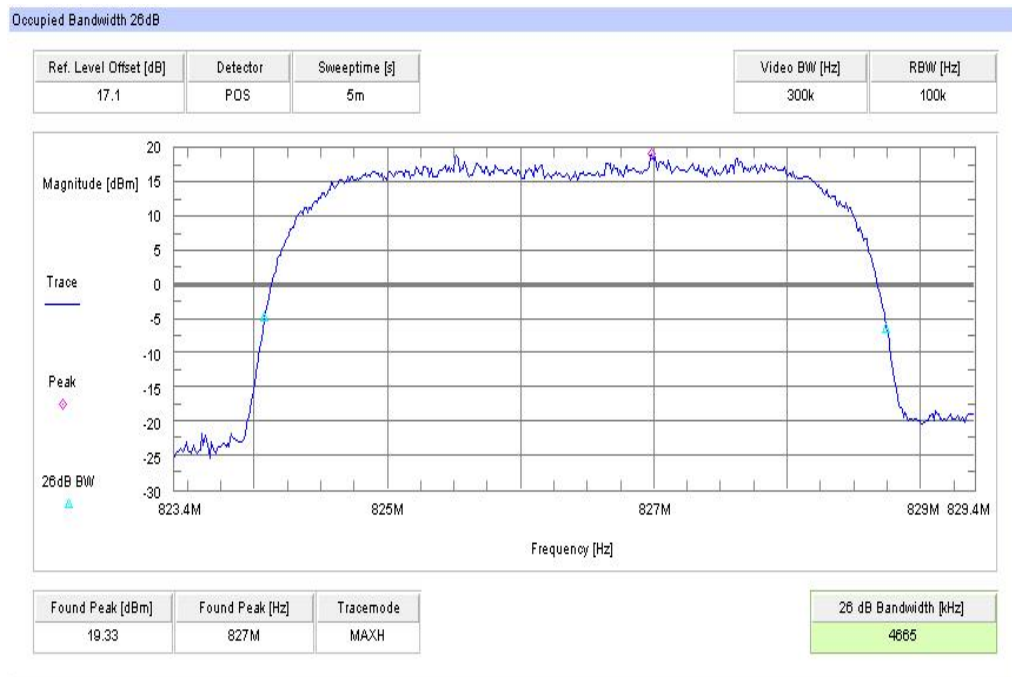

Plot 3: Channel 4180 (99% - OBW)

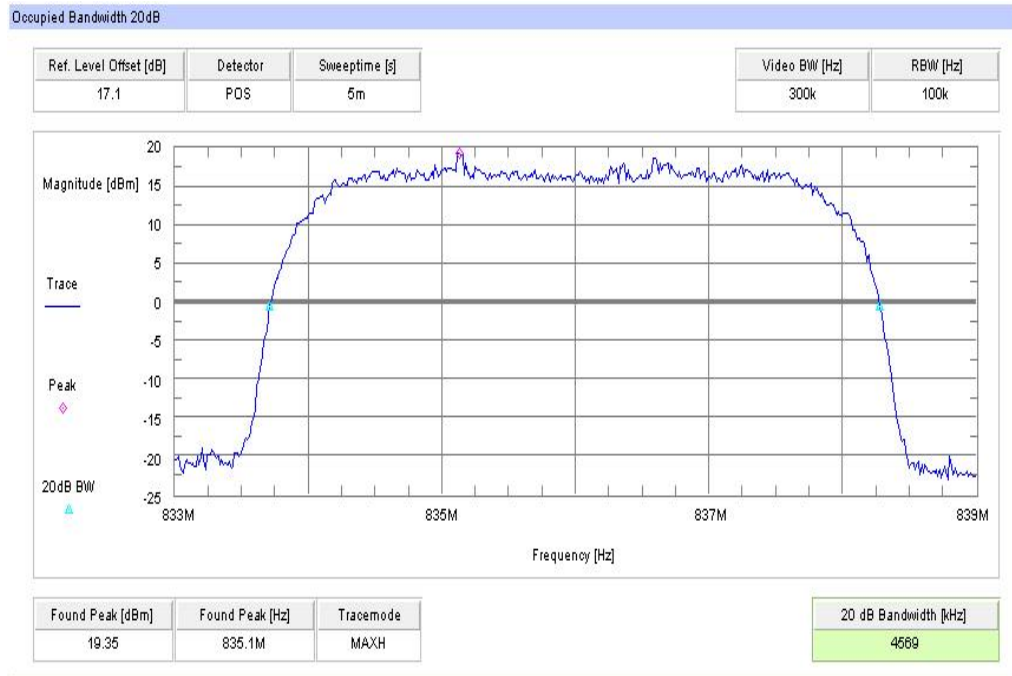

Plot 4: Channel 4180 (-26 dBc BW)

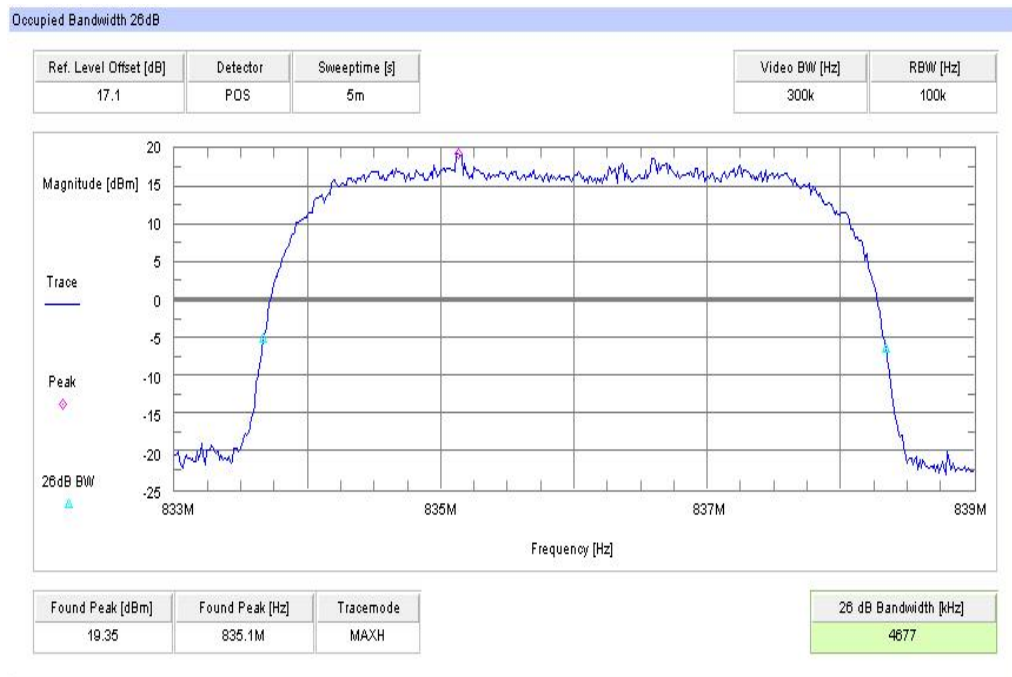

Plot 5: Channel 4233 (99% - OBW)

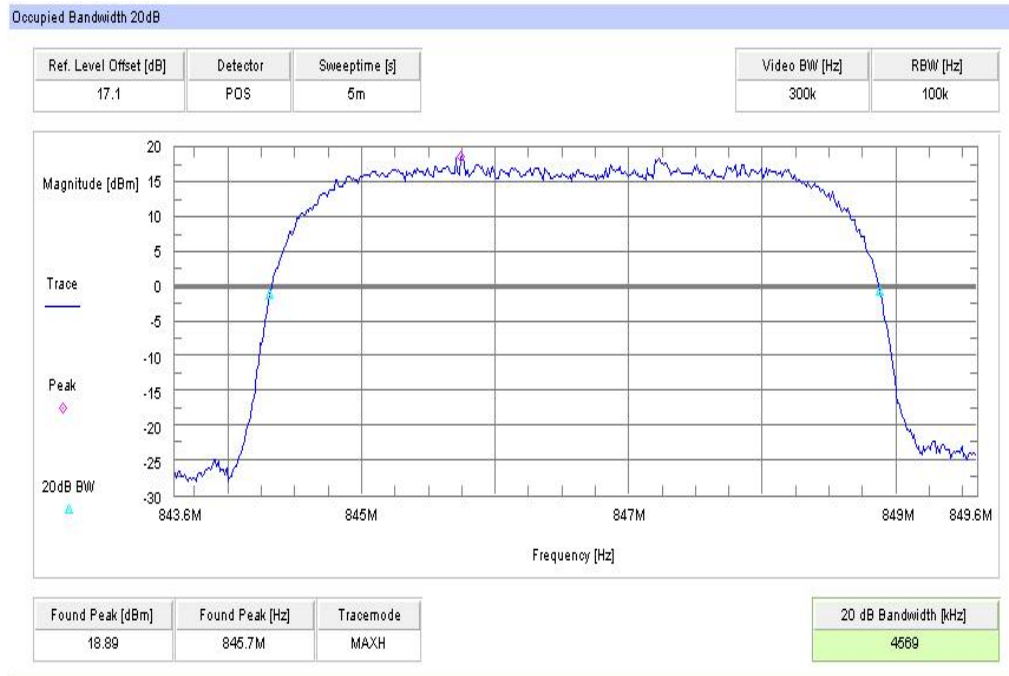

Plot 6: Channel 4233 (-26 dBc BW)

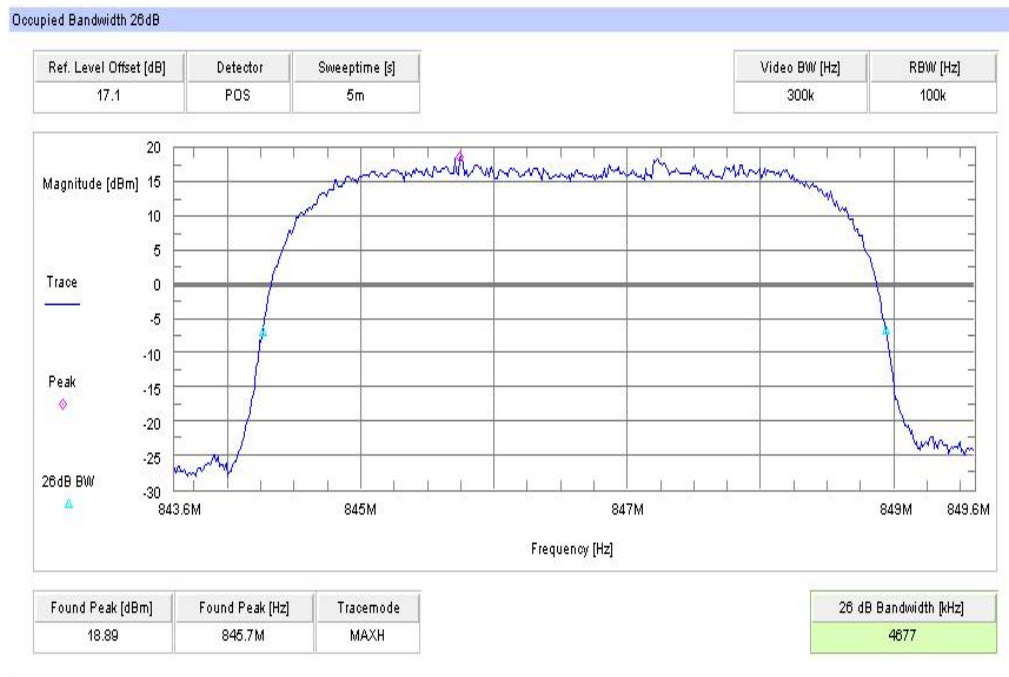

9 Test equipment and ancillaries used for tests

Typically, the calibrations of the test apparatus are commissioned to and performed by an accredited calibration laboratory. The calibration intervals are determined in accordance with the DIN EN ISO/IEC 17025. In addition to the external calibrations, the laboratory executes comparison measurements with other calibrated test systems or effective verifications. Weekly chamber inspections and range calibrations are performed. Where possible, rf-generating and signalling equipment as well as measuring receivers and analyzers are connected to an external high-precision 10 MHz reference (GPS-based or rubidium frequency standard).

In order to simplify the identification of the equipment used at some special tests, some items of test equipment and ancillaries can be provided with an identifier or number in the equipment list below (Lab/Item).

No.	Lab / Item	Equipment	Type	Manufact.	Serial No.	INV. No Cetecom	Kind of Calibration	Last Calibration	Next Calibration
11	n. a.	Double-Ridged Waveguide Horn Antenna 1-18.0GHz	3115	EMCO	8812-3088	300001032	vKI!	08.05.2013	08.05.2015
2	n. a.	Anechoic chamber	FAC 3/5m	MWB / TDK	87400/02	300000996	ev		
3	n. a.	Switch / Control Unit	3488A	HP Meßtechnik	*	300000199	ne		
4	90	Active Loop Antenna 10 kHz to 30 MHz	6502	Kontron Psychotech	8905-2342	300000256	k	13.06.2013	13.06.2015
5	n. a.	Amplifier	js42-00502650-28-5a	Parzich GMBH	928979	300003143	ne		
6	n. a.	TRILOG Broadband Test-Antenna 30 MHz - 3 GHz	VULB9163	Schwarzbeck	371	300003854	vKI!	14.10.2011	14.10.2014
7	n. a.	MXE EMI Receiver 20 Hz bis 26,5 GHz	N9038A	Agilent Technologies	MY51210197	300004405	k	13.03.2014	13.03.2015
8	n. a.	4U RF Switch Platform	L4491A	Agilent Technologies	MY50000037	300004509	ne		
9	n. a.	Switch / Control Unit	3488A	HP Meßtechnik	2605e08770	300001443	ne		
10	n. a.	Signal Analyzer 20Hz-26,5GHz-150 to + 30 DBM	FSIQ26	R&S	835111/0004	300002678	Ve	15.01.2013	15.01.2015
11	n. a.	Power Supply 0-20V; 0-5A	6632B	HP	US37478366	400000117	vKI!	20.08.2012	20.08.2014
12	n. a.	Temperature Test Chamber	VT 4002	Heraeus Voetsch	521/84193	300003889	Ve	26.09.2013	26.09.2015
13	n. a.	Universal Communication Tester	CMU200	R&S	103992	300003231	vKI!	21.08.2012	21.08.2014

Agenda: Kind of Calibration

k	calibration / calibrated	EK	limited calibration
ne	not required (k, ev, izw, zw not required)	zw	cyclical maintenance (external cyclical maintenance)
ev	periodic self verification	izw	internal cyclical maintenance
Ve	long-term stability recognized	g	blocked for accredited testing
vKI!	Attention: extended calibration interval		
NK!	Attention: not calibrated	*)	next calibration ordered / currently in progress

10 Observations

No observations exceeding those reported with the single test cases have been made.

Annex A Document history

Version	Applied changes	Date of release
	Initial release	2014-05-15

Annex B Further information**Glossary**

AVG	-	Average
DUT	-	Device under test
EMC	-	Electromagnetic Compatibility
EN	-	European Standard
EUT	-	Equipment under test
ETSI	-	European Telecommunications Standard Institute
FCC	-	Federal Communication Commission
FCC ID	-	Company Identifier at FCC
HW	-	Hardware
IC	-	Industry Canada
Inv. No.	-	Inventory number
N/A	-	Not applicable
PP	-	Positive peak
QP	-	Quasi peak
S/N	-	Serial number
SW	-	Software

Annex C Accreditation Certificate

Front side of certificate

Back side of certificate



Deutsche Akkreditierungsstelle GmbH

Bellehene gemäß § 8 Absatz 1 AkkStelleG i.V.m. § 1 Absatz 1 AkkStelleGBV
Unterzeichnerin der Multilateralen Abkommen
von EA, ILAC und IAF zur gegenseitigen Anerkennung

Akkreditierung



Die Deutsche Akkreditierungsstelle GmbH bestätigt hiermit, dass das Prüflaboratorium

CETECOM ICT Services GmbH
Untertürkheimer Straße 6-10, 66117 Saarbrücken

die Kompetenz nach DIN EN ISO/IEC 17025:2005 besitzt, Prüfungen in folgenden Bereichen durchzuführen:

Drahtgebundene Kommunikation einschließlich xDSL

VoIP und DECT

Akustik

Funk einschließlich WLAN

Short Range Devices (SRD)

RFID

WiFiMax und Richtfunk

Mobilfunk (GSM / GPRS / UTRAN / Over the Air (OTA) Performance)

Elektromagnetische Verträglichkeit (EMV) einschließlich Automotive

Produktsicherheit

SAR und Hearing Aid Compatibility (HAC)

Umweltsimulation

Smart Card Terminals

Bluetooth

Wi-Fi Services

Die Akkreditierungsurkunde gilt nur in Verbindung mit dem Bescheid vom 07.03.2014 mit der Akkreditierungsnummer D-PL-12076-01 und ist gemäß 17.01.2018. Sie besteht aus diesem Deckblatt, der Rückseite des Deckblatts und der folgenden Anlage mit insgesamt 77 Seiten.

Registrierungsnummer der Urkunde: D-PL-12076-01-00

Frankfurt am Main, 07.03.2014

Stempel der Akkreditierungsstelle

Im Auftrag D-PL-12076-01/0001/19-04
Abteilungsleiter

Deutsche Akkreditierungsstelle GmbH

Standort Berlin
Spittelmarkt 10
10117 Berlin

Standort Frankfurt am Main
Gartenstraße 6
60504 Frankfurt am Main

Standort Braunschweig
Bundesallee 100
38116 Braunschweig

Die auszugsweise Veröffentlichung der Akkreditierungsurkunde bedarf der vorherigen schriftlichen Zustimmung der Deutsche Akkreditierungsstelle GmbH (DAkkS). Ausgenommen davon ist die separate Weiterverbreitung des Deckblattes durch die umseitig genannte Konformitätsbewertungsstelle in unveränderter Form.

Es darf nicht der Anschein erweckt werden, dass sich die Akkreditierung auch auf Bereiche erstreckt, die über den durch die DAkkS bestätigten Akkreditierungsbereich hinausgehen.

Die Akkreditierung erfolgte gemäß des Gesetzes über die Akkreditierungsstellen (AkkStelleG) vom 31. Juli 2009 (BGBl. I S. 2625) sowie der Verordnung (EG) Nr. 765/2008 des Europäischen Parlaments und des Rates vom 9. Juli 2008 über die Vorschriften für die Akkreditierung und Marktüberwachung im Zusammenhang mit der Vermarktung von Produkten (Abt. L 228 vom 9. Juli 2008, S. 30). Die DAkkS ist Unterzeichnerin der Multilateralen Abkommen zur gegenseitigen Anerkennung der Europäischen Organisation für Akkreditation (EA), des International Accreditation Forum (IAF) und der International Laboratory Accreditation Cooperation (ILAC). Die Unterzeichner dieser Abkommen erkennen ihre Akkreditierungen gegenseitig an.

Der aktuelle Stand der Mitgliedschaft kann folgenden Webseiten entnommen werden:
EA: www.european-accreditation.org
IAF: www.iaf.or.jp
ILAC: www.ilac.org

Note:

The current certificate including annex is published on our website (see link below) or may be received from CETECOM ICT Services on request.

<http://www.cetecom.com/eu/de/cetecom-group/europa/deutschland-saarbruecken/akkreditierungen.html>