

# FCC/IC RF Test Report

APPLICANT : Sony Mobile Communications AB  
EQUIPMENT : Smart phone  
BRAND NAME : SONY  
MODEL NAME : D2104  
TYPE NAME : PM-0673-BV  
FCC ID : PY7PM-0673  
IC : 4170B-PM0673  
STANDARD : FCC Part 15 Subpart C §15.247  
IC RSS-210 issue 8  
CLASSIFICATION : (DTS) Digital Transmission System

The product was received on Oct. 29, 2013 and testing was completed on Nov. 27, 2013. We, SPORTON INTERNATIONAL INC., would like to declare that the tested sample has been evaluated in accordance with the procedures and shown to be compliant with the applicable technical standards.

The test results in this report apply exclusively to the tested model / sample. Without written approval of SPORTON INTERNATIONAL INC., the test report shall not be reproduced except in full.



Reviewed by: Joseph Lin / Supervisor



Approved by: Jones Tsai / Manager



## SPORTON INTERNATIONAL INC.

No. 52, Hwa Ya 1<sup>st</sup> Rd., Hwa Ya Technology Park, Kwei-Shan Hsiang, Tao Yuan Hsien, Taiwan, R.O.C.

SPORTON INTERNATIONAL INC.

TEL : 886-3-327-3456

FAX : 886-3-328-4978

FCC ID : PY7PM-0673

IC : 4170B-PM0673

Page Number : 1 of 92

Report Issued Date : Jan. 08, 2014

Report Version : Rev. 03



# TABLE OF CONTENTS

**REVISION HISTORY ..... 3**

**SUMMARY OF TEST RESULT ..... 4**

**1 GENERAL DESCRIPTION ..... 5**

    1.1 Applicant ..... 5

    1.2 Manufacturer ..... 5

    1.3 Feature of Equipment Under Test ..... 5

    1.4 Product Specification of Equipment Under Test ..... 6

    1.5 Modification of EUT ..... 7

    1.6 Testing Site ..... 7

    1.7 Applied Standards ..... 7

**2 TEST CONFIGURATION OF EQUIPMENT UNDER TEST ..... 8**

    2.1 Carrier Frequency Channel ..... 8

    2.2 Pre-Scanned RF Power ..... 9

    2.3 Test Mode ..... 10

    2.4 Connection Diagram of Test System ..... 11

    2.5 Support Unit used in test configuration and system ..... 12

    2.6 EUT Operation Test Setup ..... 12

    2.7 Measurement Results Explanation Example ..... 12

**3 TEST RESULT ..... 13**

    3.1 6dB and 99% Bandwidth Measurement ..... 13

    3.2 Output Power Measurement ..... 17

    3.3 Power Spectral Density Measurement ..... 20

    3.4 Conducted Band Edges and Spurious Emission Measurement ..... 23

    3.5 Radiated Band Edges and Spurious Emission Measurement ..... 33

    3.6 AC Conducted Emission Measurement ..... 83

    3.7 Antenna Requirements ..... 89

**4 LIST OF MEASURING EQUIPMENT ..... 90**

**5 UNCERTAINTY OF EVALUATION ..... 92**





### SUMMARY OF TEST RESULT

Report Section	FCC Rule	IC Rule	Description	Limit	Result	Remark
3.1	15.247(a)(2)	RSS-210 A8.2(a)	6dB Bandwidth	$\geq 0.5\text{MHz}$	Pass	-
3.1	-	RSS-Gen 4.6.1	99% Bandwidth	-	Pass	-
3.2	15.247(b)	RSS-210 A8.4	Power Output Measurement	$\leq 30\text{dBm}$	Pass	-
3.3	15.247(e)	RSS-210 A8.2(b)	Power Spectral Density	$\leq 8\text{dBm}/3\text{kHz}$	Pass	-
3.4	15.247(d)	RSS-210 A8.5	Conducted Band Edges	$\leq 20\text{dBc}$	Pass	-
			Conducted Spurious Emission		Pass	-
3.5	15.247(d)	RSS-210 A8.5	Radiated Band Edges and Radiated Spurious Emission	15.209(a) & 15.247(d)	Pass	Under limit 3.57 dB at 2390.000 MHz
3.6	15.207	RSS-Gen 7.2.4	AC Conducted Emission	15.207(a)	Pass	Under limit 11.60 dB at 0.406 MHz
3.7	15.203 & 15.247(b)	RSS-210 A8.4	Antenna Requirement	N/A	Pass	-



# 1 General Description

## 1.1 Applicant

**Sony Mobile Communications AB**  
Nya Vattentorget, 22188 Lund, Sweden

## 1.2 Manufacturer

**Arima Communications Corp.**  
6F., No. 866, Jhongjheng Rd., Jhonghe Dist., New Taipei City 23586, Taiwan

## 1.3 Feature of Equipment Under Test

The Equipment Under Test (hereafter called: EUT) is smart phone supporting, GSM / WCDMA / Wi-Fi 2.4GHz 802.11b/g/n, Bluetooth with FM Receiver, and GPS features, and below is details of information.

General Information of Equipment Under Test	
Equipment	Smart phone
Brand Name	SONY
Model Name	D2104
Type Name	PM-0673-BV
FCC ID	PY7PM-0673
IC	4170B-PM0673
GSM Operating Band(s)	GSM 850/900/1800/1900MHz
GPRS / EGPRS Multi Slot Class	GPRS Class 33, EGPRS Class 33
WCDMA Operating Band(s)	FDD Band I / II / V
WCDMA Rel. Version	Rel. 7
Wi-Fi Specification	802.11b/g/n (HT20)
Bluetooth Version	v3.0+EDR / v4.0-LE
Power Supply	Battery / AC Adapter / Car Charger

**Remark:** The above EUT's information was declared by manufacturer. Please refer to the specifications or user's manual for more detailed description.

### 1.4 Product Specification of Equipment Under Test

Product Specification subjective to this standard	
<b>Tx/Rx Channel Frequency Range</b>	802.11b/g/n : 2412 MHz ~ 2462 MHz
<b>Maximum Output Power to Antenna</b>	802.11b : 18.02 dBm (0.0634 W) 802.11g : 22.15 dBm (0.1641 W) 802.11n HT20 : 20.99 dBm (0.1256 W)
<b>Antenna Type</b>	PIFA Antenna type with gain 1.32 dBi
<b>Type of Modulation</b>	802.11b : DSSS (DBPSK / DQPSK / CCK) 802.11g/n : OFDM (BPSK / QPSK / 16QAM / 64QAM)
<b>EUT #1</b>	IMEI : 00440214-707873-1 S/N : WUJ016LPSP
<b>EUT #2</b>	IMEI : 00440214-707857-4 S/N : WUJ016LPD8
<b>EUT #3</b>	IMEI 1 : 00440214-707917-6 IMEI 2 : 00440214-707918-4 S/N : WUJ016MS4B
<b>HW Version</b>	A
<b>SW Version</b>	20.0.B.0.26
<b>EUT Stage</b>	Production Unit

Accessory List	
<b>AC Adapter</b>	Model No. : EP800
	Type No. : CAA-0002016-US B
<b>Battery</b>	Model No. : BA900
	Type No. : AB-0500
<b>Earphone</b>	Model No. : MH410c
	Type No. : AG-1100
<b>USB Cable</b>	Model No. : EC450
	Part No. : 1242-6715.3 12W45

**Note:**

1. Above EUT list and accessory list used are electrically identical per declared by manufacturer.
2. Above the accessories list are used to exercise the EUT during test, and the serial number of each type of accessories is listed in each section of this report.
3. For other wireless features of this EUT, test report will be issued separately.



### 1.5 Modification of EUT

No modifications are made to the EUT during all test items.

### 1.6 Testing Site

<b>Test Site</b>	SPORTON INTERNATIONAL INC.			
<b>Test Site Location</b>	No. 52, Hwa Ya 1 <sup>st</sup> Rd., Hwa Ya Technology Park, Kwei-Shan Hsiang, Tao Yuan Hsien, Taiwan, R.O.C. TEL: +886-3-3273456 / FAX: +886-3-3284978			
<b>Test Site No.</b>	<b>Sporton Site No.</b>			<b>FCC/IC Registration No.</b>
	TH02-HY	CO05-HY	03CH07-HY	722060/4086B-1

**Note:** The test site complies with ANSI C63.4 2003 requirement.

### 1.7 Applied Standards

According to the specifications of the manufacturer, the EUT must comply with the requirements of the following standards:

- FCC Part 15 Subpart C §15.247
- FCC KDB Publication No. 558074 D01 DTS Meas. Guidance v03r01
- ANSI C63.4-2003
- IC RSS-210 Issue 8
- IC RSS-Gen Issue 3
- NOTICE 2012-DRS0126

**Remark:**

1. All test items were verified and recorded according to the standards and without any deviation during the test.
2. This EUT has also been tested and complied with the requirements of FCC Part 15, Subpart B, recorded in a separate test report.
3. Per the section 2.2.3 of Notice of 2012-DRS0126, “ Receivers Excluded from Industry Canada Requirements”, only radiocommunication receivers operating in stand-alone mode within the band 30-960 MHz and scanner receivers are subject to Industry Canada requirements.



## 2 Test Configuration of Equipment Under Test

The EUT has been associated with peripherals and configuration operated in a manner tended to maximize its emission characteristics in a typical application. Frequency range investigated: conducted emission (150 kHz to 30 MHz) and radiated emission (9 kHz to the 10th harmonic of the highest fundamental frequency or to 40 GHz, whichever is lower). For radiated measurement, pre-scanned in three orthogonal panels, X, Y, Z. The worst cases (Y plane) were recorded in this report.

The final configuration from all the combinations and the worst-case data rates were investigated by measuring the maximum power across all the data rates and modulation modes under section 2.2.

Based on the worst configuration found above, the RF power setting is set individually to meet FCC compliance limit for the final conducted and radiated tests shown in section 2.3.

### 2.1 Carrier Frequency Channel

Frequency Band	Channel	Freq. (MHz)	Channel	Freq. (MHz)
2400-2483.5 MHz	1	2412	7	2442
	2	2417	8	2447
	3	2422	9	2452
	4	2427	10	2457
	5	2432	11	2462
	6	2437		





## 2.2 Pre-Scanned RF Power

Preliminary tests were performed in different data rate and data rate associated with the highest power were chosen for full test shown in the following tables.

2.4GHz 802.11b mode				
Data Rate (MHz)	1M bps	2M bps	5.5M bps	11M bps
Peak Power (dBm)	18.02	18.01	18.00	18.00

2.4GHz 802.11g mode								
Data Rate (MHz)	6M bps	9M bps	12M bps	18M bps	24M bps	36M bps	48M bps	54M bps
Peak Power (dBm)	22.15	22.05	22.12	22.10	21.98	21.92	21.99	22.12

2.4GHz 802.11n HT20 mode								
Data Rate (MHz)	MCS0	MCS1	MCS2	MCS3	MCS4	MCS5	MCS6	MCS7
Peak Power (dBm)	20.99	20.87	20.81	20.78	20.77	20.94	20.82	20.89



### 2.3 Test Mode

Final results of test modes, data rates and test channels are shown as following table.

Test Cases				
	Test Items	Mode	Data Rate	Test Channel
Conducted TCs	6dB and 99% BW Power Spectral Density	802.11b	1 Mbps	1/6/11
		802.11g	6 Mbps	1/6/11
		802.11n HT20	MCS0	1/6/11
	Output Power	802.11b	1 Mbps	1/6/11
		802.11g	6 Mbps	1/6/11
		802.11n HT20	MCS0	1/6/11
	Conducted Band Edge	802.11b	1 Mbps	1/11
		802.11g	6 Mbps	1/11
		802.11n HT20	MCS0	1/11
	Conducted Spurious Emission	802.11b	1 Mbps	1/6/11
		802.11g	6 Mbps	1/6/11
		802.11n HT20	MCS0	1/6/11
Radiated TCs	Radiated Band Edge	802.11b	1 Mbps	1/11
		802.11g	6 Mbps	1/11
		802.11n HT20	MCS0	1/11
	Radiated Spurious Emission	802.11b	1 Mbps	1/6/11
		802.11g	6 Mbps	1/6/11
		802.11n HT20	MCS0	1/6/11
AC Conducted Emission	Mode 1 : GSM1900 Idle + Bluetooth Link + WLAN Idle + MP3 + Earphone + Battery + USB Cable (Charging from Adapter) + SIM 1  Mode 2 : GSM1900 Idle + Bluetooth Idle + WLAN Link + MP3 + Earphone + Battery + USB Cable (Charging from Adapter) + SIM 1			

## 2.4 Connection Diagram of Test System

<WLAN Tx Mode>

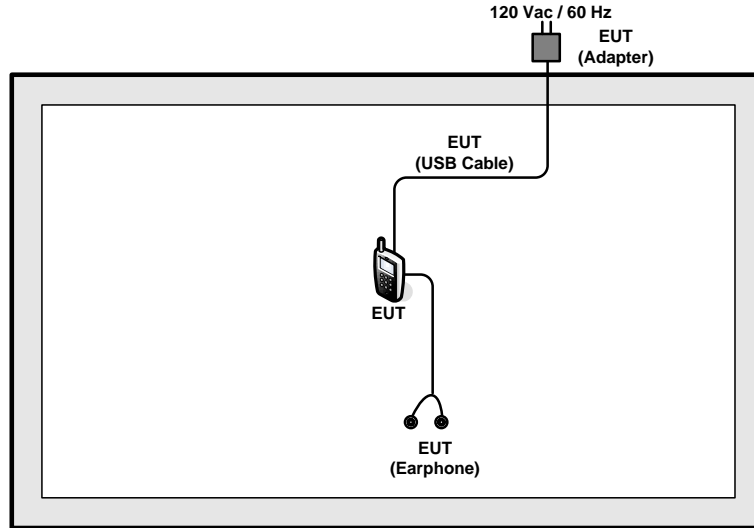

<AC Conducted Emission Mode>

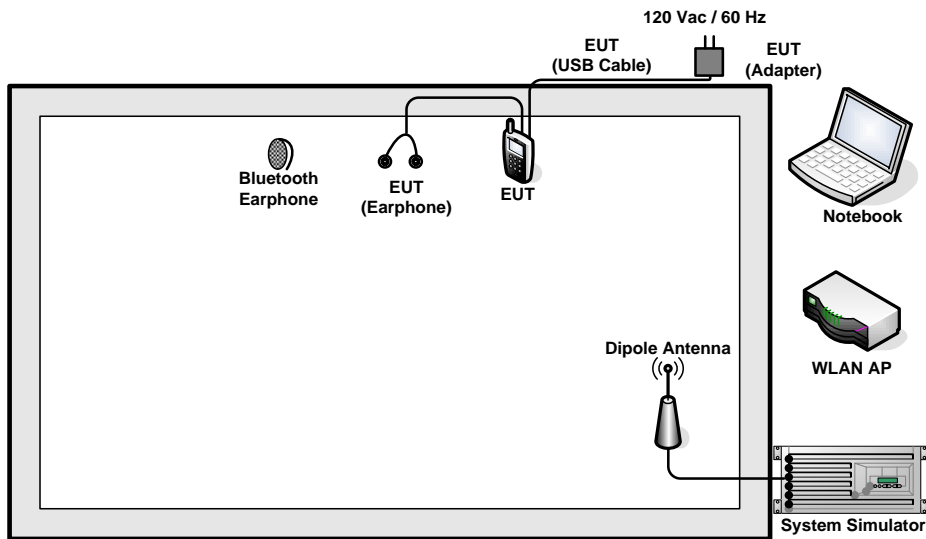

## 2.5 Support Unit used in test configuration and system

Item	Equipment	Trade Name	Model Name	FCC ID	Data Cable	Power Cord
1.	System Simulator	R&S	CMU 200	N/A	N/A	Unshielded, 1.8 m
2.	WLAN AP	D-Link	DIR-628	KA2DIR628A2	N/A	Unshielded, 1.8 m
3.	Notebook	DELL	Latitude E6320	FCC DoC	N/A	AC I/P: Unshielded, 1.2 m DC O/P: Shielded, 1.8 m
4.	Bluetooth Earphone	Sony Ericsson	MW600	PY7DDA-2029	N/A	N/A
5.	SD Card	SanDisk	MicroSD HC	FCC DoC	N/A	N/A

## 2.6 EUT Operation Test Setup

For WLAN function, an engineering test program was provided and enabled to make EUT continuous transmitting and receiving signals

## 2.7 Measurement Results Explanation Example

For all conducted test items:

The offset level is set in the spectrum analyzer to compensate the RF cable loss and attenuator factor between EUT conducted output port and spectrum analyzer. With the offset compensation, the spectrum analyzer reading level is exactly the EUT RF output level.

Example :

The spectrum analyzer offset is derived from RF cable loss and attenuator factor.

*Offset = RF cable loss + attenuator factor.*

Following shows an offset computation example with cable loss 4.2 dB and 10dB attenuator.

$$\begin{aligned} \text{Offset(dB)} &= \text{RF cable loss(dB)} + \text{attenuator factor(dB)}. \\ &= 4.2 + 10 = 14.2 \text{ (dB)} \end{aligned}$$

### 3 Test Result

#### 3.1 6dB and 99% Bandwidth Measurement

##### 3.1.1 Limit of 6dB and 99% Bandwidth

The minimum 6 dB bandwidth shall be at least 500 kHz.

##### 3.1.2 Measuring Instruments

The measuring equipment is listed in the section 4 of this test report.

##### 3.1.3 Test Procedures

1. The testing follows FCC KDB Publication No. 558074 DTS D01 Meas. Guidance v03r01.
2. The RF output of EUT was connected to the spectrum analyzer by RF cable and attenuator. The path loss was compensated to the results for each measurement.
3. Set to the maximum power setting and enable the EUT transmit continuously.
4. Make the measurement with the spectrum analyzer's resolution bandwidth (RBW) = 100 kHz. Set the Video bandwidth (VBW) = 300 kHz. In order to make an accurate measurement. The 6 dB bandwidth must be greater than 500 kHz.
5. For 99% Bandwidth Measurement, the spectrum analyzer's resolution bandwidth (RBW) = 1MHz and set the Video bandwidth (VBW) = 3MHz
6. Measure and record the results in the test report.

##### 3.1.4 Test Setup

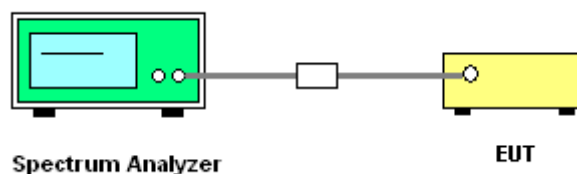



3.1.5 Test Result of 6dB Bandwidth

Test Band :	2.4GHz	Temperature :	21~25°C
Test Engineer :	Book Lin	Relative Humidity :	51~54%

Mod.	Data Rate	N <sub>TX</sub>	Channel	Freq. (MHz)	99% Bandwidth (MHz)	6dB Bandwidth (MHz)	6dB Bandwidth Min. Limit (MHz)	Pass/Fail
11b	1Mbps	1	1	2412	12.00	7.08	0.5	Pass
11b	1Mbps	1	6	2437	11.95	8.00	0.5	Pass
11b	1Mbps	1	11	2462	11.85	7.08	0.5	Pass
11g	6Mbps	1	1	2412	18.15	16.40	0.5	Pass
11g	6Mbps	1	6	2437	18.30	16.40	0.5	Pass
11g	6Mbps	1	11	2462	18.20	16.36	0.5	Pass
HT20	MCS0	1	1	2412	19.00	17.56	0.5	Pass
HT20	MCS0	1	6	2437	19.15	17.60	0.5	Pass
HT20	MCS0	1	11	2462	19.05	17.60	0.5	Pass

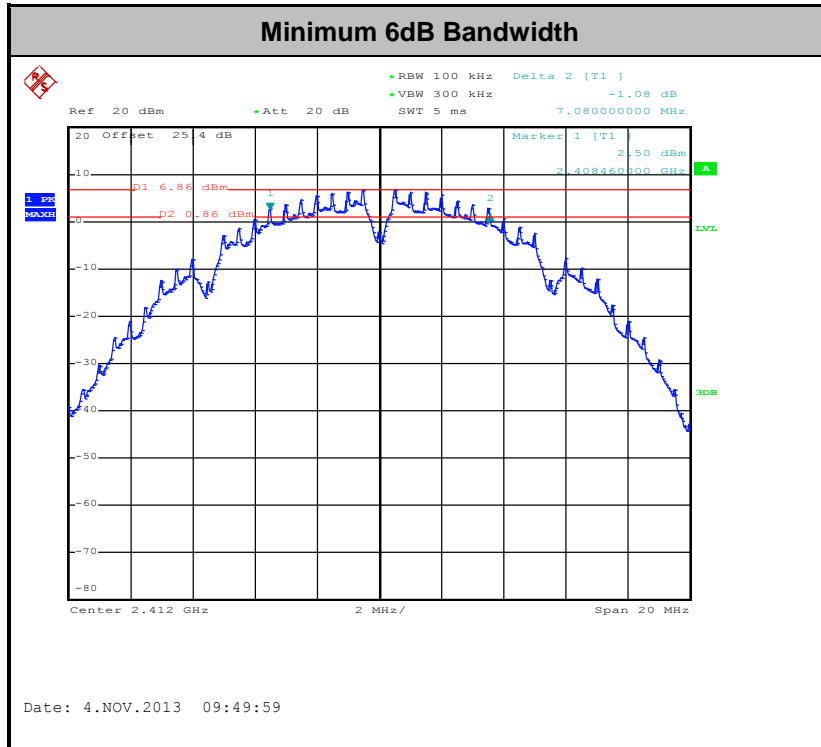

**Note:** The total loss is 25.4 dB of the RF cable and attenuator, and has been compensated to the spectrum analyzer offset.

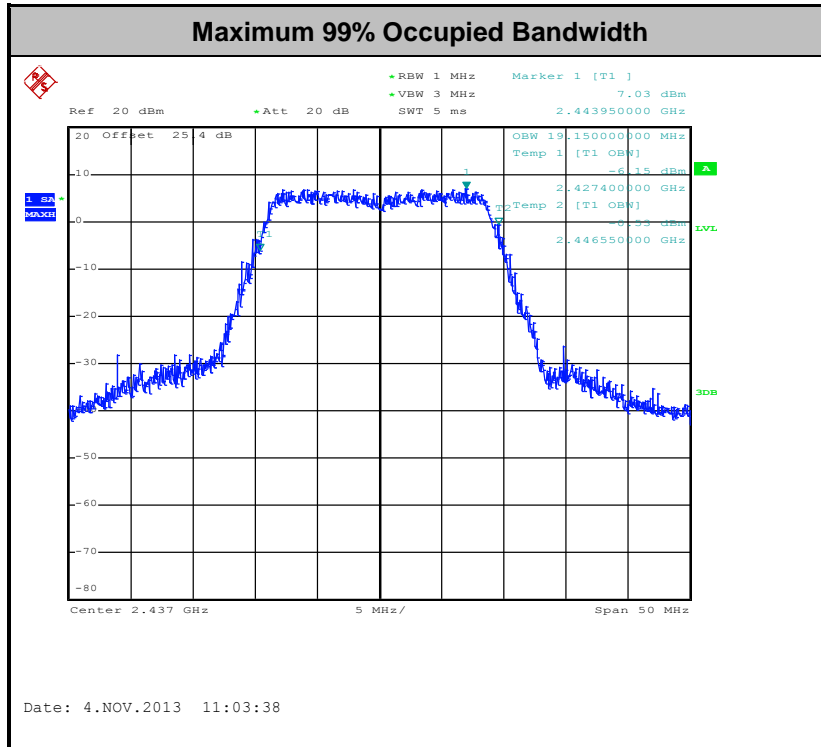

**Note:** The total loss is 25.4 dB of the RF cable and attenuator, and has been compensated to the spectrum analyzer offset.



## 3.2 Output Power Measurement

### 3.2.1 Limit of Output Power

For systems using digital modulation in the 2400-2483.5MHz, the limit for peak output power is 30dBm. If transmitting Antenna of directional gain greater than 6dBi are used the peak output power from the intentional radiator shall be reduced below the above stated value by the amount in dB that the directional gain of the Antenna exceeds 6 dBi. In case of point-to-point operation, the limit has to be reduced by 1dB for every 3dB that the directional gain of the Antenna exceeds 6dBi.

### 3.2.2 Measuring Instruments

The measuring equipment is listed in the section 4 of this test report.

### 3.2.3 Test Procedures

1. The testing follows the Measurement Procedure of FCC KDB No. 558074 DTS D01 Meas. Guidance v03r01.
2. The RF output of EUT was connected to the power meter by RF cable and attenuator. The path loss was compensated to the results for each measurement.
3. Set to the maximum power setting and enable the EUT transmit continuously.
4. Measure the conducted output power and record the results in the test report.

### 3.2.4 Test Setup

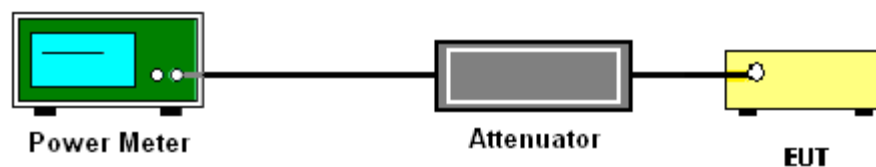



## 3.2.5 Test Result of Peak Output Power

Test Mode :	2.4GHz	Temperature :	21~25°C
Test Engineer :	Book Lin	Relative Humidity :	51~54%

Mod.	Data Rate	N <sub>TX</sub>	Channel	Freq. (MHz)	RF Output Power (dBm)	Power Limit (dBm)	DG (dBi)	Pass/Fail
11b	1Mbps	1	1	2412	17.69	30	1.32	Pass
11b	1Mbps	1	6	2437	18.02	30	1.32	Pass
11b	1Mbps	1	11	2462	18.01	30	1.32	Pass
11g	6Mbps	1	1	2412	21.87	30	1.32	Pass
11g	6Mbps	1	6	2437	22.15	30	1.32	Pass
11g	6Mbps	1	11	2462	18.56	30	1.32	Pass
HT20	MCS0	1	1	2412	20.37	30	1.32	Pass
HT20	MCS0	1	6	2437	20.99	30	1.32	Pass
HT20	MCS0	1	11	2462	18.56	30	1.32	Pass

**Note:** Measured power (dBm) has offset with cable loss.



## 3.2.6 Test Result of Average output Power (Reporting Only)

Test Mode :	2.4GHz	Temperature :	21~25°C
Test Engineer :	Book Lin	Relative Humidity :	51~54%

Mod.	Data Rate	N <sub>TX</sub>	Channel	Freq. (MHz)	Duty Factor (dB)	Average Output Power (dBm)	Power Limit (dBm)	DG (dBi)	Pass/Fail
11b	1Mbps	1	1	2412	0.00	14.52	30	1.32	Pass
11b	1Mbps	1	6	2437	0.00	14.81	30	1.32	Pass
11b	1Mbps	1	11	2462	0.00	14.77	30	1.32	Pass
11g	6Mbps	1	1	2412	0.00	12.06	30	1.32	Pass
11g	6Mbps	1	6	2437	0.00	12.31	30	1.32	Pass
11g	6Mbps	1	11	2462	0.00	7.91	30	1.32	Pass
HT20	MCS0	1	1	2412	0.00	10.01	30	1.32	Pass
HT20	MCS0	1	6	2437	0.00	10.18	30	1.32	Pass
HT20	MCS0	1	11	2462	0.00	7.89	30	1.32	Pass

**Note:** Measured power (dBm) has offset with cable loss and duty factor.

### 3.3 Power Spectral Density Measurement

#### 3.3.1 Limit of Power Spectral Density

The peak power spectral density shall not be greater than 8dBm in any 3kHz band at any time interval of continuous transmission.

#### 3.3.2 Measuring Instruments

The measuring equipment is listed in the section 4 of this test report.

#### 3.3.3 Test Procedures

1. The testing follows Measurement Procedure 10.2 Method PKPSD of FCC KDB Publication No. 558074 D01 DTS Meas. Guidance v03r01
2. The RF output of EUT was connected to the spectrum analyzer by RF cable and attenuator. The path loss was compensated to the results for each measurement.
3. Set to the maximum power setting and enable the EUT transmit continuously.
4. Make the measurement with the spectrum analyzer's resolution bandwidth (RBW) = 3 kHz. Video bandwidth VBW = 10 kHz In order to make an accurate measurement, set the span to 1.5 times DTS Channel Bandwidth. (6dB BW)
5. Detector = peak, Sweep time = auto couple, Trace mode = max hold, Allow trace to fully stabilize. Use the peak marker function to determine the maximum power level.
6. Measure and record the results in the test report.

#### 3.3.4 Test Setup

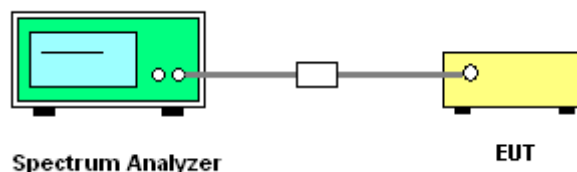



3.3.5 Test Result of Power Spectral Density

Test Mode :	2.4GHz	Temperature :	21~25°C
Test Engineer :	Book Lin	Relative Humidity :	51~54%

Mod.	Data Rate	N <sub>TX</sub>	Channel	Freq. (MHz)	Peak Power Density (dBm/3kHz)	Max. Limits (dBm/3kHz)	DG (dBi)	Pass/Fail
11b	1Mbps	1	1	2412	-6.97	8	1.32	Pass
11b	1Mbps	1	6	2437	-7.80	8	1.32	Pass
11b	1Mbps	1	11	2462	-7.30	8	1.32	Pass
11g	6Mbps	1	1	2412	-12.67	8	1.32	Pass
11g	6Mbps	1	6	2437	-12.40	8	1.32	Pass
11g	6Mbps	1	11	2462	-12.74	8	1.32	Pass
HT20	MCS0	1	1	2412	-15.13	8	1.32	Pass
HT20	MCS0	1	6	2437	-15.21	8	1.32	Pass
HT20	MCS0	1	11	2462	-15.55	8	1.32	Pass

Note: Measured power density (dBm) has offset with cable loss.

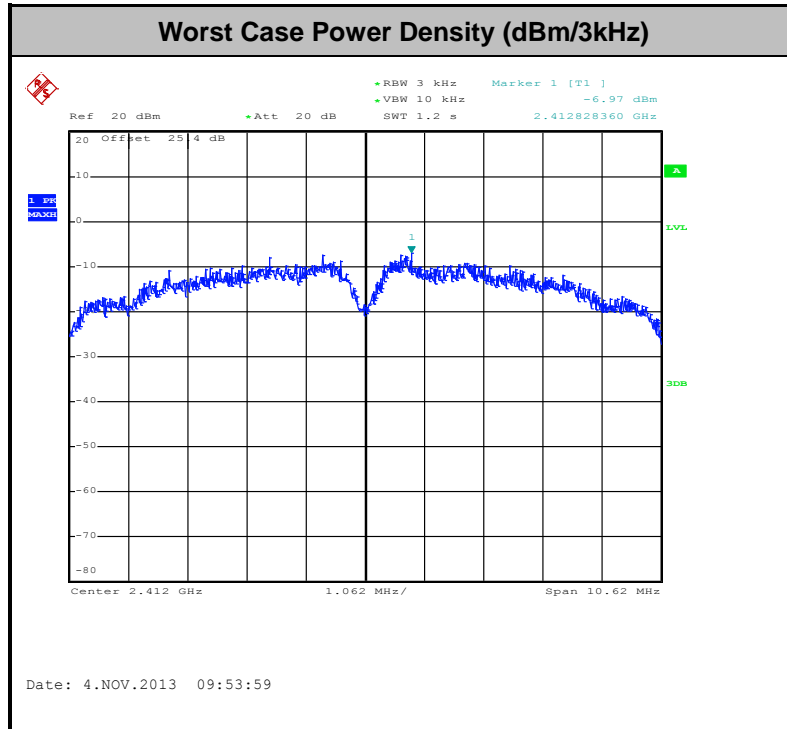

**Note:** The total loss is 25.4 dB of the RF cable and attenuator, and has been compensated to the spectrum analyzer offset.

## 3.4 Conducted Band Edges and Spurious Emission Measurement

### 3.4.1 Limit of Conducted Band Edges and Spurious Emission Measurement

In any 100 kHz bandwidth outside of the authorized frequency band, the emissions which fall in the non-restricted bands shall be attenuated at least 20 dB / 30dB relative to the maximum PSD level in 100 kHz by RF conducted measurement and radiated emissions which fall in the restricted bands, as defined in Section 15.205(a), must also comply with the radiated emission limits specified in Section 15.209(a).

### 3.4.2 Measuring Instruments

The measuring equipment is listed in the section 4 of this test report.

### 3.4.3 Test Procedures

1. The testing follows FCC KDB Publication No. 558074 D01 DTS Meas. Guidance v03r01.
2. The RF output of EUT was connected to the spectrum analyzer by RF cable and attenuator. The path loss was compensated to the results for each measurement.
3. Set to the maximum power setting and enable the EUT transmit continuously.
4. Set RBW = 100 kHz, VBW=300 kHz, Peak Detector. Unwanted Emissions measured in any 100 kHz bandwidth outside of the authorized frequency band shall be attenuated by at least 20 dB relative to the maximum in-band peak PSD level in 100 kHz when maximum peak conducted output power procedure is used. If the transmitter complies with the conducted power limits based on the use of RMS averaging over a time interval, the attenuation required under this paragraph shall be 30 dB instead of 20 dB per 15.247(d).
5. Measure and record the results in the test report.
6. The RF fundamental frequency should be excluded against the limit line in the operating frequency band.

### 3.4.4 Test Setup

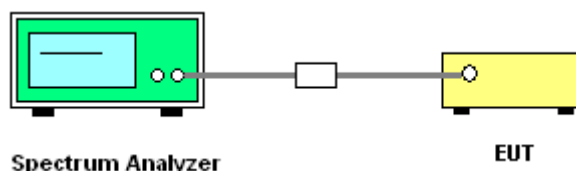



3.4.5 Test Result of Conducted Band Edges and Spurious Emission

Test Mode :	802.11b	Temperature :	21~25°C
Test Band :	2.4GHz Low	Relative Humidity :	51~54%
Test Channel :	01	Test Engineer :	Book Lin

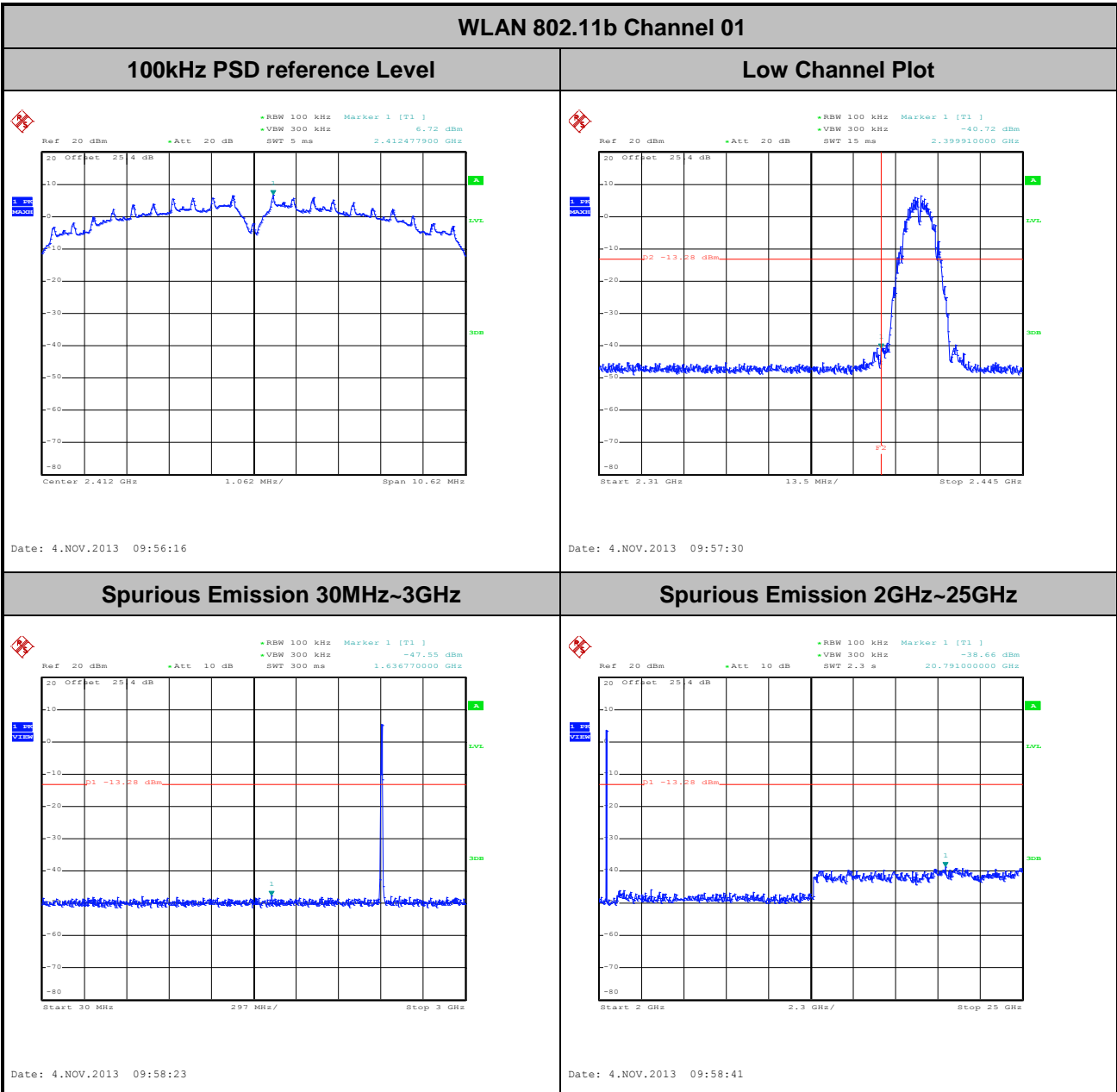

**Note:**

1. The total loss is 25.4 dB of the RF cable and attenuator, and has been compensated to the spectrum analyzer offset.
2. The RF fundamental frequency should be excluded against the limit line in the operating frequency band.





Test Mode :	802.11b	Temperature :	21~25°C
Test Band :	2.4GHz Mid	Relative Humidity :	51~54%
Test Channel :	06	Test Engineer :	Book Lin

WLAN 802.11b Channel 06

100kHz PSD reference Level

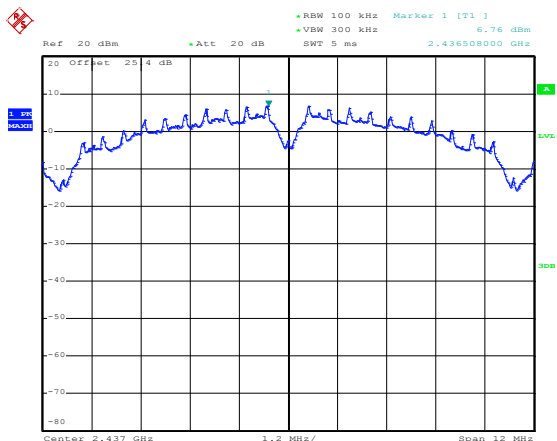

Date: 4.NOV.2013 10:06:32

Spurious Emission 30MHz~3GHz

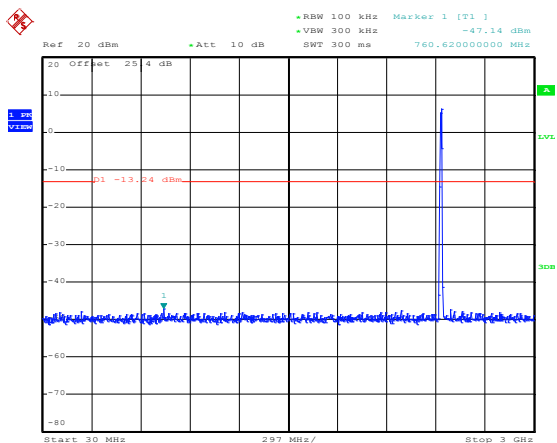

Date: 4.NOV.2013 10:07:06

Spurious Emission 2GHz~25GHz

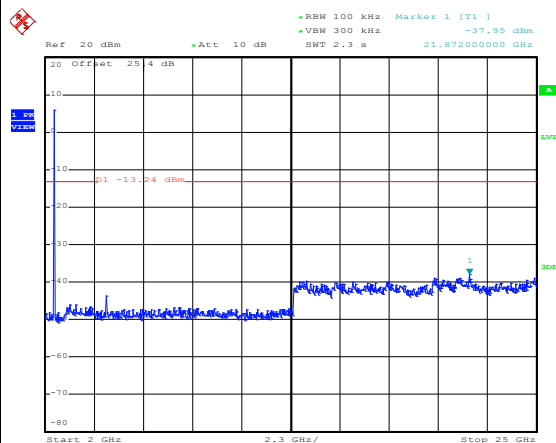

Date: 4.NOV.2013 10:07:25

Note:

1. The total loss is 25.4 dB of the RF cable and attenuator, and has been compensated to the spectrum analyzer offset.
2. The RF fundamental frequency should be excluded against the limit line in the operating frequency band.



Test Mode :	802.11b	Temperature :	21~25°C
Test Band :	2.4GHz High	Relative Humidity :	51~54%
Test Channel :	11	Test Engineer :	Book Lin

WLAN 802.11b Channel 11

100kHz PSD reference Level

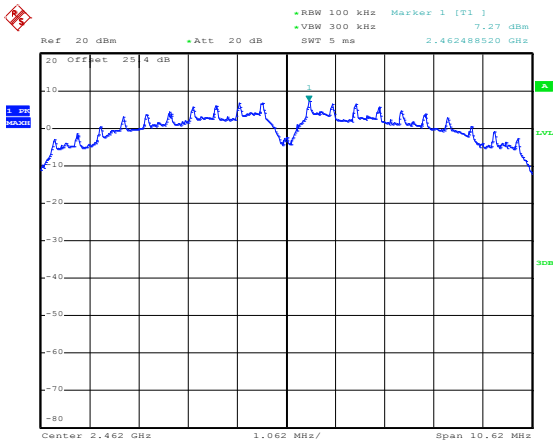

Date: 4.NOV.2013 10:15:49

High Channel Plot

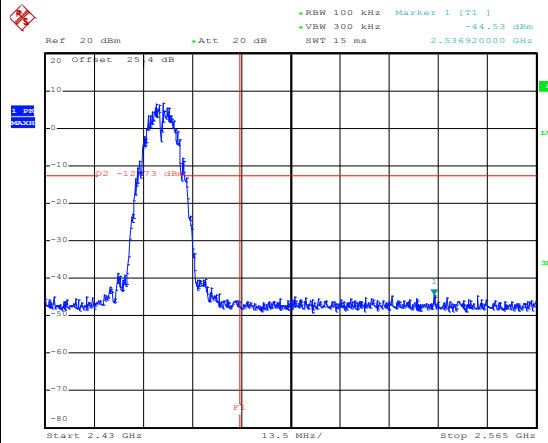

Date: 4.NOV.2013 10:16:24

Spurious Emission 30MHz~3GHz

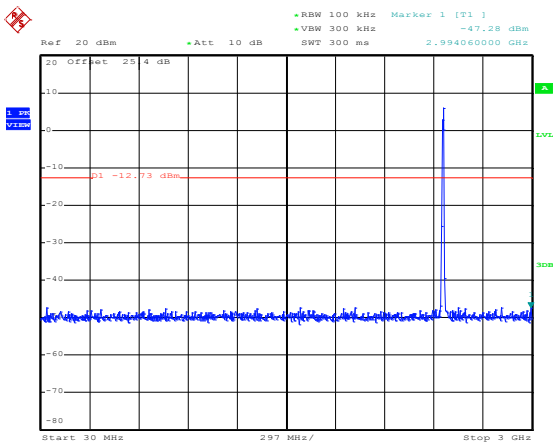

Date: 4.NOV.2013 10:17:02

Spurious Emission 2GHz~25GHz

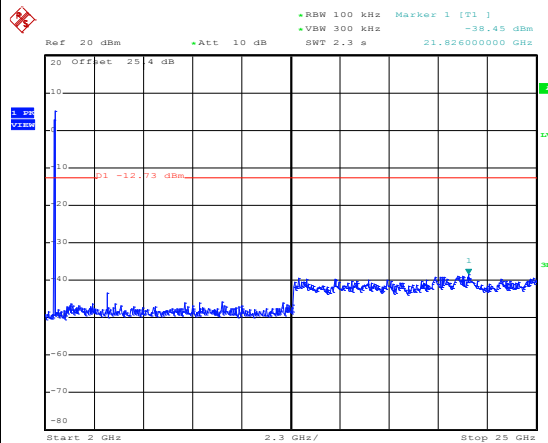

Date: 4.NOV.2013 10:17:21

Note:

1. The total loss is 25.4 dB of the RF cable and attenuator, and has been compensated to the spectrum analyzer offset.
2. The RF fundamental frequency should be excluded against the limit line in the operating frequency band.



Test Mode :	802.11g	Temperature :	21~25°C
Test Band :	2.4GHz Low	Relative Humidity :	51~54%
Test Channel :	01	Test Engineer :	Book Lin

**WLAN 802.11g Channel 01**

<b>100kHz PSD reference Level</b>	<b>Low Channel Plot</b>
-----------------------------------	-------------------------

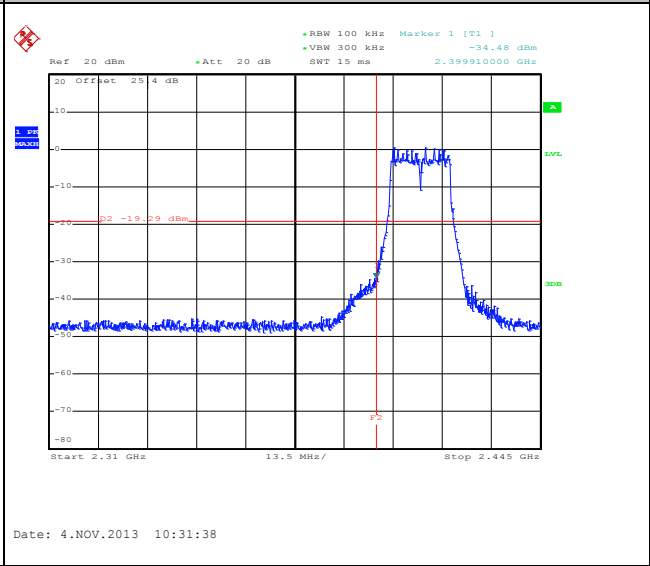
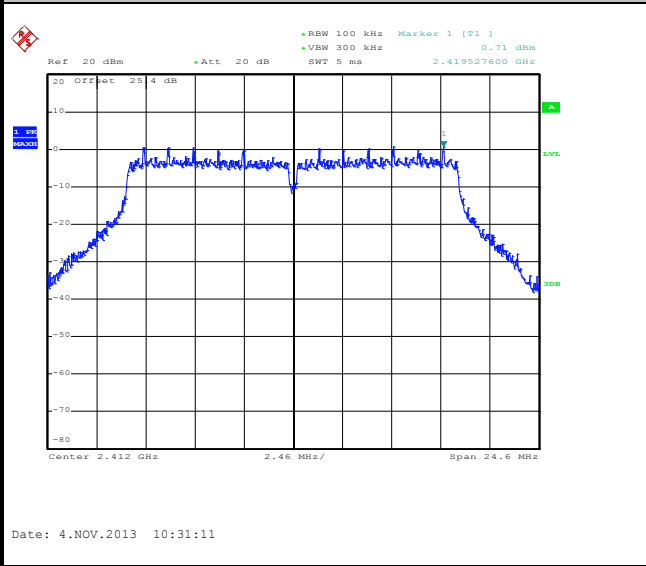

**Spurious Emission 30MHz~3GHz**

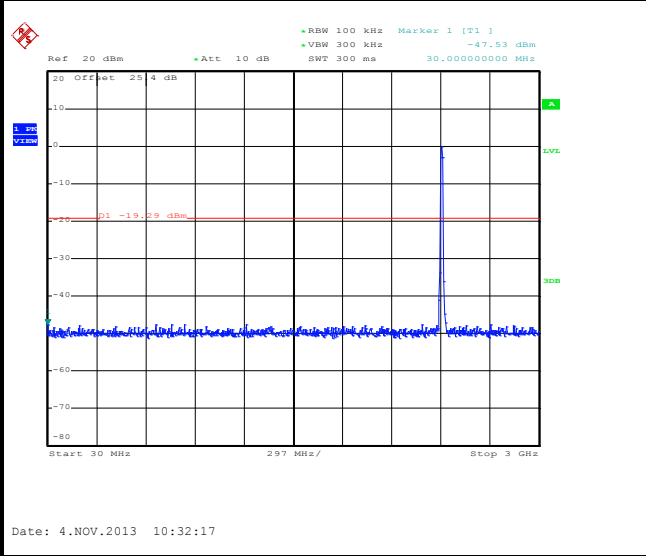

**Spurious Emission 2GHz~25GHz**

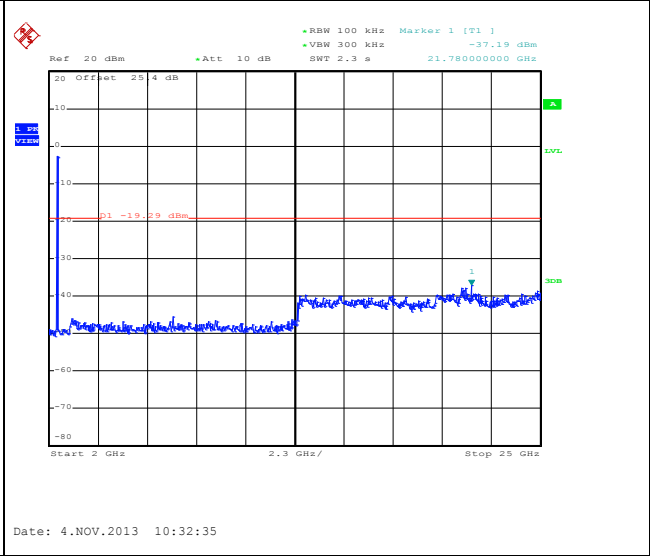

**Note:**

1. The total loss is 25.4 dB of the RF cable and attenuator, and has been compensated to the spectrum analyzer offset.
2. The RF fundamental frequency should be excluded against the limit line in the operating frequency band.



Test Mode :	802.11g	Temperature :	21~25°C
Test Band :	2.4GHz Mid	Relative Humidity :	51~54%
Test Channel :	06	Test Engineer :	Book Lin

**WLAN 802.11g Channel 06**

**100kHz PSD reference Level**

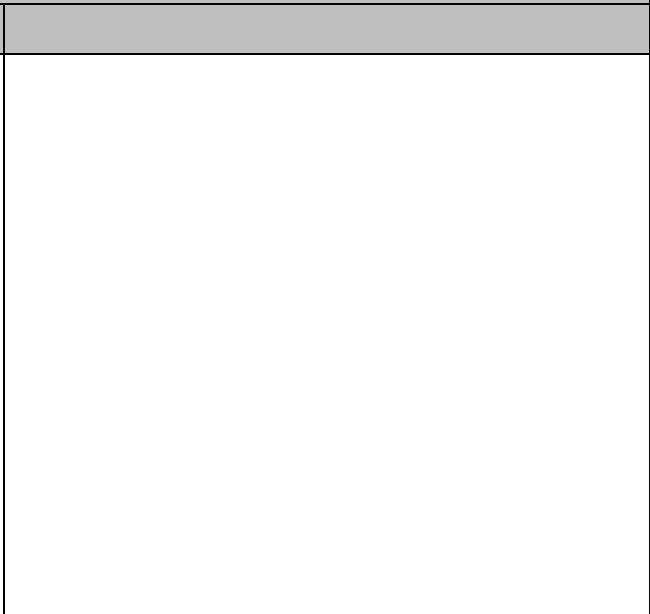
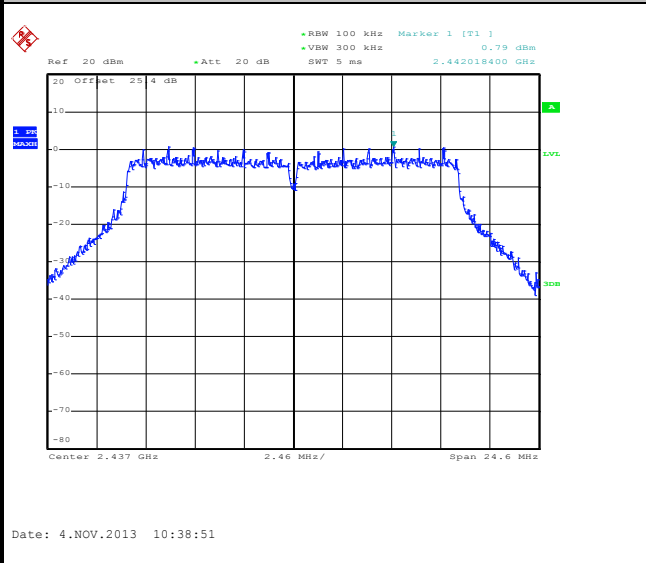

**Spurious Emission 30MHz~3GHz**

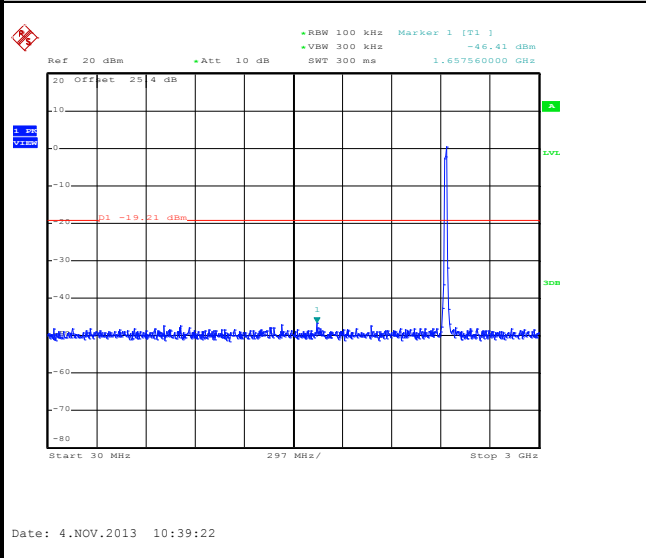

**Spurious Emission 2GHz~25GHz**

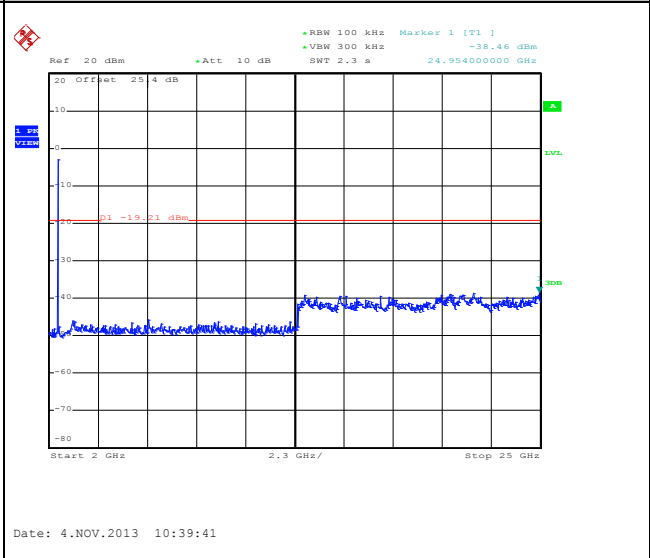

**Note:**

1. The total loss is 25.4 dB of the RF cable and attenuator, and has been compensated to the spectrum analyzer offset.
2. The RF fundamental frequency should be excluded against the limit line in the operating frequency band.



Test Mode :	802.11g	Temperature :	21~25°C
Test Band :	2.4GHz High	Relative Humidity :	51~54%
Test Channel :	11	Test Engineer :	Book Lin

**WLAN 802.11g Channel 11**

<b>100kHz PSD reference Level</b>	<b>High Channel Plot</b>
-----------------------------------	--------------------------

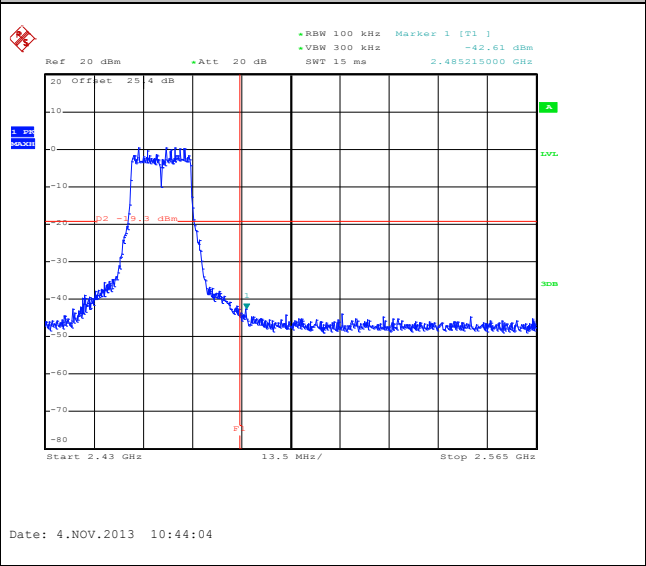
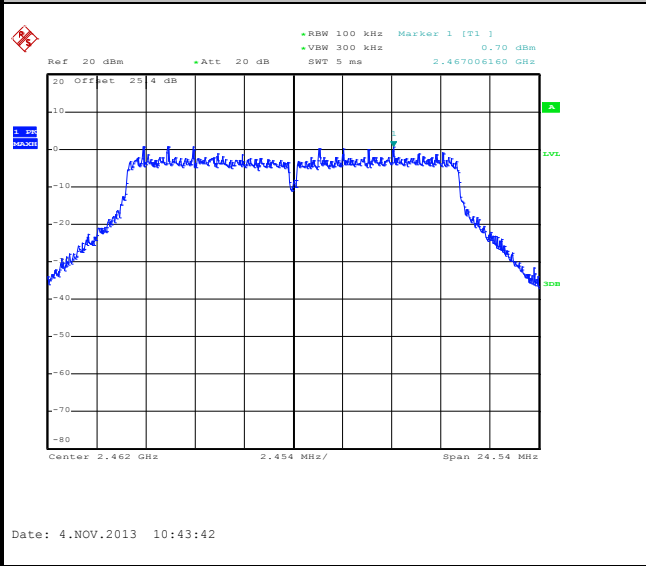

**Spurious Emission 30MHz~3GHz**

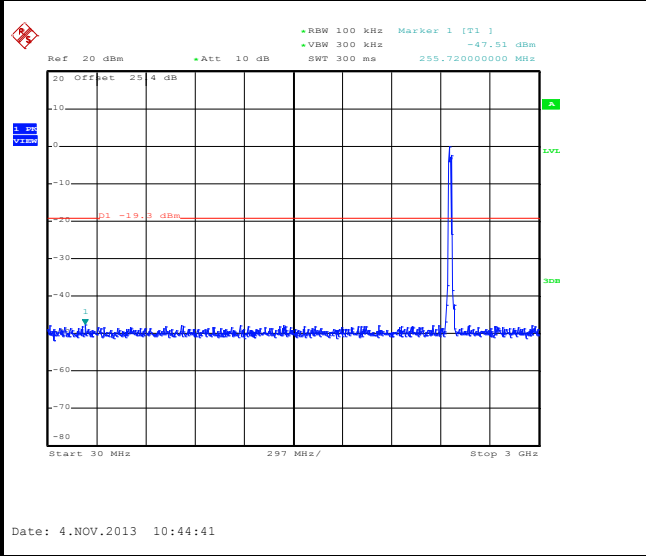

**Spurious Emission 2GHz~25GHz**

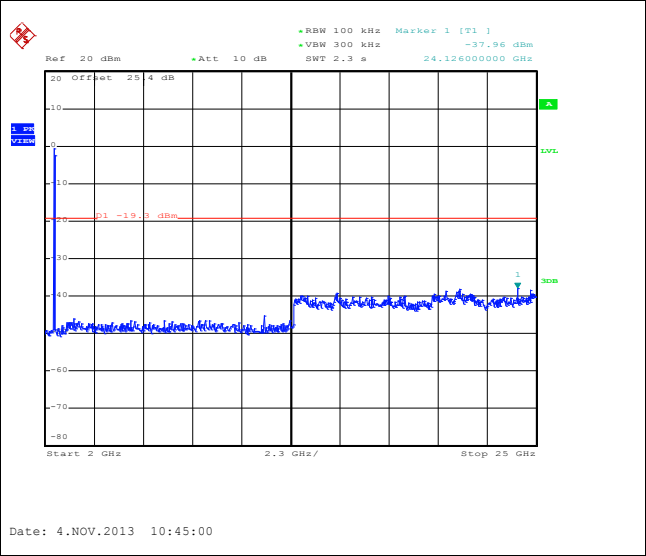

**Note:**

1. The total loss is 25.4 dB of the RF cable and attenuator, and has been compensated to the spectrum analyzer offset.
2. The RF fundamental frequency should be excluded against the limit line in the operating frequency band.



Test Mode :	802.11n HT20	Temperature :	21~25°C
Test Band :	2.4GHz Low	Relative Humidity :	51~54%
Test Channel :	01	Test Engineer :	Book Lin

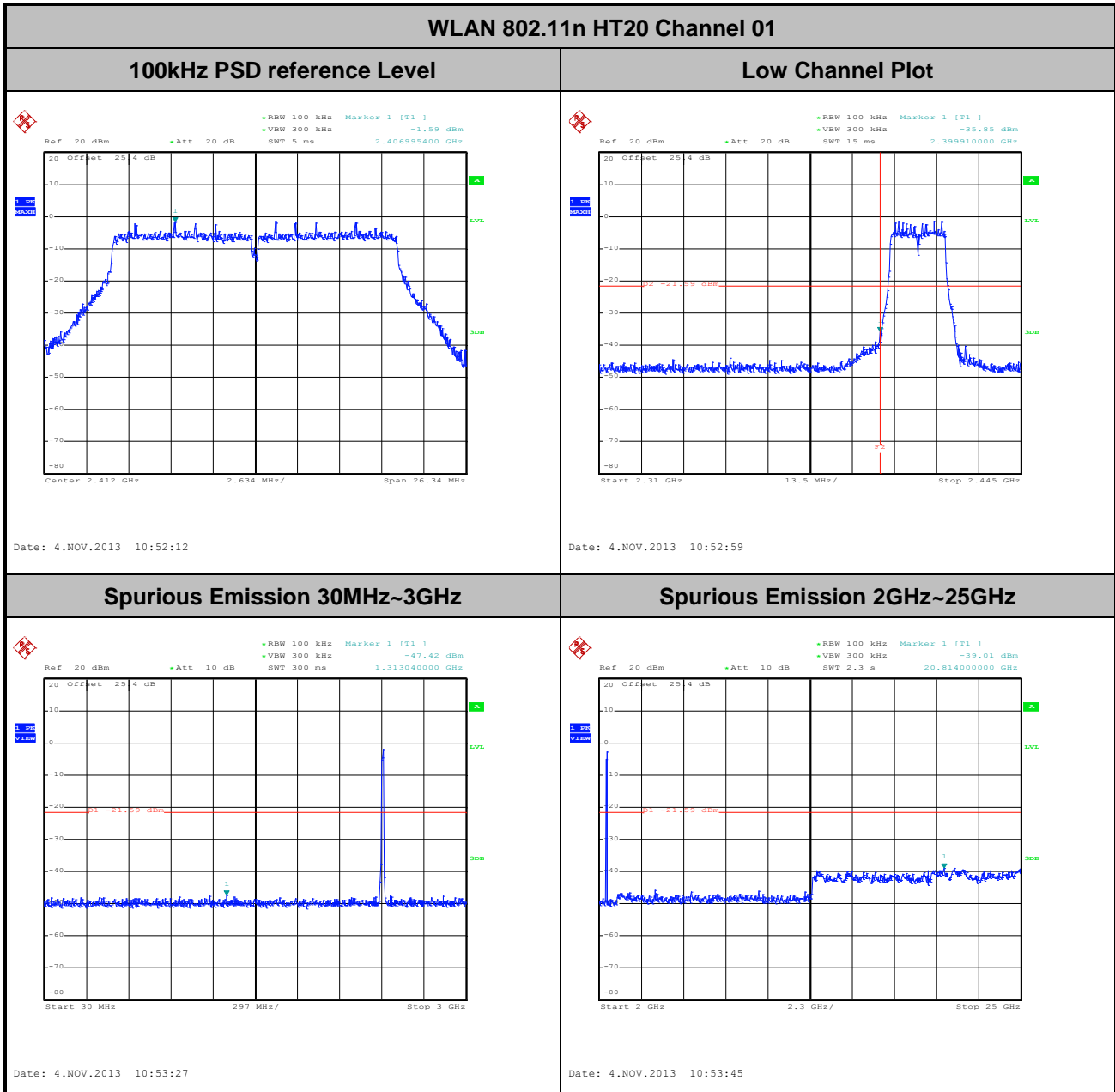

**Note:**

1. The total loss is 25.4 dB of the RF cable and attenuator, and has been compensated to the spectrum analyzer offset.
2. The RF fundamental frequency should be excluded against the limit line in the operating frequency band.



Test Mode :	802.11n HT20	Temperature :	21~25°C
Test Band :	2.4GHz Mid	Relative Humidity :	51~54%
Test Channel :	06	Test Engineer :	Book Lin

WLAN 802.11n HT20 Channel 06

100kHz PSD reference Level

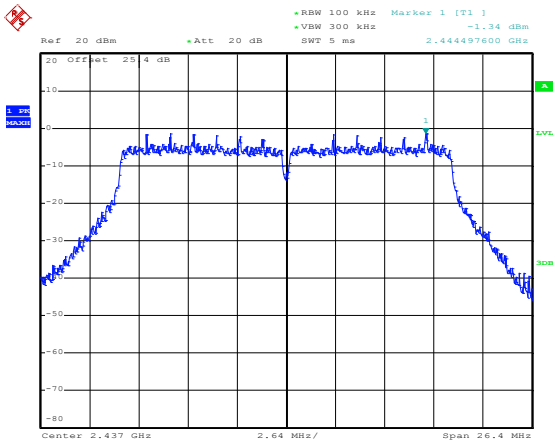

Date: 4.NOV.2013 11:02:31

Spurious Emission 30MHz~3GHz

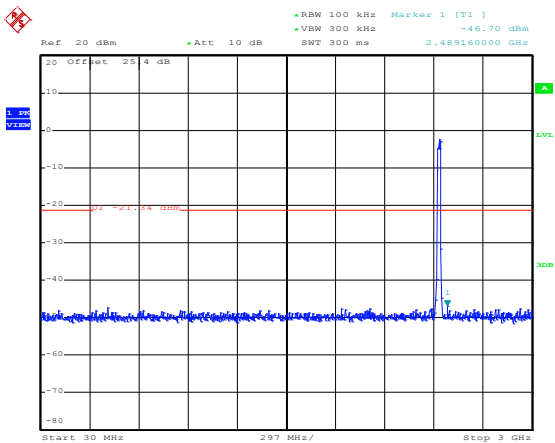

Date: 4.NOV.2013 11:03:03

Spurious Emission 2GHz~25GHz

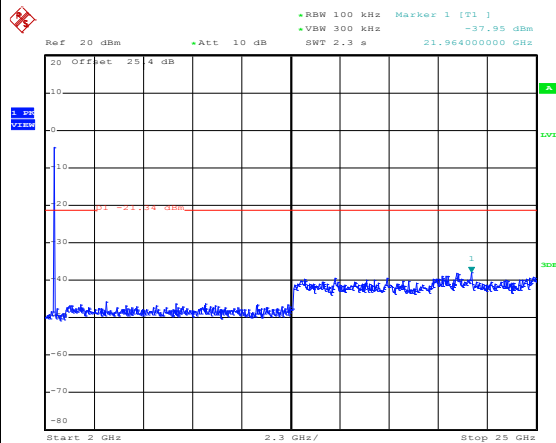

Date: 4.NOV.2013 11:03:22

Note:

1. The total loss is 25.4 dB of the RF cable and attenuator, and has been compensated to the spectrum analyzer offset.
2. The RF fundamental frequency should be excluded against the limit line in the operating frequency band.



Test Mode :	802.11n HT20	Temperature :	21~25°C
Test Band :	2.4GHz High	Relative Humidity :	51~54%
Test Channel :	11	Test Engineer :	Book Lin

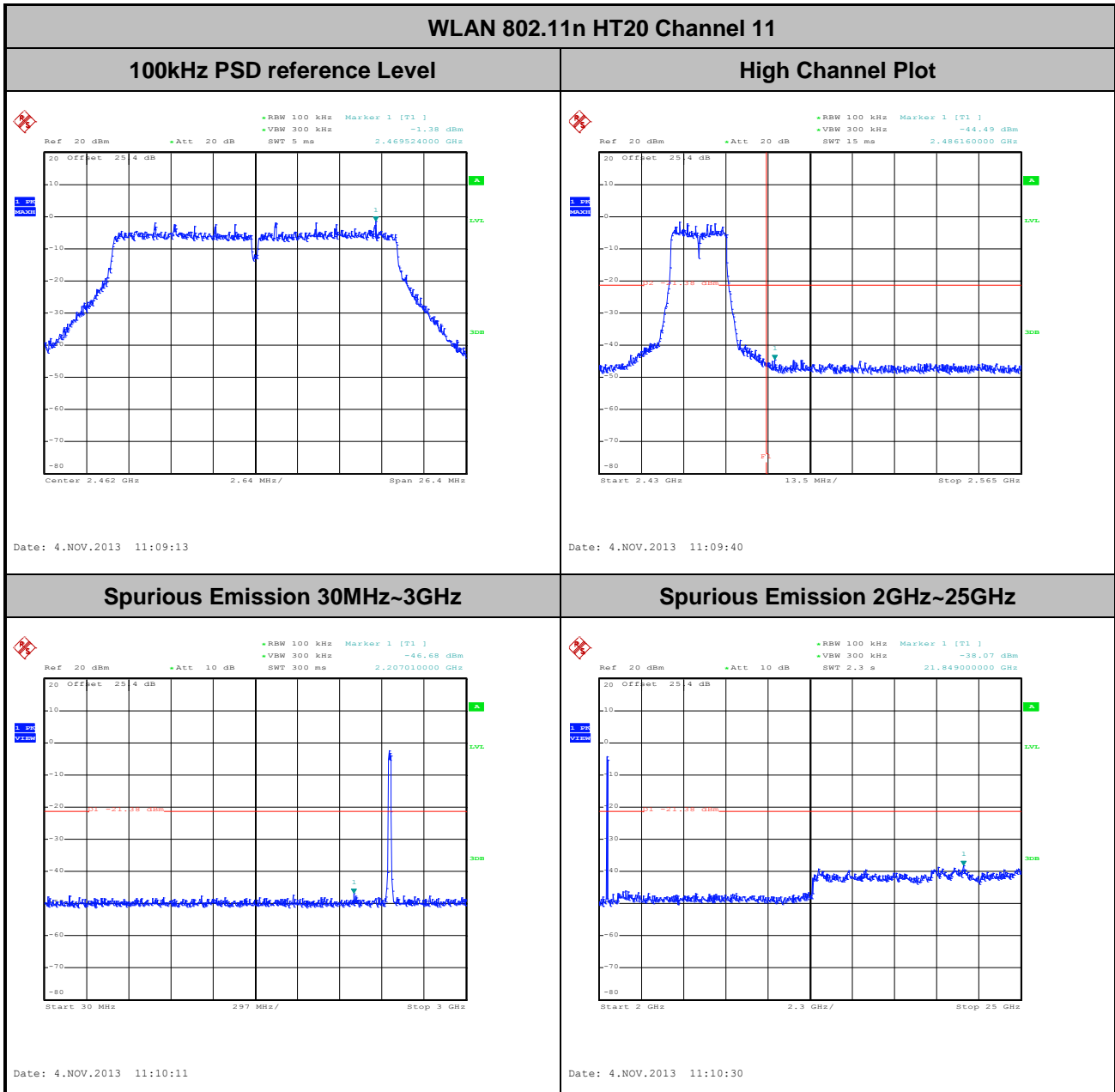

**Note:**

1. The total loss is 25.4 dB of the RF cable and attenuator, and has been compensated to the spectrum analyzer offset.
2. The RF fundamental frequency should be excluded against the limit line in the operating frequency band.





### 3.5 Radiated Band Edges and Spurious Emission Measurement

#### 3.5.1 Limit of Radiated band edge and Spurious Emission Measurement

In any 100 kHz bandwidth outside the intentional radiator frequency band, all harmonics/spurious must be at least 20 dB below the highest emission level within the authorized band. If the output power of this device was measured by spectrum analyzer, the attenuation under this paragraph shall be 30 dB instead of 20 dB. In addition, radiated emissions which fall in the restricted bands must also comply with the FCC section 15.209 limits as below.

Frequency (MHz)	Field Strength (microvolts/meter)	Measurement Distance (meters)
0.009 – 0.490	2400/F(kHz)	300
0.490 – 1.705	24000/F(kHz)	30
1.705 – 30.0	30	30
30 – 88	100	3
88 – 216	150	3
216 - 960	200	3
Above 960	500	3

#### 3.5.2 Measuring Instruments

The measuring equipment is listed in the section 4 of this test report.



3.5.3 Test Procedures

1. The testing follows FCC KDB Publication No. 558074 D01 DTS Meas. Guidance v03r01.
2. The EUT was arranged to its worst case and then tune the antenna tower (from 1 m to 4 m) and turntable (from 0 degree to 360 degrees) to find the maximum reading. A pre-amp and a high pass filter are used for the test in order to get better signal level.
3. The EUT was placed on a turntable with 0.8 meter above ground.
4. The EUT was set 3 meters from the interference receiving antenna, which was mounted on the top of a variable height antenna tower.
5. Corrected Reading: Antenna Factor + Cable Loss + Read Level - Preamp Factor = Level
6. For measurement below 1GHz, If the emission level of the EUT measured by the peak detector is 3 dB lower than the applicable limit, the peak emission level will be reported. Otherwise, the emission measurement will be repeated using the quasi-peak detector and reported.
7. Use the following spectrum analyzer settings:
  - (1) Span shall wide enough to fully capture the emission being measured;
  - (2) Set RBW=100 kHz for  $f < 1$  GHz;  $VBW \geq RBW$ ; Sweep = auto; Detector function = peak; Trace = max hold;
  - (3) Set RBW = 1 MHz, VBW= 3MHz for  $f \geq 1$  GHz for peak measurement.  
 For average measurement:
    - $VBW = 10$  Hz, when duty cycle is no less than 98 percent.
    - $VBW \geq 1/T$ , when duty cycle is less than 98 percent where T is the minimum transmission duration over which the transmitter is on and is transmitting at its maximum power control level for the tested mode of operation.

Band	Duty Cycle(%)	T(μs)	1/T(kHz)	VBW Setting
802.11b	100.00	-	-	10Hz
802.11g	100.00	-	-	10Hz
802.11n HT20	100.00	-	-	10Hz

### 3.5.4 Test Setup

For radiated emissions below 30MHz

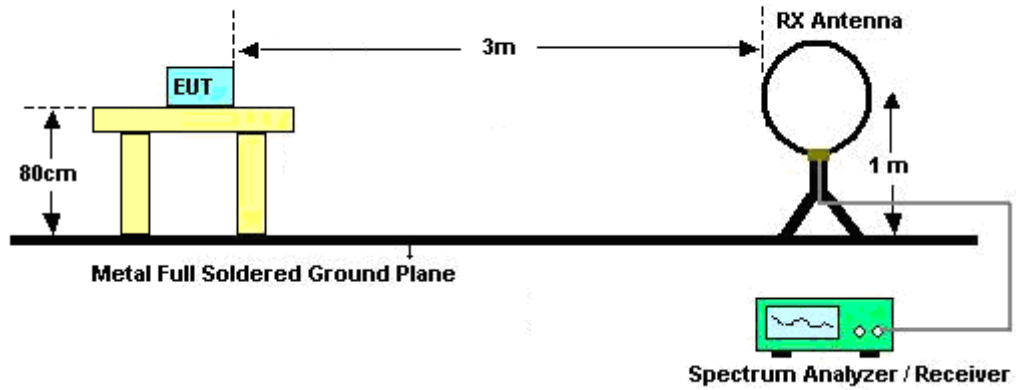

For radiated emissions from 30MHz to 1GHz

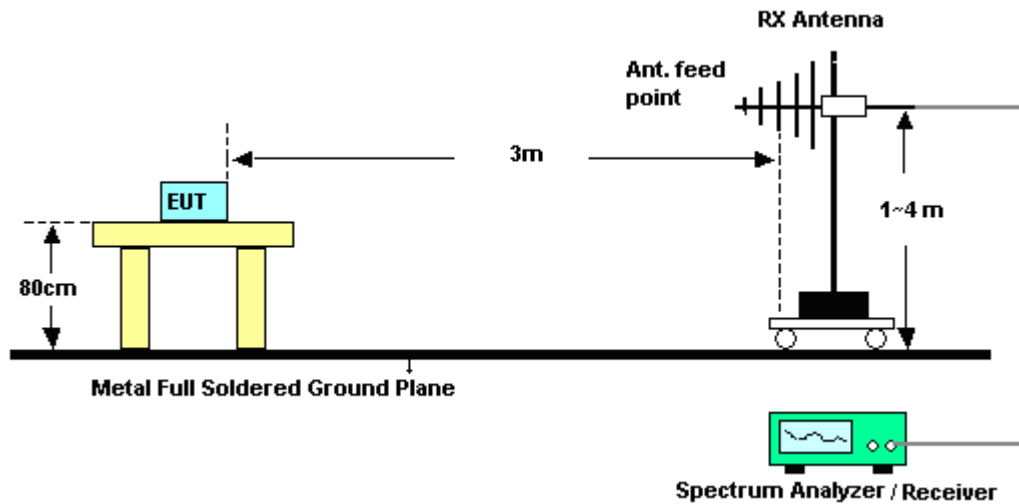

For radiated emissions above 1GHz

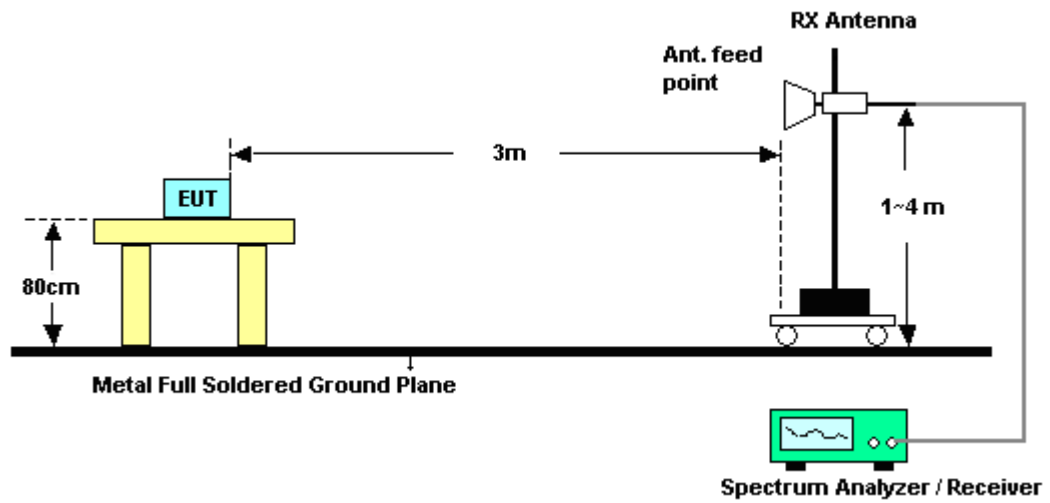

### 3.5.5 Test Results of Radiated Spurious Emissions (9kHz ~ 30MHz)

The low frequency, which started from 9 kHz to 30MHz, was pre-scanned and the result which was 20dB lower than the limit line per 15.31(o) was not reported.



3.5.6 Test Result of Radiated Spurious at Band Edges

Test Mode :	802.11b	Temperature :	21~23°C
Test Band :	Low	Relative Humidity :	49~51%
Test Channel :	01	Test Engineer :	Eric Shih

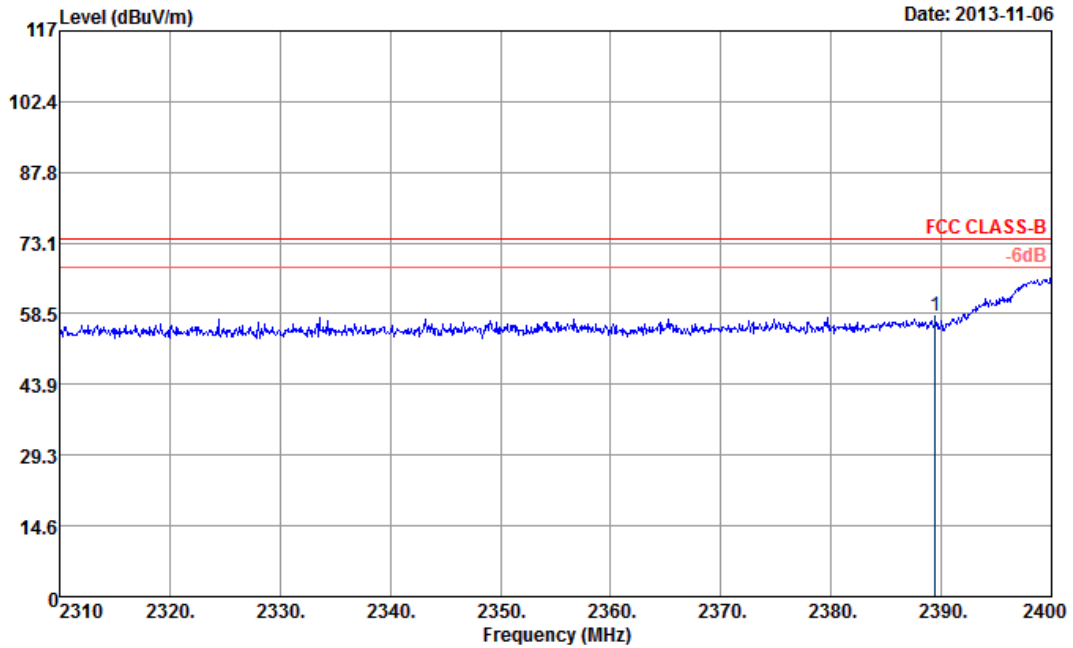

Site : 03CH07-HY  
 Condition : FCC CLASS-B 3m HF-ANT\_120823 HORIZONTAL  
 : RBW:1000.000KHz VBW:3000.000KHz SWT:Auto

ANTENNA POLARITY : HORIZONTAL

Frequency ( MHz )	Level (dBμV/m)	Over Limit ( dB )	Limit Line (dBμV/m)	Read Level (dBμV)	Antenna Factor (dB)	Cable Loss (dB)	Preamp Factor (dB)	Ant Pos (cm)	Table Pos (deg)	Remark
2389.47	57.99	-16.01	74	53.05	32.3	6.91	34.27	112	142	Peak

**Note:** Worst case measurement on 2389.47 MHz is compliance with 74/54 dBuV/m (peak/average) limit and band edge measurement in the restricted band 2310-2390MHz. And, 2390-2400 MHz is non-restricted band which limit line is 20dB below the fundamental frequency emission level which is tested by conducted spurious emission. Both the test results are compliance with the FCC limit line.



Test Mode :	802.11b	Temperature :	21~23°C
Test Band :	Low	Relative Humidity :	49~51%
Test Channel :	01	Test Engineer :	Eric Shih

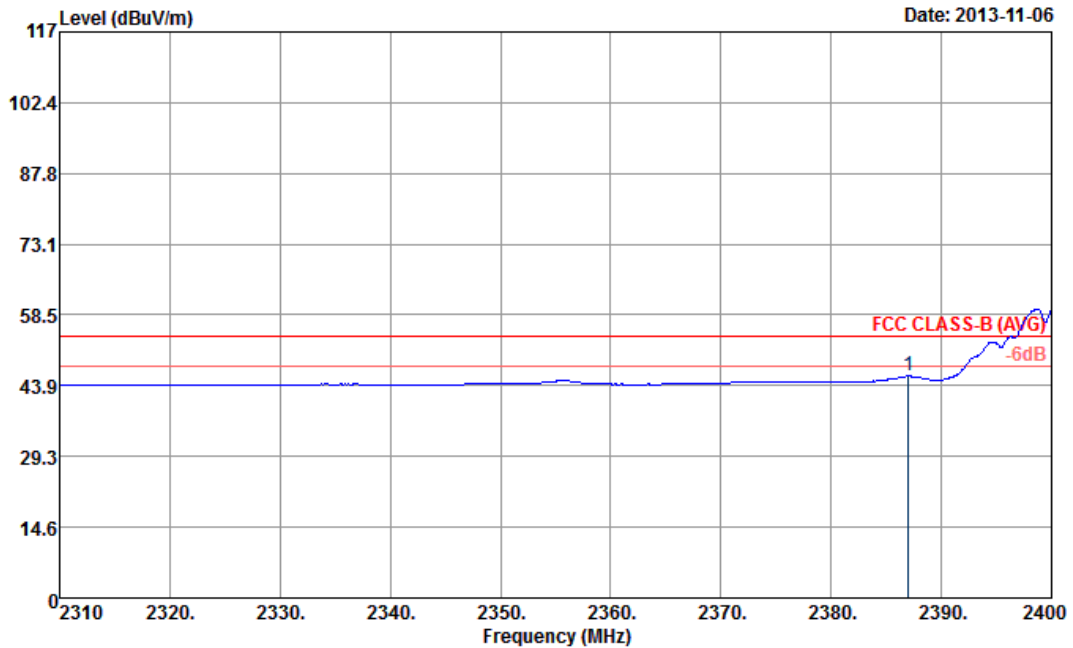

Site : 03CH07-HY  
 Condition : FCC CLASS-B (AVG) 3m HF-ANT\_120823 HORIZONTAL  
 : RBW:1000.000KHz VBW:0.010KHz SWT:Auto

ANTENNA POLARITY : HORIZONTAL

Frequency ( MHz )	Level (dBμV/m)	Over Limit ( dB )	Limit Line (dBμV/m)	Read Level (dBμV)	Antenna Factor (dB)	Cable Loss (dB)	Preamp Factor (dB)	Ant Pos (cm)	Table Pos (deg)	Remark
2387.04	45.86	-8.14	54	40.92	32.3	6.91	34.27	112	142	Average

**Note:** Worst case measurement on 2387.04 MHz is compliance with 74/54 dBuV/m (peak/average) limit and band edge measurement in the restricted band 2310-2390MHz. And, 2390-2400 MHz is non-restricted band which limit line is 20dB below the fundamental frequency emission level which is tested by conducted spurious emission. Both the test results are compliance with the FCC limit line.



Test Mode :	802.11b	Temperature :	21~23°C
Test Band :	Low	Relative Humidity :	49~51%
Test Channel :	01	Test Engineer :	Eric Shih

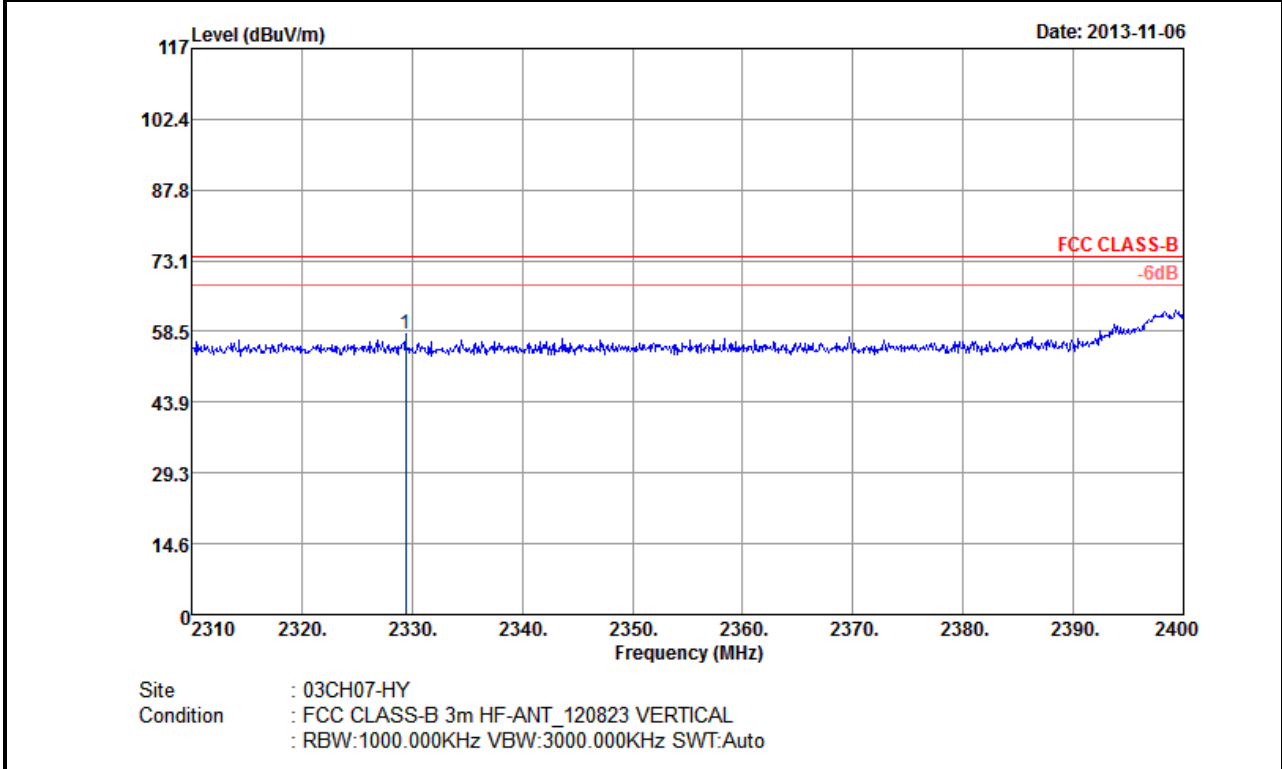

ANTENNA POLARITY : VERTICAL										
Frequency ( MHz )	Level (dBμV/m)	Over Limit ( dB )	Limit Line (dBμV/m)	Read Level (dBμV)	Antenna Factor (dB)	Cable Loss (dB)	Preamp Factor (dB)	Ant Pos (cm)	Table Pos (deg)	Remark
2329.44	57.96	-16.04	74	53.15	32.23	6.8	34.22	117	328	Peak

**Note:** Worst case measurement on 2329.44 MHz is compliance with 74/54 dBuV/m (peak/average) limit and band edge measurement in the restricted band 2310-2390MHz. And, 2390-2400 MHz is non-restricted band which limit line is 20dB below the fundamental frequency emission level which is tested by conducted spurious emission. Both the test results are compliance with the FCC limit line.



Test Mode :	802.11b	Temperature :	21~23°C
Test Band :	Low	Relative Humidity :	49~51%
Test Channel :	01	Test Engineer :	Eric Shih

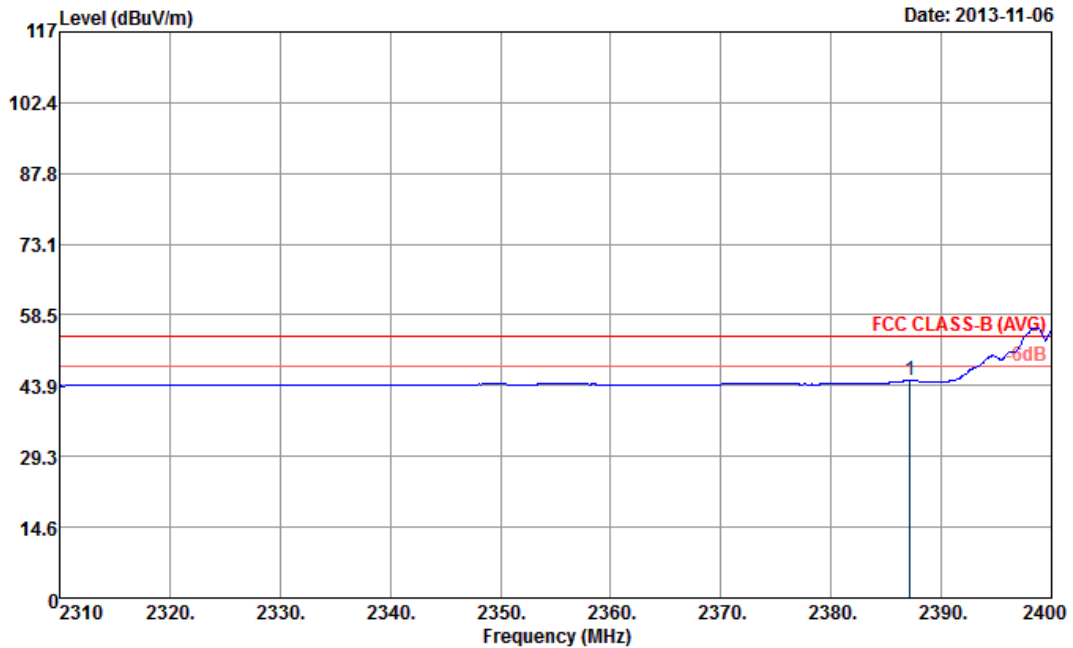

Site : 03CH07-HY  
 Condition : FCC CLASS-B (AVG) 3m HF-ANT\_120823 VERTICAL  
 : RBW:1000.000KHz VBW:0.010KHz SWT:Auto

ANTENNA POLARITY : VERTICAL

Frequency ( MHz )	Level (dBμV/m)	Over Limit ( dB )	Limit Line (dBμV/m)	Read Level (dBμV)	Antenna Factor (dB)	Cable Loss (dB)	Preamp Factor (dB)	Ant Pos (cm)	Table Pos (deg)	Remark
2387.13	44.88	-9.12	54	39.94	32.3	6.91	34.27	117	328	Average

**Note:** Worst case measurement on 2387.13 MHz is compliance with 74/54 dBuV/m (peak/average) limit and band edge measurement in the restricted band 2310-2390MHz. And, 2390-2400 MHz is non-restricted band which limit line is 20dB below the fundamental frequency emission level which is tested by conducted spurious emission. Both the test results are compliance with the FCC limit line.





Test Mode :	802.11b	Temperature :	21~23°C
Test Band :	High	Relative Humidity :	49~51%
Test Channel :	11	Test Engineer :	Eric Shih

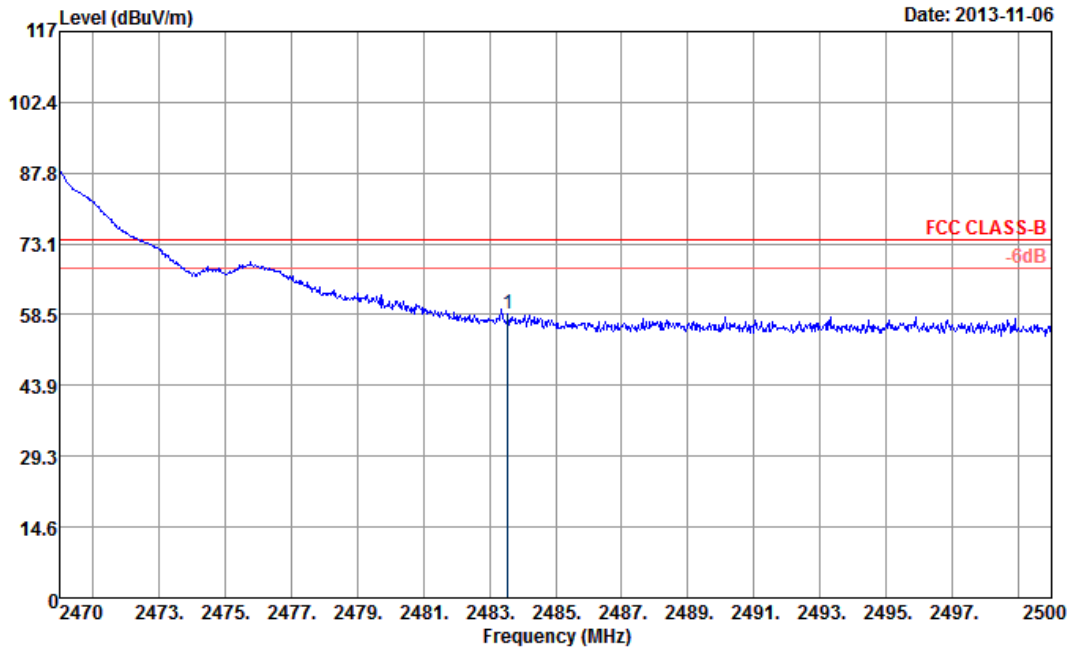

Site : 03CH07-HY  
 Condition : FCC CLASS-B 3m HF-ANT\_120823 HORIZONTAL  
 : RBW:1000.000KHz VBW:3000.000KHz SWT:Auto

ANTENNA POLARITY : HORIZONTAL

Frequency ( MHz )	Level (dBμV/m)	Over Limit ( dB )	Limit Line (dBμV/m)	Read Level (dBμV)	Antenna Factor (dB)	Cable Loss (dB)	Preamp Factor (dB)	Ant Pos (cm)	Table Pos (deg)	Remark
2483.56	58.69	-15.31	74	53.68	32.38	7.06	34.43	105	66	Peak

**Note:** Worst case measurement on 2483.56 MHz is compliance with 74/54 dBuV/m (peak/average) limit and band edge measurement in the restricted band 2483.5-2500MHz. And, 2470-2483.5MHz is within the operating band and not within the restricted band. The test result is compliance with the FCC limit line.



Test Mode :	802.11b	Temperature :	21~23°C
Test Band :	High	Relative Humidity :	49~51%
Test Channel :	11	Test Engineer :	Eric Shih

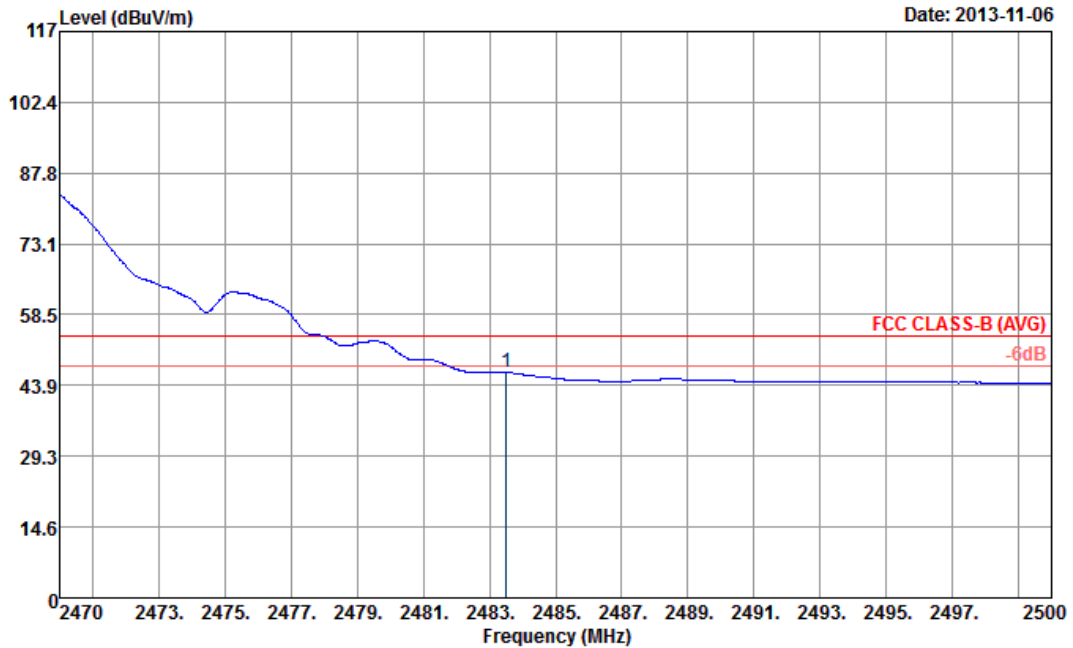

Site : 03CH07-HY  
 Condition : FCC CLASS-B (AVG) 3m HF-ANT\_120823 HORIZONTAL  
 : RBW:1000.000KHz VBW:0.010KHz SWT:Auto

ANTENNA POLARITY : HORIZONTAL

Frequency ( MHz )	Level (dBμV/m)	Over Limit ( dB )	Limit Line (dBμV/m)	Read Level (dBμV)	Antenna Factor (dB)	Cable Loss (dB)	Preamp Factor (dB)	Ant Pos (cm)	Table Pos (deg)	Remark
2483.50	46.67	-7.33	54	41.66	32.38	7.06	34.43	105	66	Average

**Note:** Worst case measurement on 2483.50 MHz is compliance with 74/54 dBuV/m (peak/average) limit and band edge measurement in the restricted band 2483.5-2500MHz. And, 2470-2483.5MHz is within the operating band and not within the restricted band. The test result is compliance with the FCC limit line.



Test Mode :	802.11b	Temperature :	21~23°C
Test Band :	High	Relative Humidity :	49~51%
Test Channel :	11	Test Engineer :	Eric Shih

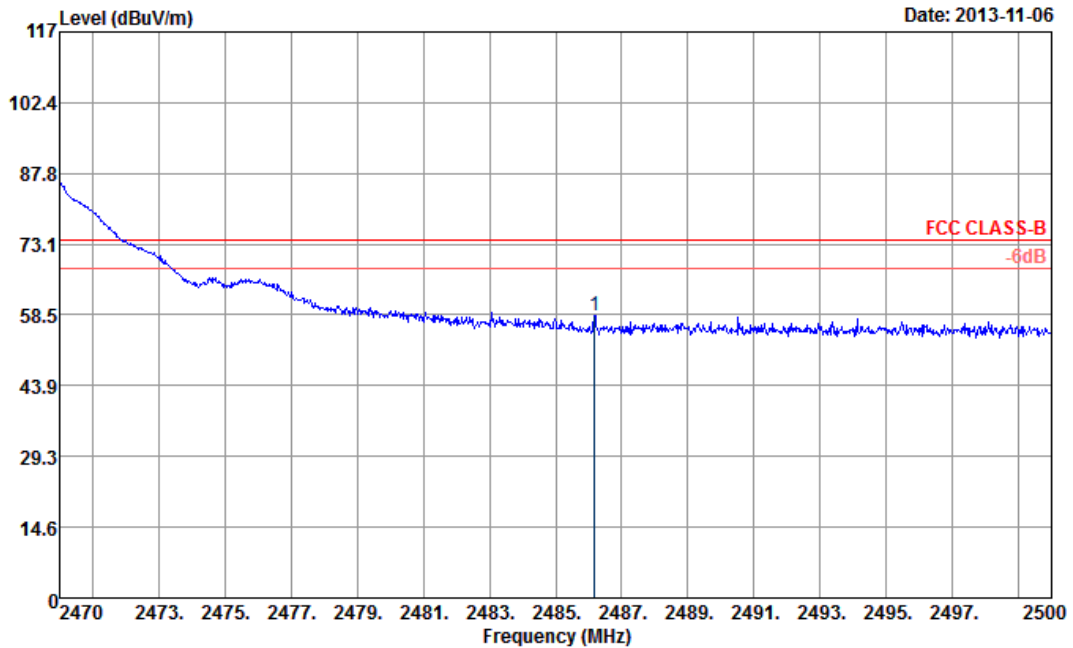

Site : 03CH07-HY  
 Condition : FCC CLASS-B 3m HF-ANT\_120823 VERTICAL  
 : RBW:1000.000KHz VBW:3000.000KHz SWT:Auto

ANTENNA POLARITY : VERTICAL

Frequency ( MHz )	Level (dBμV/m)	Over Limit ( dB )	Limit Line (dBμV/m)	Read Level (dBμV)	Antenna Factor (dB)	Cable Loss (dB)	Preamp Factor (dB)	Ant Pos (cm)	Table Pos (deg)	Remark
2486.17	58.46	-15.54	74	53.45	32.38	7.06	34.43	118	57	Peak

**Note:** Worst case measurement on 2486.17 MHz is compliance with 74/54 dBuV/m (peak/average) limit and band edge measurement in the restricted band 2483.5-2500MHz. And, 2470-2483.5MHz is within the operating band and not within the restricted band. The test result is compliance with the FCC limit line.



Test Mode :	802.11b	Temperature :	21~23°C
Test Band :	High	Relative Humidity :	49~51%
Test Channel :	11	Test Engineer :	Eric Shih

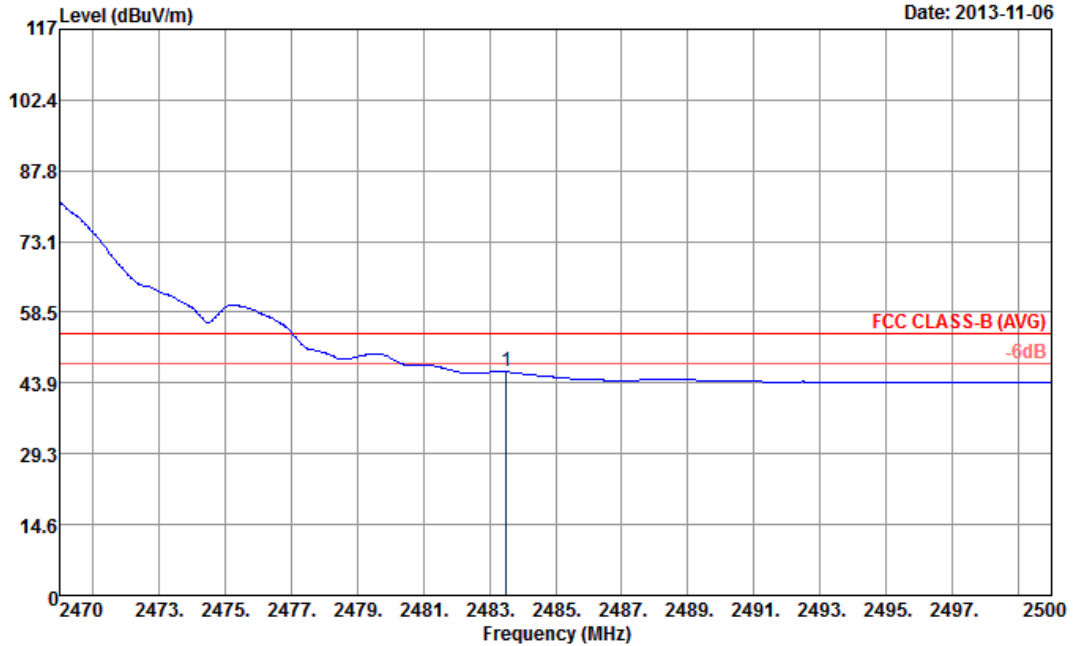

Site : 03CH07-HY  
 Condition : FCC CLASS-B (AVG) 3m HF-ANT\_120823 VERTICAL  
 : RBW:1000.000KHz VBW:0.010KHz SWT:Auto

ANTENNA POLARITY : VERTICAL

Frequency ( MHz )	Level (dBμV/m)	Over Limit ( dB )	Limit Line (dBμV/m)	Read Level (dBμV)	Antenna Factor (dB)	Cable Loss (dB)	Preamp Factor (dB)	Ant Pos (cm)	Table Pos (deg)	Remark
2483.50	46.14	-7.86	54	41.13	32.38	7.06	34.43	118	57	Average

**Note:** Worst case measurement on 2483.50 MHz is compliance with 74/54 dBuV/m (peak/average) limit and band edge measurement in the restricted band 2483.5-2500MHz. And, 2470-2483.5MHz is within the operating band and not within the restricted band. The test result is compliance with the FCC limit line.



Test Mode :	802.11g	Temperature :	21~23°C
Test Band :	Low	Relative Humidity :	49~51%
Test Channel :	01	Test Engineer :	Eric Shih

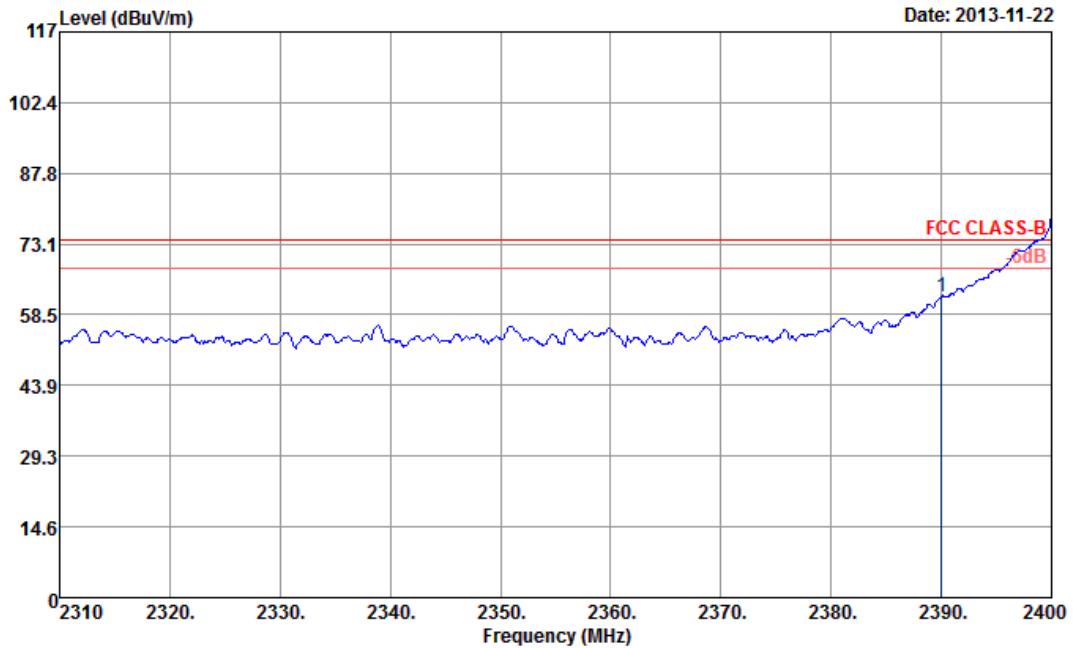

Site : 03CH07-HY  
 Condition : FCC CLASS-B 3m HF-ANT\_120823 HORIZONTAL  
 : RBW:1000.000KHz VBW:3000.000KHz SWT:Auto

ANTENNA POLARITY : HORIZONTAL

Frequency ( MHz )	Level (dBμV/m)	Over Limit ( dB )	Limit Line (dBμV/m)	Read Level (dBμV)	Antenna Factor (dB)	Cable Loss (dB)	Preamp Factor (dB)	Ant Pos (cm)	Table Pos (deg)	Remark
2390	62.39	-11.61	74	57.48	32.3	6.91	34.3	188	7	Peak

**Note:** Worst case measurement on 2390 MHz is compliance with 74/54 dBuV/m (peak/average) limit and band edge measurement in the restricted band 2310-2390MHz. And, 2390-2400 MHz is non-restricted band which limit line is 20dB below the fundamental frequency emission level which is tested by conducted spurious emission. Both the test results are compliance with the FCC limit line.



Test Mode :	802.11g	Temperature :	21~23°C
Test Band :	Low	Relative Humidity :	49~51%
Test Channel :	01	Test Engineer :	Eric Shih

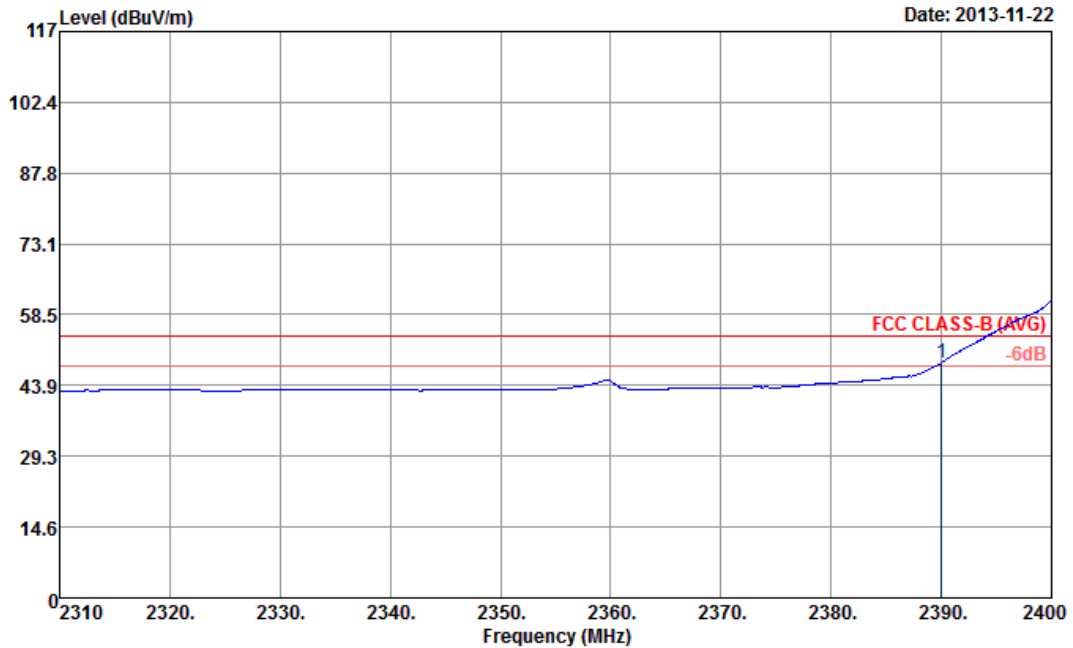

Site : 03CH07-HY  
 Condition : FCC CLASS-B (AVG) 3m HF-ANT\_120823 HORIZONTAL  
 : RBW:1000.000KHz VBW:0.010KHz SWT:Auto

ANTENNA POLARITY : HORIZONTAL

Frequency ( MHz )	Level (dBμV/m)	Over Limit ( dB )	Limit Line (dBμV/m)	Read Level (dBμV)	Antenna Factor (dB)	Cable Loss (dB)	Preamp Factor (dB)	Ant Pos (cm)	Table Pos (deg)	Remark
2390.00	48.63	-5.37	54	43.72	32.3	6.91	34.3	188	7	Average

**Note:** Worst case measurement on 2390 MHz is compliance with 74/54 dBuV/m (peak/average) limit and band edge measurement in the restricted band 2310-2390MHz. And, 2390-2400 MHz is non-restricted band which limit line is 20dB below the fundamental frequency emission level which is tested by conducted spurious emission. Both the test results are compliance with the FCC limit line.



Test Mode :	802.11g	Temperature :	21~23°C
Test Band :	Low	Relative Humidity :	49~51%
Test Channel :	01	Test Engineer :	Eric Shih

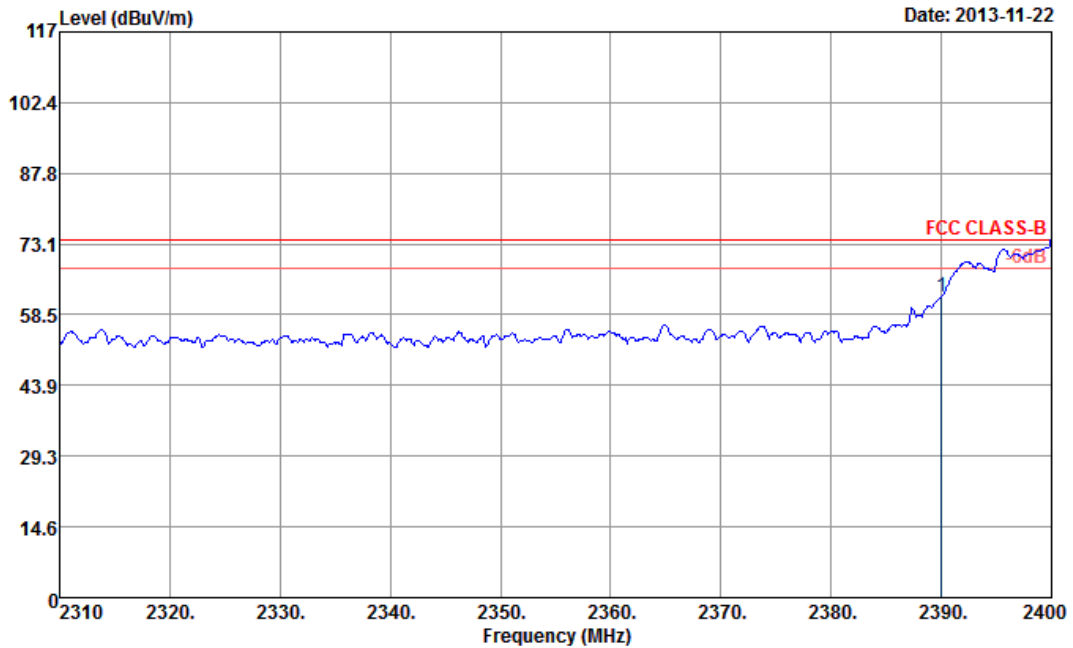

Site : 03CH07-HY  
 Condition : FCC CLASS-B 3m HF-ANT\_120823 VERTICAL  
 : RBW:1000.000KHz VBW:3000.000KHz SWT:Auto

ANTENNA POLARITY : VERTICAL

Frequency ( MHz )	Level (dBμV/m)	Over Limit ( dB )	Limit Line (dBμV/m)	Read Level (dBμV)	Antenna Factor (dB)	Cable Loss (dB)	Preamp Factor (dB)	Ant Pos (cm)	Table Pos (deg)	Remark
2390.00	62.35	-11.65	74	57.44	32.3	6.91	34.3	166	1	Peak

**Note:** Worst case measurement on 2390.00 MHz is compliance with 74/54 dBuV/m (peak/average) limit and band edge measurement in the restricted band 2310-2390MHz. And, 2390-2400 MHz is non-restricted band which limit line is 20dB below the fundamental frequency emission level which is tested by conducted spurious emission. Both the test results are compliance with the FCC limit line.



Test Mode :	802.11g	Temperature :	21~23°C
Test Band :	Low	Relative Humidity :	49~51%
Test Channel :	01	Test Engineer :	Eric Shih

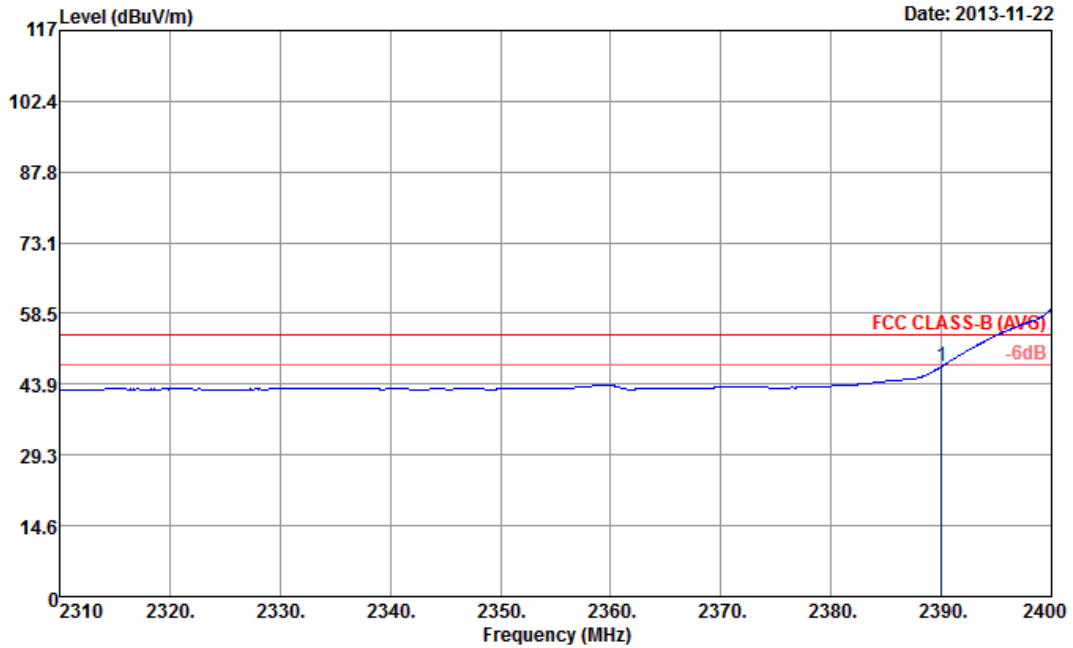

Site : 03CH07-HY  
 Condition : FCC CLASS-B (AVG) 3m HF-ANT\_120823 VERTICAL  
 : RBW:1000.000KHz VBW:0.010KHz SWT:Auto

ANTENNA POLARITY : VERTICAL

Frequency ( MHz )	Level (dBμV/m)	Over Limit ( dB )	Limit Line (dBμV/m)	Read Level (dBμV)	Antenna Factor (dB)	Cable Loss (dB)	Preamp Factor (dB)	Ant Pos (cm)	Table Pos (deg)	Remark
2390.00	47.52	-6.48	54	42.61	32.3	6.91	34.3	166	1	Average

**Note:** Worst case measurement on 2390.00 MHz is compliance with 74/54 dBuV/m (peak/average) limit and band edge measurement in the restricted band 2310-2390MHz. And, 2390-2400 MHz is non-restricted band which limit line is 20dB below the fundamental frequency emission level which is tested by conducted spurious emission. Both the test results are compliance with the FCC limit line.





Test Mode :	802.11g	Temperature :	21~23°C
Test Band :	High	Relative Humidity :	49~51%
Test Channel :	11	Test Engineer :	Eric Shih

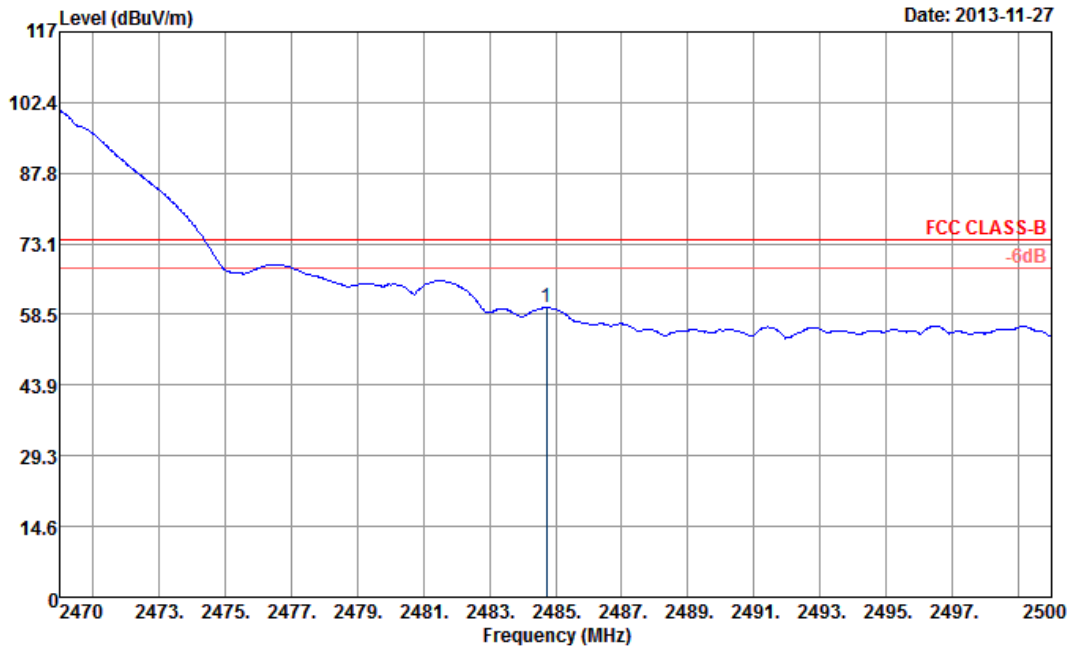

Site : 03CH07-HY  
 Condition : FCC CLASS-B 3m HF-ANT\_120823 HORIZONTAL  
 : RBW:1000.000KHz VBW:3000.000KHz SWT:Auto

ANTENNA POLARITY : HORIZONTAL

Frequency ( MHz )	Level (dBμV/m)	Over Limit ( dB )	Limit Line (dBμV/m)	Read Level (dBμV)	Antenna Factor (dB)	Cable Loss (dB)	Preamp Factor (dB)	Ant Pos (cm)	Table Pos (deg)	Remark
2484.73	59.87	-14.13	74	54.86	32.38	7.06	34.43	105	138	Peak

**Note:** Worst case measurement on 2484.73 MHz is compliance with 74/54 dBuV/m (peak/average) limit and band edge measurement in the restricted band 2483.5-2500MHz. And, 2470-2483.5MHz is within the operating band and not within the restricted band. The test result is compliance with the FCC limit line.



Test Mode :	802.11g	Temperature :	21~23°C
Test Band :	High	Relative Humidity :	49~51%
Test Channel :	11	Test Engineer :	Eric Shih

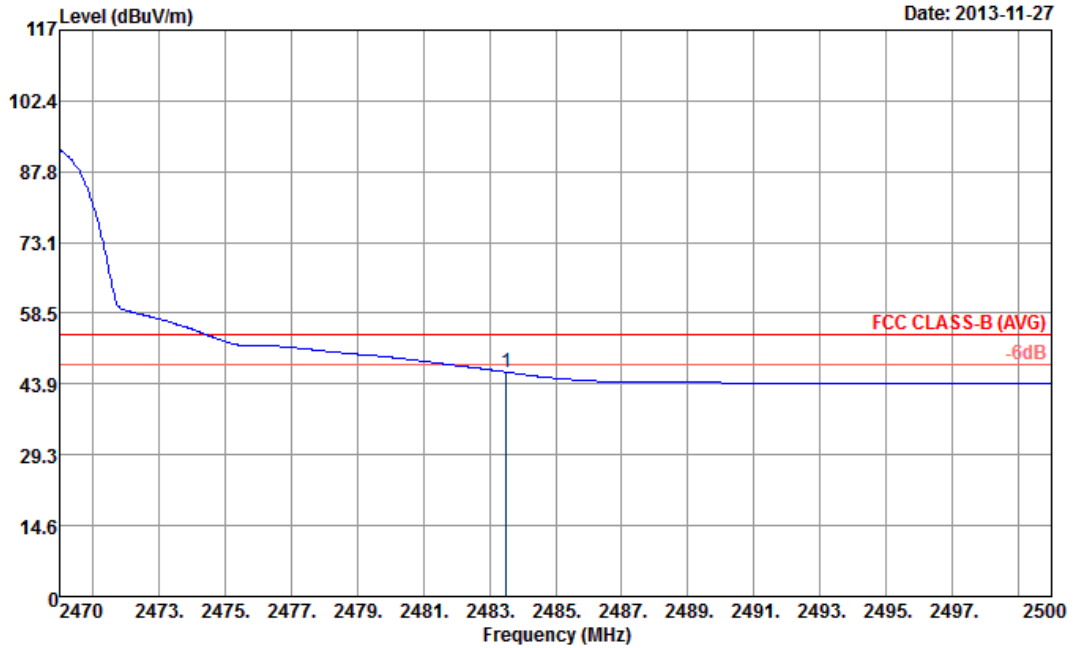

Site : 03CH07-HY  
 Condition : FCC CLASS-B (AVG) 3m HF-ANT\_120823 HORIZONTAL  
 : RBW:1000.000KHz VBW:0.010KHz SWT:Auto

ANTENNA POLARITY : HORIZONTAL

Frequency ( MHz )	Level (dBμV/m)	Over Limit ( dB )	Limit Line (dBμV/m)	Read Level (dBμV)	Antenna Factor (dB)	Cable Loss (dB)	Preamp Factor (dB)	Ant Pos (cm)	Table Pos (deg)	Remark
2483.5	46.35	-7.65	54	41.34	32.38	7.06	34.43	105	138	Average

**Note:** Worst case measurement on 2483.50 MHz is compliance with 74/54 dBuV/m (peak/average) limit and band edge measurement in the restricted band 2483.5-2500MHz. And, 2470-2483.5MHz is within the operating band and not within the restricted band. The test result is compliance with the FCC limit line.



Test Mode :	802.11g	Temperature :	21~23°C
Test Band :	High	Relative Humidity :	49~51%
Test Channel :	11	Test Engineer :	Eric Shih

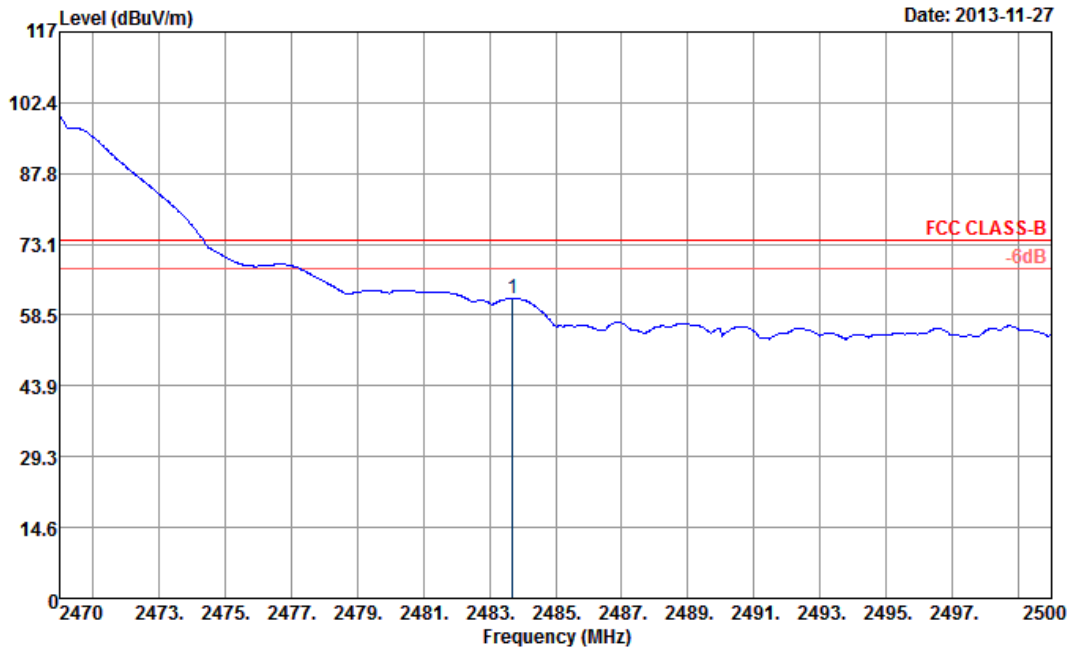

Site : 03CH07-HY  
 Condition : FCC CLASS-B 3m HF-ANT\_120823 VERTICAL  
 : RBW:1000.000KHz VBW:3000.000KHz SWT:Auto

ANTENNA POLARITY : VERTICAL

Frequency ( MHz )	Level (dBμV/m)	Over Limit ( dB )	Limit Line (dBμV/m)	Read Level (dBμV)	Antenna Factor (dB)	Cable Loss (dB)	Preamp Factor (dB)	Ant Pos (cm)	Table Pos (deg)	Remark
2483.71	61.95	-12.05	74	56.94	32.38	7.06	34.43	119	72	Peak

**Note:** Worst case measurement on 2483.71 MHz is compliance with 74/54 dBuV/m (peak/average) limit and band edge measurement in the restricted band 2483.5-2500MHz. And, 2470-2483.5MHz is within the operating band and not within the restricted band. The test result is compliance with the FCC limit line.



Test Mode :	802.11g	Temperature :	21~23°C
Test Band :	High	Relative Humidity :	49~51%
Test Channel :	11	Test Engineer :	Eric Shih

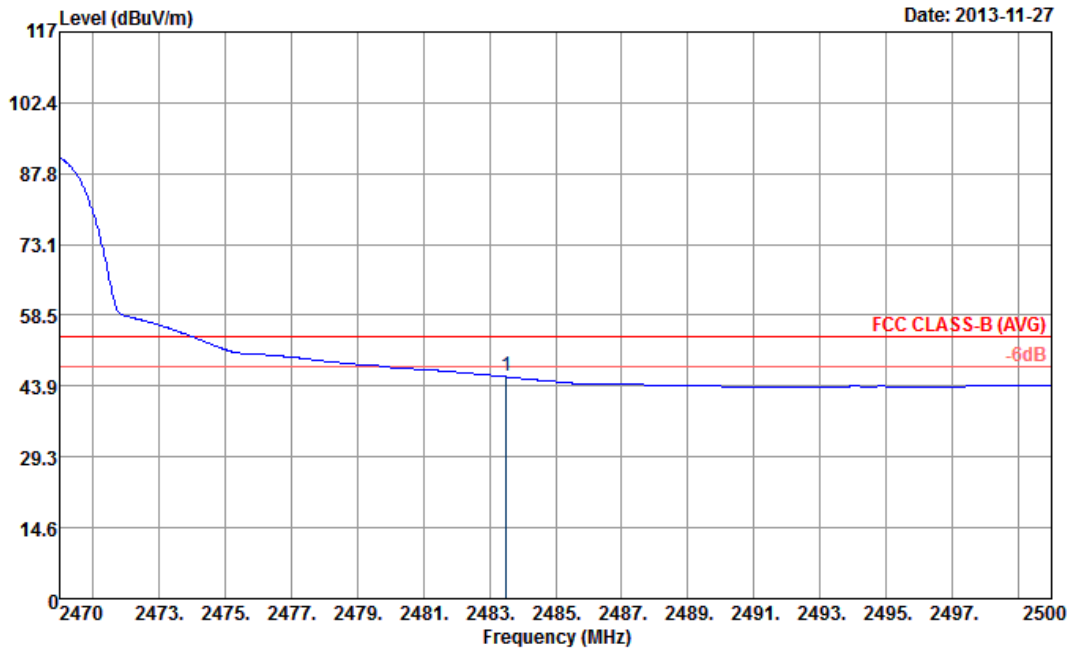

Site : 03CH07-HY  
 Condition : FCC CLASS-B (AVG) 3m HF-ANT\_120823 VERTICAL  
 : RBW:1000.000KHz VBW:0.010KHz SWT:Auto

ANTENNA POLARITY : VERTICAL

Frequency ( MHz )	Level (dBμV/m)	Over Limit ( dB )	Limit Line (dBμV/m)	Read Level (dBμV)	Antenna Factor (dB)	Cable Loss (dB)	Preamp Factor (dB)	Ant Pos (cm)	Table Pos (deg)	Remark
2483.5	45.8	-8.2	54	40.79	32.38	7.06	34.43	119	72	Average

**Note:** Worst case measurement on 2483.50 MHz is compliance with 74/54 dBuV/m (peak/average) limit and band edge measurement in the restricted band 2483.5-2500MHz. And, 2470-2483.5MHz is within the operating band and not within the restricted band. The test result is compliance with the FCC limit line.



Test Mode :	802.11n HT20	Temperature :	21~23°C
Test Band :	Low	Relative Humidity :	49~51%
Test Channel :	01	Test Engineer :	Eric Shih

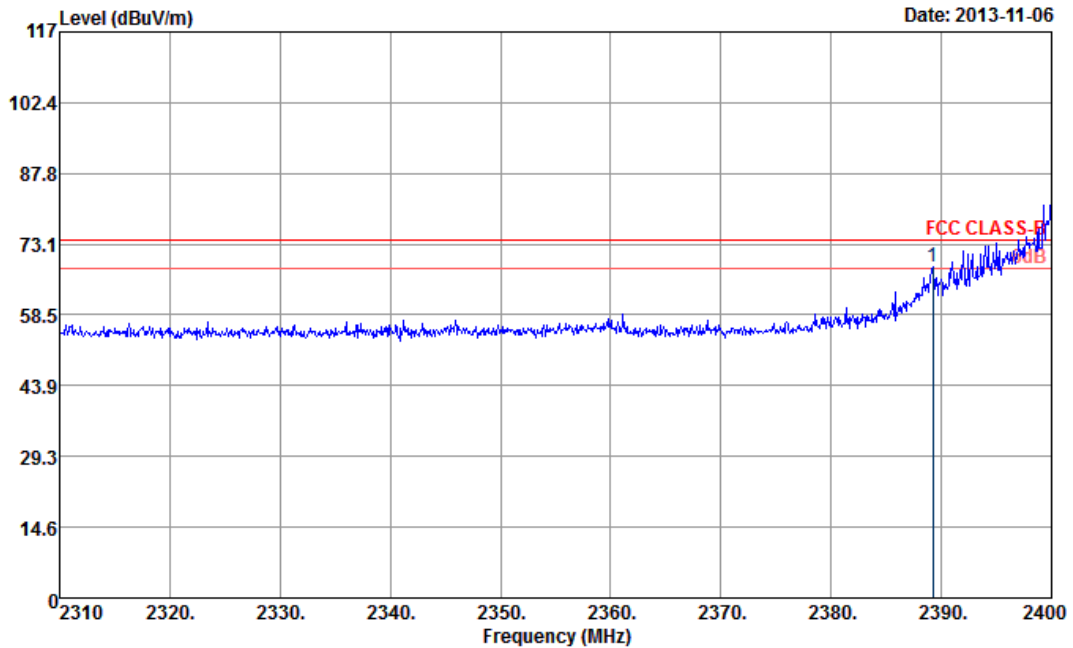

Site : 03CH07-HY  
 Condition : FCC CLASS-B 3m HF-ANT\_120823 HORIZONTAL  
 : RBW:1000.000KHz VBW:3000.000KHz SWT:Auto

ANTENNA POLARITY : HORIZONTAL

Frequency ( MHz )	Level (dBμV/m)	Over Limit ( dB )	Limit Line (dBμV/m)	Read Level (dBμV)	Antenna Factor (dB)	Cable Loss (dB)	Preamp Factor (dB)	Ant Pos (cm)	Table Pos (deg)	Remark
2389.20	68.42	-5.58	74	63.48	32.3	6.91	34.27	138	48	Peak

**Note:** Worst case measurement on 2389.20 MHz is compliance with 74/54 dBuV/m (peak/average) limit and band edge measurement in the restricted band 2310-2390MHz. And, 2390-2400 MHz is non-restricted band which limit line is 20dB below the fundamental frequency emission level which is tested by conducted spurious emission. Both the test results are compliance with the FCC limit line.



Test Mode :	802.11n HT20	Temperature :	21~23°C
Test Band :	Low	Relative Humidity :	49~51%
Test Channel :	01	Test Engineer :	Eric Shih

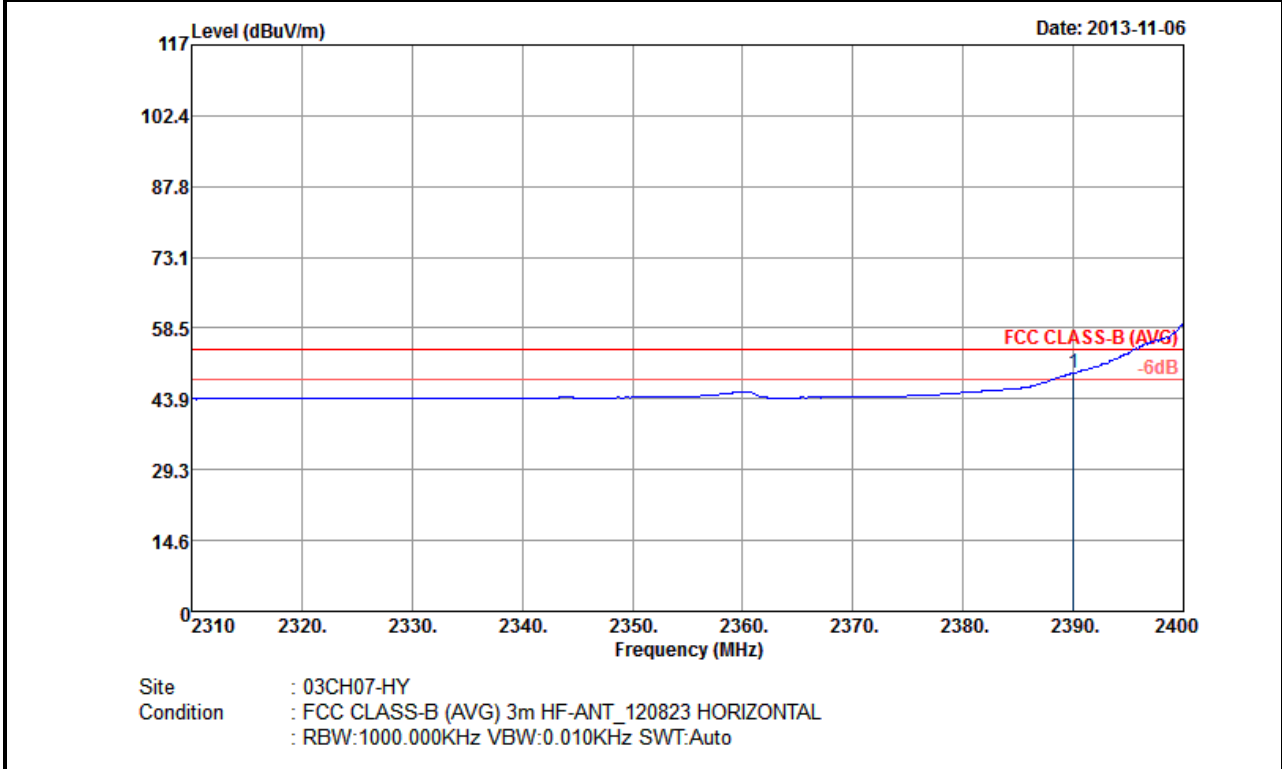

ANTENNA POLARITY : HORIZONTAL										
Frequency ( MHz )	Level (dBμV/m)	Over Limit ( dB )	Limit Line (dBμV/m)	Read Level (dBμV)	Antenna Factor (dB)	Cable Loss (dB)	Preamp Factor (dB)	Ant Pos (cm)	Table Pos (deg)	Remark
2390.00	49.29	-4.71	54	44.38	32.3	6.91	34.3	138	48	Average

**Note:** Worst case measurement on 2390.00 MHz is compliance with 74/54 dBuV/m (peak/average) limit and band edge measurement in the restricted band 2310-2390MHz. And, 2390-2400 MHz is non-restricted band which limit line is 20dB below the fundamental frequency emission level which is tested by conducted spurious emission. Both the test results are compliance with the FCC limit line.



Test Mode :	802.11n HT20	Temperature :	21~23°C
Test Band :	Low	Relative Humidity :	49~51%
Test Channel :	01	Test Engineer :	Eric Shih

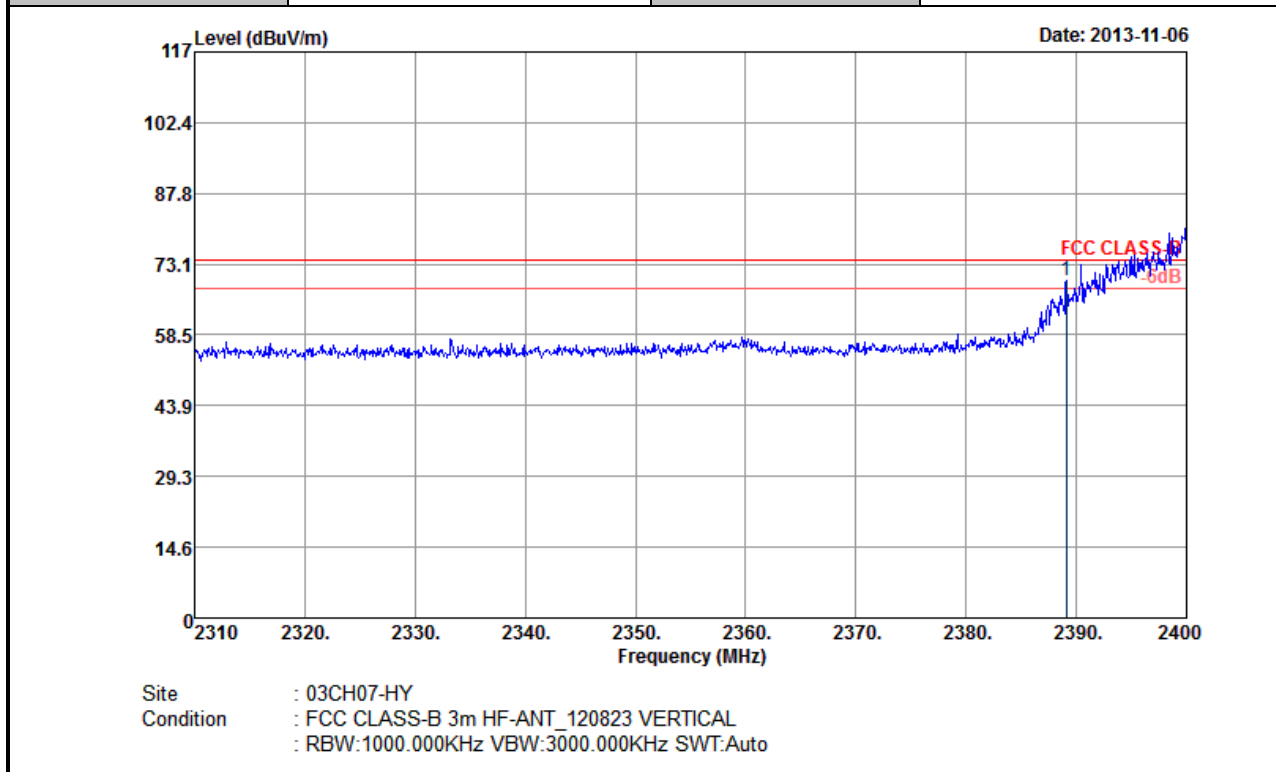

ANTENNA POLARITY : VERTICAL										
Frequency ( MHz )	Level (dBμV/m)	Over Limit ( dB )	Limit Line (dBμV/m)	Read Level (dBμV)	Antenna Factor (dB)	Cable Loss (dB)	Preamp Factor (dB)	Ant Pos (cm)	Table Pos (deg)	Remark
2389.11	69.67	-4.33	74	64.73	32.3	6.91	34.27	100	143	Peak

**Note:** Worst case measurement on 2389.11 MHz is compliance with 74/54 dBuV/m (peak/average) limit and band edge measurement in the restricted band 2310-2390MHz. And, 2390-2400 MHz is non-restricted band which limit line is 20dB below the fundamental frequency emission level which is tested by conducted spurious emission. Both the test results are compliance with the FCC limit line.



Test Mode :	802.11n HT20	Temperature :	21~23°C
Test Band :	Low	Relative Humidity :	49~51%
Test Channel :	01	Test Engineer :	Eric Shih

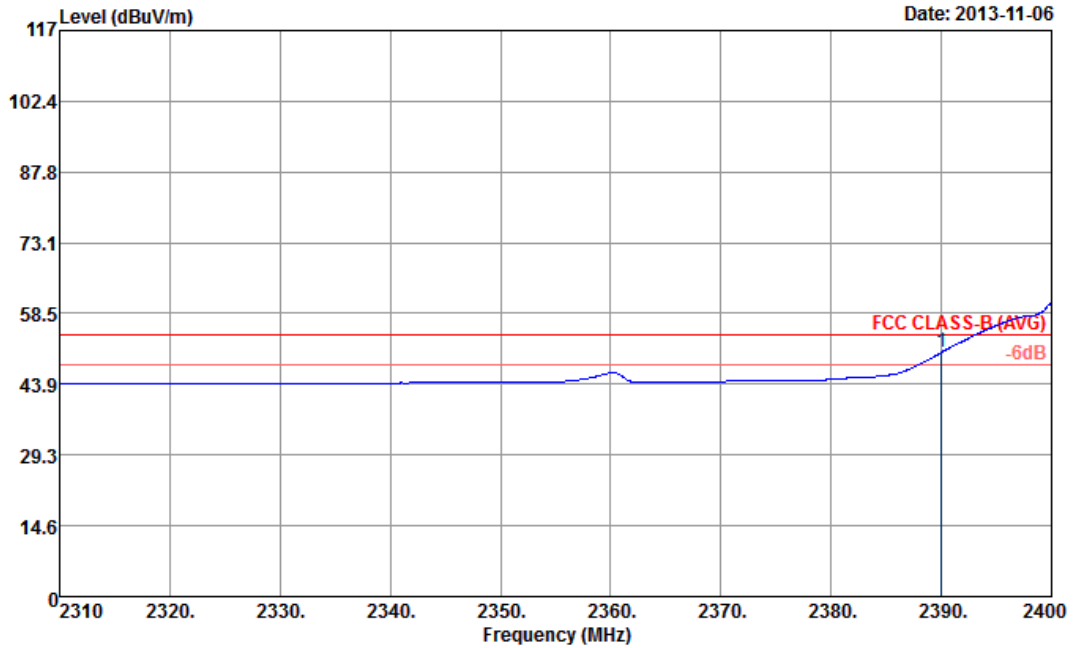

Site : 03CH07-HY  
 Condition : FCC CLASS-B (AVG) 3m HF-ANT\_120823 VERTICAL  
 : RBW:1000.000KHz VBW:0.010KHz SWT:Auto

ANTENNA POLARITY : VERTICAL

Frequency ( MHz )	Level (dBμV/m)	Over Limit ( dB )	Limit Line (dBμV/m)	Read Level (dBμV)	Antenna Factor (dB)	Cable Loss (dB)	Preamp Factor (dB)	Ant Pos (cm)	Table Pos (deg)	Remark
2390.00	50.43	-3.57	54	45.52	32.3	6.91	34.3	100	143	Average

**Note:** Worst case measurement on 2390.00 MHz is compliance with 74/54 dBuV/m (peak/average) limit and band edge measurement in the restricted band 2310-2390MHz. And, 2390-2400 MHz is non-restricted band which limit line is 20dB below the fundamental frequency emission level which is tested by conducted spurious emission. Both the test results are compliance with the FCC limit line.





Test Mode :	802.11n HT20	Temperature :	21~23°C
Test Band :	High	Relative Humidity :	49~51%
Test Channel :	11	Test Engineer :	Eric Shih

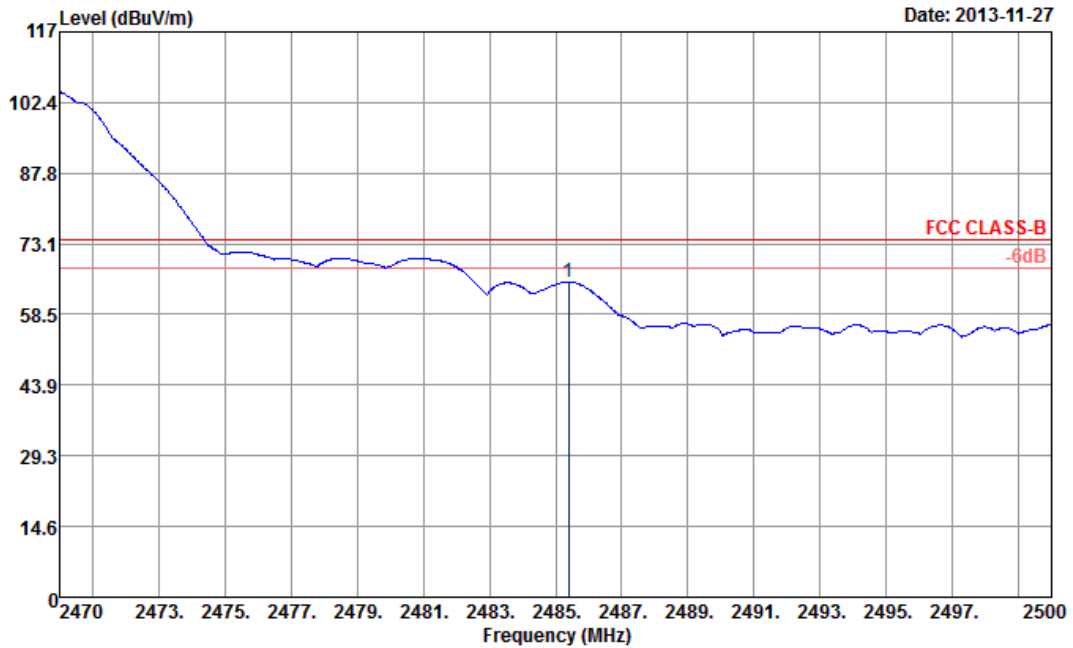

Site : 03CH07-HY  
 Condition : FCC CLASS-B 3m HF-ANT\_120823 HORIZONTAL  
 : RBW:1000.000KHz VBW:3000.000KHz SWT:Auto

ANTENNA POLARITY : HORIZONTAL

Frequency ( MHz )	Level (dBμV/m)	Over Limit ( dB )	Limit Line (dBμV/m)	Read Level (dBμV)	Antenna Factor (dB)	Cable Loss (dB)	Preamp Factor (dB)	Ant Pos (cm)	Table Pos (deg)	Remark
2485.39	65.27	-8.73	74	60.26	32.38	7.06	34.43	103	201	Peak

**Note:** Worst case measurement on 2485.39 MHz is compliance with 74/54 dBUV/m (peak/average) limit and band edge measurement in the restricted band 2483.5-2500MHz. And, 2470-2483.5MHz is within the operating band and not within the restricted band. The test result is compliance with the FCC limit line.



Test Mode :	802.11n HT20	Temperature :	21~23°C
Test Band :	High	Relative Humidity :	49~51%
Test Channel :	11	Test Engineer :	Eric Shih

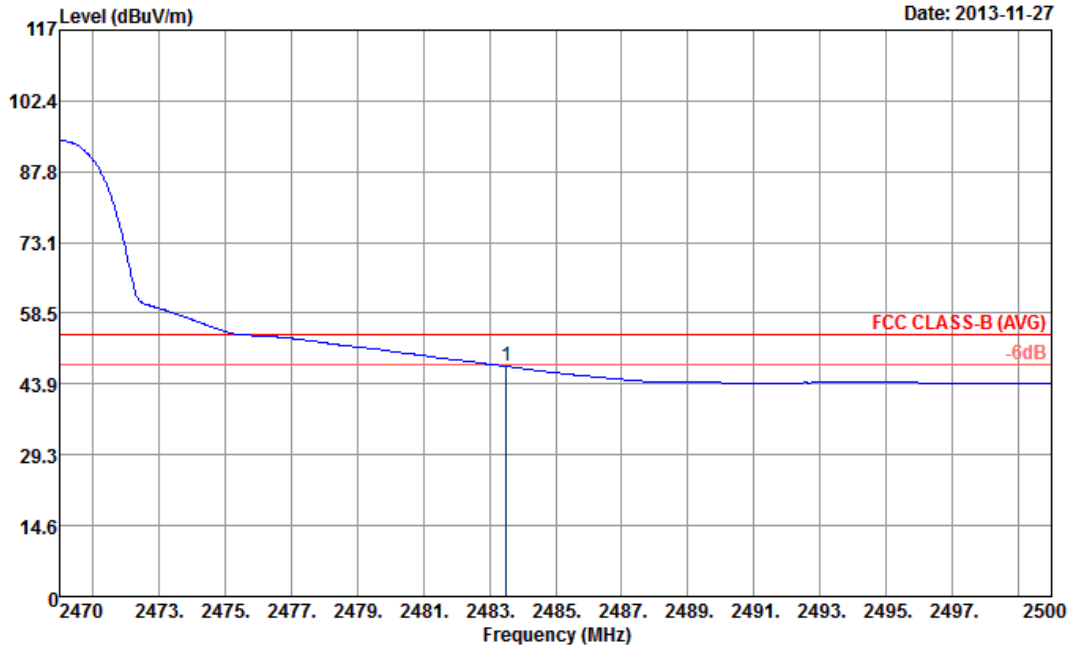

Site : 03CH07-HY  
 Condition : FCC CLASS-B (AVG) 3m HF-ANT\_120823 HORIZONTAL  
 : RBW:1000.000KHz VBW:0.010KHz SWT:Auto

ANTENNA POLARITY : HORIZONTAL

Frequency ( MHz )	Level (dBμV/m)	Over Limit ( dB )	Limit Line (dBμV/m)	Read Level (dBμV)	Antenna Factor (dB)	Cable Loss (dB)	Preamp Factor (dB)	Ant Pos (cm)	Table Pos (deg)	Remark
2483.5	47.55	-6.45	54	42.54	32.38	7.06	34.43	103	201	Average

**Note:** Worst case measurement on 2483.50 MHz is compliance with 74/54 dBuV/m (peak/average) limit and band edge measurement in the restricted band 2483.5-2500MHz. And, 2470-2483.5MHz is within the operating band and not within the restricted band. The test result is compliance with the FCC limit line.



Test Mode :	802.11n HT20	Temperature :	21~23°C
Test Band :	High	Relative Humidity :	49~51%
Test Channel :	11	Test Engineer :	Eric Shih

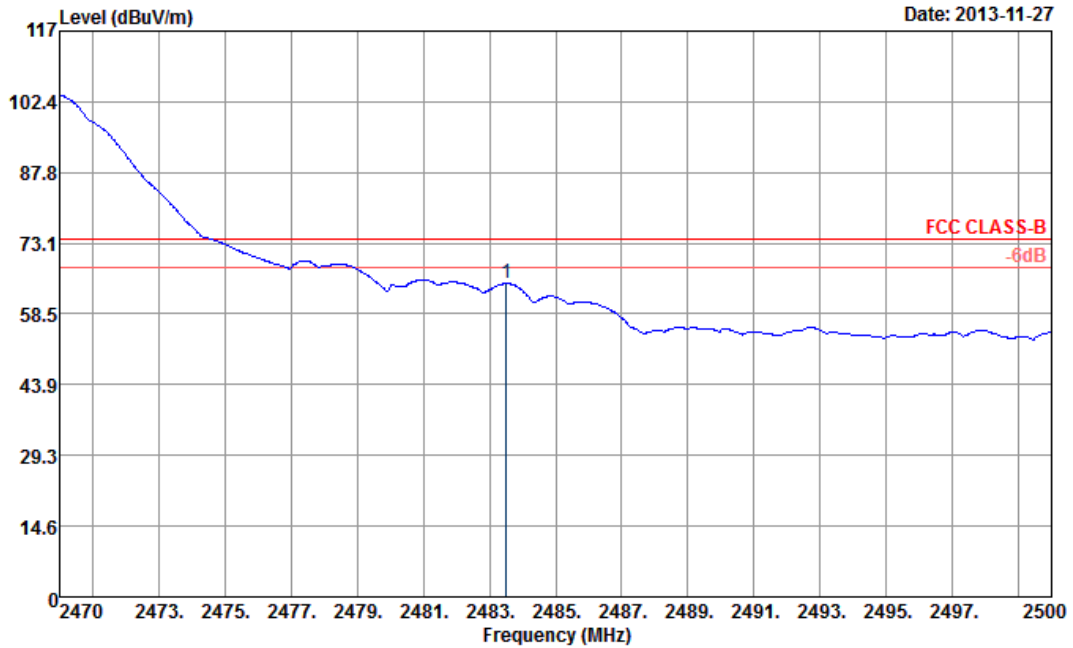

Site : 03CH07-HY  
 Condition : FCC CLASS-B 3m HF-ANT\_120823 VERTICAL  
 : RBW:1000.000KHz VBW:3000.000KHz SWT:Auto

ANTENNA POLARITY : VERTICAL

Frequency ( MHz )	Level (dBμV/m)	Over Limit ( dB )	Limit Line (dBμV/m)	Read Level (dBμV)	Antenna Factor (dB)	Cable Loss (dB)	Preamp Factor (dB)	Ant Pos (cm)	Table Pos (deg)	Remark
2483.5	64.79	-9.21	74	59.78	32.38	7.06	34.43	120	54	Peak

**Note:** Worst case measurement on 2483.5 MHz is compliance with 74/54 dBuV/m (peak/average) limit and band edge measurement in the restricted band 2483.5-2500MHz. And, 2470-2483.5MHz is within the operating band and not within the restricted band. The test result is compliance with the FCC limit line.



Test Mode :	802.11n HT20	Temperature :	21~23°C
Test Band :	High	Relative Humidity :	49~51%
Test Channel :	11	Test Engineer :	Eric Shih

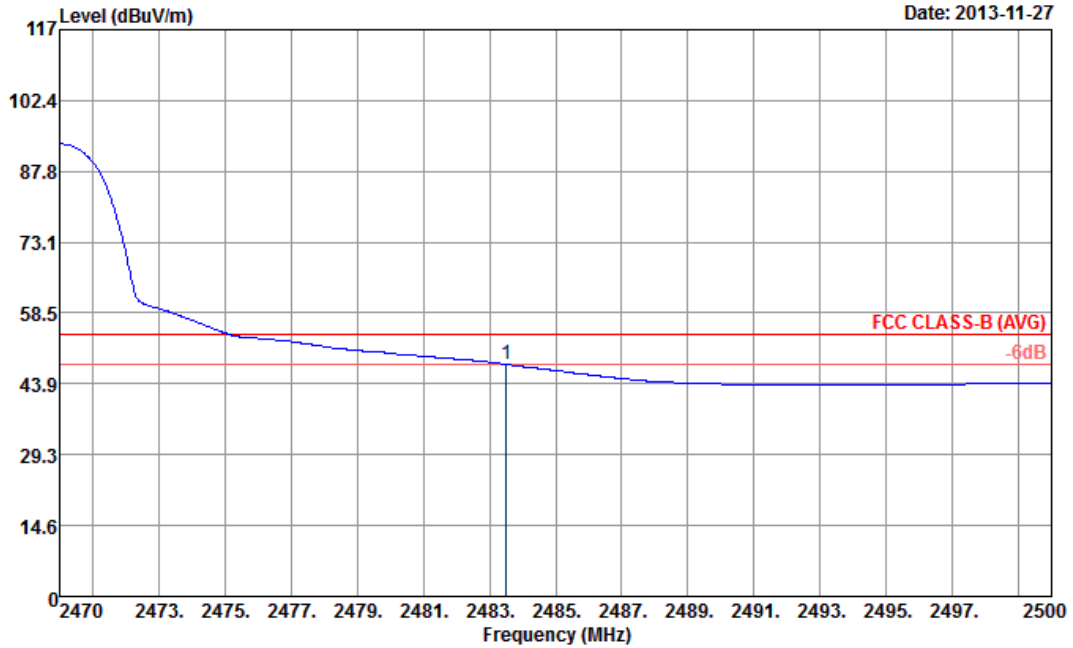

Site : 03CH07-HY  
 Condition : FCC CLASS-B (AVG) 3m HF-ANT\_120823 VERTICAL  
 : RBW:1000.000KHz VBW:0.010KHz SWT:Auto

ANTENNA POLARITY : VERTICAL

Frequency ( MHz )	Level (dBμV/m)	Over Limit ( dB )	Limit Line (dBμV/m)	Read Level (dBμV)	Antenna Factor (dB)	Cable Loss (dB)	Preamp Factor (dB)	Ant Pos (cm)	Table Pos (deg)	Remark
2483.5	47.91	-6.09	54	42.9	32.38	7.06	34.43	120	54	Average

**Note:** Worst case measurement on 2483.5 MHz is compliance with 74/54 dBuV/m (peak/average) limit and band edge measurement in the restricted band 2483.5-2500MHz. And, 2470-2483.5MHz is within the operating band and not within the restricted band. The test result is compliance with the FCC limit line.



3.5.7 Test Result of Radiated Emission (30 MHz ~ 10<sup>th</sup> Harmonic)

Test Mode :	802.11b	Temperature :	21~23°C
Test Channel :	01	Relative Humidity :	49~51%
Test Engineer :	Eric Shih		

**Remark :**

- 2414 MHz is fundamental signal which can be ignored.
- 7236 MHz and 9648 MHz are not within a restricted band, and its limit line is 20dB below the highest emission level. For example, 112.70dBμV/m - 20dB = 92.70dBμV/m.
- Average measurement was not performed if peak level went lower than the average limit.
- The harmonic (5<sup>th</sup>, 6<sup>th</sup>, 7<sup>th</sup>, ...etc.) and other spurious are not reported, because those levels are lower than average limit line and background noise.

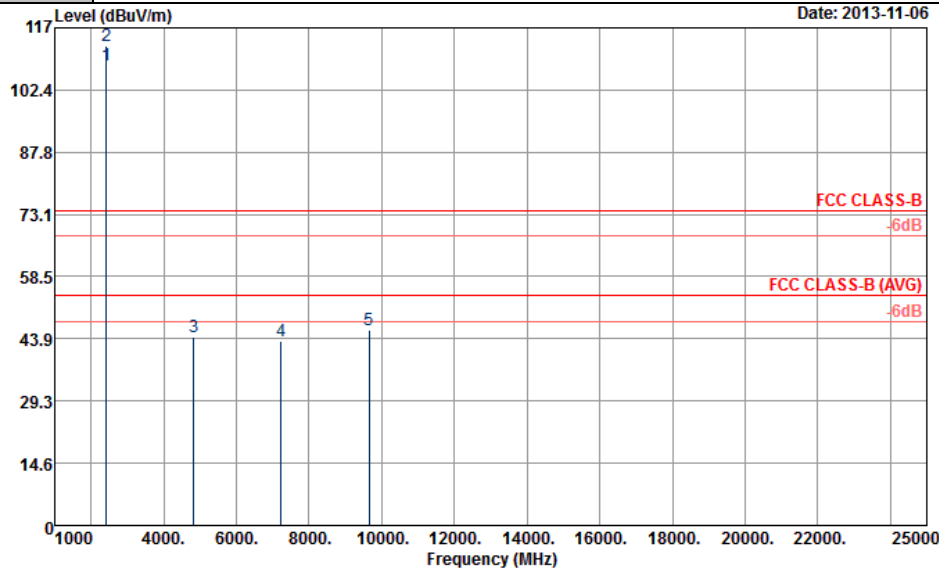

Site : 03CH07-HY  
Condition : FCC CLASS-B 3m SHF-EHF HORIZONTAL

ANTENNA POLARITY : HORIZONTAL

Frequency (MHz)	Level (dBμV/m)	Over Limit (dB)	Limit Line (dBμV/m)	Read Level (dBμV)	Antenna Factor (dB)	Cable Loss (dB)	Preamp Factor (dB)	Ant Pos (cm)	Table Pos (deg)	Remark
2414	108.20	-	-	103.24	32.31	6.95	34.3	112	142	Average
2414	112.70	-	-	107.74	32.31	6.95	34.3	112	142	Peak
4824	44.29	-29.71	74	60.48	33.97	8.77	58.93	100	0	Peak
7236	43.43	-49.27	92.70	54.71	35.55	10.83	57.66	100	0	Peak
9648	45.95	-46.75	92.70	54.44	36.52	13.69	58.7	100	0	Peak

Other harmonics are lower than background noise



Test Mode :	802.11b	Temperature :	21~23°C
Test Channel :	01	Relative Humidity :	49~51%
Test Engineer :	Eric Shih		

**Remark :**

- 2412 MHz is fundamental signal which can be ignored.
- 7236 MHz and 9648 MHz are not within a restricted band, and its limit line is 20dB below the highest emission level.
- Average measurement was not performed if peak level went lower than the average limit.
- The harmonic (5<sup>th</sup>, 6<sup>th</sup>, 7<sup>th</sup>, ...etc.) and other spurious are not reported, because those levels are lower than average limit line and background noise

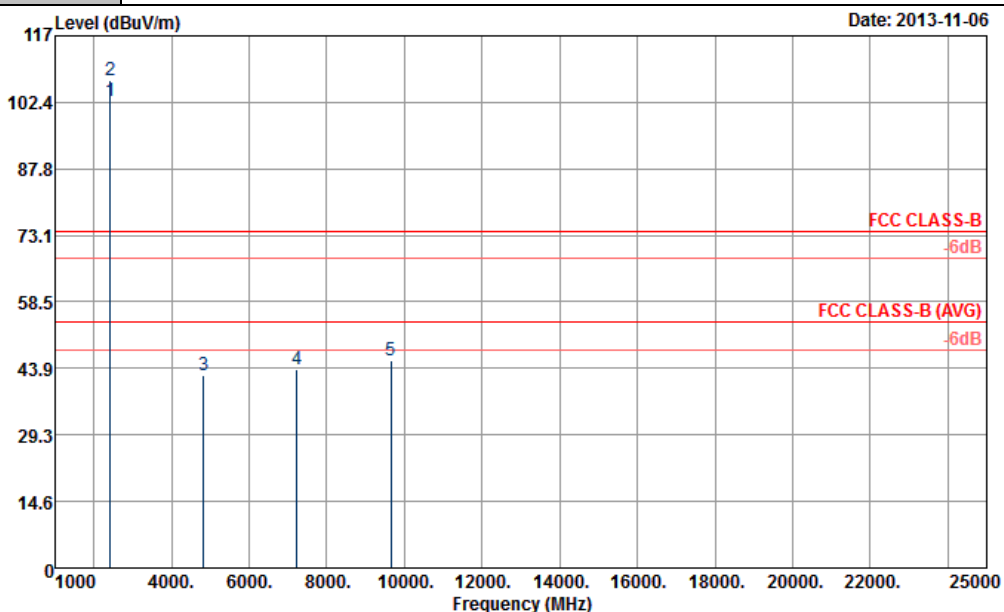

Site : 03CH07-HY  
 Condition : FCC CLASS-B 3m SHF-EHF VERTICAL

**ANTENNA POLARITY : VERTICAL**

Frequency ( MHz )	Level ( dBμV/m )	Over Limit ( dB )	Limit Line ( dBμV/m )	Read Level ( dBμV )	Antenna Factor ( dB )	Cable Loss ( dB )	Preamp Factor ( dB )	Ant Pos ( cm )	Table Pos ( deg )	Remark
2412	102.71	-	-	97.75	32.31	6.95	34.3	117	328	Average
2412	107.35	-	-	102.39	32.31	6.95	34.3	117	328	Peak
4824	42.49	-31.51	74	58.68	33.97	8.77	58.93	100	0	Peak
7236	43.82	-43.53	87.35	55.1	35.55	10.83	57.66	100	0	Peak
9648	45.58	-41.77	87.35	54.07	36.52	13.69	58.7	100	0	Peak

Other harmonics are lower than background noise



Test Mode :	802.11b	Temperature :	21~23°C
Test Channel :	06	Relative Humidity :	49~51%
Test Engineer :	Eric Shih		

**Remark :**

- 2438 MHz is fundamental signal which can be ignored.
- 9747 MHz is not within a restricted band, and its limit line is 20dB below the highest emission level.
- Average measurement was not performed if peak level went lower than the average limit.
- The harmonic (5<sup>th</sup>, 6<sup>th</sup>, 7<sup>th</sup>, ...etc.) and other spurious are not reported, because those levels are lower than average limit line and background noise

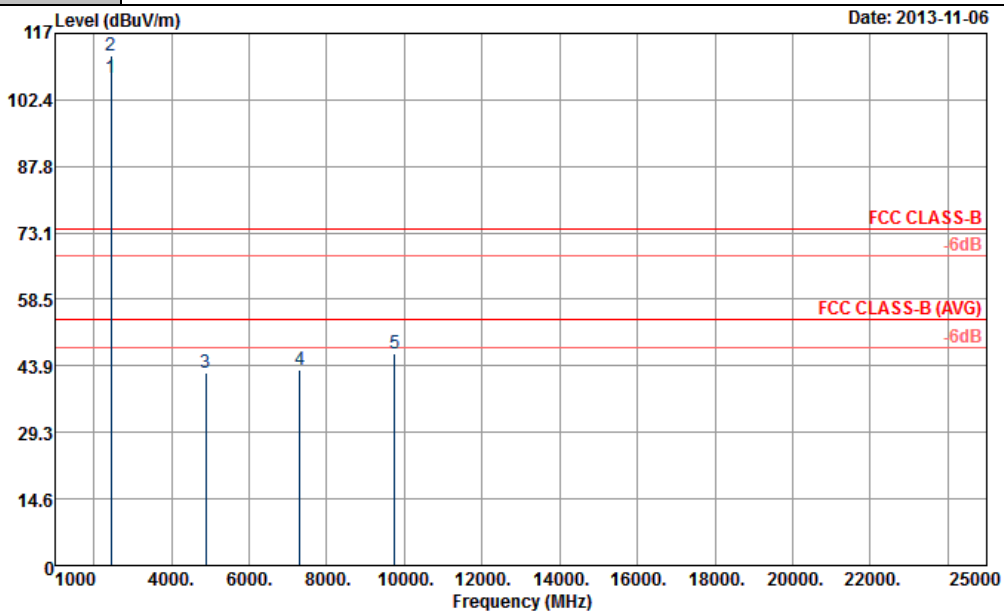

**ANTENNA POLARITY : HORIZONTAL**

Frequency ( MHz )	Level ( dBμV/m )	Over Limit ( dB )	Limit Line ( dBμV/m )	Read Level ( dBμV )	Antenna Factor ( dB )	Cable Loss ( dB )	Preamp Factor ( dB )	Ant Pos ( cm )	Table Pos ( deg )	Remark
2438	107.19	-	-	102.2	32.35	6.99	34.35	134	132	Average
2438	112.01	-	-	107.02	32.35	6.99	34.35	134	132	Peak
4875	42.22	-31.78	74	58.28	33.95	8.82	58.83	100	0	Peak
7311	43.18	-30.82	74	54.46	35.54	10.91	57.73	100	0	Peak
9747	46.48	-45.53	92.01	54.86	36.66	13.69	58.73	100	0	Peak

Other harmonics are lower than background noise



Test Mode :	802.11b	Temperature :	21~23°C
Test Channel :	06	Relative Humidity :	49~51%
Test Engineer :	Eric Shih		

**Remark :**

- 2437 MHz is fundamental signal which can be ignored.
- 9747 MHz is not within a restricted band, and its limit line is 20dB below the highest emission level.
- Average measurement was not performed if peak level went lower than the average limit.
- The harmonic (5<sup>th</sup>, 6<sup>th</sup>, 7<sup>th</sup>, ...etc.) and other spurious are not reported, because those levels are lower than average limit line and background noise

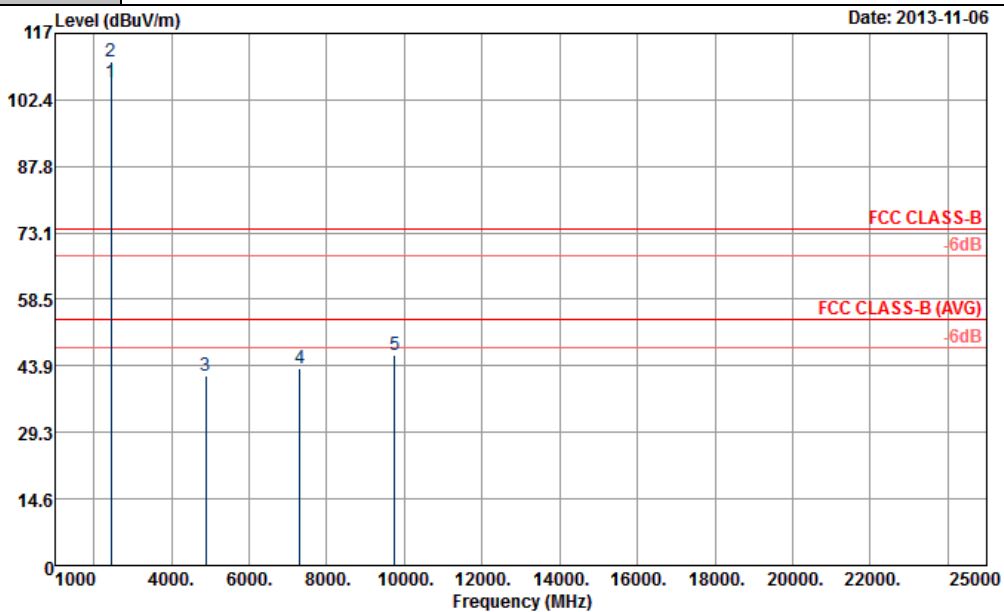

**ANTENNA POLARITY : VERTICAL**

Frequency ( MHz )	Level ( dBμV/m )	Over Limit ( dB )	Limit Line ( dBμV/m )	Read Level ( dBμV )	Antenna Factor ( dB )	Cable Loss ( dB )	Preamp Factor ( dB )	Ant Pos ( cm )	Table Pos ( deg )	Remark
2437	106.29	-	-	101.3	32.35	6.99	34.35	121	132	Average
2437	110.78	-	-	105.79	32.35	6.99	34.35	121	132	Peak
4875	41.57	-32.43	74	57.63	33.95	8.82	58.83	100	0	Peak
7311	43.35	-30.65	74	54.63	35.54	10.91	57.73	100	0	Peak
9747	46.17	-44.61	90.78	54.55	36.66	13.69	58.73	100	0	Peak

Other harmonics are lower than background noise





Test Mode :	802.11b	Temperature :	21~23°C
Test Channel :	11	Relative Humidity :	49~51%
Test Engineer :	Eric Shih		

**Remark :**

- 2464 MHz is fundamental signal which can be ignored.
- 9849 MHz is not within a restricted band, and its limit line is 20dB below the highest emission level.
- Average measurement was not performed if peak level went lower than the average limit.
- The harmonic (5<sup>th</sup>, 6<sup>th</sup>, 7<sup>th</sup>, ...etc.) and other spurious are not reported, because those levels are lower than average limit line and background noise

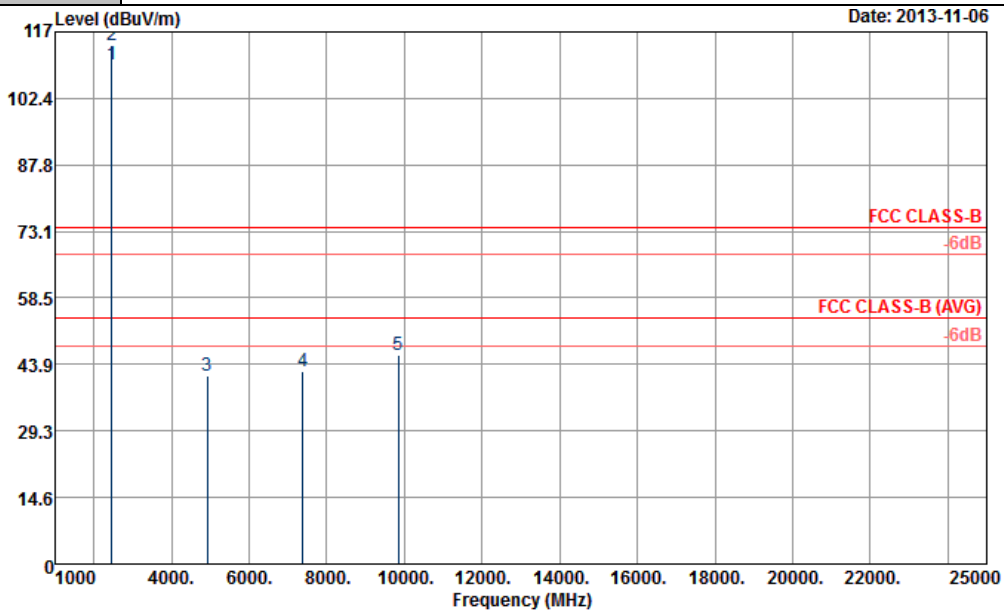

Site : 03CH07-HY  
 Condition : FCC CLASS-B 3m SHF-EHF HORIZONTAL

**ANTENNA POLARITY : HORIZONTAL**

Frequency ( MHz )	Level ( dBμV/m )	Over Limit ( dB )	Limit Line ( dBμV/m )	Read Level ( dBμV )	Antenna Factor ( dB )	Cable Loss ( dB )	Preamp Factor ( dB )	Ant Pos ( cm )	Table Pos ( deg )	Remark
2464	109.67	-	-	104.67	32.37	7.02	34.39	105	66	Average
2464	114.19	-	-	109.19	32.37	7.02	34.39	105	66	Peak
4923	41.46	-32.54	74	57.39	33.93	8.87	58.73	100	0	Peak
7386	42.4	-31.6	74	53.69	35.52	10.99	57.8	100	0	Peak
9849	46.09	-48.1	94.19	54.35	36.81	13.69	58.76	100	0	Peak

Other harmonics are lower than background noise



Test Mode :	802.11b	Temperature :	21~23°C
Test Channel :	11	Relative Humidity :	49~51%
Test Engineer :	Eric Shih		

**Remark :**

- 2462 MHz is fundamental signal which can be ignored.
- 9849 MHz is not within a restricted band, and its limit line is 20dB below the highest emission level.
- Average measurement was not performed if peak level went lower than the average limit.
- The harmonic (5<sup>th</sup>, 6<sup>th</sup>, 7<sup>th</sup>, ...etc.) and other spurious are not reported, because those levels are lower than average limit line and background noise

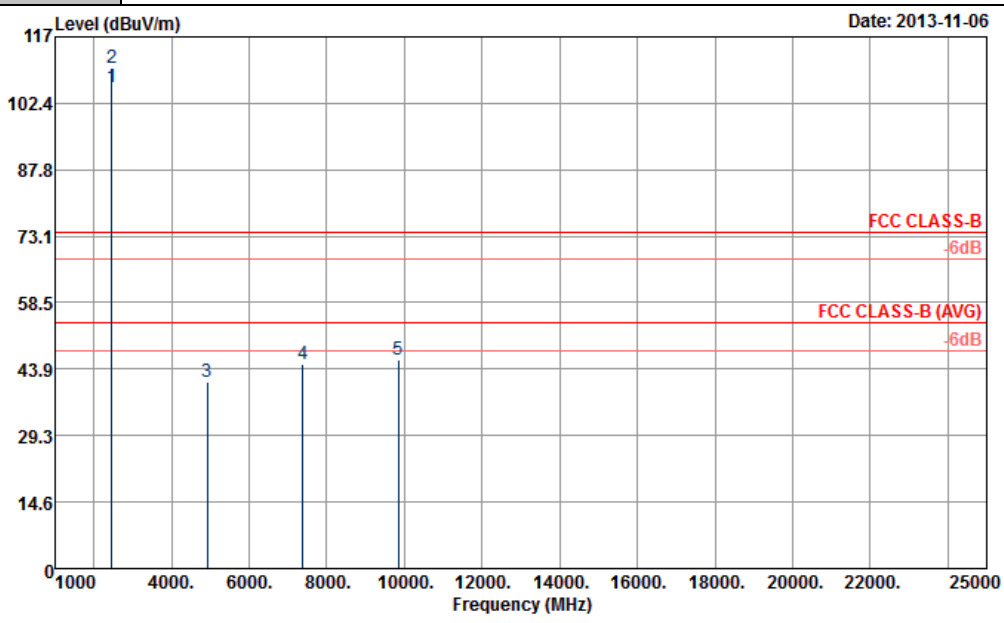

Site : 03CH07-HY  
 Condition : FCC CLASS-B 3m SHF-EHF VERTICAL

**ANTENNA POLARITY : VERTICAL**

Frequency ( MHz )	Level ( dBμV/m )	Over Limit ( dB )	Limit Line ( dBμV/m )	Read Level ( dBμV )	Antenna Factor ( dB )	Cable Loss ( dB )	Preamp Factor ( dB )	Ant Pos ( cm )	Table Pos ( deg )	Remark
2462	105.96	-	-	100.96	32.37	7.02	34.39	118	57	Average
2462	110.30	-	-	105.3	32.37	7.02	34.39	118	57	Peak
4923	40.95	-33.05	74	56.88	33.93	8.87	58.73	100	0	Peak
7386	45.01	-28.99	74	56.3	35.52	10.99	57.8	100	0	Peak
9849	46.07	-44.23	90.3	54.33	36.81	13.69	58.76	100	0	Peak

Other harmonics are lower than background noise



Test Mode :	802.11g	Temperature :	21~23°C
Test Channel :	01	Relative Humidity :	49~51%
Test Engineer :	Eric Shih		

**Remark :**

- 2410 MHz is fundamental signal which can be ignored.
- 7236 MHz and 9648 MHz are not within a restricted band, and its limit line is 20dB below the highest emission level.
- Average measurement was not performed if peak level went lower than the average limit.
- The harmonic (5<sup>th</sup>, 6<sup>th</sup>, 7<sup>th</sup>, ...etc.) and other spurious are not reported, because those levels are lower than average limit line and background noise

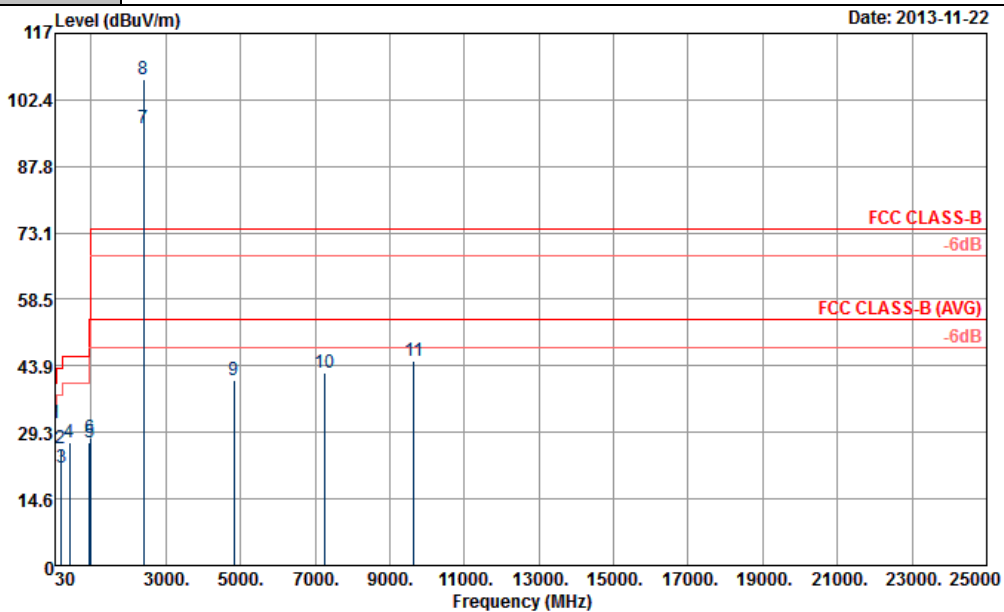

Site : 03CH07-HY  
 Condition : FCC CLASS-B 3m SHF-EHF HORIZONTAL

**ANTENNA POLARITY : HORIZONTAL**

Frequency ( MHz )	Level ( dBμV/m )	Over Limit ( dB )	Limit Line ( dBμV/m )	Read Level ( dBμV )	Antenna Factor ( dB )	Cable Loss ( dB )	Preamp Factor ( dB )	Ant Pos ( cm )	Table Pos ( deg )	Remark
49.17	31.33	-8.67	40	53.09	8.75	0.69	31.2	133	122	Peak
174.18	25.64	-17.86	43.5	46.12	9.3	1.24	31.02	-	-	Peak
191.19	21.54	-21.96	43.5	42.53	8.83	1.28	31.1	-	-	Peak
425.3	27.09	-18.91	46	38.81	16.82	2.23	30.77	-	-	Peak
955.2	26.89	-19.11	46	29.24	24.56	3.47	30.38	-	-	Peak
973.4	28.07	-25.93	54	30.02	24.88	3.48	30.31	-	-	Peak



ANTENNA POLARITY : HORIZONTAL										
Frequency ( MHz )	Level ( dB $\mu$ V/m )	Over Limit ( dB )	Limit Line ( dB $\mu$ V/m )	Read Level (dB $\mu$ V)	Antenna Factor ( dB )	Cable Loss ( dB )	Preamp Factor ( dB )	Ant Pos ( cm )	Table Pos ( deg )	Remark
2410	96.21	-	-	91.25	32.31	6.95	34.3	188	7	Average
2410	106.87	-	-	101.91	32.31	6.95	34.3	188	7	Peak
4824	40.77	-33.23	74	56.96	33.97	8.77	58.93	100	0	Peak
7236	42.39	-44.48	86.87	53.67	35.55	10.83	57.66	100	0	Peak
9648	44.83	-42.04	86.87	53.32	36.52	13.69	58.7	100	0	Peak

Other harmonics are lower than background noise



Test Mode :	802.11g	Temperature :	21~23°C
Test Channel :	01	Relative Humidity :	49~51%
Test Engineer :	Eric Shih		

**Remark :**

- 2414 MHz is fundamental signal which can be ignored.
- 7236 MHz and 9648 MHz are not within a restricted band, and its limit line is 20dB below the highest emission level.
- Average measurement was not performed if peak level went lower than the average limit.
- The harmonic (5<sup>th</sup>, 6<sup>th</sup>, 7<sup>th</sup>, ...etc.) and other spurious are not reported, because those levels are lower than average limit line and background noise

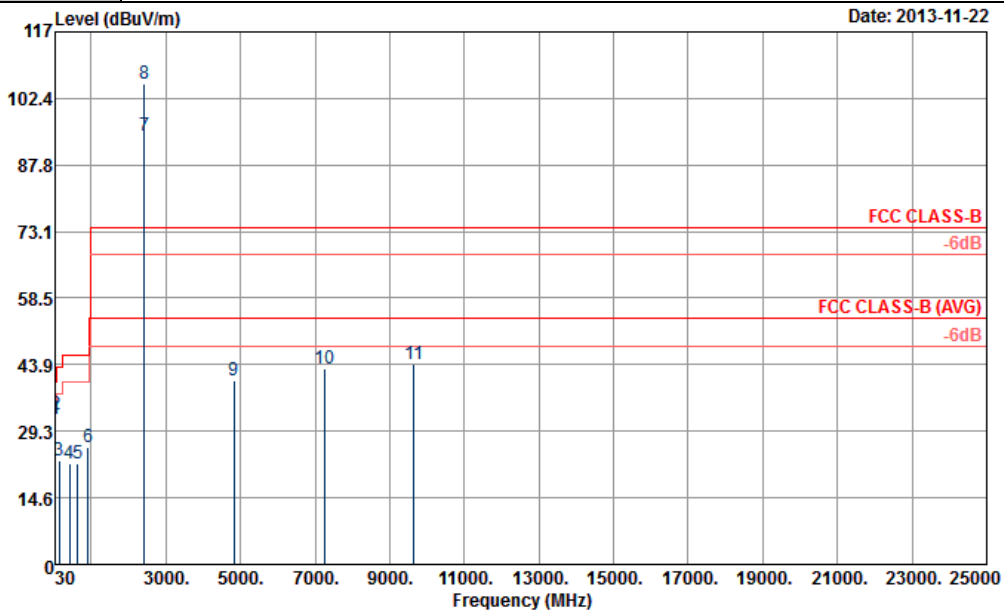

Site : 03CH07-HY  
 Condition : FCC CLASS-B 3m SHF-EHF VERTICAL

**ANTENNA POLARITY : VERTICAL**

Frequency ( MHz )	Level ( dBμV/m )	Over Limit ( dB )	Limit Line ( dBμV/m )	Read Level ( dBμV )	Antenna Factor ( dB )	Cable Loss ( dB )	Preamp Factor ( dB )	Ant Pos ( cm )	Table Pos ( deg )	Remark
39.45	32.06	-7.94	40	48.64	14	0.62	31.2	-	-	Peak
43.5	33.06	-6.94	40	52.42	11.2	0.64	31.2	157	214	Peak
138.81	22.92	-20.58	43.5	41.32	11.5	1.2	31.1	-	-	Peak
422.5	22.18	-23.82	46	33.99	16.76	2.22	30.79	-	-	Peak
633.9	22.16	-23.84	46	29.5	20.4	2.79	30.53	-	-	Peak
916	25.85	-20.15	46	29.03	23.77	3.38	30.33	-	-	Peak



ANTENNA POLARITY : VERTICAL										
Frequency ( MHz )	Level ( dBμV/m )	Over Limit ( dB )	Limit Line ( dBμV/m )	Read Level (dBμV)	Antenna Factor ( dB )	Cable Loss ( dB )	Preamp Factor ( dB )	Ant Pos ( cm )	Table Pos ( deg )	Remark
2414	94.32	-	-	89.36	32.31	6.95	34.3	166	1	Average
2414	105.53	-	-	100.57	32.31	6.95	34.3	166	1	Peak
4824	40.3	-33.7	74	56.49	33.97	8.77	58.93	100	0	Peak
7236	43.02	-42.51	85.53	54.3	35.55	10.83	57.66	100	0	Peak
9648	44.07	-41.46	85.53	52.56	36.52	13.69	58.7	100	0	Peak

Other harmonics are lower than background noise



Test Mode :	802.11g	Temperature :	21~23°C
Test Channel :	06	Relative Humidity :	49~51%
Test Engineer :	Eric Shih		

**Remark :**

- 2437 MHz is fundamental signal which can be ignored.
- 9747 MHz is not within a restricted band, and its limit line is 20dB below the highest emission level.
- Average measurement was not performed if peak level went lower than the average limit.
- The harmonic (5<sup>th</sup>, 6<sup>th</sup>, 7<sup>th</sup>, ...etc.) and other spurious are not reported, because those levels are lower than average limit line and background noise

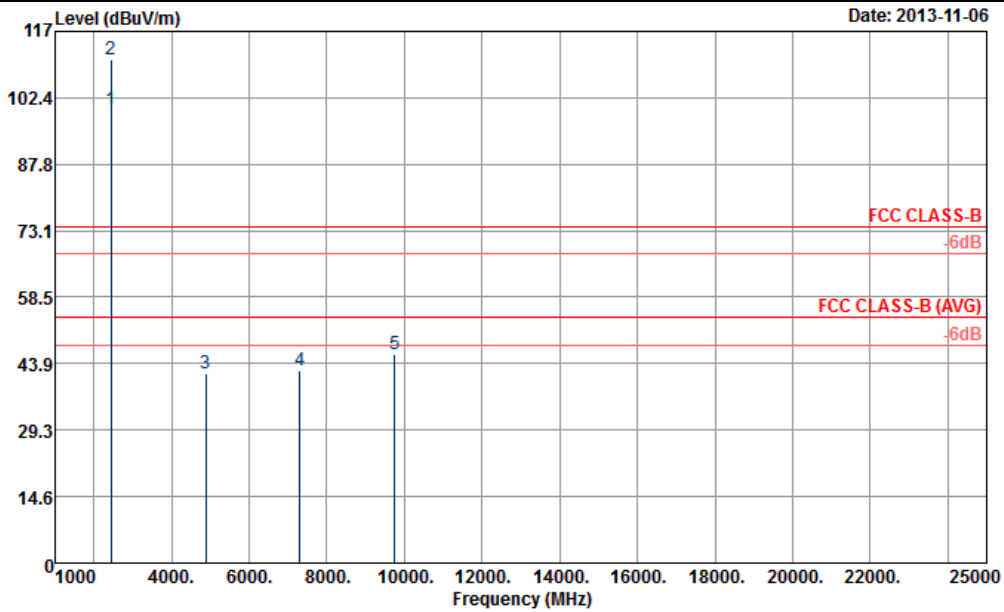

Site : 03CH07-HY  
 Condition : FCC CLASS-B 3m SHF-EHF HORIZONTAL

**ANTENNA POLARITY : HORIZONTAL**

Frequency ( MHz )	Level ( dBμV/m )	Over Limit ( dB )	Limit Line ( dBμV/m )	Read Level ( dBμV )	Antenna Factor ( dB )	Cable Loss ( dB )	Preamp Factor ( dB )	Ant Pos ( cm )	Table Pos ( deg )	Remark
2437	99.81	-	-	94.82	32.35	6.99	34.35	106	137	Average
2437	110.79	-	-	105.8	32.35	6.99	34.35	106	137	Peak
4875	41.74	-32.26	74	57.8	33.95	8.82	58.83	100	0	Peak
7311	42.22	-31.78	74	53.5	35.54	10.91	57.73	100	0	Peak
9747	46.03	-44.76	90.79	54.41	36.66	13.69	58.73	100	0	Peak

Other harmonics are lower than background noise



Test Mode :	802.11g	Temperature :	21~23°C
Test Channel :	06	Relative Humidity :	49~51%
Test Engineer :	Eric Shih		

**Remark :**

- 2437 MHz is fundamental signal which can be ignored.
- 9747 MHz is not within a restricted band, and its limit line is 20dB below the highest emission level.
- Average measurement was not performed if peak level went lower than the average limit.
- The harmonic (5<sup>th</sup>, 6<sup>th</sup>, 7<sup>th</sup>, ...etc.) and other spurious are not reported, because those levels are lower than average limit line and background noise

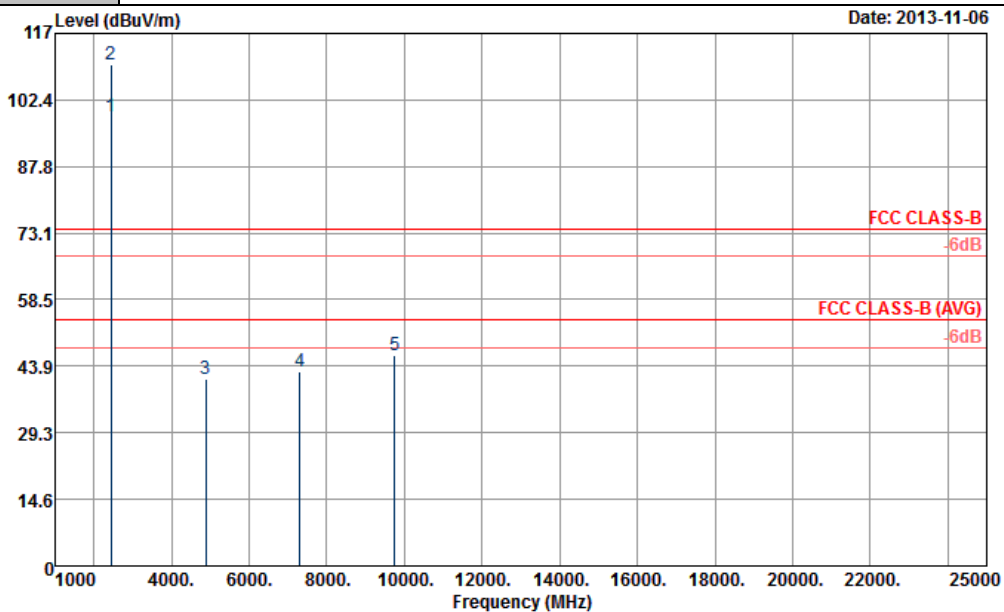

Site : 03CH07-HY  
 Condition : FCC CLASS-B 3m SHF-EHF VERTICAL

**ANTENNA POLARITY : VERTICAL**

Frequency ( MHz )	Level ( dBμV/m )	Over Limit ( dB )	Limit Line ( dBμV/m )	Read Level ( dBμV )	Antenna Factor ( dB )	Cable Loss ( dB )	Preamp Factor ( dB )	Ant Pos ( cm )	Table Pos ( deg )	Remark
2437	98.69	-	-	93.7	32.35	6.99	34.35	100	115	Average
2437	110	-	-	105.01	32.35	6.99	34.35	100	115	Peak
4875	41.05	-32.95	74	57.11	33.95	8.82	58.83	100	0	Peak
7311	42.77	-31.23	74	54.05	35.54	10.91	57.73	100	0	Peak
9747	46.27	-43.73	90	54.65	36.66	13.69	58.73	100	0	Peak

Other harmonics are lower than background noise





Test Mode :	802.11g	Temperature :	21~23°C
Test Channel :	11	Relative Humidity :	49~51%
Test Engineer :	Eric Shih		

**Remark :**

- 2464 MHz is fundamental signal which can be ignored.
- 9849 MHz is not within a restricted band, and its limit line is 20dB below the highest emission level.
- Average measurement was not performed if peak level went lower than the average limit.
- The harmonic (5<sup>th</sup>, 6<sup>th</sup>, 7<sup>th</sup>, ...etc.) and other spurious are not reported, because those levels are lower than average limit line and background noise

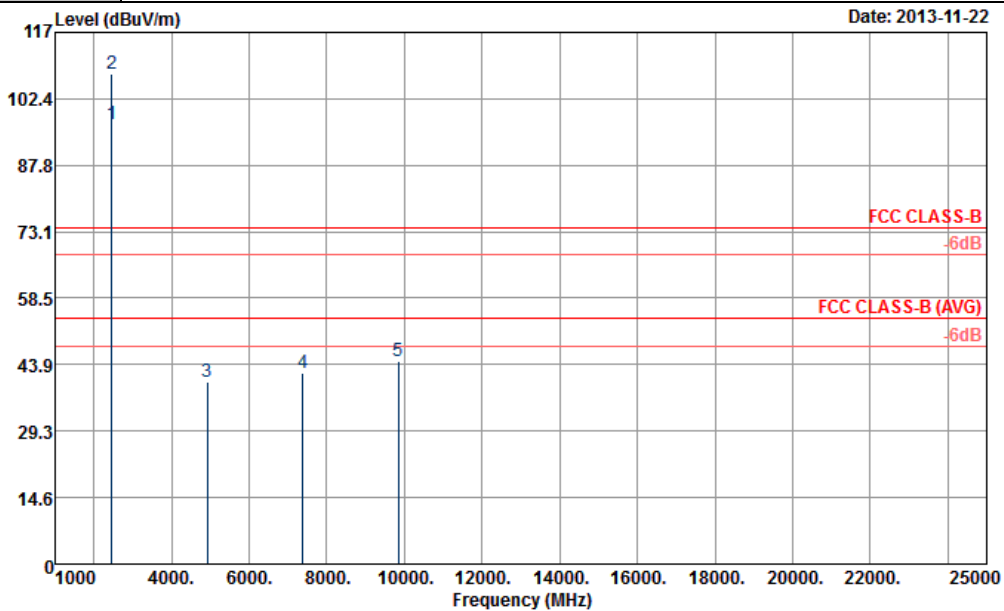

Site : 03CH07-HY  
 Condition : FCC CLASS-B 3m SHF-EHF HORIZONTAL

**ANTENNA POLARITY : HORIZONTAL**

Frequency ( MHz )	Level ( dBμV/m )	Over Limit ( dB )	Limit Line ( dBμV/m )	Read Level ( dBμV )	Antenna Factor ( dB )	Cable Loss ( dB )	Preamp Factor ( dB )	Ant Pos ( cm )	Table Pos ( deg )	Remark
2464	96.92	-	-	91.92	32.37	7.02	34.39	100	4	Average
2464	107.88	-	-	102.88	32.37	7.02	34.39	100	4	Peak
4923	40.02	-33.98	74	64.96	0	8.87	33.81	100	0	Peak
7386	42.14	-31.86	74	53.43	35.52	10.99	57.8	100	0	Peak
9849	44.59	-43.29	87.88	64.44	0	13.69	33.54	100	0	Peak

Other harmonics are lower than background noise



Test Mode :	802.11g	Temperature :	21~23°C
Test Channel :	11	Relative Humidity :	49~51%
Test Engineer :	Eric Shih		

**Remark :**

- 2464 MHz is fundamental signal which can be ignored.
- 9849 MHz is not within a restricted band, and its limit line is 20dB below the highest emission level.
- Average measurement was not performed if peak level went lower than the average limit.
- The harmonic (5<sup>th</sup>, 6<sup>th</sup>, 7<sup>th</sup>, ...etc.) and other spurious are not reported, because those levels are lower than average limit line and background noise

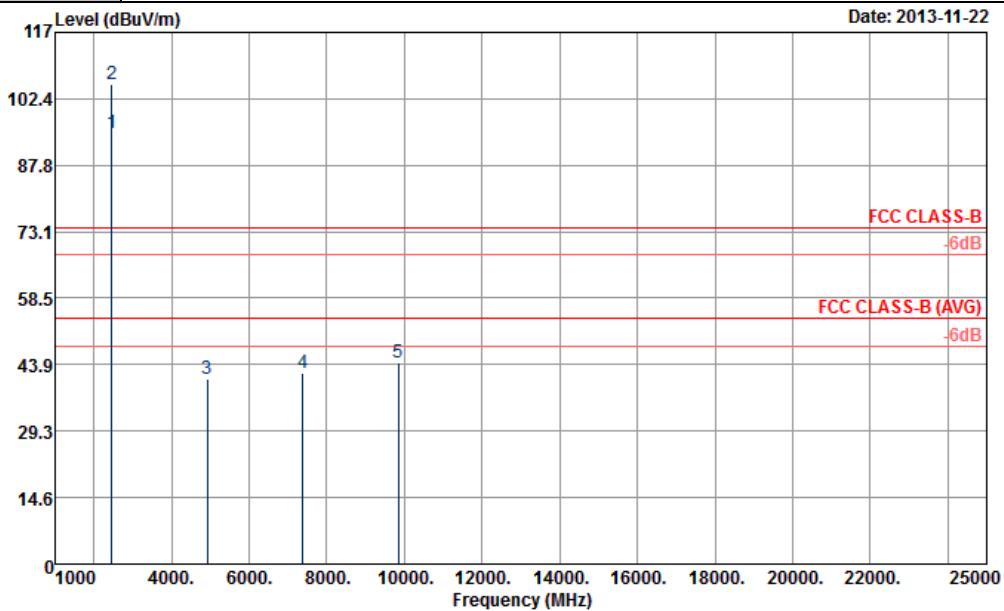

Site : 03CH07-HY  
Condition : FCC CLASS-B 3m SHF-EHF VERTICAL

**ANTENNA POLARITY : VERTICAL**

Frequency ( MHz )	Level ( dBμV/m )	Over Limit ( dB )	Limit Line ( dBμV/m )	Read Level ( dBμV )	Antenna Factor ( dB )	Cable Loss ( dB )	Preamp Factor ( dB )	Ant Pos ( cm )	Table Pos ( deg )	Remark
2464	94.96	-	-	89.96	32.37	7.02	34.39	106	3	Average
2464	105.56	-	-	100.56	32.37	7.02	34.39	106	3	Peak
4923	40.77	-33.23	74	56.7	33.93	8.87	58.73	100	0	Peak
7386	42.09	-31.91	74	64.84	0	10.99	33.74	100	0	Peak
9849	44.19	-41.37	85.56	52.45	36.81	13.69	58.76	100	0	Peak

Other harmonics are lower than background noise



Test Mode :	802.11n HT20	Temperature :	21~23°C
Test Channel :	01	Relative Humidity :	49~51%
Test Engineer :	Eric Shih		

**Remark :**

- 2412 MHz is fundamental signal which can be ignored.
- 7236 MHz and 9648 MHz are not within a restricted band, and its limit line is 20dB below the highest emission level.
- Average measurement was not performed if peak level went lower than the average limit.
- The harmonic (5<sup>th</sup>, 6<sup>th</sup>, 7<sup>th</sup>, ...etc.) and other spurious are not reported, because those levels are lower than average limit line and background noise

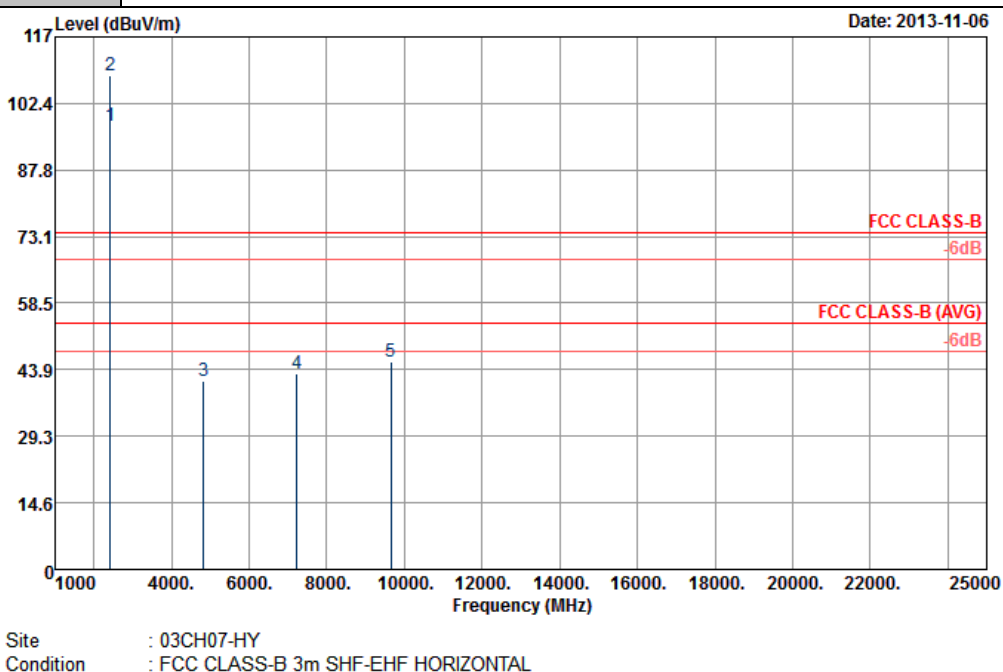

**ANTENNA POLARITY : HORIZONTAL**

Frequency ( MHz )	Level ( dBμV/m )	Over Limit ( dB )	Limit Line ( dBμV/m )	Read Level ( dBμV )	Antenna Factor ( dB )	Cable Loss ( dB )	Preamp Factor ( dB )	Ant Pos ( cm )	Table Pos ( deg )	Remark
2412	97.33	-	-	92.37	32.31	6.95	34.3	138	48	Average
2412	108.5	-	-	103.54	32.31	6.95	34.3	138	48	Peak
4824	41.52	-32.48	74	57.71	33.97	8.77	58.93	100	0	Peak
7236	42.86	-45.64	88.5	54.14	35.55	10.83	57.66	100	0	Peak
9648	45.48	-43.02	88.5	53.97	36.52	13.69	58.7	100	0	Peak

Other harmonics are lower than background noise



Test Mode :	802.11n HT20	Temperature :	21~23°C
Test Channel :	01	Relative Humidity :	49~51%
Test Engineer :	Eric Shih		

**Remark :**

- 2412 MHz is fundamental signal which can be ignored.
- 7236 MHz and 9648 MHz are not within a restricted band, and its limit line is 20dB below the highest emission level.
- Average measurement was not performed if peak level went lower than the average limit.
- The harmonic (5<sup>th</sup>, 6<sup>th</sup>, 7<sup>th</sup>, ...etc.) and other spurious are not reported, because those levels are lower than average limit line and background noise

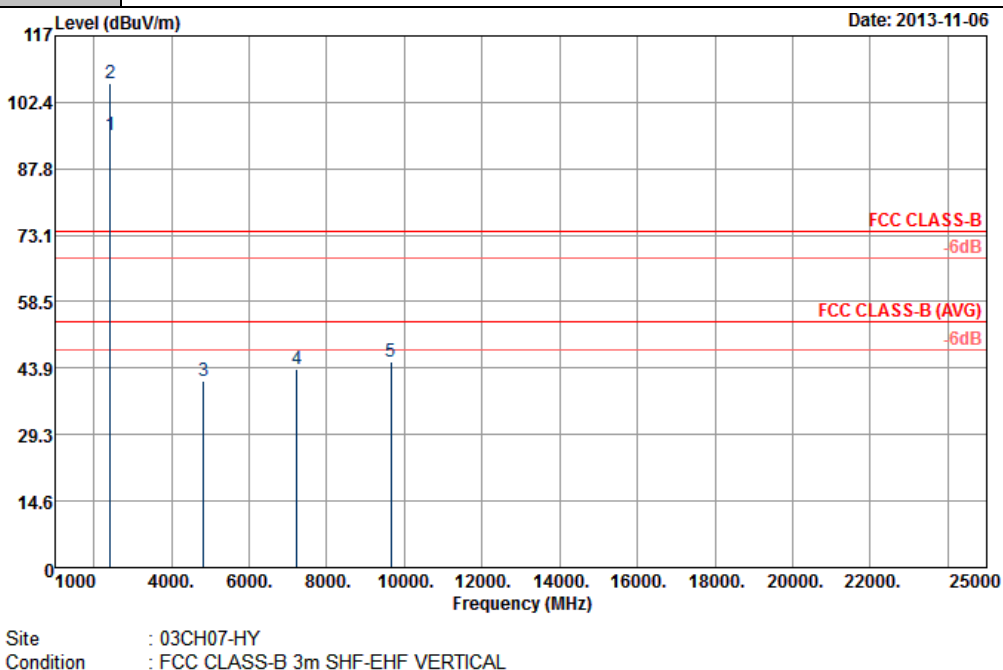

**ANTENNA POLARITY : VERTICAL**

Frequency ( MHz )	Level ( dBμV/m )	Over Limit ( dB )	Limit Line ( dBμV/m )	Read Level ( dBμV )	Antenna Factor ( dB )	Cable Loss ( dB )	Preamp Factor ( dB )	Ant Pos ( cm )	Table Pos ( deg )	Remark
2412	95.32	-	-	90.36	32.31	6.95	34.3	100	143	Average
2412	106.49	-	-	101.53	32.31	6.95	34.3	100	143	Peak
4824	41.11	-32.89	74	57.3	33.97	8.77	58.93	100	0	Peak
7236	43.71	-42.78	86.49	54.99	35.55	10.83	57.66	100	0	Peak
9648	45.21	-41.28	86.49	53.7	36.52	13.69	58.7	100	0	Peak

Other harmonics are lower than background noise



Test Mode :	802.11n HT20	Temperature :	21~23°C
Test Channel :	06	Relative Humidity :	49~51%
Test Engineer :	Eric Shih		

**Remark :**

- 2437 MHz is fundamental signal which can be ignored.
- 9747 MHz is not within a restricted band, and its limit line is 20dB below the highest emission level.
- Average measurement was not performed if peak level went lower than the average limit.
- The harmonic (5<sup>th</sup>, 6<sup>th</sup>, 7<sup>th</sup>, ...etc.) and other spurious are not reported, because those levels are lower than average limit line and background noise

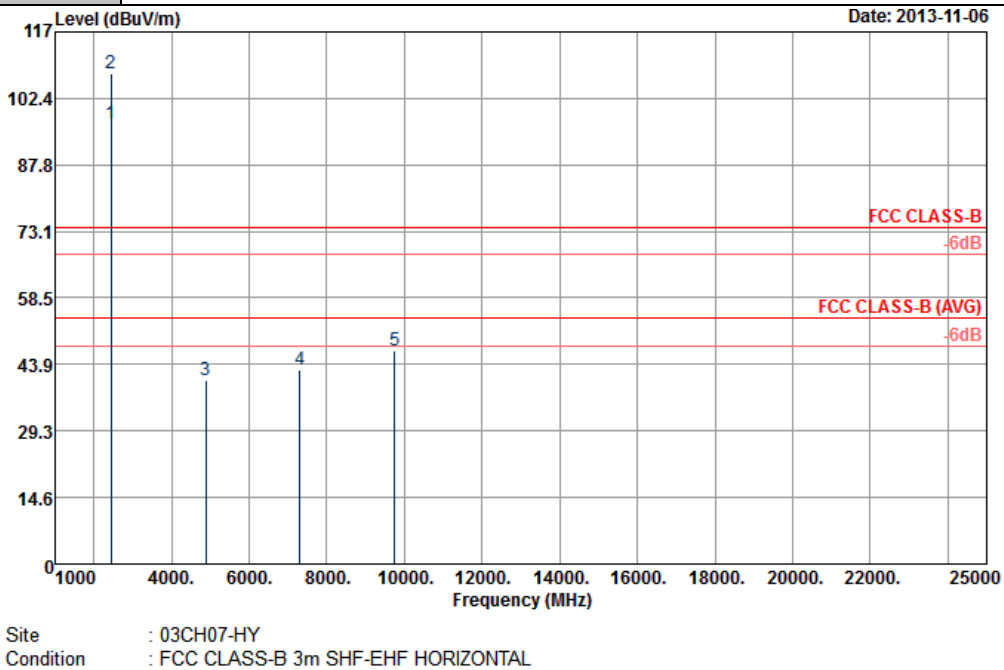

**ANTENNA POLARITY : HORIZONTAL**

Frequency ( MHz )	Level ( dBμV/m )	Over Limit ( dB )	Limit Line ( dBμV/m )	Read Level ( dBμV )	Antenna Factor ( dB )	Cable Loss ( dB )	Preamp Factor ( dB )	Ant Pos ( cm )	Table Pos ( deg )	Remark
2437	96.71	-	-	91.72	32.35	6.99	34.35	110	195	Average
2437	107.75	-	-	102.76	32.35	6.99	34.35	110	195	Peak
4875	40.4	-33.6	74	56.46	33.95	8.82	58.83	100	0	Peak
7311	42.64	-31.36	74	53.92	35.54	10.91	57.73	100	0	Peak
9747	46.84	-40.91	87.75	55.22	36.66	13.69	58.73	100	0	Peak

Other harmonics are lower than background noise



Test Mode :	802.11n HT20	Temperature :	21~23°C
Test Channel :	06	Relative Humidity :	49~51%
Test Engineer :	Eric Shih		

**Remark :**

- 2437 MHz is fundamental signal which can be ignored.
- 9747 MHz is not within a restricted band, and its limit line is 20dB below the highest emission level.
- Average measurement was not performed if peak level went lower than the average limit.
- The harmonic (5<sup>th</sup>, 6<sup>th</sup>, 7<sup>th</sup>, ...etc.) and other spurious are not reported, because those levels are lower than average limit line and background noise

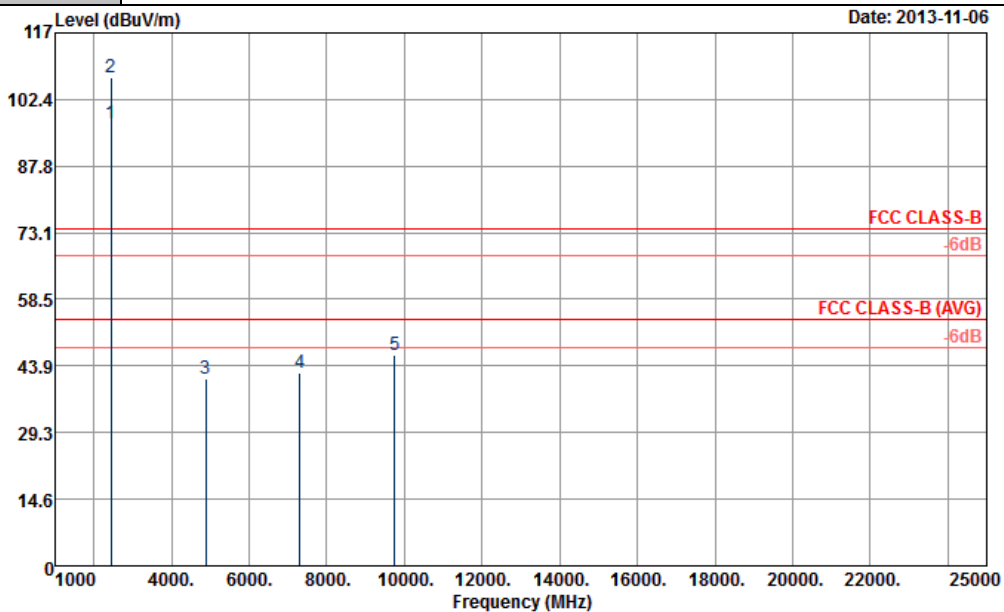

Site : 03CH07-HY  
 Condition : FCC CLASS-B 3m SHF-EHF VERTICAL

**ANTENNA POLARITY : VERTICAL**

Frequency ( MHz )	Level ( dBμV/m )	Over Limit ( dB )	Limit Line ( dBμV/m )	Read Level ( dBμV )	Antenna Factor ( dB )	Cable Loss ( dB )	Preamp Factor ( dB )	Ant Pos ( cm )	Table Pos ( deg )	Remark
2437	97.19	-	-	92.2	32.35	6.99	34.35	121	141	Average
2437	107.23	-	-	102.24	32.35	6.99	34.35	121	141	Peak
4875	41.02	-32.98	74	57.08	33.95	8.82	58.83	100	0	Peak
7311	42.34	-31.66	74	53.62	35.54	10.91	57.73	100	0	Peak
9747	46.4	-40.83	87.23	54.78	36.66	13.69	58.73	100	0	Peak

Other harmonics are lower than background noise



Test Mode :	802.11n HT20	Temperature :	21~23°C
Test Channel :	11	Relative Humidity :	49~51%
Test Engineer :	Eric Shih		

**Remark :**

- 2464 MHz is fundamental signal which can be ignored.
- 9849 MHz is not within a restricted band, and its limit line is 20dB below the highest emission level.
- Average measurement was not performed if peak level went lower than the average limit.
- The harmonic (5<sup>th</sup>, 6<sup>th</sup>, 7<sup>th</sup>, ...etc.) and other spurious are not reported, because those levels are lower than average limit line and background noise

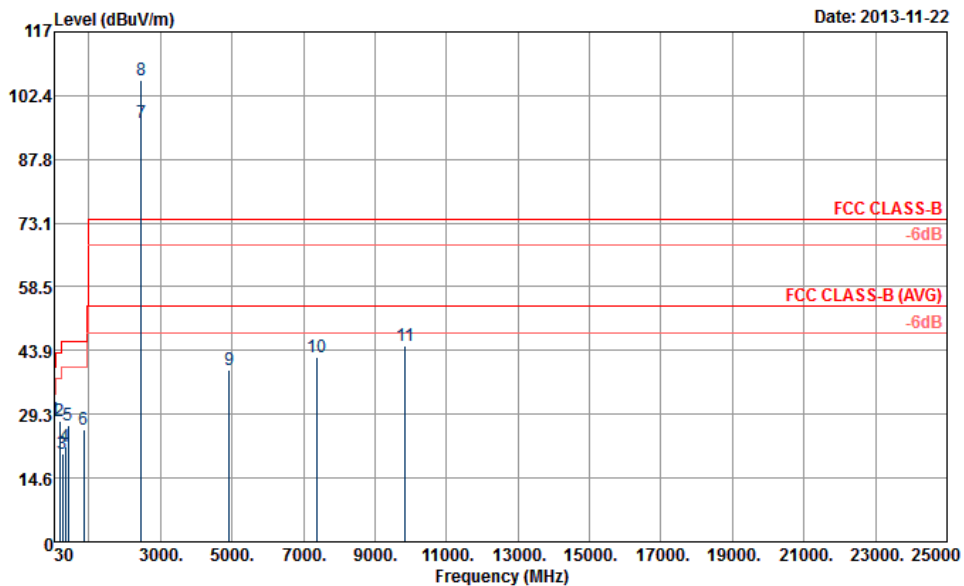

Site : 03CH07-HY  
 Condition : FCC CLASS-B 3m SHF-EHF HORIZONTAL

**ANTENNA POLARITY : HORIZONTAL**

Frequency ( MHz )	Level ( dBμV/m )	Over Limit ( dB )	Limit Line ( dBμV/m )	Read Level ( dBμV )	Antenna Factor ( dB )	Cable Loss ( dB )	Preamp Factor ( dB )	Ant Pos ( cm )	Table Pos ( deg )	Remark
47.55	28.07	-11.93	40	49.15	9.45	0.67	31.2	105	57	Peak
174.99	27.84	-15.66	43.5	48.3	9.3	1.24	31	-	-	Peak
249.78	20.26	-25.74	46	37.33	12.4	1.53	31	-	-	Peak
342	21.84	-24.16	46	36.78	14.16	1.91	31.01	-	-	Peak
425.3	26.62	-19.38	46	38.34	16.82	2.23	30.77	-	-	Peak
848.8	25.83	-20.17	46	29.67	23.29	3.27	30.4	-	-	Peak



ANTENNA POLARITY : HORIZONTAL										
Frequency ( MHz )	Level ( dBμV/m )	Over Limit ( dB )	Limit Line ( dBμV/m )	Read Level (dBμV)	Antenna Factor ( dB )	Cable Loss ( dB )	Preamp Factor ( dB )	Ant Pos ( cm )	Table Pos ( deg )	Remark
2464	96.24	-	-	91.24	32.37	7.02	34.39	100	7	Average
2464	106.08	-	-	101.08	32.37	7.02	34.39	100	7	Peak
4923	39.34	-34.66	74	55.27	33.93	8.87	58.73	100	0	Peak
7386	42.23	-31.77	74	53.52	35.52	10.99	57.8	100	0	Peak
9849	45	-41.08	86.08	53.26	36.81	13.69	58.76	100	0	Peak

Other harmonics are lower than background noise





Test Mode :	802.11n HT20	Temperature :	21~23°C
Test Channel :	11	Relative Humidity :	49~51%
Test Engineer :	Eric Shih		

**Remark :**

- 2464 MHz is fundamental signal which can be ignored.
- 9849 MHz is not within a restricted band, and its limit line is 20dB below the highest emission level.
- Average measurement was not performed if peak level went lower than the average limit.
- The harmonic (5<sup>th</sup>, 6<sup>th</sup>, 7<sup>th</sup>, ...etc.) and other spurious are not reported, because those levels are lower than average limit line and background noise

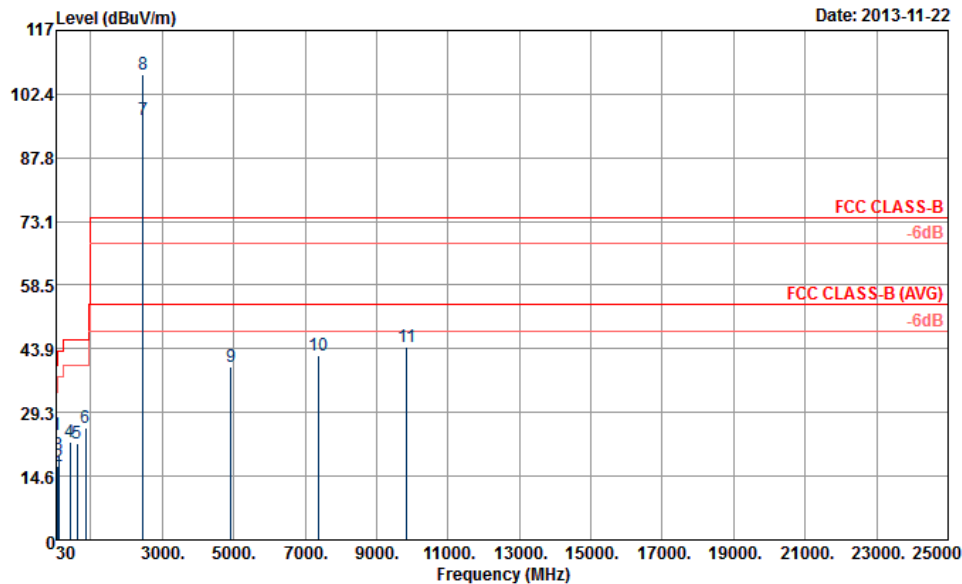

Site : 03CH07-HY  
 Condition : FCC CLASS-B 3m SHF-EHF VERTICAL

ANTENNA POLARITY : VERTICAL

Frequency ( MHz )	Level ( dBμV/m )	Over Limit ( dB )	Limit Line ( dBμV/m )	Read Level ( dBμV )	Antenna Factor ( dB )	Cable Loss ( dB )	Preamp Factor ( dB )	Ant Pos ( cm )	Table Pos ( deg )	Remark
41.61	24.16	-15.84	40	42.13	12.6	0.63	31.2	142	321	Peak
75.63	16.96	-23.04	40	40.47	6.83	0.86	31.2	-	-	Peak
106.68	19.55	-23.95	43.5	39.07	10.62	1.03	31.17	-	-	Peak
419	22.38	-23.62	46	34.32	16.65	2.21	30.8	-	-	Peak
620.6	22.17	-23.83	46	29.76	20.22	2.75	30.56	-	-	Peak
854.4	25.84	-20.16	46	29.7	23.25	3.28	30.39	-	-	Peak



ANTENNA POLARITY : VERTICAL										
Frequency ( MHz )	Level ( dBμV/m )	Over Limit ( dB )	Limit Line ( dBμV/m )	Read Level (dBμV)	Antenna Factor ( dB )	Cable Loss ( dB )	Preamp Factor ( dB )	Ant Pos ( cm )	Table Pos ( deg )	Remark
2464	96.42	-	-	91.42	32.37	7.02	34.39	106	327	Average
2464	107.06	-	-	102.06	32.37	7.02	34.39	106	327	Peak
4923	39.79	-34.21	74	55.72	33.93	8.87	58.73	100	0	Peak
7386	42.22	-31.78	74	53.51	35.52	10.99	57.8	100	0	Peak
9849	44.37	-42.69	87.06	52.63	36.81	13.69	58.76	100	0	Peak

Other harmonics are lower than background noise



### 3.6 AC Conducted Emission Measurement

#### 3.6.1 Limit of AC Conducted Emission

For equipment that is designed to be connected to the public utility (AC) power line, the radio frequency voltage that is conducted back onto the AC power line on any frequency or frequencies within the band 150 kHz to 30 MHz shall not exceed the limits in the following table.

Frequency of Emission (MHz)	Conducted Limit (dB $\mu$ V)	
	Quasi-Peak	Average
0.15-0.5	66 to 56*	56 to 46*
0.5-5	56	46
5-30	60	50

\*Decreases with the logarithm of the frequency.

#### 3.6.2 Measuring Instruments

The section 4.0 of List of Measuring Equipment of this test report is used for test.

#### 3.6.3 Test Procedures

1. The EUT was placed 0.4 meter from the conducting wall of the shielding room, and it was kept at least 80 centimeters from any other grounded conducting surface.
2. Connect EUT to the power mains through a line impedance stabilization network (LISN).
3. All the support units are connecting to the other LISN.
4. The LISN provides 50 ohm coupling impedance for the measuring instrument.
5. The FCC states that a 50 ohm, 50 microhenry LISN should be used.
6. Both sides of AC line were checked for maximum conducted interference.
7. The frequency range from 150 kHz to 30 MHz was searched.
8. Set the test-receiver system to Peak Detect Function and specified bandwidth with Maximum Hold Mode.

### 3.6.4 Test Setup

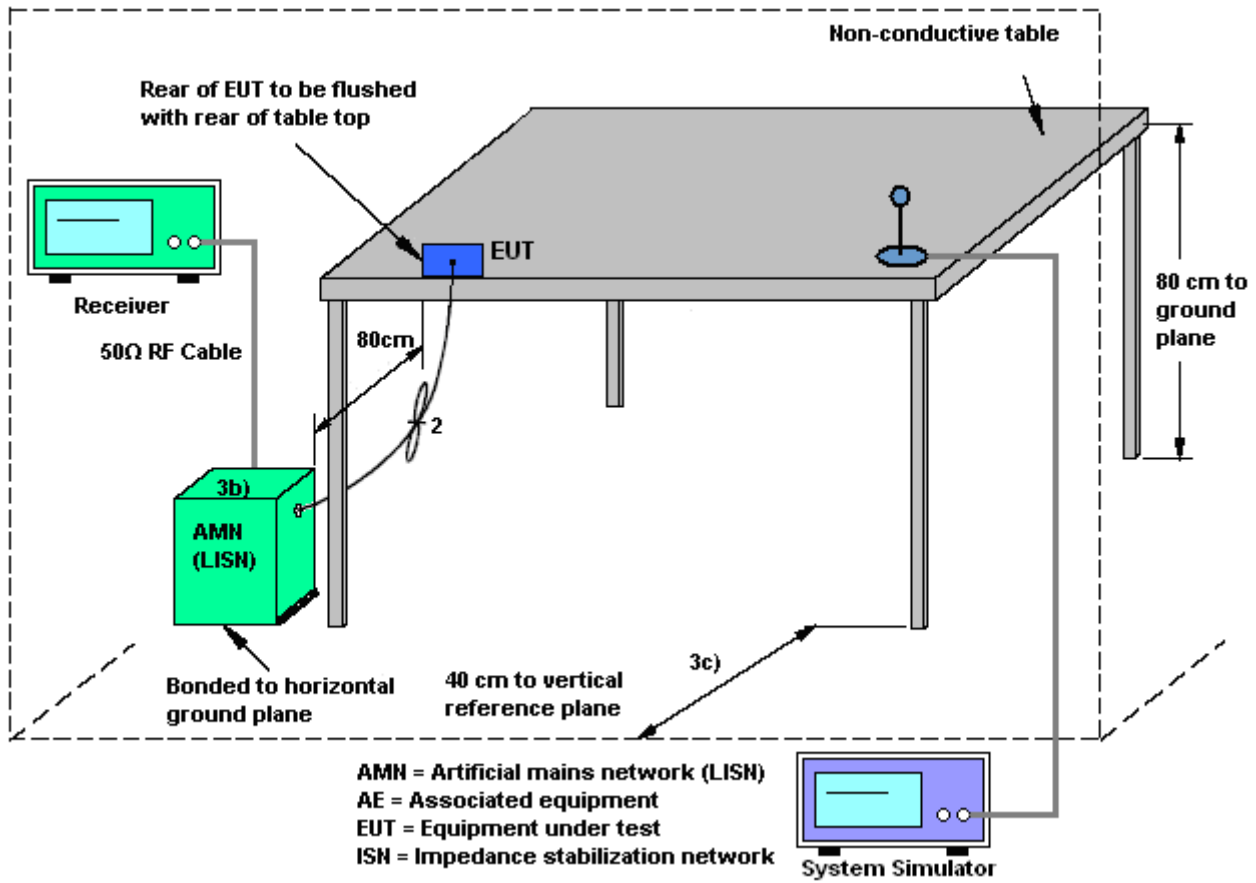

### 3.6.5 Test Result of AC Conducted Emission

Test Mode :	Mode 1	Temperature :	20~22°C
Test Engineer :	Kai-Chun Chu	Relative Humidity :	46~48%
Test Voltage :	120Vac / 60Hz	Phase :	Line
Function Type :	GSM1900 Idle + Bluetooth Link + WLAN Idle + MP3 + Earphone + Battery + USB Cable (Charging from Adapter) + SIM 1		

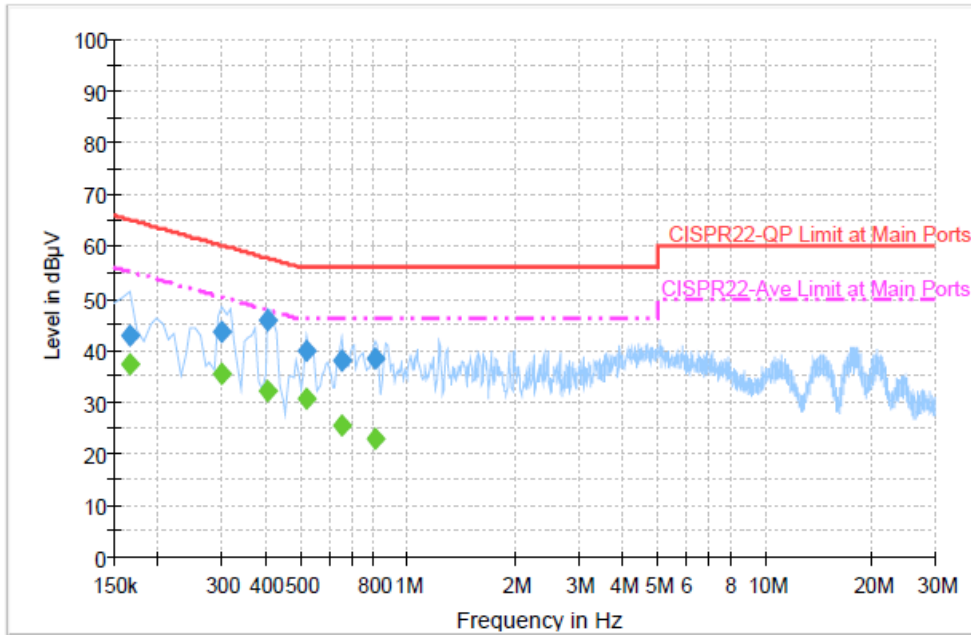

#### Final Result : Quasi-Peak

Frequency (MHz)	Quasi-Peak (dBµV)	Filter	Line	Corr. (dB)	Margin (dB)	Limit (dBµV)
0.166000	42.9	Off	L1	19.4	22.3	65.2
0.302000	43.7	Off	L1	19.3	16.5	60.2
0.406000	45.8	Off	L1	19.4	11.9	57.7
0.518000	39.8	Off	L1	19.4	16.2	56.0
0.654000	38.1	Off	L1	19.4	17.9	56.0
0.814000	38.5	Off	L1	19.5	17.5	56.0

#### Final Result : Average

Frequency (MHz)	Average (dBµV)	Filter	Line	Corr. (dB)	Margin (dB)	Limit (dBµV)
0.166000	37.2	Off	L1	19.4	18.0	55.2
0.302000	35.6	Off	L1	19.3	14.6	50.2
0.406000	32.1	Off	L1	19.4	15.6	47.7
0.518000	30.5	Off	L1	19.4	15.5	46.0
0.654000	25.3	Off	L1	19.4	20.7	46.0
0.814000	23.0	Off	L1	19.5	23.0	46.0



Test Mode :	Mode 1	Temperature :	20~22°C
Test Engineer :	Kai-Chun Chu	Relative Humidity :	46~48%
Test Voltage :	120Vac / 60Hz	Phase :	Neutral
Function Type :	GSM1900 Idle + Bluetooth Link + WLAN Idle + MP3 + Earphone + Battery + USB Cable (Charging from Adapter) + SIM 1		

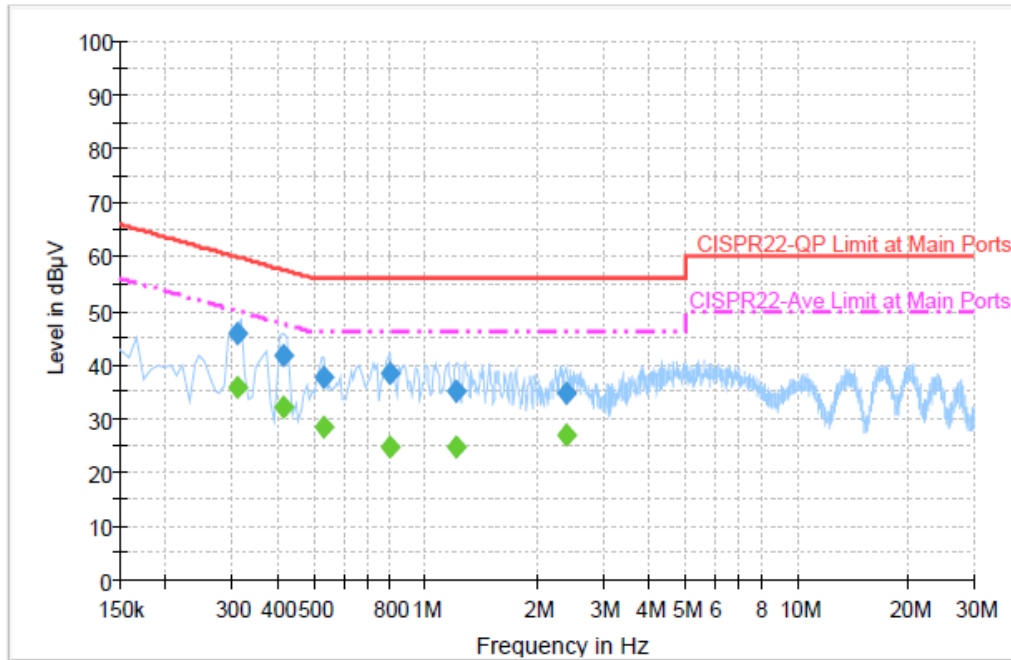

**Final Result : Quasi-Peak**

Frequency (MHz)	Quasi-Peak (dBµV)	Filter	Line	Corr. (dB)	Margin (dB)	Limit (dBµV)
0.310000	45.9	Off	N	19.4	14.1	60.0
0.414000	41.6	Off	N	19.4	16.0	57.6
0.534000	37.8	Off	N	19.4	18.2	56.0
0.798000	38.3	Off	N	19.5	17.7	56.0
1.206000	35.1	Off	N	19.5	20.9	56.0
2.382000	34.8	Off	N	19.7	21.2	56.0

**Final Result : Average**

Frequency (MHz)	Average (dBµV)	Filter	Line	Corr. (dB)	Margin (dB)	Limit (dBµV)
0.310000	35.8	Off	N	19.4	14.2	50.0
0.414000	32.1	Off	N	19.4	15.5	47.6
0.534000	28.4	Off	N	19.4	17.6	46.0
0.798000	24.6	Off	N	19.5	21.4	46.0
1.206000	24.6	Off	N	19.5	21.4	46.0
2.382000	27.0	Off	N	19.7	19.0	46.0



Test Mode :	Mode 2	Temperature :	20~22°C
Test Engineer :	Kai-Chun Chu	Relative Humidity :	46~48%
Test Voltage :	120Vac / 60Hz	Phase :	Line
Function Type :	GSM1900 Idle + Bluetooth Idle + WLAN Link + MP3 + Earphone + Battery + USB Cable (Charging from Adapter) + SIM 1		

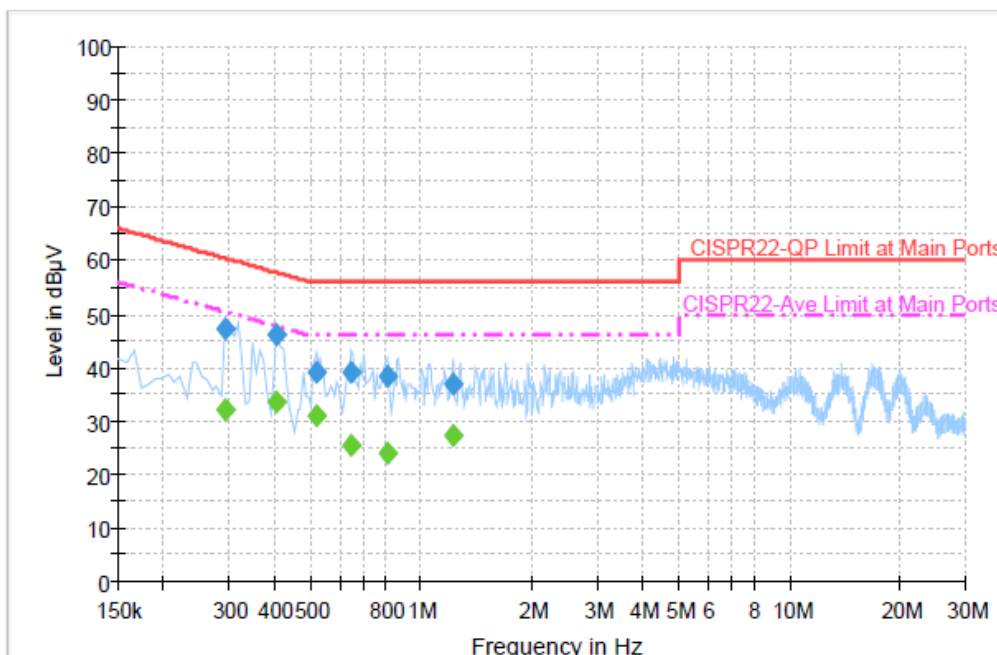

Final Result : Quasi-Peak

Frequency (MHz)	Quasi-Peak (dBµV)	Filter	Line	Corr. (dB)	Margin (dB)	Limit (dBµV)
0.294000	47.2	Off	L1	19.4	13.2	60.4
0.406000	46.1	Off	L1	19.4	11.6	57.7
0.518000	39.0	Off	L1	19.4	17.0	56.0
0.646000	39.2	Off	L1	19.4	16.8	56.0
0.814000	38.3	Off	L1	19.5	17.7	56.0
1.214000	37.1	Off	L1	19.5	18.9	56.0

Final Result : Average

Frequency (MHz)	Average (dBµV)	Filter	Line	Corr. (dB)	Margin (dB)	Limit (dBµV)
0.294000	32.1	Off	L1	19.4	18.3	50.4
0.406000	33.7	Off	L1	19.4	14.0	47.7
0.518000	31.1	Off	L1	19.4	14.9	46.0
0.646000	25.4	Off	L1	19.4	20.6	46.0
0.814000	24.1	Off	L1	19.5	21.9	46.0
1.214000	27.3	Off	L1	19.5	18.7	46.0



Test Mode :	Mode 2	Temperature :	20~22°C
Test Engineer :	Kai-Chun Chu	Relative Humidity :	46~48%
Test Voltage :	120Vac / 60Hz	Phase :	Neutral
Function Type :	GSM1900 Idle + Bluetooth Idle + WLAN Link + MP3 + Earphone + Battery + USB Cable (Charging from Adapter) + SIM 1		

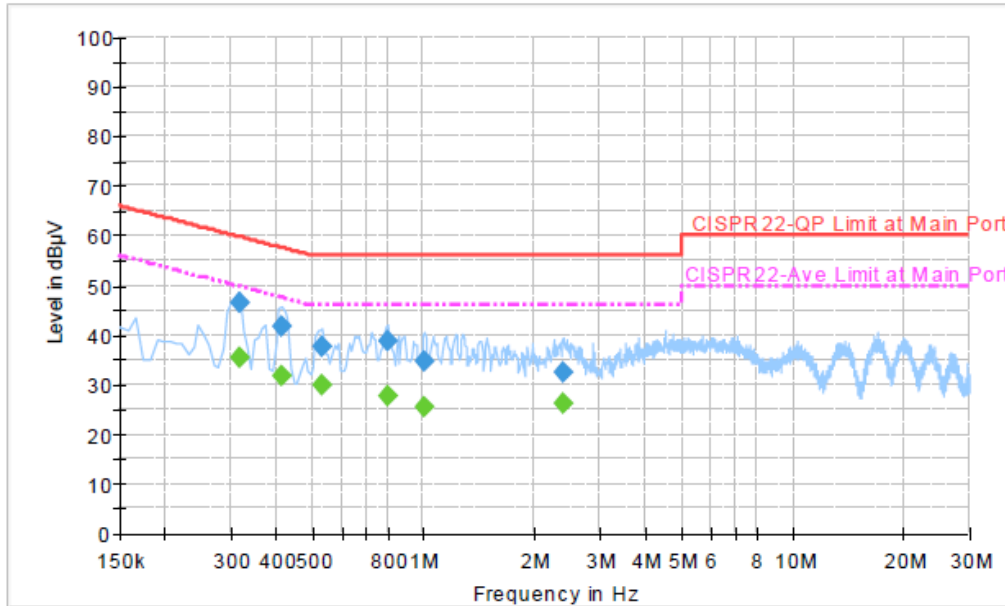

**Final Result : Quasi-Peak**

Frequency (MHz)	Quasi-Peak (dBµV)	Filter	Line	Corr. (dB)	Margin (dB)	Limit (dBµV)
0.318000	46.4	Off	N	19.4	13.4	59.8
0.414000	41.7	Off	N	19.4	15.9	57.6
0.534000	37.8	Off	N	19.4	18.2	56.0
0.798000	38.7	Off	N	19.5	17.3	56.0
1.006000	34.7	Off	N	19.4	21.3	56.0
2.382000	32.5	Off	N	19.7	23.5	56.0

**Final Result : Average**

Frequency (MHz)	Average (dBµV)	Filter	Line	Corr. (dB)	Margin (dB)	Limit (dBµV)
0.318000	35.4	Off	N	19.4	14.4	49.8
0.414000	31.9	Off	N	19.4	15.7	47.6
0.534000	29.8	Off	N	19.4	16.2	46.0
0.798000	27.7	Off	N	19.5	18.3	46.0
1.006000	25.4	Off	N	19.4	20.6	46.0
2.382000	26.2	Off	N	19.7	19.8	46.0





## **3.7 Antenna Requirements**

### **3.7.1 Standard Applicable**

If directional gain of transmitting antennas is greater than 6dBi, the power shall be reduced by the same level in dB comparing to gain minus 6dBi. For the fixed point-to-point operation, the power shall be reduced by one dB for every 3 dB that the directional gain of the antenna exceeds 6 dBi. The use of a permanently attached antenna or of an antenna that uses a unique coupling to the intentional radiator shall be considered sufficient to comply with the FCC rule.

### **3.7.2 Antenna Anti-Replacement Construction**

Non-standard antenna connector is used.

### **3.7.3 Antenna Gain**

The antenna peak gain of EUT is less than 6 dBi. Therefore, it is not necessary to reduce maximum peak output power limit.



## 4 List of Measuring Equipment

Instrument	Manufacturer	Model No.	Serial No.	Characteristics	Calibration Date	Test Date	Due Date	Remark
Spectrum Analyzer	Rohde & Schwarz	FSP40	100055	9kHz~40GHz	Jun. 07, 2013	Oct. 31, 2013 ~ Nov. 04, 2013	Jun. 06, 2014	Conducted (TH02-HY)
Power Meter	Anritsu	ML2495A	1036004	300MHz~40GHz	Aug. 17, 2013	Oct. 31, 2013 ~ Nov. 04, 2013	Aug. 16, 2014	Conducted (TH02-HY)
Power Sensor	Anritsu	MA2411B	1027253	300MHz~40GHz	Aug. 17, 2013	Oct. 31, 2013 ~ Nov. 04, 2013	Aug. 16, 2014	Conducted (TH02-HY)
Hygrometer	Testo	608-H1	34897199	N/A	May 07, 2013	Oct. 31, 2013 ~ Nov. 04, 2013	May 06, 2014	Conducted (TH02-HY)
RF cable	HONOVA	MF86	N/A	N/A	Nov. 26, 2012	Oct. 31, 2013 ~ Nov. 04, 2013	Nov. 25, 2013	Conducted (TH02-HY)
EMI Test Receiver	Rohde & Schwarz	ESCI 7	100724	9kHz~7GHz	Sep. 06, 2013	Nov. 06, 2013 ~ Nov. 27, 2013	Sep. 05, 2014	Radiation (03CH07-HY)
Spectrum Analyzer	Rohde & Schwarz	FSP30	101067	9KHz~30GHz	Nov. 30, 2012	Nov. 06, 2013 ~ Nov. 27, 2013	Nov. 29, 2013	Radiation (03CH07-HY)
Loop Antenna	Rohde & Schwarz	HFH2-Z2	860004/0001	9 kHz~30 MHz	Jul. 03, 2012	Nov. 06, 2013 ~ Nov. 27, 2013	Jul. 03, 2014	Radiation (03CH07-HY)
Bilog Antenna	Schaffner	CBL6111C	2726	30MHz ~ 1GHz	Oct. 10, 2013	Nov. 06, 2013 ~ Nov. 27, 2013	Oct. 09, 2014	Radiation (03CH07-HY)
Double Ridge Horn Antenna	ESCO	3117	75962	1GHz~18GHz	Aug. 22, 2013	Nov. 06, 2013 ~ Nov. 27, 2013	Aug. 21, 2014	Radiation (03CH07-HY)
SHF-EHF Horn Antenna	SCHWARZBECK	BBHA 9170	BBHA9170251	15GHz- 40GHz	Oct. 03, 2013	Nov. 06, 2013 ~ Nov. 27, 2013	Oct. 02, 2014	Radiation (03CH07-HY)
Preamplifier	COM-POWER	PA-103A	161241	30MHz~1GHz	Feb. 26, 2013	Nov. 06, 2013 ~ Nov. 27, 2013	Feb. 25, 2014	Radiation (03CH07-HY)
Preamplifier	MITEQ	AMF-7D-00101800-30-10P	159088	1GHz~18GHz	Feb. 27, 2013	Nov. 06, 2013 ~ Nov. 27, 2013	Feb. 26, 2014	Radiation (03CH07-HY)
Preamplifier	Agilent	8449B	3008A02362	1GHz~26.5GHz	Dec. 01, 2012	Nov. 06, 2013 ~ Nov. 27, 2013	Nov. 30, 2013	Radiation (03CH07-HY)
Turn Table	Chaintek	Chaintek 3000	N/A	0 - 360 degree	N/A	Nov. 06, 2013 ~ Nov. 27, 2013	N/A	Radiation (03CH07-HY)
Antenna Mast	Chaintek	M-400-0	114/8000604/L	1 m ~ 4 m	N/A	Nov. 06, 2013 ~ Nov. 27, 2013	N/A	Radiation (03CH07-HY)
High Pass Filter	Microwave	H03G18G3	N/A	3GHz HPF	Nov. 29, 2012	Nov. 06, 2013 ~ Nov. 27, 2013	Nov. 28, 2013	Radiation (03CH07-HY)
High Pass Filter	Microwave	H07G18G3	282388	7GHz HPF	Nov. 29, 2012	Nov. 06, 2013 ~ Nov. 27, 2013	Nov. 28, 2013	Radiation (03CH07-HY)
HF RF Cable	HUBER SUHNER	SUCOFLEX 104	38411/6	1GHz ~ 18GHz	Dec. 04 , 2012	Nov. 06, 2013 ~ Nov. 27, 2013	Dec. 03, 2013	Radiation (03CH07-HY)
LF RF Cable	Warison+HUBER SUHNER	WCBA-WC04NM.NM2	N/A	30MHz ~ 1GHz	Dec. 04 , 2012	Nov. 06, 2013 ~ Nov. 27, 2013	Dec. 03, 2013	Radiation (03CH07-HY)



Instrument	Manufacturer	Model No.	Serial No.	Characteristics	Calibration Date	Test Date	Due Date	Remark
Test Software	Audix	E3	Version 6.2009-08-24	N/A	N/A	Nov. 06, 2013 ~ Nov. 27, 2013	N/A	Radiation (03CH07-HY)
Hygrometer	Testo	608-H1	34897197	N/A	May 07, 2013	Nov. 06, 2013 ~ Nov. 27, 2013	May 06, 2014	Radiation (03CH07-HY)
EMI Test Receiver	Rohde & Schwarz	ESCS 30	100356	9kHz ~ 2.75GHz	Nov. 13, 2012	Nov. 06, 2013	Nov. 12, 2013	Conduction (CO05-HY)
Two-LISN	Rohde & Schwarz	ENV216	100081	9kHz ~ 30MHz	Dec. 12, 2012	Nov. 06, 2013	Dec. 11, 2013	Conduction (CO05-HY)
Two-LISN	Rohde & Schwarz	ENV216	100080	9kHz ~ 30MHz	Dec. 06, 2012	Nov. 06, 2013	Dec. 05, 2013	Conduction (CO05-HY)
AC Power Source	APC	APC-1000W	N/A	N/A	N/A	Nov. 06, 2013	N/A	Conduction (CO05-HY)
Test Software	N/A	EMC32	8.40.0	N/A	N/A	Nov. 06, 2013	N/A	Conduction (CO05-HY)
Hygrometer	Testo	608-H1	34913912	N/A	Apr. 25, 2013,	Nov. 06, 2013	Apr. 24, 2014	Conduction (CO05-HY)
LF Cable	Shuner	RG-402	N/A	N/A	Oct. 17, 2013	Nov. 06, 2013	Oct. 16, 2014	Conduction (CO05-HY)

**Note:** Test equipment calibration is traceable to the procedure of ISO17025.



## 5 Uncertainty of Evaluation

### Uncertainty of Conducted Emission Measurement (150kHz ~ 30MHz)

Measuring Uncertainty for a Level of Confidence of 95% ( $U = 2Uc(y)$ )	2.26
---	------

### Uncertainty of Radiated Emission Measurement (30 MHz ~ 1000 MHz)

Measuring Uncertainty for a Level of Confidence of 95% ( $U = 2Uc(y)$ )	4.50
---	------