

FCC/IC RF Test Report

APPLICANT : Sony Mobile Communications AB
EQUIPMENT : Smart phone
BRAND NAME : SONY
MODEL NAME : D2104
TYPE NAME : PM-0673-BV
FCC ID : PY7PM-0673
IC : 4170B-PM0673
STANDARD : FCC Part 15 Subpart C §15.247
IC RSS-210 issue 8
CLASSIFICATION : (DTS) Digital Transmission System

The product was received on Oct. 29, 2013 and testing was completed on Nov. 07, 2013. We, SPORTON INTERNATIONAL INC., would like to declare that the tested sample has been evaluated in accordance with the procedures and shown to be compliant with the applicable technical standards.

The test results in this report apply exclusively to the tested model / sample. Without written approval of SPORTON INTERNATIONAL INC., the test report shall not be reproduced except in full.



Reviewed by: Joseph Lin / Supervisor



Approved by: Jones Tsai / Manager



SPORTON INTERNATIONAL INC.

No. 52, Hwa Ya 1st Rd., Hwa Ya Technology Park, Kwei-Shan Hsiang, Tao Yuan Hsien, Taiwan, R.O.C.

SPORTON INTERNATIONAL INC.

TEL : 886-3-327-3456

FAX : 886-3-328-4978

FCC ID : PY7PM-0673

IC : 4170B-PM0673

Page Number : 1 of 62

Report Issued Date : Jan. 08, 2014

Report Version : Rev. 03



TABLE OF CONTENTS

REVISION HISTORY 3

SUMMARY OF TEST RESULT 4

1 GENERAL DESCRIPTION..... 5

 1.1 Applicant 5

 1.2 Manufacturer..... 5

 1.3 Feature of Equipment Under Test 5

 1.4 Product Specification of Equipment Under Test..... 6

 1.5 Modification of EUT 7

 1.6 Testing Site..... 7

 1.7 Applied Standards 7

2 TEST CONFIGURATION OF EQUIPMENT UNDER TEST..... 8

 2.1 Descriptions of Test Mode 8

 2.2 Test Mode..... 9

 2.3 Connection Diagram of Test System..... 10

 2.4 Support Unit used in test configuration and system 11

 2.5 EUT Operation Test Setup 11

 2.6 Measurement Results Explanation Example..... 11

3 TEST RESULT 12

 3.1 6dB and 99% Bandwidth Measurement 12

 3.2 Peak Output Power Measurement 17

 3.3 Power Spectral Density Measurement 19

 3.4 Conducted Band Edges and Spurious Emission Measurement 24

 3.5 Radiated Band Edges and Spurious Emission Measurement 33

 3.6 AC Conducted Emission Measurement..... 53

 3.7 Antenna Requirements 59

4 LIST OF MEASURING EQUIPMENT..... 60

5 UNCERTAINTY OF EVALUATION..... 62



REVISION HISTORY

REPORT NO.	VERSION	DESCRIPTION	ISSUED DATE
FR3O2909B	Rev. 01	Initial issue of report	Dec. 18, 2013
FR3O2909B	Rev. 02	Revising description of HW version in section 1.4 Details of Tested Sample (EUT) Information	Dec. 30, 2013
FR3O2909B	Rev. 03	Revising description of GPRS/EGPRS multi slot class 12 to 33.	Jan. 08, 2014



SUMMARY OF TEST RESULT

Report Section	FCC Rule	IC Rule	Description	Limit	Result	Remark
3.1	15.247(a)(2)	RSS-210 A8.2(a)	6dB Bandwidth	$\geq 0.5\text{MHz}$	Pass	-
3.1	-	RSS-Gen 4.6.1	99% Bandwidth	-	Pass	-
3.2	15.247(b)(1)	RSS-210 A8.1(b)	Peak Output Power	$\leq 30\text{dBm}$	Pass	-
3.3	15.247(e)	RSS-210 A8.2(b)	Power Spectral Density	$\leq 8\text{dBm}$	Pass	-
3.4	15.247(d)	RSS-210 A8.5	Conducted Band Edges and Spurious Emission	$\leq 20\text{dBc}$	Pass	-
3.5	15.247(d)	RSS-210 A8.5	Radiated Band Edges and Spurious Emission	15.209(a) & 15.247(d)	Pass	Under limit 12.49 dB at 2483.500 MHz
3.6	15.207	RSS-Gen 7.2.4	AC Conducted Emission	15.207(a)	Pass	Under limit 11.60 dB at 0.406 MHz
3.7	15.203 & 15.247(b)	RSS-210 A8.4	Antenna Requirement	N/A	Pass	-



1 General Description

1.1 Applicant

Sony Mobile Communications AB
Nya Vattentorget, 22188 Lund, Sweden

1.2 Manufacturer

Arima Communications Corp.
6F., No. 866, Jhongjheng Rd., Jhonghe Dist., New Taipei City 23586, Taiwan

1.3 Feature of Equipment Under Test

The Equipment Under Test (hereafter called: EUT) is smart phone supporting, GSM / WCDMA / Wi-Fi 2.4GHz 802.11b/g/n, Bluetooth with FM Receiver, and GPS features, and below is details of information.

General Information of Equipment Under Test	
Equipment	Smart phone
Brand Name	SONY
Model Name	D2104
Type Name	PM-0673-BV
FCC ID	PY7PM-0673
IC	4170B-PM0673
GSM Operating Band(s)	GSM 850/900/1800/1900MHz
GPRS / EGPRS Multi Slot Class	GPRS Class 33, EGPRS Class 33
WCDMA Operating Band(s)	FDD Band I / II / V
WCDMA Rel. Version	Rel. 7
Wi-Fi Specification	802.11b/g/n (HT20)
Bluetooth Version	v3.0+EDR / v4.0-LE
Power Supply	Battery / AC Adapter / Car Charger

Remark: The above EUT's information was declared by manufacturer. Please refer to the specifications or user's manual for more detailed description.



1.4 Product Specification of Equipment Under Test

Product Specification subjective to this standard	
Tx/Rx Frequency Range	2402 MHz ~ 2480 MHz
Number of Channels	40
Carrier Frequency of Each Channel	40 Channel(37 hopping + 3 advertising channel)
Maximum Output Power to Antenna	4.27 dBm (0.0026 W)
Antenna Type	PIFA Antenna type with gain 1.24 dBi
Type of Modulation	Bluetooth 4.0 - LE : GFSK
EUT #1	IMEI : 00440214-707873-1 S/N : WUJ016LPSP
EUT #2	IMEI : 00440214-707857-4 S/N : WUJ016LPD8
EUT #3	IMEI 1 : 00440214-707917-6 IMEI 2 : 00440214-707918-4 S/N : WUJ016MS4B
HW Version	A
SW Version	20.0.B.0.26
EUT Stage	Production Unit

Accessory List	
AC Adapter	Model No. : EP800
	Type No. : CAA-0002016-US B
Battery	Model No. : BA900
	Type No. : AB-0500
Earphone	Model No. : MH410c
	Type No. : AG-1100
USB Cable	Model No. : EC450
	Part No. : 1242-6715.3 12W45

Note:

1. Above EUT list and accessory list used are electrically identical per declared by manufacturer.
2. Above the accessories list are used to exercise the EUT during test, and the serial number of each type of accessories is listed in each section of this report.
3. For other wireless features of this EUT, test report will be issued separately.



1.5 Modification of EUT

No modifications are made to the EUT during all test items.

1.6 Testing Site

Test Site	SPORTON INTERNATIONAL INC.			
Test Site Location	No. 52, Hwa Ya 1 st Rd., Hwa Ya Technology Park, Kwei-Shan Hsiang, Tao Yuan Hsien, Taiwan, R.O.C. TEL: +886-3-3273456 / FAX: +886-3-3284978			
Test Site No.	Sporton Site No.			FCC/IC Registration No.
	TH02-HY	CO05-HY	03CH07-HY	722060/4086B-1

The test site complies with ANSI C63.4 2003 requirement.

1.7 Applied Standards

According to the specifications of the manufacturer, the EUT must comply with the requirements of the following standards:

- FCC Part 15 Subpart C §15.247
- FCC KDB Publication No. 558074 D01 DTS Meas. Guidance v03r01
- ANSI C63.4-2003
- IC RSS-210 Issue 8
- IC RSS-Gen Issue 3
- NOTICE 2012-DRS0126

Remark:

1. All test items were verified and recorded according to the standards and without any deviation during the test.
2. This EUT has also been tested and complied with the requirements of FCC Part 15, Subpart B, recorded in a separate test report.
3. Per the section 2.2.3 of Notice of 2012-DRS0126, " Receivers Excluded from Industry Canada Requirements", only radiocommunication receivers operating in stand-alone mode within the band 30-960 MHz and scanner receivers are subject to Industry Canada requirements.

2 Test Configuration of Equipment Under Test

2.1 Descriptions of Test Mode

The RF output power was recorded in the following table:

Channel	Frequency	Bluetooth 4.0 – LE RF Output Power	
		Data Rate / Modulation	
		GFSK	
		1Mbps	
Ch00	2402MHz	4.27	dBm
Ch19	2440MHz	4.05	dBm
Ch39	2480MHz	4.18	dBm

- a. The EUT has been associated with peripherals and configuration operated in a manner tended to maximize its emission characteristics in a typical application. Frequency range investigated: conduction (150 kHz to 30 MHz), radiation (9 kHz to the 10th harmonic of the highest fundamental frequency or to 40 GHz, whichever is lower). Pre-scanned tests, X, Y, Z in three orthogonal panels to determine the final configuration (X plane as worst plane) from all possible combinations.
- b. AC power line Conducted Emission was tested under maximum output power.



2.2 Test Mode

The following summary table is showing all test modes to demonstrate in compliance with the standard.

Summary table of Test Cases	
Test Item	Data Rate / Modulation
	Bluetooth 4.0 – LE / GFSK
Conducted TCs	Mode 1: Bluetooth Tx CH00_2402 MHz_1Mbps
	Mode 2: Bluetooth Tx CH19_2440 MHz_1Mbps
	Mode 3: Bluetooth Tx CH39_2480 MHz_1Mbps
Radiated TCs	Mode 1: Bluetooth Tx CH00_2402 MHz_1Mbps
	Mode 2: Bluetooth Tx CH19_2440 MHz_1Mbps
	Mode 3: Bluetooth Tx CH39_2480 MHz_1Mbps
AC Conducted Emission	Mode 1 :GSM1900 Idle + Bluetooth Link + WLAN Idle + MP3 + Earphone + Battery + USB Cable (Charging from Adapter) + SIM 1
	Mode 2 :GSM1900 Idle + Bluetooth Idle + WLAN Link + MP3 + Earphone + Battery + USB Cable (Charging from Adapter) + SIM 1

2.3 Connection Diagram of Test System

<Bluetooth 4.0 – LE Tx Mode>

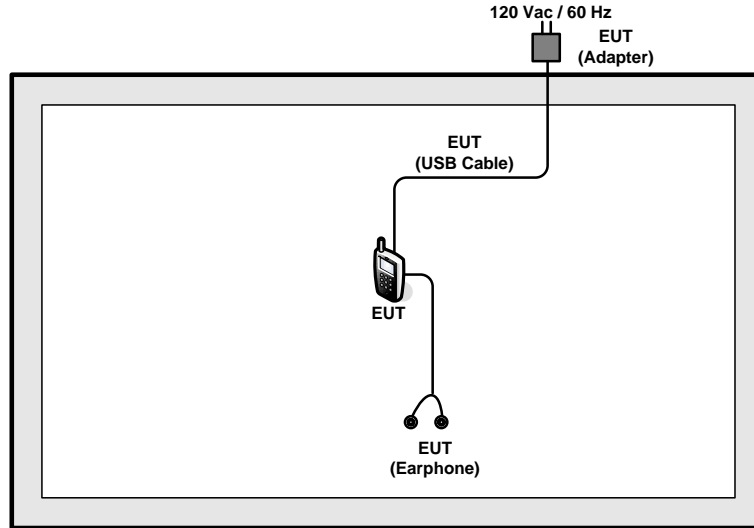

<AC Conducted Emission Mode>

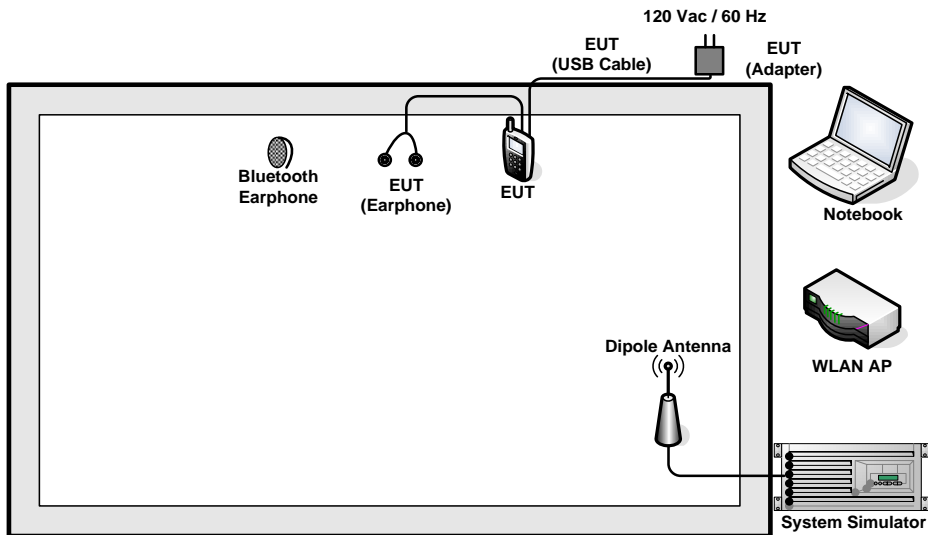

2.4 Support Unit used in test configuration and system

Item	Equipment	Trade Name	Model Name	FCC ID	Data Cable	Power Cord
1.	System Simulator	R&S	CMU 200	N/A	N/A	Unshielded, 1.8 m
2.	WLAN AP	D-Link	DIR-628	KA2DIR628A2	N/A	Unshielded, 1.8 m
3.	Notebook	DELL	Latitude E6320	FCC DoC	N/A	AC I/P: Unshielded, 1.2 m DC O/P: Shielded, 1.8 m
4.	Bluetooth Earphone	Sony Ericsson	MW600	PY7DDA-2029	N/A	N/A
5.	SD Card	SanDisk	MicroSD HC	FCC DoC	N/A	N/A

2.5 EUT Operation Test Setup

For Bluetooth 4.0-LE function, an engineering test program was provided and enabled to make EUT continuous transmitting and receiving signals

2.6 Measurement Results Explanation Example

For all conducted test items:

The offset level is set in the spectrum analyzer to compensate the RF cable loss and attenuator factor between EUT conducted output port and spectrum analyzer. With the offset compensation, the spectrum analyzer reading level is exactly the EUT RF output level.

Example :

The spectrum analyzer offset is derived from RF cable loss and attenuator factor.

Offset = RF cable loss + attenuator factor.

Following shows an offset computation example with cable loss 4.2 dB and 10dB attenuator.

$$\begin{aligned}
 \text{Offset(dB)} &= \text{RF cable loss(dB)} + \text{attenuator factor(dB)}. \\
 &= 4.2 + 10 = 14.2 \text{ (dB)}
 \end{aligned}$$

3 Test Result

3.1 6dB and 99% Bandwidth Measurement

3.1.1 Limit of 6dB and 99%Bandwidth

The minimum 6 dB bandwidth shall be at least 500 kHz.

3.1.2 Measuring Instruments

The section 4.0 of List of Measuring Equipment of this test report is used for test.

3.1.3 Test Procedures

1. The testing follows FCC KDB Publication No. 558074 D01 DTS Meas. Guidance v03r01.
2. The RF output of EUT was connected to the spectrum analyzer by RF cable and attenuator. The path loss was compensated to the results for each measurement.
3. Set to the maximum power setting and enable the EUT transmit continuously.
4. Make the measurement with the spectrum analyzer's resolution bandwidth (RBW) = 100 kHz. Set the Video bandwidth (VBW) = 300 kHz. In order to make an accurate measurement. The 6 dB bandwidth must be greater than 500 kHz.
5. For 99% Bandwidth Measurement, the spectrum analyzer's resolution bandwidth (RBW) is set 30kHz and set the Video bandwidth (VBW) = 100kHz.
6. Measure and record the results in the test report.

3.1.4 Test Setup

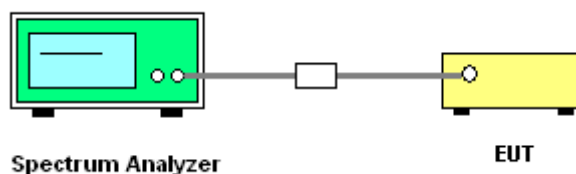



3.1.5 Test Result of 6dB Bandwidth

Test Mode :	Bluetooth 4.0 - LE	Temperature :	22~25°C
Test Engineer :	Rover Lee	Relative Humidity :	51~55%

Channel	Frequency (MHz)	6dB Bandwidth (MHz)	6dB Bandwidth Min. Limit (MHz)	Pass/Fail
00	2402	0.666	0.5	Pass
19	2440	0.674	0.5	Pass
39	2480	0.676	0.5	Pass

6 dB Bandwidth Plot on Channel 00

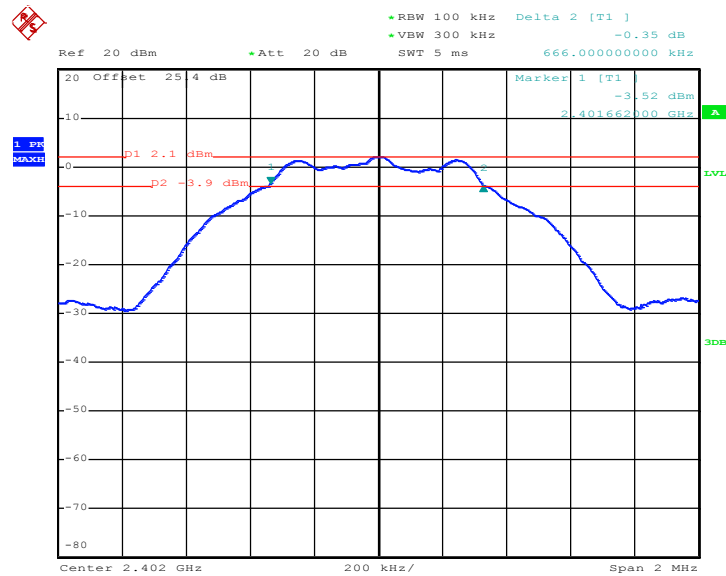

Date: 4.NOV.2013 11:25:17

Note: The total loss is 25.4 dB of the RF cable and attenuator, and has been compensated to the spectrum analyzer offset.



6 dB Bandwidth Plot on Channel 19

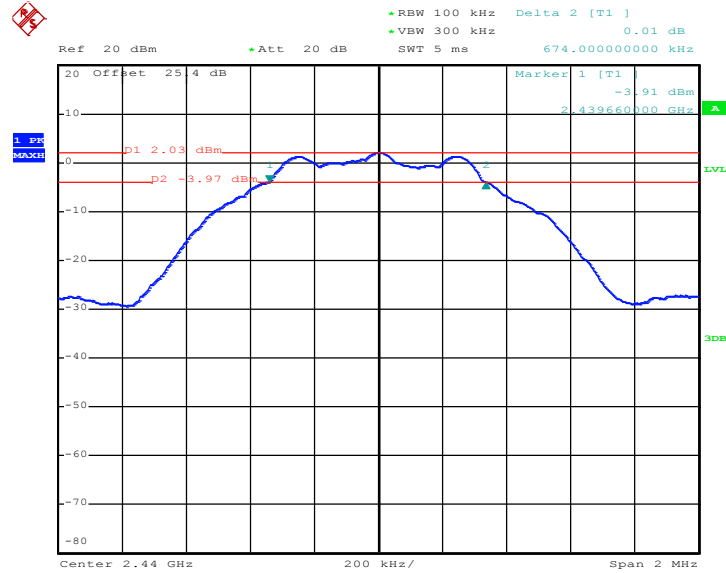

Date: 4.NOV.2013 11:35:56

6 dB Bandwidth Plot on Channel 39

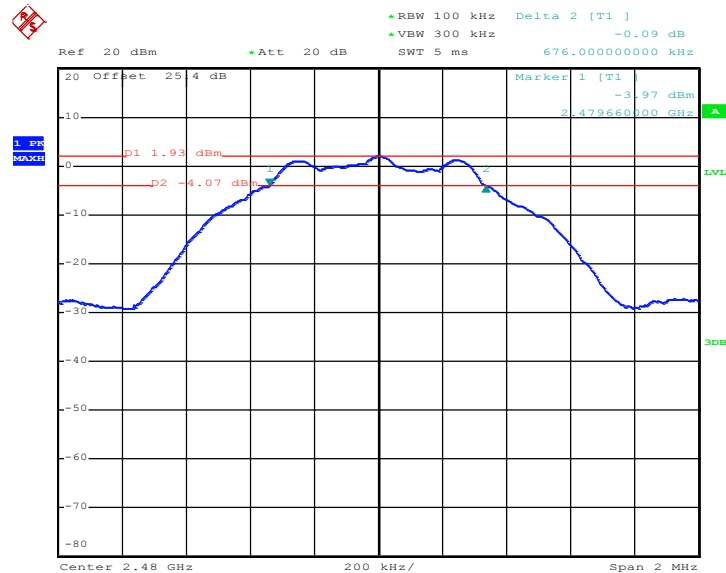

Date: 4.NOV.2013 11:41:17



3.1.6 Test Result of 99% Occupied Bandwidth

Test Mode :	Bluetooth 4.0 - LE	Temperature :	22~25°C
Test Engineer :	Rover Lee	Relative Humidity :	51~55%

Channel	Frequency (MHz)	99% Occupied Bandwidth (MHz)
00	2402	1.058
19	2440	1.056
39	2480	1.056

99% Bandwidth Plot on Channel 00

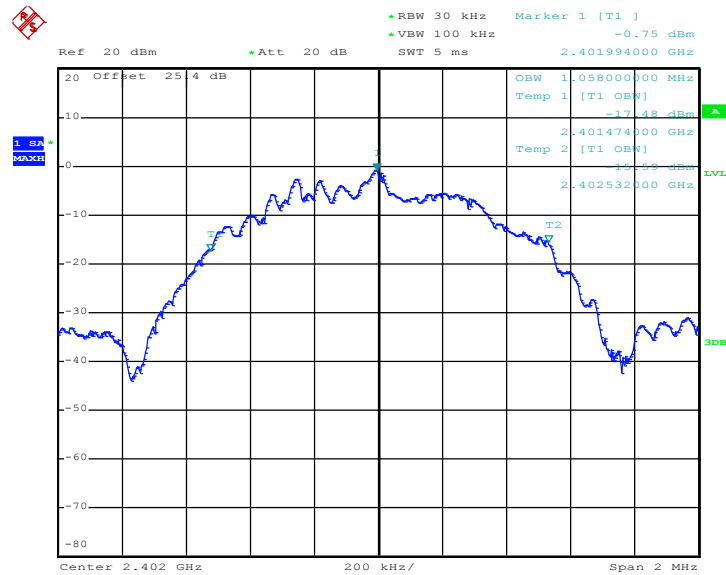

Date: 4.NOV.2013 11:30:55

Note: The total loss is 25.4 dB of the RF cable and attenuator, and has been compensated to the spectrum analyzer offset.



99% Occupied Bandwidth Plot on Channel 19

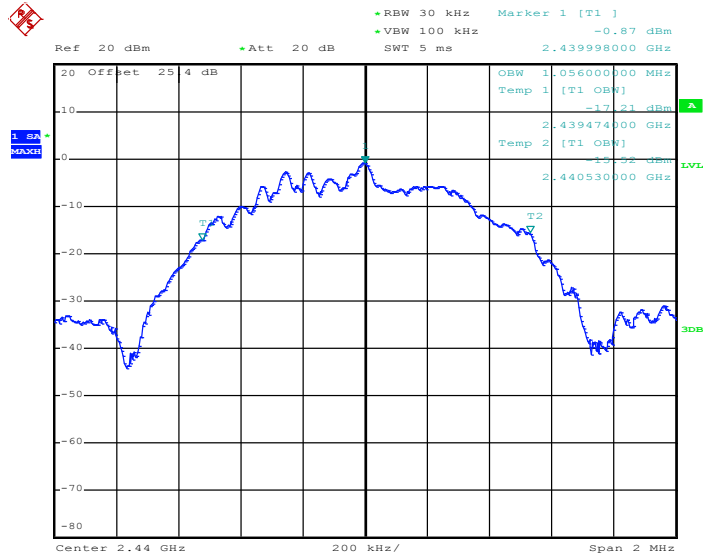

Date: 4.NOV.2013 11:38:13

99% Occupied Bandwidth Plot on Channel 39

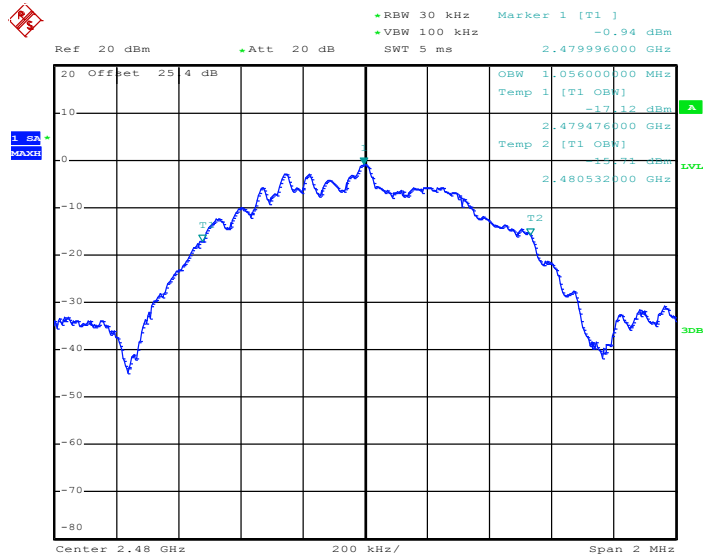

Date: 4.NOV.2013 11:44:49

3.2 Peak Output Power Measurement

3.2.1 Limit of Peak Output Power

For systems using digital modulation in the 2400-2483.5MHz, the limit for peak output power is 30dBm. If transmitting antenna of directional gain greater than 6dBi is used, the peak output power from the intentional radiator shall be reduced below the above stated value by the amount in dB that the directional gain of the antenna exceeds 6 dBi. In case of point-to-point operation, the limit has to be reduced by 1dB for every 3dB that the directional gain of the antenna exceeds 6dBi.

3.2.2 Measuring Instruments

The section 4.0 of List of Measuring Equipment of this test report is used for test.

3.2.3 Test Procedures

1. The testing follows the Measurement Procedure of FCC KDB No. 558074 DTS D01 Meas. Guidance v03r01.
2. The RF output of EUT was connected to the power meter by RF cable and attenuator. The path loss was compensated to the results for each measurement.
3. Set to the maximum power setting and enable the EUT transmit continuously.
4. Measure the conducted output power and record the results in the test report.

3.2.4 Test Setup

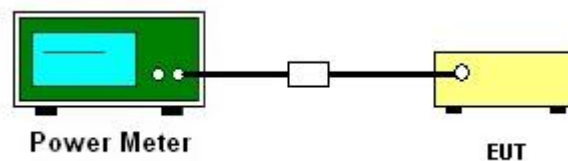



3.2.5 Test Result of Peak Output Power

Test Mode :	Bluetooth 4.0 - LE	Temperature :	22~25°C
Test Engineer :	Rover Lee	Relative Humidity :	51~55%

Channel	Frequency (MHz)	RF Power (dBm)		
		GFSK	Max. Limits (dBm)	Pass/Fail
		1 Mbps		
00	2402	4.27	30.00	Pass
19	2440	4.05	30.00	Pass
39	2480	4.18	30.00	Pass

3.3 Power Spectral Density Measurement

3.3.1 Limit of Power Spectral Density

The peak power spectral density shall not be greater than 8dBm in any 3kHz band at any time interval of continuous transmission.

3.3.2 Measuring Instruments

The section 4.0 of List of Measuring Equipment of this test report is used for test.

3.3.3 Test Procedures

1. The testing follows Measurement Procedure 10.2 Method PKPSD of FCC KDB Publication No. 558074 D01 DTS Meas. Guidance v03r01
2. The RF output of EUT was connected to the spectrum analyzer by RF cable and attenuator. The path loss was compensated to the results for each measurement.
3. Set to the maximum power setting and enable the EUT transmit continuously.
4. Make the measurement with the spectrum analyzer's resolution bandwidth (RBW) = 3 kHz. Video bandwidth VBW = 10 kHz In order to make an accurate measurement, set the span to 1.5 times DTS Channel Bandwidth. (6dB BW)
5. Detector = peak, Sweep time = auto couple, Trace mode = max hold, Allow trace to fully stabilize. Use the peak marker function to determine the maximum power level.
6. Measure and record the results in the test report.
7. The Measured power density (dBm)/ 100kHz is a reference level and used as 20dBc down limit line for Conducted Band Edges and Conducted Spurious Emission.

3.3.4 Test Setup

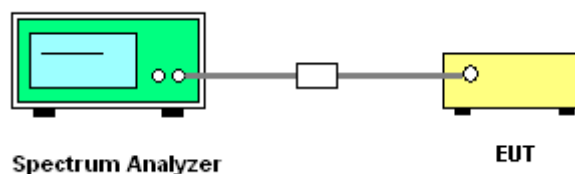



3.3.5 Test Result of Power Spectral Density

Test Mode :	Bluetooth 4.0 - LE	Temperature :	22~25°C
Test Engineer :	Rover Lee	Relative Humidity :	51~55%

Channel	Frequency (MHz)	Power Density		Max. Limits (dBm/3kHz)	Pass/Fail
		PSD/100kHz (dBm)	PSD/3kHz (dBm)		
00	2402	2.08	-13.00	8	Pass
19	2440	2.02	-13.12	8	Pass
39	2480	1.92	-13.29	8	Pass

Note:

1. The total loss is 25.4 dB of the RF cable and attenuator, and has been compensated to the spectrum analyzer offset.
2. Measured power density (dBm) has offset with cable loss.
3. The Measured power density (dBm)/ 100kHz is reference level and used as 20dBc down for Conducted Band Edges and Conducted Spurious Emission limit line.

3.3.6 Test Result of Power Spectral Density Plots (100kHz)

PSD 100kHz Plot on Channel 00

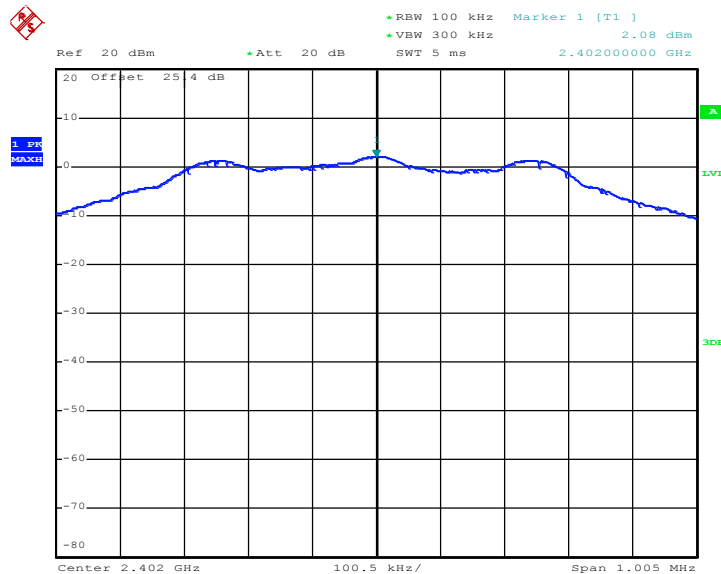

Date: 4.NOV.2013 11:27:59



PSD 100kHz Plot on Channel 19

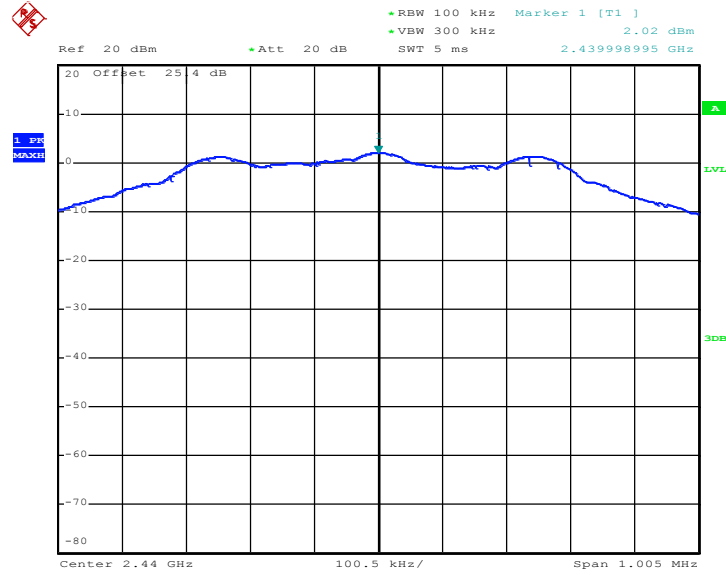

Date: 4.NOV.2013 11:37:03

PSD 100kHz Plot on Channel 39

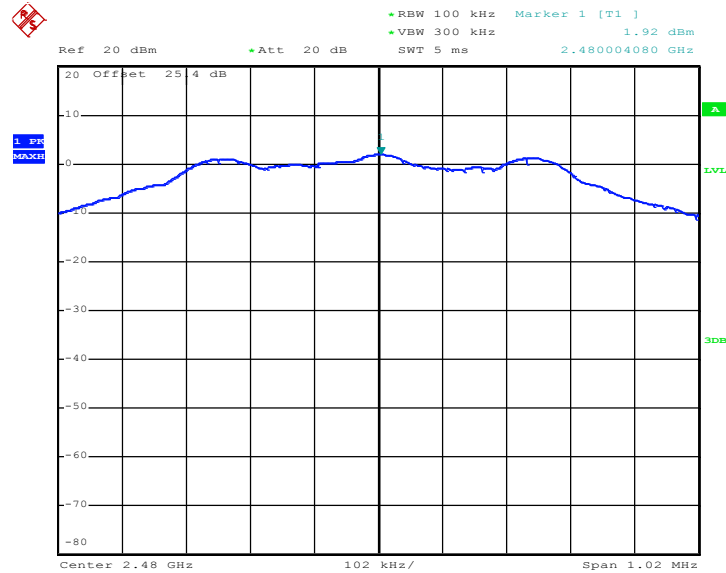

Date: 4.NOV.2013 11:42:25



3.3.7 Test Result of Power Spectral Density Plots (3kHz)

PSD 3kHz Plot on Channel 00

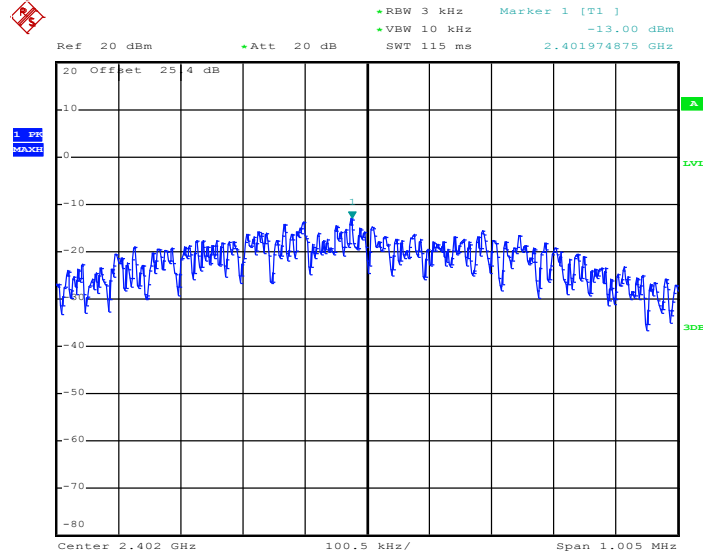

Date: 4.NOV.2013 11:27:14

PSD 3kHz Plot on Channel 19

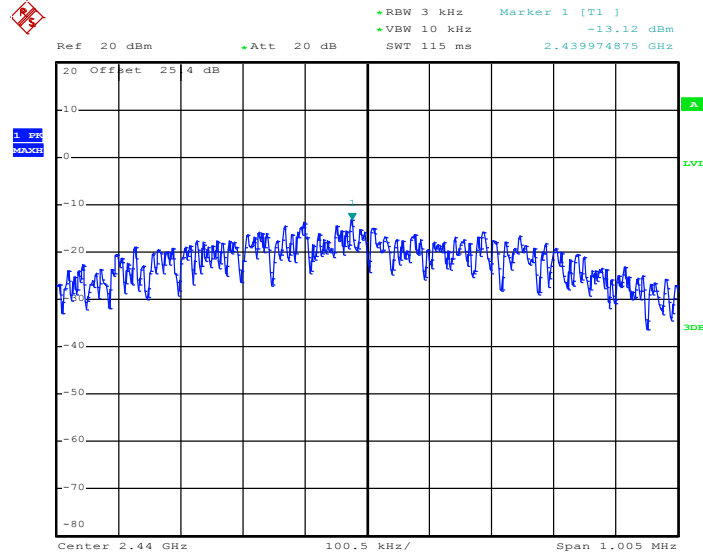

Date: 4.NOV.2013 11:36:46



PSD 3kHz Plot on Channel 39

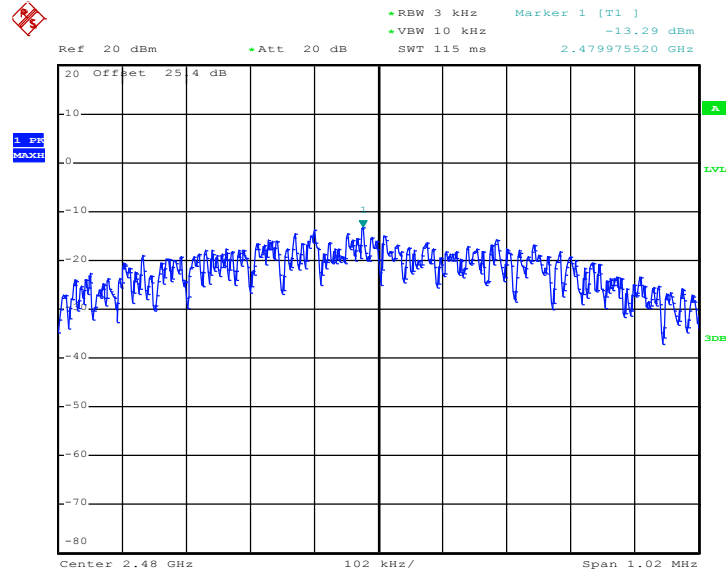

Date: 4.NOV.2013 11:42:02

3.4 Conducted Band Edges and Spurious Emission Measurement

3.4.1 Limit of Conducted Band Edges and Spurious Emission

All harmonics/spurious must be at least 20 dB down from the highest emission level within the authorized band.

3.4.2 Measuring Instruments

The section 4.0 of List of Measuring Equipment of this test report is used for test.

3.4.3 Test Procedure

1. The testing follows FCC KDB Publication No. 558074 D01 DTS Meas. Guidance v03r01.
2. The RF output of EUT was connected to the spectrum analyzer by RF cable and attenuator. The path loss was compensated to the results for each measurement.
3. Set to the maximum power setting and enable the EUT transmit continuously.
4. Set RBW = 100 kHz, VBW=300 kHz, Peak Detector. Unwanted Emissions measured in any 100 kHz bandwidth outside of the authorized frequency band shall be attenuated by at least 20 dB relative to the maximum in-band peak PSD level in 100 kHz when maximum peak conducted output power procedure is used. If the transmitter complies with the conducted power limits based on the use of RMS averaging over a time interval, the attenuation required under this paragraph shall be 30 dB instead of 20 dB per 15.247(d).
5. Measure and record the results in the test report.
6. The RF fundamental frequency should be excluded against the limit line in the operating frequency band.

3.4.4 Test Setup

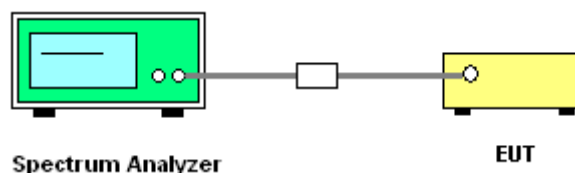



3.4.5 Test Result of Conducted Band Edges

Test Mode :	Bluetooth 4.0 - LE	Temperature :	22~25°C
Test Channel :	00 and 39	Relative Humidity :	51~55%
		Test Engineer :	Rover Lee

Low Band Edge Plot on Channel 00

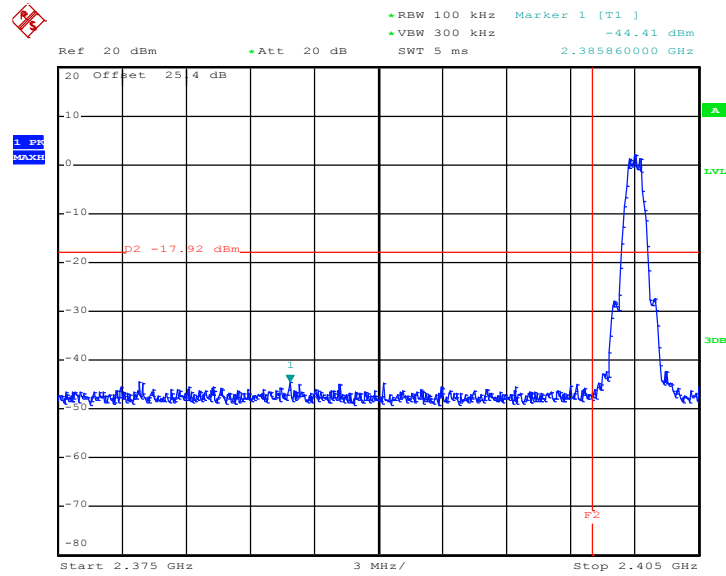

Date: 4.NOV.2013 11:28:30



High Band Edge Plot on Channel 39

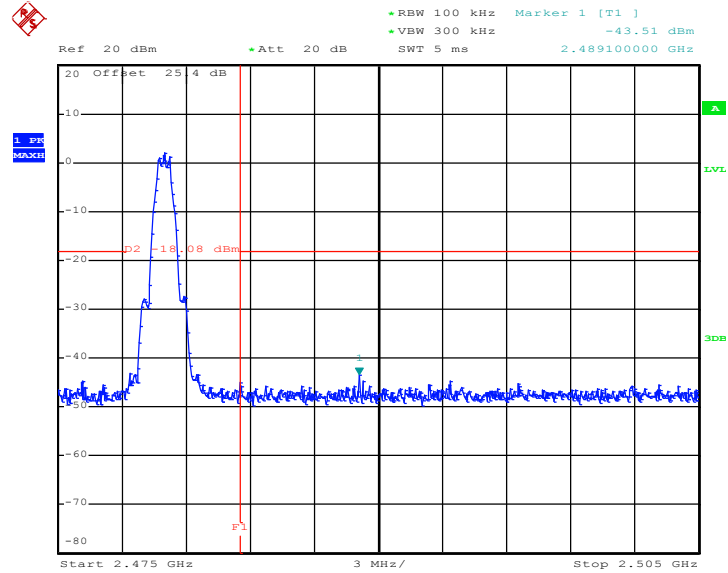

Date: 4.NOV.2013 11:43:05

3.4.6 Test Result of Conducted Spurious Emission

Test Mode :	Bluetooth 4.0 - LE	Temperature :	22~25°C
Test Channel :	00	Relative Humidity :	51~55%
		Test Engineer :	Rover Lee

Conducted Spurious Emission Plot on Bluetooth LE 1Mbps GFSK Channel 00

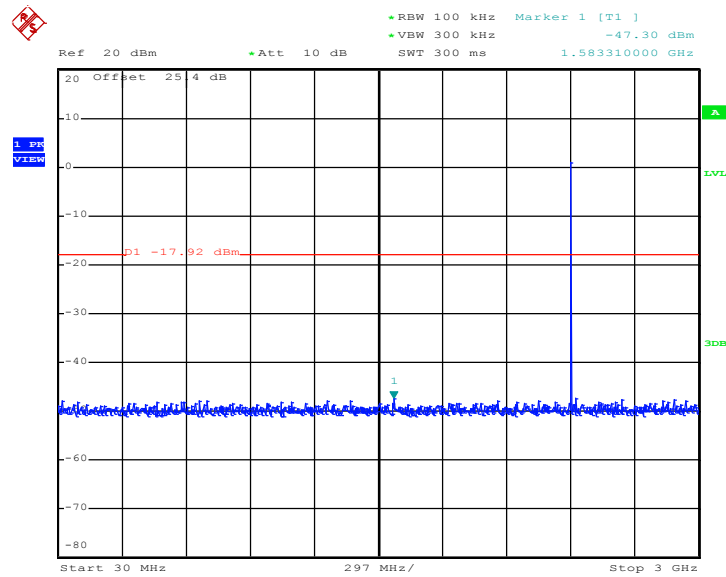

Date: 4.NOV.2013 11:30:00

Note:

1. The total loss is 25.4 dB of the RF cable and attenuator, and has been compensated to the spectrum analyzer offset.
2. The RF fundamental frequency should be excluded against the limit line in the operating frequency band.



Conducted Spurious Emission Plot on Bluetooth LE 1Mbps
GFSK Channel 00

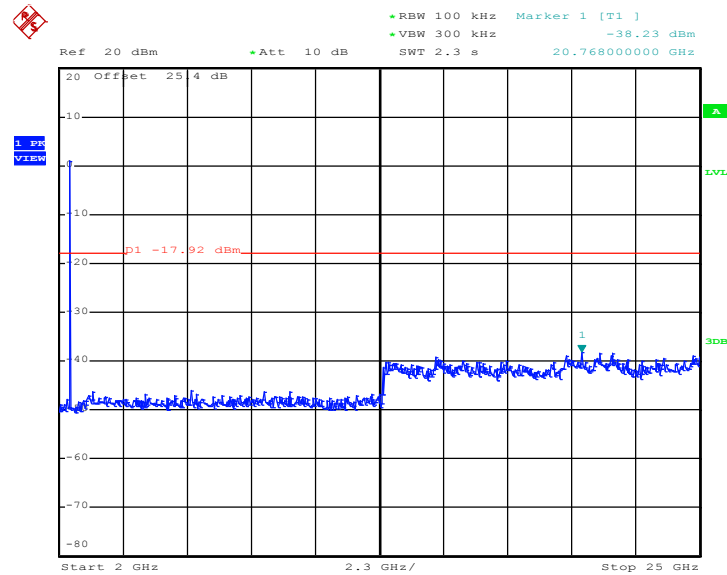

Date: 4.NOV.2013 11:30:19

Note:

1. The total loss is 25.4 dB of the RF cable and attenuator, and has been compensated to the spectrum analyzer offset.
2. The RF fundamental frequency should be excluded against the limit line in the operating frequency band.



Test Mode :	Bluetooth 4.0 - LE	Temperature :	22~25°C
Test Channel :	19	Relative Humidity :	51~55%
		Test Engineer :	Rover Lee

**Conducted Spurious Emission Plot on Bluetooth LE 1Mbps
GFSK Channel 19**

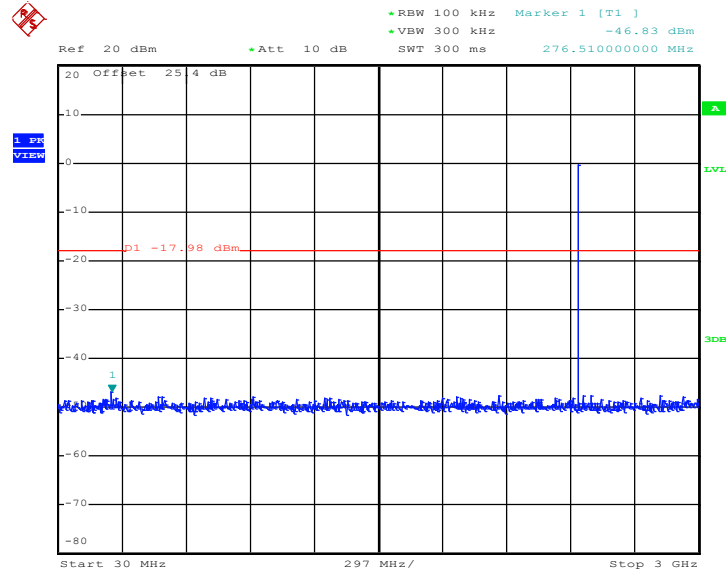

Date: 4.NOV.2013 11:37:32

Note:

1. The total loss is 25.4 dB of the RF cable and attenuator, and has been compensated to the spectrum analyzer offset.
2. The RF fundamental frequency should be excluded against the limit line in the operating frequency band.



Conducted Spurious Emission Plot on Bluetooth LE 1Mbps
GFSK Channel 19

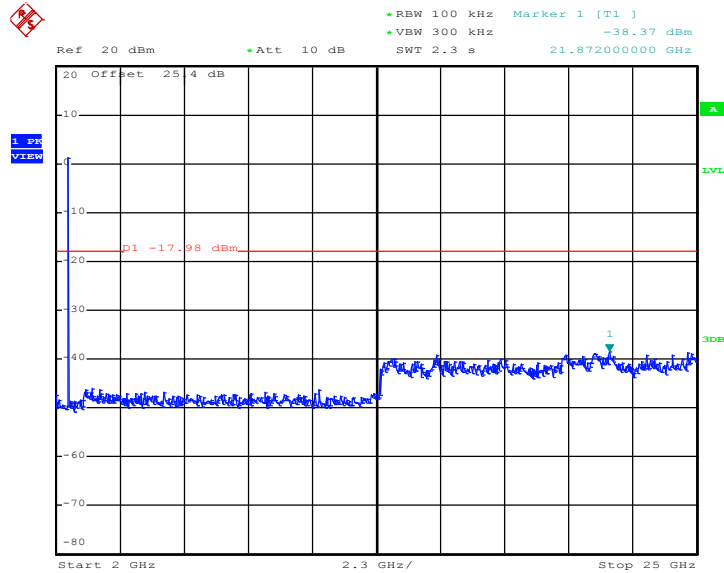

Date: 4.NOV.2013 11:37:50

Note:

1. The total loss is 25.4 dB of the RF cable and attenuator, and has been compensated to the spectrum analyzer offset.
2. The RF fundamental frequency should be excluded against the limit line in the operating frequency band.



Test Mode :	Bluetooth 4.0 - LE	Temperature :	22~25°C
Test Channel :	39	Relative Humidity :	51~55%
		Test Engineer :	Rover Lee

**Conducted Spurious Emission Plot on Bluetooth LE 1Mbps
GFSK Channel 39**

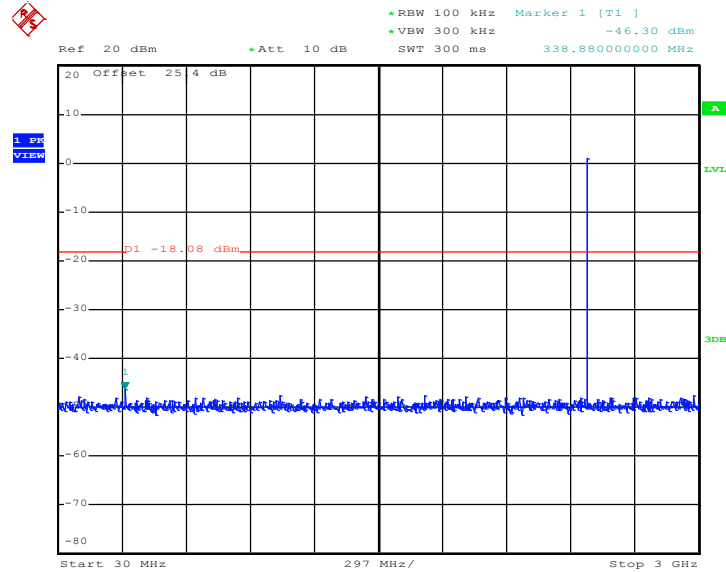

Date: 4.NOV.2013 11:43:55

Note:

1. The total loss is 25.4 dB of the RF cable and attenuator, and has been compensated to the spectrum analyzer offset.
2. The RF fundamental frequency should be excluded against the limit line in the operating frequency band.

**Conducted Spurious Emission Plot on Bluetooth LE 1Mbps
GFSK Channel 39**

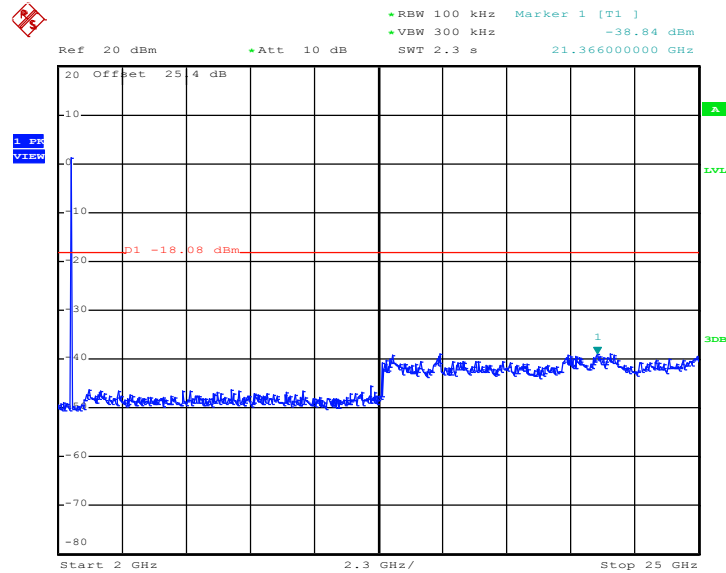

Date: 4.NOV.2013 11:44:14

Note:

1. The total loss is 25.4 dB of the RF cable and attenuator, and has been compensated to the spectrum analyzer offset.
2. The RF fundamental frequency should be excluded against the limit line in the operating frequency band.



3.5 Radiated Band Edges and Spurious Emission Measurement

3.5.1 Limit of Radiated Band Edges and Spurious Emission

In any 100 kHz bandwidth outside the intentional radiator frequency band, all harmonics/spurious must be at least 20 dB below the highest emission level within the authorized band. If the output power of this device was measured by spectrum analyzer, the attenuation under this paragraph shall be 30 dB instead of 20 dB. In addition, radiated emissions which fall in the restricted bands must also comply with the FCC section 15.209 limits as below.

Frequency (MHz)	Field Strength (microvolts/meter)	Measurement Distance (meters)
0.009 – 0.490	2400/F(kHz)	300
0.490 – 1.705	24000/F(kHz)	30
1.705 – 30.0	30	30
30 – 88	100	3
88 – 216	150	3
216 - 960	200	3
Above 960	500	3

3.5.2 Measuring Instruments

The section 4.0 of List of Measuring Equipment of this test report is used for test.



3.5.3 Test Procedures

1. The testing follows FCC KDB Publication No. 558074 D01 DTS Meas. Guidance v03r01.
2. The EUT was arranged to its worst case and then tune the antenna tower (from 1 m to 4 m) and turntable (from 0 degree to 360 degrees) to find the maximum reading. A pre-amp and a high pass filter are used for the test in order to get better signal level.
3. The EUT was placed on a turntable with 0.8 meter above ground.
4. The EUT was set 3 meters from the interference receiving antenna, which was mounted on the top of a variable height antenna tower.
5. Corrected Reading: Antenna Factor + Cable Loss + Read Level - Preamp Factor = Level
6. For measurement below 1GHz, If the emission level of the EUT measured by the peak detector is 3 dB lower than the applicable limit, the peak emission level will be reported. Otherwise, the emission measurement will be repeated using the quasi-peak detector and reported.
7. Use the following spectrum analyzer settings:
 - (1) Span shall wide enough to fully capture the emission being measured;
 - (2) Set RBW=100 kHz for $f < 1$ GHz; $VBW \geq RBW$; Sweep = auto; Detector function = peak; Trace = max hold;
 - (3) Set RBW = 1 MHz, VBW= 3MHz for $f \geq 1$ GHz for peak measurement.
For average measurement:
 - $VBW = 10$ Hz, when duty cycle is no less than 98 percent.
 - $VBW \geq 1/T$, when duty cycle is less than 98 percent where T is the minimum transmission duration over which the transmitter is on and is transmitting at its maximum power control level for the tested mode of operation.

Band	Duty Cycle(%)	T(μs)	1/T(kHz)	VBW Setting
Bluetooth 4.0 - LE	62.66	396.00	2.525	3kHz

3.5.4 Test Setup

For radiated emissions below 30MHz

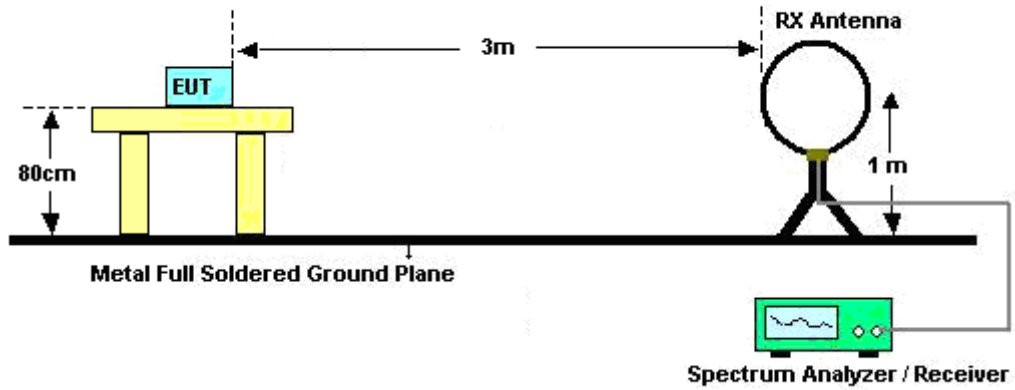

For radiated emissions from 30MHz to 1GHz

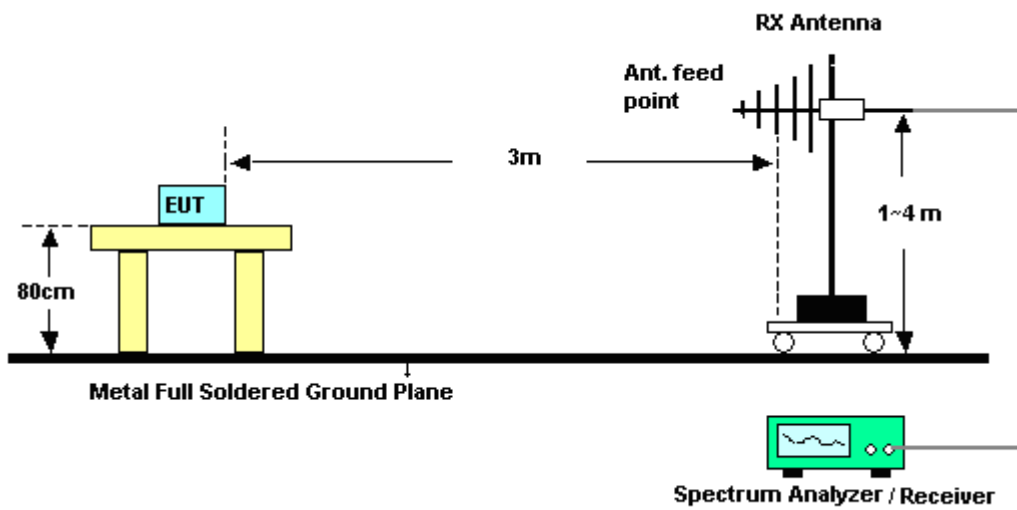

For radiated emissions above 1GHz

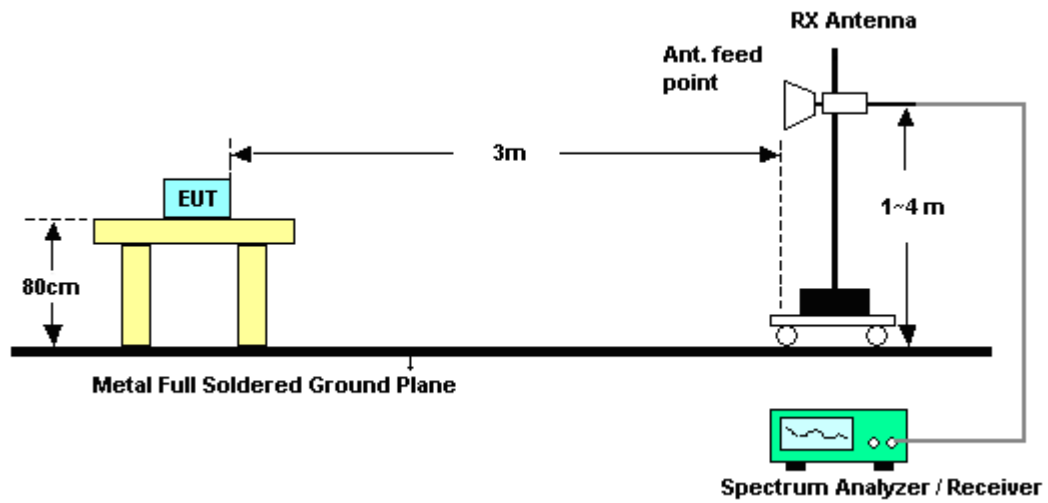

3.5.5 Test Results of Radiated Spurious Emissions (9 kHz ~ 30 MHz)

The low frequency, which started from 9 kHz to 30MHz, was pre-scanned and the result which was 20dB lower than the limit line per 15.31(o) was not reported.



3.5.6 Test Result of Radiated Spurious at Band Edges

Test Mode :	Mode 1	Temperature :	21~23°C
Test Channel :	00	Relative Humidity :	49~51%
		Test Engineer :	Eric Shih

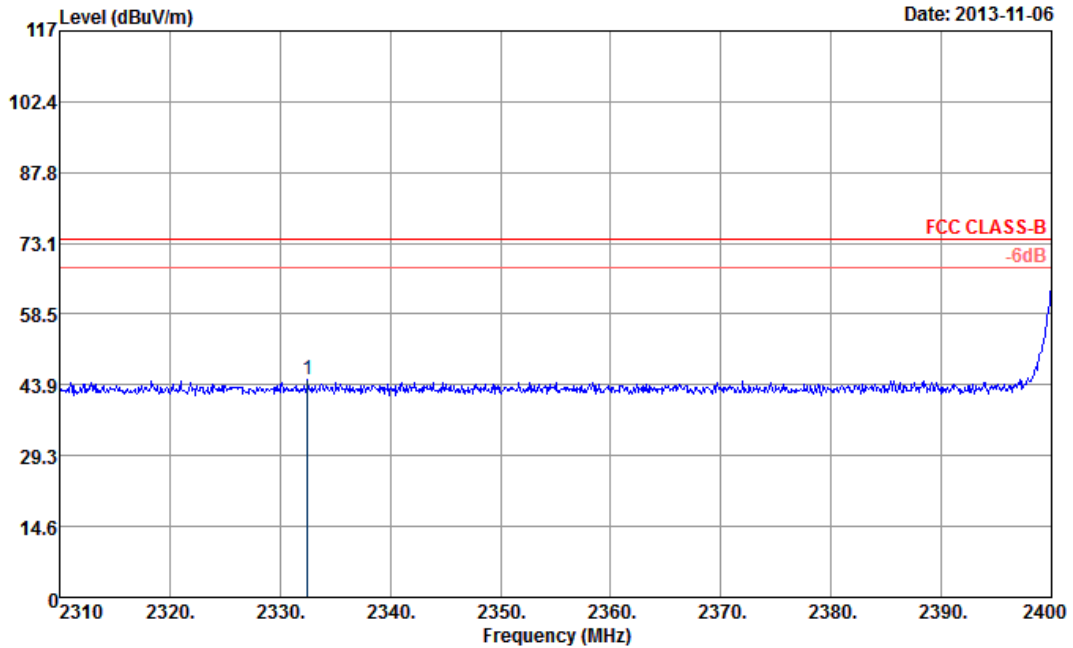

Site : 03CH07-HY
 Condition : FCC CLASS-B 3m HF-ANT_120823 HORIZONTAL
 : RBW:1000.000KHz VBW:3000.000KHz SWT:Auto

ANTENNA POLARITY : HORIZONTAL

Frequency (MHz)	Level (dBμV/m)	Over Limit (dB)	Limit Line (dBμV/m)	Read Level (dBμV)	Antenna Factor (dB)	Cable Loss (dB)	Preamp Factor (dB)	Ant Pos (cm)	Table Pos (deg)	Remark
2332.50	44.98	-29.02	74	40.13	32.23	6.84	34.22	118	22	Peak

Note: Worst case measurement on 2332.50 MHz is compliance with 74/54 dBuV/m (peak/average) limit and Edge Measurement in the restricted band 2310-2390MHz. And, 2390-2400 MHz is non-restricted band which limit line is 20dB below the fundamental frequency emission level which is tested by conducted spurious emission. Both the test results are compliance with the FCC limit line.



Test Mode :	Mode 1	Temperature :	21~23°C
Test Channel :	00	Relative Humidity :	49~51%
		Test Engineer :	Eric Shih

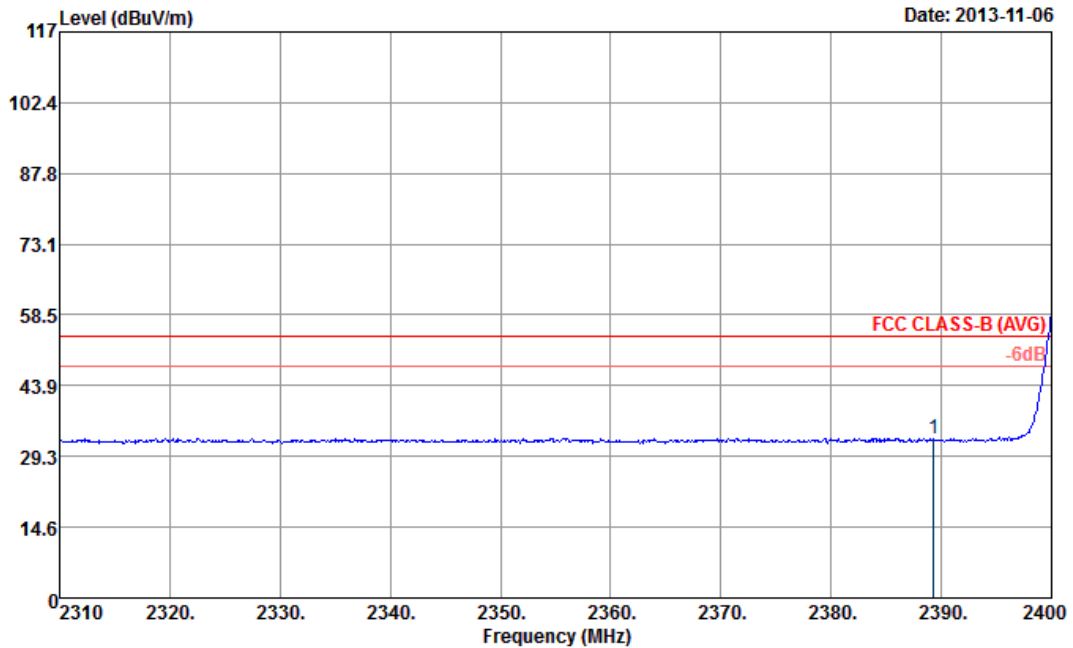

Site : 03CH07-HY
 Condition : FCC CLASS-B (AVG) 3m HF-ANT_120823 HORIZONTAL
 : RBW:1000.000KHz VBW:3.000KHz SWT:Auto

ANTENNA POLARITY : HORIZONTAL

Frequency (MHz)	Level (dBμV/m)	Over Limit (dB)	Limit Line (dBμV/m)	Read Level (dBμV)	Antenna Factor (dB)	Cable Loss (dB)	Preamp Factor (dB)	Ant Pos (cm)	Table Pos (deg)	Remark
2389.29	33.05	-20.95	54	28.11	32.3	6.91	34.27	118	22	Average

Note: Worst case measurement on 2389.29 MHz is compliance with 74/54 dBuV/m (peak/average) limit and Edge Measurement in the restricted band 2310-2390MHz. And, 2390-2400 MHz is non-restricted band which limit line is 20dB below the fundamental frequency emission level which is tested by conducted spurious emission. Both the test results are compliance with the FCC limit line.



Test Mode :	Mode 1	Temperature :	21~23°C
Test Channel :	00	Relative Humidity :	49~51%
		Test Engineer :	Eric Shih

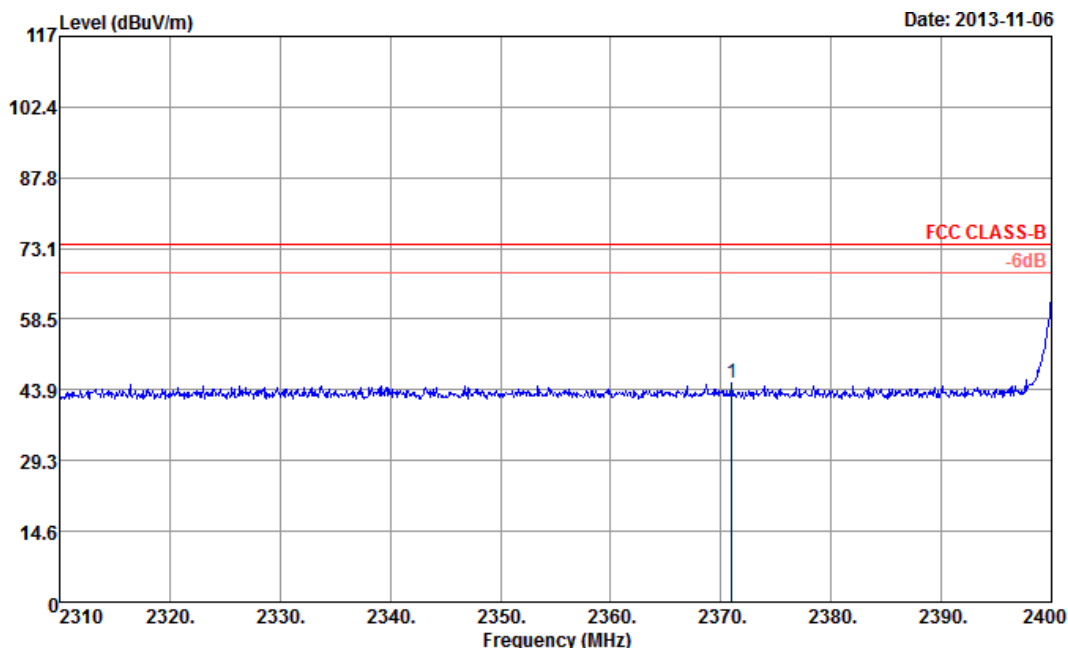

Site : 03CH07-HY
 Condition : FCC CLASS-B 3m HF-ANT_120823 VERTICAL
 : RBW:1000.000KHz VBW:3000.000KHz SWT:Auto

ANTENNA POLARITY : VERTICAL

Frequency (MHz)	Level (dBμV/m)	Over Limit (dB)	Limit Line (dBμV/m)	Read Level (dBμV)	Antenna Factor (dB)	Cable Loss (dB)	Preamp Factor (dB)	Ant Pos (cm)	Table Pos (deg)	Remark
2371.02	45.16	-28.84	74	40.27	32.28	6.88	34.27	100	352	Peak

Note: Worst case measurement on 2371.02 MHz is compliance with 74/54 dBuV/m (peak/average) limit and Edge Measurement in the restricted band 2310-2390MHz. And, 2390-2400 MHz is non-restricted band which limit line is 20dB below the fundamental frequency emission level which is tested by conducted spurious emission. Both the test results are compliance with the FCC limit line.



Test Mode :	Mode 1	Temperature :	21~23°C
Test Channel :	00	Relative Humidity :	49~51%
		Test Engineer :	Eric Shih

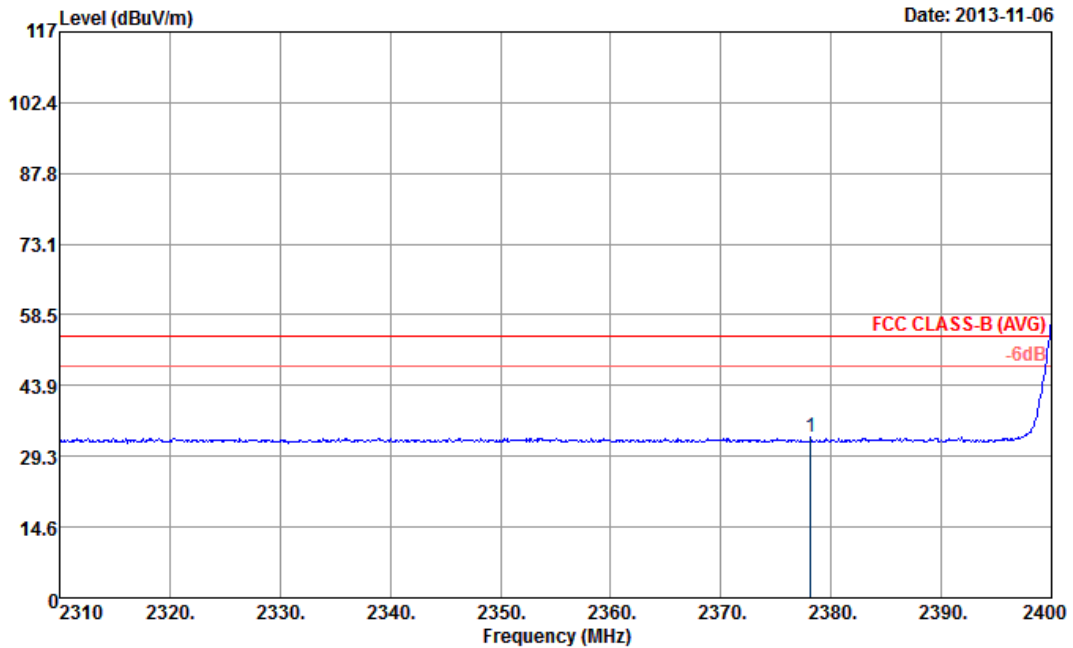

Site : 03CH07-HY
 Condition : FCC CLASS-B (AVG) 3m HF-ANT_120823 VERTICAL
 : RBW:1000.000KHz VBW:3.000KHz SWT:Auto

ANTENNA POLARITY : VERTICAL

Frequency (MHz)	Level (dBμV/m)	Over Limit (dB)	Limit Line (dBμV/m)	Read Level (dBμV)	Antenna Factor (dB)	Cable Loss (dB)	Preamp Factor (dB)	Ant Pos (cm)	Table Pos (deg)	Remark
2378.13	33.11	-20.89	54	28.22	32.28	6.88	34.27	100	352	Average

Note: Worst case measurement on 2378.13 MHz is compliance with 74/54 dBuV/m (peak/average) limit and Edge Measurement in the restricted band 2310-2390MHz. And, 2390-2400 MHz is non-restricted band which limit line is 20dB below the fundamental frequency emission level which is tested by conducted spurious emission. Both the test results are compliance with the FCC limit line.



Test Mode :	Mode 3	Temperature :	21~23°C
Test Channel :	39	Relative Humidity :	49~51%
		Test Engineer :	Eric Shih

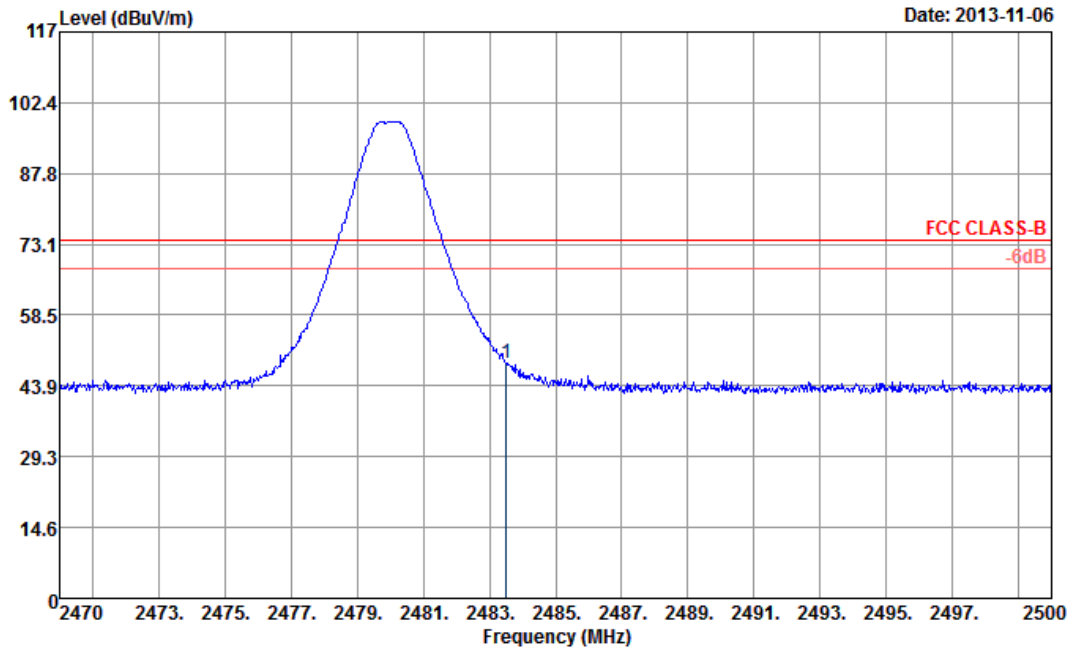

Site : 03CH07-HY
 Condition : FCC CLASS-B 3m HF-ANT_120823 HORIZONTAL
 : RBW:1000.000KHz VBW:3000.000KHz SWT:Auto

ANTENNA POLARITY : HORIZONTAL

Frequency (MHz)	Level (dBμV/m)	Over Limit (dB)	Limit Line (dBμV/m)	Read Level (dBμV)	Antenna Factor (dB)	Cable Loss (dB)	Preamp Factor (dB)	Ant Pos (cm)	Table Pos (deg)	Remark
2483.50	48.63	-25.37	74	43.62	32.38	7.06	34.43	128	302	Peak

Note: Worst case measurement on 2483.50 MHz is compliance with 74/54 dBuV/m (peak/average) limit and Edge Measurement in the restricted band 2483.5-2500 MHz. And, 2470-2483.5 MHz is non-restricted band which limit line is 20dB below the fundamental frequency emission level which is tested by conducted spurious emission. Both the test results are compliance with the FCC limit line.



Test Mode :	Mode 3	Temperature :	21~23°C
Test Channel :	39	Relative Humidity :	49~51%
		Test Engineer :	Eric Shih

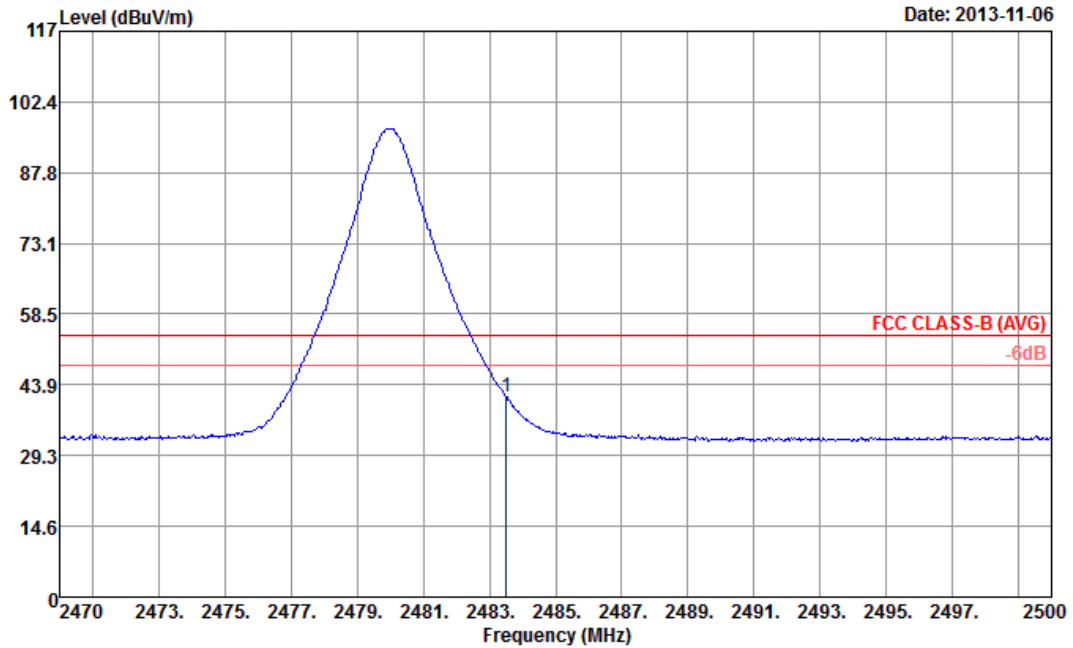

Site : 03CH07-HY
 Condition : FCC CLASS-B (AVG) 3m HF-ANT_120823 HORIZONTAL
 : RBW:1000.000KHz VBW:3.000KHz SWT:Auto

ANTENNA POLARITY : HORIZONTAL

Frequency (MHz)	Level (dBμV/m)	Over Limit (dB)	Limit Line (dBμV/m)	Read Level (dBμV)	Antenna Factor (dB)	Cable Loss (dB)	Preamp Factor (dB)	Ant Pos (cm)	Table Pos (deg)	Remark
2483.50	41.48	-12.52	54	36.47	32.38	7.06	34.43	128	302	Average

Note: Worst case measurement on 2483.50 MHz is compliance with 74/54 dBuV/m (peak/average) limit and Edge Measurement in the restricted band 2483.5-2500 MHz. And, 2470-2483.5 MHz is non-restricted band which limit line is 20dB below the fundamental frequency emission level which is tested by conducted spurious emission. Both the test results are compliance with the FCC limit line.



Test Mode :	Mode 3	Temperature :	21~23°C
Test Channel :	39	Relative Humidity :	49~51%
		Test Engineer :	Eric Shih

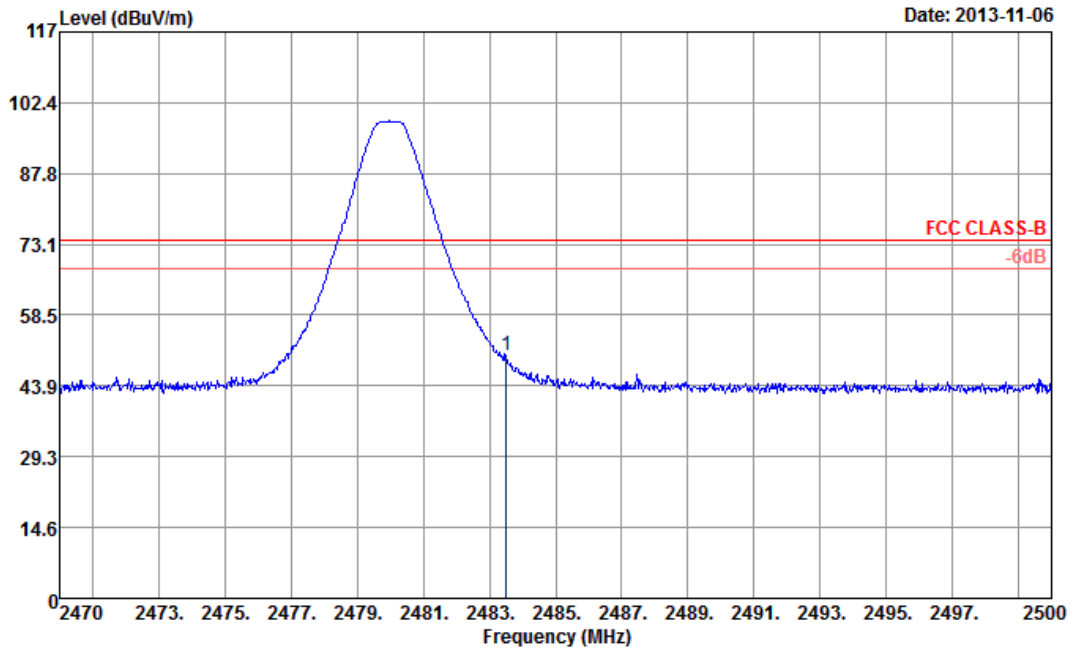

Site : 03CH07-HY
 Condition : FCC CLASS-B 3m HF-ANT_120823 VERTICAL
 : RBW:1000.000KHz VBW:3000.000KHz SWT:Auto

ANTENNA POLARITY : VERTICAL

Frequency (MHz)	Level (dBμV/m)	Over Limit (dB)	Limit Line (dBμV/m)	Read Level (dBμV)	Antenna Factor (dB)	Cable Loss (dB)	Preamp Factor (dB)	Ant Pos (cm)	Table Pos (deg)	Remark
2483.5	50.03	-23.97	74	45.02	32.38	7.06	34.43	100	208	Peak

Note: Worst case measurement on 2483.50 MHz is compliance with 74/54 dBuV/m (peak/average) limit and Edge Measurement in the restricted band 2483.5-2500 MHz. And, 2470-2483.5 MHz is non-restricted band which limit line is 20dB below the fundamental frequency emission level which is tested by conducted spurious emission. Both the test results are compliance with the FCC limit line.



Test Mode :	Mode 3	Temperature :	21~23°C
Test Channel :	39	Relative Humidity :	49~51%
		Test Engineer :	Eric Shih

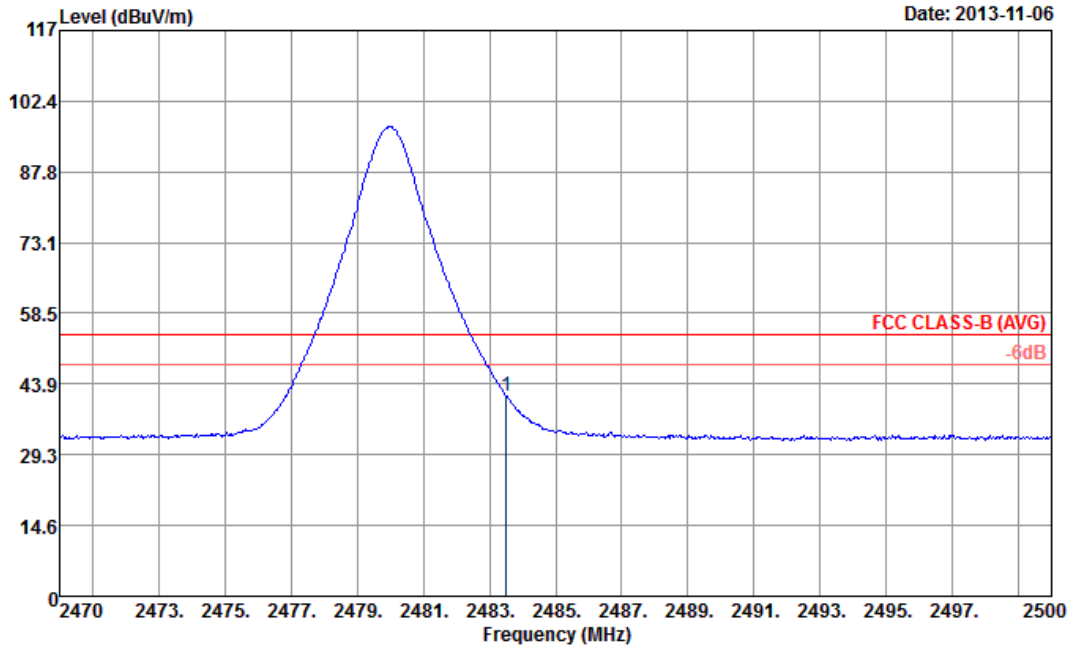

Site : 03CH07-HY
 Condition : FCC CLASS-B (AVG) 3m HF-ANT_120823 VERTICAL
 : RBW:1000.000KHz VBW:3.000KHz SWT:Auto

ANTENNA POLARITY : VERTICAL

Frequency (MHz)	Level (dBμV/m)	Over Limit (dB)	Limit Line (dBμV/m)	Read Level (dBμV)	Antenna Factor (dB)	Cable Loss (dB)	Preamp Factor (dB)	Ant Pos (cm)	Table Pos (deg)	Remark
2483.50	41.51	-12.49	54	36.5	32.38	7.06	34.43	100	208	Average

Note: Worst case measurement on 2483.50 MHz is compliance with 74/54 dBuV/m (peak/average) limit and Edge Measurement in the restricted band 2483.5-2500 MHz. And, 2470-2483.5 MHz is non-restricted band which limit line is 20dB below the fundamental frequency emission level which is tested by conducted spurious emission. Both the test results are compliance with the FCC limit line.



3.5.7 Test Result of Radiated Emission (30 MHz ~ 10th Harmonic)

Test Mode :	Mode 1	Temperature :	21~23°C
Test Channel :	00	Relative Humidity :	49~51%
Test Engineer :	Eric Shih		

Remark :

- 2402 MHz is fundamental signal which can be ignored.
- 7206 MHz and 9609 MHz are not within a restricted band, and its limit line is 20dB below the highest emission level. For example, 98.46 dB μ V/m - 20dB = 78.46 dB μ V/m.
- Average measurement was not performed if peak level went lower than the average limit.
- The harmonic (5th, 6th, 7th,...etc.) and other spurious are not reported, because those levels are lower than average limit line and background noise.

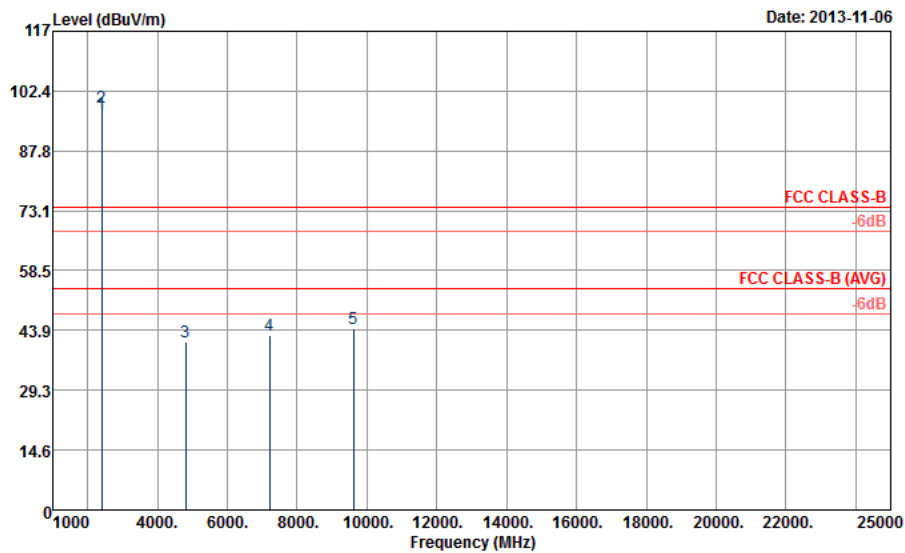

Site : 03CH07-HY
 Condition : FCC CLASS-B 3m SHF-EHF HORIZONTAL

ANTENNA POLARITY : HORIZONTAL

Frequency (MHz)	Level (dB μ V/m)	Over Limit (dB)	Limit Line (dB μ V/m)	Read Level (dB μ V)	Antenna Factor (dB)	Cable Loss (dB)	Preamp Factor (dB)	Ant Pos (cm)	Table Pos (deg)	Remark
2402	96.86	-	-	91.95	32.3	6.91	34.3	118	22	Average
2402	98.46	-	-	93.55	32.3	6.91	34.3	118	22	Peak
4803	41.03	-32.97	74	57.26	33.98	8.75	58.96	100	0	Peak
7206	42.63	-35.83	78.46	53.89	35.56	10.81	57.63	100	0	Peak
9609	44.22	-34.24	78.46	52.76	36.44	13.7	58.68	100	0	Peak

Note: Other harmonics are lower than background noise.



Test Mode :	Mode 1	Temperature :	21~23°C
Test Channel :	00	Relative Humidity :	49~51%
Test Engineer :	Eric Shih		

Remark :

- 2402 MHz is fundamental signal which can be ignored.
- 7206 MHz and 9609 MHz are not within a restricted band, and its limit line is 20dB below the highest emission level.
- Average measurement was not performed if peak level went lower than the average limit.
- The harmonic (5th, 6th, 7th,...etc.) and other spurious are not reported, because those levels are lower than average limit line and background noise.

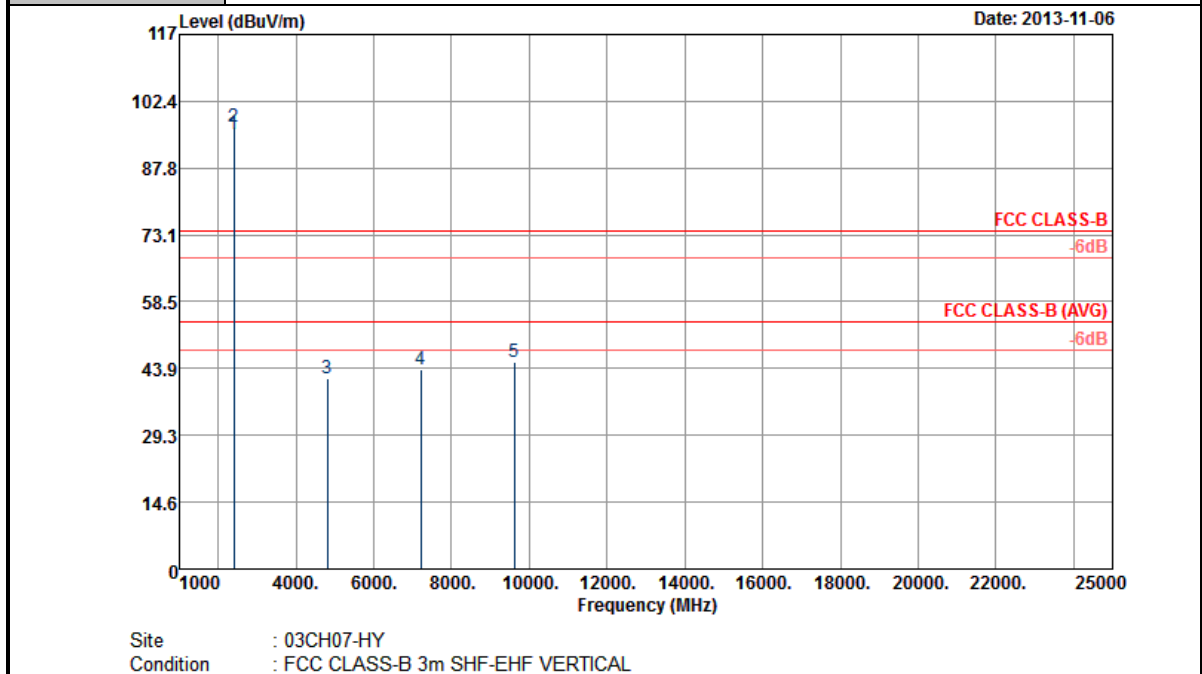

ANTENNA POLARITY : VERTICAL										
Frequency (MHz)	Level (dBμV/m)	Over Limit (dB)	Limit Line (dBμV/m)	Read Level (dBμV)	Antenna Factor (dB)	Cable Loss (dB)	Preamp Factor (dB)	Ant Pos (cm)	Table Pos (deg)	Remark
2402	95.21	-	-	90.3	32.3	6.91	34.3	100	352	Average
2402	96.74	-	-	91.83	32.3	6.91	34.3	100	352	Peak
4803	41.74	-32.26	74	57.97	33.98	8.75	58.96	100	0	Peak
7206	43.68	-33.06	76.74	54.94	35.56	10.81	57.63	100	0	Peak
9609	45.18	-31.56	76.74	53.72	36.44	13.7	58.68	100	0	Peak

Note: Other harmonics are lower than background noise.



Test Mode :	Mode 2	Temperature :	21~23°C
Test Channel :	19	Relative Humidity :	49~51%
Test Engineer :	Eric Shih		

Remark :

- 2440 MHz is fundamental signal which can be ignored.
- 9759 MHz is not within a restricted band, and its limit line is 20dB below the highest emission level.
- Average measurement was not performed if peak level went lower than the average limit.
- The harmonic (5th, 6th, 7th,...etc.) and other spurious are not reported, because those levels are lower than average limit line and background noise.

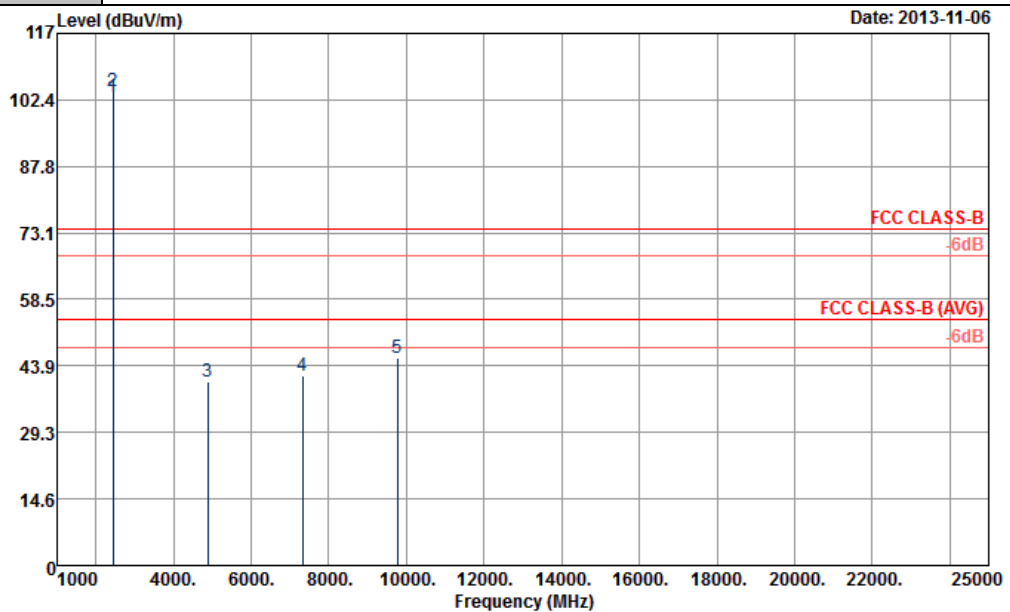

Site : 03CH07-HY
 Condition : FCC CLASS-B 3m SHF-EHF HORIZONTAL

ANTENNA POLARITY : HORIZONTAL

Frequency (MHz)	Level (dBμV/m)	Over Limit (dB)	Limit Line (dBμV/m)	Read Level (dBμV)	Antenna Factor (dB)	Cable Loss (dB)	Preamp Factor (dB)	Ant Pos (cm)	Table Pos (deg)	Remark
2440	102.84	-	-	97.85	32.35	6.99	34.35	175	95	Average
2440	104.41	-	-	99.42	32.35	6.99	34.35	175	95	Peak
4881	40.26	-33.74	74	56.29	33.95	8.85	58.83	100	0	Peak
7320	41.86	-32.14	74	53.16	35.53	10.91	57.74	100	0	Peak
9759	45.7	-38.71	84.41	54.08	36.66	13.69	58.73	100	0	Peak

Note: Other harmonics are lower than background noise.



Test Mode :	Mode 2	Temperature :	21~23°C
Test Channel :	19	Relative Humidity :	49~51%
Test Engineer :	Eric Shih		

Remark :

- 2440 MHz is fundamental signal which can be ignored.
- 9759 MHz is not within a restricted band, and its limit line is 20dB below the highest emission level.
- Average measurement was not performed if peak level went lower than the average limit.
- The harmonic (5th, 6th, 7th,...etc.) and other spurious are not reported, because those levels are lower than average limit line and background noise.

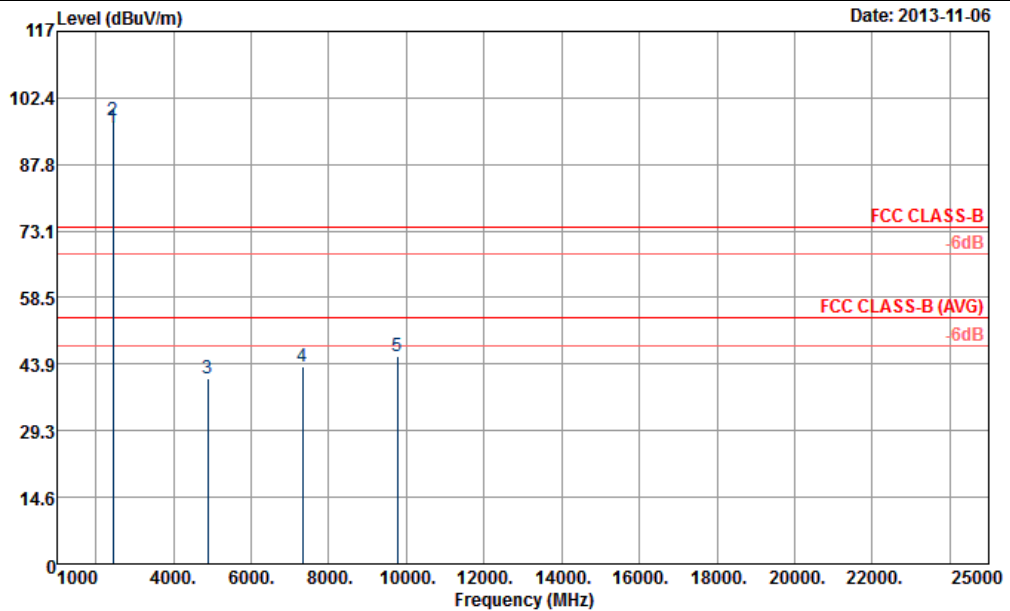

Site : 03CH07-HY
 Condition : FCC CLASS-B 3m SHF-EHF VERTICAL

ANTENNA POLARITY : VERTICAL

Frequency (MHz)	Level (dBμV/m)	Over Limit (dB)	Limit Line (dBμV/m)	Read Level (dBμV)	Antenna Factor (dB)	Cable Loss (dB)	Preamp Factor (dB)	Ant Pos (cm)	Table Pos (deg)	Remark
2440	95.95	-	-	90.96	32.35	6.99	34.35	100	52	Average
2440	97.45	-	-	92.46	32.35	6.99	34.35	100	52	Peak
4881	40.67	-33.33	74	56.7	33.95	8.85	58.83	100	0	Peak
7320	43.42	-30.58	74	54.72	35.53	10.91	57.74	100	0	Peak
9759	45.48	-31.97	77.45	53.86	36.66	13.69	58.73	100	0	Peak

Note: Other harmonics are lower than background noise.



Test Mode :	Mode 3	Temperature :	21~23°C
Test Channel :	39	Relative Humidity :	49~51%
Test Engineer :	Eric Shih		

Remark :

- 2480 MHz is fundamental signal which can be ignored.
- 9921 MHz is not within a restricted band, and its limit line is 20dB below the highest emission level.
- Average measurement was not performed if peak level went lower than the average limit.
- The harmonic (5th, 6th, 7th,...etc.) and other spurious are not reported, because those levels are lower than average limit line and background noise.

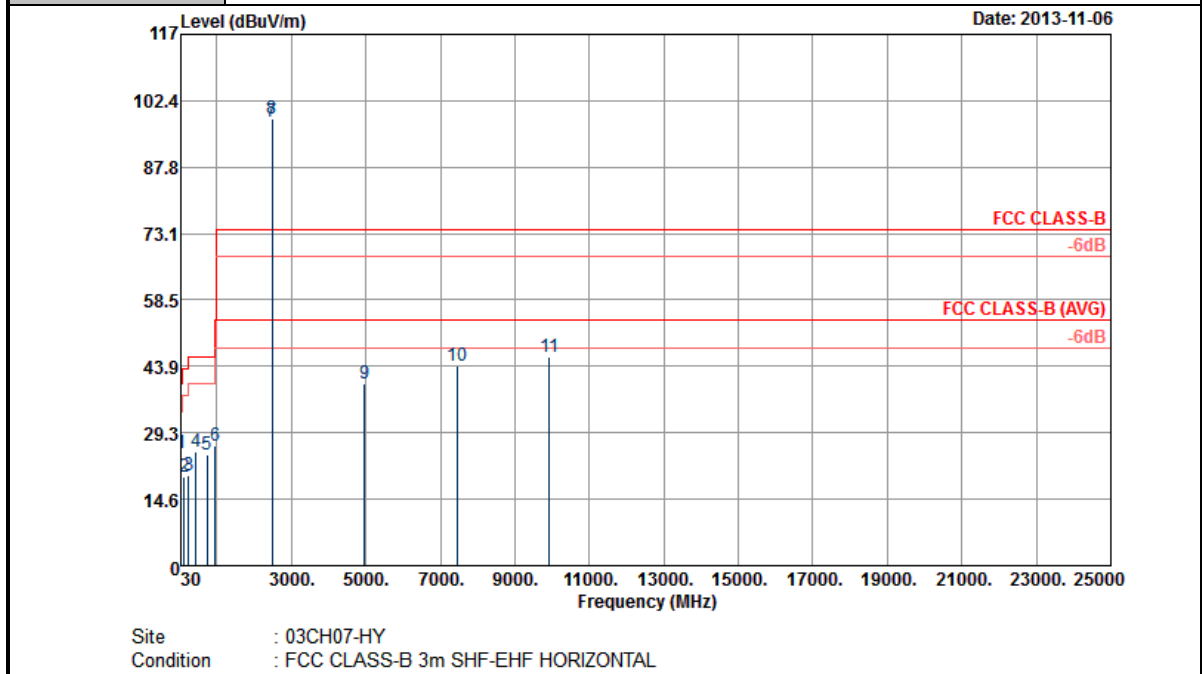

ANTENNA POLARITY : HORIZONTAL										
Frequency (MHz)	Level (dBμV/m)	Over Limit (dB)	Limit Line (dBμV/m)	Read Level (dBμV)	Antenna Factor (dB)	Cable Loss (dB)	Preamp Factor (dB)	Ant Pos (cm)	Table Pos (deg)	Remark
42.96	24.62	-15.38	40	43.28	11.9	0.64	31.2	114	55	Peak
109.65	19.72	-23.78	43.5	39.07	10.8	1.05	31.2	-	-	Peak
236.82	19.77	-26.23	46	38.32	10.94	1.51	31	-	-	Peak
431.6	25.07	-20.93	46	36.64	16.92	2.25	30.74	-	-	Peak
736.1	24.45	-21.55	46	29.7	22.12	3.03	30.4	-	-	Peak
947.5	26.34	-19.66	46	28.89	24.38	3.46	30.39	-	-	Peak



ANTENNA POLARITY : HORIZONTAL										
Frequency (MHz)	Level (dBμV/m)	Over Limit (dB)	Limit Line (dBμV/m)	Read Level (dBμV)	Antenna Factor (dB)	Cable Loss (dB)	Preamp Factor (dB)	Ant Pos (cm)	Table Pos (deg)	Remark
2480	97.65	-	-	92.64	32.38	7.06	34.43	128	302	Average
2480	98.34	-	-	93.33	32.38	7.06	34.43	128	302	Peak
4959	40.11	-33.89	74	55.94	33.91	8.92	58.66	100	0	Peak
7440	44.14	-29.86	74	55.44	35.51	11.04	57.85	100	0	Peak
9921	45.87	-32.47	78.34	54.07	36.9	13.68	58.78	100	0	Peak

Note: Other harmonics are lower than background noise.



Test Mode :	Mode 3	Temperature :	21~23°C
Test Channel :	39	Relative Humidity :	49~51%
Test Engineer :	Eric Shih		

Remark :

- 2480 MHz is fundamental signal which can be ignored.
- 9921 MHz is not within a restricted band.
- Average measurement was not performed if peak level went lower than the average limit.
- The harmonic (5th, 6th, 7th,...etc.) and other spurious are not reported, because those levels are lower than average limit line and background noise.

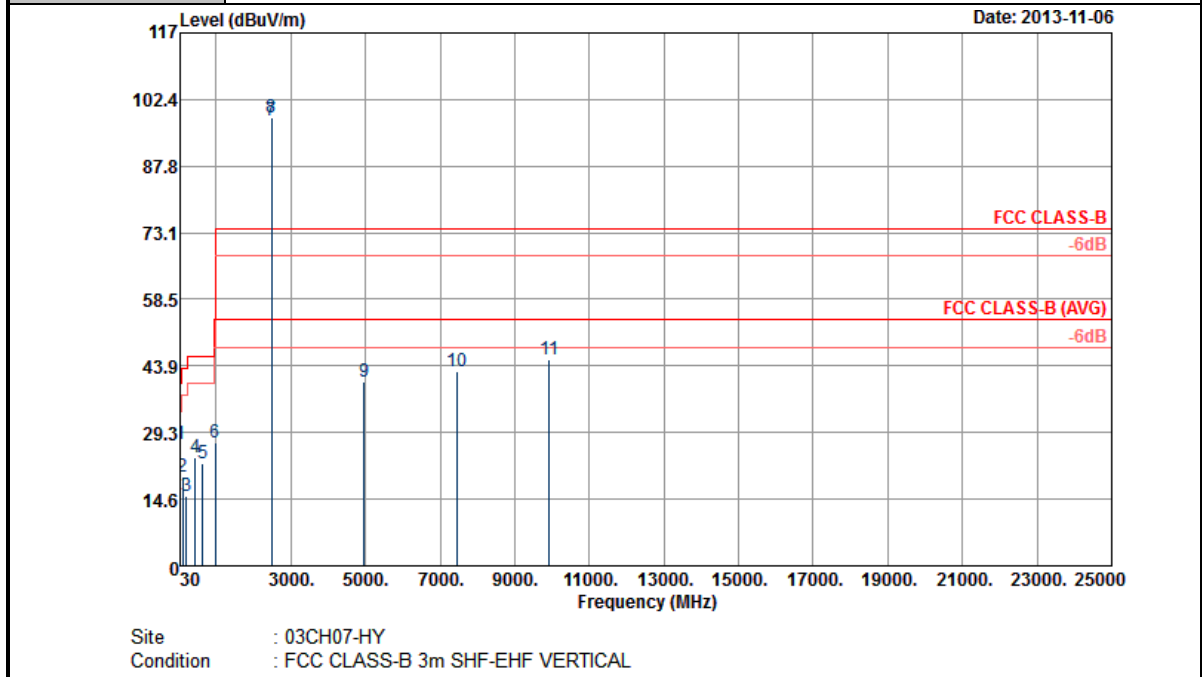

ANTENNA POLARITY : VERTICAL										
Frequency (MHz)	Level (dBμV/m)	Over Limit (dB)	Limit Line (dBμV/m)	Read Level (dBμV)	Antenna Factor (dB)	Cable Loss (dB)	Preamp Factor (dB)	Ant Pos (cm)	Table Pos (deg)	Remark
42.96	26.78	-13.22	40	45.44	11.9	0.64	31.2	196	252	Peak
106.14	19.68	-23.82	43.5	39.25	10.56	1.03	31.16	-	-	Peak
205.77	15.33	-28.17	43.5	35.94	9.15	1.34	31.1	-	-	Peak
437.9	23.71	-22.29	46	35.17	16.98	2.27	30.71	-	-	Peak
630.4	22.54	-23.46	46	29.9	20.4	2.78	30.54	-	-	Peak
974.8	26.97	-27.03	54	28.88	24.9	3.49	30.3	-	-	Peak



ANTENNA POLARITY : VERTICAL										
Frequency (MHz)	Level (dBμV/m)	Over Limit (dB)	Limit Line (dBμV/m)	Read Level (dBμV)	Antenna Factor (dB)	Cable Loss (dB)	Preamp Factor (dB)	Ant Pos (cm)	Table Pos (deg)	Remark
2480	97.72	-	-	92.71	32.38	7.06	34.43	100	208	Average
2480	98.47	-	-	93.46	32.38	7.06	34.43	100	208	Peak
4959	40.27	-33.73	74	56.1	33.91	8.92	58.66	100	0	Peak
7440	42.8	-31.2	74	54.1	35.51	11.04	57.85	100	0	Peak
9921	45.39	-33.08	78.47	53.59	36.9	13.68	58.78	100	0	Peak

Note: Other harmonics are lower than background noise.

3.6 AC Conducted Emission Measurement

3.6.1 Limit of AC Conducted Emission

For equipment that is designed to be connected to the public utility (AC) power line, the radio frequency voltage that is conducted back onto the AC power line on any frequency or frequencies within the band 150 kHz to 30 MHz shall not exceed the limits in the following table.

Frequency of emission (MHz)	Conducted limit (dB μ V)	
	Quasi-peak	Average
0.15-0.5	66 to 56*	56 to 46*
0.5-5	56	46
5-30	60	50

*Decreases with the logarithm of the frequency.

3.6.2 Measuring Instruments

The section 4.0 of List of Measuring Equipment of this test report is used for test.

3.6.3 Test Procedures

1. The EUT was placed 0.4 meter from the conducting wall of the shielding room was kept at least 80 centimeters from any other grounded conducting surface.
2. Connect EUT to the power mains through a line impedance stabilization network (LISN).
3. All the support units are connecting to the other LISN.
4. The LISN provides 50 ohm coupling impedance for the measuring instrument.
5. The FCC states that a 50 ohm, 50 microhenry LISN should be used.
6. Both sides of AC line were checked for maximum conducted interference.
7. The frequency range from 150 kHz to 30 MHz was searched.
8. Set the test-receiver system to Peak Detect Function and specified bandwidth with Maximum Hold Mode.

3.6.4 Test Setup

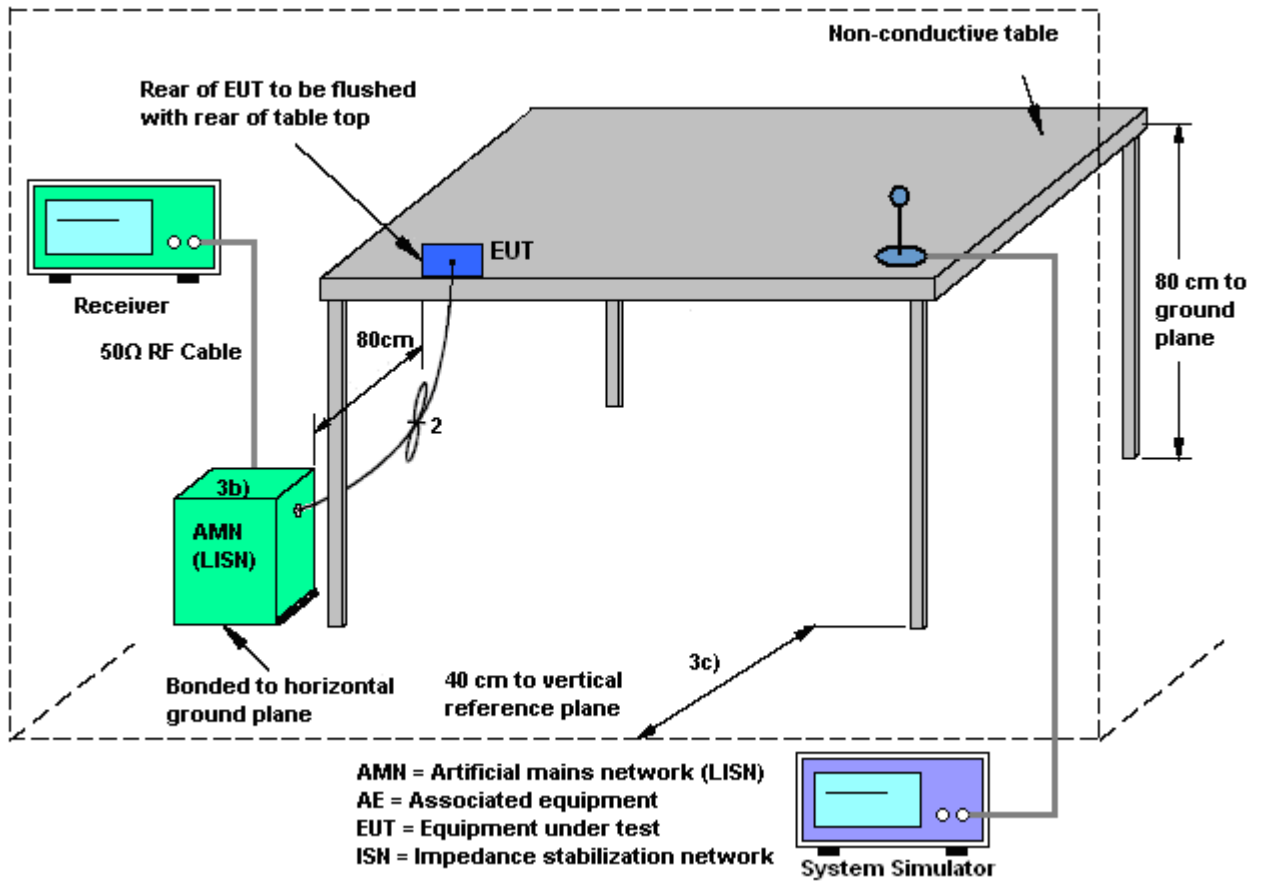

3.6.5 Test Result of AC Conducted Emission

Test Mode :	Mode 1	Temperature :	20~22°C
Test Engineer :	Kai-Chun Chu	Relative Humidity :	46~48%
Test Voltage :	120Vac / 60Hz	Phase :	Line
Function Type :	GSM1900 Idle + Bluetooth Link + WLAN Idle + MP3 + Earphone + Battery + USB Cable (Charging from Adapter) + SIM 1		

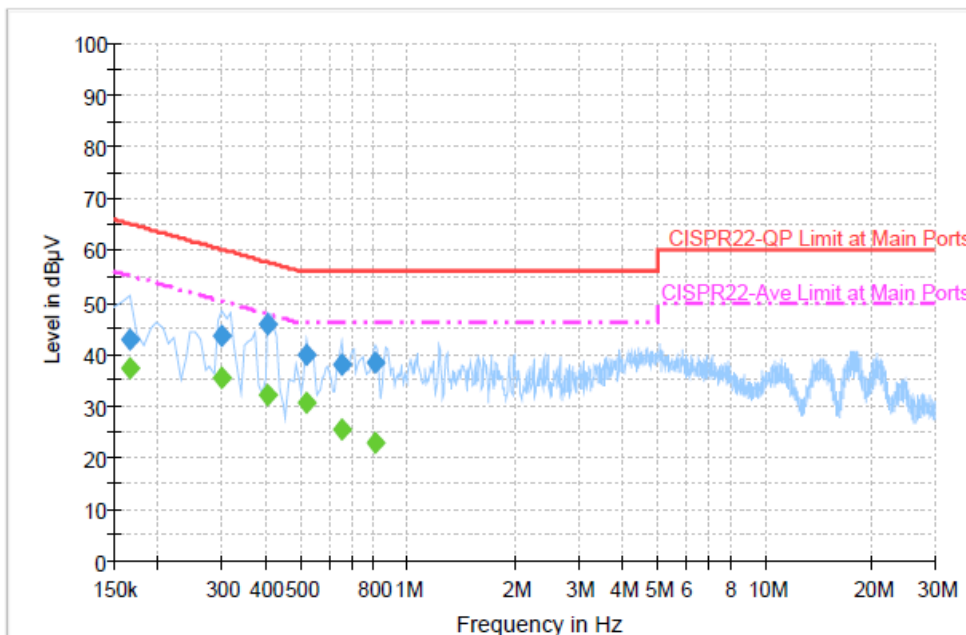

Final Result : Quasi-Peak

Frequency (MHz)	Quasi-Peak (dBµV)	Filter	Line	Corr. (dB)	Margin (dB)	Limit (dBµV)
0.166000	42.9	Off	L1	19.4	22.3	65.2
0.302000	43.7	Off	L1	19.3	16.5	60.2
0.406000	45.8	Off	L1	19.4	11.9	57.7
0.518000	39.8	Off	L1	19.4	16.2	56.0
0.654000	38.1	Off	L1	19.4	17.9	56.0
0.814000	38.5	Off	L1	19.5	17.5	56.0

Final Result : Average

Frequency (MHz)	Average (dBµV)	Filter	Line	Corr. (dB)	Margin (dB)	Limit (dBµV)
0.166000	37.2	Off	L1	19.4	18.0	55.2
0.302000	35.6	Off	L1	19.3	14.6	50.2
0.406000	32.1	Off	L1	19.4	15.6	47.7
0.518000	30.5	Off	L1	19.4	15.5	46.0
0.654000	25.3	Off	L1	19.4	20.7	46.0
0.814000	23.0	Off	L1	19.5	23.0	46.0



Test Mode :	Mode 1	Temperature :	20~22°C
Test Engineer :	Kai-Chun Chu	Relative Humidity :	46~48%
Test Voltage :	120Vac / 60Hz	Phase :	Neutral
Function Type :	GSM1900 Idle + Bluetooth Link + WLAN Idle + MP3 + Earphone + Battery + USB Cable (Charging from Adapter) + SIM 1		

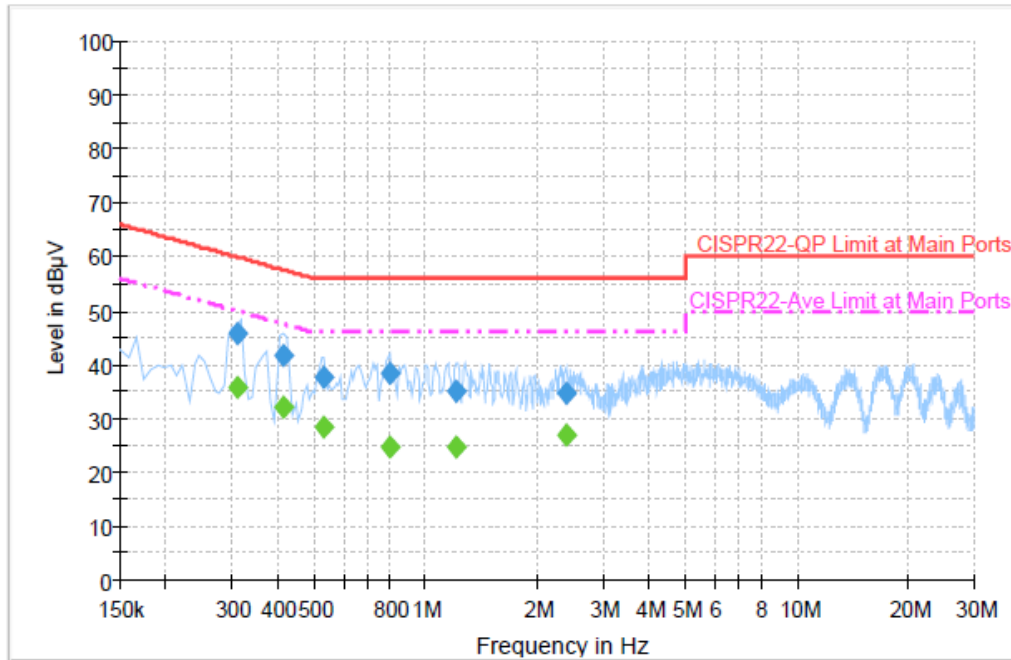

Final Result : Quasi-Peak

Frequency (MHz)	Quasi-Peak (dBµV)	Filter	Line	Corr. (dB)	Margin (dB)	Limit (dBµV)
0.310000	45.9	Off	N	19.4	14.1	60.0
0.414000	41.6	Off	N	19.4	16.0	57.6
0.534000	37.8	Off	N	19.4	18.2	56.0
0.798000	38.3	Off	N	19.5	17.7	56.0
1.206000	35.1	Off	N	19.5	20.9	56.0
2.382000	34.8	Off	N	19.7	21.2	56.0

Final Result : Average

Frequency (MHz)	Average (dBµV)	Filter	Line	Corr. (dB)	Margin (dB)	Limit (dBµV)
0.310000	35.8	Off	N	19.4	14.2	50.0
0.414000	32.1	Off	N	19.4	15.5	47.6
0.534000	28.4	Off	N	19.4	17.6	46.0
0.798000	24.6	Off	N	19.5	21.4	46.0
1.206000	24.6	Off	N	19.5	21.4	46.0
2.382000	27.0	Off	N	19.7	19.0	46.0

Test Mode :	Mode 2	Temperature :	20~22°C
Test Engineer :	Kai-Chun Chu	Relative Humidity :	46~48%
Test Voltage :	120Vac / 60Hz	Phase :	Line
Function Type :	GSM1900 Idle + Bluetooth Idle + WLAN Link + MP3 + Earphone + Battery + USB Cable (Charging from Adapter) + SIM 1		

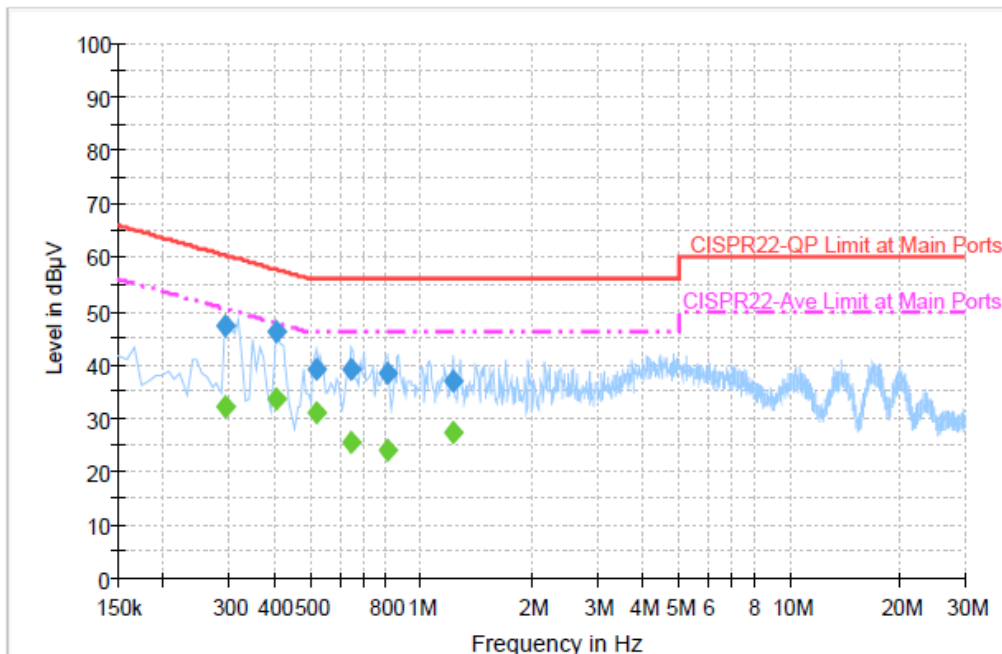

Final Result : Quasi-Peak

Frequency (MHz)	Quasi-Peak (dBµV)	Filter	Line	Corr. (dB)	Margin (dB)	Limit (dBµV)
0.294000	47.2	Off	L1	19.4	13.2	60.4
0.406000	46.1	Off	L1	19.4	11.6	57.7
0.518000	39.0	Off	L1	19.4	17.0	56.0
0.646000	39.2	Off	L1	19.4	16.8	56.0
0.814000	38.3	Off	L1	19.5	17.7	56.0
1.214000	37.1	Off	L1	19.5	18.9	56.0

Final Result : Average

Frequency (MHz)	Average (dBµV)	Filter	Line	Corr. (dB)	Margin (dB)	Limit (dBµV)
0.294000	32.1	Off	L1	19.4	18.3	50.4
0.406000	33.7	Off	L1	19.4	14.0	47.7
0.518000	31.1	Off	L1	19.4	14.9	46.0
0.646000	25.4	Off	L1	19.4	20.6	46.0
0.814000	24.1	Off	L1	19.5	21.9	46.0
1.214000	27.3	Off	L1	19.5	18.7	46.0



Test Mode :	Mode 2	Temperature :	20~22°C
Test Engineer :	Kai-Chun Chu	Relative Humidity :	46~48%
Test Voltage :	120Vac / 60Hz	Phase :	Neutral
Function Type :	GSM1900 Idle + Bluetooth Idle + WLAN Link + MP3 + Earphone + Battery + USB Cable (Charging from Adapter) + SIM 1		

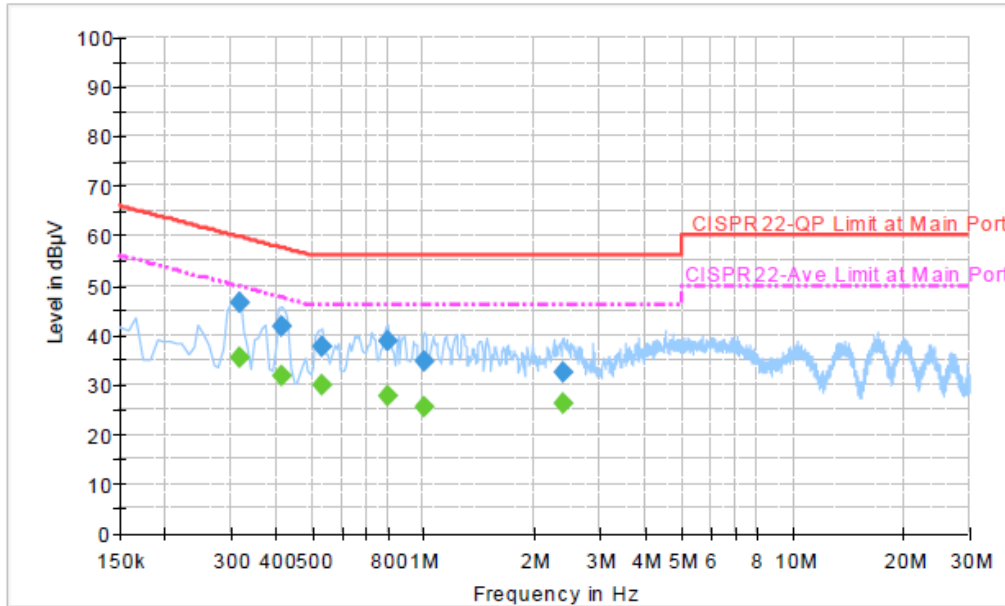

Final Result : Quasi-Peak

Frequency (MHz)	Quasi-Peak (dBµV)	Filter	Line	Corr. (dB)	Margin (dB)	Limit (dBµV)
0.318000	46.4	Off	N	19.4	13.4	59.8
0.414000	41.7	Off	N	19.4	15.9	57.6
0.534000	37.8	Off	N	19.4	18.2	56.0
0.798000	38.7	Off	N	19.5	17.3	56.0
1.006000	34.7	Off	N	19.4	21.3	56.0
2.382000	32.5	Off	N	19.7	23.5	56.0

Final Result : Average

Frequency (MHz)	Average (dBµV)	Filter	Line	Corr. (dB)	Margin (dB)	Limit (dBµV)
0.318000	35.4	Off	N	19.4	14.4	49.8
0.414000	31.9	Off	N	19.4	15.7	47.6
0.534000	29.8	Off	N	19.4	16.2	46.0
0.798000	27.7	Off	N	19.5	18.3	46.0
1.006000	25.4	Off	N	19.4	20.6	46.0
2.382000	26.2	Off	N	19.7	19.8	46.0



3.7 Antenna Requirements

3.7.1 Standard Applicable

If directional gain of transmitting antennas is greater than 6dBi, the power shall be reduced by the same level in dB comparing to gain minus 6dBi. The use of a permanently attached antenna or of an antenna that uses a unique coupling to the intentional radiator shall be considered sufficient to comply with the FCC rule.

3.7.2 Antenna Anti-Replacement Construction

Non-standard connector used.

3.7.3 Antenna Gain

The antenna peak gain of EUT is less than 6 dBi. Therefore, it is not necessary to reduce maximum peak output power limit.



4 List of Measuring Equipment

Instrument	Manufacturer	Model No.	Serial No.	Characteristics	Calibration Date	Test Date	Due Date	Remark
Spectrum Analyzer	Rohde & Schwarz	FSP40	100055	9kHz~40GHz	Jun. 07, 2013	Nov. 01, 2013 ~ Nov. 04, 2013	Jun. 06, 2014	Conducted (TH02-HY)
Power Meter	Agilent	E4416A	GB41292344	300MHz~40GHz	Feb. 05, 2013	Nov. 01, 2013 ~ Nov. 04, 2013	Feb. 04, 2014	Conducted (TH02-HY)
Power Sensor	Agilent	E9327A	US40441548	300MHz~40GHz	Feb. 05, 2013	Nov. 01, 2013 ~ Nov. 04, 2013	Feb. 04, 2014	Conducted (TH02-HY)
Hygrometer	Testo	608-H1	34897199	N/A	May 07, 2013	Nov. 01, 2013 ~ Nov. 04, 2013	May 06, 2014	Conducted (TH02-HY)
RF cable	HONOVA	MF86	N/A	N/A	Nov. 26, 2012	Nov. 01, 2013 ~ Nov. 04, 2013	Nov. 25, 2013	Conducted (TH02-HY)
EMI Test Receiver	Rohde & Schwarz	ESCI 7	100724	9kHz~7GHz	Sep. 06, 2013	Nov. 06, 2013 ~ Nov. 07, 2013	Sep. 05, 2014	Radiation (03CH07-HY)
Spectrum Analyzer	Rohde & Schwarz	FSP30	101067	9KHz~30GHz	Nov. 30, 2012	Nov. 06, 2013 ~ Nov. 07, 2013	Nov. 29, 2013	Radiation (03CH07-HY)
Loop Antenna	Rohde & Schwarz	HFH2-Z2	860004/0001	9 kHz~30 MHz	Jul. 03, 2012	Nov. 06, 2013 ~ Nov. 07, 2013	Jul. 03, 2014	Radiation (03CH07-HY)
Bilog Antenna	Schaffner	CBL6111C	2726	30MHz ~ 1GHz	Oct. 10, 2013	Nov. 06, 2013 ~ Nov. 07, 2013	Oct. 09, 2014	Radiation (03CH07-HY)
Double Ridge Horn Antenna	ESCO	3117	75962	1GHz~18GHz	Aug. 22, 2013	Nov. 06, 2013 ~ Nov. 07, 2013	Aug. 21, 2014	Radiation (03CH07-HY)
SHF-EHF Horn Antenna	SCHWARZBECK	BBHA 9170	BBHA9170251	15GHz- 40GHz	Oct. 03, 2013	Nov. 06, 2013 ~ Nov. 07, 2013	Oct. 02, 2014	Radiation (03CH07-HY)
Preamplifier	COM-POWER	PA-103A	161241	30MHz~1GHz	Feb. 26, 2013	Nov. 06, 2013 ~ Nov. 07, 2013	Feb. 25, 2014	Radiation (03CH07-HY)
Preamplifier	Agilent	8449B	3008A02362	1GHz~26.5GHz	Dec. 01, 2012	Nov. 06, 2013 ~ Nov. 07, 2013	Nov. 30, 2013	Radiation (03CH07-HY)
Preamplifier	MITEQ	AMF-7D-00 101800-30-10P	159088	DC~18G High Gain	Feb. 27, 2013	Nov. 06, 2013 ~ Nov. 07, 2013	Feb. 26, 2014	Radiation (03CH07-HY)
Turn Table	ChainTek	ChainTek 3000	N/A	0 ~ 360 degree	N/A	Nov. 06, 2013 ~ Nov. 07, 2013	N/A	Radiation (03CH07-HY)
Antenna Mast	ChainTek	ChainTek 3000	N/A	N/A	N/A	Nov. 06, 2013 ~ Nov. 07, 2013	N/A	Radiation (03CH07-HY)
High Pass Filter	Microwave	H03G18G3	N/A	3GHz HPF	Nov. 26, 2012	Nov. 06, 2013 ~ Nov. 07, 2013	Nov. 25, 2013	Radiation (03CH07-HY)
High Pass Filter	Microwave	H07G18G3	282388	7GHz HPF	Nov. 29, 2012	Nov. 06, 2013 ~ Nov. 07, 2013	Nov. 28, 2013	Radiation (03CH07-HY)
Low Pass Filter	Wainwright	WLKS1200-8SS	SN2	1.2GHz LPF	Nov. 29, 2012	Nov. 06, 2013 ~ Nov. 07, 2013	Nov. 28, 2013	Radiation (03CH07-HY)
HF RF Cable	HUBER SUHNER	SUCOFLEX 104	38411/6	1GHz ~ 18GHz	Dec. 04, 2012	Nov. 06, 2013 ~ Nov. 07, 2013	Dec. 03, 2013	Radiation (03CH07-HY)
LF RF Cable	Warison+HUBER SUHNER	WCBA-WC04NM.NM2	N/A	30MHz ~ 1GHz	Dec. 04, 2012	Nov. 06, 2013 ~ Nov. 07, 2013	Dec. 03, 2013	Radiation (03CH07-HY)



Instrument	Manufacturer	Model No.	Serial No.	Characteristics	Calibration Date	Test Date	Due Date	Remark
Test Software	Audix	E3	Version 6.2009-08-24	N/A	N/A	Nov. 06, 2013 ~ Nov. 07, 2013	N/A	Radiation (03CH07-HY)
Hygrometer	Testo	608-H1	34897197	N/A	May 07, 2013	Nov. 06, 2013 ~ Nov. 07, 2013	May 06, 2014	Radiation (03CH07-HY)
EMI Test Receiver	Rohde & Schwarz	ESCS 30	100356	9kHz ~ 2.75GHz	Nov. 13, 2012	Nov. 06, 2013	Nov. 12, 2013	Conduction (CO05-HY)
Two-LISN	Rohde & Schwarz	ENV216	100081	9kHz ~ 30MHz	Dec. 12, 2012	Nov. 06, 2013	Dec. 11, 2013	Conduction (CO05-HY)
Two-LISN	Rohde & Schwarz	ENV216	100080	9kHz ~ 30MHz	Dec. 06, 2012	Nov. 06, 2013	Dec. 05, 2013	Conduction (CO05-HY)
AC Power Source	APC	APC-1000 W	N/A	N/A	N/A	Nov. 06, 2013	N/A	Conduction (CO05-HY)
Test Software	N/A	EMC32	8.40.0	N/A	N/A	Nov. 06, 2013	N/A	Conduction (CO05-HY)
Hygrometer	Testo	608-H1	34913912	N/A	Apr. 25, 2013,	Nov. 06, 2013	Apr. 24, 2014	Conduction (CO05-HY)
LF Cable	Shuner	RG-402	N/A	N/A	Oct. 17, 2013	Nov. 06, 2013	Oct. 16, 2014	Conduction (CO05-HY)

Note: Test equipment calibration is traceable to the procedure of ISO17025.



5 Uncertainty of Evaluation

Uncertainty of Conducted Emission Measurement (150 kHz ~ 30 MHz)

Measuring Uncertainty for a Level of Confidence of 95% ($U = 2Uc(y)$)	2.26
---	------

Uncertainty of Radiated Emission Measurement (30 MHz ~ 1000 MHz)

Measuring Uncertainty for a Level of Confidence of 95% ($U = 2Uc(y)$)	4.50
---	------