

FCC SAR Test Report

APPLICANT : Sony Mobile Communications AB
EQUIPMENT : Smart phone
BRAND NAME : SONY
TYPE NAME : PM-0671-BV
MODEL NAME : D2105
FCC ID : PY7PM-0671
STANDARD : FCC 47 CFR Part 2 (2.1093)
ANSI/IEEE C95.1-1992
IEEE 1528-2003

We, SPORTON INTERNATIONAL INC., would like to declare that the tested sample has been evaluated in accordance with the procedures and shown the compliance with the applicable technical standards.

The test results in this report apply exclusively to the tested model / sample. Without written approval of SPORTON INTERNATIONAL INC., the test report shall not be reproduced except in full.

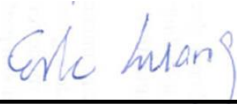

Reviewed by: Eric Huang / Deputy Manager



Approved by: Jones Tsai / Manager



SPORTON INTERNATIONAL INC.

No. 52, Hwa Ya 1st Rd., Hwa Ya Technology Park, Kwei-Shan Hsiang, Tao Yuan Hsien, Taiwan, R.O.C.



Table of Contents

1. Statement of Compliance..... 4
2. Administration Data 6
2.1 Testing Laboratory 6
2.2 Applicant..... 6
2.3 Manufacturer 6
2.4 Application Details 6
3. General Information 7
3.1 Description of Equipment Under Test (EUT)..... 7
3.2 Device Serial Number 7
3.3 Maximum RF output power among production units 8
3.4 Applied Standard 9
3.5 Device Category and SAR Limits 9
3.6 Test Conditions 9
4. Specific Absorption Rate (SAR) 10
4.1 Introduction..... 10
4.2 SAR Definition 10
5. SAR Measurement System 11
5.1 E-Field Probe 12
5.2 Data Acquisition Electronics (DAE) 13
5.3 Robot..... 13
5.4 Measurement Server 13
5.5 Phantom 14
5.6 Device Holder 15
5.7 Data Storage and Evaluation 16
5.8 Test Equipment List 18
6. Tissue Simulating Liquids 19
7. System Verification Procedures 21
7.1 Purpose of System Performance check 21
7.2 System Setup 21
7.3 SAR System Verification Results 22
8. EUT Testing Position 23
8.1 Define two imaginary lines on the handset..... 23
8.2 Cheek Position 24
8.3 Tilted Position 24
8.4 Body Worn Position 25
9. Measurement Procedures..... 26
9.1 Spatial Peak SAR Evaluation..... 26
9.2 Power Reference Measurement 27
9.3 Area & Zoom Scan Procedures..... 27
9.4 Volume Scan Procedures 28
9.5 SAR Averaged Methods..... 28
9.6 Power Drift Monitoring 28
9.7 Bluetooth Exclusions Applied..... 28
10. Conducted RF Output Power (Unit: dBm)..... 29
11. Antenna Location 32
12. SAR Test Results..... 33
12.1 Head SAR 33
12.2 Hotspot SAR..... 34
12.3 Body Worn SAR..... 35
12.4 Repeated SAR Measurement 35
12.5 Highest SAR Plot..... 36
13. Simultaneous Transmission Analysis..... 39
13.1 Head Exposure Conditions 40
13.2 Hotspot Exposure Conditions..... 41
13.3 Body-Worn Exposure Conditions 42
14. Uncertainty Assessment..... 43
15. References 45
Appendix A. Plots of System Performance Check
Appendix B. Plots of SAR Measurement
Appendix C. DASY Calibration Certificate
Appendix D. Test Setup Photos



1. Statement of Compliance

The maximum results of Specific Absorption Rate (SAR) found during testing for **Sony Mobile Communications AB Smart phone, D2105** are as follows.

<Highest 1g-SAR Summary>

Exposure Position	Frequency Band	Equipment Class	Maximum RF output power (dBm)	Reported 1g-SAR (W/kg)	Highest Reported 1g-SAR (W/kg)
Head (Separation 0cm)	GSM850 Voice	PCE	33	0.44	0.53
	GSM1900 Voice		31	0.53	
	WLAN 2.4GHz Band	DTS	16	0.42	
Hotspot (Separation 1cm)	GPRS850 (4Tx slots)	PCE	27	1.04	1.04
	GPRS1900 (2Tx slots)		28	0.72	
	WLAN 2.4GHz Band	DTS	16	0.15	
Body-worn (Separation 1.5cm)	GSM850 Voice	PCE	33	0.95	0.95
	GSM1900 Voice		31	0.39	
	WLAN 2.4GHz Band	DTS	16	0.08	

<Highest Simultaneous transmission 1gSAR>

Exposure Position	Frequency Band	Equipment Class	Maximum RF output power (dBm)	Highest Reported Simultaneous Transmission 1g-SAR (W/kg)
Head (Separation 0cm)	GSM1900 Voice	PCE	31	0.95
	WLAN 2.4GHz Band	DTS	16	
	GSM1900 Voice	PCE	31	0.91
	Bluetooth	DSS	9.5	
Hotspot (Separation 1cm)	GSM850(4Tx slots)	PCE	27	1.19
	WLAN 2.4GHz Band	DTS	16	
	GSM850(4Tx slots)	PCE	27	1.23
	Bluetooth	DSS	9.5	
Body-worn (Separation 1.5cm)	GSM850 Voice	PCE	33	1.03
	WLAN 2.4GHz Band	DTS	16	
	GSM850 Voice	PCE	33	1.08
	Bluetooth	DSS	9.5	

Note: Simultaneous transmission was not evaluated as the sum of the individual SAR for WWAN and WLAN/Bluetooth was < 1.6 W/kg. This meets the requirements and simultaneous transmission exclusion specified in FCC KDB publication 648474 D04v01r02 - SAR Handset SAR.



<Highest 10g-SAR Summary>

Exposure Position	Frequency Band	Maximum RF output power (dBm)	Reported 10g-SAR (W/kg)	Highest Reported 10g-SAR (W/kg)
Head (Separation 0cm)	GSM850 Voice	33	0.34	0.34
	GSM1900 Voice	31	0.32	
	WLAN 2.4GHz Band	16	0.22	
Hotspot (Separation 1cm)	GPRS850 (4Tx slots)	27	0.77	0.77
	GPRS1900 (2Tx slots)	28	0.42	
	WLAN 2.4GHz Band	16	0.08	
Body-worn (Separation 1.5cm)	GSM850 Voice	33	0.70	0.70
	GSM1900 Voice	31	0.24	
	WLAN 2.4GHz Band	16	0.05	

<Highest Simultaneous transmission 10gSAR>

Exposure Position	Frequency Band	Maximum RF output power (dBm)	Highest Reported Simultaneous Transmission 10g-SAR (W/kg)
Head (Separation 0cm)	GSM1900 Voice	31	0.54
	WLAN 2.4GHz Band	16	
	GSM850 Voice	33	0.49
	Bluetooth	9.5	
Hotspot (Separation 1cm)	GSM850(4Tx slots)	27	0.85
	WLAN 2.4GHz Band	16	
	GSM850(4Tx slots)	27	0.84
	Bluetooth	9.5	
Body-worn (Separation 1.5cm)	GSM850 Voice	33	0.74
	WLAN 2.4GHz Band	16	
	GSM850 Voice	33	0.75
	Bluetooth	9.5	

This device is in compliance with Specific Absorption Rate (SAR) for general population/uncontrolled exposure limits (1.6 W/kg) specified in FCC 47 CFR part 2 (2.1093) and ANSI/IEEE C95.1-1992, and had been tested in accordance with the measurement methods and procedures specified in IEEE 1528-2003.



2. Administration Data

2.1 Testing Laboratory

Test Site	SPORTON INTERNATIONAL INC.
Test Site Location	No. 52, Hwa Ya 1 st Rd., Hwa Ya Technology Park, Kwei-Shan Hsiang, Tao Yuan Hsien, Taiwan, R.O.C. TEL: +886-3-327-3456 FAX: +886-3-328-4978

2.2 Applicant

Company Name	Sony Mobile Communications AB
Address	Nya Vattentornet, 22188 Lund, Sweden

2.3 Manufacturer

Company Name	Arima Communications Corp.
Address	6F, No. 866, Jhongjheng Rd., Jhonghe Dist., New Taipei City 23586, Taiwan

2.4 Application Details

Date of Start during the Test	Nov. 09, 2013
Date of End during the Test	Nov. 21, 2013



3. General Information

3.1 Description of Equipment Under Test (EUT)

The equipment under test is a smart phone supporting, GSM850/900/1800/1900, UMTS I / VIII, WLAN2.4GHz 802.11b/g/n, Bluetooth, FM Receiver and GPS features, and below is details of information. For FCC, only wireless modes in US frequency bands are tested.

Product Feature & Specification	
EUT	Smart phone
Brand Name	SONY
Type Name	PM-0671-BV
Model Name	D2105
FCC ID	PY7PM-0671
Wireless Technology and Frequency Range	GSM850: 824.2 MHz ~ 848.8 MHz GSM1900: 1850.2 MHz ~ 1909.8 MHz WLAN 2.4GHz Band: 2412 MHz ~ 2462 MHz Bluetooth: 2402 MHz ~ 2480 MHz
Mode	<ul style="list-style-type: none"> • GSM/GPRS/EGPRS • 802.11b/g/n HT20 • Bluetooth v3.0+EDR · Bluetooth v4.0+LE
Antenna Type	WWAN: PIFA Antenna WLAN: PIFA Antenna Bluetooth: PIFA Antenna
HW Version	A
SW Version	20.0.B.0.32
Dual Transfer Mode Category	Class A – EUT can support Packet Switched and Circuit Switched Network simultaneously.
EUT Stage	Production Unit
Remark: <ol style="list-style-type: none"> 1. The above EUT's information was declared by manufacturer. Please refer to the specifications or user's manual for more detailed description. 2. This device supported VoIP in GSM (e.g. 3rd part VoIP). 3. This device 2.4GHz WLAN supports WiFi Direct and Hotspot operation. 4. This device supports GRPS/EGPRS mode up to multi-slot class33 and supports DTM up to multi-slot class11. 5. This device has 2 SIM slots and supports Dual SIM Dual Standby. The WWAN radio transmission will be enabled by either one SIM at a time (single active). 	

3.2 Device Serial Number

Sample	Serial Number	IMEI Code
WWAN SAR measurements	WUJ016R7Q2	004402147030898
WLAN SAR measurements	WUJ016R70F	004402147030211
WWAN Conducted measurements	WUJ016R7Q2	004402147030898
BT/WLAN Conducted measurements	WUJ016LPD8	004402147078574

Note:

Several samples were used with identical hardware to support SAR testing. The manufacturer has confirmed that the device tested gave the same physical, mechanical and thermal characteristics and are within operational tolerances expected for production units



3.3 Maximum RF output power among production units

Mode		GSM 850	GSM 1900
		Burst average power(dBm)	
GSM (GMSK, 1 Tx slot)		33.0	31.0
GPRS (GMSK, 1 Tx slot)		33.0	31.0
GPRS (GMSK, 2 Tx slots)		30.0	28.0
GPRS (GMSK, 3 Tx slots)		28.2	26.2
GPRS (GMSK, 4 Tx slots)		27.0	25.0
EDGE (8PSK, 1 Tx slot)		28.5	27.5
EDGE (8PSK, 2 Tx slots)		25.5	24.5
EDGE (8PSK, 3 Tx slots)		23.7	22.7
EDGE (8PSK, 4 Tx slots)		22.5	21.5
DTM 5	GSM (GMSK, 1 Tx slot)	30.0	28.0
	GPRS (GMSK, 1 Tx slot)	30.0	28.0
DTM 9	GSM (GMSK, 1 Tx slot)	30.0	28.0
	GPRS (GMSK, 1 Tx slot)	30.0	28.0
DTM 11	GSM (GMSK, 1 Tx slot)	28.2	26.2
	GPRS (GMSK, 2 Tx slots)	28.2	26.2
DTM 5	GSM (GMSK, 1 Tx slot)	30.0	28.0
	EDGE (8PSK, 1 Tx slot)	25.5	24.5
DTM 9	GSM (GMSK, 1 Tx slot)	30.0	28.0
	EDGE (8PSK, 1 Tx slot)	25.5	24.5
DTM 11	GSM (GMSK, 1 Tx slot)	28.2	26.2
	EDGE (8PSK, 2 Tx slots)	23.7	22.7

Mode	Average Power (dBm)
WLAN2.4GHz 802.11b	16.0
WLAN2.4GHz 802.11g	15.0
WLAN2.4GHz 802.11n	13.0
Bluetooth v2.1+EDR	9.5
Bluetooth v4.0+LE	9.5



3.4 Applied Standard

The Specific Absorption Rate (SAR) testing specification, method, and procedure for this device is in accordance with the following standards:

- FCC 47 CFR Part 2 (2.1093)
- ANSI/IEEE C95.1-1992
- IEEE 1528-2003
- FCC KDB 865664 D01 SAR Measurement 100 MHz to 6 GHz v01r02
- FCC KDB 865664 D02 SAR Reporting v01r01
- FCC KDB 447498 D01 General RF Exposure Guidance v05r01
- FCC KDB 648474 D04 Handset SAR v01r02
- FCC KDB 248227 D01 SAR meas for 802 11abg v01r02
- FCC KDB 941225 D03 SAR Test Reduction GSM GPRS EDGE v01
- FCC KDB 941225 D04 SAR for GSM E GPRS Dual Xfer Mode v01
- FCC KDB 941225 D06 Hot Spot SAR v01r01

3.5 Device Category and SAR Limits

This device belongs to portable device category because its radiating structure is allowed to be used within 20 centimeters of the body of the user. Limit for General Population/Uncontrolled exposure should be applied for this device, it is 1.6 W/kg as averaged over any 1 gram of tissue.

3.6 Test Conditions

3.6.1 Ambient Condition

Ambient Temperature	20 to 24 °C
Humidity	< 60 %

3.6.2 Test Configuration

For WWAN SAR testing, the device was controlled by using a base station emulator. Communication between the device and the emulator was established by air link. The distance between the EUT and the antenna of the emulator is larger than 50 cm and the output power radiated from the emulator antenna is at least 30 dB smaller than the output power of EUT.

For WLAN SAR testing, WLAN engineering testing software installed on the EUT can provide continuous transmitting RF signal.

4. Specific Absorption Rate (SAR)

4.1 Introduction

SAR is related to the rate at which energy is absorbed per unit mass in an object exposed to a radio field. The SAR distribution in a biological body is complicated and is usually carried out by experimental techniques or numerical modeling. The standard recommends limits for two tiers of groups, occupational/controlled and general population/uncontrolled, based on a person's awareness and ability to exercise control over his or her exposure. In general, occupational/controlled exposure limits are higher than the limits for general population/uncontrolled.

4.2 SAR Definition

The SAR definition is the time derivative (rate) of the incremental energy (dW) absorbed by (dissipated in) an incremental mass (dm) contained in a volume element (dv) of a given density (ρ). The equation description is as below:

$$\text{SAR} = \frac{d}{dt} \left(\frac{dW}{dm} \right) = \frac{d}{dt} \left(\frac{dW}{\rho dv} \right)$$

SAR is expressed in units of Watts per kilogram (W/kg)

SAR measurement can be either related to the temperature elevation in tissue by

$$\text{SAR} = C \left(\frac{\delta T}{\delta t} \right)$$

Where: C is the specific heat capacity, δT is the temperature rise and δt is the exposure duration, or related to the electrical field in the tissue by

$$\text{SAR} = \frac{\sigma |E|^2}{\rho}$$

Where: σ is the conductivity of the tissue, ρ is the mass density of the tissue and E is the RMS electrical field strength.

However for evaluating SAR of low power transmitter, electrical field measurement is typically applied.

5. SAR Measurement System

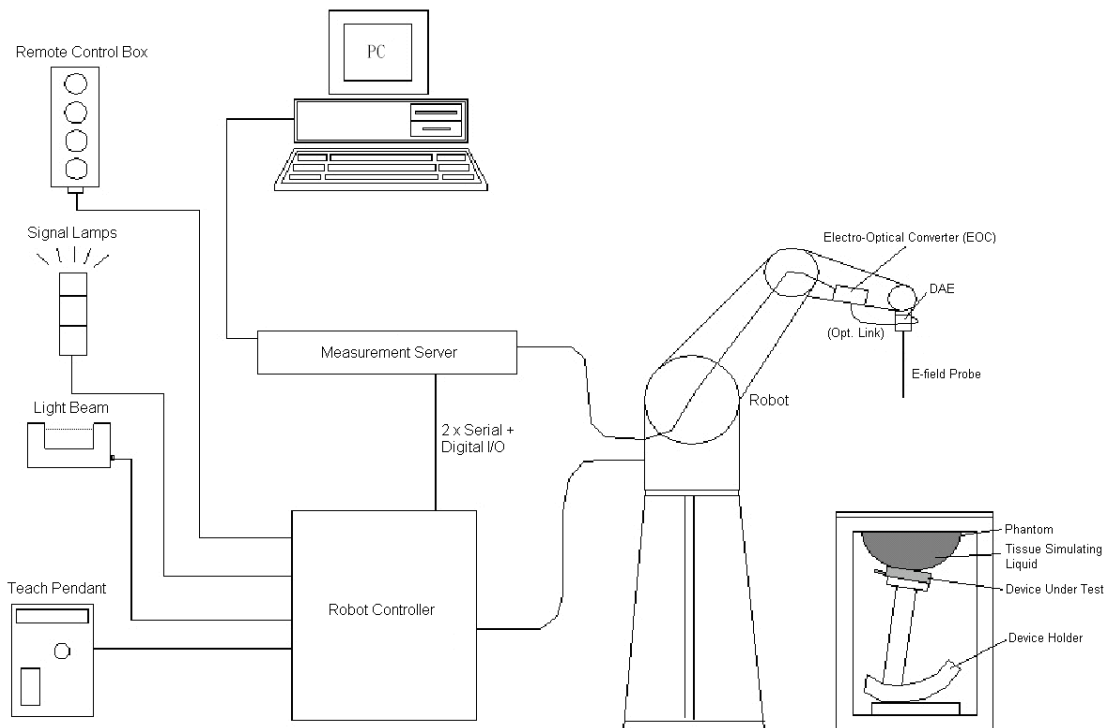

Fig 5.1 SPEAG DASY System Configurations

The DASY system for performance compliance tests is illustrated above graphically. This system consists of the following items:

- A standard high precision 6-axis robot with controller, a teach pendant and software
- A data acquisition electronic (DAE) attached to the robot arm extension
- A dosimetric probe equipped with an optical surface detector system
- The electro-optical converter (EOC) performs the conversion between optical and electrical signals
- A measurement server performs the time critical tasks such as signal filtering, control of the robot operation and fast movement interrupts.
- A probe alignment unit which improves the accuracy of the probe positioning
- A computer operating Windows XP
- DASY software
- Remote control with teach pendant and additional circuitry for robot safety such as warning lamps, etc.
- The SAM twin phantom
- A device holder
- Tissue simulating liquid
- Dipole for evaluating the proper functioning of the system

Component details are described in in the following sub-sections.

5.1 E-Field Probe

The SAR measurement is conducted with the dosimetric probe (manufactured by SPEAG). The probe is specially designed and calibrated for use in liquid with high permittivity. The dosimetric probe has special calibration in liquid at different frequency. This probe has a built in optical surface detection system to prevent from collision with phantom.

5.1.1 E-Field Probe Specification

<EX3DV4 Probe>

Construction	Symmetrical design with triangular core Built-in shielding against static charges PEEK enclosure material (resistant to organic solvents, e.g., DGBE)	 <p>Fig 5.2 Photo of EX3DV4/ES3DV4</p>
Frequency	10 MHz to 6 GHz; Linearity: ± 0.2 dB	
Directivity	± 0.3 dB in HSL (rotation around probe axis) ± 0.5 dB in tissue material (rotation normal to probe axis)	
Dynamic Range	10 μ W/g to 100 mW/g; Linearity: ± 0.2 dB (noise: typically < 1 μ W/g)	
Dimensions	Overall length: 330 mm (Tip: 20 mm) Tip diameter: 2.5 mm (Body: 12 mm) Typical distance from probe tip to dipole centers: 1 mm	

5.1.2 E-Field Probe Calibration

Each probe needs to be calibrated according to a dosimetric assessment procedure with accuracy better than $\pm 10\%$. The spherical isotropy shall be evaluated and within ± 0.25 dB. The sensitivity parameters (NormX, NormY, and NormZ), the diode compression parameter (DCP) and the conversion factor (ConvF) of the probe are tested. The calibration data can be referred to appendix C of this report.

5.2 Data Acquisition Electronics (DAE)

The data acquisition electronics (DAE) consists of a highly sensitive electrometer-grade preamplifier with auto-zeroing, a channel and gain-switching multiplexer, a fast 16 bit AD-converter and a command decoder and control logic unit. Transmission to the measurement server is accomplished through an optical downlink for data and status information as well as an optical uplink for commands and the clock. The input impedance of the DAE is 200 MOhm; the inputs are symmetrical and floating. Common mode rejection is above 80 dB.



Fig 5.3 Photo of DAE

5.3 Robot

The SPEAG DASY system uses the high precision robots (DASY4: RX90BL; DASY5: TX90XL) type from Stäubli SA (France). For the 6-axis controller system, the robot controller version (DASY4: CS7MB; DASY5: CS8c) from Stäubli is used. The Stäubli robot series have many features that are important for our application:

- High precision (repeatability ± 0.035 mm)
- High reliability (industrial design)
- Jerk-free straight movements
- Low ELF interference (the closed metallic construction shields against motor control fields)



Fig 5.4 Photo of DASY4



Fig 5.5 Photo of DASY5

5.4 Measurement Server

The measurement server is based on a PC/104 CPU board with CPU (DASY4: 166 MHz, Intel Pentium; DASY5: 400 MHz, Intel Celeron), chipdisk (DASY4: 32 MB; DASY5: 128 MB), RAM (DASY4: 64 MB, DASY5: 128 MB). The necessary circuits for communication with the DAE electronic box, as well as the 16 bit AD converter system for optical detection and digital I/O interface are contained on the DASY I/O board, which is directly connected to the PC/104 bus of the CPU board.

The measurement server performs all the real-time data evaluation for field measurements and surface detection, controls robot movements and handles safety operations.



Fig 5.6 Photo of Server for DASY4



Fig 5.7 Photo of Server for DASY5

5.5 Phantom

<SAM Twin Phantom>

Shell Thickness	2 ± 0.2 mm; Center ear point: 6 ± 0.2 mm
Filling Volume	Approx. 25 liters
Dimensions	Length: 1000 mm; Width: 500 mm; Height: adjustable feet
Measurement Areas	Left Hand, Right Hand, Flat Phantom



Fig 5.8 Photo of SAM Phantom

The bottom plate contains three pair of bolts for locking the device holder. The device holder positions are adjusted to the standard measurement positions in the three sections. A white cover is provided to tap the phantom during off-periods to prevent water evaporation and changes in the liquid parameters. On the phantom top, three reference markers are provided to identify the phantom position with respect to the robot.

<ELI4 Phantom>

Shell Thickness	2 ± 0.2 mm (sagging: <1%)
Filling Volume	Approx. 30 liters
Dimensions	Major ellipse axis: 600 mm Minor axis: 400 mm



Fig 5.9 Photo of ELI4 Phantom

The ELI4 phantom is intended for compliance testing of handheld and body-mounted wireless devices in the frequency range of 30 MHz to 6 GHz. ELI4 is fully compatible with standard and all known tissue simulating liquids.

5.6 Device Holder

<Device Holder for SAM Twin Phantom>

The SAR in the phantom is approximately inversely proportional to the square of the distance between the source and the liquid surface. For a source at 5 mm distance, a positioning uncertainty of ± 0.5 mm would produce a SAR uncertainty of ± 20 %. Accurate device positioning is therefore crucial for accurate and repeatable measurements. The positions in which the devices must be measured are defined by the standards.

The DASY device holder is designed to cope with different positions given in the standard. It has two scales for the device rotation (with respect to the body axis) and the device inclination (with respect to the line between the ear reference points). The rotation center for both scales is the ear reference point (ERP). Thus the device needs no repositioning when changing the angles.

The DASY device holder is constructed of low-loss POM material having the following dielectric parameters: relative permittivity $\epsilon = 3$ and loss tangent $\delta = 0.02$. The amount of dielectric material has been reduced in the closest vicinity of the device, since measurements have suggested that the influence of the clamp on the test results could thus be lowered.



Fig 5.10 Device Holder

<Laptop Extension Kit>

The extension is lightweight and made of POM, acrylic glass and foam. It fits easily on the upper part of the mounting device in place of the phone positioned. The extension is fully compatible with the SAM Twin and ELI phantoms.

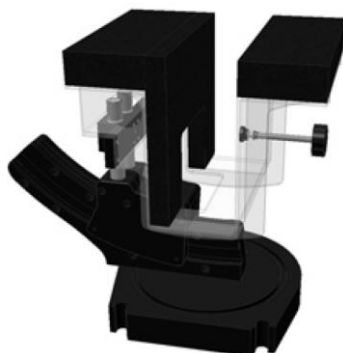

Fig 5.11 Laptop Extension Kit



5.7 Data Storage and Evaluation

5.7.1 Data Storage

The DASY software stores the assessed data from the data acquisition electronics as raw data (in microvolt readings from the probe sensors), together with all the necessary software parameters for the data evaluation (probe calibration data, liquid parameters and device frequency and modulation data) in measurement files. The post-processing software evaluates the desired unit and format for output each time the data is visualized or exported. This allows verification of the complete software setup even after the measurement and allows correction of erroneous parameter settings. For example, if a measurement has been performed with an incorrect crest factor parameter in the device setup, the parameter can be corrected afterwards and the data can be reevaluated.

The measured data can be visualized or exported in different units or formats, depending on the selected probe type (e.g., [V/m], [A/m], [mW/g]). Some of these units are not available in certain situations or give meaningless results, e.g., a SAR-output in a non-lose media, will always be zero. Raw data can also be exported to perform the evaluation with other software packages.

5.7.2 Data Evaluation

The DASY post-processing software (SEMCAD) automatically executes the following procedures to calculate the field units from the microvolt readings at the probe connector. The parameters used in the evaluation are stored in the configuration modules of the software :

Probe parameters :	- Sensitivity	Norm _i , a _{i0} , a _{i1} , a _{i2}
	- Conversion factor	ConvF _i
	- Diode compression point	dcp _i
Device parameters :	- Frequency	f
	- Crest factor	cf
Media parameters :	- Conductivity	σ
	- Density	ρ

These parameters must be set correctly in the software. They can be found in the component documents or they can be imported into the software from the configuration files issued for the DASY components. In the direct measuring mode of the multi-meter option, the parameters of the actual system setup are used. In the scan visualization and export modes, the parameters stored in the corresponding document files are used.

The first step of the evaluation is a linearization of the filtered input signal to account for the compression characteristics of the detector diode. The compensation depends on the input signal, the diode type and the DC-transmission factor from the diode to the evaluation electronics. If the exciting field is pulsed, the crest factor of the signal must be known to correctly compensate for peak power.

The formula for each channel can be given as :

$$V_i = U_i + U_i^2 \cdot \frac{cf}{dcp_i}$$

with V_i = compensated signal of channel i, (i = x, y, z)
 U_i = input signal of channel i, (i = x, y, z)
 cf = crest factor of exciting field (DASY parameter)
 dcp_i = diode compression point (DASY parameter)

From the compensated input signals, the primary field data for each channel can be evaluated :

$$\text{E-field Probes : } E_i = \sqrt{\frac{V_i}{\text{Norm}_i \cdot \text{ConvF}}}$$

$$\text{H-field Probes : } H_i = \sqrt{V_i \cdot \frac{a_{i0} + a_{i1}f + a_{i2}f^2}{f}}$$

with V_i = compensated signal of channel i, (i = x, y, z)
 Norm_i = sensor sensitivity of channel i, (i = x, y, z), $\mu\text{V}/(\text{V/m})^2$ for E-field Probes
 ConvF = sensitivity enhancement in solution
 a_{ij} = sensor sensitivity factors for H-field probes
 f = carrier frequency [GHz]
 E_i = electric field strength of channel i in V/m
 H_i = magnetic field strength of channel i in A/m

The RSS value of the field components gives the total field strength (Hermitian magnitude) :

$$E_{\text{tot}} = \sqrt{E_x^2 + E_y^2 + E_z^2}$$

The primary field data are used to calculate the derived field units.

$$\text{SAR} = E_{\text{tot}}^2 \cdot \frac{\sigma}{\rho \cdot 1000}$$

with SAR = local specific absorption rate in mW/g
 E_{tot} = total field strength in V/m
 σ = conductivity in [mho/m] or [Siemens/m]
 ρ = equivalent tissue density in g/cm^3

Note that the density is set to 1, to account for actual head tissue density rather than the density of the tissue simulating liquid.



5.8 Test Equipment List

Manufacturer	Name of Equipment	Type/Model	Serial Number	Calibration	
				Last Cal.	Due Date
SPEAG	835MHz System Validation Kit	D835V2	499	Mar. 18, 2013	Mar. 17, 2014
SPEAG	1900MHz System Validation Kit	D1900V2	5d041	Mar. 20, 2013	Mar. 19, 2014
SPEAG	2450MHz System Validation Kit	D2450V2	736	Aug. 23, 2013	Aug. 22, 2014
SPEAG	Data Acquisition Electronics	DAE3	577	May. 08, 2013	May. 07, 2014
SPEAG	Data Acquisition Electronics	DAE4	1338	Nov. 05, 2013	Nov. 04, 2014
SPEAG	Dosimetric E-Field Probe	EX3DV4	3931	Sep. 10, 2013	Sep. 09, 2014
SPEAG	Dosimetric E-Field Probe	EX3DV4	3935	Nov. 04, 2013	Nov. 03, 2014
Wisewind	Thermometer	HTC-1	TM642	Oct. 22, 2013	Oct. 21, 2014
Wisewind	Thermometer	HTC-1	TM642	Oct. 22, 2013	Oct. 21, 2014
Agilent	Wireless Communication Test Set	E5515C	MY50266977	May. 06, 2013	May. 05, 2015
R&S	Radio communication Tester	CMW500	116160	Jan. 09, 2013	Jan. 08, 2014
SPEAG	Device Holder	N/A	N/A	NCR	NCR
R&S	Signal Generator	SMF 100A	101107	May. 27, 2013	May. 26, 2014
SPEAG	Dielectric Probe Kit	DAK-3.5	1126	Jul. 23, 2013	Jul. 22, 2014
Agilent	ENA Network Analyzer	E5071C	MY46316648	Feb. 07, 2013	Feb. 06, 2014
Anritsu	Power Meter	ML2495A	1132003	Aug. 28, 2013	Aug. 27, 2014
Anritsu	Power Sensor	MA2411B	1126017	Aug. 27, 2013	Aug. 26, 2014
Agilent	Dual Directional Coupler	778D	50422	Note 2	
Woken	Attenuator 1	WK0602-XX	N/A	Note 2	
PE	Attenuator 2	PE7005-10	N/A	Note 2	
PE	Attenuator 3	PE7005- 3	N/A	Note 2	
AR	Power Amplifier	5S1G4M2	328767	Note 3	
R&S	Spectrum Analyzer	FSP 7	101131	Jul. 09, 2013	Jul. 08, 2014

Table 5.1 Test Equipment List

Note:

1. The calibration certificate of DASYS can be referred to appendix C of this report.
2. The Insertion Loss calibration of Dual Directional Coupler and Attenuator were characterized via the network analyzer and compensated during system check.
3. In system check we need to monitor the level on the power meter, and adjust the power amplifier level to have precise power level to the dipole; the measured SAR will be normalized to 1W input power according to the ratio of 1W to the input power to the dipole. For system check, the calibration of the power amplifier is deemed not critically required for correct measurement; the power meter is critical and we do have calibration for it
4. Attenuator 1 insertion loss is calibrated by the network Analyzer, which the calibration is valid, before system check.

6. Tissue Simulating Liquids

For the measurement of the field distribution inside the SAM phantom with DASY, the phantom must be filled with around 25 liters of homogeneous body tissue simulating liquid. For head SAR testing, the liquid height from the ear reference point (ERP) of the phantom to the liquid top surface is larger than 15 cm, which is shown in Fig. 6.1. For body SAR testing, the liquid height from the center of the flat phantom to the liquid top surface is larger than 15 cm, which is shown in Fig. 6.2.

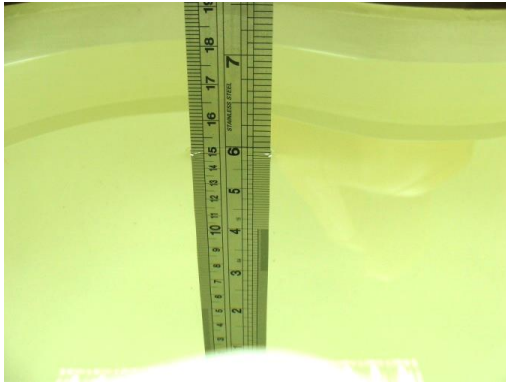

Fig 6.1 Photo of Liquid Height for Head SAR



Fig 6.2 Photo of Liquid Height for Body SAR

The following table gives the recipes for tissue simulating liquid.

Frequency (MHz)	Water (%)	Sugar (%)	Cellulose (%)	Salt (%)	Preventol (%)	DGBE (%)	Conductivity (σ)	Permittivity (ϵ_r)
For Head								
750	41.1	57.0	0.2	1.4	0.2	0	0.89	41.9
835	40.3	57.9	0.2	1.4	0.2	0	0.90	41.5
900	40.3	57.9	0.2	1.4	0.2	0	0.97	41.5
1800, 1900, 2000	55.2	0	0	0.3	0	44.5	1.40	40.0
2450	55.0	0	0	0	0	45.0	1.80	39.2
For Body								
750	51.7	47.2	0	0.9	0.1	0	0.96	55.5
835	50.8	48.2	0	0.9	0.1	0	0.97	55.2
900	50.8	48.2	0	0.9	0.1	0	1.05	55.0
1800, 1900, 2000	70.2	0	0	0.4	0	29.4	1.52	53.3
2450	68.6	0	0	0	0	31.4	1.95	52.7

Table 6.1 Recipes of Tissue Simulating Liquid

Simulating Liquid for 5G, Manufactured by SPEAG

Ingredients	(% by weight)
Water	64~78%
Mineral oil	11~18%
Emulsifiers	9~15%
Additives and Salt	2~3%



The dielectric parameters of the liquids were verified prior to the SAR evaluation using an SPEAG DAK-3.5 Dielectric Probe Kit and an Agilent Network Analyzer.

The following table shows the measuring results for simulating liquid.

Frequency (MHz)	Tissue Type	Liquid Temp. (°C)	Conductivity (σ)	Permittivity (ϵ_r)	Conductivity Target (σ)	Permittivity Target (ϵ_r)	Delta (σ) (%)	Delta (ϵ_r) (%)	Limit (%)	Date
835	Head	22.4	0.912	40.600	0.90	41.50	1.33	-2.17	±5	2013/11/13
1900	Head	22.5	1.450	38.200	1.40	40.00	3.57	-4.50	±5	2013/11/9
2450	Head	22.6	1.850	39.300	1.80	39.20	2.78	0.26	±5	2013/11/21
835	Body	22.3	0.963	54.500	0.97	55.20	-0.72	-1.27	±5	2013/11/13
1900	Body	22.6	1.530	52.300	1.52	53.30	0.66	-1.88	±5	2013/11/9
2450	Body	22.5	1.920	53.200	1.95	52.70	-1.54	0.95	±5	2013/11/20

Table 6.2 Measuring Results for Simulating Liquid

7. System Verification Procedures

Each DASY system is equipped with one or more system validation kits. These units, together with the predefined measurement procedures within the DASY software, enable the user to conduct the system performance check and system validation. System validation kit includes a dipole, tripod holder to fix it underneath the flat phantom and a corresponding distance holder.

7.1 Purpose of System Performance check

The system performance check verifies that the system operates within its specifications. System and operator errors can be detected and corrected. It is recommended that the system performance check be performed prior to any usage of the system in order to guarantee reproducible results. The system performance check uses normal SAR measurements in a simplified setup with a well characterized source. This setup was selected to give a high sensitivity to all parameters that might fail or vary over time. The system check does not intend to replace the calibration of the components, but indicates situations where the system uncertainty is exceeded due to drift or failure.

7.2 System Setup

In the simplified setup for system evaluation, the EUT is replaced by a calibrated dipole and the power source is replaced by a continuous wave that comes from a signal generator. The calibrated dipole must be placed beneath the flat phantom section of the SAM twin phantom with the correct distance holder. The distance holder should touch the phantom surface with a light pressure at the reference marking and be oriented parallel to the long side of the phantom. The equipment setup is shown below:

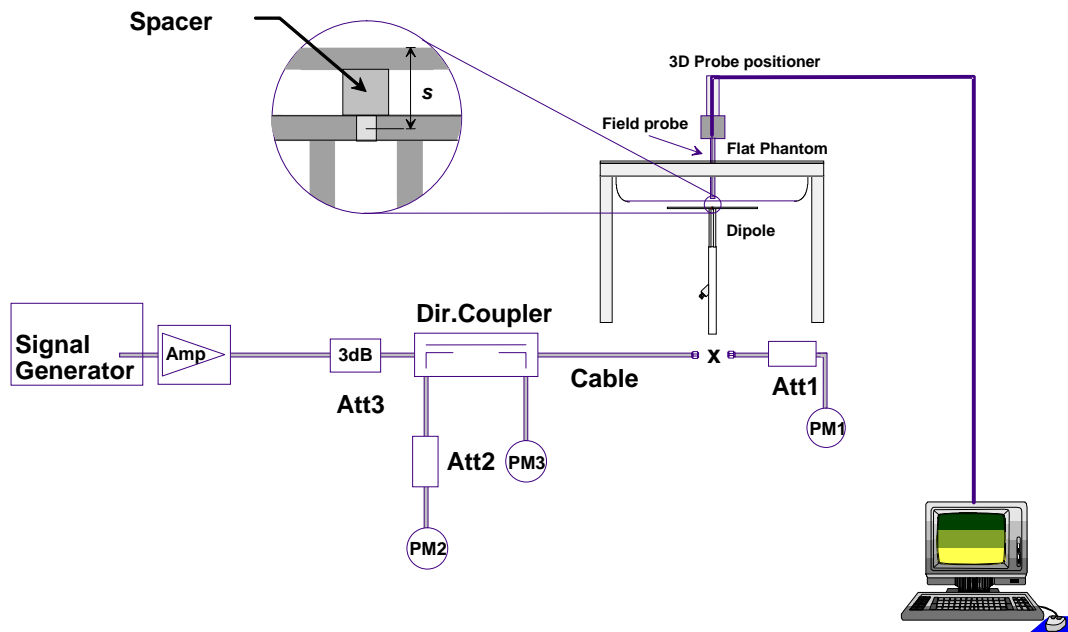

Fig 7.1 System Setup for System Evaluation

1. Signal Generator
2. Amplifier
3. Directional Coupler
4. Power Meter
5. Calibrated Dipole



Fig 7.2 Photo of Dipole Setup

7.3 SAR System Verification Results

Comparing to the original SAR value provided by SPEAG, the verification data should be within its specification of 10 %. Table 7.1 shows the target SAR and measured SAR after normalized to 1W input power. The table below indicates the system performance check can meet the variation criterion and the plots can be referred to Appendix A of this report.

Date	Frequency (MHz)	Tissue Type	Input Power (mW)	Dipole S/N	Probe S/N	DAE S/N	Measured SAR (W/kg)	Targeted SAR (W/kg)	Normalized SAR (W/kg)	Deviation (%)
2013/11/13	835	Head	250	D835V2-SN:499	3931	577	2.47	9.57	9.88	3.24
2013/11/9	1900	Head	250	D1900V2-SN:5d041	3931	577	10.90	40.60	43.6	7.39
2013/11/21	2450	Head	250	D2450V2-SN:736	3935	1338	13.60	53.20	54.4	2.26
2013/11/13	835	Body	250	D835V2-SN:499	3931	577	2.45	9.63	9.8	1.77
2013/11/9	1900	Body	250	D1900V2-SN:5d041	3931	577	10.30	40.80	41.2	0.98
2013/11/20	2450	Body	250	D2450V2-SN:736	3935	1338	13.30	51.30	53.2	3.70

Table 7.1 Target and Measurement SAR after Normalized

8. EUT Testing Position

8.1 Define two imaginary lines on the handset

- The vertical centerline passes through two points on the front side of the handset - the midpoint of the width w_t of the handset at the level of the acoustic output, and the midpoint of the width w_b of the bottom of the handset.
- The horizontal line is perpendicular to the vertical centerline and passes through the center of the acoustic output. The horizontal line is also tangential to the face of the handset at point A.
- The two lines intersect at point A. Note that for many handsets, point A coincides with the center of the acoustic output; however, the acoustic output may be located elsewhere on the horizontal line. Also note that the vertical centerline is not necessarily parallel to the front face of the handset, especially for clamshell handsets, handsets with flip covers, and other irregularly shaped handsets.

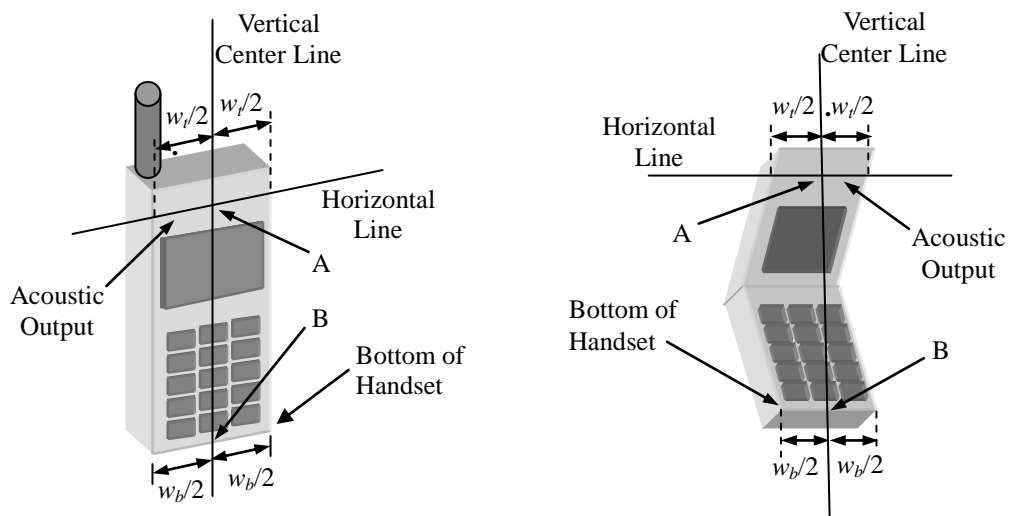

Fig 8.1 Illustration for Handset Vertical and Horizontal Reference Lines

8.2 Cheek Position

- (a) To position the device with the vertical center line of the body of the device and the horizontal line crossing the center piece in a plane parallel to the sagittal plane of the phantom. While maintaining the device in this plane, align the vertical center line with the reference plane containing the three ear and mouth reference point (M: Mouth, RE: Right Ear, and LE: Left Ear) and align the center of the ear piece with the line RE-LE.
- (b) To move the device towards the phantom with the ear piece aligned with the line LE-RE until the phone touched the ear. While maintaining the device in the reference plane and maintaining the phone contact with the ear, move the bottom of the phone until any point on the front side is in contact with the cheek of the phantom or until contact with the ear is lost (see Fig. 8.2).

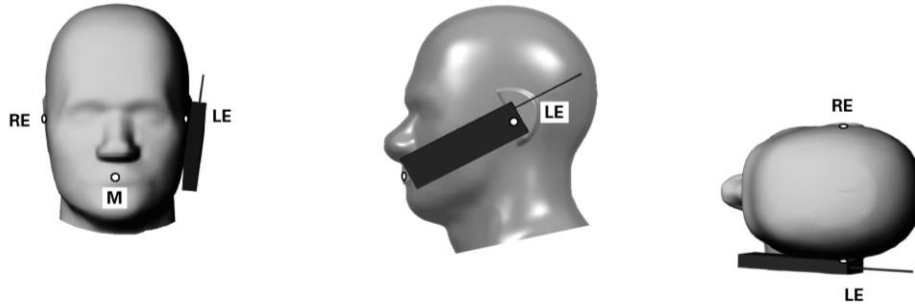

Fig 8.2 Illustration for Cheek Position

8.3 Tilted Position

- (a) To position the device in the “cheek” position described above.
- (b) While maintaining the device the reference plane described above and pivoting against the ear, moves it outward away from the mouth by an angle of 15 degrees or until contact with the ear is lost (see Fig. 8.3).

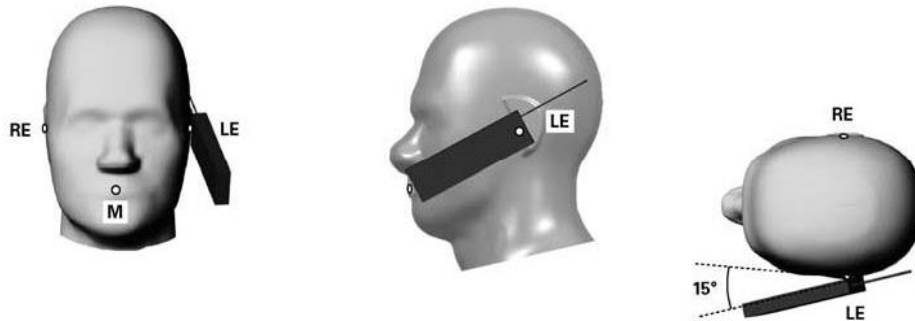

Fig 8.3 Illustration for Tilted Position

8.4 Body Worn Position

- (a) To position the device parallel to the phantom surface with either keypad up or down.
- (b) To adjust the device parallel to the flat phantom.
- (c) To adjust the distance between the device surface and the flat phantom to 1.5 cm.

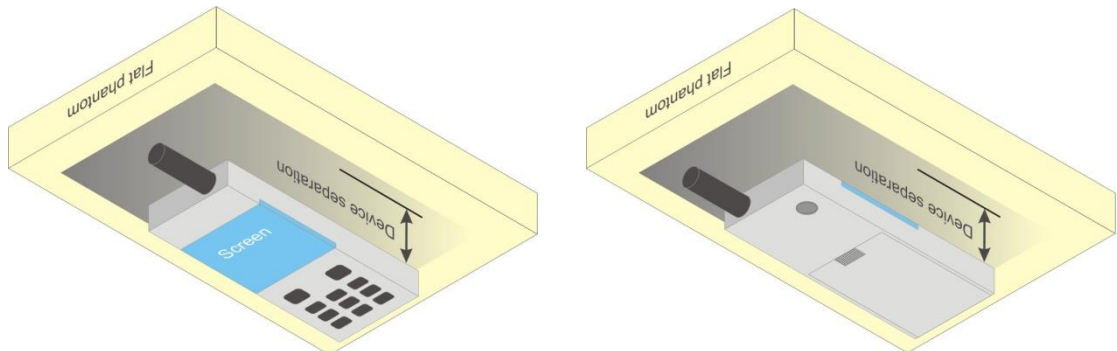

Fig 8.4 Illustration for Body Worn Position

8.5 Hotspot Position

- (a) To position the device parallel to the phantom surface with all sides and either keypad up or down.
- (b) To adjust the device parallel to the flat phantom.
- (c) To adjust the distance between the device and the flat phantom to 1.0cm.

<EUT Setup Photos>

Please refer to Appendix D for the test setup photos.



9. Measurement Procedures

The measurement procedures are as follows:

<Conducted power measurement>

- (a) For WWAN power measurement, use base station simulator to configure EUT WWAN transmission in conducted connection with RF cable, at maximum power in each supported wireless interface and frequency band.
- (b) Read the WWAN RF power level from the base station simulator.
- (c) For WLAN/BT power measurement, use engineering software to configure EUT WLAN/BT continuously transmission, at maximum RF power in each supported wireless interface and frequency band
- (d) Connect EUT RF port through RF cable to the power meter, and measure WLAN/BT output power

<SAR measurement>

- (a) Use base station simulator to configure EUT WWAN transmission in radiated connection, and engineering software to configure EUT WLAN/BT continuously transmission, at maximum RF power, in the highest power channel.
- (b) Place the EUT in the positions as Appendix D demonstrates.
- (c) Set scan area, grid size and other setting on the DASY software.
- (d) Measure SAR results for the highest power channel on each testing position.
- (e) Find out the largest SAR result on these testing positions of each band
- (f) Measure SAR results for other channels in worst SAR testing position if the reported SAR of highest power channel is larger than 0.8 W/kg

According to the test standard, the recommended procedure for assessing the peak spatial-average SAR value consists of the following steps:

- (a) Power reference measurement
- (b) Area scan
- (c) Zoom scan
- (d) Power drift measurement

9.1 Spatial Peak SAR Evaluation

The procedure for spatial peak SAR evaluation has been implemented according to the test standard. It can be conducted for 1g and 10g, as well as for user-specific masses. The DASY software includes all numerical procedures necessary to evaluate the spatial peak SAR value.

The base for the evaluation is a "cube" measurement. The measured volume must include the 1g and 10g cubes with the highest averaged SAR values. For that purpose, the center of the measured volume is aligned to the interpolated peak SAR value of a previously performed area scan.

The entire evaluation of the spatial peak values is performed within the post-processing engine (SEMCAD). The system always gives the maximum values for the 1g and 10g cubes. The algorithm to find the cube with highest averaged SAR is divided into the following stages:

- (a) Extraction of the measured data (grid and values) from the Zoom Scan
- (b) Calculation of the SAR value at every measurement point based on all stored data (A/D values and measurement parameters)
- (c) Generation of a high-resolution mesh within the measured volume
- (d) Interpolation of all measured values from the measurement grid to the high-resolution grid
- (e) Extrapolation of the entire 3-D field distribution to the phantom surface over the distance from sensor to surface
- (f) Calculation of the averaged SAR within masses of 1g and 10g

9.2 Power Reference Measurement

The Power Reference Measurement and Power Drift Measurements are for monitoring the power drift of the device under test in the batch process. The minimum distance of probe sensors to surface determines the closest measurement point to phantom surface. This distance cannot be smaller than the distance of sensor calibration points to probe tip as defined in the probe properties.

9.3 Area & Zoom Scan Procedures

First Area Scan is used to locate the approximate location(s) of the local peak SAR value(s). The measurement grid within an Area Scan is defined by the grid extent, grid step size and grid offset. Next, in order to determine the EM field distribution in a three-dimensional spatial extension, Zoom Scan is required. The Zoom Scan is performed around the highest E-field value to determine the averaged SAR-distribution over 10 g. Area scan and zoom scan resolution setting follows KDB 865664 D01v01r02 quoted below.

When the 1-g SAR of the highest peak is within 2 dB of the SAR limit, additional zoom scans are required for other peaks within 2 dB of the highest peak that have not been included in any zoom scan to ensure there is no increase in SAR.

		≤ 3 GHz	> 3 GHz	
Maximum distance from closest measurement point (geometric center of probe sensors) to phantom surface		5 ± 1 mm	$\frac{1}{2} \cdot \delta \cdot \ln(2) \pm 0.5$ mm	
Maximum probe angle from probe axis to phantom surface normal at the measurement location		$30^\circ \pm 1^\circ$	$20^\circ \pm 1^\circ$	
Maximum area scan spatial resolution: $\Delta x_{Area}, \Delta y_{Area}$		≤ 2 GHz: ≤ 15 mm 2 – 3 GHz: ≤ 12 mm	3 – 4 GHz: ≤ 12 mm 4 – 6 GHz: ≤ 10 mm	
		When the x or y dimension of the test device, in the measurement plane orientation, is smaller than the above, the measurement resolution must be \leq the corresponding x or y dimension of the test device with at least one measurement point on the test device.		
Maximum zoom scan spatial resolution: $\Delta x_{Zoom}, \Delta y_{Zoom}$		≤ 2 GHz: ≤ 8 mm 2 – 3 GHz: ≤ 5 mm*	3 – 4 GHz: ≤ 5 mm* 4 – 6 GHz: ≤ 4 mm*	
Maximum zoom scan spatial resolution, normal to phantom surface	uniform grid: $\Delta z_{Zoom}(n)$	≤ 5 mm	3 – 4 GHz: ≤ 4 mm 4 – 5 GHz: ≤ 3 mm 5 – 6 GHz: ≤ 2 mm	
	graded grid	$\Delta z_{Zoom}(1)$: between 1 st two points closest to phantom surface	≤ 4 mm	3 – 4 GHz: ≤ 3 mm 4 – 5 GHz: ≤ 2.5 mm 5 – 6 GHz: ≤ 2 mm
		$\Delta z_{Zoom}(n>1)$: between subsequent points	$\leq 1.5 \cdot \Delta z_{Zoom}(n-1)$	
Minimum zoom scan volume	x, y, z	≥ 30 mm	3 – 4 GHz: ≥ 28 mm 4 – 5 GHz: ≥ 25 mm 5 – 6 GHz: ≥ 22 mm	
<p>Note: δ is the penetration depth of a plane-wave at normal incidence to the tissue medium; see draft standard IEEE P1528-2011 for details.</p> <p>* When zoom scan is required and the <i>reported</i> SAR from the area scan based 1-g SAR estimation procedures of KDB 447498 is ≤ 1.4 W/kg, ≤ 8 mm, ≤ 7 mm and ≤ 5 mm zoom scan resolution may be applied, respectively, for 2 GHz to 3 GHz, 3 GHz to 4 GHz and 4 GHz to 6 GHz.</p>				



9.4 Volume Scan Procedures

The volume scan is used for assess overlapping SAR distributions for antennas transmitting in different frequency bands. It is equivalent to an oversized zoom scan used in standalone measurements. The measurement volume will be used to enclose all the simultaneous transmitting antennas. For antennas transmitting simultaneously in different frequency bands, the volume scan is measured separately in each frequency band. In order to sum correctly to compute the 1g aggregate SAR, the EUT remain in the same test position for all measurements and all volume scan use the same spatial resolution and grid spacing. When all volume scan were completed, the software, SEMCAD postprocessor can combine and subsequently superpose these measurement data to calculating the multiband SAR.

9.5 SAR Averaged Methods

In DASy, the interpolation and extrapolation are both based on the modified Quadratic Shepard's method. The interpolation scheme combines a least-square fitted function method and a weighted average method which are the two basic types of computational interpolation and approximation.

Extrapolation routines are used to obtain SAR values between the lowest measurement points and the inner phantom surface. The extrapolation distance is determined by the surface detection distance and the probe sensor offset. The uncertainty increases with the extrapolation distance. To keep the uncertainty within 1% for the 1 g and 10 g cubes, the extrapolation distance should not be larger than 5 mm.

9.6 Power Drift Monitoring

All SAR testing is under the EUT install full charged battery and transmit maximum output power. In DASy measurement software, the power reference measurement and power drift measurement procedures are used for monitoring the power drift of EUT during SAR test. Both these procedures measure the field at a specified reference position before and after the SAR testing. The software will calculate the field difference in dB. If the power drifts more than 5%, the SAR will be retested.

9.7 Bluetooth Exclusions Applied

Table with 3 columns: Mode Band, Average power(dBm) (Bluetooth v3.0+EDR, Bluetooth v4.0+LE), and values for 2.4GHz Bluetooth (9.5, 9.5).

Note:

- 1. Per KDB 447498 D01v05r01, the 1-g and 10-g SAR test exclusion thresholds for 100 MHz to 6 GHz at test separation distances ≤ 50 mm are determined by: [(max. power of channel, including tune-up tolerance, mW)/(min. test separation distance, mm)] · [√ f(GHz)] ≤ 3.0 for 1-g SAR and ≤ 7.5 for 10-g extremity SAR. Includes sub-points for f(GHz), rounding, and comparison.

Table with 4 columns: Bluetooth Max Power (dBm), Test Distance (mm), Frequency (GHz), and exclusion thresholds. Values: 9.5, 5, 2.48, 2.83.

- 2. Per KDB 447498 D01v05r01 exclusion thresholds is 2.83 < 3, RF exposure evaluation is not required.



10. Conducted RF Output Power (Unit: dBm)

<GSM Conducted Power>

Note:

- For DTM multi-slot class mode, the device was linked with base station simulator (Agilent E5515C) and transmit maximum power on maximum number of TX slots, i.e. one CS timeslot, and additional PS timeslots (1 for DTM class 5 and 9, 2 for DTM class 11) in one TDMA frame.
- Agilent E5515C was used to setup the device operated under DTM mode for power measurement and SAR testing. For conducted power, the power of the burst for voice and the power of the bursts for data was reported separately in the table above, and the frame-average power is derived below to determine SAR testing.

$$DTM \text{ frame average power (dBm)} = 10 \cdot \log [\sum(\text{power of each slot, in mW})/8]$$
- Per KDB 447498 D01v05r01, the maximum output power channel is used for SAR testing and for further SAR test reduction.
- For Head and Body-worn SAR testing, the EUT was set in GSM Voice for GSM850 and GSM1900..
- For hotspot mode SAR testing, GPRS, EDGE and DTM should be evaluated, therefore the EUT was set in GPRS 4 Tx slots for GSM850 and GPRS 2 Tx slots for GSM1900 due to its highest frame-average power.

Band GSM850		Burst Average Power (dBm)			Tune-up Limit (dBm)	Frame-Average Power (dBm)			Tune-up Limit (dBm)
TX Channel		128	189	251		128	189	251	
Frequency (MHz)		824.2	836.4	848.8		824.2	836.4	848.8	
GSM (GMSK, 1 Tx slot)		32.86	32.88	32.92	33.00	23.86	23.88	23.92	24.00
GPRS (GMSK, 1 Tx slot)		32.83	32.84	32.91	33.00	23.83	23.84	23.91	24.00
GPRS (GMSK, 2 Tx slots)		29.74	29.72	29.77	30.00	23.74	23.72	23.77	24.00
GPRS (GMSK, 3 Tx slots)		28.07	28.04	28.11	28.20	23.81	23.78	23.85	23.94
GPRS (GMSK, 4 Tx slots)		26.74	26.73	26.94	27.00	23.74	23.73	23.94	24.00
EDGE (8PSK, 1 Tx slot)		27.88	27.90	27.89	28.50	18.88	18.90	18.89	19.50
EDGE (8PSK, 2 Tx slots)		25.33	25.31	25.30	25.50	19.33	19.31	19.30	19.50
EDGE (8PSK, 3 Tx slots)		23.50	23.47	23.57	23.70	19.24	19.21	19.31	19.44
EDGE (8PSK, 4 Tx slots)		22.46	22.45	22.37	22.50	19.46	19.45	19.37	19.50
DTM 5 (2Tx slots)	GSM (GMSK, 1 Tx slot)	29.91	29.93	29.87	30.00	23.87	23.89	23.80	23.98
	GPRS (GMSK, 1 Tx slot)	29.88	29.90	29.78	30.00				
DTM 9 (2Tx slots)	GSM (GMSK, 1 Tx slot)	29.89	29.91	29.86	30.00	23.84	23.89	23.79	23.98
	GPRS (GMSK, 1 Tx slot)	29.84	29.91	29.77	30.00				
DTM 11 (3Tx slots)	GSM (GMSK, 1 Tx slot)	27.95	27.97	27.93	28.20	23.61	23.64	23.60	23.94
	GPRS (GMSK, 2 Tx slots)	27.83	27.86	27.82	28.20				
DTM 5 (2Tx slots)	GSM (GMSK, 1 Tx slot)	29.89	29.95	29.82	30.00	22.15	22.21	22.11	22.29
	EDGE (8PSK, 1 Tx slot)	25.28	25.35	25.34	25.50				
DTM 9 (2Tx slots)	GSM (GMSK, 1 Tx slot)	29.94	29.98	29.87	30.00	22.19	22.22	22.13	22.29
	EDGE (8PSK, 1 Tx slot)	25.29	25.29	25.28	25.50				
DTM 11 (3Tx slots)	GSM (GMSK, 1 Tx slot)	27.92	27.90	27.93	28.20	21.22	21.20	21.21	21.50
	EDGE (8PSK, 2 Tx slots)	23.43	23.40	23.39	23.70				

Remark: The frame-averaged power is linearly scaled the maximum burst averaged power over 8 time slots.

The calculated method are shown as below:

- Frame-averaged power = Maximum burst averaged power (1 Tx Slot) - 9 dB
- Frame-averaged power = Maximum burst averaged power (2 Tx Slots) - 6 dB
- Frame-averaged power = Maximum burst averaged power (3 Tx Slots) - 4.26 dB
- Frame-averaged power = Maximum burst averaged power (4 Tx Slots) - 3 dB



Band GSM1900		Burst Average Power (dBm)			Tune-up Limit (dBm)	Frame-Average Power (dBm)			Tune-up Limit (dBm)
TX Channel		512	661	810		512	661	810	
Frequency (MHz)		1850.2	1880	1909.8		1850.2	1880	1909.8	
GSM (GMSK, 1 Tx slot)		30.97	30.96	30.93	31.00	21.97	21.96	21.93	22.00
GPRS (GMSK, 1 Tx slot)		30.95	30.94	30.92	31.00	21.95	21.94	21.92	22.00
GPRS (GMSK, 2 Tx slots)		27.96	27.94	27.82	28.00	21.96	21.94	21.82	22.00
GPRS (GMSK, 3 Tx slots)		26.19	26.17	26.09	26.20	21.93	21.91	21.83	21.94
GPRS (GMSK, 4 Tx slots)		24.94	24.92	24.82	25.00	21.94	21.92	21.82	22.00
EDGE (8PSK, 1 Tx slot)		27.00	26.88	26.74	27.50	18.00	17.88	17.74	18.50
EDGE (8PSK, 2 Tx slots)		24.44	24.27	24.11	24.50	18.44	18.27	18.11	18.50
EDGE (8PSK, 3 Tx slots)		22.69	22.62	22.44	22.70	18.43	18.36	18.18	18.44
EDGE (8PSK, 4 Tx slots)		21.48	21.38	21.30	21.50	18.48	18.38	18.30	18.50
DTM 5 (2Tx slots)	GSM (GMSK, 1 Tx slot)	27.97	27.92	27.67	28.00	21.93	21.79	21.54	21.98
	GPRS (GMSK, 1 Tx slot)	27.94	27.69	27.44	28.00				
DTM 9 (2Tx slots)	GSM (GMSK, 1 Tx slot)	27.97	27.87	27.63	28.00	21.86	21.75	21.50	21.98
	GPRS (GMSK, 1 Tx slot)	27.78	27.67	27.41	28.00				
DTM 11 (3Tx slots)	GSM (GMSK, 1 Tx slot)	26.18	26.10	25.92	26.20	21.78	21.66	21.46	21.94
	GPRS (GMSK, 2 Tx slots)	25.97	25.82	25.61	26.20				
DTM 5 (2Tx slots)	GSM (GMSK, 1 Tx slot)	27.81	27.77	27.48	28.00	20.40	20.33	20.08	20.57
	EDGE (8PSK, 1 Tx slot)	24.37	24.23	24.08	24.50				
DTM 9 (2Tx slots)	GSM (GMSK, 1 Tx slot)	27.98	27.96	27.74	28.00	20.47	20.41	20.20	20.57
	EDGE (8PSK, 1 Tx slot)	24.21	24.06	23.88	24.50				
DTM 11 (3Tx slots)	GSM (GMSK, 1 Tx slot)	26.06	25.90	25.68	26.20	19.83	19.67	19.43	19.94
	EDGE (8PSK, 2 Tx slots)	22.62	22.46	22.20	22.70				

Remark: The frame-averaged power is linearly scaled the maximum burst averaged power over 8 time slots.

The calculated method are shown as below:

- Frame-averaged power = Maximum burst averaged power (1 Tx Slot) - 9 dB
- Frame-averaged power = Maximum burst averaged power (2 Tx Slots) - 6 dB
- Frame-averaged power = Maximum burst averaged power (3 Tx Slots) - 4.26 dB
- Frame-averaged power = Maximum burst averaged power (4 Tx Slots) - 3 dB



<WLAN 2.4GHz Conducted Power>

WLAN 2.4GHz 802.11b Average Power (dBm)						Tune up Limit (dBm)
Power vs. Channel			Power vs. Data Rate			
Channel	Frequency (MHz)	Data Rate 1Mbps	2Mbps	5.5Mbps	11Mbps	
CH 1	2412	14.52	14.71	14.61	14.67	16.0
CH 6	2437	14.81				
CH 11	2462	14.77				

WLAN 2.4GHz 802.11g Average Power (dBm)										Tune up Limit (dBm)
Power vs. Channel			Power vs. Data Rate							
Channel	Frequency (MHz)	Data Rate 6Mbps	9Mbps	12Mbps	18Mbps	24Mbps	36Mbps	48Mbps	54Mbps	
CH 1	2412	12.06	12.27	12.27	12.23	12.27	12.29	12.29	12.26	15.0
CH 6	2437	12.31								
CH 11	2462	12.29								

WLAN 2.4GHz 802.11n-HT20 Average Power (dBm)										Tune up Limit (dBm)
Power vs. Channel			Power vs. MCS Index							
Channel	Frequency (MHz)	MCS Index MCS0	MCS1	MCS2	MCS3	MCS4	MCS5	MCS6	MCS7	
CH 1	2412	10.01	10.17	10.16	10.12	10.11	10.04	10.14	10.06	13.0
CH 6	2437	10.18								
CH 11	2462	10.15								

Note:

1. Per KDB 248227 D01 v01r02, choose the highest output power channel to test SAR and determine further SAR exclusion
2. For each frequency band, testing at higher data rates and higher order modulations is not required when the maximum average output power for each of these configurations is less than 1/4dB higher than those measured at the lowest data rate
3. Apply the test exclusion rule in KDB 248227 D01 v01r02 11g and 11n-HT20 output power is less than 1/4dB higher than 11b mode, thus the SAR can be excluded.

11. Antenna Location

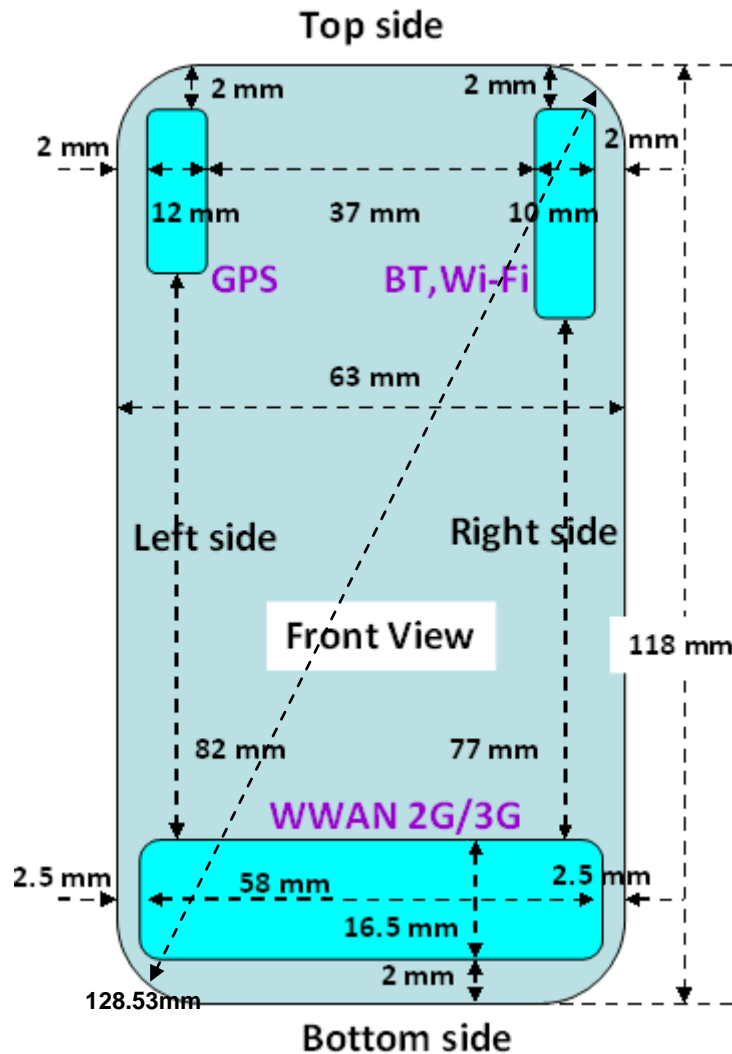

Distance of the Antenna to the EUT surface/edge						
Antennas	Back	Front	Top Side	Bottom Side	Right Side	Left Side
WWAN Main	≤ 25mm	≤ 25mm	99.5 mm	≤ 25mm	≤ 25mm	≤ 25mm
BT&WLAN	≤ 25mm	≤ 25mm	≤ 25mm	95.5mm	≤ 25mm	51mm

Positions for SAR tests; Hotspot mode						
Antennas	Back	Front	Top Side	Bottom Side	Right Side	Left Side
WWAN Main	Yes	Yes	No	Yes	Yes	Yes
BT&WLAN	Yes	Yes	Yes	No	Yes	No

Note:

- Per KDB 941225 D06 v01r01, when the overall device length and width are ≥ 9cm*5cm, the test distance is 10 mm. SAR must be measured for all sides and surfaces with a transmitting antenna located within 25mm from that surface or edge.



12. SAR Test Results

Note:

1. Per KDB 447498 D01v05r01, the reported SAR is the measured SAR value adjusted for maximum tune-up tolerance.
 - a. Tune-up scaling Factor = tune-up limit power (mW) / EUT RF power (mW), where tune-up limit is the maximum rated power among all production units.
 - b. For WWAN/WLAN: Reported SAR(W/kg)= Measured SAR(W/kg)*Tune-up Scaling Factor
2. Per KDB 447498 D01v05r01, the reported SAR is the measured SAR value adjusted for maximum tune-up tolerance. Per KDB 447498 D01v05r01, for each exposure position, testing of other required channels within the operating mode of a frequency band is not required when the *reported* 1-g or 10-g SAR for the mid-band or highest output power channel is:
 - ≤ 0.8 W/kg or 2.0 W/kg, for 1-g or 10-g respectively, when the transmission band is ≤ 100 MHz
 - ≤ 0.6 W/kg or 1.5 W/kg, for 1-g or 10-g respectively, when the transmission band is between 100 MHz and 200 MHz
 - ≤ 0.4 W/kg or 1.0 W/kg, for 1-g or 10-g respectively, when the transmission band is ≥ 200 MHz
3. Per KDB 447498 D01v05r01, for handsets the test separation distance is determined by the smallest distance between the outer surface of the device and the user; which is 0mm for head SAR, 10mm for hotspot SAR, and 15mm for body-worn SAR.
4. The device does not have limitation to operate VOIP in EGPRS wireless interface; considering the data rate of EGPRS to support VOIP quality and realistic operation, SAR testing was not performed evaluation VOIP operation in EGPRS mode.
5. Per KDB 648474 D04v01r02, when the reported SAR for a body-worn accessory measured without a headset connected to the handset is ≤ 1.2 W/kg, SAR testing with a headset connected to the handset is not required.

12.1 Head SAR

<GSM SAR>

Plot No.	Band	Mode	Modulation	Test Position	Ch.	Freq. (MHz)	Average Power (dBm)	Tune-Up Limit (dBm)	Tune-up Scaling Factor	Power Drift (dB)	Measured 1g SAR (W/kg)	Reported 1g SAR (W/kg)	Measured 10g SAR (W/kg)	Reported 10g SAR (W/kg)
12	GSM850	GSM Voice	GMSK	Right Cheek	251	848.8	32.92	33	1.019	0.011	0.436	0.444	0.335	0.341
13	GSM850	GSM Voice	GMSK	Right Tilted	251	848.8	32.92	33	1.019	-0.038	0.293	0.298	0.227	0.231
14	GSM850	GSM Voice	GMSK	Left Cheek	251	848.8	32.92	33	1.019	0.003	0.382	0.389	0.283	0.288
15	GSM850	GSM Voice	GMSK	Left Tilted	251	848.8	32.92	33	1.019	0.001	0.239	0.243	0.185	0.188
8	GSM1900	GSM Voice	GMSK	Right Cheek	512	1850.2	30.97	31	1.007	0.045	0.376	0.379	0.242	0.244
9	GSM1900	GSM Voice	GMSK	Right Tilted	512	1850.2	30.97	31	1.007	-0.058	0.257	0.259	0.148	0.149
10	GSM1900	GSM Voice	GMSK	Left Cheek	512	1850.2	30.97	31	1.007	0.02	0.527	0.531	0.316	0.318
11	GSM1900	GSM Voice	GMSK	Left Tilted	512	1850.2	30.97	31	1.007	-0.045	0.276	0.278	0.172	0.173

<WLAN2.4GHz SAR>

Plot No.	Band	Mode	Modulation	Test Position	Ch.	Freq. (MHz)	Average Power (dBm)	Tune-Up Limit (dBm)	Tune-up Scaling Factor	Power Drift (dB)	Measured 1g SAR (W/kg)	Reported 1g SAR (W/kg)	Measured 10g SAR (W/kg)	Reported 10g SAR (W/kg)
35	WLAN2.4GHz	802.11b 1Mbps	DBPSK	Right Cheek	6	2437	14.81	16	1.315	0.033	0.199	0.262	0.111	0.146
36	WLAN2.4GHz	802.11b 1Mbps	DBPSK	Right Tilted	6	2437	14.81	16	1.315	-0.033	0.166	0.218	0.088	0.116
37	WLAN2.4GHz	802.11b 1Mbps	DBPSK	Left Cheek	6	2437	14.81	16	1.315	0.027	0.32	0.421	0.167	0.220
38	WLAN2.4GHz	802.11b 1Mbps	DBPSK	Left Tilted	6	2437	14.81	16	1.315	0.046	0.195	0.256	0.098	0.129



12.2 Hotspot SAR

Distance of the Antenna to the EUT surface/edge						
Antennas	Back	Front	Top Side	Bottom Side	Right Side	Left Side
WWAN Main	≤ 25mm	≤ 25mm	99.5 mm	≤ 25mm	≤ 25mm	≤ 25mm
BT&WLAN	≤ 25mm	≤ 25mm	≤ 25mm	95.5mm	≤ 25mm	51mm

Positions for SAR tests; Hotspot mode						
Antennas	Back	Front	Top Side	Bottom Side	Right Side	Left Side
WWAN Main	Yes	Yes	No	Yes	Yes	Yes
BT&WLAN	Yes	Yes	Yes	No	Yes	No

Note:

- Per KDB 941225 D06 v01r01, when the overall device length and width are ≥ 9cm*5cm, the test distance is 10 mm. SAR must be measured for all sides and surfaces with a transmitting antenna located within 25mm from that surface or edge

<GSM SAR>

Plot No.	Band	Mode	Modulation	Test Position	Gap (cm)	Ch.	Freq. (MHz)	Average Power (dBm)	Tune-Up Limit (dBm)	Tune-up Scaling Factor	Power Drift (dB)	Measured 1g SAR (W/kg)	Reported 1g SAR (W/kg)	Measured 10g SAR (W/kg)	Reported 10g SAR (W/kg)
16	GSM850	GPRS (4 Tx slot)	GMSK	Front	1cm	251	848.8	26.94	27	1.014	0.038	0.478	0.485	0.349	0.354
17	GSM850	GPRS (4 Tx slot)	GMSK	Back	1cm	251	848.8	26.94	27	1.014	-0.024	1.03	1.044	0.756	0.767
25	GSM850	GPRS (4 Tx slot)	GMSK	Back	1cm	128	824.2	26.74	27	1.062	0.04	0.727	0.772	0.526	0.558
26	GSM850	GPRS (4 Tx slot)	GMSK	Back	1cm	189	836.4	26.73	27	1.064	0.145	0.895	0.952	0.651	0.693
18	GSM850	GPRS (4 Tx slot)	GMSK	Left Side	1cm	251	848.8	26.94	27	1.014	0.012	0.41	0.416	0.282	0.286
19	GSM850	GPRS (4 Tx slot)	GMSK	Right Side	1cm	251	848.8	26.94	27	1.014	0.022	0.513	0.520	0.358	0.363
20	GSM850	GPRS (4 Tx slot)	GMSK	Bottom Side	1cm	251	848.8	26.94	27	1.014	-0.089	0.11	0.112	0.064	0.065
1	GSM1900	GPRS (2 Tx slot)	GMSK	Front	1cm	512	1850.2	27.96	28	1.009	-0.033	0.529	0.534	0.32	0.323
2	GSM1900	GPRS (2 Tx slot)	GMSK	Back	1cm	512	1850.2	27.96	28	1.009	-0.008	0.708	0.715	0.416	0.420
3	GSM1900	GPRS (2 Tx slot)	GMSK	Left Side	1cm	512	1850.2	27.96	28	1.009	0.002	0.16	0.161	0.093	0.094
4	GSM1900	GPRS (2 Tx slot)	GMSK	Right Side	1cm	512	1850.2	27.96	28	1.009	-0.096	0.124	0.125	0.073	0.074
5	GSM1900	GPRS (2 Tx slot)	GMSK	Bottom Side	1cm	512	1850.2	27.96	28	1.009	-0.051	0.624	0.630	0.329	0.332

<WLAN2.4GHZ SAR>

Plot No.	Band	Mode	Modulation	Test Position	Gap (cm)	Ch.	Freq. (MHz)	Average Power (dBm)	Tune-Up Limit (dBm)	Tune-up Scaling Factor	Power Drift (dB)	Measured 1g SAR (W/kg)	Reported 1g SAR (W/kg)	Measured 10g SAR (W/kg)	Reported 10g SAR (W/kg)
28	WLAN2.4GHz	802.11b 1Mbps	DBPSK	Front	1cm	6	2437	14.81	16	1.315	-0.041	0.089	0.117	0.052	0.068
29	WLAN2.4GHz	802.11b 1Mbps	DBPSK	Back	1cm	6	2437	14.81	16	1.315	0.025	0.111	0.146	0.061	0.080
31	WLAN2.4GHz	802.11b 1Mbps	DBPSK	Right Side	1cm	6	2437	14.81	16	1.315	-0.01	0.115	0.151	0.063	0.083
32	WLAN2.4GHz	802.11b 1Mbps	DBPSK	Top Side	1cm	6	2437	14.81	16	1.315	0.083	0.071	0.093	0.038	0.050



12.3 Body Worn SAR

<GSM SAR>

Plot No.	Band	Mode	Modulation	Test Position	Gap (cm)	Ch.	Freq. (MHz)	Average Power (dBm)	Tune-Up Limit (dBm)	Tune-up Scaling Factor	Power Drift (dB)	Measured 1g SAR (W/kg)	Reported 1g SAR (W/kg)	Measured 10g SAR (W/kg)	Reported 10g SAR (W/kg)
21	GSM850	GSM Voice	GMSK	Front	1.5cm	251	848.8	32.92	33	1.019	0.062	0.503	0.512	0.375	0.382
22	GSM850	GSM Voice	GMSK	Back	1.5cm	251	848.8	32.92	33	1.019	0.028	0.933	0.950	0.682	0.695
23	GSM850	GSM Voice	GMSK	Back	1.5cm	128	824.2	32.86	33	1.033	0.003	0.634	0.655	0.465	0.480
24	GSM850	GSM Voice	GMSK	Back	1.5cm	189	836.4	32.88	33	1.028	0.016	0.79	0.812	0.576	0.592
6	GSM1900	GSM Voice	GMSK	Front	1.5cm	512	1850.2	30.97	31	1.007	-0.117	0.368	0.371	0.229	0.231
7	GSM1900	GSM Voice	GMSK	Back	1.5cm	512	1850.2	30.97	31	1.007	-0.021	0.387	0.390	0.238	0.240

<WLAN2.4GHz SAR>

Plot No.	Band	Mode	Modulation	Test Position	Gap (cm)	Ch.	Freq. (MHz)	Average Power (dBm)	Tune-Up Limit (dBm)	Tune-up Scaling Factor	Power Drift (dB)	Measured 1g SAR (W/kg)	Reported 1g SAR (W/kg)	Measured 10g SAR (W/kg)	Reported 10g SAR (W/kg)
33	WLAN2.4GHz	802.11b 1Mbps	DBPSK	Front	1.5cm	6	2437	14.81	16	1.315	-0.064	0.047	0.062	0.027	0.036
34	WLAN2.4GHz	802.11b 1Mbps	DBPSK	Back	1.5cm	6	2437	14.81	16	1.315	-0.072	0.059	0.078	0.036	0.047

12.4 Repeated SAR Measurement

Plot No.	Band	Mode	Test Position	Modulation	Gap (cm)	Ch.	Freq. (MHz)	Average Power (dBm)	Tune-Up Limit (dBm)	Tune-up Scaling Factor	Power Drift (dB)	Measured 1g SAR (W/kg)	Ratio	Reported 1g SAR (W/kg)
17	GSM850	GPRS (4 Tx slot)	Back	GMSK	1cm	251	848.8	26.94	27	1.014	-0.024	1.030	-	1.044
27	GSM850	GPRS (4 Tx slot)	Back	GMSK	1cm	251	848.8	26.94	27	1.014	-0.028	0.972	1.06	0.986

Note:

1. Per KDB 865664 D01v01r02, for each frequency band, repeated SAR measurement is required only when the measured SAR is $\geq 0.8W/kg$
2. Per KDB 865664 D01v01r02, if the ratio among the repeated measurement is ≤ 1.2 and the measured SAR $< 1.45W/kg$, only one repeated measurement is required.
3. The ratio is the largest SAR to the smallest SAR among original and repeated measurement.
4. All measurement SAR result is scaled-up to account for tune-up tolerance and is compliant.

12.5 Highest SAR Plot

Test Laboratory: Sporton International Inc. SAR/HAC Testing Lab

Date: 2013/11/13

#22_GSM850_GSM Voice_Back_1.5cm_Ch251

Communication System: GSM850; Frequency: 848.8 MHz; Duty Cycle: 1:8.3

Medium: MSL_850_131113 Medium parameters used: $f = 849$ MHz; $\sigma = 0.976$ mho/m; $\epsilon_r = 54.4$; $\rho = 1000$ kg/m³

Ambient Temperature : 23.3 °C; Liquid Temperature : 22.3°C

DASY4 Configuration:

- Probe: EX3DV4 - SN3931; ConvF(9.66, 9.66, 9.66); Calibrated: 2013/9/10
- Sensor-Surface: 2mm (Mechanical Surface Detection)
- Electronics: DAE3 Sn577; Calibrated: 2013/5/8
- Phantom: SAM_Right; Type: SAM; Serial: TP-1303
- Measurement SW: DASY4, V4.7 Build 80; Postprocessing SW: SEMCAD, V1.8 Build 186

Ch251/Area Scan (61x101x1): Measurement grid: dx=15mm, dy=15mm

Maximum value of SAR (interpolated) = 1.11 mW/g

Ch251/Zoom Scan (5x5x7)/Cube 0: Measurement grid: dx=8mm, dy=8mm, dz=5mm

Reference Value = 34.0 V/m; Power Drift = 0.028 dB

Peak SAR (extrapolated) = 1.23 W/kg

SAR(1 g) = 0.933 mW/g; SAR(10 g) = 0.682 mW/g

Maximum value of SAR (measured) = 1.11 mW/g

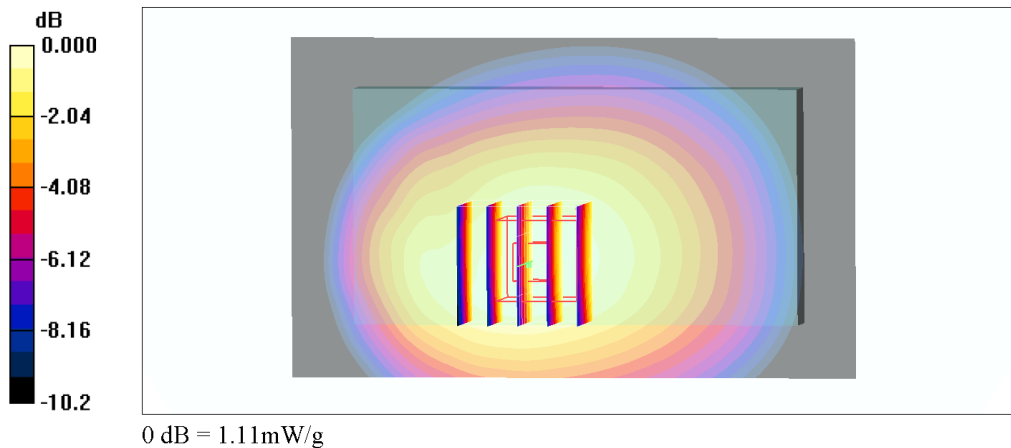

Test Laboratory: Sporton International Inc. SAR/HAC Testing Lab

Date: 2013/11/9

#02_GSM1900_GPRS (2 Tx slot)_Back_1cm_Ch512

Communication System: PCS; Frequency: 1850.2 MHz; Duty Cycle: 1:4.15

Medium: MSL_1900_131109 Medium parameters used : $f = 1850.2$ MHz; $\sigma = 1.49$ mho/m; $\epsilon_r = 52.5$; $\rho = 1000$ kg/m³

Ambient Temperature : 23.6 °C ; Liquid Temperature : 22.6 °C

DASY4 Configuration:

- Probe: EX3DV4 - SN3931; ConvF(7.61, 7.61, 7.61); Calibrated: 2013/9/10
- Sensor-Surface: 2mm (Mechanical Surface Detection)
- Electronics: DAE3 Sn577; Calibrated: 2013/5/8
- Phantom: SAM_Right; Type: SAM; Serial: TP-1303
- Measurement SW: DASY4, V4.7 Build 80; Postprocessing SW: SEMCAD, V1.8 Build 186

Ch512/Area Scan (61x101x1): Measurement grid: dx=15mm, dy=15mm

Maximum value of SAR (interpolated) = 0.971 mW/g

Ch512/Zoom Scan (5x5x7)/Cube 0: Measurement grid: dx=8mm, dy=8mm, dz=5mm

Reference Value = 24.7 V/m; Power Drift = -0.008 dB

Peak SAR (extrapolated) = 1.18 W/kg

SAR(1 g) = 0.708 mW/g; SAR(10 g) = 0.416 mW/g

Maximum value of SAR (measured) = 0.951 mW/g

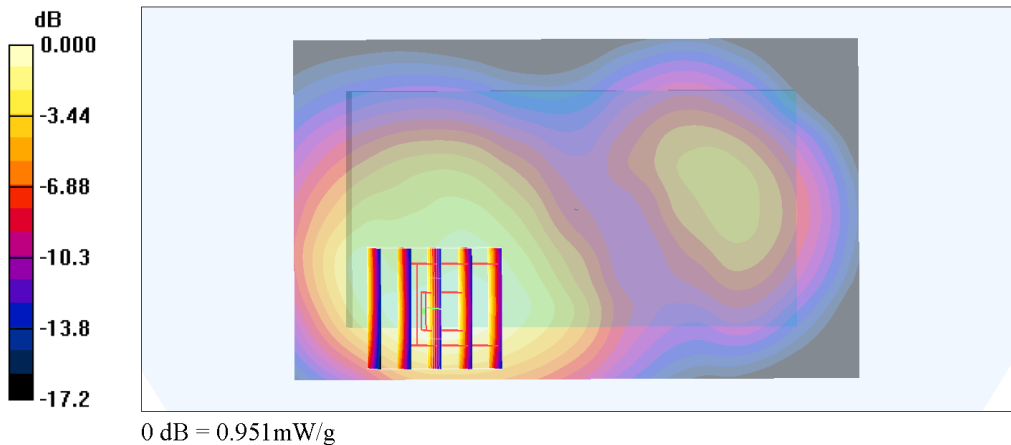

Test Laboratory: Sporton International Inc. SAR/HAC Testing Lab

Date: 2013/11/20

#31_WLAN2.4GHz_802.11b 1Mbps_Right Side_1cm_Ch6

Communication System: 802.11b ; Frequency: 2437 MHz;Duty Cycle: 1:1

Medium: MSL_2450_131120 Medium parameters used: f = 2437 MHz; $\sigma = 1.9$ mho/m; $\epsilon_r = 53.2$; $\rho = 1000$ kg/m³

Ambient Temperature : 23.5 °C ; Liquid Temperature : 22.5 °C

DASY4 Configuration:

- Probe: EX3DV4 - SN3935; ConvF(7.32, 7.32, 7.32); Calibrated: 2013/11/4
- Sensor-Surface: 2mm (Mechanical Surface Detection)
- Electronics: DAE4 Sn1338; Calibrated: 2013/11/5
- Phantom: SAM_Right; Type: SAM; Serial: TP-1303
- Measurement SW: DASY4, V4.7 Build 80; Postprocessing SW: SEMCAD, V1.8 Build 186

Ch6/Area Scan (41x121x1): Measurement grid: dx=12mm, dy=12mm

Maximum value of SAR (interpolated) = 0.179 mW/g

Ch6/Zoom Scan (7x7x7)/Cube 0: Measurement grid: dx=5mm, dy=5mm, dz=5mm

Reference Value = 9.26 V/m; Power Drift = -0.010 dB

Peak SAR (extrapolated) = 0.211 W/kg

SAR(1 g) = 0.115 mW/g; SAR(10 g) = 0.063 mW/g

Maximum value of SAR (measured) = 0.163 mW/g

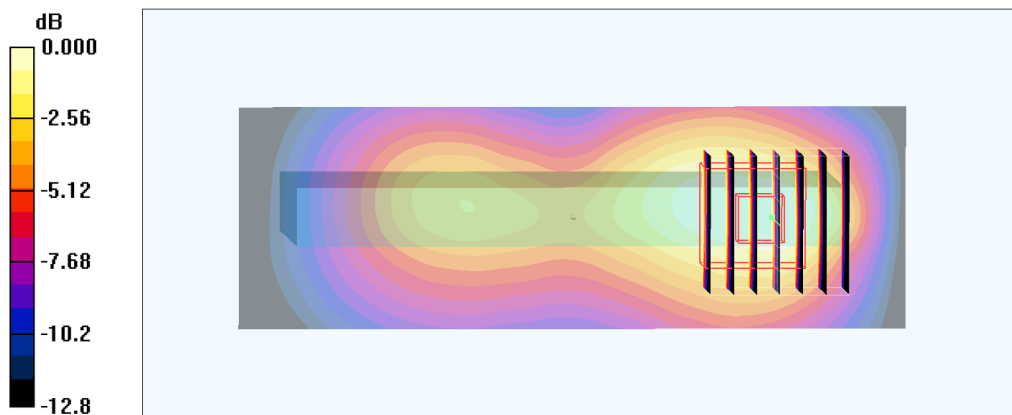

0 dB = 0.163mW/g



13. Simultaneous Transmission Analysis

NO.	Simultaneous Transmission Configurations	Smart Phone			Note
		Head	Body-worn	Hotspot	
1.	GSM(Voice) + WLAN2.4GHz(data)	Yes	Yes		
2.	GSM(Voice) + Bluetooth(data)	Yes	Yes		
3.	GPRS/EDGE(Data) + WLAN2.4GHz(data)	⁽¹⁾ Yes	⁽¹⁾ Yes	Yes	Hotspot / WiFi Direct
4.	GPRS/EDGE(Data) + Bluetooth(data)	⁽¹⁾ Yes	⁽¹⁾ Yes	Yes	Bluetooth Tethering

Note:

1. Considering the possibility of 3rd party VoIP app installation by end users and the device does not have limitation to operate VoIP in EGPRS wireless interface; considering the data rate of EGPRS to support VOIP quality and realistic operation, SAR testing was not performed evaluation VOIP operation in EGPRS mode.
2. WLAN and Bluetooth share the same antenna, and cannot transmit simultaneously.
3. The Scaled SAR summation is calculated based on the same configuration and test position.
4. Per KDB 447498 D01v05r01, simultaneous transmission SAR is compliant if,
 - i) Scalar SAR summation < 1.6W/kg.
 - ii) $SPLSR = (SAR_1 + SAR_2)^{1.5} / (min. separation distance, mm)$, and the peak separation distance is determined from the square root of $[(x_1-x_2)^2 + (y_1-y_2)^2 + (z_1-z_2)^2]$, where (x_1, y_1, z_1) and (x_2, y_2, z_2) are the coordinates of the extrapolated peak SAR locations in the zoom scan
If $SPLSR \leq 0.04$, simultaneously transmission SAR measurement is not necessary
 - iii) Simultaneously transmission SAR measurement, and the reported multi-band SAR < 1.6W/kg
5. For simultaneous transmission analysis, Bluetooth SAR is estimated per KDB 447498 D01v05r01 based on the formula below.
 - i) $(max. power of channel, including tune-up tolerance, mW) / (min. test separation distance, mm) \cdot [\sqrt{f(GHz)/x}] W/kg$ for test separation distances ≤ 50 mm; where $x = 7.5$ for 1-g SAR, and $x = 18.75$ for 10-g SAR.
 - ii) 0.4 W/kg for 1-g SAR and 1.0 W/kg for 10-g SAR, when the test separation distances is > 50 mm.

Bluetooth Max Power	Exposure Position	Head	Hotspot	Body-worn
	Test separation	0 mm	10 mm	15 mm
9.5 dBm	Estimated 1g SAR (W/kg)	0.378 W/kg	0.189 W/kg	0.126 W/kg
	Estimated 10g SAR (W/kg)	0.151 W/kg	0.076 W/kg	0.050 W/kg



13.1 Head Exposure Conditions

<WWAN + WLAN2.4GHZ>

Position	WWAN			WLAN		Summed 1g SAR (W/kg)
	WWAN Band	Plot No	SAR (W/kg)	Plot No	SAR (W/kg)	
Right Cheek	GSM850	12	0.444	35	0.262	0.71
	GSM1900	8	0.379	35	0.262	0.64
Right Tilted	GSM850	13	0.298	36	0.218	0.52
	GSM1900	9	0.259	36	0.218	0.48
Left Cheek	GSM850	14	0.389	37	0.421	0.81
	GSM1900	10	0.531	37	0.421	0.95
Left Tilted	GSM850	15	0.188	38	0.256	0.44
	GSM1900	11	0.278	38	0.256	0.53

Position	WWAN			WLAN		Summed 10g SAR (W/kg)
	WWAN Band	Plot No	SAR (W/kg)	Plot No	SAR (W/kg)	
Right Cheek	GSM850	12	0.341	35	0.146	0.49
	GSM1900	8	0.244	35	0.146	0.39
Right Tilted	GSM850	13	0.231	36	0.116	0.35
	GSM1900	9	0.149	36	0.116	0.27
Left Cheek	GSM850	14	0.288	37	0.220	0.51
	GSM1900	10	0.318	37	0.220	0.54
Left Tilted	GSM850	15	0.188	38	0.129	0.32
	GSM1900	11	0.173	38	0.129	0.30

<WWAN + Bluetooth>

Position	WWAN			Bluetooth	Summed 1g SAR (W/kg)
	WWAN Band	Plot No	SAR (W/kg)	Estimated SAR (W/kg)	
Right Cheek	GSM850	12	0.444	0.378	0.82
	GSM1900	8	0.379	0.378	0.76
Right Tilted	GSM850	13	0.298	0.378	0.68
	GSM1900	9	0.259	0.378	0.64
Left Cheek	GSM850	14	0.389	0.378	0.77
	GSM1900	10	0.531	0.378	0.91
Left Tilted	GSM850	15	0.188	0.378	0.57
	GSM1900	11	0.278	0.378	0.66

Position	WWAN			Bluetooth	Summed 10g SAR (W/kg)
	WWAN Band	Plot No	SAR (W/kg)	Estimated SAR (W/kg)	
Right Cheek	GSM850	12	0.341	0.151	0.49
	GSM1900	8	0.244	0.151	0.40
Right Tilted	GSM850	13	0.231	0.151	0.38
	GSM1900	9	0.149	0.151	0.30
Left Cheek	GSM850	14	0.288	0.151	0.44
	GSM1900	10	0.318	0.151	0.47
Left Tilted	GSM850	15	0.188	0.151	0.34
	GSM1900	11	0.173	0.151	0.32



13.2 Hotspot Exposure Conditions

Distance of the Antenna to the EUT surface/edge						
Antennas	Back	Front	Top Side	Bottom Side	Right Side	Left Side
WWAN Main	≤ 25mm	≤ 25mm	99.5 mm	≤ 25mm	≤ 25mm	≤ 25mm
BT&WLAN	≤ 25mm	≤ 25mm	≤ 25mm	95.5mm	≤ 25mm	51mm
Positions for SAR tests; Hotspot mode						
Antennas	Back	Front	Top Side	Bottom Side	Right Side	Left Side
WWAN Main	Yes	Yes	No	Yes	Yes	Yes
BT&WLAN	Yes	Yes	Yes	No	Yes	No
Simultaneous Transmission						
WWAN + BT&WLAN	Yes	Yes	No	No	Yes	No

<WWAN + WLAN2.4GHz>

Position	WWAN			WLAN		Summed 1g SAR (W/kg)
	WWAN Band	Plot No	SAR (W/kg)	Plot No	SAR (W/kg)	
Front	GSM850	16	0.485	28	0.117	0.60
	GSM1900	1	0.534	28	0.117	0.65
Back	GSM850	17	1.044	29	0.146	1.19
	GSM1900	2	0.715	29	0.146	0.86
Right Side	GSM850	19	0.520	31	0.151	0.67
	GSM1900	4	0.125	31	0.151	0.28

Position	WWAN			WLAN		Summed 10g SAR (W/kg)
	WWAN Band	Plot No	SAR (W/kg)	Plot No	SAR (W/kg)	
Front	GSM850	16	0.354	28	0.068	0.42
	GSM1900	1	0.323	28	0.068	0.39
Back	GSM850	17	0.767	29	0.080	0.85
	GSM1900	2	0.420	29	0.080	0.50
Right Side	GSM850	19	0.363	31	0.083	0.45
	GSM1900	4	0.074	31	0.083	0.16

<WWAN + Bluetooth>

Position	WWAN			Bluetooth	Summed 1g SAR (W/kg)
	WWAN Band	Plot No	SAR (W/kg)	Estimated SAR (W/kg)	
Front	GSM850	16	0.485	0.189	0.67
	GSM1900	1	0.534	0.189	0.72
Back	GSM850	17	1.044	0.189	1.23
	GSM1900	2	0.715	0.189	0.90
Right Side	GSM850	19	0.52	0.189	0.71
	GSM1900	4	0.125	0.189	0.31

Position	WWAN			Bluetooth	Summed 10g SAR (W/kg)
	WWAN Band	Plot No	SAR (W/kg)	Estimated SAR (W/kg)	
Front	GSM850	16	0.354	0.076	0.43
	GSM1900	1	0.323	0.076	0.40
Back	GSM850	17	0.767	0.076	0.84
	GSM1900	2	0.42	0.076	0.50
Right Side	GSM850	19	0.363	0.076	0.44
	GSM1900	4	0.074	0.076	0.15



13.3 Body-Worn Exposure Conditions

<WWAN + WLAN2.4GHz>

Position	WWAN			WLAN		Summed 1g SAR (W/kg)
	WWAN Band	Plot No	SAR (W/kg)	Plot No	SAR (W/kg)	
Front	GSM850	21	0.512	33	0.062	0.57
	GSM1900	6	0.371	33	0.062	0.43
Back	GSM850	22	0.950	34	0.078	1.03
	GSM1900	7	0.390	34	0.078	0.47

Position	WWAN			WLAN		Summed 10g SAR (W/kg)
	WWAN Band	Plot No	SAR (W/kg)	Plot No	SAR (W/kg)	
Front	GSM850	21	0.382	33	0.036	0.42
	GSM1900	6	0.371	33	0.036	0.41
Back	GSM850	22	0.695	34	0.047	0.74
	GSM1900	7	0.390	34	0.047	0.44

<WWAN + Bluetooth>

Position	WWAN			Bluetooth	Summed 1g SAR (W/kg)
	WWAN Band	Plot No	SAR (W/kg)	Estimated SAR (W/kg)	
Front	GSM850	21	0.512	0.126	0.64
	GSM1900	6	0.371	0.126	0.50
Back	GSM850	22	0.950	0.126	1.08
	GSM1900	7	0.390	0.126	0.52

Position	WWAN			Bluetooth	Summed 10g SAR (W/kg)
	WWAN Band	Plot No	SAR (W/kg)	Estimated SAR (W/kg)	
Front	GSM850	21	0.382	0.050	0.43
	GSM1900	6	0.371	0.050	0.42
Back	GSM850	22	0.695	0.050	0.75
	GSM1900	7	0.390	0.050	0.44

Test Engineer : Mood Huang, Jack Wu, and Iran Wang

14. Uncertainty Assessment

The component of uncertainty may generally be categorized according to the methods used to evaluate them. The evaluation of uncertainty by the statistical analysis of a series of observations is termed a Type A evaluation of uncertainty. The evaluation of uncertainty by means other than the statistical analysis of a series of observation is termed a Type B evaluation of uncertainty. Each component of uncertainty, however evaluated, is represented by an estimated standard deviation, termed standard uncertainty, which is determined by the positive square root of the estimated variance.

A Type A evaluation of standard uncertainty may be based on any valid statistical method for treating data. This includes calculating the standard deviation of the mean of a series of independent observations; using the method of least squares to fit a curve to the data in order to estimate the parameter of the curve and their standard deviations; or carrying out an analysis of variance in order to identify and quantify random effects in certain kinds of measurement.

A type B evaluation of standard uncertainty is typically based on scientific judgment using all of the relevant information available. These may include previous measurement data, experience, and knowledge of the behavior and properties of relevant materials and instruments, manufacture’s specification, data provided in calibration reports and uncertainties assigned to reference data taken from handbooks. Broadly speaking, the uncertainty is either obtained from an outdoor source or obtained from an assumed distribution, such as the normal distribution, rectangular or triangular distributions indicated in Table 14.1

Uncertainty Distributions	Normal	Rectangular	Triangular	U-Shape
Multi-plying Factor ^(a)	1/k ^(b)	1/√3	1/√6	1/√2

(a) standard uncertainty is determined as the product of the multiplying factor and the estimated range of variations in the measured quantity

(b) κ is the coverage factor

Table 14.1. Standard Uncertainty for Assumed Distribution

The combined standard uncertainty of the measurement result represents the estimated standard deviation of the result. It is obtained by combining the individual standard uncertainties of both Type A and Type B evaluation using the usual “root-sum-squares” (RSS) methods of combining standard deviations by taking the positive square root of the estimated variances.

Expanded uncertainty is a measure of uncertainty that defines an interval about the measurement result within which the measured value is confidently believed to lie. It is obtained by multiplying the combined standard uncertainty by a coverage factor. Typically, the coverage factor ranges from 2 to 3. Using a coverage factor allows the true value of a measured quantity to be specified with a defined probability within the specified uncertainty range. For purpose of this document, a coverage factor two is used, which corresponds to confidence interval of about 95 %. The DASy uncertainty Budget is shown in the following tables.



Error Description	Uncertainty Value (±%)	Probability Distribution	Divisor	Ci (1g)	Ci (10g)	Standard Uncertainty (1g)	Standard Uncertainty (10g)
Measurement System							
Probe Calibration	6.0	Normal	1	1	1	± 6.0 %	± 6.0 %
Axial Isotropy	4.7	Rectangular	√3	0.7	0.7	± 1.9 %	± 1.9 %
Hemispherical Isotropy	9.6	Rectangular	√3	0.7	0.7	± 3.9 %	± 3.9 %
Boundary Effects	1.0	Rectangular	√3	1	1	± 0.6 %	± 0.6 %
Linearity	4.7	Rectangular	√3	1	1	± 2.7 %	± 2.7 %
System Detection Limits	1.0	Rectangular	√3	1	1	± 0.6 %	± 0.6 %
Readout Electronics	0.3	Normal	1	1	1	± 0.3 %	± 0.3 %
Response Time	0.8	Rectangular	√3	1	1	± 0.5 %	± 0.5 %
Integration Time	2.6	Rectangular	√3	1	1	± 1.5 %	± 1.5 %
RF Ambient Noise	3.0	Rectangular	√3	1	1	± 1.7 %	± 1.7 %
RF Ambient Reflections	3.0	Rectangular	√3	1	1	± 1.7 %	± 1.7 %
Probe Positioner	0.4	Rectangular	√3	1	1	± 0.2 %	± 0.2 %
Probe Positioning	2.9	Rectangular	√3	1	1	± 1.7 %	± 1.7 %
Max. SAR Eval.	1.0	Rectangular	√3	1	1	± 0.6 %	± 0.6 %
Test Sample Related							
Device Positioning	2.9	Normal	1	1	1	± 2.9 %	± 2.9 %
Device Holder	3.6	Normal	1	1	1	± 3.6 %	± 3.6 %
Power Drift	5.0	Rectangular	√3	1	1	± 2.9 %	± 2.9 %
Phantom and Setup							
Phantom Uncertainty	4.0	Rectangular	√3	1	1	± 2.3 %	± 2.3 %
Liquid Conductivity (Target)	5.0	Rectangular	√3	0.64	0.43	± 1.8 %	± 1.2 %
Liquid Conductivity (Meas.)	2.5	Normal	1	0.64	0.43	± 1.6 %	± 1.1 %
Liquid Permittivity (Target)	5.0	Rectangular	√3	0.6	0.49	± 1.7 %	± 1.4 %
Liquid Permittivity (Meas.)	2.5	Normal	1	0.6	0.49	± 1.5 %	± 1.2 %
Combined Standard Uncertainty						± 11.0 %	± 10.8 %
Coverage Factor for 95 %						K=2	
Expanded Uncertainty						± 22.0 %	± 21.5 %

Table 14.2. Uncertainty Budget for frequency range 300 MHz to 3 GHz



15. References

- [1] FCC 47 CFR Part 2 “Frequency Allocations and Radio Treaty Matters; General Rules and Regulations”
- [2] ANSI/IEEE Std. C95.1-1992, “IEEE Standard for Safety Levels with Respect to Human Exposure to Radio Frequency Electromagnetic Fields, 3 kHz to 300 GHz”, September 1992
- [3] IEEE Std. 1528-2003, “Recommended Practice for Determining the Peak Spatial-Average Specific Absorption Rate (SAR) in the Human Head from Wireless Communications Devices: Measurement Techniques”, December 2003
- [4] SPEAG DASY System Handbook
- [5] FCC KDB 248227 D01 v01r02, “SAR Measurement Procedures for 802.11 a/b/g Transmitters”, May 2007
- [6] FCC KDB 447498 D01 v05r01, “Mobile and Portable Device RF Exposure Procedures and Equipment Authorization Policies”, May 2013
- [7] FCC KDB 648474 D04 v01r02, “SAR Evaluation Considerations for Wireless Handsets”, December 2013
- [8] FCC KDB 941225 D03 v01, “Recommended SAR Test Reduction Procedures for GSM / GPRS / EDGE”, December 2008.
- [9] FCC KDB 941225 D04 v01, “Evaluating SAR for GSM/(E)GPRS Dual Transfer Mode”, January 2010.
- [10] FCC KDB 941225 D06 v01r01, "SAR Evaluation Procedures for Portable Devices with Wireless Router Capabilities", May 2013
- [11] FCC KDB 865664 D01 v01r02, "SAR Measurement Requirements for 100 MHz to 6 GHz", December 2013.



Appendix A. Plots of System Performance Check

The plots are shown as follows.



Appendix B. Plots of SAR Measurement

The plots are shown as follows.



Appendix C. DASYS Calibration Certificate

The DASYS calibration certificates are shown as follows.