

**SONY**<sup>®</sup>

## Startup guide

Xperia™ Z Ultra  
C6802/C6833/C6806/C6843

XPERIA

Sony Mobile Communications AB  
SE-221 88 Lund, Sweden  
[www.sonymobile.com](http://www.sonymobile.com)

1273-3172.1

# Welcome

## Important Information

Before you use your device, please read the *Important Information* provided in your device or in the box.

## Assembly

To insert the memory card

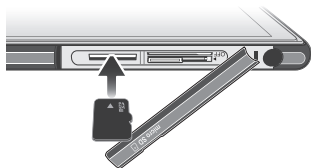

- ! The memory card may not be included at purchase in all markets.

To insert the SIM card

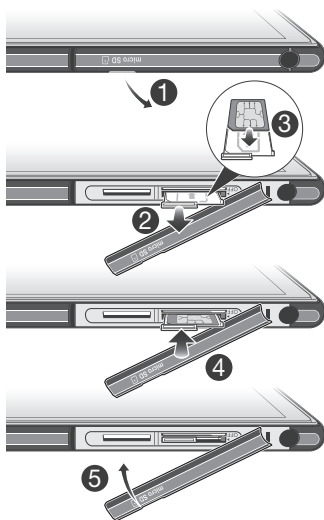

- ! Inserting the micro SIM card into the device without the SIM card holder could damage your micro SIM card or your device, and Sony does not warrant and will not be responsible for any damage caused by such action.

## To view the CE mark and the FCC ID

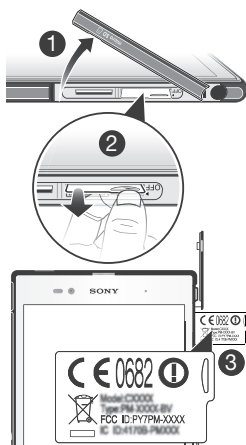

- 1 Remove the cover for the memory card and micro SIM card slots.
- 2 Insert a fingernail, or a sharp object such as a pen, into the hole in the label tray, then drag the tray outwards to view the CE mark and the FCC ID.

## Protecting your device from water and dust



Swimming pool



Diving



Sand/mud



Salt water



Other liquid chemicals

Your device has IP (Ingress Protection) ratings of IP5X, IPX5 and IPX8. These ratings mean that your device is dust resistant and is protected against low pressure water stream as well as against the effects of submersion for 30 minutes in fresh (non-saline) water up to 1.5 metres deep.

Always firmly attach all covers to ensure the water and dust resistance of the device. If liquid is detected inside the device, for example, underneath one of the covers, your warranty will be void.

If the speaker, microphone or headset jack get wet, dry these areas and wait for three hours before using them again. You can, however, use other features in the device that do not utilise the speaker or microphone.

Before using your device in water and in dusty conditions, refer to the relevant section of the User guide for your device for more detailed information. An online User guide as well as a downloadable version is available at [www.sonymobile.com/support](http://www.sonymobile.com/support).

# Basics

## Overview

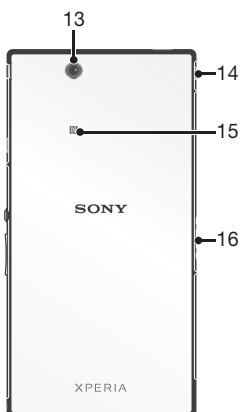
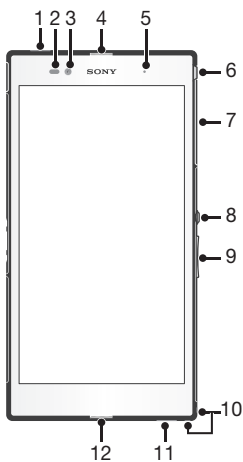

- |   |                                  |
|---|----------------------------------|
| 1. Second microphone                    | 9. Volume/Zoom key               |
| 2. Proximity sensor/Light sensor        | 10. Strap hole                   |
| 3. Front camera lens                    | 11. Speaker                      |
| 4. Ear speaker                          | 12. Main microphone              |
| 5. Charging light/Notification light    | 13. Main camera lens             |
| 6. Headset jack                         | 14. Charger/USB cable port cover |
| 7. Micro SIM and memory card slot cover | 15. NFC™ detection area          |
| 8. Power key                            | 16. Charging dock connector      |

## Turning on the device

### To turn on the device

- ! Make sure that the battery is charged for at least 30 minutes before you turn on the device for the first time.



- 1 Press and hold down the power key  until the device vibrates.
- 2 Wait a while for the device to start.

## Waking up the screen

### To activate the screen

- Briefly press the power key .

### To unlock the screen



- Swipe up or down on the lower part of the screen.

## Using the keys



### Back

- Go back to the previous screen
- Close the on-screen keypad, a dialog box, an options menu, or the Notification panel



### Home

- Go to the Home screen



### Task

- Tap to open a window showing your most recently used applications and a small apps bar

# Set up your device

## What is Android™?

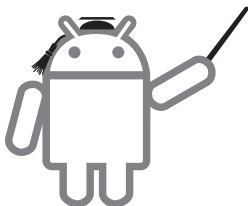

Android is your device's operating system. Since Android is developed by Google™, your device is preloaded with several Google™ services, such as Google Maps™ and Google™ web search. To use some of the services provided by Google™, you need a Google account.

### Google™ account

With a Google™ account, you can use Gmail™ to send emails, Google Talk™ to chat with friends, and Google Play™ to download applications and games, music, movies and books.

#### To set up a Google™ account on your device

- 1 From your **Home** screen, tap .
  - 2 Find and tap **Settings** > **Add account** > **Google**.
  - 3 Follow the registration wizard to create a Google™ account, or sign in if you already have an account.
- 💡 You can also sign in to or create a Google™ account from the setup guide the first time you start your device. Or you can go online and create an account at [www.google.com/accounts](http://www.google.com/accounts).

## Basic settings

The first time you start your device, a setup guide explains basic device functions and helps you enter essential settings. You can also access the setup guide later.

#### To access the setup guide manually

- 1 From the **Home** screen, tap .
- 2 Tap **Settings** > **Setup guide**.

# Transferring contacts to your new device

Transferring contacts to your new device can sometimes be complicated, but help is available.

You can transfer contacts from several device brands, including iPhone, Samsung, HTC and Nokia.

You need:

- An Internet-connected PC or Apple® Mac® computer
- A USB cable for your old device
- A USB cable for your new Android™ device
- Your old device and new Android™ device

## Get started transferring your contacts

If you are a PC user, use the PC Companion program to transfer your contacts. It's free, and the installation files are already saved on your new device. PC Companion also offers a range of other features, including help to update your device software. For Apple® Mac® computer users, the Sony™ Bridge for Mac application is available to help you transfer your contacts. It's also free and downloadable from [www.sonymobile.com/support](http://www.sonymobile.com/support).

### To install PC Companion

- 1 **New device:** Turn on your new Android™ device and connect it to a PC using a USB cable.
- 2 **New device:** Tap **Install** to install PC Companion on the PC.
- 3 **Computer:** If a popup window appears to notify you about available PC software, select *Run Startme.exe*.
- 4 **Computer:** Click *Install* to start the installation and then follow the instructions to complete the installation.

### To transfer contacts to your new device using PC Companion

- 1 Make sure that PC Companion is installed on your PC.
- 2 Open the PC Companion program on the PC, then click *Contacts Setup* and follow the instructions to transfer your contacts.

### To install Sony™ Bridge for Mac

- 1 Using your Apple Mac computer, go to [www.sonymobile.com/support](http://www.sonymobile.com/support), then search for and download the Sony™ Bridge for Mac application to a folder on the computer.
- 2 After the download is complete, open the folder and double-click the *Sony Bridge for Mac.dmg* file to start the installation.
- 3 Follow the instructions on your Apple® Mac® computer to complete the installation.

### To transfer contacts to your new device using Sony™ Bridge for Mac

- 1 Make sure the Sony™ Bridge for Mac application is installed on your Apple® Mac® computer.
- 2 Open the Sony™ Bridge for Mac application on your Apple® Mac® computer.
- 3 Double-click the Sony™ Bridge for Mac icon in the Applications folder, then follow the instructions to transfer your contacts.



# Finding your way

## Home screen

The Home screen is your gateway to the main features on your device. You can customise your **Home screen** with widgets, shortcuts, folders, themes, wallpaper and other items.

The **Home screen** extends beyond the regular screen display width, so you need to flick left or right to view content in all of the Home screen's panes.

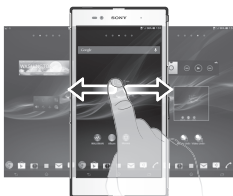

- The items in the bar at the bottom of the screen are always available for quick access.

### To go to the Home screen

- Press .

### To browse the Home screen

- Flick right or left.

## Widgets

Widgets are small applications that you can use directly on your **Home screen**. For example, the “WALKMAN” widget allows you to start playing music directly.

Some widgets are resizable, so you can expand them to view more content or shrink them to save space on your **Home screen**.

## Application screen

The Application screen, which you open from your **Home screen**, contains the applications that come pre-installed on your device as well as the applications you download. The Application screen extends beyond the regular screen width, so you need to flick left and right to view all content.

### To open the Application screen



- From your **Home screen**, tap .

### To open an application

- From your **Home screen** or the Application screen, tap the application.

## Applications

An application is a program on your device that helps you perform a task. For example, there are applications to make calls, take photos and download more applications.

## Status and notifications

The status bar at the top of your screen shows what's going on in your device. For example, new message and calendar notifications appear here.



## Checking notifications and ongoing activities

You can drag down the status bar to open the Notification panel and get more information. For example, you can use the panel to open a new message or view a calendar event. You can also open some applications that run in the background, such as the music player.

### To open the Notification panel





- Drag the status bar downwards.

# More basics

## Calling

### To make a call by dialling

- 1 From your **Home screen**, tap .
- 2 Find and tap **Phone**.
- 3 Enter the number of the recipient and tap **Call**. To delete a number, tap .

### To end a call

- Tap .







### To answer a call



- Drag  to the right across the screen.

## Multimedia and text messaging



### To create and send a message

- 1 From your **Home screen**, tap , then find and tap .
- 2 Tap .
- 3 Tap , then select the desired recipients from the **Contacts** list. If the recipient is not listed as a contact, enter the contact's number manually and tap .
- 4 When you are finished adding recipients, tap **Done**.
- 5 Tap **Write message** and enter your message text.
- 6 If you want to add a media file, tap  and select an option.
- 7 To send the message, tap **Send**.

## Settings menu

View and change settings for your device from the **Settings** menu.

### To access your device settings

- 1 From your **Home screen**, tap .
  - 2 Tap **Settings**.
- You can also drag the status bar downwards on the **Home screen** and tap  to access your device settings.

# Troubleshooting

## My device is not responding

If your device hangs, or if you cannot restart it normally, you can force the device to shut down.

To force the device to shut down

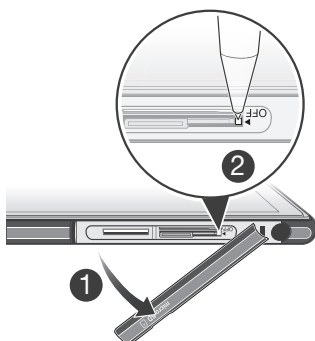

- 1 Remove the cover for the memory card and the micro SIM card.
  - 2 Using the tip of a pen or a similar object, press and hold down the OFF button until the device shuts down.
- ! Do not use overly sharp objects that could damage the OFF button.

## The device does not recognise my wired headset

- Make sure the wired headset that you are using complies to the CTIA standard. Your device supports the CTIA standard, and may not be fully compatible with other standards such as OMTP.
- If you have a wireless headset that is compatible with your device, try using that instead.

# Legal information

## Sony C6802/C6833/C6806/C6843

Google Play™ is not available in all countries. Some of the services and features described in this Startup guide are not supported in all countries/regions or by all networks and/or service providers in all areas. Without limitation, this applies to the GSM International Emergency Number 112. Please contact your network operator or service provider to determine availability of any specific service or feature and whether additional access or usage fees apply.

This Startup guide is published by Sony Mobile Communications AB or its local affiliated company, without any warranty. Improvements and changes to this Startup guide necessitated by typographical errors, inaccuracies of current information, or improvements to programs and/or equipment, may be made by Sony Mobile Communications AB at any time and without notice. Such changes will, however, be incorporated into new editions of this Startup guide.

© 2013 Sony Mobile Communications AB. All rights reserved.

Publication number: 1273-3172.1

Your device has the capability to download, store and forward additional content, e.g. ringtones. The use of such content may be restricted or prohibited by rights of third parties, including but not limited to restriction under applicable copyright laws. You, and not Sony, are entirely responsible for additional content that you download to or forward from your device. Prior to your use of any additional content, please verify that your intended use is properly licensed or is otherwise authorized. Sony does not guarantee the accuracy, integrity or quality of any additional content or any other third party content. Under no circumstances will Sony be liable in any way for your improper use of additional content or other third party content.

This Startup guide may reference services or applications provided by third parties. Use of such programming or services may require separate registration with the third party provider and may be subject to additional terms of use. For applications accessed on or through a third-party website, please review such websites' terms of use and applicable privacy policy in advance. Sony does not warrant or guarantee the availability or performance of any third-party websites or offered services.

All product and company names mentioned herein are the trademarks or registered trademarks of their respective owners. Any rights not expressly granted herein are reserved. All other trademarks are property of their respective owners. Visit [www.sonymobile.com](http://www.sonymobile.com) for more information.

All illustrations are for illustration only and may not accurately depict the actual device.

This product is protected by certain intellectual property rights of Microsoft. Use or distribution of such technology outside of this product is prohibited without a license from Microsoft.

Product compliance: This product has been manufactured by or on behalf of Sony Mobile Communications, Mobilvägen, SE-221 88 Lund, Sweden. Inquiries related to product compliance based on national legislation shall be addressed to Sony Mobile Quality Officer, Sony Mobile Communications AB, Mobilvägen, SE-221 88 Lund, Sweden. For any service or guarantee matters, please refer to the contact details provided in the separate service or guarantee documents.

# Our support to you – Xperia™ Care



## User guide

A User guide for your device is available at [www.sonymobile.com/support](http://www.sonymobile.com/support).



## Support in your device

Get user support directly in your device using the Support application.

### To access the Support application

- 1 From your Application screen, find and tap .
- 2 Find and tap the required support item.



## Support on the web

Visit [www.sonymobile.com/support](http://www.sonymobile.com/support) to access a range of support and get the most from your device.



## Customer support

Customer support – if all else fails. Access the relevant support number at [www.sonymobile.com](http://www.sonymobile.com) by clicking the Contact us link at the bottom of the page.

## Learn more

Learn more about how we can support you with Xperia™ Care at [www.sonymobile.com/support](http://www.sonymobile.com/support).

# SONY®



SAR Information  
FCC Statement  
Declaration of Conformity

## Sony C6843

UMTS HSPA Band 1 2 4 5 8 GSM GPRS/EDGE  
850/900/1800/1900 LTE Band 1 2 3 4 5 7 8 20

## Important Information

### United States & Canada

THIS PHONE MODEL HAS BEEN CERTIFIED IN COMPLIANCE WITH THE GOVERNMENT'S REQUIREMENTS FOR EXPOSURE TO RADIO WAVES.

The C6843 Series mobile phones have been designed to comply with applicable safety requirements for exposure to radio waves. Your wireless phone is a radio transmitter and receiver. It is designed to not exceed the limits\* of exposure to radio frequency (RF) energy set by governmental authorities. These limits establish permitted levels of RF energy for the general population. The guidelines are based on standards that were developed by international scientific organizations through periodic and thorough evaluation of scientific studies. The standards include a safety margin designed to assure the safety of all individuals, regardless of age and health.

The radio wave exposure guidelines employ a unit of measurement known as the Specific Absorption Rate (SAR). Tests for SAR are conducted using standardized methods with the phone transmitting at its highest certified power level in all used frequency bands. While there may be differences between the SAR levels of various phone models, they are all designed to meet the relevant guidelines for exposure to radio waves. For more information on SAR, please refer to the Important information in the Setup guide from your phone.

The highest SAR value as reported to the authorities for this phone model when tested for use by the ear is 1.102 W/kg\*, and when worn on the body is 1.009 W/kg\*. For body-worn operation, the phone has been tested when positioned a minimum of 15 mm from the body without any metal parts in the vicinity of the phone or when properly used with an appropriate accessory and worn on the body. For devices which include "WiFi hotspot" functionality, SAR measurements for the device operating in WiFi hotspot mode were taken using a separation distance of 10 mm. Use of third-party



accessories may result in different SAR levels than those reported.

**\*\*Before a phone model is available for sale to the public in the US, it must be tested and certified by the Federal Communications Commission (FCC) that it does not exceed the limit established by the government-adopted requirement for safe exposure\*. The tests are performed in positions and locations (i.e., by the ear and worn on the body) as required by the FCC for each model. The FCC has granted an Equipment Authorization for this phone model with all reported SAR levels evaluated as in compliance with the FCC RF exposure guidelines. While there may be differences between the SAR levels of various phones, all mobile phones granted an FCC equipment authorization meet the government requirement for safe exposure. SAR information on this phone model is on file at the FCC and can be found under the Display Grant section of <http://www.fcc.gov/oet/fccid> after searching on FCC ID PY7PM-0620. Additional information on SAR can be found on the Mobile Manufacturers Forum EMF website at <http://www.emfexplained.info/>.**

*\* In the United States and Canada, the SAR limit for mobile phones used by the public is 1.6 watts/kilogram (W/kg) averaged over one gram of tissue. The standard incorporates a margin of safety to give additional protection for the public and to account for any variations in measurements.*

**\*\*This paragraph is only applicable to authorities and customers in the United States.**

## Renseignements importants

### États-Unis et Canada

CE MODÈLE DE TÉLÉPHONE A ÉTÉ CERTIFIÉ CONFORME AUX EXIGENCES GOUVERNEMENTALES RELATIVES À L'EXPOSITION AUX ONDES RADIOÉLECTRIQUES.

Les téléphones mobiles de la série C6843 ont été conçus pour répondre aux normes de sécurité en vigueur en matière d'exposition aux ondes radioélectriques. Votre téléphone sans fil est un émetteur et un récepteur radio. Il est conçu de manière à ne pas dépasser les limites\* d'exposition à l'énergie des fréquences radio (RF) établies par les autorités gouvernementales. Ces limites fixent les niveaux maximaux d'énergie RF auxquels peut être soumis le grand public. Ces lignes directrices sont basées sur des normes qui ont été élaborées par des organisations scientifiques internationales par l'entremise d'évaluations périodiques et approfondies des études scientifiques. Ces normes prévoient une marge de sécurité visant à assurer la protection de tous les individus, peu importe leur âge et leur état de santé.

Les lignes directrices relatives à l'exposition aux ondes radioélectriques utilisent une unité de mesure appelée « Taux d'absorption spécifique » (TAS). Les tests de TAS sont effectués selon des méthodes normalisées dans lesquelles le téléphone émet dans toutes les bandes de fréquences utilisées, à la plus forte puissance pour laquelle il a été homologué. Bien que le TAS puisse être différent d'un modèle de téléphone à un autre, tous les appareils sont conçus pour respecter les lignes directrices relatives aux ondes radioélectriques. Pour en savoir plus sur le TAS, reportez-vous à la section Renseignements importants du guide de configuration de votre téléphone.

Le TAS le plus élevé relevé par les autorités pour ce modèle de téléphone est de 1.102 W/kg\* lorsqu'il est mis à l'essai en utilisation près de l'oreille, et de 1.009 W/kg\* lorsqu'il est porté sur le corps. En mode d'utilisation porté sur le corps, le téléphone a été testé lorsqu'il est à au moins 15 mm du corps et à l'écart de toute pièce en métal, ou lorsqu'il est utilisé de façon

adéquate avec un accessoire approprié et porté sur le corps. Pour les appareils munis de la fonctionnalité « point d'accès WiFi », en mode d'utilisation porté sur le corps, les mesures du TAS de l'appareil en mode WiFi ont été prises à une distance de sécurité de 10 mm. L'utilisation d'accessoires tiers peut produire des niveaux de TAS différents de ceux relevés.

\*\*Avant qu'un modèle de téléphone ne soit mis en vente auprès du public aux États-Unis, la Commission fédérale des communications (FCC) doit le mettre à l'essai et certifier qu'il respecte les limites fixées dans les exigences gouvernementales d'exposition sans danger\*. Pour chaque modèle, les essais sont effectués selon les positions et endroits d'utilisation (c.-à-d. près de l'oreille et porté sur le corps) requis par la FCC. La FCC a accordé une autorisation d'équipement pour ce modèle de téléphone, après que tous les niveaux de TAS indiqués aient été évalués et jugés conformes aux lignes directrices de la FCC en matière d'exposition aux radiofréquences. Même s'il peut y avoir des différences entre les niveaux de TAS des différents téléphones, tous les téléphones mobiles auxquels la FCC a accordé une autorisation d'équipement répondent aux normes gouvernementales en matière d'exposition sans danger. La FCC conserve dans ses dossiers l'information relative aux TAS relevés pour ce modèle de téléphone. Vous pouvez la consulter au <http://www.fcc.gov/oet/fccid> sous la rubrique « Display Grant », après avoir effectué une recherche sur ID PY7PM-0620 sur le site de la FCC. Vous trouverez des renseignements supplémentaires concernant le TAS sur le site Web du Mobile Manufacturers Forum (EMF) à l'adresse <http://www.emfexplained.info/>.

*\* \* Aux États-Unis et au Canada, la limite de TAS des téléphones mobiles utilisés par le public est de 1,6 watt/kg (W/kg) en moyenne sur un gramme de tissus. Cette norme comporte une marge importante de sécurité afin d'assurer une protection supplémentaire et de tenir compte de toute variation dans les mesures.*

*\*\*Ce paragraphe ne concerne que les autorités et les clients des États-Unis.*

## Información importante

### Estados Unidos y Canadá

ESTE MODELO DE TELÉFONO HA SIDO CERTIFICADO EN CUMPLIMIENTO CON LOS REQUERIMIENTOS DEL GOBIERNO PARA EXPOSICIÓN A LAS ONDAS DE RADIO.

Los teléfonos móviles serie C6843 se han diseñado para cumplir con los requerimientos de seguridad aplicables para la exposición a las ondas de radio. Su teléfono inalámbrico es un receptor y transmisor de radio. Está diseñado para no superar los límites\* de exposición a la energía de radiofrecuencia (RF) establecidos por las autoridades gubernamentales. Estos límites establecen los niveles permitidos de energía de RF para la población en general. Los lineamientos se basan en los estándares que se desarrollaron por parte de las organizaciones científicas internacionales a través de una evaluación periódica y exhaustiva de estudios científicos. Los estándares incluyen un margen de seguridad diseñado para garantizar la seguridad de todas las personas, independientemente de la edad y la salud.

Los lineamientos de exposición a las ondas de radio emplean una unidad de medida conocida como Tasa específica de absorción (SAR, por sus siglas en inglés). Las pruebas para SAR se llevan a cabo usando métodos estandarizados con el teléfono transmitiendo a su más alto nivel de energía certificada en todas las bandas de frecuencia utilizadas. Aunque existe la posibilidad que haya diferencias entre los niveles de SAR de varios modelos de teléfono, todos están diseñados para cumplir con los lineamientos relevantes de exposición a las ondas de radio. Para obtener más información sobre SAR, consulte la Información importante en el asistente de configuración de su teléfono.

El valor más alto de SAR según lo reportado a las autoridades para este modelo de teléfono cuando se realizaron las pruebas para uso en la oreja es de 1.102 W/kg\* y cuando se utilizó en el cuerpo es de 1.009 W/kg\*. Para el funcionamiento cuando se usa en el cuerpo, el teléfono ha sido probado cuando se coloca a un mínimo de 15 mm del cuerpo sin ninguna parte de metal en las cercanías del teléfono o cuando se utiliza apropiadamente

con un accesorio adecuado y se usa en el cuerpo. Para los dispositivos que incluyen la funcionalidad de la "Zona activa WiFi", se tomaron las medidas de SAR para el dispositivo que opera en el modo de la zona activa de WiFi usando una distancia de separación de 10 mm. El uso de accesorios de terceros puede tener como resultado diferentes niveles de SAR que los reportados.

\*\*Antes de que el modelo del teléfono esté disponible para la venta al público en EE.UU., deben realizarse pruebas y certificarse por parte de la Comisión de comunicaciones federales (FCC, por sus siglas en inglés) que no supera el límite establecido por el requerimiento adoptado por el gobierno para la exposición segura\*. Las pruebas se realizan en posiciones y ubicaciones (es decir, al lado de la oreja y usado en el cuerpo) según lo requerido por FCC para cada modelo. FCC ha otorgado una Autorización de equipo para este modelo de teléfono con todos los niveles de SAR reportados que se evaluaron en cumplimiento con los lineamientos de exposición a RF de FCC. Aunque existe la posibilidad que haya diferencias entre los niveles de SAR de varios teléfonos, todos los teléfonos móviles que cuentan con una autorización de equipo de FCC cumplen con el requerimiento gubernamental para la exposición segura. La información de SAR en este modelo de teléfono está archivada en la FCC y se puede encontrar bajo la sección Concesión de información de <http://www.fcc.gov/oet/fccid> después de buscar en FCC ID PY7PM-0620. La información adicional sobre SAR se puede encontrar en el sitio Web de EMF de foro de fabricantes de móviles en <http://www.emfexplained.info/>.

*\* En los Estados Unidos y Canadá, el límite de SAR para los teléfonos móviles usado por el público es 1.6 vatios/kilogramos (W/kg) promedio sobre un gramo de tejido. El estándar incorpora un margen de seguridad para dar protección adicional para el público y para tomar en cuenta cualquier variación en medidas.*

*\*\*Este párrafo únicamente aplica a las autoridades y clientes en Estados Unidos.*

## Important Information

### Latin & South America

#### Radio wave exposure and Specific Absorption Rate (SAR) information

This mobile phone model C6843 has been designed to comply with applicable safety requirements for exposure to radio waves. These requirements are based on scientific guidelines that include safety margins designed to assure the safety of all persons, regardless of age and health.

The radio wave exposure guidelines employ a unit of measurement known as the Specific Absorption Rate, or SAR.

Tests for SAR are conducted using standardized methods with the tablet personal computer transmitting at its highest certified power level in all used frequency bands.

While there may be differences between the SAR levels of various phone models, they are all designed to meet the relevant guidelines for exposure to radio waves.

For more information on SAR, please refer to the Important information in the Setup guide from your phone.

SAR data information for residents in countries that have adopted the SAR limit recommended by the International Commission of Non-Ionizing Radiation Protection (ICNIRP), which is 2 W/kg averaged over ten (10) gram of tissue (for example European Union, Japan, Brazil and New Zealand): The highest SAR value for this model phone when tested by Sony for use at the ear is 0.441 W/kg (10g).

## Información importante

### Latinoamérica y Sudamérica

#### **Información de exposición a ondas de radio y tasa específica de absorción (SAR por sus siglas en inglés).**

Este modelo de teléfono móvil C6843 ha sido diseñado para cumplir con los requisitos de seguridad aplicables sobre exposición a ondas de radio. Estos requisitos se basan en directrices científicas que incluyen márgenes de seguridad diseñados para garantizar la seguridad de todas las personas, independientemente de su edad o salud.

Las directrices de exposición a ondas de radio utilizan una unidad de medida conocida como Tasa Específica de Absorción o SAR por sus siglas en inglés.

Las pruebas de SAR se realizan utilizando métodos estandarizados con el equipo personal o tableta transmitiendo al máximo nivel certificado de potencia en todas las bandas de frecuencia utilizadas.

Aunque puede haber diferencias entre los niveles SAR de varios modelos de teléfonos, todos han sido diseñados para cumplir las directrices pertinentes sobre exposición a ondas de radio.

Para obtener más información sobre la tasa SAR, consulte la Información importante en la Guía de configuración del teléfono.

Información de los datos de SAR para los residentes en los países que han adoptado el límite de SAR recomendado por la Comisión Internacional de Protección contra las Radiaciones No Ionizantes (ICNIRP por sus siglas en inglés), que es de 2 W / kg de media sobre diez (10) gramos de tejido (por ejemplo la Unión Europea, Japón, Brasil y Nueva Zelanda): El valor más alto de SAR para este modelo de teléfono al ser analizado por Sony para su uso cerca del oído es de 0.441 W/kg (10g).

## Informações importantes

### América Latina e do Sul

#### **Informações sobre exposição a ondas de rádio e Taxa de Absorção Específica (SAR)**

Este modelo de celular C6843 foi projetado de modo a estar em conformidade com os requisitos de segurança aplicáveis para exposição a ondas de rádio. Esses requisitos se baseiam em diretrizes científicas que incluem margens de segurança projetadas para garantir a segurança de todas as pessoas, independentemente da idade e do estado de saúde.

As diretrizes de exposição a ondas de rádio empregam uma unidade de medida conhecida como Taxa de Absorção Específica, ou SAR.

Os testes relacionados à SAR são conduzidos com métodos em que o computador pessoal tablet transmite com seu nível de potência certificada mais alto em todas as bandas de frequência utilizadas.

Embora possa haver diferenças entre os níveis de SAR dos vários modelos de celular, todos eles foram projetados para atender às diretrizes relevantes de exposição a ondas de rádio.

Para obter mais informações sobre SAR, consulte a seção Informações importantes no Guia de configuração do celular.

Informações de dados de SAR para residentes em países que adotaram o limite de SAR recomendado pela Comissão Internacional de Proteção contra as Radiações Não-Ionizantes (ICNIRP), cuja média é de 2 W/kg por 10 (dez) gramas de tecido (por exemplo União Europeia, Japão, Brasil e Nova Zelândia): o mais alto valor de SAR deste modelo de celular quando testado pela Sony para uso ao ouvido é de 0.441 W/kg (10 g).



///



Anguilla	1-800-080-9518 (Toll Free)	questions.CO@support.sonymobile.com
Antigua and Barbuda	1-800-081-9518 (Toll Free)	questions.CO@support.sonymobile.com
Argentina	0800-333-7427 (número gratuito)	questions.CO@support.sonymobile.com
Australia	1300 650-050 (Toll Free)	questions.AU@support.sonymobile.com
The Bahamas	1-800-205-6062 (Toll Free)	questions.CO@support.sonymobile.com
Barbados	1-800-082-9518 (Toll Free)	questions.CO@support.sonymobile.com
Belgique/België	02-0745 1611	questions.BE@support.sonymobile.com
Belize	AN 815, PIN 5597 (Toll Free)	questions.CO@support.sonymobile.com
Bermuda	1-800-083-9518 (Toll Free)	questions.CO@support.sonymobile.com
Bolivia	800-100-542 (número gratuito)	questions.CO@support.sonymobile.com
Brasil	4001-0444 (Capitais e regiões metropolitanas) 0800 884 0444 (Demais regiões)	questions.BR@support.sonymobile.com
Canada	1 866 766 9374 (Toll Free / sans frais)	questions.CA@support.sonymobile.com
Cayman Islands	1-800-084-9518 (Toll Free)	questions.CO@support.sonymobile.com

Central and Southern Africa	+27 11 506 0123	questions.CF@support.sonymobile.com
Česká republika	844 550 055	questions.CZ@support.sonymobile.com
Chile	800-646-425 (número gratuito)	questions.CO@support.sonymobile.com
Colombia	01800-0966-080 (número gratuito)	questions.CO@support.sonymobile.com
Costa Rica	0 800 011 0400 (número gratuito)	questions.CO@support.sonymobile.com
Danmark	3331 2828	questions.DK@support.sonymobile.com
Deutschland	0180 534 2020 (ortsübliche Gebühren)	questions.DE@support.sonymobile.com
Dominica	1-800-085-9518 (Toll Free)	questions.CO@support.sonymobile.com
Ecuador	1-800-0102-50 (número gratuito)	questions.CO@support.sonymobile.com
Eesti	06 032 032	questions.EE@support.sonymobile.com
Egypt/مصر	16727	questions.EG@support.sonymobile.com
Ελλάδα	801 11 810 810 +30 210 899 19 19 (από κινητό τηλέφωνο)	questions.GR@support.sonymobile.com
El Salvador	800-6323 (número gratuito)	questions.CO@support.sonymobile.com
España	902 180 576 (tarifa local)	questions.ES@support.sonymobile.com
France	09 69 32 21 21 09 69 32 21 22 (Xperia™ uniquement)	questions.FR@support.sonymobile.com
Guatemala	1-800-300-0057 (número gratuito)	questions.CO@support.sonymobile.com

Haïti/Ayiti	AN 193, PIN 5598 (numéro gratuit / nimewo gratis)	questions.CO@support.sonymobile.com
Honduras	AN 8000122, PIN 5599 (numéro gratuito)	questions.CO@support.sonymobile.com
Hong Kong/ 香港	+852 8203 8863	questions.HK@support.sonymobile.com
Hrvatska	062 000 000	questions.HR@support.sonymobile.com
India/भारत	1800 11 1800 (Toll Free) +91 (011) 39011111	questions.IN@support.sonymobile.com
Indonesia	+62 21 2935 7669	questions.ID@support.sonymobile.com
Ireland	1850 545 888 (Local rate)	questions.IE@support.sonymobile.com
Italia	06 48895206 (tariffa locale)	questions.IT@support.sonymobile.com
Jamaica	1-800-442-3471 (Toll Free)	questions.CO@support.sonymobile.com
Κύπρος/Kib ris	0800 90 909	questions.CY@support.sonymobile.com
Latvija	67 21 43 01	questions.LV@support.sonymobile.com
Lietuva	8 700 55030	questions.LT@support.sonymobile.com
Magyarország	01 880 47 47	questions.HU@support.sonymobile.com
Malaysia	1 800-88-7666	questions.MY@support.sonymobile.com
Maroc/ المغرب	+212 2 2958 344	questions.MA@support.sonymobile.com
México	0 1800 000 4722 (numéro gratuito)	questions.MX@support.sonymobile.com
Nederland	0900 8998318	questions.NL@support.sonymobile.com
Nederlandse Antillen	001-866-509-8660 (gratis nummer)	questions.CO@support.sonymobile.com
New Zealand	0800-100-150 (Toll Free)	questions.NZ@support.sonymobile.com

Nicaragua	AN 1800-0166, PIN 5600 (número gratuito)	questions.CO@support.sonymobile.com
Norge	815 00 840 (lokaltakst)	questions.NO@support.sonymobile.com
Österreich	0810 200 245	questions.AT@support.sonymobile.com
Pakistan/ پاکستان	021 - 111 22 55 73	questions.PK@support.sonymobile.com
Panamá	00800-787-0009 (número gratuito)	questions.CO@support.sonymobile.com
Paraguay	009 800 54 20032 (número gratuito)	questions.CO@support.sonymobile.com
Perú	0800-532-38 (número gratuito)	questions.CO@support.sonymobile.com
Philippines/ Pilipinas	+632 479 9777 or 1800 1 853 7669	questions.PH@support.sonymobile.com
Polska	+48 22 22 77 444	questions.PL@support.sonymobile.com
Portugal	808 204 466 (chamada local)	questions.PT@support.sonymobile.com
República Dominicana	1-800-751-3370 (número gratuito)	questions.CO@support.sonymobile.com
România	+40 21 401 0401	questions.RO@support.sonymobile.com
Saint Kitts and Nevis	1-800-087-9518 (Toll Free)	questions.CO@support.sonymobile.com
Saint Vincent and the Grenadines	1-800-088-9518 (Toll Free)	questions.CO@support.sonymobile.com
Schweiz/Suisse/Svizzera	0848 824 040	questions.CH@support.sonymobile.com
Singapore	+65 6744 0733	questions.SG@support.sonymobile.com
Slovenia	0800 81291	questions.si@support.sonymobile.com
Slovensko	02 5443 6443	questions.SK@support.sonymobile.com
South Africa	0861 632222	questions.ZA@support.sonymobile.com
South Korea/ 대한민국	(+82) 1588 4170	questions.KO@support.sonymobile.com
Suomi		questions.FI@support.sonymobile.com

Sverige	013 24 45 00 (lokal taxa)	questions.SE@support.sonymobile.com
Thailand	001 800 852 7663 or 02401 3030	questions.CO@support.sonymobile.com
Trinidad and Tobago	1-800-080-9521 (Toll Free)	questions.CO@support.sonymobile.com
Türkiye	+90 212 473 77 77	questions.TR@support.sonymobile.com
United Kingdom	08705 237 237 (Local rate)	questions.GB@support.sonymobile.com
United States	1 866 766 9374	questions.US@support.sonymobile.com
Uruguay	000-401-787-013 (número gratuito)	questions.CO@support.sonymobile.com
Venezuela	0-800-1-00-2250 (número gratuito)	questions.CO@support.sonymobile.com
Việt Nam	1900 1525 (miễn phí)	questions.VN@support.sonymobile.com
България	0800 1 8778	questions.BG@support.sonymobile.com
Россия	8-800-1008022	questions.RU@support.sonymobile.com
Україна	+38 044 590 1515	questions.UA@support.sonymobile.com
الأردن	+971 4 3919 880	questions.JO@support.sonymobile.com
الإمارات العربية المتحدة	+971 4 3919 880 (UAE)	questions.AE@support.sonymobile.com
الكويت	+971 4 3919 880	questions.KW@support.sonymobile.com
المملكة العربية السعودية	800-8200-727	questions.SA@support.sonymobile.com
中国	+86 400 810 0000	questions.CN@sonymobile.com
台灣	+886 2 25625511	questions.TW@support.sonymobile.com
ไทย	02 2483 030	questions.TH@support.sonymobile.com

## FCC Statement

This device complies with Part 15 of the FCC rules. Operation is subject to the following two conditions:



(1) This device may not cause harmful interference, and (2) This device must accept any interference received, including interference that may cause undesired operation. Any change or modification not expressly approved by Sony may void the user's authority to operate the equipment.

This equipment has been tested and found to comply with the limits for a Class B digital device, pursuant to Part 15 of the FCC Rules. These limits are designed to provide reasonable protection against harmful interference in a residential installation. This equipment generates, uses and can radiate radio frequency energy and, if not installed and used in accordance with the instructions, may cause harmful interference to radio communications. However, there is no guarantee that interference will not occur in a particular installation.

If this equipment does cause harmful interference to radio or television reception, which can be determined by turning the equipment off and on, the user is encouraged to try to correct the interference by one or more of the following measures:

- Reorient or relocate the receiving antenna.
- Increase the separation between the equipment and receiver.
- Connect the equipment into an outlet on a circuit different from that to which the receiver is connected.
- Consult the dealer or an experienced radio/TV technician for help.

## Declaration of Conformity for C6843

We, **Sony Mobile Communications AB** of  
Nya Vattentorget  
SE-221 88 Lund, Sweden

declare under our sole responsibility that our product  
**Sony type PM-0620-BV**

and in combination with our accessories, to which this  
declaration relates is in conformity with the appropriate  
standards EN 301 511:V9.0.2, EN 301 908-1:V5.2.1,  
EN 301 908-2:V5.2.1, EN 301 908-13:V5.2.1, EN 300 328:V1.8.1,  
EN 300 440-2:V1.4.1, EN 301 489-3:V1.4.1, EN 301 489-7:V1.3.1,  
EN 301 489-17:V2.1.1, EN 301 489-24:V1.5.1,  
EN 301 893:V1.7.1, EN 302 291-2:V1.1.1, EN 62 209-1:2006 and  
EN 60 950-1:2006+A11:2009+A1:2010+A12:2011 following the  
provisions of, Radio Equipment and Telecommunication  
Terminal Equipment directive 1999/5/EC.

Lund, July 2013

**CE 0682** 



Pär Thuresson,  
*Quality Officer, SVP, Quality & Customer Services*  
We fulfil the requirements of the R&TTE Directive (1999/5/EC).  
Ce produit est conforme aux directives de R&TTE (1999/5/EC).

Cumplimos con los requisitos de la Directiva R&TTE – Normas  
sobre equipos de terminales de radio y telecomunicaciones  
(1999/5/EC).

Atendemos aos requisitos da Diretriz R&TTE (1999/5/EC).



[www.sonymobile.com](http://www.sonymobile.com)

**SONY®**

Sony Mobile Communications AB  
SE-221 88 Lund, Sweden