



**FCC PART 15
TEST REPORT
No. I14Z45356-SRD04
for
Sony Mobile Communications AB
GSM/WCDMA/LTE mobile phone
With
FCC ID: PY7PM-0611
Hardware Version: A
Software Version: s_atp_1_32_2_18_a
Issued Date: 2014-04-04**

Note:

The test results in this test report relate only to the devices specified in this report. This report shall not be reproduced except in full without the written approval of TMC Beijing.

Test Laboratory:

TMC Beijing, Telecommunication Metrology Center of Ministry of Industry and Information Technology
Shouxiang Science Building, No 51, Xueyuan Road, Haidian District, Beijing, P.R.China 100191

Tel: +86(0)10-62304633-2561, Fax: +86(0)10-62304633-2504 Email:welcome@emcite.com. www.emcite.com

CONTENTS

CONTENTS	2
1. TEST LATORATORY	3
1.1. TESTING LOCATION	3
1.2. TESTING ENVIRONMENT.....	3
1.3. PROJECT DATA	3
1.4. SIGNATURE.....	3
2. CLIENT INFORMATION	4
2.1. APPLICANT INFORMATION.....	4
2.2. MANUFACTURER INFORMATION.....	4
3. EQUIPMENT UNDER TEST (EUT) AND ANCILLARY EQUIPMENT(AE).....	5
3.1. ABOUT EUT	5
3.2. INTERNAL IDENTIFICATION OF EUT USED DURING THE TEST.....	5
3.3. GENERAL DESCRIPTION	6
4. REFERENCE DOCUMENTS	6
4.1. DOCUMENTS SUPPLIED BY APPLICANT	6
4.2. REFERENCE DOCUMENTS FOR TESTING	6
5. LABORATORY ENVIRONMENT	6
6. SUMMARY OF TEST RESULTS.....	6
6.1. SUMMARY OF TEST RESULTS	6
6.2. STATEMENTS	7
7. TEST EQUIPMENTS UTILIZED.....	7
ANNEX A: MEASUREMENT RESULTS	8
A.1. MEASUREMENT METHOD.....	8
A.2. CHANNEL MOVE TIME AND CHANNEL CLOSING TRANSMISSION TIME	10
A.3. NON-OCCUPANCY PERIOD	15
A3.1 ASSOCIATED TEST.....	15
ANNEX B: PHOTOGRAPHS OF THE TEST SET-UP.....	16

1. TEST LATORATORY

1.1. Testing Location

Company Name: TMC Beijing, Telecommunication Metrology Center of MIIT
Address: No 52 Hua Yuanbei Road, Haidian District, Beijing, P.R.China
Postal Code: 100191
Telephone: 008610623046332561
Fax: 008610623046332504

1.2. Testing Environment

Normal Temperature: 15-30℃
Extreme Temperature: -30/+55℃
Relative Humidity: 30-60%

Note:The climatic requirements above are general exclude the special requirements for dedicated test environments listed in section 5 and some specific test cases in other parts of this report.

1.3. Project data

Testing Start Date: 2013-09-27
Testing End Date: 2014-03-25

1.4. Signature

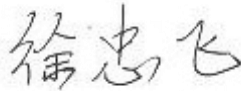

Xu Zhongfei
(Prepared this test report)

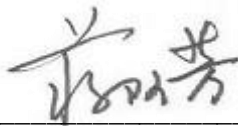

Jiang Afang
(Reviewed this test report)



Xiao Li
Deputy Director of the laboratory
(Approved this test report)

2. CLIENT INFORMATION

2.1. Applicant Information

Company Name: Sony Mobile Communications (China) Co. Ltd
Address /Post: Sony Mobile R&D Center, No. 16, Guangshun South Street,
Chaoyang District
City: Beijing
Postal Code: 100102
Country: China
Contact Person: Ma, Gang
Telephone: +86-10-58656312
Fax: +86-10-58659049

2.2. Manufacturer Information

Company Name: Sony Mobile Communications AB
Address /Post: Mobilvägen, 22188 Lund, Sweden
City: Lund
Postal Code: 22188
Country: Sweden
Contact Person: Nilsson, Mikael
Telephone: +46 703 227503
Fax: +46 706 127385

3. EQUIPMENT UNDER TEST (EUT) AND ANCILLARY

EQUIPMENT(AE)

3.1. About EUT

Description	GSM 850/900/1800/1900 quad bands, GPRS, EDGE, WCDMA FDD bands 1/5/6/19, HSDPA, HSUPA, LTE FDD bands 1/3/19/21, Bluetooth (EDR and 4.0), ANT+, WLAN (802.11 a/ac/b/g/n), NFC, FM, GPS mobile phone
FCC ID	PY7PM-0611
WLAN Frequency Range	ISM Band: -5250MHz~5350MHz -5470MHz~5725MHz
Type of modulation	OFDM
Number of Channels	15
GSM Frequency Band	GSM 850/900/1800/1900
UMTS Frequency Band	FDD Band 1 / FDD Band 5 / FDD Band 6 / FDD Band 19
LTE Frequency Band	FDD Band 1/ FDD Band 3 / TDD Band 19 / TDD Band 21
Antenna	Integral Antenna
MAX E.I.R.P.	14.19dBm(OFDM)
MIN E.I.R.P.	4.12dBm(OFDM)
Extreme Temperature	-30/+55°C
Normal Voltage	4.2VDC
Extreme Low Voltage	3.6VDC
Extreme High Voltage	4.2VDC

Note1: Photographs of EUT are shown in ANNEX C of this test report. Components list, please refer to documents of the manufacturer; it is also included in the original test record of Telecommunication Metrology Center of MIIT of People's Republic of China.

Note2: The E.I.R.P. measurement is performed with 15.407, which report number is 2013WLN0763 and applied with this report together

3.2. Internal Identification of EUT used during the test

EUT ID*	S/N	IMEI	HW Version	SW Version
EUT1	/	004402541004796	A	s_atp_1_32_2_18_a

*EUT ID: is used to identify the test sample in the lab internally.

3.3. General Description

The Equipment Under Test (EUT) is a model of GSM/UMTS/LTE mobile phone with integrated antenna and inbuilt battery.

The EUT supports GSM 850/900/1800/1900MHz bands, WCDMA FDD band 1/5/6/19 and LTE FDD bands 1/3/19/21. It supports GPRS service with multi-slots class 33 and EGPRS service with multi-slots class 33. The HSDPA and HSUPA features are also supported.

It has MP3, camera, USB memory, Mobile High-Definition Link (MHL), FM radio, GPS receiver, NFC, Bluetooth (EDR and Bluetooth 4.0), ANT+, WLAN (802.11 a/ac/b/g/n) and Wi-Fi hotspot functions. For WLAN 802.11n, it supports 20MHz bandwidth on 2.4GHz band and 20MHz/40MHz bandwidths on 5GHz/5.8GHz band. For WLAN 802.11 ac, it supports 20MHz/40MHz/80MHz bandwidths.

It consists of normal options: battery and travel charger.

Manual and specifications of the EUT were provided to fulfil the test.

Samples undergoing test were selected by the client.

4. REFERENCE DOCUMENTS

4.1. Documents supplied by applicant

EUT feature information is supplied by the applicant or manufacturer, which is the basis of testing.

4.2. Reference Documents for testing

The following documents listed in this section are referred for testing.

FCC Part15	Title 47 of the Code of Federal Regulations; Chapter I Part 15 - Radio frequency devices Subpart E – UNII Devices	Oct, 2012
FCC 06-96	Revision of Parts 2 and 15 of the Commission’s Rules to Permit Unlicensed National Information Infrastructure (U-NII) devices in the 5 GHz band	2006

5. LABORATORY ENVIRONMENT

Measurement is performed in shielding room.

6. SUMMARY OF TEST RESULTS

6.1. Summary of Test Results

SUMMARY OF MEASUREMENT RESULTS	Sub-clause of Part15E	Verdict
Channel move time and channel closing transmission time	15.407 (h)(2)(iii)	P
Non-Occupancy Period	15.407 (h)(2) (iv)	P

Please refer to **ANNEX A** for detail.

Terms used in Verdict column

P	Pass, The EUT complies with the essential requirements in the standard.
NM	Not measured, The test was not measured by TMC
NA	Not Applicable, The test was not applicable
F	Fail, The EUT does not comply with the essential requirements in the standard

6.2. Statements

TMC has evaluated the test cases requested by the client/manufacturer as listed in section 6.1 of this report for the EUT specified in section 3 according to the standards or reference documents listed in section 4.1.

This report only deal with the UNII DFS functions among the features described in section 3, and The EUT met all requirements of the reference documents.

This model is a variant product which type number is PM-0610-BV; all the test result has been derived from test report of PM-0610-BV.

End user has no way to get the parameters of the detected Radar Waveforms in this product.

Test Conditions

T nom	Normal Temperature
T min	Low Temperature
T max	High Temperature
V nom	Normal Voltage
V min	Low Voltage
V max	High Voltage
H nom	Norm Humidity
A nom	Norm Air Pressure

For this report, all the test case listed above is tested under Normal Temperature and Normal Voltage, and also under norm humidity, the specific conditions as following:

Temperature	T nom	26°C
Voltage	V nom	4.2V(By battery)
Humidity	H nom	44%
Air Pressure	A nom	1010hPa

7. TEST EQUIPMENTS UTILIZED

Conducted test system

No.	Equipment	Model	Serial Number	Manufacturer	Calibration Date	Calibration Due Date
1	Vector Signal Analyzer	FSQ40	200089	Rohde & Schwarz	2013-07-08	2014-07-07
2	Vector Signal General	SMU200A	103752	Rohde & Schwarz	2013-07-08	2014-07-07
3	Shielding Room	S81	/	ETS-Lindgren	/	/

ANNEX A: MEASUREMENT RESULTS

A.1. Measurement Method

A.1.1. Conducted Measurements

The below figure shows the DFS setup, where the EUT is a WLAN device operating in slave mode, without Radar Interference Detection function. This setup also contains a device operating in master mode. The radar test signals are injected into the master device. The EUT (slave device) is associated with the master device. WLAN traffic is generated by streaming the mpeg file from the master to the slave in full monitor video mode using the media player.

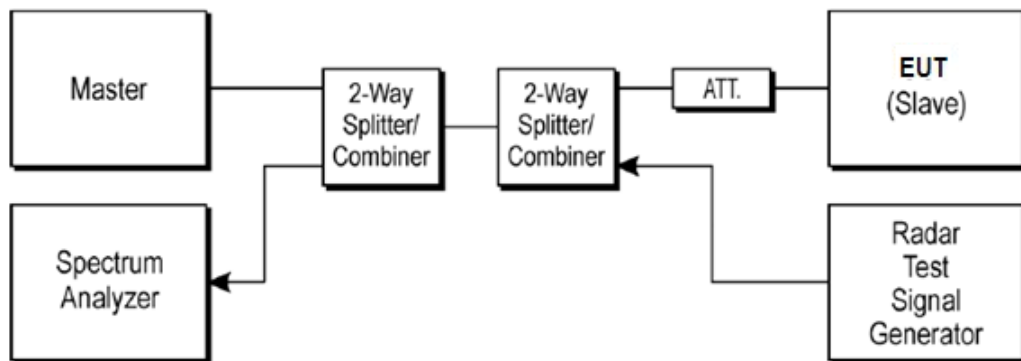

Note:

- 1) All Measurements are performed with the EUT's narrowest channel bandwidth.
- 2) The master device information is as follows
Vendor: Cisco
Model: AIR-AP1252AG-A-K9
FCC ID: LDK102061, 1DK102062
- 3) The software of radar signal generator (R&S SMU200A) is completely designed based on FCC-06-96A1/NTIA requirement.

A.1.2. Parameters of DFS test signal

1). Interference threshold values, master or client incorporation in service monitoring. For device power less than 23dBm (E.I.R.P.), the threshold level is -62 dBm at the antenna port after correction for antenna gain and procedural adjustments.

Because of conducted measurement performed, the calibration power from radar signal generator to antenna port of DFS test equipment is -62 dBm.

Maximum Transmit Power	Value
> 200 mW	-64 dBm
< 200 mW	-62 dBm

2). DFS requirement values

Parameter	Value
Non-occupancy	> 1800 s
Channel Availability Check Time	60 s
Channel Move Time	10 s
Channel Closing Transmission Time	200 ms + 60 ms
U-NII Detection Bandwidth	Minimum 80% of the 99% transmission power bandwidth

As the EUT is IP based system, the MPEG video file from NTIA website is used to steam to EUT via the Master device.

A.1.3. Measurement Uncertainty

Item	Measurement Uncertainty
Time	0.70 ms
Power	0.75 dBm

A.2. Channel move time and channel closing transmission time

Measurement Limit:

Test Items	Limit
channel closing transmission time	< 200 ms + 60 ms
Channel move time	< 10 s

Measurement Results:

HT20 Frequency Band: 5250MHz ~ 5350MHz

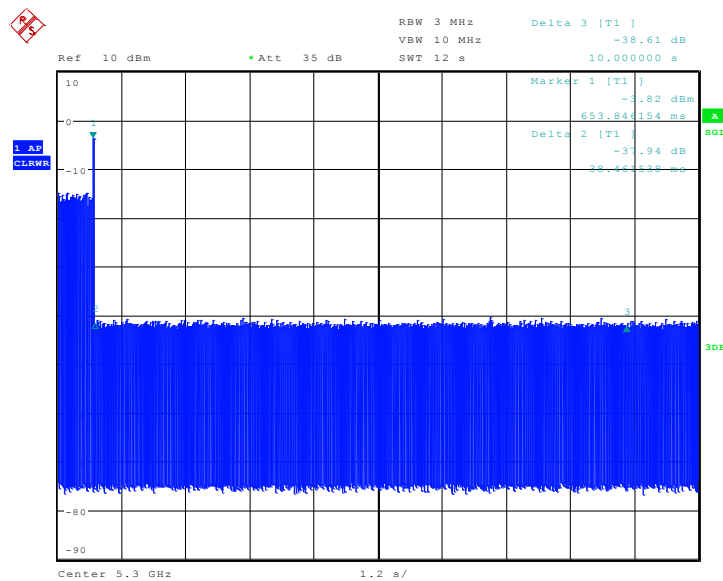

Date: 24.MAR.2014 18:48:14

The channel move time is as the figure. It shows the time of the radar and the client pulses. The figure shows that the client stops transmission within 10 seconds, and no transmissions occur after 10 seconds later of the radar burst signal.

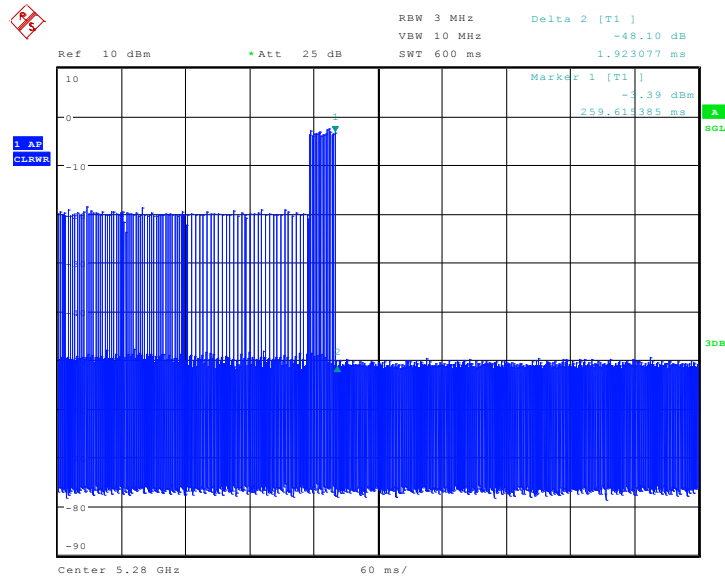

Date: 25.MAR.2014 08:29:47

The closing transmission time is as the figure, and the result is 1.92ms.

Conclusion: PASS

HT40 Frequency Band: 5250MHz ~ 5350MHz

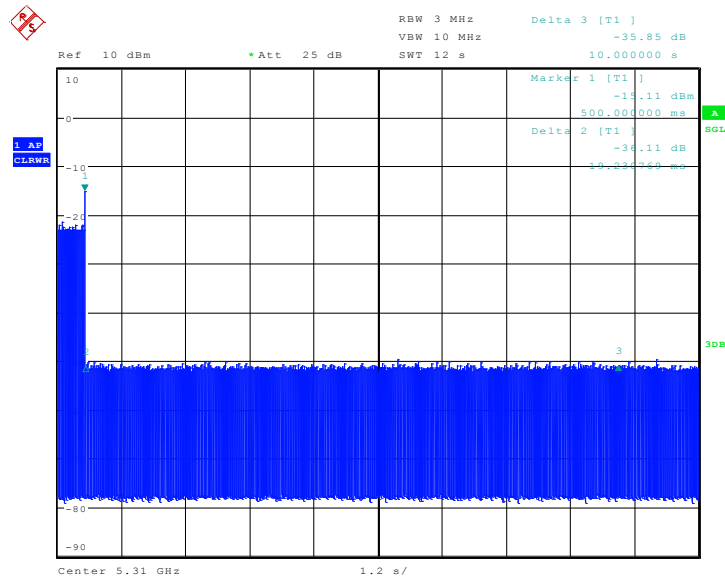

Date: 25.MAR.2014 09:44:22

The channel move time is as the figure. It shows the time of the radar and the client pulses. The figure shows that the client stops transmission within 10 seconds, and no transmissions occur after 10 seconds later of the radar burst signal.

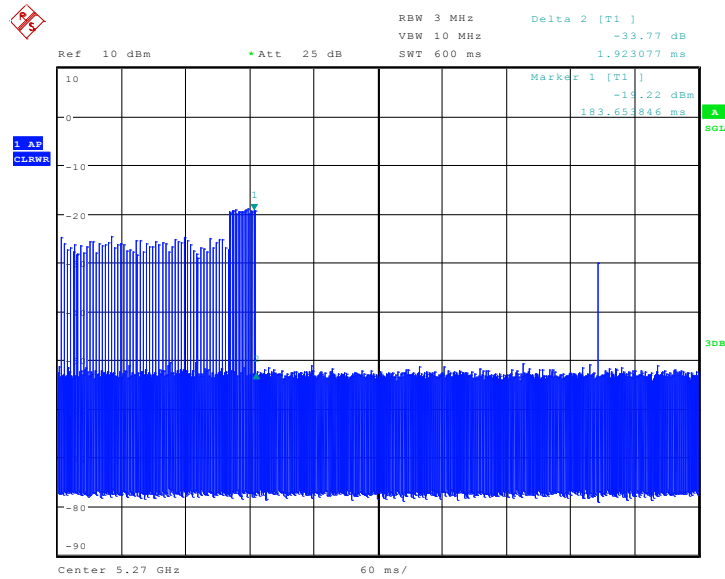

Date: 25.MAR.2014 08:31:13

The closing transmission time is as the figure, and the result is 1.92ms

Conclusion: PASS

HT20 Frequency Band 5470MHz ~ 5725MHz

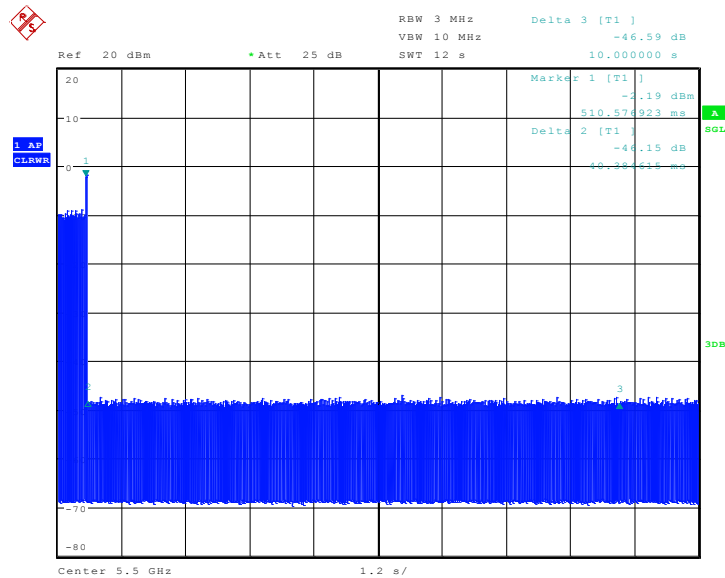

Date: 25.MAR.2014 09:05:54

The channel move time is as the figure. It shows the time of the radar and the client pulses. The figure shows that the client stops transmission within 10 seconds, and no transmissions occur after 10 seconds later of the radar burst signal.

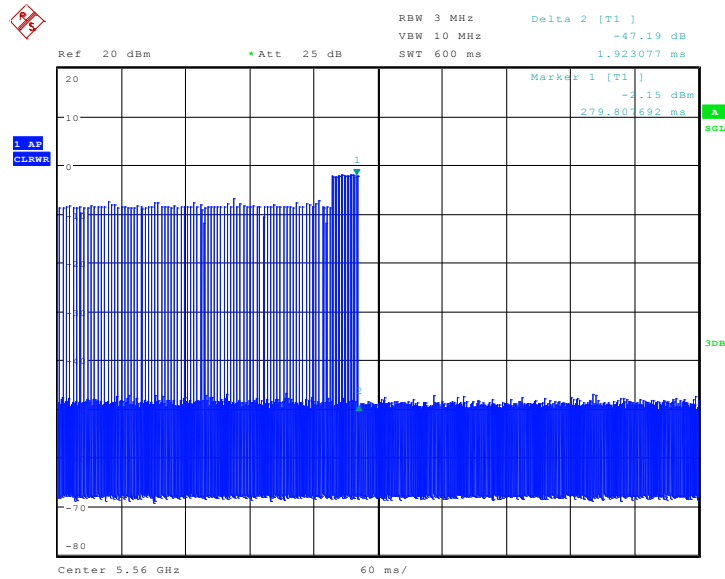

Date: 25.MAR.2014 09:02:48

The closing transmission time is as the figure, and the result is 1.92ms

Conclusion: PASS

HT40 Frequency Band 5470MHz ~ 5725MHz

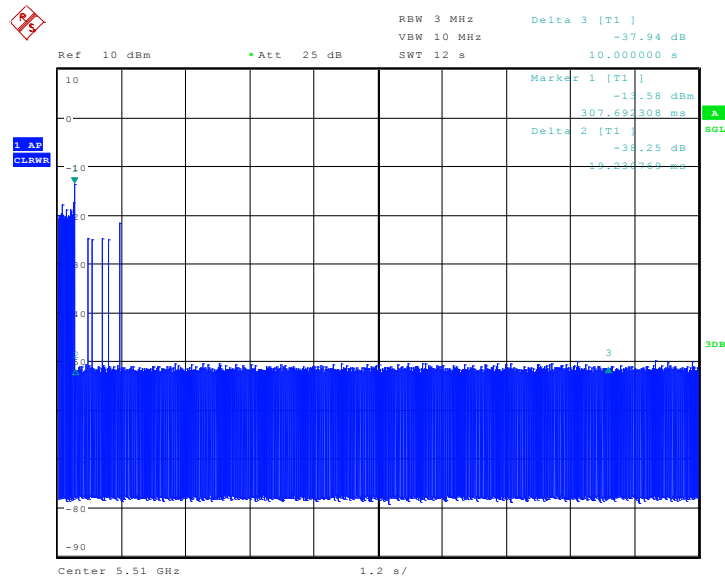

Date: 25.MAR.2014 09:26:29

The channel move time is as the figure. It shows the time of the radar and the client pulses. The figure shows that the client stops transmission within 10 seconds, and no transmissions occur after 10 seconds later of the radar burst signal.

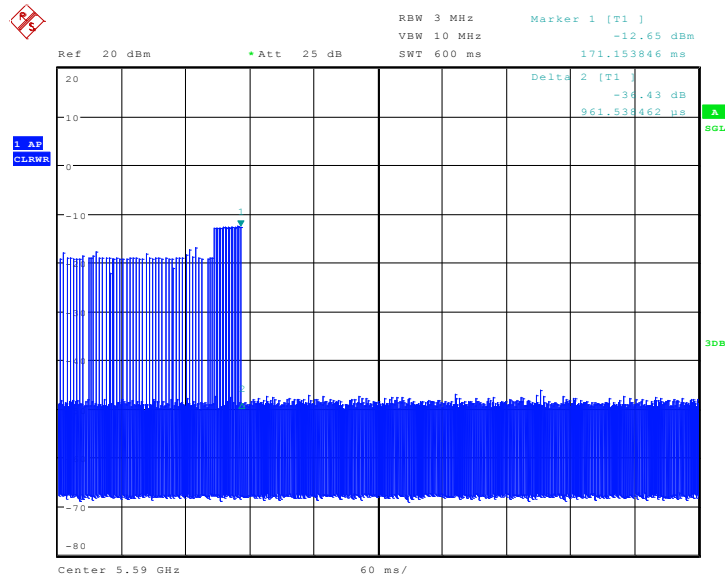

Date: 25.MAR.2014 09:15:47

The closing transmission time is as the figure, and the result is 0.96ms

Conclusion: PASS

A.3. Non-Occupancy Period

Measurement Limit:

Test Items	Limit
Non-Occupancy Period	> 1800 s

A3.1 Associated test

Associate the master and client, transmit specified stream between the master and client; monitor the analyzer on the operating frequency to make sure no beacons have been transmitted for 1800 seconds.

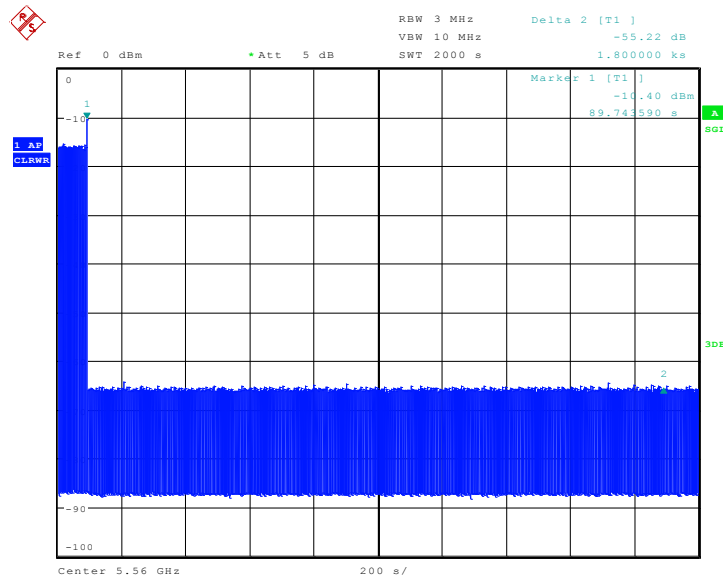

Date: 29.SEP.2013 16:02:59

The figure above shows that the client does not transmit any emission within 1800 seconds after getting the order of “stop transmits” from the DFS master (access point).

Conclusion: PASS