



# SAR TEST REPORT

No. 2013SAR00136

For

**Sony Mobile Communications AB**

**GSM/WCDMA/LTE mobile phone**

**Type number: PM-0610-BV**

With

**Hardware Version: AP1.2**

**Software Version: 14.1.H.1.55 (Main antenna)**

**s\_atp\_amami\_1\_32\_2\_18\_a (WLAN antenna)**

**FCC ID: PY7PM-0610**

**Issued Date: 2013-10-16**



**Note:**

The test results in this test report relate only to the devices specified in this report. This report shall not be reproduced except in full without the written approval of TMC Beijing.

**Test Laboratory:**

TMC Beijing, Telecommunication Metrology Center of MIIT

No. 52, Huayuan Bei Road, Haidian District, Beijing, P. R. China 100191.

Tel:+86(0)10-62304633-2079, Fax:+86(0)10-62304633 Email:welcome@emcite.com. [www.emcite.com](http://www.emcite.com)

### Revision Version

Report Number	Revision	Date	Memo
2013SAR00136	00	2013-10-16	Initial creation of test report

## TABLE OF CONTENT

<b>1 TEST LABORATORY .....</b>	<b>5</b>
1.1 TESTING LOCATION .....	5
1.2 TESTING ENVIRONMENT.....	5
1.3 PROJECT DATA .....	5
1.4 SIGNATURE.....	5
<b>2 STATEMENT OF COMPLIANCE .....</b>	<b>6</b>
<b>3 CLIENT INFORMATION .....</b>	<b>8</b>
3.1 APPLICANT INFORMATION .....	8
3.2 MANUFACTURER INFORMATION .....	8
<b>4 EQUIPMENT UNDER TEST (EUT) AND ANCILLARY EQUIPMENT (AE) .....</b>	<b>9</b>
4.1 ABOUT EUT .....	9
4.2 INTERNAL IDENTIFICATION OF EUT USED DURING THE TEST .....	9
4.3 INTERNAL IDENTIFICATION OF AE USED DURING THE TEST .....	9
<b>5 TEST METHODOLOGY .....</b>	<b>10</b>
5.1 APPLICABLE LIMIT REGULATIONS .....	10
5.2 APPLICABLE MEASUREMENT STANDARDS.....	10
<b>6 SPECIFIC ABSORPTION RATE (SAR).....</b>	<b>11</b>
6.1 INTRODUCTION.....	11
6.2 SAR DEFINITION.....	11
<b>7 TISSUE SIMULATING LIQUIDS .....</b>	<b>12</b>
7.1 TARGETS FOR TISSUE SIMULATING LIQUID .....	12
7.2 DIELECTRIC PERFORMANCE .....	12
<b>8 SYSTEM VERIFICATION .....</b>	<b>17</b>
8.1 SYSTEM SETUP.....	17
8.2 SYSTEM VERIFICATION.....	18
<b>9 MEASUREMENT PROCEDURES .....</b>	<b>19</b>
9.1 TESTS TO BE PERFORMED .....	19
9.2 GENERAL MEASUREMENT PROCEDURE.....	21
9.3 WCDMA MEASUREMENT PROCEDURES FOR SAR .....	22
9.4 BLUETOOTH & WI-FI MEASUREMENT PROCEDURES FOR SAR .....	23
9.5 POWER DRIFT.....	23
<b>10 AREA SCAN BASED 1-G SAR.....</b>	<b>24</b>
10.1 REQUIREMENT OF KDB.....	24
10.2 FAST SAR ALGORITHMS .....	24
<b>11 CONDUCTED OUTPUT POWER.....</b>	<b>25</b>

11.1 MANUFACTURING TOLERANCE .....	25
11.2 GSM MEASUREMENT RESULT .....	29
11.3 WCDMA MEASUREMENT RESULT.....	30
11.4 WI-FI AND BT MEASUREMENT RESULT .....	30
<b>12 SIMULTANEOUS TX SAR CONSIDERATIONS.....</b>	<b>35</b>
12.1 INTRODUCTION.....	35
12.2 TRANSMIT ANTENNA SEPARATION DISTANCES .....	35
12.3 SAR MEASUREMENT POSITIONS .....	35
12.4 STANDALONE SAR TEST EXCLUSION CONSIDERATIONS .....	36
<b>13 EVALUATION OF SIMULTANEOUS.....</b>	<b>37</b>
<b>14 SAR TEST RESULT .....</b>	<b>38</b>
14.1 SAR RESULTS FOR FAST SAR.....	38
14.2 SAR RESULTS FOR STANDARD PROCEDURE.....	45
<b>15 SAR MEASUREMENT VARIABILITY.....</b>	<b>48</b>
<b>16 MEASUREMENT UNCERTAINTY .....</b>	<b>49</b>
<b>17 MAIN TEST INSTRUMENTS.....</b>	<b>53</b>
<b>ANNEX A GRAPH RESULTS.....</b>	<b>54</b>
<b>ANNEX B SYSTEM VERIFICATION RESULTS .....</b>	<b>82</b>
<b>ANNEX C SAR MEASUREMENT SETUP .....</b>	<b>95</b>
<b>ANNEX D POSITION OF THE WIRELESS DEVICE IN RELATION TO THE PHANTOM .....</b>	<b>101</b>
<b>ANNEX E EQUIVALENT MEDIA RECIPES.....</b>	<b>104</b>
<b>ANNEX F SYSTEM VALIDATION .....</b>	<b>105</b>
<b>ANNEX G PROBE CALIBRATION CERTIFICATE.....</b>	<b>106</b>
<b>ANNEX H DIPOLE CALIBRATION CERTIFICATE .....</b>	<b>117</b>

## 1 Test Laboratory

### 1.1 Testing Location

Company Name:	TMC Beijing, Telecommunication Metrology Center of MIIT
Address:	No 52, Huayuan beilu, Haidian District, Beijing,P.R.China
Postal Code:	100191
Telephone:	+86-10-62304633
Fax:	+86-10-62304793

### 1.2 Testing Environment

Temperature:	18°C~25 °C,
Relative humidity:	30%~ 70%
Ground system resistance:	< 0.5 $\Omega$
Ambient noise & Reflection:	< 0.012 W/kg

### 1.3 Project Data

Project Leader:	Qi Dianyuan
Test Engineer:	Lin Xiaojun
Testing Start Date:	September 26, 2013
Testing End Date:	September 30, 2013

### 1.4 Signature



Lin Xiaojun  
(Prepared this test report)

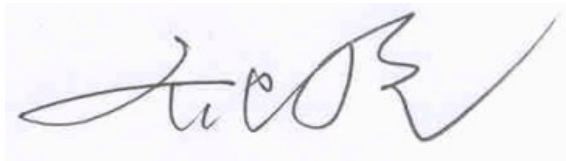

Qi Dianyuan  
(Reviewed this test report)



Xiao Li  
Deputy Director of the laboratory  
(Approved this test report)

## 2 Statement of Compliance

The maximum results of SAR found during testing for Sony Mobile Communications (China) Co. Ltd GSM/WCDMA/LTE mobile phone PM-0610-BV are as follows:

**Table 2.1: Highest Reported SAR (1g)**

Exposure Configuration	Technology Band	Highest Reported SAR 1g (W/Kg)	Equipment Class
Head (Separation Distance 0mm)	GSM 850	0.75	PCE
	PCS 1900	0.76	
	UMTS FDD 5	1.01	
	WLAN 2.4&5.8 GHz	0.13	DTS
	WLAN 5 GHz	0.09	UNII
Hotspot (Separation Distance 10mm)	GSM 850	1.01	PCE
	PCS 1900	0.93	
	UMTS FDD 5	0.86	
	WLAN 2.4 GHz	0.10	DTS
	WLAN 5 GHz	/	DTS&UNII
Body-worn (Data) (Separation Distance 15mm)	WLAN 5 GHz	0.05	DTS&UNII
Body-worn (Speech) (Separation Distance 15mm)	GSM 850	0.50	PCE
	PCS 1900	0.46	
	UMTS FDD 5	0.51	
	WLAN 2.4&5.8 GHz	/	DTS
	WLAN 5 GHz	/	UNII

**Note1:** There is not power reduction when the hotspot mode is activated. According to the client request, the body SAR is tested with 10mm for data and 15mm for speech.

**Note2:** It can't use with hotspot function for WLAN-5G. According to the client request, the WLAN-5G is only tested with 15mm.

**Note3:** It can't use with speech in the body position for the mode of WLAN.

The SAR values found for the Mobile Phone are below the maximum recommended levels of 1.6 W/Kg as averaged over any 1g tissue according to the ANSI C95.1-1999.

For body worn operation, this device has been tested and meets FCC RF exposure guidelines when used with any accessory that contains no metal and which provides a minimum separation distance of 10 mm for data and 15mm for speech between this device and the body of the user. Use of other accessories may not ensure compliance with FCC RF exposure guidelines.

The EUT battery must be fully charged and checked periodically during the test to ascertain uniform power output.

The measurement together with the test system set-up is described in annex C of this test report. A detailed description of the equipment under test can be found in chapter 4 of this test report.

The highest reported SAR value is obtained at the case of (**Table 2.1**), and the values are: **1.01 W/kg (1g)**.

**Table 2.2: The sum of reported SAR values for main antenna and WiFi**

	Position	GSM/WCDMA	WiFi (DTS)	Sum1	WiFi (UNII)	Sum2
<b>Maximum reported SAR value for Head</b>	Left hand, Touch cheek	1.01	0.13	<b>1.14</b>	0.05	<b>1.06</b>
<b>Maximum reported SAR value for Body</b>	Rear 10mm	1.01	0.10	<b>1.11</b>	/	/

Note1: Sum1 is GSM/WCDMA + WiFi (DTS). Sum2 is GSM/WCDMA + WiFi (UNII).

**Table 2.3: The sum of reported SAR values for main antenna and Bluetooth**

	Position	Main antenna	BT*	Sum
<b>Highest reported SAR value for Head</b>	Left hand, Touch cheek	1.01	0.12	<b>1.13</b>
<b>Highest reported SAR value for Body</b>	Rear 10mm	1.01	/	/

BT\* - Estimated SAR for Bluetooth (see the table 13.3)

According to the above tables, the highest sum of reported SAR values is **1.14 W/kg (1g)**. The detail for simultaneous transmission consideration is described in chapter 13.

### 3 Client Information

#### 3.1 Applicant Information

Company Name:	Sony Mobile Communications AB
Address /Post:	Sony Mobile R&D Center, No. 16, Guangshun South Street, Chaoyang District
City:	Beijing
Postal Code:	100102
Country:	China
Contact Person:	Ma, Gang
Telephone:	+86-10-58656312
Fax:	+86-10-58659049

#### 3.2 Manufacturer Information

Company Name:	Sony Mobile Communications AB
Address /Post:	Sony Mobile R&D Center, No. 16, Guangshun South Street, Chaoyang District
City:	Beijing
Postal Code:	100102
Country:	China
Contact Person:	Ma, Gang
Telephone:	+86-10-58656312
Fax:	+86-10-58659049



## 4 Equipment Under Test (EUT) and Ancillary Equipment (AE)

### 4.1 About EUT

Description:	GSM/WCDMA/LTE mobile phone
Type name:	PM-0610-BV
Operating mode(s):	GSM 850/900/1800/1900, WCDMA 850/2100 BT, Wi-Fi (2.4G&5G), LTE Band 1/3
Tested Tx Frequency:	825 – 848.8 MHz (GSM 850)
	1850.2 – 1910 MHz (GSM 1900)
	826.4–846.6 MHz (WCDMA850 Band V)
	2412 – 2462 MHz (Wi-Fi 2.4G)
	5180 – 5825 MHz (Wi-Fi 5G)
GPRS/EGPRS Multislot Class:	33
GPRS capability Class:	B
Test device Production information:	Production unit
Device type:	Portable device
Antenna type:	Integrated antenna
Accessories/Body-worn configurations:	Headset
Hotspot mode:	Support simultaneous transmission of hotspot and voice(or data)
Form factor:	127 mm × 64.9 mm

### 4.2 Internal Identification of EUT used during the test

EUT ID*	IMEI	SN	HW Version	SW Version	Tested Band
EUT1	004402541004986	CB5A1UQQC7	AP1.2	14.1.H.1.55	GSM
EUT2	004402541005272	CB5A1UQQC8	AP1.2	14.1.H.1.55	GSM
EUT3	004402541004952	CB5A1UQQCD	AP1.2	14.1.H.1.55	UMTS
EUT4	004402541004960	CB5A1UQQC4	AP1.2	14.1.H.1.55	UMTS
EUT5	004402541004820	CB5A1UQQBS	AP1.2	14.1.H.1.55	LTE
EUT6	004402541004887	CB5A1UTAHF	AP1.2	14.1.H.1.55	LTE
EUT7	004402541005140	CB5A1UQQBF	AP1.2	s_atp_amami_1_32_2_18_a	WLAN
EUT8	004402541005298	CB5A1UQQBK	AP1.2	s_atp_amami_1_32_2_18_a	WLAN
EUT9	004402541004812	CB5A1UQQCS	AP1.2	s_atp_amami_1_32_2_18_a	WLAN

\*EUT ID: is used to identify the test sample in the lab internally.

**Note:** There are different software version between the SAR sample and the WLAN sample. Because the SAR sample is controlled to work by Digital Radio Communication tester, the WLAN sample is controlled to work by the terminal software installed on the PC.

### 4.3 Internal Identification of AE used during the test

AE ID*	Description	Model	SN	Manufacturer
AE1	Battery	US385388H	/	sony
AE2	Headset	MH750c	/	Cotron

\*AE ID: is used to identify the test sample in the lab internally.

## 5 TEST METHODOLOGY

### 5.1 Applicable Limit Regulations

**ANSI C95.1–1999:** IEEE Standard for Safety Levels with Respect to Human Exposure to Radio Frequency Electromagnetic Fields, 3 kHz to 300 GHz.

It specifies the maximum exposure limit of **1.6 W/kg** as averaged over any 1 gram of tissue for portable devices being used within 20 cm of the user in the uncontrolled environment.

### 5.2 Applicable Measurement Standards

**IEEE 1528–2003:** Recommended Practice for Determining the Peak Spatial-Average Specific Absorption Rate (SAR) in the Human Body Due to Wireless Communications Devices: Experimental Techniques.

**KDB447498 D01: General RF Exposure Guidance v05r01:** Mobile and Portable Devices RF Exposure Procedures and Equipment Authorization Policies.

**KDB648474 D04 Handset SAR v01r01:** SAR Evaluation Considerations for Wireless Handsets.

**KDB941225 D01 SAR test for 3G devices v02:** SAR Measurement Procedures for 3G Devices

**KDB941225 D05 SAR for LTE Devices v02r02:** SAR Evaluation Considerations for LTE Devices

**KDB941225 D06 Hotspot Mode SAR v01r01:** SAR Evaluation Procedures for Portable Devices with Wireless Router Capabilities

**KDB248227:** SAR measurement procedures for 802.112abg transmitters

**KDB 865664 D01 SAR measurement 100 MHz to 6 GHz v01r01:** SAR Measurement Requirements for 100 MHz to 6 GHz

**KDB 865664 D02 RF Exposure Reporting v01r01:** RF Exposure Compliance Reporting and Documentation Considerations

## 6 Specific Absorption Rate (SAR)

### 6.1 Introduction

SAR is related to the rate at which energy is absorbed per unit mass in an object exposed to a radio field. The SAR distribution in a biological body is complicated and is usually carried out by experimental techniques or numerical modeling. The standard recommends limits for two tiers of groups, occupational/controlled and general population/uncontrolled, based on a person's awareness and ability to exercise control over his or her exposure. In general, occupational/controlled exposure limits are higher than the limits for general population/uncontrolled.

### 6.2 SAR Definition

The SAR definition is the time derivative (rate) of the incremental energy ( $dW$ ) absorbed by (dissipated in) an incremental mass ( $dm$ ) contained in a volume element ( $dv$ ) of a given density ( $\rho$ ). The equation description is as below:

$$SAR = \frac{d}{dt} \left( \frac{dW}{dm} \right) = \frac{d}{dt} \left( \frac{dW}{\rho dv} \right)$$

SAR is expressed in units of Watts per kilogram (W/kg)

SAR measurement can be either related to the temperature elevation in tissue by

$$SAR = c \left( \frac{\delta T}{\delta t} \right)$$

Where:  $C$  is the specific heat capacity,  $\delta T$  is the temperature rise and  $\delta t$  is the exposure duration, or related to the electrical field in the tissue by

$$SAR = \frac{\sigma |E|^2}{\rho}$$

Where:  $\sigma$  is the conductivity of the tissue,  $\rho$  is the mass density of tissue and  $E$  is the RMS electrical field strength.

However for evaluating SAR of low power transmitter, electrical field measurement is typically applied.

## 7 Tissue Simulating Liquids

### 7.1 Targets for tissue simulating liquid

**Table 7.1: Targets for tissue simulating liquid**

Frequency(MHz)	Liquid Type	Conductivity( $\sigma$ )	$\pm 5\%$ Range	Permittivity( $\epsilon$ )	$\pm 5\%$ Range
835	Head	0.90	0.86~0.95	41.5	39.4~43.6
835	Body	0.97	0.92~1.02	55.2	52.4~58.0
1900	Head	1.40	1.33~1.47	40.0	38.0~42.0
1900	Body	1.52	1.44~1.60	53.3	50.6~56.0
2450	Head	1.80	1.71~1.89	39.2	37.2~41.2
2450	Body	1.95	1.85~2.05	52.7	50.1~55.3
5200	Head	4.66	4.43~4.89	35.99	34.19~37.79
5200	Body	5.30	5.04~5.56	49.0	46.6~51.4
5500	Head	4.96	4.71~5.21	35.64	33.86~37.42
5500	Body	5.65	5.37~5.93	48.6	46.2~51.0
5800	Head	5.27	5.01~5.53	35.3	33.5~37.1
5800	Body	6.00	5.70~6.30	48.2	45.8~50.6

### 7.2 Dielectric Performance

**Table 7.2: Dielectric Performance of Tissue Simulating Liquid**

Measurement Date (yyyy-mm-dd)	Type	Frequency	Permittivity $\epsilon$	Drift (%)	Conductivity $\sigma$ (S/m)	Drift (%)
2013-09-26	Head	835 MHz	40.43	-2.58	0.892	-0.89
	Body	835 MHz	56.37	2.12	0.979	0.93
2013-09-27	Head	1900 MHz	39.16	-2.10	1.414	1.00
	Body	1900 MHz	52.11	-2.23	1.532	0.79
2013-09-28	Head	2450 MHz	38.41	-2.02	1.824	1.33
	Body	2450 MHz	53.28	1.10	1.973	1.18
2013-09-29	Head	5200 MHz	36.79	2.22	4.563	-2.08
	Body	5200 MHz	50.83	3.73	5.154	-2.75
2013-09-30	Head	5500 MHz	36.15	1.43	4.961	0.00
	Body	5500 MHz	50.18	3.25	5.626	-0.42
2013-09-30	Head	5800 MHz	35.49	0.54	5.359	1.69
	Body	5800 MHz	49.52	2.74	6.114	1.90

Note: The liquid temperature is 22.0 °C

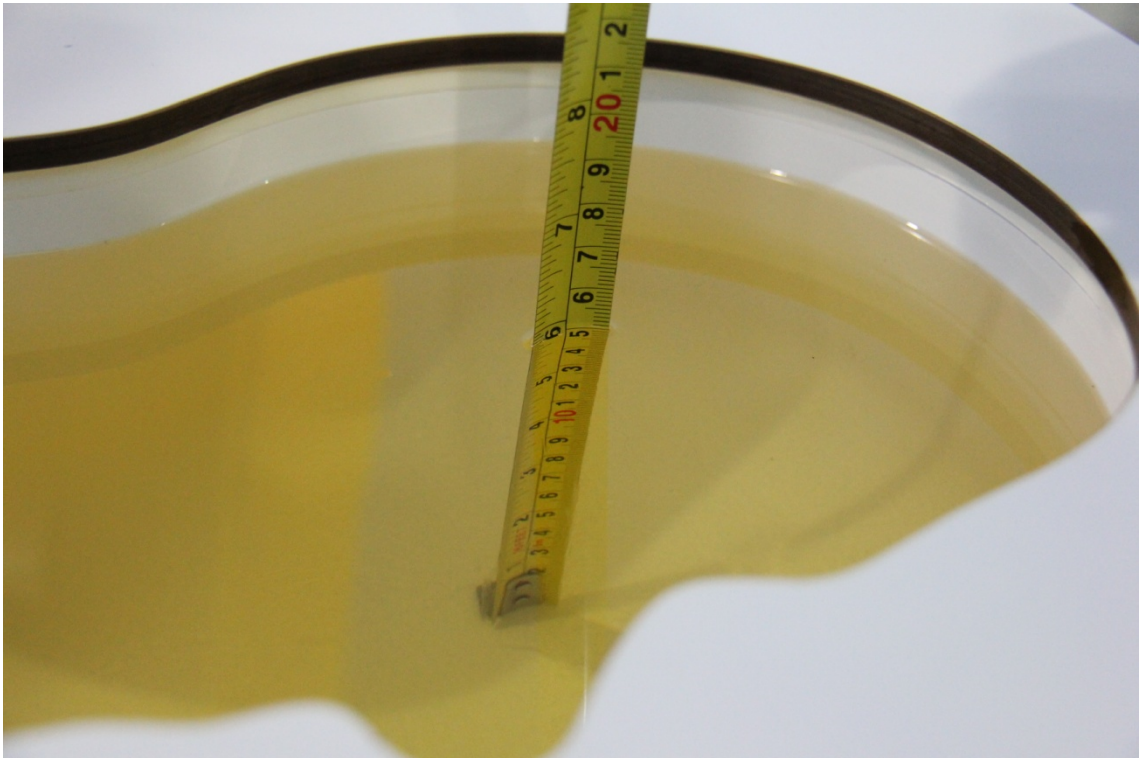

**Picture 7-1: Liquid depth in the Head Phantom (835 MHz)**

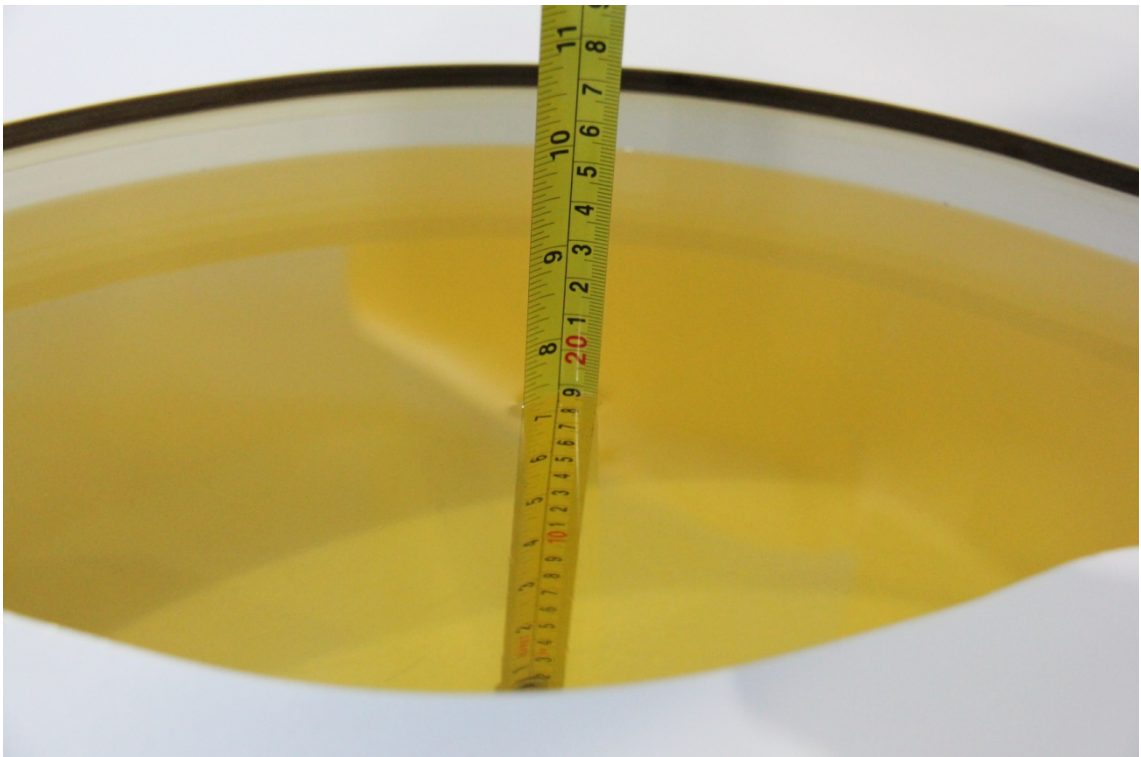

**Picture 7-2: Liquid depth in the Flat Phantom (835 MHz)**

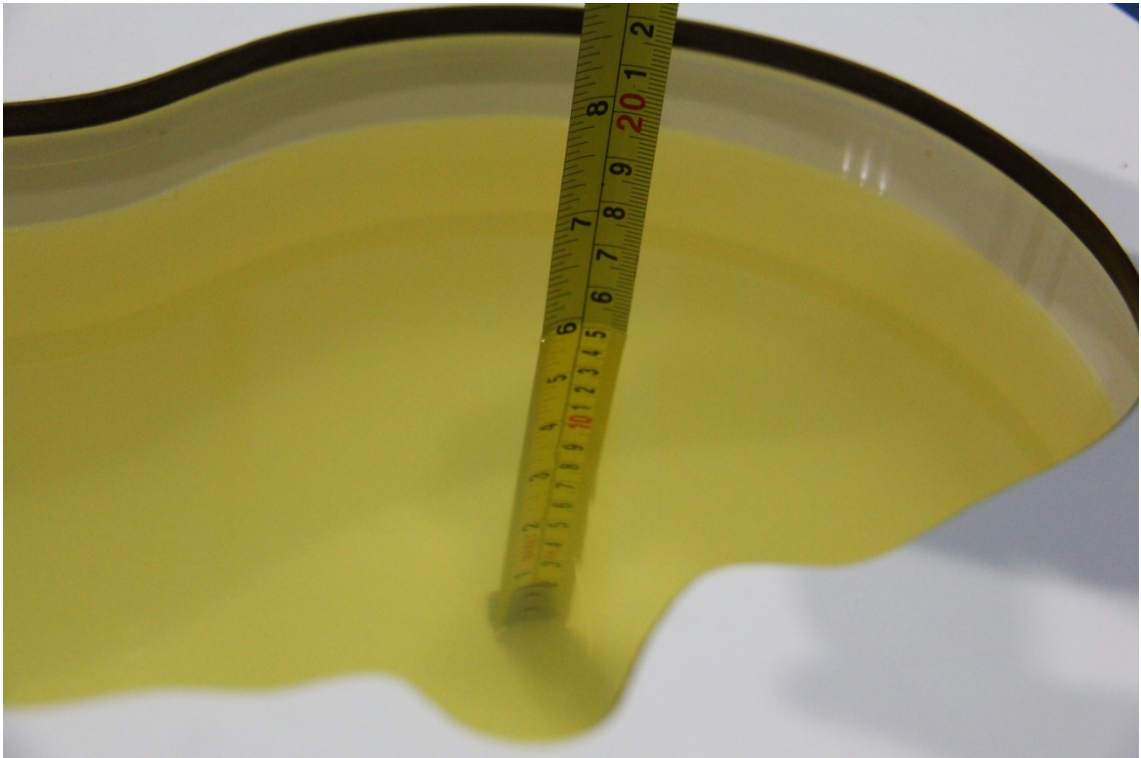

**Picture 7-3: Liquid depth in the Head Phantom (1900 MHz)**

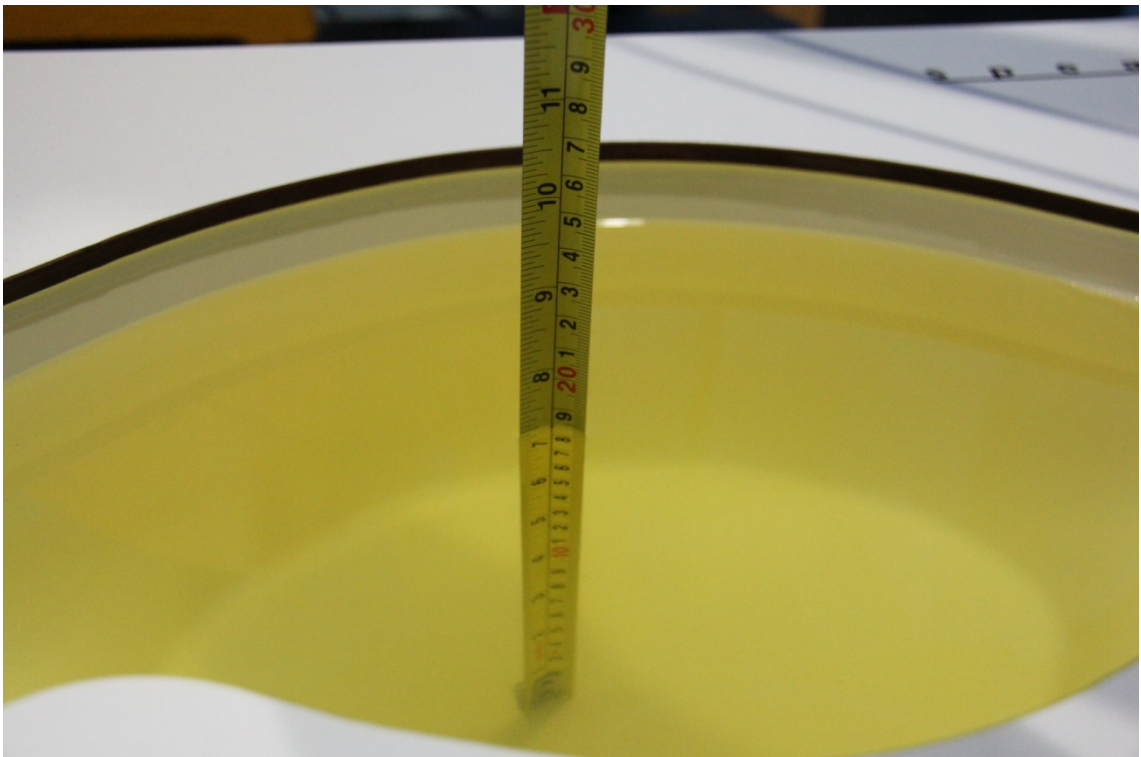

**Picture 7-4 Liquid depth in the Flat Phantom (1900MHz)**

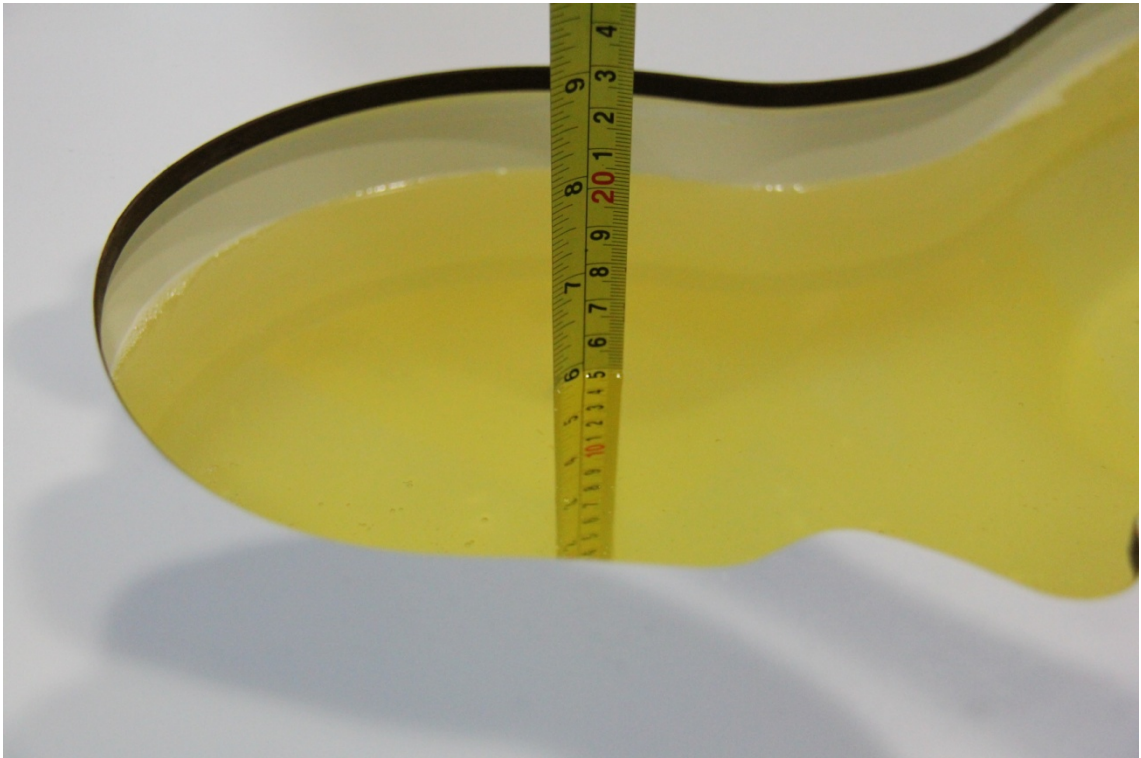

**Picture 7-5 Liquid depth in the Head Phantom (2450MHz)**

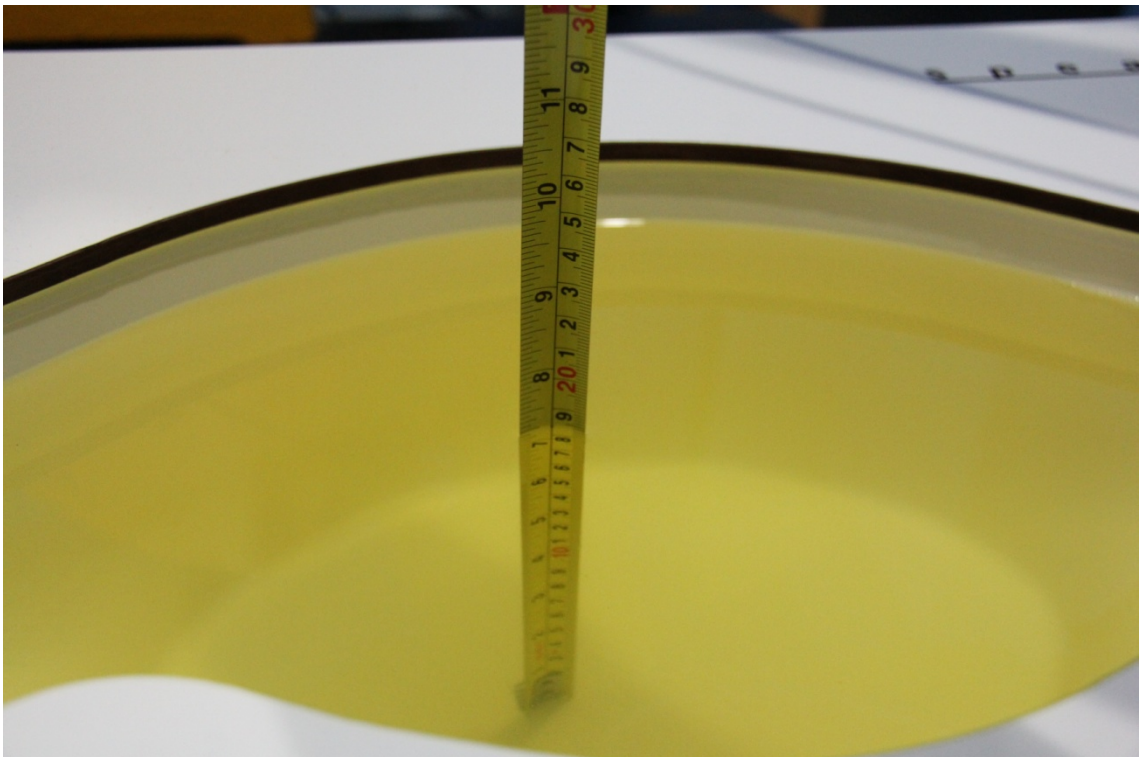

**Picture 7-6 Liquid depth in the Flat Phantom (2450MHz)**

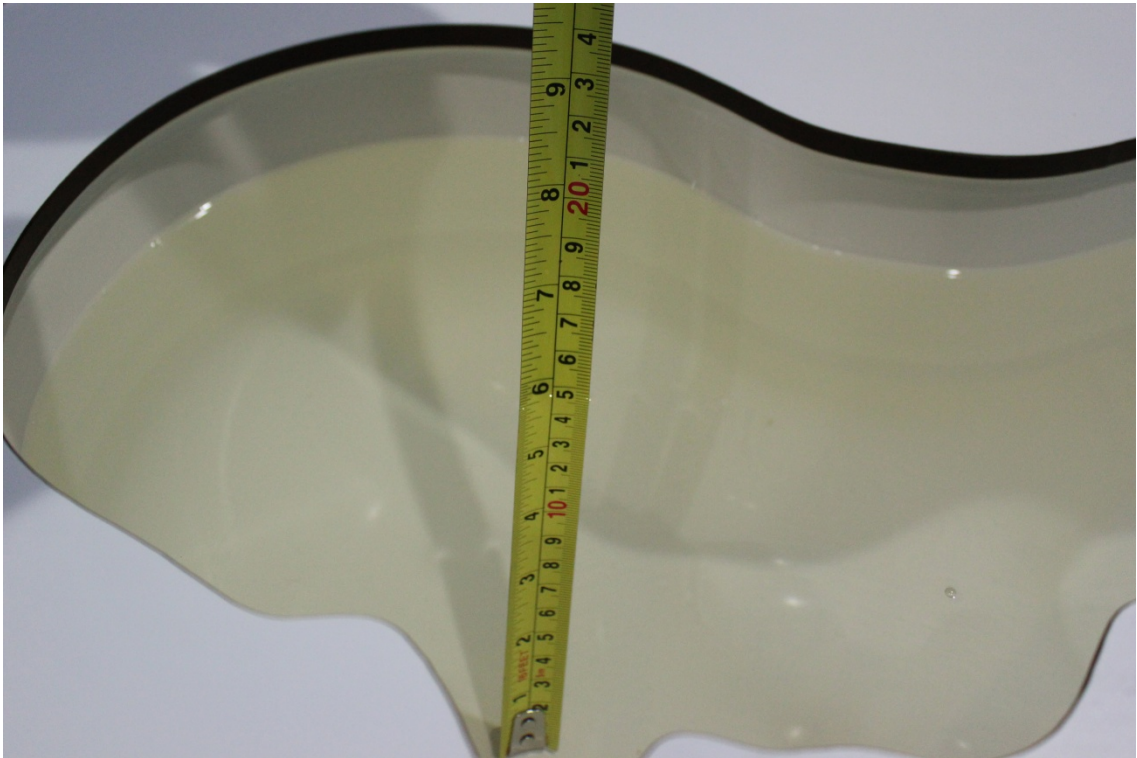

**Picture 7-7 Liquid depth in the Head Phantom (5800MHz)**

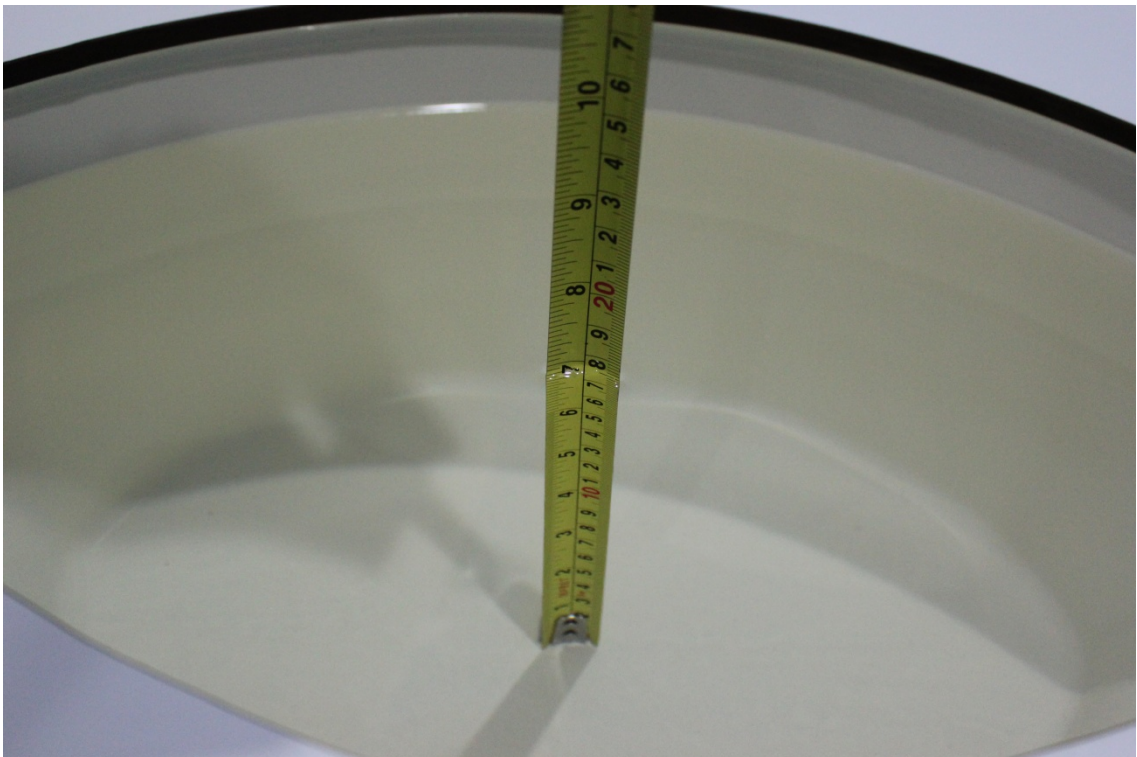

**Picture 7-8 Liquid depth in the Flat Phantom (5800MHz)**



## 8 System verification

### 8.1 System Setup

In the simplified setup for system evaluation, the DUT is replaced by a calibrated dipole and the power source is replaced by a continuous wave that comes from a signal generator. The calibrated dipole must be placed beneath the flat phantom section of the SAM twin phantom with the correct distance holder. The distance holder should touch the phantom surface with a light pressure at the reference marking and be oriented parallel to the long side of the phantom. The equipment setup is shown below:

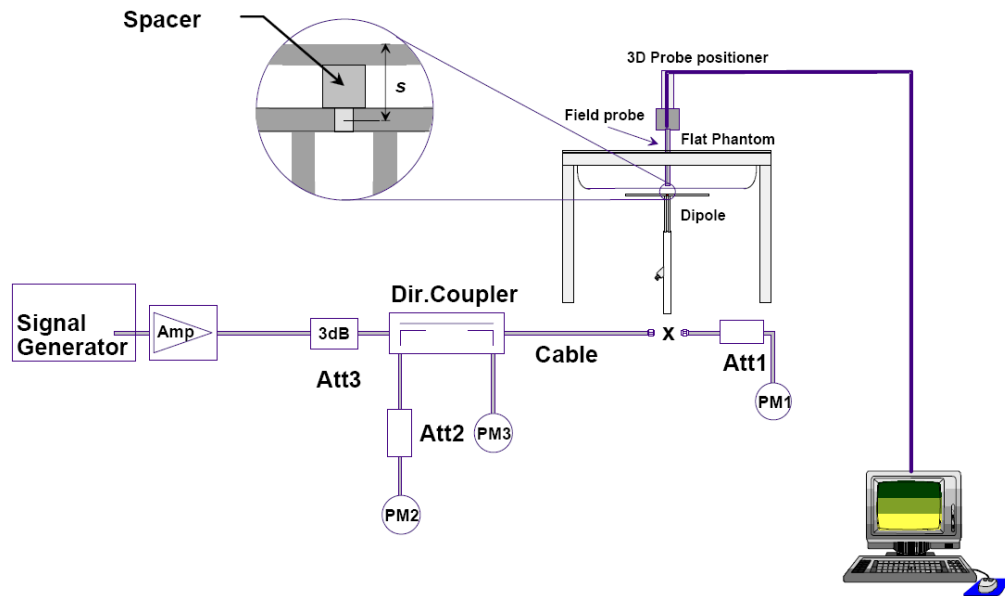

Picture 8.1 System Setup for System Evaluation

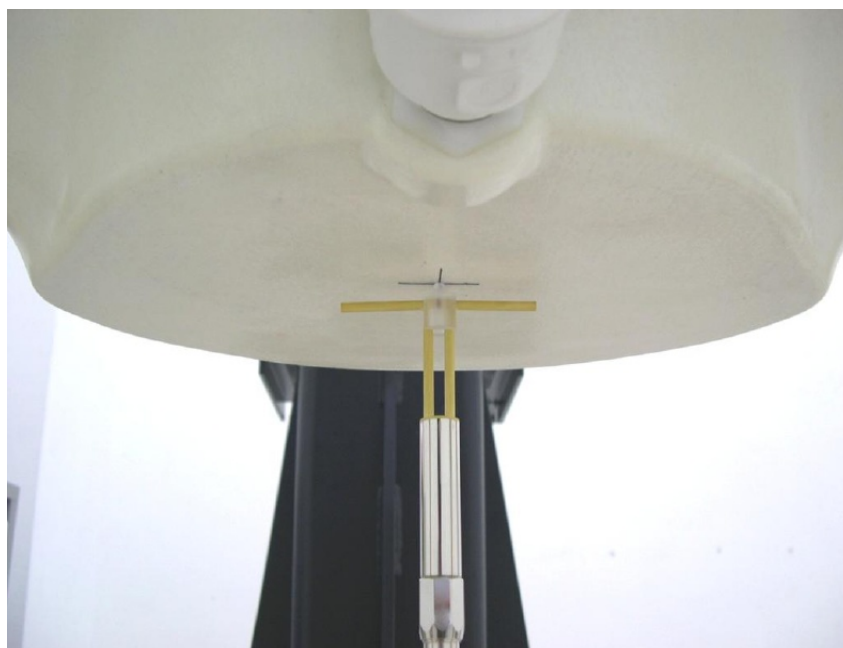

Picture 8.2 Photo of Dipole Setup

## 8.2 System Verification

SAR system verification is required to confirm measurement accuracy, according to the tissue dielectric media, probe calibration points and other system operating parameters required for measuring the SAR of a test device. The system verification must be performed for each frequency band and within the valid range of each probe calibration point required for testing the device.

The system verification results are required that the area scan estimated 1-g SAR is within 3% of the zoom scan 1-g SAR. The details are presented in annex B.

**Table 8.1: System Verification of Head**

Measurement Date (yyyy-mm-dd)	Frequency	Target value (W/kg)		Measured value (W/kg)		Deviation	
		10 g Average	1 g Average	10 g Average	1 g Average	10 g Average	1 g Average
2013-09-26	835 MHz	6.16	9.44	6.04	9.32	-1.95%	-1.27%
2013-09-27	1900 MHz	21.3	40.4	20.92	39.40	-1.78%	-2.48%
2013-09-28	2450 MHz	24.9	53.4	24.28	51.60	-2.49%	-3.37%
2013-09-29	5200 MHz	22.8	79.7	23.50	82.00	3.07%	2.89%
2013-09-29	5500 MHz	23.7	83.8	24.30	86.70	2.53%	3.46%
2013-09-30	5800 MHz	22.2	78.2	21.50	75.30	-3.15%	-3.71%

**Table 8.2: System Verification of Body**

Measurement Date (yyyy-mm-dd)	Frequency	Target value (W/kg)		Measured value (W/kg)		Deviation	
		10 g Average	1 g Average	10 g Average	1 g Average	10 g Average	1 g Average
2013-09-26	835 MHz	6.20	9.40	6.36	9.60	2.58%	2.13%
2013-09-27	1900 MHz	21.9	41.3	21.72	40.80	-0.82%	-1.21%
2013-09-28	2450 MHz	23.4	50.4	23.92	51.20	2.22%	1.59%
2013-09-29	5200 MHz	21.0	74.9	20.60	73.50	-1.90%	-1.87%
2013-09-29	5500 MHz	22.1	79.5	21.70	77.90	-1.81%	-2.01%
2013-09-30	5800 MHz	20.5	74.5	21.10	77.30	2.93%	3.76%

## 9 Measurement Procedures

### 9.1 Tests to be performed

In order to determine the highest value of the peak spatial-average SAR of a handset, all device positions, configurations and operational modes shall be tested for each frequency band according to steps 1 to 3 below. A flowchart of the test process is shown in picture 9.1.

**Step 1:** The tests described in 9.2 shall be performed at the channel that is closest to the centre of the transmit frequency band ( $f_c$ ) for:

- a) all device positions (cheek and tilt, for both left and right sides of the SAM phantom, as described in annex D),
- b) all configurations for each device position in a), e.g., antenna extended and retracted, and
- c) all operational modes, e.g., analogue and digital, for each device position in a) and configuration in b) in each frequency band.

If more than three frequencies need to be tested according to 11.1 (i.e.,  $N_c > 3$ ), then all frequencies, configurations and modes shall be tested for all of the above test conditions.

**Step 2:** For the condition providing highest peak spatial-average SAR determined in Step 1, perform all tests described in 9.2 at all other test frequencies, i.e., lowest and highest frequencies. In addition, for all other conditions (device position, configuration and operational mode) where the peak spatial-average SAR value determined in Step 1 is within 3 dB of the applicable SAR limit, it is recommended that all other test frequencies shall be tested as well.

**Step 3:** Examine all data to determine the highest value of the peak spatial-average SAR found in Steps 1 to 2.

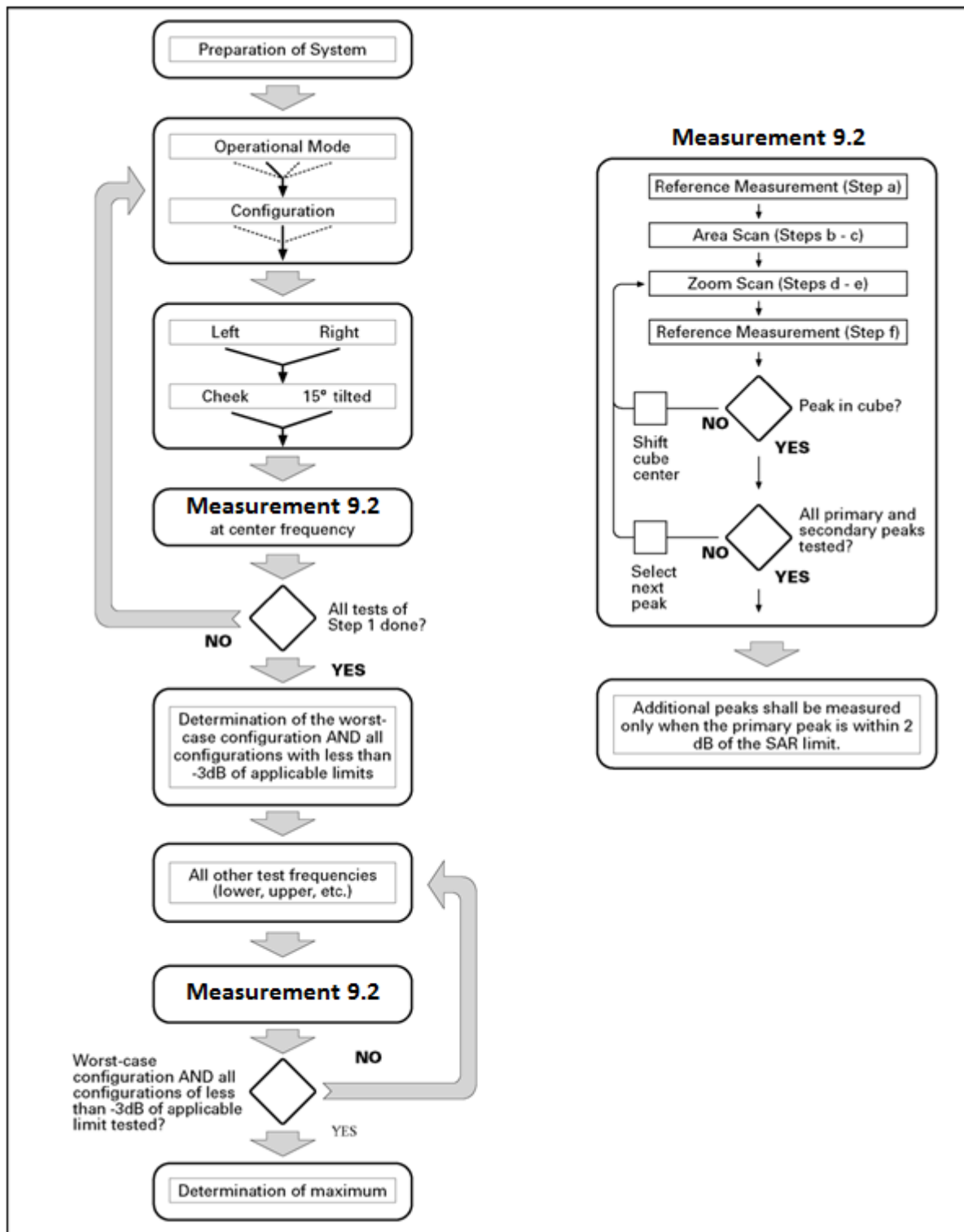

Picture 9.1 Block diagram of the tests to be performed

## 9.2 General Measurement Procedure

The area and zoom scan resolutions specified in the table below must be applied to the SAR measurements and fully documented in SAR reports to qualify for TCB approval. Probe boundary effect error compensation is required for measurements with the probe tip closer than half a probe tip diameter to the phantom surface. Both the probe tip diameter and sensor offset distance must satisfy measurement protocols; to ensure probe boundary effect errors are minimized and the higher fields closest to the phantom surface can be correctly measured and extrapolated to the phantom surface for computing 1-g SAR. Tolerances of the post-processing algorithms must be verified by the test laboratory for the scan resolutions used in the SAR measurements, according to the reference distribution functions specified in IEEE Std 1528-2003. The results should be documented as part of the system validation records and may be requested to support test results when all the measurement parameters in the following table are not satisfied.

		$\leq 3$ GHz	$> 3$ GHz
Maximum distance from closest measurement point (geometric center of probe sensors) to phantom surface		$5 \pm 1$ mm	$\frac{1}{2} \cdot \delta \cdot \ln(2) \pm 0.5$ mm
Maximum probe angle from probe axis to phantom surface normal at the measurement location		$30^\circ \pm 1^\circ$	$20^\circ \pm 1^\circ$
Maximum area scan spatial resolution: $\Delta x_{Area}$ , $\Delta y_{Area}$		$\leq 2$ GHz: $\leq 15$ mm 2 – 3 GHz: $\leq 12$ mm	3 – 4 GHz: $\leq 12$ mm 4 – 6 GHz: $\leq 10$ mm
		When the x or y dimension of the test device, in the measurement plane orientation, is smaller than the above, the measurement resolution must be $\leq$ the corresponding x or y dimension of the test device with at least one measurement point on the test device.	
Maximum zoom scan spatial resolution: $\Delta x_{Zoom}$ , $\Delta y_{Zoom}$		$\leq 2$ GHz: $\leq 8$ mm 2 – 3 GHz: $\leq 5$ mm*	3 – 4 GHz: $\leq 5$ mm* 4 – 6 GHz: $\leq 4$ mm*
Maximum zoom scan spatial resolution, normal to phantom surface	uniform grid: $\Delta z_{Zoom}(n)$	$\leq 5$ mm	3 – 4 GHz: $\leq 4$ mm 4 – 5 GHz: $\leq 3$ mm 5 – 6 GHz: $\leq 2$ mm
	graded grid	$\Delta z_{Zoom}(1)$ : between 1 <sup>st</sup> two points closest to phantom surface	$\leq 4$ mm
		$\Delta z_{Zoom}(n>1)$ : between subsequent points	$\leq 1.5 \cdot \Delta z_{Zoom}(n-1)$
Minimum zoom scan volume	x, y, z	$\geq 30$ mm	3 – 4 GHz: $\geq 28$ mm 4 – 5 GHz: $\geq 25$ mm 5 – 6 GHz: $\geq 22$ mm
Note: $\delta$ is the penetration depth of a plane-wave at normal incidence to the tissue medium; see draft standard IEEE P1528-2011 for details. * When zoom scan is required and the <i>reported</i> SAR from the area scan based 1-g SAR estimation procedures of KDB 447498 is $\leq 1.4$ W/kg, $\leq 8$ mm, $\leq 7$ mm and $\leq 5$ mm zoom scan resolution may be applied, respectively, for 2 GHz to 3 GHz, 3 GHz to 4 GHz and 4 GHz to 6 GHz.			

### 9.3 WCDMA Measurement Procedures for SAR

The following procedures are applicable to WCDMA handsets operating under 3GPP Release99, Release 5 and Release 6. The default test configuration is to measure SAR with an established radio link between the DUT and a communication test set using a 12.2kbps RMC (reference measurement channel) configured in Test Loop Mode 1. SAR is selectively confirmed for other physical channel configurations (DPCCH & DPDCH<sub>n</sub>), HSDPA and HSPA (HSUPA/HSDPA) modes according to output power, exposure conditions and device operating capabilities. Both uplink and downlink should be configured with the same RMC or AMR, when required. SAR for Release 5 HSDPA and Release 6 HSPA are measured using the applicable FRC (fixed reference channel) and E-DCH reference channel configurations. Maximum output power is verified according to applicable versions of 3GPP TS 34.121 and SAR must be measured according to these maximum output conditions. When Maximum Power Reduction (MPR) is not implemented according to Cubic Metric (CM) requirements for Release 6 HSPA, the following procedures do not apply.

#### For Release 5 HSDPA Data Devices:

Sub-test	$\beta_c$	$\beta_d$	$\beta_d$ (SF)	$\beta_c / \beta_d$	$\beta_{hs}$	CM/dB
1	2/15	15/15	64	2/15	4/15	0.0
2	12/15	15/15	64	12/15	24/25	1.0
3	15/15	8/15	64	15/8	30/15	1.5
4	15/15	4/15	64	15/4	30/15	1.5

#### For Release 6 HSPA Data Devices

Sub-test	$\beta_c$	$\beta_d$	$\beta_d$ (SF)	$\beta_c / \beta_d$	$\beta_{hs}$	$\beta_{ec}$	$\beta_{ed}$	$\beta_{ed}$ (SF)	$\beta_{ed}$ (codes)	CM (dB)	MPR (dB)	AG Index	E-TFCI
1	11/15	15/15	64	11/15	22/15	209/225	1039/225	4	1	1.0	0.0	20	75
2	6/15	15/15	64	6/15	12/15	12/15	12/15	4	1	3.0	2.0	12	67
3	15/15	9/15	64	15/9	30/15	30/15	$\beta_{ed1}:47/15$ $\beta_{ed2}:47/15$	4	2	2.0	1.0	15	92
4	2/15	15/15	64	2/15	4/15	4/15	56/75	4	1	3.0	2.0	17	71
5	15/15	15/15	64	15/15	24/15	30/15	134/15	4	1	1.0	0.0	21	81

#### **9.4 Bluetooth & Wi-Fi Measurement Procedures for SAR**

Normal network operating configurations are not suitable for measuring the SAR of 802.11 transmitters in general. Unpredictable fluctuations in network traffic and antenna diversity conditions can introduce undesirable variations in SAR results. The SAR for these devices should be measured using chipset based test mode software to ensure that the results are consistent and reliable.

Chipset based test mode software is hardware dependent and generally varies among manufacturers. The device operating parameters established in a test mode for SAR measurements must be identical to those programmed in production units, including output power levels, amplifier gain settings and other RF performance tuning parameters. The test frequencies should correspond to actual channel frequencies defined for domestic use. SAR for devices with switched diversity should be measured with only one antenna transmitting at a time during each SAR measurement, according to a fixed modulation and data rate. The same data pattern should be used for all measurements.

In order to testing the conducted power of WLAN, the DUT is controlled to transmit WLAN TX as maximum power by the terminal software installed on the PC. The procedure how to control is presented as blew:

1. Connect DUT and PC via the USB cable and check the port is opened.
2. Input the command "WLPU" to power on WLAN.
3. Input the command "WTFD" to firmware download.
4. Input the WBTX command to start transmit (i.e., WBTX=1,0,1,1500,25,0,12).
5. Input the command "WIDL" to stop transmit.
6. Input the command "WLPD" to power off WLAN.

#### **9.5 Power Drift**

To control the output power stability during the SAR test, DASY4 system calculates the power drift by measuring the E-field at the same location at the beginning and at the end of the measurement for each test position. These drift values can be found in Table 14.2 to Table 14.29 labeled as: (Power Drift [dB]). This ensures that the power drift during one measurement is within 5%.

## 10 Area Scan Based 1-g SAR

### 10.1 Requirement of KDB

According to the KDB447498 D01 v05, when the implementation is based the specific polynomial fit algorithm as presented at the 29th Bioelectromagnetics Society meeting (2007) and the estimated 1-g SAR is  $\leq 1.2$  W/kg, a zoom scan measurement is not required provided it is also not needed for any other purpose; for example, if the peak SAR location required for simultaneous transmission SAR test exclusion can be determined accurately by the SAR system or manually to discriminate between distinctive peaks and scattered noisy SAR distributions from area scans.

There must not be any warning or alert messages due to various measurement concerns identified by the SAR system; for example, noise in measurements, peaks too close to scan boundary, peaks are too sharp, spatial resolution and uncertainty issues etc. The SAR system verification must also demonstrate that the area scan estimated 1-g SAR is within 3% of the zoom scan 1-g SAR (See Annex B). When all the SAR results for each exposure condition in a frequency band and wireless mode are based on estimated 1-g SAR, the 1-g SAR for the highest SAR configuration must be determined by a zoom scan.

### 10.2 Fast SAR Algorithms

The approach is based on the area scan measurement applying a frequency dependent attenuation parameter. This attenuation parameter was empirically determined by analyzing a large number of phones. The MOTOROLA FAST SAR was developed and validated by the MOTOROLA Research Group in Ft. Lauderdale.

In the initial study, an approximation algorithm based on Linear fit was developed. The accuracy of the algorithm has been demonstrated across a broad frequency range (136-2450 MHz) and for both 1- and 10-g averaged SAR using a sample of 264 SAR measurements from 55 wireless handsets. For the sample size studied, the root-mean-squared errors of the algorithm are 1.2% and 5.8% for 1- and 10-g averaged SAR, respectively. The paper describing the algorithm in detail is expected to be published in August 2004 within the Special Issue of Transactions on MTT.

In the second step, the same research group optimized the fitting algorithm to an Polynomial fit whereby the frequency validity was extended to cover the range 30-6000MHz. Details of this study can be found in the BEMS 2007 Proceedings.

Both algorithms are implemented in DASY software.



## 11 Conducted Output Power

### 11.1 Manufacturing tolerance

**Table 11.1: GSM Speech**

GSM 850			
Channel	Channel 251	Channel 190	Channel 128
Target (dBm)	33	33	33
Tune-up (dBm)	33.6	33.6	33.6
GSM 1900			
Channel	Channel 810	Channel 661	Channel 512
Target (dBm)	30	30	30
Tune-up (dBm)	30.6	30.6	30.6

**Table 11.2: GPRS and EGPRS**

GSM 850 GPRS (GMSK)				
Channel		251	190	128
1 Txslot	Target (dBm)	33	33	33
	Tune-up (dBm)	33.6	33.6	33.6
2 Txslots	Target (dBm)	31	31	31
	Tune-up (dBm)	31.6	31.6	31.6
3 Txslots	Target (dBm)	29.5	29.5	29.5
	Tune-up (dBm)	30.1	30.1	30.1
4 Txslots	Target (dBm)	28.5	28.5	28.5
	Tune-up (dBm)	29.1	29.1	29.1
GSM 850 EGPRS (GMSK)				
Channel		251	190	128
1 Txslot	Target (dBm)	33	33	33
	Tune-up (dBm)	33.6	33.6	33.6
2 Txslots	Target (dBm)	31	31	31
	Tune-up (dBm)	31.6	31.6	31.6
3 Txslots	Target (dBm)	29.5	29.5	29.5
	Tune-up (dBm)	30.1	30.1	30.1
4 Txslots	Target (dBm)	28.5	28.5	28.5
	Tune-up (dBm)	29.1	29.1	29.1
GSM 850 EGPRS (8PSK)				
Channel		251	190	128
1 Txslot	Target (dBm)	27	27	27
	Tune-up (dBm)	28	28	28
2 Txslots	Target (dBm)	25	25	25
	Tune-up (dBm)	26	26	26

3 Txslots	Target (dBm)	24	24	24
	Tune-up (dBm)	25	25	25
4 Txslots	Target (dBm)	23	23	23
	Tune-up (dBm)	24	24	24
<b>GSM 1900 GPRS (GMSK)</b>				
Channel		<b>810</b>	<b>661</b>	<b>512</b>
1 Txslot	Target (dBm)	30	30	30
	Tune-up (dBm)	30.6	30.6	30.6
2 Txslots	Target (dBm)	27.4	27.4	27.4
	Tune-up (dBm)	28	28	28
3 Txslots	Target (dBm)	25.4	25.4	25.4
	Tune-up (dBm)	26	26	26
4 Txslots	Target (dBm)	24.4	24.4	24.4
	Tune-up (dBm)	25	25	25
<b>GSM 1900 EGPRS (GMSK)</b>				
Channel		<b>810</b>	<b>661</b>	<b>512</b>
1 Txslot	Target (dBm)	30	30	30
	Tune-up (dBm)	30.6	30.6	30.6
2 Txslots	Target (dBm)	27.4	27.4	27.4
	Tune-up (dBm)	28	28	28
3 Txslots	Target (dBm)	25.4	25.4	25.4
	Tune-up (dBm)	26	26	26
4 Txslots	Target (dBm)	24.4	24.4	24.4
	Tune-up (dBm)	25	25	25
<b>GSM 1900 EGPRS (8PSK)</b>				
Channel		<b>810</b>	<b>661</b>	<b>512</b>
1 Txslot	Target (dBm)	26	26	26
	Tune-up (dBm)	27	27	27
2 Txslots	Target (dBm)	24	24	24
	Tune-up (dBm)	25	25	25
3 Txslots	Target (dBm)	23	23	23
	Tune-up (dBm)	24	24	24
4 Txslots	Target (dBm)	22	22	22
	Tune-up (dBm)	23	23	23

**Table 11.3: WCDMA**

WCDMA 850 CS			
Channel	Channel 4233	Channel 4182	Channel 4132
Target (dBm)	24.0	24.0	24.0
Tune-up (dBm)	24.5	24.5	24.5
HSUPA (sub-test 1/5)			
Channel	Channel 4233	Channel 4182	Channel 4132
Target (dBm)	24.0	24.0	24.0
Tune-up (dBm)	24.5	24.5	24.5
HSUPA (sub-test 3)			
Channel	Channel 4233	Channel 4182	Channel 4132
Target (dBm)	23.0	23.0	23.0
Tune-up (dBm)	24.0	24.0	24.0
HSUPA (sub-test 2/4)			
Channel	Channel 4233	Channel 4182	Channel 4132
Target (dBm)	21.0	21.0	21.0
Tune-up (dBm)	23.0	23.0	23.0

**Table 11.4: Bluetooth**

Bluetooth			
Channel	Channel 0	Channel 39	Channel 78
Target (dBm)	7.0	7.5	6.5
Tune-up (dBm)	9.0	9.5	8.5



## 11.2 GSM Measurement result

During the process of testing, the EUT was controlled via Agilent Digital Radio Communication tester (E5515C) to ensure the maximum power transmission and proper modulation. This result contains conducted output power for the EUT. In all cases, the measured peak output power should be greater and within 5% than EMI measurement.

**Table 11.6: The conducted power measurement results for GSM850/1900**

GSM 850MHz	Conducted Power (dBm)		
	Channel 251(848.8MHz)	Channel 190(836.6MHz)	Channel 128(824.2MHz)
	32.78	32.75	32.88
GSM 1900MHz	Conducted Power (dBm)		
	Channel 810(1909.8MHz)	Channel 661(1880MHz)	Channel 512(1850.2MHz)
	29.89	29.78	29.81

**Table 11.7: The conducted power measurement results for GPRS and EGPRS**

GSM 850 GPRS (GMSK)	Measured Power (dBm)			calculation	Averaged Power (dBm)		
	251	190	128		251	190	128
1 Txslot	32.78	32.76	32.89	-9.03dB	23.75	23.73	23.86
<b>2 Txslots</b>	30.41	30.38	30.56	-6.02dB	<b>24.39</b>	<b>24.36</b>	<b>24.54</b>
3Txslots	28.52	28.61	28.62	-4.26dB	24.26	24.35	24.36
4 Txslots	27.12	27.10	27.35	-3.01dB	24.11	24.09	24.34
GSM 850 EGPRS (GMSK)	Measured Power (dBm)			calculation	Averaged Power (dBm)		
	251	190	128		251	190	128
1 Txslot	32.73	32.70	32.83	-9.03dB	23.70	23.67	23.80
<b>2 Txslots</b>	30.32	30.28	30.48	-6.02dB	<b>24.30</b>	<b>24.26</b>	<b>24.46</b>
3Txslots	28.44	28.34	28.54	-4.26dB	24.18	24.08	24.28
4 Txslots	27.12	27.11	27.25	-3.01dB	24.11	24.10	24.24
GSM 850 EGPRS (8PSK)	Measured Power (dBm)			calculation	Averaged Power (dBm)		
	251	190	128		251	190	128
1 Txslot	27.06	27.01	27.12	-9.03dB	18.03	17.98	18.09
2 Txslots	24.59	24.53	24.66	-6.02dB	18.57	18.51	18.64
3Txslots	23.35	23.34	23.42	-4.26dB	19.09	19.08	19.16
<b>4 Txslots</b>	22.17	22.12	22.25	-3.01dB	<b>19.16</b>	<b>19.11</b>	<b>19.24</b>
PCS1900 GPRS (GMSK)	Measured Power (dBm)			calculation	Averaged Power (dBm)		
	810	661	512		810	661	512
1 Txslot	29.92	29.84	29.86	-9.03dB	20.89	20.81	20.83
<b>2 Txslots</b>	27.42	27.30	27.36	-6.02dB	<b>21.40</b>	<b>21.28</b>	<b>21.34</b>
3Txslots	25.29	25.18	25.21	-4.26dB	21.03	20.92	20.95
4 Txslots	24.13	24.03	23.99	-3.01dB	21.12	21.02	20.98
PCS1900 EGPRS (GMSK)	Measured Power (dBm)			calculation	Averaged Power (dBm)		
	810	661	512		810	661	512
1 Txslot	29.92	29.81	29.86	-9.03dB	20.89	20.78	20.83
<b>2 Txslots</b>	27.42	27.30	27.35	-6.02dB	<b>21.40</b>	<b>21.28</b>	<b>21.33</b>
3Txslots	25.28	25.16	25.22	-4.26dB	21.02	20.90	20.96
4 Txslots	24.12	24.04	24.07	-3.01dB	21.11	21.03	21.06

PCS1900 EGPRS (8PSK)	Measured Power (dBm)			calculation	Averaged Power (dBm)		
	810	661	512		810	661	512
1 Txslot	25.32	25.23	25.18	-9.03dB	16.29	16.20	16.15
2 Txslots	23.65	23.55	23.50	-6.02dB	17.63	17.53	17.48
3Txslots	22.50	22.41	22.37	-4.26dB	18.24	18.15	18.11
<b>4 Txslots</b>	21.36	21.31	21.25	<b>-3.01dB</b>	<b>18.35</b>	<b>18.30</b>	<b>18.24</b>

NOTES:

1) Division Factors

To average the power, the division factor is as follows:

1TX-slot = 1 transmit time slot out of 8 time slots=> conducted power divided by (8/1) => -9.03dB

2TX-slots = 2 transmit time slots out of 8 time slots=> conducted power divided by (8/2) => -6.02dB

3TX-slots = 3 transmit time slots out of 8 time slots=> conducted power divided by (8/3) => -4.26dB

4TX-slots = 4 transmit time slots out of 8 time slots=> conducted power divided by (8/4) => -3.01dB

**According to the conducted power as above, the body measurements are performed with 2Txslots for GPRS and EGPRS.**

**Note: According to the KDB941225 D03, “when SAR tests for EDGE or EGPRS mode is necessary, GMSK modulation should be used”.**

### 11.3 WCDMA Measurement result

**Table 11.8: The conducted Power for WCDMA**

Item	band	FDDV result		
	ARFCN	4233 (846.6MHz)	4182 (836.4MHz)	4132 (826.4MHz)
WCDMA	\	23.74	23.84	23.93
HSUPA	1	23.40	23.93	23.59
	2	22.22	21.79	22.42
	3	22.06	23.06	22.64
	4	22.61	22.16	21.75
	5	24.15	24.15	24.26

**Note:** HSUPA body SAR for WCDMA850 is not required, because the maximum SAR for CDMA850 is not above 75% of the SAR limit.

### 11.4 Wi-Fi and BT Measurement result

The output power of BT antenna is as following:

Mode	Conducted Power (dBm)		
	Channel 0 (2402MHz)	Channel 39 (2441MHz)	Channel 78 (2480MHz)
GFSK	7.99	8.40	7.33
EDR2M-4_DQPSK	6.59	6.91	5.84
EDR3M-8DPSK	6.60	6.92	5.82

The average conducted power for Wi-Fi is as following:

802.11b (dBm)

Channel\data rate	1Mbps	2Mbps	5.5Mbps	11Mbps
1	15.67	15.71	15.79	15.90
6	16.63	16.61	16.76	16.84
11	15.38	15.37	15.60	15.56

802.11g (dBm)

Channel\data rate	6Mbps	9Mbps	12Mbps	18Mbps	24Mbps	36Mbps	48Mbps	54Mbps
1	15.18	15.17	15.13	15.11	10.43	10.39	10.33	10.30
6	15.53	15.49	15.46	15.44	11.17	11.14	11.08	11.05
11	14.29	14.26	14.24	14.21	9.90	9.84	9.79	9.76

802.11n (dBm) - HT20 (2.4G)

Channel\data rate	MCS0	MCS1	MCS2	MCS3	MCS4	MCS5	MCS6	MCS7
1	14.81	14.76	14.97	10.29	10.29	10.75	10.51	10.73
6	15.79	15.77	15.73	11.05	10.80	11.01	10.76	11.01
11	14.61	14.57	14.56	9.56	9.80	9.78	9.98	10.21

802.11a (dBm)

Channel\data rate	6Mbps	9Mbps	12Mbps	18Mbps	24Mbps	36Mbps	48Mbps	54Mbps
36(5180 MHz)	13.36	13.35	13.34	13.31	7.90	7.86	7.83	7.79
40(5200 MHz)	12.91	12.88	12.87	12.84	7.16	7.14	7.11	7.08
44(5220 MHz)	12.68	12.67	12.66	12.65	6.96	6.95	6.88	6.87
48(5240 MHz)	12.59	12.58	12.57	12.56	7.32	7.29	7.24	7.21
52(5260 MHz)	13.44	13.43	13.41	13.39	8.27	8.26	8.22	8.19
56(5280 MHz)	13.04	13.03	13.02	13.01	7.32	7.29	7.25	7.23
60(5300 MHz)	12.60	12.59	12.58	12.56	6.86	6.85	6.81	6.77
64(5320 MHz)	12.63	12.62	12.61	12.59	6.88	6.85	6.81	7.26
100(5500 MHz)	12.87	12.86	12.85	12.83	7.49	7.46	7.41	7.39
104(5520 MHz)	12.93	12.92	12.91	12.88	7.09	7.08	7.02	7.21
108(5540 MHz)	12.59	12.58	12.56	12.54	7.29	7.27	7.22	7.19
112(5560 MHz)	12.74	12.73	12.71	12.69	7.53	7.51	7.45	7.43
116(5580 MHz)	12.74	12.73	12.71	12.70	7.80	7.87	7.85	7.82
120(5600 MHz)	13.80	13.80	13.79	13.79	8.41	8.39	8.37	8.31
124(5620 MHz)	13.05	13.04	13.03	13.01	7.90	7.88	7.84	7.82
128(5640 MHz)	13.11	13.11	13.09	13.07	7.90	7.89	7.84	7.82
132(5660 MHz)	13.13	13.12	13.12	13.09	7.89	7.89	7.88	7.84
136(5680 MHz)	13.11	13.11	13.09	13.09	7.77	7.76	7.69	7.67
140(5700 MHz)	12.25	12.25	12.23	12.20	7.03	7.01	6.98	6.93
149(5745 MHz)	13.14	13.13	13.12	13.10	7.60	7.54	7.52	7.50
153(5765 MHz)	13.52	13.51	13.50	13.47	8.52	8.49	8.46	8.42
157(5785 MHz)	12.93	12.92	12.91	12.89	7.39	7.37	7.32	7.29
161(5805 MHz)	12.87	12.87	12.85	12.84	7.31	7.29	7.23	7.21
165(5825 MHz)	12.78	12.77	12.76	12.75	7.19	7.16	7.65	7.63

802.11n (dBm) - HT20 (5G)

Channel/data rate	MCS0	MCS1	MCS2	MCS3	MCS4	MCS5	MCS6	MCS7
36(5180 MHz)	13.75	13.76	13.75	7.18	7.17	7.14	7.40	7.39
40(5200 MHz)	12.93	12.91	12.89	7.26	7.25	7.24	7.23	7.22
44(5220 MHz)	12.74	12.71	12.69	7.05	7.03	7.01	7.00	7.00
48(5240 MHz)	13.06	13.45	13.44	6.44	6.43	6.41	6.41	6.41
52(5260 MHz)	13.90	13.87	13.86	7.42	7.42	7.89	7.88	7.88
56(5280 MHz)	13.09	13.08	13.08	6.47	6.46	6.44	6.42	6.43
60(5300 MHz)	12.67	12.66	12.65	6.95	6.95	6.93	6.92	6.92
64(5320 MHz)	13.11	13.11	13.10	6.49	6.48	6.47	6.45	6.45
100(5500 MHz)	12.94	12.93	12.92	7.07	7.06	7.04	7.04	7.03
104(5520 MHz)	13.44	13.43	13.42	7.21	7.21	7.18	7.18	7.24
108(5540 MHz)	13.12	13.11	13.11	7.40	7.40	7.38	7.38	7.45
112(5560 MHz)	12.81	12.81	12.79	7.16	7.16	7.15	7.14	7.13
116(5580 MHz)	13.25	13.25	13.24	7.30	7.29	7.29	7.26	7.26
120(5600 MHz)	13.88	13.88	13.87	8.05	8.05	8.03	8.03	8.01
124(5620 MHz)	13.12	13.11	13.11	7.22	7.22	7.19	7.19	7.18
128(5640 MHz)	13.19	13.18	13.16	7.33	7.33	7.32	7.31	7.29
132(5660 MHz)	13.62	13.62	13.61	7.38	7.37	7.36	7.35	7.32
136(5680 MHz)	13.17	13.17	13.16	7.36	7.35	7.34	7.32	7.32
140(5700 MHz)	12.76	12.76	12.75	6.13	6.64	6.62	6.61	6.61
149(5745 MHz)	13.21	13.20	13.19	7.21	7.20	7.20	7.19	7.18
153(5765 MHz)	13.99	13.98	13.97	7.59	7.58	7.57	7.56	7.56
157(5785 MHz)	13.47	13.46	13.45	7.01	7.01	6.99	6.98	6.98
161(5805 MHz)	12.94	12.94	12.93	6.93	6.92	6.90	6.89	6.88
165(5825 MHz)	12.85	12.85	12.85	6.82	6.81	6.80	6.78	6.78

802.11n (dBm) - HT40 (5G)

Channel/data rate	MCS0	MCS1	MCS2	MCS3	MCS4	MCS5	MCS6	MCS7
38(5190 MHz)	9.70	9.71	9.70	7.22	7.21	7.18	7.17	7.15
46(5230 MHz)	9.85	9.88	9.85	6.88	6.87	6.84	6.83	7.29
54(5270 MHz)	9.87	10.33	10.32	7.85	7.84	7.82	7.80	7.79
62(5310 MHz)	9.42	9.43	9.42	6.93	6.91	6.87	6.87	6.85
102(5510 MHz)	10.09	10.10	10.07	7.10	7.07	7.06	7.05	7.02
110(5550 MHz)	9.59	9.61	9.59	7.47	7.45	7.43	7.42	7.40
118(5590 MHz)	10.79	10.80	10.80	8.32	8.31	8.26	8.26	8.25
126(5630 MHz)	9.68	9.69	9.68	7.70	7.68	7.66	7.66	7.64
134(5670 MHz)	9.77	9.79	9.77	7.69	7.69	7.66	7.66	7.64
151(5755 MHz)	10.14	10.16	10.15	8.10	8.09	8.07	8.04	8.03
159(5795 MHz)	9.47	9.48	9.96	6.90	6.87	7.34	7.33	7.33



802.11ac (dBm) - HT20 (5G)

Channel/data rate	MCS0	MCS1	MCS2	MCS3	MCS4	MCS5	MCS6	MCS7
36(5180 MHz)	13.73	13.68	13.66	7.40	7.34	7.38	7.32	7.29
40(5200 MHz)	12.88	12.85	12.83	7.14	7.11	7.13	7.07	7.04
44(5220 MHz)	12.68	13.07	13.06	6.93	6.88	6.91	6.87	6.84
48(5240 MHz)	13.44	13.41	13.39	6.34	6.29	6.33	6.24	6.17
52(5260 MHz)	13.86	13.82	13.81	7.81	7.75	7.79	7.74	7.69
56(5280 MHz)	13.07	13.03	13.02	6.85	6.79	6.84	6.78	6.76
60(5300 MHz)	12.64	12.61	12.58	6.86	6.81	6.84	6.79	6.75
64(5320 MHz)	13.09	13.06	13.05	6.37	6.34	6.31	6.34	6.28
100(5500 MHz)	12.90	12.85	12.85	6.95	6.91	6.94	6.88	6.76
104(5520 MHz)	13.41	13.38	13.36	7.10	7.06	7.09	7.01	6.98
108(5540 MHz)	13.11	13.07	13.06	7.33	7.31	7.25	7.33	7.21
112(5560 MHz)	12.78	12.74	12.73	7.06	7.01	7.06	7.02	6.96
116(5580 MHz)	13.24	13.20	13.18	7.20	7.15	7.19	7.39	7.36
120(5600 MHz)	13.86	13.81	13.81	7.95	7.90	7.94	7.90	7.86
124(5620 MHz)	13.10	13.06	13.04	7.12	7.59	7.12	7.38	7.36
128(5640 MHz)	13.15	13.12	13.11	7.23	7.18	7.21	7.16	7.13
132(5660 MHz)	13.61	13.56	13.56	7.40	7.40	7.36	7.32	7.39
136(5680 MHz)	13.15	13.12	13.11	7.25	7.20	7.24	7.19	7.16
140(5700 MHz)	12.74	12.69	12.68	6.54	6.49	6.49	6.47	6.43
149(5745 MHz)	13.18	13.14	13.11	7.11	7.05	7.09	7.03	7.01
153(5765 MHz)	13.97	13.93	13.92	7.48	7.44	7.46	7.42	7.37
157(5785 MHz)	13.45	13.43	13.40	6.90	6.86	6.88	7.32	7.28
161(5805 MHz)	12.91	12.87	12.85	6.83	6.76	6.81	6.75	6.71
165(5825 MHz)	12.84	12.79	13.25	6.70	6.64	6.70	6.66	6.60

802.11ac (dBm) - HT40 (5G)

Channel/data rate	MCS0	MCS1	MCS2	MCS3	MCS4	MCS5	MCS6	MCS7
38(5190 MHz)	9.15	9.63	9.58	7.04	7.03	6.98	6.98	6.99
46(5230 MHz)	9.75	9.73	9.69	7.11	7.12	7.56	7.57	7.51
54(5270 MHz)	10.26	10.24	10.19	8.12	8.12	8.06	8.08	8.08
62(5310 MHz)	9.83	9.82	9.77	7.19	7.19	7.14	7.14	7.08
102(5510 MHz)	9.72	9.71	9.65	7.41	7.40	7.37	7.34	7.32
110(5550 MHz)	9.52	9.51	9.45	7.27	7.27	7.22	7.23	7.16
118(5590 MHz)	10.80	10.79	10.76	8.39	8.40	8.37	8.38	8.32
126(5630 MHz)	10.10	10.10	10.06	7.49	7.49	7.46	7.44	7.40
134(5670 MHz)	9.71	9.70	10.10	7.60	7.61	7.55	7.54	7.48
151(5755 MHz)	10.08	10.07	10.52	7.89	7.91	7.85	7.86	7.79
159(5795 MHz)	9.40	9.40	9.35	7.19	7.19	7.15	7.15	7.09

802.11ac (dBm) – HT80 (5G)

Channel/data rate	MCS0	MCS1	MCS2	MCS3	MCS4	MCS5	MCS6	MCS7	MCS8	MCS9
42(5210 MHz)	7.80	7.77	7.70	6.16	6.03	6.07	5.97	6.01	7.80	7.77
58(5290 MHz)	8.09	7.95	7.89	5.85	6.22	5.78	6.20	6.22	8.09	7.95
106(5530 MHz)	7.71	7.58	7.52	6.20	6.13	6.18	6.10	6.13	7.71	7.58
122(5610 MHz)	8.39	8.49	8.47	6.90	6.86	6.90	6.83	6.85	8.39	8.49
155(5775 MHz)	8.49	8.35	8.29	6.71	6.57	6.62	6.54	6.56	8.49	8.35

## 12 Simultaneous TX SAR Considerations

### 12.1 Introduction

The following procedures adopted from “FCC SAR Considerations for Cell Phones with Multiple Transmitters” are applicable to handsets with built-in unlicensed transmitters such as 802.11 a/b/g and Bluetooth devices which may simultaneously transmit with the licensed transmitter. For this device, the BT and Wi-Fi can transmit simultaneous with other transmitters.

### 12.2 Transmit Antenna Separation Distances

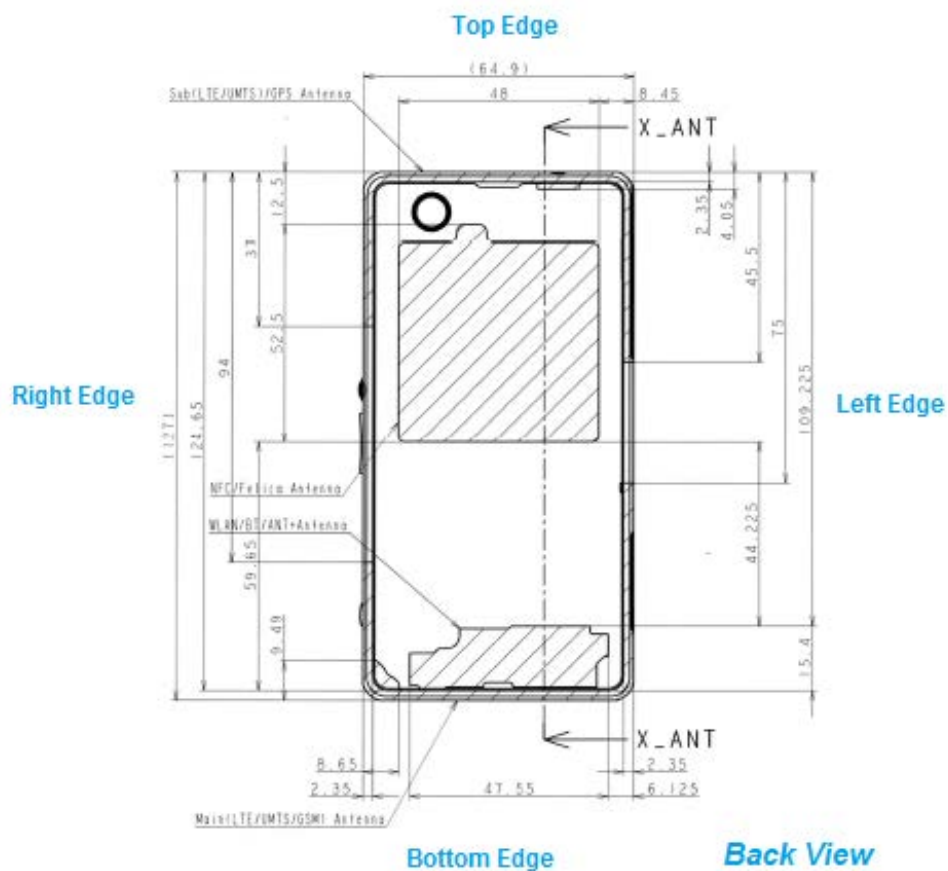

Picture 12.1 Antenna Locations

### 12.3 SAR Measurement Positions

According to the KDB941225 D06 Hot Spot SAR v01, the edges with less than 2.5 cm distance to the antennas need to be tested for SAR.

SAR measurement positions						
Mode	Front	Rear	Left edge	Right edge	Top edge	Bottom edge
Main antenna	Yes	Yes	Yes	Yes	No	Yes
WLAN	Yes	Yes	Yes	Yes	No	Yes

## 12.4 Standalone SAR Test Exclusion Considerations

Standalone 1-g head or body SAR evaluation by measurement or numerical simulation is not required when the corresponding SAR Exclusion Threshold condition, listed below, is satisfied. The 1-g SAR test exclusion threshold for 100 MHz to 6 GHz at test separation distances  $\leq 50$  mm are determined by:

$[(\text{max. power of channel, including tune-up tolerance, mW}) / (\text{min. test separation distance, mm})] \cdot [\sqrt{f(\text{GHz})}] \leq 3.0$  for 1-g SAR, where

- $f(\text{GHz})$  is the RF channel transmit frequency in GHz
- Power and distance are rounded to the nearest mW and mm before calculation
- The result is rounded to one decimal place for comparison

### Appendix A

#### SAR Test Exclusion Thresholds for 100 MHz – 6 GHz and $\leq 50$ mm

Approximate SAR Test Exclusion Power Thresholds at Selected Frequencies and Test Separation Distances are illustrated in the following Table.

MHz	5	10	15	20	25	mm
150	39	77	116	155	194	SAR Test Exclusion Threshold (mW)
300	27	55	82	110	137	
450	22	45	67	89	112	
835	16	33	49	66	82	
900	16	32	47	63	79	
1500	12	24	37	49	61	
1900	11	22	33	44	54	
2450	10	19	29	38	48	
3600	8	16	24	32	40	
5200	7	13	20	26	33	
5400	6	13	19	26	32	
5800	6	12	19	25	31	

Picture 12.2 Power Thresholds

Table 12.1: Standalone SAR test exclusion considerations

Band/Mode	F(GHz)	SAR test exclusion threshold (mW)	RF output power		SAR test exclusion
			dBm	mW	
Bluetooth	2.441	19	8.40	6.92	Yes
WLAN 2.4GHz	2.45	19	16.84	48.31	No
WLAN 5GHz	5.745	12	13.99	25.06	No

### 13 Evaluation of Simultaneous

**Table 13.1: The sum of reported SAR values for main antenna and WiFi**

	Position	GSM/WCDMA	WiFi (DTS)	Sum1	WiFi (UNII)	Sum2
Maximum reported SAR value for Head	Left hand, Touch cheek	1.01	0.13	1.14	0.05	1.06
Maximum reported SAR value for Body	Rear 10mm	1.01	0.10	1.11	/	/

Note1: Sum1 is GSM/WCDMA + WiFi (DTS). Sum2 is GSM/WCDMA + WiFi (UNII).

**Table 13.2: The sum of reported SAR values for main antenna and Bluetooth**

	Position	Main antenna	BT*	Sum
Highest reported SAR value for Head	Left hand, Touch cheek	1.01	0.12	1.13
Highest reported SAR value for Body	Rear 10mm	1.01	/	/

BT\* - Estimated SAR for Bluetooth (see the table 13.3)

**Table 13.3: Estimated SAR for Bluetooth**

Mode/Band	F (GHz)	Distance (mm)	Upper limit of power *		Estimated <sub>1g</sub> (W/kg)
			dBm	mW	
Bluetooth	2.441	15	9.5	8.91	0.12

\* - Maximum possible output power declared by manufacturer

When standalone SAR test exclusion applies to an antenna that transmits simultaneously with other antennas, the standalone SAR must be estimated according to following to determine simultaneous transmission SAR test exclusion:

$(\text{max. power of channel, including tune-up tolerance, mW}) / (\text{min. test separation distance, mm}) \cdot [\sqrt{f(\text{GHz})} / x]$  W/kg for test separation distances  $\leq 50$  mm;

where  $x = 7.5$  for 1-g SAR.

When the minimum test separation distance is  $< 5$  mm, a distance of 5 mm is applied to determine SAR test exclusion

#### Conclusion:

According to the above tables, the sum of reported SAR values is  $< 1.6$ W/kg. So the simultaneous transmission SAR with volume scans is not required.

## 14 SAR Test Result

It is determined by user manual for the distance between the EUT and the phantom bottom. The distance is 10mm for data and 15mm for speech and just applied to the condition of body worn accessory.

It is performed for all SAR measurements with area scan based 1-g SAR estimation (Fast SAR). A zoom scan measurement is added when the estimated 1-g SAR is the highest measured SAR in each exposure configuration, wireless mode and frequency band combination or more than 1.2W/kg.

The calculated SAR is obtained by the following formula:

$$\text{Reported SAR} = \text{Measured SAR} \times 10^{(P_{\text{Target}} - P_{\text{Measured}})/10}$$

Where  $P_{\text{Target}}$  is the power of manufacturing upper limit;

$P_{\text{Measured}}$  is the measured power in chapter 11.

**Table 14.1: Duty Cycle**

Mode	Duty Cycle
Speech for GSM850/1900	1:8.3
GPRS&EGPRS for GSM850/1900	1:4
WCDMA850 &WiFi	1:1

### 14.1 SAR results for Fast SAR

**Table 14.2: SAR Values (GSM 850 MHz Band - Head)**

Frequency		Side	Test Position	Figure No.	Ambient Temperature: 22.6 °C		Liquid Temperature: 22.1 °C				Power Drift (dB)
MHz	Ch.				Conducted Power (dBm)	Max. tune-up Power (dBm)	Measured SAR(10g) (W/kg)	Reported SAR(10g) (W/kg)	Measured SAR(1g) (W/kg)	Reported SAR(1g) (W/kg)	
848.8	251	Left	Touch	Fig.1	32.78	33.6	0.477	<b>0.58</b>	0.619	<b>0.75</b>	0.18
836.6	190	Left	Touch	/	32.75	33.6	0.417	<b>0.51</b>	0.536	<b>0.65</b>	-0.12
824.2	128	Left	Touch	/	32.88	33.6	0.322	<b>0.38</b>	0.413	<b>0.49</b>	0.12
836.6	190	Left	Tilt	/	32.75	33.6	0.141	<b>0.17</b>	0.180	<b>0.22</b>	-0.03
848.8	251	Right	Touch	/	32.78	33.6	0.462	<b>0.56</b>	0.597	<b>0.72</b>	0.05
836.6	190	Right	Touch	/	32.75	33.6	0.408	<b>0.50</b>	0.524	<b>0.64</b>	-0.14
824.2	128	Right	Touch	/	32.88	33.6	0.344	<b>0.41</b>	0.441	<b>0.52</b>	-0.03
836.6	190	Right	Tilt	/	32.75	33.6	0.149	<b>0.18</b>	0.192	<b>0.23</b>	-0.10

**Table 14.3: SAR Values (GSM 850 MHz Band - Body)**

Frequency		Mode (number of timeslots)	Test Position	Figure No.	Conducted Power (dBm)	Max. tune-up Power (dBm)	Measured SAR(10g) (W/kg)	Reported SAR(10g) (W/kg)	Measured SAR(1g) (W/kg)	Reported SAR(1g) (W/kg)	Power Drift (dB)
MHz	Ch.										
Ambient Temperature: 22.6 °C		Liquid Temperature: 22.1 °C									
836.6	190	GPRS (2)	Front	/	30.38	31.6	0.382	<b>0.51</b>	0.555	<b>0.74</b>	-0.05
848.8	251	GPRS (2)	Rear	Fig.2	30.41	31.6	0.599	<b>0.79</b>	0.767	<b>1.01</b>	0.07
836.6	190	GPRS (2)	Rear	/	30.38	31.6	0.379	<b>0.50</b>	0.556	<b>0.74</b>	0.07
824.2	128	GPRS (2)	Rear	/	30.56	31.6	0.383	<b>0.49</b>	0.564	<b>0.72</b>	0.03
836.6	190	GPRS (2)	Left	/	30.38	31.6	0.189	<b>0.25</b>	0.275	<b>0.36</b>	-0.03
836.6	190	GPRS (2)	Right	/	30.38	31.6	0.185	<b>0.25</b>	0.272	<b>0.36</b>	-0.04
836.6	190	GPRS (2)	Bottom	/	30.38	31.6	0.011	<b>0.02</b>	0.017	<b>0.02</b>	0.12
848.8	251	EGPRS (2)	Rear	/	30.32	31.6	0.591	<b>0.79</b>	0.752	<b>1.01</b>	-0.10
848.8	251	Speech	Rear Headset	/	32.78	33.6	0.278	<b>0.34</b>	0.410	<b>0.50</b>	0.03

Note1: The distance between the EUT and the phantom bottom is 10mm for data and 15mm for speech.

Note2: The type of Headset is MH750c

**Table 14.4: SAR Values (GSM 1900 MHz Band - Head)**

Frequency		Side	Test Position	Figure No.	Conducted Power (dBm)	Max. tune-up Power (dBm)	Measured SAR(10g) (W/kg)	Reported SAR(10g) (W/kg)	Measured SAR(1g) (W/kg)	Reported SAR(1g) (W/kg)	Power Drift (dB)
MHz	Ch.										
Ambient Temperature: 22.7 °C		Liquid Temperature: 22.2 °C									
1909.8	810	Left	Touch	Fig.3	29.89	30.6	0.408	<b>0.48</b>	0.649	<b>0.76</b>	0.13
1880	661	Left	Touch	/	29.78	30.6	0.329	<b>0.40</b>	0.563	<b>0.68</b>	0.03
1850.2	512	Left	Touch	/	29.81	30.6	0.305	<b>0.37</b>	0.524	<b>0.63</b>	0.00
1880	661	Left	Tilt	/	29.78	30.6	0.043	<b>0.05</b>	0.078	<b>0.09</b>	0.10
1909.8	810	Right	Touch	/	29.89	30.6	0.323	<b>0.38</b>	0.540	<b>0.64</b>	0.12
1880	661	Right	Touch	/	29.78	30.6	0.273	<b>0.33</b>	0.502	<b>0.61</b>	0.06
1850.2	512	Right	Touch	/	29.81	30.6	0.261	<b>0.31</b>	0.483	<b>0.58</b>	0.16
1880	661	Right	Tilt	/	29.78	30.6	0.076	<b>0.09</b>	0.148	<b>0.18</b>	0.10

**Table 14.5: SAR Values (GSM 1900 MHz Band - Body)**

Ambient Temperature: 22.7 °C      Liquid Temperature: 22.2 °C											
Frequency		Mode (number of timeslots)	Test Position	Figure No.	Conducted Power (dBm)	Max. tune-up Power (dBm)	Measured SAR(10g) (W/kg)	Reported SAR(10g) (W/kg)	Measured SAR(1g) (W/kg)	Reported SAR(1g) (W/kg)	Power Drift (dB)
MHz	Ch.										
1909.8	810	GPRS (2)	Front	Fig.4	27.42	28.0	0.486	<b>0.56</b>	0.812	<b>0.93</b>	0.07
1880	661	GPRS (2)	Front	/	27.30	28.0	0.461	<b>0.54</b>	0.714	<b>0.84</b>	0.18
1850.2	512	GPRS (2)	Front	/	27.36	28.0	0.443	<b>0.51</b>	0.679	<b>0.79</b>	0.04
1880	661	GPRS (2)	Rear	/	27.30	28.0	0.461	<b>0.54</b>	0.700	<b>0.82</b>	0.11
1880	661	GPRS (2)	Left	/	27.30	28.0	0.063	<b>0.07</b>	0.128	<b>0.15</b>	0.07
1880	661	GPRS (2)	Right	/	27.30	28.0	0.052	<b>0.06</b>	0.089	<b>0.11</b>	0.19
1880	661	GPRS (2)	Bottom	/	27.30	28.0	0.086	<b>0.10</b>	0.136	<b>0.16</b>	0.09
1909.8	810	EGPRS (2)	Front	/	27.42	28.0	0.507	<b>0.58</b>	0.799	<b>0.91</b>	-0.02
1909.8	810	Speech	Front Headset	/	29.89	30.6	0.248	<b>0.29</b>	0.387	<b>0.46</b>	0.12

Note1: The distance between the EUT and the phantom bottom is 10mm for data and 15mm for speech.

Note2: The type of Headset is MH750c

**Table 14.6: SAR Values (WCDMA 850 MHz Band - Head)**

Ambient Temperature: 22.6 °C      Liquid Temperature: 22.1 °C											
Frequency		Side	Test Position	Figure No.	Conducted Power (dBm)	Max. tune-up Power (dBm)	Measured SAR(10g) (W/kg)	Reported SAR(10g) (W/kg)	Measured SAR(1g) (W/kg)	Reported SAR(1g) (W/kg)	Power Drift (dB)
MHz	Ch.										
846.6	4233	Left	Touch	Fig.5	23.74	24.5	0.643	<b>0.77</b>	0.845	<b>1.01</b>	-0.04
836.4	4182	Left	Touch	/	23.84	24.5	0.496	<b>0.58</b>	0.728	<b>0.85</b>	-0.12
826.4	4132	Left	Touch	/	23.93	24.5	0.458	<b>0.52</b>	0.670	<b>0.76</b>	0.11
836.4	4182	Left	Tilt	/	23.84	24.5	0.263	<b>0.31</b>	0.338	<b>0.39</b>	0.15
846.6	4233	Right	Touch	/	23.74	24.5	0.522	<b>0.62</b>	0.673	<b>0.80</b>	0.03
836.4	4182	Right	Touch	/	23.84	24.5	0.419	<b>0.49</b>	0.619	<b>0.72</b>	0.17
826.4	4132	Right	Touch	/	23.93	24.5	0.396	<b>0.45</b>	0.583	<b>0.66</b>	0.14
836.4	4182	Right	Tilt	/	23.84	24.5	0.254	<b>0.30</b>	0.331	<b>0.39</b>	0.01



**Table 14.7: SAR Values (WCDMA 850 MHz Band - Body)**

Ambient Temperature: 22.6 °C						Liquid Temperature: 22.1 °C				
Frequency		Test Position	Figure No.	Conducted Power (dBm)	Max. tune-up Power (dBm)	Measured SAR(10g) (W/kg)	Reported SAR(10g) (W/kg)	Measured SAR(1g) (W/kg)	Reported SAR(1g) (W/kg)	Power Drift (dB)
MHz	Ch.									
836.4	4182	Front	/	23.84	24.5	0.574	<b>0.67</b>	0.724	<b>0.84</b>	-0.03
846.6	4233	Rear	/	23.74	24.5	0.564	<b>0.67</b>	0.723	<b>0.86</b>	0.04
836.4	4182	Rear	Fig.6	23.84	24.5	0.575	<b>0.67</b>	<b>0.734</b>	<b>0.85</b>	0.03
826.4	4132	Rear	/	23.93	24.5	0.457	<b>0.52</b>	0.671	<b>0.77</b>	-0.07
836.4	4182	Left	/	23.84	24.5	0.237	<b>0.28</b>	0.340	<b>0.40</b>	0.04
836.4	4182	Right	/	23.84	24.5	0.229	<b>0.27</b>	0.333	<b>0.39</b>	0.03
836.4	4182	Bottom	/	23.84	24.5	0.023	<b>0.03</b>	0.033	<b>0.04</b>	0.13
836.4	4182	Rear Headset	/	23.84	24.5	0.297	<b>0.35</b>	0.437	<b>0.51</b>	-0.09

Note1: The distance between the EUT and the phantom bottom is 10mm for data and 15mm for speech.

Note2: The type of Headset is MH750c

**Table 14.8: SAR Values (Wi-Fi 802.11b - Head)**

Ambient Temperature: 22.6 °C						Liquid Temperature: 22.1 °C					
Frequency		Side	Test Position	Figure No.	Conducted Power (dBm)	Max. tune-up Power (dBm)	Measured SAR(10g) (W/kg)	Reported SAR(10g) (W/kg)	Measured SAR(1g) (W/kg)	Reported SAR(1g) (W/kg)	Power Drift (dB)
MHz	Ch.										
2462	11	Left	Touch	/	15.38	16.8	0.041	<b>0.06</b>	0.082	<b>0.11</b>	-0.16
2437	6	Left	Touch	Fig.7	16.63	17.8	0.052	<b>0.07</b>	<b>0.100</b>	<b>0.13</b>	-0.17
2412	1	Left	Touch	/	15.67	17.1	0.041	<b>0.06</b>	0.074	<b>0.10</b>	0.15
2437	6	Left	Tilt	/	16.63	17.8	0.007	<b>0.01</b>	0.019	<b>0.03</b>	-0.14
2437	6	Right	Touch	/	16.63	17.8	0.019	<b>0.03</b>	0.040	<b>0.05</b>	0.00
2437	6	Right	Tilt	/	16.63	17.8	0.002	<b>0.00</b>	0.007	<b>0.01</b>	0.10

**Table 14.9: SAR Values (Wi-Fi 802.11b - Body)**

Ambient Temperature: 22.6 °C						Liquid Temperature: 22.1 °C				
Frequency		Test Position	Figure No.	Conducted Power (dBm)	Max. tune-up Power (dBm)	Measured SAR(10g) (W/kg)	Reported SAR(10g) (W/kg)	Measured SAR(1g) (W/kg)	Reported SAR(1g) (W/kg)	Power Drift (dB)
MHz	Ch.									
2437	6	Front	/	16.63	17.8	0.019	<b>0.02</b>	0.036	<b>0.05</b>	0.13
2462	11	Rear	/	15.38	16.8	0.022	<b>0.03</b>	0.047	<b>0.06</b>	0.13
2437	6	Rear	Fig.8	16.63	17.8	0.037	<b>0.05</b>	<b>0.073</b>	<b>0.10</b>	0.14
2412	1	Rear	/	15.67	17.1	0.024	<b>0.03</b>	0.050	<b>0.07</b>	0.13
2437	6	Left	/	16.63	17.8	0.008	<b>0.01</b>	0.025	<b>0.03</b>	0.13
2437	6	Right	/	16.63	17.8	0.002	<b>0.00</b>	0.005	<b>0.01</b>	0.17
2437	6	Bottom	/	16.63	17.8	0.008	<b>0.01</b>	0.017	<b>0.02</b>	0.18

Note1: The distance between the EUT and the phantom bottom is 10mm.

**Table 14.10: SAR Values (Wi-Fi 802.11a - Head)**

Frequency		Side	Test Position	Figure No.	Conducted Power (dBm)	Max. tune-up Power (dBm)	Ambient Temperature: 22.5 °C		Liquid Temperature: 22.0 °C		Power Drift (dB)
MHz	Ch.						Measured SAR(10g) (W/kg)	Reported SAR(10g) (W/kg)	Measured SAR(1g) (W/kg)	Reported SAR(1g) (W/kg)	
5180	36	Left	Touch	/	13.36	13.5	0.007	<b>0.01</b>	0.030	<b>0.03</b>	0.18
5180	36	Left	Tilt	/	13.36	13.5	0.003	<b>0.00</b>	0.013	<b>0.01</b>	0.10
5180	36	Right	Touch	Fig.9	13.36	13.5	0.022	<b>0.02</b>	0.077	<b>0.08</b>	0.13
5180	36	Right	Tilt	/	13.36	13.5	0.004	<b>0.00</b>	0.015	<b>0.02</b>	0.11
5260	52	Left	Touch	/	13.44	14.2	0.006	<b>0.01</b>	0.026	<b>0.03</b>	-0.05
5260	52	Left	Tilt	/	13.44	14.2	0.003	<b>0.00</b>	0.011	<b>0.01</b>	0.02
5260	52	Right	Touch	/	13.44	14.2	0.020	<b>0.02</b>	0.070	<b>0.08</b>	0.10
5260	52	Right	Tilt	/	13.44	14.2	0.004	<b>0.00</b>	0.013	<b>0.02</b>	0.00
5600	120	Left	Touch	/	13.80	14.2	0.003	<b>0.00</b>	0.014	<b>0.01</b>	0.12
5600	120	Left	Tilt	/	13.80	14.2	0.001	<b>0.00</b>	0.006	<b>0.01</b>	0.19
5600	120	Right	Touch	/	13.80	14.2	0.006	<b>0.01</b>	0.019	<b>0.02</b>	0.18
5600	120	Right	Tilt	/	13.80	14.2	0.002	<b>0.00</b>	0.008	<b>0.01</b>	0.00
5765	153	Left	Touch	/	13.52	14.2	0.005	<b>0.01</b>	0.022	<b>0.03</b>	0.16
5765	153	Left	Tilt	/	13.52	14.2	0.002	<b>0.00</b>	0.010	<b>0.01</b>	-0.15
5765	153	Right	Touch	/	13.52	14.2	0.007	<b>0.01</b>	0.026	<b>0.03</b>	0.00
5765	153	Right	Tilt	/	13.52	14.2	0.003	<b>0.00</b>	0.011	<b>0.01</b>	0.09

**Table 14.11: SAR Values (Wi-Fi 802.11a - Body)**

Frequency		Test Position	Figure No.	Conducted Power (dBm)	Max. tune-up Power (dBm)	Ambient Temperature: 22.5 °C		Liquid Temperature: 22.0 °C		Power Drift (dB)
MHz	Ch.					Measured SAR(10g) (W/kg)	Reported SAR(10g) (W/kg)	Measured SAR(1g) (W/kg)	Reported SAR(1g) (W/kg)	
5180	36	Front	/	13.36	13.5	0.004	<b>0.00</b>	0.014	<b>0.01</b>	0.12
5180	36	Rear	Fig.10	13.36	13.5	0.016	<b>0.02</b>	0.048	<b>0.05</b>	-0.16
5180	36	Left	/	13.36	13.5	0.004	<b>0.00</b>	0.013	<b>0.01</b>	0.13
5180	36	Right	/	13.36	13.5	0.003	<b>0.00</b>	0.009	<b>0.01</b>	0.12
5180	36	Bottom	/	13.36	13.5	0.002	<b>0.00</b>	0.006	<b>0.01</b>	0.12
5260	52	Front	/	13.44	14.2	0.005	<b>0.01</b>	0.016	<b>0.02</b>	0.04
5260	52	Rear	/	13.44	14.2	0.014	<b>0.02</b>	0.041	<b>0.05</b>	0.13
5260	52	Left	/	13.44	14.2	0.003	<b>0.00</b>	0.008	<b>0.01</b>	0.12
5260	52	Right	/	13.44	14.2	0.004	<b>0.00</b>	0.012	<b>0.01</b>	0.17
5260	52	Bottom	/	13.44	14.2	0.002	<b>0.00</b>	0.007	<b>0.01</b>	0.18
5600	120	Front	/	13.80	14.2	0.006	<b>0.01</b>	0.020	<b>0.02</b>	0.12
5600	120	Rear	/	13.80	14.2	0.015	<b>0.02</b>	0.046	<b>0.05</b>	0.12
5600	120	Left	/	13.80	14.2	0.003	<b>0.00</b>	0.008	<b>0.01</b>	-0.13
5600	120	Right	/	13.80	14.2	0.004	<b>0.00</b>	0.011	<b>0.01</b>	0.12
5600	120	Bottom	/	13.80	14.2	0.004	<b>0.00</b>	0.011	<b>0.01</b>	0.11
5765	153	Front	/	13.52	14.2	0.005	<b>0.01</b>	0.015	<b>0.02</b>	0.19
5765	153	Rear	/	13.52	14.2	0.015	<b>0.02</b>	0.046	<b>0.05</b>	0.10

5765	153	Left	/	13.52	14.2	0.006	<b>0.01</b>	0.017	<b>0.02</b>	0.01
5765	153	Right	/	13.52	14.2	0.003	<b>0.00</b>	0.008	<b>0.01</b>	0.13
5765	153	Bottom	/	13.52	14.2	0.003	<b>0.00</b>	0.009	<b>0.01</b>	-0.13

Note1: The distance between the EUT and the phantom bottom is 15mm.

**Table 14.12: SAR Values (Wi-Fi 802.11n - Head)**

				Ambient Temperature: 22.5 °C			Liquid Temperature: 22.0 °C				
Frequency		Side	Test Position	Figure No.	Conducted Power (dBm)	Max. tune-up Power (dBm)	Measured SAR(10g) (W/kg)	Reported SAR(10g) (W/kg)	Measured SAR(1g) (W/kg)	Reported SAR(1g) (W/kg)	Power Drift (dB)
MHz	Ch.										
5180	36	Left	Touch	/	13.75	13.8	0.029	<b>0.03</b>	0.050	<b>0.05</b>	0.17
5180	36	Left	Tilt	/	13.75	13.8	0.014	<b>0.01</b>	0.024	<b>0.02</b>	0.18
5180	36	Right	Touch	Fig.11	13.75	13.8	0.028	<b>0.03</b>	0.092	<b>0.09</b>	0.17
5180	36	Right	Tilt	/	13.75	13.8	0.008	<b>0.01</b>	0.024	<b>0.02</b>	0.18
5260	52	Left	Touch	/	13.90	14.5	0.015	<b>0.02</b>	0.026	<b>0.03</b>	0.16
5260	52	Left	Tilt	/	13.90	14.5	0.012	<b>0.01</b>	0.021	<b>0.02</b>	0.17
5260	52	Right	Touch	/	13.90	14.5	0.011	<b>0.01</b>	0.032	<b>0.04</b>	0.10
5260	52	Right	Tilt	/	13.90	14.5	0.008	<b>0.01</b>	0.025	<b>0.03</b>	0.13
5765	153	Left	Touch	/	13.99	14.5	0.018	<b>0.02</b>	0.031	<b>0.03</b>	0.12
5765	153	Left	Tilt	/	13.99	14.5	0.007	<b>0.01</b>	0.012	<b>0.01</b>	0.11
5765	153	Right	Touch	/	13.99	14.5	0.017	<b>0.02</b>	0.052	<b>0.06</b>	0.18
5765	153	Right	Tilt	/	13.99	14.5	0.007	<b>0.01</b>	0.020	<b>0.02</b>	0.14

**Table 14.13: SAR Values (Wi-Fi 802.11n - Body)**

				Ambient Temperature: 22.5 °C			Liquid Temperature: 22.0 °C			
Frequency		Test Position	Figure No.	Conducted Power (dBm)	Max. tune-up Power (dBm)	Measured SAR(10g) (W/kg)	Reported SAR(10g) (W/kg)	Measured SAR(1g) (W/kg)	Reported SAR(1g) (W/kg)	Power Drift (dB)
MHz	Ch.									
5180	36	Front	/	13.75	13.8	0.006	<b>0.01</b>	0.017	<b>0.02</b>	0.18
5180	36	Rear	Fig.12	13.75	13.8	0.015	<b>0.02</b>	0.043	<b>0.04</b>	-0.17
5180	36	Left	/	13.75	13.8	0.004	<b>0.00</b>	0.013	<b>0.01</b>	0.11
5180	36	Right	/	13.75	13.8	0.005	<b>0.01</b>	0.015	<b>0.02</b>	-0.15
5180	36	Bottom	/	13.75	13.8	0.005	<b>0.00</b>	0.014	<b>0.01</b>	0.11
5260	52	Front	/	13.90	14.5	0.006	<b>0.01</b>	0.018	<b>0.02</b>	0.15
5260	52	Rear	/	13.90	14.5	0.013	<b>0.01</b>	0.037	<b>0.04</b>	0.12
5260	52	Left	/	13.90	14.5	0.004	<b>0.00</b>	0.012	<b>0.01</b>	0.17
5260	52	Right	/	13.90	14.5	0.005	<b>0.01</b>	0.014	<b>0.02</b>	-0.12
5260	52	Bottom	/	13.90	14.5	0.003	<b>0.00</b>	0.010	<b>0.01</b>	0.18
5765	153	Front	/	13.99	14.5	0.007	<b>0.01</b>	0.021	<b>0.02</b>	-0.06
5765	153	Rear	/	13.99	14.5	0.014	<b>0.02</b>	0.042	<b>0.05</b>	0.10
5765	153	Left	/	13.99	14.5	0.005	<b>0.01</b>	0.014	<b>0.02</b>	-0.18
5765	153	Right	/	13.99	14.5	0.008	<b>0.01</b>	0.023	<b>0.03</b>	0.19
5765	153	Bottom	/	13.99	14.5	0.004	<b>0.00</b>	0.012	<b>0.01</b>	0.12

Note1: The distance between the EUT and the phantom bottom is 15mm.

**Table 14.14: SAR Values (Wi-Fi 802.11ac - Head)**

Frequency		Side	Test Position	Figure No.	Ambient Temperature: 22.5 °C		Liquid Temperature: 22.0 °C				Power Drift (dB)
MHz	Ch.				Conducted Power (dBm)	Max. tune-up Power (dBm)	Measured SAR(10g) (W/kg)	Reported SAR(10g) (W/kg)	Measured SAR(1g) (W/kg)	Reported SAR(1g) (W/kg)	
5180	36	Left	Touch	/	13.73	13.8	0.013	<b>0.01</b>	0.042	<b>0.04</b>	-0.15
5180	36	Left	Tilt	/	13.73	13.8	0.009	<b>0.01</b>	0.028	<b>0.03</b>	0.13
5180	36	Right	Touch	Fig.13	13.73	13.8	0.023	<b>0.02</b>	0.077	<b>0.08</b>	0.16
5180	36	Right	Tilt	/	13.73	13.8	0.007	<b>0.01</b>	0.024	<b>0.02</b>	0.10
5260	52	Left	Touch	/	13.86	14.5	0.010	<b>0.01</b>	0.031	<b>0.04</b>	0.11
5260	52	Left	Tilt	/	13.86	14.5	0.007	<b>0.01</b>	0.023	<b>0.03</b>	0.18
5260	52	Right	Touch	/	13.86	14.5	0.016	<b>0.02</b>	0.054	<b>0.06</b>	0.12
5260	52	Right	Tilt	/	13.86	14.5	0.006	<b>0.01</b>	0.021	<b>0.02</b>	0.18
5765	153	Left	Touch	/	13.97	14.5	0.011	<b>0.01</b>	0.035	<b>0.04</b>	0.10
5765	153	Left	Tilt	/	13.97	14.5	0.005	<b>0.01</b>	0.017	<b>0.02</b>	0.14
5765	153	Right	Touch	/	13.97	14.5	0.019	<b>0.02</b>	0.061	<b>0.07</b>	0.15
5765	153	Right	Tilt	/	13.97	14.5	0.006	<b>0.01</b>	0.018	<b>0.02</b>	-0.11

**Table 14.15: SAR Values (Wi-Fi 802.11ac - Body)**

Frequency		Test Position	Figure No.	Ambient Temperature: 22.5 °C		Liquid Temperature: 22.0 °C				Power Drift (dB)
MHz	Ch.			Conducted Power (dBm)	Max. tune-up Power (dBm)	Measured SAR(10g) (W/kg)	Reported SAR(10g) (W/kg)	Measured SAR(1g) (W/kg)	Reported SAR(1g) (W/kg)	
5180	36	Front	/	13.73	13.8	0.008	<b>0.01</b>	0.021	<b>0.02</b>	0.14
5180	36	Rear	Fig.14	13.73	13.8	0.017	<b>0.02</b>	0.042	<b>0.04</b>	0.19
5180	36	Left	/	13.73	13.8	0.006	<b>0.01</b>	0.016	<b>0.02</b>	0.12
5180	36	Right	/	13.73	13.8	0.008	<b>0.01</b>	0.020	<b>0.02</b>	0.12
5180	36	Bottom	/	13.73	13.8	0.012	<b>0.01</b>	0.031	<b>0.03</b>	-0.13
5260	52	Front	/	13.86	14.5	0.008	<b>0.01</b>	0.020	<b>0.02</b>	0.02
5260	52	Rear	/	13.86	14.5	0.013	<b>0.02</b>	0.033	<b>0.04</b>	0.10
5260	52	Left	/	13.86	14.5	0.005	<b>0.01</b>	0.013	<b>0.01</b>	0.16
5260	52	Right	/	13.86	14.5	0.006	<b>0.01</b>	0.016	<b>0.02</b>	0.10
5260	52	Bottom	/	13.86	14.5	0.009	<b>0.01</b>	0.023	<b>0.03</b>	0.14
5765	153	Front	/	13.97	14.5	0.010	<b>0.01</b>	0.025	<b>0.03</b>	-0.14
5765	153	Rear	/	13.97	14.5	0.016	<b>0.02</b>	0.040	<b>0.04</b>	0.16
5765	153	Left	/	13.97	14.5	0.008	<b>0.01</b>	0.019	<b>0.02</b>	-0.16
5765	153	Right	/	13.97	14.5	0.008	<b>0.01</b>	0.020	<b>0.02</b>	0.12
5765	153	Bottom	/	13.97	14.5	0.006	<b>0.01</b>	0.015	<b>0.02</b>	-0.13

Note1: The distance between the EUT and the phantom bottom is 15mm.

## 14.2 SAR results for Standard procedure

There is zoom scan measurement to be added for the highest measured SAR in each exposure configuration/band.

**Table 14.16: SAR Values (GSM 850 MHz Band - Head)**

Ambient Temperature: 22.6 °C						Liquid Temperature: 22.1 °C					
Frequency		Side	Test Position	Figure No.	Conducted Power (dBm)	Max. tune-up Power (dBm)	Measured SAR(10g) (W/kg)	Reported SAR(10g) (W/kg)	Measured SAR(1g) (W/kg)	Reported SAR(1g) (W/kg)	Power Drift (dB)
MHz	Ch.										
848.8	251	Left	Touch	Fig.1	32.78	33.6	0.477	<b>0.58</b>	0.619	<b>0.75</b>	0.18

**Table 14.17: SAR Values (GSM 850 MHz Band - Body)**

Ambient Temperature: 22.6 °C						Liquid Temperature: 22.1 °C					
Frequency		Mode (number of timeslots)	Test Position	Figure No.	Conducted Power (dBm)	Max. tune-up Power (dBm)	Measured SAR(10g) (W/kg)	Reported SAR(10g) (W/kg)	Measured SAR(1g) (W/kg)	Reported SAR(1g) (W/kg)	Power Drift (dB)
MHz	Ch.										
848.8	251	GPRS (2)	Rear	Fig.2	30.41	31.6	0.599	<b>0.79</b>	0.767	<b>1.01</b>	0.07

Note1: The distance between the EUT and the phantom bottom is 10mm for data and 15mm for speech.

**Table 14.18: SAR Values (GSM 1900 MHz Band - Head)**

Ambient Temperature: 22.7 °C						Liquid Temperature: 22.2 °C					
Frequency		Side	Test Position	Figure No.	Conducted Power (dBm)	Max. tune-up Power (dBm)	Measured SAR(10g) (W/kg)	Reported SAR(10g) (W/kg)	Measured SAR(1g) (W/kg)	Reported SAR(1g) (W/kg)	Power Drift (dB)
MHz	Ch.										
1909.8	810	Left	Touch	Fig.3	29.89	30.6	0.408	<b>0.48</b>	0.649	<b>0.76</b>	0.13

**Table 14.19: SAR Values (GSM 1900 MHz Band - Body)**

Ambient Temperature: 22.7 °C						Liquid Temperature: 22.2 °C					
Frequency		Mode (number of timeslots)	Test Position	Figure No.	Conducted Power (dBm)	Max. tune-up Power (dBm)	Measured SAR(10g) (W/kg)	Reported SAR(10g) (W/kg)	Measured SAR(1g) (W/kg)	Reported SAR(1g) (W/kg)	Power Drift (dB)
MHz	Ch.										
1909.8	810	GPRS (2)	Front	Fig.4	27.42	28.0	0.486	<b>0.56</b>	0.812	<b>0.93</b>	0.07

Note1: The distance between the EUT and the phantom bottom is 10mm for data and 15mm for speech.

**Table 14.20: SAR Values (WCDMA 850 MHz Band - Head)**

Ambient Temperature: 22.6 °C						Liquid Temperature: 22.1 °C					
Frequency		Side	Test Position	Figure No.	Conducted Power (dBm)	Max. tune-up Power (dBm)	Measured SAR(10g) (W/kg)	Reported SAR(10g) (W/kg)	Measured SAR(1g) (W/kg)	Reported SAR(1g) (W/kg)	Power Drift (dB)
MHz	Ch.										
846.6	4233	Left	Touch	Fig.5	23.74	24.5	0.643	<b>0.77</b>	0.845	<b>1.01</b>	-0.04

**Table 14.21: SAR Values (WCDMA 850 MHz Band - Body)**

Ambient Temperature: 22.6 °C						Liquid Temperature: 22.1 °C					
Frequency		Test Position	Figure No.	Conducted Power (dBm)	Max. tune-up Power (dBm)	Measured SAR(10g) (W/kg)	Reported SAR(10g) (W/kg)	Measured SAR(1g) (W/kg)	Reported SAR(1g) (W/kg)	Power Drift (dB)	
MHz	Ch.										
836.4	4182	Rear	Fig.6	23.84	24.5	0.575	<b>0.67</b>	0.734	<b>0.85</b>	0.03	

Note1: The distance between the EUT and the phantom bottom is 10mm for data and 15mm for speech.

**Table 14.22: SAR Values (Wi-Fi 802.11b - Head)**

Frequency		Side	Test Position	Figure No.	Conducted Power (dBm)	Max. tune-up Power (dBm)	Ambient Temperature: 22.6 °C		Liquid Temperature: 22.1 °C		Power Drift (dB)
MHz	Ch.						Measured SAR(10g) (W/kg)	Reported SAR(10g) (W/kg)	Measured SAR(1g) (W/kg)	Reported SAR(1g) (W/kg)	
2437	6	Left	Touch	Fig.7	16.63	17.8	0.052	<b>0.07</b>	0.100	<b>0.13</b>	-0.17

**Table 14.23: SAR Values (Wi-Fi 802.11b - Body)**

Frequency		Test Position	Figure No.	Conducted Power (dBm)	Max. tune-up Power (dBm)	Ambient Temperature: 22.6 °C		Liquid Temperature: 22.1 °C		Power Drift (dB)
MHz	Ch.					Measured SAR(10g) (W/kg)	Reported SAR(10g) (W/kg)	Measured SAR(1g) (W/kg)	Reported SAR(1g) (W/kg)	
2437	6	Rear	Fig.8	16.63	17.8	0.037	<b>0.05</b>	0.073	<b>0.10</b>	0.14

Note1: The distance between the EUT and the phantom bottom is 10mm.

**Table 14.24: SAR Values (Wi-Fi 802.11a - Head)**

Frequency		Side	Test Position	Figure No.	Conducted Power (dBm)	Max. tune-up Power (dBm)	Ambient Temperature: 22.5 °C		Liquid Temperature: 22.0 °C		Power Drift (dB)
MHz	Ch.						Measured SAR(10g) (W/kg)	Reported SAR(10g) (W/kg)	Measured SAR(1g) (W/kg)	Reported SAR(1g) (W/kg)	
5180	36	Right	Touch	Fig.9	13.36	13.5	0.022	<b>0.02</b>	0.077	<b>0.08</b>	0.13

**Table 14.25: SAR Values (Wi-Fi 802.11a - Body)**

Frequency		Test Position	Figure No.	Conducted Power (dBm)	Max. tune-up Power (dBm)	Ambient Temperature: 22.5 °C		Liquid Temperature: 22.0 °C		Power Drift (dB)
MHz	Ch.					Measured SAR(10g) (W/kg)	Reported SAR(10g) (W/kg)	Measured SAR(1g) (W/kg)	Reported SAR(1g) (W/kg)	
5180	36	Rear	Fig.10	13.36	13.5	0.016	<b>0.02</b>	0.048	<b>0.05</b>	-0.16

Note1: The distance between the EUT and the phantom bottom is 15mm.

**Table 14.26: SAR Values (Wi-Fi 802.11n - Head)**

Frequency		Side	Test Position	Figure No.	Conducted Power (dBm)	Max. tune-up Power (dBm)	Ambient Temperature: 22.5 °C		Liquid Temperature: 22.0 °C		Power Drift (dB)
MHz	Ch.						Measured SAR(10g) (W/kg)	Reported SAR(10g) (W/kg)	Measured SAR(1g) (W/kg)	Reported SAR(1g) (W/kg)	
5180	36	Right	Touch	Fig.11	13.75	13.8	0.028	<b>0.03</b>	0.092	<b>0.09</b>	0.17

**Table 14.27: SAR Values (Wi-Fi 802.11n - Body)**

Frequency		Test Position	Figure No.	Conducted Power (dBm)	Max. tune-up Power (dBm)	Ambient Temperature: 22.5 °C		Liquid Temperature: 22.0 °C		Power Drift (dB)
MHz	Ch.					Measured SAR(10g) (W/kg)	Reported SAR(10g) (W/kg)	Measured SAR(1g) (W/kg)	Reported SAR(1g) (W/kg)	
5180	36	Rear	Fig.12	13.75	13.8	0.015	<b>0.02</b>	0.043	<b>0.04</b>	-0.17

Note1: The distance between the EUT and the phantom bottom is 15mm.

**Table 14.28: SAR Values (Wi-Fi 802.11ac - Head)**

Frequency		Side	Test Position	Figure No.	Ambient Temperature: 22.5 °C		Liquid Temperature: 22.0 °C				
MHz	Ch.				Conducted Power (dBm)	Max. tune-up Power (dBm)	Measured SAR(10g) (W/kg)	Reported SAR(10g) (W/kg)	Measured SAR(1g) (W/kg)	Reported SAR(1g) (W/kg)	Power Drift (dB)
5180	36	Right	Touch	Fig.13	13.73	13.8	0.023	<b>0.02</b>	0.077	<b>0.08</b>	0.16

**Table 14.29: SAR Values (Wi-Fi 802.11ac - Body)**

Frequency		Test Position	Figure No.	Ambient Temperature: 22.5 °C		Liquid Temperature: 22.0 °C				
MHz	Ch.			Conducted Power (dBm)	Max. tune-up Power (dBm)	Measured SAR(10g) (W/kg)	Reported SAR(10g) (W/kg)	Measured SAR(1g) (W/kg)	Reported SAR(1g) (W/kg)	Power Drift (dB)
5180	36	Rear	Fig.14	13.73	13.8	0.017	<b>0.02</b>	0.042	<b>0.04</b>	0.19

Note1: The distance between the EUT and the phantom bottom is 15mm.

## 15 SAR Measurement Variability

SAR measurement variability must be assessed for each frequency band, which is determined by the SAR probe calibration point and tissue-equivalent medium used for the device measurements. When both head and body tissue-equivalent media are required for SAR measurements in a frequency band, the variability measurement procedures should be applied to the tissue medium with the highest measured SAR, using the highest measured SAR configuration for that tissue-equivalent medium.

The following procedures are applied to determine if repeated measurements are required.

- 1) Repeated measurement is not required when the original highest measured SAR is  $< 0.80$  W/kg; steps 2) through 4) do not apply.
- 2) When the original highest measured SAR is  $\geq 0.80$  W/kg, repeat that measurement once.
- 3) Perform a second repeated measurement only if the ratio of largest to smallest SAR for the original and first repeated measurements is  $> 1.20$  or when the original or repeated measurement is  $\geq 1.45$  W/kg (~ 10% from the 1-g SAR limit).
- 4) Perform a third repeated measurement only if the original, first or second repeated measurement is  $\geq 1.5$  W/kg and the ratio of largest to smallest SAR for the original, first and second repeated measurements is  $> 1.20$ .

**Table 15.1: SAR Measurement Variability for Body GSM 1900 (1g)**

Frequency		Test Position	Spacing (mm)	Original SAR (W/kg)	First Repeated SAR (W/kg)	The Ratio	Second Repeated SAR (W/kg)
MHz	Ch.						
1909.8	810	Front	10	0.812	0.807	1.01	/

**Table 15.2: SAR Measurement Variability for Head WCDMA 850 (1g)**

Frequency		Side	Test Position	Original SAR (W/kg)	First Repeated SAR (W/kg)	The Ratio	Second Repeated SAR (W/kg)
MHz	Ch.						
846.6	4233	Left	Cheek	0.845	0.837	1.01	/



## 16 Measurement Uncertainty

### 16.1 Measurement Uncertainty for Normal SAR Tests (300MHz~3GHz)

No.	Error Description	Type	Uncertainty value	Probably Distribution	Div.	(Ci) 1g	(Ci) 10g	Std. Unc. (1g)	Std. Unc. (10g)	Degree of freedom
<b>Measurement system</b>										
1	Probe calibration	B	5.5	N	1	1	1	5.5	5.5	$\infty$
2	Isotropy	B	4.7	R	$\sqrt{3}$	0.7	0.7	1.9	1.9	$\infty$
3	Boundary effect	B	1.0	R	$\sqrt{3}$	1	1	0.6	0.6	$\infty$
4	Linearity	B	4.7	R	$\sqrt{3}$	1	1	2.7	2.7	$\infty$
5	Detection limit	B	1.0	R	$\sqrt{3}$	1	1	0.6	0.6	$\infty$
6	Readout electronics	B	0.3	R	$\sqrt{3}$	1	1	0.3	0.3	$\infty$
7	Response time	B	0.8	R	$\sqrt{3}$	1	1	0.5	0.5	$\infty$
8	Integration time	B	2.6	R	$\sqrt{3}$	1	1	1.5	1.5	$\infty$
9	RF ambient conditions-noise	B	0	R	$\sqrt{3}$	1	1	0	0	$\infty$
10	RF ambient conditions-reflection	B	0	R	$\sqrt{3}$	1	1	0	0	$\infty$
11	Probe positioned mech. restrictions	B	0.4	R	$\sqrt{3}$	1	1	0.2	0.2	$\infty$
12	Probe positioning with respect to phantom shell	B	2.9	R	$\sqrt{3}$	1	1	1.7	1.7	$\infty$
13	Post-processing	B	1.0	R	$\sqrt{3}$	1	1	0.6	0.6	$\infty$
<b>Test sample related</b>										
14	Test sample positioning	A	3.3	N	1	1	1	3.3	3.3	71
15	Device holder uncertainty	A	3.4	N	1	1	1	3.4	3.4	5
16	Drift of output power	B	5.0	R	$\sqrt{3}$	1	1	2.9	2.9	$\infty$
<b>Phantom and set-up</b>										
17	Phantom uncertainty	B	4.0	R	$\sqrt{3}$	1	1	2.3	2.3	$\infty$
18	Liquid conductivity (target)	B	5.0	R	$\sqrt{3}$	0.64	0.43	1.8	1.2	$\infty$
19	Liquid conductivity (meas.)	A	2.06	N	1	0.64	0.43	1.32	0.89	43
20	Liquid permittivity (target)	B	5.0	R	$\sqrt{3}$	0.6	0.49	1.7	1.4	$\infty$
21	Liquid permittivity (meas.)	A	1.6	N	1	0.6	0.49	1.0	0.8	521

Combined standard uncertainty	$u_c = \sqrt{\sum_{i=1}^{21} c_i^2 u_i^2}$							9.25	9.12	257
Expanded uncertainty (confidence interval of 95 %)	$u_e = 2u_c$							18.5	18.2	

### 16.2 Measurement Uncertainty for Normal SAR Tests (3~6GHz)

No.	Error Description	Type	Uncertainty value	Probably Distribution	Div.	(Ci) 1g	(Ci) 10g	Std. Unc. (1g)	Std. Unc. (10g)	Degree of freedom
<b>Measurement system</b>										
1	Probe calibration	B	6.5	N	1	1	1	6.5	6.5	$\infty$
2	Isotropy	B	4.7	R	$\sqrt{3}$	0.7	0.7	1.9	1.9	$\infty$
3	Boundary effect	B	2.0	R	$\sqrt{3}$	1	1	1.2	1.2	$\infty$
4	Linearity	B	4.7	R	$\sqrt{3}$	1	1	2.7	2.7	$\infty$
5	Detection limit	B	1.0	R	$\sqrt{3}$	1	1	0.6	0.6	$\infty$
6	Readout electronics	B	0.3	R	$\sqrt{3}$	1	1	0.3	0.3	$\infty$
7	Response time	B	0.8	R	$\sqrt{3}$	1	1	0.5	0.5	$\infty$
8	Integration time	B	2.6	R	$\sqrt{3}$	1	1	1.5	1.5	$\infty$
9	RF ambient conditions-noise	B	0	R	$\sqrt{3}$	1	1	0	0	$\infty$
10	RF ambient conditions-reflection	B	0	R	$\sqrt{3}$	1	1	0	0	$\infty$
11	Probe positioned mech. restrictions	B	0.8	R	$\sqrt{3}$	1	1	0.5	0.5	$\infty$
12	Probe positioning with respect to phantom shell	B	6.7	R	$\sqrt{3}$	1	1	3.9	3.9	$\infty$
13	Post-processing	B	4.0	R	$\sqrt{3}$	1	1	2.3	2.3	$\infty$
<b>Test sample related</b>										
14	Test sample positioning	A	3.3	N	1	1	1	3.3	3.3	71
15	Device holder uncertainty	A	3.4	N	1	1	1	3.4	3.4	5
16	Drift of output power	B	5.0	R	$\sqrt{3}$	1	1	2.9	2.9	$\infty$
<b>Phantom and set-up</b>										
17	Phantom uncertainty	B	4.0	R	$\sqrt{3}$	1	1	2.3	2.3	$\infty$
18	Liquid conductivity (target)	B	5.0	R	$\sqrt{3}$	0.64	0.43	1.8	1.2	$\infty$
19	Liquid conductivity (meas.)	A	2.06	N	1	0.64	0.43	1.32	0.89	43

20	Liquid permittivity (target)	B	5.0	R	$\sqrt{3}$	0.6	0.49	1.7	1.4	$\infty$
21	Liquid permittivity (meas.)	A	1.6	N	1	0.6	0.49	1.0	0.8	521
Combined standard uncertainty		$u_c = \sqrt{\sum_{i=1}^{21} c_i^2 u_i^2}$						10.8	10.7	257
Expanded uncertainty (confidence interval of 95 %)		$u_e = 2u_c$						21.6	21.4	

### 16.3 Measurement Uncertainty for Fast SAR Tests (300MHz~3GHz)

No.	Error Description	Type	Uncertainty value	Probably Distribution	Div.	(Ci) 1g	(Ci) 10g	Std. Unc. (1g)	Std. Unc. (10g)	Degree of freedom
<b>Measurement system</b>										
1	Probe calibration	B	5.5	N	1	1	1	5.5	5.5	$\infty$
2	Isotropy	B	4.7	R	$\sqrt{3}$	0.7	0.7	1.9	1.9	$\infty$
3	Boundary effect	B	1.0	R	$\sqrt{3}$	1	1	0.6	0.6	$\infty$
4	Linearity	B	4.7	R	$\sqrt{3}$	1	1	2.7	2.7	$\infty$
5	Detection limit	B	1.0	R	$\sqrt{3}$	1	1	0.6	0.6	$\infty$
6	Readout electronics	B	0.3	R	$\sqrt{3}$	1	1	0.3	0.3	$\infty$
7	Response time	B	0.8	R	$\sqrt{3}$	1	1	0.5	0.5	$\infty$
8	Integration time	B	2.6	R	$\sqrt{3}$	1	1	1.5	1.5	$\infty$
9	RF ambient conditions-noise	B	0	R	$\sqrt{3}$	1	1	0	0	$\infty$
10	RF ambient conditions-reflection	B	0	R	$\sqrt{3}$	1	1	0	0	$\infty$
11	Probe positioned mech. Restrictions	B	0.4	R	$\sqrt{3}$	1	1	0.2	0.2	$\infty$
12	Probe positioning with respect to phantom shell	B	2.9	R	$\sqrt{3}$	1	1	1.7	1.7	$\infty$
13	Post-processing	B	1.0	R	$\sqrt{3}$	1	1	0.6	0.6	$\infty$
14	Fast SAR z-Approximation	B	7.0	R	$\sqrt{3}$	1	1	4.0	4.0	$\infty$
<b>Test sample related</b>										
15	Test sample positioning	A	3.3	N	1	1	1	3.3	3.3	71
16	Device holder uncertainty	A	3.4	N	1	1	1	3.4	3.4	5
17	Drift of output power	B	5.0	R	$\sqrt{3}$	1	1	2.9	2.9	$\infty$
<b>Phantom and set-up</b>										

18	Phantom uncertainty	B	4.0	R	$\sqrt{3}$	1	1	2.3	2.3	$\infty$
19	Liquid conductivity (target)	B	5.0	R	$\sqrt{3}$	0.64	0.43	1.8	1.2	$\infty$
20	Liquid conductivity (meas.)	A	2.06	N	1	0.64	0.43	1.32	0.89	43
21	Liquid permittivity (target)	B	5.0	R	$\sqrt{3}$	0.6	0.49	1.7	1.4	$\infty$
22	Liquid permittivity (meas.)	A	1.6	N	1	0.6	0.49	1.0	0.8	521
Combined standard uncertainty		$u_c = \sqrt{\sum_{i=1}^{22} c_i^2 u_i^2}$						10.1	9.95	257
Expanded uncertainty (confidence interval of 95 %)		$u_e = 2u_c$						20.2	19.9	

#### 16.4 Measurement Uncertainty for Fast SAR Tests (3~6GHz)

No.	Error Description	Type	Uncertainty value	Probably Distribution	Div.	(Ci) 1g	(Ci) 10g	Std. Unc. (1g)	Std. Unc. (10g)	Degree of freedom
<b>Measurement system</b>										
1	Probe calibration	B	6.5	N	1	1	1	6.5	6.5	$\infty$
2	Isotropy	B	4.7	R	$\sqrt{3}$	0.7	0.7	1.9	1.9	$\infty$
3	Boundary effect	B	2.0	R	$\sqrt{3}$	1	1	1.2	1.2	$\infty$
4	Linearity	B	4.7	R	$\sqrt{3}$	1	1	2.7	2.7	$\infty$
5	Detection limit	B	1.0	R	$\sqrt{3}$	1	1	0.6	0.6	$\infty$
6	Readout electronics	B	0.3	R	$\sqrt{3}$	1	1	0.3	0.3	$\infty$
7	Response time	B	0.8	R	$\sqrt{3}$	1	1	0.5	0.5	$\infty$
8	Integration time	B	2.6	R	$\sqrt{3}$	1	1	1.5	1.5	$\infty$
9	RF ambient conditions-noise	B	0	R	$\sqrt{3}$	1	1	0	0	$\infty$
10	RF ambient conditions-reflection	B	0	R	$\sqrt{3}$	1	1	0	0	$\infty$
11	Probe positioned mech. Restrictions	B	0.8	R	$\sqrt{3}$	1	1	0.5	0.5	$\infty$
12	Probe positioning with respect to phantom shell	B	6.7	R	$\sqrt{3}$	1	1	3.9	3.9	$\infty$
13	Post-processing	B	1.0	R	$\sqrt{3}$	1	1	0.6	0.6	$\infty$
14	Fast SAR z-Approximation	B	14.0	R	$\sqrt{3}$	1	1	8.1	8.1	$\infty$
<b>Test sample related</b>										
15	Test sample	A	3.3	N	1	1	1	3.3	3.3	71

	positioning									
16	Device holder uncertainty	A	3.4	N	1	1	1	3.4	3.4	5
17	Drift of output power	B	5.0	R	$\sqrt{3}$	1	1	2.9	2.9	$\infty$
<b>Phantom and set-up</b>										
18	Phantom uncertainty	B	4.0	R	$\sqrt{3}$	1	1	2.3	2.3	$\infty$
19	Liquid conductivity (target)	B	5.0	R	$\sqrt{3}$	0.64	0.43	1.8	1.2	$\infty$
20	Liquid conductivity (meas.)	A	2.06	N	1	0.64	0.43	1.32	0.89	43
21	Liquid permittivity (target)	B	5.0	R	$\sqrt{3}$	0.6	0.49	1.7	1.4	$\infty$
22	Liquid permittivity (meas.)	A	1.6	N	1	0.6	0.49	1.0	0.8	521
Combined standard uncertainty		$u_c = \sqrt{\sum_{i=1}^{22} c_i^2 u_i^2}$						13.3	13.2	257
Expanded uncertainty (confidence interval of 95 %)		$u_e = 2u_c$						26.6	26.4	

## 17 MAIN TEST INSTRUMENTS

Table 17.1: List of Main Instruments

No.	Name	Type	Serial Number	Calibration Date	Valid Period
01	Network analyzer	E5071C	MY46110673	February 15, 2013	One year
02	Power meter	NRVD	102083	September 11, 2013	One year
03	Power sensor	NRV-Z5	100542		
04	Signal Generator	E4438C	MY49070393	November 13, 2012	One Year
05	Amplifier	60S1G4	0331848	No Calibration Requested	
06	BTS	E5515C	MY50263375	January 30, 2013	One year
07	E-field Probe	SPEAG EX3DV4	3846	December 20, 2012	One year
08	DAE	SPEAG DAE4	771	November 20, 2012	One year
09	Dipole Validation Kit	SPEAG D835V2	443	August 29, 2013	One year
10	Dipole Validation Kit	SPEAG D1900V2	5d101	July 09, 2013	One year
11	Dipole Validation Kit	SPEAG D2450V2	853	July 08, 2013	One year
12	Dipole Validation Kit	SPEAG D5GHzV2	1060	July 03, 2013	One year

\*\*\*END OF REPORT BODY\*\*\*

## ANNEX A Graph Results

### 850 Left Cheek High

Date: 2013-9-26

Electronics: DAE4 Sn771

Medium: Head 850 MHz

Medium parameters used (interpolated):  $f = 848.8$  MHz;  $\sigma = 0.904$  mho/m;  $\epsilon_r = 40.285$ ;  $\rho = 1000$  kg/m<sup>3</sup>

Ambient Temperature: 22.6°C      Liquid Temperature: 22.1°C

Communication System: GSM 850 Frequency: 848.8 MHz Duty Cycle: 1:8.3

Probe: EX3DV4 - SN3846 ConvF(9.18, 9.18, 9.18)

**Cheek High/Area Scan (61x101x1):** Interpolated grid: dx=1.000 mm, dy=1.000 mm

Maximum value of SAR (interpolated) = 0.682 W/kg

**Cheek High/Zoom Scan (7x7x7)/Cube 0:** Measurement grid: dx=5mm, dy=5mm, dz=5mm

Reference Value = 5.105 V/m; Power Drift = 0.18 dB

Peak SAR (extrapolated) = 0.754 W/kg

**SAR(1 g) = 0.619 W/kg; SAR(10 g) = 0.477 W/kg**

Maximum value of SAR (measured) = 0.637 W/kg

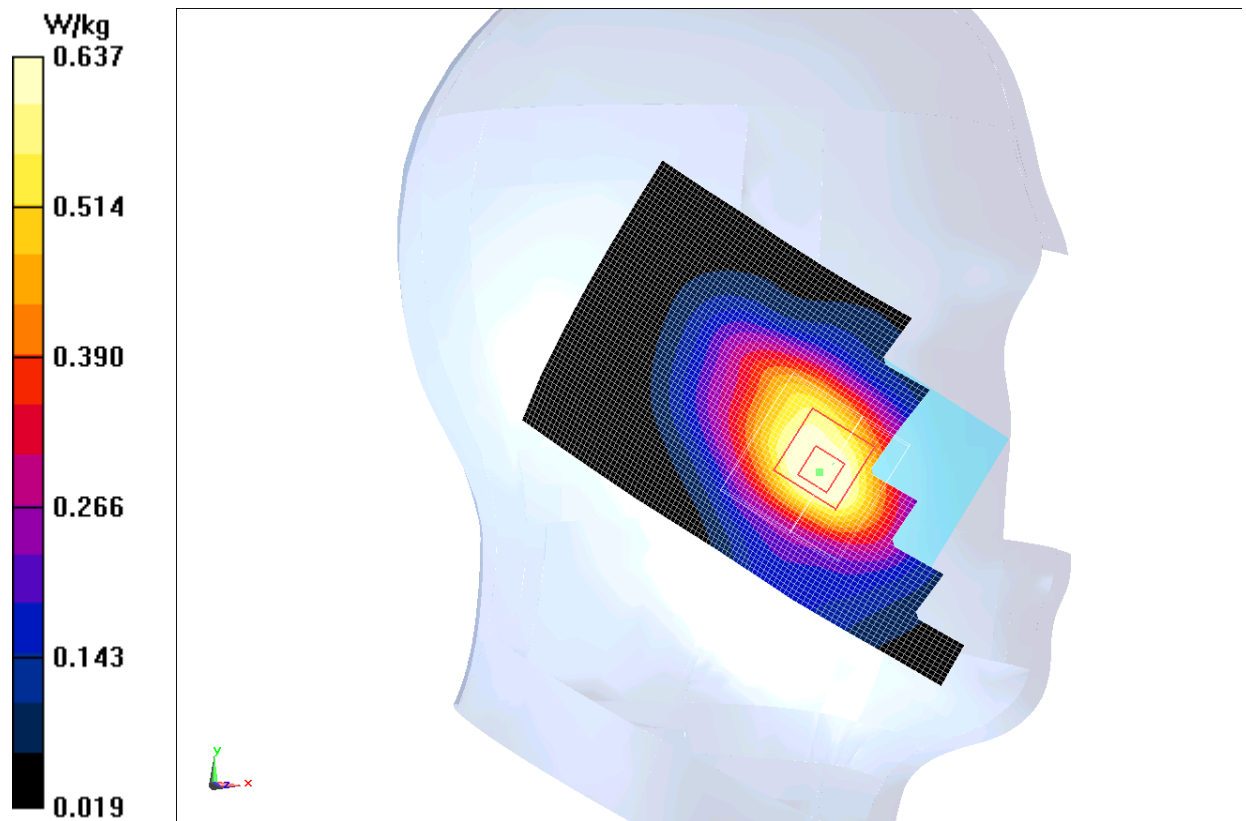
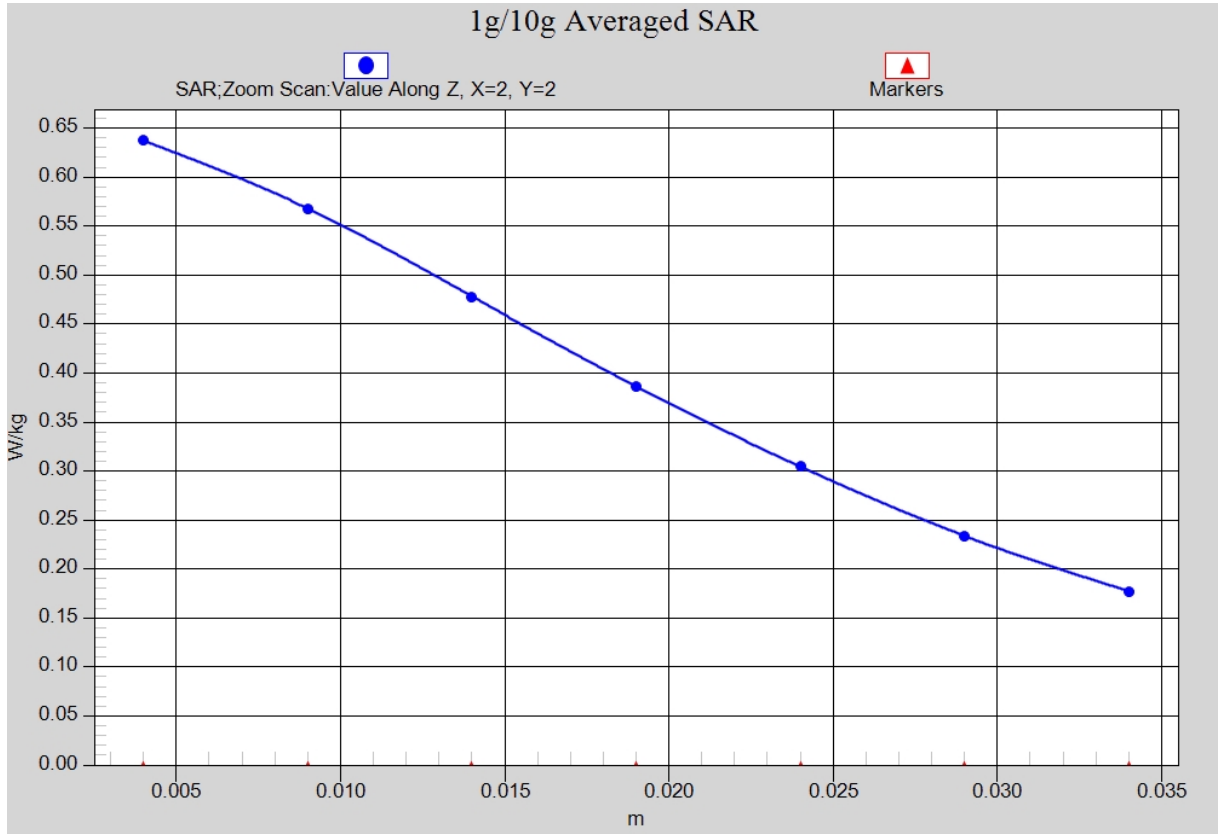

Fig.1 850MHz CH251



**Fig. 1-1 Z-Scan at power reference point (850 MHz CH251)**

### 850 Body Rear High

Date: 2013-9-26

Electronics: DAE4 Sn771

Medium: Body 850 MHz

Medium parameters used (interpolated):  $f = 848.8$  MHz;  $\sigma = 0.992$  mho/m;  $\epsilon_r = 56.199$ ;  $\rho = 1000$  kg/m<sup>3</sup>

Ambient Temperature: 22.6°C      Liquid Temperature: 22.1°C

Communication System: GSM 850 GPRS Frequency: 848.8 MHz Duty Cycle: 1:4

Probe: EX3DV4 - SN3846 ConvF(9.04, 9.04, 9.04)

**Rear High/Area Scan (61x111x1):** Interpolated grid: dx=1.000 mm, dy=1.000 mm

Maximum value of SAR (interpolated) = 0.808 W/kg

**Rear High/Zoom Scan (7x7x7)/Cube 0:** Measurement grid: dx=5mm, dy=5mm, dz=5mm

Reference Value = 26.769 V/m; Power Drift = 0.07 dB

Peak SAR (extrapolated) = 0.868 W/kg

**SAR(1 g) = 0.767 W/kg; SAR(10 g) = 0.599 W/kg**

Maximum value of SAR (measured) = 0.802 W/kg

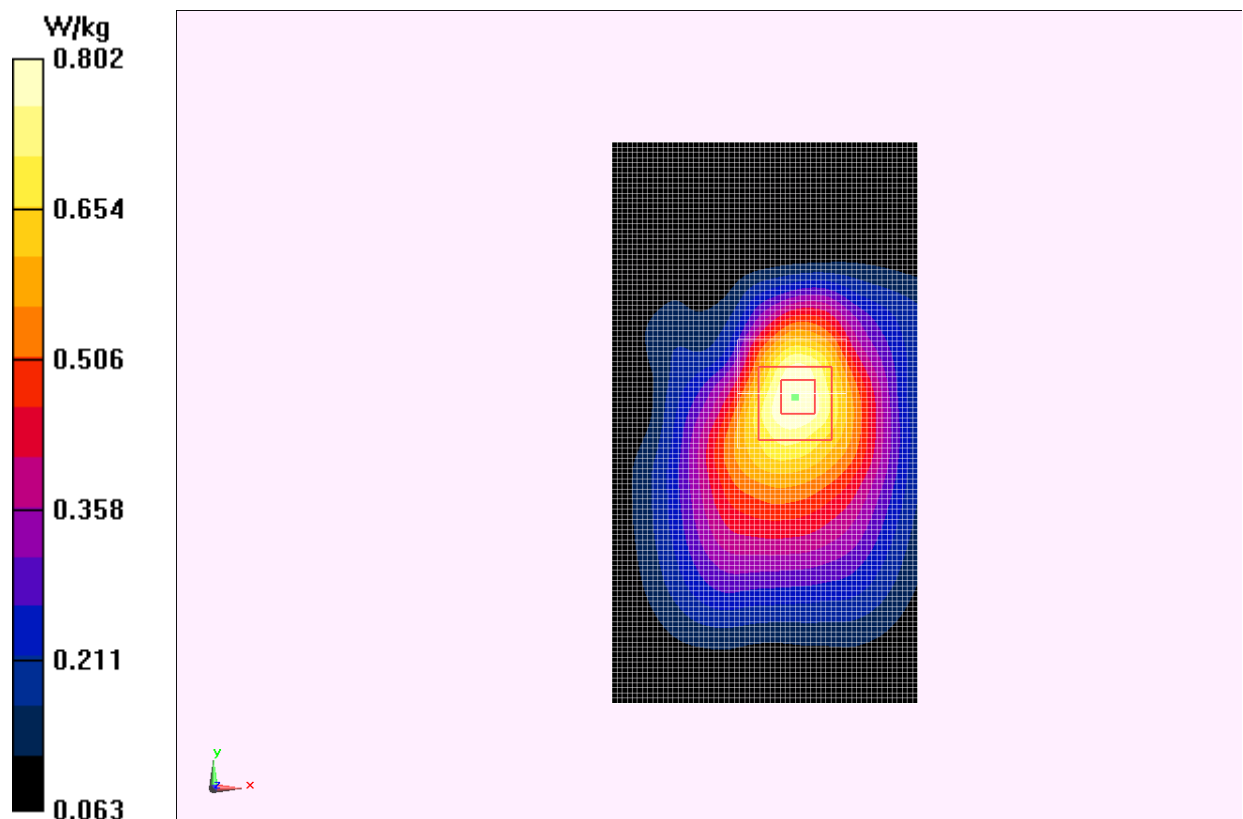

Fig.2 850 MHz CH251



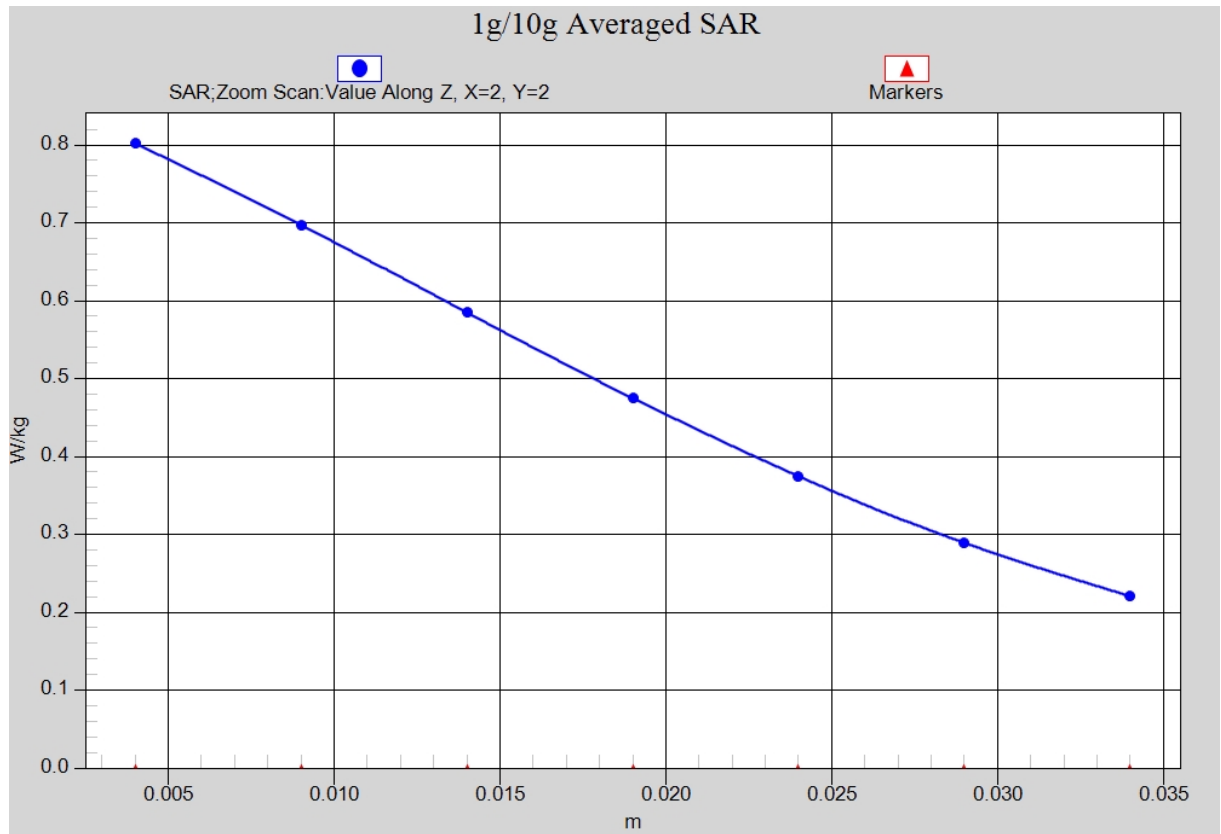

Fig. 2-1 Z-Scan at power reference point (850 MHz CH251)

### 1900 Left Cheek High

Date: 2013-9-27

Electronics: DAE4 Sn771

Medium: Head 1900 MHz

Medium parameters used:  $f = 1910$  MHz;  $\sigma = 1.382$  mho/m;  $\epsilon_r = 39.405$ ;  $\rho = 1000$  kg/m<sup>3</sup>

Ambient Temperature: 22.7°C      Liquid Temperature: 22.2°C

Communication System: GSM 1900MHz Frequency: 1909.8 MHz Duty Cycle: 1:8.3

Probe: EX3DV4 - SN3846 ConvF(8.01, 8.01, 8.01)

**Cheek High/Area Scan (61x101x1):** Interpolated grid: dx=1.000 mm, dy=1.000 mm

Maximum value of SAR (interpolated) = 0.759 W/kg

**Cheek High/Zoom Scan (7x7x7)/Cube 0:** Measurement grid: dx=5mm, dy=5mm, dz=5mm

Reference Value = 7.979 V/m; Power Drift = 0.13 dB

Peak SAR (extrapolated) = 1.29 W/kg

**SAR(1 g) = 0.649 W/kg; SAR(10 g) = 0.408 W/kg**

Maximum value of SAR (measured) = 0.706 W/kg

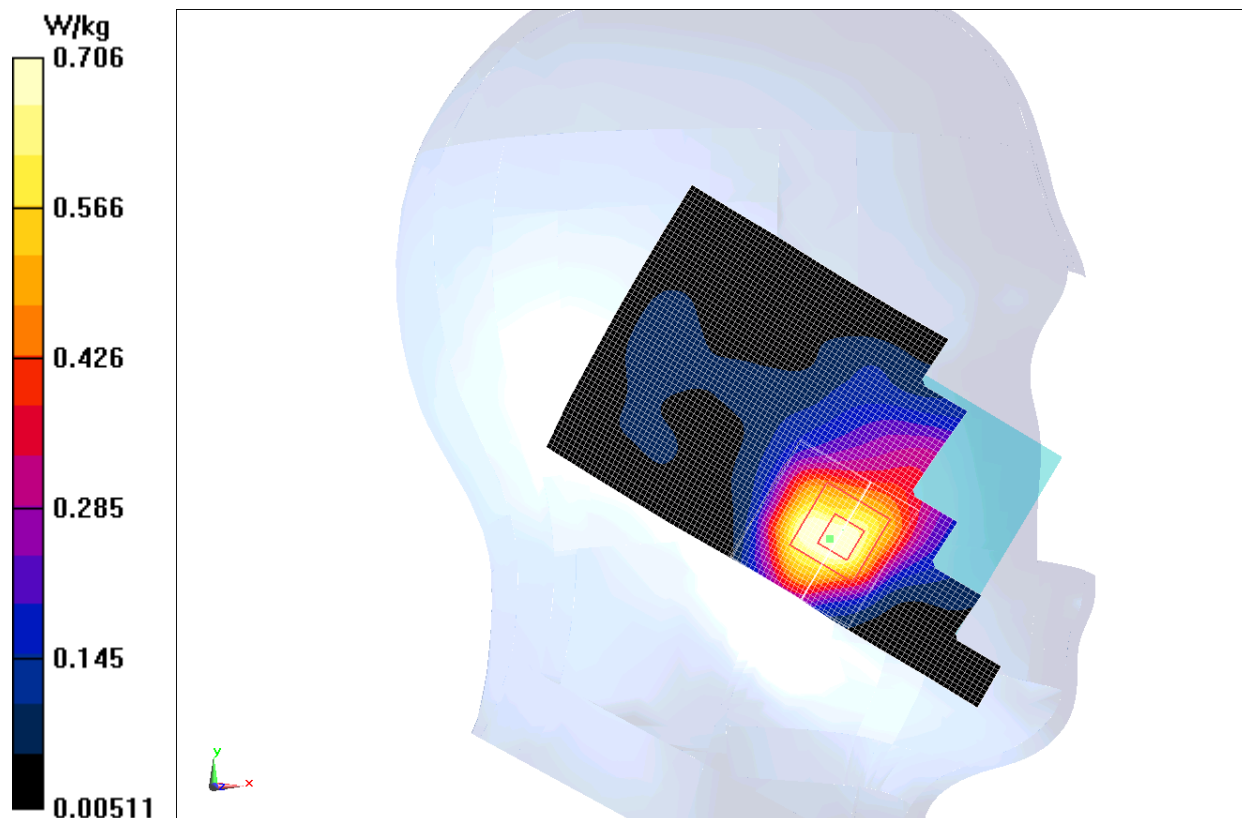
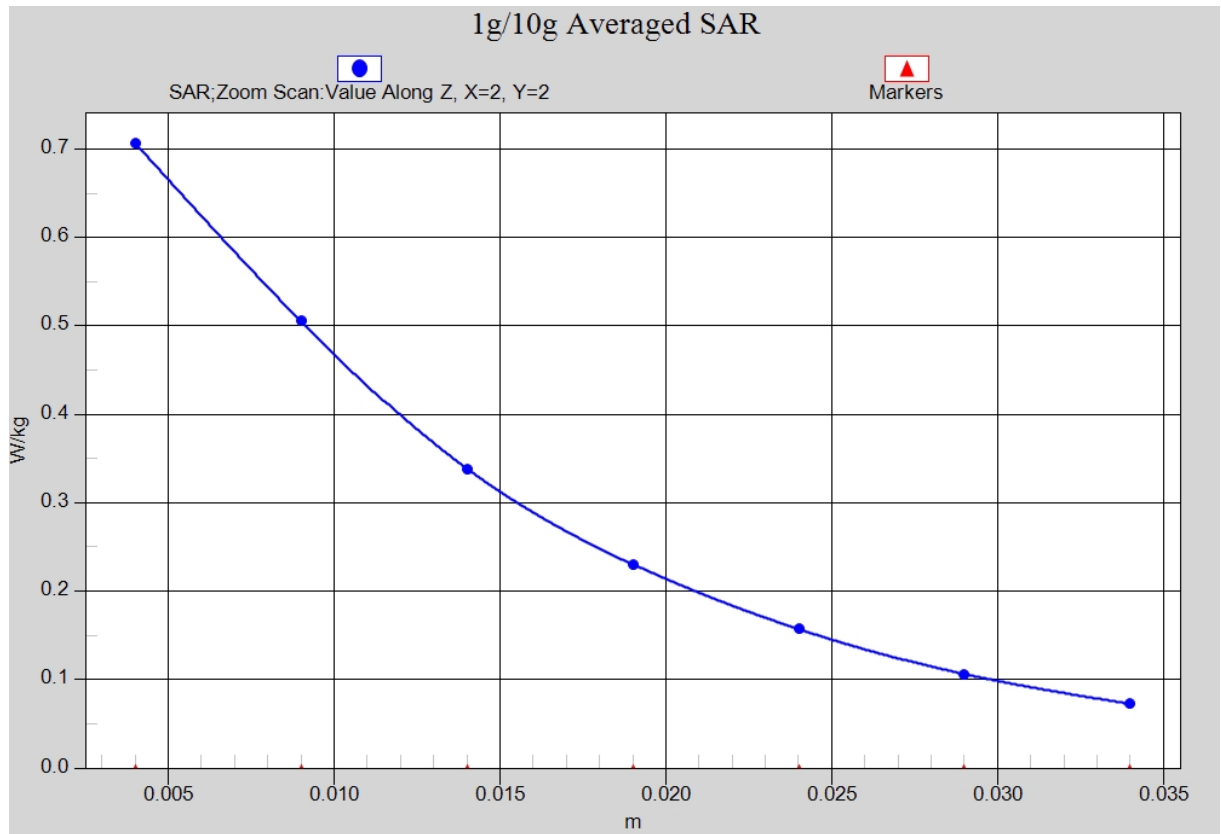

Fig.3 1900 MHz CH810



**Fig. 3-1 Z-Scan at power reference point (1900 MHz CH810)**

**1900 Body Front High**

Date: 2013-9-27

Electronics: DAE4 Sn771

Medium: Body 1900 MHz

Medium parameters used:  $f = 1910$  MHz;  $\sigma = 1.561$  mho/m;  $\epsilon_r = 54.178$ ;  $\rho = 1000$  kg/m<sup>3</sup>

Ambient Temperature: 22.7°C      Liquid Temperature: 22.2°C

Communication System: GSM 1900MHz GPRS Frequency: 1909.8 MHz Duty Cycle: 1:4

Probe: EX3DV4 - SN3846 ConvF(7.37, 7.37, 7.37)

**Front High/Area Scan (61x101x1):** Interpolated grid: dx=1.000 mm, dy=1.000 mm

Maximum value of SAR (interpolated) = 0.969 W/kg

**Front High/Zoom Scan (7x7x7)/Cube 0:** Measurement grid: dx=5mm, dy=5mm, dz=5mm

Reference Value = 10.259 V/m; Power Drift = 0.07 dB

Peak SAR (extrapolated) = 1.21 W/kg

**SAR(1 g) = 0.812 W/kg; SAR(10 g) = 0.486 W/kg**

Maximum value of SAR (measured) = 0.991 W/kg

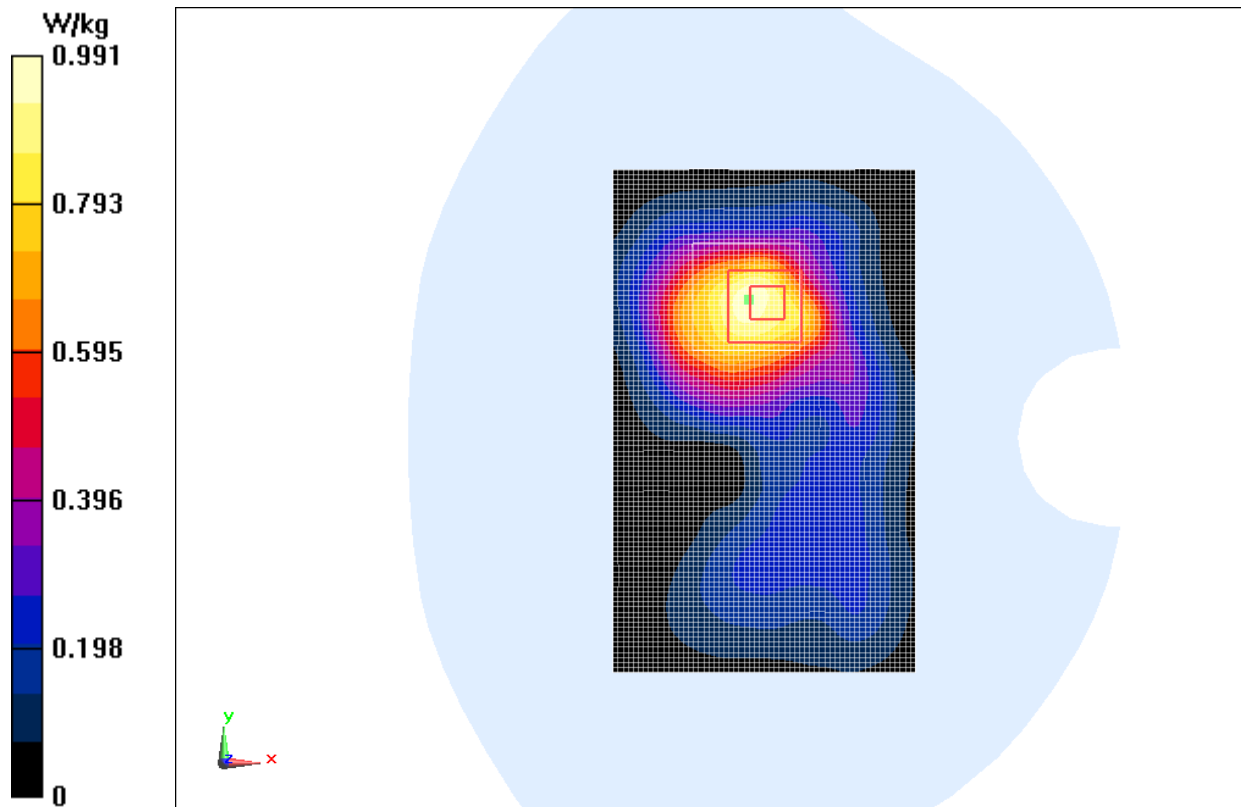

**Fig.4 1900 MHz CH810**

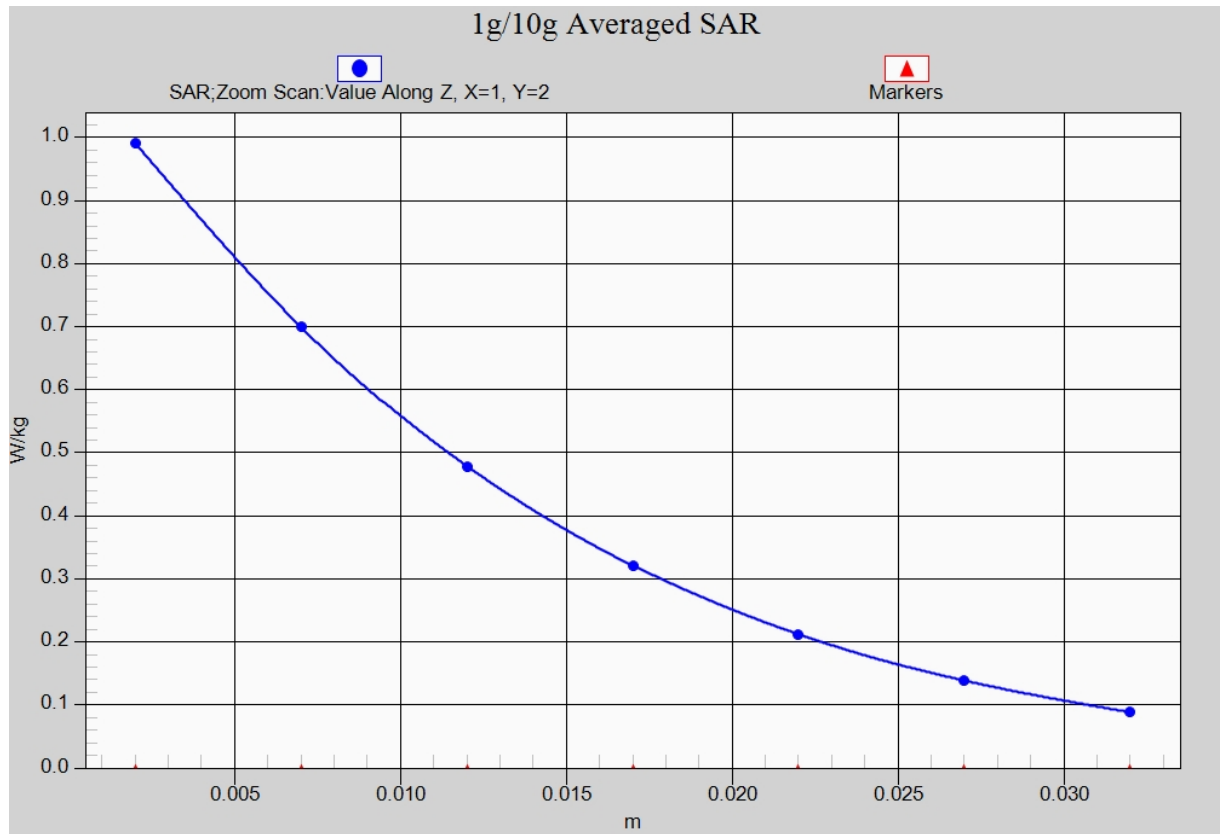

**Fig.4-1 Z-Scan at power reference point (1900 MHz CH810)**

### WCDMA 850 Left Cheek High

Date: 2013-9-26

Electronics: DAE4 Sn771

Medium: Head 850 MHz

Medium parameters used (interpolated):  $f = 846.6$  MHz;  $\sigma = 0.902$  mho/m;  $\epsilon_r = 40.302$ ;  $\rho = 1000$  kg/m<sup>3</sup>

Ambient Temperature: 22.6°C      Liquid Temperature: 22.1°C

Communication System: WCDMA; Frequency: 846.6 MHz; Duty Cycle: 1:1

Probe: EX3DV4 - SN3846 ConvF(9.18, 9.18, 9.18)

**Cheek High/Area Scan (61x101x1):** Interpolated grid: dx=1.000 mm, dy=1.000 mm

Maximum value of SAR (interpolated) = 0.991 W/kg

**Cheek High/Zoom Scan (7x7x7)/Cube 0:** Measurement grid: dx=5mm, dy=5mm, dz=5mm

Reference Value = 8.592 V/m; Power Drift = -0.04 dB

Peak SAR (extrapolated) = 1.08 W/kg

**SAR(1 g) = 0.845 W/kg; SAR(10 g) = 0.643 W/kg**

Maximum value of SAR (measured) = 0.947 W/kg

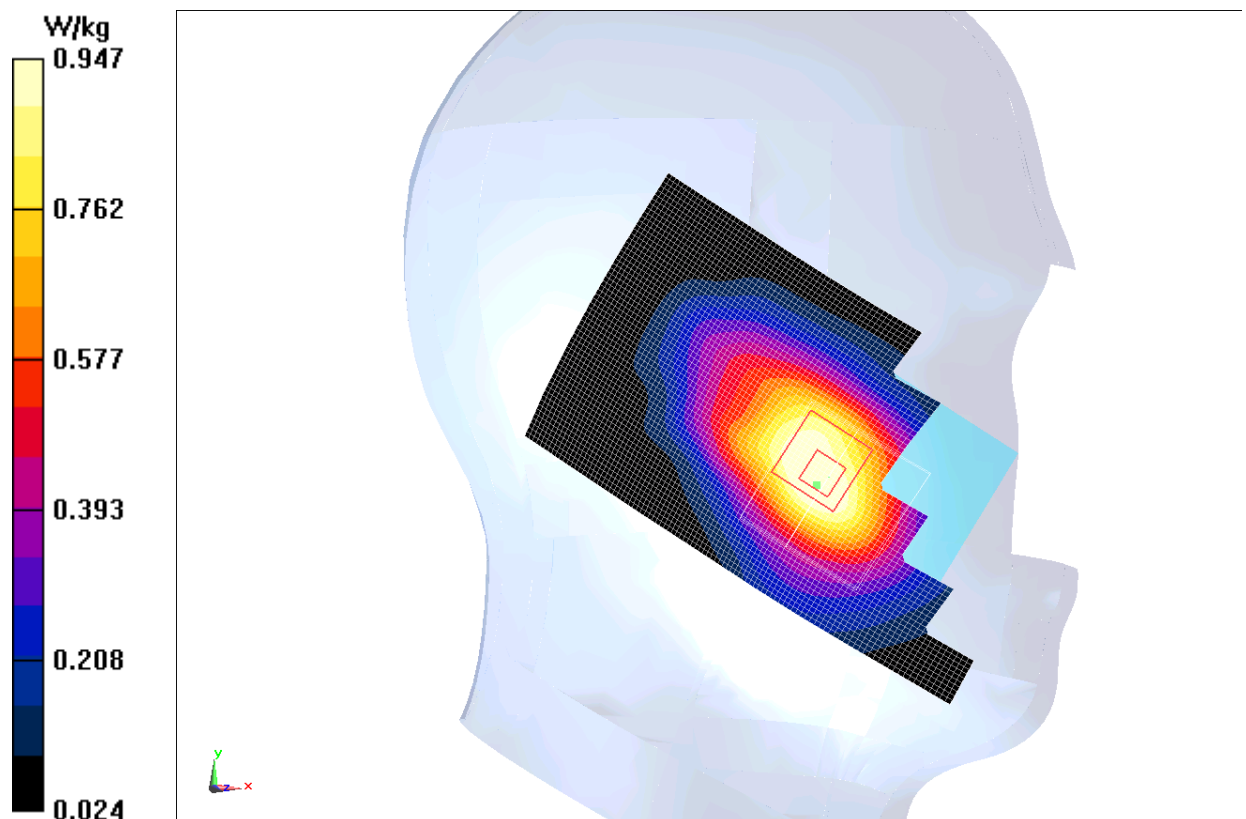
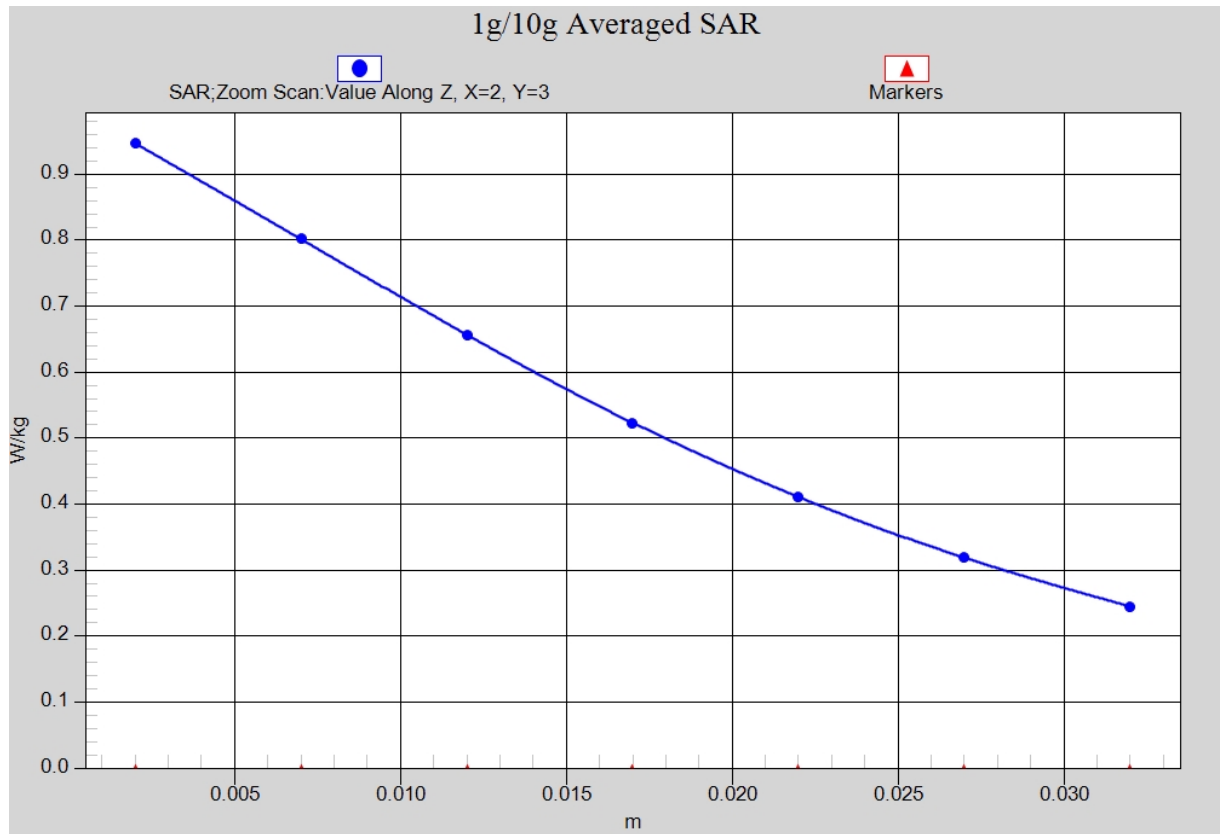

Fig.5 WCDMA 850 CH4233



**Fig. 5-1 Z-Scan at power reference point (WCDMA 850 CH4233)**

### WCDMA 850 Body Rear Middle

Date: 2013-9-26

Electronics: DAE4 Sn771

Medium: Body 850 MHz

Medium parameters used (interpolated):  $f = 836.4$  MHz;  $\sigma = 0.98$  mho/m;  $\epsilon_r = 56.351$ ;  $\rho = 1000$  kg/m<sup>3</sup>

Ambient Temperature: 22.6°C      Liquid Temperature: 22.1°C

Communication System: WCDMA; Frequency: 836.4 MHz; Duty Cycle: 1:1

Probe: EX3DV4 - SN3846 ConvF(9.04, 9.04, 9.04)

**Rear Middle/Area Scan (61x111x1):** Interpolated grid: dx=1.000 mm, dy=1.000 mm

Maximum value of SAR (interpolated) = 0.782 W/kg

**Rear Middle/Zoom Scan (7x7x7)/Cube 0:** Measurement grid: dx=5mm, dy=5mm, dz=5mm

Reference Value = 27.454 V/m; Power Drift = 0.03 dB

Peak SAR (extrapolated) = 0.853 W/kg

**SAR(1 g) = 0.734 W/kg; SAR(10 g) = 0.575 W/kg**

Maximum value of SAR (measured) = 0.769 W/kg

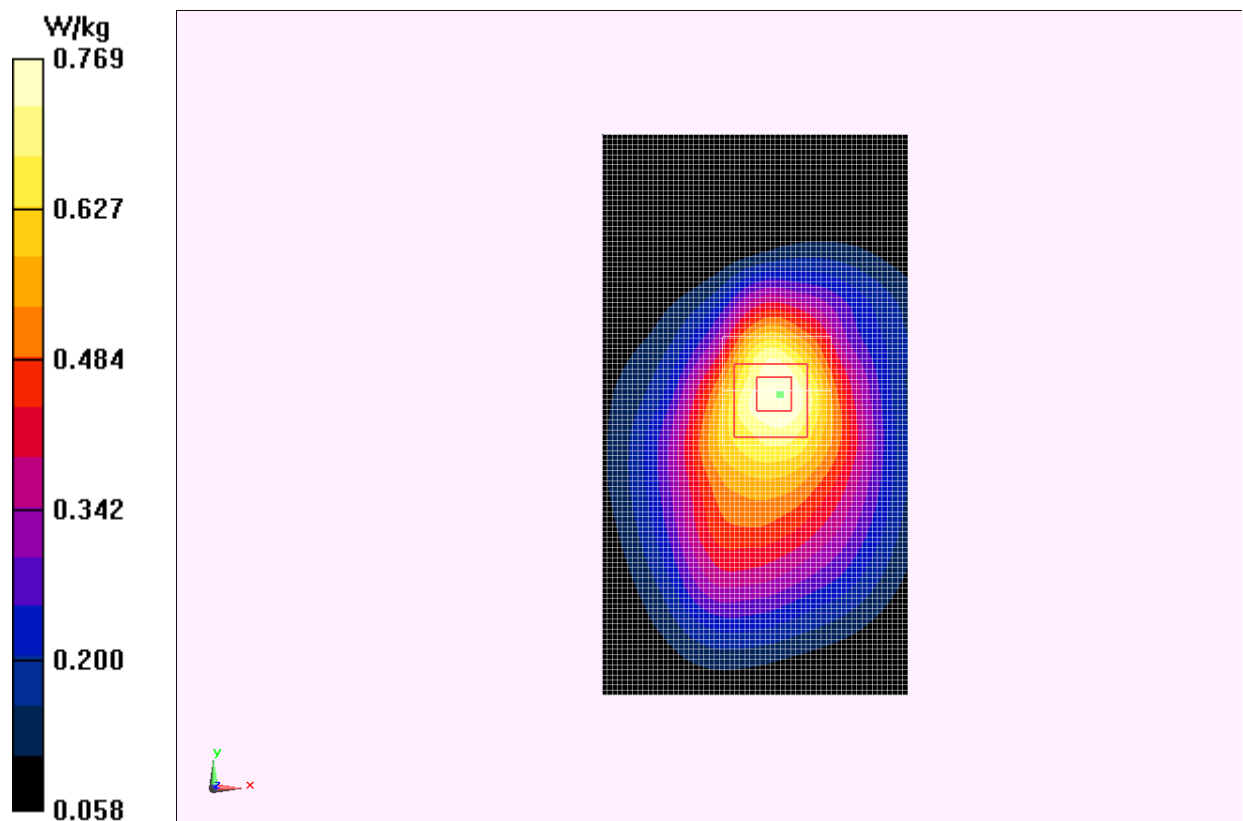

Fig.6 WCDMA 850 CH4182



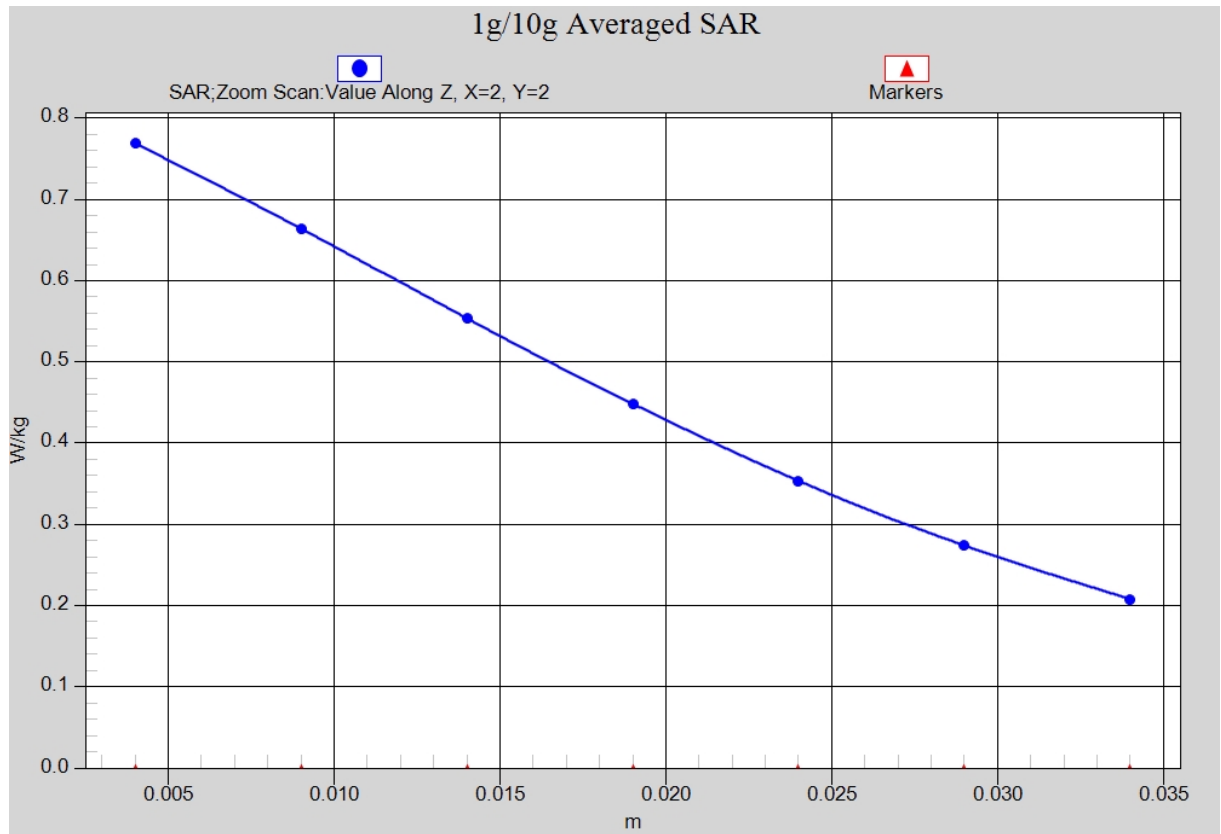

Fig. 6-1 Z-Scan at power reference point (WCDMA850 CH4182)