

ELECTROMAGNETIC EMISSIONS COMPLIANCE REPORT

INTENTIONAL RADIATOR CERTIFICATION TO FCC PART 22 SUBPART H, PART 24 SUBPART E and PART 27 SUBPART C AND INDUSTRY CANADA RSS-132, RSS-133 and RSS-139 REQUIREMENT

OF

Product Name: PDA Phone
Brand Name: Sony
Model No.: C2004
Type No.: PM-0481-BV
Model Difference: N/A
FCC ID: PY7PM-0481
IC: 4170B-PM0481
Report No.: EH/2013/70028
Issue Date: Aug. 06, 2013
FCC Rule Part: 2, 22H & 24E & 27C
IC Rule Part: RSS 132 Issue 3, RSS 133 Issue 6 and RSS 139 Issue 2
Prepared for: Sony Mobile Communications AB
Nya Vattentornet 22188 Lund/SWEDEN
Prepared by: SGS Taiwan Ltd.
Electronics & Communication Laboratory
No.134, Wu Kung Road, New Taipei Industrial Park, Wuku
District, New Taipei City, Taiwan 24803

Note: This report shall not be reproduced except in full, without the written approval of SGS Taiwan Ltd. This document may be altered or revised by SGS Taiwan Ltd. personnel only, and shall be noted in the revision section of the document.

Unless otherwise stated the results shown in this test report refer only to the sample(s) tested and such sample(s) are retained for 90 days only.

除非另有說明，此報告結果僅對測試之樣品負責，同時此樣品僅保留90天。本報告未經本公司書面許可，不可部份複製。

This document is issued by the Company subject to its General Conditions of Service printed overleaf, available on request or accessible at www.sgs.com/terms_and_conditions.htm and, for electronic format documents, subject to Terms and Conditions for Electronic Documents at www.sgs.com/terms_e-document.htm. Attention is drawn to the limitation of liability, indemnification and jurisdiction issues defined therein. Any holder of this document is advised that information contained hereon reflects the Company's findings at the time of its intervention only and within the limits of Client's instructions, if any. The Company's sole responsibility is to its Client and this document does not exonerate parties to a transaction from exercising all their rights and obligations under the transaction documents. This document cannot be reproduced except in full, without prior written approval of the Company. Any unauthorized alteration, forgery or falsification of the content or appearance of this document is unlawful and offenders may be prosecuted to the fullest extent of the law.

VERIFICATION OF COMPLIANCE

Applicant: Sony Mobile Communications AB
Nya Vattentornet 22188 Lund/SWEDEN

Product Name: PDA Phone

Brand Name: Sony

Model No.: C2004

Type No.: PM-0481-BV

Model Difference: N/A

FCC ID: PY7PM-0481

IC: 4170B-PM0481

File Number: EH/2013/70028

Date of test: Apr. 01, 2013 ~ Jul. 23, 2013

Date of EUT Received: Apr. 01, 2013

We hereby certify that:

The above equipment was tested by SGS Taiwan Ltd. Electronics & Communication Laboratory. The test data, data evaluation, test procedures, and equipment configurations shown in this report were made in accordance with the procedures given in TIA/EIA-603-C-2004, Issue 3 of RSS-Gen and the energy emitted by the sample EUT tested as described in this report is in compliance with conducted and radiated emission limits of FCC Rule PART 22 subpart H, PART 24 subpart E, PART 27 subpart C and IC standards Issue 3 of RSS-132, Issue 6 of RSS-133, Issue 2 of RSS-139.

The test results of this report relate only to the tested sample identified in this report.

Test By: Marcus Tseng **Date:** Aug. 06, 2013

Marcus Tseng / Engineer

Prepared By: Violetta Tang **Date:** Aug. 06, 2013

Violetta Tang / Clerk

Approved By: Jim Chang **Date:** Aug. 06, 2013

Jim Chang / Supervisor

Unless otherwise stated the results shown in this test report refer only to the sample(s) tested and such sample(s) are retained for 90 days only.

除非另有說明，此報告結果僅對測試之樣品負責，同時此樣品僅保留90天。本報告未經本公司書面許可，不可部份複製。

This document is issued by the Company subject to its General Conditions of Service printed overleaf, available on request or accessible at www.sgs.com/terms_and_conditions.htm and, for electronic format documents, subject to Terms and Conditions for Electronic Documents at www.sgs.com/terms_e-document.htm. Attention is drawn to the limitation of liability, indemnification and jurisdiction issues defined therein. Any holder of this document is advised that information contained hereon reflects the Company's findings at the time of its intervention only and within the limits of Client's instructions, if any. The Company's sole responsibility is to its Client and this document does not exonerate parties to a transaction from exercising all their rights and obligations under the transaction documents. This document cannot be reproduced except in full, without prior written approval of the Company. Any unauthorized alteration, forgery or falsification of the content or appearance of this document is unlawful and offenders may be prosecuted to the fullest extent of the law.

Revision History

| Report Number | Revision | Description | Issue Date |
|---------------|----------|--|---------------|
| EH/2013/70028 | Rev.01 | Initial creation of document | Jul. 26, 2013 |
| EH/2013/70028 | Rev.02 | Correct inappropriate representation of the setting on the measurement equipment of page 47, 50, 53. | Aug. 06, 2013 |
| | | | |
| | | | |

Unless otherwise stated the results shown in this test report refer only to the sample(s) tested and such sample(s) are retained for 90 days only.

除非另有說明，此報告結果僅對測試之樣品負責，同時此樣品僅保留90天。本報告未經本公司書面許可，不可部份複製。

This document is issued by the Company subject to its General Conditions of Service printed overleaf, available on request or accessible at www.sgs.com/terms_and_conditions.htm and, for electronic format documents, subject to Terms and Conditions for Electronic Documents at www.sgs.com/terms_e-document.htm. Attention is drawn to the limitation of liability, indemnification and jurisdiction issues defined therein. Any holder of this document is advised that information contained hereon reflects the Company's findings at the time of its intervention only and within the limits of Client's instructions, if any. The Company's sole responsibility is to its Client and this document does not exonerate parties to a transaction from exercising all their rights and obligations under the transaction documents. This document cannot be reproduced except in full, without prior written approval of the Company. Any unauthorized alteration, forgery or falsification of the content or appearance of this document is unlawful and offenders may be prosecuted to the fullest extent of the law.

Table of Contents

| | |
|---|-----------|
| 1. GENERAL PRODUCT INFORMATION | 6 |
| 1.1. Product Description | 6 |
| 1.2. Related Submittal(s) / Grant (s) | 12 |
| 1.3. Test Methodology | 12 |
| 1.4. Test Facility | 12 |
| 1.5. Special Accessories | 12 |
| 1.6. Equipment Modifications | 12 |
| 2. SYSTEM TEST CONFIGURATION | 13 |
| 2.1. EUT Configuration | 13 |
| 2.2. EUT Exercise | 13 |
| 2.3. Test Procedure | 13 |
| 2.4. Measurement Equipment Used: | 14 |
| 2.5. Configuration of Tested System | 17 |
| 3. SUMMARY OF TEST RESULTS | 18 |
| 4. DESCRIPTION OF TEST MODES | 20 |
| 5. MEASUREMENT UNCERTAINTY | 22 |
| 6. RF POWER OUTPUT MEASUREMENT | 23 |
| 6.1. Standard Applicable: | 23 |
| 6.2. Test Set-up: | 24 |
| 6.3. Measurement Procedure: | 24 |
| 6.4. Measurement Equipment Used: | 24 |
| 6.5. Measurement Result: | 25 |
| 7. ERP, EIRP MEASUREMENT | 36 |
| 7.1. Standard Applicable: | 36 |
| 7.2. Test SET-UP (Block Diagram of Configuration): | 36 |
| 7.3. Measurement Procedure: | 38 |
| 7.4. Measurement Equipment Used: | 39 |
| 7.5. Measurement Result: (Peak) –using option of peak measurement | 40 |
| 8. OCCUPIED BANDWIDTH MEASUREMENT | 70 |
| 8.1. Standard Applicable: | 70 |
| 8.2. Test Set-up: | 70 |
| 8.3. Measurement Procedure: | 70 |
| 8.4. Measurement Equipment Used: | 70 |
| 8.5. Measurement Result: | 70 |

Unless otherwise stated the results shown in this test report refer only to the sample(s) tested and such sample(s) are retained for 90 days only.

除非另有說明，此報告結果僅對測試之樣品負責，同時此樣品僅保留90天。本報告未經本公司書面許可，不可部份複製。

This document is issued by the Company subject to its General Conditions of Service printed overleaf, available on request or accessible at www.sgs.com/terms_and_conditions.htm and, for electronic format documents, subject to Terms and Conditions for Electronic Documents at www.sgs.com/terms_e-document.htm. Attention is drawn to the limitation of liability, indemnification and jurisdiction issues defined therein. Any holder of this document is advised that information contained hereon reflects the Company's findings at the time of its intervention only and within the limits of Client's instructions, if any. The Company's sole responsibility is to its Client and this document does not exonerate parties to a transaction from exercising all their rights and obligations under the transaction documents. This document cannot be reproduced except in full, without prior written approval of the Company. Any unauthorized alteration, forgery or falsification of the content or appearance of this document is unlawful and offenders may be prosecuted to the fullest extent of the law.

| | |
|---|------------|
| 9. OUT OF BAND EMISSION AT ANTENNA TERMINALS | 100 |
| 9.1. Standard Applicable: | 100 |
| 9.2. Test SET-UP:..... | 102 |
| 9.3. Measurement Procedure:..... | 103 |
| 9.4. Measurement Equipment Used: | 103 |
| 9.5. Measurement Result:..... | 103 |
| 10. FIELD STRENGTH OF SPURIOUS RADIATION MEASUREMENT..... | 224 |
| 10.1. Standard Applicable: | 224 |
| 10.2. EUT Setup (Block Diagram of Configuration):..... | 226 |
| 10.3. Measurement Procedure:..... | 227 |
| 10.4. Measurement Equipment Used: | 227 |
| 10.5. Measurement Result:..... | 227 |
| 11. FREQUENCY STABILITY V.S. TEMPERATURE MEASUREMENT | 288 |
| 11.1. Standard Applicable: | 288 |
| 11.2. Test Set-up:..... | 288 |
| 11.3. Measurement Procedure:..... | 289 |
| 11.4. Measurement Equipment Used: | 289 |
| 11.5. Measurement Result:..... | 290 |
| 12. FREQUENCY STABILITY V.S. VOLTAGE MEASUREMENT | 293 |
| 12.1. Standard Applicable: | 293 |
| 12.2. Test Set-up:..... | 293 |
| 12.3. Measurement Procedure:..... | 293 |
| 12.4. Measurement Equipment Used: | 293 |
| 12.5. Measurement Result:..... | 294 |
| 13. PEAK TO AVERAGE RATIO | 296 |
| 13.1. Standard Applicable: | 296 |
| 13.2. Test SET-UP (Block Diagram of Configuration):..... | 296 |
| 13.3. Measurement Procedure:..... | 296 |
| 13.4. Measurement Equipment Used: | 296 |
| 13.5. Measurement Result:..... | 296 |
| MEASUREMENT PLOT OF RADIATED SPURIOUS EMISSION | 322 |

Unless otherwise stated the results shown in this test report refer only to the sample(s) tested and such sample(s) are retained for 90 days only.

除非另有說明，此報告結果僅對測試之樣品負責，同時此樣品僅保留90天。本報告未經本公司書面許可，不可部份複製。

This document is issued by the Company subject to its General Conditions of Service printed overleaf, available on request or accessible at www.sgs.com/terms_and_conditions.htm and, for electronic format documents, subject to Terms and Conditions for Electronic Documents at www.sgs.com/terms_e-document.htm. Attention is drawn to the limitation of liability, indemnification and jurisdiction issues defined therein. Any holder of this document is advised that information contained hereon reflects the Company's findings at the time of its intervention only and within the limits of Client's instructions, if any. The Company's sole responsibility is to its Client and this document does not exonerate parties to a transaction from exercising all their rights and obligations under the transaction documents. This document cannot be reproduced except in full, without prior written approval of the Company. Any unauthorized alteration, forgery or falsification of the content or appearance of this document is unlawful and offenders may be prosecuted to the fullest extent of the law.

1. GENERAL PRODUCT INFORMATION

1.1. Product Description

General:

| | | |
|--------------------------------|--|---|
| Product Name: | PDA Phone | |
| Brand Name: | Sony | |
| Model No.: | C2004 | |
| Type No.: | PM-0481-BV | |
| Model Difference: | N/A | |
| Data Cable (USB): | Model No.: EC450, Supplier: K-one Part No.: 1242-6715.3, Length: 100 cm | |
| Simple Hands-Free (SHF-White): | Model No.: MH410c, Supplier: Foster Electric Type No.: AG-1100 | |
| Simple Hands-Free (SHF-Black): | Model No.: MH410c, Supplier: Foster Electric Type No.: CCA-0004017 | |
| Car Charger: | Model No.: AN400, Supplier: Salcomp Type No.: CAA-0003013 | |
| Hi-Fi Wireless Headset: | Model No.: MW600, Supplier: BALDA Type No.: DDA-0002029.B coupling with Simple Hands Free (Model No.: MH755, Supplier: BALDA Type No.: AG-0502) | |
| Hardware Version: | A | |
| Software Version: | 15.2.A.0.17 | |
| Power Supply: | 3.7Vdc | |
| | Battery: | Model No.: BA900, Supplier: Sony Type No.: AB-0500 |
| | Adapter: | Model No.: EP800, Supplier: Salcomp Type No.: CAA-0002016-US |

Unless otherwise stated the results shown in this test report refer only to the sample(s) tested and such sample(s) are retained for 90 days only.

除非另有說明，此報告結果僅對測試之樣品負責，同時此樣品僅保留90天。本報告未經本公司書面許可，不可部份複製。

This document is issued by the Company subject to its General Conditions of Service printed overleaf, available on request or accessible at www.sgs.com/terms_and_conditions.htm and, for electronic format documents, subject to Terms and Conditions for Electronic Documents at www.sgs.com/terms_e-document.htm. Attention is drawn to the limitation of liability, indemnification and jurisdiction issues defined therein. Any holder of this document is advised that information contained hereon reflects the Company's findings at the time of its intervention only and within the limits of Client's instructions, if any. The Company's sole responsibility is to its Client and this document does not exonerate parties to a transaction from exercising all their rights and obligations under the transaction documents. This document cannot be reproduced except in full, without prior written approval of the Company. Any unauthorized alteration, forgery or falsification of the content or appearance of this document is unlawful and offenders may be prosecuted to the fullest extent of the law.

Bluetooth_BR+EDR:

| | |
|----------------------|---|
| Bluetooth Version: | V3.0+HS |
| Channel number: | 79 channels |
| Modulation type: | Frequency Hopping Spread Spectrum |
| Transmit Power: | 10.11dBm |
| Frequency Range: | 2.402GHz – 2.480GHz |
| Dwell Time: | <= 0.4s |
| Antenna Designation: | PIFA Antenna, Gain: 2.55dBi |
| Type of Emission: | 915KF7D (GFSK) / 1M15G7D ($\pi/4$ DQPSK) / 1M20G7D (8DPSK) |

Bluetooth Low Energy:

| | |
|----------------------|-----------------------------|
| Frequency Range: | 2402 – 2480MHz |
| Bluetooth Version: | V4.0 Dual mode |
| Channel number: | 40 channels |
| Modulation type: | GFSK |
| Transmit Power: | 1.24dBm (Peak) |
| Antenna Designation: | PIFA Antenna, Gain: 2.55dBi |
| Type of Emission: | 1M05F7D |

NFC:

| | |
|----------------------|--------------------|
| Operating Frequency: | 13.56MHz |
| Transmit Power: | < 123dBuV/m at 3m. |
| Number of Channels: | 1 |
| Antenna Type: | Loop Antenna |
| Modulation Type: | ASK, BPSK |
| Type of Emission: | 15K0F1D |

Unless otherwise stated the results shown in this test report refer only to the sample(s) tested and such sample(s) are retained for 90 days only.

除非另有說明，此報告結果僅對測試之樣品負責，同時此樣品僅保留90天。本報告未經本公司書面許可，不可部份複製。

This document is issued by the Company subject to its General Conditions of Service printed overleaf, available on request or accessible at www.sgs.com/terms_and_conditions.htm and, for electronic format documents, subject to Terms and Conditions for Electronic Documents at www.sgs.com/terms_e-document.htm. Attention is drawn to the limitation of liability, indemnification and jurisdiction issues defined therein. Any holder of this document is advised that information contained hereon reflects the Company's findings at the time of its intervention only and within the limits of Client's instructions, if any. The Company's sole responsibility is to its Client and this document does not exonerate parties to a transaction from exercising all their rights and obligations under the transaction documents. This document cannot be reproduced except in full, without prior written approval of the Company. Any unauthorized alteration, forgery or falsification of the content or appearance of this document is unlawful and offenders may be prosecuted to the fullest extent of the law.

WLAN 2.4GHz+5.7GHz:

| Wi-Fi | Frequency Range | Channels | Rated Power | Modulation Technology | Type of Emission |
|----------------------|-------------------|---|----------------------------|-----------------------|--------------------------|
| 11b/g | 2412-2462 | 11 | b: 17.27dBm g: 20.82dBm | DSSS, OFDM | b: 13M5G1D g: 16M6D1D |
| 11n | HT20 2412-2462 | 11 | HT20: 20.84dBm | OFDM | n: 17M8D1D |
| 11a | 5725-5850 | 5 | a: 19.54dBm | OFDM | a: 16M7D1D |
| 11n (5GHz) | HT20 5725-5850 | 5 | HT20: 19.62dBm | | n_20HT:17M8D1D |
| 11n (5GHz) | HT40 5725-5850 | 2 | HT40: 19.18dBm | | n_40HT:36M0D1D |
| Antenna Designation: | | PIFA Antenna, 2.4GHz Gain: 2.55dBi 5GHz Gain: 1.66dBi (5725MHz-5850MHz) | | | |
| Modulation type: | | CCK, DQPSK, DBPSK for DSSS 64QAM, 16QAM, QPSK, BPSK for OFDM | | | |
| Transition Rate: | | 802.11 a: 6/9/12/18/24/36/48/54 Mbps 802.11 b: 1/2/5.5/11 Mbps 802.11 g: 6/9/12/18/24/36/48/54 Mbps 802.11 n_20MHz: 6.5 – 65.0Mbps 802.11 n_40MHz: 13.5 – 135.0Mbps | | | |

Unless otherwise stated the results shown in this test report refer only to the sample(s) tested and such sample(s) are retained for 90 days only.

除非另有說明，此報告結果僅對測試之樣品負責，同時此樣品僅保留90天。本報告未經本公司書面許可，不可部份複製。

This document is issued by the Company subject to its General Conditions of Service printed overleaf, available on request or accessible at www.sgs.com/terms_and_conditions.htm and, for electronic format documents, subject to Terms and Conditions for Electronic Documents at www.sgs.com/terms_e-document.htm. Attention is drawn to the limitation of liability, indemnification and jurisdiction issues defined therein. Any holder of this document is advised that information contained hereon reflects the Company's findings at the time of its intervention only and within the limits of Client's instructions, if any. The Company's sole responsibility is to its Client and this document does not exonerate parties to a transaction from exercising all their rights and obligations under the transaction documents. This document cannot be reproduced except in full, without prior written approval of the Company. Any unauthorized alteration, forgery or falsification of the content or appearance of this document is unlawful and offenders may be prosecuted to the fullest extent of the law.

WLAN 5GHz:

| Wi-Fi | Frequency Range | Channels | Rated Power (Avg) | Rated Power (EIRP) | Modulation Technology | Type of Emission |
|----------------------|--|----------|-------------------|--------------------|-----------------------|------------------|
| 11a | 5150~5250 | 4 | 12.77dBm | 12.03dBm | OFDM | 16M7D1D |
| | 5250~5350 | 4 | 12.78dBm | 13.79dBm | | 16M7D1D |
| | 5470~5725 | 11 | 12.87dBm | 15.57dBm | | 16M6D1D |
| 11n | HT20 5150~5250 | 4 | HT20: 12.85dBm | HT20: 12.11dBm | OFDM | 17M7D1D |
| | HT20 5250~5350 | 4 | HT20: 12.84dBm | HT20: 13.85dBm | | 17M8D1D |
| | HT20 5470~5725 | 8 | HT20: 12.88dBm | HT20: 15.58dBm | | 17M7D1D |
| 11n | HT40 5150~5250 | 2 | HT40: 11.76dBm | HT40: 11.05dBm | OFDM | 36M1D1D |
| | HT40 5250~5350 | 2 | HT40: 11.79dBm | HT40: 12.80dBm | | 36M1D1D |
| | HT40 5470~5725 | 3 | HT40: 11.87dBm | HT40: 14.57dBm | | 36M0D1D |
| Antenna Designation: | PIFA Antenna, 5GHz Gain: -0.74dBi (5150MHz-5250MHz) 5GHz Gain: 1.01dBi (5250MHz-5350MHz) 5GHz Gain: 2.70dBi (5470MHz-5725MHz) | | | | | |
| Modulation type: | CCK, DQPSK, DBPSK for DSSS 64QAM, 16QAM, QPSK, BPSK for OFDM | | | | | |
| Transition Rate: | 802.11 a: 6/9/12/18/24/36/48/54 Mbps 802.11 n_20MHz: 6.5 – 65.0Mbps 802.11 n_40MHz: 13.5 – 135.0Mbps | | | | | |

Unless otherwise stated the results shown in this test report refer only to the sample(s) tested and such sample(s) are retained for 90 days only.

除非另有說明，此報告結果僅對測試之樣品負責，同時此樣品僅保留90天。本報告未經本公司書面許可，不可部份複製。

This document is issued by the Company subject to its General Conditions of Service printed overleaf, available on request or accessible at www.sgs.com/terms_and_conditions.htm and, for electronic format documents, subject to Terms and Conditions for Electronic Documents at www.sgs.com/terms_e-document.htm. Attention is drawn to the limitation of liability, indemnification and jurisdiction issues defined therein. Any holder of this document is advised that information contained hereon reflects the Company's findings at the time of its intervention only and within the limits of Client's instructions, if any. The Company's sole responsibility is to its Client and this document does not exonerate parties to a transaction from exercising all their rights and obligations under the transaction documents. This document cannot be reproduced except in full, without prior written approval of the Company. Any unauthorized alteration, forgery or falsification of the content or appearance of this document is unlawful and offenders may be prosecuted to the fullest extent of the law.

GSM / WCDMA:

| Cellular Phone Standards Frequency Range and Power. | Operating Frequency | | Rated Power |
|---|---|-----------------------|-------------|
| | GSM/GPRS 850, Class 12 | 824.2 MHz– 848.8 MHz | 33dBm |
| | EDGE 850, Class 12 | 824.2 MHz– 848.8 MHz | 27dBm |
| | GSM/GPRS 1900, Class 12 | 1850.2MHz – 1909.8MHz | 30dBm |
| | EDGE 1900, Class 12 | 1850.2MHz – 1909.8MHz | 26dBm |
| | WCDMA/HSUPA/HSDPA /HSPA+ Band II | 1852.4MHz – 1907.6MHz | 24dBm |
| | WCDMA/HSUPA/HSDPA /HSPA+ Band IV | 1712.4MHz - 1752.6MHz | 24dBm |
| | WCDMA/HSUPA/HSDPA /HSPA+ Band V | 826.4MHz - 846.6MHz | 24dBm |
| Type of Emission: | GSM 850: 248KGXW, GSM 1900: 247KGXW GPRS 850: 247KGXW, GPRS 1900: 247KGXW EDGE 850: 244KG7W, EDGE 1900: 242KG7W WCDMA Band II: 4M20F9W, WCDMA Band IV: 4M16F9W, WCDMA Band V: 4M26F9W HSDPA Band II: 4M22F9W, HSDPA Band IV: 4M23F9W, HSDPA Band V: 4M17F9W HSUPA Band II: 4M20F9W, HSUPA Band IV: 4M25F9W, HSUPA Band V: 4M27F9W | | |
| IMEI: | 004402146722479 | | |

This test report applies for 850 / 1700 / 1900 GSM / GPRS / EDGE, WCDMA / HSDPA / HSUPA/ HSPA+ Band II/IV/V.

The spread of uplink in HSPA+ supports only up to 5.76 Mbps.

Unless otherwise stated the results shown in this test report refer only to the sample(s) tested and such sample(s) are retained for 90 days only.

除非另有說明，此報告結果僅對測試之樣品負責，同時此樣品僅保留90天。本報告未經本公司書面許可，不可部份複製。

This document is issued by the Company subject to its General Conditions of Service printed overleaf, available on request or accessible at www.sgs.com/terms_and_conditions.htm and, for electronic format documents, subject to Terms and Conditions for Electronic Documents at www.sgs.com/terms_e-document.htm. Attention is drawn to the limitation of liability, indemnification and jurisdiction issues defined therein. Any holder of this document is advised that information contained hereon reflects the Company's findings at the time of its intervention only and within the limits of Client's instructions, if any. The Company's sole responsibility is to its Client and this document does not exonerate parties to a transaction from exercising all their rights and obligations under the transaction documents. This document cannot be reproduced except in full, without prior written approval of the Company. Any unauthorized alteration, forgery or falsification of the content or appearance of this document is unlawful and offenders may be prosecuted to the fullest extent of the law.

Final Amplifier Voltage and Current Information:

| Test Mode | DC voltage (V) | DC current (mA) |
|-----------|----------------|-----------------|
| GSM 850 | 3.7 | 250 |
| GSM 1900 | 3.7 | 180 |
| GPRS 850 | 3.7 | 210 |
| GPRS 1900 | 3.7 | 160 |
| EDGE 850 | 3.7 | 130 |
| EDGE 1900 | 3.7 | 120 |
| WCDMA B2 | 3.7 | 570 |
| WCDMA B4 | 3.7 | 480 |
| WCDMA B5 | 3.7 | 530 |
| HSUPA B2 | 3.7 | 510 |
| HSUPA B4 | 3.7 | 440 |
| HSUPA B5 | 3.7 | 490 |
| HSDPA B2 | 3.7 | 520 |
| HSDPA B4 | 3.7 | 450 |
| HSDPA B5 | 3.7 | 490 |

Unless otherwise stated the results shown in this test report refer only to the sample(s) tested and such sample(s) are retained for 90 days only.

除非另有說明，此報告結果僅對測試之樣品負責，同時此樣品僅保留90天。本報告未經本公司書面許可，不可部份複製。

This document is issued by the Company subject to its General Conditions of Service printed overleaf, available on request or accessible at www.sgs.com/terms_and_conditions.htm and, for electronic format documents, subject to Terms and Conditions for Electronic Documents at www.sgs.com/terms_e-document.htm. Attention is drawn to the limitation of liability, indemnification and jurisdiction issues defined therein. Any holder of this document is advised that information contained hereon reflects the Company's findings at the time of its intervention only and within the limits of Client's instructions, if any. The Company's sole responsibility is to its Client and this document does not exonerate parties to a transaction from exercising all their rights and obligations under the transaction documents. This document cannot be reproduced except in full, without prior written approval of the Company. Any unauthorized alteration, forgery or falsification of the content or appearance of this document is unlawful and offenders may be prosecuted to the fullest extent of the law.

1.2. Related Submittal(s) / Grant (s)

This submittal(s) (test report) is intended for **FCC ID: PY7PM-0481** filing to comply with Section Part 22 subpart H, Part 24 subpart E and Part 27 subpart C of the FCC CFR 47 Rules and **IC: 4170B-PM0481** filing to comply with Issue 3 of RSS-132, Issue 6 of RSS-133 and Issue 2 of RSS-139.

1.3. Test Methodology

Both conducted and radiated testing were performed according to the procedures document of TIA/EIA 603C and FCC CFR 47 2.1046, 2.1047, 2.1049, 2.1051, 2.1053, 2.1055 and 2.1057 and issue 3 of RSS-132, issue 6 of RSS-133 and issue 2 of RSS-139, and RSS Gen Issue3.

TS 151 010-1 is used to set, and measure the output power.

The Output power Procedure of KDB941225 (SAR Measurement Procedures for 3G devices, WCDMA / HSPA) was used for EUT and Base station setting.

KDB971168 D01 Power Meas license Digital System v01 as the supplemental guideline to conduct the measurement, including Peak to Power Average Ratio, Average Power over the fundamental signal BW (EIRP/ERP) and Signal Bandwidth.

1.4. Test Facility

The measurement facilities used to collect the 3m Radiated Emission and AC power line conducted data are located on the address of SGS Taiwan Ltd. Electronics & Communication Laboratory No.134, Wu Kung Road, Wuku Industrial Zone, Taipei County, Taiwan which are constructed and calibrated to meet the FCC requirements in documents ANSI C63.4:2009. & ANSI C63.10:2009. FCC Registration Number are: 990257, Canada Registration Number: 4620A-4.

The 10 m Open Area Test Sites located on the address of SGS Taiwan Ltd. Electronics & Communication Laboratory No. 29, Pau-Tou-Tsuo Valley Chia-Pau Tsuen, Linkou Hsiang, Taipei county, which is constructed and calibrated to meet the CISPR 22/EN 55022 requirements. SGS Site No. 1(3 & 10 meters) and FCC Registration Number: 94644.

All equipment is calibrated externally and traceable to SI (International System of Unit).

1.5. Special Accessories

No special accessories were used during testing.

1.6. Equipment Modifications

There were no modifications incorporated into the EUT.

Unless otherwise stated the results shown in this test report refer only to the sample(s) tested and such sample(s) are retained for 90 days only.

除非另有說明，此報告結果僅對測試之樣品負責，同時此樣品僅保留90天。本報告未經本公司書面許可，不可部份複製。

This document is issued by the Company subject to its General Conditions of Service printed overleaf, available on request or accessible at www.sgs.com/terms_and_conditions.htm and, for electronic format documents, subject to Terms and Conditions for Electronic Documents at www.sgs.com/terms_e-document.htm. Attention is drawn to the limitation of liability, indemnification and jurisdiction issues defined therein. Any holder of this document is advised that information contained hereon reflects the Company's findings at the time of its intervention only and within the limits of Client's instructions, if any. The Company's sole responsibility is to its Client and this document does not exonerate parties to a transaction from exercising all their rights and obligations under the transaction documents. This document cannot be reproduced except in full, without prior written approval of the Company. Any unauthorized alteration, forgery or falsification of the content or appearance of this document is unlawful and offenders may be prosecuted to the fullest extent of the law.

2. SYSTEM TEST CONFIGURATION

2.1. EUT Configuration

The EUT configuration for testing is installed on RF field strength measurement to meet the Commissions requirement and operating in a manner which intends to maximize its emission characteristics in a continuous normal application.

2.2. EUT Exercise

The EUT (Transmitter) was operated in the continuous transmission mode employed with the simulator of the Base Station that fixates at test default channels to fix the Tx frequency which was for the purpose of the measurements.

2.3. Test Procedure

2.3.1 Conducted Measurement at Antenna Port:

According to measurement procured TIA/EIA 603C and RSS-Gen Issue 3, the EUT is placed on a turn table which is 0.8 m above ground plane. A low loss of RF cable was used to connect the antenna port of EUT to measurement equipment.

2.3.2 Radiated Emissions (ERP/EIRP):

According to measurement procured TIA/EIA 603C and RSS-Gen Issue 3, The EUT is a placed on as turn table which is 0.8 m above ground plane. The turn table shall rotate 360 degrees to determine the position of maximum emission level. EUT is set 3m away from the receiving antenna which varied from 1m to 4m to find out the highest emission. And also, each emission was to be maximized by changing the polarization of receiving antenna both Horizontal and Vertical. In order to find out the max. emission, the relative positions of this hand-held transmitter (EUT) was rotated through three orthogonal axes and measurement procedures for electric field radiated emissions above 1 GHz the EUT measurement is to be made “while keeping the antenna in the ‘cone of radiation’ from that area and pointed at the area both in azimuth and elevation, with polarization oriented for maximum response.” is still within the 3dB illumination BW of the measurement antenna according to the requirements in Section 8 and 13 of ANSI C63.4:2009 & ANSI C63.10:2009.

Unless otherwise stated the results shown in this test report refer only to the sample(s) tested and such sample(s) are retained for 90 days only.

除非另有說明，此報告結果僅對測試之樣品負責，同時此樣品僅保留90天。本報告未經本公司書面許可，不可部份複製。

This document is issued by the Company subject to its General Conditions of Service printed overleaf, available on request or accessible at www.sgs.com/terms_and_conditions.htm and, for electronic format documents, subject to Terms and Conditions for Electronic Documents at www.sgs.com/terms_e-document.htm. Attention is drawn to the limitation of liability, indemnification and jurisdiction issues defined therein. Any holder of this document is advised that information contained hereon reflects the Company's findings at the time of its intervention only and within the limits of Client's instructions, if any. The Company's sole responsibility is to its Client and this document does not exonerate parties to a transaction from exercising all their rights and obligations under the transaction documents. This document cannot be reproduced except in full, without prior written approval of the Company. Any unauthorized alteration, forgery or falsification of the content or appearance of this document is unlawful and offenders may be prosecuted to the fullest extent of the law.

2.4. Measurement Equipment Used:

| Conducted Emission (measured at antenna port) Test Site | | | | | |
|---|---------------|--------------|---------------|------------|------------|
| EQUIPMENT TYPE | MFR | MODEL NUMBER | SERIAL NUMBER | LAST CAL. | CAL DUE. |
| Power Sensor | Anritsu | ML2495A | 1005007 | 02/08/2012 | 02/07/2014 |
| Power Meter | Anritsu | MA2411B | 917032 | 02/08/2012 | 02/07/2014 |
| Spectrum Analyzer | Agilent | E4446A | MY51100003 | 04/15/2013 | 04/14/2014 |
| Spectrum Analyzer | Agilent | E4440A | US41160416 | 03/17/2012 | 03/16/2014 |
| Radio Communication Analyzer | R & S | CMU200 | 102189 | 08/12/2012 | 08/11/2014 |
| Radio Communication Analyzer | Anritsu | MT8820C | 6200995019 | 10/17/2012 | 10/16/2013 |
| Temperature Chamber | TERCHY | MHG-120LF | 911009 | 04/16/2012 | 04/15/2014 |
| DC Block | Mini-Circuits | BLK-18-S+ | 1 | 02/28/2013 | 02/27/2014 |
| Attenuator | Mini-Circuit | BW-S10W2+ | 002 | 02/28/2013 | 02/27/2014 |
| Splitter | Agilent | 11636B | N/A | 02/28/2013 | 02/27/2014 |
| DC Power Supply | Agilent | E3640A | MY40005907 | 07/15/2011 | 07/14/2013 |

| Conducted Emission (measured at antenna port) Test Site | | | | | |
|---|---------|--------------|---------------|------------|------------|
| EQUIPMENT TYPE | MFR | MODEL NUMBER | SERIAL NUMBER | LAST CAL. | CAL DUE. |
| DC Power Supply | Agilent | E3640A | KR93300208 | 07/24/2013 | 07/23/2014 |

Note: The measurement was taken place with the long duration of the time, and additional equipment list as shown above indicate those equipment of which has been subject to undertake the calibration in intermediate period of time of the measurement.

Unless otherwise stated the results shown in this test report refer only to the sample(s) tested and such sample(s) are retained for 90 days only.

除非另有說明，此報告結果僅對測試之樣品負責，同時此樣品僅保留90天。本報告未經本公司書面許可，不可部份複製。

This document is issued by the Company subject to its General Conditions of Service printed overleaf, available on request or accessible at www.sgs.com/terms_and_conditions.htm and, for electronic format documents, subject to Terms and Conditions for Electronic Documents at www.sgs.com/terms_e-document.htm. Attention is drawn to the limitation of liability, indemnification and jurisdiction issues defined therein. Any holder of this document is advised that information contained hereon reflects the Company's findings at the time of its intervention only and within the limits of Client's instructions, if any. The Company's sole responsibility is to its Client and this document does not exonerate parties to a transaction from exercising all their rights and obligations under the transaction documents. This document cannot be reproduced except in full, without prior written approval of the Company. Any unauthorized alteration, forgery or falsification of the content or appearance of this document is unlawful and offenders may be prosecuted to the fullest extent of the law.

| ERP, EIRP MEASUREMENT EQUIPMENT List 966 Chamber | | | | | |
|--|-----------------------|--------------------------|---------------|------------|------------|
| EQUIPMENT TYPE | MFR | MODEL NUMBER | SERIAL NUMBER | LAST CAL. | CAL DUE. |
| Spectrum Analyzer | Agilent | E4446A | MY51100003 | 04/15/2013 | 04/14/2014 |
| EXA Spectrum Analyzer | Agilent | N9010A | MY50420195 | 02/06/2013 | 02/07/2014 |
| Spectrum Analyzer | R&S | FSV-30 | 101398 | 10/18/2011 | 10/17/2013 |
| Bilog Antenna | SCHWAZBECK | VULB9168 | 378 | 01/10/2012 | 01/09/2014 |
| Bilog Antenna | SCHWAZBECK | VULB9160 | 3158 | 11/24/2011 | 11/23/2013 |
| Horn antenna | ETS.LINDGREN | 3117 | 123995 | 05/19/2013 | 05/18/2014 |
| Horn antenna | ETS.LINDGREN | 3117 | 123991 | 01/21/2013 | 01/20/2015 |
| Horn Antenna | Schwarzbeck | BBHA9170 | 184 | 01/17/2012 | 01/17/2014 |
| Horn Antenna | Schwarzbeck | BBHA9170 | 185 | 07/11/2011 | 07/10/2013 |
| RF amplifier | Miteq | AMF-6F-260040 0-40-8P | 971576 | 01/29/2013 | 01/28/2014 |
| Signal Generator | R&S | SMR40 | 100210 | 02/02/2012 | 02/01/2014 |
| Signal Generator | Agilent | E4438C | MY45093613 | 07/15/2011 | 07/14/2013 |
| Pre-Amplifier | Agilent | 8447D | 1937A02834 | 01/04/2013 | 01/03/2014 |
| Pre-Amplifier | EMC Instruments Corp. | EMC0126530 | 980038 | 01/04/2013 | 01/03/2014 |
| Attenuator | Mini-Circuit | BW-S10W2+ | 004 | 02/28/2013 | 02/27/2014 |
| Radio Communication Analyzer | R & S | CMU200 | 102189 | 08/12/2012 | 08/11/2014 |
| Radio Communication Analyzer | Anritsu | MT8820C | 6200995019 | 10/17/2012 | 10/16/2013 |
| Turn Table | HD | DT420 | N/A | N.C.R | N.C.R |
| Antenna Tower | HD | MA240-N | 240/657 | N.C.R | N.C.R |
| Controller | HD | HD100 | N/A | N.C.R | N.C.R |
| Low Loss Cable | HUBER+SUHNER | 966_Tx | 10m | 01/04/2013 | 01/03/2014 |
| Low Loss Cable | HUBER+SUHNER | 966_Rx | 3m | 01/04/2013 | 01/03/2014 |
| Filter 800-1000 | Micro-Tronics | EWT | M2 | 02/28/2013 | 02/28/2014 |
| Filter 1700-1800 | Micro-Tronics | BRC15751 | 001 | 02/28/2013 | 02/28/2014 |
| Filter 1800-2000 | Micro-Tronics | EWT | M2 | 02/28/2013 | 02/28/2014 |
| 1GHz High Pass Filter | Micro-Tronics | HPM50108 | 32 | 02/28/2013 | 02/28/2014 |
| 2GHz High Pass Filter | Micro-Tronics | HPM50110 | 36 | 02/28/2013 | 02/28/2014 |
| 3m Site NSA | SGS | 966 chamber | N/A | 07/15/2012 | 07/14/2013 |

Unless otherwise stated the results shown in this test report refer only to the sample(s) tested and such sample(s) are retained for 90 days only.

除非另有說明，此報告結果僅對測試之樣品負責，同時此樣品僅保留90天。本報告未經本公司書面許可，不可部份複製。

This document is issued by the Company subject to its General Conditions of Service printed overleaf, available on request or accessible at www.sgs.com/terms_and_conditions.htm and, for electronic format documents, subject to Terms and Conditions for Electronic Documents at www.sgs.com/terms_e-document.htm. Attention is drawn to the limitation of liability, indemnification and jurisdiction issues defined therein. Any holder of this document is advised that information contained hereon reflects the Company's findings at the time of its intervention only and within the limits of Client's instructions, if any. The Company's sole responsibility is to its Client and this document does not exonerate parties to a transaction from exercising all their rights and obligations under the transaction documents. This document cannot be reproduced except in full, without prior written approval of the Company. Any unauthorized alteration, forgery or falsification of the content or appearance of this document is unlawful and offenders may be prosecuted to the fullest extent of the law.

| ERP, EIRP MEASUREMENT EQUIPMENT List 966 Chamber | | | | | |
|--|-------------|--------------|---------------|------------|------------|
| EQUIPMENT TYPE | MFR | MODEL NUMBER | SERIAL NUMBER | LAST CAL. | CAL DUE. |
| Horn Antenna | Schwarzbeck | BBHA9170 | 185 | 07/19/2013 | 07/18/2014 |
| Signal Generator | Agilent | N5182A | MY50141462 | 02/08/2013 | 02/07/2014 |
| 3m Site NSA | SGS | 966 chamber | N/A | 07/15/2013 | 07/14/2014 |

Note: The measurement was taken place with the long duration of the time, and additional equipment list as shown above indicate those equipment of which has been subject to undertake the calibration in intermediate period of time of the measurement.

NOTE: N.C.R refers to Not Calibrated Required.

Unless otherwise stated the results shown in this test report refer only to the sample(s) tested and such sample(s) are retained for 90 days only.

除非另有說明，此報告結果僅對測試之樣品負責，同時此樣品僅保留90天。本報告未經本公司書面許可，不可部份複製。

This document is issued by the Company subject to its General Conditions of Service printed overleaf, available on request or accessible at www.sgs.com/terms_and_conditions.htm and, for electronic format documents, subject to Terms and Conditions for Electronic Documents at www.sgs.com/terms_e-document.htm. Attention is drawn to the limitation of liability, indemnification and jurisdiction issues defined therein. Any holder of this document is advised that information contained hereon reflects the Company's findings at the time of its intervention only and within the limits of Client's instructions, if any. The Company's sole responsibility is to its Client and this document does not exonerate parties to a transaction from exercising all their rights and obligations under the transaction documents. This document cannot be reproduced except in full, without prior written approval of the Company. Any unauthorized alteration, forgery or falsification of the content or appearance of this document is unlawful and offenders may be prosecuted to the fullest extent of the law.

2.5. Configuration of Tested System

Fig. 2-1 Configuration of Tested System (Fixed Channel-Conducted)

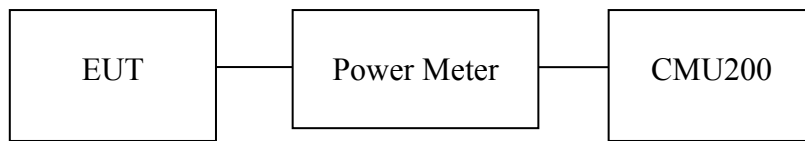

Fig. 2-2 Configuration of Tested System (Fixed Channel-Radiated)

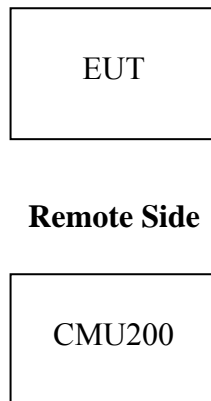

Table 2-1 Equipment Used in

| Item | Equipment | Mfr/Brand | Model/ Type No. | Series No. | Data Cable | Power Cord |
|------|--------------------------------------|-----------|--------------------|------------|------------|-------------|
| 1. | Universal Radio Communication Tester | R&S | CMU200 | 102189 | shielded | Un-shielded |
| 2. | Power Meter | Anritsu | ML2495A | 1005007 | shielded | Un-shielded |

Unless otherwise stated the results shown in this test report refer only to the sample(s) tested and such sample(s) are retained for 90 days only.

除非另有說明，此報告結果僅對測試之樣品負責，同時此樣品僅保留90天。本報告未經本公司書面許可，不可部份複製。

This document is issued by the Company subject to its General Conditions of Service printed overleaf, available on request or accessible at www.sgs.com/terms_and_conditions.htm and, for electronic format documents, subject to Terms and Conditions for Electronic Documents at www.sgs.com/terms_e-document.htm. Attention is drawn to the limitation of liability, indemnification and jurisdiction issues defined therein. Any holder of this document is advised that information contained hereon reflects the Company's findings at the time of its intervention only and within the limits of Client's instructions, if any. The Company's sole responsibility is to its Client and this document does not exonerate parties to a transaction from exercising all their rights and obligations under the transaction documents. This document cannot be reproduced except in full, without prior written approval of the Company. Any unauthorized alteration, forgery or falsification of the content or appearance of this document is unlawful and offenders may be prosecuted to the fullest extent of the law.

3. SUMMARY OF TEST RESULTS

| FCC Rules | IC Rules | Description Of Test | Result |
|---|---|--|-----------|
| §2.1046(a) | N/A | RF Power Output | Compliant |
| §2.1046(a) §22.913(a)(2) §24.232(c)§27.50(d)(4) | §4.8 (RSS-Gen Issue 3) §5.4 (RSS-132) §6.4 (RSS-133) §6.4 (RSS-139) | ERP/ EIRP measurement | Compliant |
| §2.1049(h) | §4.6.1 (RSS-Gen Issue 3) §2.3 (RSS-133) §2.3 (RSS-139) | 99% Occupied Bandwidth | Compliant |
| §2.1051 §22.917(a) §24.238(a) §27.53(h) | §4.9 (RSS-Gen Issue 3) §5.5 (RSS-132) §6.5 (RSS-133) §6.5 (RSS-139) | Out of Band Emissions at Antenna Terminals and Band Edge | Compliant |
| §2.1053 §22.917(a) §24.238(a) §27.53(h) | §4.9 (RSS-Gen Issue 3) §5.5 (RSS-132) §6.5 (RSS-133) §6.5 (RSS-139) | Field Strength of Spurious Radiation | Compliant |
| §24.232(d) §27.50(B) | §6.4 (RSS-139) §6.4 (RSS-133) §5.4 (RSS-132) | Peak to Average Ratio | Compliant |
| §2.1055(a)(1) §22.355 §24.235 §27.54 | §4.7 (RSS-Gen Issue 3) §5.3 (RSS-132) §6.3 (RSS-133) §6.3 (RSS-139) | Frequency Stability vs. Temperature | Compliant |
| §2.1055(d)(2) §22.355 §24.235 §27.54 | §4.7 (RSS-Gen Issue 3) §5.3 (RSS-132) §6.3 (RSS-133) §6.3 (RSS-139) | Frequency Stability vs. Voltage | Compliant |
| N/A | §4.10 (RSS-Gen Issue 3) §5.6 (RSS-132) §6.6 (RSS-133) §6.6 (RSS-139) | Receiver Spurious Emissions | Compliant |

Unless otherwise stated the results shown in this test report refer only to the sample(s) tested and such sample(s) are retained for 90 days only.

除非另有說明，此報告結果僅對測試之樣品負責，同時此樣品僅保留90天。本報告未經本公司書面許可，不可部份複製。

This document is issued by the Company subject to its General Conditions of Service printed overleaf, available on request or accessible at www.sgs.com/terms_and_conditions.htm and, for electronic format documents, subject to Terms and Conditions for Electronic Documents at www.sgs.com/terms_e-document.htm. Attention is drawn to the limitation of liability, indemnification and jurisdiction issues defined therein. Any holder of this document is advised that information contained hereon reflects the Company's findings at the time of its intervention only and within the limits of Client's instructions, if any. The Company's sole responsibility is to its Client and this document does not exonerate parties to a transaction from exercising all their rights and obligations under the transaction documents. This document cannot be reproduced except in full, without prior written approval of the Company. Any unauthorized alteration, forgery or falsification of the content or appearance of this document is unlawful and offenders may be prosecuted to the fullest extent of the law.

Max ERP/EIRP measurement result:

| | dBm | | W |
|----------------|-------|------|-------|
| GSM 850 Band | 26.08 | ERP | 0.406 |
| GSM 1900 Band | 31.41 | EIRP | 1.384 |
| GPRS 850 Band | 26.05 | ERP | 0.403 |
| GPRS 1900 Band | 31.18 | EIRP | 1.312 |
| EDGE 850 Band | 24.28 | ERP | 0.268 |
| EDGE 1900 Band | 29.39 | EIRP | 0.869 |
| WCDMA Band II | 27.74 | EIRP | 0.594 |
| WCDMA Band IV | 29.21 | EIRP | 0.834 |
| WCDMA Band V | 21.69 | ERP | 0.148 |
| HSUPA Band II | 27.20 | EIRP | 0.525 |
| HSUPA Band IV | 28.62 | EIRP | 0.728 |
| HSUPA Band V | 21.69 | ERP | 0.148 |
| HSDPA Band II | 27.58 | EIRP | 0.573 |
| HSDPA Band IV | 29.16 | EIRP | 0.824 |
| HSDPA Band V | 21.85 | ERP | 0.153 |

Unless otherwise stated the results shown in this test report refer only to the sample(s) tested and such sample(s) are retained for 90 days only.

除非另有說明，此報告結果僅對測試之樣品負責，同時此樣品僅保留90天。本報告未經本公司書面許可，不可部份複製。

This document is issued by the Company subject to its General Conditions of Service printed overleaf, available on request or accessible at www.sgs.com/terms_and_conditions.htm and, for electronic format documents, subject to Terms and Conditions for Electronic Documents at www.sgs.com/terms_e-document.htm. Attention is drawn to the limitation of liability, indemnification and jurisdiction issues defined therein. Any holder of this document is advised that information contained hereon reflects the Company's findings at the time of its intervention only and within the limits of Client's instructions, if any. The Company's sole responsibility is to its Client and this document does not exonerate parties to a transaction from exercising all their rights and obligations under the transaction documents. This document cannot be reproduced except in full, without prior written approval of the Company. Any unauthorized alteration, forgery or falsification of the content or appearance of this document is unlawful and offenders may be prosecuted to the fullest extent of the law.

4. DESCRIPTION OF TEST MODES

The EUT has been tested under operating condition.

EUT was staying in continuous transmitting mode. Channel Low, Mid and High for each type band with rated data rate were chosen for full testing.

The list of channel selected to conduct the measurements

GSM/GPRS/EDGE 850:

Channel Low: AFRCN 128 at 824.2MHz, Channel Mid: AFRCN 190 at 836.6MHz, Channel High: AFRCN 251 at 848.8MHz.

GSM/GPRS/EDGE 1900:

Channel Low: AFRCN 512 at 1850.2MHz, Channel Mid: AFRCN 661 at 1880.0MHz, Channel High: AFRCN 810 at 1909.8MHz

WCDMA/HSPA BII:

Channel Low: UAFRCN 9262 at 1852.4MHz, Channel Mid: UAFRCN 9400 at 1880.0MHz, Channel High: UAFRCN 9538 at 1907.6MHz.

WCDMA/HSPA BIV:

Channel Low: UAFRCN 1312 at 1712.4MHz, Channel Mid: UAFRCN 1413 at 1732.6MHz, Channel High: UAFRCN 1513 at 1752.6MHz.

WCDMA/HSPA BV:

Channel Low: UAFRCN 4132 at 826.4MHz, Channel Mid: UAFRCN 4183 at 836.6MHz, Channel High: UAFRCN 4233 at 846.6MHz.

The field strength of spurious radiation emission was measured as EUT stand-up position (H mode) and lie down position (E1, E2 mode) for GSM/EDGE and WCDMA Band II / IV/ V with power adaptor. The worst-case of E2 position for GSM 850, E1 position for GSM 1900, E1 position for WCDMA/HSPA Band II, H position for WCDMA/HSPA Band IV, E1 position for WCDMA/HSPA Band V were reported.

Unless otherwise stated the results shown in this test report refer only to the sample(s) tested and such sample(s) are retained for 90 days only.

除非另有說明，此報告結果僅對測試之樣品負責，同時此樣品僅保留90天。本報告未經本公司書面許可，不可部份複製。

This document is issued by the Company subject to its General Conditions of Service printed overleaf, available on request or accessible at www.sgs.com/terms_and_conditions.htm and, for electronic format documents, subject to Terms and Conditions for Electronic Documents at www.sgs.com/terms_e-document.htm. Attention is drawn to the limitation of liability, indemnification and jurisdiction issues defined therein. Any holder of this document is advised that information contained hereon reflects the Company's findings at the time of its intervention only and within the limits of Client's instructions, if any. The Company's sole responsibility is to its Client and this document does not exonerate parties to a transaction from exercising all their rights and obligations under the transaction documents. This document cannot be reproduced except in full, without prior written approval of the Company. Any unauthorized alteration, forgery or falsification of the content or appearance of this document is unlawful and offenders may be prosecuted to the fullest extent of the law.

The given application is dual SIM build of certified product, PY7PM-0480, 4170B-PM-0480. It differs only in the mental shield covering the portion of slot space that is preserved in the built applicable PY7PM-0480, and 4170B-PM-0480. Except for the change as aforementioned above, all hardware, software relevant to RF Parameter of Physical layer, I/O signal remains unchanged, and the data as measured in the authorization of PY7M-0480, 4170B-PM-0480, and remains, and entails representative.

This test report demonstrates the result of spot-check on Radiated Spurious Emission in order to reveal of the evidence of compliance record proving the implementation of dual SIM built causes no degradation as compared to build, PY7PM-0480/4170B-PM-0480.

Unless otherwise stated the results shown in this test report refer only to the sample(s) tested and such sample(s) are retained for 90 days only.

除非另有說明，此報告結果僅對測試之樣品負責，同時此樣品僅保留90天。本報告未經本公司書面許可，不可部份複製。

This document is issued by the Company subject to its General Conditions of Service printed overleaf, available on request or accessible at www.sgs.com/terms_and_conditions.htm and, for electronic format documents, subject to Terms and Conditions for Electronic Documents at www.sgs.com/terms_e-document.htm. Attention is drawn to the limitation of liability, indemnification and jurisdiction issues defined therein. Any holder of this document is advised that information contained hereon reflects the Company's findings at the time of its intervention only and within the limits of Client's instructions, if any. The Company's sole responsibility is to its Client and this document does not exonerate parties to a transaction from exercising all their rights and obligations under the transaction documents. This document cannot be reproduced except in full, without prior written approval of the Company. Any unauthorized alteration, forgery or falsification of the content or appearance of this document is unlawful and offenders may be prosecuted to the fullest extent of the law.

5. MEASUREMENT UNCERTAINTY

| Test Items | Uncertainty |
|--|--|
| RF Power Output | +/- 1.42 dB |
| ERP/ EIRP measurement | Vertical Polarization = +/- 4.74dB Horizontal Polarization = +/- 4.62dB |
| 99% Occupied Bandwidth | +/- 123.36 Hz |
| Out of Band Emissions at Antenna Terminals and Band Edge | +/- 1.55 dB |
| Peak to Average Ratio | +/- 1.55 dB |
| Frequency Stability vs. Temperature | +/- 123.36 Hz |
| Frequency Stability vs. Voltage | +/- 123.36 Hz |
| Temperature | +/- 0.8 °C |
| Humidity | +/- 4.7 % |
| DC / AC Power Source | DC= +/- 1%, AC= +/- 0.2% |

Radiated Spurious Emission:

| | |
|--|-----------------------------|
| Measurement uncertainty (Polarization : Vertical) | 30MHz - 180MHz: +/- 3.37dB |
| | 180MHz - 417MHz: +/- 3.19dB |
| | 0.417GHz-1GHz: +/- 3.19dB |
| | 1GHz - 18GHz: +/- 4.04dB |
| | 18GHz - 40GHz: +/- 4.04dB |

| | |
|--|-----------------------------|
| Measurement uncertainty (Polarization : Horizontal) | 30MHz - 167MHz: +/- 4.22dB |
| | 167MHz - 500MHz: +/- 3.44dB |
| | 0.5GHz-1GHz: +/- 3.39dB |
| | 1GHz - 18GHz: +/- 4.08dB |
| | 18GHz - 40GHz: +/- 4.08dB |

This uncertainty represents an expanded uncertainty expressed at approximately the 95% confidence level using a coverage factor of k=2.

Unless otherwise stated the results shown in this test report refer only to the sample(s) tested and such sample(s) are retained for 90 days only.

除非另有說明，此報告結果僅對測試之樣品負責，同時此樣品僅保留90天。本報告未經本公司書面許可，不可部份複製。

This document is issued by the Company subject to its General Conditions of Service printed overleaf, available on request or accessible at www.sgs.com/terms_and_conditions.htm and, for electronic format documents, subject to Terms and Conditions for Electronic Documents at www.sgs.com/terms_e-document.htm. Attention is drawn to the limitation of liability, indemnification and jurisdiction issues defined therein. Any holder of this document is advised that information contained hereon reflects the Company's findings at the time of its intervention only and within the limits of Client's instructions, if any. The Company's sole responsibility is to its Client and this document does not exonerate parties to a transaction from exercising all their rights and obligations under the transaction documents. This document cannot be reproduced except in full, without prior written approval of the Company. Any unauthorized alteration, forgery or falsification of the content or appearance of this document is unlawful and offenders may be prosecuted to the fullest extent of the law.

6. RF POWER OUTPUT MEASUREMENT

6.1. Standard Applicable:

According to FCC §2.1046.

FCC 22.913(a) Mobile station are limited to 7W.

FCC 24.232(c) Peak Power Measurement limited to 2W

FCC 24.232(c) Equipment must employ means to limit the power to the minimum necessary for successful communication.

Part 27, 50(d)(4) Portable stations are limited to 1W

3GPP Power limitation for HSDPA and HSUPA

Maximum Output Powers for HSDPA

| Sub-test in table C.10.1.4 | Power Class 3 | | Power Class 4 | |
|----------------------------|---------------|-----------|---------------|-----------|
| | Power (dBm) | Tol (dB) | Power (dBm) | Tol (dB) |
| 1 | +24 | +1.7/-3.7 | +21 | +2.7/-2.7 |
| 2 | +24 | +1.7/-3.7 | +21 | +2.7/-2.7 |
| 3 | +23.5 | +2.2/-3.7 | +20.5 | +3.2/-2.7 |
| 4 | +23.5 | +2.2/-3.7 | +20.5 | +3.2/-2.7 |

Maximum Output Powers for HSUPA

| Sub-test in table C.11.1.3 | Power Class 3 | | Power Class 4 | |
|----------------------------|---------------|-----------|---------------|-----------|
| | Power (dBm) | Tol (dB) | Power (dBm) | Tol (dB) |
| 1 | +24 | +1.7/-6.7 | +21 | +2.7/-5.7 |
| 2 | +22 | +3.7/-5.2 | +19 | +4.7/-4.2 |
| 3 | +23 | +2.7/-5.2 | +20 | +3.7/-4.2 |
| 4 | +22 | +3.7/-5.2 | +19 | +4.7/-4.2 |
| 5 | +24 | +1.7/-6.7 | +21 | +2.7/-5.7 |

Unless otherwise stated the results shown in this test report refer only to the sample(s) tested and such sample(s) are retained for 90 days only.

除非另有說明，此報告結果僅對測試之樣品負責，同時此樣品僅保留90天。本報告未經本公司書面許可，不可部份複製。

This document is issued by the Company subject to its General Conditions of Service printed overleaf, available on request or accessible at www.sgs.com/terms_and_conditions.htm and, for electronic format documents, subject to Terms and Conditions for Electronic Documents at www.sgs.com/terms_e-document.htm. Attention is drawn to the limitation of liability, indemnification and jurisdiction issues defined therein. Any holder of this document is advised that information contained hereon reflects the Company's findings at the time of its intervention only and within the limits of Client's instructions, if any. The Company's sole responsibility is to its Client and this document does not exonerate parties to a transaction from exercising all their rights and obligations under the transaction documents. This document cannot be reproduced except in full, without prior written approval of the Company. Any unauthorized alteration, forgery or falsification of the content or appearance of this document is unlawful and offenders may be prosecuted to the fullest extent of the law.

6.2. Test Set-up:

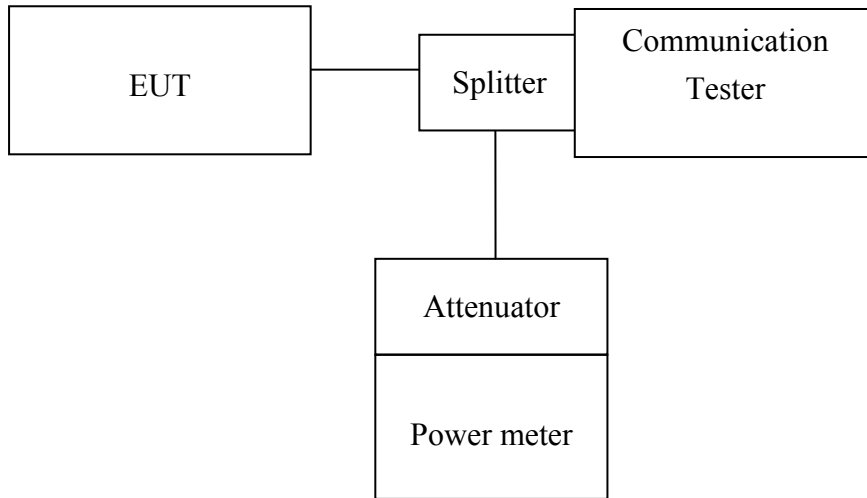

Note: Measurement setup for testing on Antenna connector

6.3. Measurement Procedure:

The transmitter output was connected to a calibrated attenuator, the other end of which was connected to a power meter. Transmitter output was read off the power meter in dBm. The power output at the transmitter antenna port was determined by adding the value of the attenuator to the power meter reading. TS 151 010-1 is reference to conduct the test measurement of output power.

The Procedure of KDB941225 (SAR Measurement Procedures for 3G devices, (WCDMA/HSPA) was used for EUT and Base station setting. RMC 12.2kps is used for this testing, and KDB 971168 D01 Power Meas License Digital System as the supplemental test methodology to adjust the proper setting obtaining the measurement results

Necessary Communication complying with 24.232 (c) and 27.5(d)(4)

Set CMU200 (base-station simulator) MS Signal with packet data submenu; SLOT Configuration Set appropriate level to verify if or not power on mobile station’s link with simulator still exists.

6.4. Measurement Equipment Used:

Refer to section 2.4 in this report

Unless otherwise stated the results shown in this test report refer only to the sample(s) tested and such sample(s) are retained for 90 days only.

除非另有說明，此報告結果僅對測試之樣品負責，同時此樣品僅保留90天。本報告未經本公司書面許可，不可部份複製。

This document is issued by the Company subject to its General Conditions of Service printed overleaf, available on request or accessible at www.sgs.com/terms_and_conditions.htm and, for electronic format documents, subject to Terms and Conditions for Electronic Documents at www.sgs.com/terms_e-document.htm. Attention is drawn to the limitation of liability, indemnification and jurisdiction issues defined therein. Any holder of this document is advised that information contained hereon reflects the Company's findings at the time of its intervention only and within the limits of Client's instructions, if any. The Company's sole responsibility is to its Client and this document does not exonerate parties to a transaction from exercising all their rights and obligations under the transaction documents. This document cannot be reproduced except in full, without prior written approval of the Company. Any unauthorized alteration, forgery or falsification of the content or appearance of this document is unlawful and offenders may be prosecuted to the fullest extent of the law.

6.5. Measurement Result:

6.5.1. RF Conducted Output Power

6.5.1.1.: GSM/GPRS/EDGE (GMSK; 8-PSK)

Result:

| EUT Mode | Frequency (MHz) | CH | Peak Power (dBm) | Averager Burst Power (dBm) |
|----------|-----------------|-----|------------------|----------------------------|
| GSM 850 | 824.2 | 128 | 33.30 | 33.00 |
| | 836.6 | 190 | 33.30 | 33.10 |
| | 848.8 | 251 | 33.40 | 33.20 |

| EUT Mode | Frequency (MHz) | CH | Peak Power (dBm) | Averager Burst Power (dBm) |
|----------|-----------------|-----|------------------|----------------------------|
| GSM 1900 | 1850.2 | 512 | 30.00 | 29.90 |
| | 1880.0 | 661 | 30.30 | 30.10 |
| | 1909.8 | 810 | 30.60 | 30.40 |

| EUT Mode | Frequency (MHz) | CH | Peak Power (4DN 1UP) Class 8 (dBm) | Average Burst Power (4DN 1UP) Class 8 (dBm) | Peak Power (4DN 2UP) Class 10 (dBm) | Average Burst Power (4DN 2UP) Class 10 (dBm) |
|----------|-----------------|-----|------------------------------------|---|-------------------------------------|--|
| GPRS 850 | 824.2 | 128 | 33.20 | 33.00 | 29.80 | 29.60 |
| | 836.6 | 190 | 33.20 | 33.10 | 29.80 | 29.70 |
| | 848.8 | 251 | 33.30 | 33.10 | 29.90 | 29.60 |

| EUT Mode | Frequency (MHz) | CH | Peak Power (4DN 3UP) Class 12 (dBm) | Average Burst Power (4DN 3UP) Class 12 (dBm) | Peak Power (4DN 4UP) Class 12 (dBm) | Average Burst Power (4DN 4UP) Class 12 (dBm) |
|----------|-----------------|-----|-------------------------------------|--|-------------------------------------|--|
| GPRS 850 | 824.2 | 128 | 28.40 | 28.20 | 27.60 | 27.40 |
| | 836.6 | 190 | 28.40 | 28.20 | 27.50 | 27.30 |
| | 848.8 | 251 | 28.60 | 28.30 | 27.50 | 27.40 |

Unless otherwise stated the results shown in this test report refer only to the sample(s) tested and such sample(s) are retained for 90 days only.

除非另有說明，此報告結果僅對測試之樣品負責，同時此樣品僅保留90天。本報告未經本公司書面許可，不可部份複製。

This document is issued by the Company subject to its General Conditions of Service printed overleaf, available on request or accessible at www.sgs.com/terms_and_conditions.htm and, for electronic format documents, subject to Terms and Conditions for Electronic Documents at www.sgs.com/terms_e-document.htm. Attention is drawn to the limitation of liability, indemnification and jurisdiction issues defined therein. Any holder of this document is advised that information contained hereon reflects the Company's findings at the time of its intervention only and within the limits of Client's instructions, if any. The Company's sole responsibility is to its Client and this document does not exonerate parties to a transaction from exercising all their rights and obligations under the transaction documents. This document cannot be reproduced except in full, without prior written approval of the Company. Any unauthorized alteration, forgery or falsification of the content or appearance of this document is unlawful and offenders may be prosecuted to the fullest extent of the law.

| EUT Mode | Frequency (MHz) | CH | Peak Power (4DN 1UP) Class 8 (dBm) | Average Burst Power (4DN 1UP) Class 8 (dBm) | Peak Power (4DN 2UP) Class 10 (dBm) | Average Burst Power (4DN 2UP) Class 10 (dBm) |
|-----------|--------------------|-----|---|---|--|--|
| GPRS 1900 | 1850.2 | 512 | 30.00 | 29.90 | 29.50 | 29.30 |
| | 1880.0 | 661 | 30.30 | 30.20 | 29.50 | 29.30 |
| | 1909.8 | 810 | 30.60 | 30.50 | 29.90 | 29.60 |

| EUT Mode | Frequency (MHz) | CH | Peak Power (4DN 3UP) Class 12 (dBm) | Average Burst Power (4DN 3UP) Class 12 (dBm) | Peak Power (4DN 4UP) Class 12 (dBm) | Average Burst Power (4DN 4UP) Class 12 (dBm) |
|-----------|--------------------|-----|--|--|--|--|
| GPRS 1900 | 1850.2 | 512 | 28.10 | 28.00 | 27.60 | 27.30 |
| | 1880.0 | 661 | 28.30 | 28.10 | 27.70 | 27.50 |
| | 1909.8 | 810 | 28.30 | 28.10 | 27.80 | 27.60 |

| EUT Mode | Frequency (MHz) | CH | Peak Power (4DN 1UP) Class 8 (dBm) | Average Burst Power (4DN 1UP) Class 8 (dBm) | Peak Power (4DN 2UP) Class 10 (dBm) | Average Burst Power (4DN 2UP) Class 10 (dBm) |
|----------|--------------------|-----|---|---|--|--|
| EDGE 850 | 824.2 | 128 | 30.00 | 26.80 | 29.60 | 26.40 |
| | 836.6 | 190 | 30.00 | 26.80 | 29.60 | 26.30 |
| | 848.8 | 251 | 30.00 | 26.80 | 29.60 | 26.50 |

| EUT Mode | Frequency (MHz) | CH | Peak Power (4DN 3UP) Class 12 (dBm) | Average Burst Power (4DN 3UP) Class 12 (dBm) | Peak Power (4DN 4UP) Class 12 (dBm) | Average Burst Power (4DN 4UP) Class 12 (dBm) |
|----------|--------------------|-----|--|--|--|--|
| EDGE 850 | 824.2 | 128 | 29.40 | 26.20 | 28.80 | 25.70 |
| | 836.6 | 190 | 29.30 | 26.20 | 28.80 | 25.70 |
| | 848.8 | 251 | 29.40 | 26.20 | 28.80 | 25.70 |

Unless otherwise stated the results shown in this test report refer only to the sample(s) tested and such sample(s) are retained for 90 days only.

除非另有說明，此報告結果僅對測試之樣品負責，同時此樣品僅保留90天。本報告未經本公司書面許可，不可部份複製。

This document is issued by the Company subject to its General Conditions of Service printed overleaf, available on request or accessible at www.sgs.com/terms_and_conditions.htm and, for electronic format documents, subject to Terms and Conditions for Electronic Documents at www.sgs.com/terms_e-document.htm. Attention is drawn to the limitation of liability, indemnification and jurisdiction issues defined therein. Any holder of this document is advised that information contained hereon reflects the Company's findings at the time of its intervention only and within the limits of Client's instructions, if any. The Company's sole responsibility is to its Client and this document does not exonerate parties to a transaction from exercising all their rights and obligations under the transaction documents. This document cannot be reproduced except in full, without prior written approval of the Company. Any unauthorized alteration, forgery or falsification of the content or appearance of this document is unlawful and offenders may be prosecuted to the fullest extent of the law.

| EUT Mode | Frequency (MHz) | CH | Peak Power (4DN 1UP) Class 8 (dBm) | Average Burst Power (4DN 1UP) Class 8 (dBm) | Peak Power (4DN 2UP) Class 10 (dBm) | Average Burst Power (4DN 2UP) Class 10 (dBm) |
|-----------|--------------------|-----|---|---|--|--|
| EDGE 1900 | 1850.2 | 512 | 28.40 | 25.20 | 28.20 | 25.00 |
| | 1880.0 | 661 | 28.70 | 25.30 | 28.40 | 25.10 |
| | 1909.8 | 810 | 28.70 | 25.50 | 28.50 | 25.30 |

| EUT Mode | Frequency (MHz) | CH | Peak Power (4DN 3UP) Class 12 (dBm) | Average Burst Power (4DN 3UP) Class 12 (dBm) | Peak Power (4DN 4UP) Class 12 (dBm) | Average Burst Power (4DN 4UP) Class 12 (dBm) |
|-----------|--------------------|-----|--|--|--|--|
| EDGE 1900 | 1850.2 | 512 | 28.10 | 24.80 | 27.70 | 24.50 |
| | 1880.0 | 661 | 28.20 | 24.90 | 27.90 | 24.60 |
| | 1909.8 | 810 | 28.10 | 25.00 | 27.90 | 24.70 |

Cable loss offset Low Band: 0.5dB

Cable loss offset High Band: 0.7dB

Unless otherwise stated the results shown in this test report refer only to the sample(s) tested and such sample(s) are retained for 90 days only.

除非另有說明，此報告結果僅對測試之樣品負責，同時此樣品僅保留90天。本報告未經本公司書面許可，不可部份複製。

This document is issued by the Company subject to its General Conditions of Service printed overleaf, available on request or accessible at www.sgs.com/terms_and_conditions.htm and, for electronic format documents, subject to Terms and Conditions for Electronic Documents at www.sgs.com/terms_e-document.htm. Attention is drawn to the limitation of liability, indemnification and jurisdiction issues defined therein. Any holder of this document is advised that information contained hereon reflects the Company's findings at the time of its intervention only and within the limits of Client's instructions, if any. The Company's sole responsibility is to its Client and this document does not exonerate parties to a transaction from exercising all their rights and obligations under the transaction documents. This document cannot be reproduced except in full, without prior written approval of the Company. Any unauthorized alteration, forgery or falsification of the content or appearance of this document is unlawful and offenders may be prosecuted to the fullest extent of the law.

6.5.1.2.: WCDMA mode

The following tests were completed according to the test requirements outlined in section 5.2 of the 3GPP TS34.121-1 V8.4.0 specification. The EUT supports power Class 3, which has a nominal maximum output power of 24 dBm (+1.7/-3.7). RMC 12.2kps is used for this testing.

Results:

| EUT Mode | Frequency (MHz) | CH | Peak Power (dBm) | Avg. Power (dBm) |
|------------------|--------------------|------|---------------------|---------------------|
| WCDMA Band II | 1852.4 | 9262 | 27.12 | 24.10 |
| | 1880.0 | 9400 | 27.25 | 24.25 |
| | 1907.6 | 9538 | 26.85 | 23.92 |

| EUT Mode | Frequency (MHz) | CH | Peak Power (dBm) | Avg. Power (dBm) |
|------------------|--------------------|------|---------------------|---------------------|
| WCDMA Band IV | 1712.4 | 1312 | 27.25 | 24.20 |
| | 1732.6 | 1412 | 27.17 | 24.13 |
| | 1752.6 | 1513 | 27.15 | 24.08 |

| EUT Mode | Frequency (MHz) | CH | Peak Power (dBm) | Avg. Power (dBm) |
|-----------------|--------------------|------|---------------------|---------------------|
| WCDMA Band V | 826.4 | 4132 | 27.44 | 24.13 |
| | 836.6 | 4183 | 27.24 | 24.15 |
| | 846.6 | 4233 | 27.30 | 24.00 |

Unless otherwise stated the results shown in this test report refer only to the sample(s) tested and such sample(s) are retained for 90 days only.

除非另有說明，此報告結果僅對測試之樣品負責，同時此樣品僅保留90天。本報告未經本公司書面許可，不可部份複製。

This document is issued by the Company subject to its General Conditions of Service printed overleaf, available on request or accessible at www.sgs.com/terms_and_conditions.htm and, for electronic format documents, subject to Terms and Conditions for Electronic Documents at www.sgs.com/terms_e-document.htm. Attention is drawn to the limitation of liability, indemnification and jurisdiction issues defined therein. Any holder of this document is advised that information contained hereon reflects the Company's findings at the time of its intervention only and within the limits of Client's instructions, if any. The Company's sole responsibility is to its Client and this document does not exonerate parties to a transaction from exercising all their rights and obligations under the transaction documents. This document cannot be reproduced except in full, without prior written approval of the Company. Any unauthorized alteration, forgery or falsification of the content or appearance of this document is unlawful and offenders may be prosecuted to the fullest extent of the law.

| EUT Mode | Frequency (MHz) | CH | Peak Power (dBm) | Avg. Power (dBm) |
|------------------|--------------------|------|---------------------|---------------------|
| HSDPA Band II | 1852.4 | 9262 | 27.23 | 23.00 |
| | 1880.0 | 9400 | 27.11 | 23.16 |
| | 1907.6 | 9538 | 27.01 | 22.83 |

| EUT Mode | Frequency (MHz) | CH | Peak Power (dBm) | Avg. Power (dBm) |
|------------------|--------------------|------|---------------------|---------------------|
| HSDPA Band IV | 1712.4 | 1312 | 27.23 | 23.09 |
| | 1732.6 | 1412 | 27.32 | 22.98 |
| | 1752.6 | 1513 | 27.03 | 22.89 |

| EUT Mode | Frequency (MHz) | CH | Peak Power (dBm) | Avg. Power (dBm) |
|-----------------|--------------------|------|---------------------|---------------------|
| HSDPA Band V | 826.4 | 4132 | 27.18 | 22.89 |
| | 836.6 | 4183 | 27.13 | 22.92 |
| | 846.6 | 4233 | 27.05 | 22.83 |

Unless otherwise stated the results shown in this test report refer only to the sample(s) tested and such sample(s) are retained for 90 days only.

除非另有說明，此報告結果僅對測試之樣品負責，同時此樣品僅保留90天。本報告未經本公司書面許可，不可部份複製。

This document is issued by the Company subject to its General Conditions of Service printed overleaf, available on request or accessible at www.sgs.com/terms_and_conditions.htm and, for electronic format documents, subject to Terms and Conditions for Electronic Documents at www.sgs.com/terms_e-document.htm. Attention is drawn to the limitation of liability, indemnification and jurisdiction issues defined therein. Any holder of this document is advised that information contained hereon reflects the Company's findings at the time of its intervention only and within the limits of Client's instructions, if any. The Company's sole responsibility is to its Client and this document does not exonerate parties to a transaction from exercising all their rights and obligations under the transaction documents. This document cannot be reproduced except in full, without prior written approval of the Company. Any unauthorized alteration, forgery or falsification of the content or appearance of this document is unlawful and offenders may be prosecuted to the fullest extent of the law.

| EUT Mode | Frequency (MHz) | CH | Peak Power (dBm) | Avg. Power (dBm) |
|------------------|--------------------|------|---------------------|---------------------|
| HSUPA Band II | 1852.4 | 9262 | 26.77 | 22.31 |
| | 1880.0 | 9400 | 26.80 | 22.51 |
| | 1907.6 | 9538 | 27.18 | 22.25 |

| EUT Mode | Frequency (MHz) | CH | Peak Power (dBm) | Avg. Power (dBm) |
|------------------|--------------------|------|---------------------|---------------------|
| HSUPA Band IV | 1712.4 | 1312 | 26.68 | 22.44 |
| | 1732.6 | 1412 | 26.79 | 22.39 |
| | 1752.6 | 1513 | 26.96 | 22.36 |

| EUT Mode | Frequency (MHz) | CH | Peak Power (dBm) | Avg. Power (dBm) |
|-----------------|--------------------|------|---------------------|---------------------|
| HSUPA Band V | 826.4 | 4132 | 27.17 | 22.29 |
| | 836.6 | 4183 | 26.69 | 22.35 |
| | 846.6 | 4233 | 26.46 | 22.21 |

Note: The results above reflect max power with all up bits.
Cable loss offset Low Band: 0.5dB
Cable loss offset High Band: 0.7dB

Unless otherwise stated the results shown in this test report refer only to the sample(s) tested and such sample(s) are retained for 90 days only.

除非另有說明，此報告結果僅對測試之樣品負責，同時此樣品僅保留90天。本報告未經本公司書面許可，不可部份複製。

This document is issued by the Company subject to its General Conditions of Service printed overleaf, available on request or accessible at www.sgs.com/terms_and_conditions.htm and, for electronic format documents, subject to Terms and Conditions for Electronic Documents at www.sgs.com/terms_e-document.htm. Attention is drawn to the limitation of liability, indemnification and jurisdiction issues defined therein. Any holder of this document is advised that information contained hereon reflects the Company's findings at the time of its intervention only and within the limits of Client's instructions, if any. The Company's sole responsibility is to its Client and this document does not exonerate parties to a transaction from exercising all their rights and obligations under the transaction documents. This document cannot be reproduced except in full, without prior written approval of the Company. Any unauthorized alteration, forgery or falsification of the content or appearance of this document is unlawful and offenders may be prosecuted to the fullest extent of the law.

6.5.1.3.:HSDPA Release 6 mode

The following 4 Sub-Tests were completed according to the test requirements outlined in section 5.2A of the 3GPP TS34.121-1 V8.4.0 specification. All TX RMS power requirements for Power Class 3 were met according to table 5.2AA.5 and 5.2B.5 All UE channels and power ratio's are set according to table C10.1.4 & C11.1.3 in the 3GPP TS34.121-1 V8.4.0. RMC 12.2kps is used for this testing.

HSDPA SUB-TEST Setting

Table C.10.1.4: β values for transmitter characteristics tests with HS-DPCCH(FOR HSDPA)

| Sub-test | β_c | β_a | β_a (SF) | β_c/β_a | β_{HS} (Note 1, Note 2) | CM (dB) (Note 3) | MPR (dB) (Note 3) | RMC (Kbps) |
|----------|-------------------|-------------------|-------------------|-------------------|-------------------------------------|---------------------|-------------------------|---------------|
| 1 | 2/15 | 15/15 | 64 | 2/15 | 4/15 | 0.0 | 0.0 | 12.2 |
| 2 | 12/15 (Note 4) | 15/15 (Note 4) | 64 | 12/15 (Note 4) | 24/15 | 1.0 | 0.0 | 12.2 |
| 3 | 15/15 | 8/15 | 64 | 15/8 | 30/15 | 1.5 | 0.5 | 12.2 |
| 4 | 15/15 | 4/15 | 64 | 15/4 | 30/15 | 1.5 | 0.5 | 12.2 |

Note: The recommended HSDPA MPRs are implemented as per following sub-tests.

Unless otherwise stated the results shown in this test report refer only to the sample(s) tested and such sample(s) are retained for 90 days only.

除非另有說明，此報告結果僅對測試之樣品負責，同時此樣品僅保留90天。本報告未經本公司書面許可，不可部份複製。

This document is issued by the Company subject to its General Conditions of Service printed overleaf, available on request or accessible at www.sgs.com/terms_and_conditions.htm and, for electronic format documents, subject to Terms and Conditions for Electronic Documents at www.sgs.com/terms_e-document.htm. Attention is drawn to the limitation of liability, indemnification and jurisdiction issues defined therein. Any holder of this document is advised that information contained hereon reflects the Company's findings at the time of its intervention only and within the limits of Client's instructions, if any. The Company's sole responsibility is to its Client and this document does not exonerate parties to a transaction from exercising all their rights and obligations under the transaction documents. This document cannot be reproduced except in full, without prior written approval of the Company. Any unauthorized alteration, forgery or falsification of the content or appearance of this document is unlawful and offenders may be prosecuted to the fullest extent of the law.

Results:

| Mode | Sub-test | Avg. Power (dBm) Channel | | | Power Class 3 Limitation (dBm) | Comments |
|---------------|----------|-----------------------------|-------|-------|--------------------------------|----------|
| | | 9262 | 9400 | 9538 | | |
| HSDPA (B2) | 1 | 24.27 | 24.14 | 23.78 | 20.3dBm – 25.7dBm | Pass |
| | 2 | 23.98 | 24.11 | 23.77 | 20.3dBm – 25.7dBm | Pass |
| | 3 | 23.79 | 23.69 | 23.25 | 19.8dBm – 25.7dBm | Pass |
| | 4 | 23.86 | 23.70 | 23.37 | 19.8dBm – 25.7dBm | Pass |

| Mode | Sub-test | Avg. Power (dBm) Channel | | | Power Class 3 Limitation (dBm) | Comments |
|---------------|----------|-----------------------------|-------|-------|--------------------------------|----------|
| | | 1312 | 1412 | 1513 | | |
| HSDPA (B4) | 1 | 23.91 | 24.23 | 23.92 | 20.3dBm – 25.7dBm | Pass |
| | 2 | 24.08 | 23.99 | 23.93 | 20.3dBm – 25.7dBm | Pass |
| | 3 | 23.43 | 23.78 | 23.39 | 19.8dBm – 25.7dBm | Pass |
| | 4 | 23.50 | 23.79 | 23.51 | 19.8dBm – 25.7dBm | Pass |

| Mode | Sub-test | Avg. Power (dBm) Channel | | | Power Class 3 Limitation (dBm) | Comments |
|---------------|----------|-----------------------------|-------|-------|--------------------------------|----------|
| | | 4132 | 4183 | 4233 | | |
| HSDPA (B5) | 1 | 23.92 | 24.01 | 24.12 | 20.3dBm – 25.7dBm | Pass |
| | 2 | 24.06 | 24.04 | 23.87 | 20.3dBm – 25.7dBm | Pass |
| | 3 | 23.46 | 23.53 | 23.63 | 19.8dBm – 25.7dBm | Pass |
| | 4 | 23.51 | 23.57 | 23.69 | 19.8dBm – 25.7dBm | Pass |

Unless otherwise stated the results shown in this test report refer only to the sample(s) tested and such sample(s) are retained for 90 days only.

除非另有說明，此報告結果僅對測試之樣品負責，同時此樣品僅保留90天。本報告未經本公司書面許可，不可部份複製。

This document is issued by the Company subject to its General Conditions of Service printed overleaf, available on request or accessible at www.sgs.com/terms_and_conditions.htm and, for electronic format documents, subject to Terms and Conditions for Electronic Documents at www.sgs.com/terms_e-document.htm. Attention is drawn to the limitation of liability, indemnification and jurisdiction issues defined therein. Any holder of this document is advised that information contained hereon reflects the Company's findings at the time of its intervention only and within the limits of Client's instructions, if any. The Company's sole responsibility is to its Client and this document does not exonerate parties to a transaction from exercising all their rights and obligations under the transaction documents. This document cannot be reproduced except in full, without prior written approval of the Company. Any unauthorized alteration, forgery or falsification of the content or appearance of this document is unlawful and offenders may be prosecuted to the fullest extent of the law.

6.5.1.4.: HSPA (HSDPA & HSUPA) Release 6 mode

The following 5 Sub-Tests were completed according to the test requirements outlined in section 5.2A of the 3GPP TS34.121-1 V8.4.0 specification. All TX RMS power requirements for Power Class 3 were met according to table 5.2AA.5 and 5.2B.5 All UE channels and power ratio's are set according to table C11.1.3 in the 3GPP TS34.121-1 V8.4.0. RMC 12.2kps is used for this testing

HSPA SUB-TEST Setting

Table C.11.1.3: β values for transmitter characteristics tests with HS-DPCCH and E-DCH(FOR HSUPA)

| Sub-test | β_c | β_d | β_d (SF) | β_c/β_d | β_{HS} | β_{ec} | β_{ed} | β_{ed} (SF) | β_{ed} (Codes) | CM (dB) | MPR (dB) | AG Index | E-TFCI | RMC (Kbps) |
|----------|----------------|----------------|----------------|-------------------|--------------|--------------|--|-------------------|----------------------|---------|----------|----------|--------|------------|
| 1 | 11/15 (Note 3) | 15/15 (Note 3) | 64 | 11/15 (Note 3) | 22/15 | 209/225 | 1309/225 | 4 | 1 | 1.0 | 0.0 | 20 | 75 | 12.2 |
| 2 | 6/15 | 15/15 | 64 | 6/15 | 12/15 | 12/15 | 94/75 | 4 | 1 | 3.0 | 2.0 | 12 | 67 | 12.2 |
| 3 | 15/15 | 9/15 | 64 | 15/9 | 30/15 | 30/15 | β_{ed1} : 47/15 β_{ed2} : 47/15 | 4 4 | 2 | 2.0 | 1.0 | 15 | 92 | 12.2 |
| 4 | 2/15 | 15/15 | 64 | 2/15 | 4/15 | 2/15 | 56/75 | 4 | 1 | 3.0 | 2.0 | 17 | 71 | 12.2 |
| 5 | 15/15 (Note 4) | 15/15 (Note 4) | 64 | 15/15 (Note 4) | 30/15 | 24/15 | 134/15 | 4 | 1 | 1.0 | 0.0 | 21 | 81 | 12.2 |

Note: The recommended HSUPA MPRs are implemented as per following sub-tests.

Unless otherwise stated the results shown in this test report refer only to the sample(s) tested and such sample(s) are retained for 90 days only.

除非另有說明，此報告結果僅對測試之樣品負責，同時此樣品僅保留90天。本報告未經本公司書面許可，不可部份複製。

This document is issued by the Company subject to its General Conditions of Service printed overleaf, available on request or accessible at www.sgs.com/terms_and_conditions.htm and, for electronic format documents, subject to Terms and Conditions for Electronic Documents at www.sgs.com/terms_e-document.htm. Attention is drawn to the limitation of liability, indemnification and jurisdiction issues defined therein. Any holder of this document is advised that information contained hereon reflects the Company's findings at the time of its intervention only and within the limits of Client's instructions, if any. The Company's sole responsibility is to its Client and this document does not exonerate parties to a transaction from exercising all their rights and obligations under the transaction documents. This document cannot be reproduced except in full, without prior written approval of the Company. Any unauthorized alteration, forgery or falsification of the content or appearance of this document is unlawful and offenders may be prosecuted to the fullest extent of the law.

Results:

| Mode | Sub-test | Avg. Power (dBm) Channel | | | Power Class 3 Limitation (dBm) | Comments |
|-----------|----------|-----------------------------|-------|-------|--------------------------------|----------|
| | | 9262 | 9400 | 9538 | | |
| HSUPA(B2) | 1 | 24.02 | 24.23 | 23.86 | 18.8dBm – 25.7dBm | Pass |
| | 2 | 22.07 | 22.30 | 21.90 | 16.8dBm – 25.7dBm | Pass |
| | 3 | 23.08 | 23.25 | 22.94 | 17.8dBm – 25.7dBm | Pass |
| | 4 | 22.20 | 22.35 | 21.94 | 16.8dBm – 25.7dBm | Pass |
| | 5 | 23.91 | 24.09 | 23.77 | 18.8dBm – 25.7dBm | Pass |

| Mode | Sub-test | Avg. Power (dBm) Channel | | | Power Class 3 Limitation (dBm) | Comments |
|-----------|----------|-----------------------------|-------|-------|--------------------------------|----------|
| | | 1312 | 1412 | 1513 | | |
| HSUPA(B4) | 1 | 24.12 | 24.11 | 24.02 | 18.8dBm – 25.7dBm | Pass |
| | 2 | 22.17 | 22.18 | 22.06 | 16.8dBm – 25.7dBm | Pass |
| | 3 | 23.18 | 23.13 | 23.10 | 17.8dBm – 25.7dBm | Pass |
| | 4 | 22.30 | 22.23 | 22.10 | 16.8dBm – 25.7dBm | Pass |
| | 5 | 24.01 | 23.97 | 23.93 | 18.8dBm – 25.7dBm | Pass |

| Mode | Sub-test | Avg. Power (dBm) Channel | | | Power Class 3 Limitation (dBm) | Comments |
|-----------|----------|-----------------------------|-------|-------|--------------------------------|----------|
| | | 4132 | 4183 | 4233 | | |
| HSUPA(B5) | 1 | 24.09 | 24.08 | 23.92 | 18.8dBm – 25.7dBm | Pass |
| | 2 | 22.15 | 22.16 | 21.96 | 16.8dBm – 25.7dBm | Pass |
| | 3 | 23.13 | 23.14 | 23.00 | 17.8dBm – 25.7dBm | Pass |
| | 4 | 22.20 | 22.22 | 22.04 | 16.8dBm – 25.7dBm | Pass |
| | 5 | 23.95 | 23.91 | 23.81 | 18.8dBm – 25.7dBm | Pass |

Unless otherwise stated the results shown in this test report refer only to the sample(s) tested and such sample(s) are retained for 90 days only.

除非另有說明，此報告結果僅對測試之樣品負責，同時此樣品僅保留90天。本報告未經本公司書面許可，不可部份複製。

This document is issued by the Company subject to its General Conditions of Service printed overleaf, available on request or accessible at www.sgs.com/terms_and_conditions.htm and, for electronic format documents, subject to Terms and Conditions for Electronic Documents at www.sgs.com/terms_e-document.htm. Attention is drawn to the limitation of liability, indemnification and jurisdiction issues defined therein. Any holder of this document is advised that information contained hereon reflects the Company's findings at the time of its intervention only and within the limits of Client's instructions, if any. The Company's sole responsibility is to its Client and this document does not exonerate parties to a transaction from exercising all their rights and obligations under the transaction documents. This document cannot be reproduced except in full, without prior written approval of the Company. Any unauthorized alteration, forgery or falsification of the content or appearance of this document is unlawful and offenders may be prosecuted to the fullest extent of the law.

6.5.2. Minimum Communications Power Measurement

PCS 1900 band

| PCL | 0 | 1 | 2 | 3 | 4 | 5 | 6 | 7 | 8 |
|--------------------|------|------|------|------|------|------|------|------|------|
| Output power (dBm) | 29.3 | 27.8 | 24.5 | 23.8 | 21.8 | 19.8 | 17.8 | 15.6 | 13.6 |

| PCL | 9 | 10 | 11 | 12 | 13 | 14 | 15 |
|--------------------|------|-----|-----|-----|-----|-----|------|
| Output power (dBm) | 11.8 | 9.7 | 7.8 | 5.6 | 3.7 | 1.8 | -0.3 |

Note: The EUT output power was controlled by simulator. Set Communication Tester CMU200 PCL as above, and get the mobile phone output power reading.

WCDMA/HSDPA/HSUPA band II, IV, V

The EUT output power was controlled by simulator. Set Communication Tester CMU200 function key “UE Power Control” and enter max rated power 24dBm. The EUT is going to be set to max output power to 24dBm. Then record the read (see page 15 for measurement data) . The min. power was measures by a function key “minimum power” then record the read. It is -52.3dBm. The power variation can be 0.1dB step by setting.

Unless otherwise stated the results shown in this test report refer only to the sample(s) tested and such sample(s) are retained for 90 days only.

除非另有說明，此報告結果僅對測試之樣品負責，同時此樣品僅保留90天。本報告未經本公司書面許可，不可部份複製。

This document is issued by the Company subject to its General Conditions of Service printed overleaf, available on request or accessible at www.sgs.com/terms_and_conditions.htm and, for electronic format documents, subject to Terms and Conditions for Electronic Documents at www.sgs.com/terms_e-document.htm. Attention is drawn to the limitation of liability, indemnification and jurisdiction issues defined therein. Any holder of this document is advised that information contained hereon reflects the Company's findings at the time of its intervention only and within the limits of Client's instructions, if any. The Company's sole responsibility is to its Client and this document does not exonerate parties to a transaction from exercising all their rights and obligations under the transaction documents. This document cannot be reproduced except in full, without prior written approval of the Company. Any unauthorized alteration, forgery or falsification of the content or appearance of this document is unlawful and offenders may be prosecuted to the fullest extent of the law.

7. ERP, EIRP MEASUREMENT

7.1. Standard Applicable:

According to FCC §2.1046

FCC 22.913(a) Mobile station is limited to 7W ERP.

FCC 24.232(b) Mobile station is limited to 2W EIRP.

FCC 27.50(d)(4) Fixed, mobile, and portable (hand-held) stations are limited to 1W EIRP.

According to IC RSS-133 §6.4

The peak e.i.r.p. for transmitters operating in the band 1850-1910 MHz shall not exceed the limits 2W which given in SRSP-510.

According to issue 3 of RSS 132, section 5.4. The transmitter output power shall not exceed the limits 11.5W / 40.60 dBm given in SRSP-503.

According to issue 2 of RSS 139, section 6.4 The transmitter output power shall not exceed the limits 1W given in SRSP-513.

The average equivalent isotropically radiated power (e.i.r.p.) for fixed, mobile and portable transmitters in the 1710-1755 MHz shall not exceed 1 watt.

7.2. Test SET-UP (Block Diagram of Configuration):

(A) Radiated Power Test Set-Up, Frequency Below 1000MHz

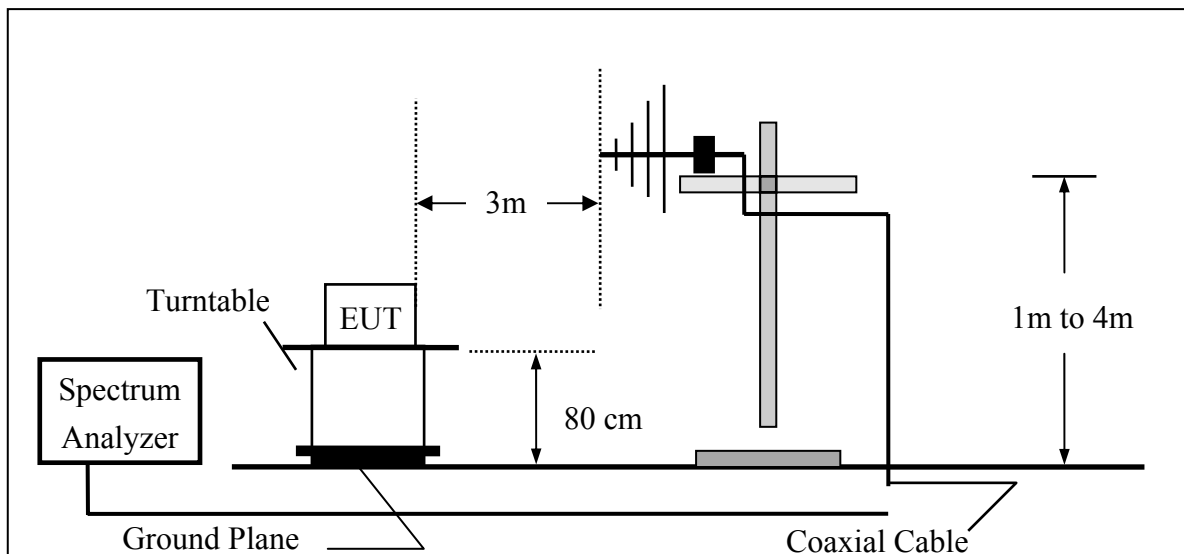

Unless otherwise stated the results shown in this test report refer only to the sample(s) tested and such sample(s) are retained for 90 days only.

除非另有說明，此報告結果僅對測試之樣品負責，同時此樣品僅保留90天。本報告未經本公司書面許可，不可部份複製。

This document is issued by the Company subject to its General Conditions of Service printed overleaf, available on request or accessible at www.sgs.com/terms_and_conditions.htm and, for electronic format documents, subject to Terms and Conditions for Electronic Documents at www.sgs.com/terms_e-document.htm. Attention is drawn to the limitation of liability, indemnification and jurisdiction issues defined therein. Any holder of this document is advised that information contained hereon reflects the Company's findings at the time of its intervention only and within the limits of Client's instructions, if any. The Company's sole responsibility is to its Client and this document does not exonerate parties to a transaction from exercising all their rights and obligations under the transaction documents. This document cannot be reproduced except in full, without prior written approval of the Company. Any unauthorized alteration, forgery or falsification of the content or appearance of this document is unlawful and offenders may be prosecuted to the fullest extent of the law.

(B) Radiated Power Test Set-UP Frequency Over 1 GHz

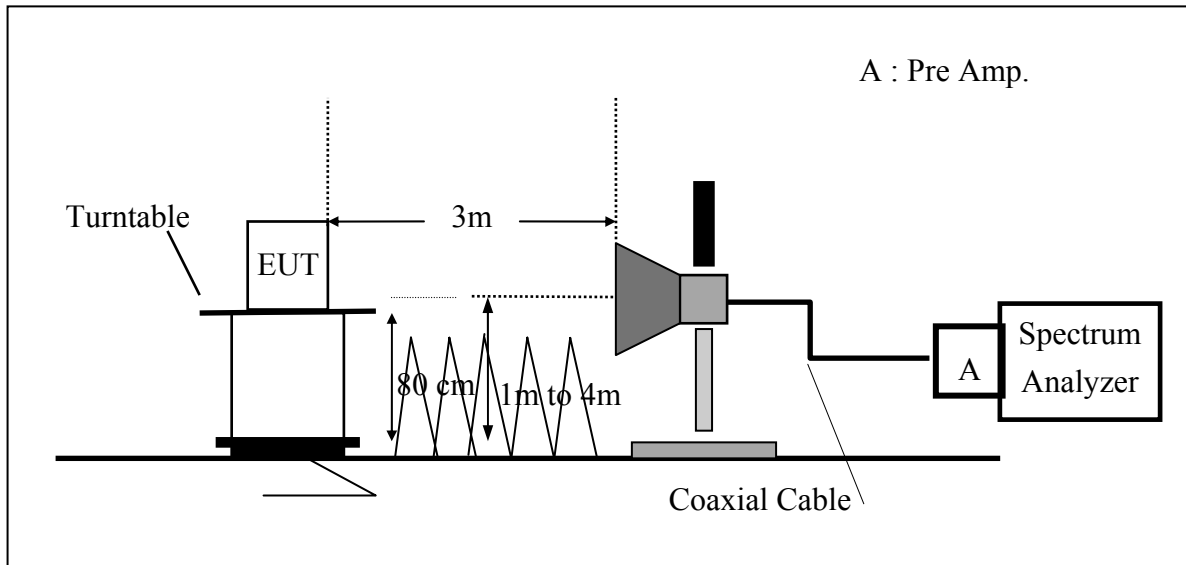

(C) Substituted Method Test Set-UP

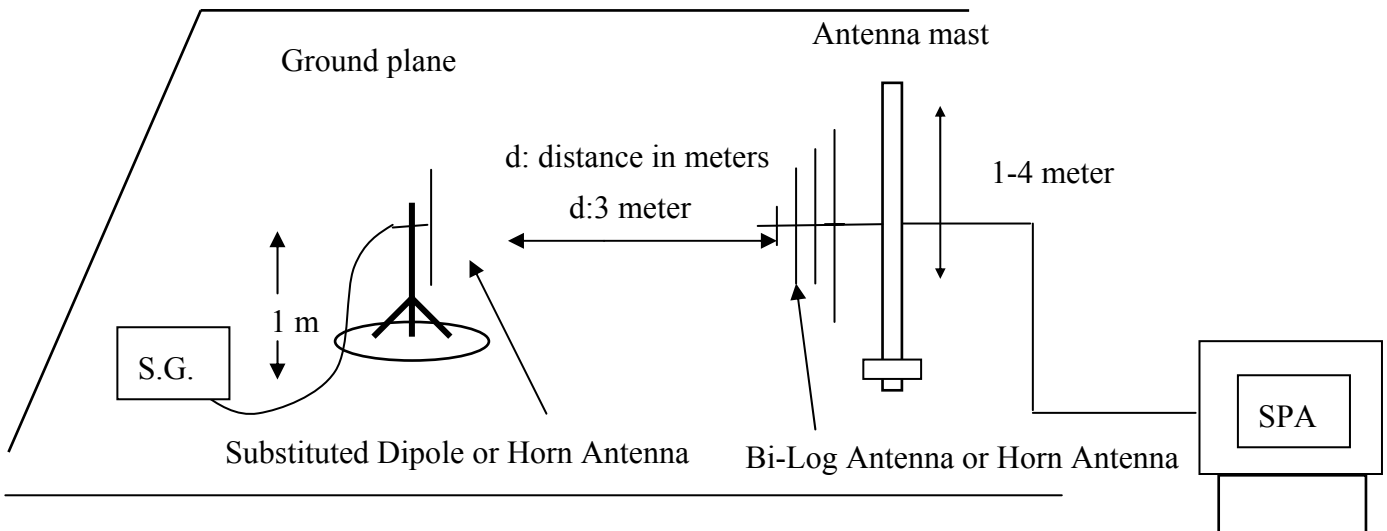

Unless otherwise stated the results shown in this test report refer only to the sample(s) tested and such sample(s) are retained for 90 days only.

除非另有說明，此報告結果僅對測試之樣品負責，同時此樣品僅保留90天。本報告未經本公司書面許可，不可部份複製。

This document is issued by the Company subject to its General Conditions of Service printed overleaf, available on request or accessible at www.sgs.com/terms_and_conditions.htm and, for electronic format documents, subject to Terms and Conditions for Electronic Documents at www.sgs.com/terms_e-document.htm. Attention is drawn to the limitation of liability, indemnification and jurisdiction issues defined therein. Any holder of this document is advised that information contained hereon reflects the Company's findings at the time of its intervention only and within the limits of Client's instructions, if any. The Company's sole responsibility is to its Client and this document does not exonerate parties to a transaction from exercising all their rights and obligations under the transaction documents. This document cannot be reproduced except in full, without prior written approval of the Company. Any unauthorized alteration, forgery or falsification of the content or appearance of this document is unlawful and offenders may be prosecuted to the fullest extent of the law.

7.3. Measurement Procedure:

The EUT was placed on a non-conductive turntable using a non-conductive support. The radiated emission at the fundamental frequency was measured at 3 m with a test antenna and EMI spectrum analyzer.

During the measurement, the EUT was communication with the station. The highest emission was recorded with the rotation of the turntable and the lowering of the test antenna from 4m to 1m. The reading was recorded and the field strength (E in dBuV/m) was calculated.

ERP in frequency band 824.2 –848.80MHz were measured using a substitution method. The EUT was replaced by dipole antenna connected, the S.G. output was recorded and ERP was calculated as follows:

EIRP in frequency band 1710-1755MHz and 1850.2 –1909.8MHz were measured using a substitution method. The EUT was replaced by a horn antenna connected, the S.G. output was recorded and EIRP was calculated as follows:

$$\text{ERP} = \text{S.G. output (dBm)} + \text{Antenna Gain (dBd)} - \text{Cable Loss (dB)}$$

$$\text{EIRP} = \text{S.G. output (dBm)} + \text{Antenna Gain (dBi)} - \text{Cable Loss (dB)}$$

Spectrum setting:

1. Detector = Peak, marker the highest value of the detector by maximum hold, set RBW wide enough to capture the entire signal of emission, and VBW $\geq 3 \times \text{RBW}$.

Or,

2. KDB 971168 D01 Power Meas License Digital Systems v01 is adopted, and the procedure as lists under item 4, Measurement of the Average Power over the Fundamental Signal Bandwidth, is followed to set correspondingly for the acquisition of proper measurement data.

Set frequency = nominal signal center frequency;

Set span = 2 X occupied BW;

Set RBW $\approx 1 \sim 5\%$ of the span, not to exceed 1 MHz

Set VBW = 3 x RBW;

Select average power (RMS) detector

Set sweep time and number of measurement points to achieve a minimum of 1 millisecond/pt integration time (ex. Point = 601points, then sweep time = $601 * 10^{-3} = 6\text{s}$).

Unless otherwise stated the results shown in this test report refer only to the sample(s) tested and such sample(s) are retained for 90 days only.

除非另有說明，此報告結果僅對測試之樣品負責，同時此樣品僅保留90天。本報告未經本公司書面許可，不可部份複製。

This document is issued by the Company subject to its General Conditions of Service printed overleaf, available on request or accessible at www.sgs.com/terms_and_conditions.htm and, for electronic format documents, subject to Terms and Conditions for Electronic Documents at www.sgs.com/terms_e-document.htm. Attention is drawn to the limitation of liability, indemnification and jurisdiction issues defined therein. Any holder of this document is advised that information contained hereon reflects the Company's findings at the time of its intervention only and within the limits of Client's instructions, if any. The Company's sole responsibility is to its Client and this document does not exonerate parties to a transaction from exercising all their rights and obligations under the transaction documents. This document cannot be reproduced except in full, without prior written approval of the Company. Any unauthorized alteration, forgery or falsification of the content or appearance of this document is unlawful and offenders may be prosecuted to the fullest extent of the law.

Activate trace averaging routine over a minimum of 10 sweeps;
Activate marker/span pair and set span = signal or channel bandwidth;
Activate the band/interval power marker function;
Record the band power level;

Record adjusted value as the average signal power level. Then activate the occupied bandwidth measurement function.

7.4. Measurement Equipment Used:

Refer to section 2.4 in this report

Unless otherwise stated the results shown in this test report refer only to the sample(s) tested and such sample(s) are retained for 90 days only.

除非另有說明，此報告結果僅對測試之樣品負責，同時此樣品僅保留90天。本報告未經本公司書面許可，不可部份複製。

This document is issued by the Company subject to its General Conditions of Service printed overleaf, available on request or accessible at www.sgs.com/terms_and_conditions.htm and, for electronic format documents, subject to Terms and Conditions for Electronic Documents at www.sgs.com/terms_e-document.htm. Attention is drawn to the limitation of liability, indemnification and jurisdiction issues defined therein. Any holder of this document is advised that information contained hereon reflects the Company's findings at the time of its intervention only and within the limits of Client's instructions, if any. The Company's sole responsibility is to its Client and this document does not exonerate parties to a transaction from exercising all their rights and obligations under the transaction documents. This document cannot be reproduced except in full, without prior written approval of the Company. Any unauthorized alteration, forgery or falsification of the content or appearance of this document is unlawful and offenders may be prosecuted to the fullest extent of the law.

7.5. Measurement Result: (Peak) –using option of peak measurement

| EUT | | | | Measurement | | | | | |
|----------------|------|-----------------------|-----|--------------|-------------|--------------|------------|--------------|-------|
| Operation Band | Pol. | Fundamental Frequency | CH | Antenna Pol. | S.G. Output | Antenna Gain | Cable Loss | ERP | Limit |
| | | MHz | | V/H | dBm | dBd | dB | dBm | dBm |
| GSM 850 | H | 824.20 | 128 | V | 24.19 | 3.96 | -2.8 | 25.35 | 38.45 |
| | | | | H | 23.22 | 3.96 | -2.8 | 24.38 | 38.45 |
| | | 836.60 | 190 | V | 24.14 | 4 | -2.82 | 25.32 | 38.45 |
| | | | | H | 22.61 | 4 | -2.82 | 23.78 | 38.45 |
| | | 848.80 | 251 | V | 24.46 | 4.03 | -2.84 | 25.65 | 38.45 |
| | | | | H | 22.75 | 4.03 | -2.84 | 23.94 | 38.45 |
| | E1 | 824.20 | 128 | V | 21.79 | 3.96 | -2.8 | 22.95 | 38.45 |
| | | | | H | 22.88 | 3.96 | -2.8 | 24.05 | 38.45 |
| | | 836.60 | 190 | V | 21.41 | 4 | -2.82 | 22.59 | 38.45 |
| | | | | H | 23.27 | 4 | -2.82 | 24.45 | 38.45 |
| | | 848.80 | 251 | V | 22.47 | 4.03 | -2.84 | 23.66 | 38.45 |
| | | | | H | 23.11 | 4.03 | -2.84 | 24.29 | 38.45 |
| | E2 | 824.20 | 128 | V | 21.91 | 3.96 | -2.8 | 23.07 | 38.45 |
| | | | | H | 24.54 | 3.96 | -2.8 | 25.71 | 38.45 |
| | | 836.60 | 190 | V | 21.76 | 4 | -2.82 | 22.93 | 38.45 |
| | | | | H | 24.66 | 4 | -2.82 | 25.84 | 38.45 |
| | | 848.80 | 251 | V | 22.29 | 4.03 | -2.84 | 23.48 | 38.45 |
| | | | | H | 24.89 | 4.03 | -2.84 | 26.08 | 38.45 |

Remark :

- (1) The RBW,VBW of SPA for measurement RBW=300 KHz, VBW=1MHz

Unless otherwise stated the results shown in this test report refer only to the sample(s) tested and such sample(s) are retained for 90 days only.

除非另有說明，此報告結果僅對測試之樣品負責，同時此樣品僅保留90天。本報告未經本公司書面許可，不可部份複製。

This document is issued by the Company subject to its General Conditions of Service printed overleaf, available on request or accessible at www.sgs.com/terms_and_conditions.htm and, for electronic format documents, subject to Terms and Conditions for Electronic Documents at www.sgs.com/terms_e-document.htm. Attention is drawn to the limitation of liability, indemnification and jurisdiction issues defined therein. Any holder of this document is advised that information contained hereon reflects the Company's findings at the time of its intervention only and within the limits of Client's instructions, if any. The Company's sole responsibility is to its Client and this document does not exonerate parties to a transaction from exercising all their rights and obligations under the transaction documents. This document cannot be reproduced except in full, without prior written approval of the Company. Any unauthorized alteration, forgery or falsification of the content or appearance of this document is unlawful and offenders may be prosecuted to the fullest extent of the law.

| EUT | | | | Measurement | | | | | |
|----------------|------|-----------------------|-----|--------------|-------------|--------------|------------|--------------|-------|
| Operation Band | Pol. | Fundamental Frequency | CH | Antenna Pol. | S.G. Output | Antenna Gain | Cable Loss | EIRP | Limit |
| | | MHz | | V/H | dBm | dBi | dB | dBm | dBm |
| GSM 1900 | H | 1850.20 | 512 | V | 29.78 | 4.17 | -4.29 | 29.66 | 33.00 |
| | | | | H | 24.33 | 4.51 | -4.29 | 24.55 | 33.00 |
| | | 1880.00 | 661 | V | 29.04 | 4.13 | -4.33 | 28.84 | 33.00 |
| | | | | H | 27.17 | 4.44 | -4.33 | 27.28 | 33.00 |
| | | 1909.80 | 810 | V | 26.73 | 4.09 | -4.37 | 26.46 | 33.00 |
| | | | | H | 25.34 | 4.36 | -4.37 | 25.34 | 33.00 |
| | E1 | 1850.20 | 512 | V | 30.67 | 4.17 | -4.29 | 30.55 | 33.00 |
| | | | | H | 26.21 | 4.51 | -4.29 | 26.43 | 33.00 |
| | | 1880.00 | 661 | V | 31.6 | 4.13 | -4.33 | 31.41 | 33.00 |
| | | | | H | 27.12 | 4.44 | -4.33 | 27.22 | 33.00 |
| | | 1909.80 | 810 | V | 28.47 | 4.09 | -4.37 | 28.2 | 33.00 |
| | | | | H | 25.58 | 4.36 | -4.37 | 25.58 | 33.00 |
| | E2 | 1850.20 | 512 | V | 26.65 | 4.17 | -4.29 | 26.53 | 33.00 |
| | | | | H | 28.98 | 4.51 | -4.29 | 29.2 | 33.00 |
| | | 1880.00 | 661 | V | 28.51 | 4.13 | -4.33 | 28.31 | 33.00 |
| | | | | H | 28.66 | 4.44 | -4.33 | 28.77 | 33.00 |
| | | 1909.80 | 810 | V | 27.78 | 4.09 | -4.37 | 27.51 | 33.00 |
| | | | | H | 28.35 | 4.36 | -4.37 | 28.35 | 33.00 |

Remark :

- (1) The RBW,VBW of SPA for measurement RBW=300K, VBW=1MHz

Unless otherwise stated the results shown in this test report refer only to the sample(s) tested and such sample(s) are retained for 90 days only.

除非另有說明，此報告結果僅對測試之樣品負責，同時此樣品僅保留90天。本報告未經本公司書面許可，不可部份複製。

This document is issued by the Company subject to its General Conditions of Service printed overleaf, available on request or accessible at www.sgs.com/terms_and_conditions.htm and, for electronic format documents, subject to Terms and Conditions for Electronic Documents at www.sgs.com/terms_e-document.htm. Attention is drawn to the limitation of liability, indemnification and jurisdiction issues defined therein. Any holder of this document is advised that information contained hereon reflects the Company's findings at the time of its intervention only and within the limits of Client's instructions, if any. The Company's sole responsibility is to its Client and this document does not exonerate parties to a transaction from exercising all their rights and obligations under the transaction documents. This document cannot be reproduced except in full, without prior written approval of the Company. Any unauthorized alteration, forgery or falsification of the content or appearance of this document is unlawful and offenders may be prosecuted to the fullest extent of the law.

| EUT | | | | Measurement | | | | | |
|----------------|------|-----------------------|-----|--------------|-------------|--------------|------------|--------------|-------|
| Operation Band | Pol. | Fundamental Frequency | CH | Antenna Pol. | S.G. Output | Antenna Gain | Cable Loss | ERP | Limit |
| | | MHz | | V/H | dBm | dBd | dB | dBm | dBm |
| GPRS 850 | H | 824.20 | 128 | V | 24.19 | 3.96 | -2.8 | 25.35 | 38.45 |
| | | | | H | 23.14 | 3.96 | -2.8 | 24.3 | 38.45 |
| | | 836.60 | 190 | V | 23.88 | 4 | -2.82 | 25.06 | 38.45 |
| | | | | H | 22.63 | 4 | -2.82 | 23.8 | 38.45 |
| | | 848.80 | 251 | V | 24.23 | 4.03 | -2.84 | 25.42 | 38.45 |
| | | | | H | 22.77 | 4.03 | -2.84 | 23.96 | 38.45 |
| | E1 | 824.20 | 128 | V | 21.66 | 3.96 | -2.8 | 22.82 | 38.45 |
| | | | | H | 22.96 | 3.96 | -2.8 | 24.12 | 38.45 |
| | | 836.60 | 190 | V | 21.43 | 4 | -2.82 | 22.61 | 38.45 |
| | | | | H | 23.26 | 4 | -2.82 | 24.44 | 38.45 |
| | | 848.80 | 251 | V | 22.49 | 4.03 | -2.84 | 23.67 | 38.45 |
| | | | | H | 23.09 | 4.03 | -2.84 | 24.27 | 38.45 |
| | E2 | 824.20 | 128 | V | 22 | 3.96 | -2.8 | 23.16 | 38.45 |
| | | | | H | 24.58 | 3.96 | -2.8 | 25.75 | 38.45 |
| | | 836.60 | 190 | V | 21.79 | 4 | -2.82 | 22.97 | 38.45 |
| | | | | H | 24.69 | 4 | -2.82 | 25.87 | 38.45 |
| | | 848.80 | 251 | V | 22.32 | 4.03 | -2.84 | 23.51 | 38.45 |
| | | | | H | 24.87 | 4.03 | -2.84 | 26.05 | 38.45 |

Remark :

- (1) The RBW,VBW of SPA for measurement RBW=300 KHz, VBW=1MHz

Unless otherwise stated the results shown in this test report refer only to the sample(s) tested and such sample(s) are retained for 90 days only.

除非另有說明，此報告結果僅對測試之樣品負責，同時此樣品僅保留90天。本報告未經本公司書面許可，不可部份複製。

This document is issued by the Company subject to its General Conditions of Service printed overleaf, available on request or accessible at www.sgs.com/terms_and_conditions.htm and, for electronic format documents, subject to Terms and Conditions for Electronic Documents at www.sgs.com/terms_e-document.htm. Attention is drawn to the limitation of liability, indemnification and jurisdiction issues defined therein. Any holder of this document is advised that information contained hereon reflects the Company's findings at the time of its intervention only and within the limits of Client's instructions, if any. The Company's sole responsibility is to its Client and this document does not exonerate parties to a transaction from exercising all their rights and obligations under the transaction documents. This document cannot be reproduced except in full, without prior written approval of the Company. Any unauthorized alteration, forgery or falsification of the content or appearance of this document is unlawful and offenders may be prosecuted to the fullest extent of the law.

| EUT | | | | Measurement | | | | | |
|----------------|------|-----------------------|-----|--------------|-------------|--------------|------------|--------------|-------|
| Operation Band | Pol. | Fundamental Frequency | CH | Antenna Pol. | S.G. Output | Antenna Gain | Cable Loss | EIRP | Limit |
| | | MHz | | V/H | dBm | dBi | dB | dBm | dBm |
| GPRS 1900 | H | 1850.20 | 512 | V | 29.3 | 4.17 | -4.29 | 29.18 | 33.00 |
| | | | | H | 26.49 | 4.51 | -4.29 | 26.71 | 33.00 |
| | | 1880.00 | 661 | V | 28.9 | 4.13 | -4.33 | 28.7 | 33.00 |
| | | | | H | 26.1 | 4.44 | -4.33 | 26.21 | 33.00 |
| | | 1909.80 | 810 | V | 26.42 | 4.09 | -4.37 | 26.14 | 33.00 |
| | | | | H | 22.49 | 4.36 | -4.37 | 22.49 | 33.00 |
| | E1 | 1850.20 | 512 | V | 30.57 | 4.17 | -4.29 | 30.45 | 33.00 |
| | | | | H | 25.89 | 4.51 | -4.29 | 26.11 | 33.00 |
| | | 1880.00 | 661 | V | 31.38 | 4.13 | -4.33 | 31.18 | 33.00 |
| | | | | H | 26.93 | 4.44 | -4.33 | 27.03 | 33.00 |
| | | 1909.80 | 810 | V | 28.31 | 4.09 | -4.37 | 28.04 | 33.00 |
| | | | | H | 25.31 | 4.36 | -4.37 | 25.31 | 33.00 |
| | E2 | 1850.20 | 512 | V | 26.64 | 4.17 | -4.29 | 26.52 | 33.00 |
| | | | | H | 29.22 | 4.51 | -4.29 | 29.44 | 33.00 |
| | | 1880.00 | 661 | V | 28.21 | 4.13 | -4.33 | 28.02 | 33.00 |
| | | | | H | 28.88 | 4.44 | -4.33 | 28.99 | 33.00 |
| | | 1909.80 | 810 | V | 27.51 | 4.09 | -4.37 | 27.23 | 33.00 |
| | | | | H | 28.83 | 4.36 | -4.37 | 28.83 | 33.00 |

Remark :

- (1) The RBW,VBW of SPA for measurement RBW=300 KHz, VBW=1MHz

Unless otherwise stated the results shown in this test report refer only to the sample(s) tested and such sample(s) are retained for 90 days only.

除非另有說明，此報告結果僅對測試之樣品負責，同時此樣品僅保留90天。本報告未經本公司書面許可，不可部份複製。

This document is issued by the Company subject to its General Conditions of Service printed overleaf, available on request or accessible at www.sgs.com/terms_and_conditions.htm and, for electronic format documents, subject to Terms and Conditions for Electronic Documents at www.sgs.com/terms_e-document.htm. Attention is drawn to the limitation of liability, indemnification and jurisdiction issues defined therein. Any holder of this document is advised that information contained hereon reflects the Company's findings at the time of its intervention only and within the limits of Client's instructions, if any. The Company's sole responsibility is to its Client and this document does not exonerate parties to a transaction from exercising all their rights and obligations under the transaction documents. This document cannot be reproduced except in full, without prior written approval of the Company. Any unauthorized alteration, forgery or falsification of the content or appearance of this document is unlawful and offenders may be prosecuted to the fullest extent of the law.

| EUT | | | | Measurement | | | | | |
|----------------|------|-----------------------|-----|--------------|-------------|--------------|------------|--------------|-------|
| Operation Band | Pol. | Fundamental Frequency | CH | Antenna Pol. | S.G. Output | Antenna Gain | Cable Loss | ERP | Limit |
| | | MHz | | V/H | dBm | dBd | dB | dBm | dBm |
| EDGE 850 | H | 824.20 | 128 | V | 21.37 | 3.96 | -2.8 | 22.54 | 38.45 |
| | | | | H | 19.94 | 3.96 | -2.8 | 21.11 | 38.45 |
| | | 836.60 | 190 | V | 20.88 | 4 | -2.82 | 22.05 | 38.45 |
| | | | | H | 19.29 | 4 | -2.82 | 20.47 | 38.45 |
| | | 848.80 | 251 | V | 21.28 | 4.03 | -2.84 | 22.47 | 38.45 |
| | | | | H | 19.42 | 4.03 | -2.84 | 20.6 | 38.45 |
| | E1 | 824.20 | 128 | V | 18.06 | 3.96 | -2.8 | 19.22 | 38.45 |
| | | | | H | 19.57 | 3.96 | -2.8 | 20.73 | 38.45 |
| | | 836.60 | 190 | V | 18.09 | 4 | -2.82 | 19.26 | 38.45 |
| | | | | H | 20.32 | 4 | -2.82 | 21.5 | 38.45 |
| | | 848.80 | 251 | V | 19.47 | 4.03 | -2.84 | 20.65 | 38.45 |
| | | | | H | 20.23 | 4.03 | -2.84 | 21.41 | 38.45 |
| | E2 | 824.20 | 128 | V | 18.7 | 3.96 | -2.8 | 19.87 | 38.45 |
| | | | | H | 22.58 | 3.96 | -2.8 | 23.75 | 38.45 |
| | | 836.60 | 190 | V | 18.59 | 4 | -2.82 | 19.77 | 38.45 |
| | | | | H | 22.88 | 4 | -2.82 | 24.05 | 38.45 |
| | | 848.80 | 251 | V | 19.17 | 4.03 | -2.84 | 20.36 | 38.45 |
| | | | | H | 23.1 | 4.03 | -2.84 | 24.28 | 38.45 |

Remark :

- (1) The RBW,VBW of SPA for measurement RBW=300 KHz, VBW=1MHz

Unless otherwise stated the results shown in this test report refer only to the sample(s) tested and such sample(s) are retained for 90 days only.

除非另有說明，此報告結果僅對測試之樣品負責，同時此樣品僅保留90天。本報告未經本公司書面許可，不可部份複製。

This document is issued by the Company subject to its General Conditions of Service printed overleaf, available on request or accessible at www.sgs.com/terms_and_conditions.htm and, for electronic format documents, subject to Terms and Conditions for Electronic Documents at www.sgs.com/terms_e-document.htm. Attention is drawn to the limitation of liability, indemnification and jurisdiction issues defined therein. Any holder of this document is advised that information contained hereon reflects the Company's findings at the time of its intervention only and within the limits of Client's instructions, if any. The Company's sole responsibility is to its Client and this document does not exonerate parties to a transaction from exercising all their rights and obligations under the transaction documents. This document cannot be reproduced except in full, without prior written approval of the Company. Any unauthorized alteration, forgery or falsification of the content or appearance of this document is unlawful and offenders may be prosecuted to the fullest extent of the law.

| EUT | | | | Measurement | | | | | |
|----------------|------|-----------------------|-----|--------------|-------------|--------------|------------|--------------|-------|
| Operation Band | Pol. | Fundamental Frequency | CH | Antenna Pol. | S.G. Output | Antenna Gain | Cable Loss | EIRP | Limit |
| | | MHz | | V/H | dBm | dBi | dB | dBm | dBm |
| EDGE 1900 | H | 1850.20 | 512 | V | 27.62 | 4.17 | -4.29 | 27.51 | 33.00 |
| | | | | H | 24.89 | 4.51 | -4.29 | 25.11 | 33.00 |
| | | 1880.00 | 661 | V | 27.09 | 4.13 | -4.33 | 26.89 | 33.00 |
| | | | | H | 24.32 | 4.44 | -4.33 | 24.43 | 33.00 |
| | | 1909.80 | 810 | V | 24.67 | 4.09 | -4.37 | 24.4 | 33.00 |
| | | | | H | 20.68 | 4.36 | -4.37 | 20.67 | 33.00 |
| | E1 | 1850.20 | 512 | V | 28.61 | 4.17 | -4.29 | 28.49 | 33.00 |
| | | | | H | 24.03 | 4.51 | -4.29 | 24.25 | 33.00 |
| | | 1880.00 | 661 | V | 29.58 | 4.13 | -4.33 | 29.39 | 33.00 |
| | | | | H | 25.1 | 4.44 | -4.33 | 25.21 | 33.00 |
| | | 1909.80 | 810 | V | 26.62 | 4.09 | -4.37 | 26.35 | 33.00 |
| | | | | H | 23.63 | 4.36 | -4.37 | 23.62 | 33.00 |
| | E2 | 1850.20 | 512 | V | 24.8 | 4.17 | -4.29 | 24.68 | 33.00 |
| | | | | H | 27.38 | 4.51 | -4.29 | 27.6 | 33.00 |
| | | 1880.00 | 661 | V | 26.49 | 4.13 | -4.33 | 26.29 | 33.00 |
| | | | | H | 27.07 | 4.44 | -4.33 | 27.18 | 33.00 |
| | | 1909.80 | 810 | V | 25.57 | 4.09 | -4.37 | 25.3 | 33.00 |
| | | | | H | 26.89 | 4.36 | -4.37 | 26.89 | 33.00 |

Remark :

- (1) The RBW,VBW of SPA for measurement RBW=300 KHz, VBW=1MHz

Unless otherwise stated the results shown in this test report refer only to the sample(s) tested and such sample(s) are retained for 90 days only.

除非另有說明，此報告結果僅對測試之樣品負責，同時此樣品僅保留90天。本報告未經本公司書面許可，不可部份複製。

This document is issued by the Company subject to its General Conditions of Service printed overleaf, available on request or accessible at www.sgs.com/terms_and_conditions.htm and, for electronic format documents, subject to Terms and Conditions for Electronic Documents at www.sgs.com/terms_e-document.htm. Attention is drawn to the limitation of liability, indemnification and jurisdiction issues defined therein. Any holder of this document is advised that information contained hereon reflects the Company's findings at the time of its intervention only and within the limits of Client's instructions, if any. The Company's sole responsibility is to its Client and this document does not exonerate parties to a transaction from exercising all their rights and obligations under the transaction documents. This document cannot be reproduced except in full, without prior written approval of the Company. Any unauthorized alteration, forgery or falsification of the content or appearance of this document is unlawful and offenders may be prosecuted to the fullest extent of the law.

| EUT | | | | Measurement | | | | | |
|----------------|------|-----------------------|------|--------------|-------------|--------------|------------|--------------|-------|
| Operation Band | Pol. | Fundamental Frequency | CH | Antenna Pol. | S.G. Output | Antenna Gain | Cable Loss | EIRP | Limit |
| | | MHz | | V/H | dBm | dBi | dB | dBm | dBm |
| WCDMA Band II | H | 1852.4 | 9262 | V | 26.44 | 4.17 | -4.3 | 26.31 | 33.00 |
| | | | | H | 23.48 | 4.51 | -4.3 | 23.69 | 33.00 |
| | | 1880.0 | 9400 | V | 25.86 | 4.13 | -4.33 | 25.66 | 33.00 |
| | | | | H | 22.96 | 4.44 | -4.33 | 23.07 | 33.00 |
| | | 1907.6 | 9538 | V | 23.65 | 4.1 | -4.36 | 23.38 | 33.00 |
| | | | | H | 19.74 | 4.37 | -4.36 | 19.75 | 33.00 |
| | E1 | 1852.4 | 9262 | V | 26.91 | 4.17 | -4.3 | 26.78 | 33.00 |
| | | | | H | 23.13 | 4.51 | -4.3 | 23.34 | 33.00 |
| | | 1880.0 | 9400 | V | 27.93 | 4.13 | -4.33 | 27.74 | 33.00 |
| | | | | H | 22.85 | 4.44 | -4.33 | 22.96 | 33.00 |
| | | 1907.6 | 9538 | V | 24.6 | 4.1 | -4.36 | 24.33 | 33.00 |
| | | | | H | 22.63 | 4.37 | -4.36 | 22.64 | 33.00 |
| | E2 | 1852.4 | 9262 | V | 22.95 | 4.17 | -4.3 | 22.82 | 33.00 |
| | | | | H | 27.17 | 4.51 | -4.3 | 27.39 | 33.00 |
| | | 1880.0 | 9400 | V | 25.01 | 4.13 | -4.33 | 24.81 | 33.00 |
| | | | | H | 26.47 | 4.44 | -4.33 | 26.57 | 33.00 |
| | | 1907.6 | 9538 | V | 23.74 | 4.1 | -4.36 | 23.47 | 33.00 |
| | | | | H | 25.54 | 4.37 | -4.36 | 25.54 | 33.00 |

Remark :

- (1) The RBW,VBW of SPA for measurement RBW= 5MHz , VBW= 8MHz

Unless otherwise stated the results shown in this test report refer only to the sample(s) tested and such sample(s) are retained for 90 days only.

除非另有說明，此報告結果僅對測試之樣品負責，同時此樣品僅保留90天。本報告未經本公司書面許可，不可部份複製。

This document is issued by the Company subject to its General Conditions of Service printed overleaf, available on request or accessible at www.sgs.com/terms_and_conditions.htm and, for electronic format documents, subject to Terms and Conditions for Electronic Documents at www.sgs.com/terms_e-document.htm. Attention is drawn to the limitation of liability, indemnification and jurisdiction issues defined therein. Any holder of this document is advised that information contained hereon reflects the Company's findings at the time of its intervention only and within the limits of Client's instructions, if any. The Company's sole responsibility is to its Client and this document does not exonerate parties to a transaction from exercising all their rights and obligations under the transaction documents. This document cannot be reproduced except in full, without prior written approval of the Company. Any unauthorized alteration, forgery or falsification of the content or appearance of this document is unlawful and offenders may be prosecuted to the fullest extent of the law.

| EUT | | | | Measurement | | | | | |
|----------------|------|-----------------------|------|--------------|-------------|--------------|------------|--------------|-------|
| Operation Band | Pol. | Fundamental Frequency | CH | Antenna Pol. | S.G. Output | Antenna Gain | Cable Loss | EIRP | Limit |
| | | MHz | | V/H | dBm | dBi | dB | dBm | dBm |
| WCDMA Band IV | H | 1712.4 | 1312 | V | 26.21 | 4.4 | -4.13 | 26.48 | 30.00 |
| | | | | H | 22.57 | 4.79 | -4.13 | 23.23 | 30.00 |
| | | 1732.6 | 1413 | V | 27 | 4.4 | -4.13 | 27.26 | 30.00 |
| | | | | H | 23.08 | 4.79 | -4.13 | 23.74 | 30.00 |
| | | 1752.6 | 1513 | V | 25.47 | 4.4 | -4.13 | 25.74 | 30.00 |
| | | | | H | 28.55 | 4.79 | -4.13 | 29.21 | 30.00 |
| | E1 | 1712.4 | 1312 | V | 27.84 | 4.35 | -4.16 | 28.04 | 30.00 |
| | | | | H | 23.19 | 4.78 | -4.16 | 23.81 | 30.00 |
| | | 1732.6 | 1413 | V | 26.21 | 4.35 | -4.16 | 26.4 | 30.00 |
| | | | | H | 21.51 | 4.78 | -4.16 | 22.13 | 30.00 |
| | | 1752.6 | 1513 | V | 22.22 | 4.35 | -4.16 | 22.41 | 30.00 |
| | | | | H | 27.92 | 4.78 | -4.16 | 28.55 | 30.00 |
| | E2 | 1712.4 | 1312 | V | 26.05 | 4.31 | -4.18 | 26.17 | 30.00 |
| | | | | H | 21.5 | 4.76 | -4.18 | 22.08 | 30.00 |
| | | 1732.6 | 1413 | V | 26.8 | 4.31 | -4.18 | 26.93 | 30.00 |
| | | | | H | 22.46 | 4.76 | -4.18 | 23.05 | 30.00 |
| | | 1752.6 | 1513 | V | 24.13 | 4.31 | -4.18 | 24.26 | 30.00 |
| | | | | H | 28.04 | 4.77 | -4.18 | 28.63 | 30.00 |

Remark :

- (1) The RBW,VBW of SPA for measurement RBW= 5MHz , VBW= 8MHz

Unless otherwise stated the results shown in this test report refer only to the sample(s) tested and such sample(s) are retained for 90 days only.

除非另有說明，此報告結果僅對測試之樣品負責，同時此樣品僅保留90天。本報告未經本公司書面許可，不可部份複製。

This document is issued by the Company subject to its General Conditions of Service printed overleaf, available on request or accessible at www.sgs.com/terms_and_conditions.htm and, for electronic format documents, subject to Terms and Conditions for Electronic Documents at www.sgs.com/terms_e-document.htm. Attention is drawn to the limitation of liability, indemnification and jurisdiction issues defined therein. Any holder of this document is advised that information contained hereon reflects the Company's findings at the time of its intervention only and within the limits of Client's instructions, if any. The Company's sole responsibility is to its Client and this document does not exonerate parties to a transaction from exercising all their rights and obligations under the transaction documents. This document cannot be reproduced except in full, without prior written approval of the Company. Any unauthorized alteration, forgery or falsification of the content or appearance of this document is unlawful and offenders may be prosecuted to the fullest extent of the law.

| EUT | | | | Measurement | | | | | |
|----------------|------|-----------------------|------|--------------|-------------|--------------|------------|--------------|-------|
| Operation Band | Pol. | Fundamental Frequency | CH | Antenna Pol. | S.G. Output | Antenna Gain | Cable Loss | ERP | Limit |
| | | MHz | | V/H | dBm | dBd | dB | dBm | dBm |
| WCDMA Band V | H | 826.40 | 4132 | V | 18.66 | 3.97 | -2.8 | 19.82 | 38.45 |
| | | | | H | 15.42 | 3.97 | -2.8 | 16.58 | 38.45 |
| | | 836.60 | 4183 | V | 18.49 | 4 | -2.82 | 19.67 | 38.45 |
| | | | | H | 15.95 | 4 | -2.82 | 17.12 | 38.45 |
| | | 846.60 | 4233 | V | 19.98 | 4.02 | -2.84 | 21.17 | 38.45 |
| | | | | H | 16.56 | 4.02 | -2.84 | 17.74 | 38.45 |
| | E1 | 826.40 | 4132 | V | 13.71 | 3.97 | -2.8 | 14.88 | 38.45 |
| | | | | H | 19.1 | 3.97 | -2.8 | 20.26 | 38.45 |
| | | 836.60 | 4183 | V | 14.14 | 4 | -2.82 | 15.32 | 38.45 |
| | | | | H | 18.84 | 4 | -2.82 | 20.01 | 38.45 |
| | | 846.60 | 4233 | V | 16.96 | 4.02 | -2.84 | 18.15 | 38.45 |
| | | | | H | 20.51 | 4.02 | -2.84 | 21.69 | 38.45 |
| | E2 | 826.40 | 4132 | V | 15.2 | 3.97 | -2.8 | 16.37 | 38.45 |
| | | | | H | 19.21 | 3.97 | -2.8 | 20.37 | 38.45 |
| | | 836.60 | 4183 | V | 13.84 | 4 | -2.82 | 15.02 | 38.45 |
| | | | | H | 19.47 | 4 | -2.82 | 20.65 | 38.45 |
| | | 846.60 | 4233 | V | 14.88 | 4.02 | -2.84 | 16.06 | 38.45 |
| | | | | H | 19.85 | 4.02 | -2.84 | 21.04 | 38.45 |

Remark :

- (1) The RBW,VBW of SPA for measurement RBW= 5MHz , VBW= 8MHz

Unless otherwise stated the results shown in this test report refer only to the sample(s) tested and such sample(s) are retained for 90 days only.

除非另有說明，此報告結果僅對測試之樣品負責，同時此樣品僅保留90天。本報告未經本公司書面許可，不可部份複製。

This document is issued by the Company subject to its General Conditions of Service printed overleaf, available on request or accessible at www.sgs.com/terms_and_conditions.htm and, for electronic format documents, subject to Terms and Conditions for Electronic Documents at www.sgs.com/terms_e-document.htm. Attention is drawn to the limitation of liability, indemnification and jurisdiction issues defined therein. Any holder of this document is advised that information contained hereon reflects the Company's findings at the time of its intervention only and within the limits of Client's instructions, if any. The Company's sole responsibility is to its Client and this document does not exonerate parties to a transaction from exercising all their rights and obligations under the transaction documents. This document cannot be reproduced except in full, without prior written approval of the Company. Any unauthorized alteration, forgery or falsification of the content or appearance of this document is unlawful and offenders may be prosecuted to the fullest extent of the law.

| EUT | | | | Measurement | | | | | |
|----------------|------|-----------------------|------|--------------|-------------|--------------|------------|-------------|-------|
| Operation Band | Pol. | Fundamental Frequency | CH | Antenna Pol. | S.G. Output | Antenna Gain | Cable Loss | EIRP | Limit |
| | | MHz | | V/H | dBm | dBi | dB | dBm | dBm |
| HSUPA Band II | H | 1852.4 | 9262 | V | 26.14 | 4.17 | -4.3 | 26.02 | 33.00 |
| | | | | H | 23.4 | 4.51 | -4.3 | 23.61 | 33.00 |
| | | 1880.0 | 9400 | V | 25.44 | 4.13 | -4.33 | 25.25 | 33.00 |
| | | | | H | 22.41 | 4.44 | -4.33 | 22.51 | 33.00 |
| | | 1907.6 | 9538 | V | 23.99 | 4.1 | -4.36 | 23.72 | 33.00 |
| | | | | H | 19.31 | 4.37 | -4.36 | 19.32 | 33.00 |
| | E1 | 1852.4 | 9262 | V | 26.43 | 4.17 | -4.3 | 26.3 | 33.00 |
| | | | | H | 22.57 | 4.51 | -4.29 | 22.78 | 33.00 |
| | | 1880.0 | 9400 | V | 27.4 | 4.13 | -4.33 | 27.2 | 33.00 |
| | | | | H | 22.26 | 4.44 | -4.33 | 22.37 | 33.00 |
| | | 1907.6 | 9538 | V | 24.32 | 4.1 | -4.36 | 24.06 | 33.00 |
| | | | | H | 22.41 | 4.37 | -4.36 | 22.42 | 33.00 |
| | E2 | 1852.4 | 9262 | V | 21.5 | 4.17 | -4.3 | 21.38 | 33.00 |
| | | | | H | 22.48 | 4.51 | -4.3 | 22.69 | 33.00 |
| | | 1880.0 | 9400 | V | 23.48 | 4.13 | -4.33 | 23.28 | 33.00 |
| | | | | H | 23.59 | 4.44 | -4.33 | 23.69 | 33.00 |
| | | 1907.6 | 9538 | V | 22.57 | 4.1 | -4.36 | 22.3 | 33.00 |
| | | | | H | 24.27 | 4.37 | -4.36 | 24.27 | 33.00 |

Remark :

- (1) The RBW,VBW of SPA for measurement RBW= 5MHz , VBW= 8MHz

Unless otherwise stated the results shown in this test report refer only to the sample(s) tested and such sample(s) are retained for 90 days only.

除非另有說明，此報告結果僅對測試之樣品負責，同時此樣品僅保留90天。本報告未經本公司書面許可，不可部份複製。

This document is issued by the Company subject to its General Conditions of Service printed overleaf, available on request or accessible at www.sgs.com/terms_and_conditions.htm and, for electronic format documents, subject to Terms and Conditions for Electronic Documents at www.sgs.com/terms_e-document.htm. Attention is drawn to the limitation of liability, indemnification and jurisdiction issues defined therein. Any holder of this document is advised that information contained hereon reflects the Company's findings at the time of its intervention only and within the limits of Client's instructions, if any. The Company's sole responsibility is to its Client and this document does not exonerate parties to a transaction from exercising all their rights and obligations under the transaction documents. This document cannot be reproduced except in full, without prior written approval of the Company. Any unauthorized alteration, forgery or falsification of the content or appearance of this document is unlawful and offenders may be prosecuted to the fullest extent of the law.

| EUT | | | | Measurement | | | | | |
|----------------|------|-----------------------|------|--------------|-------------|--------------|------------|--------------|-------|
| Operation Band | Pol. | Fundamental Frequency | CH | Antenna Pol. | S.G. Output | Antenna Gain | Cable Loss | EIRP | Limit |
| | | MHz | | V/H | dBm | dBi | dB | dBm | dBm |
| HSUPA Band IV | H | 1712.4 | 1312 | V | 26.21 | 4.4 | -4.13 | 26.9 | 30.00 |
| | | | | H | 20.46 | 4.79 | -4.13 | 21.12 | 30.00 |
| | | 1732.6 | 1413 | V | 26.93 | 4.4 | -4.13 | 27.2 | 30.00 |
| | | | | H | 22.41 | 4.79 | -4.13 | 23.07 | 30.00 |
| | | 1752.6 | 1513 | V | 24.93 | 4.4 | -4.13 | 25.2 | 30.00 |
| | | | | H | 27.96 | 4.79 | -4.13 | 28.62 | 30.00 |
| | E1 | 1712.4 | 1312 | V | 27.65 | 4.35 | -4.16 | 27.84 | 30.00 |
| | | | | H | 21.08 | 4.78 | -4.16 | 21.71 | 30.00 |
| | | 1732.6 | 1413 | V | 26.44 | 4.35 | -4.16 | 26.64 | 30.00 |
| | | | | H | 21.21 | 4.78 | -4.16 | 21.83 | 30.00 |
| | | 1752.6 | 1513 | V | 22.11 | 4.35 | -4.16 | 22.31 | 30.00 |
| | | | | H | 27.47 | 4.78 | -4.16 | 28.1 | 30.00 |
| | E2 | 1712.4 | 1312 | V | 26.54 | 4.31 | -4.18 | 26.66 | 30.00 |
| | | | | H | 19.22 | 4.76 | -4.18 | 19.81 | 30.00 |
| | | 1732.6 | 1413 | V | 26.15 | 4.31 | -4.18 | 26.28 | 30.00 |
| | | | | H | 22.65 | 4.76 | -4.18 | 23.23 | 30.00 |
| | | 1752.6 | 1513 | V | 23.74 | 4.31 | -4.18 | 23.87 | 30.00 |
| | | | | H | 27.81 | 4.77 | -4.18 | 28.39 | 30.00 |

Remark :

- (1) The RBW,VBW of SPA for measurement RBW= 5MHz , VBW= 8MHz

Unless otherwise stated the results shown in this test report refer only to the sample(s) tested and such sample(s) are retained for 90 days only.

除非另有說明，此報告結果僅對測試之樣品負責，同時此樣品僅保留90天。本報告未經本公司書面許可，不可部份複製。

This document is issued by the Company subject to its General Conditions of Service printed overleaf, available on request or accessible at www.sgs.com/terms_and_conditions.htm and, for electronic format documents, subject to Terms and Conditions for Electronic Documents at www.sgs.com/terms_e-document.htm. Attention is drawn to the limitation of liability, indemnification and jurisdiction issues defined therein. Any holder of this document is advised that information contained hereon reflects the Company's findings at the time of its intervention only and within the limits of Client's instructions, if any. The Company's sole responsibility is to its Client and this document does not exonerate parties to a transaction from exercising all their rights and obligations under the transaction documents. This document cannot be reproduced except in full, without prior written approval of the Company. Any unauthorized alteration, forgery or falsification of the content or appearance of this document is unlawful and offenders may be prosecuted to the fullest extent of the law.

| EUT | | | | Measurement | | | | | |
|----------------|------|-----------------------|------|--------------|-------------|--------------|------------|--------------|-------|
| Operation Band | Pol. | Fundamental Frequency | CH | Antenna Pol. | S.G. Output | Antenna Gain | Cable Loss | ERP | Limit |
| | | MHz | | V/H | dBm | dBd | dB | dBm | dBm |
| HSUPA Band V | H | 826.40 | 4132 | V | 18.25 | 3.97 | -2.8 | 19.42 | 38.45 |
| | | | | H | 14.99 | 3.97 | -2.8 | 16.15 | 38.45 |
| | | 836.60 | 4183 | V | 18.04 | 4 | -2.82 | 19.21 | 38.45 |
| | | | | H | 15.59 | 4 | -2.82 | 16.77 | 38.45 |
| | | 846.60 | 4233 | V | 19.75 | 4.02 | -2.84 | 20.94 | 38.45 |
| | | | | H | 16.34 | 4.02 | -2.84 | 17.52 | 38.45 |
| | E1 | 826.40 | 4132 | V | 13.68 | 3.97 | -2.8 | 14.84 | 38.45 |
| | | | | H | 18.86 | 3.97 | -2.8 | 20.02 | 38.45 |
| | | 836.60 | 4183 | V | 13.66 | 4 | -2.82 | 14.83 | 38.45 |
| | | | | H | 18.49 | 4 | -2.82 | 19.67 | 38.45 |
| | | 846.60 | 4233 | V | 16.7 | 4.02 | -2.84 | 17.88 | 38.45 |
| | | | | H | 20.5 | 4.02 | -2.84 | 21.69 | 38.45 |
| | E2 | 826.40 | 4132 | V | 15 | 3.97 | -2.8 | 16.17 | 38.45 |
| | | | | H | 18.73 | 3.97 | -2.8 | 19.89 | 38.45 |
| | | 836.60 | 4183 | V | 13.6 | 4 | -2.82 | 14.77 | 38.45 |
| | | | | H | 18.96 | 4 | -2.82 | 20.14 | 38.45 |
| | | 846.60 | 4233 | V | 14.62 | 4.02 | -2.84 | 15.81 | 38.45 |
| | | | | H | 19.8 | 4.02 | -2.84 | 20.99 | 38.45 |

Remark :

- (1) The RBW,VBW of SPA for measurement RBW= 5MHz , VBW= 8MHz

Unless otherwise stated the results shown in this test report refer only to the sample(s) tested and such sample(s) are retained for 90 days only.

除非另有說明，此報告結果僅對測試之樣品負責，同時此樣品僅保留90天。本報告未經本公司書面許可，不可部份複製。

This document is issued by the Company subject to its General Conditions of Service printed overleaf, available on request or accessible at www.sgs.com/terms_and_conditions.htm and, for electronic format documents, subject to Terms and Conditions for Electronic Documents at www.sgs.com/terms_e-document.htm. Attention is drawn to the limitation of liability, indemnification and jurisdiction issues defined therein. Any holder of this document is advised that information contained hereon reflects the Company's findings at the time of its intervention only and within the limits of Client's instructions, if any. The Company's sole responsibility is to its Client and this document does not exonerate parties to a transaction from exercising all their rights and obligations under the transaction documents. This document cannot be reproduced except in full, without prior written approval of the Company. Any unauthorized alteration, forgery or falsification of the content or appearance of this document is unlawful and offenders may be prosecuted to the fullest extent of the law.

| EUT | | | | Measurement | | | | | |
|----------------|------|-----------------------|------|--------------|-------------|--------------|------------|--------------|-------|
| Operation Band | Pol. | Fundamental Frequency | CH | Antenna Pol. | S.G. Output | Antenna Gain | Cable Loss | EIRP | Limit |
| | | MHz | | V/H | dBm | dBi | dB | dBm | dBm |
| HSDPA Band II | H | 1852.4 | 9262 | V | 26.41 | 4.17 | -4.3 | 26.28 | 33.00 |
| | | | | H | 23.51 | 4.51 | -4.3 | 23.73 | 33.00 |
| | | 1880.0 | 9400 | V | 25.78 | 4.13 | -4.33 | 25.59 | 33.00 |
| | | | | H | 22.87 | 4.44 | -4.33 | 22.98 | 33.00 |
| | | 1907.6 | 9538 | V | 23.71 | 4.1 | -4.36 | 23.45 | 33.00 |
| | | | | H | 19.6 | 4.37 | -4.36 | 19.61 | 33.00 |
| | E1 | 1852.4 | 9262 | V | 26.8 | 4.17 | -4.3 | 26.68 | 33.00 |
| | | | | H | 23.8 | 4.51 | -4.3 | 24.01 | 33.00 |
| | | 1880.0 | 9400 | V | 27.77 | 4.13 | -4.33 | 27.58 | 33.00 |
| | | | | H | 22.7 | 4.44 | -4.33 | 22.81 | 33.00 |
| | | 1907.6 | 9538 | V | 24.5 | 4.1 | -4.36 | 24.23 | 33.00 |
| | | | | H | 22.66 | 4.37 | -4.36 | 22.67 | 33.00 |
| | E2 | 1852.4 | 9262 | V | 22.01 | 4.17 | -4.3 | 21.88 | 33.00 |
| | | | | H | 25.01 | 4.51 | -4.3 | 25.22 | 33.00 |
| | | 1880.0 | 9400 | V | 23.91 | 4.13 | -4.33 | 23.72 | 33.00 |
| | | | | H | 24.45 | 4.44 | -4.33 | 24.56 | 33.00 |
| | | 1907.6 | 9538 | V | 22.77 | 4.1 | -4.36 | 22.51 | 33.00 |
| | | | | H | 24.78 | 4.37 | -4.36 | 24.79 | 33.00 |

Remark :

- (1) The RBW,VBW of SPA for measurement RBW= 5MHz , VBW= 8MHz

Unless otherwise stated the results shown in this test report refer only to the sample(s) tested and such sample(s) are retained for 90 days only.

除非另有說明，此報告結果僅對測試之樣品負責，同時此樣品僅保留90天。本報告未經本公司書面許可，不可部份複製。

This document is issued by the Company subject to its General Conditions of Service printed overleaf, available on request or accessible at www.sgs.com/terms_and_conditions.htm and, for electronic format documents, subject to Terms and Conditions for Electronic Documents at www.sgs.com/terms_e-document.htm. Attention is drawn to the limitation of liability, indemnification and jurisdiction issues defined therein. Any holder of this document is advised that information contained hereon reflects the Company's findings at the time of its intervention only and within the limits of Client's instructions, if any. The Company's sole responsibility is to its Client and this document does not exonerate parties to a transaction from exercising all their rights and obligations under the transaction documents. This document cannot be reproduced except in full, without prior written approval of the Company. Any unauthorized alteration, forgery or falsification of the content or appearance of this document is unlawful and offenders may be prosecuted to the fullest extent of the law.

| EUT | | | | Measurement | | | | | |
|----------------|------|-----------------------|------|--------------|-------------|--------------|------------|--------------|-------|
| Operation Band | Pol. | Fundamental Frequency | CH | Antenna Pol. | S.G. Output | Antenna Gain | Cable Loss | EIRP | Limit |
| | | MHz | | V/H | dBm | dBi | dB | dBm | dBm |
| HSDPA Band IV | H | 1712.4 | 1312 | V | 26.21 | 4.4 | -4.13 | 27.4 | 30.00 |
| | | | | H | 20.78 | 4.79 | -4.13 | 21.44 | 30.00 |
| | | 1732.6 | 1413 | V | 27.15 | 4.4 | -4.13 | 27.42 | 30.00 |
| | | | | H | 22.96 | 4.79 | -4.13 | 23.62 | 30.00 |
| | | 1752.6 | 1513 | V | 25.44 | 4.4 | -4.13 | 25.7 | 30.00 |
| | | | | H | 28.49 | 4.79 | -4.13 | 29.16 | 30.00 |
| | E1 | 1712.4 | 1312 | V | 28.08 | 4.35 | -4.16 | 28.27 | 30.00 |
| | | | | H | 21.3 | 4.78 | -4.16 | 21.92 | 30.00 |
| | | 1732.6 | 1413 | V | 26.25 | 4.35 | -4.16 | 26.44 | 30.00 |
| | | | | H | 21.41 | 4.78 | -4.16 | 22.04 | 30.00 |
| | | 1752.6 | 1513 | V | 22.36 | 4.35 | -4.16 | 22.56 | 30.00 |
| | | | | H | 27.82 | 4.78 | -4.16 | 28.44 | 30.00 |
| | E2 | 1712.4 | 1312 | V | 27.09 | 4.31 | -4.18 | 27.22 | 30.00 |
| | | | | H | 19.45 | 4.76 | -4.18 | 20.03 | 30.00 |
| | | 1732.6 | 1413 | V | 26.61 | 4.31 | -4.18 | 26.74 | 30.00 |
| | | | | H | 22.98 | 4.77 | -4.18 | 23.57 | 30.00 |
| | | 1752.6 | 1513 | V | 24.07 | 4.31 | -4.18 | 24.2 | 30.00 |
| | | | | H | 28.32 | 4.76 | -4.18 | 28.9 | 30.00 |

Remark :

- (1) The RBW,VBW of SPA for measurement RBW= 5MHz , VBW= 8MHz

Unless otherwise stated the results shown in this test report refer only to the sample(s) tested and such sample(s) are retained for 90 days only.

除非另有說明，此報告結果僅對測試之樣品負責，同時此樣品僅保留90天。本報告未經本公司書面許可，不可部份複製。

This document is issued by the Company subject to its General Conditions of Service printed overleaf, available on request or accessible at www.sgs.com/terms_and_conditions.htm and, for electronic format documents, subject to Terms and Conditions for Electronic Documents at www.sgs.com/terms_e-document.htm. Attention is drawn to the limitation of liability, indemnification and jurisdiction issues defined therein. Any holder of this document is advised that information contained hereon reflects the Company's findings at the time of its intervention only and within the limits of Client's instructions, if any. The Company's sole responsibility is to its Client and this document does not exonerate parties to a transaction from exercising all their rights and obligations under the transaction documents. This document cannot be reproduced except in full, without prior written approval of the Company. Any unauthorized alteration, forgery or falsification of the content or appearance of this document is unlawful and offenders may be prosecuted to the fullest extent of the law.

| EUT | | | | Measurement | | | | | |
|----------------|------|-----------------------|------|--------------|-------------|--------------|------------|--------------|-------|
| Operation Band | Pol. | Fundamental Frequency | CH | Antenna Pol. | S.G. Output | Antenna Gain | Cable Loss | ERP | Limit |
| | | MHz | | V/H | dBm | dBd | dB | dBm | dBm |
| HSDPA Band V | H | 826.40 | 4132 | V | 18.56 | 3.97 | -2.8 | 19.73 | 38.45 |
| | | | | H | 15.26 | 3.97 | -2.8 | 16.42 | 38.45 |
| | | 836.60 | 4183 | V | 18.72 | 4 | -2.82 | 19.9 | 38.45 |
| | | | | H | 16.28 | 4 | -2.82 | 17.46 | 38.45 |
| | | 846.60 | 4233 | V | 20.02 | 4.02 | -2.84 | 21.21 | 38.45 |
| | | | | H | 16.88 | 4.02 | -2.84 | 18.06 | 38.45 |
| | E1 | 826.40 | 4132 | V | 13.65 | 3.97 | -2.8 | 14.81 | 38.45 |
| | | | | H | 19.12 | 3.97 | -2.8 | 20.29 | 38.45 |
| | | 836.60 | 4183 | V | 14.02 | 4 | -2.82 | 15.2 | 38.45 |
| | | | | H | 18.87 | 4 | -2.82 | 20.05 | 38.45 |
| | | 846.60 | 4233 | V | 16.9 | 4.02 | -2.84 | 18.08 | 38.45 |
| | | | | H | 20.67 | 4.02 | -2.83 | 21.85 | 38.45 |
| | E2 | 826.40 | 4132 | V | 15.25 | 3.97 | -2.8 | 16.42 | 38.45 |
| | | | | H | 19.17 | 3.97 | -2.8 | 20.33 | 38.45 |
| | | 836.60 | 4183 | V | 14.05 | 4 | -2.82 | 15.23 | 38.45 |
| | | | | H | 19.61 | 4 | -2.82 | 20.78 | 38.45 |
| | | 846.60 | 4233 | V | 14.76 | 4.02 | -2.83 | 15.94 | 38.45 |
| | | | | H | 20.21 | 4.02 | -2.84 | 21.4 | 38.45 |

Remark :

- (1) The RBW,VBW of SPA for measurement RBW= 5MHz , VBW= 8MHz

Unless otherwise stated the results shown in this test report refer only to the sample(s) tested and such sample(s) are retained for 90 days only.

除非另有說明，此報告結果僅對測試之樣品負責，同時此樣品僅保留90天。本報告未經本公司書面許可，不可部份複製。

This document is issued by the Company subject to its General Conditions of Service printed overleaf, available on request or accessible at www.sgs.com/terms_and_conditions.htm and, for electronic format documents, subject to Terms and Conditions for Electronic Documents at www.sgs.com/terms_e-document.htm. Attention is drawn to the limitation of liability, indemnification and jurisdiction issues defined therein. Any holder of this document is advised that information contained hereon reflects the Company's findings at the time of its intervention only and within the limits of Client's instructions, if any. The Company's sole responsibility is to its Client and this document does not exonerate parties to a transaction from exercising all their rights and obligations under the transaction documents. This document cannot be reproduced except in full, without prior written approval of the Company. Any unauthorized alteration, forgery or falsification of the content or appearance of this document is unlawful and offenders may be prosecuted to the fullest extent of the law.

7.5.1 Measurement Result: (Average) – using option of RMS measurement

| EUT | | | | Measurement | | | | | |
|----------------|------|-----------------------|-----|--------------|-------------|--------------|------------|-------------|-------|
| Operation Band | Pol. | Fundamental Frequency | CH | Antenna Pol. | S.G. Output | Antenna Gain | Cable Loss | ERP | Limit |
| | | MHz | | V/H | dBm | dBd | dB | dBm | dBm |
| GSM 850 | H | 824.20 | 128 | V | 15.71 | 3.96 | -2.8 | 16.87 | 40.60 |
| | | | | H | 14.34 | 3.96 | -2.8 | 15.5 | 40.60 |
| | | 836.60 | 190 | V | 15.47 | 4 | -2.82 | 16.65 | 40.60 |
| | | | | H | 13.72 | 4 | -2.82 | 14.9 | 40.60 |
| | | 848.80 | 251 | V | 15.88 | 4.03 | -2.84 | 17.07 | 40.60 |
| | | | | H | 14.54 | 4.03 | -2.84 | 15.73 | 40.60 |
| | E1 | 824.20 | 128 | V | 12.63 | 3.96 | -2.8 | 13.8 | 40.60 |
| | | | | H | 14.27 | 3.96 | -2.8 | 15.43 | 40.60 |
| | | 836.60 | 190 | V | 13.16 | 4 | -2.82 | 14.34 | 40.60 |
| | | | | H | 14.5 | 4 | -2.82 | 15.68 | 40.60 |
| | | 848.80 | 251 | V | 14.04 | 4.03 | -2.84 | 15.23 | 40.60 |
| | | | | H | 14.27 | 4.03 | -2.84 | 15.46 | 40.60 |
| | E2 | 824.20 | 128 | V | 13.21 | 3.96 | -2.8 | 14.37 | 40.60 |
| | | | | H | 15.62 | 3.96 | -2.8 | 16.78 | 40.60 |
| | | 836.60 | 190 | V | 13.93 | 4 | -2.82 | 15.11 | 40.60 |
| | | | | H | 16.42 | 4 | -2.82 | 17.6 | 40.60 |
| | | 848.80 | 251 | V | 13.38 | 4.03 | -2.84 | 14.57 | 40.60 |
| | | | | H | 16.25 | 4.03 | -2.84 | 17.44 | 40.60 |

Remark :

- (1) The RBW,VBW of SPA for frequency RBW=6 kHz, VBW=20 kHz

Unless otherwise stated the results shown in this test report refer only to the sample(s) tested and such sample(s) are retained for 90 days only.

除非另有說明，此報告結果僅對測試之樣品負責，同時此樣品僅保留90天。本報告未經本公司書面許可，不可部份複製。

This document is issued by the Company subject to its General Conditions of Service printed overleaf, available on request or accessible at www.sgs.com/terms_and_conditions.htm and, for electronic format documents, subject to Terms and Conditions for Electronic Documents at www.sgs.com/terms_e-document.htm. Attention is drawn to the limitation of liability, indemnification and jurisdiction issues defined therein. Any holder of this document is advised that information contained hereon reflects the Company's findings at the time of its intervention only and within the limits of Client's instructions, if any. The Company's sole responsibility is to its Client and this document does not exonerate parties to a transaction from exercising all their rights and obligations under the transaction documents. This document cannot be reproduced except in full, without prior written approval of the Company. Any unauthorized alteration, forgery or falsification of the content or appearance of this document is unlawful and offenders may be prosecuted to the fullest extent of the law.

| EUT | | | | Measurement | | | | | |
|----------------|------|-----------------------|-----|--------------|-------------|--------------|------------|--------------|-------|
| Operation Band | Pol. | Fundamental Frequency | CH | Antenna Pol. | S.G. Output | Antenna Gain | Cable Loss | EIRP | Limit |
| | | MHz | | V/H | dBm | dBi | dB | dBm | dBm |
| GSM 1900 | H | 1850.20 | 512 | V | 21.37 | 4.17 | -4.29 | 21.25 | 33.00 |
| | | | | H | 17.85 | 4.51 | -4.29 | 18.07 | 33.00 |
| | | 1880.00 | 661 | V | 20.51 | 4.13 | -4.33 | 20.31 | 33.00 |
| | | | | H | 18.56 | 4.44 | -4.33 | 18.67 | 33.00 |
| | | 1909.80 | 810 | V | 16.66 | 4.09 | -4.37 | 16.38 | 33.00 |
| | | | | H | 14.56 | 4.36 | -4.37 | 14.56 | 33.00 |
| | E1 | 1850.20 | 512 | V | 21.63 | 4.17 | -4.29 | 21.51 | 33.00 |
| | | | | H | 17.55 | 4.51 | -4.29 | 17.77 | 33.00 |
| | | 1880.00 | 661 | V | 22.9 | 4.13 | -4.33 | 22.71 | 33.00 |
| | | | | H | 18.39 | 4.44 | -4.33 | 18.5 | 33.00 |
| | | 1909.80 | 810 | V | 20.05 | 4.09 | -4.37 | 19.78 | 33.00 |
| | | | | H | 16.57 | 4.36 | -4.37 | 16.57 | 33.00 |
| | E2 | 1850.20 | 512 | V | 17.5 | 4.17 | -4.29 | 17.38 | 33.00 |
| | | | | H | 20.23 | 4.51 | -4.29 | 20.45 | 33.00 |
| | | 1880.00 | 661 | V | 19.6 | 4.13 | -4.33 | 19.4 | 33.00 |
| | | | | H | 19.53 | 4.44 | -4.33 | 19.63 | 33.00 |
| | | 1909.80 | 810 | V | 18.56 | 4.09 | -4.37 | 18.29 | 33.00 |
| | | | | H | 20.02 | 4.36 | -4.37 | 20.02 | 33.00 |

Remark :

- (1) The RBW,VBW of SPA for frequency RBW=6 kHz, VBW=20 kHz

Unless otherwise stated the results shown in this test report refer only to the sample(s) tested and such sample(s) are retained for 90 days only.

除非另有說明，此報告結果僅對測試之樣品負責，同時此樣品僅保留90天。本報告未經本公司書面許可，不可部份複製。

This document is issued by the Company subject to its General Conditions of Service printed overleaf, available on request or accessible at www.sgs.com/terms_and_conditions.htm and, for electronic format documents, subject to Terms and Conditions for Electronic Documents at www.sgs.com/terms_e-document.htm. Attention is drawn to the limitation of liability, indemnification and jurisdiction issues defined therein. Any holder of this document is advised that information contained hereon reflects the Company's findings at the time of its intervention only and within the limits of Client's instructions, if any. The Company's sole responsibility is to its Client and this document does not exonerate parties to a transaction from exercising all their rights and obligations under the transaction documents. This document cannot be reproduced except in full, without prior written approval of the Company. Any unauthorized alteration, forgery or falsification of the content or appearance of this document is unlawful and offenders may be prosecuted to the fullest extent of the law.

| EUT | | | | Measurement | | | | | |
|----------------|------|-----------------------|-----|--------------|-------------|--------------|------------|--------------|-------|
| Operation Band | Pol. | Fundamental Frequency | CH | Antenna Pol. | S.G. Output | Antenna Gain | Cable Loss | ERP | Limit |
| | | MHz | | V/H | dBm | dBd | dB | dBm | dBm |
| GPRS 850 | H | 824.20 | 128 | V | 15.85 | 3.96 | -2.8 | 17.02 | 40.60 |
| | | | | H | 15.34 | 3.96 | -2.8 | 16.5 | 40.60 |
| | | 836.60 | 190 | V | 15.19 | 4 | -2.82 | 16.37 | 40.60 |
| | | | | H | 13.58 | 4 | -2.82 | 14.75 | 40.60 |
| | | 848.80 | 251 | V | 16.5 | 4.03 | -2.84 | 17.68 | 40.60 |
| | | | | H | 14.86 | 4.03 | -2.84 | 16.05 | 40.60 |
| | E1 | 824.20 | 128 | V | 12.08 | 3.96 | -2.8 | 13.25 | 40.60 |
| | | | | H | 14.75 | 3.96 | -2.8 | 15.91 | 40.60 |
| | | 836.60 | 190 | V | 12.89 | 4 | -2.82 | 14.06 | 40.60 |
| | | | | H | 15.21 | 4 | -2.82 | 16.39 | 40.60 |
| | | 848.80 | 251 | V | 13.79 | 4.03 | -2.84 | 14.98 | 40.60 |
| | | | | H | 14.34 | 4.03 | -2.84 | 15.53 | 40.60 |
| | E2 | 824.20 | 128 | V | 13.48 | 3.96 | -2.8 | 14.65 | 40.60 |
| | | | | H | 14.09 | 3.96 | -2.8 | 15.25 | 40.60 |
| | | 836.60 | 190 | V | 13.35 | 4 | -2.82 | 14.53 | 40.60 |
| | | | | H | 17.31 | 4 | -2.82 | 18.49 | 40.60 |
| | | 848.80 | 251 | V | 14.04 | 4.03 | -2.84 | 15.22 | 40.60 |
| | | | | H | 16.43 | 4.03 | -2.84 | 17.61 | 40.60 |

Remark :

- (1) The RBW,VBW of SPA for frequency RBW=6 kHz, VBW=20 kHz

Unless otherwise stated the results shown in this test report refer only to the sample(s) tested and such sample(s) are retained for 90 days only.

除非另有說明，此報告結果僅對測試之樣品負責，同時此樣品僅保留90天。本報告未經本公司書面許可，不可部份複製。

This document is issued by the Company subject to its General Conditions of Service printed overleaf, available on request or accessible at www.sgs.com/terms_and_conditions.htm and, for electronic format documents, subject to Terms and Conditions for Electronic Documents at www.sgs.com/terms_e-document.htm. Attention is drawn to the limitation of liability, indemnification and jurisdiction issues defined therein. Any holder of this document is advised that information contained hereon reflects the Company's findings at the time of its intervention only and within the limits of Client's instructions, if any. The Company's sole responsibility is to its Client and this document does not exonerate parties to a transaction from exercising all their rights and obligations under the transaction documents. This document cannot be reproduced except in full, without prior written approval of the Company. Any unauthorized alteration, forgery or falsification of the content or appearance of this document is unlawful and offenders may be prosecuted to the fullest extent of the law.

| EUT | | | | Measurement | | | | | |
|----------------|------|-----------------------|-----|--------------|-------------|--------------|------------|--------------|-------|
| Operation Band | Pol. | Fundamental Frequency | CH | Antenna Pol. | S.G. Output | Antenna Gain | Cable Loss | EIRP | Limit |
| | | MHz | | V/H | dBm | dBi | dB | dBm | dBm |
| GPRS 1900 | H | 1850.20 | 512 | V | 20.67 | 4.17 | -4.29 | 20.55 | 33.00 |
| | | | | H | 17.65 | 4.51 | -4.29 | 17.87 | 33.00 |
| | | 1880.00 | 661 | V | 19.94 | 4.13 | -4.33 | 19.74 | 33.00 |
| | | | | H | 17.39 | 4.44 | -4.33 | 17.49 | 33.00 |
| | | 1909.80 | 810 | V | 18.62 | 4.09 | -4.37 | 18.35 | 33.00 |
| | | | | H | 14.42 | 4.36 | -4.37 | 14.42 | 33.00 |
| | E1 | 1850.20 | 512 | V | 22.47 | 4.17 | -4.29 | 22.36 | 33.00 |
| | | | | H | 17.2 | 4.51 | -4.29 | 17.42 | 33.00 |
| | | 1880.00 | 661 | V | 22.78 | 4.13 | -4.33 | 22.58 | 33.00 |
| | | | | H | 17.86 | 4.44 | -4.33 | 17.97 | 33.00 |
| | | 1909.80 | 810 | V | 19.27 | 4.09 | -4.37 | 19 | 33.00 |
| | | | | H | 16.95 | 4.36 | -4.37 | 16.95 | 33.00 |
| | E2 | 1850.20 | 512 | V | 17.93 | 4.17 | -4.29 | 17.81 | 33.00 |
| | | | | H | 20.65 | 4.51 | -4.29 | 20.87 | 33.00 |
| | | 1880.00 | 661 | V | 20.4 | 4.13 | -4.33 | 20.2 | 33.00 |
| | | | | H | 20.26 | 4.44 | -4.33 | 20.37 | 33.00 |
| | | 1909.80 | 810 | V | 19.22 | 4.09 | -4.37 | 18.95 | 33.00 |
| | | | | H | 20.58 | 4.36 | -4.37 | 20.58 | 33.00 |

Remark :

- (1) The RBW,VBW of SPA for frequency RBW=6 kHz, VBW=20 kHz

Unless otherwise stated the results shown in this test report refer only to the sample(s) tested and such sample(s) are retained for 90 days only.

除非另有說明，此報告結果僅對測試之樣品負責，同時此樣品僅保留90天。本報告未經本公司書面許可，不可部份複製。

This document is issued by the Company subject to its General Conditions of Service printed overleaf, available on request or accessible at www.sgs.com/terms_and_conditions.htm and, for electronic format documents, subject to Terms and Conditions for Electronic Documents at www.sgs.com/terms_e-document.htm. Attention is drawn to the limitation of liability, indemnification and jurisdiction issues defined therein. Any holder of this document is advised that information contained hereon reflects the Company's findings at the time of its intervention only and within the limits of Client's instructions, if any. The Company's sole responsibility is to its Client and this document does not exonerate parties to a transaction from exercising all their rights and obligations under the transaction documents. This document cannot be reproduced except in full, without prior written approval of the Company. Any unauthorized alteration, forgery or falsification of the content or appearance of this document is unlawful and offenders may be prosecuted to the fullest extent of the law.

| EUT | | | | Measurement | | | | | |
|----------------|------|-----------------------|-----|--------------|-------------|--------------|------------|--------------|-------|
| Operation Band | Pol. | Fundamental Frequency | CH | Antenna Pol. | S.G. Output | Antenna Gain | Cable Loss | ERP | Limit |
| | | MHz | | V/H | dBm | dBd | dB | dBm | dBm |
| EDGE 850 | H | 824.20 | 128 | V | 9.67 | 3.96 | -2.8 | 10.83 | 40.60 |
| | | | | H | 9.4 | 3.96 | -2.8 | 10.56 | 40.60 |
| | | 836.60 | 190 | V | 9 | 4 | -2.82 | 10.17 | 40.60 |
| | | | | H | 9.78 | 4 | -2.82 | 10.95 | 40.60 |
| | | 848.80 | 251 | V | 8.74 | 4.03 | -2.84 | 9.93 | 40.60 |
| | | | | H | 9.14 | 4.03 | -2.84 | 10.33 | 40.60 |
| | E1 | 824.20 | 128 | V | 8.34 | 3.96 | -2.8 | 9.51 | 40.60 |
| | | | | H | 7.34 | 3.96 | -2.8 | 8.5 | 40.60 |
| | | 836.60 | 190 | V | 9.5 | 4 | -2.82 | 10.68 | 40.60 |
| | | | | H | 8.52 | 4 | -2.82 | 9.69 | 40.60 |
| | | 848.80 | 251 | V | 8.63 | 4.03 | -2.84 | 9.81 | 40.60 |
| | | | | H | 7.9 | 4.03 | -2.84 | 9.08 | 40.60 |
| | E2 | 824.20 | 128 | V | 7.31 | 3.96 | -2.8 | 8.48 | 40.60 |
| | | | | H | 10.85 | 3.96 | -2.8 | 12.02 | 40.60 |
| | | 836.60 | 190 | V | 7.03 | 4 | -2.82 | 8.21 | 40.60 |
| | | | | H | 11.77 | 4 | -2.82 | 12.94 | 40.60 |
| | | 848.80 | 251 | V | 7.52 | 4.03 | -2.84 | 8.7 | 40.60 |
| | | | | H | 11.64 | 4.03 | -2.84 | 12.82 | 40.60 |

Remark :

- (1) The RBW,VBW of SPA for frequency RBW=6 kHz, VBW=20 kHz

Unless otherwise stated the results shown in this test report refer only to the sample(s) tested and such sample(s) are retained for 90 days only.

除非另有說明，此報告結果僅對測試之樣品負責，同時此樣品僅保留90天。本報告未經本公司書面許可，不可部份複製。

This document is issued by the Company subject to its General Conditions of Service printed overleaf, available on request or accessible at www.sgs.com/terms_and_conditions.htm and, for electronic format documents, subject to Terms and Conditions for Electronic Documents at www.sgs.com/terms_e-document.htm. Attention is drawn to the limitation of liability, indemnification and jurisdiction issues defined therein. Any holder of this document is advised that information contained hereon reflects the Company's findings at the time of its intervention only and within the limits of Client's instructions, if any. The Company's sole responsibility is to its Client and this document does not exonerate parties to a transaction from exercising all their rights and obligations under the transaction documents. This document cannot be reproduced except in full, without prior written approval of the Company. Any unauthorized alteration, forgery or falsification of the content or appearance of this document is unlawful and offenders may be prosecuted to the fullest extent of the law.

| EUT | | | | Measurement | | | | | |
|----------------|------|-----------------------|-----|--------------|-------------|--------------|------------|--------------|-------|
| Operation Band | Pol. | Fundamental Frequency | CH | Antenna Pol. | S.G. Output | Antenna Gain | Cable Loss | EIRP | Limit |
| | | MHz | | V/H | dBm | dBi | dB | dBm | dBm |
| EDGE 1900 | H | 1850.20 | 512 | V | 16.15 | 4.17 | -4.29 | 16.03 | 33.00 |
| | | | | H | 12.9 | 4.51 | -4.29 | 13.12 | 33.00 |
| | | 1880.00 | 661 | V | 15.95 | 4.13 | -4.33 | 15.76 | 33.00 |
| | | | | H | 13.69 | 4.44 | -4.33 | 13.79 | 33.00 |
| | | 1909.80 | 810 | V | 12.88 | 4.09 | -4.37 | 12.61 | 33.00 |
| | | | | H | 9.1 | 4.36 | -4.37 | 9.1 | 33.00 |
| | E1 | 1850.20 | 512 | V | 17.27 | 4.17 | -4.29 | 17.15 | 33.00 |
| | | | | H | 12.07 | 4.51 | -4.29 | 12.29 | 33.00 |
| | | 1880.00 | 661 | V | 17.52 | 4.13 | -4.33 | 17.32 | 33.00 |
| | | | | H | 13.76 | 4.44 | -4.33 | 13.87 | 33.00 |
| | | 1909.80 | 810 | V | 15.07 | 4.09 | -4.37 | 14.8 | 33.00 |
| | | | | H | 12.44 | 4.36 | -4.37 | 12.43 | 33.00 |
| | E2 | 1850.20 | 512 | V | 12.51 | 4.17 | -4.29 | 12.39 | 33.00 |
| | | | | H | 16.27 | 4.51 | -4.29 | 16.49 | 33.00 |
| | | 1880.00 | 661 | V | 15.27 | 4.13 | -4.33 | 15.07 | 33.00 |
| | | | | H | 15.29 | 4.44 | -4.33 | 15.4 | 33.00 |
| | | 1909.80 | 810 | V | 13.99 | 4.09 | -4.37 | 13.72 | 33.00 |
| | | | | H | 15.08 | 4.36 | -4.37 | 15.08 | 33.00 |

Remark :

- (1) The RBW,VBW of SPA for frequency RBW=6 kHz, VBW=20 kHz

Unless otherwise stated the results shown in this test report refer only to the sample(s) tested and such sample(s) are retained for 90 days only.

除非另有說明，此報告結果僅對測試之樣品負責，同時此樣品僅保留90天。本報告未經本公司書面許可，不可部份複製。

This document is issued by the Company subject to its General Conditions of Service printed overleaf, available on request or accessible at www.sgs.com/terms_and_conditions.htm and, for electronic format documents, subject to Terms and Conditions for Electronic Documents at www.sgs.com/terms_e-document.htm. Attention is drawn to the limitation of liability, indemnification and jurisdiction issues defined therein. Any holder of this document is advised that information contained hereon reflects the Company's findings at the time of its intervention only and within the limits of Client's instructions, if any. The Company's sole responsibility is to its Client and this document does not exonerate parties to a transaction from exercising all their rights and obligations under the transaction documents. This document cannot be reproduced except in full, without prior written approval of the Company. Any unauthorized alteration, forgery or falsification of the content or appearance of this document is unlawful and offenders may be prosecuted to the fullest extent of the law.

| EUT | | | | Measurement | | | | | |
|----------------|------|-----------------------|------|--------------|-------------|--------------|------------|-------------|-------|
| Operation Band | Pol. | Fundamental Frequency | CH | Antenna Pol. | S.G. Output | Antenna Gain | Cable Loss | EIRP | Limit |
| | | MHz | | V/H | dBm | dBi | dB | dBm | dBm |
| WCDMA Band II | H | 1852.4 | 9262 | V | 23.07 | 4.17 | -4.3 | 22.95 | 33.00 |
| | | | | H | 20.15 | 4.51 | -4.3 | 20.36 | 33.00 |
| | | 1880.0 | 9400 | V | 22.58 | 4.13 | -4.33 | 22.39 | 33.00 |
| | | | | H | 19.61 | 4.44 | -4.33 | 19.72 | 33.00 |
| | | 1907.6 | 9538 | V | 20.28 | 4.1 | -4.36 | 20.02 | 33.00 |
| | | | | H | 16.21 | 4.37 | -4.36 | 16.21 | 33.00 |
| | E1 | 1852.4 | 9262 | V | 23.44 | 4.17 | -4.3 | 23.31 | 33.00 |
| | | | | H | 19.7 | 4.51 | -4.3 | 19.91 | 33.00 |
| | | 1880.0 | 9400 | V | 24.5 | 4.13 | -4.33 | 24.3 | 33.00 |
| | | | | H | 19.32 | 4.44 | -4.33 | 19.42 | 33.00 |
| | | 1907.6 | 9538 | V | 21.34 | 4.1 | -4.36 | 21.07 | 33.00 |
| | | | | H | 19.18 | 4.37 | -4.36 | 19.18 | 33.00 |
| | E2 | 1852.4 | 9262 | V | 18.53 | 4.17 | -4.3 | 18.41 | 33.00 |
| | | | | H | 23.85 | 4.51 | -4.3 | 24.06 | 33.00 |
| | | 1880.0 | 9400 | V | 21.57 | 4.13 | -4.33 | 21.38 | 33.00 |
| | | | | H | 23.17 | 4.44 | -4.33 | 23.28 | 33.00 |
| | | 1907.6 | 9538 | V | 20.42 | 4.1 | -4.36 | 20.15 | 33.00 |
| | | | | H | 22.13 | 4.37 | -4.36 | 22.13 | 33.00 |

Remark :

- (1) The RBW,VBW of SPA for frequency RBW= 1MHz , VBW= 3MHz

Unless otherwise stated the results shown in this test report refer only to the sample(s) tested and such sample(s) are retained for 90 days only.

除非另有說明，此報告結果僅對測試之樣品負責，同時此樣品僅保留90天。本報告未經本公司書面許可，不可部份複製。

This document is issued by the Company subject to its General Conditions of Service printed overleaf, available on request or accessible at www.sgs.com/terms_and_conditions.htm and, for electronic format documents, subject to Terms and Conditions for Electronic Documents at www.sgs.com/terms_e-document.htm. Attention is drawn to the limitation of liability, indemnification and jurisdiction issues defined therein. Any holder of this document is advised that information contained hereon reflects the Company's findings at the time of its intervention only and within the limits of Client's instructions, if any. The Company's sole responsibility is to its Client and this document does not exonerate parties to a transaction from exercising all their rights and obligations under the transaction documents. This document cannot be reproduced except in full, without prior written approval of the Company. Any unauthorized alteration, forgery or falsification of the content or appearance of this document is unlawful and offenders may be prosecuted to the fullest extent of the law.

| EUT | | | | Measurement | | | | | |
|----------------|------|-----------------------|------|--------------|-------------|--------------|------------|--------------|-------|
| Operation Band | Pol. | Fundamental Frequency | CH | Antenna Pol. | S.G. Output | Antenna Gain | Cable Loss | EIRP | Limit |
| | | MHz | | V/H | dBm | dBi | dB | dBm | dBm |
| WCDMA Band IV | H | 1712.4 | 1312 | V | 22.72 | 4.4 | -4.13 | 22.99 | 30.00 |
| | | | | H | 19.39 | 4.79 | -4.13 | 20.05 | 30.00 |
| | | 1732.6 | 1413 | V | 23.57 | 4.4 | -4.13 | 23.83 | 30.00 |
| | | | | H | 19.32 | 4.79 | -4.13 | 19.98 | 30.00 |
| | | 1752.6 | 1513 | V | 22.05 | 4.4 | -4.13 | 22.32 | 30.00 |
| | | | | H | 25.25 | 4.79 | -4.13 | 25.91 | 30.00 |
| | E1 | 1712.4 | 1312 | V | 23.74 | 4.35 | -4.16 | 23.94 | 30.00 |
| | | | | H | 20.21 | 4.78 | -4.16 | 20.83 | 30.00 |
| | | 1732.6 | 1413 | V | 23.26 | 4.35 | -4.16 | 23.46 | 30.00 |
| | | | | H | 18.53 | 4.78 | -4.16 | 19.15 | 30.00 |
| | | 1752.6 | 1513 | V | 19.46 | 4.35 | -4.16 | 19.65 | 30.00 |
| | | | | H | 24.76 | 4.78 | -4.16 | 25.39 | 30.00 |
| | E2 | 1712.4 | 1312 | V | 22.53 | 4.31 | -4.18 | 22.66 | 30.00 |
| | | | | H | 18.28 | 4.77 | -4.18 | 18.86 | 30.00 |
| | | 1732.6 | 1413 | V | 20.8 | 4.31 | -4.18 | 20.93 | 30.00 |
| | | | | H | 19.49 | 4.76 | -4.18 | 20.07 | 30.00 |
| | | 1752.6 | 1513 | V | 20.71 | 4.31 | -4.18 | 20.83 | 30.00 |
| | | | | H | 24.64 | 4.76 | -4.18 | 25.23 | 30.00 |

Remark :

- (1) The RBW,VBW of SPA for frequency RBW= 5MHz , VBW= 8MHz

Unless otherwise stated the results shown in this test report refer only to the sample(s) tested and such sample(s) are retained for 90 days only.

除非另有說明，此報告結果僅對測試之樣品負責，同時此樣品僅保留90天。本報告未經本公司書面許可，不可部份複製。

This document is issued by the Company subject to its General Conditions of Service printed overleaf, available on request or accessible at www.sgs.com/terms_and_conditions.htm and, for electronic format documents, subject to Terms and Conditions for Electronic Documents at www.sgs.com/terms_e-document.htm. Attention is drawn to the limitation of liability, indemnification and jurisdiction issues defined therein. Any holder of this document is advised that information contained hereon reflects the Company's findings at the time of its intervention only and within the limits of Client's instructions, if any. The Company's sole responsibility is to its Client and this document does not exonerate parties to a transaction from exercising all their rights and obligations under the transaction documents. This document cannot be reproduced except in full, without prior written approval of the Company. Any unauthorized alteration, forgery or falsification of the content or appearance of this document is unlawful and offenders may be prosecuted to the fullest extent of the law.

| EUT | | | | Measurement | | | | | |
|----------------|------|-----------------------|------|--------------|-------------|--------------|------------|--------------|-------|
| Operation Band | Pol. | Fundamental Frequency | CH | Antenna Pol. | S.G. Output | Antenna Gain | Cable Loss | ERP | Limit |
| | | MHz | | V/H | dBm | dBd | dB | dBm | dBm |
| WCDMA Band V | H | 826.40 | 4132 | V | 15.54 | 3.97 | -2.8 | 16.7 | 40.60 |
| | | | | H | 12.22 | 3.97 | -2.8 | 13.38 | 40.60 |
| | | 836.60 | 4183 | V | 15.01 | 4 | -2.82 | 16.18 | 40.60 |
| | | | | H | 12.65 | 4 | -2.82 | 13.83 | 40.60 |
| | | 846.60 | 4233 | V | 16.44 | 4.02 | -2.84 | 17.63 | 40.60 |
| | | | | H | 13.13 | 4.02 | -2.84 | 14.31 | 40.60 |
| | E1 | 826.40 | 4132 | V | 10.94 | 3.97 | -2.8 | 12.11 | 40.60 |
| | | | | H | 16.39 | 3.97 | -2.8 | 17.55 | 40.60 |
| | | 836.60 | 4183 | V | 10.64 | 4 | -2.82 | 11.81 | 40.60 |
| | | | | H | 15.45 | 4 | -2.82 | 16.62 | 40.60 |
| | | 846.60 | 4233 | V | 13.3 | 4.02 | -2.84 | 14.48 | 40.60 |
| | | | | H | 16.95 | 4.02 | -2.84 | 18.14 | 40.60 |
| | E2 | 826.40 | 4132 | V | 12.08 | 3.97 | -2.8 | 13.24 | 40.60 |
| | | | | H | 16 | 3.97 | -2.8 | 17.17 | 40.60 |
| | | 836.60 | 4183 | V | 10.51 | 4 | -2.82 | 11.69 | 40.60 |
| | | | | H | 16.14 | 4 | -2.82 | 17.31 | 40.60 |
| | | 846.60 | 4233 | V | 11.17 | 4.02 | -2.84 | 12.35 | 40.60 |
| | | | | H | 16.51 | 4.02 | -2.84 | 17.7 | 40.60 |

Remark :

- (1) The RBW,VBW of SPA for frequency RBW= 1MHz , VBW= 3MHz

Unless otherwise stated the results shown in this test report refer only to the sample(s) tested and such sample(s) are retained for 90 days only.

除非另有說明，此報告結果僅對測試之樣品負責，同時此樣品僅保留90天。本報告未經本公司書面許可，不可部份複製。

This document is issued by the Company subject to its General Conditions of Service printed overleaf, available on request or accessible at www.sgs.com/terms_and_conditions.htm and, for electronic format documents, subject to Terms and Conditions for Electronic Documents at www.sgs.com/terms_e-document.htm. Attention is drawn to the limitation of liability, indemnification and jurisdiction issues defined therein. Any holder of this document is advised that information contained hereon reflects the Company's findings at the time of its intervention only and within the limits of Client's instructions, if any. The Company's sole responsibility is to its Client and this document does not exonerate parties to a transaction from exercising all their rights and obligations under the transaction documents. This document cannot be reproduced except in full, without prior written approval of the Company. Any unauthorized alteration, forgery or falsification of the content or appearance of this document is unlawful and offenders may be prosecuted to the fullest extent of the law.

| EUT | | | | Measurement | | | | | |
|----------------|------|-----------------------|------|--------------|-------------|--------------|------------|--------------|-------|
| Operation Band | Pol. | Fundamental Frequency | CH | Antenna Pol. | S.G. Output | Antenna Gain | Cable Loss | EIRP | Limit |
| | | MHz | | V/H | dBm | dBi | dB | dBm | dBm |
| HSUPA Band II | H | 1852.4 | 9262 | V | 21.38 | 4.17 | -4.3 | 21.25 | 33.00 |
| | | | | H | 18.34 | 4.51 | -4.3 | 18.55 | 33.00 |
| | | 1880.0 | 9400 | V | 20.85 | 4.13 | -4.33 | 20.66 | 33.00 |
| | | | | H | 17.87 | 4.44 | -4.33 | 17.98 | 33.00 |
| | | 1907.6 | 9538 | V | 18.65 | 4.1 | -4.36 | 18.38 | 33.00 |
| | | | | H | 14.54 | 4.37 | -4.36 | 14.55 | 33.00 |
| | E1 | 1852.4 | 9262 | V | 21.56 | 4.17 | -4.3 | 21.43 | 33.00 |
| | | | | H | 17.61 | 4.51 | -4.3 | 17.82 | 33.00 |
| | | 1880.0 | 9400 | V | 22.62 | 4.13 | -4.33 | 22.42 | 33.00 |
| | | | | H | 18.14 | 4.44 | -4.33 | 18.25 | 33.00 |
| | | 1907.6 | 9538 | V | 19.64 | 4.1 | -4.36 | 19.38 | 33.00 |
| | | | | H | 17.1 | 4.37 | -4.36 | 17.1 | 33.00 |
| | E2 | 1852.4 | 9262 | V | 16.86 | 4.17 | -4.3 | 16.73 | 33.00 |
| | | | | H | 22.05 | 4.51 | -4.3 | 22.26 | 33.00 |
| | | 1880.0 | 9400 | V | 18.78 | 4.13 | -4.33 | 18.58 | 33.00 |
| | | | | H | 21.41 | 4.44 | -4.33 | 21.52 | 33.00 |
| | | 1907.6 | 9538 | V | 17.98 | 4.1 | -4.36 | 17.72 | 33.00 |
| | | | | H | 20.59 | 4.37 | -4.36 | 20.59 | 33.00 |

Remark :

- (1) The RBW,VBW of SPA for frequency RBW= 1MHz , VBW= 3MHz

Unless otherwise stated the results shown in this test report refer only to the sample(s) tested and such sample(s) are retained for 90 days only.

除非另有說明，此報告結果僅對測試之樣品負責，同時此樣品僅保留90天。本報告未經本公司書面許可，不可部份複製。

This document is issued by the Company subject to its General Conditions of Service printed overleaf, available on request or accessible at www.sgs.com/terms_and_conditions.htm and, for electronic format documents, subject to Terms and Conditions for Electronic Documents at www.sgs.com/terms_e-document.htm. Attention is drawn to the limitation of liability, indemnification and jurisdiction issues defined therein. Any holder of this document is advised that information contained hereon reflects the Company's findings at the time of its intervention only and within the limits of Client's instructions, if any. The Company's sole responsibility is to its Client and this document does not exonerate parties to a transaction from exercising all their rights and obligations under the transaction documents. This document cannot be reproduced except in full, without prior written approval of the Company. Any unauthorized alteration, forgery or falsification of the content or appearance of this document is unlawful and offenders may be prosecuted to the fullest extent of the law.

| EUT | | | | Measurement | | | | | |
|----------------|------|-----------------------|------|--------------|-------------|--------------|------------|--------------|-------|
| Operation Band | Pol. | Fundamental Frequency | CH | Antenna Pol. | S.G. Output | Antenna Gain | Cable Loss | EIRP | Limit |
| | | MHz | | V/H | dBm | dBi | dB | dBm | dBm |
| HSUPA Band IV | H | 1712.4 | 1312 | V | 21.98 | 4.4 | -4.13 | 22.24 | 33.00 |
| | | | | H | 15.68 | 4.79 | -4.13 | 16.34 | 33.00 |
| | | 1732.6 | 1413 | V | 21.79 | 4.4 | -4.13 | 22.06 | 33.00 |
| | | | | H | 17.77 | 4.79 | -4.13 | 18.43 | 33.00 |
| | | 1752.6 | 1513 | V | 20.27 | 4.4 | -4.13 | 20.53 | 33.00 |
| | | | | H | 23.42 | 4.79 | -4.13 | 24.08 | 33.00 |
| | E1 | 1712.4 | 1312 | V | 22.61 | 4.35 | -4.16 | 22.8 | 33.00 |
| | | | | H | 16.58 | 4.78 | -4.16 | 17.2 | 33.00 |
| | | 1732.6 | 1413 | V | 21.51 | 4.35 | -4.16 | 21.71 | 33.00 |
| | | | | H | 16.61 | 4.78 | -4.16 | 17.23 | 33.00 |
| | | 1752.6 | 1513 | V | 17.45 | 4.35 | -4.16 | 17.65 | 33.00 |
| | | | | H | 23 | 4.78 | -4.16 | 23.63 | 33.00 |
| | E2 | 1712.4 | 1312 | V | 21.93 | 4.31 | -4.18 | 22.06 | 33.00 |
| | | | | H | 14.47 | 4.76 | -4.18 | 15.05 | 33.00 |
| | | 1732.6 | 1413 | V | 21.36 | 4.31 | -4.18 | 21.49 | 33.00 |
| | | | | H | 17.73 | 4.76 | -4.18 | 18.31 | 33.00 |
| | | 1752.6 | 1513 | V | 19.13 | 4.31 | -4.18 | 19.26 | 33.00 |
| | | | | H | 22.92 | 4.76 | -4.18 | 23.5 | 33.00 |

Remark :

- (1) The RBW,VBW of SPA for frequency RBW= 5MHz , VBW= 8MHz

Unless otherwise stated the results shown in this test report refer only to the sample(s) tested and such sample(s) are retained for 90 days only.

除非另有說明，此報告結果僅對測試之樣品負責，同時此樣品僅保留90天。本報告未經本公司書面許可，不可部份複製。

This document is issued by the Company subject to its General Conditions of Service printed overleaf, available on request or accessible at www.sgs.com/terms_and_conditions.htm and, for electronic format documents, subject to Terms and Conditions for Electronic Documents at www.sgs.com/terms_e-document.htm. Attention is drawn to the limitation of liability, indemnification and jurisdiction issues defined therein. Any holder of this document is advised that information contained hereon reflects the Company's findings at the time of its intervention only and within the limits of Client's instructions, if any. The Company's sole responsibility is to its Client and this document does not exonerate parties to a transaction from exercising all their rights and obligations under the transaction documents. This document cannot be reproduced except in full, without prior written approval of the Company. Any unauthorized alteration, forgery or falsification of the content or appearance of this document is unlawful and offenders may be prosecuted to the fullest extent of the law.

| EUT | | | | Measurement | | | | | |
|----------------|------|-----------------------|------|--------------|-------------|--------------|------------|--------------|-------|
| Operation Band | Pol. | Fundamental Frequency | CH | Antenna Pol. | S.G. Output | Antenna Gain | Cable Loss | ERP | Limit |
| | | MHz | | V/H | dBm | dBd | dB | dBm | dBm |
| HSUPA Band V | H | 826.40 | 4132 | V | 13.73 | 3.97 | -2.8 | 14.89 | 40.60 |
| | | | | H | 8.13 | 3.97 | -2.8 | 9.29 | 40.60 |
| | | 836.60 | 4183 | V | 13.29 | 4 | -2.82 | 14.46 | 40.60 |
| | | | | H | 8.84 | 4 | -2.82 | 10.01 | 40.60 |
| | | 846.60 | 4233 | V | 14.66 | 4.02 | -2.84 | 15.84 | 40.60 |
| | | | | H | 10.42 | 4.02 | -2.84 | 11.6 | 40.60 |
| | E1 | 826.40 | 4132 | V | 12.59 | 3.97 | -2.8 | 13.76 | 40.60 |
| | | | | H | 14.58 | 3.97 | -2.8 | 15.74 | 40.60 |
| | | 836.60 | 4183 | V | 8.77 | 4 | -2.82 | 9.94 | 40.60 |
| | | | | H | 13.7 | 4 | -2.82 | 14.87 | 40.60 |
| | | 846.60 | 4233 | V | 11.77 | 4.02 | -2.84 | 12.96 | 40.60 |
| | | | | H | 15.44 | 4.02 | -2.84 | 16.62 | 40.60 |
| | E2 | 826.40 | 4132 | V | 10.36 | 3.97 | -2.8 | 11.52 | 40.60 |
| | | | | H | 14.27 | 3.97 | -2.8 | 15.44 | 40.60 |
| | | 836.60 | 4183 | V | 8.8 | 4 | -2.82 | 9.97 | 40.60 |
| | | | | H | 14.3 | 4 | -2.82 | 15.47 | 40.60 |
| | | 846.60 | 4233 | V | 9.64 | 4.02 | -2.84 | 10.82 | 40.60 |
| | | | | H | 14.72 | 4.02 | -2.84 | 15.91 | 40.60 |

Remark :

- (1) The RBW,VBW of SPA for frequency RBW= 1MHz , VBW= 3MHz

Unless otherwise stated the results shown in this test report refer only to the sample(s) tested and such sample(s) are retained for 90 days only.

除非另有說明，此報告結果僅對測試之樣品負責，同時此樣品僅保留90天。本報告未經本公司書面許可，不可部份複製。

This document is issued by the Company subject to its General Conditions of Service printed overleaf, available on request or accessible at www.sgs.com/terms_and_conditions.htm and, for electronic format documents, subject to Terms and Conditions for Electronic Documents at www.sgs.com/terms_e-document.htm. Attention is drawn to the limitation of liability, indemnification and jurisdiction issues defined therein. Any holder of this document is advised that information contained hereon reflects the Company's findings at the time of its intervention only and within the limits of Client's instructions, if any. The Company's sole responsibility is to its Client and this document does not exonerate parties to a transaction from exercising all their rights and obligations under the transaction documents. This document cannot be reproduced except in full, without prior written approval of the Company. Any unauthorized alteration, forgery or falsification of the content or appearance of this document is unlawful and offenders may be prosecuted to the fullest extent of the law.

| EUT | | | | Measurement | | | | | |
|----------------|------|-----------------------|------|--------------|-------------|--------------|------------|--------------|-------|
| Operation Band | Pol. | Fundamental Frequency | CH | Antenna Pol. | S.G. Output | Antenna Gain | Cable Loss | EIRP | Limit |
| | | MHz | | V/H | dBm | dBi | dB | dBm | dBm |
| HSDPA Band II | H | 1852.4 | 9262 | V | 21.99 | 4.17 | -4.3 | 21.86 | 33.00 |
| | | | | H | 18.83 | 4.51 | -4.3 | 19.04 | 33.00 |
| | | 1880.0 | 9400 | V | 21.44 | 4.13 | -4.33 | 21.24 | 33.00 |
| | | | | H | 18.39 | 4.44 | -4.33 | 18.49 | 33.00 |
| | | 1907.6 | 9538 | V | 19.18 | 4.1 | -4.36 | 18.91 | 33.00 |
| | | | | H | 14.99 | 4.37 | -4.36 | 15 | 33.00 |
| | E1 | 1852.4 | 9262 | V | 22.36 | 4.17 | -4.3 | 22.24 | 33.00 |
| | | | | H | 18.48 | 4.51 | -4.3 | 18.7 | 33.00 |
| | | 1880.0 | 9400 | V | 23.29 | 4.13 | -4.33 | 23.09 | 33.00 |
| | | | | H | 18.15 | 4.44 | -4.33 | 18.25 | 33.00 |
| | | 1907.6 | 9538 | V | 20.17 | 4.1 | -4.36 | 19.91 | 33.00 |
| | | | | H | 18.19 | 4.37 | -4.36 | 18.19 | 33.00 |
| | E2 | 1852.4 | 9262 | V | 17.34 | 4.17 | -4.3 | 17.21 | 33.00 |
| | | | | H | 22.66 | 4.51 | -4.3 | 22.87 | 33.00 |
| | | 1880.0 | 9400 | V | 19.43 | 4.13 | -4.33 | 19.23 | 33.00 |
| | | | | H | 21.9 | 4.44 | -4.33 | 22.01 | 33.00 |
| | | 1907.6 | 9538 | V | 18.41 | 4.1 | -4.36 | 18.14 | 33.00 |
| | | | | H | 21.03 | 4.37 | -4.36 | 21.04 | 33.00 |

Remark :

- (1) The RBW,VBW of SPA for frequency RBW= 1MHz , VBW= 3MHz

Unless otherwise stated the results shown in this test report refer only to the sample(s) tested and such sample(s) are retained for 90 days only.

除非另有說明，此報告結果僅對測試之樣品負責，同時此樣品僅保留90天。本報告未經本公司書面許可，不可部份複製。

This document is issued by the Company subject to its General Conditions of Service printed overleaf, available on request or accessible at www.sgs.com/terms_and_conditions.htm and, for electronic format documents, subject to Terms and Conditions for Electronic Documents at www.sgs.com/terms_e-document.htm. Attention is drawn to the limitation of liability, indemnification and jurisdiction issues defined therein. Any holder of this document is advised that information contained hereon reflects the Company's findings at the time of its intervention only and within the limits of Client's instructions, if any. The Company's sole responsibility is to its Client and this document does not exonerate parties to a transaction from exercising all their rights and obligations under the transaction documents. This document cannot be reproduced except in full, without prior written approval of the Company. Any unauthorized alteration, forgery or falsification of the content or appearance of this document is unlawful and offenders may be prosecuted to the fullest extent of the law.

| EUT | | | | Measurement | | | | | |
|----------------|------|-----------------------|------|--------------|-------------|--------------|------------|--------------|-------|
| Operation Band | Pol. | Fundamental Frequency | CH | Antenna Pol. | S.G. Output | Antenna Gain | Cable Loss | EIRP | Limit |
| | | MHz | | V/H | dBm | dBi | dB | dBm | dBm |
| HSDPA Band IV | H | 1712.4 | 1312 | V | 22.63 | 4.4 | -4.13 | 22.9 | 30.00 |
| | | | | H | 16.22 | 4.79 | -4.13 | 16.89 | 30.00 |
| | | 1732.6 | 1413 | V | 22.6 | 4.4 | -4.13 | 22.87 | 30.00 |
| | | | | H | 18.29 | 4.79 | -4.13 | 18.95 | 30.00 |
| | | 1752.6 | 1513 | V | 20.81 | 4.4 | -4.13 | 21.07 | 30.00 |
| | | | | H | 24.08 | 4.79 | -4.13 | 24.74 | 30.00 |
| | E1 | 1712.4 | 1312 | V | 23.23 | 4.35 | -4.16 | 23.42 | 30.00 |
| | | | | H | 16.94 | 4.78 | -4.16 | 17.56 | 30.00 |
| | | 1732.6 | 1413 | V | 22.1 | 4.35 | -4.16 | 22.29 | 30.00 |
| | | | | H | 17.24 | 4.78 | -4.16 | 17.86 | 30.00 |
| | | 1752.6 | 1513 | V | 18.1 | 4.35 | -4.16 | 18.3 | 30.00 |
| | | | | H | 23.55 | 4.78 | -4.16 | 24.17 | 30.00 |
| | E2 | 1712.4 | 1312 | V | 22.6 | 4.31 | -4.18 | 22.73 | 30.00 |
| | | | | H | 14.94 | 4.76 | -4.18 | 15.52 | 30.00 |
| | | 1732.6 | 1413 | V | 22.01 | 4.31 | -4.18 | 22.13 | 30.00 |
| | | | | H | 18.27 | 4.76 | -4.18 | 18.86 | 30.00 |
| | | 1752.6 | 1513 | V | 19.57 | 4.31 | -4.18 | 19.7 | 30.00 |
| | | | | H | 23.46 | 4.77 | -4.18 | 24.04 | 30.00 |

Remark :

- (1) The RBW,VBW of SPA for frequency RBW= 5MHz , VBW= 8MHz

Unless otherwise stated the results shown in this test report refer only to the sample(s) tested and such sample(s) are retained for 90 days only.

除非另有說明，此報告結果僅對測試之樣品負責，同時此樣品僅保留90天。本報告未經本公司書面許可，不可部份複製。

This document is issued by the Company subject to its General Conditions of Service printed overleaf, available on request or accessible at www.sgs.com/terms_and_conditions.htm and, for electronic format documents, subject to Terms and Conditions for Electronic Documents at www.sgs.com/terms_e-document.htm. Attention is drawn to the limitation of liability, indemnification and jurisdiction issues defined therein. Any holder of this document is advised that information contained hereon reflects the Company's findings at the time of its intervention only and within the limits of Client's instructions, if any. The Company's sole responsibility is to its Client and this document does not exonerate parties to a transaction from exercising all their rights and obligations under the transaction documents. This document cannot be reproduced except in full, without prior written approval of the Company. Any unauthorized alteration, forgery or falsification of the content or appearance of this document is unlawful and offenders may be prosecuted to the fullest extent of the law.

| EUT | | | | Measurement | | | | | |
|----------------|------|-----------------------|------|--------------|-------------|--------------|------------|--------------|-------|
| Operation Band | Pol. | Fundamental Frequency | CH | Antenna Pol. | S.G. Output | Antenna Gain | Cable Loss | ERP | Limit |
| | | MHz | | V/H | dBm | dBd | dB | dBm | dBm |
| HSDPA Band V | H | 826.40 | 4132 | V | 14.37 | 3.97 | -2.8 | 15.54 | 40.60 |
| | | | | H | 11.11 | 3.97 | -2.8 | 12.28 | 40.60 |
| | | 836.60 | 4183 | V | 13.83 | 4 | -2.82 | 15.01 | 40.60 |
| | | | | H | 11.55 | 4 | -2.82 | 12.72 | 40.60 |
| | | 846.60 | 4233 | V | 15.3 | 4.02 | -2.84 | 16.49 | 40.60 |
| | | | | H | 12.15 | 4.02 | -2.84 | 13.34 | 40.60 |
| | E1 | 826.40 | 4132 | V | 9.86 | 3.97 | -2.8 | 11.03 | 40.60 |
| | | | | H | 15.33 | 3.97 | -2.8 | 16.5 | 40.60 |
| | | 836.60 | 4183 | V | 9.43 | 4 | -2.82 | 10.6 | 40.60 |
| | | | | H | 14.27 | 4 | -2.82 | 15.45 | 40.60 |
| | | 846.60 | 4233 | V | 12.37 | 4.02 | -2.84 | 13.56 | 40.60 |
| | | | | H | 16.25 | 4.02 | -2.84 | 17.44 | 40.60 |
| | E2 | 826.40 | 4132 | V | 10.97 | 3.97 | -2.8 | 12.14 | 40.60 |
| | | | | H | 14.85 | 3.97 | -2.8 | 16.02 | 40.60 |
| | | 836.60 | 4183 | V | 9.37 | 4 | -2.82 | 10.55 | 40.60 |
| | | | | H | 15.09 | 4 | -2.82 | 16.26 | 40.60 |
| | | 846.60 | 4233 | V | 10.31 | 4.02 | -2.84 | 11.49 | 40.60 |
| | | | | H | 15.38 | 4.02 | -2.84 | 16.57 | 40.60 |

Remark :

- (1) The RBW,VBW of SPA for frequency RBW= 1MHz , VBW= 3MHz

Unless otherwise stated the results shown in this test report refer only to the sample(s) tested and such sample(s) are retained for 90 days only.

除非另有說明，此報告結果僅對測試之樣品負責，同時此樣品僅保留90天。本報告未經本公司書面許可，不可部份複製。

This document is issued by the Company subject to its General Conditions of Service printed overleaf, available on request or accessible at www.sgs.com/terms_and_conditions.htm and, for electronic format documents, subject to Terms and Conditions for Electronic Documents at www.sgs.com/terms_e-document.htm. Attention is drawn to the limitation of liability, indemnification and jurisdiction issues defined therein. Any holder of this document is advised that information contained hereon reflects the Company's findings at the time of its intervention only and within the limits of Client's instructions, if any. The Company's sole responsibility is to its Client and this document does not exonerate parties to a transaction from exercising all their rights and obligations under the transaction documents. This document cannot be reproduced except in full, without prior written approval of the Company. Any unauthorized alteration, forgery or falsification of the content or appearance of this document is unlawful and offenders may be prosecuted to the fullest extent of the law.

8. OCCUPIED BANDWIDTH MEASUREMENT

8.1. Standard Applicable:

According to §FCC 2.1049 (99%)

According to IC RSS-Gen Issue 3 §4.6.1 (99%)

According to IC RSS-133 §2.3 (20dB)

According to IC RSS-139 §2.3 (20dB)

8.2. Test Set-up:

Refer to section 6.2 in this report

8.3. Measurement Procedure:

The EUT's output RF connector was connected with a short cable to the spectrum analyzer, RBW was set to about 1% of emission BW, VBW= 3 times RBW, -20dBc display line was placed on the screen (or 20dB bandwidth), the occupied bandwidth is the delta frequency between the two points where the display line intersects the signal trace. Then set RBW to 99% bandwidth, RBW= 1%, VBW= 3 RBW, with span $> 2 * \text{Signal BW}$, set % Power = 99%.

NOTE: For the plot of bandwidth measurement, the marker of the 99% bandwidth is diamond-shape while the marker of the 20dB BW is arrow-mark

8.4. Measurement Equipment Used:

Refer to section 2.4 in this report

8.5. Measurement Result:

Refer to next pages.

Unless otherwise stated the results shown in this test report refer only to the sample(s) tested and such sample(s) are retained for 90 days only.

除非另有說明，此報告結果僅對測試之樣品負責，同時此樣品僅保留90天。本報告未經本公司書面許可，不可部份複製。

This document is issued by the Company subject to its General Conditions of Service printed overleaf, available on request or accessible at www.sgs.com/terms_and_conditions.htm and, for electronic format documents, subject to Terms and Conditions for Electronic Documents at www.sgs.com/terms_e-document.htm. Attention is drawn to the limitation of liability, indemnification and jurisdiction issues defined therein. Any holder of this document is advised that information contained hereon reflects the Company's findings at the time of its intervention only and within the limits of Client's instructions, if any. The Company's sole responsibility is to its Client and this document does not exonerate parties to a transaction from exercising all their rights and obligations under the transaction documents. This document cannot be reproduced except in full, without prior written approval of the Company. Any unauthorized alteration, forgery or falsification of the content or appearance of this document is unlawful and offenders may be prosecuted to the fullest extent of the law.

99% Bandwidth

| EUT Mode | Frequency (MHz) | CH | 99% Bandwidth (MHz) |
|----------|-----------------|-----|---------------------|
| GSM 850 | 824.20 | 128 | 0.248 |
| | 836.60 | 190 | 0.245 |
| | 848.80 | 251 | 0.243 |

| EUT Mode | Frequency (MHz) | CH | 99% Bandwidth (MHz) |
|----------|-----------------|-----|---------------------|
| GSM 1900 | 1850.20 | 512 | 0.241 |
| | 1880.00 | 661 | 0.247 |
| | 1909.80 | 810 | 0.240 |

| EUT Mode | Frequency (MHz) | CH | 99% Bandwidth (MHz) |
|----------|-----------------|-----|---------------------|
| GPRS 850 | 824.20 | 128 | 0.247 |
| | 836.60 | 190 | 0.244 |
| | 848.80 | 251 | 0.241 |

| EUT Mode | Frequency (MHz) | CH | 99% Bandwidth (MHz) |
|-----------|-----------------|-----|---------------------|
| GPRS 1900 | 1850.20 | 512 | 0.241 |
| | 1880.00 | 661 | 0.247 |
| | 1909.80 | 810 | 0.240 |

| EUT Mode | Frequency (MHz) | CH | 99% Bandwidth (MHz) |
|----------|-----------------|-----|---------------------|
| EDGE 850 | 824.20 | 128 | 0.242 |
| | 836.60 | 190 | 0.238 |
| | 848.80 | 251 | 0.244 |

| EUT Mode | Frequency (MHz) | CH | 99% Bandwidth (MHz) |
|-----------|-----------------|-----|---------------------|
| EDGE 1900 | 1850.20 | 512 | 0.242 |
| | 1880.00 | 661 | 0.241 |
| | 1909.80 | 810 | 0.240 |

Unless otherwise stated the results shown in this test report refer only to the sample(s) tested and such sample(s) are retained for 90 days only.

除非另有說明，此報告結果僅對測試之樣品負責，同時此樣品僅保留90天。本報告未經本公司書面許可，不可部份複製。

This document is issued by the Company subject to its General Conditions of Service printed overleaf, available on request or accessible at www.sgs.com/terms_and_conditions.htm and, for electronic format documents, subject to Terms and Conditions for Electronic Documents at www.sgs.com/terms_e-document.htm. Attention is drawn to the limitation of liability, indemnification and jurisdiction issues defined therein. Any holder of this document is advised that information contained hereon reflects the Company's findings at the time of its intervention only and within the limits of Client's instructions, if any. The Company's sole responsibility is to its Client and this document does not exonerate parties to a transaction from exercising all their rights and obligations under the transaction documents. This document cannot be reproduced except in full, without prior written approval of the Company. Any unauthorized alteration, forgery or falsification of the content or appearance of this document is unlawful and offenders may be prosecuted to the fullest extent of the law.

| EUT Mode | Frequency (MHz) | CH | 99% Bandwidth (MHz) |
|----------|-----------------|------|---------------------|
| WCDMA II | 1852.40 | 9262 | 4.2021 |
| | 1880.00 | 9400 | 4.1628 |
| | 1907.60 | 9538 | 4.1617 |

| EUT Mode | Frequency (MHz) | CH | 99% Bandwidth (MHz) |
|----------|-----------------|------|---------------------|
| WCDMA IV | 1712.40 | 1312 | 4.1346 |
| | 1732.60 | 1413 | 4.1606 |
| | 1752.60 | 1513 | 4.1488 |

| EUT Mode | Frequency (MHz) | CH | 99% Bandwidth (MHz) |
|----------|-----------------|------|---------------------|
| WCDMA V | 826.40 | 4132 | 4.2632 |
| | 836.00 | 4183 | 4.1571 |
| | 846.60 | 4233 | 4.2082 |

| EUT Mode | Frequency (MHz) | CH | 99% Bandwidth (MHz) |
|----------|-----------------|------|---------------------|
| HSDPA II | 1852.40 | 9262 | 4.1271 |
| | 1880.00 | 9400 | 4.0866 |
| | 1907.60 | 9538 | 4.2238 |

| EUT Mode | Frequency (MHz) | CH | 99% Bandwidth (MHz) |
|----------|-----------------|------|---------------------|
| HSDPA IV | 1712.40 | 1312 | 4.1813 |
| | 1732.60 | 1413 | 4.2344 |
| | 1752.60 | 1513 | 4.1586 |

| EUT Mode | Frequency (MHz) | CH | 99% Bandwidth (MHz) |
|----------|-----------------|------|---------------------|
| HSDPA V | 826.40 | 4132 | 4.1704 |
| | 836.60 | 4183 | 4.1457 |
| | 846.60 | 4233 | 4.1299 |

Unless otherwise stated the results shown in this test report refer only to the sample(s) tested and such sample(s) are retained for 90 days only.

除非另有說明，此報告結果僅對測試之樣品負責，同時此樣品僅保留90天。本報告未經本公司書面許可，不可部份複製。

This document is issued by the Company subject to its General Conditions of Service printed overleaf, available on request or accessible at www.sgs.com/terms_and_conditions.htm and, for electronic format documents, subject to Terms and Conditions for Electronic Documents at www.sgs.com/terms_e-document.htm. Attention is drawn to the limitation of liability, indemnification and jurisdiction issues defined therein. Any holder of this document is advised that information contained hereon reflects the Company's findings at the time of its intervention only and within the limits of Client's instructions, if any. The Company's sole responsibility is to its Client and this document does not exonerate parties to a transaction from exercising all their rights and obligations under the transaction documents. This document cannot be reproduced except in full, without prior written approval of the Company. Any unauthorized alteration, forgery or falsification of the content or appearance of this document is unlawful and offenders may be prosecuted to the fullest extent of the law.

| EUT Mode | Frequency (MHz) | CH | 99% Bandwidth (MHz) |
|----------|-----------------|------|---------------------|
| HSUPA II | 1852.40 | 9262 | 4.1407 |
| | 1880.00 | 9400 | 4.1999 |
| | 1907.60 | 9538 | 4.1898 |

| EUT Mode | Frequency (MHz) | CH | 99% Bandwidth (MHz) |
|----------|-----------------|------|---------------------|
| HSUPA IV | 1712.40 | 1312 | 4.1674 |
| | 1732.60 | 1413 | 4.1433 |
| | 1752.60 | 1513 | 4.2484 |

| EUT Mode | Frequency (MHz) | CH | 99% Bandwidth (MHz) |
|----------|-----------------|------|---------------------|
| HSUPA V | 826.40 | 4132 | 4.1912 |
| | 836.60 | 4183 | 4.2691 |
| | 846.60 | 4233 | 4.1768 |

Unless otherwise stated the results shown in this test report refer only to the sample(s) tested and such sample(s) are retained for 90 days only.

除非另有說明，此報告結果僅對測試之樣品負責，同時此樣品僅保留90天。本報告未經本公司書面許可，不可部份複製。

This document is issued by the Company subject to its General Conditions of Service printed overleaf, available on request or accessible at www.sgs.com/terms_and_conditions.htm and, for electronic format documents, subject to Terms and Conditions for Electronic Documents at www.sgs.com/terms_e-document.htm. Attention is drawn to the limitation of liability, indemnification and jurisdiction issues defined therein. Any holder of this document is advised that information contained hereon reflects the Company's findings at the time of its intervention only and within the limits of Client's instructions, if any. The Company's sole responsibility is to its Client and this document does not exonerate parties to a transaction from exercising all their rights and obligations under the transaction documents. This document cannot be reproduced except in full, without prior written approval of the Company. Any unauthorized alteration, forgery or falsification of the content or appearance of this document is unlawful and offenders may be prosecuted to the fullest extent of the law.

20dB Bandwidth

| EUT Mode | Frequency (MHz) | CH | 20dB Bandwidth (MHz) |
|----------|-----------------|-----|----------------------|
| GSM 850 | 824.20 | 128 | 0.295 |
| | 836.60 | 190 | 0.285 |
| | 848.80 | 251 | 0.286 |

| EUT Mode | Frequency (MHz) | CH | 20dB Bandwidth (MHz) |
|----------|-----------------|-----|----------------------|
| GSM 1900 | 1850.20 | 512 | 0.275 |
| | 1880.00 | 661 | 0.291 |
| | 1909.80 | 810 | 0.285 |

| EUT Mode | Frequency (MHz) | CH | 20dB Bandwidth (MHz) |
|----------|-----------------|-----|----------------------|
| GPRS 850 | 824.20 | 128 | 0.273 |
| | 836.60 | 190 | 0.282 |
| | 848.80 | 251 | 0.283 |

| EUT Mode | Frequency (MHz) | CH | 20dB Bandwidth (MHz) |
|-----------|-----------------|-----|----------------------|
| GPRS 1900 | 1850.20 | 512 | 0.275 |
| | 1880.00 | 661 | 0.291 |
| | 1909.80 | 810 | 0.285 |

| EUT Mode | Frequency (MHz) | CH | 20dB Bandwidth (MHz) |
|----------|-----------------|-----|----------------------|
| EDGE 850 | 824.20 | 128 | 0.275 |
| | 836.60 | 190 | 0.290 |
| | 848.80 | 251 | 0.279 |

| EUT Mode | Frequency (MHz) | CH | 20dB Bandwidth (MHz) |
|-----------|-----------------|-----|----------------------|
| EDGE 1900 | 1850.20 | 512 | 0.270 |
| | 1880.00 | 661 | 0.276 |
| | 1909.80 | 810 | 0.280 |

Unless otherwise stated the results shown in this test report refer only to the sample(s) tested and such sample(s) are retained for 90 days only.

除非另有說明，此報告結果僅對測試之樣品負責，同時此樣品僅保留90天。本報告未經本公司書面許可，不可部份複製。

This document is issued by the Company subject to its General Conditions of Service printed overleaf, available on request or accessible at www.sgs.com/terms_and_conditions.htm and, for electronic format documents, subject to Terms and Conditions for Electronic Documents at www.sgs.com/terms_e-document.htm. Attention is drawn to the limitation of liability, indemnification and jurisdiction issues defined therein. Any holder of this document is advised that information contained hereon reflects the Company's findings at the time of its intervention only and within the limits of Client's instructions, if any. The Company's sole responsibility is to its Client and this document does not exonerate parties to a transaction from exercising all their rights and obligations under the transaction documents. This document cannot be reproduced except in full, without prior written approval of the Company. Any unauthorized alteration, forgery or falsification of the content or appearance of this document is unlawful and offenders may be prosecuted to the fullest extent of the law.

| EUT Mode | Frequency (MHz) | CH | 20dB Bandwidth (MHz) |
|----------|-----------------|------|----------------------|
| WCDMA II | 1852.40 | 9262 | 4.460 |
| | 1880.00 | 9400 | 4.532 |
| | 1907.60 | 9538 | 4.500 |

| EUT Mode | Frequency (MHz) | CH | 20dB Bandwidth (MHz) |
|----------|-----------------|------|----------------------|
| WCDMA IV | 1712.40 | 1312 | 4.476 |
| | 1732.60 | 1413 | 4.542 |
| | 1752.60 | 1513 | 4.421 |

| EUT Mode | Frequency (MHz) | CH | 20dB Bandwidth (MHz) |
|----------|-----------------|------|----------------------|
| WCDMA V | 826.40 | 4132 | 4.578 |
| | 836.00 | 4183 | 4.507 |
| | 846.60 | 4233 | 4.533 |

| EUT Mode | Frequency (MHz) | CH | 20dB Bandwidth (MHz) |
|----------|-----------------|------|----------------------|
| HSDPA II | 1852.40 | 9262 | 4.473 |
| | 1880.00 | 9400 | 4.487 |
| | 1907.60 | 9538 | 4.424 |

| EUT Mode | Frequency (MHz) | CH | 20dB Bandwidth (MHz) |
|----------|-----------------|------|----------------------|
| HSDPA IV | 1712.40 | 1312 | 4.472 |
| | 1732.60 | 1413 | 4.481 |
| | 1752.60 | 1513 | 4.399 |

| EUT Mode | Frequency (MHz) | CH | 20dB Bandwidth (MHz) |
|----------|-----------------|------|----------------------|
| HSDPA V | 826.40 | 4132 | 4.469 |
| | 836.60 | 4183 | 4.415 |
| | 846.60 | 4233 | 4.443 |

Unless otherwise stated the results shown in this test report refer only to the sample(s) tested and such sample(s) are retained for 90 days only.

除非另有說明，此報告結果僅對測試之樣品負責，同時此樣品僅保留90天。本報告未經本公司書面許可，不可部份複製。

This document is issued by the Company subject to its General Conditions of Service printed overleaf, available on request or accessible at www.sgs.com/terms_and_conditions.htm and, for electronic format documents, subject to Terms and Conditions for Electronic Documents at www.sgs.com/terms_e-document.htm. Attention is drawn to the limitation of liability, indemnification and jurisdiction issues defined therein. Any holder of this document is advised that information contained hereon reflects the Company's findings at the time of its intervention only and within the limits of Client's instructions, if any. The Company's sole responsibility is to its Client and this document does not exonerate parties to a transaction from exercising all their rights and obligations under the transaction documents. This document cannot be reproduced except in full, without prior written approval of the Company. Any unauthorized alteration, forgery or falsification of the content or appearance of this document is unlawful and offenders may be prosecuted to the fullest extent of the law.

| EUT Mode | Frequency (MHz) | CH | 20dB Bandwidth (MHz) |
|----------|-----------------|------|----------------------|
| HSUPA II | 1852.40 | 9262 | 4.425 |
| | 1880.00 | 9400 | 4.517 |
| | 1907.60 | 9538 | 4.524 |

| EUT Mode | Frequency (MHz) | CH | 20dB Bandwidth (MHz) |
|----------|-----------------|------|----------------------|
| HSUPA IV | 1712.40 | 1312 | 4.428 |
| | 1732.60 | 1413 | 4.469 |
| | 1752.60 | 1513 | 4.535 |

| EUT Mode | Frequency (MHz) | CH | 20dB Bandwidth (MHz) |
|----------|-----------------|------|----------------------|
| HSUPA V | 826.40 | 4132 | 4.491 |
| | 836.60 | 4183 | 4.442 |
| | 846.60 | 4233 | 4.386 |

Unless otherwise stated the results shown in this test report refer only to the sample(s) tested and such sample(s) are retained for 90 days only.

除非另有說明，此報告結果僅對測試之樣品負責，同時此樣品僅保留90天。本報告未經本公司書面許可，不可部份複製。

This document is issued by the Company subject to its General Conditions of Service printed overleaf, available on request or accessible at www.sgs.com/terms_and_conditions.htm and, for electronic format documents, subject to Terms and Conditions for Electronic Documents at www.sgs.com/terms_e-document.htm. Attention is drawn to the limitation of liability, indemnification and jurisdiction issues defined therein. Any holder of this document is advised that information contained hereon reflects the Company's findings at the time of its intervention only and within the limits of Client's instructions, if any. The Company's sole responsibility is to its Client and this document does not exonerate parties to a transaction from exercising all their rights and obligations under the transaction documents. This document cannot be reproduced except in full, without prior written approval of the Company. Any unauthorized alteration, forgery or falsification of the content or appearance of this document is unlawful and offenders may be prosecuted to the fullest extent of the law.

99% & 20dB Bandwidth Test Data

Figure 8-1: GSM 850 Channel Low

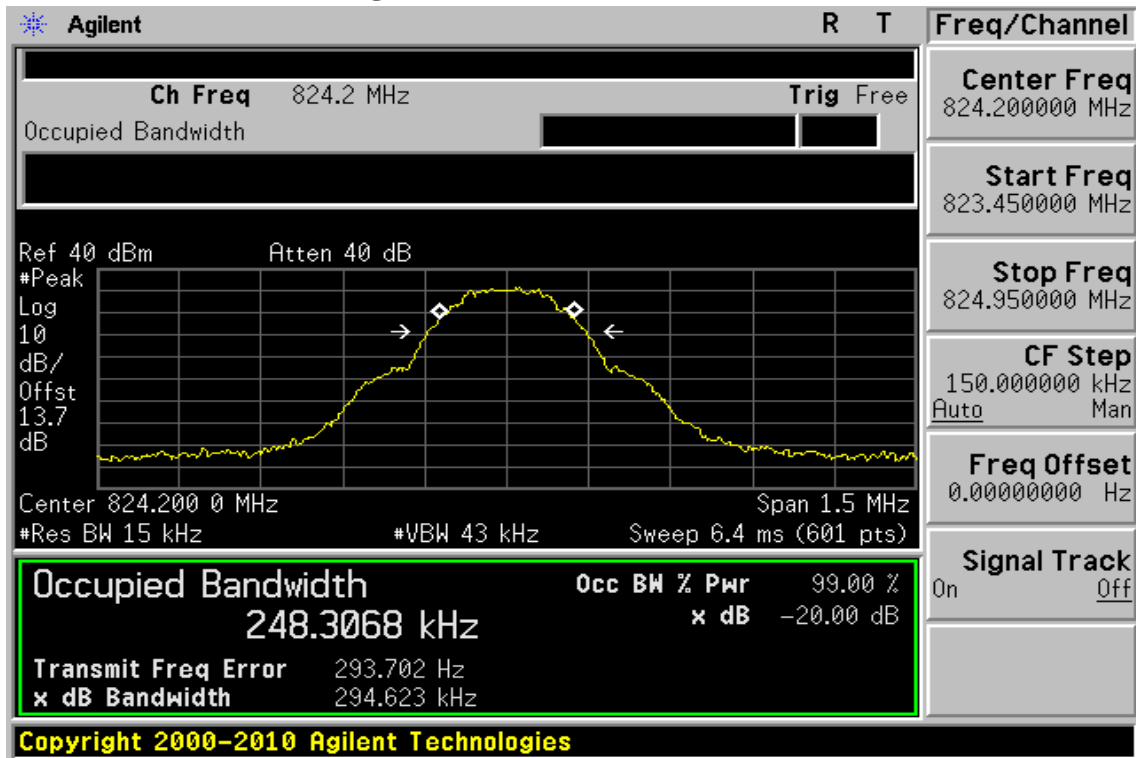
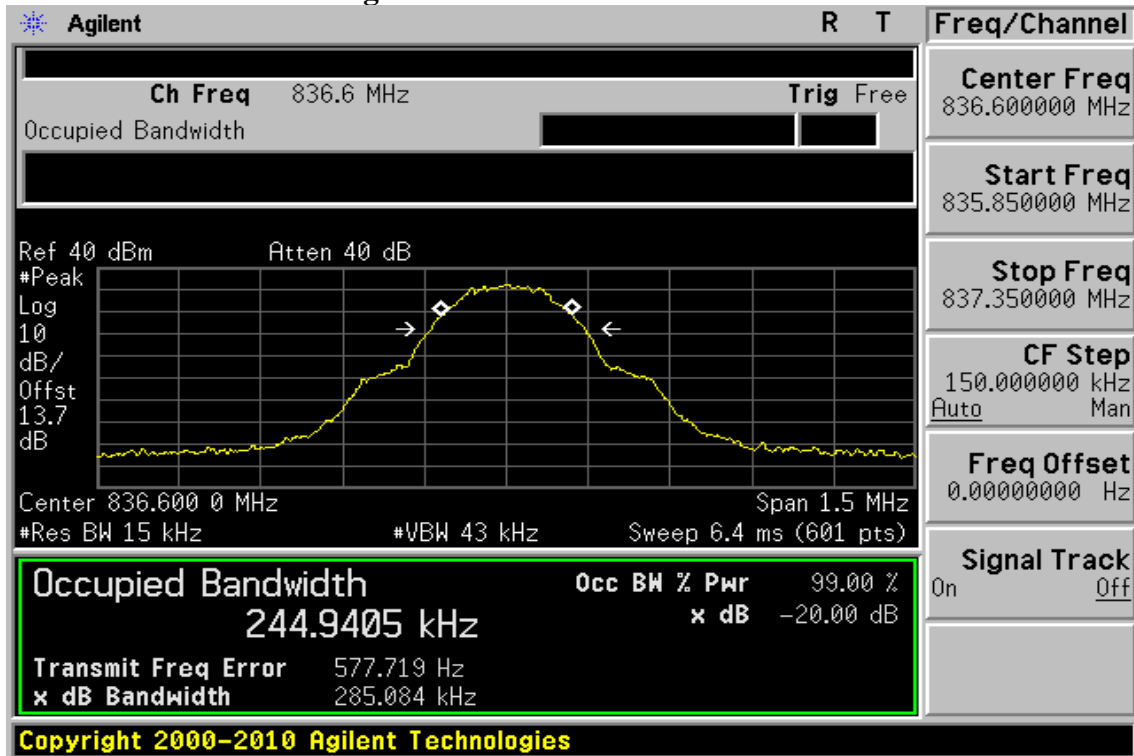

Figure 8-2: GSM 850 Channel Mid



Unless otherwise stated the results shown in this test report refer only to the sample(s) tested and such sample(s) are retained for 90 days only.

除非另有說明，此報告結果僅對測試之樣品負責，同時此樣品僅保留90天。本報告未經本公司書面許可，不可部份複製。

This document is issued by the Company subject to its General Conditions of Service printed overleaf, available on request or accessible at www.sgs.com/terms_and_conditions.htm and, for electronic format documents, subject to Terms and Conditions for Electronic Documents at www.sgs.com/terms_e-document.htm. Attention is drawn to the limitation of liability, indemnification and jurisdiction issues defined therein. Any holder of this document is advised that information contained hereon reflects the Company's findings at the time of its intervention only and within the limits of Client's instructions, if any. The Company's sole responsibility is to its Client and this document does not exonerate parties to a transaction from exercising all their rights and obligations under the transaction documents. This document cannot be reproduced except in full, without prior written approval of the Company. Any unauthorized alteration, forgery or falsification of the content or appearance of this document is unlawful and offenders may be prosecuted to the fullest extent of the law.

Figure 8-3: GSM 850 Channel High

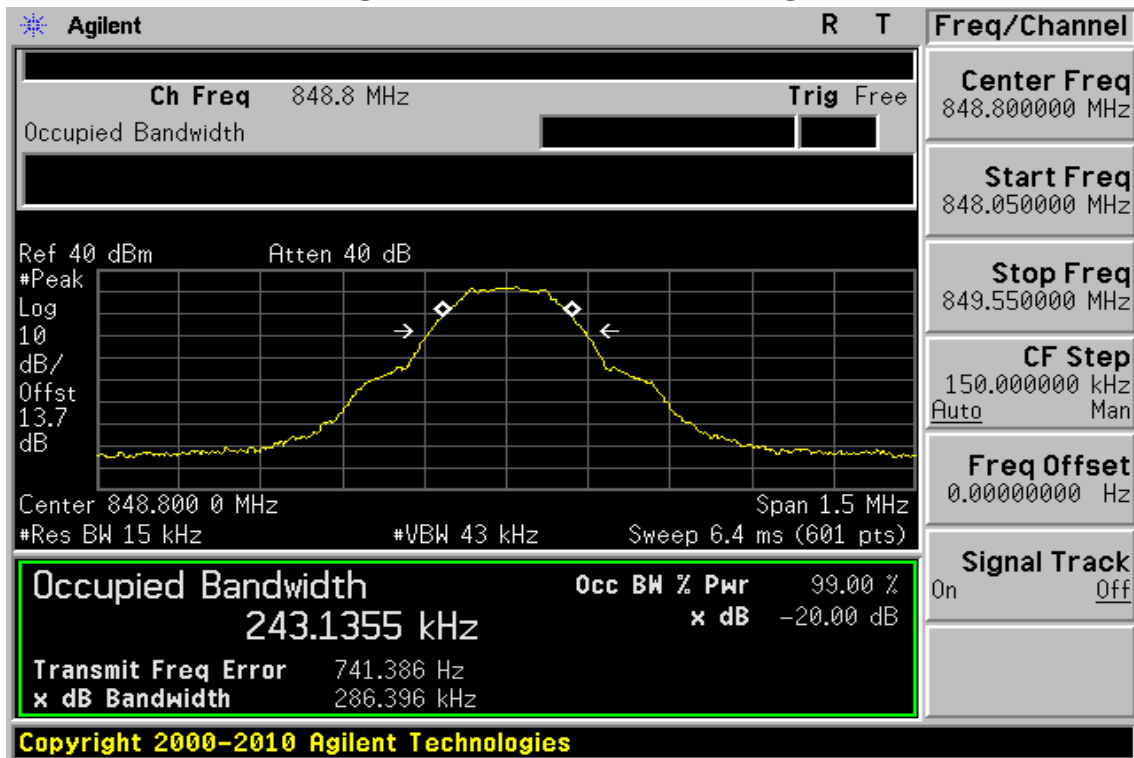
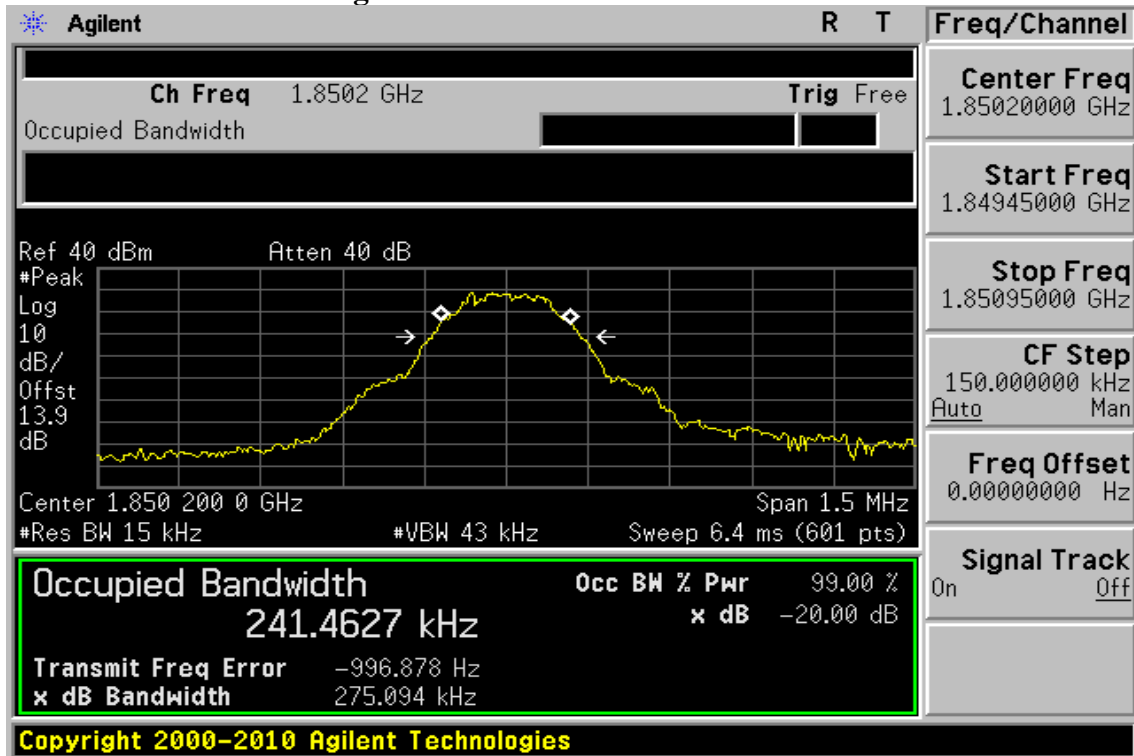

Figure 8-4: GSM 1900 Channel Low



Unless otherwise stated the results shown in this test report refer only to the sample(s) tested and such sample(s) are retained for 90 days only.

除非另有說明，此報告結果僅對測試之樣品負責，同時此樣品僅保留90天。本報告未經本公司書面許可，不可部份複製。

This document is issued by the Company subject to its General Conditions of Service printed overleaf, available on request or accessible at www.sgs.com/terms_and_conditions.htm and, for electronic format documents, subject to Terms and Conditions for Electronic Documents at www.sgs.com/terms_e-document.htm. Attention is drawn to the limitation of liability, indemnification and jurisdiction issues defined therein. Any holder of this document is advised that information contained hereon reflects the Company's findings at the time of its intervention only and within the limits of Client's instructions, if any. The Company's sole responsibility is to its Client and this document does not exonerate parties to a transaction from exercising all their rights and obligations under the transaction documents. This document cannot be reproduced except in full, without prior written approval of the Company. Any unauthorized alteration, forgery or falsification of the content or appearance of this document is unlawful and offenders may be prosecuted to the fullest extent of the law.

Figure 8-5: GSM 1900 Channel Mid

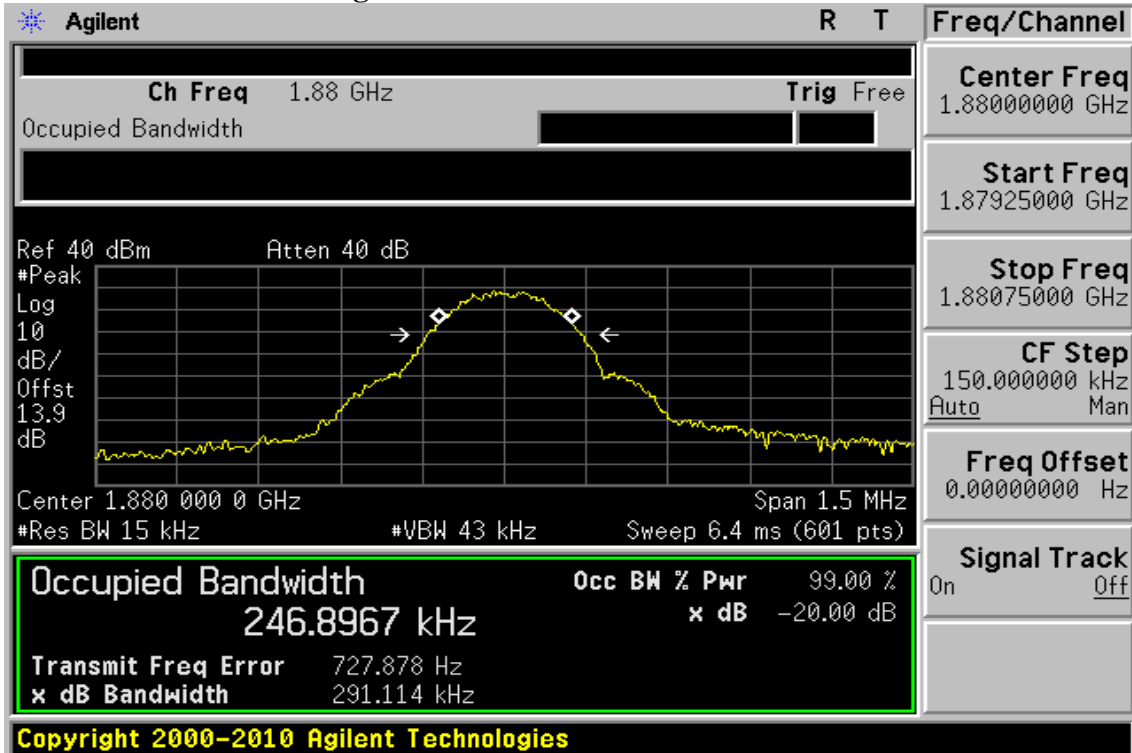
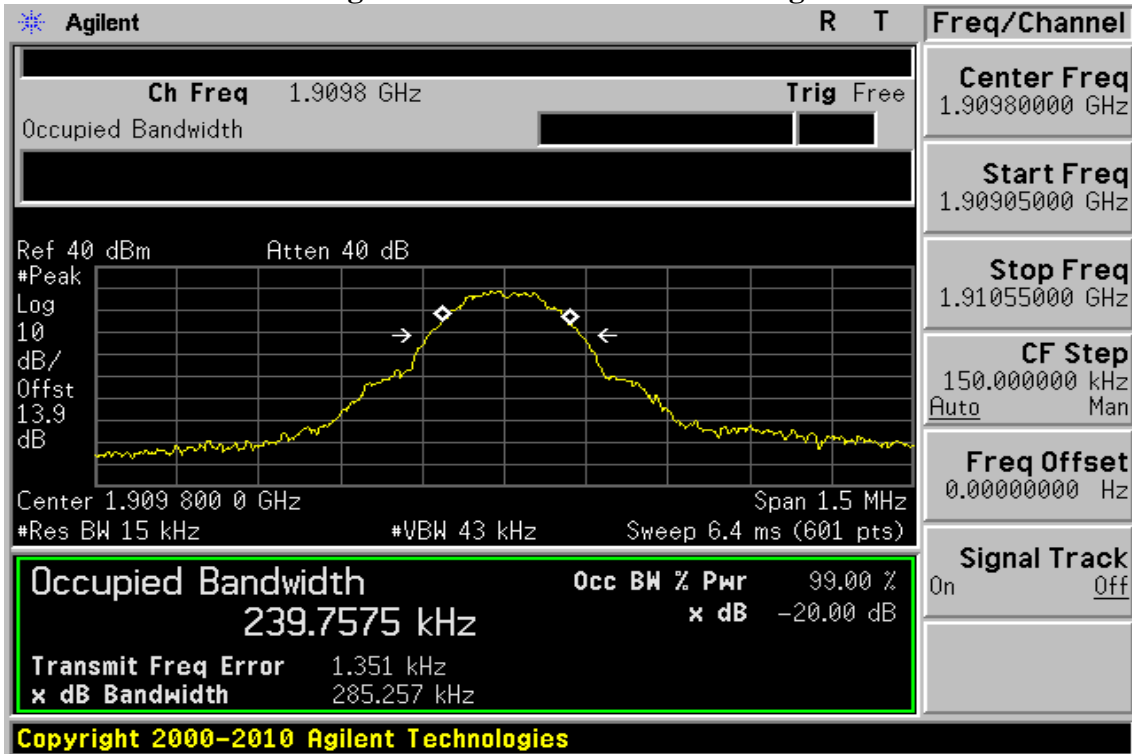

Figure 8-6: GSM 1900 Channel High



Unless otherwise stated the results shown in this test report refer only to the sample(s) tested and such sample(s) are retained for 90 days only.

除非另有說明，此報告結果僅對測試之樣品負責，同時此樣品僅保留90天。本報告未經本公司書面許可，不可部份複製。

This document is issued by the Company subject to its General Conditions of Service printed overleaf, available on request or accessible at www.sgs.com/terms_and_conditions.htm and, for electronic format documents, subject to Terms and Conditions for Electronic Documents at www.sgs.com/terms_e-document.htm. Attention is drawn to the limitation of liability, indemnification and jurisdiction issues defined therein. Any holder of this document is advised that information contained hereon reflects the Company's findings at the time of its intervention only and within the limits of Client's instructions, if any. The Company's sole responsibility is to its Client and this document does not exonerate parties to a transaction from exercising all their rights and obligations under the transaction documents. This document cannot be reproduced except in full, without prior written approval of the Company. Any unauthorized alteration, forgery or falsification of the content or appearance of this document is unlawful and offenders may be prosecuted to the fullest extent of the law.

Figure 8-7: GPRS 850 Channel Low

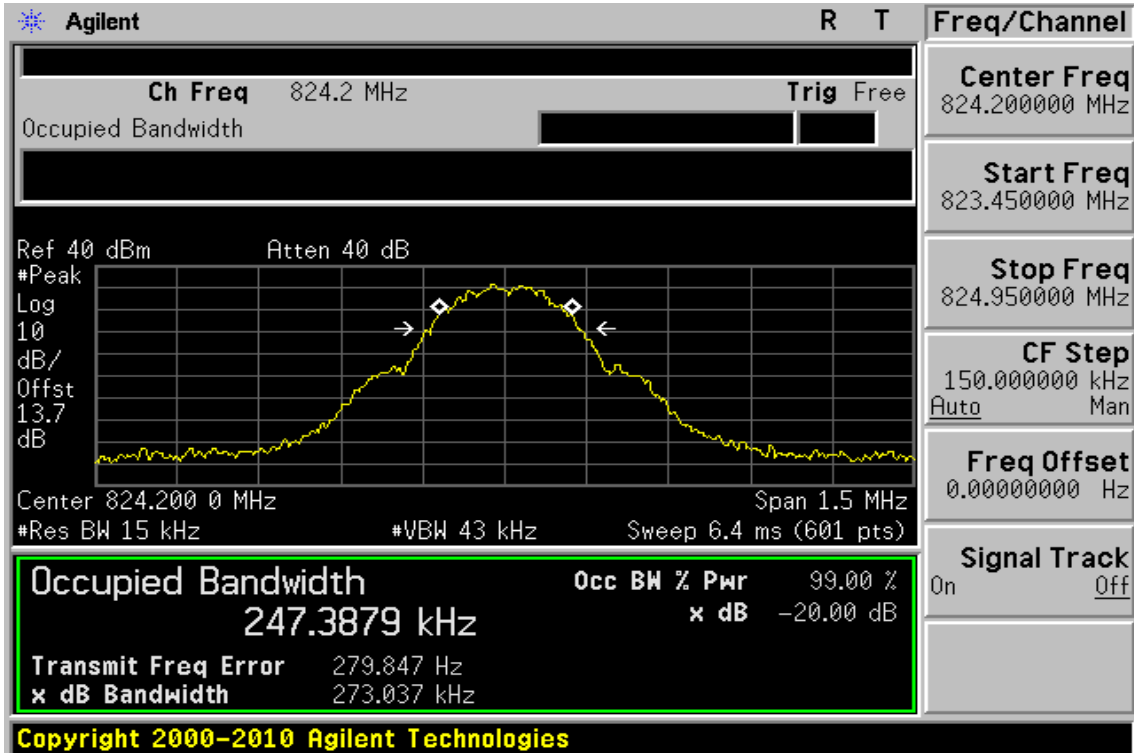
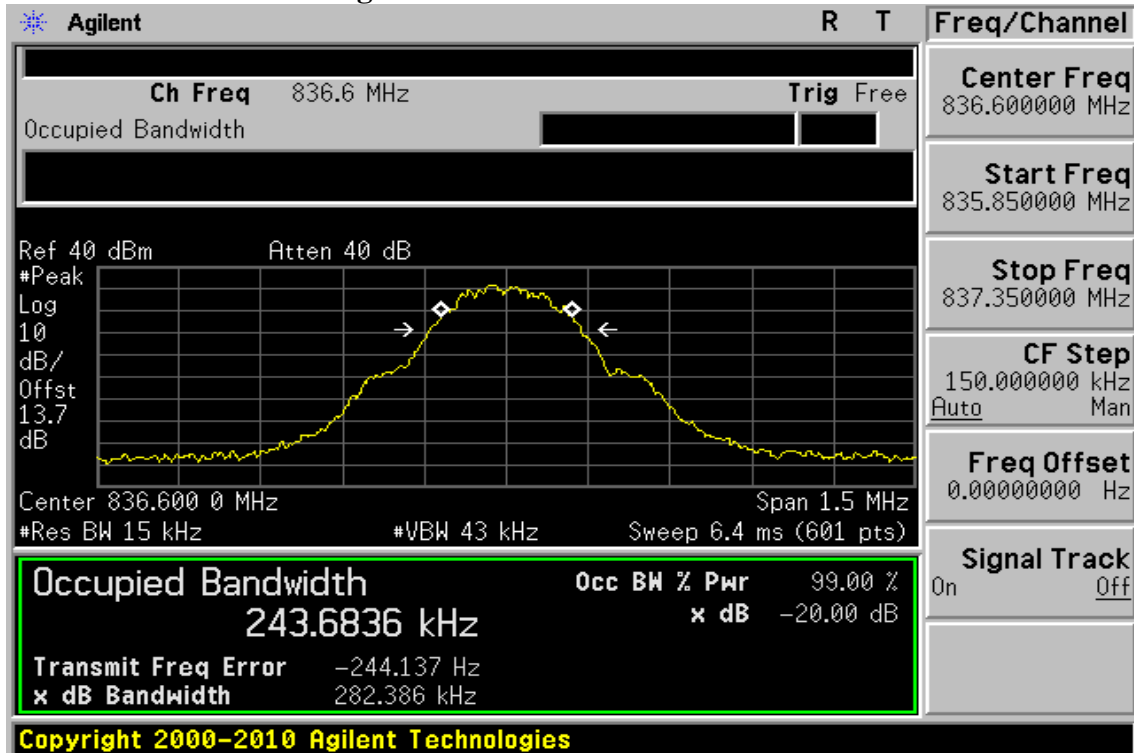

Figure 8-8: GPRS 850 Channel Mid



Unless otherwise stated the results shown in this test report refer only to the sample(s) tested and such sample(s) are retained for 90 days only.

除非另有說明，此報告結果僅對測試之樣品負責，同時此樣品僅保留90天。本報告未經本公司書面許可，不可部份複製。

This document is issued by the Company subject to its General Conditions of Service printed overleaf, available on request or accessible at www.sgs.com/terms_and_conditions.htm and, for electronic format documents, subject to Terms and Conditions for Electronic Documents at www.sgs.com/terms_e-document.htm. Attention is drawn to the limitation of liability, indemnification and jurisdiction issues defined therein. Any holder of this document is advised that information contained hereon reflects the Company's findings at the time of its intervention only and within the limits of Client's instructions, if any. The Company's sole responsibility is to its Client and this document does not exonerate parties to a transaction from exercising all their rights and obligations under the transaction documents. This document cannot be reproduced except in full, without prior written approval of the Company. Any unauthorized alteration, forgery or falsification of the content or appearance of this document is unlawful and offenders may be prosecuted to the fullest extent of the law.

GPRS Figure 8-9: GPRS 850 Channel High

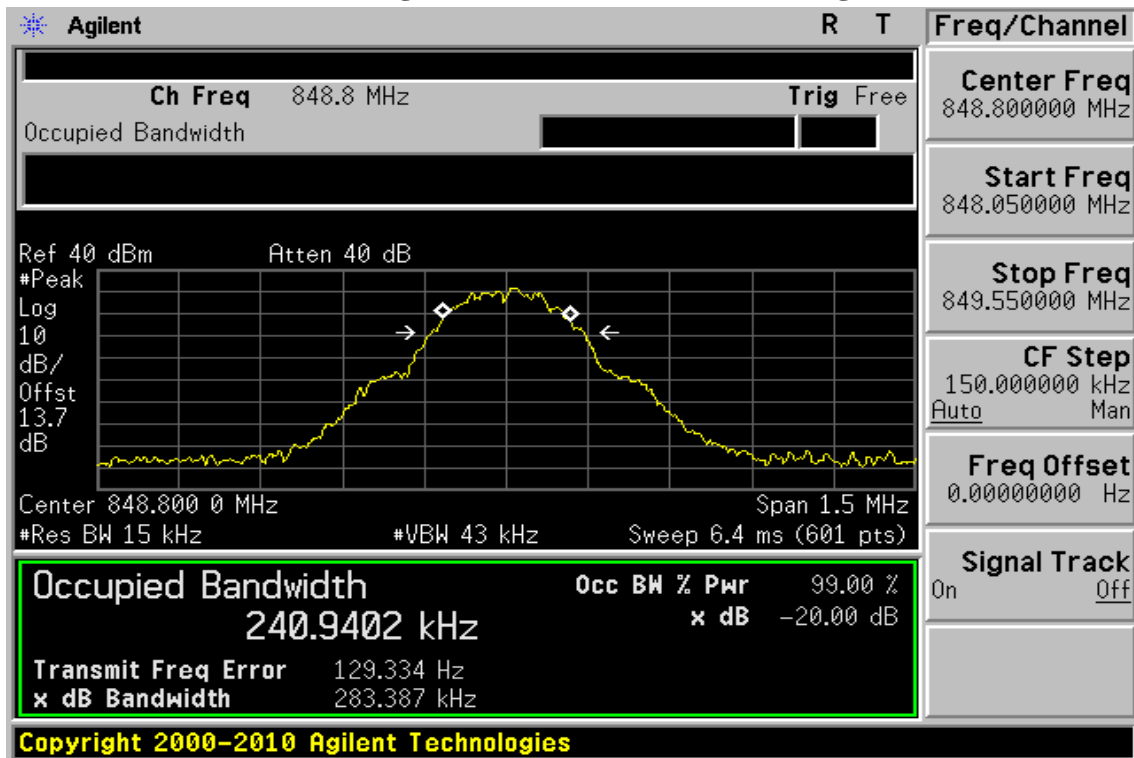
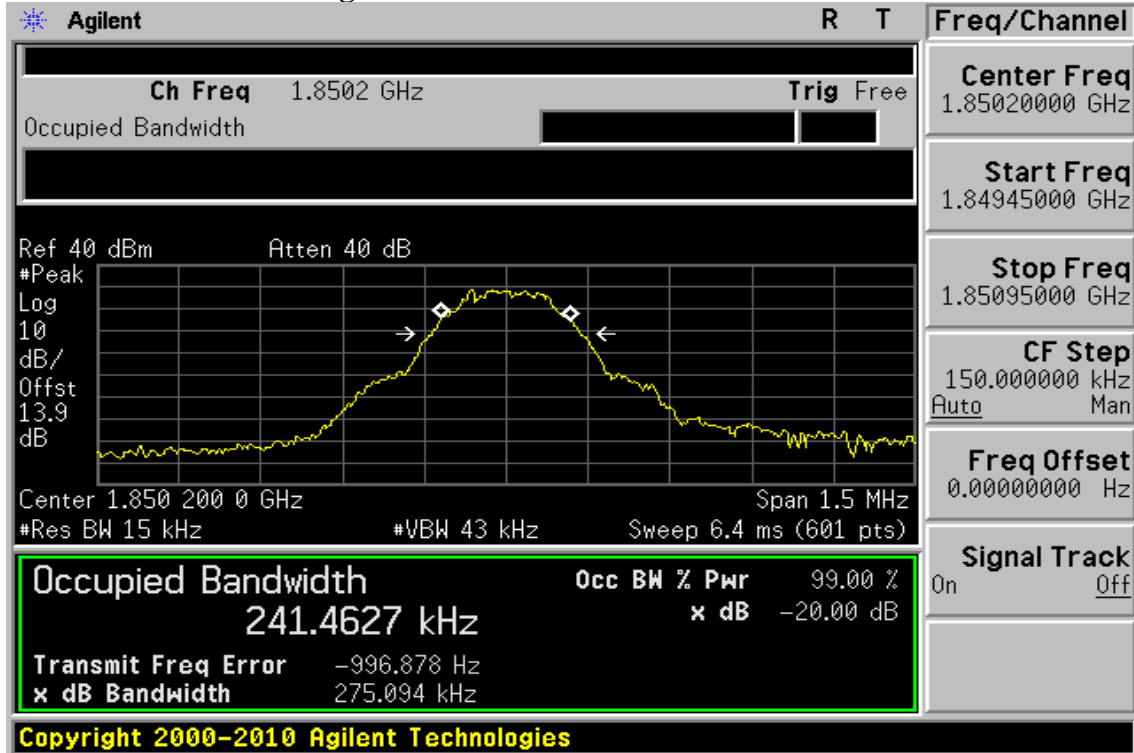

Figure 8-10: GPRS 1900 Channel Low



Unless otherwise stated the results shown in this test report refer only to the sample(s) tested and such sample(s) are retained for 90 days only.

除非另有說明，此報告結果僅對測試之樣品負責，同時此樣品僅保留90天。本報告未經本公司書面許可，不可部份複製。

This document is issued by the Company subject to its General Conditions of Service printed overleaf, available on request or accessible at www.sgs.com/terms_and_conditions.htm and, for electronic format documents, subject to Terms and Conditions for Electronic Documents at www.sgs.com/terms_e-document.htm. Attention is drawn to the limitation of liability, indemnification and jurisdiction issues defined therein. Any holder of this document is advised that information contained hereon reflects the Company's findings at the time of its intervention only and within the limits of Client's instructions, if any. The Company's sole responsibility is to its Client and this document does not exonerate parties to a transaction from exercising all their rights and obligations under the transaction documents. This document cannot be reproduced except in full, without prior written approval of the Company. Any unauthorized alteration, forgery or falsification of the content or appearance of this document is unlawful and offenders may be prosecuted to the fullest extent of the law.

Figure 8-11: GPRS 1900 Channel Mid

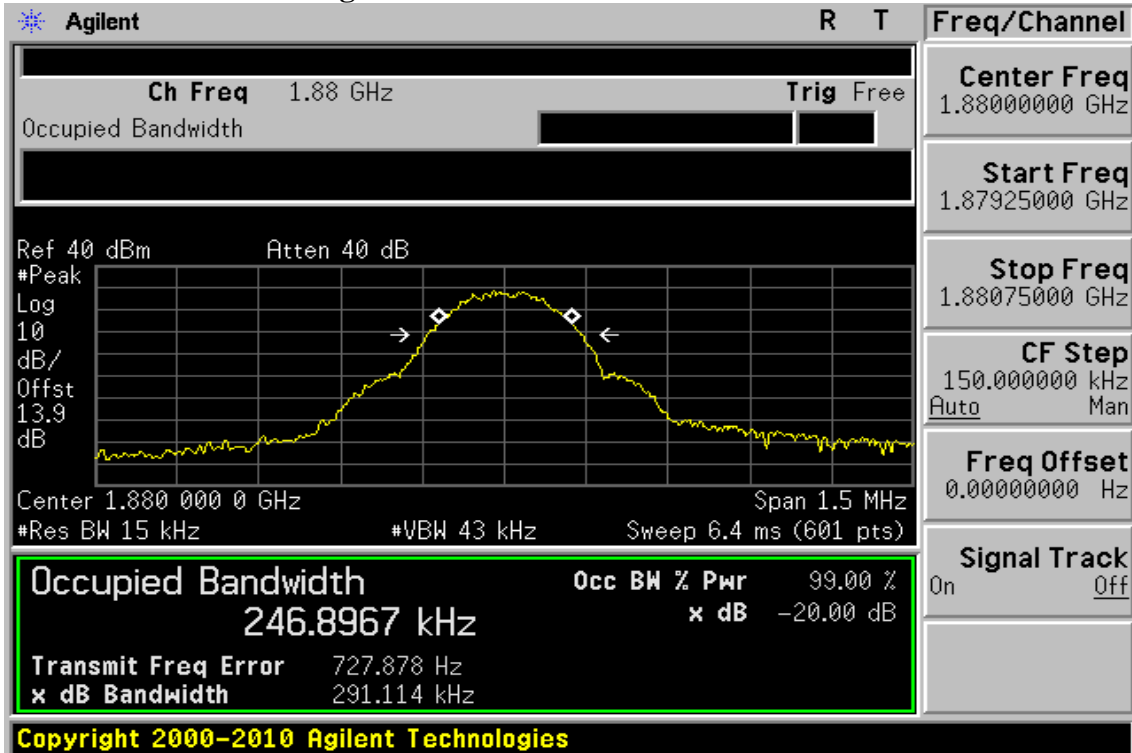
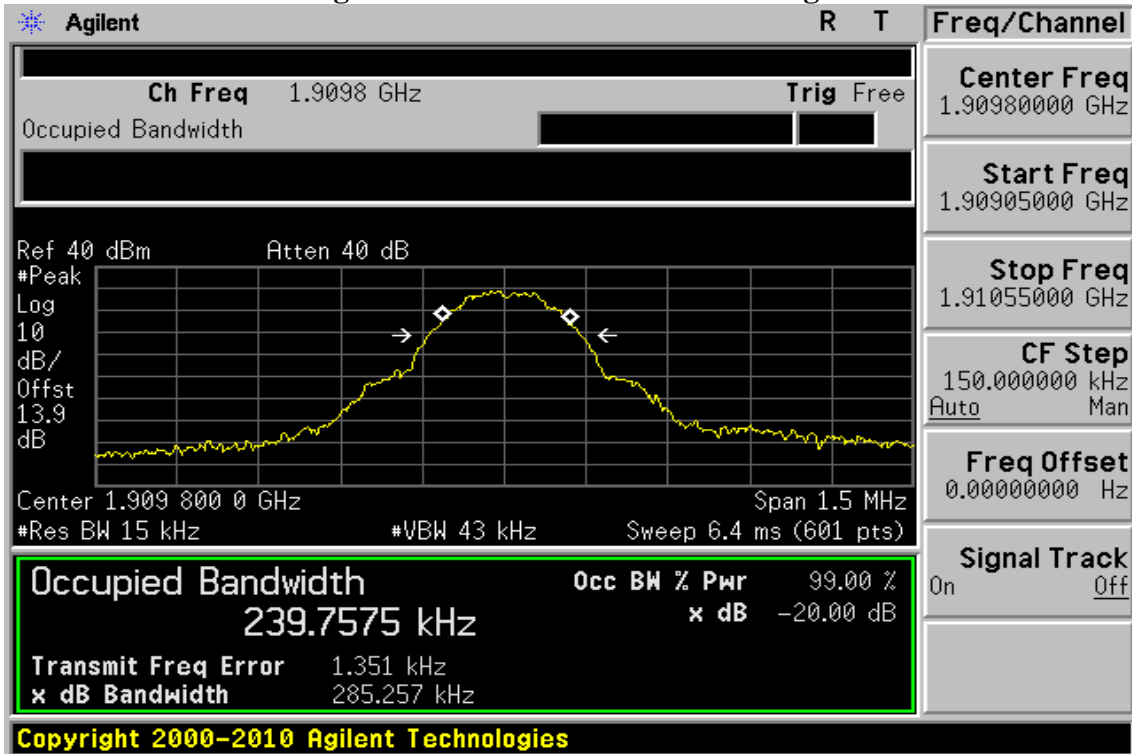

Figure 8-12: GPRS 1900 Channel High



Unless otherwise stated the results shown in this test report refer only to the sample(s) tested and such sample(s) are retained for 90 days only.

除非另有說明，此報告結果僅對測試之樣品負責，同時此樣品僅保留90天。本報告未經本公司書面許可，不可部份複製。

This document is issued by the Company subject to its General Conditions of Service printed overleaf, available on request or accessible at www.sgs.com/terms_and_conditions.htm and, for electronic format documents, subject to Terms and Conditions for Electronic Documents at www.sgs.com/terms_e-document.htm. Attention is drawn to the limitation of liability, indemnification and jurisdiction issues defined therein. Any holder of this document is advised that information contained hereon reflects the Company's findings at the time of its intervention only and within the limits of Client's instructions, if any. The Company's sole responsibility is to its Client and this document does not exonerate parties to a transaction from exercising all their rights and obligations under the transaction documents. This document cannot be reproduced except in full, without prior written approval of the Company. Any unauthorized alteration, forgery or falsification of the content or appearance of this document is unlawful and offenders may be prosecuted to the fullest extent of the law.

Figure 8-13: EDGE 850 Channel Low

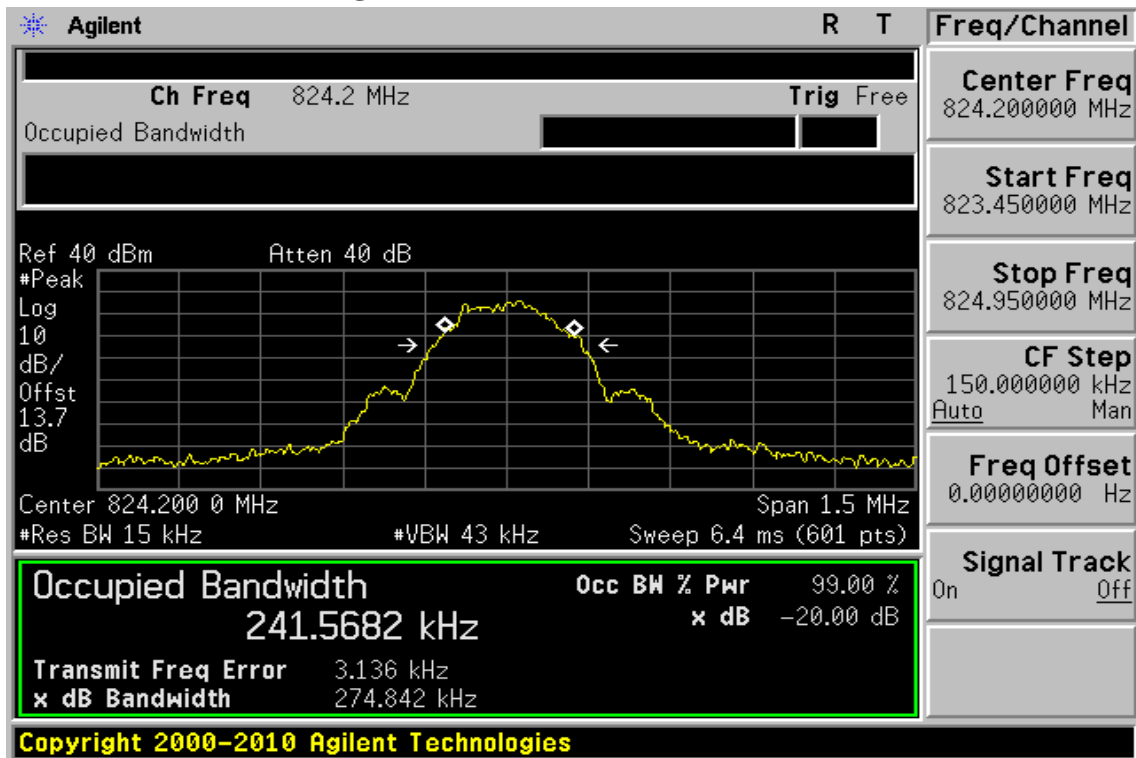
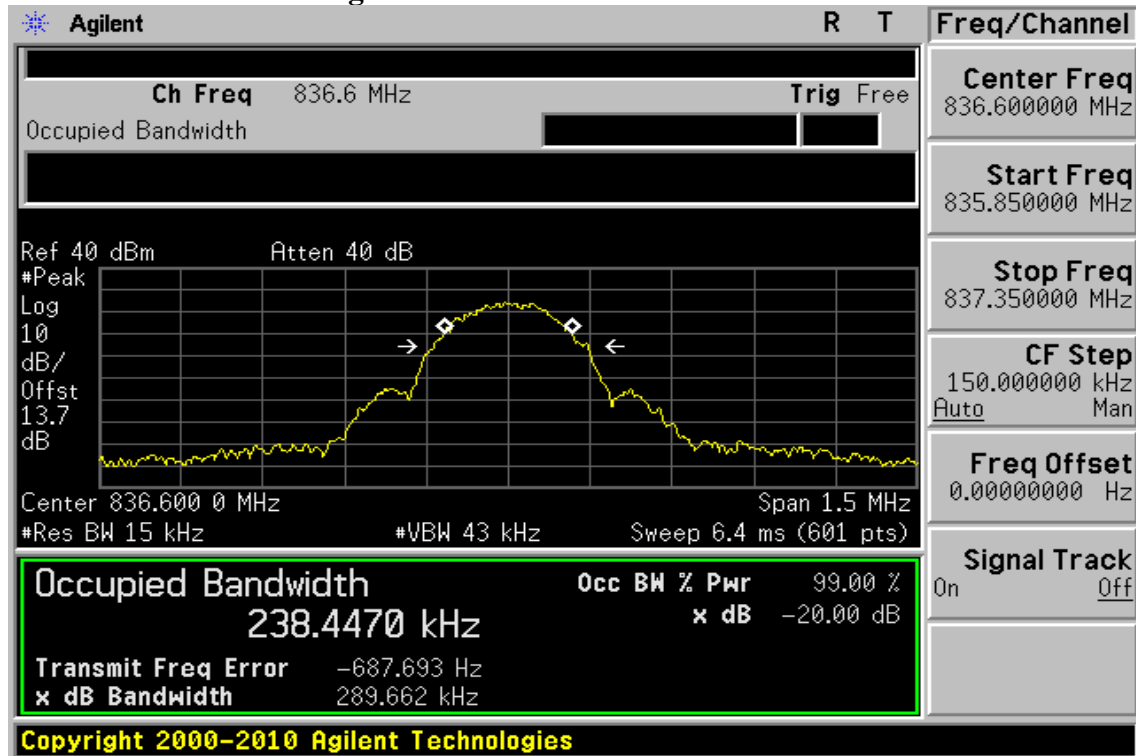

Figure 8-14: EDGE 850 Channel Mid



Unless otherwise stated the results shown in this test report refer only to the sample(s) tested and such sample(s) are retained for 90 days only.

除非另有說明，此報告結果僅對測試之樣品負責，同時此樣品僅保留90天。本報告未經本公司書面許可，不可部份複製。

This document is issued by the Company subject to its General Conditions of Service printed overleaf, available on request or accessible at www.sgs.com/terms_and_conditions.htm and, for electronic format documents, subject to Terms and Conditions for Electronic Documents at www.sgs.com/terms_e-document.htm. Attention is drawn to the limitation of liability, indemnification and jurisdiction issues defined therein. Any holder of this document is advised that information contained hereon reflects the Company's findings at the time of its intervention only and within the limits of Client's instructions, if any. The Company's sole responsibility is to its Client and this document does not exonerate parties to a transaction from exercising all their rights and obligations under the transaction documents. This document cannot be reproduced except in full, without prior written approval of the Company. Any unauthorized alteration, forgery or falsification of the content or appearance of this document is unlawful and offenders may be prosecuted to the fullest extent of the law.

GPRS Figure 8-15: EDGE 850 Channel High

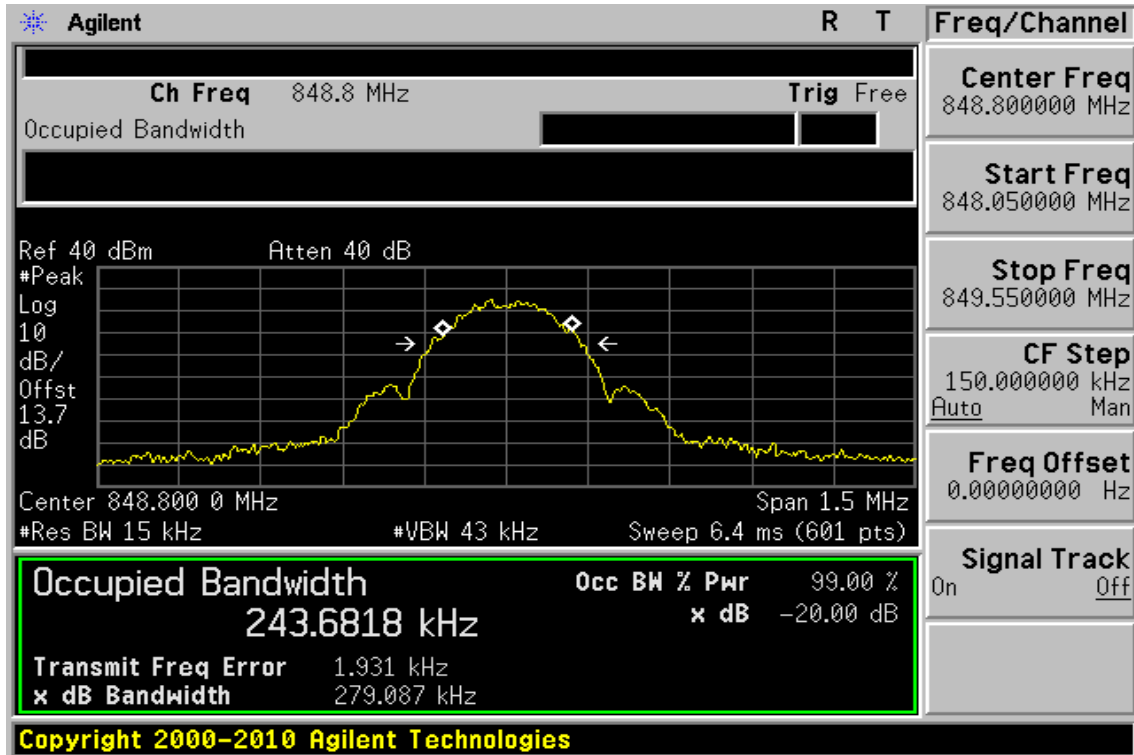
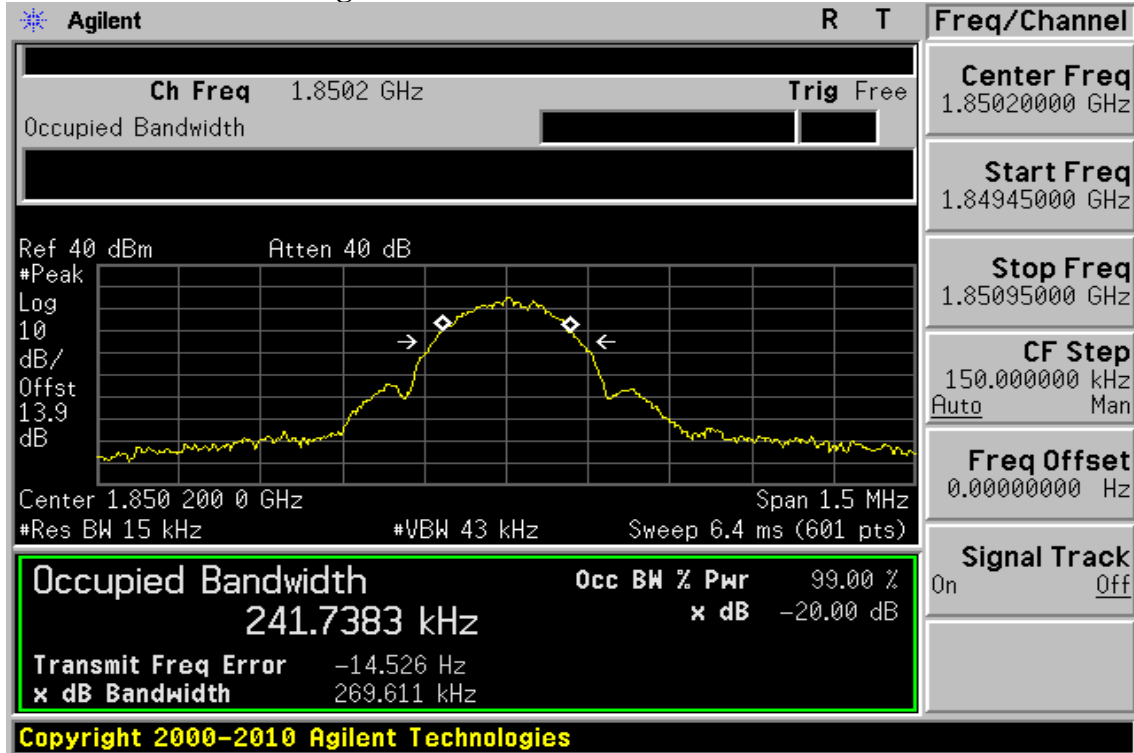

Figure 8-16: EDGE 1900 Channel Low



Unless otherwise stated the results shown in this test report refer only to the sample(s) tested and such sample(s) are retained for 90 days only.

除非另有說明，此報告結果僅對測試之樣品負責，同時此樣品僅保留90天。本報告未經本公司書面許可，不可部份複製。

This document is issued by the Company subject to its General Conditions of Service printed overleaf, available on request or accessible at www.sgs.com/terms_and_conditions.htm and, for electronic format documents, subject to Terms and Conditions for Electronic Documents at www.sgs.com/terms_e-document.htm. Attention is drawn to the limitation of liability, indemnification and jurisdiction issues defined therein. Any holder of this document is advised that information contained hereon reflects the Company's findings at the time of its intervention only and within the limits of Client's instructions, if any. The Company's sole responsibility is to its Client and this document does not exonerate parties to a transaction from exercising all their rights and obligations under the transaction documents. This document cannot be reproduced except in full, without prior written approval of the Company. Any unauthorized alteration, forgery or falsification of the content or appearance of this document is unlawful and offenders may be prosecuted to the fullest extent of the law.

Figure 8-17: EDGE 1900 Channel Mid

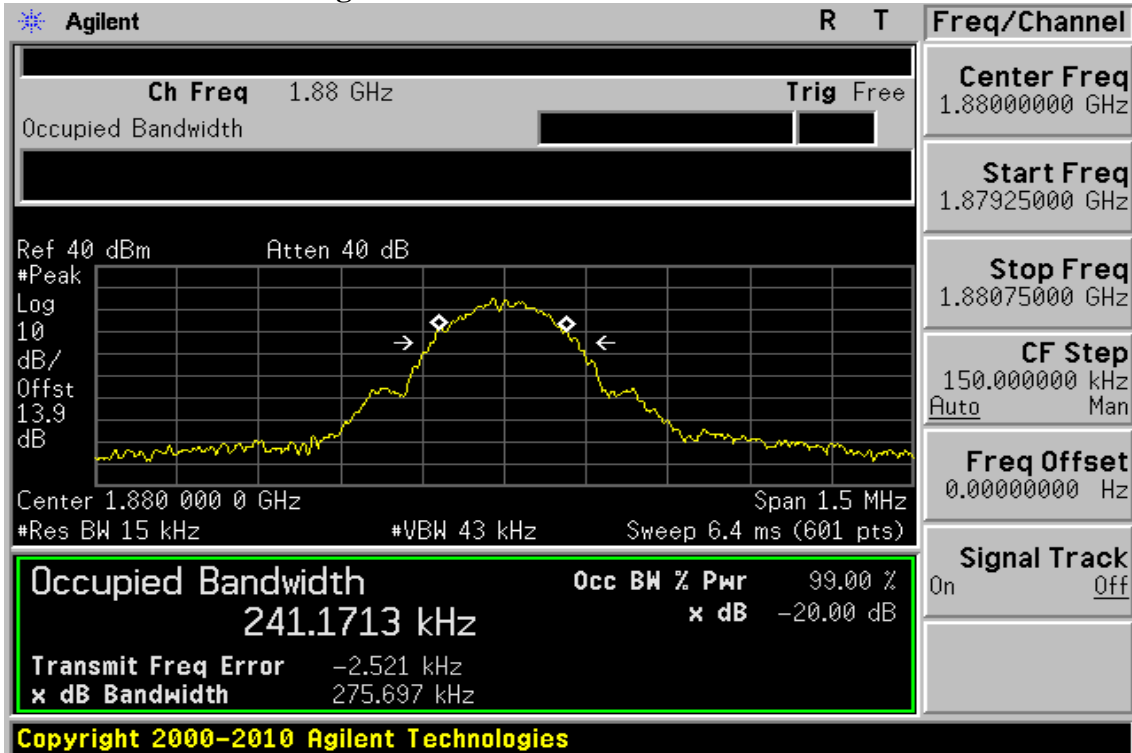
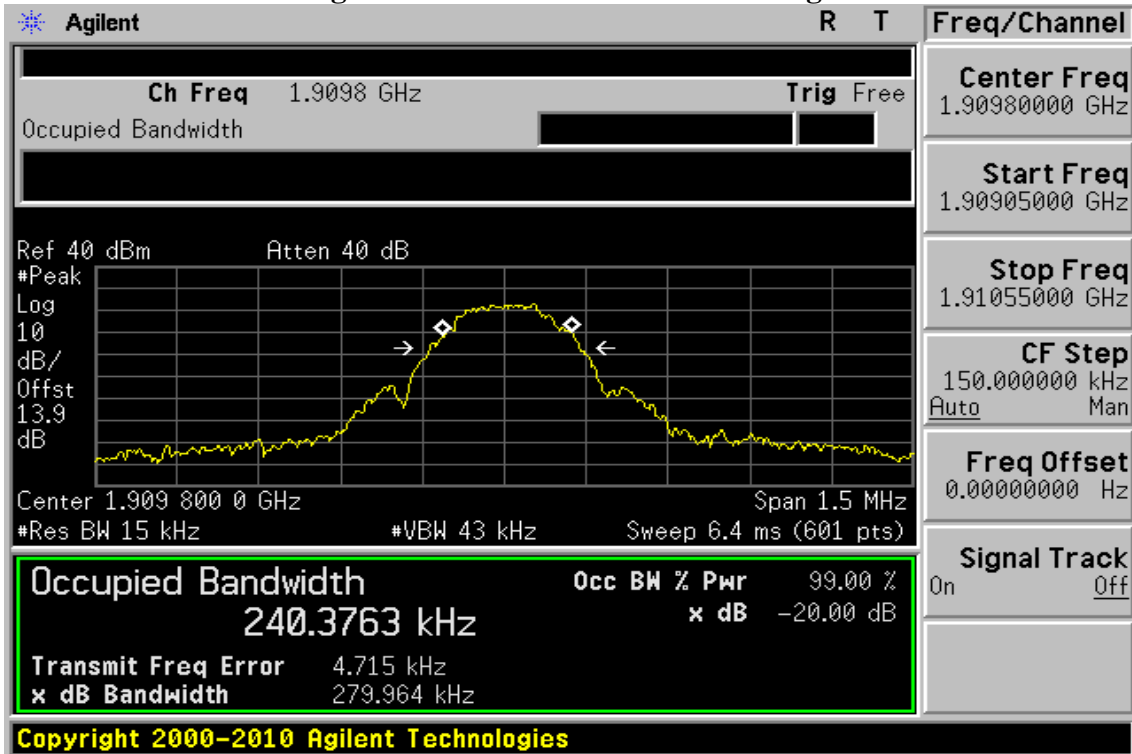

Figure 8-18: EDGE 1900 Channel High



Unless otherwise stated the results shown in this test report refer only to the sample(s) tested and such sample(s) are retained for 90 days only.

除非另有說明，此報告結果僅對測試之樣品負責，同時此樣品僅保留90天。本報告未經本公司書面許可，不可部份複製。

This document is issued by the Company subject to its General Conditions of Service printed overleaf, available on request or accessible at www.sgs.com/terms_and_conditions.htm and, for electronic format documents, subject to Terms and Conditions for Electronic Documents at www.sgs.com/terms_e-document.htm. Attention is drawn to the limitation of liability, indemnification and jurisdiction issues defined therein. Any holder of this document is advised that information contained hereon reflects the Company's findings at the time of its intervention only and within the limits of Client's instructions, if any. The Company's sole responsibility is to its Client and this document does not exonerate parties to a transaction from exercising all their rights and obligations under the transaction documents. This document cannot be reproduced except in full, without prior written approval of the Company. Any unauthorized alteration, forgery or falsification of the content or appearance of this document is unlawful and offenders may be prosecuted to the fullest extent of the law.

Figure 8-19: WCDMA II Channel Low

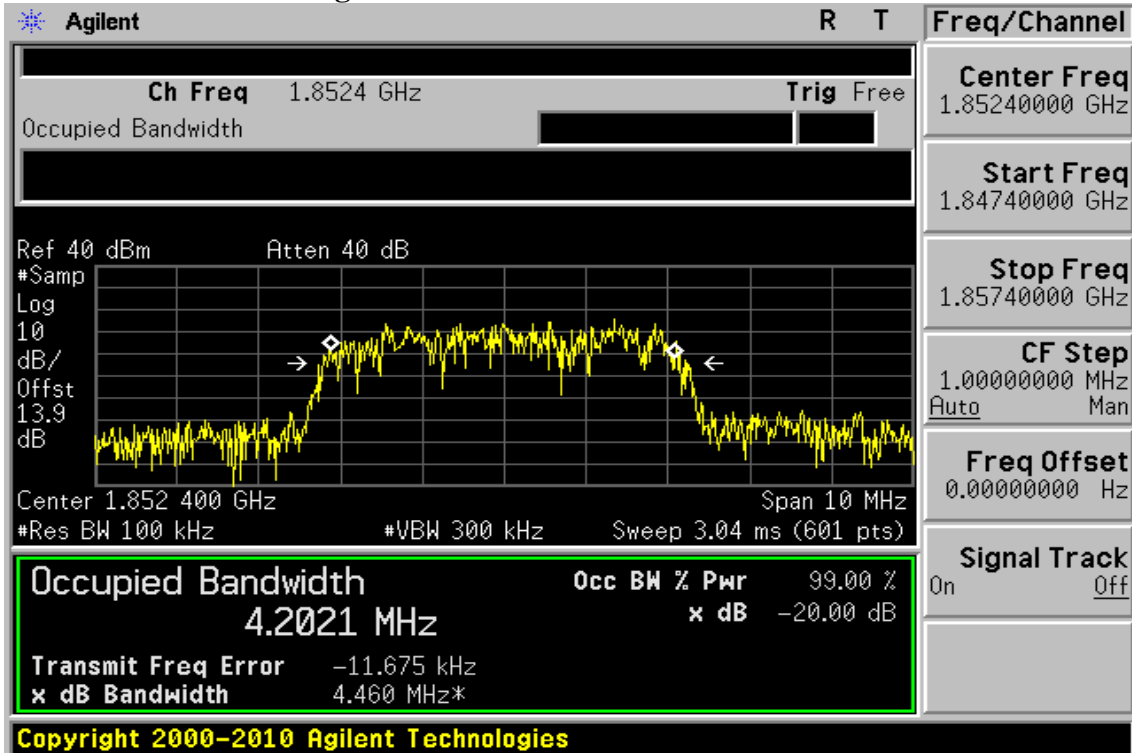
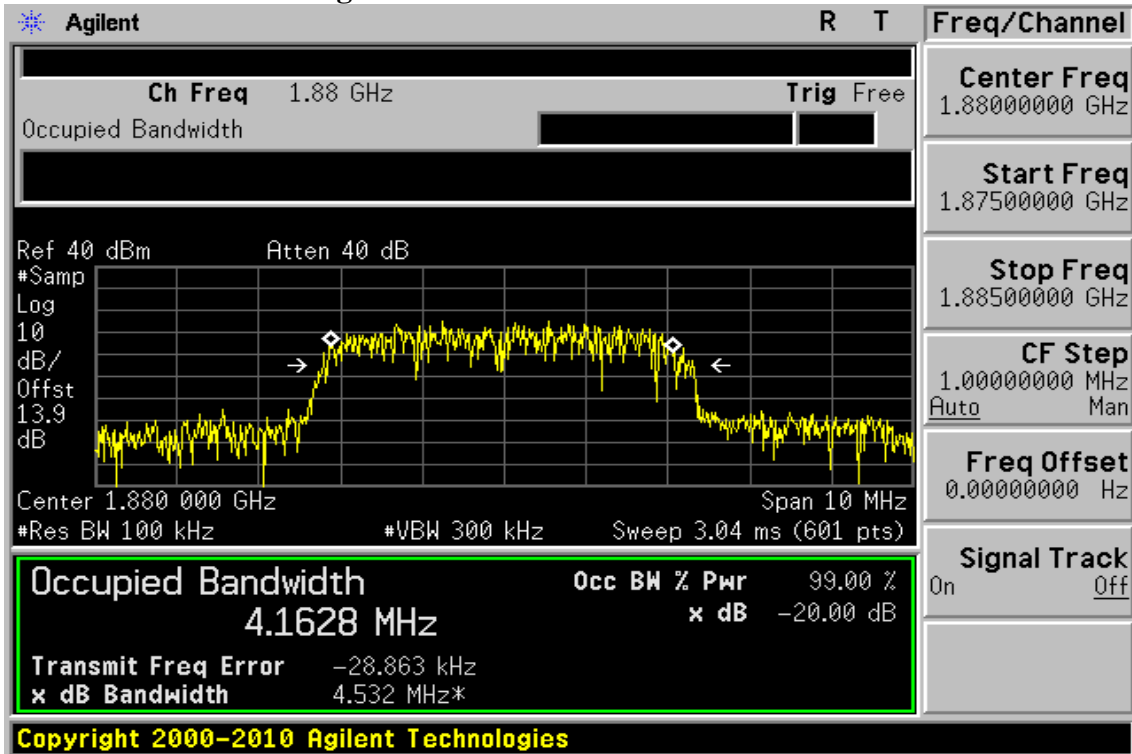

Figure 8-20: WCDMA II Channel Mid



Unless otherwise stated the results shown in this test report refer only to the sample(s) tested and such sample(s) are retained for 90 days only.

除非另有說明，此報告結果僅對測試之樣品負責，同時此樣品僅保留90天。本報告未經本公司書面許可，不可部份複製。

This document is issued by the Company subject to its General Conditions of Service printed overleaf, available on request or accessible at www.sgs.com/terms_and_conditions.htm and, for electronic format documents, subject to Terms and Conditions for Electronic Documents at www.sgs.com/terms_e-document.htm. Attention is drawn to the limitation of liability, indemnification and jurisdiction issues defined therein. Any holder of this document is advised that information contained hereon reflects the Company's findings at the time of its intervention only and within the limits of Client's instructions, if any. The Company's sole responsibility is to its Client and this document does not exonerate parties to a transaction from exercising all their rights and obligations under the transaction documents. This document cannot be reproduced except in full, without prior written approval of the Company. Any unauthorized alteration, forgery or falsification of the content or appearance of this document is unlawful and offenders may be prosecuted to the fullest extent of the law.

Figure 8-21: WCDMA II Channel High

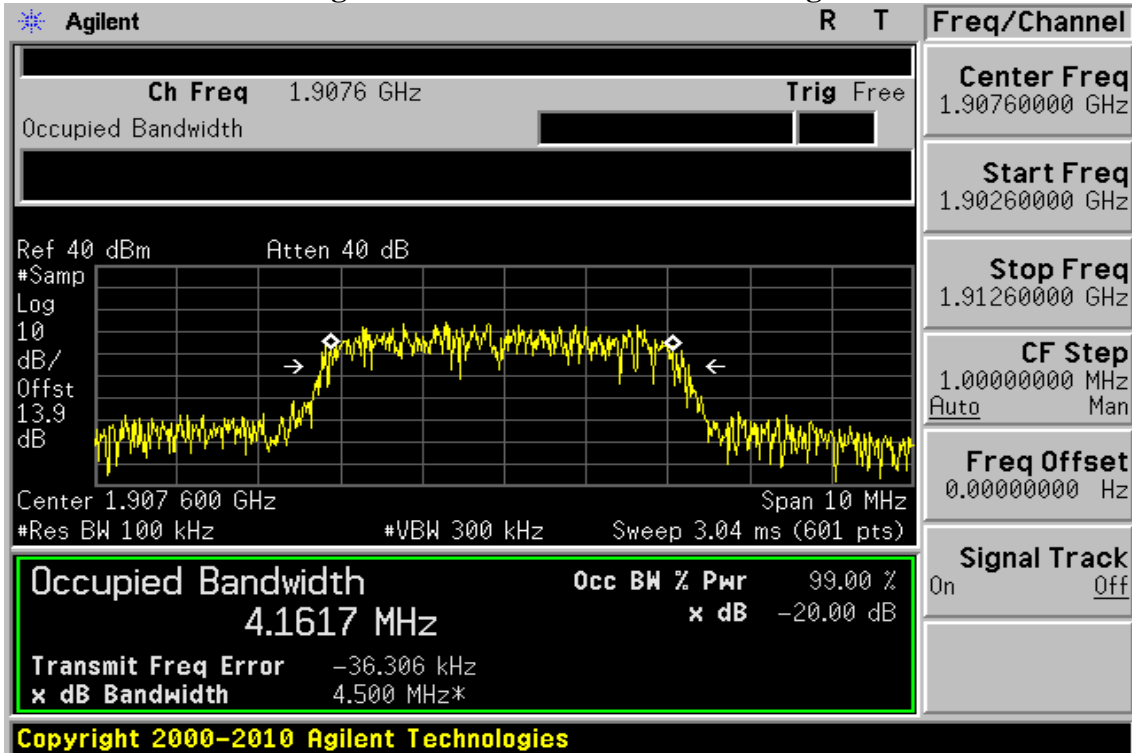
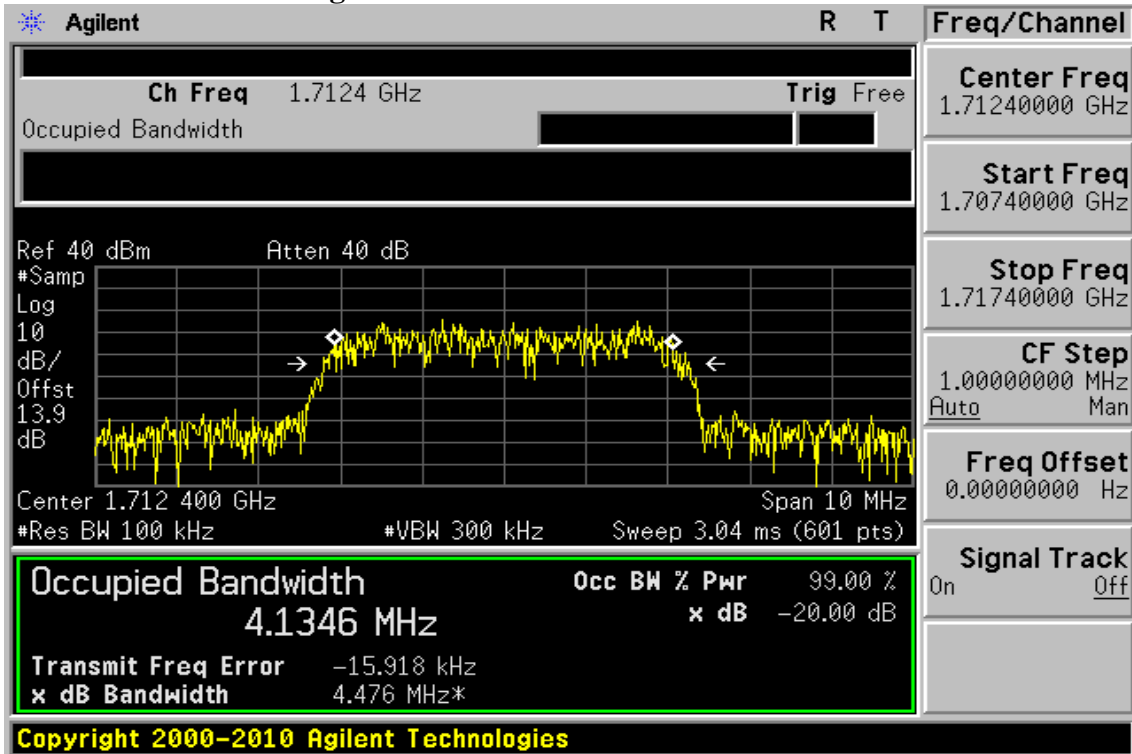

Figure 8-22: WCDMA IV Channel Low



Unless otherwise stated the results shown in this test report refer only to the sample(s) tested and such sample(s) are retained for 90 days only.

除非另有說明，此報告結果僅對測試之樣品負責，同時此樣品僅保留90天。本報告未經本公司書面許可，不可部份複製。

This document is issued by the Company subject to its General Conditions of Service printed overleaf, available on request or accessible at www.sgs.com/terms_and_conditions.htm and, for electronic format documents, subject to Terms and Conditions for Electronic Documents at www.sgs.com/terms_e-document.htm. Attention is drawn to the limitation of liability, indemnification and jurisdiction issues defined therein. Any holder of this document is advised that information contained hereon reflects the Company's findings at the time of its intervention only and within the limits of Client's instructions, if any. The Company's sole responsibility is to its Client and this document does not exonerate parties to a transaction from exercising all their rights and obligations under the transaction documents. This document cannot be reproduced except in full, without prior written approval of the Company. Any unauthorized alteration, forgery or falsification of the content or appearance of this document is unlawful and offenders may be prosecuted to the fullest extent of the law.

Figure 8-23: WCDMA IV Channel Mid

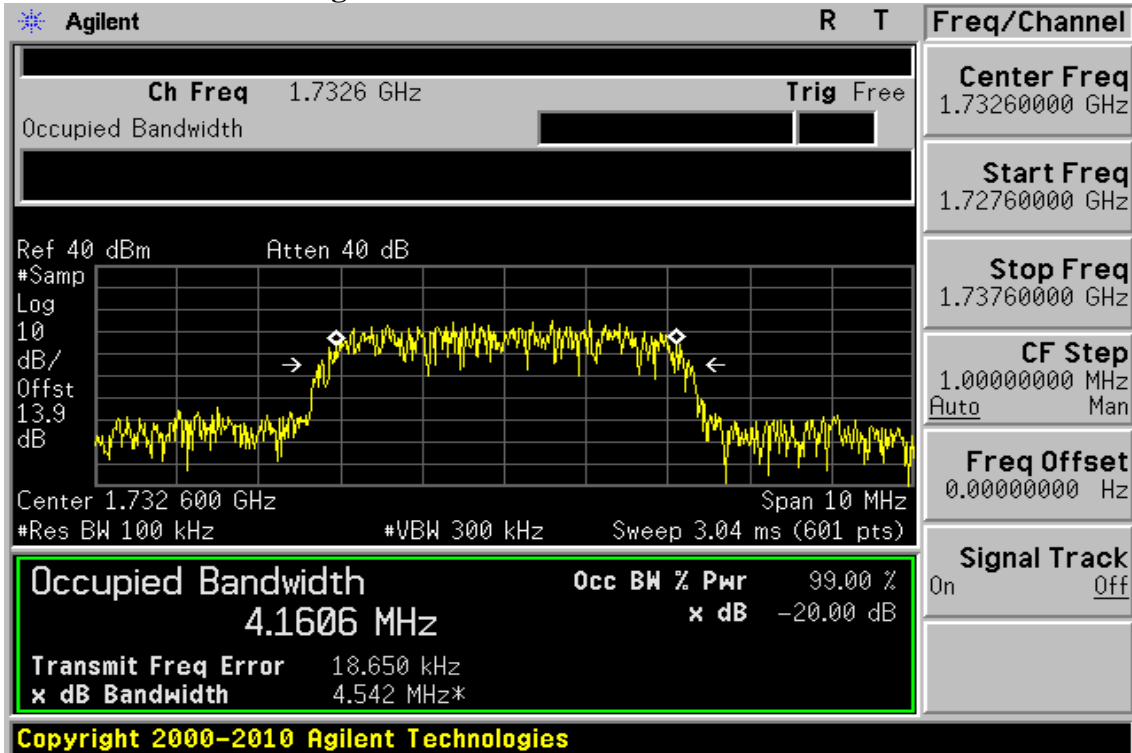
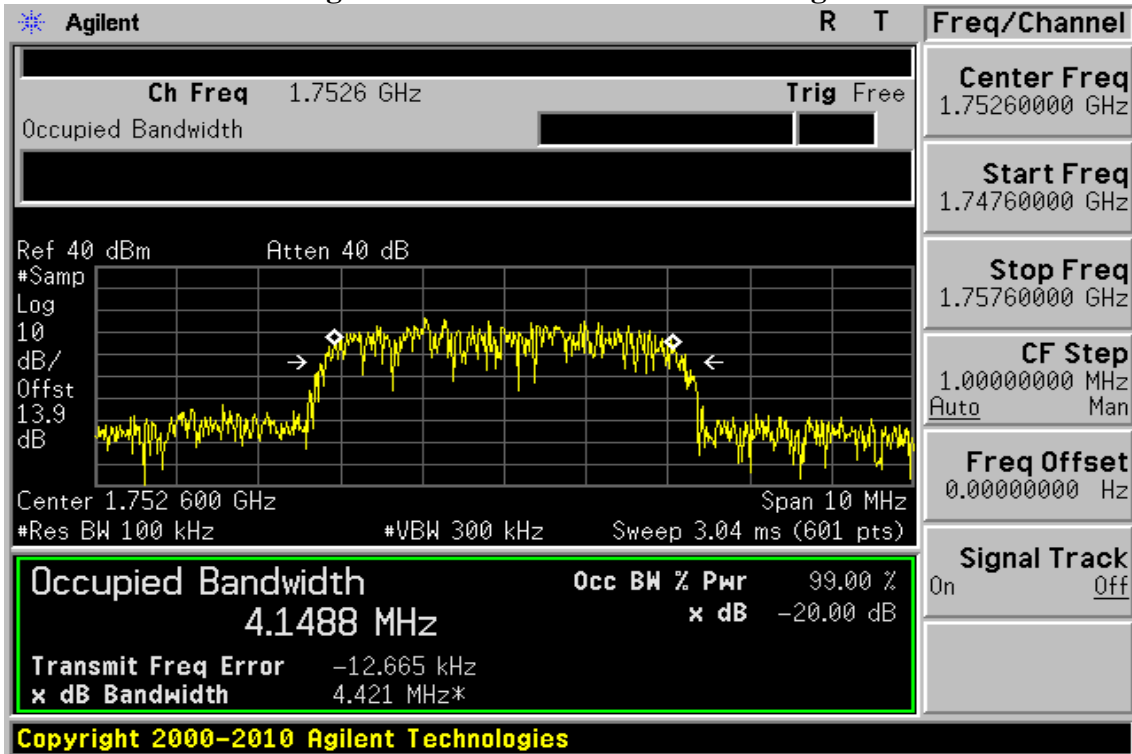

Figure 8-24: WCDMA IV Channel High



Unless otherwise stated the results shown in this test report refer only to the sample(s) tested and such sample(s) are retained for 90 days only.

除非另有說明，此報告結果僅對測試之樣品負責，同時此樣品僅保留90天。本報告未經本公司書面許可，不可部份複製。

This document is issued by the Company subject to its General Conditions of Service printed overleaf, available on request or accessible at www.sgs.com/terms_and_conditions.htm and, for electronic format documents, subject to Terms and Conditions for Electronic Documents at www.sgs.com/terms_e-document.htm. Attention is drawn to the limitation of liability, indemnification and jurisdiction issues defined therein. Any holder of this document is advised that information contained hereon reflects the Company's findings at the time of its intervention only and within the limits of Client's instructions, if any. The Company's sole responsibility is to its Client and this document does not exonerate parties to a transaction from exercising all their rights and obligations under the transaction documents. This document cannot be reproduced except in full, without prior written approval of the Company. Any unauthorized alteration, forgery or falsification of the content or appearance of this document is unlawful and offenders may be prosecuted to the fullest extent of the law.

Figure 8-25: WCDMA V Channel Low

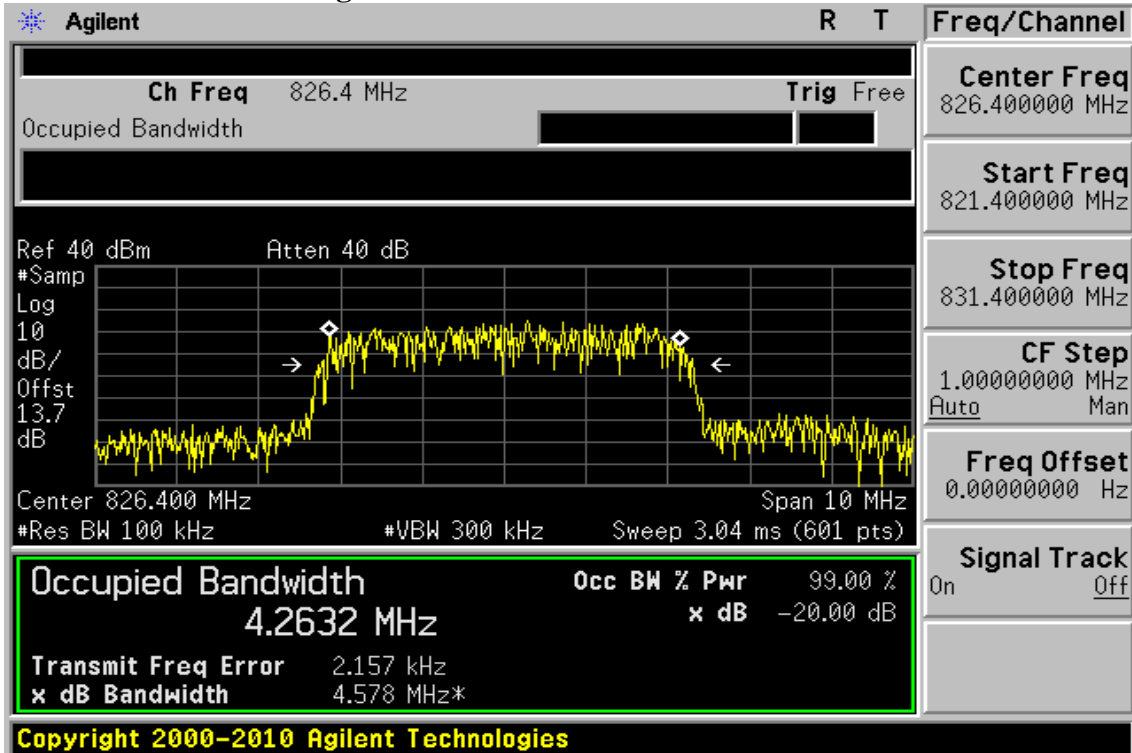
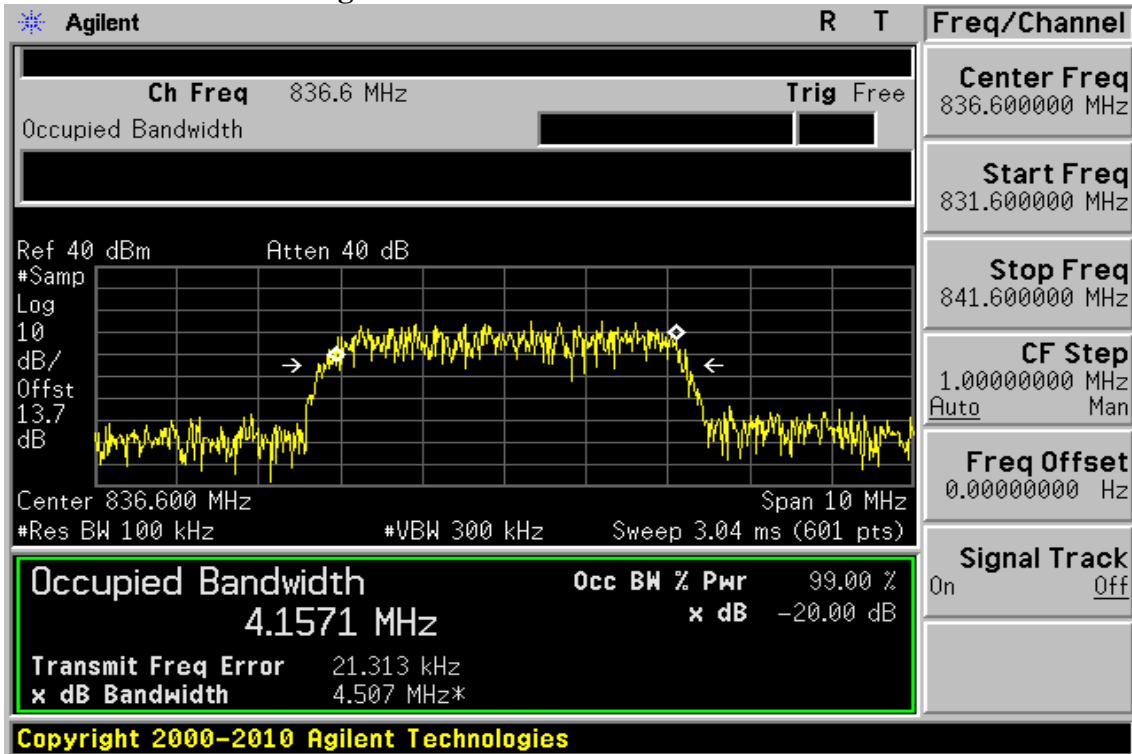

Figure 8-26: WCDMA V Channel Mid



Unless otherwise stated the results shown in this test report refer only to the sample(s) tested and such sample(s) are retained for 90 days only.

除非另有說明，此報告結果僅對測試之樣品負責，同時此樣品僅保留90天。本報告未經本公司書面許可，不可部份複製。

This document is issued by the Company subject to its General Conditions of Service printed overleaf, available on request or accessible at www.sgs.com/terms_and_conditions.htm and, for electronic format documents, subject to Terms and Conditions for Electronic Documents at www.sgs.com/terms_e-document.htm. Attention is drawn to the limitation of liability, indemnification and jurisdiction issues defined therein. Any holder of this document is advised that information contained hereon reflects the Company's findings at the time of its intervention only and within the limits of Client's instructions, if any. The Company's sole responsibility is to its Client and this document does not exonerate parties to a transaction from exercising all their rights and obligations under the transaction documents. This document cannot be reproduced except in full, without prior written approval of the Company. Any unauthorized alteration, forgery or falsification of the content or appearance of this document is unlawful and offenders may be prosecuted to the fullest extent of the law.

Figure 8-27: WCDMA V Channel High

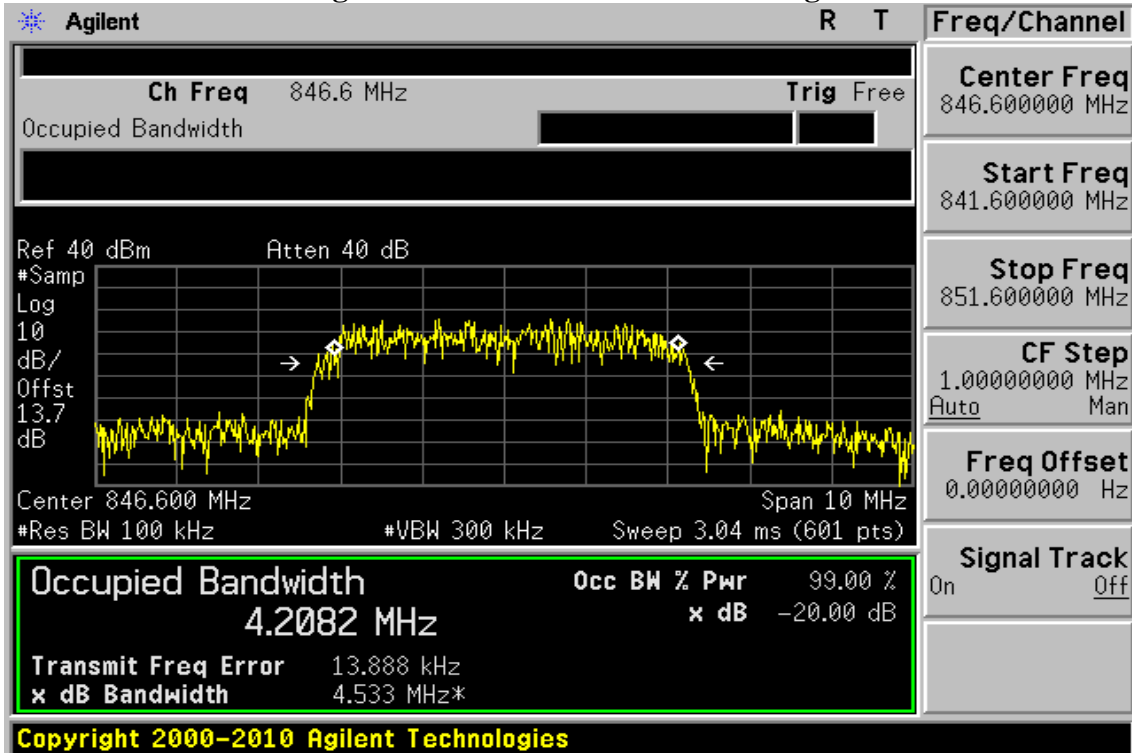
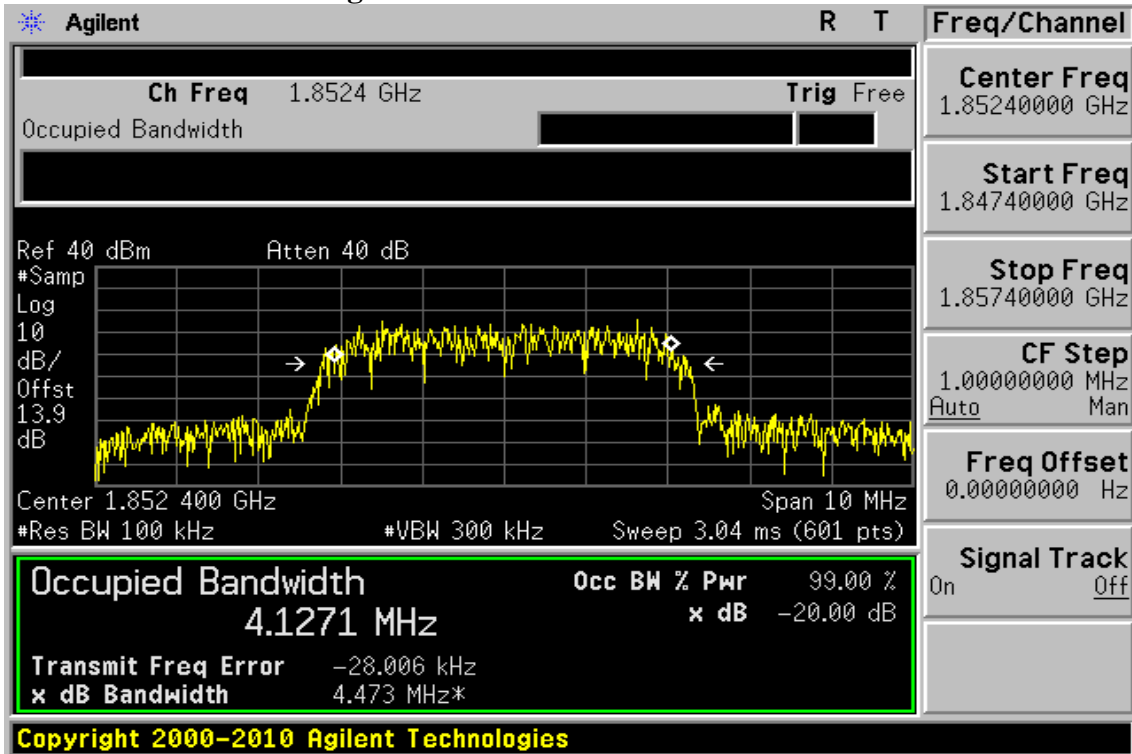

Figure 8-28: HSDPA II Channel Low



Unless otherwise stated the results shown in this test report refer only to the sample(s) tested and such sample(s) are retained for 90 days only.

除非另有說明，此報告結果僅對測試之樣品負責，同時此樣品僅保留90天。本報告未經本公司書面許可，不可部份複製。

This document is issued by the Company subject to its General Conditions of Service printed overleaf, available on request or accessible at www.sgs.com/terms_and_conditions.htm and, for electronic format documents, subject to Terms and Conditions for Electronic Documents at www.sgs.com/terms_e-document.htm. Attention is drawn to the limitation of liability, indemnification and jurisdiction issues defined therein. Any holder of this document is advised that information contained hereon reflects the Company's findings at the time of its intervention only and within the limits of Client's instructions, if any. The Company's sole responsibility is to its Client and this document does not exonerate parties to a transaction from exercising all their rights and obligations under the transaction documents. This document cannot be reproduced except in full, without prior written approval of the Company. Any unauthorized alteration, forgery or falsification of the content or appearance of this document is unlawful and offenders may be prosecuted to the fullest extent of the law.

Figure 8-29: HSDPA II Channel Mid

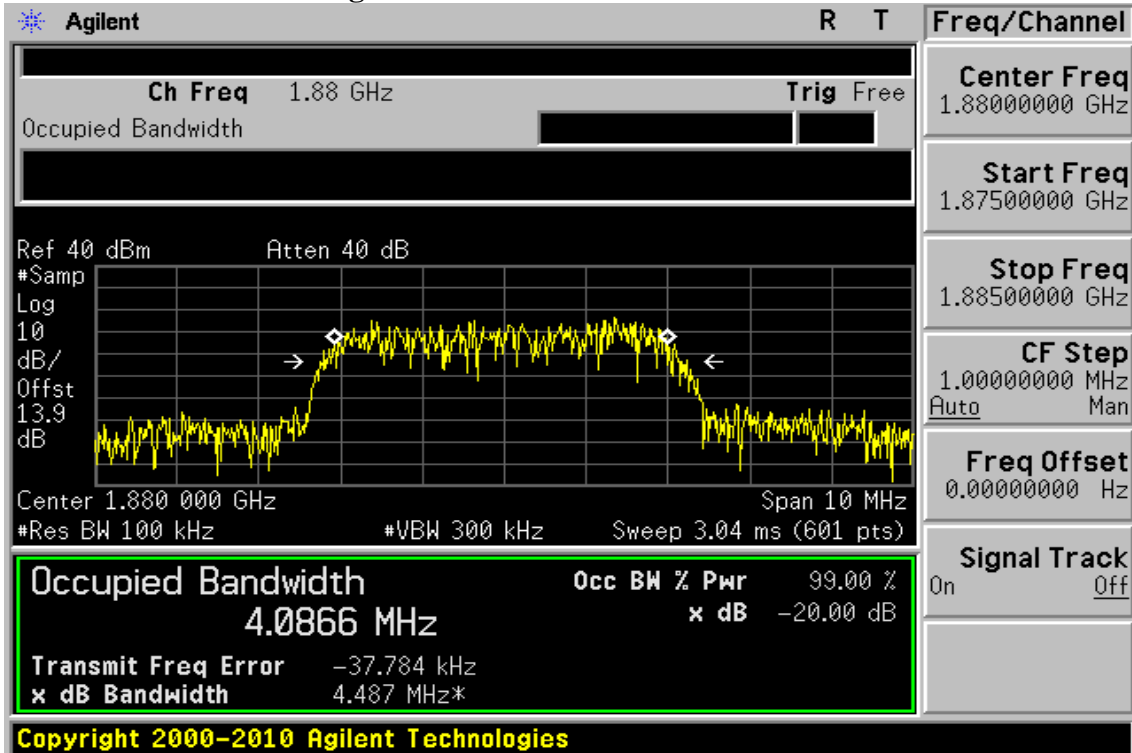
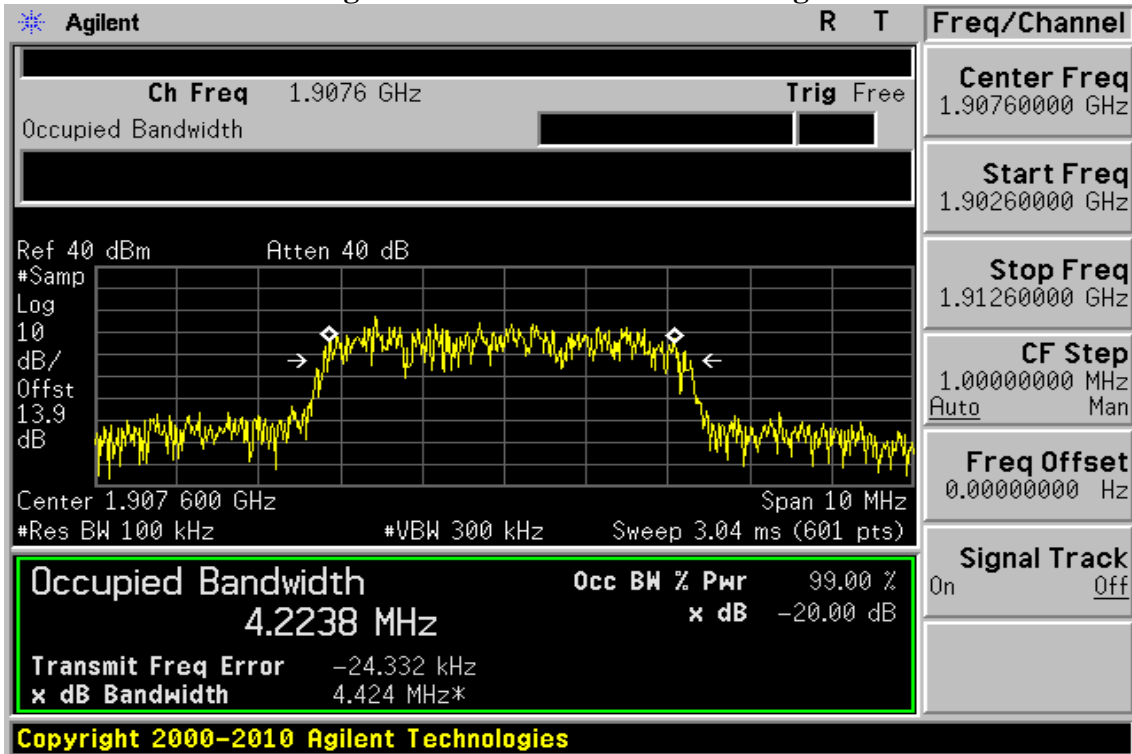

Figure 8-30: HSDPA II Channel High



Unless otherwise stated the results shown in this test report refer only to the sample(s) tested and such sample(s) are retained for 90 days only.

除非另有說明，此報告結果僅對測試之樣品負責，同時此樣品僅保留90天。本報告未經本公司書面許可，不可部份複製。

This document is issued by the Company subject to its General Conditions of Service printed overleaf, available on request or accessible at www.sgs.com/terms_and_conditions.htm and, for electronic format documents, subject to Terms and Conditions for Electronic Documents at www.sgs.com/terms_e-document.htm. Attention is drawn to the limitation of liability, indemnification and jurisdiction issues defined therein. Any holder of this document is advised that information contained hereon reflects the Company's findings at the time of its intervention only and within the limits of Client's instructions, if any. The Company's sole responsibility is to its Client and this document does not exonerate parties to a transaction from exercising all their rights and obligations under the transaction documents. This document cannot be reproduced except in full, without prior written approval of the Company. Any unauthorized alteration, forgery or falsification of the content or appearance of this document is unlawful and offenders may be prosecuted to the fullest extent of the law.

Figure 8-31: HSDPA IV Channel Low

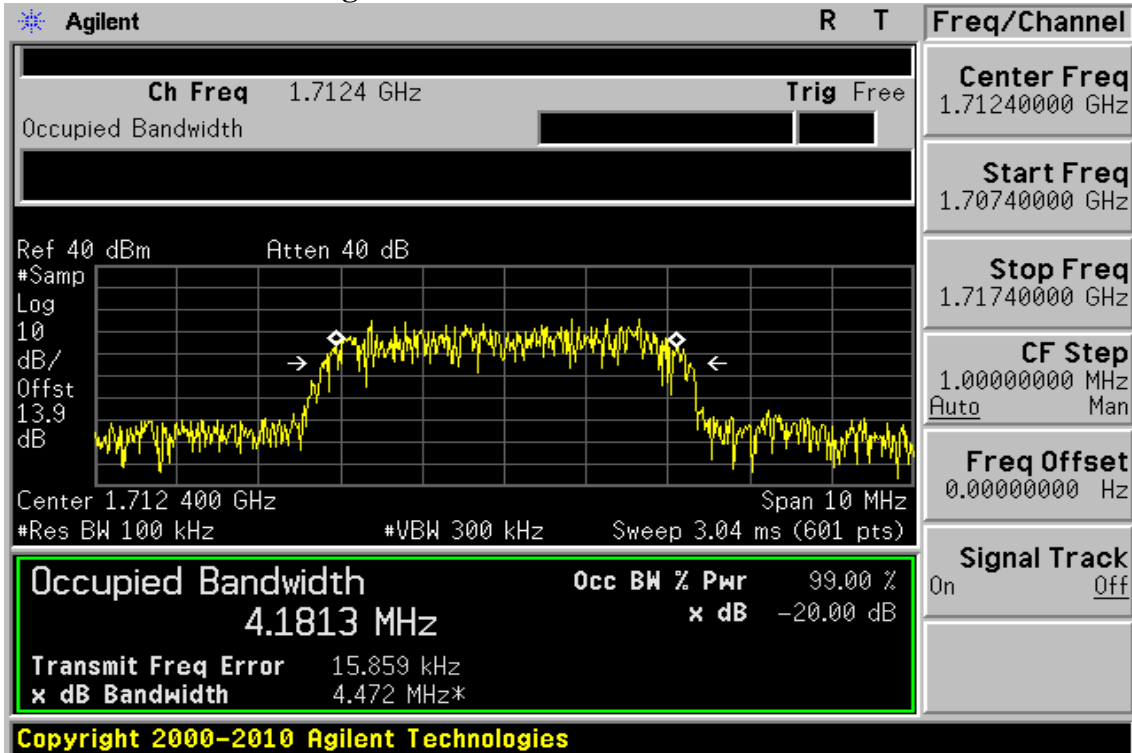
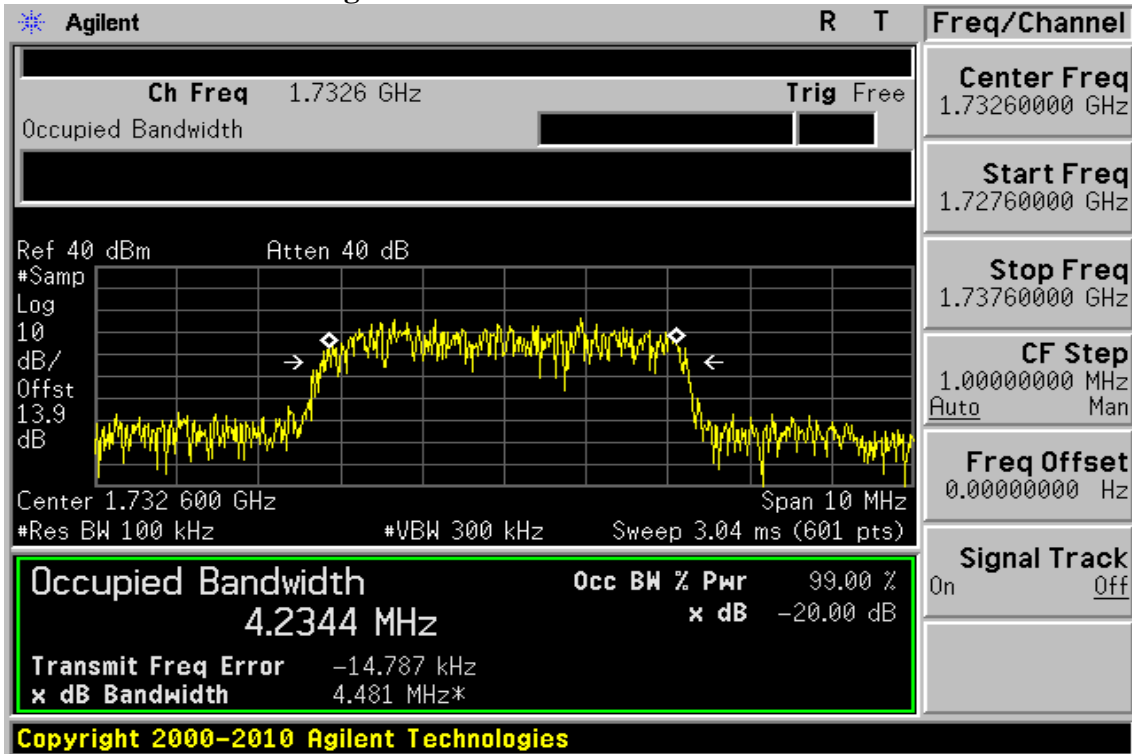

Figure 8-32: HSDPA IV Channel Mid



Unless otherwise stated the results shown in this test report refer only to the sample(s) tested and such sample(s) are retained for 90 days only.

除非另有說明，此報告結果僅對測試之樣品負責，同時此樣品僅保留90天。本報告未經本公司書面許可，不可部份複製。

This document is issued by the Company subject to its General Conditions of Service printed overleaf, available on request or accessible at www.sgs.com/terms_and_conditions.htm and, for electronic format documents, subject to Terms and Conditions for Electronic Documents at www.sgs.com/terms_e-document.htm. Attention is drawn to the limitation of liability, indemnification and jurisdiction issues defined therein. Any holder of this document is advised that information contained hereon reflects the Company's findings at the time of its intervention only and within the limits of Client's instructions, if any. The Company's sole responsibility is to its Client and this document does not exonerate parties to a transaction from exercising all their rights and obligations under the transaction documents. This document cannot be reproduced except in full, without prior written approval of the Company. Any unauthorized alteration, forgery or falsification of the content or appearance of this document is unlawful and offenders may be prosecuted to the fullest extent of the law.

Figure 8-33: HSDPA IV Channel High

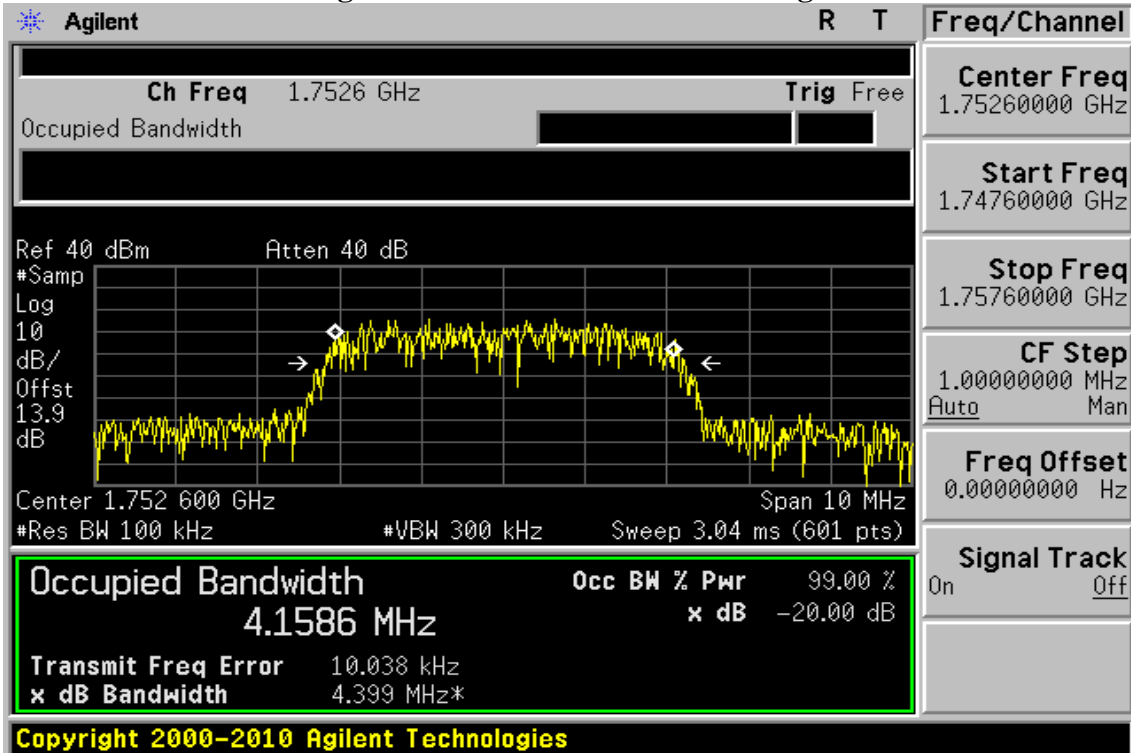
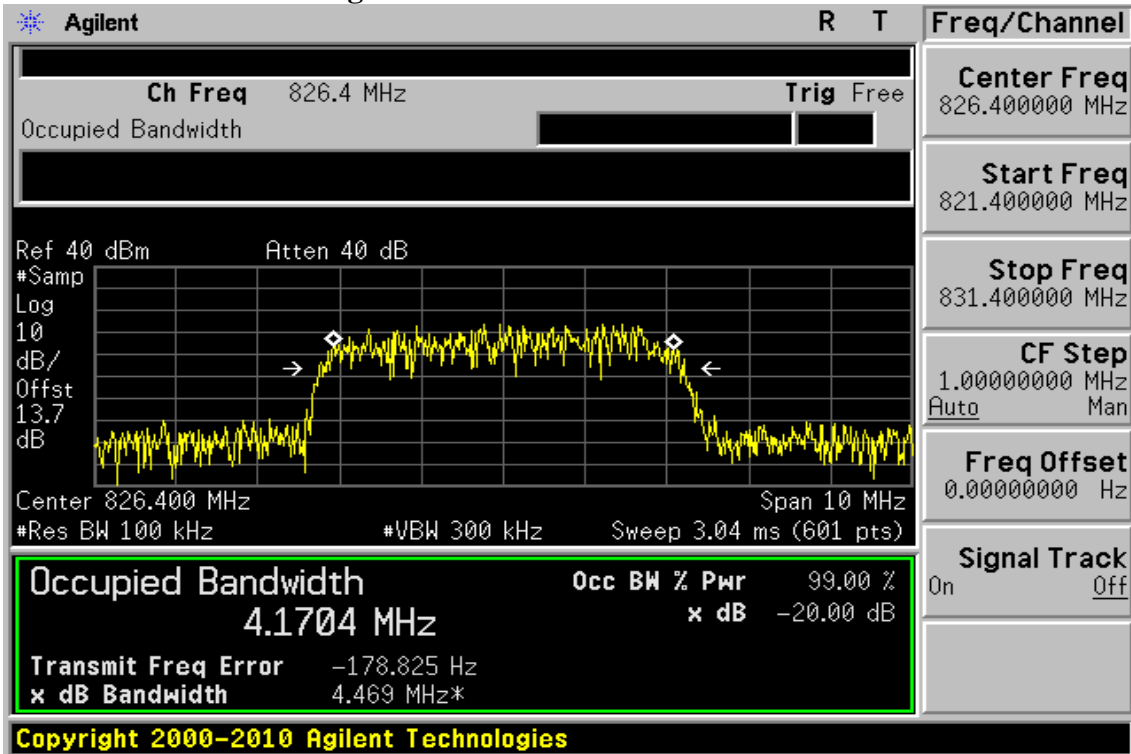

Figure 8-34: HSDPA V Channel Low



Unless otherwise stated the results shown in this test report refer only to the sample(s) tested and such sample(s) are retained for 90 days only.

除非另有說明，此報告結果僅對測試之樣品負責，同時此樣品僅保留90天。本報告未經本公司書面許可，不可部份複製。

This document is issued by the Company subject to its General Conditions of Service printed overleaf, available on request or accessible at www.sgs.com/terms_and_conditions.htm and, for electronic format documents, subject to Terms and Conditions for Electronic Documents at www.sgs.com/terms_e-document.htm. Attention is drawn to the limitation of liability, indemnification and jurisdiction issues defined therein. Any holder of this document is advised that information contained hereon reflects the Company's findings at the time of its intervention only and within the limits of Client's instructions, if any. The Company's sole responsibility is to its Client and this document does not exonerate parties to a transaction from exercising all their rights and obligations under the transaction documents. This document cannot be reproduced except in full, without prior written approval of the Company. Any unauthorized alteration, forgery or falsification of the content or appearance of this document is unlawful and offenders may be prosecuted to the fullest extent of the law.

Figure 8-35: HSDPA V Channel Mid

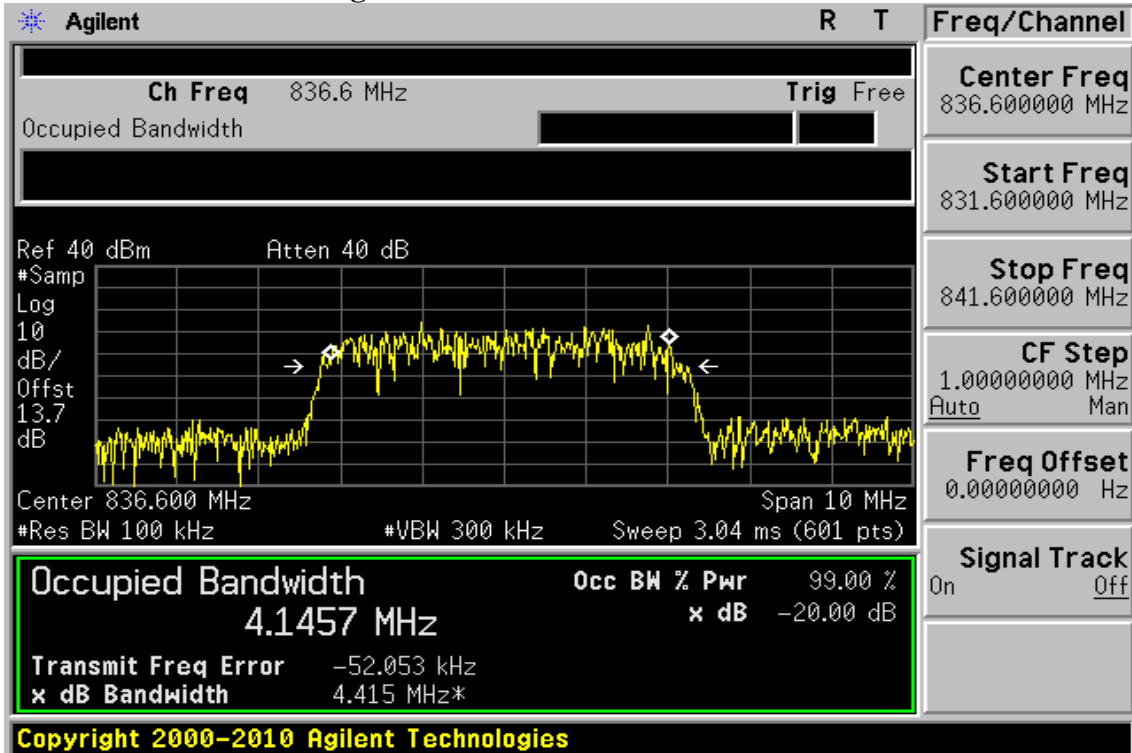
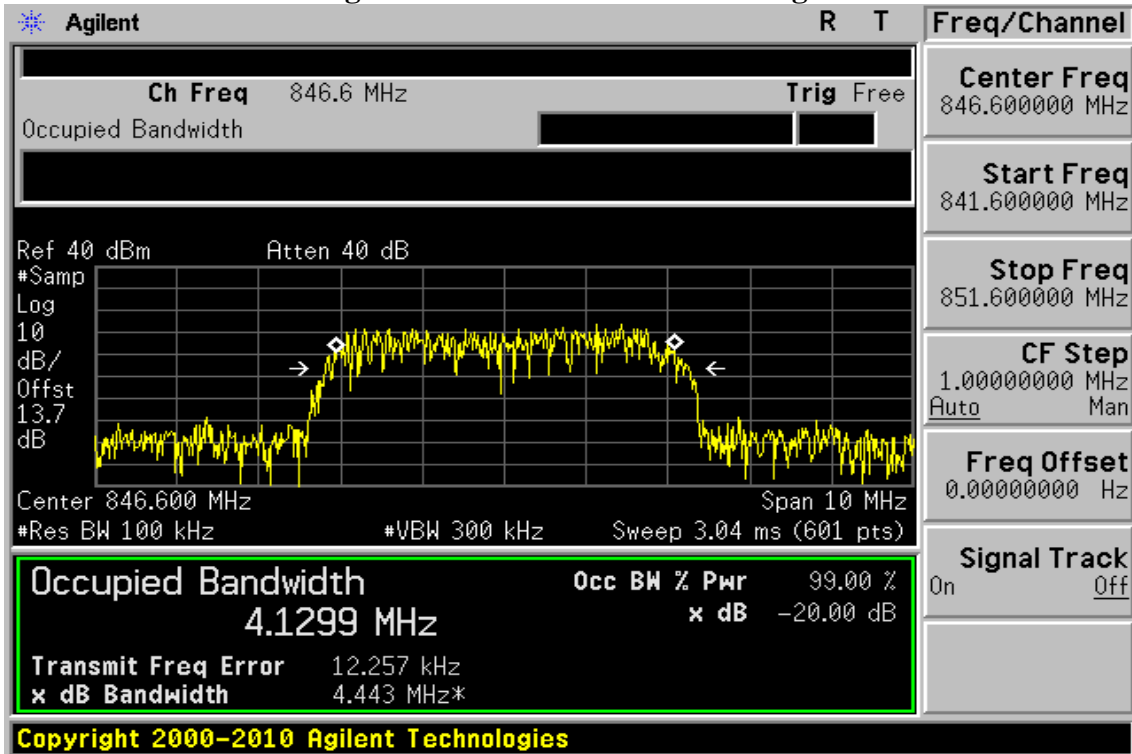

Figure 8-36: HSDPA V Channel High



Unless otherwise stated the results shown in this test report refer only to the sample(s) tested and such sample(s) are retained for 90 days only.

除非另有說明，此報告結果僅對測試之樣品負責，同時此樣品僅保留90天。本報告未經本公司書面許可，不可部份複製。

This document is issued by the Company subject to its General Conditions of Service printed overleaf, available on request or accessible at www.sgs.com/terms_and_conditions.htm and, for electronic format documents, subject to Terms and Conditions for Electronic Documents at www.sgs.com/terms_e-document.htm. Attention is drawn to the limitation of liability, indemnification and jurisdiction issues defined therein. Any holder of this document is advised that information contained hereon reflects the Company's findings at the time of its intervention only and within the limits of Client's instructions, if any. The Company's sole responsibility is to its Client and this document does not exonerate parties to a transaction from exercising all their rights and obligations under the transaction documents. This document cannot be reproduced except in full, without prior written approval of the Company. Any unauthorized alteration, forgery or falsification of the content or appearance of this document is unlawful and offenders may be prosecuted to the fullest extent of the law.

Figure 8-37: HSUPA II Channel Low

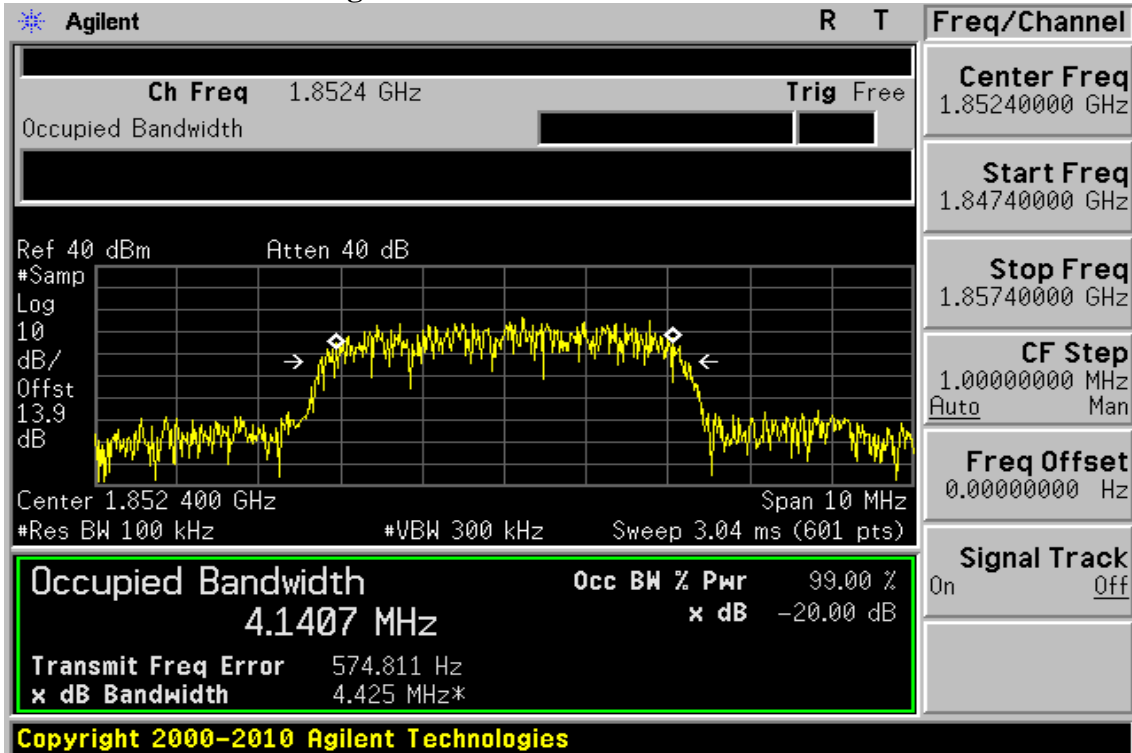
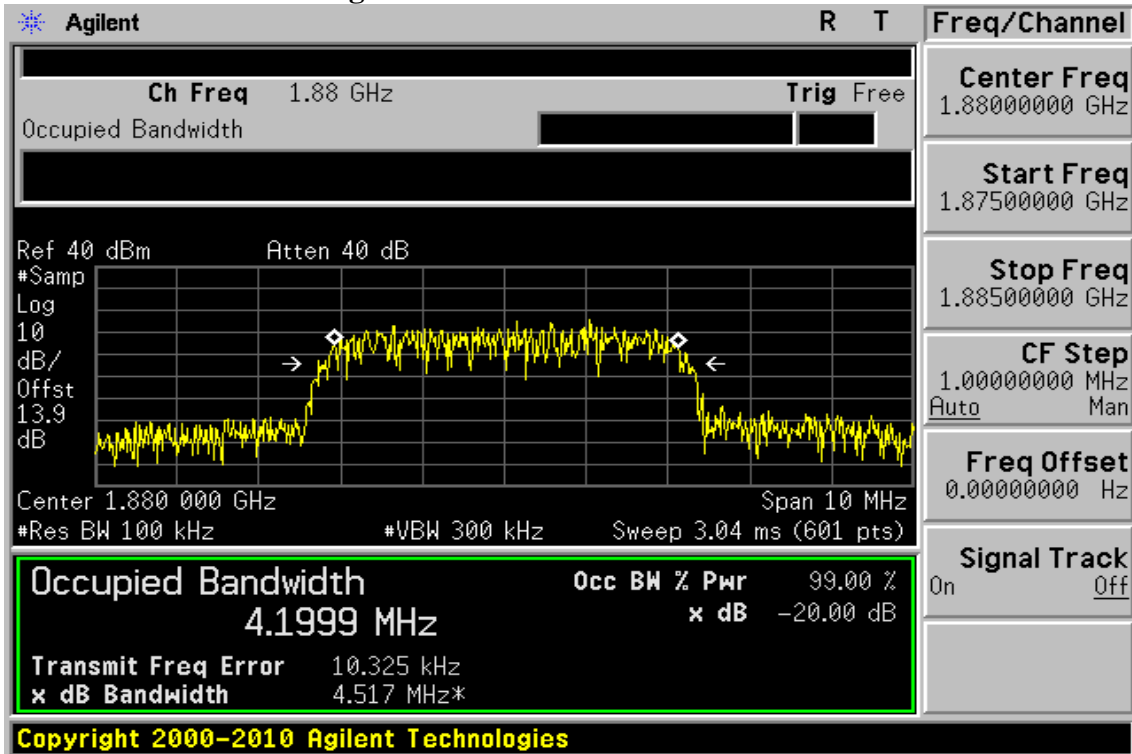

Figure 8-38: HSUPA II Channel Mid



Unless otherwise stated the results shown in this test report refer only to the sample(s) tested and such sample(s) are retained for 90 days only.

除非另有說明，此報告結果僅對測試之樣品負責，同時此樣品僅保留90天。本報告未經本公司書面許可，不可部份複製。

This document is issued by the Company subject to its General Conditions of Service printed overleaf, available on request or accessible at www.sgs.com/terms_and_conditions.htm and, for electronic format documents, subject to Terms and Conditions for Electronic Documents at www.sgs.com/terms_e-document.htm. Attention is drawn to the limitation of liability, indemnification and jurisdiction issues defined therein. Any holder of this document is advised that information contained hereon reflects the Company's findings at the time of its intervention only and within the limits of Client's instructions, if any. The Company's sole responsibility is to its Client and this document does not exonerate parties to a transaction from exercising all their rights and obligations under the transaction documents. This document cannot be reproduced except in full, without prior written approval of the Company. Any unauthorized alteration, forgery or falsification of the content or appearance of this document is unlawful and offenders may be prosecuted to the fullest extent of the law.

Figure 8-39: HSUPA II Channel High

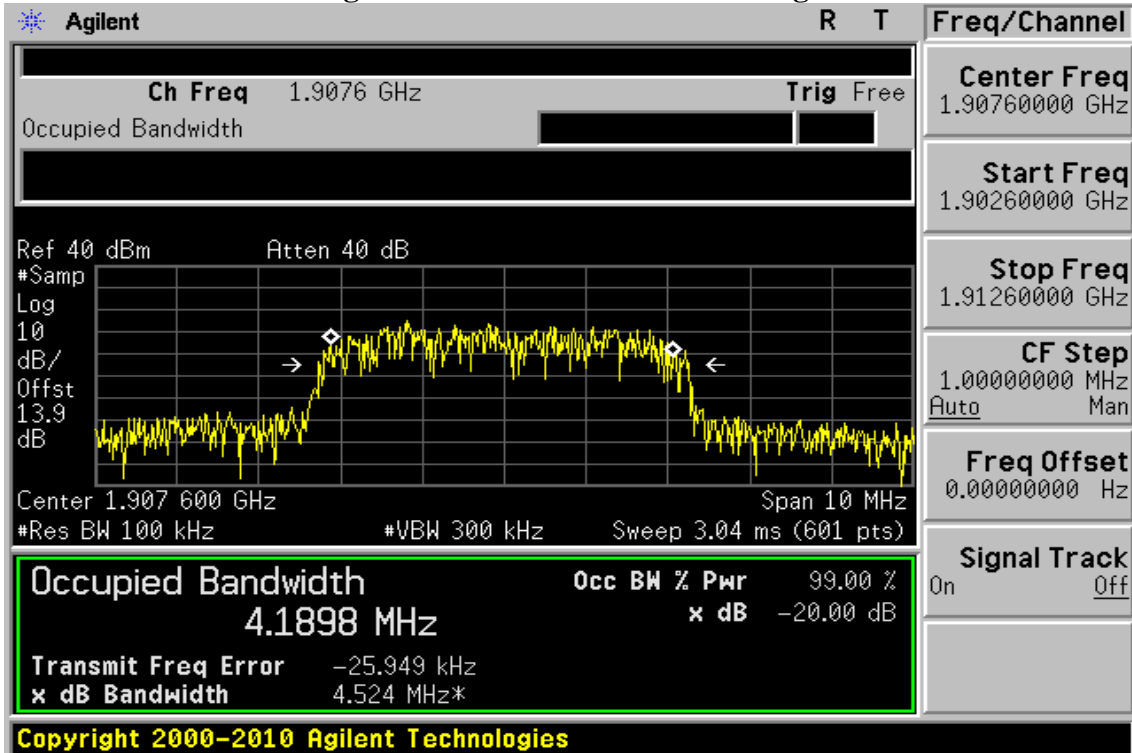
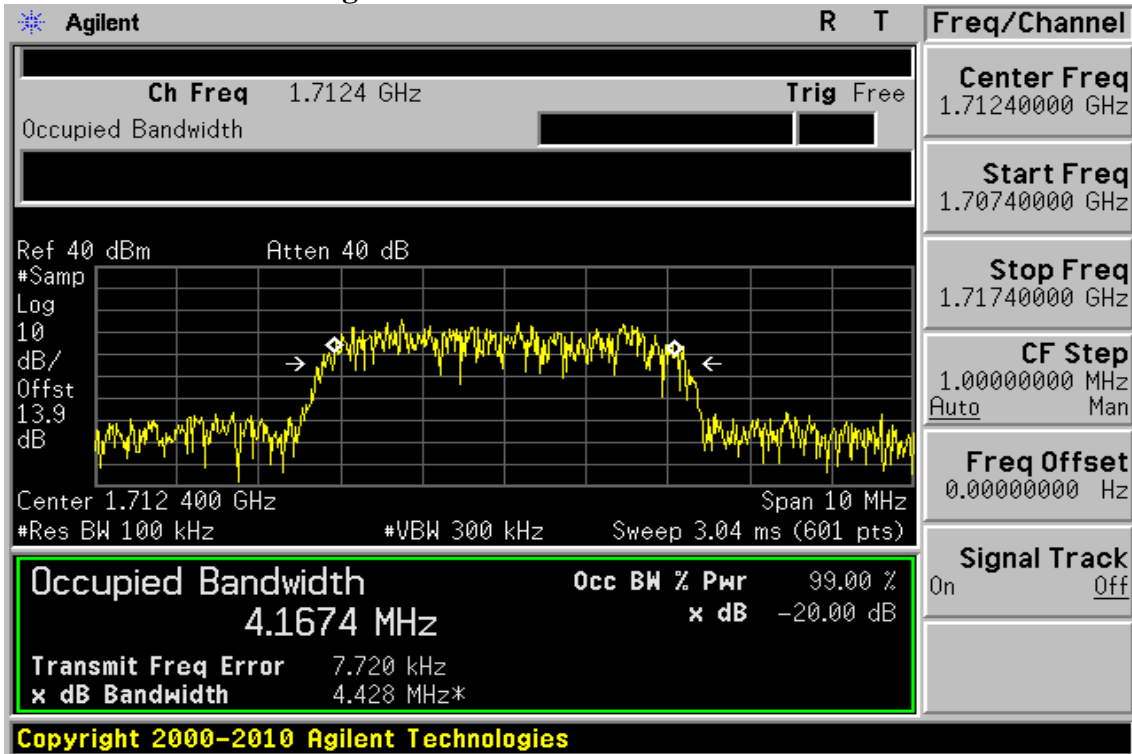

Figure 8-40: HSUPA IV Channel Low



Unless otherwise stated the results shown in this test report refer only to the sample(s) tested and such sample(s) are retained for 90 days only.

除非另有說明，此報告結果僅對測試之樣品負責，同時此樣品僅保留90天。本報告未經本公司書面許可，不可部份複製。

This document is issued by the Company subject to its General Conditions of Service printed overleaf, available on request or accessible at www.sgs.com/terms_and_conditions.htm and, for electronic format documents, subject to Terms and Conditions for Electronic Documents at www.sgs.com/terms_e-document.htm. Attention is drawn to the limitation of liability, indemnification and jurisdiction issues defined therein. Any holder of this document is advised that information contained hereon reflects the Company's findings at the time of its intervention only and within the limits of Client's instructions, if any. The Company's sole responsibility is to its Client and this document does not exonerate parties to a transaction from exercising all their rights and obligations under the transaction documents. This document cannot be reproduced except in full, without prior written approval of the Company. Any unauthorized alteration, forgery or falsification of the content or appearance of this document is unlawful and offenders may be prosecuted to the fullest extent of the law.

Figure 8-41: HSUPA IV Channel Mid

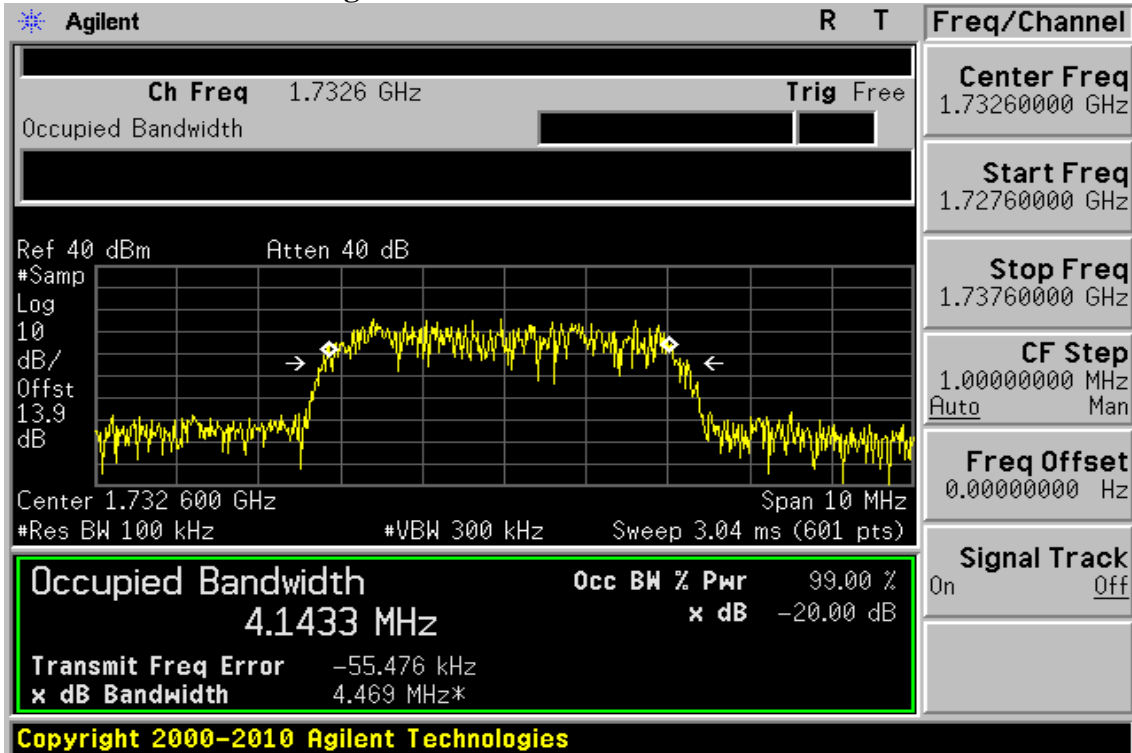
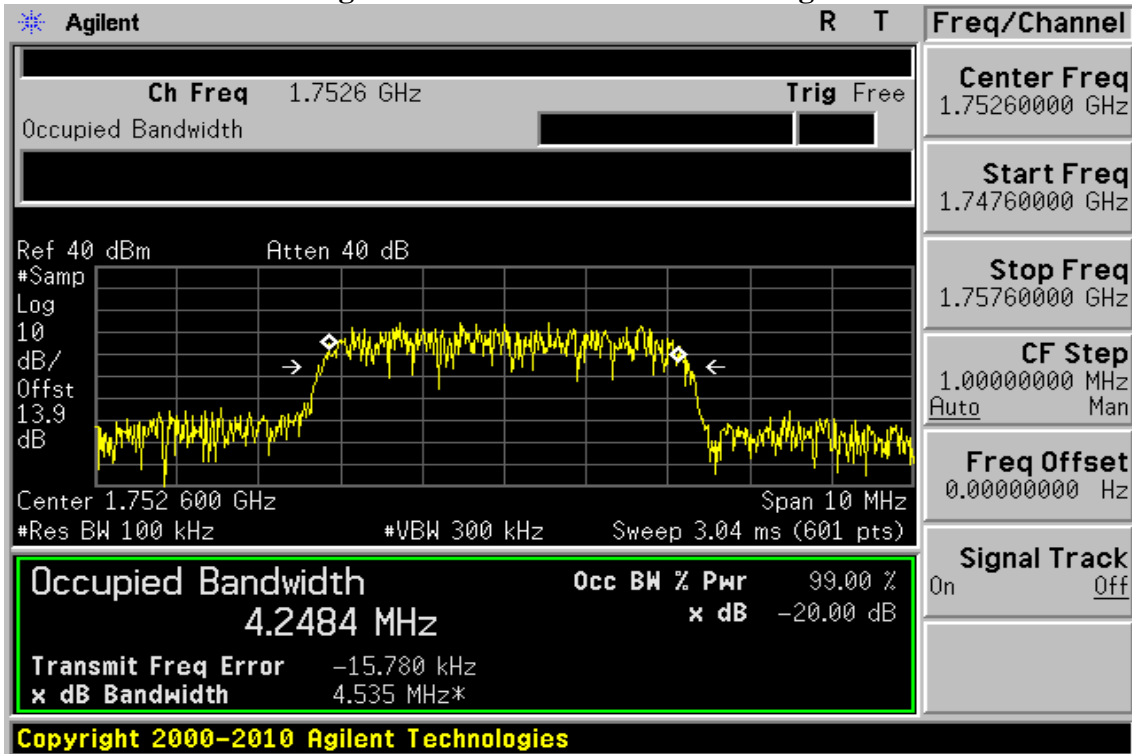

Figure 8-42: HSUPA IV Channel High



Unless otherwise stated the results shown in this test report refer only to the sample(s) tested and such sample(s) are retained for 90 days only.

除非另有說明，此報告結果僅對測試之樣品負責，同時此樣品僅保留90天。本報告未經本公司書面許可，不可部份複製。

This document is issued by the Company subject to its General Conditions of Service printed overleaf, available on request or accessible at www.sgs.com/terms_and_conditions.htm and, for electronic format documents, subject to Terms and Conditions for Electronic Documents at www.sgs.com/terms_e-document.htm. Attention is drawn to the limitation of liability, indemnification and jurisdiction issues defined therein. Any holder of this document is advised that information contained hereon reflects the Company's findings at the time of its intervention only and within the limits of Client's instructions, if any. The Company's sole responsibility is to its Client and this document does not exonerate parties to a transaction from exercising all their rights and obligations under the transaction documents. This document cannot be reproduced except in full, without prior written approval of the Company. Any unauthorized alteration, forgery or falsification of the content or appearance of this document is unlawful and offenders may be prosecuted to the fullest extent of the law.

Figure 8-43: HSUPA V Channel Low

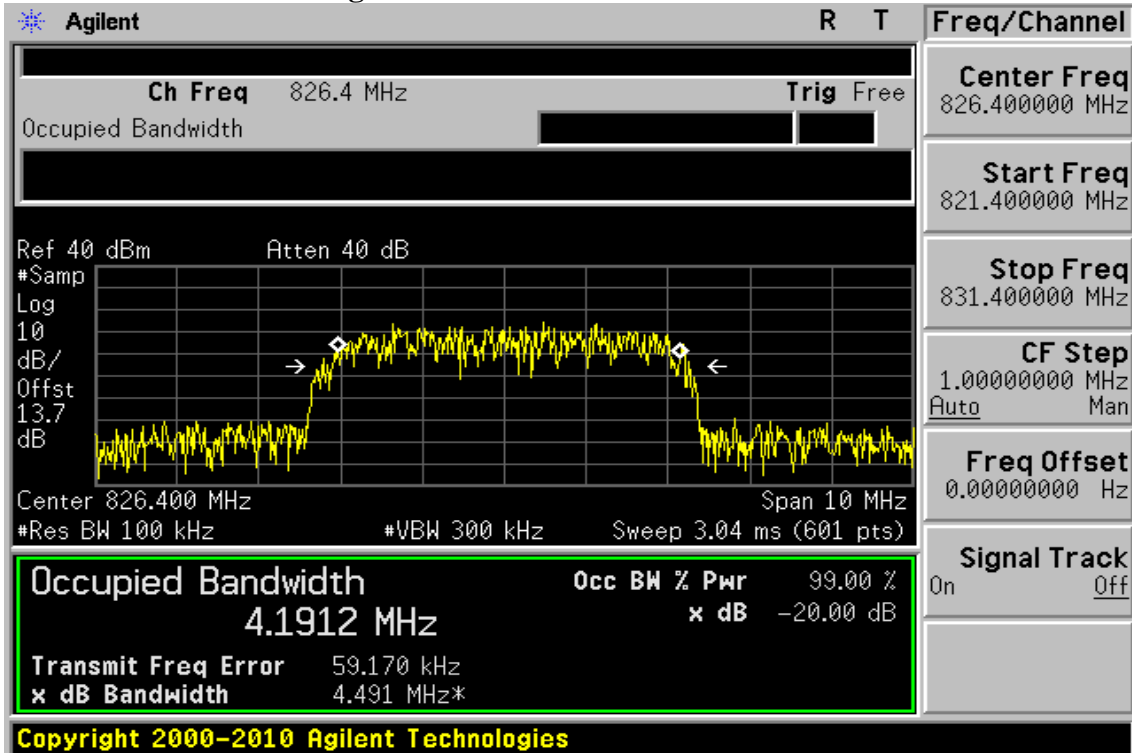
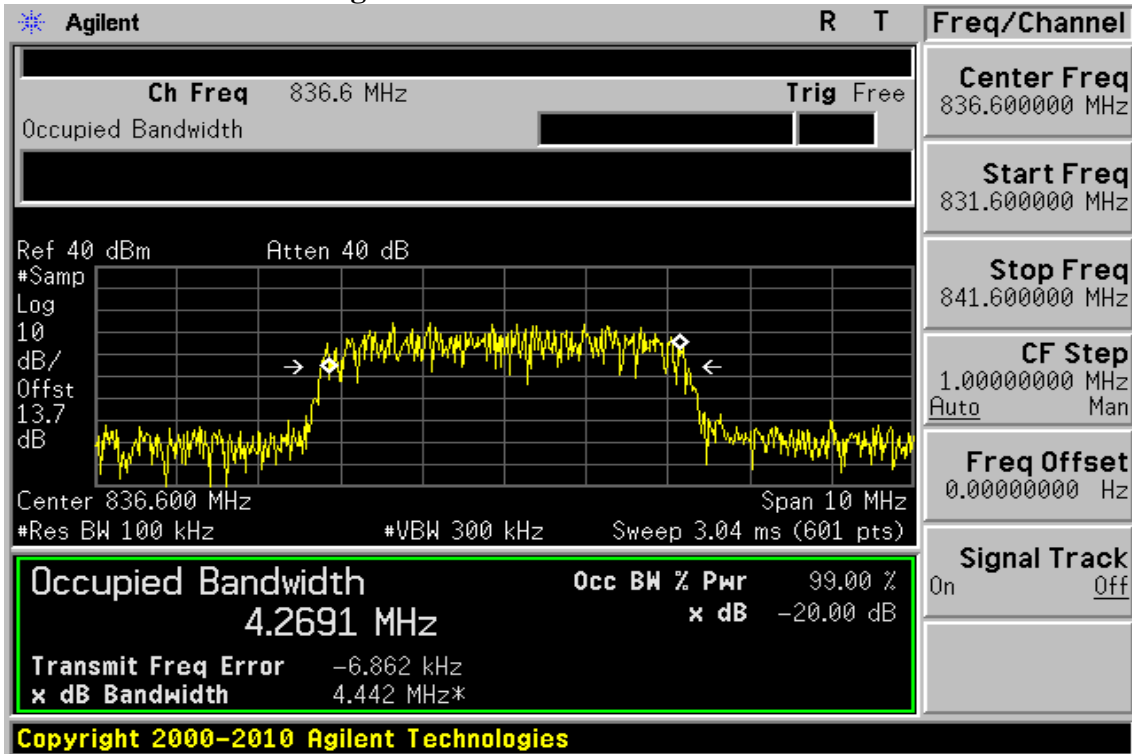

Figure 8-44: HSUPA V Channel Mid



Unless otherwise stated the results shown in this test report refer only to the sample(s) tested and such sample(s) are retained for 90 days only.

除非另有說明，此報告結果僅對測試之樣品負責，同時此樣品僅保留90天。本報告未經本公司書面許可，不可部份複製。

This document is issued by the Company subject to its General Conditions of Service printed overleaf, available on request or accessible at www.sgs.com/terms_and_conditions.htm and, for electronic format documents, subject to Terms and Conditions for Electronic Documents at www.sgs.com/terms_e-document.htm. Attention is drawn to the limitation of liability, indemnification and jurisdiction issues defined therein. Any holder of this document is advised that information contained hereon reflects the Company's findings at the time of its intervention only and within the limits of Client's instructions, if any. The Company's sole responsibility is to its Client and this document does not exonerate parties to a transaction from exercising all their rights and obligations under the transaction documents. This document cannot be reproduced except in full, without prior written approval of the Company. Any unauthorized alteration, forgery or falsification of the content or appearance of this document is unlawful and offenders may be prosecuted to the fullest extent of the law.

Figure 8-45: HSUPA V Channel High

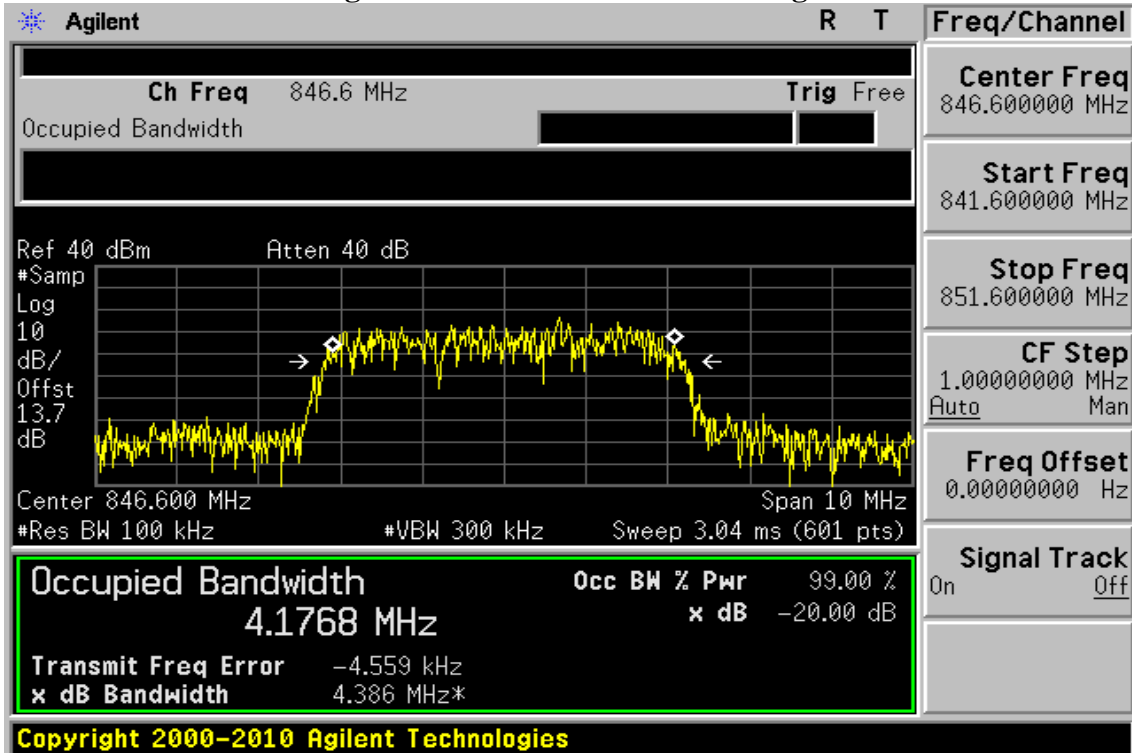

Unless otherwise stated the results shown in this test report refer only to the sample(s) tested and such sample(s) are retained for 90 days only.

除非另有說明，此報告結果僅對測試之樣品負責，同時此樣品僅保留90天。本報告未經本公司書面許可，不可部份複製。

This document is issued by the Company subject to its General Conditions of Service printed overleaf, available on request or accessible at www.sgs.com/terms_and_conditions.htm and, for electronic format documents, subject to Terms and Conditions for Electronic Documents at www.sgs.com/terms_e-document.htm. Attention is drawn to the limitation of liability, indemnification and jurisdiction issues defined therein. Any holder of this document is advised that information contained hereon reflects the Company's findings at the time of its intervention only and within the limits of Client's instructions, if any. The Company's sole responsibility is to its Client and this document does not exonerate parties to a transaction from exercising all their rights and obligations under the transaction documents. This document cannot be reproduced except in full, without prior written approval of the Company. Any unauthorized alteration, forgery or falsification of the content or appearance of this document is unlawful and offenders may be prosecuted to the fullest extent of the law.

9. OUT OF BAND EMISSION AT ANTENNA TERMINALS

9.1. Standard Applicable:

According to FCC §2.1051.

FCC §22.917(a), §24.238(a), §27.53(h) the magnitude of each spurious and harmonic emission that can be detected when the equipment is operated under the conditions specified in the instruction manual and/ or alignment procedure, shall not be less than $43 + 10 \log$ (mean output power in watts) dBc below the mean power output outside a license's frequency block (-13dBm).

According to RSS-132 §5.5

Mobile and base station equipment shall comply with the limits in (i) and (ii) below.

(i) In the first 1.0 MHz band immediately outside and adjacent to each of the sub-bands specified in Section 5.1, the power of emissions per any 1% of the occupied bandwidth shall be attenuated (in dB) below the transmitter output power P (dBW) by at least $43 + 10 \log_{10} p$ (watts).

(ii) After the first 1.0 MHz immediately outside and adjacent to each of the sub-bands, the power of emissions in any 100 kHz bandwidth shall be attenuated (in dB) below the transmitter output power P (dBW) by at least $43 + 10 \log_{10} p$ (watts). If the measurement is performed using 1% of the occupied bandwidth, power integration over 100 kHz is required.

According to RSS-133 §6.5

6.5.1 Out-of-Block Emissions

Equipment shall comply with the limits in (i) and (ii) below.

(i) In the 1.0 MHz bands immediately outside and adjacent to the equipment's operating frequency block, the emission power per any 1% of the emission bandwidth shall be attenuated (in dB) below the transmitter output power P (dBW) by at least $43 + 10 \log_{10} p$ (watts).

(ii) After the first 1.0 MHz, the emission power in any 1 MHz bandwidth shall be attenuated (in dB) below the transmitter output power P (dBW) by at least $43 + 10 \log_{10} p$ (watts). If the measurement is performed using 1% of the emission bandwidth, power integration over 1.0 MHz is required.

Unless otherwise stated the results shown in this test report refer only to the sample(s) tested and such sample(s) are retained for 90 days only.

除非另有說明，此報告結果僅對測試之樣品負責，同時此樣品僅保留90天。本報告未經本公司書面許可，不可部份複製。

This document is issued by the Company subject to its General Conditions of Service printed overleaf, available on request or accessible at www.sgs.com/terms_and_conditions.htm and, for electronic format documents, subject to Terms and Conditions for Electronic Documents at www.sgs.com/terms_e-document.htm. Attention is drawn to the limitation of liability, indemnification and jurisdiction issues defined therein. Any holder of this document is advised that information contained hereon reflects the Company's findings at the time of its intervention only and within the limits of Client's instructions, if any. The Company's sole responsibility is to its Client and this document does not exonerate parties to a transaction from exercising all their rights and obligations under the transaction documents. This document cannot be reproduced except in full, without prior written approval of the Company. Any unauthorized alteration, forgery or falsification of the content or appearance of this document is unlawful and offenders may be prosecuted to the fullest extent of the law.

According to RSS-139 §6.5

For Operation Band 1710-1755MHz and 2110-2155MHz

(i) In the first 1.0 MHz bands immediately outside and adjacent to the equipment's operating frequency block, the emission power per any 1% of the emission bandwidth shall be attenuated below the transmitter output power P (in watts) by at least $43 + 10 \log_{10}(P)$, dB. Limit = -13dBm

(ii) After the first 1.0 MHz outside the equipment's operating frequency block, the emission power in any 1 MHz bandwidth shall be attenuated below the transmitter output power P (in watts) by at least $43 + 10 \log_{10}(P)$, dB. Limit = -13dBm

Unless otherwise stated the results shown in this test report refer only to the sample(s) tested and such sample(s) are retained for 90 days only.

除非另有說明，此報告結果僅對測試之樣品負責，同時此樣品僅保留90天。本報告未經本公司書面許可，不可部份複製。

This document is issued by the Company subject to its General Conditions of Service printed overleaf, available on request or accessible at www.sgs.com/terms_and_conditions.htm and, for electronic format documents, subject to Terms and Conditions for Electronic Documents at www.sgs.com/terms_e-document.htm. Attention is drawn to the limitation of liability, indemnification and jurisdiction issues defined therein. Any holder of this document is advised that information contained hereon reflects the Company's findings at the time of its intervention only and within the limits of Client's instructions, if any. The Company's sole responsibility is to its Client and this document does not exonerate parties to a transaction from exercising all their rights and obligations under the transaction documents. This document cannot be reproduced except in full, without prior written approval of the Company. Any unauthorized alteration, forgery or falsification of the content or appearance of this document is unlawful and offenders may be prosecuted to the fullest extent of the law.

9.2. Test SET-UP:

Out of band emission

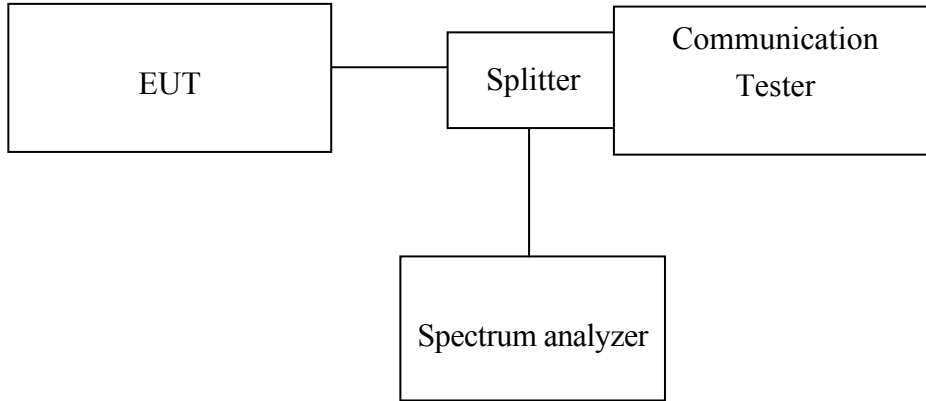

Band Edge

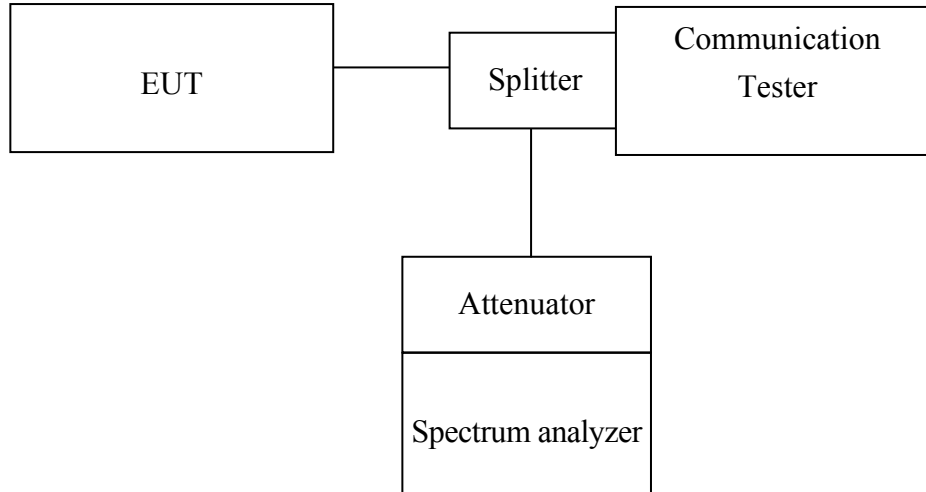

Unless otherwise stated the results shown in this test report refer only to the sample(s) tested and such sample(s) are retained for 90 days only.

除非另有說明，此報告結果僅對測試之樣品負責，同時此樣品僅保留90天。本報告未經本公司書面許可，不可部份複製。

This document is issued by the Company subject to its General Conditions of Service printed overleaf, available on request or accessible at www.sgs.com/terms_and_conditions.htm and, for electronic format documents, subject to Terms and Conditions for Electronic Documents at www.sgs.com/terms_e-document.htm. Attention is drawn to the limitation of liability, indemnification and jurisdiction issues defined therein. Any holder of this document is advised that information contained hereon reflects the Company's findings at the time of its intervention only and within the limits of Client's instructions, if any. The Company's sole responsibility is to its Client and this document does not exonerate parties to a transaction from exercising all their rights and obligations under the transaction documents. This document cannot be reproduced except in full, without prior written approval of the Company. Any unauthorized alteration, forgery or falsification of the content or appearance of this document is unlawful and offenders may be prosecuted to the fullest extent of the law.

9.3. Measurement Procedure:

The RF output of the transceiver was connected to a spectrum analyzer through appropriate attenuation. The resolution bandwidth of the spectrum analyzer was set at 1MHz, sufficient scans were taken to show the out of band Emissions if any up to 10th harmonic.

For the out of band: Set the RBW, VBW = 1MHz, Start=30MHz, Stop= 10 th harmonic. Limit = -13dBm.

Band Edge Requirements: In the 1 MHz bands immediately outside and adjacent to the frequency block, a resolution bandwidth of at least 1 percent of the emission bandwidth of the fundamental emission of the transmitter may be employed to measure the out of band Emissions. Limit, -13dBm.

h) For operations in the 1710–1755 MHz and 2110–2155 MHz bands, the power of any emission outside a licensee's frequency block shall be attenuated below the transmitter power (P) by at least $43 + 10 \log_{10}(P)$ dB. Limit, -13dBm

(1) Compliance with this provision is based on the use of measurement instrumentation employing a resolution bandwidth of 1 megahertz or greater. Limit, -13dBm

Conducted Emission:

- 1、 To connect Antenna Port of EUT to Spectrum.
- 2、 Set RBW = 1MHz & VBW = 1MHz on Spectrum.
- 3、 Sweep the frequency to determine spurious emission as seen on spectrum from span of 30 to 1G, 1G to 2.5G, 2.5G to 7.5G, 7.5G to 10G ,10G to 15G and 15G to 20GHz
- 4、 Via Software, combine 6 spans of frequency range into one plot

9.4. Measurement Equipment Used:

Refer to section 2.4 in this report

9.5. Measurement Result:

Refer to next pages.

NOTE: the occurrence of the spike on the conducted emission is the signal of the fundamental emission.

Unless otherwise stated the results shown in this test report refer only to the sample(s) tested and such sample(s) are retained for 90 days only.

除非另有說明，此報告結果僅對測試之樣品負責，同時此樣品僅保留90天。本報告未經本公司書面許可，不可部份複製。

This document is issued by the Company subject to its General Conditions of Service printed overleaf, available on request or accessible at www.sgs.com/terms_and_conditions.htm and, for electronic format documents, subject to Terms and Conditions for Electronic Documents at www.sgs.com/terms_e-document.htm. Attention is drawn to the limitation of liability, indemnification and jurisdiction issues defined therein. Any holder of this document is advised that information contained hereon reflects the Company's findings at the time of its intervention only and within the limits of Client's instructions, if any. The Company's sole responsibility is to its Client and this document does not exonerate parties to a transaction from exercising all their rights and obligations under the transaction documents. This document cannot be reproduced except in full, without prior written approval of the Company. Any unauthorized alteration, forgery or falsification of the content or appearance of this document is unlawful and offenders may be prosecuted to the fullest extent of the law.

Figure 9-1: Out of Band emission at antenna terminals – GSM 850 Channel Lowest

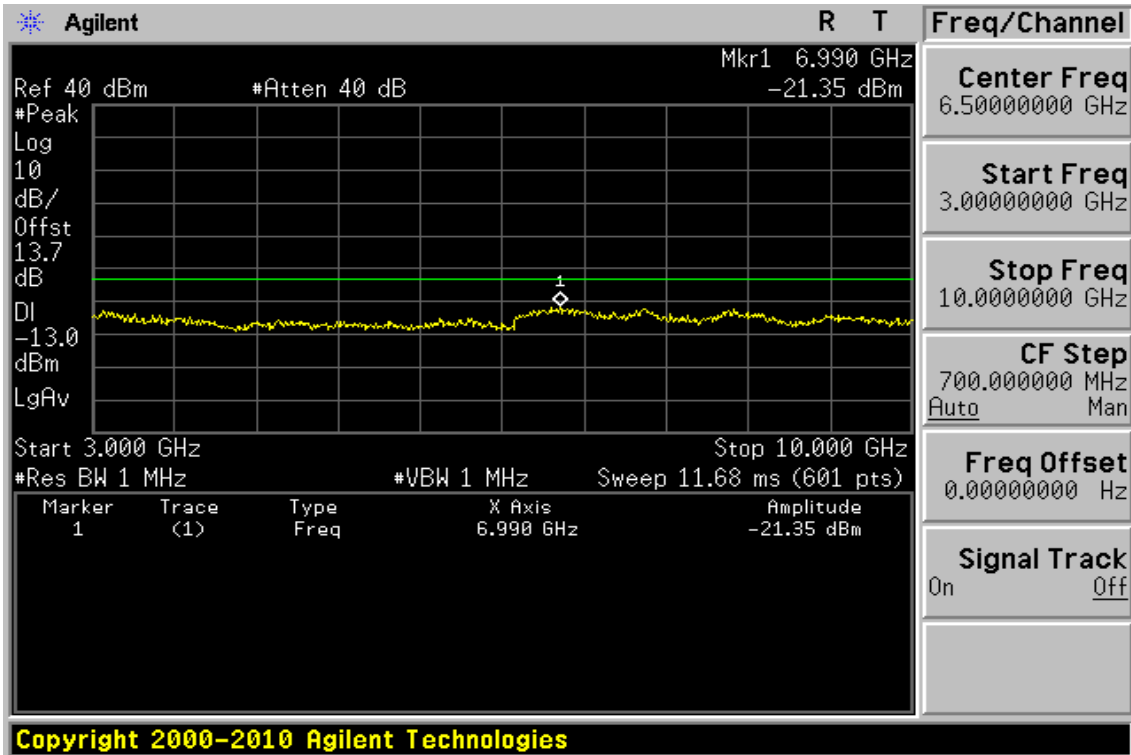
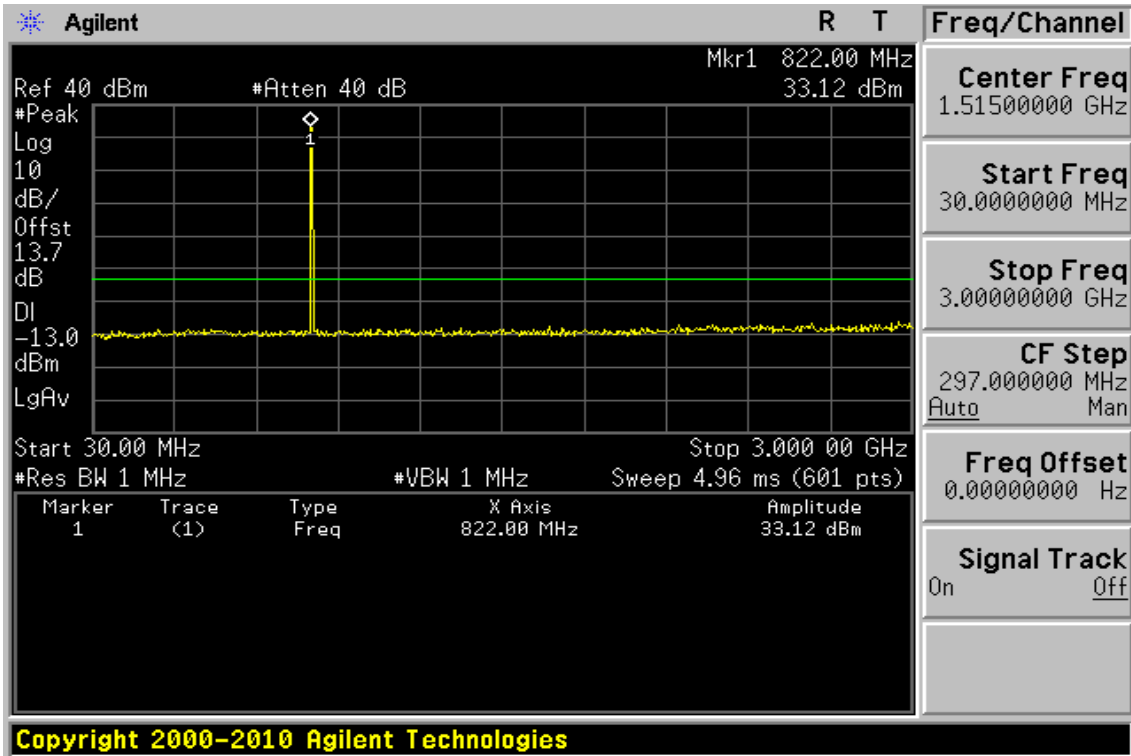

Unless otherwise stated the results shown in this test report refer only to the sample(s) tested and such sample(s) are retained for 90 days only.

除非另有說明，此報告結果僅對測試之樣品負責，同時此樣品僅保留90天。本報告未經本公司書面許可，不可部份複製。

This document is issued by the Company subject to its General Conditions of Service printed overleaf, available on request or accessible at www.sgs.com/terms_and_conditions.htm and, for electronic format documents, subject to Terms and Conditions for Electronic Documents at www.sgs.com/terms_e-document.htm. Attention is drawn to the limitation of liability, indemnification and jurisdiction issues defined therein. Any holder of this document is advised that information contained hereon reflects the Company's findings at the time of its intervention only and within the limits of Client's instructions, if any. The Company's sole responsibility is to its Client and this document does not exonerate parties to a transaction from exercising all their rights and obligations under the transaction documents. This document cannot be reproduced except in full, without prior written approval of the Company. Any unauthorized alteration, forgery or falsification of the content or appearance of this document is unlawful and offenders may be prosecuted to the fullest extent of the law.

Figure 9-2: Out of Band emission at antenna terminals – GSM 850 Channel Mid

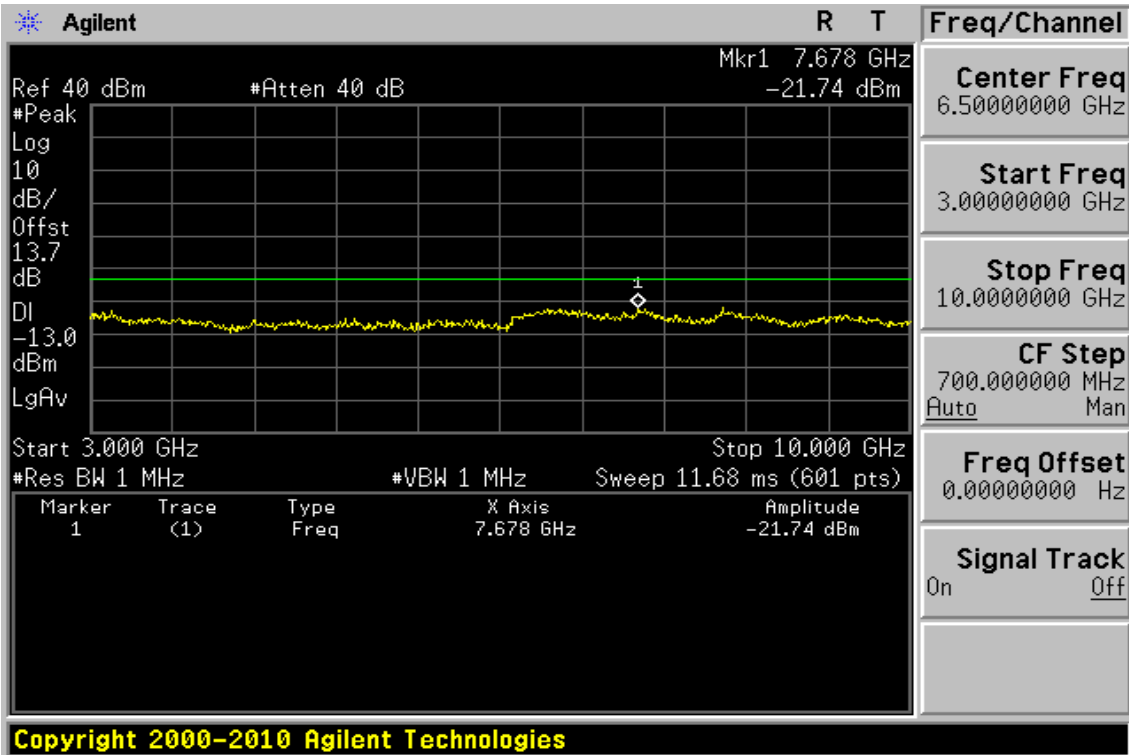
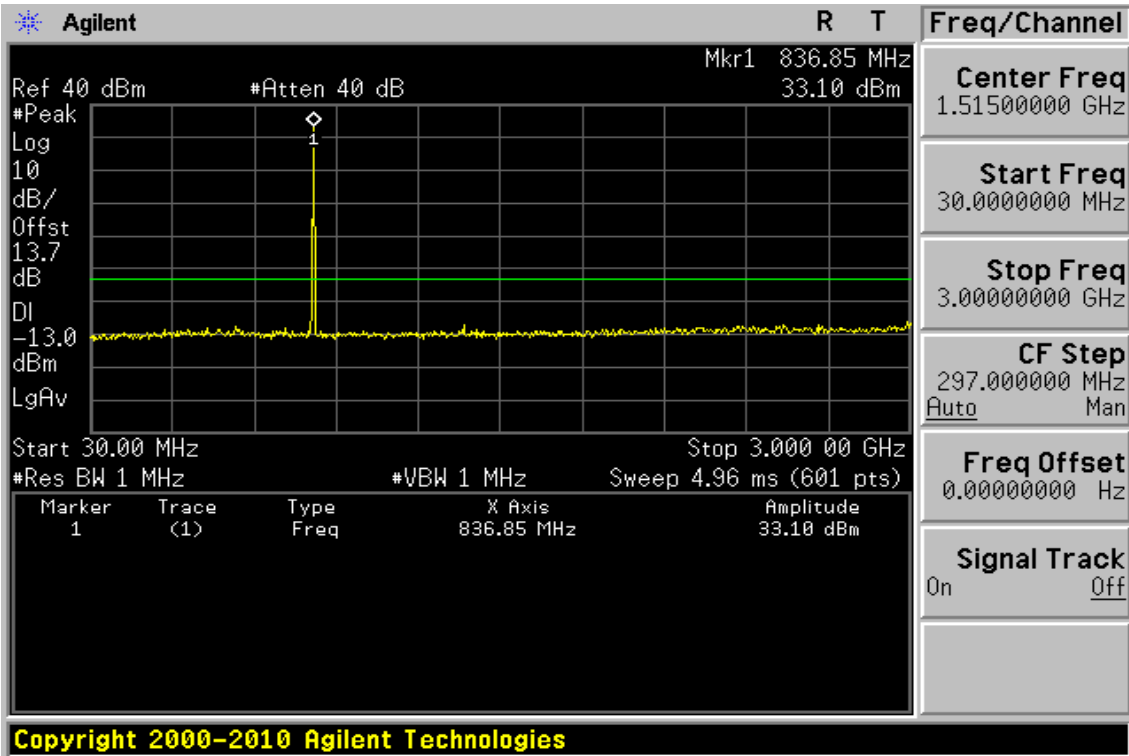

Unless otherwise stated the results shown in this test report refer only to the sample(s) tested and such sample(s) are retained for 90 days only.

除非另有說明，此報告結果僅對測試之樣品負責，同時此樣品僅保留90天。本報告未經本公司書面許可，不可部份複製。

This document is issued by the Company subject to its General Conditions of Service printed overleaf, available on request or accessible at www.sgs.com/terms_and_conditions.htm and, for electronic format documents, subject to Terms and Conditions for Electronic Documents at www.sgs.com/terms_e-document.htm. Attention is drawn to the limitation of liability, indemnification and jurisdiction issues defined therein. Any holder of this document is advised that information contained hereon reflects the Company's findings at the time of its intervention only and within the limits of Client's instructions, if any. The Company's sole responsibility is to its Client and this document does not exonerate parties to a transaction from exercising all their rights and obligations under the transaction documents. This document cannot be reproduced except in full, without prior written approval of the Company. Any unauthorized alteration, forgery or falsification of the content or appearance of this document is unlawful and offenders may be prosecuted to the fullest extent of the law.

Figure 9-3: Out of Band emission at antenna terminals – GSM 850 Channel Highest

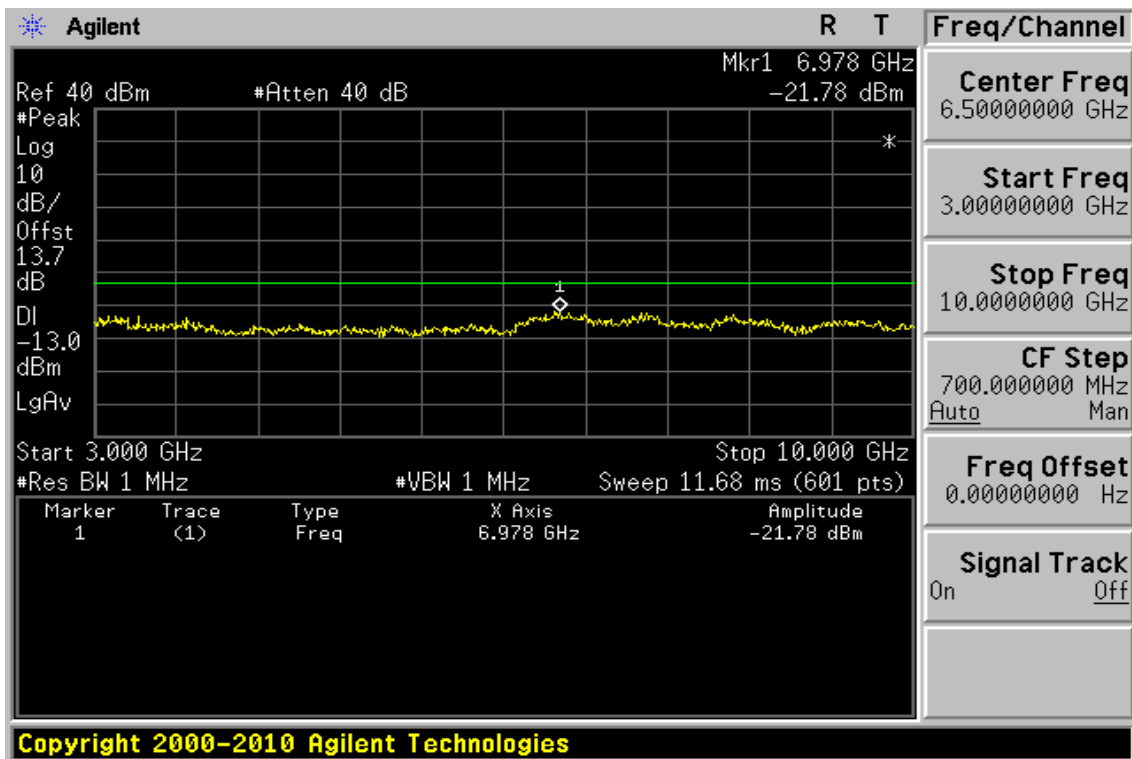
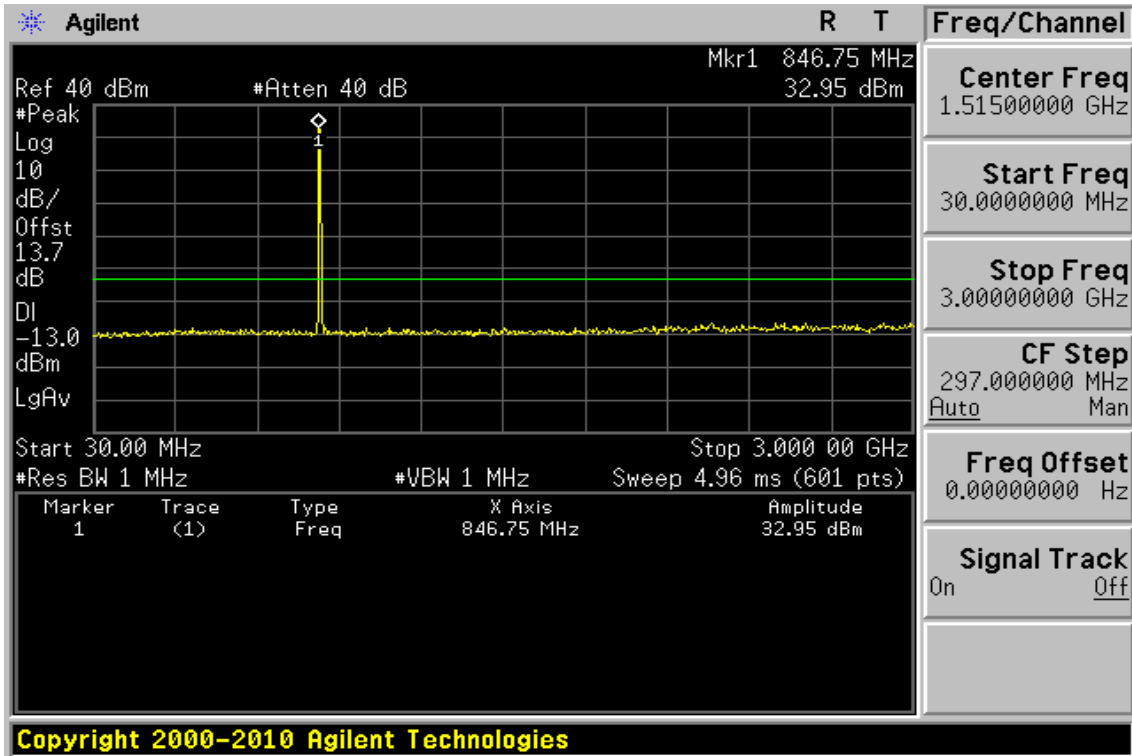

Unless otherwise stated the results shown in this test report refer only to the sample(s) tested and such sample(s) are retained for 90 days only.

除非另有說明，此報告結果僅對測試之樣品負責，同時此樣品僅保留90天。本報告未經本公司書面許可，不可部份複製。

This document is issued by the Company subject to its General Conditions of Service printed overleaf, available on request or accessible at www.sgs.com/terms_and_conditions.htm and, for electronic format documents, subject to Terms and Conditions for Electronic Documents at www.sgs.com/terms_e-document.htm. Attention is drawn to the limitation of liability, indemnification and jurisdiction issues defined therein. Any holder of this document is advised that information contained hereon reflects the Company's findings at the time of its intervention only and within the limits of Client's instructions, if any. The Company's sole responsibility is to its Client and this document does not exonerate parties to a transaction from exercising all their rights and obligations under the transaction documents. This document cannot be reproduced except in full, without prior written approval of the Company. Any unauthorized alteration, forgery or falsification of the content or appearance of this document is unlawful and offenders may be prosecuted to the fullest extent of the law.

Out of Band emission at antenna terminals – GSM 850

Fundamental Frequency :824.2 MHz Engineer :Nick
Operation Mode :TX Low

| Freq. (MHz) | Note F/H/E/S | Reading dBm | Limit dBm | Safe Margin dB |
|----------------|-----------------|----------------|--------------|----------------------|
| <30 | S | --- | -13.00 | --- |
| 30-1000 | S | --- | -13.00 | --- |
| 1648.40 | H | --- | -13.00 | --- |
| 2472.60 | H | --- | -13.00 | --- |
| 3296.80 | H | --- | -13.00 | --- |
| 4121.00 | H | --- | -13.00 | --- |
| 4945.20 | H | --- | -13.00 | --- |
| 5769.40 | H | --- | -13.00 | --- |
| 6593.60 | H | --- | -13.00 | --- |
| 6990.00 | S | -21.35 | -13.00 | 8.35 |
| 7417.80 | H | --- | -13.00 | --- |
| 8242.00 | H | --- | -13.00 | --- |

Note : “H” : denotes Harmonic Frequency. “S” : denotes Spurious Frequency.
“---” : denotes Noise Floor.

Unless otherwise stated the results shown in this test report refer only to the sample(s) tested and such sample(s) are retained for 90 days only.

除非另有說明，此報告結果僅對測試之樣品負責，同時此樣品僅保留90天。本報告未經本公司書面許可，不可部份複製。

This document is issued by the Company subject to its General Conditions of Service printed overleaf, available on request or accessible at www.sgs.com/terms_and_conditions.htm and, for electronic format documents, subject to Terms and Conditions for Electronic Documents at www.sgs.com/terms_e-document.htm. Attention is drawn to the limitation of liability, indemnification and jurisdiction issues defined therein. Any holder of this document is advised that information contained hereon reflects the Company's findings at the time of its intervention only and within the limits of Client's instructions, if any. The Company's sole responsibility is to its Client and this document does not exonerate parties to a transaction from exercising all their rights and obligations under the transaction documents. This document cannot be reproduced except in full, without prior written approval of the Company. Any unauthorized alteration, forgery or falsification of the content or appearance of this document is unlawful and offenders may be prosecuted to the fullest extent of the law.

Fundamental Frequency :836.6 MHz Engineer :Nick
Operation Mode :TX Mid

| Freq. (MHz) | Note F/H/E/S | Reading dBm | Limit dBm | Safe Margin dB |
|----------------|-----------------|----------------|--------------|----------------------|
| <30 | S | --- | -13.00 | --- |
| 30-1000 | S | --- | -13.00 | --- |
| 1673.20 | H | --- | -13.00 | --- |
| 2509.80 | H | --- | -13.00 | --- |
| 3346.40 | H | --- | -13.00 | --- |
| 4183.00 | H | --- | -13.00 | --- |
| 5019.60 | H | --- | -13.00 | --- |
| 5856.20 | H | --- | -13.00 | --- |
| 6692.80 | H | --- | -13.00 | --- |
| 7529.40 | H | --- | -13.00 | --- |
| 7678.00 | S | -21.74 | -13.00 | 8.74 |
| 8366.00 | H | --- | -13.00 | --- |

Note : “H” : denotes Harmonic Frequency. “S” : denotes Spurious Frequency.
“---” : denotes Noise Floor.

Unless otherwise stated the results shown in this test report refer only to the sample(s) tested and such sample(s) are retained for 90 days only.

除非另有說明，此報告結果僅對測試之樣品負責，同時此樣品僅保留90天。本報告未經本公司書面許可，不可部份複製。

This document is issued by the Company subject to its General Conditions of Service printed overleaf, available on request or accessible at www.sgs.com/terms_and_conditions.htm and, for electronic format documents, subject to Terms and Conditions for Electronic Documents at www.sgs.com/terms_e-document.htm. Attention is drawn to the limitation of liability, indemnification and jurisdiction issues defined therein. Any holder of this document is advised that information contained hereon reflects the Company's findings at the time of its intervention only and within the limits of Client's instructions, if any. The Company's sole responsibility is to its Client and this document does not exonerate parties to a transaction from exercising all their rights and obligations under the transaction documents. This document cannot be reproduced except in full, without prior written approval of the Company. Any unauthorized alteration, forgery or falsification of the content or appearance of this document is unlawful and offenders may be prosecuted to the fullest extent of the law.

Fundamental Frequency :848.8MHz Engineer :Nick
Operation Mode :TX High

| Freq. (MHz) | Note F/H/E/S | Reading dBm | Limit dBm | Safe Margin dB |
|----------------|-----------------|----------------|--------------|----------------------|
| <30 | S | --- | -13.00 | --- |
| 30-1000 | S | --- | -13.00 | --- |
| 1697.60 | H | --- | -13.00 | --- |
| 2546.40 | H | --- | -13.00 | --- |
| 3395.20 | H | --- | -13.00 | --- |
| 4244.00 | H | --- | -13.00 | --- |
| 5092.80 | H | --- | -13.00 | --- |
| 5941.60 | H | --- | -13.00 | --- |
| 6790.40 | H | --- | -13.00 | --- |
| 6978.00 | S | -21.78 | -13.00 | 8.78 |
| 7639.20 | H | --- | -13.00 | --- |
| 8488.00 | H | --- | -13.00 | --- |

Note : "H" : denotes Harmonic Frequency. "S" : denotes Spurious Frequency.
"---" : denotes Noise Floor.

Unless otherwise stated the results shown in this test report refer only to the sample(s) tested and such sample(s) are retained for 90 days only.

除非另有說明，此報告結果僅對測試之樣品負責，同時此樣品僅保留90天。本報告未經本公司書面許可，不可部份複製。

This document is issued by the Company subject to its General Conditions of Service printed overleaf, available on request or accessible at www.sgs.com/terms_and_conditions.htm and, for electronic format documents, subject to Terms and Conditions for Electronic Documents at www.sgs.com/terms_e-document.htm. Attention is drawn to the limitation of liability, indemnification and jurisdiction issues defined therein. Any holder of this document is advised that information contained hereon reflects the Company's findings at the time of its intervention only and within the limits of Client's instructions, if any. The Company's sole responsibility is to its Client and this document does not exonerate parties to a transaction from exercising all their rights and obligations under the transaction documents. This document cannot be reproduced except in full, without prior written approval of the Company. Any unauthorized alteration, forgery or falsification of the content or appearance of this document is unlawful and offenders may be prosecuted to the fullest extent of the law.

Figure 9-4: Band edge emission at antenna terminals – GSM 850 Channel Lowest

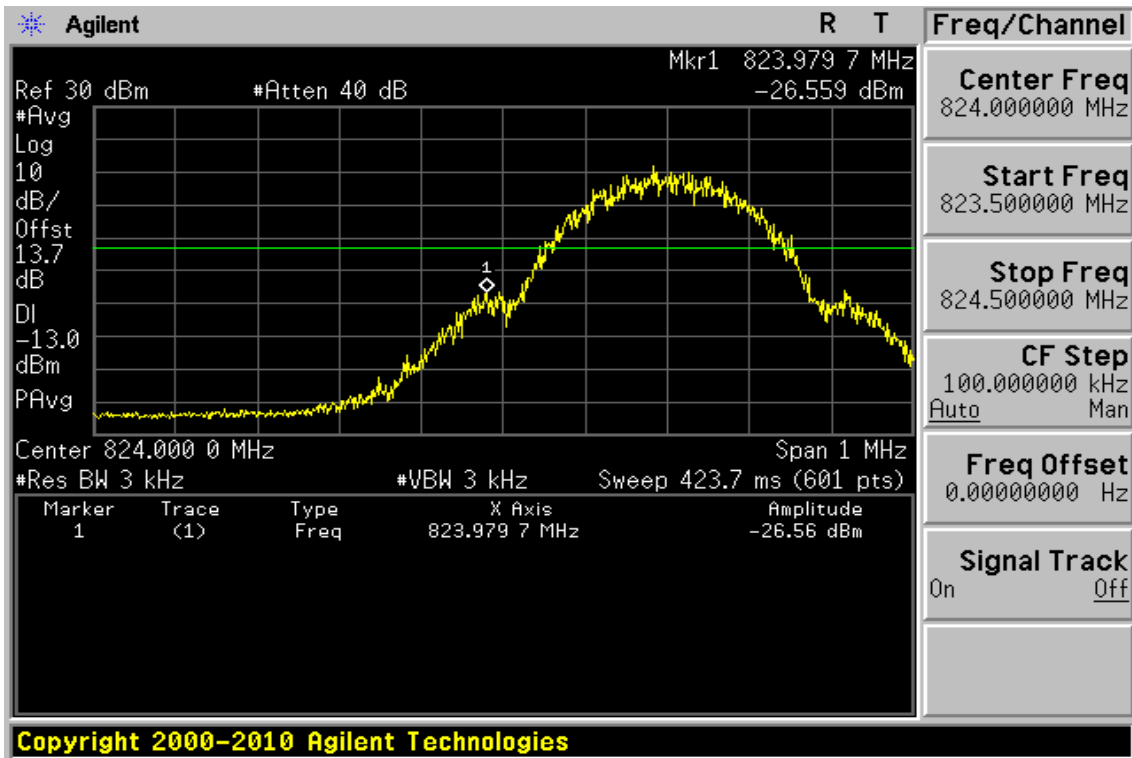
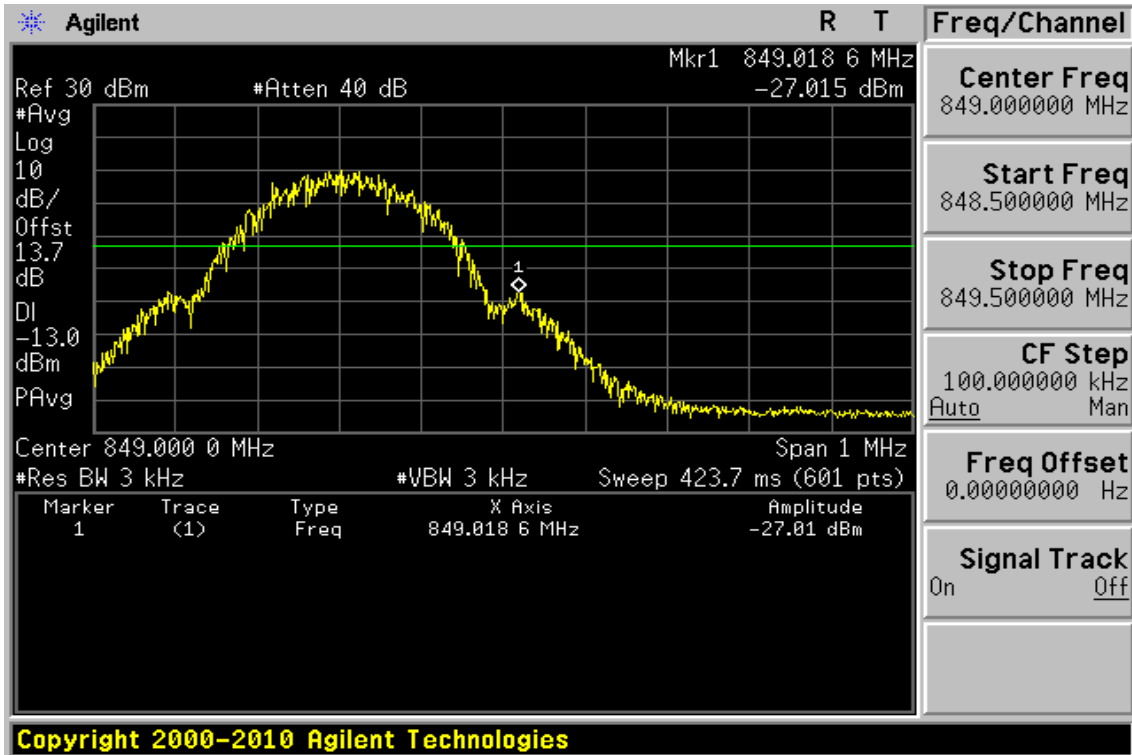

Figure 9-5: Band edge emission at antenna terminals – GSM 850 Channel Highest



Unless otherwise stated the results shown in this test report refer only to the sample(s) tested and such sample(s) are retained for 90 days only.

除非另有說明，此報告結果僅對測試之樣品負責，同時此樣品僅保留90天。本報告未經本公司書面許可，不可部份複製。

This document is issued by the Company subject to its General Conditions of Service printed overleaf, available on request or accessible at www.sgs.com/terms_and_conditions.htm and, for electronic format documents, subject to Terms and Conditions for Electronic Documents at www.sgs.com/terms_e-document.htm. Attention is drawn to the limitation of liability, indemnification and jurisdiction issues defined therein. Any holder of this document is advised that information contained hereon reflects the Company's findings at the time of its intervention only and within the limits of Client's instructions, if any. The Company's sole responsibility is to its Client and this document does not exonerate parties to a transaction from exercising all their rights and obligations under the transaction documents. This document cannot be reproduced except in full, without prior written approval of the Company. Any unauthorized alteration, forgery or falsification of the content or appearance of this document is unlawful and offenders may be prosecuted to the fullest extent of the law.

Band edge emission at antenna terminals – GSM 850 Low & High

Test Mode GSM 850 Engineer :Nick

| Freq. MHz | Reading dBm | Limit dBm | Safe Margin dB |
|--------------|----------------|--------------|----------------------|
| 823.979 | -26.56 | -13.00 | 13.56 |
| 849.018 | -27.02 | -13.00 | 14.02 |

Unless otherwise stated the results shown in this test report refer only to the sample(s) tested and such sample(s) are retained for 90 days only.

除非另有說明，此報告結果僅對測試之樣品負責，同時此樣品僅保留90天。本報告未經本公司書面許可，不可部份複製。

This document is issued by the Company subject to its General Conditions of Service printed overleaf, available on request or accessible at www.sgs.com/terms_and_conditions.htm and, for electronic format documents, subject to Terms and Conditions for Electronic Documents at www.sgs.com/terms_e-document.htm. Attention is drawn to the limitation of liability, indemnification and jurisdiction issues defined therein. Any holder of this document is advised that information contained hereon reflects the Company's findings at the time of its intervention only and within the limits of Client's instructions, if any. The Company's sole responsibility is to its Client and this document does not exonerate parties to a transaction from exercising all their rights and obligations under the transaction documents. This document cannot be reproduced except in full, without prior written approval of the Company. Any unauthorized alteration, forgery or falsification of the content or appearance of this document is unlawful and offenders may be prosecuted to the fullest extent of the law.

Figure 9-6: Out of Band emission at antenna terminals – GSM 1900 Channel Lowest

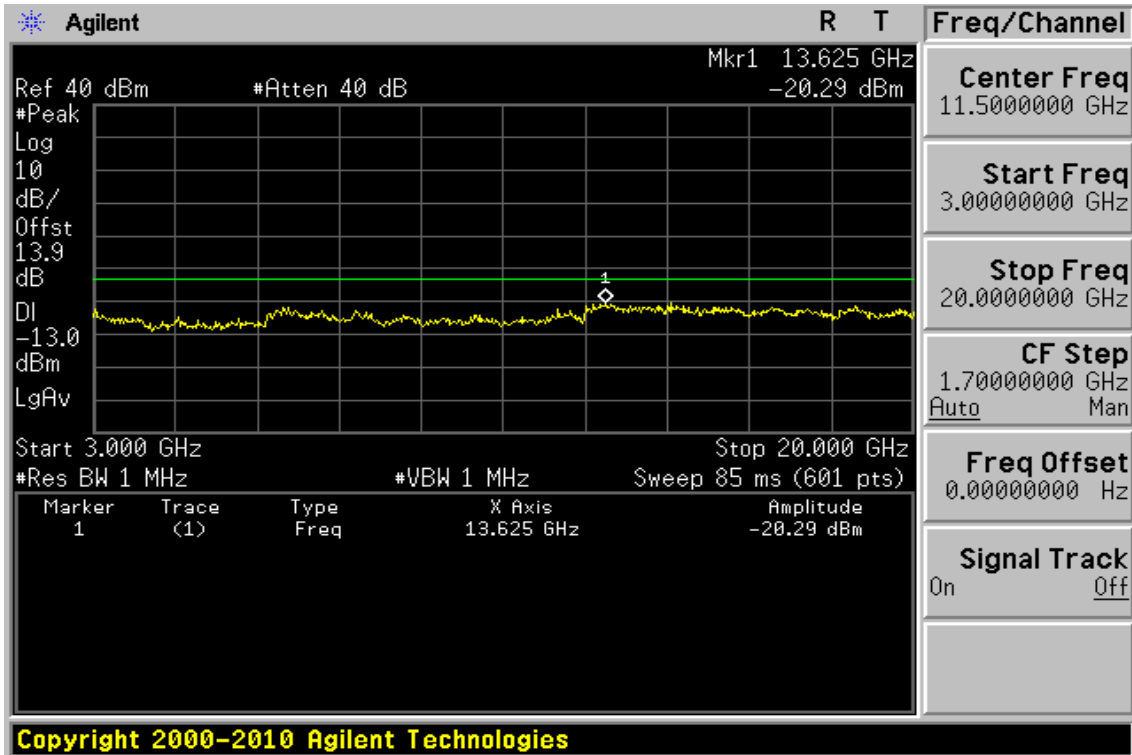
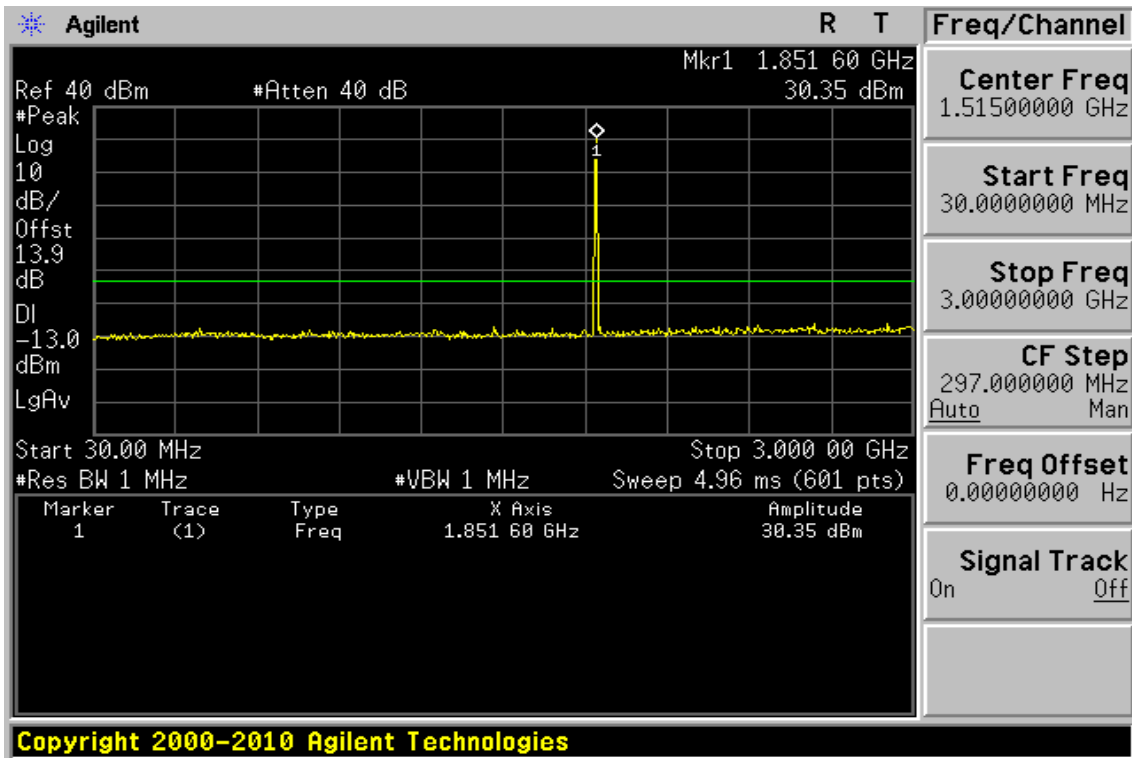

Unless otherwise stated the results shown in this test report refer only to the sample(s) tested and such sample(s) are retained for 90 days only.

除非另有說明，此報告結果僅對測試之樣品負責，同時此樣品僅保留90天。本報告未經本公司書面許可，不可部份複製。

This document is issued by the Company subject to its General Conditions of Service printed overleaf, available on request or accessible at www.sgs.com/terms_and_conditions.htm and, for electronic format documents, subject to Terms and Conditions for Electronic Documents at www.sgs.com/terms_e-document.htm. Attention is drawn to the limitation of liability, indemnification and jurisdiction issues defined therein. Any holder of this document is advised that information contained hereon reflects the Company's findings at the time of its intervention only and within the limits of Client's instructions, if any. The Company's sole responsibility is to its Client and this document does not exonerate parties to a transaction from exercising all their rights and obligations under the transaction documents. This document cannot be reproduced except in full, without prior written approval of the Company. Any unauthorized alteration, forgery or falsification of the content or appearance of this document is unlawful and offenders may be prosecuted to the fullest extent of the law.

Figure 9-7: Out of Band emission at antenna terminals – GSM 1900 Channel Mid

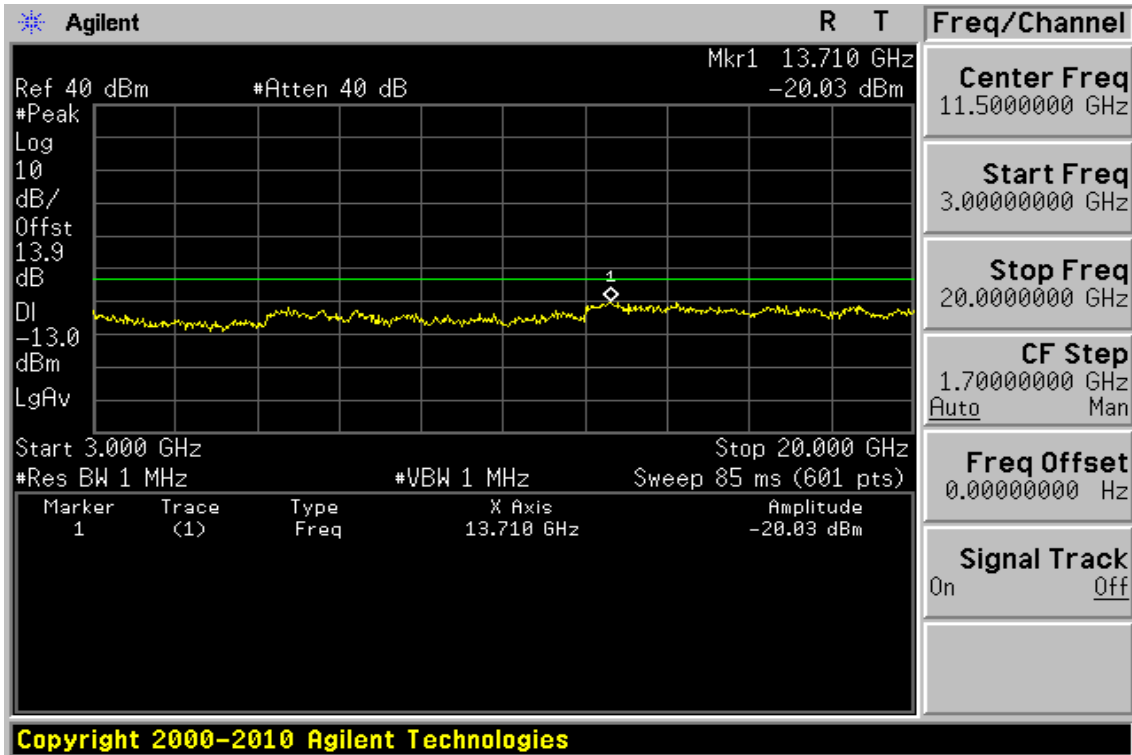
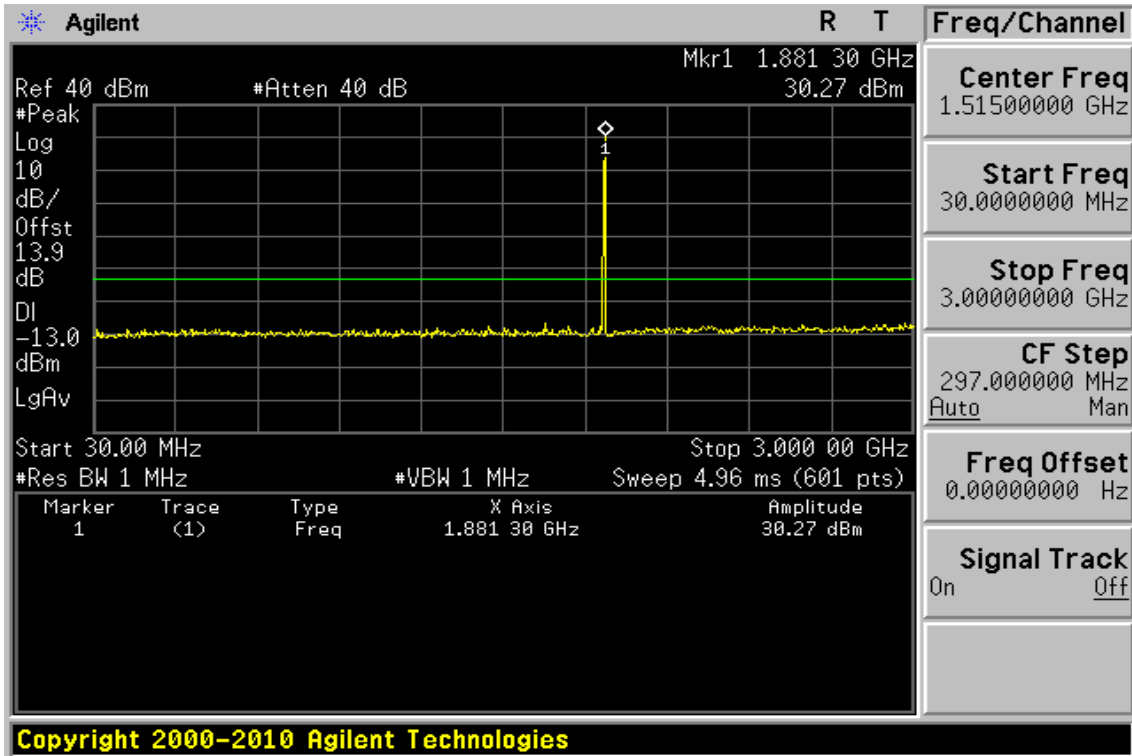

Unless otherwise stated the results shown in this test report refer only to the sample(s) tested and such sample(s) are retained for 90 days only.

除非另有說明，此報告結果僅對測試之樣品負責，同時此樣品僅保留90天。本報告未經本公司書面許可，不可部份複製。

This document is issued by the Company subject to its General Conditions of Service printed overleaf, available on request or accessible at www.sgs.com/terms_and_conditions.htm and, for electronic format documents, subject to Terms and Conditions for Electronic Documents at www.sgs.com/terms_e-document.htm. Attention is drawn to the limitation of liability, indemnification and jurisdiction issues defined therein. Any holder of this document is advised that information contained hereon reflects the Company's findings at the time of its intervention only and within the limits of Client's instructions, if any. The Company's sole responsibility is to its Client and this document does not exonerate parties to a transaction from exercising all their rights and obligations under the transaction documents. This document cannot be reproduced except in full, without prior written approval of the Company. Any unauthorized alteration, forgery or falsification of the content or appearance of this document is unlawful and offenders may be prosecuted to the fullest extent of the law.

Figure 9-8: Out of Band emission at antenna terminals – GSM 1900 Channel Highest

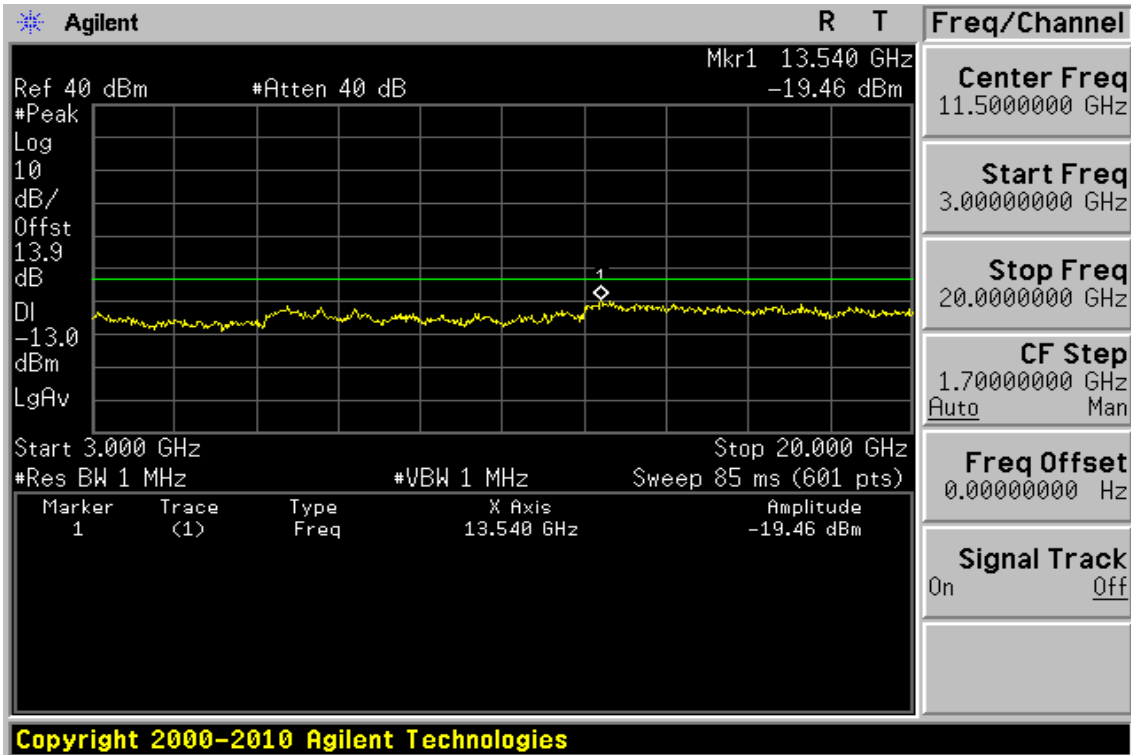
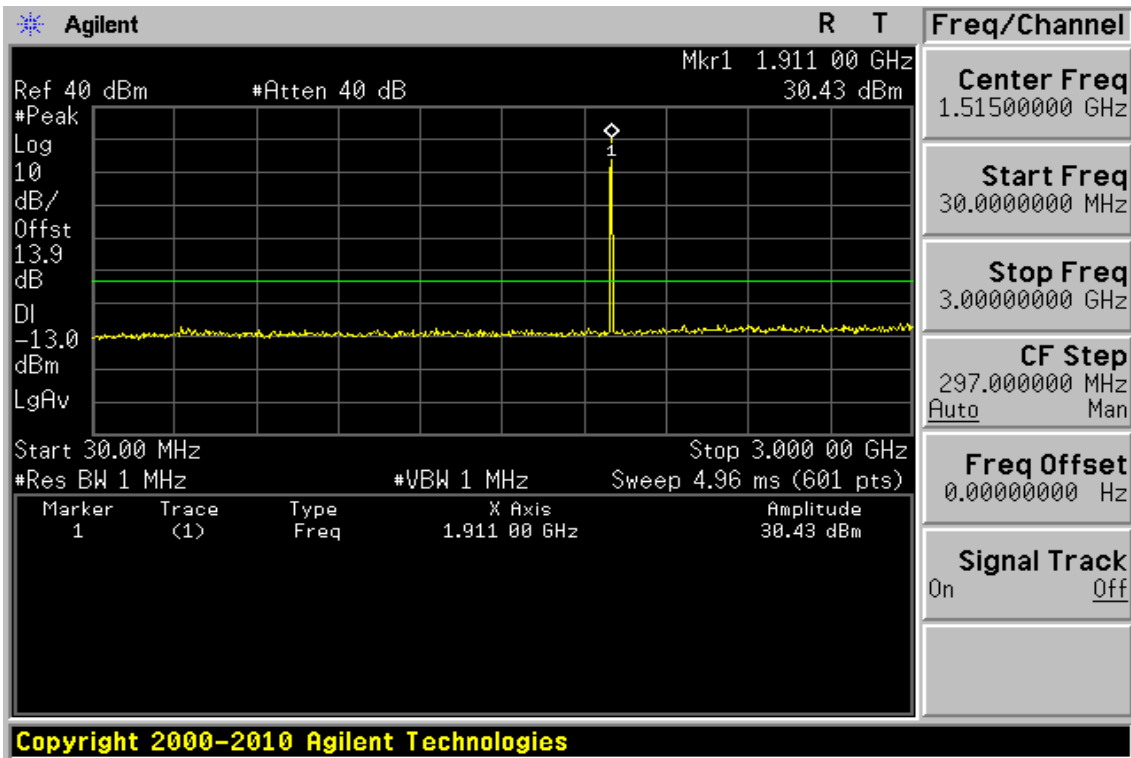

Unless otherwise stated the results shown in this test report refer only to the sample(s) tested and such sample(s) are retained for 90 days only.

除非另有說明，此報告結果僅對測試之樣品負責，同時此樣品僅保留90天。本報告未經本公司書面許可，不可部份複製。

This document is issued by the Company subject to its General Conditions of Service printed overleaf, available on request or accessible at www.sgs.com/terms_and_conditions.htm and, for electronic format documents, subject to Terms and Conditions for Electronic Documents at www.sgs.com/terms_e-document.htm. Attention is drawn to the limitation of liability, indemnification and jurisdiction issues defined therein. Any holder of this document is advised that information contained hereon reflects the Company's findings at the time of its intervention only and within the limits of Client's instructions, if any. The Company's sole responsibility is to its Client and this document does not exonerate parties to a transaction from exercising all their rights and obligations under the transaction documents. This document cannot be reproduced except in full, without prior written approval of the Company. Any unauthorized alteration, forgery or falsification of the content or appearance of this document is unlawful and offenders may be prosecuted to the fullest extent of the law.

Out of Band emission at antenna terminals – GSM 1900

Fundamental Frequency :1850.2 MHz Engineer :Nick
Operation Mode :TX Low

| Freq. (MHz) | Note F/H/E/S | Reading dBm | Limit dBm | Safe Margin dB |
|----------------|-----------------|----------------|--------------|----------------------|
| <30 | S | --- | -13.00 | --- |
| 30-1000 | S | --- | -13.00 | --- |
| 3700.40 | H | --- | -13.00 | --- |
| 5550.60 | H | --- | -13.00 | --- |
| 7400.80 | H | --- | -13.00 | --- |
| 9251.00 | H | --- | -13.00 | --- |
| 11101.20 | H | --- | -13.00 | --- |
| 12951.40 | H | --- | -13.00 | --- |
| 13625.00 | S | -20.29 | -13.00 | 7.29 |
| 14801.60 | H | --- | -13.00 | --- |
| 16651.80 | H | --- | -13.00 | --- |
| 18502.00 | H | --- | -13.00 | --- |

Note : “H” : denotes Harmonic Frequency. “S” : denotes Spurious Frequency.
“---“ : denotes Noise Floor.

Unless otherwise stated the results shown in this test report refer only to the sample(s) tested and such sample(s) are retained for 90 days only.

除非另有說明，此報告結果僅對測試之樣品負責，同時此樣品僅保留90天。本報告未經本公司書面許可，不可部份複製。

This document is issued by the Company subject to its General Conditions of Service printed overleaf, available on request or accessible at www.sgs.com/terms_and_conditions.htm and, for electronic format documents, subject to Terms and Conditions for Electronic Documents at www.sgs.com/terms_e-document.htm. Attention is drawn to the limitation of liability, indemnification and jurisdiction issues defined therein. Any holder of this document is advised that information contained hereon reflects the Company's findings at the time of its intervention only and within the limits of Client's instructions, if any. The Company's sole responsibility is to its Client and this document does not exonerate parties to a transaction from exercising all their rights and obligations under the transaction documents. This document cannot be reproduced except in full, without prior written approval of the Company. Any unauthorized alteration, forgery or falsification of the content or appearance of this document is unlawful and offenders may be prosecuted to the fullest extent of the law.

Fundamental Frequency :1880.0 MHz Engineer :Nick
Operation Mode :TX Mid

| Freq. (MHz) | Note F/H/E/S | Reading dBm | Limit dBm | Safe Margin dB |
|----------------|-----------------|----------------|--------------|----------------------|
| <30 | S | --- | -13.00 | --- |
| 30-1000 | S | --- | -13.00 | --- |
| 3760.00 | H | --- | -13.00 | --- |
| 5640.00 | H | --- | -13.00 | --- |
| 7520.00 | H | --- | -13.00 | --- |
| 9400.00 | H | --- | -13.00 | --- |
| 11280.00 | H | --- | -13.00 | --- |
| 13160.00 | H | --- | -13.00 | --- |
| 13710.00 | S | -20.03 | -13.00 | 7.03 |
| 15040.00 | H | --- | -13.00 | --- |
| 16920.00 | H | --- | -13.00 | --- |
| 18800.00 | H | --- | -13.00 | --- |

Note : "H" : denotes Harmonic Frequency. "S" : denotes Spurious Frequency.
"---" : denotes Noise Floor.

Unless otherwise stated the results shown in this test report refer only to the sample(s) tested and such sample(s) are retained for 90 days only.

除非另有說明，此報告結果僅對測試之樣品負責，同時此樣品僅保留90天。本報告未經本公司書面許可，不可部份複製。

This document is issued by the Company subject to its General Conditions of Service printed overleaf, available on request or accessible at www.sgs.com/terms_and_conditions.htm and, for electronic format documents, subject to Terms and Conditions for Electronic Documents at www.sgs.com/terms_e-document.htm. Attention is drawn to the limitation of liability, indemnification and jurisdiction issues defined therein. Any holder of this document is advised that information contained hereon reflects the Company's findings at the time of its intervention only and within the limits of Client's instructions, if any. The Company's sole responsibility is to its Client and this document does not exonerate parties to a transaction from exercising all their rights and obligations under the transaction documents. This document cannot be reproduced except in full, without prior written approval of the Company. Any unauthorized alteration, forgery or falsification of the content or appearance of this document is unlawful and offenders may be prosecuted to the fullest extent of the law.

Fundamental Frequency :1909.8 MHz Engineer :Nick
Operation Mode :TX High

| Freq. (MHz) | Note F/H/E/S | Reading dBm | Limit dBm | Safe Margin dB |
|----------------|-----------------|----------------|--------------|----------------------|
| <30 | S | --- | -13.00 | --- |
| 30-1000 | S | --- | -13.00 | --- |
| 3819.60 | H | --- | -13.00 | --- |
| 5729.40 | H | --- | -13.00 | --- |
| 7639.20 | H | --- | -13.00 | --- |
| 9549.00 | H | --- | -13.00 | --- |
| 11458.80 | H | --- | -13.00 | --- |
| 13368.60 | H | --- | -13.00 | --- |
| 13540.00 | S | -19.46 | -13.00 | 6.46 |
| 15278.40 | H | --- | -13.00 | --- |
| 17188.20 | H | --- | -13.00 | --- |
| 19098.00 | H | --- | -13.00 | --- |

Note : “H” : denotes Harmonic Frequency. “S” : denotes Spurious Frequency.
“---” : denotes Noise Floor.

Unless otherwise stated the results shown in this test report refer only to the sample(s) tested and such sample(s) are retained for 90 days only.

除非另有說明，此報告結果僅對測試之樣品負責，同時此樣品僅保留90天。本報告未經本公司書面許可，不可部份複製。

This document is issued by the Company subject to its General Conditions of Service printed overleaf, available on request or accessible at www.sgs.com/terms_and_conditions.htm and, for electronic format documents, subject to Terms and Conditions for Electronic Documents at www.sgs.com/terms_e-document.htm. Attention is drawn to the limitation of liability, indemnification and jurisdiction issues defined therein. Any holder of this document is advised that information contained hereon reflects the Company's findings at the time of its intervention only and within the limits of Client's instructions, if any. The Company's sole responsibility is to its Client and this document does not exonerate parties to a transaction from exercising all their rights and obligations under the transaction documents. This document cannot be reproduced except in full, without prior written approval of the Company. Any unauthorized alteration, forgery or falsification of the content or appearance of this document is unlawful and offenders may be prosecuted to the fullest extent of the law.

Figure 9-9: Band edge emission at antenna terminals – GSM 1900 Channel Lowest

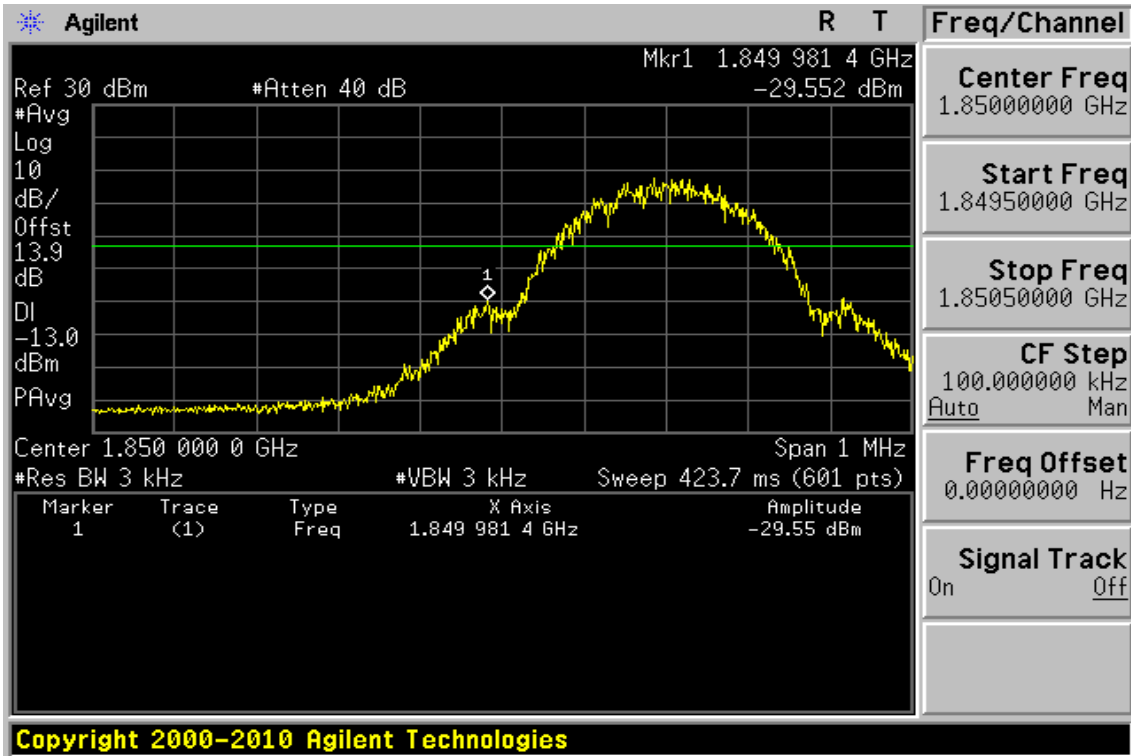
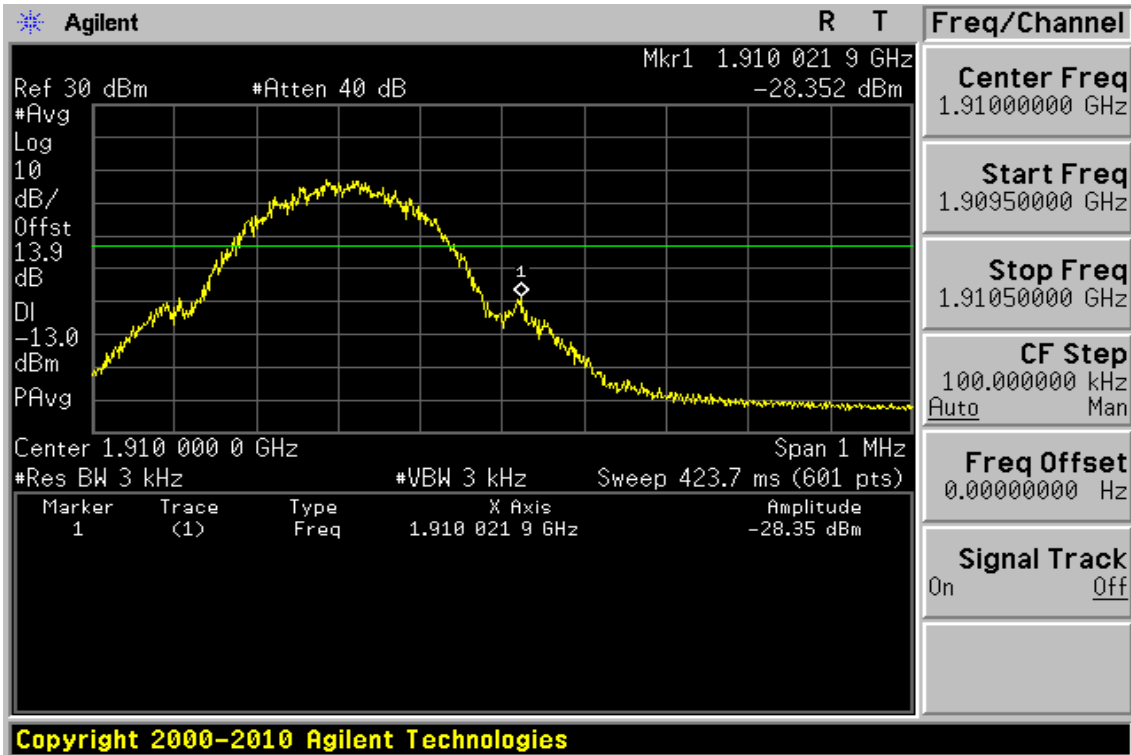

Figure 9-10: Band edge emission at antenna terminals – GSM 1900 Channel Highest



Unless otherwise stated the results shown in this test report refer only to the sample(s) tested and such sample(s) are retained for 90 days only.

除非另有說明，此報告結果僅對測試之樣品負責，同時此樣品僅保留90天。本報告未經本公司書面許可，不可部份複製。

This document is issued by the Company subject to its General Conditions of Service printed overleaf, available on request or accessible at www.sgs.com/terms_and_conditions.htm and, for electronic format documents, subject to Terms and Conditions for Electronic Documents at www.sgs.com/terms_e-document.htm. Attention is drawn to the limitation of liability, indemnification and jurisdiction issues defined therein. Any holder of this document is advised that information contained hereon reflects the Company's findings at the time of its intervention only and within the limits of Client's instructions, if any. The Company's sole responsibility is to its Client and this document does not exonerate parties to a transaction from exercising all their rights and obligations under the transaction documents. This document cannot be reproduced except in full, without prior written approval of the Company. Any unauthorized alteration, forgery or falsification of the content or appearance of this document is unlawful and offenders may be prosecuted to the fullest extent of the law.

Band edge emission at antenna terminals – GSM 1900 Low & High

Test Mode GSM 1900 Engineer :Nick

| Freq. MHz | Reading dBm | Limit dBm | Safe Margin dB |
|--------------|----------------|--------------|----------------------|
| 1849.981 | -29.55 | -13.00 | 16.55 |
| 1910.021 | -28.35 | -13.00 | 15.35 |

Unless otherwise stated the results shown in this test report refer only to the sample(s) tested and such sample(s) are retained for 90 days only.

除非另有說明，此報告結果僅對測試之樣品負責，同時此樣品僅保留90天。本報告未經本公司書面許可，不可部份複製。

This document is issued by the Company subject to its General Conditions of Service printed overleaf, available on request or accessible at www.sgs.com/terms_and_conditions.htm and, for electronic format documents, subject to Terms and Conditions for Electronic Documents at www.sgs.com/terms_e-document.htm. Attention is drawn to the limitation of liability, indemnification and jurisdiction issues defined therein. Any holder of this document is advised that information contained hereon reflects the Company's findings at the time of its intervention only and within the limits of Client's instructions, if any. The Company's sole responsibility is to its Client and this document does not exonerate parties to a transaction from exercising all their rights and obligations under the transaction documents. This document cannot be reproduced except in full, without prior written approval of the Company. Any unauthorized alteration, forgery or falsification of the content or appearance of this document is unlawful and offenders may be prosecuted to the fullest extent of the law.

Figure 9-11: Out of Band emission at antenna terminals – GPRS850 Channel Lowest

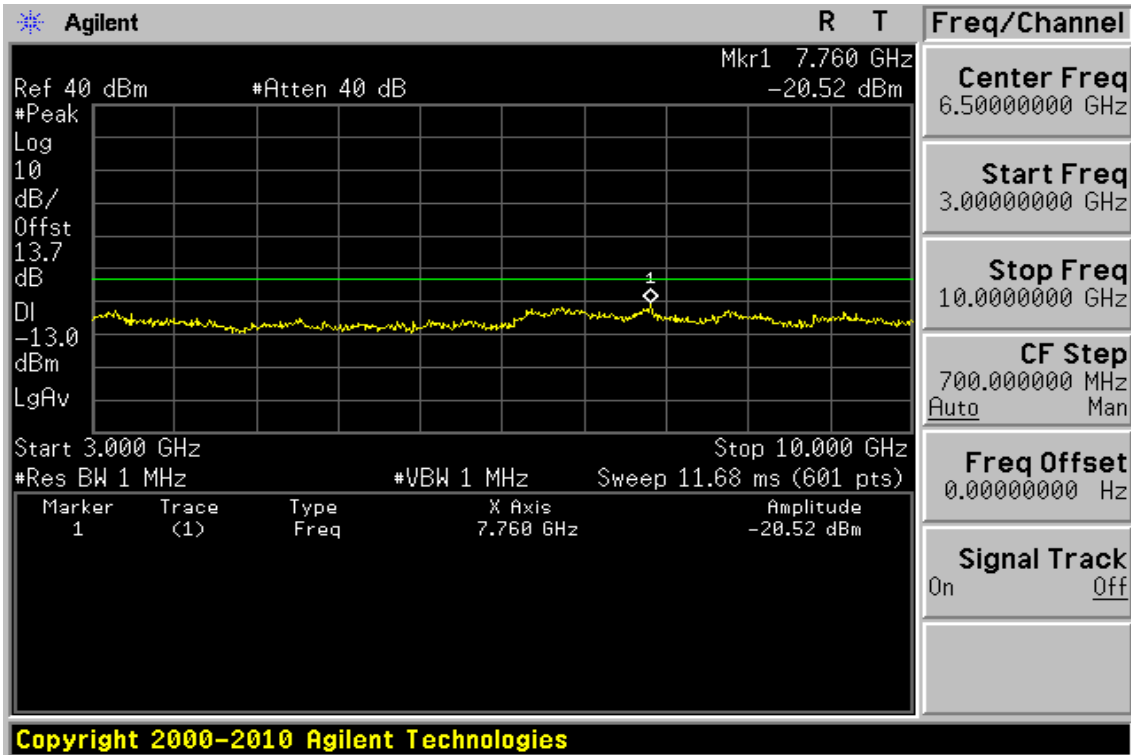
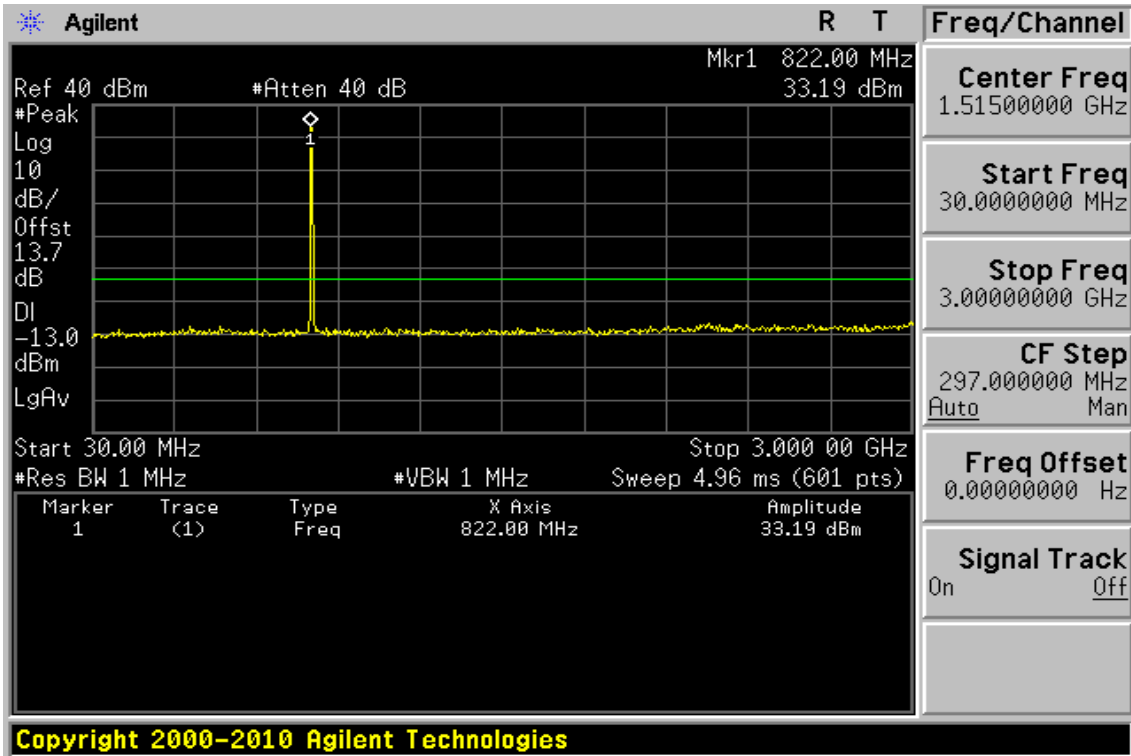

Unless otherwise stated the results shown in this test report refer only to the sample(s) tested and such sample(s) are retained for 90 days only.

除非另有說明，此報告結果僅對測試之樣品負責，同時此樣品僅保留90天。本報告未經本公司書面許可，不可部份複製。

This document is issued by the Company subject to its General Conditions of Service printed overleaf, available on request or accessible at www.sgs.com/terms_and_conditions.htm and, for electronic format documents, subject to Terms and Conditions for Electronic Documents at www.sgs.com/terms_e-document.htm. Attention is drawn to the limitation of liability, indemnification and jurisdiction issues defined therein. Any holder of this document is advised that information contained hereon reflects the Company's findings at the time of its intervention only and within the limits of Client's instructions, if any. The Company's sole responsibility is to its Client and this document does not exonerate parties to a transaction from exercising all their rights and obligations under the transaction documents. This document cannot be reproduced except in full, without prior written approval of the Company. Any unauthorized alteration, forgery or falsification of the content or appearance of this document is unlawful and offenders may be prosecuted to the fullest extent of the law.

Figure 9-12: Out of Band emission at antenna terminals – GPRS 850 Channel Mid

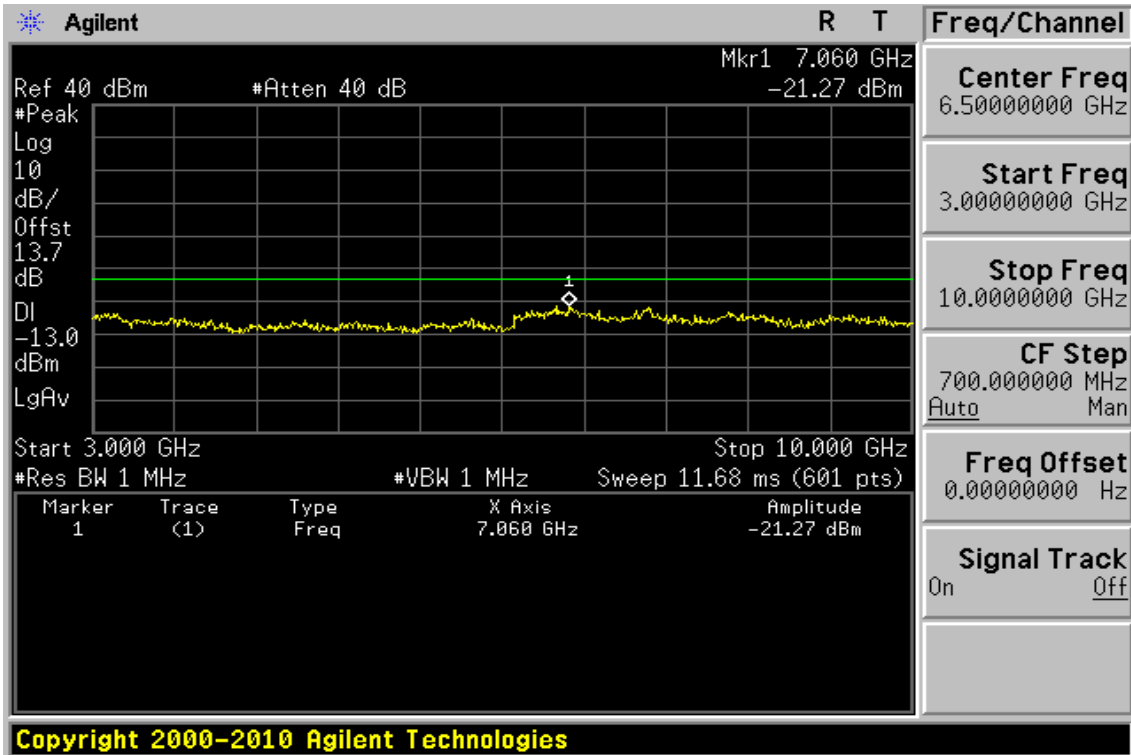
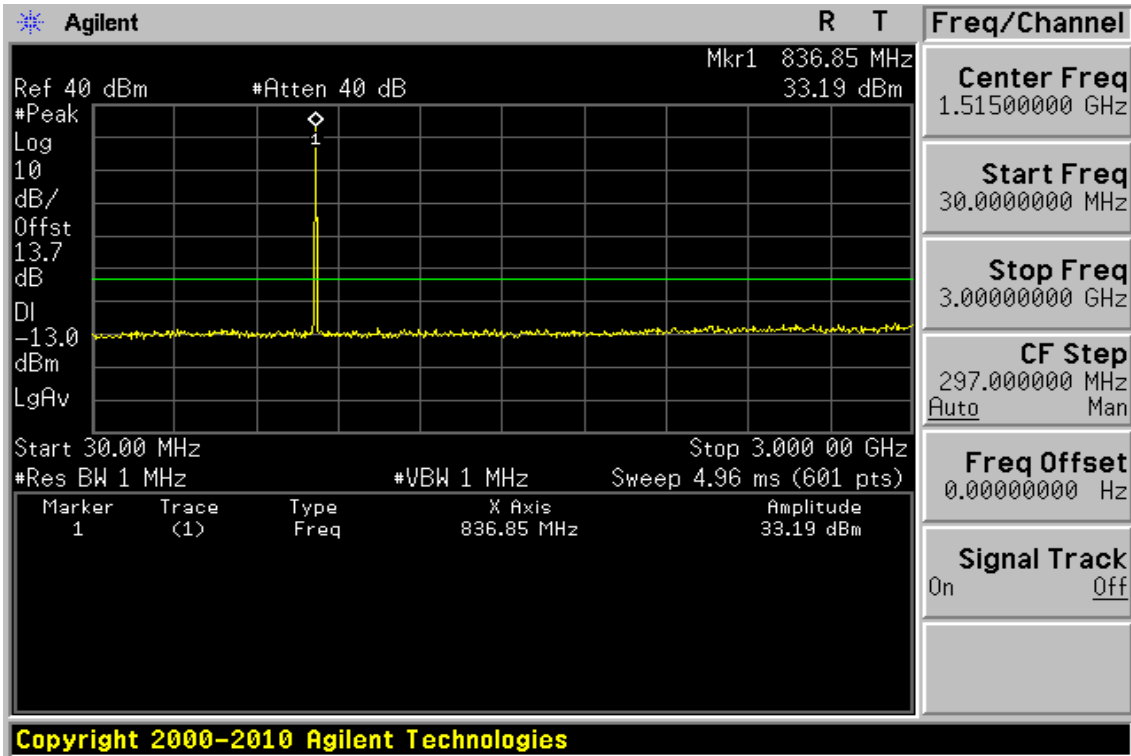

Unless otherwise stated the results shown in this test report refer only to the sample(s) tested and such sample(s) are retained for 90 days only.

除非另有說明，此報告結果僅對測試之樣品負責，同時此樣品僅保留90天。本報告未經本公司書面許可，不可部份複製。

This document is issued by the Company subject to its General Conditions of Service printed overleaf, available on request or accessible at www.sgs.com/terms_and_conditions.htm and, for electronic format documents, subject to Terms and Conditions for Electronic Documents at www.sgs.com/terms_e-document.htm. Attention is drawn to the limitation of liability, indemnification and jurisdiction issues defined therein. Any holder of this document is advised that information contained hereon reflects the Company's findings at the time of its intervention only and within the limits of Client's instructions, if any. The Company's sole responsibility is to its Client and this document does not exonerate parties to a transaction from exercising all their rights and obligations under the transaction documents. This document cannot be reproduced except in full, without prior written approval of the Company. Any unauthorized alteration, forgery or falsification of the content or appearance of this document is unlawful and offenders may be prosecuted to the fullest extent of the law.

Figure 9-13: Out of Band emission at antenna terminals – GPRS 850 Channel Highest

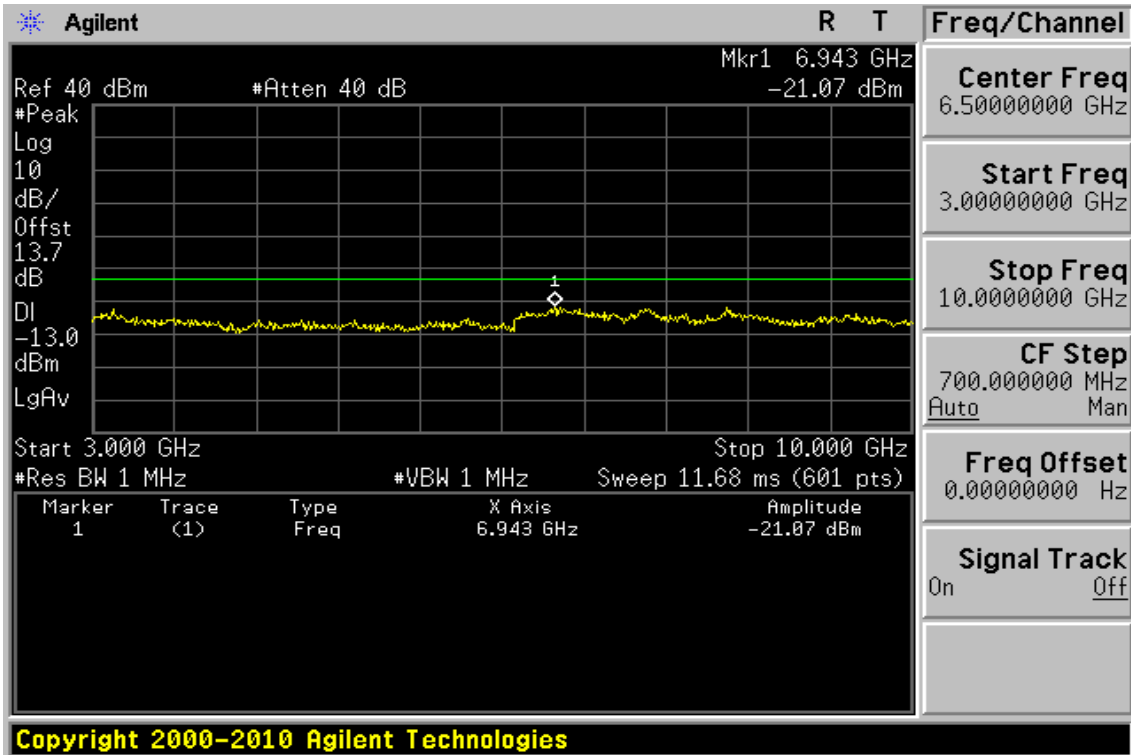
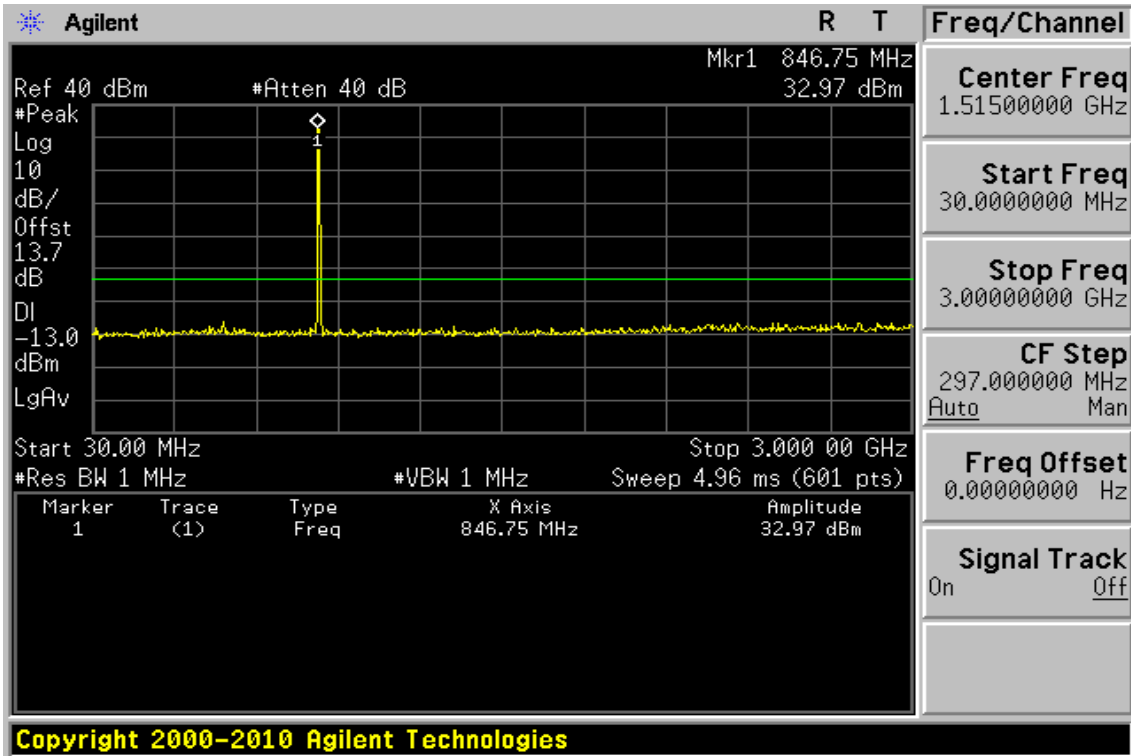

Unless otherwise stated the results shown in this test report refer only to the sample(s) tested and such sample(s) are retained for 90 days only.

除非另有說明，此報告結果僅對測試之樣品負責，同時此樣品僅保留90天。本報告未經本公司書面許可，不可部份複製。

This document is issued by the Company subject to its General Conditions of Service printed overleaf, available on request or accessible at www.sgs.com/terms_and_conditions.htm and, for electronic format documents, subject to Terms and Conditions for Electronic Documents at www.sgs.com/terms_e-document.htm. Attention is drawn to the limitation of liability, indemnification and jurisdiction issues defined therein. Any holder of this document is advised that information contained hereon reflects the Company's findings at the time of its intervention only and within the limits of Client's instructions, if any. The Company's sole responsibility is to its Client and this document does not exonerate parties to a transaction from exercising all their rights and obligations under the transaction documents. This document cannot be reproduced except in full, without prior written approval of the Company. Any unauthorized alteration, forgery or falsification of the content or appearance of this document is unlawful and offenders may be prosecuted to the fullest extent of the law.

Out of Band emission at antenna terminals – GPRS 850

Fundamental Frequency :824.2 MHz Engineer :Nick
Operation Mode :TX Low

| Freq. (MHz) | Note F/H/E/S | Reading dBm | Limit dBm | Safe Margin dB |
|----------------|-----------------|----------------|--------------|----------------------|
| <30 | S | --- | -13.00 | --- |
| 30-1000 | S | --- | -13.00 | --- |
| 1648.40 | H | --- | -13.00 | --- |
| 2472.60 | H | --- | -13.00 | --- |
| 3296.80 | H | --- | -13.00 | --- |
| 4121.00 | H | --- | -13.00 | --- |
| 4945.20 | H | --- | -13.00 | --- |
| 5769.40 | H | --- | -13.00 | --- |
| 6593.60 | H | --- | -13.00 | --- |
| 7417.80 | H | --- | -13.00 | --- |
| 7760.00 | S | -20.52 | -13.00 | 7.52 |
| 8242.00 | H | --- | -13.00 | --- |

Note : “H” : denotes Harmonic Frequency. “S” : denotes Spurious Frequency.
“---” : denotes Noise Floor.

Unless otherwise stated the results shown in this test report refer only to the sample(s) tested and such sample(s) are retained for 90 days only.

除非另有說明，此報告結果僅對測試之樣品負責，同時此樣品僅保留90天。本報告未經本公司書面許可，不可部份複製。

This document is issued by the Company subject to its General Conditions of Service printed overleaf, available on request or accessible at www.sgs.com/terms_and_conditions.htm and, for electronic format documents, subject to Terms and Conditions for Electronic Documents at www.sgs.com/terms_e-document.htm. Attention is drawn to the limitation of liability, indemnification and jurisdiction issues defined therein. Any holder of this document is advised that information contained hereon reflects the Company's findings at the time of its intervention only and within the limits of Client's instructions, if any. The Company's sole responsibility is to its Client and this document does not exonerate parties to a transaction from exercising all their rights and obligations under the transaction documents. This document cannot be reproduced except in full, without prior written approval of the Company. Any unauthorized alteration, forgery or falsification of the content or appearance of this document is unlawful and offenders may be prosecuted to the fullest extent of the law.

Fundamental Frequency :836.6 MHz Engineer :Nick
Operation Mode :TX Mid

| Freq. (MHz) | Note F/H/E/S | Reading dBm | Limit dBm | Safe Margin dB |
|----------------|-----------------|----------------|--------------|----------------------|
| <30 | S | --- | -13.00 | --- |
| 30-1000 | S | --- | -13.00 | --- |
| 1673.20 | H | --- | -13.00 | --- |
| 2509.80 | H | --- | -13.00 | --- |
| 3346.40 | H | --- | -13.00 | --- |
| 4183.00 | H | --- | -13.00 | --- |
| 5019.60 | H | --- | -13.00 | --- |
| 5856.20 | H | --- | -13.00 | --- |
| 6692.80 | H | --- | -13.00 | --- |
| 7060.00 | S | -21.27 | -13.00 | 8.27 |
| 7529.40 | H | --- | -13.00 | --- |
| 8366.00 | H | --- | -13.00 | --- |

Note : "H" : denotes Harmonic Frequency. "S" : denotes Spurious Frequency.
"---" : denotes Noise Floor.

Unless otherwise stated the results shown in this test report refer only to the sample(s) tested and such sample(s) are retained for 90 days only.

除非另有說明，此報告結果僅對測試之樣品負責，同時此樣品僅保留90天。本報告未經本公司書面許可，不可部份複製。

This document is issued by the Company subject to its General Conditions of Service printed overleaf, available on request or accessible at www.sgs.com/terms_and_conditions.htm and, for electronic format documents, subject to Terms and Conditions for Electronic Documents at www.sgs.com/terms_e-document.htm. Attention is drawn to the limitation of liability, indemnification and jurisdiction issues defined therein. Any holder of this document is advised that information contained hereon reflects the Company's findings at the time of its intervention only and within the limits of Client's instructions, if any. The Company's sole responsibility is to its Client and this document does not exonerate parties to a transaction from exercising all their rights and obligations under the transaction documents. This document cannot be reproduced except in full, without prior written approval of the Company. Any unauthorized alteration, forgery or falsification of the content or appearance of this document is unlawful and offenders may be prosecuted to the fullest extent of the law.

Fundamental Frequency :848.8MHz Engineer :Nick
Operation Mode :TX High

| Freq. (MHz) | Note F/H/E/S | Reading dBm | Limit dBm | Safe Margin dB |
|----------------|-----------------|----------------|--------------|----------------------|
| <30 | S | --- | -13.00 | --- |
| 30-1000 | S | --- | -13.00 | --- |
| 1697.60 | H | --- | -13.00 | --- |
| 2546.40 | H | --- | -13.00 | --- |
| 3395.20 | H | --- | -13.00 | --- |
| 4244.00 | H | --- | -13.00 | --- |
| 5092.80 | H | --- | -13.00 | --- |
| 5941.60 | H | --- | -13.00 | --- |
| 6790.40 | H | --- | -13.00 | --- |
| 6943.00 | S | -21.07 | -13.00 | 8.07 |
| 7639.20 | H | --- | -13.00 | --- |
| 8488.00 | H | --- | -13.00 | --- |

Note : “H” : denotes Harmonic Frequency. “S” : denotes Spurious Frequency.
“---” : denotes Noise Floor.

Unless otherwise stated the results shown in this test report refer only to the sample(s) tested and such sample(s) are retained for 90 days only.

除非另有說明，此報告結果僅對測試之樣品負責，同時此樣品僅保留90天。本報告未經本公司書面許可，不可部份複製。

This document is issued by the Company subject to its General Conditions of Service printed overleaf, available on request or accessible at www.sgs.com/terms_and_conditions.htm and, for electronic format documents, subject to Terms and Conditions for Electronic Documents at www.sgs.com/terms_e-document.htm. Attention is drawn to the limitation of liability, indemnification and jurisdiction issues defined therein. Any holder of this document is advised that information contained hereon reflects the Company's findings at the time of its intervention only and within the limits of Client's instructions, if any. The Company's sole responsibility is to its Client and this document does not exonerate parties to a transaction from exercising all their rights and obligations under the transaction documents. This document cannot be reproduced except in full, without prior written approval of the Company. Any unauthorized alteration, forgery or falsification of the content or appearance of this document is unlawful and offenders may be prosecuted to the fullest extent of the law.

Figure 9-14: Band edge emission at antenna terminals – GPRS 850 Channel Lowest

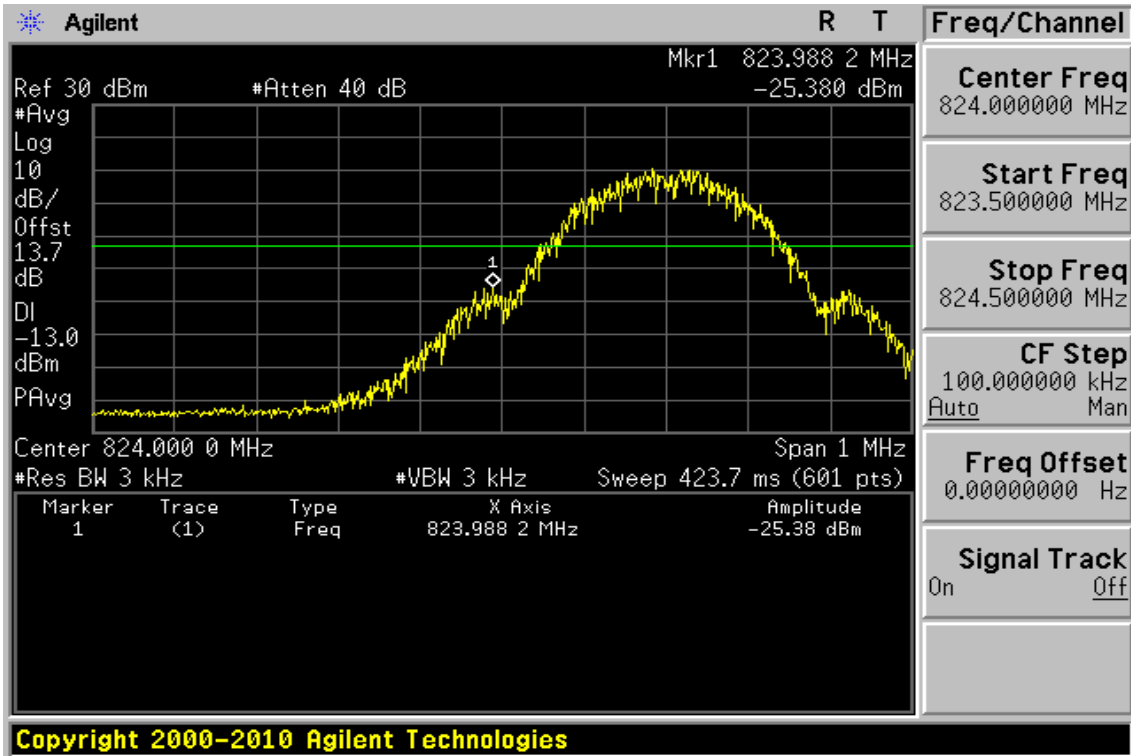
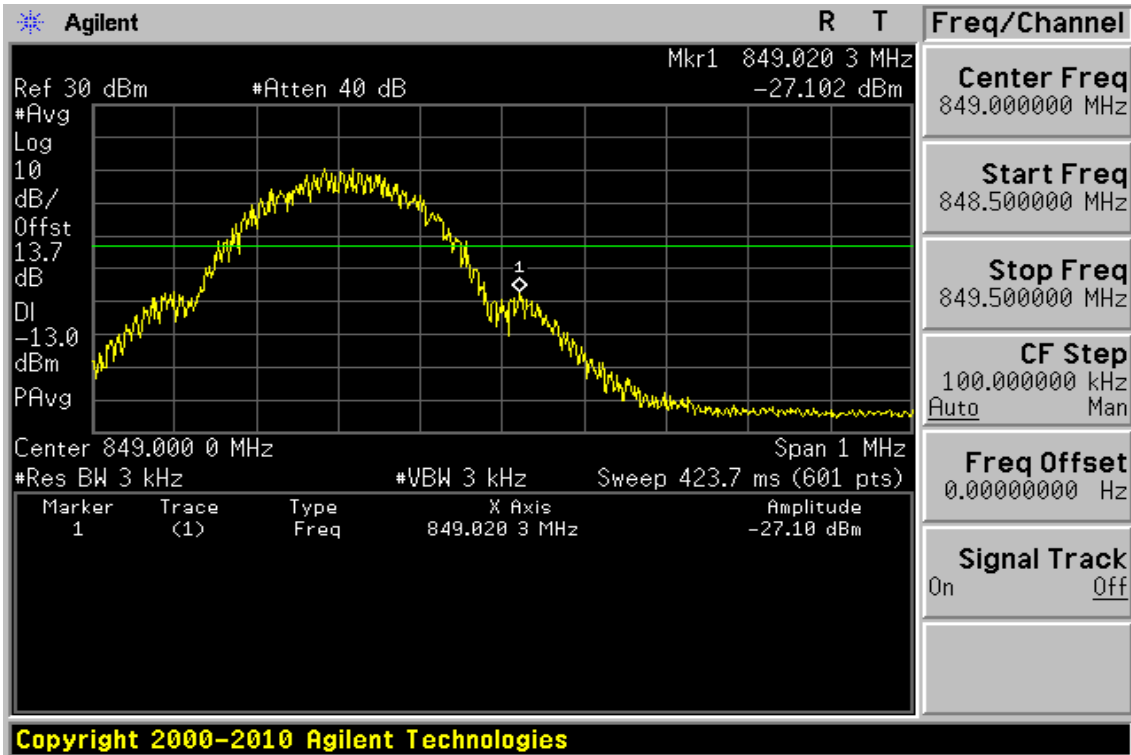

Figure 9-15: Band edge emission at antenna terminals – GPRS 850 Channel Highest



Unless otherwise stated the results shown in this test report refer only to the sample(s) tested and such sample(s) are retained for 90 days only.

除非另有說明，此報告結果僅對測試之樣品負責，同時此樣品僅保留90天。本報告未經本公司書面許可，不可部份複製。

This document is issued by the Company subject to its General Conditions of Service printed overleaf, available on request or accessible at www.sgs.com/terms_and_conditions.htm and, for electronic format documents, subject to Terms and Conditions for Electronic Documents at www.sgs.com/terms_e-document.htm. Attention is drawn to the limitation of liability, indemnification and jurisdiction issues defined therein. Any holder of this document is advised that information contained hereon reflects the Company's findings at the time of its intervention only and within the limits of Client's instructions, if any. The Company's sole responsibility is to its Client and this document does not exonerate parties to a transaction from exercising all their rights and obligations under the transaction documents. This document cannot be reproduced except in full, without prior written approval of the Company. Any unauthorized alteration, forgery or falsification of the content or appearance of this document is unlawful and offenders may be prosecuted to the fullest extent of the law.

Band edge emission at antenna terminals – GPRS 850 Low & High

Test Mode GPRS 850 Engineer :Nick

| Freq. MHz | Reading dBm | Limit dBm | Safe Margin dB |
|--------------|----------------|--------------|----------------------|
| 823.988 | -25.38 | -13.00 | 12.38 |
| 849.020 | -27.10 | -13.00 | 14.10 |

Unless otherwise stated the results shown in this test report refer only to the sample(s) tested and such sample(s) are retained for 90 days only.

除非另有說明，此報告結果僅對測試之樣品負責，同時此樣品僅保留90天。本報告未經本公司書面許可，不可部份複製。

This document is issued by the Company subject to its General Conditions of Service printed overleaf, available on request or accessible at www.sgs.com/terms_and_conditions.htm and, for electronic format documents, subject to Terms and Conditions for Electronic Documents at www.sgs.com/terms_e-document.htm. Attention is drawn to the limitation of liability, indemnification and jurisdiction issues defined therein. Any holder of this document is advised that information contained hereon reflects the Company's findings at the time of its intervention only and within the limits of Client's instructions, if any. The Company's sole responsibility is to its Client and this document does not exonerate parties to a transaction from exercising all their rights and obligations under the transaction documents. This document cannot be reproduced except in full, without prior written approval of the Company. Any unauthorized alteration, forgery or falsification of the content or appearance of this document is unlawful and offenders may be prosecuted to the fullest extent of the law.

Figure 9-16: Out of Band emission at antenna terminals – GPRS 1900 Channel Lowest

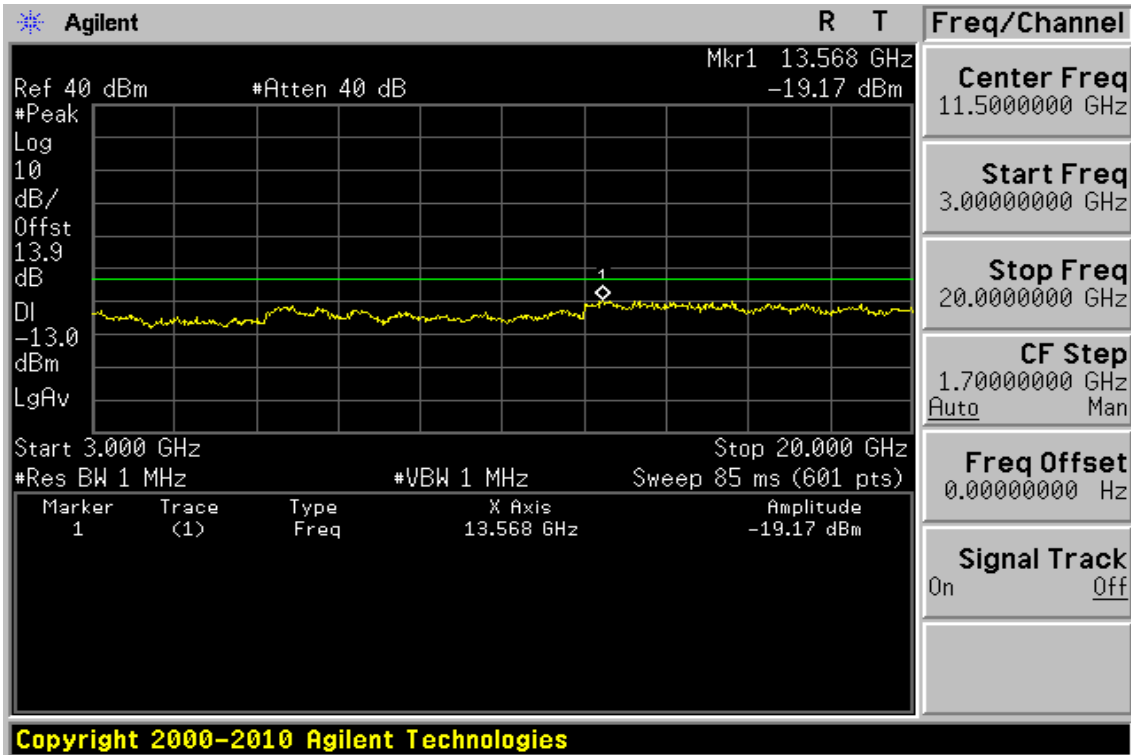
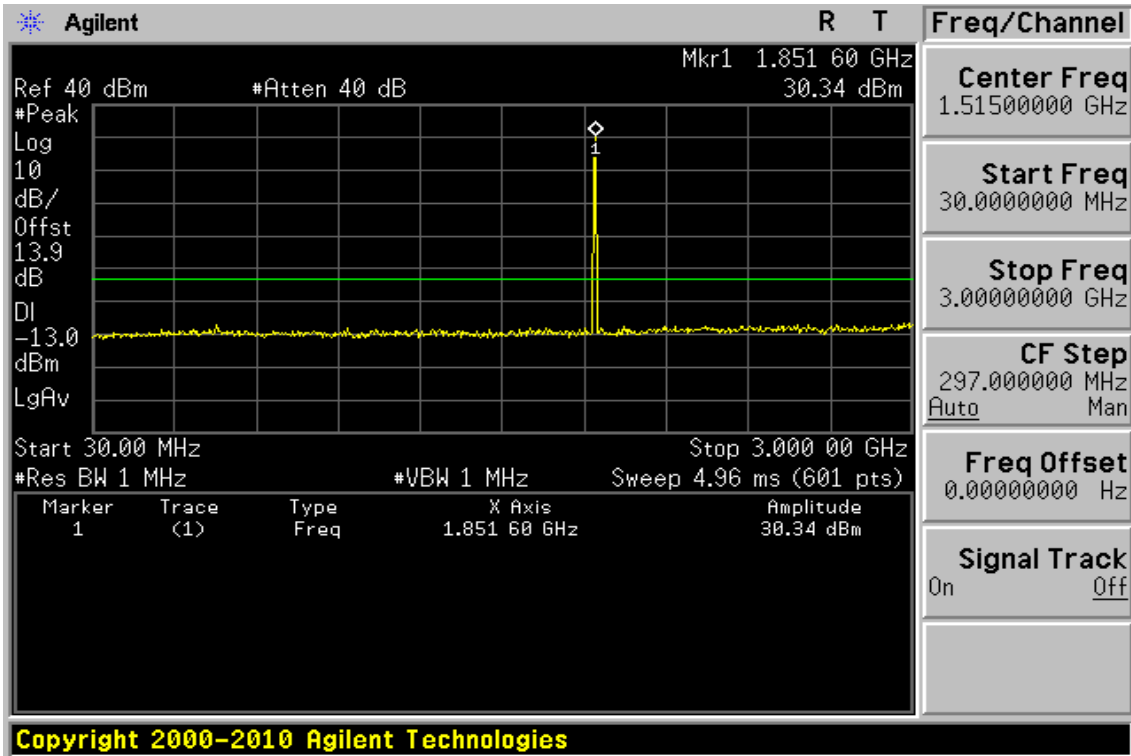

Unless otherwise stated the results shown in this test report refer only to the sample(s) tested and such sample(s) are retained for 90 days only.

除非另有說明，此報告結果僅對測試之樣品負責，同時此樣品僅保留90天。本報告未經本公司書面許可，不可部份複製。

This document is issued by the Company subject to its General Conditions of Service printed overleaf, available on request or accessible at www.sgs.com/terms_and_conditions.htm and, for electronic format documents, subject to Terms and Conditions for Electronic Documents at www.sgs.com/terms_e-document.htm. Attention is drawn to the limitation of liability, indemnification and jurisdiction issues defined therein. Any holder of this document is advised that information contained hereon reflects the Company's findings at the time of its intervention only and within the limits of Client's instructions, if any. The Company's sole responsibility is to its Client and this document does not exonerate parties to a transaction from exercising all their rights and obligations under the transaction documents. This document cannot be reproduced except in full, without prior written approval of the Company. Any unauthorized alteration, forgery or falsification of the content or appearance of this document is unlawful and offenders may be prosecuted to the fullest extent of the law.

Figure 9-17: Out of Band emission at antenna terminals – GPRS 1900 Channel Mid

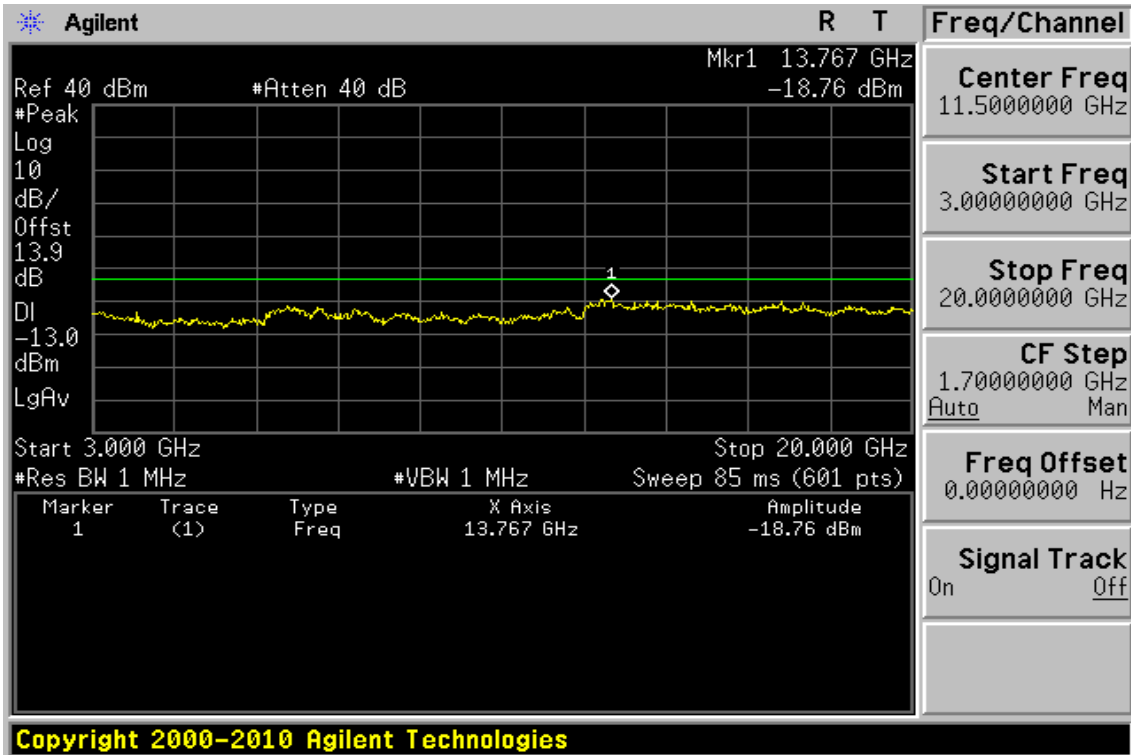
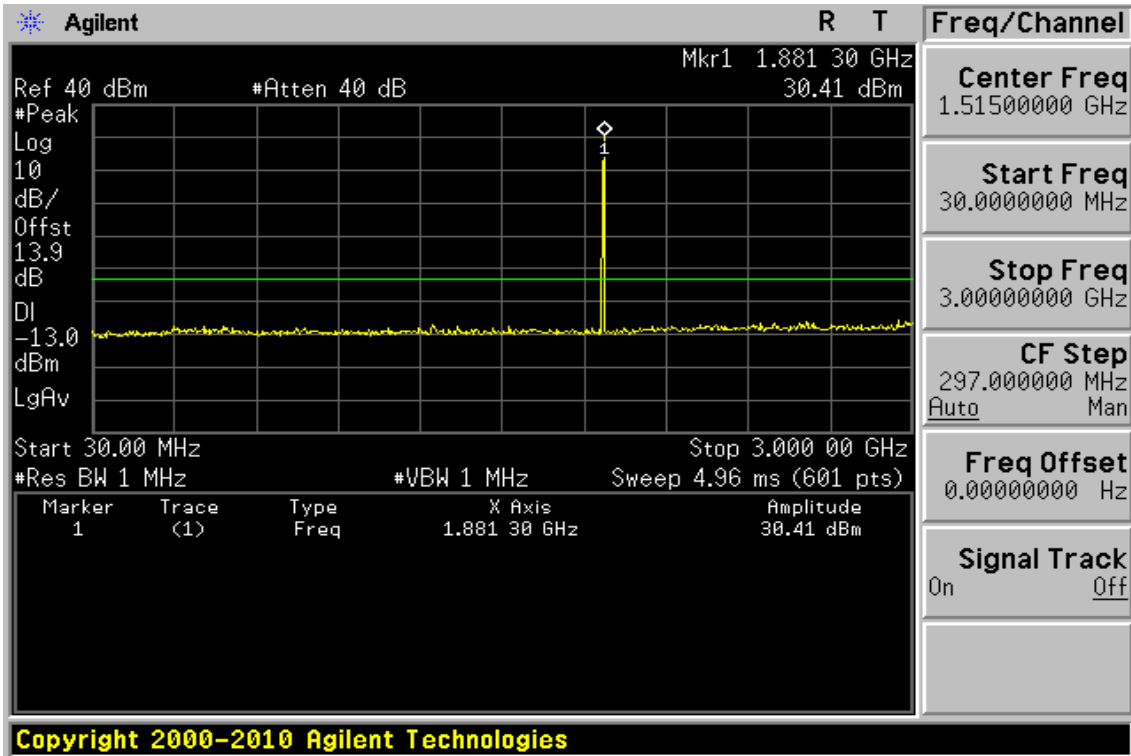

Unless otherwise stated the results shown in this test report refer only to the sample(s) tested and such sample(s) are retained for 90 days only.

除非另有說明，此報告結果僅對測試之樣品負責，同時此樣品僅保留90天。本報告未經本公司書面許可，不可部份複製。

This document is issued by the Company subject to its General Conditions of Service printed overleaf, available on request or accessible at www.sgs.com/terms_and_conditions.htm and, for electronic format documents, subject to Terms and Conditions for Electronic Documents at www.sgs.com/terms_e-document.htm. Attention is drawn to the limitation of liability, indemnification and jurisdiction issues defined therein. Any holder of this document is advised that information contained hereon reflects the Company's findings at the time of its intervention only and within the limits of Client's instructions, if any. The Company's sole responsibility is to its Client and this document does not exonerate parties to a transaction from exercising all their rights and obligations under the transaction documents. This document cannot be reproduced except in full, without prior written approval of the Company. Any unauthorized alteration, forgery or falsification of the content or appearance of this document is unlawful and offenders may be prosecuted to the fullest extent of the law.

Figure 9-18: Out of Band emission at antenna terminals – GPRS 1900 Channel Highest

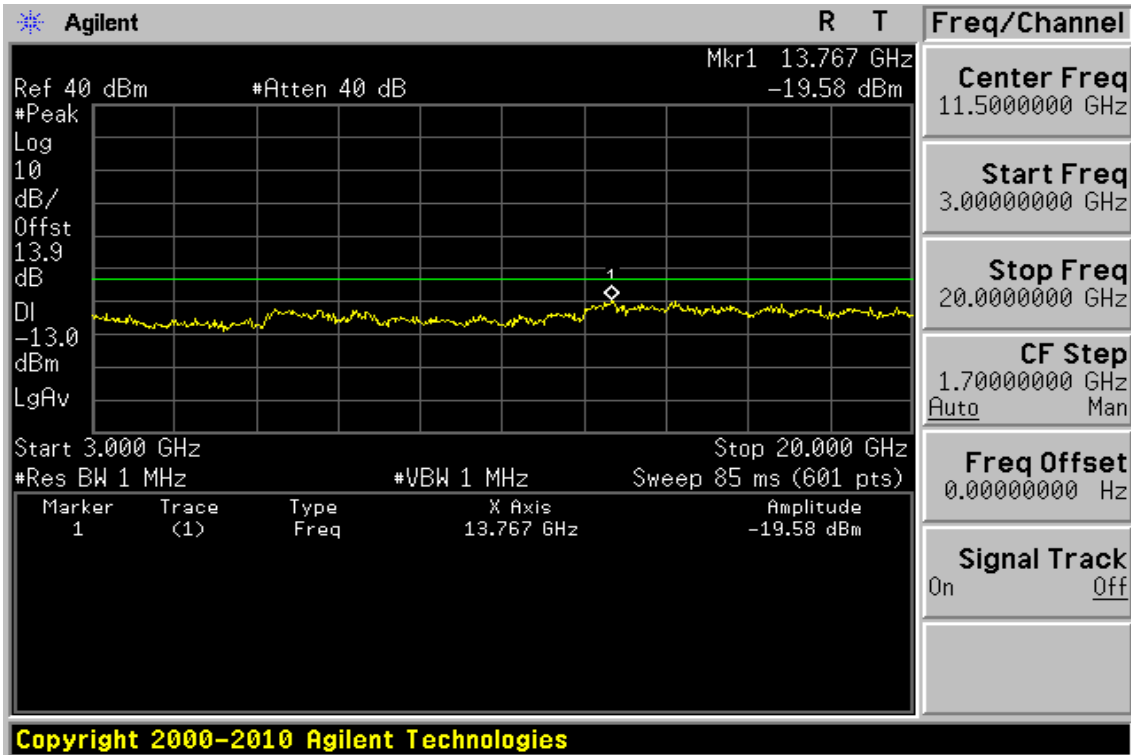
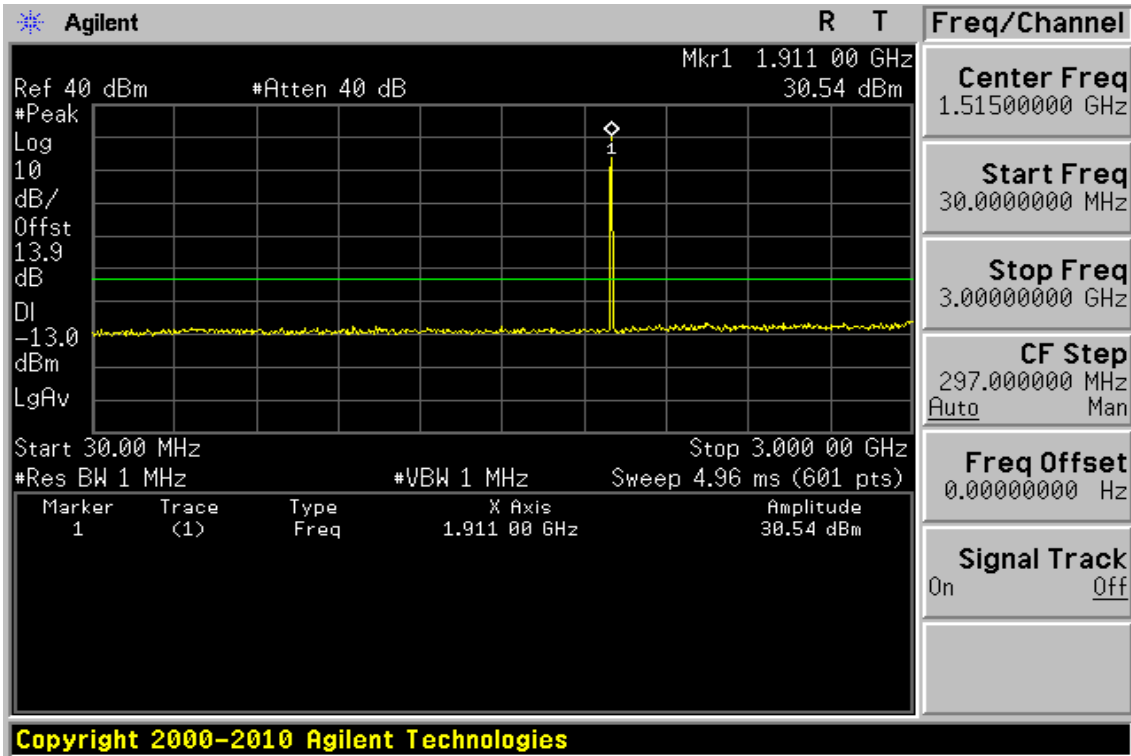

Unless otherwise stated the results shown in this test report refer only to the sample(s) tested and such sample(s) are retained for 90 days only.

除非另有說明，此報告結果僅對測試之樣品負責，同時此樣品僅保留90天。本報告未經本公司書面許可，不可部份複製。

This document is issued by the Company subject to its General Conditions of Service printed overleaf, available on request or accessible at www.sgs.com/terms_and_conditions.htm and, for electronic format documents, subject to Terms and Conditions for Electronic Documents at www.sgs.com/terms_e-document.htm. Attention is drawn to the limitation of liability, indemnification and jurisdiction issues defined therein. Any holder of this document is advised that information contained hereon reflects the Company's findings at the time of its intervention only and within the limits of Client's instructions, if any. The Company's sole responsibility is to its Client and this document does not exonerate parties to a transaction from exercising all their rights and obligations under the transaction documents. This document cannot be reproduced except in full, without prior written approval of the Company. Any unauthorized alteration, forgery or falsification of the content or appearance of this document is unlawful and offenders may be prosecuted to the fullest extent of the law.

Out of Band emission at antenna terminals – GPRS 1900

Fundamental Frequency :1850.2 MHz Engineer :Nick
Operation Mode :TX Low

| Freq. (MHz) | Note F/H/E/S | Reading dBm | Limit dBm | Safe Margin dB |
|----------------|-----------------|----------------|--------------|----------------------|
| <30 | S | --- | -13.00 | --- |
| 30-1000 | S | --- | -13.00 | --- |
| 3700.40 | H | --- | -13.00 | --- |
| 5550.60 | H | --- | -13.00 | --- |
| 7400.80 | H | --- | -13.00 | --- |
| 9251.00 | H | --- | -13.00 | --- |
| 11101.20 | H | --- | -13.00 | --- |
| 12951.40 | H | --- | -13.00 | --- |
| 13568.00 | S | -19.17 | -13.00 | 6.17 |
| 14801.60 | H | --- | -13.00 | --- |
| 16651.80 | H | --- | -13.00 | --- |
| 18502.00 | H | --- | -13.00 | --- |

Note : “H” : denotes Harmonic Frequency. “S” : denotes Spurious Frequency.
“---” : denotes Noise Floor.

Unless otherwise stated the results shown in this test report refer only to the sample(s) tested and such sample(s) are retained for 90 days only.

除非另有說明，此報告結果僅對測試之樣品負責，同時此樣品僅保留90天。本報告未經本公司書面許可，不可部份複製。

This document is issued by the Company subject to its General Conditions of Service printed overleaf, available on request or accessible at www.sgs.com/terms_and_conditions.htm and, for electronic format documents, subject to Terms and Conditions for Electronic Documents at www.sgs.com/terms_e-document.htm. Attention is drawn to the limitation of liability, indemnification and jurisdiction issues defined therein. Any holder of this document is advised that information contained hereon reflects the Company's findings at the time of its intervention only and within the limits of Client's instructions, if any. The Company's sole responsibility is to its Client and this document does not exonerate parties to a transaction from exercising all their rights and obligations under the transaction documents. This document cannot be reproduced except in full, without prior written approval of the Company. Any unauthorized alteration, forgery or falsification of the content or appearance of this document is unlawful and offenders may be prosecuted to the fullest extent of the law.

Fundamental Frequency :1880.0 MHz Engineer :Nick
Operation Mode :TX Mid

| Freq. (MHz) | Note F/H/E/S | Reading dBm | Limit dBm | Safe Margin dB |
|----------------|-----------------|----------------|--------------|----------------------|
| <30 | S | --- | -13.00 | --- |
| 30-1000 | S | --- | -13.00 | --- |
| 3760.00 | H | --- | -13.00 | --- |
| 5640.00 | H | --- | -13.00 | --- |
| 7520.00 | H | --- | -13.00 | --- |
| 9400.00 | H | --- | -13.00 | --- |
| 11280.00 | H | --- | -13.00 | --- |
| 13160.00 | H | --- | -13.00 | --- |
| 13767.00 | S | -18.76 | -13.00 | 5.76 |
| 15040.00 | H | --- | -13.00 | --- |
| 16920.00 | H | --- | -13.00 | --- |
| 18800.00 | H | --- | -13.00 | --- |

Note : "H" : denotes Harmonic Frequency. "S" : denotes Spurious Frequency.
"---" : denotes Noise Floor.

Unless otherwise stated the results shown in this test report refer only to the sample(s) tested and such sample(s) are retained for 90 days only.

除非另有說明，此報告結果僅對測試之樣品負責，同時此樣品僅保留90天。本報告未經本公司書面許可，不可部份複製。

This document is issued by the Company subject to its General Conditions of Service printed overleaf, available on request or accessible at www.sgs.com/terms_and_conditions.htm and, for electronic format documents, subject to Terms and Conditions for Electronic Documents at www.sgs.com/terms_e-document.htm. Attention is drawn to the limitation of liability, indemnification and jurisdiction issues defined therein. Any holder of this document is advised that information contained hereon reflects the Company's findings at the time of its intervention only and within the limits of Client's instructions, if any. The Company's sole responsibility is to its Client and this document does not exonerate parties to a transaction from exercising all their rights and obligations under the transaction documents. This document cannot be reproduced except in full, without prior written approval of the Company. Any unauthorized alteration, forgery or falsification of the content or appearance of this document is unlawful and offenders may be prosecuted to the fullest extent of the law.

Fundamental Frequency :1909.8 MHz Engineer :Nick
Operation Mode :TX High

| Freq. (MHz) | Note F/H/E/S | Reading dBm | Limit dBm | Safe Margin dB |
|----------------|-----------------|----------------|--------------|----------------------|
| <30 | S | --- | -13.00 | --- |
| 30-1000 | S | --- | -13.00 | --- |
| 3819.60 | H | --- | -13.00 | --- |
| 5729.40 | H | --- | -13.00 | --- |
| 7639.20 | H | --- | -13.00 | --- |
| 9549.00 | H | --- | -13.00 | --- |
| 11458.80 | H | --- | -13.00 | --- |
| 13368.60 | H | --- | -13.00 | --- |
| 13767.00 | S | -19.58 | -13.00 | 6.58 |
| 15278.40 | H | --- | -13.00 | --- |
| 17188.20 | H | --- | -13.00 | --- |
| 19098.00 | H | --- | -13.00 | --- |

Note : "H" : denotes Harmonic Frequency. "S" : denotes Spurious Frequency.
"---" : denotes Noise Floor.

Unless otherwise stated the results shown in this test report refer only to the sample(s) tested and such sample(s) are retained for 90 days only.

除非另有說明，此報告結果僅對測試之樣品負責，同時此樣品僅保留90天。本報告未經本公司書面許可，不可部份複製。

This document is issued by the Company subject to its General Conditions of Service printed overleaf, available on request or accessible at www.sgs.com/terms_and_conditions.htm and, for electronic format documents, subject to Terms and Conditions for Electronic Documents at www.sgs.com/terms_e-document.htm. Attention is drawn to the limitation of liability, indemnification and jurisdiction issues defined therein. Any holder of this document is advised that information contained hereon reflects the Company's findings at the time of its intervention only and within the limits of Client's instructions, if any. The Company's sole responsibility is to its Client and this document does not exonerate parties to a transaction from exercising all their rights and obligations under the transaction documents. This document cannot be reproduced except in full, without prior written approval of the Company. Any unauthorized alteration, forgery or falsification of the content or appearance of this document is unlawful and offenders may be prosecuted to the fullest extent of the law.

Figure 9-19: Band edge emission at antenna terminals – GPRS 1900 Channel Lowest

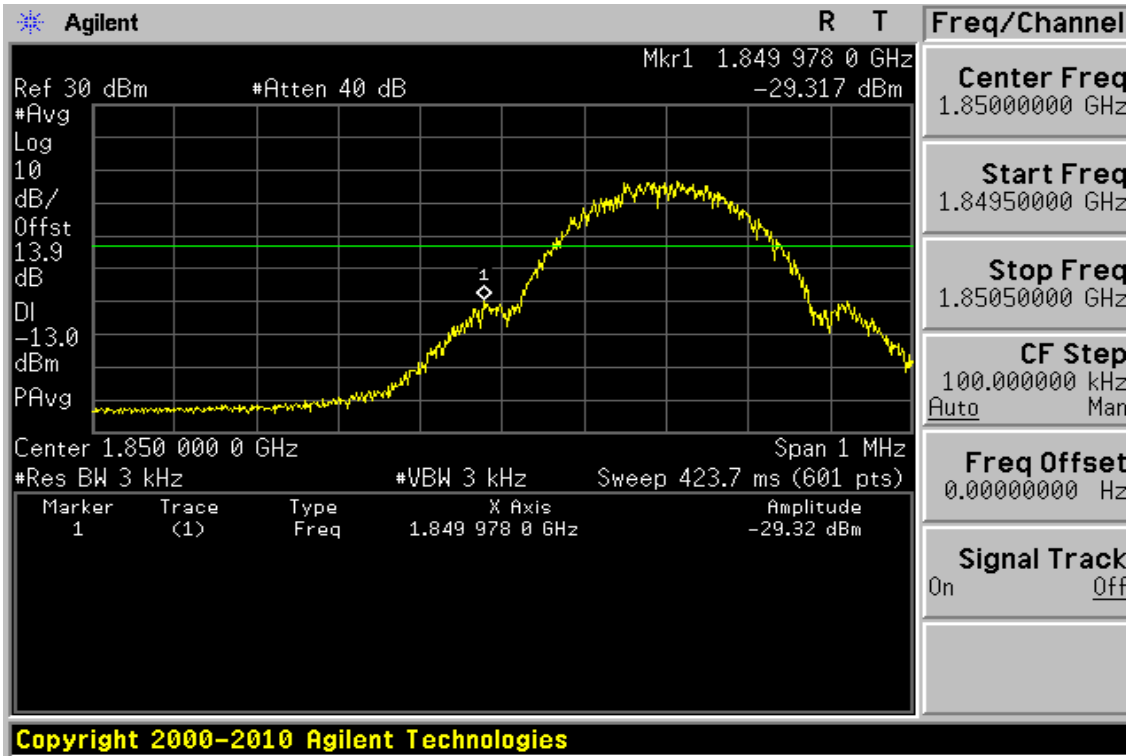
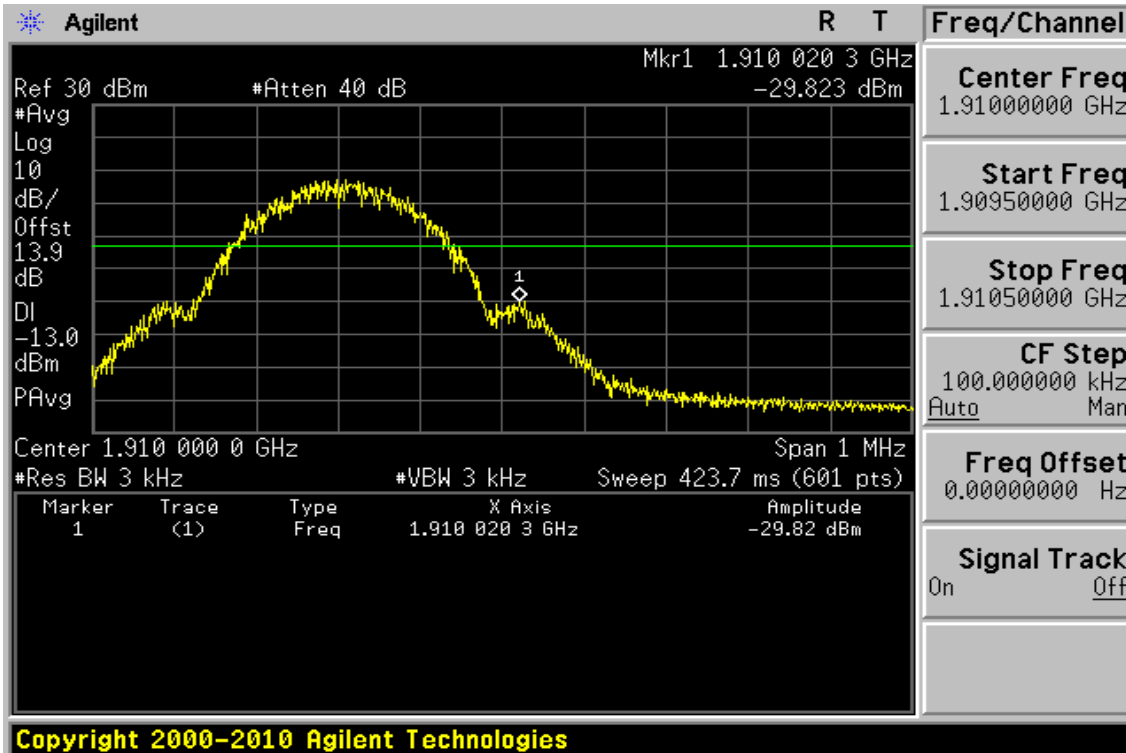

Figure 9-20: Band edge emission at antenna terminals – GPRS 1900 Channel Highest



Unless otherwise stated the results shown in this test report refer only to the sample(s) tested and such sample(s) are retained for 90 days only.

除非另有說明，此報告結果僅對測試之樣品負責，同時此樣品僅保留90天。本報告未經本公司書面許可，不可部份複製。

This document is issued by the Company subject to its General Conditions of Service printed overleaf, available on request or accessible at www.sgs.com/terms_and_conditions.htm and, for electronic format documents, subject to Terms and Conditions for Electronic Documents at www.sgs.com/terms_e-document.htm. Attention is drawn to the limitation of liability, indemnification and jurisdiction issues defined therein. Any holder of this document is advised that information contained hereon reflects the Company's findings at the time of its intervention only and within the limits of Client's instructions, if any. The Company's sole responsibility is to its Client and this document does not exonerate parties to a transaction from exercising all their rights and obligations under the transaction documents. This document cannot be reproduced except in full, without prior written approval of the Company. Any unauthorized alteration, forgery or falsification of the content or appearance of this document is unlawful and offenders may be prosecuted to the fullest extent of the law.

Band edge emission at antenna terminals – GPRS 1900 Low & High

Test Mode GPRS 1900 Engineer :Nick

| Freq. MHz | Reading dBm | Limit dBm | Safe Margin dB |
|--------------|----------------|--------------|----------------------|
| 1849.978 | -29.32 | -13.00 | 16.32 |
| 1910.020 | -29.82 | -13.00 | 16.82 |

Unless otherwise stated the results shown in this test report refer only to the sample(s) tested and such sample(s) are retained for 90 days only.

除非另有說明，此報告結果僅對測試之樣品負責，同時此樣品僅保留90天。本報告未經本公司書面許可，不可部份複製。

This document is issued by the Company subject to its General Conditions of Service printed overleaf, available on request or accessible at www.sgs.com/terms_and_conditions.htm and, for electronic format documents, subject to Terms and Conditions for Electronic Documents at www.sgs.com/terms_e-document.htm. Attention is drawn to the limitation of liability, indemnification and jurisdiction issues defined therein. Any holder of this document is advised that information contained hereon reflects the Company's findings at the time of its intervention only and within the limits of Client's instructions, if any. The Company's sole responsibility is to its Client and this document does not exonerate parties to a transaction from exercising all their rights and obligations under the transaction documents. This document cannot be reproduced except in full, without prior written approval of the Company. Any unauthorized alteration, forgery or falsification of the content or appearance of this document is unlawful and offenders may be prosecuted to the fullest extent of the law.

Figure 9-21: Out of Band emission at antenna terminals – EDGE 850 Channel Lowest

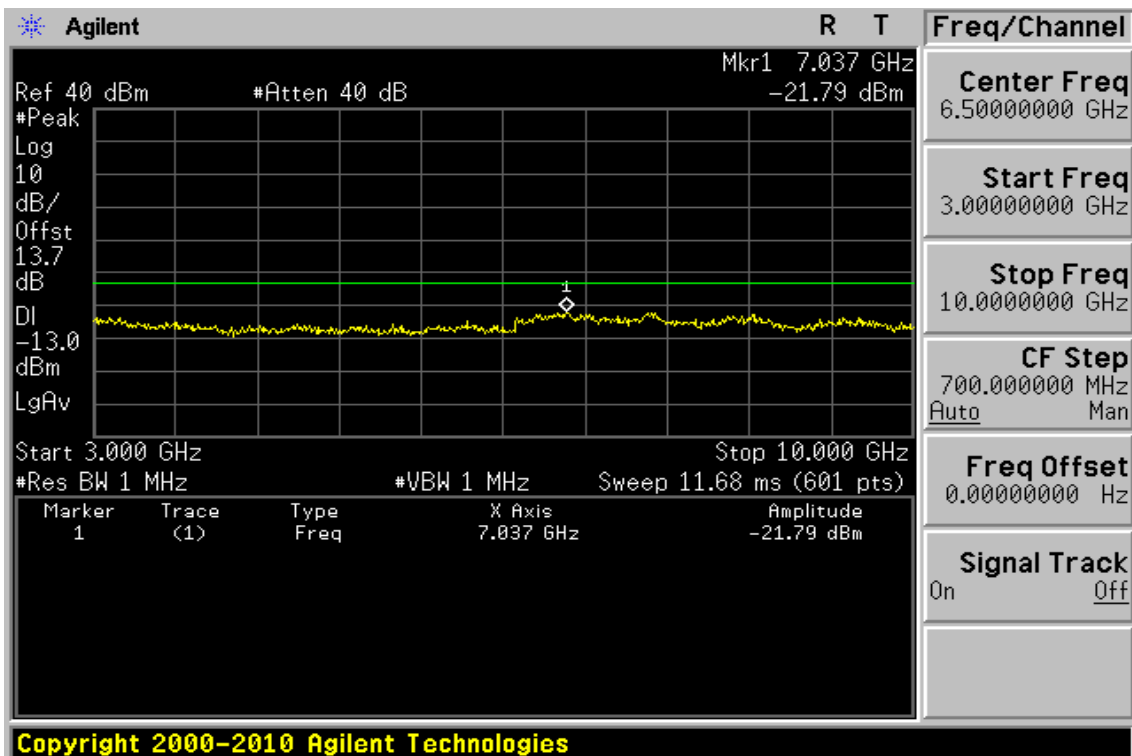
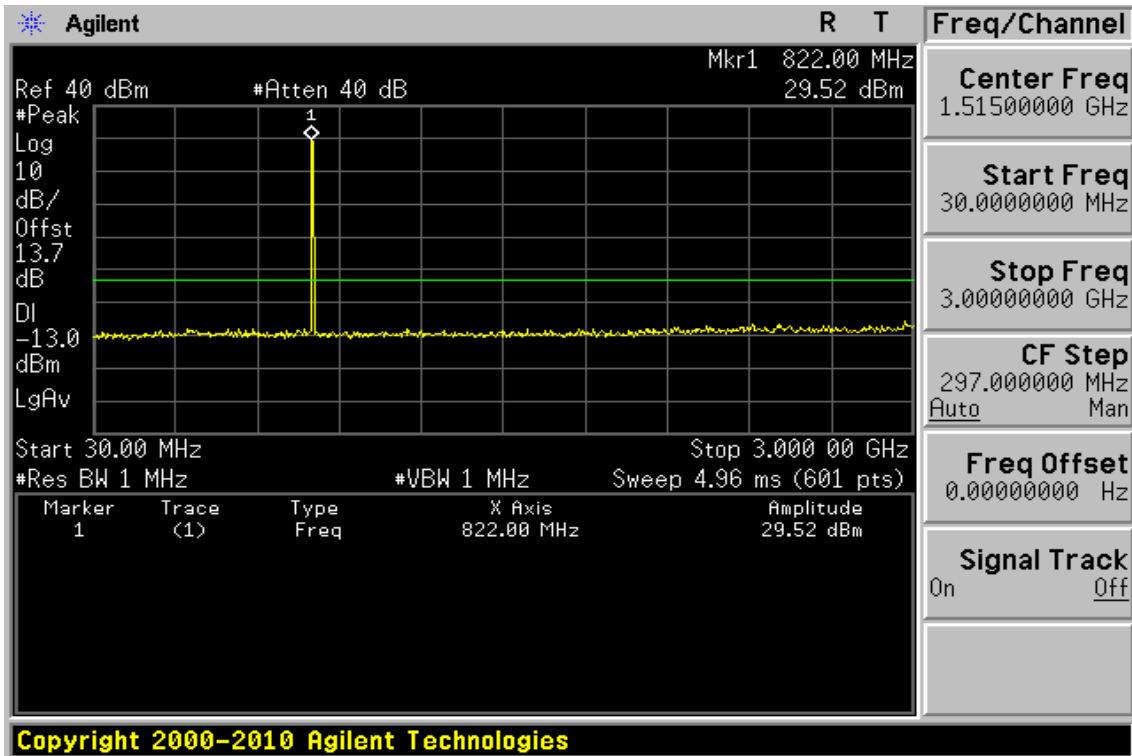

Unless otherwise stated the results shown in this test report refer only to the sample(s) tested and such sample(s) are retained for 90 days only.

除非另有說明，此報告結果僅對測試之樣品負責，同時此樣品僅保留90天。本報告未經本公司書面許可，不可部份複製。

This document is issued by the Company subject to its General Conditions of Service printed overleaf, available on request or accessible at www.sgs.com/terms_and_conditions.htm and, for electronic format documents, subject to Terms and Conditions for Electronic Documents at www.sgs.com/terms_e-document.htm. Attention is drawn to the limitation of liability, indemnification and jurisdiction issues defined therein. Any holder of this document is advised that information contained hereon reflects the Company's findings at the time of its intervention only and within the limits of Client's instructions, if any. The Company's sole responsibility is to its Client and this document does not exonerate parties to a transaction from exercising all their rights and obligations under the transaction documents. This document cannot be reproduced except in full, without prior written approval of the Company. Any unauthorized alteration, forgery or falsification of the content or appearance of this document is unlawful and offenders may be prosecuted to the fullest extent of the law.

Figure 9-22: Out of Band emission at antenna terminals – EDGE 850 Channel Mid

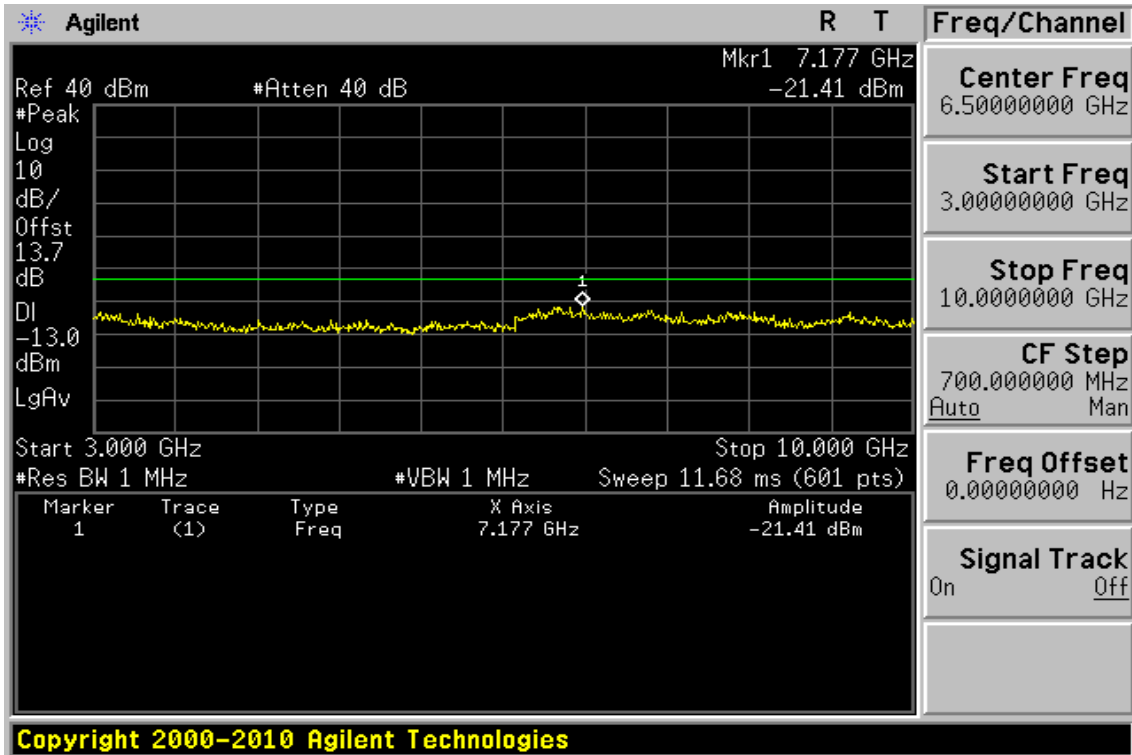
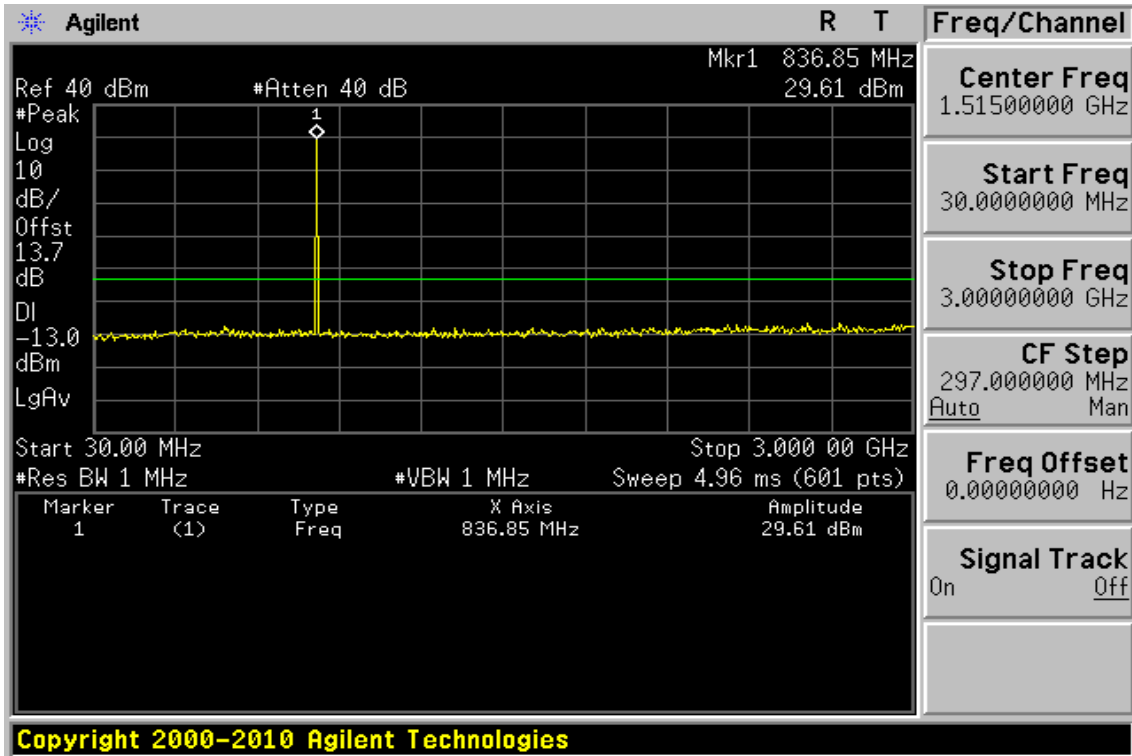

Unless otherwise stated the results shown in this test report refer only to the sample(s) tested and such sample(s) are retained for 90 days only.

除非另有說明，此報告結果僅對測試之樣品負責，同時此樣品僅保留90天。本報告未經本公司書面許可，不可部份複製。

This document is issued by the Company subject to its General Conditions of Service printed overleaf, available on request or accessible at www.sgs.com/terms_and_conditions.htm and, for electronic format documents, subject to Terms and Conditions for Electronic Documents at www.sgs.com/terms_e-document.htm. Attention is drawn to the limitation of liability, indemnification and jurisdiction issues defined therein. Any holder of this document is advised that information contained hereon reflects the Company's findings at the time of its intervention only and within the limits of Client's instructions, if any. The Company's sole responsibility is to its Client and this document does not exonerate parties to a transaction from exercising all their rights and obligations under the transaction documents. This document cannot be reproduced except in full, without prior written approval of the Company. Any unauthorized alteration, forgery or falsification of the content or appearance of this document is unlawful and offenders may be prosecuted to the fullest extent of the law.

Figure 9-23: Out of Band emission at antenna terminals – EDGE 850 Channel Highest

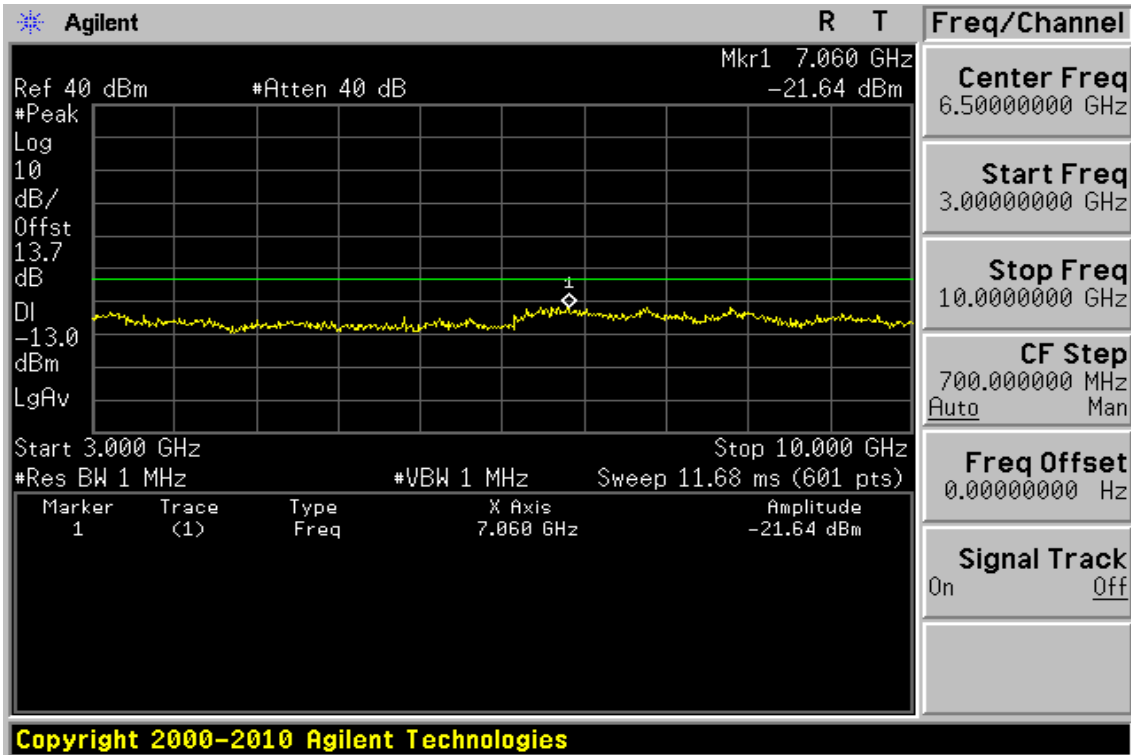
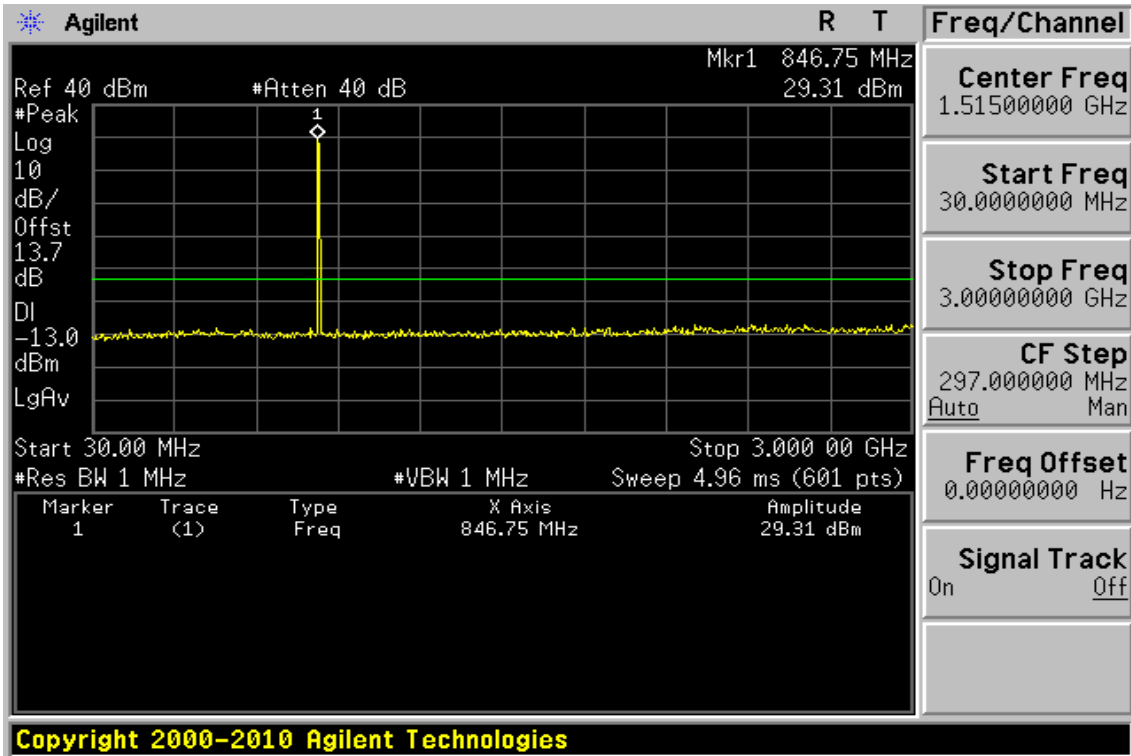

Unless otherwise stated the results shown in this test report refer only to the sample(s) tested and such sample(s) are retained for 90 days only.

除非另有說明，此報告結果僅對測試之樣品負責，同時此樣品僅保留90天。本報告未經本公司書面許可，不可部份複製。

This document is issued by the Company subject to its General Conditions of Service printed overleaf, available on request or accessible at www.sgs.com/terms_and_conditions.htm and, for electronic format documents, subject to Terms and Conditions for Electronic Documents at www.sgs.com/terms_e-document.htm. Attention is drawn to the limitation of liability, indemnification and jurisdiction issues defined therein. Any holder of this document is advised that information contained hereon reflects the Company's findings at the time of its intervention only and within the limits of Client's instructions, if any. The Company's sole responsibility is to its Client and this document does not exonerate parties to a transaction from exercising all their rights and obligations under the transaction documents. This document cannot be reproduced except in full, without prior written approval of the Company. Any unauthorized alteration, forgery or falsification of the content or appearance of this document is unlawful and offenders may be prosecuted to the fullest extent of the law.

Out of Band emission at antenna terminals – EDGE 850

Fundamental Frequency :824.2 MHz Engineer :Nick
Operation Mode :TX Low

| Freq. (MHz) | Note F/H/E/S | Reading dBm | Limit dBm | Safe Margin dB |
|----------------|-----------------|----------------|--------------|----------------------|
| <30 | S | --- | -13.00 | --- |
| 30-1000 | S | --- | -13.00 | --- |
| 1648.40 | H | --- | -13.00 | --- |
| 2472.60 | H | --- | -13.00 | --- |
| 3296.80 | H | --- | -13.00 | --- |
| 4121.00 | H | --- | -13.00 | --- |
| 4945.20 | H | --- | -13.00 | --- |
| 5769.40 | H | --- | -13.00 | --- |
| 6593.60 | H | --- | -13.00 | --- |
| 7037.00 | S | -21.79 | -13.00 | 8.79 |
| 7417.80 | H | --- | -13.00 | --- |
| 8242.00 | H | --- | -13.00 | --- |

Note : “H” : denotes Harmonic Frequency. “S” : denotes Spurious Frequency.
“---” : denotes Noise Floor.

Unless otherwise stated the results shown in this test report refer only to the sample(s) tested and such sample(s) are retained for 90 days only.

除非另有說明，此報告結果僅對測試之樣品負責，同時此樣品僅保留90天。本報告未經本公司書面許可，不可部份複製。

This document is issued by the Company subject to its General Conditions of Service printed overleaf, available on request or accessible at www.sgs.com/terms_and_conditions.htm and, for electronic format documents, subject to Terms and Conditions for Electronic Documents at www.sgs.com/terms_e-document.htm. Attention is drawn to the limitation of liability, indemnification and jurisdiction issues defined therein. Any holder of this document is advised that information contained hereon reflects the Company's findings at the time of its intervention only and within the limits of Client's instructions, if any. The Company's sole responsibility is to its Client and this document does not exonerate parties to a transaction from exercising all their rights and obligations under the transaction documents. This document cannot be reproduced except in full, without prior written approval of the Company. Any unauthorized alteration, forgery or falsification of the content or appearance of this document is unlawful and offenders may be prosecuted to the fullest extent of the law.

Fundamental Frequency :836.6 MHz Engineer :Nick
Operation Mode :TX Mid

| Freq. (MHz) | Note F/H/E/S | Reading dBm | Limit dBm | Safe Margin dB |
|----------------|-----------------|----------------|--------------|----------------------|
| <30 | S | --- | -13.00 | --- |
| 30-1000 | S | --- | -13.00 | --- |
| 1673.20 | H | --- | -13.00 | --- |
| 2509.80 | H | --- | -13.00 | --- |
| 3346.40 | H | --- | -13.00 | --- |
| 4183.00 | H | --- | -13.00 | --- |
| 5019.60 | H | --- | -13.00 | --- |
| 6692.80 | H | --- | -13.00 | --- |
| 7177.00 | S | -21.41 | -13.00 | 8.41 |
| 7529.40 | H | --- | -13.00 | --- |
| 8366.00 | H | --- | -13.00 | --- |

Note : “H” : denotes Harmonic Frequency. “S” : denotes Spurious Frequency.
“---” : denotes Noise Floor.

Unless otherwise stated the results shown in this test report refer only to the sample(s) tested and such sample(s) are retained for 90 days only.

除非另有說明，此報告結果僅對測試之樣品負責，同時此樣品僅保留90天。本報告未經本公司書面許可，不可部份複製。

This document is issued by the Company subject to its General Conditions of Service printed overleaf, available on request or accessible at www.sgs.com/terms_and_conditions.htm and, for electronic format documents, subject to Terms and Conditions for Electronic Documents at www.sgs.com/terms_e-document.htm. Attention is drawn to the limitation of liability, indemnification and jurisdiction issues defined therein. Any holder of this document is advised that information contained hereon reflects the Company's findings at the time of its intervention only and within the limits of Client's instructions, if any. The Company's sole responsibility is to its Client and this document does not exonerate parties to a transaction from exercising all their rights and obligations under the transaction documents. This document cannot be reproduced except in full, without prior written approval of the Company. Any unauthorized alteration, forgery or falsification of the content or appearance of this document is unlawful and offenders may be prosecuted to the fullest extent of the law.

Fundamental Frequency :848.8MHz Engineer :Nick
Operation Mode :TX High

| Freq. (MHz) | Note F/H/E/S | Reading dBm | Limit dBm | Safe Margin dB |
|----------------|-----------------|----------------|--------------|----------------------|
| <30 | S | --- | -13.00 | --- |
| 30-1000 | S | --- | -13.00 | --- |
| 1697.60 | H | --- | -13.00 | --- |
| 2546.40 | H | --- | -13.00 | --- |
| 3395.20 | H | --- | -13.00 | --- |
| 4244.00 | H | --- | -13.00 | --- |
| 5092.80 | H | --- | -13.00 | --- |
| 5941.60 | H | --- | -13.00 | --- |
| 6790.40 | H | --- | -13.00 | --- |
| 7060.00 | S | -21.64 | -13.00 | 8.64 |
| 7639.20 | H | --- | -13.00 | --- |
| 8488.00 | H | --- | -13.00 | --- |

Note : "H" : denotes Harmonic Frequency. "S" : denotes Spurious Frequency.
"---" : denotes Noise Floor.

Unless otherwise stated the results shown in this test report refer only to the sample(s) tested and such sample(s) are retained for 90 days only.

除非另有說明，此報告結果僅對測試之樣品負責，同時此樣品僅保留90天。本報告未經本公司書面許可，不可部份複製。

This document is issued by the Company subject to its General Conditions of Service printed overleaf, available on request or accessible at www.sgs.com/terms_and_conditions.htm and, for electronic format documents, subject to Terms and Conditions for Electronic Documents at www.sgs.com/terms_e-document.htm. Attention is drawn to the limitation of liability, indemnification and jurisdiction issues defined therein. Any holder of this document is advised that information contained hereon reflects the Company's findings at the time of its intervention only and within the limits of Client's instructions, if any. The Company's sole responsibility is to its Client and this document does not exonerate parties to a transaction from exercising all their rights and obligations under the transaction documents. This document cannot be reproduced except in full, without prior written approval of the Company. Any unauthorized alteration, forgery or falsification of the content or appearance of this document is unlawful and offenders may be prosecuted to the fullest extent of the law.

Figure 9-24: Band edge emission at antenna terminals – EDGE 850 Channel Lowest

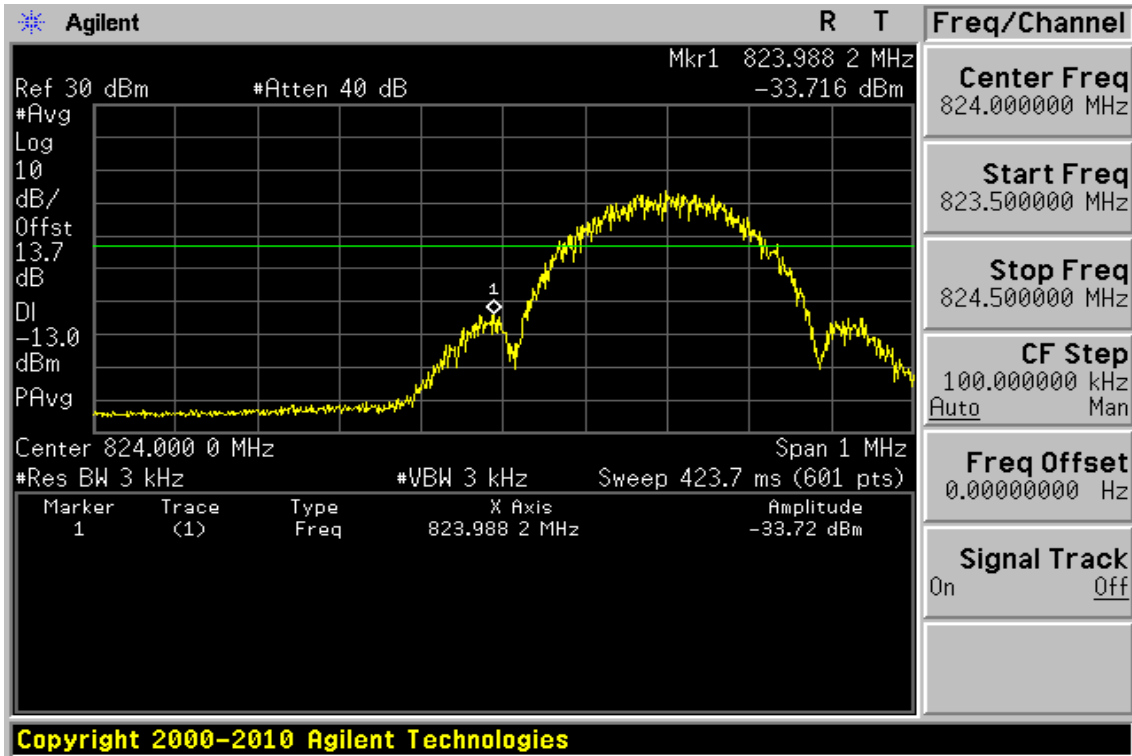
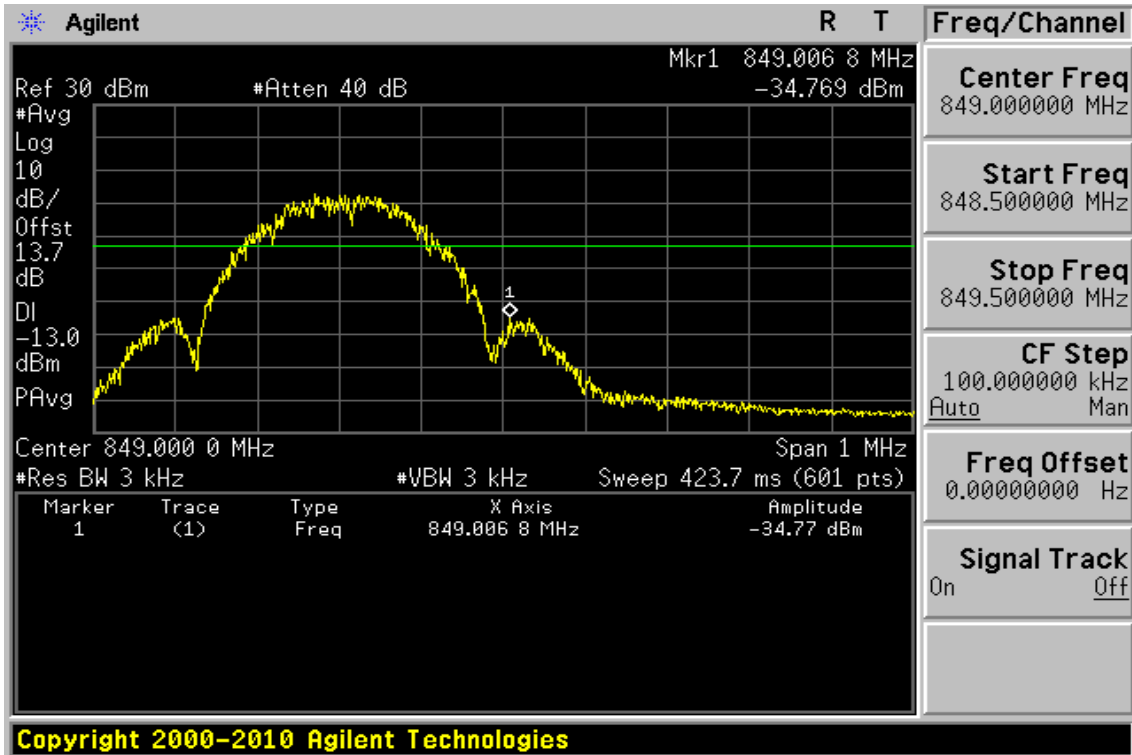

Figure 9-25: Band edge emission at antenna terminals – EDGE 850 Channel Highest



Unless otherwise stated the results shown in this test report refer only to the sample(s) tested and such sample(s) are retained for 90 days only.

除非另有說明，此報告結果僅對測試之樣品負責，同時此樣品僅保留90天。本報告未經本公司書面許可，不可部份複製。

This document is issued by the Company subject to its General Conditions of Service printed overleaf, available on request or accessible at www.sgs.com/terms_and_conditions.htm and, for electronic format documents, subject to Terms and Conditions for Electronic Documents at www.sgs.com/terms_e-document.htm. Attention is drawn to the limitation of liability, indemnification and jurisdiction issues defined therein. Any holder of this document is advised that information contained hereon reflects the Company's findings at the time of its intervention only and within the limits of Client's instructions, if any. The Company's sole responsibility is to its Client and this document does not exonerate parties to a transaction from exercising all their rights and obligations under the transaction documents. This document cannot be reproduced except in full, without prior written approval of the Company. Any unauthorized alteration, forgery or falsification of the content or appearance of this document is unlawful and offenders may be prosecuted to the fullest extent of the law.

Band edge emission at antenna terminals – EDGE 850 Low & High

Test Mode EDGE 850 Engineer :Nick

| Freq. MHz | Reading dBm | Limit dBm | Safe Margin dB |
|--------------|----------------|--------------|----------------------|
| 823.988 | -33.72 | -13.00 | 20.72 |
| 849.006 | -34.77 | -13.00 | 21.77 |

Unless otherwise stated the results shown in this test report refer only to the sample(s) tested and such sample(s) are retained for 90 days only.

除非另有說明，此報告結果僅對測試之樣品負責，同時此樣品僅保留90天。本報告未經本公司書面許可，不可部份複製。

This document is issued by the Company subject to its General Conditions of Service printed overleaf, available on request or accessible at www.sgs.com/terms_and_conditions.htm and, for electronic format documents, subject to Terms and Conditions for Electronic Documents at www.sgs.com/terms_e-document.htm. Attention is drawn to the limitation of liability, indemnification and jurisdiction issues defined therein. Any holder of this document is advised that information contained hereon reflects the Company's findings at the time of its intervention only and within the limits of Client's instructions, if any. The Company's sole responsibility is to its Client and this document does not exonerate parties to a transaction from exercising all their rights and obligations under the transaction documents. This document cannot be reproduced except in full, without prior written approval of the Company. Any unauthorized alteration, forgery or falsification of the content or appearance of this document is unlawful and offenders may be prosecuted to the fullest extent of the law.

Figure 9-26: Out of Band emission at antenna terminals – EDGE 1900 Channel Lowest

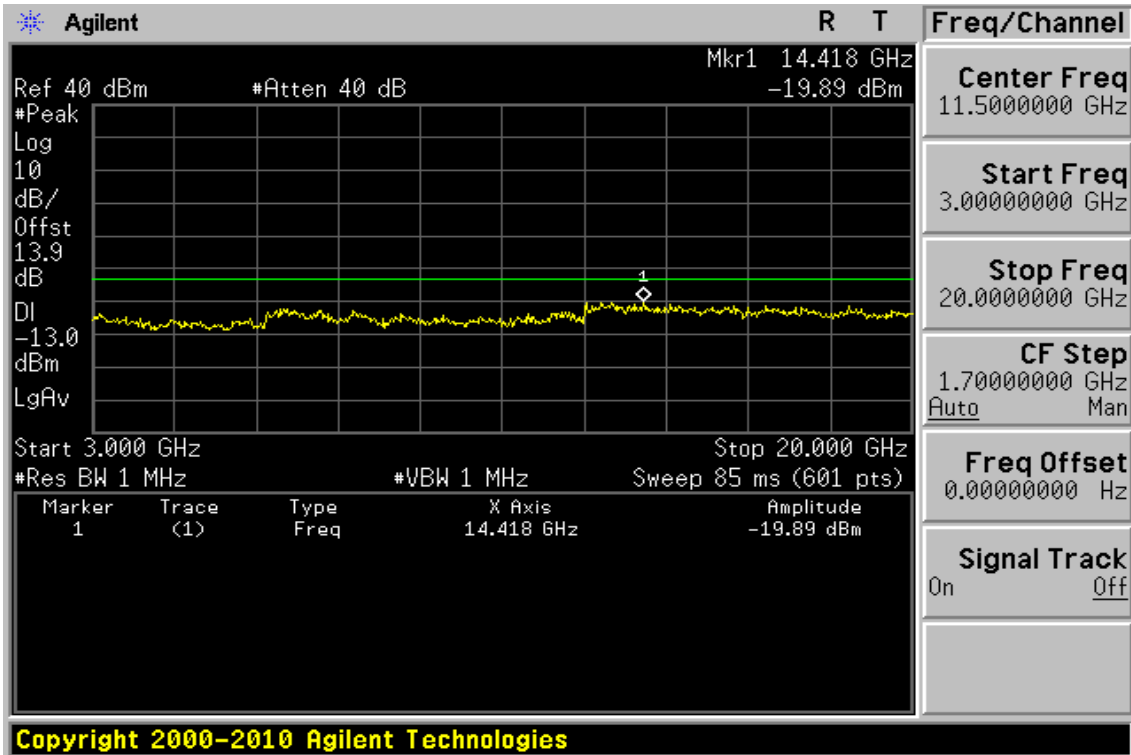
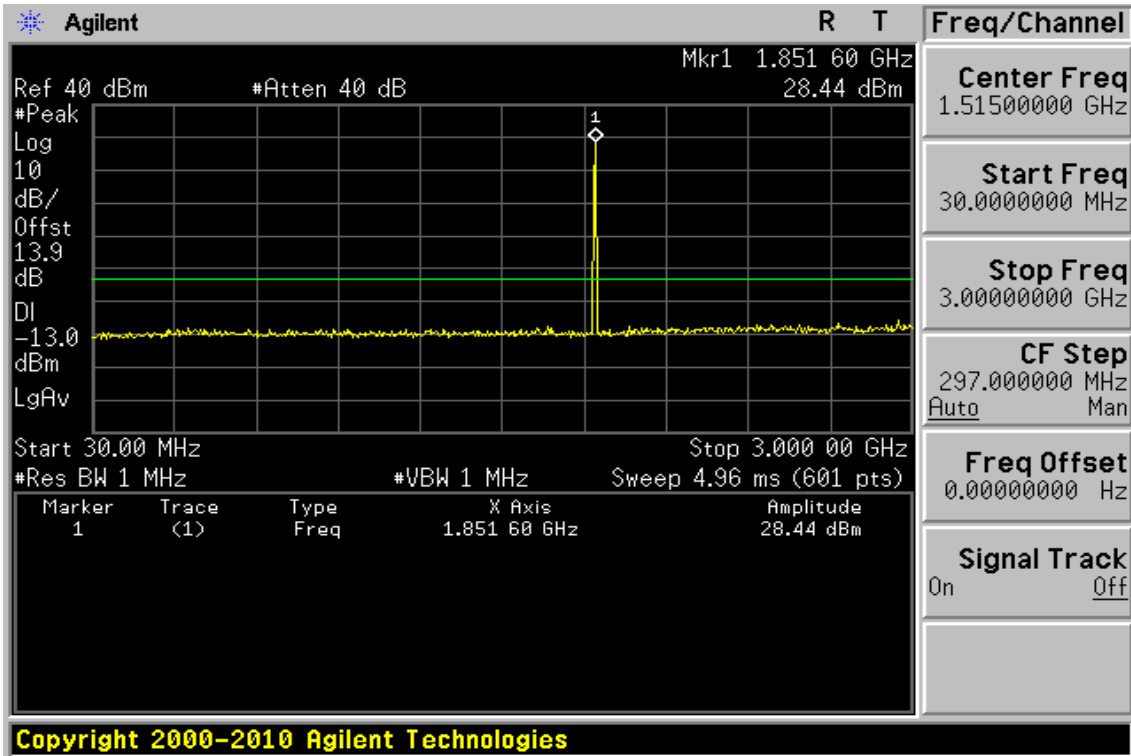

Unless otherwise stated the results shown in this test report refer only to the sample(s) tested and such sample(s) are retained for 90 days only.

除非另有說明，此報告結果僅對測試之樣品負責，同時此樣品僅保留90天。本報告未經本公司書面許可，不可部份複製。

This document is issued by the Company subject to its General Conditions of Service printed overleaf, available on request or accessible at www.sgs.com/terms_and_conditions.htm and, for electronic format documents, subject to Terms and Conditions for Electronic Documents at www.sgs.com/terms_e-document.htm. Attention is drawn to the limitation of liability, indemnification and jurisdiction issues defined therein. Any holder of this document is advised that information contained hereon reflects the Company's findings at the time of its intervention only and within the limits of Client's instructions, if any. The Company's sole responsibility is to its Client and this document does not exonerate parties to a transaction from exercising all their rights and obligations under the transaction documents. This document cannot be reproduced except in full, without prior written approval of the Company. Any unauthorized alteration, forgery or falsification of the content or appearance of this document is unlawful and offenders may be prosecuted to the fullest extent of the law.

Figure 9-27: Out of Band emission at antenna terminals – EDGE 1900 Channel Mid

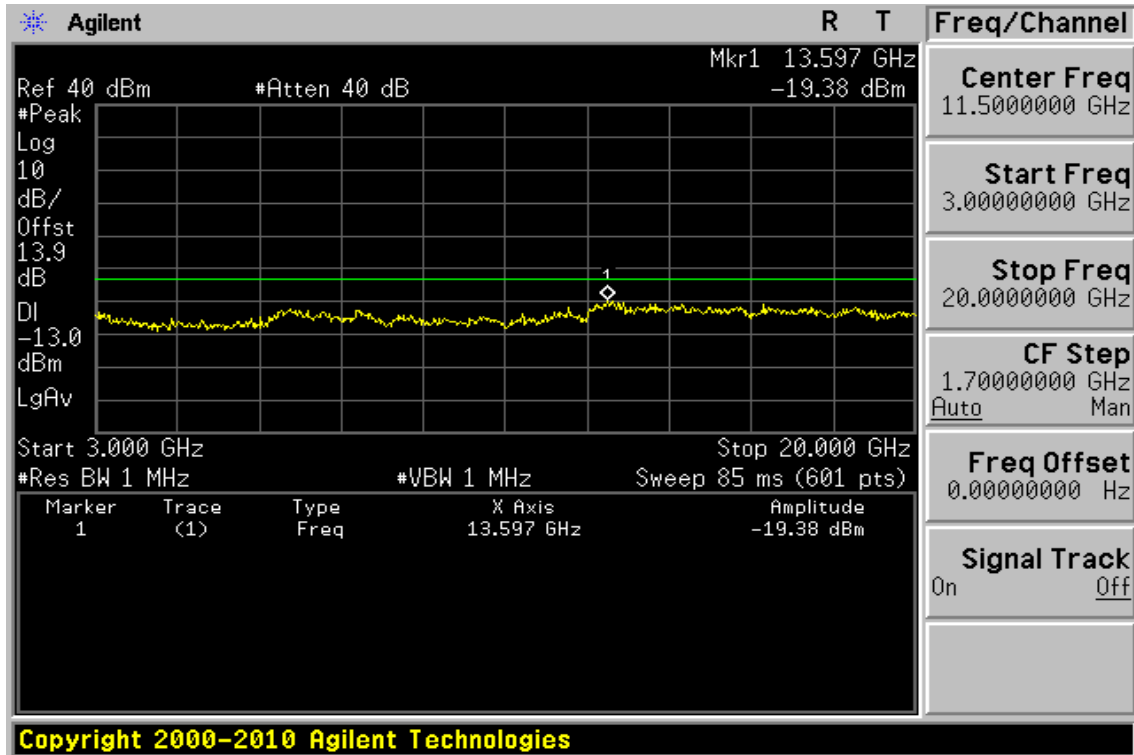
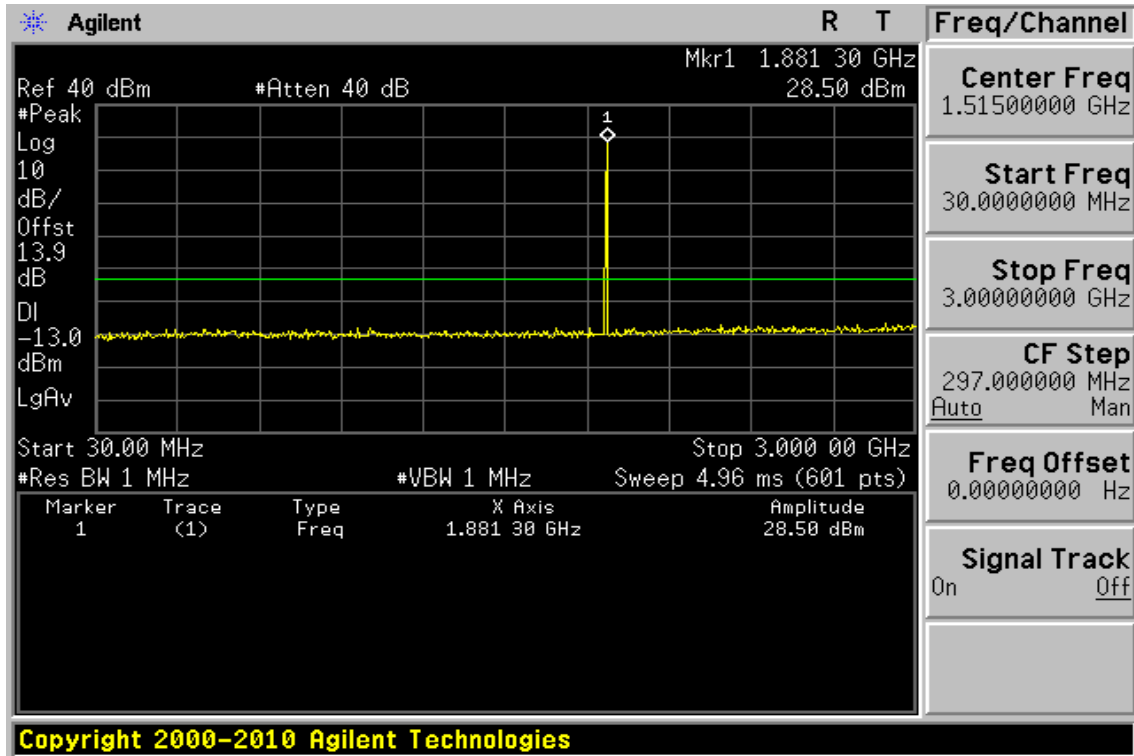

Unless otherwise stated the results shown in this test report refer only to the sample(s) tested and such sample(s) are retained for 90 days only.

除非另有說明，此報告結果僅對測試之樣品負責，同時此樣品僅保留90天。本報告未經本公司書面許可，不可部份複製。

This document is issued by the Company subject to its General Conditions of Service printed overleaf, available on request or accessible at www.sgs.com/terms_and_conditions.htm and, for electronic format documents, subject to Terms and Conditions for Electronic Documents at www.sgs.com/terms_e-document.htm. Attention is drawn to the limitation of liability, indemnification and jurisdiction issues defined therein. Any holder of this document is advised that information contained hereon reflects the Company's findings at the time of its intervention only and within the limits of Client's instructions, if any. The Company's sole responsibility is to its Client and this document does not exonerate parties to a transaction from exercising all their rights and obligations under the transaction documents. This document cannot be reproduced except in full, without prior written approval of the Company. Any unauthorized alteration, forgery or falsification of the content or appearance of this document is unlawful and offenders may be prosecuted to the fullest extent of the law.

Figure 9-28: Out of Band emission at antenna terminals – EDGE 1900 Channel Highest

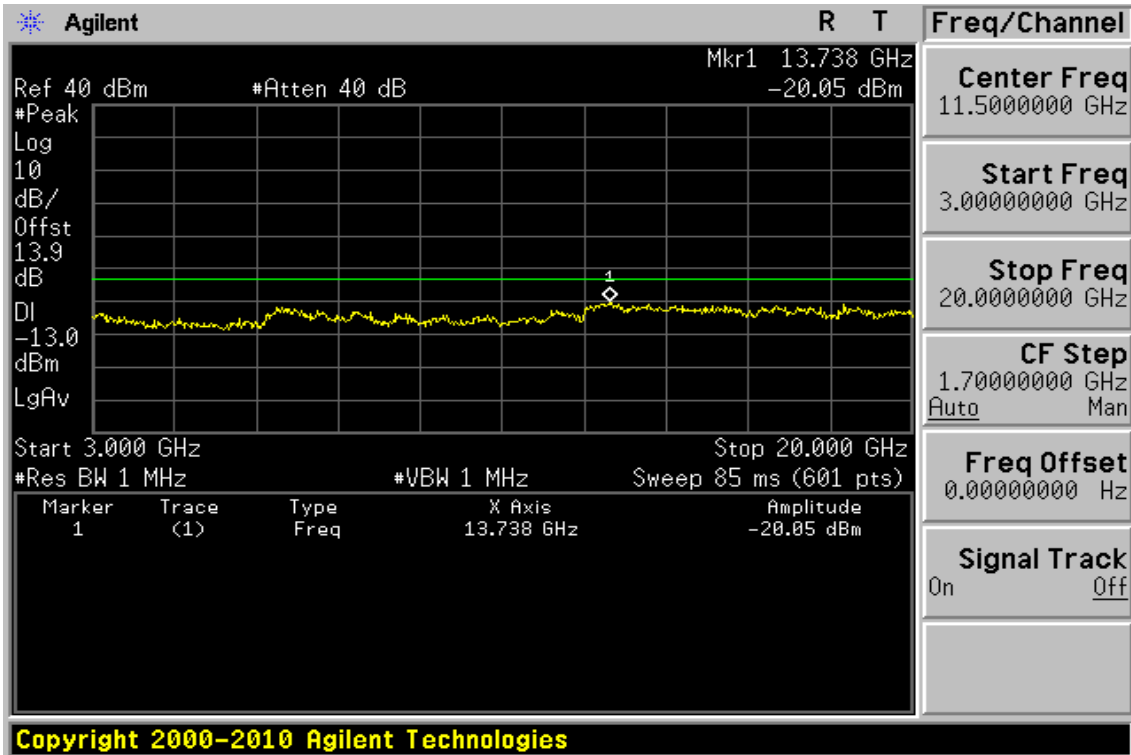
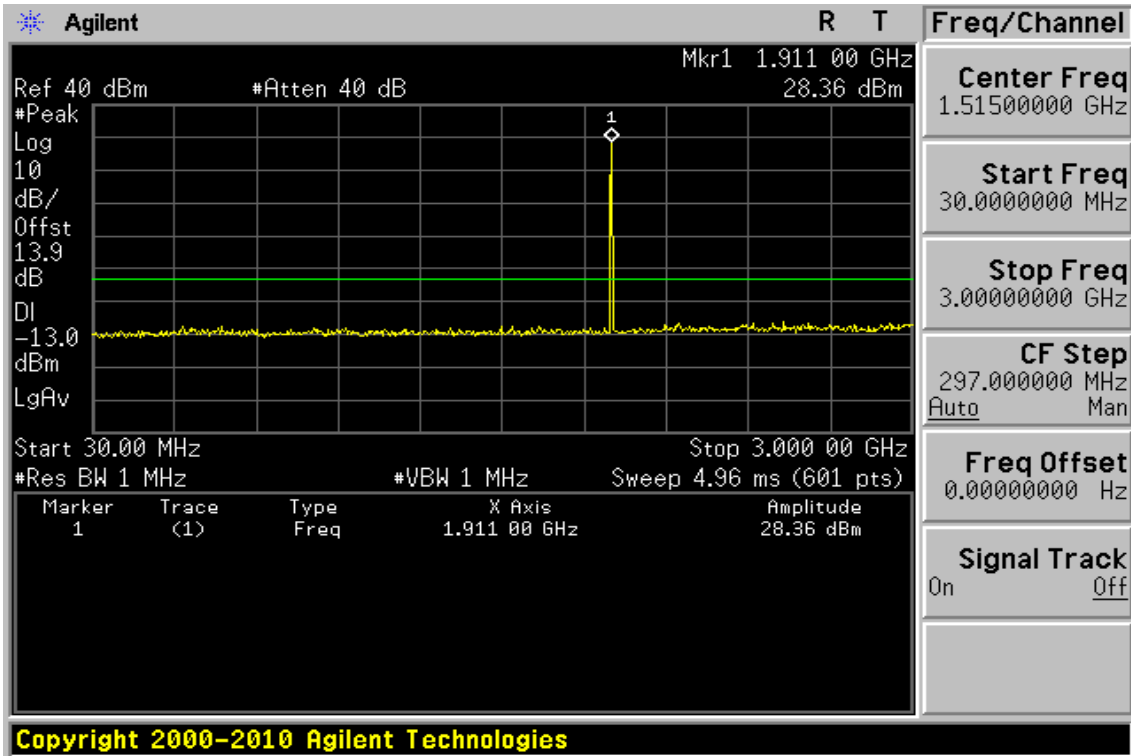

Unless otherwise stated the results shown in this test report refer only to the sample(s) tested and such sample(s) are retained for 90 days only.

除非另有說明，此報告結果僅對測試之樣品負責，同時此樣品僅保留90天。本報告未經本公司書面許可，不可部份複製。

This document is issued by the Company subject to its General Conditions of Service printed overleaf, available on request or accessible at www.sgs.com/terms_and_conditions.htm and, for electronic format documents, subject to Terms and Conditions for Electronic Documents at www.sgs.com/terms_e-document.htm. Attention is drawn to the limitation of liability, indemnification and jurisdiction issues defined therein. Any holder of this document is advised that information contained hereon reflects the Company's findings at the time of its intervention only and within the limits of Client's instructions, if any. The Company's sole responsibility is to its Client and this document does not exonerate parties to a transaction from exercising all their rights and obligations under the transaction documents. This document cannot be reproduced except in full, without prior written approval of the Company. Any unauthorized alteration, forgery or falsification of the content or appearance of this document is unlawful and offenders may be prosecuted to the fullest extent of the law.

Out of Band emission at antenna terminals – EDGE 1900

Fundamental Frequency :1850.2 MHz Engineer :Nick
Operation Mode :TX Low

| Freq. (MHz) | Note F/H/E/S | Reading dBm | Limit dBm | Safe Margin dB |
|----------------|-----------------|----------------|--------------|----------------------|
| <30 | S | --- | -13.00 | --- |
| 30-1000 | S | --- | -13.00 | --- |
| 3700.40 | H | --- | -13.00 | --- |
| 5550.60 | H | --- | -13.00 | --- |
| 7400.80 | H | --- | -13.00 | --- |
| 9251.00 | H | --- | -13.00 | --- |
| 11101.20 | H | --- | -13.00 | --- |
| 12951.40 | H | --- | -13.00 | --- |
| 14418.00 | S | -19.89 | -13.00 | 6.89 |
| 14801.60 | H | --- | -13.00 | --- |
| 16651.80 | H | --- | -13.00 | --- |
| 18502.00 | H | --- | -13.00 | --- |

Note : “H” : denotes Harmonic Frequency. “S” : denotes Spurious Frequency.
“---” : denotes Noise Floor.

Unless otherwise stated the results shown in this test report refer only to the sample(s) tested and such sample(s) are retained for 90 days only.

除非另有說明，此報告結果僅對測試之樣品負責，同時此樣品僅保留90天。本報告未經本公司書面許可，不可部份複製。

This document is issued by the Company subject to its General Conditions of Service printed overleaf, available on request or accessible at www.sgs.com/terms_and_conditions.htm and, for electronic format documents, subject to Terms and Conditions for Electronic Documents at www.sgs.com/terms_e-document.htm. Attention is drawn to the limitation of liability, indemnification and jurisdiction issues defined therein. Any holder of this document is advised that information contained hereon reflects the Company's findings at the time of its intervention only and within the limits of Client's instructions, if any. The Company's sole responsibility is to its Client and this document does not exonerate parties to a transaction from exercising all their rights and obligations under the transaction documents. This document cannot be reproduced except in full, without prior written approval of the Company. Any unauthorized alteration, forgery or falsification of the content or appearance of this document is unlawful and offenders may be prosecuted to the fullest extent of the law.

Fundamental Frequency :1880.0 MHz Engineer :Nick
Operation Mode :TX Mid

| Freq. (MHz) | Note F/H/E/S | Reading dBm | Limit dBm | Safe Margin dB |
|----------------|-----------------|----------------|--------------|----------------------|
| <30 | S | --- | -13.00 | --- |
| 30-1000 | S | --- | -13.00 | --- |
| 3760.00 | H | --- | -13.00 | --- |
| 5640.00 | H | --- | -13.00 | --- |
| 7520.00 | H | --- | -13.00 | --- |
| 9400.00 | H | --- | -13.00 | --- |
| 11280.00 | H | --- | -13.00 | --- |
| 13160.00 | H | --- | -13.00 | --- |
| 13597.00 | S | -19.38 | -13.00 | 6.38 |
| 15040.00 | H | --- | -13.00 | --- |
| 16920.00 | H | --- | -13.00 | --- |
| 18800.00 | H | --- | -13.00 | --- |

Note : “H” : denotes Harmonic Frequency. “S” : denotes Spurious Frequency.
“---” : denotes Noise Floor.

Unless otherwise stated the results shown in this test report refer only to the sample(s) tested and such sample(s) are retained for 90 days only.

除非另有說明，此報告結果僅對測試之樣品負責，同時此樣品僅保留90天。本報告未經本公司書面許可，不可部份複製。

This document is issued by the Company subject to its General Conditions of Service printed overleaf, available on request or accessible at www.sgs.com/terms_and_conditions.htm and, for electronic format documents, subject to Terms and Conditions for Electronic Documents at www.sgs.com/terms_e-document.htm. Attention is drawn to the limitation of liability, indemnification and jurisdiction issues defined therein. Any holder of this document is advised that information contained hereon reflects the Company's findings at the time of its intervention only and within the limits of Client's instructions, if any. The Company's sole responsibility is to its Client and this document does not exonerate parties to a transaction from exercising all their rights and obligations under the transaction documents. This document cannot be reproduced except in full, without prior written approval of the Company. Any unauthorized alteration, forgery or falsification of the content or appearance of this document is unlawful and offenders may be prosecuted to the fullest extent of the law.

Fundamental Frequency :1909.8 MHz Engineer :Nick
Operation Mode :TX High

| Freq. (MHz) | Note F/H/E/S | Reading dBm | Limit dBm | Safe Margin dB |
|----------------|-----------------|----------------|--------------|----------------------|
| <30 | S | --- | -13.00 | --- |
| 30-1000 | S | --- | -13.00 | --- |
| 3819.60 | H | --- | -13.00 | --- |
| 5729.40 | H | --- | -13.00 | --- |
| 7639.20 | H | --- | -13.00 | --- |
| 9549.00 | H | --- | -13.00 | --- |
| 11458.80 | H | --- | -13.00 | --- |
| 13368.60 | H | --- | -13.00 | --- |
| 13738.00 | S | -20.05 | -13.00 | 7.05 |
| 15278.40 | H | --- | -13.00 | --- |
| 17188.20 | H | --- | -13.00 | --- |
| 19098.00 | H | --- | -13.00 | --- |

Note : "H" : denotes Harmonic Frequency. "S" : denotes Spurious Frequency.
"---" : denotes Noise Floor.

Unless otherwise stated the results shown in this test report refer only to the sample(s) tested and such sample(s) are retained for 90 days only.

除非另有說明，此報告結果僅對測試之樣品負責，同時此樣品僅保留90天。本報告未經本公司書面許可，不可部份複製。

This document is issued by the Company subject to its General Conditions of Service printed overleaf, available on request or accessible at www.sgs.com/terms_and_conditions.htm and, for electronic format documents, subject to Terms and Conditions for Electronic Documents at www.sgs.com/terms_e-document.htm. Attention is drawn to the limitation of liability, indemnification and jurisdiction issues defined therein. Any holder of this document is advised that information contained hereon reflects the Company's findings at the time of its intervention only and within the limits of Client's instructions, if any. The Company's sole responsibility is to its Client and this document does not exonerate parties to a transaction from exercising all their rights and obligations under the transaction documents. This document cannot be reproduced except in full, without prior written approval of the Company. Any unauthorized alteration, forgery or falsification of the content or appearance of this document is unlawful and offenders may be prosecuted to the fullest extent of the law.

Figure 9-29: Band edge emission at antenna terminals – EDGE 1900 Channel Lowest

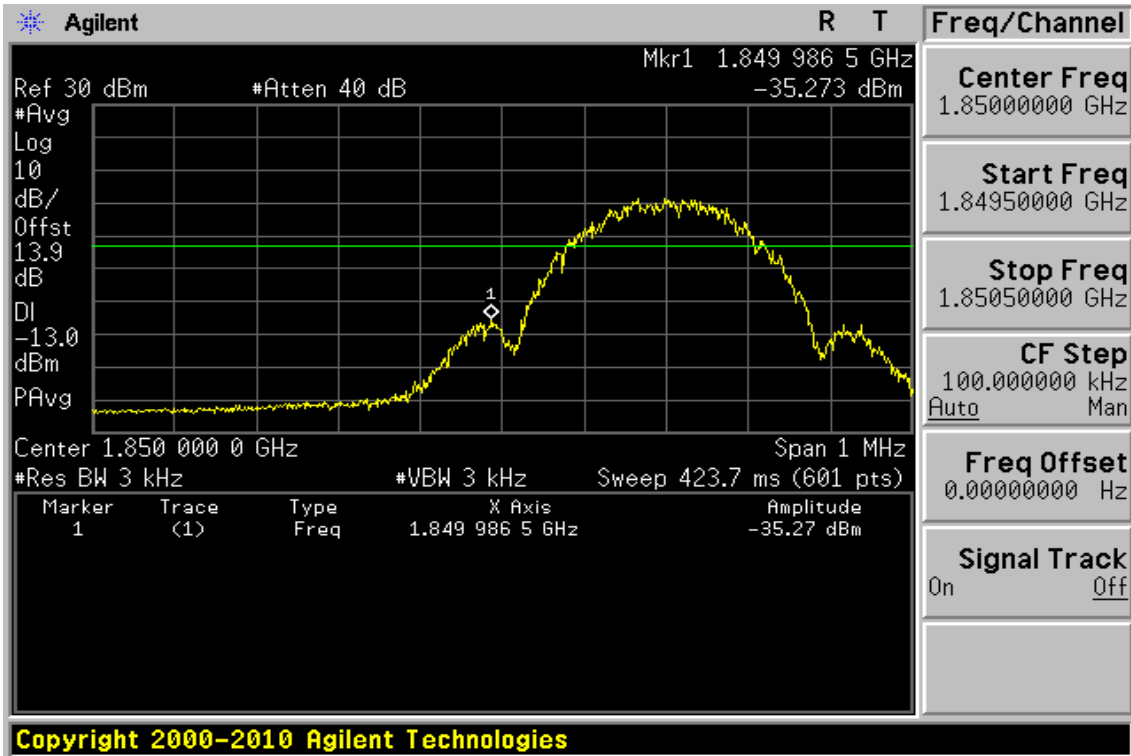
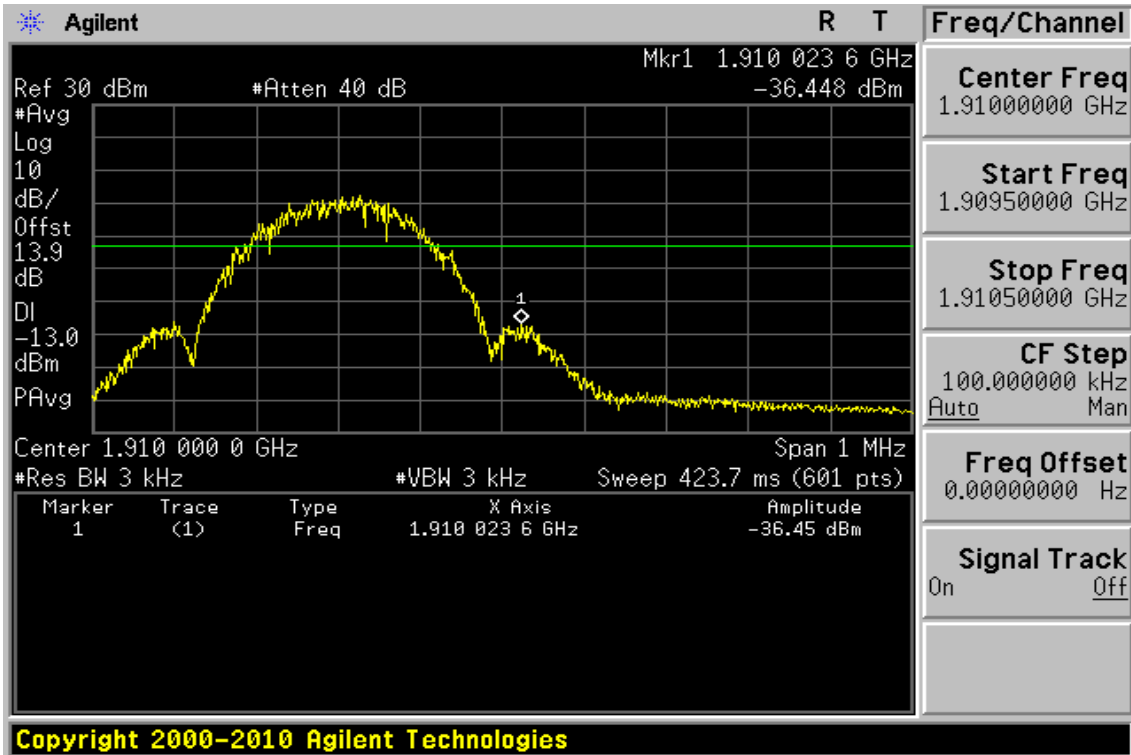

Figure 9-30: Band edge emission at antenna terminals – EDGE 1900 Channel Highest



Unless otherwise stated the results shown in this test report refer only to the sample(s) tested and such sample(s) are retained for 90 days only.

除非另有說明，此報告結果僅對測試之樣品負責，同時此樣品僅保留90天。本報告未經本公司書面許可，不可部份複製。

This document is issued by the Company subject to its General Conditions of Service printed overleaf, available on request or accessible at www.sgs.com/terms_and_conditions.htm and, for electronic format documents, subject to Terms and Conditions for Electronic Documents at www.sgs.com/terms_e-document.htm. Attention is drawn to the limitation of liability, indemnification and jurisdiction issues defined therein. Any holder of this document is advised that information contained hereon reflects the Company's findings at the time of its intervention only and within the limits of Client's instructions, if any. The Company's sole responsibility is to its Client and this document does not exonerate parties to a transaction from exercising all their rights and obligations under the transaction documents. This document cannot be reproduced except in full, without prior written approval of the Company. Any unauthorized alteration, forgery or falsification of the content or appearance of this document is unlawful and offenders may be prosecuted to the fullest extent of the law.

Band edge emission at antenna terminals – EDGE 1900 Low & High

Test Mode EDGE 1900: Engineer :Nick

| Freq. MHz | Reading dBm | Limit dBm | Safe Margin dB |
|--------------|----------------|--------------|----------------------|
| 1849.986 | -35.27 | -13.00 | 22.27 |
| 1910.023 | -36.45 | -13.00 | 23.45 |

Unless otherwise stated the results shown in this test report refer only to the sample(s) tested and such sample(s) are retained for 90 days only.

除非另有說明，此報告結果僅對測試之樣品負責，同時此樣品僅保留90天。本報告未經本公司書面許可，不可部份複製。

This document is issued by the Company subject to its General Conditions of Service printed overleaf, available on request or accessible at www.sgs.com/terms_and_conditions.htm and, for electronic format documents, subject to Terms and Conditions for Electronic Documents at www.sgs.com/terms_e-document.htm. Attention is drawn to the limitation of liability, indemnification and jurisdiction issues defined therein. Any holder of this document is advised that information contained hereon reflects the Company's findings at the time of its intervention only and within the limits of Client's instructions, if any. The Company's sole responsibility is to its Client and this document does not exonerate parties to a transaction from exercising all their rights and obligations under the transaction documents. This document cannot be reproduced except in full, without prior written approval of the Company. Any unauthorized alteration, forgery or falsification of the content or appearance of this document is unlawful and offenders may be prosecuted to the fullest extent of the law.

Figure 9-31: Out of Band emission at antenna terminals – WCDMA II Channel Lowest

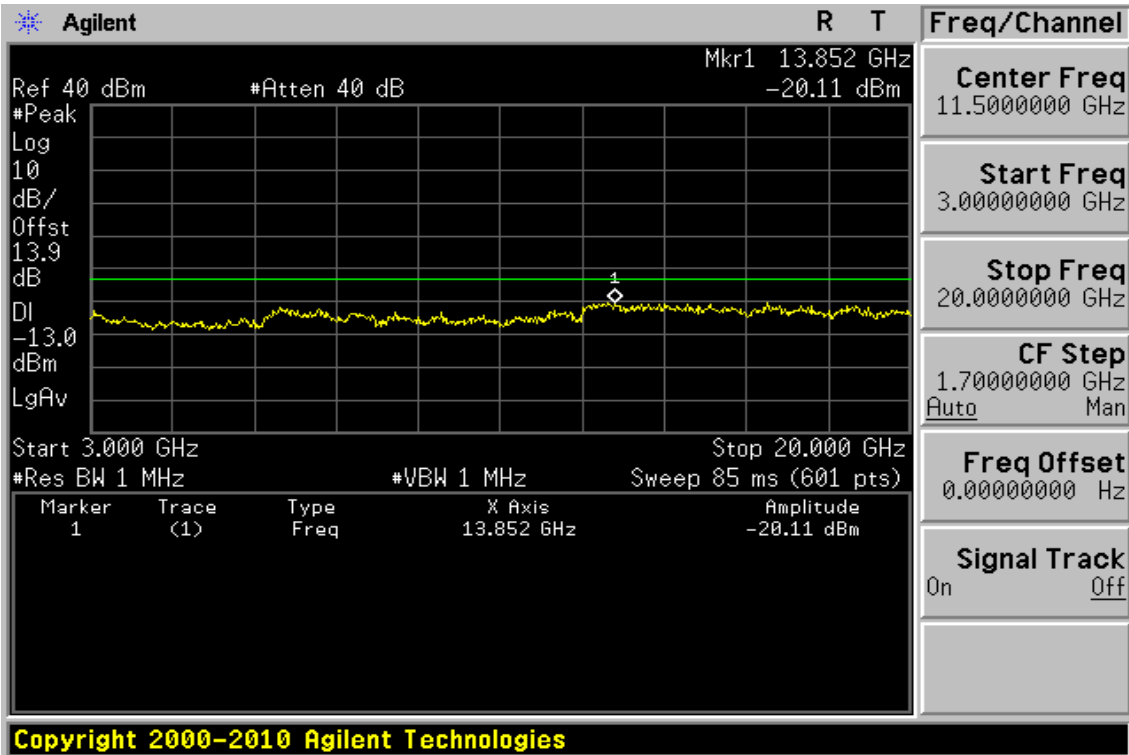
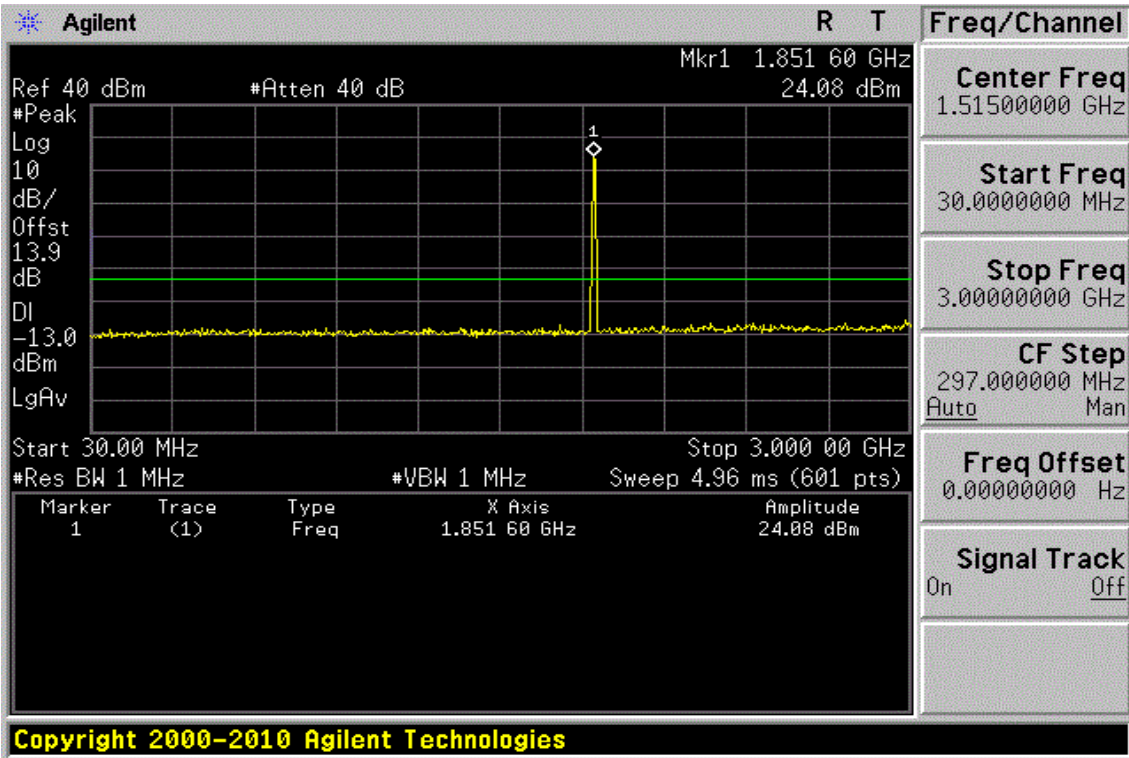

Unless otherwise stated the results shown in this test report refer only to the sample(s) tested and such sample(s) are retained for 90 days only.

除非另有說明，此報告結果僅對測試之樣品負責，同時此樣品僅保留90天。本報告未經本公司書面許可，不可部份複製。

This document is issued by the Company subject to its General Conditions of Service printed overleaf, available on request or accessible at www.sgs.com/terms_and_conditions.htm and, for electronic format documents, subject to Terms and Conditions for Electronic Documents at www.sgs.com/terms_e-document.htm. Attention is drawn to the limitation of liability, indemnification and jurisdiction issues defined therein. Any holder of this document is advised that information contained hereon reflects the Company's findings at the time of its intervention only and within the limits of Client's instructions, if any. The Company's sole responsibility is to its Client and this document does not exonerate parties to a transaction from exercising all their rights and obligations under the transaction documents. This document cannot be reproduced except in full, without prior written approval of the Company. Any unauthorized alteration, forgery or falsification of the content or appearance of this document is unlawful and offenders may be prosecuted to the fullest extent of the law.

Figure 9-32: Out of Band emission at antenna terminals – WCDMA II Channel Mid

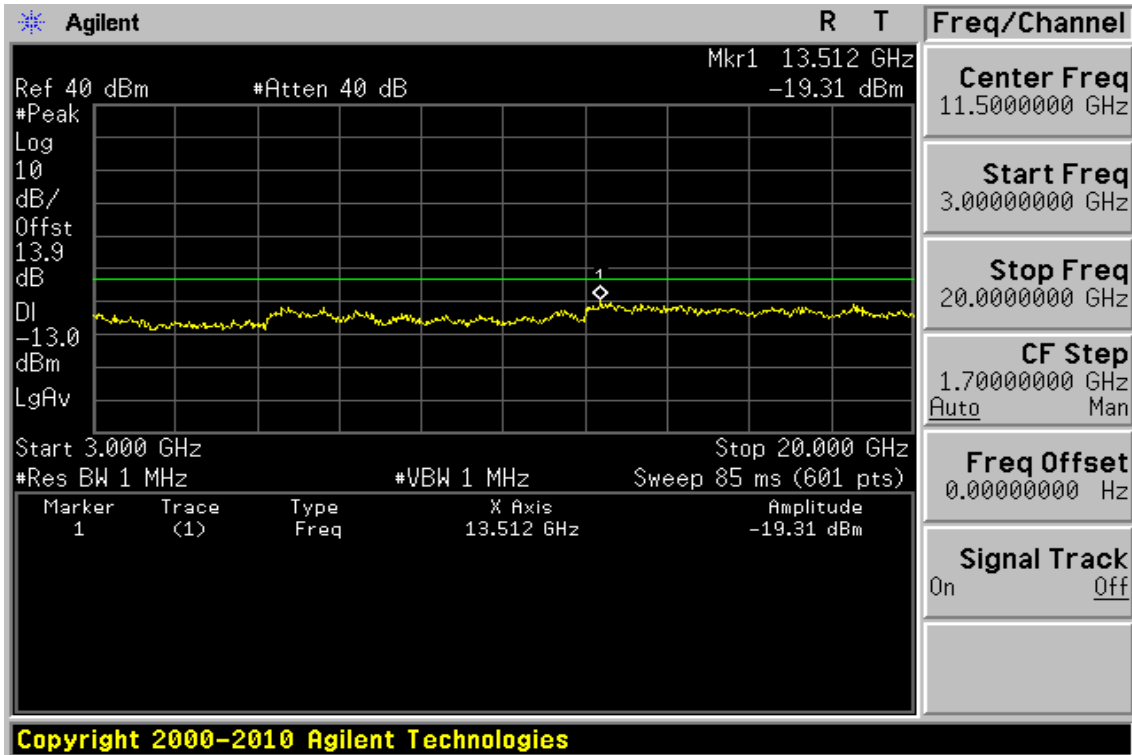
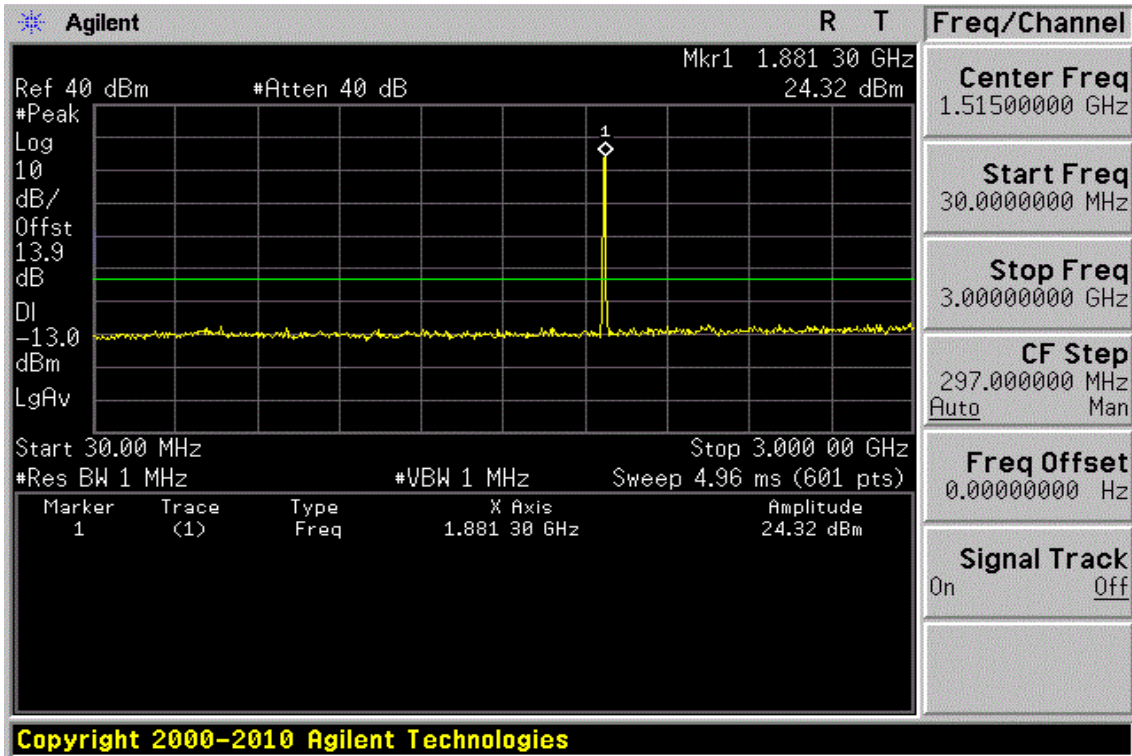

Unless otherwise stated the results shown in this test report refer only to the sample(s) tested and such sample(s) are retained for 90 days only.

除非另有說明，此報告結果僅對測試之樣品負責，同時此樣品僅保留90天。本報告未經本公司書面許可，不可部份複製。

This document is issued by the Company subject to its General Conditions of Service printed overleaf, available on request or accessible at www.sgs.com/terms_and_conditions.htm and, for electronic format documents, subject to Terms and Conditions for Electronic Documents at www.sgs.com/terms_e-document.htm. Attention is drawn to the limitation of liability, indemnification and jurisdiction issues defined therein. Any holder of this document is advised that information contained hereon reflects the Company's findings at the time of its intervention only and within the limits of Client's instructions, if any. The Company's sole responsibility is to its Client and this document does not exonerate parties to a transaction from exercising all their rights and obligations under the transaction documents. This document cannot be reproduced except in full, without prior written approval of the Company. Any unauthorized alteration, forgery or falsification of the content or appearance of this document is unlawful and offenders may be prosecuted to the fullest extent of the law.

Figure 9-33: Out of Band emission at antenna terminals – WCDMA II Channel Highest

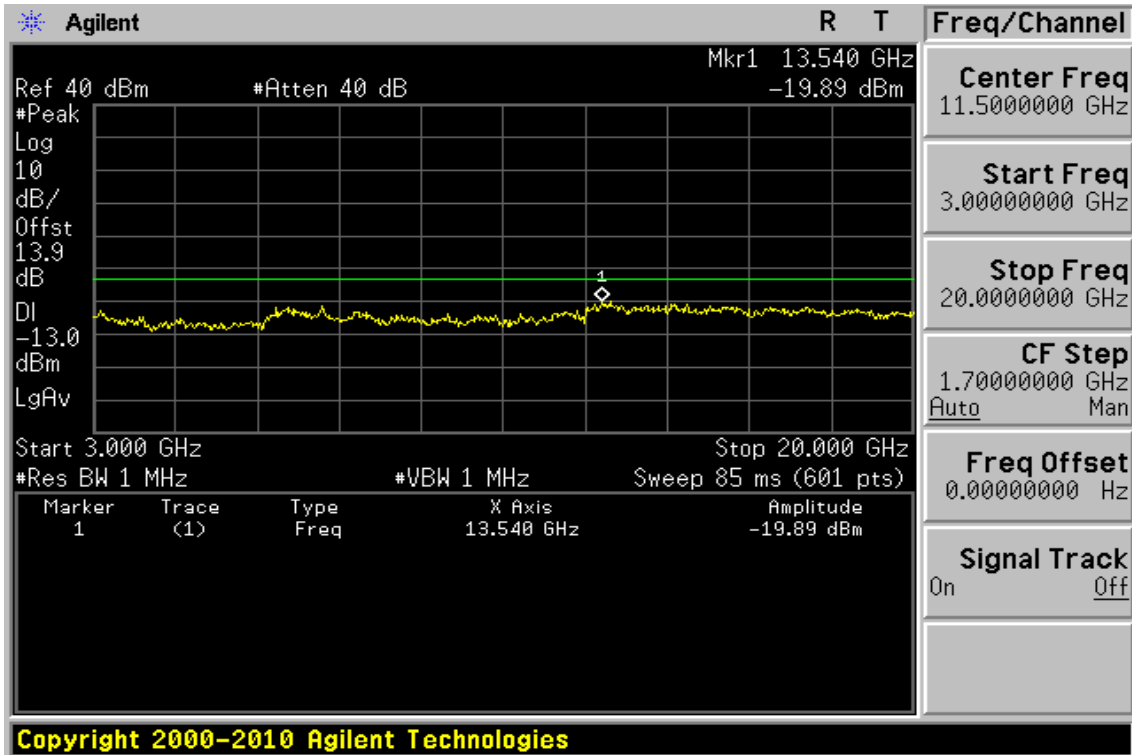
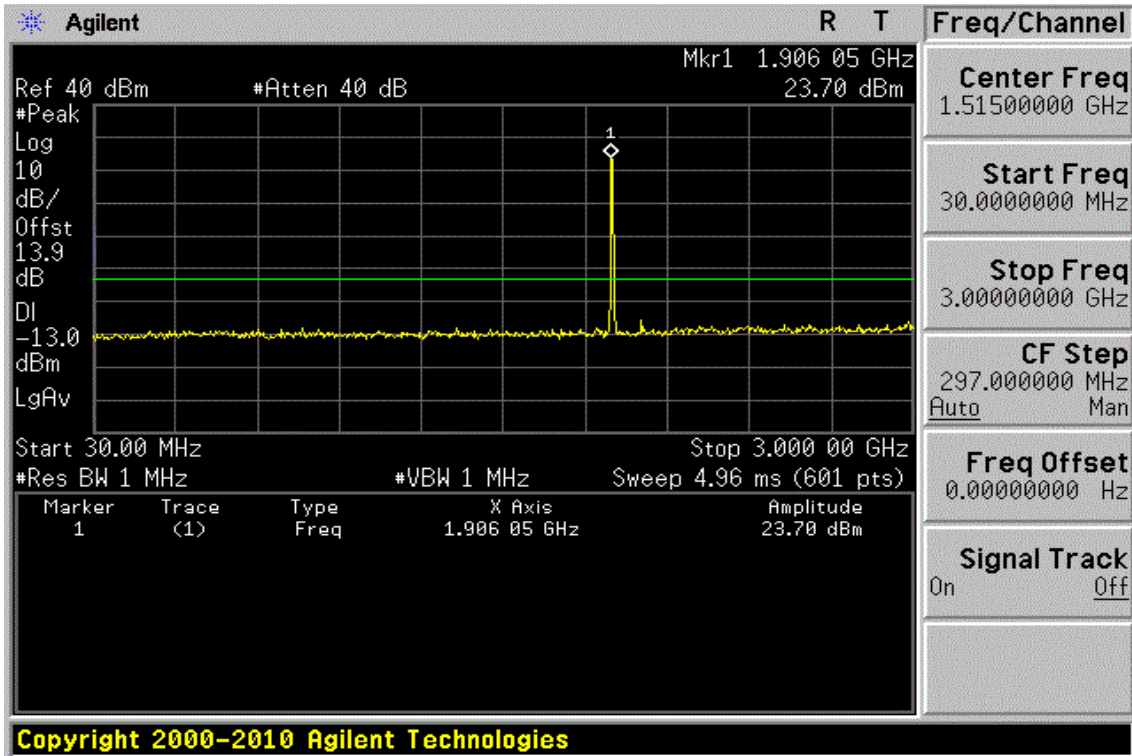

Unless otherwise stated the results shown in this test report refer only to the sample(s) tested and such sample(s) are retained for 90 days only.

除非另有說明，此報告結果僅對測試之樣品負責，同時此樣品僅保留90天。本報告未經本公司書面許可，不可部份複製。

This document is issued by the Company subject to its General Conditions of Service printed overleaf, available on request or accessible at www.sgs.com/terms_and_conditions.htm and, for electronic format documents, subject to Terms and Conditions for Electronic Documents at www.sgs.com/terms_e-document.htm. Attention is drawn to the limitation of liability, indemnification and jurisdiction issues defined therein. Any holder of this document is advised that information contained hereon reflects the Company's findings at the time of its intervention only and within the limits of Client's instructions, if any. The Company's sole responsibility is to its Client and this document does not exonerate parties to a transaction from exercising all their rights and obligations under the transaction documents. This document cannot be reproduced except in full, without prior written approval of the Company. Any unauthorized alteration, forgery or falsification of the content or appearance of this document is unlawful and offenders may be prosecuted to the fullest extent of the law.

Out of Band emission at antenna terminals – WCDMA II

Fundamental Frequency :1852.4 MHz Engineer :Nick
Operation Mode :TX Low

| Freq. (MHz) | Note F/H/E/S | Reading dBm | Limit dBm | Safe Margin dB |
|----------------|-----------------|----------------|--------------|----------------------|
| <30 | S | --- | -13.00 | --- |
| 30-1000 | S | --- | -13.00 | --- |
| 3704.80 | H | --- | -13.00 | --- |
| 5557.20 | H | --- | -13.00 | --- |
| 7409.60 | H | --- | -13.00 | --- |
| 9262.00 | H | --- | -13.00 | --- |
| 11114.40 | H | --- | -13.00 | --- |
| 12966.80 | H | --- | -13.00 | --- |
| 13852.00 | S | -20.11 | -13.00 | 7.11 |
| 14819.20 | H | --- | -13.00 | --- |
| 16671.60 | H | --- | -13.00 | --- |
| 18524.00 | H | --- | -13.00 | --- |

Note : “H” : denotes Harmonic Frequency. “S” : denotes Spurious Frequency.
“---” : denotes Noise Floor.

Unless otherwise stated the results shown in this test report refer only to the sample(s) tested and such sample(s) are retained for 90 days only.

除非另有說明，此報告結果僅對測試之樣品負責，同時此樣品僅保留90天。本報告未經本公司書面許可，不可部份複製。

This document is issued by the Company subject to its General Conditions of Service printed overleaf, available on request or accessible at www.sgs.com/terms_and_conditions.htm and, for electronic format documents, subject to Terms and Conditions for Electronic Documents at www.sgs.com/terms_e-document.htm. Attention is drawn to the limitation of liability, indemnification and jurisdiction issues defined therein. Any holder of this document is advised that information contained hereon reflects the Company's findings at the time of its intervention only and within the limits of Client's instructions, if any. The Company's sole responsibility is to its Client and this document does not exonerate parties to a transaction from exercising all their rights and obligations under the transaction documents. This document cannot be reproduced except in full, without prior written approval of the Company. Any unauthorized alteration, forgery or falsification of the content or appearance of this document is unlawful and offenders may be prosecuted to the fullest extent of the law.

Fundamental Frequency :1880.0 MHz Engineer :Nick
Operation Mode :TX Mid

| Freq. (MHz) | Note F/H/E/S | Reading dBm | Limit dBm | Safe Margin dB |
|----------------|-----------------|----------------|--------------|----------------------|
| <30 | S | --- | -13.00 | --- |
| 30-1000 | S | --- | -13.00 | --- |
| 3760.00 | H | --- | -13.00 | --- |
| 5640.00 | H | --- | -13.00 | --- |
| 7520.00 | H | --- | -13.00 | --- |
| 9400.00 | H | --- | -13.00 | --- |
| 11280.00 | H | --- | -13.00 | --- |
| 13160.00 | H | --- | -13.00 | --- |
| 13512.00 | S | -19.31 | -13.00 | 6.31 |
| 15040.00 | H | --- | -13.00 | --- |
| 16920.00 | H | --- | -13.00 | --- |
| 18800.00 | H | --- | -13.00 | --- |

Note : “H” : denotes Harmonic Frequency. “S” : denotes Spurious Frequency.
“---” : denotes Noise Floor.

Unless otherwise stated the results shown in this test report refer only to the sample(s) tested and such sample(s) are retained for 90 days only.

除非另有說明，此報告結果僅對測試之樣品負責，同時此樣品僅保留90天。本報告未經本公司書面許可，不可部份複製。

This document is issued by the Company subject to its General Conditions of Service printed overleaf, available on request or accessible at www.sgs.com/terms_and_conditions.htm and, for electronic format documents, subject to Terms and Conditions for Electronic Documents at www.sgs.com/terms_e-document.htm. Attention is drawn to the limitation of liability, indemnification and jurisdiction issues defined therein. Any holder of this document is advised that information contained hereon reflects the Company's findings at the time of its intervention only and within the limits of Client's instructions, if any. The Company's sole responsibility is to its Client and this document does not exonerate parties to a transaction from exercising all their rights and obligations under the transaction documents. This document cannot be reproduced except in full, without prior written approval of the Company. Any unauthorized alteration, forgery or falsification of the content or appearance of this document is unlawful and offenders may be prosecuted to the fullest extent of the law.

Fundamental Frequency :1907.6MHz Engineer :Nick
Operation Mode :TX High

| Freq. (MHz) | Note F/H/E/S | Reading dBm | Limit dBm | Safe Margin dB |
|----------------|-----------------|----------------|--------------|----------------------|
| <30 | S | --- | -13.00 | --- |
| 30-1000 | S | --- | -13.00 | --- |
| 3815.20 | H | --- | -13.00 | --- |
| 5722.80 | H | --- | -13.00 | --- |
| 7630.40 | H | --- | -13.00 | --- |
| 9538.00 | H | --- | -13.00 | --- |
| 11445.60 | H | --- | -13.00 | --- |
| 13353.20 | H | --- | -13.00 | --- |
| 13540.00 | S | -19.89 | -13.00 | 6.89 |
| 15260.80 | H | --- | -13.00 | --- |
| 17168.40 | H | --- | -13.00 | --- |
| 19076.00 | H | --- | -13.00 | --- |

Note : “H” : denotes Harmonic Frequency. “S” : denotes Spurious Frequency.
“---” : denotes Noise Floor.

Unless otherwise stated the results shown in this test report refer only to the sample(s) tested and such sample(s) are retained for 90 days only.

除非另有說明，此報告結果僅對測試之樣品負責，同時此樣品僅保留90天。本報告未經本公司書面許可，不可部份複製。

This document is issued by the Company subject to its General Conditions of Service printed overleaf, available on request or accessible at www.sgs.com/terms_and_conditions.htm and, for electronic format documents, subject to Terms and Conditions for Electronic Documents at www.sgs.com/terms_e-document.htm. Attention is drawn to the limitation of liability, indemnification and jurisdiction issues defined therein. Any holder of this document is advised that information contained hereon reflects the Company's findings at the time of its intervention only and within the limits of Client's instructions, if any. The Company's sole responsibility is to its Client and this document does not exonerate parties to a transaction from exercising all their rights and obligations under the transaction documents. This document cannot be reproduced except in full, without prior written approval of the Company. Any unauthorized alteration, forgery or falsification of the content or appearance of this document is unlawful and offenders may be prosecuted to the fullest extent of the law.

Figure 9-34: Band edge emission at antenna terminals – WCDMA II Channel Lowest

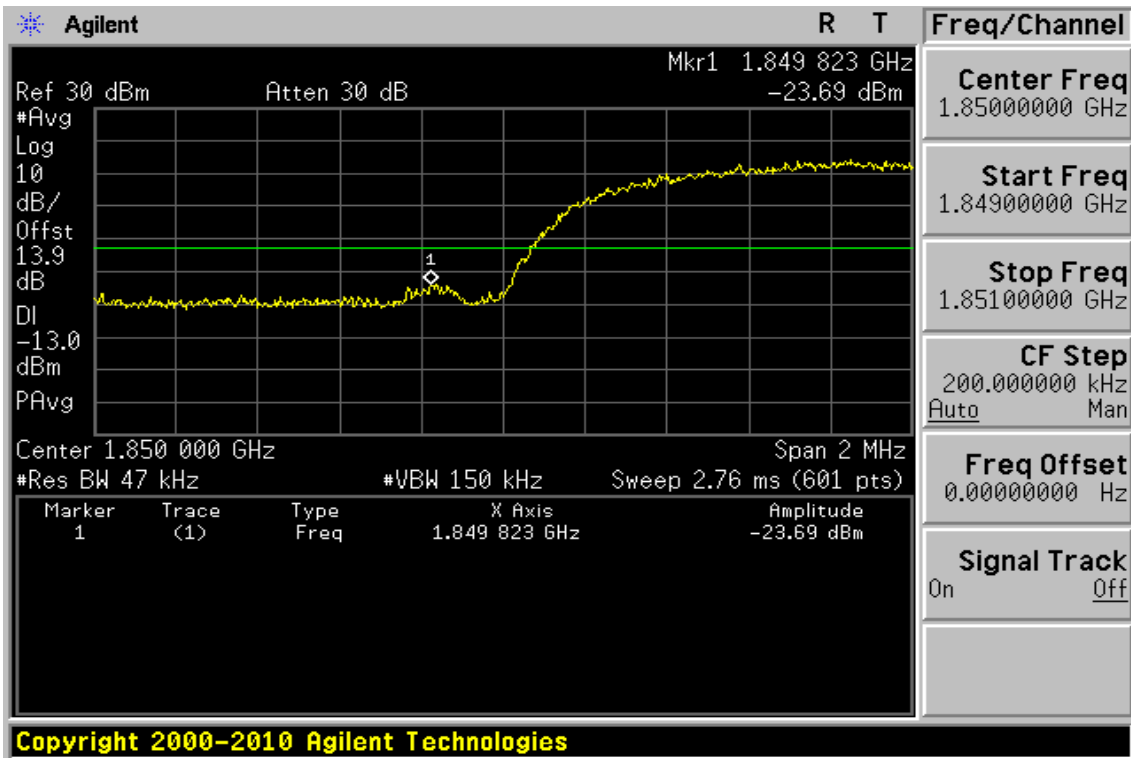
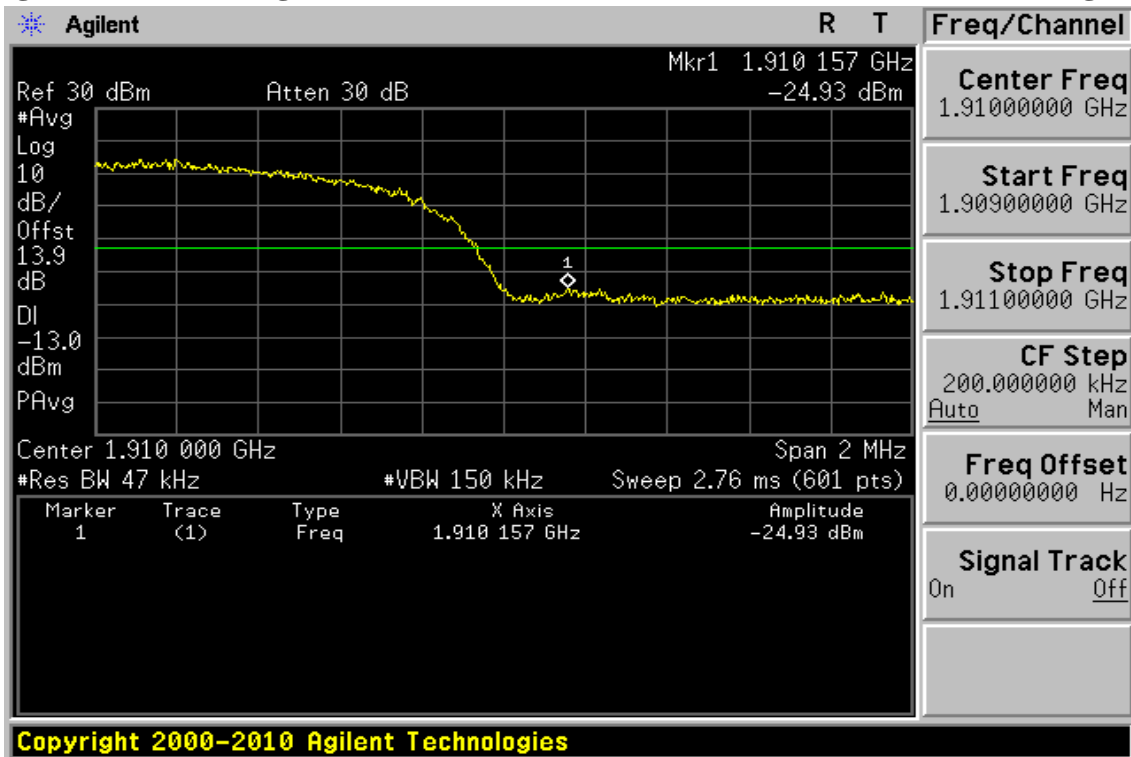

Figure 9-35: Band edge emission at antenna terminals – WCDMA II Channel Highest



Unless otherwise stated the results shown in this test report refer only to the sample(s) tested and such sample(s) are retained for 90 days only.

除非另有說明，此報告結果僅對測試之樣品負責，同時此樣品僅保留90天。本報告未經本公司書面許可，不可部份複製。

This document is issued by the Company subject to its General Conditions of Service printed overleaf, available on request or accessible at www.sgs.com/terms_and_conditions.htm and, for electronic format documents, subject to Terms and Conditions for Electronic Documents at www.sgs.com/terms_e-document.htm. Attention is drawn to the limitation of liability, indemnification and jurisdiction issues defined therein. Any holder of this document is advised that information contained hereon reflects the Company's findings at the time of its intervention only and within the limits of Client's instructions, if any. The Company's sole responsibility is to its Client and this document does not exonerate parties to a transaction from exercising all their rights and obligations under the transaction documents. This document cannot be reproduced except in full, without prior written approval of the Company. Any unauthorized alteration, forgery or falsification of the content or appearance of this document is unlawful and offenders may be prosecuted to the fullest extent of the law.

Band edge emission at antenna terminals – WCDMA II Low & High

Test Mode WCDMA II Engineer :Nick

| Freq. MHz | Reading dBm | Limit dBm | Safe Margin dB |
|--------------|----------------|--------------|----------------------|
| 1849.823 | -23.69 | -13.00 | 10.69 |
| 1910.157 | -24.93 | -13.00 | 11.93 |

Unless otherwise stated the results shown in this test report refer only to the sample(s) tested and such sample(s) are retained for 90 days only.

除非另有說明，此報告結果僅對測試之樣品負責，同時此樣品僅保留90天。本報告未經本公司書面許可，不可部份複製。

This document is issued by the Company subject to its General Conditions of Service printed overleaf, available on request or accessible at www.sgs.com/terms_and_conditions.htm and, for electronic format documents, subject to Terms and Conditions for Electronic Documents at www.sgs.com/terms_e-document.htm. Attention is drawn to the limitation of liability, indemnification and jurisdiction issues defined therein. Any holder of this document is advised that information contained hereon reflects the Company's findings at the time of its intervention only and within the limits of Client's instructions, if any. The Company's sole responsibility is to its Client and this document does not exonerate parties to a transaction from exercising all their rights and obligations under the transaction documents. This document cannot be reproduced except in full, without prior written approval of the Company. Any unauthorized alteration, forgery or falsification of the content or appearance of this document is unlawful and offenders may be prosecuted to the fullest extent of the law.

Figure 9-36: Out of Band emission at antenna terminals – WCDMA IV Channel Lowest

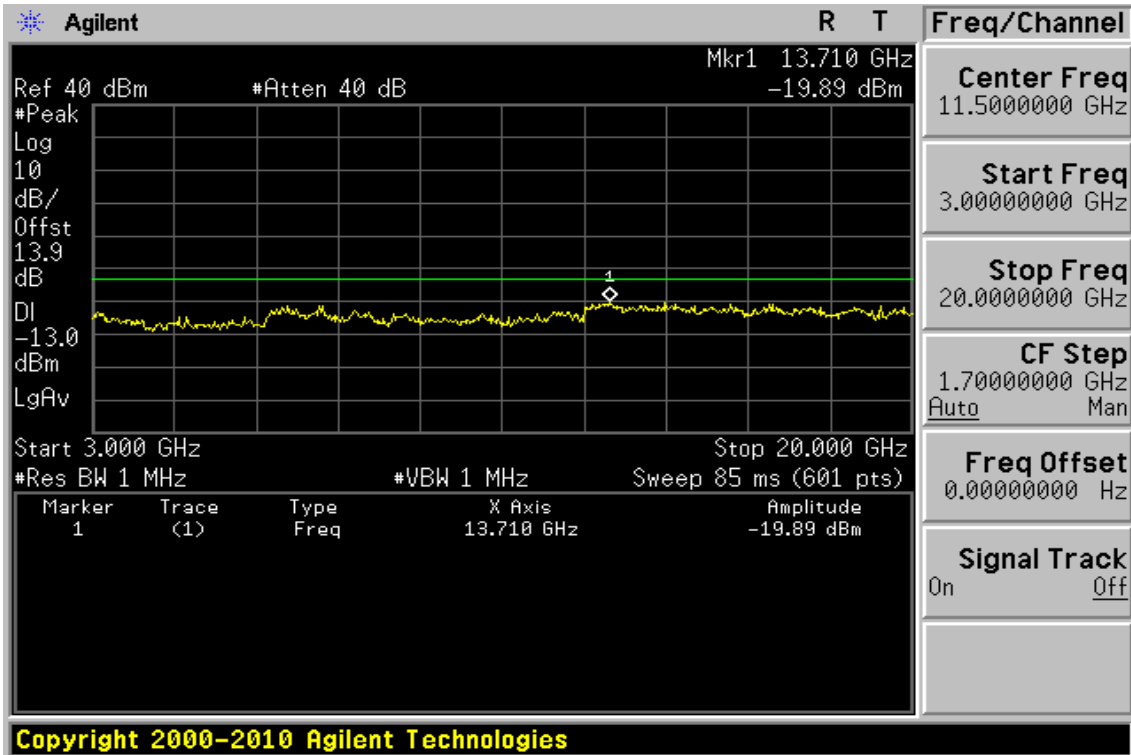
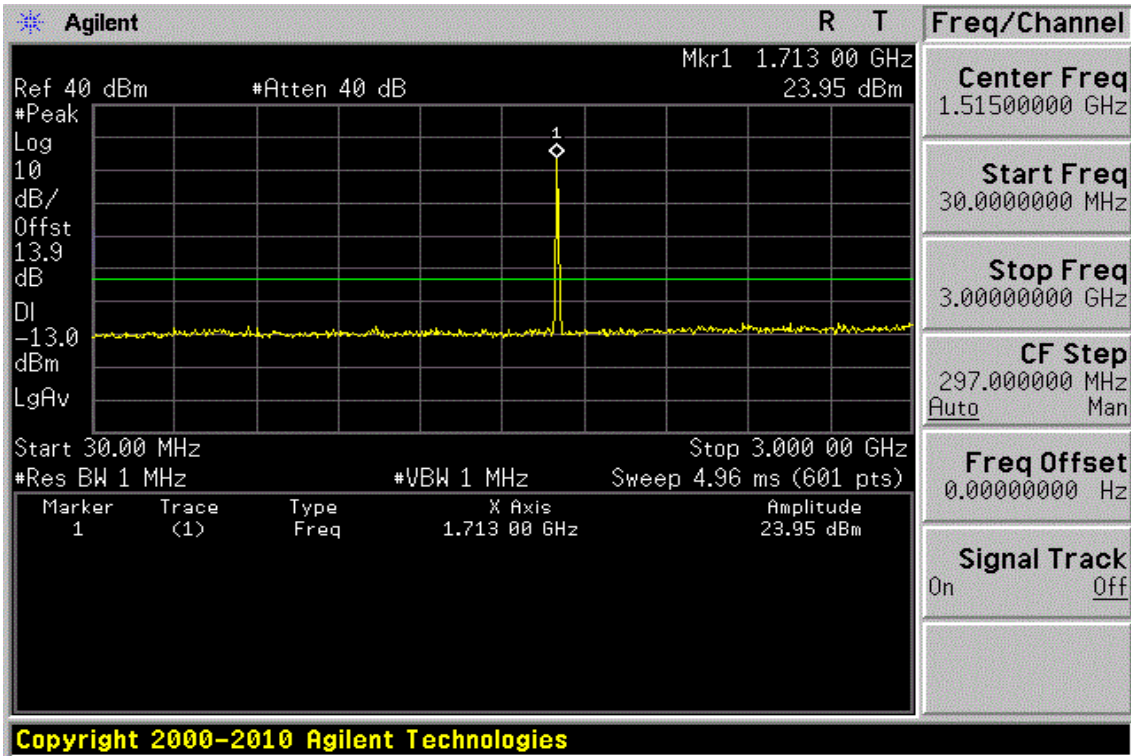

Unless otherwise stated the results shown in this test report refer only to the sample(s) tested and such sample(s) are retained for 90 days only.

除非另有說明，此報告結果僅對測試之樣品負責，同時此樣品僅保留90天。本報告未經本公司書面許可，不可部份複製。

This document is issued by the Company subject to its General Conditions of Service printed overleaf, available on request or accessible at www.sgs.com/terms_and_conditions.htm and, for electronic format documents, subject to Terms and Conditions for Electronic Documents at www.sgs.com/terms_e-document.htm. Attention is drawn to the limitation of liability, indemnification and jurisdiction issues defined therein. Any holder of this document is advised that information contained hereon reflects the Company's findings at the time of its intervention only and within the limits of Client's instructions, if any. The Company's sole responsibility is to its Client and this document does not exonerate parties to a transaction from exercising all their rights and obligations under the transaction documents. This document cannot be reproduced except in full, without prior written approval of the Company. Any unauthorized alteration, forgery or falsification of the content or appearance of this document is unlawful and offenders may be prosecuted to the fullest extent of the law.

Figure 9-37: Out of Band emission at antenna terminals – WCDMA IV Channel Mid

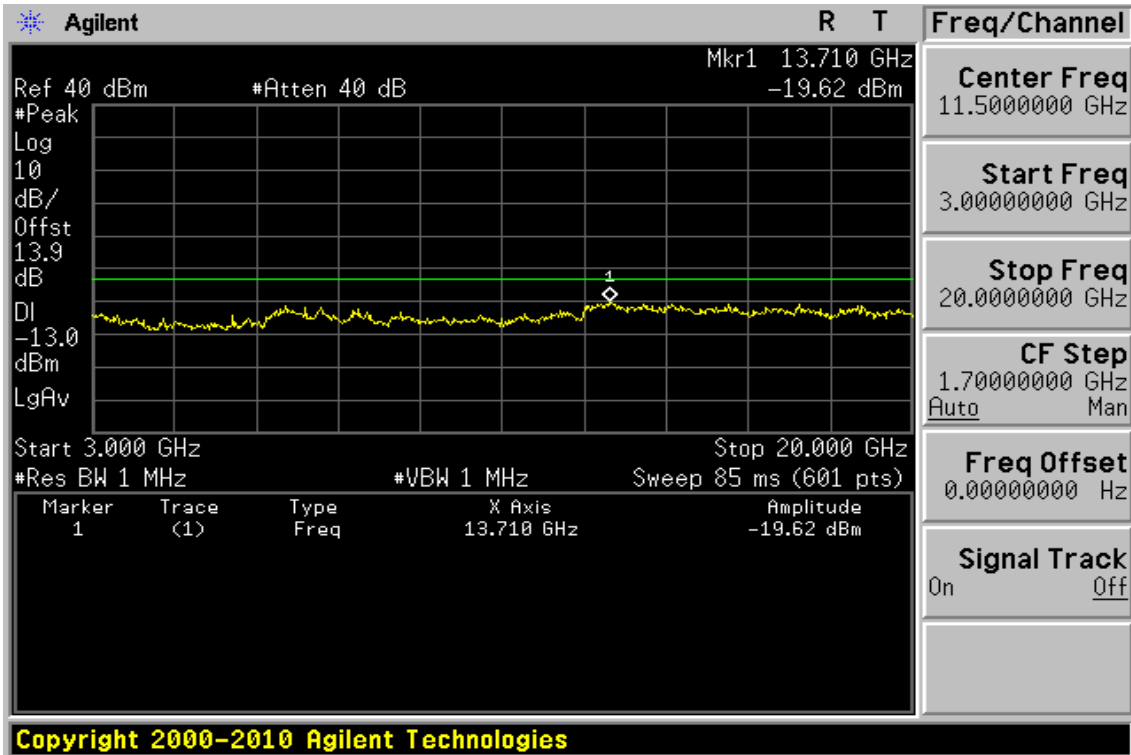
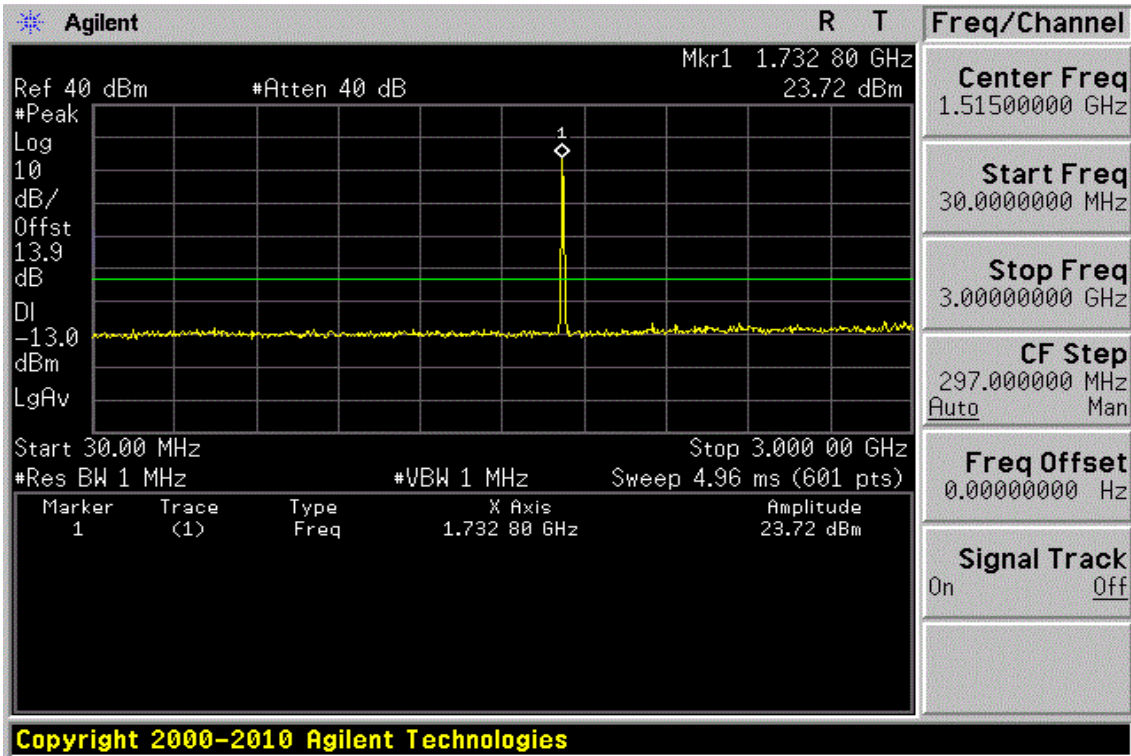

Unless otherwise stated the results shown in this test report refer only to the sample(s) tested and such sample(s) are retained for 90 days only.

除非另有說明，此報告結果僅對測試之樣品負責，同時此樣品僅保留90天。本報告未經本公司書面許可，不可部份複製。

This document is issued by the Company subject to its General Conditions of Service printed overleaf, available on request or accessible at www.sgs.com/terms_and_conditions.htm and, for electronic format documents, subject to Terms and Conditions for Electronic Documents at www.sgs.com/terms_e-document.htm. Attention is drawn to the limitation of liability, indemnification and jurisdiction issues defined therein. Any holder of this document is advised that information contained hereon reflects the Company's findings at the time of its intervention only and within the limits of Client's instructions, if any. The Company's sole responsibility is to its Client and this document does not exonerate parties to a transaction from exercising all their rights and obligations under the transaction documents. This document cannot be reproduced except in full, without prior written approval of the Company. Any unauthorized alteration, forgery or falsification of the content or appearance of this document is unlawful and offenders may be prosecuted to the fullest extent of the law.

Figure 9-38: Out of Band emission at antenna terminals – WCDMA IV Channel Highest

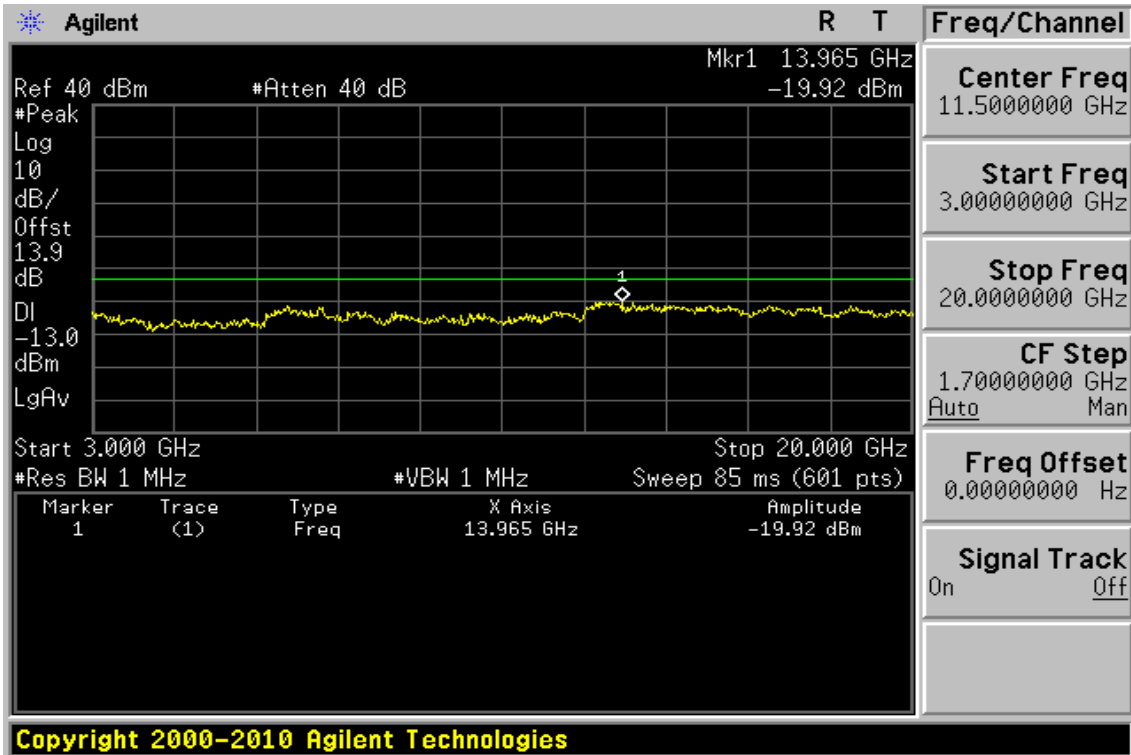
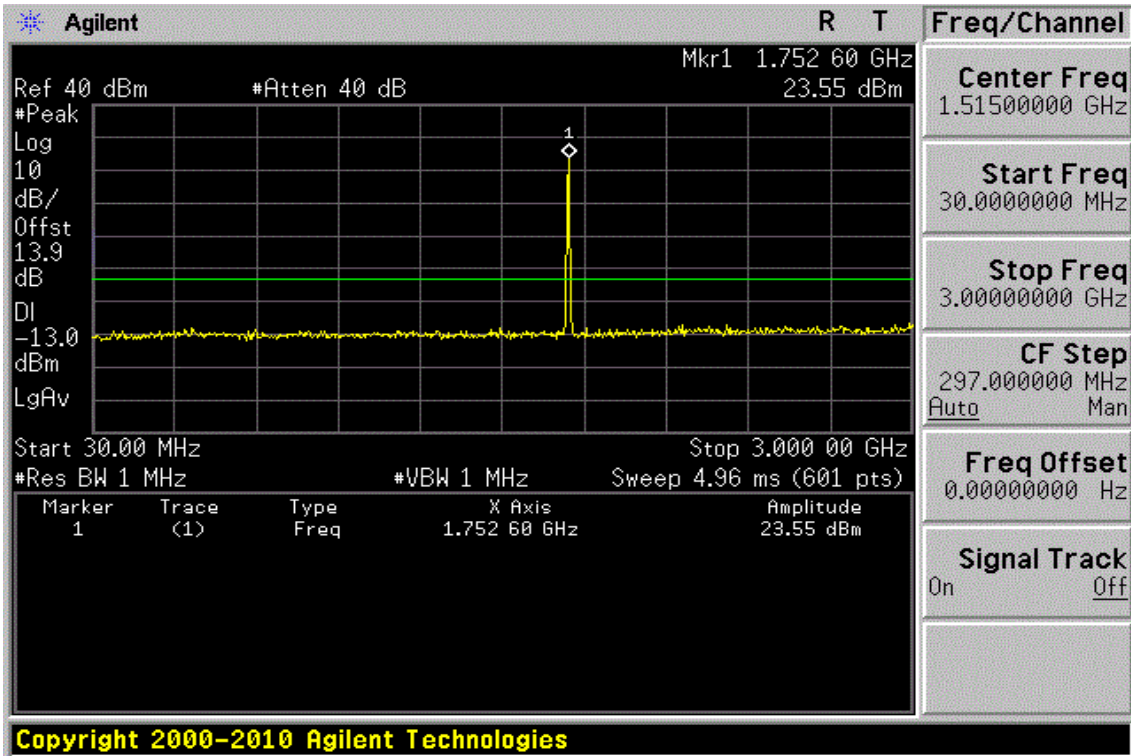

Unless otherwise stated the results shown in this test report refer only to the sample(s) tested and such sample(s) are retained for 90 days only.

除非另有說明，此報告結果僅對測試之樣品負責，同時此樣品僅保留90天。本報告未經本公司書面許可，不可部份複製。

This document is issued by the Company subject to its General Conditions of Service printed overleaf, available on request or accessible at www.sgs.com/terms_and_conditions.htm and, for electronic format documents, subject to Terms and Conditions for Electronic Documents at www.sgs.com/terms_e-document.htm. Attention is drawn to the limitation of liability, indemnification and jurisdiction issues defined therein. Any holder of this document is advised that information contained hereon reflects the Company's findings at the time of its intervention only and within the limits of Client's instructions, if any. The Company's sole responsibility is to its Client and this document does not exonerate parties to a transaction from exercising all their rights and obligations under the transaction documents. This document cannot be reproduced except in full, without prior written approval of the Company. Any unauthorized alteration, forgery or falsification of the content or appearance of this document is unlawful and offenders may be prosecuted to the fullest extent of the law.

Out of Band emission at antenna terminals – WCDMA IV

Fundamental Frequency 1712.4 MHz Engineer :Nick
Operation Mode :TX Low

| Freq. (MHz) | Note F/H/E/S | Reading dBm | Limit dBm | Safe Margin dB |
|----------------|-----------------|----------------|--------------|----------------------|
| <30 | S | --- | -13.00 | --- |
| 30-1000 | S | --- | -13.00 | --- |
| 3424.80 | H | --- | -13.00 | --- |
| 5137.20 | H | --- | -13.00 | --- |
| 6849.60 | H | --- | -13.00 | --- |
| 8562.00 | H | --- | -13.00 | --- |
| 10274.40 | H | --- | -13.00 | --- |
| 11986.80 | H | --- | -13.00 | --- |
| 13699.20 | H | --- | -13.00 | --- |
| 13710.00 | S | -19.89 | -13.00 | 6.89 |
| 15411.60 | H | --- | -13.00 | --- |
| 17124.00 | H | --- | -13.00 | --- |

Note : “H” : denotes Harmonic Frequency. “S” : denotes Spurious Frequency.
“---” : denotes Noise Floor.

Unless otherwise stated the results shown in this test report refer only to the sample(s) tested and such sample(s) are retained for 90 days only.

除非另有說明，此報告結果僅對測試之樣品負責，同時此樣品僅保留90天。本報告未經本公司書面許可，不可部份複製。

This document is issued by the Company subject to its General Conditions of Service printed overleaf, available on request or accessible at www.sgs.com/terms_and_conditions.htm and, for electronic format documents, subject to Terms and Conditions for Electronic Documents at www.sgs.com/terms_e-document.htm. Attention is drawn to the limitation of liability, indemnification and jurisdiction issues defined therein. Any holder of this document is advised that information contained hereon reflects the Company's findings at the time of its intervention only and within the limits of Client's instructions, if any. The Company's sole responsibility is to its Client and this document does not exonerate parties to a transaction from exercising all their rights and obligations under the transaction documents. This document cannot be reproduced except in full, without prior written approval of the Company. Any unauthorized alteration, forgery or falsification of the content or appearance of this document is unlawful and offenders may be prosecuted to the fullest extent of the law.

Fundamental Frequency :1732.6 MHz Engineer :Nick
Operation Mode :TX Mid

| Freq. (MHz) | Note F/H/E/S | Reading dBm | Limit dBm | Safe Margin dB |
|----------------|-----------------|----------------|--------------|----------------------|
| <30 | S | --- | -13.00 | --- |
| 30-1000 | S | --- | -13.00 | --- |
| 3465.20 | H | --- | -13.00 | --- |
| 5197.80 | H | --- | -13.00 | --- |
| 6930.40 | H | --- | -13.00 | --- |
| 8663.00 | H | --- | -13.00 | --- |
| 10395.60 | H | --- | -13.00 | --- |
| 12128.20 | H | --- | -13.00 | --- |
| 13710.00 | S | -19.62 | -13.00 | 6.62 |
| 13860.80 | H | --- | -13.00 | --- |
| 15593.40 | H | --- | -13.00 | --- |
| 17326.00 | H | --- | -13.00 | --- |

Note : "H" : denotes Harmonic Frequency. "S" : denotes Spurious Frequency.
"---" : denotes Noise Floor.

Unless otherwise stated the results shown in this test report refer only to the sample(s) tested and such sample(s) are retained for 90 days only.

除非另有說明，此報告結果僅對測試之樣品負責，同時此樣品僅保留90天。本報告未經本公司書面許可，不可部份複製。

This document is issued by the Company subject to its General Conditions of Service printed overleaf, available on request or accessible at www.sgs.com/terms_and_conditions.htm and, for electronic format documents, subject to Terms and Conditions for Electronic Documents at www.sgs.com/terms_e-document.htm. Attention is drawn to the limitation of liability, indemnification and jurisdiction issues defined therein. Any holder of this document is advised that information contained hereon reflects the Company's findings at the time of its intervention only and within the limits of Client's instructions, if any. The Company's sole responsibility is to its Client and this document does not exonerate parties to a transaction from exercising all their rights and obligations under the transaction documents. This document cannot be reproduced except in full, without prior written approval of the Company. Any unauthorized alteration, forgery or falsification of the content or appearance of this document is unlawful and offenders may be prosecuted to the fullest extent of the law.

Fundamental Frequency 1752.6MHz Engineer :Nick
Operation Mode :TX High

| Freq. (MHz) | Note F/H/E/S | Reading dBm | Limit dBm | Safe Margin dB |
|----------------|-----------------|----------------|--------------|----------------------|
| <30 | S | --- | -13.00 | --- |
| 30-1000 | S | --- | -13.00 | --- |
| 3505.20 | H | --- | -13.00 | --- |
| 5257.80 | H | --- | -13.00 | --- |
| 7010.40 | H | --- | -13.00 | --- |
| 8763.00 | H | --- | -13.00 | --- |
| 10515.60 | H | --- | -13.00 | --- |
| 12268.20 | H | --- | -13.00 | --- |
| 13965.00 | S | -19.92 | -13.00 | 6.92 |
| 14020.80 | H | --- | -13.00 | --- |
| 15773.40 | H | --- | -13.00 | --- |
| 17526.00 | H | --- | -13.00 | --- |

Note : “H” : denotes Harmonic Frequency. “S” : denotes Spurious Frequency.
“---” : denotes Noise Floor.

Unless otherwise stated the results shown in this test report refer only to the sample(s) tested and such sample(s) are retained for 90 days only.

除非另有說明，此報告結果僅對測試之樣品負責，同時此樣品僅保留90天。本報告未經本公司書面許可，不可部份複製。

This document is issued by the Company subject to its General Conditions of Service printed overleaf, available on request or accessible at www.sgs.com/terms_and_conditions.htm and, for electronic format documents, subject to Terms and Conditions for Electronic Documents at www.sgs.com/terms_e-document.htm. Attention is drawn to the limitation of liability, indemnification and jurisdiction issues defined therein. Any holder of this document is advised that information contained hereon reflects the Company's findings at the time of its intervention only and within the limits of Client's instructions, if any. The Company's sole responsibility is to its Client and this document does not exonerate parties to a transaction from exercising all their rights and obligations under the transaction documents. This document cannot be reproduced except in full, without prior written approval of the Company. Any unauthorized alteration, forgery or falsification of the content or appearance of this document is unlawful and offenders may be prosecuted to the fullest extent of the law.

Figure 9-39: Band edge emission at antenna terminals – WCDMA IV Channel Lowest

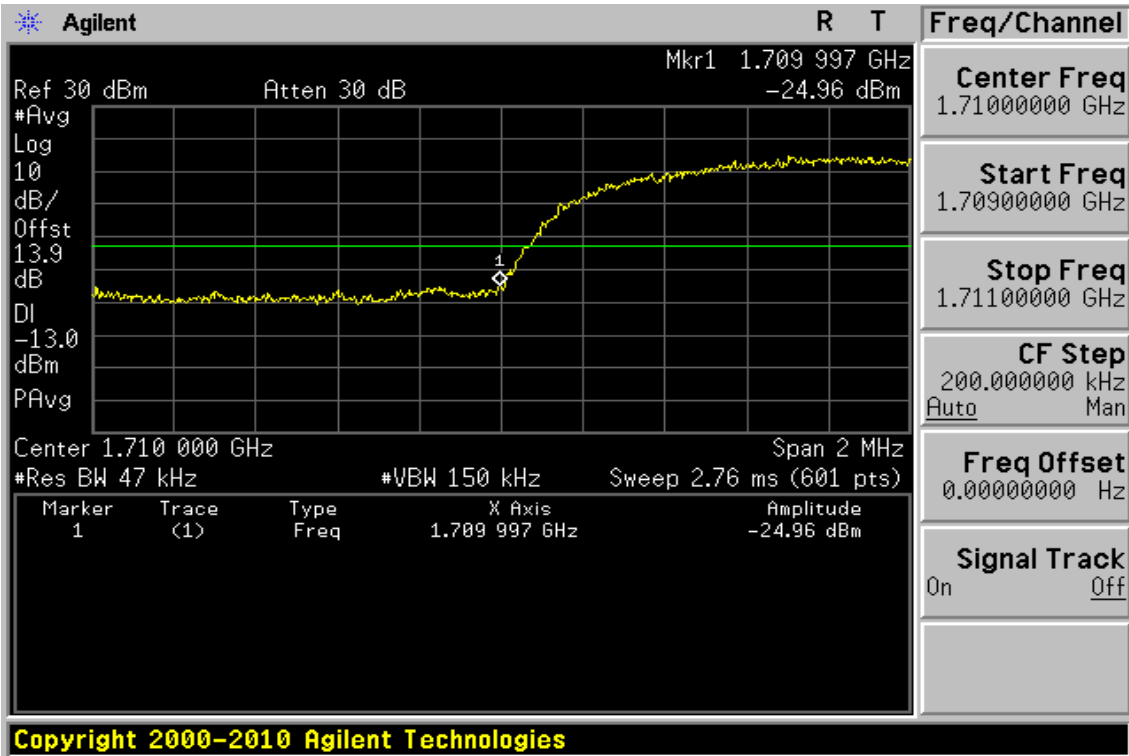
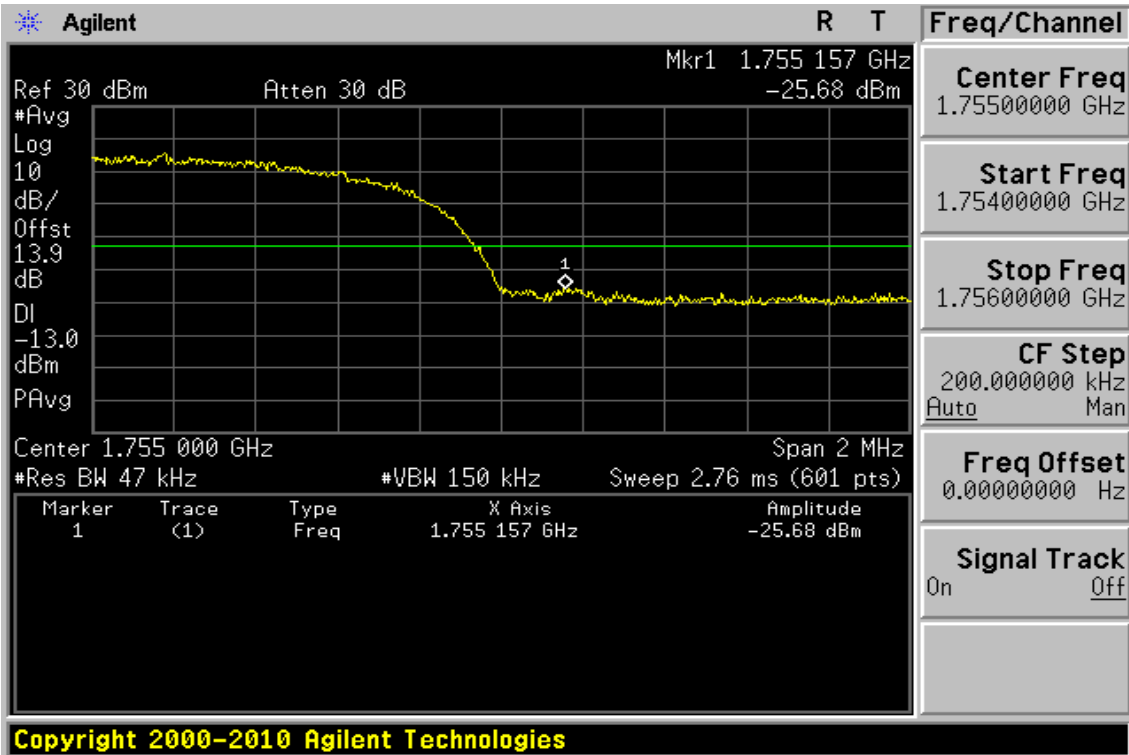

Figure 9-40: Band edge emission at antenna terminals – WCDMA IV Channel Highest



Unless otherwise stated the results shown in this test report refer only to the sample(s) tested and such sample(s) are retained for 90 days only.

除非另有說明，此報告結果僅對測試之樣品負責，同時此樣品僅保留90天。本報告未經本公司書面許可，不可部份複製。

This document is issued by the Company subject to its General Conditions of Service printed overleaf, available on request or accessible at www.sgs.com/terms_and_conditions.htm and, for electronic format documents, subject to Terms and Conditions for Electronic Documents at www.sgs.com/terms_e-document.htm. Attention is drawn to the limitation of liability, indemnification and jurisdiction issues defined therein. Any holder of this document is advised that information contained hereon reflects the Company's findings at the time of its intervention only and within the limits of Client's instructions, if any. The Company's sole responsibility is to its Client and this document does not exonerate parties to a transaction from exercising all their rights and obligations under the transaction documents. This document cannot be reproduced except in full, without prior written approval of the Company. Any unauthorized alteration, forgery or falsification of the content or appearance of this document is unlawful and offenders may be prosecuted to the fullest extent of the law.

Band edge emission at antenna terminals – WCDMA IV Low & High

Test Mode WCDMA IV Engineer :Nick

| Freq. MHz | Reading dBm | Limit dBm | Safe Margin dB |
|--------------|----------------|--------------|----------------------|
| 1709.997 | -24.96 | -13.00 | 11.96 |
| 1755.157 | -25.68 | -13.00 | 12.68 |

Unless otherwise stated the results shown in this test report refer only to the sample(s) tested and such sample(s) are retained for 90 days only.

除非另有說明，此報告結果僅對測試之樣品負責，同時此樣品僅保留90天。本報告未經本公司書面許可，不可部份複製。

This document is issued by the Company subject to its General Conditions of Service printed overleaf, available on request or accessible at www.sgs.com/terms_and_conditions.htm and, for electronic format documents, subject to Terms and Conditions for Electronic Documents at www.sgs.com/terms_e-document.htm. Attention is drawn to the limitation of liability, indemnification and jurisdiction issues defined therein. Any holder of this document is advised that information contained hereon reflects the Company's findings at the time of its intervention only and within the limits of Client's instructions, if any. The Company's sole responsibility is to its Client and this document does not exonerate parties to a transaction from exercising all their rights and obligations under the transaction documents. This document cannot be reproduced except in full, without prior written approval of the Company. Any unauthorized alteration, forgery or falsification of the content or appearance of this document is unlawful and offenders may be prosecuted to the fullest extent of the law.

Figure 9-41: Out of Band emission at antenna terminals – WCDMA V Channel Lowest

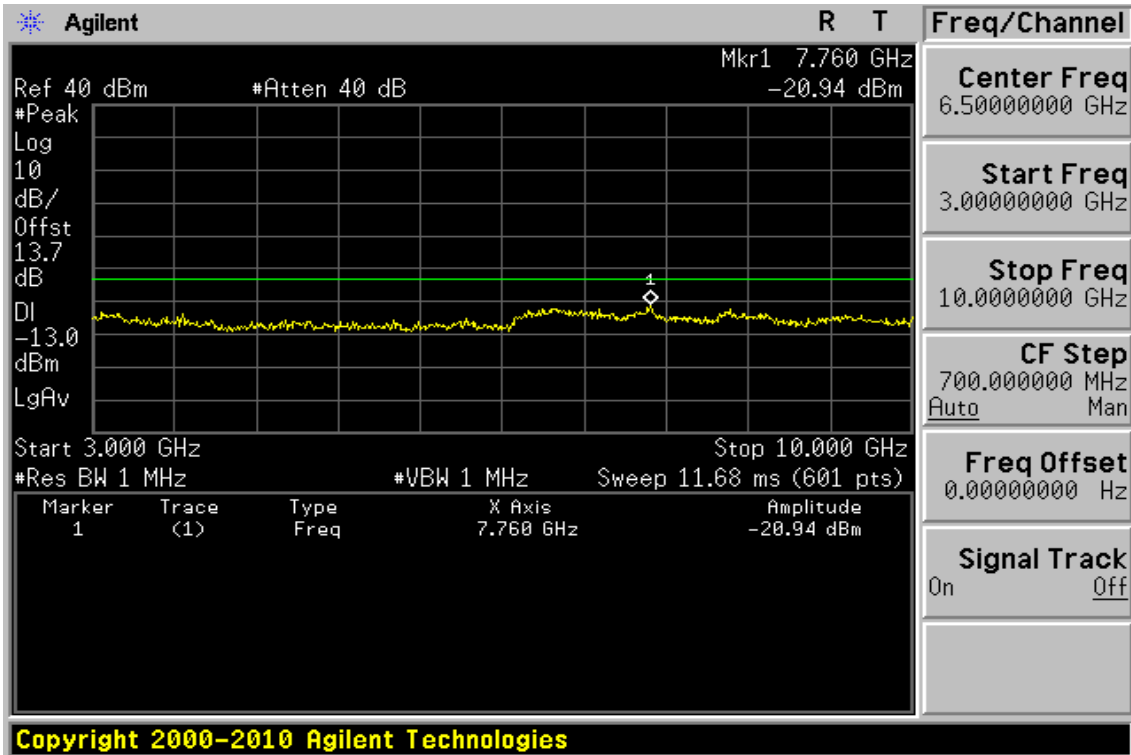
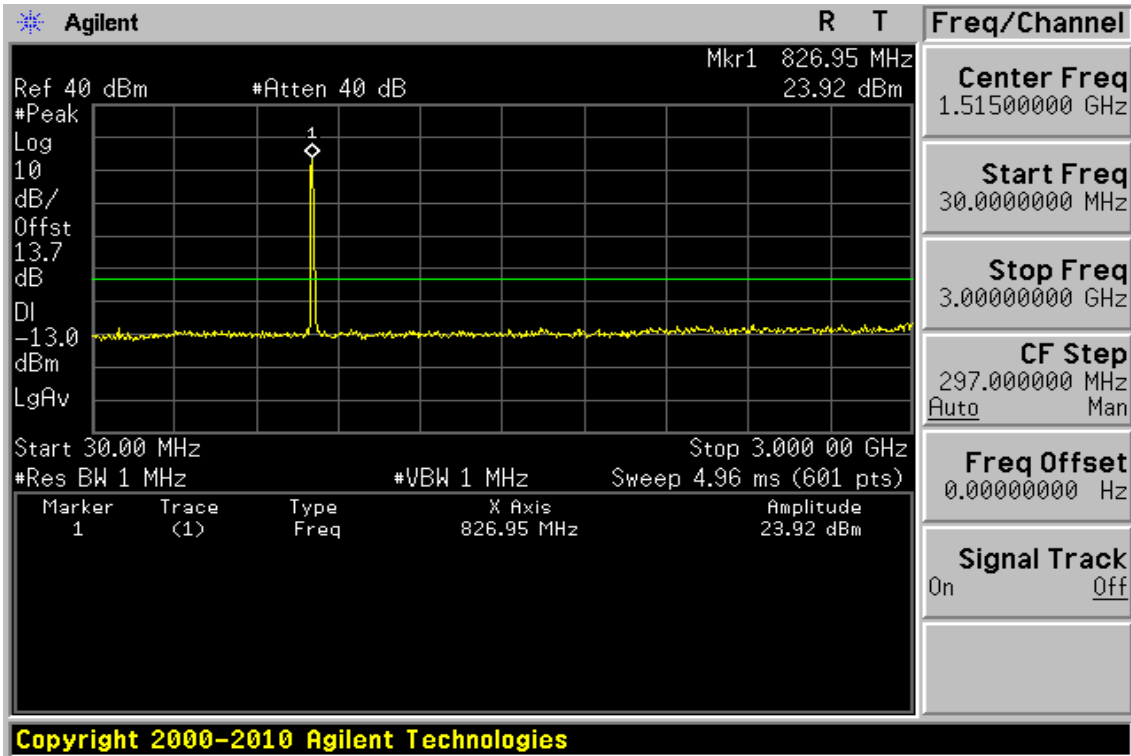

Unless otherwise stated the results shown in this test report refer only to the sample(s) tested and such sample(s) are retained for 90 days only.

除非另有說明，此報告結果僅對測試之樣品負責，同時此樣品僅保留90天。本報告未經本公司書面許可，不可部份複製。

This document is issued by the Company subject to its General Conditions of Service printed overleaf, available on request or accessible at www.sgs.com/terms_and_conditions.htm and, for electronic format documents, subject to Terms and Conditions for Electronic Documents at www.sgs.com/terms_e-document.htm. Attention is drawn to the limitation of liability, indemnification and jurisdiction issues defined therein. Any holder of this document is advised that information contained hereon reflects the Company's findings at the time of its intervention only and within the limits of Client's instructions, if any. The Company's sole responsibility is to its Client and this document does not exonerate parties to a transaction from exercising all their rights and obligations under the transaction documents. This document cannot be reproduced except in full, without prior written approval of the Company. Any unauthorized alteration, forgery or falsification of the content or appearance of this document is unlawful and offenders may be prosecuted to the fullest extent of the law.

Figure 9-42: Out of Band emission at antenna terminals – WCDMA V Channel Mid

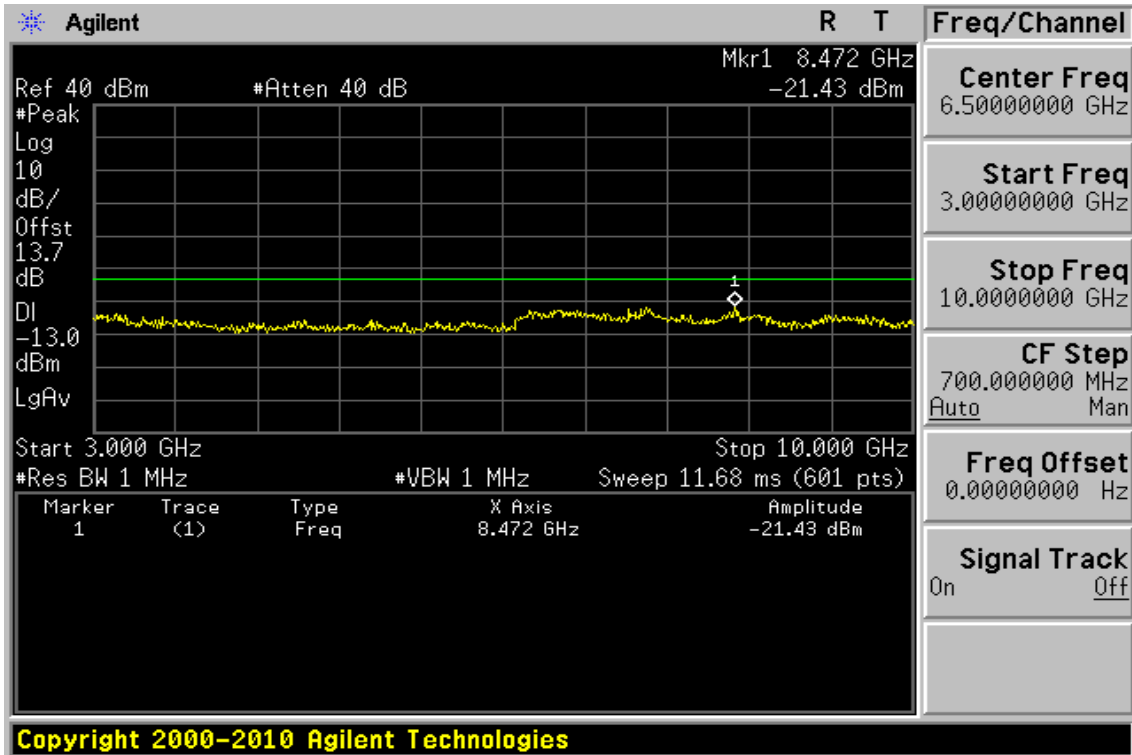
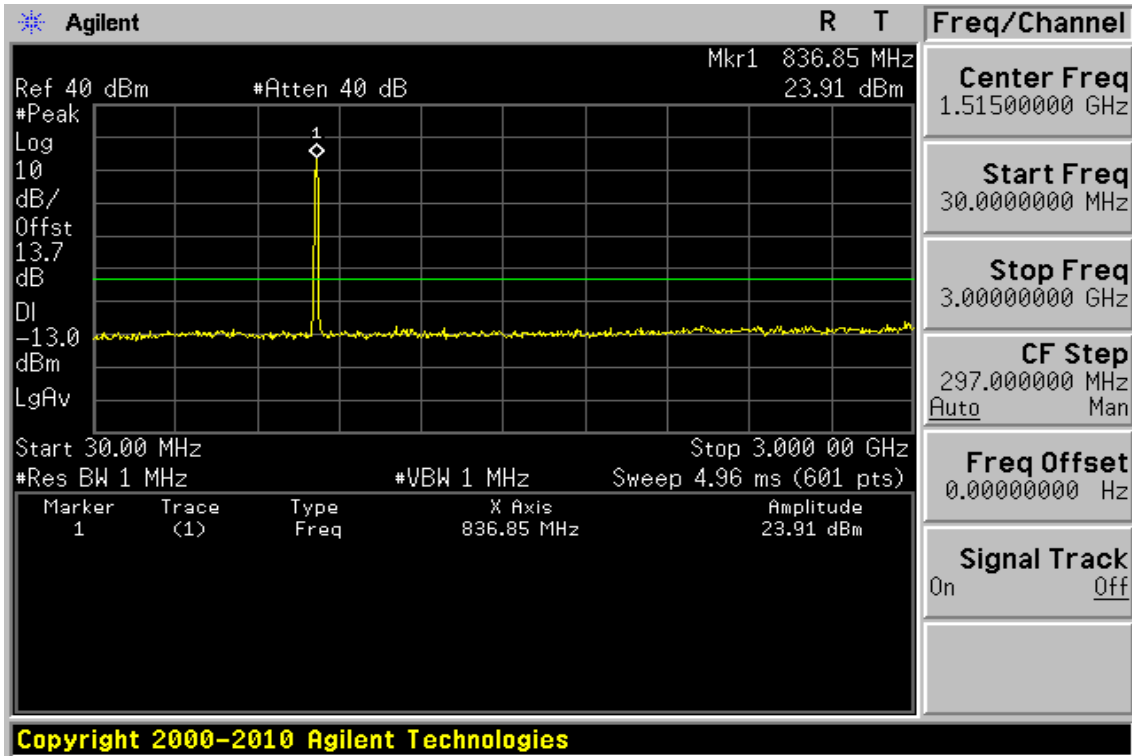

Unless otherwise stated the results shown in this test report refer only to the sample(s) tested and such sample(s) are retained for 90 days only.

除非另有說明，此報告結果僅對測試之樣品負責，同時此樣品僅保留90天。本報告未經本公司書面許可，不可部份複製。

This document is issued by the Company subject to its General Conditions of Service printed overleaf, available on request or accessible at www.sgs.com/terms_and_conditions.htm and, for electronic format documents, subject to Terms and Conditions for Electronic Documents at www.sgs.com/terms_e-document.htm. Attention is drawn to the limitation of liability, indemnification and jurisdiction issues defined therein. Any holder of this document is advised that information contained hereon reflects the Company's findings at the time of its intervention only and within the limits of Client's instructions, if any. The Company's sole responsibility is to its Client and this document does not exonerate parties to a transaction from exercising all their rights and obligations under the transaction documents. This document cannot be reproduced except in full, without prior written approval of the Company. Any unauthorized alteration, forgery or falsification of the content or appearance of this document is unlawful and offenders may be prosecuted to the fullest extent of the law.

Figure 9-43: Out of Band emission at antenna terminals – WCDMA V Channel Highest

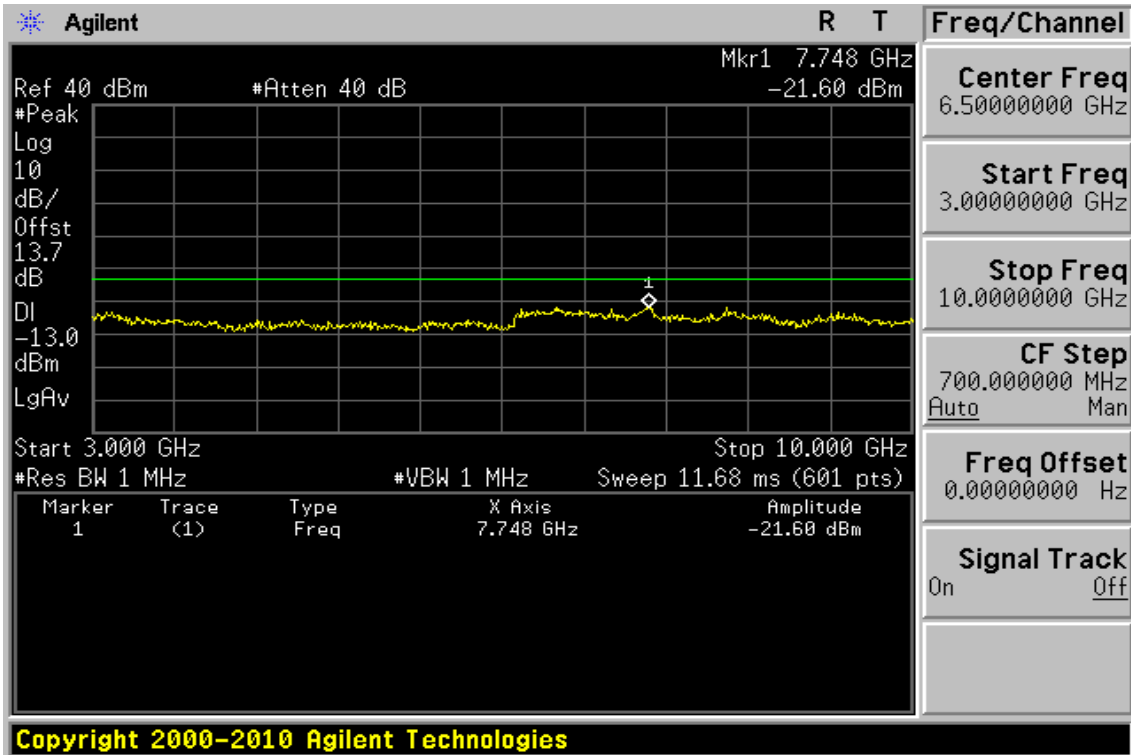
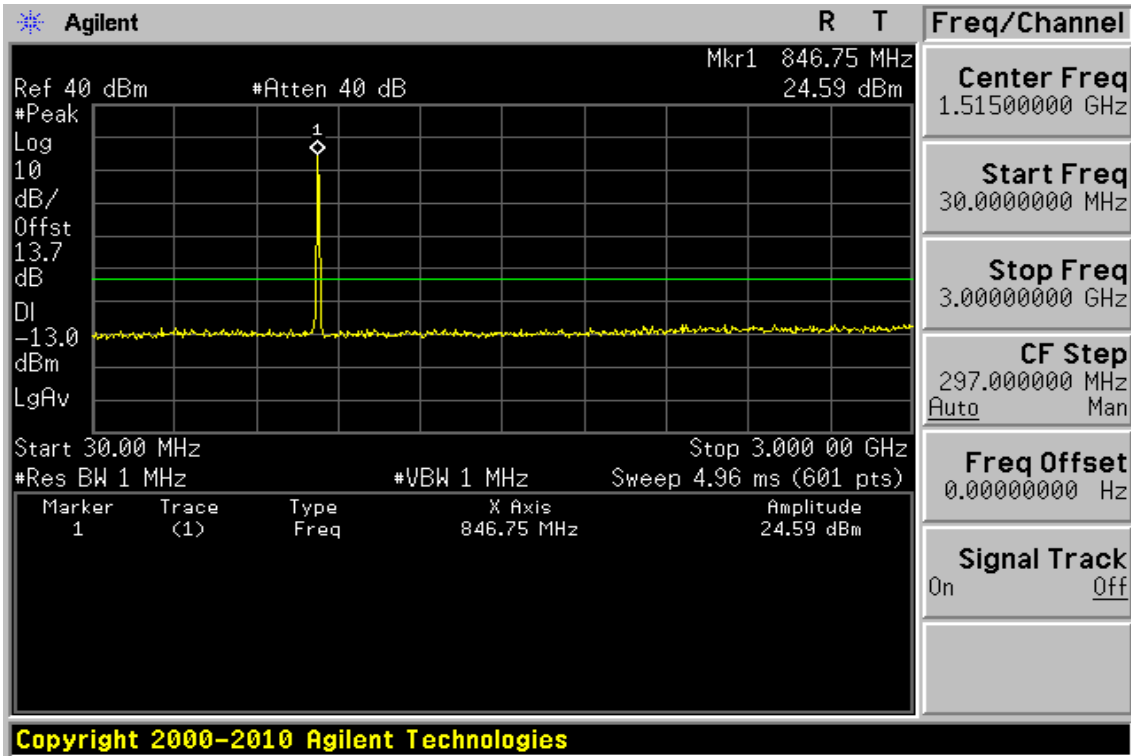

Unless otherwise stated the results shown in this test report refer only to the sample(s) tested and such sample(s) are retained for 90 days only.

除非另有說明，此報告結果僅對測試之樣品負責，同時此樣品僅保留90天。本報告未經本公司書面許可，不可部份複製。

This document is issued by the Company subject to its General Conditions of Service printed overleaf, available on request or accessible at www.sgs.com/terms_and_conditions.htm and, for electronic format documents, subject to Terms and Conditions for Electronic Documents at www.sgs.com/terms_e-document.htm. Attention is drawn to the limitation of liability, indemnification and jurisdiction issues defined therein. Any holder of this document is advised that information contained hereon reflects the Company's findings at the time of its intervention only and within the limits of Client's instructions, if any. The Company's sole responsibility is to its Client and this document does not exonerate parties to a transaction from exercising all their rights and obligations under the transaction documents. This document cannot be reproduced except in full, without prior written approval of the Company. Any unauthorized alteration, forgery or falsification of the content or appearance of this document is unlawful and offenders may be prosecuted to the fullest extent of the law.

Out of Band emission at antenna terminals – WCDMA V

Fundamental Frequency :826.4 MHz Engineer :Nick
Operation Mode :TX Low

| Freq. (MHz) | Note F/H/E/S | Reading dBm | Limit dBm | Safe Margin dB |
|----------------|-----------------|----------------|--------------|----------------------|
| <30 | S | --- | -13.00 | --- |
| 30-1000 | S | --- | -13.00 | --- |
| 1652.80 | H | --- | -13.00 | --- |
| 2479.20 | H | --- | -13.00 | --- |
| 3305.60 | H | --- | -13.00 | --- |
| 4132.00 | H | --- | -13.00 | --- |
| 4958.40 | H | --- | -13.00 | --- |
| 5784.80 | H | --- | -13.00 | --- |
| 6611.20 | H | --- | -13.00 | --- |
| 7437.60 | H | --- | -13.00 | --- |
| 7760.00 | S | -20.94 | -13.00 | 7.94 |
| 8264.00 | H | --- | -13.00 | --- |

Note : “H” : denotes Harmonic Frequency. “S” : denotes Spurious Frequency.
“---” : denotes Noise Floor.

Unless otherwise stated the results shown in this test report refer only to the sample(s) tested and such sample(s) are retained for 90 days only.

除非另有說明，此報告結果僅對測試之樣品負責，同時此樣品僅保留90天。本報告未經本公司書面許可，不可部份複製。

This document is issued by the Company subject to its General Conditions of Service printed overleaf, available on request or accessible at www.sgs.com/terms_and_conditions.htm and, for electronic format documents, subject to Terms and Conditions for Electronic Documents at www.sgs.com/terms_e-document.htm. Attention is drawn to the limitation of liability, indemnification and jurisdiction issues defined therein. Any holder of this document is advised that information contained hereon reflects the Company's findings at the time of its intervention only and within the limits of Client's instructions, if any. The Company's sole responsibility is to its Client and this document does not exonerate parties to a transaction from exercising all their rights and obligations under the transaction documents. This document cannot be reproduced except in full, without prior written approval of the Company. Any unauthorized alteration, forgery or falsification of the content or appearance of this document is unlawful and offenders may be prosecuted to the fullest extent of the law.

Fundamental Frequency :836.6 MHz Engineer :Nick
Operation Mode :TX Mid

| Freq. (MHz) | Note F/H/E/S | Reading dBm | Limit dBm | Safe Margin dB |
|----------------|-----------------|----------------|--------------|----------------------|
| <30 | S | --- | -13.00 | --- |
| 30-1000 | S | --- | -13.00 | --- |
| 1673.20 | H | --- | -13.00 | --- |
| 2509.80 | H | --- | -13.00 | --- |
| 3346.40 | H | --- | -13.00 | --- |
| 4183.00 | H | --- | -13.00 | --- |
| 5019.60 | H | --- | -13.00 | --- |
| 5856.20 | H | --- | -13.00 | --- |
| 6692.80 | H | --- | -13.00 | --- |
| 7529.40 | H | --- | -13.00 | --- |
| 8366.00 | H | --- | -13.00 | --- |
| 8472.00 | S | -21.43 | -13.00 | 8.43 |

Note : “H” : denotes Harmonic Frequency. “S” : denotes Spurious Frequency.
“---” : denotes Noise Floor.

Unless otherwise stated the results shown in this test report refer only to the sample(s) tested and such sample(s) are retained for 90 days only.

除非另有說明，此報告結果僅對測試之樣品負責，同時此樣品僅保留90天。本報告未經本公司書面許可，不可部份複製。

This document is issued by the Company subject to its General Conditions of Service printed overleaf, available on request or accessible at www.sgs.com/terms_and_conditions.htm and, for electronic format documents, subject to Terms and Conditions for Electronic Documents at www.sgs.com/terms_e-document.htm. Attention is drawn to the limitation of liability, indemnification and jurisdiction issues defined therein. Any holder of this document is advised that information contained hereon reflects the Company's findings at the time of its intervention only and within the limits of Client's instructions, if any. The Company's sole responsibility is to its Client and this document does not exonerate parties to a transaction from exercising all their rights and obligations under the transaction documents. This document cannot be reproduced except in full, without prior written approval of the Company. Any unauthorized alteration, forgery or falsification of the content or appearance of this document is unlawful and offenders may be prosecuted to the fullest extent of the law.

Fundamental Frequency :846.6MHz Engineer :Nick
Operation Mode :TX High

| Freq. (MHz) | Note F/H/E/S | Reading dBm | Limit dBm | Safe Margin dB |
|----------------|-----------------|----------------|--------------|----------------------|
| <30 | S | --- | -13.00 | --- |
| 30-1000 | S | --- | -13.00 | --- |
| 1693.20 | H | --- | -13.00 | --- |
| 2539.80 | H | --- | -13.00 | --- |
| 3386.40 | H | --- | -13.00 | --- |
| 4233.00 | H | --- | -13.00 | --- |
| 5079.60 | H | --- | -13.00 | --- |
| 5926.20 | H | --- | -13.00 | --- |
| 6772.80 | H | --- | -13.00 | --- |
| 7619.40 | H | --- | -13.00 | --- |
| 7748.00 | S | -21.60 | -13.00 | 8.60 |
| 8466.00 | H | --- | -13.00 | --- |

Note : “H” : denotes Harmonic Frequency. “S” : denotes Spurious Frequency.
“---” : denotes Noise Floor.

Unless otherwise stated the results shown in this test report refer only to the sample(s) tested and such sample(s) are retained for 90 days only.

除非另有說明，此報告結果僅對測試之樣品負責，同時此樣品僅保留90天。本報告未經本公司書面許可，不可部份複製。

This document is issued by the Company subject to its General Conditions of Service printed overleaf, available on request or accessible at www.sgs.com/terms_and_conditions.htm and, for electronic format documents, subject to Terms and Conditions for Electronic Documents at www.sgs.com/terms_e-document.htm. Attention is drawn to the limitation of liability, indemnification and jurisdiction issues defined therein. Any holder of this document is advised that information contained hereon reflects the Company's findings at the time of its intervention only and within the limits of Client's instructions, if any. The Company's sole responsibility is to its Client and this document does not exonerate parties to a transaction from exercising all their rights and obligations under the transaction documents. This document cannot be reproduced except in full, without prior written approval of the Company. Any unauthorized alteration, forgery or falsification of the content or appearance of this document is unlawful and offenders may be prosecuted to the fullest extent of the law.

Figure 9-44: Band edge emission at antenna terminals – WCDMA V Channel Lowest

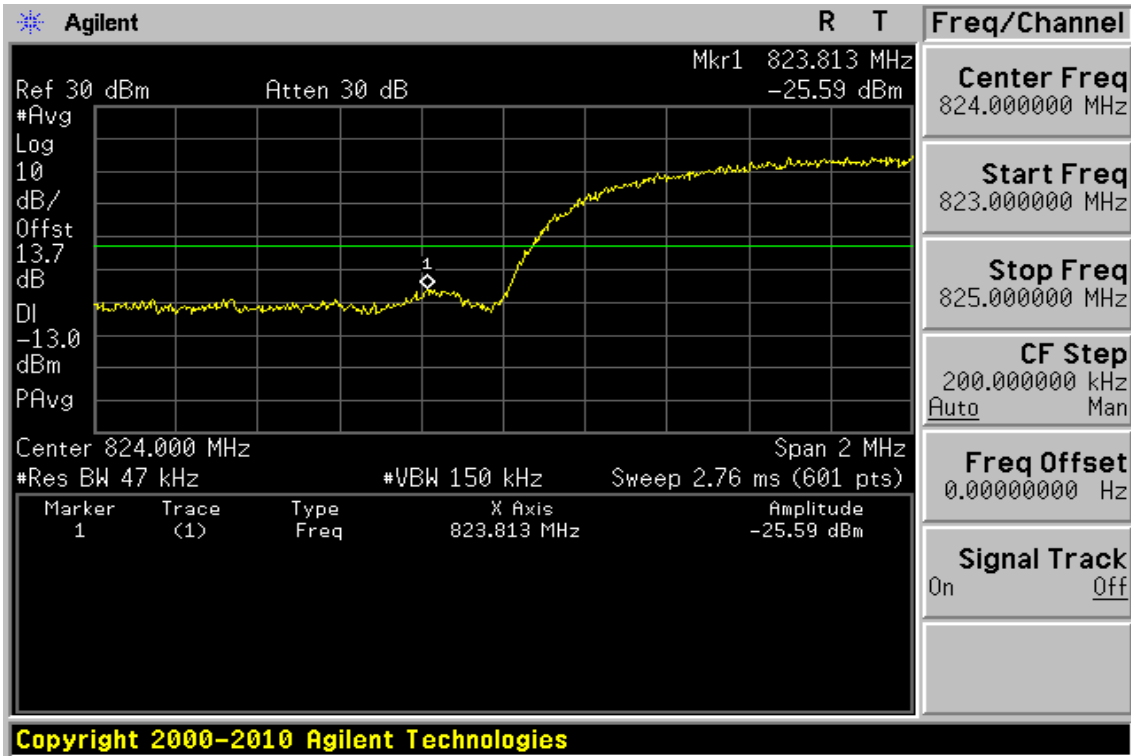
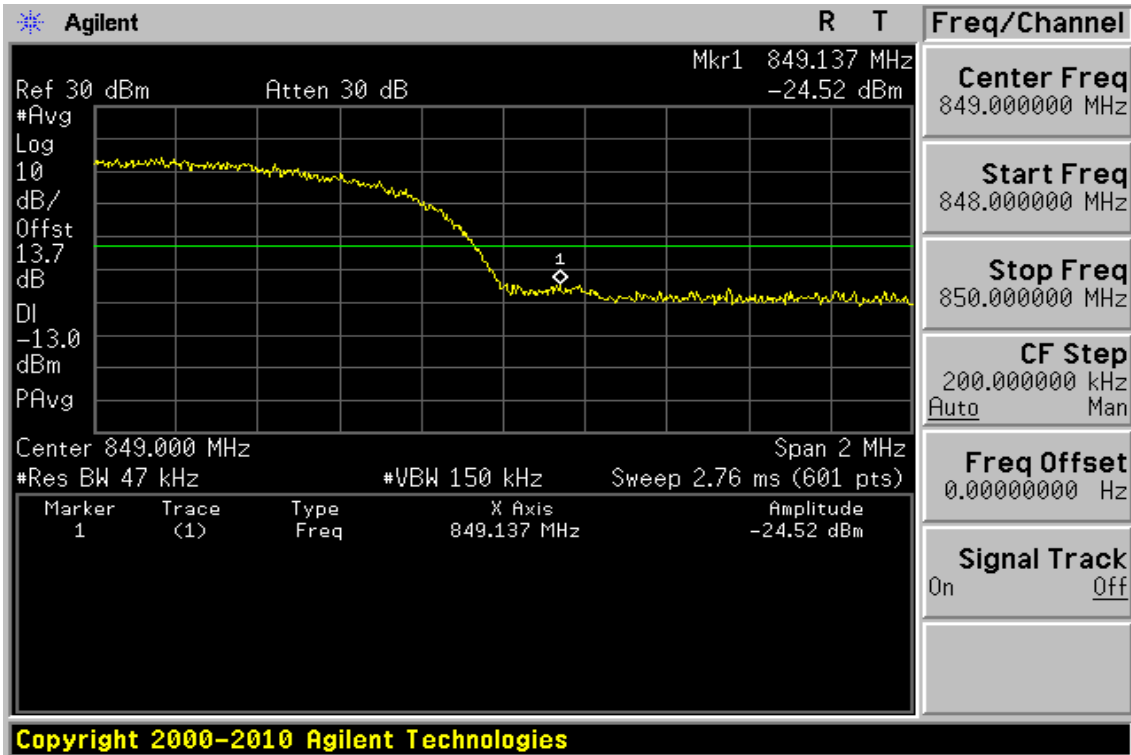

Figure 9-45: Band edge emission at antenna terminals – WCDMA V Channel Highest



Unless otherwise stated the results shown in this test report refer only to the sample(s) tested and such sample(s) are retained for 90 days only.

除非另有說明，此報告結果僅對測試之樣品負責，同時此樣品僅保留90天。本報告未經本公司書面許可，不可部份複製。

This document is issued by the Company subject to its General Conditions of Service printed overleaf, available on request or accessible at www.sgs.com/terms_and_conditions.htm and, for electronic format documents, subject to Terms and Conditions for Electronic Documents at www.sgs.com/terms_e-document.htm. Attention is drawn to the limitation of liability, indemnification and jurisdiction issues defined therein. Any holder of this document is advised that information contained hereon reflects the Company's findings at the time of its intervention only and within the limits of Client's instructions, if any. The Company's sole responsibility is to its Client and this document does not exonerate parties to a transaction from exercising all their rights and obligations under the transaction documents. This document cannot be reproduced except in full, without prior written approval of the Company. Any unauthorized alteration, forgery or falsification of the content or appearance of this document is unlawful and offenders may be prosecuted to the fullest extent of the law.

Band edge emission at antenna terminals – WCDMA V Low & High

Test Mode WCDMA V Engineer :Nick

| Freq. MHz | Reading dBm | Limit dBm | Safe Margin dB |
|--------------|----------------|--------------|----------------------|
| 823.813 | -25.59 | -13.00 | 12.59 |
| 849.137 | -24.52 | -13.00 | 11.52 |

Unless otherwise stated the results shown in this test report refer only to the sample(s) tested and such sample(s) are retained for 90 days only.

除非另有說明，此報告結果僅對測試之樣品負責，同時此樣品僅保留90天。本報告未經本公司書面許可，不可部份複製。

This document is issued by the Company subject to its General Conditions of Service printed overleaf, available on request or accessible at www.sgs.com/terms_and_conditions.htm and, for electronic format documents, subject to Terms and Conditions for Electronic Documents at www.sgs.com/terms_e-document.htm. Attention is drawn to the limitation of liability, indemnification and jurisdiction issues defined therein. Any holder of this document is advised that information contained hereon reflects the Company's findings at the time of its intervention only and within the limits of Client's instructions, if any. The Company's sole responsibility is to its Client and this document does not exonerate parties to a transaction from exercising all their rights and obligations under the transaction documents. This document cannot be reproduced except in full, without prior written approval of the Company. Any unauthorized alteration, forgery or falsification of the content or appearance of this document is unlawful and offenders may be prosecuted to the fullest extent of the law.

Figure 9-46: Out of Band emission at antenna terminals – HSDPA II Channel Lowest

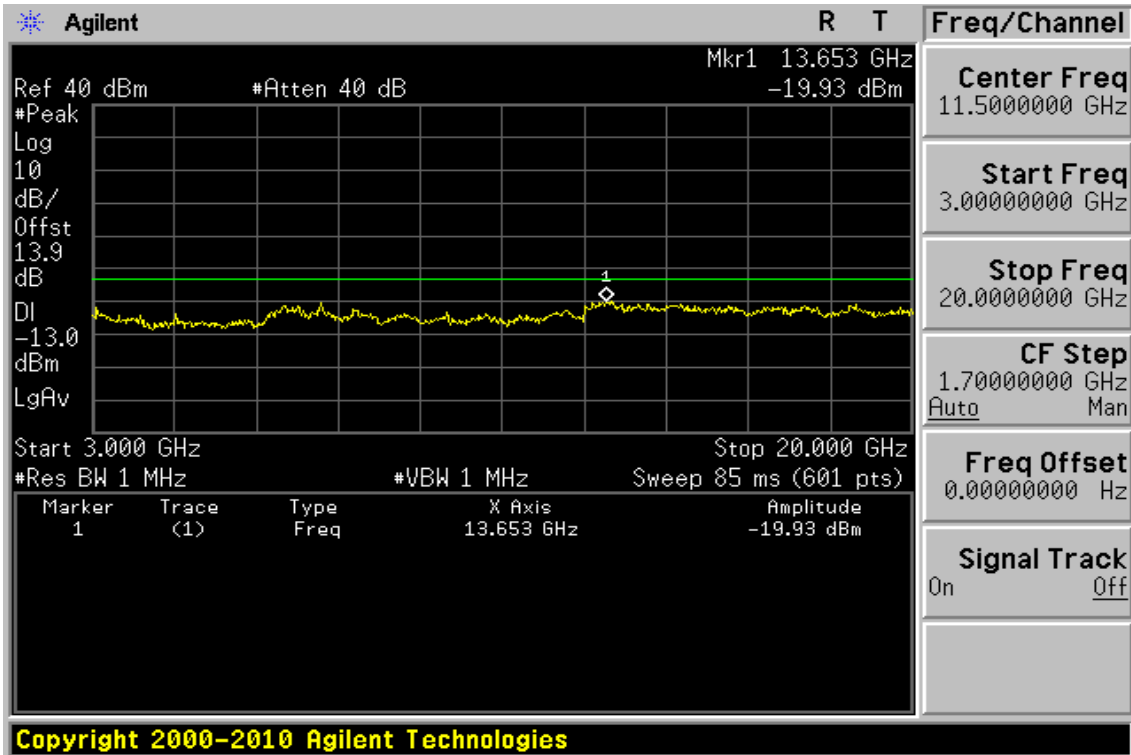
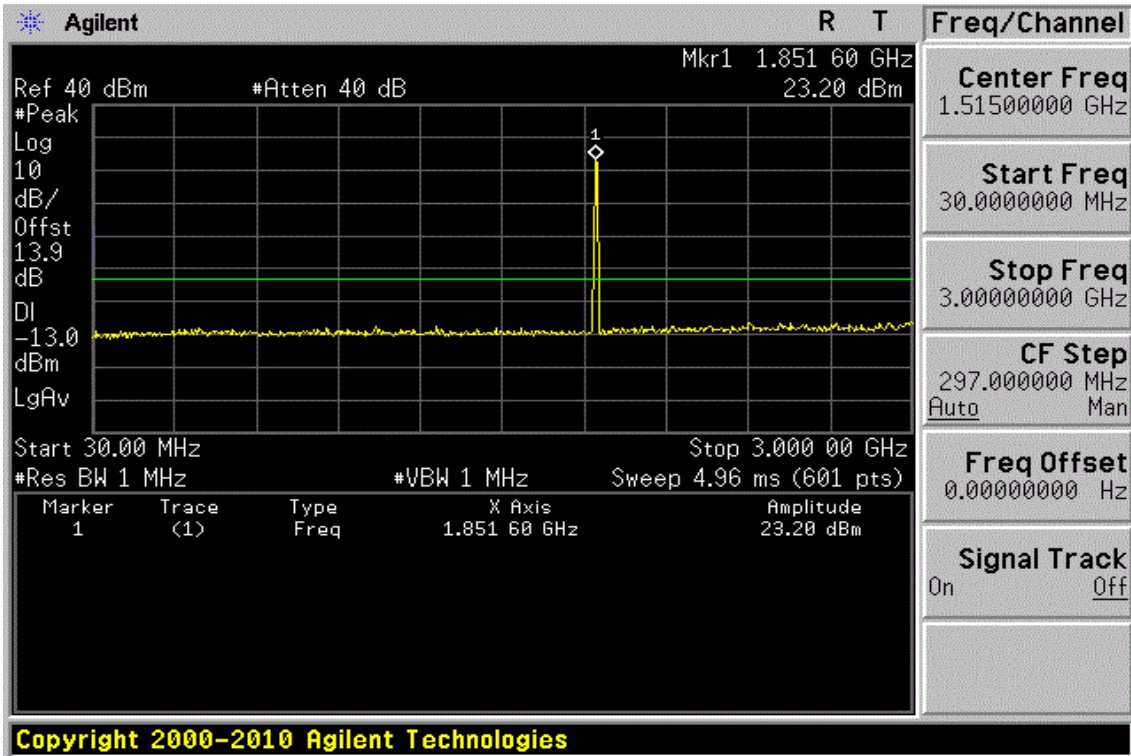

Unless otherwise stated the results shown in this test report refer only to the sample(s) tested and such sample(s) are retained for 90 days only.

除非另有說明，此報告結果僅對測試之樣品負責，同時此樣品僅保留90天。本報告未經本公司書面許可，不可部份複製。

This document is issued by the Company subject to its General Conditions of Service printed overleaf, available on request or accessible at www.sgs.com/terms_and_conditions.htm and, for electronic format documents, subject to Terms and Conditions for Electronic Documents at www.sgs.com/terms_e-document.htm. Attention is drawn to the limitation of liability, indemnification and jurisdiction issues defined therein. Any holder of this document is advised that information contained hereon reflects the Company's findings at the time of its intervention only and within the limits of Client's instructions, if any. The Company's sole responsibility is to its Client and this document does not exonerate parties to a transaction from exercising all their rights and obligations under the transaction documents. This document cannot be reproduced except in full, without prior written approval of the Company. Any unauthorized alteration, forgery or falsification of the content or appearance of this document is unlawful and offenders may be prosecuted to the fullest extent of the law.

Figure 9-47: Out of Band emission at antenna terminals – HSDPA II Channel Mid

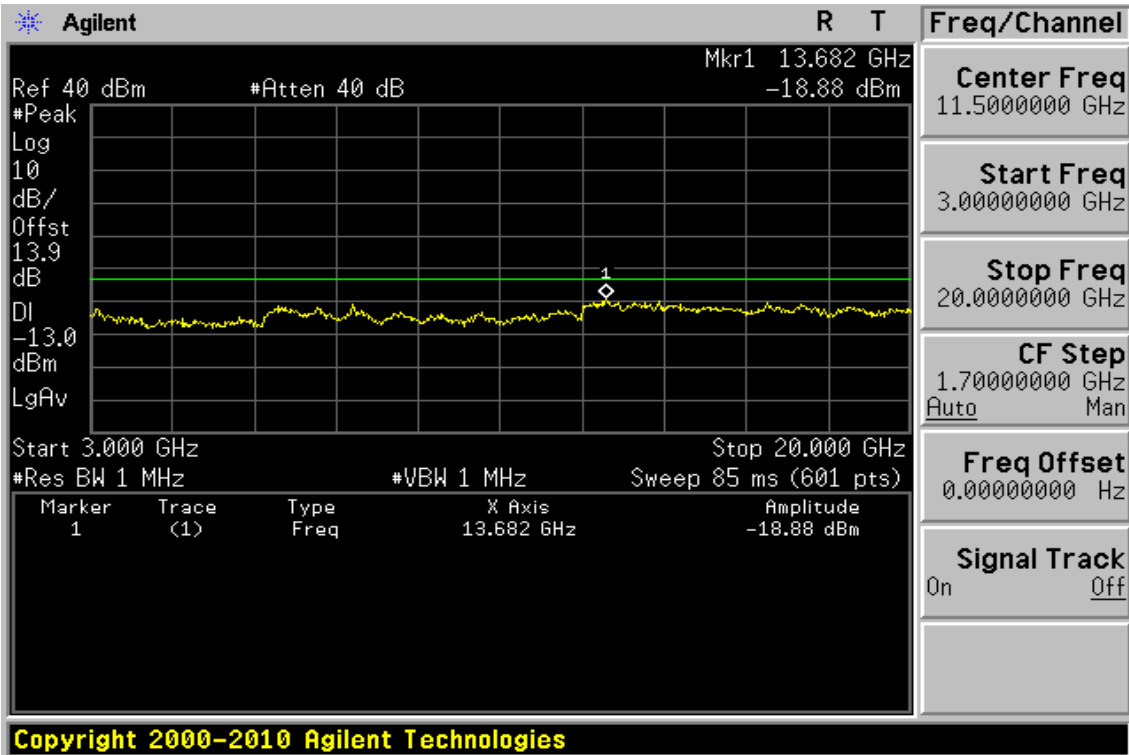
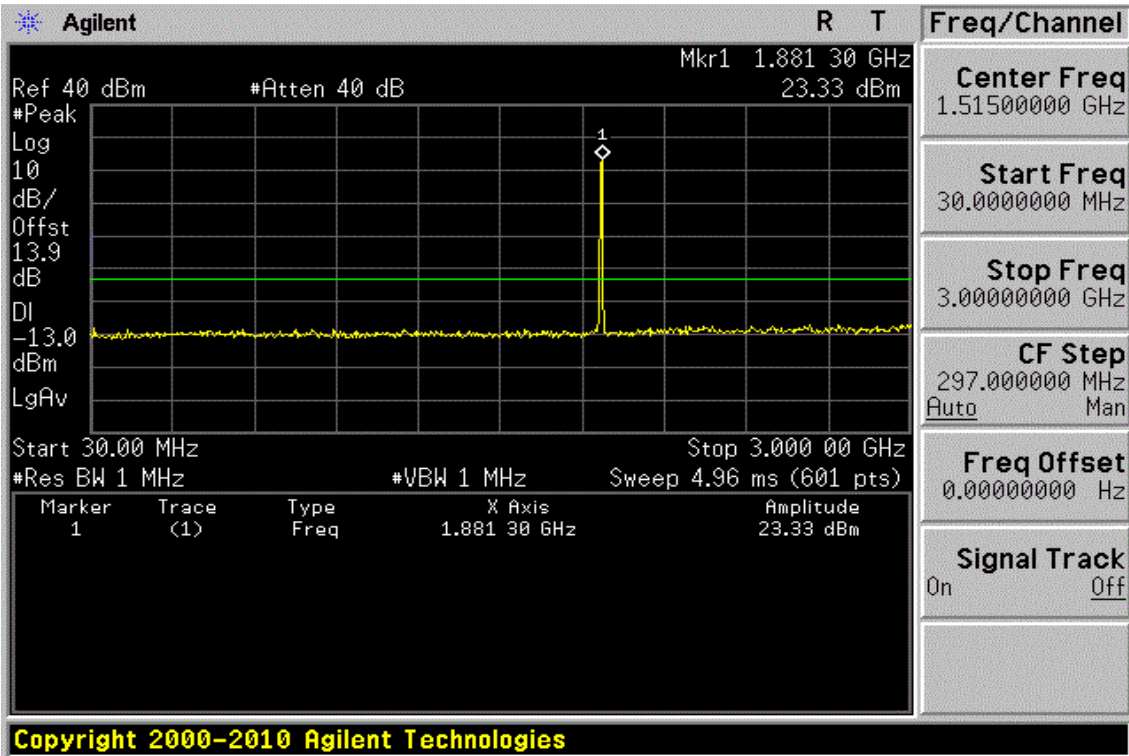

Unless otherwise stated the results shown in this test report refer only to the sample(s) tested and such sample(s) are retained for 90 days only.

除非另有說明，此報告結果僅對測試之樣品負責，同時此樣品僅保留90天。本報告未經本公司書面許可，不可部份複製。

This document is issued by the Company subject to its General Conditions of Service printed overleaf, available on request or accessible at www.sgs.com/terms_and_conditions.htm and, for electronic format documents, subject to Terms and Conditions for Electronic Documents at www.sgs.com/terms_e-document.htm. Attention is drawn to the limitation of liability, indemnification and jurisdiction issues defined therein. Any holder of this document is advised that information contained hereon reflects the Company's findings at the time of its intervention only and within the limits of Client's instructions, if any. The Company's sole responsibility is to its Client and this document does not exonerate parties to a transaction from exercising all their rights and obligations under the transaction documents. This document cannot be reproduced except in full, without prior written approval of the Company. Any unauthorized alteration, forgery or falsification of the content or appearance of this document is unlawful and offenders may be prosecuted to the fullest extent of the law.

Figure 9-48: Out of Band emission at antenna terminals – HSDPA II Channel Highest

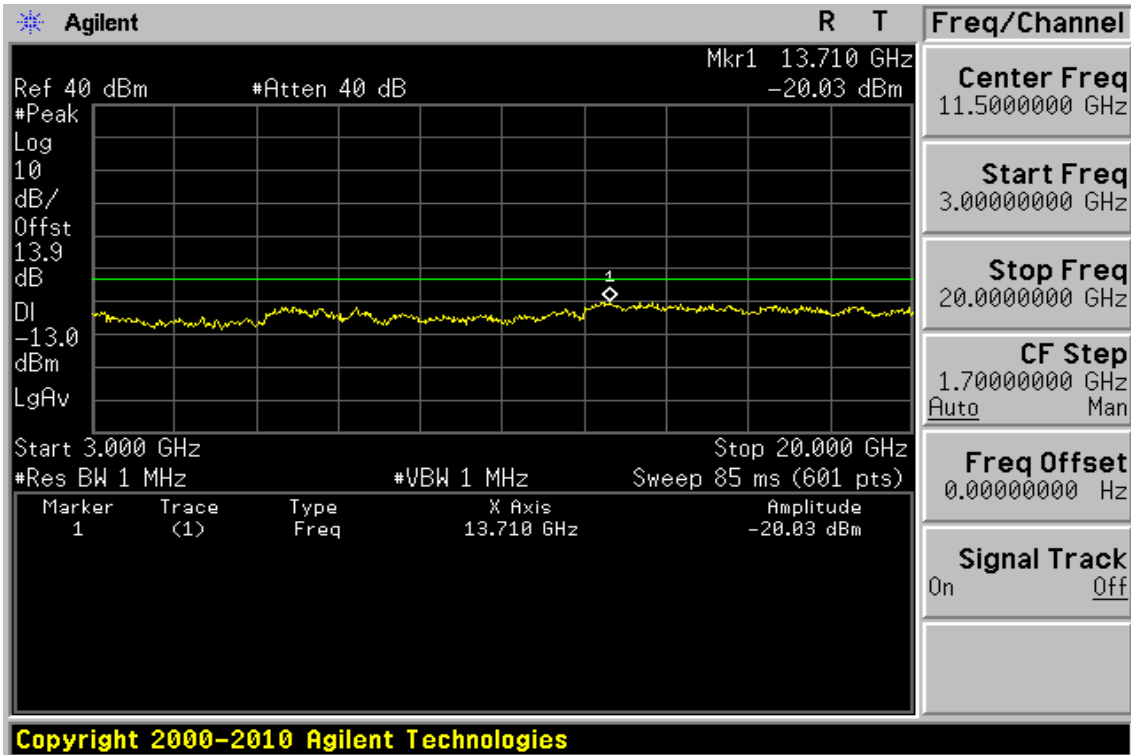
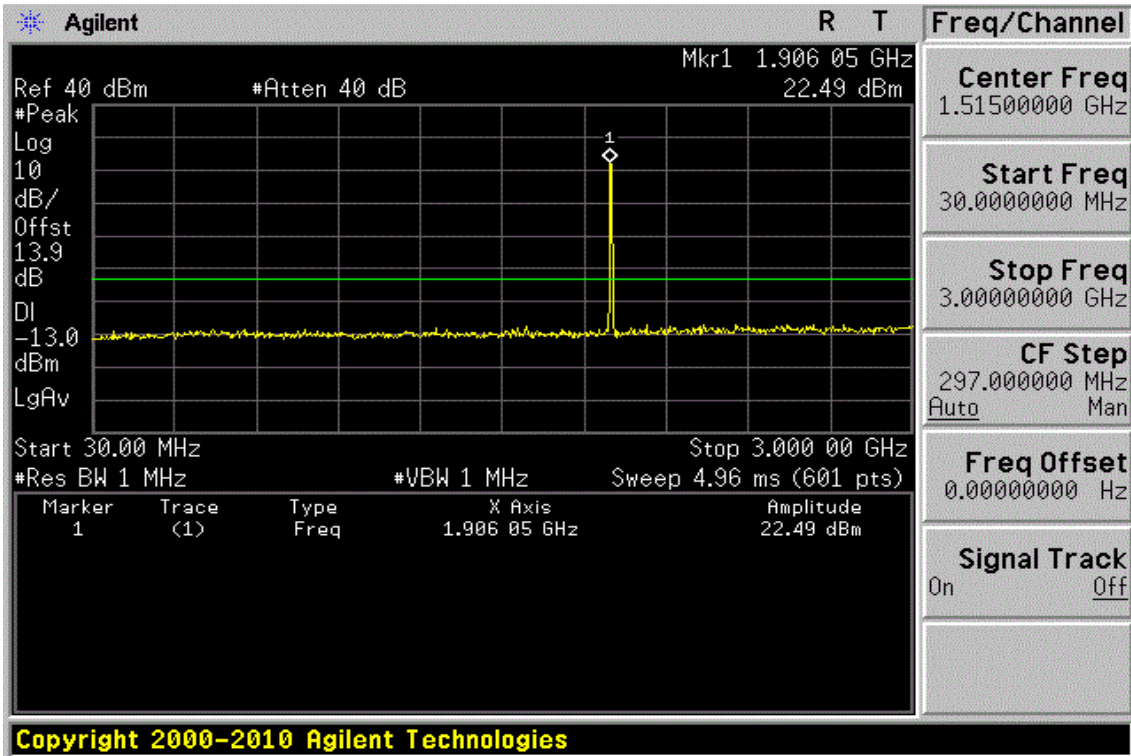

Unless otherwise stated the results shown in this test report refer only to the sample(s) tested and such sample(s) are retained for 90 days only.

除非另有說明，此報告結果僅對測試之樣品負責，同時此樣品僅保留90天。本報告未經本公司書面許可，不可部份複製。

This document is issued by the Company subject to its General Conditions of Service printed overleaf, available on request or accessible at www.sgs.com/terms_and_conditions.htm and, for electronic format documents, subject to Terms and Conditions for Electronic Documents at www.sgs.com/terms_e-document.htm. Attention is drawn to the limitation of liability, indemnification and jurisdiction issues defined therein. Any holder of this document is advised that information contained hereon reflects the Company's findings at the time of its intervention only and within the limits of Client's instructions, if any. The Company's sole responsibility is to its Client and this document does not exonerate parties to a transaction from exercising all their rights and obligations under the transaction documents. This document cannot be reproduced except in full, without prior written approval of the Company. Any unauthorized alteration, forgery or falsification of the content or appearance of this document is unlawful and offenders may be prosecuted to the fullest extent of the law.

Out of Band emission at antenna terminals – HSDPA II

Fundamental Frequency :1852.4 MHz Engineer :Nick
Operation Mode :TX Low

| Freq. (MHz) | Note F/H/E/S | Reading dBm | Limit dBm | Safe Margin dB |
|----------------|-----------------|----------------|--------------|----------------------|
| <30 | S | --- | -13.00 | --- |
| 30-1000 | S | --- | -13.00 | --- |
| 3704.80 | H | --- | -13.00 | --- |
| 5557.20 | H | --- | -13.00 | --- |
| 7409.60 | H | --- | -13.00 | --- |
| 9262.00 | H | --- | -13.00 | --- |
| 11114.40 | H | --- | -13.00 | --- |
| 12966.80 | H | --- | -13.00 | --- |
| 13653.00 | S | -19.93 | -13.00 | 6.93 |
| 14819.20 | H | --- | -13.00 | --- |
| 16671.60 | H | --- | -13.00 | --- |
| 18524.00 | H | --- | -13.00 | --- |

Note : “H” : denotes Harmonic Frequency. “S” : denotes Spurious Frequency.
“---” : denotes Noise Floor.

Unless otherwise stated the results shown in this test report refer only to the sample(s) tested and such sample(s) are retained for 90 days only.

除非另有說明，此報告結果僅對測試之樣品負責，同時此樣品僅保留90天。本報告未經本公司書面許可，不可部份複製。

This document is issued by the Company subject to its General Conditions of Service printed overleaf, available on request or accessible at www.sgs.com/terms_and_conditions.htm and, for electronic format documents, subject to Terms and Conditions for Electronic Documents at www.sgs.com/terms_e-document.htm. Attention is drawn to the limitation of liability, indemnification and jurisdiction issues defined therein. Any holder of this document is advised that information contained hereon reflects the Company's findings at the time of its intervention only and within the limits of Client's instructions, if any. The Company's sole responsibility is to its Client and this document does not exonerate parties to a transaction from exercising all their rights and obligations under the transaction documents. This document cannot be reproduced except in full, without prior written approval of the Company. Any unauthorized alteration, forgery or falsification of the content or appearance of this document is unlawful and offenders may be prosecuted to the fullest extent of the law.

Fundamental Frequency :1880.0 MHz Engineer :Nick
Operation Mode :TX Mid

| Freq. (MHz) | Note F/H/E/S | Reading dBm | Limit dBm | Safe Margin dB |
|----------------|-----------------|----------------|--------------|----------------------|
| <30 | S | --- | -13.00 | --- |
| 30-1000 | S | --- | -13.00 | --- |
| 3760.00 | H | --- | -13.00 | --- |
| 5640.00 | H | --- | -13.00 | --- |
| 7520.00 | H | --- | -13.00 | --- |
| 9400.00 | H | --- | -13.00 | --- |
| 11280.00 | H | --- | -13.00 | --- |
| 13160.00 | H | --- | -13.00 | --- |
| 13682.00 | S | -18.88 | -13.00 | 5.88 |
| 15040.00 | H | --- | -13.00 | --- |
| 16920.00 | H | --- | -13.00 | --- |
| 18800.00 | H | --- | -13.00 | --- |

Note : “H” : denotes Harmonic Frequency. “S” : denotes Spurious Frequency.
“---” : denotes Noise Floor.

Unless otherwise stated the results shown in this test report refer only to the sample(s) tested and such sample(s) are retained for 90 days only.

除非另有說明，此報告結果僅對測試之樣品負責，同時此樣品僅保留90天。本報告未經本公司書面許可，不可部份複製。

This document is issued by the Company subject to its General Conditions of Service printed overleaf, available on request or accessible at www.sgs.com/terms_and_conditions.htm and, for electronic format documents, subject to Terms and Conditions for Electronic Documents at www.sgs.com/terms_e-document.htm. Attention is drawn to the limitation of liability, indemnification and jurisdiction issues defined therein. Any holder of this document is advised that information contained hereon reflects the Company's findings at the time of its intervention only and within the limits of Client's instructions, if any. The Company's sole responsibility is to its Client and this document does not exonerate parties to a transaction from exercising all their rights and obligations under the transaction documents. This document cannot be reproduced except in full, without prior written approval of the Company. Any unauthorized alteration, forgery or falsification of the content or appearance of this document is unlawful and offenders may be prosecuted to the fullest extent of the law.

Fundamental Frequency :1907.6MHz Engineer :Nick
Operation Mode :TX High

| Freq. (MHz) | Note F/H/E/S | Reading dBm | Limit dBm | Safe Margin dB |
|----------------|-----------------|----------------|--------------|----------------------|
| <30 | S | --- | -13.00 | --- |
| 30-1000 | S | --- | -13.00 | --- |
| 3815.20 | H | --- | -13.00 | --- |
| 5722.80 | H | --- | -13.00 | --- |
| 7630.40 | H | --- | -13.00 | --- |
| 9538.00 | H | --- | -13.00 | --- |
| 11445.60 | H | --- | -13.00 | --- |
| 13353.20 | H | --- | -13.00 | --- |
| 13710.00 | S | -20.03 | -13.00 | 7.03 |
| 15260.80 | H | --- | -13.00 | --- |
| 17168.40 | H | --- | -13.00 | --- |
| 19076.00 | H | --- | -13.00 | --- |

Note : "H" : denotes Harmonic Frequency. "S" : denotes Spurious Frequency.
"---" : denotes Noise Floor.

Unless otherwise stated the results shown in this test report refer only to the sample(s) tested and such sample(s) are retained for 90 days only.

除非另有說明，此報告結果僅對測試之樣品負責，同時此樣品僅保留90天。本報告未經本公司書面許可，不可部份複製。

This document is issued by the Company subject to its General Conditions of Service printed overleaf, available on request or accessible at www.sgs.com/terms_and_conditions.htm and, for electronic format documents, subject to Terms and Conditions for Electronic Documents at www.sgs.com/terms_e-document.htm. Attention is drawn to the limitation of liability, indemnification and jurisdiction issues defined therein. Any holder of this document is advised that information contained hereon reflects the Company's findings at the time of its intervention only and within the limits of Client's instructions, if any. The Company's sole responsibility is to its Client and this document does not exonerate parties to a transaction from exercising all their rights and obligations under the transaction documents. This document cannot be reproduced except in full, without prior written approval of the Company. Any unauthorized alteration, forgery or falsification of the content or appearance of this document is unlawful and offenders may be prosecuted to the fullest extent of the law.

Figure 9-49: Band edge emission at antenna terminals – HSDPA II Channel Lowest

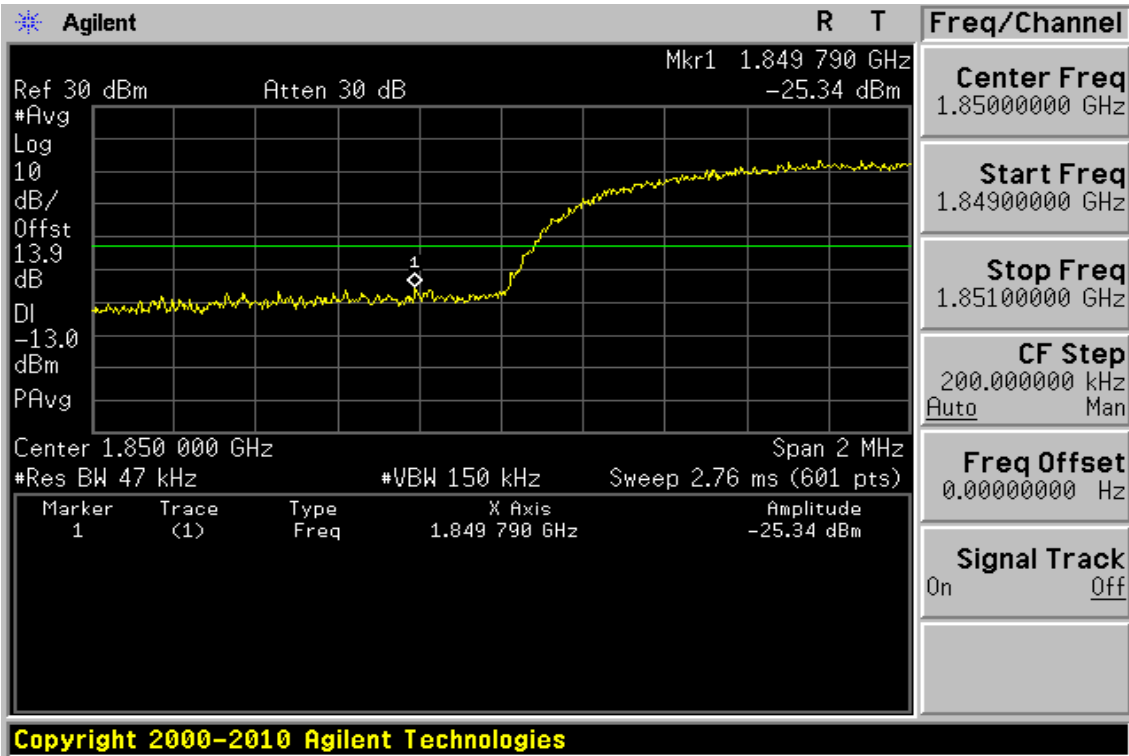
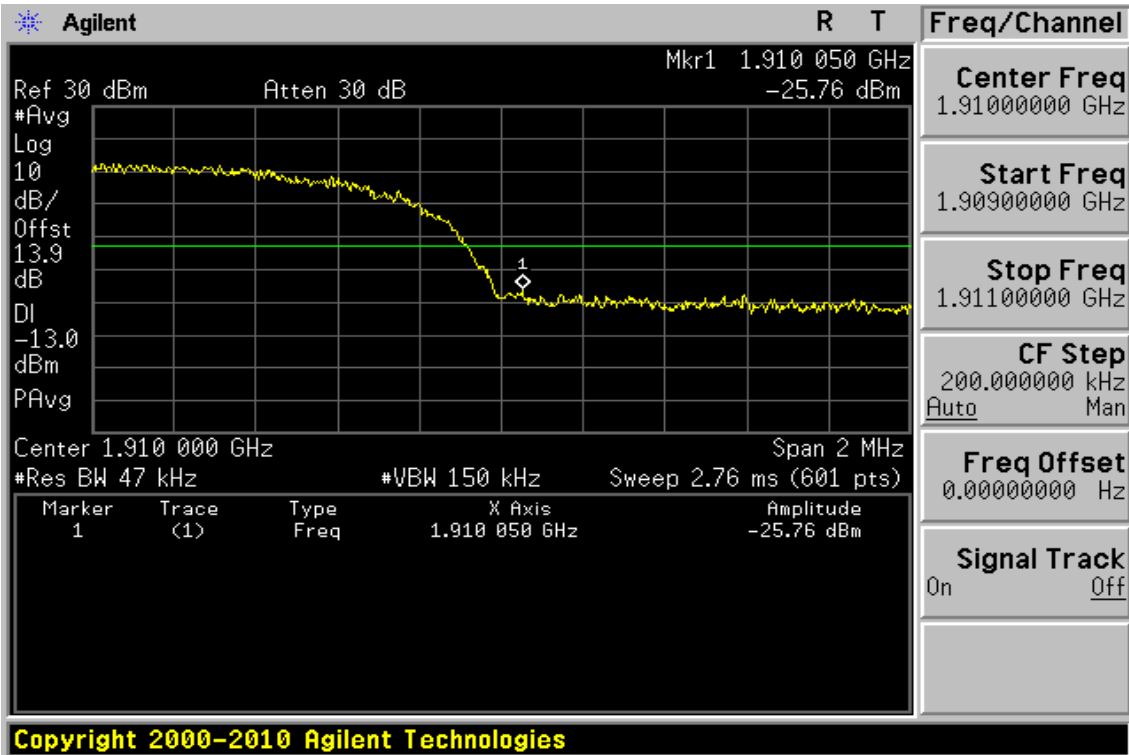

Figure 9-50: Band edge emission at antenna terminals – HSUPA II Channel Highest



Unless otherwise stated the results shown in this test report refer only to the sample(s) tested and such sample(s) are retained for 90 days only.

除非另有說明，此報告結果僅對測試之樣品負責，同時此樣品僅保留90天。本報告未經本公司書面許可，不可部份複製。

This document is issued by the Company subject to its General Conditions of Service printed overleaf, available on request or accessible at www.sgs.com/terms_and_conditions.htm and, for electronic format documents, subject to Terms and Conditions for Electronic Documents at www.sgs.com/terms_e-document.htm. Attention is drawn to the limitation of liability, indemnification and jurisdiction issues defined therein. Any holder of this document is advised that information contained hereon reflects the Company's findings at the time of its intervention only and within the limits of Client's instructions, if any. The Company's sole responsibility is to its Client and this document does not exonerate parties to a transaction from exercising all their rights and obligations under the transaction documents. This document cannot be reproduced except in full, without prior written approval of the Company. Any unauthorized alteration, forgery or falsification of the content or appearance of this document is unlawful and offenders may be prosecuted to the fullest extent of the law.

Band edge emission at antenna terminals – HSDPA II Low & High

Test Mode HSDPA II Engineer :Nick

| Freq. MHz | Reading dBm | Limit dBm | Safe Margin dB |
|--------------|----------------|--------------|----------------------|
| 1849.790 | -25.34 | -13.00 | 12.34 |
| 1910.050 | -25.76 | -13.00 | 12.76 |

Unless otherwise stated the results shown in this test report refer only to the sample(s) tested and such sample(s) are retained for 90 days only.

除非另有說明，此報告結果僅對測試之樣品負責，同時此樣品僅保留90天。本報告未經本公司書面許可，不可部份複製。

This document is issued by the Company subject to its General Conditions of Service printed overleaf, available on request or accessible at www.sgs.com/terms_and_conditions.htm and, for electronic format documents, subject to Terms and Conditions for Electronic Documents at www.sgs.com/terms_e-document.htm. Attention is drawn to the limitation of liability, indemnification and jurisdiction issues defined therein. Any holder of this document is advised that information contained hereon reflects the Company's findings at the time of its intervention only and within the limits of Client's instructions, if any. The Company's sole responsibility is to its Client and this document does not exonerate parties to a transaction from exercising all their rights and obligations under the transaction documents. This document cannot be reproduced except in full, without prior written approval of the Company. Any unauthorized alteration, forgery or falsification of the content or appearance of this document is unlawful and offenders may be prosecuted to the fullest extent of the law.

Figure 9-51: Out of Band emission at antenna terminals – HSDPA IV Channel Lowest

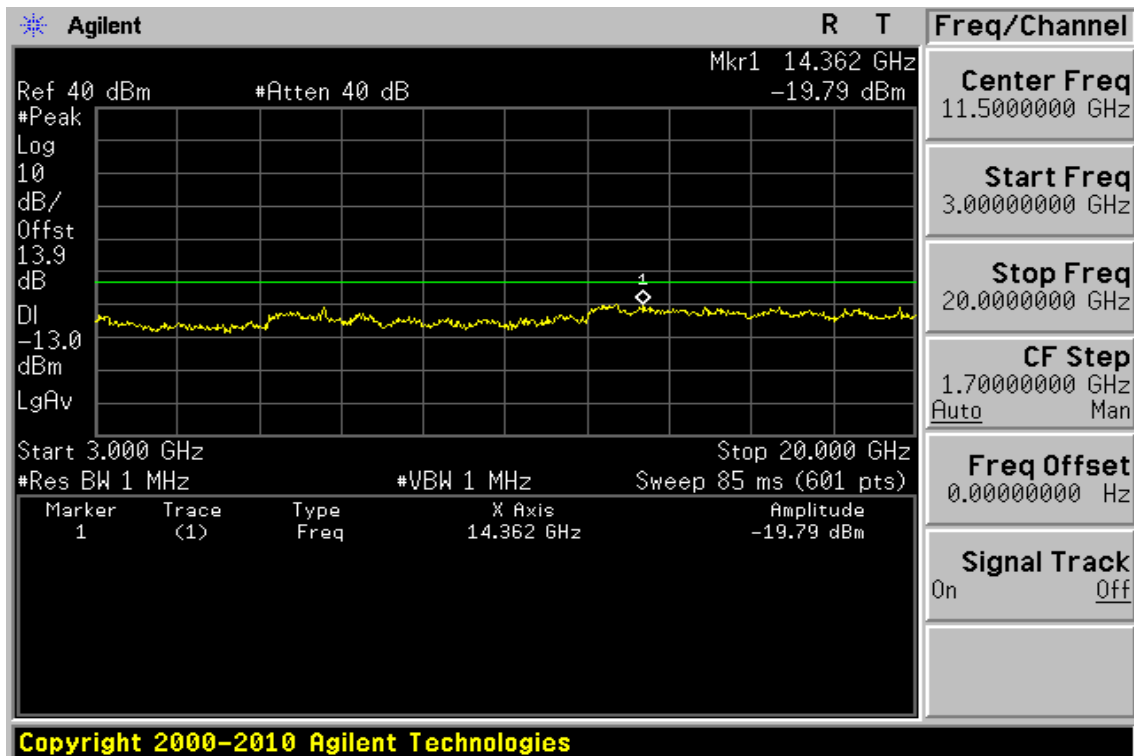
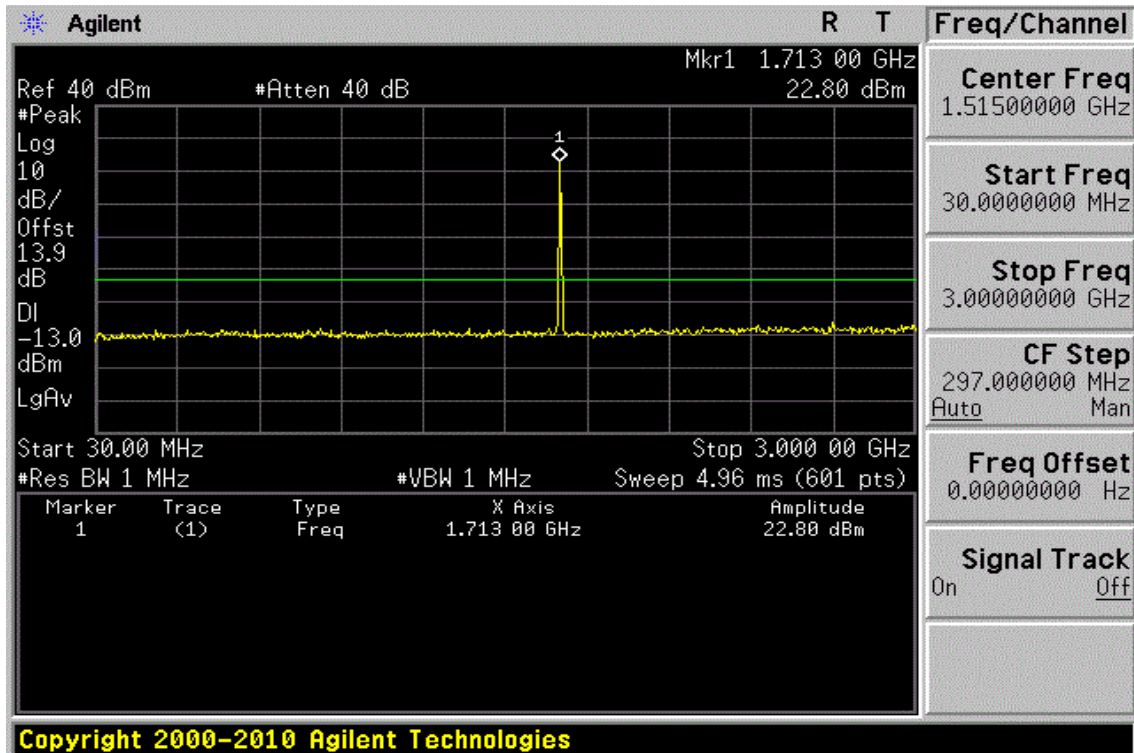

Unless otherwise stated the results shown in this test report refer only to the sample(s) tested and such sample(s) are retained for 90 days only.

除非另有說明，此報告結果僅對測試之樣品負責，同時此樣品僅保留90天。本報告未經本公司書面許可，不可部份複製。

This document is issued by the Company subject to its General Conditions of Service printed overleaf, available on request or accessible at www.sgs.com/terms_and_conditions.htm and, for electronic format documents, subject to Terms and Conditions for Electronic Documents at www.sgs.com/terms_e-document.htm. Attention is drawn to the limitation of liability, indemnification and jurisdiction issues defined therein. Any holder of this document is advised that information contained hereon reflects the Company's findings at the time of its intervention only and within the limits of Client's instructions, if any. The Company's sole responsibility is to its Client and this document does not exonerate parties to a transaction from exercising all their rights and obligations under the transaction documents. This document cannot be reproduced except in full, without prior written approval of the Company. Any unauthorized alteration, forgery or falsification of the content or appearance of this document is unlawful and offenders may be prosecuted to the fullest extent of the law.

Figure 9-52: Out of Band emission at antenna terminals –HSDPA IV Channel Mid

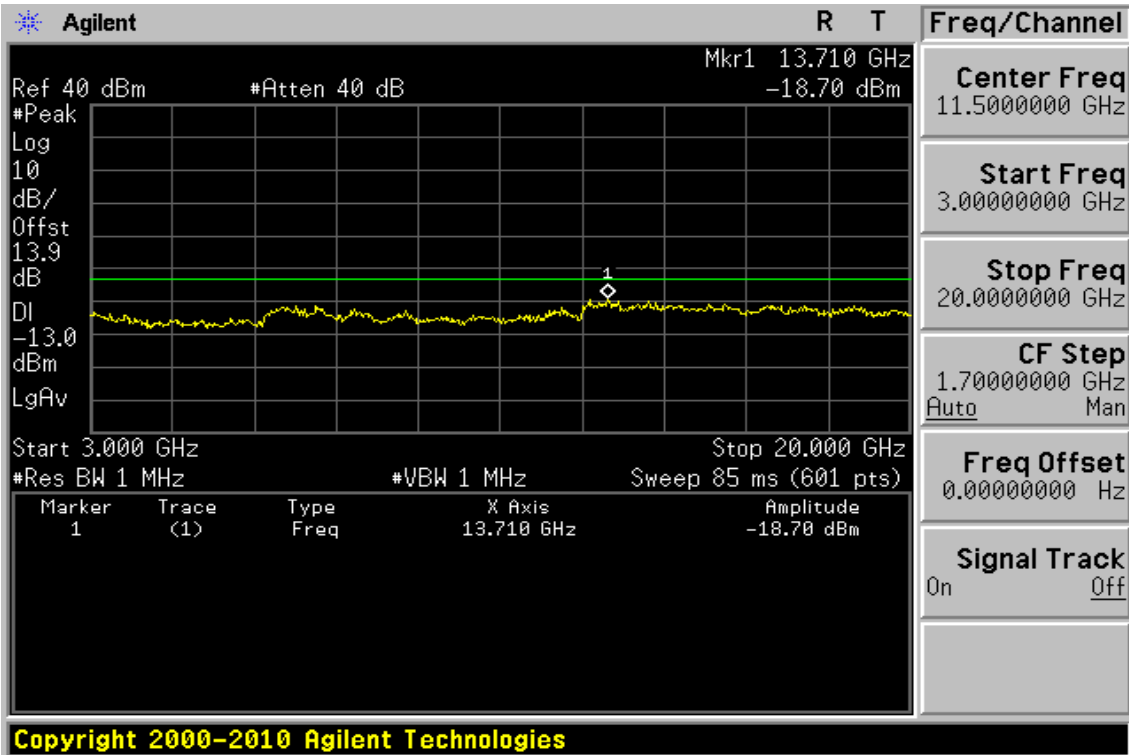
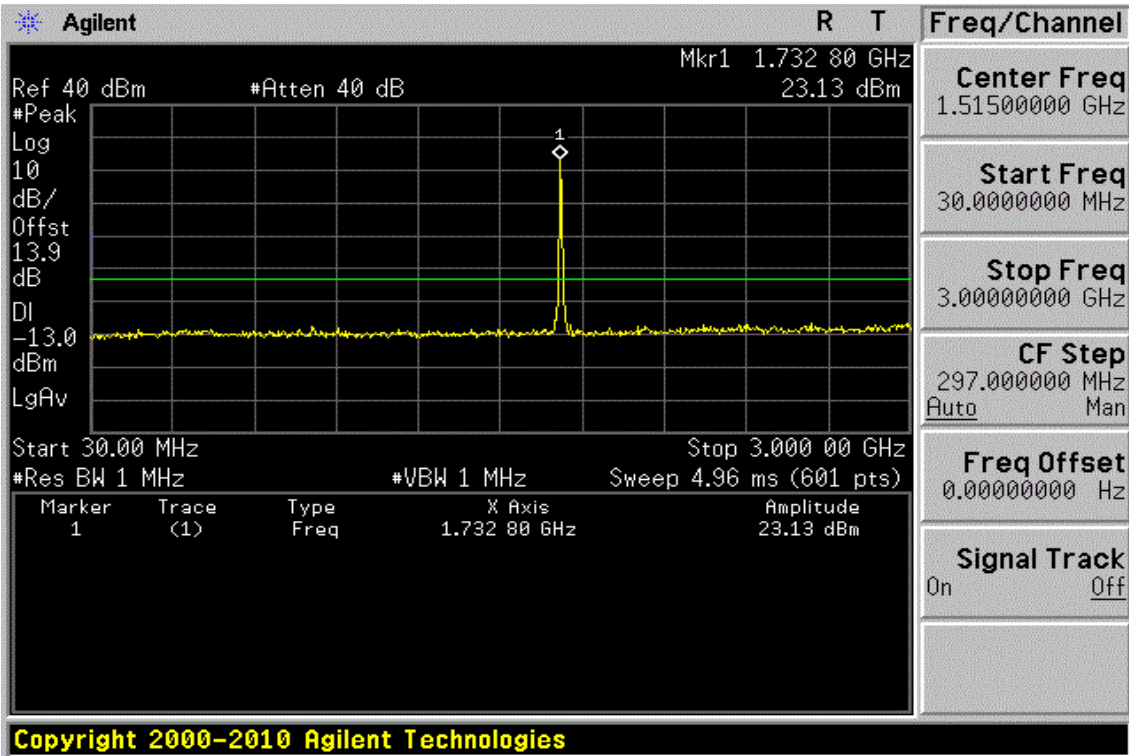

Unless otherwise stated the results shown in this test report refer only to the sample(s) tested and such sample(s) are retained for 90 days only.

除非另有說明，此報告結果僅對測試之樣品負責，同時此樣品僅保留90天。本報告未經本公司書面許可，不可部份複製。

This document is issued by the Company subject to its General Conditions of Service printed overleaf, available on request or accessible at www.sgs.com/terms_and_conditions.htm and, for electronic format documents, subject to Terms and Conditions for Electronic Documents at www.sgs.com/terms_e-document.htm. Attention is drawn to the limitation of liability, indemnification and jurisdiction issues defined therein. Any holder of this document is advised that information contained hereon reflects the Company's findings at the time of its intervention only and within the limits of Client's instructions, if any. The Company's sole responsibility is to its Client and this document does not exonerate parties to a transaction from exercising all their rights and obligations under the transaction documents. This document cannot be reproduced except in full, without prior written approval of the Company. Any unauthorized alteration, forgery or falsification of the content or appearance of this document is unlawful and offenders may be prosecuted to the fullest extent of the law.

Figure 9-53: Out of Band emission at antenna terminals –HSDPA IV Channel Highest

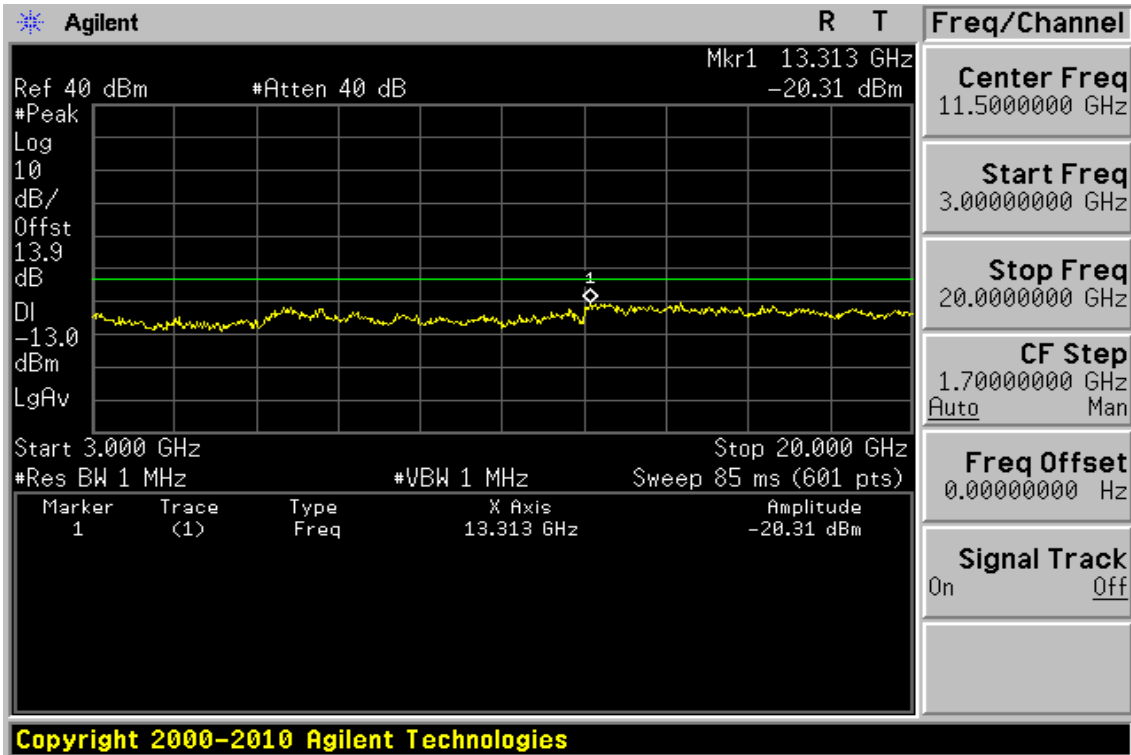
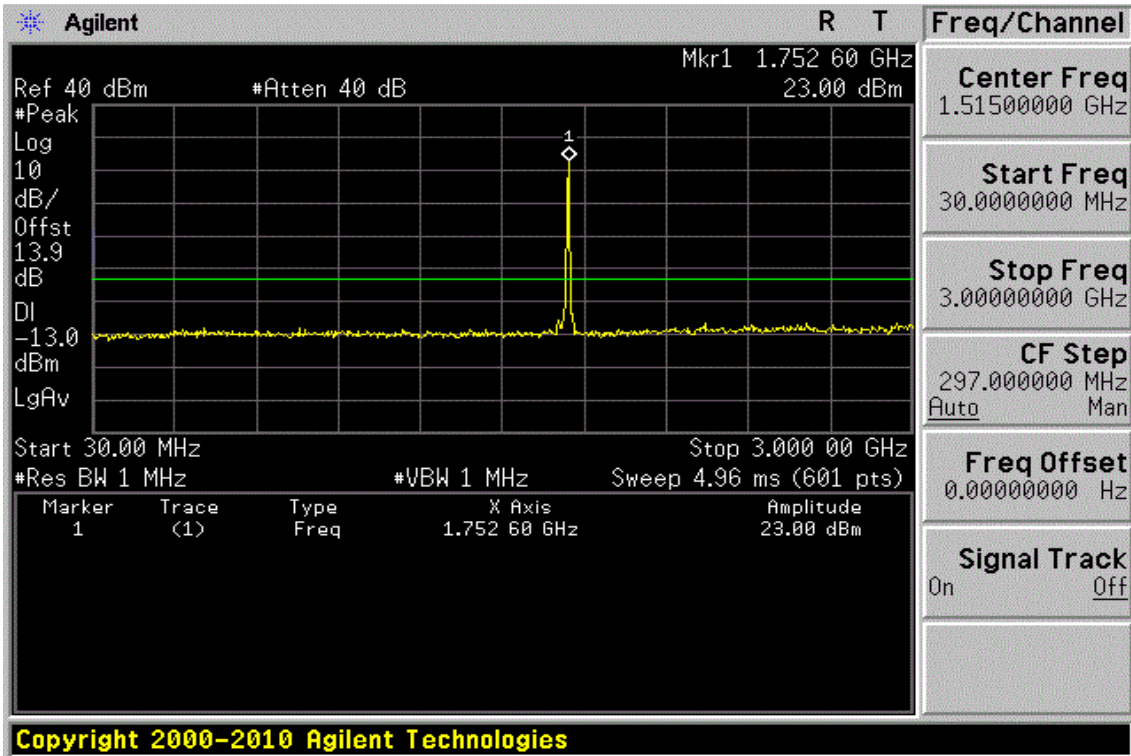

Unless otherwise stated the results shown in this test report refer only to the sample(s) tested and such sample(s) are retained for 90 days only.

除非另有說明，此報告結果僅對測試之樣品負責，同時此樣品僅保留90天。本報告未經本公司書面許可，不可部份複製。

This document is issued by the Company subject to its General Conditions of Service printed overleaf, available on request or accessible at www.sgs.com/terms_and_conditions.htm and, for electronic format documents, subject to Terms and Conditions for Electronic Documents at www.sgs.com/terms_e-document.htm. Attention is drawn to the limitation of liability, indemnification and jurisdiction issues defined therein. Any holder of this document is advised that information contained hereon reflects the Company's findings at the time of its intervention only and within the limits of Client's instructions, if any. The Company's sole responsibility is to its Client and this document does not exonerate parties to a transaction from exercising all their rights and obligations under the transaction documents. This document cannot be reproduced except in full, without prior written approval of the Company. Any unauthorized alteration, forgery or falsification of the content or appearance of this document is unlawful and offenders may be prosecuted to the fullest extent of the law.

Out of Band emission at antenna terminals –HSDPA IV

Fundamental Frequency 1712.4 MHz Engineer :Nick
Operation Mode :TX Low

| Freq. (MHz) | Note F/H/E/S | Reading dBm | Limit dBm | Safe Margin dB |
|----------------|-----------------|----------------|--------------|----------------------|
| <30 | S | --- | -13.00 | --- |
| 30-1000 | S | --- | -13.00 | --- |
| 3424.80 | H | --- | -13.00 | --- |
| 5137.20 | H | --- | -13.00 | --- |
| 6849.60 | H | --- | -13.00 | --- |
| 8562.00 | H | --- | -13.00 | --- |
| 10274.40 | H | --- | -13.00 | --- |
| 11986.80 | H | --- | -13.00 | --- |
| 13699.20 | H | --- | -13.00 | --- |
| 14362.00 | S | -19.79 | -13.00 | 6.79 |
| 15411.60 | H | --- | -13.00 | --- |
| 17124.00 | H | --- | -13.00 | --- |

Note : “H” : denotes Harmonic Frequency. “S” : denotes Spurious Frequency.
“---“ : denotes Noise Floor.

Unless otherwise stated the results shown in this test report refer only to the sample(s) tested and such sample(s) are retained for 90 days only.

除非另有說明，此報告結果僅對測試之樣品負責，同時此樣品僅保留90天。本報告未經本公司書面許可，不可部份複製。

This document is issued by the Company subject to its General Conditions of Service printed overleaf, available on request or accessible at www.sgs.com/terms_and_conditions.htm and, for electronic format documents, subject to Terms and Conditions for Electronic Documents at www.sgs.com/terms_e-document.htm. Attention is drawn to the limitation of liability, indemnification and jurisdiction issues defined therein. Any holder of this document is advised that information contained hereon reflects the Company's findings at the time of its intervention only and within the limits of Client's instructions, if any. The Company's sole responsibility is to its Client and this document does not exonerate parties to a transaction from exercising all their rights and obligations under the transaction documents. This document cannot be reproduced except in full, without prior written approval of the Company. Any unauthorized alteration, forgery or falsification of the content or appearance of this document is unlawful and offenders may be prosecuted to the fullest extent of the law.

Fundamental Frequency :1732.6 MHz Engineer :Nick
Operation Mode :TX Mid

| Freq. (MHz) | Note F/H/E/S | Reading dBm | Limit dBm | Safe Margin dB |
|----------------|-----------------|----------------|--------------|----------------------|
| <30 | S | --- | -13.00 | --- |
| 30-1000 | S | --- | -13.00 | --- |
| 3465.20 | H | --- | -13.00 | --- |
| 5197.80 | H | --- | -13.00 | --- |
| 6930.40 | H | --- | -13.00 | --- |
| 8663.00 | H | --- | -13.00 | --- |
| 10395.60 | H | --- | -13.00 | --- |
| 12128.20 | H | --- | -13.00 | --- |
| 13710.00 | S | -18.70 | -13.00 | 5.70 |
| 13860.80 | H | --- | -13.00 | --- |
| 15593.40 | H | --- | -13.00 | --- |
| 17326.00 | H | --- | -13.00 | --- |

Note : "H" : denotes Harmonic Frequency. "S" : denotes Spurious Frequency.
"---" : denotes Noise Floor.

Unless otherwise stated the results shown in this test report refer only to the sample(s) tested and such sample(s) are retained for 90 days only.

除非另有說明，此報告結果僅對測試之樣品負責，同時此樣品僅保留90天。本報告未經本公司書面許可，不可部份複製。

This document is issued by the Company subject to its General Conditions of Service printed overleaf, available on request or accessible at www.sgs.com/terms_and_conditions.htm and, for electronic format documents, subject to Terms and Conditions for Electronic Documents at www.sgs.com/terms_e-document.htm. Attention is drawn to the limitation of liability, indemnification and jurisdiction issues defined therein. Any holder of this document is advised that information contained hereon reflects the Company's findings at the time of its intervention only and within the limits of Client's instructions, if any. The Company's sole responsibility is to its Client and this document does not exonerate parties to a transaction from exercising all their rights and obligations under the transaction documents. This document cannot be reproduced except in full, without prior written approval of the Company. Any unauthorized alteration, forgery or falsification of the content or appearance of this document is unlawful and offenders may be prosecuted to the fullest extent of the law.



Fundamental Frequency 1752.6MHz Engineer :Nick
Operation Mode :TX High

| Freq. (MHz) | Note F/H/E/S | Reading dBm | Limit dBm | Safe Margin dB |
|----------------|-----------------|----------------|--------------|----------------------|
| <30 | S | --- | -13.00 | --- |
| 30-1000 | S | --- | -13.00 | --- |
| 3505.20 | H | --- | -13.00 | --- |
| 5257.80 | H | --- | -13.00 | --- |
| 7010.40 | H | --- | -13.00 | --- |
| 8763.00 | H | --- | -13.00 | --- |
| 10515.60 | H | --- | -13.00 | --- |
| 12268.20 | H | --- | -13.00 | --- |
| 13313.00 | S | -20.31 | -13.00 | 7.31 |
| 14020.80 | H | --- | -13.00 | --- |
| 15773.40 | H | --- | -13.00 | --- |
| 17526.00 | H | --- | -13.00 | --- |

Note : “H” : denotes Harmonic Frequency. “S” : denotes Spurious Frequency.
“---“ : denotes Noise Floor.

Unless otherwise stated the results shown in this test report refer only to the sample(s) tested and such sample(s) are retained for 90 days only.

除非另有說明，此報告結果僅對測試之樣品負責，同時此樣品僅保留90天。本報告未經本公司書面許可，不可部份複製。

This document is issued by the Company subject to its General Conditions of Service printed overleaf, available on request or accessible at www.sgs.com/terms_and_conditions.htm and, for electronic format documents, subject to Terms and Conditions for Electronic Documents at www.sgs.com/terms_e-document.htm. Attention is drawn to the limitation of liability, indemnification and jurisdiction issues defined therein. Any holder of this document is advised that information contained hereon reflects the Company's findings at the time of its intervention only and within the limits of Client's instructions, if any. The Company's sole responsibility is to its Client and this document does not exonerate parties to a transaction from exercising all their rights and obligations under the transaction documents. This document cannot be reproduced except in full, without prior written approval of the Company. Any unauthorized alteration, forgery or falsification of the content or appearance of this document is unlawful and offenders may be prosecuted to the fullest extent of the law.

Figure 9-54: Band edge emission at antenna terminals –HSDPA IV Channel Lowest

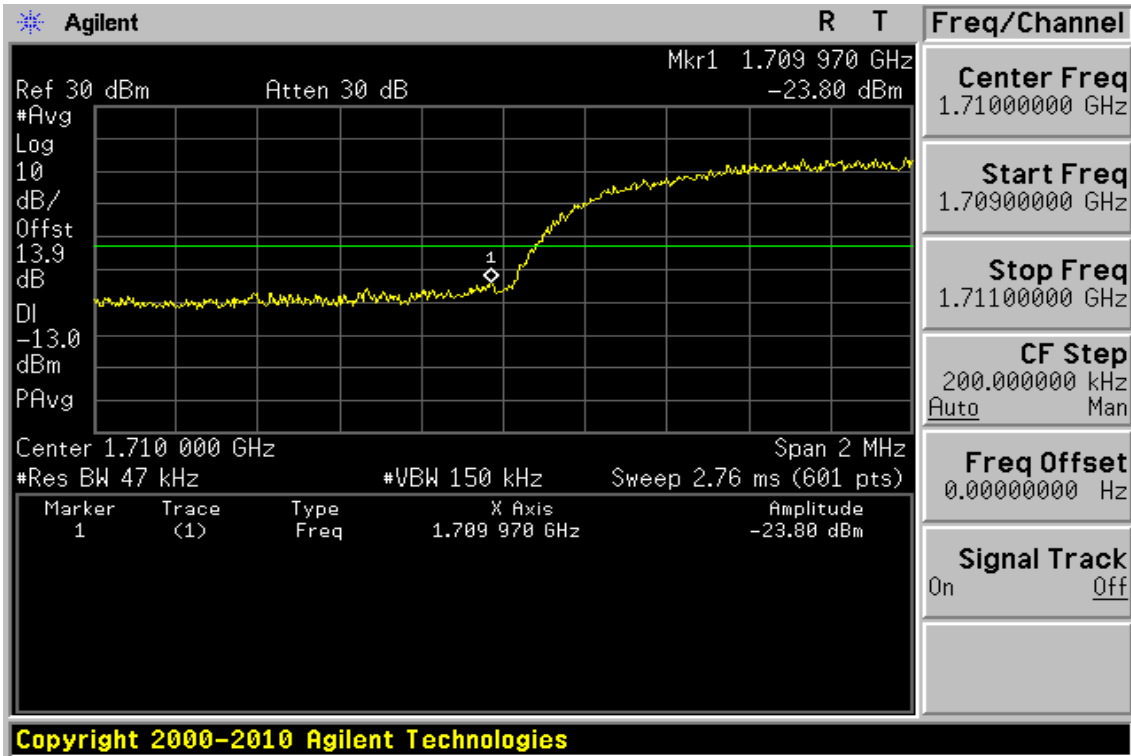
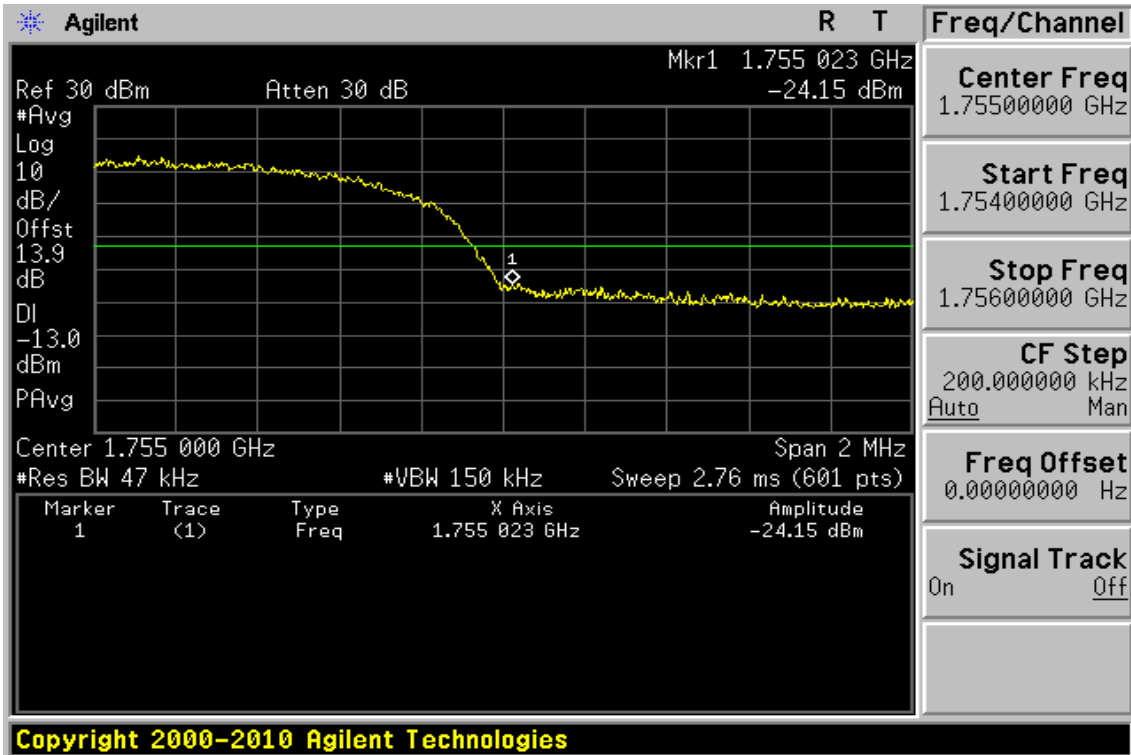

Figure 9-55: Band edge emission at antenna terminals –HSDPA IV Channel Highest



Unless otherwise stated the results shown in this test report refer only to the sample(s) tested and such sample(s) are retained for 90 days only.

除非另有說明，此報告結果僅對測試之樣品負責，同時此樣品僅保留90天。本報告未經本公司書面許可，不可部份複製。

This document is issued by the Company subject to its General Conditions of Service printed overleaf, available on request or accessible at www.sgs.com/terms_and_conditions.htm and, for electronic format documents, subject to Terms and Conditions for Electronic Documents at www.sgs.com/terms_e-document.htm. Attention is drawn to the limitation of liability, indemnification and jurisdiction issues defined therein. Any holder of this document is advised that information contained hereon reflects the Company's findings at the time of its intervention only and within the limits of Client's instructions, if any. The Company's sole responsibility is to its Client and this document does not exonerate parties to a transaction from exercising all their rights and obligations under the transaction documents. This document cannot be reproduced except in full, without prior written approval of the Company. Any unauthorized alteration, forgery or falsification of the content or appearance of this document is unlawful and offenders may be prosecuted to the fullest extent of the law.

Band edge emission at antenna terminals –HSDPA IV Low & High

Test Mode HSDPA IV Engineer :Nick

| Freq. MHz | Reading dBm | Limit dBm | Safe Margin dB |
|--------------|----------------|--------------|----------------------|
| 1709.970 | -23.80 | -13.00 | 10.80 |
| 1755.023 | -24.15 | -13.00 | 11.15 |

Unless otherwise stated the results shown in this test report refer only to the sample(s) tested and such sample(s) are retained for 90 days only.

除非另有說明，此報告結果僅對測試之樣品負責，同時此樣品僅保留90天。本報告未經本公司書面許可，不可部份複製。

This document is issued by the Company subject to its General Conditions of Service printed overleaf, available on request or accessible at www.sgs.com/terms_and_conditions.htm and, for electronic format documents, subject to Terms and Conditions for Electronic Documents at www.sgs.com/terms_e-document.htm. Attention is drawn to the limitation of liability, indemnification and jurisdiction issues defined therein. Any holder of this document is advised that information contained hereon reflects the Company's findings at the time of its intervention only and within the limits of Client's instructions, if any. The Company's sole responsibility is to its Client and this document does not exonerate parties to a transaction from exercising all their rights and obligations under the transaction documents. This document cannot be reproduced except in full, without prior written approval of the Company. Any unauthorized alteration, forgery or falsification of the content or appearance of this document is unlawful and offenders may be prosecuted to the fullest extent of the law.

Figure 9-56: Out of Band emission at antenna terminals – HSDPA V Channel Lowest

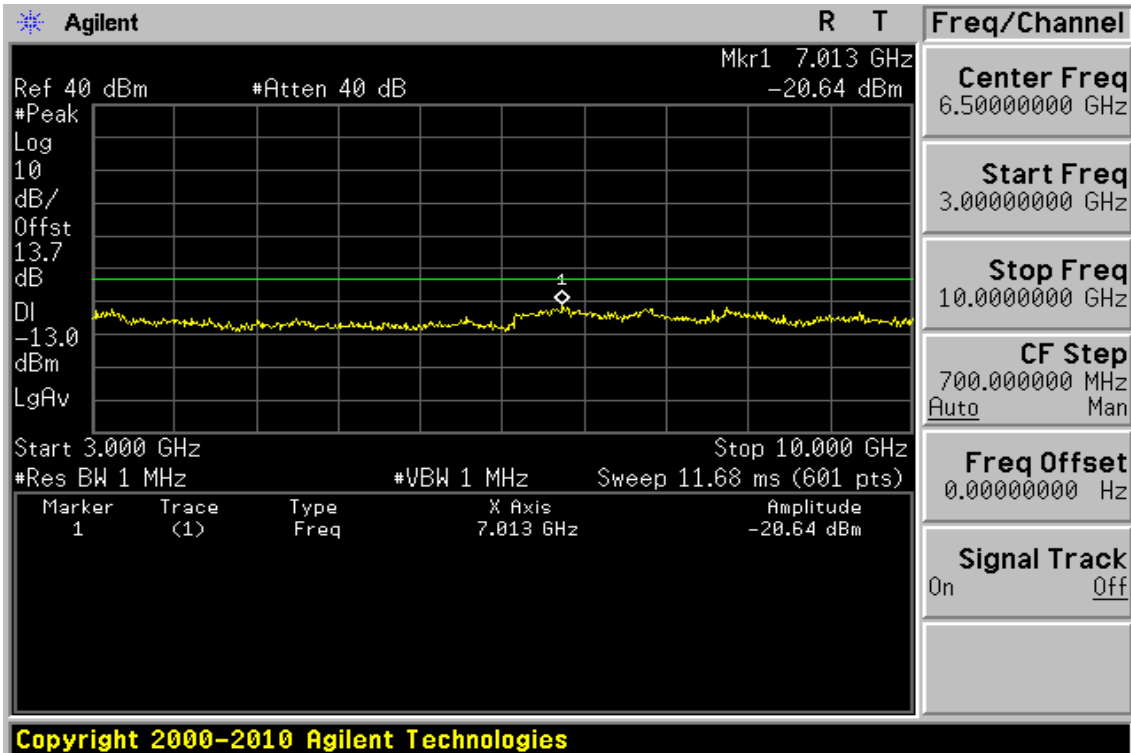
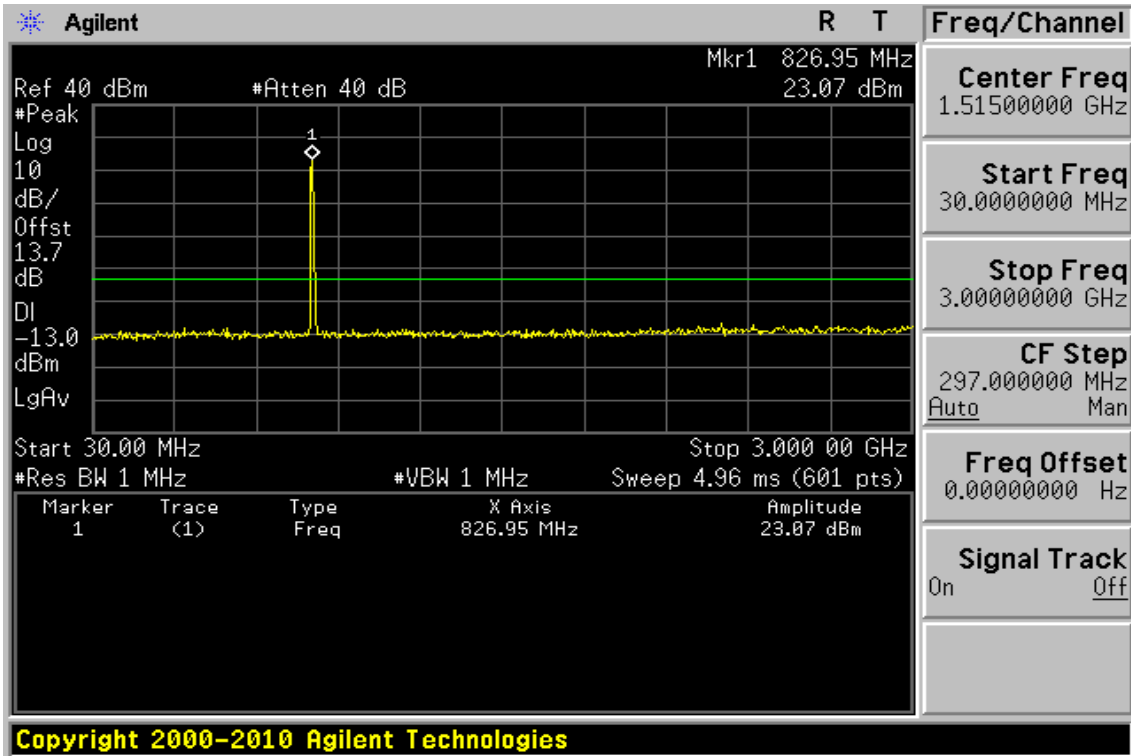

Unless otherwise stated the results shown in this test report refer only to the sample(s) tested and such sample(s) are retained for 90 days only.

除非另有說明，此報告結果僅對測試之樣品負責，同時此樣品僅保留90天。本報告未經本公司書面許可，不可部份複製。

This document is issued by the Company subject to its General Conditions of Service printed overleaf, available on request or accessible at www.sgs.com/terms_and_conditions.htm and, for electronic format documents, subject to Terms and Conditions for Electronic Documents at www.sgs.com/terms_e-document.htm. Attention is drawn to the limitation of liability, indemnification and jurisdiction issues defined therein. Any holder of this document is advised that information contained hereon reflects the Company's findings at the time of its intervention only and within the limits of Client's instructions, if any. The Company's sole responsibility is to its Client and this document does not exonerate parties to a transaction from exercising all their rights and obligations under the transaction documents. This document cannot be reproduced except in full, without prior written approval of the Company. Any unauthorized alteration, forgery or falsification of the content or appearance of this document is unlawful and offenders may be prosecuted to the fullest extent of the law.

Figure 9-57: Out of Band emission at antenna terminals – HSDPA V Channel Mid

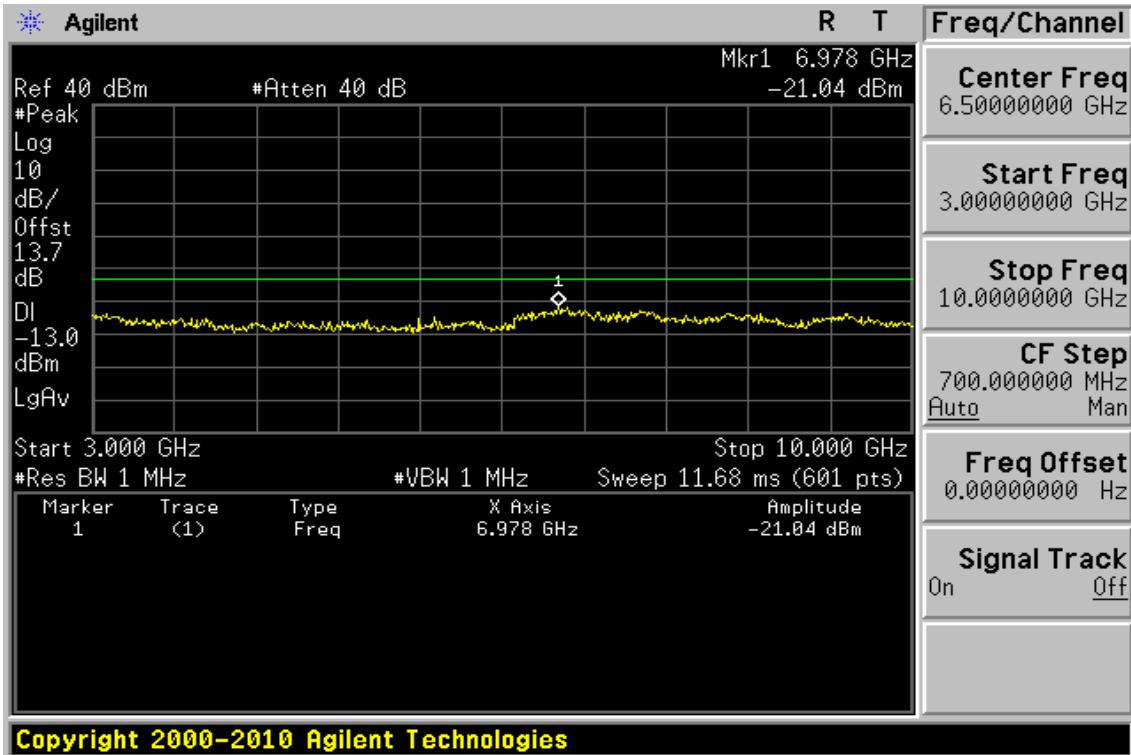
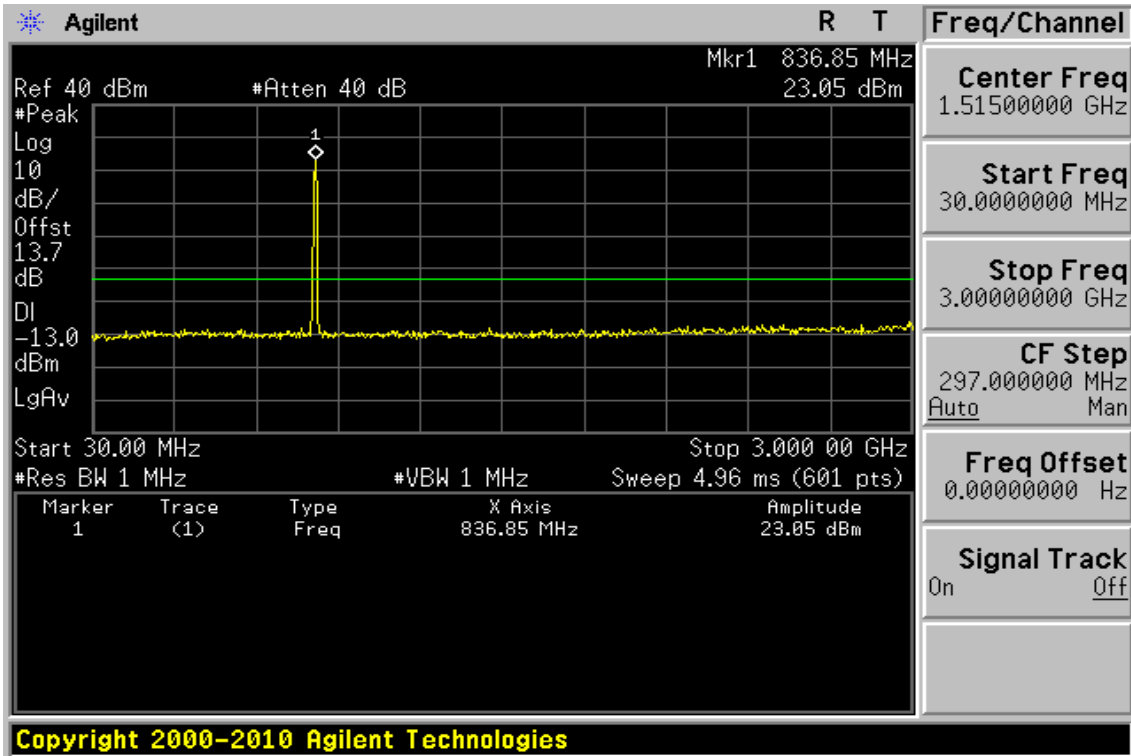

Unless otherwise stated the results shown in this test report refer only to the sample(s) tested and such sample(s) are retained for 90 days only.

除非另有說明，此報告結果僅對測試之樣品負責，同時此樣品僅保留90天。本報告未經本公司書面許可，不可部份複製。

This document is issued by the Company subject to its General Conditions of Service printed overleaf, available on request or accessible at www.sgs.com/terms_and_conditions.htm and, for electronic format documents, subject to Terms and Conditions for Electronic Documents at www.sgs.com/terms_e-document.htm. Attention is drawn to the limitation of liability, indemnification and jurisdiction issues defined therein. Any holder of this document is advised that information contained hereon reflects the Company's findings at the time of its intervention only and within the limits of Client's instructions, if any. The Company's sole responsibility is to its Client and this document does not exonerate parties to a transaction from exercising all their rights and obligations under the transaction documents. This document cannot be reproduced except in full, without prior written approval of the Company. Any unauthorized alteration, forgery or falsification of the content or appearance of this document is unlawful and offenders may be prosecuted to the fullest extent of the law.

Figure 9-58: Out of Band emission at antenna terminals – HSDPA V Channel Highest

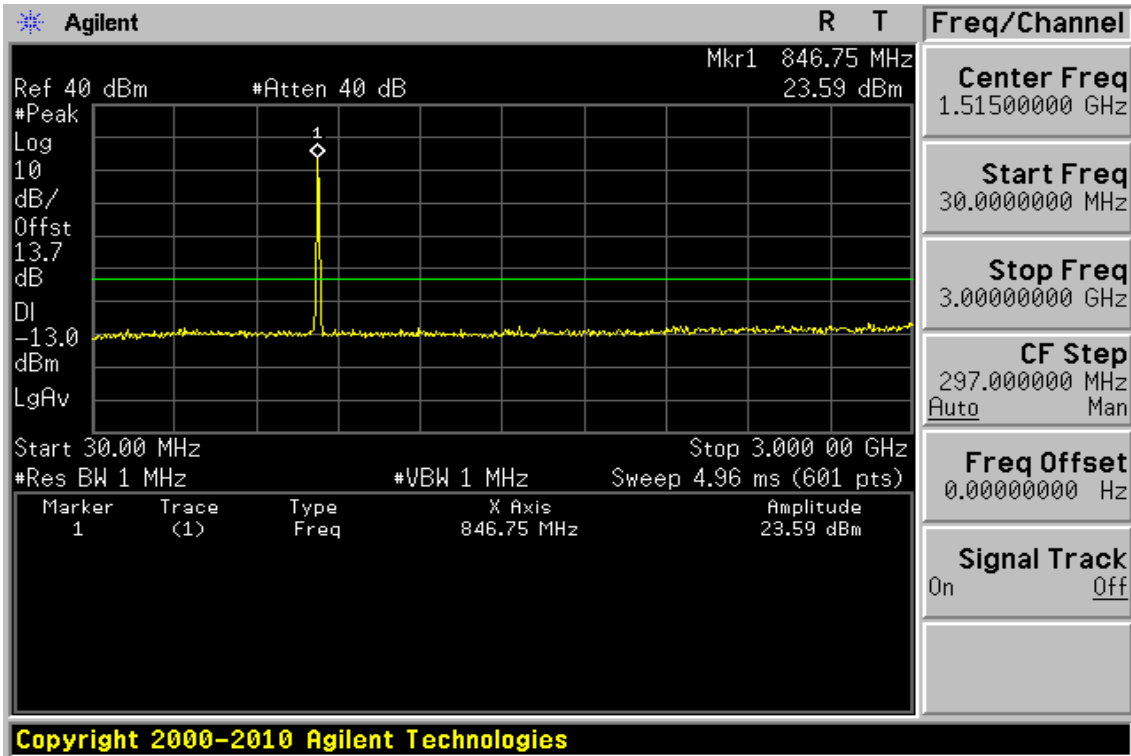

Unless otherwise stated the results shown in this test report refer only to the sample(s) tested and such sample(s) are retained for 90 days only.

除非另有說明，此報告結果僅對測試之樣品負責，同時此樣品僅保留90天。本報告未經本公司書面許可，不可部份複製。

This document is issued by the Company subject to its General Conditions of Service printed overleaf, available on request or accessible at www.sgs.com/terms_and_conditions.htm and, for electronic format documents, subject to Terms and Conditions for Electronic Documents at www.sgs.com/terms_e-document.htm. Attention is drawn to the limitation of liability, indemnification and jurisdiction issues defined therein. Any holder of this document is advised that information contained hereon reflects the Company's findings at the time of its intervention only and within the limits of Client's instructions, if any. The Company's sole responsibility is to its Client and this document does not exonerate parties to a transaction from exercising all their rights and obligations under the transaction documents. This document cannot be reproduced except in full, without prior written approval of the Company. Any unauthorized alteration, forgery or falsification of the content or appearance of this document is unlawful and offenders may be prosecuted to the fullest extent of the law.

Out of Band emission at antenna terminals – HSDPA V

Fundamental Frequency :826.4 MHz Engineer :Nick
Operation Mode :TX Low

| Freq. (MHz) | Note F/H/E/S | Reading dBm | Limit dBm | Safe Margin dB |
|----------------|-----------------|----------------|--------------|----------------------|
| <30 | S | --- | -13.00 | --- |
| 30-1000 | S | --- | -13.00 | --- |
| 1652.80 | H | --- | -13.00 | --- |
| 2479.20 | H | --- | -13.00 | --- |
| 3305.60 | H | --- | -13.00 | --- |
| 4132.00 | H | --- | -13.00 | --- |
| 4958.40 | H | --- | -13.00 | --- |
| 5784.80 | H | --- | -13.00 | --- |
| 6611.20 | H | --- | -13.00 | --- |
| 7013.00 | S | -20.64 | -13.00 | 7.64 |
| 7437.60 | H | --- | -13.00 | --- |
| 8264.00 | H | --- | -13.00 | --- |

Note : “H” : denotes Harmonic Frequency. “S” : denotes Spurious Frequency.
“---“ : denotes Noise Floor.

Unless otherwise stated the results shown in this test report refer only to the sample(s) tested and such sample(s) are retained for 90 days only.

除非另有說明，此報告結果僅對測試之樣品負責，同時此樣品僅保留90天。本報告未經本公司書面許可，不可部份複製。

This document is issued by the Company subject to its General Conditions of Service printed overleaf, available on request or accessible at www.sgs.com/terms_and_conditions.htm and, for electronic format documents, subject to Terms and Conditions for Electronic Documents at www.sgs.com/terms_e-document.htm. Attention is drawn to the limitation of liability, indemnification and jurisdiction issues defined therein. Any holder of this document is advised that information contained hereon reflects the Company's findings at the time of its intervention only and within the limits of Client's instructions, if any. The Company's sole responsibility is to its Client and this document does not exonerate parties to a transaction from exercising all their rights and obligations under the transaction documents. This document cannot be reproduced except in full, without prior written approval of the Company. Any unauthorized alteration, forgery or falsification of the content or appearance of this document is unlawful and offenders may be prosecuted to the fullest extent of the law.

Fundamental Frequency :836.6 MHz Engineer :Nick
Operation Mode :TX Mid

| Freq. (MHz) | Note F/H/E/S | Reading dBm | Limit dBm | Safe Margin dB |
|----------------|-----------------|----------------|--------------|----------------------|
| <30 | S | --- | -13.00 | --- |
| 30-1000 | S | --- | -13.00 | --- |
| 1673.20 | H | --- | -13.00 | --- |
| 2509.80 | H | --- | -13.00 | --- |
| 3346.40 | H | --- | -13.00 | --- |
| 4183.00 | H | --- | -13.00 | --- |
| 5019.60 | H | --- | -13.00 | --- |
| 5856.20 | H | --- | -13.00 | --- |
| 6692.80 | H | --- | -13.00 | --- |
| 6978.00 | S | -21.04 | -13.00 | 8.04 |
| 7529.40 | H | --- | -13.00 | --- |
| 8366.00 | H | --- | -13.00 | --- |

Note : "H" : denotes Harmonic Frequency. "S" : denotes Spurious Frequency.
"---" : denotes Noise Floor.

Unless otherwise stated the results shown in this test report refer only to the sample(s) tested and such sample(s) are retained for 90 days only.

除非另有說明，此報告結果僅對測試之樣品負責，同時此樣品僅保留90天。本報告未經本公司書面許可，不可部份複製。

This document is issued by the Company subject to its General Conditions of Service printed overleaf, available on request or accessible at www.sgs.com/terms_and_conditions.htm and, for electronic format documents, subject to Terms and Conditions for Electronic Documents at www.sgs.com/terms_e-document.htm. Attention is drawn to the limitation of liability, indemnification and jurisdiction issues defined therein. Any holder of this document is advised that information contained hereon reflects the Company's findings at the time of its intervention only and within the limits of Client's instructions, if any. The Company's sole responsibility is to its Client and this document does not exonerate parties to a transaction from exercising all their rights and obligations under the transaction documents. This document cannot be reproduced except in full, without prior written approval of the Company. Any unauthorized alteration, forgery or falsification of the content or appearance of this document is unlawful and offenders may be prosecuted to the fullest extent of the law.

Fundamental Frequency :846.6MHz Engineer :Nick
Operation Mode :TX High

| Freq. (MHz) | Note F/H/E/S | Reading dBm | Limit dBm | Safe Margin dB |
|----------------|-----------------|----------------|--------------|----------------------|
| <30 | S | --- | -13.00 | --- |
| 30-1000 | S | --- | -13.00 | --- |
| 1693.20 | H | --- | -13.00 | --- |
| 2539.80 | H | --- | -13.00 | --- |
| 3386.40 | H | --- | -13.00 | --- |
| 4233.00 | H | --- | -13.00 | --- |
| 5079.60 | H | --- | -13.00 | --- |
| 5926.20 | H | --- | -13.00 | --- |
| 6772.80 | H | --- | -13.00 | --- |
| 7619.40 | H | --- | -13.00 | --- |
| 8402.00 | S | -21.78 | -13.00 | 8.78 |
| 8466.00 | H | --- | -13.00 | --- |

Note : "H" : denotes Harmonic Frequency. "S" : denotes Spurious Frequency.
"---" : denotes Noise Floor.

Unless otherwise stated the results shown in this test report refer only to the sample(s) tested and such sample(s) are retained for 90 days only.

除非另有說明，此報告結果僅對測試之樣品負責，同時此樣品僅保留90天。本報告未經本公司書面許可，不可部份複製。

This document is issued by the Company subject to its General Conditions of Service printed overleaf, available on request or accessible at www.sgs.com/terms_and_conditions.htm and, for electronic format documents, subject to Terms and Conditions for Electronic Documents at www.sgs.com/terms_e-document.htm. Attention is drawn to the limitation of liability, indemnification and jurisdiction issues defined therein. Any holder of this document is advised that information contained hereon reflects the Company's findings at the time of its intervention only and within the limits of Client's instructions, if any. The Company's sole responsibility is to its Client and this document does not exonerate parties to a transaction from exercising all their rights and obligations under the transaction documents. This document cannot be reproduced except in full, without prior written approval of the Company. Any unauthorized alteration, forgery or falsification of the content or appearance of this document is unlawful and offenders may be prosecuted to the fullest extent of the law.

Figure 9-59: Band edge emission at antenna terminals – HSDPA V Channel Lowest

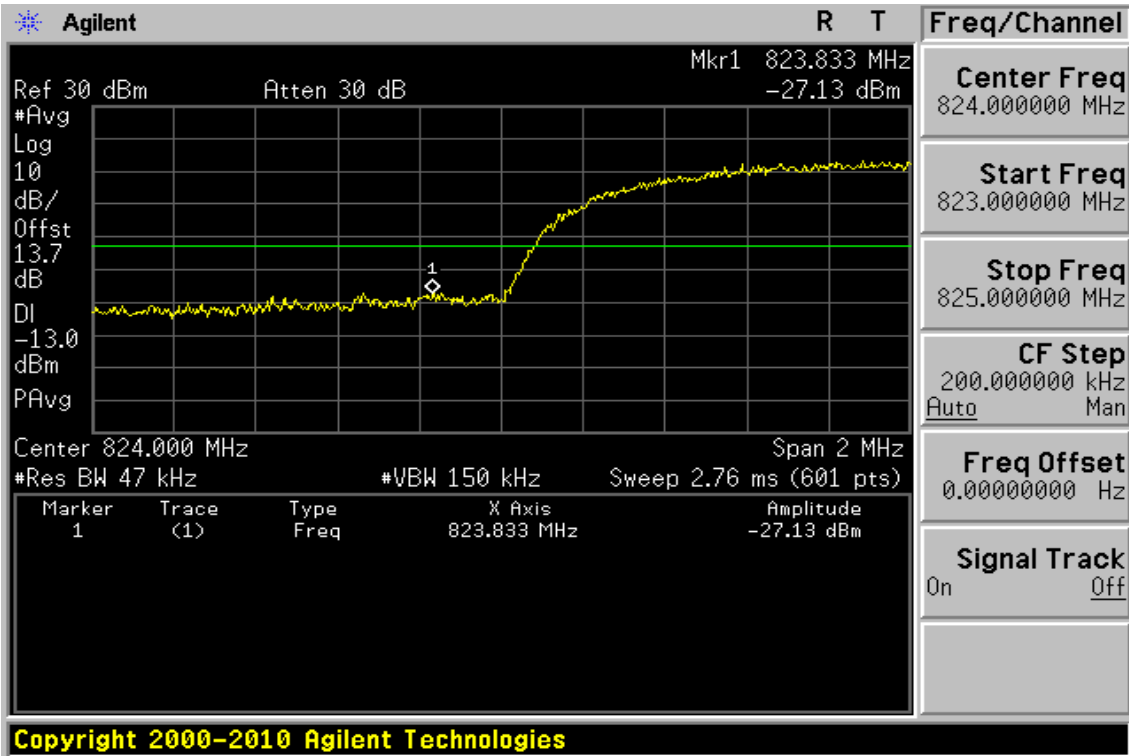
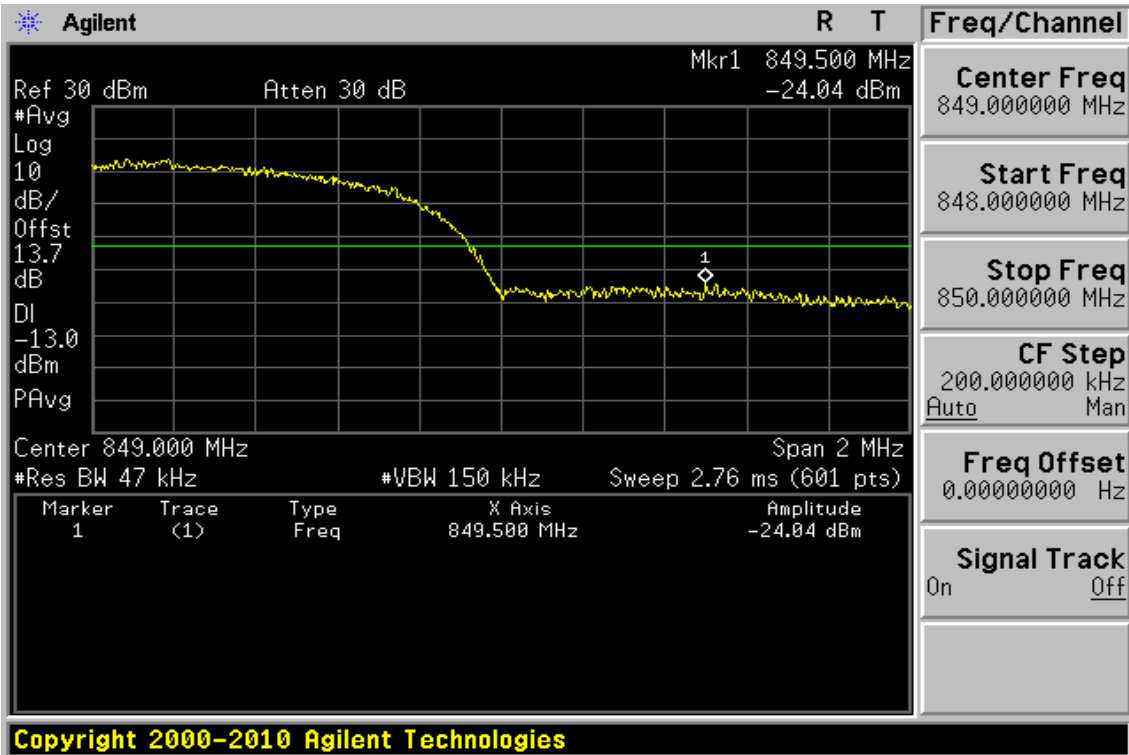

Figure 9-60: Band edge emission at antenna terminals – HSDPA V Channel Highest



Unless otherwise stated the results shown in this test report refer only to the sample(s) tested and such sample(s) are retained for 90 days only.

除非另有說明，此報告結果僅對測試之樣品負責，同時此樣品僅保留90天。本報告未經本公司書面許可，不可部份複製。

This document is issued by the Company subject to its General Conditions of Service printed overleaf, available on request or accessible at www.sgs.com/terms_and_conditions.htm and, for electronic format documents, subject to Terms and Conditions for Electronic Documents at www.sgs.com/terms_e-document.htm. Attention is drawn to the limitation of liability, indemnification and jurisdiction issues defined therein. Any holder of this document is advised that information contained hereon reflects the Company's findings at the time of its intervention only and within the limits of Client's instructions, if any. The Company's sole responsibility is to its Client and this document does not exonerate parties to a transaction from exercising all their rights and obligations under the transaction documents. This document cannot be reproduced except in full, without prior written approval of the Company. Any unauthorized alteration, forgery or falsification of the content or appearance of this document is unlawful and offenders may be prosecuted to the fullest extent of the law.

Band edge emission at antenna terminals – HSDPA V Low & High

Test Mode HSDPA V Engineer :Nick

| Freq. MHz | Reading dBm | Limit dBm | Safe Margin dB |
|--------------|----------------|--------------|----------------------|
| 823.833 | -27.13 | -13.00 | 14.13 |
| 849.500 | -24.04 | -13.00 | 11.04 |

Unless otherwise stated the results shown in this test report refer only to the sample(s) tested and such sample(s) are retained for 90 days only.

除非另有說明，此報告結果僅對測試之樣品負責，同時此樣品僅保留90天。本報告未經本公司書面許可，不可部份複製。

This document is issued by the Company subject to its General Conditions of Service printed overleaf, available on request or accessible at www.sgs.com/terms_and_conditions.htm and, for electronic format documents, subject to Terms and Conditions for Electronic Documents at www.sgs.com/terms_e-document.htm. Attention is drawn to the limitation of liability, indemnification and jurisdiction issues defined therein. Any holder of this document is advised that information contained hereon reflects the Company's findings at the time of its intervention only and within the limits of Client's instructions, if any. The Company's sole responsibility is to its Client and this document does not exonerate parties to a transaction from exercising all their rights and obligations under the transaction documents. This document cannot be reproduced except in full, without prior written approval of the Company. Any unauthorized alteration, forgery or falsification of the content or appearance of this document is unlawful and offenders may be prosecuted to the fullest extent of the law.

Figure 9-61: Out of Band emission at antenna terminals – HSUPA II Channel Lowest

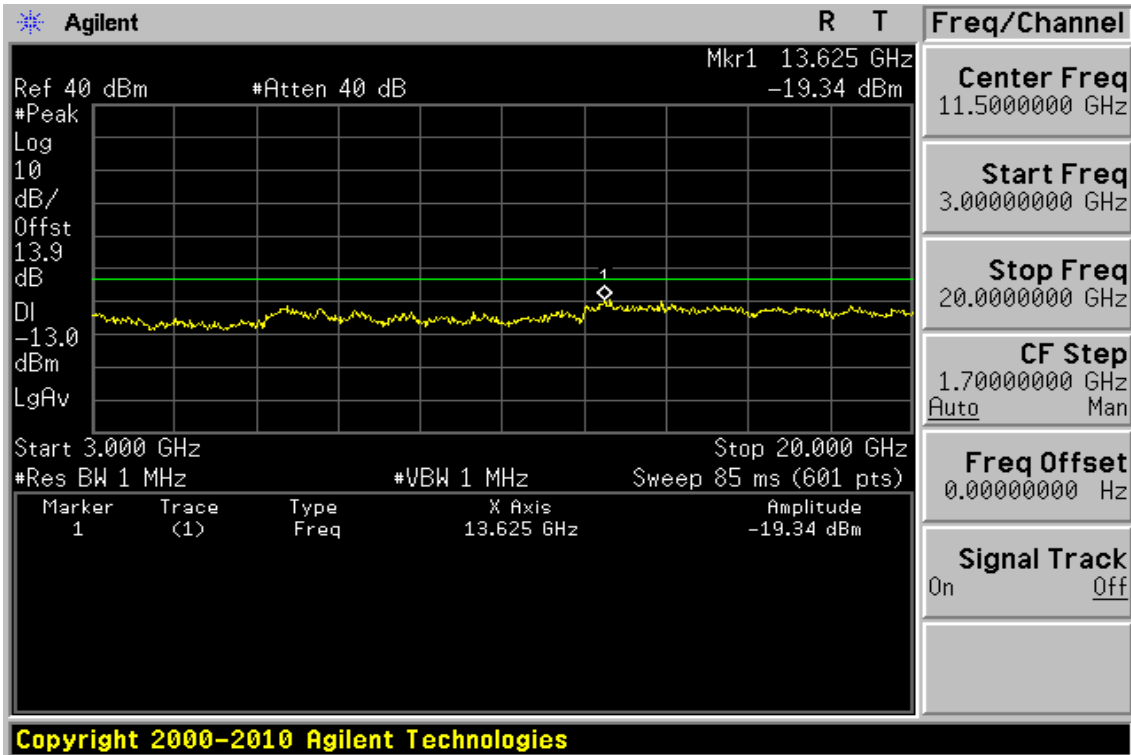
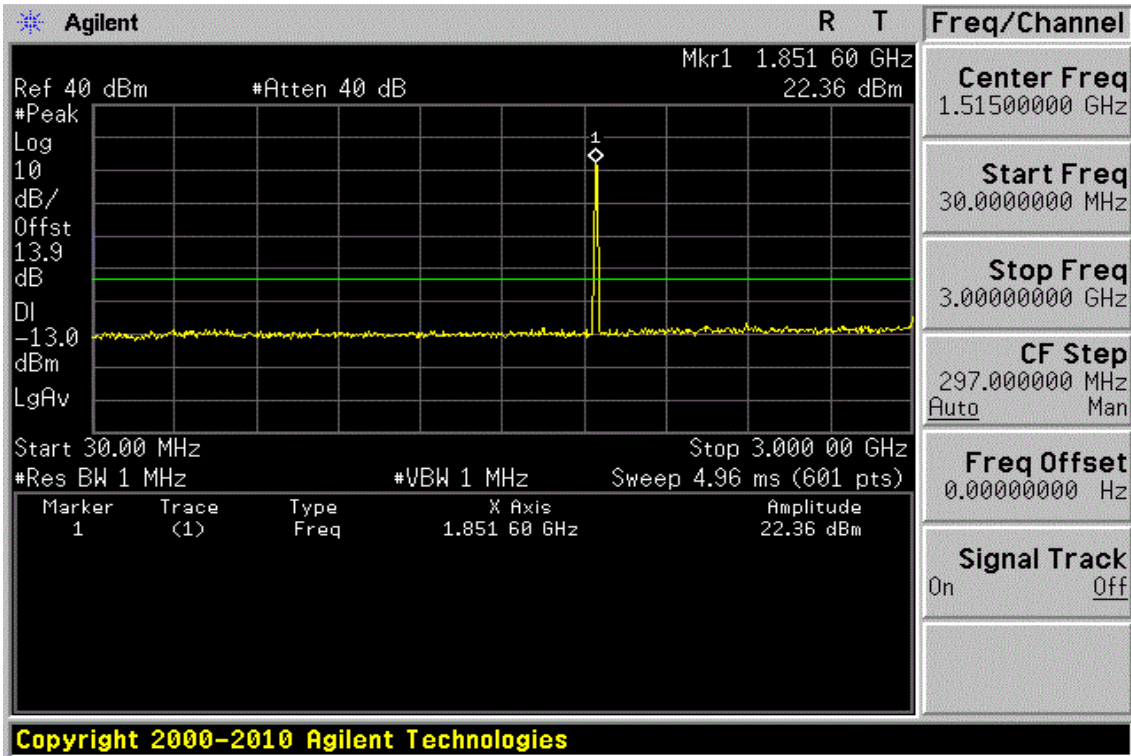

Unless otherwise stated the results shown in this test report refer only to the sample(s) tested and such sample(s) are retained for 90 days only.

除非另有說明，此報告結果僅對測試之樣品負責，同時此樣品僅保留90天。本報告未經本公司書面許可，不可部份複製。

This document is issued by the Company subject to its General Conditions of Service printed overleaf, available on request or accessible at www.sgs.com/terms_and_conditions.htm and, for electronic format documents, subject to Terms and Conditions for Electronic Documents at www.sgs.com/terms_e-document.htm. Attention is drawn to the limitation of liability, indemnification and jurisdiction issues defined therein. Any holder of this document is advised that information contained hereon reflects the Company's findings at the time of its intervention only and within the limits of Client's instructions, if any. The Company's sole responsibility is to its Client and this document does not exonerate parties to a transaction from exercising all their rights and obligations under the transaction documents. This document cannot be reproduced except in full, without prior written approval of the Company. Any unauthorized alteration, forgery or falsification of the content or appearance of this document is unlawful and offenders may be prosecuted to the fullest extent of the law.

Figure 9-62: Out of Band emission at antenna terminals – HSUPA II Channel Mid

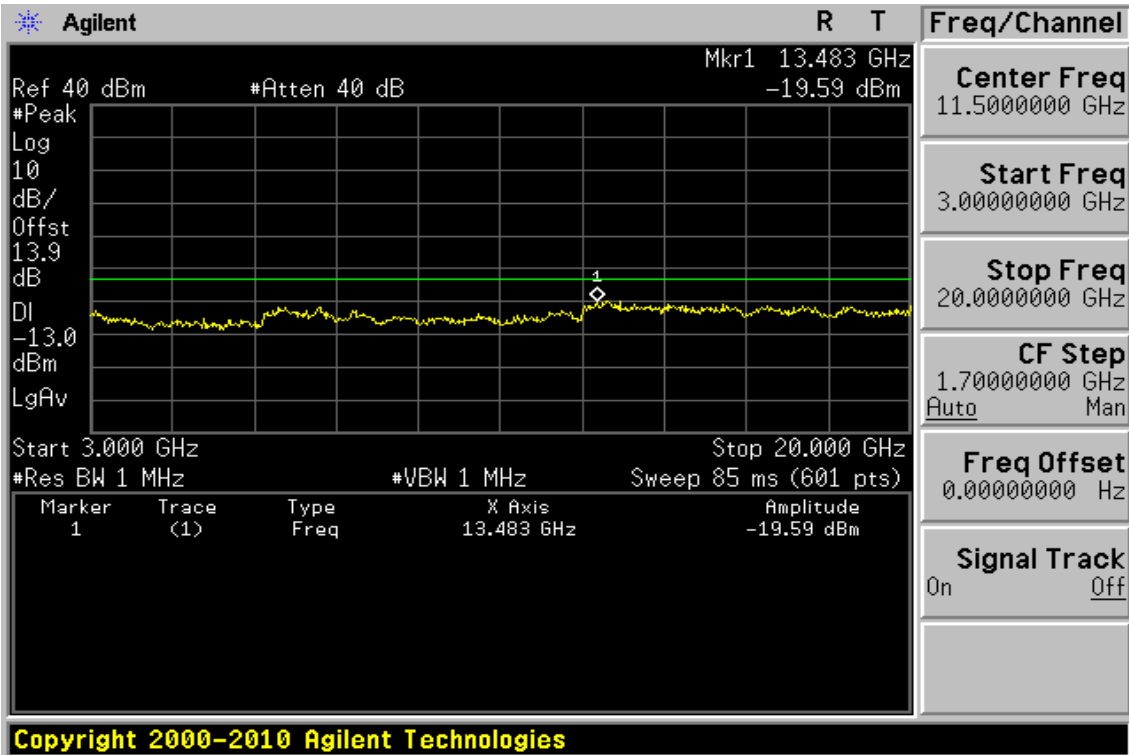
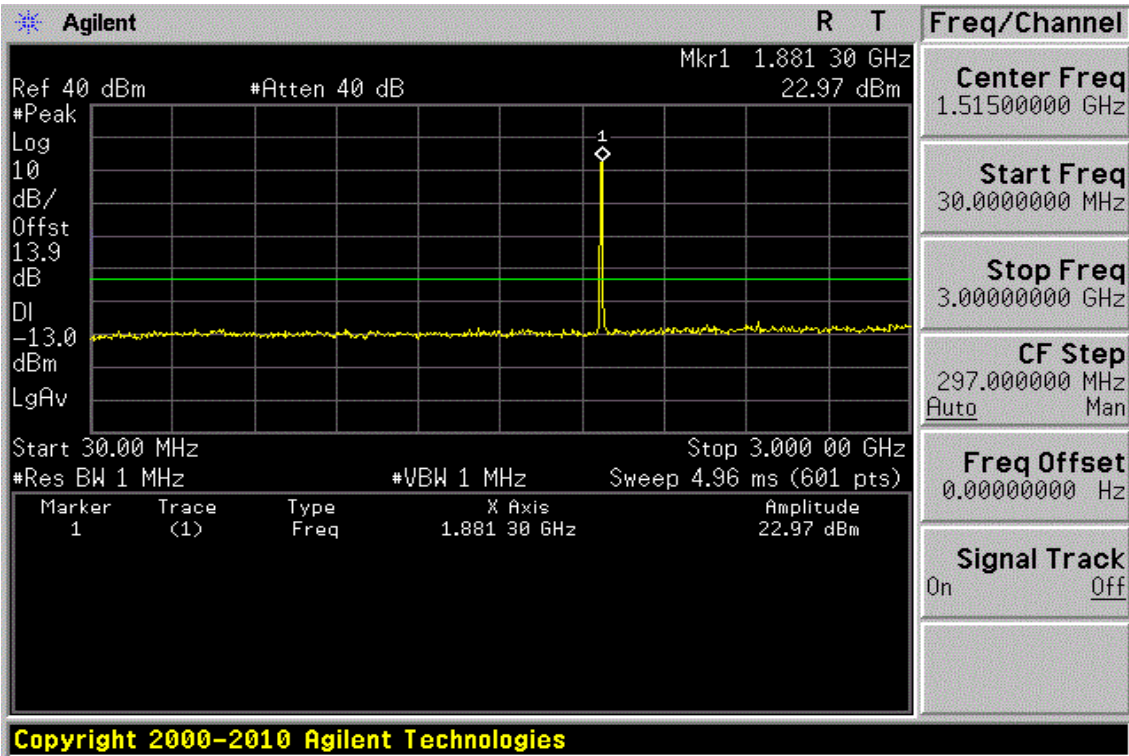

Unless otherwise stated the results shown in this test report refer only to the sample(s) tested and such sample(s) are retained for 90 days only.

除非另有說明，此報告結果僅對測試之樣品負責，同時此樣品僅保留90天。本報告未經本公司書面許可，不可部份複製。

This document is issued by the Company subject to its General Conditions of Service printed overleaf, available on request or accessible at www.sgs.com/terms_and_conditions.htm and, for electronic format documents, subject to Terms and Conditions for Electronic Documents at www.sgs.com/terms_e-document.htm. Attention is drawn to the limitation of liability, indemnification and jurisdiction issues defined therein. Any holder of this document is advised that information contained hereon reflects the Company's findings at the time of its intervention only and within the limits of Client's instructions, if any. The Company's sole responsibility is to its Client and this document does not exonerate parties to a transaction from exercising all their rights and obligations under the transaction documents. This document cannot be reproduced except in full, without prior written approval of the Company. Any unauthorized alteration, forgery or falsification of the content or appearance of this document is unlawful and offenders may be prosecuted to the fullest extent of the law.

Figure 9-63: Out of Band emission at antenna terminals – HSUPA II Channel Highest

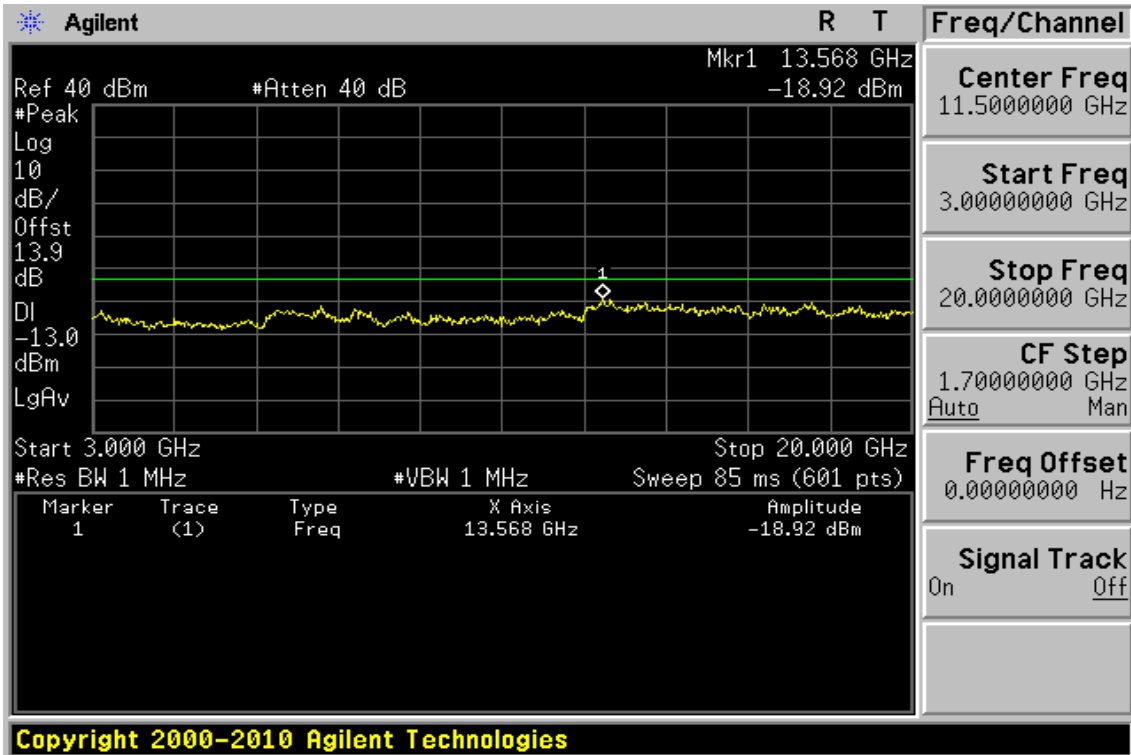
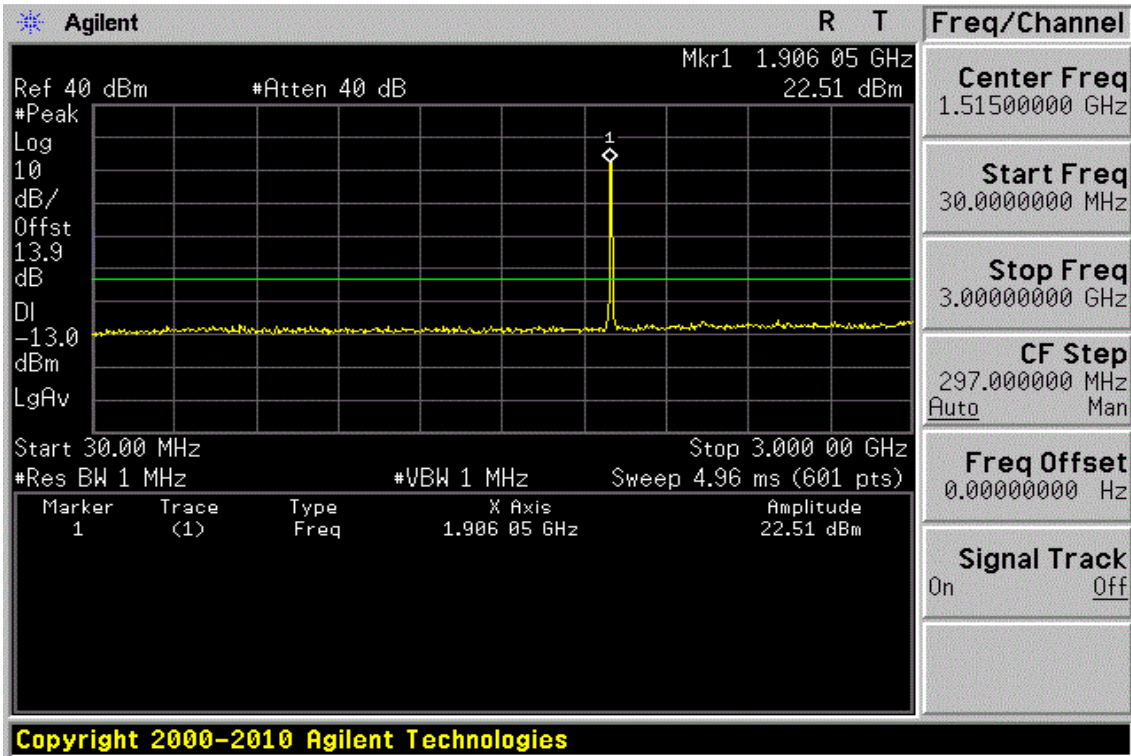

Unless otherwise stated the results shown in this test report refer only to the sample(s) tested and such sample(s) are retained for 90 days only.

除非另有說明，此報告結果僅對測試之樣品負責，同時此樣品僅保留90天。本報告未經本公司書面許可，不可部份複製。

This document is issued by the Company subject to its General Conditions of Service printed overleaf, available on request or accessible at www.sgs.com/terms_and_conditions.htm and, for electronic format documents, subject to Terms and Conditions for Electronic Documents at www.sgs.com/terms_e-document.htm. Attention is drawn to the limitation of liability, indemnification and jurisdiction issues defined therein. Any holder of this document is advised that information contained hereon reflects the Company's findings at the time of its intervention only and within the limits of Client's instructions, if any. The Company's sole responsibility is to its Client and this document does not exonerate parties to a transaction from exercising all their rights and obligations under the transaction documents. This document cannot be reproduced except in full, without prior written approval of the Company. Any unauthorized alteration, forgery or falsification of the content or appearance of this document is unlawful and offenders may be prosecuted to the fullest extent of the law.

Out of Band emission at antenna terminals – HSUPA II

Fundamental Frequency :1852.4 MHz Engineer :Nick
Operation Mode :TX Low

| Freq. (MHz) | Note F/H/E/S | Reading dBm | Limit dBm | Safe Margin dB |
|----------------|-----------------|----------------|--------------|----------------------|
| <30 | S | --- | -13.00 | --- |
| 30-1000 | S | --- | -13.00 | --- |
| 3704.80 | H | --- | -13.00 | --- |
| 5557.20 | H | --- | -13.00 | --- |
| 7409.60 | H | --- | -13.00 | --- |
| 9262.00 | H | --- | -13.00 | --- |
| 11114.40 | H | --- | -13.00 | --- |
| 12966.80 | H | --- | -13.00 | --- |
| 13625.00 | S | -19.34 | -13.00 | 6.34 |
| 14819.20 | H | --- | -13.00 | --- |
| 16671.60 | H | --- | -13.00 | --- |
| 18524.00 | H | --- | -13.00 | --- |

Note : “H” : denotes Harmonic Frequency. “S” : denotes Spurious Frequency.
“---” : denotes Noise Floor.

Unless otherwise stated the results shown in this test report refer only to the sample(s) tested and such sample(s) are retained for 90 days only.

除非另有說明，此報告結果僅對測試之樣品負責，同時此樣品僅保留90天。本報告未經本公司書面許可，不可部份複製。

This document is issued by the Company subject to its General Conditions of Service printed overleaf, available on request or accessible at www.sgs.com/terms_and_conditions.htm and, for electronic format documents, subject to Terms and Conditions for Electronic Documents at www.sgs.com/terms_e-document.htm. Attention is drawn to the limitation of liability, indemnification and jurisdiction issues defined therein. Any holder of this document is advised that information contained hereon reflects the Company's findings at the time of its intervention only and within the limits of Client's instructions, if any. The Company's sole responsibility is to its Client and this document does not exonerate parties to a transaction from exercising all their rights and obligations under the transaction documents. This document cannot be reproduced except in full, without prior written approval of the Company. Any unauthorized alteration, forgery or falsification of the content or appearance of this document is unlawful and offenders may be prosecuted to the fullest extent of the law.

Fundamental Frequency :1880.0 MHz Engineer :Nick
Operation Mode :TX Mid

| Freq. (MHz) | Note F/H/E/S | Reading dBm | Limit dBm | Safe Margin dB |
|----------------|-----------------|----------------|--------------|----------------------|
| <30 | S | --- | -13.00 | --- |
| 30-1000 | S | --- | -13.00 | --- |
| 3760.00 | H | --- | -13.00 | --- |
| 5640.00 | H | --- | -13.00 | --- |
| 7520.00 | H | --- | -13.00 | --- |
| 9400.00 | H | --- | -13.00 | --- |
| 11280.00 | H | --- | -13.00 | --- |
| 13160.00 | H | --- | -13.00 | --- |
| 13483.00 | S | -19.59 | -13.00 | 6.59 |
| 15040.00 | H | --- | -13.00 | --- |
| 16920.00 | H | --- | -13.00 | --- |
| 18800.00 | H | --- | -13.00 | --- |

Note : "H" : denotes Harmonic Frequency. "S" : denotes Spurious Frequency.
"---" : denotes Noise Floor.

Unless otherwise stated the results shown in this test report refer only to the sample(s) tested and such sample(s) are retained for 90 days only.

除非另有說明，此報告結果僅對測試之樣品負責，同時此樣品僅保留90天。本報告未經本公司書面許可，不可部份複製。

This document is issued by the Company subject to its General Conditions of Service printed overleaf, available on request or accessible at www.sgs.com/terms_and_conditions.htm and, for electronic format documents, subject to Terms and Conditions for Electronic Documents at www.sgs.com/terms_e-document.htm. Attention is drawn to the limitation of liability, indemnification and jurisdiction issues defined therein. Any holder of this document is advised that information contained hereon reflects the Company's findings at the time of its intervention only and within the limits of Client's instructions, if any. The Company's sole responsibility is to its Client and this document does not exonerate parties to a transaction from exercising all their rights and obligations under the transaction documents. This document cannot be reproduced except in full, without prior written approval of the Company. Any unauthorized alteration, forgery or falsification of the content or appearance of this document is unlawful and offenders may be prosecuted to the fullest extent of the law.

Fundamental Frequency :1907.6MHz Engineer :Nick
Operation Mode :TX High

| Freq. (MHz) | Note F/H/E/S | Reading dBm | Limit dBm | Safe Margin dB |
|----------------|-----------------|----------------|--------------|----------------------|
| <30 | S | --- | -13.00 | --- |
| 30-1000 | S | --- | -13.00 | --- |
| 3815.20 | H | --- | -13.00 | --- |
| 5722.80 | H | --- | -13.00 | --- |
| 7630.40 | H | --- | -13.00 | --- |
| 9538.00 | H | --- | -13.00 | --- |
| 11445.60 | H | --- | -13.00 | --- |
| 13353.20 | H | --- | -13.00 | --- |
| 13568.00 | S | -18.92 | -13.00 | 5.92 |
| 15260.80 | H | --- | -13.00 | --- |
| 17168.40 | H | --- | -13.00 | --- |
| 19076.00 | H | --- | -13.00 | --- |

Note : "H" : denotes Harmonic Frequency. "S" : denotes Spurious Frequency.
"---" : denotes Noise Floor.

Unless otherwise stated the results shown in this test report refer only to the sample(s) tested and such sample(s) are retained for 90 days only.

除非另有說明，此報告結果僅對測試之樣品負責，同時此樣品僅保留90天。本報告未經本公司書面許可，不可部份複製。

This document is issued by the Company subject to its General Conditions of Service printed overleaf, available on request or accessible at www.sgs.com/terms_and_conditions.htm and, for electronic format documents, subject to Terms and Conditions for Electronic Documents at www.sgs.com/terms_e-document.htm. Attention is drawn to the limitation of liability, indemnification and jurisdiction issues defined therein. Any holder of this document is advised that information contained hereon reflects the Company's findings at the time of its intervention only and within the limits of Client's instructions, if any. The Company's sole responsibility is to its Client and this document does not exonerate parties to a transaction from exercising all their rights and obligations under the transaction documents. This document cannot be reproduced except in full, without prior written approval of the Company. Any unauthorized alteration, forgery or falsification of the content or appearance of this document is unlawful and offenders may be prosecuted to the fullest extent of the law.

Figure 9-64: Band edge emission at antenna terminals – HSUPA II Channel Lowest

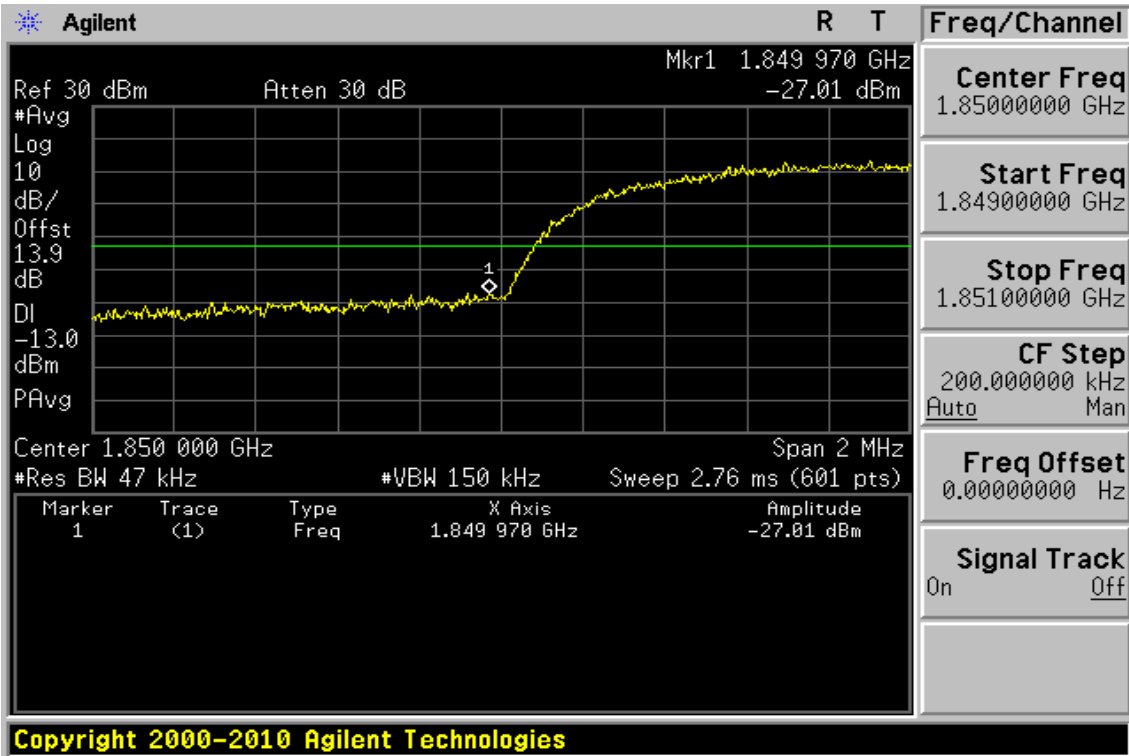
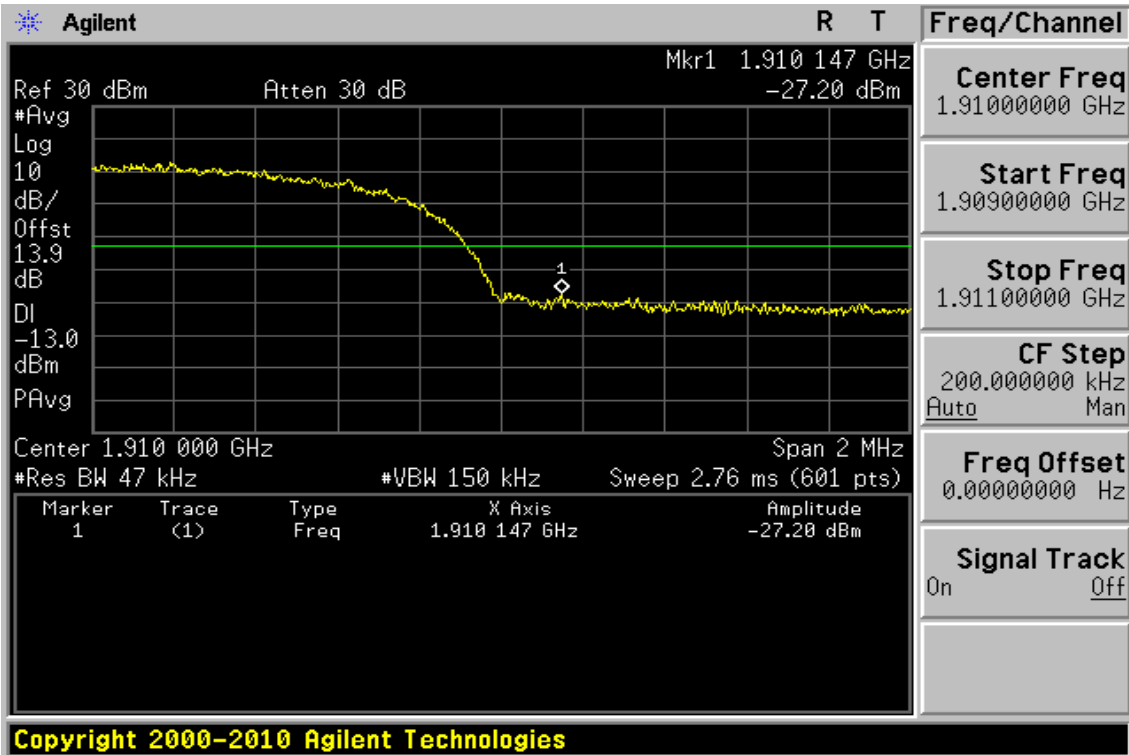

Figure 9-65: Band edge emission at antenna terminals – HSUPA II Channel Highest



Unless otherwise stated the results shown in this test report refer only to the sample(s) tested and such sample(s) are retained for 90 days only.

除非另有說明，此報告結果僅對測試之樣品負責，同時此樣品僅保留90天。本報告未經本公司書面許可，不可部份複製。

This document is issued by the Company subject to its General Conditions of Service printed overleaf, available on request or accessible at www.sgs.com/terms_and_conditions.htm and, for electronic format documents, subject to Terms and Conditions for Electronic Documents at www.sgs.com/terms_e-document.htm. Attention is drawn to the limitation of liability, indemnification and jurisdiction issues defined therein. Any holder of this document is advised that information contained hereon reflects the Company's findings at the time of its intervention only and within the limits of Client's instructions, if any. The Company's sole responsibility is to its Client and this document does not exonerate parties to a transaction from exercising all their rights and obligations under the transaction documents. This document cannot be reproduced except in full, without prior written approval of the Company. Any unauthorized alteration, forgery or falsification of the content or appearance of this document is unlawful and offenders may be prosecuted to the fullest extent of the law.

Band edge emission at antenna terminals – HSUPA II Low & High

Test Mode HSUPA II Engineer :Nick

| Freq. MHz | Reading dBm | Limit dBm | Safe Margin dB |
|--------------|----------------|--------------|----------------------|
| 1849.970 | -27.01 | -13.00 | 14.01 |
| 1910.147 | -27.20 | -13.00 | 14.20 |

Unless otherwise stated the results shown in this test report refer only to the sample(s) tested and such sample(s) are retained for 90 days only.

除非另有說明，此報告結果僅對測試之樣品負責，同時此樣品僅保留90天。本報告未經本公司書面許可，不可部份複製。

This document is issued by the Company subject to its General Conditions of Service printed overleaf, available on request or accessible at www.sgs.com/terms_and_conditions.htm and, for electronic format documents, subject to Terms and Conditions for Electronic Documents at www.sgs.com/terms_e-document.htm. Attention is drawn to the limitation of liability, indemnification and jurisdiction issues defined therein. Any holder of this document is advised that information contained hereon reflects the Company's findings at the time of its intervention only and within the limits of Client's instructions, if any. The Company's sole responsibility is to its Client and this document does not exonerate parties to a transaction from exercising all their rights and obligations under the transaction documents. This document cannot be reproduced except in full, without prior written approval of the Company. Any unauthorized alteration, forgery or falsification of the content or appearance of this document is unlawful and offenders may be prosecuted to the fullest extent of the law.

Figure 9-66: Out of Band emission at antenna terminals –HSUPA IV Channel Lowest

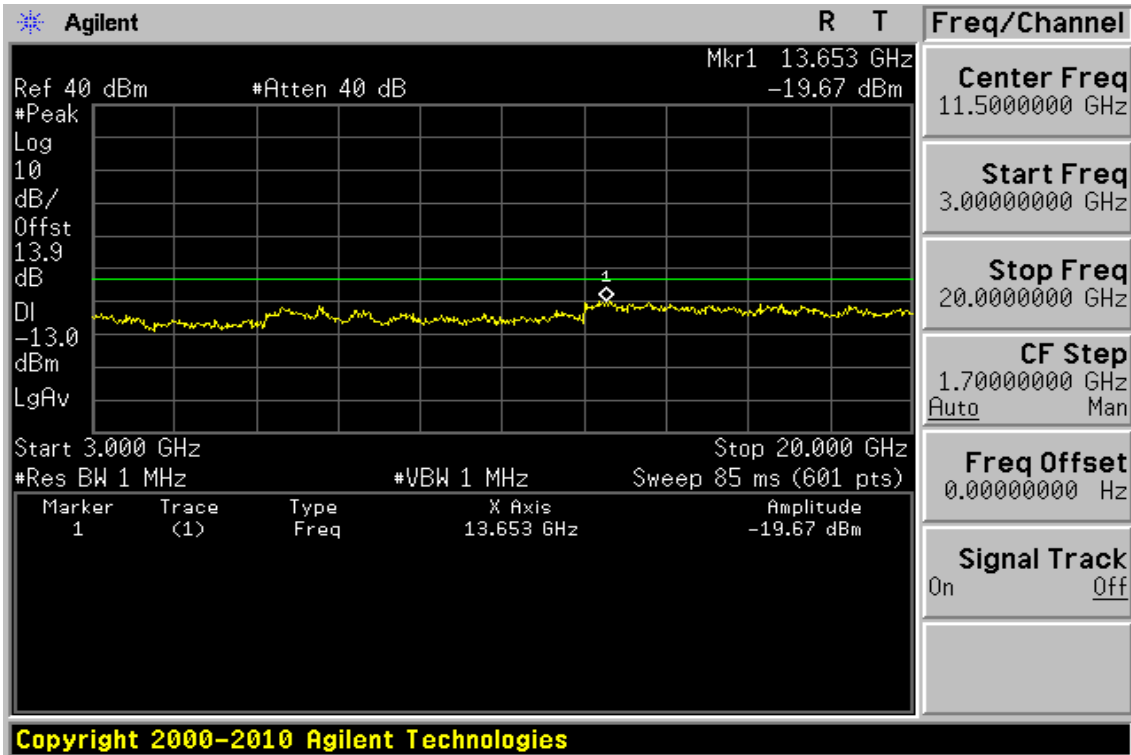
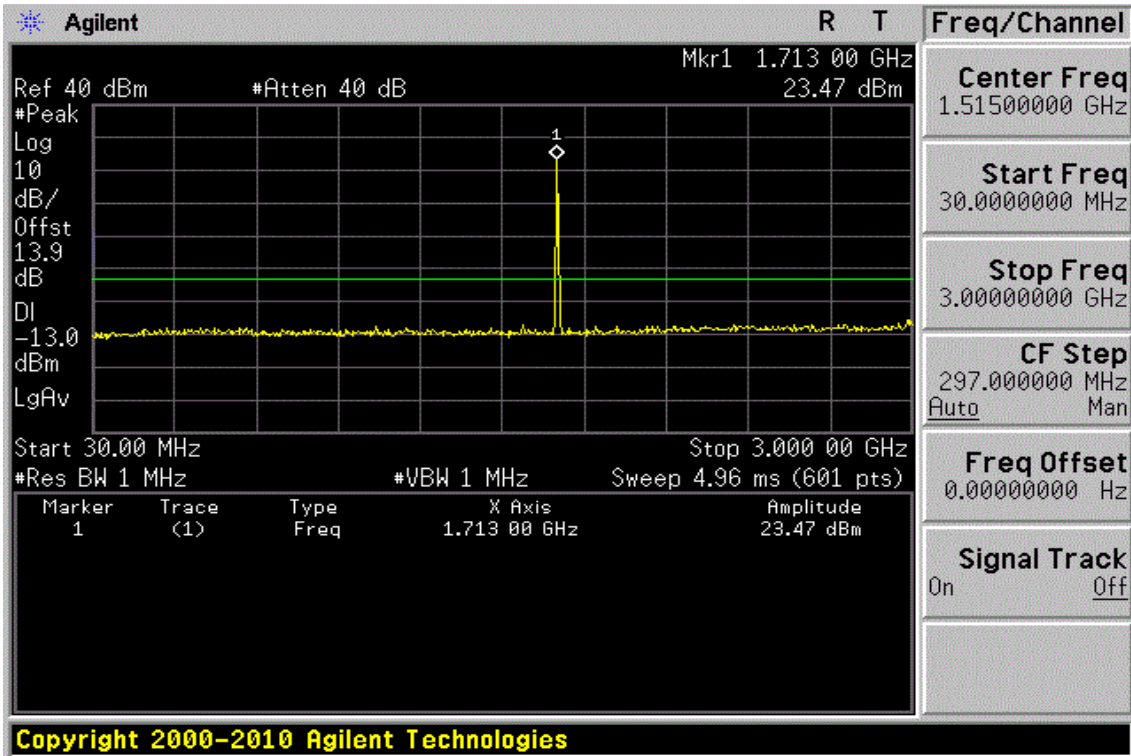

Unless otherwise stated the results shown in this test report refer only to the sample(s) tested and such sample(s) are retained for 90 days only.

除非另有說明，此報告結果僅對測試之樣品負責，同時此樣品僅保留90天。本報告未經本公司書面許可，不可部份複製。

This document is issued by the Company subject to its General Conditions of Service printed overleaf, available on request or accessible at www.sgs.com/terms_and_conditions.htm and, for electronic format documents, subject to Terms and Conditions for Electronic Documents at www.sgs.com/terms_e-document.htm. Attention is drawn to the limitation of liability, indemnification and jurisdiction issues defined therein. Any holder of this document is advised that information contained hereon reflects the Company's findings at the time of its intervention only and within the limits of Client's instructions, if any. The Company's sole responsibility is to its Client and this document does not exonerate parties to a transaction from exercising all their rights and obligations under the transaction documents. This document cannot be reproduced except in full, without prior written approval of the Company. Any unauthorized alteration, forgery or falsification of the content or appearance of this document is unlawful and offenders may be prosecuted to the fullest extent of the law.

Figure 9-67: Out of Band emission at antenna terminals –HSUPA IV Channel Mid

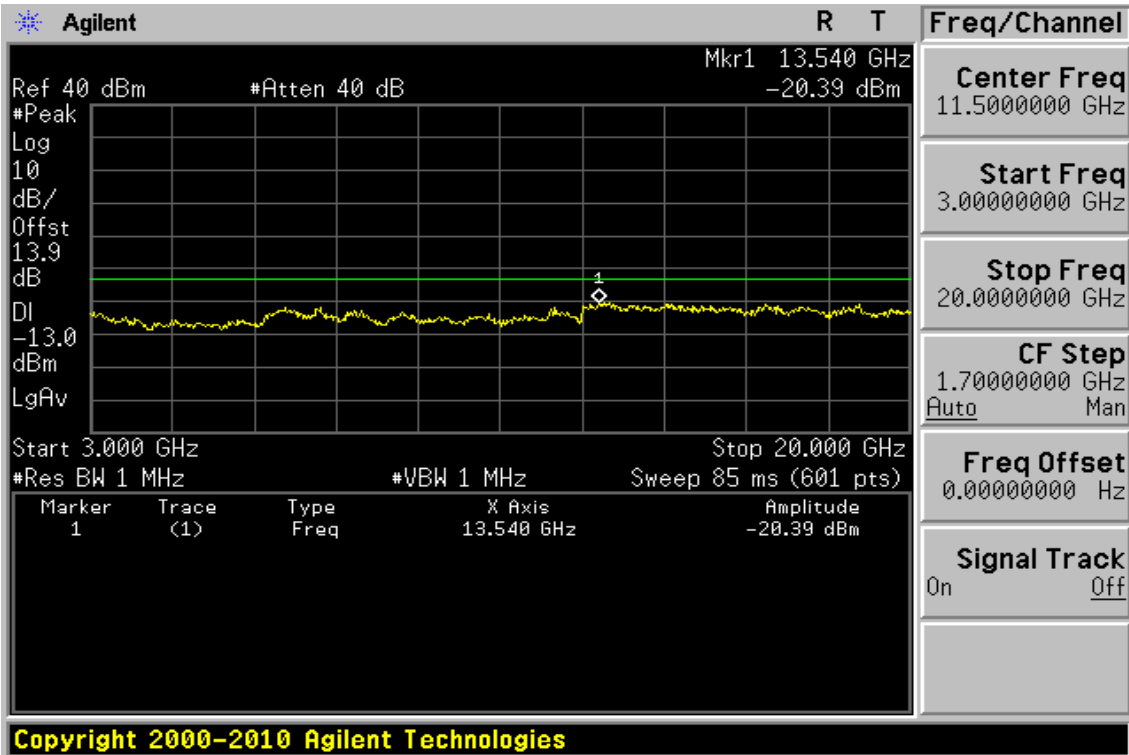
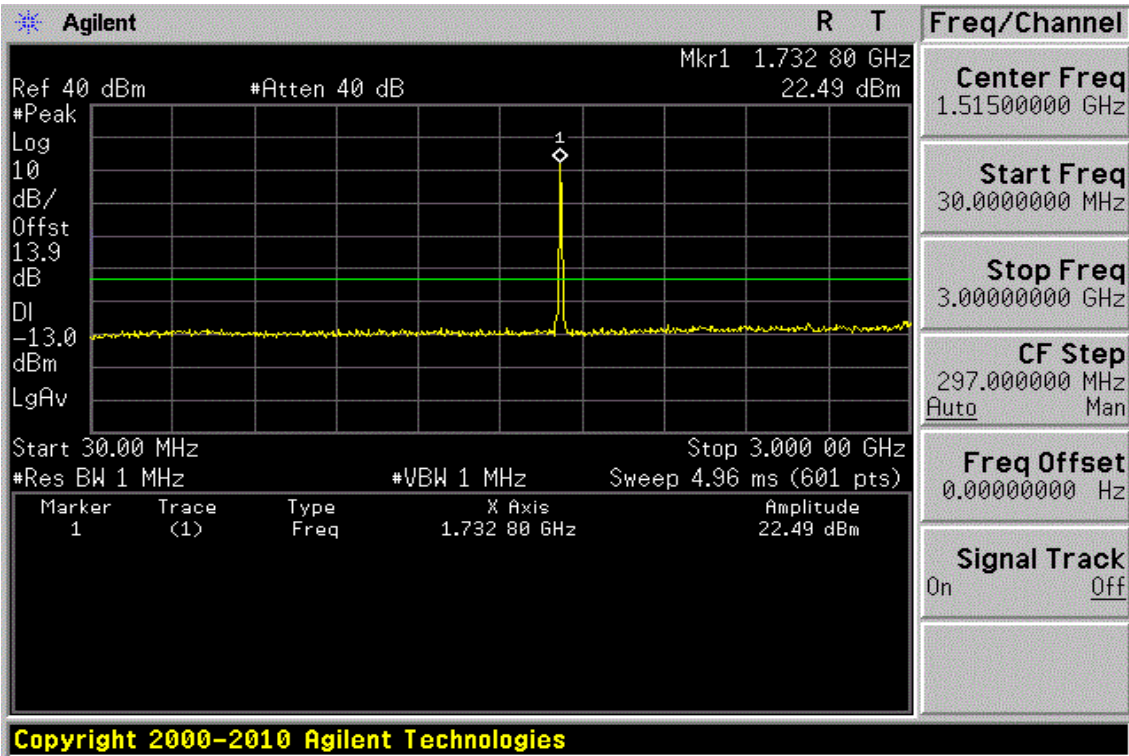

Unless otherwise stated the results shown in this test report refer only to the sample(s) tested and such sample(s) are retained for 90 days only.

除非另有說明，此報告結果僅對測試之樣品負責，同時此樣品僅保留90天。本報告未經本公司書面許可，不可部份複製。

This document is issued by the Company subject to its General Conditions of Service printed overleaf, available on request or accessible at www.sgs.com/terms_and_conditions.htm and, for electronic format documents, subject to Terms and Conditions for Electronic Documents at www.sgs.com/terms_e-document.htm. Attention is drawn to the limitation of liability, indemnification and jurisdiction issues defined therein. Any holder of this document is advised that information contained hereon reflects the Company's findings at the time of its intervention only and within the limits of Client's instructions, if any. The Company's sole responsibility is to its Client and this document does not exonerate parties to a transaction from exercising all their rights and obligations under the transaction documents. This document cannot be reproduced except in full, without prior written approval of the Company. Any unauthorized alteration, forgery or falsification of the content or appearance of this document is unlawful and offenders may be prosecuted to the fullest extent of the law.

Figure 9-68: Out of Band emission at antenna terminals –HSUPA IV Channel Highest

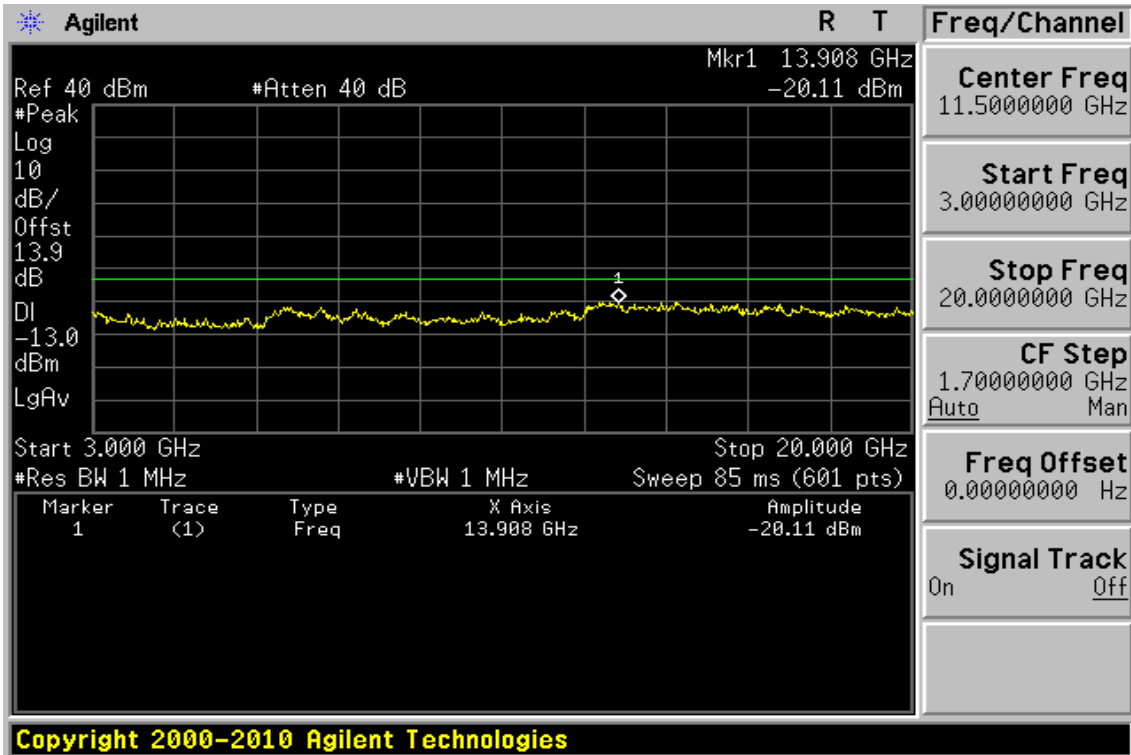
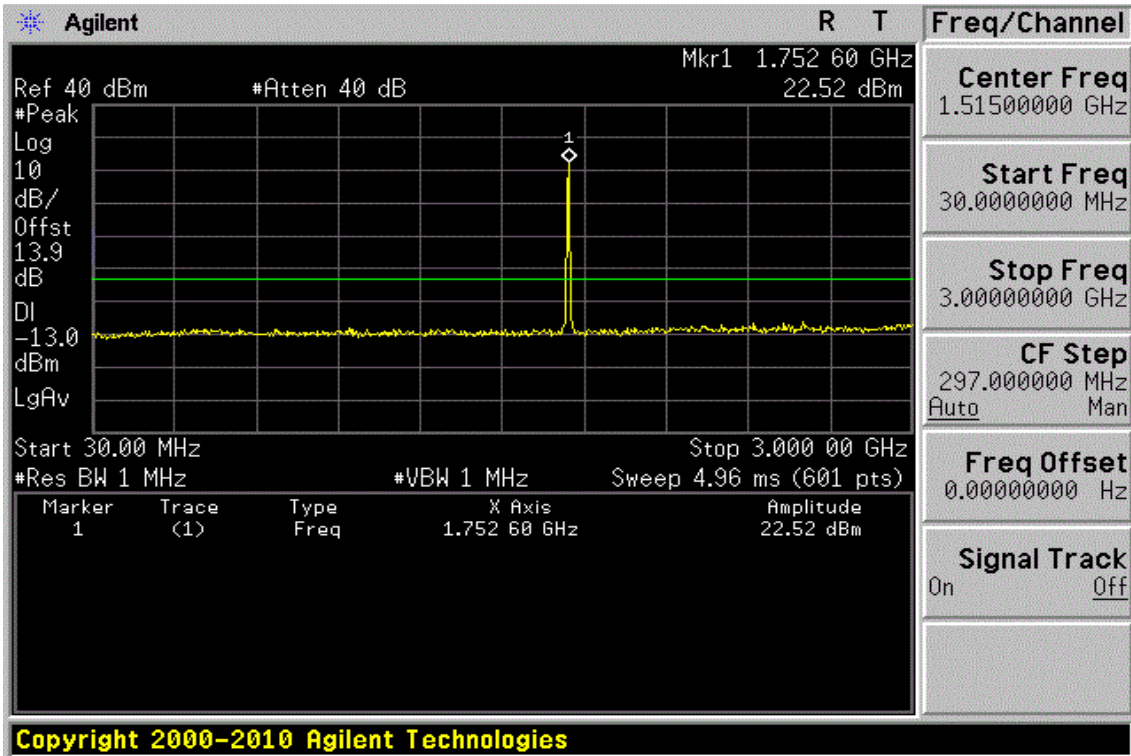

Unless otherwise stated the results shown in this test report refer only to the sample(s) tested and such sample(s) are retained for 90 days only.

除非另有說明，此報告結果僅對測試之樣品負責，同時此樣品僅保留90天。本報告未經本公司書面許可，不可部份複製。

This document is issued by the Company subject to its General Conditions of Service printed overleaf, available on request or accessible at www.sgs.com/terms_and_conditions.htm and, for electronic format documents, subject to Terms and Conditions for Electronic Documents at www.sgs.com/terms_e-document.htm. Attention is drawn to the limitation of liability, indemnification and jurisdiction issues defined therein. Any holder of this document is advised that information contained hereon reflects the Company's findings at the time of its intervention only and within the limits of Client's instructions, if any. The Company's sole responsibility is to its Client and this document does not exonerate parties to a transaction from exercising all their rights and obligations under the transaction documents. This document cannot be reproduced except in full, without prior written approval of the Company. Any unauthorized alteration, forgery or falsification of the content or appearance of this document is unlawful and offenders may be prosecuted to the fullest extent of the law.

Out of Band emission at antenna terminals –HSUPA IV

Fundamental Frequency 1712.4 MHz Engineer :Nick
Operation Mode :TX Low

| Freq. (MHz) | Note F/H/E/S | Reading dBm | Limit dBm | Safe Margin dB |
|----------------|-----------------|----------------|--------------|----------------------|
| <30 | S | --- | -13.00 | --- |
| 30-1000 | S | --- | -13.00 | --- |
| 3424.80 | H | --- | -13.00 | --- |
| 5137.20 | H | --- | -13.00 | --- |
| 6849.60 | H | --- | -13.00 | --- |
| 8562.00 | H | --- | -13.00 | --- |
| 10274.40 | H | --- | -13.00 | --- |
| 11986.80 | H | --- | -13.00 | --- |
| 13653.00 | S | -19.67 | -13.00 | 6.67 |
| 13699.20 | H | --- | -13.00 | --- |
| 15411.60 | H | --- | -13.00 | --- |
| 17124.00 | H | --- | -13.00 | --- |

Note : “H” : denotes Harmonic Frequency. “S” : denotes Spurious Frequency.
“---” : denotes Noise Floor.

Unless otherwise stated the results shown in this test report refer only to the sample(s) tested and such sample(s) are retained for 90 days only.

除非另有說明，此報告結果僅對測試之樣品負責，同時此樣品僅保留90天。本報告未經本公司書面許可，不可部份複製。

This document is issued by the Company subject to its General Conditions of Service printed overleaf, available on request or accessible at www.sgs.com/terms_and_conditions.htm and, for electronic format documents, subject to Terms and Conditions for Electronic Documents at www.sgs.com/terms_e-document.htm. Attention is drawn to the limitation of liability, indemnification and jurisdiction issues defined therein. Any holder of this document is advised that information contained hereon reflects the Company's findings at the time of its intervention only and within the limits of Client's instructions, if any. The Company's sole responsibility is to its Client and this document does not exonerate parties to a transaction from exercising all their rights and obligations under the transaction documents. This document cannot be reproduced except in full, without prior written approval of the Company. Any unauthorized alteration, forgery or falsification of the content or appearance of this document is unlawful and offenders may be prosecuted to the fullest extent of the law.

Fundamental Frequency :1732.6 MHz Engineer :Nick
Operation Mode :TX Mid

| Freq. (MHz) | Note F/H/E/S | Reading dBm | Limit dBm | Safe Margin dB |
|----------------|-----------------|----------------|--------------|----------------------|
| <30 | S | --- | -13.00 | --- |
| 30-1000 | S | --- | -13.00 | --- |
| 3465.20 | H | --- | -13.00 | --- |
| 5197.80 | H | --- | -13.00 | --- |
| 6930.40 | H | --- | -13.00 | --- |
| 8663.00 | H | --- | -13.00 | --- |
| 10395.60 | H | --- | -13.00 | --- |
| 12128.20 | H | --- | -13.00 | --- |
| 13540.00 | S | -20.39 | -13.00 | 7.39 |
| 13860.80 | H | --- | -13.00 | --- |
| 15593.40 | H | --- | -13.00 | --- |
| 17326.00 | H | --- | -13.00 | --- |

Note : "H" : denotes Harmonic Frequency. "S" : denotes Spurious Frequency.
"---" : denotes Noise Floor.

Unless otherwise stated the results shown in this test report refer only to the sample(s) tested and such sample(s) are retained for 90 days only.

除非另有說明，此報告結果僅對測試之樣品負責，同時此樣品僅保留90天。本報告未經本公司書面許可，不可部份複製。

This document is issued by the Company subject to its General Conditions of Service printed overleaf, available on request or accessible at www.sgs.com/terms_and_conditions.htm and, for electronic format documents, subject to Terms and Conditions for Electronic Documents at www.sgs.com/terms_e-document.htm. Attention is drawn to the limitation of liability, indemnification and jurisdiction issues defined therein. Any holder of this document is advised that information contained hereon reflects the Company's findings at the time of its intervention only and within the limits of Client's instructions, if any. The Company's sole responsibility is to its Client and this document does not exonerate parties to a transaction from exercising all their rights and obligations under the transaction documents. This document cannot be reproduced except in full, without prior written approval of the Company. Any unauthorized alteration, forgery or falsification of the content or appearance of this document is unlawful and offenders may be prosecuted to the fullest extent of the law.

Fundamental Frequency 1752.6MHz Engineer :Nick
Operation Mode :TX High

| Freq. (MHz) | Note F/H/E/S | Reading dBm | Limit dBm | Safe Margin dB |
|----------------|-----------------|----------------|--------------|----------------------|
| <30 | S | --- | -13.00 | --- |
| 30-1000 | S | --- | -13.00 | --- |
| 3505.20 | H | --- | -13.00 | --- |
| 5257.80 | H | --- | -13.00 | --- |
| 7010.40 | H | --- | -13.00 | --- |
| 8763.00 | H | --- | -13.00 | --- |
| 10515.60 | H | --- | -13.00 | --- |
| 12268.20 | H | --- | -13.00 | --- |
| 13908.00 | S | -20.11 | -13.00 | 7.11 |
| 14020.80 | H | --- | -13.00 | --- |
| 15773.40 | H | --- | -13.00 | --- |
| 17526.00 | H | --- | -13.00 | --- |

Note : “H” : denotes Harmonic Frequency. “S” : denotes Spurious Frequency.
“---” : denotes Noise Floor.

Unless otherwise stated the results shown in this test report refer only to the sample(s) tested and such sample(s) are retained for 90 days only.

除非另有說明，此報告結果僅對測試之樣品負責，同時此樣品僅保留90天。本報告未經本公司書面許可，不可部份複製。

This document is issued by the Company subject to its General Conditions of Service printed overleaf, available on request or accessible at www.sgs.com/terms_and_conditions.htm and, for electronic format documents, subject to Terms and Conditions for Electronic Documents at www.sgs.com/terms_e-document.htm. Attention is drawn to the limitation of liability, indemnification and jurisdiction issues defined therein. Any holder of this document is advised that information contained hereon reflects the Company's findings at the time of its intervention only and within the limits of Client's instructions, if any. The Company's sole responsibility is to its Client and this document does not exonerate parties to a transaction from exercising all their rights and obligations under the transaction documents. This document cannot be reproduced except in full, without prior written approval of the Company. Any unauthorized alteration, forgery or falsification of the content or appearance of this document is unlawful and offenders may be prosecuted to the fullest extent of the law.

Figure 9-69: Band edge emission at antenna terminals –HSUPA IV Channel Lowest

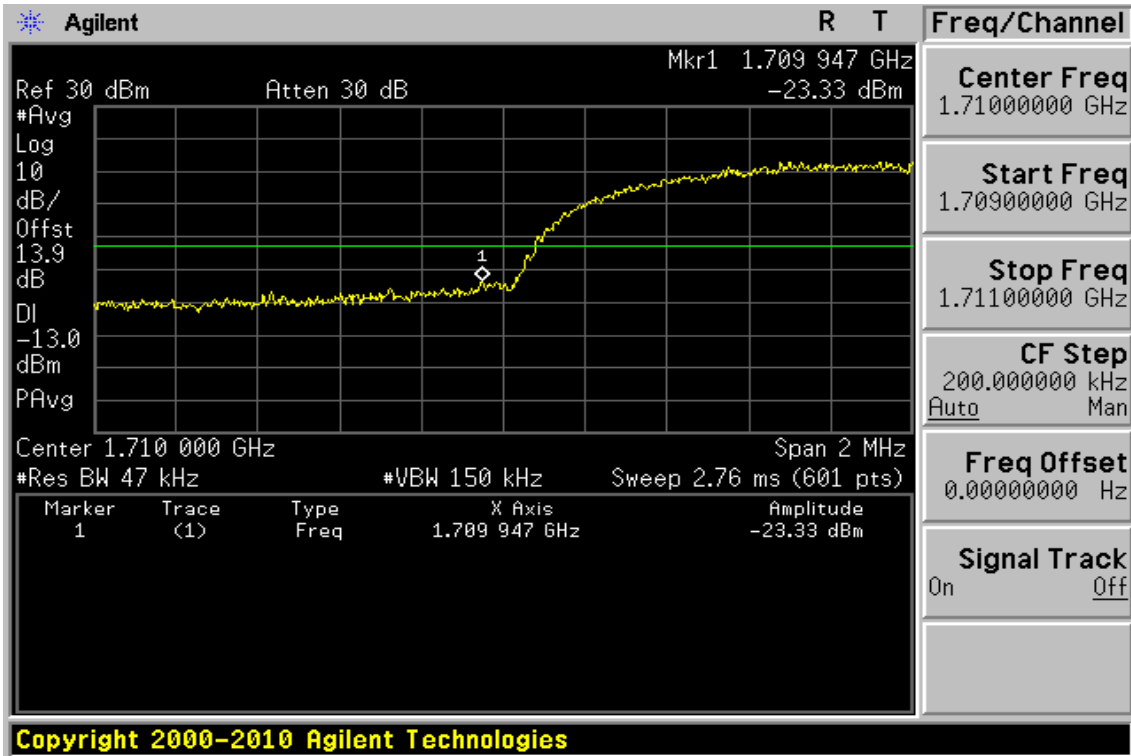
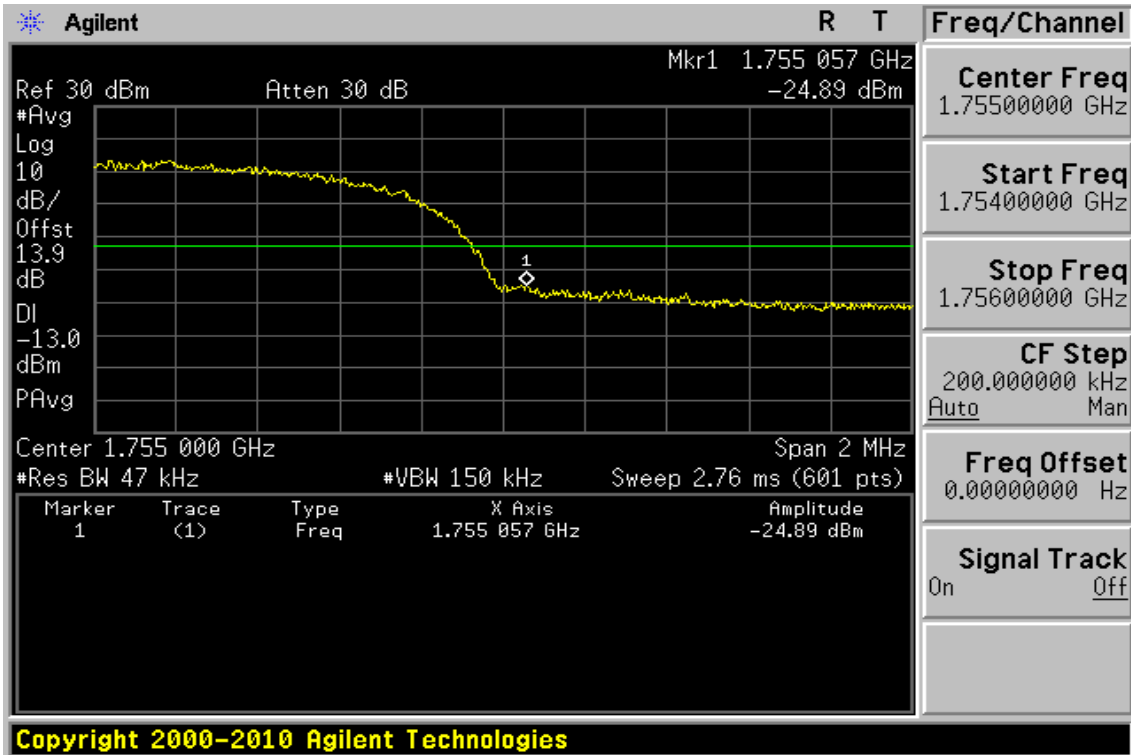

Figure 9-70: Band edge emission at antenna terminals –HSUPA IV Channel Highest



Unless otherwise stated the results shown in this test report refer only to the sample(s) tested and such sample(s) are retained for 90 days only.

除非另有說明，此報告結果僅對測試之樣品負責，同時此樣品僅保留90天。本報告未經本公司書面許可，不可部份複製。

This document is issued by the Company subject to its General Conditions of Service printed overleaf, available on request or accessible at www.sgs.com/terms_and_conditions.htm and, for electronic format documents, subject to Terms and Conditions for Electronic Documents at www.sgs.com/terms_e-document.htm. Attention is drawn to the limitation of liability, indemnification and jurisdiction issues defined therein. Any holder of this document is advised that information contained hereon reflects the Company's findings at the time of its intervention only and within the limits of Client's instructions, if any. The Company's sole responsibility is to its Client and this document does not exonerate parties to a transaction from exercising all their rights and obligations under the transaction documents. This document cannot be reproduced except in full, without prior written approval of the Company. Any unauthorized alteration, forgery or falsification of the content or appearance of this document is unlawful and offenders may be prosecuted to the fullest extent of the law.

Band edge emission at antenna terminals –HSUPA IV Low & High

Test Mode HSUPA IV Engineer :Nick

| Freq. MHz | Reading dBm | Limit dBm | Safe Margin dB |
|--------------|----------------|--------------|----------------------|
| 1709.947 | -23.33 | -13.00 | 10.33 |
| 1755.057 | -24.89 | -13.00 | 11.89 |

Unless otherwise stated the results shown in this test report refer only to the sample(s) tested and such sample(s) are retained for 90 days only.

除非另有說明，此報告結果僅對測試之樣品負責，同時此樣品僅保留90天。本報告未經本公司書面許可，不可部份複製。

This document is issued by the Company subject to its General Conditions of Service printed overleaf, available on request or accessible at www.sgs.com/terms_and_conditions.htm and, for electronic format documents, subject to Terms and Conditions for Electronic Documents at www.sgs.com/terms_e-document.htm. Attention is drawn to the limitation of liability, indemnification and jurisdiction issues defined therein. Any holder of this document is advised that information contained hereon reflects the Company's findings at the time of its intervention only and within the limits of Client's instructions, if any. The Company's sole responsibility is to its Client and this document does not exonerate parties to a transaction from exercising all their rights and obligations under the transaction documents. This document cannot be reproduced except in full, without prior written approval of the Company. Any unauthorized alteration, forgery or falsification of the content or appearance of this document is unlawful and offenders may be prosecuted to the fullest extent of the law.

Figure 9-71: Out of Band emission at antenna terminals – HSUPA V Channel Lowest

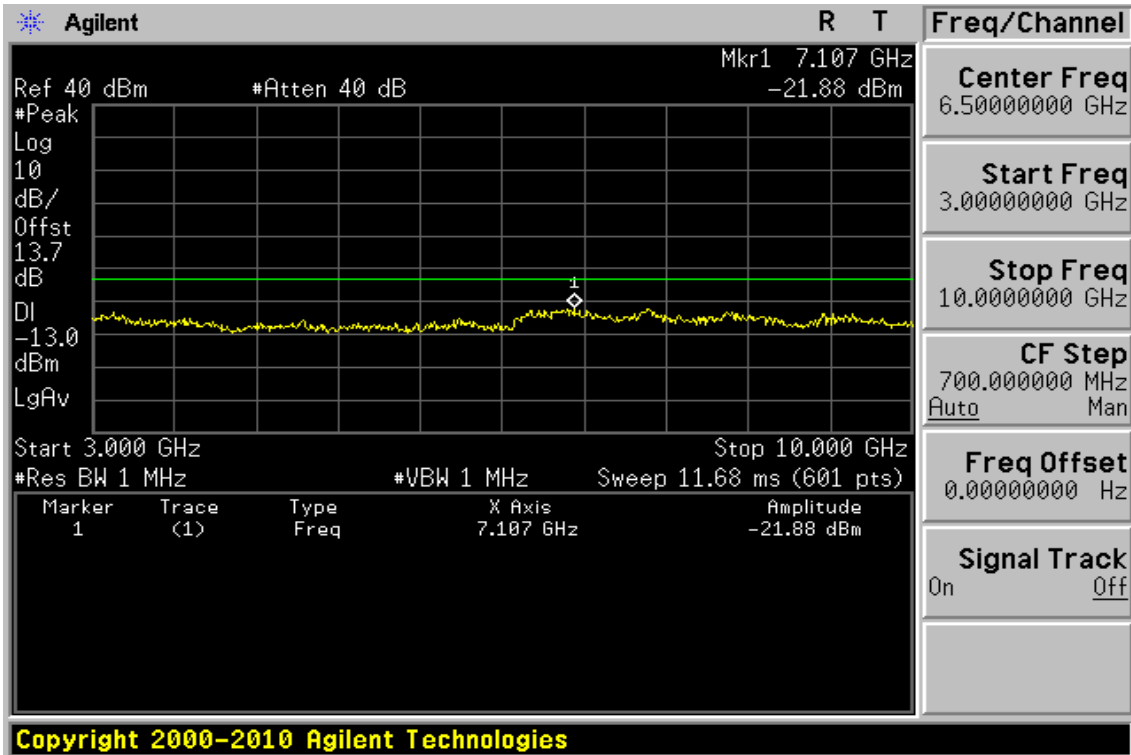
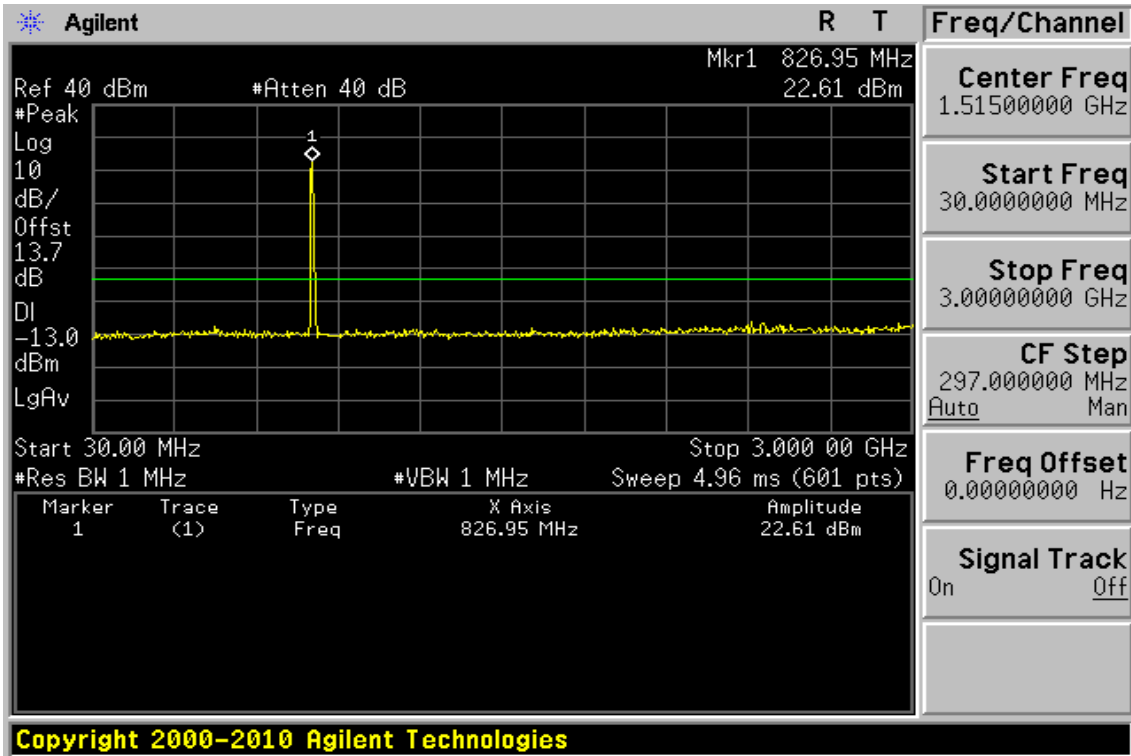

Unless otherwise stated the results shown in this test report refer only to the sample(s) tested and such sample(s) are retained for 90 days only.

除非另有說明，此報告結果僅對測試之樣品負責，同時此樣品僅保留90天。本報告未經本公司書面許可，不可部份複製。

This document is issued by the Company subject to its General Conditions of Service printed overleaf, available on request or accessible at www.sgs.com/terms_and_conditions.htm and, for electronic format documents, subject to Terms and Conditions for Electronic Documents at www.sgs.com/terms_e-document.htm. Attention is drawn to the limitation of liability, indemnification and jurisdiction issues defined therein. Any holder of this document is advised that information contained hereon reflects the Company's findings at the time of its intervention only and within the limits of Client's instructions, if any. The Company's sole responsibility is to its Client and this document does not exonerate parties to a transaction from exercising all their rights and obligations under the transaction documents. This document cannot be reproduced except in full, without prior written approval of the Company. Any unauthorized alteration, forgery or falsification of the content or appearance of this document is unlawful and offenders may be prosecuted to the fullest extent of the law.

Figure 9-72: Out of Band emission at antenna terminals – HSUPA V Channel Mid

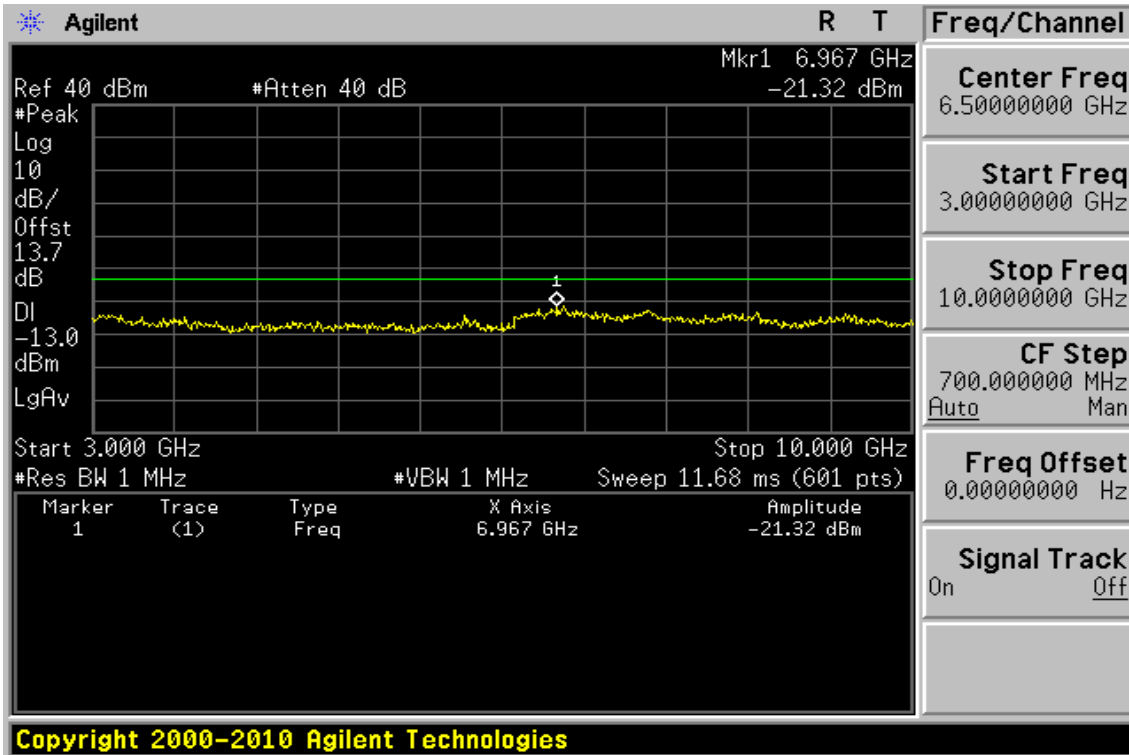
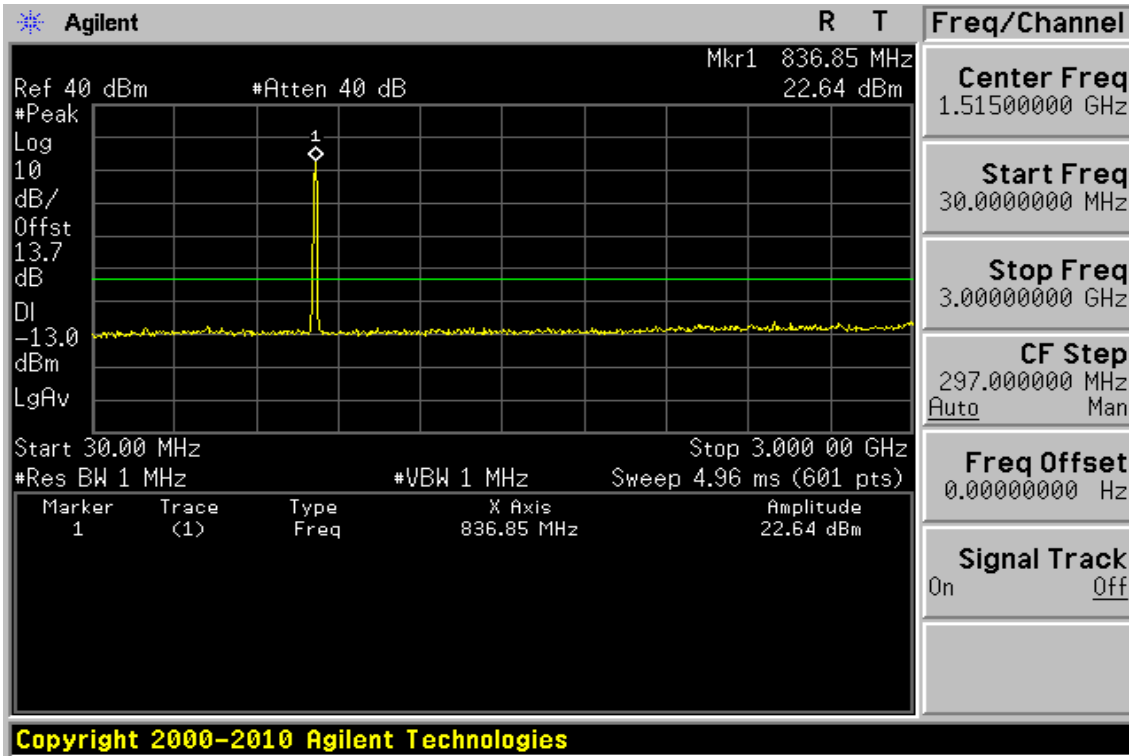

Unless otherwise stated the results shown in this test report refer only to the sample(s) tested and such sample(s) are retained for 90 days only.

除非另有說明，此報告結果僅對測試之樣品負責，同時此樣品僅保留90天。本報告未經本公司書面許可，不可部份複製。

This document is issued by the Company subject to its General Conditions of Service printed overleaf, available on request or accessible at www.sgs.com/terms_and_conditions.htm and, for electronic format documents, subject to Terms and Conditions for Electronic Documents at www.sgs.com/terms_e-document.htm. Attention is drawn to the limitation of liability, indemnification and jurisdiction issues defined therein. Any holder of this document is advised that information contained hereon reflects the Company's findings at the time of its intervention only and within the limits of Client's instructions, if any. The Company's sole responsibility is to its Client and this document does not exonerate parties to a transaction from exercising all their rights and obligations under the transaction documents. This document cannot be reproduced except in full, without prior written approval of the Company. Any unauthorized alteration, forgery or falsification of the content or appearance of this document is unlawful and offenders may be prosecuted to the fullest extent of the law.

Figure 9-73: Out of Band emission at antenna terminals – HSUPA V Channel Highest

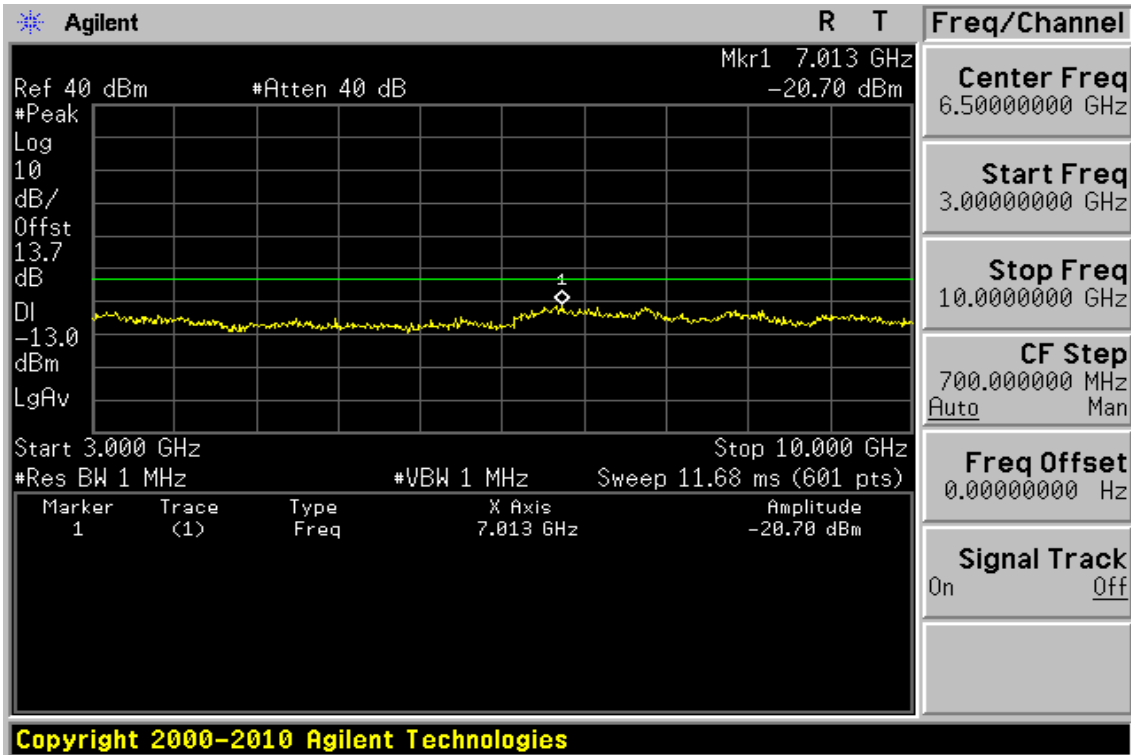
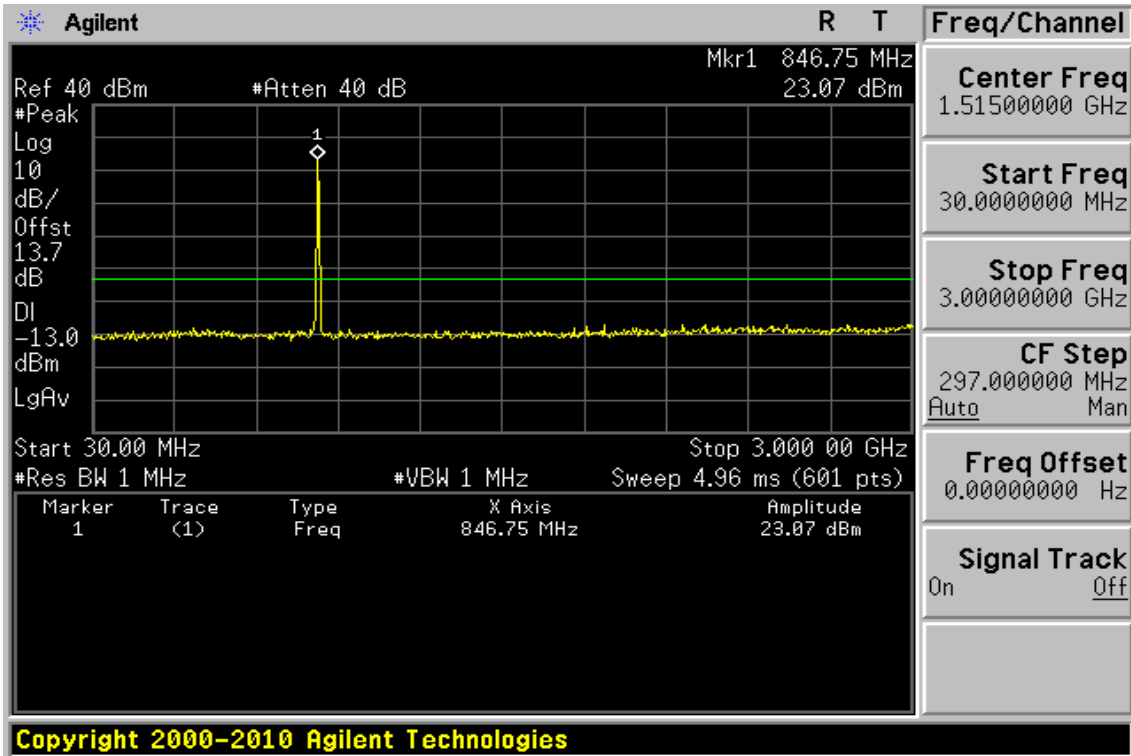

Unless otherwise stated the results shown in this test report refer only to the sample(s) tested and such sample(s) are retained for 90 days only.

除非另有說明，此報告結果僅對測試之樣品負責，同時此樣品僅保留90天。本報告未經本公司書面許可，不可部份複製。

This document is issued by the Company subject to its General Conditions of Service printed overleaf, available on request or accessible at www.sgs.com/terms_and_conditions.htm and, for electronic format documents, subject to Terms and Conditions for Electronic Documents at www.sgs.com/terms_e-document.htm. Attention is drawn to the limitation of liability, indemnification and jurisdiction issues defined therein. Any holder of this document is advised that information contained hereon reflects the Company's findings at the time of its intervention only and within the limits of Client's instructions, if any. The Company's sole responsibility is to its Client and this document does not exonerate parties to a transaction from exercising all their rights and obligations under the transaction documents. This document cannot be reproduced except in full, without prior written approval of the Company. Any unauthorized alteration, forgery or falsification of the content or appearance of this document is unlawful and offenders may be prosecuted to the fullest extent of the law.

Out of Band emission at antenna terminals – HSUPA V

Fundamental Frequency :826.4 MHz Engineer :Nick
Operation Mode :TX Low

| Freq. (MHz) | Note F/H/E/S | Reading dBm | Limit dBm | Safe Margin dB |
|----------------|-----------------|----------------|--------------|----------------------|
| <30 | S | --- | -13.00 | --- |
| 30-1000 | S | --- | -13.00 | --- |
| 1652.80 | H | --- | -13.00 | --- |
| 2479.20 | H | --- | -13.00 | --- |
| 3305.60 | H | --- | -13.00 | --- |
| 4132.00 | H | --- | -13.00 | --- |
| 4958.40 | H | --- | -13.00 | --- |
| 5784.80 | H | --- | -13.00 | --- |
| 6611.20 | H | --- | -13.00 | --- |
| 7107.00 | S | -21.88 | -13.00 | 8.88 |
| 7437.60 | H | --- | -13.00 | --- |
| 8264.00 | H | --- | -13.00 | --- |

Note : “H” : denotes Harmonic Frequency. “S” : denotes Spurious Frequency.
“---“ : denotes Noise Floor.

Unless otherwise stated the results shown in this test report refer only to the sample(s) tested and such sample(s) are retained for 90 days only.

除非另有說明，此報告結果僅對測試之樣品負責，同時此樣品僅保留90天。本報告未經本公司書面許可，不可部份複製。

This document is issued by the Company subject to its General Conditions of Service printed overleaf, available on request or accessible at www.sgs.com/terms_and_conditions.htm and, for electronic format documents, subject to Terms and Conditions for Electronic Documents at www.sgs.com/terms_e-document.htm. Attention is drawn to the limitation of liability, indemnification and jurisdiction issues defined therein. Any holder of this document is advised that information contained hereon reflects the Company's findings at the time of its intervention only and within the limits of Client's instructions, if any. The Company's sole responsibility is to its Client and this document does not exonerate parties to a transaction from exercising all their rights and obligations under the transaction documents. This document cannot be reproduced except in full, without prior written approval of the Company. Any unauthorized alteration, forgery or falsification of the content or appearance of this document is unlawful and offenders may be prosecuted to the fullest extent of the law.

Fundamental Frequency :836.6 MHz Engineer :Nick
Operation Mode :TX Mid

| Freq. (MHz) | Note F/H/E/S | Reading dBm | Limit dBm | Safe Margin dB |
|----------------|-----------------|----------------|--------------|----------------------|
| <30 | S | --- | -13.00 | --- |
| 30-1000 | S | --- | -13.00 | --- |
| 1673.20 | H | --- | -13.00 | --- |
| 2509.80 | H | --- | -13.00 | --- |
| 3346.40 | H | --- | -13.00 | --- |
| 4183.00 | H | --- | -13.00 | --- |
| 5019.60 | H | --- | -13.00 | --- |
| 5856.20 | H | --- | -13.00 | --- |
| 6692.80 | H | --- | -13.00 | --- |
| 6967.00 | S | -21.32 | -13.00 | 8.32 |
| 7529.40 | H | --- | -13.00 | --- |
| 8366.00 | H | --- | -13.00 | --- |

Note : “H” : denotes Harmonic Frequency. “S” : denotes Spurious Frequency.
“---” : denotes Noise Floor.

Unless otherwise stated the results shown in this test report refer only to the sample(s) tested and such sample(s) are retained for 90 days only.

除非另有說明，此報告結果僅對測試之樣品負責，同時此樣品僅保留90天。本報告未經本公司書面許可，不可部份複製。

This document is issued by the Company subject to its General Conditions of Service printed overleaf, available on request or accessible at www.sgs.com/terms_and_conditions.htm and, for electronic format documents, subject to Terms and Conditions for Electronic Documents at www.sgs.com/terms_e-document.htm. Attention is drawn to the limitation of liability, indemnification and jurisdiction issues defined therein. Any holder of this document is advised that information contained hereon reflects the Company's findings at the time of its intervention only and within the limits of Client's instructions, if any. The Company's sole responsibility is to its Client and this document does not exonerate parties to a transaction from exercising all their rights and obligations under the transaction documents. This document cannot be reproduced except in full, without prior written approval of the Company. Any unauthorized alteration, forgery or falsification of the content or appearance of this document is unlawful and offenders may be prosecuted to the fullest extent of the law.

Fundamental Frequency :846.6MHz Engineer :Nick
Operation Mode :TX High

| Freq. (MHz) | Note F/H/E/S | Reading dBm | Limit dBm | Safe Margin dB |
|----------------|-----------------|----------------|--------------|----------------------|
| <30 | S | --- | -13.00 | --- |
| 30-1000 | S | --- | -13.00 | --- |
| 1693.20 | H | --- | -13.00 | --- |
| 2539.80 | H | --- | -13.00 | --- |
| 3386.40 | H | --- | -13.00 | --- |
| 4233.00 | H | --- | -13.00 | --- |
| 5079.60 | H | --- | -13.00 | --- |
| 5926.20 | H | --- | -13.00 | --- |
| 6772.80 | H | --- | -13.00 | --- |
| 7013.00 | S | -20.70 | -13.00 | 7.70 |
| 7619.40 | H | --- | -13.00 | --- |
| 8466.00 | H | --- | -13.00 | --- |

Note : “H” : denotes Harmonic Frequency. “S” : denotes Spurious Frequency.
“---” : denotes Noise Floor.

Unless otherwise stated the results shown in this test report refer only to the sample(s) tested and such sample(s) are retained for 90 days only.

除非另有說明，此報告結果僅對測試之樣品負責，同時此樣品僅保留90天。本報告未經本公司書面許可，不可部份複製。

This document is issued by the Company subject to its General Conditions of Service printed overleaf, available on request or accessible at www.sgs.com/terms_and_conditions.htm and, for electronic format documents, subject to Terms and Conditions for Electronic Documents at www.sgs.com/terms_e-document.htm. Attention is drawn to the limitation of liability, indemnification and jurisdiction issues defined therein. Any holder of this document is advised that information contained hereon reflects the Company's findings at the time of its intervention only and within the limits of Client's instructions, if any. The Company's sole responsibility is to its Client and this document does not exonerate parties to a transaction from exercising all their rights and obligations under the transaction documents. This document cannot be reproduced except in full, without prior written approval of the Company. Any unauthorized alteration, forgery or falsification of the content or appearance of this document is unlawful and offenders may be prosecuted to the fullest extent of the law.

Figure 9-74: Band edge emission at antenna terminals – HSUPA V Channel Lowest

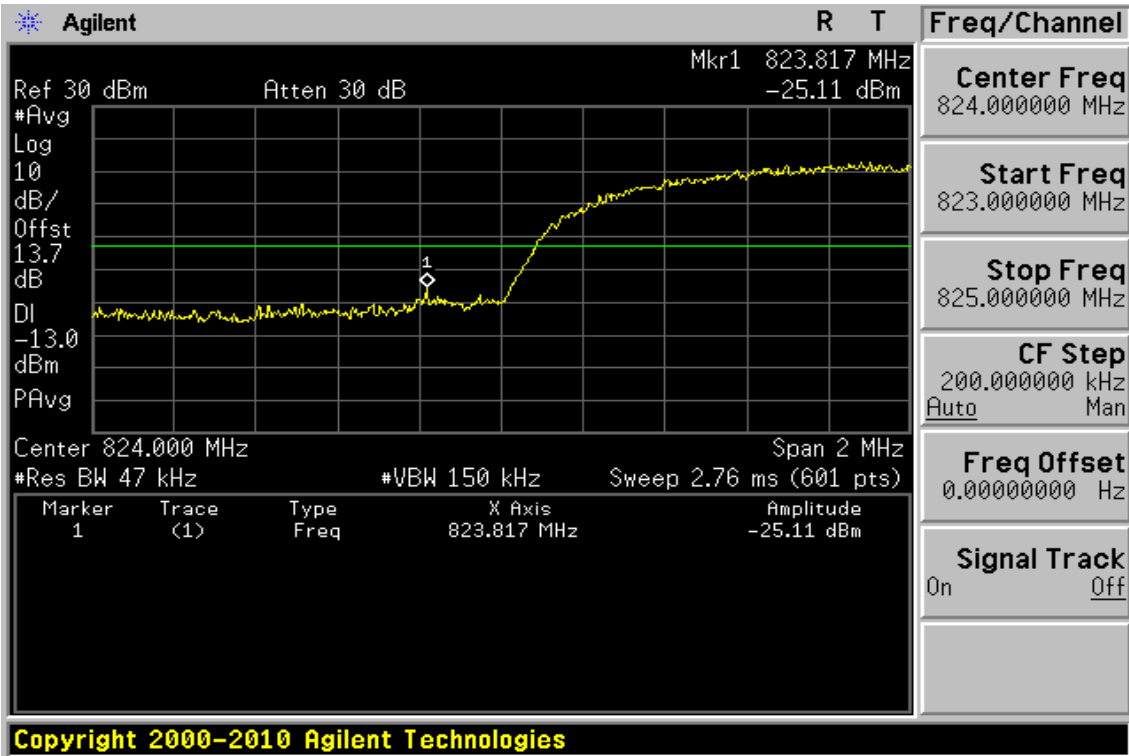
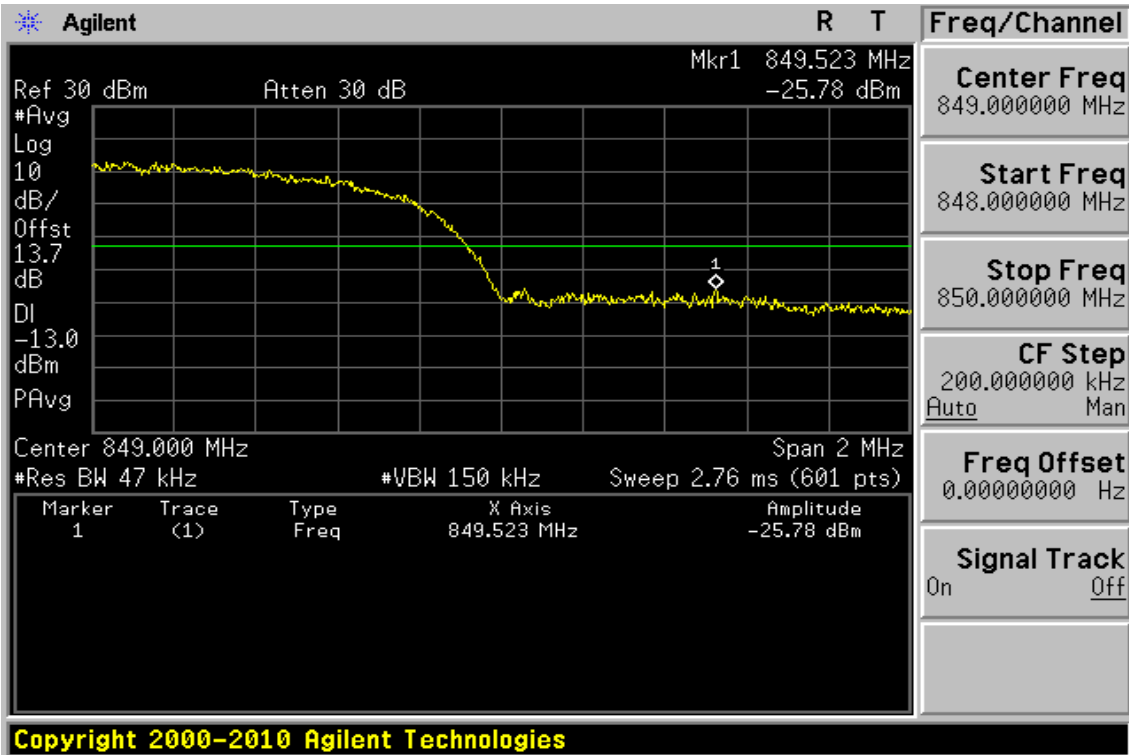

Figure 9-75: Band edge emission at antenna terminals – HSUPA V Channel Highest



Unless otherwise stated the results shown in this test report refer only to the sample(s) tested and such sample(s) are retained for 90 days only.

除非另有說明，此報告結果僅對測試之樣品負責，同時此樣品僅保留90天。本報告未經本公司書面許可，不可部份複製。

This document is issued by the Company subject to its General Conditions of Service printed overleaf, available on request or accessible at www.sgs.com/terms_and_conditions.htm and, for electronic format documents, subject to Terms and Conditions for Electronic Documents at www.sgs.com/terms_e-document.htm. Attention is drawn to the limitation of liability, indemnification and jurisdiction issues defined therein. Any holder of this document is advised that information contained hereon reflects the Company's findings at the time of its intervention only and within the limits of Client's instructions, if any. The Company's sole responsibility is to its Client and this document does not exonerate parties to a transaction from exercising all their rights and obligations under the transaction documents. This document cannot be reproduced except in full, without prior written approval of the Company. Any unauthorized alteration, forgery or falsification of the content or appearance of this document is unlawful and offenders may be prosecuted to the fullest extent of the law.

Band edge emission at antenna terminals – HSUPA V Low & High

Test Mode HSUPA V Engineer :Nick

| Freq. MHz | Reading dBm | Limit dBm | Safe Margin dB |
|--------------|----------------|--------------|----------------------|
| 823.817 | -25.11 | -13.00 | 12.11 |
| 849.523 | -25.78 | -13.00 | 12.78 |

Unless otherwise stated the results shown in this test report refer only to the sample(s) tested and such sample(s) are retained for 90 days only.

除非另有說明，此報告結果僅對測試之樣品負責，同時此樣品僅保留90天。本報告未經本公司書面許可，不可部份複製。

This document is issued by the Company subject to its General Conditions of Service printed overleaf, available on request or accessible at www.sgs.com/terms_and_conditions.htm and, for electronic format documents, subject to Terms and Conditions for Electronic Documents at www.sgs.com/terms_e-document.htm. Attention is drawn to the limitation of liability, indemnification and jurisdiction issues defined therein. Any holder of this document is advised that information contained hereon reflects the Company's findings at the time of its intervention only and within the limits of Client's instructions, if any. The Company's sole responsibility is to its Client and this document does not exonerate parties to a transaction from exercising all their rights and obligations under the transaction documents. This document cannot be reproduced except in full, without prior written approval of the Company. Any unauthorized alteration, forgery or falsification of the content or appearance of this document is unlawful and offenders may be prosecuted to the fullest extent of the law.

10. FIELD STRENGTH OF SPURIOUS RADIATION MEASUREMENT

10.1. Standard Applicable:

According to FCC §2.1053,

FCC §22.917(a), §24.238(a), §27.53(h) the magnitude of each spurious and harmonic emission that can be detected when the equipment is operated under the conditions specified in the instruction manual and/ or alignment procedure, shall not be less than $43 + 10 \log$ (mean output power in watts) dBc below the mean power output outside a license's frequency block (-13dBm).

According to RSS-132 §5.5

Mobile and base station equipment shall comply with the limits in (i) and (ii) below.

(i) In the first 1.0 MHz band immediately outside and adjacent to each of the sub-bands specified in Section 5.1, the power of emissions per any 1% of the occupied bandwidth shall be attenuated (in dB) below the transmitter output power P (dBW) by at least $43 + 10 \log_{10} p$ (watts).

(ii)

After the first 1.0 MHz immediately outside and adjacent to each of the sub-bands, the power of emissions in any 100 kHz bandwidth shall be attenuated (in dB) below the transmitter output power P (dBW) by at least $43 + 10 \log_{10} p$ (watts). If the measurement is performed using 1% of the occupied bandwidth, power integration over 100 kHz is required.

According to RSS-133 §6.5

6.5.1 Out-of-Block Emissions

Equipment shall comply with the limits in (i) and (ii) below.

(i) In the 1.0 MHz bands immediately outside and adjacent to the equipment's operating frequency block, the emission power per any 1% of the emission bandwidth shall be attenuated (in dB) below the transmitter output power P (dBW) by at least $43 + 10 \log_{10} p$ (watts).

(ii) After the first 1.0 MHz, the emission power in any 1 MHz bandwidth shall be attenuated (in dB) below the transmitter output power P (dBW) by at least $43 + 10 \log_{10} p$ (watts). If the measurement is performed using 1% of the emission bandwidth, power integration over 1.0 MHz is required.

Unless otherwise stated the results shown in this test report refer only to the sample(s) tested and such sample(s) are retained for 90 days only.

除非另有說明，此報告結果僅對測試之樣品負責，同時此樣品僅保留90天。本報告未經本公司書面許可，不可部份複製。

This document is issued by the Company subject to its General Conditions of Service printed overleaf, available on request or accessible at www.sgs.com/terms_and_conditions.htm and, for electronic format documents, subject to Terms and Conditions for Electronic Documents at www.sgs.com/terms_e-document.htm. Attention is drawn to the limitation of liability, indemnification and jurisdiction issues defined therein. Any holder of this document is advised that information contained hereon reflects the Company's findings at the time of its intervention only and within the limits of Client's instructions, if any. The Company's sole responsibility is to its Client and this document does not exonerate parties to a transaction from exercising all their rights and obligations under the transaction documents. This document cannot be reproduced except in full, without prior written approval of the Company. Any unauthorized alteration, forgery or falsification of the content or appearance of this document is unlawful and offenders may be prosecuted to the fullest extent of the law.

6.5.2 Out-of-Sub-band Emissions

Outside the sub-bands 1850-1910 MHz and 1930-1990 MHz, the attenuation shall be equal to or greater than the out-of-block emission limits in Section 6.5.1.

According to RSS-139 §6.5

(i) In the first 1.0 MHz bands immediately outside and adjacent to the equipment's operating frequency block, the emission power per any 1% of the emission bandwidth shall be attenuated below the transmitter output power P (in watts) by at least $43 + 10 \log_{10}(P)$, dB.

(ii) After the first 1.0 MHz outside the equipment's operating frequency block, the emission power in any 1 MHz bandwidth shall be attenuated below the transmitter output power P (in watts) by at least $43 + 10 \log_{10}(P)$, dB.

Receiver Spurious Emissions

Receiver spurious emissions shall comply with the limits specified in RSS-Gen.

Spurious emissions from receivers shall not exceed the radiated limits shown in the table below:

Radiated Limits of Receiver Spurious Emissions

| Frequency (MHz) | Field Strength (microvolts/m at 3 metres)* |
|-----------------|--|
| 30-88 | 100 |
| 88-216 | 150 |
| 216-960 | 200 |
| Above 960 | 500 |

Unless otherwise stated the results shown in this test report refer only to the sample(s) tested and such sample(s) are retained for 90 days only.

除非另有說明，此報告結果僅對測試之樣品負責，同時此樣品僅保留90天。本報告未經本公司書面許可，不可部份複製。

This document is issued by the Company subject to its General Conditions of Service printed overleaf, available on request or accessible at www.sgs.com/terms_and_conditions.htm and, for electronic format documents, subject to Terms and Conditions for Electronic Documents at www.sgs.com/terms_e-document.htm. Attention is drawn to the limitation of liability, indemnification and jurisdiction issues defined therein. Any holder of this document is advised that information contained hereon reflects the Company's findings at the time of its intervention only and within the limits of Client's instructions, if any. The Company's sole responsibility is to its Client and this document does not exonerate parties to a transaction from exercising all their rights and obligations under the transaction documents. This document cannot be reproduced except in full, without prior written approval of the Company. Any unauthorized alteration, forgery or falsification of the content or appearance of this document is unlawful and offenders may be prosecuted to the fullest extent of the law.

10.2. EUT Setup (Block Diagram of Configuration):

Radiated Emission Test Set-Up, Frequency Below 1000MHz

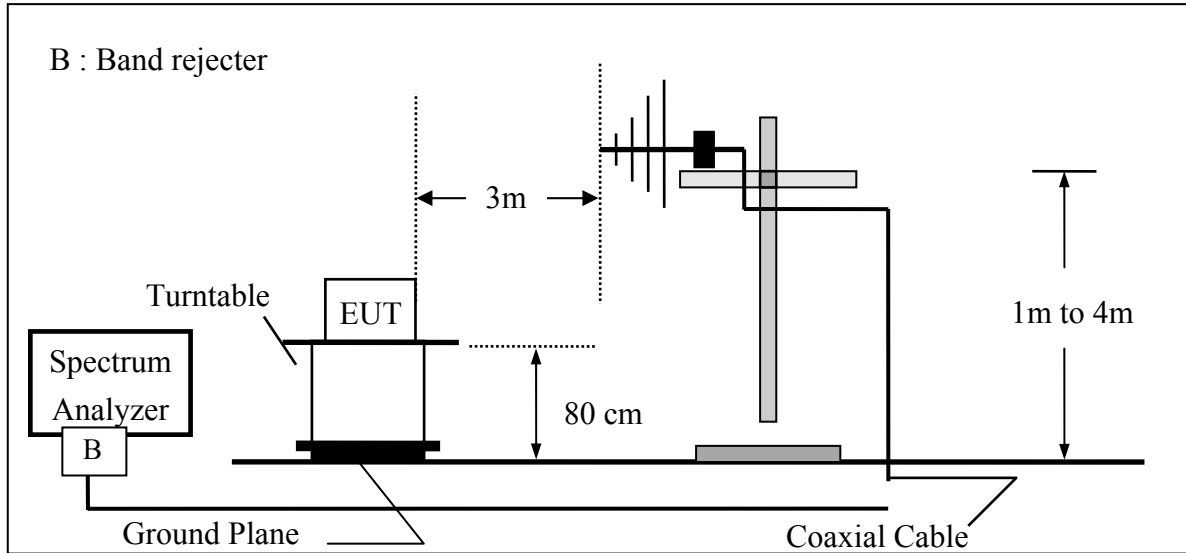

Unless otherwise stated the results shown in this test report refer only to the sample(s) tested and such sample(s) are retained for 90 days only.

除非另有說明，此報告結果僅對測試之樣品負責，同時此樣品僅保留90天。本報告未經本公司書面許可，不可部份複製。

This document is issued by the Company subject to its General Conditions of Service printed overleaf, available on request or accessible at www.sgs.com/terms_and_conditions.htm and, for electronic format documents, subject to Terms and Conditions for Electronic Documents at www.sgs.com/terms_e-document.htm. Attention is drawn to the limitation of liability, indemnification and jurisdiction issues defined therein. Any holder of this document is advised that information contained hereon reflects the Company's findings at the time of its intervention only and within the limits of Client's instructions, if any. The Company's sole responsibility is to its Client and this document does not exonerate parties to a transaction from exercising all their rights and obligations under the transaction documents. This document cannot be reproduced except in full, without prior written approval of the Company. Any unauthorized alteration, forgery or falsification of the content or appearance of this document is unlawful and offenders may be prosecuted to the fullest extent of the law.

Radiated Emission Test Set-UP Frequency Over 1 GHz

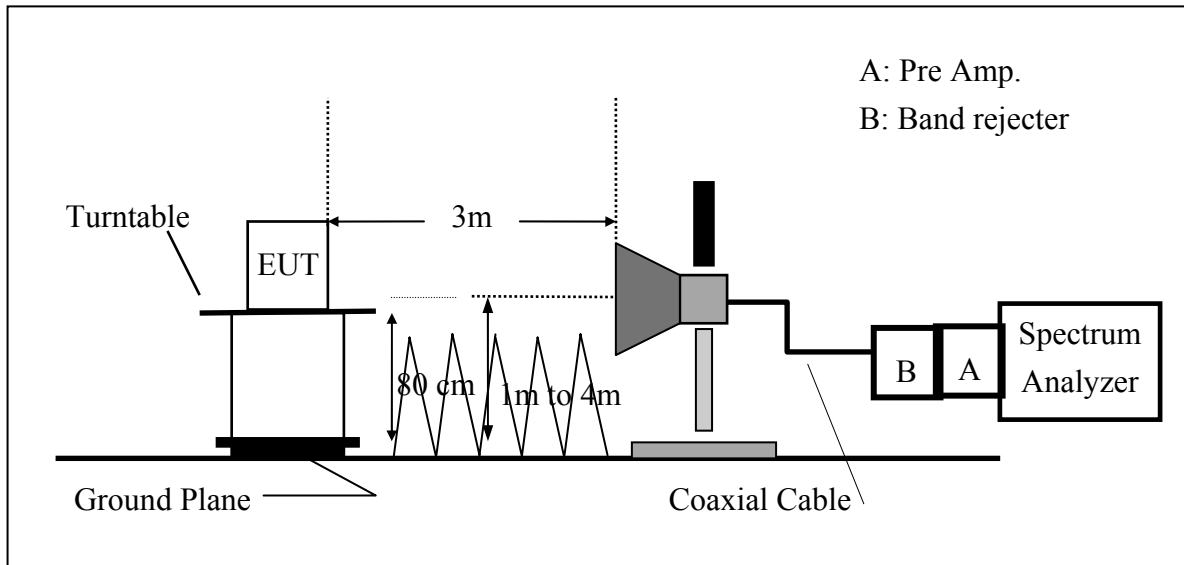

10.3. Measurement Procedure:

The EUT was placed on a non-conductive; the measurement antenna was placed at a distance of 3 meters from the EUT. During the tests, the antenna height and the EUT azimuth were varied in order to identify the maximum level of emissions from the EUT. This maximization process was repeated with the EUT positioned in each of its three orthogonal orientations.

The frequency range up to tenth harmonic was investigated for each of three fundamental frequencies (low, middle and high channels). Once spurious emission was identified, the power of the emission was determined using the substitution method.

The spurious emissions attenuation was calculated as the difference between radiated power at the fundamental frequency and the spurious emissions frequency.

$$ERP = \text{S.G. output (dBm)} + \text{Antenna Gain (dBd)} - \text{Cable Loss (dB)}$$

$$EIRP = \text{S.G. output (dBm)} + \text{Antenna Gain (dBi)} - \text{Cable Loss (dB)}$$

10.4. Measurement Equipment Used:

Refer to section 2.4 in this report

10.5. Measurement Result:

Refer to attach tabular data sheets.

For radiated plot of test data, please refer to Appendix 1, page 322

Unless otherwise stated the results shown in this test report refer only to the sample(s) tested and such sample(s) are retained for 90 days only.

除非另有說明，此報告結果僅對測試之樣品負責，同時此樣品僅保留90天。本報告未經本公司書面許可，不可部份複製。

This document is issued by the Company subject to its General Conditions of Service printed overleaf, available on request or accessible at www.sgs.com/terms_and_conditions.htm and, for electronic format documents, subject to Terms and Conditions for Electronic Documents at www.sgs.com/terms_e-document.htm. Attention is drawn to the limitation of liability, indemnification and jurisdiction issues defined therein. Any holder of this document is advised that information contained hereon reflects the Company's findings at the time of its intervention only and within the limits of Client's instructions, if any. The Company's sole responsibility is to its Client and this document does not exonerate parties to a transaction from exercising all their rights and obligations under the transaction documents. This document cannot be reproduced except in full, without prior written approval of the Company. Any unauthorized alteration, forgery or falsification of the content or appearance of this document is unlawful and offenders may be prosecuted to the fullest extent of the law.

Radiated Spurious Emission Measurement Result: GSM 850 Mode

| | | | |
|-----------------------|------------|--------------------------|---------------------|
| Operation Band | :GSM 850 | Test Date | : 2013-07-16 |
| ARFCN | :CH 128 | Temp./Humi. | :24.1 deg_C / 65 RH |
| Fundamental Frequency | :824.2 MHz | Engineer | :Allen |
| Operation Mode | :TX LOW | | |
| EUT Pol. | :E2 Plan | Measurement Antenna Pol. | :VERTICAL |

| Freq. MHz | Note F/H/E/S | ERP dBm | SG Output Level dBm | Antenna Gain dBd | Cable Loss dB | Limit dBm | Margin dB |
|--------------|-----------------|------------|---------------------------|------------------------|---------------------|--------------|--------------|
| 114.39 | S | -84.05 | -81.73 | -1.20 | -1.11 | -13.00 | -71.05 |
| 158.04 | S | -84.01 | -82.07 | -0.67 | -1.26 | -13.00 | -71.01 |
| 343.31 | S | -82.79 | -85.72 | 4.75 | -1.82 | -13.00 | -69.79 |
| 549.92 | S | -78.40 | -80.72 | 4.58 | -2.26 | -13.00 | -65.40 |
| 711.91 | S | -76.80 | -78.22 | 4.00 | -2.58 | -13.00 | -63.80 |
| 930.16 | S | -73.87 | -74.50 | 3.64 | -3.01 | -13.00 | -60.87 |
| 1648.40 | H | -51.73 | -50.07 | 2.40 | -4.05 | -13.00 | -38.73 |
| 2472.60 | H | -49.10 | -47.21 | 3.14 | -5.03 | -13.00 | -36.10 |
| 3288.00 | H | --- | | | | | |
| 4121.00 | H | --- | | | | | |
| 4945.20 | H | --- | | | | | |
| 5769.40 | H | --- | | | | | |
| 6593.60 | H | --- | | | | | |
| 7417.80 | H | --- | | | | | |
| 8242.00 | H | --- | | | | | |

ERP(dBm) = SG Level(dBm) + Antenna Gain(dBd) + Cable Loss(dB)

Note : “F” : denotes Fundamental Frequency. ; “H” : denotes Harmonic Frequency.
 “E” : denotes Band Edge Frequency. ; “S” : denotes Spurious Frequency.
 “---” : denotes Noise Floor.

Unless otherwise stated the results shown in this test report refer only to the sample(s) tested and such sample(s) are retained for 90 days only.

除非另有說明，此報告結果僅對測試之樣品負責，同時此樣品僅保留90天。本報告未經本公司書面許可，不可部份複製。
 This document is issued by the Company subject to its General Conditions of Service printed overleaf, available on request or accessible at www.sgs.com/terms_and_conditions.htm and, for electronic format documents, subject to Terms and Conditions for Electronic Documents at www.sgs.com/terms_e-document.htm. Attention is drawn to the limitation of liability, indemnification and jurisdiction issues defined therein. Any holder of this document is advised that information contained hereon reflects the Company's findings at the time of its intervention only and within the limits of Client's instructions, if any. The Company's sole responsibility is to its Client and this document does not exonerate parties to a transaction from exercising all their rights and obligations under the transaction documents. This document cannot be reproduced except in full, without prior written approval of the Company. Any unauthorized alteration, forgery or falsification of the content or appearance of this document is unlawful and offenders may be prosecuted to the fullest extent of the law.

| | | | |
|-----------------------|------------|--------------------------|---------------------|
| Operation Band | :GSM 850 | Test Date | : 2013-07-16 |
| ARFCN | :CH 128 | Temp./Humi. | :24.1 deg_C / 65 RH |
| Fundamental Frequency | :824.2 MHz | Engineer | :Allen |
| Operation Mode | :TX LOW | | |
| EUT Pol. | :E2 Plan | Measurement Antenna Pol. | :HORIZONTAL |

| Freq. | Note | ERP | SG | Antenna | Cable | Limit | Margin |
|---------|---------|--------|---------------------|-------------|------------|--------|--------|
| MHz | F/H/E/S | dBm | Output Level dBm | Gain dBd | Loss dB | dBm | dB |
| 171.62 | S | -83.55 | -83.36 | 1.12 | -1.31 | -13.00 | -70.55 |
| 309.36 | S | -72.44 | -75.36 | 4.65 | -1.73 | -13.00 | -59.44 |
| 505.30 | S | -81.25 | -83.78 | 4.70 | -2.17 | -13.00 | -68.25 |
| 602.30 | S | -80.41 | -82.06 | 4.03 | -2.38 | -13.00 | -67.41 |
| 721.61 | S | -78.28 | -79.56 | 3.88 | -2.59 | -13.00 | -65.28 |
| 953.44 | S | -75.79 | -76.39 | 3.66 | -3.06 | -13.00 | -62.79 |
| 1648.40 | H | -46.15 | -44.78 | 2.68 | -4.05 | -13.00 | -33.15 |
| 2472.60 | H | -46.06 | -44.55 | 3.52 | -5.03 | -13.00 | -33.06 |
| 3288.00 | H | --- | | | | | |
| 4121.00 | H | --- | | | | | |
| 4945.20 | H | --- | | | | | |
| 5769.40 | H | --- | | | | | |
| 6593.60 | H | --- | | | | | |
| 7417.80 | H | --- | | | | | |
| 8242.00 | H | --- | | | | | |

ERP(dBm) = SG Level(dBm) + Antenna Gain(dBd) + Cable Loss(dB)

Note : "F" : denotes Fundamental Frequency. ; "H" : denotes Harmonic Frequency.
 "E" : denotes Band Edge Frequency. ; "S" : denotes Spurious Frequency.
 "---" : denotes Noise Floor.

Unless otherwise stated the results shown in this test report refer only to the sample(s) tested and such sample(s) are retained for 90 days only.

除非另有說明，此報告結果僅對測試之樣品負責，同時此樣品僅保留90天。本報告未經本公司書面許可，不可部份複製。
 This document is issued by the Company subject to its General Conditions of Service printed overleaf, available on request or accessible at www.sgs.com/terms_and_conditions.htm and, for electronic format documents, subject to Terms and Conditions for Electronic Documents at www.sgs.com/terms_e-document.htm. Attention is drawn to the limitation of liability, indemnification and jurisdiction issues defined therein. Any holder of this document is advised that information contained hereon reflects the Company's findings at the time of its intervention only and within the limits of Client's instructions, if any. The Company's sole responsibility is to its Client and this document does not exonerate parties to a transaction from exercising all their rights and obligations under the transaction documents. This document cannot be reproduced except in full, without prior written approval of the Company. Any unauthorized alteration, forgery or falsification of the content or appearance of this document is unlawful and offenders may be prosecuted to the fullest extent of the law.

| | | | |
|-----------------------|------------|--------------------------|---------------------|
| Operation Band | :GSM 850 | Test Date | :2013-05-27 |
| ARFCN | :CH 190 | Temp./Humi. | :24.1 deg_C / 65 RH |
| Fundamental Frequency | :836.6 MHz | Engineer | :Allen |
| Operation Mode | :TX MID | | |
| EUT Pol. | :E2 Plan | Measurement Antenna Pol. | :VERTICAL |

| Freq. | Note | ERP | SG | Antenna | Cable | Limit | Margin |
|---------|---------|--------|---------------------|-------------|------------|--------|--------|
| MHz | F/H/E/S | dBm | Output Level dBm | Gain dBd | Loss dB | dBm | dB |
| 114.39 | S | -83.76 | -81.44 | -1.20 | -1.11 | -13.00 | -70.76 |
| 286.08 | S | -82.15 | -84.98 | 4.50 | -1.67 | -13.00 | -69.15 |
| 343.31 | S | -81.38 | -84.31 | 4.75 | -1.82 | -13.00 | -68.38 |
| 555.74 | S | -78.25 | -80.49 | 4.51 | -2.27 | -13.00 | -65.25 |
| 780.78 | S | -75.82 | -76.86 | 3.76 | -2.72 | -13.00 | -62.82 |
| 935.01 | S | -73.63 | -74.25 | 3.64 | -3.02 | -13.00 | -60.63 |
| 1673.20 | H | | | | | | |
| 2509.80 | H | -38.88 | -37.00 | 3.19 | -5.07 | -13.00 | -25.88 |
| 3346.40 | H | --- | | | | | |
| 4183.00 | H | --- | | | | | |
| 5019.60 | H | --- | | | | | |
| 5856.20 | H | --- | | | | | |
| 6692.80 | H | --- | | | | | |
| 7529.40 | H | --- | | | | | |
| 8366.00 | H | --- | | | | | |

ERP(dBm) = SG Level(dBm) + Antenna Gain(dBd) + Cable Loss(dB)

Note : "F" : denotes Fundamental Frequency. ; "H" : denotes Harmonic Frequency.
 "E" : denotes Band Edge Frequency. ; "S" : denotes Spurious Frequency.
 "---" : denotes Noise Floor.

Unless otherwise stated the results shown in this test report refer only to the sample(s) tested and such sample(s) are retained for 90 days only.

除非另有說明，此報告結果僅對測試之樣品負責，同時此樣品僅保留90天。本報告未經本公司書面許可，不可部份複製。

This document is issued by the Company subject to its General Conditions of Service printed overleaf, available on request or accessible at www.sgs.com/terms_and_conditions.htm and, for electronic format documents, subject to Terms and Conditions for Electronic Documents at www.sgs.com/terms_e-document.htm. Attention is drawn to the limitation of liability, indemnification and jurisdiction issues defined therein. Any holder of this document is advised that information contained hereon reflects the Company's findings at the time of its intervention only and within the limits of Client's instructions, if any. The Company's sole responsibility is to its Client and this document does not exonerate parties to a transaction from exercising all their rights and obligations under the transaction documents. This document cannot be reproduced except in full, without prior written approval of the Company. Any unauthorized alteration, forgery or falsification of the content or appearance of this document is unlawful and offenders may be prosecuted to the fullest extent of the law.

| | | | |
|-----------------------|------------|--------------------------|---------------------|
| Operation Band | :GSM 850 | Test Date | :2013-05-27 |
| ARFCN | :CH 190 | Temp./Humi. | :24.1 deg_C / 65 RH |
| Fundamental Frequency | :836.6 MHz | Engineer | :Allen |
| Operation Mode | :TX MID | | |
| EUT Pol. | :E2 Plan | Measurement Antenna Pol. | :HORIZONTAL |

| Freq. | Note | ERP | SG | Antenna | Cable | Limit | Margin |
|---------|---------|--------|---------------------|-------------|------------|--------|--------|
| MHz | F/H/E/S | dBm | Output Level dBm | Gain dBd | Loss dB | dBm | dB |
| 130.88 | S | -87.16 | -85.21 | -0.77 | -1.18 | -13.00 | -74.16 |
| 188.11 | S | -84.52 | -86.57 | 3.43 | -1.37 | -13.00 | -71.52 |
| 403.45 | S | -82.88 | -85.69 | 4.75 | -1.95 | -13.00 | -69.88 |
| 559.62 | S | -81.18 | -83.37 | 4.47 | -2.28 | -13.00 | -68.18 |
| 638.19 | S | -80.44 | -82.09 | 4.10 | -2.46 | -13.00 | -67.44 |
| 903.97 | S | -74.86 | -75.56 | 3.65 | -2.95 | -13.00 | -61.86 |
| 1673.20 | H | -54.70 | -53.28 | 2.66 | -4.08 | -13.00 | -41.70 |
| 2509.80 | H | -44.23 | -42.72 | 3.56 | -5.07 | -13.00 | -31.23 |
| 3346.40 | H | --- | | | | | |
| 4183.00 | H | --- | | | | | |
| 5019.60 | H | --- | | | | | |
| 5856.20 | H | --- | | | | | |
| 6692.80 | H | --- | | | | | |
| 7529.40 | H | --- | | | | | |
| 8366.00 | H | --- | | | | | |

ERP(dBm) = SG Level(dBm) + Antenna Gain(dBd) + Cable Loss(dB)

Note : "F" : denotes Fundamental Frequency. ; "H" : denotes Harmonic Frequency.
 "E" : denotes Band Edge Frequency. ; "S" : denotes Spurious Frequency.
 "---" : denotes Noise Floor.

Unless otherwise stated the results shown in this test report refer only to the sample(s) tested and such sample(s) are retained for 90 days only.

除非另有說明，此報告結果僅對測試之樣品負責，同時此樣品僅保留90天。本報告未經本公司書面許可，不可部份複製。

This document is issued by the Company subject to its General Conditions of Service printed overleaf, available on request or accessible at www.sgs.com/terms_and_conditions.htm and, for electronic format documents, subject to Terms and Conditions for Electronic Documents at www.sgs.com/terms_e-document.htm. Attention is drawn to the limitation of liability, indemnification and jurisdiction issues defined therein. Any holder of this document is advised that information contained hereon reflects the Company's findings at the time of its intervention only and within the limits of Client's instructions, if any. The Company's sole responsibility is to its Client and this document does not exonerate parties to a transaction from exercising all their rights and obligations under the transaction documents. This document cannot be reproduced except in full, without prior written approval of the Company. Any unauthorized alteration, forgery or falsification of the content or appearance of this document is unlawful and offenders may be prosecuted to the fullest extent of the law.

| | | | |
|-----------------------|------------|--------------------------|---------------------|
| Operation Band | :GSM 850 | Test Date | :2013-05-27 |
| ARFCN | :CH 251 | Temp./Humi. | :24.1 deg_C / 65 RH |
| Fundamental Frequency | :848.8 MHz | Engineer | :Allen |
| Operation Mode | :TX HIGH | | |
| EUT Pol. | :E2 Plan | Measurement Antenna Pol. | :VERTICAL |

| Freq. | Note | ERP | SG | Antenna | Cable | Limit | Margin |
|---------|---------|--------|---------------------|-------------|------------|--------|--------|
| MHz | F/H/E/S | dBm | Output Level dBm | Gain dBd | Loss dB | dBm | dB |
| 114.39 | S | -84.23 | -81.91 | -1.20 | -1.11 | -13.00 | -71.23 |
| 277.35 | S | -83.08 | -85.89 | 4.46 | -1.65 | -13.00 | -70.08 |
| 472.32 | S | -81.19 | -83.66 | 4.58 | -2.10 | -13.00 | -68.19 |
| 602.30 | S | -77.40 | -79.06 | 4.03 | -2.38 | -13.00 | -64.40 |
| 719.67 | S | -77.38 | -78.69 | 3.90 | -2.59 | -13.00 | -64.38 |
| 929.19 | S | -74.02 | -74.65 | 3.64 | -3.01 | -13.00 | -61.02 |
| 1697.60 | H | | | | | | |
| 2546.40 | H | -42.78 | -40.98 | 3.30 | -5.11 | -13.00 | -29.78 |
| 3395.20 | H | --- | | | | | |
| 4244.00 | H | --- | | | | | |
| 5092.80 | H | --- | | | | | |
| 5941.60 | H | --- | | | | | |
| 6790.40 | H | --- | | | | | |
| 7639.20 | H | --- | | | | | |
| 8488.00 | H | --- | | | | | |

ERP (dBm) = SG Level(dBm) + Antenna Gain(dBd) + Cable Loss(dB)

Note : “F” : denotes Fundamental Frequency. ; “H” : denotes Harmonic Frequency.

“E” : denotes Band Edge Frequency. ; “S” : denotes Spurious Frequency.

“---“ : denotes Noise Floor.

Unless otherwise stated the results shown in this test report refer only to the sample(s) tested and such sample(s) are retained for 90 days only.

除非另有說明，此報告結果僅對測試之樣品負責，同時此樣品僅保留90天。本報告未經本公司書面許可，不可部份複製。

This document is issued by the Company subject to its General Conditions of Service printed overleaf, available on request or accessible at www.sgs.com/terms_and_conditions.htm and, for electronic format documents, subject to Terms and Conditions for Electronic Documents at www.sgs.com/terms_e-document.htm. Attention is drawn to the limitation of liability, indemnification and jurisdiction issues defined therein. Any holder of this document is advised that information contained hereon reflects the Company's findings at the time of its intervention only and within the limits of Client's instructions, if any. The Company's sole responsibility is to its Client and this document does not exonerate parties to a transaction from exercising all their rights and obligations under the transaction documents. This document cannot be reproduced except in full, without prior written approval of the Company. Any unauthorized alteration, forgery or falsification of the content or appearance of this document is unlawful and offenders may be prosecuted to the fullest extent of the law.

| | | | |
|-----------------------|------------|--------------------------|---------------------|
| Operation Band | :GSM 850 | Test Date | :2013-05-27 |
| ARFCN | :CH 251 | Temp./Humi. | :24.1 deg_C / 65 RH |
| Fundamental Frequency | :848.8 MHz | Engineer | :Allen |
| Operation Mode | :TX HIGH | | |
| EUT Pol. | :E2 Plan | Measurement Antenna Pol. | :HORIZONTAL |

| Freq. | Note | ERP | SG | Antenna | Cable | Limit | Margin |
|---------|---------|--------|---------------------|-------------|------------|--------|--------|
| MHz | F/H/E/S | dBm | Output Level dBm | Gain dBd | Loss dB | dBm | dB |
| 132.82 | S | -86.99 | -84.91 | -0.89 | -1.18 | -13.00 | -73.99 |
| 286.08 | S | -86.42 | -89.24 | 4.50 | -1.67 | -13.00 | -73.42 |
| 385.99 | S | -82.29 | -85.07 | 4.69 | -1.91 | -13.00 | -69.29 |
| 519.85 | S | -80.58 | -83.04 | 4.66 | -2.20 | -13.00 | -67.58 |
| 729.37 | S | -78.18 | -79.35 | 3.78 | -2.61 | -13.00 | -65.18 |
| 926.28 | S | -75.90 | -76.53 | 3.64 | -3.00 | -13.00 | -62.90 |
| 1697.60 | H | -54.00 | -52.53 | 2.65 | -4.11 | -13.00 | -41.00 |
| 2546.40 | H | -48.26 | -46.82 | 3.66 | -5.11 | -13.00 | -35.26 |
| 3395.20 | H | --- | | | | | |
| 4244.00 | H | --- | | | | | |
| 5092.80 | H | --- | | | | | |
| 5941.60 | H | --- | | | | | |
| 6790.40 | H | --- | | | | | |
| 7639.20 | H | --- | | | | | |
| 8488.00 | H | --- | | | | | |

ERP (dBm) = SG Level(dBm) + Antenna Gain(dBd) + Cable Loss(dB)

Note : "F" : denotes Fundamental Frequency. ; "H" : denotes Harmonic Frequency.

"E" : denotes Band Edge Frequency. ; "S" : denotes Spurious Frequency.

"---" : denotes Noise Floor.

Unless otherwise stated the results shown in this test report refer only to the sample(s) tested and such sample(s) are retained for 90 days only.

除非另有說明，此報告結果僅對測試之樣品負責，同時此樣品僅保留90天。本報告未經本公司書面許可，不可部份複製。

This document is issued by the Company subject to its General Conditions of Service printed overleaf, available on request or accessible at www.sgs.com/terms_and_conditions.htm and, for electronic format documents, subject to Terms and Conditions for Electronic Documents at www.sgs.com/terms_e-document.htm. Attention is drawn to the limitation of liability, indemnification and jurisdiction issues defined therein. Any holder of this document is advised that information contained hereon reflects the Company's findings at the time of its intervention only and within the limits of Client's instructions, if any. The Company's sole responsibility is to its Client and this document does not exonerate parties to a transaction from exercising all their rights and obligations under the transaction documents. This document cannot be reproduced except in full, without prior written approval of the Company. Any unauthorized alteration, forgery or falsification of the content or appearance of this document is unlawful and offenders may be prosecuted to the fullest extent of the law.

Radiated Spurious Emission Measurement Result: GSM 1900 Mode

| | | | |
|-----------------------|-------------|--------------------------|---------------------|
| Operation Band | :GSM 1900 | Test Date | : 2013-07-16 |
| ARFCN | :CH 512 | Temp./Humi. | :24.1 deg_C / 65 RH |
| Fundamental Frequency | :1850.2 MHz | Engineer | :Allen |
| Operation Mode | :TX LOW | | |
| EUT Pol. | :E1 Plan | Measurement Antenna Pol. | :VERTICAL |

| Freq. MHz | Note F/H/E/S | EIRP dBm | SG Output Level dBm | Antenna Gain dBi | Cable Loss dB | Limit dBm | Margin dB |
|--------------|-----------------|-------------|---------------------------|------------------------|---------------------|--------------|--------------|
| 114.39 | S | -79.68 | -79.51 | 0.95 | -1.11 | -13.00 | -66.68 |
| 272.50 | S | -81.29 | -86.33 | 6.67 | -1.63 | -13.00 | -68.29 |
| 326.82 | S | -80.25 | -85.25 | 6.78 | -1.78 | -13.00 | -67.25 |
| 467.47 | S | -79.03 | -83.64 | 6.70 | -2.09 | -13.00 | -66.03 |
| 640.13 | S | -74.98 | -78.77 | 6.25 | -2.46 | -13.00 | -61.98 |
| 768.17 | S | -74.75 | -77.88 | 5.82 | -2.69 | -13.00 | -61.75 |
| 3700.40 | H | -52.32 | -53.49 | 7.40 | -6.23 | -13.00 | -39.32 |
| 5550.60 | H | --- | | | | | |
| 7400.80 | H | --- | | | | | |
| 9251.00 | H | --- | | | | | |
| 11101.20 | H | --- | | | | | |
| 12951.40 | H | --- | | | | | |
| 14801.60 | H | --- | | | | | |
| 16651.80 | H | --- | | | | | |
| 18502.00 | H | --- | | | | | |

$EIRP (dBm) = SG \text{ Level}(dBm) + Antenna \text{ Gain}(dBi) + Cable \text{ Loss}(dB)$

Note : “F” : denotes Fundamental Frequency. ; “H” : denotes Harmonic Frequency.
 “E” : denotes Band Edge Frequency. ; “S” : denotes Spurious Frequency.
 “---” : denotes Noise Floor.

Unless otherwise stated the results shown in this test report refer only to the sample(s) tested and such sample(s) are retained for 90 days only.

除非另有說明，此報告結果僅對測試之樣品負責，同時此樣品僅保留90天。本報告未經本公司書面許可，不可部份複製。
 This document is issued by the Company subject to its General Conditions of Service printed overleaf, available on request or accessible at www.sgs.com/terms_and_conditions.htm and, for electronic format documents, subject to Terms and Conditions for Electronic Documents at www.sgs.com/terms_e-document.htm. Attention is drawn to the limitation of liability, indemnification and jurisdiction issues defined therein. Any holder of this document is advised that information contained hereon reflects the Company's findings at the time of its intervention only and within the limits of Client's instructions, if any. The Company's sole responsibility is to its Client and this document does not exonerate parties to a transaction from exercising all their rights and obligations under the transaction documents. This document cannot be reproduced except in full, without prior written approval of the Company. Any unauthorized alteration, forgery or falsification of the content or appearance of this document is unlawful and offenders may be prosecuted to the fullest extent of the law.

| | | | |
|-----------------------|-------------|--------------------------|---------------------|
| Operation Band | :GSM 1900 | Test Date | : 2013-07-16 |
| ARFCN | :CH 512 | Temp./Humi. | :24.1 deg_C / 65 RH |
| Fundamental Frequency | :1850.2 MHz | Engineer | :Allen |
| Operation Mode | :TX LOW | | |
| EUT Pol. | :E1 Plan | Measurement Antenna Pol. | :HORIZONTAL |

| Freq. | Note | EIRP | SG | Antenna | Cable | Limit | Margin |
|----------|---------|--------|---------------------|-------------|------------|--------|--------|
| MHz | F/H/E/S | dBm | Output Level dBm | Gain dBi | Loss dB | dBm | dB |
| 275.41 | S | -82.31 | -87.31 | 6.63 | -1.64 | -13.00 | -69.31 |
| 538.28 | S | -78.91 | -83.43 | 6.76 | -2.24 | -13.00 | -65.91 |
| 612.97 | S | -77.59 | -81.39 | 6.20 | -2.40 | -13.00 | -64.59 |
| 771.08 | S | -75.50 | -78.63 | 5.84 | -2.70 | -13.00 | -62.50 |
| 873.90 | S | -74.36 | -77.48 | 6.00 | -2.88 | -13.00 | -61.36 |
| 978.66 | S | -72.88 | -75.78 | 5.99 | -3.09 | -13.00 | -59.88 |
| 3700.40 | H | -53.95 | -54.63 | 6.91 | -6.23 | -13.00 | -40.95 |
| 5550.60 | H | --- | | | | | |
| 7400.80 | H | --- | | | | | |
| 9251.00 | H | --- | | | | | |
| 11101.20 | H | --- | | | | | |
| 12951.40 | H | --- | | | | | |
| 14801.60 | H | --- | | | | | |
| 16651.80 | H | --- | | | | | |
| 18502.00 | H | --- | | | | | |

EIRP (dBm) = SG Level(dBm) + Antenna Gain(dBi) + Cable Loss(dB)

Note : "F" : denotes Fundamental Frequency. ; "H" : denotes Harmonic Frequency.
 "E" : denotes Band Edge Frequency. ; "S" : denotes Spurious Frequency.
 "---" : denotes Noise Floor.

Unless otherwise stated the results shown in this test report refer only to the sample(s) tested and such sample(s) are retained for 90 days only.

除非另有說明，此報告結果僅對測試之樣品負責，同時此樣品僅保留90天。本報告未經本公司書面許可，不可部份複製。

This document is issued by the Company subject to its General Conditions of Service printed overleaf, available on request or accessible at www.sgs.com/terms_and_conditions.htm and, for electronic format documents, subject to Terms and Conditions for Electronic Documents at www.sgs.com/terms_e-document.htm. Attention is drawn to the limitation of liability, indemnification and jurisdiction issues defined therein. Any holder of this document is advised that information contained hereon reflects the Company's findings at the time of its intervention only and within the limits of Client's instructions, if any. The Company's sole responsibility is to its Client and this document does not exonerate parties to a transaction from exercising all their rights and obligations under the transaction documents. This document cannot be reproduced except in full, without prior written approval of the Company. Any unauthorized alteration, forgery or falsification of the content or appearance of this document is unlawful and offenders may be prosecuted to the fullest extent of the law.

| | | | |
|-----------------------|-----------|--------------------------|---------------------|
| Operation Band | :GSM 1900 | Test Date | :2013-05-03 |
| ARFCN | :CH 661 | Temp./Humi. | :24.1 deg_C / 65 RH |
| Fundamental Frequency | :1880 MHz | Engineer | :Allen |
| Operation Mode | :TX MID | | |
| EUT Pol. | :E1 Plan | Measurement Antenna Pol. | :VERTICAL |

| Freq. | Note | EIRP | SG | Antenna | Cable | Limit | Margin |
|----------|---------|--------|---------------------|-------------|------------|--------|--------|
| MHz | F/H/E/S | dBm | Output Level dBm | Gain dBi | Loss dB | dBm | dB |
| 114.39 | S | -80.04 | -79.87 | 0.95 | -1.11 | -13.00 | -67.04 |
| 157.07 | S | -80.71 | -80.88 | 1.43 | -1.26 | -13.00 | -67.71 |
| 286.08 | S | -79.50 | -84.48 | 6.65 | -1.67 | -13.00 | -66.50 |
| 496.57 | S | -78.59 | -83.29 | 6.85 | -2.16 | -13.00 | -65.59 |
| 846.74 | S | -75.06 | -78.39 | 6.17 | -2.84 | -13.00 | -62.06 |
| 916.58 | S | -72.69 | -75.51 | 5.79 | -2.98 | -13.00 | -59.69 |
| 3760.00 | H | -51.44 | -52.54 | 7.42 | -6.32 | -13.00 | -38.44 |
| 5640.00 | H | -46.78 | -47.90 | 9.01 | -7.89 | -13.00 | -33.78 |
| 7520.00 | H | --- | | | | | |
| 9400.00 | H | --- | | | | | |
| 11280.00 | H | --- | | | | | |
| 13160.00 | H | --- | | | | | |
| 15040.00 | H | --- | | | | | |
| 16920.00 | H | --- | | | | | |
| 18800.00 | H | --- | | | | | |

EIRP (dBm) = SG Level(dBm) + Antenna Gain(dBi) + Cable Loss(dB)

Note : "F" : denotes Fundamental Frequency. ; "H" : denotes Harmonic Frequency.
 "E" : denotes Band Edge Frequency. ; "S" : denotes Spurious Frequency.
 "---" : denotes Noise Floor.

Unless otherwise stated the results shown in this test report refer only to the sample(s) tested and such sample(s) are retained for 90 days only.

除非另有說明，此報告結果僅對測試之樣品負責，同時此樣品僅保留90天。本報告未經本公司書面許可，不可部份複製。

This document is issued by the Company subject to its General Conditions of Service printed overleaf, available on request or accessible at www.sgs.com/terms_and_conditions.htm and, for electronic format documents, subject to Terms and Conditions for Electronic Documents at www.sgs.com/terms_e-document.htm. Attention is drawn to the limitation of liability, indemnification and jurisdiction issues defined therein. Any holder of this document is advised that information contained hereon reflects the Company's findings at the time of its intervention only and within the limits of Client's instructions, if any. The Company's sole responsibility is to its Client and this document does not exonerate parties to a transaction from exercising all their rights and obligations under the transaction documents. This document cannot be reproduced except in full, without prior written approval of the Company. Any unauthorized alteration, forgery or falsification of the content or appearance of this document is unlawful and offenders may be prosecuted to the fullest extent of the law.

| | | | |
|-----------------------|-----------|--------------------------|---------------------|
| Operation Band | :GSM 1900 | Test Date | :2013-05-03 |
| ARFCN | :CH 661 | Temp./Humi. | :24.1 deg_C / 65 RH |
| Fundamental Frequency | :1880 MHz | Engineer | :Allen |
| Operation Mode | :TX MID | | |
| EUT Pol. | :E1 Plan | Measurement Antenna Pol. | :HORIZONTAL |

| Freq. MHz | Note F/H/E/S | EIRP dBm | SG Output Level dBm | Antenna Gain dBi | Cable Loss dB | Limit dBm | Margin dB |
|--------------|-----------------|-------------|---------------------------|------------------------|---------------------|--------------|--------------|
| 88.20 | S | -84.32 | -84.19 | 0.86 | -0.99 | -13.00 | -71.32 |
| 271.53 | S | -84.21 | -89.27 | 6.69 | -1.63 | -13.00 | -71.21 |
| 358.83 | S | -81.97 | -86.99 | 6.87 | -1.85 | -13.00 | -68.97 |
| 705.12 | S | -77.26 | -80.92 | 6.23 | -2.57 | -13.00 | -64.26 |
| 858.38 | S | -74.85 | -78.11 | 6.11 | -2.86 | -13.00 | -61.85 |
| 942.77 | S | -74.07 | -76.81 | 5.78 | -3.04 | -13.00 | -61.07 |
| 3760.00 | H | -52.10 | -52.63 | 6.85 | -6.32 | -13.00 | -39.10 |
| 5640.00 | H | -44.43 | -44.84 | 8.30 | -7.89 | -13.00 | -31.43 |
| 7520.00 | H | --- | | | | | |
| 9400.00 | H | --- | | | | | |
| 11280.00 | H | --- | | | | | |
| 13160.00 | H | --- | | | | | |
| 15040.00 | H | --- | | | | | |
| 16920.00 | H | --- | | | | | |
| 18800.00 | H | --- | | | | | |

EIRP (dBm) = SG Level(dBm) + Antenna Gain(dBi) + Cable Loss(dB)

Note : "F" : denotes Fundamental Frequency. ; "H" : denotes Harmonic Frequency.
 "E" : denotes Band Edge Frequency. ; "S" : denotes Spurious Frequency.
 "---" : denotes Noise Floor.

Unless otherwise stated the results shown in this test report refer only to the sample(s) tested and such sample(s) are retained for 90 days only.

除非另有說明，此報告結果僅對測試之樣品負責，同時此樣品僅保留90天。本報告未經本公司書面許可，不可部份複製。

This document is issued by the Company subject to its General Conditions of Service printed overleaf, available on request or accessible at www.sgs.com/terms_and_conditions.htm and, for electronic format documents, subject to Terms and Conditions for Electronic Documents at www.sgs.com/terms_e-document.htm. Attention is drawn to the limitation of liability, indemnification and jurisdiction issues defined therein. Any holder of this document is advised that information contained hereon reflects the Company's findings at the time of its intervention only and within the limits of Client's instructions, if any. The Company's sole responsibility is to its Client and this document does not exonerate parties to a transaction from exercising all their rights and obligations under the transaction documents. This document cannot be reproduced except in full, without prior written approval of the Company. Any unauthorized alteration, forgery or falsification of the content or appearance of this document is unlawful and offenders may be prosecuted to the fullest extent of the law.

| | | | |
|-----------------------|-------------|--------------------------|---------------------|
| Operation Band | :GSM 1900 | Test Date | :2013-05-03 |
| ARFCN | :CH 810 | Temp./Humi. | :24.1 deg_C / 65 RH |
| Fundamental Frequency | :1909.8 MHz | Engineer | :Allen |
| Operation Mode | :TX HIGH | | |
| EUT Pol. | :E1 Plan | Measurement Antenna Pol. | :VERTICAL |

| Freq. | Note | EIRP | SG | Antenna | Cable | Limit | Margin |
|----------|---------|--------|---------------------|-------------|------------|--------|--------|
| MHz | F/H/E/S | dBm | Output Level dBm | Gain dBi | Loss dB | dBm | dB |
| 114.39 | S | -79.99 | -79.82 | 0.95 | -1.11 | -13.00 | -66.99 |
| 157.07 | S | -80.98 | -81.14 | 1.43 | -1.26 | -13.00 | -67.98 |
| 258.92 | S | -81.51 | -86.76 | 6.83 | -1.59 | -13.00 | -68.51 |
| 343.31 | S | -80.60 | -85.67 | 6.90 | -1.82 | -13.00 | -67.60 |
| 677.96 | S | -75.23 | -78.99 | 6.29 | -2.52 | -13.00 | -62.23 |
| 912.70 | S | -73.24 | -76.06 | 5.79 | -2.97 | -13.00 | -60.24 |
| 3819.60 | H | -50.05 | -51.18 | 7.51 | -6.39 | -13.00 | -37.05 |
| 5729.40 | H | -45.50 | -46.60 | 9.03 | -7.92 | -13.00 | -32.50 |
| 7639.20 | H | --- | | | | | |
| 9549.00 | H | --- | | | | | |
| 11458.80 | H | --- | | | | | |
| 13368.60 | H | --- | | | | | |
| 15278.40 | H | --- | | | | | |
| 17188.20 | H | --- | | | | | |
| 19098.00 | H | --- | | | | | |

EIRP (dBm) = SG Level(dBm) + Antenna Gain(dBi) + Cable Loss(dB)

Note : "F" : denotes Fundamental Frequency. ; "H" : denotes Harmonic Frequency.

"E" : denotes Band Edge Frequency. ; "S" : denotes Spurious Frequency.

"---" : denotes Noise Floor.

Unless otherwise stated the results shown in this test report refer only to the sample(s) tested and such sample(s) are retained for 90 days only.

除非另有說明，此報告結果僅對測試之樣品負責，同時此樣品僅保留90天。本報告未經本公司書面許可，不可部份複製。

This document is issued by the Company subject to its General Conditions of Service printed overleaf, available on request or accessible at www.sgs.com/terms_and_conditions.htm and, for electronic format documents, subject to Terms and Conditions for Electronic Documents at www.sgs.com/terms_e-document.htm. Attention is drawn to the limitation of liability, indemnification and jurisdiction issues defined therein. Any holder of this document is advised that information contained hereon reflects the Company's findings at the time of its intervention only and within the limits of Client's instructions, if any. The Company's sole responsibility is to its Client and this document does not exonerate parties to a transaction from exercising all their rights and obligations under the transaction documents. This document cannot be reproduced except in full, without prior written approval of the Company. Any unauthorized alteration, forgery or falsification of the content or appearance of this document is unlawful and offenders may be prosecuted to the fullest extent of the law.

| | | | |
|-----------------------|-------------|--------------------------|---------------------|
| Operation Band | :GSM 1900 | Test Date | :2013-05-03 |
| ARFCN | :CH 810 | Temp./Humi. | :24.1 deg_C / 65 RH |
| Fundamental Frequency | :1909.8 MHz | Engineer | :Allen |
| Operation Mode | :TX HIGH | | |
| EUT Pol. | :E1 Plan | Measurement Antenna Pol. | :HORIZONTAL |

| Freq. | Note | EIRP | SG | Antenna | Cable | Limit | Margin |
|----------|---------|--------|---------------------|-------------|------------|--------|--------|
| MHz | F/H/E/S | dBm | Output Level dBm | Gain dBi | Loss dB | dBm | dB |
| 154.16 | S | -84.75 | -84.76 | 1.27 | -1.25 | -13.00 | -71.75 |
| 379.20 | S | -81.56 | -86.46 | 6.79 | -1.90 | -13.00 | -68.56 |
| 504.33 | S | -79.31 | -83.99 | 6.86 | -2.17 | -13.00 | -66.31 |
| 646.92 | S | -78.37 | -82.16 | 6.26 | -2.47 | -13.00 | -65.37 |
| 770.11 | S | -74.81 | -77.94 | 5.83 | -2.70 | -13.00 | -61.81 |
| 912.70 | S | -74.22 | -77.05 | 5.79 | -2.97 | -13.00 | -61.22 |
| 3819.60 | H | -53.23 | -53.89 | 7.05 | -6.39 | -13.00 | -40.23 |
| 5729.40 | H | -44.94 | -45.33 | 8.32 | -7.92 | -13.00 | -31.94 |
| 7639.20 | H | --- | | | | | |
| 9549.00 | H | --- | | | | | |
| 11458.80 | H | --- | | | | | |
| 13368.60 | H | --- | | | | | |
| 15278.40 | H | --- | | | | | |
| 17188.20 | H | --- | | | | | |
| 19098.00 | H | --- | | | | | |

EIRP (dBm) = SG Level(dBm) + Antenna Gain(dBi) + Cable Loss(dB)

Note : "F" : denotes Fundamental Frequency. ; "H" : denotes Harmonic Frequency.

"E" : denotes Band Edge Frequency. ; "S" : denotes Spurious Frequency.

"---" : denotes Noise Floor.

Unless otherwise stated the results shown in this test report refer only to the sample(s) tested and such sample(s) are retained for 90 days only.

除非另有說明，此報告結果僅對測試之樣品負責，同時此樣品僅保留90天。本報告未經本公司書面許可，不可部份複製。

This document is issued by the Company subject to its General Conditions of Service printed overleaf, available on request or accessible at www.sgs.com/terms_and_conditions.htm and, for electronic format documents, subject to Terms and Conditions for Electronic Documents at www.sgs.com/terms_e-document.htm. Attention is drawn to the limitation of liability, indemnification and jurisdiction issues defined therein. Any holder of this document is advised that information contained hereon reflects the Company's findings at the time of its intervention only and within the limits of Client's instructions, if any. The Company's sole responsibility is to its Client and this document does not exonerate parties to a transaction from exercising all their rights and obligations under the transaction documents. This document cannot be reproduced except in full, without prior written approval of the Company. Any unauthorized alteration, forgery or falsification of the content or appearance of this document is unlawful and offenders may be prosecuted to the fullest extent of the law.

Radiated Spurious Emission Measurement Result: WCDMA II Mode

| | | | |
|-----------------------|-------------|--------------------------|---------------------|
| Operation Band | :WCDMA B2 | Test Date | : 2013-07-16 |
| ARFCN | :CH 9262 | Temp./Humi. | :24.1 deg_C / 65 RH |
| Fundamental Frequency | :1852.4 MHz | Engineer | :Allen |
| Operation Mode | :TX LOW | | |
| EUT Pol. | :E1 Plan | Measurement Antenna Pol. | :VERTICAL |

| Freq. | Note | EIRP | SG | Antenna | Cable | Limit | Margin |
|----------|---------|--------|---------------------|-------------|------------|--------|--------|
| MHz | F/H/E/S | dBm | Output Level dBm | Gain dBi | Loss dB | dBm | dB |
| 256.01 | S | -81.76 | -86.97 | 6.79 | -1.58 | -13.00 | -68.76 |
| 421.88 | S | -79.68 | -84.44 | 6.75 | -1.99 | -13.00 | -66.68 |
| 562.53 | S | -75.80 | -80.11 | 6.59 | -2.29 | -13.00 | -62.80 |
| 697.36 | S | -75.31 | -79.05 | 6.30 | -2.55 | -13.00 | -62.31 |
| 913.67 | S | -72.27 | -75.09 | 5.79 | -2.97 | -13.00 | -59.27 |
| 955.38 | S | -71.98 | -74.73 | 5.82 | -3.07 | -13.00 | -58.98 |
| 3704.80 | H | -52.14 | -53.31 | 7.40 | -6.24 | -13.00 | -39.14 |
| 5557.20 | H | --- | | | | | |
| 7409.60 | H | --- | | | | | |
| 9262.00 | H | --- | | | | | |
| 11114.40 | H | --- | | | | | |
| 12966.80 | H | --- | | | | | |
| 14819.20 | H | --- | | | | | |
| 16671.60 | H | --- | | | | | |
| 18524.00 | H | --- | | | | | |

EIRP (dBm) = SG Level(dBm) + Antenna Gain(dBi) + Cable Loss(dB)

Note : “F” : denotes Fundamental Frequency. ; “H” : denotes Harmonic Frequency.
 “E” : denotes Band Edge Frequency. ; “S” : denotes Spurious Frequency.
 “---” : denotes Noise Floor.

Unless otherwise stated the results shown in this test report refer only to the sample(s) tested and such sample(s) are retained for 90 days only.

除非另有說明，此報告結果僅對測試之樣品負責，同時此樣品僅保留90天。本報告未經本公司書面許可，不可部份複製。
 This document is issued by the Company subject to its General Conditions of Service printed overleaf, available on request or accessible at www.sgs.com/terms_and_conditions.htm and, for electronic format documents, subject to Terms and Conditions for Electronic Documents at www.sgs.com/terms_e-document.htm. Attention is drawn to the limitation of liability, indemnification and jurisdiction issues defined therein. Any holder of this document is advised that information contained hereon reflects the Company's findings at the time of its intervention only and within the limits of Client's instructions, if any. The Company's sole responsibility is to its Client and this document does not exonerate parties to a transaction from exercising all their rights and obligations under the transaction documents. This document cannot be reproduced except in full, without prior written approval of the Company. Any unauthorized alteration, forgery or falsification of the content or appearance of this document is unlawful and offenders may be prosecuted to the fullest extent of the law.

| | | | |
|-----------------------|-------------|--------------------------|---------------------|
| Operation Band | :WCDMA B2 | Test Date | : 2013-07-16 |
| ARFCN | :CH 9262 | Temp./Humi. | :24.1 deg_C / 65 RH |
| Fundamental Frequency | :1852.4 MHz | Engineer | :Allen |
| Operation Mode | :TX LOW | | |
| EUT Pol. | :E1 Plan | Measurement Antenna Pol. | :HORIZONTAL |

| Freq. | Note | EIRP | SG | Antenna | Cable | Limit | Margin |
|----------|---------|--------|---------------------|-------------|------------|--------|--------|
| MHz | F/H/E/S | dBm | Output Level dBm | Gain dBi | Loss dB | dBm | dB |
| 88.20 | S | -84.62 | -84.49 | 0.86 | -0.99 | -13.00 | -71.62 |
| 330.70 | S | -83.71 | -88.74 | 6.81 | -1.79 | -13.00 | -70.71 |
| 343.31 | S | -81.78 | -86.86 | 6.90 | -1.82 | -13.00 | -68.78 |
| 631.40 | S | -78.04 | -81.84 | 6.24 | -2.44 | -13.00 | -65.04 |
| 758.47 | S | -76.44 | -79.51 | 5.74 | -2.67 | -13.00 | -63.44 |
| 931.13 | S | -73.37 | -76.15 | 5.79 | -3.01 | -13.00 | -60.37 |
| 3704.80 | H | -53.91 | -54.57 | 6.90 | -6.24 | -13.00 | -40.91 |
| 5557.20 | H | --- | | | | | |
| 7409.60 | H | --- | | | | | |
| 9262.00 | H | --- | | | | | |
| 11114.40 | H | --- | | | | | |
| 12966.80 | H | --- | | | | | |
| 14819.20 | H | --- | | | | | |
| 16671.60 | H | --- | | | | | |
| 18524.00 | H | --- | | | | | |

EIRP (dBm) = SG Level(dBm) + Antenna Gain(dBi) + Cable Loss(dB)

Note : "F" : denotes Fundamental Frequency. ; "H" : denotes Harmonic Frequency.
 "E" : denotes Band Edge Frequency. ; "S" : denotes Spurious Frequency.
 "---" : denotes Noise Floor.

Unless otherwise stated the results shown in this test report refer only to the sample(s) tested and such sample(s) are retained for 90 days only.

除非另有說明，此報告結果僅對測試之樣品負責，同時此樣品僅保留90天。本報告未經本公司書面許可，不可部份複製。

This document is issued by the Company subject to its General Conditions of Service printed overleaf, available on request or accessible at www.sgs.com/terms_and_conditions.htm and, for electronic format documents, subject to Terms and Conditions for Electronic Documents at www.sgs.com/terms_e-document.htm. Attention is drawn to the limitation of liability, indemnification and jurisdiction issues defined therein. Any holder of this document is advised that information contained hereon reflects the Company's findings at the time of its intervention only and within the limits of Client's instructions, if any. The Company's sole responsibility is to its Client and this document does not exonerate parties to a transaction from exercising all their rights and obligations under the transaction documents. This document cannot be reproduced except in full, without prior written approval of the Company. Any unauthorized alteration, forgery or falsification of the content or appearance of this document is unlawful and offenders may be prosecuted to the fullest extent of the law.

| | | | |
|-----------------------|-----------|--------------------------|---------------------|
| Operation Band | :WCDMA B2 | Test Date | :2013-05-03 |
| ARFCN | :CH 9400 | Temp./Humi. | :24.1 deg_C / 65 RH |
| Fundamental Frequency | :1880 MHz | Engineer | :Allen |
| Operation Mode | :TX MID | | |
| EUT Pol. | :E1 Plan | Measurement Antenna Pol. | :VERTICAL |

| Freq. | Note | EIRP | SG | Antenna | Cable | Limit | Margin |
|----------|---------|--------|---------------------|-------------|------------|--------|--------|
| MHz | F/H/E/S | dBm | Output Level dBm | Gain dBi | Loss dB | dBm | dB |
| 114.39 | S | -80.54 | -80.37 | 0.95 | -1.11 | -13.00 | -67.54 |
| 343.31 | S | -80.40 | -85.48 | 6.90 | -1.82 | -13.00 | -67.40 |
| 535.37 | S | -77.03 | -81.56 | 6.77 | -2.23 | -13.00 | -64.03 |
| 630.43 | S | -75.76 | -79.55 | 6.24 | -2.44 | -13.00 | -62.76 |
| 827.34 | S | -74.54 | -77.85 | 6.12 | -2.81 | -13.00 | -61.54 |
| 954.41 | S | -71.43 | -74.18 | 5.81 | -3.07 | -13.00 | -58.43 |
| 3760.00 | H | -53.43 | -54.53 | 7.42 | -6.32 | -13.00 | -40.43 |
| 5640.00 | H | --- | | | | | |
| 7520.00 | H | --- | | | | | |
| 9400.00 | H | --- | | | | | |
| 11280.00 | H | --- | | | | | |
| 13160.00 | H | --- | | | | | |
| 15040.00 | H | --- | | | | | |
| 16920.00 | H | --- | | | | | |
| 18800.00 | H | --- | | | | | |

EIRP (dBm) = SG Level(dBm) + Antenna Gain(dBi) + Cable Loss(dB)

Note : "F" : denotes Fundamental Frequency. ; "H" : denotes Harmonic Frequency.

"E" : denotes Band Edge Frequency. ; "S" : denotes Spurious Frequency.

"---" : denotes Noise Floor.

Unless otherwise stated the results shown in this test report refer only to the sample(s) tested and such sample(s) are retained for 90 days only.

除非另有說明，此報告結果僅對測試之樣品負責，同時此樣品僅保留90天。本報告未經本公司書面許可，不可部份複製。

This document is issued by the Company subject to its General Conditions of Service printed overleaf, available on request or accessible at www.sgs.com/terms_and_conditions.htm and, for electronic format documents, subject to Terms and Conditions for Electronic Documents at www.sgs.com/terms_e-document.htm. Attention is drawn to the limitation of liability, indemnification and jurisdiction issues defined therein. Any holder of this document is advised that information contained hereon reflects the Company's findings at the time of its intervention only and within the limits of Client's instructions, if any. The Company's sole responsibility is to its Client and this document does not exonerate parties to a transaction from exercising all their rights and obligations under the transaction documents. This document cannot be reproduced except in full, without prior written approval of the Company. Any unauthorized alteration, forgery or falsification of the content or appearance of this document is unlawful and offenders may be prosecuted to the fullest extent of the law.

Operation Band :WCDMA B2 Test Date :2013-05-03
ARFCN :CH 9400 Temp./Humi. :24.1 deg_C / 65 RH
Fundamental Frequency :1880 MHz Engineer :Allen
Operation Mode :TX MID
EUT Pol. :E1 Plan Measurement Antenna Pol. :HORIZONTAL

| Freq. MHz | Note F/H/E/S | EIRP dBm | SG Output Level dBm | Antenna Gain dBi | Cable Loss dB | Limit dBm | Margin dB |
|--------------|-----------------|-------------|---------------------------|------------------------|---------------------|--------------|--------------|
| 158.04 | S | -85.26 | -85.47 | 1.48 | -1.26 | -13.00 | -72.26 |
| 387.93 | S | -81.08 | -86.01 | 6.85 | -1.92 | -13.00 | -68.08 |
| 532.46 | S | -79.66 | -84.21 | 6.78 | -2.23 | -13.00 | -66.66 |
| 677.96 | S | -77.38 | -81.14 | 6.29 | -2.52 | -13.00 | -64.38 |
| 830.25 | S | -75.01 | -78.33 | 6.13 | -2.81 | -13.00 | -62.01 |
| 949.56 | S | -73.77 | -76.49 | 5.78 | -3.06 | -13.00 | -60.77 |
| 3760.00 | H | -52.89 | -53.42 | 6.85 | -6.32 | -13.00 | -39.89 |
| 5640.00 | H | --- | | | | | |
| 7520.00 | H | --- | | | | | |
| 9400.00 | H | --- | | | | | |
| 11280.00 | H | --- | | | | | |
| 13160.00 | H | --- | | | | | |
| 15040.00 | H | --- | | | | | |
| 16920.00 | H | --- | | | | | |
| 18800.00 | H | --- | | | | | |

EIRP (dBm) = SG Level(dBm) + Antenna Gain(dBi) + Cable Loss(dB)

Note : "F" : denotes Fundamental Frequency. ; "H" : denotes Harmonic Frequency.
"E" : denotes Band Edge Frequency. ; "S" : denotes Spurious Frequency.
"---" : denotes Noise Floor.

Unless otherwise stated the results shown in this test report refer only to the sample(s) tested and such sample(s) are retained for 90 days only.

除非另有說明，此報告結果僅對測試之樣品負責，同時此樣品僅保留90天。本報告未經本公司書面許可，不可部份複製。

This document is issued by the Company subject to its General Conditions of Service printed overleaf, available on request or accessible at www.sgs.com/terms_and_conditions.htm and, for electronic format documents, subject to Terms and Conditions for Electronic Documents at www.sgs.com/terms_e-document.htm. Attention is drawn to the limitation of liability, indemnification and jurisdiction issues defined therein. Any holder of this document is advised that information contained hereon reflects the Company's findings at the time of its intervention only and within the limits of Client's instructions, if any. The Company's sole responsibility is to its Client and this document does not exonerate parties to a transaction from exercising all their rights and obligations under the transaction documents. This document cannot be reproduced except in full, without prior written approval of the Company. Any unauthorized alteration, forgery or falsification of the content or appearance of this document is unlawful and offenders may be prosecuted to the fullest extent of the law.

| | | | |
|-----------------------|-------------|--------------------------|---------------------|
| Operation Band | :WCDMA B2 | Test Date | :2013-05-03 |
| ARFCN | :CH 9538 | Temp./Humi. | :24.1 deg_C / 65 RH |
| Fundamental Frequency | :1907.6 MHz | Engineer | :Allen |
| Operation Mode | :TX HIGH | | |
| EUT Pol. | :E1 Plan | Measurement Antenna Pol. | :VERTICAL |

| Freq. | Note | EIRP | SG | Antenna | Cable | Limit | Margin |
|----------|---------|--------|---------------------|-------------|------------|--------|--------|
| MHz | F/H/E/S | dBm | Output Level dBm | Gain dBi | Loss dB | dBm | dB |
| 114.39 | S | -79.86 | -79.69 | 0.95 | -1.11 | -13.00 | -66.86 |
| 261.83 | S | -81.13 | -86.35 | 6.82 | -1.60 | -13.00 | -68.13 |
| 466.50 | S | -78.98 | -83.59 | 6.70 | -2.09 | -13.00 | -65.98 |
| 591.63 | S | -75.71 | -79.63 | 6.27 | -2.35 | -13.00 | -62.71 |
| 768.17 | S | -74.87 | -77.99 | 5.82 | -2.69 | -13.00 | -61.87 |
| 909.79 | S | -72.11 | -74.95 | 5.80 | -2.96 | -13.00 | -59.11 |
| 3815.20 | H | -54.54 | -55.66 | 7.50 | -6.38 | -13.00 | -41.54 |
| 5722.80 | H | --- | | | | | |
| 7630.40 | H | --- | | | | | |
| 9538.00 | H | --- | | | | | |
| 11445.60 | H | --- | | | | | |
| 13353.20 | H | --- | | | | | |
| 15260.80 | H | --- | | | | | |
| 17168.40 | H | --- | | | | | |
| 19076.00 | H | --- | | | | | |

EIRP (dBm) = SG Level(dBm) + Antenna Gain(dBi) + Cable Loss(dB)

Note : "F" : denotes Fundamental Frequency. ; "H" : denotes Harmonic Frequency.
 "E" : denotes Band Edge Frequency. ; "S" : denotes Spurious Frequency.
 "---" : denotes Noise Floor.

Unless otherwise stated the results shown in this test report refer only to the sample(s) tested and such sample(s) are retained for 90 days only.

除非另有說明，此報告結果僅對測試之樣品負責，同時此樣品僅保留90天。本報告未經本公司書面許可，不可部份複製。

This document is issued by the Company subject to its General Conditions of Service printed overleaf, available on request or accessible at www.sgs.com/terms_and_conditions.htm and, for electronic format documents, subject to Terms and Conditions for Electronic Documents at www.sgs.com/terms_e-document.htm. Attention is drawn to the limitation of liability, indemnification and jurisdiction issues defined therein. Any holder of this document is advised that information contained hereon reflects the Company's findings at the time of its intervention only and within the limits of Client's instructions, if any. The Company's sole responsibility is to its Client and this document does not exonerate parties to a transaction from exercising all their rights and obligations under the transaction documents. This document cannot be reproduced except in full, without prior written approval of the Company. Any unauthorized alteration, forgery or falsification of the content or appearance of this document is unlawful and offenders may be prosecuted to the fullest extent of the law.

| | | | |
|-----------------------|-------------|--------------------------|---------------------|
| Operation Band | :WCDMA B2 | Test Date | :2013-05-03 |
| ARFCN | :CH 9538 | Temp./Humi. | :24.1 deg_C / 65 RH |
| Fundamental Frequency | :1907.6 MHz | Engineer | :Allen |
| Operation Mode | :TX HIGH | | |
| EUT Pol. | :E1 Plan | Measurement Antenna Pol. | :HORIZONTAL |

| Freq. | Note | EIRP | SG | Antenna | Cable | Limit | Margin |
|----------|---------|--------|---------------------|-------------|------------|--------|--------|
| MHz | F/H/E/S | dBm | Output Level dBm | Gain dBi | Loss dB | dBm | dB |
| 143.49 | S | -84.50 | -84.18 | 0.89 | -1.22 | -13.00 | -71.50 |
| 320.03 | S | -84.05 | -89.07 | 6.78 | -1.76 | -13.00 | -71.05 |
| 545.07 | S | -78.54 | -83.03 | 6.74 | -2.25 | -13.00 | -65.54 |
| 682.81 | S | -77.13 | -80.89 | 6.29 | -2.53 | -13.00 | -64.13 |
| 779.81 | S | -74.35 | -77.54 | 5.90 | -2.72 | -13.00 | -61.35 |
| 870.99 | S | -74.22 | -77.36 | 6.02 | -2.88 | -13.00 | -61.22 |
| 3815.20 | H | -55.13 | -55.78 | 7.03 | -6.38 | -13.00 | -42.13 |
| 5722.80 | H | --- | | | | | |
| 7630.40 | H | --- | | | | | |
| 9538.00 | H | --- | | | | | |
| 11445.60 | H | --- | | | | | |
| 13353.20 | H | --- | | | | | |
| 15260.80 | H | --- | | | | | |
| 17168.40 | H | --- | | | | | |
| 19076.00 | H | --- | | | | | |

EIRP (dBm) = SG Level(dBm) + Antenna Gain(dBi) + Cable Loss(dB)

Note : "F" : denotes Fundamental Frequency. ; "H" : denotes Harmonic Frequency.
 "E" : denotes Band Edge Frequency. ; "S" : denotes Spurious Frequency.
 "---" : denotes Noise Floor.

Unless otherwise stated the results shown in this test report refer only to the sample(s) tested and such sample(s) are retained for 90 days only.

除非另有說明，此報告結果僅對測試之樣品負責，同時此樣品僅保留90天。本報告未經本公司書面許可，不可部份複製。

This document is issued by the Company subject to its General Conditions of Service printed overleaf, available on request or accessible at www.sgs.com/terms_and_conditions.htm and, for electronic format documents, subject to Terms and Conditions for Electronic Documents at www.sgs.com/terms_e-document.htm. Attention is drawn to the limitation of liability, indemnification and jurisdiction issues defined therein. Any holder of this document is advised that information contained hereon reflects the Company's findings at the time of its intervention only and within the limits of Client's instructions, if any. The Company's sole responsibility is to its Client and this document does not exonerate parties to a transaction from exercising all their rights and obligations under the transaction documents. This document cannot be reproduced except in full, without prior written approval of the Company. Any unauthorized alteration, forgery or falsification of the content or appearance of this document is unlawful and offenders may be prosecuted to the fullest extent of the law.

Radiated Spurious Emission Measurement Result: WCDMA IV Mode

| | | | |
|-----------------------|-------------|--------------------------|---------------------|
| Operation Band | :WCDMA B4 | Test Date | : 2013-07-16 |
| ARFCN | :CH 1312 | Temp./Humi. | :24.1 deg_C / 65 RH |
| Fundamental Frequency | :1712.4 MHz | Engineer | :Allen |
| Operation Mode | :TX LOW | | |
| EUT Pol. | :H Plan | Measurement Antenna Pol. | :VERTICAL |

| Freq. MHz | Note F/H/E/S | EIRP dBm | SG Output Level dBm | Antenna Gain dBi | Cable Loss dB | Limit dBm | Margin dB |
|--------------|-----------------|-------------|---------------------------|------------------------|---------------------|--------------|--------------|
| 158.04 | S | -82.37 | -82.58 | 1.48 | -1.26 | -13.00 | -69.37 |
| 329.73 | S | -79.97 | -84.99 | 6.80 | -1.78 | -13.00 | -66.97 |
| 428.67 | S | -79.32 | -84.02 | 6.71 | -2.01 | -13.00 | -66.32 |
| 609.09 | S | -75.83 | -79.64 | 6.20 | -2.39 | -13.00 | -62.83 |
| 770.11 | S | -74.15 | -77.29 | 5.83 | -2.70 | -13.00 | -61.15 |
| 875.84 | S | -73.29 | -76.39 | 5.98 | -2.88 | -13.00 | -60.29 |
| 3424.80 | H | -52.42 | -53.61 | 7.20 | -6.02 | -13.00 | -39.42 |
| 5137.20 | H | --- | | | | | |
| 6849.60 | H | --- | | | | | |
| 8562.00 | H | --- | | | | | |
| 10274.40 | H | --- | | | | | |
| 11986.80 | H | --- | | | | | |
| 13699.20 | H | --- | | | | | |
| 15411.60 | H | --- | | | | | |
| 17124.00 | H | --- | | | | | |

EIRP (dBm) = SG Level(dBm) + Antenna Gain(dBi) + Cable Loss(dB)

Note : “F” : denotes Fundamental Frequency. ; “H” : denotes Harmonic Frequency.
 “E” : denotes Band Edge Frequency. ; “S” : denotes Spurious Frequency.
 “---” : denotes Noise Floor.

Unless otherwise stated the results shown in this test report refer only to the sample(s) tested and such sample(s) are retained for 90 days only.

除非另有說明，此報告結果僅對測試之樣品負責，同時此樣品僅保留90天。本報告未經本公司書面許可，不可部份複製。

This document is issued by the Company subject to its General Conditions of Service printed overleaf, available on request or accessible at www.sgs.com/terms_and_conditions.htm and, for electronic format documents, subject to Terms and Conditions for Electronic Documents at www.sgs.com/terms_e-document.htm. Attention is drawn to the limitation of liability, indemnification and jurisdiction issues defined therein. Any holder of this document is advised that information contained hereon reflects the Company's findings at the time of its intervention only and within the limits of Client's instructions, if any. The Company's sole responsibility is to its Client and this document does not exonerate parties to a transaction from exercising all their rights and obligations under the transaction documents. This document cannot be reproduced except in full, without prior written approval of the Company. Any unauthorized alteration, forgery or falsification of the content or appearance of this document is unlawful and offenders may be prosecuted to the fullest extent of the law.

Operation Band :WCDMA B4 Test Date : 2013-07-16
ARFCN :CH 1312 Temp./Humi. :24.1 deg_C / 65 RH
Fundamental Frequency :1712.4 MHz Engineer :Allen
Operation Mode :TX LOW
EUT Pol. :H Plan Measurement Antenna Pol. :HORIZONTAL

| Freq. MHz | Note F/H/E/S | EIRP dBm | SG Output Level dBm | Antenna Gain dBi | Cable Loss dB | Limit dBm | Margin dB |
|--------------|-----------------|-------------|---------------------------|------------------------|---------------------|--------------|--------------|
| 166.77 | S | -87.06 | -88.32 | 2.56 | -1.30 | -13.00 | -74.06 |
| 339.43 | S | -80.42 | -85.48 | 6.87 | -1.81 | -13.00 | -67.42 |
| 564.47 | S | -79.16 | -83.44 | 6.57 | -2.29 | -13.00 | -66.16 |
| 717.73 | S | -76.50 | -79.99 | 6.08 | -2.59 | -13.00 | -63.50 |
| 855.47 | S | -74.14 | -77.43 | 6.14 | -2.85 | -13.00 | -61.14 |
| 952.47 | S | -74.06 | -76.80 | 5.80 | -3.06 | -13.00 | -61.06 |
| 3424.80 | H | -54.19 | -55.31 | 7.15 | -6.02 | -13.00 | -41.19 |
| 5137.20 | H | --- | | | | | |
| 6849.60 | H | --- | | | | | |
| 8562.00 | H | --- | | | | | |
| 10274.40 | H | --- | | | | | |
| 11986.80 | H | --- | | | | | |
| 13699.20 | H | --- | | | | | |
| 15411.60 | H | --- | | | | | |
| 17124.00 | H | --- | | | | | |

EIRP (dBm) = SG Level(dBm) + Antenna Gain(dBi) + Cable Loss(dB)

Note : "F" : denotes Fundamental Frequency. ; "H" : denotes Harmonic Frequency.
"E" : denotes Band Edge Frequency. ; "S" : denotes Spurious Frequency.
"---" : denotes Noise Floor.

Unless otherwise stated the results shown in this test report refer only to the sample(s) tested and such sample(s) are retained for 90 days only.

除非另有說明，此報告結果僅對測試之樣品負責，同時此樣品僅保留90天。本報告未經本公司書面許可，不可部份複製。

This document is issued by the Company subject to its General Conditions of Service printed overleaf, available on request or accessible at www.sgs.com/terms_and_conditions.htm and, for electronic format documents, subject to Terms and Conditions for Electronic Documents at www.sgs.com/terms_e-document.htm. Attention is drawn to the limitation of liability, indemnification and jurisdiction issues defined therein. Any holder of this document is advised that information contained hereon reflects the Company's findings at the time of its intervention only and within the limits of Client's instructions, if any. The Company's sole responsibility is to its Client and this document does not exonerate parties to a transaction from exercising all their rights and obligations under the transaction documents. This document cannot be reproduced except in full, without prior written approval of the Company. Any unauthorized alteration, forgery or falsification of the content or appearance of this document is unlawful and offenders may be prosecuted to the fullest extent of the law.

| | | | |
|-----------------------|-------------|--------------------------|---------------------|
| Operation Band | :WCDMA B4 | Test Date | :2013-05-03 |
| ARFCN | :CH 1413 | Temp./Humi. | :24.1 deg_C / 65 RH |
| Fundamental Frequency | :1732.6 MHz | Engineer | :Allen |
| Operation Mode | :TX MID | | |
| EUT Pol. | :H Plan | Measurement Antenna Pol. | :VERTICAL |

| Freq. | Note | EIRP | SG | Antenna | Cable | Limit | Margin |
|----------|---------|--------|---------------------|-------------|------------|--------|--------|
| MHz | F/H/E/S | dBm | Output Level dBm | Gain dBi | Loss dB | dBm | dB |
| 148.34 | S | -82.95 | -82.72 | 1.00 | -1.23 | -13.00 | -69.95 |
| 332.64 | S | -79.75 | -84.78 | 6.82 | -1.79 | -13.00 | -66.75 |
| 512.09 | S | -77.50 | -82.14 | 6.83 | -2.19 | -13.00 | -64.50 |
| 645.95 | S | -74.86 | -78.66 | 6.26 | -2.47 | -13.00 | -61.86 |
| 792.42 | S | -74.25 | -77.50 | 6.00 | -2.74 | -13.00 | -61.25 |
| 920.46 | S | -72.84 | -75.65 | 5.79 | -2.99 | -13.00 | -59.84 |
| 3465.20 | H | -52.55 | -53.81 | 7.31 | -6.05 | -13.00 | -39.55 |
| 5197.80 | H | --- | | | | | |
| 6930.40 | H | --- | | | | | |
| 8663.00 | H | --- | | | | | |
| 10395.60 | H | --- | | | | | |
| 12128.20 | H | --- | | | | | |
| 13860.80 | H | --- | | | | | |
| 15593.40 | H | --- | | | | | |
| 17326.00 | H | --- | | | | | |

EIRP (dBm) = SG Level(dBm) + Antenna Gain(dBi) + Cable Loss(dB)

Note : "F" : denotes Fundamental Frequency. ; "H" : denotes Harmonic Frequency.

"E" : denotes Band Edge Frequency. ; "S" : denotes Spurious Frequency.

"---" : denotes Noise Floor.

Unless otherwise stated the results shown in this test report refer only to the sample(s) tested and such sample(s) are retained for 90 days only.

除非另有說明，此報告結果僅對測試之樣品負責，同時此樣品僅保留90天。本報告未經本公司書面許可，不可部份複製。

This document is issued by the Company subject to its General Conditions of Service printed overleaf, available on request or accessible at www.sgs.com/terms_and_conditions.htm and, for electronic format documents, subject to Terms and Conditions for Electronic Documents at www.sgs.com/terms_e-document.htm. Attention is drawn to the limitation of liability, indemnification and jurisdiction issues defined therein. Any holder of this document is advised that information contained hereon reflects the Company's findings at the time of its intervention only and within the limits of Client's instructions, if any. The Company's sole responsibility is to its Client and this document does not exonerate parties to a transaction from exercising all their rights and obligations under the transaction documents. This document cannot be reproduced except in full, without prior written approval of the Company. Any unauthorized alteration, forgery or falsification of the content or appearance of this document is unlawful and offenders may be prosecuted to the fullest extent of the law.

| | | | |
|-----------------------|-------------|--------------------------|---------------------|
| Operation Band | :WCDMA B4 | Test Date | :2013-05-03 |
| ARFCN | :CH 1413 | Temp./Humi. | :24.1 deg_C / 65 RH |
| Fundamental Frequency | :1732.6 MHz | Engineer | :Allen |
| Operation Mode | :TX MID | | |
| EUT Pol. | :H Plan | Measurement Antenna Pol. | :HORIZONTAL |

| Freq. MHz | Note F/H/E/S | EIRP dBm | SG Output Level dBm | Antenna Gain dBi | Cable Loss dB | Limit dBm | Margin dB |
|--------------|-----------------|-------------|---------------------------|------------------------|---------------------|--------------|--------------|
| 133.79 | S | -84.79 | -84.80 | 1.20 | -1.19 | -13.00 | -71.79 |
| 394.72 | S | -80.49 | -85.45 | 6.89 | -1.93 | -13.00 | -67.49 |
| 500.45 | S | -79.04 | -83.75 | 6.87 | -2.16 | -13.00 | -66.04 |
| 690.57 | S | -77.43 | -81.18 | 6.29 | -2.54 | -13.00 | -64.43 |
| 842.86 | S | -74.92 | -78.25 | 6.16 | -2.83 | -13.00 | -61.92 |
| 960.23 | S | -74.43 | -77.21 | 5.86 | -3.08 | -13.00 | -61.43 |
| 3465.20 | H | -52.35 | -53.54 | 7.24 | -6.05 | -13.00 | -39.35 |
| 5197.80 | H | --- | | | | | |
| 6930.40 | H | --- | | | | | |
| 8663.00 | H | --- | | | | | |
| 10395.60 | H | --- | | | | | |
| 12128.20 | H | --- | | | | | |
| 13860.80 | H | --- | | | | | |
| 15593.40 | H | --- | | | | | |
| 17326.00 | H | --- | | | | | |

EIRP (dBm) = SG Level(dBm) + Antenna Gain(dBi) + Cable Loss(dB)

Note : "F" : denotes Fundamental Frequency. ; "H" : denotes Harmonic Frequency.

"E" : denotes Band Edge Frequency. ; "S" : denotes Spurious Frequency.

"---" : denotes Noise Floor.

Unless otherwise stated the results shown in this test report refer only to the sample(s) tested and such sample(s) are retained for 90 days only.

除非另有說明，此報告結果僅對測試之樣品負責，同時此樣品僅保留90天。本報告未經本公司書面許可，不可部份複製。

This document is issued by the Company subject to its General Conditions of Service printed overleaf, available on request or accessible at www.sgs.com/terms_and_conditions.htm and, for electronic format documents, subject to Terms and Conditions for Electronic Documents at www.sgs.com/terms_e-document.htm. Attention is drawn to the limitation of liability, indemnification and jurisdiction issues defined therein. Any holder of this document is advised that information contained hereon reflects the Company's findings at the time of its intervention only and within the limits of Client's instructions, if any. The Company's sole responsibility is to its Client and this document does not exonerate parties to a transaction from exercising all their rights and obligations under the transaction documents. This document cannot be reproduced except in full, without prior written approval of the Company. Any unauthorized alteration, forgery or falsification of the content or appearance of this document is unlawful and offenders may be prosecuted to the fullest extent of the law.

| | | | |
|-----------------------|-------------|--------------------------|---------------------|
| Operation Band | :WCDMA B4 | Test Date | :2013-05-03 |
| ARFCN | :CH 1513 | Temp./Humi. | :24.1 deg_C / 65 RH |
| Fundamental Frequency | :1752.6 MHz | Engineer | :Allen |
| Operation Mode | :TX HIGH | | |
| EUT Pol. | :H Plan | Measurement Antenna Pol. | :VERTICAL |

| Freq. MHz | Note F/H/E/S | EIRP dBm | SG Output Level dBm | Antenna Gain dBi | Cable Loss dB | Limit dBm | Margin dB |
|--------------|-----------------|-------------|---------------------------|------------------------|---------------------|--------------|--------------|
| 50.37 | S | -80.62 | -71.06 | -8.66 | -0.90 | -13.00 | -67.62 |
| 164.83 | S | -83.02 | -84.01 | 2.28 | -1.29 | -13.00 | -70.02 |
| 332.64 | S | -79.88 | -84.91 | 6.82 | -1.79 | -13.00 | -66.88 |
| 530.52 | S | -76.86 | -81.42 | 6.78 | -2.22 | -13.00 | -63.86 |
| 718.70 | S | -74.49 | -77.97 | 6.06 | -2.59 | -13.00 | -61.49 |
| 917.55 | S | -72.08 | -74.89 | 5.79 | -2.98 | -13.00 | -59.08 |
| 3505.20 | H | -50.43 | -51.77 | 7.40 | -6.06 | -13.00 | -37.43 |
| 5257.80 | H | --- | | | | | |
| 7010.40 | H | --- | | | | | |
| 8763.00 | H | --- | | | | | |
| 10515.60 | H | --- | | | | | |
| 12268.20 | H | --- | | | | | |
| 14020.80 | H | --- | | | | | |
| 15773.40 | H | --- | | | | | |
| 3505.20 | H | --- | | | | | |

EIRP (dBm) = SG Level(dBm) + Antenna Gain(dBi) + Cable Loss(dB)

Note : "F" : denotes Fundamental Frequency. ; "H" : denotes Harmonic Frequency.
"E" : denotes Band Edge Frequency. ; "S" : denotes Spurious Frequency.
"---" : denotes Noise Floor.

Unless otherwise stated the results shown in this test report refer only to the sample(s) tested and such sample(s) are retained for 90 days only.

除非另有說明，此報告結果僅對測試之樣品負責，同時此樣品僅保留90天。本報告未經本公司書面許可，不可部份複製。

This document is issued by the Company subject to its General Conditions of Service printed overleaf, available on request or accessible at www.sgs.com/terms_and_conditions.htm and, for electronic format documents, subject to Terms and Conditions for Electronic Documents at www.sgs.com/terms_e-document.htm. Attention is drawn to the limitation of liability, indemnification and jurisdiction issues defined therein. Any holder of this document is advised that information contained hereon reflects the Company's findings at the time of its intervention only and within the limits of Client's instructions, if any. The Company's sole responsibility is to its Client and this document does not exonerate parties to a transaction from exercising all their rights and obligations under the transaction documents. This document cannot be reproduced except in full, without prior written approval of the Company. Any unauthorized alteration, forgery or falsification of the content or appearance of this document is unlawful and offenders may be prosecuted to the fullest extent of the law.

| | | | |
|-----------------------|-------------|--------------------------|---------------------|
| Operation Band | :WCDMA B4 | Test Date | :2013-05-03 |
| ARFCN | :CH 1513 | Temp./Humi. | :24.1 deg_C / 65 RH |
| Fundamental Frequency | :1752.6 MHz | Engineer | :Allen |
| Operation Mode | :TX HIGH | | |
| EUT Pol. | :H Plan | Measurement Antenna Pol. | :HORIZONTAL |

| Freq. MHz | Note F/H/E/S | EIRP dBm | SG Output Level dBm | Antenna Gain dBi | Cable Loss dB | Limit dBm | Margin dB |
|--------------|-----------------|-------------|---------------------------|------------------------|---------------------|--------------|--------------|
| 142.52 | S | -85.16 | -84.82 | 0.87 | -1.22 | -13.00 | -72.16 |
| 349.13 | S | -81.07 | -86.17 | 6.93 | -1.83 | -13.00 | -68.07 |
| 462.62 | S | -79.06 | -83.66 | 6.68 | -2.08 | -13.00 | -66.06 |
| 638.19 | S | -78.16 | -81.96 | 6.25 | -2.46 | -13.00 | -65.16 |
| 766.23 | S | -75.33 | -78.44 | 5.80 | -2.69 | -13.00 | -62.33 |
| 952.47 | S | -74.08 | -76.82 | 5.80 | -3.06 | -13.00 | -61.08 |
| 3505.20 | H | -51.22 | -52.48 | 7.31 | -6.06 | -13.00 | -38.22 |
| 5257.80 | H | --- | | | | | |
| 7010.40 | H | --- | | | | | |
| 8763.00 | H | --- | | | | | |
| 10515.60 | H | --- | | | | | |
| 12268.20 | H | --- | | | | | |
| 14020.80 | H | --- | | | | | |
| 15773.40 | H | --- | | | | | |
| 3505.20 | H | --- | | | | | |

EIRP (dBm) = SG Level(dBm) + Antenna Gain(dBi) + Cable Loss(dB)

Note : "F" : denotes Fundamental Frequency. ; "H" : denotes Harmonic Frequency.
 "E" : denotes Band Edge Frequency. ; "S" : denotes Spurious Frequency.
 "---" : denotes Noise Floor.

Unless otherwise stated the results shown in this test report refer only to the sample(s) tested and such sample(s) are retained for 90 days only.

除非另有說明，此報告結果僅對測試之樣品負責，同時此樣品僅保留90天。本報告未經本公司書面許可，不可部份複製。

This document is issued by the Company subject to its General Conditions of Service printed overleaf, available on request or accessible at www.sgs.com/terms_and_conditions.htm and, for electronic format documents, subject to Terms and Conditions for Electronic Documents at www.sgs.com/terms_e-document.htm. Attention is drawn to the limitation of liability, indemnification and jurisdiction issues defined therein. Any holder of this document is advised that information contained hereon reflects the Company's findings at the time of its intervention only and within the limits of Client's instructions, if any. The Company's sole responsibility is to its Client and this document does not exonerate parties to a transaction from exercising all their rights and obligations under the transaction documents. This document cannot be reproduced except in full, without prior written approval of the Company. Any unauthorized alteration, forgery or falsification of the content or appearance of this document is unlawful and offenders may be prosecuted to the fullest extent of the law.

Radiated Spurious Emission Measurement Result: HSDPA V Mode

| | | | |
|-----------------------|------------|--------------------------|---------------------|
| Operation Band | :HSDPA B5 | Test Date | : 2013-07-16 |
| ARFCN | :CH 4132 | Temp./Humi. | :24.1 deg_C / 65 RH |
| Fundamental Frequency | :826.4 MHz | Engineer | :Allen |
| Operation Mode | :TX LOW | | |
| EUT Pol. | :E1 Plan | Measurement Antenna Pol. | :VERTICAL |

| Freq. MHz | Note F/H/E/S | ERP dBm | SG Output Level dBm | Antenna Gain dBd | Cable Loss dB | Limit dBm | Margin dB |
|--------------|-----------------|------------|---------------------------|------------------------|---------------------|--------------|--------------|
| 114.39 | S | -82.87 | -80.55 | -1.20 | -1.11 | -13.00 | -69.87 |
| 253.10 | S | -83.69 | -86.72 | 4.60 | -1.57 | -13.00 | -70.69 |
| 439.34 | S | -82.17 | -84.65 | 4.52 | -2.03 | -13.00 | -69.17 |
| 613.94 | S | -77.17 | -78.82 | 4.06 | -2.40 | -13.00 | -64.17 |
| 695.42 | S | -76.94 | -78.54 | 4.15 | -2.55 | -13.00 | -63.94 |
| 918.52 | S | -74.31 | -74.97 | 3.64 | -2.98 | -13.00 | -61.31 |
| 1652.80 | H | -58.43 | -56.77 | 2.39 | -4.05 | -13.00 | -45.43 |
| 2479.20 | H | -55.51 | -53.62 | 3.14 | -5.04 | -13.00 | -42.51 |
| 3305.60 | H | --- | | | | | |
| 4132.00 | H | --- | | | | | |
| 4958.40 | H | --- | | | | | |
| 5784.80 | H | --- | | | | | |
| 6611.20 | H | --- | | | | | |
| 7437.60 | H | --- | | | | | |
| 8264.00 | H | --- | | | | | |

ERP (dBm) = SG Level(dBm) + Antenna Gain(dBd) + Cable Loss(dB)

Note : “F” : denotes Fundamental Frequency. ; “H” : denotes Harmonic Frequency.
 “E” : denotes Band Edge Frequency. ; “S” : denotes Spurious Frequency.
 “---” : denotes Noise Floor.

Unless otherwise stated the results shown in this test report refer only to the sample(s) tested and such sample(s) are retained for 90 days only.

除非另有說明，此報告結果僅對測試之樣品負責，同時此樣品僅保留90天。本報告未經本公司書面許可，不可部份複製。

This document is issued by the Company subject to its General Conditions of Service printed overleaf, available on request or accessible at www.sgs.com/terms_and_conditions.htm and, for electronic format documents, subject to Terms and Conditions for Electronic Documents at www.sgs.com/terms_e-document.htm. Attention is drawn to the limitation of liability, indemnification and jurisdiction issues defined therein. Any holder of this document is advised that information contained hereon reflects the Company's findings at the time of its intervention only and within the limits of Client's instructions, if any. The Company's sole responsibility is to its Client and this document does not exonerate parties to a transaction from exercising all their rights and obligations under the transaction documents. This document cannot be reproduced except in full, without prior written approval of the Company. Any unauthorized alteration, forgery or falsification of the content or appearance of this document is unlawful and offenders may be prosecuted to the fullest extent of the law.

| | | | |
|-----------------------|-------------|--------------------------|----------------------|
| Operation Band | : HSDPA B5 | Test Date | : 2013-07-16 |
| ARFCN | : CH 4132 | Temp./Humi. | : 24.1 deg_C / 65 RH |
| Fundamental Frequency | : 826.4 MHz | Engineer | : Allen |
| Operation Mode | : TX LOW | | |
| EUT Pol. | : E1 Plan | Measurement Antenna Pol. | : HORIZONTAL |

| Freq. | Note | ERP | SG | Antenna | Cable | Limit | Margin |
|---------|---------|--------|---------------------|-------------|------------|--------|--------|
| MHz | F/H/E/S | dBm | Output Level dBm | Gain dBd | Loss dB | dBm | dB |
| 153.19 | S | -87.04 | -84.86 | -0.93 | -1.25 | -13.00 | -74.04 |
| 384.05 | S | -82.60 | -85.37 | 4.67 | -1.91 | -13.00 | -69.60 |
| 579.02 | S | -81.34 | -83.27 | 4.25 | -2.32 | -13.00 | -68.34 |
| 649.83 | S | -79.79 | -81.44 | 4.12 | -2.48 | -13.00 | -66.79 |
| 731.31 | S | -78.53 | -79.68 | 3.76 | -2.61 | -13.00 | -65.53 |
| 935.98 | S | -75.79 | -76.41 | 3.64 | -3.02 | -13.00 | -62.79 |
| 1652.80 | H | -58.55 | -57.18 | 2.67 | -4.05 | -13.00 | -45.55 |
| 2479.20 | H | -55.72 | -54.20 | 3.52 | -5.04 | -13.00 | -42.72 |
| 3305.60 | H | --- | | | | | |
| 4132.00 | H | --- | | | | | |
| 4958.40 | H | --- | | | | | |
| 5784.80 | H | --- | | | | | |
| 6611.20 | H | --- | | | | | |
| 7437.60 | H | --- | | | | | |
| 8264.00 | H | --- | | | | | |

ERP (dBm) = SG Level(dBm) + Antenna Gain(dBd) + Cable Loss(dB)

Note : "F" : denotes Fundamental Frequency. ; "H" : denotes Harmonic Frequency.

"E" : denotes Band Edge Frequency. ; "S" : denotes Spurious Frequency.

"---" : denotes Noise Floor.

Unless otherwise stated the results shown in this test report refer only to the sample(s) tested and such sample(s) are retained for 90 days only.

除非另有說明，此報告結果僅對測試之樣品負責，同時此樣品僅保留90天。本報告未經本公司書面許可，不可部份複製。

This document is issued by the Company subject to its General Conditions of Service printed overleaf, available on request or accessible at www.sgs.com/terms_and_conditions.htm and, for electronic format documents, subject to Terms and Conditions for Electronic Documents at www.sgs.com/terms_e-document.htm. Attention is drawn to the limitation of liability, indemnification and jurisdiction issues defined therein. Any holder of this document is advised that information contained hereon reflects the Company's findings at the time of its intervention only and within the limits of Client's instructions, if any. The Company's sole responsibility is to its Client and this document does not exonerate parties to a transaction from exercising all their rights and obligations under the transaction documents. This document cannot be reproduced except in full, without prior written approval of the Company. Any unauthorized alteration, forgery or falsification of the content or appearance of this document is unlawful and offenders may be prosecuted to the fullest extent of the law.

| | | | |
|-----------------------|------------|--------------------------|---------------------|
| Operation Band | :HSDPA B5 | Test Date | : 2013-07-16 |
| ARFCN | :CH 4183 | Temp./Humi. | :24.1 deg_C / 65 RH |
| Fundamental Frequency | :836.6 MHz | Engineer | :Allen |
| Operation Mode | :TX MID | | |
| EUT Pol. | :E1 Plan | Measurement Antenna Pol. | :VERTICAL |

| Freq. | Note | ERP | SG | Antenna | Cable | Limit | Margin |
|---------|---------|--------|---------------------|-------------|------------|--------|--------|
| MHz | F/H/E/S | dBm | Output Level dBm | Gain dBd | Loss dB | dBm | dB |
| 114.39 | S | -82.68 | -80.36 | -1.20 | -1.11 | -13.00 | -69.68 |
| 252.13 | S | -83.07 | -86.08 | 4.58 | -1.57 | -13.00 | -70.07 |
| 343.31 | S | -82.59 | -85.52 | 4.75 | -1.82 | -13.00 | -69.59 |
| 486.87 | S | -80.02 | -82.53 | 4.65 | -2.13 | -13.00 | -67.02 |
| 679.90 | S | -77.29 | -78.90 | 4.14 | -2.53 | -13.00 | -64.29 |
| 916.58 | S | -74.53 | -75.20 | 3.64 | -2.98 | -13.00 | -61.53 |
| 1673.20 | H | -57.17 | -55.42 | 2.34 | -4.08 | -13.00 | -44.17 |
| 2509.80 | H | --- | | | | | |
| 3346.40 | H | --- | | | | | |
| 4183.00 | H | --- | | | | | |
| 5019.60 | H | --- | | | | | |
| 5856.20 | H | --- | | | | | |
| 6692.80 | H | --- | | | | | |
| 7529.40 | H | --- | | | | | |
| 8366.00 | H | --- | | | | | |

ERP (dBm) = SG Level(dBm) + Antenna Gain(dBd) + Cable Loss(dB)

Note : “F” : denotes Fundamental Frequency. ; “H” : denotes Harmonic Frequency.

“E” : denotes Band Edge Frequency. ; “S” : denotes Spurious Frequency.

“---“ : denotes Noise Floor.

Unless otherwise stated the results shown in this test report refer only to the sample(s) tested and such sample(s) are retained for 90 days only.

除非另有說明，此報告結果僅對測試之樣品負責，同時此樣品僅保留90天。本報告未經本公司書面許可，不可部份複製。

This document is issued by the Company subject to its General Conditions of Service printed overleaf, available on request or accessible at www.sgs.com/terms_and_conditions.htm and, for electronic format documents, subject to Terms and Conditions for Electronic Documents at www.sgs.com/terms_e-document.htm. Attention is drawn to the limitation of liability, indemnification and jurisdiction issues defined therein. Any holder of this document is advised that information contained hereon reflects the Company's findings at the time of its intervention only and within the limits of Client's instructions, if any. The Company's sole responsibility is to its Client and this document does not exonerate parties to a transaction from exercising all their rights and obligations under the transaction documents. This document cannot be reproduced except in full, without prior written approval of the Company. Any unauthorized alteration, forgery or falsification of the content or appearance of this document is unlawful and offenders may be prosecuted to the fullest extent of the law.

| | | | |
|-----------------------|------------|--------------------------|---------------------|
| Operation Band | :HSDPA B5 | Test Date | : 2013-07-16 |
| ARFCN | :CH 4183 | Temp./Humi. | :24.1 deg_C / 65 RH |
| Fundamental Frequency | :836.6 MHz | Engineer | :Allen |
| Operation Mode | :TX MID | | |
| EUT Pol. | :E1 Plan | Measurement Antenna Pol. | :HORIZONTAL |

| Freq. | Note | ERP | SG | Antenna | Cable | Limit | Margin |
|---------|---------|--------|---------------------|-------------|------------|--------|--------|
| MHz | F/H/E/S | dBm | Output Level dBm | Gain dBd | Loss dB | dBm | dB |
| 139.61 | S | -86.37 | -83.84 | -1.32 | -1.21 | -13.00 | -73.37 |
| 246.31 | S | -88.09 | -91.03 | 4.49 | -1.55 | -13.00 | -75.09 |
| 360.77 | S | -83.48 | -86.34 | 4.71 | -1.86 | -13.00 | -70.48 |
| 555.74 | S | -81.42 | -83.66 | 4.51 | -2.27 | -13.00 | -68.42 |
| 726.46 | S | -78.79 | -80.00 | 3.82 | -2.60 | -13.00 | -65.79 |
| 916.58 | S | -75.71 | -76.37 | 3.64 | -2.98 | -13.00 | -62.71 |
| 1673.20 | H | -58.80 | -57.38 | 2.66 | -4.08 | -13.00 | -45.80 |
| 2509.80 | H | --- | | | | | |
| 3346.40 | H | --- | | | | | |
| 4183.00 | H | --- | | | | | |
| 5019.60 | H | --- | | | | | |
| 5856.20 | H | --- | | | | | |
| 6692.80 | H | --- | | | | | |
| 7529.40 | H | --- | | | | | |
| 8366.00 | H | --- | | | | | |

ERP (dBm) = SG Level(dBm) + Antenna Gain(dBd) + Cable Loss(dB)

Note : "F" : denotes Fundamental Frequency. ; "H" : denotes Harmonic Frequency.
 "E" : denotes Band Edge Frequency. ; "S" : denotes Spurious Frequency.
 "---" : denotes Noise Floor.

Unless otherwise stated the results shown in this test report refer only to the sample(s) tested and such sample(s) are retained for 90 days only.

除非另有說明，此報告結果僅對測試之樣品負責，同時此樣品僅保留90天。本報告未經本公司書面許可，不可部份複製。

This document is issued by the Company subject to its General Conditions of Service printed overleaf, available on request or accessible at www.sgs.com/terms_and_conditions.htm and, for electronic format documents, subject to Terms and Conditions for Electronic Documents at www.sgs.com/terms_e-document.htm. Attention is drawn to the limitation of liability, indemnification and jurisdiction issues defined therein. Any holder of this document is advised that information contained hereon reflects the Company's findings at the time of its intervention only and within the limits of Client's instructions, if any. The Company's sole responsibility is to its Client and this document does not exonerate parties to a transaction from exercising all their rights and obligations under the transaction documents. This document cannot be reproduced except in full, without prior written approval of the Company. Any unauthorized alteration, forgery or falsification of the content or appearance of this document is unlawful and offenders may be prosecuted to the fullest extent of the law.

| | | | |
|-----------------------|------------|--------------------------|---------------------|
| Operation Band | :HSDPA B5 | Test Date | : 2013-07-16 |
| ARFCN | :CH 4233 | Temp./Humi. | :24.1 deg_C / 65 RH |
| Fundamental Frequency | :846.6 MHz | Engineer | :Allen |
| Operation Mode | :TX HIGH | | |
| EUT Pol. | :E1 Plan | Measurement Antenna Pol. | :VERTICAL |

| Freq. | Note | ERP | SG | Antenna | Cable | Limit | Margin |
|---------|---------|--------|---------------------|-------------|------------|--------|--------|
| MHz | F/H/E/S | dBm | Output Level dBm | Gain dBd | Loss dB | dBm | dB |
| 114.39 | S | -83.36 | -81.04 | -1.20 | -1.11 | -13.00 | -70.36 |
| 343.31 | S | -82.64 | -85.57 | 4.75 | -1.82 | -13.00 | -69.64 |
| 440.31 | S | -81.16 | -83.64 | 4.51 | -2.03 | -13.00 | -68.16 |
| 600.36 | S | -77.10 | -78.76 | 4.03 | -2.37 | -13.00 | -64.10 |
| 784.66 | S | -76.63 | -77.69 | 3.79 | -2.73 | -13.00 | -63.63 |
| 936.95 | S | -74.35 | -74.96 | 3.64 | -3.03 | -13.00 | -61.35 |
| 1693.20 | H | -55.98 | -54.17 | 2.29 | -4.11 | -13.00 | -42.98 |
| 2539.80 | H | --- | | | | | |
| 3386.40 | H | --- | | | | | |
| 4233.00 | H | --- | | | | | |
| 5079.60 | H | --- | | | | | |
| 5926.20 | H | --- | | | | | |
| 6772.80 | H | --- | | | | | |
| 7619.40 | H | --- | | | | | |
| 8466.00 | H | --- | | | | | |

ERP (dBm) = SG Level(dBm) + Antenna Gain(dBd) + Cable Loss(dB)

Note : "F" : denotes Fundamental Frequency. ; "H" : denotes Harmonic Frequency.
 "E" : denotes Band Edge Frequency. ; "S" : denotes Spurious Frequency.
 "---" : denotes Noise Floor.

Unless otherwise stated the results shown in this test report refer only to the sample(s) tested and such sample(s) are retained for 90 days only.

除非另有說明，此報告結果僅對測試之樣品負責，同時此樣品僅保留90天。本報告未經本公司書面許可，不可部份複製。

This document is issued by the Company subject to its General Conditions of Service printed overleaf, available on request or accessible at www.sgs.com/terms_and_conditions.htm and, for electronic format documents, subject to Terms and Conditions for Electronic Documents at www.sgs.com/terms_e-document.htm. Attention is drawn to the limitation of liability, indemnification and jurisdiction issues defined therein. Any holder of this document is advised that information contained hereon reflects the Company's findings at the time of its intervention only and within the limits of Client's instructions, if any. The Company's sole responsibility is to its Client and this document does not exonerate parties to a transaction from exercising all their rights and obligations under the transaction documents. This document cannot be reproduced except in full, without prior written approval of the Company. Any unauthorized alteration, forgery or falsification of the content or appearance of this document is unlawful and offenders may be prosecuted to the fullest extent of the law.

| | | | |
|-----------------------|------------|--------------------------|---------------------|
| Operation Band | :HSDPA B5 | Test Date | : 2013-07-16 |
| ARFCN | :CH 4233 | Temp./Humi. | :24.1 deg_C / 65 RH |
| Fundamental Frequency | :846.6 MHz | Engineer | :Allen |
| Operation Mode | :TX HIGH | | |
| EUT Pol. | :E1 Plan | Measurement Antenna Pol. | :HORIZONTAL |

| Freq. | Note | ERP | SG | Antenna | Cable | Limit | Margin |
|---------|---------|--------|---------------------|-------------|------------|--------|--------|
| MHz | F/H/E/S | dBm | Output Level dBm | Gain dBd | Loss dB | dBm | dB |
| 138.64 | S | -87.48 | -85.02 | -1.26 | -1.20 | -13.00 | -74.48 |
| 383.08 | S | -83.38 | -86.14 | 4.67 | -1.90 | -13.00 | -70.38 |
| 521.79 | S | -81.31 | -83.76 | 4.66 | -2.21 | -13.00 | -68.31 |
| 614.91 | S | -79.65 | -81.30 | 4.06 | -2.41 | -13.00 | -66.65 |
| 773.02 | S | -77.42 | -78.42 | 3.70 | -2.70 | -13.00 | -64.42 |
| 910.76 | S | -75.81 | -76.49 | 3.65 | -2.96 | -13.00 | -62.81 |
| 1693.20 | H | -53.58 | -52.12 | 2.65 | -4.11 | -13.00 | -40.58 |
| 2539.80 | H | --- | | | | | |
| 3386.40 | H | --- | | | | | |
| 4233.00 | H | --- | | | | | |
| 5079.60 | H | --- | | | | | |
| 5926.20 | H | --- | | | | | |
| 6772.80 | H | --- | | | | | |
| 7619.40 | H | --- | | | | | |
| 8466.00 | H | --- | | | | | |

ERP (dBm) = SG Level(dBm) + Antenna Gain(dBd) + Cable Loss(dB)

Note : "F" : denotes Fundamental Frequency. ; "H" : denotes Harmonic Frequency.

"E" : denotes Band Edge Frequency. ; "S" : denotes Spurious Frequency.

"---" : denotes Noise Floor.

Unless otherwise stated the results shown in this test report refer only to the sample(s) tested and such sample(s) are retained for 90 days only.

除非另有說明，此報告結果僅對測試之樣品負責，同時此樣品僅保留90天。本報告未經本公司書面許可，不可部份複製。

This document is issued by the Company subject to its General Conditions of Service printed overleaf, available on request or accessible at www.sgs.com/terms_and_conditions.htm and, for electronic format documents, subject to Terms and Conditions for Electronic Documents at www.sgs.com/terms_e-document.htm. Attention is drawn to the limitation of liability, indemnification and jurisdiction issues defined therein. Any holder of this document is advised that information contained hereon reflects the Company's findings at the time of its intervention only and within the limits of Client's instructions, if any. The Company's sole responsibility is to its Client and this document does not exonerate parties to a transaction from exercising all their rights and obligations under the transaction documents. This document cannot be reproduced except in full, without prior written approval of the Company. Any unauthorized alteration, forgery or falsification of the content or appearance of this document is unlawful and offenders may be prosecuted to the fullest extent of the law.

Radiated Spurious Emission Measurement Result: GSM 850 Mode

| | | | |
|-----------------------|------------|--------------------------|---------------------|
| Operation Band | :GSM 850 | Test Date | :2013-05-03 |
| Fundamental Frequency | :824.2 MHz | Temp./Humi. | :24.1 deg_C / 65 RH |
| Operation Mode | :RX LOW | Engineer | :Allen |
| EUT Pol. | :E2 Plan | Measurement Antenna Pol. | :VERTICAL |

Actual FS(dBμV/m) = SPA. Reading level(dBμV) + Factor(dB)

Factor(dB) = Antenna Factor(dBμV/m) + Cable Loss(dB) – Pre_Amplifier Gain(dB)

Note : “F” : denotes Fundamental Frequency. ; “H” : denotes Harmonic Frequency.

“E” : denotes Band Edge Frequency. ; “S” : denotes Spurious Frequency.

“---“ : denotes Noise Floor.

| Freq. | Note | Detector Mode | Spectrum Reading Level | Factor | Actual FS | Limit @3m | Margin |
|---------|---------|---------------|------------------------|--------|-----------|-----------|--------|
| MHz | F/H/E/S | PK/QP/AV | dBμV | dB | dBμV/m | dBμV/m | dB |
| 41.64 | S | Peak | 30.74 | -13.56 | 17.18 | 40.00 | -22.82 |
| 157.07 | S | Peak | 28.08 | -12.29 | 15.79 | 43.50 | -27.71 |
| 241.46 | S | Peak | 26.67 | -14.16 | 12.51 | 46.00 | -33.49 |
| 515.97 | S | Peak | 27.38 | -9.28 | 18.10 | 46.00 | -27.90 |
| 774.96 | S | Peak | 27.78 | -4.54 | 23.24 | 46.00 | -22.76 |
| 908.82 | S | Peak | 27.27 | -2.63 | 24.64 | 46.00 | -21.36 |
| 1648.40 | H | Peak | 40.69 | -1.68 | 39.01 | 54.00 | -14.99 |
| 2472.60 | H | --- | | | | | |
| 3288.00 | H | --- | | | | | |
| 4121.00 | H | --- | | | | | |
| 4945.20 | H | --- | | | | | |
| 5769.40 | H | --- | | | | | |
| 6593.60 | H | --- | | | | | |
| 7417.80 | H | --- | | | | | |
| 8242.00 | H | --- | | | | | |

Unless otherwise stated the results shown in this test report refer only to the sample(s) tested and such sample(s) are retained for 90 days only.

除非另有說明，此報告結果僅對測試之樣品負責，同時此樣品僅保留90天。本報告未經本公司書面許可，不可部份複製。

This document is issued by the Company subject to its General Conditions of Service printed overleaf, available on request or accessible at www.sgs.com/terms_and_conditions.htm and, for electronic format documents, subject to Terms and Conditions for Electronic Documents at www.sgs.com/terms_e-document.htm. Attention is drawn to the limitation of liability, indemnification and jurisdiction issues defined therein. Any holder of this document is advised that information contained hereon reflects the Company's findings at the time of its intervention only and within the limits of Client's instructions, if any. The Company's sole responsibility is to its Client and this document does not exonerate parties to a transaction from exercising all their rights and obligations under the transaction documents. This document cannot be reproduced except in full, without prior written approval of the Company. Any unauthorized alteration, forgery or falsification of the content or appearance of this document is unlawful and offenders may be prosecuted to the fullest extent of the law.

| | | | |
|-----------------------|------------|--------------------------|---------------------|
| Operation Band | :GSM 850 | Test Date | :2013-05-03 |
| Fundamental Frequency | :824.2 MHz | Temp./Humi. | :24.1 deg_C / 65 RH |
| Operation Mode | :RX LOW | Engineer | :Allen |
| EUT Pol. | :E2 Plan | Measurement Antenna Pol. | :HORIZONTAL |

Actual FS(dBμV/m) = SPA. Reading level(dBμV) + Factor(dB)

Factor(dB) = Antenna Factor(dBμV/m) + Cable Loss(dB) – Pre_Amplifier Gain(dB)

Note : “F” : denotes Fundamental Frequency. ; “H” : denotes Harmonic Frequency.

“E” : denotes Band Edge Frequency. ; “S” : denotes Spurious Frequency.

“---“ : denotes Noise Floor.

| Freq. MHz | Note F/H/E/S | Detector Mode PK/QP/AV | Spectrum Reading Level dBμV | Factor dB | Actual FS dBμV/m | Limit @3m dBμV/m | Margin dB |
|--------------|-----------------|------------------------------|-----------------------------------|--------------|------------------------|------------------------|--------------|
| 155.13 | S | Peak | 26.82 | -12.30 | 14.52 | 43.50 | -28.98 |
| 272.50 | S | Peak | 29.05 | -13.28 | 15.77 | 46.00 | -30.23 |
| 368.53 | S | Peak | 27.02 | -11.45 | 15.57 | 46.00 | -30.43 |
| 583.87 | S | Peak | 28.22 | -7.90 | 20.32 | 46.00 | -25.68 |
| 719.67 | S | Peak | 28.76 | -5.44 | 23.32 | 46.00 | -22.68 |
| 811.82 | S | Peak | 28.28 | -4.06 | 24.22 | 46.00 | -21.78 |
| 1648.40 | H | Peak | 39.48 | -0.96 | 38.52 | 54.00 | -15.48 |
| 2472.60 | H | --- | | | | | |
| 3288.00 | H | --- | | | | | |
| 4121.00 | H | --- | | | | | |
| 4945.20 | H | --- | | | | | |
| 5769.40 | H | --- | | | | | |
| 6593.60 | H | --- | | | | | |
| 7417.80 | H | --- | | | | | |
| 8242.00 | H | --- | | | | | |

Unless otherwise stated the results shown in this test report refer only to the sample(s) tested and such sample(s) are retained for 90 days only.

除非另有說明，此報告結果僅對測試之樣品負責，同時此樣品僅保留90天。本報告未經本公司書面許可，不可部份複製。

This document is issued by the Company subject to its General Conditions of Service printed overleaf, available on request or accessible at www.sgs.com/terms_and_conditions.htm and, for electronic format documents, subject to Terms and Conditions for Electronic Documents at www.sgs.com/terms_e-document.htm. Attention is drawn to the limitation of liability, indemnification and jurisdiction issues defined therein. Any holder of this document is advised that information contained hereon reflects the Company's findings at the time of its intervention only and within the limits of Client's instructions, if any. The Company's sole responsibility is to its Client and this document does not exonerate parties to a transaction from exercising all their rights and obligations under the transaction documents. This document cannot be reproduced except in full, without prior written approval of the Company. Any unauthorized alteration, forgery or falsification of the content or appearance of this document is unlawful and offenders may be prosecuted to the fullest extent of the law.

| | | | |
|-----------------------|------------|--------------------------|---------------------|
| Operation Band | :GSM 850 | Test Date | :2013-05-03 |
| Fundamental Frequency | :836.6 MHz | Temp./Humi. | :24.1 deg_C / 65 RH |
| Operation Mode | :RX MID | Engineer | :Allen |
| EUT Pol. | :E2 Plan | Measurement Antenna Pol. | :VERTICAL |

Actual FS(dBμV/m) = SPA. Reading level(dBμV) + Factor(dB)

Factor(dB) = Antenna Factor(dBμV/m) + Cable Loss(dB) – Pre_Amplifier Gain(dB)

Note : “F” : denotes Fundamental Frequency. ; “H” : denotes Harmonic Frequency.

“E” : denotes Band Edge Frequency. ; “S” : denotes Spurious Frequency.

“---“ : denotes Noise Floor.

| Freq. | Note | Detector Mode | Spectrum Reading Level | Factor | Actual FS | Limit @3m | Margin |
|---------|---------|------------------|---------------------------|--------|--------------|--------------|--------|
| MHz | F/H/E/S | PK/QP/AV | dBμV | dB | dBμV/m | dBμV/m | dB |
| 329.73 | S | Peak | 26.39 | -11.92 | 14.47 | 46.00 | -31.53 |
| 418.97 | S | Peak | 27.22 | -10.66 | 16.56 | 46.00 | -29.44 |
| 602.30 | S | Peak | 28.32 | -7.51 | 20.81 | 46.00 | -25.19 |
| 734.22 | S | Peak | 28.03 | -5.23 | 22.80 | 46.00 | -23.20 |
| 812.79 | S | Peak | 27.24 | -4.04 | 23.20 | 46.00 | -22.80 |
| 897.18 | S | Peak | 26.79 | -2.87 | 23.92 | 46.00 | -22.08 |
| 1673.20 | H | Peak | 39.63 | -1.38 | 38.25 | 54.00 | -15.75 |
| 2509.80 | H | --- | | | | | |
| 3346.40 | H | --- | | | | | |
| 4183.00 | H | --- | | | | | |
| 5019.60 | H | --- | | | | | |
| 5856.20 | H | --- | | | | | |
| 6692.80 | H | --- | | | | | |
| 7529.40 | H | --- | | | | | |
| 8366.00 | H | --- | | | | | |

Unless otherwise stated the results shown in this test report refer only to the sample(s) tested and such sample(s) are retained for 90 days only.

除非另有說明，此報告結果僅對測試之樣品負責，同時此樣品僅保留90天。本報告未經本公司書面許可，不可部份複製。

This document is issued by the Company subject to its General Conditions of Service printed overleaf, available on request or accessible at www.sgs.com/terms_and_conditions.htm and, for electronic format documents, subject to Terms and Conditions for Electronic Documents at www.sgs.com/terms_e-document.htm. Attention is drawn to the limitation of liability, indemnification and jurisdiction issues defined therein. Any holder of this document is advised that information contained hereon reflects the Company's findings at the time of its intervention only and within the limits of Client's instructions, if any. The Company's sole responsibility is to its Client and this document does not exonerate parties to a transaction from exercising all their rights and obligations under the transaction documents. This document cannot be reproduced except in full, without prior written approval of the Company. Any unauthorized alteration, forgery or falsification of the content or appearance of this document is unlawful and offenders may be prosecuted to the fullest extent of the law.

| | | | |
|-----------------------|------------|--------------------------|---------------------|
| Operation Band | :GSM 850 | Test Date | :2013-05-03 |
| Fundamental Frequency | :836.6 MHz | Temp./Humi. | :24.1 deg_C / 65 RH |
| Operation Mode | :RX MID | Engineer | :Allen |
| EUT Pol. | :E2 Plan | Measurement Antenna Pol. | :HORIZONTAL |

Actual FS(dBμV/m) = SPA. Reading level(dBμV) + Factor(dB)

Factor(dB) = Antenna Factor(dBμV/m) + Cable Loss(dB) – Pre_Amplifier Gain(dB)

Note : “F” : denotes Fundamental Frequency. ; “H” : denotes Harmonic Frequency.

“E” : denotes Band Edge Frequency. ; “S” : denotes Spurious Frequency.

“---“ : denotes Noise Floor.

| Freq. MHz | Note F/H/E/S | Detector Mode PK/QP/AV | Spectrum Reading Level dBμV | Factor dB | Actual FS dBμV/m | Limit @3m dBμV/m | Margin dB |
|--------------|-----------------|------------------------------|-----------------------------------|--------------|------------------------|------------------------|--------------|
| 87.23 | S | Peak | 31.47 | -17.69 | 13.78 | 40.00 | -26.22 |
| 160.95 | S | Peak | 27.14 | -12.36 | 14.78 | 43.50 | -28.72 |
| 275.41 | S | Peak | 27.80 | -13.19 | 14.61 | 46.00 | -31.39 |
| 401.51 | S | Peak | 28.57 | -11.02 | 17.55 | 46.00 | -28.45 |
| 601.33 | S | Peak | 27.40 | -7.52 | 19.88 | 46.00 | -26.12 |
| 898.15 | S | Peak | 26.58 | -2.85 | 23.73 | 46.00 | -22.27 |
| 1673.20 | H | Peak | 40.72 | -0.59 | 40.13 | 54.00 | -13.87 |
| 2509.80 | H | --- | | | | | |
| 3346.40 | H | --- | | | | | |
| 4183.00 | H | --- | | | | | |
| 5019.60 | H | --- | | | | | |
| 5856.20 | H | --- | | | | | |
| 6692.80 | H | --- | | | | | |
| 7529.40 | H | --- | | | | | |
| 8366.00 | H | --- | | | | | |

Unless otherwise stated the results shown in this test report refer only to the sample(s) tested and such sample(s) are retained for 90 days only.

除非另有說明，此報告結果僅對測試之樣品負責，同時此樣品僅保留90天。本報告未經本公司書面許可，不可部份複製。

This document is issued by the Company subject to its General Conditions of Service printed overleaf, available on request or accessible at www.sgs.com/terms_and_conditions.htm and, for electronic format documents, subject to Terms and Conditions for Electronic Documents at www.sgs.com/terms_e-document.htm. Attention is drawn to the limitation of liability, indemnification and jurisdiction issues defined therein. Any holder of this document is advised that information contained hereon reflects the Company's findings at the time of its intervention only and within the limits of Client's instructions, if any. The Company's sole responsibility is to its Client and this document does not exonerate parties to a transaction from exercising all their rights and obligations under the transaction documents. This document cannot be reproduced except in full, without prior written approval of the Company. Any unauthorized alteration, forgery or falsification of the content or appearance of this document is unlawful and offenders may be prosecuted to the fullest extent of the law.

| | | | |
|-----------------------|------------|--------------------------|---------------------|
| Operation Band | :GSM 850 | Test Date | :2013-05-03 |
| Fundamental Frequency | :848.8 MHz | Temp./Humi. | :24.1 deg_C / 65 RH |
| Operation Mode | :RX HIGH | Engineer | :Allen |
| EUT Pol. | :E2 Plan | Measurement Antenna Pol. | :VERTICAL |

Actual FS(dBμV/m) = SPA. Reading level(dBμV) + Factor(dB)

Factor(dB) = Antenna Factor(dBμV/m) + Cable Loss(dB) – Pre_Amplifier Gain(dB)

Note : “F” : denotes Fundamental Frequency. ; “H” : denotes Harmonic Frequency.

“E” : denotes Band Edge Frequency. ; “S” : denotes Spurious Frequency.

“---“ : denotes Noise Floor.

| Freq. | Note | Detector Mode | Spectrum Reading Level | Factor | Actual FS | Limit @3m | Margin |
|---------|---------|------------------|---------------------------|--------|--------------|--------------|--------|
| MHz | F/H/E/S | PK/QP/AV | dBμV | dB | dBμV/m | dBμV/m | dB |
| 114.39 | S | Peak | 34.03 | -15.22 | 18.81 | 43.50 | -24.69 |
| 157.07 | S | Peak | 27.96 | -12.29 | 15.67 | 43.50 | -27.83 |
| 424.79 | S | Peak | 27.08 | -10.54 | 16.54 | 46.00 | -29.46 |
| 725.49 | S | Peak | 28.03 | -5.35 | 22.68 | 46.00 | -23.32 |
| 823.46 | S | Peak | 27.64 | -3.94 | 23.70 | 46.00 | -22.30 |
| 886.51 | S | Peak | 27.62 | -3.07 | 24.55 | 46.00 | -21.45 |
| 1697.60 | H | Peak | 39.53 | -1.08 | 38.45 | 54.00 | -15.55 |
| 2546.40 | H | --- | | | | | |
| 3395.20 | H | --- | | | | | |
| 4244.00 | H | --- | | | | | |
| 5092.80 | H | --- | | | | | |
| 5941.60 | H | --- | | | | | |
| 6790.40 | H | --- | | | | | |
| 7639.20 | H | --- | | | | | |
| 8488.00 | H | --- | | | | | |

Unless otherwise stated the results shown in this test report refer only to the sample(s) tested and such sample(s) are retained for 90 days only.

除非另有說明，此報告結果僅對測試之樣品負責，同時此樣品僅保留90天。本報告未經本公司書面許可，不可部份複製。

This document is issued by the Company subject to its General Conditions of Service printed overleaf, available on request or accessible at www.sgs.com/terms_and_conditions.htm and, for electronic format documents, subject to Terms and Conditions for Electronic Documents at www.sgs.com/terms_e-document.htm. Attention is drawn to the limitation of liability, indemnification and jurisdiction issues defined therein. Any holder of this document is advised that information contained hereon reflects the Company's findings at the time of its intervention only and within the limits of Client's instructions, if any. The Company's sole responsibility is to its Client and this document does not exonerate parties to a transaction from exercising all their rights and obligations under the transaction documents. This document cannot be reproduced except in full, without prior written approval of the Company. Any unauthorized alteration, forgery or falsification of the content or appearance of this document is unlawful and offenders may be prosecuted to the fullest extent of the law.

| | | | |
|-----------------------|------------|--------------------------|---------------------|
| Operation Band | :GSM 850 | Test Date | :2013-05-03 |
| Fundamental Frequency | :848.8 MHz | Temp./Humi. | :24.1 deg_C / 65 RH |
| Operation Mode | :RX HIGH | Engineer | :Allen |
| EUT Pol. | :E2 Plan | Measurement Antenna Pol. | :HORIZONTAL |

Actual FS(dBμV/m) = SPA. Reading level(dBμV) + Factor(dB)

Factor(dB) = Antenna Factor(dBμV/m) + Cable Loss(dB) – Pre_Amplifier Gain(dB)

Note : “F” : denotes Fundamental Frequency. ; “H” : denotes Harmonic Frequency.

“E” : denotes Band Edge Frequency. ; “S” : denotes Spurious Frequency.

“---“ : denotes Noise Floor.

| Freq. MHz | Note F/H/E/S | Detector Mode PK/QP/AV | Spectrum Reading Level dBμV | Factor dB | Actual FS dBμV/m | Limit @3m dBμV/m | Margin dB |
|--------------|-----------------|------------------------------|-----------------------------------|--------------|------------------------|------------------------|--------------|
| 58.13 | S | Peak | 28.50 | -14.45 | 14.05 | 40.00 | -25.95 |
| 146.40 | S | Peak | 26.98 | -12.60 | 14.38 | 43.50 | -29.12 |
| 286.08 | S | Peak | 27.26 | -12.89 | 14.37 | 46.00 | -31.63 |
| 371.44 | S | Peak | 27.02 | -11.41 | 15.61 | 46.00 | -30.39 |
| 482.99 | S | Peak | 27.95 | -9.78 | 18.17 | 46.00 | -27.83 |
| 788.54 | S | Peak | 27.32 | -4.35 | 22.97 | 46.00 | -23.03 |
| 1697.60 | H | Peak | 39.88 | -0.23 | 39.65 | 54.00 | -14.35 |
| 2546.40 | H | --- | | | | | |
| 3395.20 | H | --- | | | | | |
| 4244.00 | H | --- | | | | | |
| 5092.80 | H | --- | | | | | |
| 5941.60 | H | --- | | | | | |
| 6790.40 | H | --- | | | | | |
| 7639.20 | H | --- | | | | | |
| 8488.00 | H | --- | | | | | |

Unless otherwise stated the results shown in this test report refer only to the sample(s) tested and such sample(s) are retained for 90 days only.

除非另有說明，此報告結果僅對測試之樣品負責，同時此樣品僅保留90天。本報告未經本公司書面許可，不可部份複製。

This document is issued by the Company subject to its General Conditions of Service printed overleaf, available on request or accessible at www.sgs.com/terms_and_conditions.htm and, for electronic format documents, subject to Terms and Conditions for Electronic Documents at www.sgs.com/terms_e-document.htm. Attention is drawn to the limitation of liability, indemnification and jurisdiction issues defined therein. Any holder of this document is advised that information contained hereon reflects the Company's findings at the time of its intervention only and within the limits of Client's instructions, if any. The Company's sole responsibility is to its Client and this document does not exonerate parties to a transaction from exercising all their rights and obligations under the transaction documents. This document cannot be reproduced except in full, without prior written approval of the Company. Any unauthorized alteration, forgery or falsification of the content or appearance of this document is unlawful and offenders may be prosecuted to the fullest extent of the law.

Radiated Spurious Emission Measurement Result: GSM 1900 Mode

| | | | |
|-----------------------|-------------|--------------------------|---------------------|
| Operation Band | :GSM 1900 | Test Date | :2013-05-03 |
| Fundamental Frequency | :1850.2 MHz | Temp./Humi. | :24.1 deg_C / 65 RH |
| Operation Mode | :RX LOW | Engineer | :Allen |
| EUT Pol. | :E1 Plan | Measurement Antenna Pol. | :VERTICAL |

Actual FS(dBμV/m) = SPA. Reading level(dBμV) + Factor(dB)

Factor(dB) = Antenna Factor(dBμV/m) + Cable Loss(dB) – Pre_Amplifier Gain(dB)

Note : “F” : denotes Fundamental Frequency. ; “H” : denotes Harmonic Frequency.

“E” : denotes Band Edge Frequency. ; “S” : denotes Spurious Frequency.

“---“ : denotes Noise Floor.

| Freq. MHz | Note F/H/E/S | Detector Mode PK/QP/AV | Spectrum Reading Level dBμV | Factor dB | Actual FS dBμV/m | Limit @3m dBμV/m | Margin dB |
|--------------|-----------------|------------------------------|-----------------------------------|--------------|------------------------|------------------------|--------------|
| 157.07 | S | Peak | 27.53 | -12.29 | 15.24 | 43.50 | -28.26 |
| 407.33 | S | Peak | 27.27 | -10.90 | 16.37 | 46.00 | -29.63 |
| 504.33 | S | Peak | 27.51 | -9.50 | 18.01 | 46.00 | -27.99 |
| 691.54 | S | Peak | 28.79 | -5.86 | 22.93 | 46.00 | -23.07 |
| 769.14 | S | Peak | 28.01 | -4.63 | 23.38 | 46.00 | -22.62 |
| 933.07 | S | Peak | 27.64 | -2.26 | 25.38 | 46.00 | -20.62 |
| 3700.40 | H | Peak | 37.49 | 5.18 | 42.67 | 54.00 | -11.33 |
| 5550.60 | H | --- | | | | | |
| 7400.80 | H | --- | | | | | |
| 9251.00 | H | --- | | | | | |
| 11101.20 | H | --- | | | | | |
| 12951.40 | H | --- | | | | | |
| 14801.60 | H | --- | | | | | |
| 16651.80 | H | --- | | | | | |
| 18502.00 | H | --- | | | | | |

Unless otherwise stated the results shown in this test report refer only to the sample(s) tested and such sample(s) are retained for 90 days only.

除非另有說明，此報告結果僅對測試之樣品負責，同時此樣品僅保留90天。本報告未經本公司書面許可，不可部份複製。

This document is issued by the Company subject to its General Conditions of Service printed overleaf, available on request or accessible at www.sgs.com/terms_and_conditions.htm and, for electronic format documents, subject to Terms and Conditions for Electronic Documents at www.sgs.com/terms_e-document.htm. Attention is drawn to the limitation of liability, indemnification and jurisdiction issues defined therein. Any holder of this document is advised that information contained hereon reflects the Company's findings at the time of its intervention only and within the limits of Client's instructions, if any. The Company's sole responsibility is to its Client and this document does not exonerate parties to a transaction from exercising all their rights and obligations under the transaction documents. This document cannot be reproduced except in full, without prior written approval of the Company. Any unauthorized alteration, forgery or falsification of the content or appearance of this document is unlawful and offenders may be prosecuted to the fullest extent of the law.

| | | | |
|-----------------------|-------------|--------------------------|---------------------|
| Operation Band | :GSM 1900 | Test Date | :2013-05-03 |
| Fundamental Frequency | :1850.2 MHz | Temp./Humi. | :24.1 deg_C / 65 RH |
| Operation Mode | :RX LOW | Engineer | :Allen |
| EUT Pol. | :E1 Plan | Measurement Antenna Pol. | :HORIZONTAL |

Actual FS(dBμV/m) = SPA. Reading level(dBμV) + Factor(dB)

Factor(dB) = Antenna Factor(dBμV/m) + Cable Loss(dB) – Pre_Amplifier Gain(dB)

Note : “F” : denotes Fundamental Frequency. ; “H” : denotes Harmonic Frequency.

“E” : denotes Band Edge Frequency. ; “S” : denotes Spurious Frequency.

“---” : denotes Noise Floor.

| Freq. MHz | Note F/H/E/S | Detector Mode PK/QP/AV | Spectrum Reading Level dBμV | Factor dB | Actual FS dBμV/m | Limit @3m dBμV/m | Margin dB |
|--------------|-----------------|------------------------------|-----------------------------------|--------------|------------------------|------------------------|--------------|
| 41.64 | S | Peak | 27.56 | -13.56 | 14.00 | 40.00 | -26.00 |
| 154.16 | S | Peak | 26.45 | -12.30 | 14.15 | 43.50 | -29.35 |
| 343.31 | S | Peak | 27.88 | -11.76 | 16.12 | 46.00 | -29.88 |
| 427.70 | S | Peak | 27.13 | -10.47 | 16.66 | 46.00 | -29.34 |
| 515.00 | S | Peak | 27.63 | -9.30 | 18.33 | 46.00 | -27.67 |
| 652.74 | S | Peak | 28.32 | -6.53 | 21.79 | 46.00 | -24.21 |
| 3700.40 | H | Peak | 37.13 | 5.12 | 42.25 | 54.00 | -11.75 |
| 5550.60 | H | --- | | | | | |
| 7400.80 | H | --- | | | | | |
| 9251.00 | H | --- | | | | | |
| 11101.20 | H | --- | | | | | |
| 12951.40 | H | --- | | | | | |
| 14801.60 | H | --- | | | | | |
| 16651.80 | H | --- | | | | | |
| 18502.00 | H | --- | | | | | |

Unless otherwise stated the results shown in this test report refer only to the sample(s) tested and such sample(s) are retained for 90 days only.

除非另有說明，此報告結果僅對測試之樣品負責，同時此樣品僅保留90天。本報告未經本公司書面許可，不可部份複製。

This document is issued by the Company subject to its General Conditions of Service printed overleaf, available on request or accessible at www.sgs.com/terms_and_conditions.htm and, for electronic format documents, subject to Terms and Conditions for Electronic Documents at www.sgs.com/terms_e-document.htm. Attention is drawn to the limitation of liability, indemnification and jurisdiction issues defined therein. Any holder of this document is advised that information contained hereon reflects the Company's findings at the time of its intervention only and within the limits of Client's instructions, if any. The Company's sole responsibility is to its Client and this document does not exonerate parties to a transaction from exercising all their rights and obligations under the transaction documents. This document cannot be reproduced except in full, without prior written approval of the Company. Any unauthorized alteration, forgery or falsification of the content or appearance of this document is unlawful and offenders may be prosecuted to the fullest extent of the law.

| | | | |
|-----------------------|-----------|--------------------------|---------------------|
| Operation Band | :GSM 1900 | Test Date | :2013-05-03 |
| Fundamental Frequency | :1880 MHz | Temp./Humi. | :24.1 deg_C / 65 RH |
| Operation Mode | :RX MID | Engineer | :Allen |
| EUT Pol. | :E1 Plan | Measurement Antenna Pol. | :VERTICAL |

Actual FS(dBμV/m) = SPA. Reading level(dBμV) + Factor(dB)

Factor(dB) = Antenna Factor(dBμV/m) + Cable Loss(dB) – Pre_Amplifier Gain(dB)

Note : “F” : denotes Fundamental Frequency. ; “H” : denotes Harmonic Frequency.

“E” : denotes Band Edge Frequency. ; “S” : denotes Spurious Frequency.

“---“ : denotes Noise Floor.

| Freq. | Note | Detector Mode | Spectrum Reading Level | Factor | Actual FS | Limit @3m | Margin |
|----------|---------|---------------|------------------------|--------|-----------|-----------|--------|
| MHz | F/H/E/S | PK/QP/AV | dBμV | dB | dBμV/m | dBμV/m | dB |
| 41.64 | S | Peak | 30.55 | -13.56 | 16.99 | 40.00 | -23.01 |
| 157.07 | S | Peak | 28.05 | -12.29 | 15.76 | 43.50 | -27.74 |
| 507.24 | S | Peak | 27.64 | -9.45 | 18.19 | 46.00 | -27.81 |
| 611.03 | S | Peak | 27.34 | -7.32 | 20.02 | 46.00 | -25.98 |
| 687.66 | S | Peak | 27.47 | -5.91 | 21.56 | 46.00 | -24.44 |
| 903.97 | S | Peak | 27.36 | -2.73 | 24.63 | 46.00 | -21.37 |
| 3760.00 | H | Peak | 37.04 | 5.53 | 42.57 | 54.00 | -11.43 |
| 5640.00 | H | --- | | | | | |
| 7520.00 | H | --- | | | | | |
| 9400.00 | H | --- | | | | | |
| 11280.00 | H | --- | | | | | |
| 13160.00 | H | --- | | | | | |
| 15040.00 | H | --- | | | | | |
| 16920.00 | H | --- | | | | | |
| 18800.00 | H | --- | | | | | |

Unless otherwise stated the results shown in this test report refer only to the sample(s) tested and such sample(s) are retained for 90 days only.

除非另有說明，此報告結果僅對測試之樣品負責，同時此樣品僅保留90天。本報告未經本公司書面許可，不可部份複製。

This document is issued by the Company subject to its General Conditions of Service printed overleaf, available on request or accessible at www.sgs.com/terms_and_conditions.htm and, for electronic format documents, subject to Terms and Conditions for Electronic Documents at www.sgs.com/terms_e-document.htm. Attention is drawn to the limitation of liability, indemnification and jurisdiction issues defined therein. Any holder of this document is advised that information contained hereon reflects the Company's findings at the time of its intervention only and within the limits of Client's instructions, if any. The Company's sole responsibility is to its Client and this document does not exonerate parties to a transaction from exercising all their rights and obligations under the transaction documents. This document cannot be reproduced except in full, without prior written approval of the Company. Any unauthorized alteration, forgery or falsification of the content or appearance of this document is unlawful and offenders may be prosecuted to the fullest extent of the law.

| | | | |
|-----------------------|-----------|--------------------------|---------------------|
| Operation Band | :GSM 1900 | Test Date | :2013-05-03 |
| Fundamental Frequency | :1880 MHz | Temp./Humi. | :24.1 deg_C / 65 RH |
| Operation Mode | :RX MID | Engineer | :Allen |
| EUT Pol. | :E1 Plan | Measurement Antenna Pol. | :HORIZONTAL |

Actual FS(dBμV/m) = SPA. Reading level(dBμV) + Factor(dB)

Factor(dB) = Antenna Factor(dBμV/m) + Cable Loss(dB) – Pre_Amplifier Gain(dB)

Note : “F” : denotes Fundamental Frequency. ; “H” : denotes Harmonic Frequency.

“E” : denotes Band Edge Frequency. ; “S” : denotes Spurious Frequency.

“---“ : denotes Noise Floor.

| Freq. | Note | Detector | Spectrum | Factor | Actual | Limit | Margin |
|----------|---------|----------|---------------|--------|--------|--------|--------|
| MHz | F/H/E/S | Mode | Reading Level | dB | FS | @3m | dB |
| | | PK/QP/AV | dBμV | | dBμV/m | dBμV/m | |
| 88.20 | S | Peak | 30.58 | -17.68 | 12.90 | 43.50 | -30.60 |
| 157.07 | S | Peak | 26.49 | -12.29 | 14.20 | 43.50 | -29.30 |
| 386.96 | S | Peak | 27.21 | -11.19 | 16.02 | 46.00 | -29.98 |
| 540.22 | S | Peak | 27.62 | -8.78 | 18.84 | 46.00 | -27.16 |
| 657.59 | S | Peak | 27.22 | -6.43 | 20.79 | 46.00 | -25.21 |
| 766.23 | S | Peak | 27.78 | -4.69 | 23.09 | 46.00 | -22.91 |
| 3760.00 | H | Peak | 35.92 | 5.54 | 41.46 | 54.00 | -12.54 |
| 5640.00 | H | --- | | | | | |
| 7520.00 | H | --- | | | | | |
| 9400.00 | H | --- | | | | | |
| 11280.00 | H | --- | | | | | |
| 13160.00 | H | --- | | | | | |
| 15040.00 | H | --- | | | | | |
| 16920.00 | H | --- | | | | | |
| 18800.00 | H | --- | | | | | |

Unless otherwise stated the results shown in this test report refer only to the sample(s) tested and such sample(s) are retained for 90 days only.

除非另有說明，此報告結果僅對測試之樣品負責，同時此樣品僅保留90天。本報告未經本公司書面許可，不可部份複製。

This document is issued by the Company subject to its General Conditions of Service printed overleaf, available on request or accessible at www.sgs.com/terms_and_conditions.htm and, for electronic format documents, subject to Terms and Conditions for Electronic Documents at www.sgs.com/terms_e-document.htm. Attention is drawn to the limitation of liability, indemnification and jurisdiction issues defined therein. Any holder of this document is advised that information contained hereon reflects the Company's findings at the time of its intervention only and within the limits of Client's instructions, if any. The Company's sole responsibility is to its Client and this document does not exonerate parties to a transaction from exercising all their rights and obligations under the transaction documents. This document cannot be reproduced except in full, without prior written approval of the Company. Any unauthorized alteration, forgery or falsification of the content or appearance of this document is unlawful and offenders may be prosecuted to the fullest extent of the law.

| | | | |
|-----------------------|-------------|--------------------------|---------------------|
| Operation Band | :GSM 1900 | Test Date | :2013-05-03 |
| Fundamental Frequency | :1909.8 MHz | Temp./Humi. | :24.1 deg_C / 65 RH |
| Operation Mode | :RX HIGH | Engineer | :Allen |
| EUT Pol. | :E1 Plan | Measurement Antenna Pol. | :VERTICAL |

Actual FS(dBμV/m) = SPA. Reading level(dBμV) + Factor(dB)

Factor(dB) = Antenna Factor(dBμV/m) + Cable Loss(dB) – Pre_Amplifier Gain(dB)

Note : “F” : denotes Fundamental Frequency. ; “H” : denotes Harmonic Frequency.

“E” : denotes Band Edge Frequency. ; “S” : denotes Spurious Frequency.

“---“ : denotes Noise Floor.

| Freq. MHz | Note F/H/E/S | Detector Mode PK/QP/AV | Spectrum Reading Level dBμV | Factor dB | Actual FS dBμV/m | Limit @3m dBμV/m | Margin dB |
|--------------|-----------------|------------------------------|-----------------------------------|--------------|------------------------|------------------------|--------------|
| 157.07 | S | Peak | 27.67 | -12.29 | 15.38 | 43.50 | -28.12 |
| 447.10 | S | Peak | 27.52 | -10.08 | 17.44 | 46.00 | -28.56 |
| 497.54 | S | Peak | 27.39 | -9.62 | 17.77 | 46.00 | -28.23 |
| 600.36 | S | Peak | 27.74 | -7.55 | 20.19 | 46.00 | -25.81 |
| 770.11 | S | Peak | 27.32 | -4.61 | 22.71 | 46.00 | -23.29 |
| 915.61 | S | Peak | 27.58 | -2.51 | 25.07 | 46.00 | -20.93 |
| 3819.60 | H | Peak | 36.82 | 5.34 | 42.16 | 54.00 | -11.84 |
| 5729.40 | H | --- | | | | | |
| 7639.20 | H | --- | | | | | |
| 9549.00 | H | --- | | | | | |
| 11458.80 | H | --- | | | | | |
| 13368.60 | H | --- | | | | | |
| 15278.40 | H | --- | | | | | |
| 17188.20 | H | --- | | | | | |
| 19098.00 | H | --- | | | | | |

Unless otherwise stated the results shown in this test report refer only to the sample(s) tested and such sample(s) are retained for 90 days only.

除非另有說明，此報告結果僅對測試之樣品負責，同時此樣品僅保留90天。本報告未經本公司書面許可，不可部份複製。

This document is issued by the Company subject to its General Conditions of Service printed overleaf, available on request or accessible at www.sgs.com/terms_and_conditions.htm and, for electronic format documents, subject to Terms and Conditions for Electronic Documents at www.sgs.com/terms_e-document.htm. Attention is drawn to the limitation of liability, indemnification and jurisdiction issues defined therein. Any holder of this document is advised that information contained hereon reflects the Company's findings at the time of its intervention only and within the limits of Client's instructions, if any. The Company's sole responsibility is to its Client and this document does not exonerate parties to a transaction from exercising all their rights and obligations under the transaction documents. This document cannot be reproduced except in full, without prior written approval of the Company. Any unauthorized alteration, forgery or falsification of the content or appearance of this document is unlawful and offenders may be prosecuted to the fullest extent of the law.

| | | | |
|-----------------------|-------------|--------------------------|---------------------|
| Operation Band | :GSM 1900 | Test Date | :2013-05-03 |
| Fundamental Frequency | :1909.8 MHz | Temp./Humi. | :24.1 deg_C / 65 RH |
| Operation Mode | :RX HIGH | Engineer | :Allen |
| EUT Pol. | :E1 Plan | Measurement Antenna Pol. | :HORIZONTAL |

Actual FS(dBμV/m) = SPA. Reading level(dBμV) + Factor(dB)

Factor(dB) = Antenna Factor(dBμV/m) + Cable Loss(dB) – Pre_Amplifier Gain(dB)

Note : “F” : denotes Fundamental Frequency. ; “H” : denotes Harmonic Frequency.

“E” : denotes Band Edge Frequency. ; “S” : denotes Spurious Frequency.

“---“ : denotes Noise Floor.

| Freq. MHz | Note F/H/E/S | Detector Mode PK/QP/AV | Spectrum Reading Level dBμV | Factor dB | Actual FS dBμV/m | Limit @3m dBμV/m | Margin dB |
|--------------|-----------------|------------------------------|-----------------------------------|--------------|------------------------|------------------------|--------------|
| 53.28 | S | Peak | 27.64 | -14.14 | 13.50 | 40.00 | -26.50 |
| 159.98 | S | Peak | 26.83 | -12.26 | 14.57 | 43.50 | -28.93 |
| 259.89 | S | Peak | 27.55 | -13.75 | 13.80 | 46.00 | -32.20 |
| 321.00 | S | Peak | 27.29 | -12.08 | 15.21 | 46.00 | -30.79 |
| 607.15 | S | Peak | 28.09 | -7.40 | 20.69 | 46.00 | -25.31 |
| 889.42 | S | Peak | 27.46 | -3.02 | 24.44 | 46.00 | -21.56 |
| 3819.60 | H | Peak | 36.91 | 5.40 | 42.31 | 54.00 | -11.69 |
| 5729.40 | H | --- | | | | | |
| 7639.20 | H | --- | | | | | |
| 9549.00 | H | --- | | | | | |
| 11458.80 | H | --- | | | | | |
| 13368.60 | H | --- | | | | | |
| 15278.40 | H | --- | | | | | |
| 17188.20 | H | --- | | | | | |
| 19098.00 | H | --- | | | | | |

Unless otherwise stated the results shown in this test report refer only to the sample(s) tested and such sample(s) are retained for 90 days only.

除非另有說明，此報告結果僅對測試之樣品負責，同時此樣品僅保留90天。本報告未經本公司書面許可，不可部份複製。

This document is issued by the Company subject to its General Conditions of Service printed overleaf, available on request or accessible at www.sgs.com/terms_and_conditions.htm and, for electronic format documents, subject to Terms and Conditions for Electronic Documents at www.sgs.com/terms_e-document.htm. Attention is drawn to the limitation of liability, indemnification and jurisdiction issues defined therein. Any holder of this document is advised that information contained hereon reflects the Company's findings at the time of its intervention only and within the limits of Client's instructions, if any. The Company's sole responsibility is to its Client and this document does not exonerate parties to a transaction from exercising all their rights and obligations under the transaction documents. This document cannot be reproduced except in full, without prior written approval of the Company. Any unauthorized alteration, forgery or falsification of the content or appearance of this document is unlawful and offenders may be prosecuted to the fullest extent of the law.

Radiated Spurious Emission Measurement Result: WCDMA II Mode

| | | | |
|-----------------------|-------------|--------------------------|---------------------|
| Operation Band | :WCDMA B2 | Test Date | :2013-05-03 |
| Fundamental Frequency | :1852.4 MHz | Temp./Humi. | :24.1 deg_C / 65 RH |
| Operation Mode | :RX LOW | Engineer | :Allen |
| EUT Pol. | :E1 Plan | Measurement Antenna Pol. | :VERTICAL |

Actual FS(dBμV/m) = SPA. Reading level(dBμV) + Factor(dB)

Factor(dB) = Antenna Factor(dBμV/m) + Cable Loss(dB) – Pre_Amplifier Gain(dB)

Note : “F” : denotes Fundamental Frequency. ; “H” : denotes Harmonic Frequency.

“E” : denotes Band Edge Frequency. ; “S” : denotes Spurious Frequency.

“---“ : denotes Noise Floor.

| Freq. MHz | Note F/H/E/S | Detector Mode PK/QP/AV | Spectrum Reading Level dBμV | Factor dB | Actual FS dBμV/m | Limit @3m dBμV/m | Margin dB |
|--------------|-----------------|------------------------------|-----------------------------------|--------------|------------------------|------------------------|--------------|
| 53.28 | S | Peak | 29.73 | -14.14 | 15.59 | 40.00 | -24.41 |
| 158.04 | S | Peak | 27.44 | -12.30 | 15.14 | 43.50 | -28.36 |
| 385.99 | S | Peak | 26.96 | -11.20 | 15.76 | 46.00 | -30.24 |
| 608.12 | S | Peak | 28.27 | -7.38 | 20.89 | 46.00 | -25.11 |
| 774.96 | S | Peak | 28.07 | -4.54 | 23.53 | 46.00 | -22.47 |
| 914.64 | S | Peak | 28.26 | -2.53 | 25.73 | 46.00 | -20.27 |
| 3704.80 | H | Peak | 36.31 | 5.22 | 41.53 | 74.00 | -32.47 |
| 5557.20 | H | --- | | | | | |
| 7409.60 | H | --- | | | | | |
| 9262.00 | H | --- | | | | | |
| 11114.40 | H | --- | | | | | |
| 12966.80 | H | --- | | | | | |
| 14819.20 | H | --- | | | | | |
| 16671.60 | H | --- | | | | | |
| 18524.00 | H | --- | | | | | |

Unless otherwise stated the results shown in this test report refer only to the sample(s) tested and such sample(s) are retained for 90 days only.

除非另有說明，此報告結果僅對測試之樣品負責，同時此樣品僅保留90天。本報告未經本公司書面許可，不可部份複製。

This document is issued by the Company subject to its General Conditions of Service printed overleaf, available on request or accessible at www.sgs.com/terms_and_conditions.htm and, for electronic format documents, subject to Terms and Conditions for Electronic Documents at www.sgs.com/terms_e-document.htm. Attention is drawn to the limitation of liability, indemnification and jurisdiction issues defined therein. Any holder of this document is advised that information contained hereon reflects the Company's findings at the time of its intervention only and within the limits of Client's instructions, if any. The Company's sole responsibility is to its Client and this document does not exonerate parties to a transaction from exercising all their rights and obligations under the transaction documents. This document cannot be reproduced except in full, without prior written approval of the Company. Any unauthorized alteration, forgery or falsification of the content or appearance of this document is unlawful and offenders may be prosecuted to the fullest extent of the law.

| | | | |
|-----------------------|-------------|--------------------------|---------------------|
| Operation Band | :WCDMA B2 | Test Date | :2013-05-03 |
| Fundamental Frequency | :1852.4 MHz | Temp./Humi. | :24.1 deg_C / 65 RH |
| Operation Mode | :RX LOW | Engineer | :Allen |
| EUT Pol. | :E1 Plan | Measurement Antenna Pol. | :HORIZONTAL |

Actual FS(dBμV/m) = SPA. Reading level(dBμV) + Factor(dB)

Factor(dB) = Antenna Factor(dBμV/m) + Cable Loss(dB) – Pre_Amplifier Gain(dB)

Note : “F” : denotes Fundamental Frequency. ; “H” : denotes Harmonic Frequency.

“E” : denotes Band Edge Frequency. ; “S” : denotes Spurious Frequency.

“---” : denotes Noise Floor.

| Freq. | Note | Detector Mode | Spectrum Reading Level | Factor | Actual FS | Limit @3m | Margin |
|----------|---------|---------------|------------------------|--------|-----------|-----------|--------|
| MHz | F/H/E/S | PK/QP/AV | dBμV | dB | dBμV/m | dBμV/m | dB |
| 87.23 | S | Peak | 31.09 | -17.69 | 13.40 | 40.00 | -26.60 |
| 154.16 | S | Peak | 27.31 | -12.30 | 15.01 | 43.50 | -28.49 |
| 476.20 | S | Peak | 28.08 | -9.84 | 18.24 | 46.00 | -27.76 |
| 579.99 | S | Peak | 27.91 | -7.99 | 19.92 | 46.00 | -26.08 |
| 775.93 | S | Peak | 28.34 | -4.52 | 23.82 | 46.00 | -22.18 |
| 936.95 | S | Peak | 26.71 | -2.23 | 24.48 | 46.00 | -21.52 |
| 3704.80 | H | Peak | 38.72 | 5.17 | 43.89 | 74.00 | -30.11 |
| 5557.20 | H | --- | | | | | |
| 7409.60 | H | --- | | | | | |
| 9262.00 | H | --- | | | | | |
| 11114.40 | H | --- | | | | | |
| 12966.80 | H | --- | | | | | |
| 14819.20 | H | --- | | | | | |
| 16671.60 | H | --- | | | | | |
| 18524.00 | H | --- | | | | | |

Unless otherwise stated the results shown in this test report refer only to the sample(s) tested and such sample(s) are retained for 90 days only.

除非另有說明，此報告結果僅對測試之樣品負責，同時此樣品僅保留90天。本報告未經本公司書面許可，不可部份複製。

This document is issued by the Company subject to its General Conditions of Service printed overleaf, available on request or accessible at www.sgs.com/terms_and_conditions.htm and, for electronic format documents, subject to Terms and Conditions for Electronic Documents at www.sgs.com/terms_e-document.htm. Attention is drawn to the limitation of liability, indemnification and jurisdiction issues defined therein. Any holder of this document is advised that information contained hereon reflects the Company's findings at the time of its intervention only and within the limits of Client's instructions, if any. The Company's sole responsibility is to its Client and this document does not exonerate parties to a transaction from exercising all their rights and obligations under the transaction documents. This document cannot be reproduced except in full, without prior written approval of the Company. Any unauthorized alteration, forgery or falsification of the content or appearance of this document is unlawful and offenders may be prosecuted to the fullest extent of the law.

| | | | |
|-----------------------|-----------|--------------------------|---------------------|
| Operation Band | :WCDMA B2 | Test Date | :2013-05-03 |
| Fundamental Frequency | :1880 MHz | Temp./Humi. | :24.1 deg_C / 65 RH |
| Operation Mode | :RX MID | Engineer | :Allen |
| EUT Pol. | :E1 Plan | Measurement Antenna Pol. | :VERTICAL |

Actual FS(dBμV/m) = SPA. Reading level(dBμV) + Factor(dB)

Factor(dB) = Antenna Factor(dBμV/m) + Cable Loss(dB) – Pre_Amplifier Gain(dB)

Note : “F” : denotes Fundamental Frequency. ; “H” : denotes Harmonic Frequency.

“E” : denotes Band Edge Frequency. ; “S” : denotes Spurious Frequency.

“---“ : denotes Noise Floor.

| Freq. MHz | Note F/H/E/S | Detector Mode PK/QP/AV | Spectrum Reading Level dBμV | Factor dB | Actual FS dBμV/m | Limit @3m dBμV/m | Margin dB |
|--------------|-----------------|------------------------------|-----------------------------------|--------------|------------------------|------------------------|--------------|
| 37.76 | S | Peak | 30.85 | -13.72 | 17.13 | 40.00 | -22.87 |
| 157.07 | S | Peak | 27.10 | -12.29 | 14.81 | 43.50 | -28.69 |
| 391.81 | S | Peak | 27.05 | -11.15 | 15.90 | 46.00 | -30.10 |
| 643.04 | S | Peak | 27.40 | -6.72 | 20.68 | 46.00 | -25.32 |
| 806.00 | S | Peak | 27.73 | -4.12 | 23.61 | 46.00 | -22.39 |
| 932.10 | S | Peak | 26.59 | -2.27 | 24.32 | 46.00 | -21.68 |
| 3760.00 | H | Peak | 38.02 | 5.53 | 43.55 | 74.00 | -30.45 |
| 5640.00 | H | --- | | | | | |
| 7520.00 | H | --- | | | | | |
| 9400.00 | H | --- | | | | | |
| 11280.00 | H | --- | | | | | |
| 13160.00 | H | --- | | | | | |
| 15040.00 | H | --- | | | | | |
| 16920.00 | H | --- | | | | | |
| 18800.00 | H | --- | | | | | |

Unless otherwise stated the results shown in this test report refer only to the sample(s) tested and such sample(s) are retained for 90 days only.

除非另有說明，此報告結果僅對測試之樣品負責，同時此樣品僅保留90天。本報告未經本公司書面許可，不可部份複製。

This document is issued by the Company subject to its General Conditions of Service printed overleaf, available on request or accessible at www.sgs.com/terms_and_conditions.htm and, for electronic format documents, subject to Terms and Conditions for Electronic Documents at www.sgs.com/terms_e-document.htm. Attention is drawn to the limitation of liability, indemnification and jurisdiction issues defined therein. Any holder of this document is advised that information contained hereon reflects the Company's findings at the time of its intervention only and within the limits of Client's instructions, if any. The Company's sole responsibility is to its Client and this document does not exonerate parties to a transaction from exercising all their rights and obligations under the transaction documents. This document cannot be reproduced except in full, without prior written approval of the Company. Any unauthorized alteration, forgery or falsification of the content or appearance of this document is unlawful and offenders may be prosecuted to the fullest extent of the law.

| | | | |
|-----------------------|-----------|--------------------------|---------------------|
| Operation Band | :WCDMA B2 | Test Date | :2013-05-03 |
| Fundamental Frequency | :1880 MHz | Temp./Humi. | :24.1 deg_C / 65 RH |
| Operation Mode | :RX MID | Engineer | :Allen |
| EUT Pol. | :E1 Plan | Measurement Antenna Pol. | :HORIZONTAL |

Actual FS(dBμV/m) = SPA. Reading level(dBμV) + Factor(dB)

Factor(dB) = Antenna Factor(dBμV/m) + Cable Loss(dB) – Pre_Amplifier Gain(dB)

Note : “F” : denotes Fundamental Frequency. ; “H” : denotes Harmonic Frequency.

“E” : denotes Band Edge Frequency. ; “S” : denotes Spurious Frequency.

“---“ : denotes Noise Floor.

| Freq. | Note | Detector | Spectrum | Factor | Actual | Limit | Margin |
|----------|---------|----------|---------------|--------|--------|--------|--------|
| MHz | F/H/E/S | Mode | Reading Level | dB | FS | @3m | dB |
| | | PK/QP/AV | dBμV | | dBμV/m | dBμV/m | |
| 154.16 | S | Peak | 27.04 | -12.30 | 14.74 | 43.50 | -28.76 |
| 271.53 | S | Peak | 28.21 | -13.32 | 14.89 | 46.00 | -31.11 |
| 564.47 | S | Peak | 27.53 | -8.28 | 19.25 | 46.00 | -26.75 |
| 642.07 | S | Peak | 27.82 | -6.73 | 21.09 | 46.00 | -24.91 |
| 817.64 | S | Peak | 27.74 | -4.00 | 23.74 | 46.00 | -22.26 |
| 920.46 | S | Peak | 27.99 | -2.42 | 25.57 | 46.00 | -20.43 |
| 3760.00 | H | Peak | 37.59 | 5.54 | 43.13 | 74.00 | -30.87 |
| 5640.00 | H | --- | | | | | |
| 7520.00 | H | --- | | | | | |
| 9400.00 | H | --- | | | | | |
| 11280.00 | H | --- | | | | | |
| 13160.00 | H | --- | | | | | |
| 15040.00 | H | --- | | | | | |
| 16920.00 | H | --- | | | | | |
| 18800.00 | H | --- | | | | | |

Unless otherwise stated the results shown in this test report refer only to the sample(s) tested and such sample(s) are retained for 90 days only.

除非另有說明，此報告結果僅對測試之樣品負責，同時此樣品僅保留90天。本報告未經本公司書面許可，不可部份複製。

This document is issued by the Company subject to its General Conditions of Service printed overleaf, available on request or accessible at www.sgs.com/terms_and_conditions.htm and, for electronic format documents, subject to Terms and Conditions for Electronic Documents at www.sgs.com/terms_e-document.htm. Attention is drawn to the limitation of liability, indemnification and jurisdiction issues defined therein. Any holder of this document is advised that information contained hereon reflects the Company's findings at the time of its intervention only and within the limits of Client's instructions, if any. The Company's sole responsibility is to its Client and this document does not exonerate parties to a transaction from exercising all their rights and obligations under the transaction documents. This document cannot be reproduced except in full, without prior written approval of the Company. Any unauthorized alteration, forgery or falsification of the content or appearance of this document is unlawful and offenders may be prosecuted to the fullest extent of the law.

| | | | |
|-----------------------|-------------|--------------------------|---------------------|
| Operation Band | :WCDMA B2 | Test Date | :2013-05-03 |
| Fundamental Frequency | :1907.6 MHz | Temp./Humi. | :24.1 deg_C / 65 RH |
| Operation Mode | :RX HIGH | Engineer | :Allen |
| EUT Pol. | :E1 Plan | Measurement Antenna Pol. | :VERTICAL |

Actual FS(dBμV/m) = SPA. Reading level(dBμV) + Factor(dB)

Factor(dB) = Antenna Factor(dBμV/m) + Cable Loss(dB) – Pre_Amplifier Gain(dB)

Note : “F” : denotes Fundamental Frequency. ; “H” : denotes Harmonic Frequency.

“E” : denotes Band Edge Frequency. ; “S” : denotes Spurious Frequency.

“---“ : denotes Noise Floor.

| Freq. | Note | Detector Mode | Spectrum Reading Level | Factor | Actual FS | Limit @3m | Margin |
|----------|---------|---------------|------------------------|--------|-----------|-----------|--------|
| MHz | F/H/E/S | PK/QP/AV | dBμV | dB | dBμV/m | dBμV/m | dB |
| 52.31 | S | Peak | 29.90 | -14.06 | 15.84 | 40.00 | -24.16 |
| 343.31 | S | Peak | 27.17 | -11.76 | 15.41 | 46.00 | -30.59 |
| 472.32 | S | Peak | 27.79 | -9.88 | 17.91 | 46.00 | -28.09 |
| 669.23 | S | Peak | 27.07 | -6.21 | 20.86 | 46.00 | -25.14 |
| 844.80 | S | Peak | 27.26 | -3.73 | 23.53 | 46.00 | -22.47 |
| 936.95 | S | Peak | 26.73 | -2.23 | 24.50 | 46.00 | -21.50 |
| 3815.20 | H | Peak | 37.80 | 5.32 | 43.12 | 74.00 | -30.88 |
| 5722.80 | H | --- | | | | | |
| 7630.40 | H | --- | | | | | |
| 9538.00 | H | --- | | | | | |
| 11445.60 | H | --- | | | | | |
| 13353.20 | H | --- | | | | | |
| 15260.80 | H | --- | | | | | |
| 17168.40 | H | --- | | | | | |
| 19076.00 | H | --- | | | | | |

Unless otherwise stated the results shown in this test report refer only to the sample(s) tested and such sample(s) are retained for 90 days only.

除非另有說明，此報告結果僅對測試之樣品負責，同時此樣品僅保留90天。本報告未經本公司書面許可，不可部份複製。

This document is issued by the Company subject to its General Conditions of Service printed overleaf, available on request or accessible at www.sgs.com/terms_and_conditions.htm and, for electronic format documents, subject to Terms and Conditions for Electronic Documents at www.sgs.com/terms_e-document.htm. Attention is drawn to the limitation of liability, indemnification and jurisdiction issues defined therein. Any holder of this document is advised that information contained hereon reflects the Company's findings at the time of its intervention only and within the limits of Client's instructions, if any. The Company's sole responsibility is to its Client and this document does not exonerate parties to a transaction from exercising all their rights and obligations under the transaction documents. This document cannot be reproduced except in full, without prior written approval of the Company. Any unauthorized alteration, forgery or falsification of the content or appearance of this document is unlawful and offenders may be prosecuted to the fullest extent of the law.

| | | | |
|-----------------------|-------------|--------------------------|---------------------|
| Operation Band | :WCDMA B2 | Test Date | :2013-05-03 |
| Fundamental Frequency | :1907.6 MHz | Temp./Humi. | :24.1 deg_C / 65 RH |
| Operation Mode | :RX HIGH | Engineer | :Allen |
| EUT Pol. | :E1 Plan | Measurement Antenna Pol. | :HORIZONTAL |

Actual FS(dBμV/m) = SPA. Reading level(dBμV) + Factor(dB)

Factor(dB) = Antenna Factor(dBμV/m) + Cable Loss(dB) – Pre_Amplifier Gain(dB)

Note : “F” : denotes Fundamental Frequency. ; “H” : denotes Harmonic Frequency.

“E” : denotes Band Edge Frequency. ; “S” : denotes Spurious Frequency.

“---“ : denotes Noise Floor.

| Freq. | Note | Detector Mode | Spectrum Reading Level | Factor | Actual FS | Limit @3m | Margin |
|----------|---------|---------------|------------------------|--------|-----------|-----------|--------|
| MHz | F/H/E/S | PK/QP/AV | dBμV | dB | dBμV/m | dBμV/m | dB |
| 50.37 | S | Peak | 27.56 | -13.93 | 13.63 | 40.00 | -26.37 |
| 161.92 | S | Peak | 26.68 | -12.43 | 14.25 | 43.50 | -29.25 |
| 271.53 | S | Peak | 28.20 | -13.32 | 14.88 | 46.00 | -31.12 |
| 566.41 | S | Peak | 27.94 | -8.25 | 19.69 | 46.00 | -26.31 |
| 646.92 | S | Peak | 27.38 | -6.65 | 20.73 | 46.00 | -25.27 |
| 857.41 | S | Peak | 27.42 | -3.58 | 23.84 | 46.00 | -22.16 |
| 3815.20 | H | Peak | 39.49 | 5.37 | 44.86 | 74.00 | -29.14 |
| 5722.80 | H | --- | | | | | |
| 7630.40 | H | --- | | | | | |
| 9538.00 | H | --- | | | | | |
| 11445.60 | H | --- | | | | | |
| 13353.20 | H | --- | | | | | |
| 15260.80 | H | --- | | | | | |
| 17168.40 | H | --- | | | | | |
| 19076.00 | H | --- | | | | | |

Unless otherwise stated the results shown in this test report refer only to the sample(s) tested and such sample(s) are retained for 90 days only.

除非另有說明，此報告結果僅對測試之樣品負責，同時此樣品僅保留90天。本報告未經本公司書面許可，不可部份複製。

This document is issued by the Company subject to its General Conditions of Service printed overleaf, available on request or accessible at www.sgs.com/terms_and_conditions.htm and, for electronic format documents, subject to Terms and Conditions for Electronic Documents at www.sgs.com/terms_e-document.htm. Attention is drawn to the limitation of liability, indemnification and jurisdiction issues defined therein. Any holder of this document is advised that information contained hereon reflects the Company's findings at the time of its intervention only and within the limits of Client's instructions, if any. The Company's sole responsibility is to its Client and this document does not exonerate parties to a transaction from exercising all their rights and obligations under the transaction documents. This document cannot be reproduced except in full, without prior written approval of the Company. Any unauthorized alteration, forgery or falsification of the content or appearance of this document is unlawful and offenders may be prosecuted to the fullest extent of the law.

Radiated Spurious Emission Measurement Result: WCDMA IV Mode

| | | | |
|-----------------------|-------------|--------------------------|---------------------|
| Operation Band | :WCDMA B4 | Test Date | :2013-05-03 |
| Fundamental Frequency | :1712.4 MHz | Temp./Humi. | :24.1 deg_C / 65 RH |
| Operation Mode | :RX LOW | Engineer | :Allen |
| EUT Pol. | :H Plan | Measurement Antenna Pol. | :VERTICAL |

Actual FS(dBμV/m) = SPA. Reading level(dBμV) + Factor(dB)

Factor(dB) = Antenna Factor(dBμV/m) + Cable Loss(dB) – Pre_Amplifier Gain(dB)

Note : “F” : denotes Fundamental Frequency. ; “H” : denotes Harmonic Frequency.

“E” : denotes Band Edge Frequency. ; “S” : denotes Spurious Frequency.

“---“ : denotes Noise Floor.

| Freq. MHz | Note F/H/E/S | Detector Mode PK/QP/AV | Spectrum Reading Level dBμV | Factor dB | Actual FS dBμV/m | Limit @3m dBμV/m | Margin dB |
|--------------|-----------------|------------------------------|-----------------------------------|--------------|------------------------|------------------------|--------------|
| 153.19 | S | Peak | 26.87 | -12.32 | 14.55 | 43.50 | -28.95 |
| 329.73 | S | Peak | 28.22 | -11.92 | 16.30 | 46.00 | -29.70 |
| 471.35 | S | Peak | 28.17 | -9.90 | 18.27 | 46.00 | -27.73 |
| 652.74 | S | Peak | 28.19 | -6.53 | 21.66 | 46.00 | -24.34 |
| 765.26 | S | Peak | 28.16 | -4.70 | 23.46 | 46.00 | -22.54 |
| 946.65 | S | Peak | 27.66 | -2.12 | 25.54 | 46.00 | -20.46 |
| 3424.80 | H | Peak | 36.80 | 4.20 | 41.00 | 54.00 | -13.00 |
| 5137.20 | H | --- | | | | | |
| 6849.60 | H | --- | | | | | |
| 8562.00 | H | --- | | | | | |
| 10274.40 | H | --- | | | | | |
| 11986.80 | H | --- | | | | | |
| 13699.20 | H | --- | | | | | |
| 15411.60 | H | --- | | | | | |
| 17124.00 | H | --- | | | | | |

Unless otherwise stated the results shown in this test report refer only to the sample(s) tested and such sample(s) are retained for 90 days only.

除非另有說明，此報告結果僅對測試之樣品負責，同時此樣品僅保留90天。本報告未經本公司書面許可，不可部份複製。

This document is issued by the Company subject to its General Conditions of Service printed overleaf, available on request or accessible at www.sgs.com/terms_and_conditions.htm and, for electronic format documents, subject to Terms and Conditions for Electronic Documents at www.sgs.com/terms_e-document.htm. Attention is drawn to the limitation of liability, indemnification and jurisdiction issues defined therein. Any holder of this document is advised that information contained hereon reflects the Company's findings at the time of its intervention only and within the limits of Client's instructions, if any. The Company's sole responsibility is to its Client and this document does not exonerate parties to a transaction from exercising all their rights and obligations under the transaction documents. This document cannot be reproduced except in full, without prior written approval of the Company. Any unauthorized alteration, forgery or falsification of the content or appearance of this document is unlawful and offenders may be prosecuted to the fullest extent of the law.

| | | | |
|-----------------------|-------------|--------------------------|---------------------|
| Operation Band | :WCDMA B4 | Test Date | :2013-05-03 |
| Fundamental Frequency | :1712.4 MHz | Temp./Humi. | :24.1 deg_C / 65 RH |
| Operation Mode | :RX LOW | Engineer | :Allen |
| EUT Pol. | :H Plan | Measurement Antenna Pol. | :HORIZONTAL |

Actual FS(dBμV/m) = SPA. Reading level(dBμV) + Factor(dB)

Factor(dB) = Antenna Factor(dBμV/m) + Cable Loss(dB) – Pre_Amplifier Gain(dB)

Note : “F” : denotes Fundamental Frequency. ; “H” : denotes Harmonic Frequency.

“E” : denotes Band Edge Frequency. ; “S” : denotes Spurious Frequency.

“---“ : denotes Noise Floor.

| Freq. MHz | Note F/H/E/S | Detector Mode PK/QP/AV | Spectrum Reading Level dBμV | Factor dB | Actual FS dBμV/m | Limit @3m dBμV/m | Margin dB |
|--------------|-----------------|------------------------------|-----------------------------------|--------------|------------------------|------------------------|--------------|
| 42.61 | S | Peak | 27.54 | -13.63 | 13.91 | 40.00 | -26.09 |
| 151.25 | S | Peak | 27.15 | -12.34 | 14.81 | 43.50 | -28.69 |
| 335.55 | S | Peak | 28.98 | -11.86 | 17.12 | 46.00 | -28.88 |
| 512.09 | S | Peak | 29.30 | -9.36 | 19.94 | 46.00 | -26.06 |
| 617.82 | S | Peak | 28.78 | -7.18 | 21.60 | 46.00 | -24.40 |
| 911.73 | S | Peak | 27.14 | -2.58 | 24.56 | 46.00 | -21.44 |
| 3424.80 | H | Peak | 37.75 | 4.08 | 41.83 | 54.00 | -12.17 |
| 5137.20 | H | --- | | | | | |
| 6849.60 | H | --- | | | | | |
| 8562.00 | H | --- | | | | | |
| 10274.40 | H | --- | | | | | |
| 11986.80 | H | --- | | | | | |
| 13699.20 | H | --- | | | | | |
| 15411.60 | H | --- | | | | | |
| 17124.00 | H | --- | | | | | |

Unless otherwise stated the results shown in this test report refer only to the sample(s) tested and such sample(s) are retained for 90 days only.

除非另有說明，此報告結果僅對測試之樣品負責，同時此樣品僅保留90天。本報告未經本公司書面許可，不可部份複製。

This document is issued by the Company subject to its General Conditions of Service printed overleaf, available on request or accessible at www.sgs.com/terms_and_conditions.htm and, for electronic format documents, subject to Terms and Conditions for Electronic Documents at www.sgs.com/terms_e-document.htm. Attention is drawn to the limitation of liability, indemnification and jurisdiction issues defined therein. Any holder of this document is advised that information contained hereon reflects the Company's findings at the time of its intervention only and within the limits of Client's instructions, if any. The Company's sole responsibility is to its Client and this document does not exonerate parties to a transaction from exercising all their rights and obligations under the transaction documents. This document cannot be reproduced except in full, without prior written approval of the Company. Any unauthorized alteration, forgery or falsification of the content or appearance of this document is unlawful and offenders may be prosecuted to the fullest extent of the law.

| | | | |
|-----------------------|-------------|--------------------------|---------------------|
| Operation Band | :WCDMA B4 | Test Date | :2013-05-03 |
| Fundamental Frequency | :1732.6 MHz | Temp./Humi. | :24.1 deg_C / 65 RH |
| Operation Mode | :RX MID | Engineer | :Allen |
| EUT Pol. | :H Plan | Measurement Antenna Pol. | :VERTICAL |

Actual FS(dBμV/m) = SPA. Reading level(dBμV) + Factor(dB)

Factor(dB) = Antenna Factor(dBμV/m) + Cable Loss(dB) – Pre_Amplifier Gain(dB)

Note : “F” : denotes Fundamental Frequency. ; “H” : denotes Harmonic Frequency.

“E” : denotes Band Edge Frequency. ; “S” : denotes Spurious Frequency.

“---“ : denotes Noise Floor.

| Freq. | Note | Detector Mode | Spectrum Reading Level | Factor | Actual FS | Limit @3m | Margin |
|----------|---------|---------------|------------------------|--------|-----------|-----------|--------|
| MHz | F/H/E/S | PK/QP/AV | dBμV | dB | dBμV/m | dBμV/m | dB |
| 48.43 | S | Peak | 35.59 | -13.88 | 21.71 | 40.00 | -18.29 |
| 150.28 | S | Peak | 26.50 | -12.35 | 14.15 | 43.50 | -29.35 |
| 321.97 | S | Peak | 26.35 | -12.04 | 14.31 | 46.00 | -31.69 |
| 648.86 | S | Peak | 28.45 | -6.62 | 21.83 | 46.00 | -24.17 |
| 855.47 | S | Peak | 28.65 | -3.60 | 25.05 | 46.00 | -20.95 |
| 908.82 | S | Peak | 27.36 | -2.63 | 24.73 | 46.00 | -21.27 |
| 3465.20 | H | Peak | 36.67 | 4.85 | 41.52 | 54.00 | -12.48 |
| 5197.80 | H | --- | | | | | |
| 6930.40 | H | --- | | | | | |
| 8663.00 | H | --- | | | | | |
| 10395.60 | H | --- | | | | | |
| 12128.20 | H | --- | | | | | |
| 13860.80 | H | --- | | | | | |
| 15593.40 | H | --- | | | | | |
| 17326.00 | H | --- | | | | | |

Unless otherwise stated the results shown in this test report refer only to the sample(s) tested and such sample(s) are retained for 90 days only.

除非另有說明，此報告結果僅對測試之樣品負責，同時此樣品僅保留90天。本報告未經本公司書面許可，不可部份複製。

This document is issued by the Company subject to its General Conditions of Service printed overleaf, available on request or accessible at www.sgs.com/terms_and_conditions.htm and, for electronic format documents, subject to Terms and Conditions for Electronic Documents at www.sgs.com/terms_e-document.htm. Attention is drawn to the limitation of liability, indemnification and jurisdiction issues defined therein. Any holder of this document is advised that information contained hereon reflects the Company's findings at the time of its intervention only and within the limits of Client's instructions, if any. The Company's sole responsibility is to its Client and this document does not exonerate parties to a transaction from exercising all their rights and obligations under the transaction documents. This document cannot be reproduced except in full, without prior written approval of the Company. Any unauthorized alteration, forgery or falsification of the content or appearance of this document is unlawful and offenders may be prosecuted to the fullest extent of the law.

| | | | |
|-----------------------|-------------|--------------------------|---------------------|
| Operation Band | :WCDMA B4 | Test Date | :2013-05-03 |
| Fundamental Frequency | :1732.6 MHz | Temp./Humi. | :24.1 deg_C / 65 RH |
| Operation Mode | :RX MID | Engineer | :Allen |
| EUT Pol. | :H Plan | Measurement Antenna Pol. | :HORIZONTAL |

Actual FS(dBμV/m) = SPA. Reading level(dBμV) + Factor(dB)

Factor(dB) = Antenna Factor(dBμV/m) + Cable Loss(dB) – Pre_Amplifier Gain(dB)

Note : “F” : denotes Fundamental Frequency. ; “H” : denotes Harmonic Frequency.

“E” : denotes Band Edge Frequency. ; “S” : denotes Spurious Frequency.

“---“ : denotes Noise Floor.

| Freq. MHz | Note F/H/E/S | Detector Mode PK/QP/AV | Spectrum Reading Level dBμV | Factor dB | Actual FS dBμV/m | Limit @3m dBμV/m | Margin dB |
|--------------|-----------------|------------------------------|-----------------------------------|--------------|------------------------|------------------------|--------------|
| 50.37 | S | Peak | 28.50 | -13.93 | 14.57 | 40.00 | -25.43 |
| 148.34 | S | Peak | 27.43 | -12.45 | 14.98 | 43.50 | -28.52 |
| 329.73 | S | Peak | 28.85 | -11.92 | 16.93 | 46.00 | -29.07 |
| 515.00 | S | Peak | 27.88 | -9.30 | 18.58 | 46.00 | -27.42 |
| 591.63 | S | Peak | 27.79 | -7.73 | 20.06 | 46.00 | -25.94 |
| 864.20 | S | Peak | 27.35 | -3.47 | 23.88 | 46.00 | -22.12 |
| 3465.20 | H | Peak | 38.70 | 4.64 | 43.34 | 54.00 | -10.66 |
| 5197.80 | H | --- | | | | | |
| 6930.40 | H | --- | | | | | |
| 8663.00 | H | --- | | | | | |
| 10395.60 | H | --- | | | | | |
| 12128.20 | H | --- | | | | | |
| 13860.80 | H | --- | | | | | |
| 15593.40 | H | --- | | | | | |
| 17326.00 | H | --- | | | | | |

Unless otherwise stated the results shown in this test report refer only to the sample(s) tested and such sample(s) are retained for 90 days only.

除非另有說明，此報告結果僅對測試之樣品負責，同時此樣品僅保留90天。本報告未經本公司書面許可，不可部份複製。

This document is issued by the Company subject to its General Conditions of Service printed overleaf, available on request or accessible at www.sgs.com/terms_and_conditions.htm and, for electronic format documents, subject to Terms and Conditions for Electronic Documents at www.sgs.com/terms_e-document.htm. Attention is drawn to the limitation of liability, indemnification and jurisdiction issues defined therein. Any holder of this document is advised that information contained hereon reflects the Company's findings at the time of its intervention only and within the limits of Client's instructions, if any. The Company's sole responsibility is to its Client and this document does not exonerate parties to a transaction from exercising all their rights and obligations under the transaction documents. This document cannot be reproduced except in full, without prior written approval of the Company. Any unauthorized alteration, forgery or falsification of the content or appearance of this document is unlawful and offenders may be prosecuted to the fullest extent of the law.

| | | | |
|-----------------------|-------------|--------------------------|---------------------|
| Operation Band | :WCDMA B4 | Test Date | :2013-05-03 |
| Fundamental Frequency | :1752.6 MHz | Temp./Humi. | :24.1 deg_C / 65 RH |
| Operation Mode | :RX HIGH | Engineer | :Allen |
| EUT Pol. | :H Plan | Measurement Antenna Pol. | :VERTICAL |

Actual FS(dBμV/m) = SPA. Reading level(dBμV) + Factor(dB)

Factor(dB) = Antenna Factor(dBμV/m) + Cable Loss(dB) – Pre_Amplifier Gain(dB)

Note : “F” : denotes Fundamental Frequency. ; “H” : denotes Harmonic Frequency.

“E” : denotes Band Edge Frequency. ; “S” : denotes Spurious Frequency.

“---“ : denotes Noise Floor.

| Freq. MHz | Note F/H/E/S | Detector Mode PK/QP/AV | Spectrum Reading Level dBμV | Factor dB | Actual FS dBμV/m | Limit @3m dBμV/m | Margin dB |
|--------------|-----------------|------------------------------|-----------------------------------|--------------|------------------------|------------------------|--------------|
| 161.92 | S | Peak | 27.32 | -12.43 | 14.89 | 43.50 | -28.61 |
| 339.43 | S | Peak | 28.24 | -11.82 | 16.42 | 46.00 | -29.58 |
| 545.07 | S | Peak | 28.40 | -8.67 | 19.73 | 46.00 | -26.27 |
| 731.31 | S | Peak | 28.26 | -5.27 | 22.99 | 46.00 | -23.01 |
| 855.47 | S | Peak | 28.14 | -3.60 | 24.54 | 46.00 | -21.46 |
| 947.62 | S | Peak | 27.11 | -2.12 | 24.99 | 46.00 | -21.01 |
| 3505.20 | H | Peak | 37.51 | 5.00 | 42.51 | 54.00 | -11.49 |
| 5257.80 | H | --- | | | | | |
| 7010.40 | H | --- | | | | | |
| 8763.00 | H | --- | | | | | |
| 10515.60 | H | --- | | | | | |
| 12268.20 | H | --- | | | | | |
| 14020.80 | H | --- | | | | | |
| 15773.40 | H | --- | | | | | |
| 17526.00 | H | --- | | | | | |

Unless otherwise stated the results shown in this test report refer only to the sample(s) tested and such sample(s) are retained for 90 days only.

除非另有說明，此報告結果僅對測試之樣品負責，同時此樣品僅保留90天。本報告未經本公司書面許可，不可部份複製。

This document is issued by the Company subject to its General Conditions of Service printed overleaf, available on request or accessible at www.sgs.com/terms_and_conditions.htm and, for electronic format documents, subject to Terms and Conditions for Electronic Documents at www.sgs.com/terms_e-document.htm. Attention is drawn to the limitation of liability, indemnification and jurisdiction issues defined therein. Any holder of this document is advised that information contained hereon reflects the Company's findings at the time of its intervention only and within the limits of Client's instructions, if any. The Company's sole responsibility is to its Client and this document does not exonerate parties to a transaction from exercising all their rights and obligations under the transaction documents. This document cannot be reproduced except in full, without prior written approval of the Company. Any unauthorized alteration, forgery or falsification of the content or appearance of this document is unlawful and offenders may be prosecuted to the fullest extent of the law.

| | | | |
|-----------------------|-------------|--------------------------|---------------------|
| Operation Band | :WCDMA B4 | Test Date | :2013-05-03 |
| Fundamental Frequency | :1752.6 MHz | Temp./Humi. | :24.1 deg_C / 65 RH |
| Operation Mode | :RX HIGH | Engineer | :Allen |
| EUT Pol. | :H Plan | Measurement Antenna Pol. | :HORIZONTAL |

Actual FS(dBμV/m) = SPA. Reading level(dBμV) + Factor(dB)

Factor(dB) = Antenna Factor(dBμV/m) + Cable Loss(dB) – Pre_Amplifier Gain(dB)

Note : “F” : denotes Fundamental Frequency. ; “H” : denotes Harmonic Frequency.

“E” : denotes Band Edge Frequency. ; “S” : denotes Spurious Frequency.

“---“ : denotes Noise Floor.

| Freq. | Note | Detector Mode | Spectrum Reading Level | Factor | Actual FS | Limit @3m | Margin |
|----------|---------|---------------|------------------------|--------|-----------|-----------|--------|
| MHz | F/H/E/S | PK/QP/AV | dBμV | dB | dBμV/m | dBμV/m | dB |
| 44.55 | S | Peak | 27.33 | -13.76 | 13.57 | 40.00 | -26.43 |
| 155.13 | S | Peak | 27.07 | -12.30 | 14.77 | 43.50 | -28.73 |
| 332.64 | S | Peak | 28.55 | -11.89 | 16.66 | 46.00 | -29.34 |
| 431.58 | S | Peak | 28.17 | -10.40 | 17.77 | 46.00 | -28.23 |
| 545.07 | S | Peak | 28.09 | -8.67 | 19.42 | 46.00 | -26.58 |
| 905.91 | S | Peak | 28.63 | -2.68 | 25.95 | 46.00 | -20.05 |
| 3505.20 | H | Peak | 36.88 | 4.71 | 41.59 | 54.00 | -12.41 |
| 5257.80 | H | --- | | | | | |
| 7010.40 | H | --- | | | | | |
| 8763.00 | H | --- | | | | | |
| 10515.60 | H | --- | | | | | |
| 12268.20 | H | --- | | | | | |
| 14020.80 | H | --- | | | | | |
| 15773.40 | H | --- | | | | | |
| 17526.00 | H | --- | | | | | |

Unless otherwise stated the results shown in this test report refer only to the sample(s) tested and such sample(s) are retained for 90 days only.

除非另有說明，此報告結果僅對測試之樣品負責，同時此樣品僅保留90天。本報告未經本公司書面許可，不可部份複製。

This document is issued by the Company subject to its General Conditions of Service printed overleaf, available on request or accessible at www.sgs.com/terms_and_conditions.htm and, for electronic format documents, subject to Terms and Conditions for Electronic Documents at www.sgs.com/terms_e-document.htm. Attention is drawn to the limitation of liability, indemnification and jurisdiction issues defined therein. Any holder of this document is advised that information contained hereon reflects the Company's findings at the time of its intervention only and within the limits of Client's instructions, if any. The Company's sole responsibility is to its Client and this document does not exonerate parties to a transaction from exercising all their rights and obligations under the transaction documents. This document cannot be reproduced except in full, without prior written approval of the Company. Any unauthorized alteration, forgery or falsification of the content or appearance of this document is unlawful and offenders may be prosecuted to the fullest extent of the law.

Radiated Spurious Emission Measurement Result: HSDPA V Mode

| | | | |
|-----------------------|------------|--------------------------|---------------------|
| Operation Band | :HSDPA B5 | Test Date | :2013-05-03 |
| Fundamental Frequency | :826.4 MHz | Temp./Humi. | :24.1 deg_C / 65 RH |
| Operation Mode | :RX LOW | Engineer | :Allen |
| EUT Pol. | :E1 Plan | Measurement Antenna Pol. | :VERTICAL |

Actual FS(dBμV/m) = SPA. Reading level(dBμV) + Factor(dB)

Factor(dB) = Antenna Factor(dBμV/m) + Cable Loss(dB) – Pre_Amplifier Gain(dB)

Note : “F” : denotes Fundamental Frequency. ; “H” : denotes Harmonic Frequency.

“E” : denotes Band Edge Frequency. ; “S” : denotes Spurious Frequency.

“---“ : denotes Noise Floor.

| Freq. MHz | Note F/H/E/S | Detector Mode PK/QP/AV | Spectrum Reading Level dBμV | Factor dB | Actual FS dBμV/m | Limit @3m dBμV/m | Margin dB |
|--------------|-----------------|------------------------------|-----------------------------------|--------------|------------------------|------------------------|--------------|
| 114.39 | S | Peak | 33.05 | -15.22 | 17.83 | 43.50 | -25.67 |
| 343.31 | S | Peak | 27.04 | -11.76 | 15.28 | 46.00 | -30.72 |
| 454.86 | S | Peak | 27.79 | -9.99 | 17.80 | 46.00 | -28.20 |
| 734.22 | S | Peak | 27.99 | -5.23 | 22.76 | 46.00 | -23.24 |
| 813.76 | S | Peak | 27.63 | -4.04 | 23.59 | 46.00 | -22.41 |
| 916.58 | S | Peak | 27.79 | -2.49 | 25.30 | 46.00 | -20.70 |
| 1652.80 | H | Peak | 40.18 | -1.62 | 38.56 | 74.00 | -35.44 |
| 2479.20 | H | --- | | | | | |
| 3305.60 | H | --- | | | | | |
| 4132.00 | H | --- | | | | | |
| 4958.40 | H | --- | | | | | |
| 5784.80 | H | --- | | | | | |
| 6611.20 | H | --- | | | | | |
| 7437.60 | H | --- | | | | | |
| 8264.00 | H | --- | | | | | |

Unless otherwise stated the results shown in this test report refer only to the sample(s) tested and such sample(s) are retained for 90 days only.

除非另有說明，此報告結果僅對測試之樣品負責，同時此樣品僅保留90天。本報告未經本公司書面許可，不可部份複製。

This document is issued by the Company subject to its General Conditions of Service printed overleaf, available on request or accessible at www.sgs.com/terms_and_conditions.htm and, for electronic format documents, subject to Terms and Conditions for Electronic Documents at www.sgs.com/terms_e-document.htm. Attention is drawn to the limitation of liability, indemnification and jurisdiction issues defined therein. Any holder of this document is advised that information contained hereon reflects the Company's findings at the time of its intervention only and within the limits of Client's instructions, if any. The Company's sole responsibility is to its Client and this document does not exonerate parties to a transaction from exercising all their rights and obligations under the transaction documents. This document cannot be reproduced except in full, without prior written approval of the Company. Any unauthorized alteration, forgery or falsification of the content or appearance of this document is unlawful and offenders may be prosecuted to the fullest extent of the law.

| | | | |
|-----------------------|------------|--------------------------|---------------------|
| Operation Band | :HSDPA B5 | Test Date | :2013-05-03 |
| Fundamental Frequency | :826.4 MHz | Temp./Humi. | :24.1 deg_C / 65 RH |
| Operation Mode | :RX LOW | Engineer | :Allen |
| EUT Pol. | :E1 Plan | Measurement Antenna Pol. | :HORIZONTAL |

Actual FS(dBμV/m) = SPA. Reading level(dBμV) + Factor(dB)

Factor(dB) = Antenna Factor(dBμV/m) + Cable Loss(dB) – Pre_Amplifier Gain(dB)

Note : “F” : denotes Fundamental Frequency. ; “H” : denotes Harmonic Frequency.

“E” : denotes Band Edge Frequency. ; “S” : denotes Spurious Frequency.

“---“ : denotes Noise Floor.

| Freq. MHz | Note F/H/E/S | Detector Mode PK/QP/AV | Spectrum Reading Level dBμV | Factor dB | Actual FS dBμV/m | Limit @3m dBμV/m | Margin dB |
|--------------|-----------------|------------------------------|-----------------------------------|--------------|------------------------|------------------------|--------------|
| 146.40 | S | Peak | 27.26 | -12.60 | 14.66 | 43.50 | -28.84 |
| 307.42 | S | Peak | 27.25 | -12.40 | 14.85 | 46.00 | -31.15 |
| 547.01 | S | Peak | 27.25 | -8.63 | 18.62 | 46.00 | -27.38 |
| 658.56 | S | Peak | 28.50 | -6.40 | 22.10 | 46.00 | -23.90 |
| 809.88 | S | Peak | 27.64 | -4.07 | 23.57 | 46.00 | -22.43 |
| 906.88 | S | Peak | 27.48 | -2.67 | 24.81 | 46.00 | -21.19 |
| 1652.80 | H | Peak | 39.44 | -0.89 | 38.55 | 74.00 | -35.45 |
| 2479.20 | H | --- | | | | | |
| 3305.60 | H | --- | | | | | |
| 4132.00 | H | --- | | | | | |
| 4958.40 | H | --- | | | | | |
| 5784.80 | H | --- | | | | | |
| 6611.20 | H | --- | | | | | |
| 7437.60 | H | --- | | | | | |
| 8264.00 | H | --- | | | | | |

Unless otherwise stated the results shown in this test report refer only to the sample(s) tested and such sample(s) are retained for 90 days only.

除非另有說明，此報告結果僅對測試之樣品負責，同時此樣品僅保留90天。本報告未經本公司書面許可，不可部份複製。

This document is issued by the Company subject to its General Conditions of Service printed overleaf, available on request or accessible at www.sgs.com/terms_and_conditions.htm and, for electronic format documents, subject to Terms and Conditions for Electronic Documents at www.sgs.com/terms_e-document.htm. Attention is drawn to the limitation of liability, indemnification and jurisdiction issues defined therein. Any holder of this document is advised that information contained hereon reflects the Company's findings at the time of its intervention only and within the limits of Client's instructions, if any. The Company's sole responsibility is to its Client and this document does not exonerate parties to a transaction from exercising all their rights and obligations under the transaction documents. This document cannot be reproduced except in full, without prior written approval of the Company. Any unauthorized alteration, forgery or falsification of the content or appearance of this document is unlawful and offenders may be prosecuted to the fullest extent of the law.

| | | | |
|-----------------------|------------|--------------------------|---------------------|
| Operation Band | :HSDPA B5 | Test Date | :2013-05-03 |
| Fundamental Frequency | :836.6 MHz | Temp./Humi. | :24.1 deg_C / 65 RH |
| Operation Mode | :RX MID | Engineer | :Allen |
| EUT Pol. | :E1 Plan | Measurement Antenna Pol. | :VERTICAL |

Actual FS(dBμV/m) = SPA. Reading level(dBμV) + Factor(dB)

Factor(dB) = Antenna Factor(dBμV/m) + Cable Loss(dB) – Pre_Amplifier Gain(dB)

Note : “F” : denotes Fundamental Frequency. ; “H” : denotes Harmonic Frequency.

“E” : denotes Band Edge Frequency. ; “S” : denotes Spurious Frequency.

“---“ : denotes Noise Floor.

| Freq. MHz | Note F/H/E/S | Detector Mode PK/QP/AV | Spectrum Reading Level dBμV | Factor dB | Actual FS dBμV/m | Limit @3m dBμV/m | Margin dB |
|--------------|-----------------|------------------------------|-----------------------------------|--------------|------------------------|------------------------|--------------|
| 47.46 | S | Peak | 29.36 | -13.85 | 15.51 | 40.00 | -24.49 |
| 114.39 | S | Peak | 33.63 | -15.22 | 18.41 | 43.50 | -25.09 |
| 583.87 | S | Peak | 28.23 | -7.90 | 20.33 | 46.00 | -25.67 |
| 696.39 | S | Peak | 27.94 | -5.79 | 22.15 | 46.00 | -23.85 |
| 825.40 | S | Peak | 27.36 | -3.92 | 23.44 | 46.00 | -22.56 |
| 909.79 | S | Peak | 27.46 | -2.62 | 24.84 | 46.00 | -21.16 |
| 1673.20 | H | Peak | 39.51 | -1.38 | 38.13 | 74.00 | -35.87 |
| 2509.80 | H | --- | | | | | |
| 3346.40 | H | --- | | | | | |
| 4183.00 | H | --- | | | | | |
| 5019.60 | H | --- | | | | | |
| 5856.20 | H | --- | | | | | |
| 6692.80 | H | --- | | | | | |
| 7529.40 | H | --- | | | | | |
| 8366.00 | H | --- | | | | | |

Unless otherwise stated the results shown in this test report refer only to the sample(s) tested and such sample(s) are retained for 90 days only.

除非另有說明，此報告結果僅對測試之樣品負責，同時此樣品僅保留90天。本報告未經本公司書面許可，不可部份複製。

This document is issued by the Company subject to its General Conditions of Service printed overleaf, available on request or accessible at www.sgs.com/terms_and_conditions.htm and, for electronic format documents, subject to Terms and Conditions for Electronic Documents at www.sgs.com/terms_e-document.htm. Attention is drawn to the limitation of liability, indemnification and jurisdiction issues defined therein. Any holder of this document is advised that information contained hereon reflects the Company's findings at the time of its intervention only and within the limits of Client's instructions, if any. The Company's sole responsibility is to its Client and this document does not exonerate parties to a transaction from exercising all their rights and obligations under the transaction documents. This document cannot be reproduced except in full, without prior written approval of the Company. Any unauthorized alteration, forgery or falsification of the content or appearance of this document is unlawful and offenders may be prosecuted to the fullest extent of the law.

| | | | |
|-----------------------|------------|--------------------------|---------------------|
| Operation Band | :HSDPA B5 | Test Date | :2013-05-03 |
| Fundamental Frequency | :836.6 MHz | Temp./Humi. | :24.1 deg_C / 65 RH |
| Operation Mode | :RX MID | Engineer | :Allen |
| EUT Pol. | :E1 Plan | Measurement Antenna Pol. | :HORIZONTAL |

Actual FS(dBμV/m) = SPA. Reading level(dBμV) + Factor(dB)

Factor(dB) = Antenna Factor(dBμV/m) + Cable Loss(dB) – Pre_Amplifier Gain(dB)

Note : “F” : denotes Fundamental Frequency. ; “H” : denotes Harmonic Frequency.

“E” : denotes Band Edge Frequency. ; “S” : denotes Spurious Frequency.

“---” : denotes Noise Floor.

| Freq. MHz | Note F/H/E/S | Detector Mode PK/QP/AV | Spectrum Reading Level dBμV | Factor dB | Actual FS dBμV/m | Limit @3m dBμV/m | Margin dB |
|--------------|-----------------|------------------------------|-----------------------------------|--------------|------------------------|------------------------|--------------|
| 52.31 | S | Peak | 28.09 | -14.06 | 14.03 | 40.00 | -25.97 |
| 144.46 | S | Peak | 27.57 | -12.74 | 14.83 | 43.50 | -28.67 |
| 351.07 | S | Peak | 27.61 | -11.68 | 15.93 | 46.00 | -30.07 |
| 463.59 | S | Peak | 27.25 | -9.92 | 17.33 | 46.00 | -28.67 |
| 683.78 | S | Peak | 27.36 | -5.96 | 21.40 | 46.00 | -24.60 |
| 907.85 | S | Peak | 27.21 | -2.66 | 24.55 | 46.00 | -21.45 |
| 1673.20 | H | Peak | 41.24 | -0.59 | 40.65 | 74.00 | -33.35 |
| 2509.80 | H | --- | | | | | |
| 3346.40 | H | --- | | | | | |
| 4183.00 | H | --- | | | | | |
| 5019.60 | H | --- | | | | | |
| 5856.20 | H | --- | | | | | |
| 6692.80 | H | --- | | | | | |
| 7529.40 | H | --- | | | | | |
| 8366.00 | H | --- | | | | | |

Unless otherwise stated the results shown in this test report refer only to the sample(s) tested and such sample(s) are retained for 90 days only.

除非另有說明，此報告結果僅對測試之樣品負責，同時此樣品僅保留90天。本報告未經本公司書面許可，不可部份複製。

This document is issued by the Company subject to its General Conditions of Service printed overleaf, available on request or accessible at www.sgs.com/terms_and_conditions.htm and, for electronic format documents, subject to Terms and Conditions for Electronic Documents at www.sgs.com/terms_e-document.htm. Attention is drawn to the limitation of liability, indemnification and jurisdiction issues defined therein. Any holder of this document is advised that information contained hereon reflects the Company's findings at the time of its intervention only and within the limits of Client's instructions, if any. The Company's sole responsibility is to its Client and this document does not exonerate parties to a transaction from exercising all their rights and obligations under the transaction documents. This document cannot be reproduced except in full, without prior written approval of the Company. Any unauthorized alteration, forgery or falsification of the content or appearance of this document is unlawful and offenders may be prosecuted to the fullest extent of the law.

| | | | |
|-----------------------|------------|--------------------------|---------------------|
| Operation Band | :HSDPA B5 | Test Date | :2013-05-03 |
| Fundamental Frequency | :846.6 MHz | Temp./Humi. | :24.1 deg_C / 65 RH |
| Operation Mode | :RX HIGH | Engineer | :Allen |
| EUT Pol. | :E1 Plan | Measurement Antenna Pol. | :VERTICAL |

Actual FS(dBμV/m) = SPA. Reading level(dBμV) + Factor(dB)

Factor(dB) = Antenna Factor(dBμV/m) + Cable Loss(dB) – Pre_Amplifier Gain(dB)

Note : “F” : denotes Fundamental Frequency. ; “H” : denotes Harmonic Frequency.

“E” : denotes Band Edge Frequency. ; “S” : denotes Spurious Frequency.

“---“ : denotes Noise Floor.

| Freq. MHz | Note F/H/E/S | Detector Mode PK/QP/AV | Spectrum Reading Level dBμV | Factor dB | Actual FS dBμV/m | Limit @3m dBμV/m | Margin dB |
|--------------|-----------------|------------------------------|-----------------------------------|--------------|------------------------|------------------------|--------------|
| 114.39 | S | Peak | 33.10 | -15.22 | 17.88 | 43.50 | -25.62 |
| 343.31 | S | Peak | 28.43 | -11.76 | 16.67 | 46.00 | -29.33 |
| 466.50 | S | Peak | 27.72 | -9.91 | 17.81 | 46.00 | -28.19 |
| 644.98 | S | Peak | 27.98 | -6.68 | 21.30 | 46.00 | -24.70 |
| 820.55 | S | Peak | 27.68 | -3.96 | 23.72 | 46.00 | -22.28 |
| 907.85 | S | Peak | 27.70 | -2.66 | 25.04 | 46.00 | -20.96 |
| 1693.20 | H | Peak | 40.59 | -1.14 | 39.45 | 74.00 | -34.55 |
| 2539.80 | H | --- | | | | | |
| 3386.40 | H | --- | | | | | |
| 4233.00 | H | --- | | | | | |
| 5079.60 | H | --- | | | | | |
| 5926.20 | H | --- | | | | | |
| 6772.80 | H | --- | | | | | |
| 7619.40 | H | --- | | | | | |
| 8466.00 | H | --- | | | | | |

Unless otherwise stated the results shown in this test report refer only to the sample(s) tested and such sample(s) are retained for 90 days only.

除非另有說明，此報告結果僅對測試之樣品負責，同時此樣品僅保留90天。本報告未經本公司書面許可，不可部份複製。

This document is issued by the Company subject to its General Conditions of Service printed overleaf, available on request or accessible at www.sgs.com/terms_and_conditions.htm and, for electronic format documents, subject to Terms and Conditions for Electronic Documents at www.sgs.com/terms_e-document.htm. Attention is drawn to the limitation of liability, indemnification and jurisdiction issues defined therein. Any holder of this document is advised that information contained hereon reflects the Company's findings at the time of its intervention only and within the limits of Client's instructions, if any. The Company's sole responsibility is to its Client and this document does not exonerate parties to a transaction from exercising all their rights and obligations under the transaction documents. This document cannot be reproduced except in full, without prior written approval of the Company. Any unauthorized alteration, forgery or falsification of the content or appearance of this document is unlawful and offenders may be prosecuted to the fullest extent of the law.

| | | | |
|-----------------------|------------|--------------------------|---------------------|
| Operation Band | :HSDPA B5 | Test Date | :2013-05-03 |
| Fundamental Frequency | :846.6 MHz | Temp./Humi. | :24.1 deg_C / 65 RH |
| Operation Mode | :RX HIGH | Engineer | :Allen |
| EUT Pol. | :E1 Plan | Measurement Antenna Pol. | :HORIZONTAL |

Actual FS(dBμV/m) = SPA. Reading level(dBμV) + Factor(dB)

Factor(dB) = Antenna Factor(dBμV/m) + Cable Loss(dB) – Pre_Amplifier Gain(dB)

Note : “F” : denotes Fundamental Frequency. ; “H” : denotes Harmonic Frequency.

“E” : denotes Band Edge Frequency. ; “S” : denotes Spurious Frequency.

“---“ : denotes Noise Floor.

| Freq. | Note | Detector Mode | Spectrum Reading Level | Factor | Actual FS | Limit @3m | Margin |
|---------|---------|---------------|------------------------|--------|-----------|-----------|--------|
| MHz | F/H/E/S | PK/QP/AV | dBμV | dB | dBμV/m | dBμV/m | dB |
| 154.16 | S | Peak | 26.75 | -12.30 | 14.45 | 43.50 | -29.05 |
| 281.23 | S | Peak | 27.83 | -13.02 | 14.81 | 46.00 | -31.19 |
| 463.59 | S | Peak | 27.60 | -9.92 | 17.68 | 46.00 | -28.32 |
| 675.05 | S | Peak | 27.52 | -6.11 | 21.41 | 46.00 | -24.59 |
| 762.35 | S | Peak | 27.76 | -4.77 | 22.99 | 46.00 | -23.01 |
| 922.40 | S | Peak | 26.62 | -2.37 | 24.25 | 46.00 | -21.75 |
| 1693.20 | H | Peak | 39.95 | -0.30 | 39.65 | 74.00 | -34.35 |
| 2539.80 | H | --- | | | | | |
| 3386.40 | H | --- | | | | | |
| 4233.00 | H | --- | | | | | |
| 5079.60 | H | --- | | | | | |
| 5926.20 | H | --- | | | | | |
| 6772.80 | H | --- | | | | | |
| 7619.40 | H | --- | | | | | |
| 8466.00 | H | --- | | | | | |

Unless otherwise stated the results shown in this test report refer only to the sample(s) tested and such sample(s) are retained for 90 days only.

除非另有說明，此報告結果僅對測試之樣品負責，同時此樣品僅保留90天。本報告未經本公司書面許可，不可部份複製。

This document is issued by the Company subject to its General Conditions of Service printed overleaf, available on request or accessible at www.sgs.com/terms_and_conditions.htm and, for electronic format documents, subject to Terms and Conditions for Electronic Documents at www.sgs.com/terms_e-document.htm. Attention is drawn to the limitation of liability, indemnification and jurisdiction issues defined therein. Any holder of this document is advised that information contained hereon reflects the Company's findings at the time of its intervention only and within the limits of Client's instructions, if any. The Company's sole responsibility is to its Client and this document does not exonerate parties to a transaction from exercising all their rights and obligations under the transaction documents. This document cannot be reproduced except in full, without prior written approval of the Company. Any unauthorized alteration, forgery or falsification of the content or appearance of this document is unlawful and offenders may be prosecuted to the fullest extent of the law.

11. FREQUENCY STABILITY V.S. TEMPERATURE MEASUREMENT

11.1. Standard Applicable:

According to FCC §2.1055(a) (1)

Frequency Tolerance: +/-2.5ppm for 850MHz band

+/-2.5ppm for 1900MHz band

+/-2.5ppm for 1700MHz band

According to RSS-133 §6.3, RSS-132 §5.3, RSS-139 §6.3

The carrier frequency shall not depart from the reference frequency in excess of ± 2.5 ppm for mobile stations

11.2. Test Set-up:

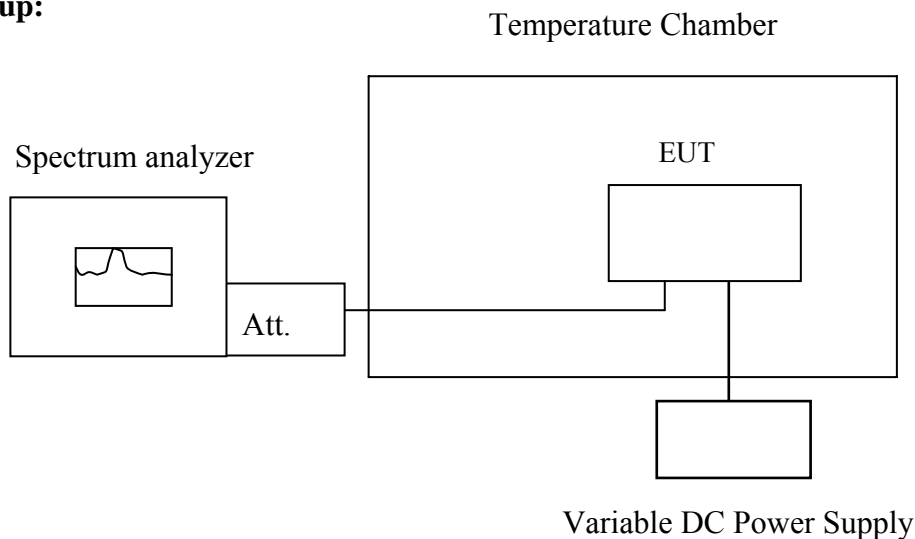

Note: Measurement setup for testing on Antenna connector

Unless otherwise stated the results shown in this test report refer only to the sample(s) tested and such sample(s) are retained for 90 days only.

除非另有說明，此報告結果僅對測試之樣品負責，同時此樣品僅保留90天。本報告未經本公司書面許可，不可部份複製。

This document is issued by the Company subject to its General Conditions of Service printed overleaf, available on request or accessible at www.sgs.com/terms_and_conditions.htm and, for electronic format documents, subject to Terms and Conditions for Electronic Documents at www.sgs.com/terms_e-document.htm. Attention is drawn to the limitation of liability, indemnification and jurisdiction issues defined therein. Any holder of this document is advised that information contained hereon reflects the Company's findings at the time of its intervention only and within the limits of Client's instructions, if any. The Company's sole responsibility is to its Client and this document does not exonerate parties to a transaction from exercising all their rights and obligations under the transaction documents. This document cannot be reproduced except in full, without prior written approval of the Company. Any unauthorized alteration, forgery or falsification of the content or appearance of this document is unlawful and offenders may be prosecuted to the fullest extent of the law.

11.3. Measurement Procedure:

The equipment under test was connected to an external AC or DC power supply and input rated voltage. RF output was connected to a frequency counter or spectrum analyzer via feed through attenuators. The EUT was placed inside the temperature chamber. Set the spectrum analyzer RBW low enough to obtain the desired frequency resolution and measure EUT 25°C operating frequency as reference frequency. Turn EUT off and set the chamber temperature to -30°C. After the temperature stabilized for approximately 30 minutes recorded the frequency. Repeat step measure with 10°C increased per stage until the highest temperature of +50°C reached.

11.4. Measurement Equipment Used:

Refer to section 2.4 in this report

Unless otherwise stated the results shown in this test report refer only to the sample(s) tested and such sample(s) are retained for 90 days only.

除非另有說明，此報告結果僅對測試之樣品負責，同時此樣品僅保留90天。本報告未經本公司書面許可，不可部份複製。

This document is issued by the Company subject to its General Conditions of Service printed overleaf, available on request or accessible at www.sgs.com/terms_and_conditions.htm and, for electronic format documents, subject to Terms and Conditions for Electronic Documents at www.sgs.com/terms_e-document.htm. Attention is drawn to the limitation of liability, indemnification and jurisdiction issues defined therein. Any holder of this document is advised that information contained hereon reflects the Company's findings at the time of its intervention only and within the limits of Client's instructions, if any. The Company's sole responsibility is to its Client and this document does not exonerate parties to a transaction from exercising all their rights and obligations under the transaction documents. This document cannot be reproduced except in full, without prior written approval of the Company. Any unauthorized alteration, forgery or falsification of the content or appearance of this document is unlawful and offenders may be prosecuted to the fullest extent of the law.

11.5. Measurement Result:

| Reference Frequency: GPRS 850 Mid Channel 836.6 MHz | | | | |
|---|-----------------|-----------|------------|------------|
| Limit: +/- 2.5 ppm = 2091 Hz | | | | |
| Power Supply | Environment | Frequency | Delta (Hz) | Limit (Hz) |
| Vdc | Temperature () | (MHz) | | |
| 3.7 | 50 | 836599997 | -9 | 2091 |
| 3.7 | 40 | 836599996 | -10 | 2091 |
| 3.7 | 30 | 836600006 | 0 | 2091 |
| 3.7 | 20 | 836600006 | 0 | 2091 |
| 3.7 | 10 | 836600004 | -2 | 2091 |
| 3.7 | 0 | 836600008 | 2 | 2091 |
| 3.7 | -10 | 836600008 | 2 | 2091 |
| 3.7 | -20 | 836599995 | -11 | 2091 |
| 3.7 | -30 | 836599994 | -12 | 2091 |

| Reference Frequency: GPRS 1900 Mid Channel 1880 MHz | | | | |
|---|-----------------|------------|------------|------------|
| Limit: +/- 2.5 ppm = 4700 Hz | | | | |
| Power Supply | Environment | Frequency | Delta (Hz) | Limit (Hz) |
| Vdc | Temperature () | (MHz) | | |
| 3.7 | 50 | 1880000004 | -6 | 4700 |
| 3.7 | 40 | 1879999997 | -13 | 4700 |
| 3.7 | 30 | 1879999995 | -15 | 4700 |
| 3.7 | 20 | 1880000010 | 0 | 4700 |
| 3.7 | 10 | 1879999997 | -13 | 4700 |
| 3.7 | 0 | 1880000000 | -10 | 4700 |
| 3.7 | -10 | 1879999995 | -15 | 4700 |
| 3.7 | -20 | 1880000000 | -10 | 4700 |
| 3.7 | -30 | 1880000000 | -10 | 4700 |

Unless otherwise stated the results shown in this test report refer only to the sample(s) tested and such sample(s) are retained for 90 days only.

除非另有說明，此報告結果僅對測試之樣品負責，同時此樣品僅保留90天。本報告未經本公司書面許可，不可部份複製。

This document is issued by the Company subject to its General Conditions of Service printed overleaf, available on request or accessible at www.sgs.com/terms_and_conditions.htm and, for electronic format documents, subject to Terms and Conditions for Electronic Documents at www.sgs.com/terms_e-document.htm. Attention is drawn to the limitation of liability, indemnification and jurisdiction issues defined therein. Any holder of this document is advised that information contained hereon reflects the Company's findings at the time of its intervention only and within the limits of Client's instructions, if any. The Company's sole responsibility is to its Client and this document does not exonerate parties to a transaction from exercising all their rights and obligations under the transaction documents. This document cannot be reproduced except in full, without prior written approval of the Company. Any unauthorized alteration, forgery or falsification of the content or appearance of this document is unlawful and offenders may be prosecuted to the fullest extent of the law.

| Reference Frequency: WCDMA V Mid Channel 836.6 MHz | | | | |
|--|-----------------|-----------|------------|------------|
| Limit: +/- 2.5 ppm = 2091 Hz | | | | |
| Power Supply | Environment | Frequency | Delta (Hz) | Limit (Hz) |
| Vdc | Temperature () | (MHz) | | |
| 3.7 | 50 | 836600009 | -1 | 2091 |
| 3.7 | 40 | 836600001 | -9 | 2091 |
| 3.7 | 30 | 836600000 | -10 | 2091 |
| 3.7 | 20 | 836600010 | 0 | 2091 |
| 3.7 | 10 | 836600005 | -5 | 2091 |
| 3.7 | 0 | 836600001 | -9 | 2091 |
| 3.7 | -10 | 836599992 | -18 | 2091 |
| 3.7 | -20 | 836600011 | 1 | 2091 |
| 3.7 | -30 | 836599992 | -18 | 2091 |

| Reference Frequency: WCDMA IV Mid Channel 1732.6 | | | | |
|--|-----------------|-----------|------------|------------|
| Limit: +/- 2.5 ppm = 4331 Hz | | | | |
| Power Supply | Environment | Frequency | Delta (Hz) | Limit (Hz) |
| Vdc | Temperature () | (MHz) | | |
| 3.7 | 50 | 173260005 | 13 | 4331 |
| 3.7 | 40 | 173259993 | 1 | 4331 |
| 3.7 | 30 | 173259996 | 4 | 4331 |
| 3.7 | 20 | 173259992 | 0 | 4331 |
| 3.7 | 10 | 173259998 | 6 | 4331 |
| 3.7 | 0 | 173259994 | 2 | 4331 |
| 3.7 | -10 | 173260004 | 12 | 4331 |
| 3.7 | -20 | 173259994 | 2 | 4331 |
| 3.7 | -30 | 173259997 | 5 | 4331 |

Unless otherwise stated the results shown in this test report refer only to the sample(s) tested and such sample(s) are retained for 90 days only.

除非另有說明，此報告結果僅對測試之樣品負責，同時此樣品僅保留90天。本報告未經本公司書面許可，不可部份複製。

This document is issued by the Company subject to its General Conditions of Service printed overleaf, available on request or accessible at www.sgs.com/terms_and_conditions.htm and, for electronic format documents, subject to Terms and Conditions for Electronic Documents at www.sgs.com/terms_e-document.htm. Attention is drawn to the limitation of liability, indemnification and jurisdiction issues defined therein. Any holder of this document is advised that information contained hereon reflects the Company's findings at the time of its intervention only and within the limits of Client's instructions, if any. The Company's sole responsibility is to its Client and this document does not exonerate parties to a transaction from exercising all their rights and obligations under the transaction documents. This document cannot be reproduced except in full, without prior written approval of the Company. Any unauthorized alteration, forgery or falsification of the content or appearance of this document is unlawful and offenders may be prosecuted to the fullest extent of the law.

| Reference Frequency: WCDMA II Mid Channel 1880 | | | | |
|--|-----------------|------------|------------|------------|
| Limit: +/- 2.5 ppm = 4700 Hz | | | | |
| Power Supply | Environment | Frequency | Delta (Hz) | Limit (Hz) |
| Vdc | Temperature () | (MHz) | | |
| 3.7 | 50 | 1880000000 | -4 | 4700 |
| 3.7 | 40 | 1879999997 | -7 | 4700 |
| 3.7 | 30 | 1879999997 | -7 | 4700 |
| 3.7 | 20 | 1880000004 | 0 | 4700 |
| 3.7 | 10 | 1879999989 | -15 | 4700 |
| 3.7 | 0 | 1879999995 | -9 | 4700 |
| 3.7 | -10 | 1879999998 | -6 | 4700 |
| 3.7 | -20 | 1879999999 | -5 | 4700 |
| 3.7 | -30 | 1879999998 | -6 | 4700 |

Note: The battery is rated 3.7V dc.

Unless otherwise stated the results shown in this test report refer only to the sample(s) tested and such sample(s) are retained for 90 days only.

除非另有說明，此報告結果僅對測試之樣品負責，同時此樣品僅保留90天。本報告未經本公司書面許可，不可部份複製。

This document is issued by the Company subject to its General Conditions of Service printed overleaf, available on request or accessible at www.sgs.com/terms_and_conditions.htm and, for electronic format documents, subject to Terms and Conditions for Electronic Documents at www.sgs.com/terms_e-document.htm. Attention is drawn to the limitation of liability, indemnification and jurisdiction issues defined therein. Any holder of this document is advised that information contained hereon reflects the Company's findings at the time of its intervention only and within the limits of Client's instructions, if any. The Company's sole responsibility is to its Client and this document does not exonerate parties to a transaction from exercising all their rights and obligations under the transaction documents. This document cannot be reproduced except in full, without prior written approval of the Company. Any unauthorized alteration, forgery or falsification of the content or appearance of this document is unlawful and offenders may be prosecuted to the fullest extent of the law.

12. FREQUENCY STABILITY V.S. VOLTAGE MEASUREMENT

12.1. Standard Applicable:

According to FCC §2.1055(d) (2)

Frequency Tolerance: +/-2.5ppm for 850MHz band

+/-2.5ppm for 1900MHz band

+/-2.5ppm for 1700MHz band

According to RSS-133 §6.3, RSS-132 §5.3, RSS-139 §6.3

The carrier frequency shall not depart from the reference frequency in excess of ± 2.5 ppm for mobile stations.

12.2. Test Set-up:

Refer to section 11.2 in this report

12.3. Measurement Procedure:

Set chamber temperature to 20 . Use a variable AC power supply / DC power source to power the EUT and set the voltage to rated voltage. Set the spectrum analyzer RBW low enough to obtain the desired frequency resolution and recorded the frequency.

Reduce the input voltage to specify extreme voltage variation (+/- 15%) and endpoint as declared by the manufacturer, record the maximum frequency change.

12.4. Measurement Equipment Used:

Refer to section 2.4 in this report

Unless otherwise stated the results shown in this test report refer only to the sample(s) tested and such sample(s) are retained for 90 days only.

除非另有說明，此報告結果僅對測試之樣品負責，同時此樣品僅保留90天。本報告未經本公司書面許可，不可部份複製。

This document is issued by the Company subject to its General Conditions of Service printed overleaf, available on request or accessible at www.sgs.com/terms_and_conditions.htm and, for electronic format documents, subject to Terms and Conditions for Electronic Documents at www.sgs.com/terms_e-document.htm. Attention is drawn to the limitation of liability, indemnification and jurisdiction issues defined therein. Any holder of this document is advised that information contained hereon reflects the Company's findings at the time of its intervention only and within the limits of Client's instructions, if any. The Company's sole responsibility is to its Client and this document does not exonerate parties to a transaction from exercising all their rights and obligations under the transaction documents. This document cannot be reproduced except in full, without prior written approval of the Company. Any unauthorized alteration, forgery or falsification of the content or appearance of this document is unlawful and offenders may be prosecuted to the fullest extent of the law.

12.5. Measurement Result:

| Reference Frequency: GPRS 850 Mid Channel 836.6 MHz | | | | |
|---|-----------------|-----------|------------|------------|
| Limit: +/- 2.5 ppm = 2091 Hz | | | | |
| Power Supply | Environment | Frequency | Delta (Hz) | Limit (Hz) |
| Vdc | Temperature () | (MHz) | | |
| 4.2 | 20 | 836600004 | -2 | 2091 |
| 3.7 | 20 | 836600006 | 0 | 2091 |
| 3.4 | 20 | 836599990 | -16 | 2091 |
| 2.9 (End point) | 20 | 836600001 | -5 | 2091 |

| Reference Frequency: GPRS 1900 Mid Channel 1880 MHz | | | | |
|---|-----------------|------------|------------|------------|
| Limit: +/- 2.5 ppm = 4700 Hz | | | | |
| Power Supply | Environment | Frequency | Delta (Hz) | Limit (Hz) |
| Vdc | Temperature () | (MHz) | | |
| 4.2 | 20 | 1880000001 | -9 | 4700 |
| 3.7 | 20 | 1880000010 | 0 | 4700 |
| 3.4 | 20 | 1880000006 | -4 | 4700 |
| 2.9 (End point) | 20 | 1879999997 | -13 | 4700 |

Unless otherwise stated the results shown in this test report refer only to the sample(s) tested and such sample(s) are retained for 90 days only.

除非另有說明，此報告結果僅對測試之樣品負責，同時此樣品僅保留90天。本報告未經本公司書面許可，不可部份複製。

This document is issued by the Company subject to its General Conditions of Service printed overleaf, available on request or accessible at www.sgs.com/terms_and_conditions.htm and, for electronic format documents, subject to Terms and Conditions for Electronic Documents at www.sgs.com/terms_e-document.htm. Attention is drawn to the limitation of liability, indemnification and jurisdiction issues defined therein. Any holder of this document is advised that information contained hereon reflects the Company's findings at the time of its intervention only and within the limits of Client's instructions, if any. The Company's sole responsibility is to its Client and this document does not exonerate parties to a transaction from exercising all their rights and obligations under the transaction documents. This document cannot be reproduced except in full, without prior written approval of the Company. Any unauthorized alteration, forgery or falsification of the content or appearance of this document is unlawful and offenders may be prosecuted to the fullest extent of the law.

| Reference Frequency: WCDMA II Mid Channel 1880 MHz | | | | |
|--|-----------------|------------|------------|------------|
| Limit: +/- 2.5 ppm = 4700 Hz | | | | |
| Power Supply | Environment | Frequency | Delta (Hz) | Limit (Hz) |
| Vdc | Temperature () | (MHz) | | |
| 4.2 | 20 | 1879999996 | -8 | 4700 |
| 3.7 | 20 | 1880000004 | 0 | 4700 |
| 3.4 | 20 | 1879999996 | -8 | 4700 |
| 2.9 (End point) | 20 | 1879999999 | -5 | 4700 |

| Reference Frequency: WCDMA IV Mid Channel 1732.6 MHz | | | | |
|--|-----------------|-----------|------------|------------|
| Limit: +/- 2.5 ppm = 2091 Hz | | | | |
| Power Supply | Environment | Frequency | Delta (Hz) | Limit (Hz) |
| Vdc | Temperature () | (MHz) | | |
| 4.2 | 20 | 173259997 | 5 | 4331 |
| 3.7 | 20 | 173259992 | 0 | 4331 |
| 3.4 | 20 | 173260003 | 11 | 4331 |
| 2.9 (End point) | 20 | 173259995 | 3 | 4331 |

| Reference Frequency: WCDMA V Mid Channel 836.6 MHz | | | | |
|--|-----------------|-----------|------------|------------|
| Limit: +/- 2.5 ppm = 2091 Hz | | | | |
| Power Supply | Environment | Frequency | Delta (Hz) | Limit (Hz) |
| Vdc | Temperature () | (MHz) | | |
| 4.2 | 20 | 836599996 | -14 | 2091.00 |
| 3.7 | 20 | 836600010 | 0 | 2091.00 |
| 3.4 | 20 | 836600007 | -3 | 2091.00 |
| 2.9 (End point) | 20 | 836599999 | -11 | 2091.00 |

Unless otherwise stated the results shown in this test report refer only to the sample(s) tested and such sample(s) are retained for 90 days only.

除非另有說明，此報告結果僅對測試之樣品負責，同時此樣品僅保留90天。本報告未經本公司書面許可，不可部份複製。

This document is issued by the Company subject to its General Conditions of Service printed overleaf, available on request or accessible at www.sgs.com/terms_and_conditions.htm and, for electronic format documents, subject to Terms and Conditions for Electronic Documents at www.sgs.com/terms_e-document.htm. Attention is drawn to the limitation of liability, indemnification and jurisdiction issues defined therein. Any holder of this document is advised that information contained hereon reflects the Company's findings at the time of its intervention only and within the limits of Client's instructions, if any. The Company's sole responsibility is to its Client and this document does not exonerate parties to a transaction from exercising all their rights and obligations under the transaction documents. This document cannot be reproduced except in full, without prior written approval of the Company. Any unauthorized alteration, forgery or falsification of the content or appearance of this document is unlawful and offenders may be prosecuted to the fullest extent of the law.

13. PEAK TO AVERAGE RATIO

13.1. Standard Applicable:

According FCC 24.232(d), FCC 27.50 (d) (5) – The peak-to-average ration (PAR) of the transmission may not exceed 13dB.

According to issue 3 of RSS 132, section 5.4, issue 6 of RSS 133, section 6.4, and RSS-139, section 6.4. Transmitter power is measured in terms of average value, the peak-to-average ratio of the power shall not exceed 13 dB.

13.2. Test SET-UP (Block Diagram of Configuration):

Refer to section 2.4 in this report

13.3. Measurement Procedure:

KDB 971168 D01 is employed as the following procedure is proper adjusted accordingly:

Set resolution/measurement bandwidth \geq signal's occupied bandwidth; & internal =1ms

Set the number of counts to a value that stabilizes the measured CCDF curve.

13.4. Measurement Equipment Used:

Refer to section 2.4 in this report

13.5. Measurement Result:

Refer to next page for tabular, and plot results

Unless otherwise stated the results shown in this test report refer only to the sample(s) tested and such sample(s) are retained for 90 days only.

除非另有說明，此報告結果僅對測試之樣品負責，同時此樣品僅保留90天。本報告未經本公司書面許可，不可部份複製。

This document is issued by the Company subject to its General Conditions of Service printed overleaf, available on request or accessible at www.sgs.com/terms_and_conditions.htm and, for electronic format documents, subject to Terms and Conditions for Electronic Documents at www.sgs.com/terms_e-document.htm. Attention is drawn to the limitation of liability, indemnification and jurisdiction issues defined therein. Any holder of this document is advised that information contained hereon reflects the Company's findings at the time of its intervention only and within the limits of Client's instructions, if any. The Company's sole responsibility is to its Client and this document does not exonerate parties to a transaction from exercising all their rights and obligations under the transaction documents. This document cannot be reproduced except in full, without prior written approval of the Company. Any unauthorized alteration, forgery or falsification of the content or appearance of this document is unlawful and offenders may be prosecuted to the fullest extent of the law.

13.5.1 Tabular Results:

| TEST CONDITIONS | Peak-to-Average Ratio | | | | | |
|--------------------|-----------------------|-------|----------------|-------|----------------|-------|
| | Channel 128(L) | | Channel 190(M) | | Channel 251(H) | |
| | 824.2MHz | | 836.6MHz | | 848.8MHz | |
| | dB | | dB | | dB | |
| Tnom / Vnom | Measured | Limit | Measured | Limit | Measured | Limit |
| GSM 850 | 9.82 | 13 | 10.08 | 13 | 9.93 | 13 |
| GPRS 850 | 9.58 | 13 | 9.87 | 13 | 10.99 | 13 |
| EDGE 850 | 10.45 | 13 | 11.32 | 13 | 11.57 | 13 |

| TEST CONDITIONS | Peak-to-Average Ratio | | | | | |
|--------------------|-----------------------|-------|----------------|-------|----------------|-------|
| | Channel 512(L) | | Channel 661(M) | | Channel 810(H) | |
| | 1850.2MHz | | 1880.0MHz | | 1909.8MHz | |
| | dB | | dB | | dB | |
| Tnom / Vnom | Measured | Limit | Measured | Limit | Measured | Limit |
| GSM 1900 | 10.47 | 13 | 10.96 | 13 | 10.56 | 13 |
| GPRS 1900 | 11.28 | 13 | 10.58 | 13 | 11.49 | 13 |
| EDGE 1900 | 11.03 | 13 | 9.54 | 13 | 10.09 | 13 |

| TEST CONDITIONS | Peak-to-Average Ratio | | | | | |
|--------------------|-----------------------|-------|-----------------|-------|-----------------|-------|
| | Channel 9262(L) | | Channel 9400(M) | | Channel 9538(H) | |
| | 1852.4MHz | | 1880.0MHz | | 1907.6MHz | |
| | dB | | dB | | dB | |
| Tnom / Vnom | Measured | Limit | Measured | Limit | Measured | Limit |
| WCDMA Band II | 3.00 | 13 | 2.97 | 13 | 2.97 | 13 |
| HSUPA Band II | 2.96 | 13 | 2.98 | 13 | 2.96 | 13 |
| HSDPA Band II | 3.02 | 13 | 2.96 | 13 | 2.96 | 13 |

Unless otherwise stated the results shown in this test report refer only to the sample(s) tested and such sample(s) are retained for 90 days only.

除非另有說明，此報告結果僅對測試之樣品負責，同時此樣品僅保留90天。本報告未經本公司書面許可，不可部份複製。

This document is issued by the Company subject to its General Conditions of Service printed overleaf, available on request or accessible at www.sgs.com/terms_and_conditions.htm and, for electronic format documents, subject to Terms and Conditions for Electronic Documents at www.sgs.com/terms_e-document.htm. Attention is drawn to the limitation of liability, indemnification and jurisdiction issues defined therein. Any holder of this document is advised that information contained hereon reflects the Company's findings at the time of its intervention only and within the limits of Client's instructions, if any. The Company's sole responsibility is to its Client and this document does not exonerate parties to a transaction from exercising all their rights and obligations under the transaction documents. This document cannot be reproduced except in full, without prior written approval of the Company. Any unauthorized alteration, forgery or falsification of the content or appearance of this document is unlawful and offenders may be prosecuted to the fullest extent of the law.

| TEST CONDITIONS | Peak-to-Average Ratio | | | | | |
|--------------------|-----------------------|-------|-----------------|-------|-----------------|-------|
| | Channel 1312(L) | | Channel 1413(M) | | Channel 1513(H) | |
| | 1712.4MHz | | 1732.6MHz | | 1752.6MHz | |
| | dB | | dB | | dB | |
| Tnom / Vnom | Measured | Limit | Measured | Limit | Measured | Limit |
| WCDMA Band IV | 2.94 | 13 | 3.02 | 13 | 2.95 | 13 |
| HSUPA Band IV | 2.95 | 13 | 3.04 | 13 | 2.93 | 13 |
| HSDPA Band IV | 2.96 | 13 | 3.01 | 13 | 2.93 | 13 |

| TEST CONDITIONS | Peak-to-Average Ratio | | | | | |
|--------------------|-----------------------|-------|-----------------|-------|-----------------|-------|
| | Channel 4132(L) | | Channel 4183(M) | | Channel 4233(H) | |
| | 826.4MHz | | 836.6MHz | | 846.6MHz | |
| | dB | | dB | | dB | |
| Tnom / Vnom | Measured | Limit | Measured | Limit | Measured | Limit |
| WCDMA Band V | 2.94 | 13 | 3.00 | 13 | 2.95 | 13 |
| HSUPA Band V | 2.93 | 13 | 2.99 | 13 | 2.96 | 13 |
| HSDPA Band V | 2.93 | 13 | 2.99 | 13 | 2.95 | 13 |

Unless otherwise stated the results shown in this test report refer only to the sample(s) tested and such sample(s) are retained for 90 days only.

除非另有說明，此報告結果僅對測試之樣品負責，同時此樣品僅保留90天。本報告未經本公司書面許可，不可部份複製。

This document is issued by the Company subject to its General Conditions of Service printed overleaf, available on request or accessible at www.sgs.com/terms_and_conditions.htm and, for electronic format documents, subject to Terms and Conditions for Electronic Documents at www.sgs.com/terms_e-document.htm. Attention is drawn to the limitation of liability, indemnification and jurisdiction issues defined therein. Any holder of this document is advised that information contained hereon reflects the Company's findings at the time of its intervention only and within the limits of Client's instructions, if any. The Company's sole responsibility is to its Client and this document does not exonerate parties to a transaction from exercising all their rights and obligations under the transaction documents. This document cannot be reproduced except in full, without prior written approval of the Company. Any unauthorized alteration, forgery or falsification of the content or appearance of this document is unlawful and offenders may be prosecuted to the fullest extent of the law.

13.5.2 Measurement Results:

Figure 13-1: GSM 850 Channel Low

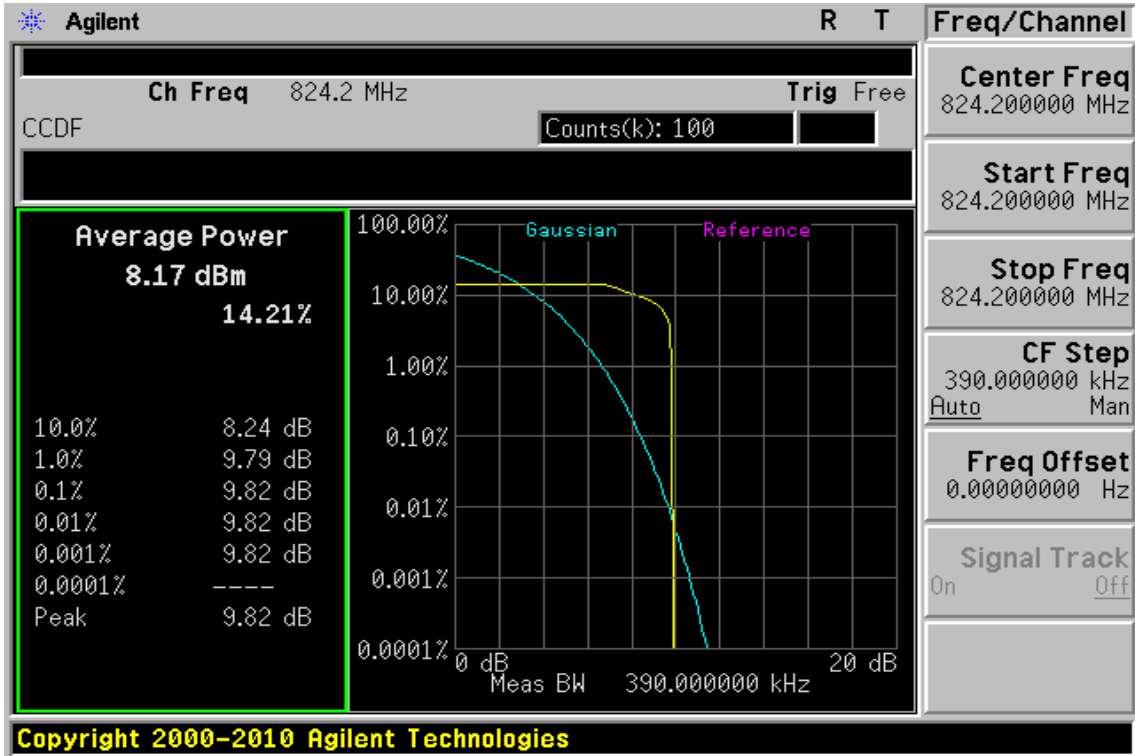
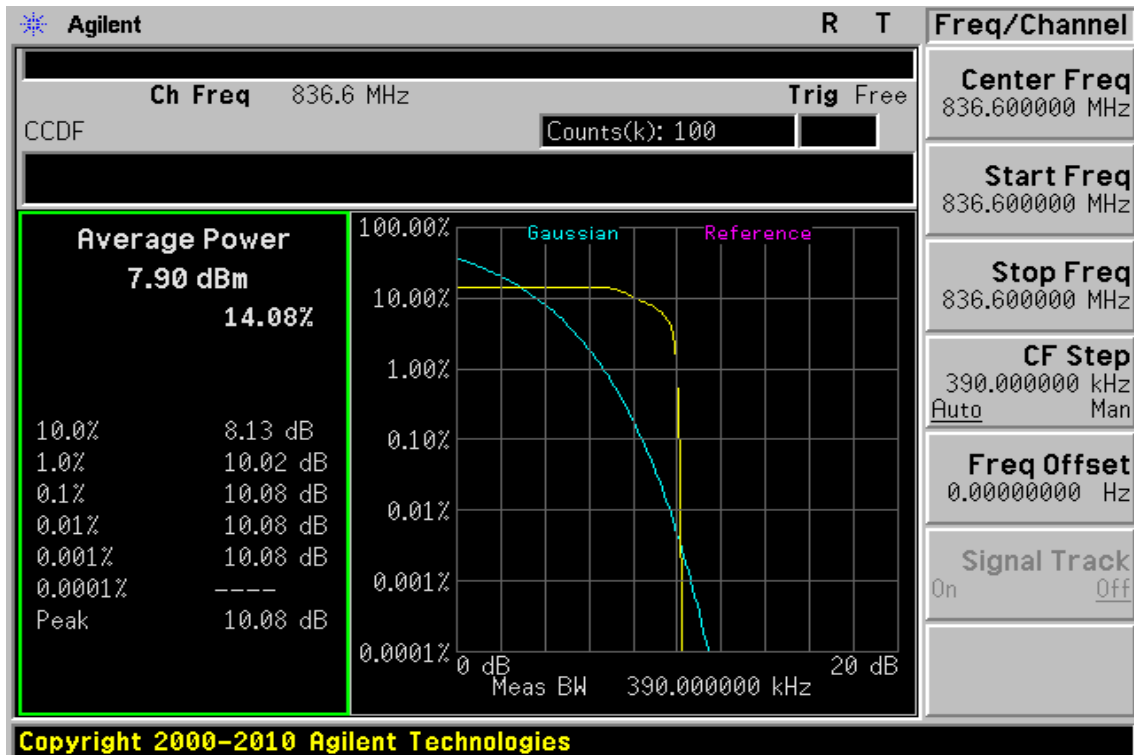

Figure 13-2: GSM 850 Channel Mid



Unless otherwise stated the results shown in this test report refer only to the sample(s) tested and such sample(s) are retained for 90 days only.

除非另有說明，此報告結果僅對測試之樣品負責，同時此樣品僅保留90天。本報告未經本公司書面許可，不可部份複製。

This document is issued by the Company subject to its General Conditions of Service printed overleaf, available on request or accessible at www.sgs.com/terms_and_conditions.htm and, for electronic format documents, subject to Terms and Conditions for Electronic Documents at www.sgs.com/terms_e-document.htm. Attention is drawn to the limitation of liability, indemnification and jurisdiction issues defined therein. Any holder of this document is advised that information contained hereon reflects the Company's findings at the time of its intervention only and within the limits of Client's instructions, if any. The Company's sole responsibility is to its Client and this document does not exonerate parties to a transaction from exercising all their rights and obligations under the transaction documents. This document cannot be reproduced except in full, without prior written approval of the Company. Any unauthorized alteration, forgery or falsification of the content or appearance of this document is unlawful and offenders may be prosecuted to the fullest extent of the law.

Figure 13-3: GSM 850 Channel High

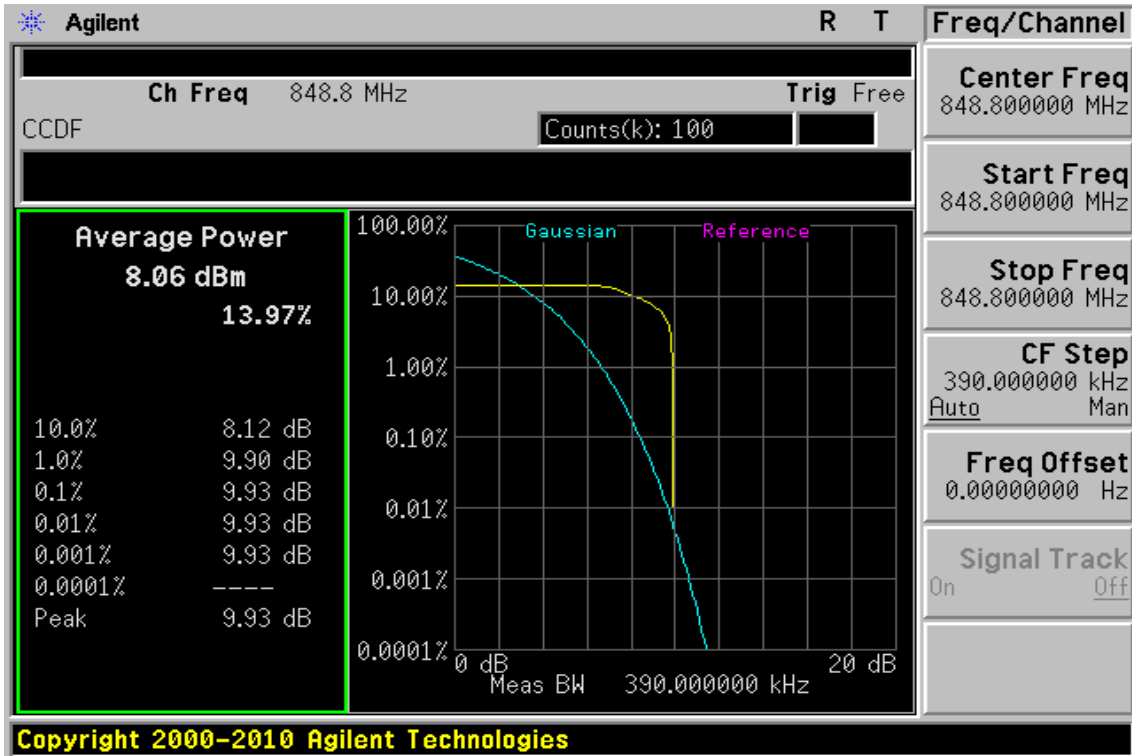
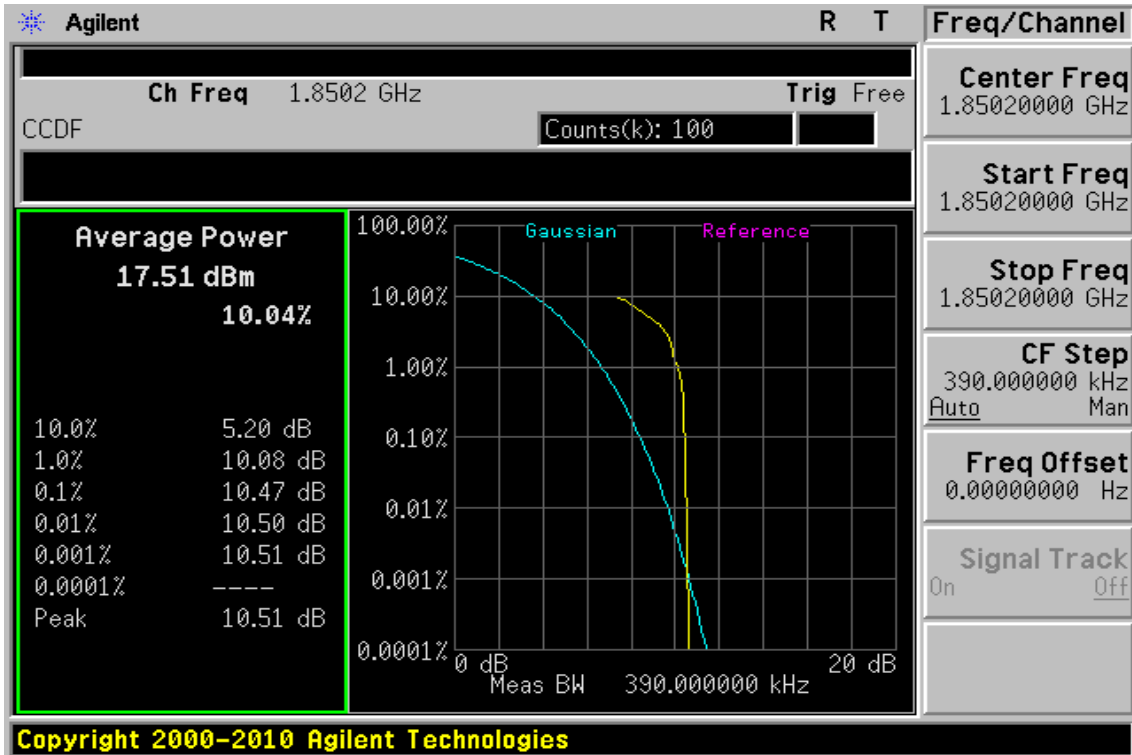

Figure 13-4: GSM 1900 Channel Low



Unless otherwise stated the results shown in this test report refer only to the sample(s) tested and such sample(s) are retained for 90 days only.

除非另有說明，此報告結果僅對測試之樣品負責，同時此樣品僅保留90天。本報告未經本公司書面許可，不可部份複製。

This document is issued by the Company subject to its General Conditions of Service printed overleaf, available on request or accessible at www.sgs.com/terms_and_conditions.htm and, for electronic format documents, subject to Terms and Conditions for Electronic Documents at www.sgs.com/terms_e-document.htm. Attention is drawn to the limitation of liability, indemnification and jurisdiction issues defined therein. Any holder of this document is advised that information contained hereon reflects the Company's findings at the time of its intervention only and within the limits of Client's instructions, if any. The Company's sole responsibility is to its Client and this document does not exonerate parties to a transaction from exercising all their rights and obligations under the transaction documents. This document cannot be reproduced except in full, without prior written approval of the Company. Any unauthorized alteration, forgery or falsification of the content or appearance of this document is unlawful and offenders may be prosecuted to the fullest extent of the law.

Figure 13-5: GSM 1900 Channel Mid

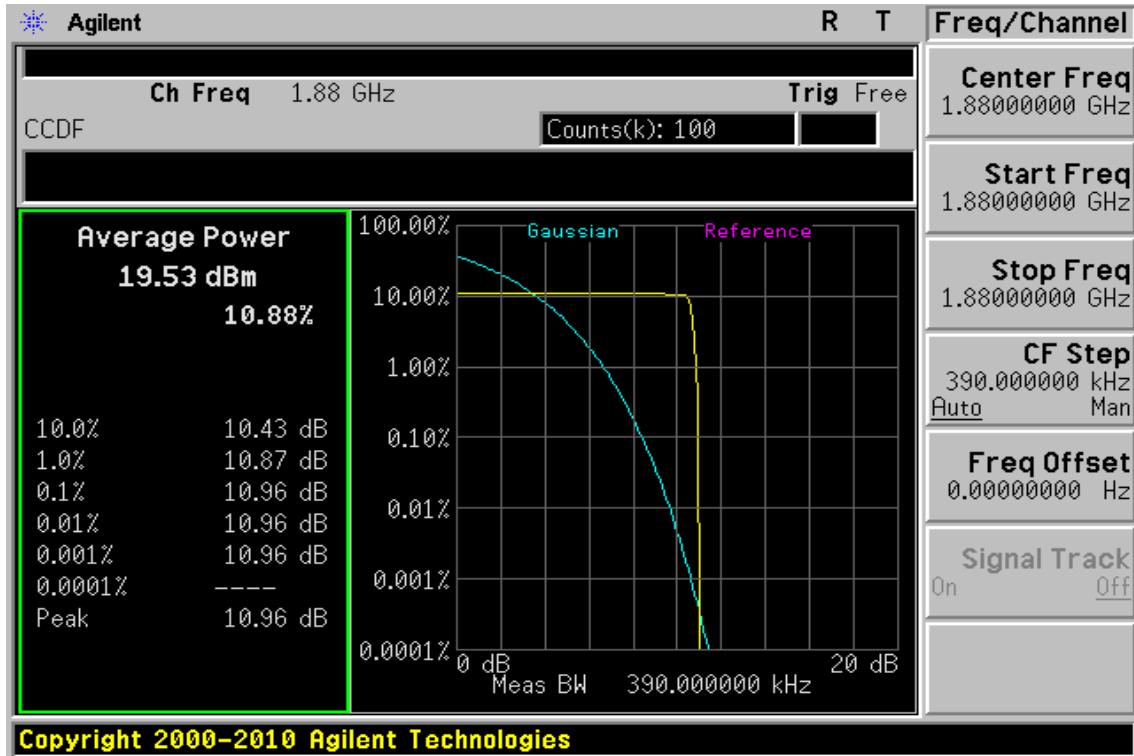
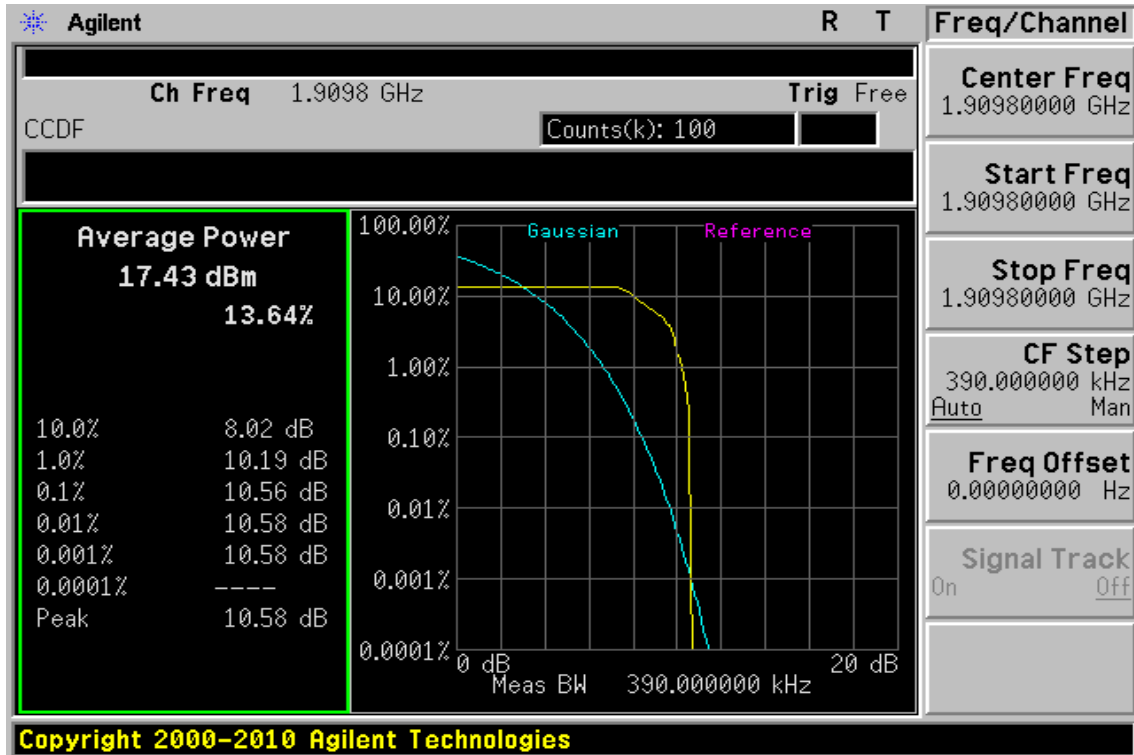

Figure 13-6: GSM 1900 Channel High



Unless otherwise stated the results shown in this test report refer only to the sample(s) tested and such sample(s) are retained for 90 days only.

除非另有說明，此報告結果僅對測試之樣品負責，同時此樣品僅保留90天。本報告未經本公司書面許可，不可部份複製。

This document is issued by the Company subject to its General Conditions of Service printed overleaf, available on request or accessible at www.sgs.com/terms_and_conditions.htm and, for electronic format documents, subject to Terms and Conditions for Electronic Documents at www.sgs.com/terms_e-document.htm. Attention is drawn to the limitation of liability, indemnification and jurisdiction issues defined therein. Any holder of this document is advised that information contained hereon reflects the Company's findings at the time of its intervention only and within the limits of Client's instructions, if any. The Company's sole responsibility is to its Client and this document does not exonerate parties to a transaction from exercising all their rights and obligations under the transaction documents. This document cannot be reproduced except in full, without prior written approval of the Company. Any unauthorized alteration, forgery or falsification of the content or appearance of this document is unlawful and offenders may be prosecuted to the fullest extent of the law.

Figure 13-7: GPRS 850 Channel Low

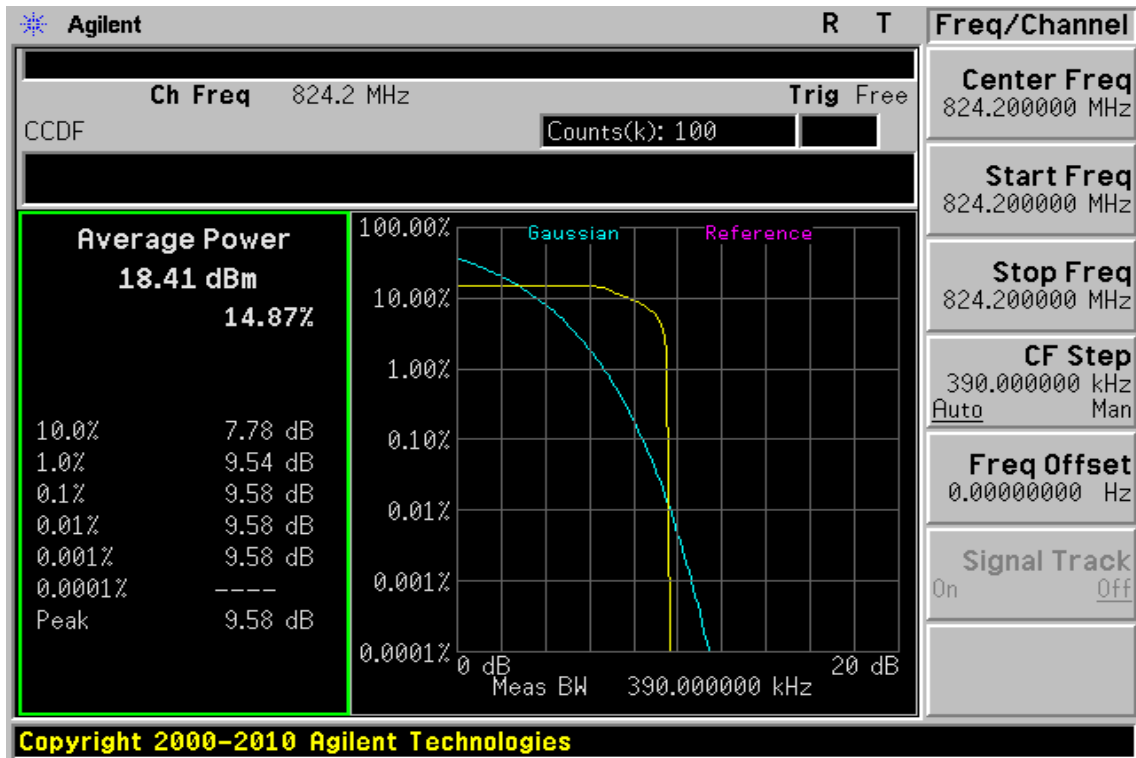
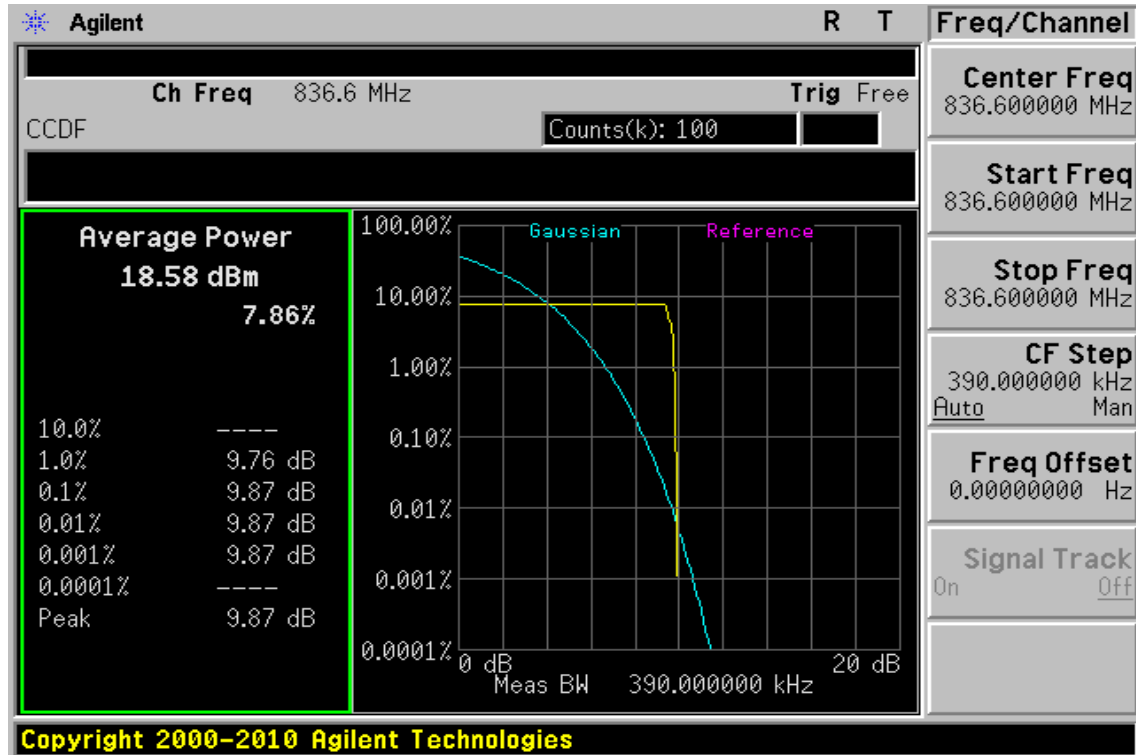

Figure 13-8: GPRS 850 Channel Mid



Unless otherwise stated the results shown in this test report refer only to the sample(s) tested and such sample(s) are retained for 90 days only.

除非另有說明，此報告結果僅對測試之樣品負責，同時此樣品僅保留90天。本報告未經本公司書面許可，不可部份複製。

This document is issued by the Company subject to its General Conditions of Service printed overleaf, available on request or accessible at www.sgs.com/terms_and_conditions.htm and, for electronic format documents, subject to Terms and Conditions for Electronic Documents at www.sgs.com/terms_e-document.htm. Attention is drawn to the limitation of liability, indemnification and jurisdiction issues defined therein. Any holder of this document is advised that information contained hereon reflects the Company's findings at the time of its intervention only and within the limits of Client's instructions, if any. The Company's sole responsibility is to its Client and this document does not exonerate parties to a transaction from exercising all their rights and obligations under the transaction documents. This document cannot be reproduced except in full, without prior written approval of the Company. Any unauthorized alteration, forgery or falsification of the content or appearance of this document is unlawful and offenders may be prosecuted to the fullest extent of the law.

Figure 13-9: GPRS 850 Channel High

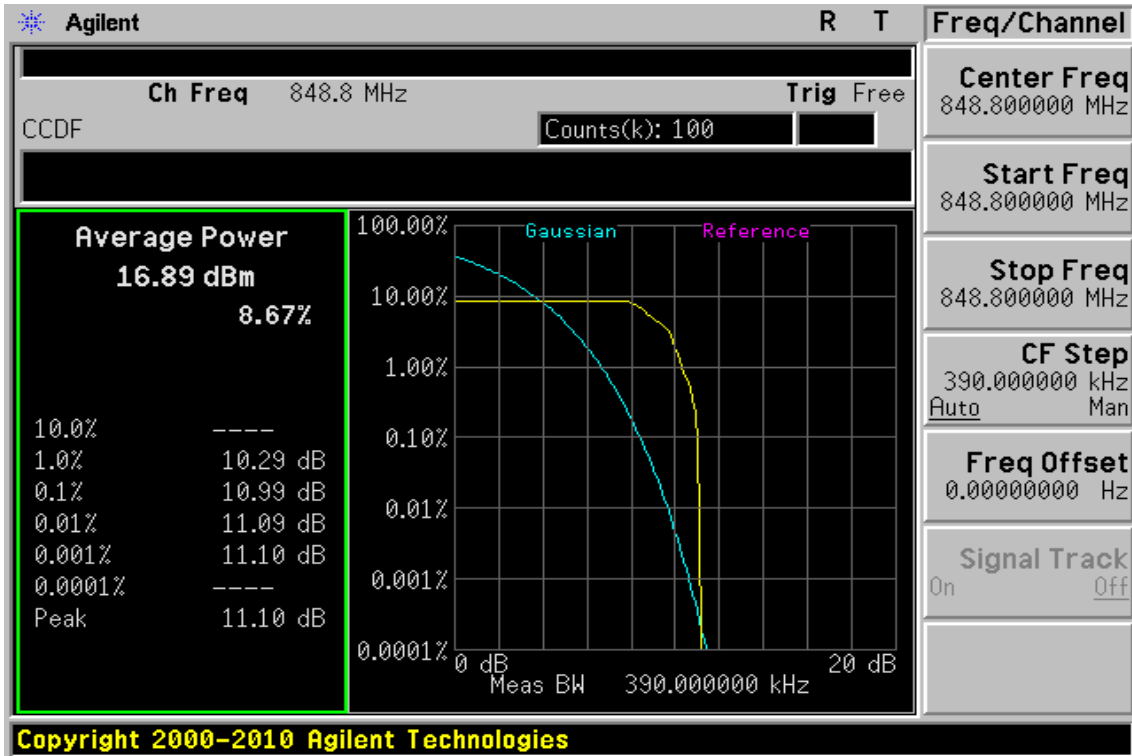
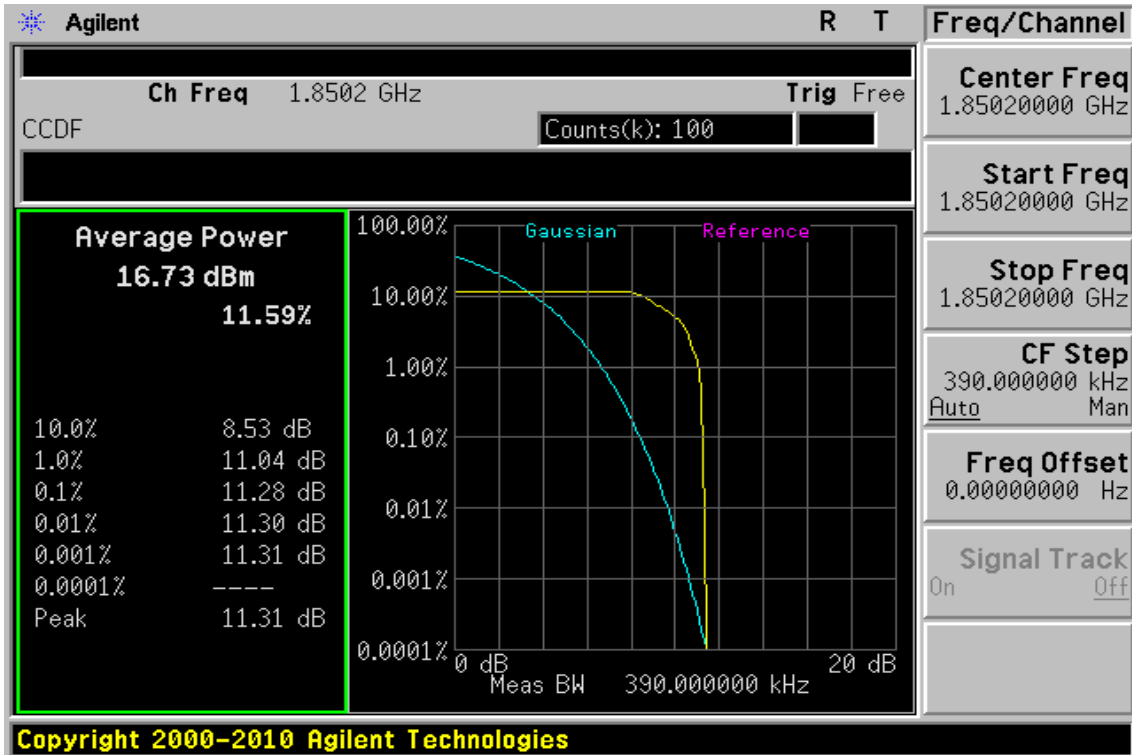

Figure 13-10: GPRS 1900 Channel Low



Unless otherwise stated the results shown in this test report refer only to the sample(s) tested and such sample(s) are retained for 90 days only.

除非另有說明，此報告結果僅對測試之樣品負責，同時此樣品僅保留90天。本報告未經本公司書面許可，不可部份複製。

This document is issued by the Company subject to its General Conditions of Service printed overleaf, available on request or accessible at www.sgs.com/terms_and_conditions.htm and, for electronic format documents, subject to Terms and Conditions for Electronic Documents at www.sgs.com/terms_e-document.htm. Attention is drawn to the limitation of liability, indemnification and jurisdiction issues defined therein. Any holder of this document is advised that information contained hereon reflects the Company's findings at the time of its intervention only and within the limits of Client's instructions, if any. The Company's sole responsibility is to its Client and this document does not exonerate parties to a transaction from exercising all their rights and obligations under the transaction documents. This document cannot be reproduced except in full, without prior written approval of the Company. Any unauthorized alteration, forgery or falsification of the content or appearance of this document is unlawful and offenders may be prosecuted to the fullest extent of the law.

Figure 13-11 GPRS 1900 Channel Mid

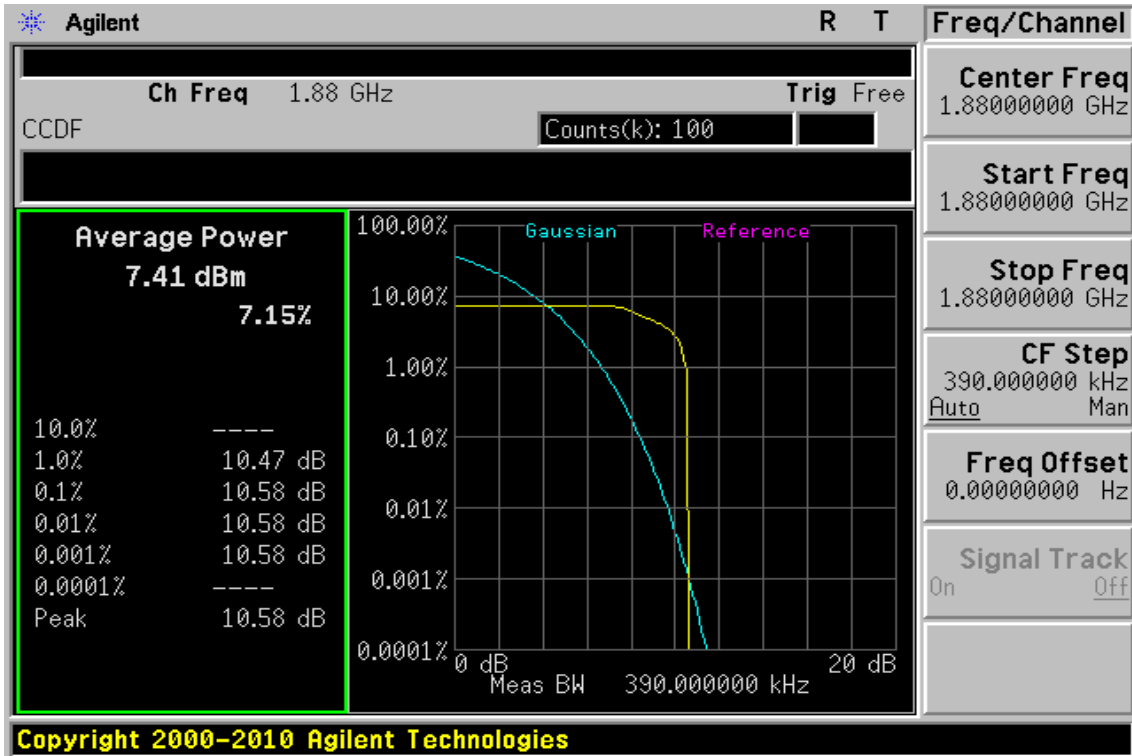
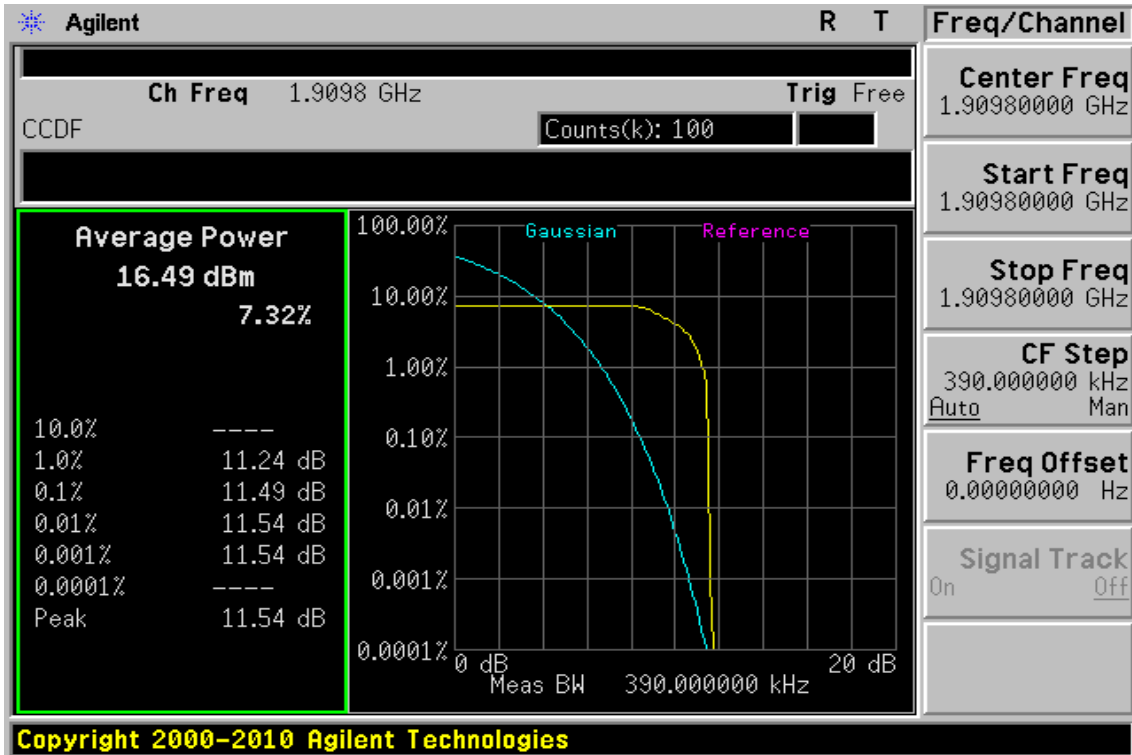

Figure 13-12: GPRS 1900 Channel High



Unless otherwise stated the results shown in this test report refer only to the sample(s) tested and such sample(s) are retained for 90 days only.

除非另有說明，此報告結果僅對測試之樣品負責，同時此樣品僅保留90天。本報告未經本公司書面許可，不可部份複製。

This document is issued by the Company subject to its General Conditions of Service printed overleaf, available on request or accessible at www.sgs.com/terms_and_conditions.htm and, for electronic format documents, subject to Terms and Conditions for Electronic Documents at www.sgs.com/terms_e-document.htm. Attention is drawn to the limitation of liability, indemnification and jurisdiction issues defined therein. Any holder of this document is advised that information contained hereon reflects the Company's findings at the time of its intervention only and within the limits of Client's instructions, if any. The Company's sole responsibility is to its Client and this document does not exonerate parties to a transaction from exercising all their rights and obligations under the transaction documents. This document cannot be reproduced except in full, without prior written approval of the Company. Any unauthorized alteration, forgery or falsification of the content or appearance of this document is unlawful and offenders may be prosecuted to the fullest extent of the law.

Figure 13-13: EDGE 850 Channel Low

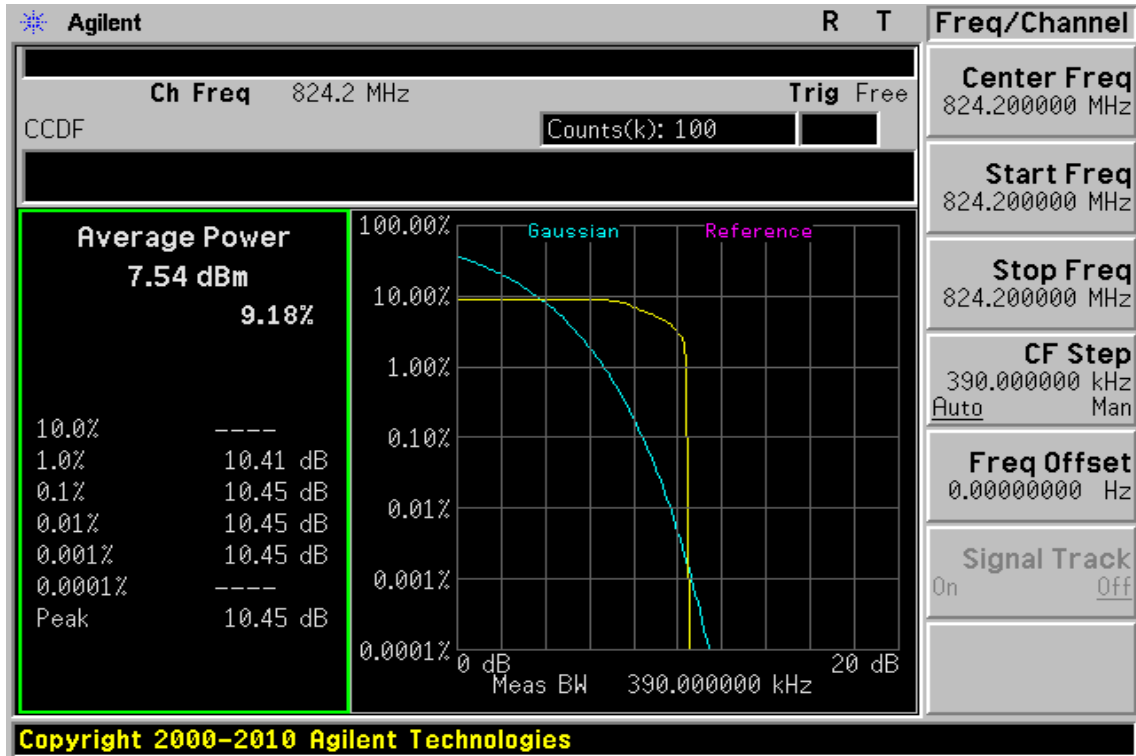
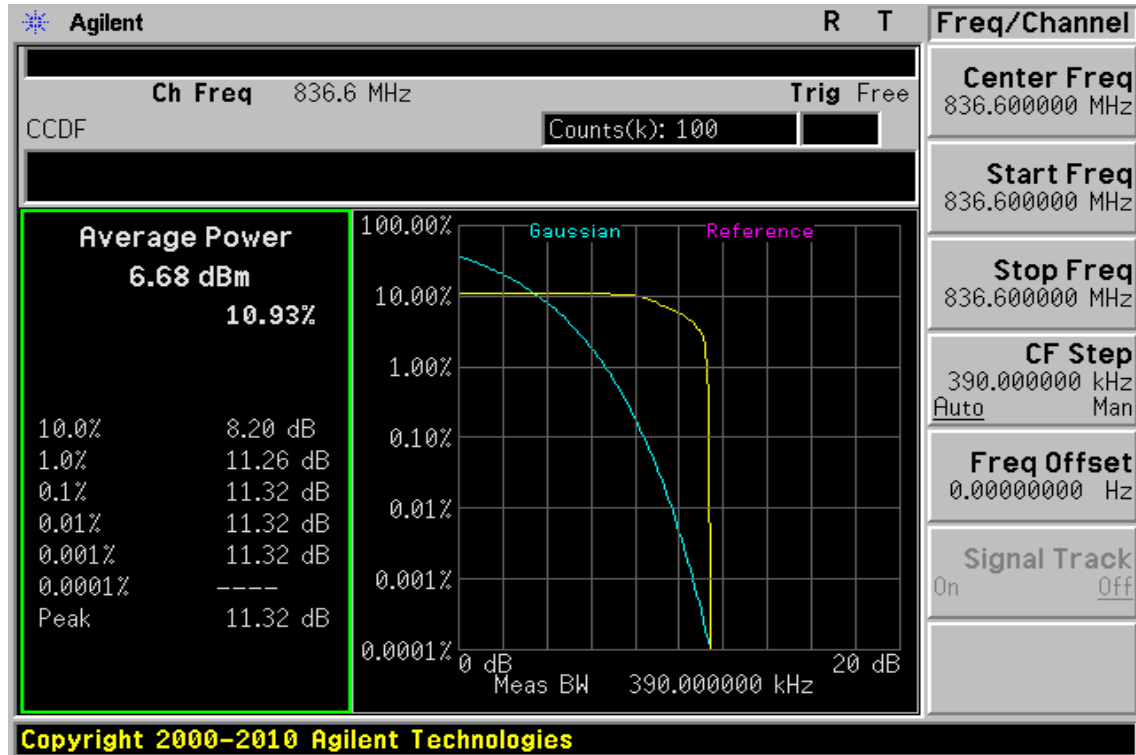

Figure 13-14 EDGE 850 Channel Mid



Unless otherwise stated the results shown in this test report refer only to the sample(s) tested and such sample(s) are retained for 90 days only.

除非另有說明，此報告結果僅對測試之樣品負責，同時此樣品僅保留90天。本報告未經本公司書面許可，不可部份複製。

This document is issued by the Company subject to its General Conditions of Service printed overleaf, available on request or accessible at www.sgs.com/terms_and_conditions.htm and, for electronic format documents, subject to Terms and Conditions for Electronic Documents at www.sgs.com/terms_e-document.htm. Attention is drawn to the limitation of liability, indemnification and jurisdiction issues defined therein. Any holder of this document is advised that information contained hereon reflects the Company's findings at the time of its intervention only and within the limits of Client's instructions, if any. The Company's sole responsibility is to its Client and this document does not exonerate parties to a transaction from exercising all their rights and obligations under the transaction documents. This document cannot be reproduced except in full, without prior written approval of the Company. Any unauthorized alteration, forgery or falsification of the content or appearance of this document is unlawful and offenders may be prosecuted to the fullest extent of the law.

Figure 13-15: EDGE 850 Channel High

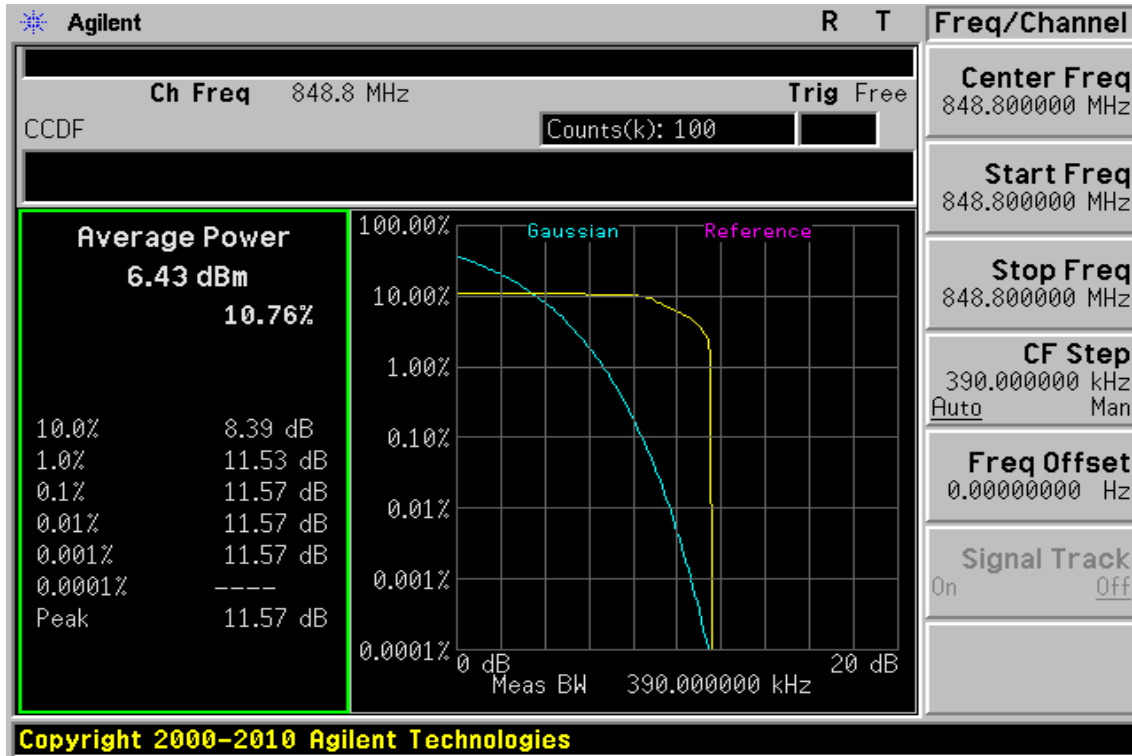
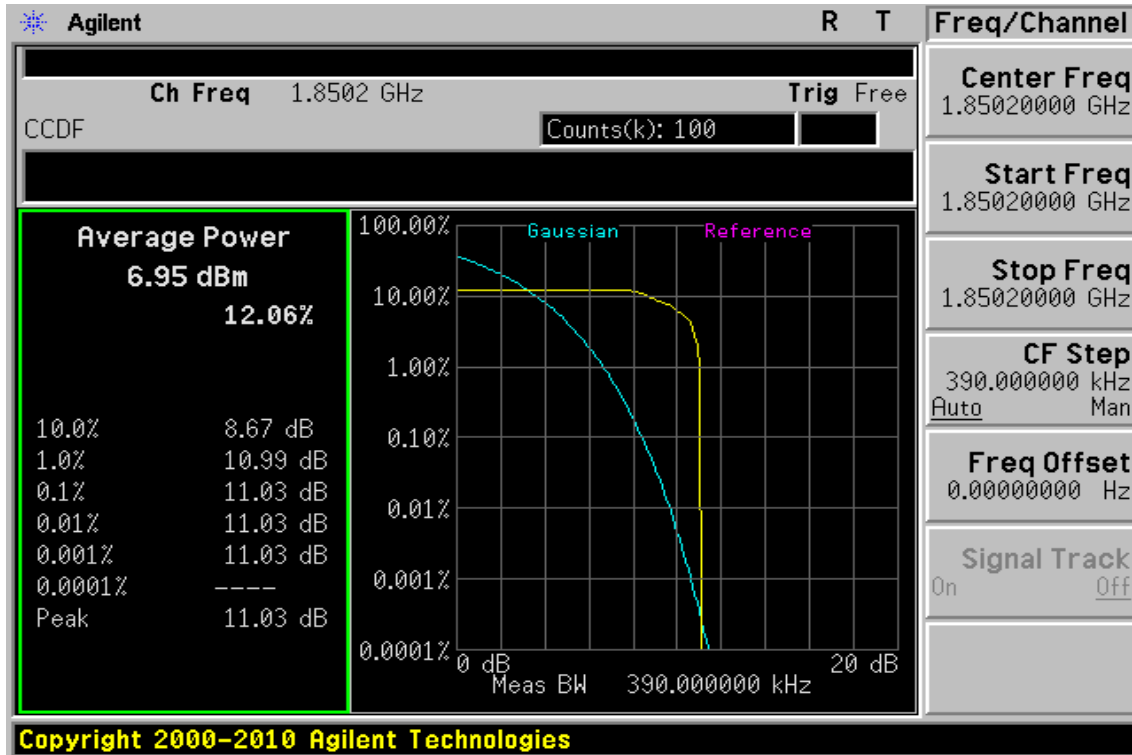

Figure 13-16: EDGE 1900 Channel Low



Unless otherwise stated the results shown in this test report refer only to the sample(s) tested and such sample(s) are retained for 90 days only.

除非另有說明，此報告結果僅對測試之樣品負責，同時此樣品僅保留90天。本報告未經本公司書面許可，不可部份複製。

This document is issued by the Company subject to its General Conditions of Service printed overleaf, available on request or accessible at www.sgs.com/terms_and_conditions.htm and, for electronic format documents, subject to Terms and Conditions for Electronic Documents at www.sgs.com/terms_e-document.htm. Attention is drawn to the limitation of liability, indemnification and jurisdiction issues defined therein. Any holder of this document is advised that information contained hereon reflects the Company's findings at the time of its intervention only and within the limits of Client's instructions, if any. The Company's sole responsibility is to its Client and this document does not exonerate parties to a transaction from exercising all their rights and obligations under the transaction documents. This document cannot be reproduced except in full, without prior written approval of the Company. Any unauthorized alteration, forgery or falsification of the content or appearance of this document is unlawful and offenders may be prosecuted to the fullest extent of the law.

Figure 13-17 EDGE 1900 Channel Mid

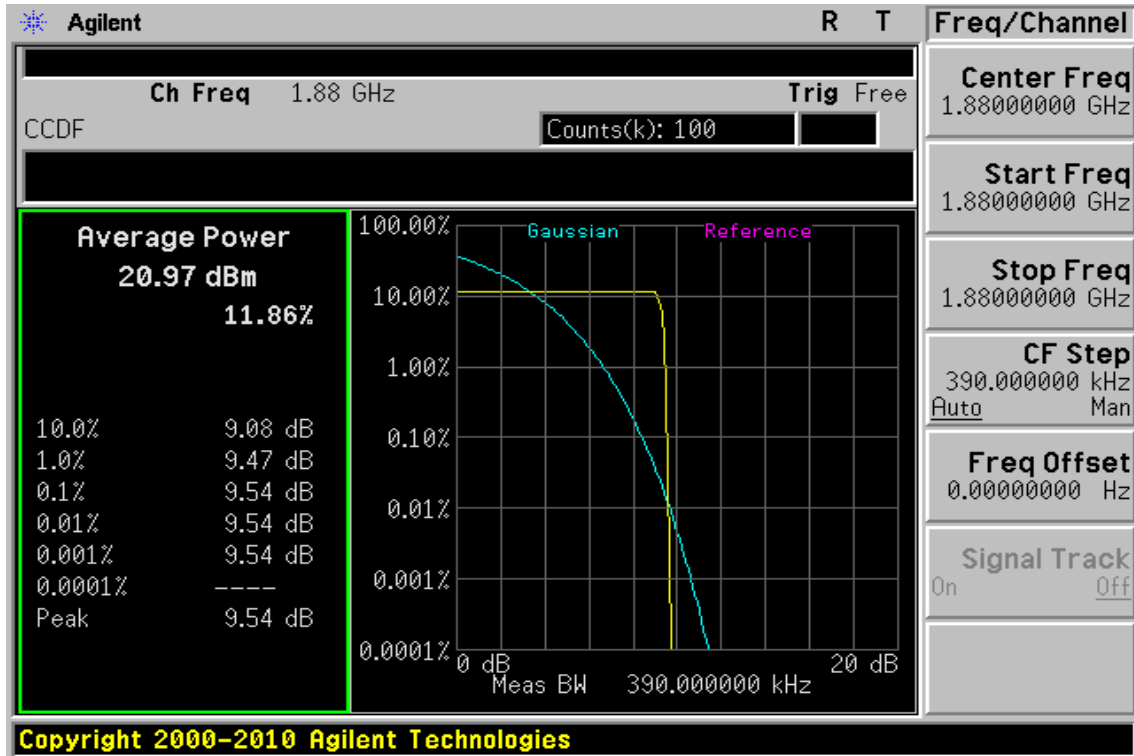
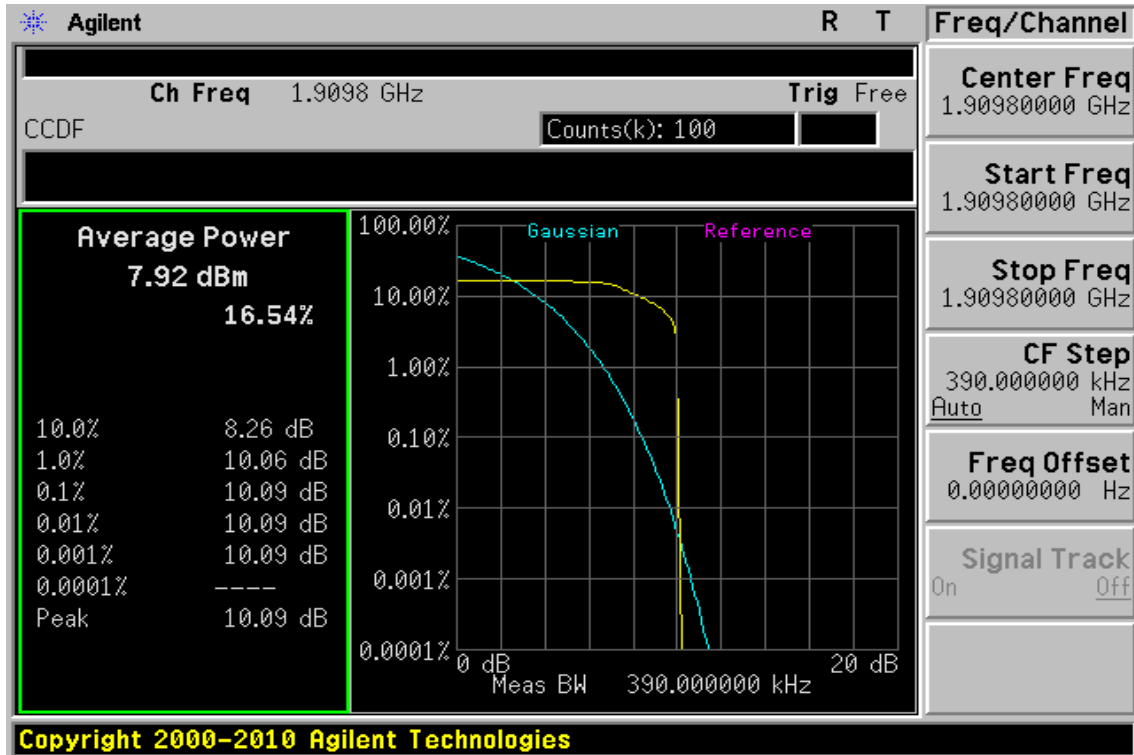

Figure 13-18: EDGE 1900 Channel High



Unless otherwise stated the results shown in this test report refer only to the sample(s) tested and such sample(s) are retained for 90 days only.

除非另有說明，此報告結果僅對測試之樣品負責，同時此樣品僅保留90天。本報告未經本公司書面許可，不可部份複製。

This document is issued by the Company subject to its General Conditions of Service printed overleaf, available on request or accessible at www.sgs.com/terms_and_conditions.htm and, for electronic format documents, subject to Terms and Conditions for Electronic Documents at www.sgs.com/terms_e-document.htm. Attention is drawn to the limitation of liability, indemnification and jurisdiction issues defined therein. Any holder of this document is advised that information contained hereon reflects the Company's findings at the time of its intervention only and within the limits of Client's instructions, if any. The Company's sole responsibility is to its Client and this document does not exonerate parties to a transaction from exercising all their rights and obligations under the transaction documents. This document cannot be reproduced except in full, without prior written approval of the Company. Any unauthorized alteration, forgery or falsification of the content or appearance of this document is unlawful and offenders may be prosecuted to the fullest extent of the law.

Figure 13-19: WCDMA Band II Channel Low

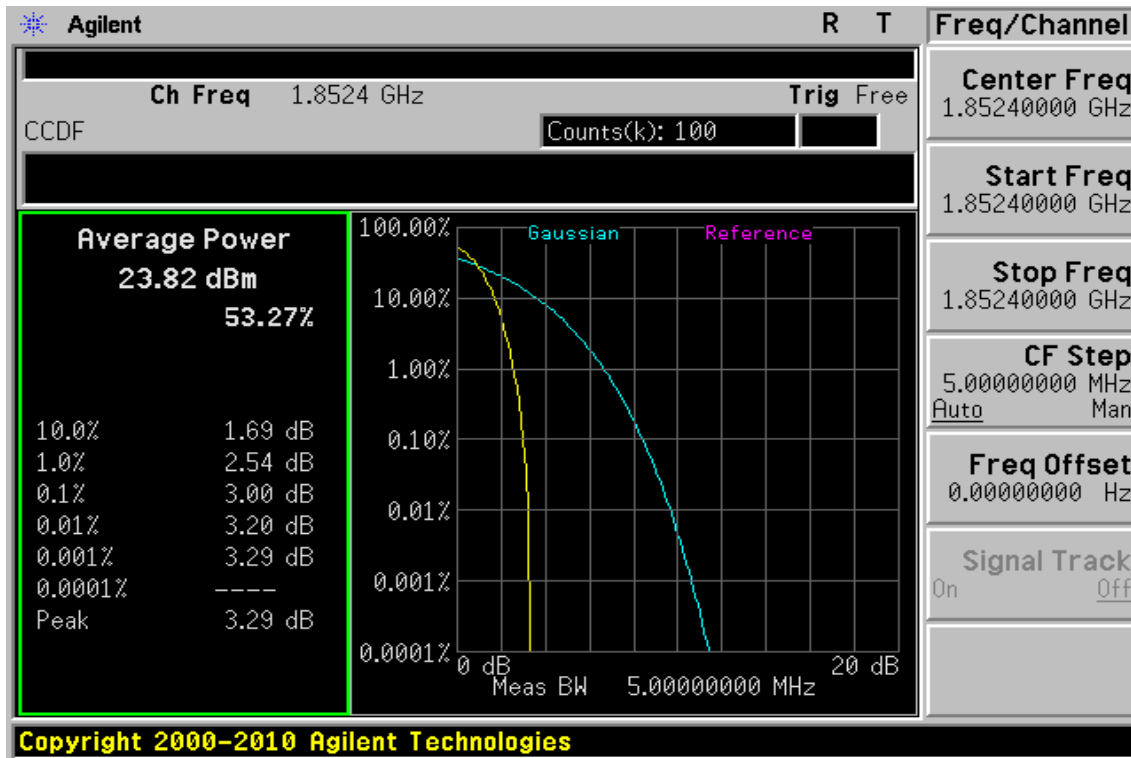
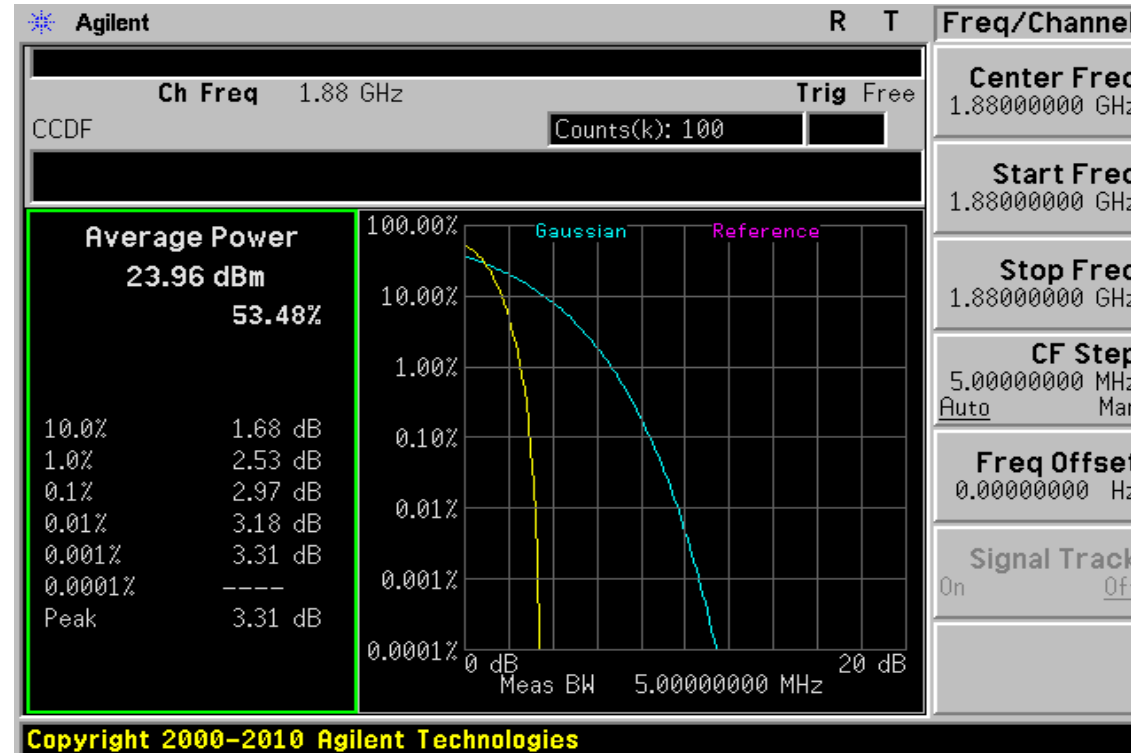

Figure 13-20: WCDMA Band II Channel Mid



Unless otherwise stated the results shown in this test report refer only to the sample(s) tested and such sample(s) are retained for 90 days only.

除非另有說明，此報告結果僅對測試之樣品負責，同時此樣品僅保留90天。本報告未經本公司書面許可，不可部份複製。

This document is issued by the Company subject to its General Conditions of Service printed overleaf, available on request or accessible at www.sgs.com/terms_and_conditions.htm and, for electronic format documents, subject to Terms and Conditions for Electronic Documents at www.sgs.com/terms_e-document.htm. Attention is drawn to the limitation of liability, indemnification and jurisdiction issues defined therein. Any holder of this document is advised that information contained hereon reflects the Company's findings at the time of its intervention only and within the limits of Client's instructions, if any. The Company's sole responsibility is to its Client and this document does not exonerate parties to a transaction from exercising all their rights and obligations under the transaction documents. This document cannot be reproduced except in full, without prior written approval of the Company. Any unauthorized alteration, forgery or falsification of the content or appearance of this document is unlawful and offenders may be prosecuted to the fullest extent of the law.

Figure 13-21: WCDMA Band II Channel High

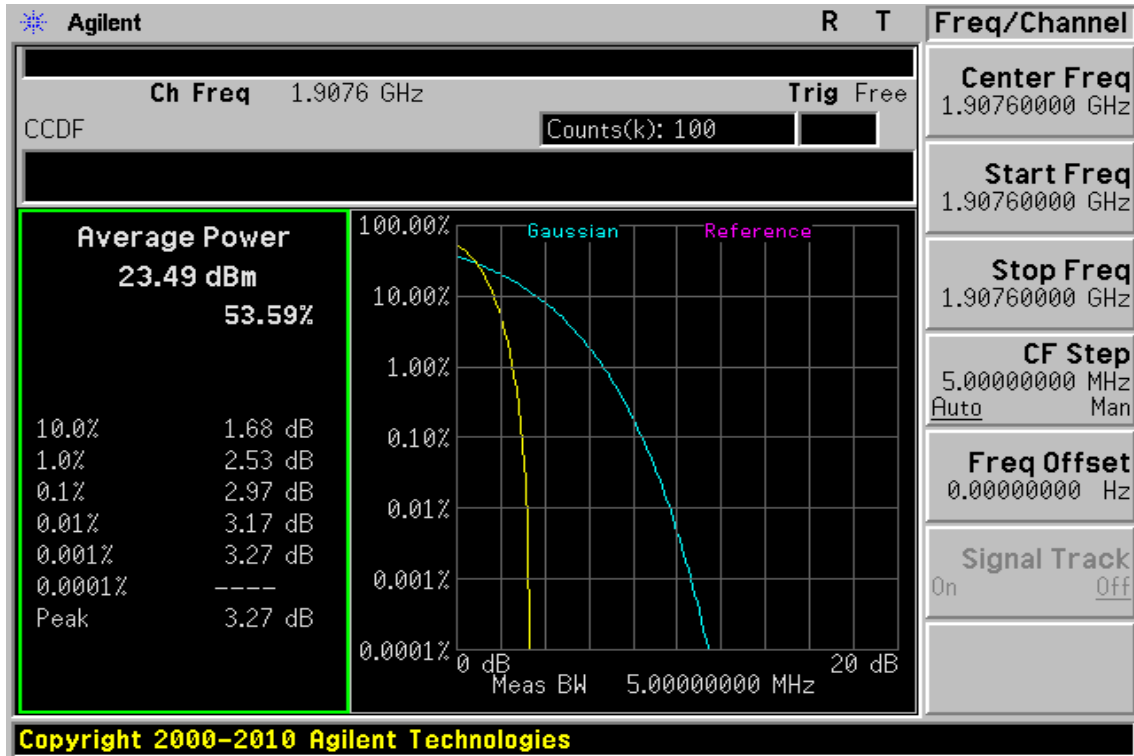
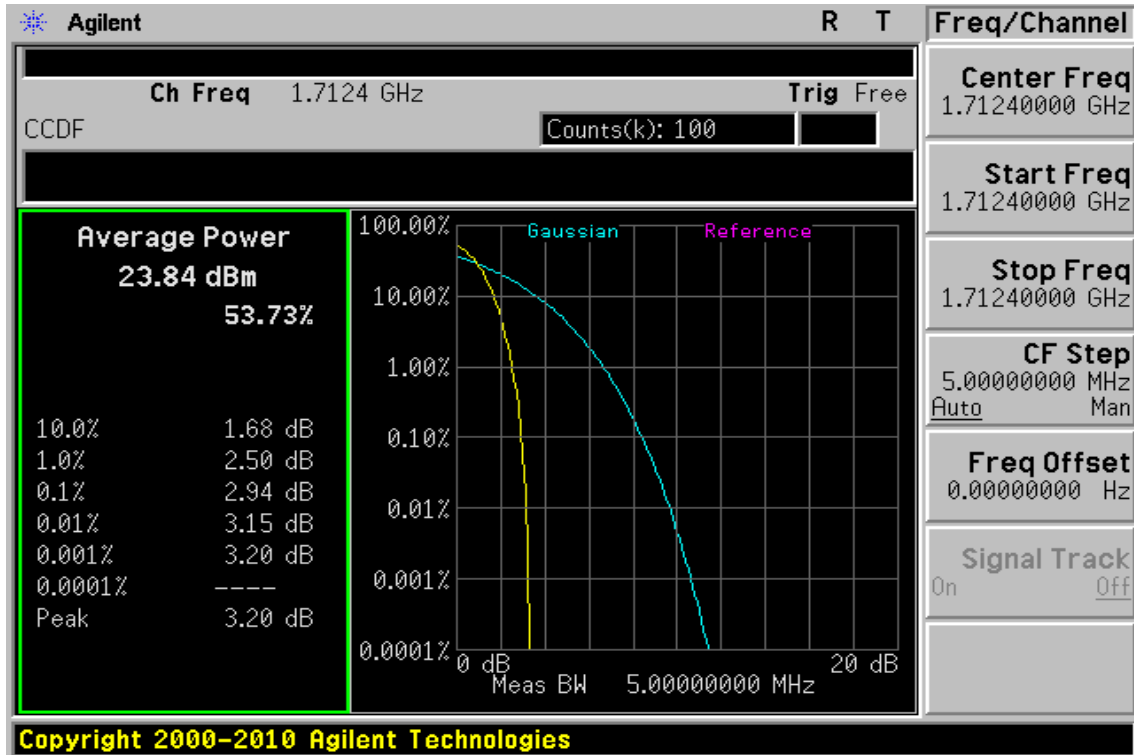

Figure 13-22: WCDMA Band IV Channel Low



Unless otherwise stated the results shown in this test report refer only to the sample(s) tested and such sample(s) are retained for 90 days only.

除非另有說明，此報告結果僅對測試之樣品負責，同時此樣品僅保留90天。本報告未經本公司書面許可，不可部份複製。

This document is issued by the Company subject to its General Conditions of Service printed overleaf, available on request or accessible at www.sgs.com/terms_and_conditions.htm and, for electronic format documents, subject to Terms and Conditions for Electronic Documents at www.sgs.com/terms_e-document.htm. Attention is drawn to the limitation of liability, indemnification and jurisdiction issues defined therein. Any holder of this document is advised that information contained hereon reflects the Company's findings at the time of its intervention only and within the limits of Client's instructions, if any. The Company's sole responsibility is to its Client and this document does not exonerate parties to a transaction from exercising all their rights and obligations under the transaction documents. This document cannot be reproduced except in full, without prior written approval of the Company. Any unauthorized alteration, forgery or falsification of the content or appearance of this document is unlawful and offenders may be prosecuted to the fullest extent of the law.

Figure 13-23: WCDMA Band IV Channel Mid

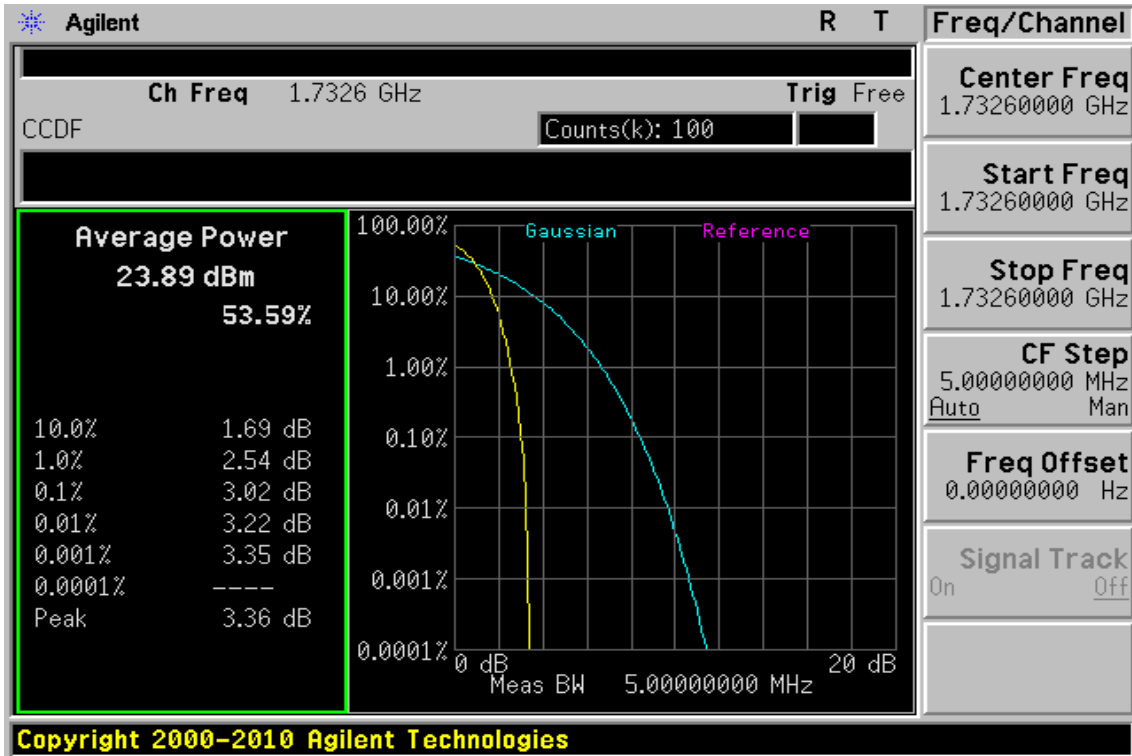
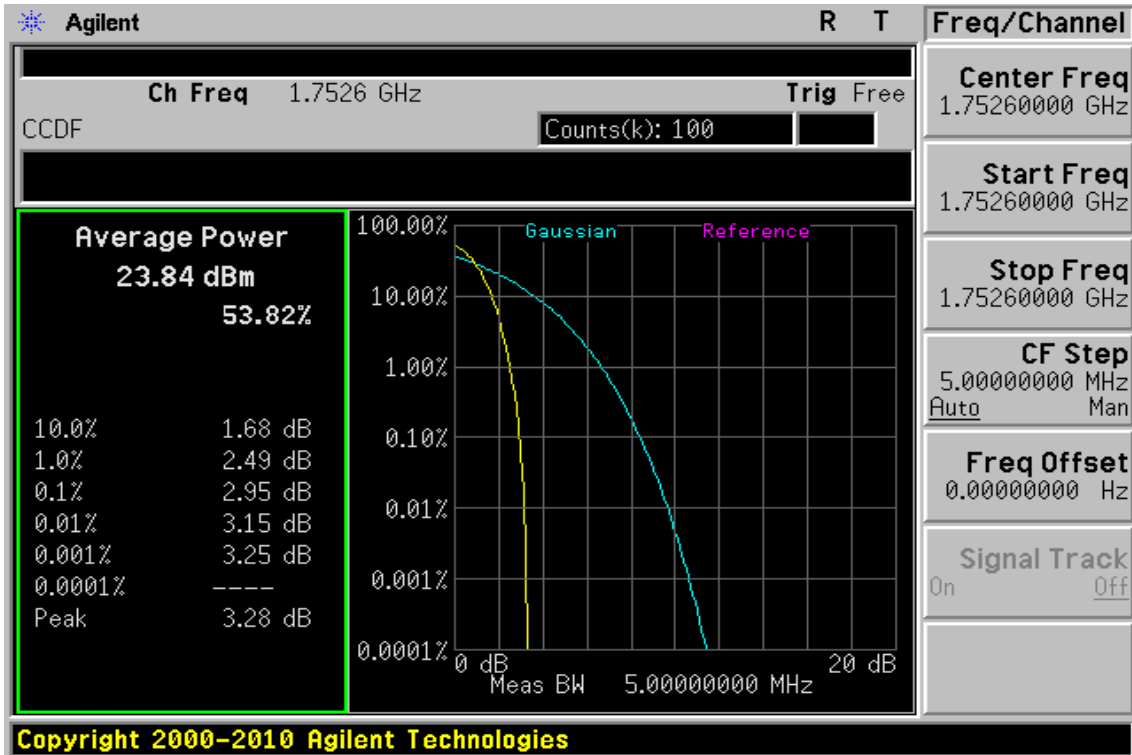

Figure 13-24: WCDMA Band IV Channel High



Unless otherwise stated the results shown in this test report refer only to the sample(s) tested and such sample(s) are retained for 90 days only.

除非另有說明，此報告結果僅對測試之樣品負責，同時此樣品僅保留90天。本報告未經本公司書面許可，不可部份複製。

This document is issued by the Company subject to its General Conditions of Service printed overleaf, available on request or accessible at www.sgs.com/terms_and_conditions.htm and, for electronic format documents, subject to Terms and Conditions for Electronic Documents at www.sgs.com/terms_e-document.htm. Attention is drawn to the limitation of liability, indemnification and jurisdiction issues defined therein. Any holder of this document is advised that information contained hereon reflects the Company's findings at the time of its intervention only and within the limits of Client's instructions, if any. The Company's sole responsibility is to its Client and this document does not exonerate parties to a transaction from exercising all their rights and obligations under the transaction documents. This document cannot be reproduced except in full, without prior written approval of the Company. Any unauthorized alteration, forgery or falsification of the content or appearance of this document is unlawful and offenders may be prosecuted to the fullest extent of the law.

Figure 13-25: WCDMA Band V Channel Low

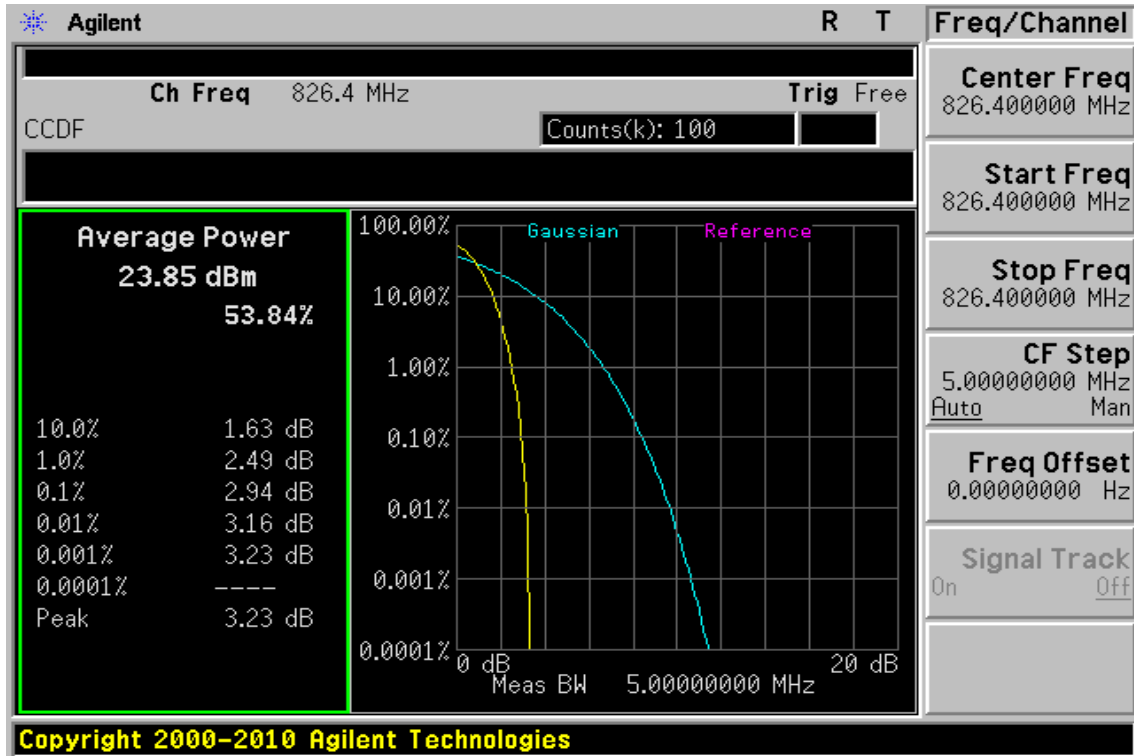
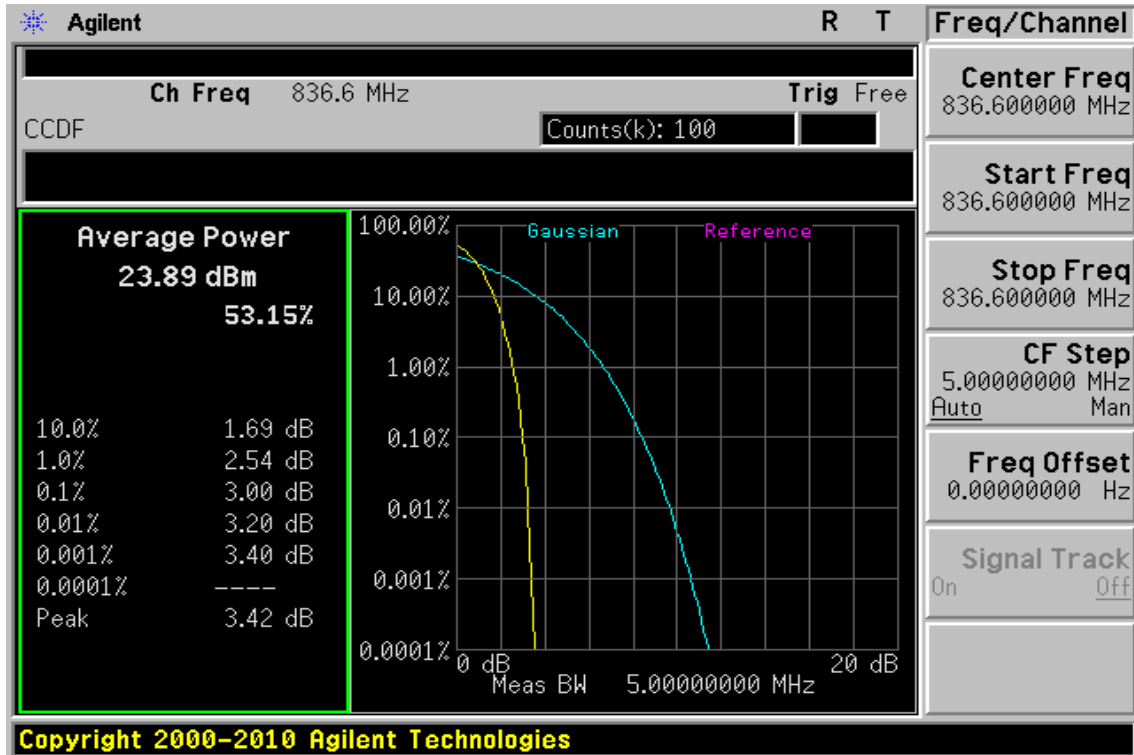

Figure 13-26: WCDMA Band V Channel Mid



Unless otherwise stated the results shown in this test report refer only to the sample(s) tested and such sample(s) are retained for 90 days only.

除非另有說明，此報告結果僅對測試之樣品負責，同時此樣品僅保留90天。本報告未經本公司書面許可，不可部份複製。

This document is issued by the Company subject to its General Conditions of Service printed overleaf, available on request or accessible at www.sgs.com/terms_and_conditions.htm and, for electronic format documents, subject to Terms and Conditions for Electronic Documents at www.sgs.com/terms_e-document.htm. Attention is drawn to the limitation of liability, indemnification and jurisdiction issues defined therein. Any holder of this document is advised that information contained hereon reflects the Company's findings at the time of its intervention only and within the limits of Client's instructions, if any. The Company's sole responsibility is to its Client and this document does not exonerate parties to a transaction from exercising all their rights and obligations under the transaction documents. This document cannot be reproduced except in full, without prior written approval of the Company. Any unauthorized alteration, forgery or falsification of the content or appearance of this document is unlawful and offenders may be prosecuted to the fullest extent of the law.

Figure 13-27: WCDMA Band V Channel High

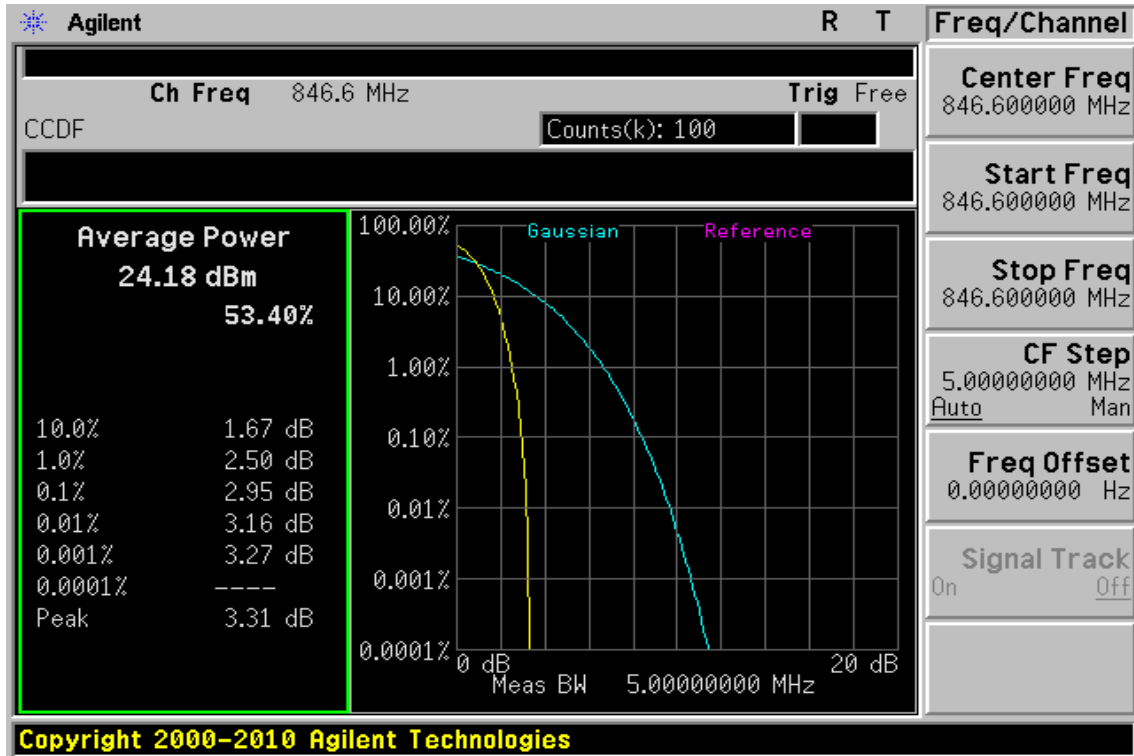
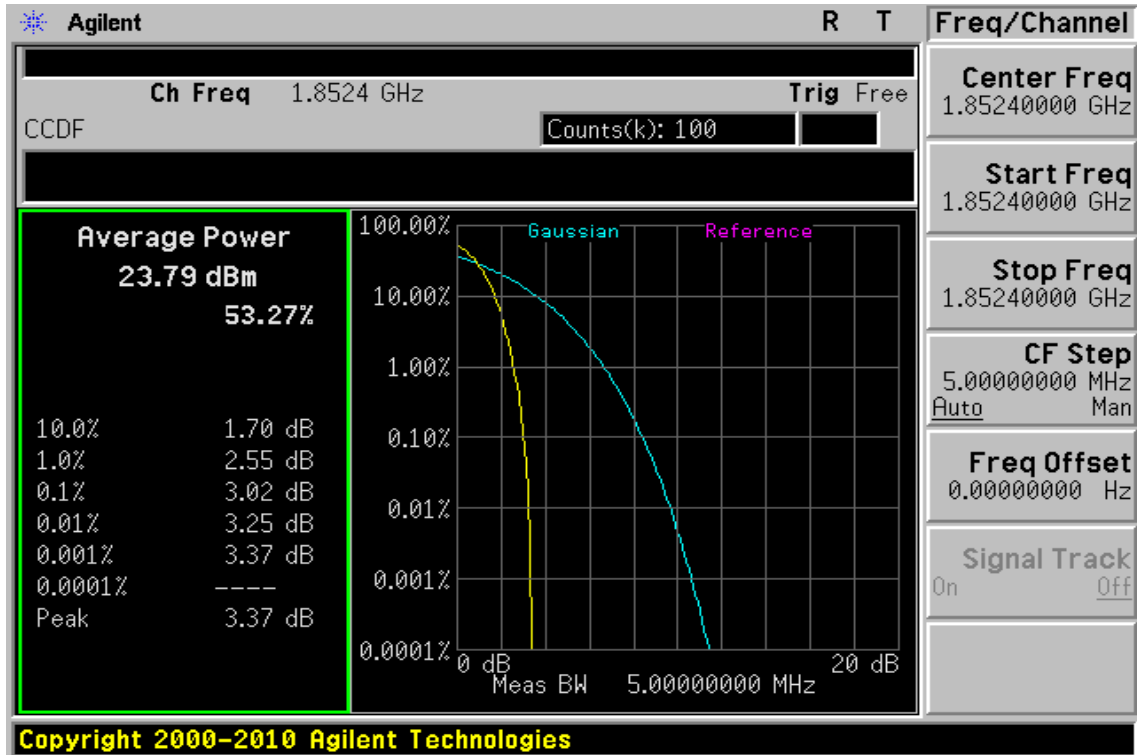

Figure 13-28: HSDPA Band II Channel Low



Unless otherwise stated the results shown in this test report refer only to the sample(s) tested and such sample(s) are retained for 90 days only.

除非另有說明，此報告結果僅對測試之樣品負責，同時此樣品僅保留90天。本報告未經本公司書面許可，不可部份複製。

This document is issued by the Company subject to its General Conditions of Service printed overleaf, available on request or accessible at www.sgs.com/terms_and_conditions.htm and, for electronic format documents, subject to Terms and Conditions for Electronic Documents at www.sgs.com/terms_e-document.htm. Attention is drawn to the limitation of liability, indemnification and jurisdiction issues defined therein. Any holder of this document is advised that information contained hereon reflects the Company's findings at the time of its intervention only and within the limits of Client's instructions, if any. The Company's sole responsibility is to its Client and this document does not exonerate parties to a transaction from exercising all their rights and obligations under the transaction documents. This document cannot be reproduced except in full, without prior written approval of the Company. Any unauthorized alteration, forgery or falsification of the content or appearance of this document is unlawful and offenders may be prosecuted to the fullest extent of the law.

Figure 13-29: HSDPA Band II Channel Mid

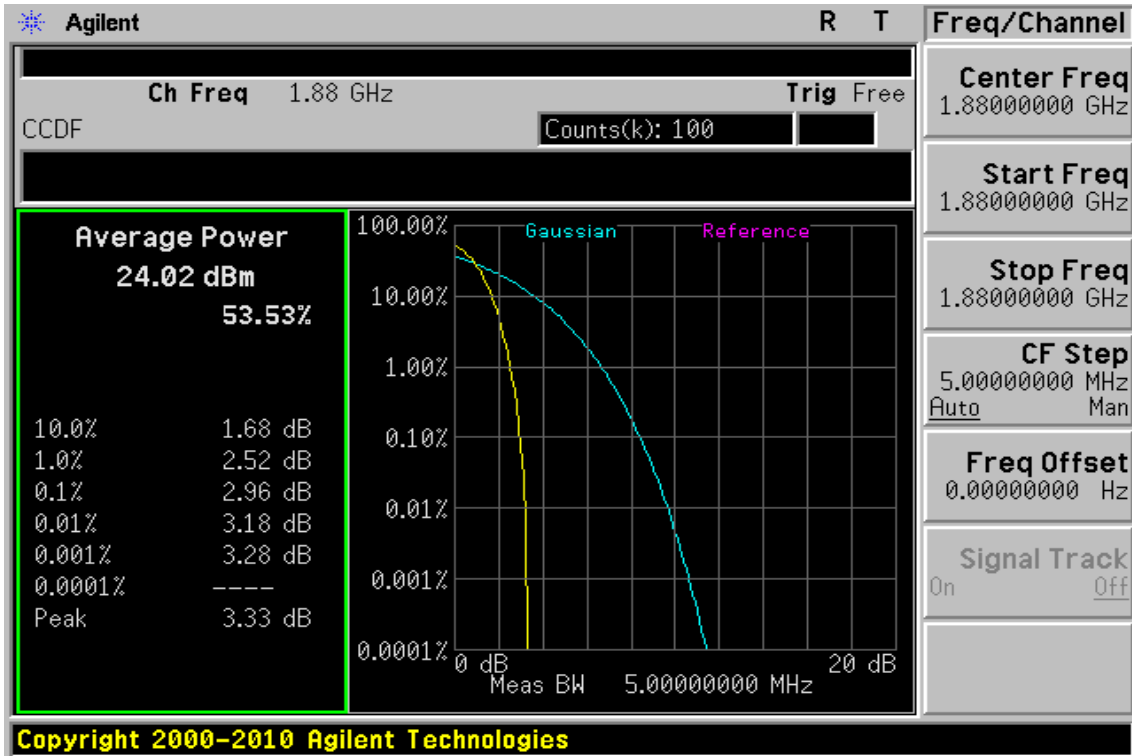
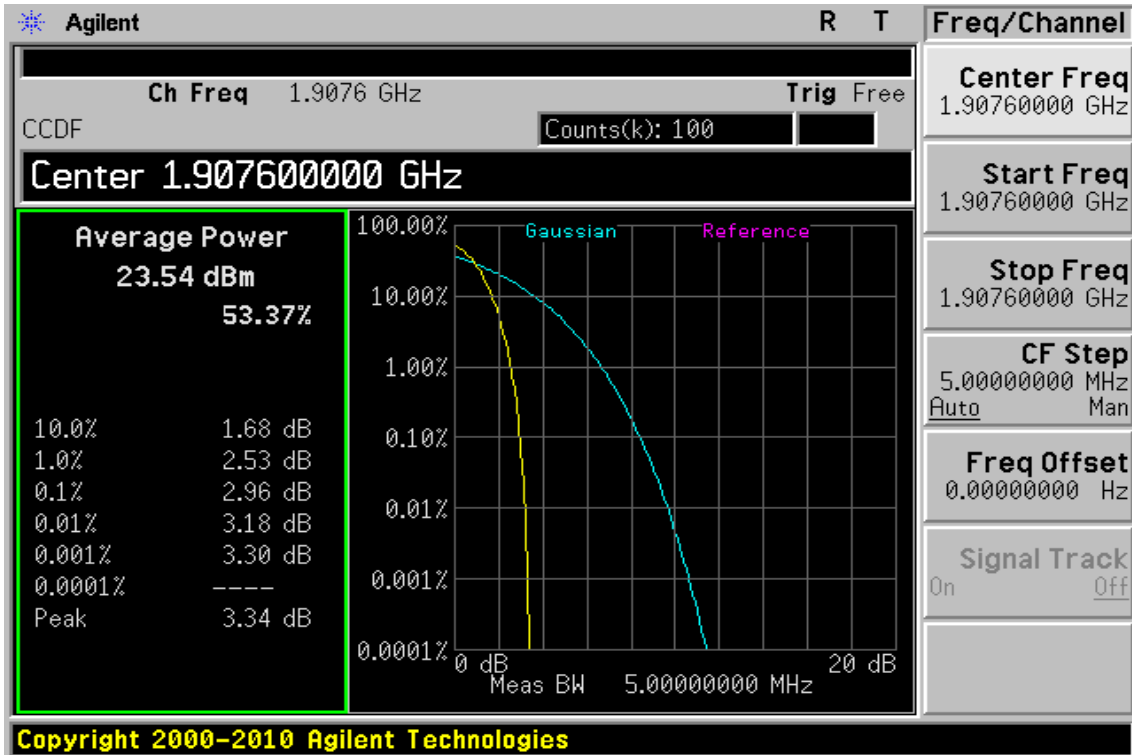

Figure 13-30: HSDPA Band II Channel High



Unless otherwise stated the results shown in this test report refer only to the sample(s) tested and such sample(s) are retained for 90 days only.

除非另有說明，此報告結果僅對測試之樣品負責，同時此樣品僅保留90天。本報告未經本公司書面許可，不可部份複製。

This document is issued by the Company subject to its General Conditions of Service printed overleaf, available on request or accessible at www.sgs.com/terms_and_conditions.htm and, for electronic format documents, subject to Terms and Conditions for Electronic Documents at www.sgs.com/terms_e-document.htm. Attention is drawn to the limitation of liability, indemnification and jurisdiction issues defined therein. Any holder of this document is advised that information contained hereon reflects the Company's findings at the time of its intervention only and within the limits of Client's instructions, if any. The Company's sole responsibility is to its Client and this document does not exonerate parties to a transaction from exercising all their rights and obligations under the transaction documents. This document cannot be reproduced except in full, without prior written approval of the Company. Any unauthorized alteration, forgery or falsification of the content or appearance of this document is unlawful and offenders may be prosecuted to the fullest extent of the law.

Figure 13-31: HSDPA Band IV Channel Low

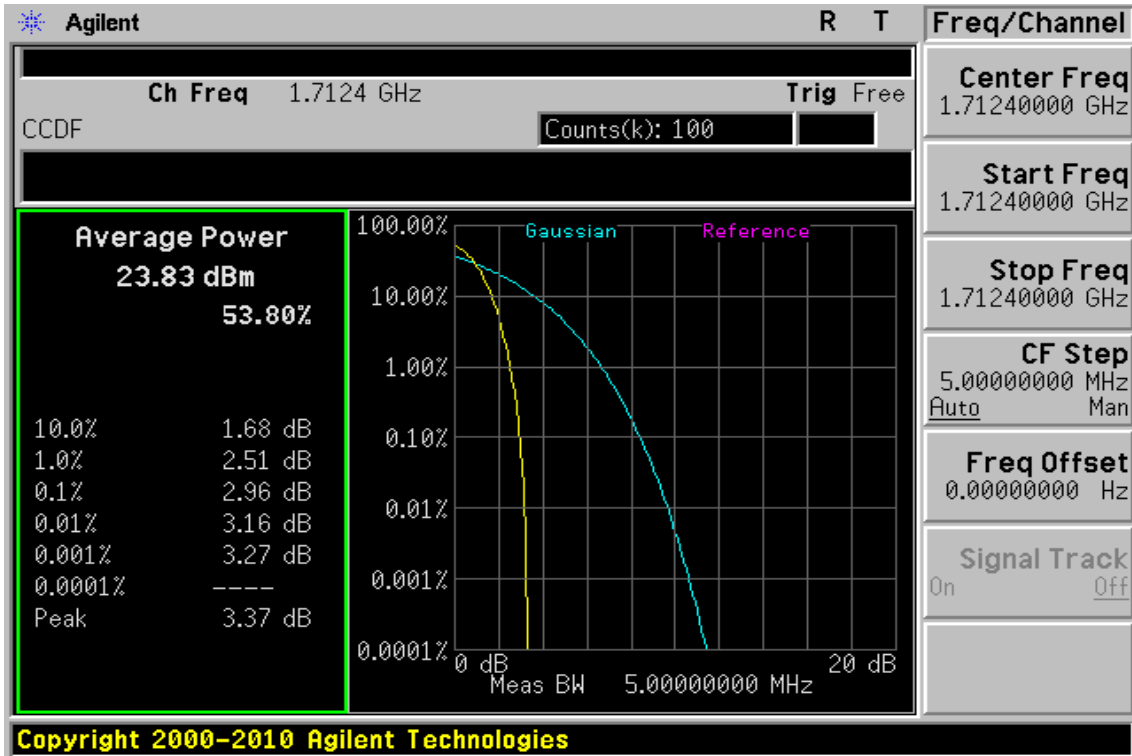
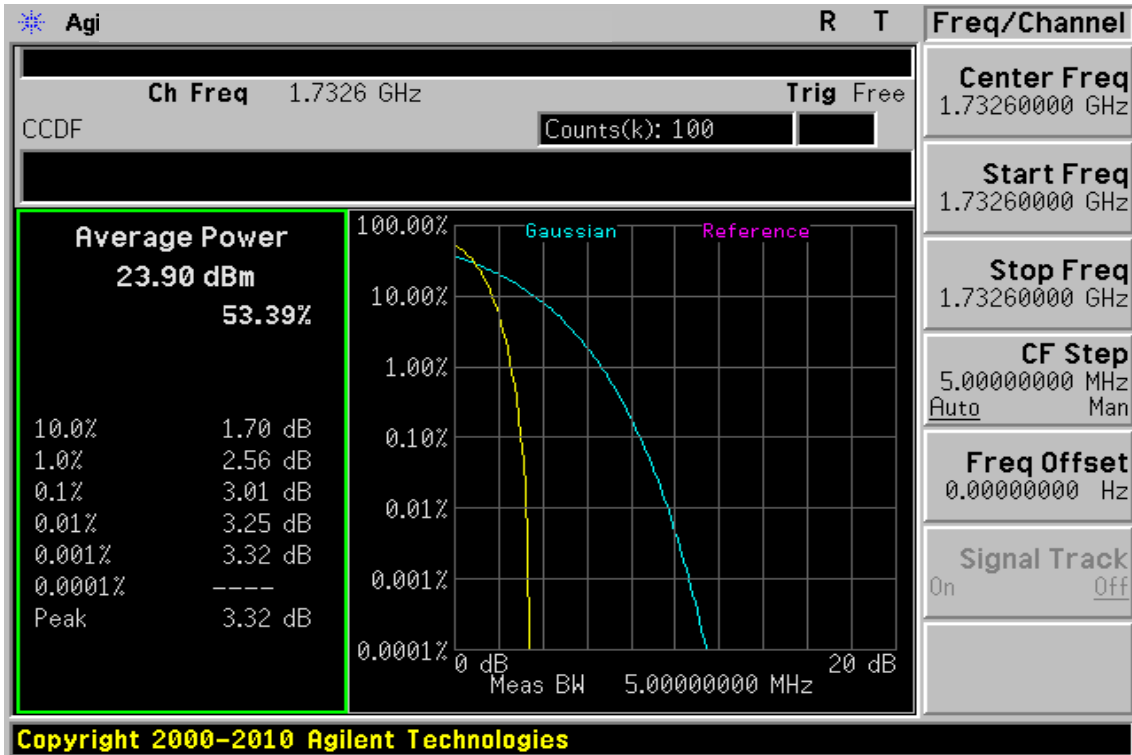

Figure 13-32: HSDPA Band IV Channel Mid



Unless otherwise stated the results shown in this test report refer only to the sample(s) tested and such sample(s) are retained for 90 days only.

除非另有說明，此報告結果僅對測試之樣品負責，同時此樣品僅保留90天。本報告未經本公司書面許可，不可部份複製。

This document is issued by the Company subject to its General Conditions of Service printed overleaf, available on request or accessible at www.sgs.com/terms_and_conditions.htm and, for electronic format documents, subject to Terms and Conditions for Electronic Documents at www.sgs.com/terms_e-document.htm. Attention is drawn to the limitation of liability, indemnification and jurisdiction issues defined therein. Any holder of this document is advised that information contained hereon reflects the Company's findings at the time of its intervention only and within the limits of Client's instructions, if any. The Company's sole responsibility is to its Client and this document does not exonerate parties to a transaction from exercising all their rights and obligations under the transaction documents. This document cannot be reproduced except in full, without prior written approval of the Company. Any unauthorized alteration, forgery or falsification of the content or appearance of this document is unlawful and offenders may be prosecuted to the fullest extent of the law.

Figure 13-33: HSDPA Band IV Channel High

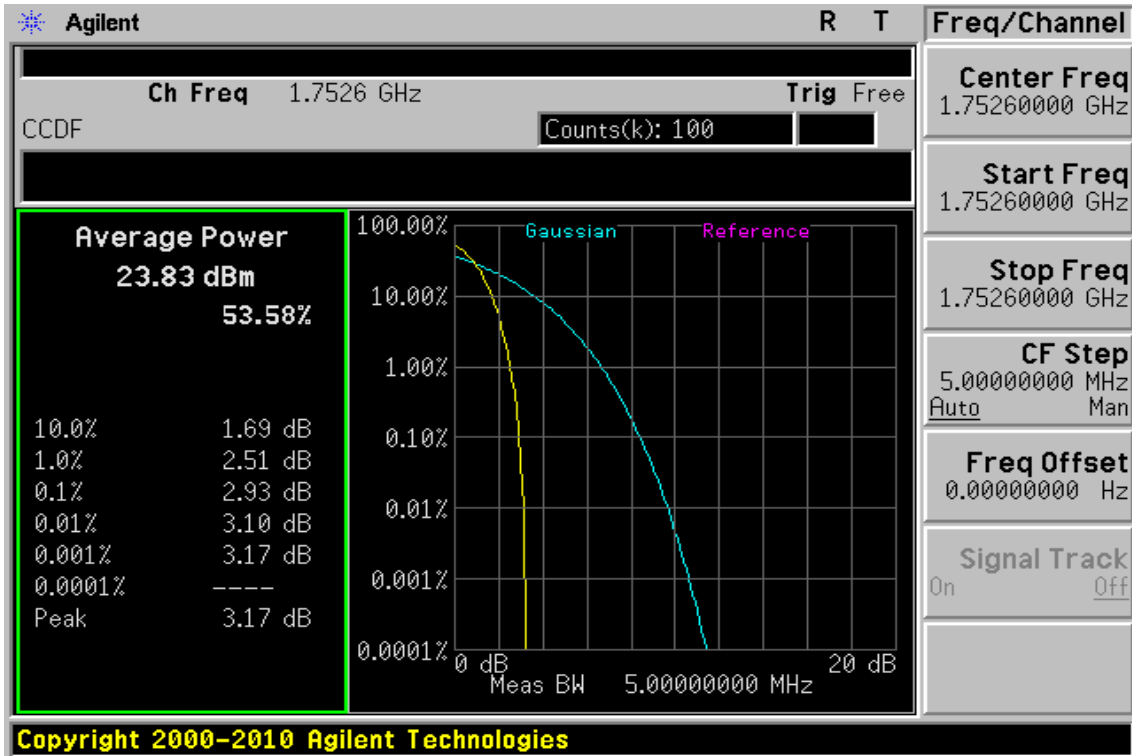
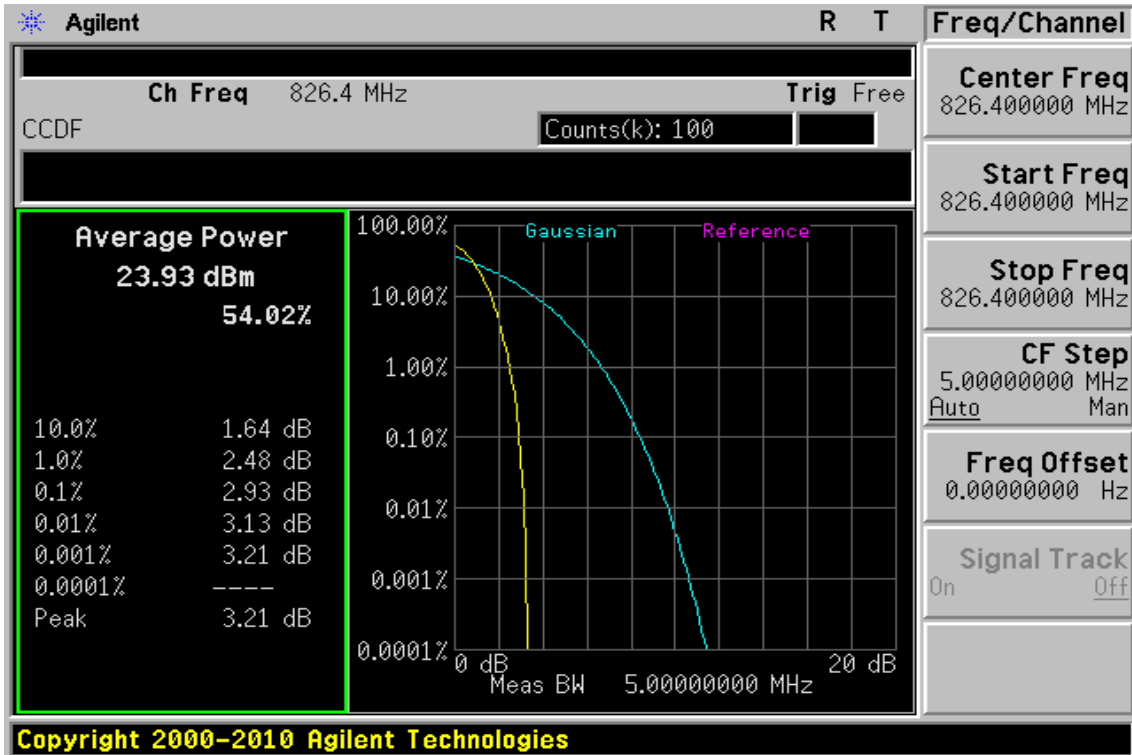

Figure 13-34: HSDPA Band V Channel Low



Unless otherwise stated the results shown in this test report refer only to the sample(s) tested and such sample(s) are retained for 90 days only.

除非另有說明，此報告結果僅對測試之樣品負責，同時此樣品僅保留90天。本報告未經本公司書面許可，不可部份複製。

This document is issued by the Company subject to its General Conditions of Service printed overleaf, available on request or accessible at www.sgs.com/terms_and_conditions.htm and, for electronic format documents, subject to Terms and Conditions for Electronic Documents at www.sgs.com/terms_e-document.htm. Attention is drawn to the limitation of liability, indemnification and jurisdiction issues defined therein. Any holder of this document is advised that information contained hereon reflects the Company's findings at the time of its intervention only and within the limits of Client's instructions, if any. The Company's sole responsibility is to its Client and this document does not exonerate parties to a transaction from exercising all their rights and obligations under the transaction documents. This document cannot be reproduced except in full, without prior written approval of the Company. Any unauthorized alteration, forgery or falsification of the content or appearance of this document is unlawful and offenders may be prosecuted to the fullest extent of the law.

Figure 13-35: HSDPA Band V Channel Mid

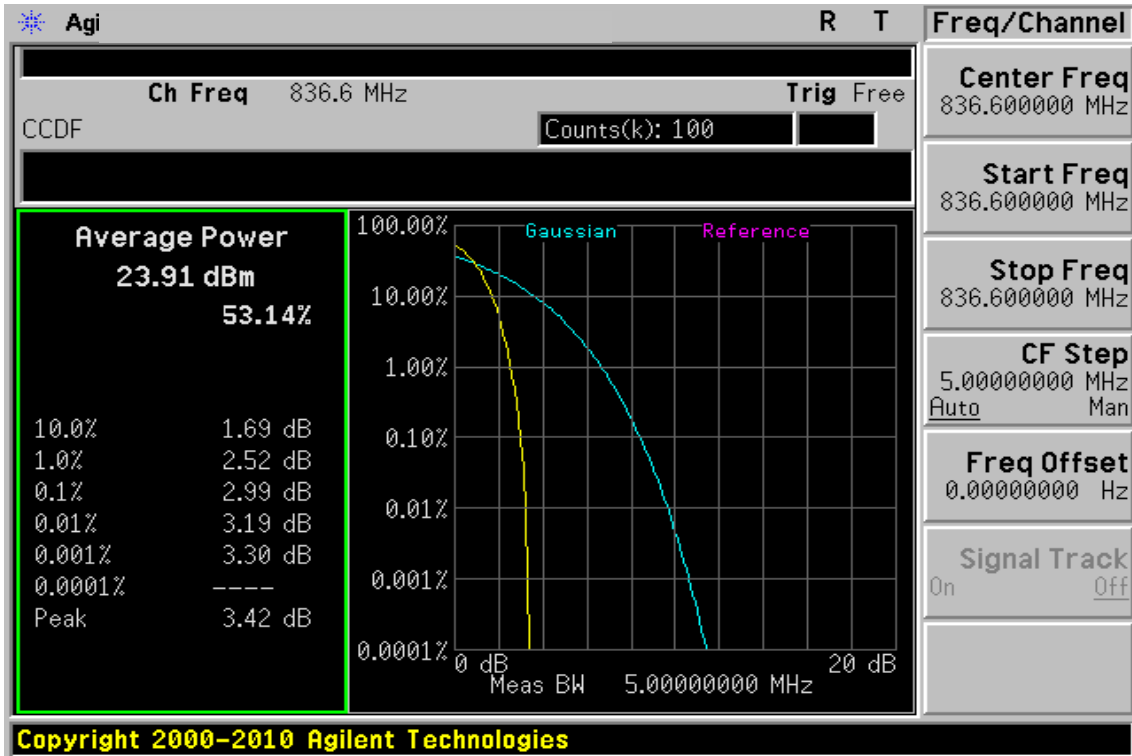
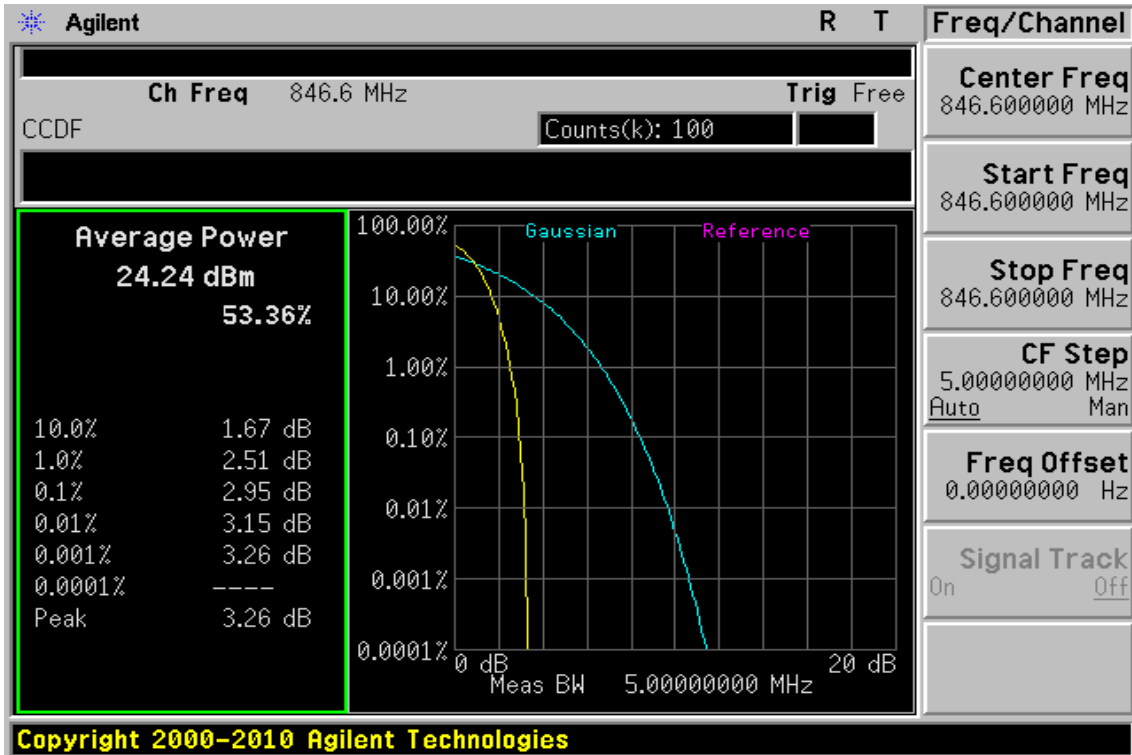

Figure 13-36: HSDPA Band V Channel High



Unless otherwise stated the results shown in this test report refer only to the sample(s) tested and such sample(s) are retained for 90 days only.

除非另有說明，此報告結果僅對測試之樣品負責，同時此樣品僅保留90天。本報告未經本公司書面許可，不可部份複製。

This document is issued by the Company subject to its General Conditions of Service printed overleaf, available on request or accessible at www.sgs.com/terms_and_conditions.htm and, for electronic format documents, subject to Terms and Conditions for Electronic Documents at www.sgs.com/terms_e-document.htm. Attention is drawn to the limitation of liability, indemnification and jurisdiction issues defined therein. Any holder of this document is advised that information contained hereon reflects the Company's findings at the time of its intervention only and within the limits of Client's instructions, if any. The Company's sole responsibility is to its Client and this document does not exonerate parties to a transaction from exercising all their rights and obligations under the transaction documents. This document cannot be reproduced except in full, without prior written approval of the Company. Any unauthorized alteration, forgery or falsification of the content or appearance of this document is unlawful and offenders may be prosecuted to the fullest extent of the law.

Figure 13-37: HSUPA Band II Channel Low

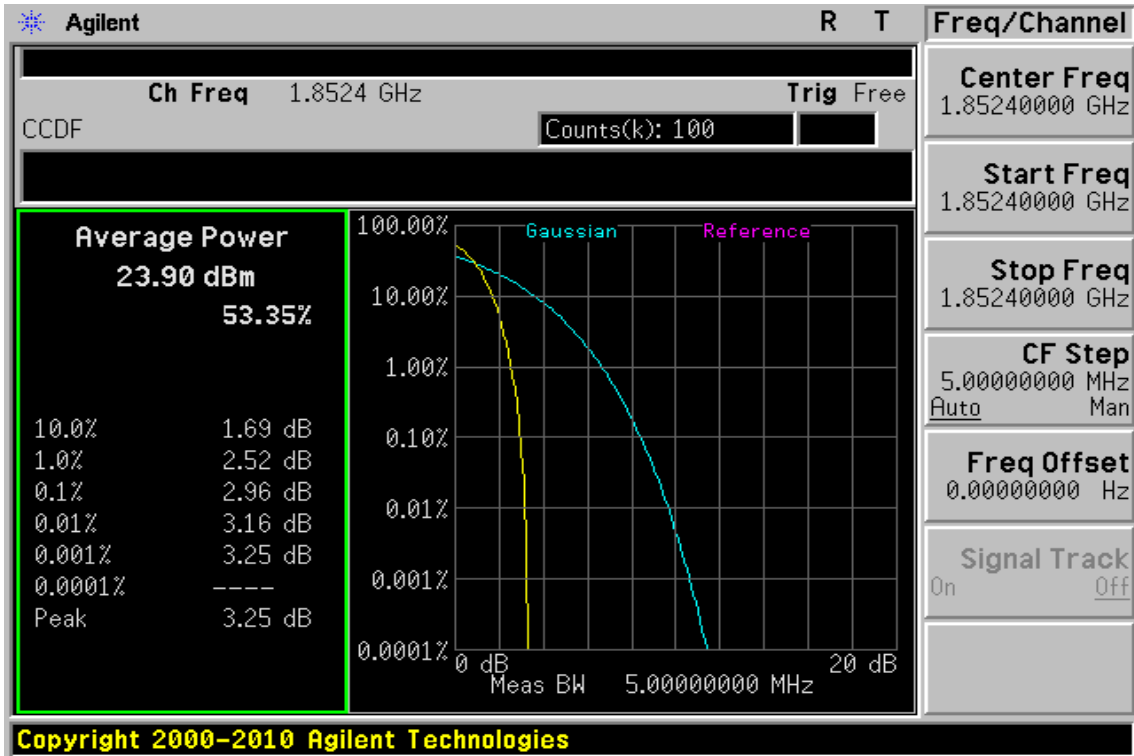
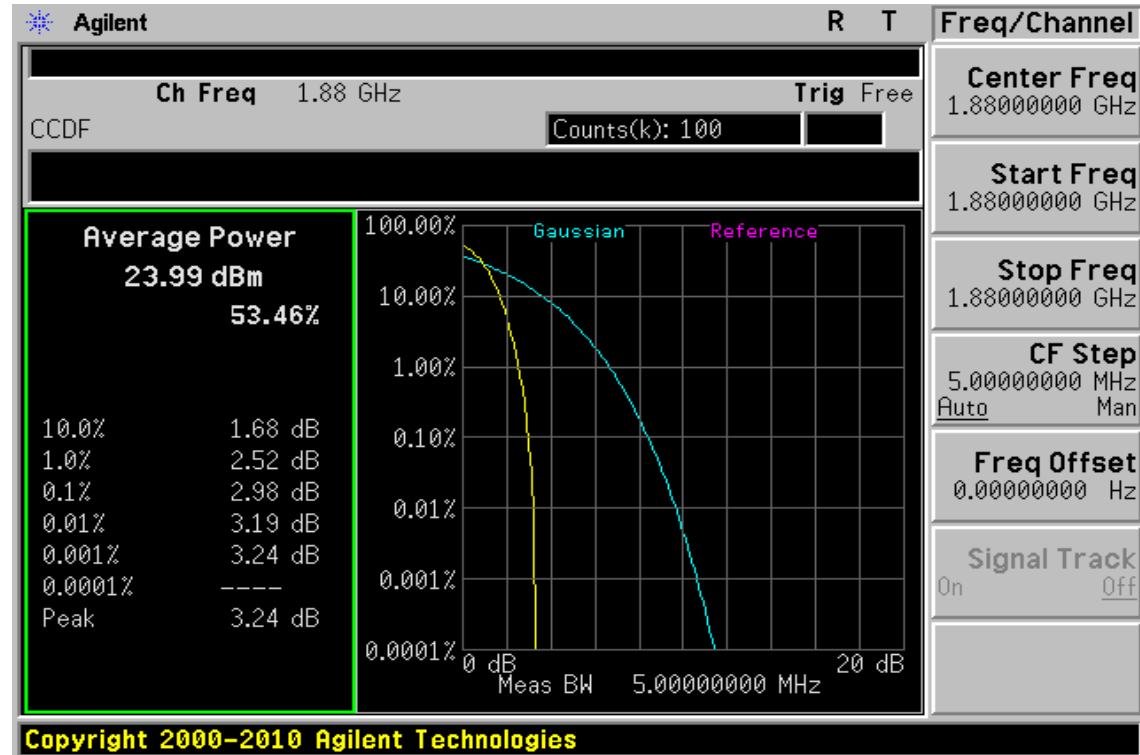

Figure 13-38: HSUPA Band II Channel Mid



Unless otherwise stated the results shown in this test report refer only to the sample(s) tested and such sample(s) are retained for 90 days only.

除非另有說明，此報告結果僅對測試之樣品負責，同時此樣品僅保留90天。本報告未經本公司書面許可，不可部份複製。

This document is issued by the Company subject to its General Conditions of Service printed overleaf, available on request or accessible at www.sgs.com/terms_and_conditions.htm and, for electronic format documents, subject to Terms and Conditions for Electronic Documents at www.sgs.com/terms_e-document.htm. Attention is drawn to the limitation of liability, indemnification and jurisdiction issues defined therein. Any holder of this document is advised that information contained hereon reflects the Company's findings at the time of its intervention only and within the limits of Client's instructions, if any. The Company's sole responsibility is to its Client and this document does not exonerate parties to a transaction from exercising all their rights and obligations under the transaction documents. This document cannot be reproduced except in full, without prior written approval of the Company. Any unauthorized alteration, forgery or falsification of the content or appearance of this document is unlawful and offenders may be prosecuted to the fullest extent of the law.

Figure 13-39: HSUPA Band II Channel High

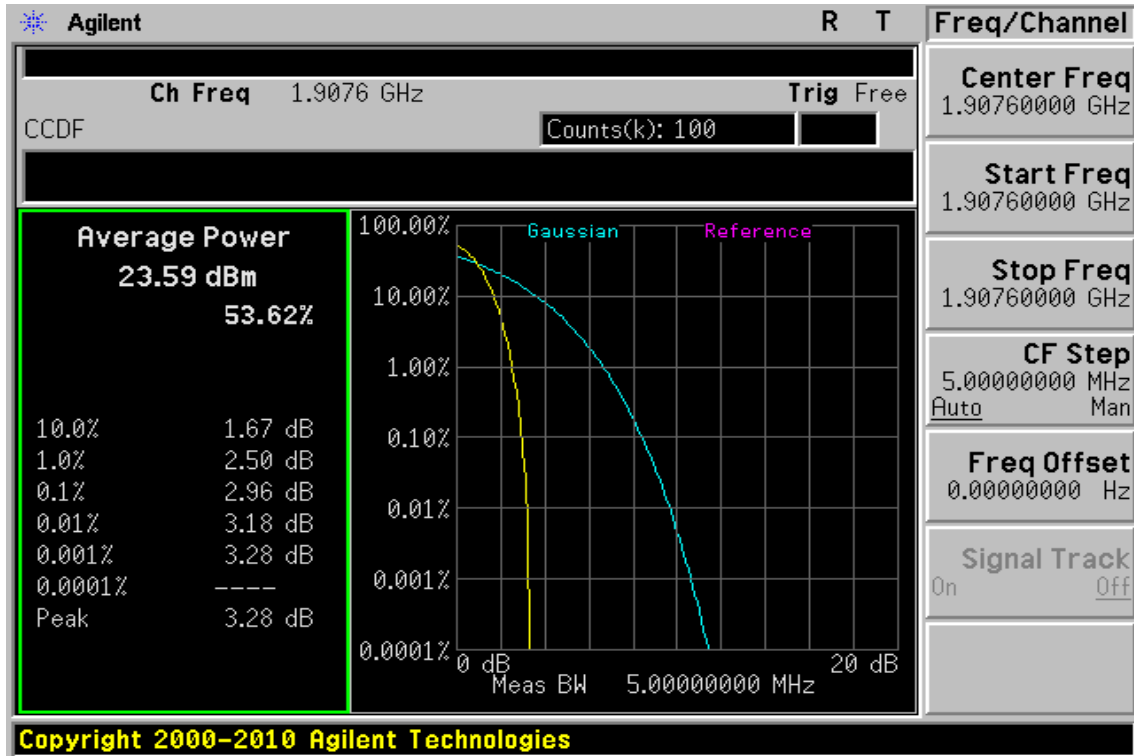
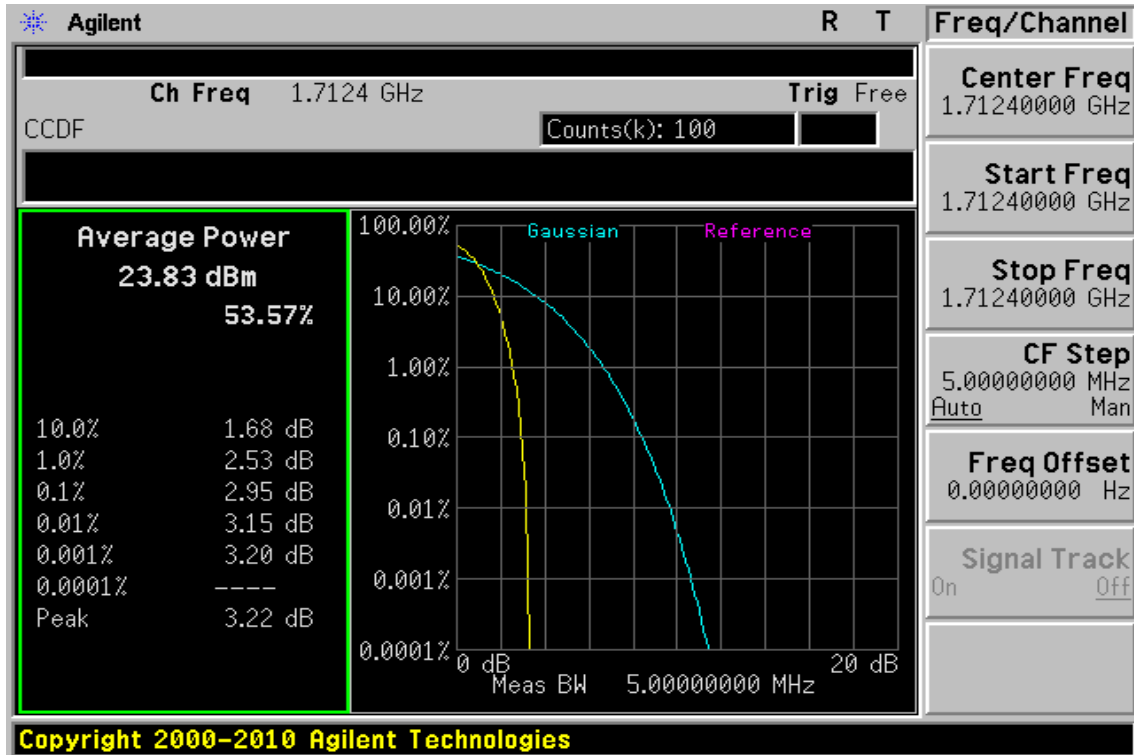

Figure 13-40: HSUPA Band IV Channel Low



Unless otherwise stated the results shown in this test report refer only to the sample(s) tested and such sample(s) are retained for 90 days only.

除非另有說明，此報告結果僅對測試之樣品負責，同時此樣品僅保留90天。本報告未經本公司書面許可，不可部份複製。

This document is issued by the Company subject to its General Conditions of Service printed overleaf, available on request or accessible at www.sgs.com/terms_and_conditions.htm and, for electronic format documents, subject to Terms and Conditions for Electronic Documents at www.sgs.com/terms_e-document.htm. Attention is drawn to the limitation of liability, indemnification and jurisdiction issues defined therein. Any holder of this document is advised that information contained hereon reflects the Company's findings at the time of its intervention only and within the limits of Client's instructions, if any. The Company's sole responsibility is to its Client and this document does not exonerate parties to a transaction from exercising all their rights and obligations under the transaction documents. This document cannot be reproduced except in full, without prior written approval of the Company. Any unauthorized alteration, forgery or falsification of the content or appearance of this document is unlawful and offenders may be prosecuted to the fullest extent of the law.

Figure 13-41: HSUPA Band IV Channel Mid

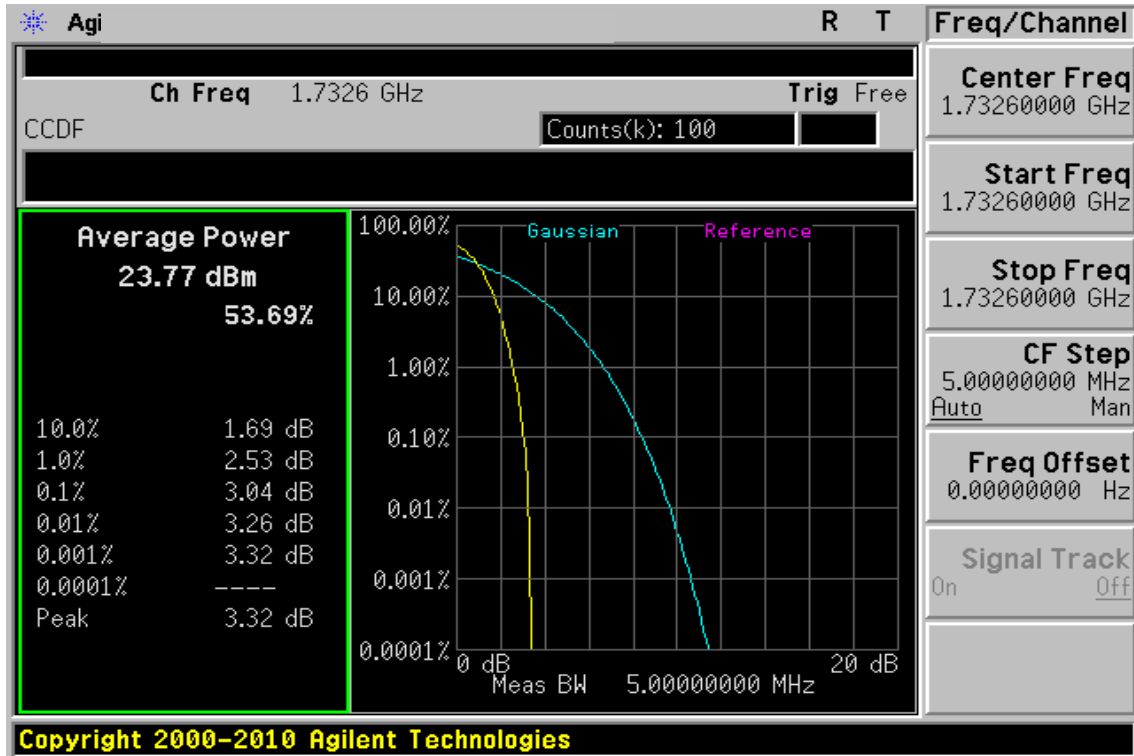
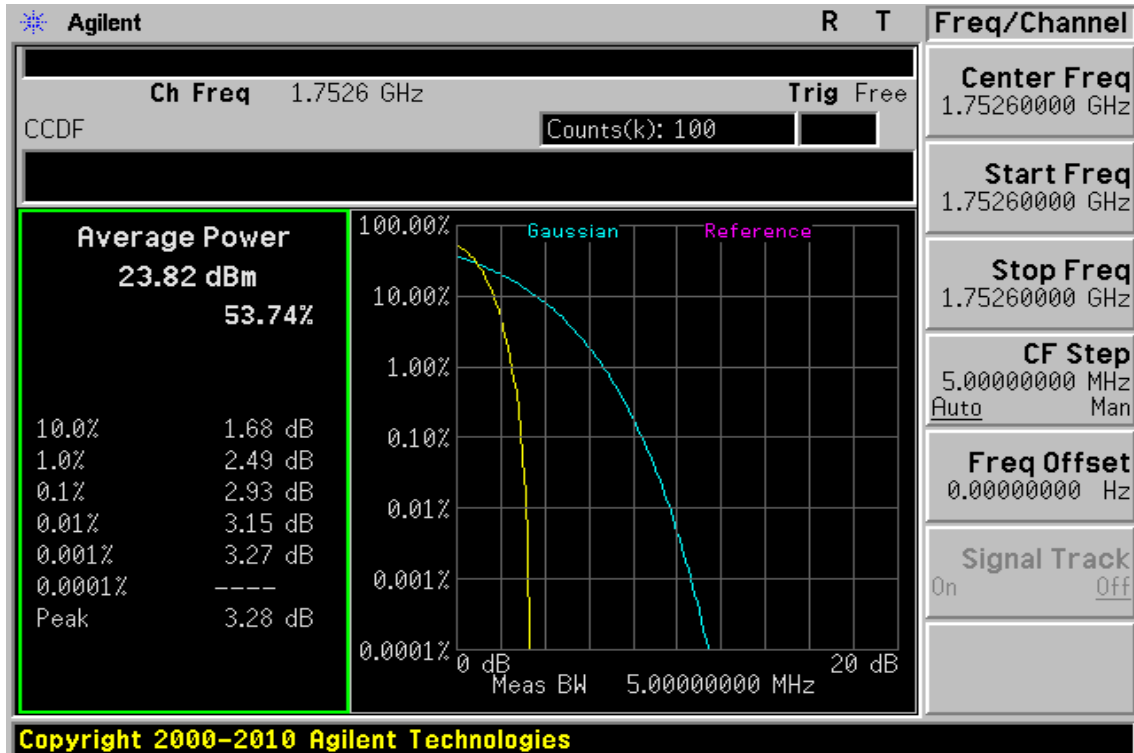

Figure 13-42: HSUPA Band IV Channel High



Unless otherwise stated the results shown in this test report refer only to the sample(s) tested and such sample(s) are retained for 90 days only.

除非另有說明，此報告結果僅對測試之樣品負責，同時此樣品僅保留90天。本報告未經本公司書面許可，不可部份複製。

This document is issued by the Company subject to its General Conditions of Service printed overleaf, available on request or accessible at www.sgs.com/terms_and_conditions.htm and, for electronic format documents, subject to Terms and Conditions for Electronic Documents at www.sgs.com/terms_e-document.htm. Attention is drawn to the limitation of liability, indemnification and jurisdiction issues defined therein. Any holder of this document is advised that information contained hereon reflects the Company's findings at the time of its intervention only and within the limits of Client's instructions, if any. The Company's sole responsibility is to its Client and this document does not exonerate parties to a transaction from exercising all their rights and obligations under the transaction documents. This document cannot be reproduced except in full, without prior written approval of the Company. Any unauthorized alteration, forgery or falsification of the content or appearance of this document is unlawful and offenders may be prosecuted to the fullest extent of the law.

Figure 13-43: HSUPA Band V Channel Low

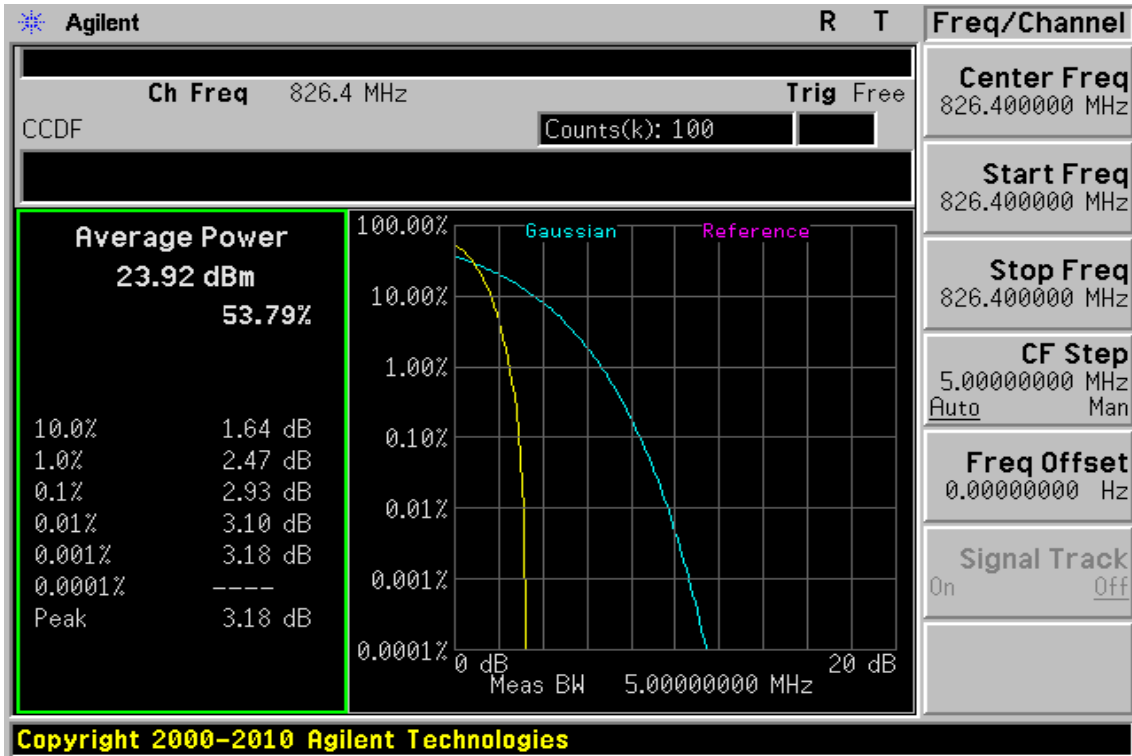
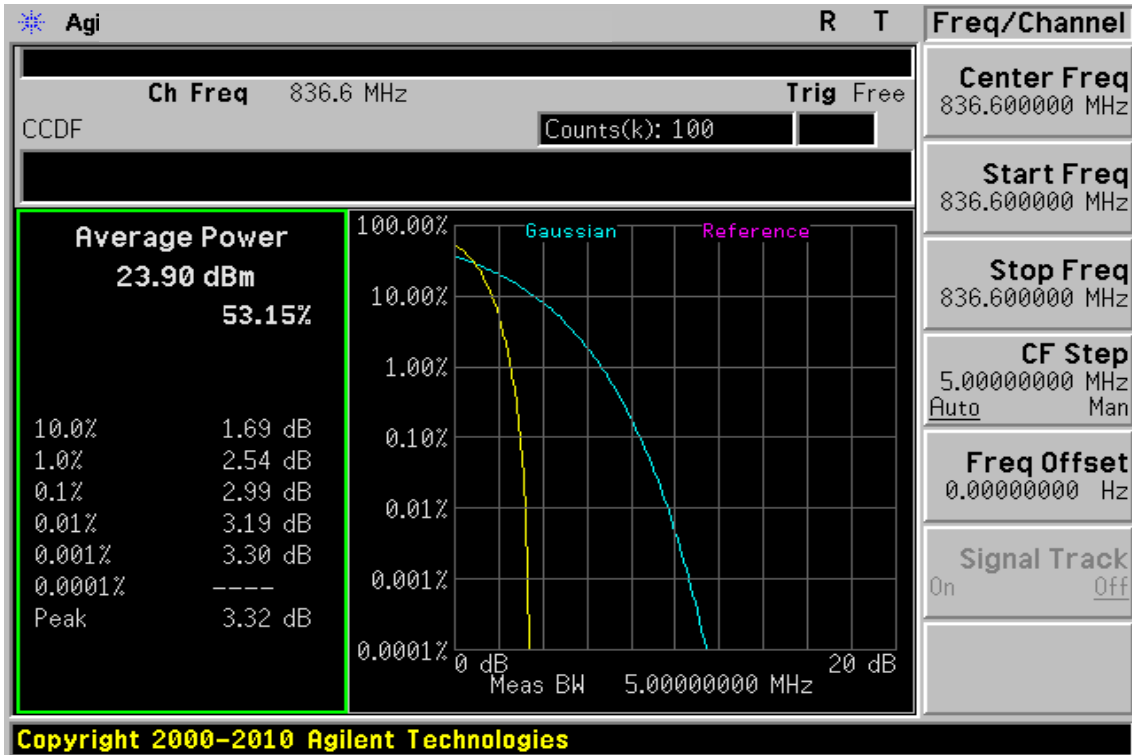

Figure 13-44: HSUPA Band V Channel Mid



Unless otherwise stated the results shown in this test report refer only to the sample(s) tested and such sample(s) are retained for 90 days only.

除非另有說明，此報告結果僅對測試之樣品負責，同時此樣品僅保留90天。本報告未經本公司書面許可，不可部份複製。

This document is issued by the Company subject to its General Conditions of Service printed overleaf, available on request or accessible at www.sgs.com/terms_and_conditions.htm and, for electronic format documents, subject to Terms and Conditions for Electronic Documents at www.sgs.com/terms_e-document.htm. Attention is drawn to the limitation of liability, indemnification and jurisdiction issues defined therein. Any holder of this document is advised that information contained hereon reflects the Company's findings at the time of its intervention only and within the limits of Client's instructions, if any. The Company's sole responsibility is to its Client and this document does not exonerate parties to a transaction from exercising all their rights and obligations under the transaction documents. This document cannot be reproduced except in full, without prior written approval of the Company. Any unauthorized alteration, forgery or falsification of the content or appearance of this document is unlawful and offenders may be prosecuted to the fullest extent of the law.

Figure 13-45: HSUPA Band V Channel High

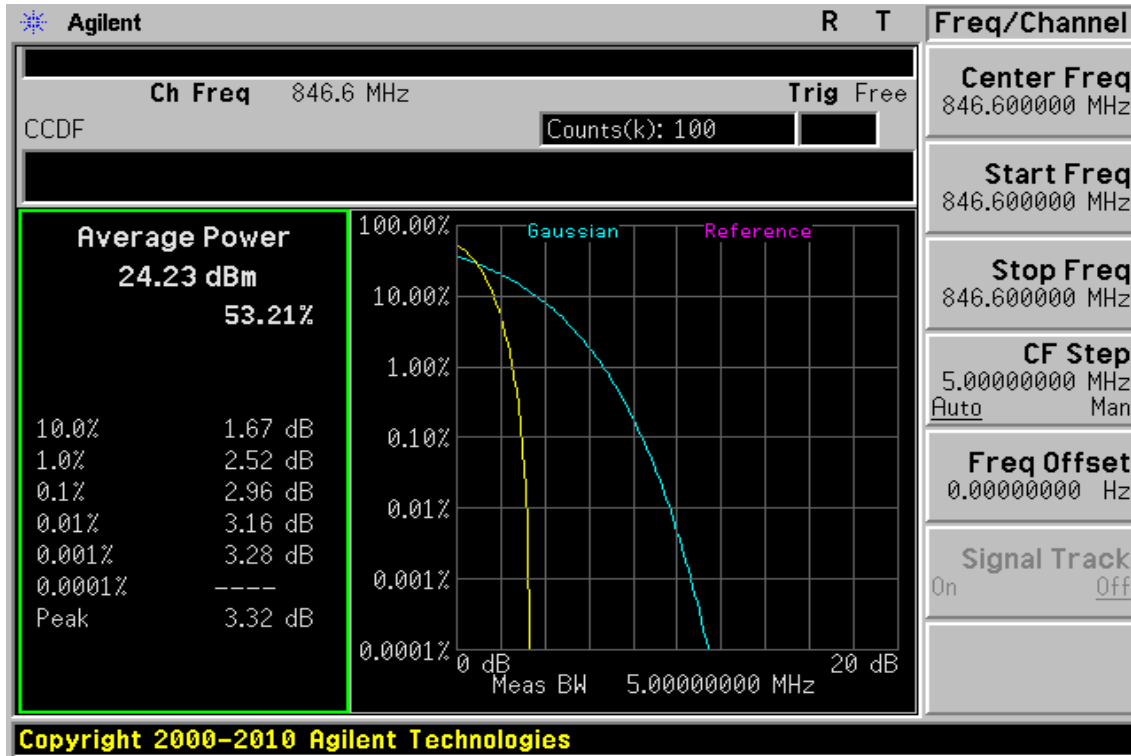

Unless otherwise stated the results shown in this test report refer only to the sample(s) tested and such sample(s) are retained for 90 days only.

除非另有說明，此報告結果僅對測試之樣品負責，同時此樣品僅保留90天。本報告未經本公司書面許可，不可部份複製。

This document is issued by the Company subject to its General Conditions of Service printed overleaf, available on request or accessible at www.sgs.com/terms_and_conditions.htm and, for electronic format documents, subject to Terms and Conditions for Electronic Documents at www.sgs.com/terms_e-document.htm. Attention is drawn to the limitation of liability, indemnification and jurisdiction issues defined therein. Any holder of this document is advised that information contained hereon reflects the Company's findings at the time of its intervention only and within the limits of Client's instructions, if any. The Company's sole responsibility is to its Client and this document does not exonerate parties to a transaction from exercising all their rights and obligations under the transaction documents. This document cannot be reproduced except in full, without prior written approval of the Company. Any unauthorized alteration, forgery or falsification of the content or appearance of this document is unlawful and offenders may be prosecuted to the fullest extent of the law.

APPENDIX 1

MEASUREMENT PLOT OF RADIATED SPURIOUS EMISSION

Unless otherwise stated the results shown in this test report refer only to the sample(s) tested and such sample(s) are retained for 90 days only.

除非另有說明，此報告結果僅對測試之樣品負責，同時此樣品僅保留90天。本報告未經本公司書面許可，不可部份複製。

This document is issued by the Company subject to its General Conditions of Service printed overleaf, available on request or accessible at www.sgs.com/terms_and_conditions.htm and, for electronic format documents, subject to Terms and Conditions for Electronic Documents at www.sgs.com/terms_e-document.htm. Attention is drawn to the limitation of liability, indemnification and jurisdiction issues defined therein. Any holder of this document is advised that information contained hereon reflects the Company's findings at the time of its intervention only and within the limits of Client's instructions, if any. The Company's sole responsibility is to its Client and this document does not exonerate parties to a transaction from exercising all their rights and obligations under the transaction documents. This document cannot be reproduced except in full, without prior written approval of the Company. Any unauthorized alteration, forgery or falsification of the content or appearance of this document is unlawful and offenders may be prosecuted to the fullest extent of the law.

Radiated Spurious Emission Measurement Result: GSM 850 Mode

| | | | |
|-----------------------|------------|--------------------------|---------------------|
| Operation Band | :GSM 850 | Test Date | : 2013-07-16 |
| ARFCN | :CH 128 | Temp./Humi. | :24.1 deg_C / 65 RH |
| Fundamental Frequency | :824.2 MHz | Engineer | :Allen |
| Operation Mode | :TX LOW | | |
| EUT Pol. | :E2 Plan | Measurement Antenna Pol. | :VERTICAL |

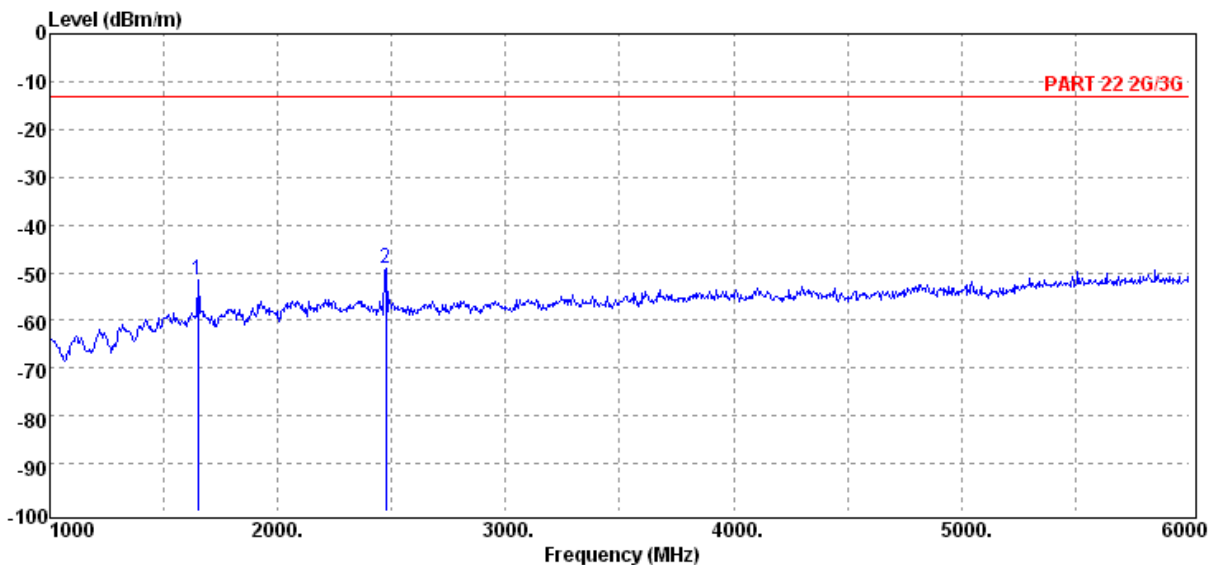
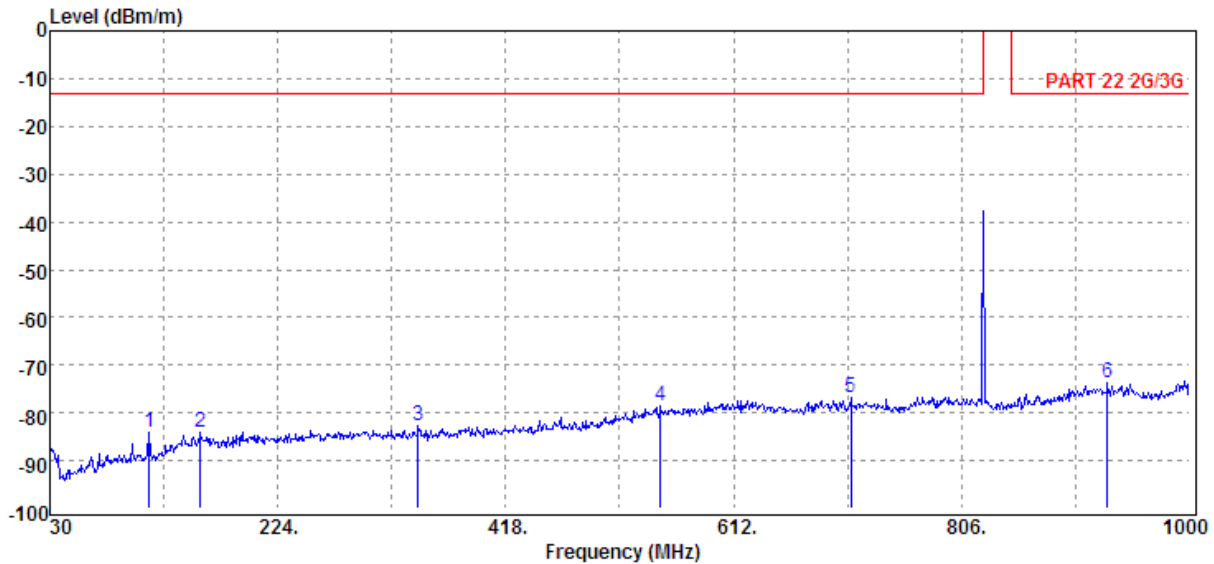

Unless otherwise stated the results shown in this test report refer only to the sample(s) tested and such sample(s) are retained for 90 days only.

除非另有說明，此報告結果僅對測試之樣品負責，同時此樣品僅保留90天。本報告未經本公司書面許可，不可部份複製。

This document is issued by the Company subject to its General Conditions of Service printed overleaf, available on request or accessible at www.sgs.com/terms_and_conditions.htm and, for electronic format documents, subject to Terms and Conditions for Electronic Documents at www.sgs.com/terms_e-document.htm. Attention is drawn to the limitation of liability, indemnification and jurisdiction issues defined therein. Any holder of this document is advised that information contained hereon reflects the Company's findings at the time of its intervention only and within the limits of Client's instructions, if any. The Company's sole responsibility is to its Client and this document does not exonerate parties to a transaction from exercising all their rights and obligations under the transaction documents. This document cannot be reproduced except in full, without prior written approval of the Company. Any unauthorized alteration, forgery or falsification of the content or appearance of this document is unlawful and offenders may be prosecuted to the fullest extent of the law.

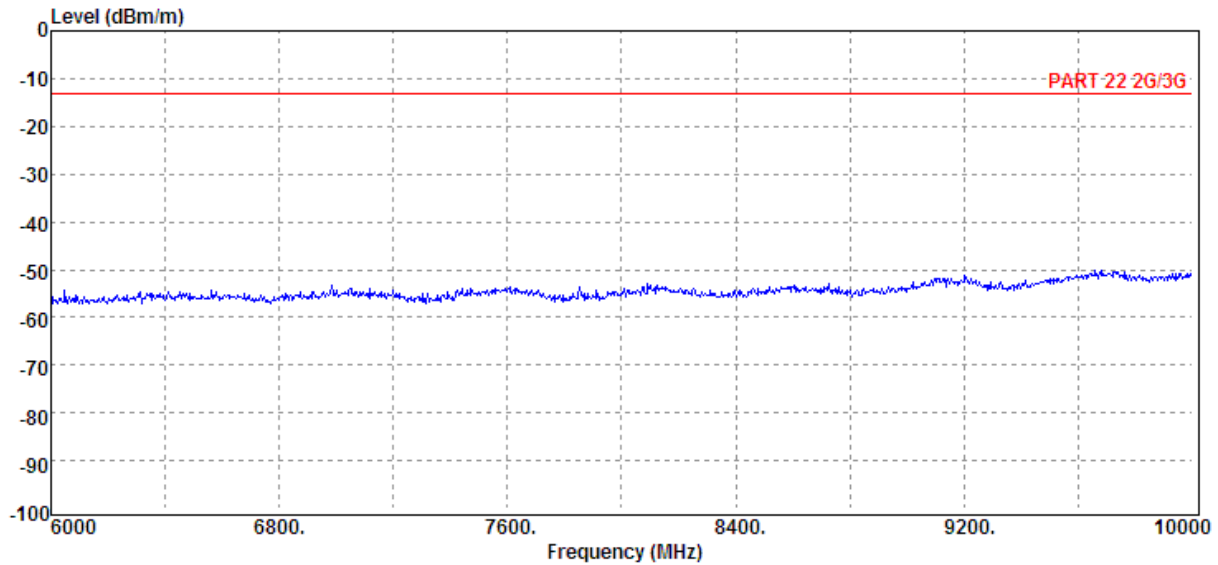

Unless otherwise stated the results shown in this test report refer only to the sample(s) tested and such sample(s) are retained for 90 days only.

除非另有說明，此報告結果僅對測試之樣品負責，同時此樣品僅保留90天。本報告未經本公司書面許可，不可部份複製。

This document is issued by the Company subject to its General Conditions of Service printed overleaf, available on request or accessible at www.sgs.com/terms_and_conditions.htm and, for electronic format documents, subject to Terms and Conditions for Electronic Documents at www.sgs.com/terms_e-document.htm. Attention is drawn to the limitation of liability, indemnification and jurisdiction issues defined therein. Any holder of this document is advised that information contained hereon reflects the Company's findings at the time of its intervention only and within the limits of Client's instructions, if any. The Company's sole responsibility is to its Client and this document does not exonerate parties to a transaction from exercising all their rights and obligations under the transaction documents. This document cannot be reproduced except in full, without prior written approval of the Company. Any unauthorized alteration, forgery or falsification of the content or appearance of this document is unlawful and offenders may be prosecuted to the fullest extent of the law.

| | | | |
|-----------------------|-------------|--------------------------|----------------------|
| Operation Band | : GSM 850 | Test Date | : 2013-07-16 |
| ARFCN | : CH 128 | Temp./Humi. | : 24.1 deg_C / 65 RH |
| Fundamental Frequency | : 824.2 MHz | Engineer | : Allen |
| Operation Mode | : TX LOW | | |
| EUT Pol. | : E2 Plan | Measurement Antenna Pol. | : HORIZONTAL |

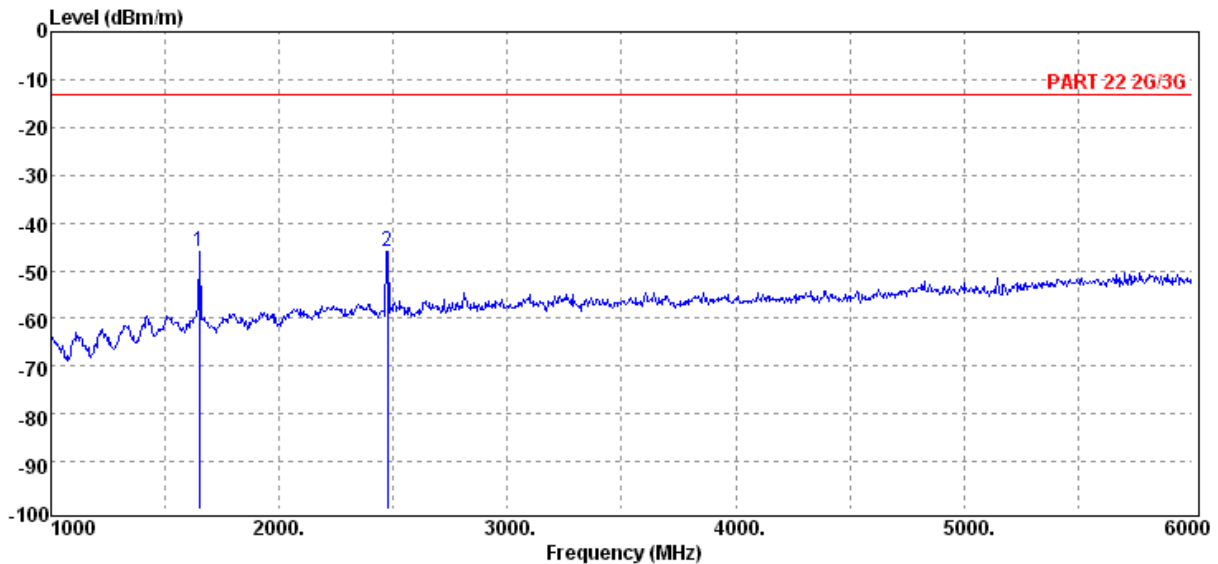
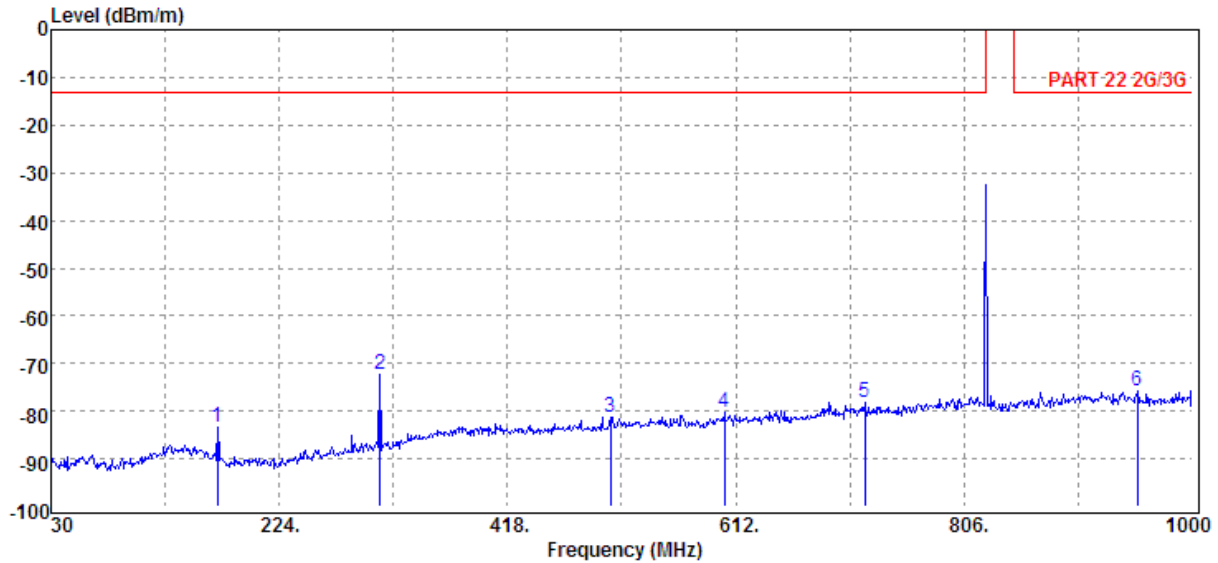

Unless otherwise stated the results shown in this test report refer only to the sample(s) tested and such sample(s) are retained for 90 days only.

除非另有說明，此報告結果僅對測試之樣品負責，同時此樣品僅保留90天。本報告未經本公司書面許可，不可部份複製。

This document is issued by the Company subject to its General Conditions of Service printed overleaf, available on request or accessible at www.sgs.com/terms_and_conditions.htm and, for electronic format documents, subject to Terms and Conditions for Electronic Documents at www.sgs.com/terms_e-document.htm. Attention is drawn to the limitation of liability, indemnification and jurisdiction issues defined therein. Any holder of this document is advised that information contained hereon reflects the Company's findings at the time of its intervention only and within the limits of Client's instructions, if any. The Company's sole responsibility is to its Client and this document does not exonerate parties to a transaction from exercising all their rights and obligations under the transaction documents. This document cannot be reproduced except in full, without prior written approval of the Company. Any unauthorized alteration, forgery or falsification of the content or appearance of this document is unlawful and offenders may be prosecuted to the fullest extent of the law.

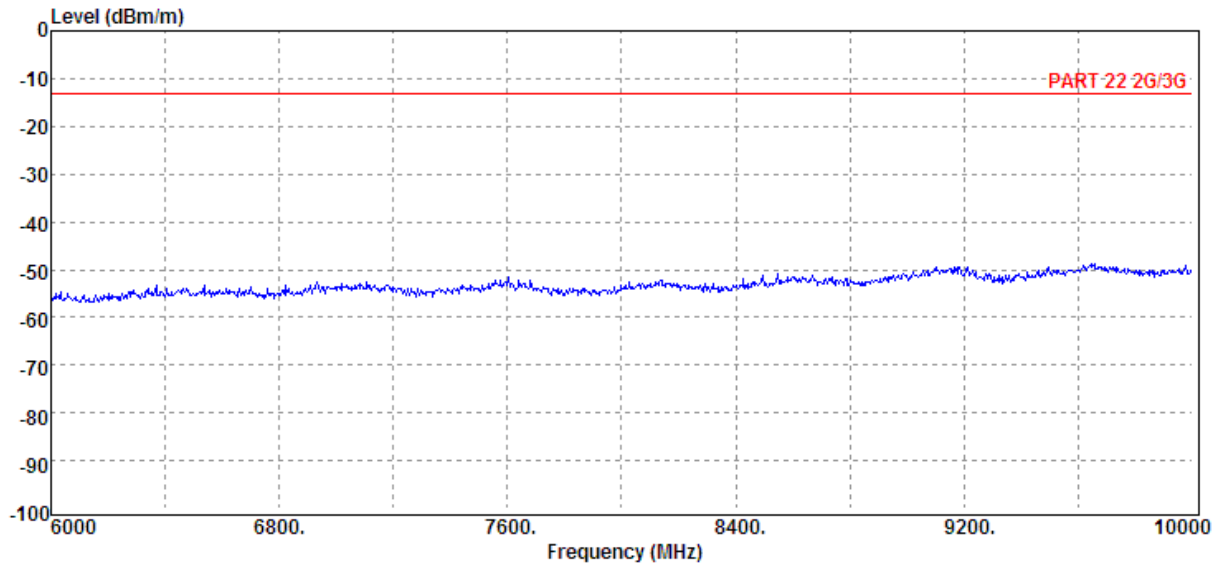

Unless otherwise stated the results shown in this test report refer only to the sample(s) tested and such sample(s) are retained for 90 days only.

除非另有說明，此報告結果僅對測試之樣品負責，同時此樣品僅保留90天。本報告未經本公司書面許可，不可部份複製。

This document is issued by the Company subject to its General Conditions of Service printed overleaf, available on request or accessible at www.sgs.com/terms_and_conditions.htm and, for electronic format documents, subject to Terms and Conditions for Electronic Documents at www.sgs.com/terms_e-document.htm. Attention is drawn to the limitation of liability, indemnification and jurisdiction issues defined therein. Any holder of this document is advised that information contained hereon reflects the Company's findings at the time of its intervention only and within the limits of Client's instructions, if any. The Company's sole responsibility is to its Client and this document does not exonerate parties to a transaction from exercising all their rights and obligations under the transaction documents. This document cannot be reproduced except in full, without prior written approval of the Company. Any unauthorized alteration, forgery or falsification of the content or appearance of this document is unlawful and offenders may be prosecuted to the fullest extent of the law.

| | | | |
|-----------------------|------------|--------------------------|---------------------|
| Operation Band | :GSM 850 | Test Date | :2013-05-27 |
| ARFCN | :CH 190 | Temp./Humi. | :24.1 deg_C / 65 RH |
| Fundamental Frequency | :836.6 MHz | Engineer | :Allen |
| Operation Mode | :TX MID | Measurement Antenna Pol. | :VERTICAL |
| EUT Pol. | :E2 Plan | | |

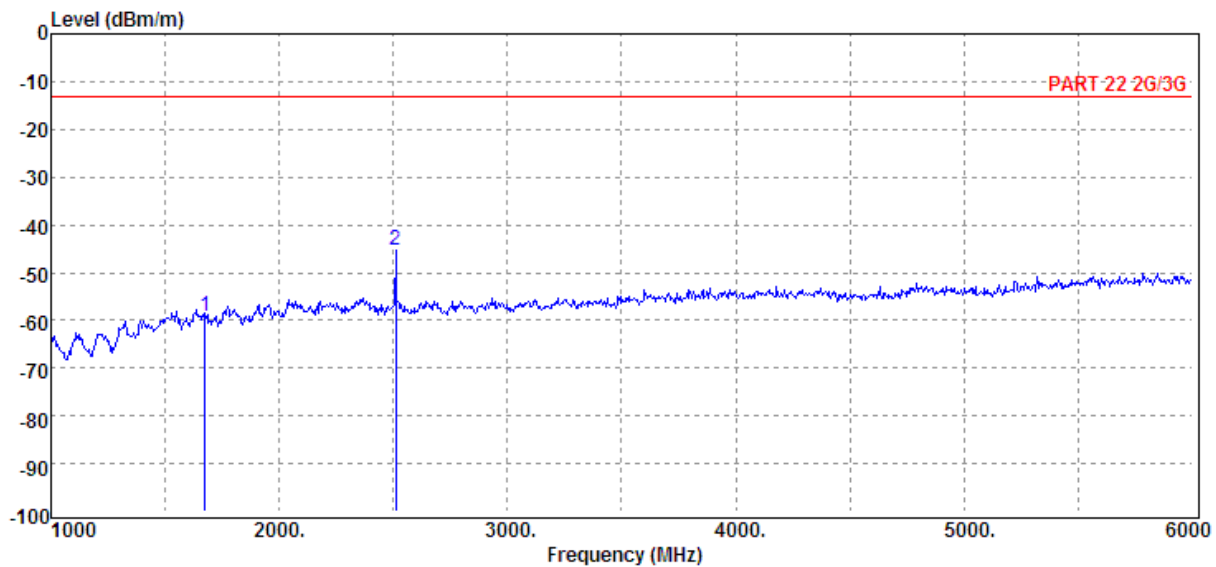
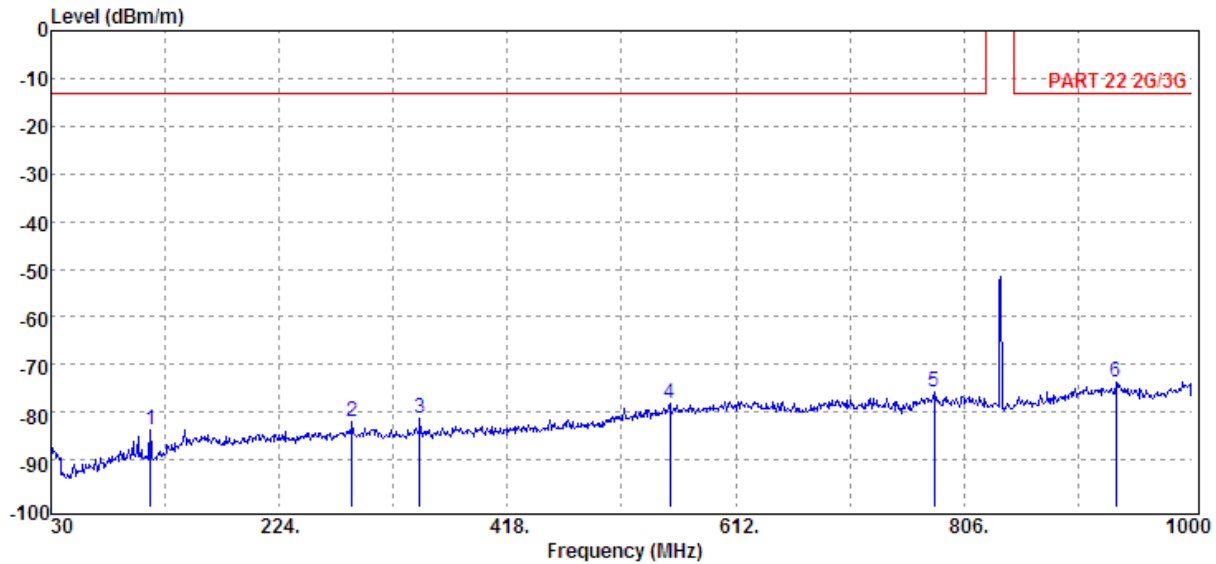

Unless otherwise stated the results shown in this test report refer only to the sample(s) tested and such sample(s) are retained for 90 days only.

除非另有說明，此報告結果僅對測試之樣品負責，同時此樣品僅保留90天。本報告未經本公司書面許可，不可部份複製。

This document is issued by the Company subject to its General Conditions of Service printed overleaf, available on request or accessible at www.sgs.com/terms_and_conditions.htm and, for electronic format documents, subject to Terms and Conditions for Electronic Documents at www.sgs.com/terms_e-document.htm. Attention is drawn to the limitation of liability, indemnification and jurisdiction issues defined therein. Any holder of this document is advised that information contained hereon reflects the Company's findings at the time of its intervention only and within the limits of Client's instructions, if any. The Company's sole responsibility is to its Client and this document does not exonerate parties to a transaction from exercising all their rights and obligations under the transaction documents. This document cannot be reproduced except in full, without prior written approval of the Company. Any unauthorized alteration, forgery or falsification of the content or appearance of this document is unlawful and offenders may be prosecuted to the fullest extent of the law.

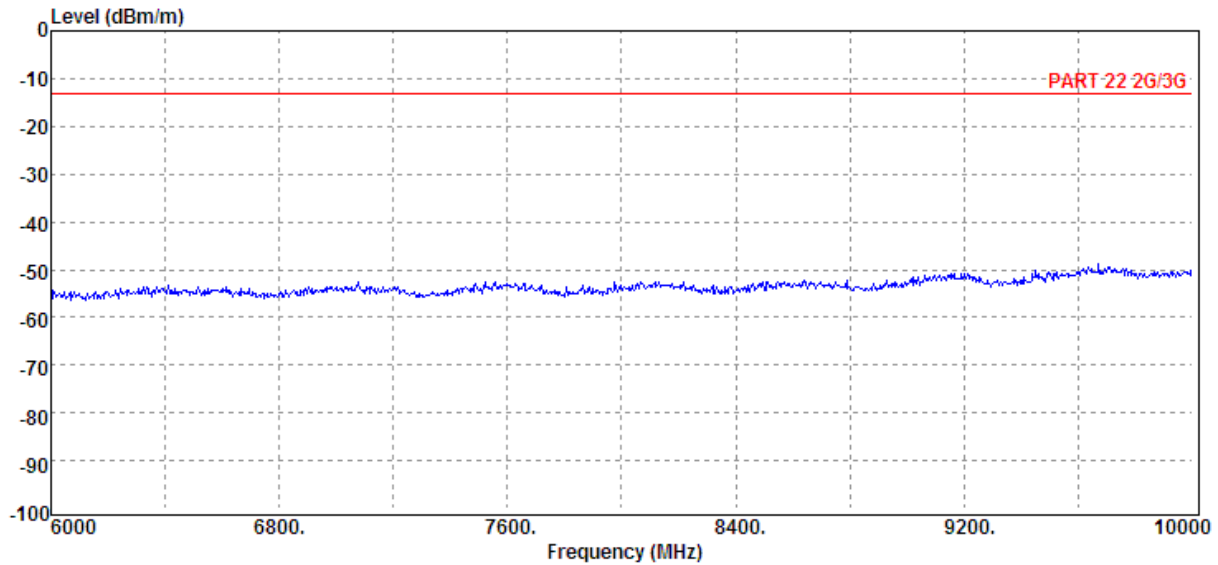

Unless otherwise stated the results shown in this test report refer only to the sample(s) tested and such sample(s) are retained for 90 days only.

除非另有說明，此報告結果僅對測試之樣品負責，同時此樣品僅保留90天。本報告未經本公司書面許可，不可部份複製。

This document is issued by the Company subject to its General Conditions of Service printed overleaf, available on request or accessible at www.sgs.com/terms_and_conditions.htm and, for electronic format documents, subject to Terms and Conditions for Electronic Documents at www.sgs.com/terms_e-document.htm. Attention is drawn to the limitation of liability, indemnification and jurisdiction issues defined therein. Any holder of this document is advised that information contained hereon reflects the Company's findings at the time of its intervention only and within the limits of Client's instructions, if any. The Company's sole responsibility is to its Client and this document does not exonerate parties to a transaction from exercising all their rights and obligations under the transaction documents. This document cannot be reproduced except in full, without prior written approval of the Company. Any unauthorized alteration, forgery or falsification of the content or appearance of this document is unlawful and offenders may be prosecuted to the fullest extent of the law.

| | | | |
|-----------------------|------------|--------------------------|---------------------|
| Operation Band | :GSM 850 | Test Date | :2013-05-27 |
| ARFCN | :CH 190 | Temp./Humi. | :24.1 deg_C / 65 RH |
| Fundamental Frequency | :836.6 MHz | Engineer | :Allen |
| Operation Mode | :TX MID | Measurement Antenna Pol. | :HORIZONTAL |
| EUT Pol. | :E2 Plan | | |

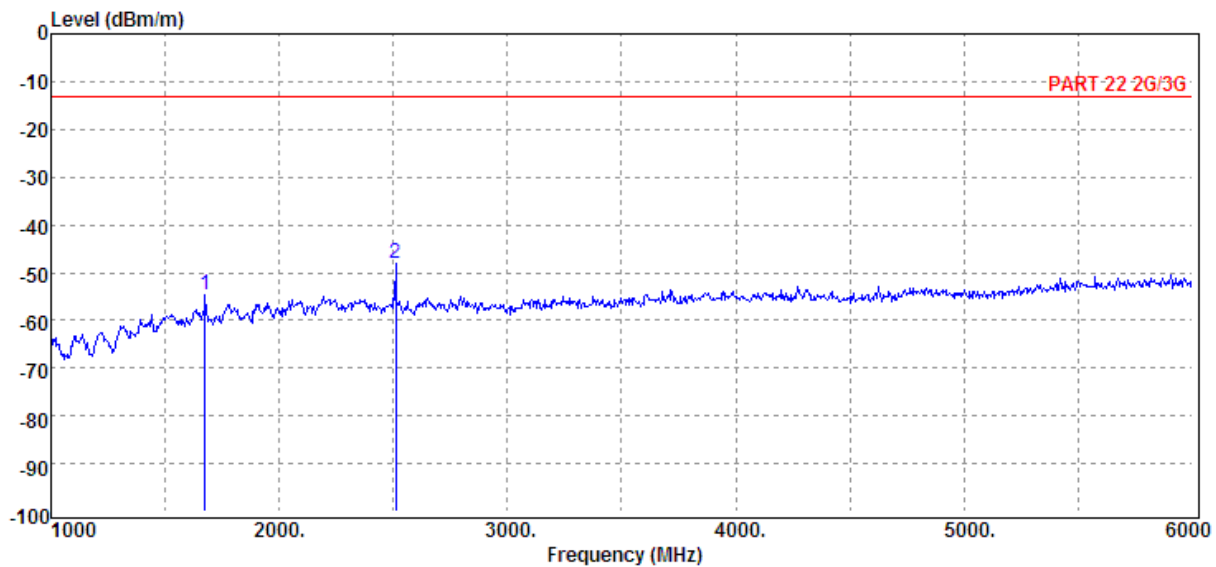
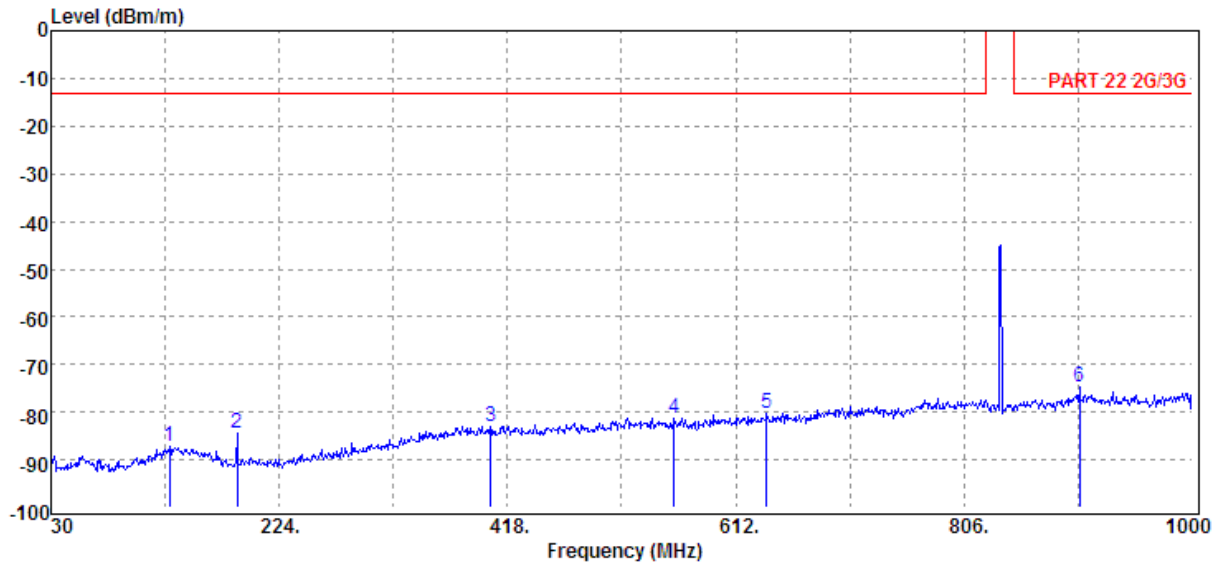

Unless otherwise stated the results shown in this test report refer only to the sample(s) tested and such sample(s) are retained for 90 days only.

除非另有說明，此報告結果僅對測試之樣品負責，同時此樣品僅保留90天。本報告未經本公司書面許可，不可部份複製。

This document is issued by the Company subject to its General Conditions of Service printed overleaf, available on request or accessible at www.sgs.com/terms_and_conditions.htm and, for electronic format documents, subject to Terms and Conditions for Electronic Documents at www.sgs.com/terms_e-document.htm. Attention is drawn to the limitation of liability, indemnification and jurisdiction issues defined therein. Any holder of this document is advised that information contained hereon reflects the Company's findings at the time of its intervention only and within the limits of Client's instructions, if any. The Company's sole responsibility is to its Client and this document does not exonerate parties to a transaction from exercising all their rights and obligations under the transaction documents. This document cannot be reproduced except in full, without prior written approval of the Company. Any unauthorized alteration, forgery or falsification of the content or appearance of this document is unlawful and offenders may be prosecuted to the fullest extent of the law.

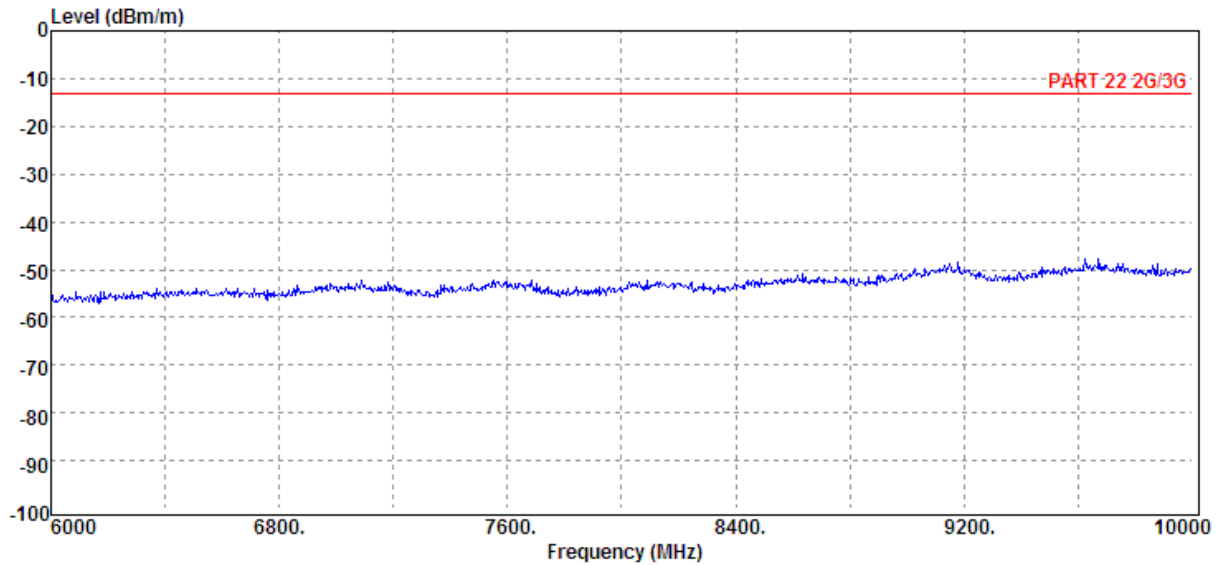

Unless otherwise stated the results shown in this test report refer only to the sample(s) tested and such sample(s) are retained for 90 days only.

除非另有說明，此報告結果僅對測試之樣品負責，同時此樣品僅保留90天。本報告未經本公司書面許可，不可部份複製。

This document is issued by the Company subject to its General Conditions of Service printed overleaf, available on request or accessible at www.sgs.com/terms_and_conditions.htm and, for electronic format documents, subject to Terms and Conditions for Electronic Documents at www.sgs.com/terms_e-document.htm. Attention is drawn to the limitation of liability, indemnification and jurisdiction issues defined therein. Any holder of this document is advised that information contained hereon reflects the Company's findings at the time of its intervention only and within the limits of Client's instructions, if any. The Company's sole responsibility is to its Client and this document does not exonerate parties to a transaction from exercising all their rights and obligations under the transaction documents. This document cannot be reproduced except in full, without prior written approval of the Company. Any unauthorized alteration, forgery or falsification of the content or appearance of this document is unlawful and offenders may be prosecuted to the fullest extent of the law.

| | | | |
|-----------------------|------------|--------------------------|---------------------|
| Operation Band | :GSM 850 | Test Date | :2013-05-27 |
| ARFCN | :CH 251 | Temp./Humi. | :24.1 deg_C / 65 RH |
| Fundamental Frequency | :848.8 MHz | Engineer | :Allen |
| Operation Mode | :TX HIGH | Measurement Antenna Pol. | :VERTICAL |
| EUT Pol. | :E2 Plan | | |

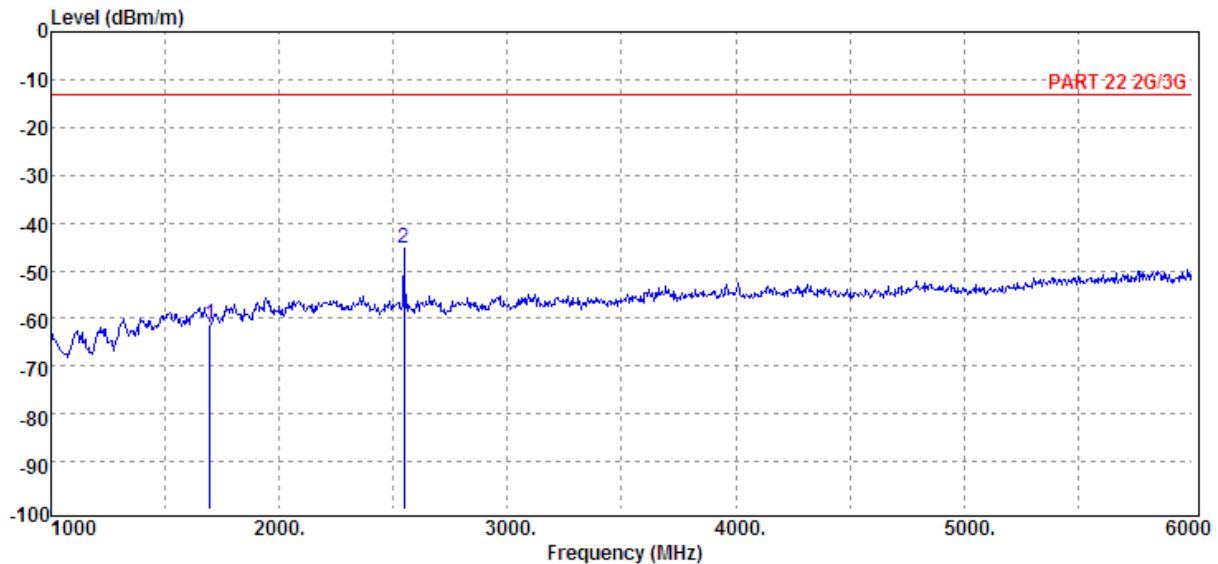
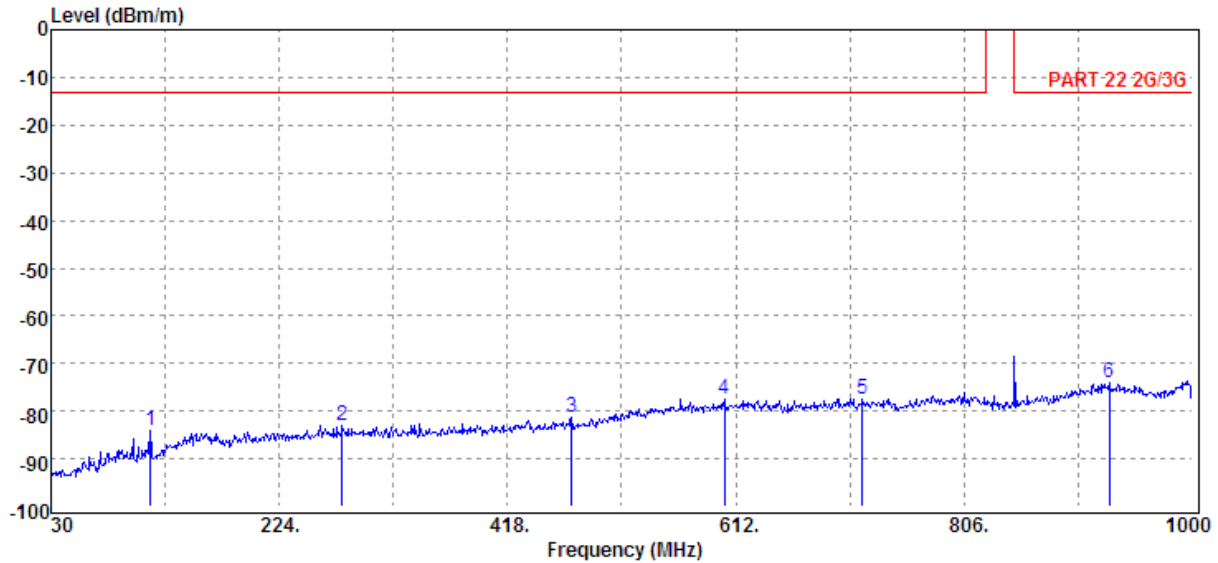

Unless otherwise stated the results shown in this test report refer only to the sample(s) tested and such sample(s) are retained for 90 days only.

除非另有說明，此報告結果僅對測試之樣品負責，同時此樣品僅保留90天。本報告未經本公司書面許可，不可部份複製。

This document is issued by the Company subject to its General Conditions of Service printed overleaf, available on request or accessible at www.sgs.com/terms_and_conditions.htm and, for electronic format documents, subject to Terms and Conditions for Electronic Documents at www.sgs.com/terms_e-document.htm. Attention is drawn to the limitation of liability, indemnification and jurisdiction issues defined therein. Any holder of this document is advised that information contained hereon reflects the Company's findings at the time of its intervention only and within the limits of Client's instructions, if any. The Company's sole responsibility is to its Client and this document does not exonerate parties to a transaction from exercising all their rights and obligations under the transaction documents. This document cannot be reproduced except in full, without prior written approval of the Company. Any unauthorized alteration, forgery or falsification of the content or appearance of this document is unlawful and offenders may be prosecuted to the fullest extent of the law.

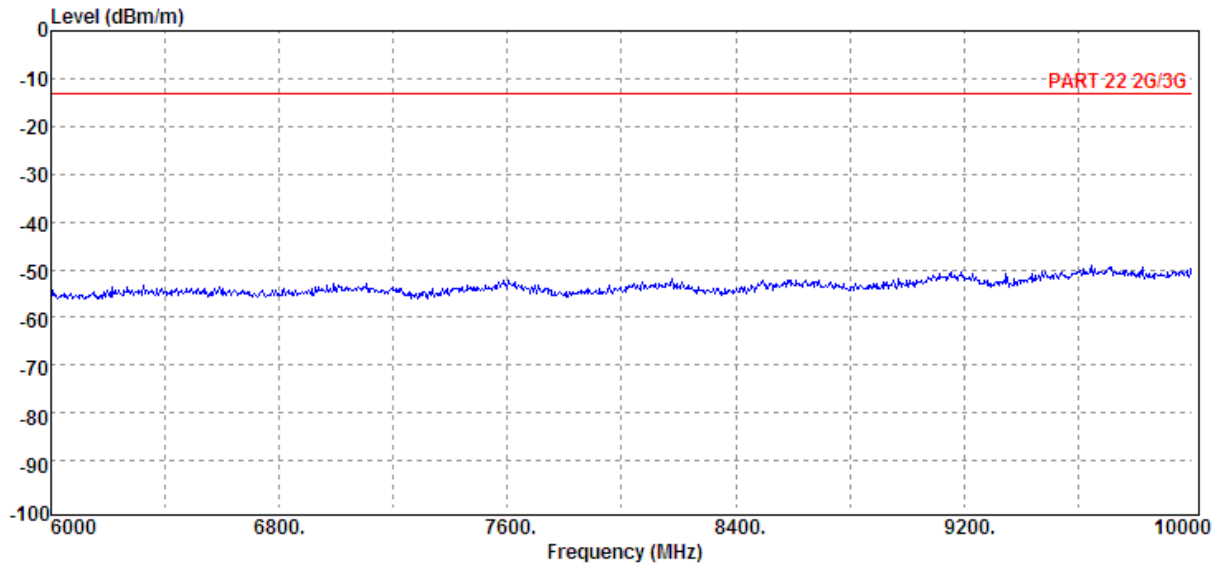

Unless otherwise stated the results shown in this test report refer only to the sample(s) tested and such sample(s) are retained for 90 days only.

除非另有說明，此報告結果僅對測試之樣品負責，同時此樣品僅保留90天。本報告未經本公司書面許可，不可部份複製。

This document is issued by the Company subject to its General Conditions of Service printed overleaf, available on request or accessible at www.sgs.com/terms_and_conditions.htm and, for electronic format documents, subject to Terms and Conditions for Electronic Documents at www.sgs.com/terms_e-document.htm. Attention is drawn to the limitation of liability, indemnification and jurisdiction issues defined therein. Any holder of this document is advised that information contained hereon reflects the Company's findings at the time of its intervention only and within the limits of Client's instructions, if any. The Company's sole responsibility is to its Client and this document does not exonerate parties to a transaction from exercising all their rights and obligations under the transaction documents. This document cannot be reproduced except in full, without prior written approval of the Company. Any unauthorized alteration, forgery or falsification of the content or appearance of this document is unlawful and offenders may be prosecuted to the fullest extent of the law.

| | | | |
|-----------------------|------------|--------------------------|---------------------|
| Operation Band | :GSM 850 | Test Date | :2013-05-27 |
| ARFCN | :CH 251 | Temp./Humi. | :24.1 deg_C / 65 RH |
| Fundamental Frequency | :848.8 MHz | Engineer | :Allen |
| Operation Mode | :TX HIGH | Measurement Antenna Pol. | :HORIZONTAL |
| EUT Pol. | :E2 Plan | | |

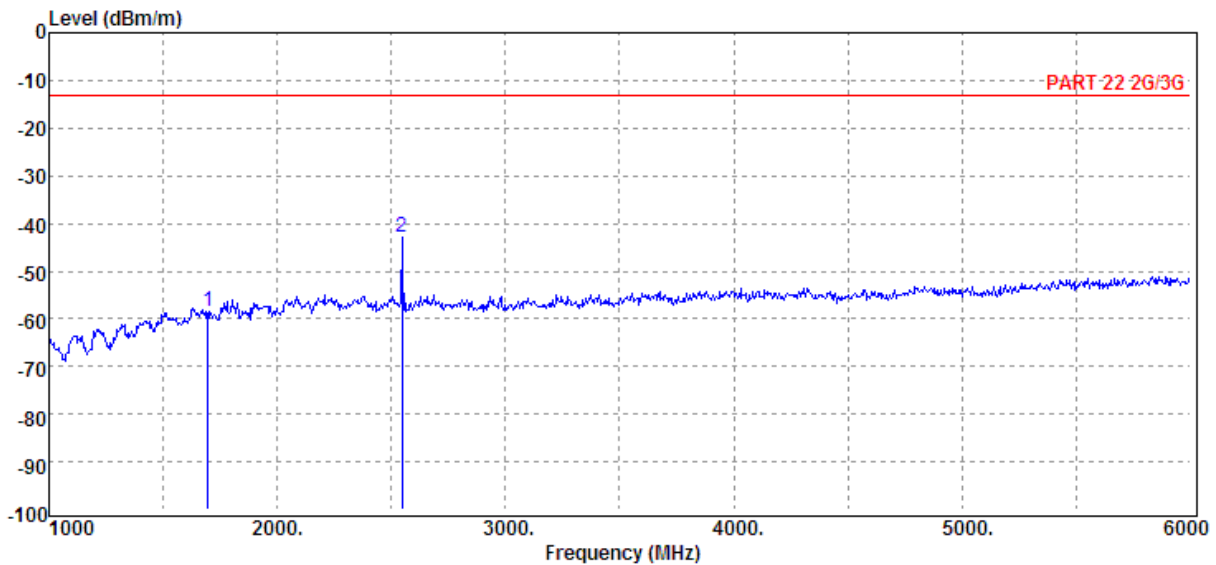
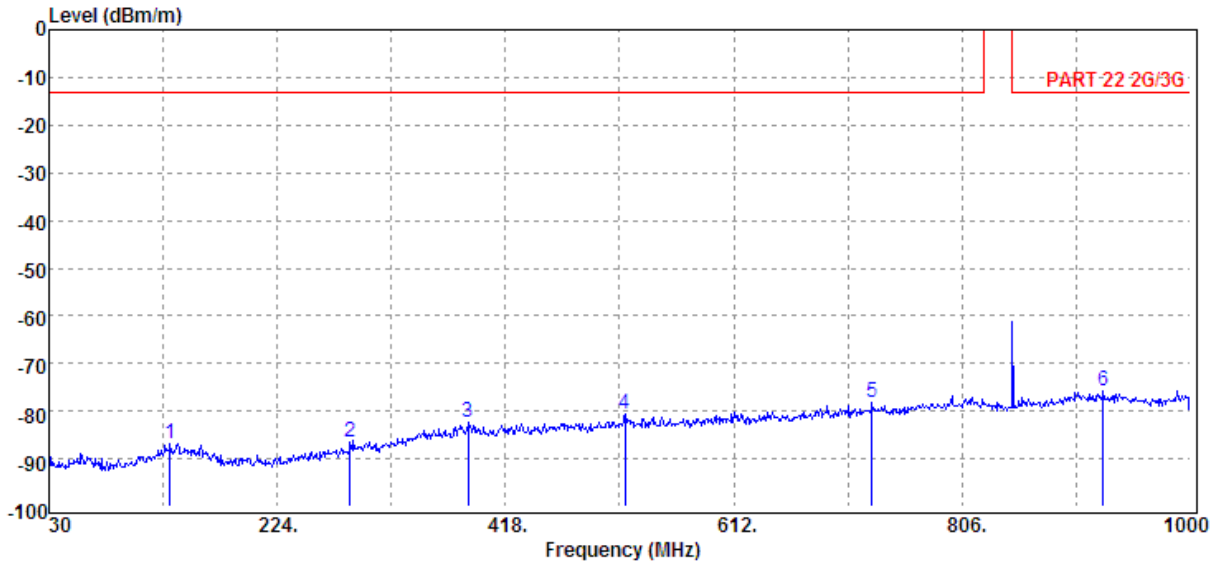

Unless otherwise stated the results shown in this test report refer only to the sample(s) tested and such sample(s) are retained for 90 days only.

除非另有說明，此報告結果僅對測試之樣品負責，同時此樣品僅保留90天。本報告未經本公司書面許可，不可部份複製。

This document is issued by the Company subject to its General Conditions of Service printed overleaf, available on request or accessible at www.sgs.com/terms_and_conditions.htm and, for electronic format documents, subject to Terms and Conditions for Electronic Documents at www.sgs.com/terms_e-document.htm. Attention is drawn to the limitation of liability, indemnification and jurisdiction issues defined therein. Any holder of this document is advised that information contained hereon reflects the Company's findings at the time of its intervention only and within the limits of Client's instructions, if any. The Company's sole responsibility is to its Client and this document does not exonerate parties to a transaction from exercising all their rights and obligations under the transaction documents. This document cannot be reproduced except in full, without prior written approval of the Company. Any unauthorized alteration, forgery or falsification of the content or appearance of this document is unlawful and offenders may be prosecuted to the fullest extent of the law.

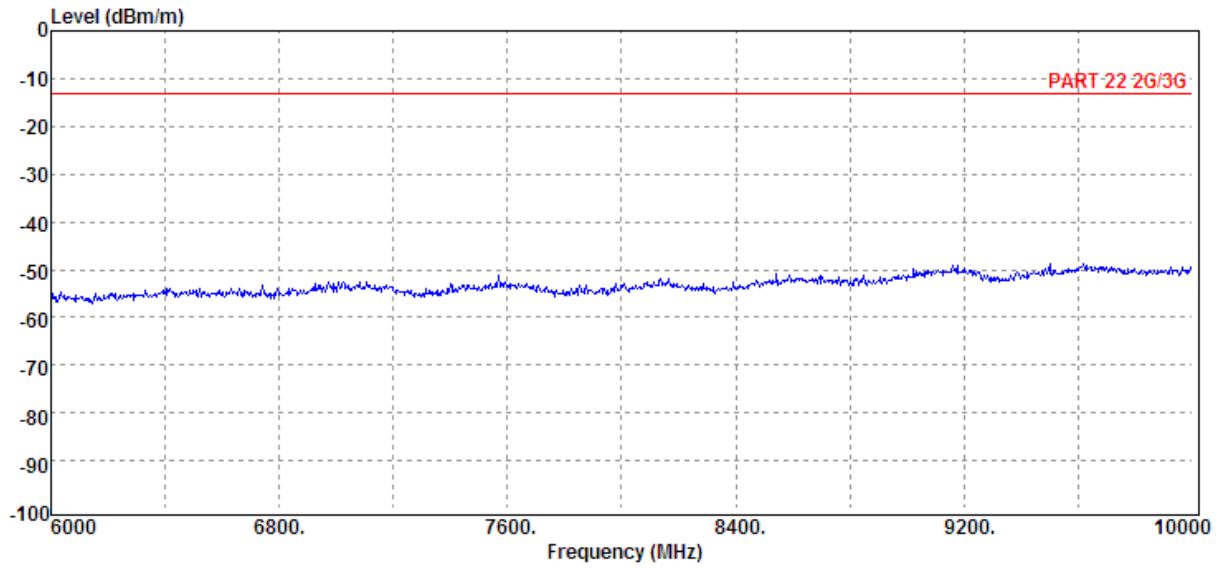

Unless otherwise stated the results shown in this test report refer only to the sample(s) tested and such sample(s) are retained for 90 days only.

除非另有說明，此報告結果僅對測試之樣品負責，同時此樣品僅保留90天。本報告未經本公司書面許可，不可部份複製。

This document is issued by the Company subject to its General Conditions of Service printed overleaf, available on request or accessible at www.sgs.com/terms_and_conditions.htm and, for electronic format documents, subject to Terms and Conditions for Electronic Documents at www.sgs.com/terms_e-document.htm. Attention is drawn to the limitation of liability, indemnification and jurisdiction issues defined therein. Any holder of this document is advised that information contained hereon reflects the Company's findings at the time of its intervention only and within the limits of Client's instructions, if any. The Company's sole responsibility is to its Client and this document does not exonerate parties to a transaction from exercising all their rights and obligations under the transaction documents. This document cannot be reproduced except in full, without prior written approval of the Company. Any unauthorized alteration, forgery or falsification of the content or appearance of this document is unlawful and offenders may be prosecuted to the fullest extent of the law.

Radiated Spurious Emission Measurement Result: GSM 1900 Mode

| | | | |
|-----------------------|-------------|--------------------------|---------------------|
| Operation Band | :GSM 1900 | Test Date | : 2013-07-16 |
| ARFCN | :CH 512 | Temp./Humi. | :24.1 deg_C / 65 RH |
| Fundamental Frequency | :1850.2 MHz | Engineer | :Allen |
| Operation Mode | :TX LOW | | |
| EUT Pol. | :E1 Plan | Measurement Antenna Pol. | :VERTICAL |

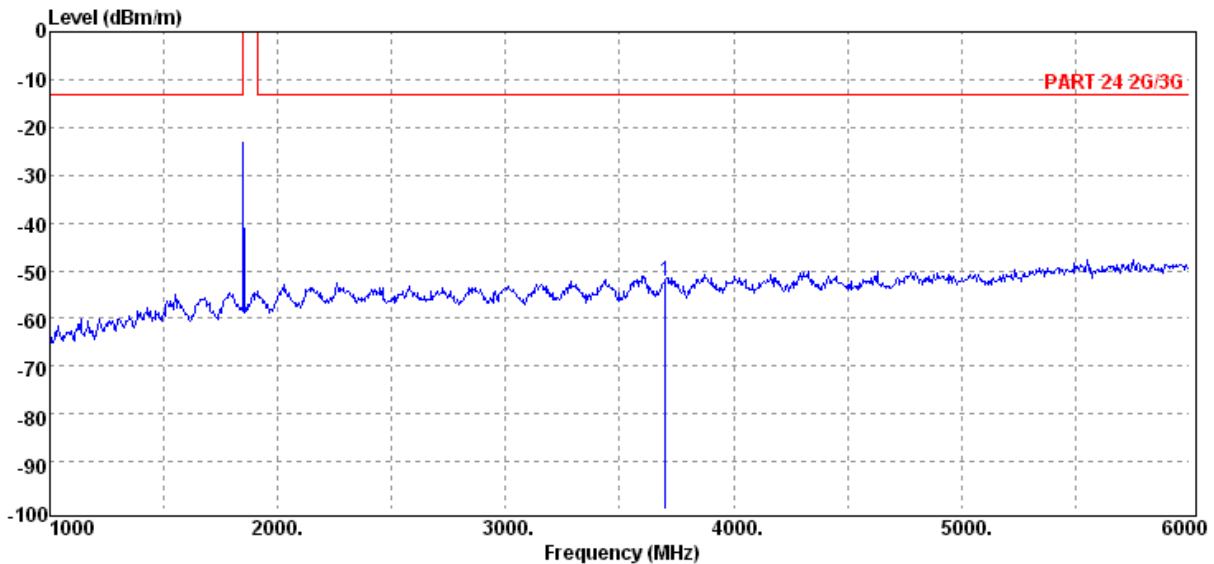
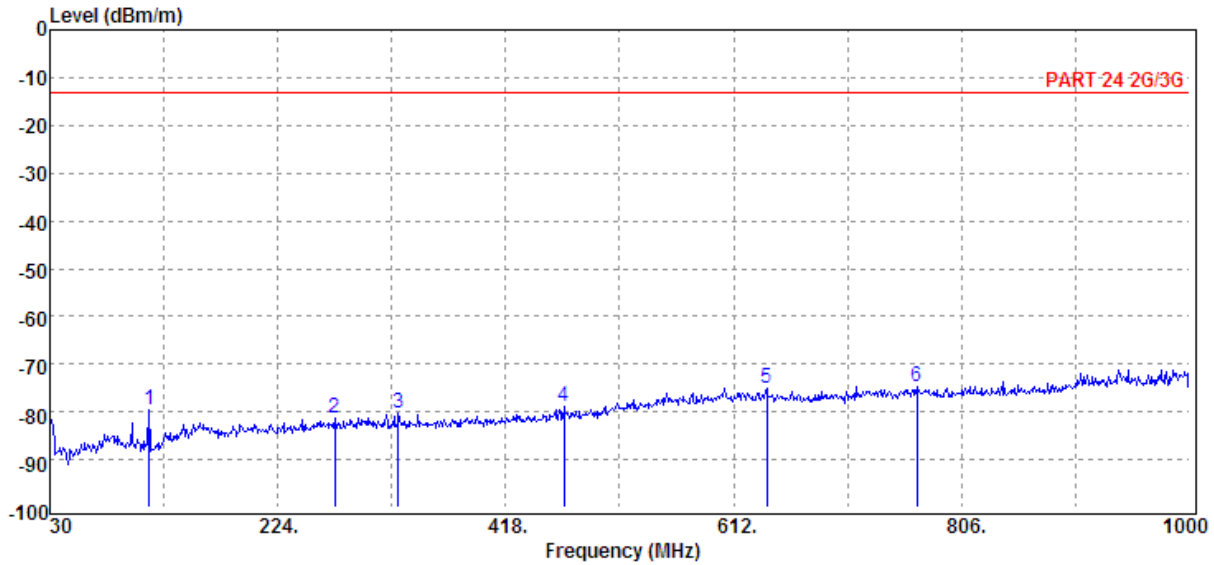

Unless otherwise stated the results shown in this test report refer only to the sample(s) tested and such sample(s) are retained for 90 days only.

除非另有說明，此報告結果僅對測試之樣品負責，同時此樣品僅保留90天。本報告未經本公司書面許可，不可部份複製。

This document is issued by the Company subject to its General Conditions of Service printed overleaf, available on request or accessible at www.sgs.com/terms_and_conditions.htm and, for electronic format documents, subject to Terms and Conditions for Electronic Documents at www.sgs.com/terms_e-document.htm. Attention is drawn to the limitation of liability, indemnification and jurisdiction issues defined therein. Any holder of this document is advised that information contained hereon reflects the Company's findings at the time of its intervention only and within the limits of Client's instructions, if any. The Company's sole responsibility is to its Client and this document does not exonerate parties to a transaction from exercising all their rights and obligations under the transaction documents. This document cannot be reproduced except in full, without prior written approval of the Company. Any unauthorized alteration, forgery or falsification of the content or appearance of this document is unlawful and offenders may be prosecuted to the fullest extent of the law.

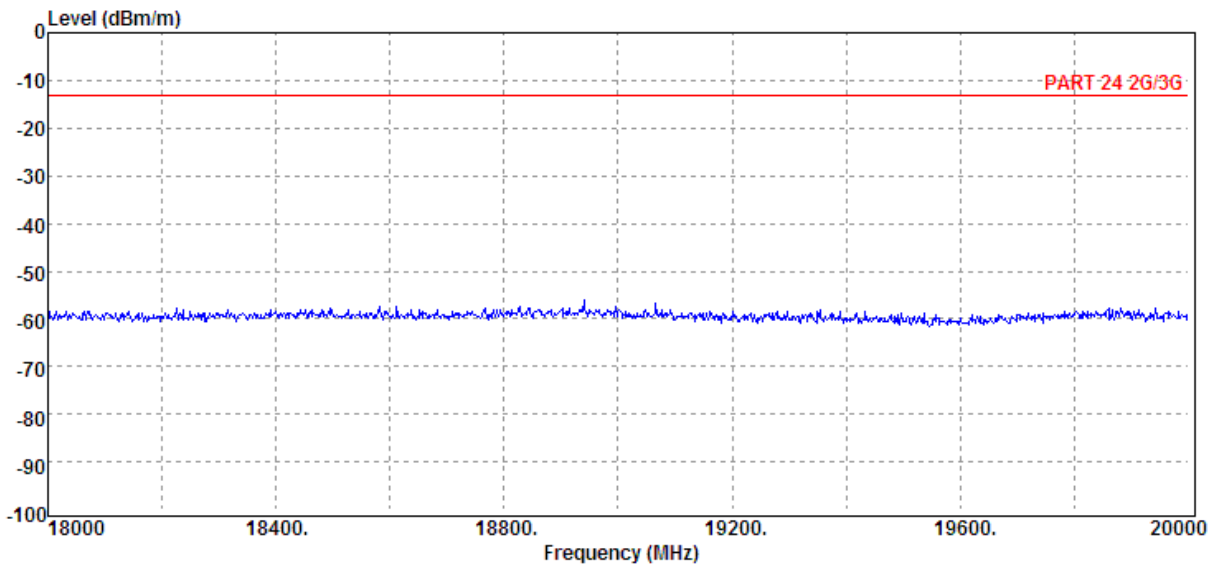
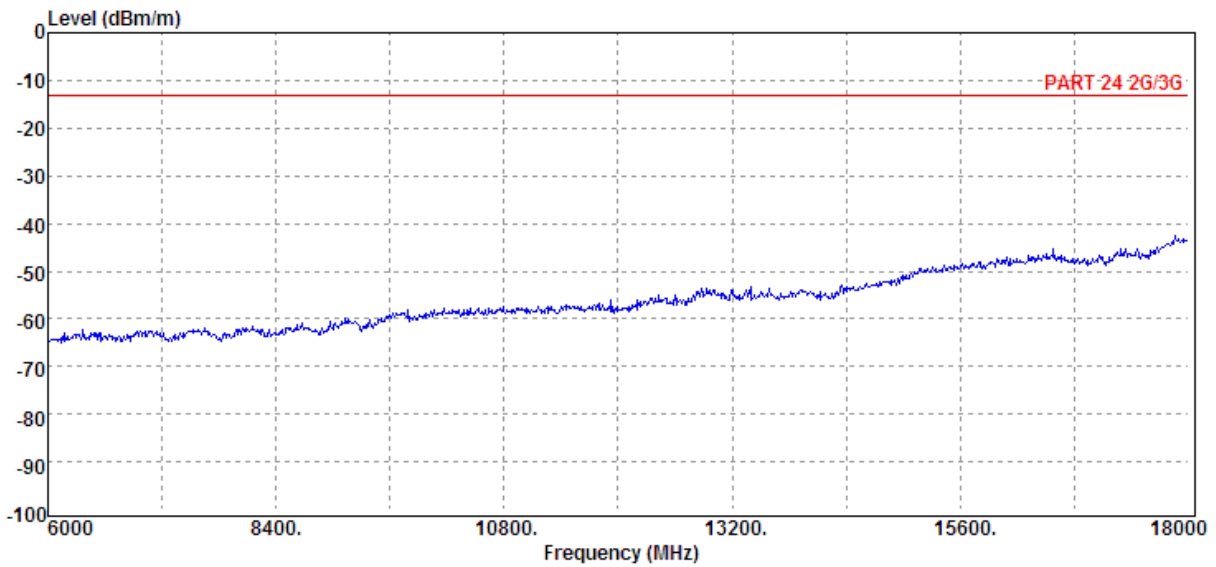

Unless otherwise stated the results shown in this test report refer only to the sample(s) tested and such sample(s) are retained for 90 days only.

除非另有說明，此報告結果僅對測試之樣品負責，同時此樣品僅保留90天。本報告未經本公司書面許可，不可部份複製。

This document is issued by the Company subject to its General Conditions of Service printed overleaf, available on request or accessible at www.sgs.com/terms_and_conditions.htm and, for electronic format documents, subject to Terms and Conditions for Electronic Documents at www.sgs.com/terms_e-document.htm. Attention is drawn to the limitation of liability, indemnification and jurisdiction issues defined therein. Any holder of this document is advised that information contained hereon reflects the Company's findings at the time of its intervention only and within the limits of Client's instructions, if any. The Company's sole responsibility is to its Client and this document does not exonerate parties to a transaction from exercising all their rights and obligations under the transaction documents. This document cannot be reproduced except in full, without prior written approval of the Company. Any unauthorized alteration, forgery or falsification of the content or appearance of this document is unlawful and offenders may be prosecuted to the fullest extent of the law.

| | | | |
|-----------------------|-------------|--------------------------|---------------------|
| Operation Band | :GSM 1900 | Test Date | : 2013-07-16 |
| ARFCN | :CH 512 | Temp./Humi. | :24.1 deg_C / 65 RH |
| Fundamental Frequency | :1850.2 MHz | Engineer | :Allen |
| Operation Mode | :TX LOW | Measurement Antenna Pol. | :HORIZONTAL |
| EUT Pol. | :E1 Plan | | |

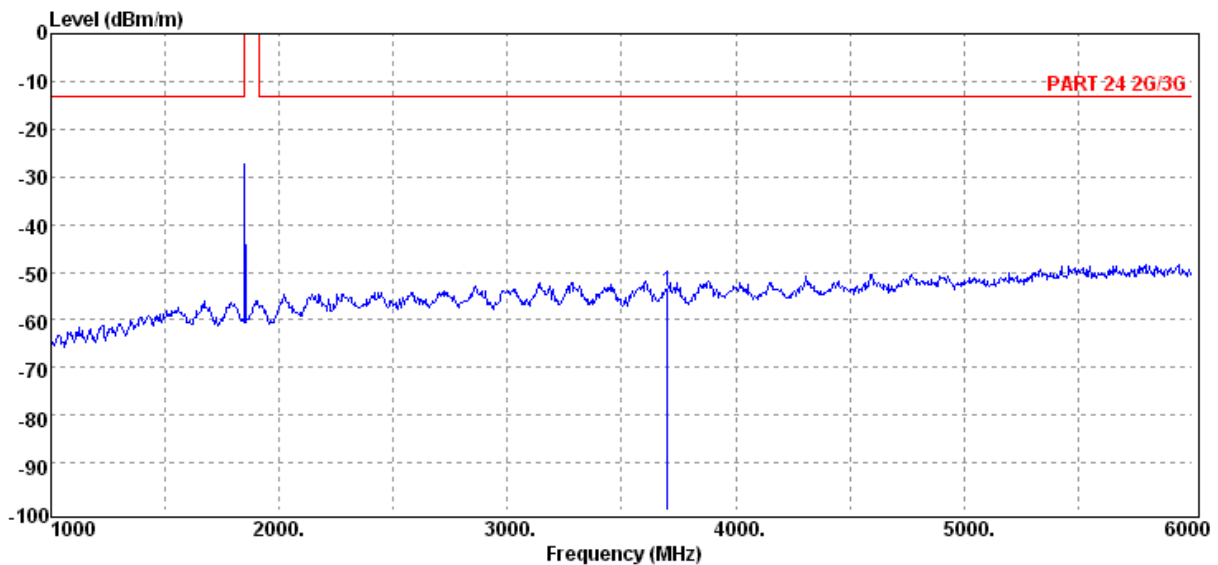
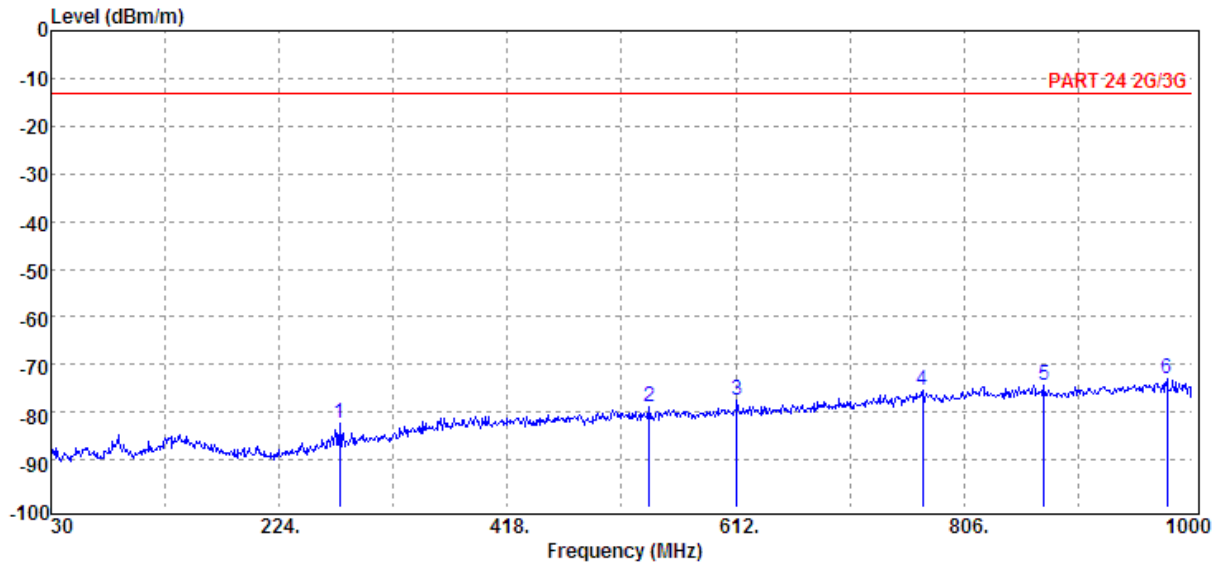

Unless otherwise stated the results shown in this test report refer only to the sample(s) tested and such sample(s) are retained for 90 days only.

除非另有說明，此報告結果僅對測試之樣品負責，同時此樣品僅保留90天。本報告未經本公司書面許可，不可部份複製。

This document is issued by the Company subject to its General Conditions of Service printed overleaf, available on request or accessible at www.sgs.com/terms_and_conditions.htm and, for electronic format documents, subject to Terms and Conditions for Electronic Documents at www.sgs.com/terms_e-document.htm. Attention is drawn to the limitation of liability, indemnification and jurisdiction issues defined therein. Any holder of this document is advised that information contained hereon reflects the Company's findings at the time of its intervention only and within the limits of Client's instructions, if any. The Company's sole responsibility is to its Client and this document does not exonerate parties to a transaction from exercising all their rights and obligations under the transaction documents. This document cannot be reproduced except in full, without prior written approval of the Company. Any unauthorized alteration, forgery or falsification of the content or appearance of this document is unlawful and offenders may be prosecuted to the fullest extent of the law.

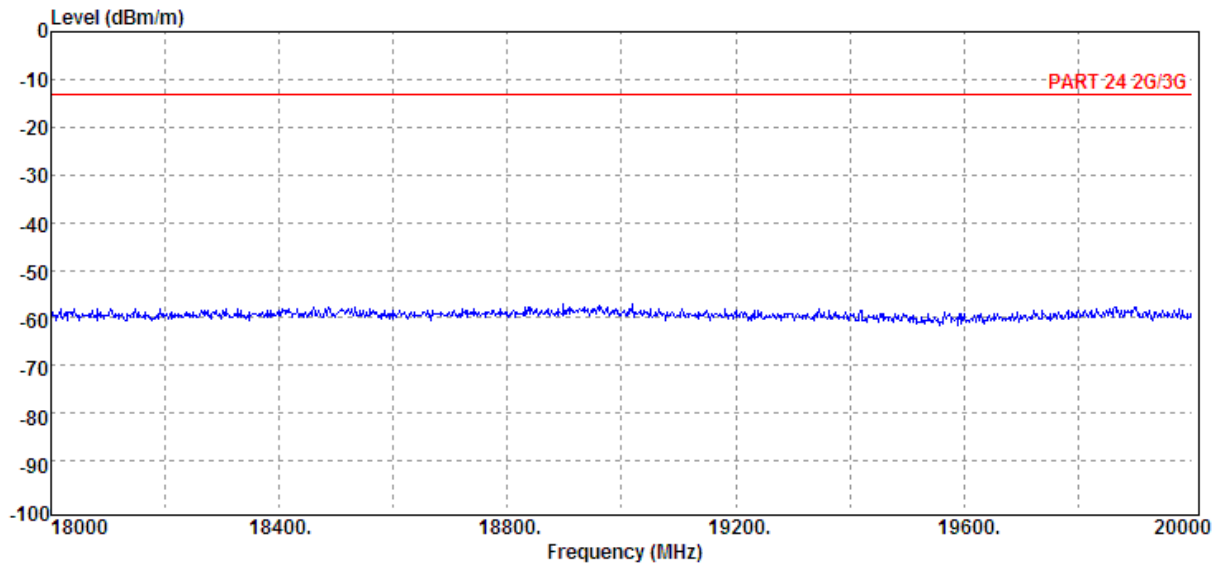
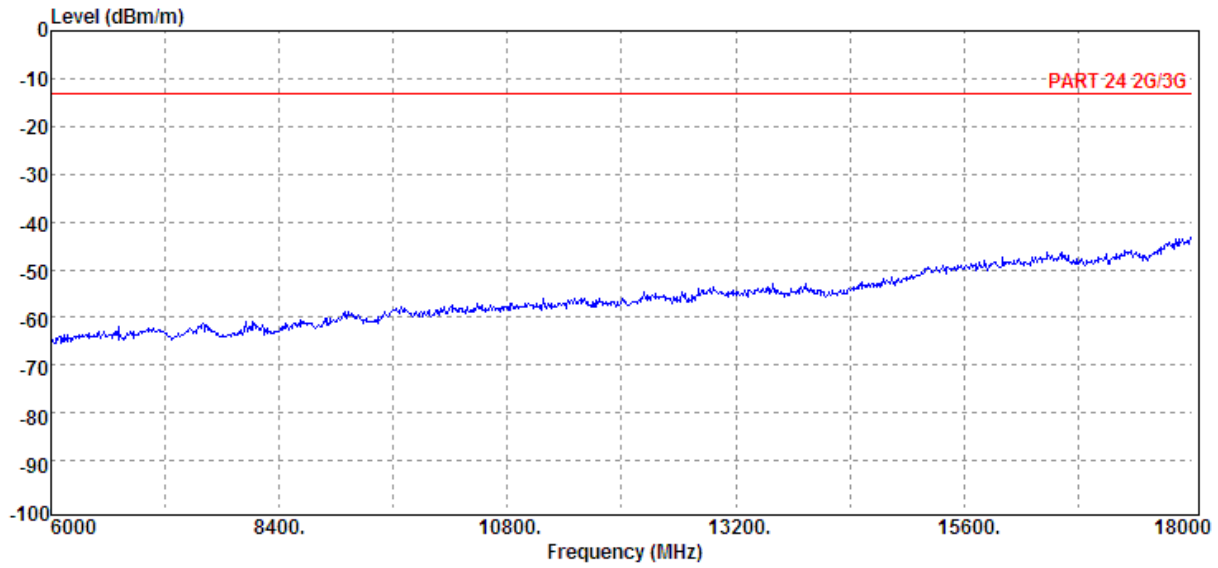

Unless otherwise stated the results shown in this test report refer only to the sample(s) tested and such sample(s) are retained for 90 days only.

除非另有說明，此報告結果僅對測試之樣品負責，同時此樣品僅保留90天。本報告未經本公司書面許可，不可部份複製。

This document is issued by the Company subject to its General Conditions of Service printed overleaf, available on request or accessible at www.sgs.com/terms_and_conditions.htm and, for electronic format documents, subject to Terms and Conditions for Electronic Documents at www.sgs.com/terms_e-document.htm. Attention is drawn to the limitation of liability, indemnification and jurisdiction issues defined therein. Any holder of this document is advised that information contained hereon reflects the Company's findings at the time of its intervention only and within the limits of Client's instructions, if any. The Company's sole responsibility is to its Client and this document does not exonerate parties to a transaction from exercising all their rights and obligations under the transaction documents. This document cannot be reproduced except in full, without prior written approval of the Company. Any unauthorized alteration, forgery or falsification of the content or appearance of this document is unlawful and offenders may be prosecuted to the fullest extent of the law.

| | | | |
|-----------------------|-----------|--------------------------|---------------------|
| Operation Band | :GSM 1900 | Test Date | :2013-05-03 |
| ARFCN | :CH 661 | Temp./Humi. | :24.1 deg_C / 65 RH |
| Fundamental Frequency | :1880 MHz | Engineer | :Allen |
| Operation Mode | :TX MID | Measurement Antenna Pol. | :VERTICAL |
| EUT Pol. | :E1 Plan | | |

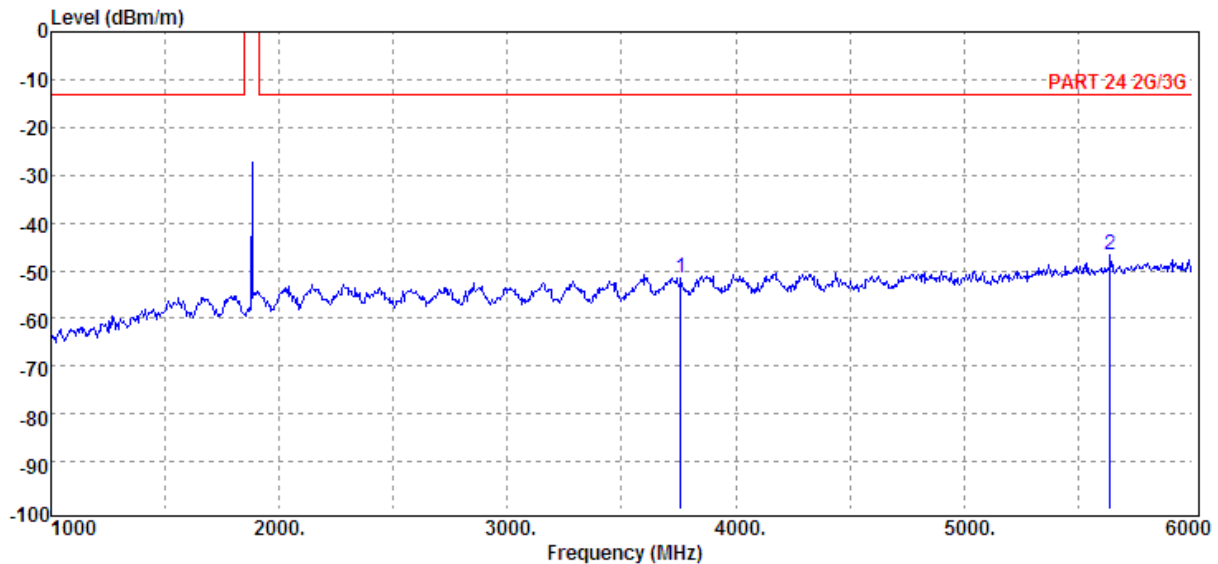
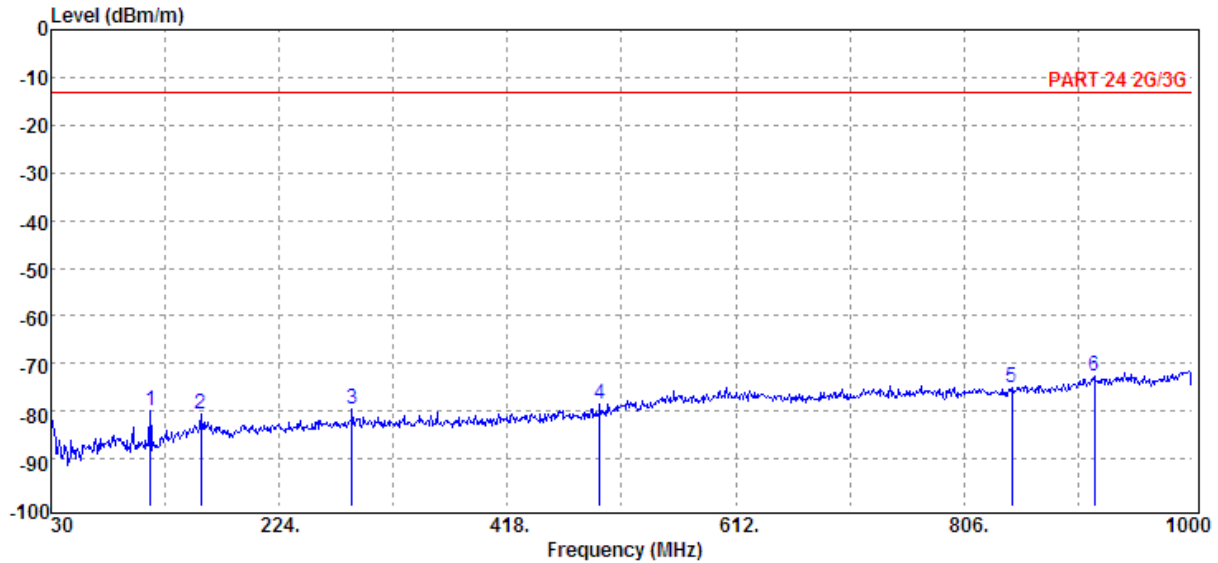

Unless otherwise stated the results shown in this test report refer only to the sample(s) tested and such sample(s) are retained for 90 days only.

除非另有說明，此報告結果僅對測試之樣品負責，同時此樣品僅保留90天。本報告未經本公司書面許可，不可部份複製。

This document is issued by the Company subject to its General Conditions of Service printed overleaf, available on request or accessible at www.sgs.com/terms_and_conditions.htm and, for electronic format documents, subject to Terms and Conditions for Electronic Documents at www.sgs.com/terms_e-document.htm. Attention is drawn to the limitation of liability, indemnification and jurisdiction issues defined therein. Any holder of this document is advised that information contained hereon reflects the Company's findings at the time of its intervention only and within the limits of Client's instructions, if any. The Company's sole responsibility is to its Client and this document does not exonerate parties to a transaction from exercising all their rights and obligations under the transaction documents. This document cannot be reproduced except in full, without prior written approval of the Company. Any unauthorized alteration, forgery or falsification of the content or appearance of this document is unlawful and offenders may be prosecuted to the fullest extent of the law.

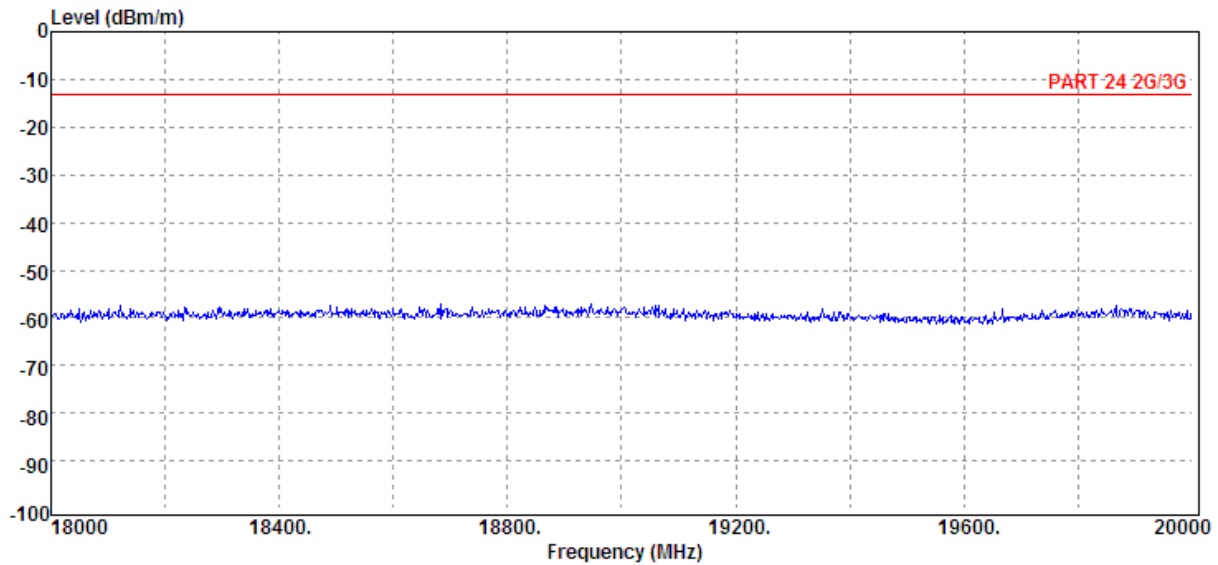
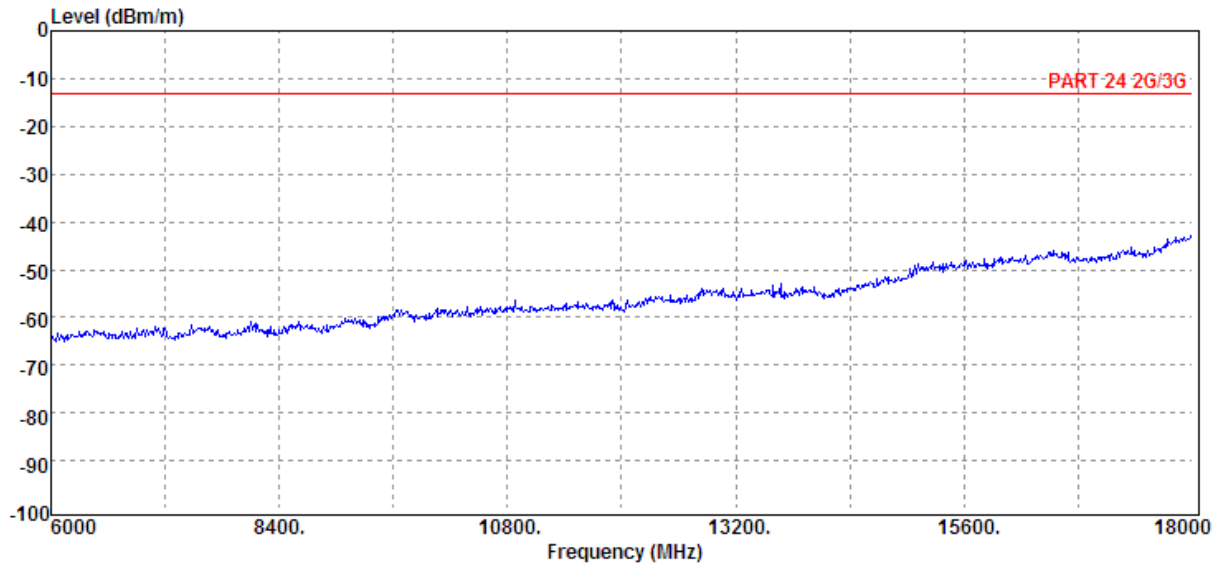

Unless otherwise stated the results shown in this test report refer only to the sample(s) tested and such sample(s) are retained for 90 days only.

除非另有說明，此報告結果僅對測試之樣品負責，同時此樣品僅保留90天。本報告未經本公司書面許可，不可部份複製。

This document is issued by the Company subject to its General Conditions of Service printed overleaf, available on request or accessible at www.sgs.com/terms_and_conditions.htm and, for electronic format documents, subject to Terms and Conditions for Electronic Documents at www.sgs.com/terms_e-document.htm. Attention is drawn to the limitation of liability, indemnification and jurisdiction issues defined therein. Any holder of this document is advised that information contained hereon reflects the Company's findings at the time of its intervention only and within the limits of Client's instructions, if any. The Company's sole responsibility is to its Client and this document does not exonerate parties to a transaction from exercising all their rights and obligations under the transaction documents. This document cannot be reproduced except in full, without prior written approval of the Company. Any unauthorized alteration, forgery or falsification of the content or appearance of this document is unlawful and offenders may be prosecuted to the fullest extent of the law.

| | | | |
|-----------------------|-----------|--------------------------|---------------------|
| Operation Band | :GSM 1900 | Test Date | :2013-05-03 |
| ARFCN | :CH 661 | Temp./Humi. | :24.1 deg_C / 65 RH |
| Fundamental Frequency | :1880 MHz | Engineer | :Allen |
| Operation Mode | :TX MID | Measurement Antenna Pol. | :HORIZONTAL |
| EUT Pol. | :E1 Plan | | |

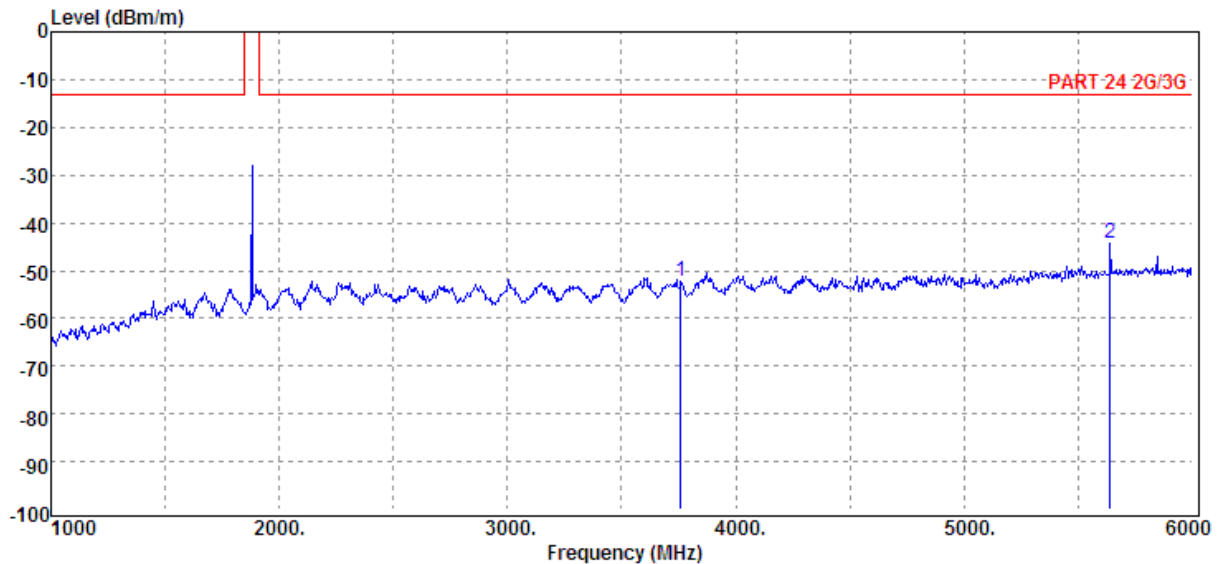
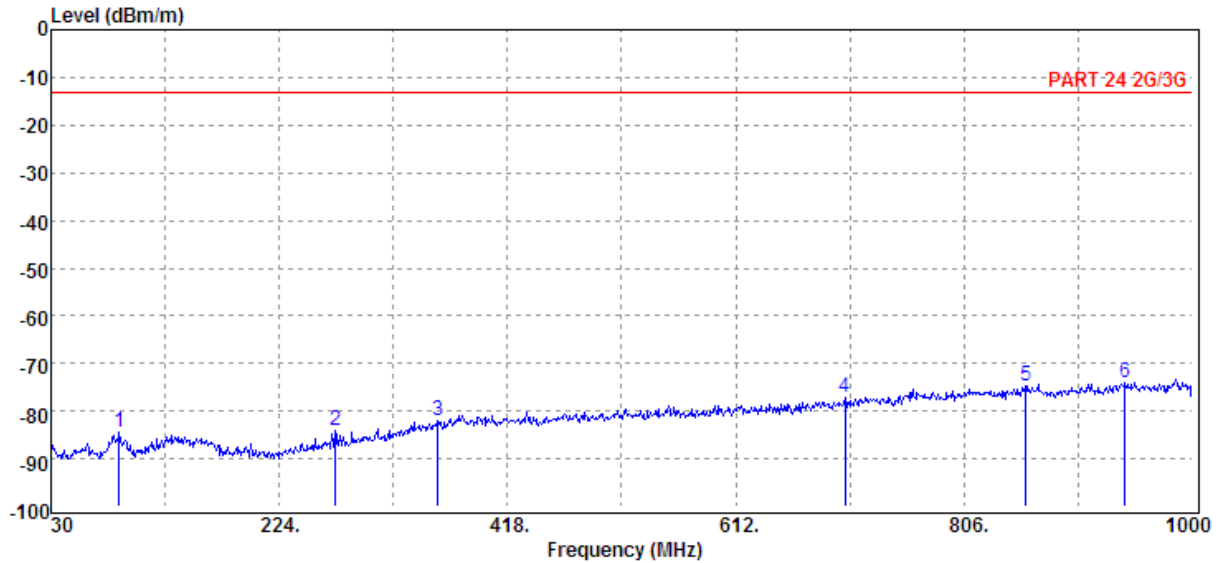

Unless otherwise stated the results shown in this test report refer only to the sample(s) tested and such sample(s) are retained for 90 days only.

除非另有說明，此報告結果僅對測試之樣品負責，同時此樣品僅保留90天。本報告未經本公司書面許可，不可部份複製。

This document is issued by the Company subject to its General Conditions of Service printed overleaf, available on request or accessible at www.sgs.com/terms_and_conditions.htm and, for electronic format documents, subject to Terms and Conditions for Electronic Documents at www.sgs.com/terms_e-document.htm. Attention is drawn to the limitation of liability, indemnification and jurisdiction issues defined therein. Any holder of this document is advised that information contained hereon reflects the Company's findings at the time of its intervention only and within the limits of Client's instructions, if any. The Company's sole responsibility is to its Client and this document does not exonerate parties to a transaction from exercising all their rights and obligations under the transaction documents. This document cannot be reproduced except in full, without prior written approval of the Company. Any unauthorized alteration, forgery or falsification of the content or appearance of this document is unlawful and offenders may be prosecuted to the fullest extent of the law.

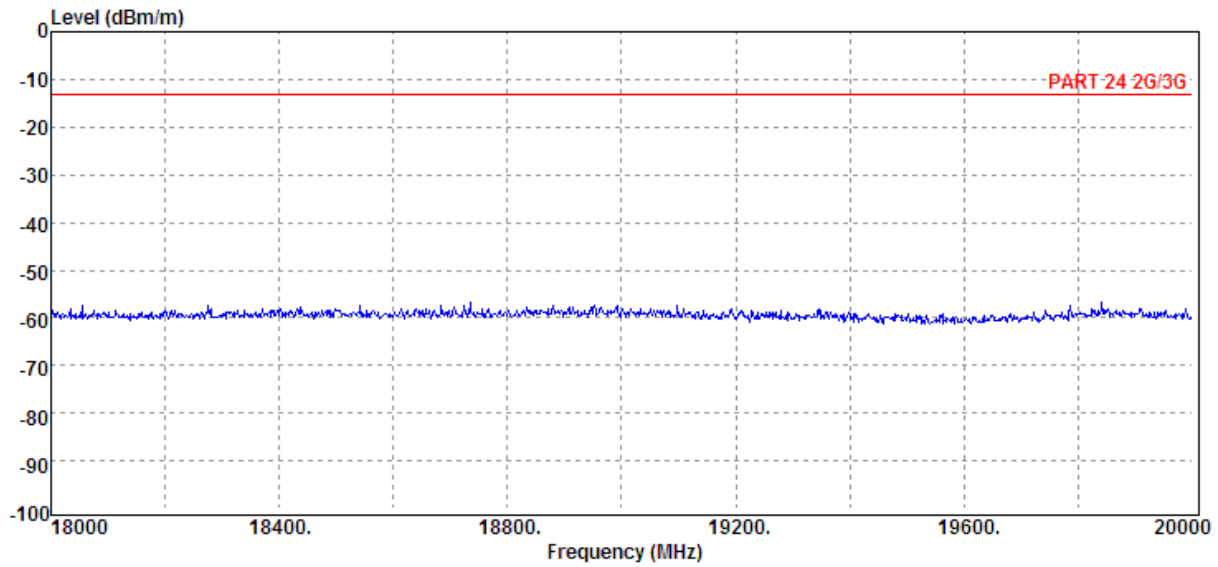
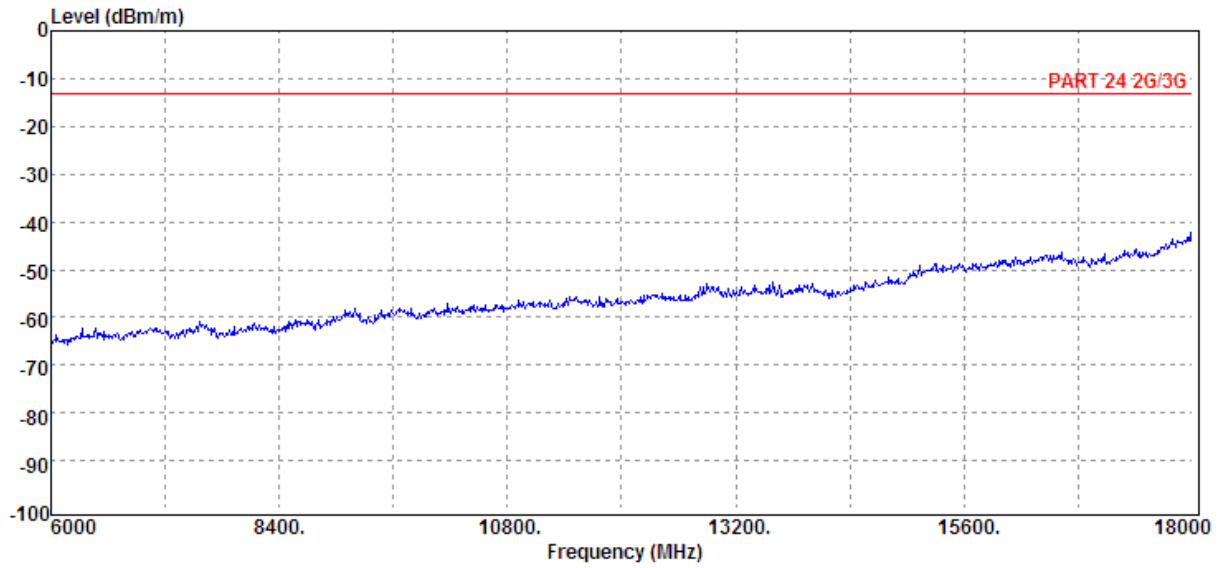

Unless otherwise stated the results shown in this test report refer only to the sample(s) tested and such sample(s) are retained for 90 days only.

除非另有說明，此報告結果僅對測試之樣品負責，同時此樣品僅保留90天。本報告未經本公司書面許可，不可部份複製。

This document is issued by the Company subject to its General Conditions of Service printed overleaf, available on request or accessible at www.sgs.com/terms_and_conditions.htm and, for electronic format documents, subject to Terms and Conditions for Electronic Documents at www.sgs.com/terms_e-document.htm. Attention is drawn to the limitation of liability, indemnification and jurisdiction issues defined therein. Any holder of this document is advised that information contained hereon reflects the Company's findings at the time of its intervention only and within the limits of Client's instructions, if any. The Company's sole responsibility is to its Client and this document does not exonerate parties to a transaction from exercising all their rights and obligations under the transaction documents. This document cannot be reproduced except in full, without prior written approval of the Company. Any unauthorized alteration, forgery or falsification of the content or appearance of this document is unlawful and offenders may be prosecuted to the fullest extent of the law.

| | | | |
|-----------------------|-------------|--------------------------|---------------------|
| Operation Band | :GSM 1900 | Test Date | :2013-05-03 |
| ARFCN | :CH 810 | Temp./Humi. | :24.1 deg_C / 65 RH |
| Fundamental Frequency | :1909.8 MHz | Engineer | :Allen |
| Operation Mode | :TX HIGH | Measurement Antenna Pol. | :VERTICAL |
| EUT Pol. | :E1 Plan | | |

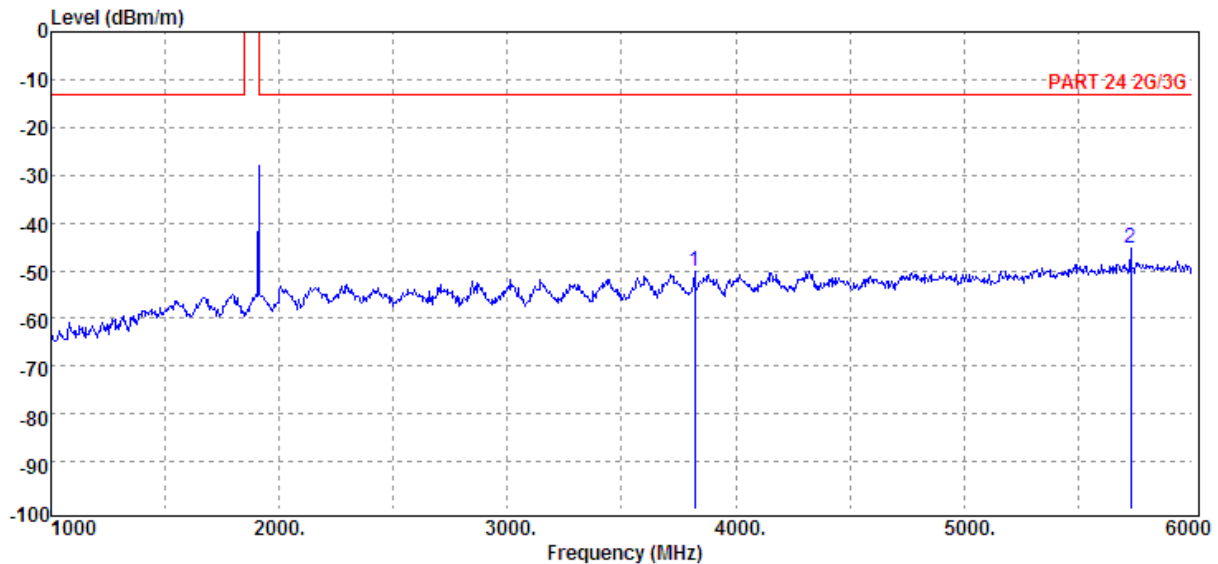
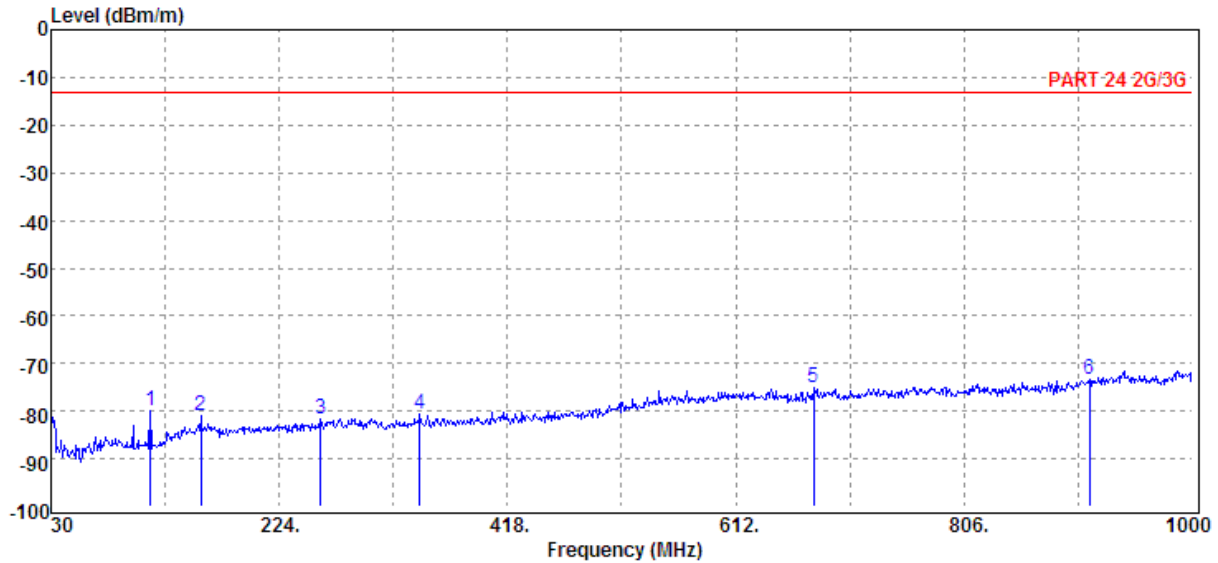

Unless otherwise stated the results shown in this test report refer only to the sample(s) tested and such sample(s) are retained for 90 days only.

除非另有說明，此報告結果僅對測試之樣品負責，同時此樣品僅保留90天。本報告未經本公司書面許可，不可部份複製。

This document is issued by the Company subject to its General Conditions of Service printed overleaf, available on request or accessible at www.sgs.com/terms_and_conditions.htm and, for electronic format documents, subject to Terms and Conditions for Electronic Documents at www.sgs.com/terms_e-document.htm. Attention is drawn to the limitation of liability, indemnification and jurisdiction issues defined therein. Any holder of this document is advised that information contained hereon reflects the Company's findings at the time of its intervention only and within the limits of Client's instructions, if any. The Company's sole responsibility is to its Client and this document does not exonerate parties to a transaction from exercising all their rights and obligations under the transaction documents. This document cannot be reproduced except in full, without prior written approval of the Company. Any unauthorized alteration, forgery or falsification of the content or appearance of this document is unlawful and offenders may be prosecuted to the fullest extent of the law.

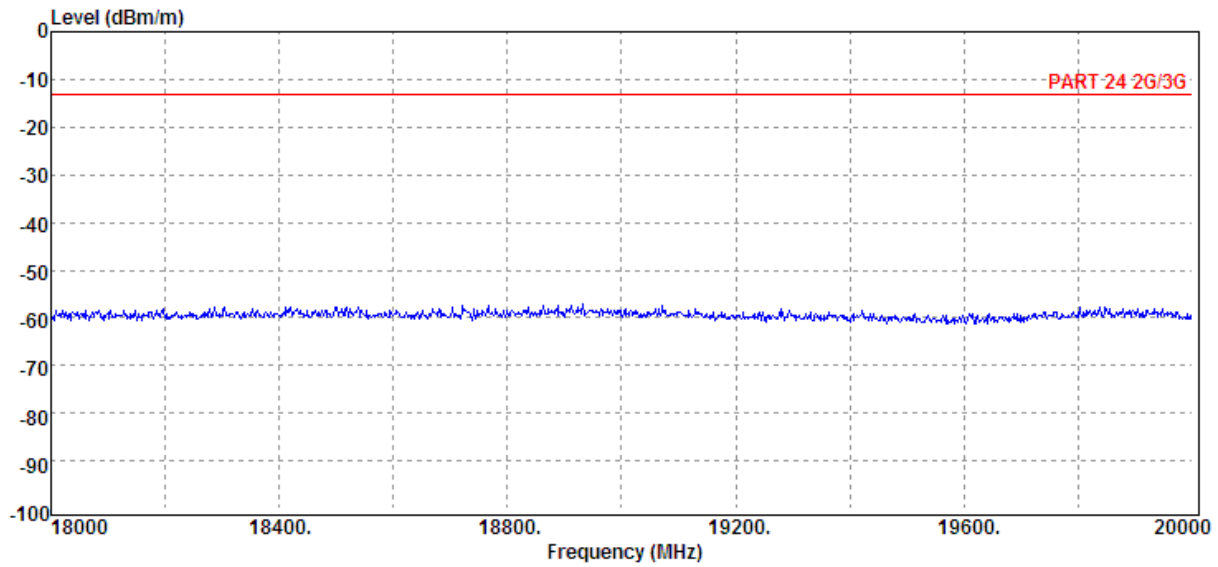
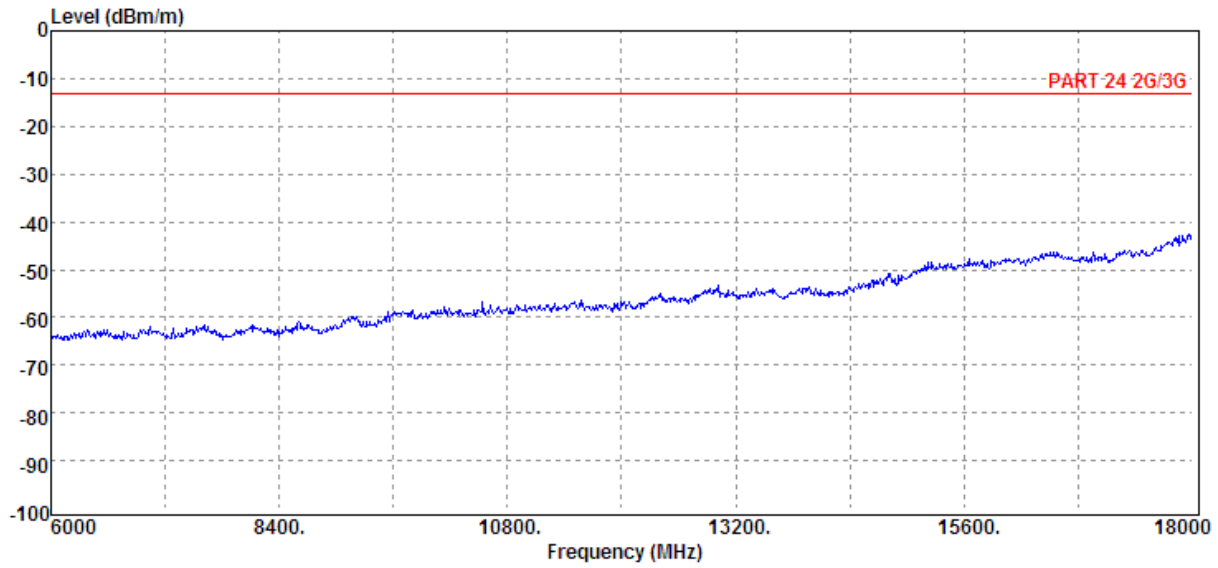

Unless otherwise stated the results shown in this test report refer only to the sample(s) tested and such sample(s) are retained for 90 days only.

除非另有說明，此報告結果僅對測試之樣品負責，同時此樣品僅保留90天。本報告未經本公司書面許可，不可部份複製。

This document is issued by the Company subject to its General Conditions of Service printed overleaf, available on request or accessible at www.sgs.com/terms_and_conditions.htm and, for electronic format documents, subject to Terms and Conditions for Electronic Documents at www.sgs.com/terms_e-document.htm. Attention is drawn to the limitation of liability, indemnification and jurisdiction issues defined therein. Any holder of this document is advised that information contained hereon reflects the Company's findings at the time of its intervention only and within the limits of Client's instructions, if any. The Company's sole responsibility is to its Client and this document does not exonerate parties to a transaction from exercising all their rights and obligations under the transaction documents. This document cannot be reproduced except in full, without prior written approval of the Company. Any unauthorized alteration, forgery or falsification of the content or appearance of this document is unlawful and offenders may be prosecuted to the fullest extent of the law.

| | | | |
|-----------------------|-------------|--------------------------|---------------------|
| Operation Band | :GSM 1900 | Test Date | :2013-05-03 |
| ARFCN | :CH 810 | Temp./Humi. | :24.1 deg_C / 65 RH |
| Fundamental Frequency | :1909.8 MHz | Engineer | :Allen |
| Operation Mode | :TX HIGH | Measurement Antenna Pol. | :HORIZONTAL |
| EUT Pol. | :E1 Plan | | |

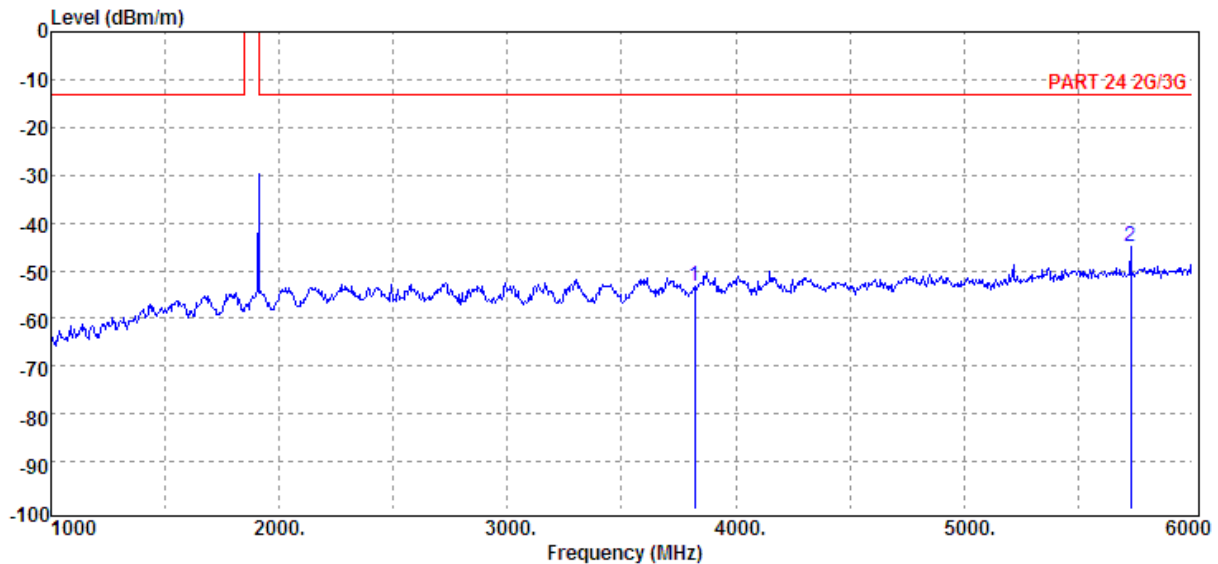
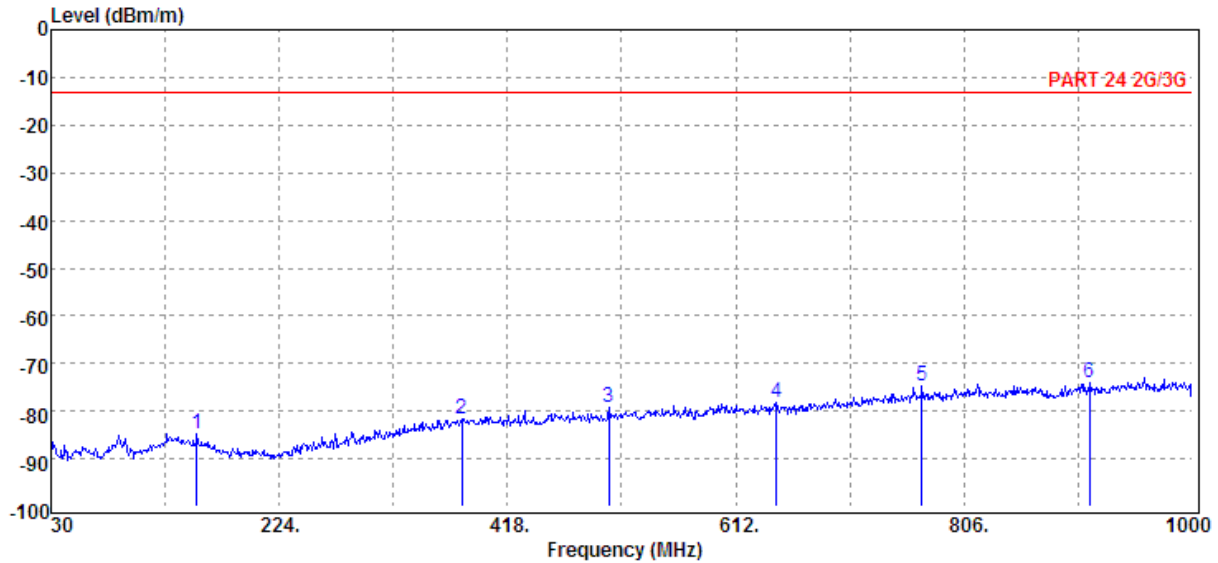

Unless otherwise stated the results shown in this test report refer only to the sample(s) tested and such sample(s) are retained for 90 days only.

除非另有說明，此報告結果僅對測試之樣品負責，同時此樣品僅保留90天。本報告未經本公司書面許可，不可部份複製。

This document is issued by the Company subject to its General Conditions of Service printed overleaf, available on request or accessible at www.sgs.com/terms_and_conditions.htm and, for electronic format documents, subject to Terms and Conditions for Electronic Documents at www.sgs.com/terms_e-document.htm. Attention is drawn to the limitation of liability, indemnification and jurisdiction issues defined therein. Any holder of this document is advised that information contained hereon reflects the Company's findings at the time of its intervention only and within the limits of Client's instructions, if any. The Company's sole responsibility is to its Client and this document does not exonerate parties to a transaction from exercising all their rights and obligations under the transaction documents. This document cannot be reproduced except in full, without prior written approval of the Company. Any unauthorized alteration, forgery or falsification of the content or appearance of this document is unlawful and offenders may be prosecuted to the fullest extent of the law.

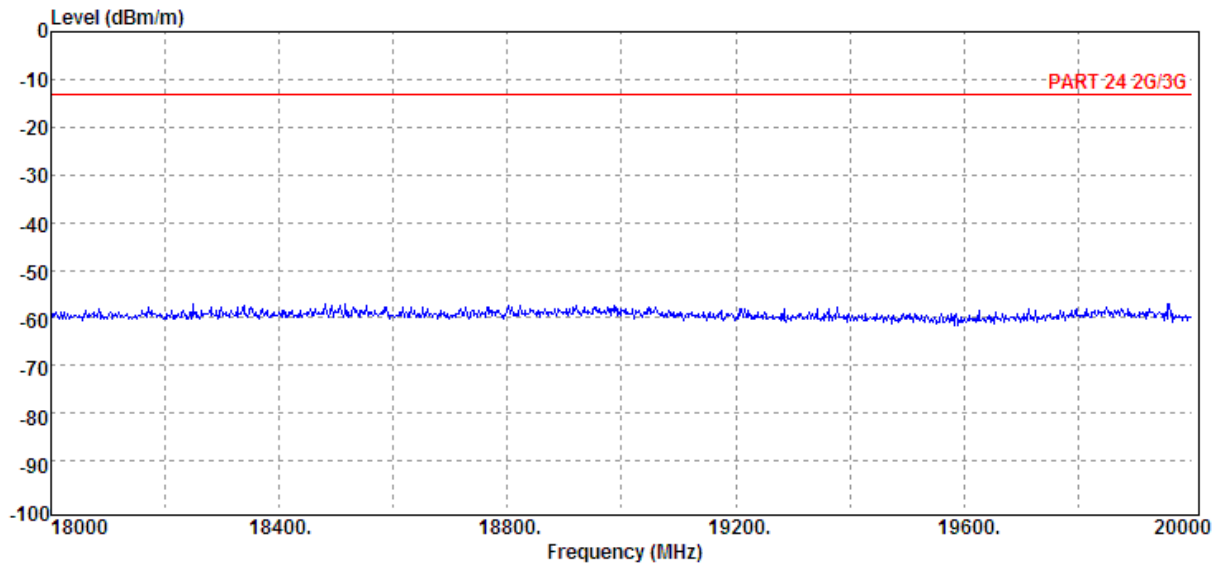
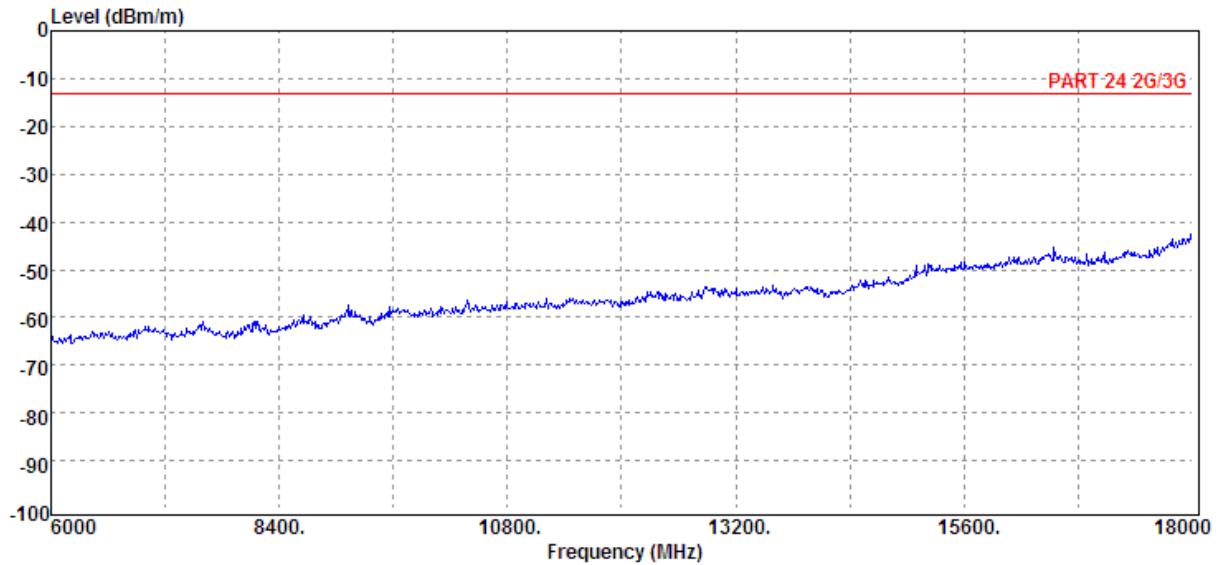

Unless otherwise stated the results shown in this test report refer only to the sample(s) tested and such sample(s) are retained for 90 days only.

除非另有說明，此報告結果僅對測試之樣品負責，同時此樣品僅保留90天。本報告未經本公司書面許可，不可部份複製。

This document is issued by the Company subject to its General Conditions of Service printed overleaf, available on request or accessible at www.sgs.com/terms_and_conditions.htm and, for electronic format documents, subject to Terms and Conditions for Electronic Documents at www.sgs.com/terms_e-document.htm. Attention is drawn to the limitation of liability, indemnification and jurisdiction issues defined therein. Any holder of this document is advised that information contained hereon reflects the Company's findings at the time of its intervention only and within the limits of Client's instructions, if any. The Company's sole responsibility is to its Client and this document does not exonerate parties to a transaction from exercising all their rights and obligations under the transaction documents. This document cannot be reproduced except in full, without prior written approval of the Company. Any unauthorized alteration, forgery or falsification of the content or appearance of this document is unlawful and offenders may be prosecuted to the fullest extent of the law.

Radiated Spurious Emission Measurement Result: WCDMA II Mode

| | | | |
|-----------------------|-------------|--------------------------|---------------------|
| Operation Band | :WCDMA B2 | Test Date | : 2013-07-16 |
| ARFCN | :CH 9262 | Temp./Humi. | :24.1 deg_C / 65 RH |
| Fundamental Frequency | :1852.4 MHz | Engineer | :Allen |
| Operation Mode | :TX LOW | | |
| EUT Pol. | :E1 Plan | Measurement Antenna Pol. | :VERTICAL |

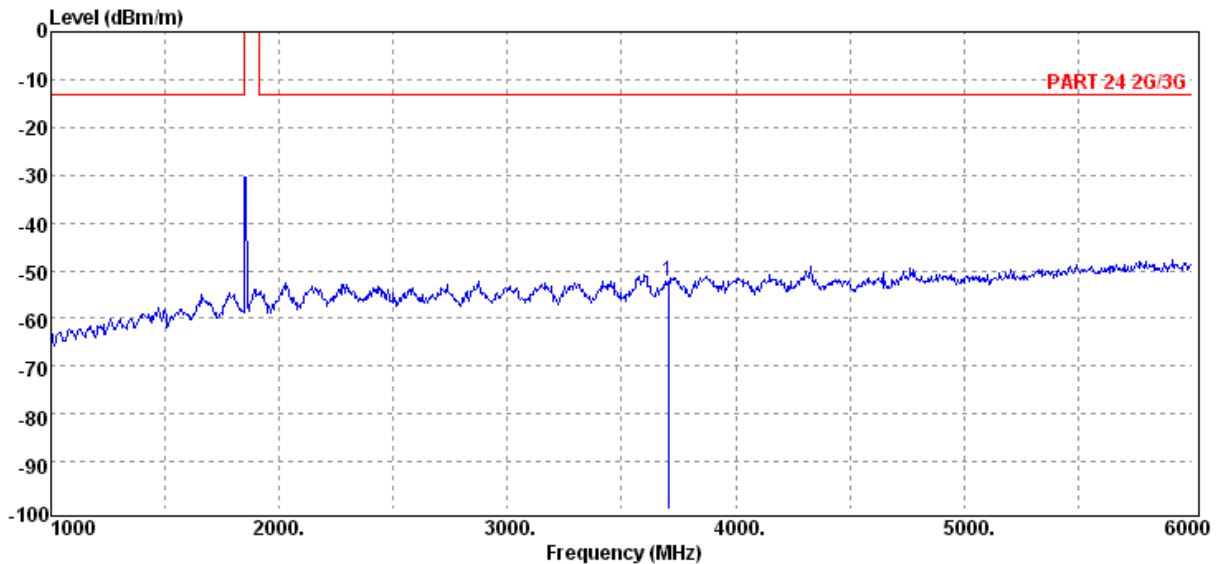
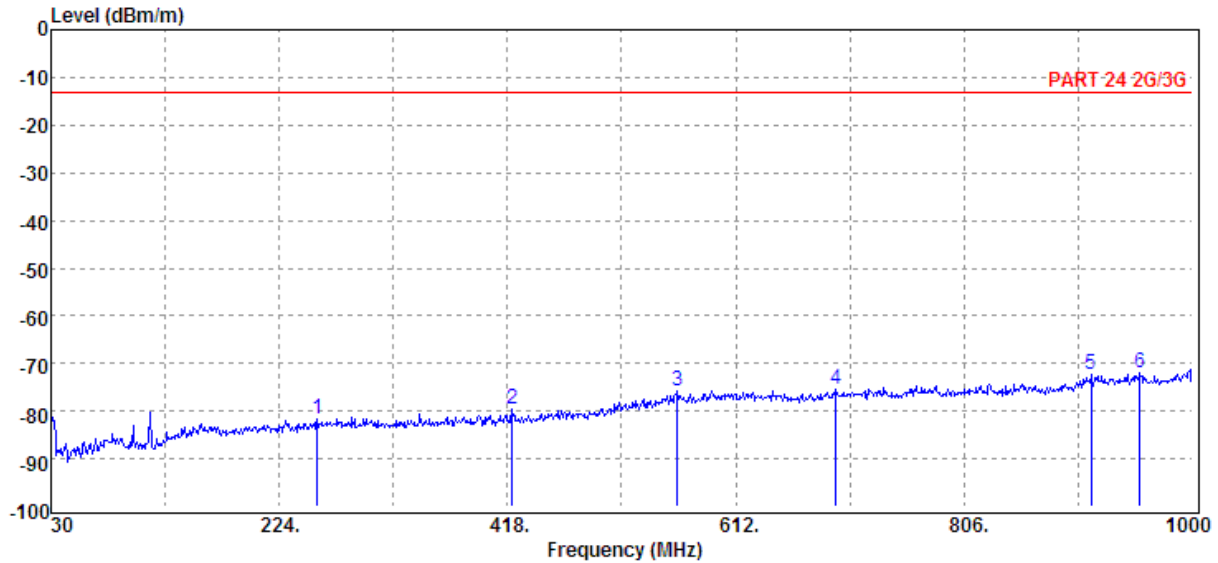

Unless otherwise stated the results shown in this test report refer only to the sample(s) tested and such sample(s) are retained for 90 days only.

除非另有說明，此報告結果僅對測試之樣品負責，同時此樣品僅保留90天。本報告未經本公司書面許可，不可部份複製。

This document is issued by the Company subject to its General Conditions of Service printed overleaf, available on request or accessible at www.sgs.com/terms_and_conditions.htm and, for electronic format documents, subject to Terms and Conditions for Electronic Documents at www.sgs.com/terms_e-document.htm. Attention is drawn to the limitation of liability, indemnification and jurisdiction issues defined therein. Any holder of this document is advised that information contained hereon reflects the Company's findings at the time of its intervention only and within the limits of Client's instructions, if any. The Company's sole responsibility is to its Client and this document does not exonerate parties to a transaction from exercising all their rights and obligations under the transaction documents. This document cannot be reproduced except in full, without prior written approval of the Company. Any unauthorized alteration, forgery or falsification of the content or appearance of this document is unlawful and offenders may be prosecuted to the fullest extent of the law.

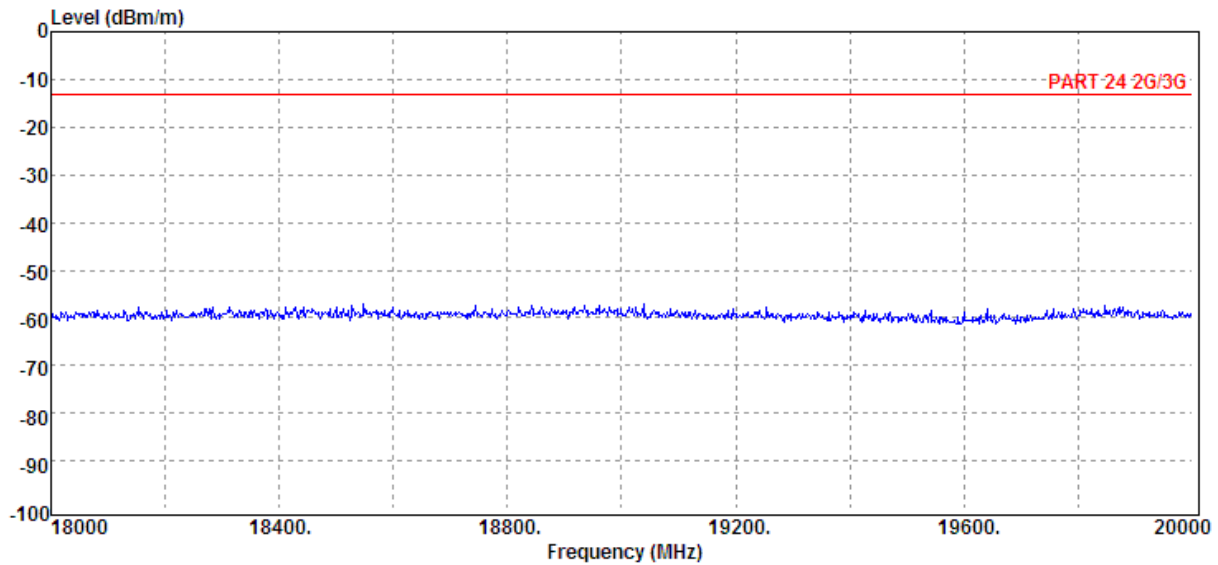
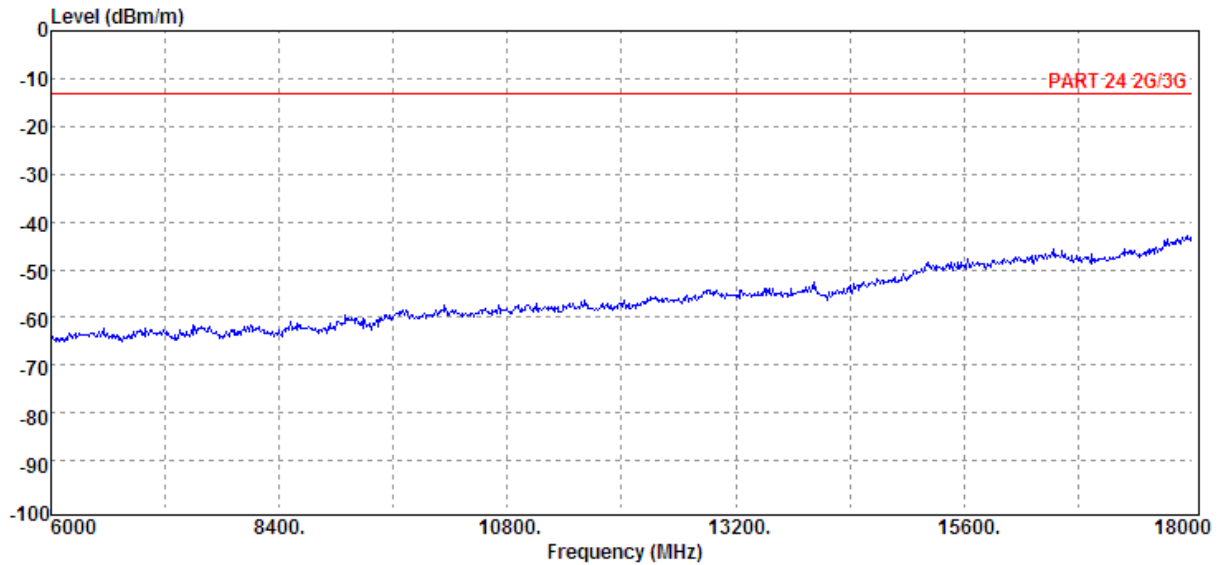

Unless otherwise stated the results shown in this test report refer only to the sample(s) tested and such sample(s) are retained for 90 days only.

除非另有說明，此報告結果僅對測試之樣品負責，同時此樣品僅保留90天。本報告未經本公司書面許可，不可部份複製。

This document is issued by the Company subject to its General Conditions of Service printed overleaf, available on request or accessible at www.sgs.com/terms_and_conditions.htm and, for electronic format documents, subject to Terms and Conditions for Electronic Documents at www.sgs.com/terms_e-document.htm. Attention is drawn to the limitation of liability, indemnification and jurisdiction issues defined therein. Any holder of this document is advised that information contained hereon reflects the Company's findings at the time of its intervention only and within the limits of Client's instructions, if any. The Company's sole responsibility is to its Client and this document does not exonerate parties to a transaction from exercising all their rights and obligations under the transaction documents. This document cannot be reproduced except in full, without prior written approval of the Company. Any unauthorized alteration, forgery or falsification of the content or appearance of this document is unlawful and offenders may be prosecuted to the fullest extent of the law.

| | | | |
|-----------------------|-------------|--------------------------|---------------------|
| Operation Band | :WCDMA B2 | Test Date | : 2013-07-16 |
| ARFCN | :CH 9262 | Temp./Humi. | :24.1 deg_C / 65 RH |
| Fundamental Frequency | :1852.4 MHz | Engineer | :Allen |
| Operation Mode | :TX LOW | Measurement Antenna Pol. | :HORIZONTAL |
| EUT Pol. | :E1 Plan | | |

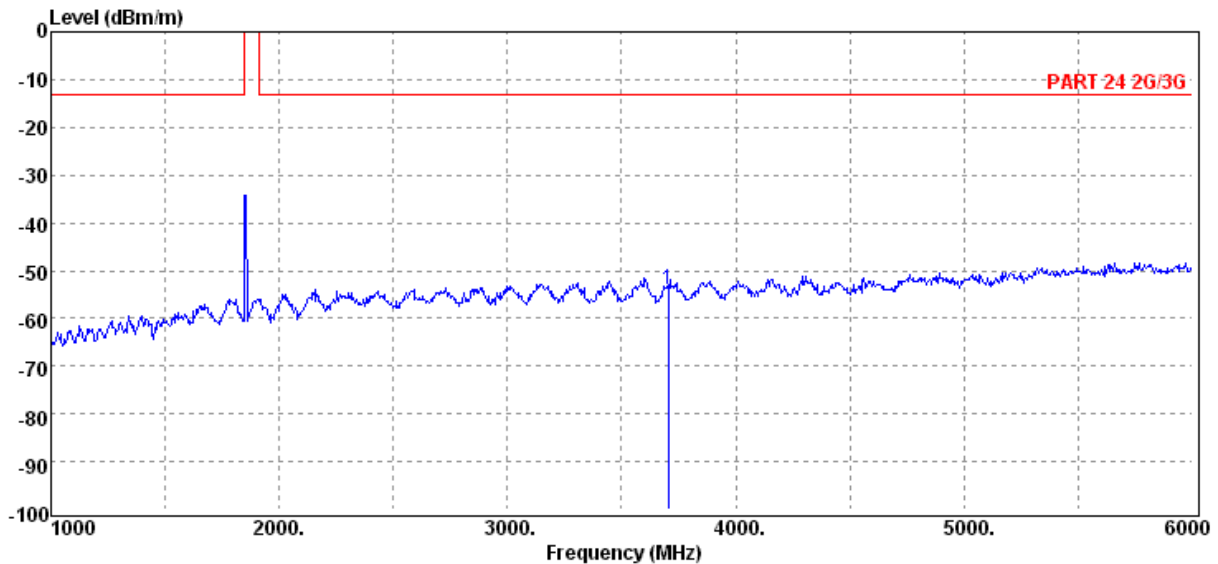
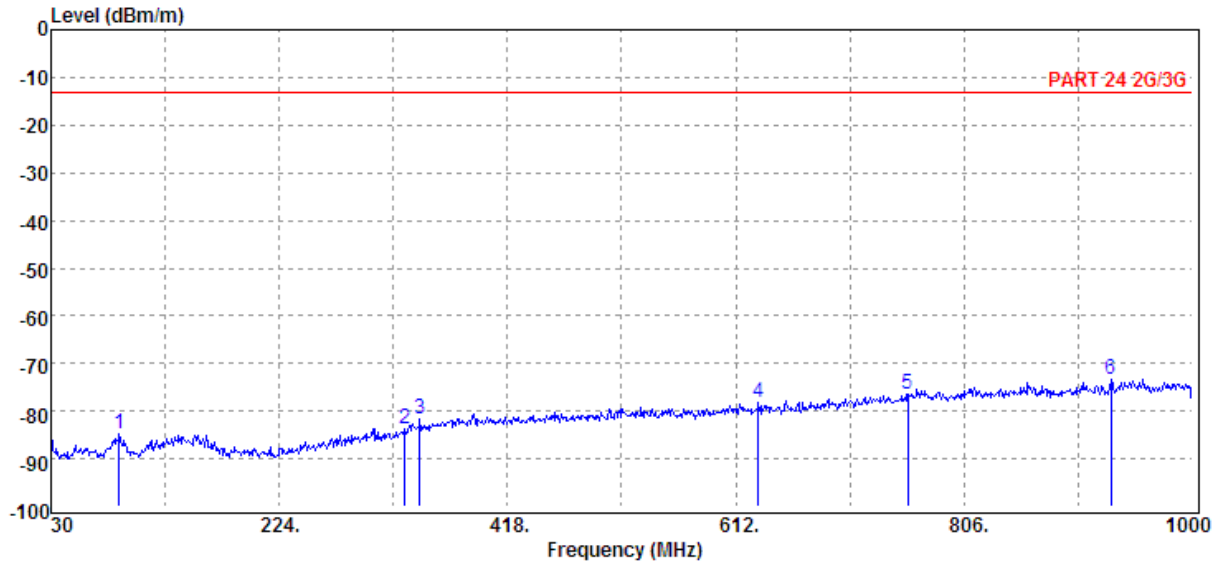

Unless otherwise stated the results shown in this test report refer only to the sample(s) tested and such sample(s) are retained for 90 days only.

除非另有說明，此報告結果僅對測試之樣品負責，同時此樣品僅保留90天。本報告未經本公司書面許可，不可部份複製。

This document is issued by the Company subject to its General Conditions of Service printed overleaf, available on request or accessible at www.sgs.com/terms_and_conditions.htm and, for electronic format documents, subject to Terms and Conditions for Electronic Documents at www.sgs.com/terms_e-document.htm. Attention is drawn to the limitation of liability, indemnification and jurisdiction issues defined therein. Any holder of this document is advised that information contained hereon reflects the Company's findings at the time of its intervention only and within the limits of Client's instructions, if any. The Company's sole responsibility is to its Client and this document does not exonerate parties to a transaction from exercising all their rights and obligations under the transaction documents. This document cannot be reproduced except in full, without prior written approval of the Company. Any unauthorized alteration, forgery or falsification of the content or appearance of this document is unlawful and offenders may be prosecuted to the fullest extent of the law.

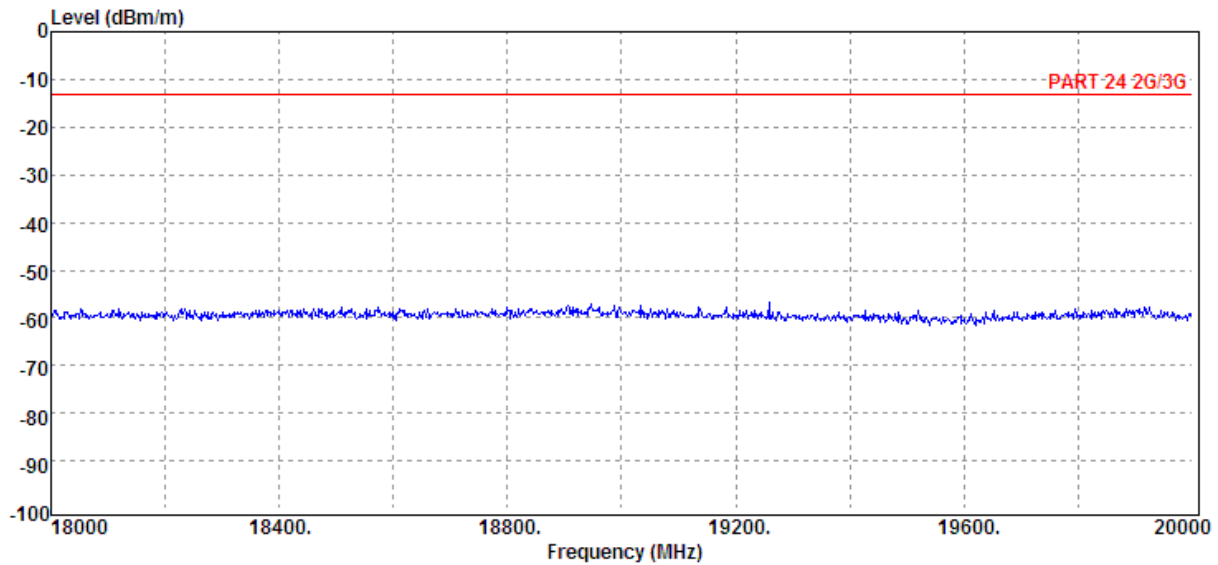
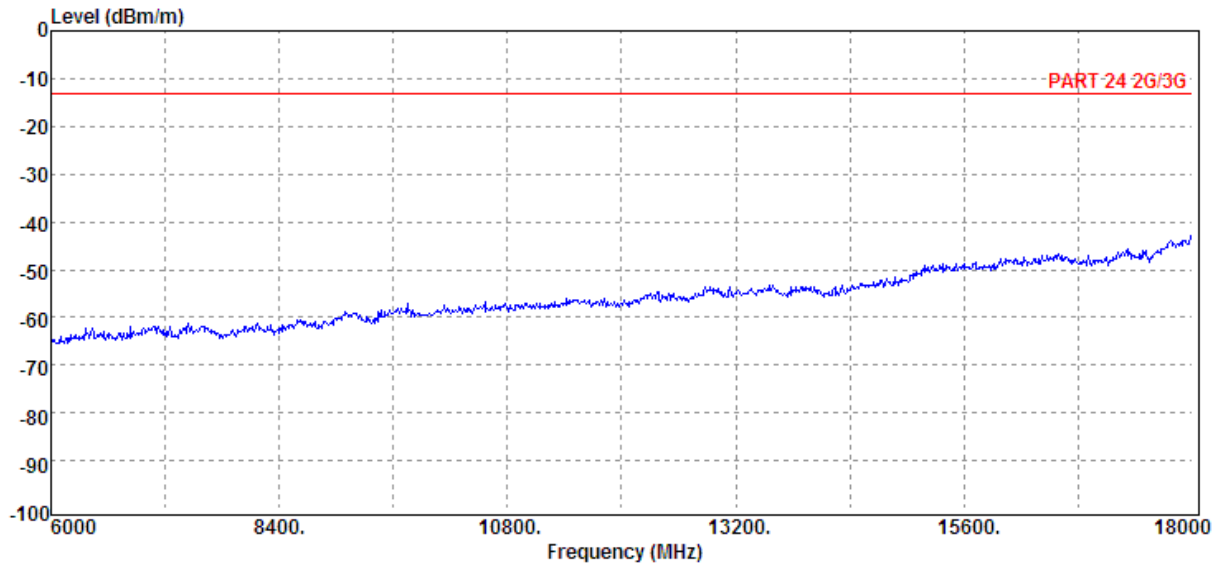

Unless otherwise stated the results shown in this test report refer only to the sample(s) tested and such sample(s) are retained for 90 days only.

除非另有說明，此報告結果僅對測試之樣品負責，同時此樣品僅保留90天。本報告未經本公司書面許可，不可部份複製。

This document is issued by the Company subject to its General Conditions of Service printed overleaf, available on request or accessible at www.sgs.com/terms_and_conditions.htm and, for electronic format documents, subject to Terms and Conditions for Electronic Documents at www.sgs.com/terms_e-document.htm. Attention is drawn to the limitation of liability, indemnification and jurisdiction issues defined therein. Any holder of this document is advised that information contained hereon reflects the Company's findings at the time of its intervention only and within the limits of Client's instructions, if any. The Company's sole responsibility is to its Client and this document does not exonerate parties to a transaction from exercising all their rights and obligations under the transaction documents. This document cannot be reproduced except in full, without prior written approval of the Company. Any unauthorized alteration, forgery or falsification of the content or appearance of this document is unlawful and offenders may be prosecuted to the fullest extent of the law.

| | | | |
|-----------------------|-----------|--------------------------|---------------------|
| Operation Band | :WCDMA B2 | Test Date | :2013-05-03 |
| ARFCN | :CH 9400 | Temp./Humi. | :24.1 deg_C / 65 RH |
| Fundamental Frequency | :1880 MHz | Engineer | :Allen |
| Operation Mode | :TX MID | Measurement Antenna Pol. | :VERTICAL |
| EUT Pol. | :E1 Plan | | |

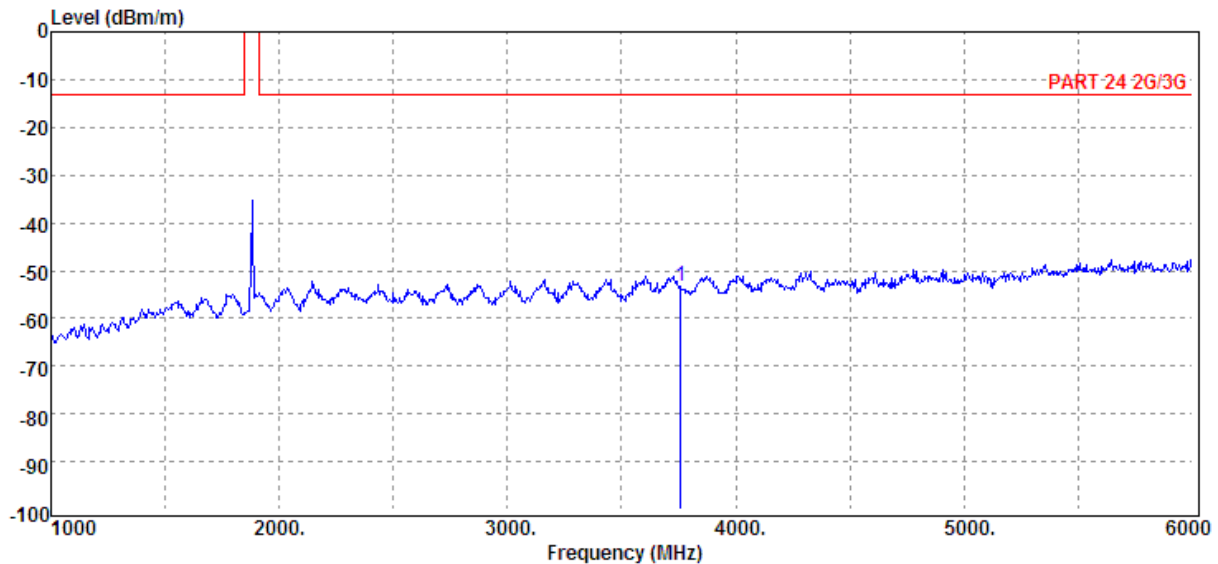
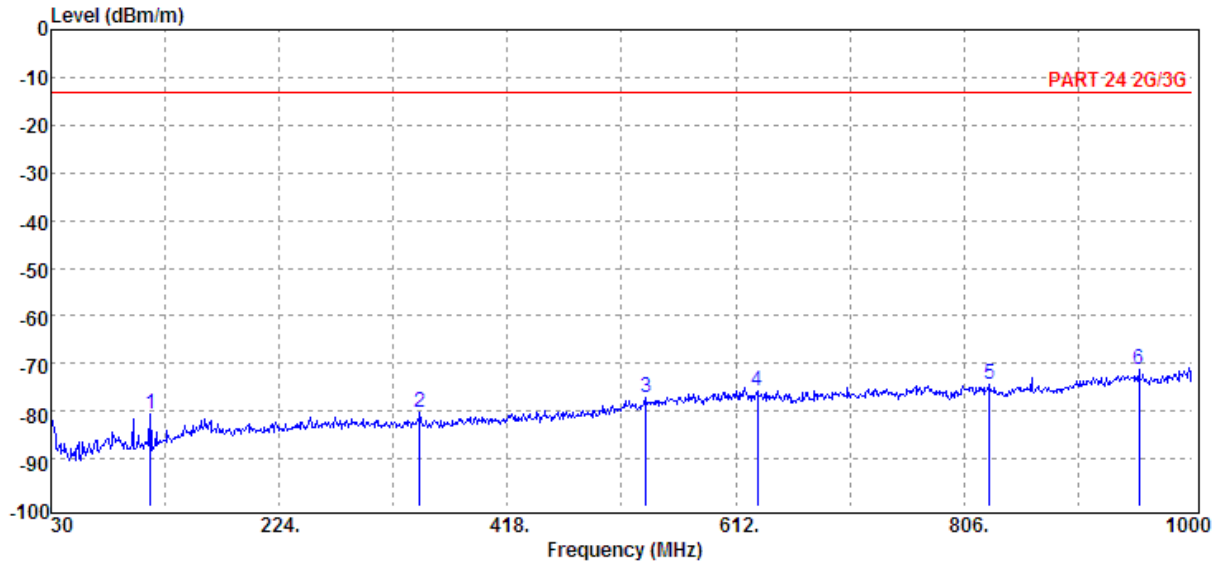

Unless otherwise stated the results shown in this test report refer only to the sample(s) tested and such sample(s) are retained for 90 days only.

除非另有說明，此報告結果僅對測試之樣品負責，同時此樣品僅保留90天。本報告未經本公司書面許可，不可部份複製。

This document is issued by the Company subject to its General Conditions of Service printed overleaf, available on request or accessible at www.sgs.com/terms_and_conditions.htm and, for electronic format documents, subject to Terms and Conditions for Electronic Documents at www.sgs.com/terms_e-document.htm. Attention is drawn to the limitation of liability, indemnification and jurisdiction issues defined therein. Any holder of this document is advised that information contained hereon reflects the Company's findings at the time of its intervention only and within the limits of Client's instructions, if any. The Company's sole responsibility is to its Client and this document does not exonerate parties to a transaction from exercising all their rights and obligations under the transaction documents. This document cannot be reproduced except in full, without prior written approval of the Company. Any unauthorized alteration, forgery or falsification of the content or appearance of this document is unlawful and offenders may be prosecuted to the fullest extent of the law.

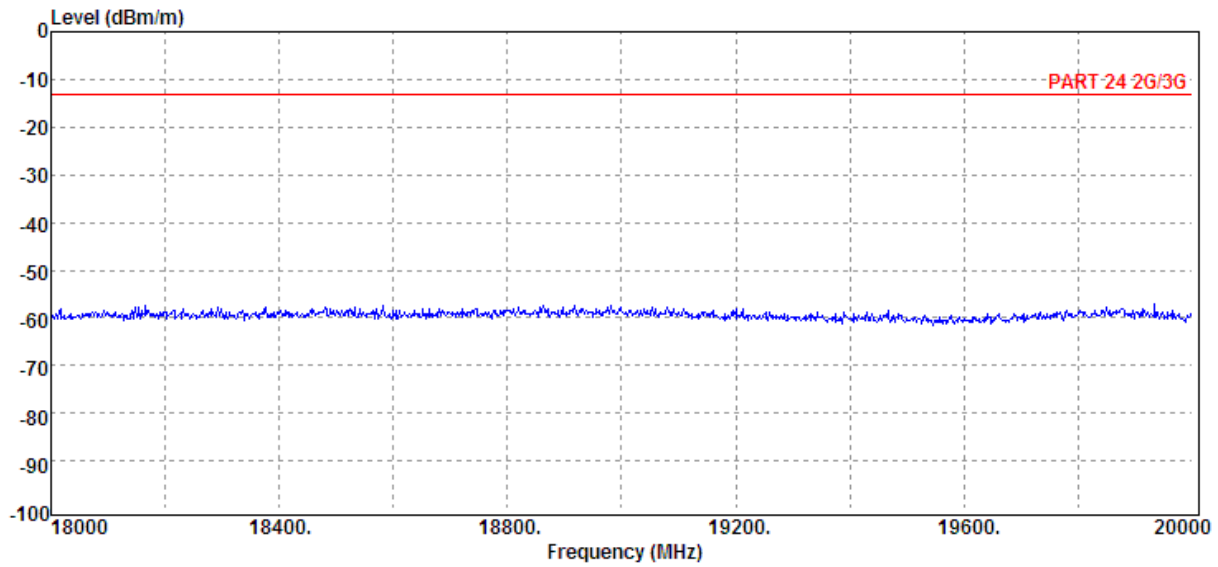
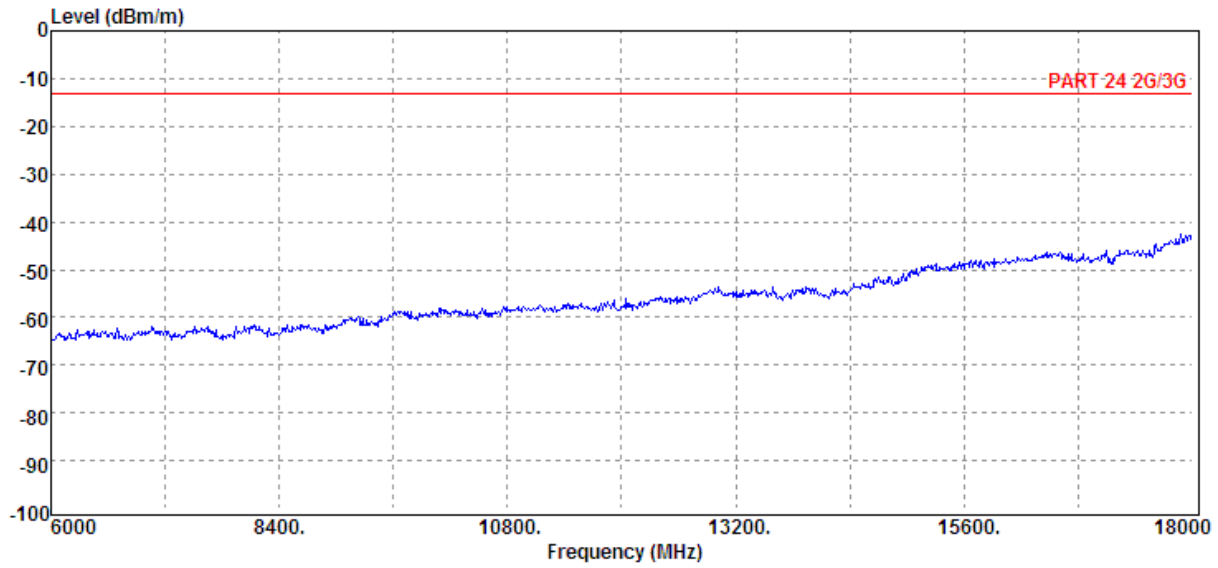

Unless otherwise stated the results shown in this test report refer only to the sample(s) tested and such sample(s) are retained for 90 days only.

除非另有說明，此報告結果僅對測試之樣品負責，同時此樣品僅保留90天。本報告未經本公司書面許可，不可部份複製。

This document is issued by the Company subject to its General Conditions of Service printed overleaf, available on request or accessible at www.sgs.com/terms_and_conditions.htm and, for electronic format documents, subject to Terms and Conditions for Electronic Documents at www.sgs.com/terms_e-document.htm. Attention is drawn to the limitation of liability, indemnification and jurisdiction issues defined therein. Any holder of this document is advised that information contained hereon reflects the Company's findings at the time of its intervention only and within the limits of Client's instructions, if any. The Company's sole responsibility is to its Client and this document does not exonerate parties to a transaction from exercising all their rights and obligations under the transaction documents. This document cannot be reproduced except in full, without prior written approval of the Company. Any unauthorized alteration, forgery or falsification of the content or appearance of this document is unlawful and offenders may be prosecuted to the fullest extent of the law.

| | | | |
|-----------------------|-----------|--------------------------|---------------------|
| Operation Band | :WCDMA B2 | Test Date | :2013-05-03 |
| ARFCN | :CH 9400 | Temp./Humi. | :24.1 deg_C / 65 RH |
| Fundamental Frequency | :1880 MHz | Engineer | :Allen |
| Operation Mode | :TX MID | | |
| EUT Pol. | :E1 Plan | Measurement Antenna Pol. | :HORIZONTAL |

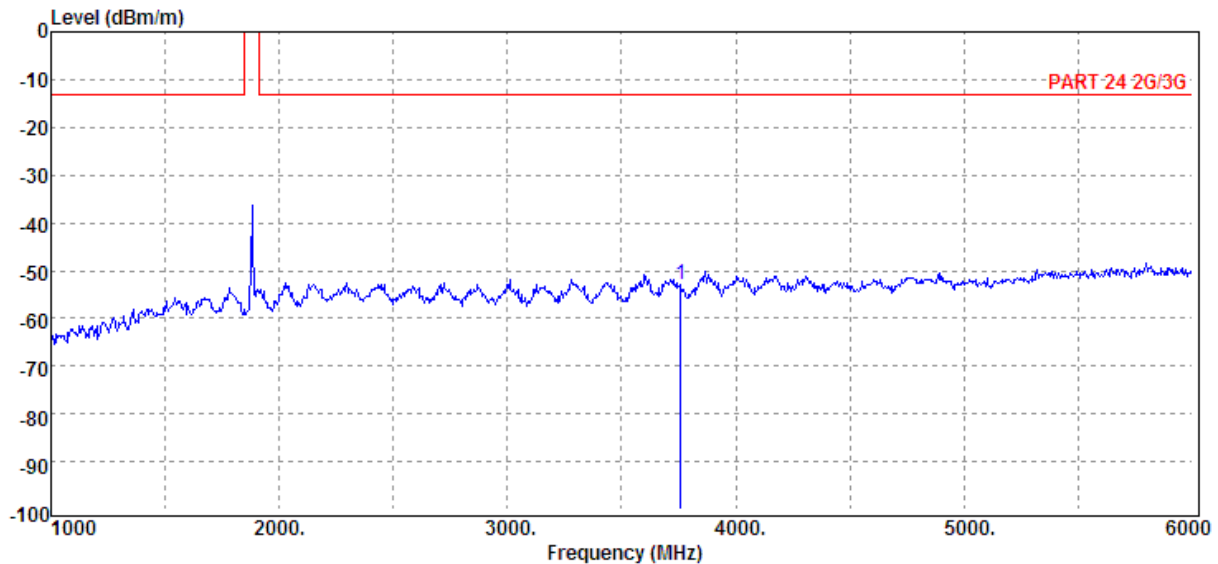
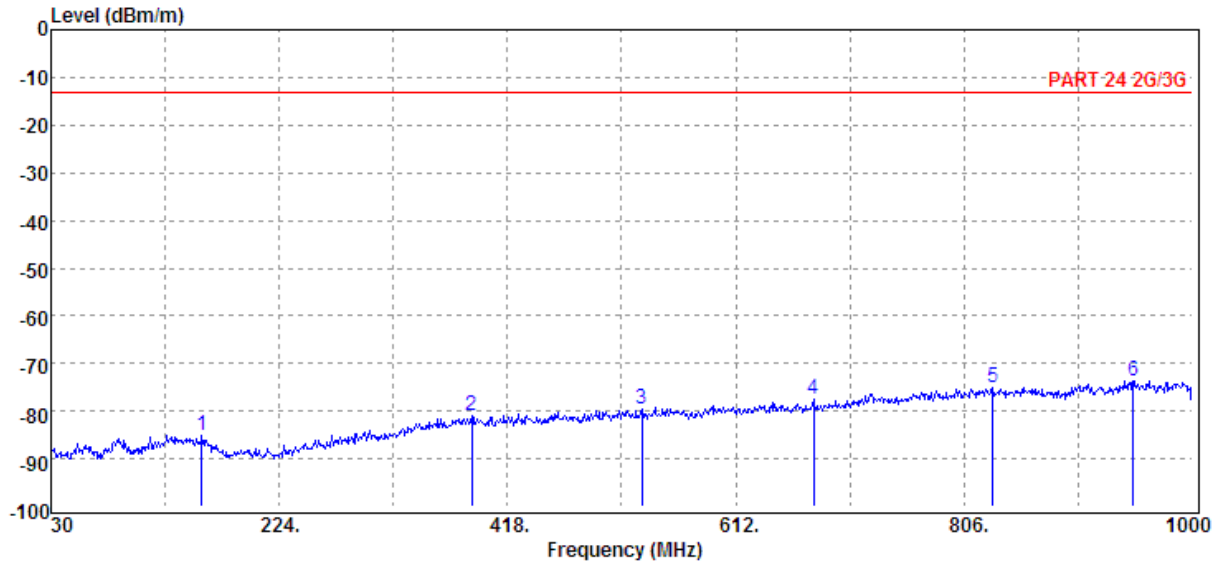

Unless otherwise stated the results shown in this test report refer only to the sample(s) tested and such sample(s) are retained for 90 days only.

除非另有說明，此報告結果僅對測試之樣品負責，同時此樣品僅保留90天。本報告未經本公司書面許可，不可部份複製。

This document is issued by the Company subject to its General Conditions of Service printed overleaf, available on request or accessible at www.sgs.com/terms_and_conditions.htm and, for electronic format documents, subject to Terms and Conditions for Electronic Documents at www.sgs.com/terms_e-document.htm. Attention is drawn to the limitation of liability, indemnification and jurisdiction issues defined therein. Any holder of this document is advised that information contained hereon reflects the Company's findings at the time of its intervention only and within the limits of Client's instructions, if any. The Company's sole responsibility is to its Client and this document does not exonerate parties to a transaction from exercising all their rights and obligations under the transaction documents. This document cannot be reproduced except in full, without prior written approval of the Company. Any unauthorized alteration, forgery or falsification of the content or appearance of this document is unlawful and offenders may be prosecuted to the fullest extent of the law.

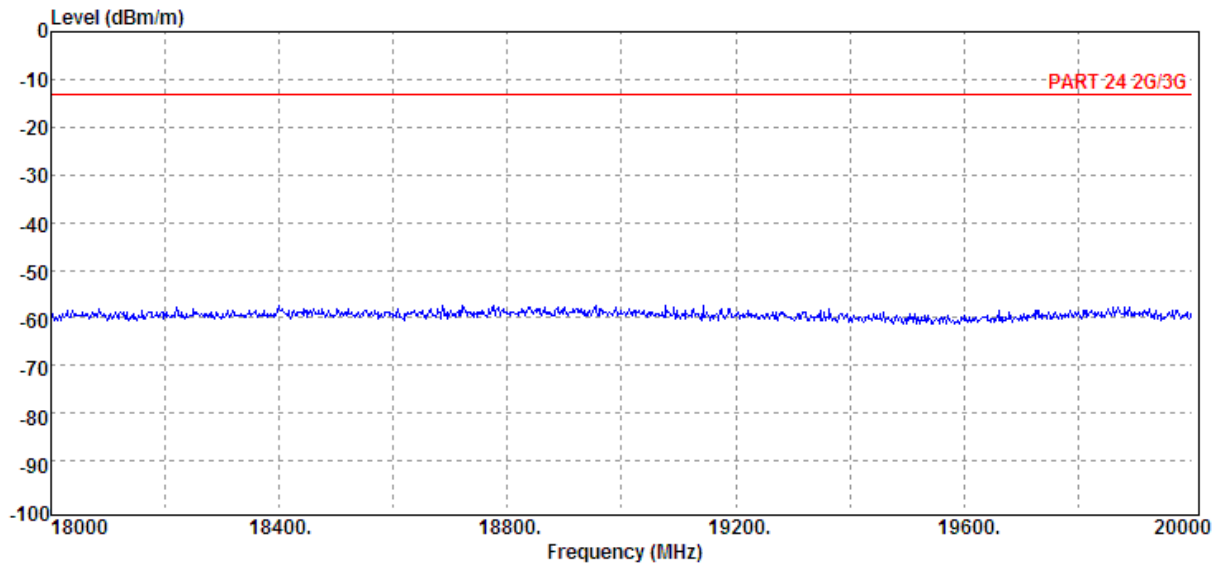
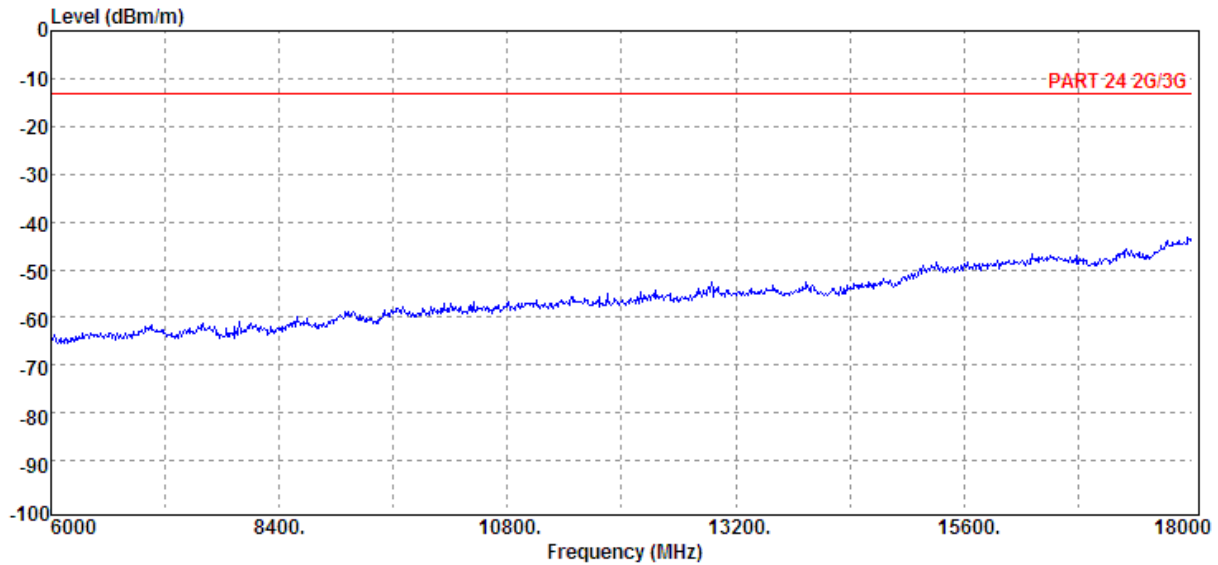

Unless otherwise stated the results shown in this test report refer only to the sample(s) tested and such sample(s) are retained for 90 days only.

除非另有說明，此報告結果僅對測試之樣品負責，同時此樣品僅保留90天。本報告未經本公司書面許可，不可部份複製。

This document is issued by the Company subject to its General Conditions of Service printed overleaf, available on request or accessible at www.sgs.com/terms_and_conditions.htm and, for electronic format documents, subject to Terms and Conditions for Electronic Documents at www.sgs.com/terms_e-document.htm. Attention is drawn to the limitation of liability, indemnification and jurisdiction issues defined therein. Any holder of this document is advised that information contained hereon reflects the Company's findings at the time of its intervention only and within the limits of Client's instructions, if any. The Company's sole responsibility is to its Client and this document does not exonerate parties to a transaction from exercising all their rights and obligations under the transaction documents. This document cannot be reproduced except in full, without prior written approval of the Company. Any unauthorized alteration, forgery or falsification of the content or appearance of this document is unlawful and offenders may be prosecuted to the fullest extent of the law.

| | | | |
|-----------------------|-------------|--------------------------|---------------------|
| Operation Band | :WCDMA B2 | Test Date | :2013-05-03 |
| ARFCN | :CH 9538 | Temp./Humi. | :24.1 deg_C / 65 RH |
| Fundamental Frequency | :1907.6 MHz | Engineer | :Allen |
| Operation Mode | :TX HIGH | Measurement Antenna Pol. | :VERTICAL |
| EUT Pol. | :E1 Plan | | |

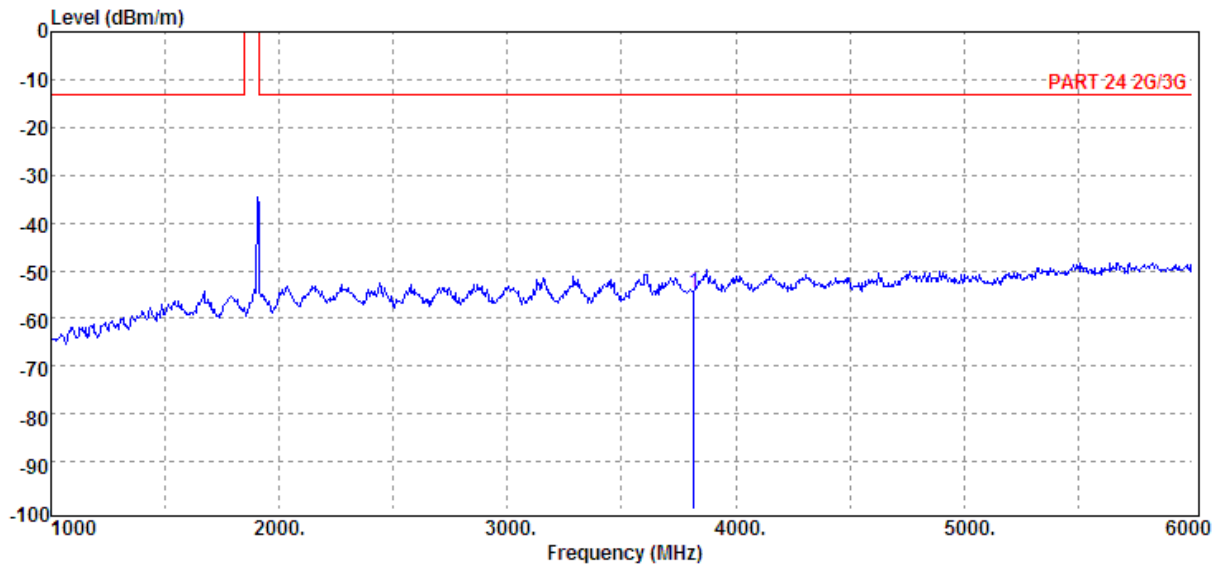
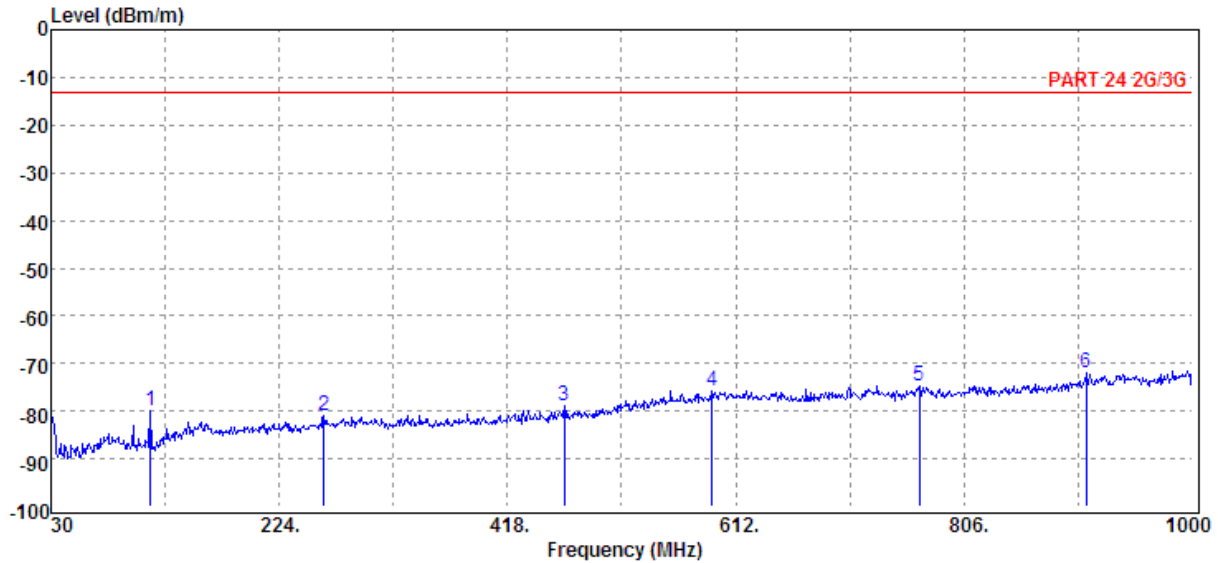

Unless otherwise stated the results shown in this test report refer only to the sample(s) tested and such sample(s) are retained for 90 days only.

除非另有說明，此報告結果僅對測試之樣品負責，同時此樣品僅保留90天。本報告未經本公司書面許可，不可部份複製。

This document is issued by the Company subject to its General Conditions of Service printed overleaf, available on request or accessible at www.sgs.com/terms_and_conditions.htm and, for electronic format documents, subject to Terms and Conditions for Electronic Documents at www.sgs.com/terms_e-document.htm. Attention is drawn to the limitation of liability, indemnification and jurisdiction issues defined therein. Any holder of this document is advised that information contained hereon reflects the Company's findings at the time of its intervention only and within the limits of Client's instructions, if any. The Company's sole responsibility is to its Client and this document does not exonerate parties to a transaction from exercising all their rights and obligations under the transaction documents. This document cannot be reproduced except in full, without prior written approval of the Company. Any unauthorized alteration, forgery or falsification of the content or appearance of this document is unlawful and offenders may be prosecuted to the fullest extent of the law.

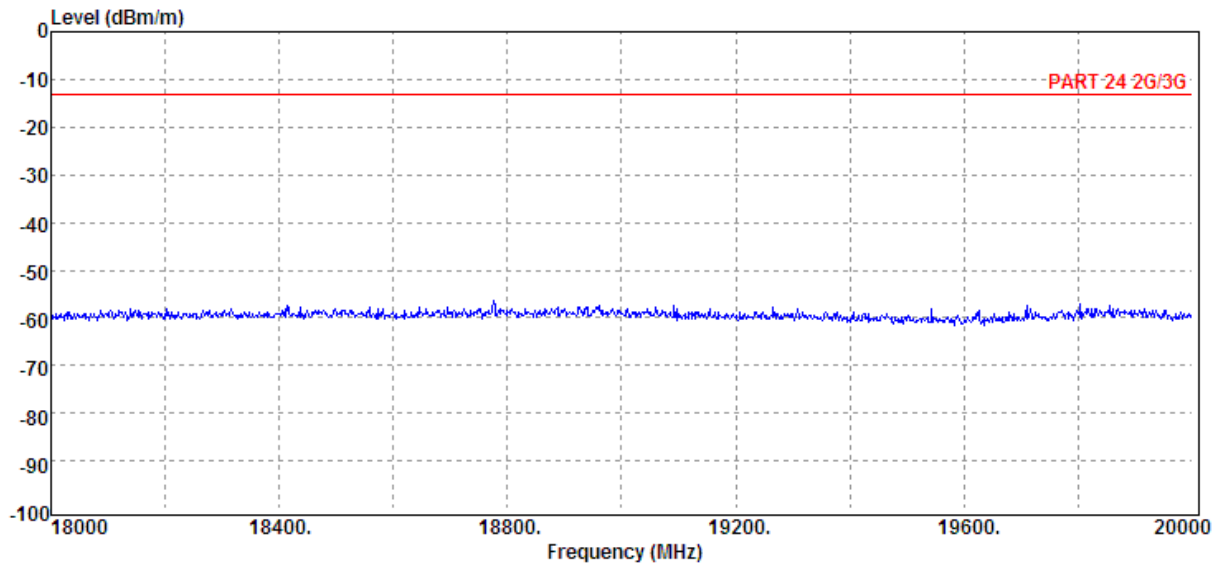
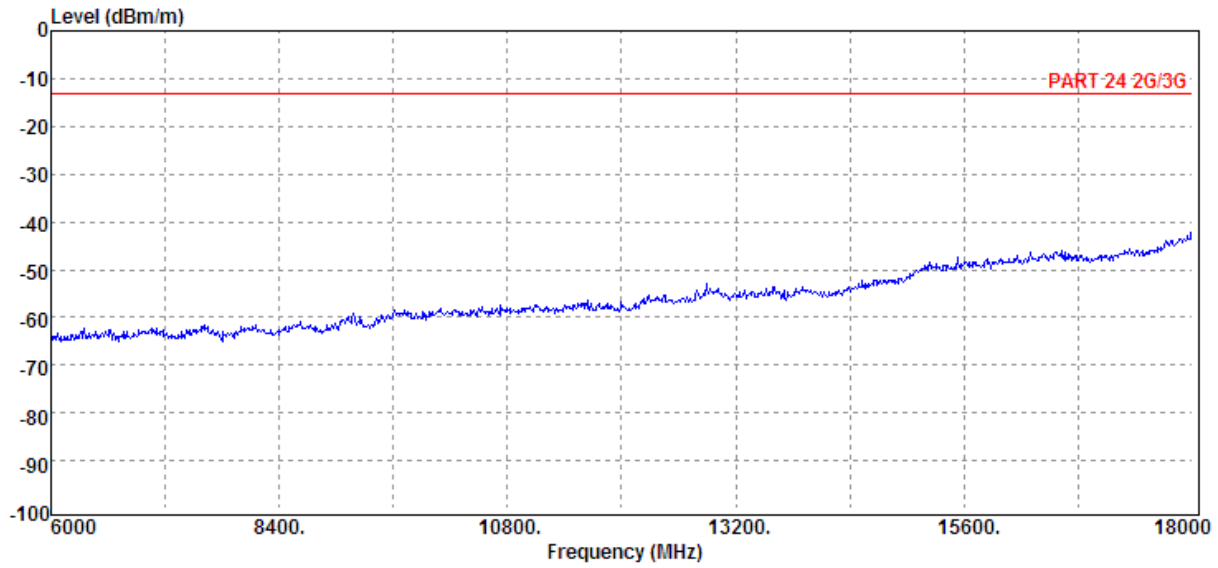

Unless otherwise stated the results shown in this test report refer only to the sample(s) tested and such sample(s) are retained for 90 days only.

除非另有說明，此報告結果僅對測試之樣品負責，同時此樣品僅保留90天。本報告未經本公司書面許可，不可部份複製。

This document is issued by the Company subject to its General Conditions of Service printed overleaf, available on request or accessible at www.sgs.com/terms_and_conditions.htm and, for electronic format documents, subject to Terms and Conditions for Electronic Documents at www.sgs.com/terms_e-document.htm. Attention is drawn to the limitation of liability, indemnification and jurisdiction issues defined therein. Any holder of this document is advised that information contained hereon reflects the Company's findings at the time of its intervention only and within the limits of Client's instructions, if any. The Company's sole responsibility is to its Client and this document does not exonerate parties to a transaction from exercising all their rights and obligations under the transaction documents. This document cannot be reproduced except in full, without prior written approval of the Company. Any unauthorized alteration, forgery or falsification of the content or appearance of this document is unlawful and offenders may be prosecuted to the fullest extent of the law.

| | | | |
|-----------------------|-------------|--------------------------|---------------------|
| Operation Band | :WCDMA B2 | Test Date | :2013-05-03 |
| ARFCN | :CH 9538 | Temp./Humi. | :24.1 deg_C / 65 RH |
| Fundamental Frequency | :1907.6 MHz | Engineer | :Allen |
| Operation Mode | :TX HIGH | Measurement Antenna Pol. | :HORIZONTAL |
| EUT Pol. | :E1 Plan | | |

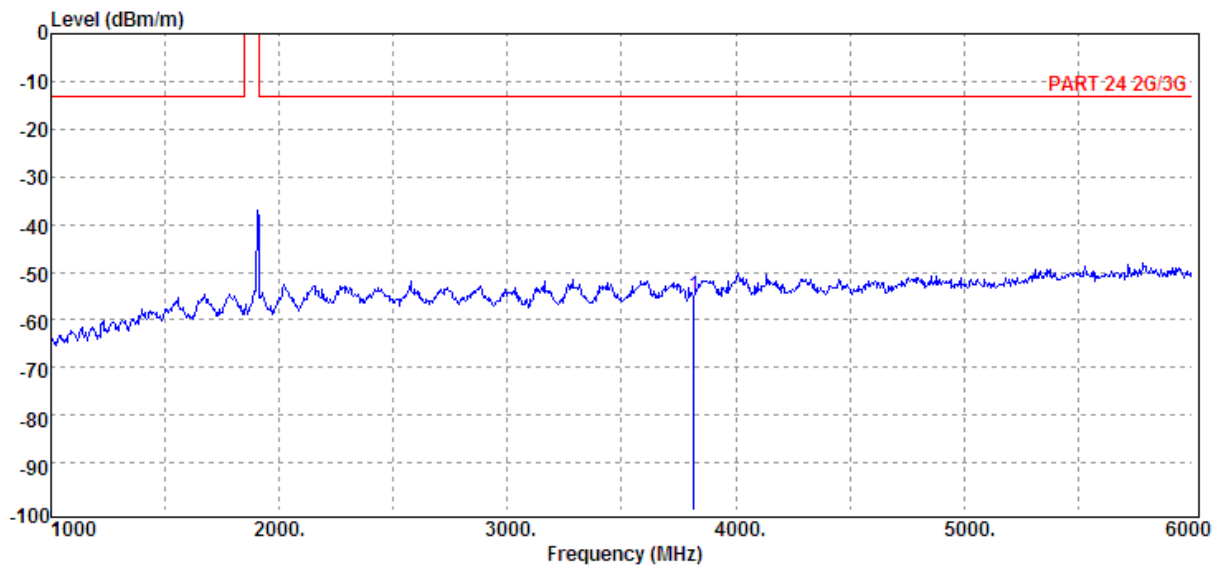
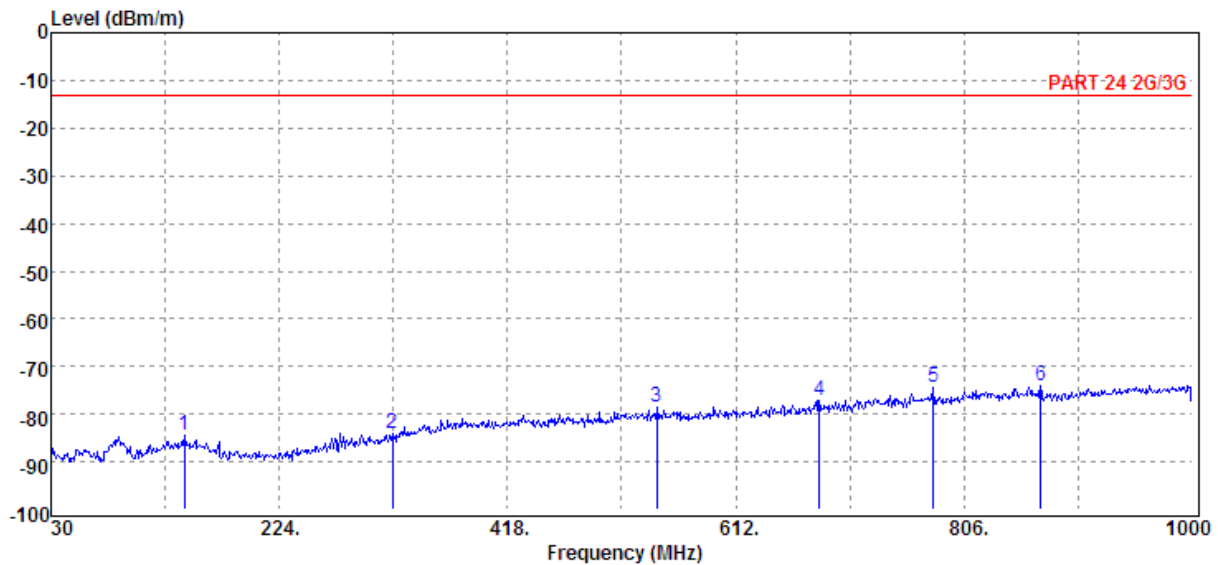

Unless otherwise stated the results shown in this test report refer only to the sample(s) tested and such sample(s) are retained for 90 days only.

除非另有說明，此報告結果僅對測試之樣品負責，同時此樣品僅保留90天。本報告未經本公司書面許可，不可部份複製。

This document is issued by the Company subject to its General Conditions of Service printed overleaf, available on request or accessible at www.sgs.com/terms_and_conditions.htm and, for electronic format documents, subject to Terms and Conditions for Electronic Documents at www.sgs.com/terms_e-document.htm. Attention is drawn to the limitation of liability, indemnification and jurisdiction issues defined therein. Any holder of this document is advised that information contained hereon reflects the Company's findings at the time of its intervention only and within the limits of Client's instructions, if any. The Company's sole responsibility is to its Client and this document does not exonerate parties to a transaction from exercising all their rights and obligations under the transaction documents. This document cannot be reproduced except in full, without prior written approval of the Company. Any unauthorized alteration, forgery or falsification of the content or appearance of this document is unlawful and offenders may be prosecuted to the fullest extent of the law.

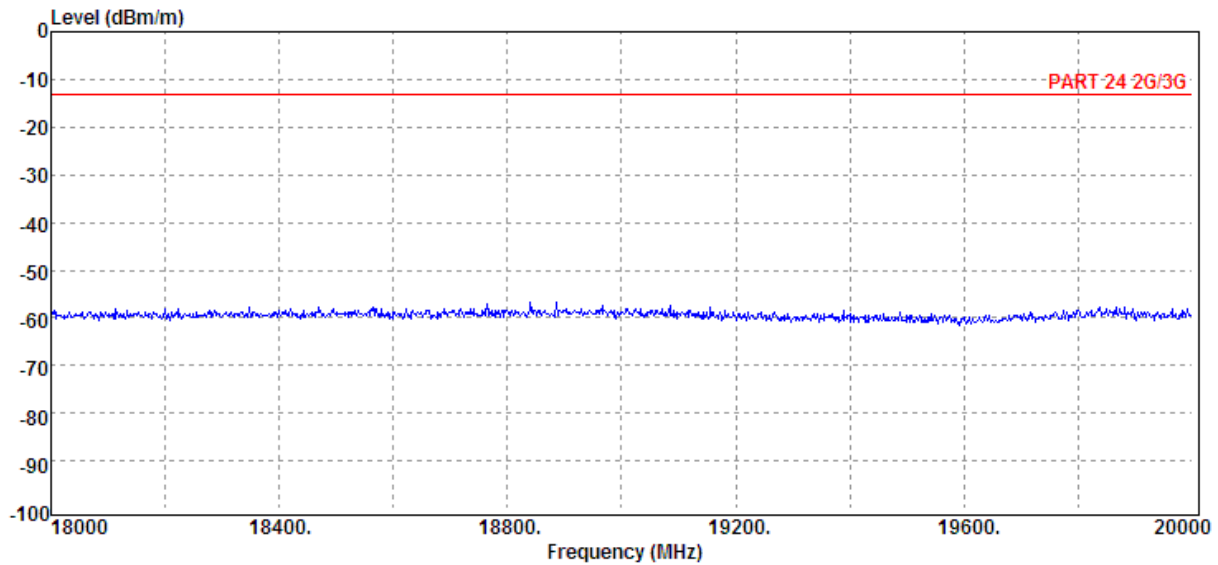
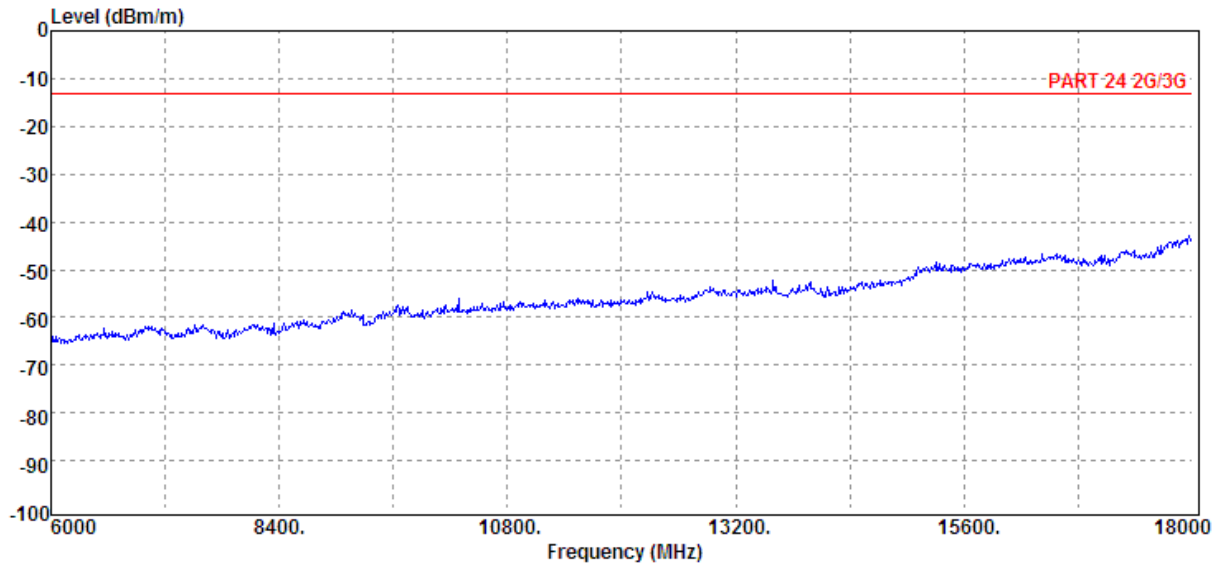

Unless otherwise stated the results shown in this test report refer only to the sample(s) tested and such sample(s) are retained for 90 days only.

除非另有說明，此報告結果僅對測試之樣品負責，同時此樣品僅保留90天。本報告未經本公司書面許可，不可部份複製。

This document is issued by the Company subject to its General Conditions of Service printed overleaf, available on request or accessible at www.sgs.com/terms_and_conditions.htm and, for electronic format documents, subject to Terms and Conditions for Electronic Documents at www.sgs.com/terms_e-document.htm. Attention is drawn to the limitation of liability, indemnification and jurisdiction issues defined therein. Any holder of this document is advised that information contained hereon reflects the Company's findings at the time of its intervention only and within the limits of Client's instructions, if any. The Company's sole responsibility is to its Client and this document does not exonerate parties to a transaction from exercising all their rights and obligations under the transaction documents. This document cannot be reproduced except in full, without prior written approval of the Company. Any unauthorized alteration, forgery or falsification of the content or appearance of this document is unlawful and offenders may be prosecuted to the fullest extent of the law.

Radiated Spurious Emission Measurement Result: WCDMA IV Mode

| | | | |
|-----------------------|-------------|--------------------------|---------------------|
| Operation Band | :WCDMA B4 | Test Date | : 2013-07-16 |
| ARFCN | :CH 1312 | Temp./Humi. | :24.1 deg_C / 65 RH |
| Fundamental Frequency | :1712.4 MHz | Engineer | :Allen |
| Operation Mode | :TX LOW | | |
| EUT Pol. | :H Plan | Measurement Antenna Pol. | :VERTICAL |

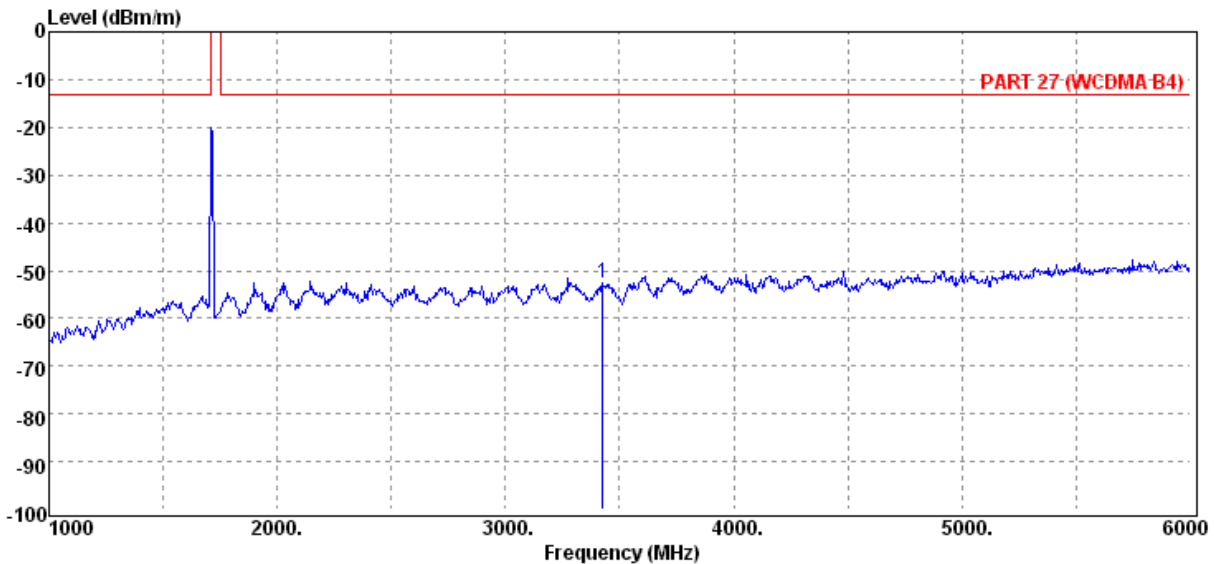
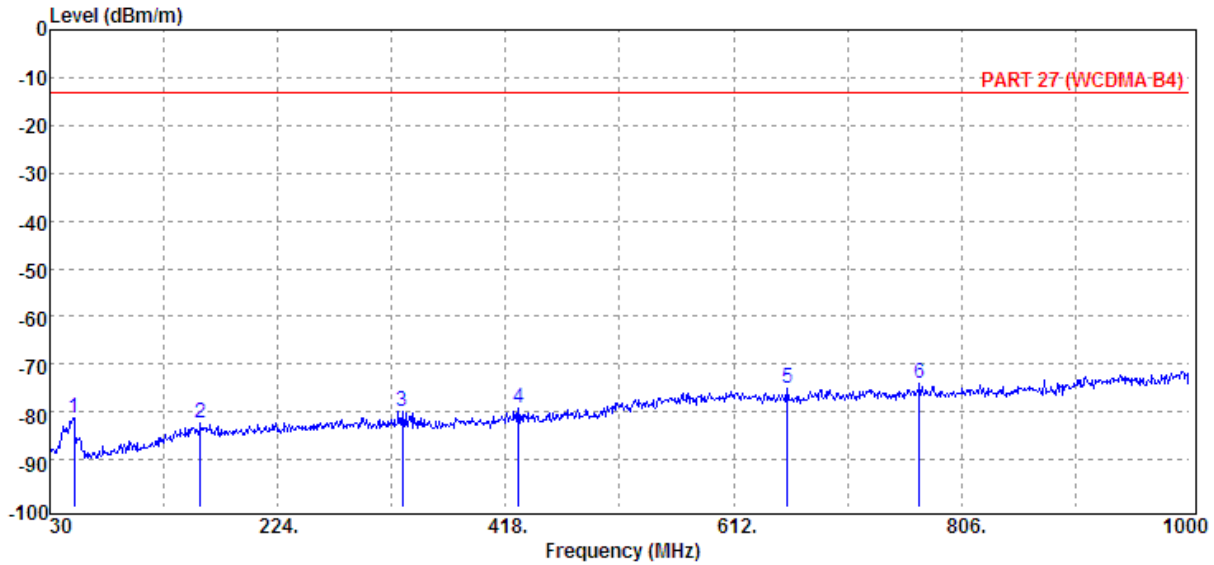

Unless otherwise stated the results shown in this test report refer only to the sample(s) tested and such sample(s) are retained for 90 days only.

除非另有說明，此報告結果僅對測試之樣品負責，同時此樣品僅保留90天。本報告未經本公司書面許可，不可部份複製。

This document is issued by the Company subject to its General Conditions of Service printed overleaf, available on request or accessible at www.sgs.com/terms_and_conditions.htm and, for electronic format documents, subject to Terms and Conditions for Electronic Documents at www.sgs.com/terms_e-document.htm. Attention is drawn to the limitation of liability, indemnification and jurisdiction issues defined therein. Any holder of this document is advised that information contained hereon reflects the Company's findings at the time of its intervention only and within the limits of Client's instructions, if any. The Company's sole responsibility is to its Client and this document does not exonerate parties to a transaction from exercising all their rights and obligations under the transaction documents. This document cannot be reproduced except in full, without prior written approval of the Company. Any unauthorized alteration, forgery or falsification of the content or appearance of this document is unlawful and offenders may be prosecuted to the fullest extent of the law.

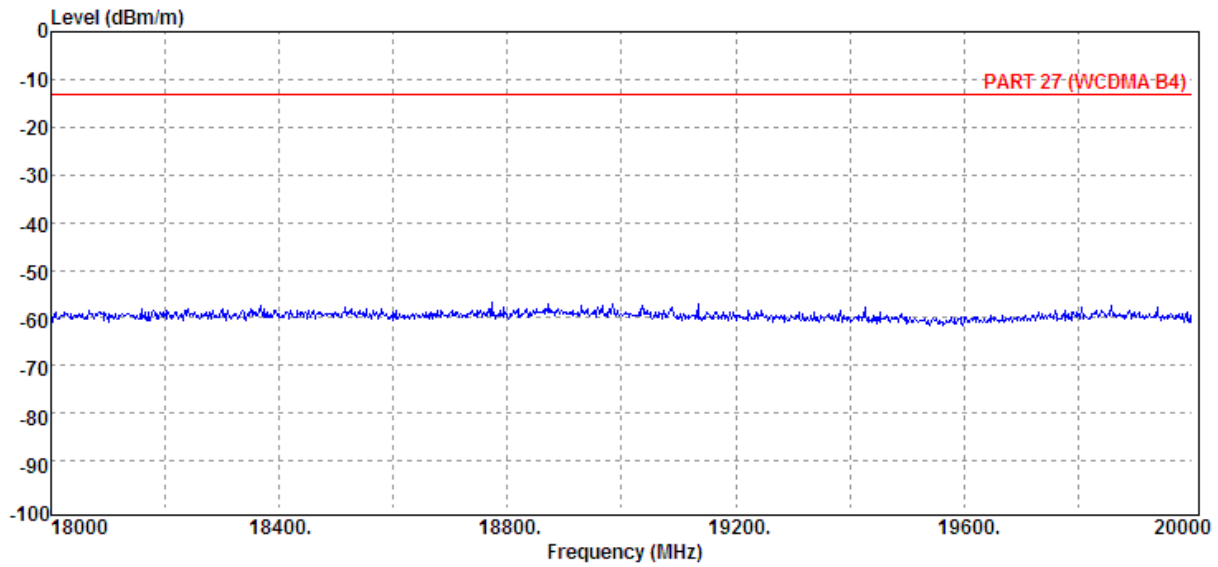
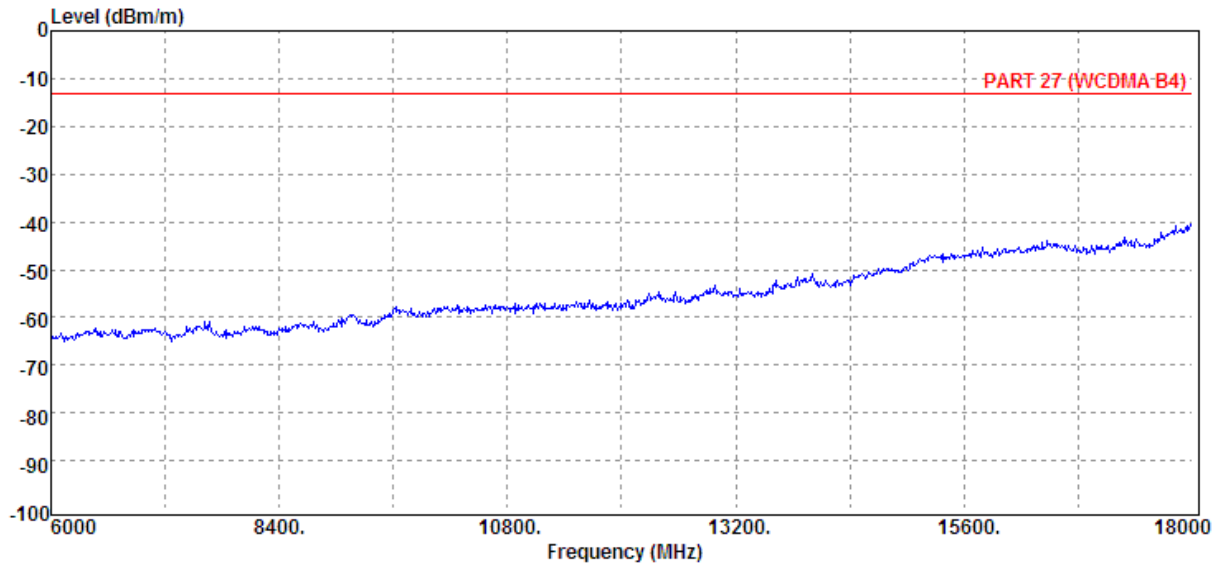

Unless otherwise stated the results shown in this test report refer only to the sample(s) tested and such sample(s) are retained for 90 days only.

除非另有說明，此報告結果僅對測試之樣品負責，同時此樣品僅保留90天。本報告未經本公司書面許可，不可部份複製。

This document is issued by the Company subject to its General Conditions of Service printed overleaf, available on request or accessible at www.sgs.com/terms_and_conditions.htm and, for electronic format documents, subject to Terms and Conditions for Electronic Documents at www.sgs.com/terms_e-document.htm. Attention is drawn to the limitation of liability, indemnification and jurisdiction issues defined therein. Any holder of this document is advised that information contained hereon reflects the Company's findings at the time of its intervention only and within the limits of Client's instructions, if any. The Company's sole responsibility is to its Client and this document does not exonerate parties to a transaction from exercising all their rights and obligations under the transaction documents. This document cannot be reproduced except in full, without prior written approval of the Company. Any unauthorized alteration, forgery or falsification of the content or appearance of this document is unlawful and offenders may be prosecuted to the fullest extent of the law.

| | | | |
|-----------------------|-------------|--------------------------|---------------------|
| Operation Band | :WCDMA B4 | Test Date | : 2013-07-16 |
| ARFCN | :CH 1312 | Temp./Humi. | :24.1 deg_C / 65 RH |
| Fundamental Frequency | :1712.4 MHz | Engineer | :Allen |
| Operation Mode | :TX LOW | Measurement Antenna Pol. | :HORIZONTAL |
| EUT Pol. | :H Plan | | |

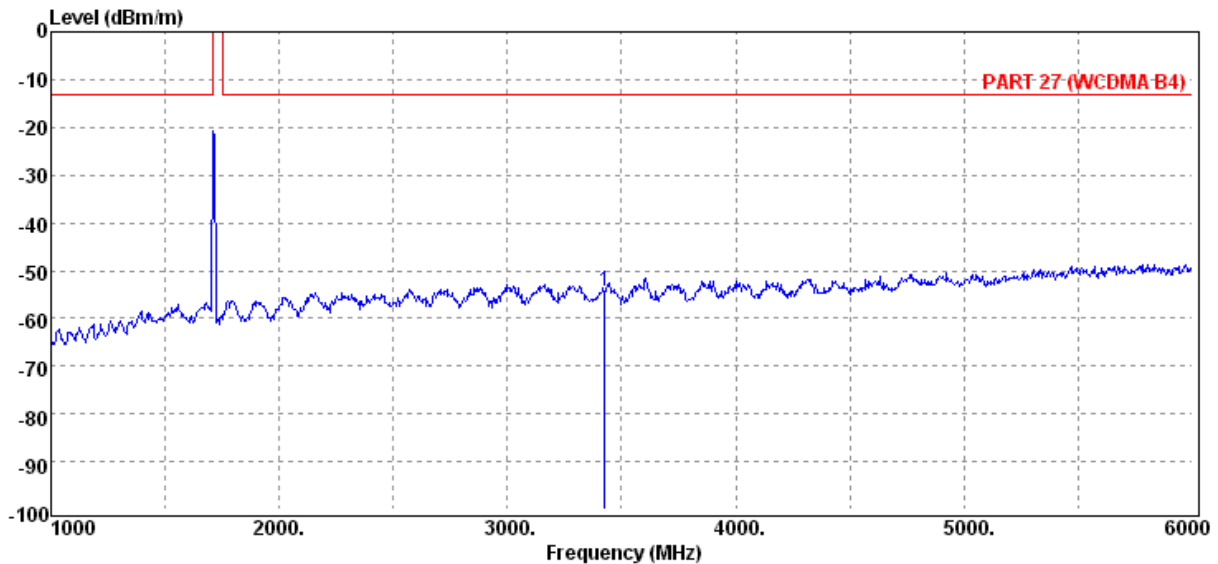
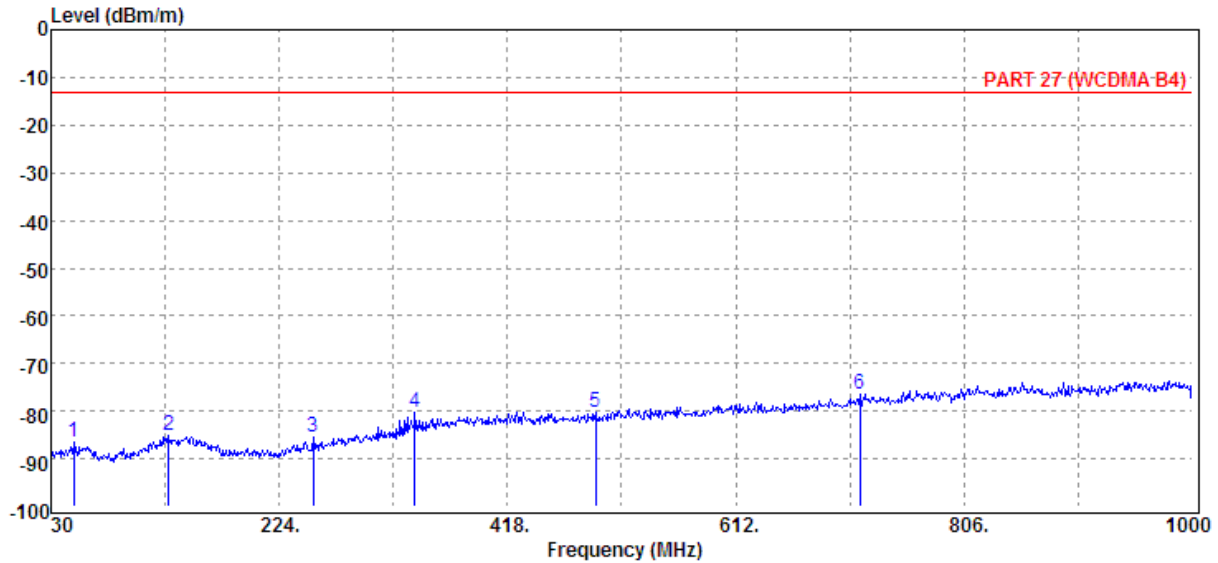

Unless otherwise stated the results shown in this test report refer only to the sample(s) tested and such sample(s) are retained for 90 days only.

除非另有說明，此報告結果僅對測試之樣品負責，同時此樣品僅保留90天。本報告未經本公司書面許可，不可部份複製。

This document is issued by the Company subject to its General Conditions of Service printed overleaf, available on request or accessible at www.sgs.com/terms_and_conditions.htm and, for electronic format documents, subject to Terms and Conditions for Electronic Documents at www.sgs.com/terms_e-document.htm. Attention is drawn to the limitation of liability, indemnification and jurisdiction issues defined therein. Any holder of this document is advised that information contained hereon reflects the Company's findings at the time of its intervention only and within the limits of Client's instructions, if any. The Company's sole responsibility is to its Client and this document does not exonerate parties to a transaction from exercising all their rights and obligations under the transaction documents. This document cannot be reproduced except in full, without prior written approval of the Company. Any unauthorized alteration, forgery or falsification of the content or appearance of this document is unlawful and offenders may be prosecuted to the fullest extent of the law.

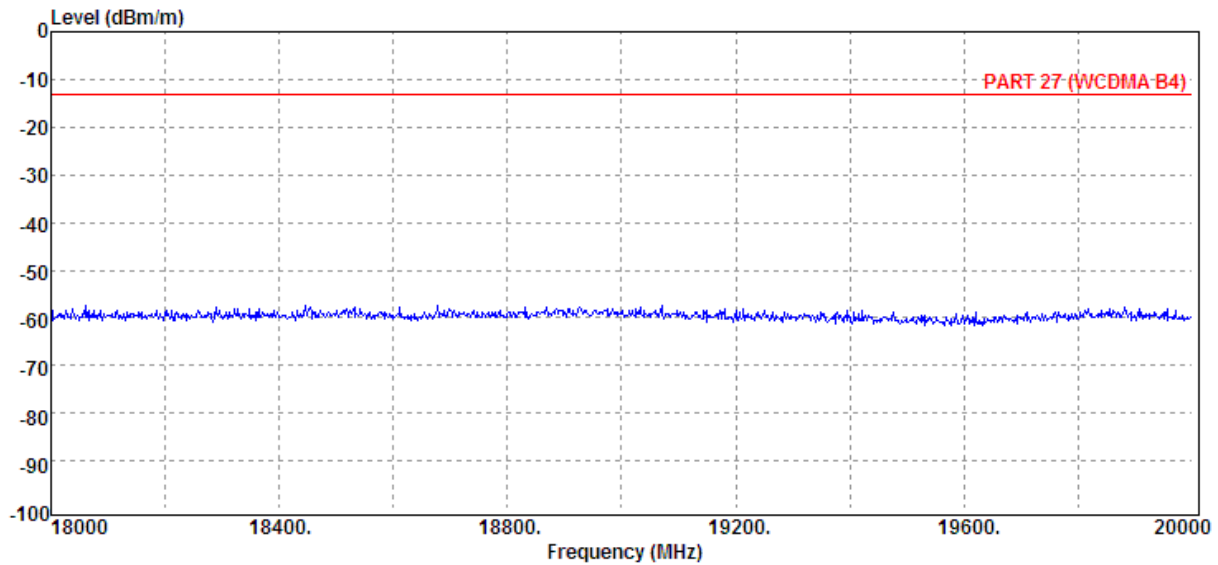
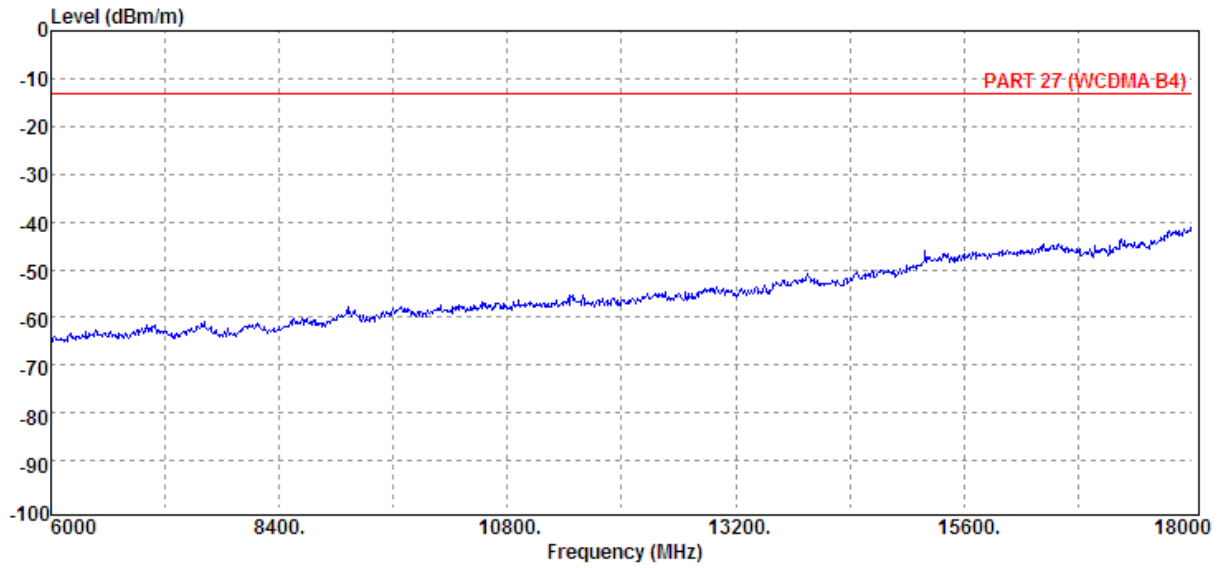

Unless otherwise stated the results shown in this test report refer only to the sample(s) tested and such sample(s) are retained for 90 days only.

除非另有說明，此報告結果僅對測試之樣品負責，同時此樣品僅保留90天。本報告未經本公司書面許可，不可部份複製。

This document is issued by the Company subject to its General Conditions of Service printed overleaf, available on request or accessible at www.sgs.com/terms_and_conditions.htm and, for electronic format documents, subject to Terms and Conditions for Electronic Documents at www.sgs.com/terms_e-document.htm. Attention is drawn to the limitation of liability, indemnification and jurisdiction issues defined therein. Any holder of this document is advised that information contained hereon reflects the Company's findings at the time of its intervention only and within the limits of Client's instructions, if any. The Company's sole responsibility is to its Client and this document does not exonerate parties to a transaction from exercising all their rights and obligations under the transaction documents. This document cannot be reproduced except in full, without prior written approval of the Company. Any unauthorized alteration, forgery or falsification of the content or appearance of this document is unlawful and offenders may be prosecuted to the fullest extent of the law.

| | | | |
|-----------------------|-------------|--------------------------|---------------------|
| Operation Band | :WCDMA B4 | Test Date | :2013-05-03 |
| ARFCN | :CH 1413 | Temp./Humi. | :24.1 deg_C / 65 RH |
| Fundamental Frequency | :1732.6 MHz | Engineer | :Allen |
| Operation Mode | :TX MID | Measurement Antenna Pol. | :VERTICAL |
| EUT Pol. | :H Plan | | |

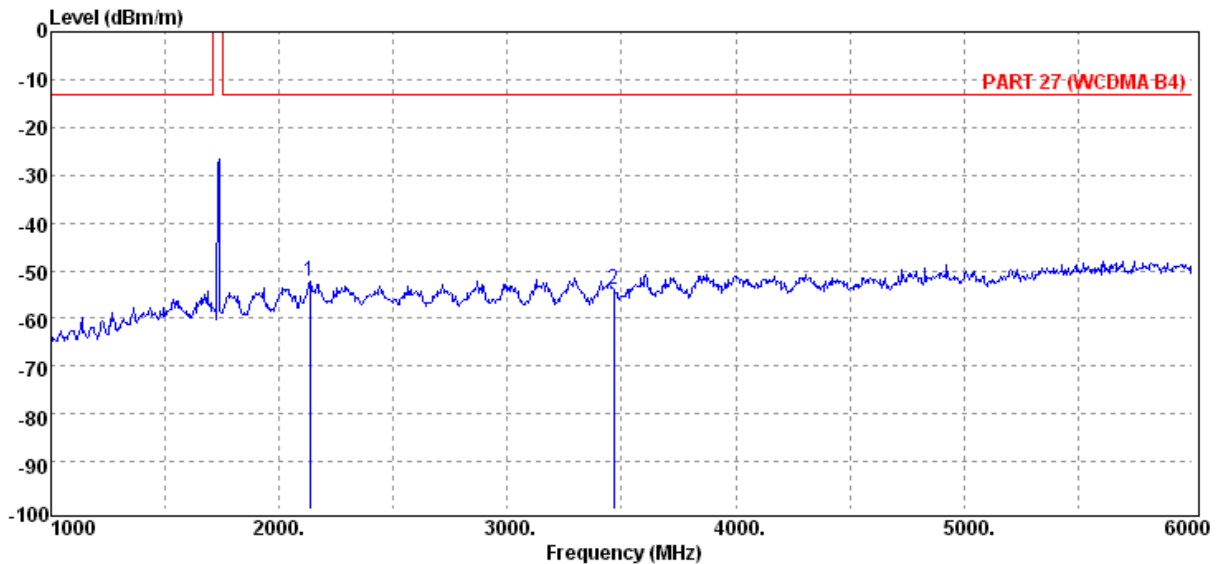
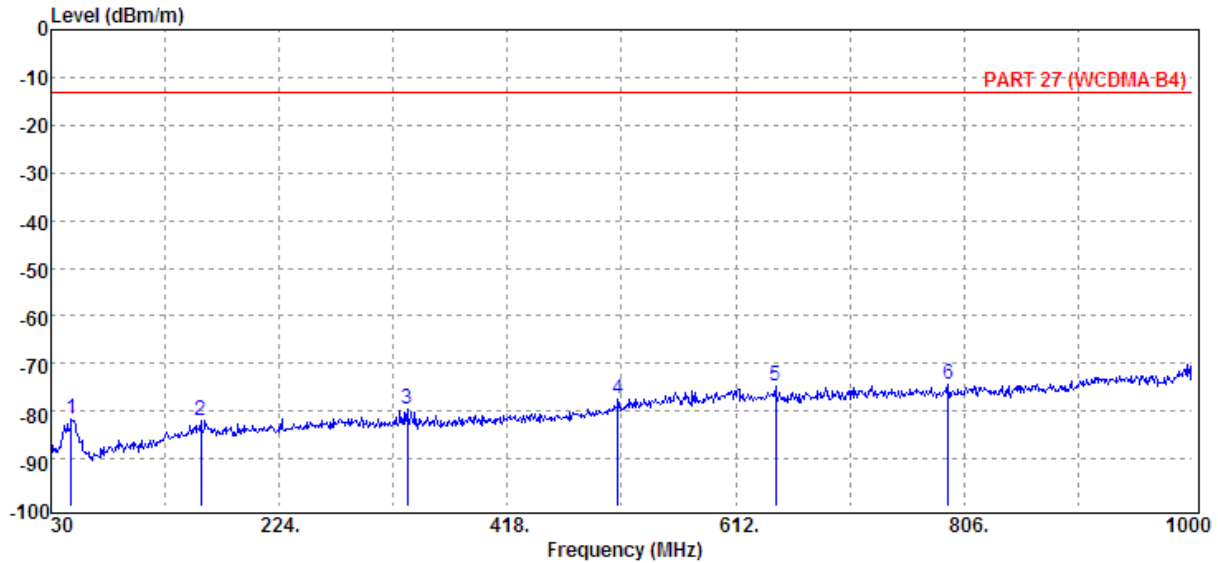

Unless otherwise stated the results shown in this test report refer only to the sample(s) tested and such sample(s) are retained for 90 days only.

除非另有說明，此報告結果僅對測試之樣品負責，同時此樣品僅保留90天。本報告未經本公司書面許可，不可部份複製。

This document is issued by the Company subject to its General Conditions of Service printed overleaf, available on request or accessible at www.sgs.com/terms_and_conditions.htm and, for electronic format documents, subject to Terms and Conditions for Electronic Documents at www.sgs.com/terms_e-document.htm. Attention is drawn to the limitation of liability, indemnification and jurisdiction issues defined therein. Any holder of this document is advised that information contained hereon reflects the Company's findings at the time of its intervention only and within the limits of Client's instructions, if any. The Company's sole responsibility is to its Client and this document does not exonerate parties to a transaction from exercising all their rights and obligations under the transaction documents. This document cannot be reproduced except in full, without prior written approval of the Company. Any unauthorized alteration, forgery or falsification of the content or appearance of this document is unlawful and offenders may be prosecuted to the fullest extent of the law.

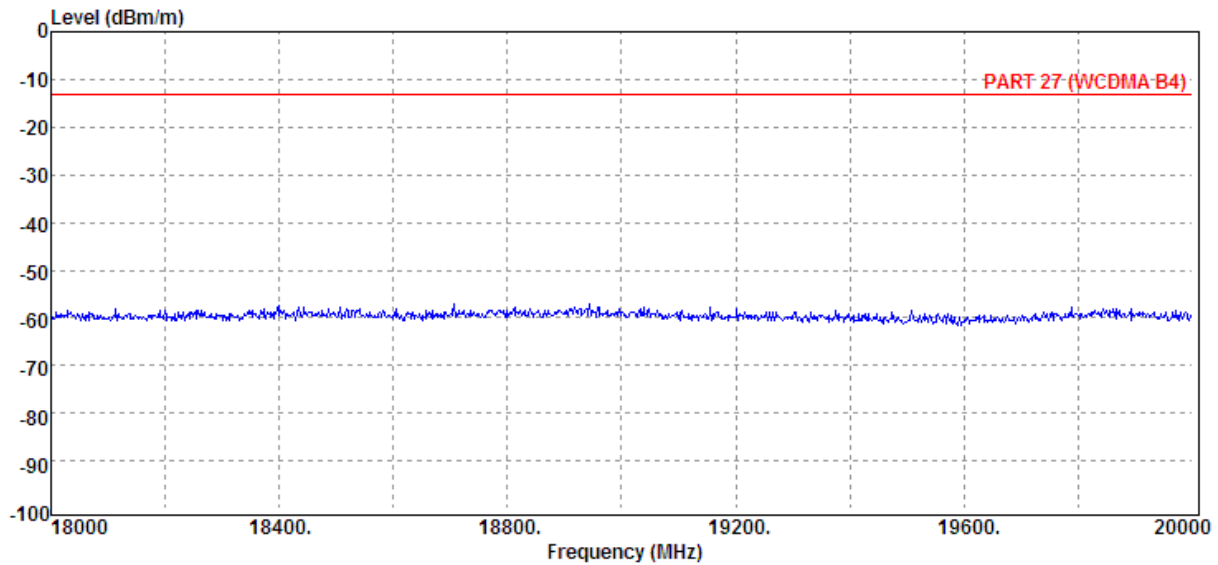
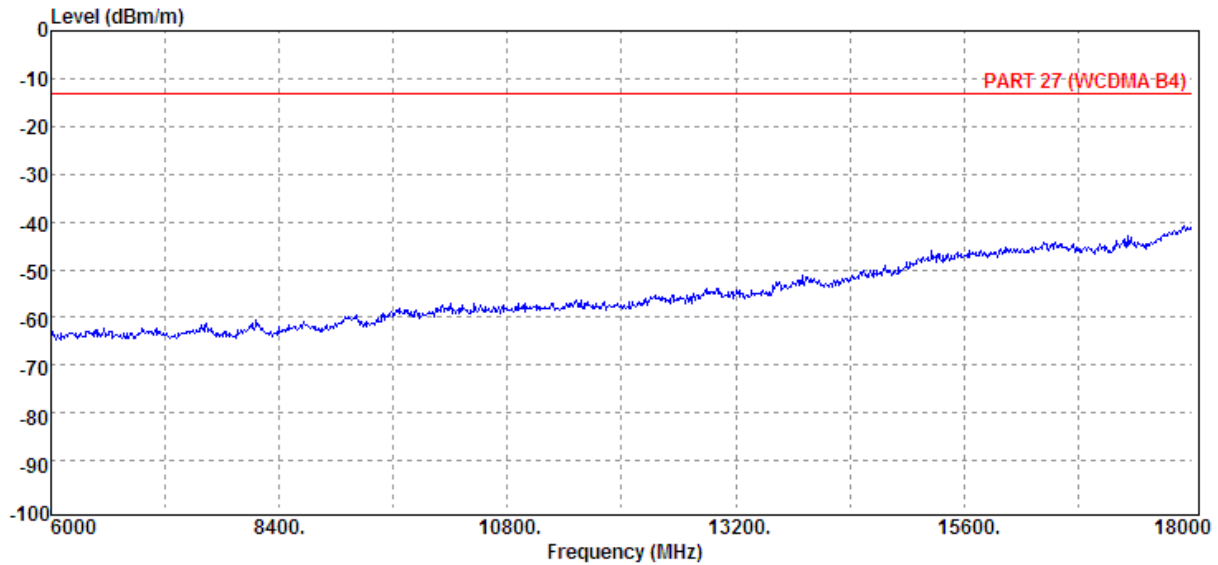

Unless otherwise stated the results shown in this test report refer only to the sample(s) tested and such sample(s) are retained for 90 days only.

除非另有說明，此報告結果僅對測試之樣品負責，同時此樣品僅保留90天。本報告未經本公司書面許可，不可部份複製。

This document is issued by the Company subject to its General Conditions of Service printed overleaf, available on request or accessible at www.sgs.com/terms_and_conditions.htm and, for electronic format documents, subject to Terms and Conditions for Electronic Documents at www.sgs.com/terms_e-document.htm. Attention is drawn to the limitation of liability, indemnification and jurisdiction issues defined therein. Any holder of this document is advised that information contained hereon reflects the Company's findings at the time of its intervention only and within the limits of Client's instructions, if any. The Company's sole responsibility is to its Client and this document does not exonerate parties to a transaction from exercising all their rights and obligations under the transaction documents. This document cannot be reproduced except in full, without prior written approval of the Company. Any unauthorized alteration, forgery or falsification of the content or appearance of this document is unlawful and offenders may be prosecuted to the fullest extent of the law.

| | | | |
|-----------------------|-------------|--------------------------|---------------------|
| Operation Band | :WCDMA B4 | Test Date | :2013-05-03 |
| ARFCN | :CH 1413 | Temp./Humi. | :24.1 deg_C / 65 RH |
| Fundamental Frequency | :1732.6 MHz | Engineer | :Allen |
| Operation Mode | :TX MID | Measurement Antenna Pol. | :HORIZONTAL |
| EUT Pol. | :H Plan | | |

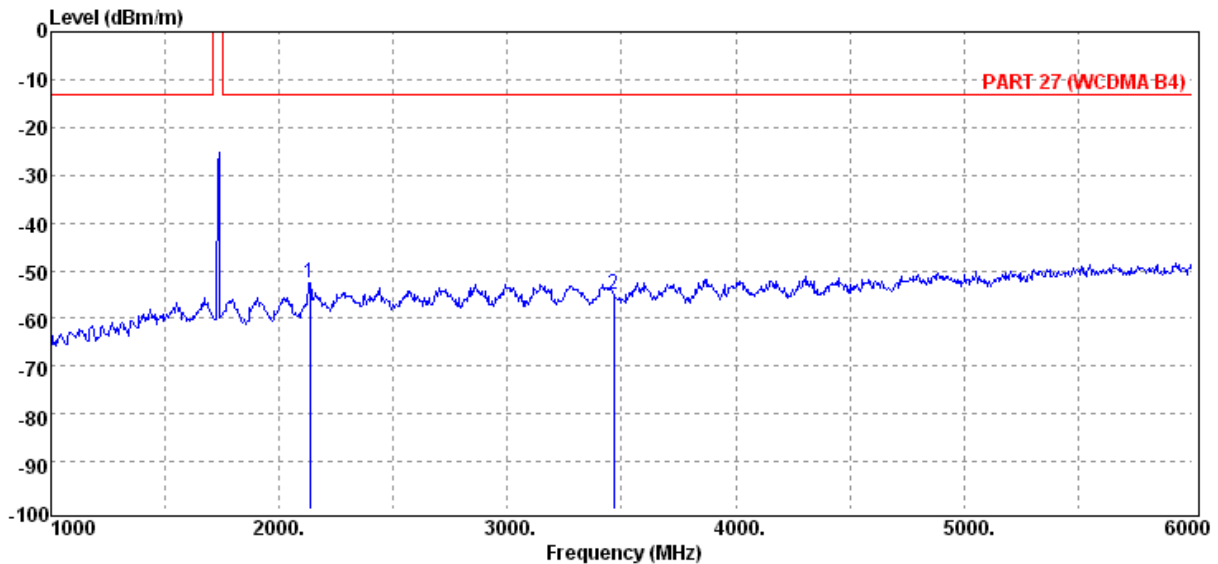
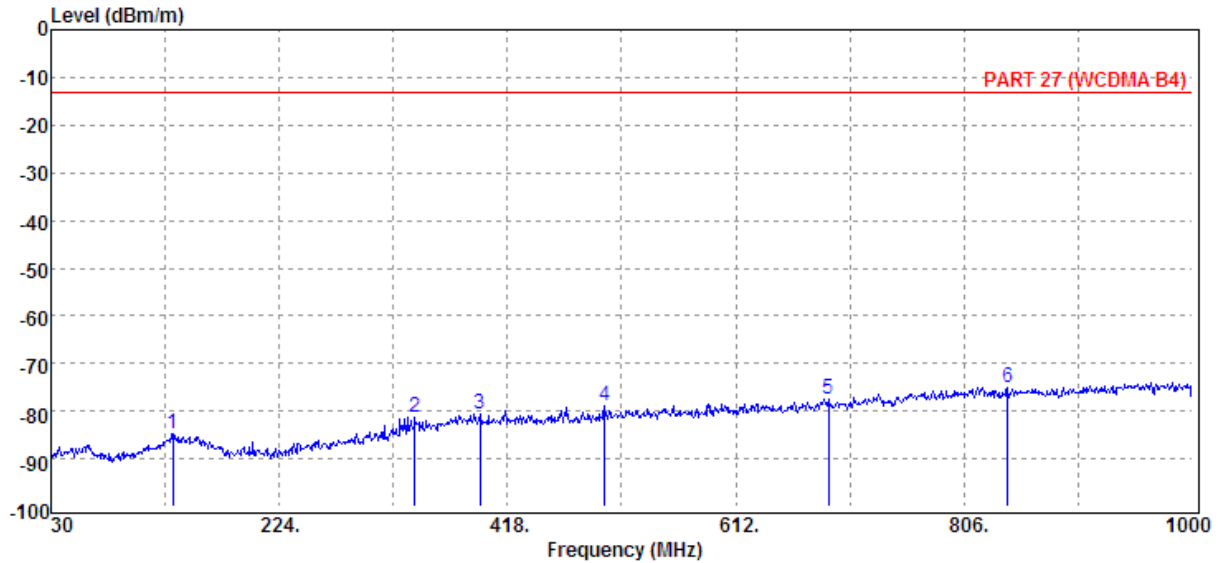

Unless otherwise stated the results shown in this test report refer only to the sample(s) tested and such sample(s) are retained for 90 days only.

除非另有說明，此報告結果僅對測試之樣品負責，同時此樣品僅保留90天。本報告未經本公司書面許可，不可部份複製。

This document is issued by the Company subject to its General Conditions of Service printed overleaf, available on request or accessible at www.sgs.com/terms_and_conditions.htm and, for electronic format documents, subject to Terms and Conditions for Electronic Documents at www.sgs.com/terms_e-document.htm. Attention is drawn to the limitation of liability, indemnification and jurisdiction issues defined therein. Any holder of this document is advised that information contained hereon reflects the Company's findings at the time of its intervention only and within the limits of Client's instructions, if any. The Company's sole responsibility is to its Client and this document does not exonerate parties to a transaction from exercising all their rights and obligations under the transaction documents. This document cannot be reproduced except in full, without prior written approval of the Company. Any unauthorized alteration, forgery or falsification of the content or appearance of this document is unlawful and offenders may be prosecuted to the fullest extent of the law.

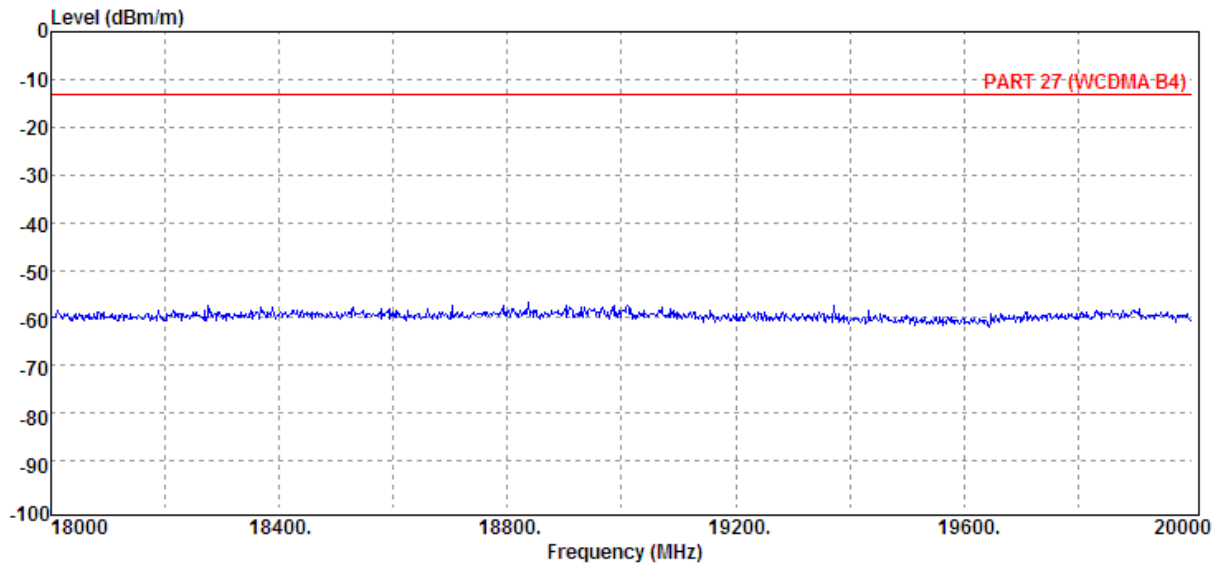
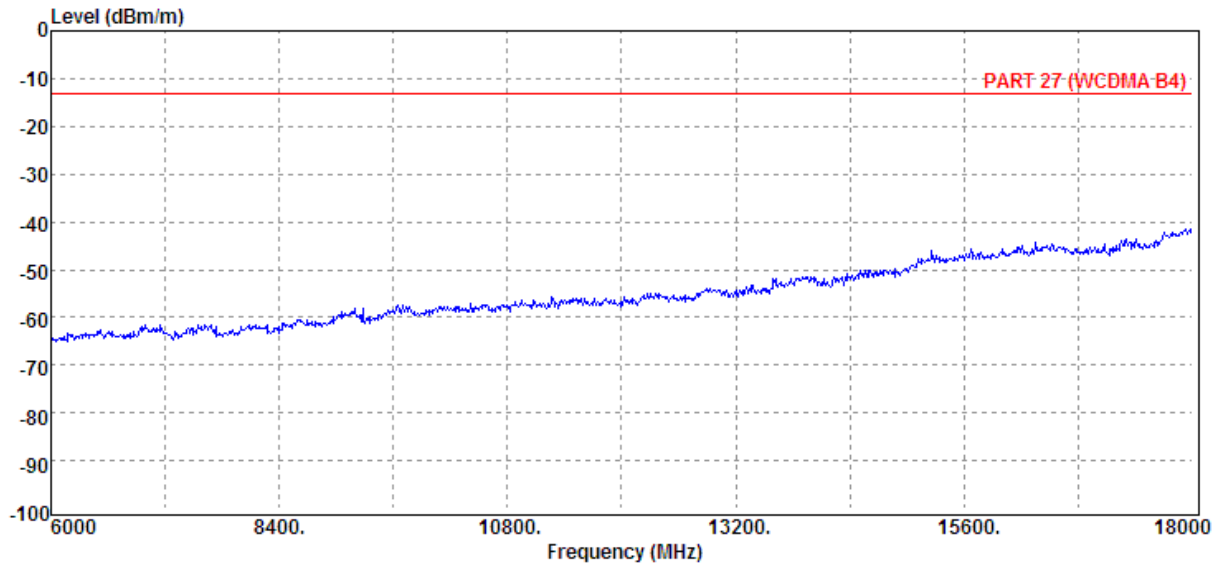

Unless otherwise stated the results shown in this test report refer only to the sample(s) tested and such sample(s) are retained for 90 days only.

除非另有說明，此報告結果僅對測試之樣品負責，同時此樣品僅保留90天。本報告未經本公司書面許可，不可部份複製。

This document is issued by the Company subject to its General Conditions of Service printed overleaf, available on request or accessible at www.sgs.com/terms_and_conditions.htm and, for electronic format documents, subject to Terms and Conditions for Electronic Documents at www.sgs.com/terms_e-document.htm. Attention is drawn to the limitation of liability, indemnification and jurisdiction issues defined therein. Any holder of this document is advised that information contained hereon reflects the Company's findings at the time of its intervention only and within the limits of Client's instructions, if any. The Company's sole responsibility is to its Client and this document does not exonerate parties to a transaction from exercising all their rights and obligations under the transaction documents. This document cannot be reproduced except in full, without prior written approval of the Company. Any unauthorized alteration, forgery or falsification of the content or appearance of this document is unlawful and offenders may be prosecuted to the fullest extent of the law.

| | | | |
|-----------------------|-------------|--------------------------|---------------------|
| Operation Band | :WCDMA B4 | Test Date | :2013-05-03 |
| ARFCN | :CH 1513 | Temp./Humi. | :24.1 deg_C / 65 RH |
| Fundamental Frequency | :1752.6 MHz | Engineer | :Allen |
| Operation Mode | :TX HIGH | Measurement Antenna Pol. | :VERTICAL |
| EUT Pol. | :H Plan | | |

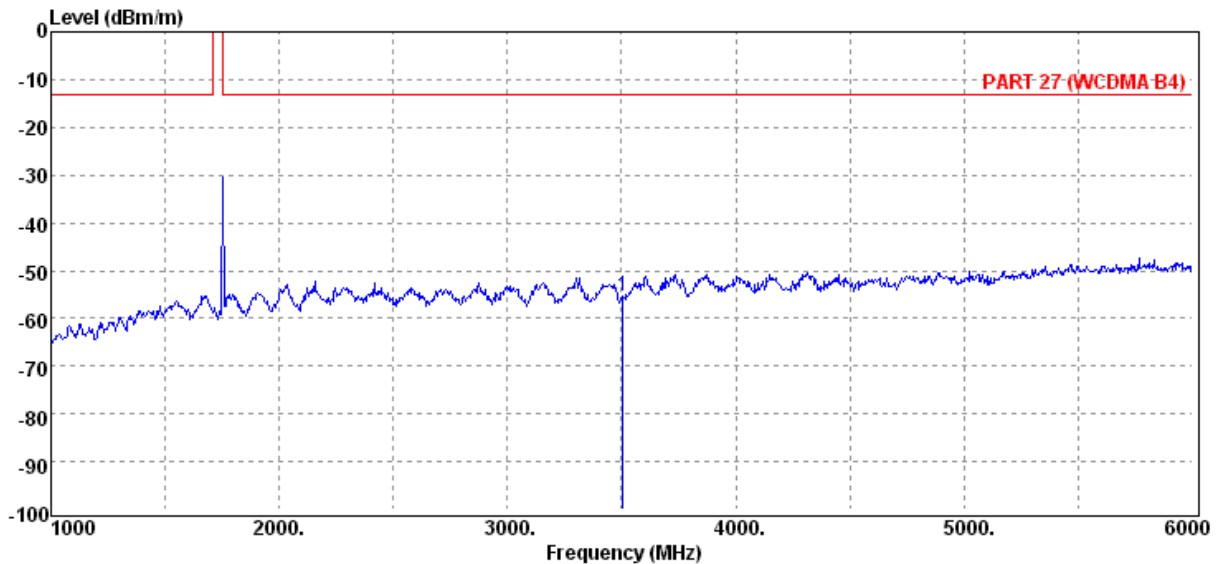
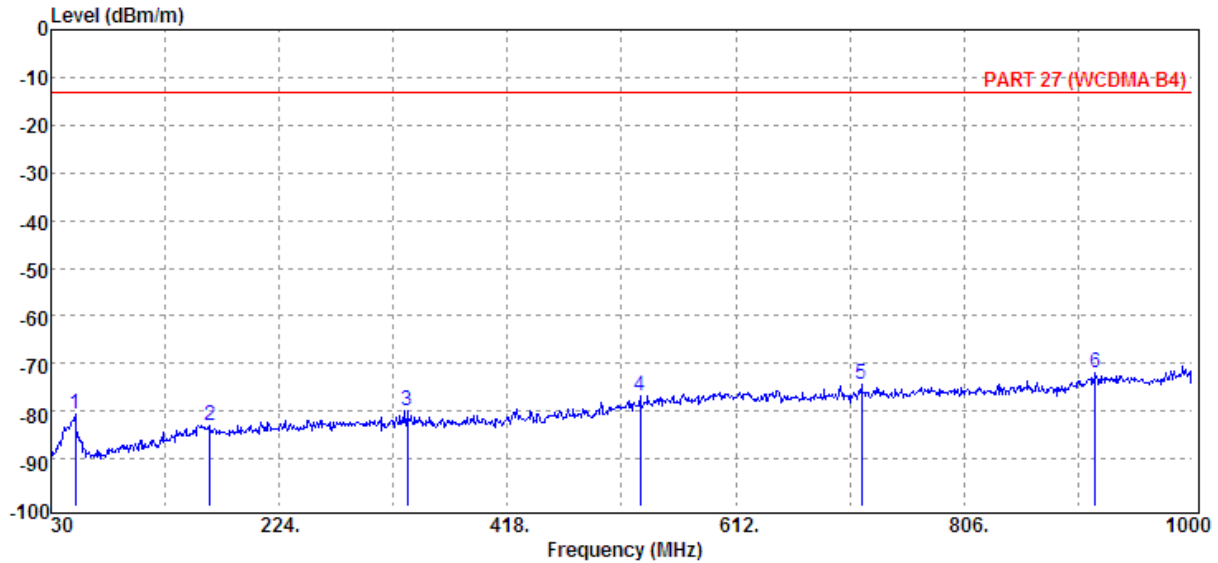

Unless otherwise stated the results shown in this test report refer only to the sample(s) tested and such sample(s) are retained for 90 days only.

除非另有說明，此報告結果僅對測試之樣品負責，同時此樣品僅保留90天。本報告未經本公司書面許可，不可部份複製。

This document is issued by the Company subject to its General Conditions of Service printed overleaf, available on request or accessible at www.sgs.com/terms_and_conditions.htm and, for electronic format documents, subject to Terms and Conditions for Electronic Documents at www.sgs.com/terms_e-document.htm. Attention is drawn to the limitation of liability, indemnification and jurisdiction issues defined therein. Any holder of this document is advised that information contained hereon reflects the Company's findings at the time of its intervention only and within the limits of Client's instructions, if any. The Company's sole responsibility is to its Client and this document does not exonerate parties to a transaction from exercising all their rights and obligations under the transaction documents. This document cannot be reproduced except in full, without prior written approval of the Company. Any unauthorized alteration, forgery or falsification of the content or appearance of this document is unlawful and offenders may be prosecuted to the fullest extent of the law.

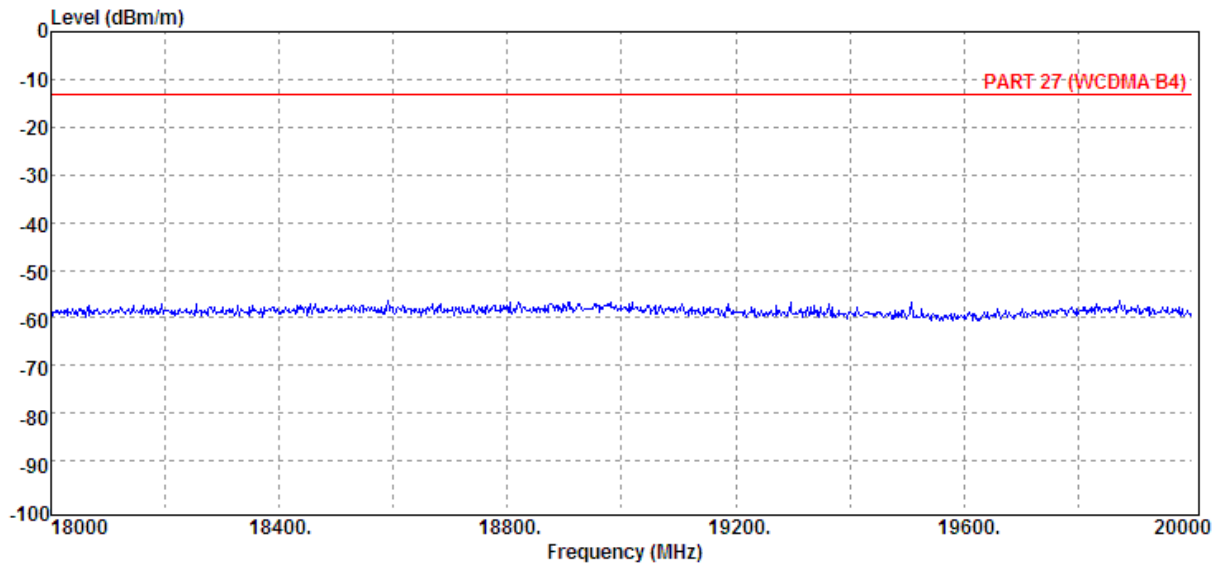
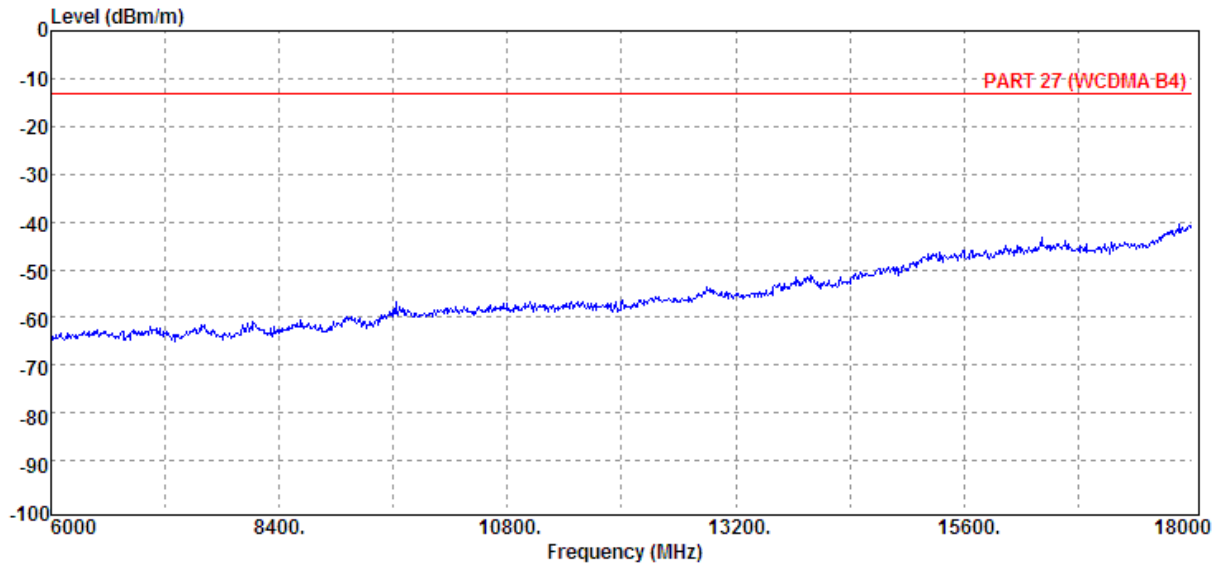

Unless otherwise stated the results shown in this test report refer only to the sample(s) tested and such sample(s) are retained for 90 days only.

除非另有說明，此報告結果僅對測試之樣品負責，同時此樣品僅保留90天。本報告未經本公司書面許可，不可部份複製。

This document is issued by the Company subject to its General Conditions of Service printed overleaf, available on request or accessible at www.sgs.com/terms_and_conditions.htm and, for electronic format documents, subject to Terms and Conditions for Electronic Documents at www.sgs.com/terms_e-document.htm. Attention is drawn to the limitation of liability, indemnification and jurisdiction issues defined therein. Any holder of this document is advised that information contained hereon reflects the Company's findings at the time of its intervention only and within the limits of Client's instructions, if any. The Company's sole responsibility is to its Client and this document does not exonerate parties to a transaction from exercising all their rights and obligations under the transaction documents. This document cannot be reproduced except in full, without prior written approval of the Company. Any unauthorized alteration, forgery or falsification of the content or appearance of this document is unlawful and offenders may be prosecuted to the fullest extent of the law.

| | | | |
|-----------------------|-------------|--------------------------|---------------------|
| Operation Band | :WCDMA B4 | Test Date | :2013-05-03 |
| ARFCN | :CH 1513 | Temp./Humi. | :24.1 deg_C / 65 RH |
| Fundamental Frequency | :1752.6 MHz | Engineer | :Allen |
| Operation Mode | :TX HIGH | Measurement Antenna Pol. | :HORIZONTAL |
| EUT Pol. | :H Plan | | |

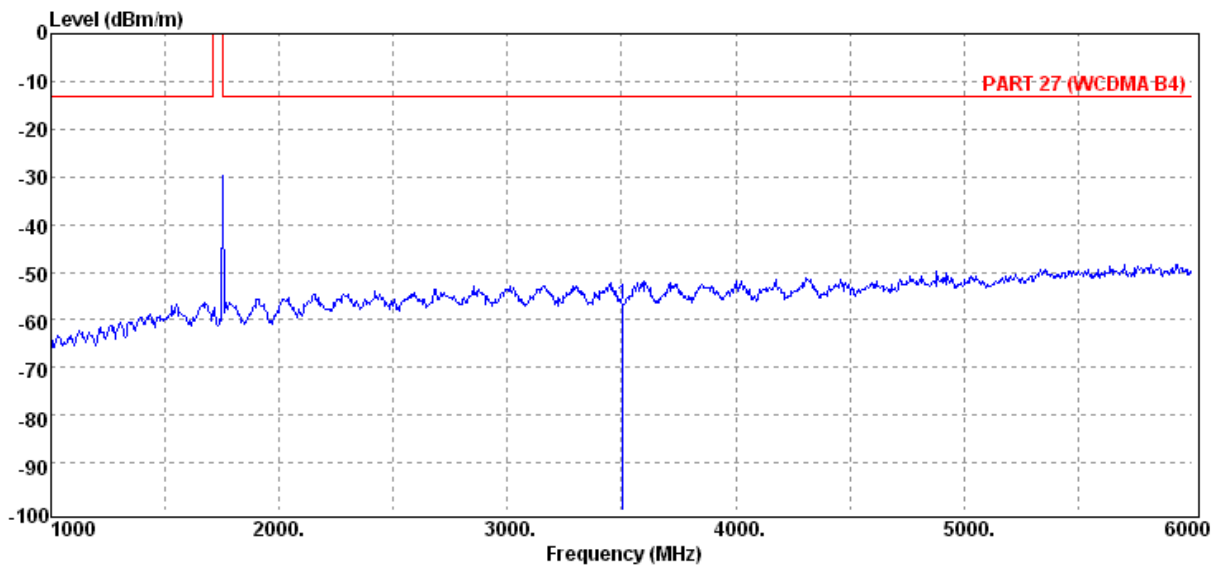
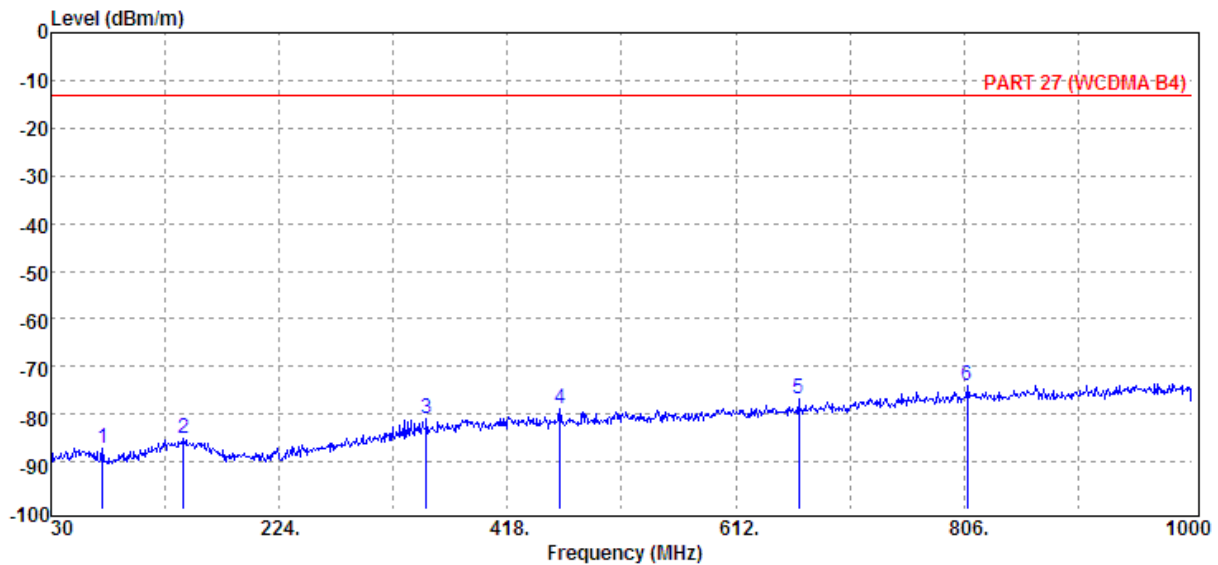

Unless otherwise stated the results shown in this test report refer only to the sample(s) tested and such sample(s) are retained for 90 days only.

除非另有說明，此報告結果僅對測試之樣品負責，同時此樣品僅保留90天。本報告未經本公司書面許可，不可部份複製。

This document is issued by the Company subject to its General Conditions of Service printed overleaf, available on request or accessible at www.sgs.com/terms_and_conditions.htm and, for electronic format documents, subject to Terms and Conditions for Electronic Documents at www.sgs.com/terms_e-document.htm. Attention is drawn to the limitation of liability, indemnification and jurisdiction issues defined therein. Any holder of this document is advised that information contained hereon reflects the Company's findings at the time of its intervention only and within the limits of Client's instructions, if any. The Company's sole responsibility is to its Client and this document does not exonerate parties to a transaction from exercising all their rights and obligations under the transaction documents. This document cannot be reproduced except in full, without prior written approval of the Company. Any unauthorized alteration, forgery or falsification of the content or appearance of this document is unlawful and offenders may be prosecuted to the fullest extent of the law.

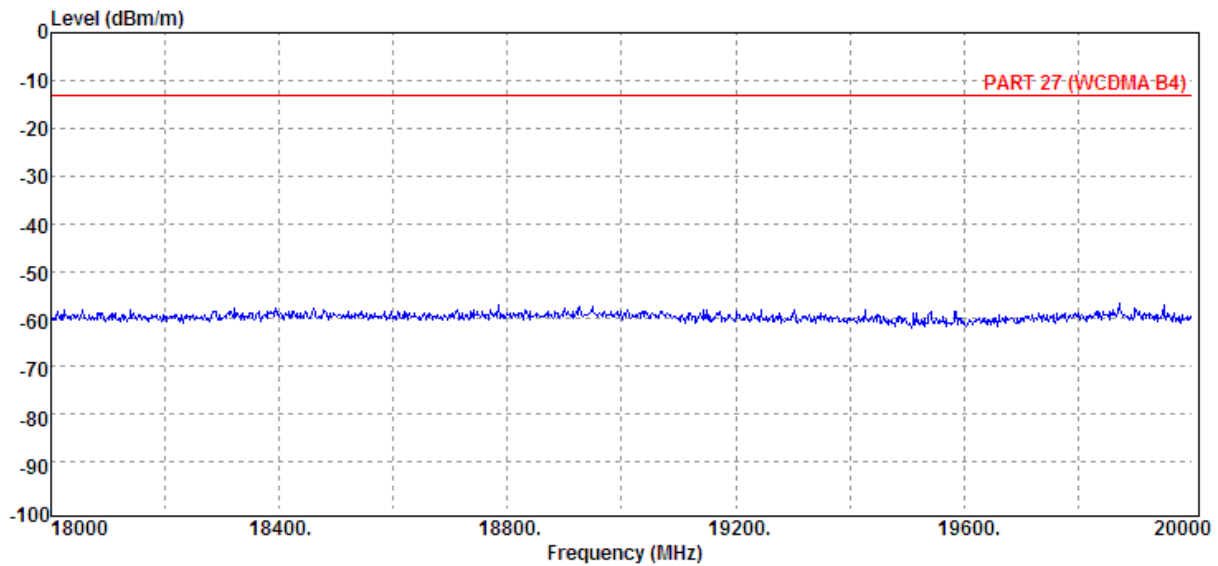
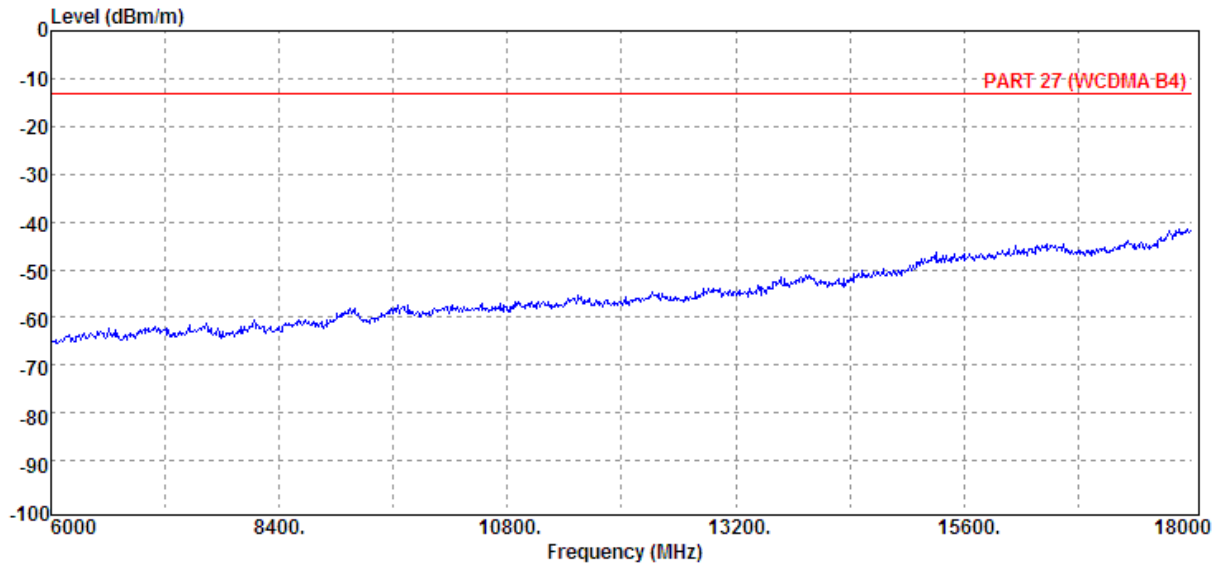

Unless otherwise stated the results shown in this test report refer only to the sample(s) tested and such sample(s) are retained for 90 days only.

除非另有說明，此報告結果僅對測試之樣品負責，同時此樣品僅保留90天。本報告未經本公司書面許可，不可部份複製。

This document is issued by the Company subject to its General Conditions of Service printed overleaf, available on request or accessible at www.sgs.com/terms_and_conditions.htm and, for electronic format documents, subject to Terms and Conditions for Electronic Documents at www.sgs.com/terms_e-document.htm. Attention is drawn to the limitation of liability, indemnification and jurisdiction issues defined therein. Any holder of this document is advised that information contained hereon reflects the Company's findings at the time of its intervention only and within the limits of Client's instructions, if any. The Company's sole responsibility is to its Client and this document does not exonerate parties to a transaction from exercising all their rights and obligations under the transaction documents. This document cannot be reproduced except in full, without prior written approval of the Company. Any unauthorized alteration, forgery or falsification of the content or appearance of this document is unlawful and offenders may be prosecuted to the fullest extent of the law.

Radiated Spurious Emission Measurement Result: HSDPA V Mode

| | | | |
|-----------------------|------------|--------------------------|---------------------|
| Operation Band | :HSDPA B5 | Test Date | : 2013-07-16 |
| ARFCN | :CH 4132 | Temp./Humi. | :24.1 deg_C / 65 RH |
| Fundamental Frequency | :826.4 MHz | Engineer | :Allen |
| Operation Mode | :TX LOW | | |
| EUT Pol. | :E1 Plan | Measurement Antenna Pol. | :VERTICAL |

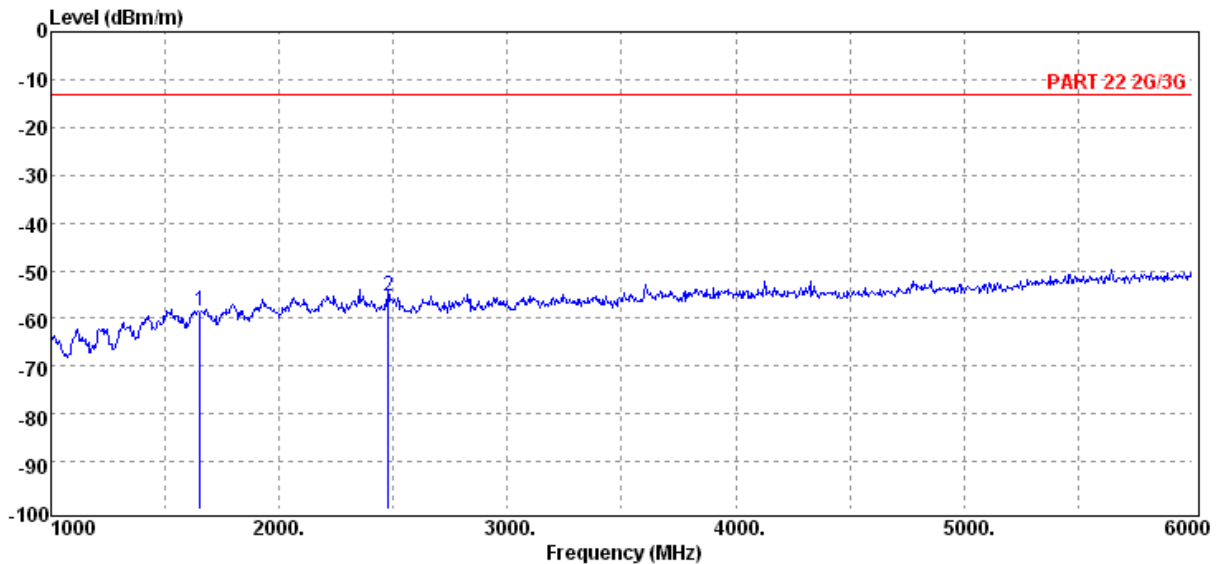
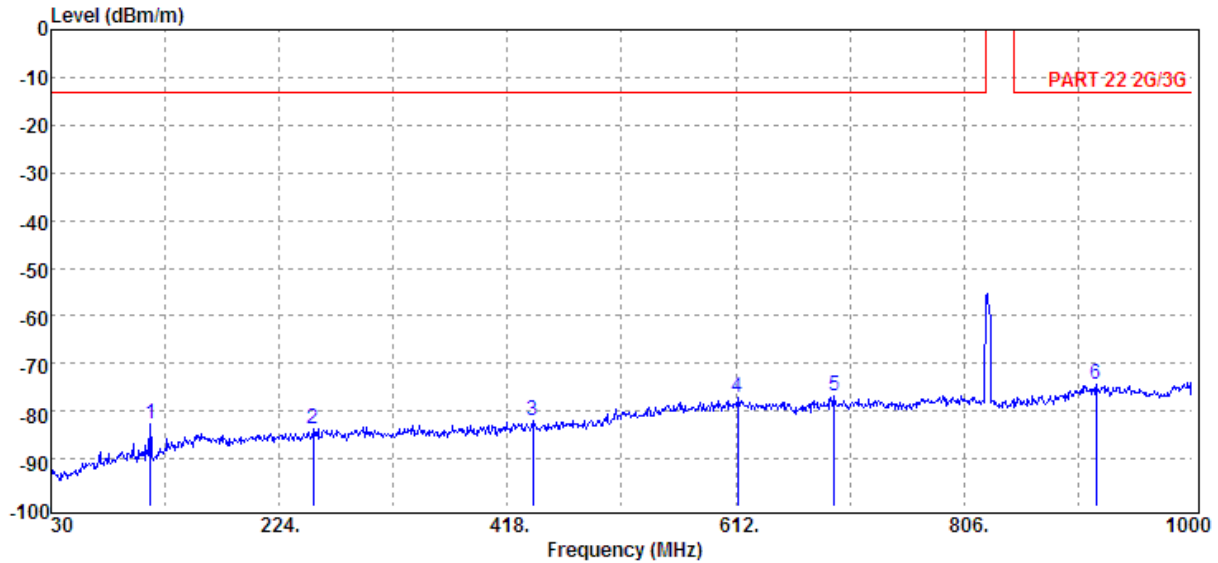

Unless otherwise stated the results shown in this test report refer only to the sample(s) tested and such sample(s) are retained for 90 days only.

除非另有說明，此報告結果僅對測試之樣品負責，同時此樣品僅保留90天。本報告未經本公司書面許可，不可部份複製。

This document is issued by the Company subject to its General Conditions of Service printed overleaf, available on request or accessible at www.sgs.com/terms_and_conditions.htm and, for electronic format documents, subject to Terms and Conditions for Electronic Documents at www.sgs.com/terms_e-document.htm. Attention is drawn to the limitation of liability, indemnification and jurisdiction issues defined therein. Any holder of this document is advised that information contained hereon reflects the Company's findings at the time of its intervention only and within the limits of Client's instructions, if any. The Company's sole responsibility is to its Client and this document does not exonerate parties to a transaction from exercising all their rights and obligations under the transaction documents. This document cannot be reproduced except in full, without prior written approval of the Company. Any unauthorized alteration, forgery or falsification of the content or appearance of this document is unlawful and offenders may be prosecuted to the fullest extent of the law.

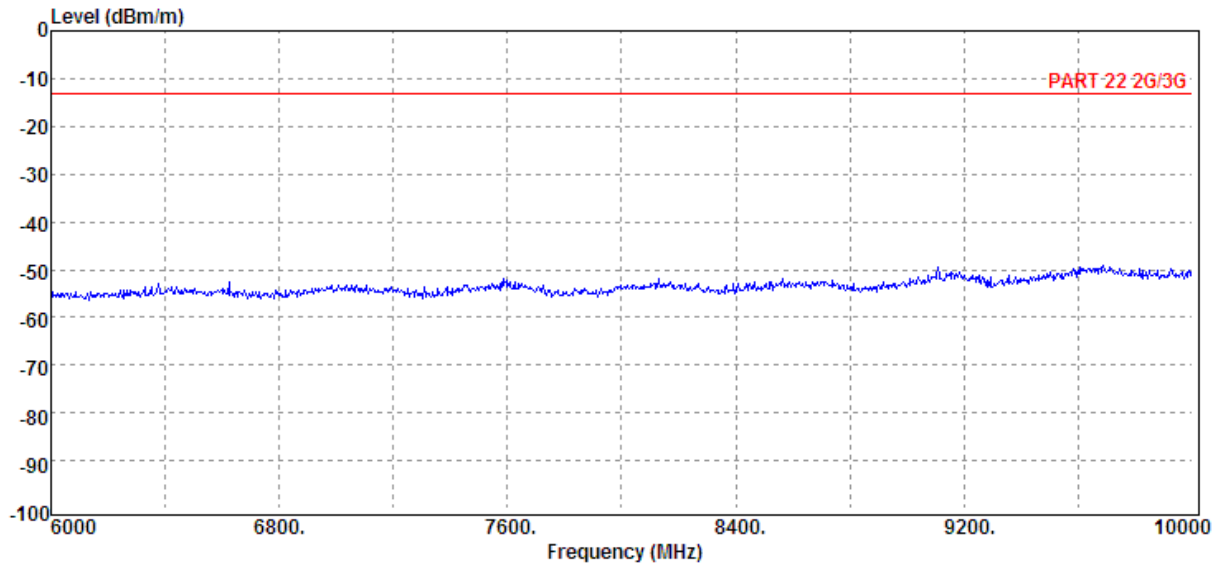

Unless otherwise stated the results shown in this test report refer only to the sample(s) tested and such sample(s) are retained for 90 days only.

除非另有說明，此報告結果僅對測試之樣品負責，同時此樣品僅保留90天。本報告未經本公司書面許可，不可部份複製。

This document is issued by the Company subject to its General Conditions of Service printed overleaf, available on request or accessible at www.sgs.com/terms_and_conditions.htm and, for electronic format documents, subject to Terms and Conditions for Electronic Documents at www.sgs.com/terms_e-document.htm. Attention is drawn to the limitation of liability, indemnification and jurisdiction issues defined therein. Any holder of this document is advised that information contained hereon reflects the Company's findings at the time of its intervention only and within the limits of Client's instructions, if any. The Company's sole responsibility is to its Client and this document does not exonerate parties to a transaction from exercising all their rights and obligations under the transaction documents. This document cannot be reproduced except in full, without prior written approval of the Company. Any unauthorized alteration, forgery or falsification of the content or appearance of this document is unlawful and offenders may be prosecuted to the fullest extent of the law.

| | | | |
|-----------------------|------------|--------------------------|---------------------|
| Operation Band | :HSDPA B5 | Test Date | : 2013-07-16 |
| ARFCN | :CH 4132 | Temp./Humi. | :24.1 deg_C / 65 RH |
| Fundamental Frequency | :826.4 MHz | Engineer | :Allen |
| Operation Mode | :TX LOW | Measurement Antenna Pol. | :HORIZONTAL |
| EUT Pol. | :E1 Plan | | |

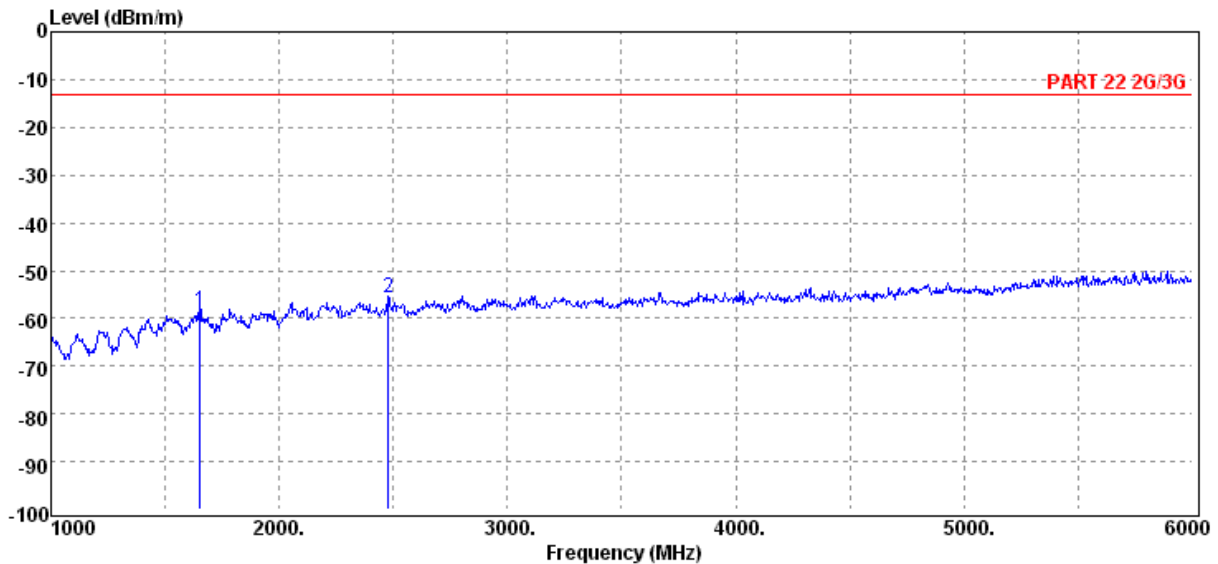
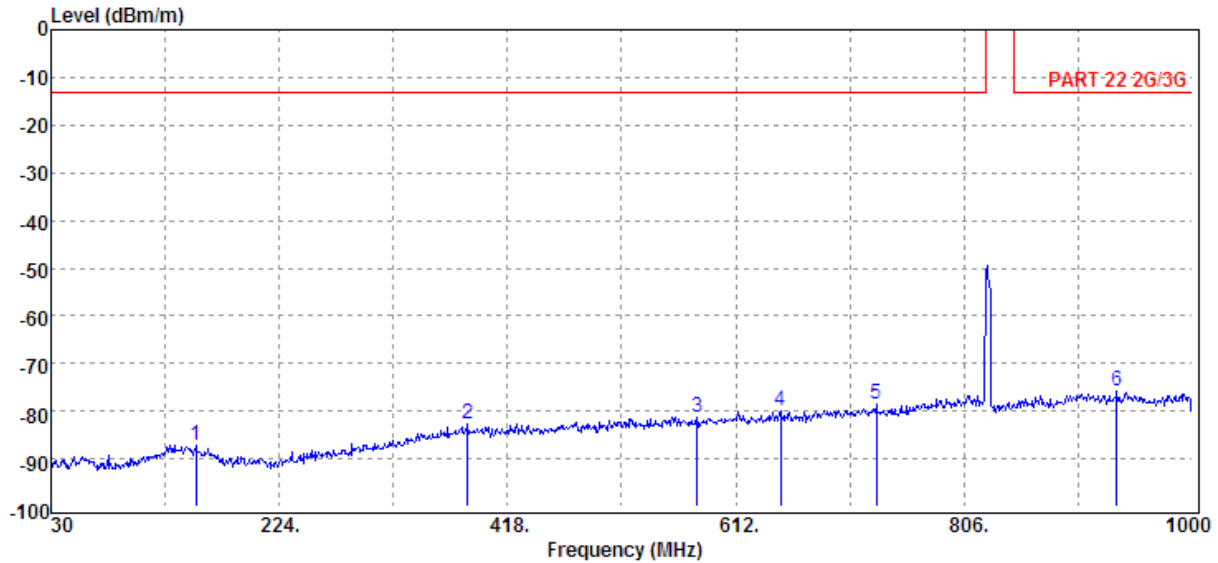

Unless otherwise stated the results shown in this test report refer only to the sample(s) tested and such sample(s) are retained for 90 days only.

除非另有說明，此報告結果僅對測試之樣品負責，同時此樣品僅保留90天。本報告未經本公司書面許可，不可部份複製。

This document is issued by the Company subject to its General Conditions of Service printed overleaf, available on request or accessible at www.sgs.com/terms_and_conditions.htm and, for electronic format documents, subject to Terms and Conditions for Electronic Documents at www.sgs.com/terms_e-document.htm. Attention is drawn to the limitation of liability, indemnification and jurisdiction issues defined therein. Any holder of this document is advised that information contained hereon reflects the Company's findings at the time of its intervention only and within the limits of Client's instructions, if any. The Company's sole responsibility is to its Client and this document does not exonerate parties to a transaction from exercising all their rights and obligations under the transaction documents. This document cannot be reproduced except in full, without prior written approval of the Company. Any unauthorized alteration, forgery or falsification of the content or appearance of this document is unlawful and offenders may be prosecuted to the fullest extent of the law.

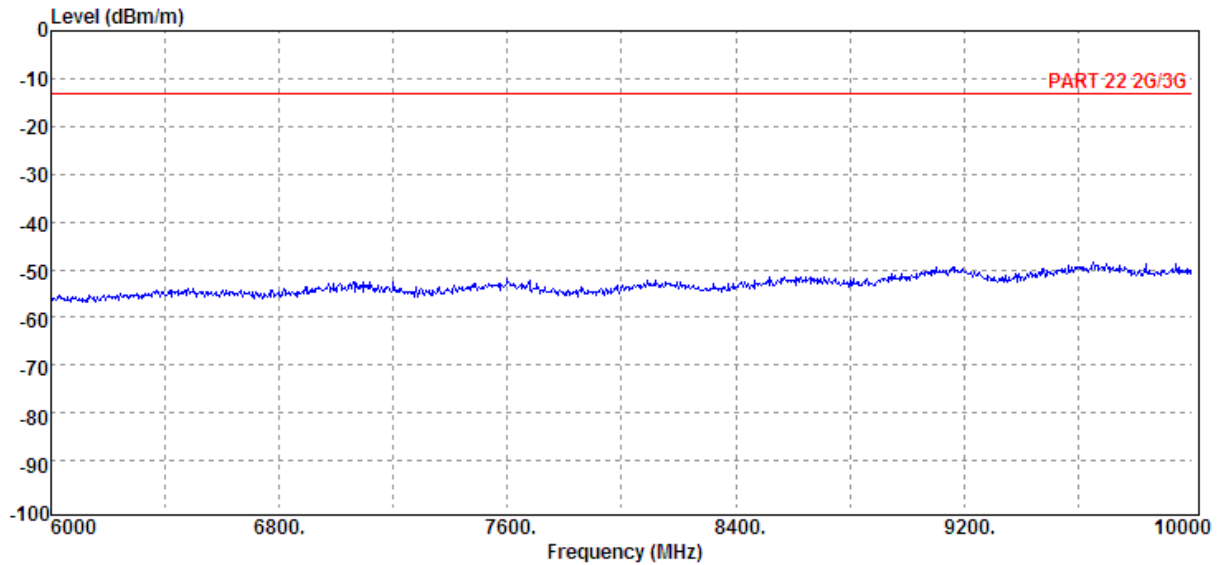

Unless otherwise stated the results shown in this test report refer only to the sample(s) tested and such sample(s) are retained for 90 days only.

除非另有說明，此報告結果僅對測試之樣品負責，同時此樣品僅保留90天。本報告未經本公司書面許可，不可部份複製。

This document is issued by the Company subject to its General Conditions of Service printed overleaf, available on request or accessible at www.sgs.com/terms_and_conditions.htm and, for electronic format documents, subject to Terms and Conditions for Electronic Documents at www.sgs.com/terms_e-document.htm. Attention is drawn to the limitation of liability, indemnification and jurisdiction issues defined therein. Any holder of this document is advised that information contained hereon reflects the Company's findings at the time of its intervention only and within the limits of Client's instructions, if any. The Company's sole responsibility is to its Client and this document does not exonerate parties to a transaction from exercising all their rights and obligations under the transaction documents. This document cannot be reproduced except in full, without prior written approval of the Company. Any unauthorized alteration, forgery or falsification of the content or appearance of this document is unlawful and offenders may be prosecuted to the fullest extent of the law.

| | | | |
|-----------------------|------------|--------------------------|---------------------|
| Operation Band | :HSDPA B5 | Test Date | : 2013-07-16 |
| ARFCN | :CH 4183 | Temp./Humi. | :24.1 deg_C / 65 RH |
| Fundamental Frequency | :836.6 MHz | Engineer | :Allen |
| Operation Mode | :TX MID | Measurement Antenna Pol. | :VERTICAL |
| EUT Pol. | :E1 Plan | | |

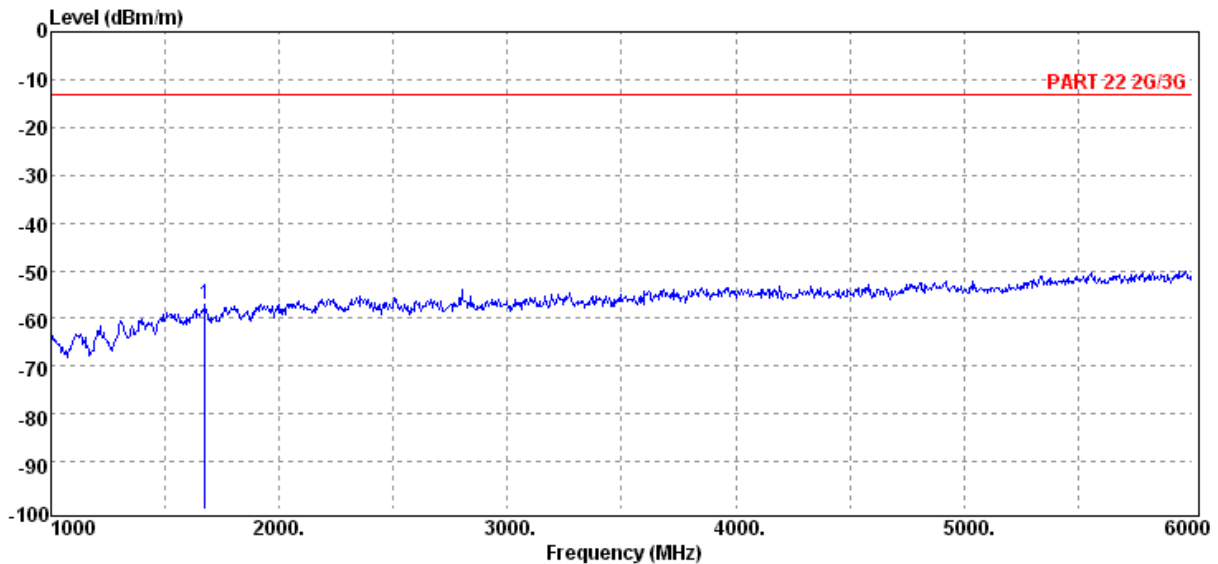
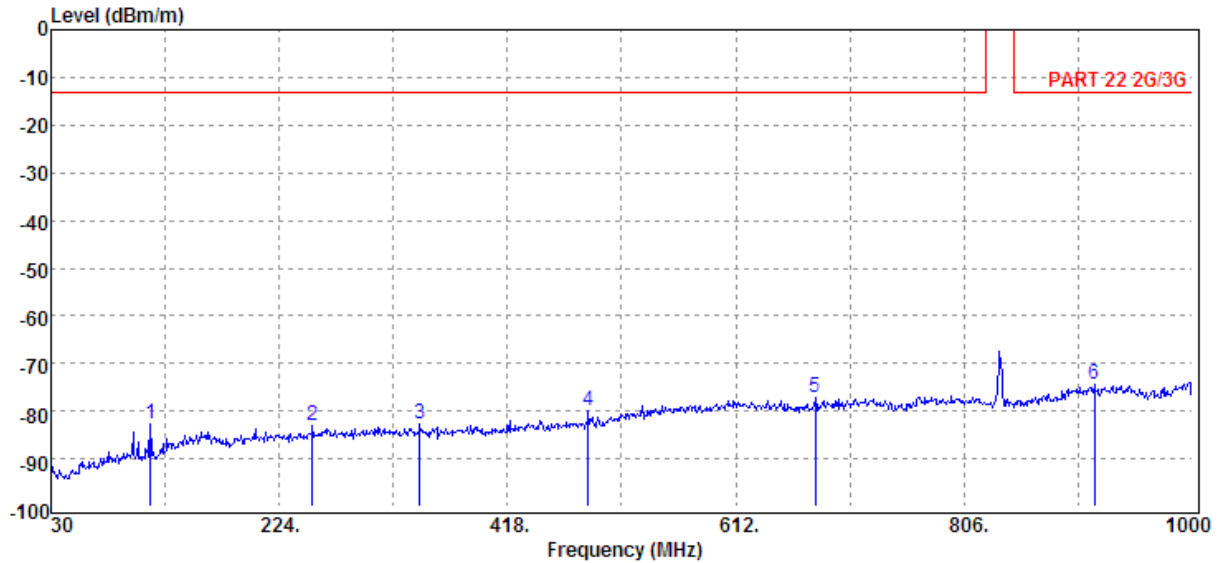

Unless otherwise stated the results shown in this test report refer only to the sample(s) tested and such sample(s) are retained for 90 days only.

除非另有說明，此報告結果僅對測試之樣品負責，同時此樣品僅保留90天。本報告未經本公司書面許可，不可部份複製。

This document is issued by the Company subject to its General Conditions of Service printed overleaf, available on request or accessible at www.sgs.com/terms_and_conditions.htm and, for electronic format documents, subject to Terms and Conditions for Electronic Documents at www.sgs.com/terms_e-document.htm. Attention is drawn to the limitation of liability, indemnification and jurisdiction issues defined therein. Any holder of this document is advised that information contained hereon reflects the Company's findings at the time of its intervention only and within the limits of Client's instructions, if any. The Company's sole responsibility is to its Client and this document does not exonerate parties to a transaction from exercising all their rights and obligations under the transaction documents. This document cannot be reproduced except in full, without prior written approval of the Company. Any unauthorized alteration, forgery or falsification of the content or appearance of this document is unlawful and offenders may be prosecuted to the fullest extent of the law.

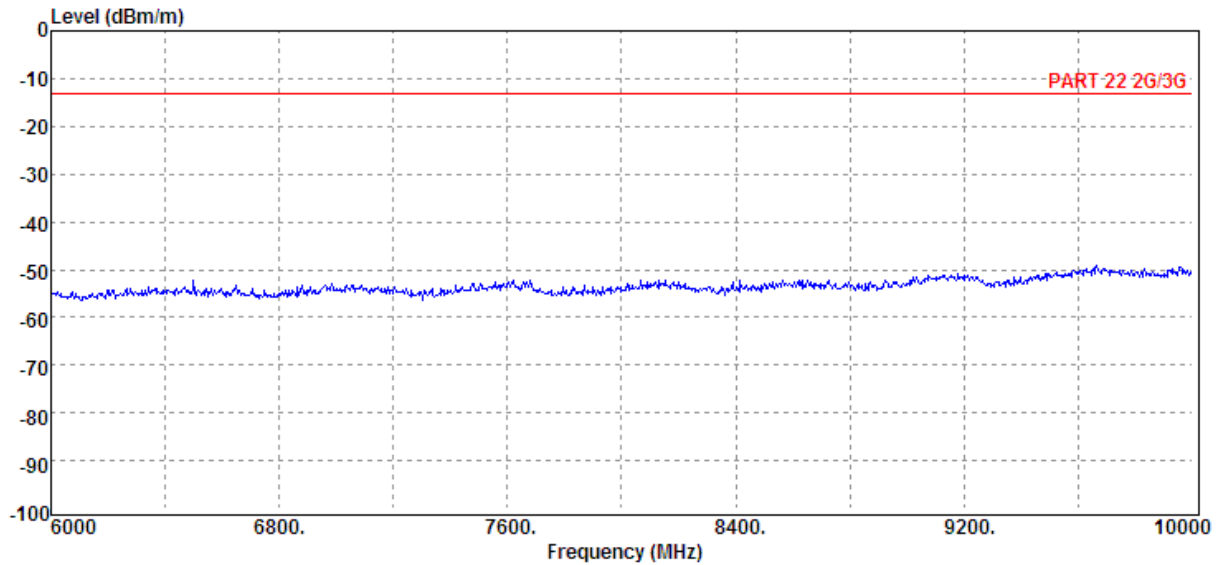

Unless otherwise stated the results shown in this test report refer only to the sample(s) tested and such sample(s) are retained for 90 days only.

除非另有說明，此報告結果僅對測試之樣品負責，同時此樣品僅保留90天。本報告未經本公司書面許可，不可部份複製。

This document is issued by the Company subject to its General Conditions of Service printed overleaf, available on request or accessible at www.sgs.com/terms_and_conditions.htm and, for electronic format documents, subject to Terms and Conditions for Electronic Documents at www.sgs.com/terms_e-document.htm. Attention is drawn to the limitation of liability, indemnification and jurisdiction issues defined therein. Any holder of this document is advised that information contained hereon reflects the Company's findings at the time of its intervention only and within the limits of Client's instructions, if any. The Company's sole responsibility is to its Client and this document does not exonerate parties to a transaction from exercising all their rights and obligations under the transaction documents. This document cannot be reproduced except in full, without prior written approval of the Company. Any unauthorized alteration, forgery or falsification of the content or appearance of this document is unlawful and offenders may be prosecuted to the fullest extent of the law.

| | | | |
|-----------------------|------------|--------------------------|---------------------|
| Operation Band | :HSDPA B5 | Test Date | : 2013-07-16 |
| ARFCN | :CH 4183 | Temp./Humi. | :24.1 deg_C / 65 RH |
| Fundamental Frequency | :836.6 MHz | Engineer | :Allen |
| Operation Mode | :TX MID | Measurement Antenna Pol. | :HORIZONTAL |
| EUT Pol. | :E1 Plan | | |

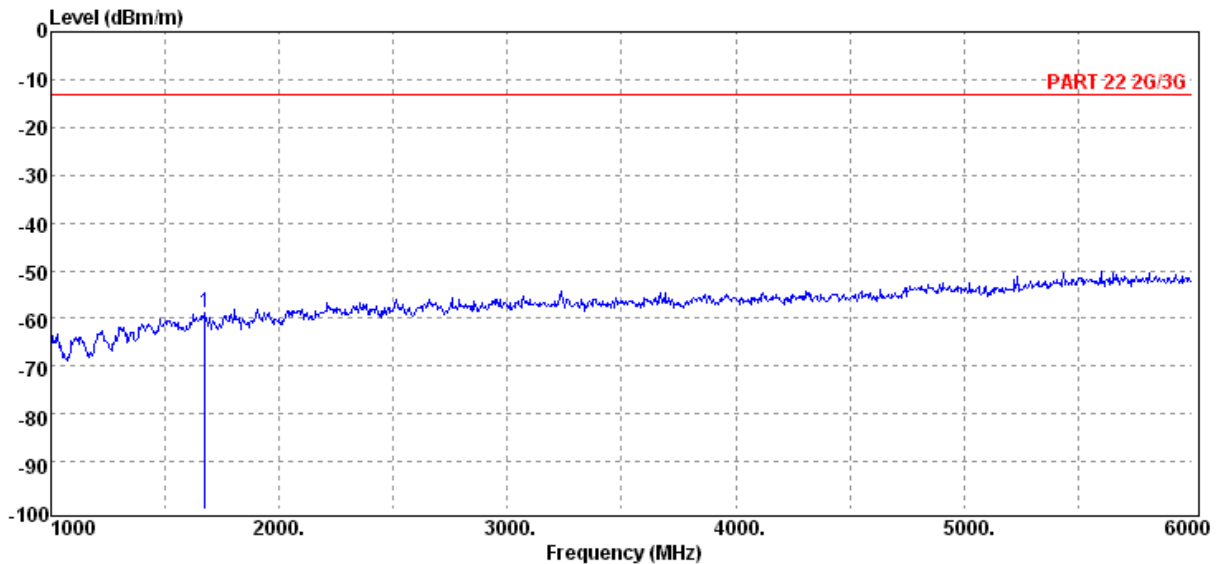
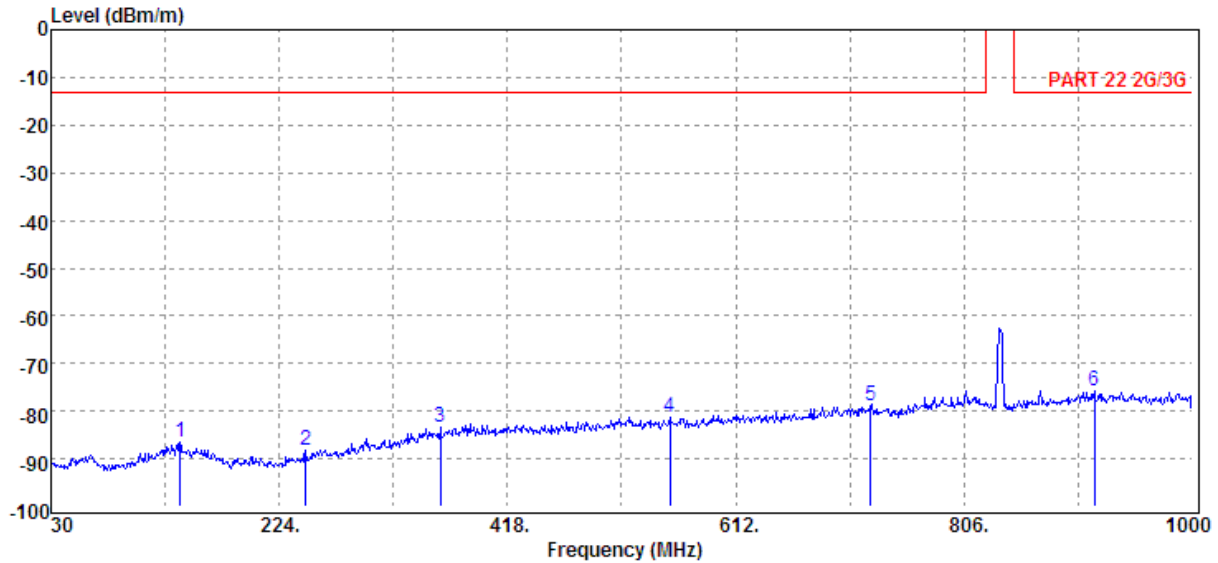

Unless otherwise stated the results shown in this test report refer only to the sample(s) tested and such sample(s) are retained for 90 days only.

除非另有說明，此報告結果僅對測試之樣品負責，同時此樣品僅保留90天。本報告未經本公司書面許可，不可部份複製。

This document is issued by the Company subject to its General Conditions of Service printed overleaf, available on request or accessible at www.sgs.com/terms_and_conditions.htm and, for electronic format documents, subject to Terms and Conditions for Electronic Documents at www.sgs.com/terms_e-document.htm. Attention is drawn to the limitation of liability, indemnification and jurisdiction issues defined therein. Any holder of this document is advised that information contained hereon reflects the Company's findings at the time of its intervention only and within the limits of Client's instructions, if any. The Company's sole responsibility is to its Client and this document does not exonerate parties to a transaction from exercising all their rights and obligations under the transaction documents. This document cannot be reproduced except in full, without prior written approval of the Company. Any unauthorized alteration, forgery or falsification of the content or appearance of this document is unlawful and offenders may be prosecuted to the fullest extent of the law.

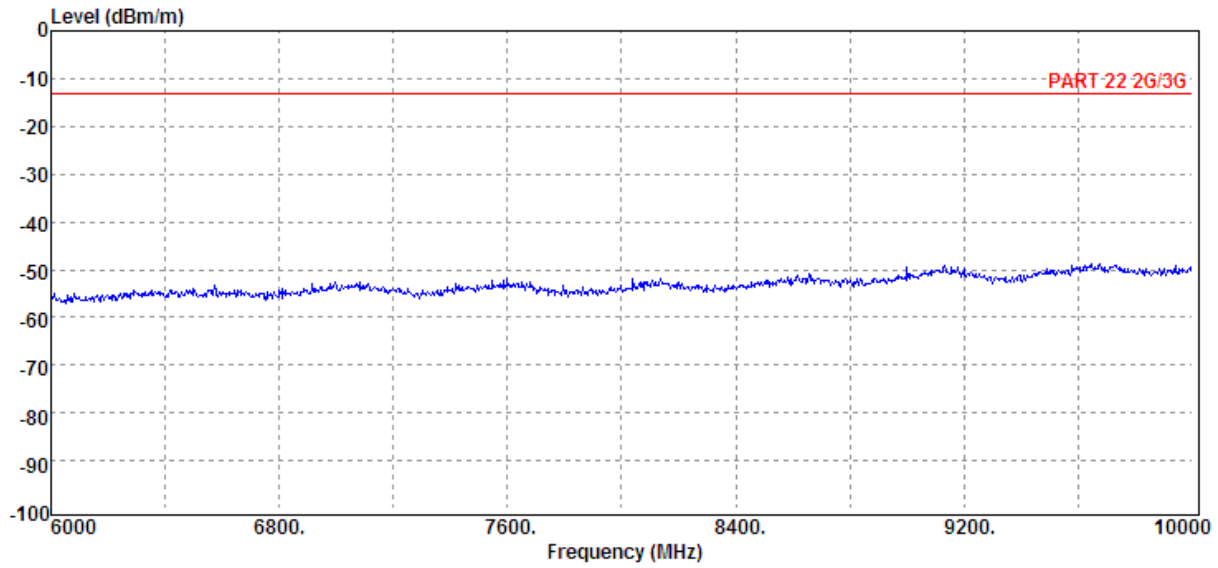

Unless otherwise stated the results shown in this test report refer only to the sample(s) tested and such sample(s) are retained for 90 days only.

除非另有說明，此報告結果僅對測試之樣品負責，同時此樣品僅保留90天。本報告未經本公司書面許可，不可部份複製。

This document is issued by the Company subject to its General Conditions of Service printed overleaf, available on request or accessible at www.sgs.com/terms_and_conditions.htm and, for electronic format documents, subject to Terms and Conditions for Electronic Documents at www.sgs.com/terms_e-document.htm. Attention is drawn to the limitation of liability, indemnification and jurisdiction issues defined therein. Any holder of this document is advised that information contained hereon reflects the Company's findings at the time of its intervention only and within the limits of Client's instructions, if any. The Company's sole responsibility is to its Client and this document does not exonerate parties to a transaction from exercising all their rights and obligations under the transaction documents. This document cannot be reproduced except in full, without prior written approval of the Company. Any unauthorized alteration, forgery or falsification of the content or appearance of this document is unlawful and offenders may be prosecuted to the fullest extent of the law.

| | | | |
|-----------------------|------------|--------------------------|---------------------|
| Operation Band | :HSDPA B5 | Test Date | : 2013-07-16 |
| ARFCN | :CH 4233 | Temp./Humi. | :24.1 deg_C / 65 RH |
| Fundamental Frequency | :846.6 MHz | Engineer | :Allen |
| Operation Mode | :TX HIGH | Measurement Antenna Pol. | :VERTICAL |
| EUT Pol. | :E1 Plan | | |

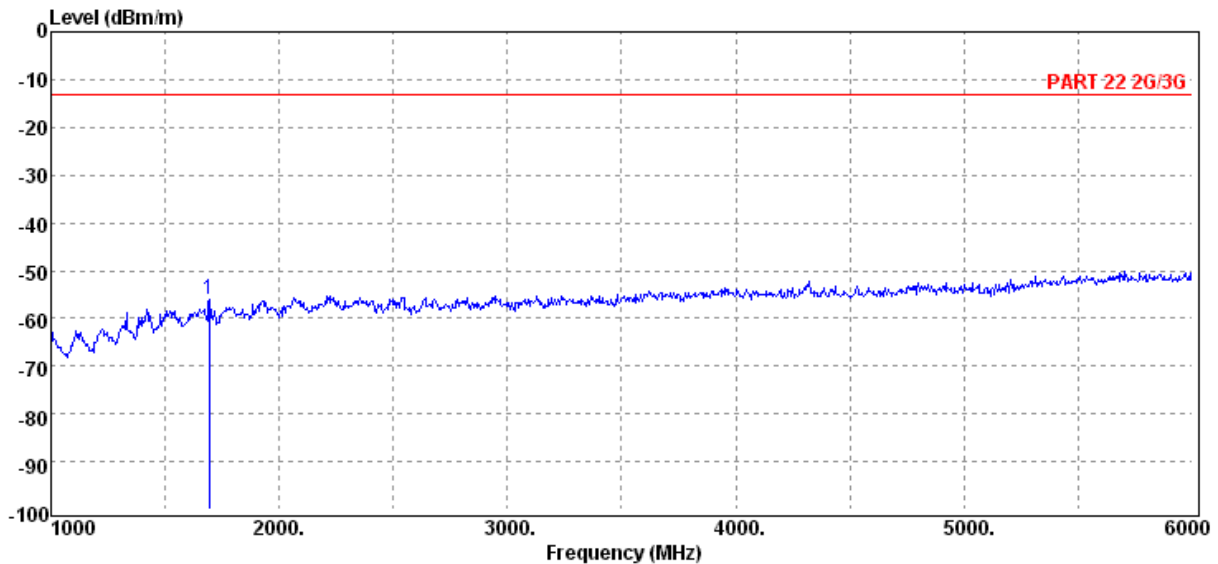
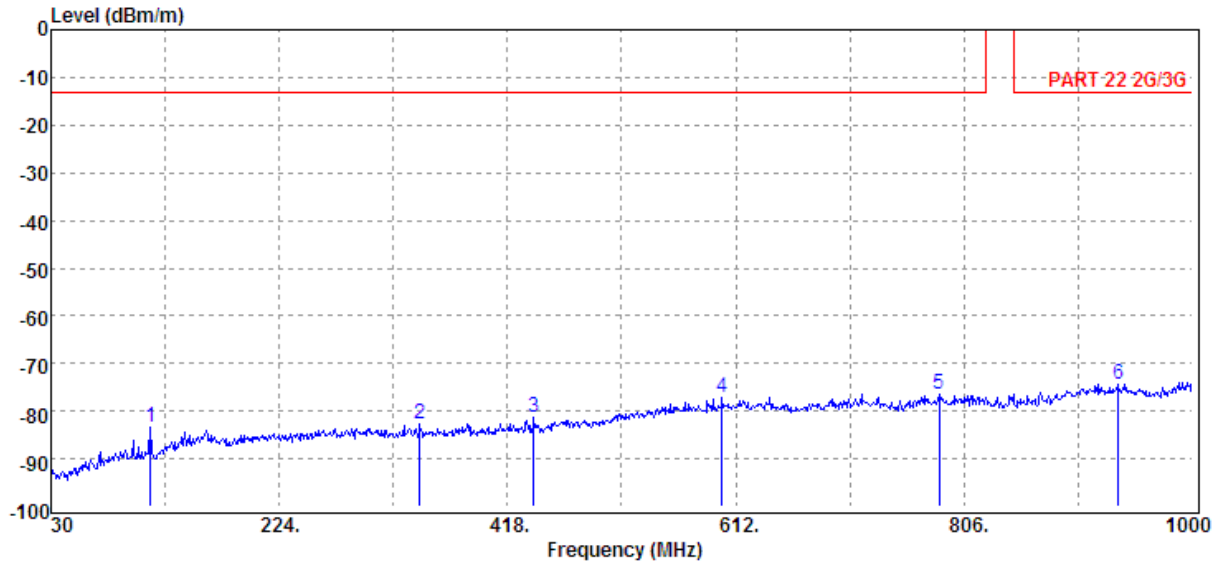

Unless otherwise stated the results shown in this test report refer only to the sample(s) tested and such sample(s) are retained for 90 days only.

除非另有說明，此報告結果僅對測試之樣品負責，同時此樣品僅保留90天。本報告未經本公司書面許可，不可部份複製。

This document is issued by the Company subject to its General Conditions of Service printed overleaf, available on request or accessible at www.sgs.com/terms_and_conditions.htm and, for electronic format documents, subject to Terms and Conditions for Electronic Documents at www.sgs.com/terms_e-document.htm. Attention is drawn to the limitation of liability, indemnification and jurisdiction issues defined therein. Any holder of this document is advised that information contained hereon reflects the Company's findings at the time of its intervention only and within the limits of Client's instructions, if any. The Company's sole responsibility is to its Client and this document does not exonerate parties to a transaction from exercising all their rights and obligations under the transaction documents. This document cannot be reproduced except in full, without prior written approval of the Company. Any unauthorized alteration, forgery or falsification of the content or appearance of this document is unlawful and offenders may be prosecuted to the fullest extent of the law.

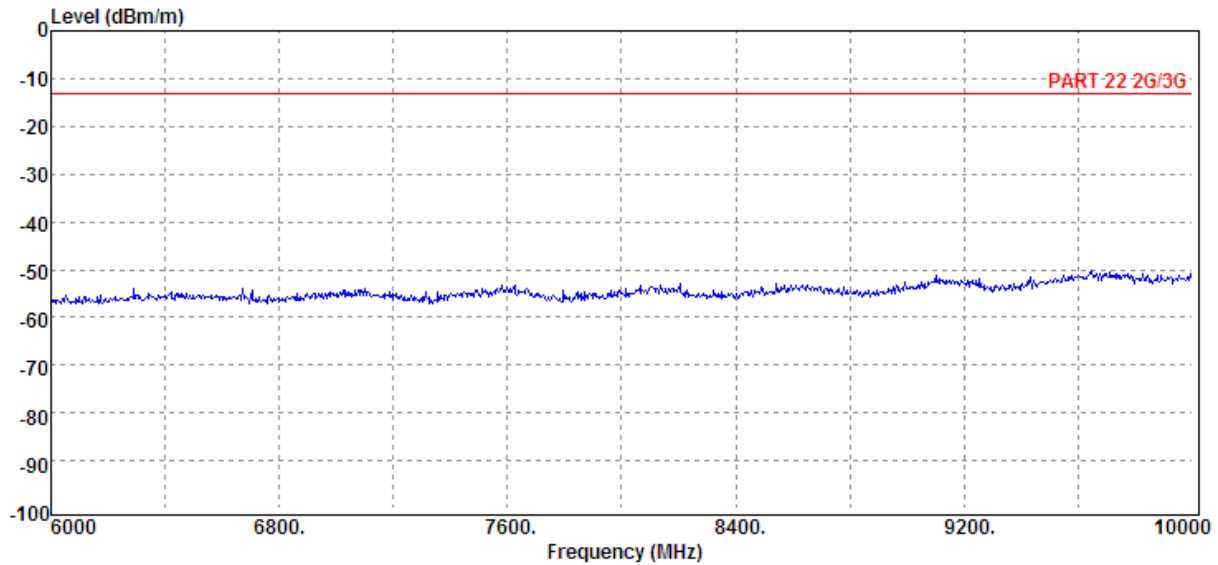

Unless otherwise stated the results shown in this test report refer only to the sample(s) tested and such sample(s) are retained for 90 days only.

除非另有說明，此報告結果僅對測試之樣品負責，同時此樣品僅保留90天。本報告未經本公司書面許可，不可部份複製。

This document is issued by the Company subject to its General Conditions of Service printed overleaf, available on request or accessible at www.sgs.com/terms_and_conditions.htm and, for electronic format documents, subject to Terms and Conditions for Electronic Documents at www.sgs.com/terms_e-document.htm. Attention is drawn to the limitation of liability, indemnification and jurisdiction issues defined therein. Any holder of this document is advised that information contained hereon reflects the Company's findings at the time of its intervention only and within the limits of Client's instructions, if any. The Company's sole responsibility is to its Client and this document does not exonerate parties to a transaction from exercising all their rights and obligations under the transaction documents. This document cannot be reproduced except in full, without prior written approval of the Company. Any unauthorized alteration, forgery or falsification of the content or appearance of this document is unlawful and offenders may be prosecuted to the fullest extent of the law.

| | | | |
|-----------------------|------------|--------------------------|---------------------|
| Operation Band | :HSDPA B5 | Test Date | : 2013-07-16 |
| ARFCN | :CH 4233 | Temp./Humi. | :24.1 deg_C / 65 RH |
| Fundamental Frequency | :846.6 MHz | Engineer | :Allen |
| Operation Mode | :TX HIGH | Measurement Antenna Pol. | :HORIZONTAL |
| EUT Pol. | :E1 Plan | | |

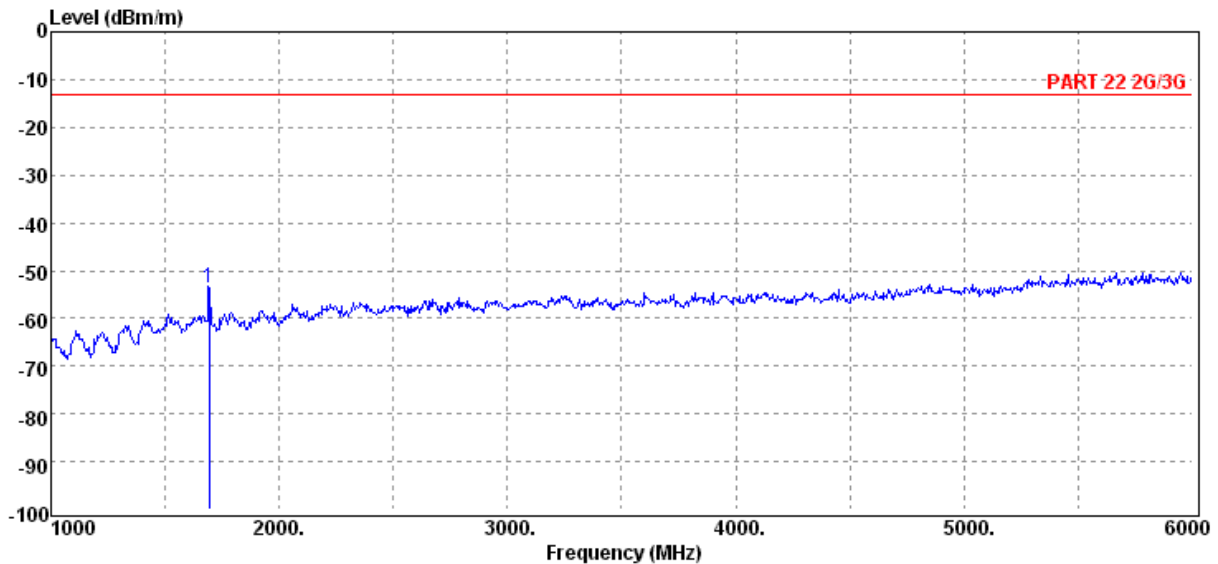
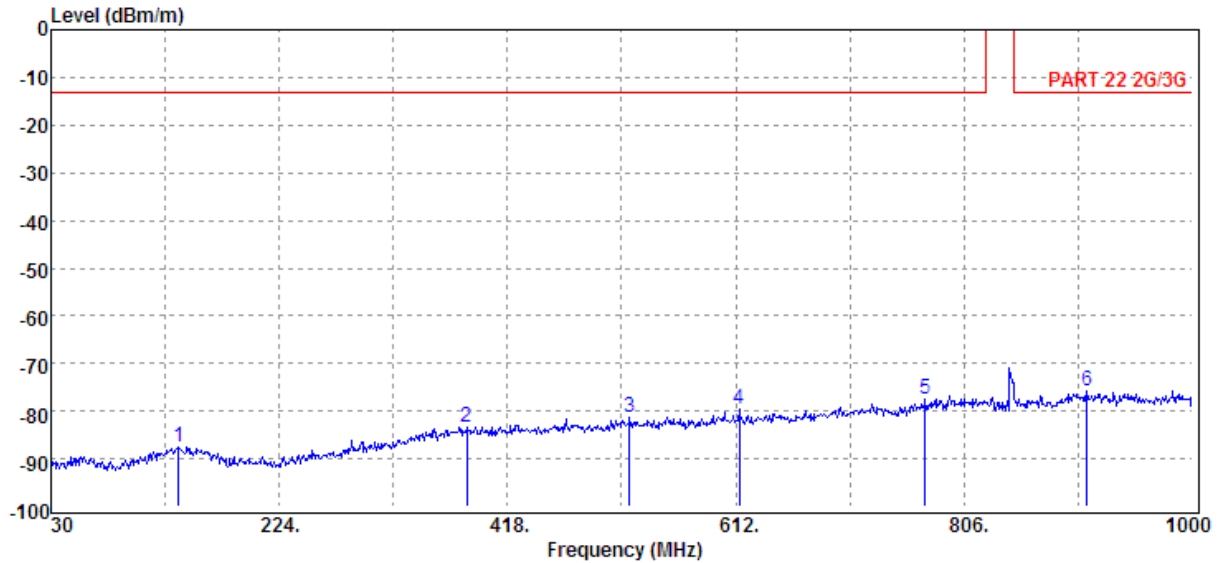

Unless otherwise stated the results shown in this test report refer only to the sample(s) tested and such sample(s) are retained for 90 days only.

除非另有說明，此報告結果僅對測試之樣品負責，同時此樣品僅保留90天。本報告未經本公司書面許可，不可部份複製。

This document is issued by the Company subject to its General Conditions of Service printed overleaf, available on request or accessible at www.sgs.com/terms_and_conditions.htm and, for electronic format documents, subject to Terms and Conditions for Electronic Documents at www.sgs.com/terms_e-document.htm. Attention is drawn to the limitation of liability, indemnification and jurisdiction issues defined therein. Any holder of this document is advised that information contained hereon reflects the Company's findings at the time of its intervention only and within the limits of Client's instructions, if any. The Company's sole responsibility is to its Client and this document does not exonerate parties to a transaction from exercising all their rights and obligations under the transaction documents. This document cannot be reproduced except in full, without prior written approval of the Company. Any unauthorized alteration, forgery or falsification of the content or appearance of this document is unlawful and offenders may be prosecuted to the fullest extent of the law.

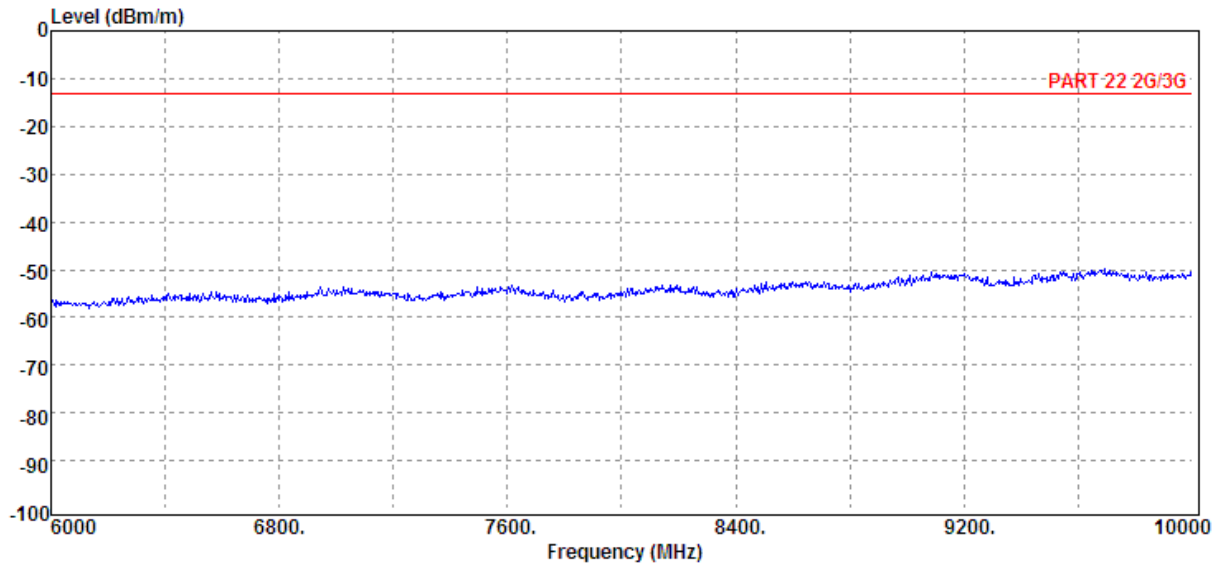

Unless otherwise stated the results shown in this test report refer only to the sample(s) tested and such sample(s) are retained for 90 days only.

除非另有說明，此報告結果僅對測試之樣品負責，同時此樣品僅保留90天。本報告未經本公司書面許可，不可部份複製。

This document is issued by the Company subject to its General Conditions of Service printed overleaf, available on request or accessible at www.sgs.com/terms_and_conditions.htm and, for electronic format documents, subject to Terms and Conditions for Electronic Documents at www.sgs.com/terms_e-document.htm. Attention is drawn to the limitation of liability, indemnification and jurisdiction issues defined therein. Any holder of this document is advised that information contained hereon reflects the Company's findings at the time of its intervention only and within the limits of Client's instructions, if any. The Company's sole responsibility is to its Client and this document does not exonerate parties to a transaction from exercising all their rights and obligations under the transaction documents. This document cannot be reproduced except in full, without prior written approval of the Company. Any unauthorized alteration, forgery or falsification of the content or appearance of this document is unlawful and offenders may be prosecuted to the fullest extent of the law.

Radiated Spurious Emission Measurement Result: GSM 850 Mode

| | | | |
|-----------------------|------------|--------------------------|---------------------|
| Operation Band | :GSM 850 | Test Date | :2013-05-03 |
| Fundamental Frequency | :824.2 MHz | Temp./Humi. | :24.1 deg_C / 65 RH |
| Operation Mode | :RX LOW | Engineer | :Allen |
| EUT Pol. | :E2 Plan | Measurement Antenna Pol. | :VERTICAL |

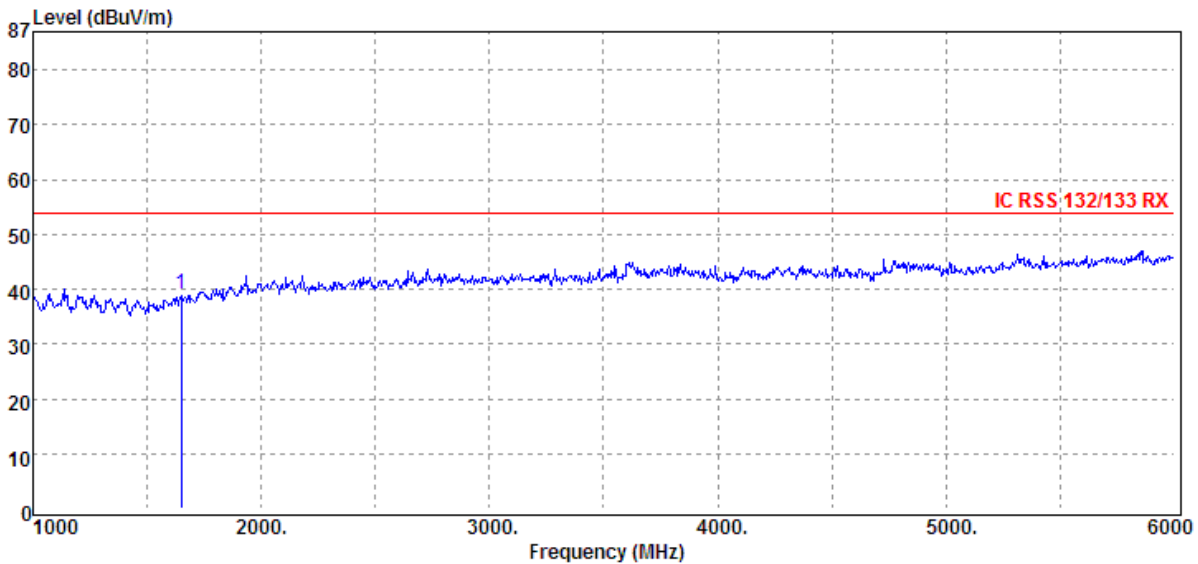
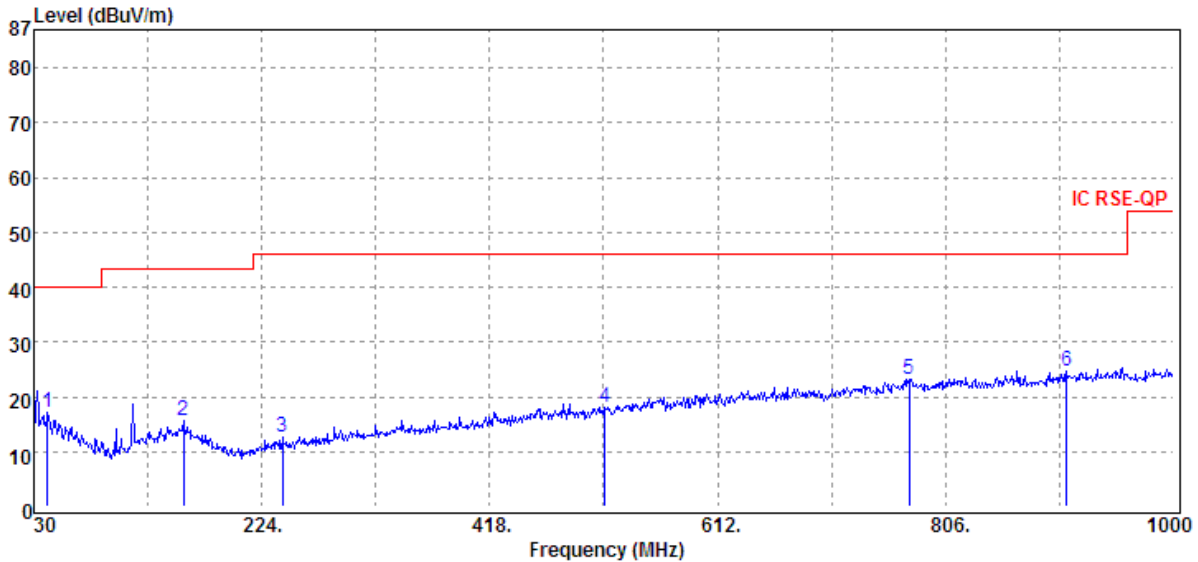

Unless otherwise stated the results shown in this test report refer only to the sample(s) tested and such sample(s) are retained for 90 days only.

除非另有說明，此報告結果僅對測試之樣品負責，同時此樣品僅保留90天。本報告未經本公司書面許可，不可部份複製。

This document is issued by the Company subject to its General Conditions of Service printed overleaf, available on request or accessible at www.sgs.com/terms_and_conditions.htm and, for electronic format documents, subject to Terms and Conditions for Electronic Documents at www.sgs.com/terms_e-document.htm. Attention is drawn to the limitation of liability, indemnification and jurisdiction issues defined therein. Any holder of this document is advised that information contained hereon reflects the Company's findings at the time of its intervention only and within the limits of Client's instructions, if any. The Company's sole responsibility is to its Client and this document does not exonerate parties to a transaction from exercising all their rights and obligations under the transaction documents. This document cannot be reproduced except in full, without prior written approval of the Company. Any unauthorized alteration, forgery or falsification of the content or appearance of this document is unlawful and offenders may be prosecuted to the fullest extent of the law.

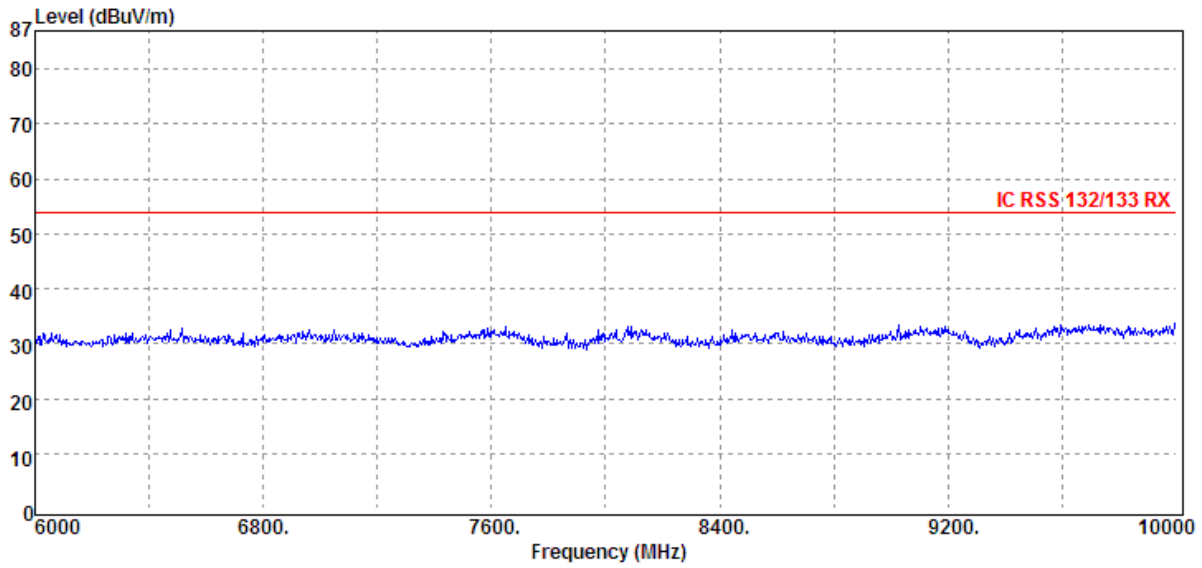

Unless otherwise stated the results shown in this test report refer only to the sample(s) tested and such sample(s) are retained for 90 days only.

除非另有說明，此報告結果僅對測試之樣品負責，同時此樣品僅保留90天。本報告未經本公司書面許可，不可部份複製。

This document is issued by the Company subject to its General Conditions of Service printed overleaf, available on request or accessible at www.sgs.com/terms_and_conditions.htm and, for electronic format documents, subject to Terms and Conditions for Electronic Documents at www.sgs.com/terms_e-document.htm. Attention is drawn to the limitation of liability, indemnification and jurisdiction issues defined therein. Any holder of this document is advised that information contained hereon reflects the Company's findings at the time of its intervention only and within the limits of Client's instructions, if any. The Company's sole responsibility is to its Client and this document does not exonerate parties to a transaction from exercising all their rights and obligations under the transaction documents. This document cannot be reproduced except in full, without prior written approval of the Company. Any unauthorized alteration, forgery or falsification of the content or appearance of this document is unlawful and offenders may be prosecuted to the fullest extent of the law.

| | | | |
|-----------------------|------------|--------------------------|---------------------|
| Operation Band | :GSM 850 | Test Date | :2013-05-03 |
| Fundamental Frequency | :824.2 MHz | Temp./Humi. | :24.1 deg_C / 65 RH |
| Operation Mode | :RX LOW | Engineer | :Allen |
| EUT Pol. | :E2 Plan | Measurement Antenna Pol. | :HORIZONTAL |

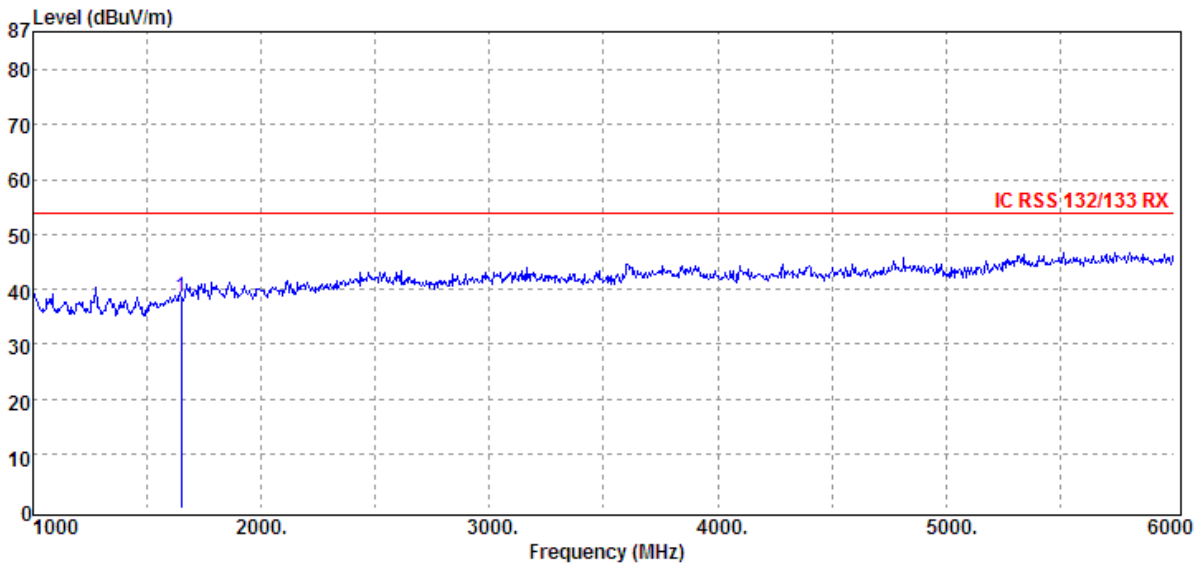
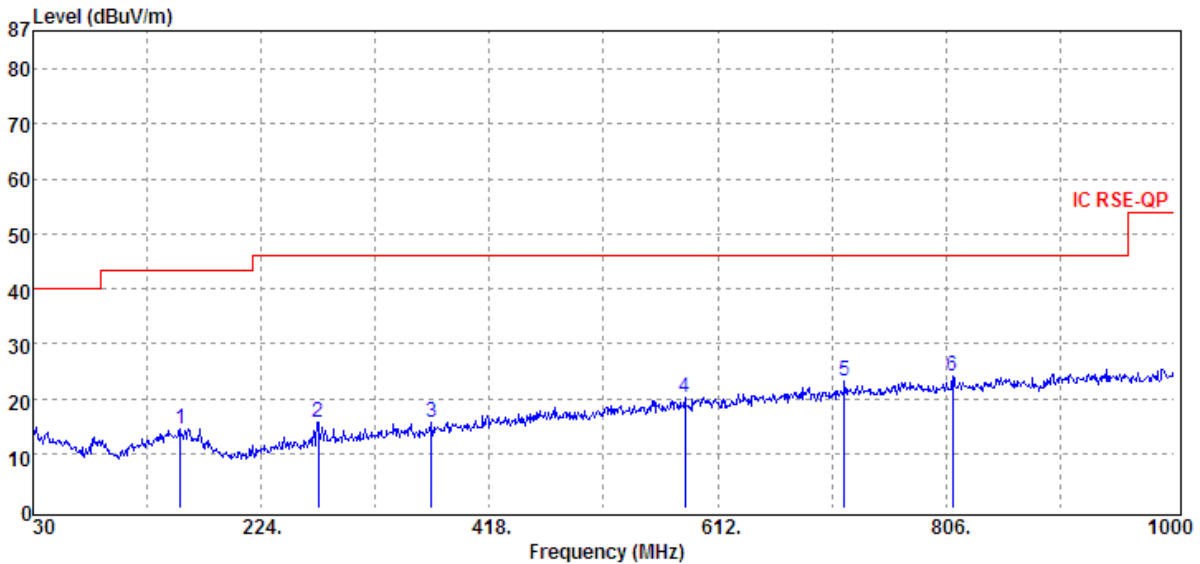

Unless otherwise stated the results shown in this test report refer only to the sample(s) tested and such sample(s) are retained for 90 days only.

除非另有說明，此報告結果僅對測試之樣品負責，同時此樣品僅保留90天。本報告未經本公司書面許可，不可部份複製。

This document is issued by the Company subject to its General Conditions of Service printed overleaf, available on request or accessible at www.sgs.com/terms_and_conditions.htm and, for electronic format documents, subject to Terms and Conditions for Electronic Documents at www.sgs.com/terms_e-document.htm. Attention is drawn to the limitation of liability, indemnification and jurisdiction issues defined therein. Any holder of this document is advised that information contained hereon reflects the Company's findings at the time of its intervention only and within the limits of Client's instructions, if any. The Company's sole responsibility is to its Client and this document does not exonerate parties to a transaction from exercising all their rights and obligations under the transaction documents. This document cannot be reproduced except in full, without prior written approval of the Company. Any unauthorized alteration, forgery or falsification of the content or appearance of this document is unlawful and offenders may be prosecuted to the fullest extent of the law.

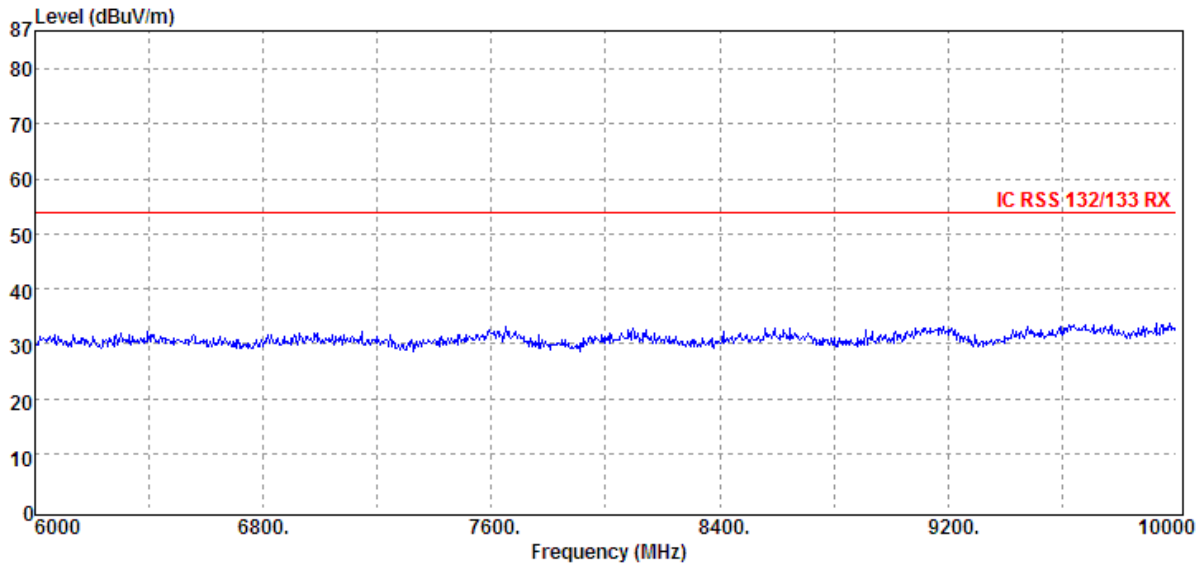

Unless otherwise stated the results shown in this test report refer only to the sample(s) tested and such sample(s) are retained for 90 days only.

除非另有說明，此報告結果僅對測試之樣品負責，同時此樣品僅保留90天。本報告未經本公司書面許可，不可部份複製。

This document is issued by the Company subject to its General Conditions of Service printed overleaf, available on request or accessible at www.sgs.com/terms_and_conditions.htm and, for electronic format documents, subject to Terms and Conditions for Electronic Documents at www.sgs.com/terms_e-document.htm. Attention is drawn to the limitation of liability, indemnification and jurisdiction issues defined therein. Any holder of this document is advised that information contained hereon reflects the Company's findings at the time of its intervention only and within the limits of Client's instructions, if any. The Company's sole responsibility is to its Client and this document does not exonerate parties to a transaction from exercising all their rights and obligations under the transaction documents. This document cannot be reproduced except in full, without prior written approval of the Company. Any unauthorized alteration, forgery or falsification of the content or appearance of this document is unlawful and offenders may be prosecuted to the fullest extent of the law.

| | | | |
|-----------------------|------------|--------------------------|---------------------|
| Operation Band | :GSM 850 | Test Date | :2013-05-03 |
| Fundamental Frequency | :836.6 MHz | Temp./Humi. | :24.1 deg_C / 65 RH |
| Operation Mode | :RX MID | Engineer | :Allen |
| EUT Pol. | :E2 Plan | Measurement Antenna Pol. | :VERTICAL |

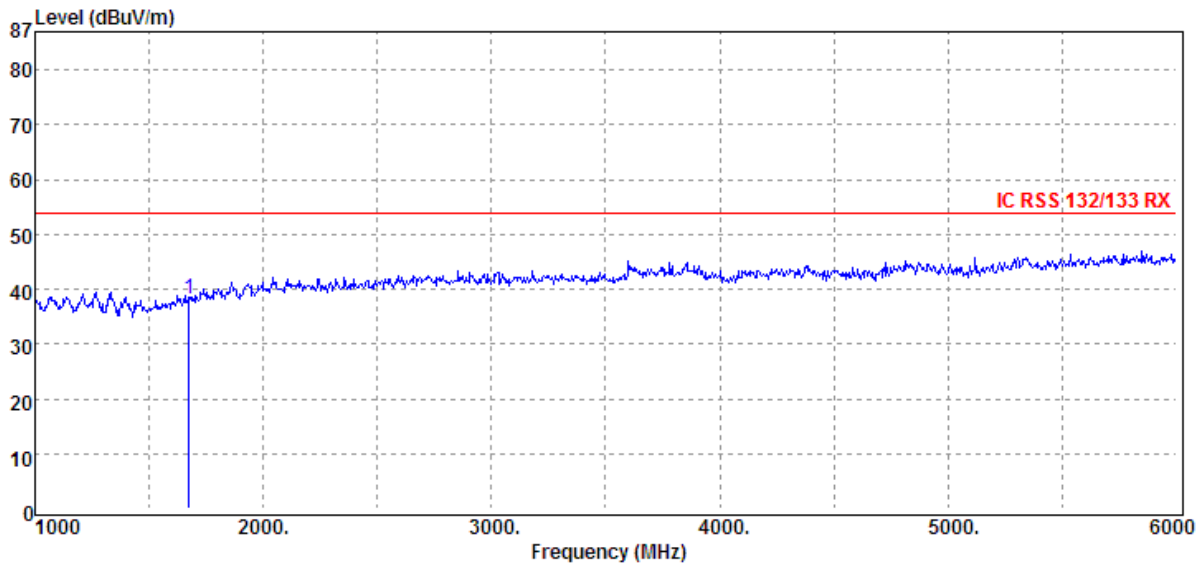
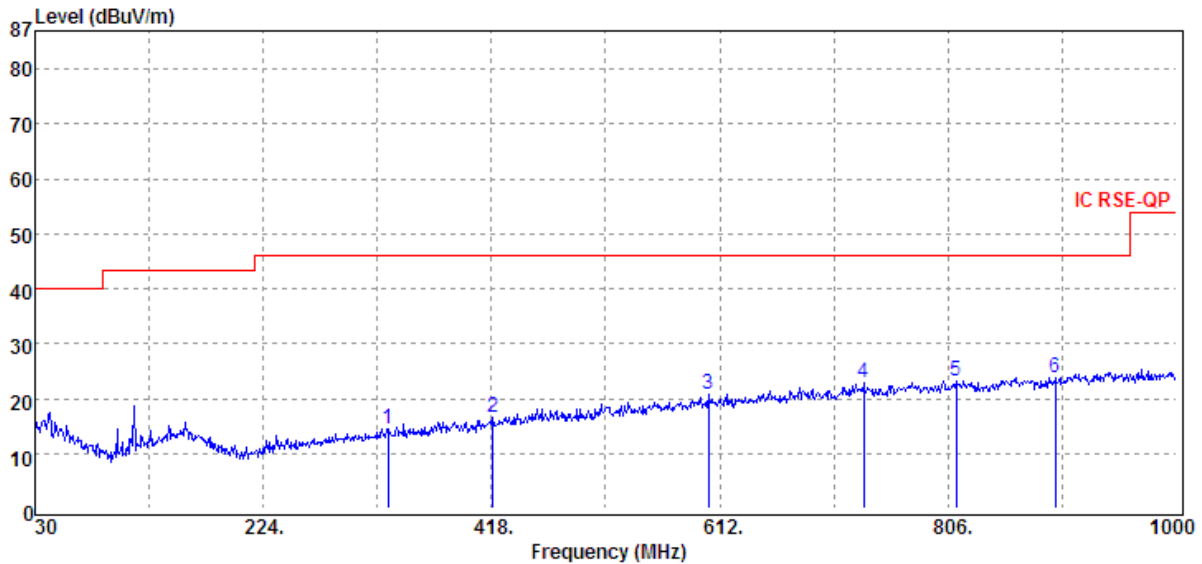

Unless otherwise stated the results shown in this test report refer only to the sample(s) tested and such sample(s) are retained for 90 days only.

除非另有說明，此報告結果僅對測試之樣品負責，同時此樣品僅保留90天。本報告未經本公司書面許可，不可部份複製。

This document is issued by the Company subject to its General Conditions of Service printed overleaf, available on request or accessible at www.sgs.com/terms_and_conditions.htm and, for electronic format documents, subject to Terms and Conditions for Electronic Documents at www.sgs.com/terms_e-document.htm. Attention is drawn to the limitation of liability, indemnification and jurisdiction issues defined therein. Any holder of this document is advised that information contained hereon reflects the Company's findings at the time of its intervention only and within the limits of Client's instructions, if any. The Company's sole responsibility is to its Client and this document does not exonerate parties to a transaction from exercising all their rights and obligations under the transaction documents. This document cannot be reproduced except in full, without prior written approval of the Company. Any unauthorized alteration, forgery or falsification of the content or appearance of this document is unlawful and offenders may be prosecuted to the fullest extent of the law.

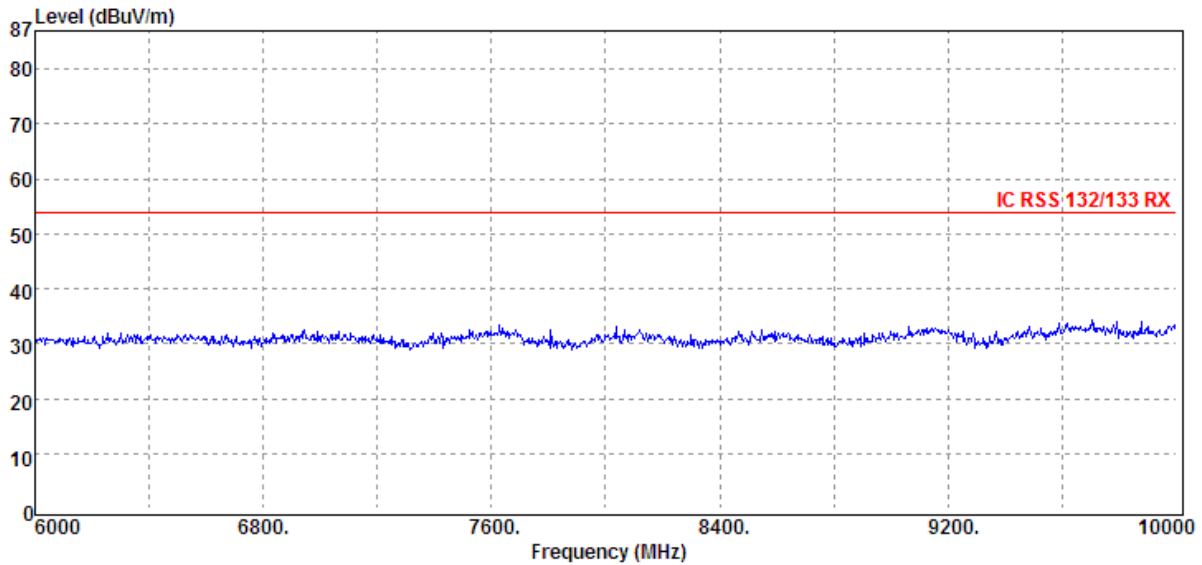

Unless otherwise stated the results shown in this test report refer only to the sample(s) tested and such sample(s) are retained for 90 days only.

除非另有說明，此報告結果僅對測試之樣品負責，同時此樣品僅保留90天。本報告未經本公司書面許可，不可部份複製。

This document is issued by the Company subject to its General Conditions of Service printed overleaf, available on request or accessible at www.sgs.com/terms_and_conditions.htm and, for electronic format documents, subject to Terms and Conditions for Electronic Documents at www.sgs.com/terms_e-document.htm. Attention is drawn to the limitation of liability, indemnification and jurisdiction issues defined therein. Any holder of this document is advised that information contained hereon reflects the Company's findings at the time of its intervention only and within the limits of Client's instructions, if any. The Company's sole responsibility is to its Client and this document does not exonerate parties to a transaction from exercising all their rights and obligations under the transaction documents. This document cannot be reproduced except in full, without prior written approval of the Company. Any unauthorized alteration, forgery or falsification of the content or appearance of this document is unlawful and offenders may be prosecuted to the fullest extent of the law.

| | | | |
|-----------------------|------------|--------------------------|---------------------|
| Operation Band | :GSM 850 | Test Date | :2013-05-03 |
| Fundamental Frequency | :836.6 MHz | Temp./Humi. | :24.1 deg_C / 65 RH |
| Operation Mode | :RX MID | Engineer | :Allen |
| EUT Pol. | :E2 Plan | Measurement Antenna Pol. | :HORIZONTAL |

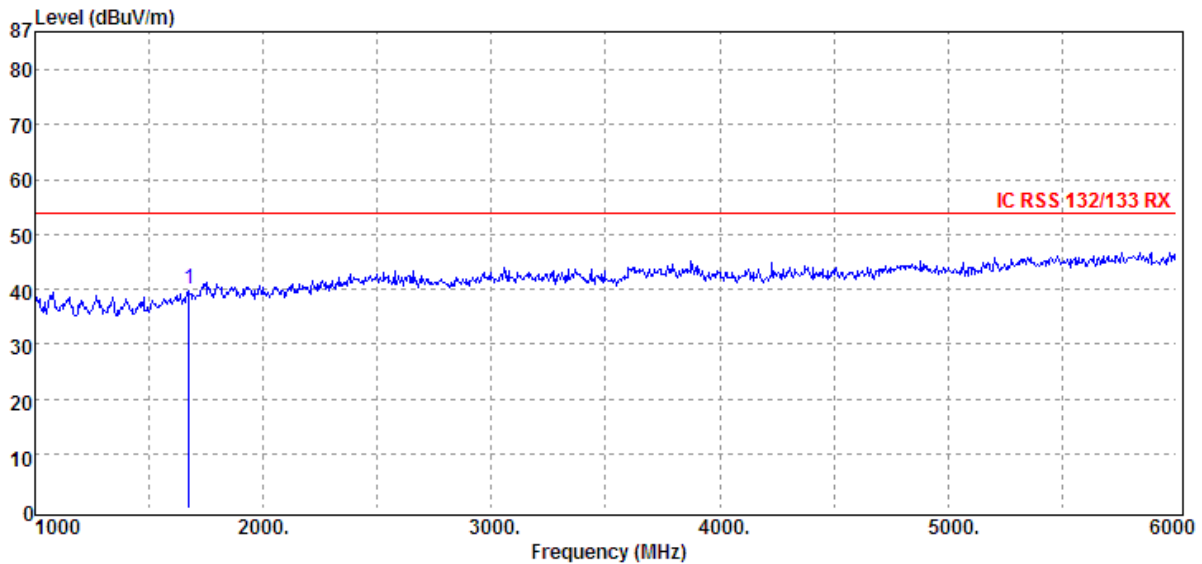
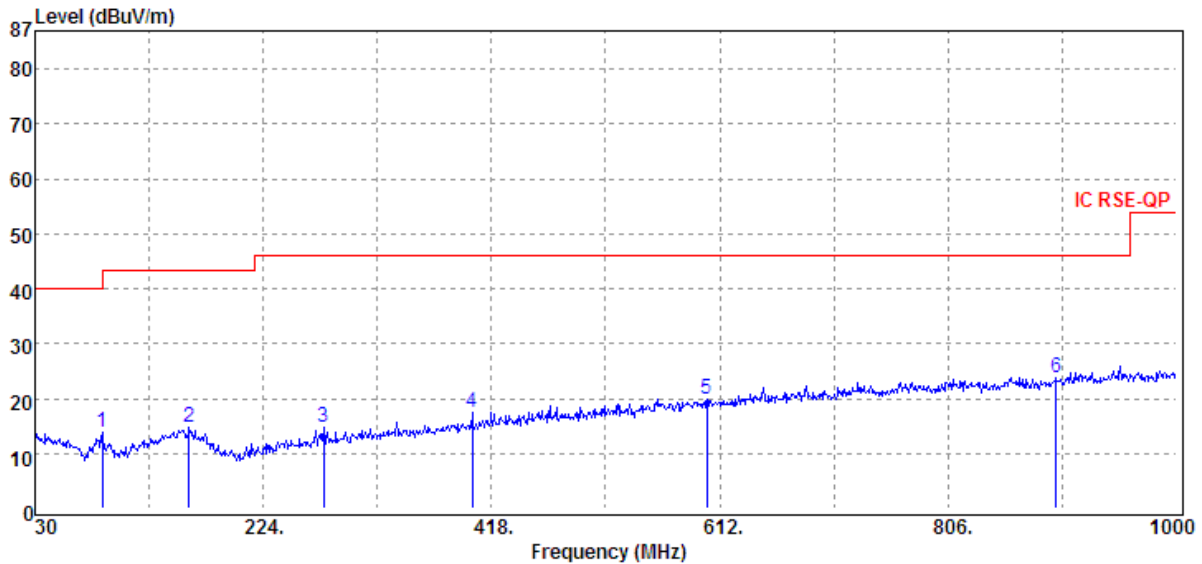

Unless otherwise stated the results shown in this test report refer only to the sample(s) tested and such sample(s) are retained for 90 days only.

除非另有說明，此報告結果僅對測試之樣品負責，同時此樣品僅保留90天。本報告未經本公司書面許可，不可部份複製。

This document is issued by the Company subject to its General Conditions of Service printed overleaf, available on request or accessible at www.sgs.com/terms_and_conditions.htm and, for electronic format documents, subject to Terms and Conditions for Electronic Documents at www.sgs.com/terms_e-document.htm. Attention is drawn to the limitation of liability, indemnification and jurisdiction issues defined therein. Any holder of this document is advised that information contained hereon reflects the Company's findings at the time of its intervention only and within the limits of Client's instructions, if any. The Company's sole responsibility is to its Client and this document does not exonerate parties to a transaction from exercising all their rights and obligations under the transaction documents. This document cannot be reproduced except in full, without prior written approval of the Company. Any unauthorized alteration, forgery or falsification of the content or appearance of this document is unlawful and offenders may be prosecuted to the fullest extent of the law.

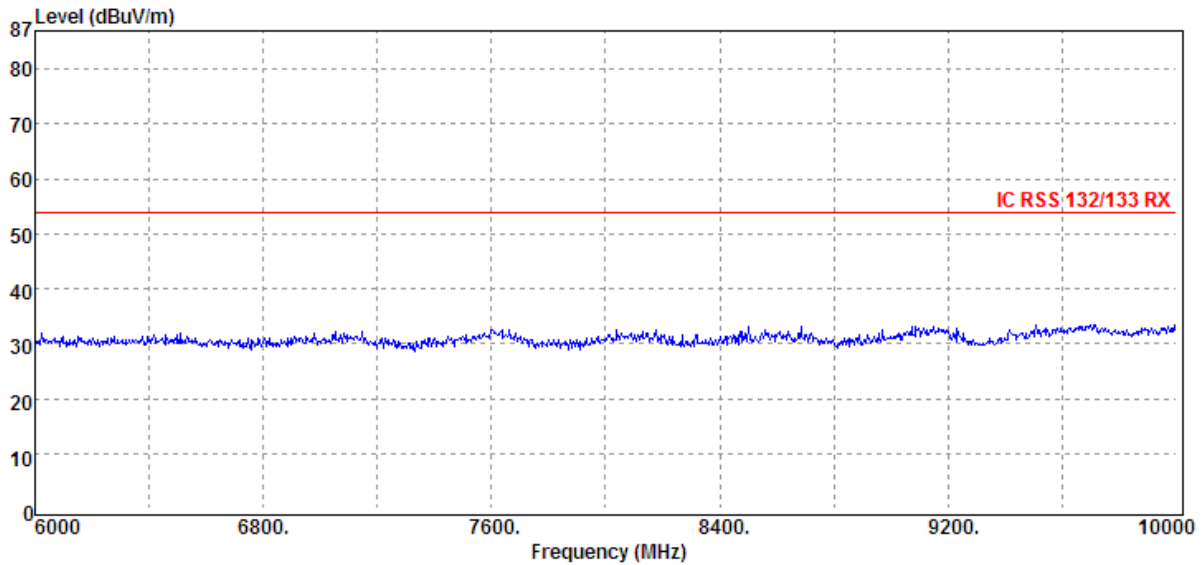

Unless otherwise stated the results shown in this test report refer only to the sample(s) tested and such sample(s) are retained for 90 days only.

除非另有說明，此報告結果僅對測試之樣品負責，同時此樣品僅保留90天。本報告未經本公司書面許可，不可部份複製。

This document is issued by the Company subject to its General Conditions of Service printed overleaf, available on request or accessible at www.sgs.com/terms_and_conditions.htm and, for electronic format documents, subject to Terms and Conditions for Electronic Documents at www.sgs.com/terms_e-document.htm. Attention is drawn to the limitation of liability, indemnification and jurisdiction issues defined therein. Any holder of this document is advised that information contained hereon reflects the Company's findings at the time of its intervention only and within the limits of Client's instructions, if any. The Company's sole responsibility is to its Client and this document does not exonerate parties to a transaction from exercising all their rights and obligations under the transaction documents. This document cannot be reproduced except in full, without prior written approval of the Company. Any unauthorized alteration, forgery or falsification of the content or appearance of this document is unlawful and offenders may be prosecuted to the fullest extent of the law.

| | | | |
|-----------------------|------------|--------------------------|---------------------|
| Operation Band | :GSM 850 | Test Date | :2013-05-03 |
| Fundamental Frequency | :848.8 MHz | Temp./Humi. | :24.1 deg_C / 65 RH |
| Operation Mode | :RX HIGH | Engineer | :Allen |
| EUT Pol. | :E2 Plan | Measurement Antenna Pol. | :VERTICAL |

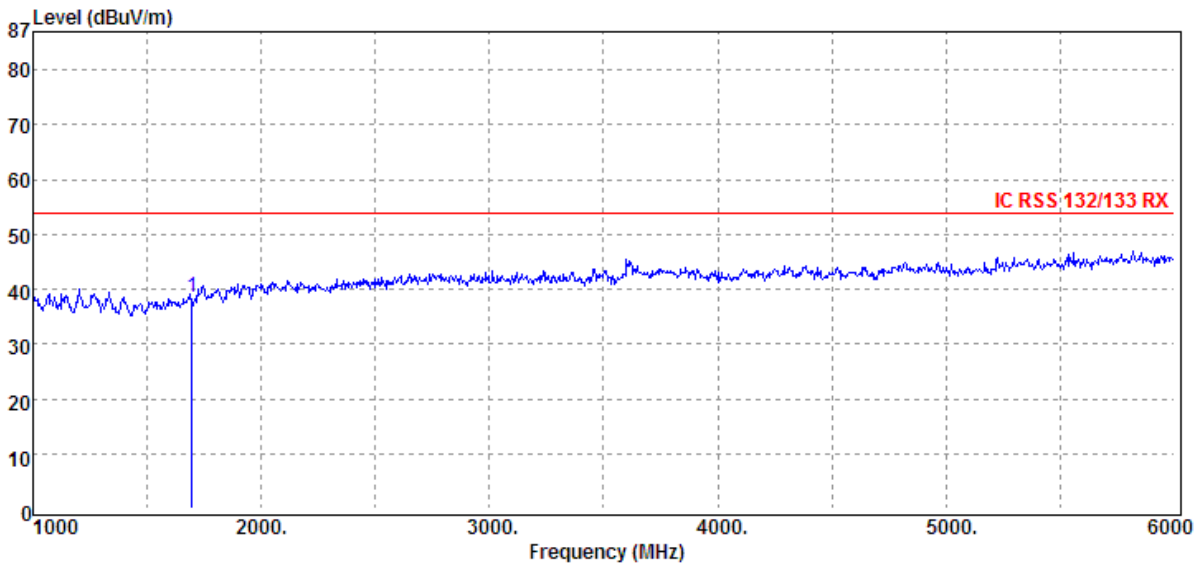
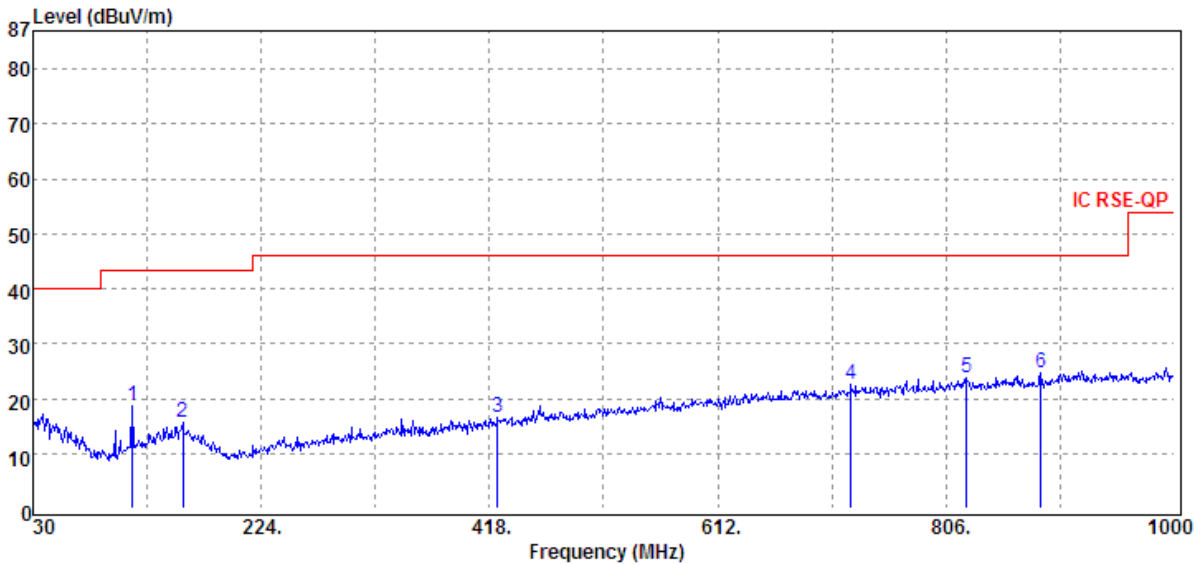

Unless otherwise stated the results shown in this test report refer only to the sample(s) tested and such sample(s) are retained for 90 days only.

除非另有說明，此報告結果僅對測試之樣品負責，同時此樣品僅保留90天。本報告未經本公司書面許可，不可部份複製。

This document is issued by the Company subject to its General Conditions of Service printed overleaf, available on request or accessible at www.sgs.com/terms_and_conditions.htm and, for electronic format documents, subject to Terms and Conditions for Electronic Documents at www.sgs.com/terms_e-document.htm. Attention is drawn to the limitation of liability, indemnification and jurisdiction issues defined therein. Any holder of this document is advised that information contained hereon reflects the Company's findings at the time of its intervention only and within the limits of Client's instructions, if any. The Company's sole responsibility is to its Client and this document does not exonerate parties to a transaction from exercising all their rights and obligations under the transaction documents. This document cannot be reproduced except in full, without prior written approval of the Company. Any unauthorized alteration, forgery or falsification of the content or appearance of this document is unlawful and offenders may be prosecuted to the fullest extent of the law.

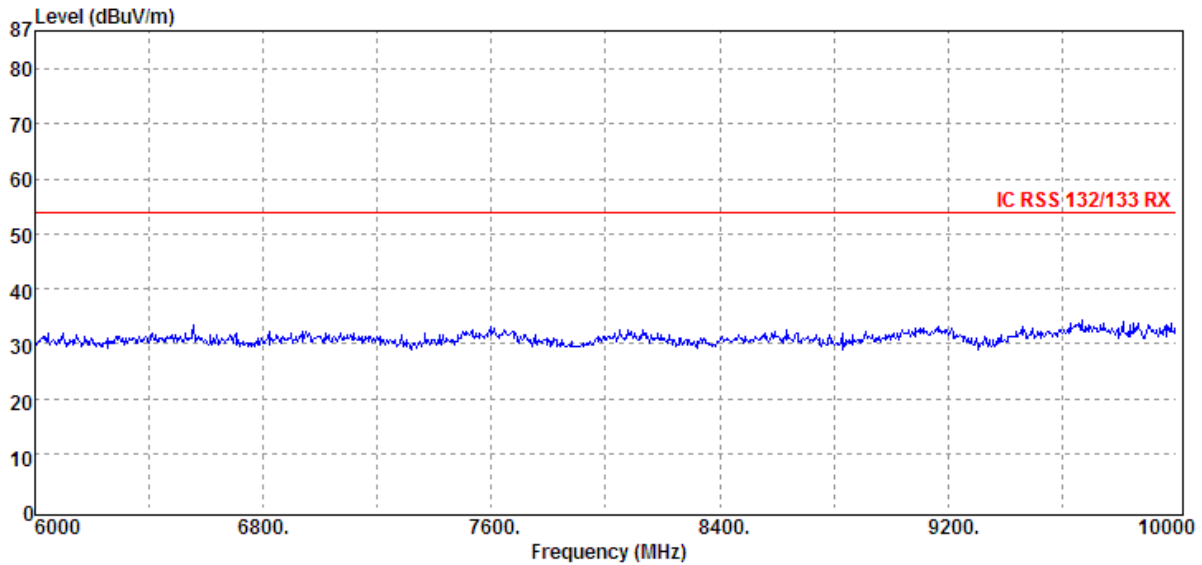

Unless otherwise stated the results shown in this test report refer only to the sample(s) tested and such sample(s) are retained for 90 days only.

除非另有說明，此報告結果僅對測試之樣品負責，同時此樣品僅保留90天。本報告未經本公司書面許可，不可部份複製。

This document is issued by the Company subject to its General Conditions of Service printed overleaf, available on request or accessible at www.sgs.com/terms_and_conditions.htm and, for electronic format documents, subject to Terms and Conditions for Electronic Documents at www.sgs.com/terms_e-document.htm. Attention is drawn to the limitation of liability, indemnification and jurisdiction issues defined therein. Any holder of this document is advised that information contained hereon reflects the Company's findings at the time of its intervention only and within the limits of Client's instructions, if any. The Company's sole responsibility is to its Client and this document does not exonerate parties to a transaction from exercising all their rights and obligations under the transaction documents. This document cannot be reproduced except in full, without prior written approval of the Company. Any unauthorized alteration, forgery or falsification of the content or appearance of this document is unlawful and offenders may be prosecuted to the fullest extent of the law.

| | | | |
|-----------------------|------------|--------------------------|---------------------|
| Operation Band | :GSM 850 | Test Date | :2013-05-03 |
| Fundamental Frequency | :848.8 MHz | Temp./Humi. | :24.1 deg_C / 65 RH |
| Operation Mode | :RX HIGH | Engineer | :Allen |
| EUT Pol. | :E2 Plan | Measurement Antenna Pol. | :HORIZONTAL |

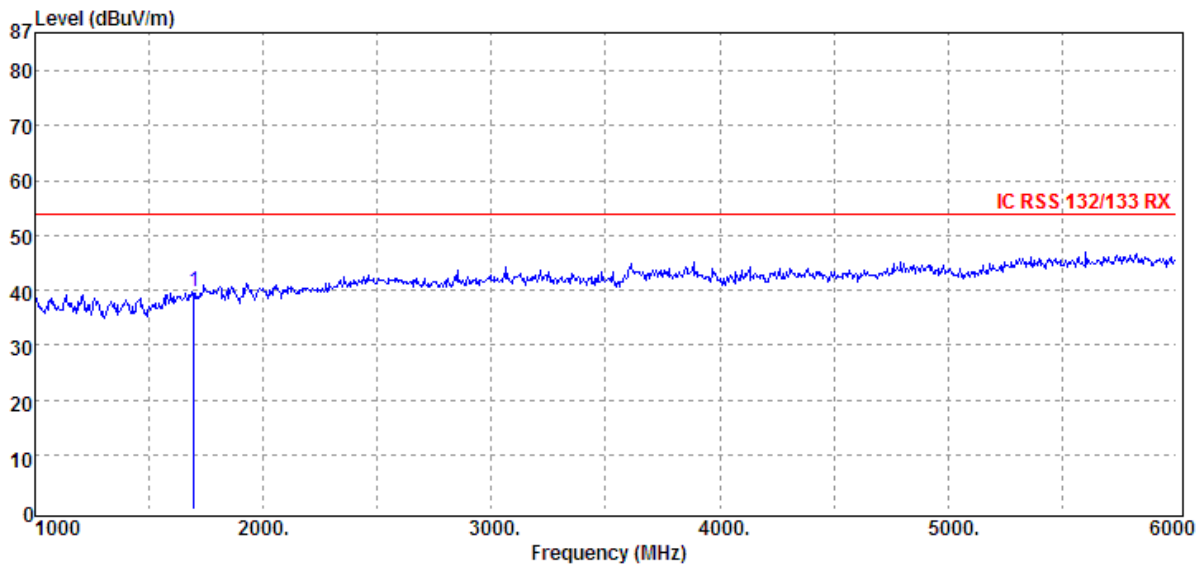
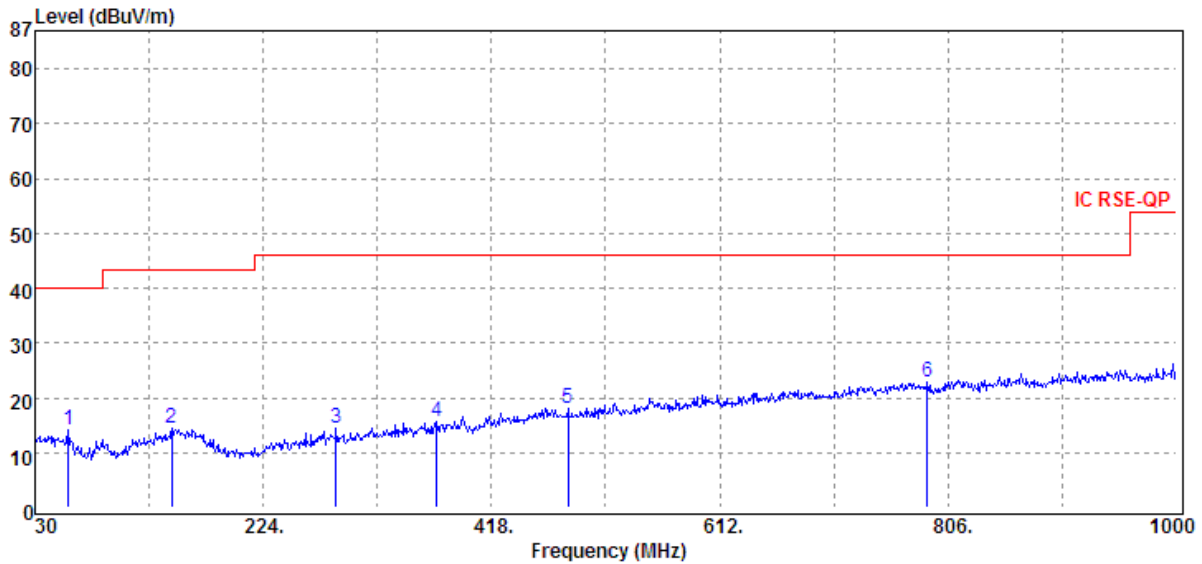

Unless otherwise stated the results shown in this test report refer only to the sample(s) tested and such sample(s) are retained for 90 days only.

除非另有說明，此報告結果僅對測試之樣品負責，同時此樣品僅保留90天。本報告未經本公司書面許可，不可部份複製。

This document is issued by the Company subject to its General Conditions of Service printed overleaf, available on request or accessible at www.sgs.com/terms_and_conditions.htm and, for electronic format documents, subject to Terms and Conditions for Electronic Documents at www.sgs.com/terms_e-document.htm. Attention is drawn to the limitation of liability, indemnification and jurisdiction issues defined therein. Any holder of this document is advised that information contained hereon reflects the Company's findings at the time of its intervention only and within the limits of Client's instructions, if any. The Company's sole responsibility is to its Client and this document does not exonerate parties to a transaction from exercising all their rights and obligations under the transaction documents. This document cannot be reproduced except in full, without prior written approval of the Company. Any unauthorized alteration, forgery or falsification of the content or appearance of this document is unlawful and offenders may be prosecuted to the fullest extent of the law.

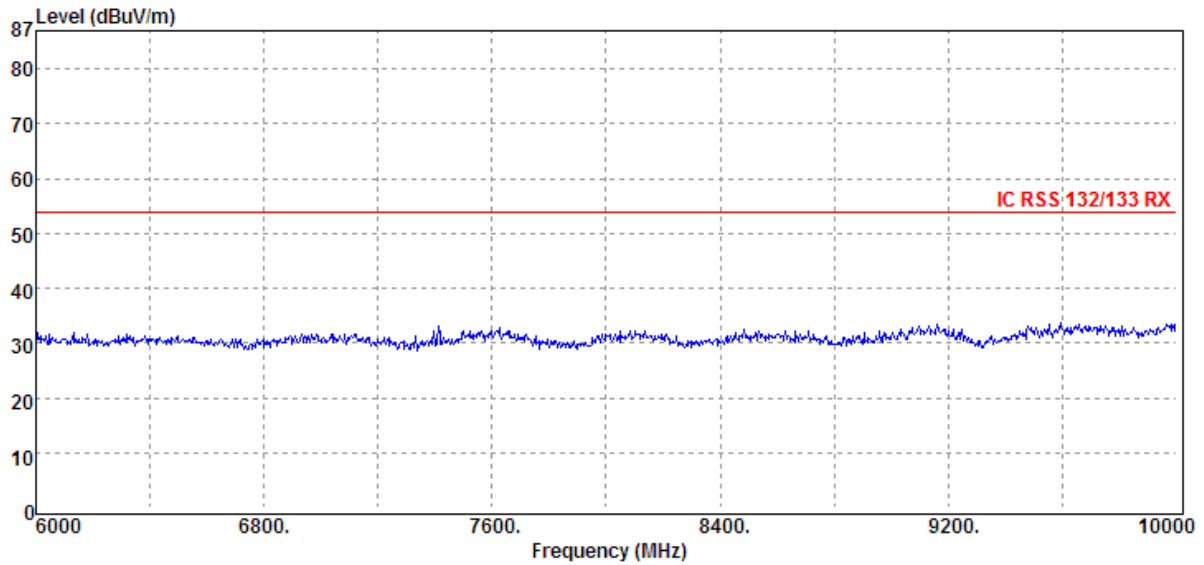

Unless otherwise stated the results shown in this test report refer only to the sample(s) tested and such sample(s) are retained for 90 days only.

除非另有說明，此報告結果僅對測試之樣品負責，同時此樣品僅保留90天。本報告未經本公司書面許可，不可部份複製。

This document is issued by the Company subject to its General Conditions of Service printed overleaf, available on request or accessible at www.sgs.com/terms_and_conditions.htm and, for electronic format documents, subject to Terms and Conditions for Electronic Documents at www.sgs.com/terms_e-document.htm. Attention is drawn to the limitation of liability, indemnification and jurisdiction issues defined therein. Any holder of this document is advised that information contained hereon reflects the Company's findings at the time of its intervention only and within the limits of Client's instructions, if any. The Company's sole responsibility is to its Client and this document does not exonerate parties to a transaction from exercising all their rights and obligations under the transaction documents. This document cannot be reproduced except in full, without prior written approval of the Company. Any unauthorized alteration, forgery or falsification of the content or appearance of this document is unlawful and offenders may be prosecuted to the fullest extent of the law.

Radiated Spurious Emission Measurement Result: GSM 1900 Mode

| | | | |
|-----------------------|-------------|--------------------------|---------------------|
| Operation Band | :GSM 1900 | Test Date | :2013-05-03 |
| Fundamental Frequency | :1850.2 MHz | Temp./Humi. | :24.1 deg_C / 65 RH |
| Operation Mode | :RX LOW | Engineer | :Allen |
| EUT Pol. | :E1 Plan | Measurement Antenna Pol. | :VERTICAL |

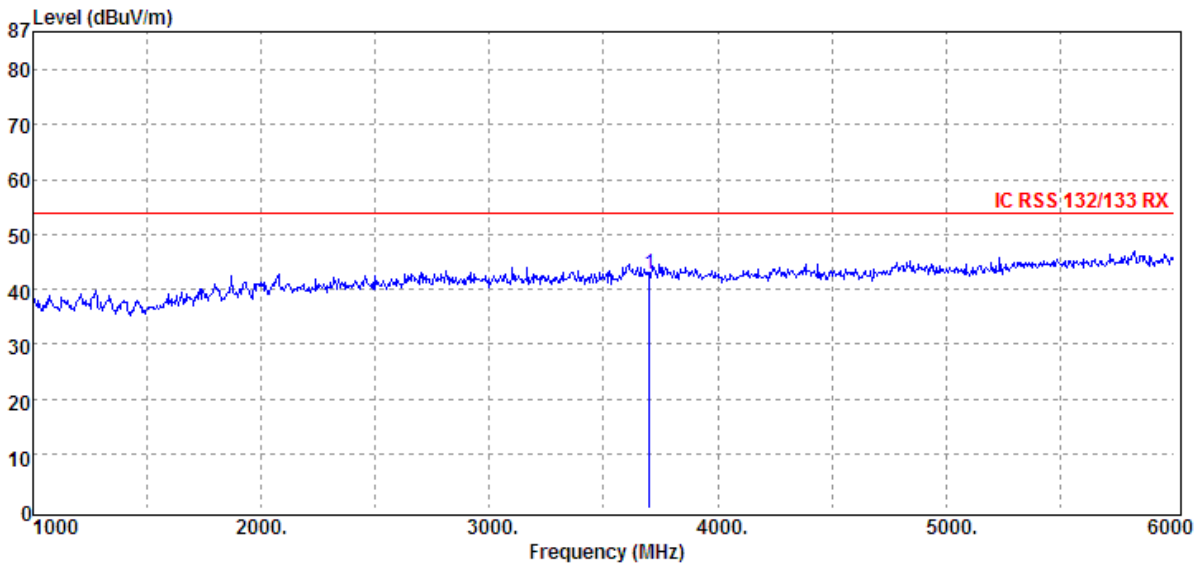
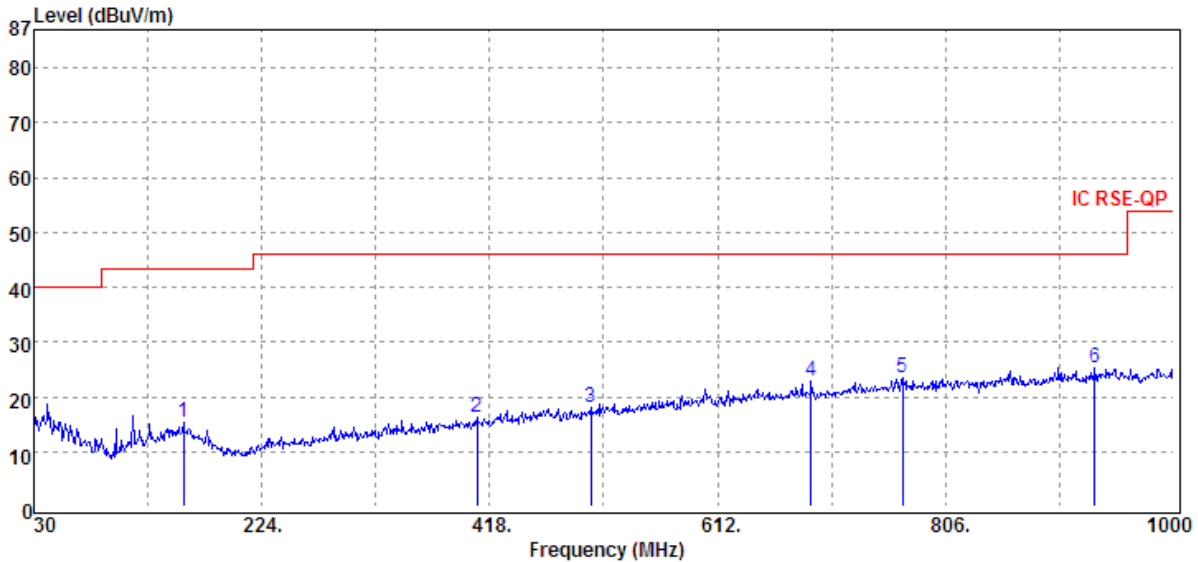

Unless otherwise stated the results shown in this test report refer only to the sample(s) tested and such sample(s) are retained for 90 days only.

除非另有說明，此報告結果僅對測試之樣品負責，同時此樣品僅保留90天。本報告未經本公司書面許可，不可部份複製。

This document is issued by the Company subject to its General Conditions of Service printed overleaf, available on request or accessible at www.sgs.com/terms_and_conditions.htm and, for electronic format documents, subject to Terms and Conditions for Electronic Documents at www.sgs.com/terms_e-document.htm. Attention is drawn to the limitation of liability, indemnification and jurisdiction issues defined therein. Any holder of this document is advised that information contained hereon reflects the Company's findings at the time of its intervention only and within the limits of Client's instructions, if any. The Company's sole responsibility is to its Client and this document does not exonerate parties to a transaction from exercising all their rights and obligations under the transaction documents. This document cannot be reproduced except in full, without prior written approval of the Company. Any unauthorized alteration, forgery or falsification of the content or appearance of this document is unlawful and offenders may be prosecuted to the fullest extent of the law.

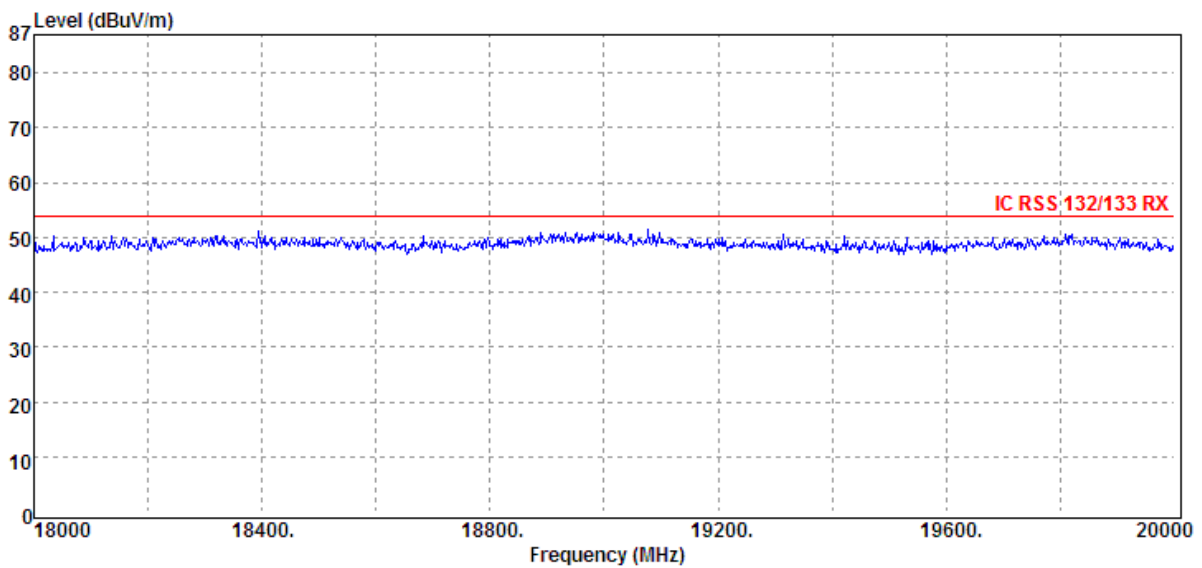
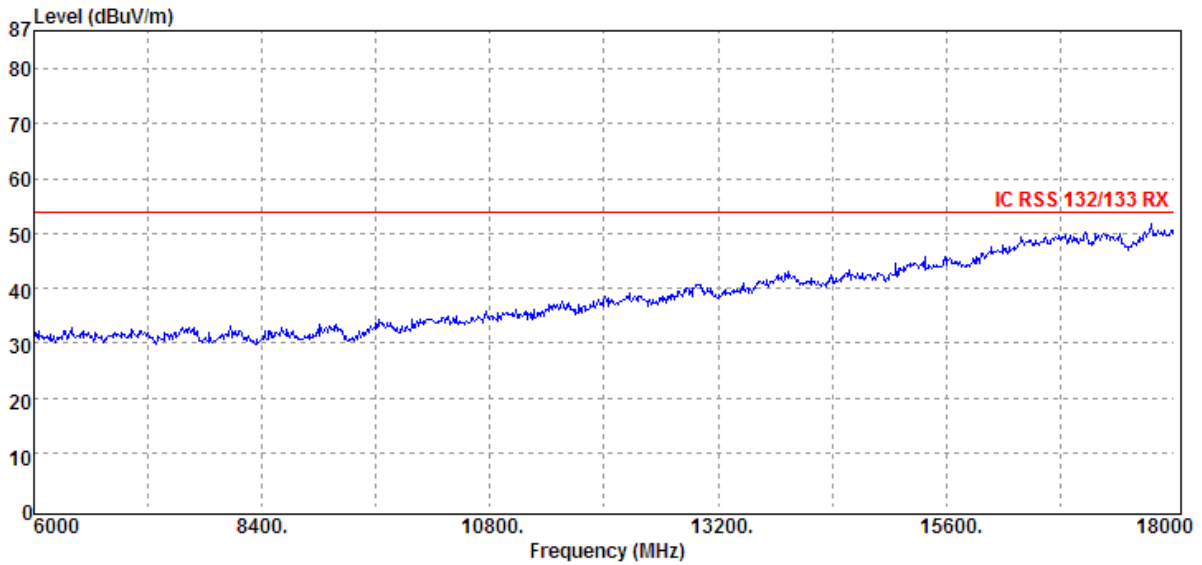

Unless otherwise stated the results shown in this test report refer only to the sample(s) tested and such sample(s) are retained for 90 days only.

除非另有說明，此報告結果僅對測試之樣品負責，同時此樣品僅保留90天。本報告未經本公司書面許可，不可部份複製。

This document is issued by the Company subject to its General Conditions of Service printed overleaf, available on request or accessible at www.sgs.com/terms_and_conditions.htm and, for electronic format documents, subject to Terms and Conditions for Electronic Documents at www.sgs.com/terms_e-document.htm. Attention is drawn to the limitation of liability, indemnification and jurisdiction issues defined therein. Any holder of this document is advised that information contained hereon reflects the Company's findings at the time of its intervention only and within the limits of Client's instructions, if any. The Company's sole responsibility is to its Client and this document does not exonerate parties to a transaction from exercising all their rights and obligations under the transaction documents. This document cannot be reproduced except in full, without prior written approval of the Company. Any unauthorized alteration, forgery or falsification of the content or appearance of this document is unlawful and offenders may be prosecuted to the fullest extent of the law.

| | | | |
|-----------------------|-------------|--------------------------|---------------------|
| Operation Band | :GSM 1900 | Test Date | :2013-05-03 |
| Fundamental Frequency | :1850.2 MHz | Temp./Humi. | :24.1 deg_C / 65 RH |
| Operation Mode | :RX LOW | Engineer | :Allen |
| EUT Pol. | :E1 Plan | Measurement Antenna Pol. | :HORIZONTAL |

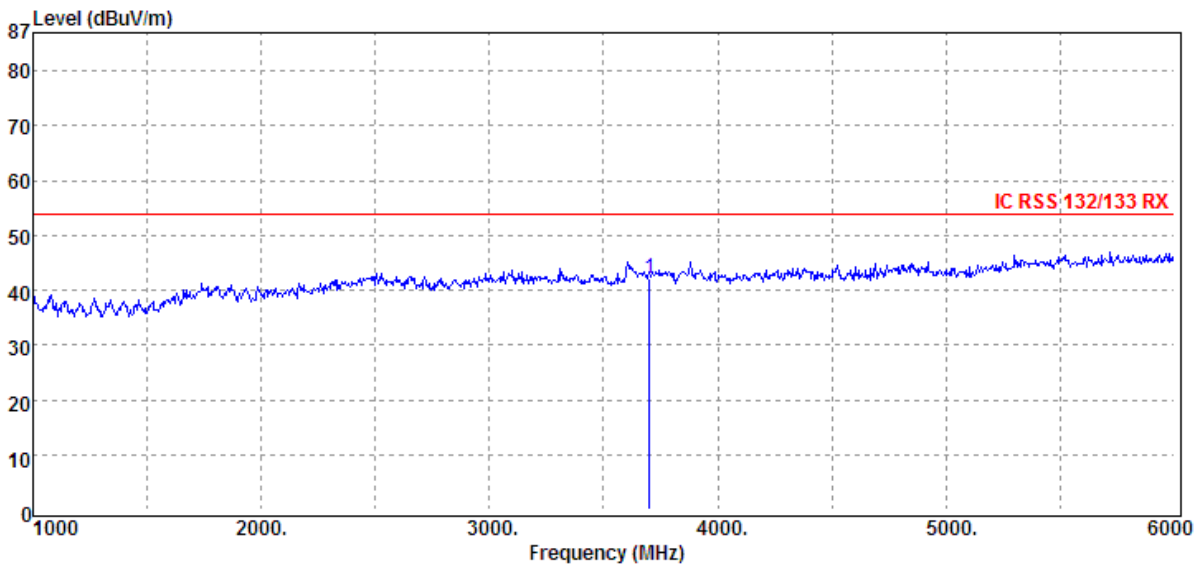
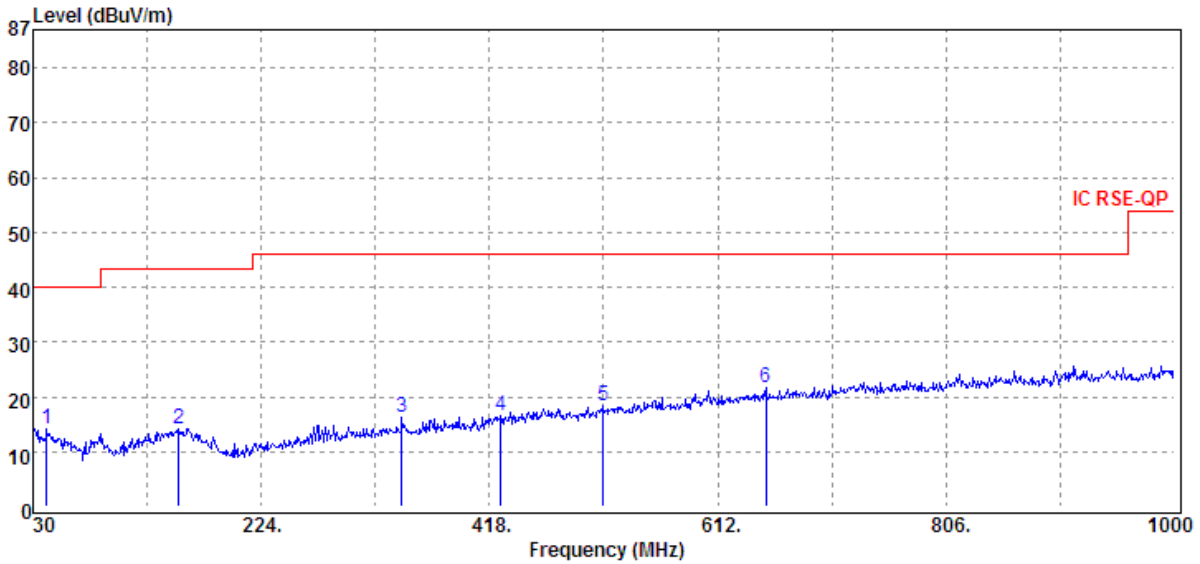

Unless otherwise stated the results shown in this test report refer only to the sample(s) tested and such sample(s) are retained for 90 days only.

除非另有說明，此報告結果僅對測試之樣品負責，同時此樣品僅保留90天。本報告未經本公司書面許可，不可部份複製。

This document is issued by the Company subject to its General Conditions of Service printed overleaf, available on request or accessible at www.sgs.com/terms_and_conditions.htm and, for electronic format documents, subject to Terms and Conditions for Electronic Documents at www.sgs.com/terms_e-document.htm. Attention is drawn to the limitation of liability, indemnification and jurisdiction issues defined therein. Any holder of this document is advised that information contained hereon reflects the Company's findings at the time of its intervention only and within the limits of Client's instructions, if any. The Company's sole responsibility is to its Client and this document does not exonerate parties to a transaction from exercising all their rights and obligations under the transaction documents. This document cannot be reproduced except in full, without prior written approval of the Company. Any unauthorized alteration, forgery or falsification of the content or appearance of this document is unlawful and offenders may be prosecuted to the fullest extent of the law.

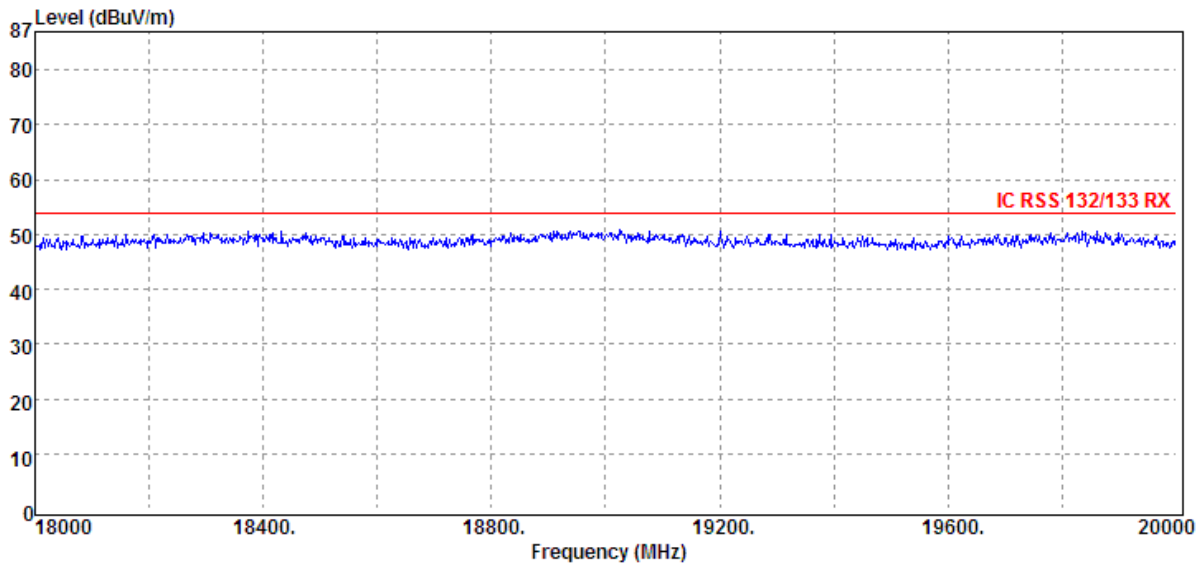
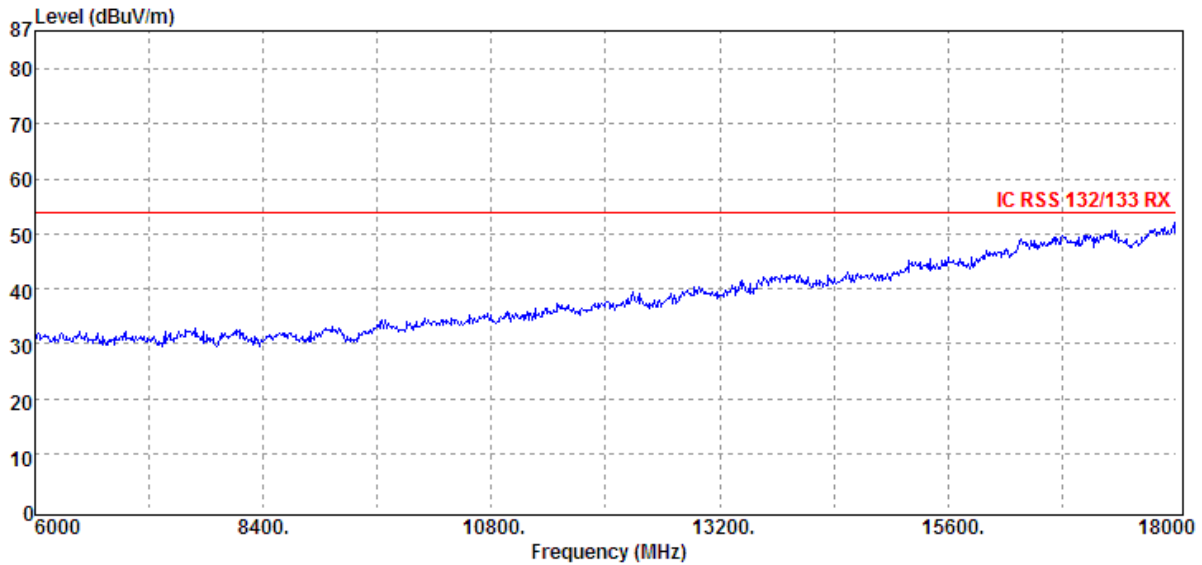

Unless otherwise stated the results shown in this test report refer only to the sample(s) tested and such sample(s) are retained for 90 days only.

除非另有說明，此報告結果僅對測試之樣品負責，同時此樣品僅保留90天。本報告未經本公司書面許可，不可部份複製。

This document is issued by the Company subject to its General Conditions of Service printed overleaf, available on request or accessible at www.sgs.com/terms_and_conditions.htm and, for electronic format documents, subject to Terms and Conditions for Electronic Documents at www.sgs.com/terms_e-document.htm. Attention is drawn to the limitation of liability, indemnification and jurisdiction issues defined therein. Any holder of this document is advised that information contained hereon reflects the Company's findings at the time of its intervention only and within the limits of Client's instructions, if any. The Company's sole responsibility is to its Client and this document does not exonerate parties to a transaction from exercising all their rights and obligations under the transaction documents. This document cannot be reproduced except in full, without prior written approval of the Company. Any unauthorized alteration, forgery or falsification of the content or appearance of this document is unlawful and offenders may be prosecuted to the fullest extent of the law.

| | | | |
|-----------------------|-----------|--------------------------|---------------------|
| Operation Band | :GSM 1900 | Test Date | :2013-05-03 |
| Fundamental Frequency | :1880 MHz | Temp./Humi. | :24.1 deg_C / 65 RH |
| Operation Mode | :RX MID | Engineer | :Allen |
| EUT Pol. | :E1 Plan | Measurement Antenna Pol. | :VERTICAL |

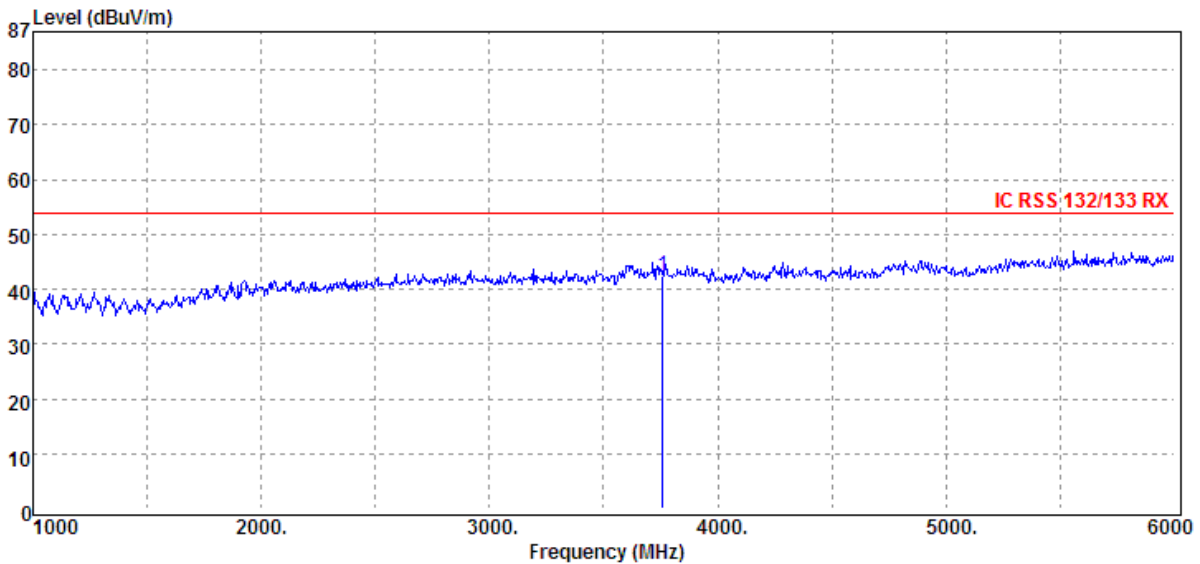
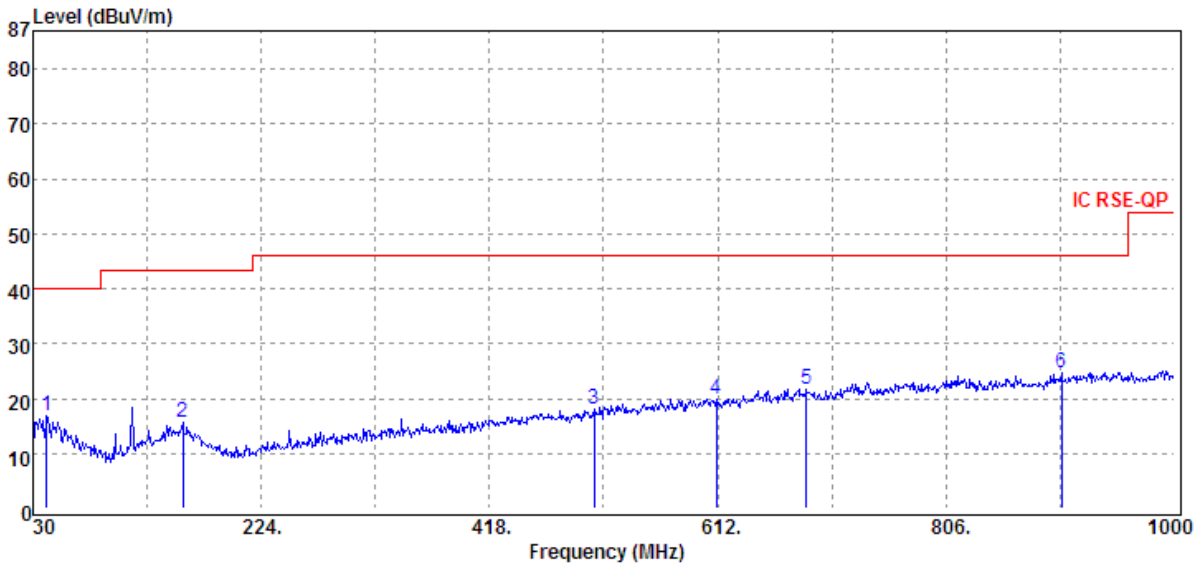

Unless otherwise stated the results shown in this test report refer only to the sample(s) tested and such sample(s) are retained for 90 days only.

除非另有說明，此報告結果僅對測試之樣品負責，同時此樣品僅保留90天。本報告未經本公司書面許可，不可部份複製。

This document is issued by the Company subject to its General Conditions of Service printed overleaf, available on request or accessible at www.sgs.com/terms_and_conditions.htm and, for electronic format documents, subject to Terms and Conditions for Electronic Documents at www.sgs.com/terms_e-document.htm. Attention is drawn to the limitation of liability, indemnification and jurisdiction issues defined therein. Any holder of this document is advised that information contained hereon reflects the Company's findings at the time of its intervention only and within the limits of Client's instructions, if any. The Company's sole responsibility is to its Client and this document does not exonerate parties to a transaction from exercising all their rights and obligations under the transaction documents. This document cannot be reproduced except in full, without prior written approval of the Company. Any unauthorized alteration, forgery or falsification of the content or appearance of this document is unlawful and offenders may be prosecuted to the fullest extent of the law.

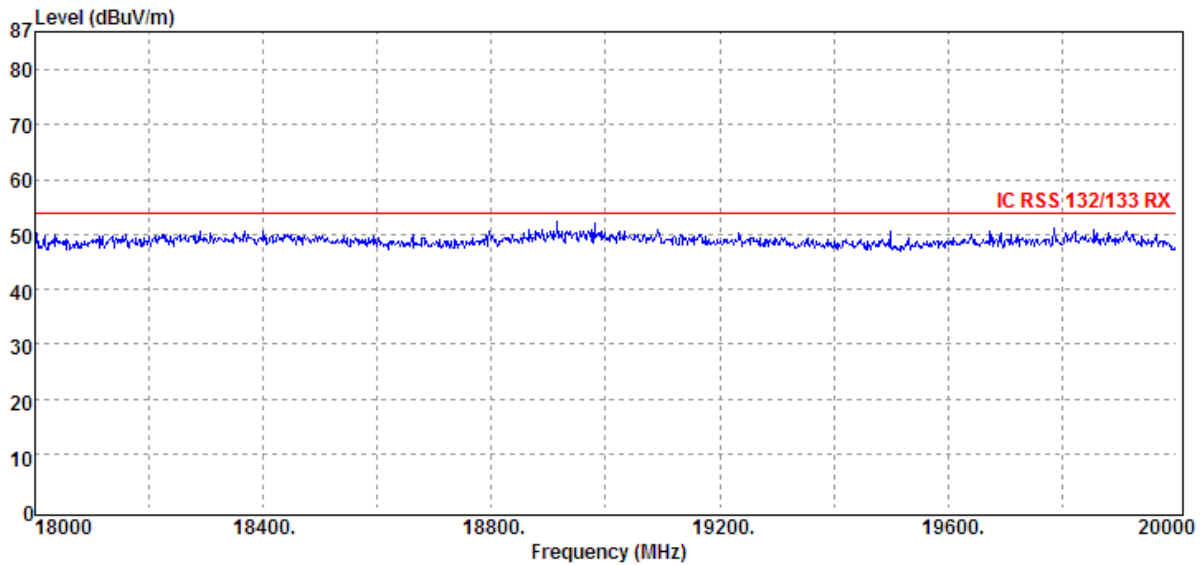
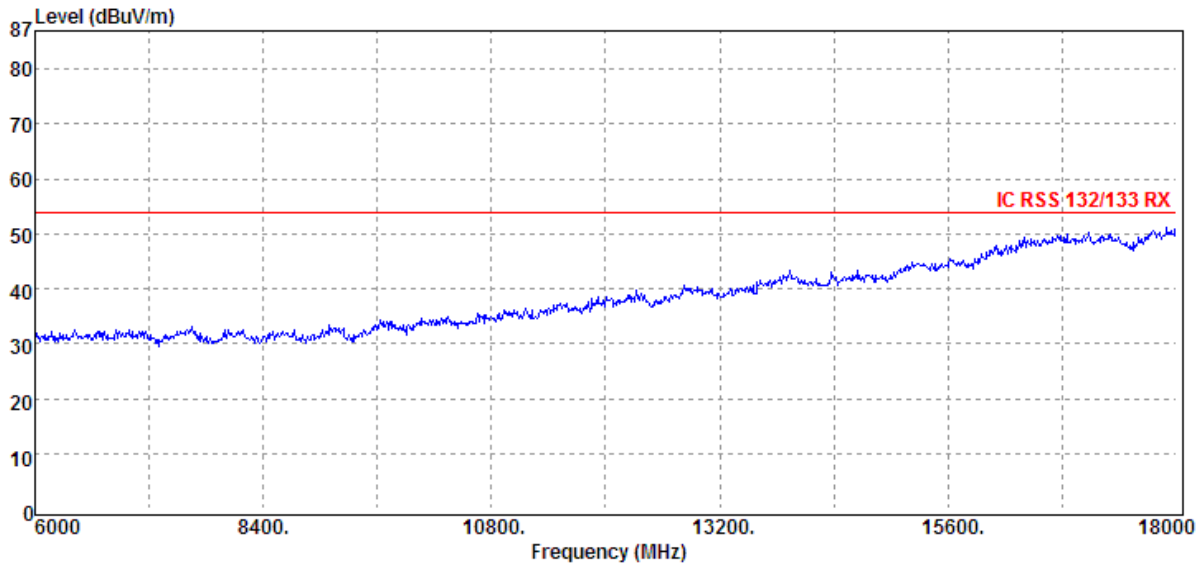

Unless otherwise stated the results shown in this test report refer only to the sample(s) tested and such sample(s) are retained for 90 days only.

除非另有說明，此報告結果僅對測試之樣品負責，同時此樣品僅保留90天。本報告未經本公司書面許可，不可部份複製。

This document is issued by the Company subject to its General Conditions of Service printed overleaf, available on request or accessible at www.sgs.com/terms_and_conditions.htm and, for electronic format documents, subject to Terms and Conditions for Electronic Documents at www.sgs.com/terms_e-document.htm. Attention is drawn to the limitation of liability, indemnification and jurisdiction issues defined therein. Any holder of this document is advised that information contained hereon reflects the Company's findings at the time of its intervention only and within the limits of Client's instructions, if any. The Company's sole responsibility is to its Client and this document does not exonerate parties to a transaction from exercising all their rights and obligations under the transaction documents. This document cannot be reproduced except in full, without prior written approval of the Company. Any unauthorized alteration, forgery or falsification of the content or appearance of this document is unlawful and offenders may be prosecuted to the fullest extent of the law.

| | | | |
|-----------------------|-----------|--------------------------|---------------------|
| Operation Band | :GSM 1900 | Test Date | :2013-05-03 |
| Fundamental Frequency | :1880 MHz | Temp./Humi. | :24.1 deg_C / 65 RH |
| Operation Mode | :RX MID | Engineer | :Allen |
| EUT Pol. | :E1 Plan | Measurement Antenna Pol. | :HORIZONTAL |

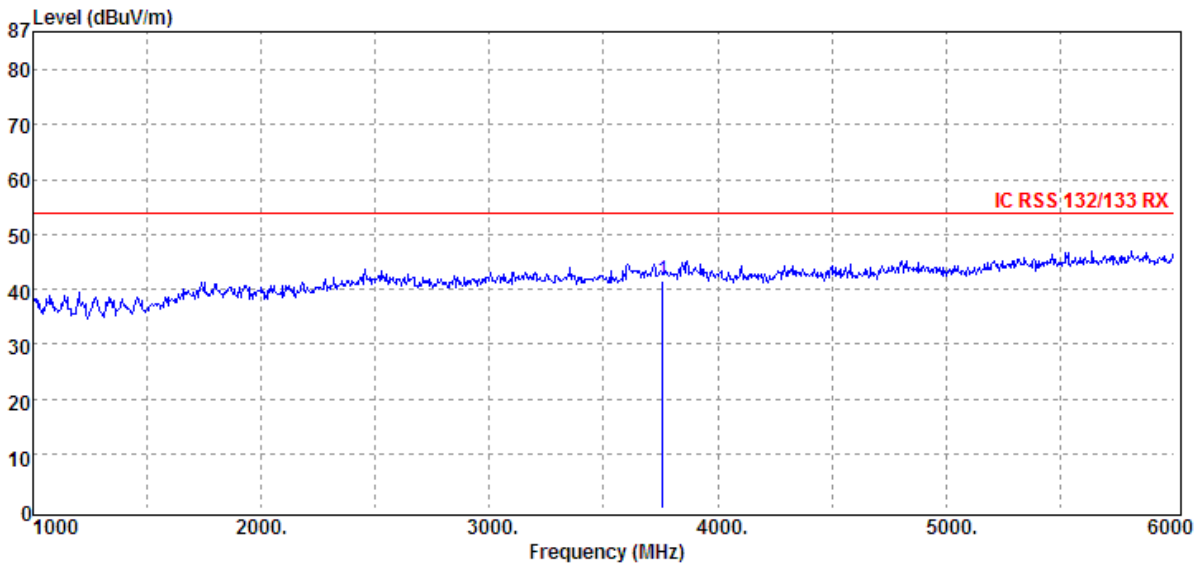
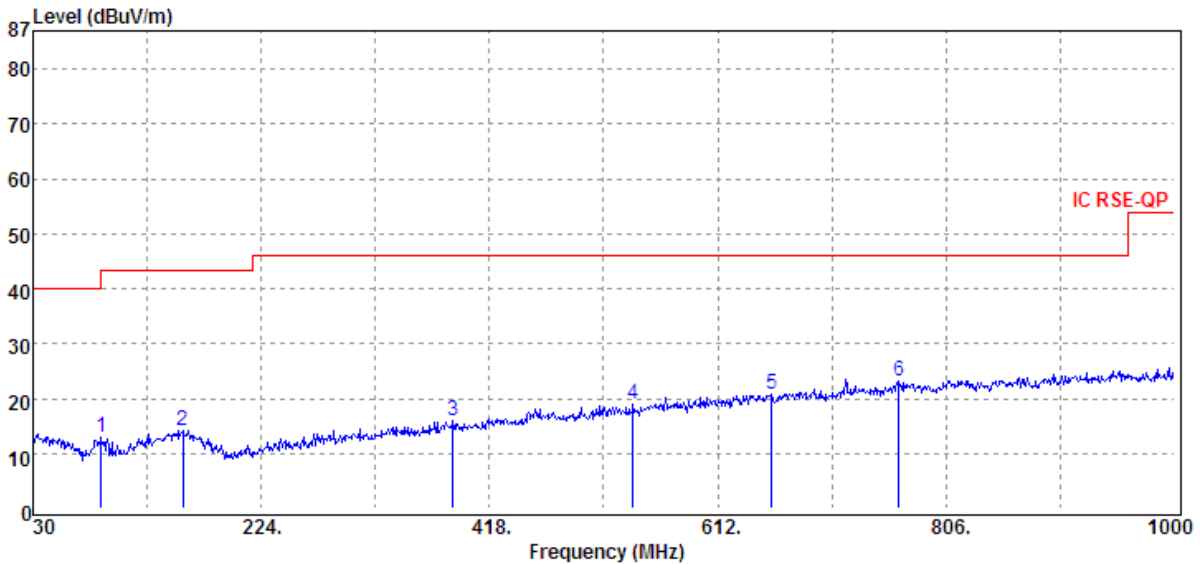

Unless otherwise stated the results shown in this test report refer only to the sample(s) tested and such sample(s) are retained for 90 days only.

除非另有說明，此報告結果僅對測試之樣品負責，同時此樣品僅保留90天。本報告未經本公司書面許可，不可部份複製。

This document is issued by the Company subject to its General Conditions of Service printed overleaf, available on request or accessible at www.sgs.com/terms_and_conditions.htm and, for electronic format documents, subject to Terms and Conditions for Electronic Documents at www.sgs.com/terms_e-document.htm. Attention is drawn to the limitation of liability, indemnification and jurisdiction issues defined therein. Any holder of this document is advised that information contained hereon reflects the Company's findings at the time of its intervention only and within the limits of Client's instructions, if any. The Company's sole responsibility is to its Client and this document does not exonerate parties to a transaction from exercising all their rights and obligations under the transaction documents. This document cannot be reproduced except in full, without prior written approval of the Company. Any unauthorized alteration, forgery or falsification of the content or appearance of this document is unlawful and offenders may be prosecuted to the fullest extent of the law.

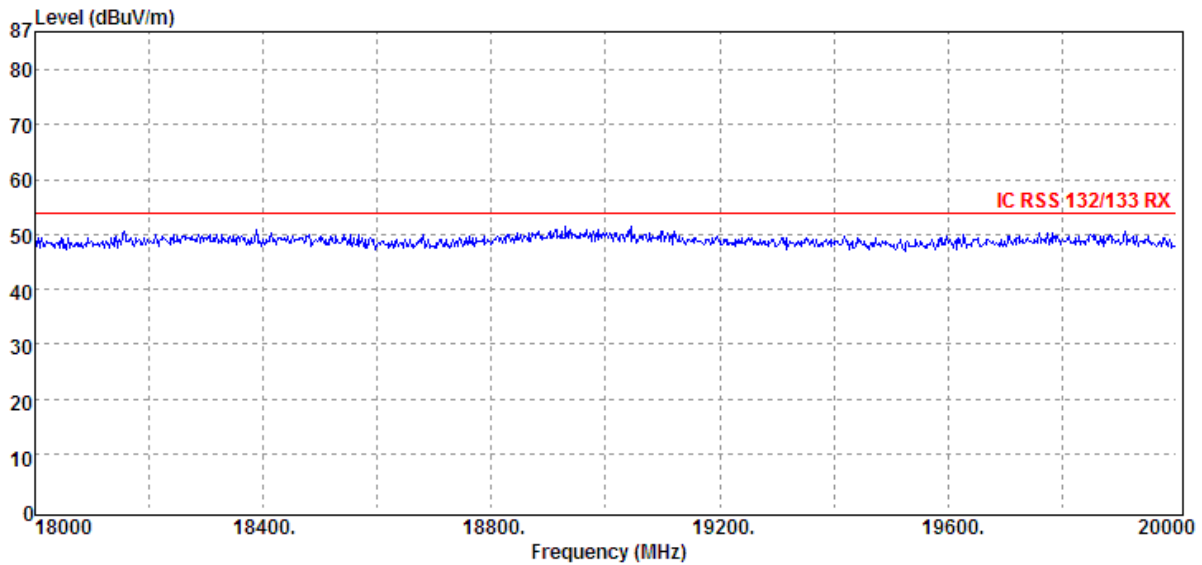
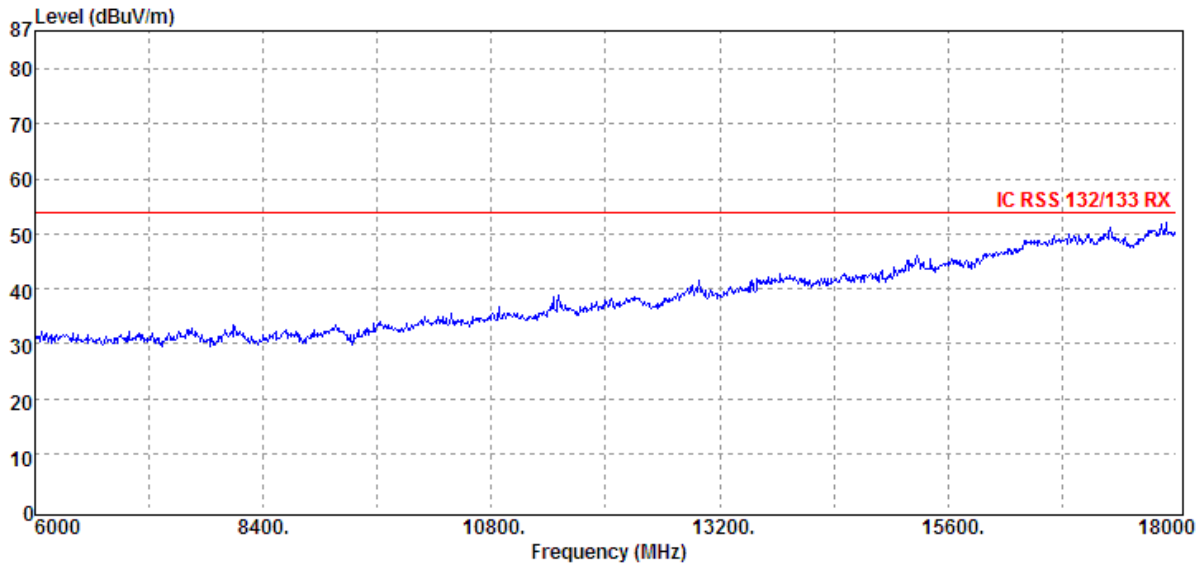

Unless otherwise stated the results shown in this test report refer only to the sample(s) tested and such sample(s) are retained for 90 days only.

除非另有說明，此報告結果僅對測試之樣品負責，同時此樣品僅保留90天。本報告未經本公司書面許可，不可部份複製。

This document is issued by the Company subject to its General Conditions of Service printed overleaf, available on request or accessible at www.sgs.com/terms_and_conditions.htm and, for electronic format documents, subject to Terms and Conditions for Electronic Documents at www.sgs.com/terms_e-document.htm. Attention is drawn to the limitation of liability, indemnification and jurisdiction issues defined therein. Any holder of this document is advised that information contained hereon reflects the Company's findings at the time of its intervention only and within the limits of Client's instructions, if any. The Company's sole responsibility is to its Client and this document does not exonerate parties to a transaction from exercising all their rights and obligations under the transaction documents. This document cannot be reproduced except in full, without prior written approval of the Company. Any unauthorized alteration, forgery or falsification of the content or appearance of this document is unlawful and offenders may be prosecuted to the fullest extent of the law.

| | | | |
|-----------------------|-------------|--------------------------|---------------------|
| Operation Band | :GSM 1900 | Test Date | :2013-05-03 |
| Fundamental Frequency | :1909.8 MHz | Temp./Humi. | :24.1 deg_C / 65 RH |
| Operation Mode | :RX HIGH | Engineer | :Allen |
| EUT Pol. | :E1 Plan | Measurement Antenna Pol. | :VERTICAL |

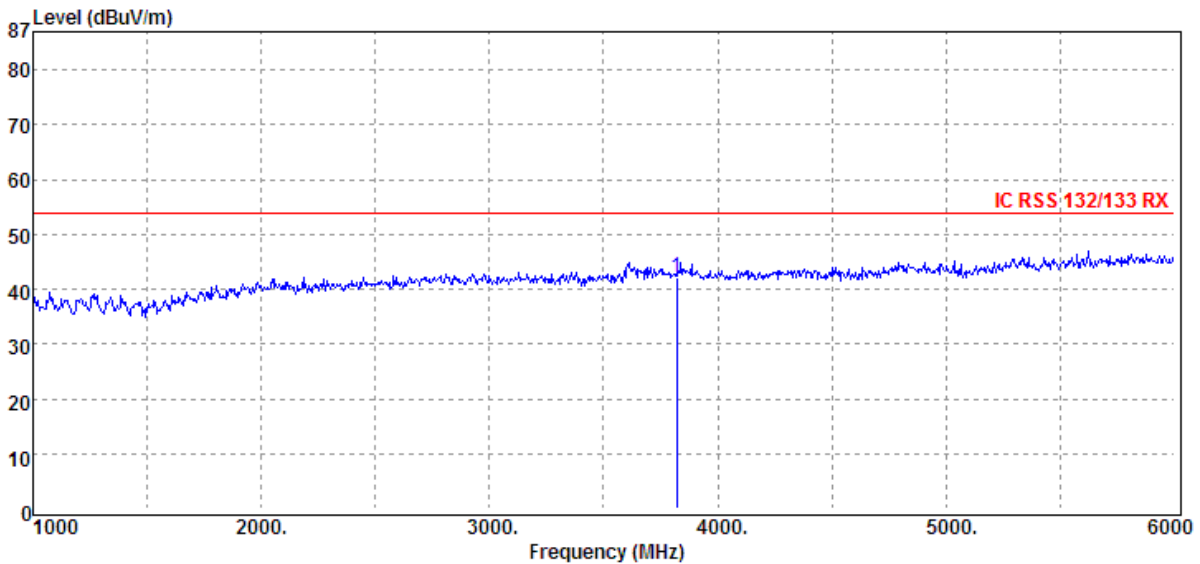
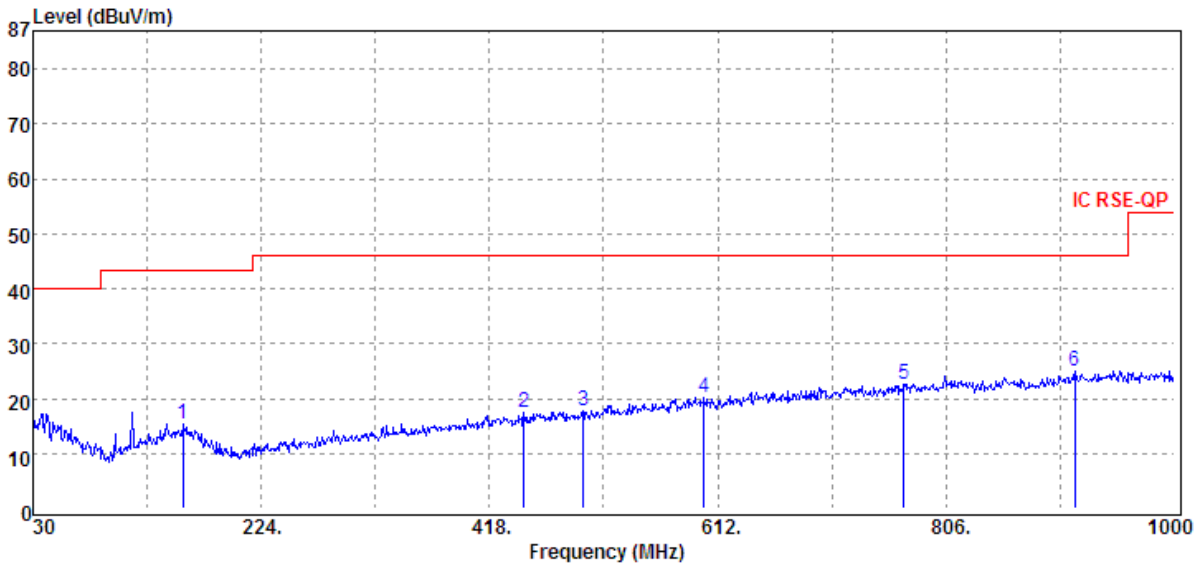

Unless otherwise stated the results shown in this test report refer only to the sample(s) tested and such sample(s) are retained for 90 days only.

除非另有說明，此報告結果僅對測試之樣品負責，同時此樣品僅保留90天。本報告未經本公司書面許可，不可部份複製。

This document is issued by the Company subject to its General Conditions of Service printed overleaf, available on request or accessible at www.sgs.com/terms_and_conditions.htm and, for electronic format documents, subject to Terms and Conditions for Electronic Documents at www.sgs.com/terms_e-document.htm. Attention is drawn to the limitation of liability, indemnification and jurisdiction issues defined therein. Any holder of this document is advised that information contained hereon reflects the Company's findings at the time of its intervention only and within the limits of Client's instructions, if any. The Company's sole responsibility is to its Client and this document does not exonerate parties to a transaction from exercising all their rights and obligations under the transaction documents. This document cannot be reproduced except in full, without prior written approval of the Company. Any unauthorized alteration, forgery or falsification of the content or appearance of this document is unlawful and offenders may be prosecuted to the fullest extent of the law.

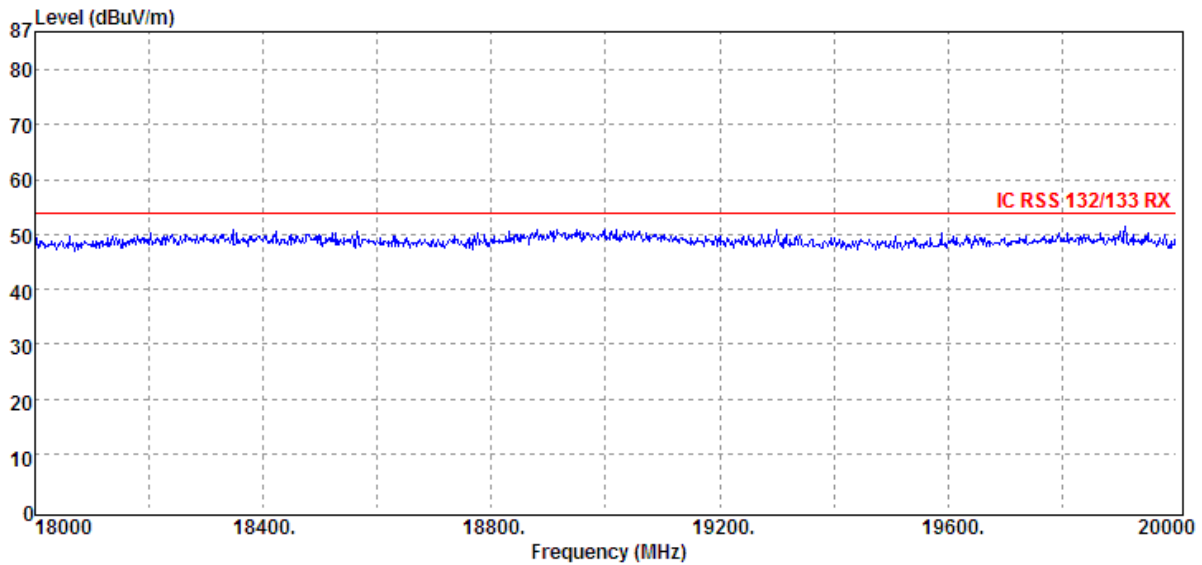
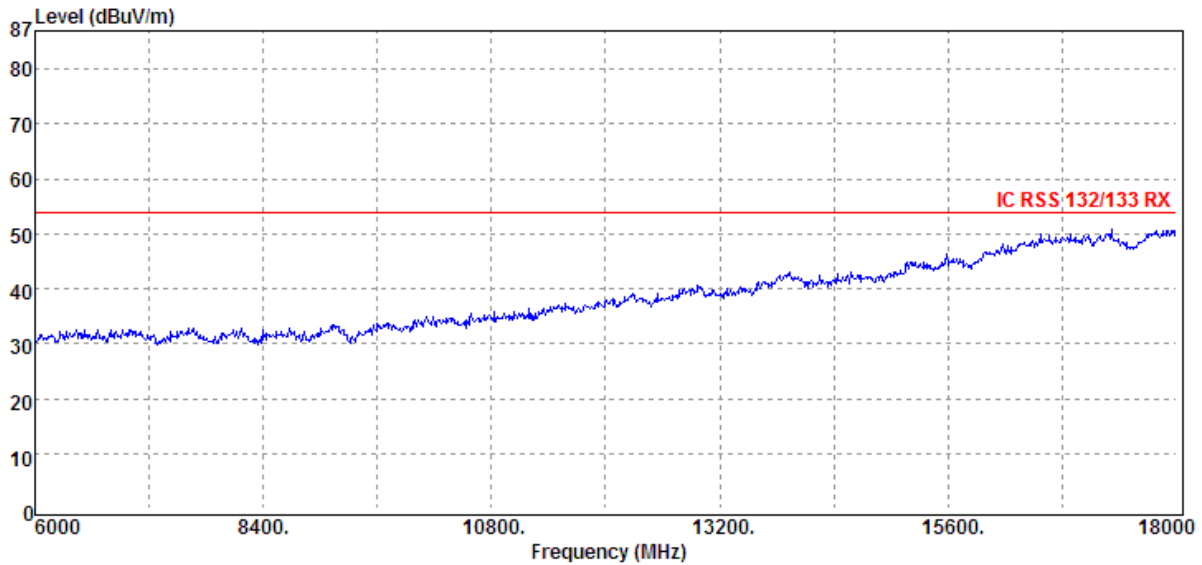

Unless otherwise stated the results shown in this test report refer only to the sample(s) tested and such sample(s) are retained for 90 days only.

除非另有說明，此報告結果僅對測試之樣品負責，同時此樣品僅保留90天。本報告未經本公司書面許可，不可部份複製。

This document is issued by the Company subject to its General Conditions of Service printed overleaf, available on request or accessible at www.sgs.com/terms_and_conditions.htm and, for electronic format documents, subject to Terms and Conditions for Electronic Documents at www.sgs.com/terms_e-document.htm. Attention is drawn to the limitation of liability, indemnification and jurisdiction issues defined therein. Any holder of this document is advised that information contained hereon reflects the Company's findings at the time of its intervention only and within the limits of Client's instructions, if any. The Company's sole responsibility is to its Client and this document does not exonerate parties to a transaction from exercising all their rights and obligations under the transaction documents. This document cannot be reproduced except in full, without prior written approval of the Company. Any unauthorized alteration, forgery or falsification of the content or appearance of this document is unlawful and offenders may be prosecuted to the fullest extent of the law.

| | | | |
|-----------------------|-------------|--------------------------|---------------------|
| Operation Band | :GSM 1900 | Test Date | :2013-05-03 |
| Fundamental Frequency | :1909.8 MHz | Temp./Humi. | :24.1 deg_C / 65 RH |
| Operation Mode | :RX HIGH | Engineer | :Allen |
| EUT Pol. | :E1 Plan | Measurement Antenna Pol. | :HORIZONTAL |

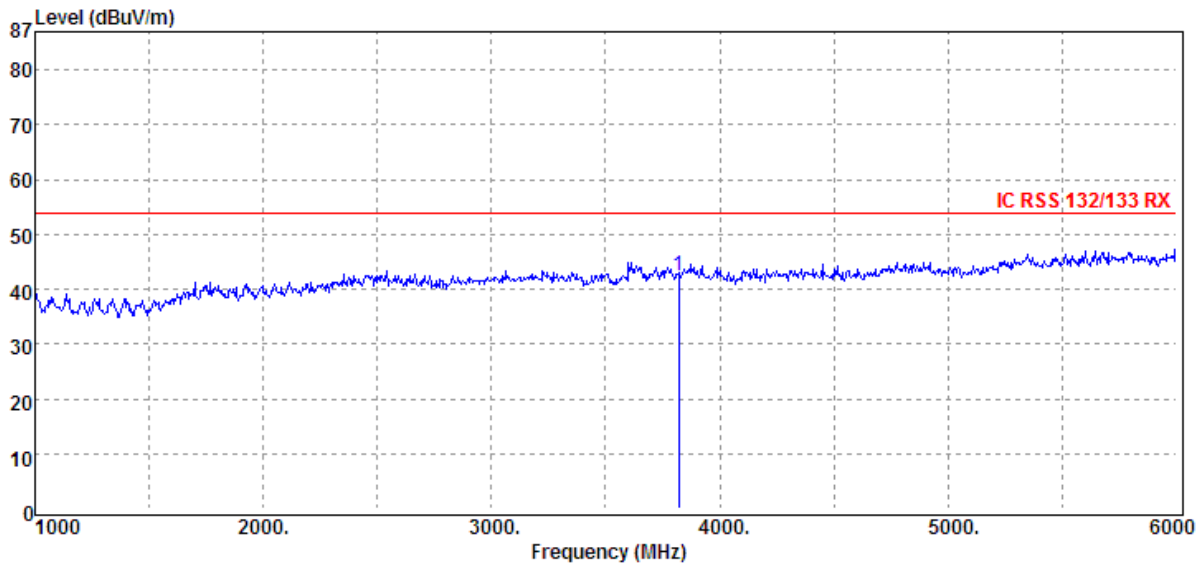
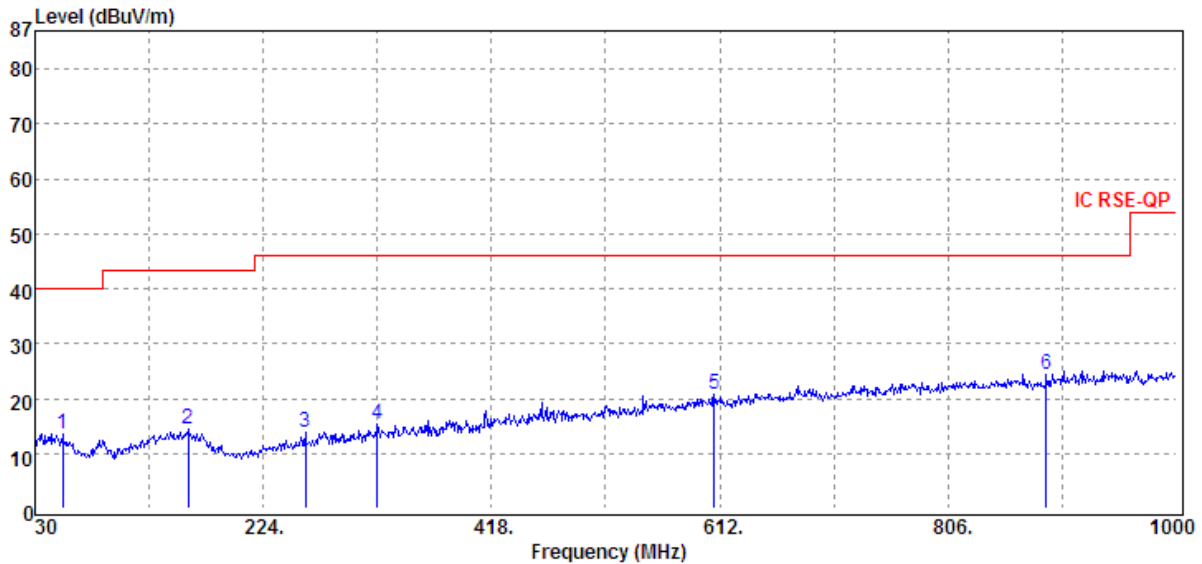

Unless otherwise stated the results shown in this test report refer only to the sample(s) tested and such sample(s) are retained for 90 days only.

除非另有說明，此報告結果僅對測試之樣品負責，同時此樣品僅保留90天。本報告未經本公司書面許可，不可部份複製。

This document is issued by the Company subject to its General Conditions of Service printed overleaf, available on request or accessible at www.sgs.com/terms_and_conditions.htm and, for electronic format documents, subject to Terms and Conditions for Electronic Documents at www.sgs.com/terms_e-document.htm. Attention is drawn to the limitation of liability, indemnification and jurisdiction issues defined therein. Any holder of this document is advised that information contained hereon reflects the Company's findings at the time of its intervention only and within the limits of Client's instructions, if any. The Company's sole responsibility is to its Client and this document does not exonerate parties to a transaction from exercising all their rights and obligations under the transaction documents. This document cannot be reproduced except in full, without prior written approval of the Company. Any unauthorized alteration, forgery or falsification of the content or appearance of this document is unlawful and offenders may be prosecuted to the fullest extent of the law.

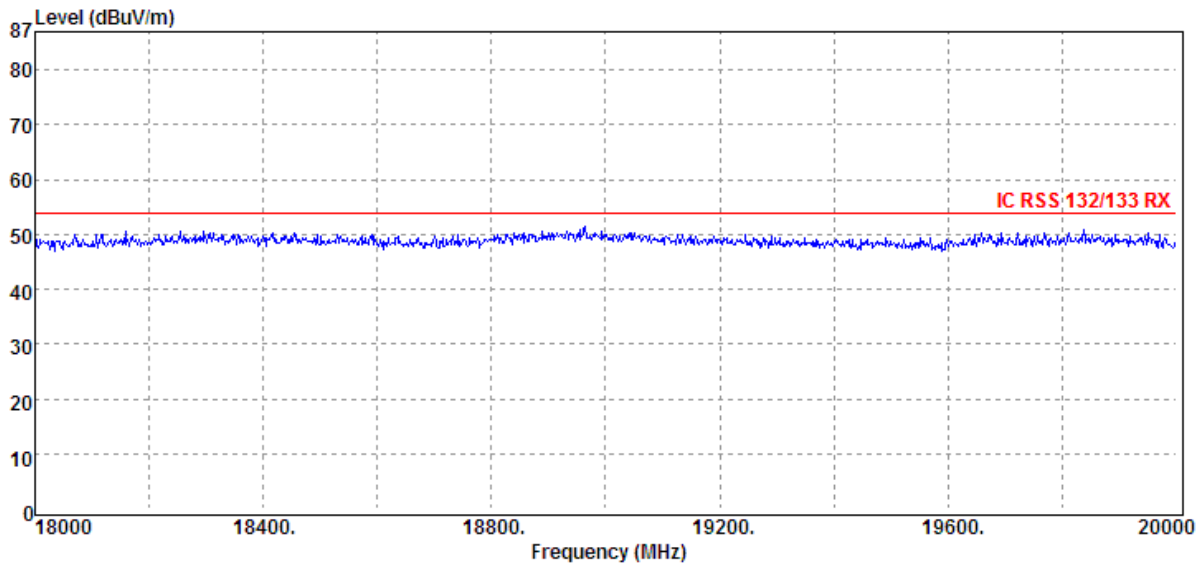
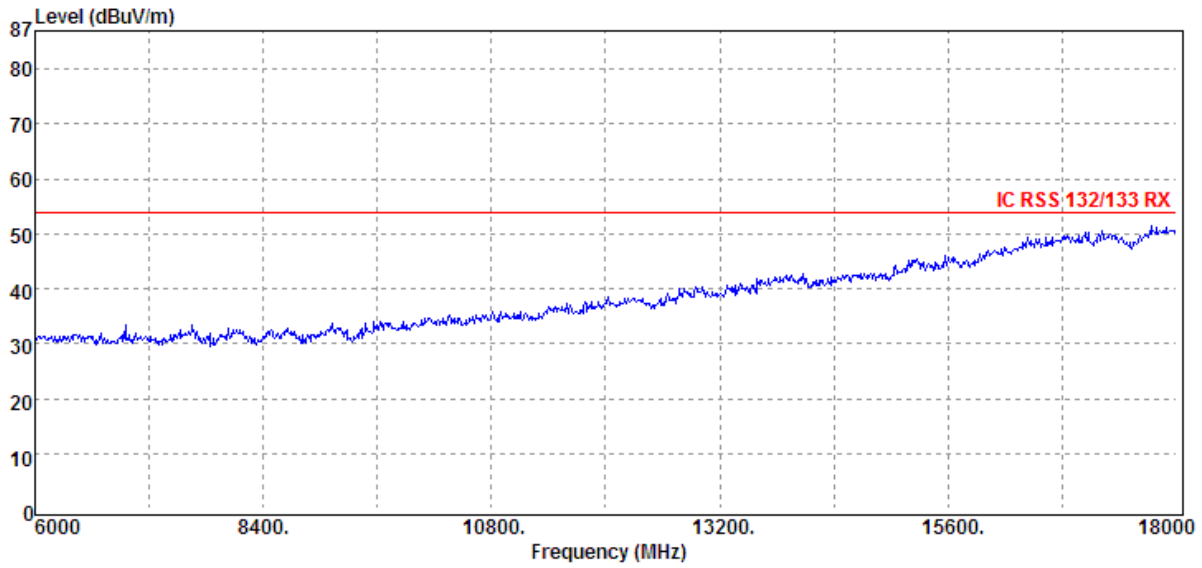

Unless otherwise stated the results shown in this test report refer only to the sample(s) tested and such sample(s) are retained for 90 days only.

除非另有說明，此報告結果僅對測試之樣品負責，同時此樣品僅保留90天。本報告未經本公司書面許可，不可部份複製。
This document is issued by the Company subject to its General Conditions of Service printed overleaf, available on request or accessible at www.sgs.com/terms_and_conditions.htm and, for electronic format documents, subject to Terms and Conditions for Electronic Documents at www.sgs.com/terms_e-document.htm. Attention is drawn to the limitation of liability, indemnification and jurisdiction issues defined therein. Any holder of this document is advised that information contained hereon reflects the Company's findings at the time of its intervention only and within the limits of Client's instructions, if any. The Company's sole responsibility is to its Client and this document does not exonerate parties to a transaction from exercising all their rights and obligations under the transaction documents. This document cannot be reproduced except in full, without prior written approval of the Company. Any unauthorized alteration, forgery or falsification of the content or appearance of this document is unlawful and offenders may be prosecuted to the fullest extent of the law.

Radiated Spurious Emission Measurement Result: WCDMA II Mode

| | | | |
|-----------------------|-------------|--------------------------|---------------------|
| Operation Band | :WCDMA B2 | Test Date | :2013-05-03 |
| Fundamental Frequency | :1852.4 MHz | Temp./Humi. | :24.1 deg_C / 65 RH |
| Operation Mode | :RX LOW | Engineer | :Allen |
| EUT Pol. | :E1 Plan | Measurement Antenna Pol. | :VERTICAL |

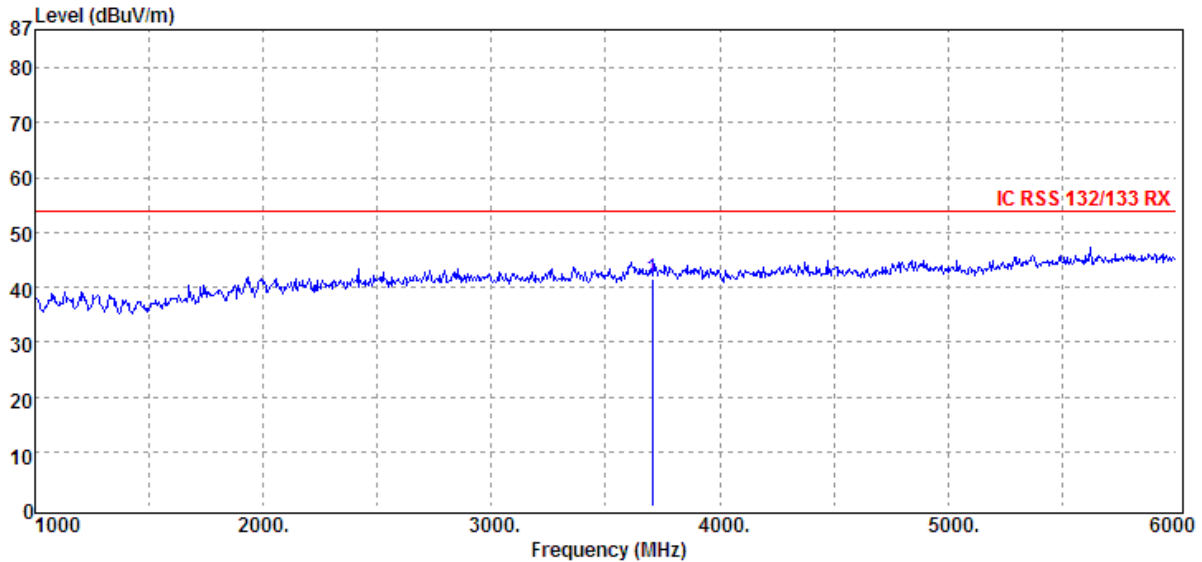
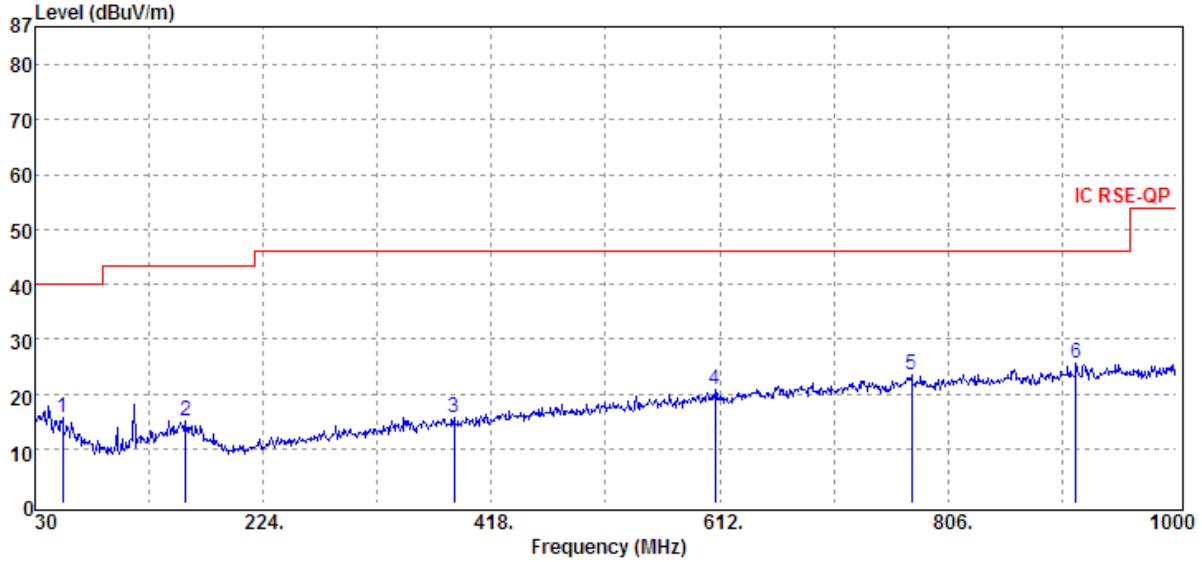

Unless otherwise stated the results shown in this test report refer only to the sample(s) tested and such sample(s) are retained for 90 days only.

除非另有說明，此報告結果僅對測試之樣品負責，同時此樣品僅保留90天。本報告未經本公司書面許可，不可部份複製。

This document is issued by the Company subject to its General Conditions of Service printed overleaf, available on request or accessible at www.sgs.com/terms_and_conditions.htm and, for electronic format documents, subject to Terms and Conditions for Electronic Documents at www.sgs.com/terms_e-document.htm. Attention is drawn to the limitation of liability, indemnification and jurisdiction issues defined therein. Any holder of this document is advised that information contained hereon reflects the Company's findings at the time of its intervention only and within the limits of Client's instructions, if any. The Company's sole responsibility is to its Client and this document does not exonerate parties to a transaction from exercising all their rights and obligations under the transaction documents. This document cannot be reproduced except in full, without prior written approval of the Company. Any unauthorized alteration, forgery or falsification of the content or appearance of this document is unlawful and offenders may be prosecuted to the fullest extent of the law.

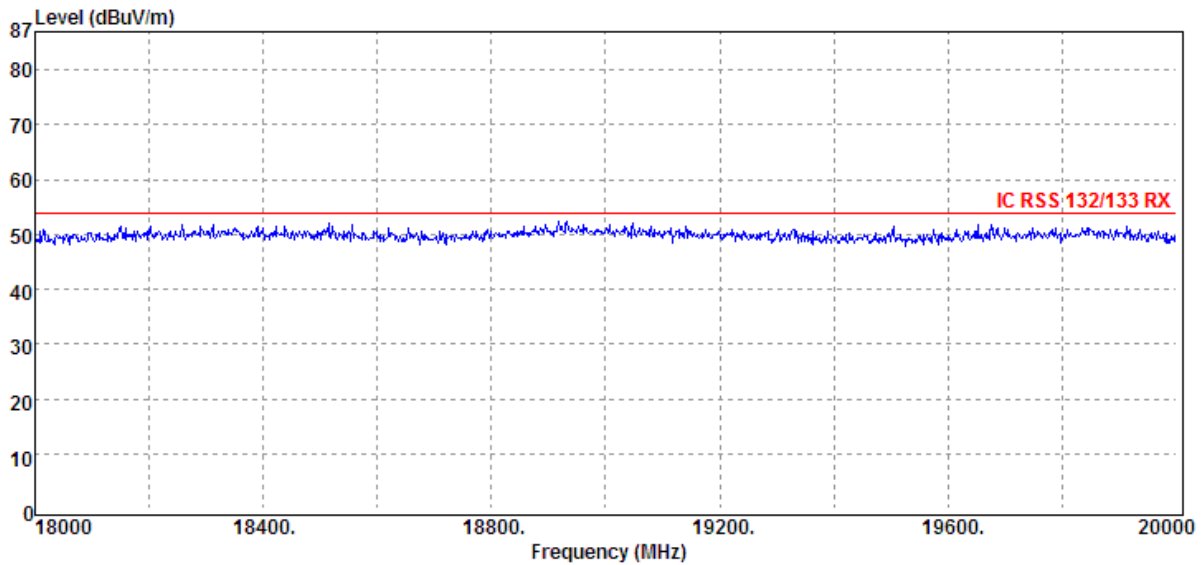
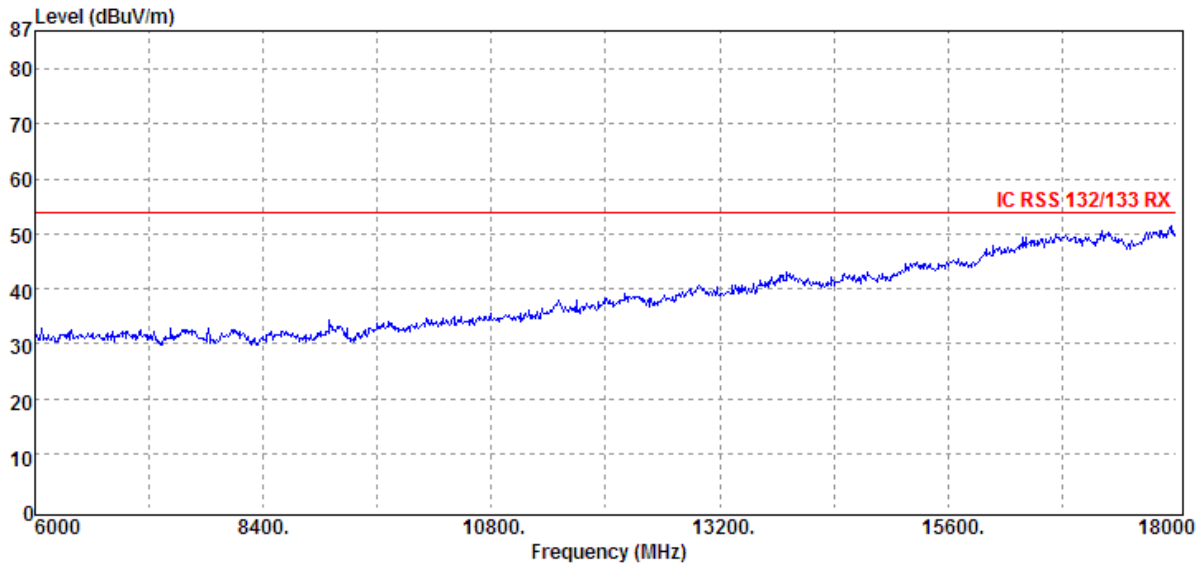

Unless otherwise stated the results shown in this test report refer only to the sample(s) tested and such sample(s) are retained for 90 days only.

除非另有說明，此報告結果僅對測試之樣品負責，同時此樣品僅保留90天。本報告未經本公司書面許可，不可部份複製。
This document is issued by the Company subject to its General Conditions of Service printed overleaf, available on request or accessible at www.sgs.com/terms_and_conditions.htm and, for electronic format documents, subject to Terms and Conditions for Electronic Documents at www.sgs.com/terms_e-document.htm. Attention is drawn to the limitation of liability, indemnification and jurisdiction issues defined therein. Any holder of this document is advised that information contained hereon reflects the Company's findings at the time of its intervention only and within the limits of Client's instructions, if any. The Company's sole responsibility is to its Client and this document does not exonerate parties to a transaction from exercising all their rights and obligations under the transaction documents. This document cannot be reproduced except in full, without prior written approval of the Company. Any unauthorized alteration, forgery or falsification of the content or appearance of this document is unlawful and offenders may be prosecuted to the fullest extent of the law.

| | | | |
|-----------------------|-------------|--------------------------|---------------------|
| Operation Band | :WCDMA B2 | Test Date | :2013-05-03 |
| Fundamental Frequency | :1852.4 MHz | Temp./Humi. | :24.1 deg_C / 65 RH |
| Operation Mode | :RX LOW | Engineer | :Allen |
| EUT Pol. | :E1 Plan | Measurement Antenna Pol. | :HORIZONTAL |

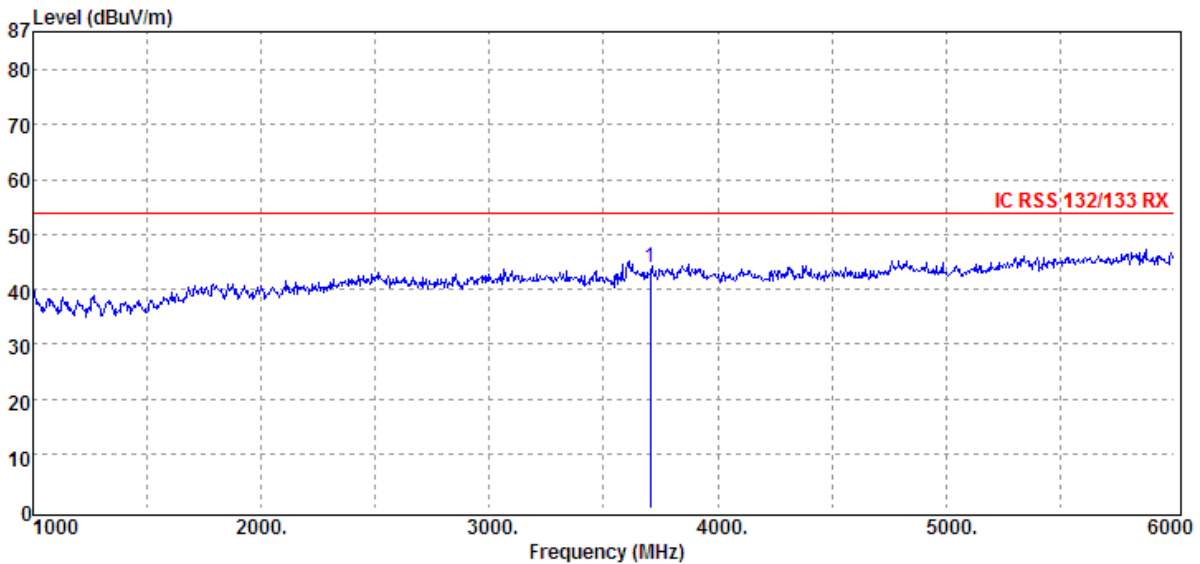
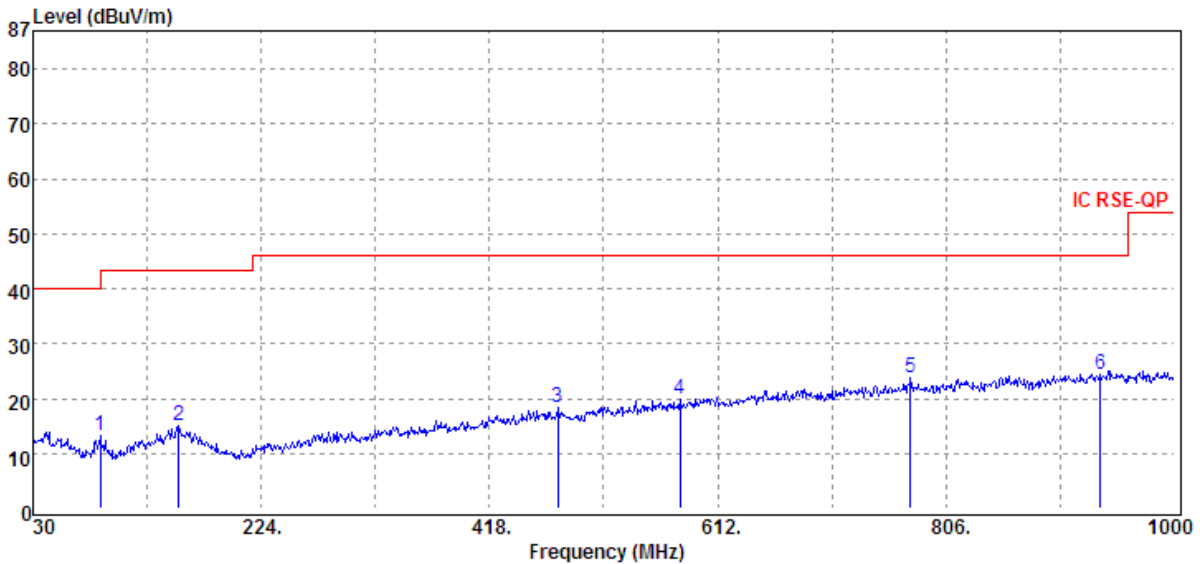

Unless otherwise stated the results shown in this test report refer only to the sample(s) tested and such sample(s) are retained for 90 days only.

除非另有說明，此報告結果僅對測試之樣品負責，同時此樣品僅保留90天。本報告未經本公司書面許可，不可部份複製。

This document is issued by the Company subject to its General Conditions of Service printed overleaf, available on request or accessible at www.sgs.com/terms_and_conditions.htm and, for electronic format documents, subject to Terms and Conditions for Electronic Documents at www.sgs.com/terms_e-document.htm. Attention is drawn to the limitation of liability, indemnification and jurisdiction issues defined therein. Any holder of this document is advised that information contained hereon reflects the Company's findings at the time of its intervention only and within the limits of Client's instructions, if any. The Company's sole responsibility is to its Client and this document does not exonerate parties to a transaction from exercising all their rights and obligations under the transaction documents. This document cannot be reproduced except in full, without prior written approval of the Company. Any unauthorized alteration, forgery or falsification of the content or appearance of this document is unlawful and offenders may be prosecuted to the fullest extent of the law.

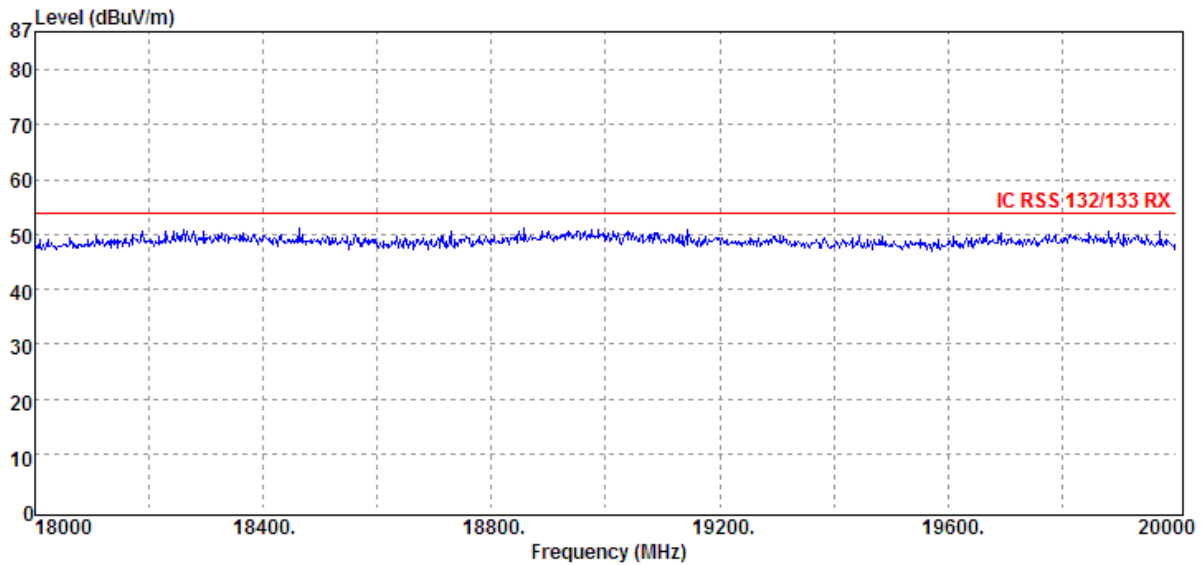
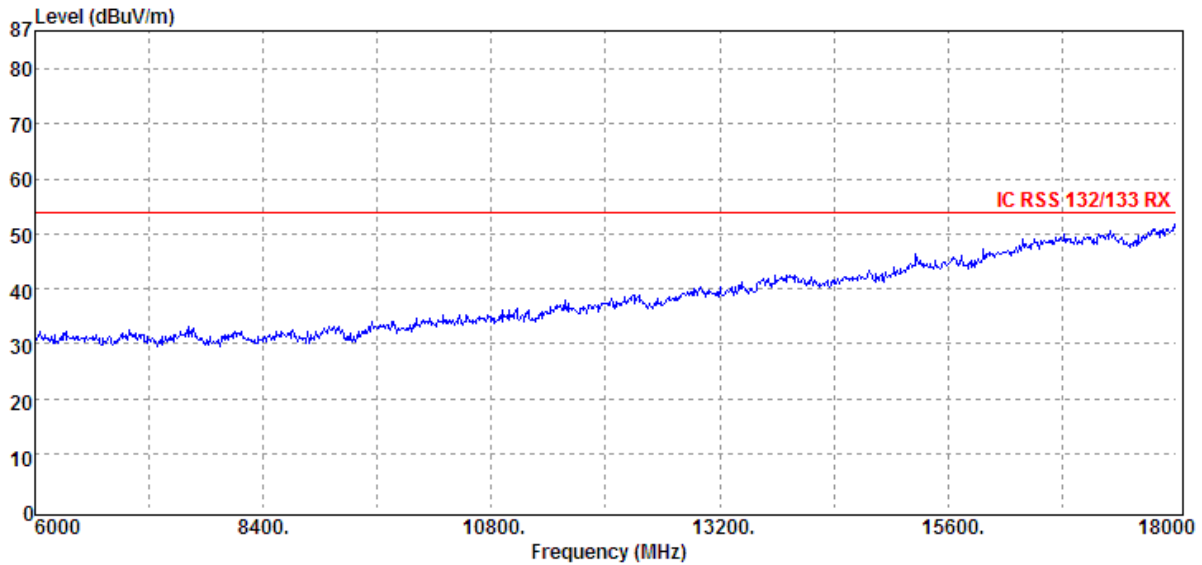

Unless otherwise stated the results shown in this test report refer only to the sample(s) tested and such sample(s) are retained for 90 days only.

除非另有說明，此報告結果僅對測試之樣品負責，同時此樣品僅保留90天。本報告未經本公司書面許可，不可部份複製。

This document is issued by the Company subject to its General Conditions of Service printed overleaf, available on request or accessible at www.sgs.com/terms_and_conditions.htm and, for electronic format documents, subject to Terms and Conditions for Electronic Documents at www.sgs.com/terms_e-document.htm. Attention is drawn to the limitation of liability, indemnification and jurisdiction issues defined therein. Any holder of this document is advised that information contained hereon reflects the Company's findings at the time of its intervention only and within the limits of Client's instructions, if any. The Company's sole responsibility is to its Client and this document does not exonerate parties to a transaction from exercising all their rights and obligations under the transaction documents. This document cannot be reproduced except in full, without prior written approval of the Company. Any unauthorized alteration, forgery or falsification of the content or appearance of this document is unlawful and offenders may be prosecuted to the fullest extent of the law.

| | | | |
|-----------------------|-----------|--------------------------|---------------------|
| Operation Band | :WCDMA B2 | Test Date | :2013-05-03 |
| Fundamental Frequency | :1880 MHz | Temp./Humi. | :24.1 deg_C / 65 RH |
| Operation Mode | :RX MID | Engineer | :Allen |
| EUT Pol. | :E1 Plan | Measurement Antenna Pol. | :VERTICAL |

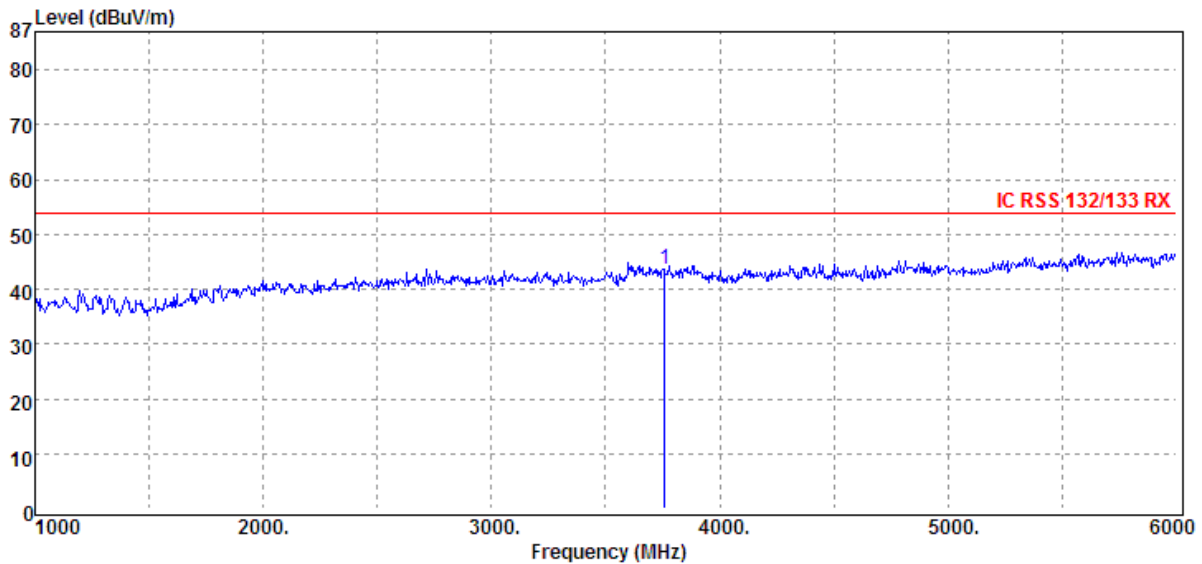
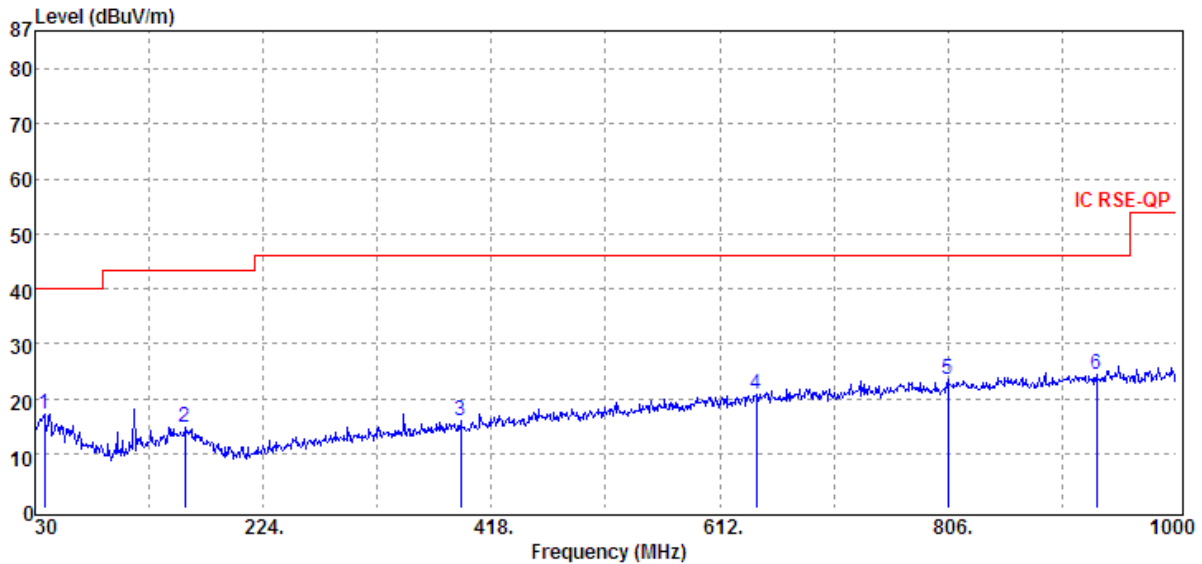

Unless otherwise stated the results shown in this test report refer only to the sample(s) tested and such sample(s) are retained for 90 days only.

除非另有說明，此報告結果僅對測試之樣品負責，同時此樣品僅保留90天。本報告未經本公司書面許可，不可部份複製。

This document is issued by the Company subject to its General Conditions of Service printed overleaf, available on request or accessible at www.sgs.com/terms_and_conditions.htm and, for electronic format documents, subject to Terms and Conditions for Electronic Documents at www.sgs.com/terms_e-document.htm. Attention is drawn to the limitation of liability, indemnification and jurisdiction issues defined therein. Any holder of this document is advised that information contained hereon reflects the Company's findings at the time of its intervention only and within the limits of Client's instructions, if any. The Company's sole responsibility is to its Client and this document does not exonerate parties to a transaction from exercising all their rights and obligations under the transaction documents. This document cannot be reproduced except in full, without prior written approval of the Company. Any unauthorized alteration, forgery or falsification of the content or appearance of this document is unlawful and offenders may be prosecuted to the fullest extent of the law.

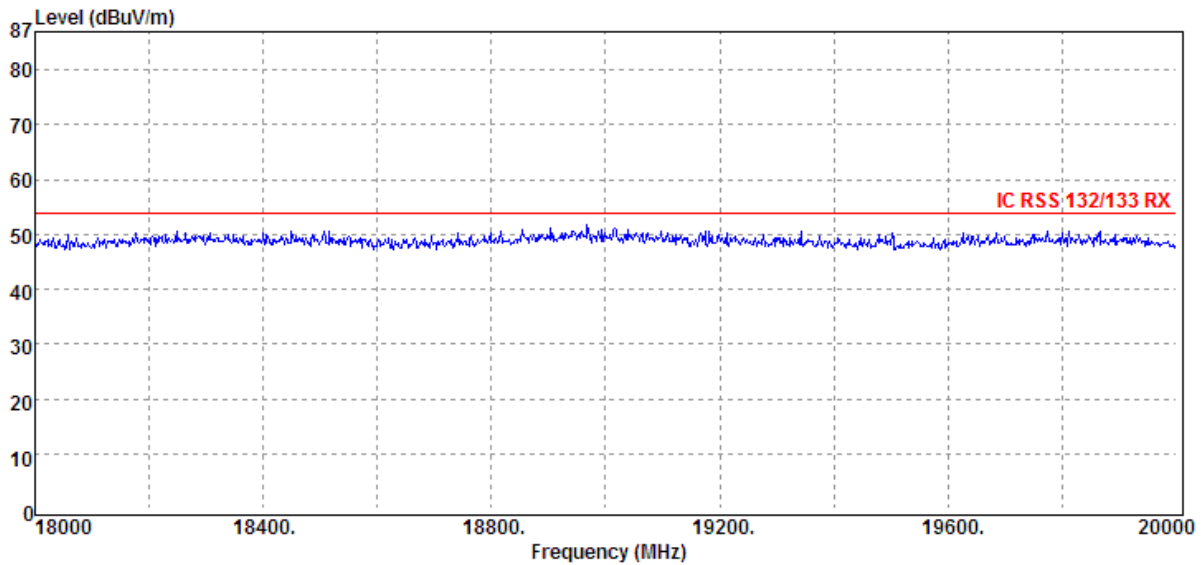
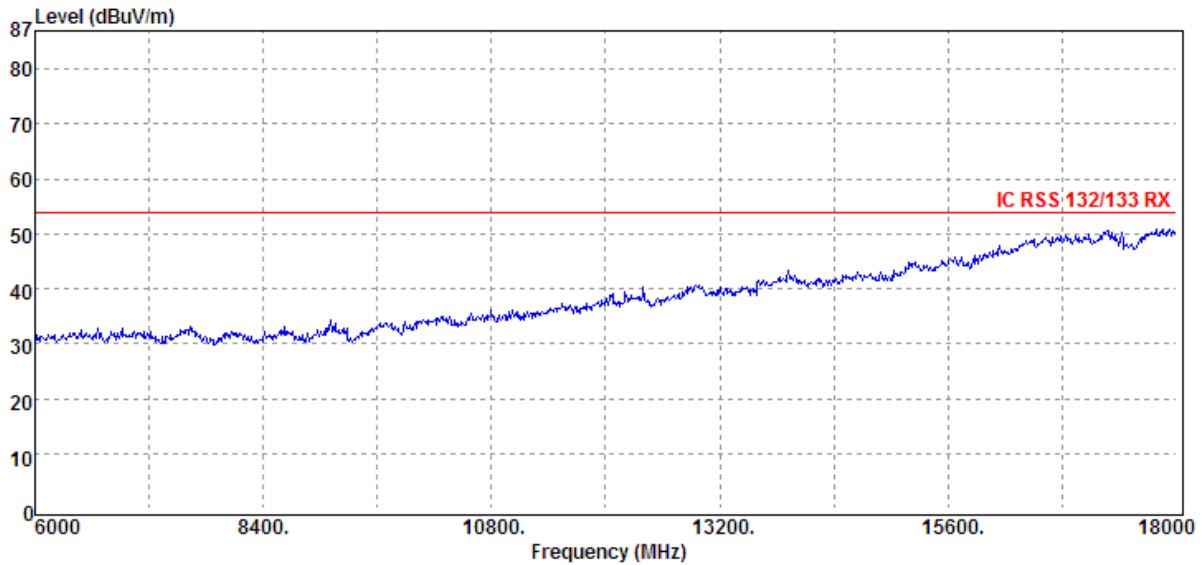

Unless otherwise stated the results shown in this test report refer only to the sample(s) tested and such sample(s) are retained for 90 days only.

除非另有說明，此報告結果僅對測試之樣品負責，同時此樣品僅保留90天。本報告未經本公司書面許可，不可部份複製。
This document is issued by the Company subject to its General Conditions of Service printed overleaf, available on request or accessible at www.sgs.com/terms_and_conditions.htm and, for electronic format documents, subject to Terms and Conditions for Electronic Documents at www.sgs.com/terms_e-document.htm. Attention is drawn to the limitation of liability, indemnification and jurisdiction issues defined therein. Any holder of this document is advised that information contained hereon reflects the Company's findings at the time of its intervention only and within the limits of Client's instructions, if any. The Company's sole responsibility is to its Client and this document does not exonerate parties to a transaction from exercising all their rights and obligations under the transaction documents. This document cannot be reproduced except in full, without prior written approval of the Company. Any unauthorized alteration, forgery or falsification of the content or appearance of this document is unlawful and offenders may be prosecuted to the fullest extent of the law.

| | | | |
|-----------------------|-----------|--------------------------|---------------------|
| Operation Band | :WCDMA B2 | Test Date | :2013-05-03 |
| Fundamental Frequency | :1880 MHz | Temp./Humi. | :24.1 deg_C / 65 RH |
| Operation Mode | :RX MID | Engineer | :Allen |
| EUT Pol. | :E1 Plan | Measurement Antenna Pol. | :HORIZONTAL |

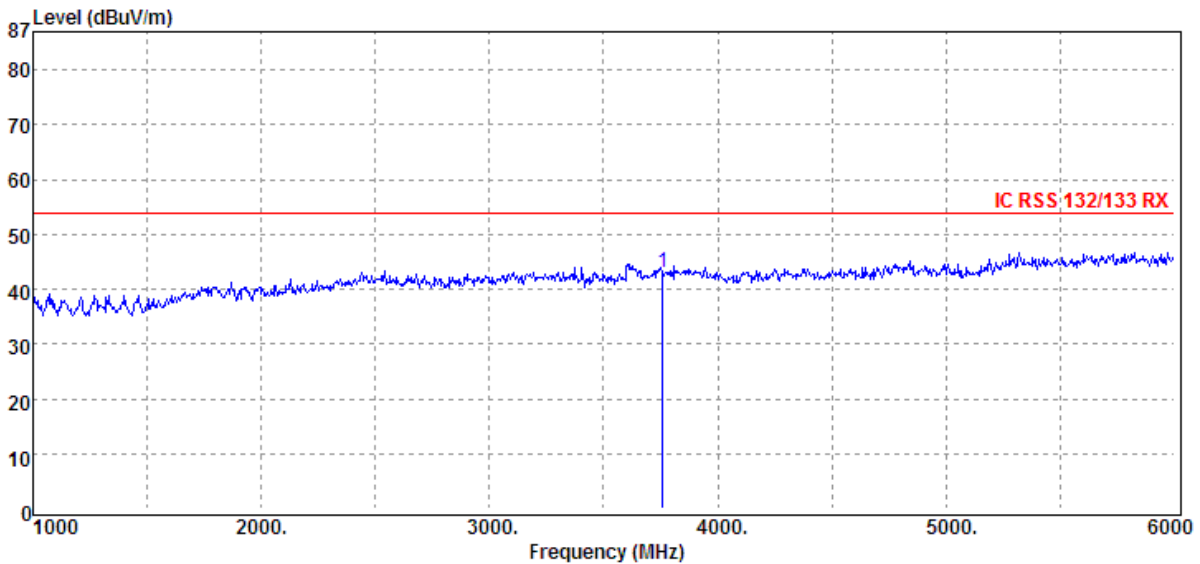
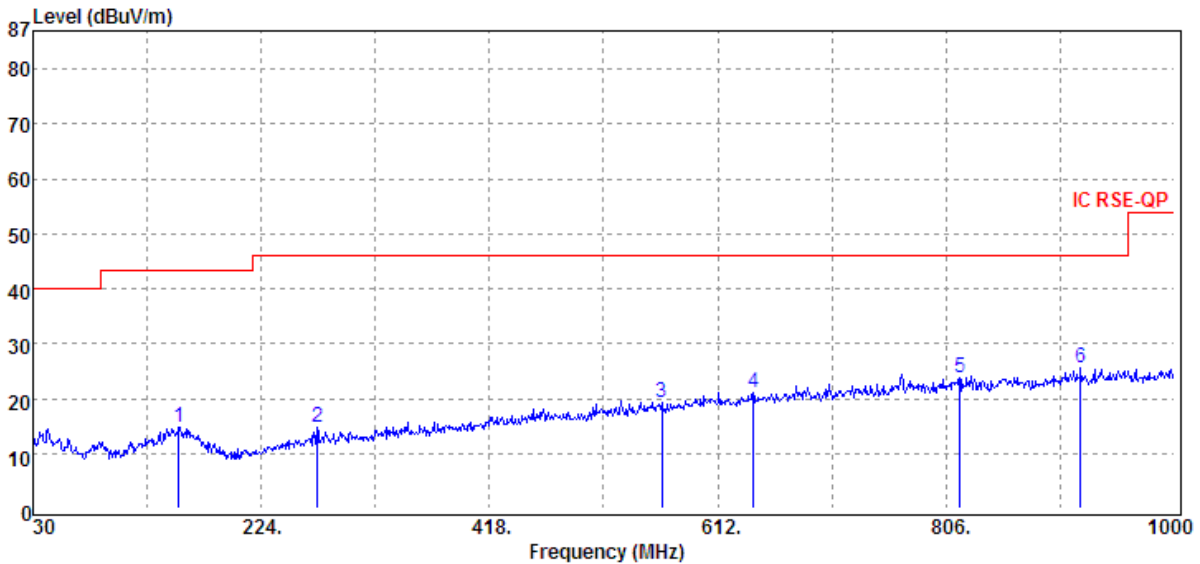

Unless otherwise stated the results shown in this test report refer only to the sample(s) tested and such sample(s) are retained for 90 days only.

除非另有說明，此報告結果僅對測試之樣品負責，同時此樣品僅保留90天。本報告未經本公司書面許可，不可部份複製。

This document is issued by the Company subject to its General Conditions of Service printed overleaf, available on request or accessible at www.sgs.com/terms_and_conditions.htm and, for electronic format documents, subject to Terms and Conditions for Electronic Documents at www.sgs.com/terms_e-document.htm. Attention is drawn to the limitation of liability, indemnification and jurisdiction issues defined therein. Any holder of this document is advised that information contained hereon reflects the Company's findings at the time of its intervention only and within the limits of Client's instructions, if any. The Company's sole responsibility is to its Client and this document does not exonerate parties to a transaction from exercising all their rights and obligations under the transaction documents. This document cannot be reproduced except in full, without prior written approval of the Company. Any unauthorized alteration, forgery or falsification of the content or appearance of this document is unlawful and offenders may be prosecuted to the fullest extent of the law.

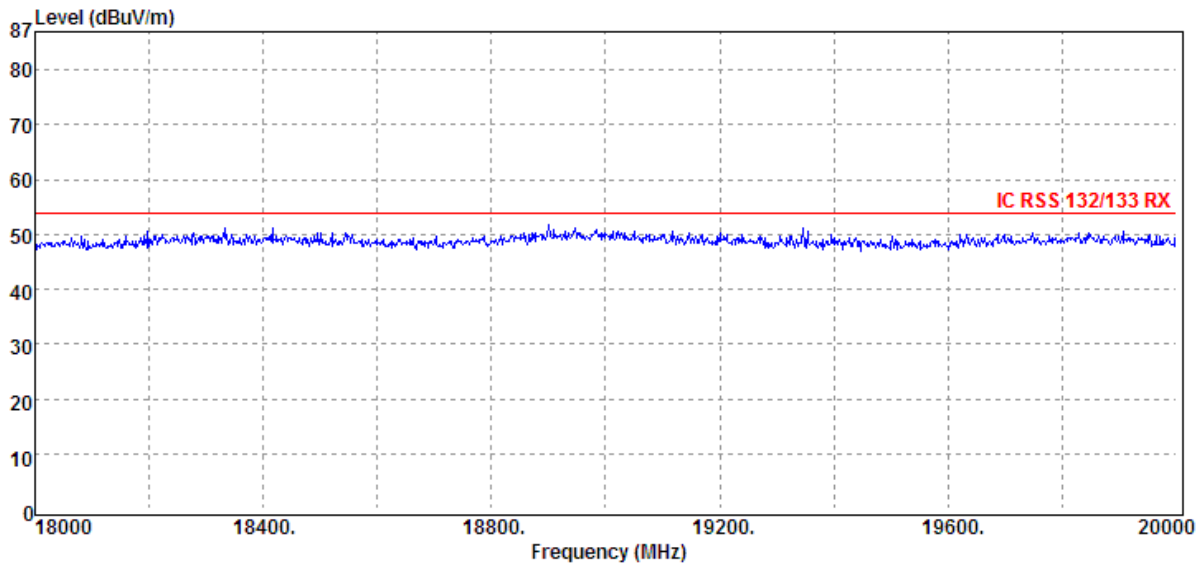
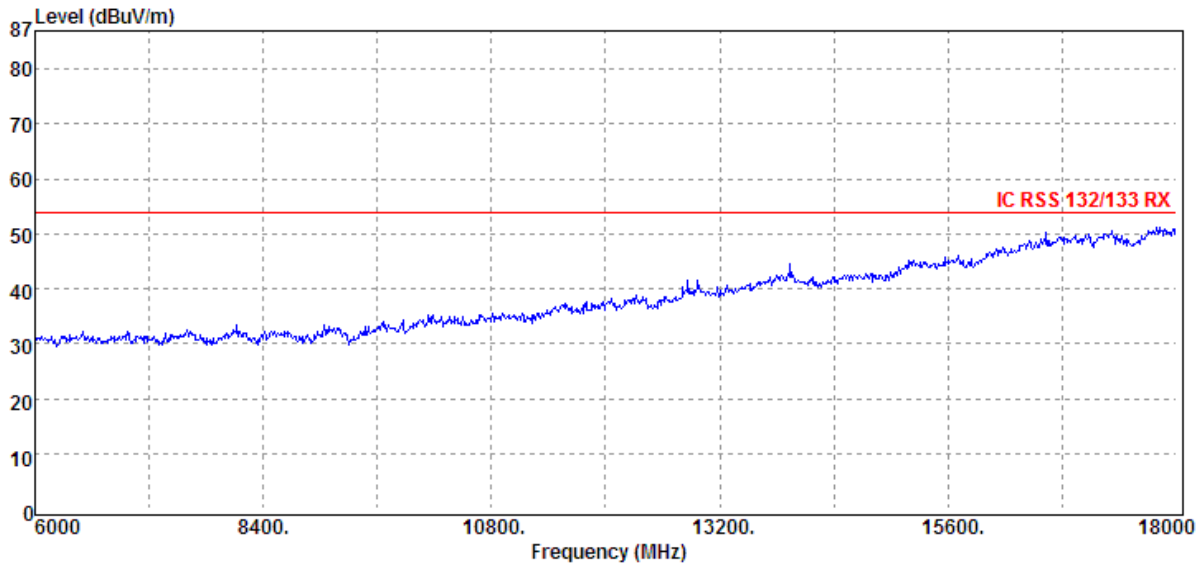

Unless otherwise stated the results shown in this test report refer only to the sample(s) tested and such sample(s) are retained for 90 days only.

除非另有說明，此報告結果僅對測試之樣品負責，同時此樣品僅保留90天。本報告未經本公司書面許可，不可部份複製。

This document is issued by the Company subject to its General Conditions of Service printed overleaf, available on request or accessible at www.sgs.com/terms_and_conditions.htm and, for electronic format documents, subject to Terms and Conditions for Electronic Documents at www.sgs.com/terms_e-document.htm. Attention is drawn to the limitation of liability, indemnification and jurisdiction issues defined therein. Any holder of this document is advised that information contained hereon reflects the Company's findings at the time of its intervention only and within the limits of Client's instructions, if any. The Company's sole responsibility is to its Client and this document does not exonerate parties to a transaction from exercising all their rights and obligations under the transaction documents. This document cannot be reproduced except in full, without prior written approval of the Company. Any unauthorized alteration, forgery or falsification of the content or appearance of this document is unlawful and offenders may be prosecuted to the fullest extent of the law.

| | | | |
|-----------------------|-------------|--------------------------|---------------------|
| Operation Band | :WCDMA B2 | Test Date | :2013-05-03 |
| Fundamental Frequency | :1907.6 MHz | Temp./Humi. | :24.1 deg_C / 65 RH |
| Operation Mode | :RX HIGH | Engineer | :Allen |
| EUT Pol. | :E1 Plan | Measurement Antenna Pol. | :VERTICAL |

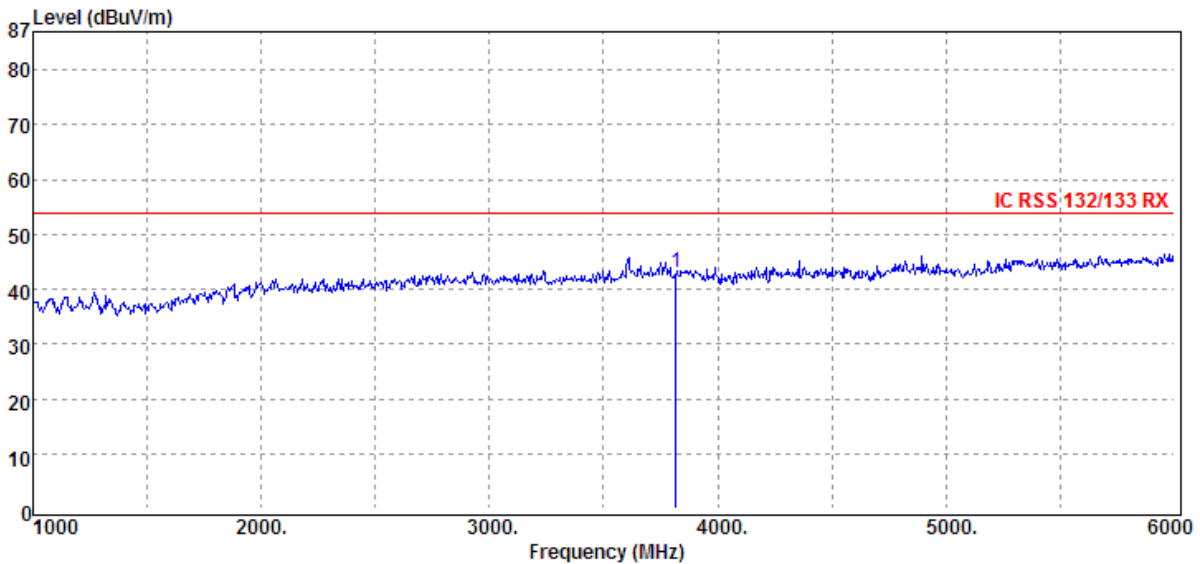
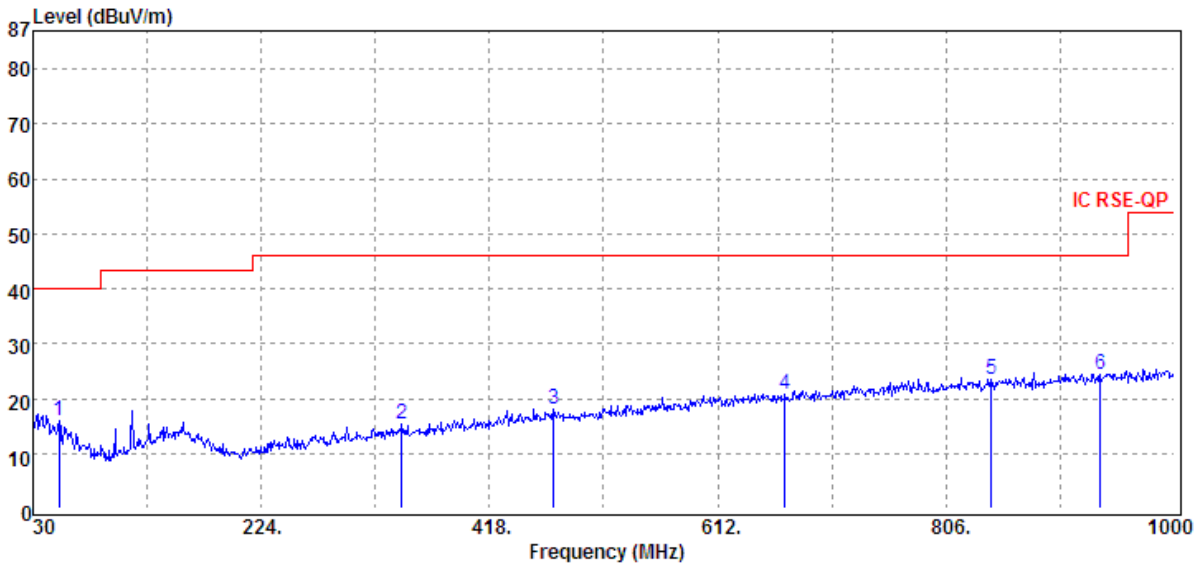

Unless otherwise stated the results shown in this test report refer only to the sample(s) tested and such sample(s) are retained for 90 days only.

除非另有說明，此報告結果僅對測試之樣品負責，同時此樣品僅保留90天。本報告未經本公司書面許可，不可部份複製。

This document is issued by the Company subject to its General Conditions of Service printed overleaf, available on request or accessible at www.sgs.com/terms_and_conditions.htm and, for electronic format documents, subject to Terms and Conditions for Electronic Documents at www.sgs.com/terms_e-document.htm. Attention is drawn to the limitation of liability, indemnification and jurisdiction issues defined therein. Any holder of this document is advised that information contained hereon reflects the Company's findings at the time of its intervention only and within the limits of Client's instructions, if any. The Company's sole responsibility is to its Client and this document does not exonerate parties to a transaction from exercising all their rights and obligations under the transaction documents. This document cannot be reproduced except in full, without prior written approval of the Company. Any unauthorized alteration, forgery or falsification of the content or appearance of this document is unlawful and offenders may be prosecuted to the fullest extent of the law.

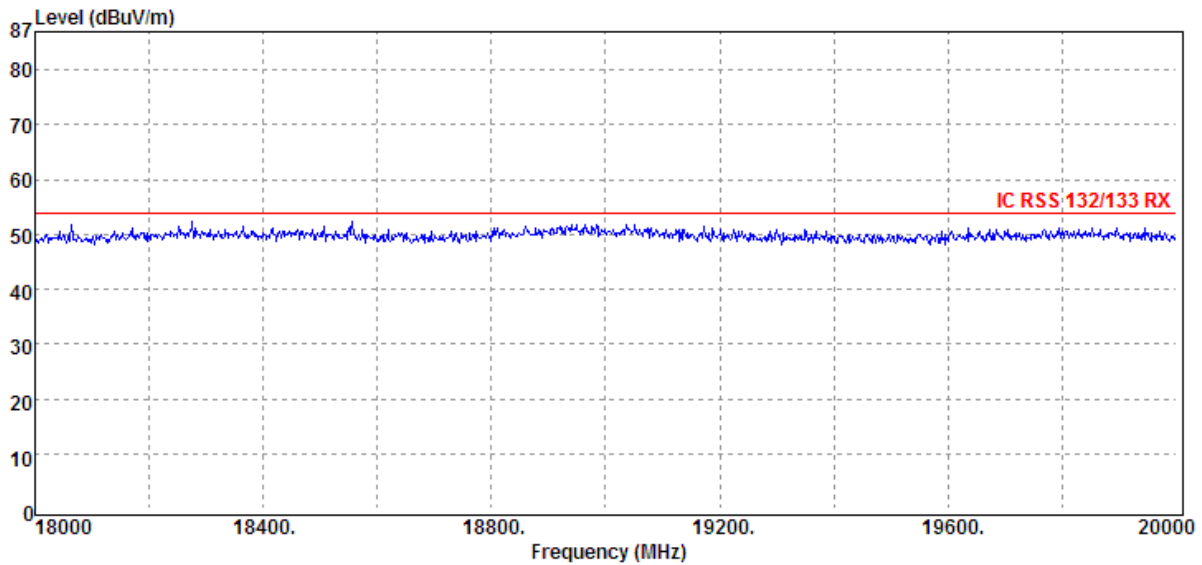
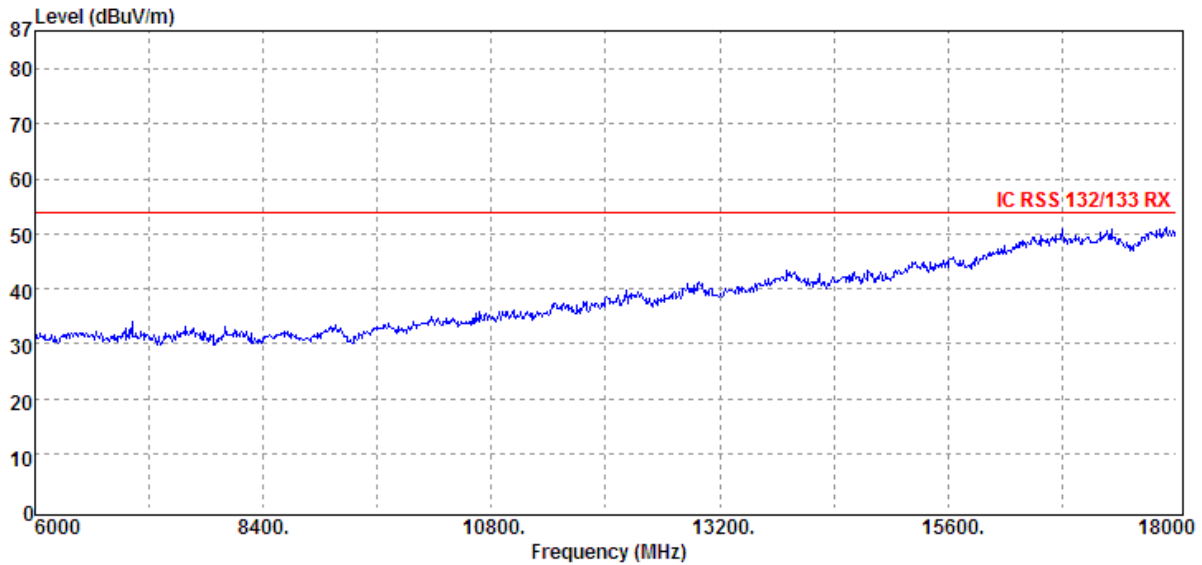

Unless otherwise stated the results shown in this test report refer only to the sample(s) tested and such sample(s) are retained for 90 days only.

除非另有說明，此報告結果僅對測試之樣品負責，同時此樣品僅保留90天。本報告未經本公司書面許可，不可部份複製。

This document is issued by the Company subject to its General Conditions of Service printed overleaf, available on request or accessible at www.sgs.com/terms_and_conditions.htm and, for electronic format documents, subject to Terms and Conditions for Electronic Documents at www.sgs.com/terms_e-document.htm. Attention is drawn to the limitation of liability, indemnification and jurisdiction issues defined therein. Any holder of this document is advised that information contained hereon reflects the Company's findings at the time of its intervention only and within the limits of Client's instructions, if any. The Company's sole responsibility is to its Client and this document does not exonerate parties to a transaction from exercising all their rights and obligations under the transaction documents. This document cannot be reproduced except in full, without prior written approval of the Company. Any unauthorized alteration, forgery or falsification of the content or appearance of this document is unlawful and offenders may be prosecuted to the fullest extent of the law.

| | | | |
|-----------------------|-------------|--------------------------|---------------------|
| Operation Band | :WCDMA B2 | Test Date | :2013-05-03 |
| Fundamental Frequency | :1907.6 MHz | Temp./Humi. | :24.1 deg_C / 65 RH |
| Operation Mode | :RX HIGH | Engineer | :Allen |
| EUT Pol. | :E1 Plan | Measurement Antenna Pol. | :HORIZONTAL |

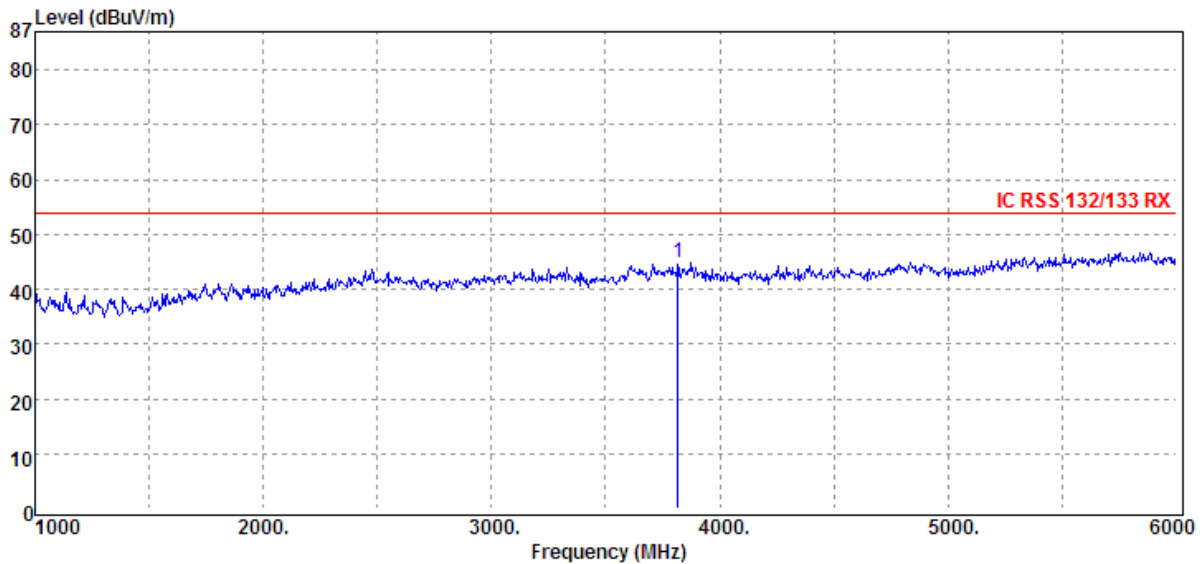
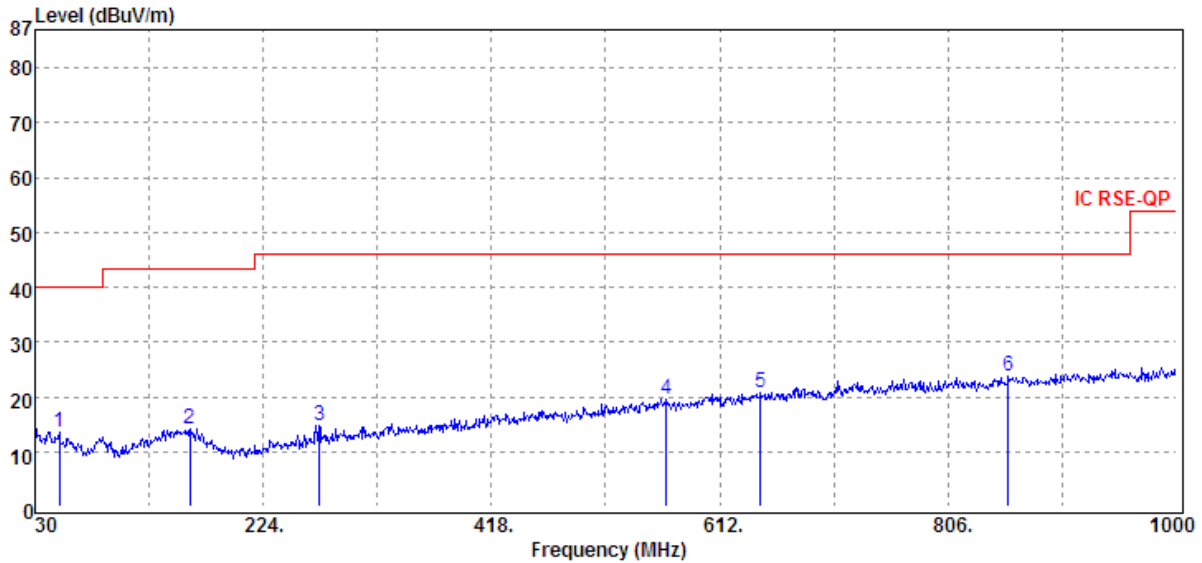

Unless otherwise stated the results shown in this test report refer only to the sample(s) tested and such sample(s) are retained for 90 days only.

除非另有說明，此報告結果僅對測試之樣品負責，同時此樣品僅保留90天。本報告未經本公司書面許可，不可部份複製。

This document is issued by the Company subject to its General Conditions of Service printed overleaf, available on request or accessible at www.sgs.com/terms_and_conditions.htm and, for electronic format documents, subject to Terms and Conditions for Electronic Documents at www.sgs.com/terms_e-document.htm. Attention is drawn to the limitation of liability, indemnification and jurisdiction issues defined therein. Any holder of this document is advised that information contained hereon reflects the Company's findings at the time of its intervention only and within the limits of Client's instructions, if any. The Company's sole responsibility is to its Client and this document does not exonerate parties to a transaction from exercising all their rights and obligations under the transaction documents. This document cannot be reproduced except in full, without prior written approval of the Company. Any unauthorized alteration, forgery or falsification of the content or appearance of this document is unlawful and offenders may be prosecuted to the fullest extent of the law.

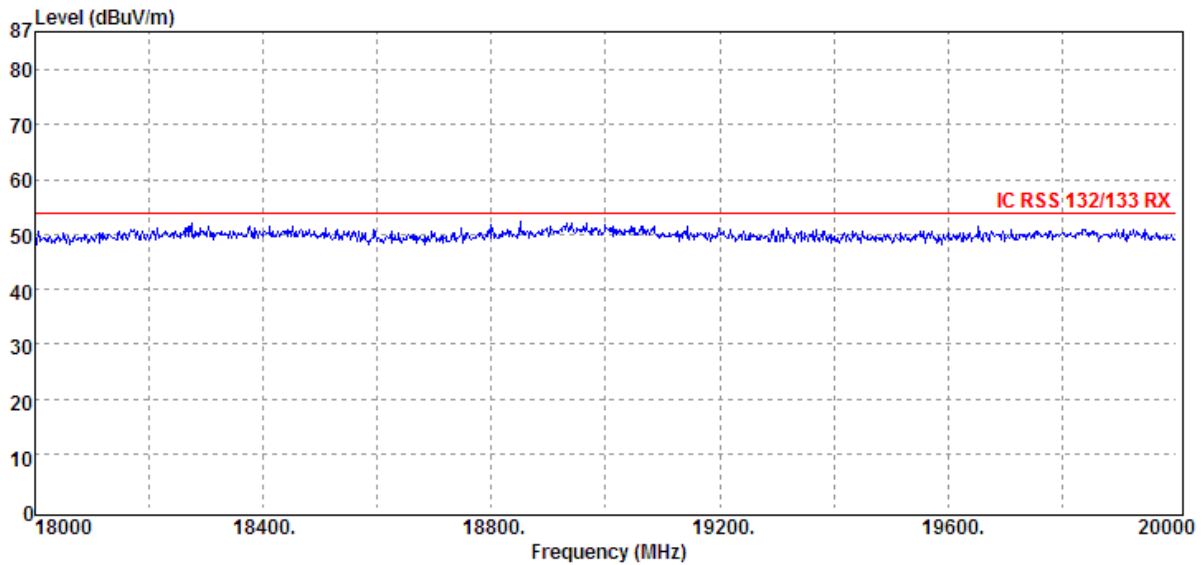
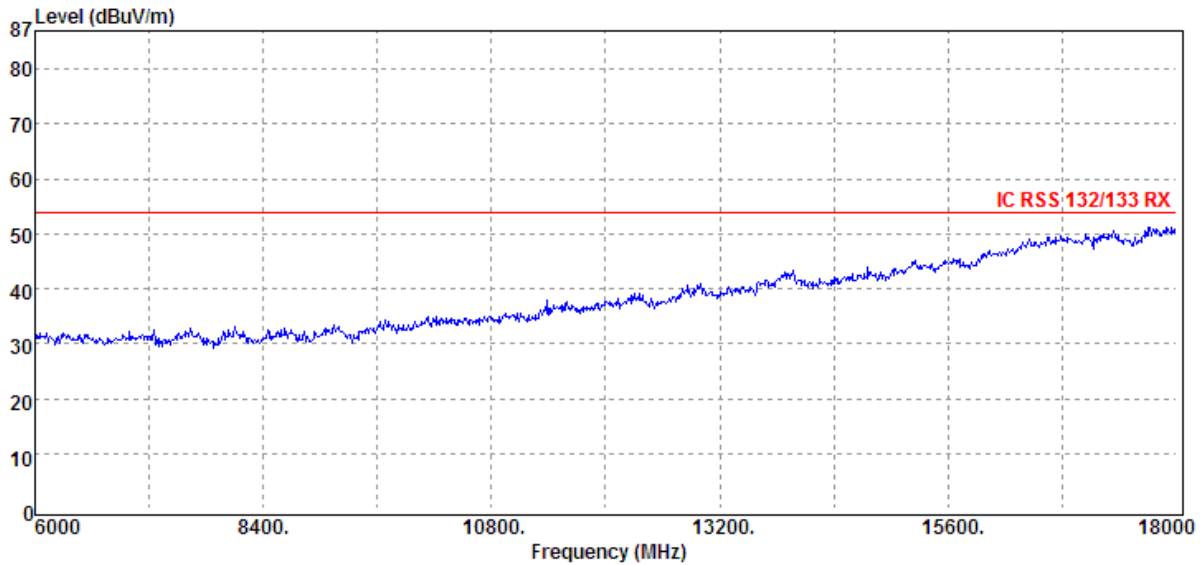

Unless otherwise stated the results shown in this test report refer only to the sample(s) tested and such sample(s) are retained for 90 days only.

除非另有說明，此報告結果僅對測試之樣品負責，同時此樣品僅保留90天。本報告未經本公司書面許可，不可部份複製。
This document is issued by the Company subject to its General Conditions of Service printed overleaf, available on request or accessible at www.sgs.com/terms_and_conditions.htm and, for electronic format documents, subject to Terms and Conditions for Electronic Documents at www.sgs.com/terms_e-document.htm. Attention is drawn to the limitation of liability, indemnification and jurisdiction issues defined therein. Any holder of this document is advised that information contained hereon reflects the Company's findings at the time of its intervention only and within the limits of Client's instructions, if any. The Company's sole responsibility is to its Client and this document does not exonerate parties to a transaction from exercising all their rights and obligations under the transaction documents. This document cannot be reproduced except in full, without prior written approval of the Company. Any unauthorized alteration, forgery or falsification of the content or appearance of this document is unlawful and offenders may be prosecuted to the fullest extent of the law.

Radiated Spurious Emission Measurement Result: WCDMA IV Mode

| | | | |
|-----------------------|-------------|--------------------------|---------------------|
| Operation Band | :WCDMA B4 | Test Date | :2013-05-03 |
| Fundamental Frequency | :1712.4 MHz | Temp./Humi. | :24.1 deg_C / 65 RH |
| Operation Mode | :RX LOW | Engineer | :Allen |
| EUT Pol. | :H Plan | Measurement Antenna Pol. | :VERTICAL |

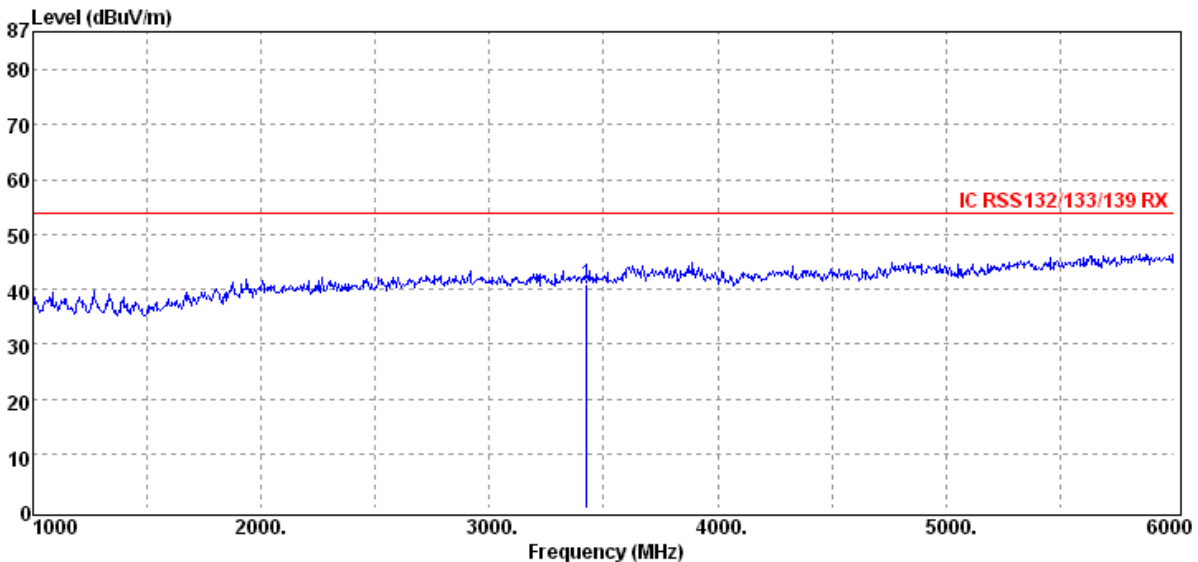
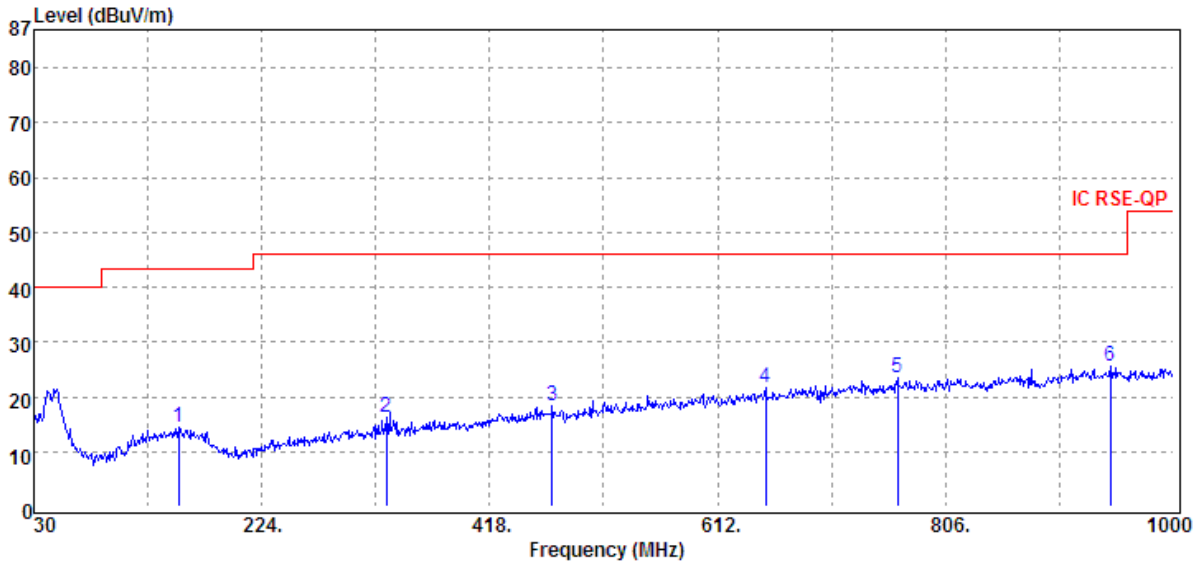

Unless otherwise stated the results shown in this test report refer only to the sample(s) tested and such sample(s) are retained for 90 days only.

除非另有說明，此報告結果僅對測試之樣品負責，同時此樣品僅保留90天。本報告未經本公司書面許可，不可部份複製。

This document is issued by the Company subject to its General Conditions of Service printed overleaf, available on request or accessible at www.sgs.com/terms_and_conditions.htm and, for electronic format documents, subject to Terms and Conditions for Electronic Documents at www.sgs.com/terms_e-document.htm. Attention is drawn to the limitation of liability, indemnification and jurisdiction issues defined therein. Any holder of this document is advised that information contained hereon reflects the Company's findings at the time of its intervention only and within the limits of Client's instructions, if any. The Company's sole responsibility is to its Client and this document does not exonerate parties to a transaction from exercising all their rights and obligations under the transaction documents. This document cannot be reproduced except in full, without prior written approval of the Company. Any unauthorized alteration, forgery or falsification of the content or appearance of this document is unlawful and offenders may be prosecuted to the fullest extent of the law.

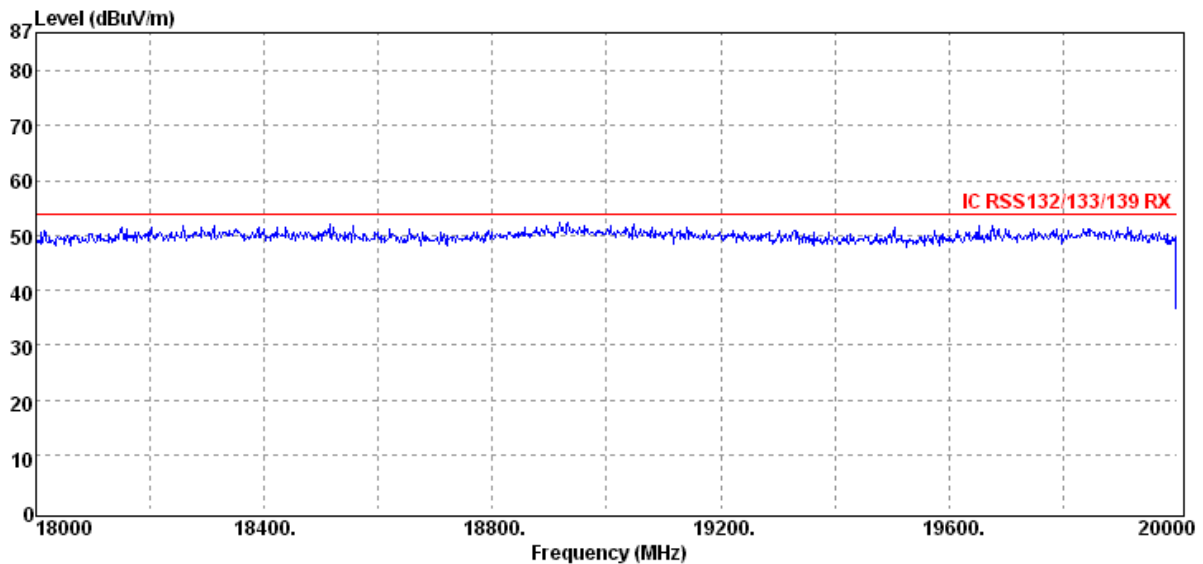
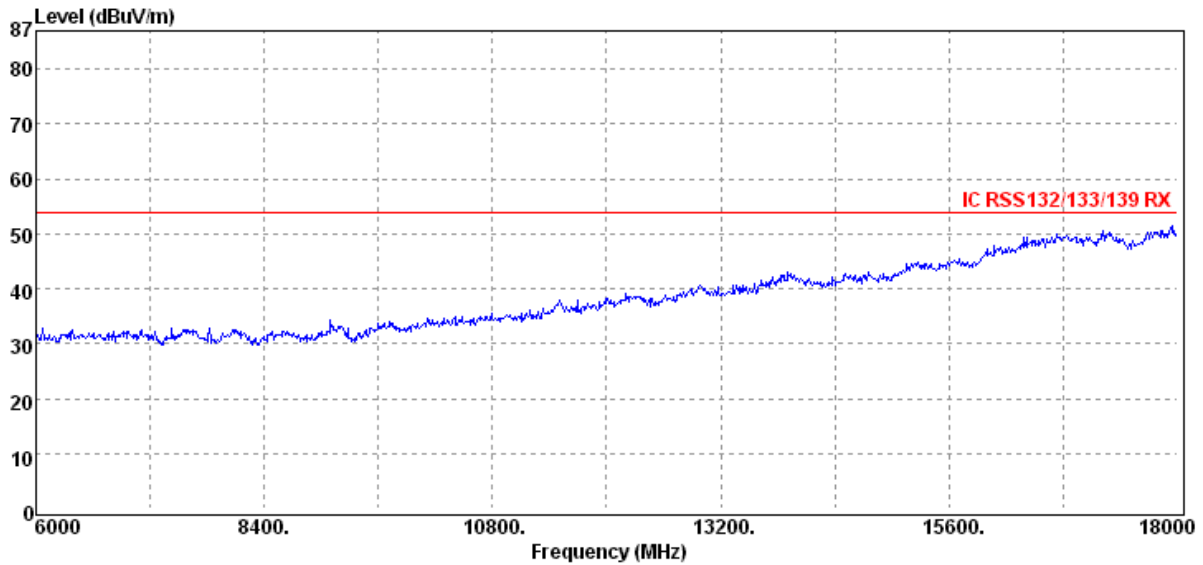

Unless otherwise stated the results shown in this test report refer only to the sample(s) tested and such sample(s) are retained for 90 days only.

除非另有說明，此報告結果僅對測試之樣品負責，同時此樣品僅保留90天。本報告未經本公司書面許可，不可部份複製。

This document is issued by the Company subject to its General Conditions of Service printed overleaf, available on request or accessible at www.sgs.com/terms_and_conditions.htm and, for electronic format documents, subject to Terms and Conditions for Electronic Documents at www.sgs.com/terms_e-document.htm. Attention is drawn to the limitation of liability, indemnification and jurisdiction issues defined therein. Any holder of this document is advised that information contained hereon reflects the Company's findings at the time of its intervention only and within the limits of Client's instructions, if any. The Company's sole responsibility is to its Client and this document does not exonerate parties to a transaction from exercising all their rights and obligations under the transaction documents. This document cannot be reproduced except in full, without prior written approval of the Company. Any unauthorized alteration, forgery or falsification of the content or appearance of this document is unlawful and offenders may be prosecuted to the fullest extent of the law.

| | | | |
|-----------------------|-------------|--------------------------|---------------------|
| Operation Band | :WCDMA B4 | Test Date | :2013-05-03 |
| Fundamental Frequency | :1712.4 MHz | Temp./Humi. | :24.1 deg_C / 65 RH |
| Operation Mode | :RX LOW | Engineer | :Allen |
| EUT Pol. | :H Plan | Measurement Antenna Pol. | :HORIZONTAL |

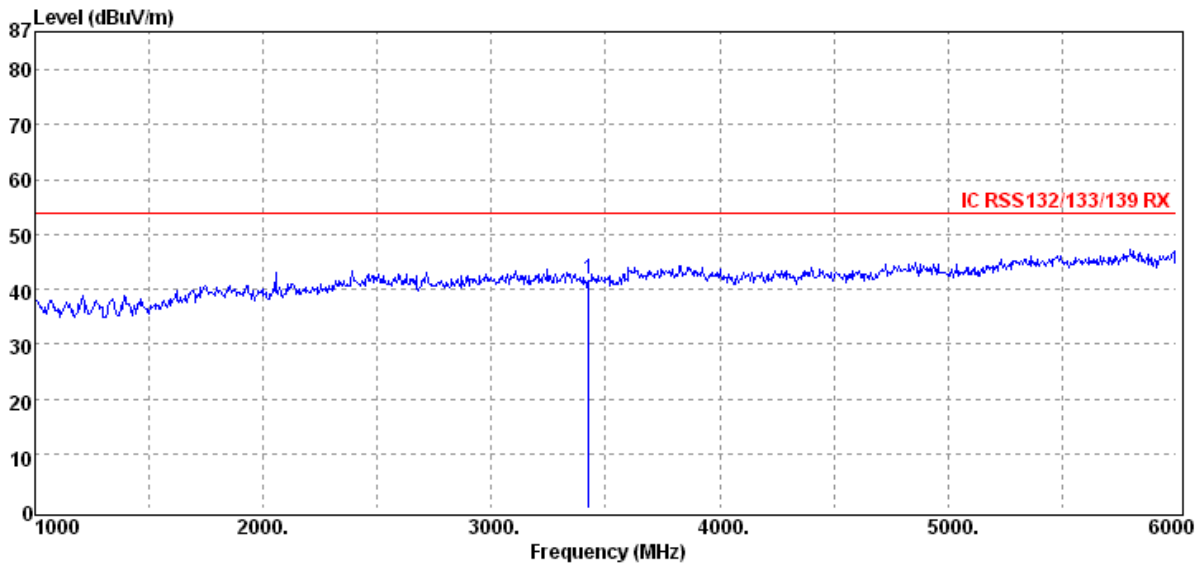
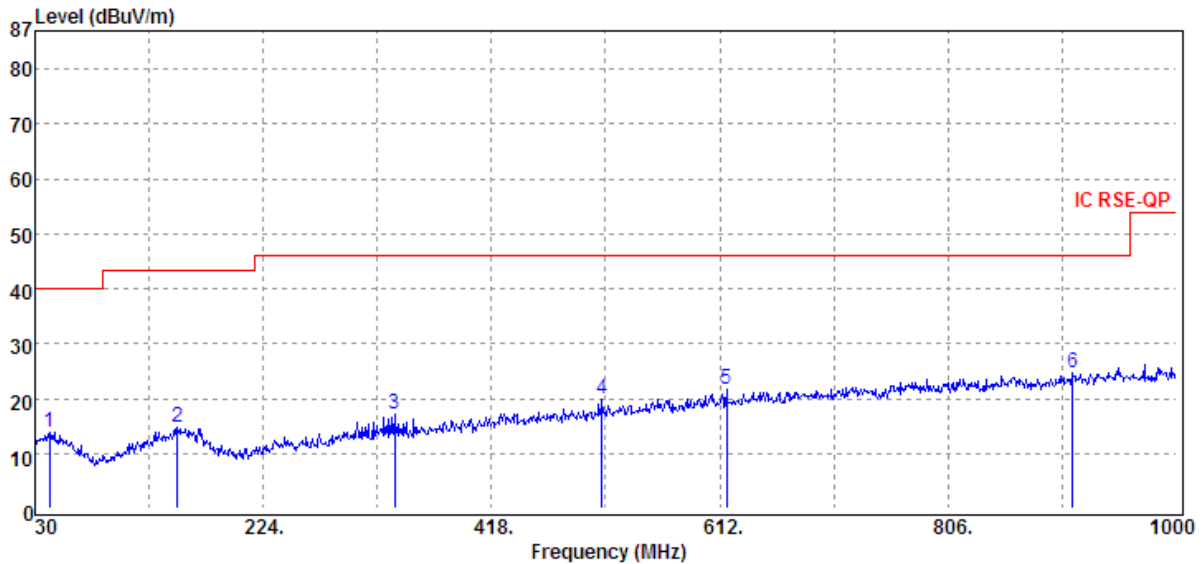

Unless otherwise stated the results shown in this test report refer only to the sample(s) tested and such sample(s) are retained for 90 days only.

除非另有說明，此報告結果僅對測試之樣品負責，同時此樣品僅保留90天。本報告未經本公司書面許可，不可部份複製。

This document is issued by the Company subject to its General Conditions of Service printed overleaf, available on request or accessible at www.sgs.com/terms_and_conditions.htm and, for electronic format documents, subject to Terms and Conditions for Electronic Documents at www.sgs.com/terms_e-document.htm. Attention is drawn to the limitation of liability, indemnification and jurisdiction issues defined therein. Any holder of this document is advised that information contained hereon reflects the Company's findings at the time of its intervention only and within the limits of Client's instructions, if any. The Company's sole responsibility is to its Client and this document does not exonerate parties to a transaction from exercising all their rights and obligations under the transaction documents. This document cannot be reproduced except in full, without prior written approval of the Company. Any unauthorized alteration, forgery or falsification of the content or appearance of this document is unlawful and offenders may be prosecuted to the fullest extent of the law.

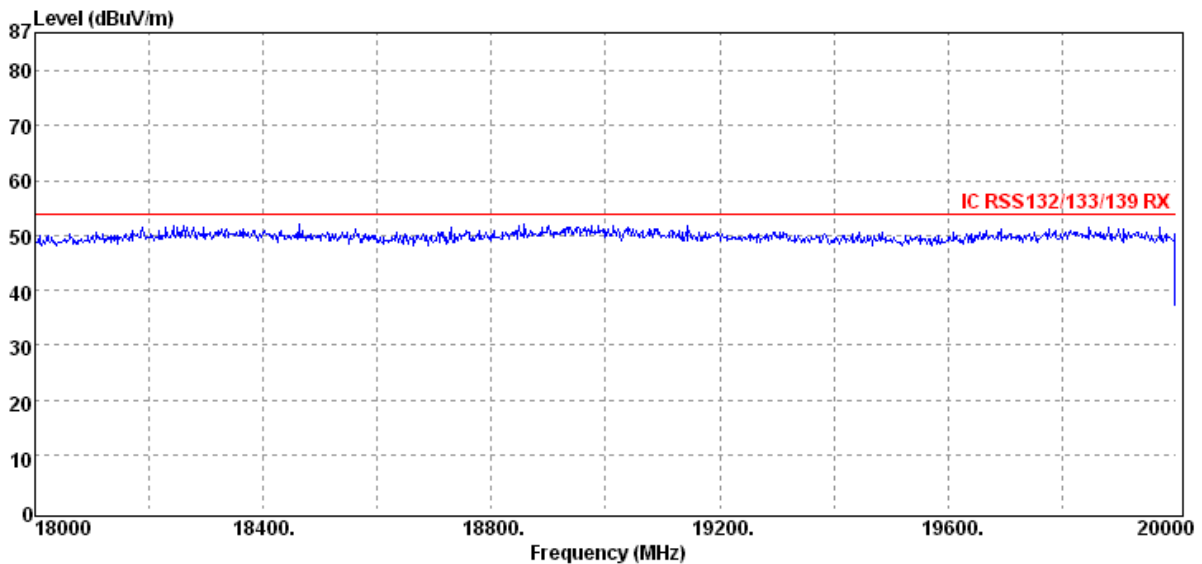
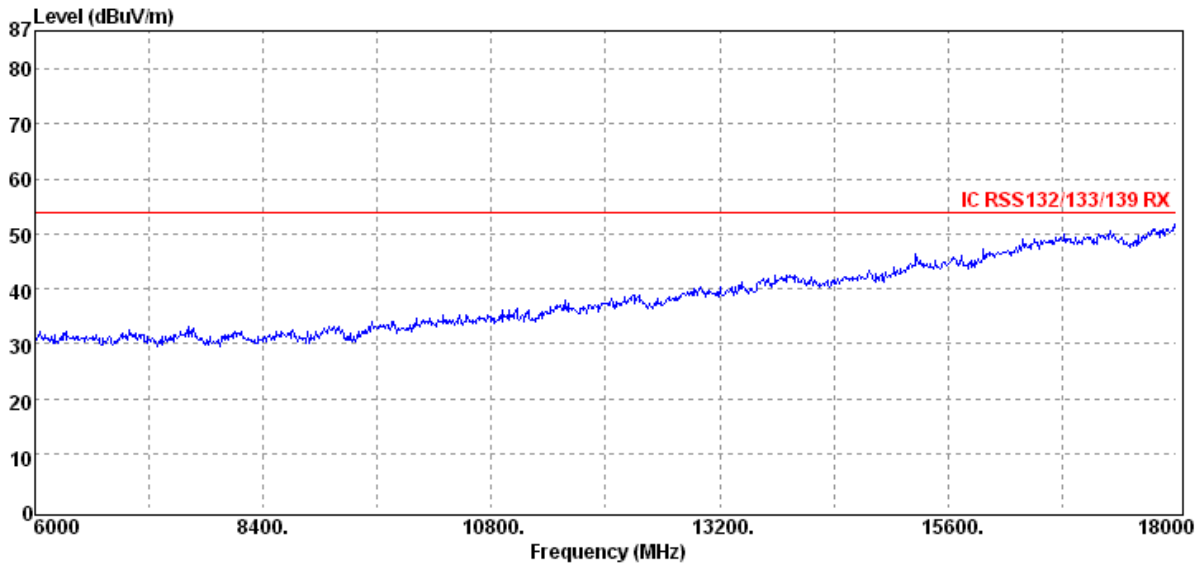

Unless otherwise stated the results shown in this test report refer only to the sample(s) tested and such sample(s) are retained for 90 days only.

除非另有說明，此報告結果僅對測試之樣品負責，同時此樣品僅保留90天。本報告未經本公司書面許可，不可部份複製。

This document is issued by the Company subject to its General Conditions of Service printed overleaf, available on request or accessible at www.sgs.com/terms_and_conditions.htm and, for electronic format documents, subject to Terms and Conditions for Electronic Documents at www.sgs.com/terms_e-document.htm. Attention is drawn to the limitation of liability, indemnification and jurisdiction issues defined therein. Any holder of this document is advised that information contained hereon reflects the Company's findings at the time of its intervention only and within the limits of Client's instructions, if any. The Company's sole responsibility is to its Client and this document does not exonerate parties to a transaction from exercising all their rights and obligations under the transaction documents. This document cannot be reproduced except in full, without prior written approval of the Company. Any unauthorized alteration, forgery or falsification of the content or appearance of this document is unlawful and offenders may be prosecuted to the fullest extent of the law.

| | | | |
|-----------------------|-------------|--------------------------|---------------------|
| Operation Band | :WCDMA B4 | Test Date | :2013-05-03 |
| Fundamental Frequency | :1732.6 MHz | Temp./Humi. | :24.1 deg_C / 65 RH |
| Operation Mode | :RX MID | Engineer | :Allen |
| EUT Pol. | :H Plan | Measurement Antenna Pol. | :VERTICAL |

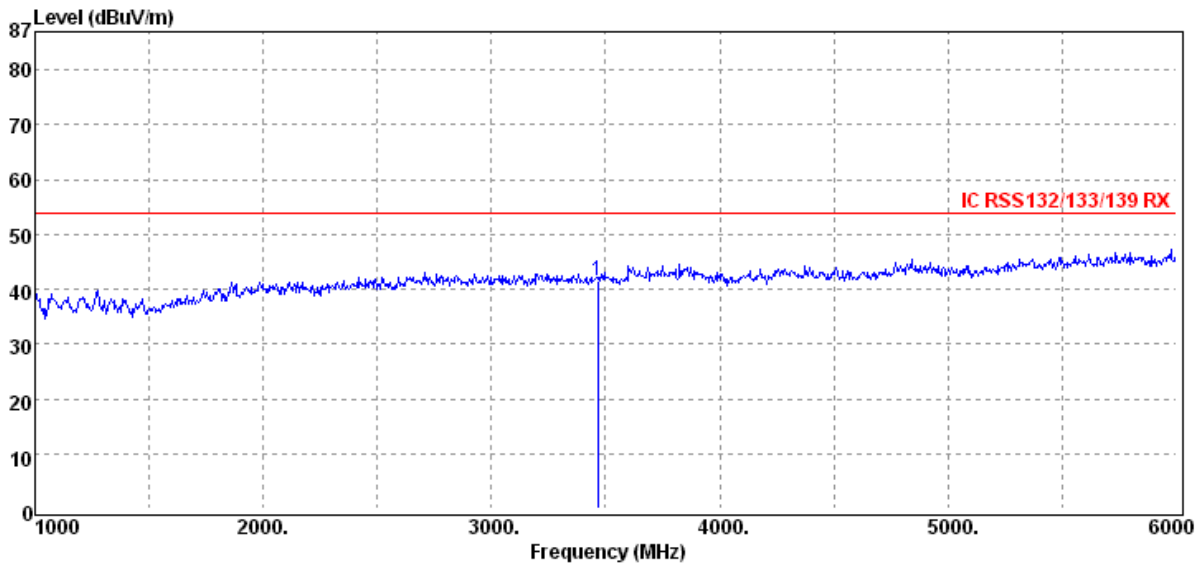
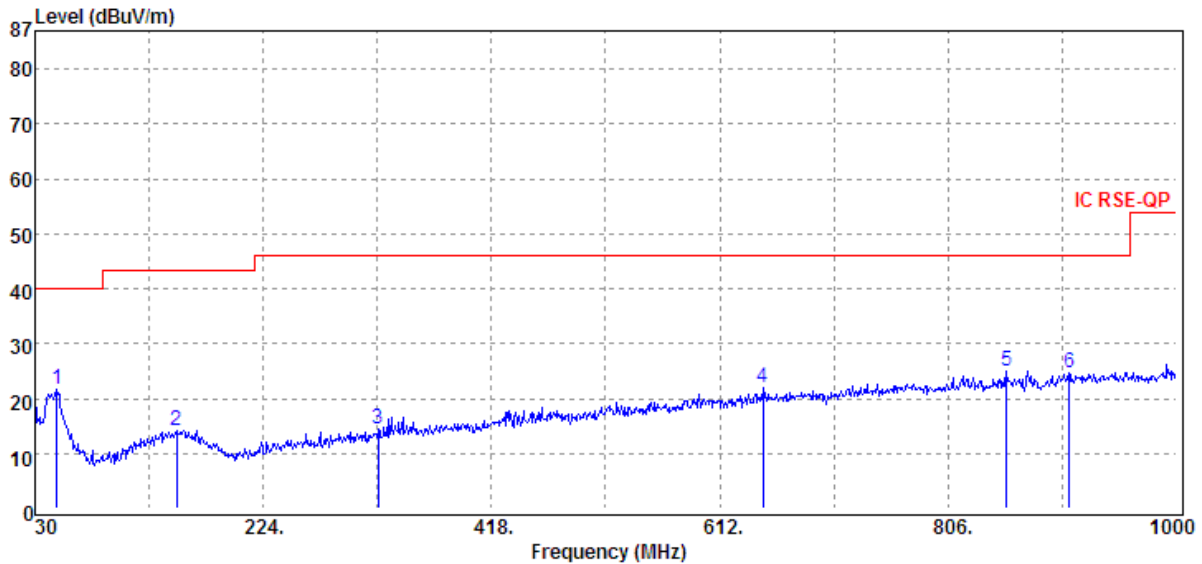

Unless otherwise stated the results shown in this test report refer only to the sample(s) tested and such sample(s) are retained for 90 days only.

除非另有說明，此報告結果僅對測試之樣品負責，同時此樣品僅保留90天。本報告未經本公司書面許可，不可部份複製。

This document is issued by the Company subject to its General Conditions of Service printed overleaf, available on request or accessible at www.sgs.com/terms_and_conditions.htm and, for electronic format documents, subject to Terms and Conditions for Electronic Documents at www.sgs.com/terms_e-document.htm. Attention is drawn to the limitation of liability, indemnification and jurisdiction issues defined therein. Any holder of this document is advised that information contained hereon reflects the Company's findings at the time of its intervention only and within the limits of Client's instructions, if any. The Company's sole responsibility is to its Client and this document does not exonerate parties to a transaction from exercising all their rights and obligations under the transaction documents. This document cannot be reproduced except in full, without prior written approval of the Company. Any unauthorized alteration, forgery or falsification of the content or appearance of this document is unlawful and offenders may be prosecuted to the fullest extent of the law.

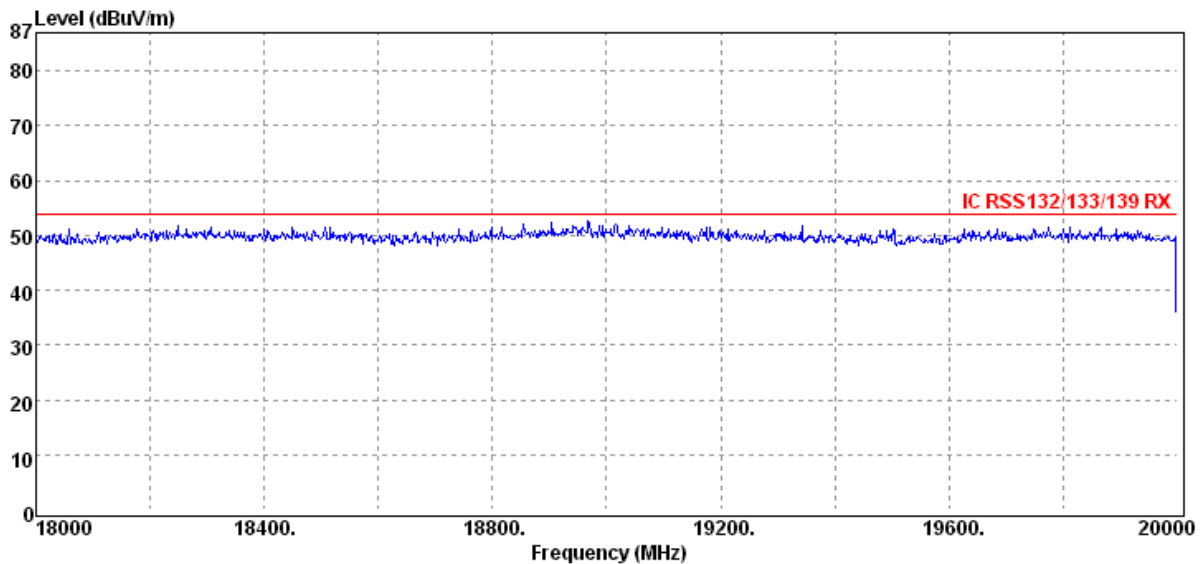
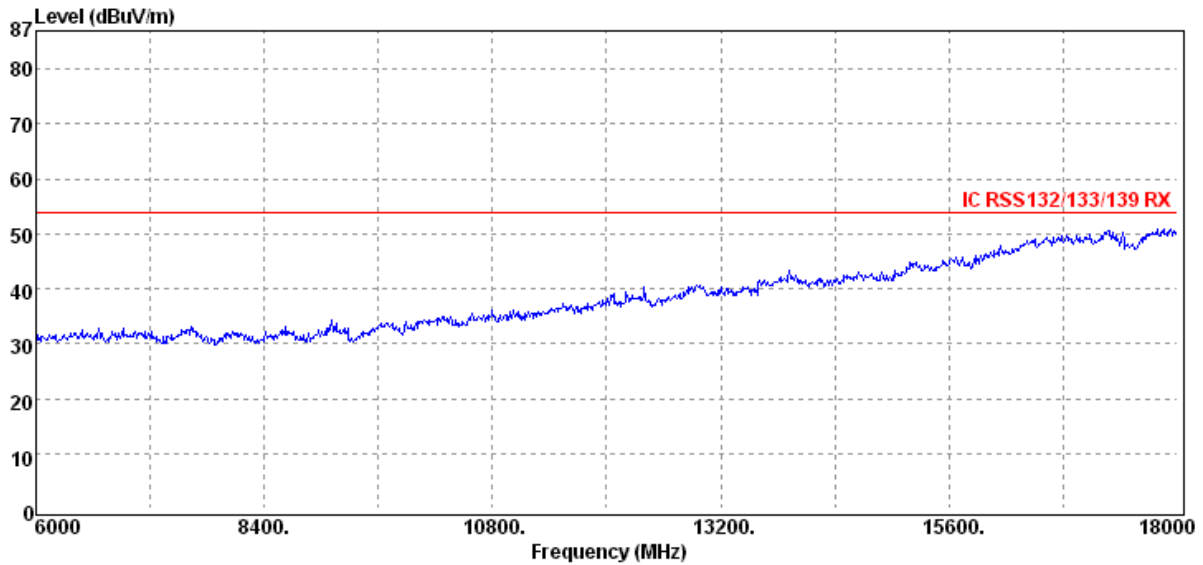

Unless otherwise stated the results shown in this test report refer only to the sample(s) tested and such sample(s) are retained for 90 days only.

除非另有說明，此報告結果僅對測試之樣品負責，同時此樣品僅保留90天。本報告未經本公司書面許可，不可部份複製。

This document is issued by the Company subject to its General Conditions of Service printed overleaf, available on request or accessible at www.sgs.com/terms_and_conditions.htm and, for electronic format documents, subject to Terms and Conditions for Electronic Documents at www.sgs.com/terms_e-document.htm. Attention is drawn to the limitation of liability, indemnification and jurisdiction issues defined therein. Any holder of this document is advised that information contained hereon reflects the Company's findings at the time of its intervention only and within the limits of Client's instructions, if any. The Company's sole responsibility is to its Client and this document does not exonerate parties to a transaction from exercising all their rights and obligations under the transaction documents. This document cannot be reproduced except in full, without prior written approval of the Company. Any unauthorized alteration, forgery or falsification of the content or appearance of this document is unlawful and offenders may be prosecuted to the fullest extent of the law.

| | | | |
|-----------------------|-------------|--------------------------|---------------------|
| Operation Band | :WCDMA B4 | Test Date | :2013-05-03 |
| Fundamental Frequency | :1732.6 MHz | Temp./Humi. | :24.1 deg_C / 65 RH |
| Operation Mode | :RX MID | Engineer | :Allen |
| EUT Pol. | :H Plan | Measurement Antenna Pol. | :HORIZONTAL |

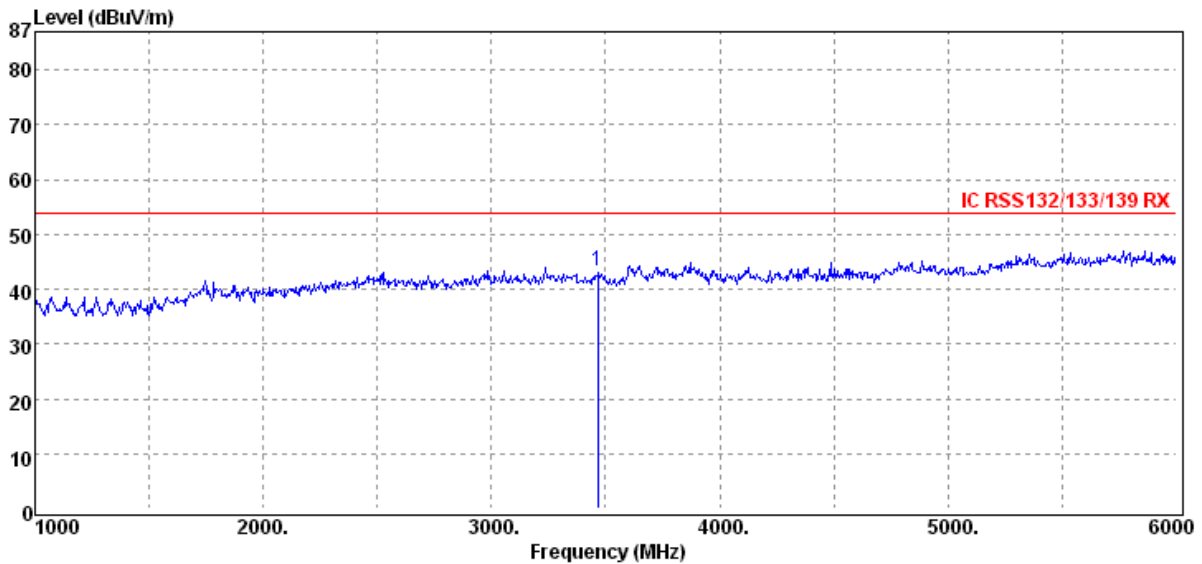
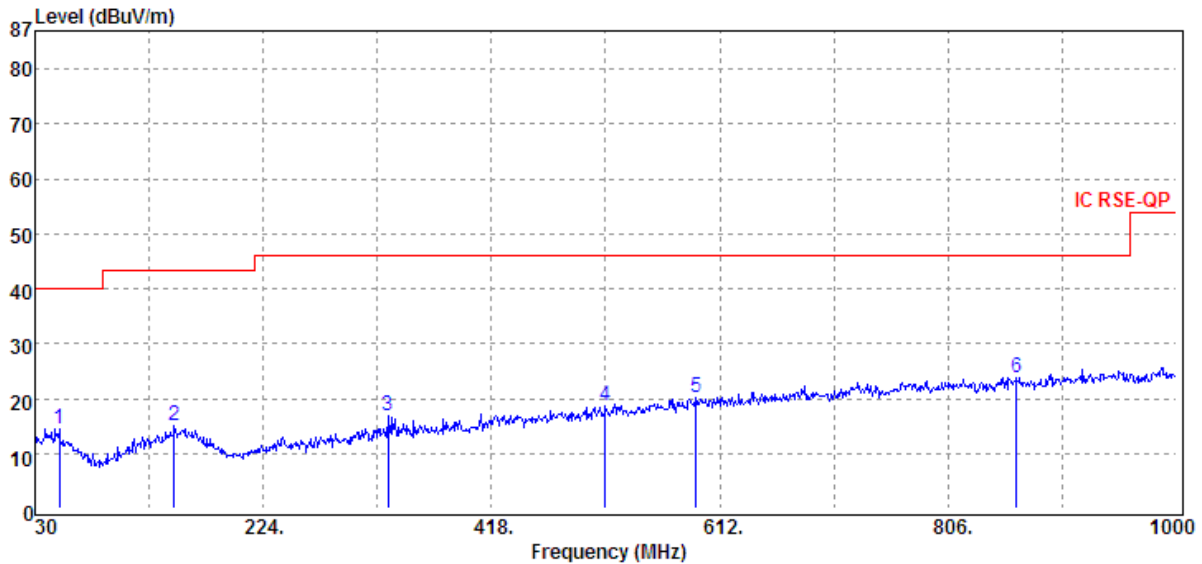

Unless otherwise stated the results shown in this test report refer only to the sample(s) tested and such sample(s) are retained for 90 days only.

除非另有說明，此報告結果僅對測試之樣品負責，同時此樣品僅保留90天。本報告未經本公司書面許可，不可部份複製。

This document is issued by the Company subject to its General Conditions of Service printed overleaf, available on request or accessible at www.sgs.com/terms_and_conditions.htm and, for electronic format documents, subject to Terms and Conditions for Electronic Documents at www.sgs.com/terms_e-document.htm. Attention is drawn to the limitation of liability, indemnification and jurisdiction issues defined therein. Any holder of this document is advised that information contained hereon reflects the Company's findings at the time of its intervention only and within the limits of Client's instructions, if any. The Company's sole responsibility is to its Client and this document does not exonerate parties to a transaction from exercising all their rights and obligations under the transaction documents. This document cannot be reproduced except in full, without prior written approval of the Company. Any unauthorized alteration, forgery or falsification of the content or appearance of this document is unlawful and offenders may be prosecuted to the fullest extent of the law.

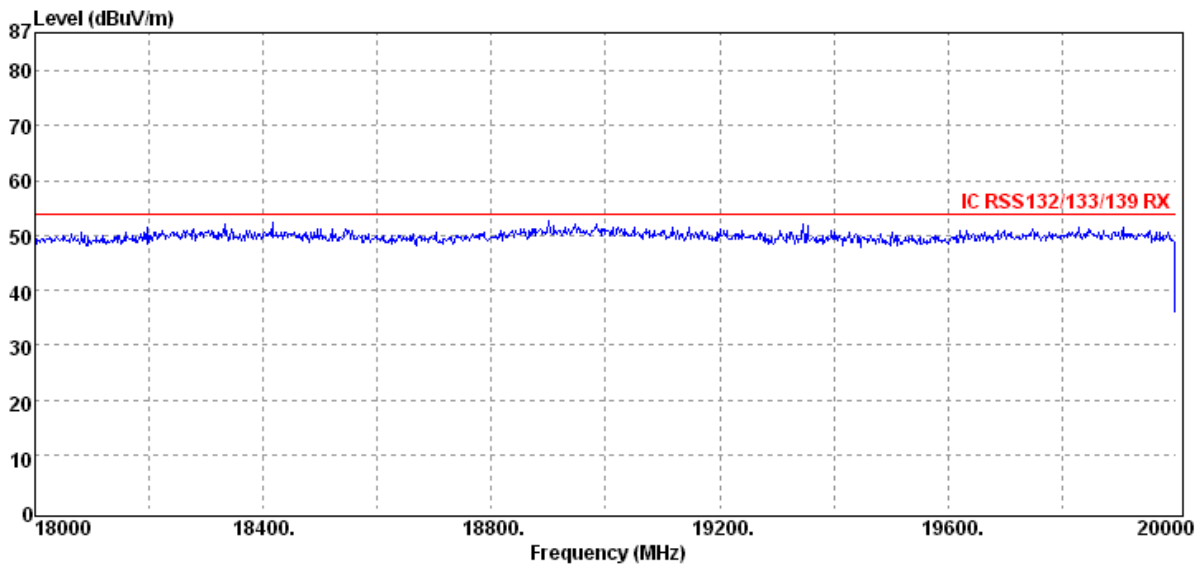
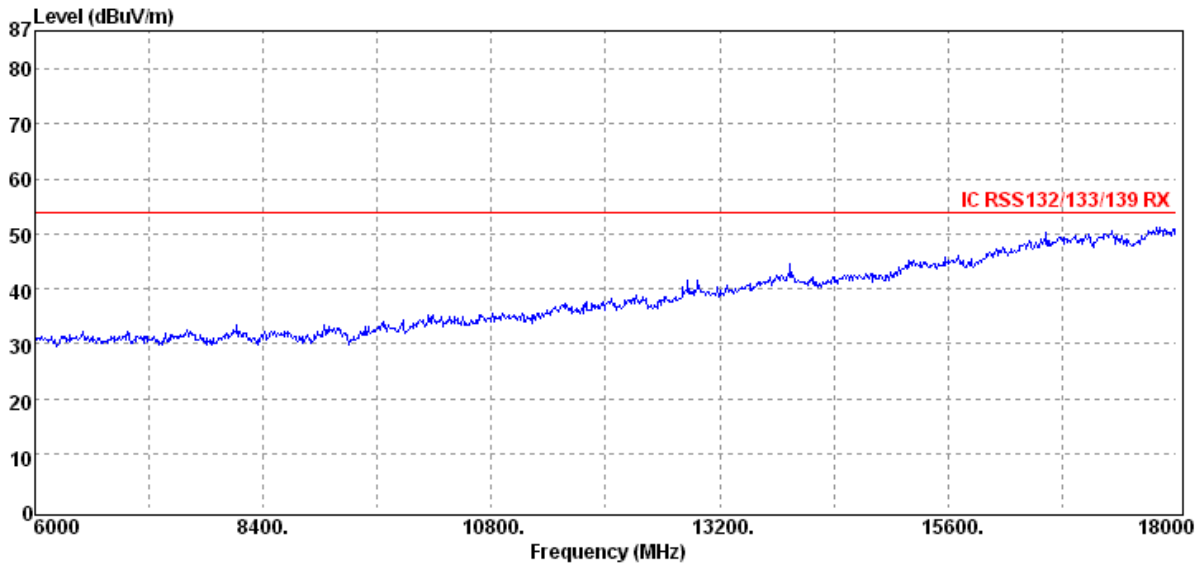

Unless otherwise stated the results shown in this test report refer only to the sample(s) tested and such sample(s) are retained for 90 days only.

除非另有說明，此報告結果僅對測試之樣品負責，同時此樣品僅保留90天。本報告未經本公司書面許可，不可部份複製。

This document is issued by the Company subject to its General Conditions of Service printed overleaf, available on request or accessible at www.sgs.com/terms_and_conditions.htm and, for electronic format documents, subject to Terms and Conditions for Electronic Documents at www.sgs.com/terms_e-document.htm. Attention is drawn to the limitation of liability, indemnification and jurisdiction issues defined therein. Any holder of this document is advised that information contained hereon reflects the Company's findings at the time of its intervention only and within the limits of Client's instructions, if any. The Company's sole responsibility is to its Client and this document does not exonerate parties to a transaction from exercising all their rights and obligations under the transaction documents. This document cannot be reproduced except in full, without prior written approval of the Company. Any unauthorized alteration, forgery or falsification of the content or appearance of this document is unlawful and offenders may be prosecuted to the fullest extent of the law.

| | | | |
|-----------------------|-------------|--------------------------|---------------------|
| Operation Band | :WCDMA B4 | Test Date | :2013-05-03 |
| Fundamental Frequency | :1752.6 MHz | Temp./Humi. | :24.1 deg_C / 65 RH |
| Operation Mode | :RX HIGH | Engineer | :Allen |
| EUT Pol. | :H Plan | Measurement Antenna Pol. | :VERTICAL |

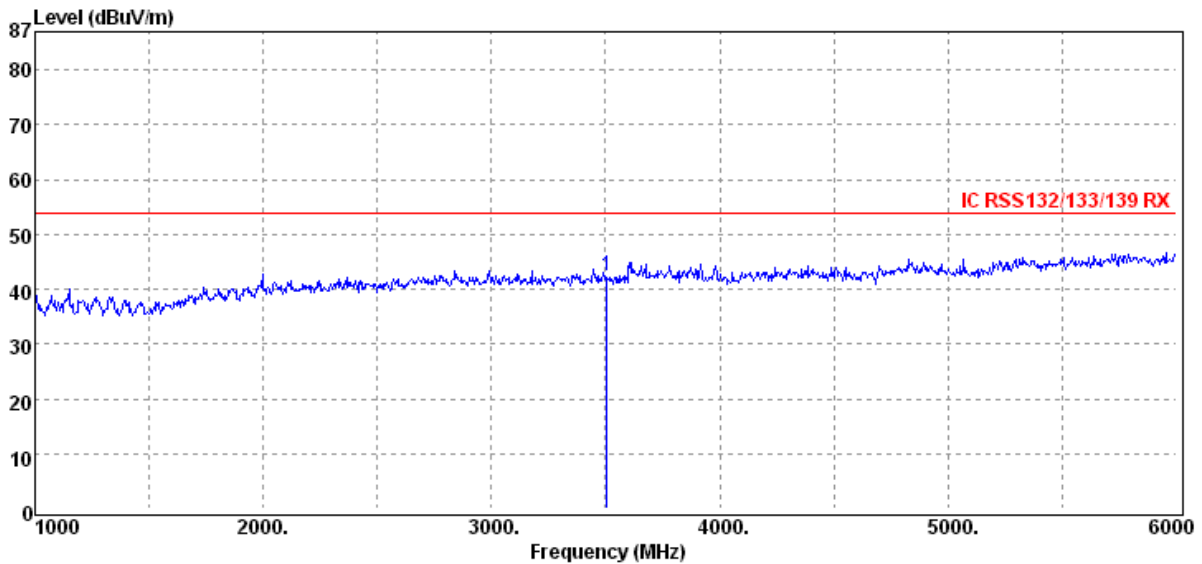
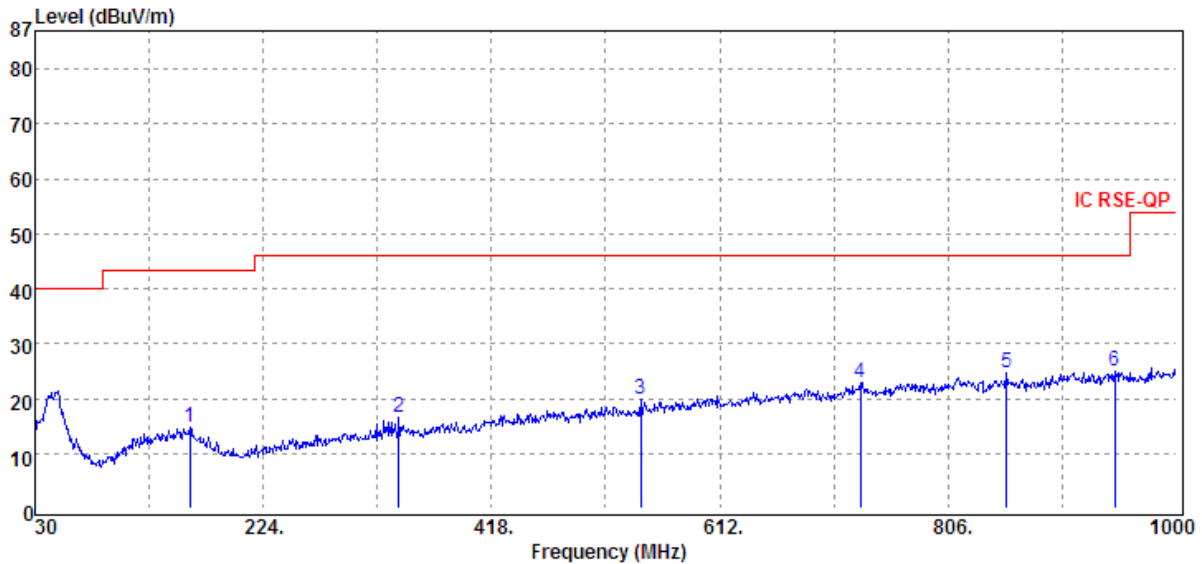

Unless otherwise stated the results shown in this test report refer only to the sample(s) tested and such sample(s) are retained for 90 days only.

除非另有說明，此報告結果僅對測試之樣品負責，同時此樣品僅保留90天。本報告未經本公司書面許可，不可部份複製。

This document is issued by the Company subject to its General Conditions of Service printed overleaf, available on request or accessible at www.sgs.com/terms_and_conditions.htm and, for electronic format documents, subject to Terms and Conditions for Electronic Documents at www.sgs.com/terms_e-document.htm. Attention is drawn to the limitation of liability, indemnification and jurisdiction issues defined therein. Any holder of this document is advised that information contained hereon reflects the Company's findings at the time of its intervention only and within the limits of Client's instructions, if any. The Company's sole responsibility is to its Client and this document does not exonerate parties to a transaction from exercising all their rights and obligations under the transaction documents. This document cannot be reproduced except in full, without prior written approval of the Company. Any unauthorized alteration, forgery or falsification of the content or appearance of this document is unlawful and offenders may be prosecuted to the fullest extent of the law.

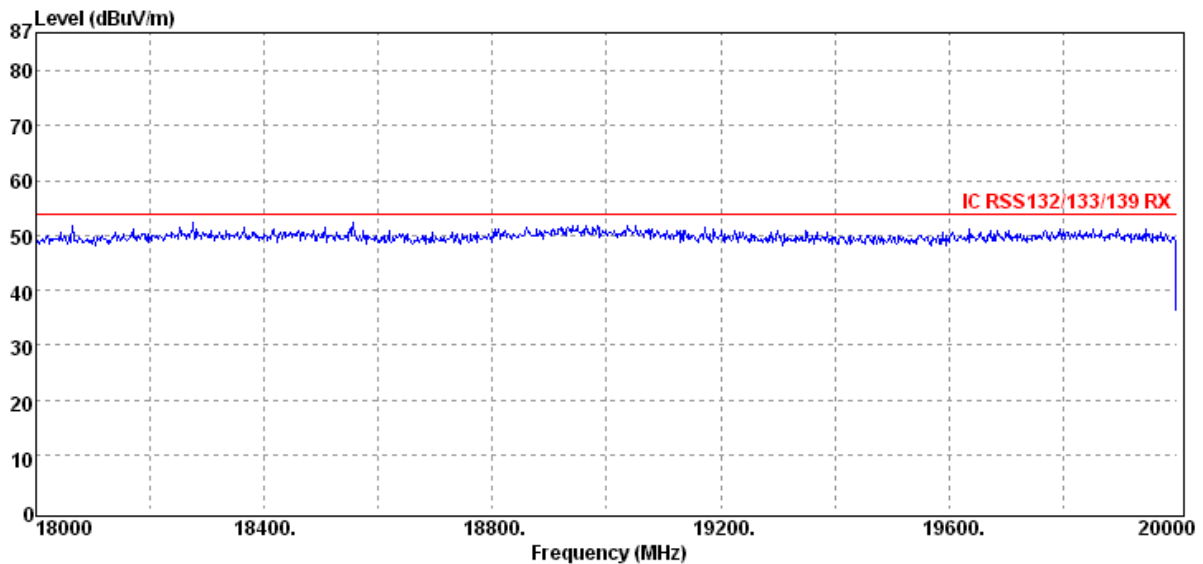
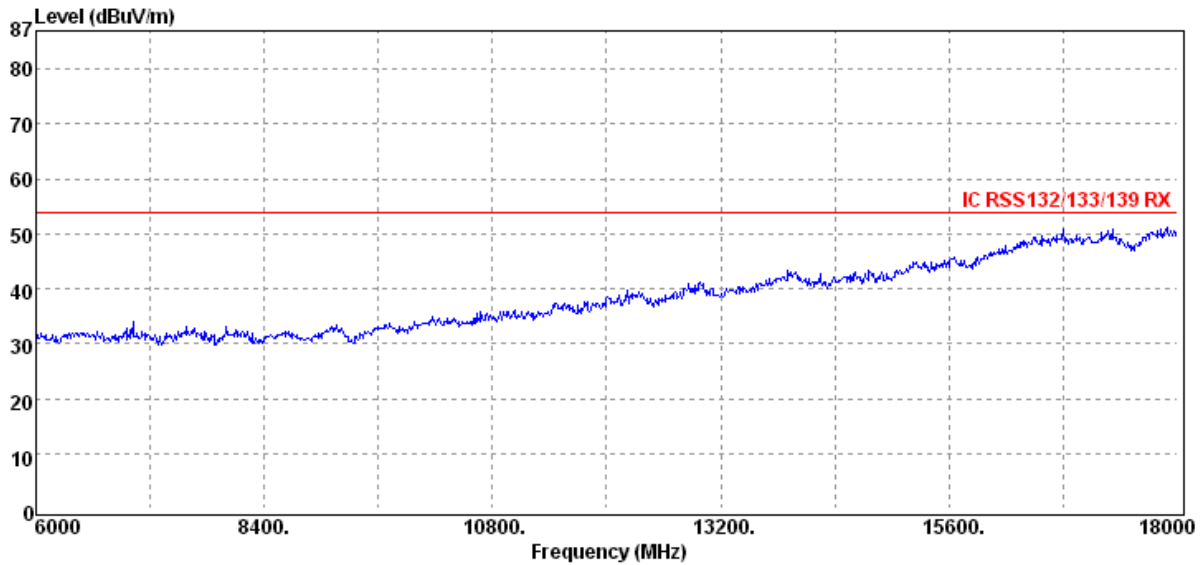

Unless otherwise stated the results shown in this test report refer only to the sample(s) tested and such sample(s) are retained for 90 days only.

除非另有說明，此報告結果僅對測試之樣品負責，同時此樣品僅保留90天。本報告未經本公司書面許可，不可部份複製。

This document is issued by the Company subject to its General Conditions of Service printed overleaf, available on request or accessible at www.sgs.com/terms_and_conditions.htm and, for electronic format documents, subject to Terms and Conditions for Electronic Documents at www.sgs.com/terms_e-document.htm. Attention is drawn to the limitation of liability, indemnification and jurisdiction issues defined therein. Any holder of this document is advised that information contained hereon reflects the Company's findings at the time of its intervention only and within the limits of Client's instructions, if any. The Company's sole responsibility is to its Client and this document does not exonerate parties to a transaction from exercising all their rights and obligations under the transaction documents. This document cannot be reproduced except in full, without prior written approval of the Company. Any unauthorized alteration, forgery or falsification of the content or appearance of this document is unlawful and offenders may be prosecuted to the fullest extent of the law.

| | | | |
|-----------------------|-------------|--------------------------|---------------------|
| Operation Band | :WCDMA B4 | Test Date | :2013-05-03 |
| Fundamental Frequency | :1752.6 MHz | Temp./Humi. | :24.1 deg_C / 65 RH |
| Operation Mode | :RX HIGH | Engineer | :Allen |
| EUT Pol. | :H Plan | Measurement Antenna Pol. | :HORIZONTAL |

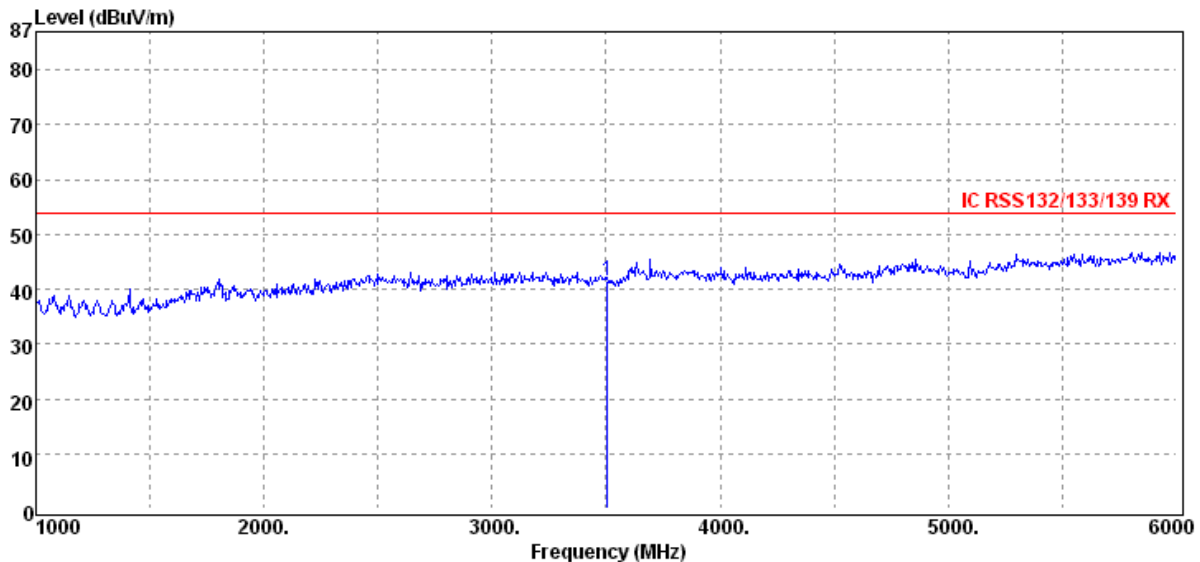
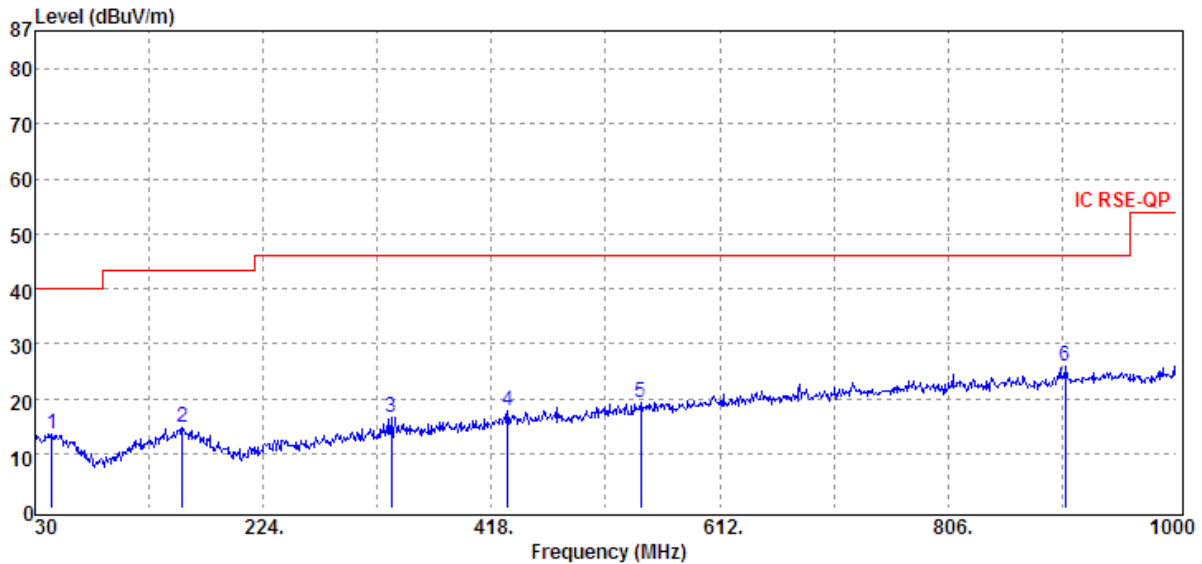

Unless otherwise stated the results shown in this test report refer only to the sample(s) tested and such sample(s) are retained for 90 days only.

除非另有說明，此報告結果僅對測試之樣品負責，同時此樣品僅保留90天。本報告未經本公司書面許可，不可部份複製。

This document is issued by the Company subject to its General Conditions of Service printed overleaf, available on request or accessible at www.sgs.com/terms_and_conditions.htm and, for electronic format documents, subject to Terms and Conditions for Electronic Documents at www.sgs.com/terms_e-document.htm. Attention is drawn to the limitation of liability, indemnification and jurisdiction issues defined therein. Any holder of this document is advised that information contained hereon reflects the Company's findings at the time of its intervention only and within the limits of Client's instructions, if any. The Company's sole responsibility is to its Client and this document does not exonerate parties to a transaction from exercising all their rights and obligations under the transaction documents. This document cannot be reproduced except in full, without prior written approval of the Company. Any unauthorized alteration, forgery or falsification of the content or appearance of this document is unlawful and offenders may be prosecuted to the fullest extent of the law.

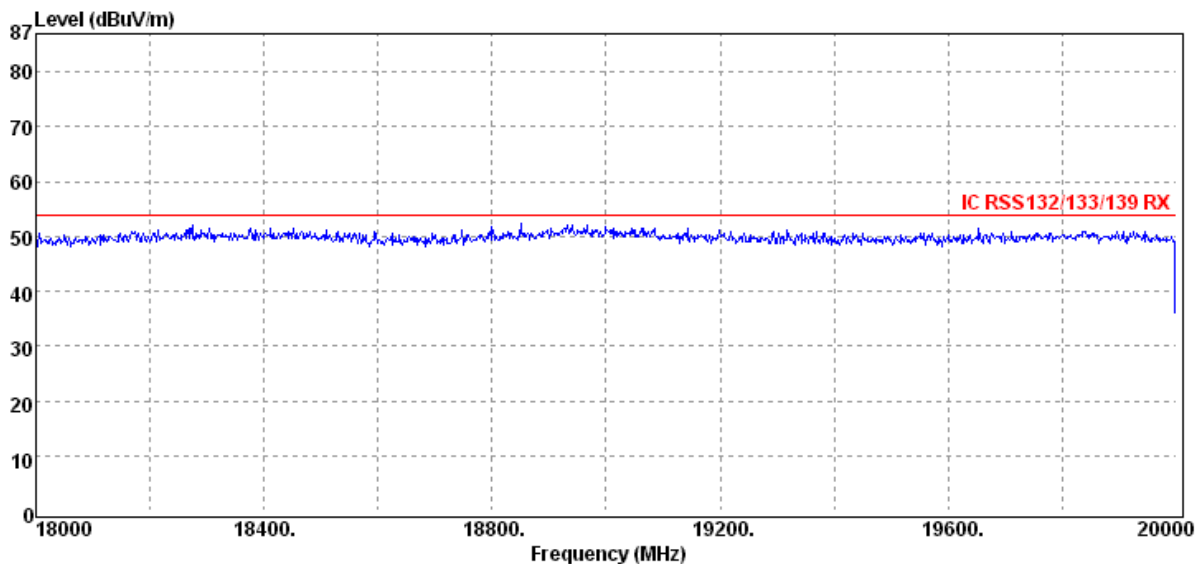
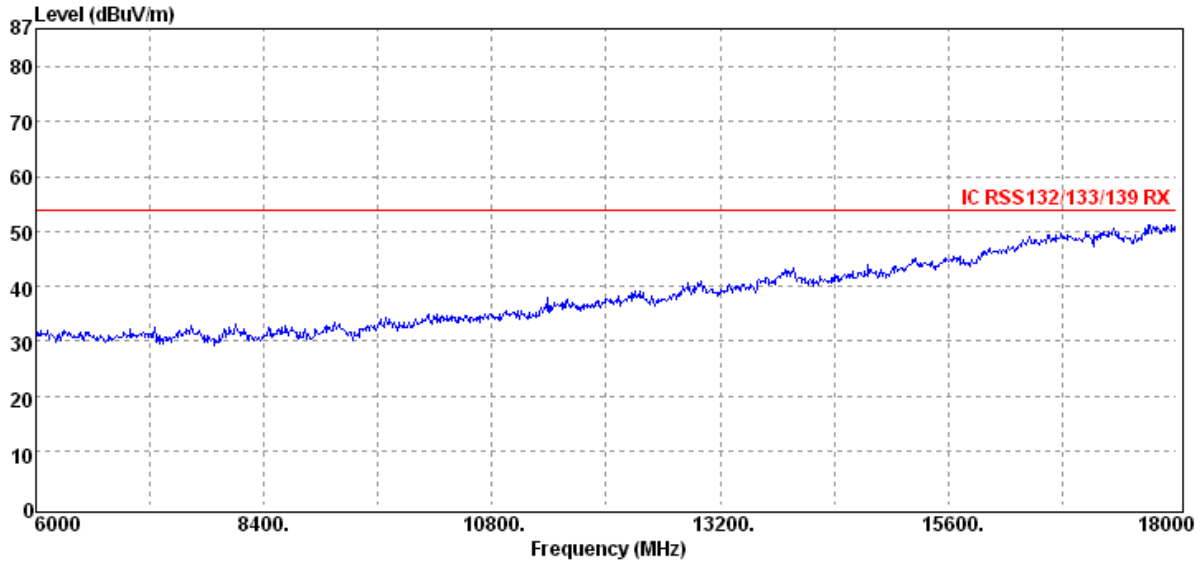

Unless otherwise stated the results shown in this test report refer only to the sample(s) tested and such sample(s) are retained for 90 days only.

除非另有說明，此報告結果僅對測試之樣品負責，同時此樣品僅保留90天。本報告未經本公司書面許可，不可部份複製。

This document is issued by the Company subject to its General Conditions of Service printed overleaf, available on request or accessible at www.sgs.com/terms_and_conditions.htm and, for electronic format documents, subject to Terms and Conditions for Electronic Documents at www.sgs.com/terms_e-document.htm. Attention is drawn to the limitation of liability, indemnification and jurisdiction issues defined therein. Any holder of this document is advised that information contained hereon reflects the Company's findings at the time of its intervention only and within the limits of Client's instructions, if any. The Company's sole responsibility is to its Client and this document does not exonerate parties to a transaction from exercising all their rights and obligations under the transaction documents. This document cannot be reproduced except in full, without prior written approval of the Company. Any unauthorized alteration, forgery or falsification of the content or appearance of this document is unlawful and offenders may be prosecuted to the fullest extent of the law.

Radiated Spurious Emission Measurement Result: HSDPA V Mode

| | | | |
|-----------------------|------------|--------------------------|---------------------|
| Operation Band | :HSDPA B5 | Test Date | :2013-05-03 |
| Fundamental Frequency | :826.4 MHz | Temp./Humi. | :24.1 deg_C / 65 RH |
| Operation Mode | :RX LOW | Engineer | :Allen |
| EUT Pol. | :E1 Plan | Measurement Antenna Pol. | :VERTICAL |

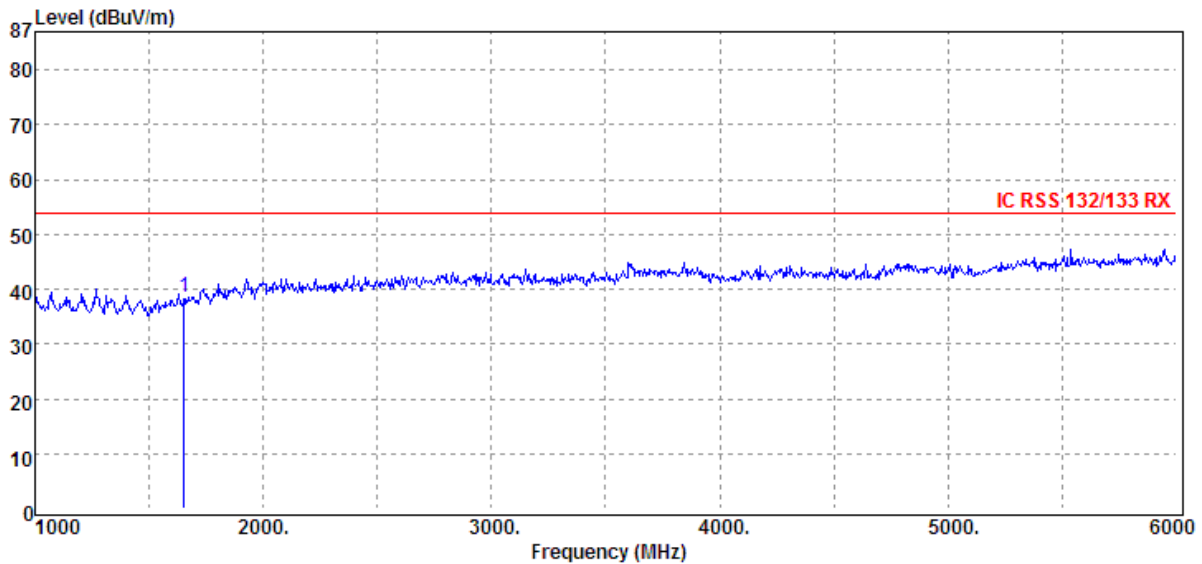
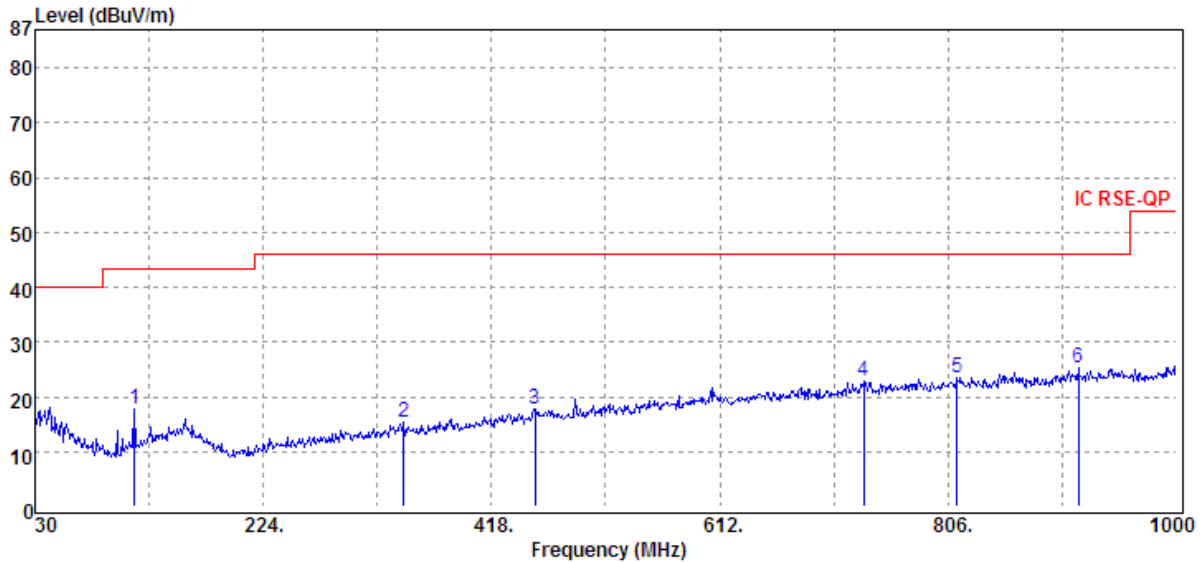

Unless otherwise stated the results shown in this test report refer only to the sample(s) tested and such sample(s) are retained for 90 days only.

除非另有說明，此報告結果僅對測試之樣品負責，同時此樣品僅保留90天。本報告未經本公司書面許可，不可部份複製。

This document is issued by the Company subject to its General Conditions of Service printed overleaf, available on request or accessible at www.sgs.com/terms_and_conditions.htm and, for electronic format documents, subject to Terms and Conditions for Electronic Documents at www.sgs.com/terms_e-document.htm. Attention is drawn to the limitation of liability, indemnification and jurisdiction issues defined therein. Any holder of this document is advised that information contained hereon reflects the Company's findings at the time of its intervention only and within the limits of Client's instructions, if any. The Company's sole responsibility is to its Client and this document does not exonerate parties to a transaction from exercising all their rights and obligations under the transaction documents. This document cannot be reproduced except in full, without prior written approval of the Company. Any unauthorized alteration, forgery or falsification of the content or appearance of this document is unlawful and offenders may be prosecuted to the fullest extent of the law.

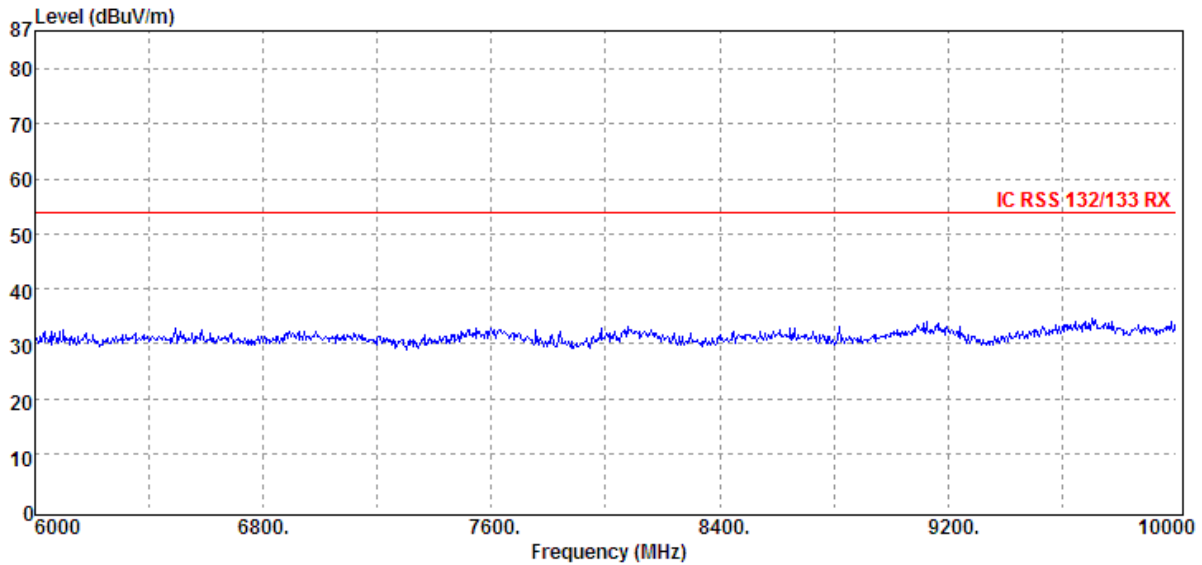

Unless otherwise stated the results shown in this test report refer only to the sample(s) tested and such sample(s) are retained for 90 days only.

除非另有說明，此報告結果僅對測試之樣品負責，同時此樣品僅保留90天。本報告未經本公司書面許可，不可部份複製。

This document is issued by the Company subject to its General Conditions of Service printed overleaf, available on request or accessible at www.sgs.com/terms_and_conditions.htm and, for electronic format documents, subject to Terms and Conditions for Electronic Documents at www.sgs.com/terms_e-document.htm. Attention is drawn to the limitation of liability, indemnification and jurisdiction issues defined therein. Any holder of this document is advised that information contained hereon reflects the Company's findings at the time of its intervention only and within the limits of Client's instructions, if any. The Company's sole responsibility is to its Client and this document does not exonerate parties to a transaction from exercising all their rights and obligations under the transaction documents. This document cannot be reproduced except in full, without prior written approval of the Company. Any unauthorized alteration, forgery or falsification of the content or appearance of this document is unlawful and offenders may be prosecuted to the fullest extent of the law.

| | | | |
|-----------------------|------------|--------------------------|---------------------|
| Operation Band | :HSDPA B5 | Test Date | :2013-05-03 |
| Fundamental Frequency | :826.4 MHz | Temp./Humi. | :24.1 deg_C / 65 RH |
| Operation Mode | :RX LOW | Engineer | :Allen |
| EUT Pol. | :E1 Plan | Measurement Antenna Pol. | :HORIZONTAL |

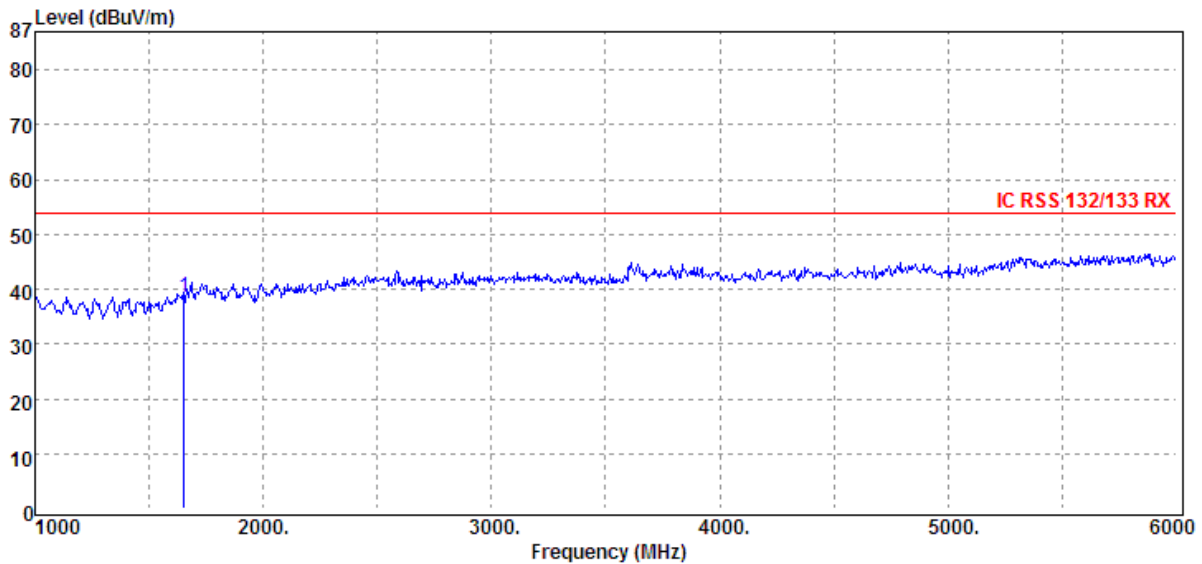
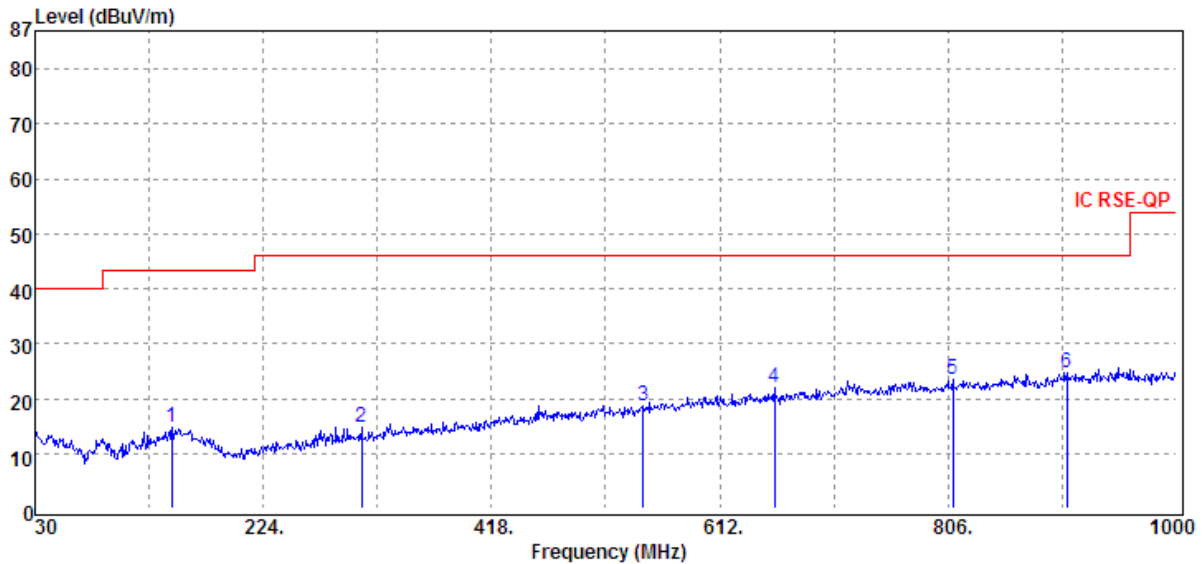

Unless otherwise stated the results shown in this test report refer only to the sample(s) tested and such sample(s) are retained for 90 days only.

除非另有說明，此報告結果僅對測試之樣品負責，同時此樣品僅保留90天。本報告未經本公司書面許可，不可部份複製。

This document is issued by the Company subject to its General Conditions of Service printed overleaf, available on request or accessible at www.sgs.com/terms_and_conditions.htm and, for electronic format documents, subject to Terms and Conditions for Electronic Documents at www.sgs.com/terms_e-document.htm. Attention is drawn to the limitation of liability, indemnification and jurisdiction issues defined therein. Any holder of this document is advised that information contained hereon reflects the Company's findings at the time of its intervention only and within the limits of Client's instructions, if any. The Company's sole responsibility is to its Client and this document does not exonerate parties to a transaction from exercising all their rights and obligations under the transaction documents. This document cannot be reproduced except in full, without prior written approval of the Company. Any unauthorized alteration, forgery or falsification of the content or appearance of this document is unlawful and offenders may be prosecuted to the fullest extent of the law.

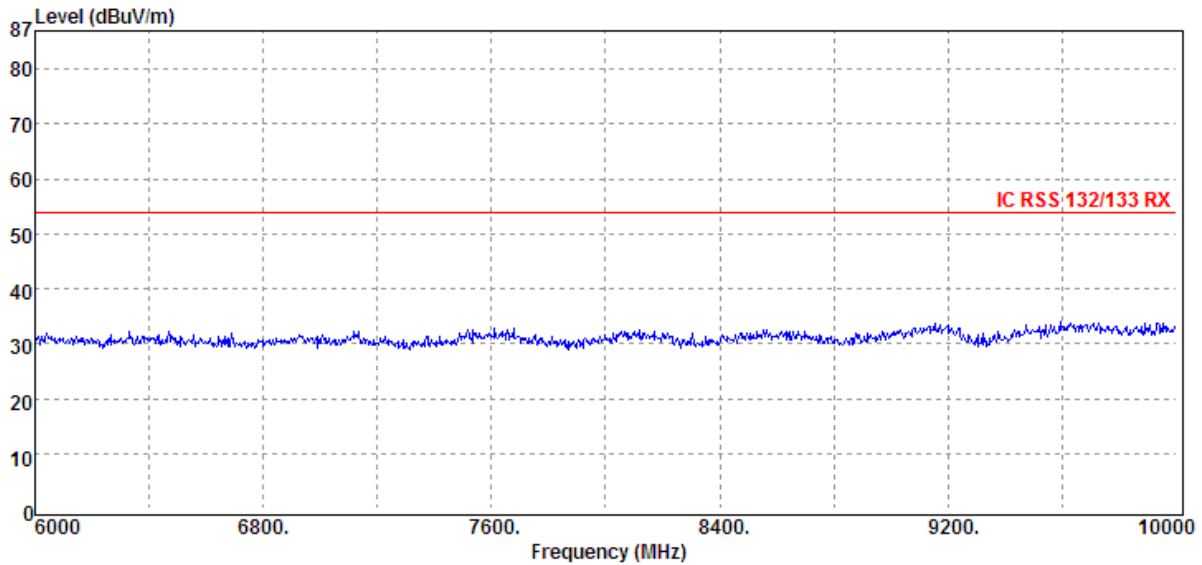

Unless otherwise stated the results shown in this test report refer only to the sample(s) tested and such sample(s) are retained for 90 days only.

除非另有說明，此報告結果僅對測試之樣品負責，同時此樣品僅保留90天。本報告未經本公司書面許可，不可部份複製。

This document is issued by the Company subject to its General Conditions of Service printed overleaf, available on request or accessible at www.sgs.com/terms_and_conditions.htm and, for electronic format documents, subject to Terms and Conditions for Electronic Documents at www.sgs.com/terms_e-document.htm. Attention is drawn to the limitation of liability, indemnification and jurisdiction issues defined therein. Any holder of this document is advised that information contained hereon reflects the Company's findings at the time of its intervention only and within the limits of Client's instructions, if any. The Company's sole responsibility is to its Client and this document does not exonerate parties to a transaction from exercising all their rights and obligations under the transaction documents. This document cannot be reproduced except in full, without prior written approval of the Company. Any unauthorized alteration, forgery or falsification of the content or appearance of this document is unlawful and offenders may be prosecuted to the fullest extent of the law.

| | | | |
|-----------------------|------------|--------------------------|---------------------|
| Operation Band | :HSDPA B5 | Test Date | :2013-05-03 |
| Fundamental Frequency | :836.6 MHz | Temp./Humi. | :24.1 deg_C / 65 RH |
| Operation Mode | :RX MID | Engineer | :Allen |
| EUT Pol. | :E1 Plan | Measurement Antenna Pol. | :VERTICAL |

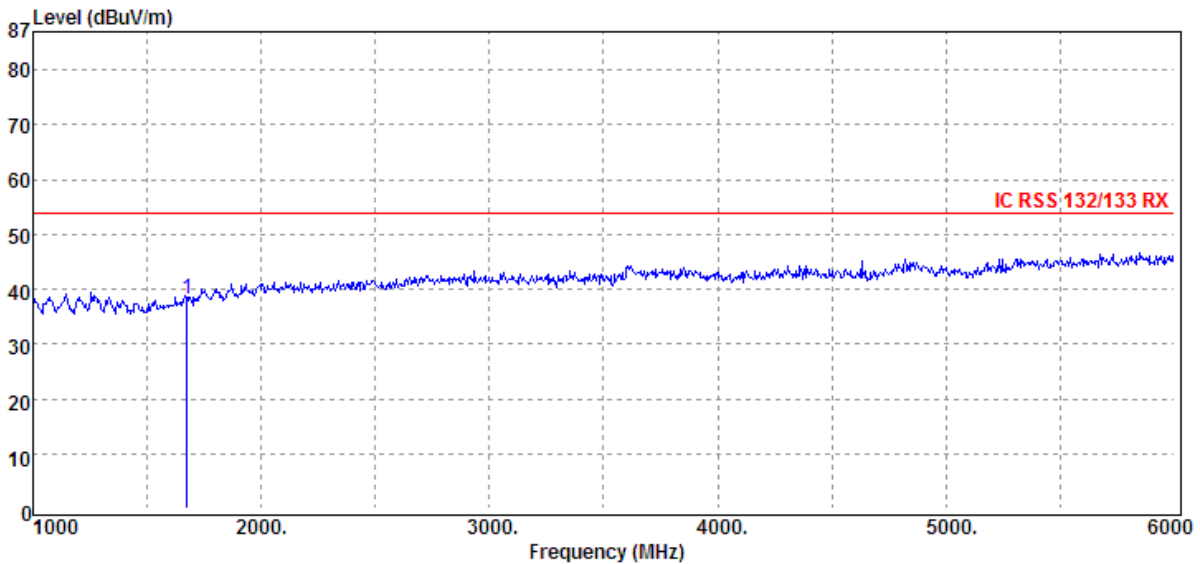
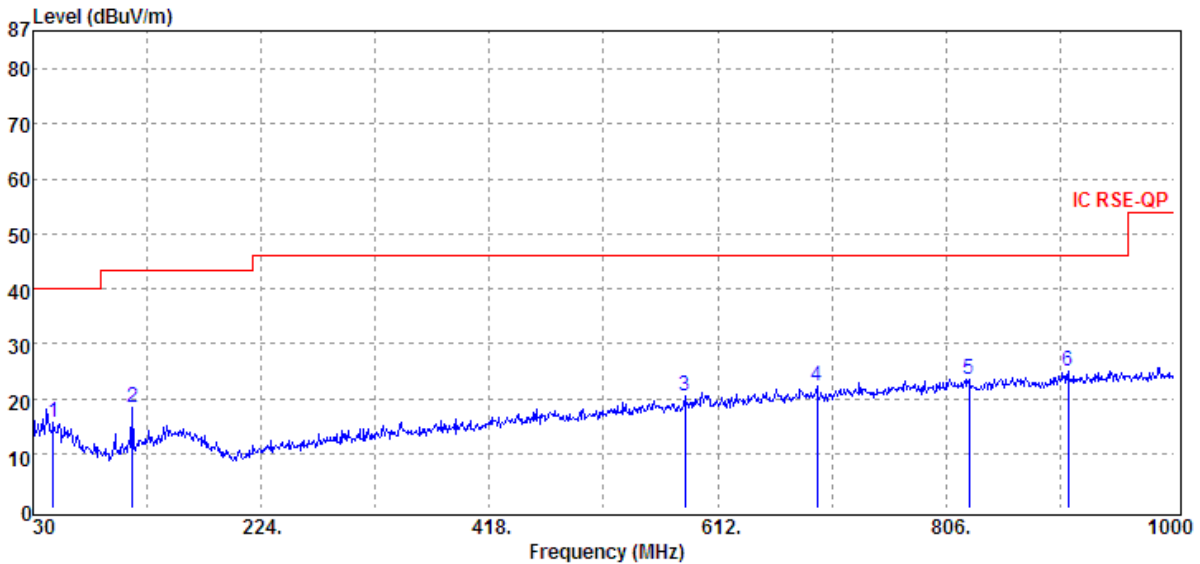

Unless otherwise stated the results shown in this test report refer only to the sample(s) tested and such sample(s) are retained for 90 days only.

除非另有說明，此報告結果僅對測試之樣品負責，同時此樣品僅保留90天。本報告未經本公司書面許可，不可部份複製。

This document is issued by the Company subject to its General Conditions of Service printed overleaf, available on request or accessible at www.sgs.com/terms_and_conditions.htm and, for electronic format documents, subject to Terms and Conditions for Electronic Documents at www.sgs.com/terms_e-document.htm. Attention is drawn to the limitation of liability, indemnification and jurisdiction issues defined therein. Any holder of this document is advised that information contained hereon reflects the Company's findings at the time of its intervention only and within the limits of Client's instructions, if any. The Company's sole responsibility is to its Client and this document does not exonerate parties to a transaction from exercising all their rights and obligations under the transaction documents. This document cannot be reproduced except in full, without prior written approval of the Company. Any unauthorized alteration, forgery or falsification of the content or appearance of this document is unlawful and offenders may be prosecuted to the fullest extent of the law.

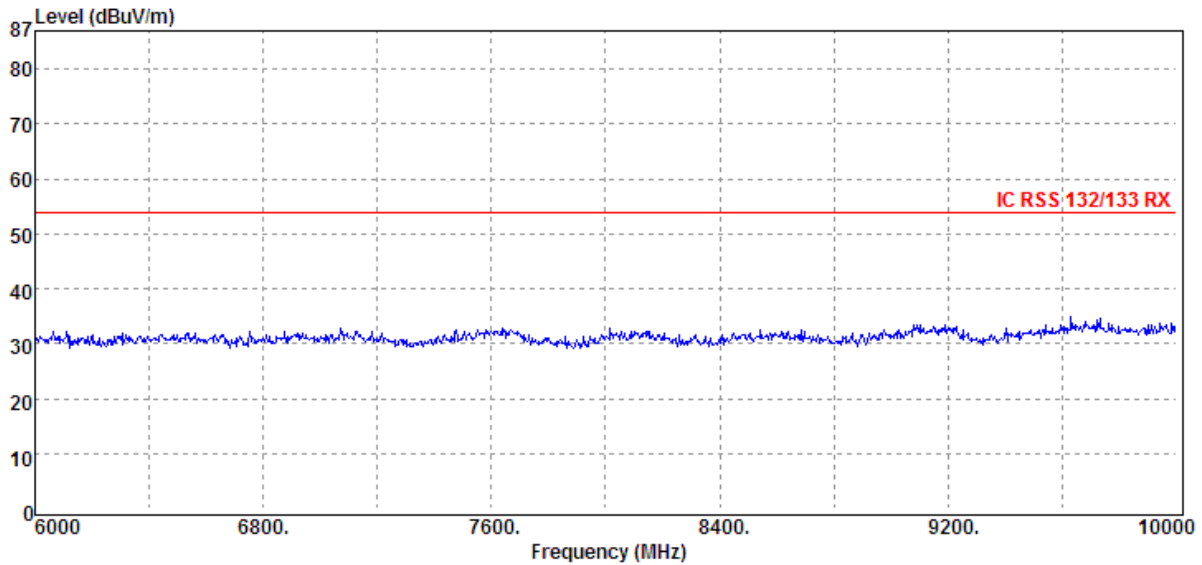

Unless otherwise stated the results shown in this test report refer only to the sample(s) tested and such sample(s) are retained for 90 days only.

除非另有說明，此報告結果僅對測試之樣品負責，同時此樣品僅保留90天。本報告未經本公司書面許可，不可部份複製。

This document is issued by the Company subject to its General Conditions of Service printed overleaf, available on request or accessible at www.sgs.com/terms_and_conditions.htm and, for electronic format documents, subject to Terms and Conditions for Electronic Documents at www.sgs.com/terms_e-document.htm. Attention is drawn to the limitation of liability, indemnification and jurisdiction issues defined therein. Any holder of this document is advised that information contained hereon reflects the Company's findings at the time of its intervention only and within the limits of Client's instructions, if any. The Company's sole responsibility is to its Client and this document does not exonerate parties to a transaction from exercising all their rights and obligations under the transaction documents. This document cannot be reproduced except in full, without prior written approval of the Company. Any unauthorized alteration, forgery or falsification of the content or appearance of this document is unlawful and offenders may be prosecuted to the fullest extent of the law.

| | | | |
|-----------------------|------------|--------------------------|---------------------|
| Operation Band | :HSDPA B5 | Test Date | :2013-05-03 |
| Fundamental Frequency | :836.6 MHz | Temp./Humi. | :24.1 deg_C / 65 RH |
| Operation Mode | :RX MID | Engineer | :Allen |
| EUT Pol. | :E1 Plan | Measurement Antenna Pol. | :HORIZONTAL |

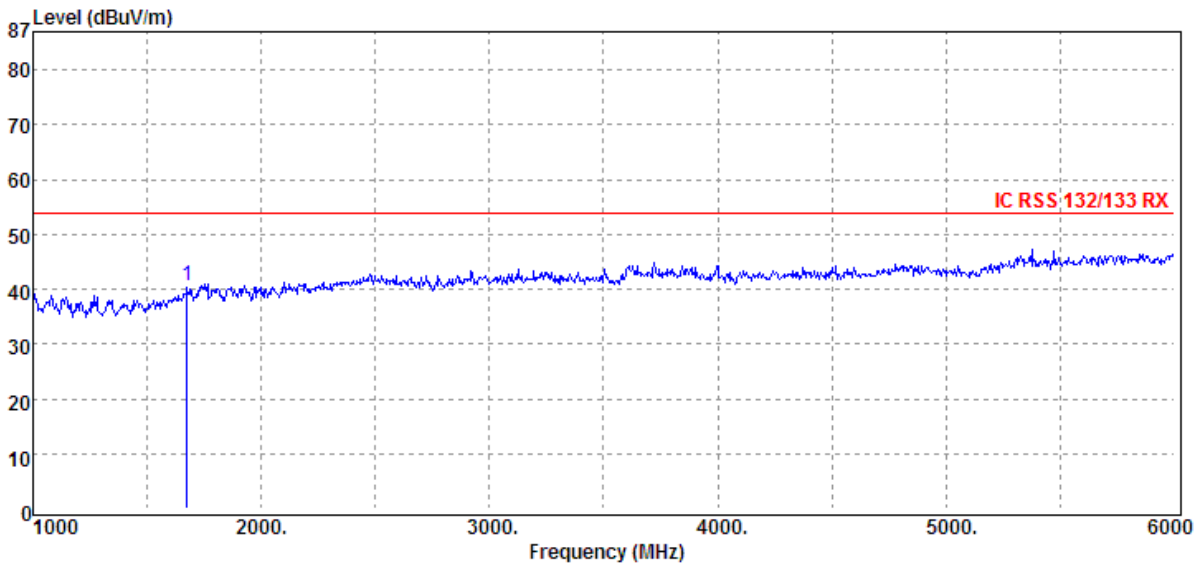
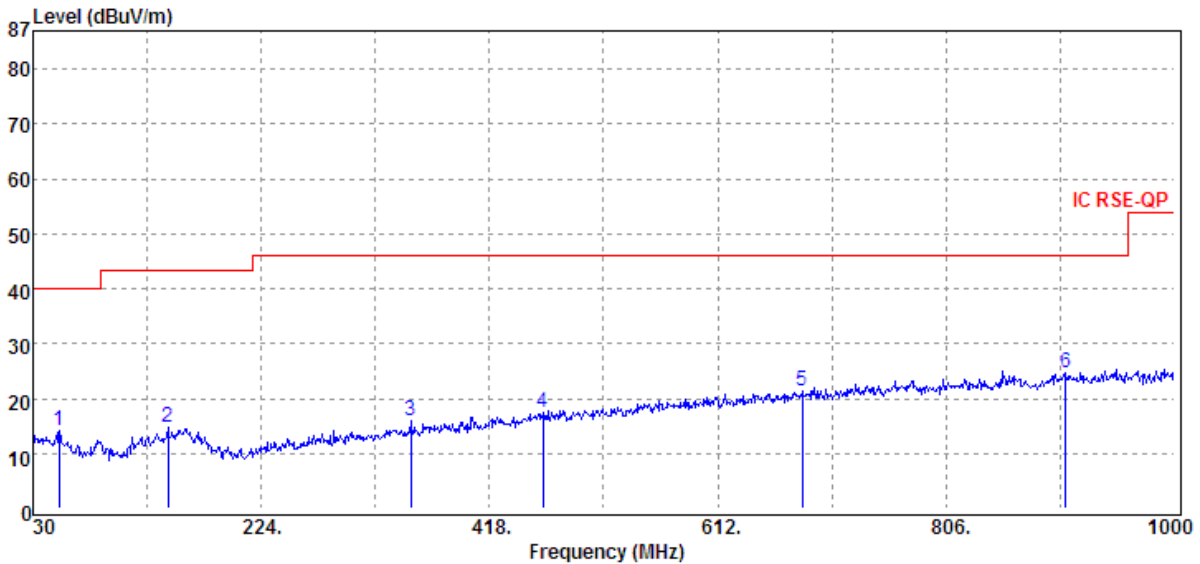

Unless otherwise stated the results shown in this test report refer only to the sample(s) tested and such sample(s) are retained for 90 days only.

除非另有說明，此報告結果僅對測試之樣品負責，同時此樣品僅保留90天。本報告未經本公司書面許可，不可部份複製。

This document is issued by the Company subject to its General Conditions of Service printed overleaf, available on request or accessible at www.sgs.com/terms_and_conditions.htm and, for electronic format documents, subject to Terms and Conditions for Electronic Documents at www.sgs.com/terms_e-document.htm. Attention is drawn to the limitation of liability, indemnification and jurisdiction issues defined therein. Any holder of this document is advised that information contained hereon reflects the Company's findings at the time of its intervention only and within the limits of Client's instructions, if any. The Company's sole responsibility is to its Client and this document does not exonerate parties to a transaction from exercising all their rights and obligations under the transaction documents. This document cannot be reproduced except in full, without prior written approval of the Company. Any unauthorized alteration, forgery or falsification of the content or appearance of this document is unlawful and offenders may be prosecuted to the fullest extent of the law.

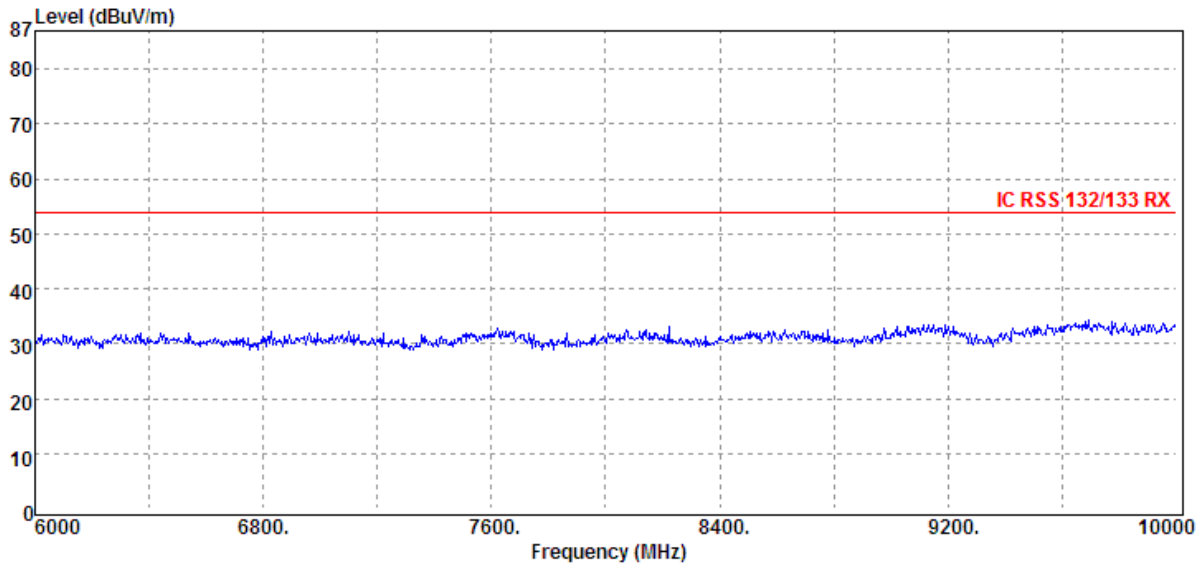

Unless otherwise stated the results shown in this test report refer only to the sample(s) tested and such sample(s) are retained for 90 days only.

除非另有說明，此報告結果僅對測試之樣品負責，同時此樣品僅保留90天。本報告未經本公司書面許可，不可部份複製。

This document is issued by the Company subject to its General Conditions of Service printed overleaf, available on request or accessible at www.sgs.com/terms_and_conditions.htm and, for electronic format documents, subject to Terms and Conditions for Electronic Documents at www.sgs.com/terms_e-document.htm. Attention is drawn to the limitation of liability, indemnification and jurisdiction issues defined therein. Any holder of this document is advised that information contained hereon reflects the Company's findings at the time of its intervention only and within the limits of Client's instructions, if any. The Company's sole responsibility is to its Client and this document does not exonerate parties to a transaction from exercising all their rights and obligations under the transaction documents. This document cannot be reproduced except in full, without prior written approval of the Company. Any unauthorized alteration, forgery or falsification of the content or appearance of this document is unlawful and offenders may be prosecuted to the fullest extent of the law.

| | | | |
|-----------------------|------------|--------------------------|---------------------|
| Operation Band | :HSDPA B5 | Test Date | :2013-05-03 |
| Fundamental Frequency | :846.6 MHz | Temp./Humi. | :24.1 deg_C / 65 RH |
| Operation Mode | :RX HIGH | Engineer | :Allen |
| EUT Pol. | :E1 Plan | Measurement Antenna Pol. | :VERTICAL |

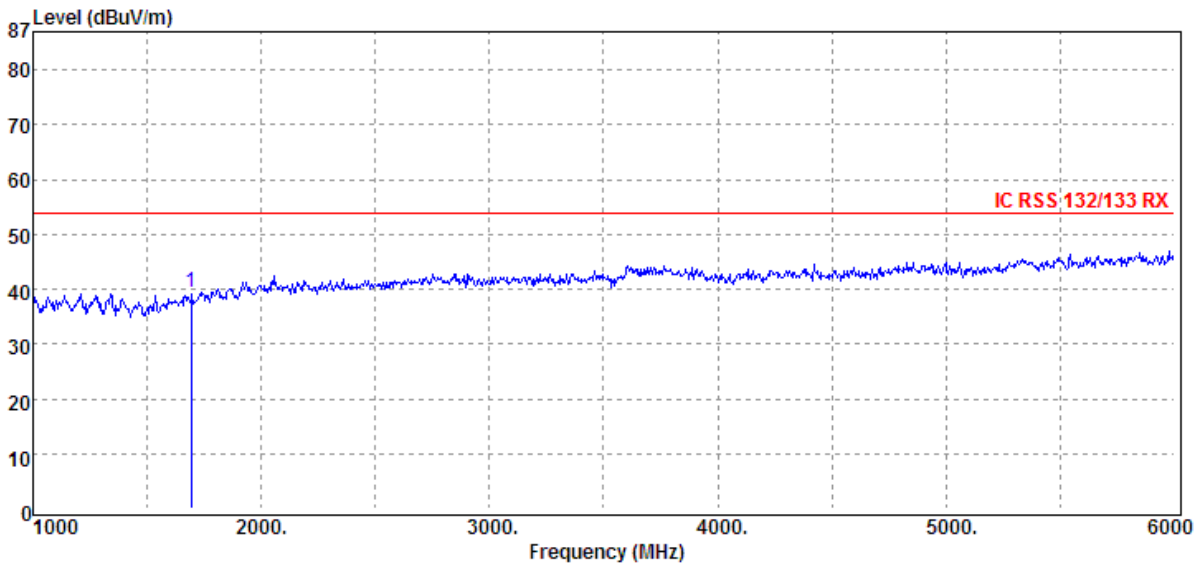
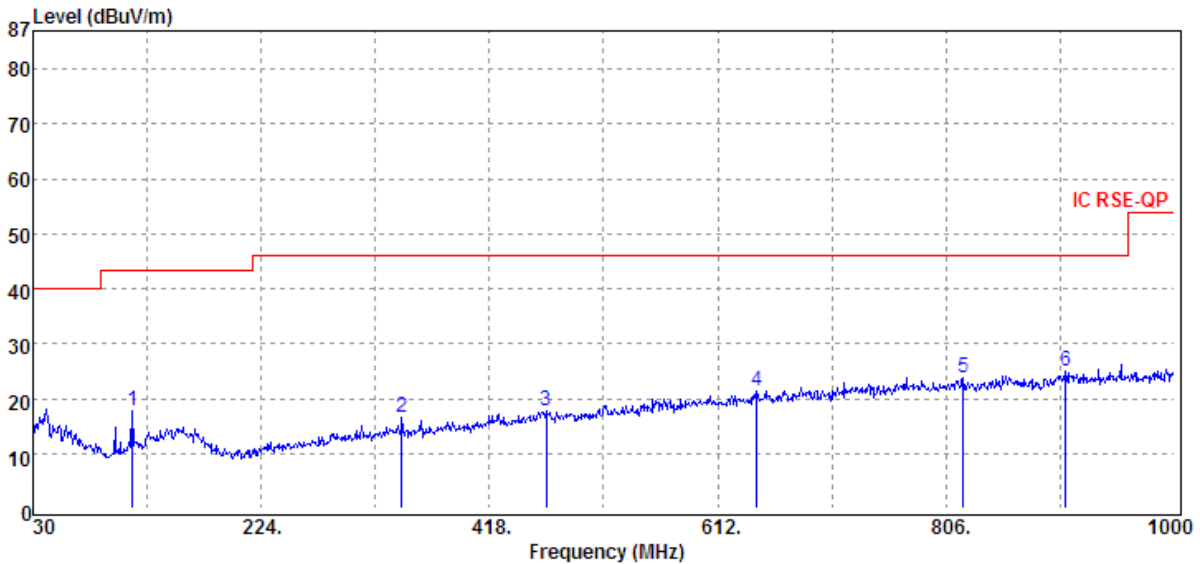

Unless otherwise stated the results shown in this test report refer only to the sample(s) tested and such sample(s) are retained for 90 days only.

除非另有說明，此報告結果僅對測試之樣品負責，同時此樣品僅保留90天。本報告未經本公司書面許可，不可部份複製。

This document is issued by the Company subject to its General Conditions of Service printed overleaf, available on request or accessible at www.sgs.com/terms_and_conditions.htm and, for electronic format documents, subject to Terms and Conditions for Electronic Documents at www.sgs.com/terms_e-document.htm. Attention is drawn to the limitation of liability, indemnification and jurisdiction issues defined therein. Any holder of this document is advised that information contained hereon reflects the Company's findings at the time of its intervention only and within the limits of Client's instructions, if any. The Company's sole responsibility is to its Client and this document does not exonerate parties to a transaction from exercising all their rights and obligations under the transaction documents. This document cannot be reproduced except in full, without prior written approval of the Company. Any unauthorized alteration, forgery or falsification of the content or appearance of this document is unlawful and offenders may be prosecuted to the fullest extent of the law.

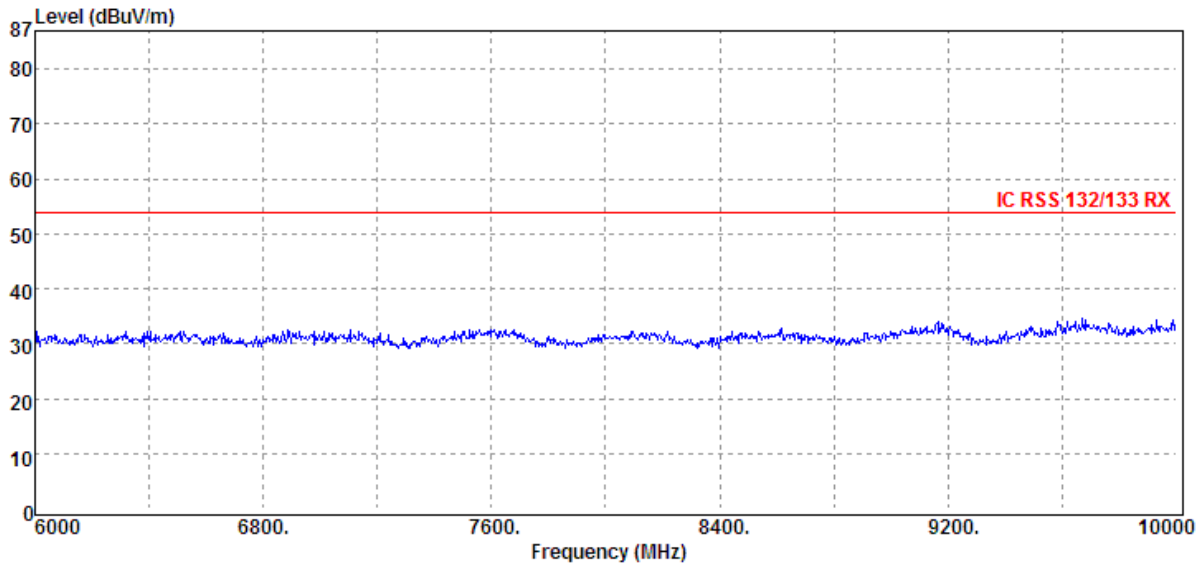

Unless otherwise stated the results shown in this test report refer only to the sample(s) tested and such sample(s) are retained for 90 days only.

除非另有說明，此報告結果僅對測試之樣品負責，同時此樣品僅保留90天。本報告未經本公司書面許可，不可部份複製。

This document is issued by the Company subject to its General Conditions of Service printed overleaf, available on request or accessible at www.sgs.com/terms_and_conditions.htm and, for electronic format documents, subject to Terms and Conditions for Electronic Documents at www.sgs.com/terms_e-document.htm. Attention is drawn to the limitation of liability, indemnification and jurisdiction issues defined therein. Any holder of this document is advised that information contained hereon reflects the Company's findings at the time of its intervention only and within the limits of Client's instructions, if any. The Company's sole responsibility is to its Client and this document does not exonerate parties to a transaction from exercising all their rights and obligations under the transaction documents. This document cannot be reproduced except in full, without prior written approval of the Company. Any unauthorized alteration, forgery or falsification of the content or appearance of this document is unlawful and offenders may be prosecuted to the fullest extent of the law.

| | | | |
|-----------------------|------------|--------------------------|---------------------|
| Operation Band | :HSDPA B5 | Test Date | :2013-05-03 |
| Fundamental Frequency | :846.6 MHz | Temp./Humi. | :24.1 deg_C / 65 RH |
| Operation Mode | :RX HIGH | Engineer | :Allen |
| EUT Pol. | :E1 Plan | Measurement Antenna Pol. | :HORIZONTAL |

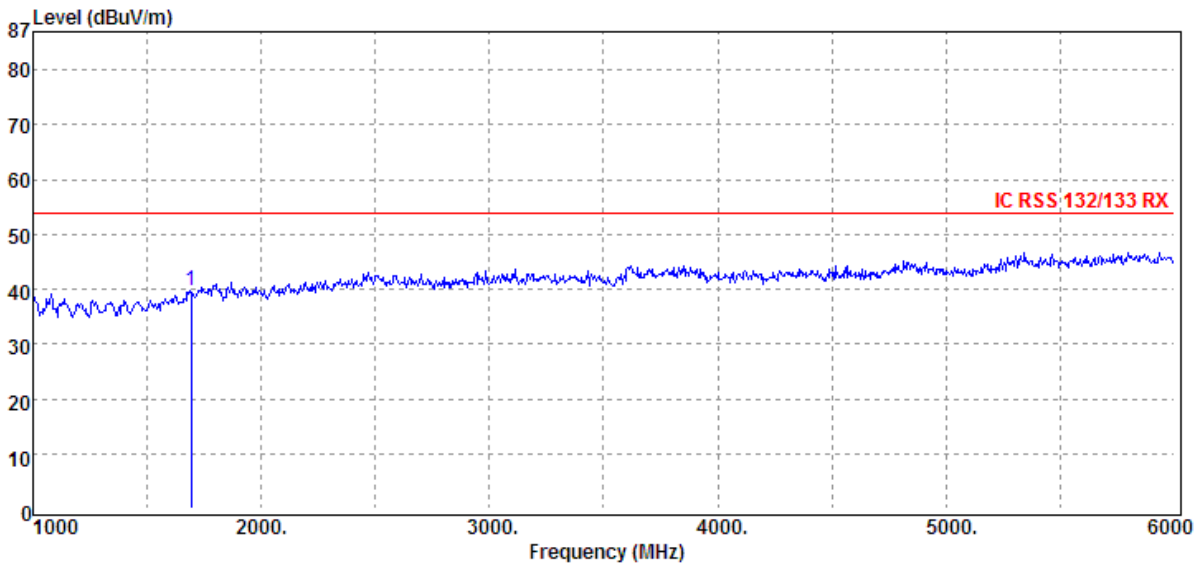
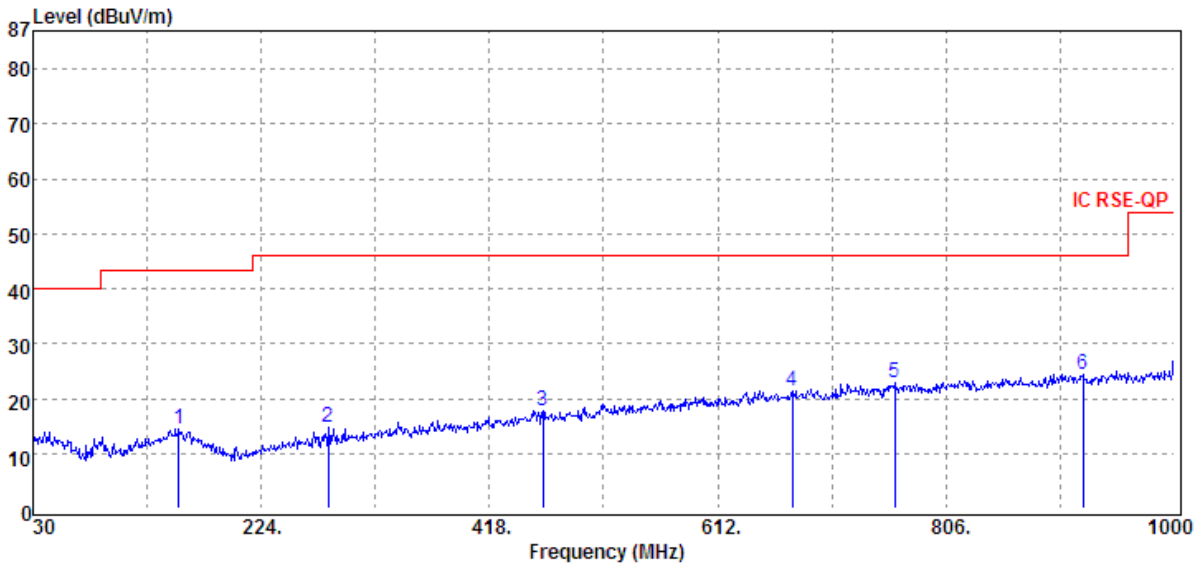

Unless otherwise stated the results shown in this test report refer only to the sample(s) tested and such sample(s) are retained for 90 days only.

除非另有說明，此報告結果僅對測試之樣品負責，同時此樣品僅保留90天。本報告未經本公司書面許可，不可部份複製。

This document is issued by the Company subject to its General Conditions of Service printed overleaf, available on request or accessible at www.sgs.com/terms_and_conditions.htm and, for electronic format documents, subject to Terms and Conditions for Electronic Documents at www.sgs.com/terms_e-document.htm. Attention is drawn to the limitation of liability, indemnification and jurisdiction issues defined therein. Any holder of this document is advised that information contained hereon reflects the Company's findings at the time of its intervention only and within the limits of Client's instructions, if any. The Company's sole responsibility is to its Client and this document does not exonerate parties to a transaction from exercising all their rights and obligations under the transaction documents. This document cannot be reproduced except in full, without prior written approval of the Company. Any unauthorized alteration, forgery or falsification of the content or appearance of this document is unlawful and offenders may be prosecuted to the fullest extent of the law.

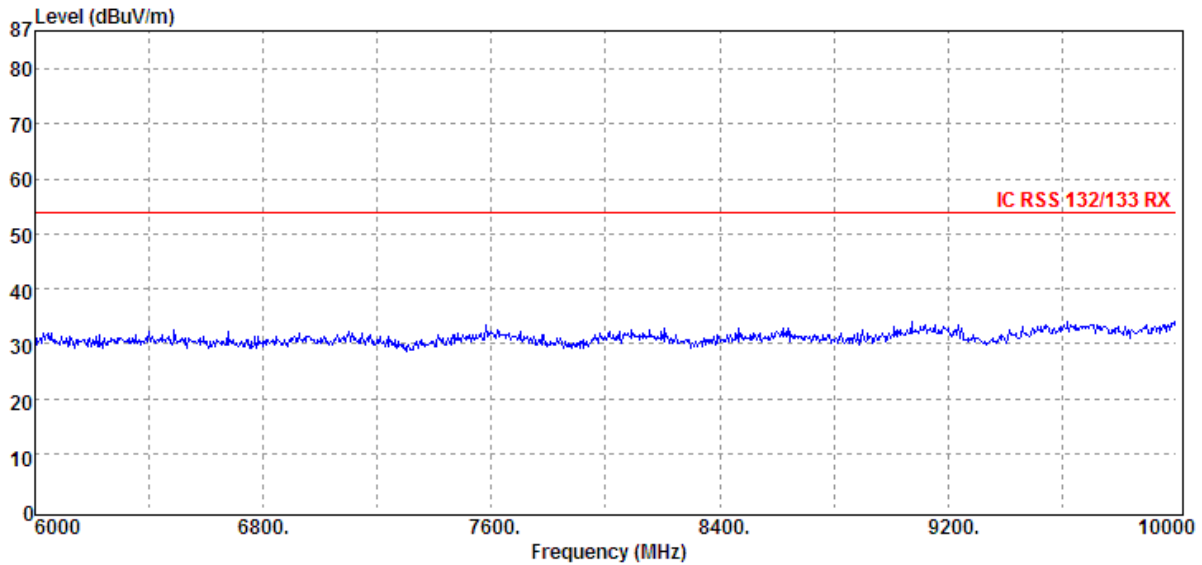

~ End of Report ~

Unless otherwise stated the results shown in this test report refer only to the sample(s) tested and such sample(s) are retained for 90 days only.

除非另有說明，此報告結果僅對測試之樣品負責，同時此樣品僅保留90天。本報告未經本公司書面許可，不可部份複製。

This document is issued by the Company subject to its General Conditions of Service printed overleaf, available on request or accessible at www.sgs.com/terms_and_conditions.htm and, for electronic format documents, subject to Terms and Conditions for Electronic Documents at www.sgs.com/terms_e-document.htm. Attention is drawn to the limitation of liability, indemnification and jurisdiction issues defined therein. Any holder of this document is advised that information contained hereon reflects the Company's findings at the time of its intervention only and within the limits of Client's instructions, if any. The Company's sole responsibility is to its Client and this document does not exonerate parties to a transaction from exercising all their rights and obligations under the transaction documents. This document cannot be reproduced except in full, without prior written approval of the Company. Any unauthorized alteration, forgery or falsification of the content or appearance of this document is unlawful and offenders may be prosecuted to the fullest extent of the law.