

ELECTROMAGNETIC EMISSIONS COMPLIANCE REPORT

INTENTIONAL RADIATOR CERTIFICATION TO FCC PART 22 SUBPART H, PART 24 SUBPART E and PART 27 SUBPART C AND INDUSTRY CANADA RSS-132, RSS-133 and RSS-139 REQUIREMENT

OF

Product Name:	PDA Phone
Brand Name:	Sony
Model No.:	C1904
Type No.:	PM-0480-BV
Model Difference:	N/A
FCC ID:	PY7PM-0480
IC:	4170B-PM0480
Report No.:	EH/2013/40011
Issue Date:	Jun. 06, 2013
FCC Rule Part:	2, 22H & 24E & 27C
IC Rule Part:	RSS 132 Issue 3, RSS 133 Issue 6 and RSS 139 Issue 2
Prepared for:	Sony Mobile Communications AB Nya Vattentornet 22188 Lund/SWEDEN
Prepared by:	SGS Taiwan Ltd. Electronics & Communication Laboratory No.134, Wu Kung Road, New Taipei Industrial Park, Wuku District, New Taipei City, Taiwan 24803

Note: This report shall not be reproduced except in full, without the written approval of SGS Taiwan Ltd. This document may be altered or revised by SGS Taiwan Ltd. personnel only, and shall be noted in the revision section of the document.

Unless otherwise stated the results shown in this test report refer only to the sample(s) tested and such sample(s) are retained for 90 days only.

除非另有說明，此報告結果僅對測試之樣品負責，同時此樣品僅保留90天。本報告未經本公司書面許可，不可部份複製。

This document is issued by the Company subject to its General Conditions of Service printed overleaf, available on request or accessible at www.sgs.com/terms_and_conditions.htm and, for electronic format documents, subject to Terms and Conditions for Electronic Documents at www.sgs.com/terms_e-document.htm. Attention is drawn to the limitation of liability, indemnification and jurisdiction issues defined therein. Any holder of this document is advised that information contained hereon reflects the Company's findings at the time of its intervention only and within the limits of Client's instructions, if any. The Company's sole responsibility is to its Client and this document does not exonerate parties to a transaction from exercising all their rights and obligations under the transaction documents. This document cannot be reproduced except in full, without prior written approval of the Company. Any unauthorized alteration, forgery or falsification of the content or appearance of this document is unlawful and offenders may be prosecuted to the fullest extent of the law.

VERIFICATION OF COMPLIANCE

Applicant: Sony Mobile Communications AB
Nya Vattentorget 22188 Lund/SWEDEN

Product Name: PDA Phone

Brand Name: Sony

Model No.: C1904

Type No.: PM-0480-BV

Model Difference: N/A

FCC ID: PY7PM-0480

IC: 4170B-PM0480

File Number: EH/2013/40011

Date of test: Apr. 01, 2013 ~ May. 27, 2013

Date of EUT Received: Apr. 01, 2013

We hereby certify that:

The above equipment was tested by SGS Taiwan Ltd. Electronics & Communication Laboratory. The test data, data evaluation, test procedures, and equipment configurations shown in this report were made in accordance with the procedures given in TIA/EIA-603-C-2004, Issue 3 of RSS-Gen and the energy emitted by the sample EUT tested as described in this report is in compliance with conducted and radiated emission limits of FCC Rule PART 22 subpart H, PART 24 subpart E, PART 27 subpart C and IC standards Issue 3 of RSS-132, Issue 6 of RSS-133, Issue 2 of RSS-139.

The test results of this report relate only to the tested sample identified in this report.

Test By:

Marcus Tseng

Date:

Jun. 06, 2013

Marcus Tseng / Engineer

Prepared By:

Violetta Tang

Date:

Jun. 06, 2013

Violetta Tang / Clerk

Approved By:

Jim Chang

Date:

Jun. 06, 2013

Jim Chang / Supervisor

Unless otherwise stated the results shown in this test report refer only to the sample(s) tested and such sample(s) are retained for 90 days only.

除非另有說明，此報告結果僅對測試之樣品負責，同時此樣品僅保留90天。本報告未經本公司書面許可，不可部份複製。

This document is issued by the Company subject to its General Conditions of Service printed overleaf, available on request or accessible at www.sgs.com/terms_and_conditions.htm and, for electronic format documents, subject to Terms and Conditions for Electronic Documents at www.sgs.com/terms_e-document.htm. Attention is drawn to the limitation of liability, indemnification and jurisdiction issues defined therein. Any holder of this document is advised that information contained hereon reflects the Company's findings at the time of its intervention only and within the limits of Client's instructions, if any. The Company's sole responsibility is to its Client and this document does not exonerate parties to a transaction from exercising all their rights and obligations under the transaction documents. This document cannot be reproduced except in full, without prior written approval of the Company. Any unauthorized alteration, forgery or falsification of the content or appearance of this document is unlawful and offenders may be prosecuted to the fullest extent of the law.

Revision History

Report Number	Revision	Description	Issue Date
EH/2013/40011	Rev.01	Initial creation of document	May. 28, 2013
EH/2013/40011	Rev.02	1. Update Product Description "Marketing Name" into "Model No." and update "Model No." into "Type No." on Page 1, 2 and 6.	Jun. 06, 2013

Unless otherwise stated the results shown in this test report refer only to the sample(s) tested and such sample(s) are retained for 90 days only.

除非另有說明，此報告結果僅對測試之樣品負責，同時此樣品僅保留90天。本報告未經本公司書面許可，不可部份複製。

This document is issued by the Company subject to its General Conditions of Service printed overleaf, available on request or accessible at www.sgs.com/terms_and_conditions.htm and, for electronic format documents, subject to Terms and Conditions for Electronic Documents at www.sgs.com/terms_e-document.htm. Attention is drawn to the limitation of liability, indemnification and jurisdiction issues defined therein. Any holder of this document is advised that information contained hereon reflects the Company's findings at the time of its intervention only and within the limits of Client's instructions, if any. The Company's sole responsibility is to its Client and this document does not exonerate parties to a transaction from exercising all their rights and obligations under the transaction documents. This document cannot be reproduced except in full, without prior written approval of the Company. Any unauthorized alteration, forgery or falsification of the content or appearance of this document is unlawful and offenders may be prosecuted to the fullest extent of the law.

Table of Contents

1. GENERAL PRODUCT INFORMATION	6
1.1. Product Description	6
1.2. Related Submittal(s) / Grant (s)	12
1.3. Test Methodology	12
1.4. Test Facility	12
1.5. Special Accessories	12
1.6. Equipment Modifications	12
2. SYSTEM TEST CONFIGURATION	13
2.1. EUT Configuration	13
2.2. EUT Exercise	13
2.3. Test Procedure	13
2.4. Measurement Equipment Used:	14
2.5. Configuration of Tested System	16
3. SUMMARY OF TEST RESULTS	17
4. DESCRIPTION OF TEST MODES	19
5. MEASUREMENT UNCERTAINTY	20
6. RF POWER OUTPUT MEASUREMENT	21
6.1. Standard Applicable:	21
6.2. Test Set-up:	22
6.3. Measurement Procedure:	22
6.4. Measurement Equipment Used:	22
6.5. Measurement Result:	23
7. ERP, EIRP MEASUREMENT	34
7.1. Standard Applicable:	34
7.2. Test SET-UP (Block Diagram of Configuration):	35
7.3. Measurement Procedure:	37
7.4. Measurement Equipment Used:	38
7.5. Measurement Result: (Peak) –using option of peak measurement	39
8. OCCUPIED BANDWIDTH MEASUREMENT	69
8.1. Standard Applicable:	69
8.2. Test Set-up:	69
8.3. Measurement Procedure:	69
8.4. Measurement Equipment Used:	69
8.5. Measurement Result:	69

Unless otherwise stated the results shown in this test report refer only to the sample(s) tested and such sample(s) are retained for 90 days only.

除非另有說明，此報告結果僅對測試之樣品負責，同時此樣品僅保留90天。本報告未經本公司書面許可，不可部份複製。

This document is issued by the Company subject to its General Conditions of Service printed overleaf, available on request or accessible at www.sgs.com/terms_and_conditions.htm and, for electronic format documents, subject to Terms and Conditions for Electronic Documents at www.sgs.com/terms_e-document.htm. Attention is drawn to the limitation of liability, indemnification and jurisdiction issues defined therein. Any holder of this document is advised that information contained hereon reflects the Company's findings at the time of its intervention only and within the limits of Client's instructions, if any. The Company's sole responsibility is to its Client and this document does not exonerate parties to a transaction from exercising all their rights and obligations under the transaction documents. This document cannot be reproduced except in full, without prior written approval of the Company. Any unauthorized alteration, forgery or falsification of the content or appearance of this document is unlawful and offenders may be prosecuted to the fullest extent of the law.

9. OUT OF BAND EMISSION AT ANTENNA TERMINALS	99
9.1. Standard Applicable:	99
9.2. Test SET-UP:.....	101
9.3. Measurement Procedure:.....	102
9.4. Measurement Equipment Used:	102
9.5. Measurement Result:.....	102
10. FIELD STRENGTH OF SPURIOUS RADIATION MEASUREMENT.....	223
10.1. Standard Applicable:	223
10.2. EUT Setup (Block Diagram of Configuration):	225
10.3. Measurement Procedure:.....	226
10.4. Measurement Equipment Used:	226
10.5. Measurement Result:.....	226
11. FREQUENCY STABILITY V.S. TEMPERATURE MEASUREMENT	287
11.1. Standard Applicable:	287
11.2. Test Set-up:.....	287
11.3. Measurement Procedure:.....	288
11.4. Measurement Equipment Used:	288
11.5. Measurement Result:.....	289
12. FREQUENCY STABILITY V.S. VOLTAGE MEASUREMENT	292
12.1. Standard Applicable:	292
12.2. Test Set-up:.....	292
12.3. Measurement Procedure:.....	292
12.4. Measurement Equipment Used:	292
12.5. Measurement Result:.....	293
13. PEAK TO AVERAGE RATIO	295
13.1. Standard Applicable:	295
13.2. Test SET-UP (Block Diagram of Configuration):	295
13.3. Measurement Procedure:.....	295
13.4. Measurement Equipment Used:	295
13.5. Measurement Result:.....	295
MEASUREMENT PLOT OF RADIATED SPURIOUS EMISSION	321

Unless otherwise stated the results shown in this test report refer only to the sample(s) tested and such sample(s) are retained for 90 days only.

除非另有說明，此報告結果僅對測試之樣品負責，同時此樣品僅保留90天。本報告未經本公司書面許可，不可部份複製。

This document is issued by the Company subject to its General Conditions of Service printed overleaf, available on request or accessible at www.sgs.com/terms_and_conditions.htm and, for electronic format documents, subject to Terms and Conditions for Electronic Documents at www.sgs.com/terms_e-document.htm. Attention is drawn to the limitation of liability, indemnification and jurisdiction issues defined therein. Any holder of this document is advised that information contained hereon reflects the Company's findings at the time of its intervention only and within the limits of Client's instructions, if any. The Company's sole responsibility is to its Client and this document does not exonerate parties to a transaction from exercising all their rights and obligations under the transaction documents. This document cannot be reproduced except in full, without prior written approval of the Company. Any unauthorized alteration, forgery or falsification of the content or appearance of this document is unlawful and offenders may be prosecuted to the fullest extent of the law.

1. GENERAL PRODUCT INFORMATION

1.1. Product Description

General:

Product Name:	PDA Phone	
Brand Name:	Sony	
Model No.:	C1904	
Type No.:	PM-0480-BV	
Model Difference:	N/A	
Data Cable (USB):	Model No.: EC450, Supplier: K-one Part No.: 1242-6715.3, Length: 100 cm	
Simple Hands-Free (SHF-White):	Model No.: MH410c, Supplier: Foster Electric Type No.: AG-1100	
Simple Hands-Free (SHF-Black):	Model No.: MH410c, Supplier: Foster Electric Type No.: CCA-0004017	
Car Charger:	Model No.: AN400, Supplier: Salcomp Type No.: CAA-0003013	
Hi-Fi Wireless Headset:	Model No.: MW600, Supplier: BALDA Type No.: DDA-0002029.B coupling with Simple Hands Free (Model No.: MH755, Supplier: BALDA Type No.: AG-0502)	
Hardware Version:	A	
Software Version:	15.1.A.1.3	
Power Supply:	3.7Vdc	
	Battery:	Model No.: BA900, Supplier: Sony Type No.: AB-0500
	Adapter:	Model No.: EP800, Supplier: Salcomp Type No.: CAA-0002016-US

Unless otherwise stated the results shown in this test report refer only to the sample(s) tested and such sample(s) are retained for 90 days only.

除非另有說明，此報告結果僅對測試之樣品負責，同時此樣品僅保留90天。本報告未經本公司書面許可，不可部份複製。

This document is issued by the Company subject to its General Conditions of Service printed overleaf, available on request or accessible at www.sgs.com/terms_and_conditions.htm and, for electronic format documents, subject to Terms and Conditions for Electronic Documents at www.sgs.com/terms_e-document.htm. Attention is drawn to the limitation of liability, indemnification and jurisdiction issues defined therein. Any holder of this document is advised that information contained hereon reflects the Company's findings at the time of its intervention only and within the limits of Client's instructions, if any. The Company's sole responsibility is to its Client and this document does not exonerate parties to a transaction from exercising all their rights and obligations under the transaction documents. This document cannot be reproduced except in full, without prior written approval of the Company. Any unauthorized alteration, forgery or falsification of the content or appearance of this document is unlawful and offenders may be prosecuted to the fullest extent of the law.

Bluetooth_BR+EDR:

Bluetooth Version:	V3.0+HS
Channel number:	79 channels
Modulation type:	Frequency Hopping Spread Spectrum
Transmit Power:	9.22dBm
Frequency Range:	2.402GHz – 2.480GHz
Dwell Time:	<= 0.4s
Antenna Designation:	PIFA Antenna, Gain: 2.55dBi
Type of Emission:	915KF7D (GFSK) / 1M15G7D ($\pi/4$ DQPSK) / 1M20G7D (8DPSK)

Bluetooth Low Energy:

Frequency Range:	2402 – 2480MHz
Bluetooth Version:	V4.0 Dual mode
Channel number:	40 channels
Modulation type:	GFSK
Transmit Power:	1.46dBm (Peak)
Antenna Designation:	PIFA Antenna, Gain: 2.55dBi
Type of Emission:	1M05F7D

NFC:

Operating Frequency	13.56MHz
Transmit Power	< 123dBuV/m at 3m.
Number of Channels	1
Antenna Type	Loop Antenna
Modulation Type	ASK, BPSK
Type of Emission:	15K0F1D

Unless otherwise stated the results shown in this test report refer only to the sample(s) tested and such sample(s) are retained for 90 days only.

除非另有說明，此報告結果僅對測試之樣品負責，同時此樣品僅保留90天。本報告未經本公司書面許可，不可部份複製。

This document is issued by the Company subject to its General Conditions of Service printed overleaf, available on request or accessible at www.sgs.com/terms_and_conditions.htm and, for electronic format documents, subject to Terms and Conditions for Electronic Documents at www.sgs.com/terms_e-document.htm. Attention is drawn to the limitation of liability, indemnification and jurisdiction issues defined therein. Any holder of this document is advised that information contained hereon reflects the Company's findings at the time of its intervention only and within the limits of Client's instructions, if any. The Company's sole responsibility is to its Client and this document does not exonerate parties to a transaction from exercising all their rights and obligations under the transaction documents. This document cannot be reproduced except in full, without prior written approval of the Company. Any unauthorized alteration, forgery or falsification of the content or appearance of this document is unlawful and offenders may be prosecuted to the fullest extent of the law.

WLAN 2.4GHz+5.7GHz:

Wi-Fi	Frequency Range	Channels	Rated Power	Modulation Technology	Type of Emission
11b/g	2412-2462	11	b: 17.61dBm g: 21.00dBm	DSSS, OFDM	b: 13M5G1D g: 16M6D1D
11n	HT20 2412-2462	11	HT20: 21.11dBm	OFDM	n: 17M8D1D
11a	5725-5850	5	a: 20.12dBm	OFDM	a: 16M7D1D
11n (5GHz)	HT20 5725-5850	5	HT20: 20.13dBm		n_20HT:17M8D1D
11n (5GHz)	HT40 5725-5850	2	HT40: 19.66dBm		n_40HT:36M0D1D
Antenna Designation:		PIFA Antenna, 2.4GHz Gain: 2.55dBi 5GHz Gain: 1.66dBi (5725MHz-5850MHz)			
Modulation type:		CCK, DQPSK, DBPSK for DSSS 64QAM, 16QAM, QPSK, BPSK for OFDM			
Transition Rate:		802.11 a: 6/9/12/18/24/36/48/54 Mbps 802.11 b: 1/2/5.5/11 Mbps 802.11 g: 6/9/12/18/24/36/48/54 Mbps 802.11 n_20MHz: 6.5 – 65.0Mbps 802.11 n_40MHz: 13.5 – 135.0Mbps			

Unless otherwise stated the results shown in this test report refer only to the sample(s) tested and such sample(s) are retained for 90 days only.

除非另有說明，此報告結果僅對測試之樣品負責，同時此樣品僅保留90天。本報告未經本公司書面許可，不可部份複製。

This document is issued by the Company subject to its General Conditions of Service printed overleaf, available on request or accessible at www.sgs.com/terms_and_conditions.htm and, for electronic format documents, subject to Terms and Conditions for Electronic Documents at www.sgs.com/terms_e-document.htm. Attention is drawn to the limitation of liability, indemnification and jurisdiction issues defined therein. Any holder of this document is advised that information contained hereon reflects the Company's findings at the time of its intervention only and within the limits of Client's instructions, if any. The Company's sole responsibility is to its Client and this document does not exonerate parties to a transaction from exercising all their rights and obligations under the transaction documents. This document cannot be reproduced except in full, without prior written approval of the Company. Any unauthorized alteration, forgery or falsification of the content or appearance of this document is unlawful and offenders may be prosecuted to the fullest extent of the law.

WLAN 5GHz:

Wi-Fi	Frequency Range	Channels	Rated Power (Avg)	Rated Power (EIRP)	Modulation Technology	Type of Emission
11a	5150~5250	4	12.85dBm	12.11dBm	OFDM	16M7D1D
	5250~5350	4	12.81dBm	13.82dBm		16M7D1D
	5470~5725	11	12.94dBm	15.64dBm		16M6D1D
11n	HT20 5150~5250	4	HT20: 12.87dBm	HT20: 12.13dBm	OFDM	17M7D1D
	HT20 5250~5350	4	HT20: 12.87dBm	HT20: 13.88dBm		17M8D1D
	HT20 5470~5725	8	HT20: 12.94dBm	HT20: 15.64dBm		17M7D1D
11n	HT40 5150~5250	2	HT40: 11.77dBm	HT40: 11.73dBm	OFDM	36M1D1D
	HT40 5250~5350	2	HT40: 11.83dBm	HT40: 12.84dBm		36M1D1D
	HT40 5470~5725	3	HT40: 11.88dBm	HT40: 14.58dBm		36M0D1D
Antenna Designation		PIFA Antenna, 5GHz Gain: -0.74dBi (5150MHz-5250MHz) 5GHz Gain: 1.01dBi (5250MHz-5350MHz) 5GHz Gain: 2.70dBi (5470MHz-5725MHz)				
Modulation type		CCK, DQPSK, DBPSK for DSSS 64QAM, 16QAM, QPSK, BPSK for OFDM				
Transition Rate:		802.11 a: 6/9/12/18/24/36/48/54 Mbps 802.11 n_20MHz: 6.5 – 65.0Mbps 802.11 n_40MHz: 13.5 – 135.0Mbps				

Unless otherwise stated the results shown in this test report refer only to the sample(s) tested and such sample(s) are retained for 90 days only.

除非另有說明，此報告結果僅對測試之樣品負責，同時此樣品僅保留90天。本報告未經本公司書面許可，不可部份複製。

This document is issued by the Company subject to its General Conditions of Service printed overleaf, available on request or accessible at www.sgs.com/terms_and_conditions.htm and, for electronic format documents, subject to Terms and Conditions for Electronic Documents at www.sgs.com/terms_e-document.htm. Attention is drawn to the limitation of liability, indemnification and jurisdiction issues defined therein. Any holder of this document is advised that information contained hereon reflects the Company's findings at the time of its intervention only and within the limits of Client's instructions, if any. The Company's sole responsibility is to its Client and this document does not exonerate parties to a transaction from exercising all their rights and obligations under the transaction documents. This document cannot be reproduced except in full, without prior written approval of the Company. Any unauthorized alteration, forgery or falsification of the content or appearance of this document is unlawful and offenders may be prosecuted to the fullest extent of the law.

GSM / WCDMA:

Cellular Phone Standards Frequency Range and Power.	Operating Frequency		Rated Power
	GSM/GPRS 850, Class 12	824.2 MHz– 848.8 MHz	33dBm
	EDGE 850, Class 12	824.2 MHz– 848.8 MHz	27dBm
	GSM/GPRS 1900, Class 12	1850.2MHz – 1909.8MHz	30dBm
	EDGE 1900, Class 12	1850.2MHz – 1909.8MHz	26dBm
	WCDMA/HSUPA/HSDPA /HSPA+ Band II	1852.4MHz – 1907.6MHz	24dBm
	WCDMA/HSUPA/HSDPA /HSPA+ Band IV	1712.4MHz - 1752.6MHz	24dBm
	WCDMA/HSUPA/HSDPA /HSPA+ Band V	826.4MHz - 846.6MHz	24dBm
Type of Emission:	GSM 850: 248KGXW, GSM 1900: 247KGXW GPRS 850: 247KGXW, GPRS 1900: 247KGXW EDGE 850: 244KG7W, EDGE 1900: 242KG7W WCDMA Band II: 4M20F9W, WCDMA Band IV: 4M16F9W, WCDMA Band V: 4M26F9W HSDPA Band II: 4M22F9W, HSDPA Band IV: 4M23F9W, HSDPA Band V: 4M17F9W HSUPA Band II: 4M20F9W, HSUPA Band IV: 4M25F9W, HSUPA Band V: 4M27F9W		
IMEI:	004402146699511		

This test report applies for 850 / 1700 / 1900 GSM / GPRS / EDGE, WCDMA / HSDPA / HSUPA/ HSPA+ Band II/IV/V.

The spread of uplink in HSPA+ supports only up to 5.76 Mbps.

Unless otherwise stated the results shown in this test report refer only to the sample(s) tested and such sample(s) are retained for 90 days only.

除非另有說明，此報告結果僅對測試之樣品負責，同時此樣品僅保留90天。本報告未經本公司書面許可，不可部份複製。

This document is issued by the Company subject to its General Conditions of Service printed overleaf, available on request or accessible at www.sgs.com/terms_and_conditions.htm and, for electronic format documents, subject to Terms and Conditions for Electronic Documents at www.sgs.com/terms_e-document.htm. Attention is drawn to the limitation of liability, indemnification and jurisdiction issues defined therein. Any holder of this document is advised that information contained hereon reflects the Company's findings at the time of its intervention only and within the limits of Client's instructions, if any. The Company's sole responsibility is to its Client and this document does not exonerate parties to a transaction from exercising all their rights and obligations under the transaction documents. This document cannot be reproduced except in full, without prior written approval of the Company. Any unauthorized alteration, forgery or falsification of the content or appearance of this document is unlawful and offenders may be prosecuted to the fullest extent of the law.

Final Amplifier Voltage and Current Information:

Test Mode	DC voltage (V)	DC current (mA)
GSM 850	3.7	250
GSM 1900	3.7	180
GPRS 850	3.7	210
GPRS 1900	3.7	160
EDGE 850	3.7	130
EDGE 1900	3.7	120
WCDMA B2	3.7	570
WCDMA B4	3.7	480
WCDMA B5	3.7	530
HSUPA B2	3.7	510
HSUPA B4	3.7	440
HSUPA B5	3.7	490
HSDPA B2	3.7	520
HSDPA B4	3.7	450
HSDPA B5	3.7	490

Unless otherwise stated the results shown in this test report refer only to the sample(s) tested and such sample(s) are retained for 90 days only.

除非另有說明，此報告結果僅對測試之樣品負責，同時此樣品僅保留90天。本報告未經本公司書面許可，不可部份複製。

This document is issued by the Company subject to its General Conditions of Service printed overleaf, available on request or accessible at www.sgs.com/terms_and_conditions.htm and, for electronic format documents, subject to Terms and Conditions for Electronic Documents at www.sgs.com/terms_e-document.htm. Attention is drawn to the limitation of liability, indemnification and jurisdiction issues defined therein. Any holder of this document is advised that information contained hereon reflects the Company's findings at the time of its intervention only and within the limits of Client's instructions, if any. The Company's sole responsibility is to its Client and this document does not exonerate parties to a transaction from exercising all their rights and obligations under the transaction documents. This document cannot be reproduced except in full, without prior written approval of the Company. Any unauthorized alteration, forgery or falsification of the content or appearance of this document is unlawful and offenders may be prosecuted to the fullest extent of the law.

1.2. Related Submittal(s) / Grant (s)

This submittal(s) (test report) is intended for **FCC ID: PY7PM-0480** filing to comply with Section Part 22 subpart H, Part 24 subpart E and Part27 subpart C of the FCC CFR 47 Rules and **IC: 4170B-PM0480** filing to comply with Issue 3 of RSS-132, Issue 6 of RSS-133 and Issue 2 of RSS-139.

1.3. Test Methodology

Both conducted and radiated testing were performed according to the procedures document of TIA/EIA 603C and FCC CFR 47 2.1046, 2.1047, 2.1049, 2.1051, 2.1053, 2.1055 and 2.1057 and issue 3 of RSS-132, issue 6 of RSS-133 and issue 2 of RSS-139, and RSS Gen Issue3.

TS 151 010-1 is used to set, and measure the output power.

The Output power Procedure of KDB941225 (SAR Measurement Procedures for 3G devices, WCDMA / HSPA) was used for EUT and Base station setting.

KDB971168 D01 Power Meas license Digital System v01 as the supplemental guideline to conduct the measurement, including Peak to Power Average Ratio, Average Power over the fundamental signal BW (EIRP/ERP) and Signal Bandwidth.

1.4. Test Facility

The measurement facilities used to collect the 3m Radiated Emission and AC power line conducted data are located on the address of SGS Taiwan Ltd. Electronics & Communication Laboratory No.134, Wu Kung Road, Wuku Industrial Zone, Taipei County, Taiwan which are constructed and calibrated to meet the FCC requirements in documents ANSI C63.4:2009. & ANSI C63.10:2009. FCC Registration Number are: 990257, Canada Registration Number: 4620A-4.

The 10 m Open Area Test Sites located on the address of SGS Taiwan Ltd. Electronics & Communication Laboratory No. 29, Pau-Tou-Tsuo Valley Chia-Pau Tsuen, Linkou Hsiang, Taipei county, which is constructed and calibrated to meet the CISPR 22/EN 55022 requirements. SGS Site No. 1(3 &10 meters) and FCC Registration Number: 94644.

All equipment is calibrated externally and traceable to SI (International System of Unit).

1.5. Special Accessories

No special accessories were used during testing.

1.6. Equipment Modifications

There were no modifications incorporated into the EUT.

Unless otherwise stated the results shown in this test report refer only to the sample(s) tested and such sample(s) are retained for 90 days only.

除非另有說明，此報告結果僅對測試之樣品負責，同時此樣品僅保留90天。本報告未經本公司書面許可，不可部份複製。

This document is issued by the Company subject to its General Conditions of Service printed overleaf, available on request or accessible at www.sgs.com/terms_and_conditions.htm and, for electronic format documents, subject to Terms and Conditions for Electronic Documents at www.sgs.com/terms_e-document.htm. Attention is drawn to the limitation of liability, indemnification and jurisdiction issues defined therein. Any holder of this document is advised that information contained hereon reflects the Company's findings at the time of its intervention only and within the limits of Client's instructions, if any. The Company's sole responsibility is to its Client and this document does not exonerate parties to a transaction from exercising all their rights and obligations under the transaction documents. This document cannot be reproduced except in full, without prior written approval of the Company. Any unauthorized alteration, forgery or falsification of the content or appearance of this document is unlawful and offenders may be prosecuted to the fullest extent of the law.

2. SYSTEM TEST CONFIGURATION

2.1. EUT Configuration

The EUT configuration for testing is installed on RF field strength measurement to meet the Commissions requirement and operating in a manner which intends to maximize its emission characteristics in a continuous normal application.

2.2. EUT Exercise

The EUT (Transmitter) was operated in the continuous transmission mode employed with the simulator of the Base Station that fixates at test default channels to fix the Tx frequency which was for the purpose of the measurements.

2.3. Test Procedure

2.3.1 Conducted Measurement at Antenna Port:

According to measurement procured TIA/EIA 603C and RSS-Gen Issue 3, the EUT is placed on a turn table which is 0.8 m above ground plane. A low loss of RF cable was used to connect the antenna port of EUT to measurement equipment.

2.3.2 Radiated Emissions (ERP/EIRP):

According to measurement procured TIA/EIA 603C and RSS-Gen Issue 3, The EUT is a placed on as turn table which is 0.8 m above ground plane. The turn table shall rotate 360 degrees to determine the position of maximum emission level. EUT is set 3m away from the receiving antenna which varied from 1m to 4m to find out the highest emission. And also, each emission was to be maximized by changing the polarization of receiving antenna both Horizontal and Vertical. In order to find out the max. emission, the relative positions of this hand-held transmitter (EUT) was rotated through three orthogonal axes and measurement procedures for electric field radiated emissions above 1 GHz the EUT measurement is to be made “while keeping the antenna in the ‘cone of radiation’ from that area and pointed at the area both in azimuth and elevation, with polarization oriented for maximum response.” is still within the 3dB illumination BW of the measurement antenna according to the requirements in Section 8 and 13 of ANSI C63.4:2009 & ANSI C63.10:2009.

Unless otherwise stated the results shown in this test report refer only to the sample(s) tested and such sample(s) are retained for 90 days only.

除非另有說明，此報告結果僅對測試之樣品負責，同時此樣品僅保留90天。本報告未經本公司書面許可，不可部份複製。

This document is issued by the Company subject to its General Conditions of Service printed overleaf, available on request or accessible at www.sgs.com/terms_and_conditions.htm and, for electronic format documents, subject to Terms and Conditions for Electronic Documents at www.sgs.com/terms_e-document.htm. Attention is drawn to the limitation of liability, indemnification and jurisdiction issues defined therein. Any holder of this document is advised that information contained hereon reflects the Company's findings at the time of its intervention only and within the limits of Client's instructions, if any. The Company's sole responsibility is to its Client and this document does not exonerate parties to a transaction from exercising all their rights and obligations under the transaction documents. This document cannot be reproduced except in full, without prior written approval of the Company. Any unauthorized alteration, forgery or falsification of the content or appearance of this document is unlawful and offenders may be prosecuted to the fullest extent of the law.

2.4. Measurement Equipment Used:

Conducted Emission (measured at antenna port) Test Site					
EQUIPMENT TYPE	MFR	MODEL NUMBER	SERIAL NUMBER	LAST CAL.	CAL DUE.
Power Sensor	Anritsu	ML2495A	1005007	02/08/2012	02/07/2014
Power Meter	Anritsu	MA2411B	917032	02/08/2012	02/07/2014
Spectrum Analyzer	Agilent	E4446A	MY51100003	04/15/2013	04/14/2014
Spectrum Analyzer	Agilent	E4440A	US41160416	03/17/2012	03/16/2014
Radio Communication Analyzer	R & S	CMU200	102189	08/12/2012	08/11/2014
Radio Communication Analyzer	Anritsu	MT8820C	6200995019	10/17/2012	10/16/2013
Temperature Chamber	TERCHY	MHG-120LF	911009	04/16/2012	04/15/2014
DC Block	Mini-Circuits	BLK-18-S+	1	02/28/2013	02/27/2014
Attenuator	Mini-Circuit	BW-S10W2+	002	02/28/2013	02/27/2014
Splitter	Agilent	11636B	N/A	02/28/2013	02/27/2014
DC Power Supply	Agilent	E3640A	MY40005907	07/15/2011	07/14/2013

Unless otherwise stated the results shown in this test report refer only to the sample(s) tested and such sample(s) are retained for 90 days only.

除非另有說明，此報告結果僅對測試之樣品負責，同時此樣品僅保留90天。本報告未經本公司書面許可，不可部份複製。

This document is issued by the Company subject to its General Conditions of Service printed overleaf, available on request or accessible at www.sgs.com/terms_and_conditions.htm and, for electronic format documents, subject to Terms and Conditions for Electronic Documents at www.sgs.com/terms_e-document.htm. Attention is drawn to the limitation of liability, indemnification and jurisdiction issues defined therein. Any holder of this document is advised that information contained hereon reflects the Company's findings at the time of its intervention only and within the limits of Client's instructions, if any. The Company's sole responsibility is to its Client and this document does not exonerate parties to a transaction from exercising all their rights and obligations under the transaction documents. This document cannot be reproduced except in full, without prior written approval of the Company. Any unauthorized alteration, forgery or falsification of the content or appearance of this document is unlawful and offenders may be prosecuted to the fullest extent of the law.

ERP, EIRP MEASUREMENT EQUIPMENT List 966 Chamber					
EQUIPMENT TYPE	MFR	MODEL NUMBER	SERIAL NUMBER	LAST CAL.	CAL DUE.
Spectrum Analyzer	Agilent	E4446A	MY51100003	04/15/2013	04/14/2014
EXA Spectrum Analyzer	Agilent	N9010A	MY50420195	02/06/2013	02/07/2014
Spectrum Analyzer	R&S	FSV-30	101398	10/18/2011	10/17/2013
Bilog Antenna	SCHWAZBECK	VULB9168	378	01/10/2012	01/09/2014
Bilog Antenna	SCHWAZBECK	VULB9160	3158	11/24/2011	11/23/2013
Dipole Antenna	SCHWAZBECK	VHAP	908/909	07/17/2010	07/16/2013
Dipole Antenna	SCHWAZBECK	UHAP	891/892	07/17/2010	07/16/2013
Horn antenna	ETS.LINDGREN	3117	123995	05/19/2013	05/18/2014
Horn antenna	ETS.LINDGREN	3117	123991	01/21/2013	01/20/2015
Horn Antenna	Schwarzbeck	BBHA9170	184	01/17/2012	01/17/2014
Horn Antenna	Schwarzbeck	BBHA9170	185	07/11/2011	07/10/2013
RF amplifier	Miteq	AMF-6F-260040 0-40-8P	971576	01/29/2013	01/28/2014
Signal Generator	R&S	SMR40	100210	02/02/2012	02/01/2014
Signal Generator	Agilent	E4438C	MY45093613	07/15/2011	07/14/2013
Pre-Amplifier	Agilent	8447D	1937A02834	01/04/2013	01/03/2014
Pre-Amplifier	EMC Instruments Corp.	EMC0126530	980038	01/04/2013	01/03/2014
Attenuator	Mini-Circuit	BW-S10W2+	004	02/28/2013	02/27/2014
Radio Communication Analyzer	R & S	CMU200	102189	08/12/2012	08/11/2014
Radio Communication Analyzer	Anritsu	MT8820C	6200995019	10/17/2012	10/16/2013
Turn Table	HD	DT420	N/A	N.C.R	N.C.R
Antenna Tower	HD	MA240-N	240/657	N.C.R	N.C.R
Controller	HD	HD100	N/A	N.C.R	N.C.R
Low Loss Cable	HUBER+SUHNER	966_Tx	10m	01/04/2013	01/03/2014
Low Loss Cable	HUBER+SUHNER	966_Rx	3m	01/04/2013	01/03/2014
Filter 800-1000	Micro-Tronics	EWT	M2	02/28/2013	02/28/2014
Filter 1700-1800	Micro-Tronics	BRC15751	001	02/28/2013	02/28/2014
Filter 1800-2000	Micro-Tronics	EWT	M2	02/28/2013	02/28/2014
1GHz High Pass Filter	Micro-Tronics	HPM50108	32	02/28/2013	02/28/2014
2GHz High Pass Filter	Micro-Tronics	HPM50110	36	02/28/2013	02/28/2014
3m Site NSA	SGS	966 chamber	N/A	07/15/2012	07/14/2013

Unless otherwise stated the results shown in this test report refer only to the sample(s) tested and such sample(s) are retained for 90 days only.

除非另有說明，此報告結果僅對測試之樣品負責，同時此樣品僅保留90天。本報告未經本公司書面許可，不可部份複製。

This document is issued by the Company subject to its General Conditions of Service printed overleaf, available on request or accessible at www.sgs.com/terms_and_conditions.htm and, for electronic format documents, subject to Terms and Conditions for Electronic Documents at www.sgs.com/terms_e-document.htm. Attention is drawn to the limitation of liability, indemnification and jurisdiction issues defined therein. Any holder of this document is advised that information contained hereon reflects the Company's findings at the time of its intervention only and within the limits of Client's instructions, if any. The Company's sole responsibility is to its Client and this document does not exonerate parties to a transaction from exercising all their rights and obligations under the transaction documents. This document cannot be reproduced except in full, without prior written approval of the Company. Any unauthorized alteration, forgery or falsification of the content or appearance of this document is unlawful and offenders may be prosecuted to the fullest extent of the law.

2.5. Configuration of Tested System

Fig. 2-1 Configuration of Tested System (Fixed Channel-Conducted)

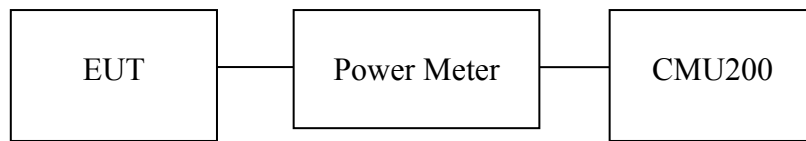

Fig. 2-2 Configuration of Tested System (Fixed Channel-Radiated)

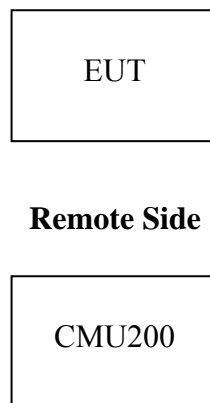

Table 2-1 Equipment Used in

Item	Equipment	Mfr/Brand	Model/ Type No.	Series No.	Data Cable	Power Cord
1.	Universal Radio Communication Tester	R&S	CMU200	102189	shielded	Un-shielded
2.	Power Meter	Anritsu	ML2495A	1005007	shielded	Un-shielded

Unless otherwise stated the results shown in this test report refer only to the sample(s) tested and such sample(s) are retained for 90 days only.

除非另有說明，此報告結果僅對測試之樣品負責，同時此樣品僅保留90天。本報告未經本公司書面許可，不可部份複製。

This document is issued by the Company subject to its General Conditions of Service printed overleaf, available on request or accessible at www.sgs.com/terms_and_conditions.htm and, for electronic format documents, subject to Terms and Conditions for Electronic Documents at www.sgs.com/terms_e-document.htm. Attention is drawn to the limitation of liability, indemnification and jurisdiction issues defined therein. Any holder of this document is advised that information contained hereon reflects the Company's findings at the time of its intervention only and within the limits of Client's instructions, if any. The Company's sole responsibility is to its Client and this document does not exonerate parties to a transaction from exercising all their rights and obligations under the transaction documents. This document cannot be reproduced except in full, without prior written approval of the Company. Any unauthorized alteration, forgery or falsification of the content or appearance of this document is unlawful and offenders may be prosecuted to the fullest extent of the law.

3. SUMMARY OF TEST RESULTS

FCC Rules	IC Rules	Description Of Test	Result
§2.1046(a)	N/A	RF Power Output	Compliant
§2.1046(a) §22.913(a)(2) §24.232(c)§27.50(d)(4)	§4.8 (RSS-Gen Issue 3) §5.4 (RSS-132) §6.4 (RSS-133) §6.4 (RSS-139)	ERP/ EIRP measurement	Compliant
§2.1049(h)	§4.6.1 (RSS-Gen Issue 3) §2.3 (RSS-133) §2.3 (RSS-139)	99% Occupied Bandwidth	Compliant
§2.1051 §22.917(a) §24.238(a) §27.53(h)	§4.9 (RSS-Gen Issue 3) §5.5 (RSS-132) §6.5 (RSS-133) §6.5 (RSS-139)	Out of Band Emissions at Antenna Terminals and Band Edge	Compliant
§2.1053 §22.917(a) §24.238(a) §27.53(h)	§4.9 (RSS-Gen Issue 3) §5.5 (RSS-132) §6.5 (RSS-133) §6.5 (RSS-139)	Field Strength of Spurious Radiation	Compliant
§24.232(d) §27.50(B)	§6.4 (RSS-139) §6.4 (RSS-133) §5.4 (RSS-132)	Peak to Average Ratio	Compliant
§2.1055(a)(1) §22.355 §24.235 §27.54	§4.7 (RSS-Gen Issue 3) §5.3 (RSS-132) §6.3 (RSS-133) §6.3 (RSS-139)	Frequency Stability vs. Temperature	Compliant
§2.1055(d)(2) §22.355 §24.235 §27.54	§4.7 (RSS-Gen Issue 3) §5.3 (RSS-132) §6.3 (RSS-133) §6.3 (RSS-139)	Frequency Stability vs. Voltage	Compliant
N/A	§4.10 (RSS-Gen Issue 3) §5.6 (RSS-132) §6.6 (RSS-133) §6.6 (RSS-139)	Receiver Spurious Emissions	Compliant

Unless otherwise stated the results shown in this test report refer only to the sample(s) tested and such sample(s) are retained for 90 days only.

除非另有說明，此報告結果僅對測試之樣品負責，同時此樣品僅保留90天。本報告未經本公司書面許可，不可部份複製。

This document is issued by the Company subject to its General Conditions of Service printed overleaf, available on request or accessible at www.sgs.com/terms_and_conditions.htm and, for electronic format documents, subject to Terms and Conditions for Electronic Documents at www.sgs.com/terms_e-document.htm. Attention is drawn to the limitation of liability, indemnification and jurisdiction issues defined therein. Any holder of this document is advised that information contained hereon reflects the Company's findings at the time of its intervention only and within the limits of Client's instructions, if any. The Company's sole responsibility is to its Client and this document does not exonerate parties to a transaction from exercising all their rights and obligations under the transaction documents. This document cannot be reproduced except in full, without prior written approval of the Company. Any unauthorized alteration, forgery or falsification of the content or appearance of this document is unlawful and offenders may be prosecuted to the fullest extent of the law.

Max ERP/EIRP measurement result:

	dBm		W
GSM 850 Band	26.08	ERP	0.406
GSM 1900 Band	31.41	EIRP	1.384
GPRS 850 Band	26.05	ERP	0.403
GPRS 1900 Band	31.18	EIRP	1.312
EDGE 850 Band	24.28	ERP	0.268
EDGE 1900 Band	29.39	EIRP	0.869
WCDMA Band II	27.74	EIRP	0.594
WCDMA Band IV	29.21	EIRP	0.834
WCDMA Band V	21.69	ERP	0.148
HSUPA Band II	27.20	EIRP	0.525
HSUPA Band IV	28.62	EIRP	0.728
HSUPA Band V	21.69	ERP	0.148
HSDPA Band II	27.58	EIRP	0.573
HSDPA Band IV	29.16	EIRP	0.824
HSDPA Band V	21.85	ERP	0.153

Unless otherwise stated the results shown in this test report refer only to the sample(s) tested and such sample(s) are retained for 90 days only.

除非另有說明，此報告結果僅對測試之樣品負責，同時此樣品僅保留90天。本報告未經本公司書面許可，不可部份複製。

This document is issued by the Company subject to its General Conditions of Service printed overleaf, available on request or accessible at www.sgs.com/terms_and_conditions.htm and, for electronic format documents, subject to Terms and Conditions for Electronic Documents at www.sgs.com/terms_e-document.htm. Attention is drawn to the limitation of liability, indemnification and jurisdiction issues defined therein. Any holder of this document is advised that information contained hereon reflects the Company's findings at the time of its intervention only and within the limits of Client's instructions, if any. The Company's sole responsibility is to its Client and this document does not exonerate parties to a transaction from exercising all their rights and obligations under the transaction documents. This document cannot be reproduced except in full, without prior written approval of the Company. Any unauthorized alteration, forgery or falsification of the content or appearance of this document is unlawful and offenders may be prosecuted to the fullest extent of the law.

4. DESCRIPTION OF TEST MODES

The EUT has been tested under operating condition.

EUT was staying in continuous transmitting mode. Channel Low, Mid and High for each type band with rated data rate were chosen for full testing.

The list of channel selected to conduct the measurements

GSM/GPRS/EDGE 850:

Channel Low: AFRCN 128 at 824.2MHz, Channel Mid: AFRCN 190 at 836.6MHz, Channel High: AFRCN 251 at 848.8MHz.

GSM/GPRS/EDGE 1900:

Channel Low: AFRCN 512 at 1850.2MHz, Channel Mid: AFRCN 661 at 1880.0MHz, Channel High: AFRCN 810 at 1909.8MHz

WCDMA/HSPA BII:

Channel Low: UAFRCN 9262 at 1852.4MHz, Channel Mid: UAFRCN 9400 at 1880.0MHz, Channel High: UAFRCN 9538 at 1907.6MHz.

WCDMA/HSPA BIV:

Channel Low: UAFRCN 1312 at 1712.4MHz, Channel Mid: UAFRCN 1413 at 1732.6MHz, Channel High: UAFRCN 1513 at 1752.6MHz.

WCDMA/HSPA BV:

Channel Low: UAFRCN 4132 at 826.4MHz, Channel Mid: UAFRCN 4183 at 836.6MHz, Channel High: UAFRCN 4233 at 846.6MHz.

The field strength of spurious radiation emission was measured as EUT stand-up position (H mode) and lie down position (E1, E2 mode) for GSM/EDGE and WCDMA Band II / IV/ V with power adaptor. The worst-case of E2 position for GSM 850, E1 position for GSM 1900, E1 position for WCDMA/HSPA Band II, H position for WCDMA/HSPA Band IV, E1 position for WCDMA/HSPA Band V were reported.

Unless otherwise stated the results shown in this test report refer only to the sample(s) tested and such sample(s) are retained for 90 days only.

除非另有說明，此報告結果僅對測試之樣品負責，同時此樣品僅保留90天。本報告未經本公司書面許可，不可部份複製。

This document is issued by the Company subject to its General Conditions of Service printed overleaf, available on request or accessible at www.sgs.com/terms_and_conditions.htm and, for electronic format documents, subject to Terms and Conditions for Electronic Documents at www.sgs.com/terms_e-document.htm. Attention is drawn to the limitation of liability, indemnification and jurisdiction issues defined therein. Any holder of this document is advised that information contained hereon reflects the Company's findings at the time of its intervention only and within the limits of Client's instructions, if any. The Company's sole responsibility is to its Client and this document does not exonerate parties to a transaction from exercising all their rights and obligations under the transaction documents. This document cannot be reproduced except in full, without prior written approval of the Company. Any unauthorized alteration, forgery or falsification of the content or appearance of this document is unlawful and offenders may be prosecuted to the fullest extent of the law.

5. MEASUREMENT UNCERTAINTY

Test Items	Uncertainty
RF Power Output	+/- 1.42 dB
ERP/ EIRP measurement	Vertical Polarization = +/- 4.74dB Horizontal Polarization = +/- 4.62dB
99% Occupied Bandwidth	+/- 123.36 Hz
Out of Band Emissions at Antenna Terminals and Band Edge	+/- 1.55 dB
Peak to Average Ratio	+/- 1.55 dB
Frequency Stability vs. Temperature	+/- 123.36 Hz
Frequency Stability vs. Voltage	+/- 123.36 Hz
Temperature	+/- 0.8 °C
Humidity	+/- 4.7 %
DC / AC Power Source	DC= +/- 1%, AC= +/- 0.2%

Radiated Spurious Emission:

Measurement uncertainty (Polarization : Vertical)	30MHz - 180MHz: +/- 3.37dB
	180MHz - 417MHz: +/- 3.19dB
	0.417GHz-1GHz: +/- 3.19dB
	1GHz - 18GHz: +/- 4.04dB
	18GHz - 40GHz: +/- 4.04dB

Measurement uncertainty (Polarization : Horizontal)	30MHz - 167MHz: +/- 4.22dB
	167MHz - 500MHz: +/- 3.44dB
	0.5GHz-1GHz: +/- 3.39dB
	1GHz - 18GHz: +/- 4.08dB
	18GHz - 40GHz: +/- 4.08dB

This uncertainty represents an expanded uncertainty expressed at approximately the 95% confidence level using a coverage factor of k=2.

Unless otherwise stated the results shown in this test report refer only to the sample(s) tested and such sample(s) are retained for 90 days only.

除非另有說明，此報告結果僅對測試之樣品負責，同時此樣品僅保留90天。本報告未經本公司書面許可，不可部份複製。

This document is issued by the Company subject to its General Conditions of Service printed overleaf, available on request or accessible at www.sgs.com/terms_and_conditions.htm and, for electronic format documents, subject to Terms and Conditions for Electronic Documents at www.sgs.com/terms_e-document.htm. Attention is drawn to the limitation of liability, indemnification and jurisdiction issues defined therein. Any holder of this document is advised that information contained hereon reflects the Company's findings at the time of its intervention only and within the limits of Client's instructions, if any. The Company's sole responsibility is to its Client and this document does not exonerate parties to a transaction from exercising all their rights and obligations under the transaction documents. This document cannot be reproduced except in full, without prior written approval of the Company. Any unauthorized alteration, forgery or falsification of the content or appearance of this document is unlawful and offenders may be prosecuted to the fullest extent of the law.

6. RF POWER OUTPUT MEASUREMENT

6.1. Standard Applicable:

According to FCC §2.1046.

FCC 22.913(a) Mobile station are limited to 7W.

FCC 24.232(c) Peak Power Measurement limited to 2W

FCC 24.232(c) Equipment must employ means to limit the power to the minimum necessary for successful communication.

Part 27, 50(d)(4) Portable stations are limited to 1W

3GPP Power limitation for HSDPA and HSUPA

Maximum Output Powers for HSDPA

Sub-test in table C.10.1.4	Power Class 3		Power Class 4	
	Power (dBm)	Tol (dB)	Power (dBm)	Tol (dB)
1	+24	+1.7/-3.7	+21	+2.7/-2.7
2	+24	+1.7/-3.7	+21	+2.7/-2.7
3	+23.5	+2.2/-3.7	+20.5	+3.2/-2.7
4	+23.5	+2.2/-3.7	+20.5	+3.2/-2.7

Maximum Output Powers for HSUPA

Sub-test in table C.11.1.3	Power Class 3		Power Class 4	
	Power (dBm)	Tol (dB)	Power (dBm)	Tol (dB)
1	+24	+1.7/-6.7	+21	+2.7/-5.7
2	+22	+3.7/-5.2	+19	+4.7/-4.2
3	+23	+2.7/-5.2	+20	+3.7/-4.2
4	+22	+3.7/-5.2	+19	+4.7/-4.2
5	+24	+1.7/-6.7	+21	+2.7/-5.7

Unless otherwise stated the results shown in this test report refer only to the sample(s) tested and such sample(s) are retained for 90 days only.

除非另有說明，此報告結果僅對測試之樣品負責，同時此樣品僅保留90天。本報告未經本公司書面許可，不可部份複製。

This document is issued by the Company subject to its General Conditions of Service printed overleaf, available on request or accessible at www.sgs.com/terms_and_conditions.htm and, for electronic format documents, subject to Terms and Conditions for Electronic Documents at www.sgs.com/terms_e-document.htm. Attention is drawn to the limitation of liability, indemnification and jurisdiction issues defined therein. Any holder of this document is advised that information contained hereon reflects the Company's findings at the time of its intervention only and within the limits of Client's instructions, if any. The Company's sole responsibility is to its Client and this document does not exonerate parties to a transaction from exercising all their rights and obligations under the transaction documents. This document cannot be reproduced except in full, without prior written approval of the Company. Any unauthorized alteration, forgery or falsification of the content or appearance of this document is unlawful and offenders may be prosecuted to the fullest extent of the law.

6.2. Test Set-up:

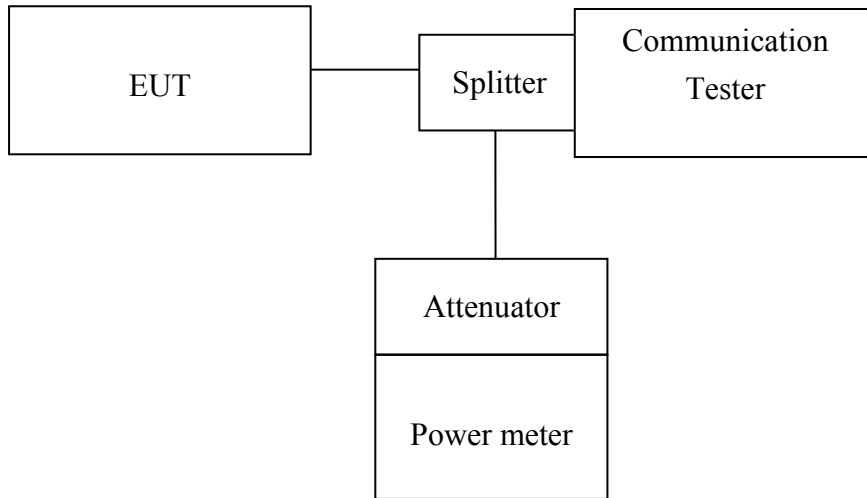

Note: Measurement setup for testing on Antenna connector

6.3. Measurement Procedure:

The transmitter output was connected to a calibrated attenuator, the other end of which was connected to a power meter. Transmitter output was read off the power meter in dBm. The power output at the transmitter antenna port was determined by adding the value of the attenuator to the power meter reading. TS 151 010-1 is reference to conduct the test measurement of output power.

The Procedure of KDB941225 (SAR Measurement Procedures for 3G devices, (WCDMA/HSPA) was used for EUT and Base station setting. RMC 12.2kps is used for this testing, and KDB 971168 D01 Power Meas License Digital System as the supplemental test methodology to adjust the proper setting obtaining the measurement results

Necessary Communication complying with 24.232 (c) and 27.5(d)(4)

Set CMU200 (base-station simulator) MS Signal with packet data submenu; SLOT Configuration
Set appropriate level to verify if or not power on mobile station's link with simulator still exists.

6.4. Measurement Equipment Used:

Refer to section 2.4 in this report

Unless otherwise stated the results shown in this test report refer only to the sample(s) tested and such sample(s) are retained for 90 days only.

除非另有說明，此報告結果僅對測試之樣品負責，同時此樣品僅保留90天。本報告未經本公司書面許可，不可部份複製。

This document is issued by the Company subject to its General Conditions of Service printed overleaf, available on request or accessible at www.sgs.com/terms_and_conditions.htm and, for electronic format documents, subject to Terms and Conditions for Electronic Documents at www.sgs.com/terms_e-document.htm. Attention is drawn to the limitation of liability, indemnification and jurisdiction issues defined therein. Any holder of this document is advised that information contained hereon reflects the Company's findings at the time of its intervention only and within the limits of Client's instructions, if any. The Company's sole responsibility is to its Client and this document does not exonerate parties to a transaction from exercising all their rights and obligations under the transaction documents. This document cannot be reproduced except in full, without prior written approval of the Company. Any unauthorized alteration, forgery or falsification of the content or appearance of this document is unlawful and offenders may be prosecuted to the fullest extent of the law.

6.5. Measurement Result:

6.5.1. RF Conducted Output Power

6.5.1.1.: GSM/GPRS/EDGE (GMSK; 8-PSK)

Result:

EUT Mode	Frequency (MHz)	CH	Peak Power (dBm)	Averager Burst Power (dBm)
GSM 850	824.2	128	33.00	33.00
	836.6	190	33.00	33.00
	848.8	251	32.90	33.00

EUT Mode	Frequency (MHz)	CH	Peak Power (dBm)	Averager Burst Power (dBm)
GSM 1900	1850.2	512	30.50	30.30
	1880.0	661	30.40	30.20
	1909.8	810	30.30	30.10

EUT Mode	Frequency (MHz)	CH	Peak Power (4DN 1UP) Class 8 (dBm)	Average Burst Power (4DN 1UP) Class 8 (dBm)	Peak Power (4DN 2UP) Class 10 (dBm)	Average Burst Power (4DN 2UP) Class 10 (dBm)
GPRS 850	824.2	128	30.10	32.90	29.50	29.30
	836.6	190	33.20	33.00	29.40	29.20
	848.8	251	33.10	33.00	29.40	29.20

EUT Mode	Frequency (MHz)	CH	Peak Power (4DN 3UP) Class 12 (dBm)	Average Burst Power (4DN 3UP) Class 12 (dBm)	Peak Power (4DN 4UP) Class 12 (dBm)	Average Burst Power (4DN 4UP) Class 12 (dBm)
GPRS 850	824.2	128	28.20	28.00	27.70	27.50
	836.6	190	28.30	28.10	27.70	27.50
	848.8	251	28.20	28.00	27.70	27.50

Unless otherwise stated the results shown in this test report refer only to the sample(s) tested and such sample(s) are retained for 90 days only.

除非另有說明，此報告結果僅對測試之樣品負責，同時此樣品僅保留90天。本報告未經本公司書面許可，不可部份複製。

This document is issued by the Company subject to its General Conditions of Service printed overleaf, available on request or accessible at www.sgs.com/terms_and_conditions.htm and, for electronic format documents, subject to Terms and Conditions for Electronic Documents at www.sgs.com/terms_e-document.htm. Attention is drawn to the limitation of liability, indemnification and jurisdiction issues defined therein. Any holder of this document is advised that information contained hereon reflects the Company's findings at the time of its intervention only and within the limits of Client's instructions, if any. The Company's sole responsibility is to its Client and this document does not exonerate parties to a transaction from exercising all their rights and obligations under the transaction documents. This document cannot be reproduced except in full, without prior written approval of the Company. Any unauthorized alteration, forgery or falsification of the content or appearance of this document is unlawful and offenders may be prosecuted to the fullest extent of the law.

EUT Mode	Frequency (MHz)	CH	Peak Power (4DN 1UP) Class 8 (dBm)	Average Burst Power (4DN 1UP) Class 8 (dBm)	Peak Power (4DN 2UP) Class 10 (dBm)	Average Burst Power (4DN 2UP) Class 10 (dBm)
GPRS 1900	1850.2	512	30.60	30.30	29.90	29.70
	1880.0	661	30.50	30.30	29.70	29.50
	1909.8	810	30.40	30.10	29.60	29.30

EUT Mode	Frequency (MHz)	CH	Peak Power (4DN 3UP) Class 12 (dBm)	Average Burst Power (4DN 3UP) Class 12 (dBm)	Peak Power (4DN 4UP) Class 12 (dBm)	Average Burst Power (4DN 4UP) Class 12 (dBm)
GPRS 1900	1850.2	512	28.60	28.40	27.80	27.60
	1880.0	661	28.40	28.20	27.60	27.40
	1909.8	810	28.10	28.00	27.50	27.20

EUT Mode	Frequency (MHz)	CH	Peak Power (4DN 1UP) Class 8 (dBm)	Average Burst Power (4DN 1UP) Class 8 (dBm)	Peak Power (4DN 2UP) Class 10 (dBm)	Average Burst Power (4DN 2UP) Class 10 (dBm)
EDGE 850	824.2	128	29.70	26.40	29.60	26.30
	836.6	190	29.70	26.50	29.60	26.40
	848.8	251	29.50	26.40	29.50	26.40

EUT Mode	Frequency (MHz)	CH	Peak Power (4DN 3UP) Class 12 (dBm)	Average Burst Power (4DN 3UP) Class 12 (dBm)	Peak Power (4DN 4UP) Class 12 (dBm)	Average Burst Power (4DN 4UP) Class 12 (dBm)
EDGE 850	824.2	128	29.10	26.00	28.90	25.80
	836.6	190	29.00	26.00	28.90	25.80
	848.8	251	29.00	26.00	28.90	25.90

Unless otherwise stated the results shown in this test report refer only to the sample(s) tested and such sample(s) are retained for 90 days only.

除非另有說明，此報告結果僅對測試之樣品負責，同時此樣品僅保留90天。本報告未經本公司書面許可，不可部份複製。

This document is issued by the Company subject to its General Conditions of Service printed overleaf, available on request or accessible at www.sgs.com/terms_and_conditions.htm and, for electronic format documents, subject to Terms and Conditions for Electronic Documents at www.sgs.com/terms_e-document.htm. Attention is drawn to the limitation of liability, indemnification and jurisdiction issues defined therein. Any holder of this document is advised that information contained hereon reflects the Company's findings at the time of its intervention only and within the limits of Client's instructions, if any. The Company's sole responsibility is to its Client and this document does not exonerate parties to a transaction from exercising all their rights and obligations under the transaction documents. This document cannot be reproduced except in full, without prior written approval of the Company. Any unauthorized alteration, forgery or falsification of the content or appearance of this document is unlawful and offenders may be prosecuted to the fullest extent of the law.

EUT Mode	Frequency (MHz)	CH	Peak Power (4DN 1UP) Class 8 (dBm)	Average Burst Power (4DN 1UP) Class 8 (dBm)	Peak Power (1DN 2UP) Class 10 (dBm)	Average Burst Power (1DN 2UP) Class 10 (dBm)
EDGE 1900	1850.2	512	28.50	25.40	28.10	25.00
	1880.0	661	28.50	25.30	28.00	24.90
	1909.8	810	28.30	25.10	27.80	24.70

EUT Mode	Frequency (MHz)	CH	Peak Power (1DN 3UP) Class 12 (dBm)	Average Burst Power (1DN 3UP) Class 12 (dBm)	Peak Power (1DN 4UP) Class 12 (dBm)	Average Burst Power (1DN 4UP) Class 12 (dBm)
EDGE 1900	1850.2	512	28.20	25.00	28.10	25.00
	1880.0	661	28.00	24.90	28.00	24.80
	1909.8	810	27.80	24.80	27.80	24.70

Cable loss offset Low Band: 13.7dB

Cable loss offset High Band: 13.9dB

Unless otherwise stated the results shown in this test report refer only to the sample(s) tested and such sample(s) are retained for 90 days only.

除非另有說明，此報告結果僅對測試之樣品負責，同時此樣品僅保留90天。本報告未經本公司書面許可，不可部份複製。

This document is issued by the Company subject to its General Conditions of Service printed overleaf, available on request or accessible at www.sgs.com/terms_and_conditions.htm and, for electronic format documents, subject to Terms and Conditions for Electronic Documents at www.sgs.com/terms_e-document.htm. Attention is drawn to the limitation of liability, indemnification and jurisdiction issues defined therein. Any holder of this document is advised that information contained hereon reflects the Company's findings at the time of its intervention only and within the limits of Client's instructions, if any. The Company's sole responsibility is to its Client and this document does not exonerate parties to a transaction from exercising all their rights and obligations under the transaction documents. This document cannot be reproduced except in full, without prior written approval of the Company. Any unauthorized alteration, forgery or falsification of the content or appearance of this document is unlawful and offenders may be prosecuted to the fullest extent of the law.

6.5.1.2.: WCDMA mode

The following tests were completed according to the test requirements outlined in section 5.2 of the 3GPP TS34.121-1 V8.4.0 specification. The EUT supports power Class 3, which has a nominal maximum output power of 24 dBm (+1.7/-3.7). RMC 12.2kps is used for this testing.

Results:

EUT Mode	Frequency (MHz)	CH	Peak Power (dBm)	Avg. Power (dBm)
WCDMA Band II	1852.4	9262	27.12	24.08
	1880.0	9400	27.34	24.28
	1907.6	9538	26.83	23.60

EUT Mode	Frequency (MHz)	CH	Peak Power (dBm)	Avg. Power (dBm)
WCDMA Band IV	1712.4	1312	27.22	24.11
	1732.6	1412	27.12	23.96
	1752.6	1513	27.14	24.09

EUT Mode	Frequency (MHz)	CH	Peak Power (dBm)	Avg. Power (dBm)
WCDMA Band V	826.4	4132	27.62	24.20
	836.6	4183	27.25	24.11
	846.6	4233	27.35	24.15

EUT Mode	Frequency (MHz)	CH	Peak Power (dBm)	Avg. Power (dBm)
HSDPA Band II	1852.4	9262	27.15	23.00
	1880.0	9400	27.34	23.15
	1907.6	9538	26.97	22.45

Unless otherwise stated the results shown in this test report refer only to the sample(s) tested and such sample(s) are retained for 90 days only.

除非另有說明，此報告結果僅對測試之樣品負責，同時此樣品僅保留90天。本報告未經本公司書面許可，不可部份複製。

This document is issued by the Company subject to its General Conditions of Service printed overleaf, available on request or accessible at www.sgs.com/terms_and_conditions.htm and, for electronic format documents, subject to Terms and Conditions for Electronic Documents at www.sgs.com/terms_e-document.htm. Attention is drawn to the limitation of liability, indemnification and jurisdiction issues defined therein. Any holder of this document is advised that information contained hereon reflects the Company's findings at the time of its intervention only and within the limits of Client's instructions, if any. The Company's sole responsibility is to its Client and this document does not exonerate parties to a transaction from exercising all their rights and obligations under the transaction documents. This document cannot be reproduced except in full, without prior written approval of the Company. Any unauthorized alteration, forgery or falsification of the content or appearance of this document is unlawful and offenders may be prosecuted to the fullest extent of the law.

EUT Mode	Frequency (MHz)	CH	Peak Power (dBm)	Avg. Power (dBm)
HSDPA Band IV	1712.4	1312	27.21	22.94
	1732.6	1412	27.20	22.90
	1752.6	1513	27.22	22.90

EUT Mode	Frequency (MHz)	CH	Peak Power (dBm)	Avg. Power (dBm)
HSDPA Band V	826.4	4132	27.16	22.94
	836.6	4183	27.03	22.88
	846.6	4233	27.17	23.05

EUT Mode	Frequency (MHz)	CH	Peak Power (dBm)	Avg. Power (dBm)
HSUPA Band II	1852.4	9262	26.68	22.38
	1880.0	9400	26.91	22.55
	1907.6	9538	27.09	21.90

EUT Mode	Frequency (MHz)	CH	Peak Power (dBm)	Avg. Power (dBm)
HSUPA Band IV	1712.4	1312	26.79	22.37
	1732.6	1412	26.28	22.33
	1752.6	1513	26.88	22.40

Unless otherwise stated the results shown in this test report refer only to the sample(s) tested and such sample(s) are retained for 90 days only.

除非另有說明，此報告結果僅對測試之樣品負責，同時此樣品僅保留90天。本報告未經本公司書面許可，不可部份複製。

This document is issued by the Company subject to its General Conditions of Service printed overleaf, available on request or accessible at www.sgs.com/terms_and_conditions.htm and, for electronic format documents, subject to Terms and Conditions for Electronic Documents at www.sgs.com/terms_e-document.htm. Attention is drawn to the limitation of liability, indemnification and jurisdiction issues defined therein. Any holder of this document is advised that information contained hereon reflects the Company's findings at the time of its intervention only and within the limits of Client's instructions, if any. The Company's sole responsibility is to its Client and this document does not exonerate parties to a transaction from exercising all their rights and obligations under the transaction documents. This document cannot be reproduced except in full, without prior written approval of the Company. Any unauthorized alteration, forgery or falsification of the content or appearance of this document is unlawful and offenders may be prosecuted to the fullest extent of the law.

EUT Mode	Frequency (MHz)	CH	Peak Power (dBm)	Avg. Power (dBm)
HSUPA Band V	826.4	4132	27.43	22.36
	836.6	4183	26.56	22.25
	846.6	4233	26.74	22.33

Note: The results above reflect max power with all up bits.

Cable loss offset Low Band: 13.7dB

Cable loss offset High Band: 13.9dB

Unless otherwise stated the results shown in this test report refer only to the sample(s) tested and such sample(s) are retained for 90 days only.

除非另有說明，此報告結果僅對測試之樣品負責，同時此樣品僅保留90天。本報告未經本公司書面許可，不可部份複製。

This document is issued by the Company subject to its General Conditions of Service printed overleaf, available on request or accessible at www.sgs.com/terms_and_conditions.htm and, for electronic format documents, subject to Terms and Conditions for Electronic Documents at www.sgs.com/terms_e-document.htm. Attention is drawn to the limitation of liability, indemnification and jurisdiction issues defined therein. Any holder of this document is advised that information contained hereon reflects the Company's findings at the time of its intervention only and within the limits of Client's instructions, if any. The Company's sole responsibility is to its Client and this document does not exonerate parties to a transaction from exercising all their rights and obligations under the transaction documents. This document cannot be reproduced except in full, without prior written approval of the Company. Any unauthorized alteration, forgery or falsification of the content or appearance of this document is unlawful and offenders may be prosecuted to the fullest extent of the law.

6.5.1.3.:HSDPA Release 6 mode

The following 4 Sub-Tests were completed according to the test requirements outlined in section 5.2A of the 3GPP TS34.121-1 V8.4.0 specification. All TX RMS power requirements for Power Class 3 were met according to table 5.2AA.5 and 5.2B.5 All UE channels and power ratio's are set according to table C10.1.4 & C11.1.3 in the 3GPP TS34.121-1 V8.4.0. RMC 12.2kps is used for this testing.

HSDPA SUB-TEST Setting

Table C.10.1.4: β values for transmitter characteristics tests with HS-DPCCH(FOR HSDPA)

Sub-test	β_c	β_a	β_a (SF)	β_c/β_a	β_{HS} (Note 1, Note 2)	CM (dB) (Note 3)	MPR (dB) (Note 3)	RMC (Kbps)
1	2/15	15/15	64	2/15	4/15	0.0	0.0	12.2
2	12/15 (Note 4)	15/15 (Note 4)	64	12/15 (Note 4)	24/15	1.0	0.0	12.2
3	15/15	8/15	64	15/8	30/15	1.5	0.5	12.2
4	15/15	4/15	64	15/4	30/15	1.5	0.5	12.2

Note: The recommended HSDPA MPRs are implemented as per following sub-tests.

Unless otherwise stated the results shown in this test report refer only to the sample(s) tested and such sample(s) are retained for 90 days only.

除非另有說明，此報告結果僅對測試之樣品負責，同時此樣品僅保留90天。本報告未經本公司書面許可，不可部份複製。

This document is issued by the Company subject to its General Conditions of Service printed overleaf, available on request or accessible at www.sgs.com/terms_and_conditions.htm and, for electronic format documents, subject to Terms and Conditions for Electronic Documents at www.sgs.com/terms_e-document.htm. Attention is drawn to the limitation of liability, indemnification and jurisdiction issues defined therein. Any holder of this document is advised that information contained hereon reflects the Company's findings at the time of its intervention only and within the limits of Client's instructions, if any. The Company's sole responsibility is to its Client and this document does not exonerate parties to a transaction from exercising all their rights and obligations under the transaction documents. This document cannot be reproduced except in full, without prior written approval of the Company. Any unauthorized alteration, forgery or falsification of the content or appearance of this document is unlawful and offenders may be prosecuted to the fullest extent of the law.

Results:

Mode	Sub-test	Avg. Power (dBm) Channel			Power Class 3 Limitation (dBm)	Comments
		9262	9400	9538		
HSDPA (B2)	1	24.25	24.17	23.46	20.3dBm – 25.7dBm	Pass
	2	23.96	24.14	23.45	20.3dBm – 25.7dBm	Pass
	3	23.77	23.72	22.93	19.8dBm – 25.7dBm	Pass
	4	23.84	23.73	23.05	19.8dBm – 25.7dBm	Pass

Mode	Sub-test	Avg. Power (dBm) Channel			Power Class 3 Limitation (dBm)	Comments
		1312	1412	1513		
HSDPA (B4)	1	23.82	24.06	23.93	20.3dBm – 25.7dBm	Pass
	2	23.99	23.82	23.94	20.3dBm – 25.7dBm	Pass
	3	23.34	23.61	23.40	19.8dBm – 25.7dBm	Pass
	4	23.41	23.62	23.52	19.8dBm – 25.7dBm	Pass

Mode	Sub-test	Avg. Power (dBm) Channel			Power Class 3 Limitation (dBm)	Comments
		4132	4183	4233		
HSDPA (B5)	1	23.99	23.97	24.27	20.3dBm – 25.7dBm	Pass
	2	24.13	24	24.02	20.3dBm – 25.7dBm	Pass
	3	23.53	23.49	23.78	19.8dBm – 25.7dBm	Pass
	4	23.58	23.53	23.84	19.8dBm – 25.7dBm	Pass

Unless otherwise stated the results shown in this test report refer only to the sample(s) tested and such sample(s) are retained for 90 days only.

除非另有說明，此報告結果僅對測試之樣品負責，同時此樣品僅保留90天。本報告未經本公司書面許可，不可部份複製。

This document is issued by the Company subject to its General Conditions of Service printed overleaf, available on request or accessible at www.sgs.com/terms_and_conditions.htm and, for electronic format documents, subject to Terms and Conditions for Electronic Documents at www.sgs.com/terms_e-document.htm. Attention is drawn to the limitation of liability, indemnification and jurisdiction issues defined therein. Any holder of this document is advised that information contained hereon reflects the Company's findings at the time of its intervention only and within the limits of Client's instructions, if any. The Company's sole responsibility is to its Client and this document does not exonerate parties to a transaction from exercising all their rights and obligations under the transaction documents. This document cannot be reproduced except in full, without prior written approval of the Company. Any unauthorized alteration, forgery or falsification of the content or appearance of this document is unlawful and offenders may be prosecuted to the fullest extent of the law.

6.5.1.4.: HSPA (HSDPA & HSUPA) Release 6 mode

The following 5 Sub-Tests were completed according to the test requirements outlined in section 5.2A of the 3GPP TS34.121-1 V8.4.0 specification. All TX RMS power requirements for Power Class 3 were met according to table 5.2AA.5 and 5.2B.5 All UE channels and power ratio's are set according to table C11.1.3 in the 3GPP TS34.121-1 V8.4.0. RMC 12.2kps is used for this testing

HSPA SUB-TEST Setting

Table C.11.1.3: β values for transmitter characteristics tests with HS-DPCCH and E-DCH(FOR HSUPA)

Sub-test	β_c	β_d	β_d (SF)	β_c/β_d	β_{HS}	β_{ec}	β_{ed}	β_{ed} (SF)	β_{ed} (Codes)	CM (dB)	MPR (dB)	AG Index	E-TFCI	RMC (Kbps)
1	11/15 (Note 3)	15/15 (Note 3)	64	11/15 (Note 3)	22/15	209/225	1309/225	4	1	1.0	0.0	20	75	12.2
2	6/15	15/15	64	6/15	12/15	12/15	94/75	4	1	3.0	2.0	12	67	12.2
3	15/15	9/15	64	15/9	30/15	30/15	β_{ed1} : 47/15 β_{ed2} : 47/15	4 4	2	2.0	1.0	15	92	12.2
4	2/15	15/15	64	2/15	4/15	2/15	56/75	4	1	3.0	2.0	17	71	12.2
5	15/15 (Note 4)	15/15 (Note 4)	64	15/15 (Note 4)	30/15	24/15	134/15	4	1	1.0	0.0	21	81	12.2

Note: The recommended HSUPA MPRs are implemented as per following sub-tests.

Unless otherwise stated the results shown in this test report refer only to the sample(s) tested and such sample(s) are retained for 90 days only.

除非另有說明，此報告結果僅對測試之樣品負責，同時此樣品僅保留90天。本報告未經本公司書面許可，不可部份複製。

This document is issued by the Company subject to its General Conditions of Service printed overleaf, available on request or accessible at www.sgs.com/terms_and_conditions.htm and, for electronic format documents, subject to Terms and Conditions for Electronic Documents at www.sgs.com/terms_e-document.htm. Attention is drawn to the limitation of liability, indemnification and jurisdiction issues defined therein. Any holder of this document is advised that information contained hereon reflects the Company's findings at the time of its intervention only and within the limits of Client's instructions, if any. The Company's sole responsibility is to its Client and this document does not exonerate parties to a transaction from exercising all their rights and obligations under the transaction documents. This document cannot be reproduced except in full, without prior written approval of the Company. Any unauthorized alteration, forgery or falsification of the content or appearance of this document is unlawful and offenders may be prosecuted to the fullest extent of the law.

Results:

Mode	Sub-test	Avg. Power (dBm) Channel			Power Class 3 Limitation (dBm)	Comments
		9262	9400	9538		
HSUPA(B2)	1	24	24.26	23.54	18.8dBm – 25.7dBm	Pass
	2	22.05	22.33	21.58	16.8dBm – 25.7dBm	Pass
	3	23.06	23.28	22.62	17.8dBm – 25.7dBm	Pass
	4	22.18	22.38	21.62	16.8dBm – 25.7dBm	Pass
	5	23.89	24.12	23.45	18.8dBm – 25.7dBm	Pass

Mode	Sub-test	Avg. Power (dBm) Channel			Power Class 3 Limitation (dBm)	Comments
		1312	1412	1513		
HSUPA(B4)	1	24.03	23.94	24.03	18.8dBm – 25.7dBm	Pass
	2	22.08	22.01	22.07	16.8dBm – 25.7dBm	Pass
	3	23.09	22.96	23.11	17.8dBm – 25.7dBm	Pass
	4	22.21	22.06	22.11	16.8dBm – 25.7dBm	Pass
	5	23.92	23.80	23.94	18.8dBm – 25.7dBm	Pass

Mode	Sub-test	Avg. Power (dBm) Channel			Power Class 3 Limitation (dBm)	Comments
		4132	4183	4233		
HSUPA(B5)	1	24.16	24.04	24.07	18.8dBm – 25.7dBm	Pass
	2	22.22	22.12	22.11	16.8dBm – 25.7dBm	Pass
	3	23.2	23.1	23.15	17.8dBm – 25.7dBm	Pass
	4	22.27	22.18	22.19	16.8dBm – 25.7dBm	Pass
	5	24.02	23.87	23.96	18.8dBm – 25.7dBm	Pass

Unless otherwise stated the results shown in this test report refer only to the sample(s) tested and such sample(s) are retained for 90 days only.

除非另有說明，此報告結果僅對測試之樣品負責，同時此樣品僅保留90天。本報告未經本公司書面許可，不可部份複製。

This document is issued by the Company subject to its General Conditions of Service printed overleaf, available on request or accessible at www.sgs.com/terms_and_conditions.htm and, for electronic format documents, subject to Terms and Conditions for Electronic Documents at www.sgs.com/terms_e-document.htm. Attention is drawn to the limitation of liability, indemnification and jurisdiction issues defined therein. Any holder of this document is advised that information contained hereon reflects the Company's findings at the time of its intervention only and within the limits of Client's instructions, if any. The Company's sole responsibility is to its Client and this document does not exonerate parties to a transaction from exercising all their rights and obligations under the transaction documents. This document cannot be reproduced except in full, without prior written approval of the Company. Any unauthorized alteration, forgery or falsification of the content or appearance of this document is unlawful and offenders may be prosecuted to the fullest extent of the law.

6.5.2. Minimum Communications Power Measurement

PCS 1900 band

PCL	0	1	2	3	4	5	6	7	8
Output power (dBm)	29.3	27.8	24.5	23.8	21.8	19.8	17.8	15.6	13.6

PCL	9	10	11	12	13	14	15
Output power (dBm)	11.8	9.7	7.8	5.6	3.7	1.8	-0.3

Note: The EUT output power was controlled by simulator. Set Communication Tester CMU200 PCL as above, and get the mobile phone output power reading.

WCDMA/HSDPA/HSUPA band II, IV, V

The EUT output power was controlled by simulator. Set Communication Tester CMU200 function key “UE Power Control” and enter max rated power 24dBm. The EUT is going to be set to max output power to 24dBm. Then record the read (see page 15 for measurement data) . The min. power was measures by a function key “minimum power” then record the read. It is -52.3dBm. The power variation can be 0.1dB step by setting.

Unless otherwise stated the results shown in this test report refer only to the sample(s) tested and such sample(s) are retained for 90 days only.

除非另有說明，此報告結果僅對測試之樣品負責，同時此樣品僅保留90天。本報告未經本公司書面許可，不可部份複製。

This document is issued by the Company subject to its General Conditions of Service printed overleaf, available on request or accessible at www.sgs.com/terms_and_conditions.htm and, for electronic format documents, subject to Terms and Conditions for Electronic Documents at www.sgs.com/terms_e-document.htm. Attention is drawn to the limitation of liability, indemnification and jurisdiction issues defined therein. Any holder of this document is advised that information contained hereon reflects the Company's findings at the time of its intervention only and within the limits of Client's instructions, if any. The Company's sole responsibility is to its Client and this document does not exonerate parties to a transaction from exercising all their rights and obligations under the transaction documents. This document cannot be reproduced except in full, without prior written approval of the Company. Any unauthorized alteration, forgery or falsification of the content or appearance of this document is unlawful and offenders may be prosecuted to the fullest extent of the law.

7. ERP, EIRP MEASUREMENT

7.1. Standard Applicable:

According to FCC §2.1046

FCC 22.913(a) Mobile station is limited to 7W ERP.

FCC 24.232(b) Mobile station is limited to 2W EIRP.

FCC 27.50(d)(4) Fixed, mobile, and portable (hand-held) stations are limited to 1W EIRP.

According to IC RSS-133 §6.4

The peak e.i.r.p. for transmitters operating in the band 1850-1910 MHz shall not exceed the limits 2W which given in SRSP-510.

According to issue 3 of RSS 132, section 5.4. The transmitter output power shall not exceed the limits 11.5W / 40.60 dBm given in SRSP-503.

According to issue 2 of RSS 139, section 6.4 The transmitter output power shall not exceed the limits 1W given in SRSP-513.

The average equivalent isotropically radiated power (e.i.r.p.) for fixed, mobile and portable transmitters in the 1710-1755 MHz shall not exceed 1 watt.

Unless otherwise stated the results shown in this test report refer only to the sample(s) tested and such sample(s) are retained for 90 days only.

除非另有說明，此報告結果僅對測試之樣品負責，同時此樣品僅保留90天。本報告未經本公司書面許可，不可部份複製。

This document is issued by the Company subject to its General Conditions of Service printed overleaf, available on request or accessible at www.sgs.com/terms_and_conditions.htm and, for electronic format documents, subject to Terms and Conditions for Electronic Documents at www.sgs.com/terms_e-document.htm. Attention is drawn to the limitation of liability, indemnification and jurisdiction issues defined therein. Any holder of this document is advised that information contained hereon reflects the Company's findings at the time of its intervention only and within the limits of Client's instructions, if any. The Company's sole responsibility is to its Client and this document does not exonerate parties to a transaction from exercising all their rights and obligations under the transaction documents. This document cannot be reproduced except in full, without prior written approval of the Company. Any unauthorized alteration, forgery or falsification of the content or appearance of this document is unlawful and offenders may be prosecuted to the fullest extent of the law.

7.2. Test SET-UP (Block Diagram of Configuration):

(A) Radiated Power Test Set-Up, Frequency Below 1000MHz

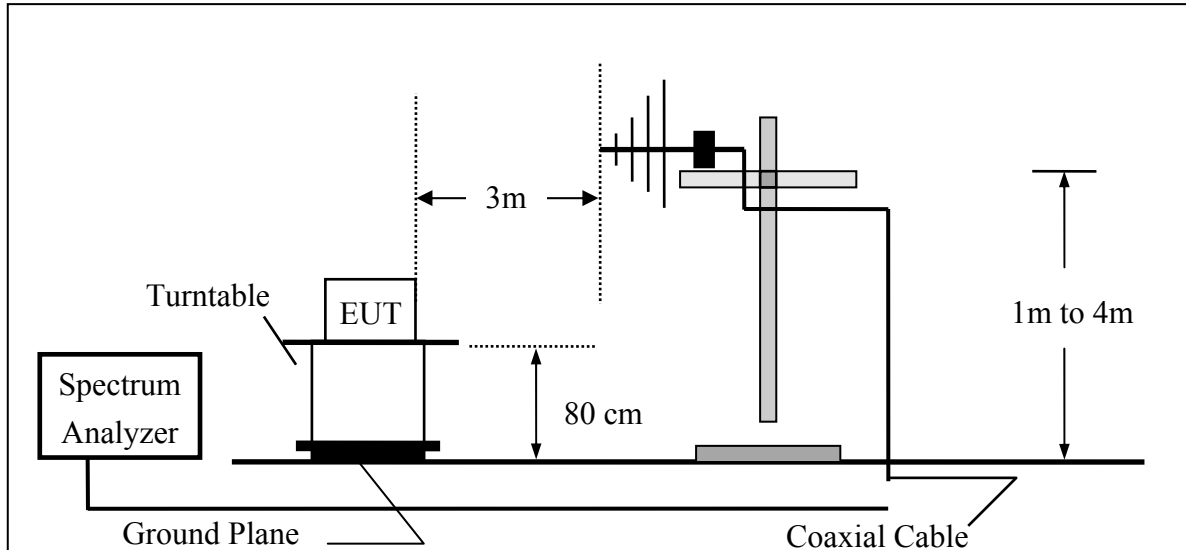

Unless otherwise stated the results shown in this test report refer only to the sample(s) tested and such sample(s) are retained for 90 days only.

除非另有說明，此報告結果僅對測試之樣品負責，同時此樣品僅保留90天。本報告未經本公司書面許可，不可部份複製。

This document is issued by the Company subject to its General Conditions of Service printed overleaf, available on request or accessible at www.sgs.com/terms_and_conditions.htm and, for electronic format documents, subject to Terms and Conditions for Electronic Documents at www.sgs.com/terms_e-document.htm. Attention is drawn to the limitation of liability, indemnification and jurisdiction issues defined therein. Any holder of this document is advised that information contained hereon reflects the Company's findings at the time of its intervention only and within the limits of Client's instructions, if any. The Company's sole responsibility is to its Client and this document does not exonerate parties to a transaction from exercising all their rights and obligations under the transaction documents. This document cannot be reproduced except in full, without prior written approval of the Company. Any unauthorized alteration, forgery or falsification of the content or appearance of this document is unlawful and offenders may be prosecuted to the fullest extent of the law.

(B) Radiated Power Test Set-UP Frequency Over 1 GHz

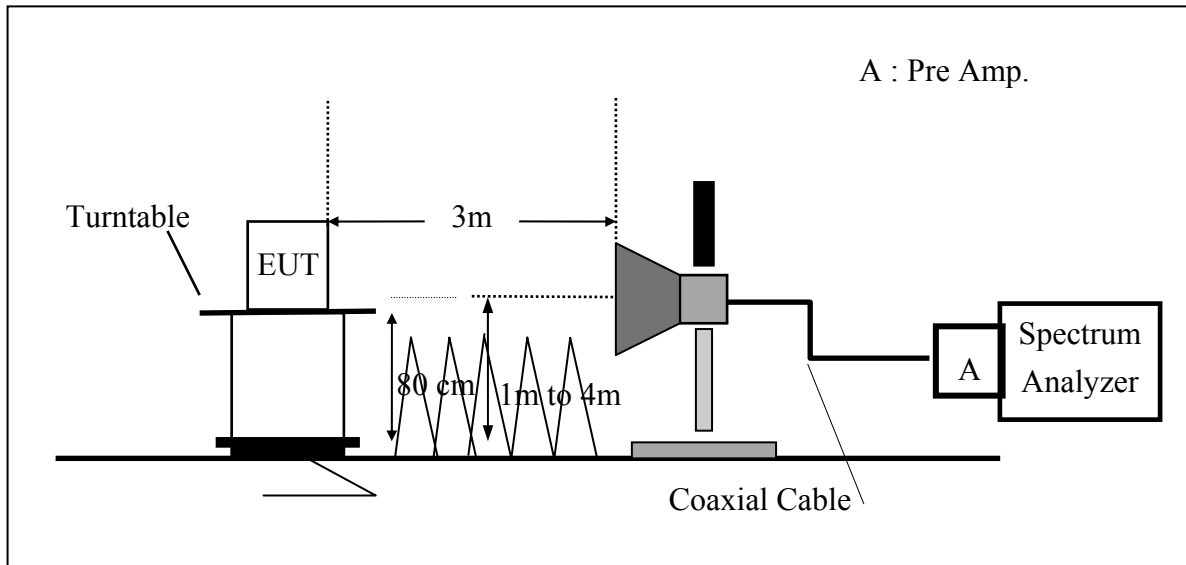

(C) Substituted Method Test Set-UP

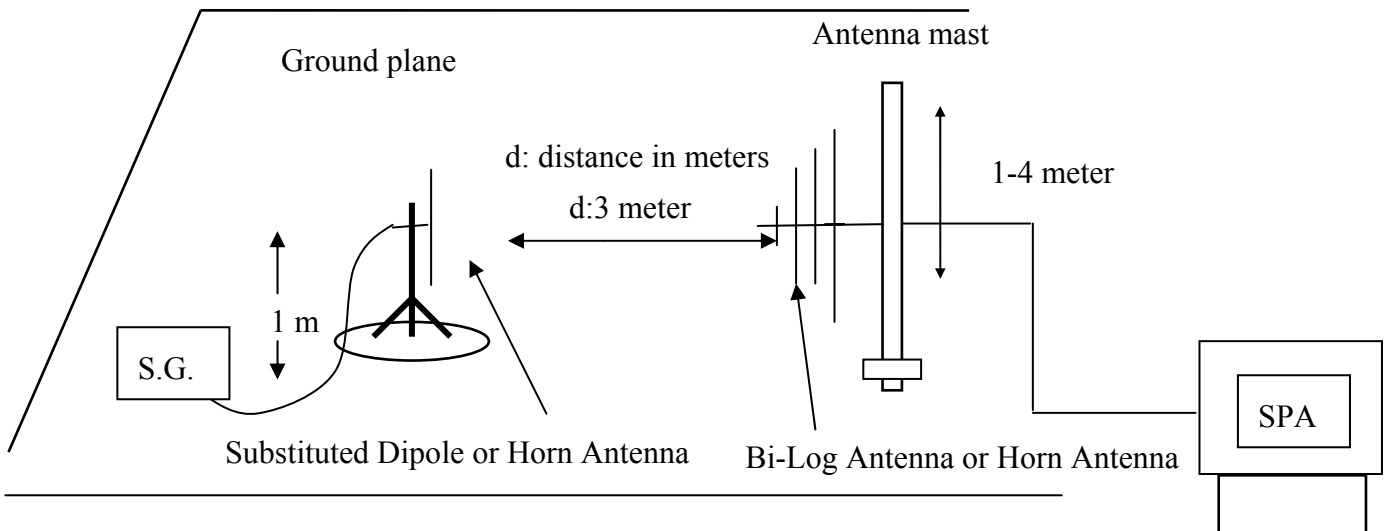

Unless otherwise stated the results shown in this test report refer only to the sample(s) tested and such sample(s) are retained for 90 days only.

除非另有說明，此報告結果僅對測試之樣品負責，同時此樣品僅保留90天。本報告未經本公司書面許可，不可部份複製。

This document is issued by the Company subject to its General Conditions of Service printed overleaf, available on request or accessible at www.sgs.com/terms_and_conditions.htm and, for electronic format documents, subject to Terms and Conditions for Electronic Documents at www.sgs.com/terms_e-document.htm. Attention is drawn to the limitation of liability, indemnification and jurisdiction issues defined therein. Any holder of this document is advised that information contained hereon reflects the Company's findings at the time of its intervention only and within the limits of Client's instructions, if any. The Company's sole responsibility is to its Client and this document does not exonerate parties to a transaction from exercising all their rights and obligations under the transaction documents. This document cannot be reproduced except in full, without prior written approval of the Company. Any unauthorized alteration, forgery or falsification of the content or appearance of this document is unlawful and offenders may be prosecuted to the fullest extent of the law.

7.3. Measurement Procedure:

The EUT was placed on a non-conductive turntable using a non-conductive support. The radiated emission at the fundamental frequency was measured at 3 m with a test antenna and EMI spectrum analyzer.

During the measurement, the EUT was communication with the station. The highest emission was recorded with the rotation of the turntable and the lowering of the test antenna from 4m to 1m. The reading was recorded and the field strength (E in dBuV/m) was calculated.

ERP in frequency band 824.2 –848.80MHz were measured using a substitution method. The EUT was replaced by dipole antenna connected, the S.G. output was recorded and ERP was calculated as follows:

EIRP in frequency band 1710-1755MHz and 1850.2 –1909.8MHz were measured using a substitution method. The EUT was replaced by a horn antenna connected, the S.G. output was recorded and EIRP was calculated as follows:

$$\text{ERP} = \text{S.G. output (dBm)} + \text{Antenna Gain (dBd)} - \text{Cable Loss (dB)}$$

$$\text{EIRP} = \text{S.G. output (dBm)} + \text{Antenna Gain (dBi)} - \text{Cable Loss (dB)}$$

Spectrum setting:

1. Detector = Peak, marker the highest value of the detector by maximum hold, set RBW wide enough to capture the entire signal of emission, and VBW $\geq 3 \times \text{RBW}$.

Or,

2. KDB 971168 D01 Power Meas License Digital Systems v01 is adopted, and the procedure as lists under item 4, Measurement of the Average Power over the Fundamental Signal Bandwidth, is followed to set correspondingly for the acquisition of proper measurement data.

Set frequency = nominal signal center frequency;

Set span = 2 X occupied BW;

Set RBW $\approx 1 \sim 5\%$ of the span, not to exceed 1 MHz

Set VBW = 3 x RBW;

Select average power (RMS) detector

Set sweep time and number of measurement points to achieve a minimum of 1 millisecond/pt integration time (ex. Point = 601points, then sweep time = $601 * 10^{-3} = 6\text{s}$).

Unless otherwise stated the results shown in this test report refer only to the sample(s) tested and such sample(s) are retained for 90 days only.

除非另有說明，此報告結果僅對測試之樣品負責，同時此樣品僅保留90天。本報告未經本公司書面許可，不可部份複製。

This document is issued by the Company subject to its General Conditions of Service printed overleaf, available on request or accessible at www.sgs.com/terms_and_conditions.htm and, for electronic format documents, subject to Terms and Conditions for Electronic Documents at www.sgs.com/terms_e-document.htm. Attention is drawn to the limitation of liability, indemnification and jurisdiction issues defined therein. Any holder of this document is advised that information contained hereon reflects the Company's findings at the time of its intervention only and within the limits of Client's instructions, if any. The Company's sole responsibility is to its Client and this document does not exonerate parties to a transaction from exercising all their rights and obligations under the transaction documents. This document cannot be reproduced except in full, without prior written approval of the Company. Any unauthorized alteration, forgery or falsification of the content or appearance of this document is unlawful and offenders may be prosecuted to the fullest extent of the law.

Activate trace averaging routine over a minimum of 10 sweeps;
Activate marker/span pair and set span = signal or channel bandwidth;
Activate the band/interval power marker function;
Record the band power level;

Record adjusted value as the average signal power level. Then activate the occupied bandwidth measurement function.

7.4. Measurement Equipment Used:

Refer to section 2.4 in this report

Unless otherwise stated the results shown in this test report refer only to the sample(s) tested and such sample(s) are retained for 90 days only.

除非另有說明，此報告結果僅對測試之樣品負責，同時此樣品僅保留90天。本報告未經本公司書面許可，不可部份複製。

This document is issued by the Company subject to its General Conditions of Service printed overleaf, available on request or accessible at www.sgs.com/terms_and_conditions.htm and, for electronic format documents, subject to Terms and Conditions for Electronic Documents at www.sgs.com/terms_e-document.htm. Attention is drawn to the limitation of liability, indemnification and jurisdiction issues defined therein. Any holder of this document is advised that information contained hereon reflects the Company's findings at the time of its intervention only and within the limits of Client's instructions, if any. The Company's sole responsibility is to its Client and this document does not exonerate parties to a transaction from exercising all their rights and obligations under the transaction documents. This document cannot be reproduced except in full, without prior written approval of the Company. Any unauthorized alteration, forgery or falsification of the content or appearance of this document is unlawful and offenders may be prosecuted to the fullest extent of the law.

7.5. Measurement Result: (Peak) –using option of peak measurement

EUT				Measurement					
Operation Band	Pol.	Fundamental Frequency	CH	Antenna Pol.	S.G. Output	Antenna Gain	Cable Loss	ERP	Limit
		MHz		V/H	dBm	dBd	dB	dBm	dBm
GSM 850	H	824.20	128	V	24.19	3.96	-2.8	25.35	38.45
				H	23.22	3.96	-2.8	24.38	38.45
		836.60	190	V	24.14	4	-2.82	25.32	38.45
				H	22.61	4	-2.82	23.78	38.45
		848.80	251	V	24.46	4.03	-2.84	25.65	38.45
				H	22.75	4.03	-2.84	23.94	38.45
	E1	824.20	128	V	21.79	3.96	-2.8	22.95	38.45
				H	22.88	3.96	-2.8	24.05	38.45
		836.60	190	V	21.41	4	-2.82	22.59	38.45
				H	23.27	4	-2.82	24.45	38.45
		848.80	251	V	22.47	4.03	-2.84	23.66	38.45
				H	23.11	4.03	-2.84	24.29	38.45
	E2	824.20	128	V	21.91	3.96	-2.8	23.07	38.45
				H	24.54	3.96	-2.8	25.71	38.45
		836.60	190	V	21.76	4	-2.82	22.93	38.45
				H	24.66	4	-2.82	25.84	38.45
		848.80	251	V	22.29	4.03	-2.84	23.48	38.45
				H	24.89	4.03	-2.84	26.08	38.45

Remark :

- (1) The RBW,VBW of SPA for measurement RBW=300 KHz, VBW=1MHz

Unless otherwise stated the results shown in this test report refer only to the sample(s) tested and such sample(s) are retained for 90 days only.

除非另有說明，此報告結果僅對測試之樣品負責，同時此樣品僅保留90天。本報告未經本公司書面許可，不可部份複製。

This document is issued by the Company subject to its General Conditions of Service printed overleaf, available on request or accessible at www.sgs.com/terms_and_conditions.htm and, for electronic format documents, subject to Terms and Conditions for Electronic Documents at www.sgs.com/terms_e-document.htm. Attention is drawn to the limitation of liability, indemnification and jurisdiction issues defined therein. Any holder of this document is advised that information contained hereon reflects the Company's findings at the time of its intervention only and within the limits of Client's instructions, if any. The Company's sole responsibility is to its Client and this document does not exonerate parties to a transaction from exercising all their rights and obligations under the transaction documents. This document cannot be reproduced except in full, without prior written approval of the Company. Any unauthorized alteration, forgery or falsification of the content or appearance of this document is unlawful and offenders may be prosecuted to the fullest extent of the law.

EUT				Measurement					
Operation Band	Pol.	Fundamental Frequency	CH	Antenna Pol.	S.G. Output	Antenna Gain	Cable Loss	EIRP	Limit
		MHz		V/H	dBm	dBi	dB	dBm	dBm
GSM 1900	H	1850.20	512	V	29.78	4.17	-4.29	29.66	33.00
				H	24.33	4.51	-4.29	24.55	33.00
		1880.00	661	V	29.04	4.13	-4.33	28.84	33.00
				H	27.17	4.44	-4.33	27.28	33.00
		1909.80	810	V	26.73	4.09	-4.37	26.46	33.00
				H	25.34	4.36	-4.37	25.34	33.00
	E1	1850.20	512	V	30.67	4.17	-4.29	30.55	33.00
				H	26.21	4.51	-4.29	26.43	33.00
		1880.00	661	V	31.6	4.13	-4.33	31.41	33.00
				H	27.12	4.44	-4.33	27.22	33.00
		1909.80	810	V	28.47	4.09	-4.37	28.2	33.00
				H	25.58	4.36	-4.37	25.58	33.00
	E2	1850.20	512	V	26.65	4.17	-4.29	26.53	33.00
				H	28.98	4.51	-4.29	29.2	33.00
		1880.00	661	V	28.51	4.13	-4.33	28.31	33.00
				H	28.66	4.44	-4.33	28.77	33.00
		1909.80	810	V	27.78	4.09	-4.37	27.51	33.00
				H	28.35	4.36	-4.37	28.35	33.00

Remark :

- (1) The RBW,VBW of SPA for measurement RBW=300K, VBW=1MHz

Unless otherwise stated the results shown in this test report refer only to the sample(s) tested and such sample(s) are retained for 90 days only.

除非另有說明，此報告結果僅對測試之樣品負責，同時此樣品僅保留90天。本報告未經本公司書面許可，不可部份複製。

This document is issued by the Company subject to its General Conditions of Service printed overleaf, available on request or accessible at www.sgs.com/terms_and_conditions.htm and, for electronic format documents, subject to Terms and Conditions for Electronic Documents at www.sgs.com/terms_e-document.htm. Attention is drawn to the limitation of liability, indemnification and jurisdiction issues defined therein. Any holder of this document is advised that information contained hereon reflects the Company's findings at the time of its intervention only and within the limits of Client's instructions, if any. The Company's sole responsibility is to its Client and this document does not exonerate parties to a transaction from exercising all their rights and obligations under the transaction documents. This document cannot be reproduced except in full, without prior written approval of the Company. Any unauthorized alteration, forgery or falsification of the content or appearance of this document is unlawful and offenders may be prosecuted to the fullest extent of the law.

EUT				Measurement					
Operation Band	Pol.	Fundamental Frequency	CH	Antenna Pol.	S.G. Output	Antenna Gain	Cable Loss	ERP	Limit
		MHz		V/H	dBm	dBd	dB	dBm	dBm
GPRS 850	H	824.20	128	V	24.19	3.96	-2.8	25.35	38.45
				H	23.14	3.96	-2.8	24.3	38.45
		836.60	190	V	23.88	4	-2.82	25.06	38.45
				H	22.63	4	-2.82	23.8	38.45
		848.80	251	V	24.23	4.03	-2.84	25.42	38.45
				H	22.77	4.03	-2.84	23.96	38.45
	E1	824.20	128	V	21.66	3.96	-2.8	22.82	38.45
				H	22.96	3.96	-2.8	24.12	38.45
		836.60	190	V	21.43	4	-2.82	22.61	38.45
				H	23.26	4	-2.82	24.44	38.45
		848.80	251	V	22.49	4.03	-2.84	23.67	38.45
				H	23.09	4.03	-2.84	24.27	38.45
	E2	824.20	128	V	22	3.96	-2.8	23.16	38.45
				H	24.58	3.96	-2.8	25.75	38.45
		836.60	190	V	21.79	4	-2.82	22.97	38.45
				H	24.69	4	-2.82	25.87	38.45
		848.80	251	V	22.32	4.03	-2.84	23.51	38.45
				H	24.87	4.03	-2.84	26.05	38.45

Remark :

- (1) The RBW,VBW of SPA for measurement RBW=300 KHz, VBW=1MHz

Unless otherwise stated the results shown in this test report refer only to the sample(s) tested and such sample(s) are retained for 90 days only.

除非另有說明，此報告結果僅對測試之樣品負責，同時此樣品僅保留90天。本報告未經本公司書面許可，不可部份複製。

This document is issued by the Company subject to its General Conditions of Service printed overleaf, available on request or accessible at www.sgs.com/terms_and_conditions.htm and, for electronic format documents, subject to Terms and Conditions for Electronic Documents at www.sgs.com/terms_e-document.htm. Attention is drawn to the limitation of liability, indemnification and jurisdiction issues defined therein. Any holder of this document is advised that information contained hereon reflects the Company's findings at the time of its intervention only and within the limits of Client's instructions, if any. The Company's sole responsibility is to its Client and this document does not exonerate parties to a transaction from exercising all their rights and obligations under the transaction documents. This document cannot be reproduced except in full, without prior written approval of the Company. Any unauthorized alteration, forgery or falsification of the content or appearance of this document is unlawful and offenders may be prosecuted to the fullest extent of the law.

EUT				Measurement					
Operation Band	Pol.	Fundamental Frequency	CH	Antenna Pol.	S.G. Output	Antenna Gain	Cable Loss	EIRP	Limit
		MHz		V/H	dBm	dBi	dB	dBm	dBm
GPRS 1900	H	1850.20	512	V	29.3	4.17	-4.29	29.18	33.00
				H	26.49	4.51	-4.29	26.71	33.00
		1880.00	661	V	28.9	4.13	-4.33	28.7	33.00
				H	26.1	4.44	-4.33	26.21	33.00
		1909.80	810	V	26.42	4.09	-4.37	26.14	33.00
				H	22.49	4.36	-4.37	22.49	33.00
	E1	1850.20	512	V	30.57	4.17	-4.29	30.45	33.00
				H	25.89	4.51	-4.29	26.11	33.00
		1880.00	661	V	31.38	4.13	-4.33	31.18	33.00
				H	26.93	4.44	-4.33	27.03	33.00
		1909.80	810	V	28.31	4.09	-4.37	28.04	33.00
				H	25.31	4.36	-4.37	25.31	33.00
	E2	1850.20	512	V	26.64	4.17	-4.29	26.52	33.00
				H	29.22	4.51	-4.29	29.44	33.00
		1880.00	661	V	28.21	4.13	-4.33	28.02	33.00
				H	28.88	4.44	-4.33	28.99	33.00
		1909.80	810	V	27.51	4.09	-4.37	27.23	33.00
				H	28.83	4.36	-4.37	28.83	33.00

Remark :

- (1) The RBW,VBW of SPA for measurement RBW=300 KHz, VBW=1MHz

Unless otherwise stated the results shown in this test report refer only to the sample(s) tested and such sample(s) are retained for 90 days only.

除非另有說明，此報告結果僅對測試之樣品負責，同時此樣品僅保留90天。本報告未經本公司書面許可，不可部份複製。

This document is issued by the Company subject to its General Conditions of Service printed overleaf, available on request or accessible at www.sgs.com/terms_and_conditions.htm and, for electronic format documents, subject to Terms and Conditions for Electronic Documents at www.sgs.com/terms_e-document.htm. Attention is drawn to the limitation of liability, indemnification and jurisdiction issues defined therein. Any holder of this document is advised that information contained hereon reflects the Company's findings at the time of its intervention only and within the limits of Client's instructions, if any. The Company's sole responsibility is to its Client and this document does not exonerate parties to a transaction from exercising all their rights and obligations under the transaction documents. This document cannot be reproduced except in full, without prior written approval of the Company. Any unauthorized alteration, forgery or falsification of the content or appearance of this document is unlawful and offenders may be prosecuted to the fullest extent of the law.

EUT				Measurement					
Operation Band	Pol.	Fundamental Frequency	CH	Antenna Pol.	S.G. Output	Antenna Gain	Cable Loss	ERP	Limit
		MHz		V/H	dBm	dBd	dB	dBm	dBm
EDGE 850	H	824.20	128	V	21.37	3.96	-2.8	22.54	38.45
				H	19.94	3.96	-2.8	21.11	38.45
		836.60	190	V	20.88	4	-2.82	22.05	38.45
				H	19.29	4	-2.82	20.47	38.45
		848.80	251	V	21.28	4.03	-2.84	22.47	38.45
				H	19.42	4.03	-2.84	20.6	38.45
	E1	824.20	128	V	18.06	3.96	-2.8	19.22	38.45
				H	19.57	3.96	-2.8	20.73	38.45
		836.60	190	V	18.09	4	-2.82	19.26	38.45
				H	20.32	4	-2.82	21.5	38.45
		848.80	251	V	19.47	4.03	-2.84	20.65	38.45
				H	20.23	4.03	-2.84	21.41	38.45
	E2	824.20	128	V	18.7	3.96	-2.8	19.87	38.45
				H	22.58	3.96	-2.8	23.75	38.45
		836.60	190	V	18.59	4	-2.82	19.77	38.45
				H	22.88	4	-2.82	24.05	38.45
		848.80	251	V	19.17	4.03	-2.84	20.36	38.45
				H	23.1	4.03	-2.84	24.28	38.45

Remark :

- (1) The RBW,VBW of SPA for measurement RBW=300 KHz, VBW=1MHz

Unless otherwise stated the results shown in this test report refer only to the sample(s) tested and such sample(s) are retained for 90 days only.

除非另有說明，此報告結果僅對測試之樣品負責，同時此樣品僅保留90天。本報告未經本公司書面許可，不可部份複製。

This document is issued by the Company subject to its General Conditions of Service printed overleaf, available on request or accessible at www.sgs.com/terms_and_conditions.htm and, for electronic format documents, subject to Terms and Conditions for Electronic Documents at www.sgs.com/terms_e-document.htm. Attention is drawn to the limitation of liability, indemnification and jurisdiction issues defined therein. Any holder of this document is advised that information contained hereon reflects the Company's findings at the time of its intervention only and within the limits of Client's instructions, if any. The Company's sole responsibility is to its Client and this document does not exonerate parties to a transaction from exercising all their rights and obligations under the transaction documents. This document cannot be reproduced except in full, without prior written approval of the Company. Any unauthorized alteration, forgery or falsification of the content or appearance of this document is unlawful and offenders may be prosecuted to the fullest extent of the law.

EUT				Measurement					
Operation Band	Pol.	Fundamental Frequency	CH	Antenna Pol.	S.G. Output	Antenna Gain	Cable Loss	EIRP	Limit
		MHz		V/H	dBm	dBi	dB	dBm	dBm
EDGE 1900	H	1850.20	512	V	27.62	4.17	-4.29	27.51	33.00
				H	24.89	4.51	-4.29	25.11	33.00
		1880.00	661	V	27.09	4.13	-4.33	26.89	33.00
				H	24.32	4.44	-4.33	24.43	33.00
		1909.80	810	V	24.67	4.09	-4.37	24.4	33.00
				H	20.68	4.36	-4.37	20.67	33.00
	E1	1850.20	512	V	28.61	4.17	-4.29	28.49	33.00
				H	24.03	4.51	-4.29	24.25	33.00
		1880.00	661	V	29.58	4.13	-4.33	29.39	33.00
				H	25.1	4.44	-4.33	25.21	33.00
		1909.80	810	V	26.62	4.09	-4.37	26.35	33.00
				H	23.63	4.36	-4.37	23.62	33.00
	E2	1850.20	512	V	24.8	4.17	-4.29	24.68	33.00
				H	27.38	4.51	-4.29	27.6	33.00
		1880.00	661	V	26.49	4.13	-4.33	26.29	33.00
				H	27.07	4.44	-4.33	27.18	33.00
		1909.80	810	V	25.57	4.09	-4.37	25.3	33.00
				H	26.89	4.36	-4.37	26.89	33.00

Remark :

- (1) The RBW,VBW of SPA for measurement RBW=300 KHz, VBW=1MHz

Unless otherwise stated the results shown in this test report refer only to the sample(s) tested and such sample(s) are retained for 90 days only.

除非另有說明，此報告結果僅對測試之樣品負責，同時此樣品僅保留90天。本報告未經本公司書面許可，不可部份複製。

This document is issued by the Company subject to its General Conditions of Service printed overleaf, available on request or accessible at www.sgs.com/terms_and_conditions.htm and, for electronic format documents, subject to Terms and Conditions for Electronic Documents at www.sgs.com/terms_e-document.htm. Attention is drawn to the limitation of liability, indemnification and jurisdiction issues defined therein. Any holder of this document is advised that information contained hereon reflects the Company's findings at the time of its intervention only and within the limits of Client's instructions, if any. The Company's sole responsibility is to its Client and this document does not exonerate parties to a transaction from exercising all their rights and obligations under the transaction documents. This document cannot be reproduced except in full, without prior written approval of the Company. Any unauthorized alteration, forgery or falsification of the content or appearance of this document is unlawful and offenders may be prosecuted to the fullest extent of the law.

EUT				Measurement					
Operation Band	Pol.	Fundamental Frequency	CH	Antenna Pol.	S.G. Output	Antenna Gain	Cable Loss	EIRP	Limit
		MHz		V/H	dBm	dBi	dB	dBm	dBm
WCDMA Band II	H	1852.4	9262	V	26.44	4.17	-4.3	26.31	33.00
				H	23.48	4.51	-4.3	23.69	33.00
		1880.0	9400	V	25.86	4.13	-4.33	25.66	33.00
				H	22.96	4.44	-4.33	23.07	33.00
		1907.6	9538	V	23.65	4.1	-4.36	23.38	33.00
				H	19.74	4.37	-4.36	19.75	33.00
	E1	1852.4	9262	V	26.91	4.17	-4.3	26.78	33.00
				H	23.13	4.51	-4.3	23.34	33.00
		1880.0	9400	V	27.93	4.13	-4.33	27.74	33.00
				H	22.85	4.44	-4.33	22.96	33.00
		1907.6	9538	V	24.6	4.1	-4.36	24.33	33.00
				H	22.63	4.37	-4.36	22.64	33.00
	E2	1852.4	9262	V	22.95	4.17	-4.3	22.82	33.00
				H	27.17	4.51	-4.3	27.39	33.00
		1880.0	9400	V	25.01	4.13	-4.33	24.81	33.00
				H	26.47	4.44	-4.33	26.57	33.00
		1907.6	9538	V	23.74	4.1	-4.36	23.47	33.00
				H	25.54	4.37	-4.36	25.54	33.00

Remark :

- (1) The RBW,VBW of SPA for measurement RBW= 5MHz , VBW= 8MHz

Unless otherwise stated the results shown in this test report refer only to the sample(s) tested and such sample(s) are retained for 90 days only.

除非另有說明，此報告結果僅對測試之樣品負責，同時此樣品僅保留90天。本報告未經本公司書面許可，不可部份複製。

This document is issued by the Company subject to its General Conditions of Service printed overleaf, available on request or accessible at www.sgs.com/terms_and_conditions.htm and, for electronic format documents, subject to Terms and Conditions for Electronic Documents at www.sgs.com/terms_e-document.htm. Attention is drawn to the limitation of liability, indemnification and jurisdiction issues defined therein. Any holder of this document is advised that information contained hereon reflects the Company's findings at the time of its intervention only and within the limits of Client's instructions, if any. The Company's sole responsibility is to its Client and this document does not exonerate parties to a transaction from exercising all their rights and obligations under the transaction documents. This document cannot be reproduced except in full, without prior written approval of the Company. Any unauthorized alteration, forgery or falsification of the content or appearance of this document is unlawful and offenders may be prosecuted to the fullest extent of the law.

EUT				Measurement					
Operation Band	Pol.	Fundamental Frequency	CH	Antenna Pol.	S.G. Output	Antenna Gain	Cable Loss	EIRP	Limit
		MHz		V/H	dBm	dBi	dB	dBm	dBm
WCDMA Band IV	H	1712.4	1312	V	26.21	4.4	-4.13	26.48	30.00
				H	22.57	4.79	-4.13	23.23	30.00
		1732.6	1413	V	27	4.4	-4.13	27.26	30.00
				H	23.08	4.79	-4.13	23.74	30.00
		1752.6	1513	V	25.47	4.4	-4.13	25.74	30.00
				H	28.55	4.79	-4.13	29.21	30.00
	E1	1712.4	1312	V	27.84	4.35	-4.16	28.04	30.00
				H	23.19	4.78	-4.16	23.81	30.00
		1732.6	1413	V	26.21	4.35	-4.16	26.4	30.00
				H	21.51	4.78	-4.16	22.13	30.00
		1752.6	1513	V	22.22	4.35	-4.16	22.41	30.00
				H	27.92	4.78	-4.16	28.55	30.00
	E2	1712.4	1312	V	26.05	4.31	-4.18	26.17	30.00
				H	21.5	4.76	-4.18	22.08	30.00
		1732.6	1413	V	26.8	4.31	-4.18	26.93	30.00
				H	22.46	4.76	-4.18	23.05	30.00
		1752.6	1513	V	24.13	4.31	-4.18	24.26	30.00
				H	28.04	4.77	-4.18	28.63	30.00

Remark :

- (1) The RBW,VBW of SPA for measurement RBW= 1MHz , VBW= 3MHz

Unless otherwise stated the results shown in this test report refer only to the sample(s) tested and such sample(s) are retained for 90 days only.

除非另有說明，此報告結果僅對測試之樣品負責，同時此樣品僅保留90天。本報告未經本公司書面許可，不可部份複製。

This document is issued by the Company subject to its General Conditions of Service printed overleaf, available on request or accessible at www.sgs.com/terms_and_conditions.htm and, for electronic format documents, subject to Terms and Conditions for Electronic Documents at www.sgs.com/terms_e-document.htm. Attention is drawn to the limitation of liability, indemnification and jurisdiction issues defined therein. Any holder of this document is advised that information contained hereon reflects the Company's findings at the time of its intervention only and within the limits of Client's instructions, if any. The Company's sole responsibility is to its Client and this document does not exonerate parties to a transaction from exercising all their rights and obligations under the transaction documents. This document cannot be reproduced except in full, without prior written approval of the Company. Any unauthorized alteration, forgery or falsification of the content or appearance of this document is unlawful and offenders may be prosecuted to the fullest extent of the law.

EUT				Measurement					
Operation Band	Pol.	Fundamental Frequency	CH	Antenna Pol.	S.G. Output	Antenna Gain	Cable Loss	ERP	Limit
		MHz		V/H	dBm	dBd	dB	dBm	dBm
WCDMA Band V	H	826.40	4132	V	18.66	3.97	-2.8	19.82	38.45
				H	15.42	3.97	-2.8	16.58	38.45
		836.60	4183	V	18.49	4	-2.82	19.67	38.45
				H	15.95	4	-2.82	17.12	38.45
		846.60	4233	V	19.98	4.02	-2.84	21.17	38.45
				H	16.56	4.02	-2.84	17.74	38.45
	E1	826.40	4132	V	13.71	3.97	-2.8	14.88	38.45
				H	19.1	3.97	-2.8	20.26	38.45
		836.60	4183	V	14.14	4	-2.82	15.32	38.45
				H	18.84	4	-2.82	20.01	38.45
		846.60	4233	V	16.96	4.02	-2.84	18.15	38.45
				H	20.51	4.02	-2.84	21.69	38.45
	E2	826.40	4132	V	15.2	3.97	-2.8	16.37	38.45
				H	19.21	3.97	-2.8	20.37	38.45
		836.60	4183	V	13.84	4	-2.82	15.02	38.45
				H	19.47	4	-2.82	20.65	38.45
		846.60	4233	V	14.88	4.02	-2.84	16.06	38.45
				H	19.85	4.02	-2.84	21.04	38.45

Remark :

- (1) The RBW,VBW of SPA for measurement RBW= 5MHz , VBW= 8MHz

Unless otherwise stated the results shown in this test report refer only to the sample(s) tested and such sample(s) are retained for 90 days only.

除非另有說明，此報告結果僅對測試之樣品負責，同時此樣品僅保留90天。本報告未經本公司書面許可，不可部份複製。

This document is issued by the Company subject to its General Conditions of Service printed overleaf, available on request or accessible at www.sgs.com/terms_and_conditions.htm and, for electronic format documents, subject to Terms and Conditions for Electronic Documents at www.sgs.com/terms_e-document.htm. Attention is drawn to the limitation of liability, indemnification and jurisdiction issues defined therein. Any holder of this document is advised that information contained hereon reflects the Company's findings at the time of its intervention only and within the limits of Client's instructions, if any. The Company's sole responsibility is to its Client and this document does not exonerate parties to a transaction from exercising all their rights and obligations under the transaction documents. This document cannot be reproduced except in full, without prior written approval of the Company. Any unauthorized alteration, forgery or falsification of the content or appearance of this document is unlawful and offenders may be prosecuted to the fullest extent of the law.

EUT				Measurement					
Operation Band	Pol.	Fundamental Frequency	CH	Antenna Pol.	S.G. Output	Antenna Gain	Cable Loss	EIRP	Limit
		MHz		V/H	dBm	dBi	dB	dBm	dBm
HSUPA Band II	H	1852.4	9262	V	26.14	4.17	-4.3	26.02	33.00
				H	23.4	4.51	-4.3	23.61	33.00
		1880.0	9400	V	25.44	4.13	-4.33	25.25	33.00
				H	22.41	4.44	-4.33	22.51	33.00
		1907.6	9538	V	23.99	4.1	-4.36	23.72	33.00
				H	19.31	4.37	-4.36	19.32	33.00
	E1	1852.4	9262	V	26.43	4.17	-4.3	26.3	33.00
				H	22.57	4.51	-4.29	22.78	33.00
		1880.0	9400	V	27.4	4.13	-4.33	27.2	33.00
				H	22.26	4.44	-4.33	22.37	33.00
		1907.6	9538	V	24.32	4.1	-4.36	24.06	33.00
				H	22.41	4.37	-4.36	22.42	33.00
	E2	1852.4	9262	V	21.5	4.17	-4.3	21.38	33.00
				H	22.48	4.51	-4.3	22.69	33.00
		1880.0	9400	V	23.48	4.13	-4.33	23.28	33.00
				H	23.59	4.44	-4.33	23.69	33.00
		1907.6	9538	V	22.57	4.1	-4.36	22.3	33.00
				H	24.27	4.37	-4.36	24.27	33.00

Remark :

- (1) The RBW,VBW of SPA for measurement RBW= 5MHz , VBW= 8MHz

Unless otherwise stated the results shown in this test report refer only to the sample(s) tested and such sample(s) are retained for 90 days only.

除非另有說明，此報告結果僅對測試之樣品負責，同時此樣品僅保留90天。本報告未經本公司書面許可，不可部份複製。

This document is issued by the Company subject to its General Conditions of Service printed overleaf, available on request or accessible at www.sgs.com/terms_and_conditions.htm and, for electronic format documents, subject to Terms and Conditions for Electronic Documents at www.sgs.com/terms_e-document.htm. Attention is drawn to the limitation of liability, indemnification and jurisdiction issues defined therein. Any holder of this document is advised that information contained hereon reflects the Company's findings at the time of its intervention only and within the limits of Client's instructions, if any. The Company's sole responsibility is to its Client and this document does not exonerate parties to a transaction from exercising all their rights and obligations under the transaction documents. This document cannot be reproduced except in full, without prior written approval of the Company. Any unauthorized alteration, forgery or falsification of the content or appearance of this document is unlawful and offenders may be prosecuted to the fullest extent of the law.

EUT				Measurement					
Operation Band	Pol.	Fundamental Frequency	CH	Antenna Pol.	S.G. Output	Antenna Gain	Cable Loss	EIRP	Limit
		MHz		V/H	dBm	dBi	dB	dBm	dBm
HSUPA Band IV	H	1712.4	1312	V	26.21	4.4	-4.13	26.9	30.00
				H	20.46	4.79	-4.13	21.12	30.00
		1732.6	1413	V	26.93	4.4	-4.13	27.2	30.00
				H	22.41	4.79	-4.13	23.07	30.00
		1752.6	1513	V	24.93	4.4	-4.13	25.2	30.00
				H	27.96	4.79	-4.13	28.62	30.00
	E1	1712.4	1312	V	27.65	4.35	-4.16	27.84	30.00
				H	21.08	4.78	-4.16	21.71	30.00
		1732.6	1413	V	26.44	4.35	-4.16	26.64	30.00
				H	21.21	4.78	-4.16	21.83	30.00
		1752.6	1513	V	22.11	4.35	-4.16	22.31	30.00
				H	27.47	4.78	-4.16	28.1	30.00
	E2	1712.4	1312	V	26.54	4.31	-4.18	26.66	30.00
				H	19.22	4.76	-4.18	19.81	30.00
		1732.6	1413	V	26.15	4.31	-4.18	26.28	30.00
				H	22.65	4.76	-4.18	23.23	30.00
		1752.6	1513	V	23.74	4.31	-4.18	23.87	30.00
				H	27.81	4.77	-4.18	28.39	30.00

Remark :

- (1) The RBW,VBW of SPA for measurement RBW= 1MHz , VBW= 3MHz

Unless otherwise stated the results shown in this test report refer only to the sample(s) tested and such sample(s) are retained for 90 days only.

除非另有說明，此報告結果僅對測試之樣品負責，同時此樣品僅保留90天。本報告未經本公司書面許可，不可部份複製。

This document is issued by the Company subject to its General Conditions of Service printed overleaf, available on request or accessible at www.sgs.com/terms_and_conditions.htm and, for electronic format documents, subject to Terms and Conditions for Electronic Documents at www.sgs.com/terms_e-document.htm. Attention is drawn to the limitation of liability, indemnification and jurisdiction issues defined therein. Any holder of this document is advised that information contained hereon reflects the Company's findings at the time of its intervention only and within the limits of Client's instructions, if any. The Company's sole responsibility is to its Client and this document does not exonerate parties to a transaction from exercising all their rights and obligations under the transaction documents. This document cannot be reproduced except in full, without prior written approval of the Company. Any unauthorized alteration, forgery or falsification of the content or appearance of this document is unlawful and offenders may be prosecuted to the fullest extent of the law.

EUT				Measurement					
Operation Band	Pol.	Fundamental Frequency	CH	Antenna Pol.	S.G. Output	Antenna Gain	Cable Loss	ERP	Limit
		MHz		V/H	dBm	dBd	dB	dBm	dBm
HSUPA Band V	H	826.40	4132	V	18.25	3.97	-2.8	19.42	38.45
				H	14.99	3.97	-2.8	16.15	38.45
		836.60	4183	V	18.04	4	-2.82	19.21	38.45
				H	15.59	4	-2.82	16.77	38.45
		846.60	4233	V	19.75	4.02	-2.84	20.94	38.45
				H	16.34	4.02	-2.84	17.52	38.45
	E1	826.40	4132	V	13.68	3.97	-2.8	14.84	38.45
				H	18.86	3.97	-2.8	20.02	38.45
		836.60	4183	V	13.66	4	-2.82	14.83	38.45
				H	18.49	4	-2.82	19.67	38.45
		846.60	4233	V	16.7	4.02	-2.84	17.88	38.45
				H	20.5	4.02	-2.84	21.69	38.45
	E2	826.40	4132	V	15	3.97	-2.8	16.17	38.45
				H	18.73	3.97	-2.8	19.89	38.45
		836.60	4183	V	13.6	4	-2.82	14.77	38.45
				H	18.96	4	-2.82	20.14	38.45
		846.60	4233	V	14.62	4.02	-2.84	15.81	38.45
				H	19.8	4.02	-2.84	20.99	38.45

Remark :

- (1) The RBW,VBW of SPA for measurement RBW= 5MHz , VBW= 8MHz

Unless otherwise stated the results shown in this test report refer only to the sample(s) tested and such sample(s) are retained for 90 days only.

除非另有說明，此報告結果僅對測試之樣品負責，同時此樣品僅保留90天。本報告未經本公司書面許可，不可部份複製。

This document is issued by the Company subject to its General Conditions of Service printed overleaf, available on request or accessible at www.sgs.com/terms_and_conditions.htm and, for electronic format documents, subject to Terms and Conditions for Electronic Documents at www.sgs.com/terms_e-document.htm. Attention is drawn to the limitation of liability, indemnification and jurisdiction issues defined therein. Any holder of this document is advised that information contained hereon reflects the Company's findings at the time of its intervention only and within the limits of Client's instructions, if any. The Company's sole responsibility is to its Client and this document does not exonerate parties to a transaction from exercising all their rights and obligations under the transaction documents. This document cannot be reproduced except in full, without prior written approval of the Company. Any unauthorized alteration, forgery or falsification of the content or appearance of this document is unlawful and offenders may be prosecuted to the fullest extent of the law.

EUT				Measurement					
Operation Band	Pol.	Fundamental Frequency	CH	Antenna Pol.	S.G. Output	Antenna Gain	Cable Loss	EIRP	Limit
		MHz		V/H	dBm	dBi	dB	dBm	dBm
HSDPA Band II	H	1852.4	9262	V	26.41	4.17	-4.3	26.28	33.00
				H	23.51	4.51	-4.3	23.73	33.00
		1880.0	9400	V	25.78	4.13	-4.33	25.59	33.00
				H	22.87	4.44	-4.33	22.98	33.00
		1907.6	9538	V	23.71	4.1	-4.36	23.45	33.00
				H	19.6	4.37	-4.36	19.61	33.00
	E1	1852.4	9262	V	26.8	4.17	-4.3	26.68	33.00
				H	23.8	4.51	-4.3	24.01	33.00
		1880.0	9400	V	27.77	4.13	-4.33	27.58	33.00
				H	22.7	4.44	-4.33	22.81	33.00
		1907.6	9538	V	24.5	4.1	-4.36	24.23	33.00
				H	22.66	4.37	-4.36	22.67	33.00
	E2	1852.4	9262	V	22.01	4.17	-4.3	21.88	33.00
				H	25.01	4.51	-4.3	25.22	33.00
		1880.0	9400	V	23.91	4.13	-4.33	23.72	33.00
				H	24.45	4.44	-4.33	24.56	33.00
		1907.6	9538	V	22.77	4.1	-4.36	22.51	33.00
				H	24.78	4.37	-4.36	24.79	33.00

Remark :

- (1) The RBW,VBW of SPA for measurement RBW= 5MHz , VBW= 8MHz

Unless otherwise stated the results shown in this test report refer only to the sample(s) tested and such sample(s) are retained for 90 days only.

除非另有說明，此報告結果僅對測試之樣品負責，同時此樣品僅保留90天。本報告未經本公司書面許可，不可部份複製。

This document is issued by the Company subject to its General Conditions of Service printed overleaf, available on request or accessible at www.sgs.com/terms_and_conditions.htm and, for electronic format documents, subject to Terms and Conditions for Electronic Documents at www.sgs.com/terms_e-document.htm. Attention is drawn to the limitation of liability, indemnification and jurisdiction issues defined therein. Any holder of this document is advised that information contained hereon reflects the Company's findings at the time of its intervention only and within the limits of Client's instructions, if any. The Company's sole responsibility is to its Client and this document does not exonerate parties to a transaction from exercising all their rights and obligations under the transaction documents. This document cannot be reproduced except in full, without prior written approval of the Company. Any unauthorized alteration, forgery or falsification of the content or appearance of this document is unlawful and offenders may be prosecuted to the fullest extent of the law.

EUT				Measurement					
Operation Band	Pol.	Fundamental Frequency	CH	Antenna Pol.	S.G. Output	Antenna Gain	Cable Loss	EIRP	Limit
		MHz		V/H	dBm	dBi	dB	dBm	dBm
HSDPA Band IV	H	1712.4	1312	V	26.21	4.4	-4.13	27.4	30.00
				H	20.78	4.79	-4.13	21.44	30.00
		1732.6	1413	V	27.15	4.4	-4.13	27.42	30.00
				H	22.96	4.79	-4.13	23.62	30.00
		1752.6	1513	V	25.44	4.4	-4.13	25.7	30.00
				H	28.49	4.79	-4.13	29.16	30.00
	E1	1712.4	1312	V	28.08	4.35	-4.16	28.27	30.00
				H	21.3	4.78	-4.16	21.92	30.00
		1732.6	1413	V	26.25	4.35	-4.16	26.44	30.00
				H	21.41	4.78	-4.16	22.04	30.00
		1752.6	1513	V	22.36	4.35	-4.16	22.56	30.00
				H	27.82	4.78	-4.16	28.44	30.00
	E2	1712.4	1312	V	27.09	4.31	-4.18	27.22	30.00
				H	19.45	4.76	-4.18	20.03	30.00
		1732.6	1413	V	26.61	4.31	-4.18	26.74	30.00
				H	22.98	4.77	-4.18	23.57	30.00
		1752.6	1513	V	24.07	4.31	-4.18	24.2	30.00
				H	28.32	4.76	-4.18	28.9	30.00

Remark :

- (1) The RBW,VBW of SPA for measurement RBW= 1MHz , VBW= 3MHz

Unless otherwise stated the results shown in this test report refer only to the sample(s) tested and such sample(s) are retained for 90 days only.

除非另有說明，此報告結果僅對測試之樣品負責，同時此樣品僅保留90天。本報告未經本公司書面許可，不可部份複製。

This document is issued by the Company subject to its General Conditions of Service printed overleaf, available on request or accessible at www.sgs.com/terms_and_conditions.htm and, for electronic format documents, subject to Terms and Conditions for Electronic Documents at www.sgs.com/terms_e-document.htm. Attention is drawn to the limitation of liability, indemnification and jurisdiction issues defined therein. Any holder of this document is advised that information contained hereon reflects the Company's findings at the time of its intervention only and within the limits of Client's instructions, if any. The Company's sole responsibility is to its Client and this document does not exonerate parties to a transaction from exercising all their rights and obligations under the transaction documents. This document cannot be reproduced except in full, without prior written approval of the Company. Any unauthorized alteration, forgery or falsification of the content or appearance of this document is unlawful and offenders may be prosecuted to the fullest extent of the law.

EUT				Measurement					
Operation Band	Pol.	Fundamental Frequency	CH	Antenna Pol.	S.G. Output	Antenna Gain	Cable Loss	ERP	Limit
		MHz		V/H	dBm	dBd	dB	dBm	dBm
HSDPA Band V	H	826.40	4132	V	18.56	3.97	-2.8	19.73	38.45
				H	15.26	3.97	-2.8	16.42	38.45
		836.60	4183	V	18.72	4	-2.82	19.9	38.45
				H	16.28	4	-2.82	17.46	38.45
		846.60	4233	V	20.02	4.02	-2.84	21.21	38.45
				H	16.88	4.02	-2.84	18.06	38.45
	E1	826.40	4132	V	13.65	3.97	-2.8	14.81	38.45
				H	19.12	3.97	-2.8	20.29	38.45
		836.60	4183	V	14.02	4	-2.82	15.2	38.45
				H	18.87	4	-2.82	20.05	38.45
		846.60	4233	V	16.9	4.02	-2.84	18.08	38.45
				H	20.67	4.02	-2.83	21.85	38.45
	E2	826.40	4132	V	15.25	3.97	-2.8	16.42	38.45
				H	19.17	3.97	-2.8	20.33	38.45
		836.60	4183	V	14.05	4	-2.82	15.23	38.45
				H	19.61	4	-2.82	20.78	38.45
		846.60	4233	V	14.76	4.02	-2.83	15.94	38.45
				H	20.21	4.02	-2.84	21.4	38.45

Remark :

- (1) The RBW,VBW of SPA for measurement RBW= 5MHz , VBW= 8MHz

Unless otherwise stated the results shown in this test report refer only to the sample(s) tested and such sample(s) are retained for 90 days only.

除非另有說明，此報告結果僅對測試之樣品負責，同時此樣品僅保留90天。本報告未經本公司書面許可，不可部份複製。

This document is issued by the Company subject to its General Conditions of Service printed overleaf, available on request or accessible at www.sgs.com/terms_and_conditions.htm and, for electronic format documents, subject to Terms and Conditions for Electronic Documents at www.sgs.com/terms_e-document.htm. Attention is drawn to the limitation of liability, indemnification and jurisdiction issues defined therein. Any holder of this document is advised that information contained hereon reflects the Company's findings at the time of its intervention only and within the limits of Client's instructions, if any. The Company's sole responsibility is to its Client and this document does not exonerate parties to a transaction from exercising all their rights and obligations under the transaction documents. This document cannot be reproduced except in full, without prior written approval of the Company. Any unauthorized alteration, forgery or falsification of the content or appearance of this document is unlawful and offenders may be prosecuted to the fullest extent of the law.

7.5.1 Measurement Result: (Average) – using option of RMS measurement

EUT				Measurement					
Operation Band	Pol.	Fundamental Frequency	CH	Antenna Pol.	S.G. Output	Antenna Gain	Cable Loss	ERP	Limit
		MHz		V/H	dBm	dBd	dB	dBm	dBm
GSM 850	H	824.20	128	V	15.71	3.96	-2.8	16.87	40.60
				H	14.34	3.96	-2.8	15.5	40.60
		836.60	190	V	15.47	4	-2.82	16.65	40.60
				H	13.72	4	-2.82	14.9	40.60
		848.80	251	V	15.88	4.03	-2.84	17.07	40.60
				H	14.54	4.03	-2.84	15.73	40.60
	E1	824.20	128	V	12.63	3.96	-2.8	13.8	40.60
				H	14.27	3.96	-2.8	15.43	40.60
		836.60	190	V	13.16	4	-2.82	14.34	40.60
				H	14.5	4	-2.82	15.68	40.60
		848.80	251	V	14.04	4.03	-2.84	15.23	40.60
				H	14.27	4.03	-2.84	15.46	40.60
	E2	824.20	128	V	13.21	3.96	-2.8	14.37	40.60
				H	15.62	3.96	-2.8	16.78	40.60
		836.60	190	V	13.93	4	-2.82	15.11	40.60
				H	16.42	4	-2.82	17.6	40.60
		848.80	251	V	13.38	4.03	-2.84	14.57	40.60
				H	16.25	4.03	-2.84	17.44	40.60

Remark :

- (1) The RBW,VBW of SPA for frequency RBW=6 kHz, VBW=20 kHz

Unless otherwise stated the results shown in this test report refer only to the sample(s) tested and such sample(s) are retained for 90 days only.

除非另有說明，此報告結果僅對測試之樣品負責，同時此樣品僅保留90天。本報告未經本公司書面許可，不可部份複製。

This document is issued by the Company subject to its General Conditions of Service printed overleaf, available on request or accessible at www.sgs.com/terms_and_conditions.htm and, for electronic format documents, subject to Terms and Conditions for Electronic Documents at www.sgs.com/terms_e-document.htm. Attention is drawn to the limitation of liability, indemnification and jurisdiction issues defined therein. Any holder of this document is advised that information contained hereon reflects the Company's findings at the time of its intervention only and within the limits of Client's instructions, if any. The Company's sole responsibility is to its Client and this document does not exonerate parties to a transaction from exercising all their rights and obligations under the transaction documents. This document cannot be reproduced except in full, without prior written approval of the Company. Any unauthorized alteration, forgery or falsification of the content or appearance of this document is unlawful and offenders may be prosecuted to the fullest extent of the law.

EUT				Measurement					
Operation Band	Pol.	Fundamental Frequency	CH	Antenna Pol.	S.G. Output	Antenna Gain	Cable Loss	EIRP	Limit
		MHz		V/H	dBm	dBi	dB	dBm	dBm
GSM 1900	H	1850.20	512	V	21.37	4.17	-4.29	21.25	33.00
				H	17.85	4.51	-4.29	18.07	33.00
		1880.00	661	V	20.51	4.13	-4.33	20.31	33.00
				H	18.56	4.44	-4.33	18.67	33.00
		1909.80	810	V	16.66	4.09	-4.37	16.38	33.00
				H	14.56	4.36	-4.37	14.56	33.00
	E1	1850.20	512	V	21.63	4.17	-4.29	21.51	33.00
				H	17.55	4.51	-4.29	17.77	33.00
		1880.00	661	V	22.9	4.13	-4.33	22.71	33.00
				H	18.39	4.44	-4.33	18.5	33.00
		1909.80	810	V	20.05	4.09	-4.37	19.78	33.00
				H	16.57	4.36	-4.37	16.57	33.00
	E2	1850.20	512	V	17.5	4.17	-4.29	17.38	33.00
				H	20.23	4.51	-4.29	20.45	33.00
		1880.00	661	V	19.6	4.13	-4.33	19.4	33.00
				H	19.53	4.44	-4.33	19.63	33.00
		1909.80	810	V	18.56	4.09	-4.37	18.29	33.00
				H	20.02	4.36	-4.37	20.02	33.00

Remark :

- (1) The RBW,VBW of SPA for frequency RBW=6 kHz, VBW=20 kHz

Unless otherwise stated the results shown in this test report refer only to the sample(s) tested and such sample(s) are retained for 90 days only.

除非另有說明，此報告結果僅對測試之樣品負責，同時此樣品僅保留90天。本報告未經本公司書面許可，不可部份複製。

This document is issued by the Company subject to its General Conditions of Service printed overleaf, available on request or accessible at www.sgs.com/terms_and_conditions.htm and, for electronic format documents, subject to Terms and Conditions for Electronic Documents at www.sgs.com/terms_e-document.htm. Attention is drawn to the limitation of liability, indemnification and jurisdiction issues defined therein. Any holder of this document is advised that information contained hereon reflects the Company's findings at the time of its intervention only and within the limits of Client's instructions, if any. The Company's sole responsibility is to its Client and this document does not exonerate parties to a transaction from exercising all their rights and obligations under the transaction documents. This document cannot be reproduced except in full, without prior written approval of the Company. Any unauthorized alteration, forgery or falsification of the content or appearance of this document is unlawful and offenders may be prosecuted to the fullest extent of the law.

EUT				Measurement					
Operation Band	Pol.	Fundamental Frequency	CH	Antenna Pol.	S.G. Output	Antenna Gain	Cable Loss	ERP	Limit
		MHz		V/H	dBm	dBd	dB	dBm	dBm
GPRS 850	H	824.20	128	V	15.85	3.96	-2.8	17.02	40.60
				H	15.34	3.96	-2.8	16.5	40.60
		836.60	190	V	15.19	4	-2.82	16.37	40.60
				H	13.58	4	-2.82	14.75	40.60
		848.80	251	V	16.5	4.03	-2.84	17.68	40.60
				H	14.86	4.03	-2.84	16.05	40.60
	E1	824.20	128	V	12.08	3.96	-2.8	13.25	40.60
				H	14.75	3.96	-2.8	15.91	40.60
		836.60	190	V	12.89	4	-2.82	14.06	40.60
				H	15.21	4	-2.82	16.39	40.60
		848.80	251	V	13.79	4.03	-2.84	14.98	40.60
				H	14.34	4.03	-2.84	15.53	40.60
	E2	824.20	128	V	13.48	3.96	-2.8	14.65	40.60
				H	14.09	3.96	-2.8	15.25	40.60
		836.60	190	V	13.35	4	-2.82	14.53	40.60
				H	17.31	4	-2.82	18.49	40.60
		848.80	251	V	14.04	4.03	-2.84	15.22	40.60
				H	16.43	4.03	-2.84	17.61	40.60

Remark :

- (1) The RBW,VBW of SPA for frequency RBW=6 kHz, VBW=20 kHz

Unless otherwise stated the results shown in this test report refer only to the sample(s) tested and such sample(s) are retained for 90 days only.

除非另有說明，此報告結果僅對測試之樣品負責，同時此樣品僅保留90天。本報告未經本公司書面許可，不可部份複製。

This document is issued by the Company subject to its General Conditions of Service printed overleaf, available on request or accessible at www.sgs.com/terms_and_conditions.htm and, for electronic format documents, subject to Terms and Conditions for Electronic Documents at www.sgs.com/terms_e-document.htm. Attention is drawn to the limitation of liability, indemnification and jurisdiction issues defined therein. Any holder of this document is advised that information contained hereon reflects the Company's findings at the time of its intervention only and within the limits of Client's instructions, if any. The Company's sole responsibility is to its Client and this document does not exonerate parties to a transaction from exercising all their rights and obligations under the transaction documents. This document cannot be reproduced except in full, without prior written approval of the Company. Any unauthorized alteration, forgery or falsification of the content or appearance of this document is unlawful and offenders may be prosecuted to the fullest extent of the law.

EUT				Measurement					
Operation Band	Pol.	Fundamental Frequency	CH	Antenna Pol.	S.G. Output	Antenna Gain	Cable Loss	EIRP	Limit
		MHz		V/H	dBm	dBi	dB	dBm	dBm
GPRS 1900	H	1850.20	512	V	20.67	4.17	-4.29	20.55	33.00
				H	17.65	4.51	-4.29	17.87	33.00
		1880.00	661	V	19.94	4.13	-4.33	19.74	33.00
				H	17.39	4.44	-4.33	17.49	33.00
		1909.80	810	V	18.62	4.09	-4.37	18.35	33.00
				H	14.42	4.36	-4.37	14.42	33.00
	E1	1850.20	512	V	22.47	4.17	-4.29	22.36	33.00
				H	17.2	4.51	-4.29	17.42	33.00
		1880.00	661	V	22.78	4.13	-4.33	22.58	33.00
				H	17.86	4.44	-4.33	17.97	33.00
		1909.80	810	V	19.27	4.09	-4.37	19	33.00
				H	16.95	4.36	-4.37	16.95	33.00
	E2	1850.20	512	V	17.93	4.17	-4.29	17.81	33.00
				H	20.65	4.51	-4.29	20.87	33.00
		1880.00	661	V	20.4	4.13	-4.33	20.2	33.00
				H	20.26	4.44	-4.33	20.37	33.00
		1909.80	810	V	19.22	4.09	-4.37	18.95	33.00
				H	20.58	4.36	-4.37	20.58	33.00

Remark :

- (1) The RBW,VBW of SPA for frequency RBW=6 kHz, VBW=20 kHz

Unless otherwise stated the results shown in this test report refer only to the sample(s) tested and such sample(s) are retained for 90 days only.

除非另有說明，此報告結果僅對測試之樣品負責，同時此樣品僅保留90天。本報告未經本公司書面許可，不可部份複製。

This document is issued by the Company subject to its General Conditions of Service printed overleaf, available on request or accessible at www.sgs.com/terms_and_conditions.htm and, for electronic format documents, subject to Terms and Conditions for Electronic Documents at www.sgs.com/terms_e-document.htm. Attention is drawn to the limitation of liability, indemnification and jurisdiction issues defined therein. Any holder of this document is advised that information contained hereon reflects the Company's findings at the time of its intervention only and within the limits of Client's instructions, if any. The Company's sole responsibility is to its Client and this document does not exonerate parties to a transaction from exercising all their rights and obligations under the transaction documents. This document cannot be reproduced except in full, without prior written approval of the Company. Any unauthorized alteration, forgery or falsification of the content or appearance of this document is unlawful and offenders may be prosecuted to the fullest extent of the law.

EUT				Measurement					
Operation Band	Pol.	Fundamental Frequency	CH	Antenna Pol.	S.G. Output	Antenna Gain	Cable Loss	ERP	Limit
		MHz		V/H	dBm	dBd	dB	dBm	dBm
EDGE 850	H	824.20	128	V	9.67	3.96	-2.8	10.83	40.60
				H	9.4	3.96	-2.8	10.56	40.60
		836.60	190	V	9	4	-2.82	10.17	40.60
				H	9.78	4	-2.82	10.95	40.60
		848.80	251	V	8.74	4.03	-2.84	9.93	40.60
				H	9.14	4.03	-2.84	10.33	40.60
	E1	824.20	128	V	8.34	3.96	-2.8	9.51	40.60
				H	7.34	3.96	-2.8	8.5	40.60
		836.60	190	V	9.5	4	-2.82	10.68	40.60
				H	8.52	4	-2.82	9.69	40.60
		848.80	251	V	8.63	4.03	-2.84	9.81	40.60
				H	7.9	4.03	-2.84	9.08	40.60
	E2	824.20	128	V	7.31	3.96	-2.8	8.48	40.60
				H	10.85	3.96	-2.8	12.02	40.60
		836.60	190	V	7.03	4	-2.82	8.21	40.60
				H	11.77	4	-2.82	12.94	40.60
		848.80	251	V	7.52	4.03	-2.84	8.7	40.60
				H	11.64	4.03	-2.84	12.82	40.60

Remark :

- (1) The RBW,VBW of SPA for frequency RBW=6 kHz, VBW=20 kHz

Unless otherwise stated the results shown in this test report refer only to the sample(s) tested and such sample(s) are retained for 90 days only.

除非另有說明，此報告結果僅對測試之樣品負責，同時此樣品僅保留90天。本報告未經本公司書面許可，不可部份複製。

This document is issued by the Company subject to its General Conditions of Service printed overleaf, available on request or accessible at www.sgs.com/terms_and_conditions.htm and, for electronic format documents, subject to Terms and Conditions for Electronic Documents at www.sgs.com/terms_e-document.htm. Attention is drawn to the limitation of liability, indemnification and jurisdiction issues defined therein. Any holder of this document is advised that information contained hereon reflects the Company's findings at the time of its intervention only and within the limits of Client's instructions, if any. The Company's sole responsibility is to its Client and this document does not exonerate parties to a transaction from exercising all their rights and obligations under the transaction documents. This document cannot be reproduced except in full, without prior written approval of the Company. Any unauthorized alteration, forgery or falsification of the content or appearance of this document is unlawful and offenders may be prosecuted to the fullest extent of the law.

EUT				Measurement					
Operation Band	Pol.	Fundamental Frequency	CH	Antenna Pol.	S.G. Output	Antenna Gain	Cable Loss	EIRP	Limit
		MHz		V/H	dBm	dBi	dB	dBm	dBm
EDGE 1900	H	1850.20	512	V	16.15	4.17	-4.29	16.03	33.00
				H	12.9	4.51	-4.29	13.12	33.00
		1880.00	661	V	15.95	4.13	-4.33	15.76	33.00
				H	13.69	4.44	-4.33	13.79	33.00
		1909.80	810	V	12.88	4.09	-4.37	12.61	33.00
				H	9.1	4.36	-4.37	9.1	33.00
	E1	1850.20	512	V	17.27	4.17	-4.29	17.15	33.00
				H	12.07	4.51	-4.29	12.29	33.00
		1880.00	661	V	17.52	4.13	-4.33	17.32	33.00
				H	13.76	4.44	-4.33	13.87	33.00
		1909.80	810	V	15.07	4.09	-4.37	14.8	33.00
				H	12.44	4.36	-4.37	12.43	33.00
	E2	1850.20	512	V	12.51	4.17	-4.29	12.39	33.00
				H	16.27	4.51	-4.29	16.49	33.00
		1880.00	661	V	15.27	4.13	-4.33	15.07	33.00
				H	15.29	4.44	-4.33	15.4	33.00
		1909.80	810	V	13.99	4.09	-4.37	13.72	33.00
				H	15.08	4.36	-4.37	15.08	33.00

Remark :

- (1) The RBW,VBW of SPA for frequency RBW=6 kHz, VBW=20 kHz

Unless otherwise stated the results shown in this test report refer only to the sample(s) tested and such sample(s) are retained for 90 days only.

除非另有說明，此報告結果僅對測試之樣品負責，同時此樣品僅保留90天。本報告未經本公司書面許可，不可部份複製。

This document is issued by the Company subject to its General Conditions of Service printed overleaf, available on request or accessible at www.sgs.com/terms_and_conditions.htm and, for electronic format documents, subject to Terms and Conditions for Electronic Documents at www.sgs.com/terms_e-document.htm. Attention is drawn to the limitation of liability, indemnification and jurisdiction issues defined therein. Any holder of this document is advised that information contained hereon reflects the Company's findings at the time of its intervention only and within the limits of Client's instructions, if any. The Company's sole responsibility is to its Client and this document does not exonerate parties to a transaction from exercising all their rights and obligations under the transaction documents. This document cannot be reproduced except in full, without prior written approval of the Company. Any unauthorized alteration, forgery or falsification of the content or appearance of this document is unlawful and offenders may be prosecuted to the fullest extent of the law.

EUT				Measurement					
Operation Band	Pol.	Fundamental Frequency	CH	Antenna Pol.	S.G. Output	Antenna Gain	Cable Loss	EIRP	Limit
		MHz		V/H	dBm	dBi	dB	dBm	dBm
WCDMA Band II	H	1852.4	9262	V	23.07	4.17	-4.3	22.95	33.00
				H	20.15	4.51	-4.3	20.36	33.00
		1880.0	9400	V	22.58	4.13	-4.33	22.39	33.00
				H	19.61	4.44	-4.33	19.72	33.00
		1907.6	9538	V	20.28	4.1	-4.36	20.02	33.00
				H	16.21	4.37	-4.36	16.21	33.00
	E1	1852.4	9262	V	23.44	4.17	-4.3	23.31	33.00
				H	19.7	4.51	-4.3	19.91	33.00
		1880.0	9400	V	24.5	4.13	-4.33	24.3	33.00
				H	19.32	4.44	-4.33	19.42	33.00
		1907.6	9538	V	21.34	4.1	-4.36	21.07	33.00
				H	19.18	4.37	-4.36	19.18	33.00
	E2	1852.4	9262	V	18.53	4.17	-4.3	18.41	33.00
				H	23.85	4.51	-4.3	24.06	33.00
		1880.0	9400	V	21.57	4.13	-4.33	21.38	33.00
				H	23.17	4.44	-4.33	23.28	33.00
		1907.6	9538	V	20.42	4.1	-4.36	20.15	33.00
				H	22.13	4.37	-4.36	22.13	33.00

Remark :

- (1) The RBW,VBW of SPA for frequency RBW= 1MHz , VBW= 3MHz

Unless otherwise stated the results shown in this test report refer only to the sample(s) tested and such sample(s) are retained for 90 days only.

除非另有說明，此報告結果僅對測試之樣品負責，同時此樣品僅保留90天。本報告未經本公司書面許可，不可部份複製。

This document is issued by the Company subject to its General Conditions of Service printed overleaf, available on request or accessible at www.sgs.com/terms_and_conditions.htm and, for electronic format documents, subject to Terms and Conditions for Electronic Documents at www.sgs.com/terms_e-document.htm. Attention is drawn to the limitation of liability, indemnification and jurisdiction issues defined therein. Any holder of this document is advised that information contained hereon reflects the Company's findings at the time of its intervention only and within the limits of Client's instructions, if any. The Company's sole responsibility is to its Client and this document does not exonerate parties to a transaction from exercising all their rights and obligations under the transaction documents. This document cannot be reproduced except in full, without prior written approval of the Company. Any unauthorized alteration, forgery or falsification of the content or appearance of this document is unlawful and offenders may be prosecuted to the fullest extent of the law.

EUT				Measurement					
Operation Band	Pol.	Fundamental Frequency	CH	Antenna Pol.	S.G. Output	Antenna Gain	Cable Loss	EIRP	Limit
		MHz		V/H	dBm	dBi	dB	dBm	dBm
WCDMA Band IV	H	1712.4	1312	V	22.72	4.4	-4.13	22.99	30.00
				H	19.39	4.79	-4.13	20.05	30.00
		1732.6	1413	V	23.57	4.4	-4.13	23.83	30.00
				H	19.32	4.79	-4.13	19.98	30.00
		1752.6	1513	V	22.05	4.4	-4.13	22.32	30.00
				H	25.25	4.79	-4.13	25.91	30.00
	E1	1712.4	1312	V	23.74	4.35	-4.16	23.94	30.00
				H	20.21	4.78	-4.16	20.83	30.00
		1732.6	1413	V	23.26	4.35	-4.16	23.46	30.00
				H	18.53	4.78	-4.16	19.15	30.00
		1752.6	1513	V	19.46	4.35	-4.16	19.65	30.00
				H	24.76	4.78	-4.16	25.39	30.00
	E2	1712.4	1312	V	22.53	4.31	-4.18	22.66	30.00
				H	18.28	4.77	-4.18	18.86	30.00
		1732.6	1413	V	20.8	4.31	-4.18	20.93	30.00
				H	19.49	4.76	-4.18	20.07	30.00
		1752.6	1513	V	20.71	4.31	-4.18	20.83	30.00
				H	24.64	4.76	-4.18	25.23	30.00

Remark :

- (1) The RBW,VBW of SPA for frequency RBW= 5MHz , VBW= 8MHz

Unless otherwise stated the results shown in this test report refer only to the sample(s) tested and such sample(s) are retained for 90 days only.

除非另有說明，此報告結果僅對測試之樣品負責，同時此樣品僅保留90天。本報告未經本公司書面許可，不可部份複製。

This document is issued by the Company subject to its General Conditions of Service printed overleaf, available on request or accessible at www.sgs.com/terms_and_conditions.htm and, for electronic format documents, subject to Terms and Conditions for Electronic Documents at www.sgs.com/terms_e-document.htm. Attention is drawn to the limitation of liability, indemnification and jurisdiction issues defined therein. Any holder of this document is advised that information contained hereon reflects the Company's findings at the time of its intervention only and within the limits of Client's instructions, if any. The Company's sole responsibility is to its Client and this document does not exonerate parties to a transaction from exercising all their rights and obligations under the transaction documents. This document cannot be reproduced except in full, without prior written approval of the Company. Any unauthorized alteration, forgery or falsification of the content or appearance of this document is unlawful and offenders may be prosecuted to the fullest extent of the law.

EUT				Measurement					
Operation Band	Pol.	Fundamental Frequency	CH	Antenna Pol.	S.G. Output	Antenna Gain	Cable Loss	ERP	Limit
		MHz		V/H	dBm	dBd	dB	dBm	dBm
WCDMA Band V	H	826.40	4132	V	15.54	3.97	-2.8	16.7	40.60
				H	12.22	3.97	-2.8	13.38	40.60
		836.60	4183	V	15.01	4	-2.82	16.18	40.60
				H	12.65	4	-2.82	13.83	40.60
		846.60	4233	V	16.44	4.02	-2.84	17.63	40.60
				H	13.13	4.02	-2.84	14.31	40.60
	E1	826.40	4132	V	10.94	3.97	-2.8	12.11	40.60
				H	16.39	3.97	-2.8	17.55	40.60
		836.60	4183	V	10.64	4	-2.82	11.81	40.60
				H	15.45	4	-2.82	16.62	40.60
		846.60	4233	V	13.3	4.02	-2.84	14.48	40.60
				H	16.95	4.02	-2.84	18.14	40.60
	E2	826.40	4132	V	12.08	3.97	-2.8	13.24	40.60
				H	16	3.97	-2.8	17.17	40.60
		836.60	4183	V	10.51	4	-2.82	11.69	40.60
				H	16.14	4	-2.82	17.31	40.60
		846.60	4233	V	11.17	4.02	-2.84	12.35	40.60
				H	16.51	4.02	-2.84	17.7	40.60

Remark :

- (1) The RBW,VBW of SPA for frequency RBW= 1MHz , VBW= 3MHz

Unless otherwise stated the results shown in this test report refer only to the sample(s) tested and such sample(s) are retained for 90 days only.

除非另有說明，此報告結果僅對測試之樣品負責，同時此樣品僅保留90天。本報告未經本公司書面許可，不可部份複製。

This document is issued by the Company subject to its General Conditions of Service printed overleaf, available on request or accessible at www.sgs.com/terms_and_conditions.htm and, for electronic format documents, subject to Terms and Conditions for Electronic Documents at www.sgs.com/terms_e-document.htm. Attention is drawn to the limitation of liability, indemnification and jurisdiction issues defined therein. Any holder of this document is advised that information contained hereon reflects the Company's findings at the time of its intervention only and within the limits of Client's instructions, if any. The Company's sole responsibility is to its Client and this document does not exonerate parties to a transaction from exercising all their rights and obligations under the transaction documents. This document cannot be reproduced except in full, without prior written approval of the Company. Any unauthorized alteration, forgery or falsification of the content or appearance of this document is unlawful and offenders may be prosecuted to the fullest extent of the law.

EUT				Measurement					
Operation Band	Pol.	Fundamental Frequency	CH	Antenna Pol.	S.G. Output	Antenna Gain	Cable Loss	EIRP	Limit
		MHz		V/H	dBm	dBi	dB	dBm	dBm
HSUPA Band II	H	1852.4	9262	V	21.38	4.17	-4.3	21.25	33.00
				H	18.34	4.51	-4.3	18.55	33.00
		1880.0	9400	V	20.85	4.13	-4.33	20.66	33.00
				H	17.87	4.44	-4.33	17.98	33.00
		1907.6	9538	V	18.65	4.1	-4.36	18.38	33.00
				H	14.54	4.37	-4.36	14.55	33.00
	E1	1852.4	9262	V	21.56	4.17	-4.3	21.43	33.00
				H	17.61	4.51	-4.3	17.82	33.00
		1880.0	9400	V	22.62	4.13	-4.33	22.42	33.00
				H	18.14	4.44	-4.33	18.25	33.00
		1907.6	9538	V	19.64	4.1	-4.36	19.38	33.00
				H	17.1	4.37	-4.36	17.1	33.00
	E2	1852.4	9262	V	16.86	4.17	-4.3	16.73	33.00
				H	22.05	4.51	-4.3	22.26	33.00
		1880.0	9400	V	18.78	4.13	-4.33	18.58	33.00
				H	21.41	4.44	-4.33	21.52	33.00
		1907.6	9538	V	17.98	4.1	-4.36	17.72	33.00
				H	20.59	4.37	-4.36	20.59	33.00

Remark :

- (1) The RBW,VBW of SPA for frequency RBW= 1MHz , VBW= 3MHz

Unless otherwise stated the results shown in this test report refer only to the sample(s) tested and such sample(s) are retained for 90 days only.

除非另有說明，此報告結果僅對測試之樣品負責，同時此樣品僅保留90天。本報告未經本公司書面許可，不可部份複製。

This document is issued by the Company subject to its General Conditions of Service printed overleaf, available on request or accessible at www.sgs.com/terms_and_conditions.htm and, for electronic format documents, subject to Terms and Conditions for Electronic Documents at www.sgs.com/terms_e-document.htm. Attention is drawn to the limitation of liability, indemnification and jurisdiction issues defined therein. Any holder of this document is advised that information contained hereon reflects the Company's findings at the time of its intervention only and within the limits of Client's instructions, if any. The Company's sole responsibility is to its Client and this document does not exonerate parties to a transaction from exercising all their rights and obligations under the transaction documents. This document cannot be reproduced except in full, without prior written approval of the Company. Any unauthorized alteration, forgery or falsification of the content or appearance of this document is unlawful and offenders may be prosecuted to the fullest extent of the law.

EUT				Measurement					
Operation Band	Pol.	Fundamental Frequency	CH	Antenna Pol.	S.G. Output	Antenna Gain	Cable Loss	EIRP	Limit
		MHz		V/H	dBm	dBi	dB	dBm	dBm
HSUPA Band IV	H	1712.4	1312	V	21.98	4.4	-4.13	22.24	33.00
				H	15.68	4.79	-4.13	16.34	33.00
		1732.6	1413	V	21.79	4.4	-4.13	22.06	33.00
				H	17.77	4.79	-4.13	18.43	33.00
		1752.6	1513	V	20.27	4.4	-4.13	20.53	33.00
				H	23.42	4.79	-4.13	24.08	33.00
	E1	1712.4	1312	V	22.61	4.35	-4.16	22.8	33.00
				H	16.58	4.78	-4.16	17.2	33.00
		1732.6	1413	V	21.51	4.35	-4.16	21.71	33.00
				H	16.61	4.78	-4.16	17.23	33.00
		1752.6	1513	V	17.45	4.35	-4.16	17.65	33.00
				H	23	4.78	-4.16	23.63	33.00
	E2	1712.4	1312	V	21.93	4.31	-4.18	22.06	33.00
				H	14.47	4.76	-4.18	15.05	33.00
		1732.6	1413	V	21.36	4.31	-4.18	21.49	33.00
				H	17.73	4.76	-4.18	18.31	33.00
		1752.6	1513	V	19.13	4.31	-4.18	19.26	33.00
				H	22.92	4.76	-4.18	23.5	33.00

Remark :

- (1) The RBW,VBW of SPA for frequency RBW= 5MHz , VBW= 8MHz

Unless otherwise stated the results shown in this test report refer only to the sample(s) tested and such sample(s) are retained for 90 days only.

除非另有說明，此報告結果僅對測試之樣品負責，同時此樣品僅保留90天。本報告未經本公司書面許可，不可部份複製。

This document is issued by the Company subject to its General Conditions of Service printed overleaf, available on request or accessible at www.sgs.com/terms_and_conditions.htm and, for electronic format documents, subject to Terms and Conditions for Electronic Documents at www.sgs.com/terms_e-document.htm. Attention is drawn to the limitation of liability, indemnification and jurisdiction issues defined therein. Any holder of this document is advised that information contained hereon reflects the Company's findings at the time of its intervention only and within the limits of Client's instructions, if any. The Company's sole responsibility is to its Client and this document does not exonerate parties to a transaction from exercising all their rights and obligations under the transaction documents. This document cannot be reproduced except in full, without prior written approval of the Company. Any unauthorized alteration, forgery or falsification of the content or appearance of this document is unlawful and offenders may be prosecuted to the fullest extent of the law.

EUT				Measurement					
Operation Band	Pol.	Fundamental Frequency	CH	Antenna Pol.	S.G. Output	Antenna Gain	Cable Loss	ERP	Limit
		MHz		V/H	dBm	dBd	dB	dBm	dBm
HSUPA Band V	H	826.40	4132	V	13.73	3.97	-2.8	14.89	40.60
				H	8.13	3.97	-2.8	9.29	40.60
		836.60	4183	V	13.29	4	-2.82	14.46	40.60
				H	8.84	4	-2.82	10.01	40.60
		846.60	4233	V	14.66	4.02	-2.84	15.84	40.60
				H	10.42	4.02	-2.84	11.6	40.60
	E1	826.40	4132	V	12.59	3.97	-2.8	13.76	40.60
				H	14.58	3.97	-2.8	15.74	40.60
		836.60	4183	V	8.77	4	-2.82	9.94	40.60
				H	13.7	4	-2.82	14.87	40.60
		846.60	4233	V	11.77	4.02	-2.84	12.96	40.60
				H	15.44	4.02	-2.84	16.62	40.60
	E2	826.40	4132	V	10.36	3.97	-2.8	11.52	40.60
				H	14.27	3.97	-2.8	15.44	40.60
		836.60	4183	V	8.8	4	-2.82	9.97	40.60
				H	14.3	4	-2.82	15.47	40.60
		846.60	4233	V	9.64	4.02	-2.84	10.82	40.60
				H	14.72	4.02	-2.84	15.91	40.60

Remark :

- (1) The RBW,VBW of SPA for frequency RBW= 1MHz , VBW= 3MHz

Unless otherwise stated the results shown in this test report refer only to the sample(s) tested and such sample(s) are retained for 90 days only.

除非另有說明，此報告結果僅對測試之樣品負責，同時此樣品僅保留90天。本報告未經本公司書面許可，不可部份複製。

This document is issued by the Company subject to its General Conditions of Service printed overleaf, available on request or accessible at www.sgs.com/terms_and_conditions.htm and, for electronic format documents, subject to Terms and Conditions for Electronic Documents at www.sgs.com/terms_e-document.htm. Attention is drawn to the limitation of liability, indemnification and jurisdiction issues defined therein. Any holder of this document is advised that information contained hereon reflects the Company's findings at the time of its intervention only and within the limits of Client's instructions, if any. The Company's sole responsibility is to its Client and this document does not exonerate parties to a transaction from exercising all their rights and obligations under the transaction documents. This document cannot be reproduced except in full, without prior written approval of the Company. Any unauthorized alteration, forgery or falsification of the content or appearance of this document is unlawful and offenders may be prosecuted to the fullest extent of the law.

EUT				Measurement					
Operation Band	Pol.	Fundamental Frequency	CH	Antenna Pol.	S.G. Output	Antenna Gain	Cable Loss	EIRP	Limit
		MHz		V/H	dBm	dBi	dB	dBm	dBm
HSDPA Band II	H	1852.4	9262	V	21.99	4.17	-4.3	21.86	33.00
				H	18.83	4.51	-4.3	19.04	33.00
		1880.0	9400	V	21.44	4.13	-4.33	21.24	33.00
				H	18.39	4.44	-4.33	18.49	33.00
		1907.6	9538	V	19.18	4.1	-4.36	18.91	33.00
				H	14.99	4.37	-4.36	15	33.00
	E1	1852.4	9262	V	22.36	4.17	-4.3	22.24	33.00
				H	18.48	4.51	-4.3	18.7	33.00
		1880.0	9400	V	23.29	4.13	-4.33	23.09	33.00
				H	18.15	4.44	-4.33	18.25	33.00
		1907.6	9538	V	20.17	4.1	-4.36	19.91	33.00
				H	18.19	4.37	-4.36	18.19	33.00
	E2	1852.4	9262	V	17.34	4.17	-4.3	17.21	33.00
				H	22.66	4.51	-4.3	22.87	33.00
		1880.0	9400	V	19.43	4.13	-4.33	19.23	33.00
				H	21.9	4.44	-4.33	22.01	33.00
		1907.6	9538	V	18.41	4.1	-4.36	18.14	33.00
				H	21.03	4.37	-4.36	21.04	33.00

Remark :

- (1) The RBW,VBW of SPA for frequency RBW= 1MHz , VBW= 3MHz

Unless otherwise stated the results shown in this test report refer only to the sample(s) tested and such sample(s) are retained for 90 days only.

除非另有說明，此報告結果僅對測試之樣品負責，同時此樣品僅保留90天。本報告未經本公司書面許可，不可部份複製。

This document is issued by the Company subject to its General Conditions of Service printed overleaf, available on request or accessible at www.sgs.com/terms_and_conditions.htm and, for electronic format documents, subject to Terms and Conditions for Electronic Documents at www.sgs.com/terms_e-document.htm. Attention is drawn to the limitation of liability, indemnification and jurisdiction issues defined therein. Any holder of this document is advised that information contained hereon reflects the Company's findings at the time of its intervention only and within the limits of Client's instructions, if any. The Company's sole responsibility is to its Client and this document does not exonerate parties to a transaction from exercising all their rights and obligations under the transaction documents. This document cannot be reproduced except in full, without prior written approval of the Company. Any unauthorized alteration, forgery or falsification of the content or appearance of this document is unlawful and offenders may be prosecuted to the fullest extent of the law.

EUT				Measurement					
Operation Band	Pol.	Fundamental Frequency	CH	Antenna Pol.	S.G. Output	Antenna Gain	Cable Loss	EIRP	Limit
		MHz		V/H	dBm	dBi	dB	dBm	dBm
HSDPA Band IV	H	1712.4	1312	V	22.63	4.4	-4.13	22.9	30.00
				H	16.22	4.79	-4.13	16.89	30.00
		1732.6	1413	V	22.6	4.4	-4.13	22.87	30.00
				H	18.29	4.79	-4.13	18.95	30.00
		1752.6	1513	V	20.81	4.4	-4.13	21.07	30.00
				H	24.08	4.79	-4.13	24.74	30.00
	E1	1712.4	1312	V	23.23	4.35	-4.16	23.42	30.00
				H	16.94	4.78	-4.16	17.56	30.00
		1732.6	1413	V	22.1	4.35	-4.16	22.29	30.00
				H	17.24	4.78	-4.16	17.86	30.00
		1752.6	1513	V	18.1	4.35	-4.16	18.3	30.00
				H	23.55	4.78	-4.16	24.17	30.00
	E2	1712.4	1312	V	22.6	4.31	-4.18	22.73	30.00
				H	14.94	4.76	-4.18	15.52	30.00
		1732.6	1413	V	22.01	4.31	-4.18	22.13	30.00
				H	18.27	4.76	-4.18	18.86	30.00
		1752.6	1513	V	19.57	4.31	-4.18	19.7	30.00
				H	23.46	4.77	-4.18	24.04	30.00

Remark :

- (1) The RBW,VBW of SPA for frequency RBW= 5MHz , VBW= 8MHz

Unless otherwise stated the results shown in this test report refer only to the sample(s) tested and such sample(s) are retained for 90 days only.

除非另有說明，此報告結果僅對測試之樣品負責，同時此樣品僅保留90天。本報告未經本公司書面許可，不可部份複製。

This document is issued by the Company subject to its General Conditions of Service printed overleaf, available on request or accessible at www.sgs.com/terms_and_conditions.htm and, for electronic format documents, subject to Terms and Conditions for Electronic Documents at www.sgs.com/terms_e-document.htm. Attention is drawn to the limitation of liability, indemnification and jurisdiction issues defined therein. Any holder of this document is advised that information contained hereon reflects the Company's findings at the time of its intervention only and within the limits of Client's instructions, if any. The Company's sole responsibility is to its Client and this document does not exonerate parties to a transaction from exercising all their rights and obligations under the transaction documents. This document cannot be reproduced except in full, without prior written approval of the Company. Any unauthorized alteration, forgery or falsification of the content or appearance of this document is unlawful and offenders may be prosecuted to the fullest extent of the law.

EUT				Measurement					
Operation Band	Pol.	Fundamental Frequency	CH	Antenna Pol.	S.G. Output	Antenna Gain	Cable Loss	ERP	Limit
		MHz		V/H	dBm	dBd	dB	dBm	dBm
HSDPA Band V	H	826.40	4132	V	14.37	3.97	-2.8	15.54	40.60
				H	11.11	3.97	-2.8	12.28	40.60
		836.60	4183	V	13.83	4	-2.82	15.01	40.60
				H	11.55	4	-2.82	12.72	40.60
		846.60	4233	V	15.3	4.02	-2.84	16.49	40.60
				H	12.15	4.02	-2.84	13.34	40.60
	E1	826.40	4132	V	9.86	3.97	-2.8	11.03	40.60
				H	15.33	3.97	-2.8	16.5	40.60
		836.60	4183	V	9.43	4	-2.82	10.6	40.60
				H	14.27	4	-2.82	15.45	40.60
		846.60	4233	V	12.37	4.02	-2.84	13.56	40.60
				H	16.25	4.02	-2.84	17.44	40.60
	E2	826.40	4132	V	10.97	3.97	-2.8	12.14	40.60
				H	14.85	3.97	-2.8	16.02	40.60
		836.60	4183	V	9.37	4	-2.82	10.55	40.60
				H	15.09	4	-2.82	16.26	40.60
		846.60	4233	V	10.31	4.02	-2.84	11.49	40.60
				H	15.38	4.02	-2.84	16.57	40.60

Remark :

- (1) The RBW,VBW of SPA for frequency RBW= 1MHz , VBW= 3MHz

Unless otherwise stated the results shown in this test report refer only to the sample(s) tested and such sample(s) are retained for 90 days only.
除非另有說明，此報告結果僅對測試之樣品負責，同時此樣品僅保留90天。本報告未經本公司書面許可，不可部份複製。

This document is issued by the Company subject to its General Conditions of Service printed overleaf, available on request or accessible at www.sgs.com/terms_and_conditions.htm and, for electronic format documents, subject to Terms and Conditions for Electronic Documents at www.sgs.com/terms_e-document.htm. Attention is drawn to the limitation of liability, indemnification and jurisdiction issues defined therein. Any holder of this document is advised that information contained hereon reflects the Company's findings at the time of its intervention only and within the limits of Client's instructions, if any. The Company's sole responsibility is to its Client and this document does not exonerate parties to a transaction from exercising all their rights and obligations under the transaction documents. This document cannot be reproduced except in full, without prior written approval of the Company. Any unauthorized alteration, forgery or falsification of the content or appearance of this document is unlawful and offenders may be prosecuted to the fullest extent of the law.

8. OCCUPIED BANDWIDTH MEASUREMENT

8.1. Standard Applicable:

According to §FCC 2.1049 (99%)

According to IC RSS-Gen Issue 3 §4.6.1 (99%)

According to IC RSS-133 §2.3 (20dB)

According to IC RSS-139 §2.3 (20dB)

8.2. Test Set-up:

Refer to section 6.2 in this report

8.3. Measurement Procedure:

The EUT's output RF connector was connected with a short cable to the spectrum analyzer, RBW was set to about 1% of emission BW, VBW= 3 times RBW, -20dBc display line was placed on the screen (or 20dB bandwidth), the occupied bandwidth is the delta frequency between the two points where the display line intersects the signal trace. Then set RBW to 99% bandwidth, RBW= 1%, VBW= 3 RBW, with span $> 2 * \text{Signal BW}$, set % Power = 99%.

NOTE: For the plot of bandwidth measurement, the marker of the 99% bandwidth is diamond-shape while the marker of the 20dB BW is arrow-mark

8.4. Measurement Equipment Used:

Refer to section 2.4 in this report

8.5. Measurement Result:

Refer to next pages.

Unless otherwise stated the results shown in this test report refer only to the sample(s) tested and such sample(s) are retained for 90 days only.

除非另有說明，此報告結果僅對測試之樣品負責，同時此樣品僅保留90天。本報告未經本公司書面許可，不可部份複製。

This document is issued by the Company subject to its General Conditions of Service printed overleaf, available on request or accessible at www.sgs.com/terms_and_conditions.htm and, for electronic format documents, subject to Terms and Conditions for Electronic Documents at www.sgs.com/terms_e-document.htm. Attention is drawn to the limitation of liability, indemnification and jurisdiction issues defined therein. Any holder of this document is advised that information contained hereon reflects the Company's findings at the time of its intervention only and within the limits of Client's instructions, if any. The Company's sole responsibility is to its Client and this document does not exonerate parties to a transaction from exercising all their rights and obligations under the transaction documents. This document cannot be reproduced except in full, without prior written approval of the Company. Any unauthorized alteration, forgery or falsification of the content or appearance of this document is unlawful and offenders may be prosecuted to the fullest extent of the law.

99% Bandwidth

EUT Mode	Frequency (MHz)	CH	99% Bandwidth (MHz)
GSM 850	824.20	128	0.248
	836.60	190	0.245
	848.80	251	0.243

EUT Mode	Frequency (MHz)	CH	99% Bandwidth (MHz)
GSM 1900	1850.20	512	0.241
	1880.00	661	0.247
	1909.80	810	0.240

EUT Mode	Frequency (MHz)	CH	99% Bandwidth (MHz)
GPRS 850	824.20	128	0.247
	836.60	190	0.244
	848.80	251	0.241

EUT Mode	Frequency (MHz)	CH	99% Bandwidth (MHz)
GPRS 1900	1850.20	512	0.241
	1880.00	661	0.247
	1909.80	810	0.240

EUT Mode	Frequency (MHz)	CH	99% Bandwidth (MHz)
EDGE 850	824.20	128	0.242
	836.60	190	0.238
	848.80	251	0.244

EUT Mode	Frequency (MHz)	CH	99% Bandwidth (MHz)
EDGE 1900	1850.20	512	0.242
	1880.00	661	0.241
	1909.80	810	0.240

Unless otherwise stated the results shown in this test report refer only to the sample(s) tested and such sample(s) are retained for 90 days only.

除非另有說明，此報告結果僅對測試之樣品負責，同時此樣品僅保留90天。本報告未經本公司書面許可，不可部份複製。

This document is issued by the Company subject to its General Conditions of Service printed overleaf, available on request or accessible at www.sgs.com/terms_and_conditions.htm and, for electronic format documents, subject to Terms and Conditions for Electronic Documents at www.sgs.com/terms_e-document.htm. Attention is drawn to the limitation of liability, indemnification and jurisdiction issues defined therein. Any holder of this document is advised that information contained hereon reflects the Company's findings at the time of its intervention only and within the limits of Client's instructions, if any. The Company's sole responsibility is to its Client and this document does not exonerate parties to a transaction from exercising all their rights and obligations under the transaction documents. This document cannot be reproduced except in full, without prior written approval of the Company. Any unauthorized alteration, forgery or falsification of the content or appearance of this document is unlawful and offenders may be prosecuted to the fullest extent of the law.

EUT Mode	Frequency (MHz)	CH	99% Bandwidth (MHz)
WCDMA II	1852.40	9262	4.2021
	1880.00	9400	4.1628
	1907.60	9538	4.1617

EUT Mode	Frequency (MHz)	CH	99% Bandwidth (MHz)
WCDMA IV	1712.40	1312	4.1346
	1732.60	1413	4.1606
	1752.60	1513	4.1488

EUT Mode	Frequency (MHz)	CH	99% Bandwidth (MHz)
WCDMA V	826.40	4132	4.2632
	836.00	4183	4.1571
	846.60	4233	4.2082

EUT Mode	Frequency (MHz)	CH	99% Bandwidth (MHz)
HSDPA II	1852.40	9262	4.1271
	1880.00	9400	4.0866
	1907.60	9538	4.2238

EUT Mode	Frequency (MHz)	CH	99% Bandwidth (MHz)
HSDPA IV	1712.40	1312	4.1813
	1732.60	1413	4.2344
	1752.60	1513	4.1586

EUT Mode	Frequency (MHz)	CH	99% Bandwidth (MHz)
HSDPA V	826.40	4132	4.1704
	836.60	4183	4.1457
	846.60	4233	4.1299

Unless otherwise stated the results shown in this test report refer only to the sample(s) tested and such sample(s) are retained for 90 days only.

除非另有說明，此報告結果僅對測試之樣品負責，同時此樣品僅保留90天。本報告未經本公司書面許可，不可部份複製。

This document is issued by the Company subject to its General Conditions of Service printed overleaf, available on request or accessible at www.sgs.com/terms_and_conditions.htm and, for electronic format documents, subject to Terms and Conditions for Electronic Documents at www.sgs.com/terms_e-document.htm. Attention is drawn to the limitation of liability, indemnification and jurisdiction issues defined therein. Any holder of this document is advised that information contained hereon reflects the Company's findings at the time of its intervention only and within the limits of Client's instructions, if any. The Company's sole responsibility is to its Client and this document does not exonerate parties to a transaction from exercising all their rights and obligations under the transaction documents. This document cannot be reproduced except in full, without prior written approval of the Company. Any unauthorized alteration, forgery or falsification of the content or appearance of this document is unlawful and offenders may be prosecuted to the fullest extent of the law.

EUT Mode	Frequency (MHz)	CH	99% Bandwidth (MHz)
HSUPA II	1852.40	9262	4.1407
	1880.00	9400	4.1999
	1907.60	9538	4.1898

EUT Mode	Frequency (MHz)	CH	99% Bandwidth (MHz)
HSUPA IV	1712.40	1312	4.1674
	1732.60	1413	4.1433
	1752.60	1513	4.2484

EUT Mode	Frequency (MHz)	CH	99% Bandwidth (MHz)
HSUPA V	826.40	4132	4.1912
	836.60	4183	4.2691
	846.60	4233	4.1768

Unless otherwise stated the results shown in this test report refer only to the sample(s) tested and such sample(s) are retained for 90 days only.

除非另有說明，此報告結果僅對測試之樣品負責，同時此樣品僅保留90天。本報告未經本公司書面許可，不可部份複製。

This document is issued by the Company subject to its General Conditions of Service printed overleaf, available on request or accessible at www.sgs.com/terms_and_conditions.htm and, for electronic format documents, subject to Terms and Conditions for Electronic Documents at www.sgs.com/terms_e-document.htm. Attention is drawn to the limitation of liability, indemnification and jurisdiction issues defined therein. Any holder of this document is advised that information contained hereon reflects the Company's findings at the time of its intervention only and within the limits of Client's instructions, if any. The Company's sole responsibility is to its Client and this document does not exonerate parties to a transaction from exercising all their rights and obligations under the transaction documents. This document cannot be reproduced except in full, without prior written approval of the Company. Any unauthorized alteration, forgery or falsification of the content or appearance of this document is unlawful and offenders may be prosecuted to the fullest extent of the law.

20dB Bandwidth

EUT Mode	Frequency (MHz)	CH	20dB Bandwidth (MHz)
GSM 850	824.20	128	0.295
	836.60	190	0.285
	848.80	251	0.286

EUT Mode	Frequency (MHz)	CH	20dB Bandwidth (MHz)
GSM 1900	1850.20	512	0.275
	1880.00	661	0.291
	1909.80	810	0.285

EUT Mode	Frequency (MHz)	CH	20dB Bandwidth (MHz)
GPRS 850	824.20	128	0.273
	836.60	190	0.282
	848.80	251	0.283

EUT Mode	Frequency (MHz)	CH	20dB Bandwidth (MHz)
GPRS 1900	1850.20	512	0.275
	1880.00	661	0.291
	1909.80	810	0.285

EUT Mode	Frequency (MHz)	CH	20dB Bandwidth (MHz)
EDGE 850	824.20	128	0.275
	836.60	190	0.290
	848.80	251	0.279

EUT Mode	Frequency (MHz)	CH	20dB Bandwidth (MHz)
EDGE 1900	1850.20	512	0.270
	1880.00	661	0.276
	1909.80	810	0.280

Unless otherwise stated the results shown in this test report refer only to the sample(s) tested and such sample(s) are retained for 90 days only.

除非另有說明，此報告結果僅對測試之樣品負責，同時此樣品僅保留90天。本報告未經本公司書面許可，不可部份複製。

This document is issued by the Company subject to its General Conditions of Service printed overleaf, available on request or accessible at www.sgs.com/terms_and_conditions.htm and, for electronic format documents, subject to Terms and Conditions for Electronic Documents at www.sgs.com/terms_e-document.htm. Attention is drawn to the limitation of liability, indemnification and jurisdiction issues defined therein. Any holder of this document is advised that information contained hereon reflects the Company's findings at the time of its intervention only and within the limits of Client's instructions, if any. The Company's sole responsibility is to its Client and this document does not exonerate parties to a transaction from exercising all their rights and obligations under the transaction documents. This document cannot be reproduced except in full, without prior written approval of the Company. Any unauthorized alteration, forgery or falsification of the content or appearance of this document is unlawful and offenders may be prosecuted to the fullest extent of the law.

EUT Mode	Frequency (MHz)	CH	20dB Bandwidth (MHz)
WCDMA II	1852.40	9262	4.460
	1880.00	9400	4.532
	1907.60	9538	4.500

EUT Mode	Frequency (MHz)	CH	20dB Bandwidth (MHz)
WCDMA IV	1712.40	1312	4.476
	1732.60	1413	4.542
	1752.60	1513	4.421

EUT Mode	Frequency (MHz)	CH	20dB Bandwidth (MHz)
WCDMA V	826.40	4132	4.578
	836.00	4183	4.507
	846.60	4233	4.533

EUT Mode	Frequency (MHz)	CH	20dB Bandwidth (MHz)
HSDPA II	1852.40	9262	4.473
	1880.00	9400	4.487
	1907.60	9538	4.424

EUT Mode	Frequency (MHz)	CH	20dB Bandwidth (MHz)
HSDPA IV	1712.40	1312	4.472
	1732.60	1413	4.481
	1752.60	1513	4.399

EUT Mode	Frequency (MHz)	CH	20dB Bandwidth (MHz)
HSDPA V	826.40	4132	4.469
	836.60	4183	4.415
	846.60	4233	4.443

Unless otherwise stated the results shown in this test report refer only to the sample(s) tested and such sample(s) are retained for 90 days only.

除非另有說明，此報告結果僅對測試之樣品負責，同時此樣品僅保留90天。本報告未經本公司書面許可，不可部份複製。

This document is issued by the Company subject to its General Conditions of Service printed overleaf, available on request or accessible at www.sgs.com/terms_and_conditions.htm and, for electronic format documents, subject to Terms and Conditions for Electronic Documents at www.sgs.com/terms_e-document.htm. Attention is drawn to the limitation of liability, indemnification and jurisdiction issues defined therein. Any holder of this document is advised that information contained hereon reflects the Company's findings at the time of its intervention only and within the limits of Client's instructions, if any. The Company's sole responsibility is to its Client and this document does not exonerate parties to a transaction from exercising all their rights and obligations under the transaction documents. This document cannot be reproduced except in full, without prior written approval of the Company. Any unauthorized alteration, forgery or falsification of the content or appearance of this document is unlawful and offenders may be prosecuted to the fullest extent of the law.

EUT Mode	Frequency (MHz)	CH	20dB Bandwidth (MHz)
HSUPA II	1852.40	9262	4.425
	1880.00	9400	4.517
	1907.60	9538	4.524

EUT Mode	Frequency (MHz)	CH	20dB Bandwidth (MHz)
HSUPA IV	1712.40	1312	4.428
	1732.60	1413	4.469
	1752.60	1513	4.535

EUT Mode	Frequency (MHz)	CH	20dB Bandwidth (MHz)
HSUPA V	826.40	4132	4.491
	836.60	4183	4.442
	846.60	4233	4.386

Unless otherwise stated the results shown in this test report refer only to the sample(s) tested and such sample(s) are retained for 90 days only.

除非另有說明，此報告結果僅對測試之樣品負責，同時此樣品僅保留90天。本報告未經本公司書面許可，不可部份複製。

This document is issued by the Company subject to its General Conditions of Service printed overleaf, available on request or accessible at www.sgs.com/terms_and_conditions.htm and, for electronic format documents, subject to Terms and Conditions for Electronic Documents at www.sgs.com/terms_e-document.htm. Attention is drawn to the limitation of liability, indemnification and jurisdiction issues defined therein. Any holder of this document is advised that information contained hereon reflects the Company's findings at the time of its intervention only and within the limits of Client's instructions, if any. The Company's sole responsibility is to its Client and this document does not exonerate parties to a transaction from exercising all their rights and obligations under the transaction documents. This document cannot be reproduced except in full, without prior written approval of the Company. Any unauthorized alteration, forgery or falsification of the content or appearance of this document is unlawful and offenders may be prosecuted to the fullest extent of the law.

99% & 20dB Bandwidth Test Data

Figure 8-1: GSM 850 Channel Low

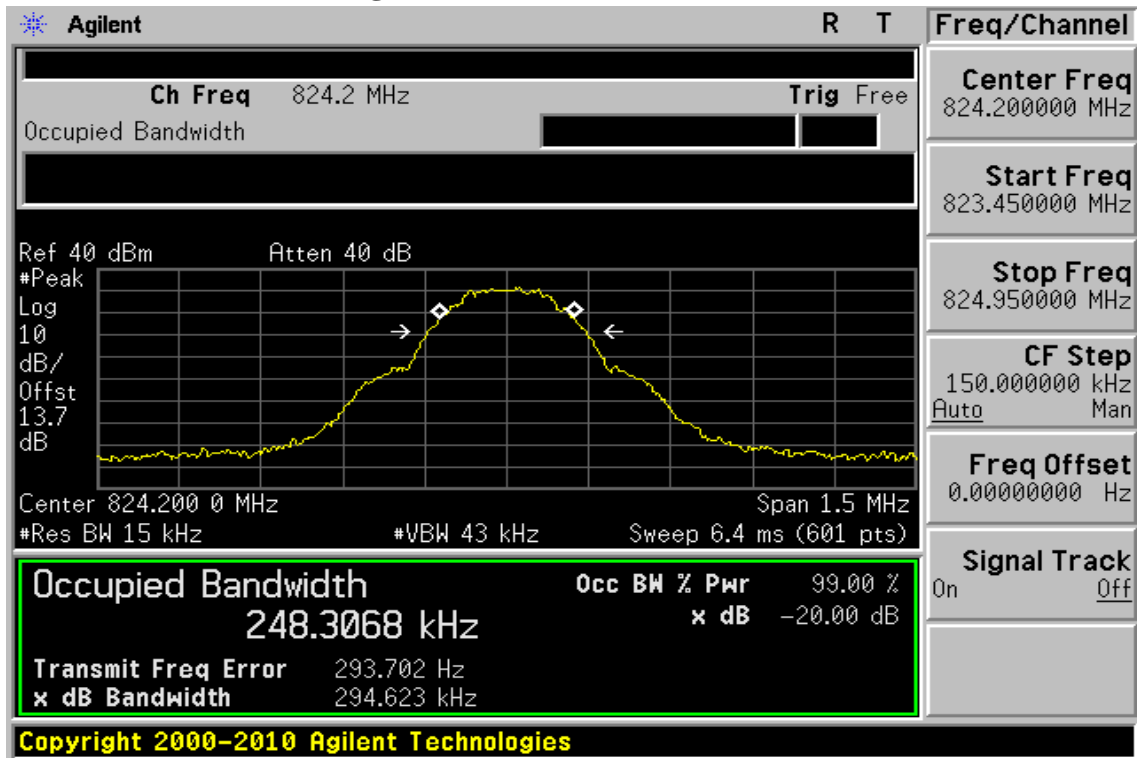
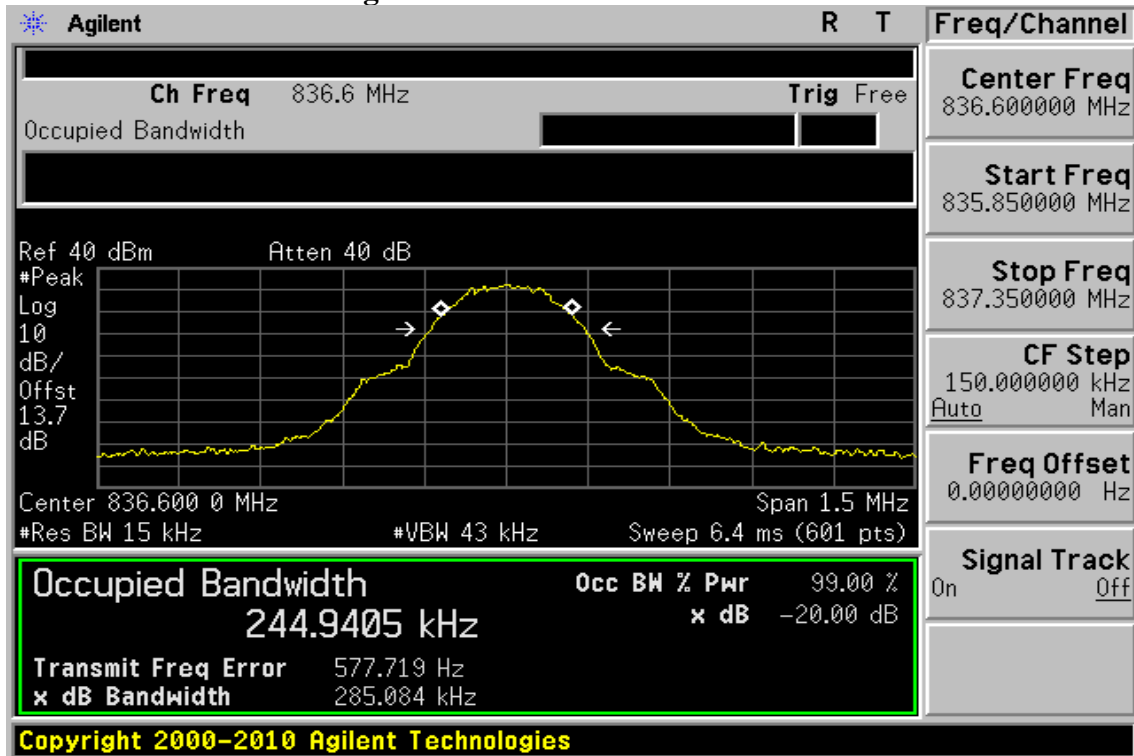

Figure 8-2: GSM 850 Channel Mid



Unless otherwise stated the results shown in this test report refer only to the sample(s) tested and such sample(s) are retained for 90 days only.

除非另有說明，此報告結果僅對測試之樣品負責，同時此樣品僅保留90天。本報告未經本公司書面許可，不可部份複製。

This document is issued by the Company subject to its General Conditions of Service printed overleaf, available on request or accessible at www.sgs.com/terms_and_conditions.htm and, for electronic format documents, subject to Terms and Conditions for Electronic Documents at www.sgs.com/terms_e-document.htm. Attention is drawn to the limitation of liability, indemnification and jurisdiction issues defined therein. Any holder of this document is advised that information contained hereon reflects the Company's findings at the time of its intervention only and within the limits of Client's instructions, if any. The Company's sole responsibility is to its Client and this document does not exonerate parties to a transaction from exercising all their rights and obligations under the transaction documents. This document cannot be reproduced except in full, without prior written approval of the Company. Any unauthorized alteration, forgery or falsification of the content or appearance of this document is unlawful and offenders may be prosecuted to the fullest extent of the law.

Figure 8-3: GSM 850 Channel High

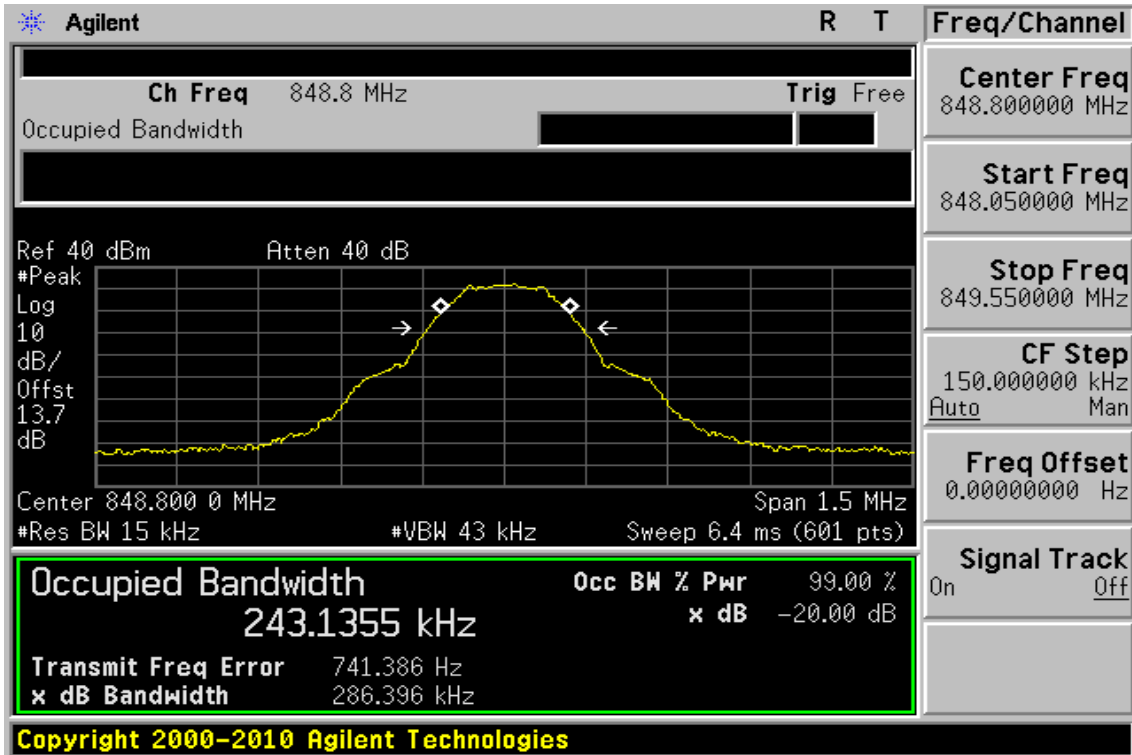
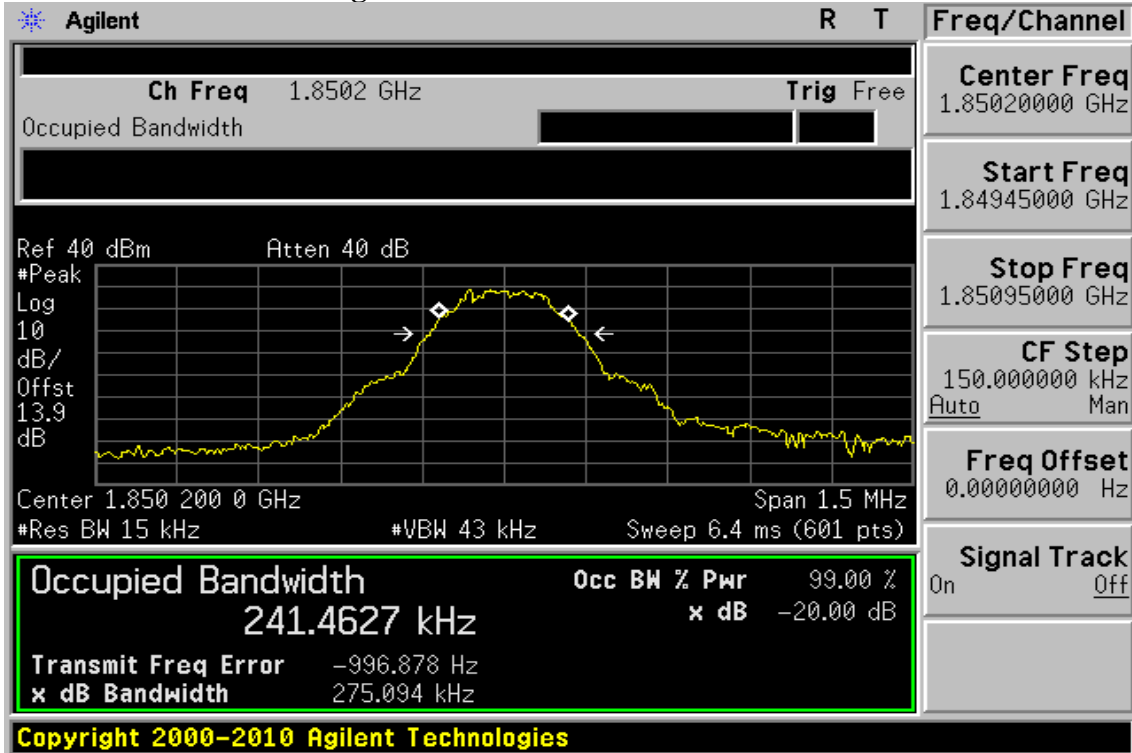

Figure 8-4: GSM 1900 Channel Low



Unless otherwise stated the results shown in this test report refer only to the sample(s) tested and such sample(s) are retained for 90 days only.

除非另有說明，此報告結果僅對測試之樣品負責，同時此樣品僅保留90天。本報告未經本公司書面許可，不可部份複製。

This document is issued by the Company subject to its General Conditions of Service printed overleaf, available on request or accessible at www.sgs.com/terms_and_conditions.htm and, for electronic format documents, subject to Terms and Conditions for Electronic Documents at www.sgs.com/terms_e-document.htm. Attention is drawn to the limitation of liability, indemnification and jurisdiction issues defined therein. Any holder of this document is advised that information contained hereon reflects the Company's findings at the time of its intervention only and within the limits of Client's instructions, if any. The Company's sole responsibility is to its Client and this document does not exonerate parties to a transaction from exercising all their rights and obligations under the transaction documents. This document cannot be reproduced except in full, without prior written approval of the Company. Any unauthorized alteration, forgery or falsification of the content or appearance of this document is unlawful and offenders may be prosecuted to the fullest extent of the law.

Figure 8-5: GSM 1900 Channel Mid

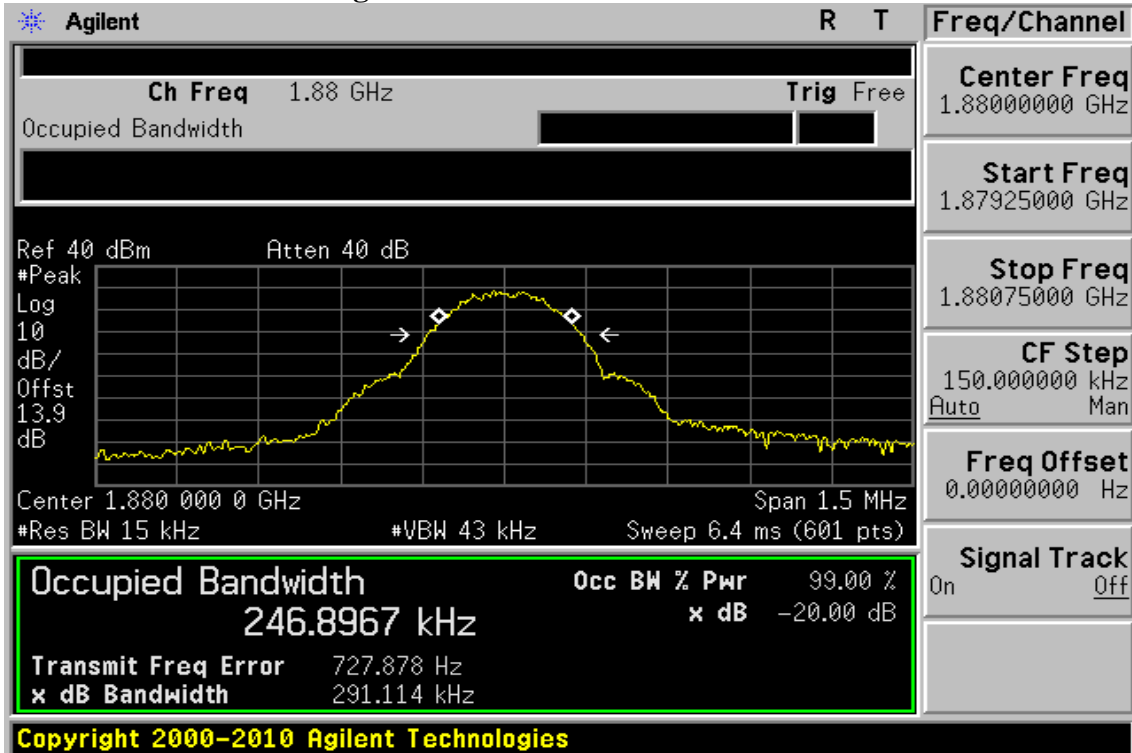
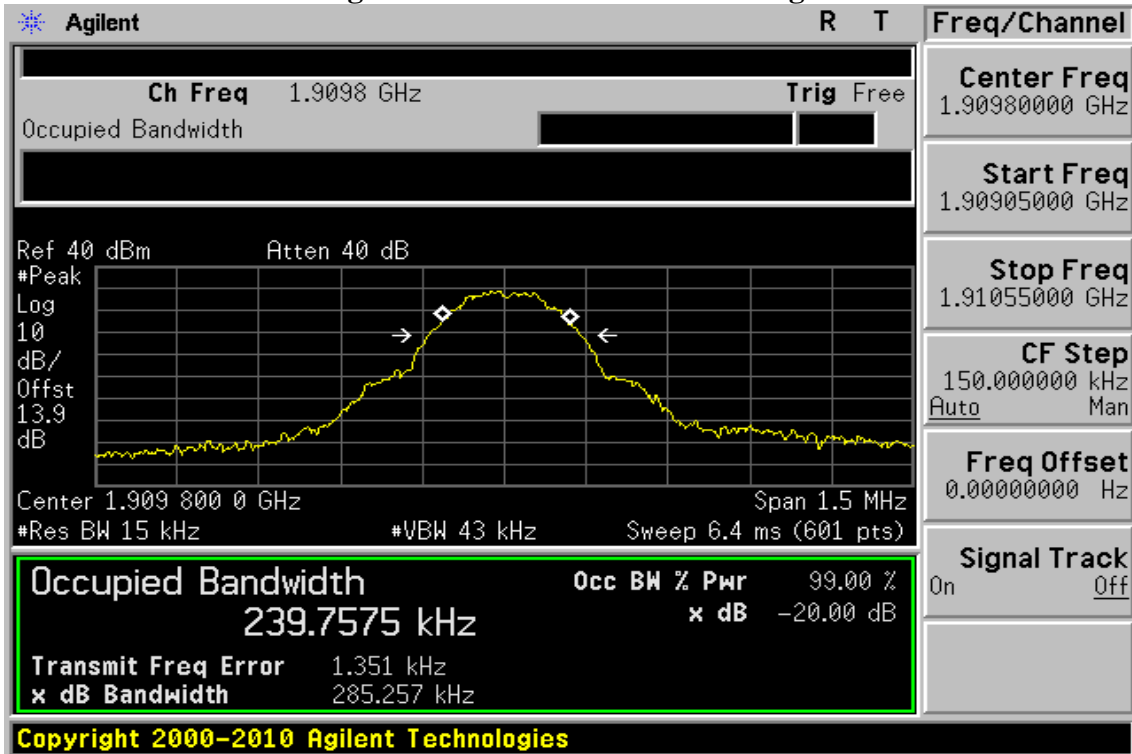

Figure 8-6: GSM 1900 Channel High



Unless otherwise stated the results shown in this test report refer only to the sample(s) tested and such sample(s) are retained for 90 days only.

除非另有說明，此報告結果僅對測試之樣品負責，同時此樣品僅保留90天。本報告未經本公司書面許可，不可部份複製。

This document is issued by the Company subject to its General Conditions of Service printed overleaf, available on request or accessible at www.sgs.com/terms_and_conditions.htm and, for electronic format documents, subject to Terms and Conditions for Electronic Documents at www.sgs.com/terms_e-document.htm. Attention is drawn to the limitation of liability, indemnification and jurisdiction issues defined therein. Any holder of this document is advised that information contained hereon reflects the Company's findings at the time of its intervention only and within the limits of Client's instructions, if any. The Company's sole responsibility is to its Client and this document does not exonerate parties to a transaction from exercising all their rights and obligations under the transaction documents. This document cannot be reproduced except in full, without prior written approval of the Company. Any unauthorized alteration, forgery or falsification of the content or appearance of this document is unlawful and offenders may be prosecuted to the fullest extent of the law.

Figure 8-7: GPRS 850 Channel Low

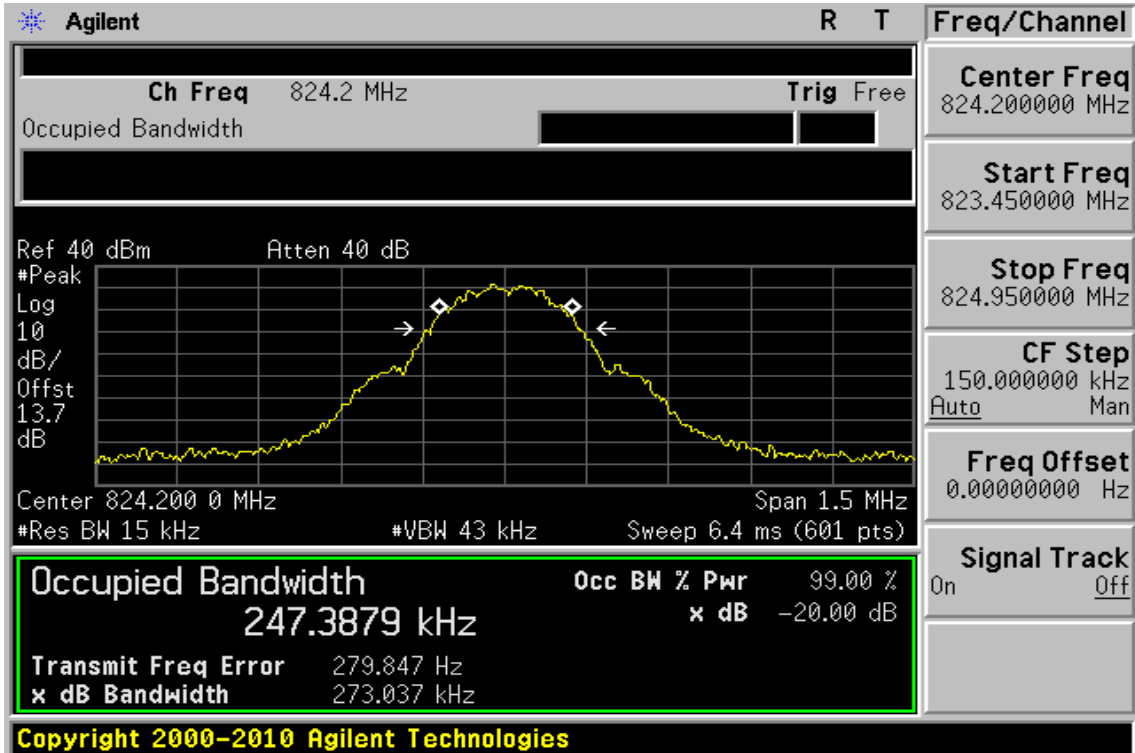
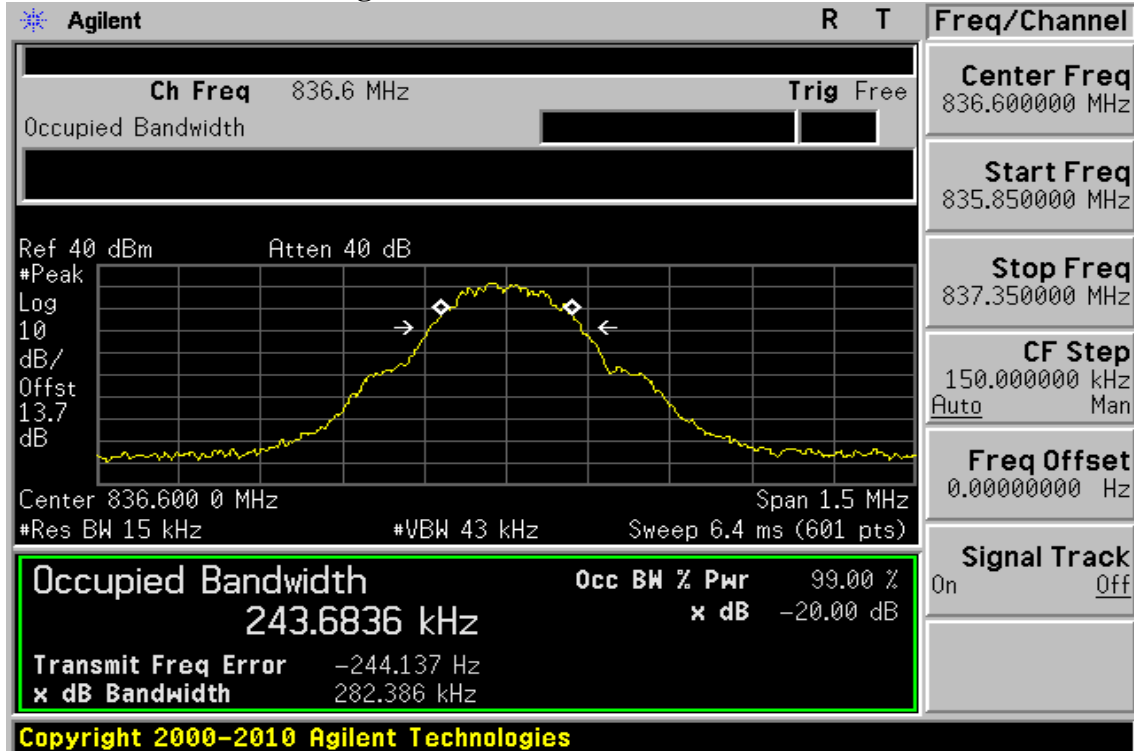

Figure 8-8: GPRS 850 Channel Mid



Unless otherwise stated the results shown in this test report refer only to the sample(s) tested and such sample(s) are retained for 90 days only.

除非另有說明，此報告結果僅對測試之樣品負責，同時此樣品僅保留90天。本報告未經本公司書面許可，不可部份複製。

This document is issued by the Company subject to its General Conditions of Service printed overleaf, available on request or accessible at www.sgs.com/terms_and_conditions.htm and, for electronic format documents, subject to Terms and Conditions for Electronic Documents at www.sgs.com/terms_e-document.htm. Attention is drawn to the limitation of liability, indemnification and jurisdiction issues defined therein. Any holder of this document is advised that information contained hereon reflects the Company's findings at the time of its intervention only and within the limits of Client's instructions, if any. The Company's sole responsibility is to its Client and this document does not exonerate parties to a transaction from exercising all their rights and obligations under the transaction documents. This document cannot be reproduced except in full, without prior written approval of the Company. Any unauthorized alteration, forgery or falsification of the content or appearance of this document is unlawful and offenders may be prosecuted to the fullest extent of the law.

GPRS Figure 8-9: GPRS 850 Channel High

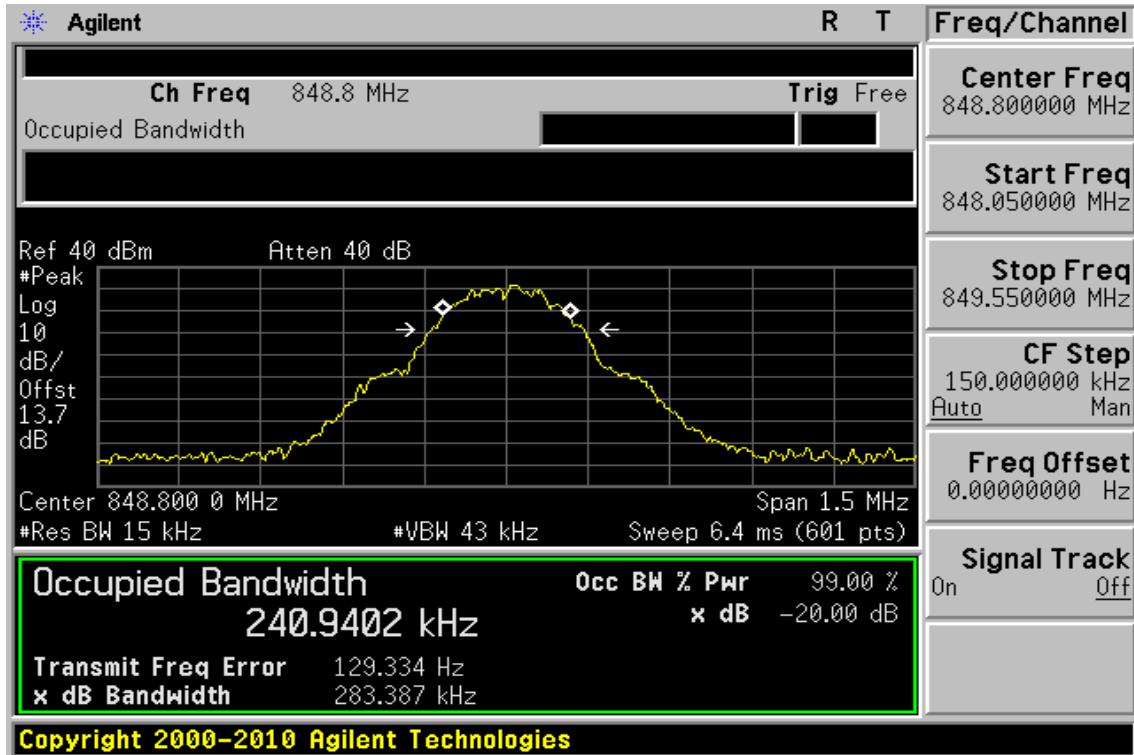
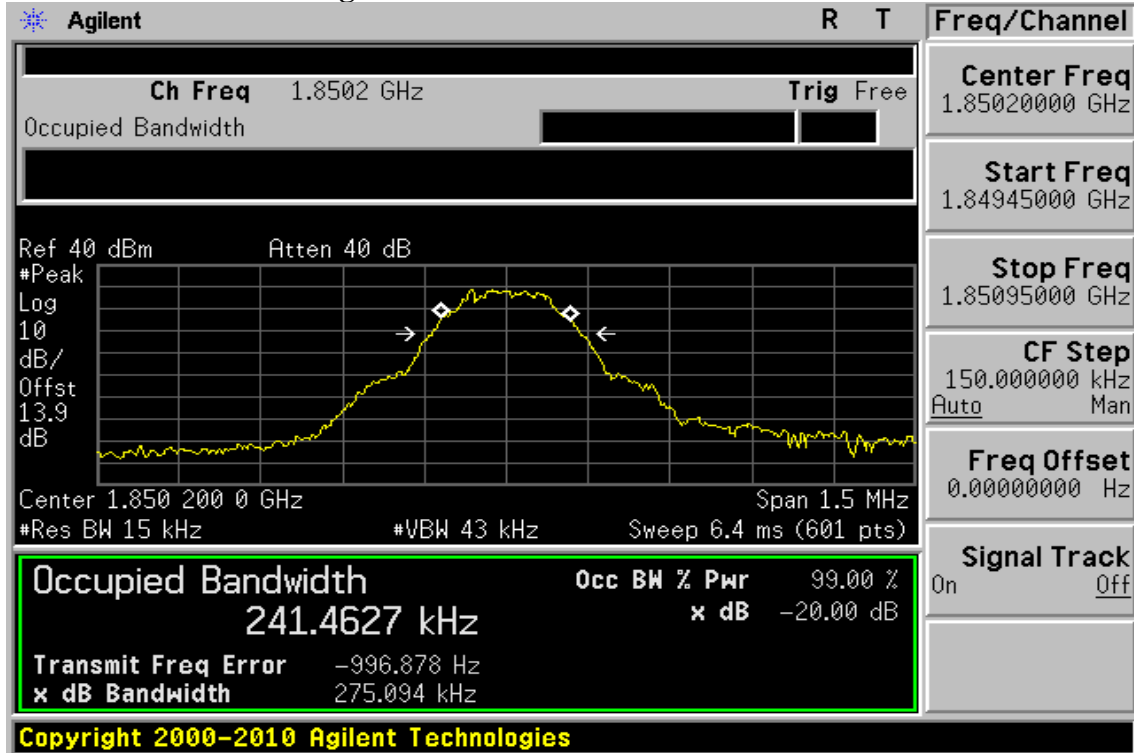

Figure 8-10: GPRS 1900 Channel Low



Unless otherwise stated the results shown in this test report refer only to the sample(s) tested and such sample(s) are retained for 90 days only.

除非另有說明，此報告結果僅對測試之樣品負責，同時此樣品僅保留90天。本報告未經本公司書面許可，不可部份複製。

This document is issued by the Company subject to its General Conditions of Service printed overleaf, available on request or accessible at www.sgs.com/terms_and_conditions.htm and, for electronic format documents, subject to Terms and Conditions for Electronic Documents at www.sgs.com/terms_e-document.htm. Attention is drawn to the limitation of liability, indemnification and jurisdiction issues defined therein. Any holder of this document is advised that information contained hereon reflects the Company's findings at the time of its intervention only and within the limits of Client's instructions, if any. The Company's sole responsibility is to its Client and this document does not exonerate parties to a transaction from exercising all their rights and obligations under the transaction documents. This document cannot be reproduced except in full, without prior written approval of the Company. Any unauthorized alteration, forgery or falsification of the content or appearance of this document is unlawful and offenders may be prosecuted to the fullest extent of the law.

Figure 8-11: GPRS 1900 Channel Mid

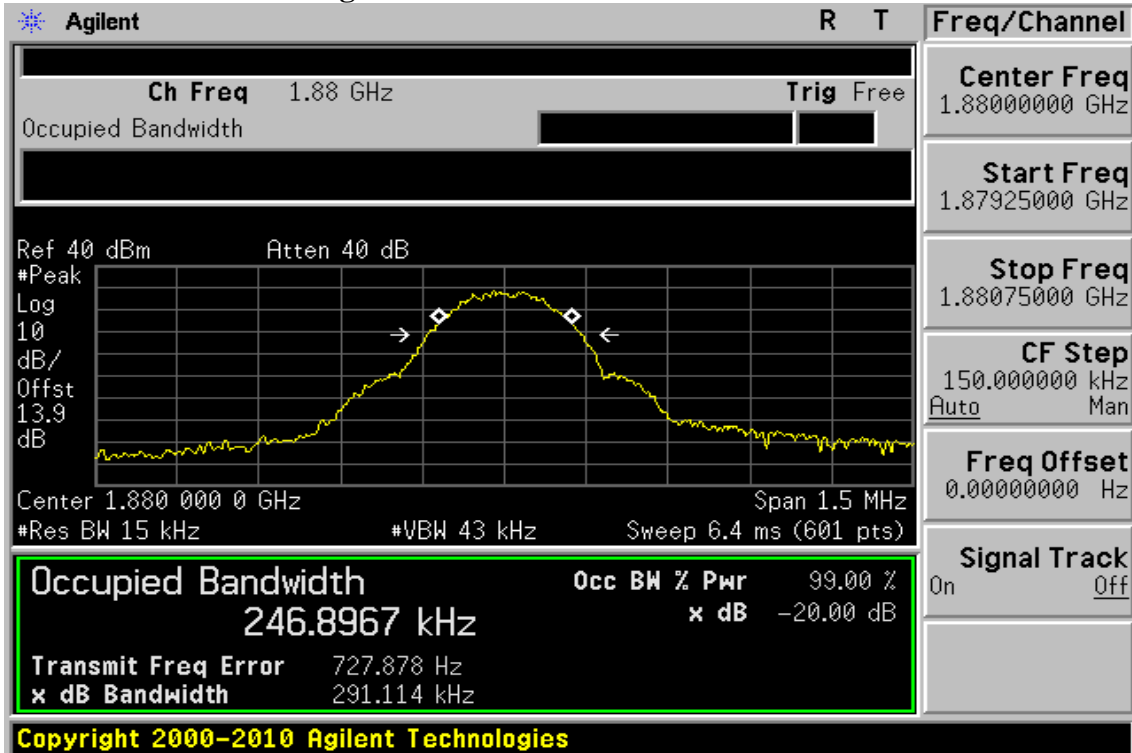
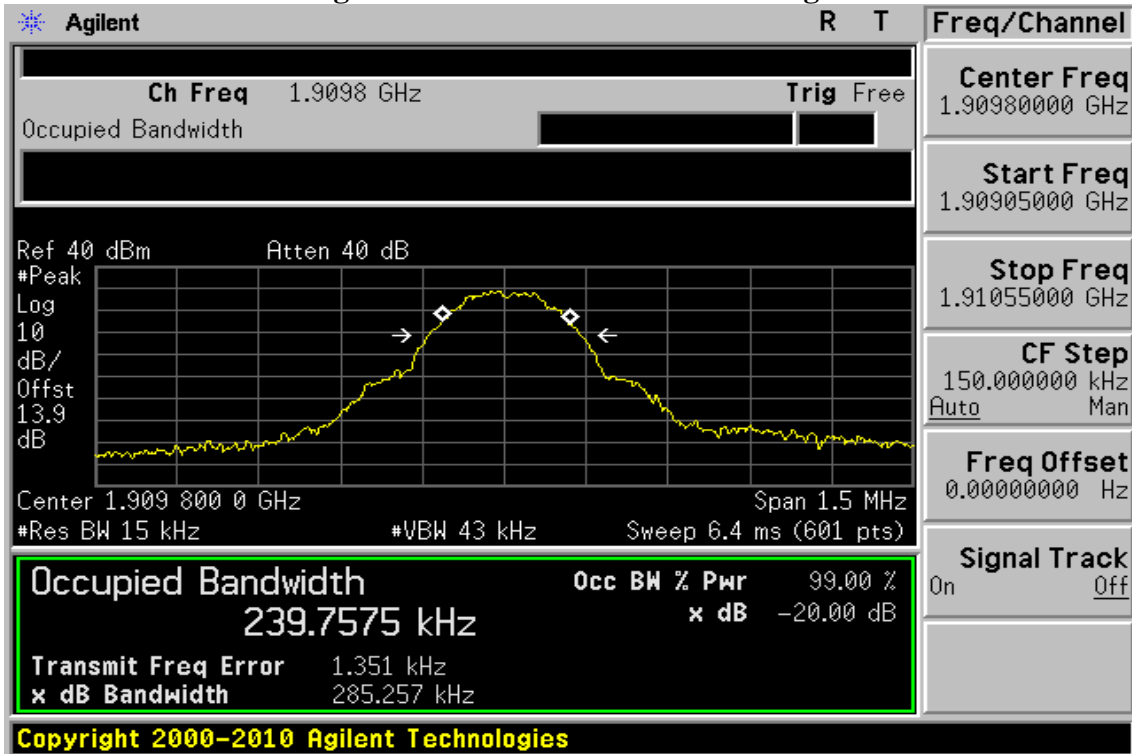

Figure 8-12: GPRS 1900 Channel High



Unless otherwise stated the results shown in this test report refer only to the sample(s) tested and such sample(s) are retained for 90 days only.

除非另有說明，此報告結果僅對測試之樣品負責，同時此樣品僅保留90天。本報告未經本公司書面許可，不可部份複製。

This document is issued by the Company subject to its General Conditions of Service printed overleaf, available on request or accessible at www.sgs.com/terms_and_conditions.htm and, for electronic format documents, subject to Terms and Conditions for Electronic Documents at www.sgs.com/terms_e-document.htm. Attention is drawn to the limitation of liability, indemnification and jurisdiction issues defined therein. Any holder of this document is advised that information contained hereon reflects the Company's findings at the time of its intervention only and within the limits of Client's instructions, if any. The Company's sole responsibility is to its Client and this document does not exonerate parties to a transaction from exercising all their rights and obligations under the transaction documents. This document cannot be reproduced except in full, without prior written approval of the Company. Any unauthorized alteration, forgery or falsification of the content or appearance of this document is unlawful and offenders may be prosecuted to the fullest extent of the law.

Figure 8-13: EDGE 850 Channel Low

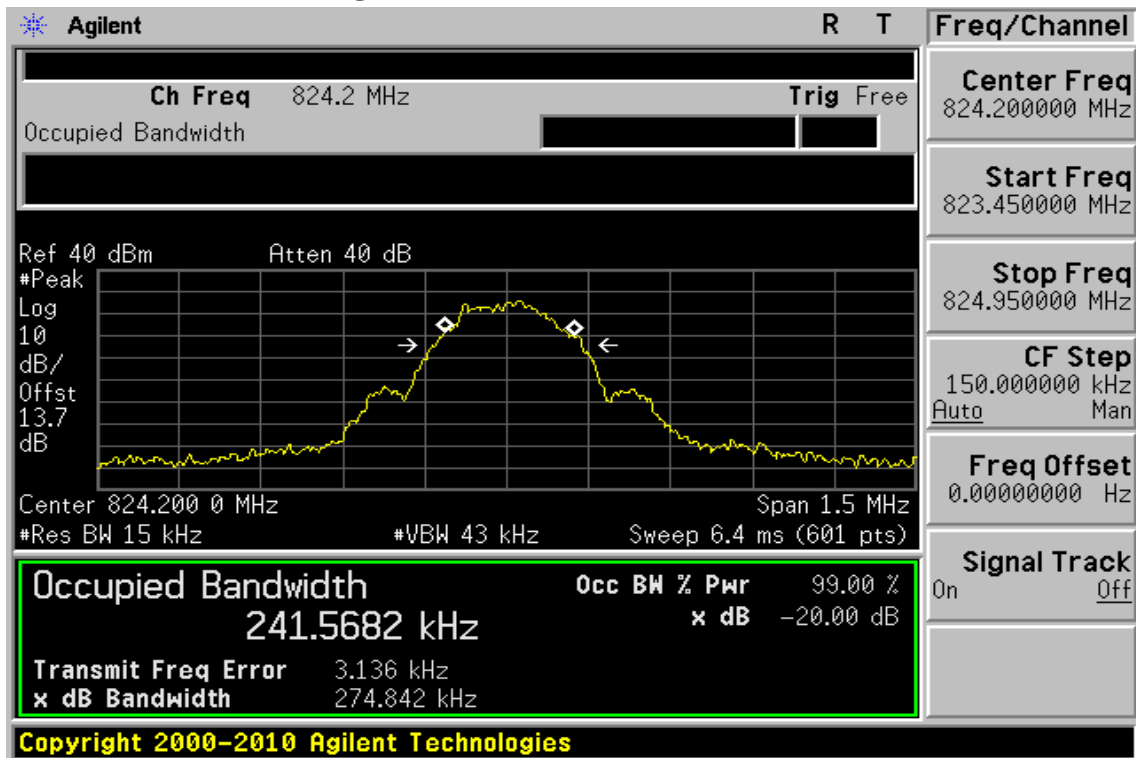
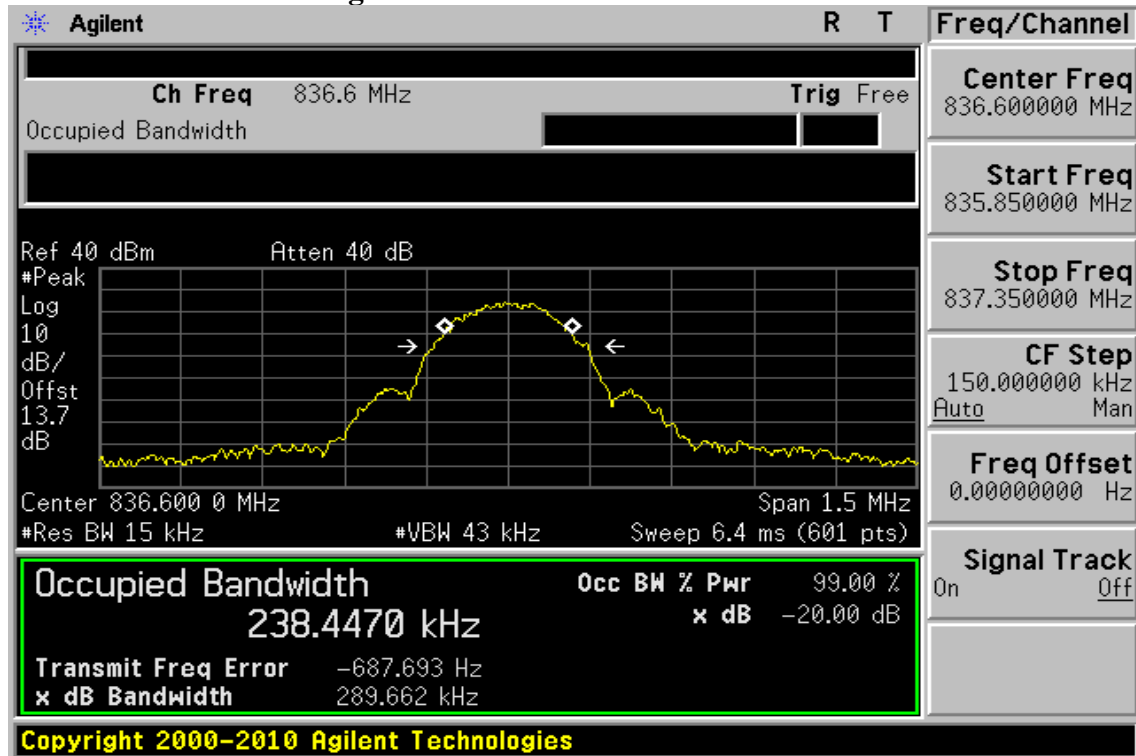

Figure 8-14: EDGE 850 Channel Mid



Unless otherwise stated the results shown in this test report refer only to the sample(s) tested and such sample(s) are retained for 90 days only.

除非另有說明，此報告結果僅對測試之樣品負責，同時此樣品僅保留90天。本報告未經本公司書面許可，不可部份複製。

This document is issued by the Company subject to its General Conditions of Service printed overleaf, available on request or accessible at www.sgs.com/terms_and_conditions.htm and, for electronic format documents, subject to Terms and Conditions for Electronic Documents at www.sgs.com/terms_e-document.htm. Attention is drawn to the limitation of liability, indemnification and jurisdiction issues defined therein. Any holder of this document is advised that information contained hereon reflects the Company's findings at the time of its intervention only and within the limits of Client's instructions, if any. The Company's sole responsibility is to its Client and this document does not exonerate parties to a transaction from exercising all their rights and obligations under the transaction documents. This document cannot be reproduced except in full, without prior written approval of the Company. Any unauthorized alteration, forgery or falsification of the content or appearance of this document is unlawful and offenders may be prosecuted to the fullest extent of the law.

GPRS Figure 8-15: EDGE 850 Channel High

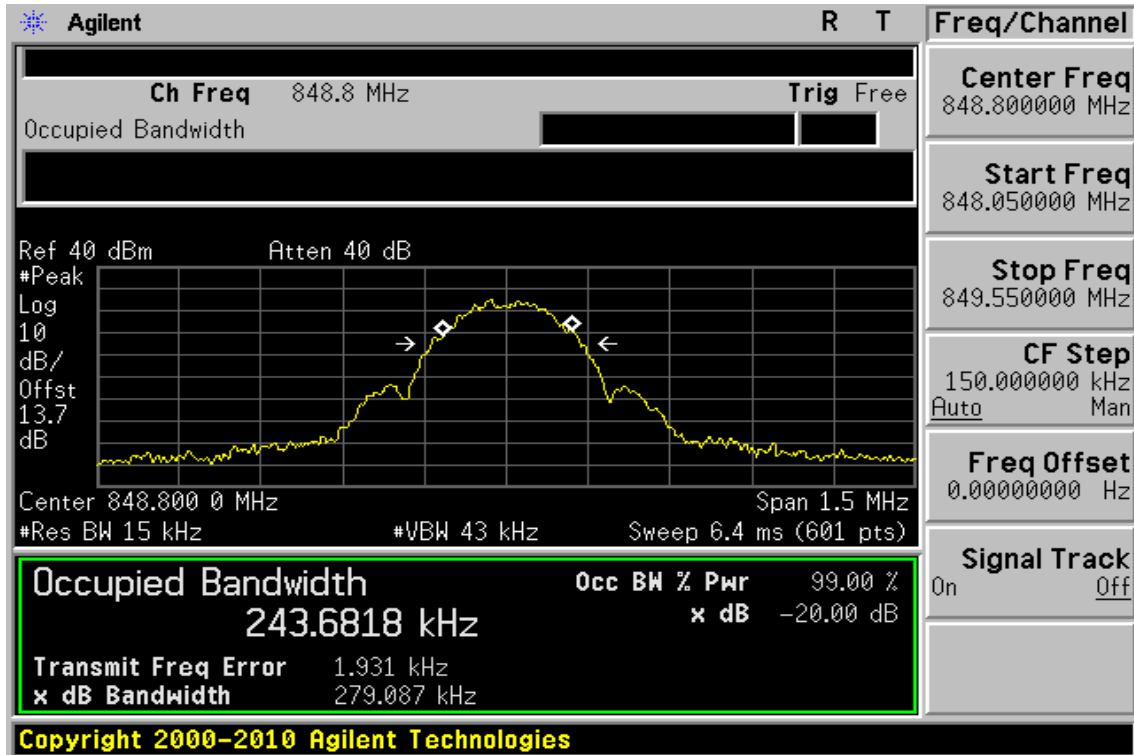
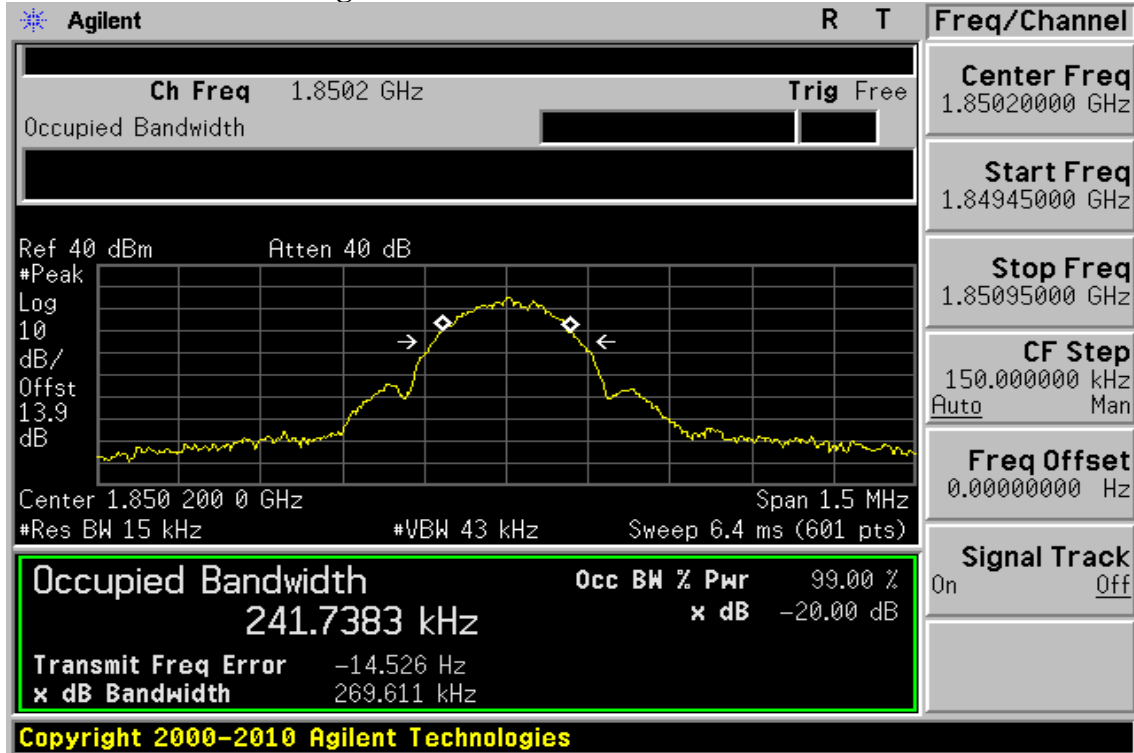

Figure 8-16: EDGE 1900 Channel Low



Unless otherwise stated the results shown in this test report refer only to the sample(s) tested and such sample(s) are retained for 90 days only.

除非另有說明，此報告結果僅對測試之樣品負責，同時此樣品僅保留90天。本報告未經本公司書面許可，不可部份複製。

This document is issued by the Company subject to its General Conditions of Service printed overleaf, available on request or accessible at www.sgs.com/terms_and_conditions.htm and, for electronic format documents, subject to Terms and Conditions for Electronic Documents at www.sgs.com/terms_e-document.htm. Attention is drawn to the limitation of liability, indemnification and jurisdiction issues defined therein. Any holder of this document is advised that information contained hereon reflects the Company's findings at the time of its intervention only and within the limits of Client's instructions, if any. The Company's sole responsibility is to its Client and this document does not exonerate parties to a transaction from exercising all their rights and obligations under the transaction documents. This document cannot be reproduced except in full, without prior written approval of the Company. Any unauthorized alteration, forgery or falsification of the content or appearance of this document is unlawful and offenders may be prosecuted to the fullest extent of the law.

Figure 8-17: EDGE 1900 Channel Mid

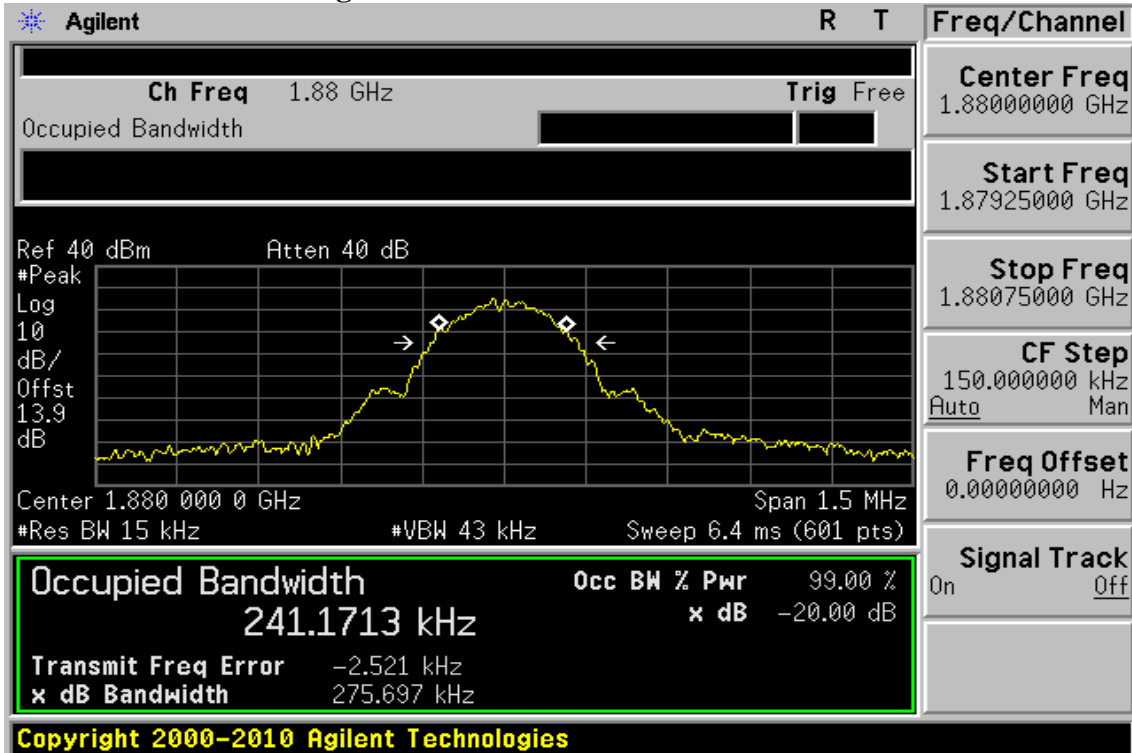
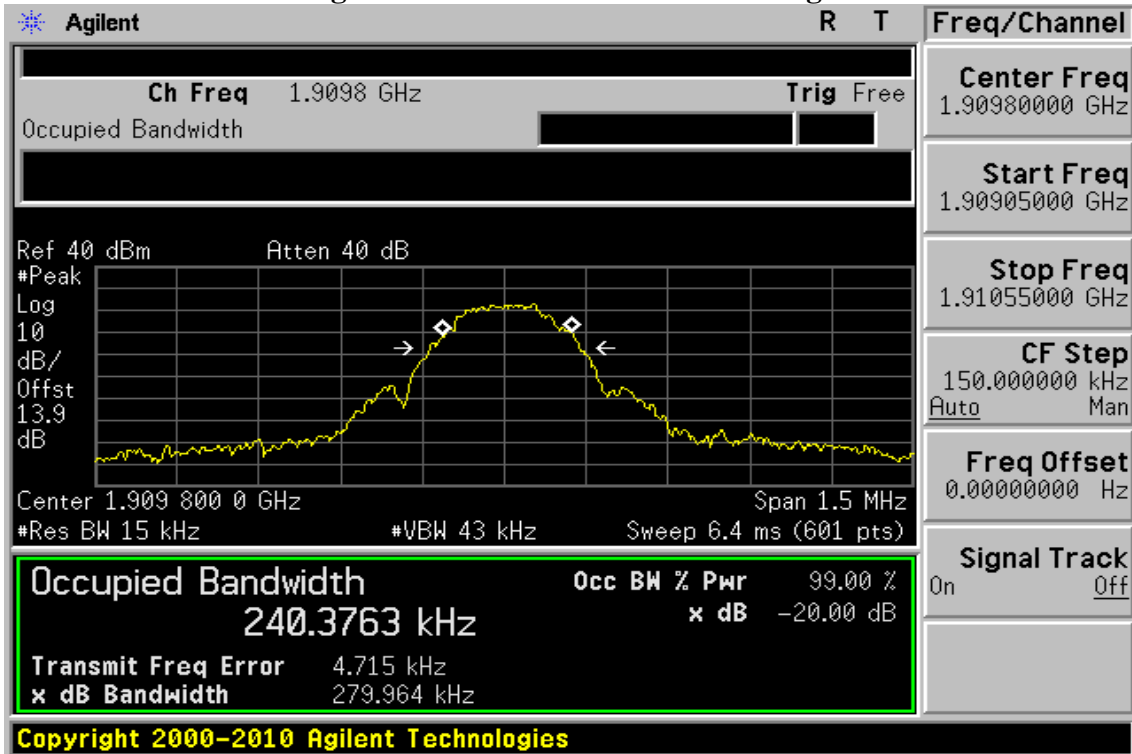

Figure 8-18: EDGE 1900 Channel High



Unless otherwise stated the results shown in this test report refer only to the sample(s) tested and such sample(s) are retained for 90 days only.

除非另有說明，此報告結果僅對測試之樣品負責，同時此樣品僅保留90天。本報告未經本公司書面許可，不可部份複製。

This document is issued by the Company subject to its General Conditions of Service printed overleaf, available on request or accessible at www.sgs.com/terms_and_conditions.htm and, for electronic format documents, subject to Terms and Conditions for Electronic Documents at www.sgs.com/terms_e-document.htm. Attention is drawn to the limitation of liability, indemnification and jurisdiction issues defined therein. Any holder of this document is advised that information contained hereon reflects the Company's findings at the time of its intervention only and within the limits of Client's instructions, if any. The Company's sole responsibility is to its Client and this document does not exonerate parties to a transaction from exercising all their rights and obligations under the transaction documents. This document cannot be reproduced except in full, without prior written approval of the Company. Any unauthorized alteration, forgery or falsification of the content or appearance of this document is unlawful and offenders may be prosecuted to the fullest extent of the law.

Figure 8-19: WCDMA II Channel Low

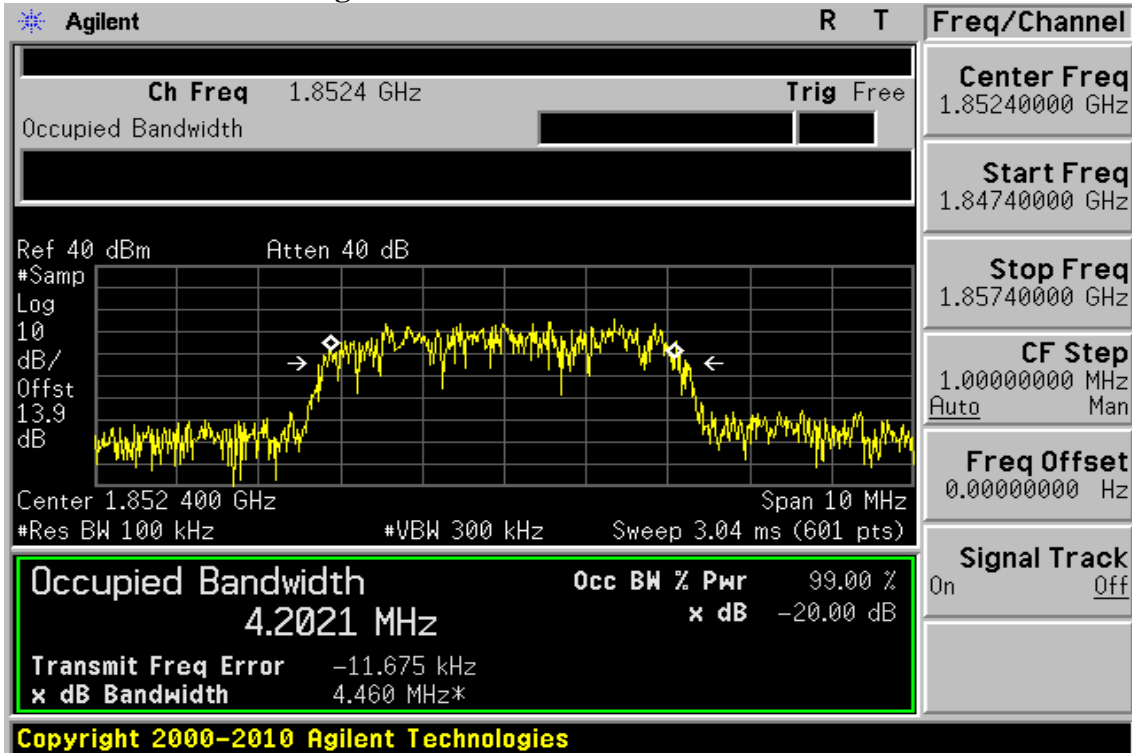
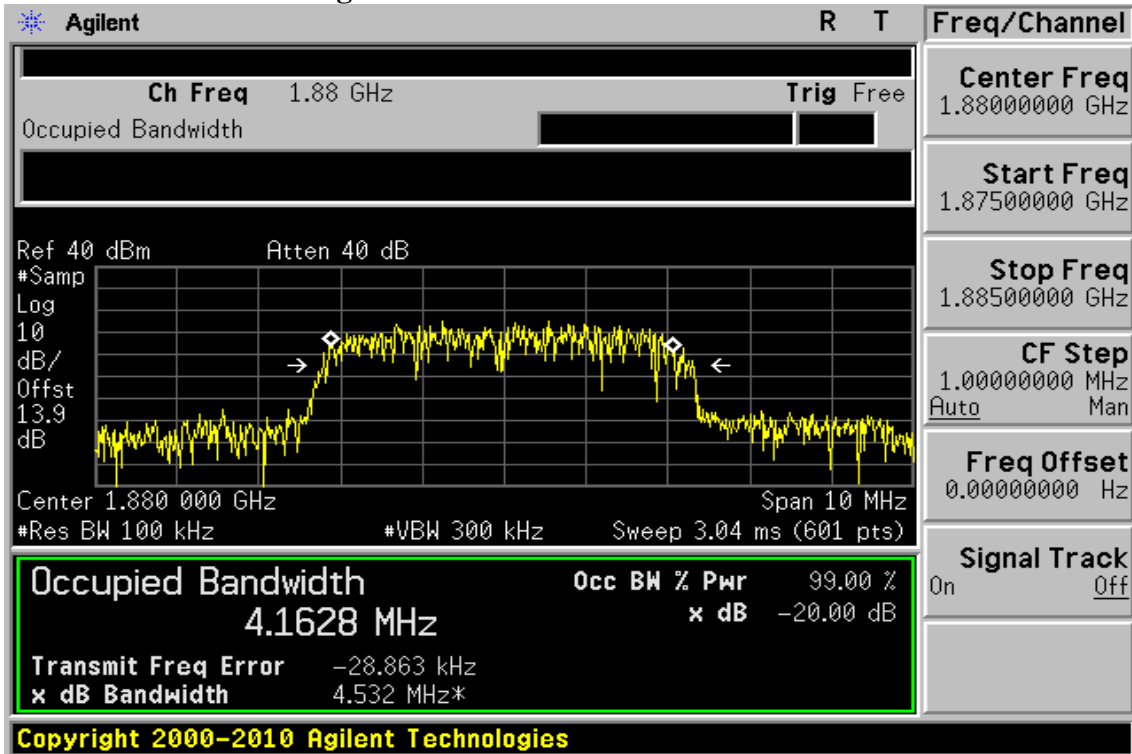

Figure 8-20: WCDMA II Channel Mid



Unless otherwise stated the results shown in this test report refer only to the sample(s) tested and such sample(s) are retained for 90 days only.

除非另有說明，此報告結果僅對測試之樣品負責，同時此樣品僅保留90天。本報告未經本公司書面許可，不可部份複製。

This document is issued by the Company subject to its General Conditions of Service printed overleaf, available on request or accessible at www.sgs.com/terms_and_conditions.htm and, for electronic format documents, subject to Terms and Conditions for Electronic Documents at www.sgs.com/terms_e-document.htm. Attention is drawn to the limitation of liability, indemnification and jurisdiction issues defined therein. Any holder of this document is advised that information contained hereon reflects the Company's findings at the time of its intervention only and within the limits of Client's instructions, if any. The Company's sole responsibility is to its Client and this document does not exonerate parties to a transaction from exercising all their rights and obligations under the transaction documents. This document cannot be reproduced except in full, without prior written approval of the Company. Any unauthorized alteration, forgery or falsification of the content or appearance of this document is unlawful and offenders may be prosecuted to the fullest extent of the law.

Figure 8-21: WCDMA II Channel High

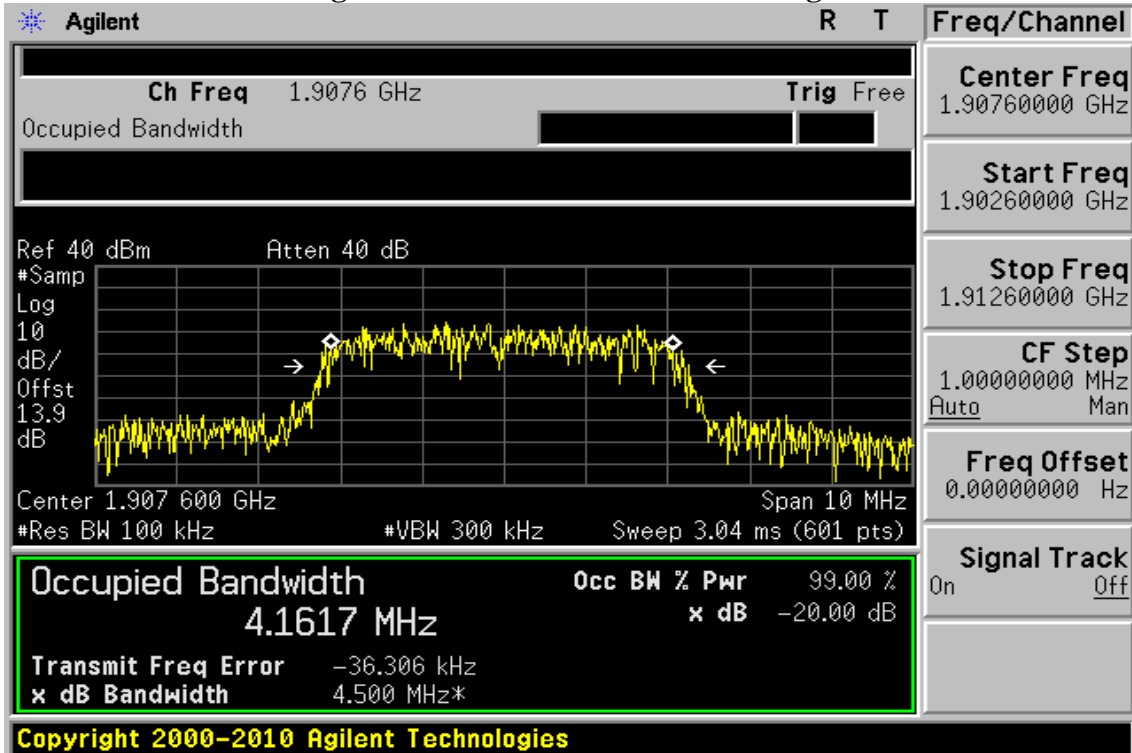
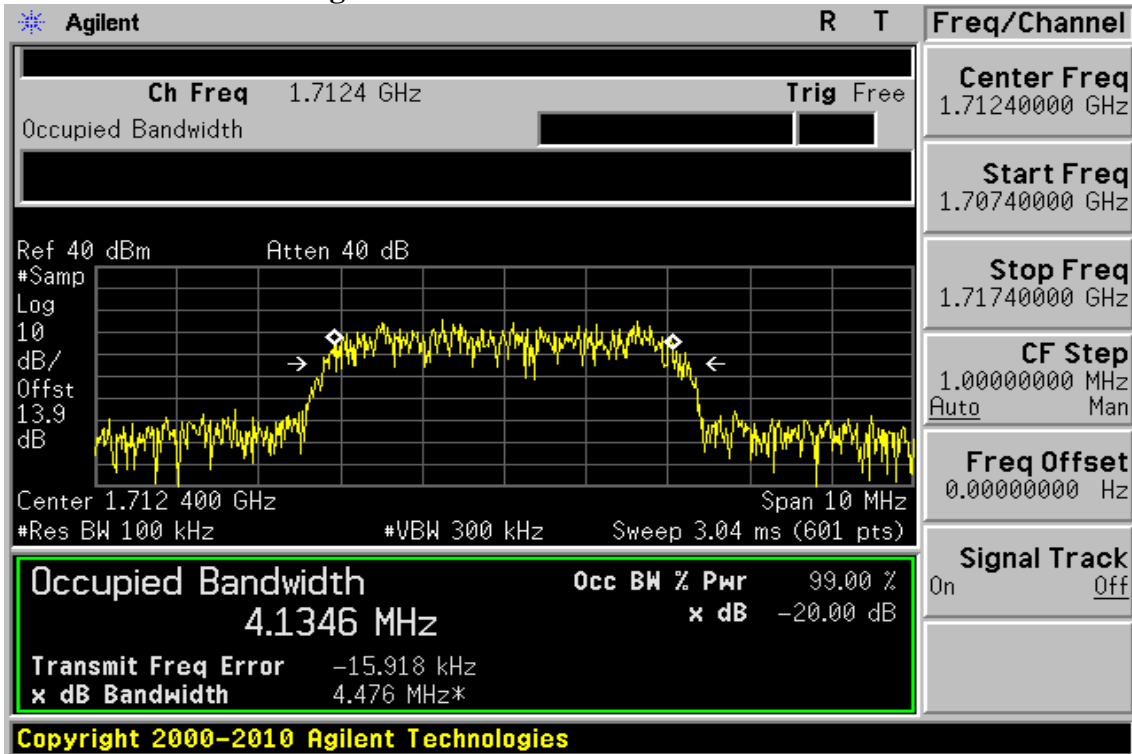

Figure 8-22: WCDMA IV Channel Low



Unless otherwise stated the results shown in this test report refer only to the sample(s) tested and such sample(s) are retained for 90 days only.

除非另有說明，此報告結果僅對測試之樣品負責，同時此樣品僅保留90天。本報告未經本公司書面許可，不可部份複製。

This document is issued by the Company subject to its General Conditions of Service printed overleaf, available on request or accessible at www.sgs.com/terms_and_conditions.htm and, for electronic format documents, subject to Terms and Conditions for Electronic Documents at www.sgs.com/terms_e-document.htm. Attention is drawn to the limitation of liability, indemnification and jurisdiction issues defined therein. Any holder of this document is advised that information contained hereon reflects the Company's findings at the time of its intervention only and within the limits of Client's instructions, if any. The Company's sole responsibility is to its Client and this document does not exonerate parties to a transaction from exercising all their rights and obligations under the transaction documents. This document cannot be reproduced except in full, without prior written approval of the Company. Any unauthorized alteration, forgery or falsification of the content or appearance of this document is unlawful and offenders may be prosecuted to the fullest extent of the law.

Figure 8-23: WCDMA IV Channel Mid

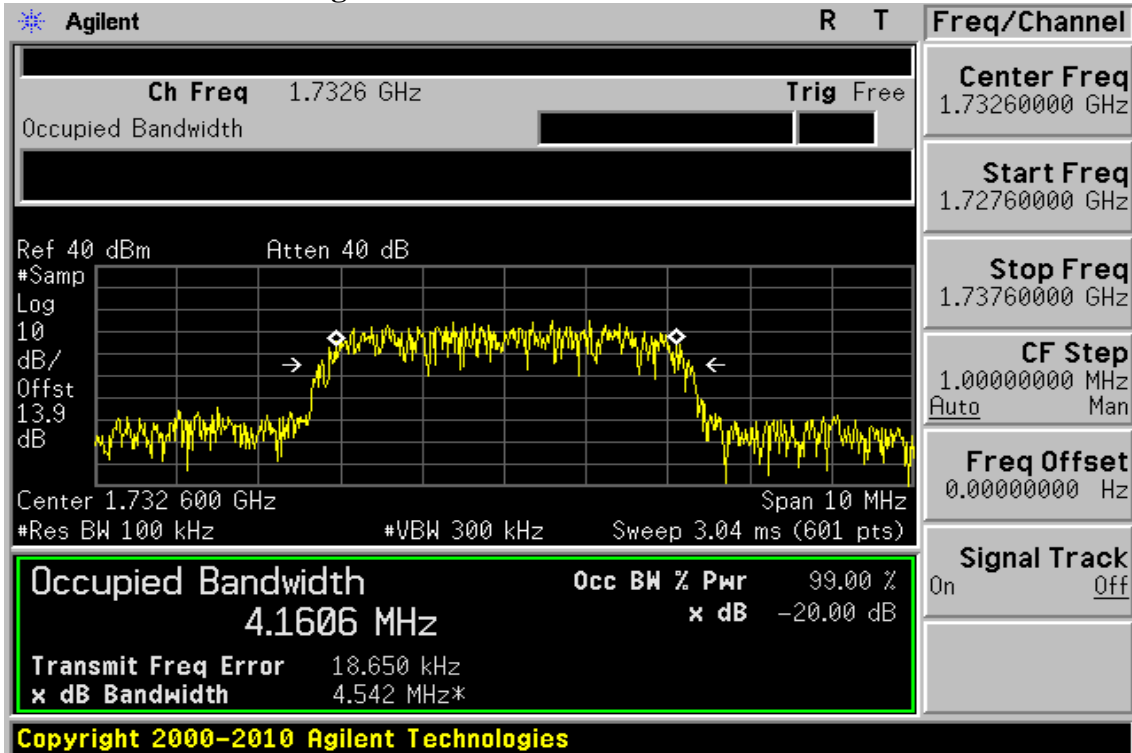
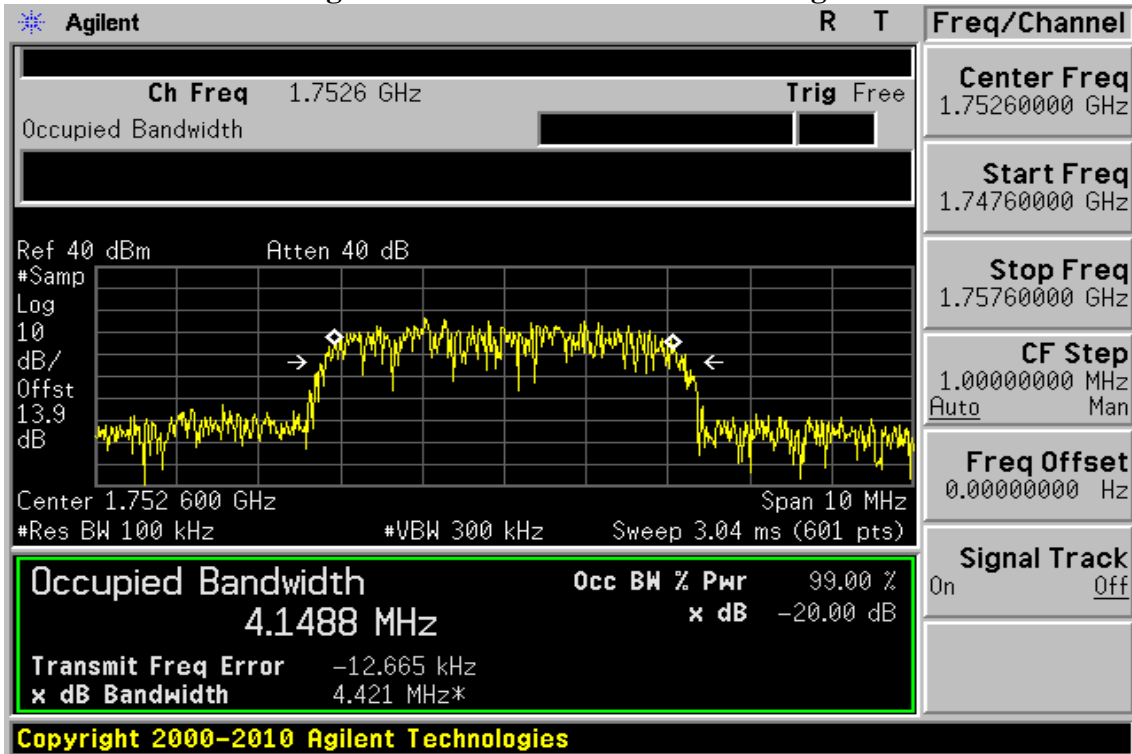

Figure 8-24: WCDMA IV Channel High



Unless otherwise stated the results shown in this test report refer only to the sample(s) tested and such sample(s) are retained for 90 days only.

除非另有說明，此報告結果僅對測試之樣品負責，同時此樣品僅保留90天。本報告未經本公司書面許可，不可部份複製。

This document is issued by the Company subject to its General Conditions of Service printed overleaf, available on request or accessible at www.sgs.com/terms_and_conditions.htm and, for electronic format documents, subject to Terms and Conditions for Electronic Documents at www.sgs.com/terms_e-document.htm. Attention is drawn to the limitation of liability, indemnification and jurisdiction issues defined therein. Any holder of this document is advised that information contained hereon reflects the Company's findings at the time of its intervention only and within the limits of Client's instructions, if any. The Company's sole responsibility is to its Client and this document does not exonerate parties to a transaction from exercising all their rights and obligations under the transaction documents. This document cannot be reproduced except in full, without prior written approval of the Company. Any unauthorized alteration, forgery or falsification of the content or appearance of this document is unlawful and offenders may be prosecuted to the fullest extent of the law.

Figure 8-25: WCDMA V Channel Low

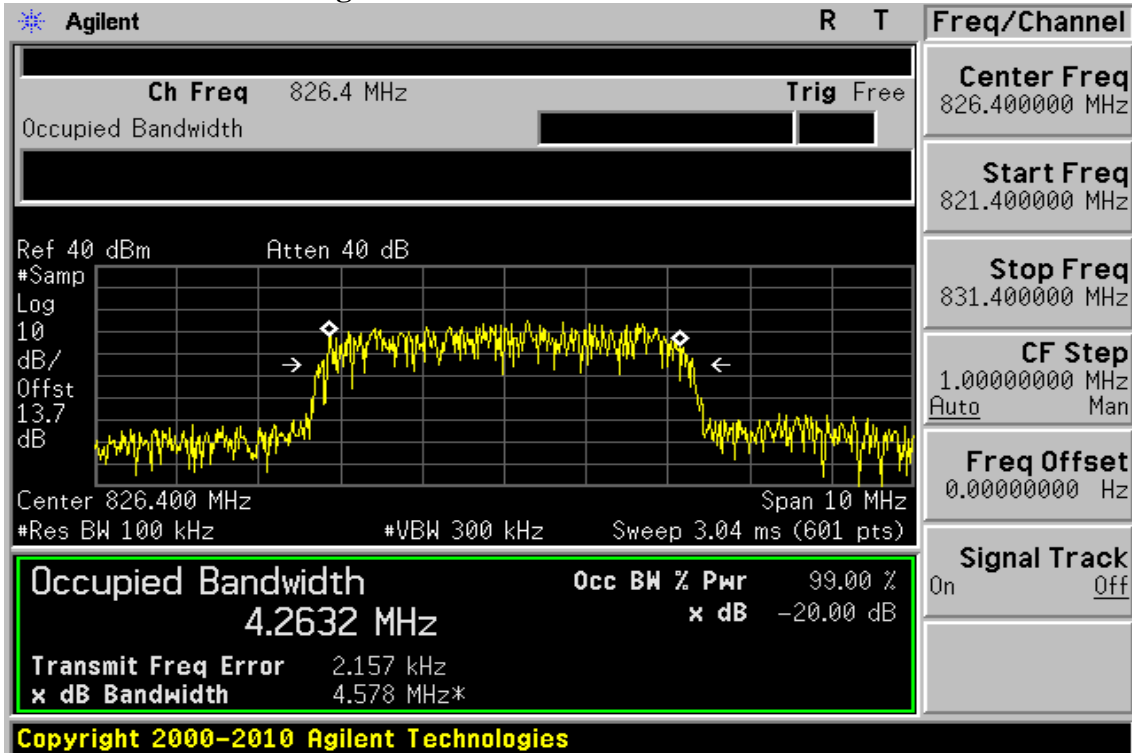
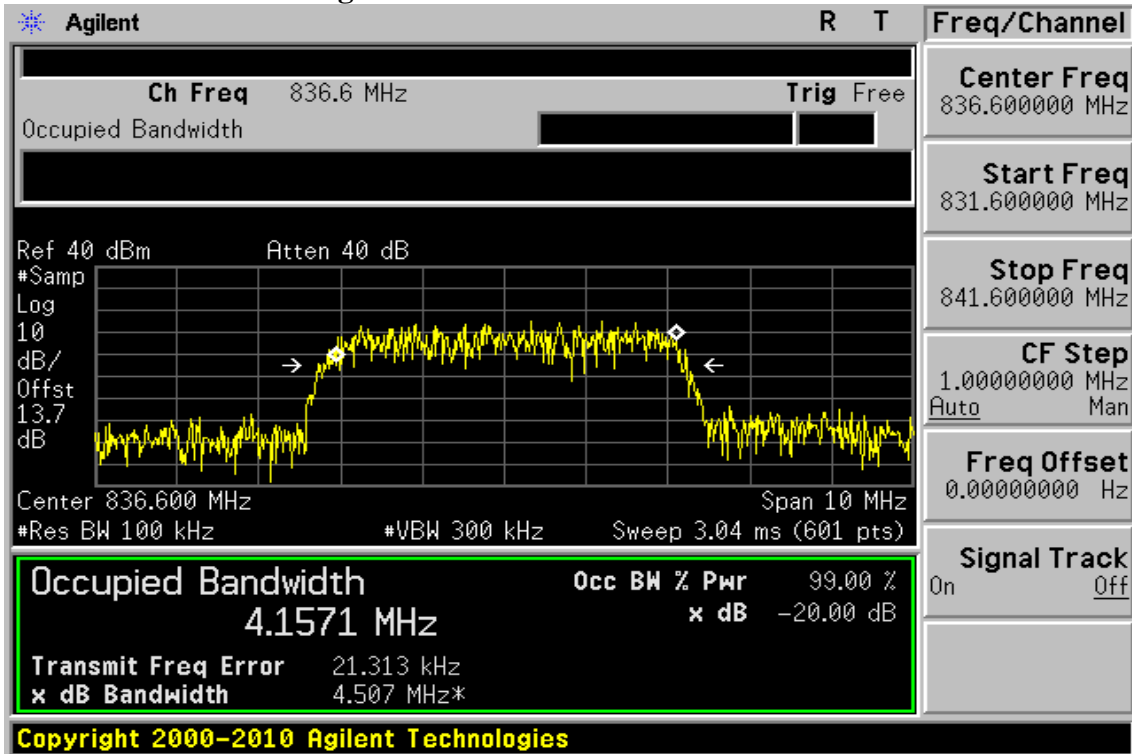

Figure 8-26: WCDMA V Channel Mid



Unless otherwise stated the results shown in this test report refer only to the sample(s) tested and such sample(s) are retained for 90 days only.

除非另有說明，此報告結果僅對測試之樣品負責，同時此樣品僅保留90天。本報告未經本公司書面許可，不可部份複製。

This document is issued by the Company subject to its General Conditions of Service printed overleaf, available on request or accessible at www.sgs.com/terms_and_conditions.htm and, for electronic format documents, subject to Terms and Conditions for Electronic Documents at www.sgs.com/terms_e-document.htm. Attention is drawn to the limitation of liability, indemnification and jurisdiction issues defined therein. Any holder of this document is advised that information contained hereon reflects the Company's findings at the time of its intervention only and within the limits of Client's instructions, if any. The Company's sole responsibility is to its Client and this document does not exonerate parties to a transaction from exercising all their rights and obligations under the transaction documents. This document cannot be reproduced except in full, without prior written approval of the Company. Any unauthorized alteration, forgery or falsification of the content or appearance of this document is unlawful and offenders may be prosecuted to the fullest extent of the law.

Figure 8-27: WCDMA V Channel High

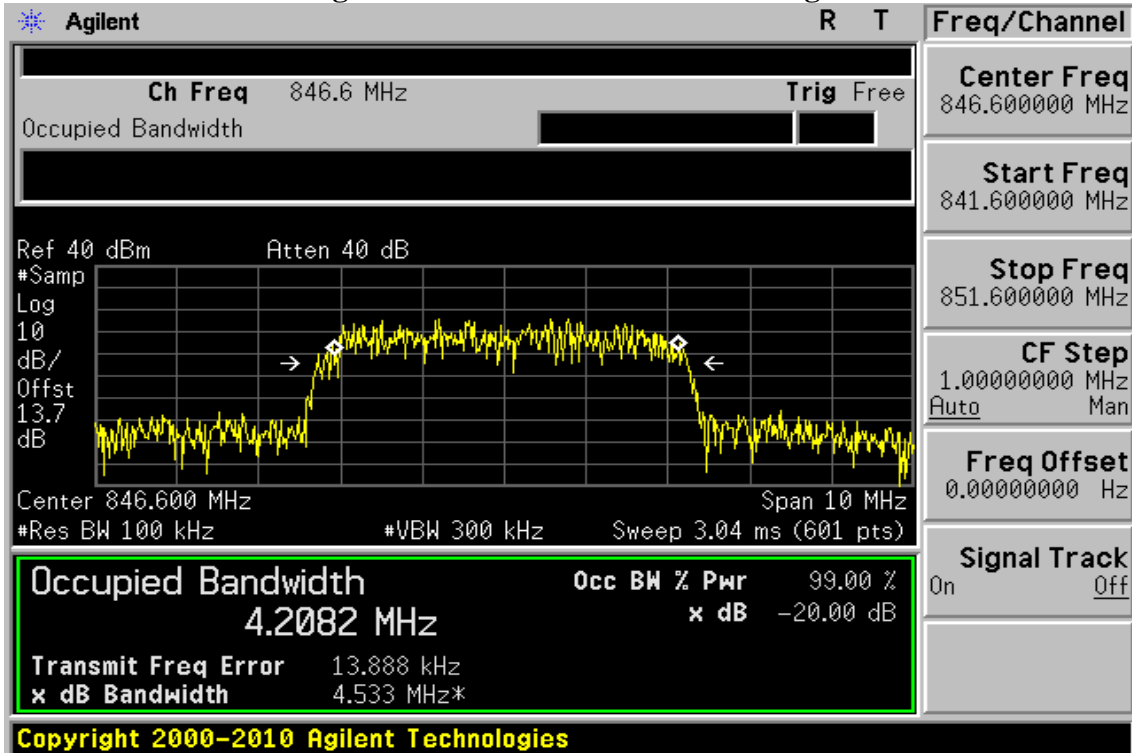
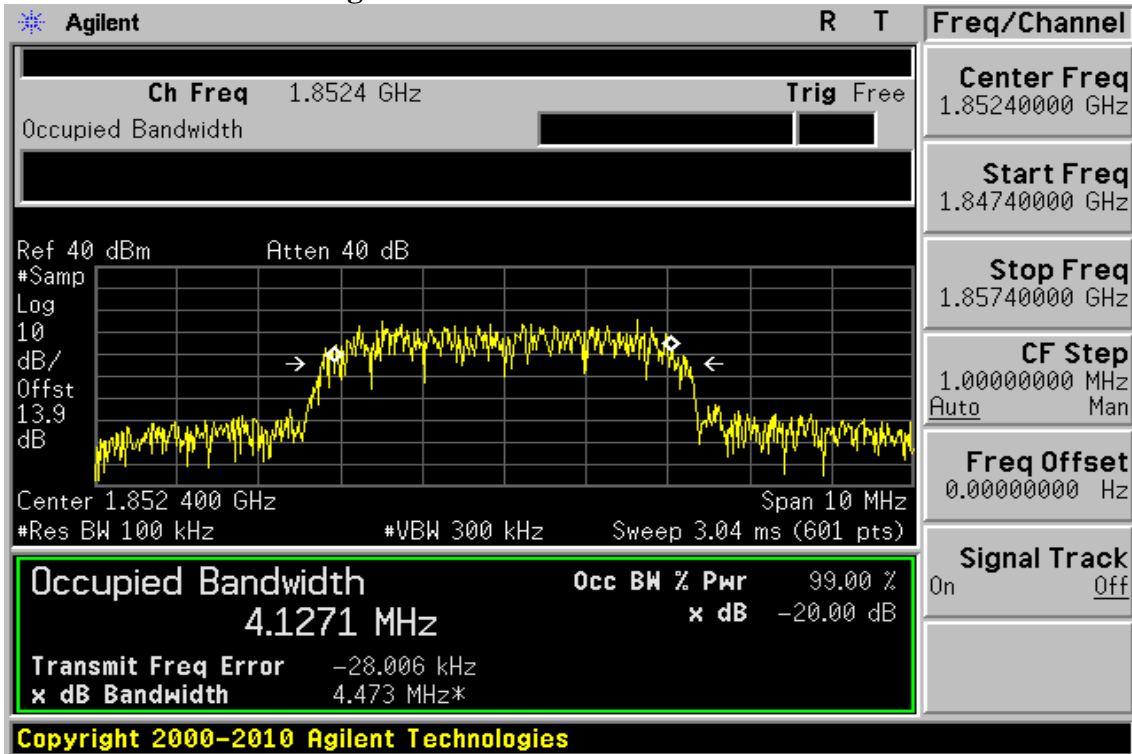

Figure 8-28: HSDPA II Channel Low



Unless otherwise stated the results shown in this test report refer only to the sample(s) tested and such sample(s) are retained for 90 days only.

除非另有說明，此報告結果僅對測試之樣品負責，同時此樣品僅保留90天。本報告未經本公司書面許可，不可部份複製。

This document is issued by the Company subject to its General Conditions of Service printed overleaf, available on request or accessible at www.sgs.com/terms_and_conditions.htm and, for electronic format documents, subject to Terms and Conditions for Electronic Documents at www.sgs.com/terms_e-document.htm. Attention is drawn to the limitation of liability, indemnification and jurisdiction issues defined therein. Any holder of this document is advised that information contained hereon reflects the Company's findings at the time of its intervention only and within the limits of Client's instructions, if any. The Company's sole responsibility is to its Client and this document does not exonerate parties to a transaction from exercising all their rights and obligations under the transaction documents. This document cannot be reproduced except in full, without prior written approval of the Company. Any unauthorized alteration, forgery or falsification of the content or appearance of this document is unlawful and offenders may be prosecuted to the fullest extent of the law.

Figure 8-29: HSDPA II Channel Mid

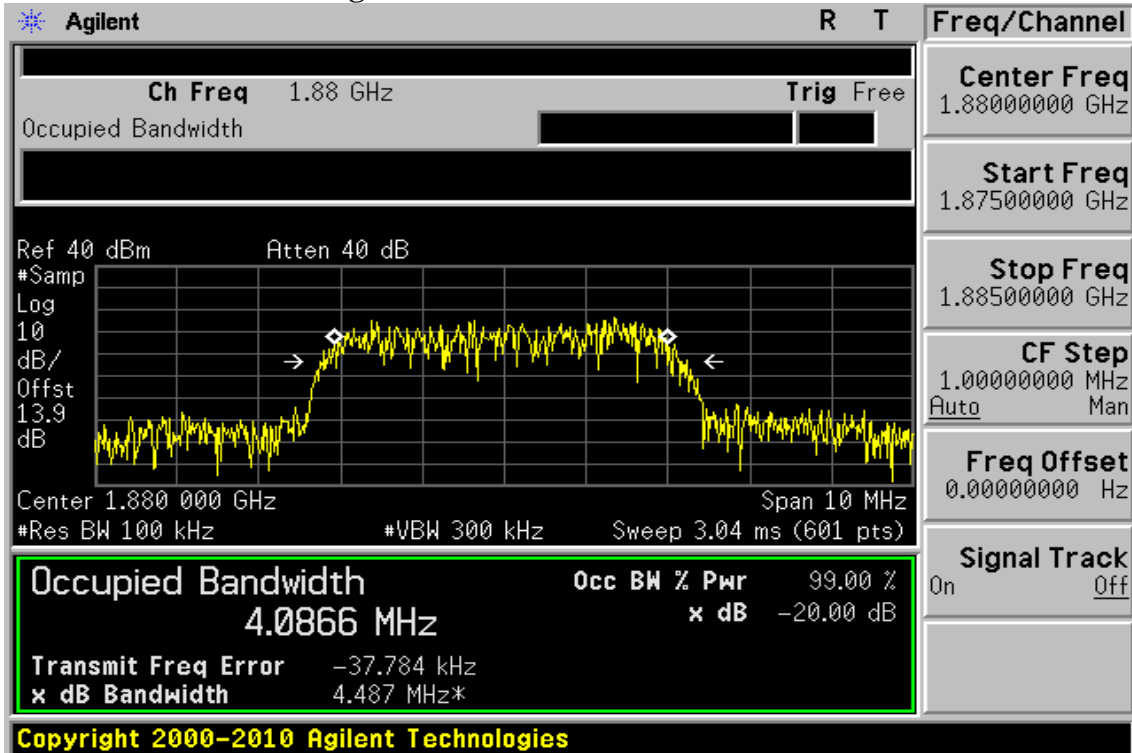
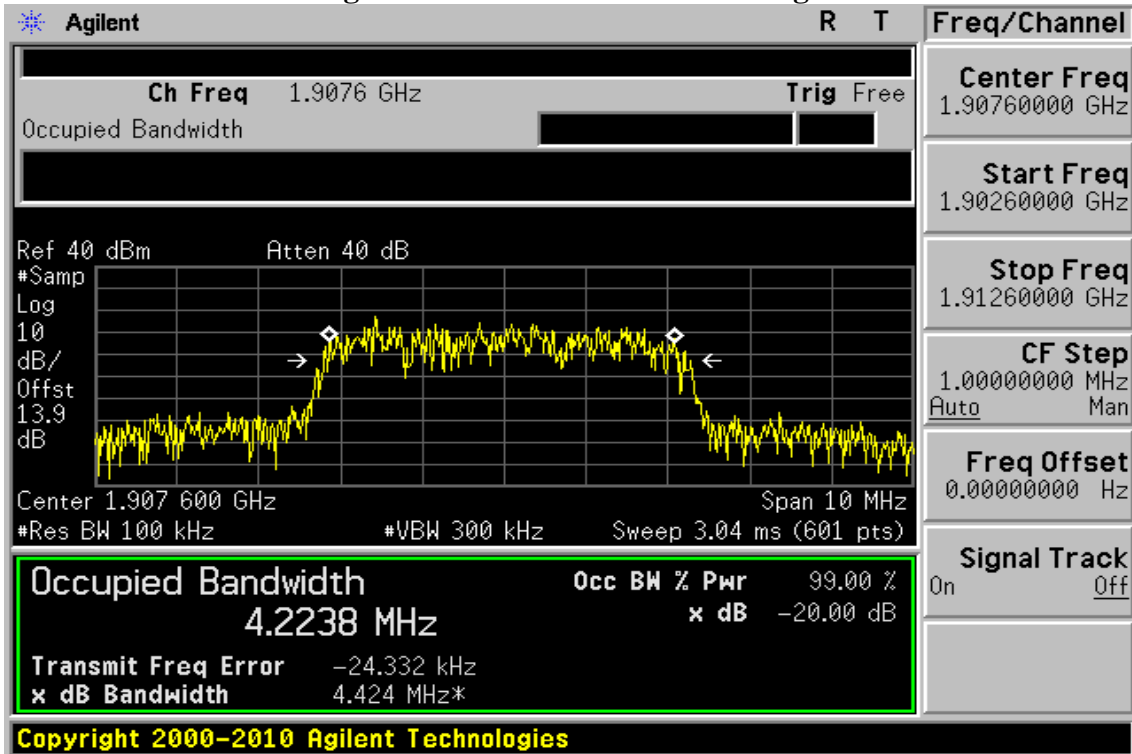

Figure 8-30: HSDPA II Channel High



Unless otherwise stated the results shown in this test report refer only to the sample(s) tested and such sample(s) are retained for 90 days only.

除非另有說明，此報告結果僅對測試之樣品負責，同時此樣品僅保留90天。本報告未經本公司書面許可，不可部份複製。

This document is issued by the Company subject to its General Conditions of Service printed overleaf, available on request or accessible at www.sgs.com/terms_and_conditions.htm and, for electronic format documents, subject to Terms and Conditions for Electronic Documents at www.sgs.com/terms_e-document.htm. Attention is drawn to the limitation of liability, indemnification and jurisdiction issues defined therein. Any holder of this document is advised that information contained hereon reflects the Company's findings at the time of its intervention only and within the limits of Client's instructions, if any. The Company's sole responsibility is to its Client and this document does not exonerate parties to a transaction from exercising all their rights and obligations under the transaction documents. This document cannot be reproduced except in full, without prior written approval of the Company. Any unauthorized alteration, forgery or falsification of the content or appearance of this document is unlawful and offenders may be prosecuted to the fullest extent of the law.

Figure 8-31: HSDPA IV Channel Low

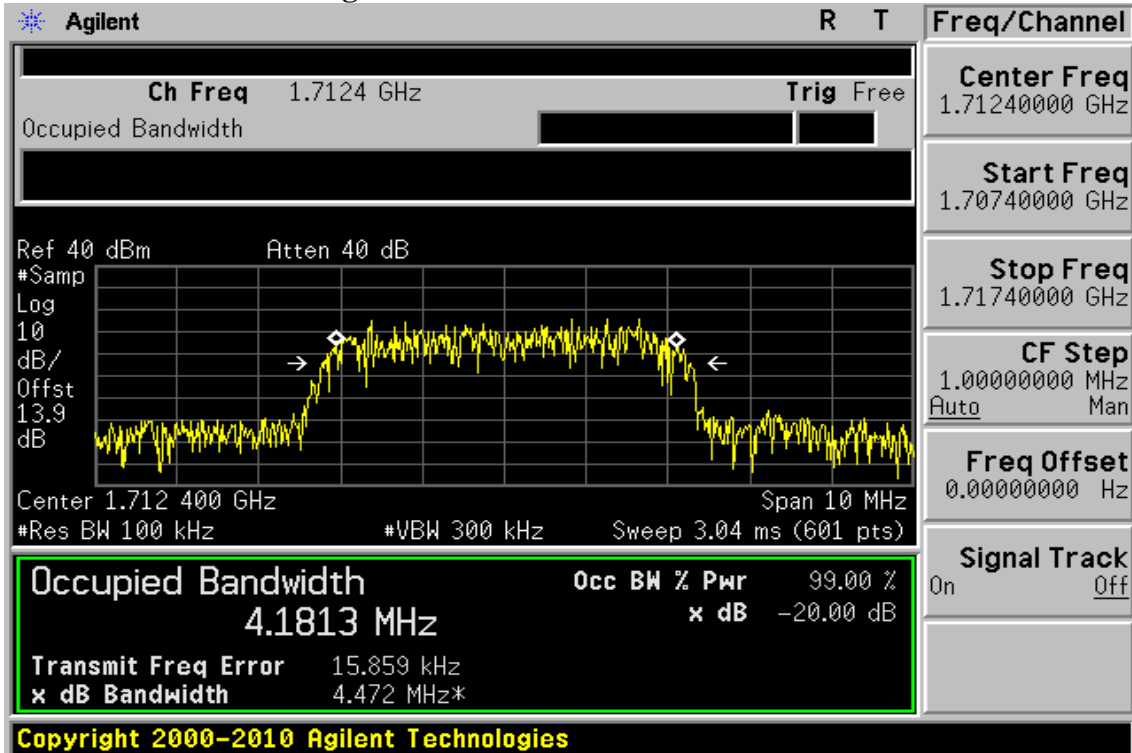
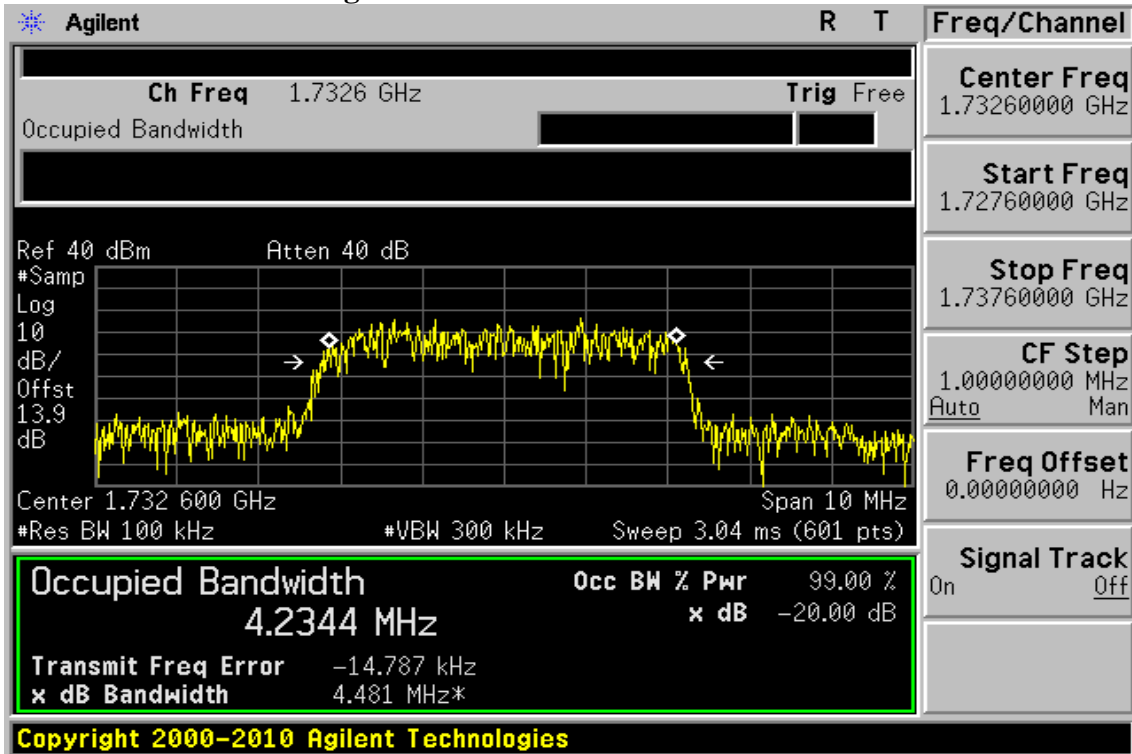

Figure 8-32: HSDPA IV Channel Mid



Unless otherwise stated the results shown in this test report refer only to the sample(s) tested and such sample(s) are retained for 90 days only.

除非另有說明，此報告結果僅對測試之樣品負責，同時此樣品僅保留90天。本報告未經本公司書面許可，不可部份複製。

This document is issued by the Company subject to its General Conditions of Service printed overleaf, available on request or accessible at www.sgs.com/terms_and_conditions.htm and, for electronic format documents, subject to Terms and Conditions for Electronic Documents at www.sgs.com/terms_e-document.htm. Attention is drawn to the limitation of liability, indemnification and jurisdiction issues defined therein. Any holder of this document is advised that information contained hereon reflects the Company's findings at the time of its intervention only and within the limits of Client's instructions, if any. The Company's sole responsibility is to its Client and this document does not exonerate parties to a transaction from exercising all their rights and obligations under the transaction documents. This document cannot be reproduced except in full, without prior written approval of the Company. Any unauthorized alteration, forgery or falsification of the content or appearance of this document is unlawful and offenders may be prosecuted to the fullest extent of the law.

Figure 8-33: HSDPA IV Channel High

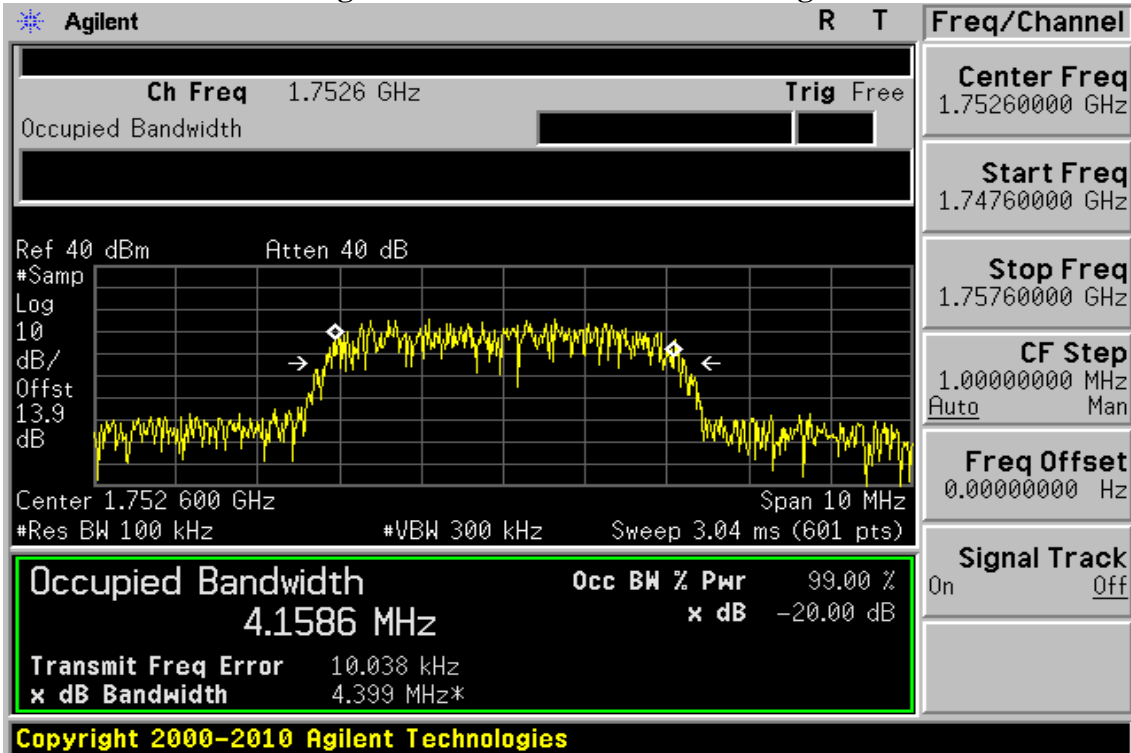
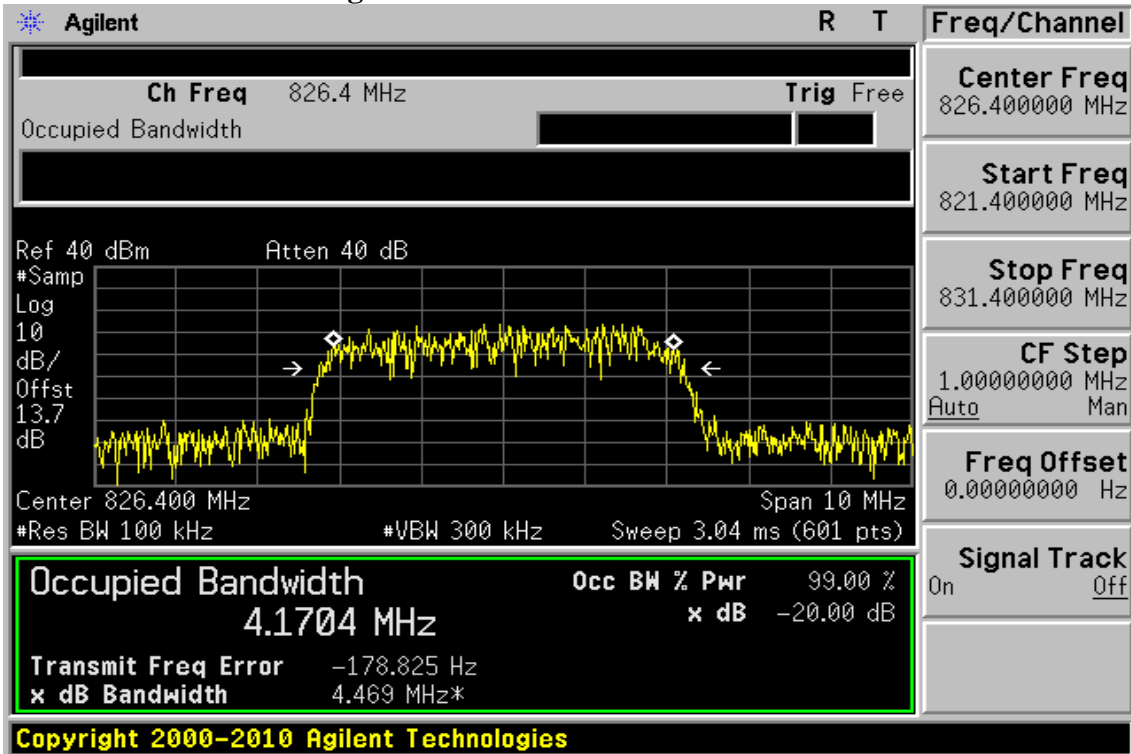

Figure 8-34: HSDPA V Channel Low



Unless otherwise stated the results shown in this test report refer only to the sample(s) tested and such sample(s) are retained for 90 days only.

除非另有說明，此報告結果僅對測試之樣品負責，同時此樣品僅保留90天。本報告未經本公司書面許可，不可部份複製。

This document is issued by the Company subject to its General Conditions of Service printed overleaf, available on request or accessible at www.sgs.com/terms_and_conditions.htm and, for electronic format documents, subject to Terms and Conditions for Electronic Documents at www.sgs.com/terms_e-document.htm. Attention is drawn to the limitation of liability, indemnification and jurisdiction issues defined therein. Any holder of this document is advised that information contained hereon reflects the Company's findings at the time of its intervention only and within the limits of Client's instructions, if any. The Company's sole responsibility is to its Client and this document does not exonerate parties to a transaction from exercising all their rights and obligations under the transaction documents. This document cannot be reproduced except in full, without prior written approval of the Company. Any unauthorized alteration, forgery or falsification of the content or appearance of this document is unlawful and offenders may be prosecuted to the fullest extent of the law.

Figure 8-35: HSDPA V Channel Mid

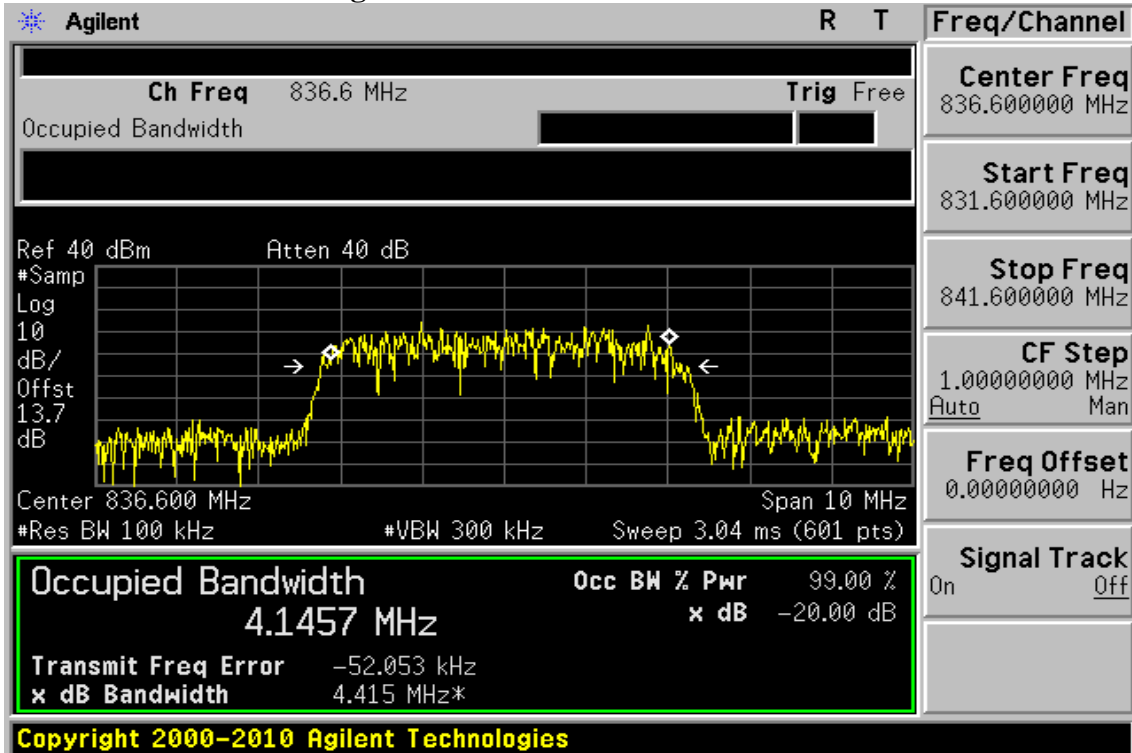
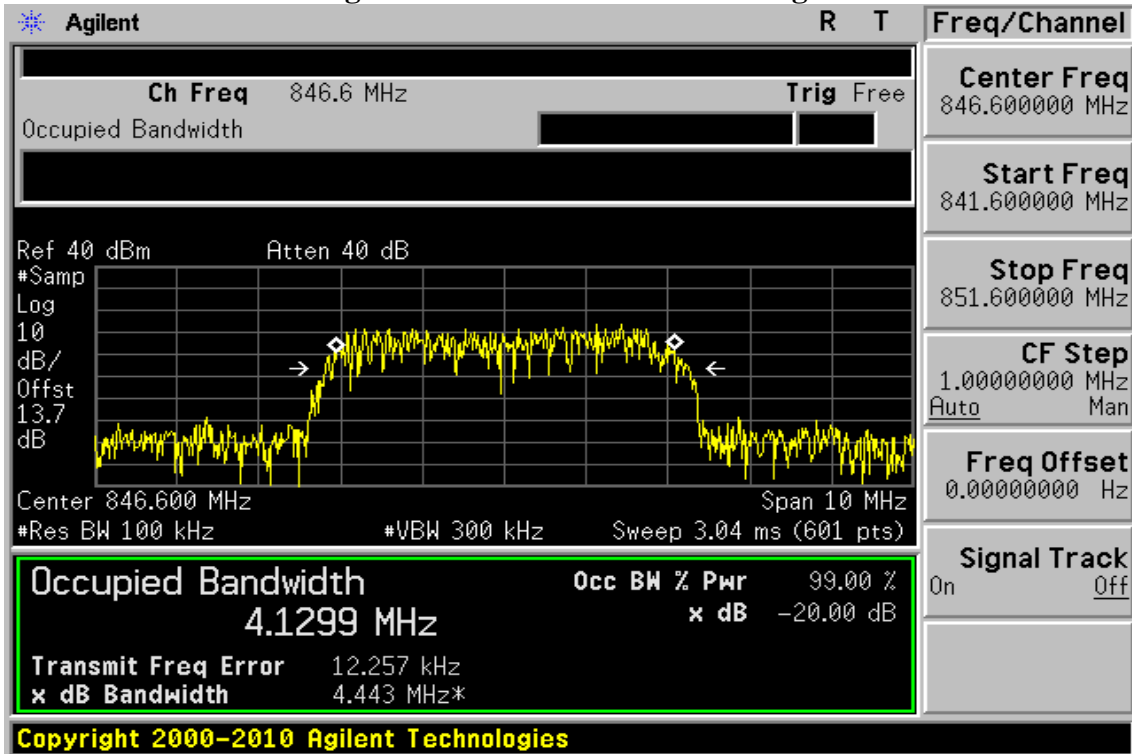

Figure 8-36: HSDPA V Channel High



Unless otherwise stated the results shown in this test report refer only to the sample(s) tested and such sample(s) are retained for 90 days only.

除非另有說明，此報告結果僅對測試之樣品負責，同時此樣品僅保留90天。本報告未經本公司書面許可，不可部份複製。

This document is issued by the Company subject to its General Conditions of Service printed overleaf, available on request or accessible at www.sgs.com/terms_and_conditions.htm and, for electronic format documents, subject to Terms and Conditions for Electronic Documents at www.sgs.com/terms_e-document.htm. Attention is drawn to the limitation of liability, indemnification and jurisdiction issues defined therein. Any holder of this document is advised that information contained hereon reflects the Company's findings at the time of its intervention only and within the limits of Client's instructions, if any. The Company's sole responsibility is to its Client and this document does not exonerate parties to a transaction from exercising all their rights and obligations under the transaction documents. This document cannot be reproduced except in full, without prior written approval of the Company. Any unauthorized alteration, forgery or falsification of the content or appearance of this document is unlawful and offenders may be prosecuted to the fullest extent of the law.

Figure 8-37: HSUPA II Channel Low

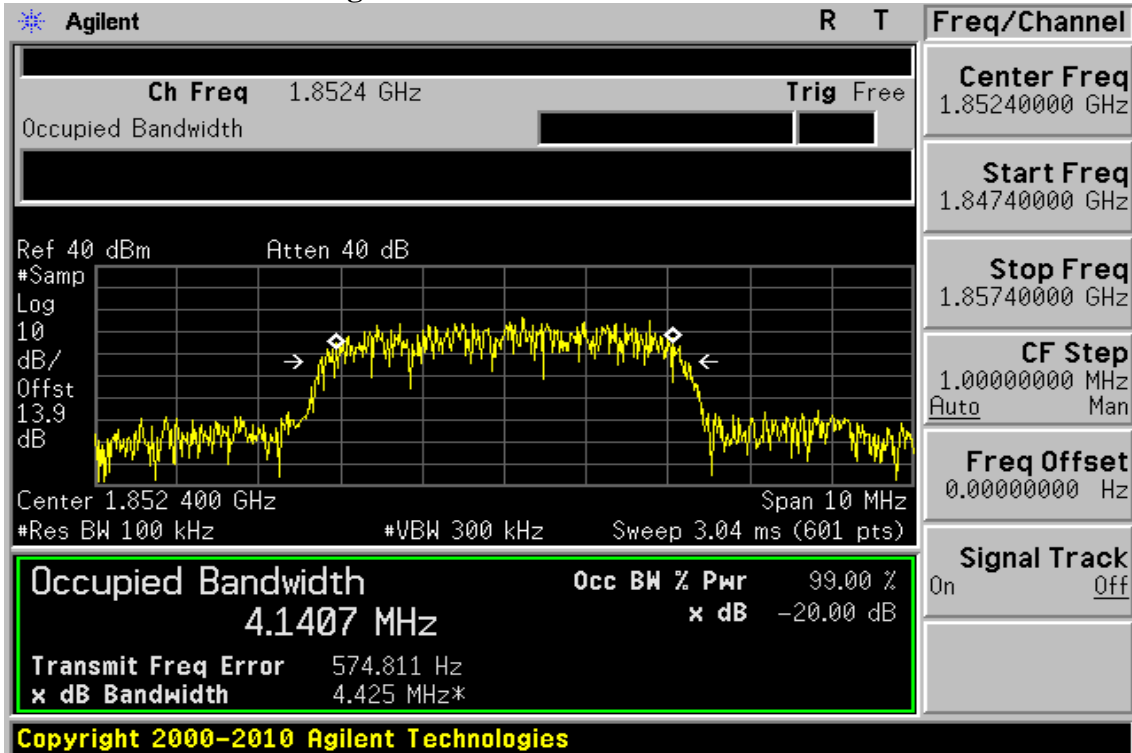
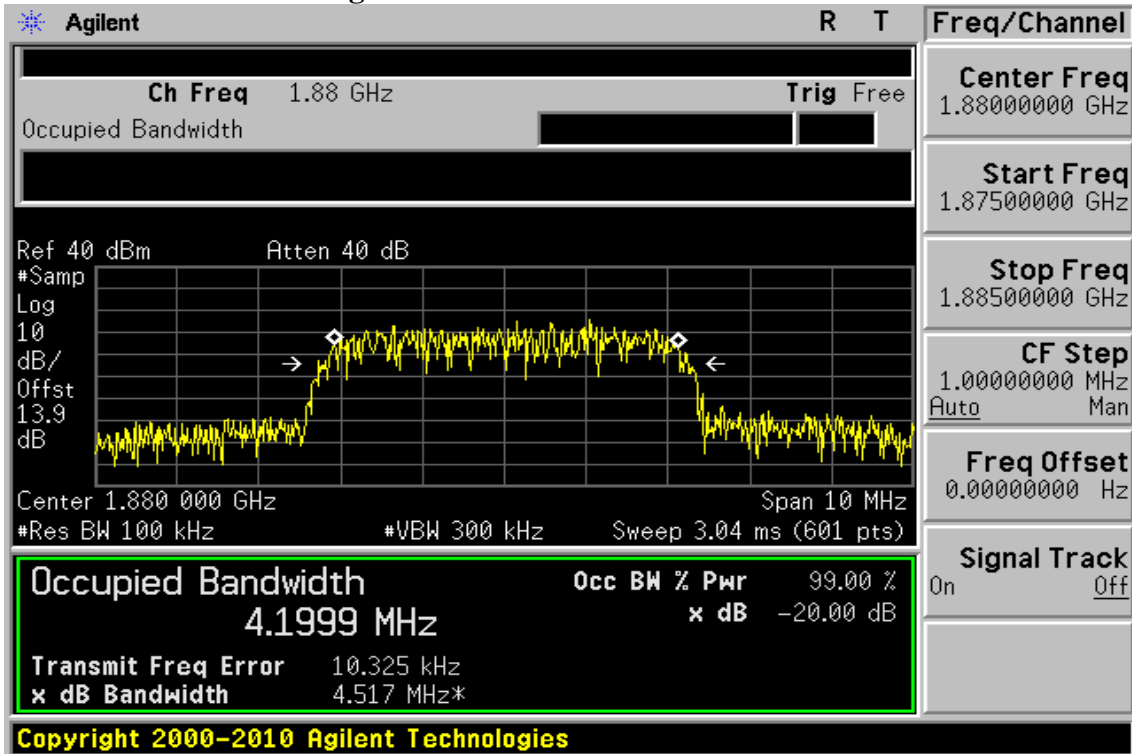

Figure 8-38: HSUPA II Channel Mid



Unless otherwise stated the results shown in this test report refer only to the sample(s) tested and such sample(s) are retained for 90 days only.

除非另有說明，此報告結果僅對測試之樣品負責，同時此樣品僅保留90天。本報告未經本公司書面許可，不可部份複製。

This document is issued by the Company subject to its General Conditions of Service printed overleaf, available on request or accessible at www.sgs.com/terms_and_conditions.htm and, for electronic format documents, subject to Terms and Conditions for Electronic Documents at www.sgs.com/terms_e-document.htm. Attention is drawn to the limitation of liability, indemnification and jurisdiction issues defined therein. Any holder of this document is advised that information contained hereon reflects the Company's findings at the time of its intervention only and within the limits of Client's instructions, if any. The Company's sole responsibility is to its Client and this document does not exonerate parties to a transaction from exercising all their rights and obligations under the transaction documents. This document cannot be reproduced except in full, without prior written approval of the Company. Any unauthorized alteration, forgery or falsification of the content or appearance of this document is unlawful and offenders may be prosecuted to the fullest extent of the law.

Figure 8-39: HSUPA II Channel High

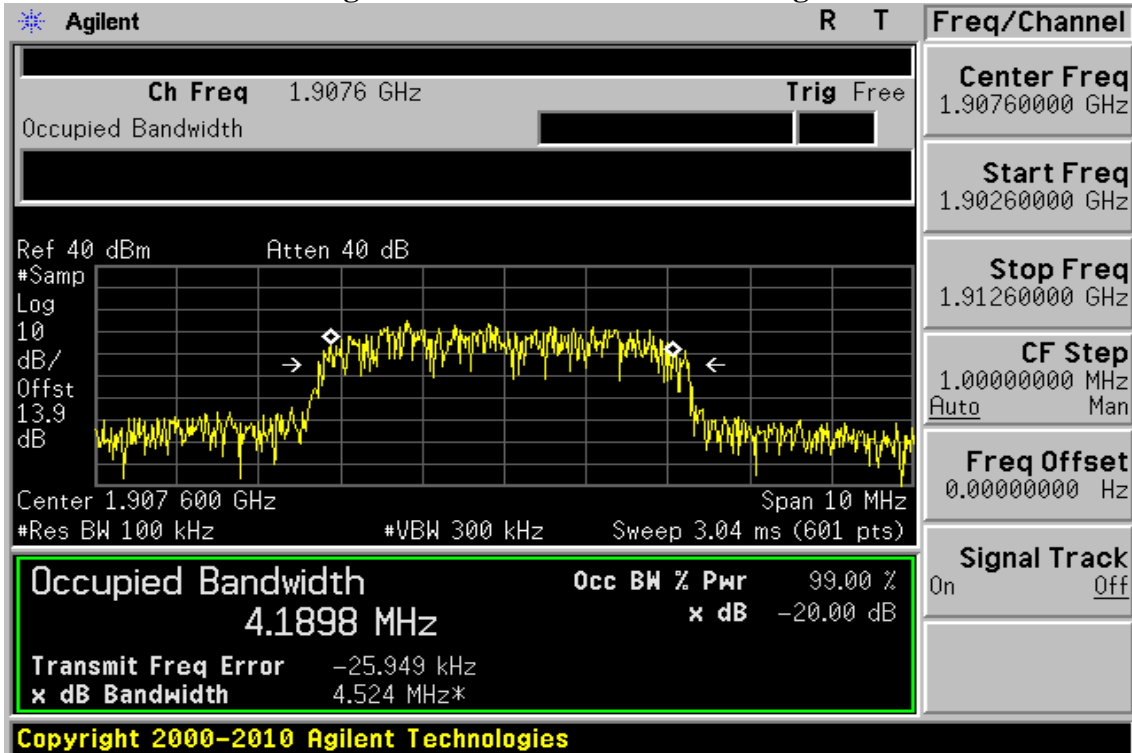
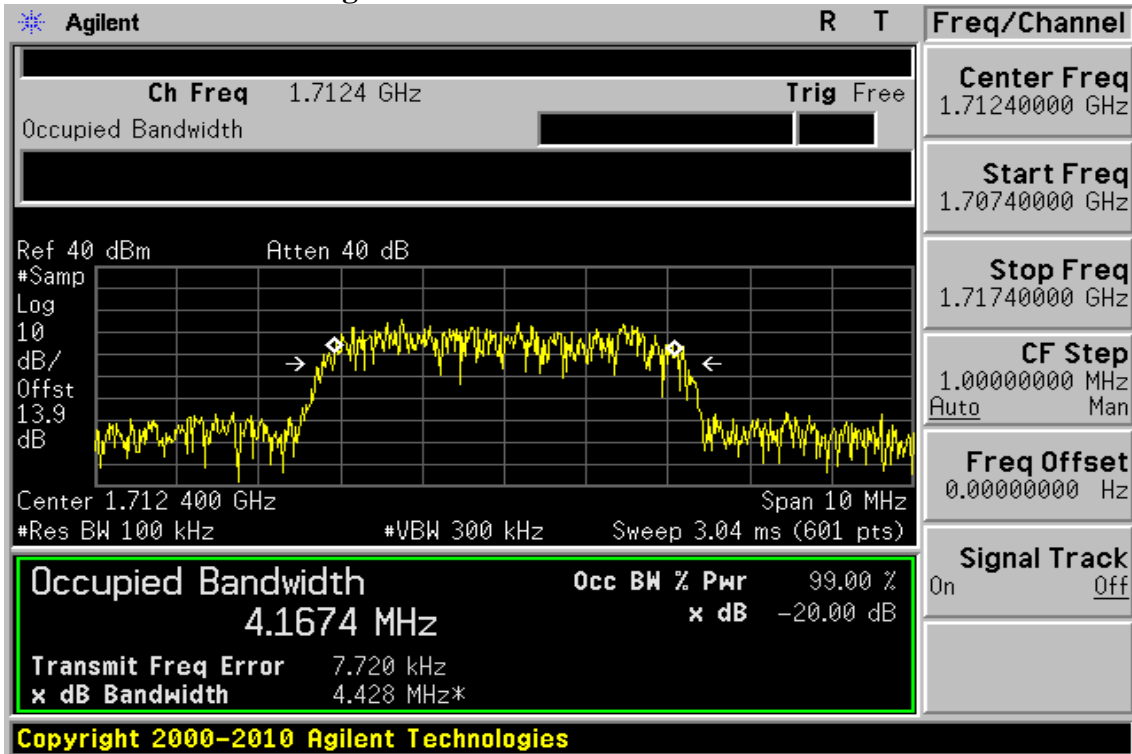

Figure 8-40: HSUPA IV Channel Low



Unless otherwise stated the results shown in this test report refer only to the sample(s) tested and such sample(s) are retained for 90 days only.

除非另有說明，此報告結果僅對測試之樣品負責，同時此樣品僅保留90天。本報告未經本公司書面許可，不可部份複製。

This document is issued by the Company subject to its General Conditions of Service printed overleaf, available on request or accessible at www.sgs.com/terms_and_conditions.htm and, for electronic format documents, subject to Terms and Conditions for Electronic Documents at www.sgs.com/terms_e-document.htm. Attention is drawn to the limitation of liability, indemnification and jurisdiction issues defined therein. Any holder of this document is advised that information contained hereon reflects the Company's findings at the time of its intervention only and within the limits of Client's instructions, if any. The Company's sole responsibility is to its Client and this document does not exonerate parties to a transaction from exercising all their rights and obligations under the transaction documents. This document cannot be reproduced except in full, without prior written approval of the Company. Any unauthorized alteration, forgery or falsification of the content or appearance of this document is unlawful and offenders may be prosecuted to the fullest extent of the law.

Figure 8-41: HSUPA IV Channel Mid

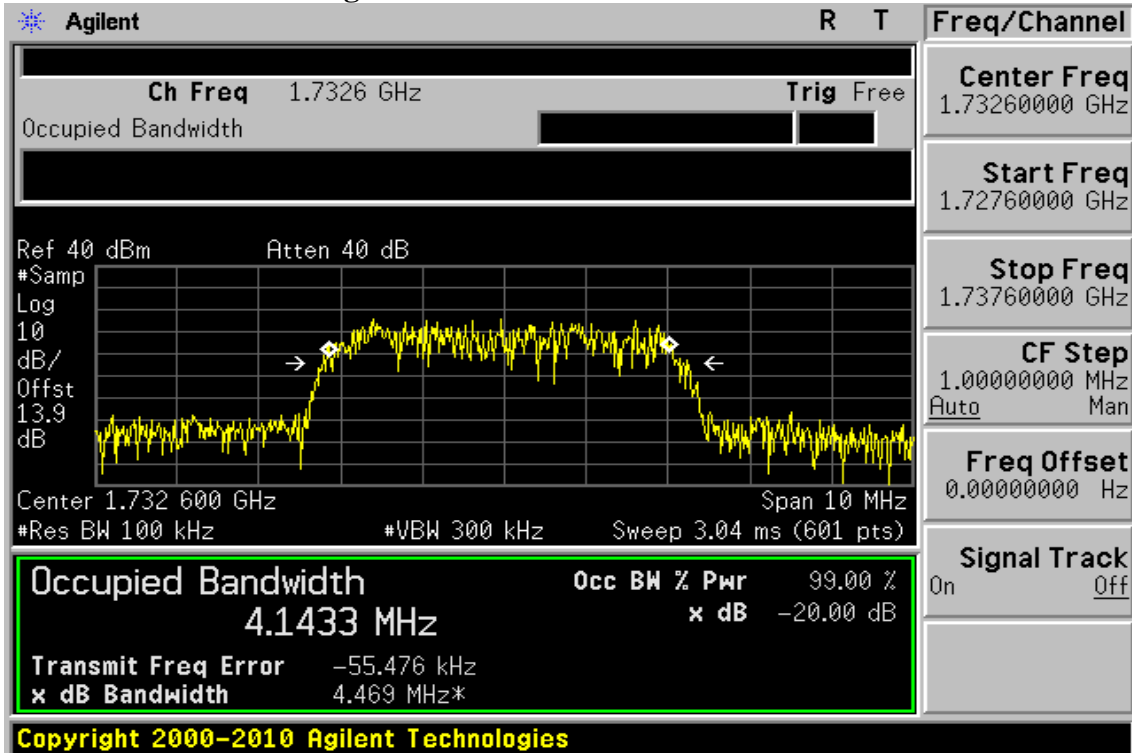
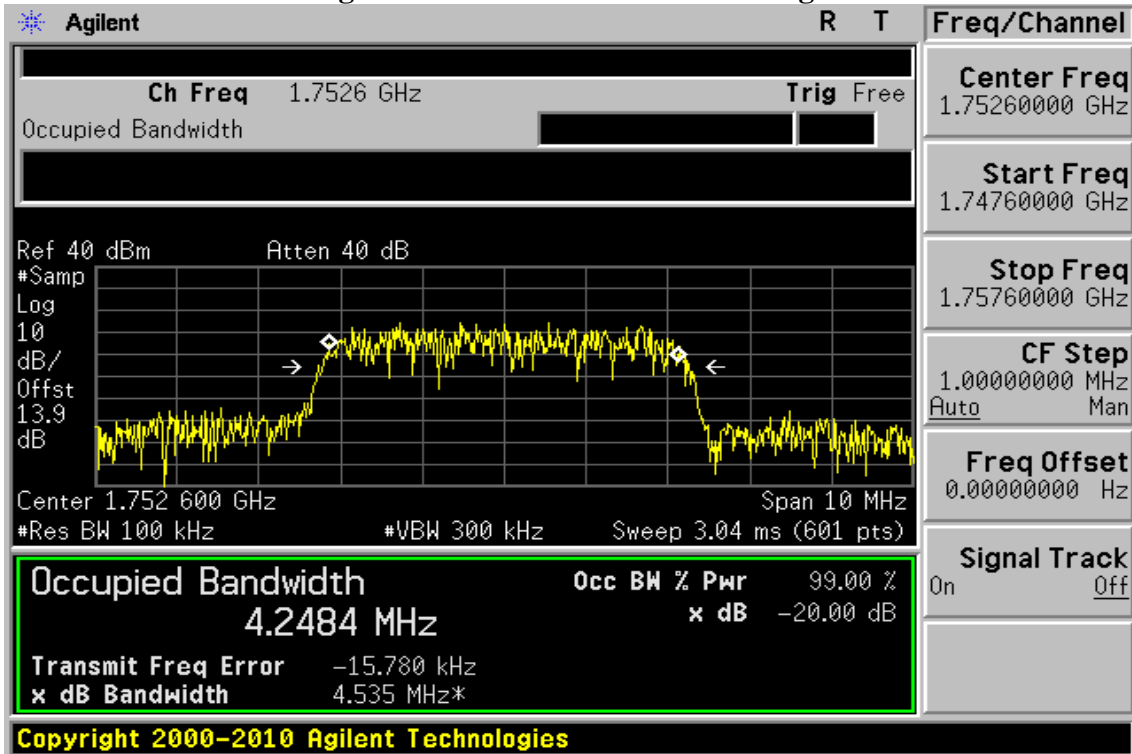

Figure 8-42: HSUPA IV Channel High



Unless otherwise stated the results shown in this test report refer only to the sample(s) tested and such sample(s) are retained for 90 days only.

除非另有說明，此報告結果僅對測試之樣品負責，同時此樣品僅保留90天。本報告未經本公司書面許可，不可部份複製。

This document is issued by the Company subject to its General Conditions of Service printed overleaf, available on request or accessible at www.sgs.com/terms_and_conditions.htm and, for electronic format documents, subject to Terms and Conditions for Electronic Documents at www.sgs.com/terms_e-document.htm. Attention is drawn to the limitation of liability, indemnification and jurisdiction issues defined therein. Any holder of this document is advised that information contained hereon reflects the Company's findings at the time of its intervention only and within the limits of Client's instructions, if any. The Company's sole responsibility is to its Client and this document does not exonerate parties to a transaction from exercising all their rights and obligations under the transaction documents. This document cannot be reproduced except in full, without prior written approval of the Company. Any unauthorized alteration, forgery or falsification of the content or appearance of this document is unlawful and offenders may be prosecuted to the fullest extent of the law.

Figure 8-43: HSUPA V Channel Low

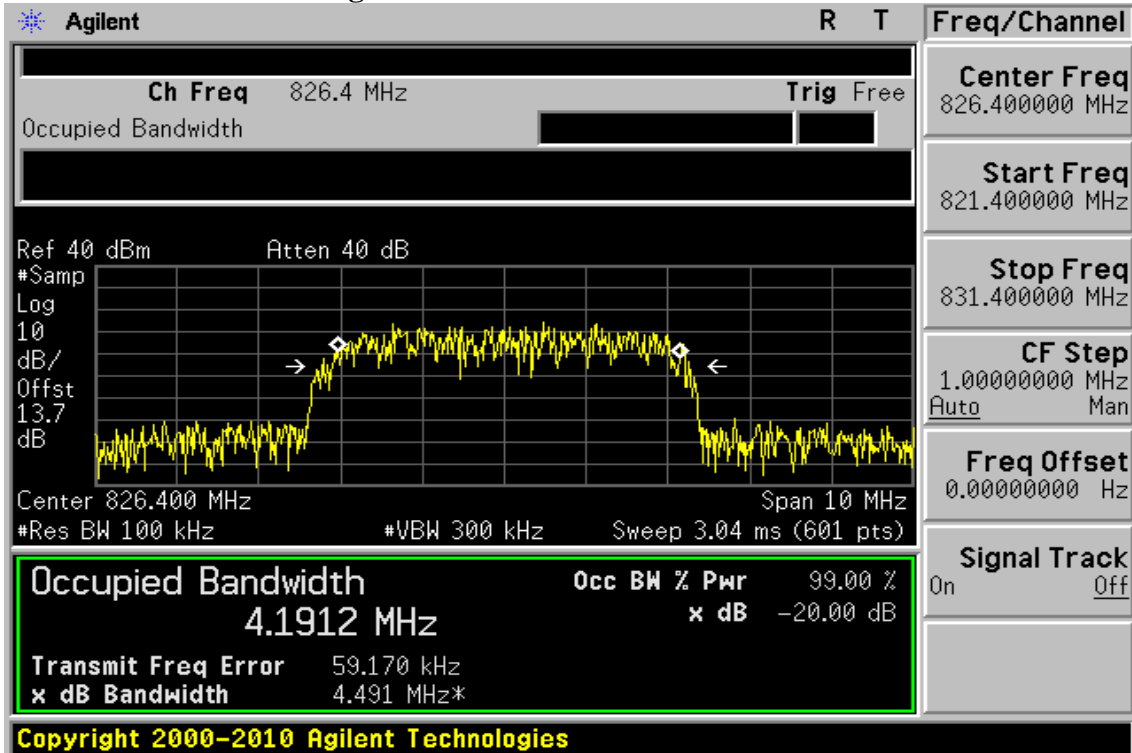
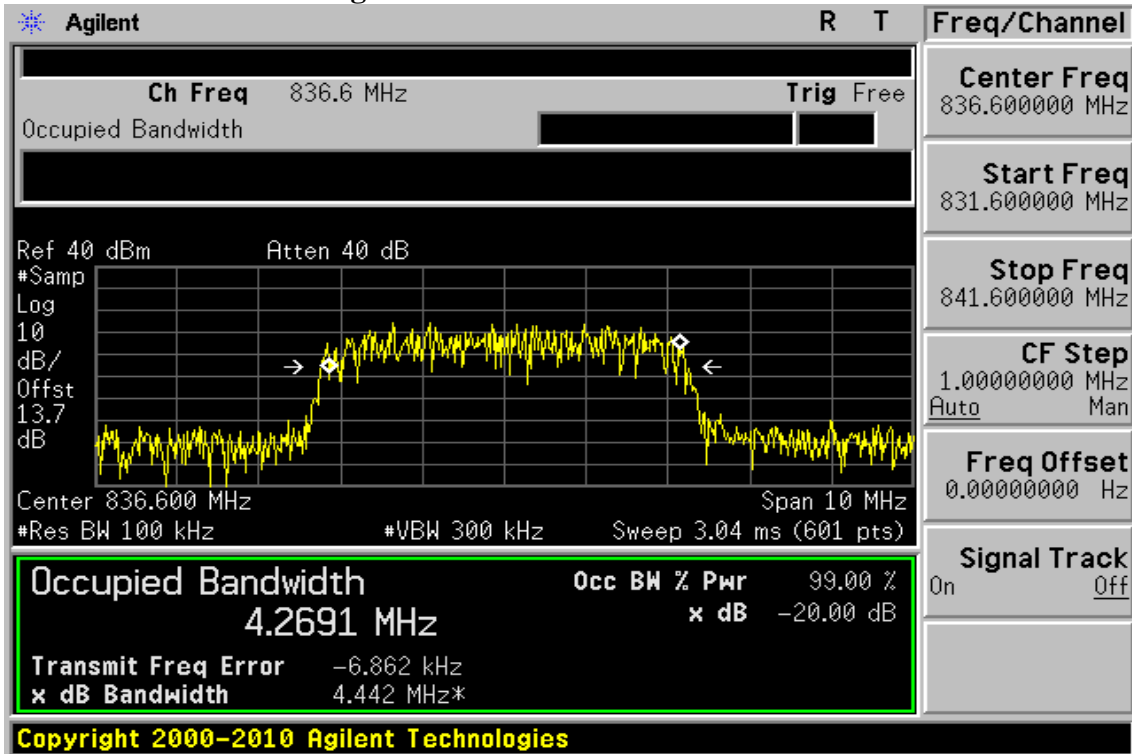

Figure 8-44: HSUPA V Channel Mid



Unless otherwise stated the results shown in this test report refer only to the sample(s) tested and such sample(s) are retained for 90 days only.

除非另有說明，此報告結果僅對測試之樣品負責，同時此樣品僅保留90天。本報告未經本公司書面許可，不可部份複製。

This document is issued by the Company subject to its General Conditions of Service printed overleaf, available on request or accessible at www.sgs.com/terms_and_conditions.htm and, for electronic format documents, subject to Terms and Conditions for Electronic Documents at www.sgs.com/terms_e-document.htm. Attention is drawn to the limitation of liability, indemnification and jurisdiction issues defined therein. Any holder of this document is advised that information contained hereon reflects the Company's findings at the time of its intervention only and within the limits of Client's instructions, if any. The Company's sole responsibility is to its Client and this document does not exonerate parties to a transaction from exercising all their rights and obligations under the transaction documents. This document cannot be reproduced except in full, without prior written approval of the Company. Any unauthorized alteration, forgery or falsification of the content or appearance of this document is unlawful and offenders may be prosecuted to the fullest extent of the law.

Figure 8-45: HSUPA V Channel High

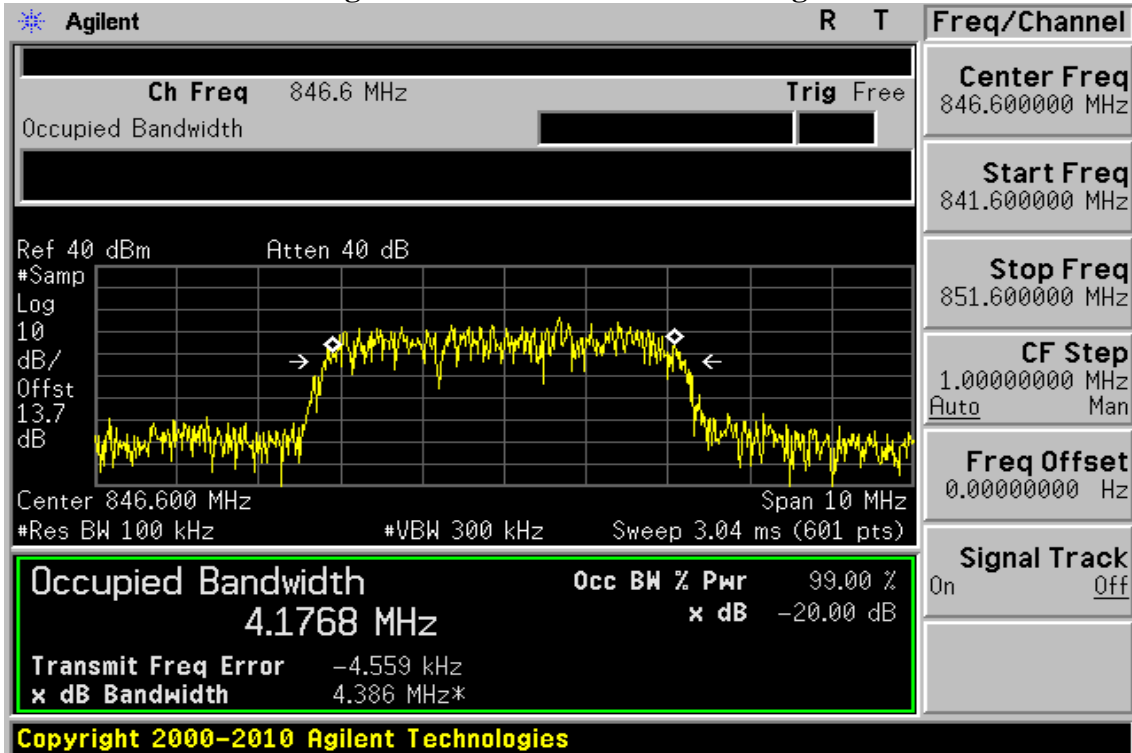

Unless otherwise stated the results shown in this test report refer only to the sample(s) tested and such sample(s) are retained for 90 days only.

除非另有說明，此報告結果僅對測試之樣品負責，同時此樣品僅保留90天。本報告未經本公司書面許可，不可部份複製。

This document is issued by the Company subject to its General Conditions of Service printed overleaf, available on request or accessible at www.sgs.com/terms_and_conditions.htm and, for electronic format documents, subject to Terms and Conditions for Electronic Documents at www.sgs.com/terms_e-document.htm. Attention is drawn to the limitation of liability, indemnification and jurisdiction issues defined therein. Any holder of this document is advised that information contained hereon reflects the Company's findings at the time of its intervention only and within the limits of Client's instructions, if any. The Company's sole responsibility is to its Client and this document does not exonerate parties to a transaction from exercising all their rights and obligations under the transaction documents. This document cannot be reproduced except in full, without prior written approval of the Company. Any unauthorized alteration, forgery or falsification of the content or appearance of this document is unlawful and offenders may be prosecuted to the fullest extent of the law.

9. OUT OF BAND EMISSION AT ANTENNA TERMINALS

9.1. Standard Applicable:

According to FCC §2.1051.

FCC §22.917(a), §24.238(a), §27.53(h) the magnitude of each spurious and harmonic emission that can be detected when the equipment is operated under the conditions specified in the instruction manual and/ or alignment procedure, shall not be less than $43 + 10 \log$ (mean output power in watts) dBc below the mean power output outside a license's frequency block (-13dBm).

According to RSS-132 §5.5

Mobile and base station equipment shall comply with the limits in (i) and (ii) below.

(i) In the first 1.0 MHz band immediately outside and adjacent to each of the sub-bands specified in Section 5.1, the power of emissions per any 1% of the occupied bandwidth shall be attenuated (in dB) below the transmitter output power P (dBW) by at least $43 + 10 \log_{10} p$ (watts).

(ii) After the first 1.0 MHz immediately outside and adjacent to each of the sub-bands, the power of emissions in any 100 kHz bandwidth shall be attenuated (in dB) below the transmitter output power P (dBW) by at least $43 + 10 \log_{10} p$ (watts). If the measurement is performed using 1% of the occupied bandwidth, power integration over 100 kHz is required.

According to RSS-133 §6.5

6.5.1 Out-of-Block Emissions

Equipment shall comply with the limits in (i) and (ii) below.

(i) In the 1.0 MHz bands immediately outside and adjacent to the equipment's operating frequency block, the emission power per any 1% of the emission bandwidth shall be attenuated (in dB) below the transmitter output power P (dBW) by at least $43 + 10 \log_{10} p$ (watts).

(ii) After the first 1.0 MHz, the emission power in any 1 MHz bandwidth shall be attenuated (in dB) below the transmitter output power P (dBW) by at least $43 + 10 \log_{10} p$ (watts). If the measurement is performed using 1% of the emission bandwidth, power integration over 1.0 MHz is required.

Unless otherwise stated the results shown in this test report refer only to the sample(s) tested and such sample(s) are retained for 90 days only.

除非另有說明，此報告結果僅對測試之樣品負責，同時此樣品僅保留90天。本報告未經本公司書面許可，不可部份複製。

This document is issued by the Company subject to its General Conditions of Service printed overleaf, available on request or accessible at www.sgs.com/terms_and_conditions.htm and, for electronic format documents, subject to Terms and Conditions for Electronic Documents at www.sgs.com/terms_e-document.htm. Attention is drawn to the limitation of liability, indemnification and jurisdiction issues defined therein. Any holder of this document is advised that information contained hereon reflects the Company's findings at the time of its intervention only and within the limits of Client's instructions, if any. The Company's sole responsibility is to its Client and this document does not exonerate parties to a transaction from exercising all their rights and obligations under the transaction documents. This document cannot be reproduced except in full, without prior written approval of the Company. Any unauthorized alteration, forgery or falsification of the content or appearance of this document is unlawful and offenders may be prosecuted to the fullest extent of the law.

According to RSS-139 §6.5

For Operation Band 1710-1755MHz and 2110-2155MHz

(i) In the first 1.0 MHz bands immediately outside and adjacent to the equipment's operating frequency block, the emission power per any 1% of the emission bandwidth shall be attenuated below the transmitter output power P (in watts) by at least $43 + 10 \log_{10}(P)$, dB. Limit = 13dBm

(ii) After the first 1.0 MHz outside the equipment's operating frequency block, the emission power in any 1 MHz bandwidth shall be attenuated below the transmitter output power P (in watts) by at least $43 + 10 \log_{10}(P)$, dB. Limit = -13dBm

Unless otherwise stated the results shown in this test report refer only to the sample(s) tested and such sample(s) are retained for 90 days only.

除非另有說明，此報告結果僅對測試之樣品負責，同時此樣品僅保留90天。本報告未經本公司書面許可，不可部份複製。

This document is issued by the Company subject to its General Conditions of Service printed overleaf, available on request or accessible at www.sgs.com/terms_and_conditions.htm and, for electronic format documents, subject to Terms and Conditions for Electronic Documents at www.sgs.com/terms_e-document.htm. Attention is drawn to the limitation of liability, indemnification and jurisdiction issues defined therein. Any holder of this document is advised that information contained hereon reflects the Company's findings at the time of its intervention only and within the limits of Client's instructions, if any. The Company's sole responsibility is to its Client and this document does not exonerate parties to a transaction from exercising all their rights and obligations under the transaction documents. This document cannot be reproduced except in full, without prior written approval of the Company. Any unauthorized alteration, forgery or falsification of the content or appearance of this document is unlawful and offenders may be prosecuted to the fullest extent of the law.

9.2. Test SET-UP:

Out of band emission

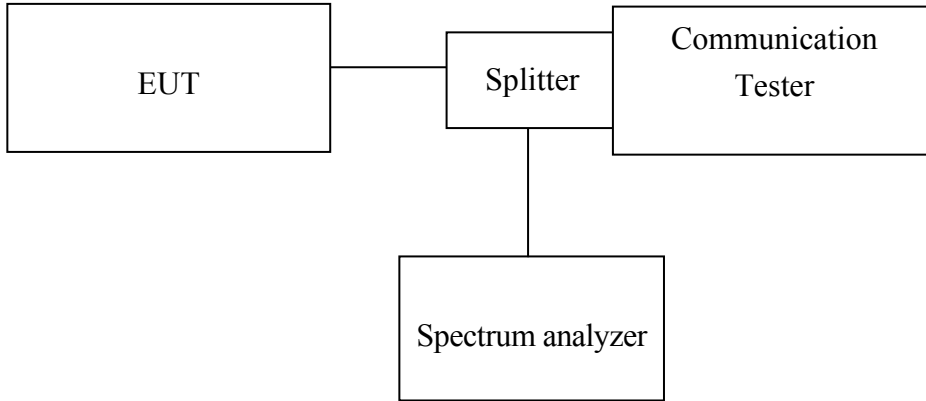

Band Edge

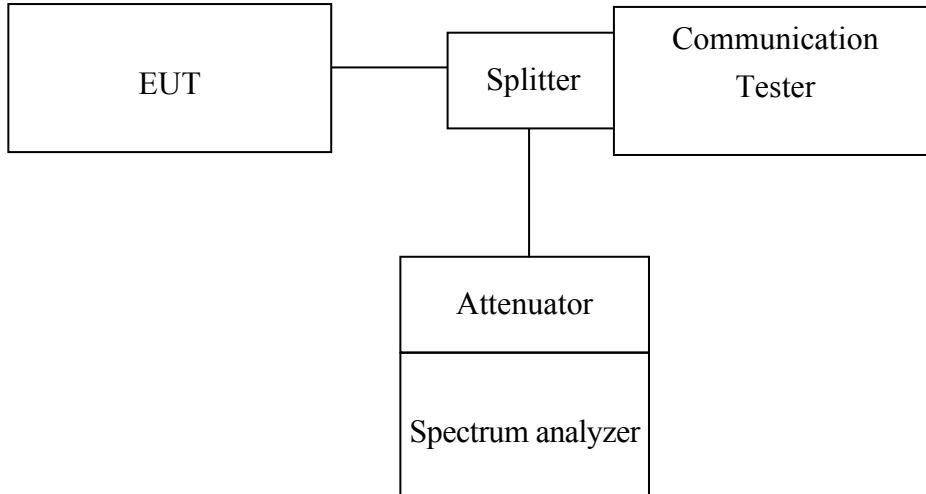

Unless otherwise stated the results shown in this test report refer only to the sample(s) tested and such sample(s) are retained for 90 days only.

除非另有說明，此報告結果僅對測試之樣品負責，同時此樣品僅保留90天。本報告未經本公司書面許可，不可部份複製。

This document is issued by the Company subject to its General Conditions of Service printed overleaf, available on request or accessible at www.sgs.com/terms_and_conditions.htm and, for electronic format documents, subject to Terms and Conditions for Electronic Documents at www.sgs.com/terms_e-document.htm. Attention is drawn to the limitation of liability, indemnification and jurisdiction issues defined therein. Any holder of this document is advised that information contained hereon reflects the Company's findings at the time of its intervention only and within the limits of Client's instructions, if any. The Company's sole responsibility is to its Client and this document does not exonerate parties to a transaction from exercising all their rights and obligations under the transaction documents. This document cannot be reproduced except in full, without prior written approval of the Company. Any unauthorized alteration, forgery or falsification of the content or appearance of this document is unlawful and offenders may be prosecuted to the fullest extent of the law.

9.3. Measurement Procedure:

The RF output of the transceiver was connected to a spectrum analyzer through appropriate attenuation. The resolution bandwidth of the spectrum analyzer was set at 1MHz, sufficient scans were taken to show the out of band Emissions if any up to 10th harmonic.

For the out of band: Set the RBW, VBW = 1MHz, Start=30MHz, Stop= 10 th harmonic. Limit = -13dBm.

Band Edge Requirements: In the 1 MHz bands immediately outside and adjacent to the frequency block, a resolution bandwidth of at least 1 percent of the emission bandwidth of the fundamental emission of the transmitter may be employed to measure the out of band Emissions. Limit, -13dBm.

h) For operations in the 1710–1755 MHz and 2110–2155 MHz bands, the power of any emission outside a licensee's frequency block shall be attenuated below the transmitter power (P) by at least $43 + 10 \log_{10}(P)$ dB. Limit, -13dBm

(1) Compliance with this provision is based on the use of measurement instrumentation employing a resolution bandwidth of 1 megahertz or greater. Limit, -13dBm

Conducted Emission:

- 1、 To connect Antenna Port of EUT to Spectrum.
- 2、 Set RBW = 1MHz & VBW = 1MHz on Spectrum.
- 3、 Sweep the frequency to determine spurious emission as seen on spectrum from span of 30 to 1G, 1G to 2.5G, 2.5G to 7.5G, 7.5G to 10G ,10G to 15G and 15G to 20GHz
- 4、 Via Software, combine 6 spans of frequency range into one plot

9.4. Measurement Equipment Used:

Refer to section 2.4 in this report

9.5. Measurement Result:

Refer to next pages.

NOTE: the occurrence of the spike on the conducted emission is the signal of the fundamental emission.

Unless otherwise stated the results shown in this test report refer only to the sample(s) tested and such sample(s) are retained for 90 days only.

除非另有說明，此報告結果僅對測試之樣品負責，同時此樣品僅保留90天。本報告未經本公司書面許可，不可部份複製。

This document is issued by the Company subject to its General Conditions of Service printed overleaf, available on request or accessible at www.sgs.com/terms_and_conditions.htm and, for electronic format documents, subject to Terms and Conditions for Electronic Documents at www.sgs.com/terms_e-document.htm. Attention is drawn to the limitation of liability, indemnification and jurisdiction issues defined therein. Any holder of this document is advised that information contained hereon reflects the Company's findings at the time of its intervention only and within the limits of Client's instructions, if any. The Company's sole responsibility is to its Client and this document does not exonerate parties to a transaction from exercising all their rights and obligations under the transaction documents. This document cannot be reproduced except in full, without prior written approval of the Company. Any unauthorized alteration, forgery or falsification of the content or appearance of this document is unlawful and offenders may be prosecuted to the fullest extent of the law.

Figure 9-1: Out of Band emission at antenna terminals – GSM 850 Channel Lowest

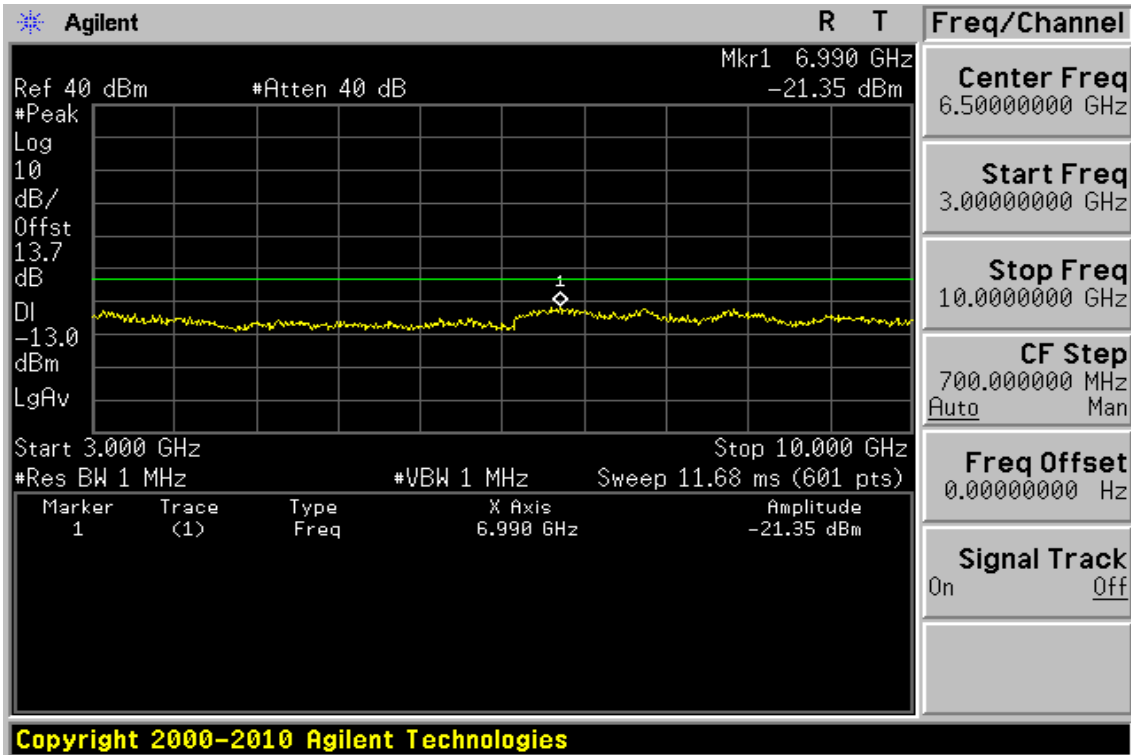
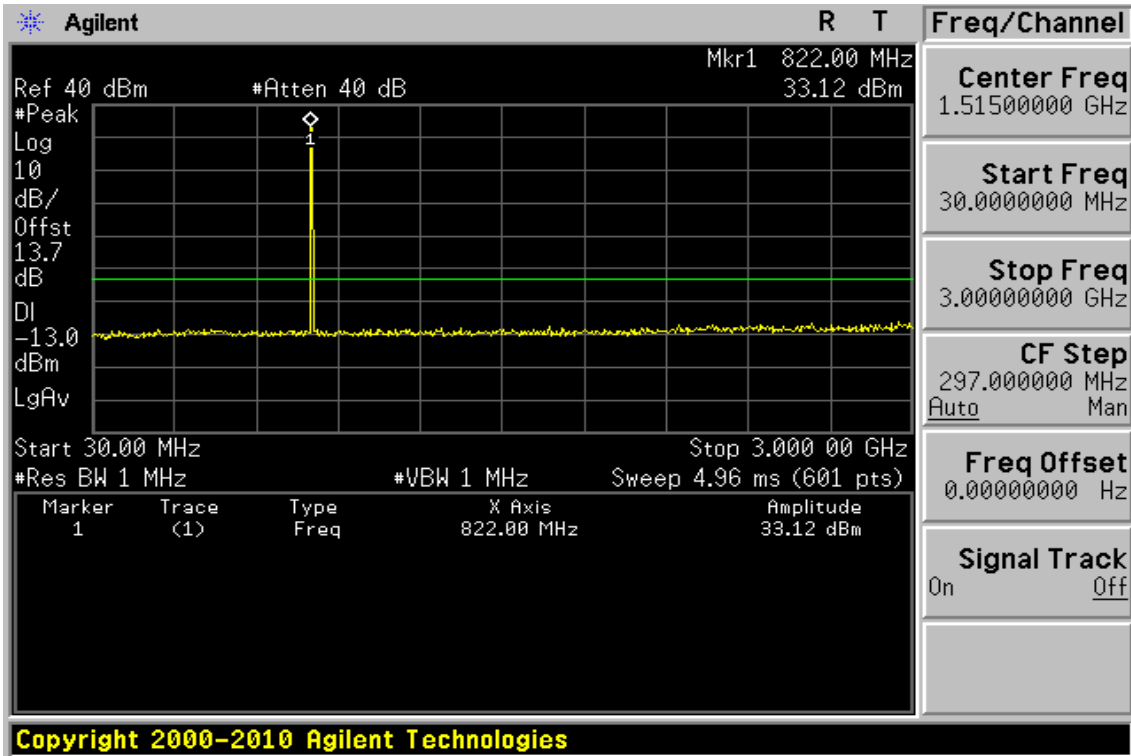

Unless otherwise stated the results shown in this test report refer only to the sample(s) tested and such sample(s) are retained for 90 days only.

除非另有說明，此報告結果僅對測試之樣品負責，同時此樣品僅保留90天。本報告未經本公司書面許可，不可部份複製。

This document is issued by the Company subject to its General Conditions of Service printed overleaf, available on request or accessible at www.sgs.com/terms_and_conditions.htm and, for electronic format documents, subject to Terms and Conditions for Electronic Documents at www.sgs.com/terms_e-document.htm. Attention is drawn to the limitation of liability, indemnification and jurisdiction issues defined therein. Any holder of this document is advised that information contained hereon reflects the Company's findings at the time of its intervention only and within the limits of Client's instructions, if any. The Company's sole responsibility is to its Client and this document does not exonerate parties to a transaction from exercising all their rights and obligations under the transaction documents. This document cannot be reproduced except in full, without prior written approval of the Company. Any unauthorized alteration, forgery or falsification of the content or appearance of this document is unlawful and offenders may be prosecuted to the fullest extent of the law.

Figure 9-2: Out of Band emission at antenna terminals – GSM 850 Channel Mid

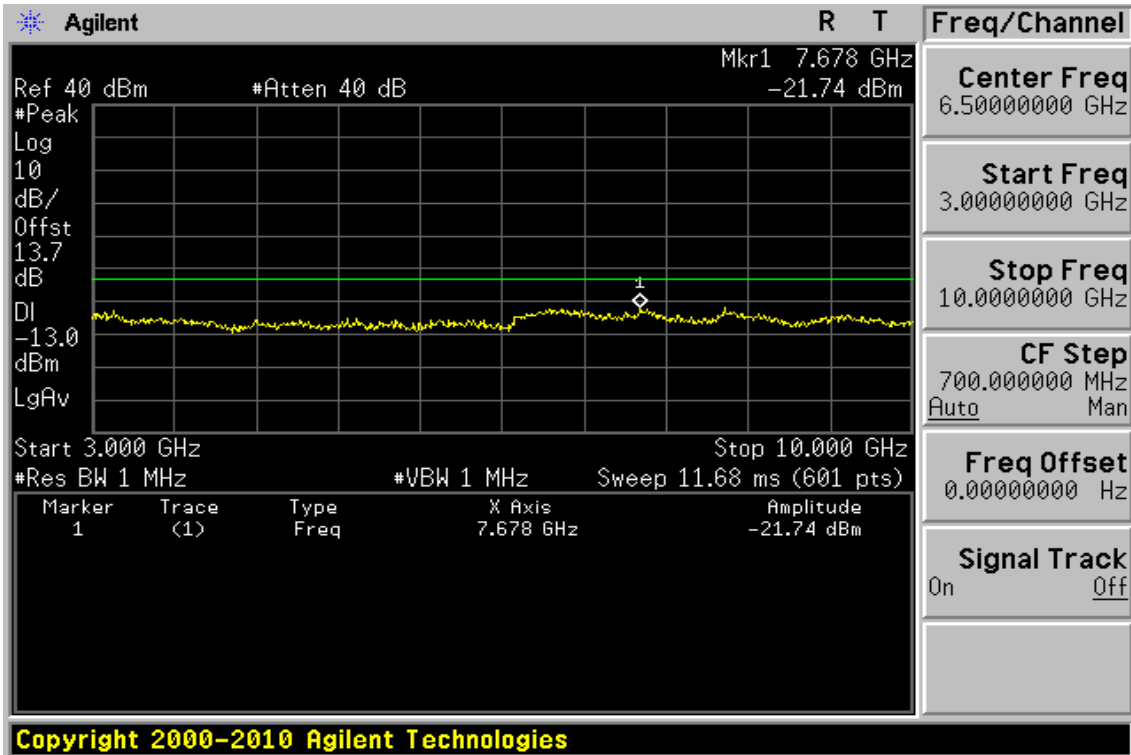
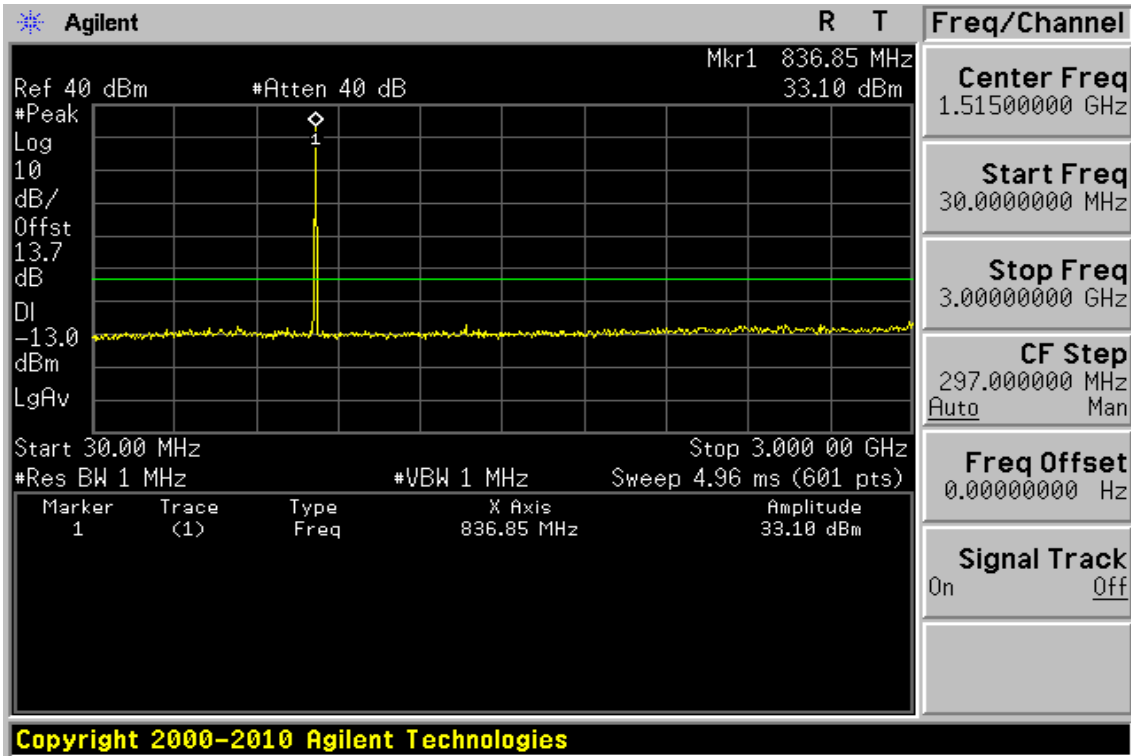

Unless otherwise stated the results shown in this test report refer only to the sample(s) tested and such sample(s) are retained for 90 days only.

除非另有說明，此報告結果僅對測試之樣品負責，同時此樣品僅保留90天。本報告未經本公司書面許可，不可部份複製。

This document is issued by the Company subject to its General Conditions of Service printed overleaf, available on request or accessible at www.sgs.com/terms_and_conditions.htm and, for electronic format documents, subject to Terms and Conditions for Electronic Documents at www.sgs.com/terms_e-document.htm. Attention is drawn to the limitation of liability, indemnification and jurisdiction issues defined therein. Any holder of this document is advised that information contained hereon reflects the Company's findings at the time of its intervention only and within the limits of Client's instructions, if any. The Company's sole responsibility is to its Client and this document does not exonerate parties to a transaction from exercising all their rights and obligations under the transaction documents. This document cannot be reproduced except in full, without prior written approval of the Company. Any unauthorized alteration, forgery or falsification of the content or appearance of this document is unlawful and offenders may be prosecuted to the fullest extent of the law.

Figure 9-3: Out of Band emission at antenna terminals – GSM 850 Channel Highest

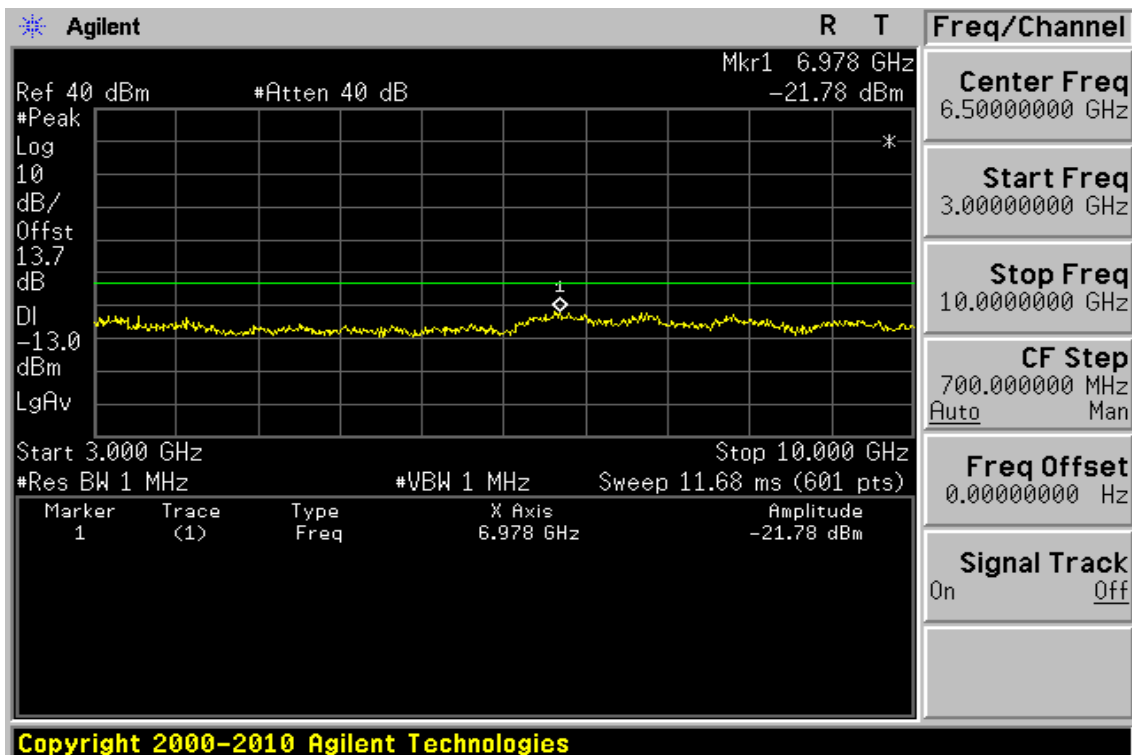
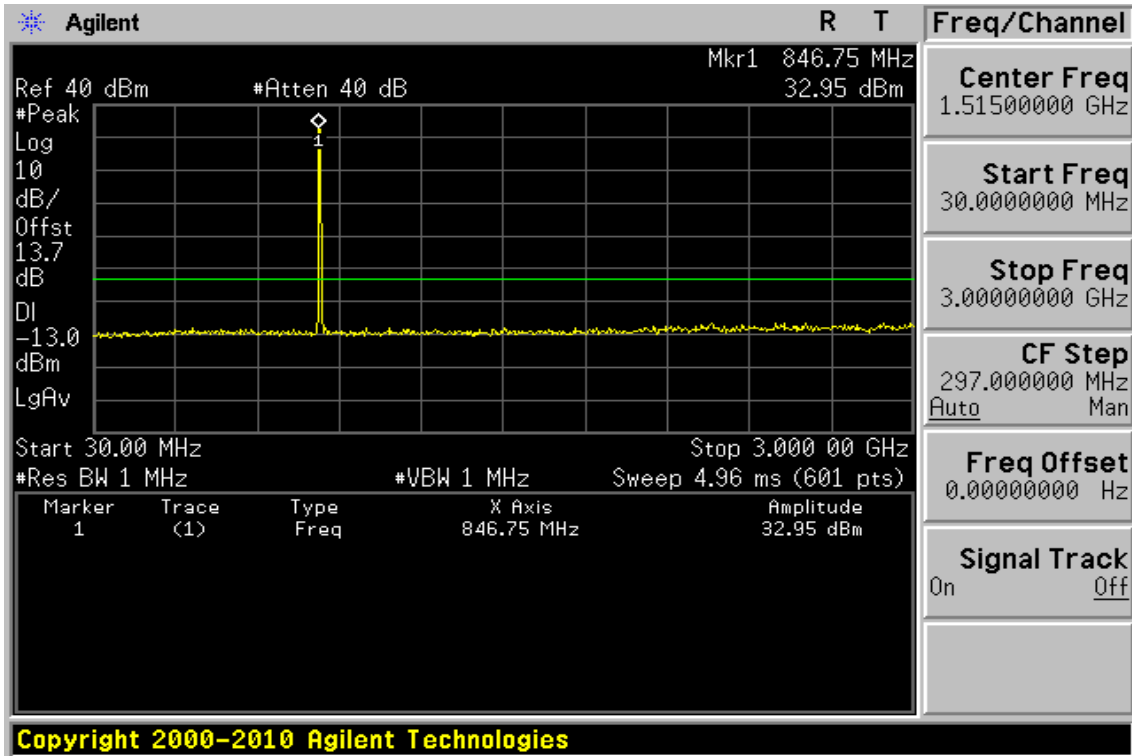

Unless otherwise stated the results shown in this test report refer only to the sample(s) tested and such sample(s) are retained for 90 days only.

除非另有說明，此報告結果僅對測試之樣品負責，同時此樣品僅保留90天。本報告未經本公司書面許可，不可部份複製。

This document is issued by the Company subject to its General Conditions of Service printed overleaf, available on request or accessible at www.sgs.com/terms_and_conditions.htm and, for electronic format documents, subject to Terms and Conditions for Electronic Documents at www.sgs.com/terms_e-document.htm. Attention is drawn to the limitation of liability, indemnification and jurisdiction issues defined therein. Any holder of this document is advised that information contained hereon reflects the Company's findings at the time of its intervention only and within the limits of Client's instructions, if any. The Company's sole responsibility is to its Client and this document does not exonerate parties to a transaction from exercising all their rights and obligations under the transaction documents. This document cannot be reproduced except in full, without prior written approval of the Company. Any unauthorized alteration, forgery or falsification of the content or appearance of this document is unlawful and offenders may be prosecuted to the fullest extent of the law.

Out of Band emission at antenna terminals – GSM 850

Fundamental Frequency :824.2 MHz Engineer :Nick
Operation Mode :TX Low

Freq. (MHz)	Note F/H/E/S	Reading dBm	Limit dBm	Safe Margin dB
<30	S	---	-13.00	---
30-1000	S	---	-13.00	---
1648.40	H	---	-13.00	---
2472.60	H	---	-13.00	---
3296.80	H	---	-13.00	---
4121.00	H	---	-13.00	---
4945.20	H	---	-13.00	---
5769.40	H	---	-13.00	---
6593.60	H	---	-13.00	---
6990.00	S	-21.35	-13.00	8.35
7417.80	H	---	-13.00	---
8242.00	H	---	-13.00	---

Note : “H” : denotes Harmonic Frequency. “S” : denotes Spurious Frequency.
“---” : denotes Noise Floor.

Unless otherwise stated the results shown in this test report refer only to the sample(s) tested and such sample(s) are retained for 90 days only.

除非另有說明，此報告結果僅對測試之樣品負責，同時此樣品僅保留90天。本報告未經本公司書面許可，不可部份複製。

This document is issued by the Company subject to its General Conditions of Service printed overleaf, available on request or accessible at www.sgs.com/terms_and_conditions.htm and, for electronic format documents, subject to Terms and Conditions for Electronic Documents at www.sgs.com/terms_e-document.htm. Attention is drawn to the limitation of liability, indemnification and jurisdiction issues defined therein. Any holder of this document is advised that information contained hereon reflects the Company's findings at the time of its intervention only and within the limits of Client's instructions, if any. The Company's sole responsibility is to its Client and this document does not exonerate parties to a transaction from exercising all their rights and obligations under the transaction documents. This document cannot be reproduced except in full, without prior written approval of the Company. Any unauthorized alteration, forgery or falsification of the content or appearance of this document is unlawful and offenders may be prosecuted to the fullest extent of the law.

Fundamental Frequency :836.6 MHz Engineer :Nick
Operation Mode :TX Mid

Freq. (MHz)	Note F/H/E/S	Reading dBm	Limit dBm	Safe Margin dB
<30	S	---	-13.00	---
30-1000	S	---	-13.00	---
1673.20	H	---	-13.00	---
2509.80	H	---	-13.00	---
3346.40	H	---	-13.00	---
4183.00	H	---	-13.00	---
5019.60	H	---	-13.00	---
5856.20	H	---	-13.00	---
6692.80	H	---	-13.00	---
7529.40	H	---	-13.00	---
7678.00	S	-21.74	-13.00	8.74
8366.00	H	---	-13.00	---

Note : “H” : denotes Harmonic Frequency. “S” : denotes Spurious Frequency.
“---” : denotes Noise Floor.

Unless otherwise stated the results shown in this test report refer only to the sample(s) tested and such sample(s) are retained for 90 days only.

除非另有說明，此報告結果僅對測試之樣品負責，同時此樣品僅保留90天。本報告未經本公司書面許可，不可部份複製。

This document is issued by the Company subject to its General Conditions of Service printed overleaf, available on request or accessible at www.sgs.com/terms_and_conditions.htm and, for electronic format documents, subject to Terms and Conditions for Electronic Documents at www.sgs.com/terms_e-document.htm. Attention is drawn to the limitation of liability, indemnification and jurisdiction issues defined therein. Any holder of this document is advised that information contained hereon reflects the Company's findings at the time of its intervention only and within the limits of Client's instructions, if any. The Company's sole responsibility is to its Client and this document does not exonerate parties to a transaction from exercising all their rights and obligations under the transaction documents. This document cannot be reproduced except in full, without prior written approval of the Company. Any unauthorized alteration, forgery or falsification of the content or appearance of this document is unlawful and offenders may be prosecuted to the fullest extent of the law.

Fundamental Frequency :848.8MHz Engineer :Nick
Operation Mode :TX High

Freq. (MHz)	Note F/H/E/S	Reading dBm	Limit dBm	Safe Margin dB
<30	S	---	-13.00	---
30-1000	S	---	-13.00	---
1697.60	H	---	-13.00	---
2546.40	H	---	-13.00	---
3395.20	H	---	-13.00	---
4244.00	H	---	-13.00	---
5092.80	H	---	-13.00	---
5941.60	H	---	-13.00	---
6790.40	H	---	-13.00	---
6978.00	S	-21.78	-13.00	8.78
7639.20	H	---	-13.00	---
8488.00	H	---	-13.00	---

Note : "H" : denotes Harmonic Frequency. "S" : denotes Spurious Frequency.
"---" : denotes Noise Floor.

Unless otherwise stated the results shown in this test report refer only to the sample(s) tested and such sample(s) are retained for 90 days only.

除非另有說明，此報告結果僅對測試之樣品負責，同時此樣品僅保留90天。本報告未經本公司書面許可，不可部份複製。

This document is issued by the Company subject to its General Conditions of Service printed overleaf, available on request or accessible at www.sgs.com/terms_and_conditions.htm and, for electronic format documents, subject to Terms and Conditions for Electronic Documents at www.sgs.com/terms_e-document.htm. Attention is drawn to the limitation of liability, indemnification and jurisdiction issues defined therein. Any holder of this document is advised that information contained hereon reflects the Company's findings at the time of its intervention only and within the limits of Client's instructions, if any. The Company's sole responsibility is to its Client and this document does not exonerate parties to a transaction from exercising all their rights and obligations under the transaction documents. This document cannot be reproduced except in full, without prior written approval of the Company. Any unauthorized alteration, forgery or falsification of the content or appearance of this document is unlawful and offenders may be prosecuted to the fullest extent of the law.

Figure 9-4: Band edge emission at antenna terminals – GSM 850 Channel Lowest

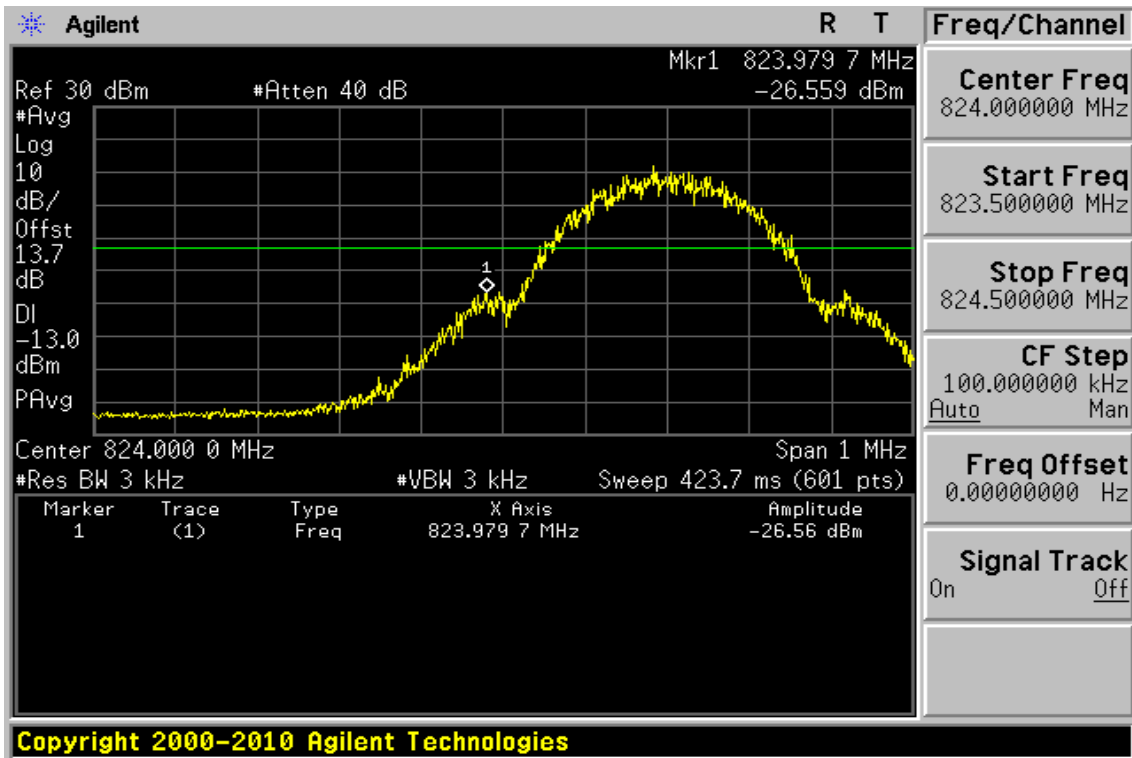
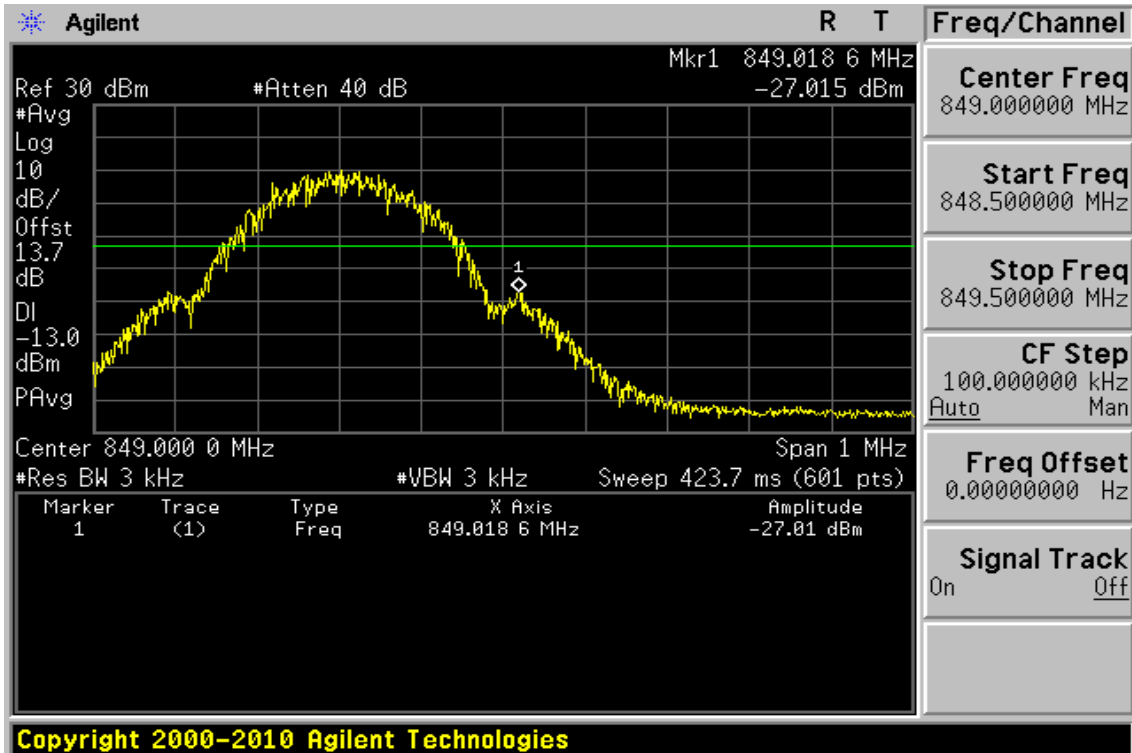

Figure 9-5: Band edge emission at antenna terminals – GSM 850 Channel Highest



Unless otherwise stated the results shown in this test report refer only to the sample(s) tested and such sample(s) are retained for 90 days only.

除非另有說明，此報告結果僅對測試之樣品負責，同時此樣品僅保留90天。本報告未經本公司書面許可，不可部份複製。

This document is issued by the Company subject to its General Conditions of Service printed overleaf, available on request or accessible at www.sgs.com/terms_and_conditions.htm and, for electronic format documents, subject to Terms and Conditions for Electronic Documents at www.sgs.com/terms_e-document.htm. Attention is drawn to the limitation of liability, indemnification and jurisdiction issues defined therein. Any holder of this document is advised that information contained hereon reflects the Company's findings at the time of its intervention only and within the limits of Client's instructions, if any. The Company's sole responsibility is to its Client and this document does not exonerate parties to a transaction from exercising all their rights and obligations under the transaction documents. This document cannot be reproduced except in full, without prior written approval of the Company. Any unauthorized alteration, forgery or falsification of the content or appearance of this document is unlawful and offenders may be prosecuted to the fullest extent of the law.

Band edge emission at antenna terminals – GSM 850 Low & High

Test Mode GSM 850 Engineer :Nick

Freq. MHz	Reading dBm	Limit dBm	Safe Margin dB
823.979	-26.56	-13.00	13.56
849.018	-27.02	-13.00	14.02

Unless otherwise stated the results shown in this test report refer only to the sample(s) tested and such sample(s) are retained for 90 days only.

除非另有說明，此報告結果僅對測試之樣品負責，同時此樣品僅保留90天。本報告未經本公司書面許可，不可部份複製。

This document is issued by the Company subject to its General Conditions of Service printed overleaf, available on request or accessible at www.sgs.com/terms_and_conditions.htm and, for electronic format documents, subject to Terms and Conditions for Electronic Documents at www.sgs.com/terms_e-document.htm. Attention is drawn to the limitation of liability, indemnification and jurisdiction issues defined therein. Any holder of this document is advised that information contained hereon reflects the Company's findings at the time of its intervention only and within the limits of Client's instructions, if any. The Company's sole responsibility is to its Client and this document does not exonerate parties to a transaction from exercising all their rights and obligations under the transaction documents. This document cannot be reproduced except in full, without prior written approval of the Company. Any unauthorized alteration, forgery or falsification of the content or appearance of this document is unlawful and offenders may be prosecuted to the fullest extent of the law.

Figure 9-6: Out of Band emission at antenna terminals – GSM 1900 Channel Lowest

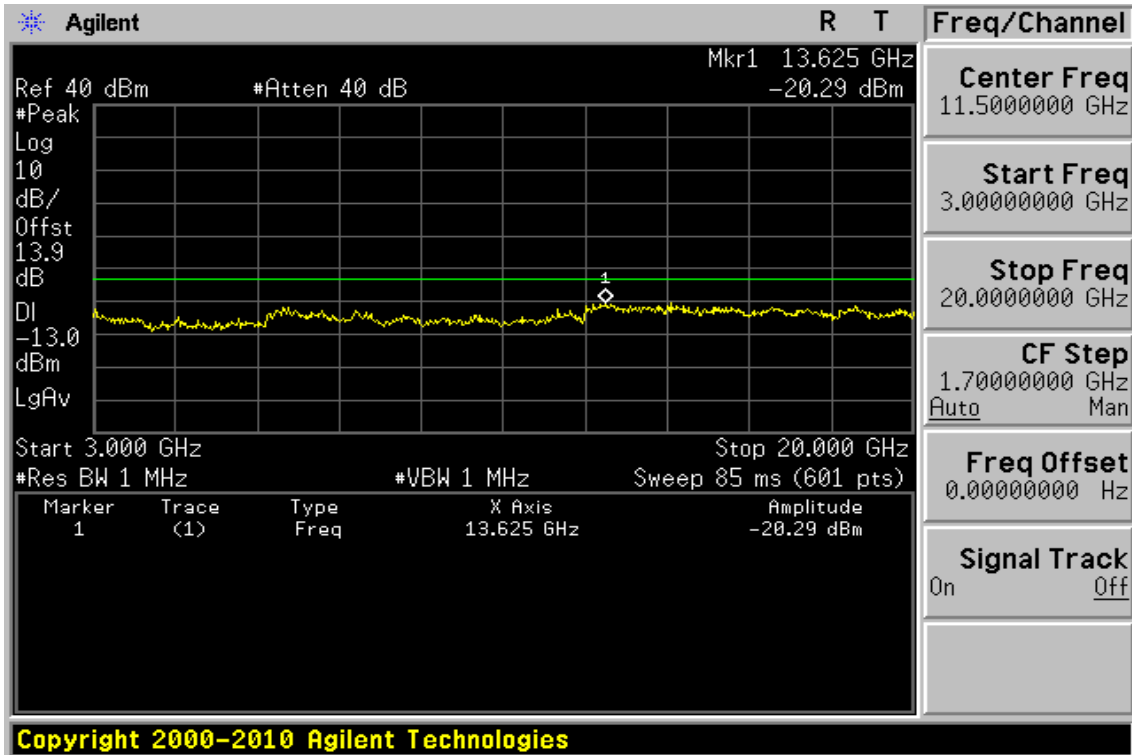
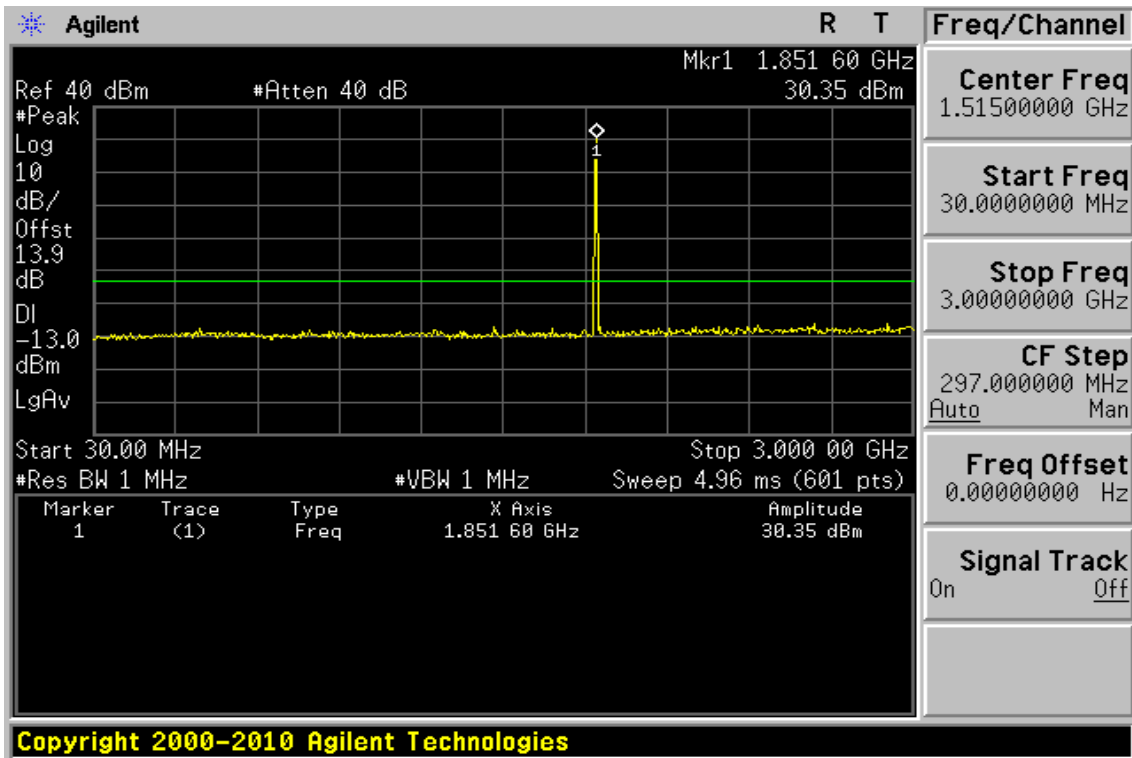

Unless otherwise stated the results shown in this test report refer only to the sample(s) tested and such sample(s) are retained for 90 days only.

除非另有說明，此報告結果僅對測試之樣品負責，同時此樣品僅保留90天。本報告未經本公司書面許可，不可部份複製。

This document is issued by the Company subject to its General Conditions of Service printed overleaf, available on request or accessible at www.sgs.com/terms_and_conditions.htm and, for electronic format documents, subject to Terms and Conditions for Electronic Documents at www.sgs.com/terms_e-document.htm. Attention is drawn to the limitation of liability, indemnification and jurisdiction issues defined therein. Any holder of this document is advised that information contained hereon reflects the Company's findings at the time of its intervention only and within the limits of Client's instructions, if any. The Company's sole responsibility is to its Client and this document does not exonerate parties to a transaction from exercising all their rights and obligations under the transaction documents. This document cannot be reproduced except in full, without prior written approval of the Company. Any unauthorized alteration, forgery or falsification of the content or appearance of this document is unlawful and offenders may be prosecuted to the fullest extent of the law.

Figure 9-7: Out of Band emission at antenna terminals – GSM 1900 Channel Mid

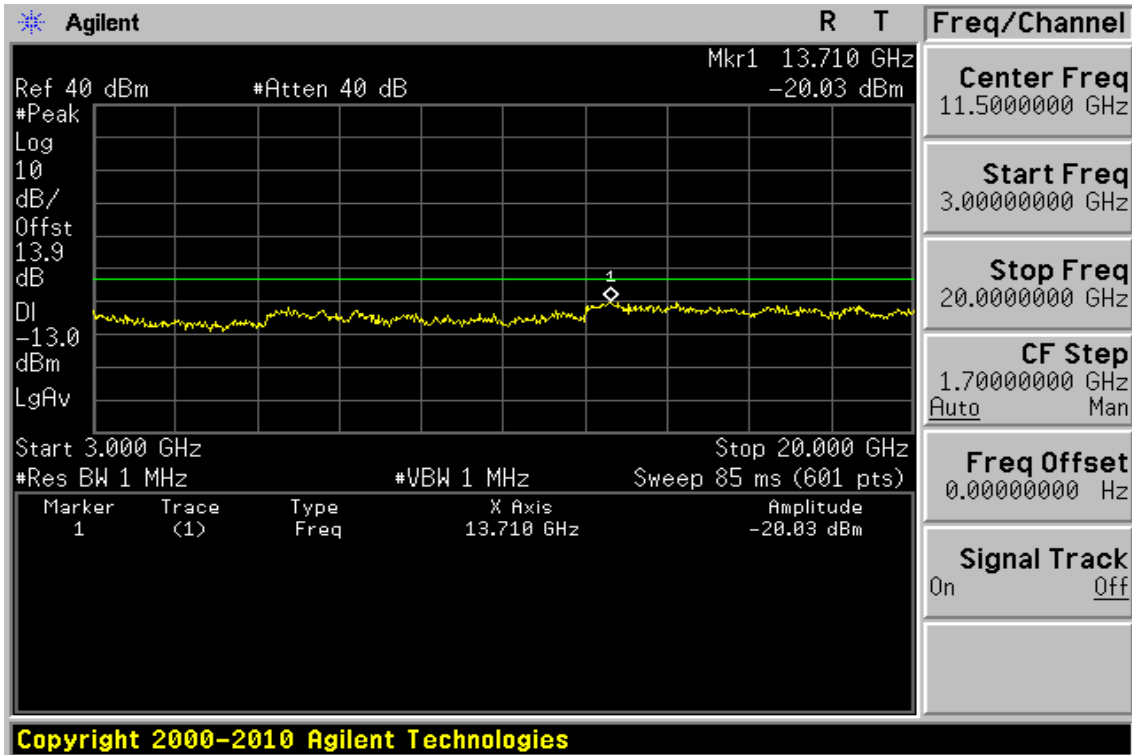
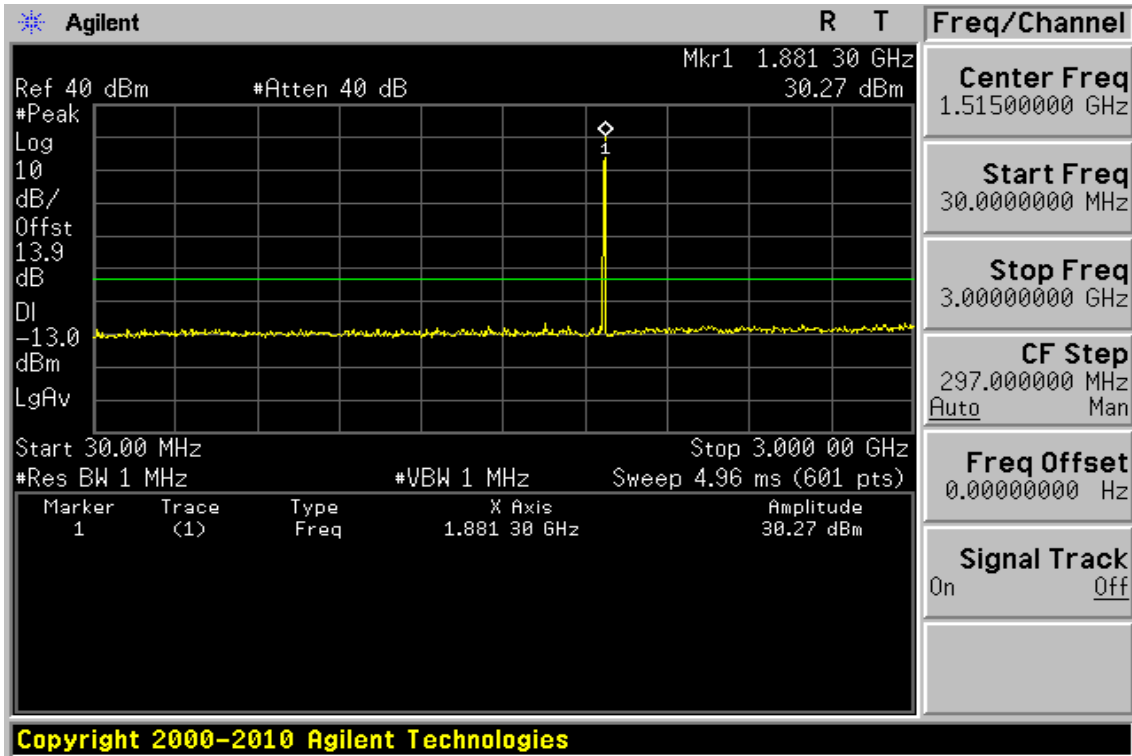

Unless otherwise stated the results shown in this test report refer only to the sample(s) tested and such sample(s) are retained for 90 days only.

除非另有說明，此報告結果僅對測試之樣品負責，同時此樣品僅保留90天。本報告未經本公司書面許可，不可部份複製。

This document is issued by the Company subject to its General Conditions of Service printed overleaf, available on request or accessible at www.sgs.com/terms_and_conditions.htm and, for electronic format documents, subject to Terms and Conditions for Electronic Documents at www.sgs.com/terms_e-document.htm. Attention is drawn to the limitation of liability, indemnification and jurisdiction issues defined therein. Any holder of this document is advised that information contained hereon reflects the Company's findings at the time of its intervention only and within the limits of Client's instructions, if any. The Company's sole responsibility is to its Client and this document does not exonerate parties to a transaction from exercising all their rights and obligations under the transaction documents. This document cannot be reproduced except in full, without prior written approval of the Company. Any unauthorized alteration, forgery or falsification of the content or appearance of this document is unlawful and offenders may be prosecuted to the fullest extent of the law.

Figure 9-8: Out of Band emission at antenna terminals – GSM 1900 Channel Highest

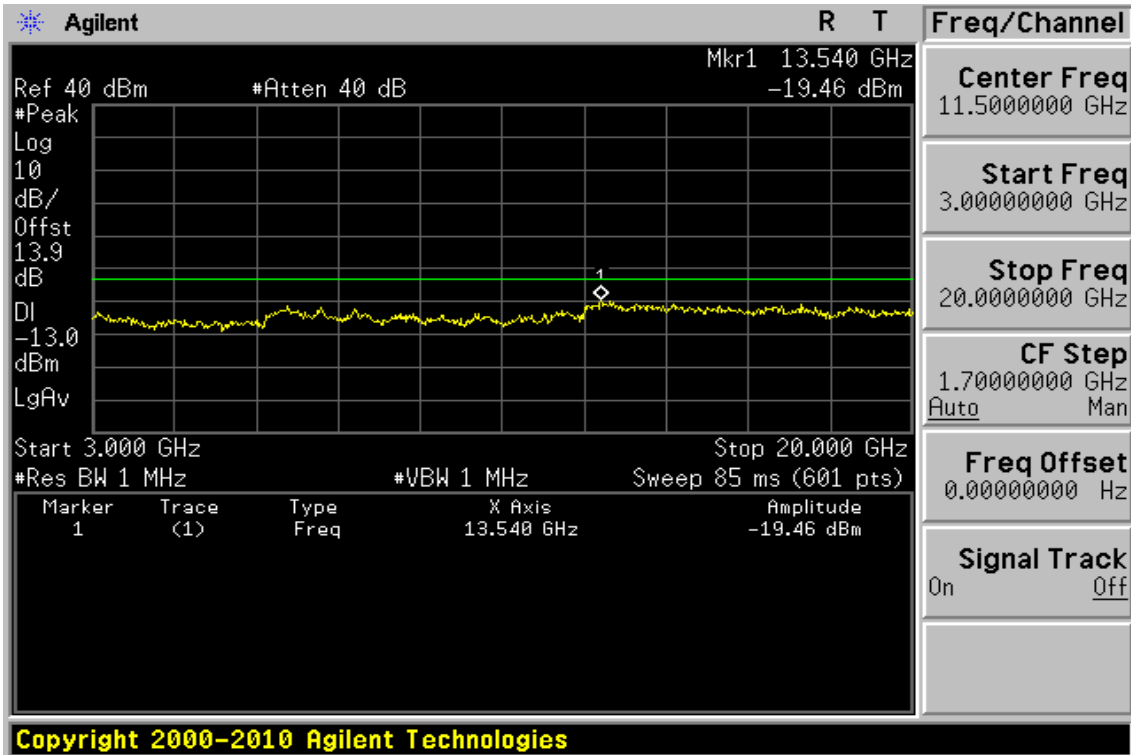
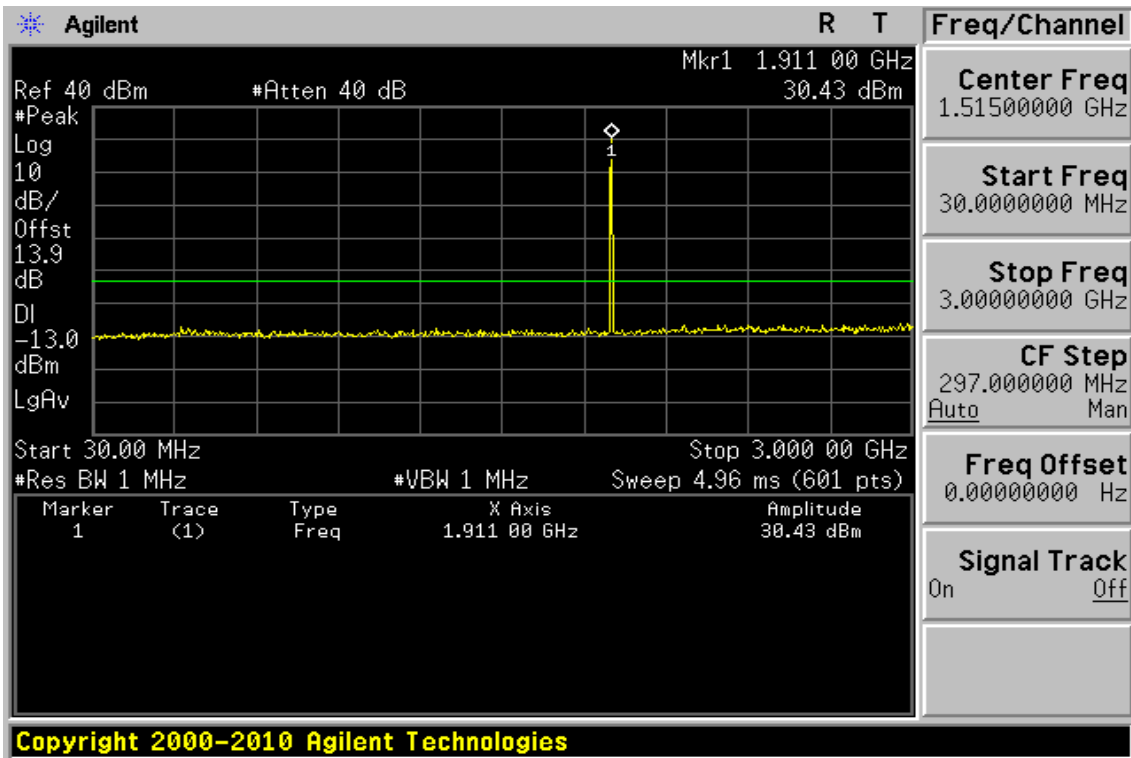

Unless otherwise stated the results shown in this test report refer only to the sample(s) tested and such sample(s) are retained for 90 days only.

除非另有說明，此報告結果僅對測試之樣品負責，同時此樣品僅保留90天。本報告未經本公司書面許可，不可部份複製。

This document is issued by the Company subject to its General Conditions of Service printed overleaf, available on request or accessible at www.sgs.com/terms_and_conditions.htm and, for electronic format documents, subject to Terms and Conditions for Electronic Documents at www.sgs.com/terms_e-document.htm. Attention is drawn to the limitation of liability, indemnification and jurisdiction issues defined therein. Any holder of this document is advised that information contained hereon reflects the Company's findings at the time of its intervention only and within the limits of Client's instructions, if any. The Company's sole responsibility is to its Client and this document does not exonerate parties to a transaction from exercising all their rights and obligations under the transaction documents. This document cannot be reproduced except in full, without prior written approval of the Company. Any unauthorized alteration, forgery or falsification of the content or appearance of this document is unlawful and offenders may be prosecuted to the fullest extent of the law.

Out of Band emission at antenna terminals – GSM 1900

Fundamental Frequency :1850.2 MHz Engineer :Nick
Operation Mode :TX Low

Freq. (MHz)	Note F/H/E/S	Reading dBm	Limit dBm	Safe Margin dB
<30	S	---	-13.00	---
30-1000	S	---	-13.00	---
3700.40	H	---	-13.00	---
5550.60	H	---	-13.00	---
7400.80	H	---	-13.00	---
9251.00	H	---	-13.00	---
11101.20	H	---	-13.00	---
12951.40	H	---	-13.00	---
13625.00	S	-20.29	-13.00	7.29
14801.60	H	---	-13.00	---
16651.80	H	---	-13.00	---
18502.00	H	---	-13.00	---

Note : “H” : denotes Harmonic Frequency. “S” : denotes Spurious Frequency.
“---” : denotes Noise Floor.

Unless otherwise stated the results shown in this test report refer only to the sample(s) tested and such sample(s) are retained for 90 days only.

除非另有說明，此報告結果僅對測試之樣品負責，同時此樣品僅保留90天。本報告未經本公司書面許可，不可部份複製。

This document is issued by the Company subject to its General Conditions of Service printed overleaf, available on request or accessible at www.sgs.com/terms_and_conditions.htm and, for electronic format documents, subject to Terms and Conditions for Electronic Documents at www.sgs.com/terms_e-document.htm. Attention is drawn to the limitation of liability, indemnification and jurisdiction issues defined therein. Any holder of this document is advised that information contained hereon reflects the Company's findings at the time of its intervention only and within the limits of Client's instructions, if any. The Company's sole responsibility is to its Client and this document does not exonerate parties to a transaction from exercising all their rights and obligations under the transaction documents. This document cannot be reproduced except in full, without prior written approval of the Company. Any unauthorized alteration, forgery or falsification of the content or appearance of this document is unlawful and offenders may be prosecuted to the fullest extent of the law.

Fundamental Frequency :1880.0 MHz Engineer :Nick
Operation Mode :TX Mid

Freq. (MHz)	Note F/H/E/S	Reading dBm	Limit dBm	Safe Margin dB
<30	S	---	-13.00	---
30-1000	S	---	-13.00	---
3760.00	H	---	-13.00	---
5640.00	H	---	-13.00	---
7520.00	H	---	-13.00	---
9400.00	H	---	-13.00	---
11280.00	H	---	-13.00	---
13160.00	H	---	-13.00	---
13710.00	S	-20.03	-13.00	7.03
15040.00	H	---	-13.00	---
16920.00	H	---	-13.00	---
18800.00	H	---	-13.00	---

Note : "H" : denotes Harmonic Frequency. "S" : denotes Spurious Frequency.
"---" : denotes Noise Floor.

Unless otherwise stated the results shown in this test report refer only to the sample(s) tested and such sample(s) are retained for 90 days only.

除非另有說明，此報告結果僅對測試之樣品負責，同時此樣品僅保留90天。本報告未經本公司書面許可，不可部份複製。

This document is issued by the Company subject to its General Conditions of Service printed overleaf, available on request or accessible at www.sgs.com/terms_and_conditions.htm and, for electronic format documents, subject to Terms and Conditions for Electronic Documents at www.sgs.com/terms_e-document.htm. Attention is drawn to the limitation of liability, indemnification and jurisdiction issues defined therein. Any holder of this document is advised that information contained hereon reflects the Company's findings at the time of its intervention only and within the limits of Client's instructions, if any. The Company's sole responsibility is to its Client and this document does not exonerate parties to a transaction from exercising all their rights and obligations under the transaction documents. This document cannot be reproduced except in full, without prior written approval of the Company. Any unauthorized alteration, forgery or falsification of the content or appearance of this document is unlawful and offenders may be prosecuted to the fullest extent of the law.

Fundamental Frequency :1909.8 MHz Engineer :Nick
Operation Mode :TX High

Freq. (MHz)	Note F/H/E/S	Reading dBm	Limit dBm	Safe Margin dB
<30	S	---	-13.00	---
30-1000	S	---	-13.00	---
3819.60	H	---	-13.00	---
5729.40	H	---	-13.00	---
7639.20	H	---	-13.00	---
9549.00	H	---	-13.00	---
11458.80	H	---	-13.00	---
13368.60	H	---	-13.00	---
13540.00	S	-19.46	-13.00	6.46
15278.40	H	---	-13.00	---
17188.20	H	---	-13.00	---
19098.00	H	---	-13.00	---

Note : "H" : denotes Harmonic Frequency. "S" : denotes Spurious Frequency.
"---" : denotes Noise Floor.

Unless otherwise stated the results shown in this test report refer only to the sample(s) tested and such sample(s) are retained for 90 days only.

除非另有說明，此報告結果僅對測試之樣品負責，同時此樣品僅保留90天。本報告未經本公司書面許可，不可部份複製。

This document is issued by the Company subject to its General Conditions of Service printed overleaf, available on request or accessible at www.sgs.com/terms_and_conditions.htm and, for electronic format documents, subject to Terms and Conditions for Electronic Documents at www.sgs.com/terms_e-document.htm. Attention is drawn to the limitation of liability, indemnification and jurisdiction issues defined therein. Any holder of this document is advised that information contained hereon reflects the Company's findings at the time of its intervention only and within the limits of Client's instructions, if any. The Company's sole responsibility is to its Client and this document does not exonerate parties to a transaction from exercising all their rights and obligations under the transaction documents. This document cannot be reproduced except in full, without prior written approval of the Company. Any unauthorized alteration, forgery or falsification of the content or appearance of this document is unlawful and offenders may be prosecuted to the fullest extent of the law.

Figure 9-9: Band edge emission at antenna terminals – GSM 1900 Channel Lowest

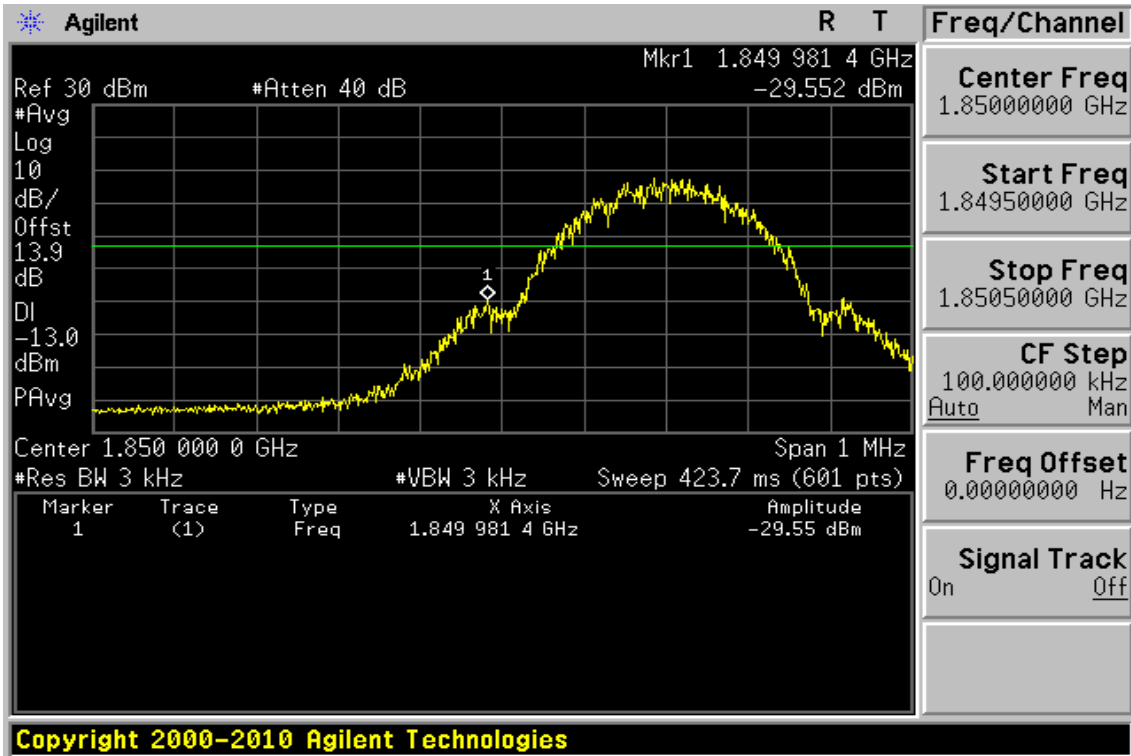
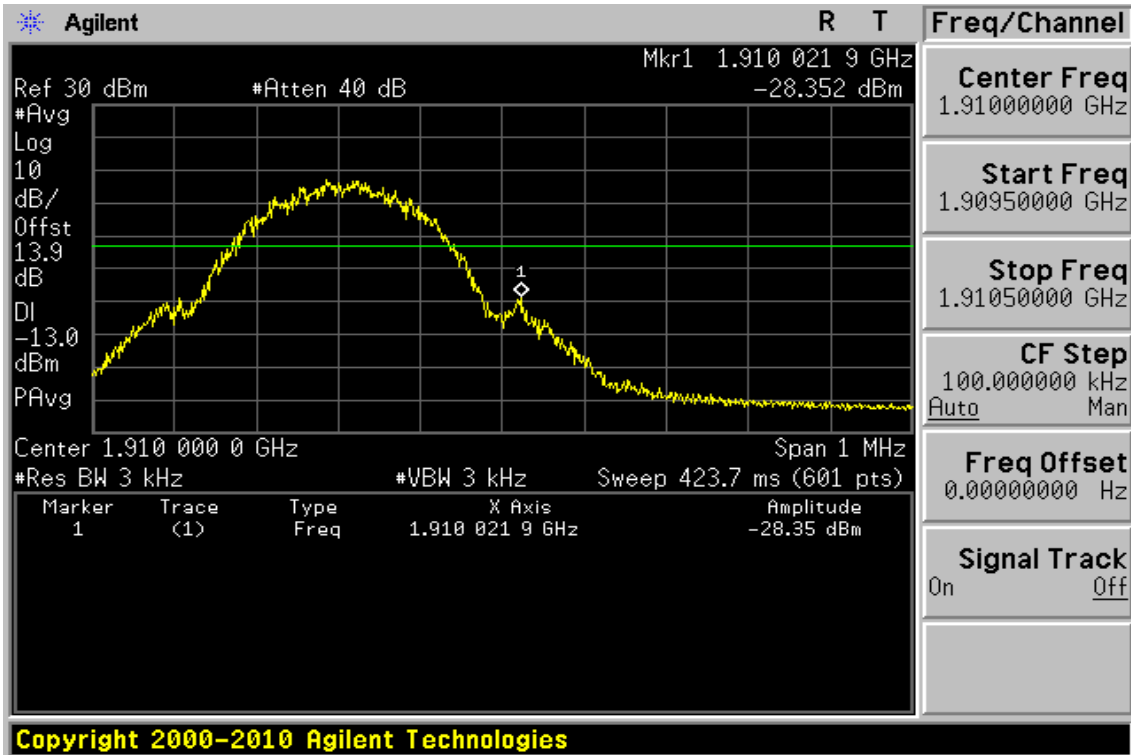

Figure 9-10: Band edge emission at antenna terminals – GSM 1900 Channel Highest



Unless otherwise stated the results shown in this test report refer only to the sample(s) tested and such sample(s) are retained for 90 days only.

除非另有說明，此報告結果僅對測試之樣品負責，同時此樣品僅保留90天。本報告未經本公司書面許可，不可部份複製。

This document is issued by the Company subject to its General Conditions of Service printed overleaf, available on request or accessible at www.sgs.com/terms_and_conditions.htm and, for electronic format documents, subject to Terms and Conditions for Electronic Documents at www.sgs.com/terms_e-document.htm. Attention is drawn to the limitation of liability, indemnification and jurisdiction issues defined therein. Any holder of this document is advised that information contained hereon reflects the Company's findings at the time of its intervention only and within the limits of Client's instructions, if any. The Company's sole responsibility is to its Client and this document does not exonerate parties to a transaction from exercising all their rights and obligations under the transaction documents. This document cannot be reproduced except in full, without prior written approval of the Company. Any unauthorized alteration, forgery or falsification of the content or appearance of this document is unlawful and offenders may be prosecuted to the fullest extent of the law.

Band edge emission at antenna terminals – GSM 1900 Low & High

Test Mode GSM 1900 Engineer :Nick

Freq. MHz	Reading dBm	Limit dBm	Safe Margin dB
1849.981	-29.55	-13.00	16.55
1910.021	-28.35	-13.00	15.35

Unless otherwise stated the results shown in this test report refer only to the sample(s) tested and such sample(s) are retained for 90 days only.

除非另有說明，此報告結果僅對測試之樣品負責，同時此樣品僅保留90天。本報告未經本公司書面許可，不可部份複製。

This document is issued by the Company subject to its General Conditions of Service printed overleaf, available on request or accessible at www.sgs.com/terms_and_conditions.htm and, for electronic format documents, subject to Terms and Conditions for Electronic Documents at www.sgs.com/terms_e-document.htm. Attention is drawn to the limitation of liability, indemnification and jurisdiction issues defined therein. Any holder of this document is advised that information contained hereon reflects the Company's findings at the time of its intervention only and within the limits of Client's instructions, if any. The Company's sole responsibility is to its Client and this document does not exonerate parties to a transaction from exercising all their rights and obligations under the transaction documents. This document cannot be reproduced except in full, without prior written approval of the Company. Any unauthorized alteration, forgery or falsification of the content or appearance of this document is unlawful and offenders may be prosecuted to the fullest extent of the law.

Figure 9-12: Out of Band emission at antenna terminals – GPRS 850 Channel Mid

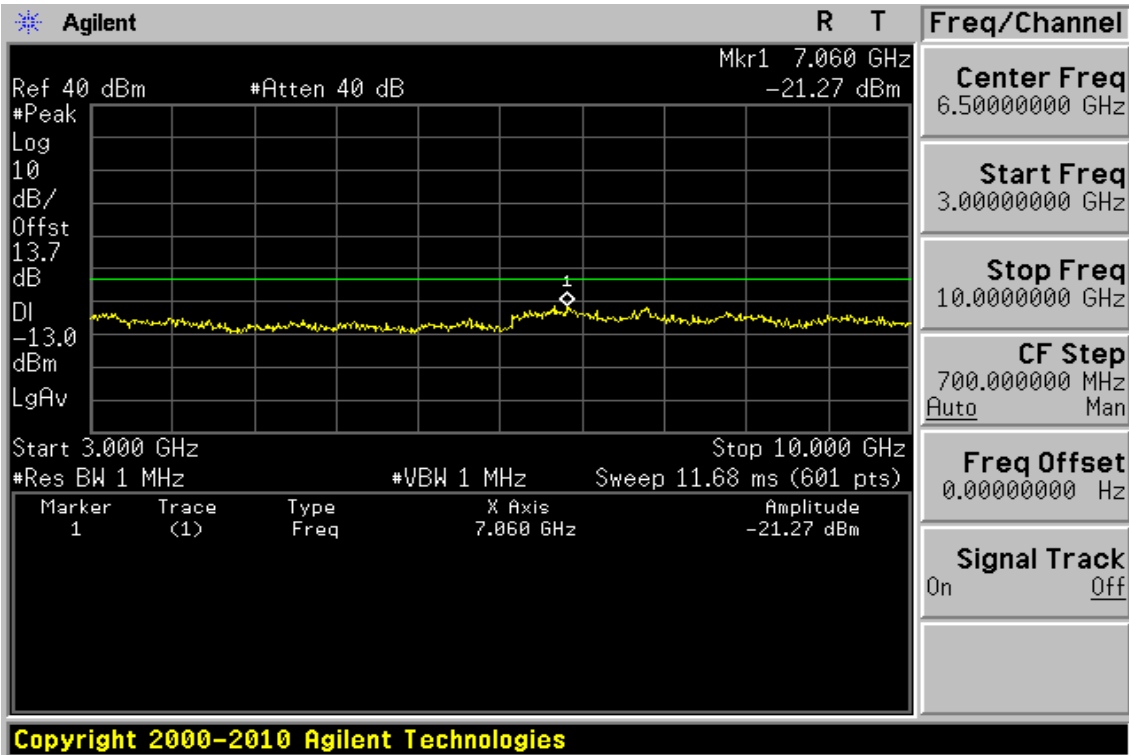
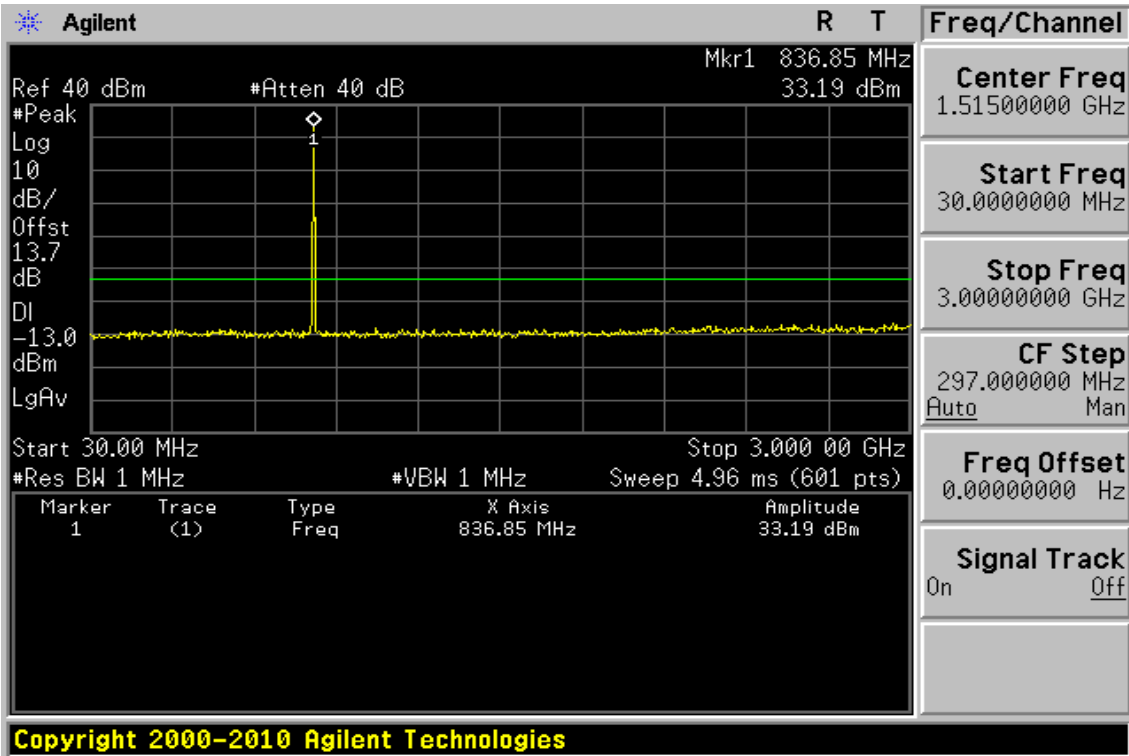

Unless otherwise stated the results shown in this test report refer only to the sample(s) tested and such sample(s) are retained for 90 days only.

除非另有說明，此報告結果僅對測試之樣品負責，同時此樣品僅保留90天。本報告未經本公司書面許可，不可部份複製。

This document is issued by the Company subject to its General Conditions of Service printed overleaf, available on request or accessible at www.sgs.com/terms_and_conditions.htm and, for electronic format documents, subject to Terms and Conditions for Electronic Documents at www.sgs.com/terms_e-document.htm. Attention is drawn to the limitation of liability, indemnification and jurisdiction issues defined therein. Any holder of this document is advised that information contained hereon reflects the Company's findings at the time of its intervention only and within the limits of Client's instructions, if any. The Company's sole responsibility is to its Client and this document does not exonerate parties to a transaction from exercising all their rights and obligations under the transaction documents. This document cannot be reproduced except in full, without prior written approval of the Company. Any unauthorized alteration, forgery or falsification of the content or appearance of this document is unlawful and offenders may be prosecuted to the fullest extent of the law.

Figure 9-13: Out of Band emission at antenna terminals – GPRS 850 Channel Highest

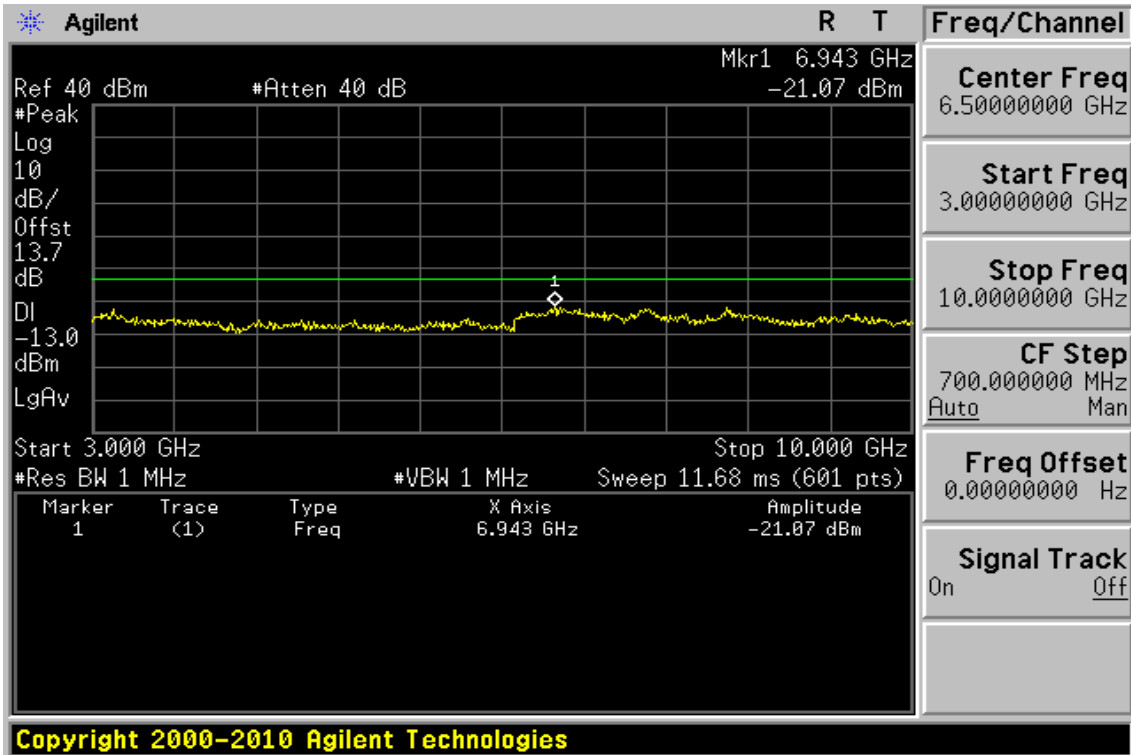
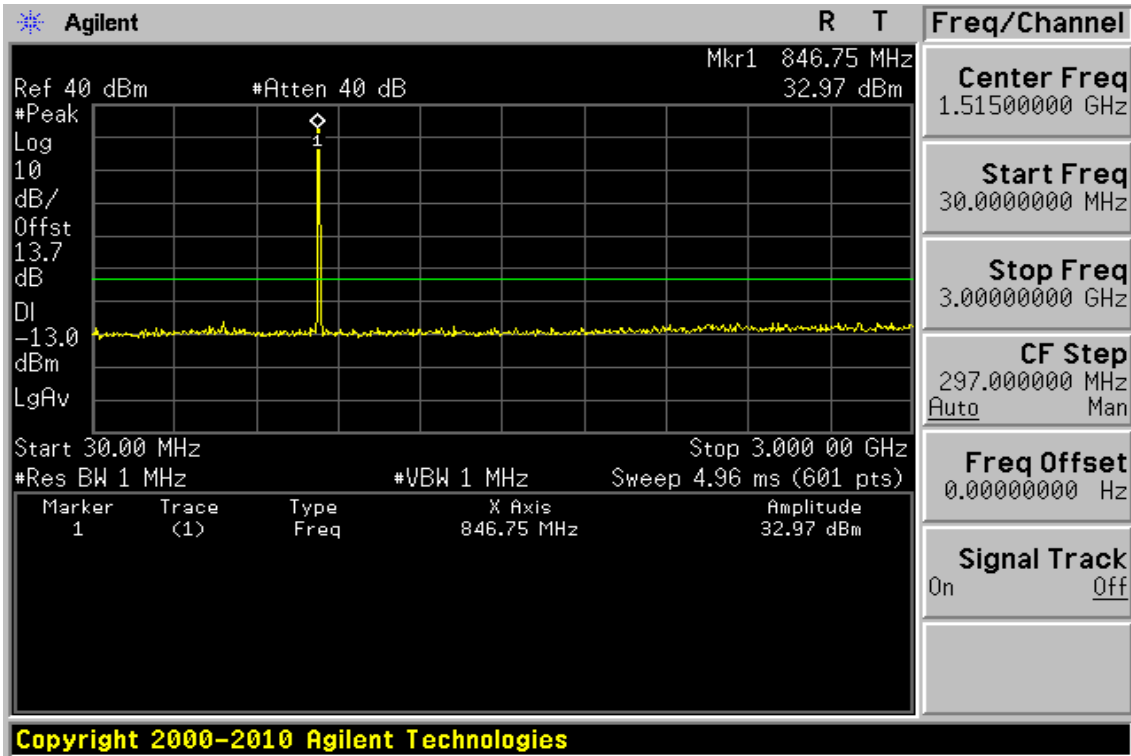

Unless otherwise stated the results shown in this test report refer only to the sample(s) tested and such sample(s) are retained for 90 days only.

除非另有說明，此報告結果僅對測試之樣品負責，同時此樣品僅保留90天。本報告未經本公司書面許可，不可部份複製。

This document is issued by the Company subject to its General Conditions of Service printed overleaf, available on request or accessible at www.sgs.com/terms_and_conditions.htm and, for electronic format documents, subject to Terms and Conditions for Electronic Documents at www.sgs.com/terms_e-document.htm. Attention is drawn to the limitation of liability, indemnification and jurisdiction issues defined therein. Any holder of this document is advised that information contained hereon reflects the Company's findings at the time of its intervention only and within the limits of Client's instructions, if any. The Company's sole responsibility is to its Client and this document does not exonerate parties to a transaction from exercising all their rights and obligations under the transaction documents. This document cannot be reproduced except in full, without prior written approval of the Company. Any unauthorized alteration, forgery or falsification of the content or appearance of this document is unlawful and offenders may be prosecuted to the fullest extent of the law.

Out of Band emission at antenna terminals – GPRS 850

Fundamental Frequency :824.2 MHz Engineer :Nick
Operation Mode :TX Low

Freq. (MHz)	Note F/H/E/S	Reading dBm	Limit dBm	Safe Margin dB
<30	S	---	-13.00	---
30-1000	S	---	-13.00	---
1648.40	H	---	-13.00	---
2472.60	H	---	-13.00	---
3296.80	H	---	-13.00	---
4121.00	H	---	-13.00	---
4945.20	H	---	-13.00	---
5769.40	H	---	-13.00	---
6593.60	H	---	-13.00	---
7417.80	H	---	-13.00	---
7760.00	S	-20.52	-13.00	7.52
8242.00	H	---	-13.00	---

Note : “H” : denotes Harmonic Frequency. “S” : denotes Spurious Frequency.
“---” : denotes Noise Floor.

Unless otherwise stated the results shown in this test report refer only to the sample(s) tested and such sample(s) are retained for 90 days only.

除非另有說明，此報告結果僅對測試之樣品負責，同時此樣品僅保留90天。本報告未經本公司書面許可，不可部份複製。

This document is issued by the Company subject to its General Conditions of Service printed overleaf, available on request or accessible at www.sgs.com/terms_and_conditions.htm and, for electronic format documents, subject to Terms and Conditions for Electronic Documents at www.sgs.com/terms_e-document.htm. Attention is drawn to the limitation of liability, indemnification and jurisdiction issues defined therein. Any holder of this document is advised that information contained hereon reflects the Company's findings at the time of its intervention only and within the limits of Client's instructions, if any. The Company's sole responsibility is to its Client and this document does not exonerate parties to a transaction from exercising all their rights and obligations under the transaction documents. This document cannot be reproduced except in full, without prior written approval of the Company. Any unauthorized alteration, forgery or falsification of the content or appearance of this document is unlawful and offenders may be prosecuted to the fullest extent of the law.

Fundamental Frequency :836.6 MHz Engineer :Nick
Operation Mode :TX Mid

Freq. (MHz)	Note F/H/E/S	Reading dBm	Limit dBm	Safe Margin dB
<30	S	---	-13.00	---
30-1000	S	---	-13.00	---
1673.20	H	---	-13.00	---
2509.80	H	---	-13.00	---
3346.40	H	---	-13.00	---
4183.00	H	---	-13.00	---
5019.60	H	---	-13.00	---
5856.20	H	---	-13.00	---
6692.80	H	---	-13.00	---
7060.00	S	-21.27	-13.00	8.27
7529.40	H	---	-13.00	---
8366.00	H	---	-13.00	---

Note : "H" : denotes Harmonic Frequency. "S" : denotes Spurious Frequency.
"---" : denotes Noise Floor.

Unless otherwise stated the results shown in this test report refer only to the sample(s) tested and such sample(s) are retained for 90 days only.

除非另有說明，此報告結果僅對測試之樣品負責，同時此樣品僅保留90天。本報告未經本公司書面許可，不可部份複製。

This document is issued by the Company subject to its General Conditions of Service printed overleaf, available on request or accessible at www.sgs.com/terms_and_conditions.htm and, for electronic format documents, subject to Terms and Conditions for Electronic Documents at www.sgs.com/terms_e-document.htm. Attention is drawn to the limitation of liability, indemnification and jurisdiction issues defined therein. Any holder of this document is advised that information contained hereon reflects the Company's findings at the time of its intervention only and within the limits of Client's instructions, if any. The Company's sole responsibility is to its Client and this document does not exonerate parties to a transaction from exercising all their rights and obligations under the transaction documents. This document cannot be reproduced except in full, without prior written approval of the Company. Any unauthorized alteration, forgery or falsification of the content or appearance of this document is unlawful and offenders may be prosecuted to the fullest extent of the law.

Fundamental Frequency :848.8MHz Engineer :Nick
Operation Mode :TX High

Freq. (MHz)	Note F/H/E/S	Reading dBm	Limit dBm	Safe Margin dB
<30	S	---	-13.00	---
30-1000	S	---	-13.00	---
1697.60	H	---	-13.00	---
2546.40	H	---	-13.00	---
3395.20	H	---	-13.00	---
4244.00	H	---	-13.00	---
5092.80	H	---	-13.00	---
5941.60	H	---	-13.00	---
6790.40	H	---	-13.00	---
6943.00	S	-21.07	-13.00	8.07
7639.20	H	---	-13.00	---
8488.00	H	---	-13.00	---

Note : "H" : denotes Harmonic Frequency. "S" : denotes Spurious Frequency.
"---" : denotes Noise Floor.

Unless otherwise stated the results shown in this test report refer only to the sample(s) tested and such sample(s) are retained for 90 days only.

除非另有說明，此報告結果僅對測試之樣品負責，同時此樣品僅保留90天。本報告未經本公司書面許可，不可部份複製。

This document is issued by the Company subject to its General Conditions of Service printed overleaf, available on request or accessible at www.sgs.com/terms_and_conditions.htm and, for electronic format documents, subject to Terms and Conditions for Electronic Documents at www.sgs.com/terms_e-document.htm. Attention is drawn to the limitation of liability, indemnification and jurisdiction issues defined therein. Any holder of this document is advised that information contained hereon reflects the Company's findings at the time of its intervention only and within the limits of Client's instructions, if any. The Company's sole responsibility is to its Client and this document does not exonerate parties to a transaction from exercising all their rights and obligations under the transaction documents. This document cannot be reproduced except in full, without prior written approval of the Company. Any unauthorized alteration, forgery or falsification of the content or appearance of this document is unlawful and offenders may be prosecuted to the fullest extent of the law.

Figure 9-14: Band edge emission at antenna terminals – GPRS 850 Channel Lowest

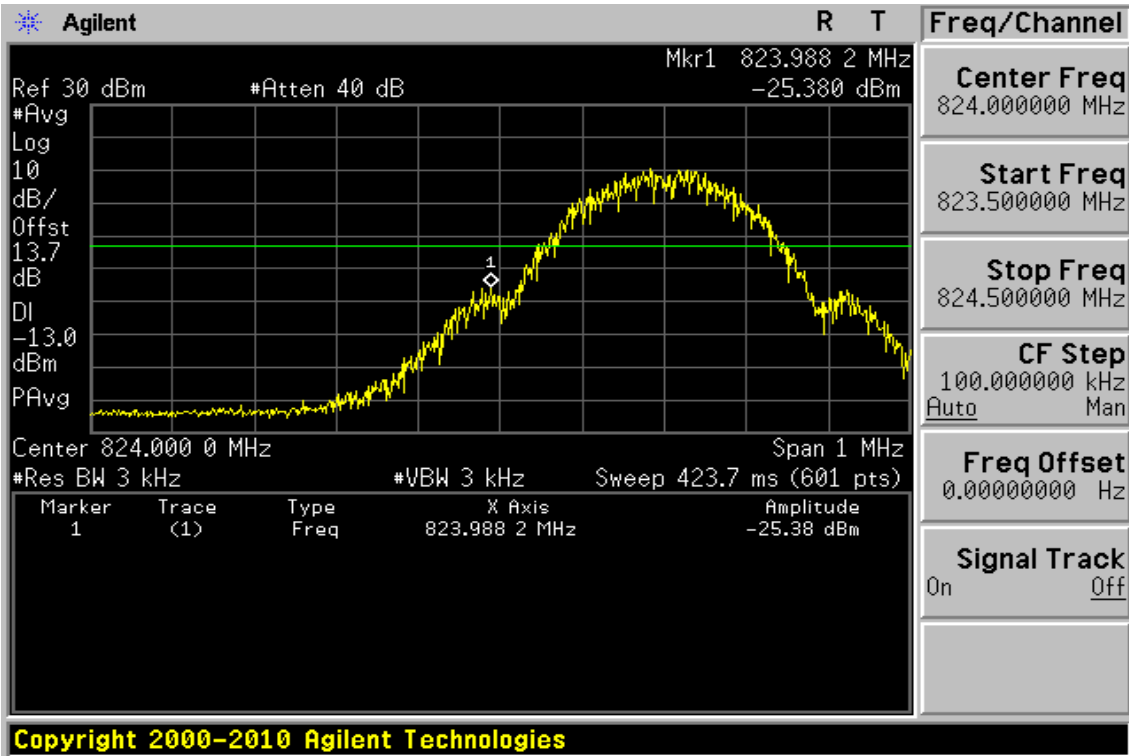
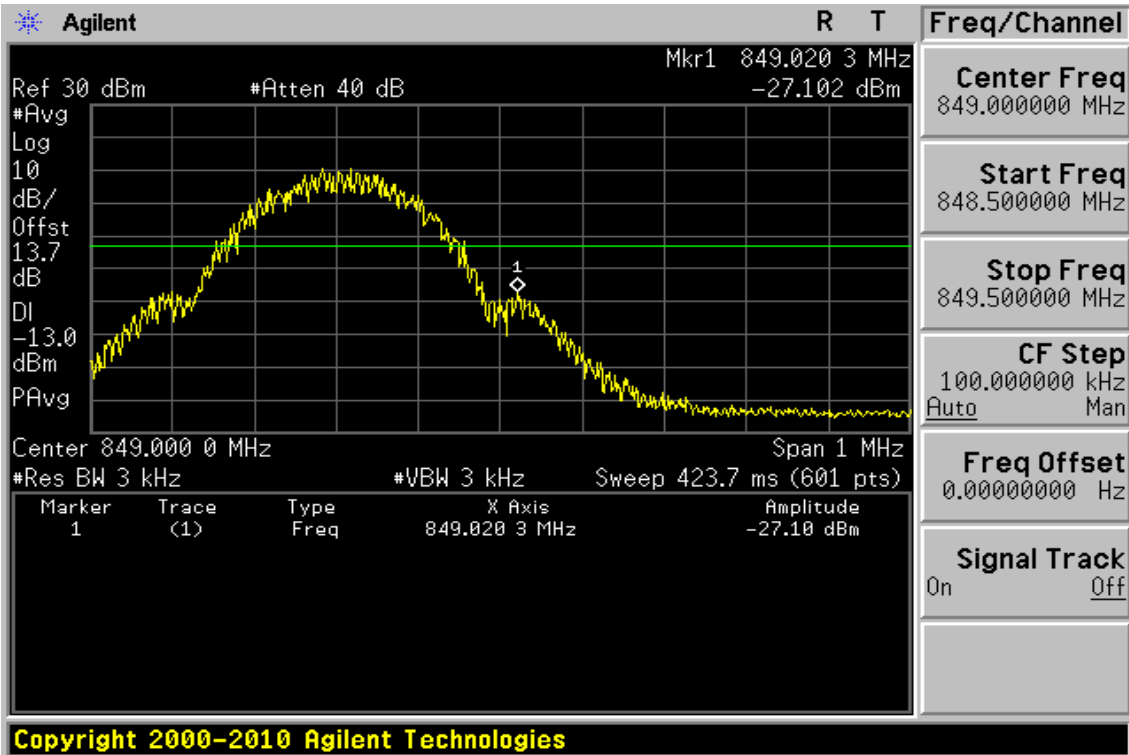

Figure 9-15: Band edge emission at antenna terminals – GPRS 850 Channel Highest



Unless otherwise stated the results shown in this test report refer only to the sample(s) tested and such sample(s) are retained for 90 days only.

除非另有說明，此報告結果僅對測試之樣品負責，同時此樣品僅保留90天。本報告未經本公司書面許可，不可部份複製。

This document is issued by the Company subject to its General Conditions of Service printed overleaf, available on request or accessible at www.sgs.com/terms_and_conditions.htm and, for electronic format documents, subject to Terms and Conditions for Electronic Documents at www.sgs.com/terms_e-document.htm. Attention is drawn to the limitation of liability, indemnification and jurisdiction issues defined therein. Any holder of this document is advised that information contained hereon reflects the Company's findings at the time of its intervention only and within the limits of Client's instructions, if any. The Company's sole responsibility is to its Client and this document does not exonerate parties to a transaction from exercising all their rights and obligations under the transaction documents. This document cannot be reproduced except in full, without prior written approval of the Company. Any unauthorized alteration, forgery or falsification of the content or appearance of this document is unlawful and offenders may be prosecuted to the fullest extent of the law.

Band edge emission at antenna terminals – GPRS 850 Low & High

Test Mode GPRS 850 Engineer :Nick

Freq. MHz	Reading dBm	Limit dBm	Safe Margin dB
823.988	-25.38	-13.00	12.38
849.020	-27.10	-13.00	14.10

Unless otherwise stated the results shown in this test report refer only to the sample(s) tested and such sample(s) are retained for 90 days only.

除非另有說明，此報告結果僅對測試之樣品負責，同時此樣品僅保留90天。本報告未經本公司書面許可，不可部份複製。

This document is issued by the Company subject to its General Conditions of Service printed overleaf, available on request or accessible at www.sgs.com/terms_and_conditions.htm and, for electronic format documents, subject to Terms and Conditions for Electronic Documents at www.sgs.com/terms_e-document.htm. Attention is drawn to the limitation of liability, indemnification and jurisdiction issues defined therein. Any holder of this document is advised that information contained hereon reflects the Company's findings at the time of its intervention only and within the limits of Client's instructions, if any. The Company's sole responsibility is to its Client and this document does not exonerate parties to a transaction from exercising all their rights and obligations under the transaction documents. This document cannot be reproduced except in full, without prior written approval of the Company. Any unauthorized alteration, forgery or falsification of the content or appearance of this document is unlawful and offenders may be prosecuted to the fullest extent of the law.

Figure 9-16: Out of Band emission at antenna terminals – GPRS 1900 Channel Lowest

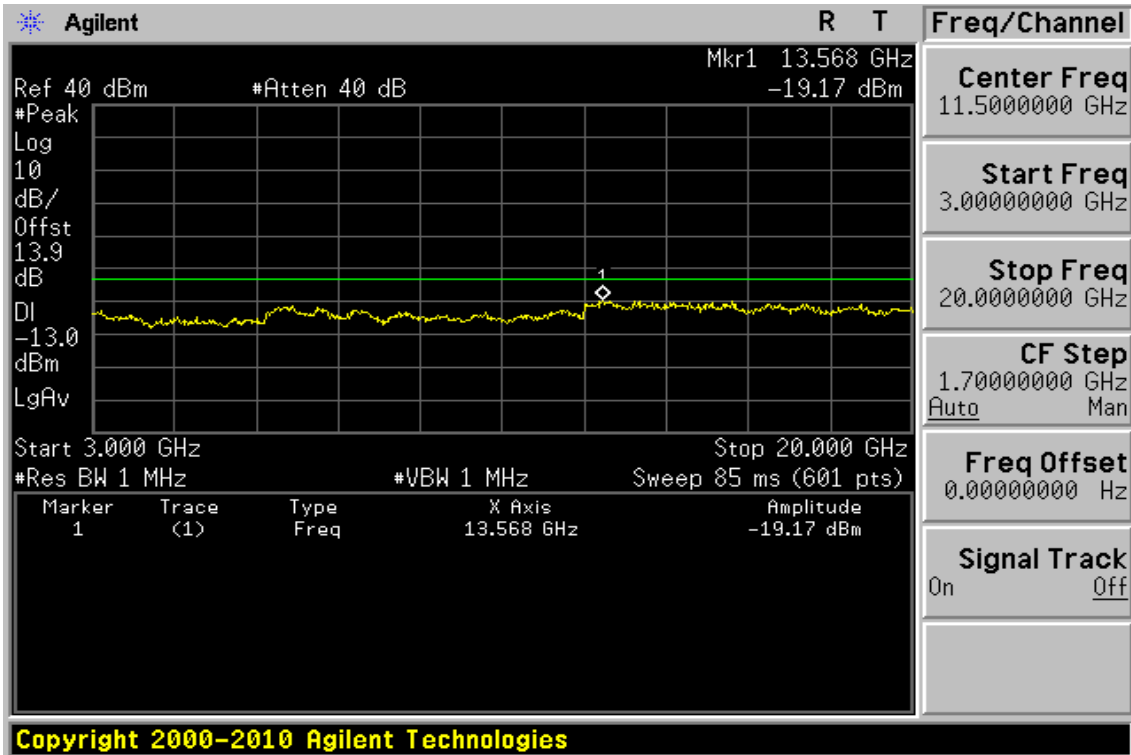
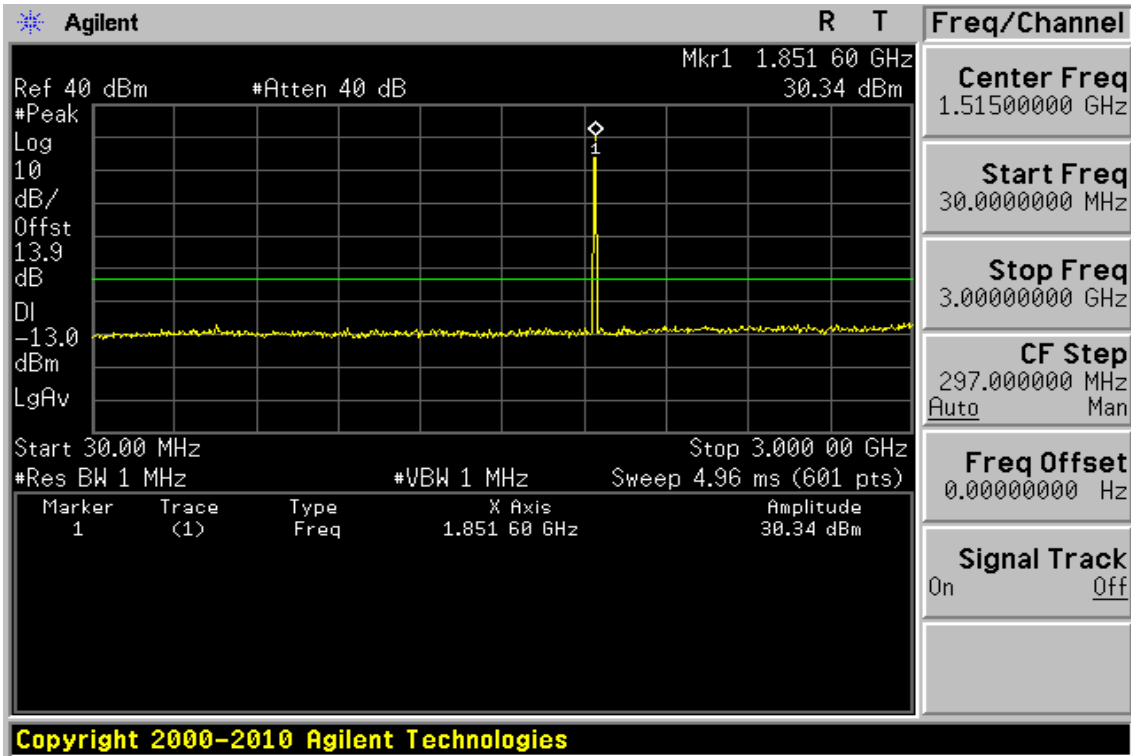

Unless otherwise stated the results shown in this test report refer only to the sample(s) tested and such sample(s) are retained for 90 days only.

除非另有說明，此報告結果僅對測試之樣品負責，同時此樣品僅保留90天。本報告未經本公司書面許可，不可部份複製。

This document is issued by the Company subject to its General Conditions of Service printed overleaf, available on request or accessible at www.sgs.com/terms_and_conditions.htm and, for electronic format documents, subject to Terms and Conditions for Electronic Documents at www.sgs.com/terms_e-document.htm. Attention is drawn to the limitation of liability, indemnification and jurisdiction issues defined therein. Any holder of this document is advised that information contained hereon reflects the Company's findings at the time of its intervention only and within the limits of Client's instructions, if any. The Company's sole responsibility is to its Client and this document does not exonerate parties to a transaction from exercising all their rights and obligations under the transaction documents. This document cannot be reproduced except in full, without prior written approval of the Company. Any unauthorized alteration, forgery or falsification of the content or appearance of this document is unlawful and offenders may be prosecuted to the fullest extent of the law.

Figure 9-17: Out of Band emission at antenna terminals – GPRS 1900 Channel Mid

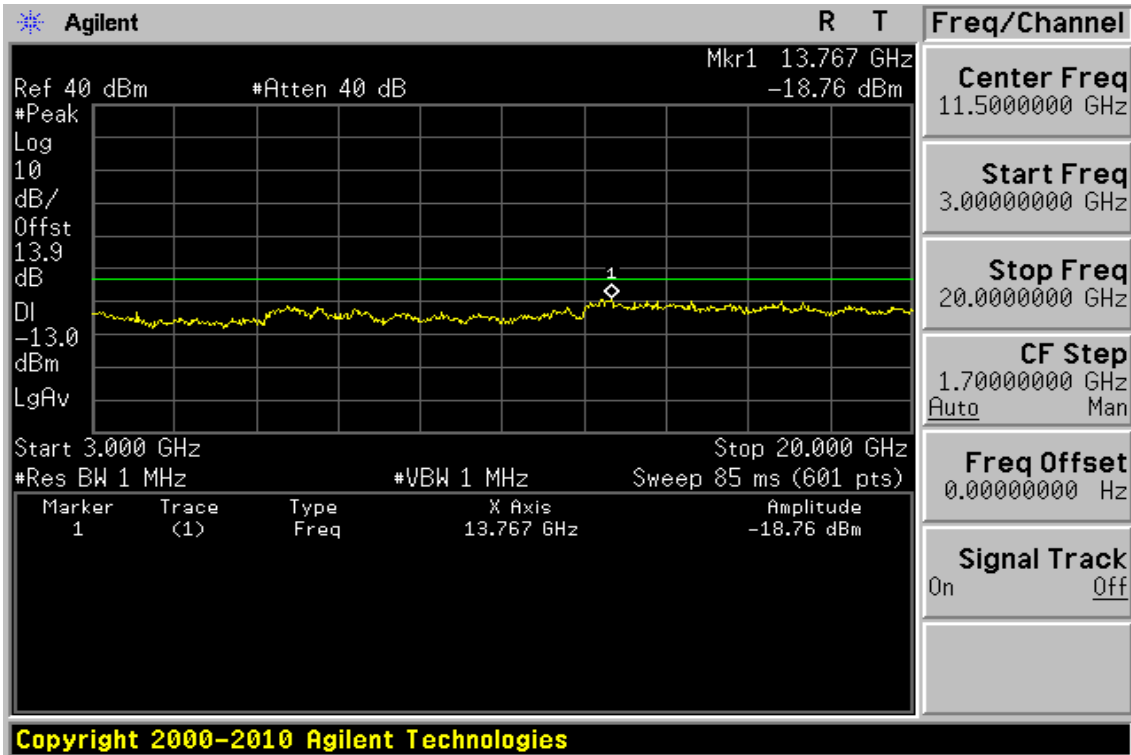
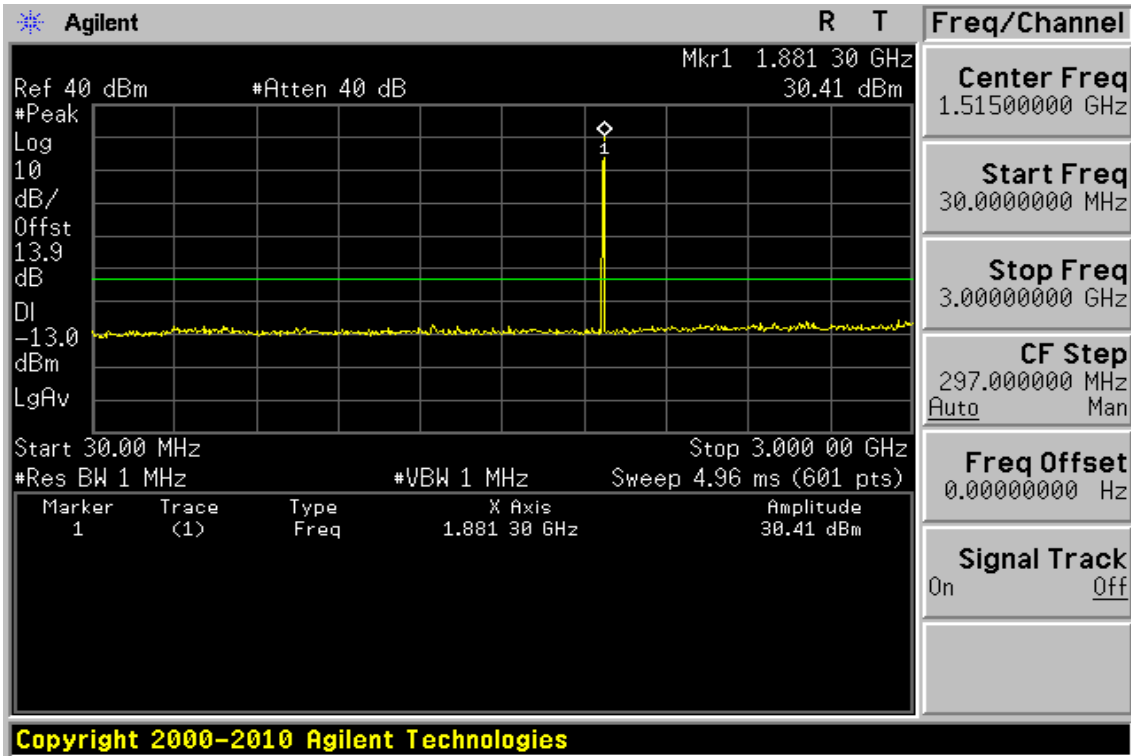

Unless otherwise stated the results shown in this test report refer only to the sample(s) tested and such sample(s) are retained for 90 days only.

除非另有說明，此報告結果僅對測試之樣品負責，同時此樣品僅保留90天。本報告未經本公司書面許可，不可部份複製。

This document is issued by the Company subject to its General Conditions of Service printed overleaf, available on request or accessible at www.sgs.com/terms_and_conditions.htm and, for electronic format documents, subject to Terms and Conditions for Electronic Documents at www.sgs.com/terms_e-document.htm. Attention is drawn to the limitation of liability, indemnification and jurisdiction issues defined therein. Any holder of this document is advised that information contained hereon reflects the Company's findings at the time of its intervention only and within the limits of Client's instructions, if any. The Company's sole responsibility is to its Client and this document does not exonerate parties to a transaction from exercising all their rights and obligations under the transaction documents. This document cannot be reproduced except in full, without prior written approval of the Company. Any unauthorized alteration, forgery or falsification of the content or appearance of this document is unlawful and offenders may be prosecuted to the fullest extent of the law.

Figure 9-18: Out of Band emission at antenna terminals – GPRS 1900 Channel Highest

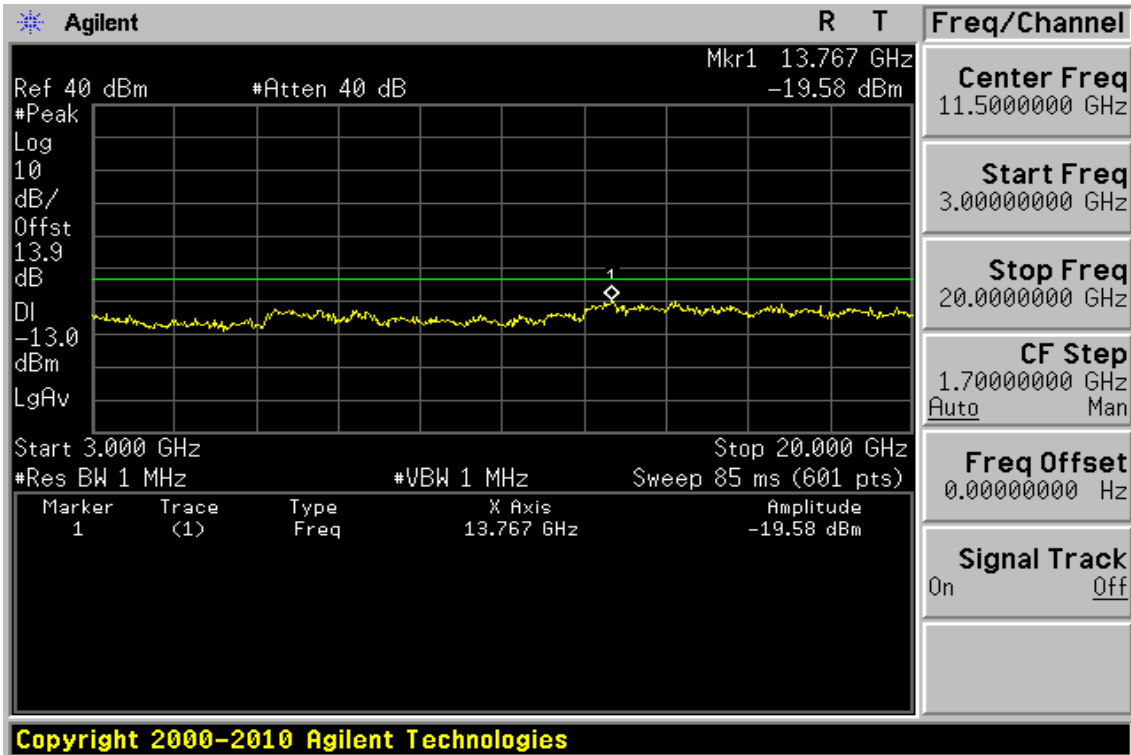
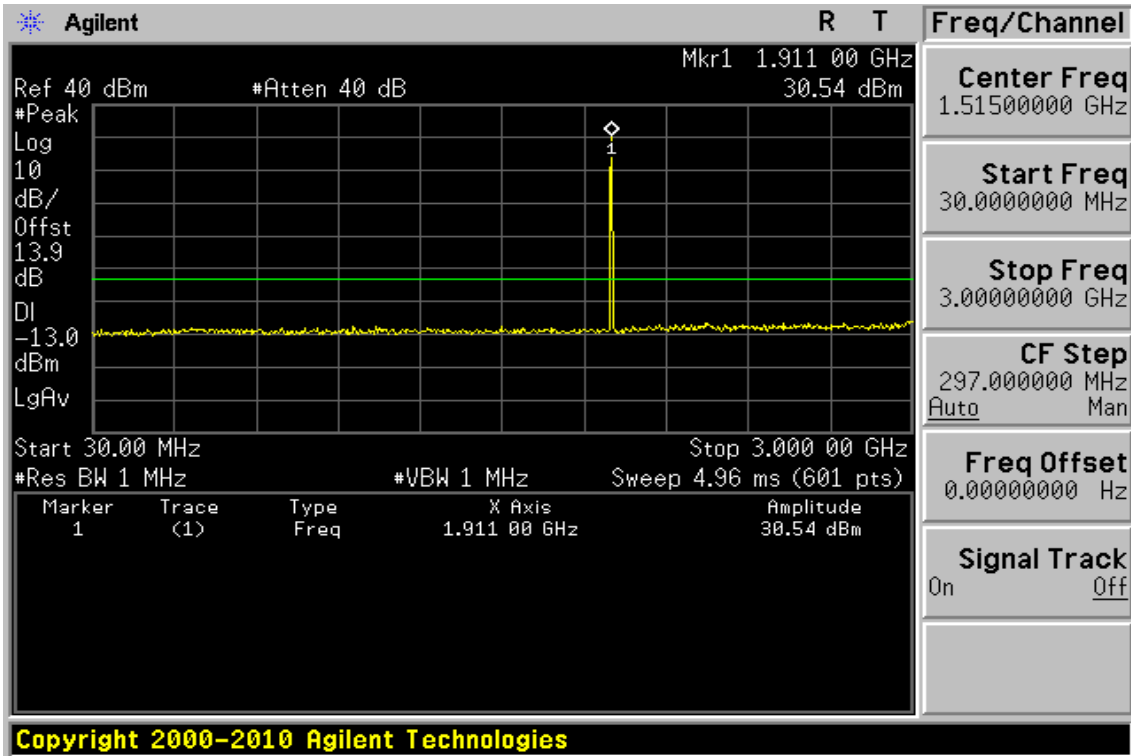

Unless otherwise stated the results shown in this test report refer only to the sample(s) tested and such sample(s) are retained for 90 days only.

除非另有說明，此報告結果僅對測試之樣品負責，同時此樣品僅保留90天。本報告未經本公司書面許可，不可部份複製。

This document is issued by the Company subject to its General Conditions of Service printed overleaf, available on request or accessible at www.sgs.com/terms_and_conditions.htm and, for electronic format documents, subject to Terms and Conditions for Electronic Documents at www.sgs.com/terms_e-document.htm. Attention is drawn to the limitation of liability, indemnification and jurisdiction issues defined therein. Any holder of this document is advised that information contained hereon reflects the Company's findings at the time of its intervention only and within the limits of Client's instructions, if any. The Company's sole responsibility is to its Client and this document does not exonerate parties to a transaction from exercising all their rights and obligations under the transaction documents. This document cannot be reproduced except in full, without prior written approval of the Company. Any unauthorized alteration, forgery or falsification of the content or appearance of this document is unlawful and offenders may be prosecuted to the fullest extent of the law.

Out of Band emission at antenna terminals – GPRS 1900

Fundamental Frequency :1850.2 MHz Engineer :Nick
Operation Mode :TX Low

Freq. (MHz)	Note F/H/E/S	Reading dBm	Limit dBm	Safe Margin dB
<30	S	---	-13.00	---
30-1000	S	---	-13.00	---
3700.40	H	---	-13.00	---
5550.60	H	---	-13.00	---
7400.80	H	---	-13.00	---
9251.00	H	---	-13.00	---
11101.20	H	---	-13.00	---
12951.40	H	---	-13.00	---
13568.00	S	-19.17	-13.00	6.17
14801.60	H	---	-13.00	---
16651.80	H	---	-13.00	---
18502.00	H	---	-13.00	---

Note : “H” : denotes Harmonic Frequency. “S” : denotes Spurious Frequency.
“---” : denotes Noise Floor.

Unless otherwise stated the results shown in this test report refer only to the sample(s) tested and such sample(s) are retained for 90 days only.

除非另有說明，此報告結果僅對測試之樣品負責，同時此樣品僅保留90天。本報告未經本公司書面許可，不可部份複製。

This document is issued by the Company subject to its General Conditions of Service printed overleaf, available on request or accessible at www.sgs.com/terms_and_conditions.htm and, for electronic format documents, subject to Terms and Conditions for Electronic Documents at www.sgs.com/terms_e-document.htm. Attention is drawn to the limitation of liability, indemnification and jurisdiction issues defined therein. Any holder of this document is advised that information contained hereon reflects the Company's findings at the time of its intervention only and within the limits of Client's instructions, if any. The Company's sole responsibility is to its Client and this document does not exonerate parties to a transaction from exercising all their rights and obligations under the transaction documents. This document cannot be reproduced except in full, without prior written approval of the Company. Any unauthorized alteration, forgery or falsification of the content or appearance of this document is unlawful and offenders may be prosecuted to the fullest extent of the law.

Fundamental Frequency :1880.0 MHz Engineer :Nick
Operation Mode :TX Mid

Freq. (MHz)	Note F/H/E/S	Reading dBm	Limit dBm	Safe Margin dB
<30	S	---	-13.00	---
30-1000	S	---	-13.00	---
3760.00	H	---	-13.00	---
5640.00	H	---	-13.00	---
7520.00	H	---	-13.00	---
9400.00	H	---	-13.00	---
11280.00	H	---	-13.00	---
13160.00	H	---	-13.00	---
13767.00	S	-18.76	-13.00	5.76
15040.00	H	---	-13.00	---
16920.00	H	---	-13.00	---
18800.00	H	---	-13.00	---

Note : “H” : denotes Harmonic Frequency. “S” : denotes Spurious Frequency.
“---” : denotes Noise Floor.

Unless otherwise stated the results shown in this test report refer only to the sample(s) tested and such sample(s) are retained for 90 days only.

除非另有說明，此報告結果僅對測試之樣品負責，同時此樣品僅保留90天。本報告未經本公司書面許可，不可部份複製。

This document is issued by the Company subject to its General Conditions of Service printed overleaf, available on request or accessible at www.sgs.com/terms_and_conditions.htm and, for electronic format documents, subject to Terms and Conditions for Electronic Documents at www.sgs.com/terms_e-document.htm. Attention is drawn to the limitation of liability, indemnification and jurisdiction issues defined therein. Any holder of this document is advised that information contained hereon reflects the Company's findings at the time of its intervention only and within the limits of Client's instructions, if any. The Company's sole responsibility is to its Client and this document does not exonerate parties to a transaction from exercising all their rights and obligations under the transaction documents. This document cannot be reproduced except in full, without prior written approval of the Company. Any unauthorized alteration, forgery or falsification of the content or appearance of this document is unlawful and offenders may be prosecuted to the fullest extent of the law.

Figure 9-19: Band edge emission at antenna terminals – GPRS 1900 Channel Lowest

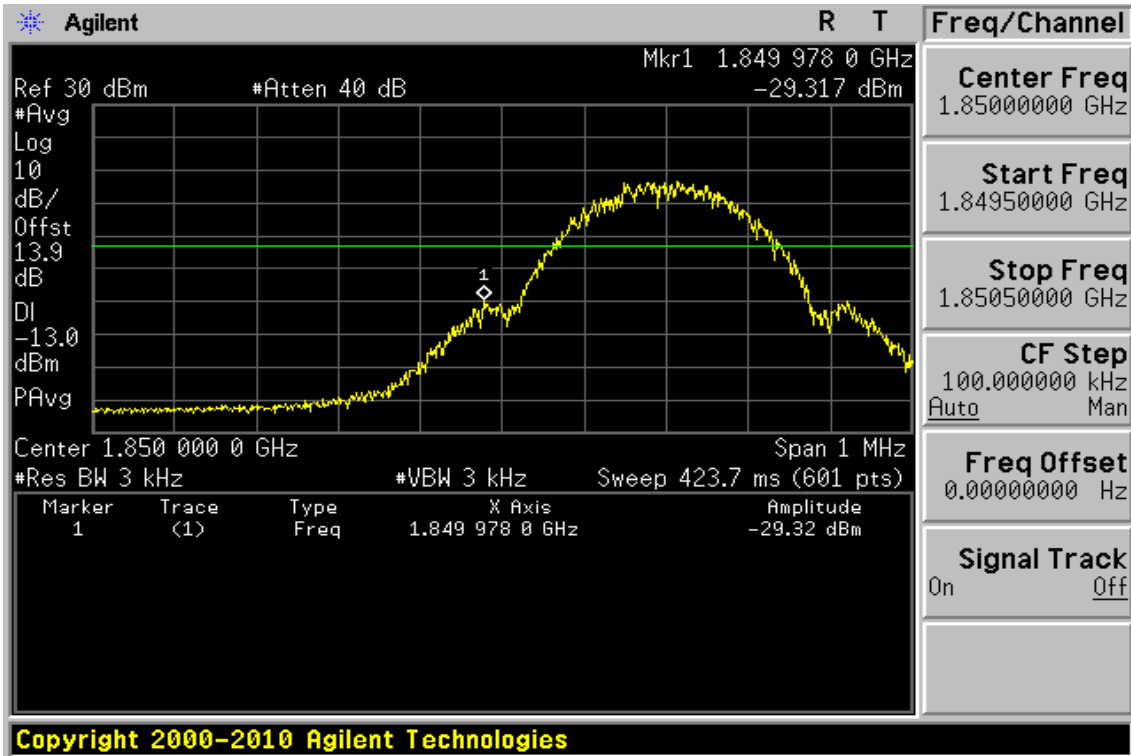
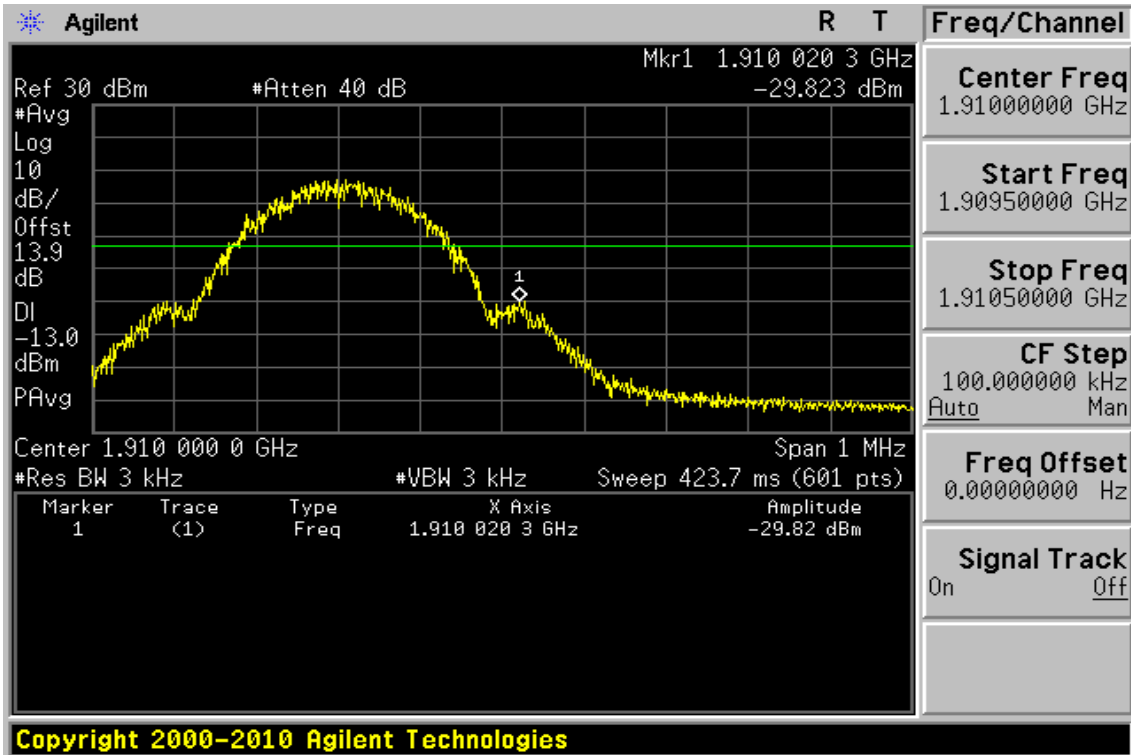

Figure 9-20: Band edge emission at antenna terminals – GPRS 1900 Channel Highest



Unless otherwise stated the results shown in this test report refer only to the sample(s) tested and such sample(s) are retained for 90 days only.

除非另有說明，此報告結果僅對測試之樣品負責，同時此樣品僅保留90天。本報告未經本公司書面許可，不可部份複製。

This document is issued by the Company subject to its General Conditions of Service printed overleaf, available on request or accessible at www.sgs.com/terms_and_conditions.htm and, for electronic format documents, subject to Terms and Conditions for Electronic Documents at www.sgs.com/terms_e-document.htm. Attention is drawn to the limitation of liability, indemnification and jurisdiction issues defined therein. Any holder of this document is advised that information contained hereon reflects the Company's findings at the time of its intervention only and within the limits of Client's instructions, if any. The Company's sole responsibility is to its Client and this document does not exonerate parties to a transaction from exercising all their rights and obligations under the transaction documents. This document cannot be reproduced except in full, without prior written approval of the Company. Any unauthorized alteration, forgery or falsification of the content or appearance of this document is unlawful and offenders may be prosecuted to the fullest extent of the law.

Band edge emission at antenna terminals – GPRS 1900 Low & High

Test Mode GPRS 1900 Engineer :Nick

Freq. MHz	Reading dBm	Limit dBm	Safe Margin dB
1849.978	-29.32	-13.00	16.32
1910.020	-29.82	-13.00	16.82

Unless otherwise stated the results shown in this test report refer only to the sample(s) tested and such sample(s) are retained for 90 days only.

除非另有說明，此報告結果僅對測試之樣品負責，同時此樣品僅保留90天。本報告未經本公司書面許可，不可部份複製。

This document is issued by the Company subject to its General Conditions of Service printed overleaf, available on request or accessible at www.sgs.com/terms_and_conditions.htm and, for electronic format documents, subject to Terms and Conditions for Electronic Documents at www.sgs.com/terms_e-document.htm. Attention is drawn to the limitation of liability, indemnification and jurisdiction issues defined therein. Any holder of this document is advised that information contained hereon reflects the Company's findings at the time of its intervention only and within the limits of Client's instructions, if any. The Company's sole responsibility is to its Client and this document does not exonerate parties to a transaction from exercising all their rights and obligations under the transaction documents. This document cannot be reproduced except in full, without prior written approval of the Company. Any unauthorized alteration, forgery or falsification of the content or appearance of this document is unlawful and offenders may be prosecuted to the fullest extent of the law.

Figure 9-21: Out of Band emission at antenna terminals – EDGE 850 Channel Lowest

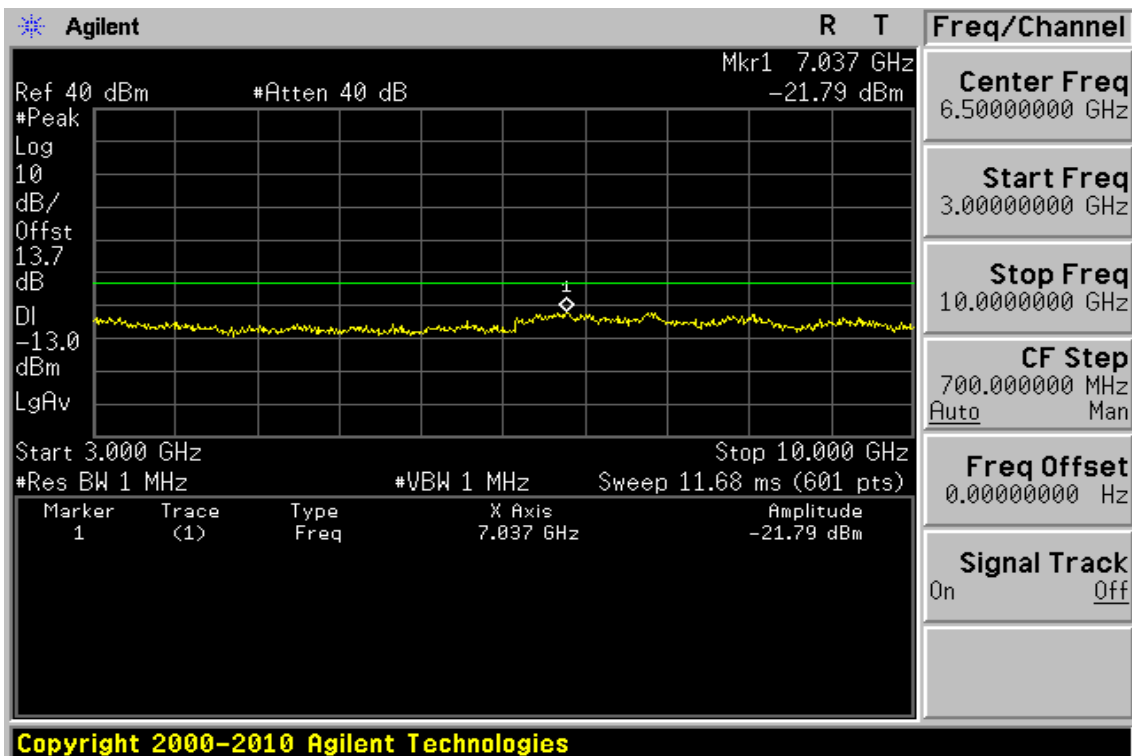
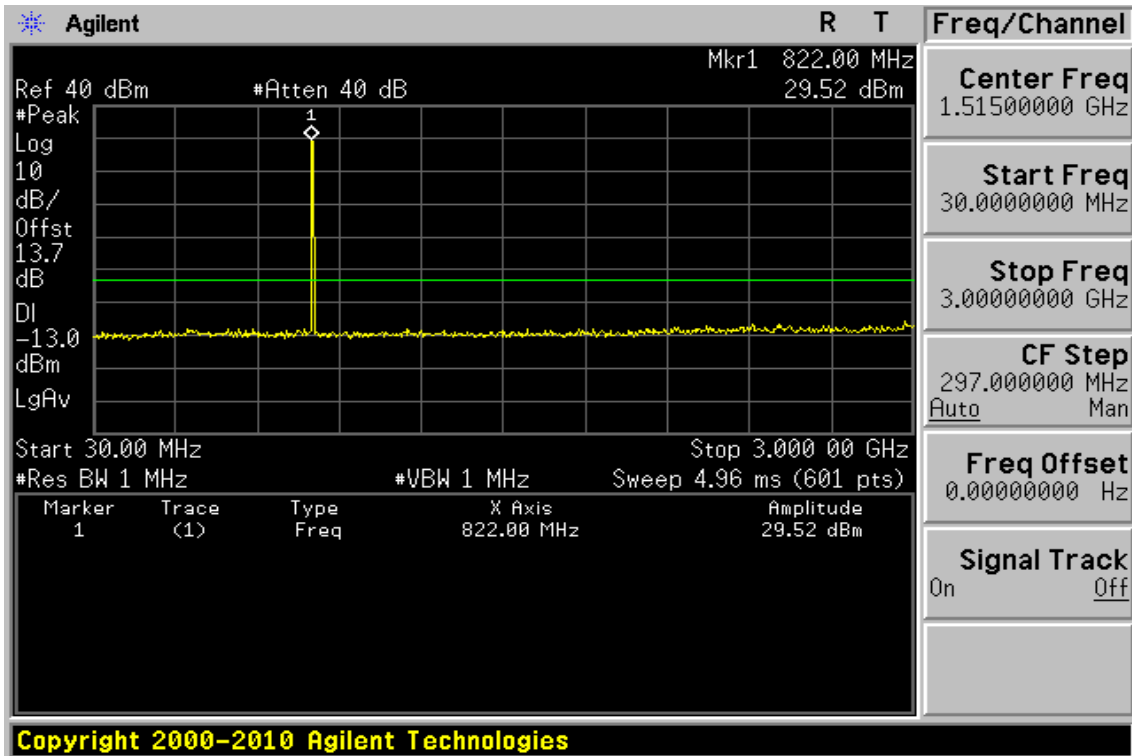

Unless otherwise stated the results shown in this test report refer only to the sample(s) tested and such sample(s) are retained for 90 days only.

除非另有說明，此報告結果僅對測試之樣品負責，同時此樣品僅保留90天。本報告未經本公司書面許可，不可部份複製。

This document is issued by the Company subject to its General Conditions of Service printed overleaf, available on request or accessible at www.sgs.com/terms_and_conditions.htm and, for electronic format documents, subject to Terms and Conditions for Electronic Documents at www.sgs.com/terms_e-document.htm. Attention is drawn to the limitation of liability, indemnification and jurisdiction issues defined therein. Any holder of this document is advised that information contained hereon reflects the Company's findings at the time of its intervention only and within the limits of Client's instructions, if any. The Company's sole responsibility is to its Client and this document does not exonerate parties to a transaction from exercising all their rights and obligations under the transaction documents. This document cannot be reproduced except in full, without prior written approval of the Company. Any unauthorized alteration, forgery or falsification of the content or appearance of this document is unlawful and offenders may be prosecuted to the fullest extent of the law.

Figure 9-22: Out of Band emission at antenna terminals – EDGE 850 Channel Mid

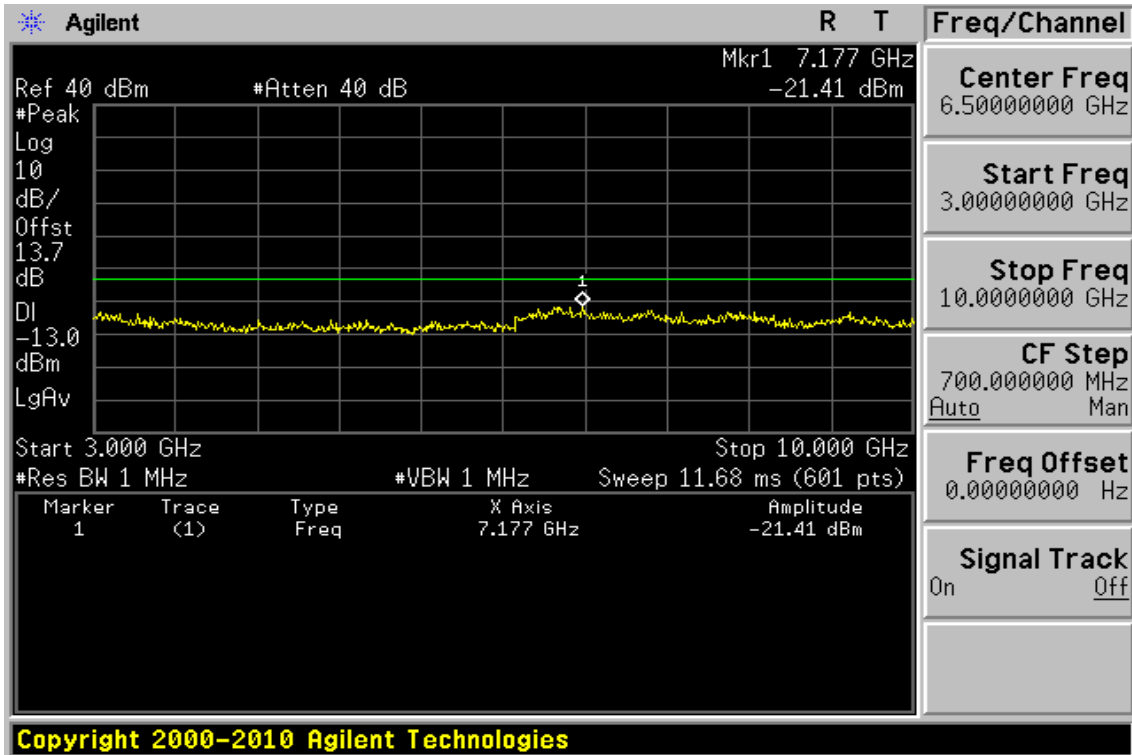
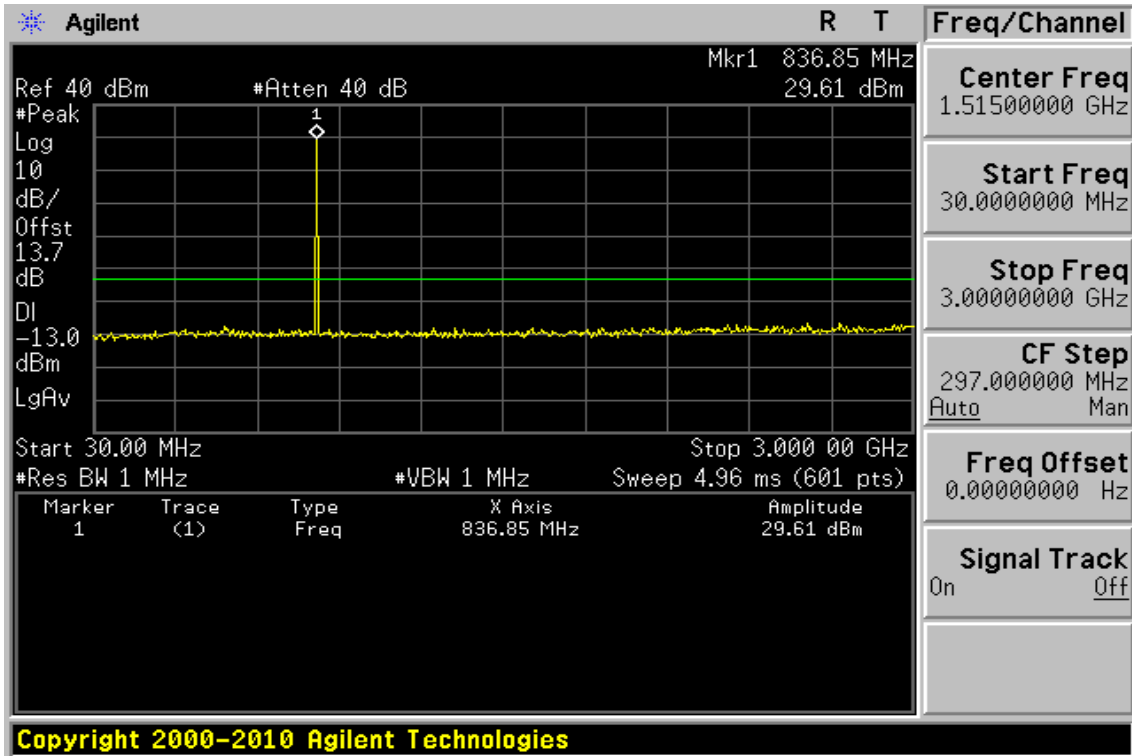

Unless otherwise stated the results shown in this test report refer only to the sample(s) tested and such sample(s) are retained for 90 days only.

除非另有說明，此報告結果僅對測試之樣品負責，同時此樣品僅保留90天。本報告未經本公司書面許可，不可部份複製。

This document is issued by the Company subject to its General Conditions of Service printed overleaf, available on request or accessible at www.sgs.com/terms_and_conditions.htm and, for electronic format documents, subject to Terms and Conditions for Electronic Documents at www.sgs.com/terms_e-document.htm. Attention is drawn to the limitation of liability, indemnification and jurisdiction issues defined therein. Any holder of this document is advised that information contained hereon reflects the Company's findings at the time of its intervention only and within the limits of Client's instructions, if any. The Company's sole responsibility is to its Client and this document does not exonerate parties to a transaction from exercising all their rights and obligations under the transaction documents. This document cannot be reproduced except in full, without prior written approval of the Company. Any unauthorized alteration, forgery or falsification of the content or appearance of this document is unlawful and offenders may be prosecuted to the fullest extent of the law.

Figure 9-23: Out of Band emission at antenna terminals – EDGE 850 Channel Highest

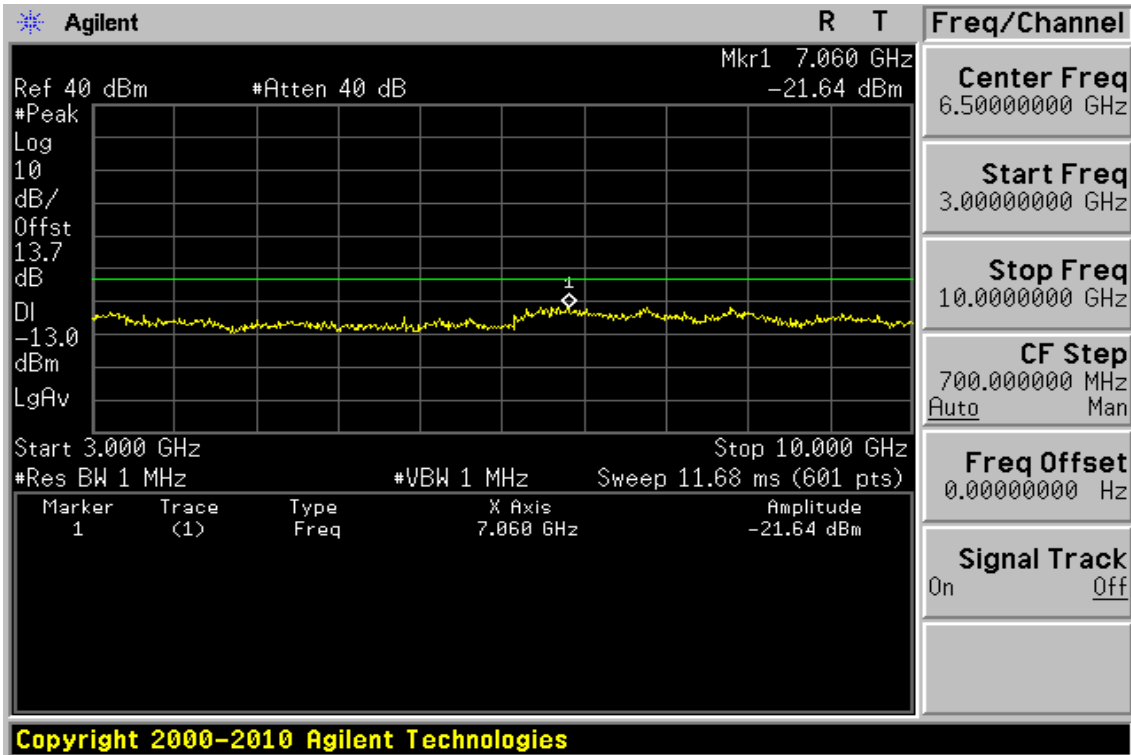
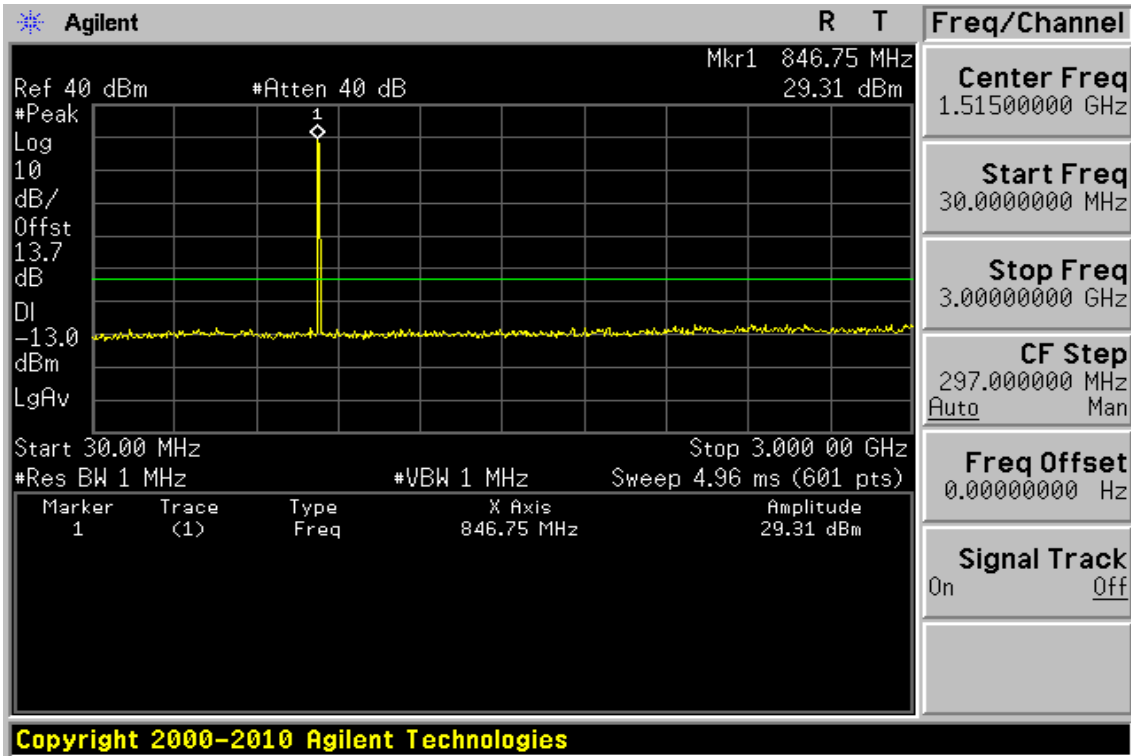

Unless otherwise stated the results shown in this test report refer only to the sample(s) tested and such sample(s) are retained for 90 days only.

除非另有說明，此報告結果僅對測試之樣品負責，同時此樣品僅保留90天。本報告未經本公司書面許可，不可部份複製。

This document is issued by the Company subject to its General Conditions of Service printed overleaf, available on request or accessible at www.sgs.com/terms_and_conditions.htm and, for electronic format documents, subject to Terms and Conditions for Electronic Documents at www.sgs.com/terms_e-document.htm. Attention is drawn to the limitation of liability, indemnification and jurisdiction issues defined therein. Any holder of this document is advised that information contained hereon reflects the Company's findings at the time of its intervention only and within the limits of Client's instructions, if any. The Company's sole responsibility is to its Client and this document does not exonerate parties to a transaction from exercising all their rights and obligations under the transaction documents. This document cannot be reproduced except in full, without prior written approval of the Company. Any unauthorized alteration, forgery or falsification of the content or appearance of this document is unlawful and offenders may be prosecuted to the fullest extent of the law.

Out of Band emission at antenna terminals – EDGE 850

Fundamental Frequency :824.2 MHz Engineer :Nick
Operation Mode :TX Low

Freq. (MHz)	Note F/H/E/S	Reading dBm	Limit dBm	Safe Margin dB
<30	S	---	-13.00	---
30-1000	S	---	-13.00	---
1648.40	H	---	-13.00	---
2472.60	H	---	-13.00	---
3296.80	H	---	-13.00	---
4121.00	H	---	-13.00	---
4945.20	H	---	-13.00	---
5769.40	H	---	-13.00	---
6593.60	H	---	-13.00	---
7037.00	S	-21.79	-13.00	8.79
7417.80	H	---	-13.00	---
8242.00	H	---	-13.00	---

Note : “H” : denotes Harmonic Frequency. “S” : denotes Spurious Frequency.
“---” : denotes Noise Floor.

Unless otherwise stated the results shown in this test report refer only to the sample(s) tested and such sample(s) are retained for 90 days only.

除非另有說明，此報告結果僅對測試之樣品負責，同時此樣品僅保留90天。本報告未經本公司書面許可，不可部份複製。

This document is issued by the Company subject to its General Conditions of Service printed overleaf, available on request or accessible at www.sgs.com/terms_and_conditions.htm and, for electronic format documents, subject to Terms and Conditions for Electronic Documents at www.sgs.com/terms_e-document.htm. Attention is drawn to the limitation of liability, indemnification and jurisdiction issues defined therein. Any holder of this document is advised that information contained hereon reflects the Company's findings at the time of its intervention only and within the limits of Client's instructions, if any. The Company's sole responsibility is to its Client and this document does not exonerate parties to a transaction from exercising all their rights and obligations under the transaction documents. This document cannot be reproduced except in full, without prior written approval of the Company. Any unauthorized alteration, forgery or falsification of the content or appearance of this document is unlawful and offenders may be prosecuted to the fullest extent of the law.

Fundamental Frequency :836.6 MHz Engineer :Nick
Operation Mode :TX Mid

Freq. (MHz)	Note F/H/E/S	Reading dBm	Limit dBm	Safe Margin dB
<30	S	---	-13.00	---
30-1000	S	---	-13.00	---
1673.20	H	---	-13.00	---
2509.80	H	---	-13.00	---
3346.40	H	---	-13.00	---
4183.00	H	---	-13.00	---
5019.60	H	---	-13.00	---
6692.80	H	---	-13.00	---
7177.00	S	-21.41	-13.00	8.41
7529.40	H	---	-13.00	---
8366.00	H	---	-13.00	---

Note : "H" : denotes Harmonic Frequency. "S" : denotes Spurious Frequency.
"---" : denotes Noise Floor.

Unless otherwise stated the results shown in this test report refer only to the sample(s) tested and such sample(s) are retained for 90 days only.

除非另有說明，此報告結果僅對測試之樣品負責，同時此樣品僅保留90天。本報告未經本公司書面許可，不可部份複製。

This document is issued by the Company subject to its General Conditions of Service printed overleaf, available on request or accessible at www.sgs.com/terms_and_conditions.htm and, for electronic format documents, subject to Terms and Conditions for Electronic Documents at www.sgs.com/terms_e-document.htm. Attention is drawn to the limitation of liability, indemnification and jurisdiction issues defined therein. Any holder of this document is advised that information contained hereon reflects the Company's findings at the time of its intervention only and within the limits of Client's instructions, if any. The Company's sole responsibility is to its Client and this document does not exonerate parties to a transaction from exercising all their rights and obligations under the transaction documents. This document cannot be reproduced except in full, without prior written approval of the Company. Any unauthorized alteration, forgery or falsification of the content or appearance of this document is unlawful and offenders may be prosecuted to the fullest extent of the law.

Fundamental Frequency :848.8MHz Engineer :Nick
Operation Mode :TX High

Freq. (MHz)	Note F/H/E/S	Reading dBm	Limit dBm	Safe Margin dB
<30	S	---	-13.00	---
30-1000	S	---	-13.00	---
1697.60	H	---	-13.00	---
2546.40	H	---	-13.00	---
3395.20	H	---	-13.00	---
4244.00	H	---	-13.00	---
5092.80	H	---	-13.00	---
5941.60	H	---	-13.00	---
6790.40	H	---	-13.00	---
7060.00	S	-21.64	-13.00	8.64
7639.20	H	---	-13.00	---
8488.00	H	---	-13.00	---

Note : “H” : denotes Harmonic Frequency. “S” : denotes Spurious Frequency.
“---” : denotes Noise Floor.

Unless otherwise stated the results shown in this test report refer only to the sample(s) tested and such sample(s) are retained for 90 days only.

除非另有說明，此報告結果僅對測試之樣品負責，同時此樣品僅保留90天。本報告未經本公司書面許可，不可部份複製。

This document is issued by the Company subject to its General Conditions of Service printed overleaf, available on request or accessible at www.sgs.com/terms_and_conditions.htm and, for electronic format documents, subject to Terms and Conditions for Electronic Documents at www.sgs.com/terms_e-document.htm. Attention is drawn to the limitation of liability, indemnification and jurisdiction issues defined therein. Any holder of this document is advised that information contained hereon reflects the Company's findings at the time of its intervention only and within the limits of Client's instructions, if any. The Company's sole responsibility is to its Client and this document does not exonerate parties to a transaction from exercising all their rights and obligations under the transaction documents. This document cannot be reproduced except in full, without prior written approval of the Company. Any unauthorized alteration, forgery or falsification of the content or appearance of this document is unlawful and offenders may be prosecuted to the fullest extent of the law.

Figure 9-24: Band edge emission at antenna terminals – EDGE 850 Channel Lowest

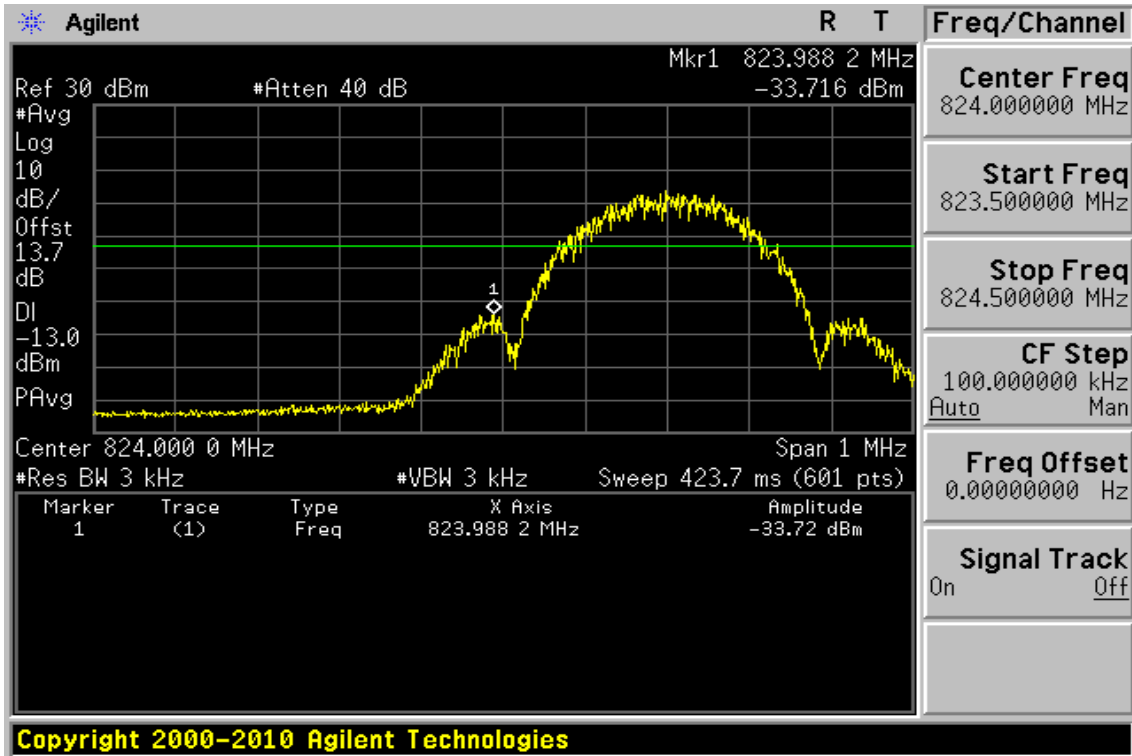
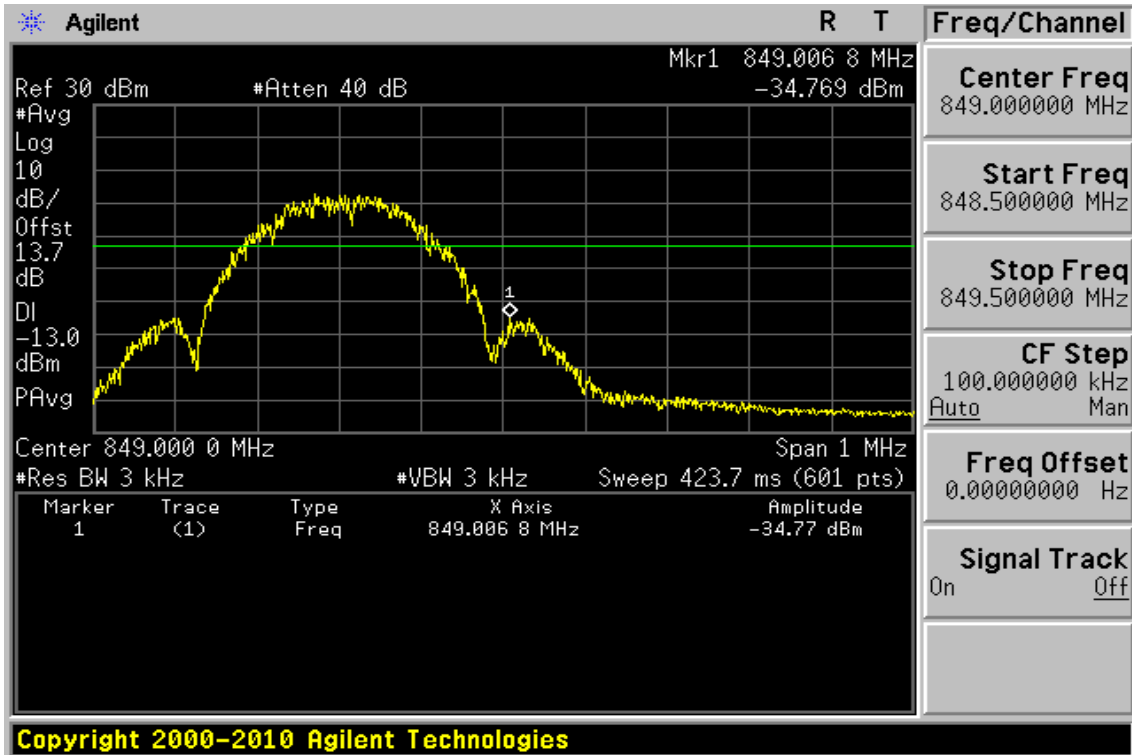

Figure 9-25: Band edge emission at antenna terminals – EDGE 850 Channel Highest



Unless otherwise stated the results shown in this test report refer only to the sample(s) tested and such sample(s) are retained for 90 days only.

除非另有說明，此報告結果僅對測試之樣品負責，同時此樣品僅保留90天。本報告未經本公司書面許可，不可部份複製。

This document is issued by the Company subject to its General Conditions of Service printed overleaf, available on request or accessible at www.sgs.com/terms_and_conditions.htm and, for electronic format documents, subject to Terms and Conditions for Electronic Documents at www.sgs.com/terms_e-document.htm. Attention is drawn to the limitation of liability, indemnification and jurisdiction issues defined therein. Any holder of this document is advised that information contained hereon reflects the Company's findings at the time of its intervention only and within the limits of Client's instructions, if any. The Company's sole responsibility is to its Client and this document does not exonerate parties to a transaction from exercising all their rights and obligations under the transaction documents. This document cannot be reproduced except in full, without prior written approval of the Company. Any unauthorized alteration, forgery or falsification of the content or appearance of this document is unlawful and offenders may be prosecuted to the fullest extent of the law.

Band edge emission at antenna terminals – EDGE 850 Low & High

Test Mode EDGE 850 Engineer :Nick

Freq. MHz	Reading dBm	Limit dBm	Safe Margin dB
823.988	-33.72	-13.00	20.72
849.006	-34.77	-13.00	21.77

Unless otherwise stated the results shown in this test report refer only to the sample(s) tested and such sample(s) are retained for 90 days only.

除非另有說明，此報告結果僅對測試之樣品負責，同時此樣品僅保留90天。本報告未經本公司書面許可，不可部份複製。

This document is issued by the Company subject to its General Conditions of Service printed overleaf, available on request or accessible at www.sgs.com/terms_and_conditions.htm and, for electronic format documents, subject to Terms and Conditions for Electronic Documents at www.sgs.com/terms_e-document.htm. Attention is drawn to the limitation of liability, indemnification and jurisdiction issues defined therein. Any holder of this document is advised that information contained hereon reflects the Company's findings at the time of its intervention only and within the limits of Client's instructions, if any. The Company's sole responsibility is to its Client and this document does not exonerate parties to a transaction from exercising all their rights and obligations under the transaction documents. This document cannot be reproduced except in full, without prior written approval of the Company. Any unauthorized alteration, forgery or falsification of the content or appearance of this document is unlawful and offenders may be prosecuted to the fullest extent of the law.

Figure 9-26: Out of Band emission at antenna terminals – EDGE 1900 Channel Lowest

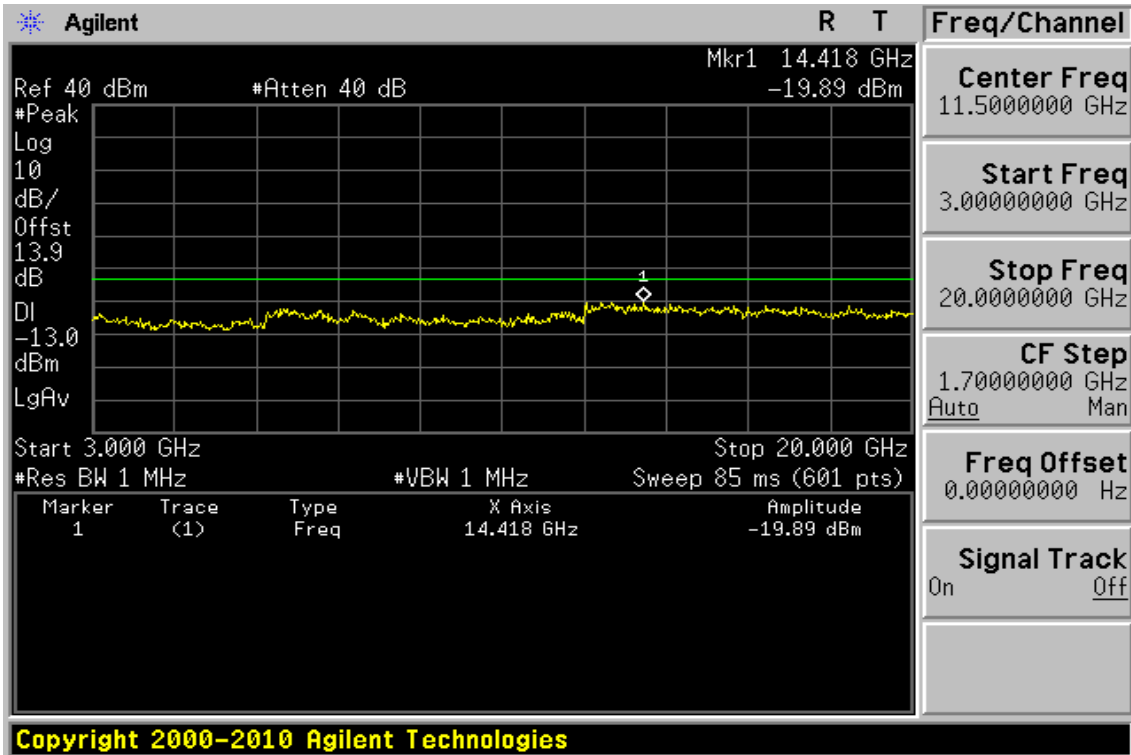
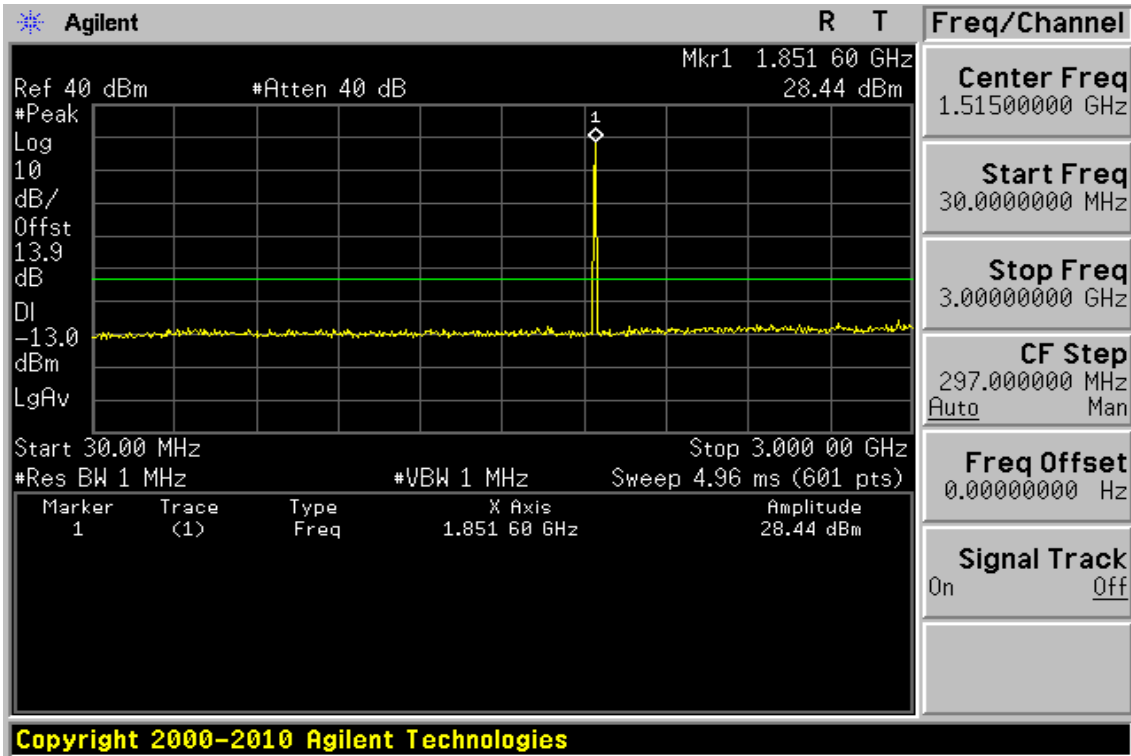

Unless otherwise stated the results shown in this test report refer only to the sample(s) tested and such sample(s) are retained for 90 days only.

除非另有說明，此報告結果僅對測試之樣品負責，同時此樣品僅保留90天。本報告未經本公司書面許可，不可部份複製。

This document is issued by the Company subject to its General Conditions of Service printed overleaf, available on request or accessible at www.sgs.com/terms_and_conditions.htm and, for electronic format documents, subject to Terms and Conditions for Electronic Documents at www.sgs.com/terms_e-document.htm. Attention is drawn to the limitation of liability, indemnification and jurisdiction issues defined therein. Any holder of this document is advised that information contained hereon reflects the Company's findings at the time of its intervention only and within the limits of Client's instructions, if any. The Company's sole responsibility is to its Client and this document does not exonerate parties to a transaction from exercising all their rights and obligations under the transaction documents. This document cannot be reproduced except in full, without prior written approval of the Company. Any unauthorized alteration, forgery or falsification of the content or appearance of this document is unlawful and offenders may be prosecuted to the fullest extent of the law.

Figure 9-27: Out of Band emission at antenna terminals – EDGE 1900 Channel Mid

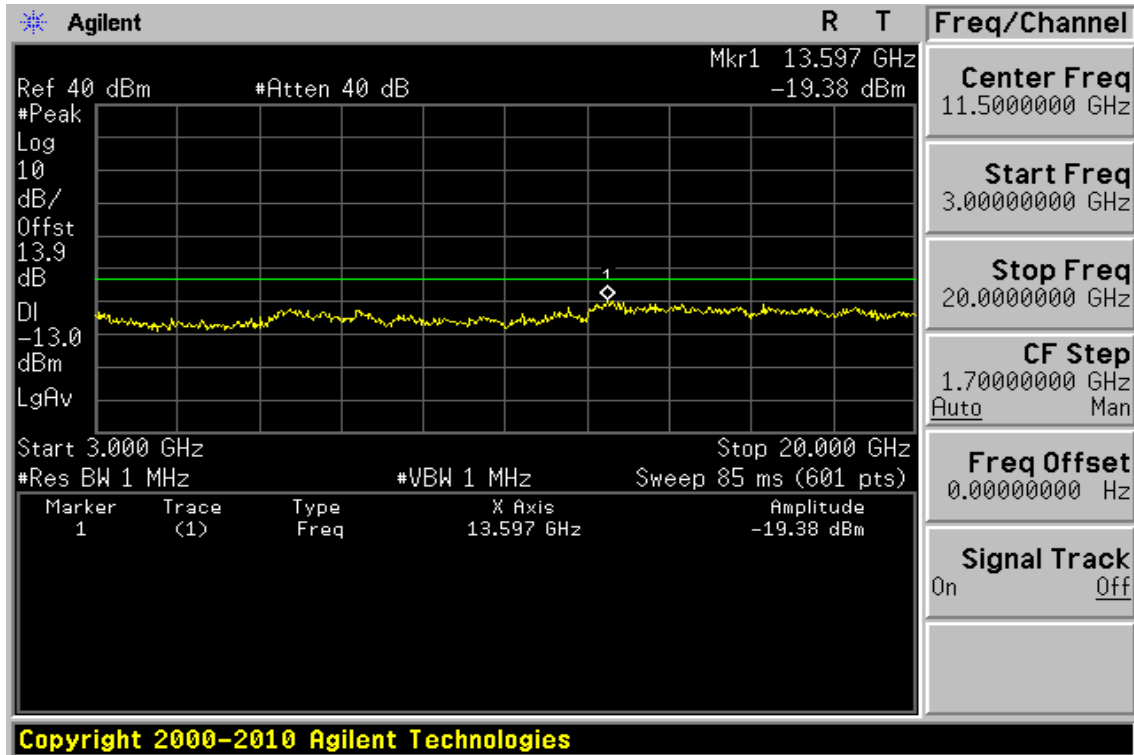
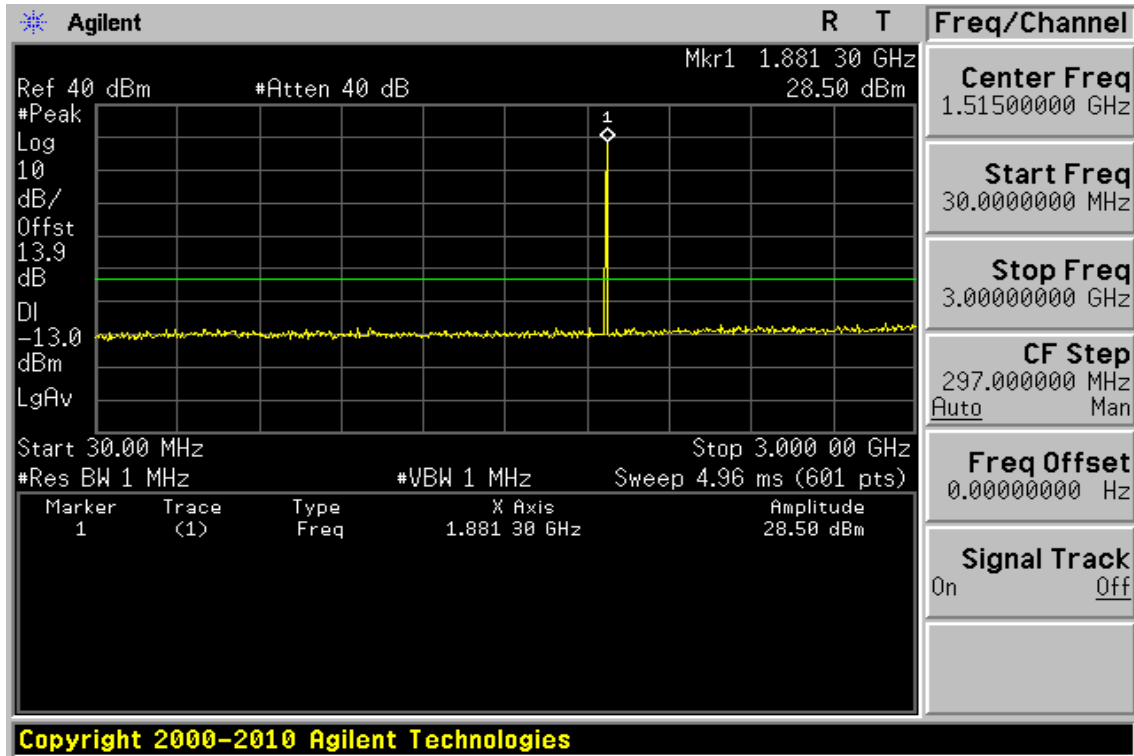

Unless otherwise stated the results shown in this test report refer only to the sample(s) tested and such sample(s) are retained for 90 days only.

除非另有說明，此報告結果僅對測試之樣品負責，同時此樣品僅保留90天。本報告未經本公司書面許可，不可部份複製。

This document is issued by the Company subject to its General Conditions of Service printed overleaf, available on request or accessible at www.sgs.com/terms_and_conditions.htm and, for electronic format documents, subject to Terms and Conditions for Electronic Documents at www.sgs.com/terms_e-document.htm. Attention is drawn to the limitation of liability, indemnification and jurisdiction issues defined therein. Any holder of this document is advised that information contained hereon reflects the Company's findings at the time of its intervention only and within the limits of Client's instructions, if any. The Company's sole responsibility is to its Client and this document does not exonerate parties to a transaction from exercising all their rights and obligations under the transaction documents. This document cannot be reproduced except in full, without prior written approval of the Company. Any unauthorized alteration, forgery or falsification of the content or appearance of this document is unlawful and offenders may be prosecuted to the fullest extent of the law.

Out of Band emission at antenna terminals – EDGE 1900

Fundamental Frequency :1850.2 MHz Engineer :Nick
Operation Mode :TX Low

Freq. (MHz)	Note F/H/E/S	Reading dBm	Limit dBm	Safe Margin dB
<30	S	---	-13.00	---
30-1000	S	---	-13.00	---
3700.40	H	---	-13.00	---
5550.60	H	---	-13.00	---
7400.80	H	---	-13.00	---
9251.00	H	---	-13.00	---
11101.20	H	---	-13.00	---
12951.40	H	---	-13.00	---
14418.00	S	-19.89	-13.00	6.89
14801.60	H	---	-13.00	---
16651.80	H	---	-13.00	---
18502.00	H	---	-13.00	---

Note : “H” : denotes Harmonic Frequency. “S” : denotes Spurious Frequency.
“---“ : denotes Noise Floor.

Unless otherwise stated the results shown in this test report refer only to the sample(s) tested and such sample(s) are retained for 90 days only.

除非另有說明，此報告結果僅對測試之樣品負責，同時此樣品僅保留90天。本報告未經本公司書面許可，不可部份複製。

This document is issued by the Company subject to its General Conditions of Service printed overleaf, available on request or accessible at www.sgs.com/terms_and_conditions.htm and, for electronic format documents, subject to Terms and Conditions for Electronic Documents at www.sgs.com/terms_e-document.htm. Attention is drawn to the limitation of liability, indemnification and jurisdiction issues defined therein. Any holder of this document is advised that information contained hereon reflects the Company's findings at the time of its intervention only and within the limits of Client's instructions, if any. The Company's sole responsibility is to its Client and this document does not exonerate parties to a transaction from exercising all their rights and obligations under the transaction documents. This document cannot be reproduced except in full, without prior written approval of the Company. Any unauthorized alteration, forgery or falsification of the content or appearance of this document is unlawful and offenders may be prosecuted to the fullest extent of the law.

Fundamental Frequency :1880.0 MHz Engineer :Nick
Operation Mode :TX Mid

Freq. (MHz)	Note F/H/E/S	Reading dBm	Limit dBm	Safe Margin dB
<30	S	---	-13.00	---
30-1000	S	---	-13.00	---
3760.00	H	---	-13.00	---
5640.00	H	---	-13.00	---
7520.00	H	---	-13.00	---
9400.00	H	---	-13.00	---
11280.00	H	---	-13.00	---
13160.00	H	---	-13.00	---
13597.00	S	-19.38	-13.00	6.38
15040.00	H	---	-13.00	---
16920.00	H	---	-13.00	---
18800.00	H	---	-13.00	---

Note : “H” : denotes Harmonic Frequency. “S” : denotes Spurious Frequency.
“---” : denotes Noise Floor.

Unless otherwise stated the results shown in this test report refer only to the sample(s) tested and such sample(s) are retained for 90 days only.

除非另有說明，此報告結果僅對測試之樣品負責，同時此樣品僅保留90天。本報告未經本公司書面許可，不可部份複製。

This document is issued by the Company subject to its General Conditions of Service printed overleaf, available on request or accessible at www.sgs.com/terms_and_conditions.htm and, for electronic format documents, subject to Terms and Conditions for Electronic Documents at www.sgs.com/terms_e-document.htm. Attention is drawn to the limitation of liability, indemnification and jurisdiction issues defined therein. Any holder of this document is advised that information contained hereon reflects the Company's findings at the time of its intervention only and within the limits of Client's instructions, if any. The Company's sole responsibility is to its Client and this document does not exonerate parties to a transaction from exercising all their rights and obligations under the transaction documents. This document cannot be reproduced except in full, without prior written approval of the Company. Any unauthorized alteration, forgery or falsification of the content or appearance of this document is unlawful and offenders may be prosecuted to the fullest extent of the law.

Fundamental Frequency :1909.8 MHz Engineer :Nick
Operation Mode :TX High

Freq. (MHz)	Note F/H/E/S	Reading dBm	Limit dBm	Safe Margin dB
<30	S	---	-13.00	---
30-1000	S	---	-13.00	---
3819.60	H	---	-13.00	---
5729.40	H	---	-13.00	---
7639.20	H	---	-13.00	---
9549.00	H	---	-13.00	---
11458.80	H	---	-13.00	---
13368.60	H	---	-13.00	---
13738.00	S	-20.05	-13.00	7.05
15278.40	H	---	-13.00	---
17188.20	H	---	-13.00	---
19098.00	H	---	-13.00	---

Note : “H” : denotes Harmonic Frequency. “S” : denotes Spurious Frequency.
“---” : denotes Noise Floor.

Unless otherwise stated the results shown in this test report refer only to the sample(s) tested and such sample(s) are retained for 90 days only.

除非另有說明，此報告結果僅對測試之樣品負責，同時此樣品僅保留90天。本報告未經本公司書面許可，不可部份複製。

This document is issued by the Company subject to its General Conditions of Service printed overleaf, available on request or accessible at www.sgs.com/terms_and_conditions.htm and, for electronic format documents, subject to Terms and Conditions for Electronic Documents at www.sgs.com/terms_e-document.htm. Attention is drawn to the limitation of liability, indemnification and jurisdiction issues defined therein. Any holder of this document is advised that information contained hereon reflects the Company's findings at the time of its intervention only and within the limits of Client's instructions, if any. The Company's sole responsibility is to its Client and this document does not exonerate parties to a transaction from exercising all their rights and obligations under the transaction documents. This document cannot be reproduced except in full, without prior written approval of the Company. Any unauthorized alteration, forgery or falsification of the content or appearance of this document is unlawful and offenders may be prosecuted to the fullest extent of the law.

Figure 9-29: Band edge emission at antenna terminals – EDGE 1900 Channel Lowest

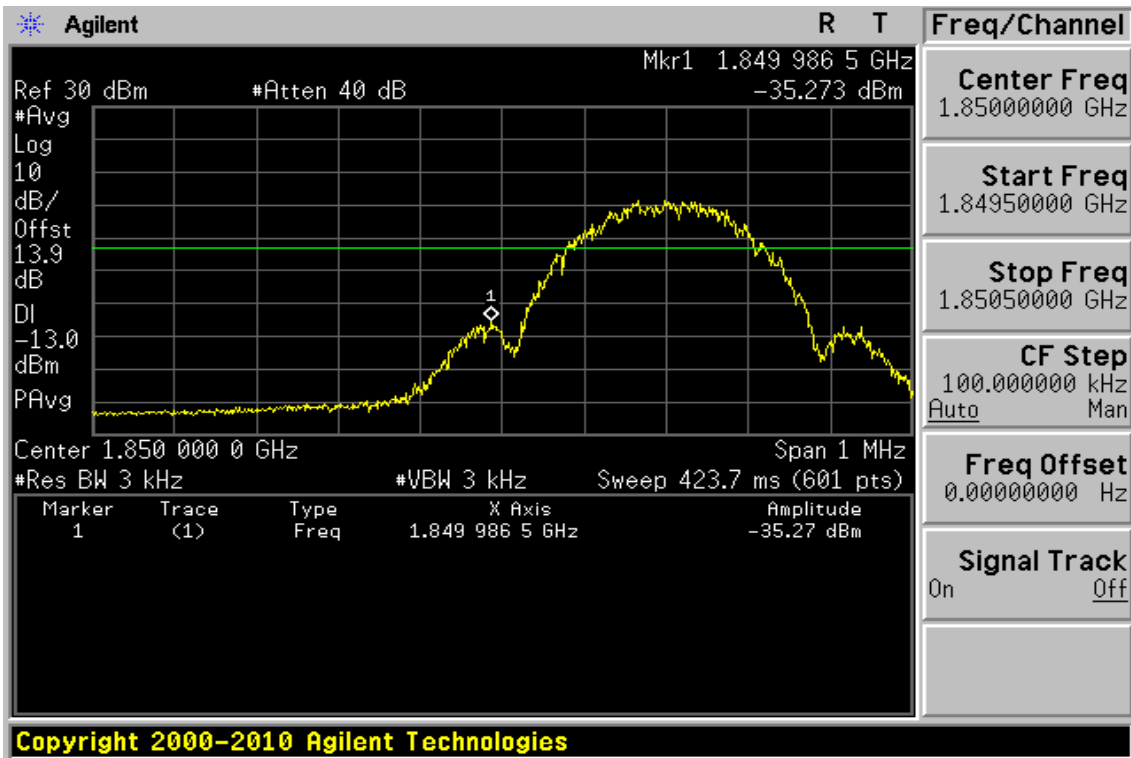
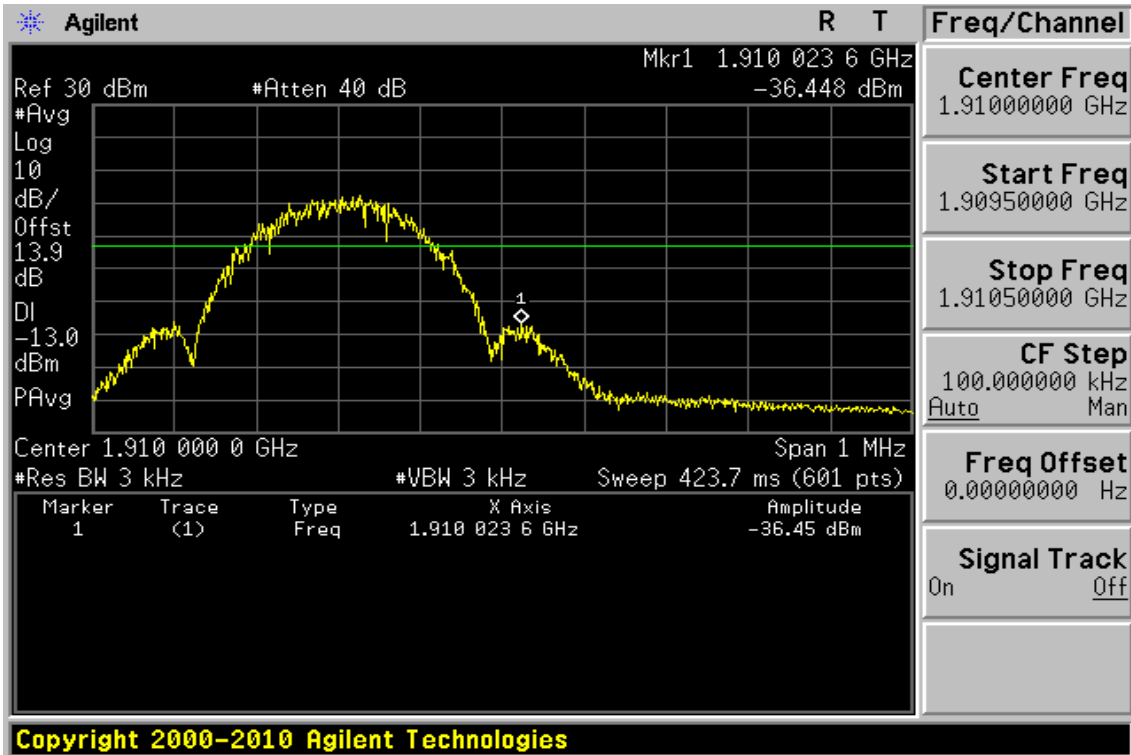

Figure 9-30: Band edge emission at antenna terminals – EDGE 1900 Channel Highest



Unless otherwise stated the results shown in this test report refer only to the sample(s) tested and such sample(s) are retained for 90 days only.

除非另有說明，此報告結果僅對測試之樣品負責，同時此樣品僅保留90天。本報告未經本公司書面許可，不可部份複製。

This document is issued by the Company subject to its General Conditions of Service printed overleaf, available on request or accessible at www.sgs.com/terms_and_conditions.htm and, for electronic format documents, subject to Terms and Conditions for Electronic Documents at www.sgs.com/terms_e-document.htm. Attention is drawn to the limitation of liability, indemnification and jurisdiction issues defined therein. Any holder of this document is advised that information contained hereon reflects the Company's findings at the time of its intervention only and within the limits of Client's instructions, if any. The Company's sole responsibility is to its Client and this document does not exonerate parties to a transaction from exercising all their rights and obligations under the transaction documents. This document cannot be reproduced except in full, without prior written approval of the Company. Any unauthorized alteration, forgery or falsification of the content or appearance of this document is unlawful and offenders may be prosecuted to the fullest extent of the law.

Band edge emission at antenna terminals – EDGE 1900 Low & High

Test Mode EDGE 1900: Engineer :Nick

Freq. MHz	Reading dBm	Limit dBm	Safe Margin dB
1849.986	-35.27	-13.00	22.27
1910.023	-36.45	-13.00	23.45

Unless otherwise stated the results shown in this test report refer only to the sample(s) tested and such sample(s) are retained for 90 days only.

除非另有說明，此報告結果僅對測試之樣品負責，同時此樣品僅保留90天。本報告未經本公司書面許可，不可部份複製。

This document is issued by the Company subject to its General Conditions of Service printed overleaf, available on request or accessible at www.sgs.com/terms_and_conditions.htm and, for electronic format documents, subject to Terms and Conditions for Electronic Documents at www.sgs.com/terms_e-document.htm. Attention is drawn to the limitation of liability, indemnification and jurisdiction issues defined therein. Any holder of this document is advised that information contained hereon reflects the Company's findings at the time of its intervention only and within the limits of Client's instructions, if any. The Company's sole responsibility is to its Client and this document does not exonerate parties to a transaction from exercising all their rights and obligations under the transaction documents. This document cannot be reproduced except in full, without prior written approval of the Company. Any unauthorized alteration, forgery or falsification of the content or appearance of this document is unlawful and offenders may be prosecuted to the fullest extent of the law.

Figure 9-31: Out of Band emission at antenna terminals – WCDMA II Channel Lowest

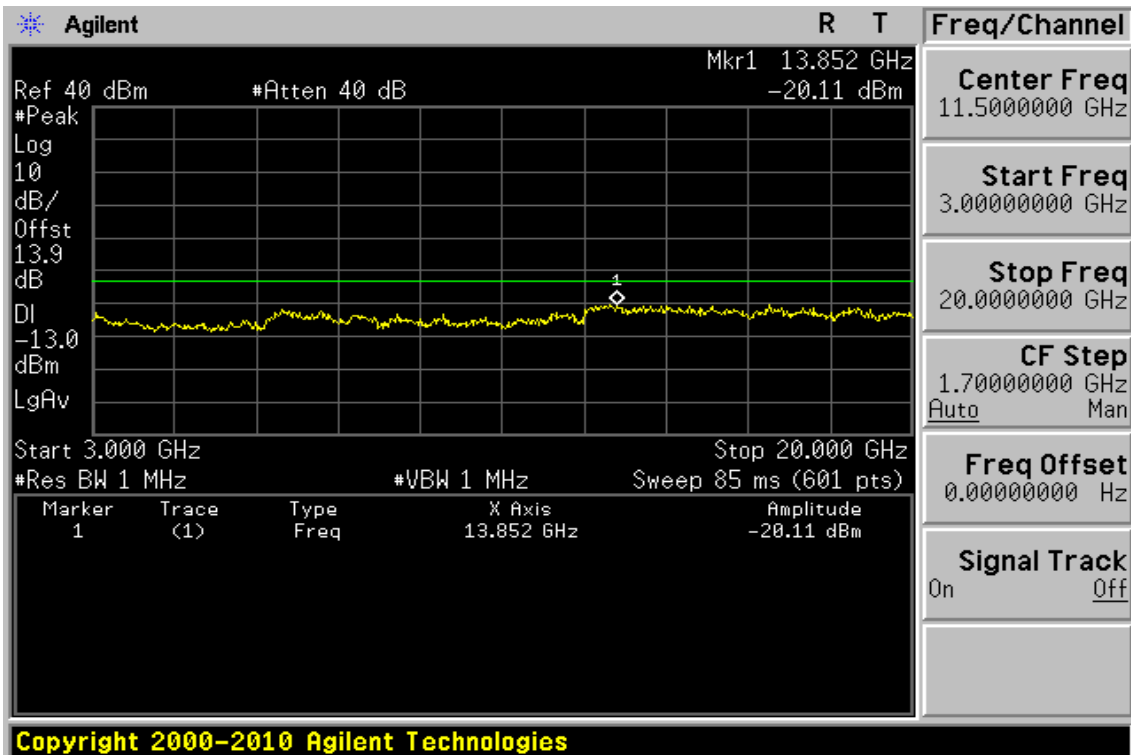
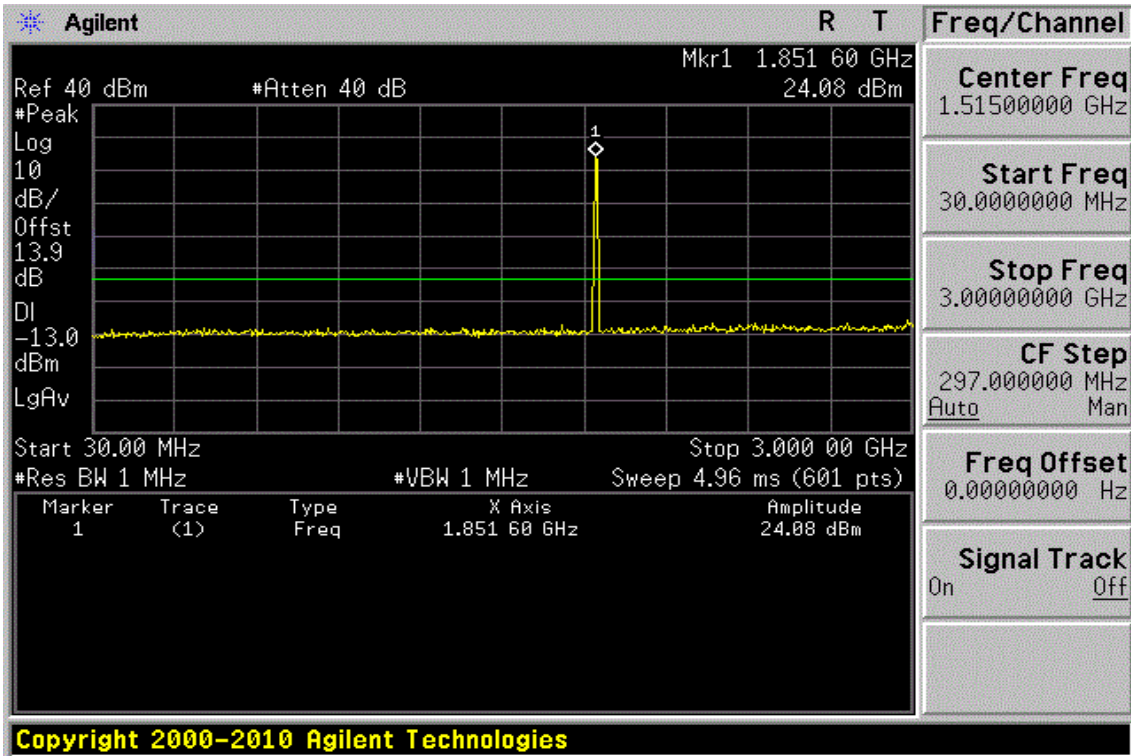

Unless otherwise stated the results shown in this test report refer only to the sample(s) tested and such sample(s) are retained for 90 days only.

除非另有說明，此報告結果僅對測試之樣品負責，同時此樣品僅保留90天。本報告未經本公司書面許可，不可部份複製。

This document is issued by the Company subject to its General Conditions of Service printed overleaf, available on request or accessible at www.sgs.com/terms_and_conditions.htm and, for electronic format documents, subject to Terms and Conditions for Electronic Documents at www.sgs.com/terms_e-document.htm. Attention is drawn to the limitation of liability, indemnification and jurisdiction issues defined therein. Any holder of this document is advised that information contained hereon reflects the Company's findings at the time of its intervention only and within the limits of Client's instructions, if any. The Company's sole responsibility is to its Client and this document does not exonerate parties to a transaction from exercising all their rights and obligations under the transaction documents. This document cannot be reproduced except in full, without prior written approval of the Company. Any unauthorized alteration, forgery or falsification of the content or appearance of this document is unlawful and offenders may be prosecuted to the fullest extent of the law.

Figure 9-32: Out of Band emission at antenna terminals – WCDMA II Channel Mid

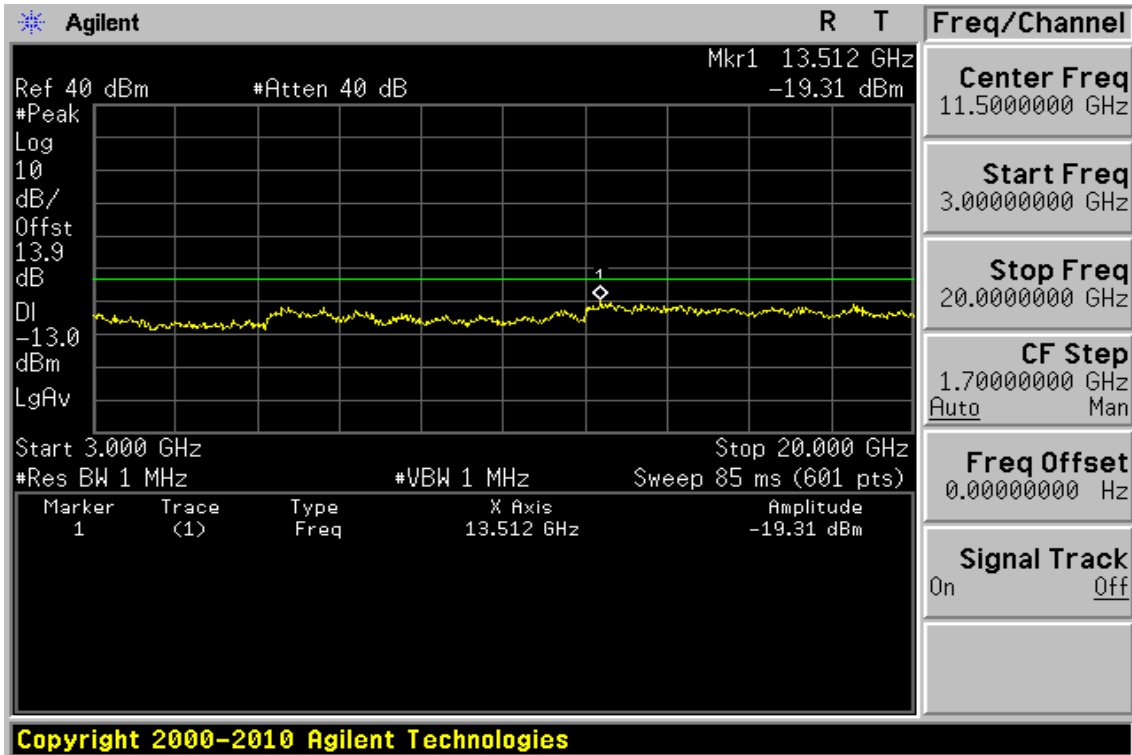
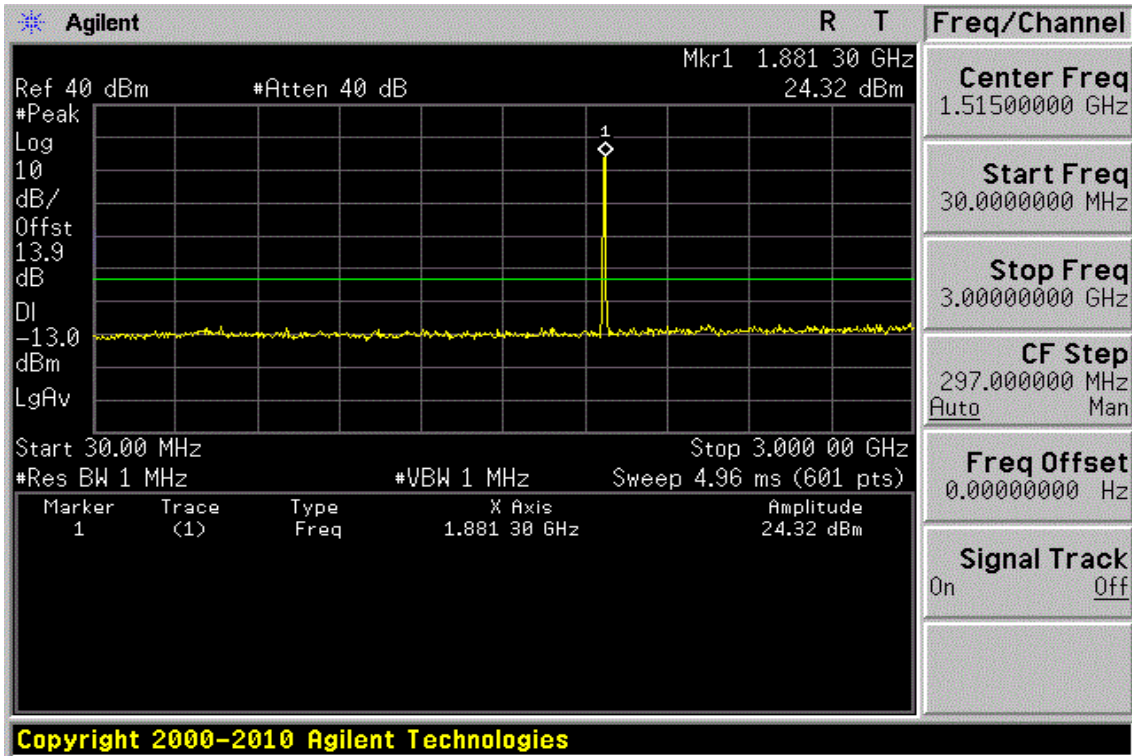

Unless otherwise stated the results shown in this test report refer only to the sample(s) tested and such sample(s) are retained for 90 days only.

除非另有說明，此報告結果僅對測試之樣品負責，同時此樣品僅保留90天。本報告未經本公司書面許可，不可部份複製。

This document is issued by the Company subject to its General Conditions of Service printed overleaf, available on request or accessible at www.sgs.com/terms_and_conditions.htm and, for electronic format documents, subject to Terms and Conditions for Electronic Documents at www.sgs.com/terms_e-document.htm. Attention is drawn to the limitation of liability, indemnification and jurisdiction issues defined therein. Any holder of this document is advised that information contained hereon reflects the Company's findings at the time of its intervention only and within the limits of Client's instructions, if any. The Company's sole responsibility is to its Client and this document does not exonerate parties to a transaction from exercising all their rights and obligations under the transaction documents. This document cannot be reproduced except in full, without prior written approval of the Company. Any unauthorized alteration, forgery or falsification of the content or appearance of this document is unlawful and offenders may be prosecuted to the fullest extent of the law.

Figure 9-33: Out of Band emission at antenna terminals – WCDMA II Channel Highest

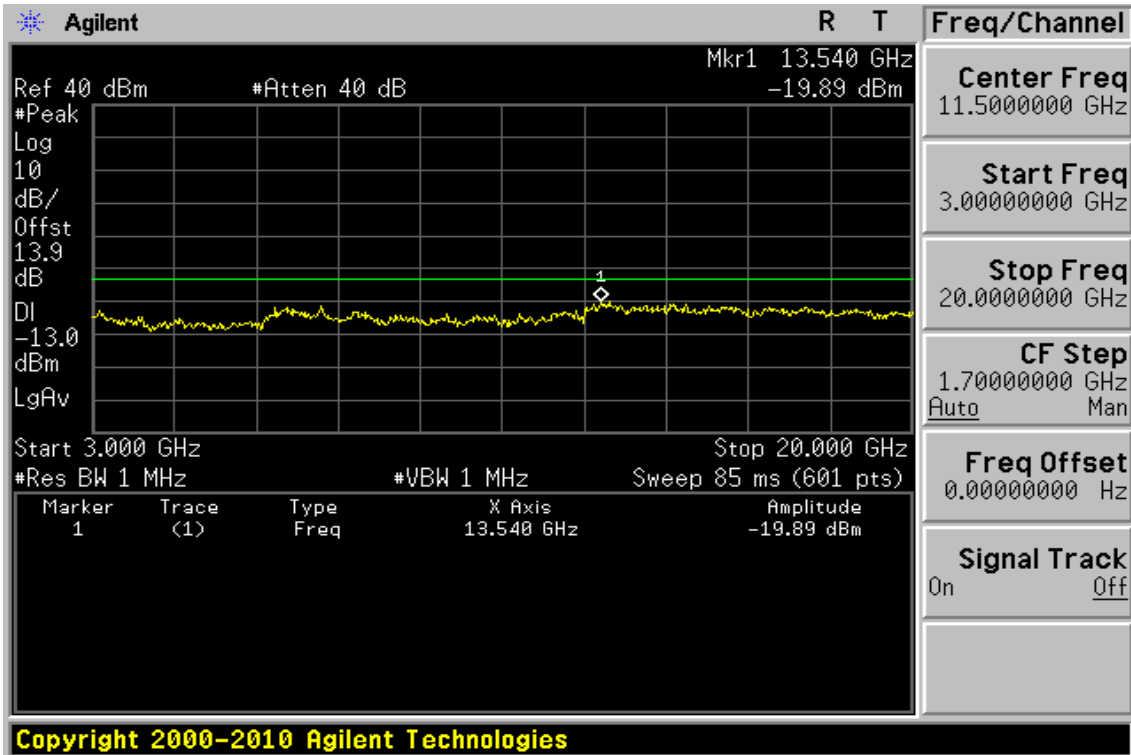
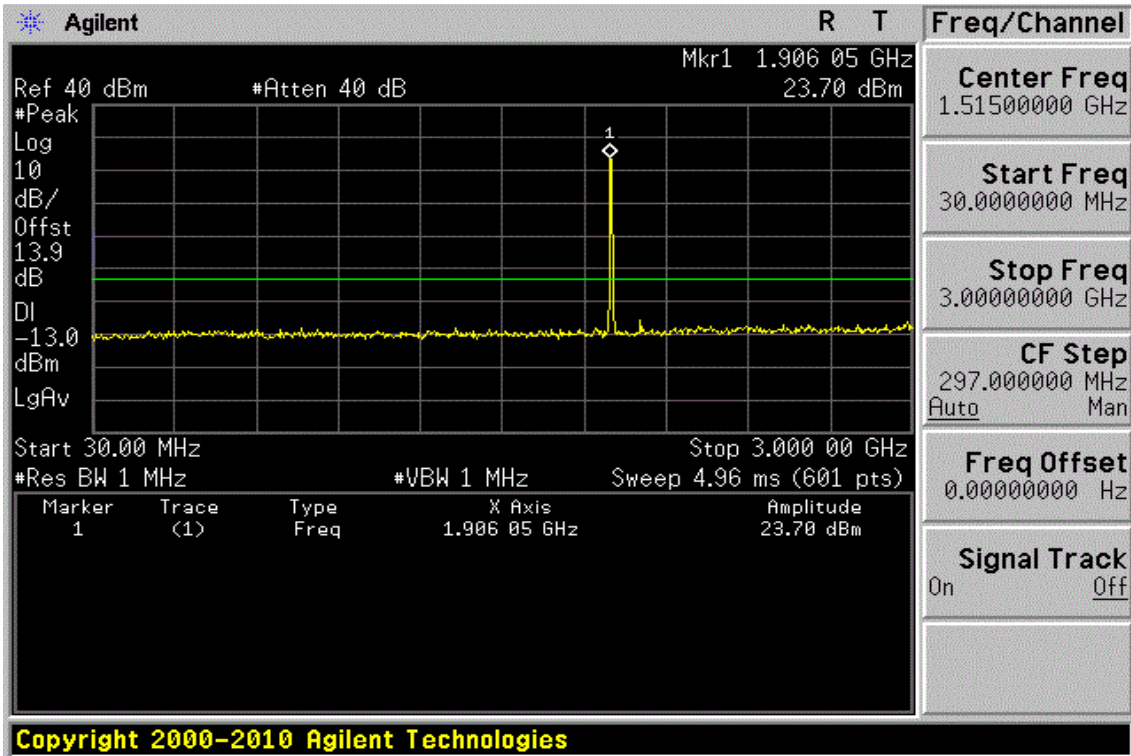

Unless otherwise stated the results shown in this test report refer only to the sample(s) tested and such sample(s) are retained for 90 days only.

除非另有說明，此報告結果僅對測試之樣品負責，同時此樣品僅保留90天。本報告未經本公司書面許可，不可部份複製。

This document is issued by the Company subject to its General Conditions of Service printed overleaf, available on request or accessible at www.sgs.com/terms_and_conditions.htm and, for electronic format documents, subject to Terms and Conditions for Electronic Documents at www.sgs.com/terms_e-document.htm. Attention is drawn to the limitation of liability, indemnification and jurisdiction issues defined therein. Any holder of this document is advised that information contained hereon reflects the Company's findings at the time of its intervention only and within the limits of Client's instructions, if any. The Company's sole responsibility is to its Client and this document does not exonerate parties to a transaction from exercising all their rights and obligations under the transaction documents. This document cannot be reproduced except in full, without prior written approval of the Company. Any unauthorized alteration, forgery or falsification of the content or appearance of this document is unlawful and offenders may be prosecuted to the fullest extent of the law.

Out of Band emission at antenna terminals – WCDMA II

Fundamental Frequency :1852.4 MHz Engineer :Nick
Operation Mode :TX Low

Freq. (MHz)	Note F/H/E/S	Reading dBm	Limit dBm	Safe Margin dB
<30	S	---	-13.00	---
30-1000	S	---	-13.00	---
3704.80	H	---	-13.00	---
5557.20	H	---	-13.00	---
7409.60	H	---	-13.00	---
9262.00	H	---	-13.00	---
11114.40	H	---	-13.00	---
12966.80	H	---	-13.00	---
13852.00	S	-20.11	-13.00	7.11
14819.20	H	---	-13.00	---
16671.60	H	---	-13.00	---
18524.00	H	---	-13.00	---

Note : “H” : denotes Harmonic Frequency. “S” : denotes Spurious Frequency.
“---” : denotes Noise Floor.

Unless otherwise stated the results shown in this test report refer only to the sample(s) tested and such sample(s) are retained for 90 days only.

除非另有說明，此報告結果僅對測試之樣品負責，同時此樣品僅保留90天。本報告未經本公司書面許可，不可部份複製。

This document is issued by the Company subject to its General Conditions of Service printed overleaf, available on request or accessible at www.sgs.com/terms_and_conditions.htm and, for electronic format documents, subject to Terms and Conditions for Electronic Documents at www.sgs.com/terms_e-document.htm. Attention is drawn to the limitation of liability, indemnification and jurisdiction issues defined therein. Any holder of this document is advised that information contained hereon reflects the Company's findings at the time of its intervention only and within the limits of Client's instructions, if any. The Company's sole responsibility is to its Client and this document does not exonerate parties to a transaction from exercising all their rights and obligations under the transaction documents. This document cannot be reproduced except in full, without prior written approval of the Company. Any unauthorized alteration, forgery or falsification of the content or appearance of this document is unlawful and offenders may be prosecuted to the fullest extent of the law.

Fundamental Frequency :1880.0 MHz Engineer :Nick
Operation Mode :TX Mid

Freq. (MHz)	Note F/H/E/S	Reading dBm	Limit dBm	Safe Margin dB
<30	S	---	-13.00	---
30-1000	S	---	-13.00	---
3760.00	H	---	-13.00	---
5640.00	H	---	-13.00	---
7520.00	H	---	-13.00	---
9400.00	H	---	-13.00	---
11280.00	H	---	-13.00	---
13160.00	H	---	-13.00	---
13512.00	S	-19.31	-13.00	6.31
15040.00	H	---	-13.00	---
16920.00	H	---	-13.00	---
18800.00	H	---	-13.00	---

Note : "H" : denotes Harmonic Frequency. "S" : denotes Spurious Frequency.
"---" : denotes Noise Floor.

Unless otherwise stated the results shown in this test report refer only to the sample(s) tested and such sample(s) are retained for 90 days only.

除非另有說明，此報告結果僅對測試之樣品負責，同時此樣品僅保留90天。本報告未經本公司書面許可，不可部份複製。

This document is issued by the Company subject to its General Conditions of Service printed overleaf, available on request or accessible at www.sgs.com/terms_and_conditions.htm and, for electronic format documents, subject to Terms and Conditions for Electronic Documents at www.sgs.com/terms_e-document.htm. Attention is drawn to the limitation of liability, indemnification and jurisdiction issues defined therein. Any holder of this document is advised that information contained hereon reflects the Company's findings at the time of its intervention only and within the limits of Client's instructions, if any. The Company's sole responsibility is to its Client and this document does not exonerate parties to a transaction from exercising all their rights and obligations under the transaction documents. This document cannot be reproduced except in full, without prior written approval of the Company. Any unauthorized alteration, forgery or falsification of the content or appearance of this document is unlawful and offenders may be prosecuted to the fullest extent of the law.

Fundamental Frequency :1907.6MHz Engineer :Nick
Operation Mode :TX High

Freq. (MHz)	Note F/H/E/S	Reading dBm	Limit dBm	Safe Margin dB
<30	S	---	-13.00	---
30-1000	S	---	-13.00	---
3815.20	H	---	-13.00	---
5722.80	H	---	-13.00	---
7630.40	H	---	-13.00	---
9538.00	H	---	-13.00	---
11445.60	H	---	-13.00	---
13353.20	H	---	-13.00	---
13540.00	S	-19.89	-13.00	6.89
15260.80	H	---	-13.00	---
17168.40	H	---	-13.00	---
19076.00	H	---	-13.00	---

Note : "H" : denotes Harmonic Frequency. "S" : denotes Spurious Frequency.
"---" : denotes Noise Floor.

Unless otherwise stated the results shown in this test report refer only to the sample(s) tested and such sample(s) are retained for 90 days only.

除非另有說明，此報告結果僅對測試之樣品負責，同時此樣品僅保留90天。本報告未經本公司書面許可，不可部份複製。

This document is issued by the Company subject to its General Conditions of Service printed overleaf, available on request or accessible at www.sgs.com/terms_and_conditions.htm and, for electronic format documents, subject to Terms and Conditions for Electronic Documents at www.sgs.com/terms_e-document.htm. Attention is drawn to the limitation of liability, indemnification and jurisdiction issues defined therein. Any holder of this document is advised that information contained hereon reflects the Company's findings at the time of its intervention only and within the limits of Client's instructions, if any. The Company's sole responsibility is to its Client and this document does not exonerate parties to a transaction from exercising all their rights and obligations under the transaction documents. This document cannot be reproduced except in full, without prior written approval of the Company. Any unauthorized alteration, forgery or falsification of the content or appearance of this document is unlawful and offenders may be prosecuted to the fullest extent of the law.

Figure 9-34: Band edge emission at antenna terminals – WCDMA II Channel Lowest

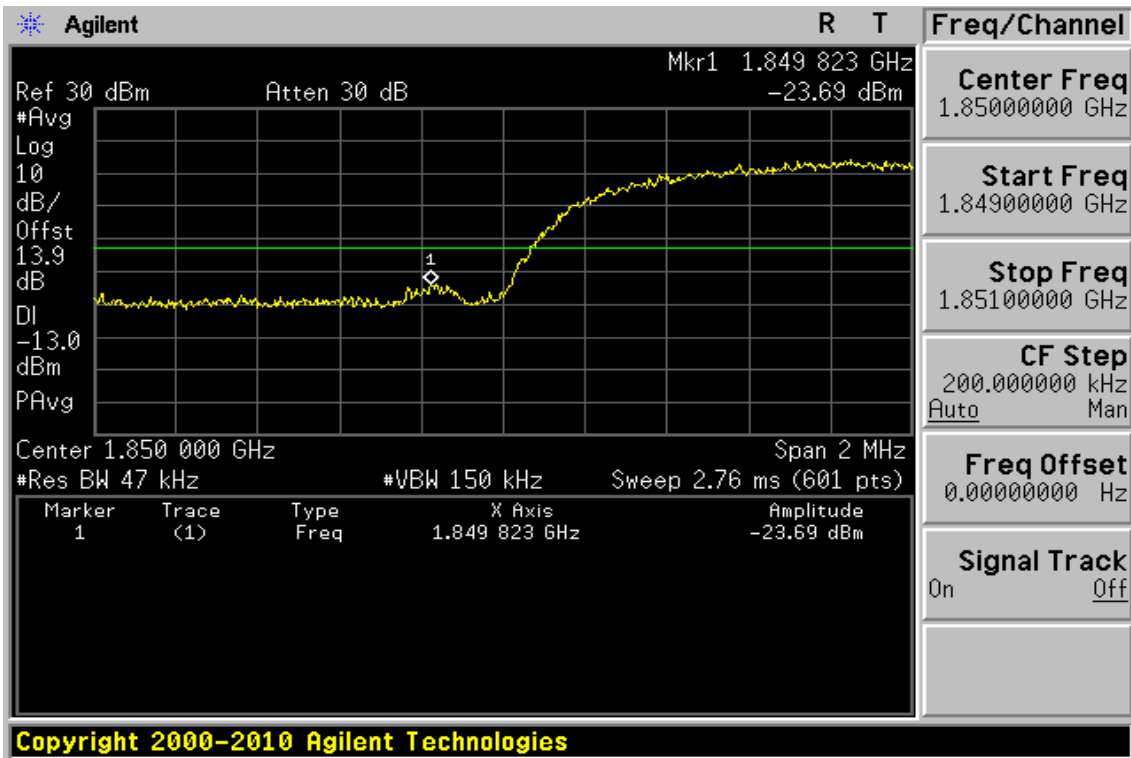
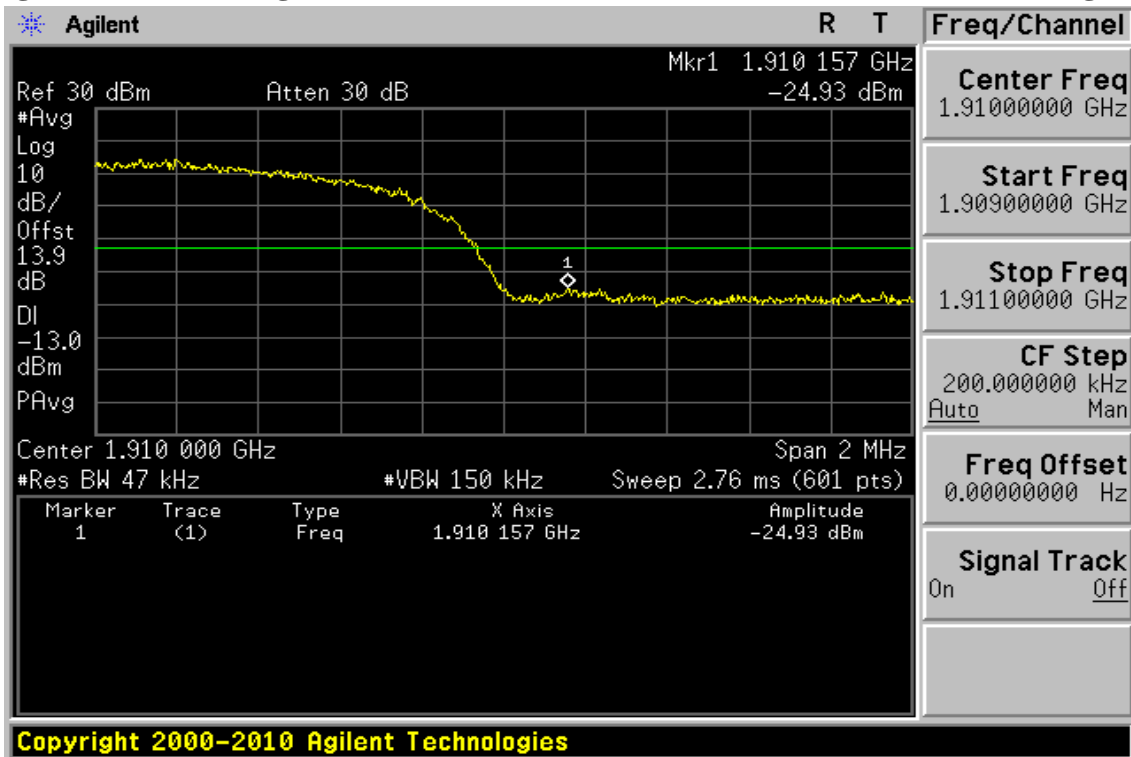

Figure 9-35: Band edge emission at antenna terminals – WCDMA II Channel Highest



Unless otherwise stated the results shown in this test report refer only to the sample(s) tested and such sample(s) are retained for 90 days only.

除非另有說明，此報告結果僅對測試之樣品負責，同時此樣品僅保留90天。本報告未經本公司書面許可，不可部份複製。

This document is issued by the Company subject to its General Conditions of Service printed overleaf, available on request or accessible at www.sgs.com/terms_and_conditions.htm and, for electronic format documents, subject to Terms and Conditions for Electronic Documents at www.sgs.com/terms_e-document.htm. Attention is drawn to the limitation of liability, indemnification and jurisdiction issues defined therein. Any holder of this document is advised that information contained hereon reflects the Company's findings at the time of its intervention only and within the limits of Client's instructions, if any. The Company's sole responsibility is to its Client and this document does not exonerate parties to a transaction from exercising all their rights and obligations under the transaction documents. This document cannot be reproduced except in full, without prior written approval of the Company. Any unauthorized alteration, forgery or falsification of the content or appearance of this document is unlawful and offenders may be prosecuted to the fullest extent of the law.

Band edge emission at antenna terminals – WCDMA II Low & High

Test Mode WCDMA II Engineer :Nick

Freq. MHz	Reading dBm	Limit dBm	Safe Margin dB
1849.823	-23.69	-13.00	10.69
1910.157	-24.93	-13.00	11.93

Unless otherwise stated the results shown in this test report refer only to the sample(s) tested and such sample(s) are retained for 90 days only.

除非另有說明，此報告結果僅對測試之樣品負責，同時此樣品僅保留90天。本報告未經本公司書面許可，不可部份複製。

This document is issued by the Company subject to its General Conditions of Service printed overleaf, available on request or accessible at www.sgs.com/terms_and_conditions.htm and, for electronic format documents, subject to Terms and Conditions for Electronic Documents at www.sgs.com/terms_e-document.htm. Attention is drawn to the limitation of liability, indemnification and jurisdiction issues defined therein. Any holder of this document is advised that information contained hereon reflects the Company's findings at the time of its intervention only and within the limits of Client's instructions, if any. The Company's sole responsibility is to its Client and this document does not exonerate parties to a transaction from exercising all their rights and obligations under the transaction documents. This document cannot be reproduced except in full, without prior written approval of the Company. Any unauthorized alteration, forgery or falsification of the content or appearance of this document is unlawful and offenders may be prosecuted to the fullest extent of the law.

Figure 9-36: Out of Band emission at antenna terminals – WCDMA IV Channel Lowest

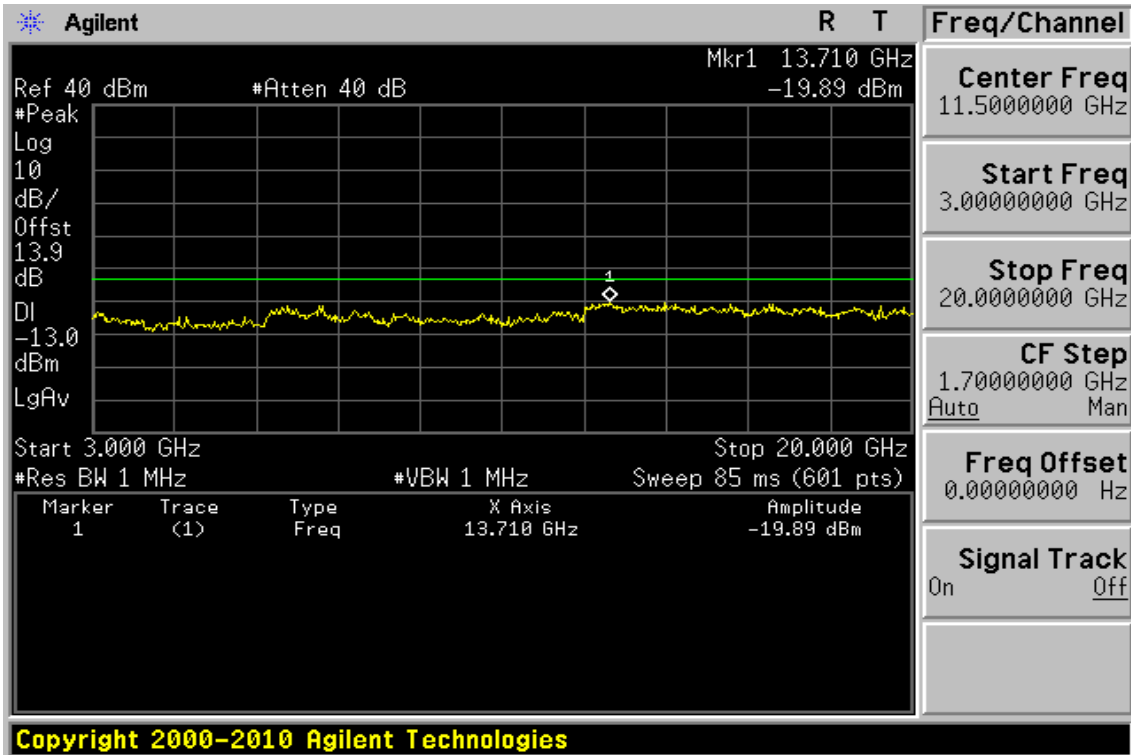
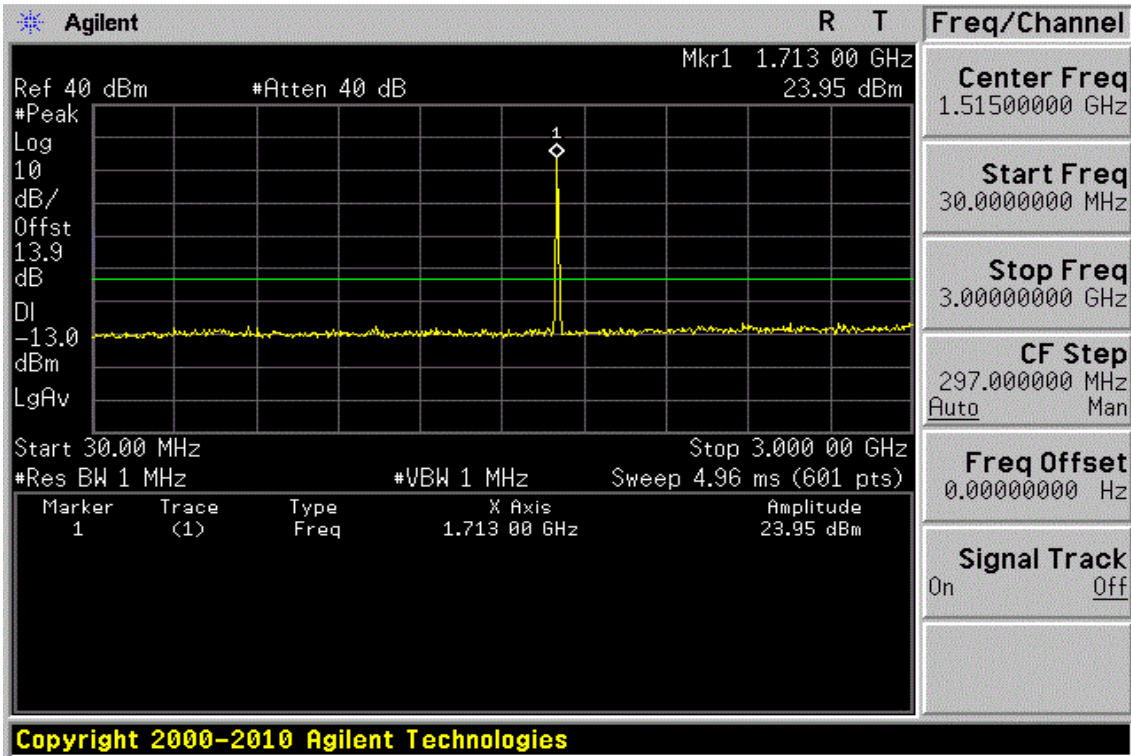

Unless otherwise stated the results shown in this test report refer only to the sample(s) tested and such sample(s) are retained for 90 days only.

除非另有說明，此報告結果僅對測試之樣品負責，同時此樣品僅保留90天。本報告未經本公司書面許可，不可部份複製。

This document is issued by the Company subject to its General Conditions of Service printed overleaf, available on request or accessible at www.sgs.com/terms_and_conditions.htm and, for electronic format documents, subject to Terms and Conditions for Electronic Documents at www.sgs.com/terms_e-document.htm. Attention is drawn to the limitation of liability, indemnification and jurisdiction issues defined therein. Any holder of this document is advised that information contained hereon reflects the Company's findings at the time of its intervention only and within the limits of Client's instructions, if any. The Company's sole responsibility is to its Client and this document does not exonerate parties to a transaction from exercising all their rights and obligations under the transaction documents. This document cannot be reproduced except in full, without prior written approval of the Company. Any unauthorized alteration, forgery or falsification of the content or appearance of this document is unlawful and offenders may be prosecuted to the fullest extent of the law.

Figure 9-37: Out of Band emission at antenna terminals – WCDMA IV Channel Mid

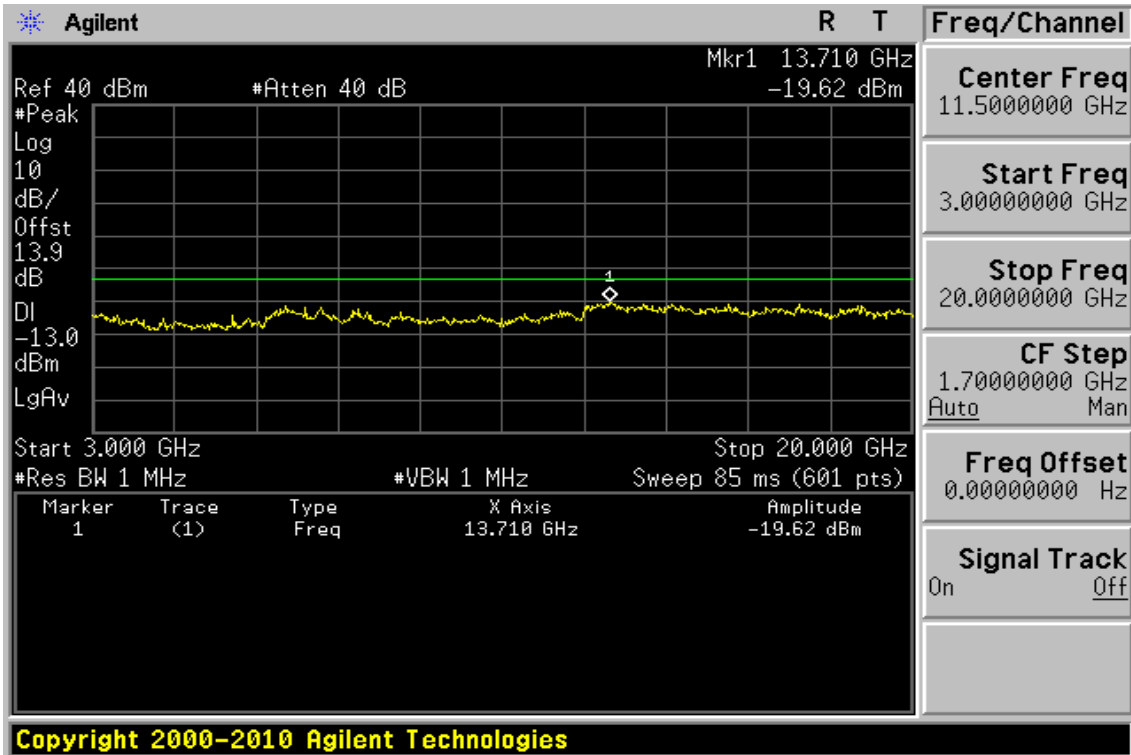
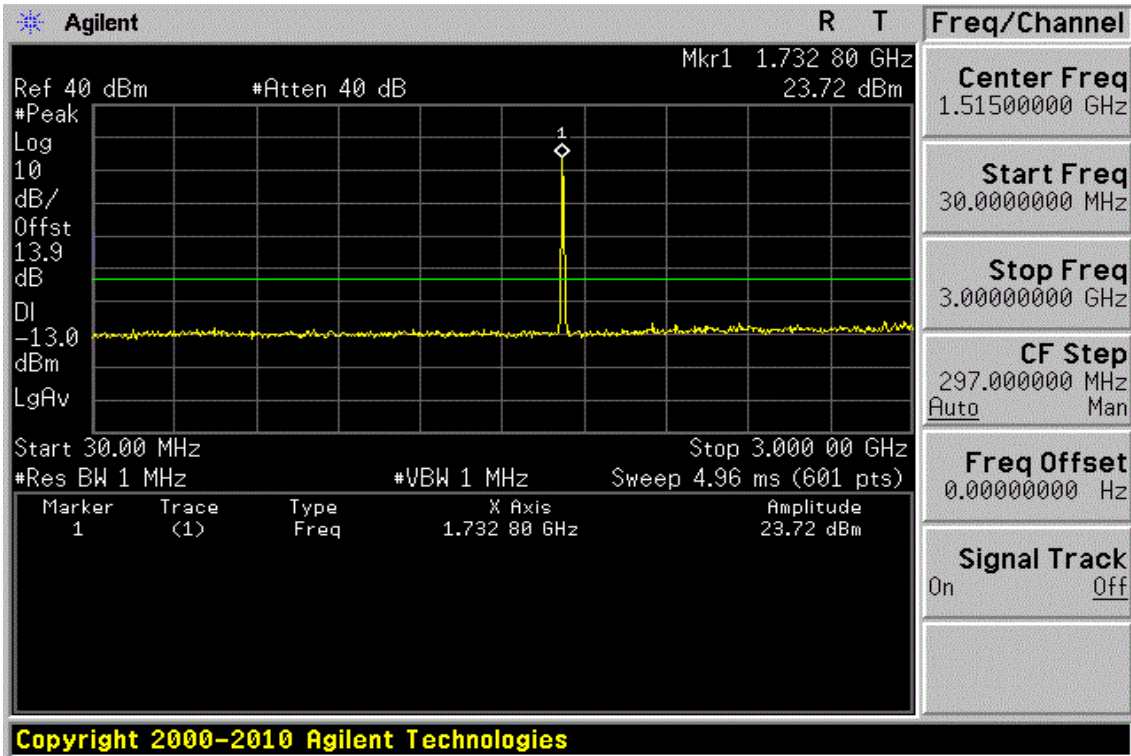

Unless otherwise stated the results shown in this test report refer only to the sample(s) tested and such sample(s) are retained for 90 days only.

除非另有說明，此報告結果僅對測試之樣品負責，同時此樣品僅保留90天。本報告未經本公司書面許可，不可部份複製。

This document is issued by the Company subject to its General Conditions of Service printed overleaf, available on request or accessible at www.sgs.com/terms_and_conditions.htm and, for electronic format documents, subject to Terms and Conditions for Electronic Documents at www.sgs.com/terms_e-document.htm. Attention is drawn to the limitation of liability, indemnification and jurisdiction issues defined therein. Any holder of this document is advised that information contained hereon reflects the Company's findings at the time of its intervention only and within the limits of Client's instructions, if any. The Company's sole responsibility is to its Client and this document does not exonerate parties to a transaction from exercising all their rights and obligations under the transaction documents. This document cannot be reproduced except in full, without prior written approval of the Company. Any unauthorized alteration, forgery or falsification of the content or appearance of this document is unlawful and offenders may be prosecuted to the fullest extent of the law.

Figure 9-38: Out of Band emission at antenna terminals – WCDMA IV Channel Highest

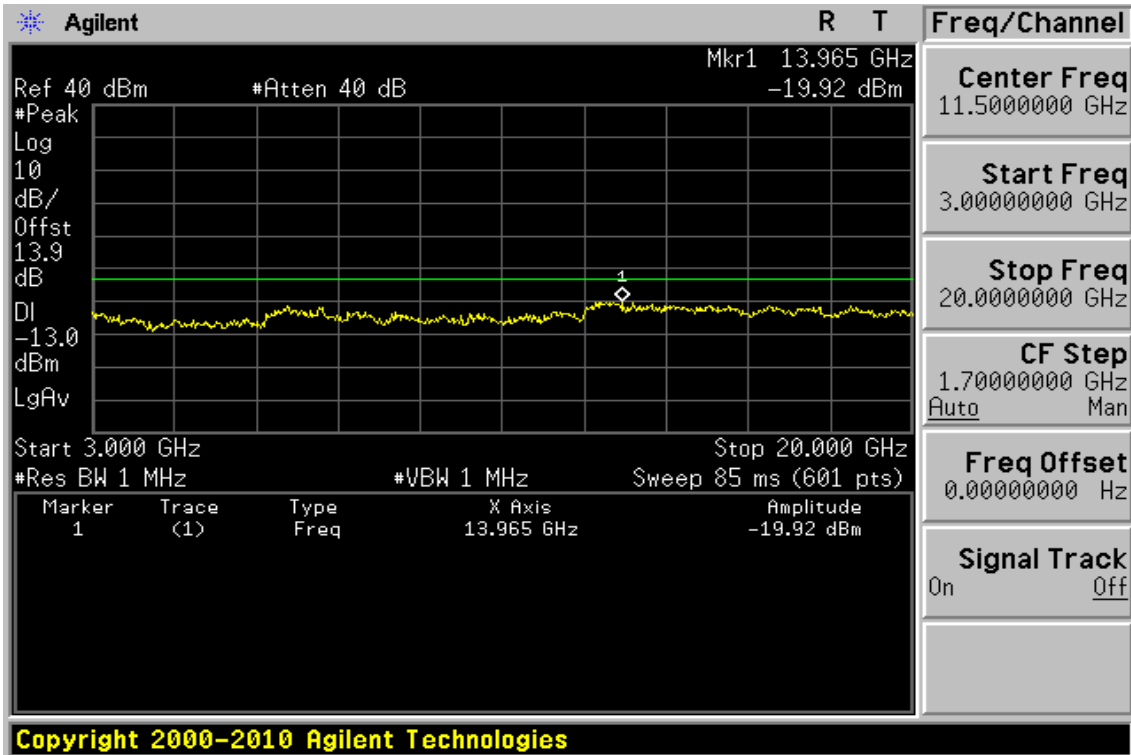
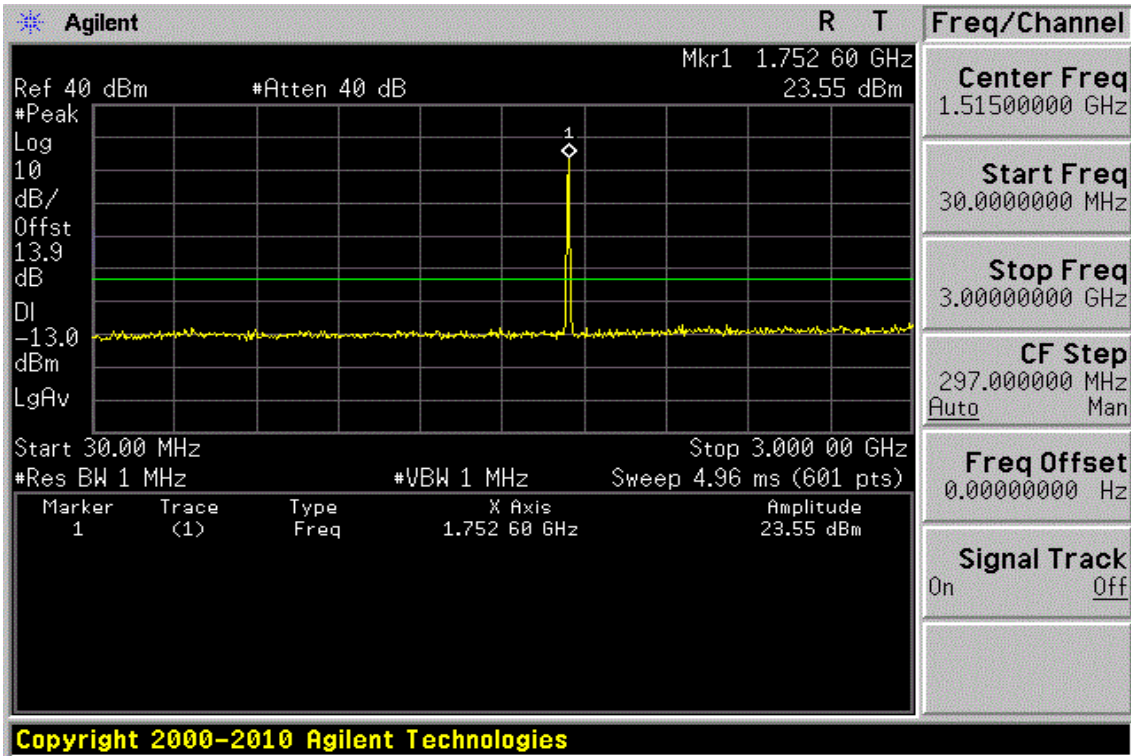

Unless otherwise stated the results shown in this test report refer only to the sample(s) tested and such sample(s) are retained for 90 days only.

除非另有說明，此報告結果僅對測試之樣品負責，同時此樣品僅保留90天。本報告未經本公司書面許可，不可部份複製。

This document is issued by the Company subject to its General Conditions of Service printed overleaf, available on request or accessible at www.sgs.com/terms_and_conditions.htm and, for electronic format documents, subject to Terms and Conditions for Electronic Documents at www.sgs.com/terms_e-document.htm. Attention is drawn to the limitation of liability, indemnification and jurisdiction issues defined therein. Any holder of this document is advised that information contained hereon reflects the Company's findings at the time of its intervention only and within the limits of Client's instructions, if any. The Company's sole responsibility is to its Client and this document does not exonerate parties to a transaction from exercising all their rights and obligations under the transaction documents. This document cannot be reproduced except in full, without prior written approval of the Company. Any unauthorized alteration, forgery or falsification of the content or appearance of this document is unlawful and offenders may be prosecuted to the fullest extent of the law.

Out of Band emission at antenna terminals – WCDMA IV

Fundamental Frequency 1712.4 MHz Engineer :Nick
Operation Mode :TX Low

Freq. (MHz)	Note F/H/E/S	Reading dBm	Limit dBm	Safe Margin dB
<30	S	---	-13.00	---
30-1000	S	---	-13.00	---
3424.80	H	---	-13.00	---
5137.20	H	---	-13.00	---
6849.60	H	---	-13.00	---
8562.00	H	---	-13.00	---
10274.40	H	---	-13.00	---
11986.80	H	---	-13.00	---
13699.20	H	---	-13.00	---
13710.00	S	-19.89	-13.00	6.89
15411.60	H	---	-13.00	---
17124.00	H	---	-13.00	---

Note : “H” : denotes Harmonic Frequency. “S” : denotes Spurious Frequency.
“---” : denotes Noise Floor.

Unless otherwise stated the results shown in this test report refer only to the sample(s) tested and such sample(s) are retained for 90 days only.

除非另有說明，此報告結果僅對測試之樣品負責，同時此樣品僅保留90天。本報告未經本公司書面許可，不可部份複製。

This document is issued by the Company subject to its General Conditions of Service printed overleaf, available on request or accessible at www.sgs.com/terms_and_conditions.htm and, for electronic format documents, subject to Terms and Conditions for Electronic Documents at www.sgs.com/terms_e-document.htm. Attention is drawn to the limitation of liability, indemnification and jurisdiction issues defined therein. Any holder of this document is advised that information contained hereon reflects the Company's findings at the time of its intervention only and within the limits of Client's instructions, if any. The Company's sole responsibility is to its Client and this document does not exonerate parties to a transaction from exercising all their rights and obligations under the transaction documents. This document cannot be reproduced except in full, without prior written approval of the Company. Any unauthorized alteration, forgery or falsification of the content or appearance of this document is unlawful and offenders may be prosecuted to the fullest extent of the law.

Fundamental Frequency :1732.6 MHz Engineer :Nick
Operation Mode :TX Mid

Freq. (MHz)	Note F/H/E/S	Reading dBm	Limit dBm	Safe Margin dB
<30	S	---	-13.00	---
30-1000	S	---	-13.00	---
3465.20	H	---	-13.00	---
5197.80	H	---	-13.00	---
6930.40	H	---	-13.00	---
8663.00	H	---	-13.00	---
10395.60	H	---	-13.00	---
12128.20	H	---	-13.00	---
13710.00	S	-19.62	-13.00	6.62
13860.80	H	---	-13.00	---
15593.40	H	---	-13.00	---
17326.00	H	---	-13.00	---

Note : "H" : denotes Harmonic Frequency. "S" : denotes Spurious Frequency.
"---" : denotes Noise Floor.

Unless otherwise stated the results shown in this test report refer only to the sample(s) tested and such sample(s) are retained for 90 days only.

除非另有說明，此報告結果僅對測試之樣品負責，同時此樣品僅保留90天。本報告未經本公司書面許可，不可部份複製。

This document is issued by the Company subject to its General Conditions of Service printed overleaf, available on request or accessible at www.sgs.com/terms_and_conditions.htm and, for electronic format documents, subject to Terms and Conditions for Electronic Documents at www.sgs.com/terms_e-document.htm. Attention is drawn to the limitation of liability, indemnification and jurisdiction issues defined therein. Any holder of this document is advised that information contained hereon reflects the Company's findings at the time of its intervention only and within the limits of Client's instructions, if any. The Company's sole responsibility is to its Client and this document does not exonerate parties to a transaction from exercising all their rights and obligations under the transaction documents. This document cannot be reproduced except in full, without prior written approval of the Company. Any unauthorized alteration, forgery or falsification of the content or appearance of this document is unlawful and offenders may be prosecuted to the fullest extent of the law.

Figure 9-39: Band edge emission at antenna terminals – WCDMA IV Channel Lowest

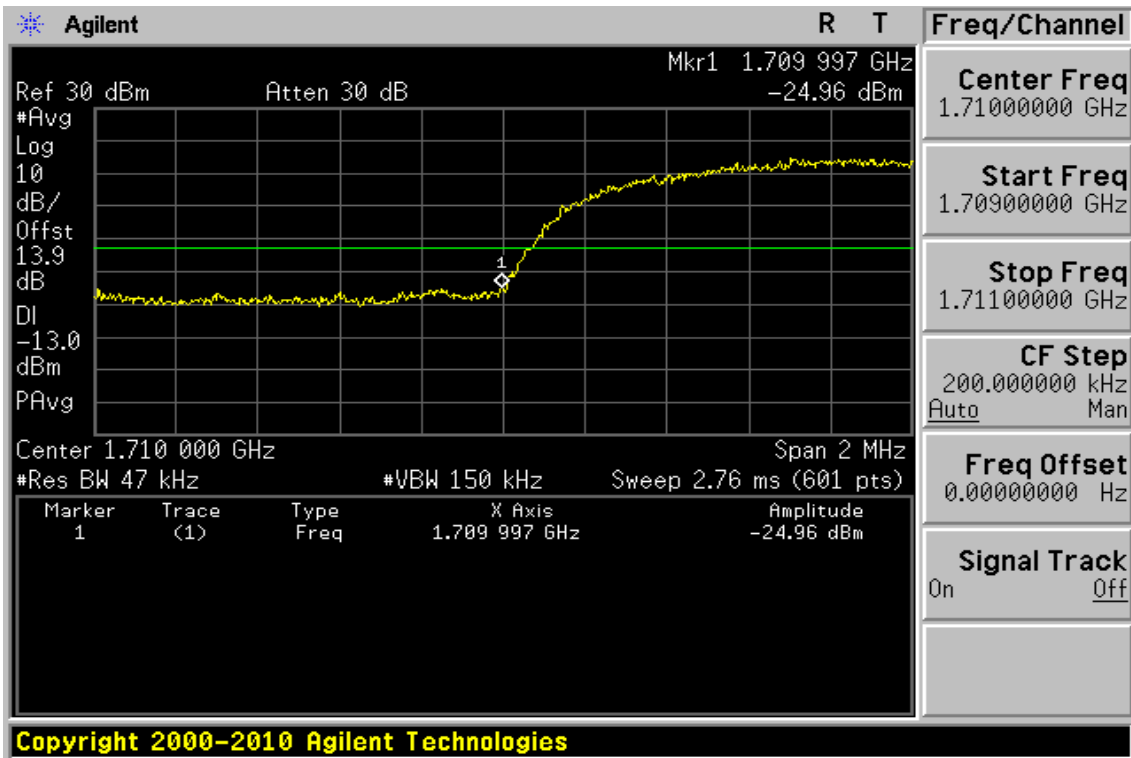
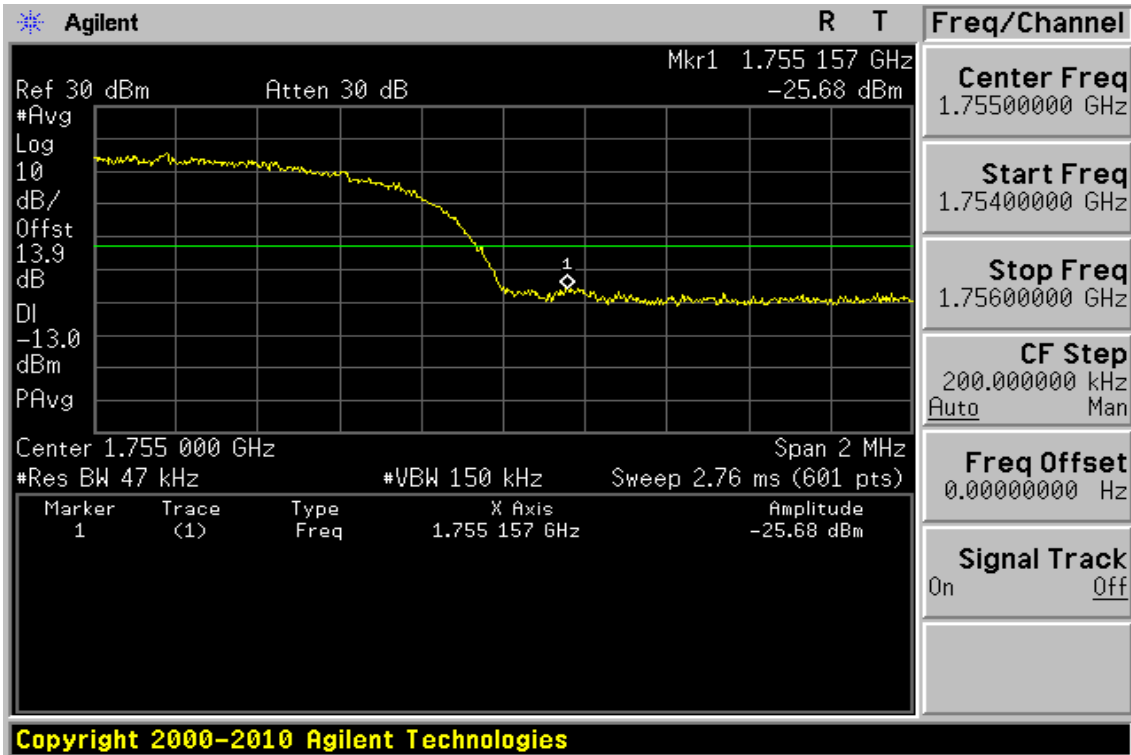

Figure 9-40: Band edge emission at antenna terminals – WCDMA IV Channel Highest



Unless otherwise stated the results shown in this test report refer only to the sample(s) tested and such sample(s) are retained for 90 days only.

除非另有說明，此報告結果僅對測試之樣品負責，同時此樣品僅保留90天。本報告未經本公司書面許可，不可部份複製。

This document is issued by the Company subject to its General Conditions of Service printed overleaf, available on request or accessible at www.sgs.com/terms_and_conditions.htm and, for electronic format documents, subject to Terms and Conditions for Electronic Documents at www.sgs.com/terms_e-document.htm. Attention is drawn to the limitation of liability, indemnification and jurisdiction issues defined therein. Any holder of this document is advised that information contained hereon reflects the Company's findings at the time of its intervention only and within the limits of Client's instructions, if any. The Company's sole responsibility is to its Client and this document does not exonerate parties to a transaction from exercising all their rights and obligations under the transaction documents. This document cannot be reproduced except in full, without prior written approval of the Company. Any unauthorized alteration, forgery or falsification of the content or appearance of this document is unlawful and offenders may be prosecuted to the fullest extent of the law.

Band edge emission at antenna terminals – WCDMA IV Low & High

Test Mode WCDMA IV Engineer :Nick

Freq. MHz	Reading dBm	Limit dBm	Safe Margin dB
1709.997	-24.96	-13.00	11.96
1755.157	-25.68	-13.00	12.68

Unless otherwise stated the results shown in this test report refer only to the sample(s) tested and such sample(s) are retained for 90 days only.

除非另有說明，此報告結果僅對測試之樣品負責，同時此樣品僅保留90天。本報告未經本公司書面許可，不可部份複製。

This document is issued by the Company subject to its General Conditions of Service printed overleaf, available on request or accessible at www.sgs.com/terms_and_conditions.htm and, for electronic format documents, subject to Terms and Conditions for Electronic Documents at www.sgs.com/terms_e-document.htm. Attention is drawn to the limitation of liability, indemnification and jurisdiction issues defined therein. Any holder of this document is advised that information contained hereon reflects the Company's findings at the time of its intervention only and within the limits of Client's instructions, if any. The Company's sole responsibility is to its Client and this document does not exonerate parties to a transaction from exercising all their rights and obligations under the transaction documents. This document cannot be reproduced except in full, without prior written approval of the Company. Any unauthorized alteration, forgery or falsification of the content or appearance of this document is unlawful and offenders may be prosecuted to the fullest extent of the law.

Figure 9-41: Out of Band emission at antenna terminals – WCDMA V Channel Lowest

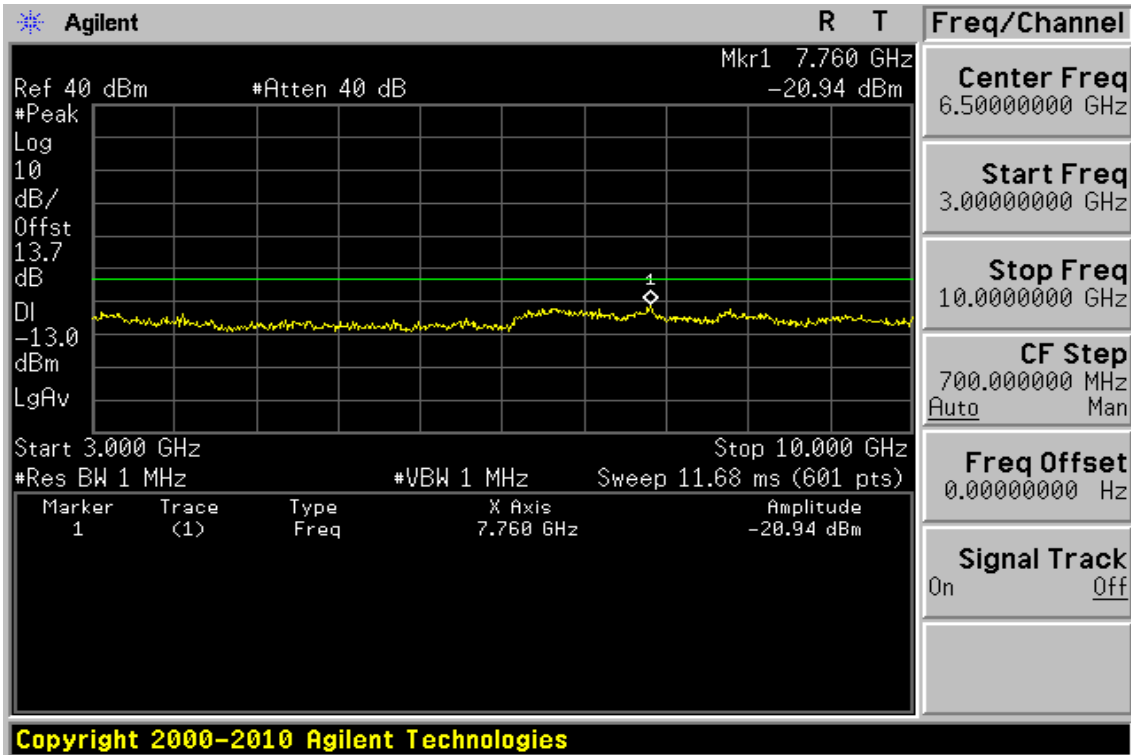
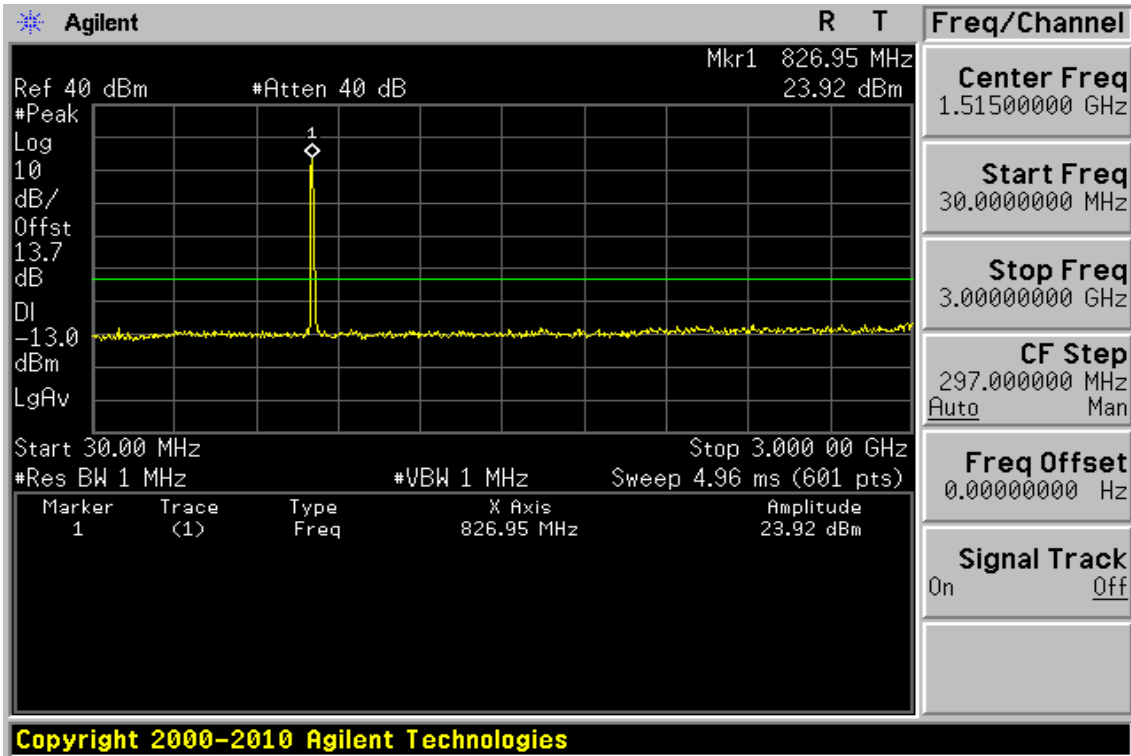

Unless otherwise stated the results shown in this test report refer only to the sample(s) tested and such sample(s) are retained for 90 days only.

除非另有說明，此報告結果僅對測試之樣品負責，同時此樣品僅保留90天。本報告未經本公司書面許可，不可部份複製。

This document is issued by the Company subject to its General Conditions of Service printed overleaf, available on request or accessible at www.sgs.com/terms_and_conditions.htm and, for electronic format documents, subject to Terms and Conditions for Electronic Documents at www.sgs.com/terms_e-document.htm. Attention is drawn to the limitation of liability, indemnification and jurisdiction issues defined therein. Any holder of this document is advised that information contained hereon reflects the Company's findings at the time of its intervention only and within the limits of Client's instructions, if any. The Company's sole responsibility is to its Client and this document does not exonerate parties to a transaction from exercising all their rights and obligations under the transaction documents. This document cannot be reproduced except in full, without prior written approval of the Company. Any unauthorized alteration, forgery or falsification of the content or appearance of this document is unlawful and offenders may be prosecuted to the fullest extent of the law.

Figure 9-42: Out of Band emission at antenna terminals – WCDMA V Channel Mid

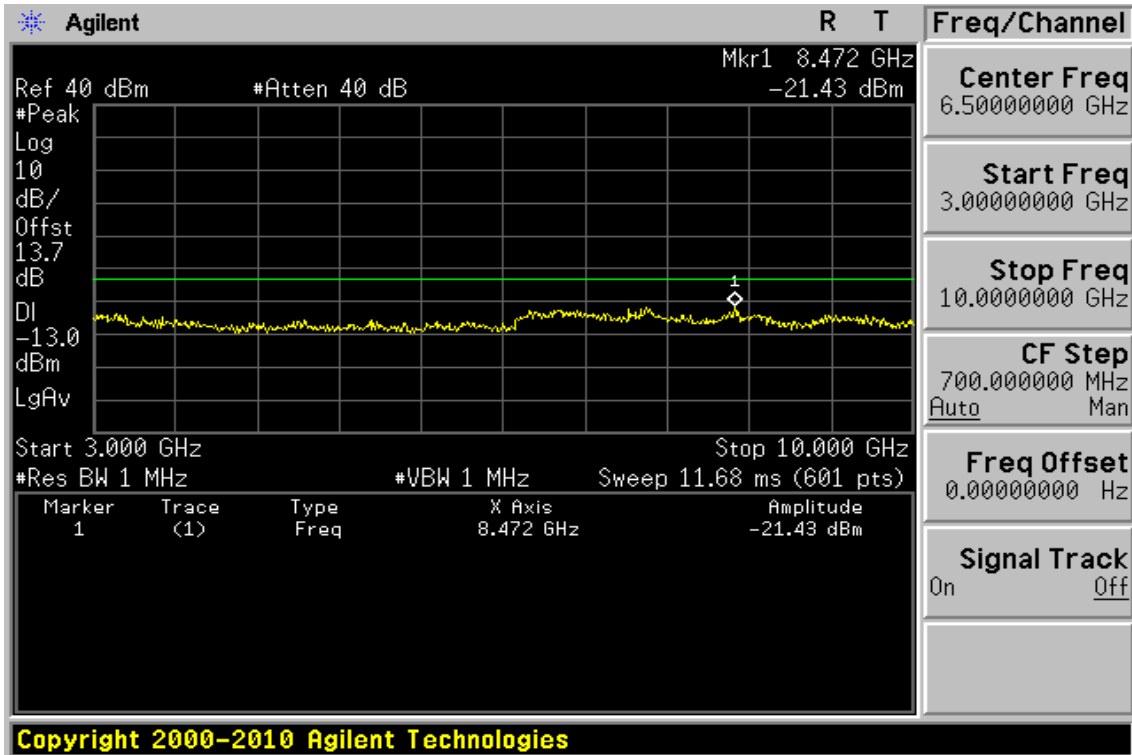
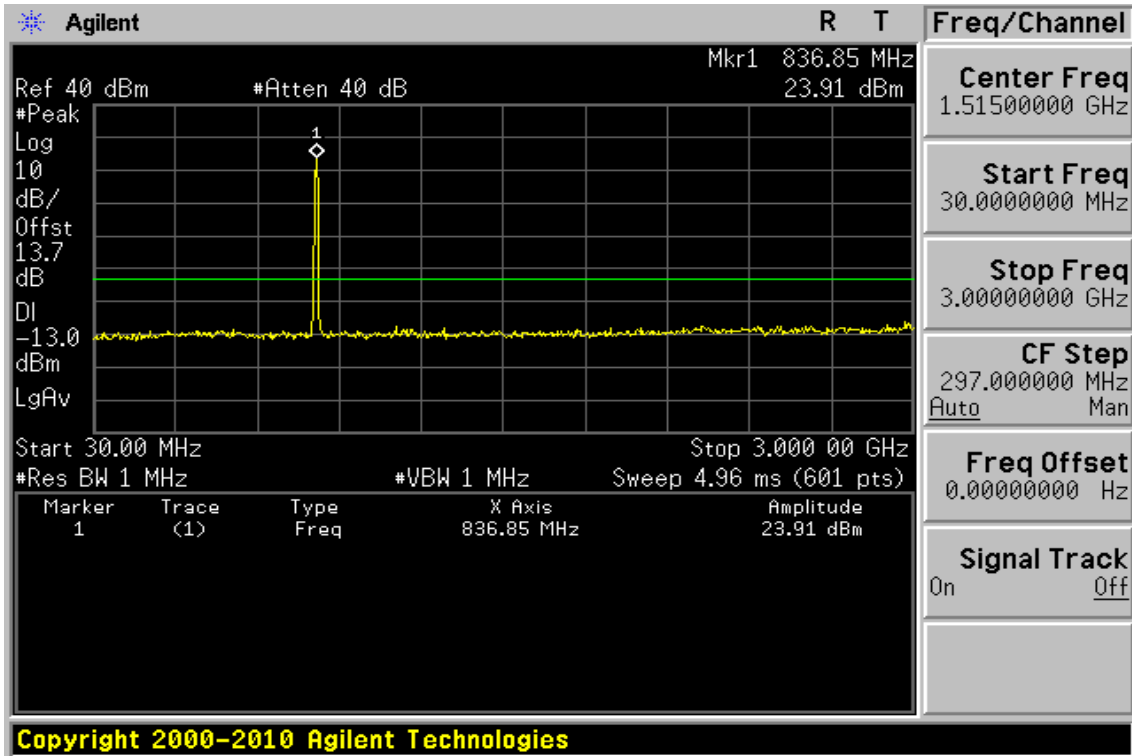

Unless otherwise stated the results shown in this test report refer only to the sample(s) tested and such sample(s) are retained for 90 days only.

除非另有說明，此報告結果僅對測試之樣品負責，同時此樣品僅保留90天。本報告未經本公司書面許可，不可部份複製。

This document is issued by the Company subject to its General Conditions of Service printed overleaf, available on request or accessible at www.sgs.com/terms_and_conditions.htm and, for electronic format documents, subject to Terms and Conditions for Electronic Documents at www.sgs.com/terms_e-document.htm. Attention is drawn to the limitation of liability, indemnification and jurisdiction issues defined therein. Any holder of this document is advised that information contained hereon reflects the Company's findings at the time of its intervention only and within the limits of Client's instructions, if any. The Company's sole responsibility is to its Client and this document does not exonerate parties to a transaction from exercising all their rights and obligations under the transaction documents. This document cannot be reproduced except in full, without prior written approval of the Company. Any unauthorized alteration, forgery or falsification of the content or appearance of this document is unlawful and offenders may be prosecuted to the fullest extent of the law.

Figure 9-43: Out of Band emission at antenna terminals – WCDMA V Channel Highest

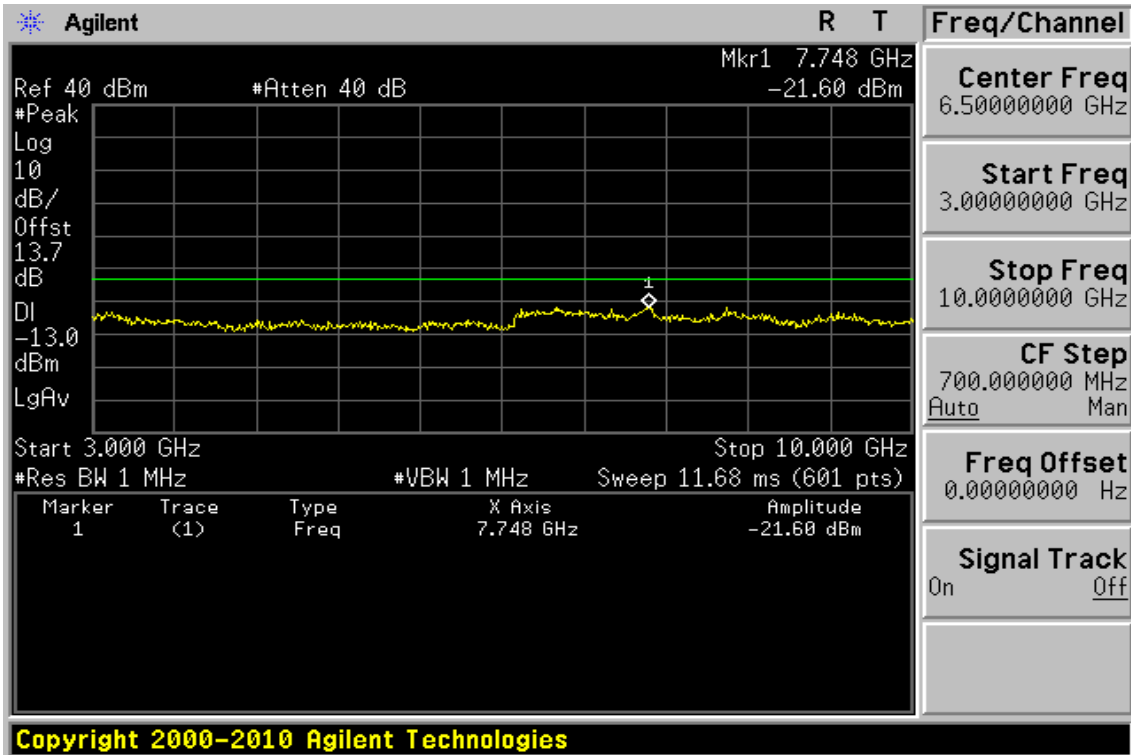
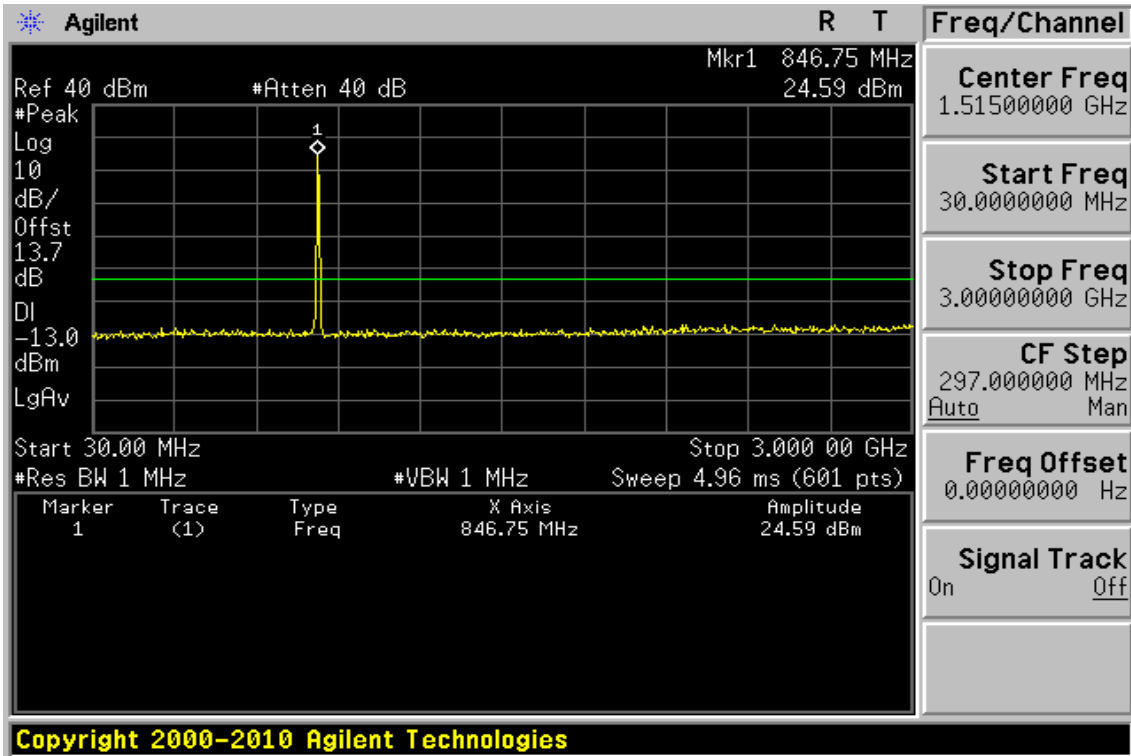

Unless otherwise stated the results shown in this test report refer only to the sample(s) tested and such sample(s) are retained for 90 days only.

除非另有說明，此報告結果僅對測試之樣品負責，同時此樣品僅保留90天。本報告未經本公司書面許可，不可部份複製。

This document is issued by the Company subject to its General Conditions of Service printed overleaf, available on request or accessible at www.sgs.com/terms_and_conditions.htm and, for electronic format documents, subject to Terms and Conditions for Electronic Documents at www.sgs.com/terms_e-document.htm. Attention is drawn to the limitation of liability, indemnification and jurisdiction issues defined therein. Any holder of this document is advised that information contained hereon reflects the Company's findings at the time of its intervention only and within the limits of Client's instructions, if any. The Company's sole responsibility is to its Client and this document does not exonerate parties to a transaction from exercising all their rights and obligations under the transaction documents. This document cannot be reproduced except in full, without prior written approval of the Company. Any unauthorized alteration, forgery or falsification of the content or appearance of this document is unlawful and offenders may be prosecuted to the fullest extent of the law.

Out of Band emission at antenna terminals – WCDMA V

Fundamental Frequency :826.4 MHz Engineer :Nick
Operation Mode :TX Low

Freq. (MHz)	Note F/H/E/S	Reading dBm	Limit dBm	Safe Margin dB
<30	S	---	-13.00	---
30-1000	S	---	-13.00	---
1652.80	H	---	-13.00	---
2479.20	H	---	-13.00	---
3305.60	H	---	-13.00	---
4132.00	H	---	-13.00	---
4958.40	H	---	-13.00	---
5784.80	H	---	-13.00	---
6611.20	H	---	-13.00	---
7437.60	H	---	-13.00	---
7760.00	S	-20.94	-13.00	7.94
8264.00	H	---	-13.00	---

Note : “H” : denotes Harmonic Frequency. “S” : denotes Spurious Frequency.
“---“ : denotes Noise Floor.

Unless otherwise stated the results shown in this test report refer only to the sample(s) tested and such sample(s) are retained for 90 days only.

除非另有說明，此報告結果僅對測試之樣品負責，同時此樣品僅保留90天。本報告未經本公司書面許可，不可部份複製。

This document is issued by the Company subject to its General Conditions of Service printed overleaf, available on request or accessible at www.sgs.com/terms_and_conditions.htm and, for electronic format documents, subject to Terms and Conditions for Electronic Documents at www.sgs.com/terms_e-document.htm. Attention is drawn to the limitation of liability, indemnification and jurisdiction issues defined therein. Any holder of this document is advised that information contained hereon reflects the Company's findings at the time of its intervention only and within the limits of Client's instructions, if any. The Company's sole responsibility is to its Client and this document does not exonerate parties to a transaction from exercising all their rights and obligations under the transaction documents. This document cannot be reproduced except in full, without prior written approval of the Company. Any unauthorized alteration, forgery or falsification of the content or appearance of this document is unlawful and offenders may be prosecuted to the fullest extent of the law.

Fundamental Frequency :836.6 MHz Engineer :Nick
Operation Mode :TX Mid

Freq. (MHz)	Note F/H/E/S	Reading dBm	Limit dBm	Safe Margin dB
<30	S	---	-13.00	---
30-1000	S	---	-13.00	---
1673.20	H	---	-13.00	---
2509.80	H	---	-13.00	---
3346.40	H	---	-13.00	---
4183.00	H	---	-13.00	---
5019.60	H	---	-13.00	---
5856.20	H	---	-13.00	---
6692.80	H	---	-13.00	---
7529.40	H	---	-13.00	---
8366.00	H	---	-13.00	---
8472.00	S	-21.43	-13.00	8.43

Note : "H" : denotes Harmonic Frequency. "S" : denotes Spurious Frequency.
"---" : denotes Noise Floor.

Unless otherwise stated the results shown in this test report refer only to the sample(s) tested and such sample(s) are retained for 90 days only.

除非另有說明，此報告結果僅對測試之樣品負責，同時此樣品僅保留90天。本報告未經本公司書面許可，不可部份複製。

This document is issued by the Company subject to its General Conditions of Service printed overleaf, available on request or accessible at www.sgs.com/terms_and_conditions.htm and, for electronic format documents, subject to Terms and Conditions for Electronic Documents at www.sgs.com/terms_e-document.htm. Attention is drawn to the limitation of liability, indemnification and jurisdiction issues defined therein. Any holder of this document is advised that information contained hereon reflects the Company's findings at the time of its intervention only and within the limits of Client's instructions, if any. The Company's sole responsibility is to its Client and this document does not exonerate parties to a transaction from exercising all their rights and obligations under the transaction documents. This document cannot be reproduced except in full, without prior written approval of the Company. Any unauthorized alteration, forgery or falsification of the content or appearance of this document is unlawful and offenders may be prosecuted to the fullest extent of the law.

Fundamental Frequency :846.6MHz Engineer :Nick
Operation Mode :TX High

Freq. (MHz)	Note F/H/E/S	Reading dBm	Limit dBm	Safe Margin dB
<30	S	---	-13.00	---
30-1000	S	---	-13.00	---
1693.20	H	---	-13.00	---
2539.80	H	---	-13.00	---
3386.40	H	---	-13.00	---
4233.00	H	---	-13.00	---
5079.60	H	---	-13.00	---
5926.20	H	---	-13.00	---
6772.80	H	---	-13.00	---
7619.40	H	---	-13.00	---
7748.00	S	-21.60	-13.00	8.60
8466.00	H	---	-13.00	---

Note : "H" : denotes Harmonic Frequency. "S" : denotes Spurious Frequency.
"---" : denotes Noise Floor.

Unless otherwise stated the results shown in this test report refer only to the sample(s) tested and such sample(s) are retained for 90 days only.

除非另有說明，此報告結果僅對測試之樣品負責，同時此樣品僅保留90天。本報告未經本公司書面許可，不可部份複製。

This document is issued by the Company subject to its General Conditions of Service printed overleaf, available on request or accessible at www.sgs.com/terms_and_conditions.htm and, for electronic format documents, subject to Terms and Conditions for Electronic Documents at www.sgs.com/terms_e-document.htm. Attention is drawn to the limitation of liability, indemnification and jurisdiction issues defined therein. Any holder of this document is advised that information contained hereon reflects the Company's findings at the time of its intervention only and within the limits of Client's instructions, if any. The Company's sole responsibility is to its Client and this document does not exonerate parties to a transaction from exercising all their rights and obligations under the transaction documents. This document cannot be reproduced except in full, without prior written approval of the Company. Any unauthorized alteration, forgery or falsification of the content or appearance of this document is unlawful and offenders may be prosecuted to the fullest extent of the law.

Figure 9-44: Band edge emission at antenna terminals – WCDMA V Channel Lowest

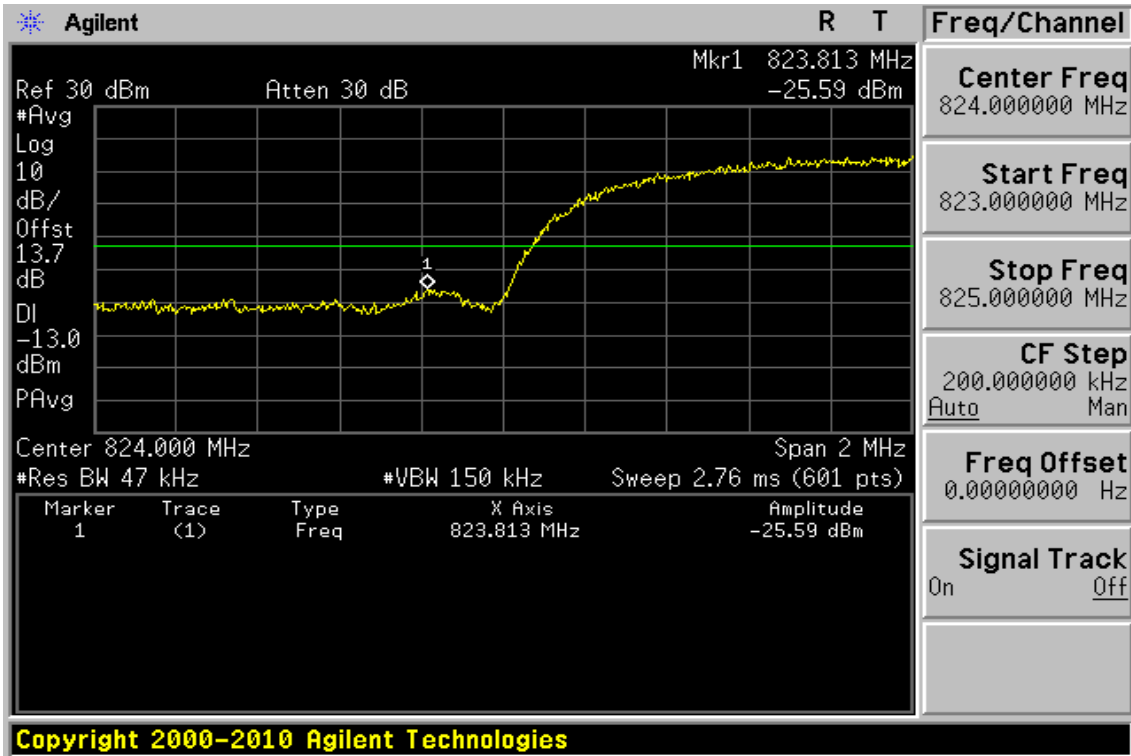
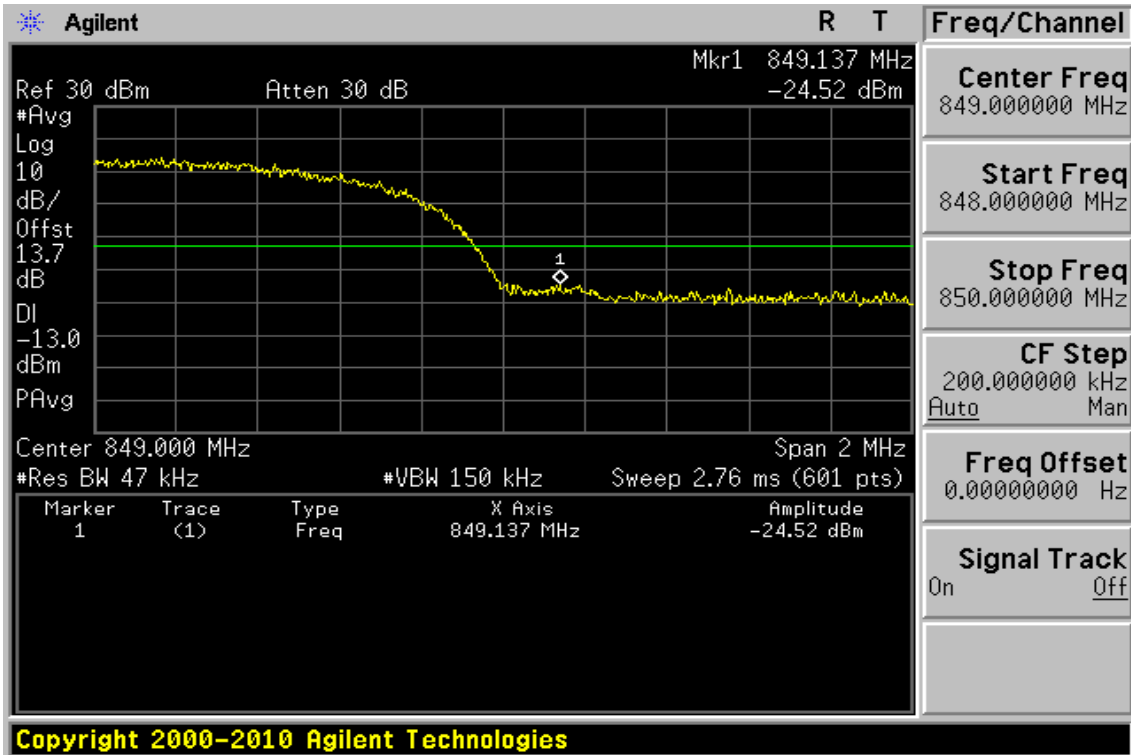

Figure 9-45: Band edge emission at antenna terminals – WCDMA V Channel Highest



Unless otherwise stated the results shown in this test report refer only to the sample(s) tested and such sample(s) are retained for 90 days only.

除非另有說明，此報告結果僅對測試之樣品負責，同時此樣品僅保留90天。本報告未經本公司書面許可，不可部份複製。

This document is issued by the Company subject to its General Conditions of Service printed overleaf, available on request or accessible at www.sgs.com/terms_and_conditions.htm and, for electronic format documents, subject to Terms and Conditions for Electronic Documents at www.sgs.com/terms_e-document.htm. Attention is drawn to the limitation of liability, indemnification and jurisdiction issues defined therein. Any holder of this document is advised that information contained hereon reflects the Company's findings at the time of its intervention only and within the limits of Client's instructions, if any. The Company's sole responsibility is to its Client and this document does not exonerate parties to a transaction from exercising all their rights and obligations under the transaction documents. This document cannot be reproduced except in full, without prior written approval of the Company. Any unauthorized alteration, forgery or falsification of the content or appearance of this document is unlawful and offenders may be prosecuted to the fullest extent of the law.

Band edge emission at antenna terminals – WCDMA V Low & High

Test Mode WCDMA V Engineer :Nick

Freq. MHz	Reading dBm	Limit dBm	Safe Margin dB
823.813	-25.59	-13.00	12.59
849.137	-24.52	-13.00	11.52

Unless otherwise stated the results shown in this test report refer only to the sample(s) tested and such sample(s) are retained for 90 days only.

除非另有說明，此報告結果僅對測試之樣品負責，同時此樣品僅保留90天。本報告未經本公司書面許可，不可部份複製。

This document is issued by the Company subject to its General Conditions of Service printed overleaf, available on request or accessible at www.sgs.com/terms_and_conditions.htm and, for electronic format documents, subject to Terms and Conditions for Electronic Documents at www.sgs.com/terms_e-document.htm. Attention is drawn to the limitation of liability, indemnification and jurisdiction issues defined therein. Any holder of this document is advised that information contained hereon reflects the Company's findings at the time of its intervention only and within the limits of Client's instructions, if any. The Company's sole responsibility is to its Client and this document does not exonerate parties to a transaction from exercising all their rights and obligations under the transaction documents. This document cannot be reproduced except in full, without prior written approval of the Company. Any unauthorized alteration, forgery or falsification of the content or appearance of this document is unlawful and offenders may be prosecuted to the fullest extent of the law.

Figure 9-46: Out of Band emission at antenna terminals – HSDPA II Channel Lowest

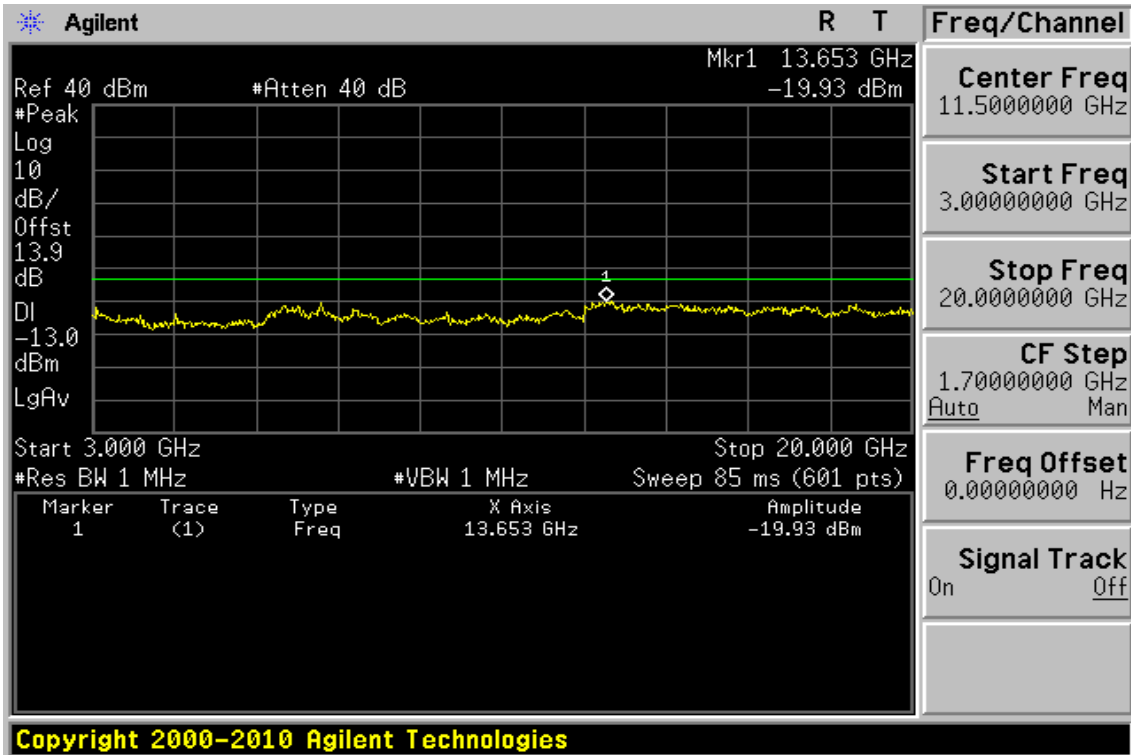
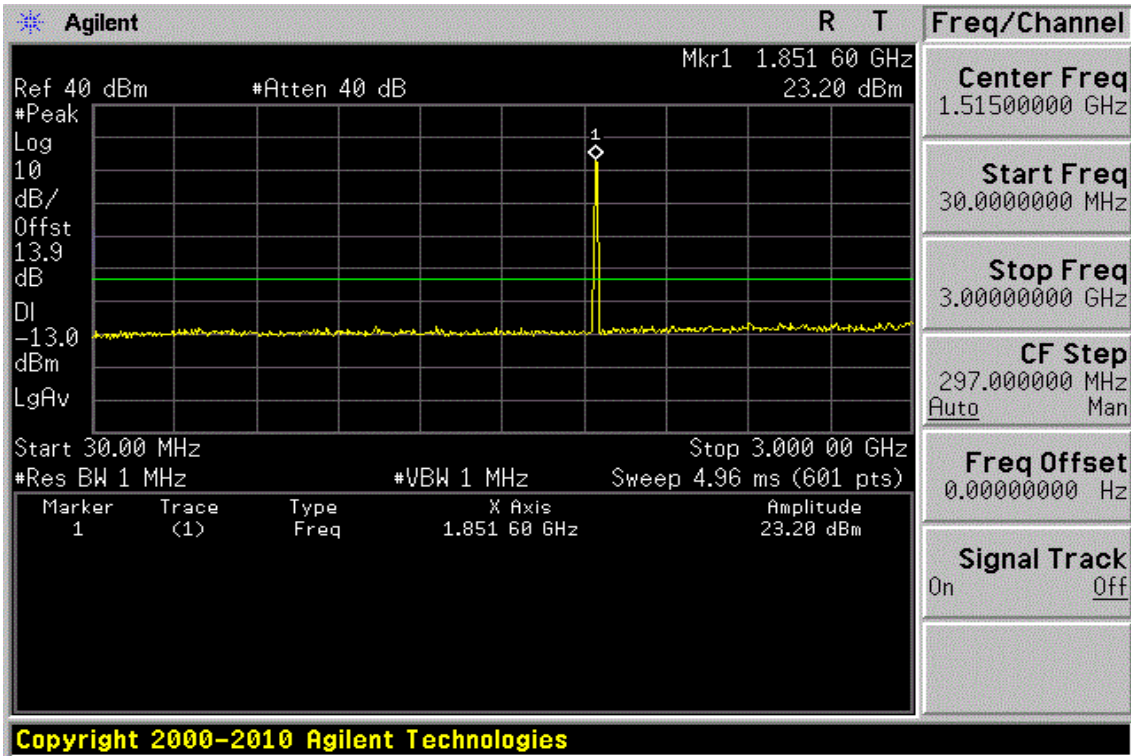

Unless otherwise stated the results shown in this test report refer only to the sample(s) tested and such sample(s) are retained for 90 days only.

除非另有說明，此報告結果僅對測試之樣品負責，同時此樣品僅保留90天。本報告未經本公司書面許可，不可部份複製。

This document is issued by the Company subject to its General Conditions of Service printed overleaf, available on request or accessible at www.sgs.com/terms_and_conditions.htm and, for electronic format documents, subject to Terms and Conditions for Electronic Documents at www.sgs.com/terms_e-document.htm. Attention is drawn to the limitation of liability, indemnification and jurisdiction issues defined therein. Any holder of this document is advised that information contained hereon reflects the Company's findings at the time of its intervention only and within the limits of Client's instructions, if any. The Company's sole responsibility is to its Client and this document does not exonerate parties to a transaction from exercising all their rights and obligations under the transaction documents. This document cannot be reproduced except in full, without prior written approval of the Company. Any unauthorized alteration, forgery or falsification of the content or appearance of this document is unlawful and offenders may be prosecuted to the fullest extent of the law.

Figure 9-47: Out of Band emission at antenna terminals – HSDPA II Channel Mid

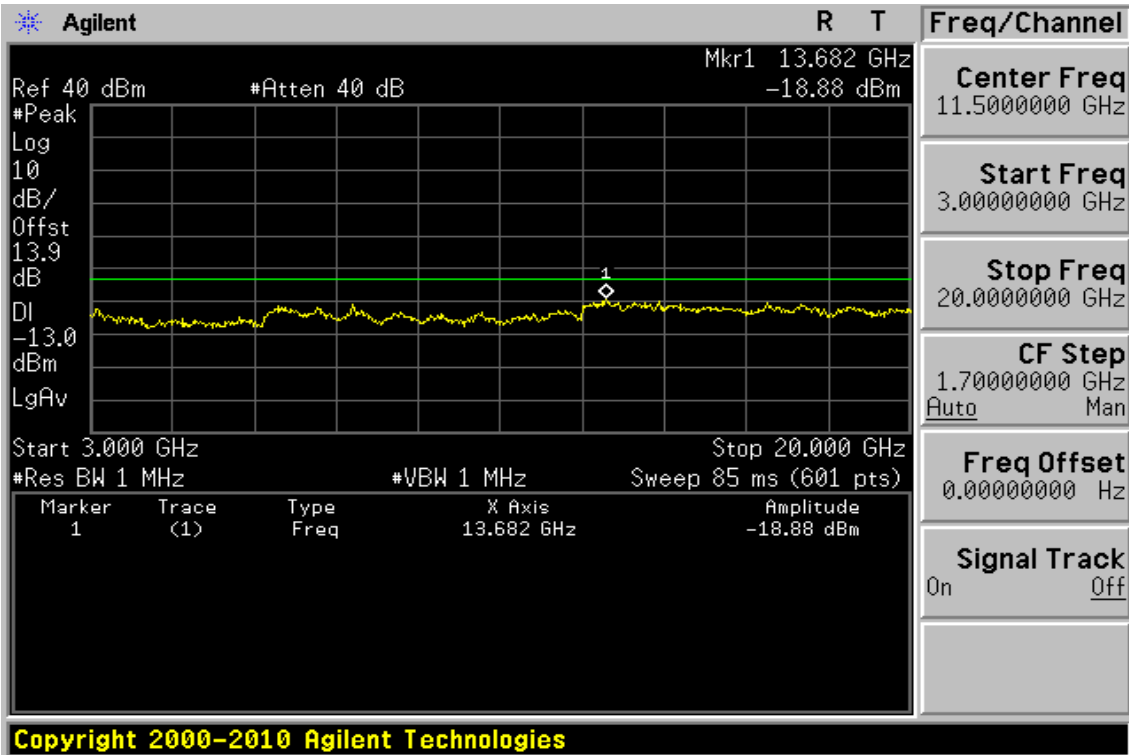
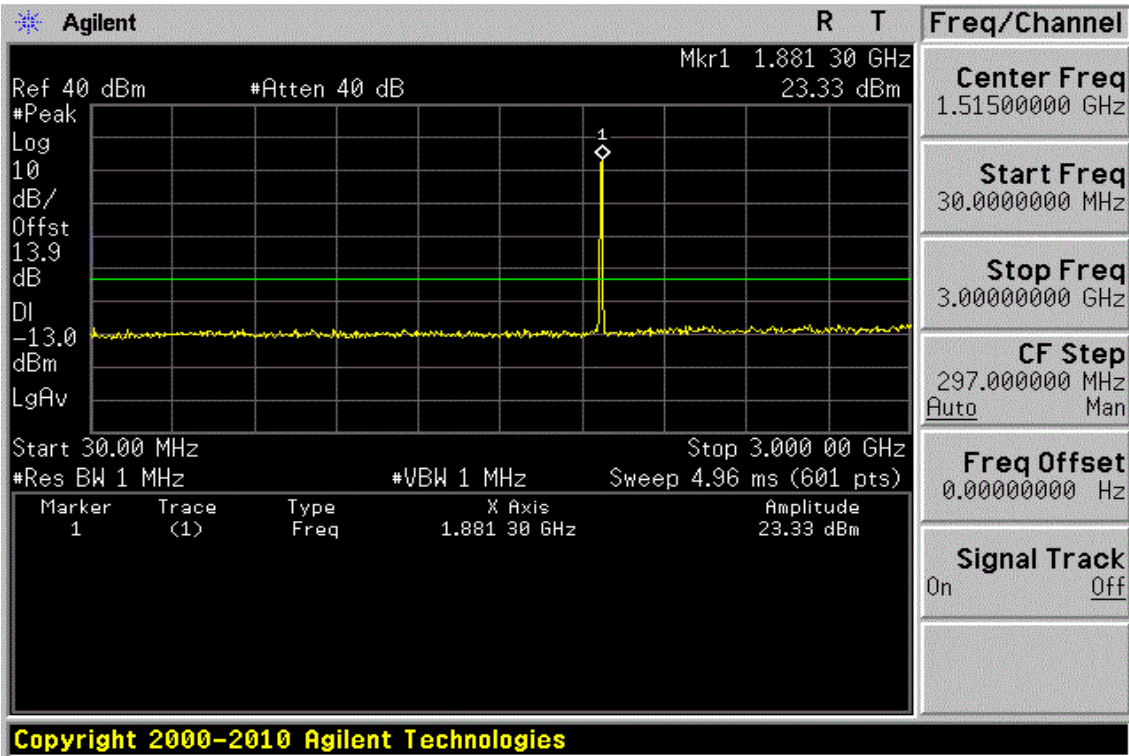

Unless otherwise stated the results shown in this test report refer only to the sample(s) tested and such sample(s) are retained for 90 days only.

除非另有說明，此報告結果僅對測試之樣品負責，同時此樣品僅保留90天。本報告未經本公司書面許可，不可部份複製。

This document is issued by the Company subject to its General Conditions of Service printed overleaf, available on request or accessible at www.sgs.com/terms_and_conditions.htm and, for electronic format documents, subject to Terms and Conditions for Electronic Documents at www.sgs.com/terms_e-document.htm. Attention is drawn to the limitation of liability, indemnification and jurisdiction issues defined therein. Any holder of this document is advised that information contained hereon reflects the Company's findings at the time of its intervention only and within the limits of Client's instructions, if any. The Company's sole responsibility is to its Client and this document does not exonerate parties to a transaction from exercising all their rights and obligations under the transaction documents. This document cannot be reproduced except in full, without prior written approval of the Company. Any unauthorized alteration, forgery or falsification of the content or appearance of this document is unlawful and offenders may be prosecuted to the fullest extent of the law.

Figure 9-48: Out of Band emission at antenna terminals – HSDPA II Channel Highest

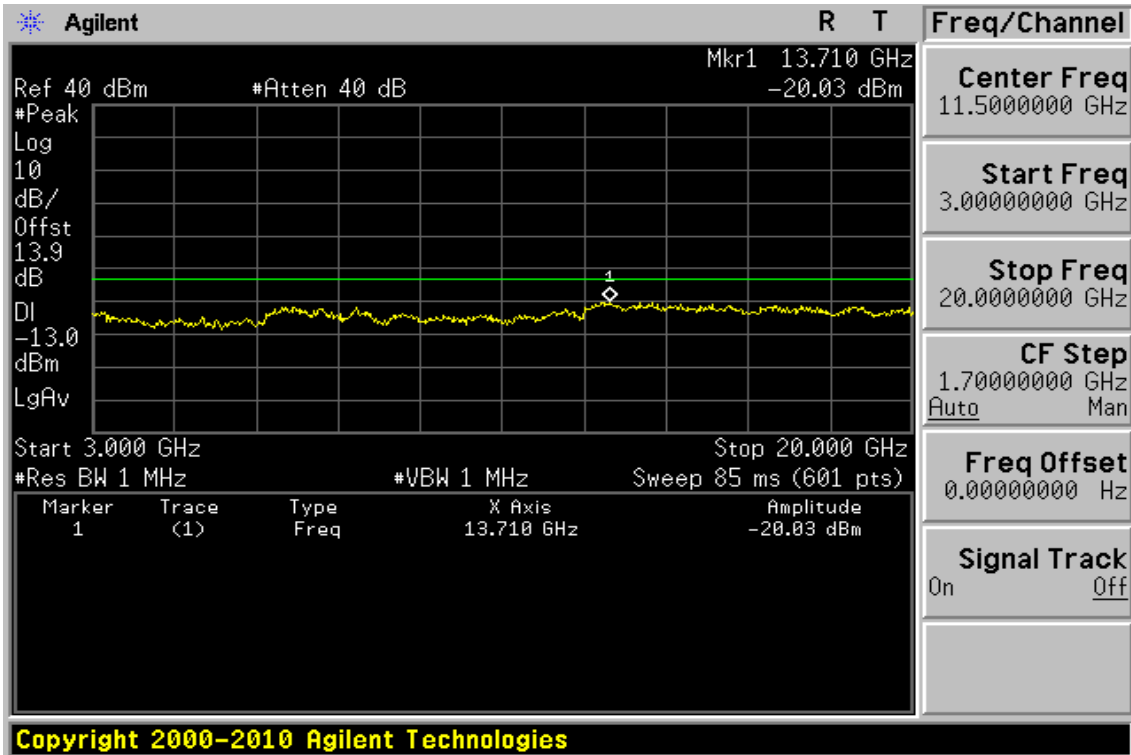
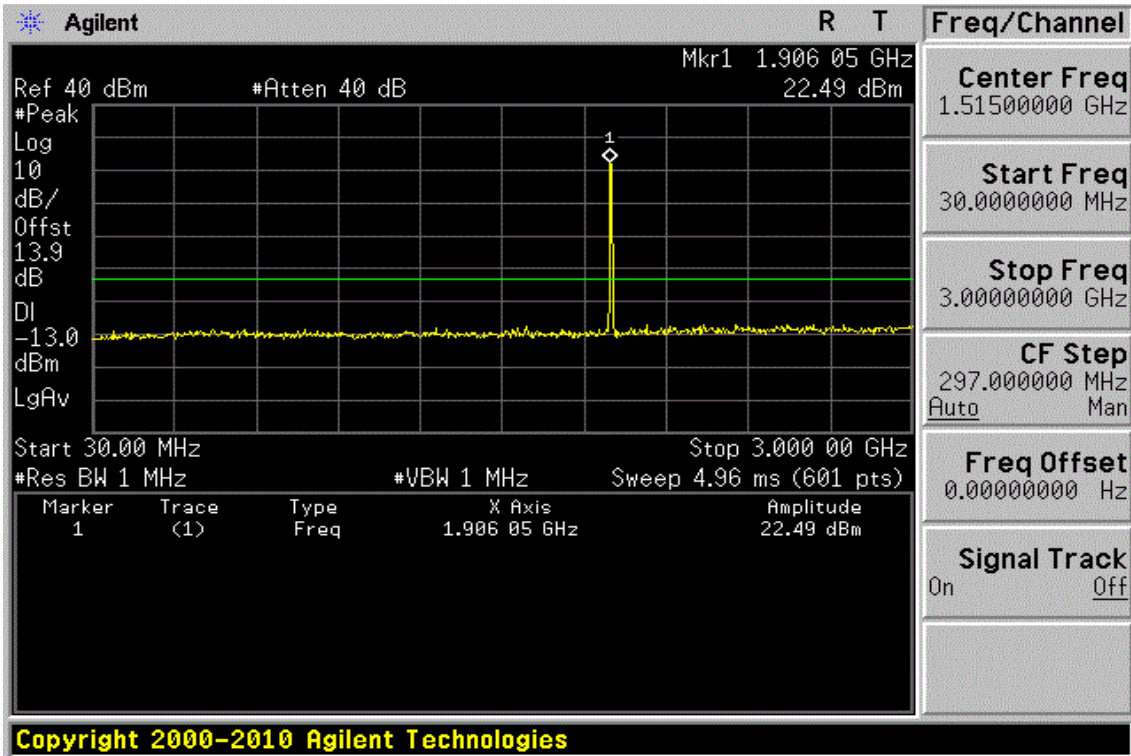

Unless otherwise stated the results shown in this test report refer only to the sample(s) tested and such sample(s) are retained for 90 days only.

除非另有說明，此報告結果僅對測試之樣品負責，同時此樣品僅保留90天。本報告未經本公司書面許可，不可部份複製。

This document is issued by the Company subject to its General Conditions of Service printed overleaf, available on request or accessible at www.sgs.com/terms_and_conditions.htm and, for electronic format documents, subject to Terms and Conditions for Electronic Documents at www.sgs.com/terms_e-document.htm. Attention is drawn to the limitation of liability, indemnification and jurisdiction issues defined therein. Any holder of this document is advised that information contained hereon reflects the Company's findings at the time of its intervention only and within the limits of Client's instructions, if any. The Company's sole responsibility is to its Client and this document does not exonerate parties to a transaction from exercising all their rights and obligations under the transaction documents. This document cannot be reproduced except in full, without prior written approval of the Company. Any unauthorized alteration, forgery or falsification of the content or appearance of this document is unlawful and offenders may be prosecuted to the fullest extent of the law.

Out of Band emission at antenna terminals – HSDPA II

Fundamental Frequency :1852.4 MHz Engineer :Nick
Operation Mode :TX Low

Freq. (MHz)	Note F/H/E/S	Reading dBm	Limit dBm	Safe Margin dB
<30	S	---	-13.00	---
30-1000	S	---	-13.00	---
3704.80	H	---	-13.00	---
5557.20	H	---	-13.00	---
7409.60	H	---	-13.00	---
9262.00	H	---	-13.00	---
11114.40	H	---	-13.00	---
12966.80	H	---	-13.00	---
13653.00	S	-19.93	-13.00	6.93
14819.20	H	---	-13.00	---
16671.60	H	---	-13.00	---
18524.00	H	---	-13.00	---

Note : “H” : denotes Harmonic Frequency. “S” : denotes Spurious Frequency.
“---“ : denotes Noise Floor.

Unless otherwise stated the results shown in this test report refer only to the sample(s) tested and such sample(s) are retained for 90 days only.

除非另有說明，此報告結果僅對測試之樣品負責，同時此樣品僅保留90天。本報告未經本公司書面許可，不可部份複製。

This document is issued by the Company subject to its General Conditions of Service printed overleaf, available on request or accessible at www.sgs.com/terms_and_conditions.htm and, for electronic format documents, subject to Terms and Conditions for Electronic Documents at www.sgs.com/terms_e-document.htm. Attention is drawn to the limitation of liability, indemnification and jurisdiction issues defined therein. Any holder of this document is advised that information contained hereon reflects the Company's findings at the time of its intervention only and within the limits of Client's instructions, if any. The Company's sole responsibility is to its Client and this document does not exonerate parties to a transaction from exercising all their rights and obligations under the transaction documents. This document cannot be reproduced except in full, without prior written approval of the Company. Any unauthorized alteration, forgery or falsification of the content or appearance of this document is unlawful and offenders may be prosecuted to the fullest extent of the law.

Fundamental Frequency :1907.6MHz Engineer :Nick
Operation Mode :TX High

Freq. (MHz)	Note F/H/E/S	Reading dBm	Limit dBm	Safe Margin dB
<30	S	---	-13.00	---
30-1000	S	---	-13.00	---
3815.20	H	---	-13.00	---
5722.80	H	---	-13.00	---
7630.40	H	---	-13.00	---
9538.00	H	---	-13.00	---
11445.60	H	---	-13.00	---
13353.20	H	---	-13.00	---
13710.00	S	-20.03	-13.00	7.03
15260.80	H	---	-13.00	---
17168.40	H	---	-13.00	---
19076.00	H	---	-13.00	---

Note : “H” : denotes Harmonic Frequency. “S” : denotes Spurious Frequency.
“---” : denotes Noise Floor.

Unless otherwise stated the results shown in this test report refer only to the sample(s) tested and such sample(s) are retained for 90 days only.

除非另有說明，此報告結果僅對測試之樣品負責，同時此樣品僅保留90天。本報告未經本公司書面許可，不可部份複製。

This document is issued by the Company subject to its General Conditions of Service printed overleaf, available on request or accessible at www.sgs.com/terms_and_conditions.htm and, for electronic format documents, subject to Terms and Conditions for Electronic Documents at www.sgs.com/terms_e-document.htm. Attention is drawn to the limitation of liability, indemnification and jurisdiction issues defined therein. Any holder of this document is advised that information contained hereon reflects the Company's findings at the time of its intervention only and within the limits of Client's instructions, if any. The Company's sole responsibility is to its Client and this document does not exonerate parties to a transaction from exercising all their rights and obligations under the transaction documents. This document cannot be reproduced except in full, without prior written approval of the Company. Any unauthorized alteration, forgery or falsification of the content or appearance of this document is unlawful and offenders may be prosecuted to the fullest extent of the law.

Figure 9-49: Band edge emission at antenna terminals – HSDPA II Channel Lowest

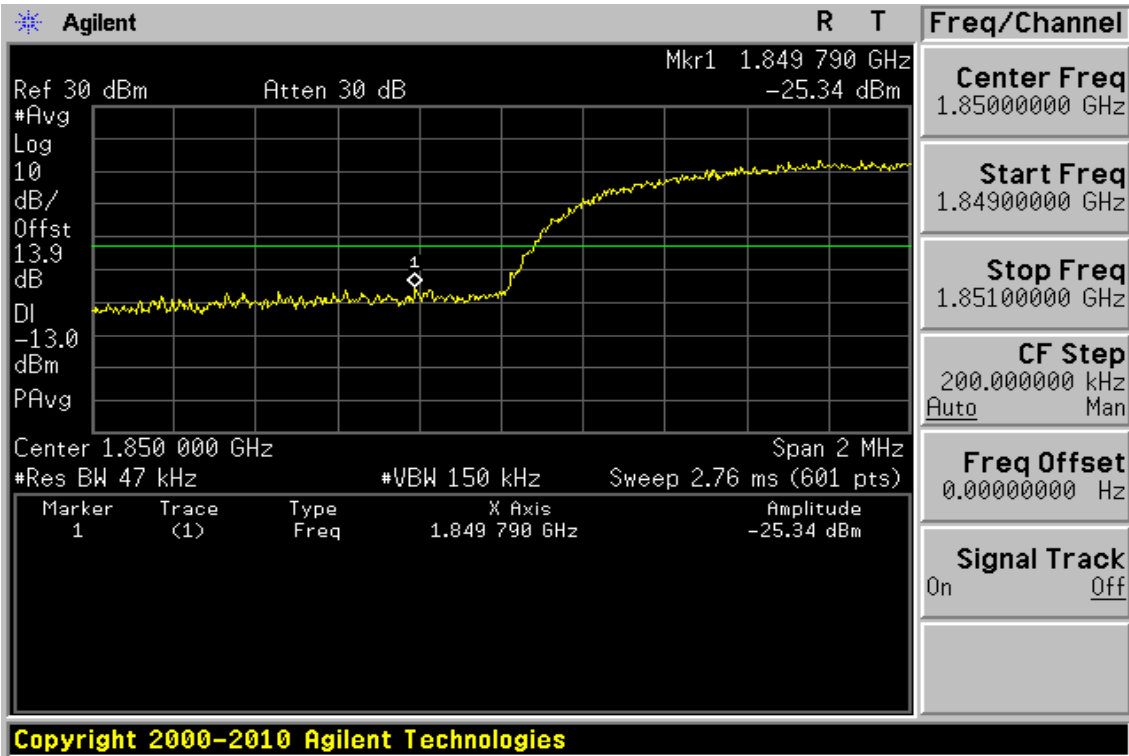
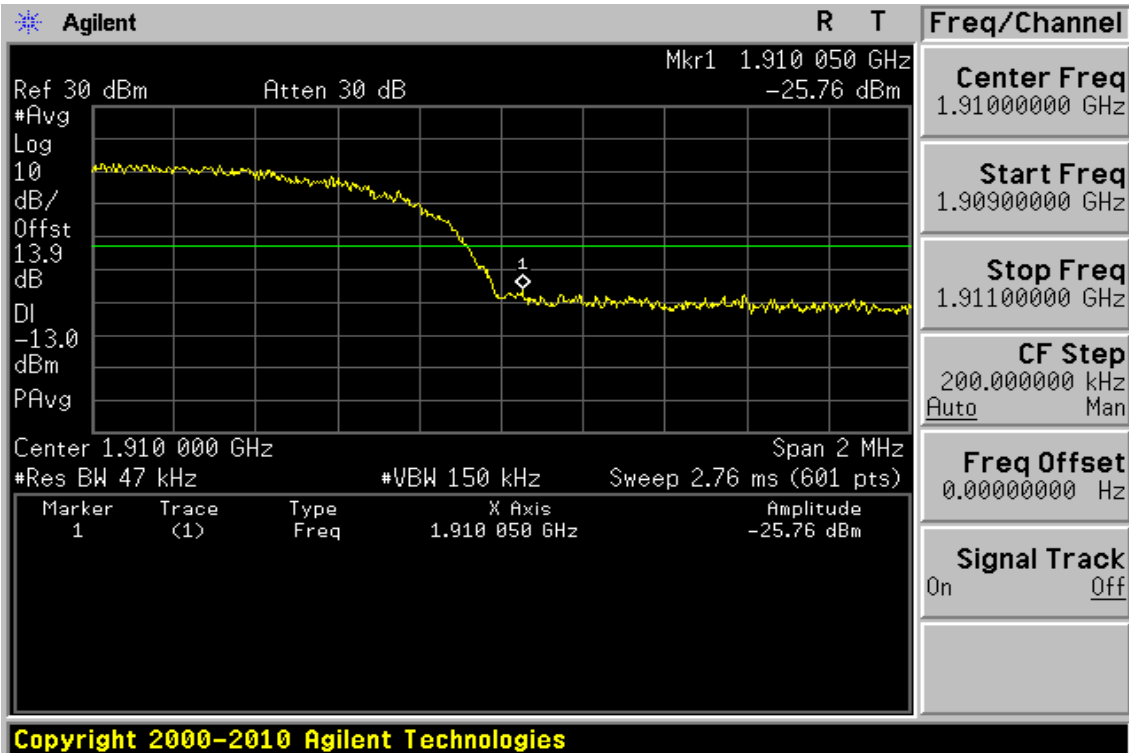

Figure 9-50: Band edge emission at antenna terminals – HSUPA II Channel Highest



Unless otherwise stated the results shown in this test report refer only to the sample(s) tested and such sample(s) are retained for 90 days only.

除非另有說明，此報告結果僅對測試之樣品負責，同時此樣品僅保留90天。本報告未經本公司書面許可，不可部份複製。

This document is issued by the Company subject to its General Conditions of Service printed overleaf, available on request or accessible at www.sgs.com/terms_and_conditions.htm and, for electronic format documents, subject to Terms and Conditions for Electronic Documents at www.sgs.com/terms_e-document.htm. Attention is drawn to the limitation of liability, indemnification and jurisdiction issues defined therein. Any holder of this document is advised that information contained hereon reflects the Company's findings at the time of its intervention only and within the limits of Client's instructions, if any. The Company's sole responsibility is to its Client and this document does not exonerate parties to a transaction from exercising all their rights and obligations under the transaction documents. This document cannot be reproduced except in full, without prior written approval of the Company. Any unauthorized alteration, forgery or falsification of the content or appearance of this document is unlawful and offenders may be prosecuted to the fullest extent of the law.

Band edge emission at antenna terminals – HSDPA II Low & High

Test Mode HSDPA II Engineer :Nick

Freq. MHz	Reading dBm	Limit dBm	Safe Margin dB
1849.790	-25.34	-13.00	12.34
1910.050	-25.76	-13.00	12.76

Unless otherwise stated the results shown in this test report refer only to the sample(s) tested and such sample(s) are retained for 90 days only.

除非另有說明，此報告結果僅對測試之樣品負責，同時此樣品僅保留90天。本報告未經本公司書面許可，不可部份複製。

This document is issued by the Company subject to its General Conditions of Service printed overleaf, available on request or accessible at www.sgs.com/terms_and_conditions.htm and, for electronic format documents, subject to Terms and Conditions for Electronic Documents at www.sgs.com/terms_e-document.htm. Attention is drawn to the limitation of liability, indemnification and jurisdiction issues defined therein. Any holder of this document is advised that information contained hereon reflects the Company's findings at the time of its intervention only and within the limits of Client's instructions, if any. The Company's sole responsibility is to its Client and this document does not exonerate parties to a transaction from exercising all their rights and obligations under the transaction documents. This document cannot be reproduced except in full, without prior written approval of the Company. Any unauthorized alteration, forgery or falsification of the content or appearance of this document is unlawful and offenders may be prosecuted to the fullest extent of the law.

Figure 9-51: Out of Band emission at antenna terminals – HSDPA IV Channel Lowest

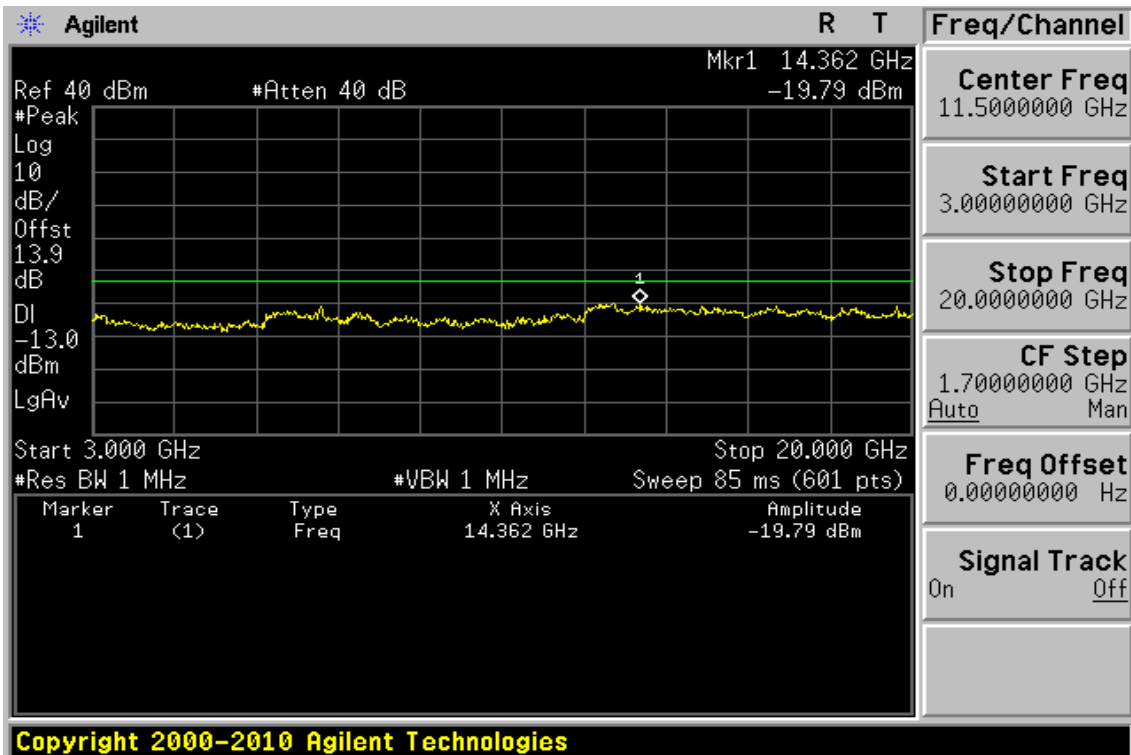
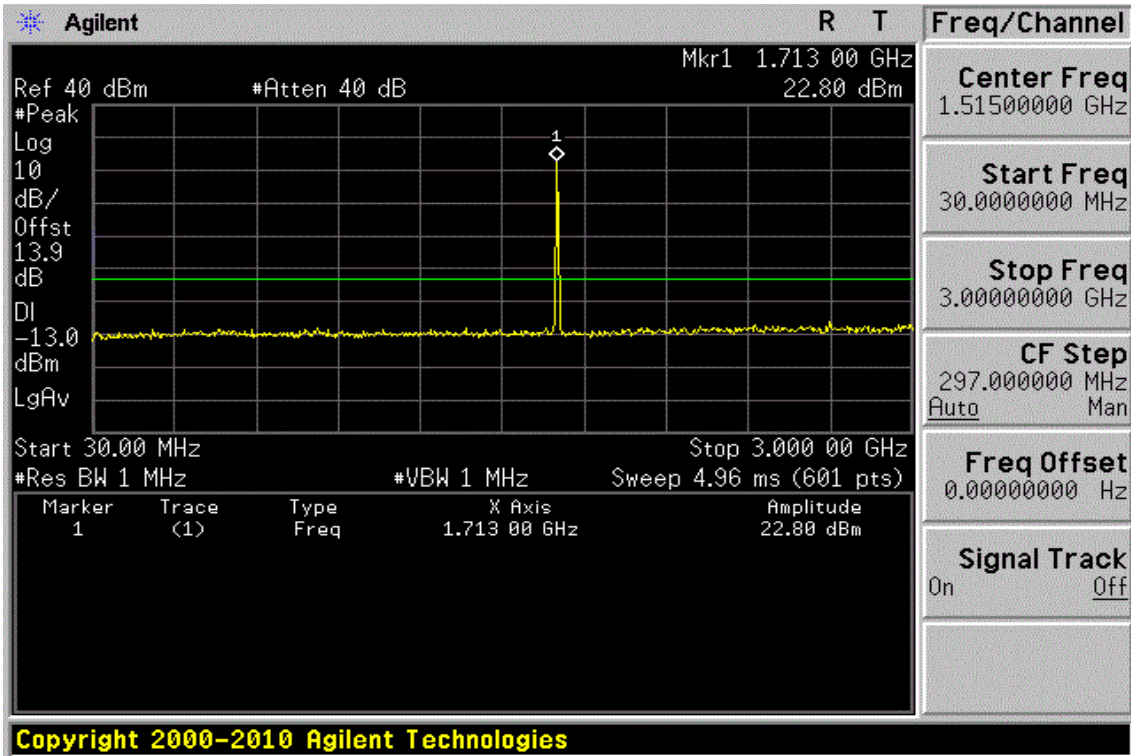

Unless otherwise stated the results shown in this test report refer only to the sample(s) tested and such sample(s) are retained for 90 days only.

除非另有說明，此報告結果僅對測試之樣品負責，同時此樣品僅保留90天。本報告未經本公司書面許可，不可部份複製。

This document is issued by the Company subject to its General Conditions of Service printed overleaf, available on request or accessible at www.sgs.com/terms_and_conditions.htm and, for electronic format documents, subject to Terms and Conditions for Electronic Documents at www.sgs.com/terms_e-document.htm. Attention is drawn to the limitation of liability, indemnification and jurisdiction issues defined therein. Any holder of this document is advised that information contained hereon reflects the Company's findings at the time of its intervention only and within the limits of Client's instructions, if any. The Company's sole responsibility is to its Client and this document does not exonerate parties to a transaction from exercising all their rights and obligations under the transaction documents. This document cannot be reproduced except in full, without prior written approval of the Company. Any unauthorized alteration, forgery or falsification of the content or appearance of this document is unlawful and offenders may be prosecuted to the fullest extent of the law.

Figure 9-52: Out of Band emission at antenna terminals –HSDPA IV Channel Mid

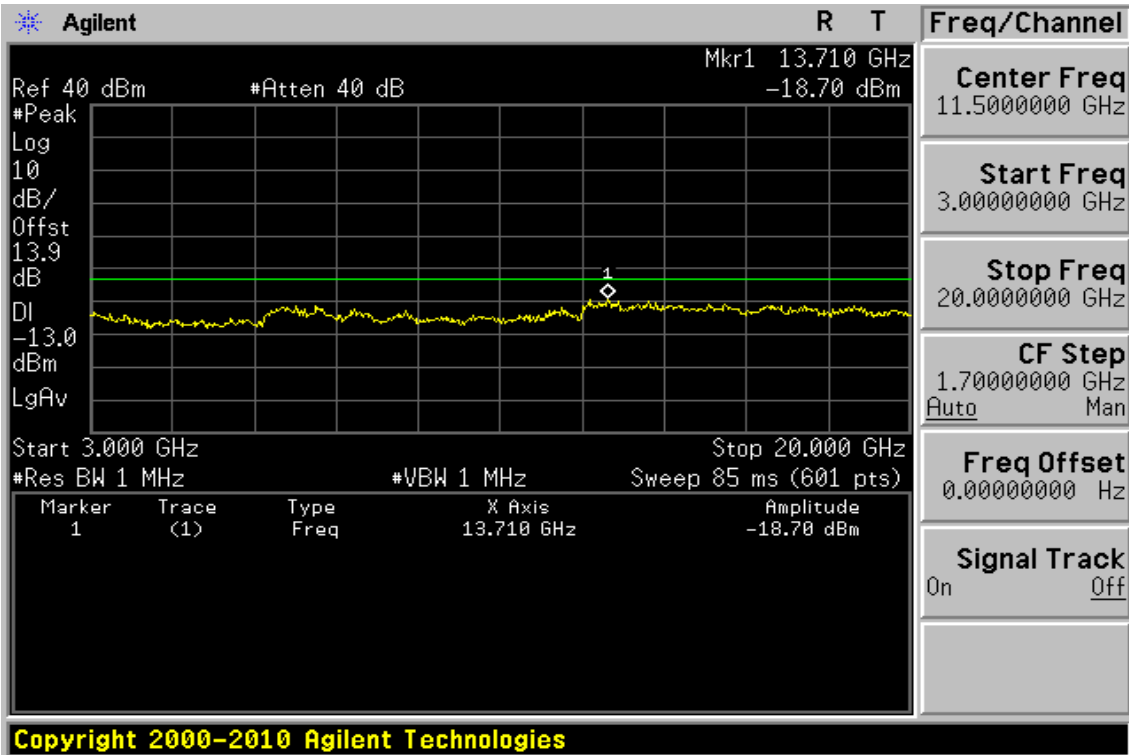
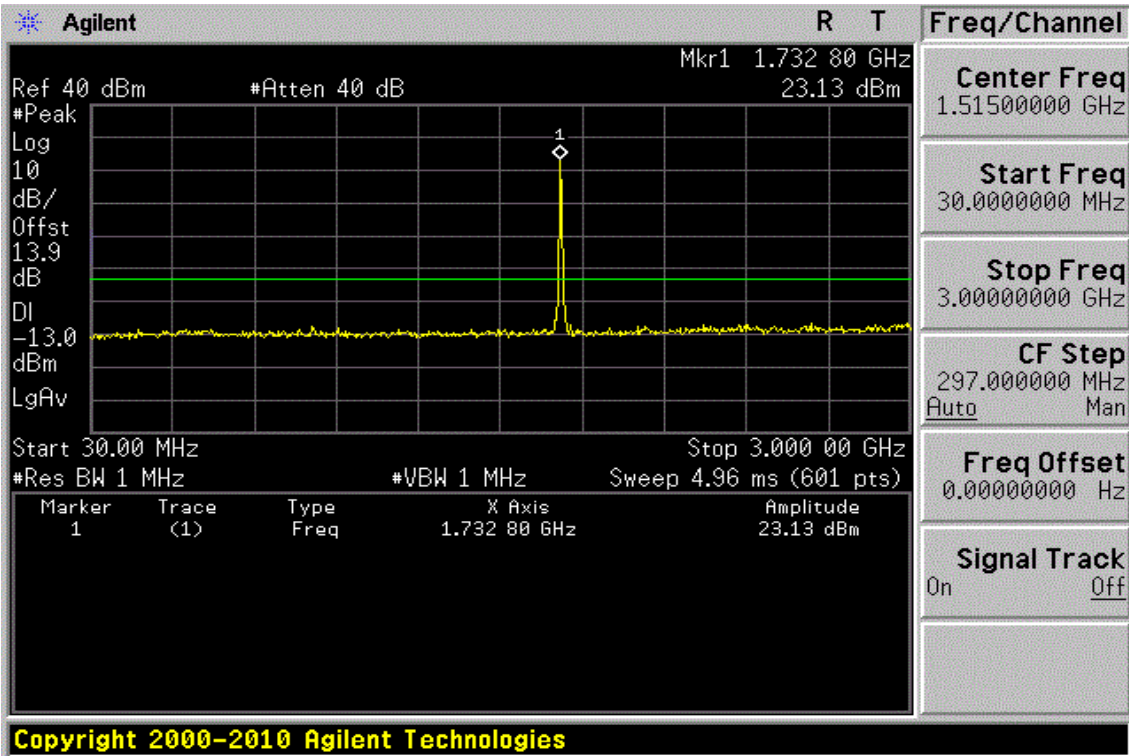

Unless otherwise stated the results shown in this test report refer only to the sample(s) tested and such sample(s) are retained for 90 days only.

除非另有說明，此報告結果僅對測試之樣品負責，同時此樣品僅保留90天。本報告未經本公司書面許可，不可部份複製。

This document is issued by the Company subject to its General Conditions of Service printed overleaf, available on request or accessible at www.sgs.com/terms_and_conditions.htm and, for electronic format documents, subject to Terms and Conditions for Electronic Documents at www.sgs.com/terms_e-document.htm. Attention is drawn to the limitation of liability, indemnification and jurisdiction issues defined therein. Any holder of this document is advised that information contained hereon reflects the Company's findings at the time of its intervention only and within the limits of Client's instructions, if any. The Company's sole responsibility is to its Client and this document does not exonerate parties to a transaction from exercising all their rights and obligations under the transaction documents. This document cannot be reproduced except in full, without prior written approval of the Company. Any unauthorized alteration, forgery or falsification of the content or appearance of this document is unlawful and offenders may be prosecuted to the fullest extent of the law.

Figure 9-53: Out of Band emission at antenna terminals –HSDPA IV Channel Highest

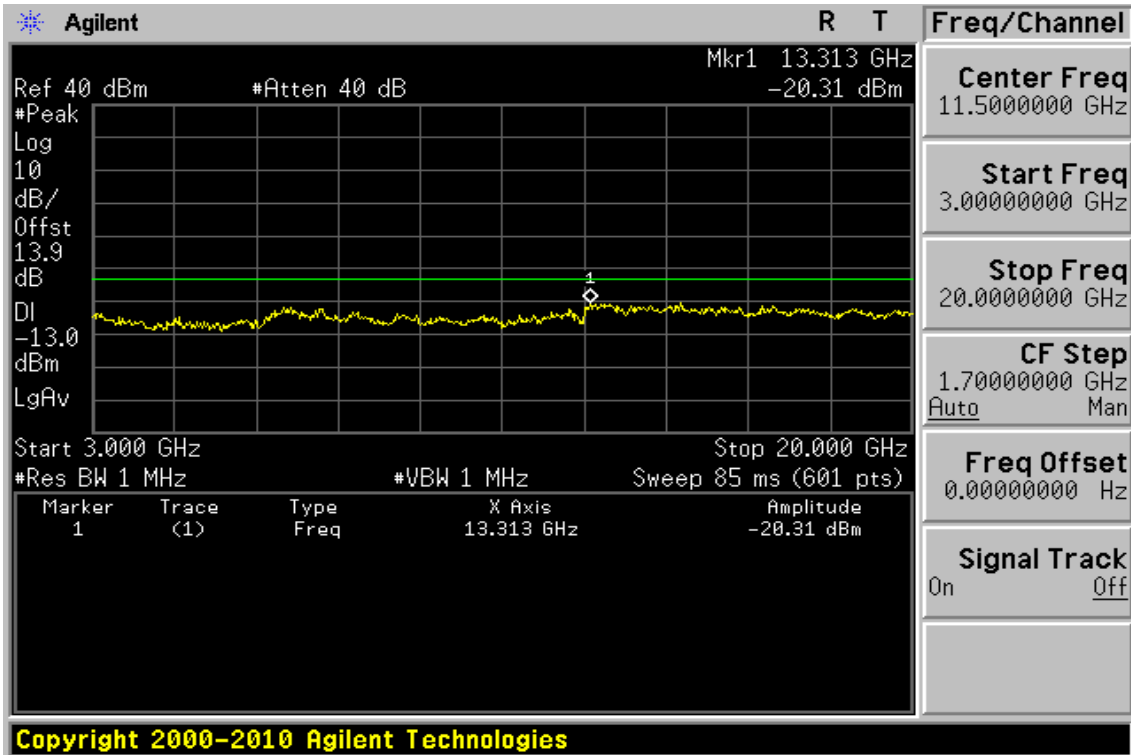
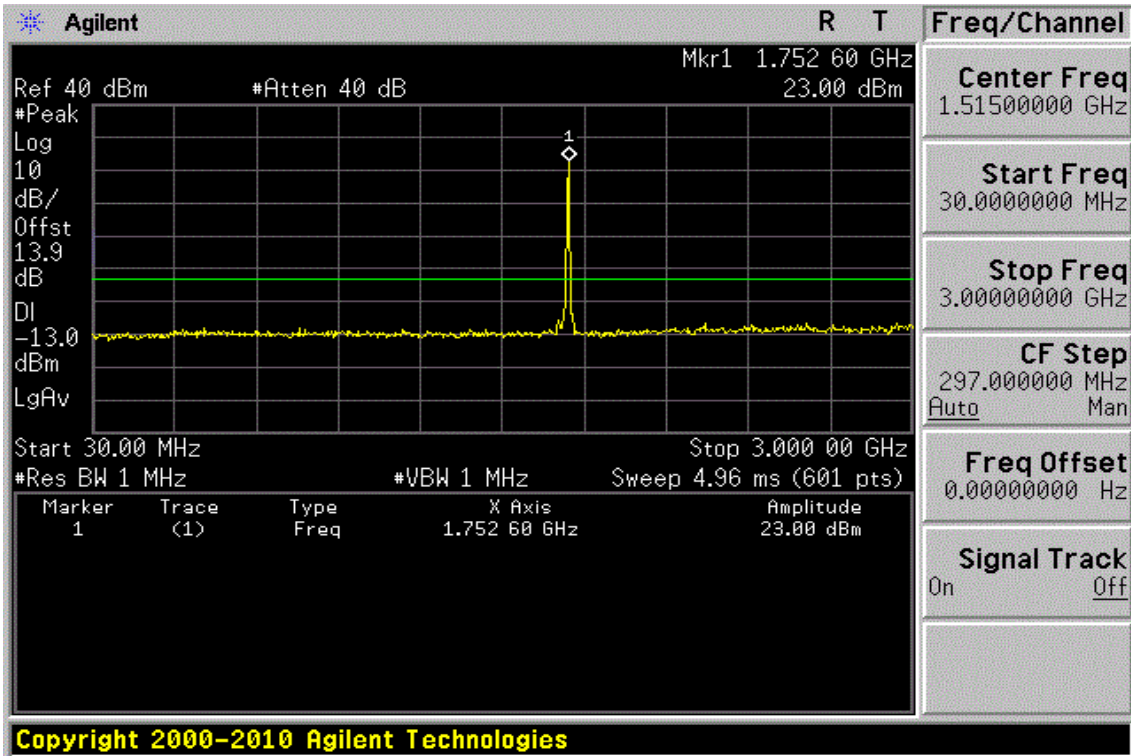

Unless otherwise stated the results shown in this test report refer only to the sample(s) tested and such sample(s) are retained for 90 days only.

除非另有說明，此報告結果僅對測試之樣品負責，同時此樣品僅保留90天。本報告未經本公司書面許可，不可部份複製。

This document is issued by the Company subject to its General Conditions of Service printed overleaf, available on request or accessible at www.sgs.com/terms_and_conditions.htm and, for electronic format documents, subject to Terms and Conditions for Electronic Documents at www.sgs.com/terms_e-document.htm. Attention is drawn to the limitation of liability, indemnification and jurisdiction issues defined therein. Any holder of this document is advised that information contained hereon reflects the Company's findings at the time of its intervention only and within the limits of Client's instructions, if any. The Company's sole responsibility is to its Client and this document does not exonerate parties to a transaction from exercising all their rights and obligations under the transaction documents. This document cannot be reproduced except in full, without prior written approval of the Company. Any unauthorized alteration, forgery or falsification of the content or appearance of this document is unlawful and offenders may be prosecuted to the fullest extent of the law.

Out of Band emission at antenna terminals –HSDPA IV

Fundamental Frequency 1712.4 MHz Engineer :Nick
Operation Mode :TX Low

Freq. (MHz)	Note F/H/E/S	Reading dBm	Limit dBm	Safe Margin dB
<30	S	---	-13.00	---
30-1000	S	---	-13.00	---
3424.80	H	---	-13.00	---
5137.20	H	---	-13.00	---
6849.60	H	---	-13.00	---
8562.00	H	---	-13.00	---
10274.40	H	---	-13.00	---
11986.80	H	---	-13.00	---
13699.20	H	---	-13.00	---
14362.00	S	-19.79	-13.00	6.79
15411.60	H	---	-13.00	---
17124.00	H	---	-13.00	---

Note : “H” : denotes Harmonic Frequency. “S” : denotes Spurious Frequency.
“---“ : denotes Noise Floor.

Unless otherwise stated the results shown in this test report refer only to the sample(s) tested and such sample(s) are retained for 90 days only.

除非另有說明，此報告結果僅對測試之樣品負責，同時此樣品僅保留90天。本報告未經本公司書面許可，不可部份複製。

This document is issued by the Company subject to its General Conditions of Service printed overleaf, available on request or accessible at www.sgs.com/terms_and_conditions.htm and, for electronic format documents, subject to Terms and Conditions for Electronic Documents at www.sgs.com/terms_e-document.htm. Attention is drawn to the limitation of liability, indemnification and jurisdiction issues defined therein. Any holder of this document is advised that information contained hereon reflects the Company's findings at the time of its intervention only and within the limits of Client's instructions, if any. The Company's sole responsibility is to its Client and this document does not exonerate parties to a transaction from exercising all their rights and obligations under the transaction documents. This document cannot be reproduced except in full, without prior written approval of the Company. Any unauthorized alteration, forgery or falsification of the content or appearance of this document is unlawful and offenders may be prosecuted to the fullest extent of the law.

Fundamental Frequency :1732.6 MHz Engineer :Nick
Operation Mode :TX Mid

Freq. (MHz)	Note F/H/E/S	Reading dBm	Limit dBm	Safe Margin dB
<30	S	---	-13.00	---
30-1000	S	---	-13.00	---
3465.20	H	---	-13.00	---
5197.80	H	---	-13.00	---
6930.40	H	---	-13.00	---
8663.00	H	---	-13.00	---
10395.60	H	---	-13.00	---
12128.20	H	---	-13.00	---
13710.00	S	-18.70	-13.00	5.70
13860.80	H	---	-13.00	---
15593.40	H	---	-13.00	---
17326.00	H	---	-13.00	---

Note : “H” : denotes Harmonic Frequency. “S” : denotes Spurious Frequency.
“---” : denotes Noise Floor.

Unless otherwise stated the results shown in this test report refer only to the sample(s) tested and such sample(s) are retained for 90 days only.

除非另有說明，此報告結果僅對測試之樣品負責，同時此樣品僅保留90天。本報告未經本公司書面許可，不可部份複製。

This document is issued by the Company subject to its General Conditions of Service printed overleaf, available on request or accessible at www.sgs.com/terms_and_conditions.htm and, for electronic format documents, subject to Terms and Conditions for Electronic Documents at www.sgs.com/terms_e-document.htm. Attention is drawn to the limitation of liability, indemnification and jurisdiction issues defined therein. Any holder of this document is advised that information contained hereon reflects the Company's findings at the time of its intervention only and within the limits of Client's instructions, if any. The Company's sole responsibility is to its Client and this document does not exonerate parties to a transaction from exercising all their rights and obligations under the transaction documents. This document cannot be reproduced except in full, without prior written approval of the Company. Any unauthorized alteration, forgery or falsification of the content or appearance of this document is unlawful and offenders may be prosecuted to the fullest extent of the law.

Figure 9-54: Band edge emission at antenna terminals –HSDPA IV Channel Lowest

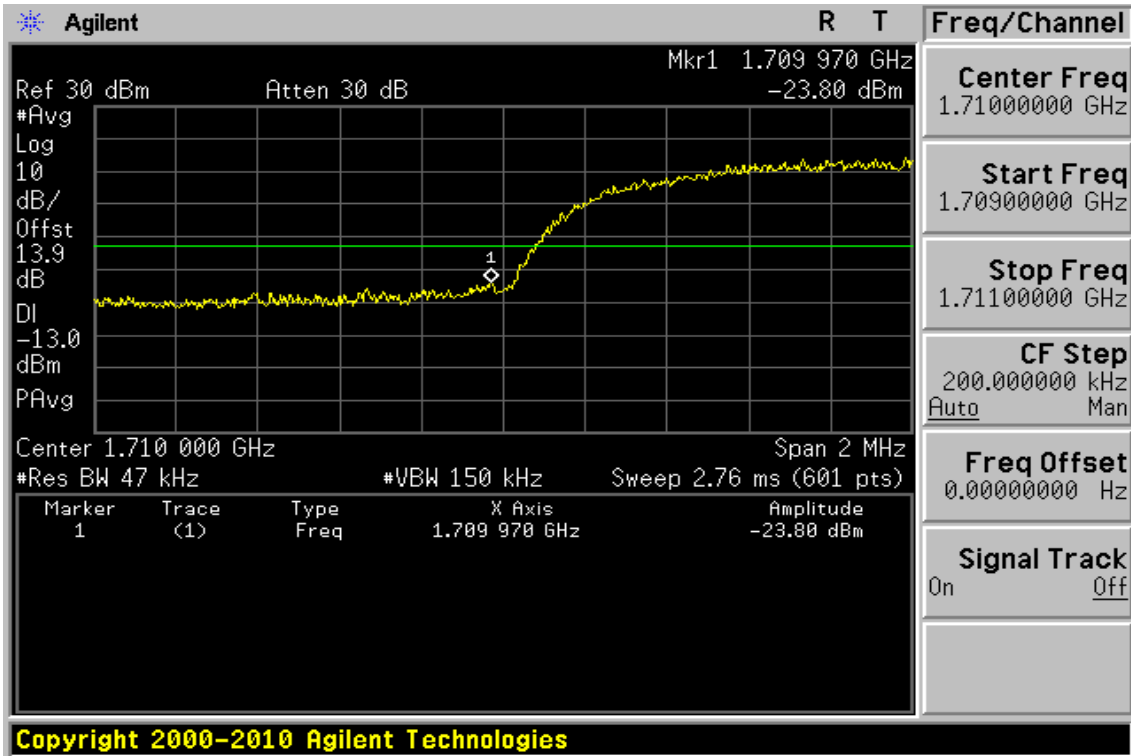
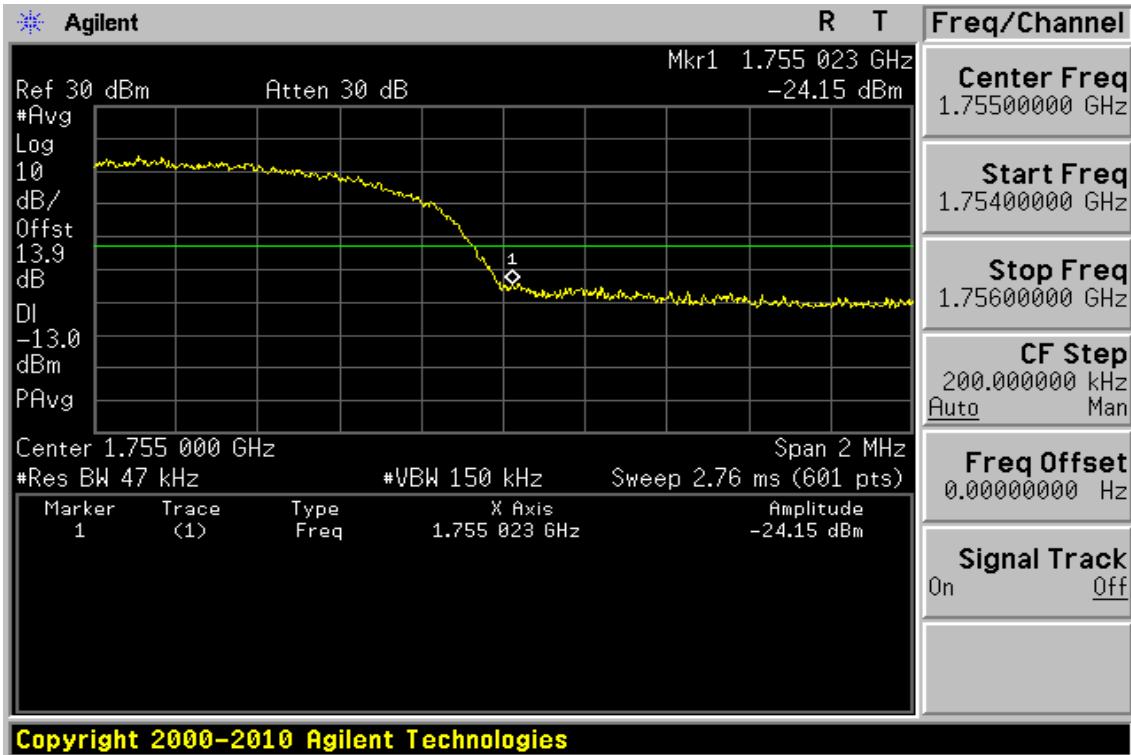

Figure 9-55: Band edge emission at antenna terminals –HSDPA IV Channel Highest



Unless otherwise stated the results shown in this test report refer only to the sample(s) tested and such sample(s) are retained for 90 days only.

除非另有說明，此報告結果僅對測試之樣品負責，同時此樣品僅保留90天。本報告未經本公司書面許可，不可部份複製。

This document is issued by the Company subject to its General Conditions of Service printed overleaf, available on request or accessible at www.sgs.com/terms_and_conditions.htm and, for electronic format documents, subject to Terms and Conditions for Electronic Documents at www.sgs.com/terms_e-document.htm. Attention is drawn to the limitation of liability, indemnification and jurisdiction issues defined therein. Any holder of this document is advised that information contained hereon reflects the Company's findings at the time of its intervention only and within the limits of Client's instructions, if any. The Company's sole responsibility is to its Client and this document does not exonerate parties to a transaction from exercising all their rights and obligations under the transaction documents. This document cannot be reproduced except in full, without prior written approval of the Company. Any unauthorized alteration, forgery or falsification of the content or appearance of this document is unlawful and offenders may be prosecuted to the fullest extent of the law.

Band edge emission at antenna terminals –HSDPA IV Low & High

Test Mode HSDPA IV Engineer :Nick

Freq. MHz	Reading dBm	Limit dBm	Safe Margin dB
1709.970	-23.80	-13.00	10.80
1755.023	-24.15	-13.00	11.15

Unless otherwise stated the results shown in this test report refer only to the sample(s) tested and such sample(s) are retained for 90 days only.

除非另有說明，此報告結果僅對測試之樣品負責，同時此樣品僅保留90天。本報告未經本公司書面許可，不可部份複製。

This document is issued by the Company subject to its General Conditions of Service printed overleaf, available on request or accessible at www.sgs.com/terms_and_conditions.htm and, for electronic format documents, subject to Terms and Conditions for Electronic Documents at www.sgs.com/terms_e-document.htm. Attention is drawn to the limitation of liability, indemnification and jurisdiction issues defined therein. Any holder of this document is advised that information contained hereon reflects the Company's findings at the time of its intervention only and within the limits of Client's instructions, if any. The Company's sole responsibility is to its Client and this document does not exonerate parties to a transaction from exercising all their rights and obligations under the transaction documents. This document cannot be reproduced except in full, without prior written approval of the Company. Any unauthorized alteration, forgery or falsification of the content or appearance of this document is unlawful and offenders may be prosecuted to the fullest extent of the law.

Figure 9-56: Out of Band emission at antenna terminals – HSDPA V Channel Lowest

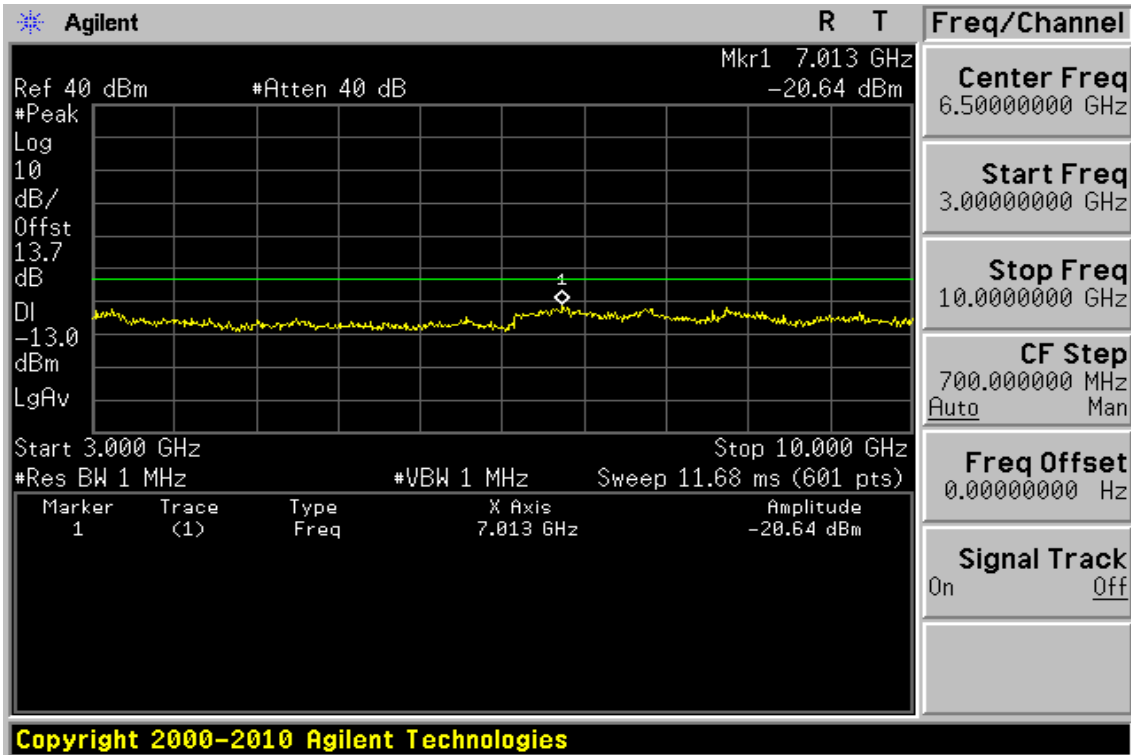
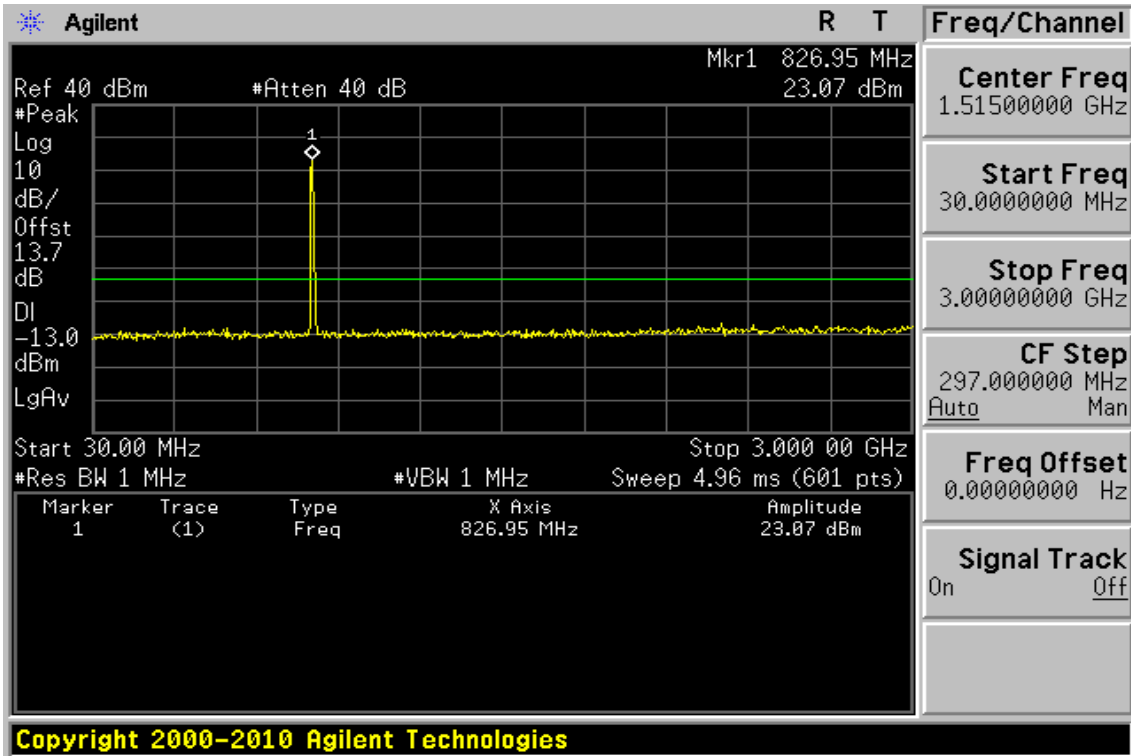

Unless otherwise stated the results shown in this test report refer only to the sample(s) tested and such sample(s) are retained for 90 days only.

除非另有說明，此報告結果僅對測試之樣品負責，同時此樣品僅保留90天。本報告未經本公司書面許可，不可部份複製。

This document is issued by the Company subject to its General Conditions of Service printed overleaf, available on request or accessible at www.sgs.com/terms_and_conditions.htm and, for electronic format documents, subject to Terms and Conditions for Electronic Documents at www.sgs.com/terms_e-document.htm. Attention is drawn to the limitation of liability, indemnification and jurisdiction issues defined therein. Any holder of this document is advised that information contained hereon reflects the Company's findings at the time of its intervention only and within the limits of Client's instructions, if any. The Company's sole responsibility is to its Client and this document does not exonerate parties to a transaction from exercising all their rights and obligations under the transaction documents. This document cannot be reproduced except in full, without prior written approval of the Company. Any unauthorized alteration, forgery or falsification of the content or appearance of this document is unlawful and offenders may be prosecuted to the fullest extent of the law.

Figure 9-57: Out of Band emission at antenna terminals – HSDPA V Channel Mid

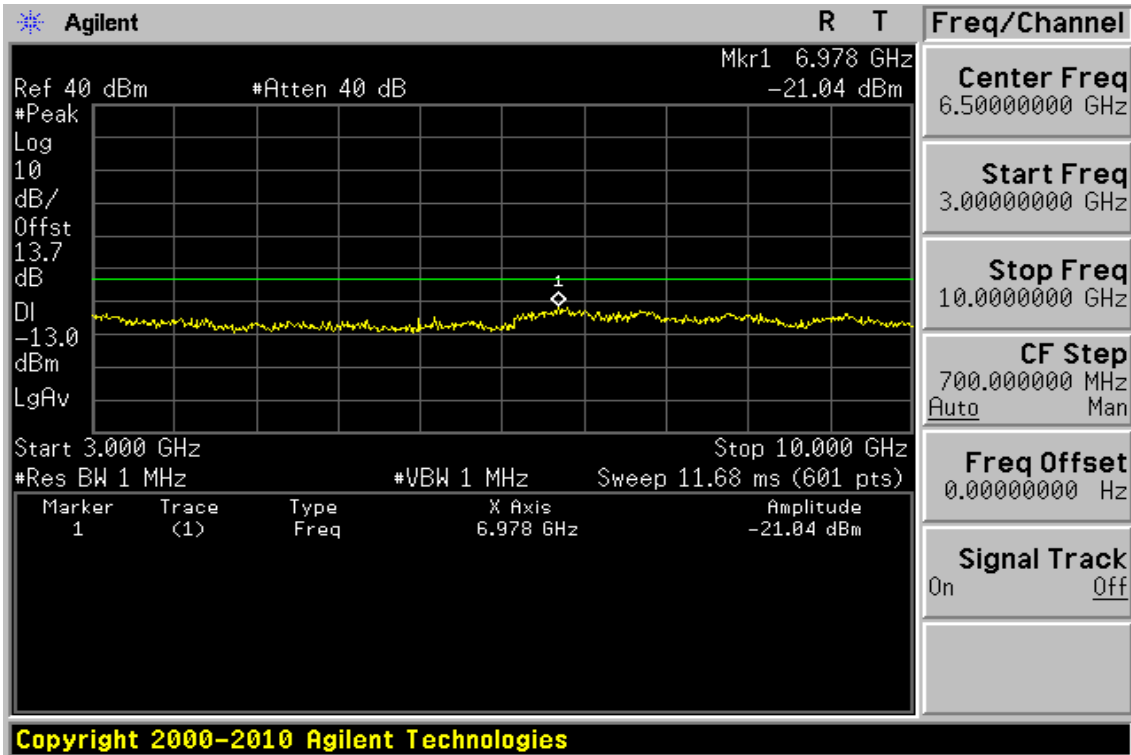
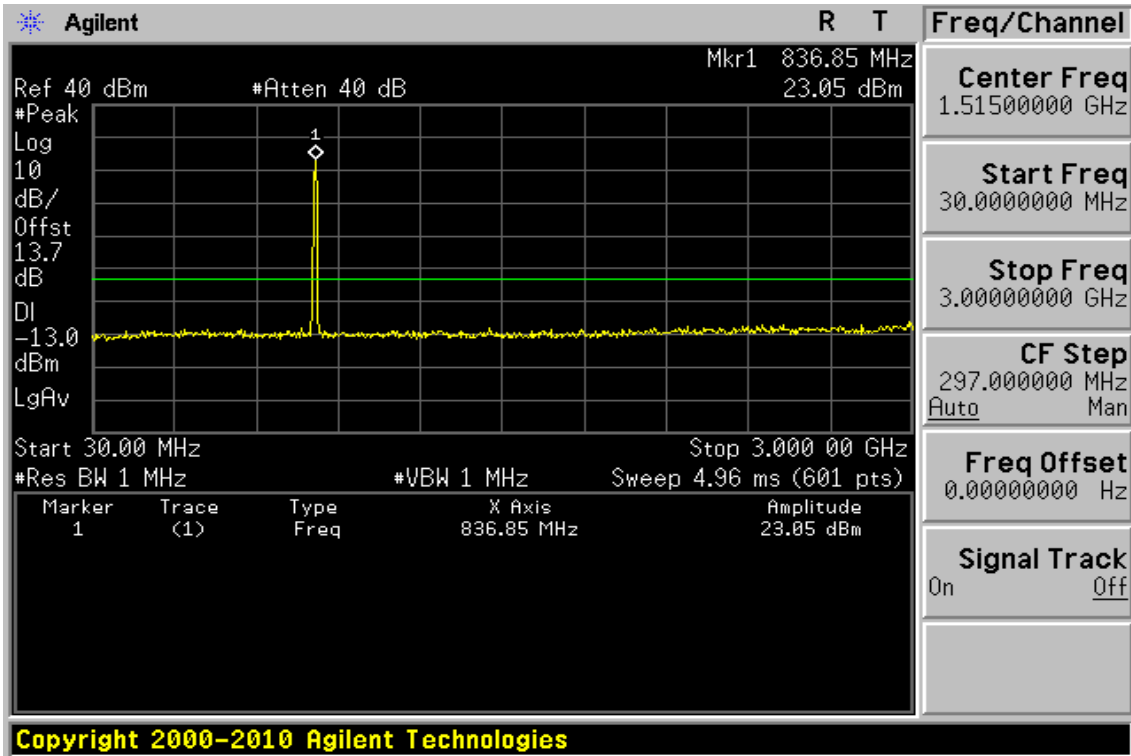

Unless otherwise stated the results shown in this test report refer only to the sample(s) tested and such sample(s) are retained for 90 days only.

除非另有說明，此報告結果僅對測試之樣品負責，同時此樣品僅保留90天。本報告未經本公司書面許可，不可部份複製。

This document is issued by the Company subject to its General Conditions of Service printed overleaf, available on request or accessible at www.sgs.com/terms_and_conditions.htm and, for electronic format documents, subject to Terms and Conditions for Electronic Documents at www.sgs.com/terms_e-document.htm. Attention is drawn to the limitation of liability, indemnification and jurisdiction issues defined therein. Any holder of this document is advised that information contained hereon reflects the Company's findings at the time of its intervention only and within the limits of Client's instructions, if any. The Company's sole responsibility is to its Client and this document does not exonerate parties to a transaction from exercising all their rights and obligations under the transaction documents. This document cannot be reproduced except in full, without prior written approval of the Company. Any unauthorized alteration, forgery or falsification of the content or appearance of this document is unlawful and offenders may be prosecuted to the fullest extent of the law.

Figure 9-58: Out of Band emission at antenna terminals – HSDPA V Channel Highest

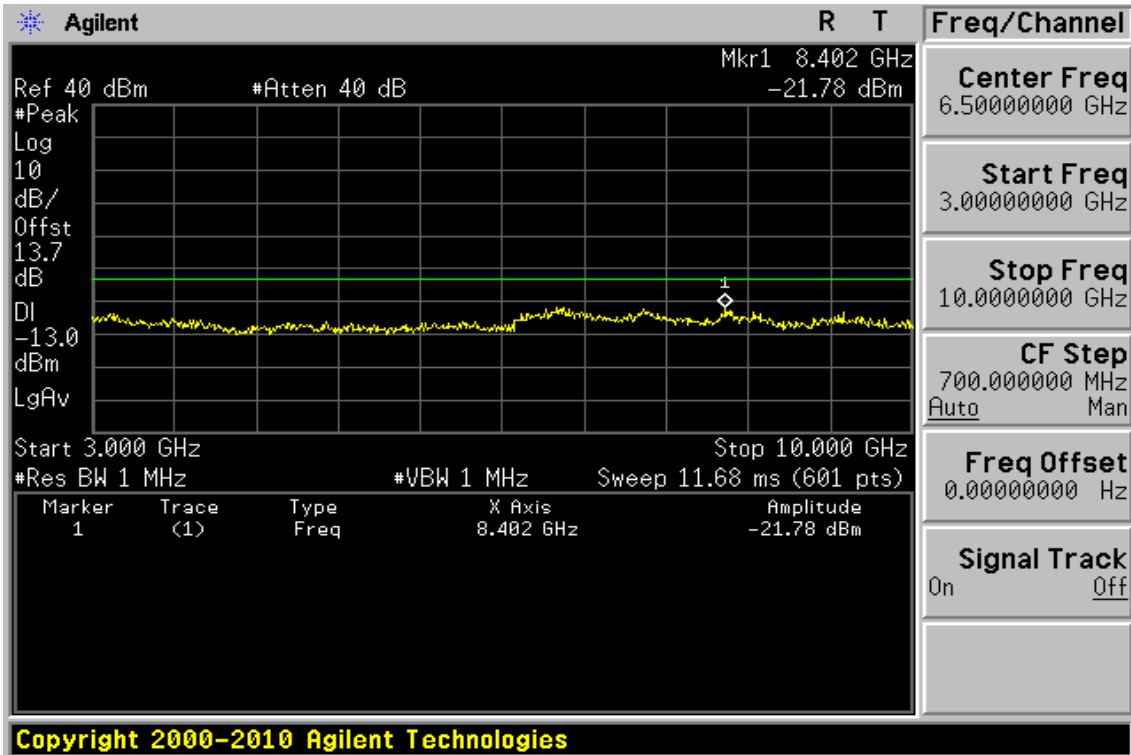
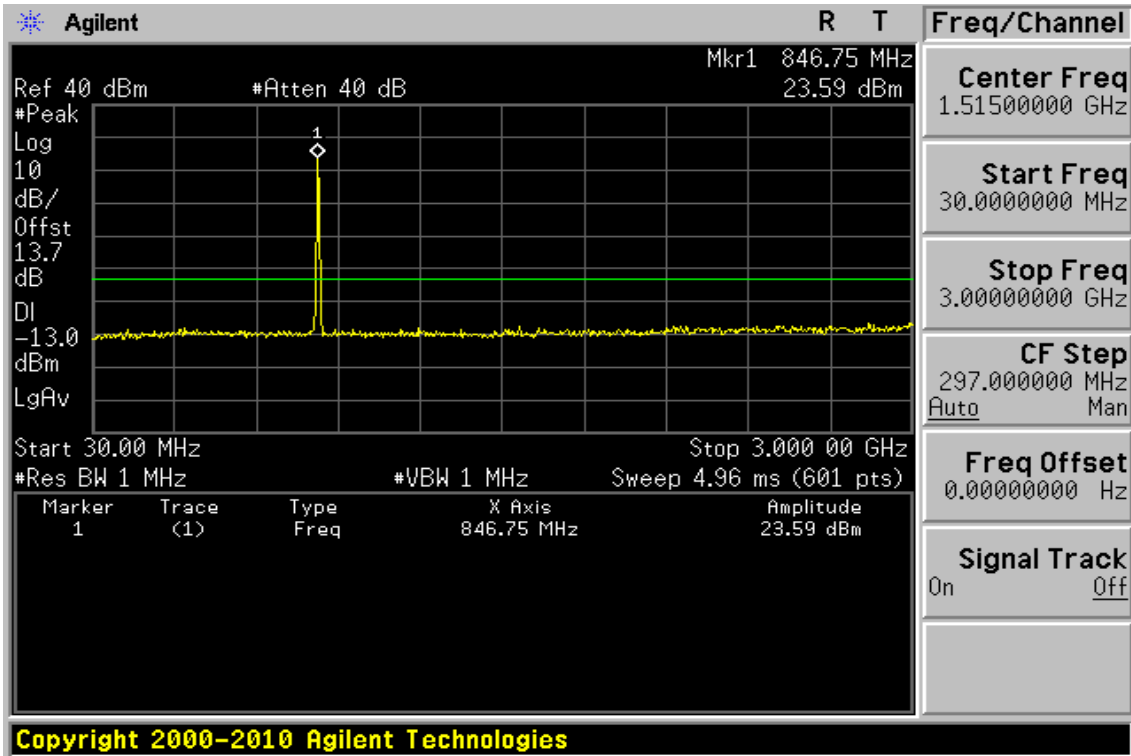

Unless otherwise stated the results shown in this test report refer only to the sample(s) tested and such sample(s) are retained for 90 days only.

除非另有說明，此報告結果僅對測試之樣品負責，同時此樣品僅保留90天。本報告未經本公司書面許可，不可部份複製。

This document is issued by the Company subject to its General Conditions of Service printed overleaf, available on request or accessible at www.sgs.com/terms_and_conditions.htm and, for electronic format documents, subject to Terms and Conditions for Electronic Documents at www.sgs.com/terms_e-document.htm. Attention is drawn to the limitation of liability, indemnification and jurisdiction issues defined therein. Any holder of this document is advised that information contained hereon reflects the Company's findings at the time of its intervention only and within the limits of Client's instructions, if any. The Company's sole responsibility is to its Client and this document does not exonerate parties to a transaction from exercising all their rights and obligations under the transaction documents. This document cannot be reproduced except in full, without prior written approval of the Company. Any unauthorized alteration, forgery or falsification of the content or appearance of this document is unlawful and offenders may be prosecuted to the fullest extent of the law.

Out of Band emission at antenna terminals – HSDPA V

Fundamental Frequency :826.4 MHz Engineer :Nick
Operation Mode :TX Low

Freq. (MHz)	Note F/H/E/S	Reading dBm	Limit dBm	Safe Margin dB
<30	S	---	-13.00	---
30-1000	S	---	-13.00	---
1652.80	H	---	-13.00	---
2479.20	H	---	-13.00	---
3305.60	H	---	-13.00	---
4132.00	H	---	-13.00	---
4958.40	H	---	-13.00	---
5784.80	H	---	-13.00	---
6611.20	H	---	-13.00	---
7013.00	S	-20.64	-13.00	7.64
7437.60	H	---	-13.00	---
8264.00	H	---	-13.00	---

Note : “H” : denotes Harmonic Frequency. “S” : denotes Spurious Frequency.
“---” : denotes Noise Floor.

Unless otherwise stated the results shown in this test report refer only to the sample(s) tested and such sample(s) are retained for 90 days only.

除非另有說明，此報告結果僅對測試之樣品負責，同時此樣品僅保留90天。本報告未經本公司書面許可，不可部份複製。

This document is issued by the Company subject to its General Conditions of Service printed overleaf, available on request or accessible at www.sgs.com/terms_and_conditions.htm and, for electronic format documents, subject to Terms and Conditions for Electronic Documents at www.sgs.com/terms_e-document.htm. Attention is drawn to the limitation of liability, indemnification and jurisdiction issues defined therein. Any holder of this document is advised that information contained hereon reflects the Company's findings at the time of its intervention only and within the limits of Client's instructions, if any. The Company's sole responsibility is to its Client and this document does not exonerate parties to a transaction from exercising all their rights and obligations under the transaction documents. This document cannot be reproduced except in full, without prior written approval of the Company. Any unauthorized alteration, forgery or falsification of the content or appearance of this document is unlawful and offenders may be prosecuted to the fullest extent of the law.

Fundamental Frequency :836.6 MHz Engineer :Nick
Operation Mode :TX Mid

Freq. (MHz)	Note F/H/E/S	Reading dBm	Limit dBm	Safe Margin dB
<30	S	---	-13.00	---
30-1000	S	---	-13.00	---
1673.20	H	---	-13.00	---
2509.80	H	---	-13.00	---
3346.40	H	---	-13.00	---
4183.00	H	---	-13.00	---
5019.60	H	---	-13.00	---
5856.20	H	---	-13.00	---
6692.80	H	---	-13.00	---
6978.00	S	-21.04	-13.00	8.04
7529.40	H	---	-13.00	---
8366.00	H	---	-13.00	---

Note : “H” : denotes Harmonic Frequency. “S” : denotes Spurious Frequency.
“---” : denotes Noise Floor.

Unless otherwise stated the results shown in this test report refer only to the sample(s) tested and such sample(s) are retained for 90 days only.

除非另有說明，此報告結果僅對測試之樣品負責，同時此樣品僅保留90天。本報告未經本公司書面許可，不可部份複製。

This document is issued by the Company subject to its General Conditions of Service printed overleaf, available on request or accessible at www.sgs.com/terms_and_conditions.htm and, for electronic format documents, subject to Terms and Conditions for Electronic Documents at www.sgs.com/terms_e-document.htm. Attention is drawn to the limitation of liability, indemnification and jurisdiction issues defined therein. Any holder of this document is advised that information contained hereon reflects the Company's findings at the time of its intervention only and within the limits of Client's instructions, if any. The Company's sole responsibility is to its Client and this document does not exonerate parties to a transaction from exercising all their rights and obligations under the transaction documents. This document cannot be reproduced except in full, without prior written approval of the Company. Any unauthorized alteration, forgery or falsification of the content or appearance of this document is unlawful and offenders may be prosecuted to the fullest extent of the law.

Fundamental Frequency :846.6MHz Engineer :Nick
Operation Mode :TX High

Freq. (MHz)	Note F/H/E/S	Reading dBm	Limit dBm	Safe Margin dB
<30	S	---	-13.00	---
30-1000	S	---	-13.00	---
1693.20	H	---	-13.00	---
2539.80	H	---	-13.00	---
3386.40	H	---	-13.00	---
4233.00	H	---	-13.00	---
5079.60	H	---	-13.00	---
5926.20	H	---	-13.00	---
6772.80	H	---	-13.00	---
7619.40	H	---	-13.00	---
8402.00	S	-21.78	-13.00	8.78
8466.00	H	---	-13.00	---

Note : "H" : denotes Harmonic Frequency. "S" : denotes Spurious Frequency.
"---" : denotes Noise Floor.

Unless otherwise stated the results shown in this test report refer only to the sample(s) tested and such sample(s) are retained for 90 days only.

除非另有說明，此報告結果僅對測試之樣品負責，同時此樣品僅保留90天。本報告未經本公司書面許可，不可部份複製。

This document is issued by the Company subject to its General Conditions of Service printed overleaf, available on request or accessible at www.sgs.com/terms_and_conditions.htm and, for electronic format documents, subject to Terms and Conditions for Electronic Documents at www.sgs.com/terms_e-document.htm. Attention is drawn to the limitation of liability, indemnification and jurisdiction issues defined therein. Any holder of this document is advised that information contained hereon reflects the Company's findings at the time of its intervention only and within the limits of Client's instructions, if any. The Company's sole responsibility is to its Client and this document does not exonerate parties to a transaction from exercising all their rights and obligations under the transaction documents. This document cannot be reproduced except in full, without prior written approval of the Company. Any unauthorized alteration, forgery or falsification of the content or appearance of this document is unlawful and offenders may be prosecuted to the fullest extent of the law.

Figure 9-59: Band edge emission at antenna terminals – HSDPA V Channel Lowest

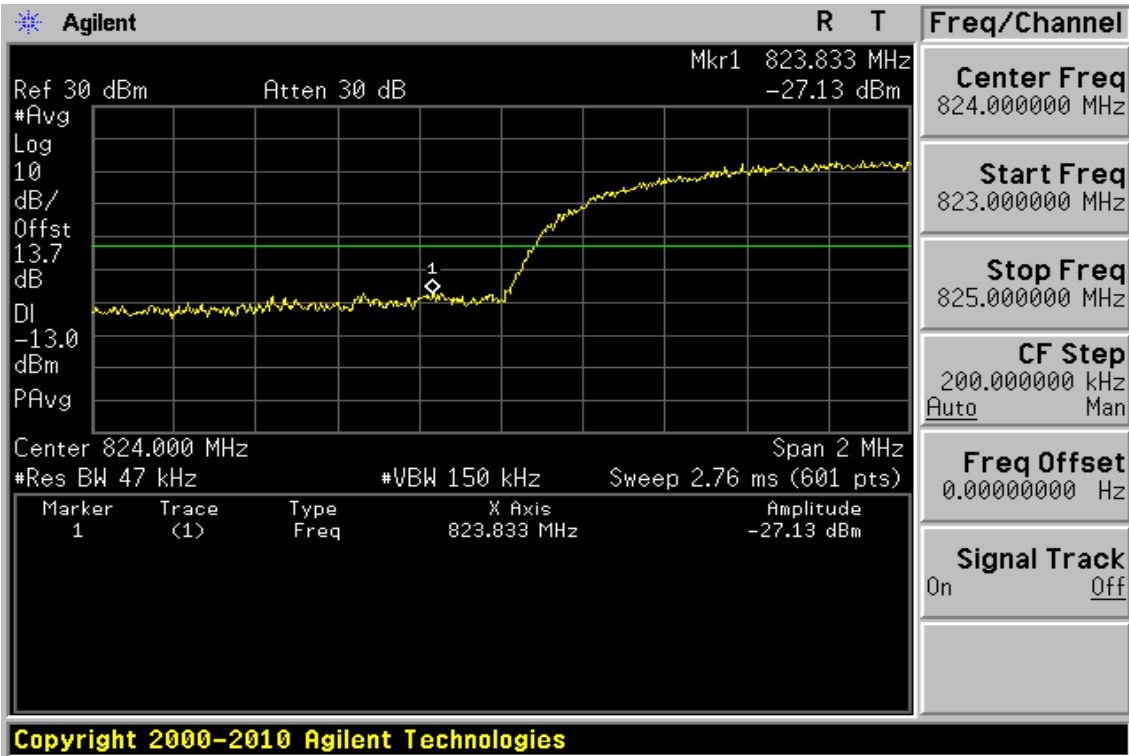
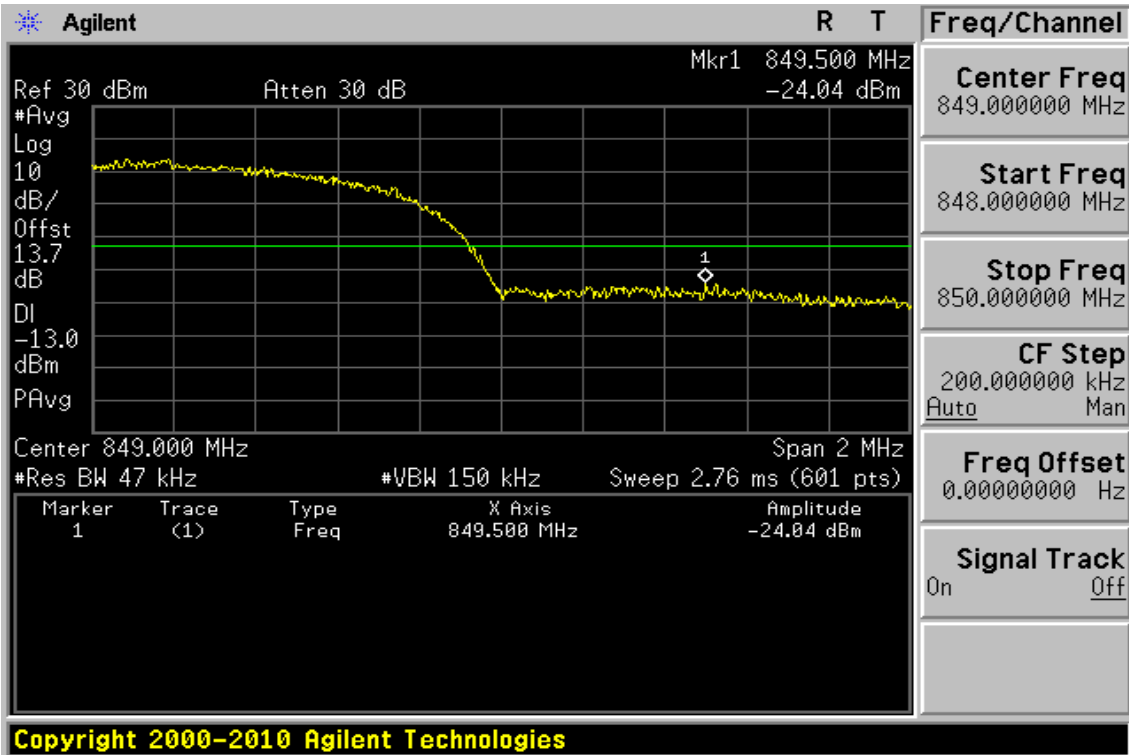

Figure 9-60: Band edge emission at antenna terminals – HSDPA V Channel Highest



Unless otherwise stated the results shown in this test report refer only to the sample(s) tested and such sample(s) are retained for 90 days only.

除非另有說明，此報告結果僅對測試之樣品負責，同時此樣品僅保留90天。本報告未經本公司書面許可，不可部份複製。

This document is issued by the Company subject to its General Conditions of Service printed overleaf, available on request or accessible at www.sgs.com/terms_and_conditions.htm and, for electronic format documents, subject to Terms and Conditions for Electronic Documents at www.sgs.com/terms_e-document.htm. Attention is drawn to the limitation of liability, indemnification and jurisdiction issues defined therein. Any holder of this document is advised that information contained hereon reflects the Company's findings at the time of its intervention only and within the limits of Client's instructions, if any. The Company's sole responsibility is to its Client and this document does not exonerate parties to a transaction from exercising all their rights and obligations under the transaction documents. This document cannot be reproduced except in full, without prior written approval of the Company. Any unauthorized alteration, forgery or falsification of the content or appearance of this document is unlawful and offenders may be prosecuted to the fullest extent of the law.

Band edge emission at antenna terminals – HSDPA V Low & High

Test Mode HSDPA V Engineer :Nick

Freq. MHz	Reading dBm	Limit dBm	Safe Margin dB
823.833	-27.13	-13.00	14.13
849.500	-24.04	-13.00	11.04

Unless otherwise stated the results shown in this test report refer only to the sample(s) tested and such sample(s) are retained for 90 days only.

除非另有說明，此報告結果僅對測試之樣品負責，同時此樣品僅保留90天。本報告未經本公司書面許可，不可部份複製。

This document is issued by the Company subject to its General Conditions of Service printed overleaf, available on request or accessible at www.sgs.com/terms_and_conditions.htm and, for electronic format documents, subject to Terms and Conditions for Electronic Documents at www.sgs.com/terms_e-document.htm. Attention is drawn to the limitation of liability, indemnification and jurisdiction issues defined therein. Any holder of this document is advised that information contained hereon reflects the Company's findings at the time of its intervention only and within the limits of Client's instructions, if any. The Company's sole responsibility is to its Client and this document does not exonerate parties to a transaction from exercising all their rights and obligations under the transaction documents. This document cannot be reproduced except in full, without prior written approval of the Company. Any unauthorized alteration, forgery or falsification of the content or appearance of this document is unlawful and offenders may be prosecuted to the fullest extent of the law.

Figure 9-61: Out of Band emission at antenna terminals – HSUPA II Channel Lowest

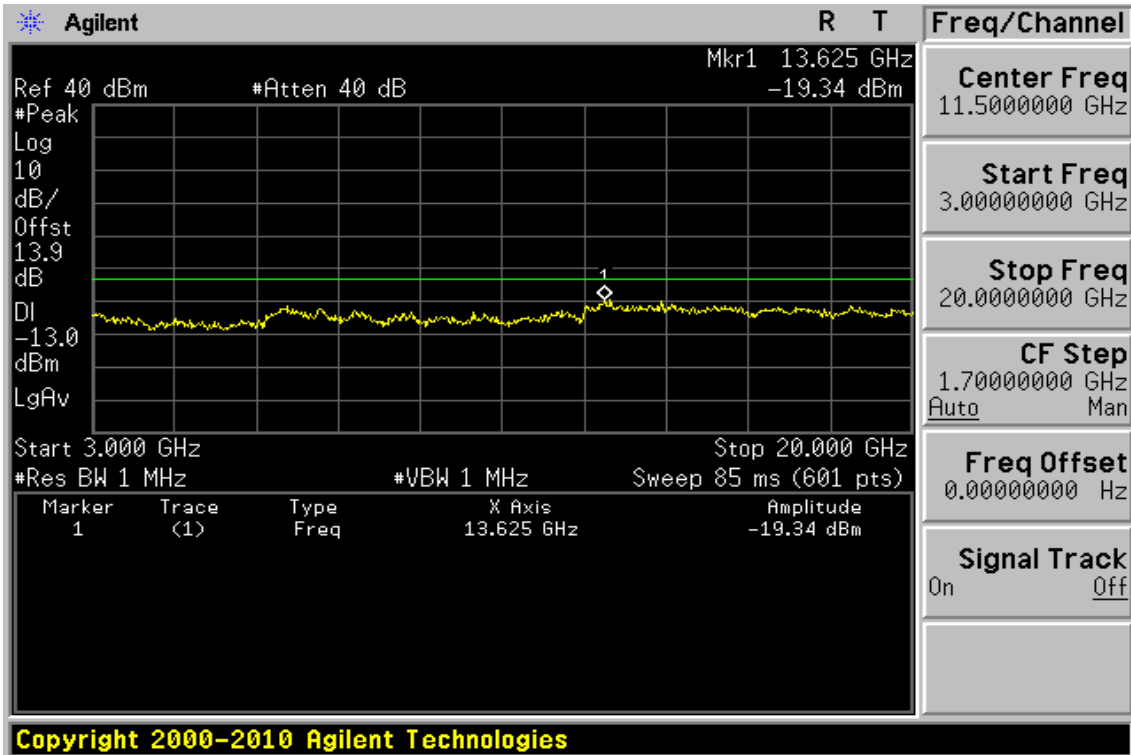
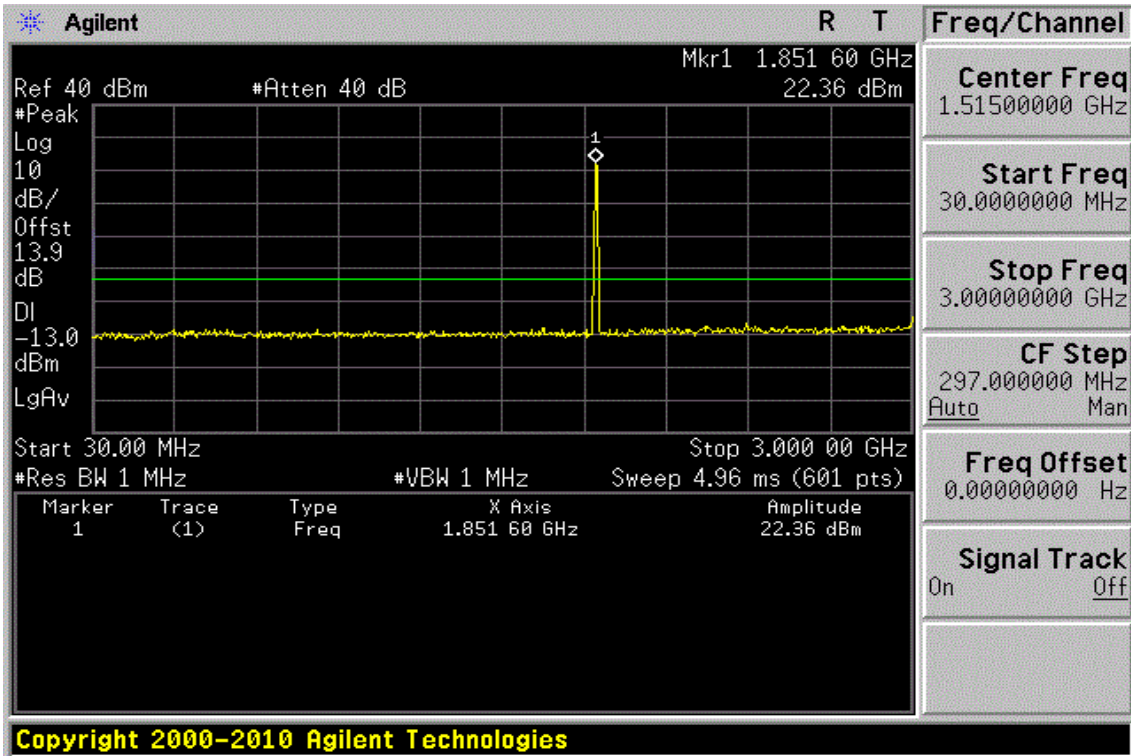

Unless otherwise stated the results shown in this test report refer only to the sample(s) tested and such sample(s) are retained for 90 days only.

除非另有說明，此報告結果僅對測試之樣品負責，同時此樣品僅保留90天。本報告未經本公司書面許可，不可部份複製。

This document is issued by the Company subject to its General Conditions of Service printed overleaf, available on request or accessible at www.sgs.com/terms_and_conditions.htm and, for electronic format documents, subject to Terms and Conditions for Electronic Documents at www.sgs.com/terms_e-document.htm. Attention is drawn to the limitation of liability, indemnification and jurisdiction issues defined therein. Any holder of this document is advised that information contained hereon reflects the Company's findings at the time of its intervention only and within the limits of Client's instructions, if any. The Company's sole responsibility is to its Client and this document does not exonerate parties to a transaction from exercising all their rights and obligations under the transaction documents. This document cannot be reproduced except in full, without prior written approval of the Company. Any unauthorized alteration, forgery or falsification of the content or appearance of this document is unlawful and offenders may be prosecuted to the fullest extent of the law.

Figure 9-62: Out of Band emission at antenna terminals – HSUPA II Channel Mid

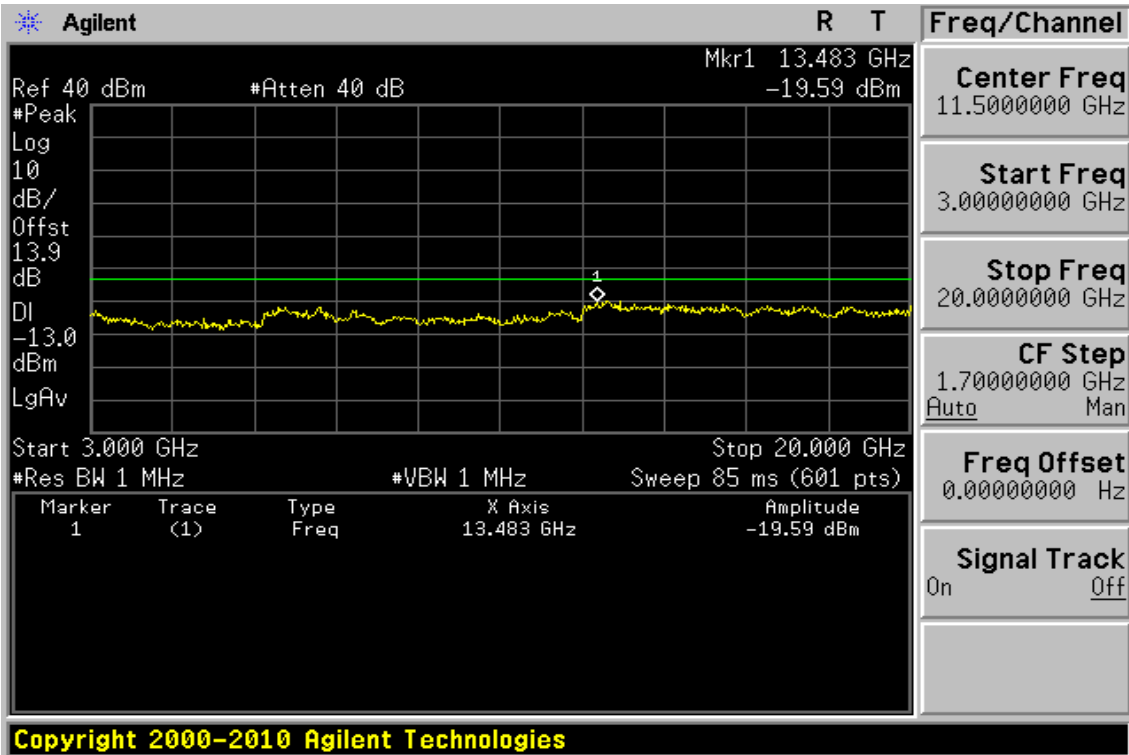
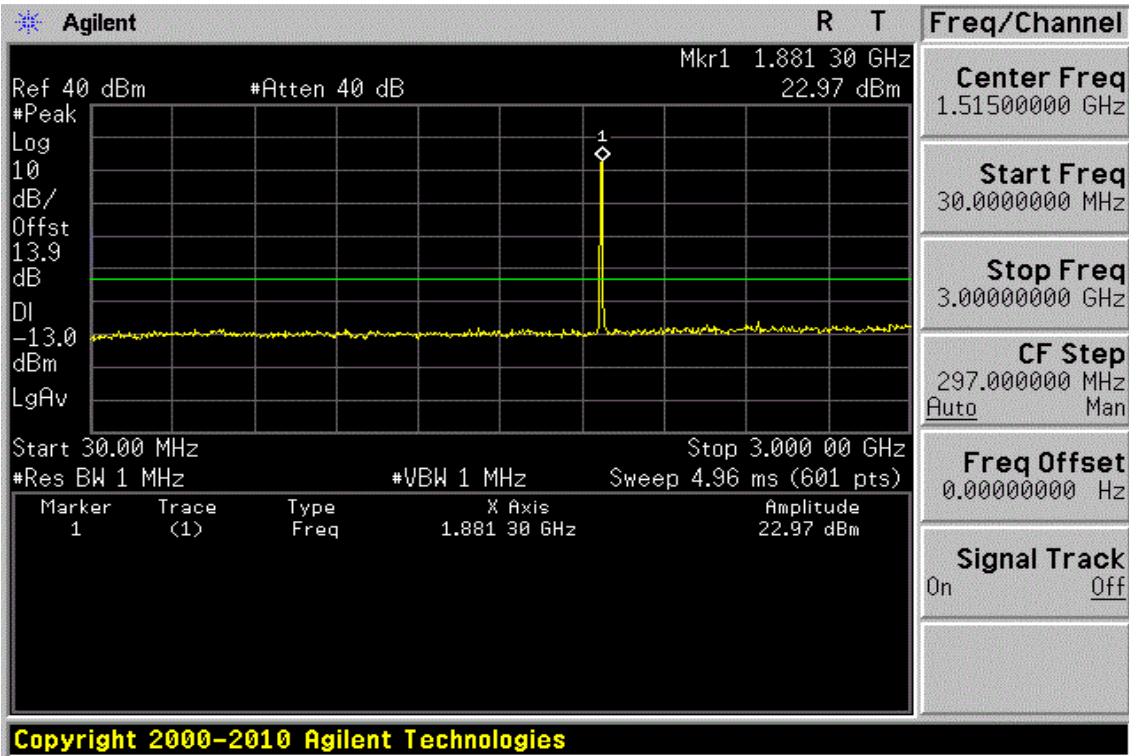

Unless otherwise stated the results shown in this test report refer only to the sample(s) tested and such sample(s) are retained for 90 days only.

除非另有說明，此報告結果僅對測試之樣品負責，同時此樣品僅保留90天。本報告未經本公司書面許可，不可部份複製。

This document is issued by the Company subject to its General Conditions of Service printed overleaf, available on request or accessible at www.sgs.com/terms_and_conditions.htm and, for electronic format documents, subject to Terms and Conditions for Electronic Documents at www.sgs.com/terms_e-document.htm. Attention is drawn to the limitation of liability, indemnification and jurisdiction issues defined therein. Any holder of this document is advised that information contained hereon reflects the Company's findings at the time of its intervention only and within the limits of Client's instructions, if any. The Company's sole responsibility is to its Client and this document does not exonerate parties to a transaction from exercising all their rights and obligations under the transaction documents. This document cannot be reproduced except in full, without prior written approval of the Company. Any unauthorized alteration, forgery or falsification of the content or appearance of this document is unlawful and offenders may be prosecuted to the fullest extent of the law.

Figure 9-63: Out of Band emission at antenna terminals – HSUPA II Channel Highest

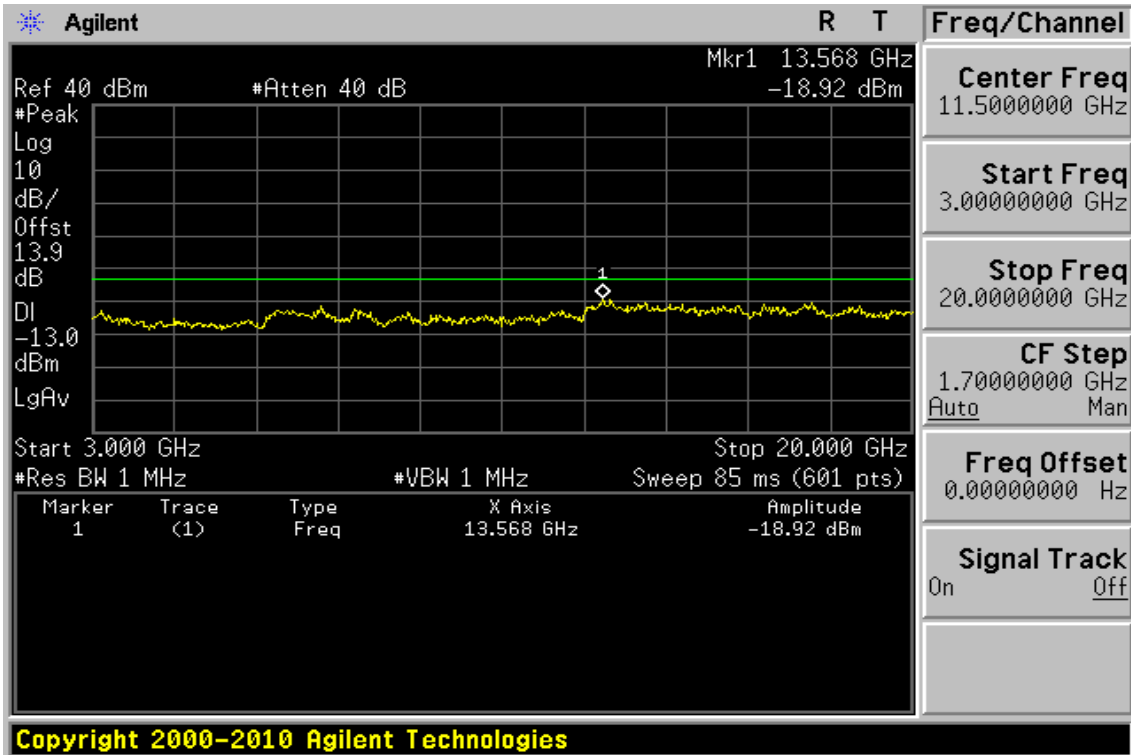
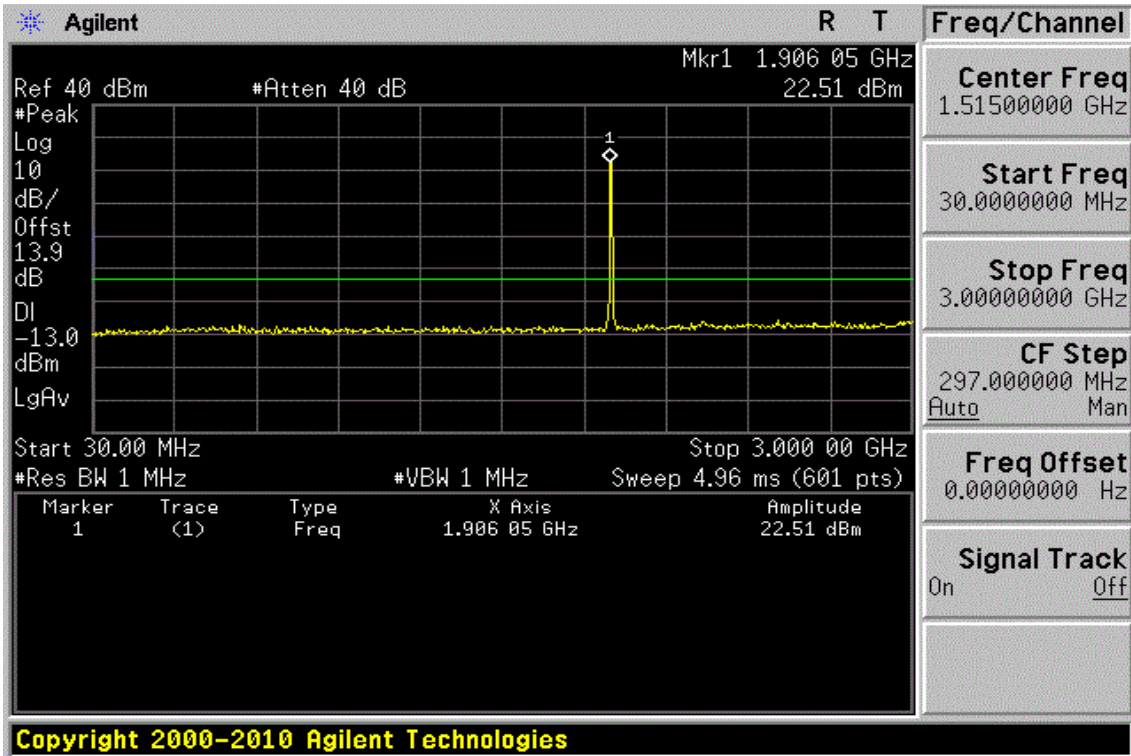

Unless otherwise stated the results shown in this test report refer only to the sample(s) tested and such sample(s) are retained for 90 days only.

除非另有說明，此報告結果僅對測試之樣品負責，同時此樣品僅保留90天。本報告未經本公司書面許可，不可部份複製。

This document is issued by the Company subject to its General Conditions of Service printed overleaf, available on request or accessible at www.sgs.com/terms_and_conditions.htm and, for electronic format documents, subject to Terms and Conditions for Electronic Documents at www.sgs.com/terms_e-document.htm. Attention is drawn to the limitation of liability, indemnification and jurisdiction issues defined therein. Any holder of this document is advised that information contained hereon reflects the Company's findings at the time of its intervention only and within the limits of Client's instructions, if any. The Company's sole responsibility is to its Client and this document does not exonerate parties to a transaction from exercising all their rights and obligations under the transaction documents. This document cannot be reproduced except in full, without prior written approval of the Company. Any unauthorized alteration, forgery or falsification of the content or appearance of this document is unlawful and offenders may be prosecuted to the fullest extent of the law.

Out of Band emission at antenna terminals – HSUPA II

Fundamental Frequency :1852.4 MHz Engineer :Nick
Operation Mode :TX Low

Freq. (MHz)	Note F/H/E/S	Reading dBm	Limit dBm	Safe Margin dB
<30	S	---	-13.00	---
30-1000	S	---	-13.00	---
3704.80	H	---	-13.00	---
5557.20	H	---	-13.00	---
7409.60	H	---	-13.00	---
9262.00	H	---	-13.00	---
11114.40	H	---	-13.00	---
12966.80	H	---	-13.00	---
13625.00	S	-19.34	-13.00	6.34
14819.20	H	---	-13.00	---
16671.60	H	---	-13.00	---
18524.00	H	---	-13.00	---

Note : “H” : denotes Harmonic Frequency. “S” : denotes Spurious Frequency.
“---” : denotes Noise Floor.

Unless otherwise stated the results shown in this test report refer only to the sample(s) tested and such sample(s) are retained for 90 days only.

除非另有說明，此報告結果僅對測試之樣品負責，同時此樣品僅保留90天。本報告未經本公司書面許可，不可部份複製。

This document is issued by the Company subject to its General Conditions of Service printed overleaf, available on request or accessible at www.sgs.com/terms_and_conditions.htm and, for electronic format documents, subject to Terms and Conditions for Electronic Documents at www.sgs.com/terms_e-document.htm. Attention is drawn to the limitation of liability, indemnification and jurisdiction issues defined therein. Any holder of this document is advised that information contained hereon reflects the Company's findings at the time of its intervention only and within the limits of Client's instructions, if any. The Company's sole responsibility is to its Client and this document does not exonerate parties to a transaction from exercising all their rights and obligations under the transaction documents. This document cannot be reproduced except in full, without prior written approval of the Company. Any unauthorized alteration, forgery or falsification of the content or appearance of this document is unlawful and offenders may be prosecuted to the fullest extent of the law.

Fundamental Frequency :1880.0 MHz Engineer :Nick
Operation Mode :TX Mid

Freq. (MHz)	Note F/H/E/S	Reading dBm	Limit dBm	Safe Margin dB
<30	S	---	-13.00	---
30-1000	S	---	-13.00	---
3760.00	H	---	-13.00	---
5640.00	H	---	-13.00	---
7520.00	H	---	-13.00	---
9400.00	H	---	-13.00	---
11280.00	H	---	-13.00	---
13160.00	H	---	-13.00	---
13483.00	S	-19.59	-13.00	6.59
15040.00	H	---	-13.00	---
16920.00	H	---	-13.00	---
18800.00	H	---	-13.00	---

Note : "H" : denotes Harmonic Frequency. "S" : denotes Spurious Frequency.
"---" : denotes Noise Floor.

Unless otherwise stated the results shown in this test report refer only to the sample(s) tested and such sample(s) are retained for 90 days only.

除非另有說明，此報告結果僅對測試之樣品負責，同時此樣品僅保留90天。本報告未經本公司書面許可，不可部份複製。

This document is issued by the Company subject to its General Conditions of Service printed overleaf, available on request or accessible at www.sgs.com/terms_and_conditions.htm and, for electronic format documents, subject to Terms and Conditions for Electronic Documents at www.sgs.com/terms_e-document.htm. Attention is drawn to the limitation of liability, indemnification and jurisdiction issues defined therein. Any holder of this document is advised that information contained hereon reflects the Company's findings at the time of its intervention only and within the limits of Client's instructions, if any. The Company's sole responsibility is to its Client and this document does not exonerate parties to a transaction from exercising all their rights and obligations under the transaction documents. This document cannot be reproduced except in full, without prior written approval of the Company. Any unauthorized alteration, forgery or falsification of the content or appearance of this document is unlawful and offenders may be prosecuted to the fullest extent of the law.

Fundamental Frequency :1907.6MHz Engineer :Nick
Operation Mode :TX High

Freq. (MHz)	Note F/H/E/S	Reading dBm	Limit dBm	Safe Margin dB
<30	S	---	-13.00	---
30-1000	S	---	-13.00	---
3815.20	H	---	-13.00	---
5722.80	H	---	-13.00	---
7630.40	H	---	-13.00	---
9538.00	H	---	-13.00	---
11445.60	H	---	-13.00	---
13353.20	H	---	-13.00	---
13568.00	S	-18.92	-13.00	5.92
15260.80	H	---	-13.00	---
17168.40	H	---	-13.00	---
19076.00	H	---	-13.00	---

Note : “H” : denotes Harmonic Frequency. “S” : denotes Spurious Frequency.
“---” : denotes Noise Floor.

Unless otherwise stated the results shown in this test report refer only to the sample(s) tested and such sample(s) are retained for 90 days only.

除非另有說明，此報告結果僅對測試之樣品負責，同時此樣品僅保留90天。本報告未經本公司書面許可，不可部份複製。

This document is issued by the Company subject to its General Conditions of Service printed overleaf, available on request or accessible at www.sgs.com/terms_and_conditions.htm and, for electronic format documents, subject to Terms and Conditions for Electronic Documents at www.sgs.com/terms_e-document.htm. Attention is drawn to the limitation of liability, indemnification and jurisdiction issues defined therein. Any holder of this document is advised that information contained hereon reflects the Company's findings at the time of its intervention only and within the limits of Client's instructions, if any. The Company's sole responsibility is to its Client and this document does not exonerate parties to a transaction from exercising all their rights and obligations under the transaction documents. This document cannot be reproduced except in full, without prior written approval of the Company. Any unauthorized alteration, forgery or falsification of the content or appearance of this document is unlawful and offenders may be prosecuted to the fullest extent of the law.

Figure 9-64: Band edge emission at antenna terminals – HSUPA II Channel Lowest

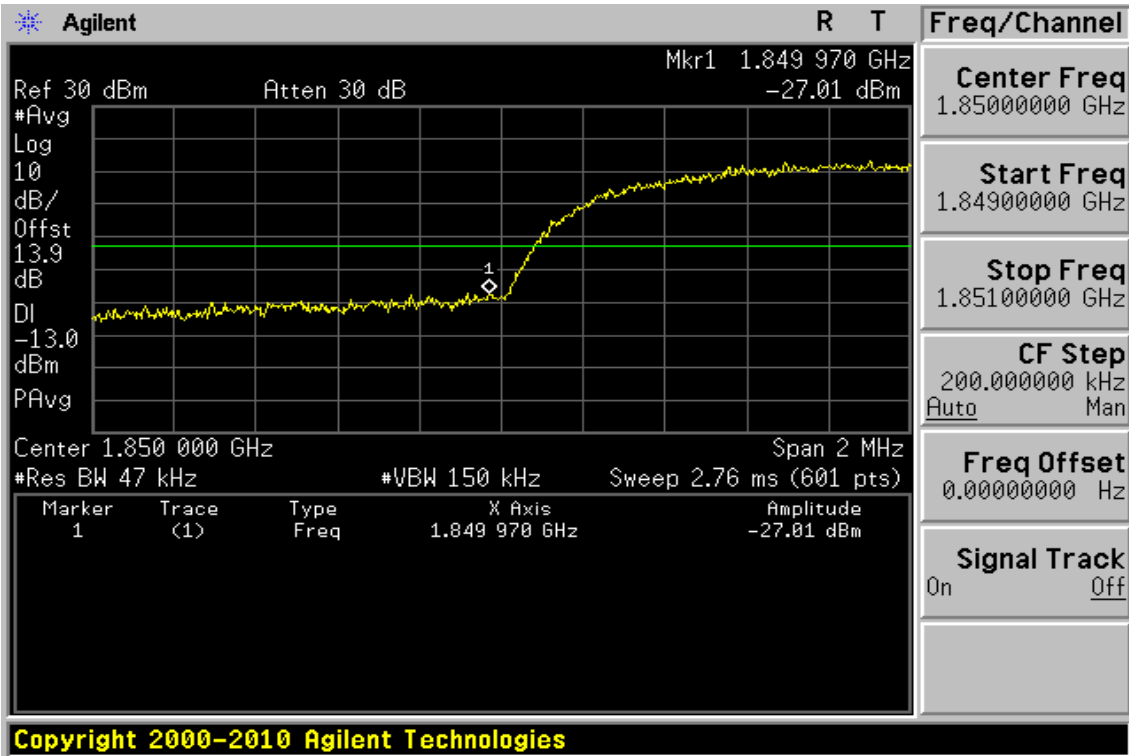
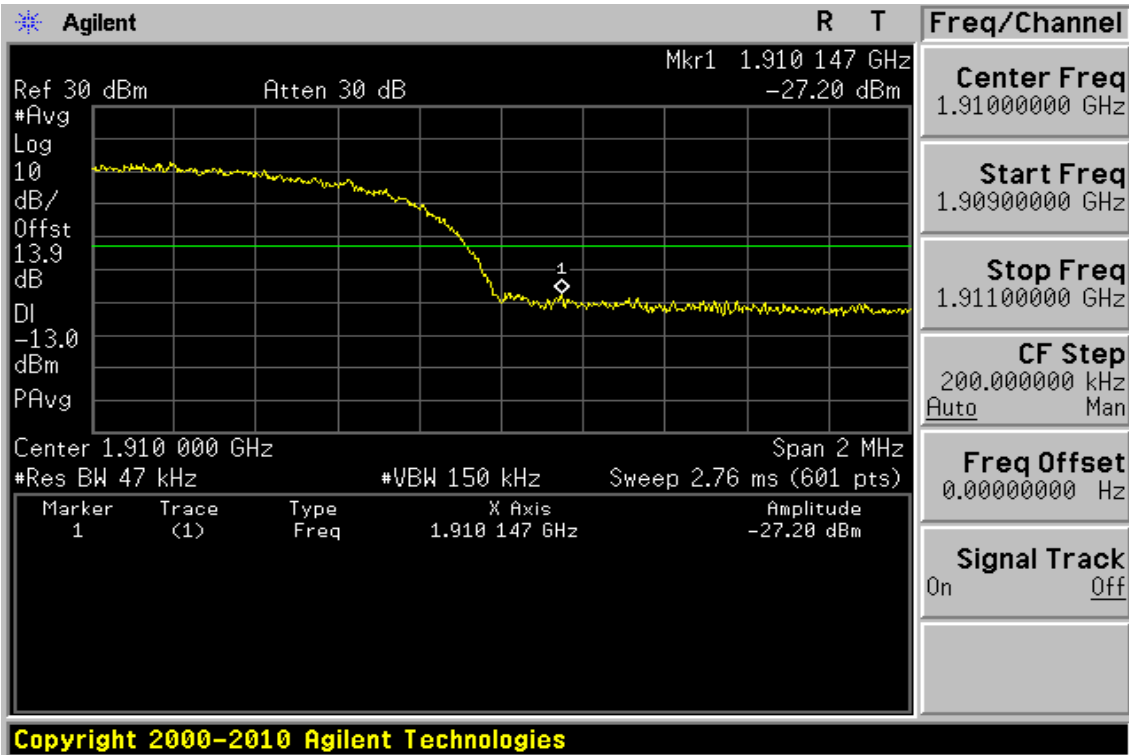

Figure 9-65: Band edge emission at antenna terminals – HSUPA II Channel Highest



Unless otherwise stated the results shown in this test report refer only to the sample(s) tested and such sample(s) are retained for 90 days only.

除非另有說明，此報告結果僅對測試之樣品負責，同時此樣品僅保留90天。本報告未經本公司書面許可，不可部份複製。

This document is issued by the Company subject to its General Conditions of Service printed overleaf, available on request or accessible at www.sgs.com/terms_and_conditions.htm and, for electronic format documents, subject to Terms and Conditions for Electronic Documents at www.sgs.com/terms_e-document.htm. Attention is drawn to the limitation of liability, indemnification and jurisdiction issues defined therein. Any holder of this document is advised that information contained hereon reflects the Company's findings at the time of its intervention only and within the limits of Client's instructions, if any. The Company's sole responsibility is to its Client and this document does not exonerate parties to a transaction from exercising all their rights and obligations under the transaction documents. This document cannot be reproduced except in full, without prior written approval of the Company. Any unauthorized alteration, forgery or falsification of the content or appearance of this document is unlawful and offenders may be prosecuted to the fullest extent of the law.

Band edge emission at antenna terminals – HSUPA II Low & High

Test Mode HSUPA II Engineer :Nick

Freq. MHz	Reading dBm	Limit dBm	Safe Margin dB
1849.970	-27.01	-13.00	14.01
1910.147	-27.20	-13.00	14.20

Unless otherwise stated the results shown in this test report refer only to the sample(s) tested and such sample(s) are retained for 90 days only.

除非另有說明，此報告結果僅對測試之樣品負責，同時此樣品僅保留90天。本報告未經本公司書面許可，不可部份複製。

This document is issued by the Company subject to its General Conditions of Service printed overleaf, available on request or accessible at www.sgs.com/terms_and_conditions.htm and, for electronic format documents, subject to Terms and Conditions for Electronic Documents at www.sgs.com/terms_e-document.htm. Attention is drawn to the limitation of liability, indemnification and jurisdiction issues defined therein. Any holder of this document is advised that information contained hereon reflects the Company's findings at the time of its intervention only and within the limits of Client's instructions, if any. The Company's sole responsibility is to its Client and this document does not exonerate parties to a transaction from exercising all their rights and obligations under the transaction documents. This document cannot be reproduced except in full, without prior written approval of the Company. Any unauthorized alteration, forgery or falsification of the content or appearance of this document is unlawful and offenders may be prosecuted to the fullest extent of the law.

Figure 9-66: Out of Band emission at antenna terminals –HSUPA IV Channel Lowest

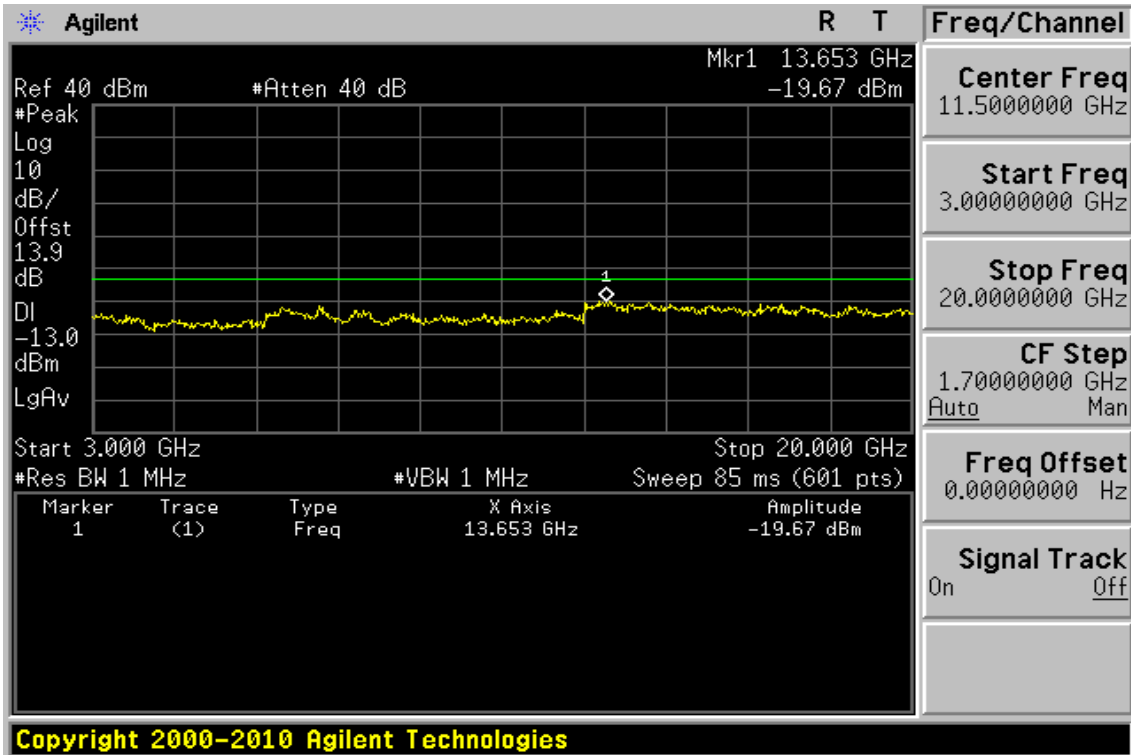
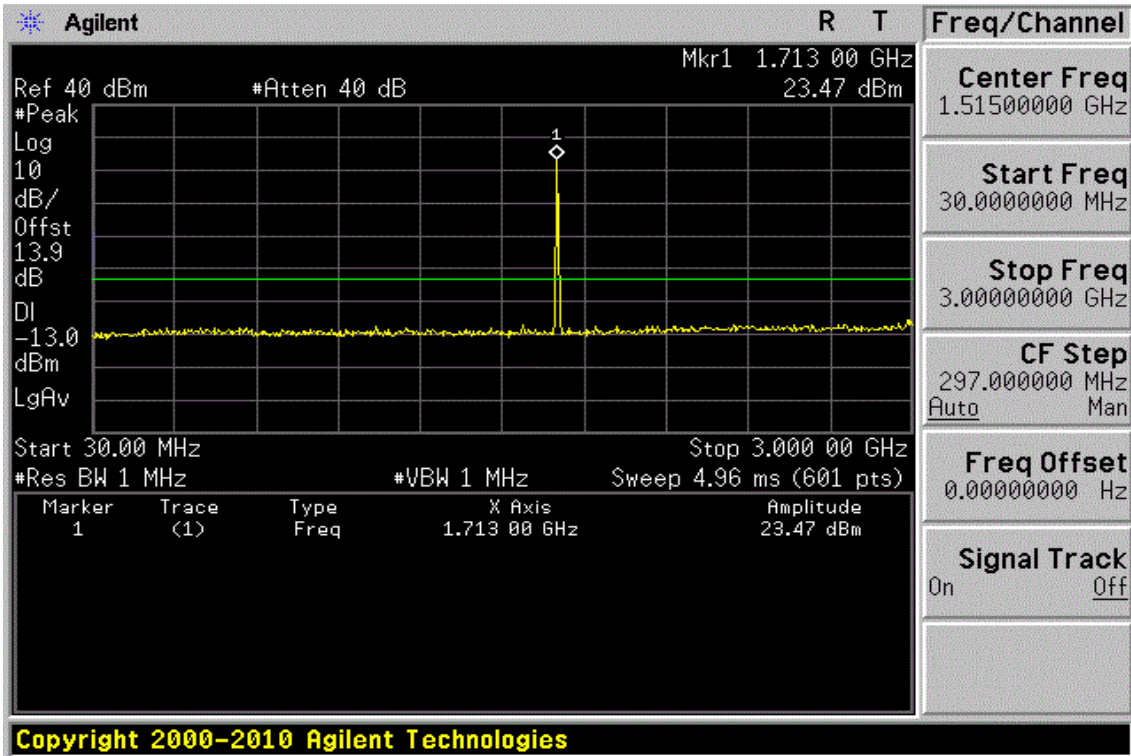

Unless otherwise stated the results shown in this test report refer only to the sample(s) tested and such sample(s) are retained for 90 days only.

除非另有說明，此報告結果僅對測試之樣品負責，同時此樣品僅保留90天。本報告未經本公司書面許可，不可部份複製。

This document is issued by the Company subject to its General Conditions of Service printed overleaf, available on request or accessible at www.sgs.com/terms_and_conditions.htm and, for electronic format documents, subject to Terms and Conditions for Electronic Documents at www.sgs.com/terms_e-document.htm. Attention is drawn to the limitation of liability, indemnification and jurisdiction issues defined therein. Any holder of this document is advised that information contained hereon reflects the Company's findings at the time of its intervention only and within the limits of Client's instructions, if any. The Company's sole responsibility is to its Client and this document does not exonerate parties to a transaction from exercising all their rights and obligations under the transaction documents. This document cannot be reproduced except in full, without prior written approval of the Company. Any unauthorized alteration, forgery or falsification of the content or appearance of this document is unlawful and offenders may be prosecuted to the fullest extent of the law.

Figure 9-67: Out of Band emission at antenna terminals –HSUPA IV Channel Mid

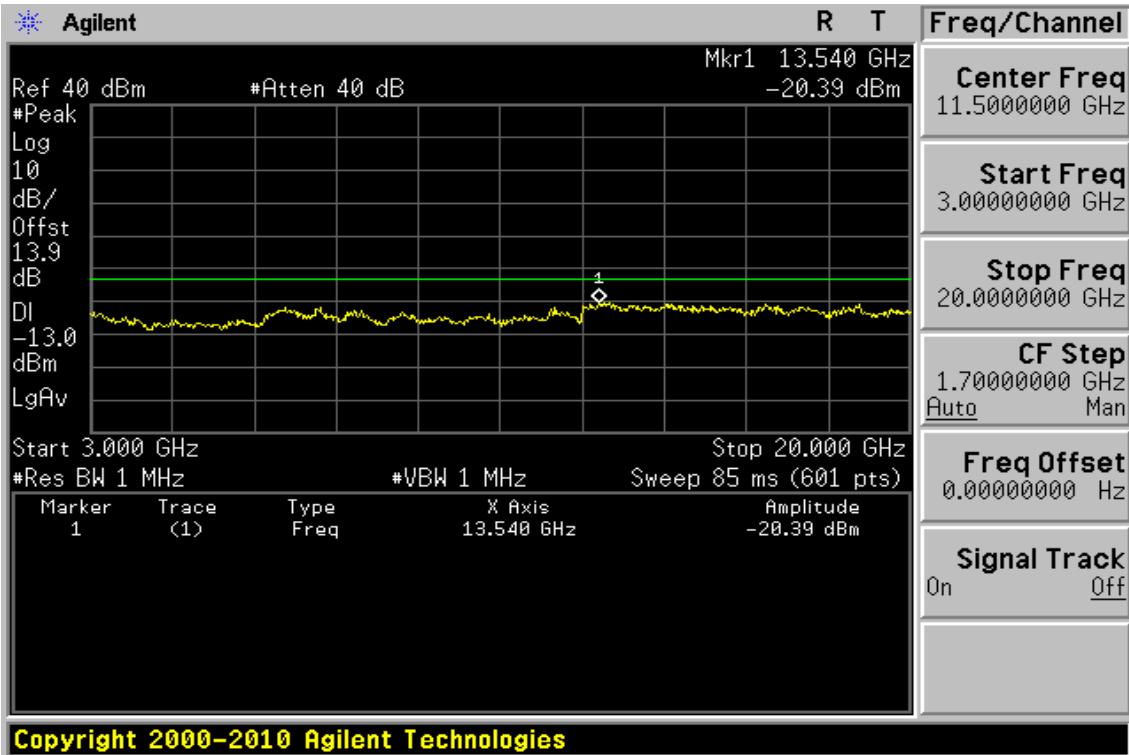
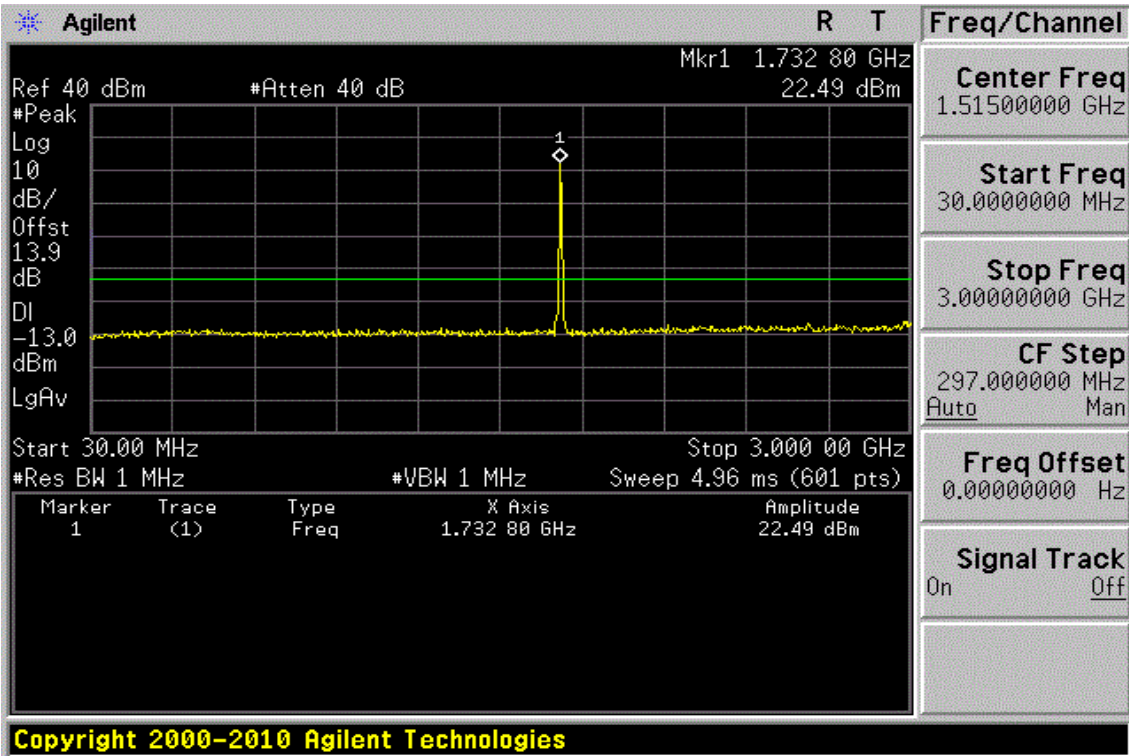

Unless otherwise stated the results shown in this test report refer only to the sample(s) tested and such sample(s) are retained for 90 days only.

除非另有說明，此報告結果僅對測試之樣品負責，同時此樣品僅保留90天。本報告未經本公司書面許可，不可部份複製。

This document is issued by the Company subject to its General Conditions of Service printed overleaf, available on request or accessible at www.sgs.com/terms_and_conditions.htm and, for electronic format documents, subject to Terms and Conditions for Electronic Documents at www.sgs.com/terms_e-document.htm. Attention is drawn to the limitation of liability, indemnification and jurisdiction issues defined therein. Any holder of this document is advised that information contained hereon reflects the Company's findings at the time of its intervention only and within the limits of Client's instructions, if any. The Company's sole responsibility is to its Client and this document does not exonerate parties to a transaction from exercising all their rights and obligations under the transaction documents. This document cannot be reproduced except in full, without prior written approval of the Company. Any unauthorized alteration, forgery or falsification of the content or appearance of this document is unlawful and offenders may be prosecuted to the fullest extent of the law.

Figure 9-68: Out of Band emission at antenna terminals –HSUPA IV Channel Highest

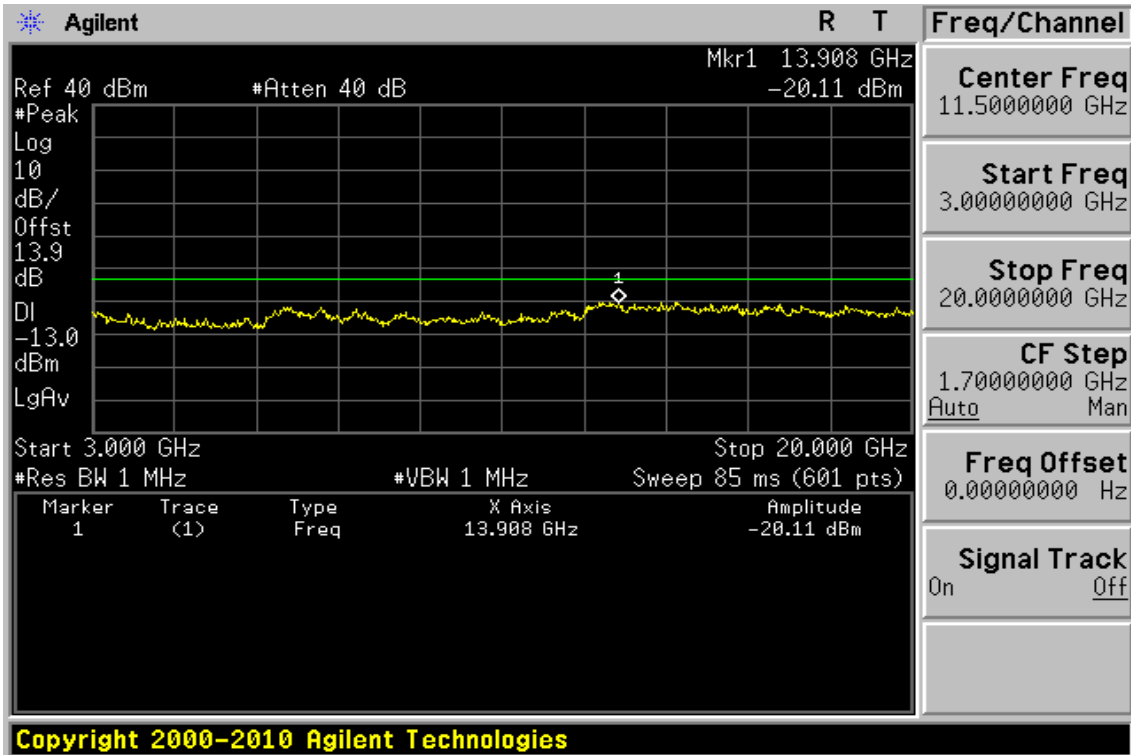
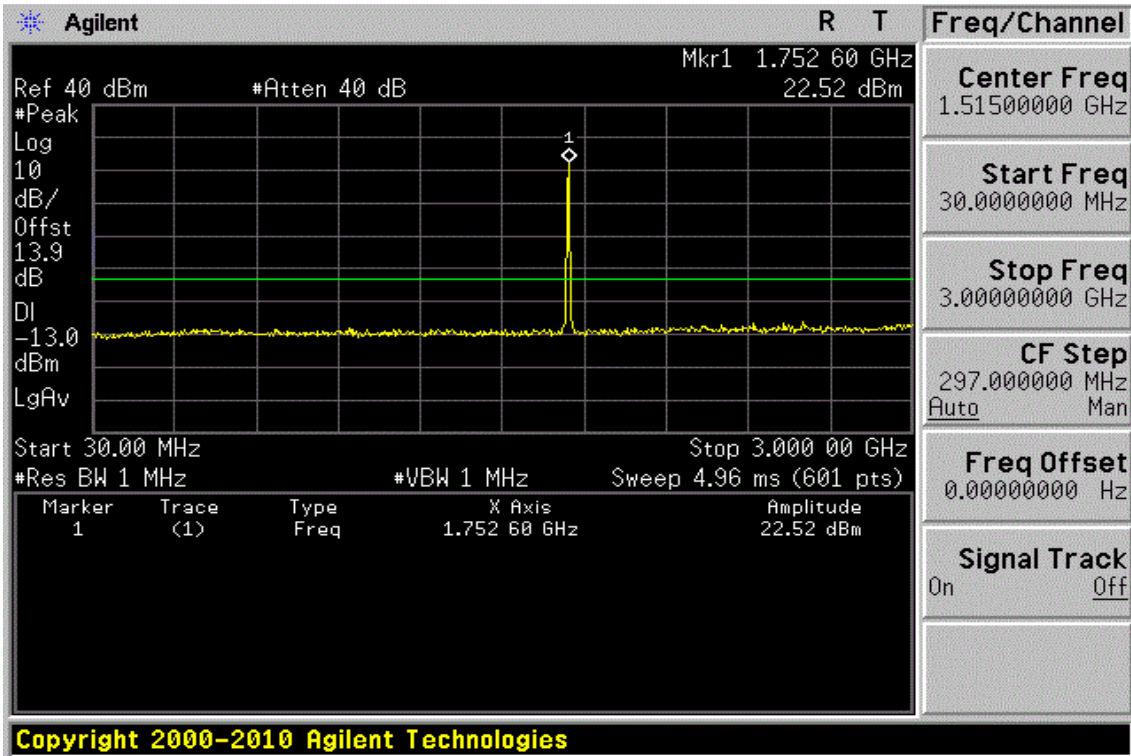

Unless otherwise stated the results shown in this test report refer only to the sample(s) tested and such sample(s) are retained for 90 days only.

除非另有說明，此報告結果僅對測試之樣品負責，同時此樣品僅保留90天。本報告未經本公司書面許可，不可部份複製。

This document is issued by the Company subject to its General Conditions of Service printed overleaf, available on request or accessible at www.sgs.com/terms_and_conditions.htm and, for electronic format documents, subject to Terms and Conditions for Electronic Documents at www.sgs.com/terms_e-document.htm. Attention is drawn to the limitation of liability, indemnification and jurisdiction issues defined therein. Any holder of this document is advised that information contained hereon reflects the Company's findings at the time of its intervention only and within the limits of Client's instructions, if any. The Company's sole responsibility is to its Client and this document does not exonerate parties to a transaction from exercising all their rights and obligations under the transaction documents. This document cannot be reproduced except in full, without prior written approval of the Company. Any unauthorized alteration, forgery or falsification of the content or appearance of this document is unlawful and offenders may be prosecuted to the fullest extent of the law.

Out of Band emission at antenna terminals –HSUPA IV

Fundamental Frequency 1712.4 MHz Engineer :Nick
Operation Mode :TX Low

Freq. (MHz)	Note F/H/E/S	Reading dBm	Limit dBm	Safe Margin dB
<30	S	---	-13.00	---
30-1000	S	---	-13.00	---
3424.80	H	---	-13.00	---
5137.20	H	---	-13.00	---
6849.60	H	---	-13.00	---
8562.00	H	---	-13.00	---
10274.40	H	---	-13.00	---
11986.80	H	---	-13.00	---
13653.00	S	-19.67	-13.00	6.67
13699.20	H	---	-13.00	---
15411.60	H	---	-13.00	---
17124.00	H	---	-13.00	---

Note : “H” : denotes Harmonic Frequency. “S” : denotes Spurious Frequency.
“---” : denotes Noise Floor.

Unless otherwise stated the results shown in this test report refer only to the sample(s) tested and such sample(s) are retained for 90 days only.

除非另有說明，此報告結果僅對測試之樣品負責，同時此樣品僅保留90天。本報告未經本公司書面許可，不可部份複製。

This document is issued by the Company subject to its General Conditions of Service printed overleaf, available on request or accessible at www.sgs.com/terms_and_conditions.htm and, for electronic format documents, subject to Terms and Conditions for Electronic Documents at www.sgs.com/terms_e-document.htm. Attention is drawn to the limitation of liability, indemnification and jurisdiction issues defined therein. Any holder of this document is advised that information contained hereon reflects the Company's findings at the time of its intervention only and within the limits of Client's instructions, if any. The Company's sole responsibility is to its Client and this document does not exonerate parties to a transaction from exercising all their rights and obligations under the transaction documents. This document cannot be reproduced except in full, without prior written approval of the Company. Any unauthorized alteration, forgery or falsification of the content or appearance of this document is unlawful and offenders may be prosecuted to the fullest extent of the law.

Fundamental Frequency :1732.6 MHz Engineer :Nick
Operation Mode :TX Mid

Freq. (MHz)	Note F/H/E/S	Reading dBm	Limit dBm	Safe Margin dB
<30	S	---	-13.00	---
30-1000	S	---	-13.00	---
3465.20	H	---	-13.00	---
5197.80	H	---	-13.00	---
6930.40	H	---	-13.00	---
8663.00	H	---	-13.00	---
10395.60	H	---	-13.00	---
12128.20	H	---	-13.00	---
13540.00	S	-20.39	-13.00	7.39
13860.80	H	---	-13.00	---
15593.40	H	---	-13.00	---
17326.00	H	---	-13.00	---

Note : “H” : denotes Harmonic Frequency. “S” : denotes Spurious Frequency.
“---” : denotes Noise Floor.

Unless otherwise stated the results shown in this test report refer only to the sample(s) tested and such sample(s) are retained for 90 days only.

除非另有說明，此報告結果僅對測試之樣品負責，同時此樣品僅保留90天。本報告未經本公司書面許可，不可部份複製。

This document is issued by the Company subject to its General Conditions of Service printed overleaf, available on request or accessible at www.sgs.com/terms_and_conditions.htm and, for electronic format documents, subject to Terms and Conditions for Electronic Documents at www.sgs.com/terms_e-document.htm. Attention is drawn to the limitation of liability, indemnification and jurisdiction issues defined therein. Any holder of this document is advised that information contained hereon reflects the Company's findings at the time of its intervention only and within the limits of Client's instructions, if any. The Company's sole responsibility is to its Client and this document does not exonerate parties to a transaction from exercising all their rights and obligations under the transaction documents. This document cannot be reproduced except in full, without prior written approval of the Company. Any unauthorized alteration, forgery or falsification of the content or appearance of this document is unlawful and offenders may be prosecuted to the fullest extent of the law.

Figure 9-69: Band edge emission at antenna terminals –HSUPA IV Channel Lowest

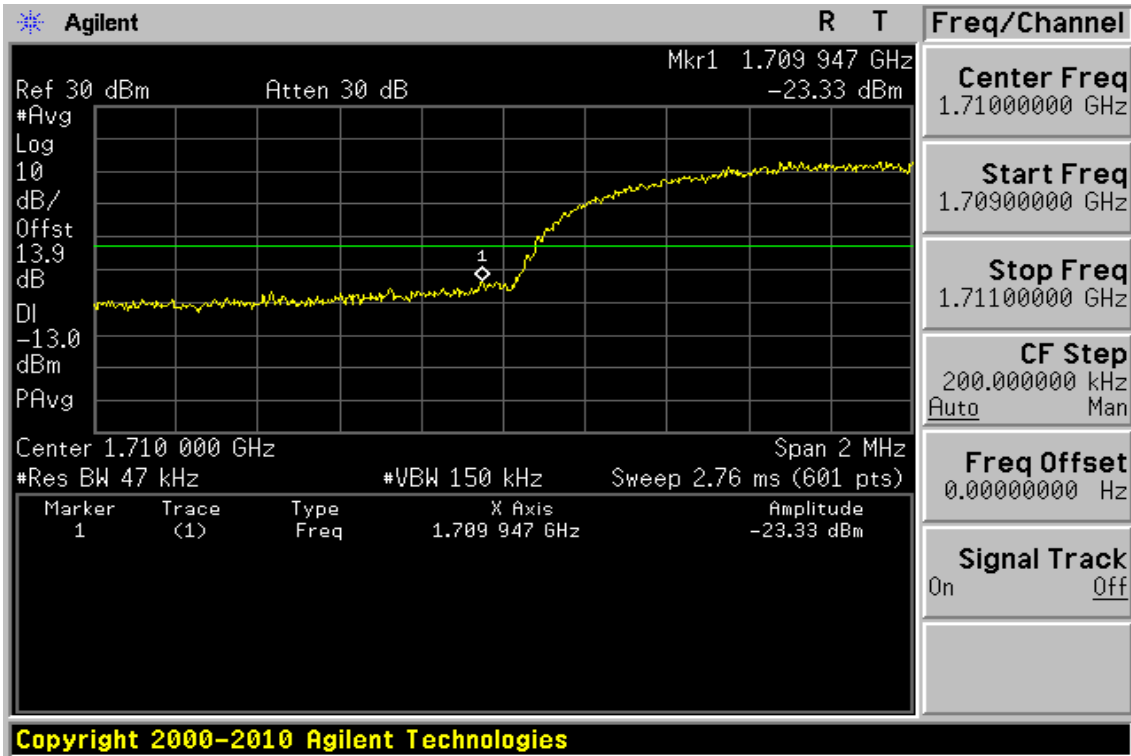
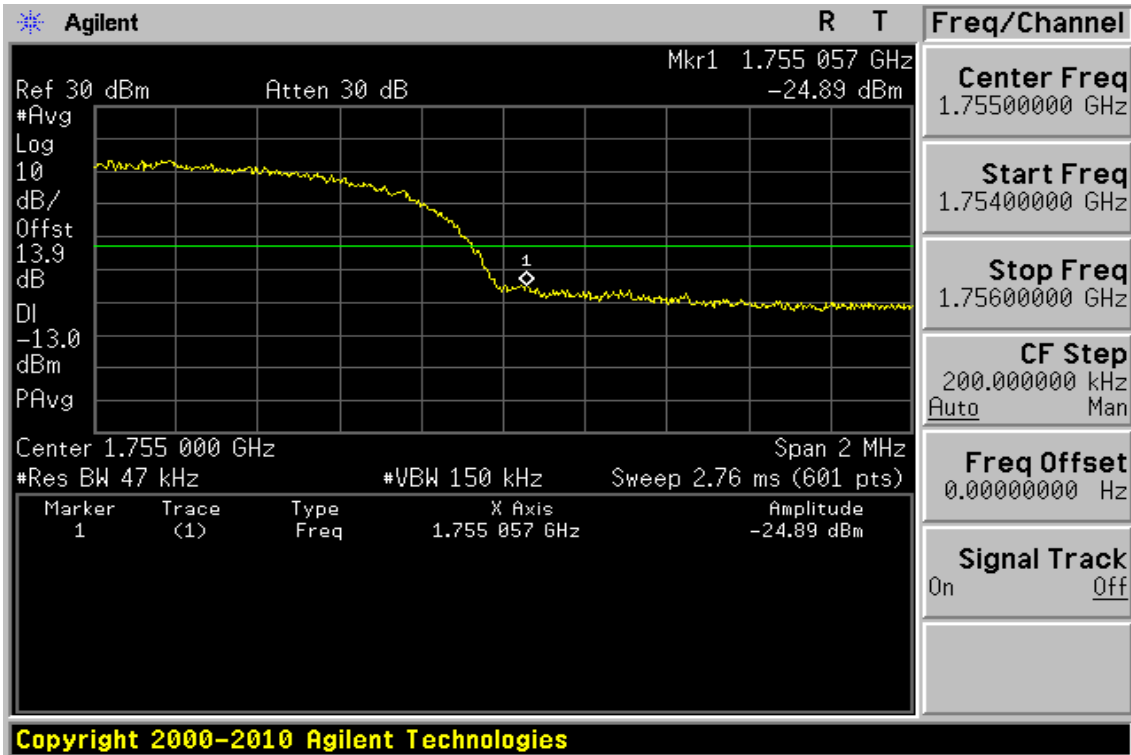

Figure 9-70: Band edge emission at antenna terminals –HSUPA IV Channel Highest



Unless otherwise stated the results shown in this test report refer only to the sample(s) tested and such sample(s) are retained for 90 days only.

除非另有說明，此報告結果僅對測試之樣品負責，同時此樣品僅保留90天。本報告未經本公司書面許可，不可部份複製。

This document is issued by the Company subject to its General Conditions of Service printed overleaf, available on request or accessible at www.sgs.com/terms_and_conditions.htm and, for electronic format documents, subject to Terms and Conditions for Electronic Documents at www.sgs.com/terms_e-document.htm. Attention is drawn to the limitation of liability, indemnification and jurisdiction issues defined therein. Any holder of this document is advised that information contained hereon reflects the Company's findings at the time of its intervention only and within the limits of Client's instructions, if any. The Company's sole responsibility is to its Client and this document does not exonerate parties to a transaction from exercising all their rights and obligations under the transaction documents. This document cannot be reproduced except in full, without prior written approval of the Company. Any unauthorized alteration, forgery or falsification of the content or appearance of this document is unlawful and offenders may be prosecuted to the fullest extent of the law.

Band edge emission at antenna terminals –HSUPA IV Low & High

Test Mode HSUPA IV Engineer :Nick

Freq. MHz	Reading dBm	Limit dBm	Safe Margin dB
1709.947	-23.33	-13.00	10.33
1755.057	-24.89	-13.00	11.89

Unless otherwise stated the results shown in this test report refer only to the sample(s) tested and such sample(s) are retained for 90 days only.

除非另有說明，此報告結果僅對測試之樣品負責，同時此樣品僅保留90天。本報告未經本公司書面許可，不可部份複製。

This document is issued by the Company subject to its General Conditions of Service printed overleaf, available on request or accessible at www.sgs.com/terms_and_conditions.htm and, for electronic format documents, subject to Terms and Conditions for Electronic Documents at www.sgs.com/terms_e-document.htm. Attention is drawn to the limitation of liability, indemnification and jurisdiction issues defined therein. Any holder of this document is advised that information contained hereon reflects the Company's findings at the time of its intervention only and within the limits of Client's instructions, if any. The Company's sole responsibility is to its Client and this document does not exonerate parties to a transaction from exercising all their rights and obligations under the transaction documents. This document cannot be reproduced except in full, without prior written approval of the Company. Any unauthorized alteration, forgery or falsification of the content or appearance of this document is unlawful and offenders may be prosecuted to the fullest extent of the law.

Figure 9-71: Out of Band emission at antenna terminals – HSUPA V Channel Lowest

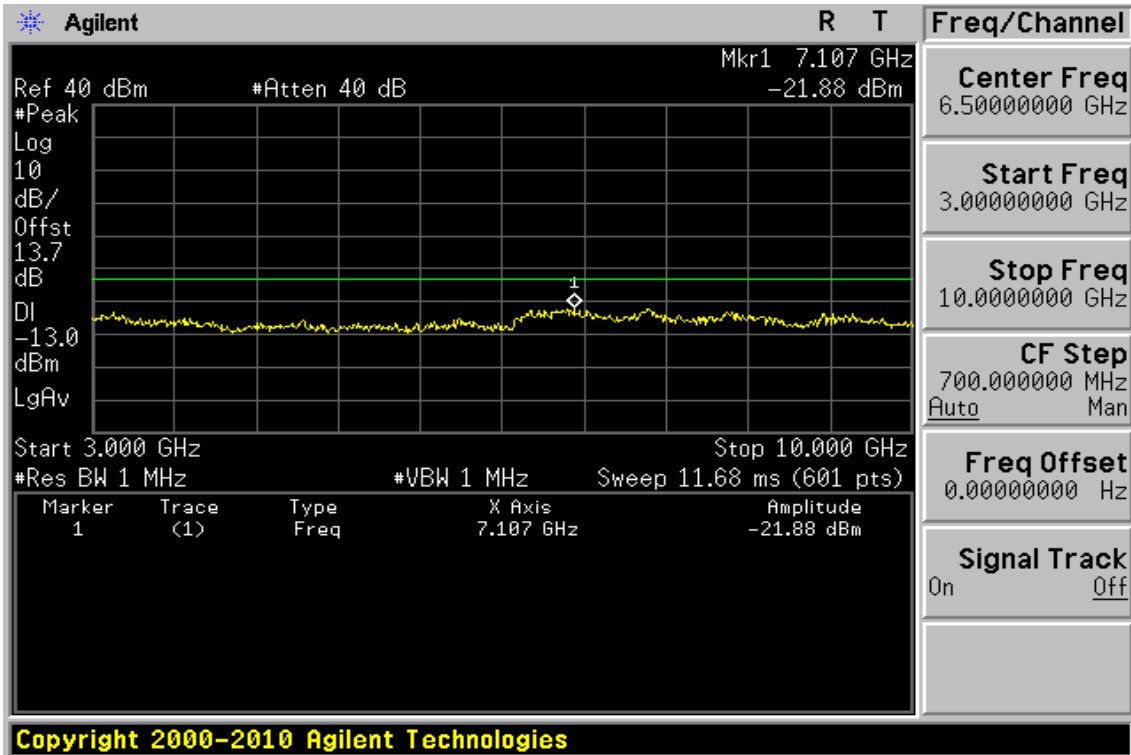
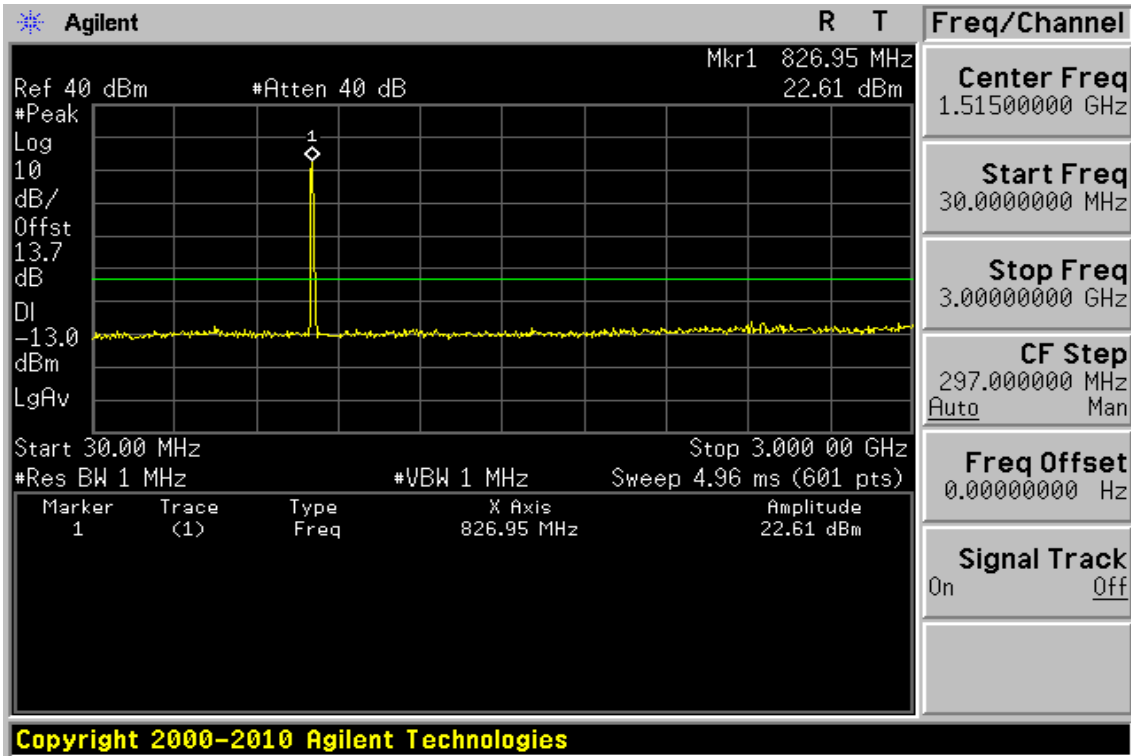

Unless otherwise stated the results shown in this test report refer only to the sample(s) tested and such sample(s) are retained for 90 days only.

除非另有說明，此報告結果僅對測試之樣品負責，同時此樣品僅保留90天。本報告未經本公司書面許可，不可部份複製。

This document is issued by the Company subject to its General Conditions of Service printed overleaf, available on request or accessible at www.sgs.com/terms_and_conditions.htm and, for electronic format documents, subject to Terms and Conditions for Electronic Documents at www.sgs.com/terms_e-document.htm. Attention is drawn to the limitation of liability, indemnification and jurisdiction issues defined therein. Any holder of this document is advised that information contained hereon reflects the Company's findings at the time of its intervention only and within the limits of Client's instructions, if any. The Company's sole responsibility is to its Client and this document does not exonerate parties to a transaction from exercising all their rights and obligations under the transaction documents. This document cannot be reproduced except in full, without prior written approval of the Company. Any unauthorized alteration, forgery or falsification of the content or appearance of this document is unlawful and offenders may be prosecuted to the fullest extent of the law.

Figure 9-72: Out of Band emission at antenna terminals – HSUPA V Channel Mid

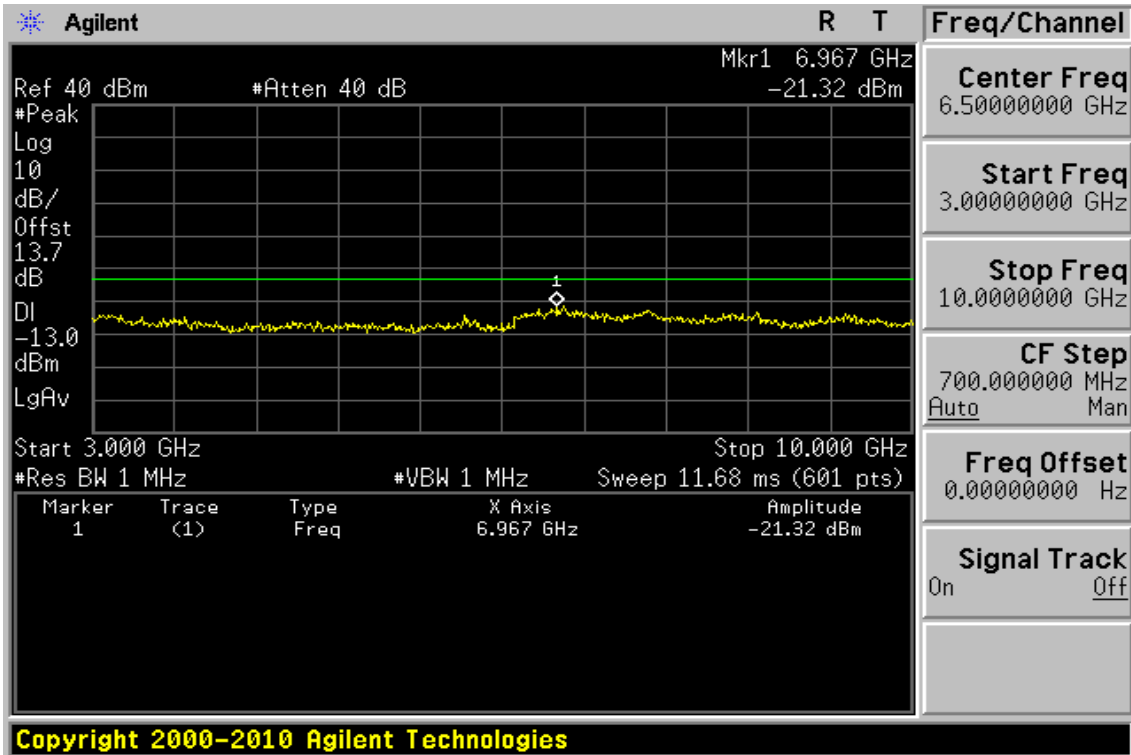
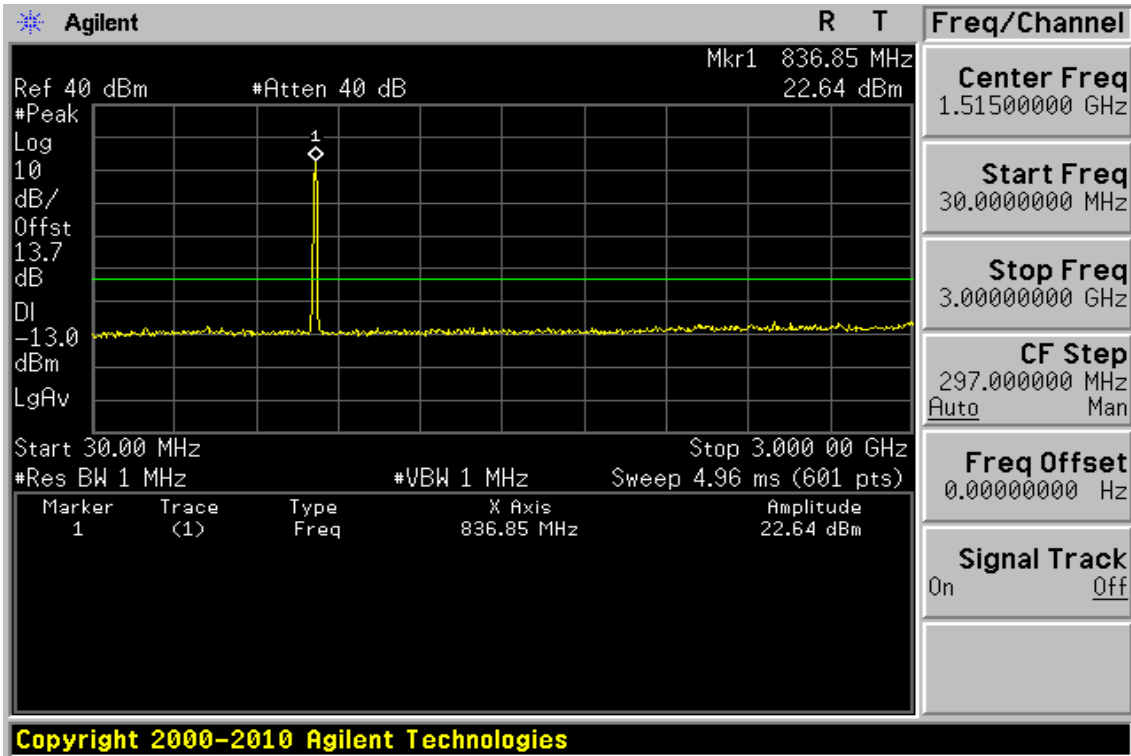

Unless otherwise stated the results shown in this test report refer only to the sample(s) tested and such sample(s) are retained for 90 days only.

除非另有說明，此報告結果僅對測試之樣品負責，同時此樣品僅保留90天。本報告未經本公司書面許可，不可部份複製。

This document is issued by the Company subject to its General Conditions of Service printed overleaf, available on request or accessible at www.sgs.com/terms_and_conditions.htm and, for electronic format documents, subject to Terms and Conditions for Electronic Documents at www.sgs.com/terms_e-document.htm. Attention is drawn to the limitation of liability, indemnification and jurisdiction issues defined therein. Any holder of this document is advised that information contained hereon reflects the Company's findings at the time of its intervention only and within the limits of Client's instructions, if any. The Company's sole responsibility is to its Client and this document does not exonerate parties to a transaction from exercising all their rights and obligations under the transaction documents. This document cannot be reproduced except in full, without prior written approval of the Company. Any unauthorized alteration, forgery or falsification of the content or appearance of this document is unlawful and offenders may be prosecuted to the fullest extent of the law.

Figure 9-73: Out of Band emission at antenna terminals – HSUPA V Channel Highest

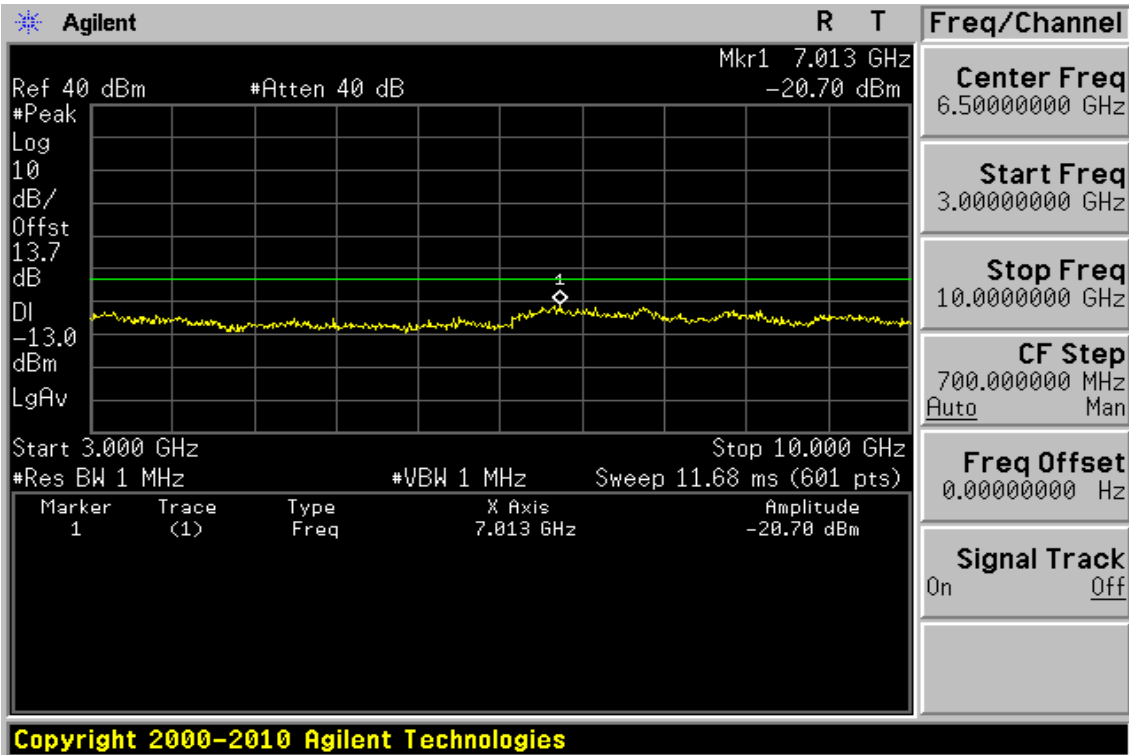
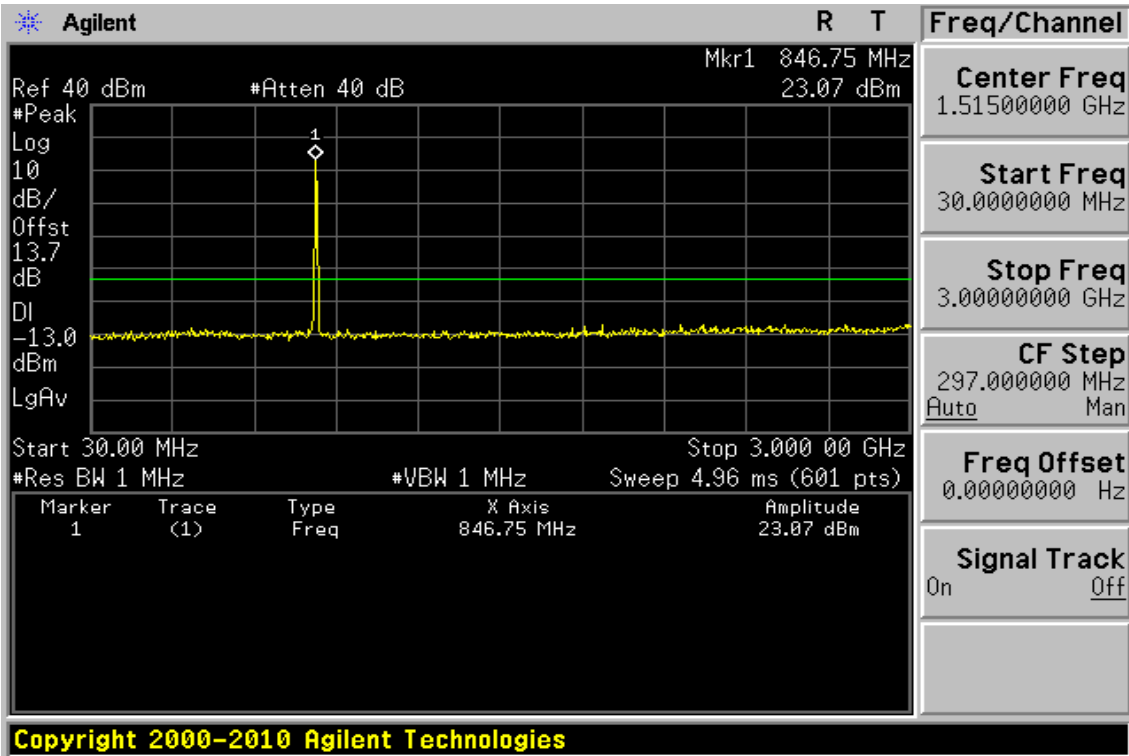

Unless otherwise stated the results shown in this test report refer only to the sample(s) tested and such sample(s) are retained for 90 days only.

除非另有說明，此報告結果僅對測試之樣品負責，同時此樣品僅保留90天。本報告未經本公司書面許可，不可部份複製。

This document is issued by the Company subject to its General Conditions of Service printed overleaf, available on request or accessible at www.sgs.com/terms_and_conditions.htm and, for electronic format documents, subject to Terms and Conditions for Electronic Documents at www.sgs.com/terms_e-document.htm. Attention is drawn to the limitation of liability, indemnification and jurisdiction issues defined therein. Any holder of this document is advised that information contained hereon reflects the Company's findings at the time of its intervention only and within the limits of Client's instructions, if any. The Company's sole responsibility is to its Client and this document does not exonerate parties to a transaction from exercising all their rights and obligations under the transaction documents. This document cannot be reproduced except in full, without prior written approval of the Company. Any unauthorized alteration, forgery or falsification of the content or appearance of this document is unlawful and offenders may be prosecuted to the fullest extent of the law.

Out of Band emission at antenna terminals – HSUPA V

Fundamental Frequency :826.4 MHz Engineer :Nick
Operation Mode :TX Low

Freq. (MHz)	Note F/H/E/S	Reading dBm	Limit dBm	Safe Margin dB
<30	S	---	-13.00	---
30-1000	S	---	-13.00	---
1652.80	H	---	-13.00	---
2479.20	H	---	-13.00	---
3305.60	H	---	-13.00	---
4132.00	H	---	-13.00	---
4958.40	H	---	-13.00	---
5784.80	H	---	-13.00	---
6611.20	H	---	-13.00	---
7107.00	S	-21.88	-13.00	8.88
7437.60	H	---	-13.00	---
8264.00	H	---	-13.00	---

Note : “H” : denotes Harmonic Frequency. “S” : denotes Spurious Frequency.
“---” : denotes Noise Floor.

Unless otherwise stated the results shown in this test report refer only to the sample(s) tested and such sample(s) are retained for 90 days only.

除非另有說明，此報告結果僅對測試之樣品負責，同時此樣品僅保留90天。本報告未經本公司書面許可，不可部份複製。

This document is issued by the Company subject to its General Conditions of Service printed overleaf, available on request or accessible at www.sgs.com/terms_and_conditions.htm and, for electronic format documents, subject to Terms and Conditions for Electronic Documents at www.sgs.com/terms_e-document.htm. Attention is drawn to the limitation of liability, indemnification and jurisdiction issues defined therein. Any holder of this document is advised that information contained hereon reflects the Company's findings at the time of its intervention only and within the limits of Client's instructions, if any. The Company's sole responsibility is to its Client and this document does not exonerate parties to a transaction from exercising all their rights and obligations under the transaction documents. This document cannot be reproduced except in full, without prior written approval of the Company. Any unauthorized alteration, forgery or falsification of the content or appearance of this document is unlawful and offenders may be prosecuted to the fullest extent of the law.

Fundamental Frequency :836.6 MHz Engineer :Nick
Operation Mode :TX Mid

Freq. (MHz)	Note F/H/E/S	Reading dBm	Limit dBm	Safe Margin dB
<30	S	---	-13.00	---
30-1000	S	---	-13.00	---
1673.20	H	---	-13.00	---
2509.80	H	---	-13.00	---
3346.40	H	---	-13.00	---
4183.00	H	---	-13.00	---
5019.60	H	---	-13.00	---
5856.20	H	---	-13.00	---
6692.80	H	---	-13.00	---
6967.00	S	-21.32	-13.00	8.32
7529.40	H	---	-13.00	---
8366.00	H	---	-13.00	---

Note : “H” : denotes Harmonic Frequency. “S” : denotes Spurious Frequency.
“---” : denotes Noise Floor.

Unless otherwise stated the results shown in this test report refer only to the sample(s) tested and such sample(s) are retained for 90 days only.

除非另有說明，此報告結果僅對測試之樣品負責，同時此樣品僅保留90天。本報告未經本公司書面許可，不可部份複製。

This document is issued by the Company subject to its General Conditions of Service printed overleaf, available on request or accessible at www.sgs.com/terms_and_conditions.htm and, for electronic format documents, subject to Terms and Conditions for Electronic Documents at www.sgs.com/terms_e-document.htm. Attention is drawn to the limitation of liability, indemnification and jurisdiction issues defined therein. Any holder of this document is advised that information contained hereon reflects the Company's findings at the time of its intervention only and within the limits of Client's instructions, if any. The Company's sole responsibility is to its Client and this document does not exonerate parties to a transaction from exercising all their rights and obligations under the transaction documents. This document cannot be reproduced except in full, without prior written approval of the Company. Any unauthorized alteration, forgery or falsification of the content or appearance of this document is unlawful and offenders may be prosecuted to the fullest extent of the law.

Fundamental Frequency :846.6MHz Engineer :Nick
Operation Mode :TX High

Freq. (MHz)	Note F/H/E/S	Reading dBm	Limit dBm	Safe Margin dB
<30	S	---	-13.00	---
30-1000	S	---	-13.00	---
1693.20	H	---	-13.00	---
2539.80	H	---	-13.00	---
3386.40	H	---	-13.00	---
4233.00	H	---	-13.00	---
5079.60	H	---	-13.00	---
5926.20	H	---	-13.00	---
6772.80	H	---	-13.00	---
7013.00	S	-20.70	-13.00	7.70
7619.40	H	---	-13.00	---
8466.00	H	---	-13.00	---

Note : "H" : denotes Harmonic Frequency. "S" : denotes Spurious Frequency.
"---" : denotes Noise Floor.

Unless otherwise stated the results shown in this test report refer only to the sample(s) tested and such sample(s) are retained for 90 days only.

除非另有說明，此報告結果僅對測試之樣品負責，同時此樣品僅保留90天。本報告未經本公司書面許可，不可部份複製。

This document is issued by the Company subject to its General Conditions of Service printed overleaf, available on request or accessible at www.sgs.com/terms_and_conditions.htm and, for electronic format documents, subject to Terms and Conditions for Electronic Documents at www.sgs.com/terms_e-document.htm. Attention is drawn to the limitation of liability, indemnification and jurisdiction issues defined therein. Any holder of this document is advised that information contained hereon reflects the Company's findings at the time of its intervention only and within the limits of Client's instructions, if any. The Company's sole responsibility is to its Client and this document does not exonerate parties to a transaction from exercising all their rights and obligations under the transaction documents. This document cannot be reproduced except in full, without prior written approval of the Company. Any unauthorized alteration, forgery or falsification of the content or appearance of this document is unlawful and offenders may be prosecuted to the fullest extent of the law.

Figure 9-74: Band edge emission at antenna terminals – HSUPA V Channel Lowest

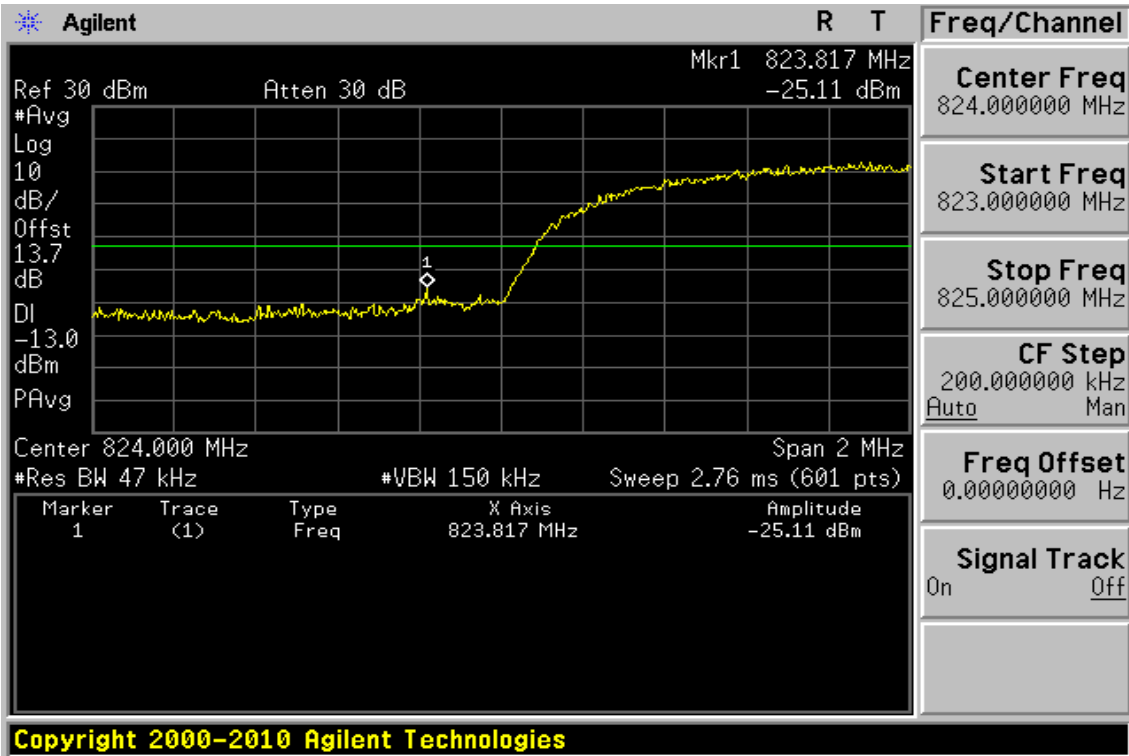
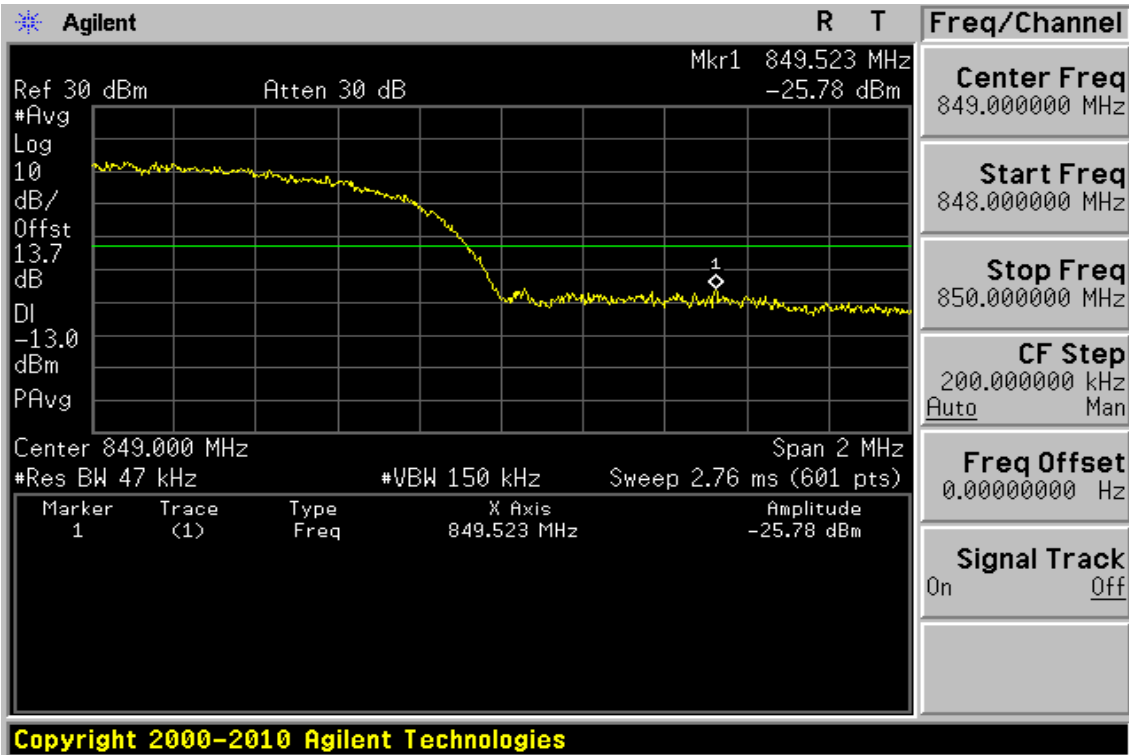

Figure 9-75: Band edge emission at antenna terminals – HSUPA V Channel Highest



Unless otherwise stated the results shown in this test report refer only to the sample(s) tested and such sample(s) are retained for 90 days only.

除非另有說明，此報告結果僅對測試之樣品負責，同時此樣品僅保留90天。本報告未經本公司書面許可，不可部份複製。

This document is issued by the Company subject to its General Conditions of Service printed overleaf, available on request or accessible at www.sgs.com/terms_and_conditions.htm and, for electronic format documents, subject to Terms and Conditions for Electronic Documents at www.sgs.com/terms_e-document.htm. Attention is drawn to the limitation of liability, indemnification and jurisdiction issues defined therein. Any holder of this document is advised that information contained hereon reflects the Company's findings at the time of its intervention only and within the limits of Client's instructions, if any. The Company's sole responsibility is to its Client and this document does not exonerate parties to a transaction from exercising all their rights and obligations under the transaction documents. This document cannot be reproduced except in full, without prior written approval of the Company. Any unauthorized alteration, forgery or falsification of the content or appearance of this document is unlawful and offenders may be prosecuted to the fullest extent of the law.

Band edge emission at antenna terminals – HSUPA V Low & High

Test Mode HSUPA V Engineer :Nick

Freq. MHz	Reading dBm	Limit dBm	Safe Margin dB
823.817	-25.11	-13.00	12.11
849.523	-25.78	-13.00	12.78

Unless otherwise stated the results shown in this test report refer only to the sample(s) tested and such sample(s) are retained for 90 days only.

除非另有說明，此報告結果僅對測試之樣品負責，同時此樣品僅保留90天。本報告未經本公司書面許可，不可部份複製。

This document is issued by the Company subject to its General Conditions of Service printed overleaf, available on request or accessible at www.sgs.com/terms_and_conditions.htm and, for electronic format documents, subject to Terms and Conditions for Electronic Documents at www.sgs.com/terms_e-document.htm. Attention is drawn to the limitation of liability, indemnification and jurisdiction issues defined therein. Any holder of this document is advised that information contained hereon reflects the Company's findings at the time of its intervention only and within the limits of Client's instructions, if any. The Company's sole responsibility is to its Client and this document does not exonerate parties to a transaction from exercising all their rights and obligations under the transaction documents. This document cannot be reproduced except in full, without prior written approval of the Company. Any unauthorized alteration, forgery or falsification of the content or appearance of this document is unlawful and offenders may be prosecuted to the fullest extent of the law.

10. FIELD STRENGTH OF SPURIOUS RADIATION MEASUREMENT

10.1. Standard Applicable:

According to FCC §2.1053,

FCC §22.917(a), §24.238(a), §27.53(h) the magnitude of each spurious and harmonic emission that can be detected when the equipment is operated under the conditions specified in the instruction manual and/ or alignment procedure, shall not be less than $43 + 10 \log$ (mean output power in watts) dBc below the mean power output outside a license's frequency block (-13dBm).

According to RSS-132 §5.5

Mobile and base station equipment shall comply with the limits in (i) and (ii) below.

(i) In the first 1.0 MHz band immediately outside and adjacent to each of the sub-bands specified in Section 5.1, the power of emissions per any 1% of the occupied bandwidth shall be attenuated (in dB) below the transmitter output power P (dBW) by at least $43 + 10 \log_{10} p$ (watts).

(ii)

After the first 1.0 MHz immediately outside and adjacent to each of the sub-bands, the power of emissions in any 100 kHz bandwidth shall be attenuated (in dB) below the transmitter output power P (dBW) by at least $43 + 10 \log_{10} p$ (watts). If the measurement is performed using 1% of the occupied bandwidth, power integration over 100 kHz is required.

According to RSS-133 §6.5

6.5.1 Out-of-Block Emissions

Equipment shall comply with the limits in (i) and (ii) below.

(i) In the 1.0 MHz bands immediately outside and adjacent to the equipment's operating frequency block, the emission power per any 1% of the emission bandwidth shall be attenuated (in dB) below the transmitter output power P (dBW) by at least $43 + 10 \log_{10} p$ (watts).

(ii) After the first 1.0 MHz, the emission power in any 1 MHz bandwidth shall be attenuated (in dB) below the transmitter output power P (dBW) by at least $43 + 10 \log_{10} p$ (watts). If the measurement is performed using 1% of the emission bandwidth, power integration over 1.0 MHz is required.

Unless otherwise stated the results shown in this test report refer only to the sample(s) tested and such sample(s) are retained for 90 days only.

除非另有說明，此報告結果僅對測試之樣品負責，同時此樣品僅保留90天。本報告未經本公司書面許可，不可部份複製。

This document is issued by the Company subject to its General Conditions of Service printed overleaf, available on request or accessible at www.sgs.com/terms_and_conditions.htm and, for electronic format documents, subject to Terms and Conditions for Electronic Documents at www.sgs.com/terms_e-document.htm. Attention is drawn to the limitation of liability, indemnification and jurisdiction issues defined therein. Any holder of this document is advised that information contained hereon reflects the Company's findings at the time of its intervention only and within the limits of Client's instructions, if any. The Company's sole responsibility is to its Client and this document does not exonerate parties to a transaction from exercising all their rights and obligations under the transaction documents. This document cannot be reproduced except in full, without prior written approval of the Company. Any unauthorized alteration, forgery or falsification of the content or appearance of this document is unlawful and offenders may be prosecuted to the fullest extent of the law.

6.5.2 Out-of-Sub-band Emissions

Outside the sub-bands 1850-1910 MHz and 1930-1990 MHz, the attenuation shall be equal to or greater than the out-of-block emission limits in Section 6.5.1.

According to RSS-139 §6.5

- (i) In the first 1.0 MHz bands immediately outside and adjacent to the equipment's operating frequency block, the emission power per any 1% of the emission bandwidth shall be attenuated below the transmitter output power P (in watts) by at least $43 + 10 \log_{10}(P)$, dB.
- (ii) After the first 1.0 MHz outside the equipment's operating frequency block, the emission power in any 1 MHz bandwidth shall be attenuated below the transmitter output power P (in watts) by at least $43 + 10 \log_{10}(P)$, dB.

Receiver Spurious Emissions

Receiver spurious emissions shall comply with the limits specified in RSS-Gen.

Spurious emissions from receivers shall not exceed the radiated limits shown in the table below:

Radiated Limits of Receiver Spurious Emissions

Frequency (MHz)	Field Strength (microvolts/m at 3 metres)*
30-88	100
88-216	150
216-960	200
Above 960	500

Unless otherwise stated the results shown in this test report refer only to the sample(s) tested and such sample(s) are retained for 90 days only.

除非另有說明，此報告結果僅對測試之樣品負責，同時此樣品僅保留90天。本報告未經本公司書面許可，不可部份複製。

This document is issued by the Company subject to its General Conditions of Service printed overleaf, available on request or accessible at www.sgs.com/terms_and_conditions.htm and, for electronic format documents, subject to Terms and Conditions for Electronic Documents at www.sgs.com/terms_e-document.htm. Attention is drawn to the limitation of liability, indemnification and jurisdiction issues defined therein. Any holder of this document is advised that information contained hereon reflects the Company's findings at the time of its intervention only and within the limits of Client's instructions, if any. The Company's sole responsibility is to its Client and this document does not exonerate parties to a transaction from exercising all their rights and obligations under the transaction documents. This document cannot be reproduced except in full, without prior written approval of the Company. Any unauthorized alteration, forgery or falsification of the content or appearance of this document is unlawful and offenders may be prosecuted to the fullest extent of the law.

10.2. EUT Setup (Block Diagram of Configuration):

Radiated Emission Test Set-Up, Frequency Below 1000MHz

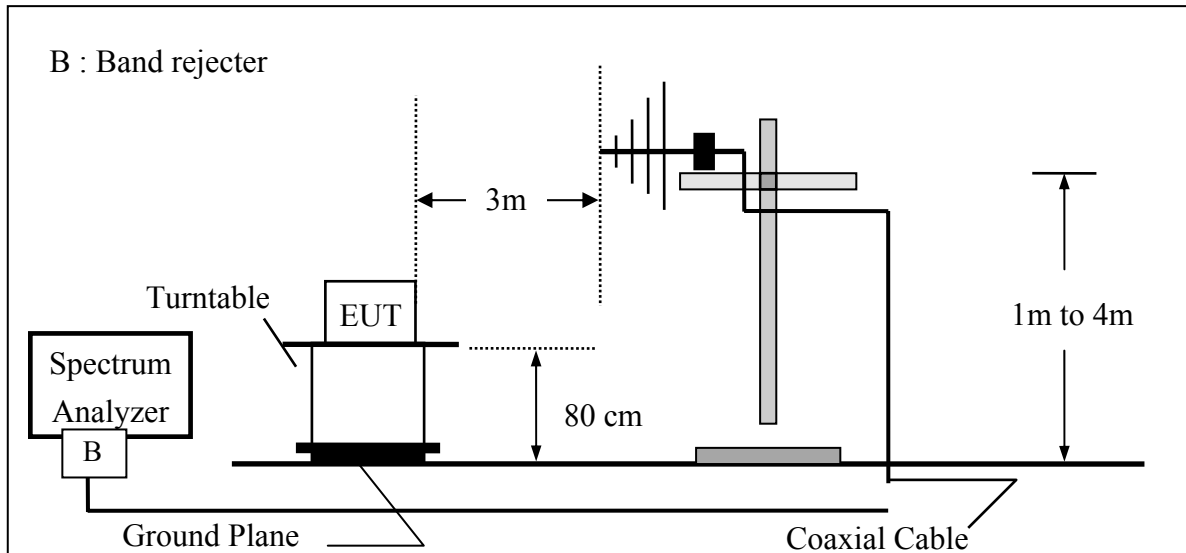

Unless otherwise stated the results shown in this test report refer only to the sample(s) tested and such sample(s) are retained for 90 days only.

除非另有說明，此報告結果僅對測試之樣品負責，同時此樣品僅保留90天。本報告未經本公司書面許可，不可部份複製。

This document is issued by the Company subject to its General Conditions of Service printed overleaf, available on request or accessible at www.sgs.com/terms_and_conditions.htm and, for electronic format documents, subject to Terms and Conditions for Electronic Documents at www.sgs.com/terms_e-document.htm. Attention is drawn to the limitation of liability, indemnification and jurisdiction issues defined therein. Any holder of this document is advised that information contained hereon reflects the Company's findings at the time of its intervention only and within the limits of Client's instructions, if any. The Company's sole responsibility is to its Client and this document does not exonerate parties to a transaction from exercising all their rights and obligations under the transaction documents. This document cannot be reproduced except in full, without prior written approval of the Company. Any unauthorized alteration, forgery or falsification of the content or appearance of this document is unlawful and offenders may be prosecuted to the fullest extent of the law.

Radiated Emission Test Set-UP Frequency Over 1 GHz

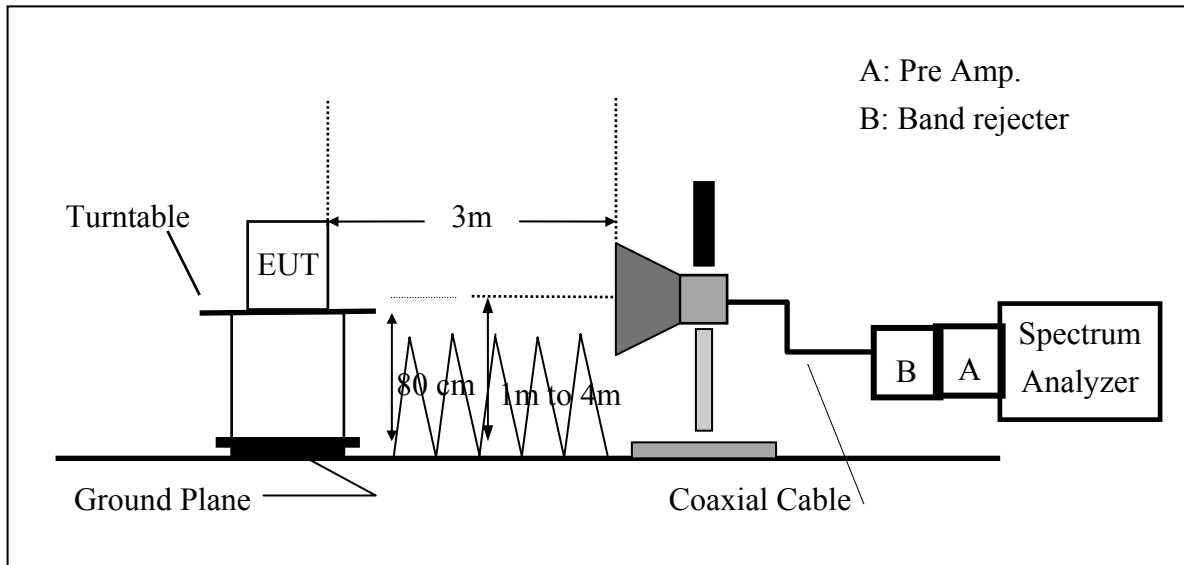

10.3. Measurement Procedure:

The EUT was placed on a non-conductive; the measurement antenna was placed at a distance of 3 meters from the EUT. During the tests, the antenna height and the EUT azimuth were varied in order to identify the maximum level of emissions from the EUT. This maximization process was repeated with the EUT positioned in each of its three orthogonal orientations.

The frequency range up to tenth harmonic was investigated for each of three fundamental frequencies (low, middle and high channels). Once spurious emission was identified, the power of the emission was determined using the substitution method.

The spurious emissions attenuation was calculated as the difference between radiated power at the fundamental frequency and the spurious emissions frequency.

$$ERP = \text{S.G. output (dBm)} + \text{Antenna Gain (dBd)} - \text{Cable Loss (dB)}$$

$$EIRP = \text{S.G. output (dBm)} + \text{Antenna Gain (dBi)} - \text{Cable Loss (dB)}$$

10.4. Measurement Equipment Used:

Refer to section 2.4 in this report

10.5. Measurement Result:

Refer to attach tabular data sheets.

For radiated plot of test data, please refer to Appendix 1, page 321

Unless otherwise stated the results shown in this test report refer only to the sample(s) tested and such sample(s) are retained for 90 days only.

除非另有說明，此報告結果僅對測試之樣品負責，同時此樣品僅保留90天。本報告未經本公司書面許可，不可部份複製。

This document is issued by the Company subject to its General Conditions of Service printed overleaf, available on request or accessible at www.sgs.com/terms_and_conditions.htm and, for electronic format documents, subject to Terms and Conditions for Electronic Documents at www.sgs.com/terms_e-document.htm. Attention is drawn to the limitation of liability, indemnification and jurisdiction issues defined therein. Any holder of this document is advised that information contained hereon reflects the Company's findings at the time of its intervention only and within the limits of Client's instructions, if any. The Company's sole responsibility is to its Client and this document does not exonerate parties to a transaction from exercising all their rights and obligations under the transaction documents. This document cannot be reproduced except in full, without prior written approval of the Company. Any unauthorized alteration, forgery or falsification of the content or appearance of this document is unlawful and offenders may be prosecuted to the fullest extent of the law.

Radiated Spurious Emission Measurement Result: GSM 850 Mode

Operation Band	:GSM 850	Test Date	:2013-05-27
ARFCN	:CH 128	Temp./Humi.	:24.1 deg_C / 65 RH
Fundamental Frequency	:824.2 MHz	Engineer	:Allen
Operation Mode	:TX LOW		
EUT Pol.	:E2 Plan	Measurement Antenna Pol.	:VERTICAL

Freq.	Note	ERP	SG	Antenna	Cable	Limit	Margin
MHz	F/H/E/S	dBm	Output Level dBm	Gain dBd	Loss dB	dBm	dB
114.39	S	-84.05	-81.73	-1.20	-1.11	-13.00	-71.05
158.04	S	-84.01	-82.07	-0.67	-1.26	-13.00	-71.01
343.31	S	-82.79	-85.72	4.75	-1.82	-13.00	-69.79
549.92	S	-78.40	-80.72	4.58	-2.26	-13.00	-65.40
711.91	S	-76.80	-78.22	4.00	-2.58	-13.00	-63.80
930.16	S	-73.87	-74.50	3.64	-3.01	-13.00	-60.87
1648.40	H	---					
2472.60	H	-39.38	-37.49	3.14	-5.03	-13.00	-26.38
3296.80	H	---					
4121.00	H	---					
4945.20	H	---					
5769.40	H	---					
6593.60	H	---					
7417.80	H	---					
8242.00	H	---					

ERP(dBm) = SG Level(dBm) + Antenna Gain(dBd) + Cable Loss(dB)

Note : "F" : denotes Fundamental Frequency. ; "H" : denotes Harmonic Frequency.
 "E" : denotes Band Edge Frequency. ; "S" : denotes Spurious Frequency.
 "---" : denotes Noise Floor.

Unless otherwise stated the results shown in this test report refer only to the sample(s) tested and such sample(s) are retained for 90 days only.

除非另有說明，此報告結果僅對測試之樣品負責，同時此樣品僅保留90天。本報告未經本公司書面許可，不可部份複製。

This document is issued by the Company subject to its General Conditions of Service printed overleaf, available on request or accessible at www.sgs.com/terms_and_conditions.htm and, for electronic format documents, subject to Terms and Conditions for Electronic Documents at www.sgs.com/terms_e-document.htm. Attention is drawn to the limitation of liability, indemnification and jurisdiction issues defined therein. Any holder of this document is advised that information contained hereon reflects the Company's findings at the time of its intervention only and within the limits of Client's instructions, if any. The Company's sole responsibility is to its Client and this document does not exonerate parties to a transaction from exercising all their rights and obligations under the transaction documents. This document cannot be reproduced except in full, without prior written approval of the Company. Any unauthorized alteration, forgery or falsification of the content or appearance of this document is unlawful and offenders may be prosecuted to the fullest extent of the law.

Operation Band	:GSM 850	Test Date	:2013-05-27
ARFCN	:CH 128	Temp./Humi.	:24.1 deg_C / 65 RH
Fundamental Frequency	:824.2 MHz	Engineer	:Allen
Operation Mode	:TX LOW		
EUT Pol.	:E2 Plan	Measurement Antenna Pol.	:HORIZONTAL

Freq.	Note	ERP	SG	Antenna	Cable	Limit	Margin
MHz	F/H/E/S	dBm	Output Level dBm	Gain dBd	Loss dB	dBm	dB
171.62	S	-83.55	-83.36	1.12	-1.31	-13.00	-70.55
309.36	S	-72.44	-75.36	4.65	-1.73	-13.00	-59.44
505.30	S	-81.25	-83.78	4.70	-2.17	-13.00	-68.25
602.30	S	-80.41	-82.06	4.03	-2.38	-13.00	-67.41
721.61	S	-78.28	-79.56	3.88	-2.59	-13.00	-65.28
953.44	S	-75.79	-76.39	3.66	-3.06	-13.00	-62.79
1648.40	H	-51.16	-49.79	2.68	-4.05	-13.00	-38.16
2472.60	H	-45.42	-43.91	3.52	-5.03	-13.00	-32.42
3288.00	H	---					
4121.00	H	---					
4945.20	H	---					
5769.40	H	---					
6593.60	H	---					
7417.80	H	---					
8242.00	H	---					

ERP(dBm) = SG Level(dBm) + Antenna Gain(dBd) + Cable Loss(dB)

Note : "F" : denotes Fundamental Frequency. ; "H" : denotes Harmonic Frequency.
 "E" : denotes Band Edge Frequency. ; "S" : denotes Spurious Frequency.
 "---" : denotes Noise Floor.

Unless otherwise stated the results shown in this test report refer only to the sample(s) tested and such sample(s) are retained for 90 days only.

除非另有說明，此報告結果僅對測試之樣品負責，同時此樣品僅保留90天。本報告未經本公司書面許可，不可部份複製。

This document is issued by the Company subject to its General Conditions of Service printed overleaf, available on request or accessible at www.sgs.com/terms_and_conditions.htm and, for electronic format documents, subject to Terms and Conditions for Electronic Documents at www.sgs.com/terms_e-document.htm. Attention is drawn to the limitation of liability, indemnification and jurisdiction issues defined therein. Any holder of this document is advised that information contained hereon reflects the Company's findings at the time of its intervention only and within the limits of Client's instructions, if any. The Company's sole responsibility is to its Client and this document does not exonerate parties to a transaction from exercising all their rights and obligations under the transaction documents. This document cannot be reproduced except in full, without prior written approval of the Company. Any unauthorized alteration, forgery or falsification of the content or appearance of this document is unlawful and offenders may be prosecuted to the fullest extent of the law.

Operation Band	:GSM 850	Test Date	:2013-05-27
ARFCN	:CH 190	Temp./Humi.	:24.1 deg_C / 65 RH
Fundamental Frequency	:836.6 MHz	Engineer	:Allen
Operation Mode	:TX MID		
EUT Pol.	:E2 Plan	Measurement Antenna Pol.	:VERTICAL

Freq.	Note	ERP	SG	Antenna	Cable	Limit	Margin
MHz	F/H/E/S	dBm	Output Level dBm	Gain dBd	Loss dB	dBm	dB
114.39	S	-83.76	-81.44	-1.20	-1.11	-13.00	-70.76
286.08	S	-82.15	-84.98	4.50	-1.67	-13.00	-69.15
343.31	S	-81.38	-84.31	4.75	-1.82	-13.00	-68.38
555.74	S	-78.25	-80.49	4.51	-2.27	-13.00	-65.25
780.78	S	-75.82	-76.86	3.76	-2.72	-13.00	-62.82
935.01	S	-73.63	-74.25	3.64	-3.02	-13.00	-60.63
1673.20	H						
2509.80	H	-38.88	-37.00	3.19	-5.07	-13.00	-25.88
3346.40	H	---					
4183.00	H	---					
5019.60	H	---					
5856.20	H	---					
6692.80	H	---					
7529.40	H	---					
8366.00	H	---					

ERP(dBm) = SG Level(dBm) + Antenna Gain(dBd) + Cable Loss(dB)

Note : "F" : denotes Fundamental Frequency. ; "H" : denotes Harmonic Frequency.
 "E" : denotes Band Edge Frequency. ; "S" : denotes Spurious Frequency.
 "---" : denotes Noise Floor.

Unless otherwise stated the results shown in this test report refer only to the sample(s) tested and such sample(s) are retained for 90 days only.

除非另有說明，此報告結果僅對測試之樣品負責，同時此樣品僅保留90天。本報告未經本公司書面許可，不可部份複製。

This document is issued by the Company subject to its General Conditions of Service printed overleaf, available on request or accessible at www.sgs.com/terms_and_conditions.htm and, for electronic format documents, subject to Terms and Conditions for Electronic Documents at www.sgs.com/terms_e-document.htm. Attention is drawn to the limitation of liability, indemnification and jurisdiction issues defined therein. Any holder of this document is advised that information contained hereon reflects the Company's findings at the time of its intervention only and within the limits of Client's instructions, if any. The Company's sole responsibility is to its Client and this document does not exonerate parties to a transaction from exercising all their rights and obligations under the transaction documents. This document cannot be reproduced except in full, without prior written approval of the Company. Any unauthorized alteration, forgery or falsification of the content or appearance of this document is unlawful and offenders may be prosecuted to the fullest extent of the law.

Operation Band	:GSM 850	Test Date	:2013-05-27
ARFCN	:CH 190	Temp./Humi.	:24.1 deg_C / 65 RH
Fundamental Frequency	:836.6 MHz	Engineer	:Allen
Operation Mode	:TX MID		
EUT Pol.	:E2 Plan	Measurement Antenna Pol.	:HORIZONTAL

Freq.	Note	ERP	SG	Antenna	Cable	Limit	Margin
MHz	F/H/E/S	dBm	Output Level dBm	Gain dBd	Loss dB	dBm	dB
130.88	S	-87.16	-85.21	-0.77	-1.18	-13.00	-74.16
188.11	S	-84.52	-86.57	3.43	-1.37	-13.00	-71.52
403.45	S	-82.88	-85.69	4.75	-1.95	-13.00	-69.88
559.62	S	-81.18	-83.37	4.47	-2.28	-13.00	-68.18
638.19	S	-80.44	-82.09	4.10	-2.46	-13.00	-67.44
903.97	S	-74.86	-75.56	3.65	-2.95	-13.00	-61.86
1673.20	H	-54.70	-53.28	2.66	-4.08	-13.00	-41.70
2509.80	H	-44.23	-42.72	3.56	-5.07	-13.00	-31.23
3346.40	H	---					
4183.00	H	---					
5019.60	H	---					
5856.20	H	---					
6692.80	H	---					
7529.40	H	---					
8366.00	H	---					

ERP(dBm) = SG Level(dBm) + Antenna Gain(dBd) + Cable Loss(dB)

Note : "F" : denotes Fundamental Frequency. ; "H" : denotes Harmonic Frequency.
 "E" : denotes Band Edge Frequency. ; "S" : denotes Spurious Frequency.
 "---" : denotes Noise Floor.

Unless otherwise stated the results shown in this test report refer only to the sample(s) tested and such sample(s) are retained for 90 days only.

除非另有說明，此報告結果僅對測試之樣品負責，同時此樣品僅保留90天。本報告未經本公司書面許可，不可部份複製。

This document is issued by the Company subject to its General Conditions of Service printed overleaf, available on request or accessible at www.sgs.com/terms_and_conditions.htm and, for electronic format documents, subject to Terms and Conditions for Electronic Documents at www.sgs.com/terms_e-document.htm. Attention is drawn to the limitation of liability, indemnification and jurisdiction issues defined therein. Any holder of this document is advised that information contained hereon reflects the Company's findings at the time of its intervention only and within the limits of Client's instructions, if any. The Company's sole responsibility is to its Client and this document does not exonerate parties to a transaction from exercising all their rights and obligations under the transaction documents. This document cannot be reproduced except in full, without prior written approval of the Company. Any unauthorized alteration, forgery or falsification of the content or appearance of this document is unlawful and offenders may be prosecuted to the fullest extent of the law.

Operation Band	:GSM 850	Test Date	:2013-05-27
ARFCN	:CH 251	Temp./Humi.	:24.1 deg_C / 65 RH
Fundamental Frequency	:848.8 MHz	Engineer	:Allen
Operation Mode	:TX HIGH		
EUT Pol.	:E2 Plan	Measurement Antenna Pol.	:VERTICAL

Freq.	Note	ERP	SG	Antenna	Cable	Limit	Margin
MHz	F/H/E/S	dBm	Output Level dBm	Gain dBd	Loss dB	dBm	dB
114.39	S	-84.23	-81.91	-1.20	-1.11	-13.00	-71.23
277.35	S	-83.08	-85.89	4.46	-1.65	-13.00	-70.08
472.32	S	-81.19	-83.66	4.58	-2.10	-13.00	-68.19
602.30	S	-77.40	-79.06	4.03	-2.38	-13.00	-64.40
719.67	S	-77.38	-78.69	3.90	-2.59	-13.00	-64.38
929.19	S	-74.02	-74.65	3.64	-3.01	-13.00	-61.02
1697.60	H						
2546.40	H	-42.78	-40.98	3.30	-5.11	-13.00	-29.78
3395.20	H	---					
4244.00	H	---					
5092.80	H	---					
5941.60	H	---					
6790.40	H	---					
7639.20	H	---					
8488.00	H	---					

ERP (dBm) = SG Level(dBm) + Antenna Gain(dBd) + Cable Loss(dB)

Note : “F” : denotes Fundamental Frequency. ; “H” : denotes Harmonic Frequency.

“E” : denotes Band Edge Frequency. ; “S” : denotes Spurious Frequency.

“---“ : denotes Noise Floor.

Unless otherwise stated the results shown in this test report refer only to the sample(s) tested and such sample(s) are retained for 90 days only.

除非另有說明，此報告結果僅對測試之樣品負責，同時此樣品僅保留90天。本報告未經本公司書面許可，不可部份複製。

This document is issued by the Company subject to its General Conditions of Service printed overleaf, available on request or accessible at www.sgs.com/terms_and_conditions.htm and, for electronic format documents, subject to Terms and Conditions for Electronic Documents at www.sgs.com/terms_e-document.htm. Attention is drawn to the limitation of liability, indemnification and jurisdiction issues defined therein. Any holder of this document is advised that information contained hereon reflects the Company's findings at the time of its intervention only and within the limits of Client's instructions, if any. The Company's sole responsibility is to its Client and this document does not exonerate parties to a transaction from exercising all their rights and obligations under the transaction documents. This document cannot be reproduced except in full, without prior written approval of the Company. Any unauthorized alteration, forgery or falsification of the content or appearance of this document is unlawful and offenders may be prosecuted to the fullest extent of the law.

Operation Band	:GSM 850	Test Date	:2013-05-27
ARFCN	:CH 251	Temp./Humi.	:24.1 deg_C / 65 RH
Fundamental Frequency	:848.8 MHz	Engineer	:Allen
Operation Mode	:TX HIGH		
EUT Pol.	:E2 Plan	Measurement Antenna Pol.	:HORIZONTAL

Freq.	Note	ERP	SG	Antenna	Cable	Limit	Margin
MHz	F/H/E/S	dBm	Output Level dBm	Gain dBd	Loss dB	dBm	dB
132.82	S	-86.99	-84.91	-0.89	-1.18	-13.00	-73.99
286.08	S	-86.42	-89.24	4.50	-1.67	-13.00	-73.42
385.99	S	-82.29	-85.07	4.69	-1.91	-13.00	-69.29
519.85	S	-80.58	-83.04	4.66	-2.20	-13.00	-67.58
729.37	S	-78.18	-79.35	3.78	-2.61	-13.00	-65.18
926.28	S	-75.90	-76.53	3.64	-3.00	-13.00	-62.90
1697.60	H	-54.00	-52.53	2.65	-4.11	-13.00	-41.00
2546.40	H	-48.26	-46.82	3.66	-5.11	-13.00	-35.26
3395.20	H	---					
4244.00	H	---					
5092.80	H	---					
5941.60	H	---					
6790.40	H	---					
7639.20	H	---					
8488.00	H	---					

ERP (dBm) = SG Level(dBm) + Antenna Gain(dBd) + Cable Loss(dB)

Note : "F" : denotes Fundamental Frequency. ; "H" : denotes Harmonic Frequency.
 "E" : denotes Band Edge Frequency. ; "S" : denotes Spurious Frequency.
 "---" : denotes Noise Floor.

Unless otherwise stated the results shown in this test report refer only to the sample(s) tested and such sample(s) are retained for 90 days only.

除非另有說明，此報告結果僅對測試之樣品負責，同時此樣品僅保留90天。本報告未經本公司書面許可，不可部份複製。

This document is issued by the Company subject to its General Conditions of Service printed overleaf, available on request or accessible at www.sgs.com/terms_and_conditions.htm and, for electronic format documents, subject to Terms and Conditions for Electronic Documents at www.sgs.com/terms_e-document.htm. Attention is drawn to the limitation of liability, indemnification and jurisdiction issues defined therein. Any holder of this document is advised that information contained hereon reflects the Company's findings at the time of its intervention only and within the limits of Client's instructions, if any. The Company's sole responsibility is to its Client and this document does not exonerate parties to a transaction from exercising all their rights and obligations under the transaction documents. This document cannot be reproduced except in full, without prior written approval of the Company. Any unauthorized alteration, forgery or falsification of the content or appearance of this document is unlawful and offenders may be prosecuted to the fullest extent of the law.

Radiated Spurious Emission Measurement Result: GSM 1900 Mode

Operation Band	:GSM 1900	Test Date	:2013-05-03
ARFCN	:CH 512	Temp./Humi.	:24.1 deg_C / 65 RH
Fundamental Frequency	:1850.2 MHz	Engineer	:Allen
Operation Mode	:TX LOW		
EUT Pol.	:E1 Plan	Measurement Antenna Pol.	:VERTICAL

Freq. MHz	Note F/H/E/S	EIRP dBm	SG Output Level dBm	Antenna Gain dBi	Cable Loss dB	Limit dBm	Margin dB
114.39	S	-79.68	-79.51	0.95	-1.11	-13.00	-66.68
272.50	S	-81.29	-86.33	6.67	-1.63	-13.00	-68.29
326.82	S	-80.25	-85.25	6.78	-1.78	-13.00	-67.25
467.47	S	-79.03	-83.64	6.70	-2.09	-13.00	-66.03
640.13	S	-74.98	-78.77	6.25	-2.46	-13.00	-61.98
768.17	S	-74.75	-77.88	5.82	-2.69	-13.00	-61.75
3700.40	H	-52.74	-53.91	7.40	-6.23	-13.00	-39.74
5550.60	H	-41.66	-42.85	8.99	-7.80	-13.00	-28.66
7400.80	H	---					
9251.00	H	---					
11101.20	H	---					
12951.40	H	---					
14801.60	H	---					
16651.80	H	---					
18502.00	H	---					

$EIRP (dBm) = SG \text{ Level}(dBm) + Antenna \text{ Gain}(dBi) + Cable \text{ Loss}(dB)$

Note : “F” : denotes Fundamental Frequency. ; “H” : denotes Harmonic Frequency.
 “E” : denotes Band Edge Frequency. ; “S” : denotes Spurious Frequency.
 “---” : denotes Noise Floor.

Unless otherwise stated the results shown in this test report refer only to the sample(s) tested and such sample(s) are retained for 90 days only.

除非另有說明，此報告結果僅對測試之樣品負責，同時此樣品僅保留90天。本報告未經本公司書面許可，不可部份複製。

This document is issued by the Company subject to its General Conditions of Service printed overleaf, available on request or accessible at www.sgs.com/terms_and_conditions.htm and, for electronic format documents, subject to Terms and Conditions for Electronic Documents at www.sgs.com/terms_e-document.htm. Attention is drawn to the limitation of liability, indemnification and jurisdiction issues defined therein. Any holder of this document is advised that information contained hereon reflects the Company's findings at the time of its intervention only and within the limits of Client's instructions, if any. The Company's sole responsibility is to its Client and this document does not exonerate parties to a transaction from exercising all their rights and obligations under the transaction documents. This document cannot be reproduced except in full, without prior written approval of the Company. Any unauthorized alteration, forgery or falsification of the content or appearance of this document is unlawful and offenders may be prosecuted to the fullest extent of the law.

Operation Band	:GSM 1900	Test Date	:2013-05-03
ARFCN	:CH 512	Temp./Humi.	:24.1 deg_C / 65 RH
Fundamental Frequency	:1850.2 MHz	Engineer	:Allen
Operation Mode	:TX LOW		
EUT Pol.	:E1 Plan	Measurement Antenna Pol.	:HORIZONTAL

Freq.	Note	EIRP	SG	Antenna	Cable	Limit	Margin
MHz	F/H/E/S	dBm	Output Level dBm	Gain dBi	Loss dB	dBm	dB
275.41	S	-82.31	-87.31	6.63	-1.64	-13.00	-69.31
538.28	S	-78.91	-83.43	6.76	-2.24	-13.00	-65.91
612.97	S	-77.59	-81.39	6.20	-2.40	-13.00	-64.59
771.08	S	-75.50	-78.63	5.84	-2.70	-13.00	-62.50
873.90	S	-74.36	-77.48	6.00	-2.88	-13.00	-61.36
978.66	S	-72.88	-75.78	5.99	-3.09	-13.00	-59.88
3700.40	H	-52.56	-53.24	6.91	-6.23	-13.00	-39.56
5550.60	H	-42.19	-42.67	8.27	-7.80	-13.00	-29.19
7400.80	H	---					
9251.00	H	---					
11101.20	H	---					
12951.40	H	---					
14801.60	H	---					
16651.80	H	---					
18502.00	H	---					

EIRP (dBm) = SG Level(dBm) + Antenna Gain(dBi) + Cable Loss(dB)

Note : "F" : denotes Fundamental Frequency. ; "H" : denotes Harmonic Frequency.
 "E" : denotes Band Edge Frequency. ; "S" : denotes Spurious Frequency.
 "---" : denotes Noise Floor.

Unless otherwise stated the results shown in this test report refer only to the sample(s) tested and such sample(s) are retained for 90 days only.

除非另有說明，此報告結果僅對測試之樣品負責，同時此樣品僅保留90天。本報告未經本公司書面許可，不可部份複製。

This document is issued by the Company subject to its General Conditions of Service printed overleaf, available on request or accessible at www.sgs.com/terms_and_conditions.htm and, for electronic format documents, subject to Terms and Conditions for Electronic Documents at www.sgs.com/terms_e-document.htm. Attention is drawn to the limitation of liability, indemnification and jurisdiction issues defined therein. Any holder of this document is advised that information contained hereon reflects the Company's findings at the time of its intervention only and within the limits of Client's instructions, if any. The Company's sole responsibility is to its Client and this document does not exonerate parties to a transaction from exercising all their rights and obligations under the transaction documents. This document cannot be reproduced except in full, without prior written approval of the Company. Any unauthorized alteration, forgery or falsification of the content or appearance of this document is unlawful and offenders may be prosecuted to the fullest extent of the law.

Operation Band	:GSM 1900	Test Date	:2013-05-03
ARFCN	:CH 661	Temp./Humi.	:24.1 deg_C / 65 RH
Fundamental Frequency	:1880 MHz	Engineer	:Allen
Operation Mode	:TX MID		
EUT Pol.	:E1 Plan	Measurement Antenna Pol.	:VERTICAL

Freq.	Note	EIRP	SG	Antenna	Cable	Limit	Margin
MHz	F/H/E/S	dBm	Output Level dBm	Gain dBi	Loss dB	dBm	dB
114.39	S	-80.04	-79.87	0.95	-1.11	-13.00	-67.04
157.07	S	-80.71	-80.88	1.43	-1.26	-13.00	-67.71
286.08	S	-79.50	-84.48	6.65	-1.67	-13.00	-66.50
496.57	S	-78.59	-83.29	6.85	-2.16	-13.00	-65.59
846.74	S	-75.06	-78.39	6.17	-2.84	-13.00	-62.06
916.58	S	-72.69	-75.51	5.79	-2.98	-13.00	-59.69
3760.00	H	-51.44	-52.54	7.42	-6.32	-13.00	-38.44
5640.00	H	-46.78	-47.90	9.01	-7.89	-13.00	-33.78
7520.00	H	---					
9400.00	H	---					
11280.00	H	---					
13160.00	H	---					
15040.00	H	---					
16920.00	H	---					
18800.00	H	---					

EIRP (dBm) = SG Level(dBm) + Antenna Gain(dBi) + Cable Loss(dB)

Note : "F" : denotes Fundamental Frequency. ; "H" : denotes Harmonic Frequency.
 "E" : denotes Band Edge Frequency. ; "S" : denotes Spurious Frequency.
 "---" : denotes Noise Floor.

Unless otherwise stated the results shown in this test report refer only to the sample(s) tested and such sample(s) are retained for 90 days only.

除非另有說明，此報告結果僅對測試之樣品負責，同時此樣品僅保留90天。本報告未經本公司書面許可，不可部份複製。

This document is issued by the Company subject to its General Conditions of Service printed overleaf, available on request or accessible at www.sgs.com/terms_and_conditions.htm and, for electronic format documents, subject to Terms and Conditions for Electronic Documents at www.sgs.com/terms_e-document.htm. Attention is drawn to the limitation of liability, indemnification and jurisdiction issues defined therein. Any holder of this document is advised that information contained hereon reflects the Company's findings at the time of its intervention only and within the limits of Client's instructions, if any. The Company's sole responsibility is to its Client and this document does not exonerate parties to a transaction from exercising all their rights and obligations under the transaction documents. This document cannot be reproduced except in full, without prior written approval of the Company. Any unauthorized alteration, forgery or falsification of the content or appearance of this document is unlawful and offenders may be prosecuted to the fullest extent of the law.

Operation Band	:GSM 1900	Test Date	:2013-05-03
ARFCN	:CH 661	Temp./Humi.	:24.1 deg_C / 65 RH
Fundamental Frequency	:1880 MHz	Engineer	:Allen
Operation Mode	:TX MID		
EUT Pol.	:E1 Plan	Measurement Antenna Pol.	:HORIZONTAL

Freq.	Note	EIRP	SG	Antenna	Cable	Limit	Margin
MHz	F/H/E/S	dBm	Output Level dBm	Gain dBi	Loss dB	dBm	dB
88.20	S	-84.32	-84.19	0.86	-0.99	-13.00	-71.32
271.53	S	-84.21	-89.27	6.69	-1.63	-13.00	-71.21
358.83	S	-81.97	-86.99	6.87	-1.85	-13.00	-68.97
705.12	S	-77.26	-80.92	6.23	-2.57	-13.00	-64.26
858.38	S	-74.85	-78.11	6.11	-2.86	-13.00	-61.85
942.77	S	-74.07	-76.81	5.78	-3.04	-13.00	-61.07
3760.00	H	-52.10	-52.63	6.85	-6.32	-13.00	-39.10
5640.00	H	-44.43	-44.84	8.30	-7.89	-13.00	-31.43
7520.00	H	---					
9400.00	H	---					
11280.00	H	---					
13160.00	H	---					
15040.00	H	---					
16920.00	H	---					
18800.00	H	---					

EIRP (dBm) = SG Level(dBm) + Antenna Gain(dBi) + Cable Loss(dB)

Note : "F" : denotes Fundamental Frequency. ; "H" : denotes Harmonic Frequency.

"E" : denotes Band Edge Frequency. ; "S" : denotes Spurious Frequency.

"---" : denotes Noise Floor.

Unless otherwise stated the results shown in this test report refer only to the sample(s) tested and such sample(s) are retained for 90 days only.

除非另有說明，此報告結果僅對測試之樣品負責，同時此樣品僅保留90天。本報告未經本公司書面許可，不可部份複製。

This document is issued by the Company subject to its General Conditions of Service printed overleaf, available on request or accessible at www.sgs.com/terms_and_conditions.htm and, for electronic format documents, subject to Terms and Conditions for Electronic Documents at www.sgs.com/terms_e-document.htm. Attention is drawn to the limitation of liability, indemnification and jurisdiction issues defined therein. Any holder of this document is advised that information contained hereon reflects the Company's findings at the time of its intervention only and within the limits of Client's instructions, if any. The Company's sole responsibility is to its Client and this document does not exonerate parties to a transaction from exercising all their rights and obligations under the transaction documents. This document cannot be reproduced except in full, without prior written approval of the Company. Any unauthorized alteration, forgery or falsification of the content or appearance of this document is unlawful and offenders may be prosecuted to the fullest extent of the law.

Operation Band	:GSM 1900	Test Date	:2013-05-03
ARFCN	:CH 810	Temp./Humi.	:24.1 deg_C / 65 RH
Fundamental Frequency	:1909.8 MHz	Engineer	:Allen
Operation Mode	:TX HIGH		
EUT Pol.	:E1 Plan	Measurement Antenna Pol.	:VERTICAL

Freq.	Note	EIRP	SG	Antenna	Cable	Limit	Margin
MHz	F/H/E/S	dBm	Output Level dBm	Gain dBi	Loss dB	dBm	dB
114.39	S	-79.99	-79.82	0.95	-1.11	-13.00	-66.99
157.07	S	-80.98	-81.14	1.43	-1.26	-13.00	-67.98
258.92	S	-81.51	-86.76	6.83	-1.59	-13.00	-68.51
343.31	S	-80.60	-85.67	6.90	-1.82	-13.00	-67.60
677.96	S	-75.23	-78.99	6.29	-2.52	-13.00	-62.23
912.70	S	-73.24	-76.06	5.79	-2.97	-13.00	-60.24
3819.60	H	-50.05	-51.18	7.51	-6.39	-13.00	-37.05
5729.40	H	-45.50	-46.60	9.03	-7.92	-13.00	-32.50
7639.20	H	---					
9549.00	H	---					
11458.80	H	---					
13368.60	H	---					
15278.40	H	---					
17188.20	H	---					
19098.00	H	---					

EIRP (dBm) = SG Level(dBm) + Antenna Gain(dBi) + Cable Loss(dB)

Note : "F" : denotes Fundamental Frequency. ; "H" : denotes Harmonic Frequency.

"E" : denotes Band Edge Frequency. ; "S" : denotes Spurious Frequency.

"---" : denotes Noise Floor.

Unless otherwise stated the results shown in this test report refer only to the sample(s) tested and such sample(s) are retained for 90 days only.

除非另有說明，此報告結果僅對測試之樣品負責，同時此樣品僅保留90天。本報告未經本公司書面許可，不可部份複製。

This document is issued by the Company subject to its General Conditions of Service printed overleaf, available on request or accessible at www.sgs.com/terms_and_conditions.htm and, for electronic format documents, subject to Terms and Conditions for Electronic Documents at www.sgs.com/terms_e-document.htm. Attention is drawn to the limitation of liability, indemnification and jurisdiction issues defined therein. Any holder of this document is advised that information contained hereon reflects the Company's findings at the time of its intervention only and within the limits of Client's instructions, if any. The Company's sole responsibility is to its Client and this document does not exonerate parties to a transaction from exercising all their rights and obligations under the transaction documents. This document cannot be reproduced except in full, without prior written approval of the Company. Any unauthorized alteration, forgery or falsification of the content or appearance of this document is unlawful and offenders may be prosecuted to the fullest extent of the law.

Operation Band	:GSM 1900	Test Date	:2013-05-03
ARFCN	:CH 810	Temp./Humi.	:24.1 deg_C / 65 RH
Fundamental Frequency	:1909.8 MHz	Engineer	:Allen
Operation Mode	:TX HIGH		
EUT Pol.	:E1 Plan	Measurement Antenna Pol.	:HORIZONTAL

Freq.	Note	EIRP	SG	Antenna	Cable	Limit	Margin
MHz	F/H/E/S	dBm	Output Level dBm	Gain dBi	Loss dB	dBm	dB
154.16	S	-84.75	-84.76	1.27	-1.25	-13.00	-71.75
379.20	S	-81.56	-86.46	6.79	-1.90	-13.00	-68.56
504.33	S	-79.31	-83.99	6.86	-2.17	-13.00	-66.31
646.92	S	-78.37	-82.16	6.26	-2.47	-13.00	-65.37
770.11	S	-74.81	-77.94	5.83	-2.70	-13.00	-61.81
912.70	S	-74.22	-77.05	5.79	-2.97	-13.00	-61.22
3819.60	H	-53.23	-53.89	7.05	-6.39	-13.00	-40.23
5729.40	H	-44.94	-45.33	8.32	-7.92	-13.00	-31.94
7639.20	H	---					
9549.00	H	---					
11458.80	H	---					
13368.60	H	---					
15278.40	H	---					
17188.20	H	---					
19098.00	H	---					

EIRP (dBm) = SG Level(dBm) + Antenna Gain(dBi) + Cable Loss(dB)

Note : "F" : denotes Fundamental Frequency. ; "H" : denotes Harmonic Frequency.
 "E" : denotes Band Edge Frequency. ; "S" : denotes Spurious Frequency.
 "---" : denotes Noise Floor.

Unless otherwise stated the results shown in this test report refer only to the sample(s) tested and such sample(s) are retained for 90 days only.

除非另有說明，此報告結果僅對測試之樣品負責，同時此樣品僅保留90天。本報告未經本公司書面許可，不可部份複製。

This document is issued by the Company subject to its General Conditions of Service printed overleaf, available on request or accessible at www.sgs.com/terms_and_conditions.htm and, for electronic format documents, subject to Terms and Conditions for Electronic Documents at www.sgs.com/terms_e-document.htm. Attention is drawn to the limitation of liability, indemnification and jurisdiction issues defined therein. Any holder of this document is advised that information contained hereon reflects the Company's findings at the time of its intervention only and within the limits of Client's instructions, if any. The Company's sole responsibility is to its Client and this document does not exonerate parties to a transaction from exercising all their rights and obligations under the transaction documents. This document cannot be reproduced except in full, without prior written approval of the Company. Any unauthorized alteration, forgery or falsification of the content or appearance of this document is unlawful and offenders may be prosecuted to the fullest extent of the law.

Radiated Spurious Emission Measurement Result: WCDMA II Mode

Operation Band	:WCDMA B2	Test Date	:2013-05-03
ARFCN	:CH 9262	Temp./Humi.	:24.1 deg_C / 65 RH
Fundamental Frequency	:1852.4 MHz	Engineer	:Allen
Operation Mode	:TX LOW		
EUT Pol.	:E1 Plan	Measurement Antenna Pol.	:VERTICAL

Freq.	Note	EIRP	SG	Antenna	Cable	Limit	Margin
MHz	F/H/E/S	dBm	Output Level dBm	Gain dBi	Loss dB	dBm	dB
256.01	S	-81.76	-86.97	6.79	-1.58	-13.00	-68.76
421.88	S	-79.68	-84.44	6.75	-1.99	-13.00	-66.68
562.53	S	-75.80	-80.11	6.59	-2.29	-13.00	-62.80
697.36	S	-75.31	-79.05	6.30	-2.55	-13.00	-62.31
913.67	S	-72.27	-75.09	5.79	-2.97	-13.00	-59.27
955.38	S	-71.98	-74.73	5.82	-3.07	-13.00	-58.98
3704.80	H	-52.84	-54.01	7.40	-6.24	-13.00	-39.84
5557.20	H	---					
7409.60	H	---					
9262.00	H	---					
11114.40	H	---					
12966.80	H	---					
14819.20	H	---					
16671.60	H	---					
18524.00	H	---					

EIRP (dBm) = SG Level(dBm) + Antenna Gain(dBi) + Cable Loss(dB)

Note : “F” : denotes Fundamental Frequency. ; “H” : denotes Harmonic Frequency.
 “E” : denotes Band Edge Frequency. ; “S” : denotes Spurious Frequency.
 “---” : denotes Noise Floor.

Unless otherwise stated the results shown in this test report refer only to the sample(s) tested and such sample(s) are retained for 90 days only.

除非另有說明，此報告結果僅對測試之樣品負責，同時此樣品僅保留90天。本報告未經本公司書面許可，不可部份複製。
 This document is issued by the Company subject to its General Conditions of Service printed overleaf, available on request or accessible at www.sgs.com/terms_and_conditions.htm and, for electronic format documents, subject to Terms and Conditions for Electronic Documents at www.sgs.com/terms_e-document.htm. Attention is drawn to the limitation of liability, indemnification and jurisdiction issues defined therein. Any holder of this document is advised that information contained hereon reflects the Company's findings at the time of its intervention only and within the limits of Client's instructions, if any. The Company's sole responsibility is to its Client and this document does not exonerate parties to a transaction from exercising all their rights and obligations under the transaction documents. This document cannot be reproduced except in full, without prior written approval of the Company. Any unauthorized alteration, forgery or falsification of the content or appearance of this document is unlawful and offenders may be prosecuted to the fullest extent of the law.

Operation Band	:WCDMA B2	Test Date	:2013-05-03
ARFCN	:CH 9262	Temp./Humi.	:24.1 deg_C / 65 RH
Fundamental Frequency	:1852.4 MHz	Engineer	:Allen
Operation Mode	:TX LOW		
EUT Pol.	:E1 Plan	Measurement Antenna Pol.	:HORIZONTAL

Freq.	Note	EIRP	SG	Antenna	Cable	Limit	Margin
MHz	F/H/E/S	dBm	Output Level dBm	Gain dBi	Loss dB	dBm	dB
88.20	S	-84.62	-84.49	0.86	-0.99	-13.00	-71.62
330.70	S	-83.71	-88.74	6.81	-1.79	-13.00	-70.71
343.31	S	-81.78	-86.86	6.90	-1.82	-13.00	-68.78
631.40	S	-78.04	-81.84	6.24	-2.44	-13.00	-65.04
758.47	S	-76.44	-79.51	5.74	-2.67	-13.00	-63.44
931.13	S	-73.37	-76.15	5.79	-3.01	-13.00	-60.37
3704.80	H	-53.72	-54.38	6.90	-6.24	-13.00	-40.72
5557.20	H	---					
7409.60	H	---					
9262.00	H	---					
11114.40	H	---					
12966.80	H	---					
14819.20	H	---					
16671.60	H	---					
18524.00	H	---					

EIRP (dBm) = SG Level(dBm) + Antenna Gain(dBi) + Cable Loss(dB)

Note : "F" : denotes Fundamental Frequency. ; "H" : denotes Harmonic Frequency.
 "E" : denotes Band Edge Frequency. ; "S" : denotes Spurious Frequency.
 "---" : denotes Noise Floor.

Unless otherwise stated the results shown in this test report refer only to the sample(s) tested and such sample(s) are retained for 90 days only.

除非另有說明，此報告結果僅對測試之樣品負責，同時此樣品僅保留90天。本報告未經本公司書面許可，不可部份複製。

This document is issued by the Company subject to its General Conditions of Service printed overleaf, available on request or accessible at www.sgs.com/terms_and_conditions.htm and, for electronic format documents, subject to Terms and Conditions for Electronic Documents at www.sgs.com/terms_e-document.htm. Attention is drawn to the limitation of liability, indemnification and jurisdiction issues defined therein. Any holder of this document is advised that information contained hereon reflects the Company's findings at the time of its intervention only and within the limits of Client's instructions, if any. The Company's sole responsibility is to its Client and this document does not exonerate parties to a transaction from exercising all their rights and obligations under the transaction documents. This document cannot be reproduced except in full, without prior written approval of the Company. Any unauthorized alteration, forgery or falsification of the content or appearance of this document is unlawful and offenders may be prosecuted to the fullest extent of the law.

Operation Band	:WCDMA B2	Test Date	:2013-05-03
ARFCN	:CH 9400	Temp./Humi.	:24.1 deg_C / 65 RH
Fundamental Frequency	:1880 MHz	Engineer	:Allen
Operation Mode	:TX MID		
EUT Pol.	:E1 Plan	Measurement Antenna Pol.	:VERTICAL

Freq.	Note	EIRP	SG	Antenna	Cable	Limit	Margin
MHz	F/H/E/S	dBm	Output Level dBm	Gain dBi	Loss dB	dBm	dB
114.39	S	-80.54	-80.37	0.95	-1.11	-13.00	-67.54
343.31	S	-80.40	-85.48	6.90	-1.82	-13.00	-67.40
535.37	S	-77.03	-81.56	6.77	-2.23	-13.00	-64.03
630.43	S	-75.76	-79.55	6.24	-2.44	-13.00	-62.76
827.34	S	-74.54	-77.85	6.12	-2.81	-13.00	-61.54
954.41	S	-71.43	-74.18	5.81	-3.07	-13.00	-58.43
3760.00	H	-53.43	-54.53	7.42	-6.32	-13.00	-40.43
5640.00	H	---					
7520.00	H	---					
9400.00	H	---					
11280.00	H	---					
13160.00	H	---					
15040.00	H	---					
16920.00	H	---					
18800.00	H	---					

EIRP (dBm) = SG Level(dBm) + Antenna Gain(dBi) + Cable Loss(dB)

Note : "F" : denotes Fundamental Frequency. ; "H" : denotes Harmonic Frequency.

"E" : denotes Band Edge Frequency. ; "S" : denotes Spurious Frequency.

"---" : denotes Noise Floor.

Unless otherwise stated the results shown in this test report refer only to the sample(s) tested and such sample(s) are retained for 90 days only.

除非另有說明，此報告結果僅對測試之樣品負責，同時此樣品僅保留90天。本報告未經本公司書面許可，不可部份複製。

This document is issued by the Company subject to its General Conditions of Service printed overleaf, available on request or accessible at www.sgs.com/terms_and_conditions.htm and, for electronic format documents, subject to Terms and Conditions for Electronic Documents at www.sgs.com/terms_e-document.htm. Attention is drawn to the limitation of liability, indemnification and jurisdiction issues defined therein. Any holder of this document is advised that information contained hereon reflects the Company's findings at the time of its intervention only and within the limits of Client's instructions, if any. The Company's sole responsibility is to its Client and this document does not exonerate parties to a transaction from exercising all their rights and obligations under the transaction documents. This document cannot be reproduced except in full, without prior written approval of the Company. Any unauthorized alteration, forgery or falsification of the content or appearance of this document is unlawful and offenders may be prosecuted to the fullest extent of the law.

Operation Band	:WCDMA B2	Test Date	:2013-05-03
ARFCN	:CH 9400	Temp./Humi.	:24.1 deg_C / 65 RH
Fundamental Frequency	:1880 MHz	Engineer	:Allen
Operation Mode	:TX MID		
EUT Pol.	:E1 Plan	Measurement Antenna Pol.	:HORIZONTAL

Freq.	Note	EIRP	SG	Antenna	Cable	Limit	Margin
MHz	F/H/E/S	dBm	Output Level dBm	Gain dBi	Loss dB	dBm	dB
158.04	S	-85.26	-85.47	1.48	-1.26	-13.00	-72.26
387.93	S	-81.08	-86.01	6.85	-1.92	-13.00	-68.08
532.46	S	-79.66	-84.21	6.78	-2.23	-13.00	-66.66
677.96	S	-77.38	-81.14	6.29	-2.52	-13.00	-64.38
830.25	S	-75.01	-78.33	6.13	-2.81	-13.00	-62.01
949.56	S	-73.77	-76.49	5.78	-3.06	-13.00	-60.77
3760.00	H	-52.89	-53.42	6.85	-6.32	-13.00	-39.89
5640.00	H	---					
7520.00	H	---					
9400.00	H	---					
11280.00	H	---					
13160.00	H	---					
15040.00	H	---					
16920.00	H	---					
18800.00	H	---					

EIRP (dBm) = SG Level(dBm) + Antenna Gain(dBi) + Cable Loss(dB)

Note : "F" : denotes Fundamental Frequency. ; "H" : denotes Harmonic Frequency.
 "E" : denotes Band Edge Frequency. ; "S" : denotes Spurious Frequency.
 "---" : denotes Noise Floor.

Unless otherwise stated the results shown in this test report refer only to the sample(s) tested and such sample(s) are retained for 90 days only.

除非另有說明，此報告結果僅對測試之樣品負責，同時此樣品僅保留90天。本報告未經本公司書面許可，不可部份複製。

This document is issued by the Company subject to its General Conditions of Service printed overleaf, available on request or accessible at www.sgs.com/terms_and_conditions.htm and, for electronic format documents, subject to Terms and Conditions for Electronic Documents at www.sgs.com/terms_e-document.htm. Attention is drawn to the limitation of liability, indemnification and jurisdiction issues defined therein. Any holder of this document is advised that information contained hereon reflects the Company's findings at the time of its intervention only and within the limits of Client's instructions, if any. The Company's sole responsibility is to its Client and this document does not exonerate parties to a transaction from exercising all their rights and obligations under the transaction documents. This document cannot be reproduced except in full, without prior written approval of the Company. Any unauthorized alteration, forgery or falsification of the content or appearance of this document is unlawful and offenders may be prosecuted to the fullest extent of the law.

Operation Band	:WCDMA B2	Test Date	:2013-05-03
ARFCN	:CH 9538	Temp./Humi.	:24.1 deg_C / 65 RH
Fundamental Frequency	:1907.6 MHz	Engineer	:Allen
Operation Mode	:TX HIGH		
EUT Pol.	:E1 Plan	Measurement Antenna Pol.	:VERTICAL

Freq.	Note	EIRP	SG	Antenna	Cable	Limit	Margin
MHz	F/H/E/S	dBm	Output Level dBm	Gain dBi	Loss dB	dBm	dB
114.39	S	-79.86	-79.69	0.95	-1.11	-13.00	-66.86
261.83	S	-81.13	-86.35	6.82	-1.60	-13.00	-68.13
466.50	S	-78.98	-83.59	6.70	-2.09	-13.00	-65.98
591.63	S	-75.71	-79.63	6.27	-2.35	-13.00	-62.71
768.17	S	-74.87	-77.99	5.82	-2.69	-13.00	-61.87
909.79	S	-72.11	-74.95	5.80	-2.96	-13.00	-59.11
3815.20	H	-54.54	-55.66	7.50	-6.38	-13.00	-41.54
5722.80	H	---					
7630.40	H	---					
9538.00	H	---					
11445.60	H	---					
13353.20	H	---					
15260.80	H	---					
17168.40	H	---					
19076.00	H	---					

EIRP (dBm) = SG Level(dBm) + Antenna Gain(dBi) + Cable Loss(dB)

Note : "F" : denotes Fundamental Frequency. ; "H" : denotes Harmonic Frequency.
 "E" : denotes Band Edge Frequency. ; "S" : denotes Spurious Frequency.
 "---" : denotes Noise Floor.

Unless otherwise stated the results shown in this test report refer only to the sample(s) tested and such sample(s) are retained for 90 days only.

除非另有說明，此報告結果僅對測試之樣品負責，同時此樣品僅保留90天。本報告未經本公司書面許可，不可部份複製。

This document is issued by the Company subject to its General Conditions of Service printed overleaf, available on request or accessible at www.sgs.com/terms_and_conditions.htm and, for electronic format documents, subject to Terms and Conditions for Electronic Documents at www.sgs.com/terms_e-document.htm. Attention is drawn to the limitation of liability, indemnification and jurisdiction issues defined therein. Any holder of this document is advised that information contained hereon reflects the Company's findings at the time of its intervention only and within the limits of Client's instructions, if any. The Company's sole responsibility is to its Client and this document does not exonerate parties to a transaction from exercising all their rights and obligations under the transaction documents. This document cannot be reproduced except in full, without prior written approval of the Company. Any unauthorized alteration, forgery or falsification of the content or appearance of this document is unlawful and offenders may be prosecuted to the fullest extent of the law.

Operation Band	:WCDMA B2	Test Date	:2013-05-03
ARFCN	:CH 9538	Temp./Humi.	:24.1 deg_C / 65 RH
Fundamental Frequency	:1907.6 MHz	Engineer	:Allen
Operation Mode	:TX HIGH		
EUT Pol.	:E1 Plan	Measurement Antenna Pol.	:HORIZONTAL

Freq.	Note	EIRP	SG	Antenna	Cable	Limit	Margin
MHz	F/H/E/S	dBm	Output Level dBm	Gain dBi	Loss dB	dBm	dB
143.49	S	-84.50	-84.18	0.89	-1.22	-13.00	-71.50
320.03	S	-84.05	-89.07	6.78	-1.76	-13.00	-71.05
545.07	S	-78.54	-83.03	6.74	-2.25	-13.00	-65.54
682.81	S	-77.13	-80.89	6.29	-2.53	-13.00	-64.13
779.81	S	-74.35	-77.54	5.90	-2.72	-13.00	-61.35
870.99	S	-74.22	-77.36	6.02	-2.88	-13.00	-61.22
3815.20	H	-55.13	-55.78	7.03	-6.38	-13.00	-42.13
5722.80	H	---					
7630.40	H	---					
9538.00	H	---					
11445.60	H	---					
13353.20	H	---					
15260.80	H	---					
17168.40	H	---					
19076.00	H	---					

EIRP (dBm) = SG Level(dBm) + Antenna Gain(dBi) + Cable Loss(dB)

Note : "F" : denotes Fundamental Frequency. ; "H" : denotes Harmonic Frequency.
 "E" : denotes Band Edge Frequency. ; "S" : denotes Spurious Frequency.
 "---" : denotes Noise Floor.

Unless otherwise stated the results shown in this test report refer only to the sample(s) tested and such sample(s) are retained for 90 days only.

除非另有說明，此報告結果僅對測試之樣品負責，同時此樣品僅保留90天。本報告未經本公司書面許可，不可部份複製。

This document is issued by the Company subject to its General Conditions of Service printed overleaf, available on request or accessible at www.sgs.com/terms_and_conditions.htm and, for electronic format documents, subject to Terms and Conditions for Electronic Documents at www.sgs.com/terms_e-document.htm. Attention is drawn to the limitation of liability, indemnification and jurisdiction issues defined therein. Any holder of this document is advised that information contained hereon reflects the Company's findings at the time of its intervention only and within the limits of Client's instructions, if any. The Company's sole responsibility is to its Client and this document does not exonerate parties to a transaction from exercising all their rights and obligations under the transaction documents. This document cannot be reproduced except in full, without prior written approval of the Company. Any unauthorized alteration, forgery or falsification of the content or appearance of this document is unlawful and offenders may be prosecuted to the fullest extent of the law.

Radiated Spurious Emission Measurement Result: WCDMA IV Mode

Operation Band	:WCDMA B4	Test Date	:2013-05-03
ARFCN	:CH 1312	Temp./Humi.	:24.1 deg_C / 65 RH
Fundamental Frequency	:1712.4 MHz	Engineer	:Allen
Operation Mode	:TX LOW		
EUT Pol.	:H Plan	Measurement Antenna Pol.	:VERTICAL

Freq. MHz	Note F/H/E/S	EIRP dBm	SG Output Level dBm	Antenna Gain dBi	Cable Loss dB	Limit dBm	Margin dB
158.04	S	-82.37	-82.58	1.48	-1.26	-13.00	-69.37
329.73	S	-79.97	-84.99	6.80	-1.78	-13.00	-66.97
428.67	S	-79.32	-84.02	6.71	-2.01	-13.00	-66.32
609.09	S	-75.83	-79.64	6.20	-2.39	-13.00	-62.83
770.11	S	-74.15	-77.29	5.83	-2.70	-13.00	-61.15
875.84	S	-73.29	-76.39	5.98	-2.88	-13.00	-60.29
3424.80	H	-52.72	-53.90	7.20	-6.02	-13.00	-39.72
5137.20	H	---					
6849.60	H	---					
8562.00	H	---					
10274.40	H	---					
11986.80	H	---					
13699.20	H	---					
15411.60	H	---					
17124.00	H	---					

EIRP (dBm) = SG Level(dBm) + Antenna Gain(dBi) + Cable Loss(dB)

Note : "F" : denotes Fundamental Frequency. ; "H" : denotes Harmonic Frequency.
 "E" : denotes Band Edge Frequency. ; "S" : denotes Spurious Frequency.
 "---" : denotes Noise Floor.

Unless otherwise stated the results shown in this test report refer only to the sample(s) tested and such sample(s) are retained for 90 days only.

除非另有說明，此報告結果僅對測試之樣品負責，同時此樣品僅保留90天。本報告未經本公司書面許可，不可部份複製。

This document is issued by the Company subject to its General Conditions of Service printed overleaf, available on request or accessible at www.sgs.com/terms_and_conditions.htm and, for electronic format documents, subject to Terms and Conditions for Electronic Documents at www.sgs.com/terms_e-document.htm. Attention is drawn to the limitation of liability, indemnification and jurisdiction issues defined therein. Any holder of this document is advised that information contained hereon reflects the Company's findings at the time of its intervention only and within the limits of Client's instructions, if any. The Company's sole responsibility is to its Client and this document does not exonerate parties to a transaction from exercising all their rights and obligations under the transaction documents. This document cannot be reproduced except in full, without prior written approval of the Company. Any unauthorized alteration, forgery or falsification of the content or appearance of this document is unlawful and offenders may be prosecuted to the fullest extent of the law.

Operation Band	:WCDMA B4	Test Date	:2013-05-03
ARFCN	:CH 1312	Temp./Humi.	:24.1 deg_C / 65 RH
Fundamental Frequency	:1712.4 MHz	Engineer	:Allen
Operation Mode	:TX LOW		
EUT Pol.	:H Plan	Measurement Antenna Pol.	:HORIZONTAL

Freq. MHz	Note F/H/E/S	EIRP dBm	SG Output Level dBm	Antenna Gain dBi	Cable Loss dB	Limit dBm	Margin dB
166.77	S	-87.06	-88.32	2.56	-1.30	-13.00	-74.06
339.43	S	-80.42	-85.48	6.87	-1.81	-13.00	-67.42
564.47	S	-79.16	-83.44	6.57	-2.29	-13.00	-66.16
717.73	S	-76.50	-79.99	6.08	-2.59	-13.00	-63.50
855.47	S	-74.14	-77.43	6.14	-2.85	-13.00	-61.14
952.47	S	-74.06	-76.80	5.80	-3.06	-13.00	-61.06
3424.80	H	-51.67	-52.80	7.14	-6.01	-13.00	-38.67
5137.20	H	---					
6849.60	H	---					
8562.00	H	---					
10274.40	H	---					
11986.80	H	---					
13699.20	H	---					
15411.60	H	---					
17124.00	H	---					

EIRP (dBm) = SG Level(dBm) + Antenna Gain(dBi) + Cable Loss(dB)

Note : "F" : denotes Fundamental Frequency. ; "H" : denotes Harmonic Frequency.
 "E" : denotes Band Edge Frequency. ; "S" : denotes Spurious Frequency.
 "---" : denotes Noise Floor.

Unless otherwise stated the results shown in this test report refer only to the sample(s) tested and such sample(s) are retained for 90 days only.

除非另有說明，此報告結果僅對測試之樣品負責，同時此樣品僅保留90天。本報告未經本公司書面許可，不可部份複製。

This document is issued by the Company subject to its General Conditions of Service printed overleaf, available on request or accessible at www.sgs.com/terms_and_conditions.htm and, for electronic format documents, subject to Terms and Conditions for Electronic Documents at www.sgs.com/terms_e-document.htm. Attention is drawn to the limitation of liability, indemnification and jurisdiction issues defined therein. Any holder of this document is advised that information contained hereon reflects the Company's findings at the time of its intervention only and within the limits of Client's instructions, if any. The Company's sole responsibility is to its Client and this document does not exonerate parties to a transaction from exercising all their rights and obligations under the transaction documents. This document cannot be reproduced except in full, without prior written approval of the Company. Any unauthorized alteration, forgery or falsification of the content or appearance of this document is unlawful and offenders may be prosecuted to the fullest extent of the law.

Operation Band	:WCDMA B4	Test Date	:2013-05-03
ARFCN	:CH 1413	Temp./Humi.	:24.1 deg_C / 65 RH
Fundamental Frequency	:1732.6 MHz	Engineer	:Allen
Operation Mode	:TX MID		
EUT Pol.	:H Plan	Measurement Antenna Pol.	:VERTICAL

Freq. MHz	Note F/H/E/S	EIRP dBm	SG Output Level dBm	Antenna Gain dBi	Cable Loss dB	Limit dBm	Margin dB
148.34	S	-82.95	-82.72	1.00	-1.23	-13.00	-69.95
332.64	S	-79.75	-84.78	6.82	-1.79	-13.00	-66.75
512.09	S	-77.50	-82.14	6.83	-2.19	-13.00	-64.50
645.95	S	-74.86	-78.66	6.26	-2.47	-13.00	-61.86
792.42	S	-74.25	-77.50	6.00	-2.74	-13.00	-61.25
920.46	S	-72.84	-75.65	5.79	-2.99	-13.00	-59.84
3465.20	H	-52.55	-53.81	7.31	-6.05	-13.00	-39.55
5197.80	H	---					
6930.40	H	---					
8663.00	H	---					
10395.60	H	---					
12128.20	H	---					
13860.80	H	---					
15593.40	H	---					
17326.00	H	---					

EIRP (dBm) = SG Level(dBm) + Antenna Gain(dBi) + Cable Loss(dB)

Note : "F" : denotes Fundamental Frequency. ; "H" : denotes Harmonic Frequency.
 "E" : denotes Band Edge Frequency. ; "S" : denotes Spurious Frequency.
 "---" : denotes Noise Floor.

Unless otherwise stated the results shown in this test report refer only to the sample(s) tested and such sample(s) are retained for 90 days only.

除非另有說明，此報告結果僅對測試之樣品負責，同時此樣品僅保留90天。本報告未經本公司書面許可，不可部份複製。

This document is issued by the Company subject to its General Conditions of Service printed overleaf, available on request or accessible at www.sgs.com/terms_and_conditions.htm and, for electronic format documents, subject to Terms and Conditions for Electronic Documents at www.sgs.com/terms_e-document.htm. Attention is drawn to the limitation of liability, indemnification and jurisdiction issues defined therein. Any holder of this document is advised that information contained hereon reflects the Company's findings at the time of its intervention only and within the limits of Client's instructions, if any. The Company's sole responsibility is to its Client and this document does not exonerate parties to a transaction from exercising all their rights and obligations under the transaction documents. This document cannot be reproduced except in full, without prior written approval of the Company. Any unauthorized alteration, forgery or falsification of the content or appearance of this document is unlawful and offenders may be prosecuted to the fullest extent of the law.

Operation Band	:WCDMA B4	Test Date	:2013-05-03
ARFCN	:CH 1413	Temp./Humi.	:24.1 deg_C / 65 RH
Fundamental Frequency	:1732.6 MHz	Engineer	:Allen
Operation Mode	:TX MID		
EUT Pol.	:H Plan	Measurement Antenna Pol.	:HORIZONTAL

Freq. MHz	Note F/H/E/S	EIRP dBm	SG Output Level dBm	Antenna Gain dBi	Cable Loss dB	Limit dBm	Margin dB
133.79	S	-84.79	-84.80	1.20	-1.19	-13.00	-71.79
394.72	S	-80.49	-85.45	6.89	-1.93	-13.00	-67.49
500.45	S	-79.04	-83.75	6.87	-2.16	-13.00	-66.04
690.57	S	-77.43	-81.18	6.29	-2.54	-13.00	-64.43
842.86	S	-74.92	-78.25	6.16	-2.83	-13.00	-61.92
960.23	S	-74.43	-77.21	5.86	-3.08	-13.00	-61.43
3465.20	H	-52.35	-53.54	7.24	-6.05	-13.00	-39.35
5197.80	H	---					
6930.40	H	---					
8663.00	H	---					
10395.60	H	---					
12128.20	H	---					
13860.80	H	---					
15593.40	H	---					
17326.00	H	---					

EIRP (dBm) = SG Level(dBm) + Antenna Gain(dBi) + Cable Loss(dB)

Note : "F" : denotes Fundamental Frequency. ; "H" : denotes Harmonic Frequency.
 "E" : denotes Band Edge Frequency. ; "S" : denotes Spurious Frequency.
 "---" : denotes Noise Floor.

Unless otherwise stated the results shown in this test report refer only to the sample(s) tested and such sample(s) are retained for 90 days only.

除非另有說明，此報告結果僅對測試之樣品負責，同時此樣品僅保留90天。本報告未經本公司書面許可，不可部份複製。

This document is issued by the Company subject to its General Conditions of Service printed overleaf, available on request or accessible at www.sgs.com/terms_and_conditions.htm and, for electronic format documents, subject to Terms and Conditions for Electronic Documents at www.sgs.com/terms_e-document.htm. Attention is drawn to the limitation of liability, indemnification and jurisdiction issues defined therein. Any holder of this document is advised that information contained hereon reflects the Company's findings at the time of its intervention only and within the limits of Client's instructions, if any. The Company's sole responsibility is to its Client and this document does not exonerate parties to a transaction from exercising all their rights and obligations under the transaction documents. This document cannot be reproduced except in full, without prior written approval of the Company. Any unauthorized alteration, forgery or falsification of the content or appearance of this document is unlawful and offenders may be prosecuted to the fullest extent of the law.

Operation Band	:WCDMA B4	Test Date	:2013-05-03
ARFCN	:CH 1513	Temp./Humi.	:24.1 deg_C / 65 RH
Fundamental Frequency	:1752.6 MHz	Engineer	:Allen
Operation Mode	:TX HIGH		
EUT Pol.	:H Plan	Measurement Antenna Pol.	:VERTICAL

Freq. MHz	Note F/H/E/S	EIRP dBm	SG Output Level dBm	Antenna Gain dBi	Cable Loss dB	Limit dBm	Margin dB
50.37	S	-80.62	-71.06	-8.66	-0.90	-13.00	-67.62
164.83	S	-83.02	-84.01	2.28	-1.29	-13.00	-70.02
332.64	S	-79.88	-84.91	6.82	-1.79	-13.00	-66.88
530.52	S	-76.86	-81.42	6.78	-2.22	-13.00	-63.86
718.70	S	-74.49	-77.97	6.06	-2.59	-13.00	-61.49
917.55	S	-72.08	-74.89	5.79	-2.98	-13.00	-59.08
3505.20	H	-50.43	-51.77	7.40	-6.06	-13.00	-37.43
5257.80	H	---					
7010.40	H	---					
8763.00	H	---					
10515.60	H	---					
12268.20	H	---					
14020.80	H	---					
15773.40	H	---					
3505.20	H	---					

EIRP (dBm) = SG Level(dBm) + Antenna Gain(dBi) + Cable Loss(dB)

Note : "F" : denotes Fundamental Frequency. ; "H" : denotes Harmonic Frequency.
 "E" : denotes Band Edge Frequency. ; "S" : denotes Spurious Frequency.
 "---" : denotes Noise Floor.

Unless otherwise stated the results shown in this test report refer only to the sample(s) tested and such sample(s) are retained for 90 days only.

除非另有說明，此報告結果僅對測試之樣品負責，同時此樣品僅保留90天。本報告未經本公司書面許可，不可部份複製。

This document is issued by the Company subject to its General Conditions of Service printed overleaf, available on request or accessible at www.sgs.com/terms_and_conditions.htm and, for electronic format documents, subject to Terms and Conditions for Electronic Documents at www.sgs.com/terms_e-document.htm. Attention is drawn to the limitation of liability, indemnification and jurisdiction issues defined therein. Any holder of this document is advised that information contained hereon reflects the Company's findings at the time of its intervention only and within the limits of Client's instructions, if any. The Company's sole responsibility is to its Client and this document does not exonerate parties to a transaction from exercising all their rights and obligations under the transaction documents. This document cannot be reproduced except in full, without prior written approval of the Company. Any unauthorized alteration, forgery or falsification of the content or appearance of this document is unlawful and offenders may be prosecuted to the fullest extent of the law.

Operation Band	:WCDMA B4	Test Date	:2013-05-03
ARFCN	:CH 1513	Temp./Humi.	:24.1 deg_C / 65 RH
Fundamental Frequency	:1752.6 MHz	Engineer	:Allen
Operation Mode	:TX HIGH		
EUT Pol.	:H Plan	Measurement Antenna Pol.	:HORIZONTAL

Freq.	Note	EIRP	SG	Antenna	Cable	Limit	Margin
MHz	F/H/E/S	dBm	Output Level dBm	Gain dBi	Loss dB	dBm	dB
142.52	S	-85.16	-84.82	0.87	-1.22	-13.00	-72.16
349.13	S	-81.07	-86.17	6.93	-1.83	-13.00	-68.07
462.62	S	-79.06	-83.66	6.68	-2.08	-13.00	-66.06
638.19	S	-78.16	-81.96	6.25	-2.46	-13.00	-65.16
766.23	S	-75.33	-78.44	5.80	-2.69	-13.00	-62.33
952.47	S	-74.08	-76.82	5.80	-3.06	-13.00	-61.08
3505.20	H	-51.22	-52.48	7.31	-6.06	-13.00	-38.22
5257.80	H	---					
7010.40	H	---					
8763.00	H	---					
10515.60	H	---					
12268.20	H	---					
14020.80	H	---					
15773.40	H	---					
3505.20	H	---					

EIRP (dBm) = SG Level(dBm) + Antenna Gain(dBi) + Cable Loss(dB)

Note : "F" : denotes Fundamental Frequency. ; "H" : denotes Harmonic Frequency.
 "E" : denotes Band Edge Frequency. ; "S" : denotes Spurious Frequency.
 "---" : denotes Noise Floor.

Unless otherwise stated the results shown in this test report refer only to the sample(s) tested and such sample(s) are retained for 90 days only.

除非另有說明，此報告結果僅對測試之樣品負責，同時此樣品僅保留90天。本報告未經本公司書面許可，不可部份複製。

This document is issued by the Company subject to its General Conditions of Service printed overleaf, available on request or accessible at www.sgs.com/terms_and_conditions.htm and, for electronic format documents, subject to Terms and Conditions for Electronic Documents at www.sgs.com/terms_e-document.htm. Attention is drawn to the limitation of liability, indemnification and jurisdiction issues defined therein. Any holder of this document is advised that information contained hereon reflects the Company's findings at the time of its intervention only and within the limits of Client's instructions, if any. The Company's sole responsibility is to its Client and this document does not exonerate parties to a transaction from exercising all their rights and obligations under the transaction documents. This document cannot be reproduced except in full, without prior written approval of the Company. Any unauthorized alteration, forgery or falsification of the content or appearance of this document is unlawful and offenders may be prosecuted to the fullest extent of the law.

Radiated Spurious Emission Measurement Result: HSDPA V Mode

Operation Band	:HSDPA B5	Test Date	:2013-05-03
ARFCN	:CH 4132	Temp./Humi.	:24.1 deg_C / 65 RH
Fundamental Frequency	:826.4 MHz	Engineer	:Allen
Operation Mode	:TX LOW		
EUT Pol.	:E1 Plan	Measurement Antenna Pol.	:VERTICAL

Freq.	Note	ERP	SG	Antenna	Cable	Limit	Margin
MHz	F/H/E/S	dBm	Output Level dBm	Gain dBd	Loss dB	dBm	dB
114.39	S	-82.87	-80.55	-1.20	-1.11	-13.00	-69.87
253.10	S	-83.69	-86.72	4.60	-1.57	-13.00	-70.69
439.34	S	-82.17	-84.65	4.52	-2.03	-13.00	-69.17
613.94	S	-77.17	-78.82	4.06	-2.40	-13.00	-64.17
695.42	S	-76.94	-78.54	4.15	-2.55	-13.00	-63.94
918.52	S	-74.31	-74.97	3.64	-2.98	-13.00	-61.31
1652.80	H	-59.32	-57.66	2.39	-4.05	-13.00	-46.32
2479.20	H	---					
3305.60	H	---					
4132.00	H	---					
4958.40	H	---					
5784.80	H	---					
6611.20	H	---					
7437.60	H	---					
8264.00	H	---					

ERP (dBm) = SG Level(dBm) + Antenna Gain(dBd) + Cable Loss(dB)

Note : “F” : denotes Fundamental Frequency. ; “H” : denotes Harmonic Frequency.
 “E” : denotes Band Edge Frequency. ; “S” : denotes Spurious Frequency.
 “---” : denotes Noise Floor.

Unless otherwise stated the results shown in this test report refer only to the sample(s) tested and such sample(s) are retained for 90 days only.

除非另有說明，此報告結果僅對測試之樣品負責，同時此樣品僅保留90天。本報告未經本公司書面許可，不可部份複製。

This document is issued by the Company subject to its General Conditions of Service printed overleaf, available on request or accessible at www.sgs.com/terms_and_conditions.htm and, for electronic format documents, subject to Terms and Conditions for Electronic Documents at www.sgs.com/terms_e-document.htm. Attention is drawn to the limitation of liability, indemnification and jurisdiction issues defined therein. Any holder of this document is advised that information contained hereon reflects the Company's findings at the time of its intervention only and within the limits of Client's instructions, if any. The Company's sole responsibility is to its Client and this document does not exonerate parties to a transaction from exercising all their rights and obligations under the transaction documents. This document cannot be reproduced except in full, without prior written approval of the Company. Any unauthorized alteration, forgery or falsification of the content or appearance of this document is unlawful and offenders may be prosecuted to the fullest extent of the law.

Operation Band	: HSDPA B5	Test Date	:2013-05-03
ARFCN	:CH 4132	Temp./Humi.	:24.1 deg_C / 65 RH
Fundamental Frequency	:826.4 MHz	Engineer	:Allen
Operation Mode	:TX LOW		
EUT Pol.	:E1 Plan	Measurement Antenna Pol.	:HORIZONTAL

Freq.	Note	ERP	SG	Antenna	Cable	Limit	Margin
MHz	F/H/E/S	dBm	Output Level dBm	Gain dBd	Loss dB	dBm	dB
153.19	S	-87.04	-84.86	-0.93	-1.25	-13.00	-74.04
384.05	S	-82.60	-85.37	4.67	-1.91	-13.00	-69.60
579.02	S	-81.34	-83.27	4.25	-2.32	-13.00	-68.34
649.83	S	-79.79	-81.44	4.12	-2.48	-13.00	-66.79
731.31	S	-78.53	-79.68	3.76	-2.61	-13.00	-65.53
935.98	S	-75.79	-76.41	3.64	-3.02	-13.00	-62.79
1652.80	H	-59.15	-57.77	2.67	-4.05	-13.00	-46.15
2479.20	H	---					
3305.60	H	---					
4132.00	H	---					
4958.40	H	---					
5784.80	H	---					
6611.20	H	---					
7437.60	H	---					
8264.00	H	---					

ERP (dBm) = SG Level(dBm) + Antenna Gain(dBd) + Cable Loss(dB)

Note : “F” : denotes Fundamental Frequency. ; “H” : denotes Harmonic Frequency.

“E” : denotes Band Edge Frequency. ; “S” : denotes Spurious Frequency.

“---“ : denotes Noise Floor.

Unless otherwise stated the results shown in this test report refer only to the sample(s) tested and such sample(s) are retained for 90 days only.

除非另有說明，此報告結果僅對測試之樣品負責，同時此樣品僅保留90天。本報告未經本公司書面許可，不可部份複製。

This document is issued by the Company subject to its General Conditions of Service printed overleaf, available on request or accessible at www.sgs.com/terms_and_conditions.htm and, for electronic format documents, subject to Terms and Conditions for Electronic Documents at www.sgs.com/terms_e-document.htm. Attention is drawn to the limitation of liability, indemnification and jurisdiction issues defined therein. Any holder of this document is advised that information contained hereon reflects the Company's findings at the time of its intervention only and within the limits of Client's instructions, if any. The Company's sole responsibility is to its Client and this document does not exonerate parties to a transaction from exercising all their rights and obligations under the transaction documents. This document cannot be reproduced except in full, without prior written approval of the Company. Any unauthorized alteration, forgery or falsification of the content or appearance of this document is unlawful and offenders may be prosecuted to the fullest extent of the law.

Operation Band	:HSDPA B5	Test Date	:2013-05-03
ARFCN	:CH 4183	Temp./Humi.	:24.1 deg_C / 65 RH
Fundamental Frequency	:836.6 MHz	Engineer	:Allen
Operation Mode	:TX MID		
EUT Pol.	:E1 Plan	Measurement Antenna Pol.	:VERTICAL

Freq.	Note	ERP	SG	Antenna	Cable	Limit	Margin
MHz	F/H/E/S	dBm	Output Level dBm	Gain dBd	Loss dB	dBm	dB
114.39	S	-82.68	-80.36	-1.20	-1.11	-13.00	-69.68
252.13	S	-83.07	-86.08	4.58	-1.57	-13.00	-70.07
343.31	S	-82.59	-85.52	4.75	-1.82	-13.00	-69.59
486.87	S	-80.02	-82.53	4.65	-2.13	-13.00	-67.02
679.90	S	-77.29	-78.90	4.14	-2.53	-13.00	-64.29
916.58	S	-74.53	-75.20	3.64	-2.98	-13.00	-61.53
1673.20	H	-57.45	-55.70	2.34	-4.08	-13.00	-44.45
2509.80	H	---					
3346.40	H	---					
4183.00	H	---					
5019.60	H	---					
5856.20	H	---					
6692.80	H	---					
7529.40	H	---					
8366.00	H	---					

ERP (dBm) = SG Level(dBm) + Antenna Gain(dBd) + Cable Loss(dB)

Note : “F” : denotes Fundamental Frequency. ; “H” : denotes Harmonic Frequency.
 “E” : denotes Band Edge Frequency. ; “S” : denotes Spurious Frequency.
 “---” : denotes Noise Floor.

Unless otherwise stated the results shown in this test report refer only to the sample(s) tested and such sample(s) are retained for 90 days only.

除非另有說明，此報告結果僅對測試之樣品負責，同時此樣品僅保留90天。本報告未經本公司書面許可，不可部份複製。

This document is issued by the Company subject to its General Conditions of Service printed overleaf, available on request or accessible at www.sgs.com/terms_and_conditions.htm and, for electronic format documents, subject to Terms and Conditions for Electronic Documents at www.sgs.com/terms_e-document.htm. Attention is drawn to the limitation of liability, indemnification and jurisdiction issues defined therein. Any holder of this document is advised that information contained hereon reflects the Company's findings at the time of its intervention only and within the limits of Client's instructions, if any. The Company's sole responsibility is to its Client and this document does not exonerate parties to a transaction from exercising all their rights and obligations under the transaction documents. This document cannot be reproduced except in full, without prior written approval of the Company. Any unauthorized alteration, forgery or falsification of the content or appearance of this document is unlawful and offenders may be prosecuted to the fullest extent of the law.

Operation Band	:HSDPA B5	Test Date	:2013-05-03
ARFCN	:CH 4183	Temp./Humi.	:24.1 deg_C / 65 RH
Fundamental Frequency	:836.6 MHz	Engineer	:Allen
Operation Mode	:TX MID		
EUT Pol.	:E1 Plan	Measurement Antenna Pol.	:HORIZONTAL

Freq.	Note	ERP	SG	Antenna	Cable	Limit	Margin
MHz	F/H/E/S	dBm	Output Level dBm	Gain dBd	Loss dB	dBm	dB
139.61	S	-86.37	-83.84	-1.32	-1.21	-13.00	-73.37
246.31	S	-88.09	-91.03	4.49	-1.55	-13.00	-75.09
360.77	S	-83.48	-86.34	4.71	-1.86	-13.00	-70.48
555.74	S	-81.42	-83.66	4.51	-2.27	-13.00	-68.42
726.46	S	-78.79	-80.00	3.82	-2.60	-13.00	-65.79
916.58	S	-75.71	-76.37	3.64	-2.98	-13.00	-62.71
1673.20	H	-57.85	-56.44	2.66	-4.08	-13.00	-44.85
2509.80	H	---					
3346.40	H	---					
4183.00	H	---					
5019.60	H	---					
5856.20	H	---					
6692.80	H	---					
7529.40	H	---					
8366.00	H	---					

ERP (dBm) = SG Level(dBm) + Antenna Gain(dBd) + Cable Loss(dB)

Note : "F" : denotes Fundamental Frequency. ; "H" : denotes Harmonic Frequency.

"E" : denotes Band Edge Frequency. ; "S" : denotes Spurious Frequency.

"---" : denotes Noise Floor.

Unless otherwise stated the results shown in this test report refer only to the sample(s) tested and such sample(s) are retained for 90 days only.

除非另有說明，此報告結果僅對測試之樣品負責，同時此樣品僅保留90天。本報告未經本公司書面許可，不可部份複製。

This document is issued by the Company subject to its General Conditions of Service printed overleaf, available on request or accessible at www.sgs.com/terms_and_conditions.htm and, for electronic format documents, subject to Terms and Conditions for Electronic Documents at www.sgs.com/terms_e-document.htm. Attention is drawn to the limitation of liability, indemnification and jurisdiction issues defined therein. Any holder of this document is advised that information contained hereon reflects the Company's findings at the time of its intervention only and within the limits of Client's instructions, if any. The Company's sole responsibility is to its Client and this document does not exonerate parties to a transaction from exercising all their rights and obligations under the transaction documents. This document cannot be reproduced except in full, without prior written approval of the Company. Any unauthorized alteration, forgery or falsification of the content or appearance of this document is unlawful and offenders may be prosecuted to the fullest extent of the law.

Operation Band	:HSDPA B5	Test Date	:2013-05-03
ARFCN	:CH 4233	Temp./Humi.	:24.1 deg_C / 65 RH
Fundamental Frequency	:846.6 MHz	Engineer	:Allen
Operation Mode	:TX HIGH		
EUT Pol.	:E1 Plan	Measurement Antenna Pol.	:VERTICAL

Freq.	Note	ERP	SG	Antenna	Cable	Limit	Margin
MHz	F/H/E/S	dBm	Output Level dBm	Gain dBd	Loss dB	dBm	dB
114.39	S	-83.36	-81.04	-1.20	-1.11	-13.00	-70.36
343.31	S	-82.64	-85.57	4.75	-1.82	-13.00	-69.64
440.31	S	-81.16	-83.64	4.51	-2.03	-13.00	-68.16
600.36	S	-77.10	-78.76	4.03	-2.37	-13.00	-64.10
784.66	S	-76.63	-77.69	3.79	-2.73	-13.00	-63.63
936.95	S	-74.35	-74.96	3.64	-3.03	-13.00	-61.35
1693.20	H	-60.68	-58.86	2.29	-4.11	-13.00	-47.68
2539.80	H	---					
3386.40	H	---					
4233.00	H	---					
5079.60	H	---					
5926.20	H	---					
6772.80	H	---					
7619.40	H	---					
8466.00	H	---					

ERP (dBm) = SG Level(dBm) + Antenna Gain(dBd) + Cable Loss(dB)

Note : "F" : denotes Fundamental Frequency. ; "H" : denotes Harmonic Frequency.
 "E" : denotes Band Edge Frequency. ; "S" : denotes Spurious Frequency.
 "---" : denotes Noise Floor.

Unless otherwise stated the results shown in this test report refer only to the sample(s) tested and such sample(s) are retained for 90 days only.

除非另有說明，此報告結果僅對測試之樣品負責，同時此樣品僅保留90天。本報告未經本公司書面許可，不可部份複製。

This document is issued by the Company subject to its General Conditions of Service printed overleaf, available on request or accessible at www.sgs.com/terms_and_conditions.htm and, for electronic format documents, subject to Terms and Conditions for Electronic Documents at www.sgs.com/terms_e-document.htm. Attention is drawn to the limitation of liability, indemnification and jurisdiction issues defined therein. Any holder of this document is advised that information contained hereon reflects the Company's findings at the time of its intervention only and within the limits of Client's instructions, if any. The Company's sole responsibility is to its Client and this document does not exonerate parties to a transaction from exercising all their rights and obligations under the transaction documents. This document cannot be reproduced except in full, without prior written approval of the Company. Any unauthorized alteration, forgery or falsification of the content or appearance of this document is unlawful and offenders may be prosecuted to the fullest extent of the law.

Operation Band	:HSDPA B5	Test Date	:2013-05-03
ARFCN	:CH 4233	Temp./Humi.	:24.1 deg_C / 65 RH
Fundamental Frequency	:846.6 MHz	Engineer	:Allen
Operation Mode	:TX HIGH		
EUT Pol.	:E1 Plan	Measurement Antenna Pol.	:HORIZONTAL

Freq.	Note	ERP	SG	Antenna	Cable	Limit	Margin
MHz	F/H/E/S	dBm	Output Level dBm	Gain dBd	Loss dB	dBm	dB
138.64	S	-87.48	-85.02	-1.26	-1.20	-13.00	-74.48
383.08	S	-83.38	-86.14	4.67	-1.90	-13.00	-70.38
521.79	S	-81.31	-83.76	4.66	-2.21	-13.00	-68.31
614.91	S	-79.65	-81.30	4.06	-2.41	-13.00	-66.65
773.02	S	-77.42	-78.42	3.70	-2.70	-13.00	-64.42
910.76	S	-75.81	-76.49	3.65	-2.96	-13.00	-62.81
1693.20	H	-59.16	-57.71	2.65	-4.11	-13.00	-46.16
2539.80	H	---					
3386.40	H	---					
4233.00	H	---					
5079.60	H	---					
5926.20	H	---					
6772.80	H	---					
7619.40	H	---					
8466.00	H	---					

ERP (dBm) = SG Level(dBm) + Antenna Gain(dBd) + Cable Loss(dB)

Note : "F" : denotes Fundamental Frequency. ; "H" : denotes Harmonic Frequency.

"E" : denotes Band Edge Frequency. ; "S" : denotes Spurious Frequency.

"---" : denotes Noise Floor.

Unless otherwise stated the results shown in this test report refer only to the sample(s) tested and such sample(s) are retained for 90 days only.

除非另有說明，此報告結果僅對測試之樣品負責，同時此樣品僅保留90天。本報告未經本公司書面許可，不可部份複製。

This document is issued by the Company subject to its General Conditions of Service printed overleaf, available on request or accessible at www.sgs.com/terms_and_conditions.htm and, for electronic format documents, subject to Terms and Conditions for Electronic Documents at www.sgs.com/terms_e-document.htm. Attention is drawn to the limitation of liability, indemnification and jurisdiction issues defined therein. Any holder of this document is advised that information contained hereon reflects the Company's findings at the time of its intervention only and within the limits of Client's instructions, if any. The Company's sole responsibility is to its Client and this document does not exonerate parties to a transaction from exercising all their rights and obligations under the transaction documents. This document cannot be reproduced except in full, without prior written approval of the Company. Any unauthorized alteration, forgery or falsification of the content or appearance of this document is unlawful and offenders may be prosecuted to the fullest extent of the law.

Radiated Spurious Emission Measurement Result: GSM 850 Mode

Operation Band	:GSM 850	Test Date	:2013-05-03
Fundamental Frequency	:824.2 MHz	Temp./Humi.	:24.1 deg_C / 65 RH
Operation Mode	:RX LOW	Engineer	:Allen
EUT Pol.	:E2 Plan	Measurement Antenna Pol.	:VERTICAL

Actual FS(dBµV/m) = SPA. Reading level(dBµV) + Factor(dB)

Factor(dB) = Antenna Factor(dBµV/m) + Cable Loss(dB) – Pre_Amplifier Gain(dB)

Note : “F” : denotes Fundamental Frequency. ; “H” : denotes Harmonic Frequency.

“E” : denotes Band Edge Frequency. ; “S” : denotes Spurious Frequency.

“---“ : denotes Noise Floor.

Freq. MHz	Note F/H/E/S	Detector Mode PK/QP/AV	Spectrum Reading Level dBµV	Factor dB	Actual FS dBµV/m	Limit @3m dBµV/m	Margin dB
41.64	S	Peak	30.74	-13.56	17.18	40.00	-22.82
157.07	S	Peak	28.08	-12.29	15.79	43.50	-27.71
241.46	S	Peak	26.67	-14.16	12.51	46.00	-33.49
515.97	S	Peak	27.38	-9.28	18.10	46.00	-27.90
774.96	S	Peak	27.78	-4.54	23.24	46.00	-22.76
908.82	S	Peak	27.27	-2.63	24.64	46.00	-21.36
1648.40	H	Peak	40.69	-1.68	39.01	54.00	-14.99
2472.60	H	---					
3288.00	H	---					
4121.00	H	---					
4945.20	H	---					
5769.40	H	---					
6593.60	H	---					
7417.80	H	---					
8242.00	H	---					

Unless otherwise stated the results shown in this test report refer only to the sample(s) tested and such sample(s) are retained for 90 days only.

除非另有說明，此報告結果僅對測試之樣品負責，同時此樣品僅保留90天。本報告未經本公司書面許可，不可部份複製。

This document is issued by the Company subject to its General Conditions of Service printed overleaf, available on request or accessible at www.sgs.com/terms_and_conditions.htm and, for electronic format documents, subject to Terms and Conditions for Electronic Documents at www.sgs.com/terms_e-document.htm. Attention is drawn to the limitation of liability, indemnification and jurisdiction issues defined therein. Any holder of this document is advised that information contained hereon reflects the Company's findings at the time of its intervention only and within the limits of Client's instructions, if any. The Company's sole responsibility is to its Client and this document does not exonerate parties to a transaction from exercising all their rights and obligations under the transaction documents. This document cannot be reproduced except in full, without prior written approval of the Company. Any unauthorized alteration, forgery or falsification of the content or appearance of this document is unlawful and offenders may be prosecuted to the fullest extent of the law.

Operation Band	:GSM 850	Test Date	:2013-05-03
Fundamental Frequency	:824.2 MHz	Temp./Humi.	:24.1 deg_C / 65 RH
Operation Mode	:RX LOW	Engineer	:Allen
EUT Pol.	:E2 Plan	Measurement Antenna Pol.	:HORIZONTAL

Actual FS(dBμV/m) = SPA. Reading level(dBμV) + Factor(dB)

Factor(dB) = Antenna Factor(dBμV/m) + Cable Loss(dB) – Pre_Amplifier Gain(dB)

Note : “F” : denotes Fundamental Frequency. ; “H” : denotes Harmonic Frequency.

“E” : denotes Band Edge Frequency. ; “S” : denotes Spurious Frequency.

“---“ : denotes Noise Floor.

Freq.	Note	Detector Mode	Spectrum Reading Level	Factor	Actual FS	Limit @3m	Margin
MHz	F/H/E/S	PK/QP/AV	dBμV	dB	dBμV/m	dBμV/m	dB
155.13	S	Peak	26.82	-12.30	14.52	43.50	-28.98
272.50	S	Peak	29.05	-13.28	15.77	46.00	-30.23
368.53	S	Peak	27.02	-11.45	15.57	46.00	-30.43
583.87	S	Peak	28.22	-7.90	20.32	46.00	-25.68
719.67	S	Peak	28.76	-5.44	23.32	46.00	-22.68
811.82	S	Peak	28.28	-4.06	24.22	46.00	-21.78
1648.40	H	Peak	39.48	-0.96	38.52	54.00	-15.48
2472.60	H	---					
3288.00	H	---					
4121.00	H	---					
4945.20	H	---					
5769.40	H	---					
6593.60	H	---					
7417.80	H	---					
8242.00	H	---					

Unless otherwise stated the results shown in this test report refer only to the sample(s) tested and such sample(s) are retained for 90 days only.

除非另有說明，此報告結果僅對測試之樣品負責，同時此樣品僅保留90天。本報告未經本公司書面許可，不可部份複製。

This document is issued by the Company subject to its General Conditions of Service printed overleaf, available on request or accessible at www.sgs.com/terms_and_conditions.htm and, for electronic format documents, subject to Terms and Conditions for Electronic Documents at www.sgs.com/terms_e-document.htm. Attention is drawn to the limitation of liability, indemnification and jurisdiction issues defined therein. Any holder of this document is advised that information contained hereon reflects the Company's findings at the time of its intervention only and within the limits of Client's instructions, if any. The Company's sole responsibility is to its Client and this document does not exonerate parties to a transaction from exercising all their rights and obligations under the transaction documents. This document cannot be reproduced except in full, without prior written approval of the Company. Any unauthorized alteration, forgery or falsification of the content or appearance of this document is unlawful and offenders may be prosecuted to the fullest extent of the law.

Operation Band	:GSM 850	Test Date	:2013-05-03
Fundamental Frequency	:836.6 MHz	Temp./Humi.	:24.1 deg_C / 65 RH
Operation Mode	:RX MID	Engineer	:Allen
EUT Pol.	:E2 Plan	Measurement Antenna Pol.	:VERTICAL

Actual FS(dBμV/m) = SPA. Reading level(dBμV) + Factor(dB)

Factor(dB) = Antenna Factor(dBμV/m) + Cable Loss(dB) – Pre_Amplifier Gain(dB)

Note : “F” : denotes Fundamental Frequency. ; “H” : denotes Harmonic Frequency.

“E” : denotes Band Edge Frequency. ; “S” : denotes Spurious Frequency.

“---“ : denotes Noise Floor.

Freq.	Note	Detector Mode	Spectrum Reading Level	Factor	Actual FS	Limit @3m	Margin
MHz	F/H/E/S	PK/QP/AV	dBμV	dB	dBμV/m	dBμV/m	dB
329.73	S	Peak	26.39	-11.92	14.47	46.00	-31.53
418.97	S	Peak	27.22	-10.66	16.56	46.00	-29.44
602.30	S	Peak	28.32	-7.51	20.81	46.00	-25.19
734.22	S	Peak	28.03	-5.23	22.80	46.00	-23.20
812.79	S	Peak	27.24	-4.04	23.20	46.00	-22.80
897.18	S	Peak	26.79	-2.87	23.92	46.00	-22.08
1673.20	H	Peak	39.63	-1.38	38.25	54.00	-15.75
2509.80	H	---					
3346.40	H	---					
4183.00	H	---					
5019.60	H	---					
5856.20	H	---					
6692.80	H	---					
7529.40	H	---					
8366.00	H	---					

Unless otherwise stated the results shown in this test report refer only to the sample(s) tested and such sample(s) are retained for 90 days only.

除非另有說明，此報告結果僅對測試之樣品負責，同時此樣品僅保留90天。本報告未經本公司書面許可，不可部份複製。

This document is issued by the Company subject to its General Conditions of Service printed overleaf, available on request or accessible at www.sgs.com/terms_and_conditions.htm and, for electronic format documents, subject to Terms and Conditions for Electronic Documents at www.sgs.com/terms_e-document.htm. Attention is drawn to the limitation of liability, indemnification and jurisdiction issues defined therein. Any holder of this document is advised that information contained hereon reflects the Company's findings at the time of its intervention only and within the limits of Client's instructions, if any. The Company's sole responsibility is to its Client and this document does not exonerate parties to a transaction from exercising all their rights and obligations under the transaction documents. This document cannot be reproduced except in full, without prior written approval of the Company. Any unauthorized alteration, forgery or falsification of the content or appearance of this document is unlawful and offenders may be prosecuted to the fullest extent of the law.

Operation Band	:GSM 850	Test Date	:2013-05-03
Fundamental Frequency	:836.6 MHz	Temp./Humi.	:24.1 deg_C / 65 RH
Operation Mode	:RX MID	Engineer	:Allen
EUT Pol.	:E2 Plan	Measurement Antenna Pol.	:HORIZONTAL

Actual FS(dBμV/m) = SPA. Reading level(dBμV) + Factor(dB)

Factor(dB) = Antenna Factor(dBμV/m) + Cable Loss(dB) – Pre_Amplifier Gain(dB)

Note : “F” : denotes Fundamental Frequency. ; “H” : denotes Harmonic Frequency.

“E” : denotes Band Edge Frequency. ; “S” : denotes Spurious Frequency.

“---“ : denotes Noise Floor.

Freq.	Note	Detector Mode	Spectrum Reading Level	Factor	Actual FS	Limit @3m	Margin
MHz	F/H/E/S	PK/QP/AV	dBμV	dB	dBμV/m	dBμV/m	dB
87.23	S	Peak	31.47	-17.69	13.78	40.00	-26.22
160.95	S	Peak	27.14	-12.36	14.78	43.50	-28.72
275.41	S	Peak	27.80	-13.19	14.61	46.00	-31.39
401.51	S	Peak	28.57	-11.02	17.55	46.00	-28.45
601.33	S	Peak	27.40	-7.52	19.88	46.00	-26.12
898.15	S	Peak	26.58	-2.85	23.73	46.00	-22.27
1673.20	H	Peak	40.72	-0.59	40.13	54.00	-13.87
2509.80	H	---					
3346.40	H	---					
4183.00	H	---					
5019.60	H	---					
5856.20	H	---					
6692.80	H	---					
7529.40	H	---					
8366.00	H	---					

Unless otherwise stated the results shown in this test report refer only to the sample(s) tested and such sample(s) are retained for 90 days only.

除非另有說明，此報告結果僅對測試之樣品負責，同時此樣品僅保留90天。本報告未經本公司書面許可，不可部份複製。

This document is issued by the Company subject to its General Conditions of Service printed overleaf, available on request or accessible at www.sgs.com/terms_and_conditions.htm and, for electronic format documents, subject to Terms and Conditions for Electronic Documents at www.sgs.com/terms_e-document.htm. Attention is drawn to the limitation of liability, indemnification and jurisdiction issues defined therein. Any holder of this document is advised that information contained hereon reflects the Company's findings at the time of its intervention only and within the limits of Client's instructions, if any. The Company's sole responsibility is to its Client and this document does not exonerate parties to a transaction from exercising all their rights and obligations under the transaction documents. This document cannot be reproduced except in full, without prior written approval of the Company. Any unauthorized alteration, forgery or falsification of the content or appearance of this document is unlawful and offenders may be prosecuted to the fullest extent of the law.

Operation Band	:GSM 850	Test Date	:2013-05-03
Fundamental Frequency	:848.8 MHz	Temp./Humi.	:24.1 deg_C / 65 RH
Operation Mode	:RX HIGH	Engineer	:Allen
EUT Pol.	:E2 Plan	Measurement Antenna Pol.	:VERTICAL

Actual FS(dBμV/m) = SPA. Reading level(dBμV) + Factor(dB)

Factor(dB) = Antenna Factor(dBμV/m) + Cable Loss(dB) – Pre_Amplifier Gain(dB)

Note : “F” : denotes Fundamental Frequency. ; “H” : denotes Harmonic Frequency.

“E” : denotes Band Edge Frequency. ; “S” : denotes Spurious Frequency.

“---“ : denotes Noise Floor.

Freq. MHz	Note F/H/E/S	Detector Mode PK/QP/AV	Spectrum Reading Level dBμV	Factor dB	Actual FS dBμV/m	Limit @3m dBμV/m	Margin dB
114.39	S	Peak	34.03	-15.22	18.81	43.50	-24.69
157.07	S	Peak	27.96	-12.29	15.67	43.50	-27.83
424.79	S	Peak	27.08	-10.54	16.54	46.00	-29.46
725.49	S	Peak	28.03	-5.35	22.68	46.00	-23.32
823.46	S	Peak	27.64	-3.94	23.70	46.00	-22.30
886.51	S	Peak	27.62	-3.07	24.55	46.00	-21.45
1697.60	H	Peak	39.53	-1.08	38.45	54.00	-15.55
2546.40	H	---					
3395.20	H	---					
4244.00	H	---					
5092.80	H	---					
5941.60	H	---					
6790.40	H	---					
7639.20	H	---					
8488.00	H	---					

Unless otherwise stated the results shown in this test report refer only to the sample(s) tested and such sample(s) are retained for 90 days only.

除非另有說明，此報告結果僅對測試之樣品負責，同時此樣品僅保留90天。本報告未經本公司書面許可，不可部份複製。

This document is issued by the Company subject to its General Conditions of Service printed overleaf, available on request or accessible at www.sgs.com/terms_and_conditions.htm and, for electronic format documents, subject to Terms and Conditions for Electronic Documents at www.sgs.com/terms_e-document.htm. Attention is drawn to the limitation of liability, indemnification and jurisdiction issues defined therein. Any holder of this document is advised that information contained hereon reflects the Company's findings at the time of its intervention only and within the limits of Client's instructions, if any. The Company's sole responsibility is to its Client and this document does not exonerate parties to a transaction from exercising all their rights and obligations under the transaction documents. This document cannot be reproduced except in full, without prior written approval of the Company. Any unauthorized alteration, forgery or falsification of the content or appearance of this document is unlawful and offenders may be prosecuted to the fullest extent of the law.

Operation Band	:GSM 850	Test Date	:2013-05-03
Fundamental Frequency	:848.8 MHz	Temp./Humi.	:24.1 deg_C / 65 RH
Operation Mode	:RX HIGH	Engineer	:Allen
EUT Pol.	:E2 Plan	Measurement Antenna Pol.	:HORIZONTAL

Actual FS(dBμV/m) = SPA. Reading level(dBμV) + Factor(dB)

Factor(dB) = Antenna Factor(dBμV/m) + Cable Loss(dB) – Pre_Amplifier Gain(dB)

Note : “F” : denotes Fundamental Frequency. ; “H” : denotes Harmonic Frequency.

“E” : denotes Band Edge Frequency. ; “S” : denotes Spurious Frequency.

“---“ : denotes Noise Floor.

Freq. MHz	Note F/H/E/S	Detector Mode PK/QP/AV	Spectrum Reading Level dBμV	Factor dB	Actual FS dBμV/m	Limit @3m dBμV/m	Margin dB
58.13	S	Peak	28.50	-14.45	14.05	40.00	-25.95
146.40	S	Peak	26.98	-12.60	14.38	43.50	-29.12
286.08	S	Peak	27.26	-12.89	14.37	46.00	-31.63
371.44	S	Peak	27.02	-11.41	15.61	46.00	-30.39
482.99	S	Peak	27.95	-9.78	18.17	46.00	-27.83
788.54	S	Peak	27.32	-4.35	22.97	46.00	-23.03
1697.60	H	Peak	39.88	-0.23	39.65	54.00	-14.35
2546.40	H	---					
3395.20	H	---					
4244.00	H	---					
5092.80	H	---					
5941.60	H	---					
6790.40	H	---					
7639.20	H	---					
8488.00	H	---					

Unless otherwise stated the results shown in this test report refer only to the sample(s) tested and such sample(s) are retained for 90 days only.

除非另有說明，此報告結果僅對測試之樣品負責，同時此樣品僅保留90天。本報告未經本公司書面許可，不可部份複製。

This document is issued by the Company subject to its General Conditions of Service printed overleaf, available on request or accessible at www.sgs.com/terms_and_conditions.htm and, for electronic format documents, subject to Terms and Conditions for Electronic Documents at www.sgs.com/terms_e-document.htm. Attention is drawn to the limitation of liability, indemnification and jurisdiction issues defined therein. Any holder of this document is advised that information contained hereon reflects the Company's findings at the time of its intervention only and within the limits of Client's instructions, if any. The Company's sole responsibility is to its Client and this document does not exonerate parties to a transaction from exercising all their rights and obligations under the transaction documents. This document cannot be reproduced except in full, without prior written approval of the Company. Any unauthorized alteration, forgery or falsification of the content or appearance of this document is unlawful and offenders may be prosecuted to the fullest extent of the law.

Radiated Spurious Emission Measurement Result: GSM 1900 Mode

Operation Band	:GSM 1900	Test Date	:2013-05-03
Fundamental Frequency	:1850.2 MHz	Temp./Humi.	:24.1 deg_C / 65 RH
Operation Mode	:RX LOW	Engineer	:Allen
EUT Pol.	:E1 Plan	Measurement Antenna Pol.	:VERTICAL

Actual FS(dBμV/m) = SPA. Reading level(dBμV) + Factor(dB)

Factor(dB) = Antenna Factor(dBμV/m) + Cable Loss(dB) – Pre_Amplifier Gain(dB)

Note : “F” : denotes Fundamental Frequency. ; “H” : denotes Harmonic Frequency.

“E” : denotes Band Edge Frequency. ; “S” : denotes Spurious Frequency.

“---“ : denotes Noise Floor.

Freq. MHz	Note F/H/E/S	Detector Mode PK/QP/AV	Spectrum Reading Level dBμV	Factor dB	Actual FS dBμV/m	Limit @3m dBμV/m	Margin dB
157.07	S	Peak	27.53	-12.29	15.24	43.50	-28.26
407.33	S	Peak	27.27	-10.90	16.37	46.00	-29.63
504.33	S	Peak	27.51	-9.50	18.01	46.00	-27.99
691.54	S	Peak	28.79	-5.86	22.93	46.00	-23.07
769.14	S	Peak	28.01	-4.63	23.38	46.00	-22.62
933.07	S	Peak	27.64	-2.26	25.38	46.00	-20.62
3700.40	H	Peak	37.49	5.18	42.67	54.00	-11.33
5550.60	H	---					
7400.80	H	---					
9251.00	H	---					
11101.20	H	---					
12951.40	H	---					
14801.60	H	---					
16651.80	H	---					
18502.00	H	---					

Unless otherwise stated the results shown in this test report refer only to the sample(s) tested and such sample(s) are retained for 90 days only.

除非另有說明，此報告結果僅對測試之樣品負責，同時此樣品僅保留90天。本報告未經本公司書面許可，不可部份複製。

This document is issued by the Company subject to its General Conditions of Service printed overleaf, available on request or accessible at www.sgs.com/terms_and_conditions.htm and, for electronic format documents, subject to Terms and Conditions for Electronic Documents at www.sgs.com/terms_e-document.htm. Attention is drawn to the limitation of liability, indemnification and jurisdiction issues defined therein. Any holder of this document is advised that information contained hereon reflects the Company's findings at the time of its intervention only and within the limits of Client's instructions, if any. The Company's sole responsibility is to its Client and this document does not exonerate parties to a transaction from exercising all their rights and obligations under the transaction documents. This document cannot be reproduced except in full, without prior written approval of the Company. Any unauthorized alteration, forgery or falsification of the content or appearance of this document is unlawful and offenders may be prosecuted to the fullest extent of the law.

Operation Band	:GSM 1900	Test Date	:2013-05-03
Fundamental Frequency	:1850.2 MHz	Temp./Humi.	:24.1 deg_C / 65 RH
Operation Mode	:RX LOW	Engineer	:Allen
EUT Pol.	:E1 Plan	Measurement Antenna Pol.	:HORIZONTAL

Actual FS(dBμV/m) = SPA. Reading level(dBμV) + Factor(dB)

Factor(dB) = Antenna Factor(dBμV/m) + Cable Loss(dB) – Pre_Amplifier Gain(dB)

Note : “F” : denotes Fundamental Frequency. ; “H” : denotes Harmonic Frequency.

“E” : denotes Band Edge Frequency. ; “S” : denotes Spurious Frequency.

“---“ : denotes Noise Floor.

Freq. MHz	Note F/H/E/S	Detector Mode PK/QP/AV	Spectrum Reading Level dBμV	Factor dB	Actual FS dBμV/m	Limit @3m dBμV/m	Margin dB
41.64	S	Peak	27.56	-13.56	14.00	40.00	-26.00
154.16	S	Peak	26.45	-12.30	14.15	43.50	-29.35
343.31	S	Peak	27.88	-11.76	16.12	46.00	-29.88
427.70	S	Peak	27.13	-10.47	16.66	46.00	-29.34
515.00	S	Peak	27.63	-9.30	18.33	46.00	-27.67
652.74	S	Peak	28.32	-6.53	21.79	46.00	-24.21
3700.40	H	Peak	37.13	5.12	42.25	54.00	-11.75
5550.60	H	---					
7400.80	H	---					
9251.00	H	---					
11101.20	H	---					
12951.40	H	---					
14801.60	H	---					
16651.80	H	---					
18502.00	H	---					

Unless otherwise stated the results shown in this test report refer only to the sample(s) tested and such sample(s) are retained for 90 days only.

除非另有說明，此報告結果僅對測試之樣品負責，同時此樣品僅保留90天。本報告未經本公司書面許可，不可部份複製。

This document is issued by the Company subject to its General Conditions of Service printed overleaf, available on request or accessible at www.sgs.com/terms_and_conditions.htm and, for electronic format documents, subject to Terms and Conditions for Electronic Documents at www.sgs.com/terms_e-document.htm. Attention is drawn to the limitation of liability, indemnification and jurisdiction issues defined therein. Any holder of this document is advised that information contained hereon reflects the Company's findings at the time of its intervention only and within the limits of Client's instructions, if any. The Company's sole responsibility is to its Client and this document does not exonerate parties to a transaction from exercising all their rights and obligations under the transaction documents. This document cannot be reproduced except in full, without prior written approval of the Company. Any unauthorized alteration, forgery or falsification of the content or appearance of this document is unlawful and offenders may be prosecuted to the fullest extent of the law.

Operation Band	:GSM 1900	Test Date	:2013-05-03
Fundamental Frequency	:1880 MHz	Temp./Humi.	:24.1 deg_C / 65 RH
Operation Mode	:RX MID	Engineer	:Allen
EUT Pol.	:E1 Plan	Measurement Antenna Pol.	:VERTICAL

Actual FS(dBμV/m) = SPA. Reading level(dBμV) + Factor(dB)

Factor(dB) = Antenna Factor(dBμV/m) + Cable Loss(dB) – Pre_Amplifier Gain(dB)

Note : “F” : denotes Fundamental Frequency. ; “H” : denotes Harmonic Frequency.

“E” : denotes Band Edge Frequency. ; “S” : denotes Spurious Frequency.

“---“ : denotes Noise Floor.

Freq.	Note	Detector Mode	Spectrum Reading Level	Factor	Actual FS	Limit @3m	Margin
MHz	F/H/E/S	PK/QP/AV	dBμV	dB	dBμV/m	dBμV/m	dB
41.64	S	Peak	30.55	-13.56	16.99	40.00	-23.01
157.07	S	Peak	28.05	-12.29	15.76	43.50	-27.74
507.24	S	Peak	27.64	-9.45	18.19	46.00	-27.81
611.03	S	Peak	27.34	-7.32	20.02	46.00	-25.98
687.66	S	Peak	27.47	-5.91	21.56	46.00	-24.44
903.97	S	Peak	27.36	-2.73	24.63	46.00	-21.37
3760.00	H	Peak	37.04	5.53	42.57	54.00	-11.43
5640.00	H	---					
7520.00	H	---					
9400.00	H	---					
11280.00	H	---					
13160.00	H	---					
15040.00	H	---					
16920.00	H	---					
18800.00	H	---					

Unless otherwise stated the results shown in this test report refer only to the sample(s) tested and such sample(s) are retained for 90 days only.

除非另有說明，此報告結果僅對測試之樣品負責，同時此樣品僅保留90天。本報告未經本公司書面許可，不可部份複製。

This document is issued by the Company subject to its General Conditions of Service printed overleaf, available on request or accessible at www.sgs.com/terms_and_conditions.htm and, for electronic format documents, subject to Terms and Conditions for Electronic Documents at www.sgs.com/terms_e-document.htm. Attention is drawn to the limitation of liability, indemnification and jurisdiction issues defined therein. Any holder of this document is advised that information contained hereon reflects the Company's findings at the time of its intervention only and within the limits of Client's instructions, if any. The Company's sole responsibility is to its Client and this document does not exonerate parties to a transaction from exercising all their rights and obligations under the transaction documents. This document cannot be reproduced except in full, without prior written approval of the Company. Any unauthorized alteration, forgery or falsification of the content or appearance of this document is unlawful and offenders may be prosecuted to the fullest extent of the law.

Operation Band	:GSM 1900	Test Date	:2013-05-03
Fundamental Frequency	:1880 MHz	Temp./Humi.	:24.1 deg_C / 65 RH
Operation Mode	:RX MID	Engineer	:Allen
EUT Pol.	:E1 Plan	Measurement Antenna Pol.	:HORIZONTAL

Actual FS(dBμV/m) = SPA. Reading level(dBμV) + Factor(dB)

Factor(dB) = Antenna Factor(dBμV/m) + Cable Loss(dB) – Pre_Amplifier Gain(dB)

Note : “F” : denotes Fundamental Frequency. ; “H” : denotes Harmonic Frequency.

“E” : denotes Band Edge Frequency. ; “S” : denotes Spurious Frequency.

“---“ : denotes Noise Floor.

Freq.	Note	Detector Mode	Spectrum Reading Level	Factor	Actual FS	Limit @3m	Margin
MHz	F/H/E/S	PK/QP/AV	dBμV	dB	dBμV/m	dBμV/m	dB
88.20	S	Peak	30.58	-17.68	12.90	43.50	-30.60
157.07	S	Peak	26.49	-12.29	14.20	43.50	-29.30
386.96	S	Peak	27.21	-11.19	16.02	46.00	-29.98
540.22	S	Peak	27.62	-8.78	18.84	46.00	-27.16
657.59	S	Peak	27.22	-6.43	20.79	46.00	-25.21
766.23	S	Peak	27.78	-4.69	23.09	46.00	-22.91
3760.00	H	Peak	35.92	5.54	41.46	54.00	-12.54
5640.00	H	---					
7520.00	H	---					
9400.00	H	---					
11280.00	H	---					
13160.00	H	---					
15040.00	H	---					
16920.00	H	---					
18800.00	H	---					

Unless otherwise stated the results shown in this test report refer only to the sample(s) tested and such sample(s) are retained for 90 days only.

除非另有說明，此報告結果僅對測試之樣品負責，同時此樣品僅保留90天。本報告未經本公司書面許可，不可部份複製。

This document is issued by the Company subject to its General Conditions of Service printed overleaf, available on request or accessible at www.sgs.com/terms_and_conditions.htm and, for electronic format documents, subject to Terms and Conditions for Electronic Documents at www.sgs.com/terms_e-document.htm. Attention is drawn to the limitation of liability, indemnification and jurisdiction issues defined therein. Any holder of this document is advised that information contained hereon reflects the Company's findings at the time of its intervention only and within the limits of Client's instructions, if any. The Company's sole responsibility is to its Client and this document does not exonerate parties to a transaction from exercising all their rights and obligations under the transaction documents. This document cannot be reproduced except in full, without prior written approval of the Company. Any unauthorized alteration, forgery or falsification of the content or appearance of this document is unlawful and offenders may be prosecuted to the fullest extent of the law.

Operation Band	:GSM 1900	Test Date	:2013-05-03
Fundamental Frequency	:1909.8 MHz	Temp./Humi.	:24.1 deg_C / 65 RH
Operation Mode	:RX HIGH	Engineer	:Allen
EUT Pol.	:E1 Plan	Measurement Antenna Pol.	:VERTICAL

Actual FS(dBμV/m) = SPA. Reading level(dBμV) + Factor(dB)

Factor(dB) = Antenna Factor(dBμV/m) + Cable Loss(dB) – Pre_Amplifier Gain(dB)

Note : “F” : denotes Fundamental Frequency. ; “H” : denotes Harmonic Frequency.

“E” : denotes Band Edge Frequency. ; “S” : denotes Spurious Frequency.

“---” : denotes Noise Floor.

Freq. MHz	Note F/H/E/S	Detector Mode PK/QP/AV	Spectrum Reading Level dBμV	Factor dB	Actual FS dBμV/m	Limit @3m dBμV/m	Margin dB
157.07	S	Peak	27.67	-12.29	15.38	43.50	-28.12
447.10	S	Peak	27.52	-10.08	17.44	46.00	-28.56
497.54	S	Peak	27.39	-9.62	17.77	46.00	-28.23
600.36	S	Peak	27.74	-7.55	20.19	46.00	-25.81
770.11	S	Peak	27.32	-4.61	22.71	46.00	-23.29
915.61	S	Peak	27.58	-2.51	25.07	46.00	-20.93
3819.60	H	Peak	36.82	5.34	42.16	54.00	-11.84
5729.40	H	---					
7639.20	H	---					
9549.00	H	---					
11458.80	H	---					
13368.60	H	---					
15278.40	H	---					
17188.20	H	---					
19098.00	H	---					

Unless otherwise stated the results shown in this test report refer only to the sample(s) tested and such sample(s) are retained for 90 days only.

除非另有說明，此報告結果僅對測試之樣品負責，同時此樣品僅保留90天。本報告未經本公司書面許可，不可部份複製。

This document is issued by the Company subject to its General Conditions of Service printed overleaf, available on request or accessible at www.sgs.com/terms_and_conditions.htm and, for electronic format documents, subject to Terms and Conditions for Electronic Documents at www.sgs.com/terms_e-document.htm. Attention is drawn to the limitation of liability, indemnification and jurisdiction issues defined therein. Any holder of this document is advised that information contained hereon reflects the Company's findings at the time of its intervention only and within the limits of Client's instructions, if any. The Company's sole responsibility is to its Client and this document does not exonerate parties to a transaction from exercising all their rights and obligations under the transaction documents. This document cannot be reproduced except in full, without prior written approval of the Company. Any unauthorized alteration, forgery or falsification of the content or appearance of this document is unlawful and offenders may be prosecuted to the fullest extent of the law.

Operation Band	:GSM 1900	Test Date	:2013-05-03
Fundamental Frequency	:1909.8 MHz	Temp./Humi.	:24.1 deg_C / 65 RH
Operation Mode	:RX HIGH	Engineer	:Allen
EUT Pol.	:E1 Plan	Measurement Antenna Pol.	:HORIZONTAL

Actual FS(dBμV/m) = SPA. Reading level(dBμV) + Factor(dB)

Factor(dB) = Antenna Factor(dBμV/m) + Cable Loss(dB) – Pre_Amplifier Gain(dB)

Note : “F” : denotes Fundamental Frequency. ; “H” : denotes Harmonic Frequency.

“E” : denotes Band Edge Frequency. ; “S” : denotes Spurious Frequency.

“---“ : denotes Noise Floor.

Freq.	Note	Detector Mode	Spectrum Reading Level	Factor	Actual FS	Limit @3m	Margin
MHz	F/H/E/S	PK/QP/AV	dBμV	dB	dBμV/m	dBμV/m	dB
53.28	S	Peak	27.64	-14.14	13.50	40.00	-26.50
159.98	S	Peak	26.83	-12.26	14.57	43.50	-28.93
259.89	S	Peak	27.55	-13.75	13.80	46.00	-32.20
321.00	S	Peak	27.29	-12.08	15.21	46.00	-30.79
607.15	S	Peak	28.09	-7.40	20.69	46.00	-25.31
889.42	S	Peak	27.46	-3.02	24.44	46.00	-21.56
3819.60	H	Peak	36.91	5.40	42.31	54.00	-11.69
5729.40	H	---					
7639.20	H	---					
9549.00	H	---					
11458.80	H	---					
13368.60	H	---					
15278.40	H	---					
17188.20	H	---					
19098.00	H	---					

Unless otherwise stated the results shown in this test report refer only to the sample(s) tested and such sample(s) are retained for 90 days only.

除非另有說明，此報告結果僅對測試之樣品負責，同時此樣品僅保留90天。本報告未經本公司書面許可，不可部份複製。

This document is issued by the Company subject to its General Conditions of Service printed overleaf, available on request or accessible at www.sgs.com/terms_and_conditions.htm and, for electronic format documents, subject to Terms and Conditions for Electronic Documents at www.sgs.com/terms_e-document.htm. Attention is drawn to the limitation of liability, indemnification and jurisdiction issues defined therein. Any holder of this document is advised that information contained hereon reflects the Company's findings at the time of its intervention only and within the limits of Client's instructions, if any. The Company's sole responsibility is to its Client and this document does not exonerate parties to a transaction from exercising all their rights and obligations under the transaction documents. This document cannot be reproduced except in full, without prior written approval of the Company. Any unauthorized alteration, forgery or falsification of the content or appearance of this document is unlawful and offenders may be prosecuted to the fullest extent of the law.

Radiated Spurious Emission Measurement Result: WCDMA II Mode

Operation Band	:WCDMA B2	Test Date	:2013-05-03
Fundamental Frequency	:1852.4 MHz	Temp./Humi.	:24.1 deg_C / 65 RH
Operation Mode	:RX LOW	Engineer	:Allen
EUT Pol.	:E1 Plan	Measurement Antenna Pol.	:VERTICAL

Actual FS(dBμV/m) = SPA. Reading level(dBμV) + Factor(dB)

Factor(dB) = Antenna Factor(dBμV/m) + Cable Loss(dB) – Pre_Amplifier Gain(dB)

Note : “F” : denotes Fundamental Frequency. ; “H” : denotes Harmonic Frequency.

“E” : denotes Band Edge Frequency. ; “S” : denotes Spurious Frequency.

“---“ : denotes Noise Floor.

Freq. MHz	Note F/H/E/S	Detector Mode PK/QP/AV	Spectrum Reading Level dBμV	Factor dB	Actual FS dBμV/m	Limit @3m dBμV/m	Margin dB
53.28	S	Peak	29.73	-14.14	15.59	40.00	-24.41
158.04	S	Peak	27.44	-12.30	15.14	43.50	-28.36
385.99	S	Peak	26.96	-11.20	15.76	46.00	-30.24
608.12	S	Peak	28.27	-7.38	20.89	46.00	-25.11
774.96	S	Peak	28.07	-4.54	23.53	46.00	-22.47
914.64	S	Peak	28.26	-2.53	25.73	46.00	-20.27
3704.80	H	Peak	36.31	5.22	41.53	74.00	-32.47
5557.20	H	---					
7409.60	H	---					
9262.00	H	---					
11114.40	H	---					
12966.80	H	---					
14819.20	H	---					
16671.60	H	---					
18524.00	H	---					

Unless otherwise stated the results shown in this test report refer only to the sample(s) tested and such sample(s) are retained for 90 days only.

除非另有說明，此報告結果僅對測試之樣品負責，同時此樣品僅保留90天。本報告未經本公司書面許可，不可部份複製。

This document is issued by the Company subject to its General Conditions of Service printed overleaf, available on request or accessible at www.sgs.com/terms_and_conditions.htm and, for electronic format documents, subject to Terms and Conditions for Electronic Documents at www.sgs.com/terms_e-document.htm. Attention is drawn to the limitation of liability, indemnification and jurisdiction issues defined therein. Any holder of this document is advised that information contained hereon reflects the Company's findings at the time of its intervention only and within the limits of Client's instructions, if any. The Company's sole responsibility is to its Client and this document does not exonerate parties to a transaction from exercising all their rights and obligations under the transaction documents. This document cannot be reproduced except in full, without prior written approval of the Company. Any unauthorized alteration, forgery or falsification of the content or appearance of this document is unlawful and offenders may be prosecuted to the fullest extent of the law.

Operation Band	:WCDMA B2	Test Date	:2013-05-03
Fundamental Frequency	:1852.4 MHz	Temp./Humi.	:24.1 deg_C / 65 RH
Operation Mode	:RX LOW	Engineer	:Allen
EUT Pol.	:E1 Plan	Measurement Antenna Pol.	:HORIZONTAL

Actual FS(dBμV/m) = SPA. Reading level(dBμV) + Factor(dB)

Factor(dB) = Antenna Factor(dBμV/m) + Cable Loss(dB) – Pre_Amplifier Gain(dB)

Note : “F” : denotes Fundamental Frequency. ; “H” : denotes Harmonic Frequency.

“E” : denotes Band Edge Frequency. ; “S” : denotes Spurious Frequency.

“---” : denotes Noise Floor.

Freq. MHz	Note F/H/E/S	Detector Mode PK/QP/AV	Spectrum Reading Level dBμV	Factor dB	Actual FS dBμV/m	Limit @3m dBμV/m	Margin dB
87.23	S	Peak	31.09	-17.69	13.40	40.00	-26.60
154.16	S	Peak	27.31	-12.30	15.01	43.50	-28.49
476.20	S	Peak	28.08	-9.84	18.24	46.00	-27.76
579.99	S	Peak	27.91	-7.99	19.92	46.00	-26.08
775.93	S	Peak	28.34	-4.52	23.82	46.00	-22.18
936.95	S	Peak	26.71	-2.23	24.48	46.00	-21.52
3704.80	H	Peak	38.72	5.17	43.89	74.00	-30.11
5557.20	H	---					
7409.60	H	---					
9262.00	H	---					
11114.40	H	---					
12966.80	H	---					
14819.20	H	---					
16671.60	H	---					
18524.00	H	---					

Unless otherwise stated the results shown in this test report refer only to the sample(s) tested and such sample(s) are retained for 90 days only.

除非另有說明，此報告結果僅對測試之樣品負責，同時此樣品僅保留90天。本報告未經本公司書面許可，不可部份複製。

This document is issued by the Company subject to its General Conditions of Service printed overleaf, available on request or accessible at www.sgs.com/terms_and_conditions.htm and, for electronic format documents, subject to Terms and Conditions for Electronic Documents at www.sgs.com/terms_e-document.htm. Attention is drawn to the limitation of liability, indemnification and jurisdiction issues defined therein. Any holder of this document is advised that information contained hereon reflects the Company's findings at the time of its intervention only and within the limits of Client's instructions, if any. The Company's sole responsibility is to its Client and this document does not exonerate parties to a transaction from exercising all their rights and obligations under the transaction documents. This document cannot be reproduced except in full, without prior written approval of the Company. Any unauthorized alteration, forgery or falsification of the content or appearance of this document is unlawful and offenders may be prosecuted to the fullest extent of the law.

Operation Band	:WCDMA B2	Test Date	:2013-05-03
Fundamental Frequency	:1880 MHz	Temp./Humi.	:24.1 deg_C / 65 RH
Operation Mode	:RX MID	Engineer	:Allen
EUT Pol.	:E1 Plan	Measurement Antenna Pol.	:VERTICAL

Actual FS(dBμV/m) = SPA. Reading level(dBμV) + Factor(dB)

Factor(dB) = Antenna Factor(dBμV/m) + Cable Loss(dB) – Pre_Amplifier Gain(dB)

Note : “F” : denotes Fundamental Frequency. ; “H” : denotes Harmonic Frequency.

“E” : denotes Band Edge Frequency. ; “S” : denotes Spurious Frequency.

“---“ : denotes Noise Floor.

Freq.	Note	Detector Mode	Spectrum Reading Level	Factor	Actual FS	Limit @3m	Margin
MHz	F/H/E/S	PK/QP/AV	dBμV	dB	dBμV/m	dBμV/m	dB
37.76	S	Peak	30.85	-13.72	17.13	40.00	-22.87
157.07	S	Peak	27.10	-12.29	14.81	43.50	-28.69
391.81	S	Peak	27.05	-11.15	15.90	46.00	-30.10
643.04	S	Peak	27.40	-6.72	20.68	46.00	-25.32
806.00	S	Peak	27.73	-4.12	23.61	46.00	-22.39
932.10	S	Peak	26.59	-2.27	24.32	46.00	-21.68
3760.00	H	Peak	38.02	5.53	43.55	74.00	-30.45
5640.00	H	---					
7520.00	H	---					
9400.00	H	---					
11280.00	H	---					
13160.00	H	---					
15040.00	H	---					
16920.00	H	---					
18800.00	H	---					

Unless otherwise stated the results shown in this test report refer only to the sample(s) tested and such sample(s) are retained for 90 days only.

除非另有說明，此報告結果僅對測試之樣品負責，同時此樣品僅保留90天。本報告未經本公司書面許可，不可部份複製。

This document is issued by the Company subject to its General Conditions of Service printed overleaf, available on request or accessible at www.sgs.com/terms_and_conditions.htm and, for electronic format documents, subject to Terms and Conditions for Electronic Documents at www.sgs.com/terms_e-document.htm. Attention is drawn to the limitation of liability, indemnification and jurisdiction issues defined therein. Any holder of this document is advised that information contained hereon reflects the Company's findings at the time of its intervention only and within the limits of Client's instructions, if any. The Company's sole responsibility is to its Client and this document does not exonerate parties to a transaction from exercising all their rights and obligations under the transaction documents. This document cannot be reproduced except in full, without prior written approval of the Company. Any unauthorized alteration, forgery or falsification of the content or appearance of this document is unlawful and offenders may be prosecuted to the fullest extent of the law.

Operation Band	:WCDMA B2	Test Date	:2013-05-03
Fundamental Frequency	:1880 MHz	Temp./Humi.	:24.1 deg_C / 65 RH
Operation Mode	:RX MID	Engineer	:Allen
EUT Pol.	:E1 Plan	Measurement Antenna Pol.	:HORIZONTAL

Actual FS(dBμV/m) = SPA. Reading level(dBμV) + Factor(dB)

Factor(dB) = Antenna Factor(dBμV/m) + Cable Loss(dB) – Pre_Amplifier Gain(dB)

Note : “F” : denotes Fundamental Frequency. ; “H” : denotes Harmonic Frequency.

“E” : denotes Band Edge Frequency. ; “S” : denotes Spurious Frequency.

“---“ : denotes Noise Floor.

Freq.	Note	Detector Mode	Spectrum Reading Level	Factor	Actual FS	Limit @3m	Margin
MHz	F/H/E/S	PK/QP/AV	dBμV	dB	dBμV/m	dBμV/m	dB
154.16	S	Peak	27.04	-12.30	14.74	43.50	-28.76
271.53	S	Peak	28.21	-13.32	14.89	46.00	-31.11
564.47	S	Peak	27.53	-8.28	19.25	46.00	-26.75
642.07	S	Peak	27.82	-6.73	21.09	46.00	-24.91
817.64	S	Peak	27.74	-4.00	23.74	46.00	-22.26
920.46	S	Peak	27.99	-2.42	25.57	46.00	-20.43
3760.00	H	Peak	37.59	5.54	43.13	74.00	-30.87
5640.00	H	---					
7520.00	H	---					
9400.00	H	---					
11280.00	H	---					
13160.00	H	---					
15040.00	H	---					
16920.00	H	---					
18800.00	H	---					

Unless otherwise stated the results shown in this test report refer only to the sample(s) tested and such sample(s) are retained for 90 days only.

除非另有說明，此報告結果僅對測試之樣品負責，同時此樣品僅保留90天。本報告未經本公司書面許可，不可部份複製。

This document is issued by the Company subject to its General Conditions of Service printed overleaf, available on request or accessible at www.sgs.com/terms_and_conditions.htm and, for electronic format documents, subject to Terms and Conditions for Electronic Documents at www.sgs.com/terms_e-document.htm. Attention is drawn to the limitation of liability, indemnification and jurisdiction issues defined therein. Any holder of this document is advised that information contained hereon reflects the Company's findings at the time of its intervention only and within the limits of Client's instructions, if any. The Company's sole responsibility is to its Client and this document does not exonerate parties to a transaction from exercising all their rights and obligations under the transaction documents. This document cannot be reproduced except in full, without prior written approval of the Company. Any unauthorized alteration, forgery or falsification of the content or appearance of this document is unlawful and offenders may be prosecuted to the fullest extent of the law.

Operation Band	:WCDMA B2	Test Date	:2013-05-03
Fundamental Frequency	:1907.6 MHz	Temp./Humi.	:24.1 deg_C / 65 RH
Operation Mode	:RX HIGH	Engineer	:Allen
EUT Pol.	:E1 Plan	Measurement Antenna Pol.	:VERTICAL

Actual FS(dBμV/m) = SPA. Reading level(dBμV) + Factor(dB)

Factor(dB) = Antenna Factor(dBμV/m) + Cable Loss(dB) – Pre_Amplifier Gain(dB)

Note : “F” : denotes Fundamental Frequency. ; “H” : denotes Harmonic Frequency.

“E” : denotes Band Edge Frequency. ; “S” : denotes Spurious Frequency.

“---“ : denotes Noise Floor.

Freq. MHz	Note F/H/E/S	Detector Mode PK/QP/AV	Spectrum Reading Level dBμV	Factor dB	Actual FS dBμV/m	Limit @3m dBμV/m	Margin dB
52.31	S	Peak	29.90	-14.06	15.84	40.00	-24.16
343.31	S	Peak	27.17	-11.76	15.41	46.00	-30.59
472.32	S	Peak	27.79	-9.88	17.91	46.00	-28.09
669.23	S	Peak	27.07	-6.21	20.86	46.00	-25.14
844.80	S	Peak	27.26	-3.73	23.53	46.00	-22.47
936.95	S	Peak	26.73	-2.23	24.50	46.00	-21.50
3815.20	H	Peak	37.80	5.32	43.12	74.00	-30.88
5722.80	H	---					
7630.40	H	---					
9538.00	H	---					
11445.60	H	---					
13353.20	H	---					
15260.80	H	---					
17168.40	H	---					
19076.00	H	---					

Unless otherwise stated the results shown in this test report refer only to the sample(s) tested and such sample(s) are retained for 90 days only.

除非另有說明，此報告結果僅對測試之樣品負責，同時此樣品僅保留90天。本報告未經本公司書面許可，不可部份複製。

This document is issued by the Company subject to its General Conditions of Service printed overleaf, available on request or accessible at www.sgs.com/terms_and_conditions.htm and, for electronic format documents, subject to Terms and Conditions for Electronic Documents at www.sgs.com/terms_e-document.htm. Attention is drawn to the limitation of liability, indemnification and jurisdiction issues defined therein. Any holder of this document is advised that information contained hereon reflects the Company's findings at the time of its intervention only and within the limits of Client's instructions, if any. The Company's sole responsibility is to its Client and this document does not exonerate parties to a transaction from exercising all their rights and obligations under the transaction documents. This document cannot be reproduced except in full, without prior written approval of the Company. Any unauthorized alteration, forgery or falsification of the content or appearance of this document is unlawful and offenders may be prosecuted to the fullest extent of the law.

Operation Band	:WCDMA B2	Test Date	:2013-05-03
Fundamental Frequency	:1907.6 MHz	Temp./Humi.	:24.1 deg_C / 65 RH
Operation Mode	:RX HIGH	Engineer	:Allen
EUT Pol.	:E1 Plan	Measurement Antenna Pol.	:HORIZONTAL

Actual FS(dBμV/m) = SPA. Reading level(dBμV) + Factor(dB)

Factor(dB) = Antenna Factor(dBμV/m) + Cable Loss(dB) – Pre_Amplifier Gain(dB)

Note : “F” : denotes Fundamental Frequency. ; “H” : denotes Harmonic Frequency.

“E” : denotes Band Edge Frequency. ; “S” : denotes Spurious Frequency.

“---” : denotes Noise Floor.

Freq.	Note	Detector Mode	Spectrum Reading Level	Factor	Actual FS	Limit @3m	Margin
MHz	F/H/E/S	PK/QP/AV	dBμV	dB	dBμV/m	dBμV/m	dB
50.37	S	Peak	27.56	-13.93	13.63	40.00	-26.37
161.92	S	Peak	26.68	-12.43	14.25	43.50	-29.25
271.53	S	Peak	28.20	-13.32	14.88	46.00	-31.12
566.41	S	Peak	27.94	-8.25	19.69	46.00	-26.31
646.92	S	Peak	27.38	-6.65	20.73	46.00	-25.27
857.41	S	Peak	27.42	-3.58	23.84	46.00	-22.16
3815.20	H	Peak	39.49	5.37	44.86	74.00	-29.14
5722.80	H	---					
7630.40	H	---					
9538.00	H	---					
11445.60	H	---					
13353.20	H	---					
15260.80	H	---					
17168.40	H	---					
19076.00	H	---					

Unless otherwise stated the results shown in this test report refer only to the sample(s) tested and such sample(s) are retained for 90 days only.

除非另有說明，此報告結果僅對測試之樣品負責，同時此樣品僅保留90天。本報告未經本公司書面許可，不可部份複製。

This document is issued by the Company subject to its General Conditions of Service printed overleaf, available on request or accessible at www.sgs.com/terms_and_conditions.htm and, for electronic format documents, subject to Terms and Conditions for Electronic Documents at www.sgs.com/terms_e-document.htm. Attention is drawn to the limitation of liability, indemnification and jurisdiction issues defined therein. Any holder of this document is advised that information contained hereon reflects the Company's findings at the time of its intervention only and within the limits of Client's instructions, if any. The Company's sole responsibility is to its Client and this document does not exonerate parties to a transaction from exercising all their rights and obligations under the transaction documents. This document cannot be reproduced except in full, without prior written approval of the Company. Any unauthorized alteration, forgery or falsification of the content or appearance of this document is unlawful and offenders may be prosecuted to the fullest extent of the law.

Radiated Spurious Emission Measurement Result: WCDMA IV Mode

Operation Band	:WCDMA B4	Test Date	:2013-05-03
Fundamental Frequency	:1712.4 MHz	Temp./Humi.	:24.1 deg_C / 65 RH
Operation Mode	:RX LOW	Engineer	:Allen
EUT Pol.	:H Plan	Measurement Antenna Pol.	:VERTICAL

Actual FS(dBμV/m) = SPA. Reading level(dBμV) + Factor(dB)

Factor(dB) = Antenna Factor(dBμV/m) + Cable Loss(dB) – Pre_Amplifier Gain(dB)

Note : “F” : denotes Fundamental Frequency. ; “H” : denotes Harmonic Frequency.

“E” : denotes Band Edge Frequency. ; “S” : denotes Spurious Frequency.

“---“ : denotes Noise Floor.

Freq. MHz	Note F/H/E/S	Detector Mode PK/QP/AV	Spectrum Reading Level dBμV	Factor dB	Actual FS dBμV/m	Limit @3m dBμV/m	Margin dB
153.19	S	Peak	26.87	-12.32	14.55	43.50	-28.95
329.73	S	Peak	28.22	-11.92	16.30	46.00	-29.70
471.35	S	Peak	28.17	-9.90	18.27	46.00	-27.73
652.74	S	Peak	28.19	-6.53	21.66	46.00	-24.34
765.26	S	Peak	28.16	-4.70	23.46	46.00	-22.54
946.65	S	Peak	27.66	-2.12	25.54	46.00	-20.46
3424.80	H	Peak	36.80	4.20	41.00	54.00	-13.00
5137.20	H	---					
6849.60	H	---					
8562.00	H	---					
10274.40	H	---					
11986.80	H	---					
13699.20	H	---					
15411.60	H	---					
17124.00	H	---					

Unless otherwise stated the results shown in this test report refer only to the sample(s) tested and such sample(s) are retained for 90 days only.

除非另有說明，此報告結果僅對測試之樣品負責，同時此樣品僅保留90天。本報告未經本公司書面許可，不可部份複製。

This document is issued by the Company subject to its General Conditions of Service printed overleaf, available on request or accessible at www.sgs.com/terms_and_conditions.htm and, for electronic format documents, subject to Terms and Conditions for Electronic Documents at www.sgs.com/terms_e-document.htm. Attention is drawn to the limitation of liability, indemnification and jurisdiction issues defined therein. Any holder of this document is advised that information contained hereon reflects the Company's findings at the time of its intervention only and within the limits of Client's instructions, if any. The Company's sole responsibility is to its Client and this document does not exonerate parties to a transaction from exercising all their rights and obligations under the transaction documents. This document cannot be reproduced except in full, without prior written approval of the Company. Any unauthorized alteration, forgery or falsification of the content or appearance of this document is unlawful and offenders may be prosecuted to the fullest extent of the law.

Operation Band	:WCDMA B4	Test Date	:2013-05-03
Fundamental Frequency	:1712.4 MHz	Temp./Humi.	:24.1 deg_C / 65 RH
Operation Mode	:RX LOW	Engineer	:Allen
EUT Pol.	:H Plan	Measurement Antenna Pol.	:HORIZONTAL

Actual FS(dBμV/m) = SPA. Reading level(dBμV) + Factor(dB)

Factor(dB) = Antenna Factor(dBμV/m) + Cable Loss(dB) – Pre_Amplifier Gain(dB)

Note : “F” : denotes Fundamental Frequency. ; “H” : denotes Harmonic Frequency.

“E” : denotes Band Edge Frequency. ; “S” : denotes Spurious Frequency.

“---“ : denotes Noise Floor.

Freq. MHz	Note F/H/E/S	Detector Mode PK/QP/AV	Spectrum Reading Level dBμV	Factor dB	Actual FS dBμV/m	Limit @3m dBμV/m	Margin dB
42.61	S	Peak	27.54	-13.63	13.91	40.00	-26.09
151.25	S	Peak	27.15	-12.34	14.81	43.50	-28.69
335.55	S	Peak	28.98	-11.86	17.12	46.00	-28.88
512.09	S	Peak	29.30	-9.36	19.94	46.00	-26.06
617.82	S	Peak	28.78	-7.18	21.60	46.00	-24.40
911.73	S	Peak	27.14	-2.58	24.56	46.00	-21.44
3424.80	H	Peak	37.75	4.08	41.83	54.00	-12.17
5137.20	H	---					
6849.60	H	---					
8562.00	H	---					
10274.40	H	---					
11986.80	H	---					
13699.20	H	---					
15411.60	H	---					
17124.00	H	---					

Unless otherwise stated the results shown in this test report refer only to the sample(s) tested and such sample(s) are retained for 90 days only.

除非另有說明，此報告結果僅對測試之樣品負責，同時此樣品僅保留90天。本報告未經本公司書面許可，不可部份複製。

This document is issued by the Company subject to its General Conditions of Service printed overleaf, available on request or accessible at www.sgs.com/terms_and_conditions.htm and, for electronic format documents, subject to Terms and Conditions for Electronic Documents at www.sgs.com/terms_e-document.htm. Attention is drawn to the limitation of liability, indemnification and jurisdiction issues defined therein. Any holder of this document is advised that information contained hereon reflects the Company's findings at the time of its intervention only and within the limits of Client's instructions, if any. The Company's sole responsibility is to its Client and this document does not exonerate parties to a transaction from exercising all their rights and obligations under the transaction documents. This document cannot be reproduced except in full, without prior written approval of the Company. Any unauthorized alteration, forgery or falsification of the content or appearance of this document is unlawful and offenders may be prosecuted to the fullest extent of the law.

Operation Band	:WCDMA B4	Test Date	:2013-05-03
Fundamental Frequency	:1732.6 MHz	Temp./Humi.	:24.1 deg_C / 65 RH
Operation Mode	:RX MID	Engineer	:Allen
EUT Pol.	:H Plan	Measurement Antenna Pol.	:VERTICAL

Actual FS(dBμV/m) = SPA. Reading level(dBμV) + Factor(dB)

Factor(dB) = Antenna Factor(dBμV/m) + Cable Loss(dB) – Pre_Amplifier Gain(dB)

Note : “F” : denotes Fundamental Frequency. ; “H” : denotes Harmonic Frequency.

“E” : denotes Band Edge Frequency. ; “S” : denotes Spurious Frequency.

“---“ : denotes Noise Floor.

Freq.	Note	Detector Mode	Spectrum Reading Level	Factor	Actual FS	Limit @3m	Margin
MHz	F/H/E/S	PK/QP/AV	dBμV	dB	dBμV/m	dBμV/m	dB
48.43	S	Peak	35.59	-13.88	21.71	40.00	-18.29
150.28	S	Peak	26.50	-12.35	14.15	43.50	-29.35
321.97	S	Peak	26.35	-12.04	14.31	46.00	-31.69
648.86	S	Peak	28.45	-6.62	21.83	46.00	-24.17
855.47	S	Peak	28.65	-3.60	25.05	46.00	-20.95
908.82	S	Peak	27.36	-2.63	24.73	46.00	-21.27
3465.20	H	Peak	36.67	4.85	41.52	54.00	-12.48
5197.80	H	---					
6930.40	H	---					
8663.00	H	---					
10395.60	H	---					
12128.20	H	---					
13860.80	H	---					
15593.40	H	---					
17326.00	H	---					

Unless otherwise stated the results shown in this test report refer only to the sample(s) tested and such sample(s) are retained for 90 days only.

除非另有說明，此報告結果僅對測試之樣品負責，同時此樣品僅保留90天。本報告未經本公司書面許可，不可部份複製。

This document is issued by the Company subject to its General Conditions of Service printed overleaf, available on request or accessible at www.sgs.com/terms_and_conditions.htm and, for electronic format documents, subject to Terms and Conditions for Electronic Documents at www.sgs.com/terms_e-document.htm. Attention is drawn to the limitation of liability, indemnification and jurisdiction issues defined therein. Any holder of this document is advised that information contained hereon reflects the Company's findings at the time of its intervention only and within the limits of Client's instructions, if any. The Company's sole responsibility is to its Client and this document does not exonerate parties to a transaction from exercising all their rights and obligations under the transaction documents. This document cannot be reproduced except in full, without prior written approval of the Company. Any unauthorized alteration, forgery or falsification of the content or appearance of this document is unlawful and offenders may be prosecuted to the fullest extent of the law.

Operation Band	:WCDMA B4	Test Date	:2013-05-03
Fundamental Frequency	:1732.6 MHz	Temp./Humi.	:24.1 deg_C / 65 RH
Operation Mode	:RX MID	Engineer	:Allen
EUT Pol.	:H Plan	Measurement Antenna Pol.	:HORIZONTAL

Actual FS(dBμV/m) = SPA. Reading level(dBμV) + Factor(dB)

Factor(dB) = Antenna Factor(dBμV/m) + Cable Loss(dB) – Pre_Amplifier Gain(dB)

Note : “F” : denotes Fundamental Frequency. ; “H” : denotes Harmonic Frequency.

“E” : denotes Band Edge Frequency. ; “S” : denotes Spurious Frequency.

“---“ : denotes Noise Floor.

Freq. MHz	Note F/H/E/S	Detector Mode PK/QP/AV	Spectrum Reading Level dBμV	Factor dB	Actual FS dBμV/m	Limit @3m dBμV/m	Margin dB
50.37	S	Peak	28.50	-13.93	14.57	40.00	-25.43
148.34	S	Peak	27.43	-12.45	14.98	43.50	-28.52
329.73	S	Peak	28.85	-11.92	16.93	46.00	-29.07
515.00	S	Peak	27.88	-9.30	18.58	46.00	-27.42
591.63	S	Peak	27.79	-7.73	20.06	46.00	-25.94
864.20	S	Peak	27.35	-3.47	23.88	46.00	-22.12
3465.20	H	Peak	38.70	4.64	43.34	54.00	-10.66
5197.80	H	---					
6930.40	H	---					
8663.00	H	---					
10395.60	H	---					
12128.20	H	---					
13860.80	H	---					
15593.40	H	---					
17326.00	H	---					

Unless otherwise stated the results shown in this test report refer only to the sample(s) tested and such sample(s) are retained for 90 days only.

除非另有說明，此報告結果僅對測試之樣品負責，同時此樣品僅保留90天。本報告未經本公司書面許可，不可部份複製。

This document is issued by the Company subject to its General Conditions of Service printed overleaf, available on request or accessible at www.sgs.com/terms_and_conditions.htm and, for electronic format documents, subject to Terms and Conditions for Electronic Documents at www.sgs.com/terms_e-document.htm. Attention is drawn to the limitation of liability, indemnification and jurisdiction issues defined therein. Any holder of this document is advised that information contained hereon reflects the Company's findings at the time of its intervention only and within the limits of Client's instructions, if any. The Company's sole responsibility is to its Client and this document does not exonerate parties to a transaction from exercising all their rights and obligations under the transaction documents. This document cannot be reproduced except in full, without prior written approval of the Company. Any unauthorized alteration, forgery or falsification of the content or appearance of this document is unlawful and offenders may be prosecuted to the fullest extent of the law.

Operation Band	:WCDMA B4	Test Date	:2013-05-03
Fundamental Frequency	:1752.6 MHz	Temp./Humi.	:24.1 deg_C / 65 RH
Operation Mode	:RX HIGH	Engineer	:Allen
EUT Pol.	:H Plan	Measurement Antenna Pol.	:VERTICAL

Actual FS(dBμV/m) = SPA. Reading level(dBμV) + Factor(dB)

Factor(dB) = Antenna Factor(dBμV/m) + Cable Loss(dB) – Pre_Amplifier Gain(dB)

Note : “F” : denotes Fundamental Frequency. ; “H” : denotes Harmonic Frequency.

“E” : denotes Band Edge Frequency. ; “S” : denotes Spurious Frequency.

“---“ : denotes Noise Floor.

Freq.	Note	Detector Mode	Spectrum Reading Level	Factor	Actual FS	Limit @3m	Margin
MHz	F/H/E/S	PK/QP/AV	dBμV	dB	dBμV/m	dBμV/m	dB
161.92	S	Peak	27.32	-12.43	14.89	43.50	-28.61
339.43	S	Peak	28.24	-11.82	16.42	46.00	-29.58
545.07	S	Peak	28.40	-8.67	19.73	46.00	-26.27
731.31	S	Peak	28.26	-5.27	22.99	46.00	-23.01
855.47	S	Peak	28.14	-3.60	24.54	46.00	-21.46
947.62	S	Peak	27.11	-2.12	24.99	46.00	-21.01
3505.20	H	Peak	37.51	5.00	42.51	54.00	-11.49
5257.80	H	---					
7010.40	H	---					
8763.00	H	---					
10515.60	H	---					
12268.20	H	---					
14020.80	H	---					
15773.40	H	---					
17526.00	H	---					

Unless otherwise stated the results shown in this test report refer only to the sample(s) tested and such sample(s) are retained for 90 days only.

除非另有說明，此報告結果僅對測試之樣品負責，同時此樣品僅保留90天。本報告未經本公司書面許可，不可部份複製。

This document is issued by the Company subject to its General Conditions of Service printed overleaf, available on request or accessible at www.sgs.com/terms_and_conditions.htm and, for electronic format documents, subject to Terms and Conditions for Electronic Documents at www.sgs.com/terms_e-document.htm. Attention is drawn to the limitation of liability, indemnification and jurisdiction issues defined therein. Any holder of this document is advised that information contained hereon reflects the Company's findings at the time of its intervention only and within the limits of Client's instructions, if any. The Company's sole responsibility is to its Client and this document does not exonerate parties to a transaction from exercising all their rights and obligations under the transaction documents. This document cannot be reproduced except in full, without prior written approval of the Company. Any unauthorized alteration, forgery or falsification of the content or appearance of this document is unlawful and offenders may be prosecuted to the fullest extent of the law.

Operation Band	:WCDMA B4	Test Date	:2013-05-03
Fundamental Frequency	:1752.6 MHz	Temp./Humi.	:24.1 deg_C / 65 RH
Operation Mode	:RX HIGH	Engineer	:Allen
EUT Pol.	:H Plan	Measurement Antenna Pol.	:HORIZONTAL

Actual FS(dBμV/m) = SPA. Reading level(dBμV) + Factor(dB)

Factor(dB) = Antenna Factor(dBμV/m) + Cable Loss(dB) – Pre_Amplifier Gain(dB)

Note : “F” : denotes Fundamental Frequency. ; “H” : denotes Harmonic Frequency.

“E” : denotes Band Edge Frequency. ; “S” : denotes Spurious Frequency.

“---“ : denotes Noise Floor.

Freq.	Note	Detector Mode	Spectrum Reading Level	Factor	Actual FS	Limit @3m	Margin
MHz	F/H/E/S	PK/QP/AV	dBμV	dB	dBμV/m	dBμV/m	dB
44.55	S	Peak	27.33	-13.76	13.57	40.00	-26.43
155.13	S	Peak	27.07	-12.30	14.77	43.50	-28.73
332.64	S	Peak	28.55	-11.89	16.66	46.00	-29.34
431.58	S	Peak	28.17	-10.40	17.77	46.00	-28.23
545.07	S	Peak	28.09	-8.67	19.42	46.00	-26.58
905.91	S	Peak	28.63	-2.68	25.95	46.00	-20.05
3505.20	H	Peak	36.88	4.71	41.59	54.00	-12.41
5257.80	H	---					
7010.40	H	---					
8763.00	H	---					
10515.60	H	---					
12268.20	H	---					
14020.80	H	---					
15773.40	H	---					
17526.00	H	---					

Unless otherwise stated the results shown in this test report refer only to the sample(s) tested and such sample(s) are retained for 90 days only.

除非另有說明，此報告結果僅對測試之樣品負責，同時此樣品僅保留90天。本報告未經本公司書面許可，不可部份複製。

This document is issued by the Company subject to its General Conditions of Service printed overleaf, available on request or accessible at www.sgs.com/terms_and_conditions.htm and, for electronic format documents, subject to Terms and Conditions for Electronic Documents at www.sgs.com/terms_e-document.htm. Attention is drawn to the limitation of liability, indemnification and jurisdiction issues defined therein. Any holder of this document is advised that information contained hereon reflects the Company's findings at the time of its intervention only and within the limits of Client's instructions, if any. The Company's sole responsibility is to its Client and this document does not exonerate parties to a transaction from exercising all their rights and obligations under the transaction documents. This document cannot be reproduced except in full, without prior written approval of the Company. Any unauthorized alteration, forgery or falsification of the content or appearance of this document is unlawful and offenders may be prosecuted to the fullest extent of the law.

Radiated Spurious Emission Measurement Result: HSDPA V Mode

Operation Band	:HSDPA B5	Test Date	:2013-05-03
Fundamental Frequency	:826.4 MHz	Temp./Humi.	:24.1 deg_C / 65 RH
Operation Mode	:RX LOW	Engineer	:Allen
EUT Pol.	:E1 Plan	Measurement Antenna Pol.	:VERTICAL

Actual FS(dBμV/m) = SPA. Reading level(dBμV) + Factor(dB)

Factor(dB) = Antenna Factor(dBμV/m) + Cable Loss(dB) – Pre_Amplifier Gain(dB)

Note : “F” : denotes Fundamental Frequency. ; “H” : denotes Harmonic Frequency.

“E” : denotes Band Edge Frequency. ; “S” : denotes Spurious Frequency.

“---“ : denotes Noise Floor.

Freq. MHz	Note F/H/E/S	Detector Mode PK/QP/AV	Spectrum Reading Level dBμV	Factor dB	Actual FS dBμV/m	Limit @3m dBμV/m	Margin dB
114.39	S	Peak	33.05	-15.22	17.83	43.50	-25.67
343.31	S	Peak	27.04	-11.76	15.28	46.00	-30.72
454.86	S	Peak	27.79	-9.99	17.80	46.00	-28.20
734.22	S	Peak	27.99	-5.23	22.76	46.00	-23.24
813.76	S	Peak	27.63	-4.04	23.59	46.00	-22.41
916.58	S	Peak	27.79	-2.49	25.30	46.00	-20.70
1652.80	H	Peak	40.18	-1.62	38.56	74.00	-35.44
2479.20	H	---					
3305.60	H	---					
4132.00	H	---					
4958.40	H	---					
5784.80	H	---					
6611.20	H	---					
7437.60	H	---					
8264.00	H	---					

Unless otherwise stated the results shown in this test report refer only to the sample(s) tested and such sample(s) are retained for 90 days only.

除非另有說明，此報告結果僅對測試之樣品負責，同時此樣品僅保留90天。本報告未經本公司書面許可，不可部份複製。

This document is issued by the Company subject to its General Conditions of Service printed overleaf, available on request or accessible at www.sgs.com/terms_and_conditions.htm and, for electronic format documents, subject to Terms and Conditions for Electronic Documents at www.sgs.com/terms_e-document.htm. Attention is drawn to the limitation of liability, indemnification and jurisdiction issues defined therein. Any holder of this document is advised that information contained hereon reflects the Company's findings at the time of its intervention only and within the limits of Client's instructions, if any. The Company's sole responsibility is to its Client and this document does not exonerate parties to a transaction from exercising all their rights and obligations under the transaction documents. This document cannot be reproduced except in full, without prior written approval of the Company. Any unauthorized alteration, forgery or falsification of the content or appearance of this document is unlawful and offenders may be prosecuted to the fullest extent of the law.

Operation Band	:HSDPA B5	Test Date	:2013-05-03
Fundamental Frequency	:826.4 MHz	Temp./Humi.	:24.1 deg_C / 65 RH
Operation Mode	:RX LOW	Engineer	:Allen
EUT Pol.	:E1 Plan	Measurement Antenna Pol.	:HORIZONTAL

Actual FS(dBμV/m) = SPA. Reading level(dBμV) + Factor(dB)

Factor(dB) = Antenna Factor(dBμV/m) + Cable Loss(dB) – Pre_Amplifier Gain(dB)

Note : “F” : denotes Fundamental Frequency. ; “H” : denotes Harmonic Frequency.

“E” : denotes Band Edge Frequency. ; “S” : denotes Spurious Frequency.

“---“ : denotes Noise Floor.

Freq. MHz	Note F/H/E/S	Detector Mode PK/QP/AV	Spectrum Reading Level dBμV	Factor dB	Actual FS dBμV/m	Limit @3m dBμV/m	Margin dB
146.40	S	Peak	27.26	-12.60	14.66	43.50	-28.84
307.42	S	Peak	27.25	-12.40	14.85	46.00	-31.15
547.01	S	Peak	27.25	-8.63	18.62	46.00	-27.38
658.56	S	Peak	28.50	-6.40	22.10	46.00	-23.90
809.88	S	Peak	27.64	-4.07	23.57	46.00	-22.43
906.88	S	Peak	27.48	-2.67	24.81	46.00	-21.19
1652.80	H	Peak	39.44	-0.89	38.55	74.00	-35.45
2479.20	H	---					
3305.60	H	---					
4132.00	H	---					
4958.40	H	---					
5784.80	H	---					
6611.20	H	---					
7437.60	H	---					
8264.00	H	---					

Unless otherwise stated the results shown in this test report refer only to the sample(s) tested and such sample(s) are retained for 90 days only.

除非另有說明，此報告結果僅對測試之樣品負責，同時此樣品僅保留90天。本報告未經本公司書面許可，不可部份複製。

This document is issued by the Company subject to its General Conditions of Service printed overleaf, available on request or accessible at www.sgs.com/terms_and_conditions.htm and, for electronic format documents, subject to Terms and Conditions for Electronic Documents at www.sgs.com/terms_e-document.htm. Attention is drawn to the limitation of liability, indemnification and jurisdiction issues defined therein. Any holder of this document is advised that information contained hereon reflects the Company's findings at the time of its intervention only and within the limits of Client's instructions, if any. The Company's sole responsibility is to its Client and this document does not exonerate parties to a transaction from exercising all their rights and obligations under the transaction documents. This document cannot be reproduced except in full, without prior written approval of the Company. Any unauthorized alteration, forgery or falsification of the content or appearance of this document is unlawful and offenders may be prosecuted to the fullest extent of the law.

Operation Band	:HSDPA B5	Test Date	:2013-05-03
Fundamental Frequency	:836.6 MHz	Temp./Humi.	:24.1 deg_C / 65 RH
Operation Mode	:RX MID	Engineer	:Allen
EUT Pol.	:E1 Plan	Measurement Antenna Pol.	:VERTICAL

Actual FS(dBμV/m) = SPA. Reading level(dBμV) + Factor(dB)

Factor(dB) = Antenna Factor(dBμV/m) + Cable Loss(dB) – Pre_Amplifier Gain(dB)

Note : “F” : denotes Fundamental Frequency. ; “H” : denotes Harmonic Frequency.

“E” : denotes Band Edge Frequency. ; “S” : denotes Spurious Frequency.

“---” : denotes Noise Floor.

Freq. MHz	Note F/H/E/S	Detector Mode PK/QP/AV	Spectrum Reading Level dBμV	Factor dB	Actual FS dBμV/m	Limit @3m dBμV/m	Margin dB
47.46	S	Peak	29.36	-13.85	15.51	40.00	-24.49
114.39	S	Peak	33.63	-15.22	18.41	43.50	-25.09
583.87	S	Peak	28.23	-7.90	20.33	46.00	-25.67
696.39	S	Peak	27.94	-5.79	22.15	46.00	-23.85
825.40	S	Peak	27.36	-3.92	23.44	46.00	-22.56
909.79	S	Peak	27.46	-2.62	24.84	46.00	-21.16
1673.20	H	Peak	39.51	-1.38	38.13	74.00	-35.87
2509.80	H	---					
3346.40	H	---					
4183.00	H	---					
5019.60	H	---					
5856.20	H	---					
6692.80	H	---					
7529.40	H	---					
8366.00	H	---					

Unless otherwise stated the results shown in this test report refer only to the sample(s) tested and such sample(s) are retained for 90 days only.

除非另有說明，此報告結果僅對測試之樣品負責，同時此樣品僅保留90天。本報告未經本公司書面許可，不可部份複製。

This document is issued by the Company subject to its General Conditions of Service printed overleaf, available on request or accessible at www.sgs.com/terms_and_conditions.htm and, for electronic format documents, subject to Terms and Conditions for Electronic Documents at www.sgs.com/terms_e-document.htm. Attention is drawn to the limitation of liability, indemnification and jurisdiction issues defined therein. Any holder of this document is advised that information contained hereon reflects the Company's findings at the time of its intervention only and within the limits of Client's instructions, if any. The Company's sole responsibility is to its Client and this document does not exonerate parties to a transaction from exercising all their rights and obligations under the transaction documents. This document cannot be reproduced except in full, without prior written approval of the Company. Any unauthorized alteration, forgery or falsification of the content or appearance of this document is unlawful and offenders may be prosecuted to the fullest extent of the law.

Operation Band	:HSDPA B5	Test Date	:2013-05-03
Fundamental Frequency	:836.6 MHz	Temp./Humi.	:24.1 deg_C / 65 RH
Operation Mode	:RX MID	Engineer	:Allen
EUT Pol.	:E1 Plan	Measurement Antenna Pol.	:HORIZONTAL

Actual FS(dBμV/m) = SPA. Reading level(dBμV) + Factor(dB)

Factor(dB) = Antenna Factor(dBμV/m) + Cable Loss(dB) – Pre_Amplifier Gain(dB)

Note : “F” : denotes Fundamental Frequency. ; “H” : denotes Harmonic Frequency.

“E” : denotes Band Edge Frequency. ; “S” : denotes Spurious Frequency.

“---“ : denotes Noise Floor.

Freq.	Note	Detector	Spectrum	Factor	Actual	Limit	Margin
MHz	F/H/E/S	Mode	Reading Level	dB	FS	@3m	dB
		PK/QP/AV	dBμV		dBμV/m	dBμV/m	
52.31	S	Peak	28.09	-14.06	14.03	40.00	-25.97
144.46	S	Peak	27.57	-12.74	14.83	43.50	-28.67
351.07	S	Peak	27.61	-11.68	15.93	46.00	-30.07
463.59	S	Peak	27.25	-9.92	17.33	46.00	-28.67
683.78	S	Peak	27.36	-5.96	21.40	46.00	-24.60
907.85	S	Peak	27.21	-2.66	24.55	46.00	-21.45
1673.20	H	Peak	41.24	-0.59	40.65	74.00	-33.35
2509.80	H	---					
3346.40	H	---					
4183.00	H	---					
5019.60	H	---					
5856.20	H	---					
6692.80	H	---					
7529.40	H	---					
8366.00	H	---					

Unless otherwise stated the results shown in this test report refer only to the sample(s) tested and such sample(s) are retained for 90 days only.

除非另有說明，此報告結果僅對測試之樣品負責，同時此樣品僅保留90天。本報告未經本公司書面許可，不可部份複製。

This document is issued by the Company subject to its General Conditions of Service printed overleaf, available on request or accessible at www.sgs.com/terms_and_conditions.htm and, for electronic format documents, subject to Terms and Conditions for Electronic Documents at www.sgs.com/terms_e-document.htm. Attention is drawn to the limitation of liability, indemnification and jurisdiction issues defined therein. Any holder of this document is advised that information contained hereon reflects the Company's findings at the time of its intervention only and within the limits of Client's instructions, if any. The Company's sole responsibility is to its Client and this document does not exonerate parties to a transaction from exercising all their rights and obligations under the transaction documents. This document cannot be reproduced except in full, without prior written approval of the Company. Any unauthorized alteration, forgery or falsification of the content or appearance of this document is unlawful and offenders may be prosecuted to the fullest extent of the law.

Operation Band	:HSDPA B5	Test Date	:2013-05-03
Fundamental Frequency	:846.6 MHz	Temp./Humi.	:24.1 deg_C / 65 RH
Operation Mode	:RX HIGH	Engineer	:Allen
EUT Pol.	:E1 Plan	Measurement Antenna Pol.	:VERTICAL

Actual FS(dBμV/m) = SPA. Reading level(dBμV) + Factor(dB)

Factor(dB) = Antenna Factor(dBμV/m) + Cable Loss(dB) – Pre_Amplifier Gain(dB)

Note : “F” : denotes Fundamental Frequency. ; “H” : denotes Harmonic Frequency.

“E” : denotes Band Edge Frequency. ; “S” : denotes Spurious Frequency.

“---“ : denotes Noise Floor.

Freq. MHz	Note F/H/E/S	Detector Mode PK/QP/AV	Spectrum Reading Level dBμV	Factor dB	Actual FS dBμV/m	Limit @3m dBμV/m	Margin dB
114.39	S	Peak	33.10	-15.22	17.88	43.50	-25.62
343.31	S	Peak	28.43	-11.76	16.67	46.00	-29.33
466.50	S	Peak	27.72	-9.91	17.81	46.00	-28.19
644.98	S	Peak	27.98	-6.68	21.30	46.00	-24.70
820.55	S	Peak	27.68	-3.96	23.72	46.00	-22.28
907.85	S	Peak	27.70	-2.66	25.04	46.00	-20.96
1693.20	H	Peak	40.59	-1.14	39.45	74.00	-34.55
2539.80	H	---					
3386.40	H	---					
4233.00	H	---					
5079.60	H	---					
5926.20	H	---					
6772.80	H	---					
7619.40	H	---					
8466.00	H	---					

Unless otherwise stated the results shown in this test report refer only to the sample(s) tested and such sample(s) are retained for 90 days only.

除非另有說明，此報告結果僅對測試之樣品負責，同時此樣品僅保留90天。本報告未經本公司書面許可，不可部份複製。

This document is issued by the Company subject to its General Conditions of Service printed overleaf, available on request or accessible at www.sgs.com/terms_and_conditions.htm and, for electronic format documents, subject to Terms and Conditions for Electronic Documents at www.sgs.com/terms_e-document.htm. Attention is drawn to the limitation of liability, indemnification and jurisdiction issues defined therein. Any holder of this document is advised that information contained hereon reflects the Company's findings at the time of its intervention only and within the limits of Client's instructions, if any. The Company's sole responsibility is to its Client and this document does not exonerate parties to a transaction from exercising all their rights and obligations under the transaction documents. This document cannot be reproduced except in full, without prior written approval of the Company. Any unauthorized alteration, forgery or falsification of the content or appearance of this document is unlawful and offenders may be prosecuted to the fullest extent of the law.

Operation Band	:HSDPA B5	Test Date	:2013-05-03
Fundamental Frequency	:846.6 MHz	Temp./Humi.	:24.1 deg_C / 65 RH
Operation Mode	:RX HIGH	Engineer	:Allen
EUT Pol.	:E1 Plan	Measurement Antenna Pol.	:HORIZONTAL

Actual FS(dBμV/m) = SPA. Reading level(dBμV) + Factor(dB)

Factor(dB) = Antenna Factor(dBμV/m) + Cable Loss(dB) – Pre_Amplifier Gain(dB)

Note : “F” : denotes Fundamental Frequency. ; “H” : denotes Harmonic Frequency.

“E” : denotes Band Edge Frequency. ; “S” : denotes Spurious Frequency.

“---” : denotes Noise Floor.

Freq. MHz	Note F/H/E/S	Detector Mode PK/QP/AV	Spectrum Reading Level dBμV	Factor dB	Actual FS dBμV/m	Limit @3m dBμV/m	Margin dB
154.16	S	Peak	26.75	-12.30	14.45	43.50	-29.05
281.23	S	Peak	27.83	-13.02	14.81	46.00	-31.19
463.59	S	Peak	27.60	-9.92	17.68	46.00	-28.32
675.05	S	Peak	27.52	-6.11	21.41	46.00	-24.59
762.35	S	Peak	27.76	-4.77	22.99	46.00	-23.01
922.40	S	Peak	26.62	-2.37	24.25	46.00	-21.75
1693.20	H	Peak	39.95	-0.30	39.65	74.00	-34.35
2539.80	H	---					
3386.40	H	---					
4233.00	H	---					
5079.60	H	---					
5926.20	H	---					
6772.80	H	---					
7619.40	H	---					
8466.00	H	---					

Unless otherwise stated the results shown in this test report refer only to the sample(s) tested and such sample(s) are retained for 90 days only.

除非另有說明，此報告結果僅對測試之樣品負責，同時此樣品僅保留90天。本報告未經本公司書面許可，不可部份複製。

This document is issued by the Company subject to its General Conditions of Service printed overleaf, available on request or accessible at www.sgs.com/terms_and_conditions.htm and, for electronic format documents, subject to Terms and Conditions for Electronic Documents at www.sgs.com/terms_e-document.htm. Attention is drawn to the limitation of liability, indemnification and jurisdiction issues defined therein. Any holder of this document is advised that information contained hereon reflects the Company's findings at the time of its intervention only and within the limits of Client's instructions, if any. The Company's sole responsibility is to its Client and this document does not exonerate parties to a transaction from exercising all their rights and obligations under the transaction documents. This document cannot be reproduced except in full, without prior written approval of the Company. Any unauthorized alteration, forgery or falsification of the content or appearance of this document is unlawful and offenders may be prosecuted to the fullest extent of the law.

11. FREQUENCY STABILITY V.S. TEMPERATURE MEASUREMENT

11.1. Standard Applicable:

According to FCC §2.1055(a) (1)

Frequency Tolerance: +/-2.5ppm for 850MHz band

+/-2.5ppm for 1900MHz band

+/-2.5ppm for 1700MHz band

According to RSS-133 §6.3, RSS-132 §5.3, RSS-139 §6.3

The carrier frequency shall not depart from the reference frequency in excess of ± 2.5 ppm for mobile stations

11.2. Test Set-up:

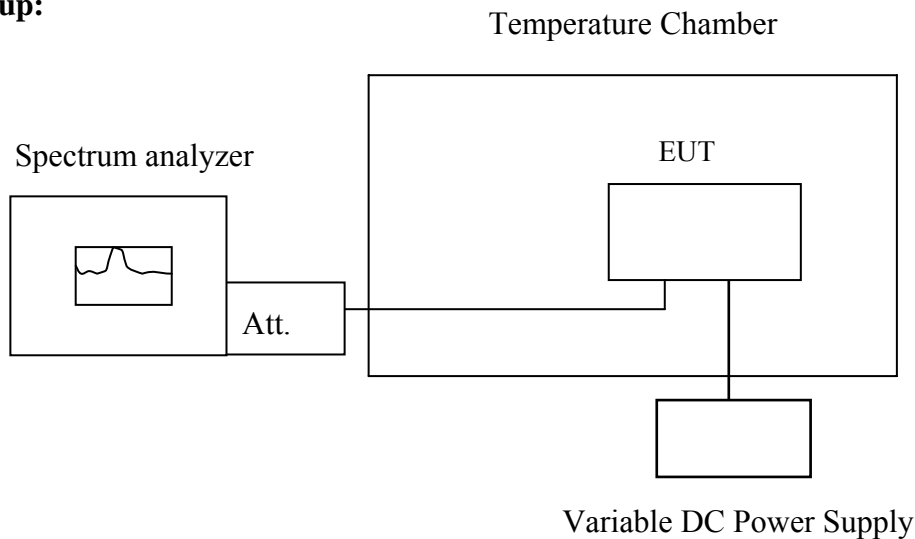

Note: Measurement setup for testing on Antenna connector

Unless otherwise stated the results shown in this test report refer only to the sample(s) tested and such sample(s) are retained for 90 days only.

除非另有說明，此報告結果僅對測試之樣品負責，同時此樣品僅保留90天。本報告未經本公司書面許可，不可部份複製。

This document is issued by the Company subject to its General Conditions of Service printed overleaf, available on request or accessible at www.sgs.com/terms_and_conditions.htm and, for electronic format documents, subject to Terms and Conditions for Electronic Documents at www.sgs.com/terms_e-document.htm. Attention is drawn to the limitation of liability, indemnification and jurisdiction issues defined therein. Any holder of this document is advised that information contained hereon reflects the Company's findings at the time of its intervention only and within the limits of Client's instructions, if any. The Company's sole responsibility is to its Client and this document does not exonerate parties to a transaction from exercising all their rights and obligations under the transaction documents. This document cannot be reproduced except in full, without prior written approval of the Company. Any unauthorized alteration, forgery or falsification of the content or appearance of this document is unlawful and offenders may be prosecuted to the fullest extent of the law.

11.3. Measurement Procedure:

The equipment under test was connected to an external AC or DC power supply and input rated voltage. RF output was connected to a frequency counter or spectrum analyzer via feed through attenuators. The EUT was placed inside the temperature chamber. Set the spectrum analyzer RBW low enough to obtain the desired frequency resolution and measure EUT 25°C operating frequency as reference frequency. Turn EUT off and set the chamber temperature to -30°C. After the temperature stabilized for approximately 30 minutes recorded the frequency. Repeat step measure with 10°C increased per stage until the highest temperature of +50°C reached.

11.4. Measurement Equipment Used:

Refer to section 2.4 in this report

Unless otherwise stated the results shown in this test report refer only to the sample(s) tested and such sample(s) are retained for 90 days only.

除非另有說明，此報告結果僅對測試之樣品負責，同時此樣品僅保留90天。本報告未經本公司書面許可，不可部份複製。

This document is issued by the Company subject to its General Conditions of Service printed overleaf, available on request or accessible at www.sgs.com/terms_and_conditions.htm and, for electronic format documents, subject to Terms and Conditions for Electronic Documents at www.sgs.com/terms_e-document.htm. Attention is drawn to the limitation of liability, indemnification and jurisdiction issues defined therein. Any holder of this document is advised that information contained hereon reflects the Company's findings at the time of its intervention only and within the limits of Client's instructions, if any. The Company's sole responsibility is to its Client and this document does not exonerate parties to a transaction from exercising all their rights and obligations under the transaction documents. This document cannot be reproduced except in full, without prior written approval of the Company. Any unauthorized alteration, forgery or falsification of the content or appearance of this document is unlawful and offenders may be prosecuted to the fullest extent of the law.

11.5. Measurement Result:

Reference Frequency: GPRS 850 Mid Channel 836.6 MHz				
Limit: +/- 2.5 ppm = 2091 Hz				
Power Supply	Environment	Frequency	Delta (Hz)	Limit (Hz)
Vdc	Temperature ()	(MHz)		
3.7	50	836599997	-9	2091
3.7	40	836599996	-10	2091
3.7	30	836600006	0	2091
3.7	20	836600006	0	2091
3.7	10	836600004	-2	2091
3.7	0	836600008	2	2091
3.7	-10	836600008	2	2091
3.7	-20	836599995	-11	2091
3.7	-30	836599994	-12	2091

Reference Frequency: GPRS 1900 Mid Channel 1880 MHz				
Limit: +/- 2.5 ppm = 4700 Hz				
Power Supply	Environment	Frequency	Delta (Hz)	Limit (Hz)
Vdc	Temperature ()	(MHz)		
3.7	50	1880000004	-6	4700
3.7	40	1879999997	-13	4700
3.7	30	1879999995	-15	4700
3.7	20	1880000010	0	4700
3.7	10	1879999997	-13	4700
3.7	0	1880000000	-10	4700
3.7	-10	1879999995	-15	4700
3.7	-20	1880000000	-10	4700
3.7	-30	1880000000	-10	4700

Unless otherwise stated the results shown in this test report refer only to the sample(s) tested and such sample(s) are retained for 90 days only.

除非另有說明，此報告結果僅對測試之樣品負責，同時此樣品僅保留90天。本報告未經本公司書面許可，不可部份複製。

This document is issued by the Company subject to its General Conditions of Service printed overleaf, available on request or accessible at www.sgs.com/terms_and_conditions.htm and, for electronic format documents, subject to Terms and Conditions for Electronic Documents at www.sgs.com/terms_e-document.htm. Attention is drawn to the limitation of liability, indemnification and jurisdiction issues defined therein. Any holder of this document is advised that information contained hereon reflects the Company's findings at the time of its intervention only and within the limits of Client's instructions, if any. The Company's sole responsibility is to its Client and this document does not exonerate parties to a transaction from exercising all their rights and obligations under the transaction documents. This document cannot be reproduced except in full, without prior written approval of the Company. Any unauthorized alteration, forgery or falsification of the content or appearance of this document is unlawful and offenders may be prosecuted to the fullest extent of the law.

Reference Frequency: WCDMA V Mid Channel 836.6 MHz				
Limit: +/- 2.5 ppm = 2091 Hz				
Power Supply	Environment	Frequency	Delta (Hz)	Limit (Hz)
Vdc	Temperature ()	(MHz)		
3.7	50	836600009	-1	2091
3.7	40	836600001	-9	2091
3.7	30	836600000	-10	2091
3.7	20	836600010	0	2091
3.7	10	836600005	-5	2091
3.7	0	836600001	-9	2091
3.7	-10	836599992	-18	2091
3.7	-20	836600011	1	2091
3.7	-30	836599992	-18	2091

Reference Frequency: WCDMA IV Mid Channel 1732.6				
Limit: +/- 2.5 ppm = 4331 Hz				
Power Supply	Environment	Frequency	Delta (Hz)	Limit (Hz)
Vdc	Temperature ()	(MHz)		
3.7	50	173260005	13	4331
3.7	40	173259993	1	4331
3.7	30	173259996	4	4331
3.7	20	173259992	0	4331
3.7	10	173259998	6	4331
3.7	0	173259994	2	4331
3.7	-10	173260004	12	4331
3.7	-20	173259994	2	4331
3.7	-30	173259997	5	4331

Unless otherwise stated the results shown in this test report refer only to the sample(s) tested and such sample(s) are retained for 90 days only.

除非另有說明，此報告結果僅對測試之樣品負責，同時此樣品僅保留90天。本報告未經本公司書面許可，不可部份複製。

This document is issued by the Company subject to its General Conditions of Service printed overleaf, available on request or accessible at www.sgs.com/terms_and_conditions.htm and, for electronic format documents, subject to Terms and Conditions for Electronic Documents at www.sgs.com/terms_e-document.htm. Attention is drawn to the limitation of liability, indemnification and jurisdiction issues defined therein. Any holder of this document is advised that information contained hereon reflects the Company's findings at the time of its intervention only and within the limits of Client's instructions, if any. The Company's sole responsibility is to its Client and this document does not exonerate parties to a transaction from exercising all their rights and obligations under the transaction documents. This document cannot be reproduced except in full, without prior written approval of the Company. Any unauthorized alteration, forgery or falsification of the content or appearance of this document is unlawful and offenders may be prosecuted to the fullest extent of the law.

Reference Frequency: WCDMA II Mid Channel 1880				
Limit: +/- 2.5 ppm = 4700 Hz				
Power Supply	Environment	Frequency	Delta (Hz)	Limit (Hz)
Vdc	Temperature ()	(MHz)		
3.7	50	1880000000	-4	4700
3.7	40	1879999997	-7	4700
3.7	30	1879999997	-7	4700
3.7	20	1880000004	0	4700
3.7	10	1879999989	-15	4700
3.7	0	1879999995	-9	4700
3.7	-10	1879999998	-6	4700
3.7	-20	1879999999	-5	4700
3.7	-30	1879999998	-6	4700

Note: The battery is rated 3.7V dc.

Unless otherwise stated the results shown in this test report refer only to the sample(s) tested and such sample(s) are retained for 90 days only.

除非另有說明，此報告結果僅對測試之樣品負責，同時此樣品僅保留90天。本報告未經本公司書面許可，不可部份複製。

This document is issued by the Company subject to its General Conditions of Service printed overleaf, available on request or accessible at www.sgs.com/terms_and_conditions.htm and, for electronic format documents, subject to Terms and Conditions for Electronic Documents at www.sgs.com/terms_e-document.htm. Attention is drawn to the limitation of liability, indemnification and jurisdiction issues defined therein. Any holder of this document is advised that information contained hereon reflects the Company's findings at the time of its intervention only and within the limits of Client's instructions, if any. The Company's sole responsibility is to its Client and this document does not exonerate parties to a transaction from exercising all their rights and obligations under the transaction documents. This document cannot be reproduced except in full, without prior written approval of the Company. Any unauthorized alteration, forgery or falsification of the content or appearance of this document is unlawful and offenders may be prosecuted to the fullest extent of the law.

12. FREQUENCY STABILITY V.S. VOLTAGE MEASUREMENT

12.1. Standard Applicable:

According to FCC §2.1055(d) (2)

Frequency Tolerance: +/-2.5ppm for 850MHz band

+/-2.5ppm for 1900MHz band

+/-2.5ppm for 1700MHz band

According to RSS-133 §6.3, RSS-132 §5.3, RSS-139 §6.3

The carrier frequency shall not depart from the reference frequency in excess of ± 2.5 ppm for mobile stations.

12.2. Test Set-up:

Refer to section 11.2 in this report

12.3. Measurement Procedure:

Set chamber temperature to 20 . Use a variable AC power supply / DC power source to power the EUT and set the voltage to rated voltage. Set the spectrum analyzer RBW low enough to obtain the desired frequency resolution and recorded the frequency.

Reduce the input voltage to specify extreme voltage variation (+/- 15%) and endpoint as declared by the manufacturer, record the maximum frequency change.

12.4. Measurement Equipment Used:

Refer to section 2.4 in this report

Unless otherwise stated the results shown in this test report refer only to the sample(s) tested and such sample(s) are retained for 90 days only.

除非另有說明，此報告結果僅對測試之樣品負責，同時此樣品僅保留90天。本報告未經本公司書面許可，不可部份複製。

This document is issued by the Company subject to its General Conditions of Service printed overleaf, available on request or accessible at www.sgs.com/terms_and_conditions.htm and, for electronic format documents, subject to Terms and Conditions for Electronic Documents at www.sgs.com/terms_e-document.htm. Attention is drawn to the limitation of liability, indemnification and jurisdiction issues defined therein. Any holder of this document is advised that information contained hereon reflects the Company's findings at the time of its intervention only and within the limits of Client's instructions, if any. The Company's sole responsibility is to its Client and this document does not exonerate parties to a transaction from exercising all their rights and obligations under the transaction documents. This document cannot be reproduced except in full, without prior written approval of the Company. Any unauthorized alteration, forgery or falsification of the content or appearance of this document is unlawful and offenders may be prosecuted to the fullest extent of the law.

12.5. Measurement Result:

Reference Frequency: GPRS 850 Mid Channel 836.6 MHz				
Limit: +/- 2.5 ppm = 2091 Hz				
Power Supply	Environment	Frequency	Delta (Hz)	Limit (Hz)
Vdc	Temperature ()	(MHz)		
4.2	20	836600004	-2	2091
3.7	20	836600006	0	2091
3.4	20	836599990	-16	2091
2.9 (End point)	20	836600001	-5	2091

Reference Frequency: GPRS 1900 Mid Channel 1880 MHz				
Limit: +/- 2.5 ppm = 4700 Hz				
Power Supply	Environment	Frequency	Delta (Hz)	Limit (Hz)
Vdc	Temperature ()	(MHz)		
4.2	20	1880000001	-9	4700
3.7	20	1880000010	0	4700
3.4	20	1880000006	-4	4700
2.9 (End point)	20	1879999997	-13	4700

Unless otherwise stated the results shown in this test report refer only to the sample(s) tested and such sample(s) are retained for 90 days only.

除非另有說明，此報告結果僅對測試之樣品負責，同時此樣品僅保留90天。本報告未經本公司書面許可，不可部份複製。

This document is issued by the Company subject to its General Conditions of Service printed overleaf, available on request or accessible at www.sgs.com/terms_and_conditions.htm and, for electronic format documents, subject to Terms and Conditions for Electronic Documents at www.sgs.com/terms_e-document.htm. Attention is drawn to the limitation of liability, indemnification and jurisdiction issues defined therein. Any holder of this document is advised that information contained hereon reflects the Company's findings at the time of its intervention only and within the limits of Client's instructions, if any. The Company's sole responsibility is to its Client and this document does not exonerate parties to a transaction from exercising all their rights and obligations under the transaction documents. This document cannot be reproduced except in full, without prior written approval of the Company. Any unauthorized alteration, forgery or falsification of the content or appearance of this document is unlawful and offenders may be prosecuted to the fullest extent of the law.

Reference Frequency: WCDMA II Mid Channel 1880 MHz				
Limit: +/- 2.5 ppm = 4700 Hz				
Power Supply	Environment	Frequency	Delta (Hz)	Limit (Hz)
Vdc	Temperature ()	(MHz)		
4.2	20	1879999996	-8	4700
3.7	20	1880000004	0	4700
3.4	20	1879999996	-8	4700
2.9 (End point)	20	1879999999	-5	4700

Reference Frequency: WCDMA IV Mid Channel 1732.6 MHz				
Limit: +/- 2.5 ppm = 2091 Hz				
Power Supply	Environment	Frequency	Delta (Hz)	Limit (Hz)
Vdc	Temperature ()	(MHz)		
4.2	20	173259997	5	4331
3.7	20	173259992	0	4331
3.4	20	173260003	11	4331
2.9 (End point)	20	173259995	3	4331

Reference Frequency: WCDMA V Mid Channel 836.6 MHz				
Limit: +/- 2.5 ppm = 2091 Hz				
Power Supply	Environment	Frequency	Delta (Hz)	Limit (Hz)
Vdc	Temperature ()	(MHz)		
4.2	20	836599996	-14	2091.00
3.7	20	836600010	0	2091.00
3.4	20	836600007	-3	2091.00
2.9 (End point)	20	836599999	-11	2091.00

Unless otherwise stated the results shown in this test report refer only to the sample(s) tested and such sample(s) are retained for 90 days only.

除非另有說明，此報告結果僅對測試之樣品負責，同時此樣品僅保留90天。本報告未經本公司書面許可，不可部份複製。

This document is issued by the Company subject to its General Conditions of Service printed overleaf, available on request or accessible at www.sgs.com/terms_and_conditions.htm and, for electronic format documents, subject to Terms and Conditions for Electronic Documents at www.sgs.com/terms_e-document.htm. Attention is drawn to the limitation of liability, indemnification and jurisdiction issues defined therein. Any holder of this document is advised that information contained hereon reflects the Company's findings at the time of its intervention only and within the limits of Client's instructions, if any. The Company's sole responsibility is to its Client and this document does not exonerate parties to a transaction from exercising all their rights and obligations under the transaction documents. This document cannot be reproduced except in full, without prior written approval of the Company. Any unauthorized alteration, forgery or falsification of the content or appearance of this document is unlawful and offenders may be prosecuted to the fullest extent of the law.

13. PEAK TO AVERAGE RATIO

13.1. Standard Applicable:

According to FCC 24.232(d), FCC 27.50 (d) (5) – The peak-to-average ration (PAR) of the transmission may not exceed 13dB.

According to issue 3 of RSS 132, section 5.4, issue 6 of RSS 133, section 6.4, and RSS-139, section 6.4. Transmitter power is measured in terms of average value, the peak-to-average ratio of the power shall not exceed 13 dB.

13.2. Test SET-UP (Block Diagram of Configuration):

Refer to section 2.4 in this report

13.3. Measurement Procedure:

KDB 971168 D01 is employed as the following procedure is proper adjusted accordingly:

Set resolution/measurement bandwidth \geq signal's occupied bandwidth; & internal = 1ms

Set the number of counts to a value that stabilizes the measured CCDF curve.

13.4. Measurement Equipment Used:

Refer to section 2.4 in this report

13.5. Measurement Result:

Refer to next page for tabular, and plot results

Unless otherwise stated the results shown in this test report refer only to the sample(s) tested and such sample(s) are retained for 90 days only.

除非另有說明，此報告結果僅對測試之樣品負責，同時此樣品僅保留90天。本報告未經本公司書面許可，不可部份複製。

This document is issued by the Company subject to its General Conditions of Service printed overleaf, available on request or accessible at www.sgs.com/terms_and_conditions.htm and, for electronic format documents, subject to Terms and Conditions for Electronic Documents at www.sgs.com/terms_e-document.htm. Attention is drawn to the limitation of liability, indemnification and jurisdiction issues defined therein. Any holder of this document is advised that information contained hereon reflects the Company's findings at the time of its intervention only and within the limits of Client's instructions, if any. The Company's sole responsibility is to its Client and this document does not exonerate parties to a transaction from exercising all their rights and obligations under the transaction documents. This document cannot be reproduced except in full, without prior written approval of the Company. Any unauthorized alteration, forgery or falsification of the content or appearance of this document is unlawful and offenders may be prosecuted to the fullest extent of the law.

13.5.1 Tabular Results:

TEST CONDITIONS	Peak-to-Average Ratio					
	Channel 128(L)		Channel 190(M)		Channel 251(H)	
	824.2MHz		836.6MHz		848.8MHz	
	dB		dB		dB	
Tnom / Vnom	Measured	Limit	Measured	Limit	Measured	Limit
GSM 850	9.82	13	10.08	13	9.93	13
GPRS 850	9.58	13	9.87	13	10.99	13
EDGE 850	10.45	13	11.32	13	11.57	13

TEST CONDITIONS	Peak-to-Average Ratio					
	Channel 512(L)		Channel 661(M)		Channel 810(H)	
	1850.2MHz		1880.0MHz		1909.8MHz	
	dB		dB		dB	
Tnom / Vnom	Measured	Limit	Measured	Limit	Measured	Limit
GSM 1900	10.47	13	10.96	13	10.56	13
GPRS 1900	11.28	13	10.58	13	11.49	13
EDGE 1900	11.03	13	9.54	13	10.09	13

TEST CONDITIONS	Peak-to-Average Ratio					
	Channel 9262(L)		Channel 9400(M)		Channel 9538(H)	
	1852.4MHz		1880.0MHz		1907.6MHz	
	dB		dB		dB	
Tnom / Vnom	Measured	Limit	Measured	Limit	Measured	Limit
WCDMA Band II	3.00	13	2.97	13	2.97	13
HSUPA Band II	2.96	13	2.98	13	2.96	13
HSDPA Band II	3.02	13	2.96	13	2.96	13

Unless otherwise stated the results shown in this test report refer only to the sample(s) tested and such sample(s) are retained for 90 days only.

除非另有說明，此報告結果僅對測試之樣品負責，同時此樣品僅保留90天。本報告未經本公司書面許可，不可部份複製。

This document is issued by the Company subject to its General Conditions of Service printed overleaf, available on request or accessible at www.sgs.com/terms_and_conditions.htm and, for electronic format documents, subject to Terms and Conditions for Electronic Documents at www.sgs.com/terms_e-document.htm. Attention is drawn to the limitation of liability, indemnification and jurisdiction issues defined therein. Any holder of this document is advised that information contained hereon reflects the Company's findings at the time of its intervention only and within the limits of Client's instructions, if any. The Company's sole responsibility is to its Client and this document does not exonerate parties to a transaction from exercising all their rights and obligations under the transaction documents. This document cannot be reproduced except in full, without prior written approval of the Company. Any unauthorized alteration, forgery or falsification of the content or appearance of this document is unlawful and offenders may be prosecuted to the fullest extent of the law.

TEST CONDITIONS	Peak-to-Average Ratio					
	Channel 1312(L)		Channel 1413(M)		Channel 1513(H)	
	1712.4MHz		1732.6MHz		1752.6MHz	
	dB		dB		dB	
Tnom / Vnom	Measured	Limit	Measured	Limit	Measured	Limit
WCDMA Band IV	2.94	13	3.02	13	2.95	13
HSUPA Band IV	2.95	13	3.04	13	2.93	13
HSDPA Band IV	2.96	13	3.01	13	2.93	13

TEST CONDITIONS	Peak-to-Average Ratio					
	Channel 4132(L)		Channel 4183(M)		Channel 4233(H)	
	826.4MHz		836.6MHz		846.6MHz	
	dB		dB		dB	
Tnom / Vnom	Measured	Limit	Measured	Limit	Measured	Limit
WCDMA Band V	2.94	13	3.00	13	2.95	13
HSUPA Band V	2.93	13	2.99	13	2.96	13
HSDPA Band V	2.93	13	2.99	13	2.95	13

Unless otherwise stated the results shown in this test report refer only to the sample(s) tested and such sample(s) are retained for 90 days only.

除非另有說明，此報告結果僅對測試之樣品負責，同時此樣品僅保留90天。本報告未經本公司書面許可，不可部份複製。

This document is issued by the Company subject to its General Conditions of Service printed overleaf, available on request or accessible at www.sgs.com/terms_and_conditions.htm and, for electronic format documents, subject to Terms and Conditions for Electronic Documents at www.sgs.com/terms_e-document.htm. Attention is drawn to the limitation of liability, indemnification and jurisdiction issues defined therein. Any holder of this document is advised that information contained hereon reflects the Company's findings at the time of its intervention only and within the limits of Client's instructions, if any. The Company's sole responsibility is to its Client and this document does not exonerate parties to a transaction from exercising all their rights and obligations under the transaction documents. This document cannot be reproduced except in full, without prior written approval of the Company. Any unauthorized alteration, forgery or falsification of the content or appearance of this document is unlawful and offenders may be prosecuted to the fullest extent of the law.

13.5.2 Measurement Results:

Figure 13-1: GSM 850 Channel Low

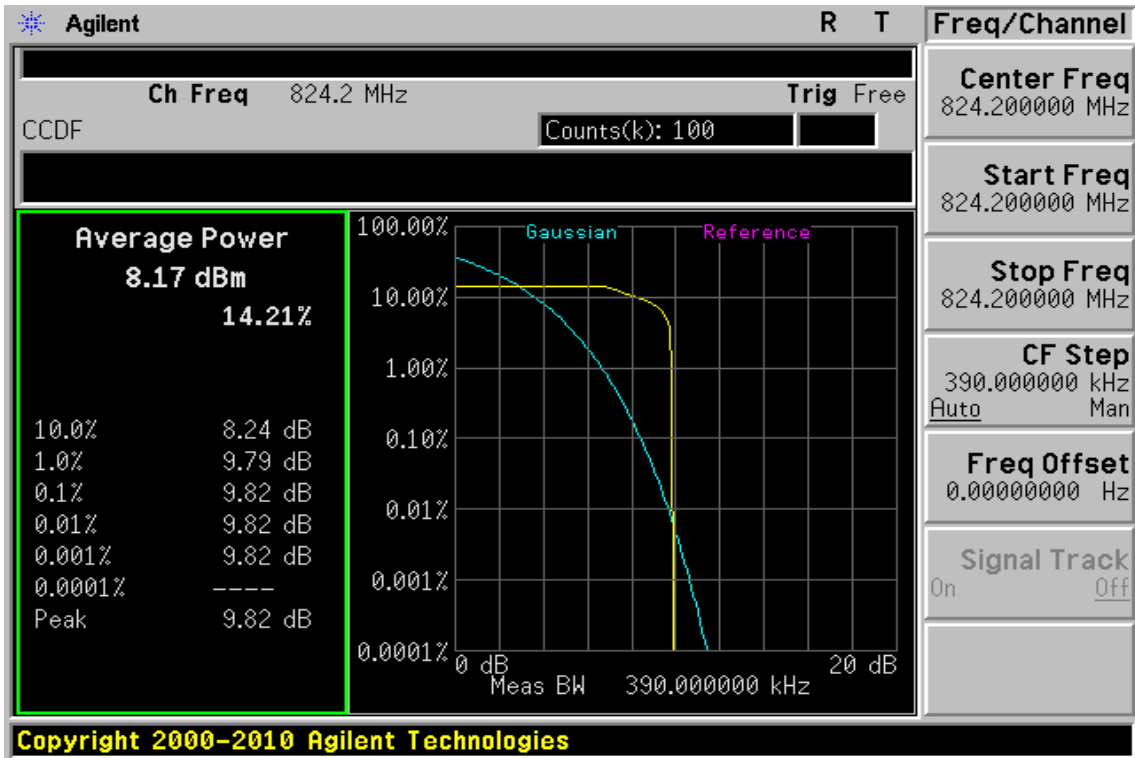
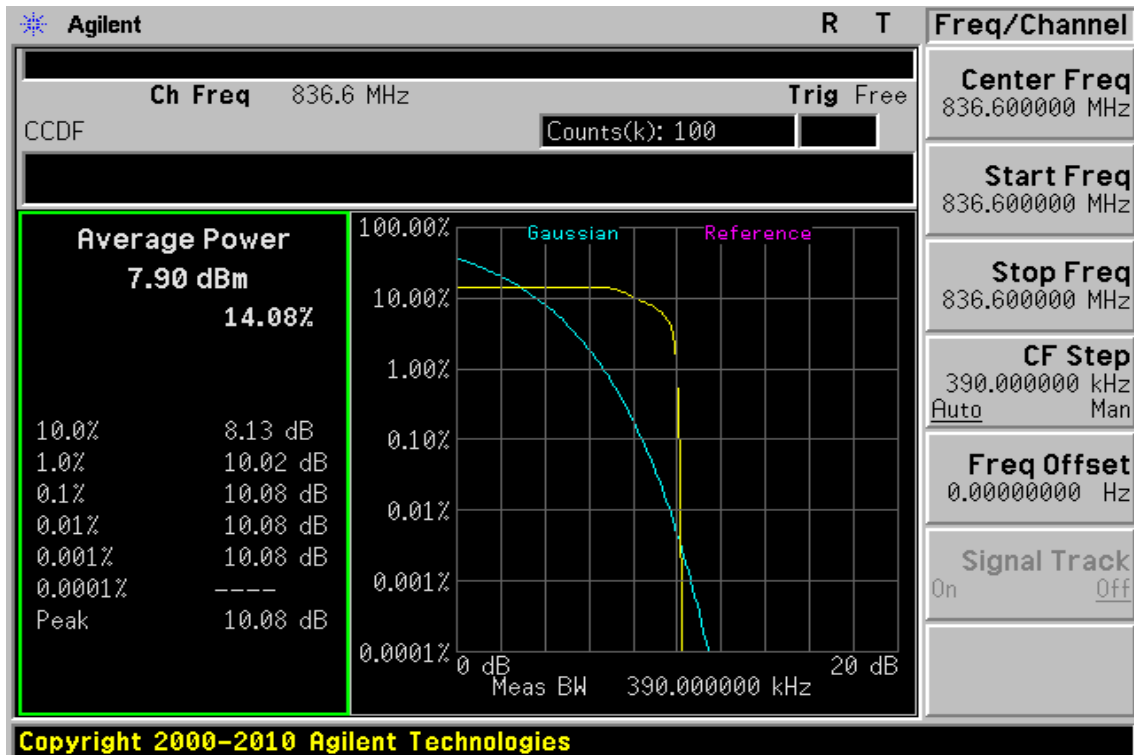

Figure 13-2: GSM 850 Channel Mid



Unless otherwise stated the results shown in this test report refer only to the sample(s) tested and such sample(s) are retained for 90 days only.

除非另有說明，此報告結果僅對測試之樣品負責，同時此樣品僅保留90天。本報告未經本公司書面許可，不可部份複製。

This document is issued by the Company subject to its General Conditions of Service printed overleaf, available on request or accessible at www.sgs.com/terms_and_conditions.htm and, for electronic format documents, subject to Terms and Conditions for Electronic Documents at www.sgs.com/terms_e-document.htm. Attention is drawn to the limitation of liability, indemnification and jurisdiction issues defined therein. Any holder of this document is advised that information contained hereon reflects the Company's findings at the time of its intervention only and within the limits of Client's instructions, if any. The Company's sole responsibility is to its Client and this document does not exonerate parties to a transaction from exercising all their rights and obligations under the transaction documents. This document cannot be reproduced except in full, without prior written approval of the Company. Any unauthorized alteration, forgery or falsification of the content or appearance of this document is unlawful and offenders may be prosecuted to the fullest extent of the law.

Figure 13-3: GSM 850 Channel High

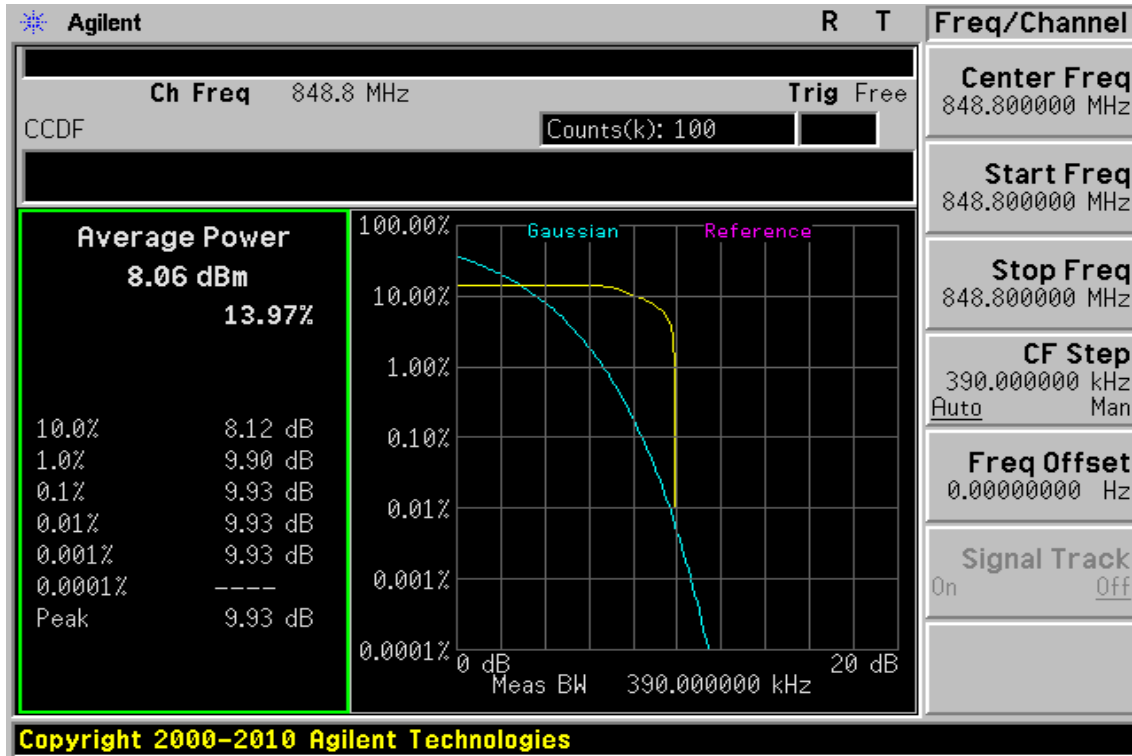
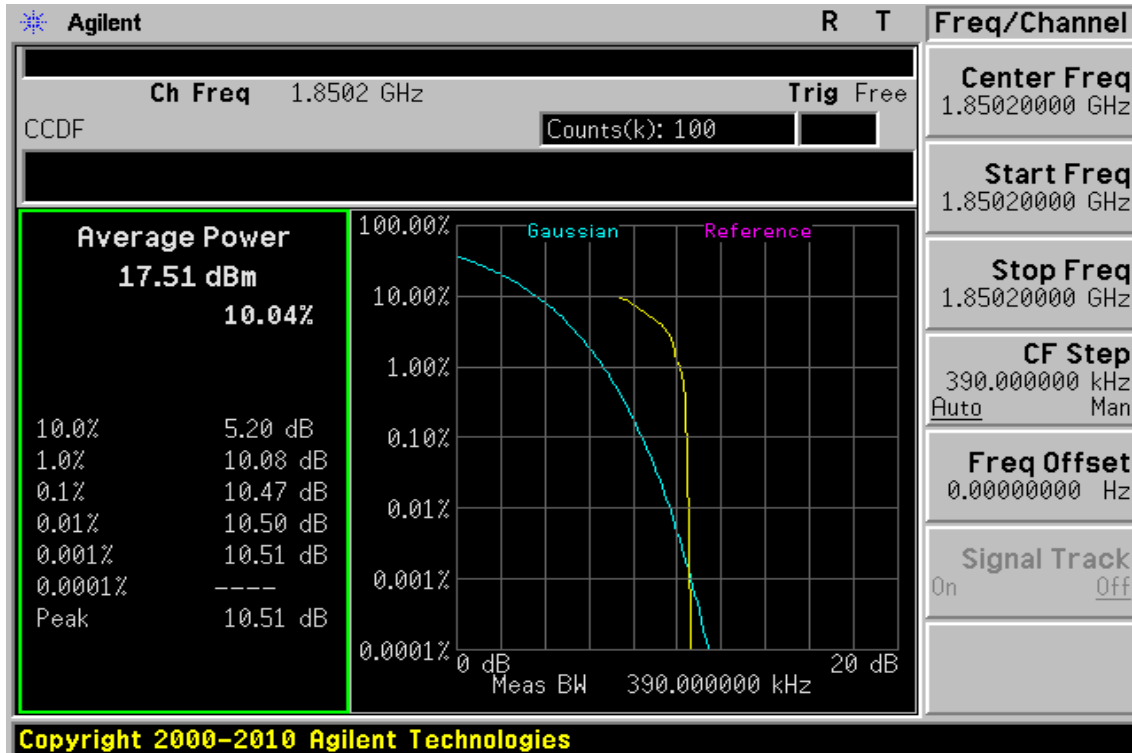

Figure 13-4: GSM 1900 Channel Low



Unless otherwise stated the results shown in this test report refer only to the sample(s) tested and such sample(s) are retained for 90 days only.

除非另有說明，此報告結果僅對測試之樣品負責，同時此樣品僅保留90天。本報告未經本公司書面許可，不可部份複製。

This document is issued by the Company subject to its General Conditions of Service printed overleaf, available on request or accessible at www.sgs.com/terms_and_conditions.htm and, for electronic format documents, subject to Terms and Conditions for Electronic Documents at www.sgs.com/terms_e-document.htm. Attention is drawn to the limitation of liability, indemnification and jurisdiction issues defined therein. Any holder of this document is advised that information contained hereon reflects the Company's findings at the time of its intervention only and within the limits of Client's instructions, if any. The Company's sole responsibility is to its Client and this document does not exonerate parties to a transaction from exercising all their rights and obligations under the transaction documents. This document cannot be reproduced except in full, without prior written approval of the Company. Any unauthorized alteration, forgery or falsification of the content or appearance of this document is unlawful and offenders may be prosecuted to the fullest extent of the law.

Figure 13-5: GSM 1900 Channel Mid

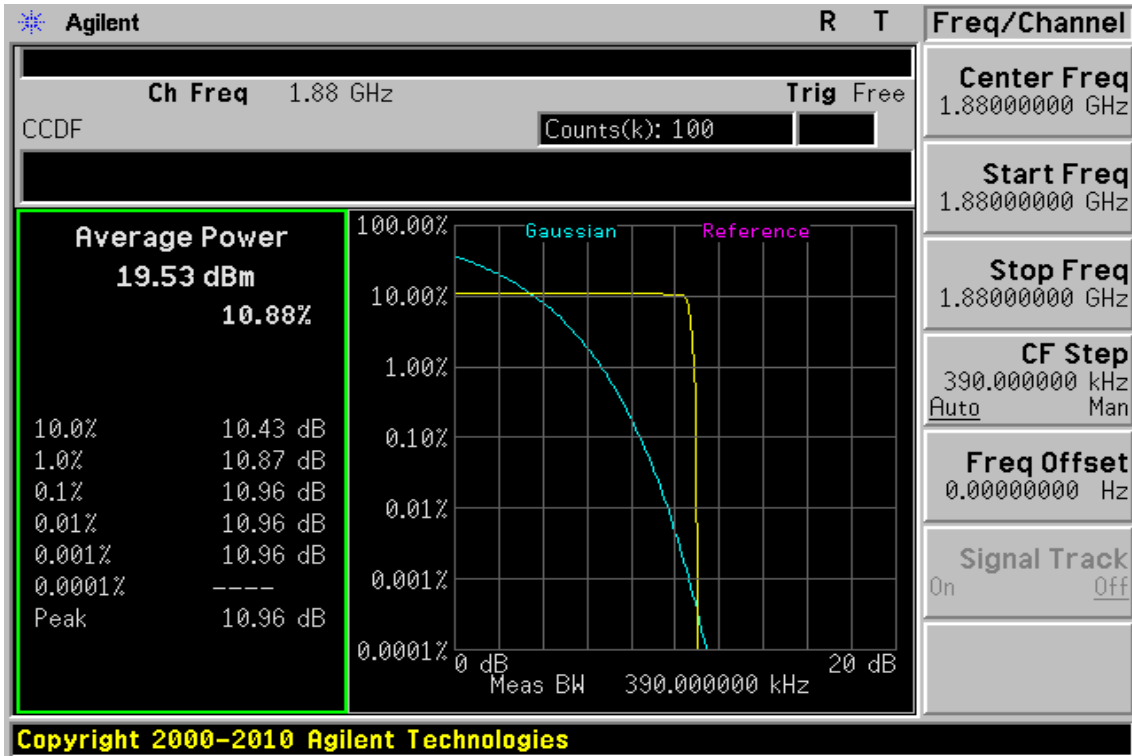
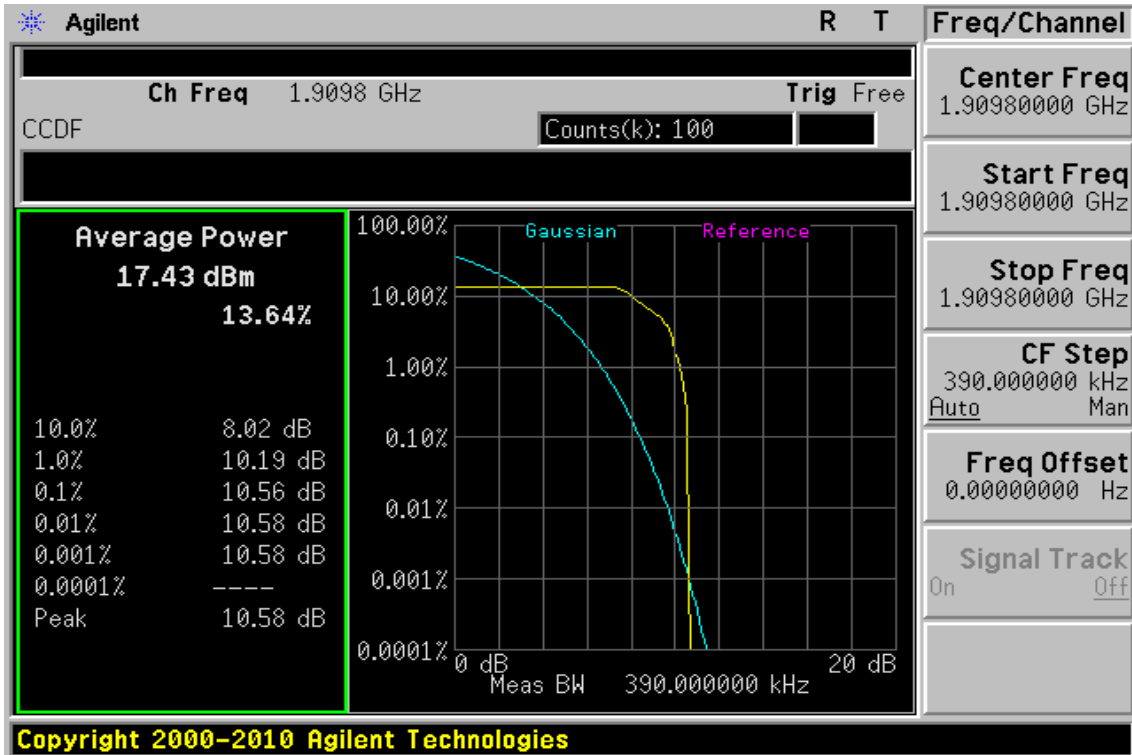

Figure 13-6: GSM 1900 Channel High



Unless otherwise stated the results shown in this test report refer only to the sample(s) tested and such sample(s) are retained for 90 days only.

除非另有說明，此報告結果僅對測試之樣品負責，同時此樣品僅保留90天。本報告未經本公司書面許可，不可部份複製。

This document is issued by the Company subject to its General Conditions of Service printed overleaf, available on request or accessible at www.sgs.com/terms_and_conditions.htm and, for electronic format documents, subject to Terms and Conditions for Electronic Documents at www.sgs.com/terms_e-document.htm. Attention is drawn to the limitation of liability, indemnification and jurisdiction issues defined therein. Any holder of this document is advised that information contained hereon reflects the Company's findings at the time of its intervention only and within the limits of Client's instructions, if any. The Company's sole responsibility is to its Client and this document does not exonerate parties to a transaction from exercising all their rights and obligations under the transaction documents. This document cannot be reproduced except in full, without prior written approval of the Company. Any unauthorized alteration, forgery or falsification of the content or appearance of this document is unlawful and offenders may be prosecuted to the fullest extent of the law.

Figure 13-7: GPRS 850 Channel Low

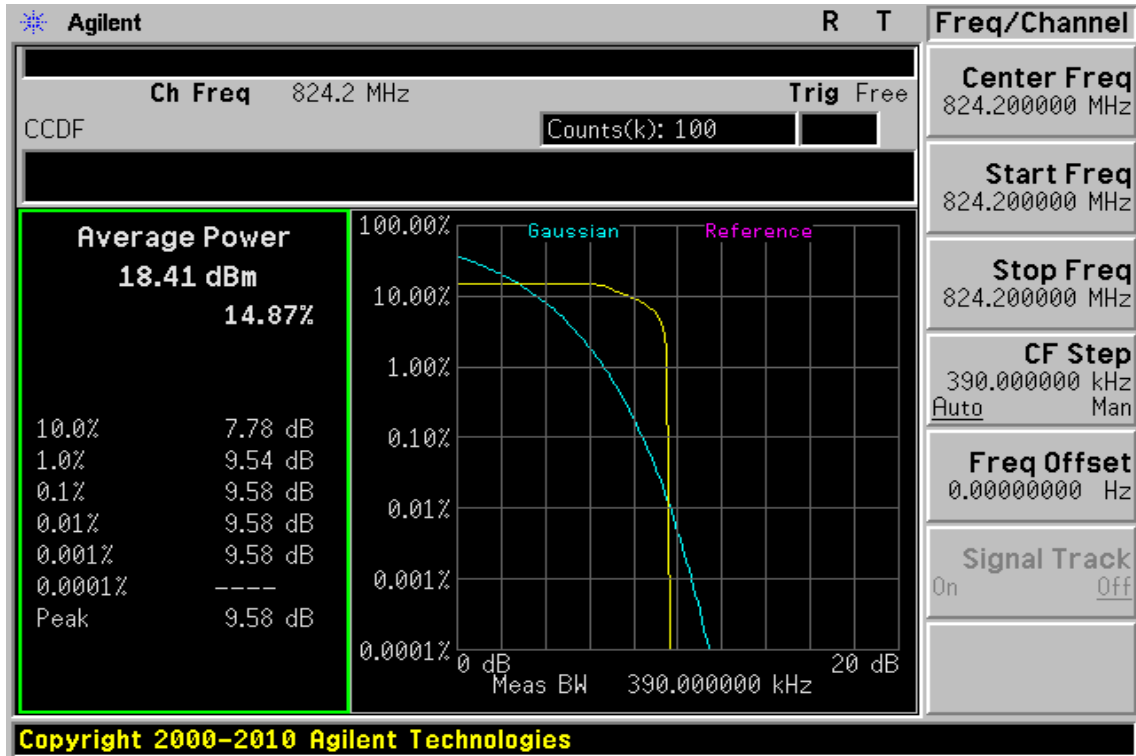
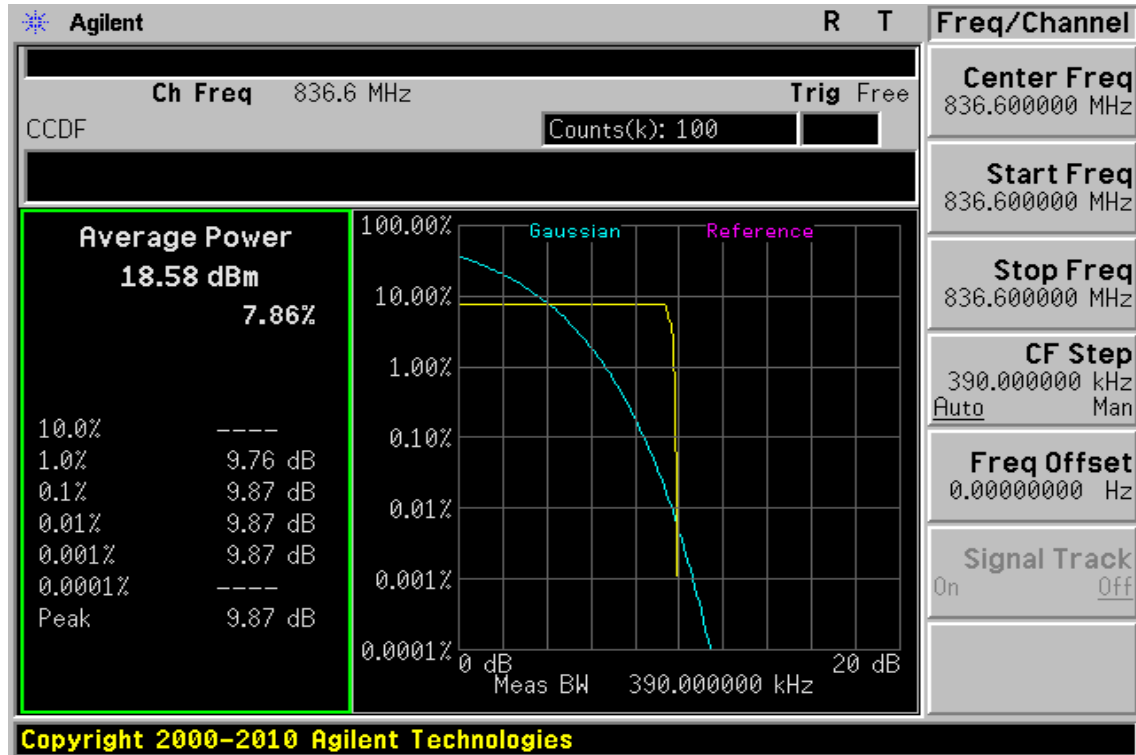

Figure 13-8: GPRS 850 Channel Mid



Unless otherwise stated the results shown in this test report refer only to the sample(s) tested and such sample(s) are retained for 90 days only.

除非另有說明，此報告結果僅對測試之樣品負責，同時此樣品僅保留90天。本報告未經本公司書面許可，不可部份複製。

This document is issued by the Company subject to its General Conditions of Service printed overleaf, available on request or accessible at www.sgs.com/terms_and_conditions.htm and, for electronic format documents, subject to Terms and Conditions for Electronic Documents at www.sgs.com/terms_e-document.htm. Attention is drawn to the limitation of liability, indemnification and jurisdiction issues defined therein. Any holder of this document is advised that information contained hereon reflects the Company's findings at the time of its intervention only and within the limits of Client's instructions, if any. The Company's sole responsibility is to its Client and this document does not exonerate parties to a transaction from exercising all their rights and obligations under the transaction documents. This document cannot be reproduced except in full, without prior written approval of the Company. Any unauthorized alteration, forgery or falsification of the content or appearance of this document is unlawful and offenders may be prosecuted to the fullest extent of the law.

Figure 13-9: GPRS 850 Channel High

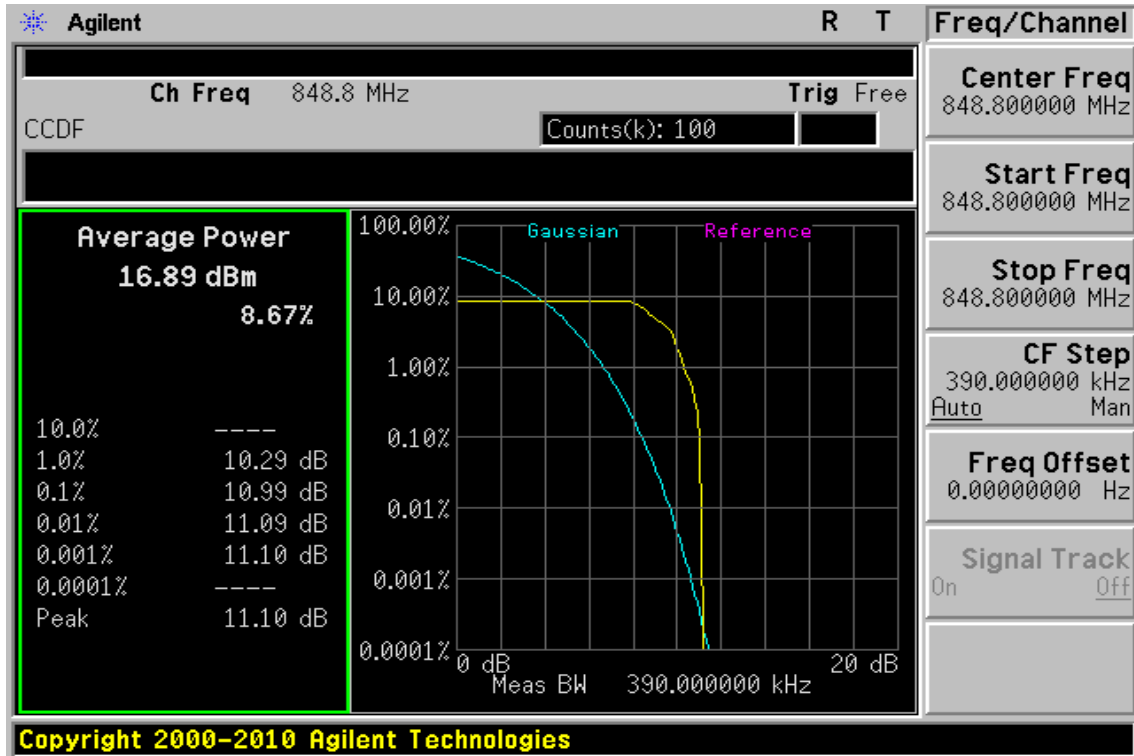
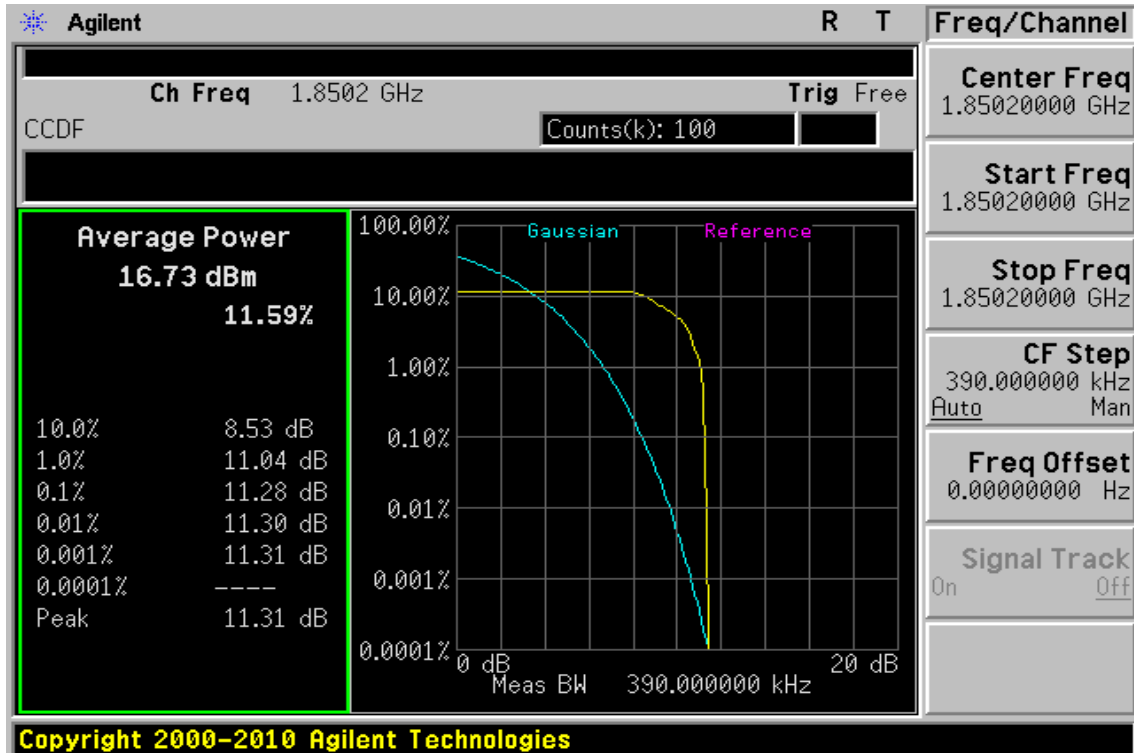

Figure 13-10: GPRS 1900 Channel Low



Unless otherwise stated the results shown in this test report refer only to the sample(s) tested and such sample(s) are retained for 90 days only.

除非另有說明，此報告結果僅對測試之樣品負責，同時此樣品僅保留90天。本報告未經本公司書面許可，不可部份複製。

This document is issued by the Company subject to its General Conditions of Service printed overleaf, available on request or accessible at www.sgs.com/terms_and_conditions.htm and, for electronic format documents, subject to Terms and Conditions for Electronic Documents at www.sgs.com/terms_e-document.htm. Attention is drawn to the limitation of liability, indemnification and jurisdiction issues defined therein. Any holder of this document is advised that information contained hereon reflects the Company's findings at the time of its intervention only and within the limits of Client's instructions, if any. The Company's sole responsibility is to its Client and this document does not exonerate parties to a transaction from exercising all their rights and obligations under the transaction documents. This document cannot be reproduced except in full, without prior written approval of the Company. Any unauthorized alteration, forgery or falsification of the content or appearance of this document is unlawful and offenders may be prosecuted to the fullest extent of the law.

Figure 13-11 GPRS 1900 Channel Mid

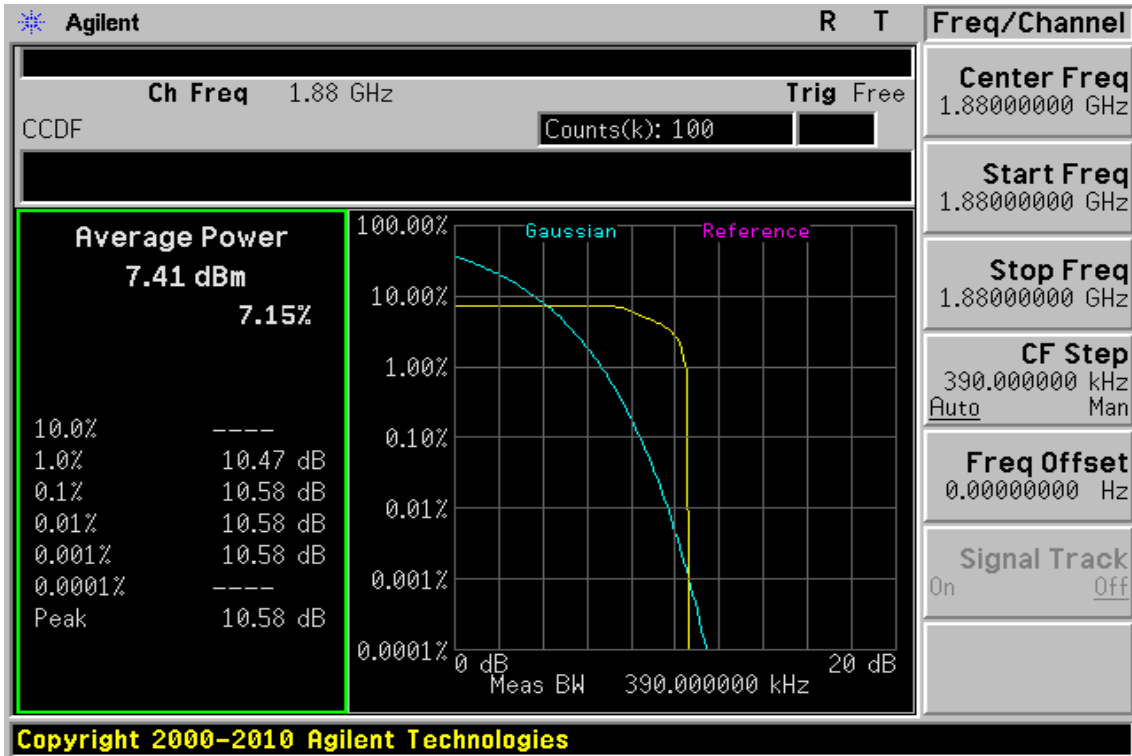
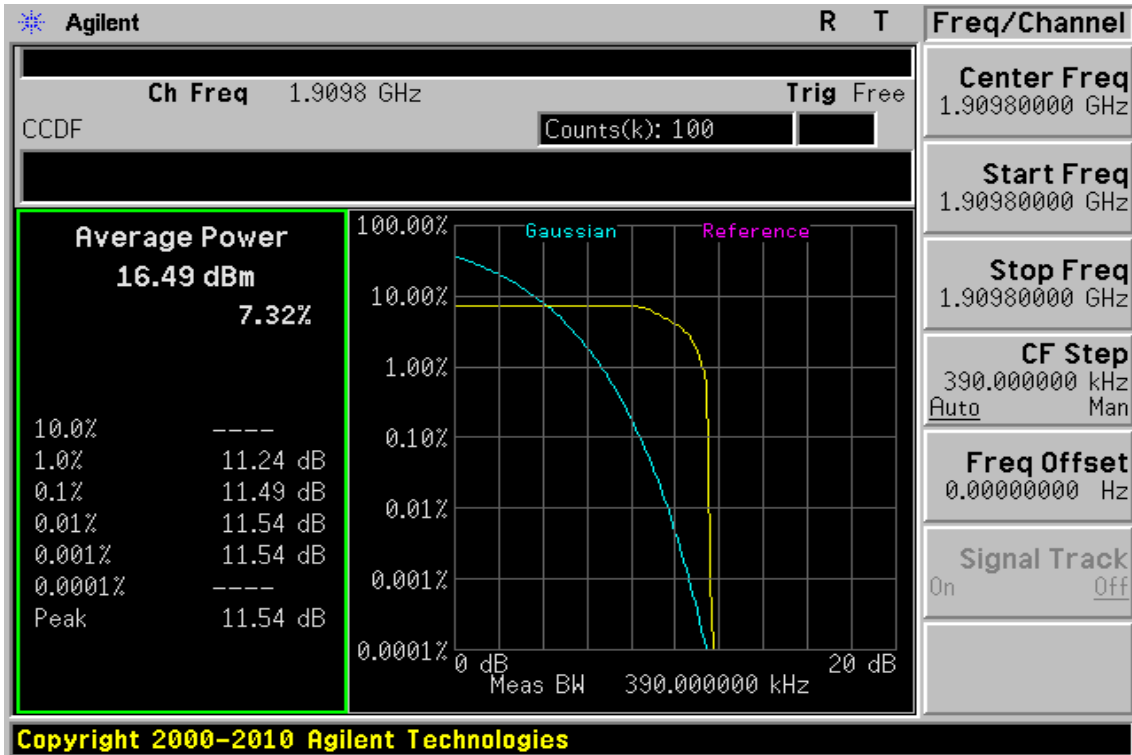

Figure 13-12: GPRS 1900 Channel High



Unless otherwise stated the results shown in this test report refer only to the sample(s) tested and such sample(s) are retained for 90 days only.

除非另有說明，此報告結果僅對測試之樣品負責，同時此樣品僅保留90天。本報告未經本公司書面許可，不可部份複製。

This document is issued by the Company subject to its General Conditions of Service printed overleaf, available on request or accessible at www.sgs.com/terms_and_conditions.htm and, for electronic format documents, subject to Terms and Conditions for Electronic Documents at www.sgs.com/terms_e-document.htm. Attention is drawn to the limitation of liability, indemnification and jurisdiction issues defined therein. Any holder of this document is advised that information contained hereon reflects the Company's findings at the time of its intervention only and within the limits of Client's instructions, if any. The Company's sole responsibility is to its Client and this document does not exonerate parties to a transaction from exercising all their rights and obligations under the transaction documents. This document cannot be reproduced except in full, without prior written approval of the Company. Any unauthorized alteration, forgery or falsification of the content or appearance of this document is unlawful and offenders may be prosecuted to the fullest extent of the law.

Figure 13-13: EDGE 850 Channel Low

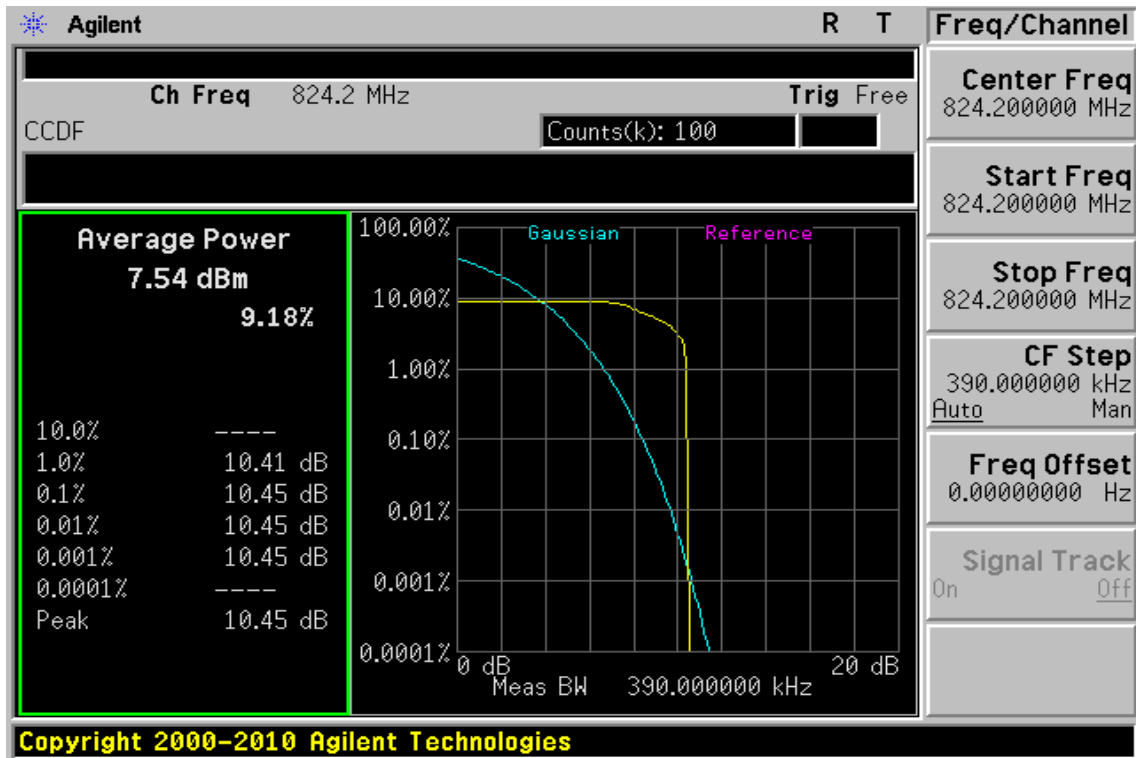
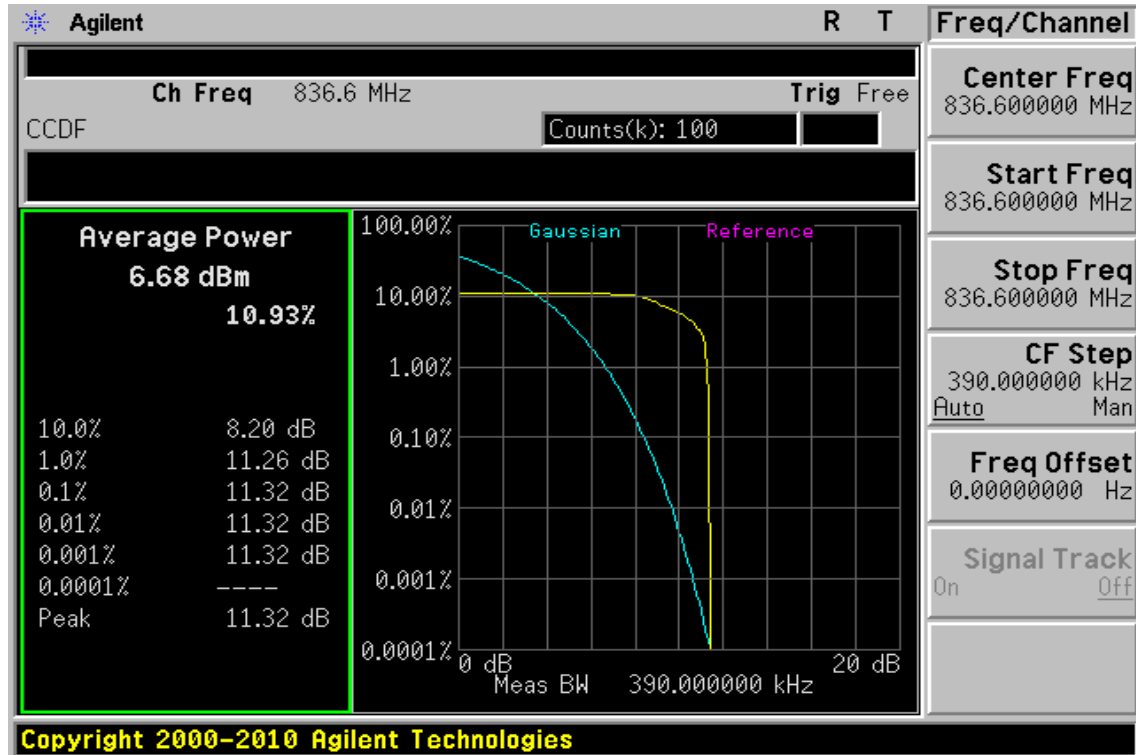

Figure 13-14 EDGE 850 Channel Mid



Unless otherwise stated the results shown in this test report refer only to the sample(s) tested and such sample(s) are retained for 90 days only.

除非另有說明，此報告結果僅對測試之樣品負責，同時此樣品僅保留90天。本報告未經本公司書面許可，不可部份複製。

This document is issued by the Company subject to its General Conditions of Service printed overleaf, available on request or accessible at www.sgs.com/terms_and_conditions.htm and, for electronic format documents, subject to Terms and Conditions for Electronic Documents at www.sgs.com/terms_e-document.htm. Attention is drawn to the limitation of liability, indemnification and jurisdiction issues defined therein. Any holder of this document is advised that information contained hereon reflects the Company's findings at the time of its intervention only and within the limits of Client's instructions, if any. The Company's sole responsibility is to its Client and this document does not exonerate parties to a transaction from exercising all their rights and obligations under the transaction documents. This document cannot be reproduced except in full, without prior written approval of the Company. Any unauthorized alteration, forgery or falsification of the content or appearance of this document is unlawful and offenders may be prosecuted to the fullest extent of the law.

Figure 13-15: EDGE 850 Channel High

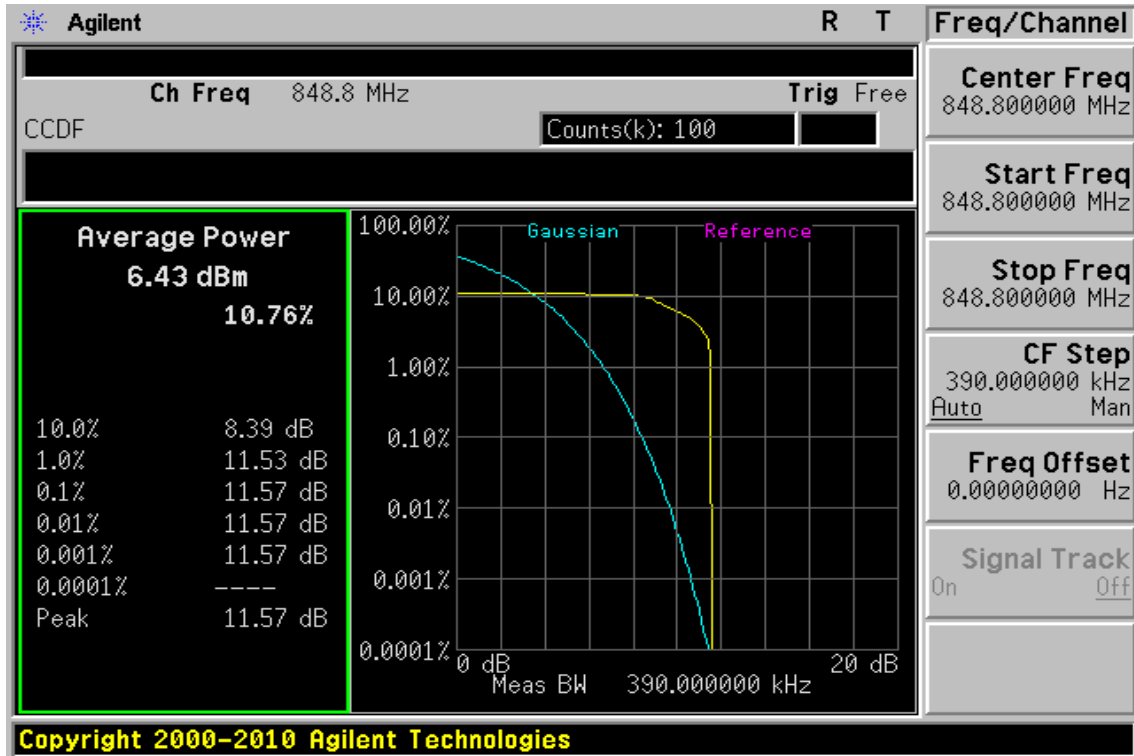
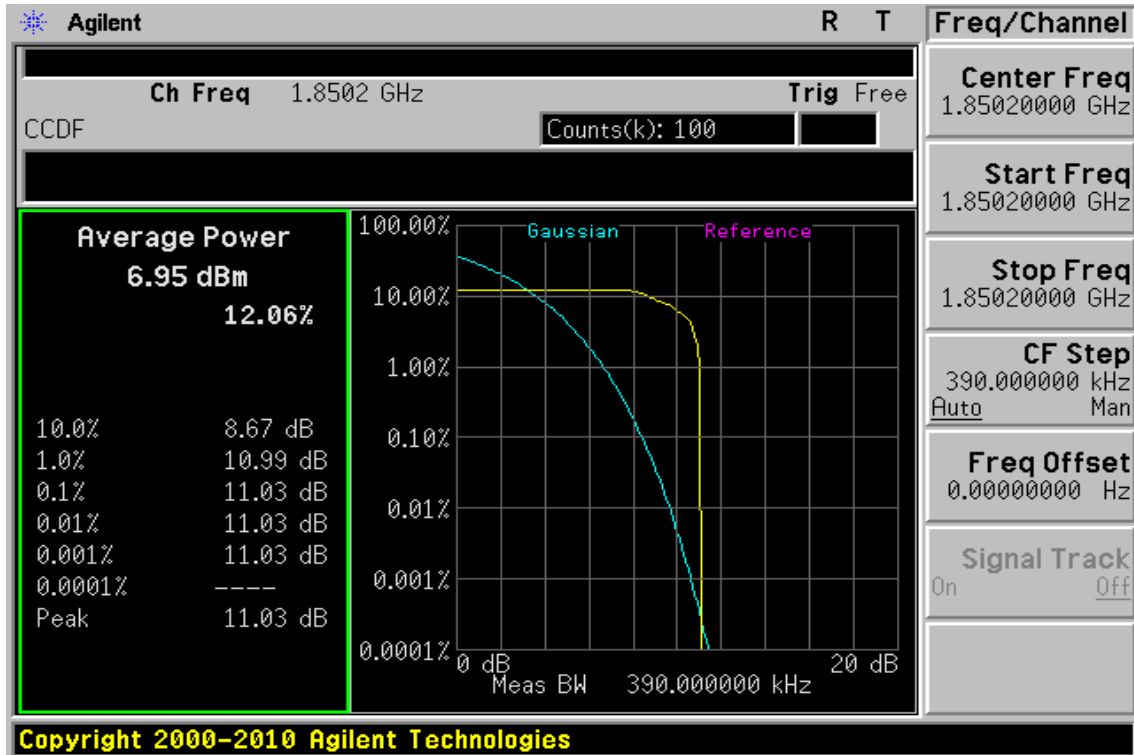

Figure 13-16: EDGE 1900 Channel Low



Unless otherwise stated the results shown in this test report refer only to the sample(s) tested and such sample(s) are retained for 90 days only.

除非另有說明，此報告結果僅對測試之樣品負責，同時此樣品僅保留90天。本報告未經本公司書面許可，不可部份複製。

This document is issued by the Company subject to its General Conditions of Service printed overleaf, available on request or accessible at www.sgs.com/terms_and_conditions.htm and, for electronic format documents, subject to Terms and Conditions for Electronic Documents at www.sgs.com/terms_e-document.htm. Attention is drawn to the limitation of liability, indemnification and jurisdiction issues defined therein. Any holder of this document is advised that information contained hereon reflects the Company's findings at the time of its intervention only and within the limits of Client's instructions, if any. The Company's sole responsibility is to its Client and this document does not exonerate parties to a transaction from exercising all their rights and obligations under the transaction documents. This document cannot be reproduced except in full, without prior written approval of the Company. Any unauthorized alteration, forgery or falsification of the content or appearance of this document is unlawful and offenders may be prosecuted to the fullest extent of the law.

Figure 13-17 EDGE 1900 Channel Mid

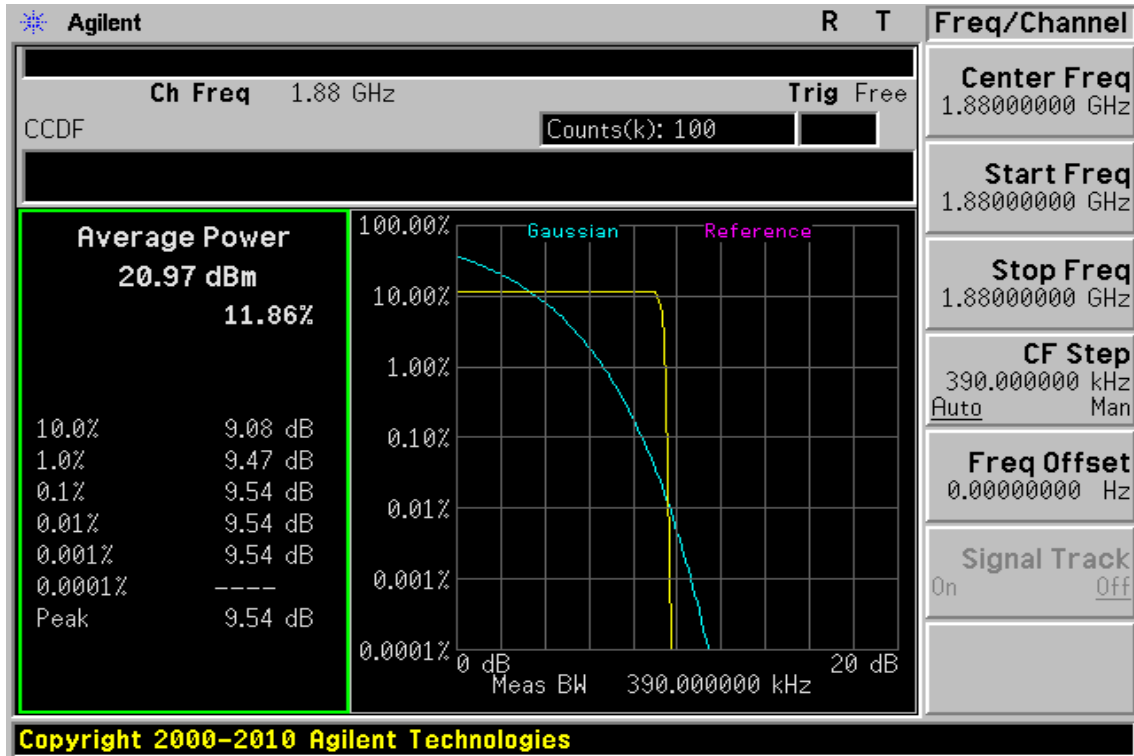
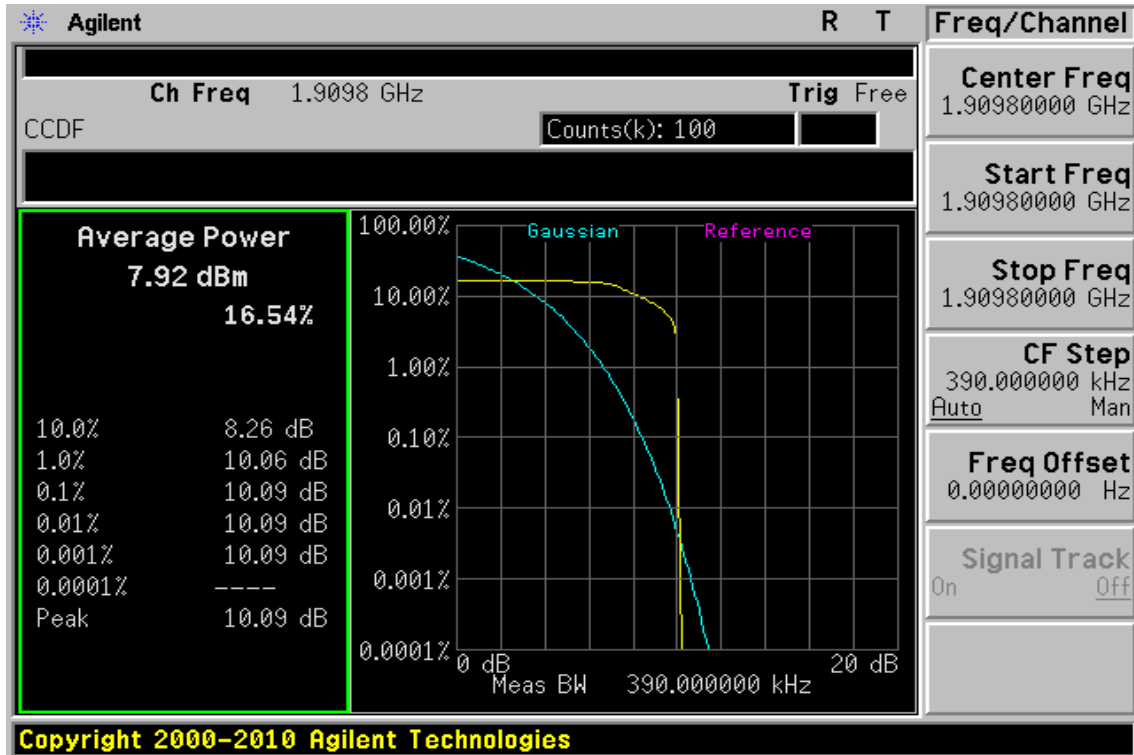

Figure 13-18: EDGE 1900 Channel High



Unless otherwise stated the results shown in this test report refer only to the sample(s) tested and such sample(s) are retained for 90 days only.

除非另有說明，此報告結果僅對測試之樣品負責，同時此樣品僅保留90天。本報告未經本公司書面許可，不可部份複製。

This document is issued by the Company subject to its General Conditions of Service printed overleaf, available on request or accessible at www.sgs.com/terms_and_conditions.htm and, for electronic format documents, subject to Terms and Conditions for Electronic Documents at www.sgs.com/terms_e-document.htm. Attention is drawn to the limitation of liability, indemnification and jurisdiction issues defined therein. Any holder of this document is advised that information contained hereon reflects the Company's findings at the time of its intervention only and within the limits of Client's instructions, if any. The Company's sole responsibility is to its Client and this document does not exonerate parties to a transaction from exercising all their rights and obligations under the transaction documents. This document cannot be reproduced except in full, without prior written approval of the Company. Any unauthorized alteration, forgery or falsification of the content or appearance of this document is unlawful and offenders may be prosecuted to the fullest extent of the law.

Figure 13-19: WCDMA Band II Channel Low

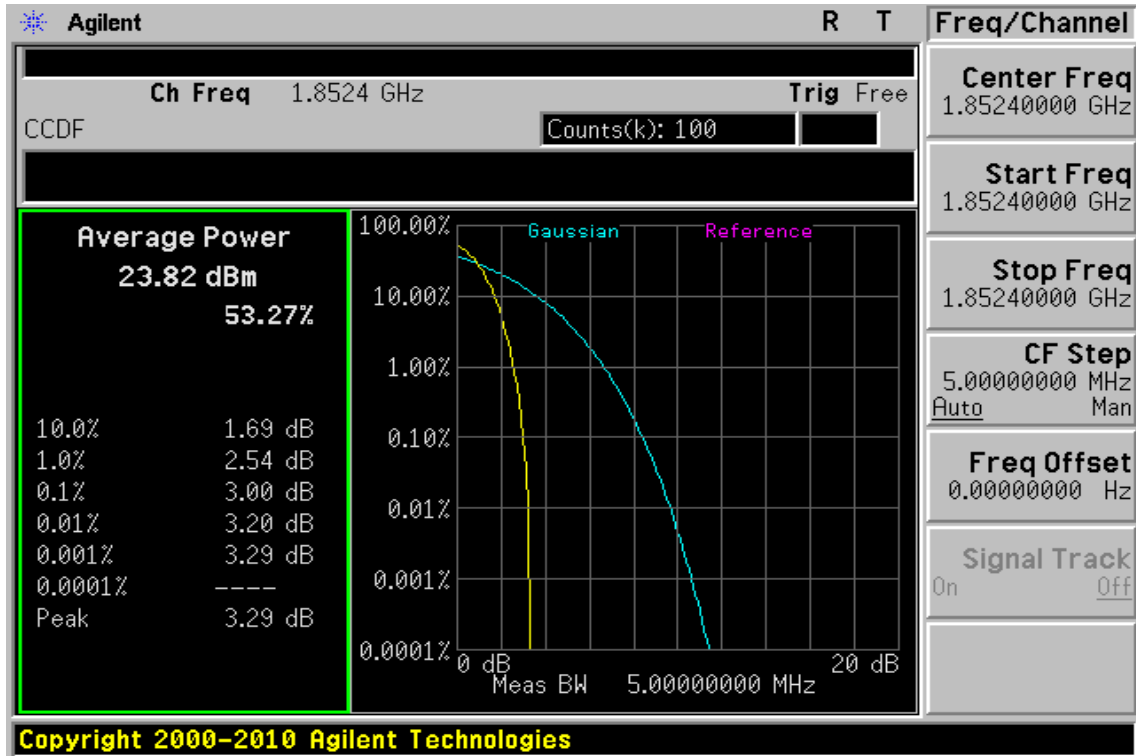
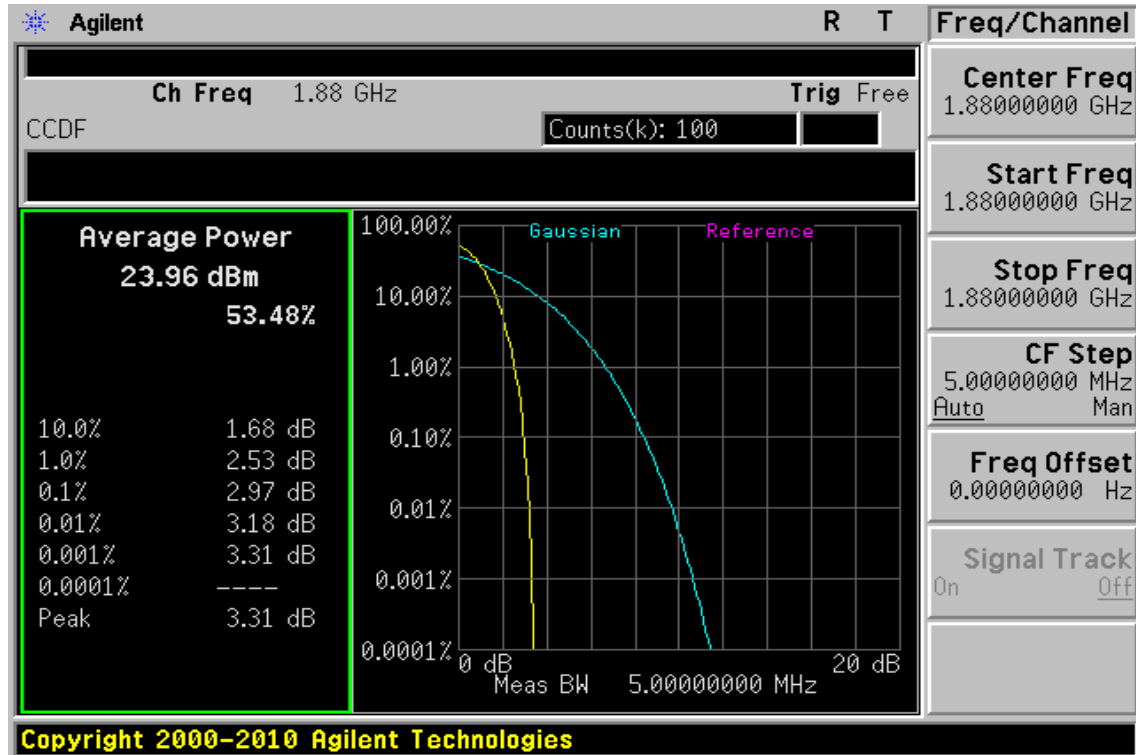

Figure 13-20: WCDMA Band II Channel Mid



Unless otherwise stated the results shown in this test report refer only to the sample(s) tested and such sample(s) are retained for 90 days only.

除非另有說明，此報告結果僅對測試之樣品負責，同時此樣品僅保留90天。本報告未經本公司書面許可，不可部份複製。

This document is issued by the Company subject to its General Conditions of Service printed overleaf, available on request or accessible at www.sgs.com/terms_and_conditions.htm and, for electronic format documents, subject to Terms and Conditions for Electronic Documents at www.sgs.com/terms_e-document.htm. Attention is drawn to the limitation of liability, indemnification and jurisdiction issues defined therein. Any holder of this document is advised that information contained hereon reflects the Company's findings at the time of its intervention only and within the limits of Client's instructions, if any. The Company's sole responsibility is to its Client and this document does not exonerate parties to a transaction from exercising all their rights and obligations under the transaction documents. This document cannot be reproduced except in full, without prior written approval of the Company. Any unauthorized alteration, forgery or falsification of the content or appearance of this document is unlawful and offenders may be prosecuted to the fullest extent of the law.

Figure 13-21: WCDMA Band II Channel High

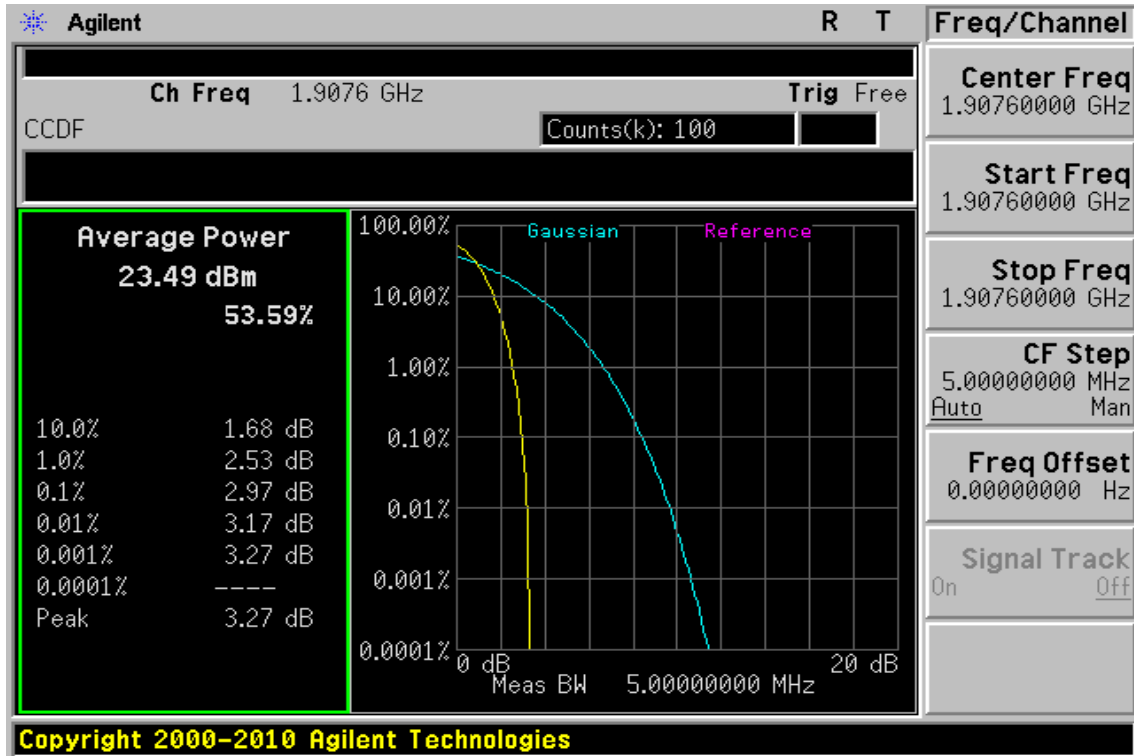
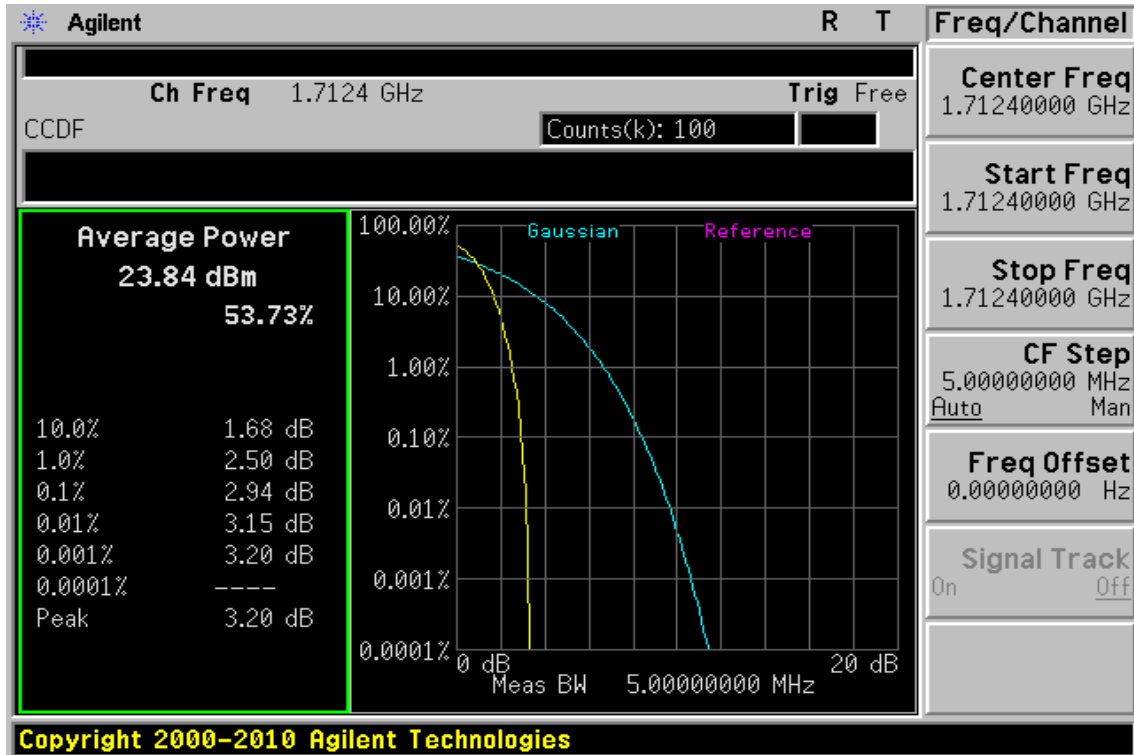

Figure 13-22: WCDMA Band IV Channel Low



Unless otherwise stated the results shown in this test report refer only to the sample(s) tested and such sample(s) are retained for 90 days only.

除非另有說明，此報告結果僅對測試之樣品負責，同時此樣品僅保留90天。本報告未經本公司書面許可，不可部份複製。

This document is issued by the Company subject to its General Conditions of Service printed overleaf, available on request or accessible at www.sgs.com/terms_and_conditions.htm and, for electronic format documents, subject to Terms and Conditions for Electronic Documents at www.sgs.com/terms_e-document.htm. Attention is drawn to the limitation of liability, indemnification and jurisdiction issues defined therein. Any holder of this document is advised that information contained hereon reflects the Company's findings at the time of its intervention only and within the limits of Client's instructions, if any. The Company's sole responsibility is to its Client and this document does not exonerate parties to a transaction from exercising all their rights and obligations under the transaction documents. This document cannot be reproduced except in full, without prior written approval of the Company. Any unauthorized alteration, forgery or falsification of the content or appearance of this document is unlawful and offenders may be prosecuted to the fullest extent of the law.

Figure 13-23: WCDMA Band IV Channel Mid

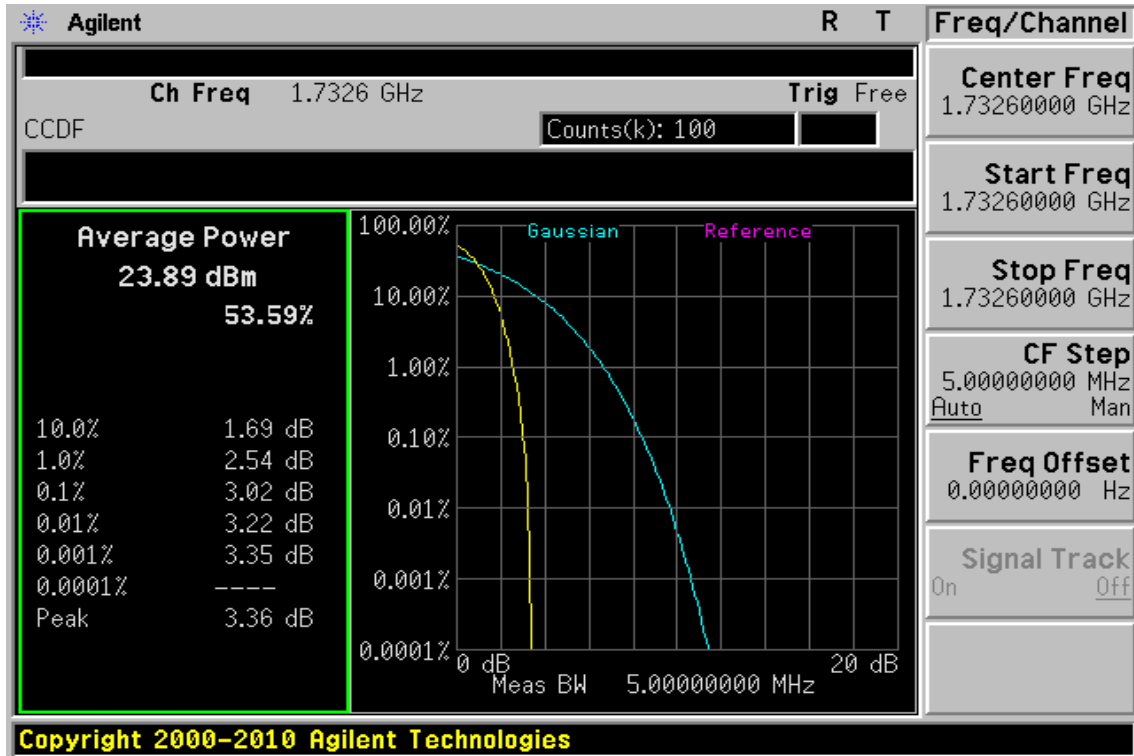
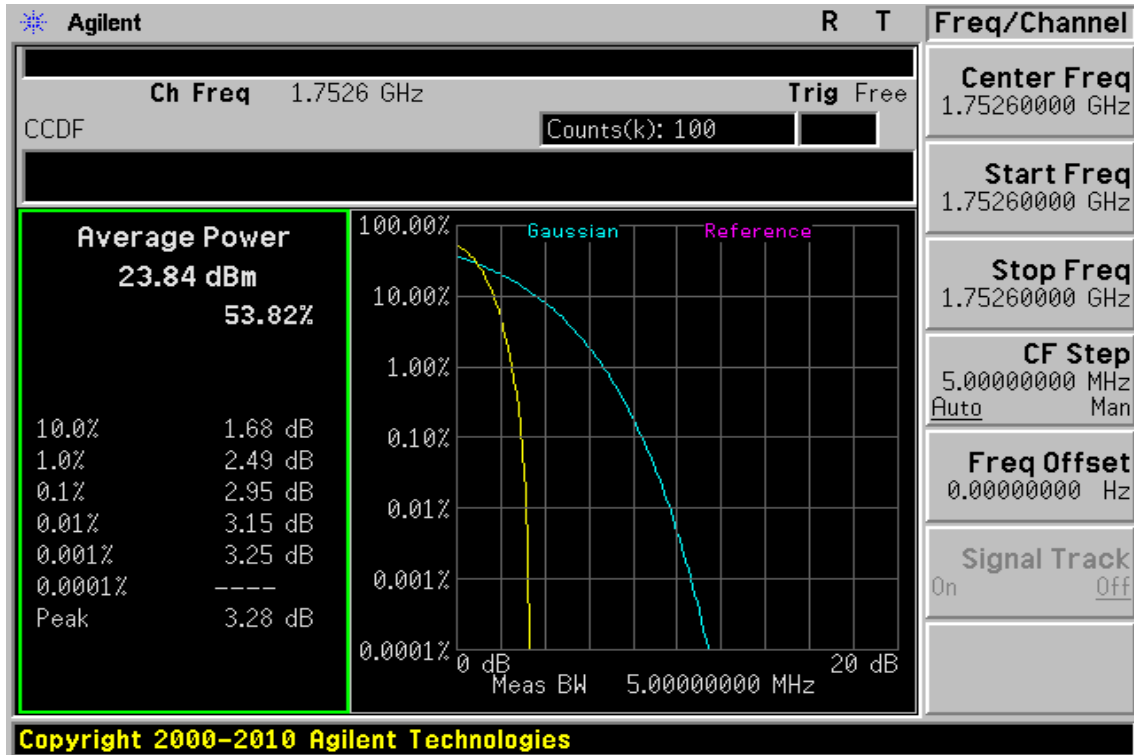

Figure 13-24: WCDMA Band IV Channel High



Unless otherwise stated the results shown in this test report refer only to the sample(s) tested and such sample(s) are retained for 90 days only.

除非另有說明，此報告結果僅對測試之樣品負責，同時此樣品僅保留90天。本報告未經本公司書面許可，不可部份複製。

This document is issued by the Company subject to its General Conditions of Service printed overleaf, available on request or accessible at www.sgs.com/terms_and_conditions.htm and, for electronic format documents, subject to Terms and Conditions for Electronic Documents at www.sgs.com/terms_e-document.htm. Attention is drawn to the limitation of liability, indemnification and jurisdiction issues defined therein. Any holder of this document is advised that information contained hereon reflects the Company's findings at the time of its intervention only and within the limits of Client's instructions, if any. The Company's sole responsibility is to its Client and this document does not exonerate parties to a transaction from exercising all their rights and obligations under the transaction documents. This document cannot be reproduced except in full, without prior written approval of the Company. Any unauthorized alteration, forgery or falsification of the content or appearance of this document is unlawful and offenders may be prosecuted to the fullest extent of the law.

Figure 13-25: WCDMA Band V Channel Low

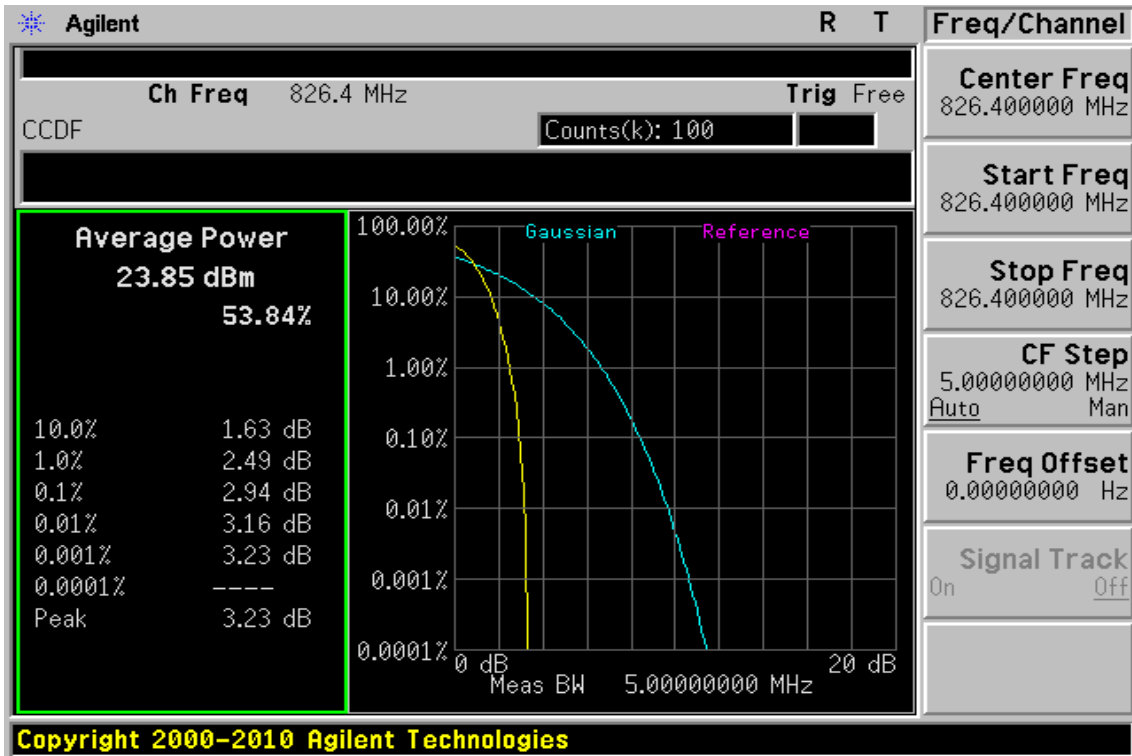
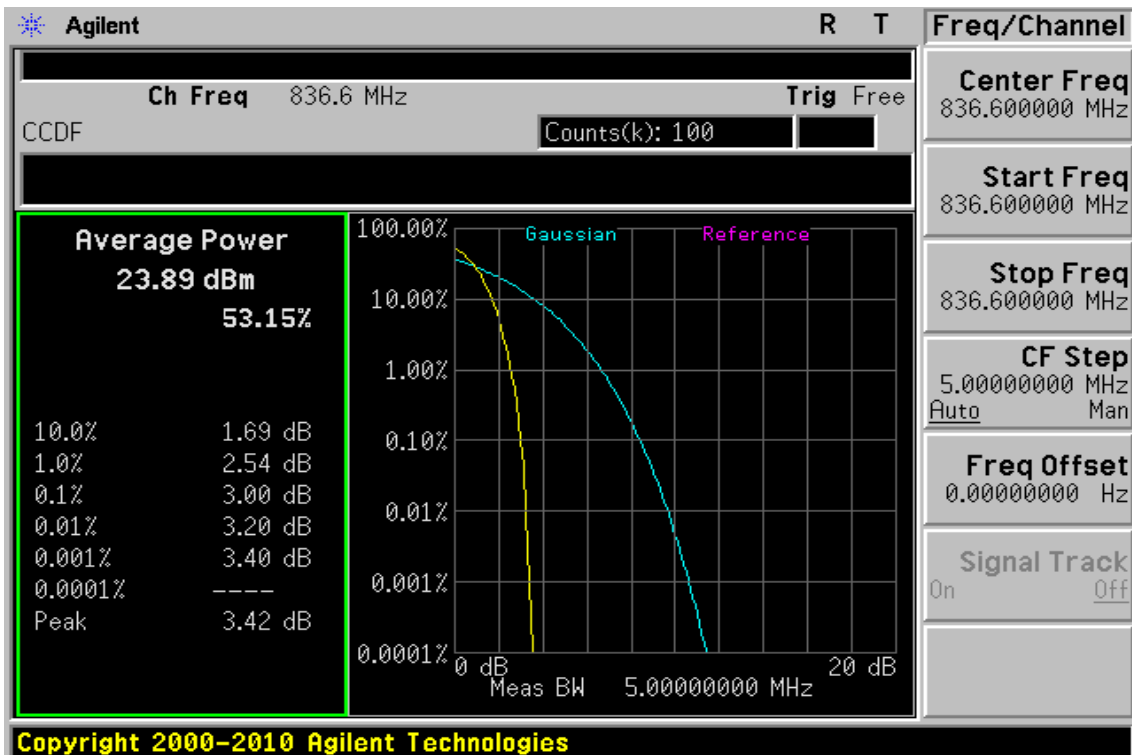

Figure 13-26: WCDMA Band V Channel Mid



Unless otherwise stated the results shown in this test report refer only to the sample(s) tested and such sample(s) are retained for 90 days only.

除非另有說明，此報告結果僅對測試之樣品負責，同時此樣品僅保留90天。本報告未經本公司書面許可，不可部份複製。

This document is issued by the Company subject to its General Conditions of Service printed overleaf, available on request or accessible at www.sgs.com/terms_and_conditions.htm and, for electronic format documents, subject to Terms and Conditions for Electronic Documents at www.sgs.com/terms_e-document.htm. Attention is drawn to the limitation of liability, indemnification and jurisdiction issues defined therein. Any holder of this document is advised that information contained hereon reflects the Company's findings at the time of its intervention only and within the limits of Client's instructions, if any. The Company's sole responsibility is to its Client and this document does not exonerate parties to a transaction from exercising all their rights and obligations under the transaction documents. This document cannot be reproduced except in full, without prior written approval of the Company. Any unauthorized alteration, forgery or falsification of the content or appearance of this document is unlawful and offenders may be prosecuted to the fullest extent of the law.

Figure 13-27: WCDMA Band V Channel High

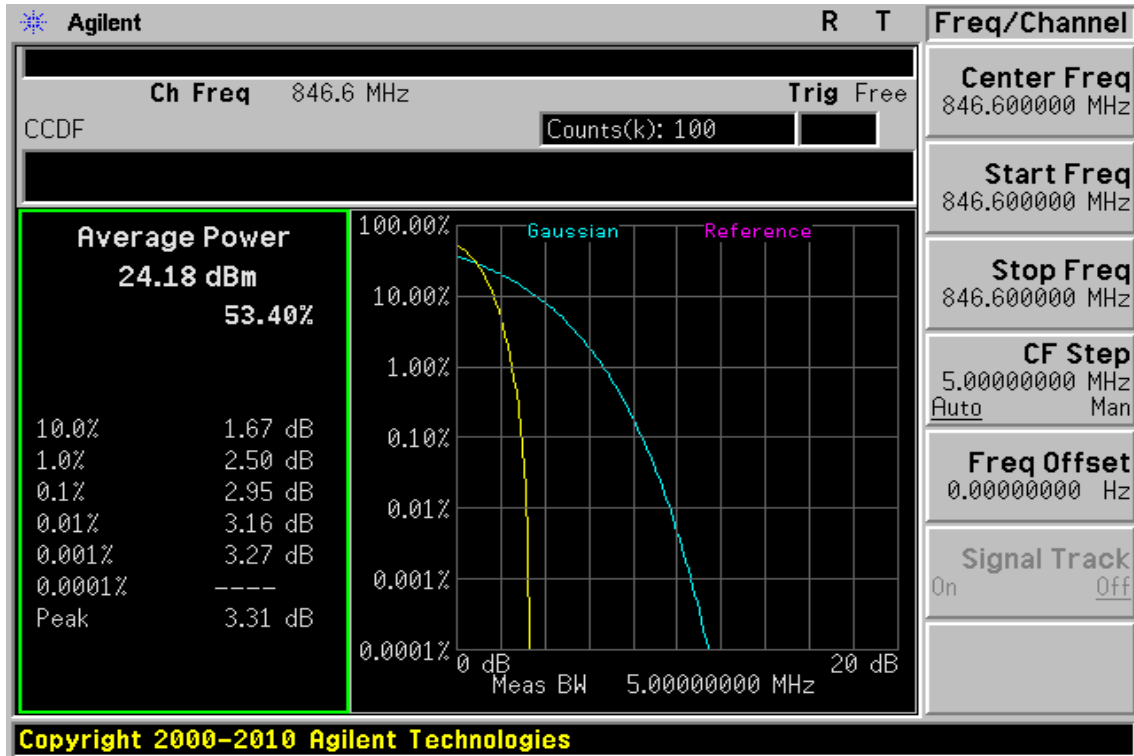
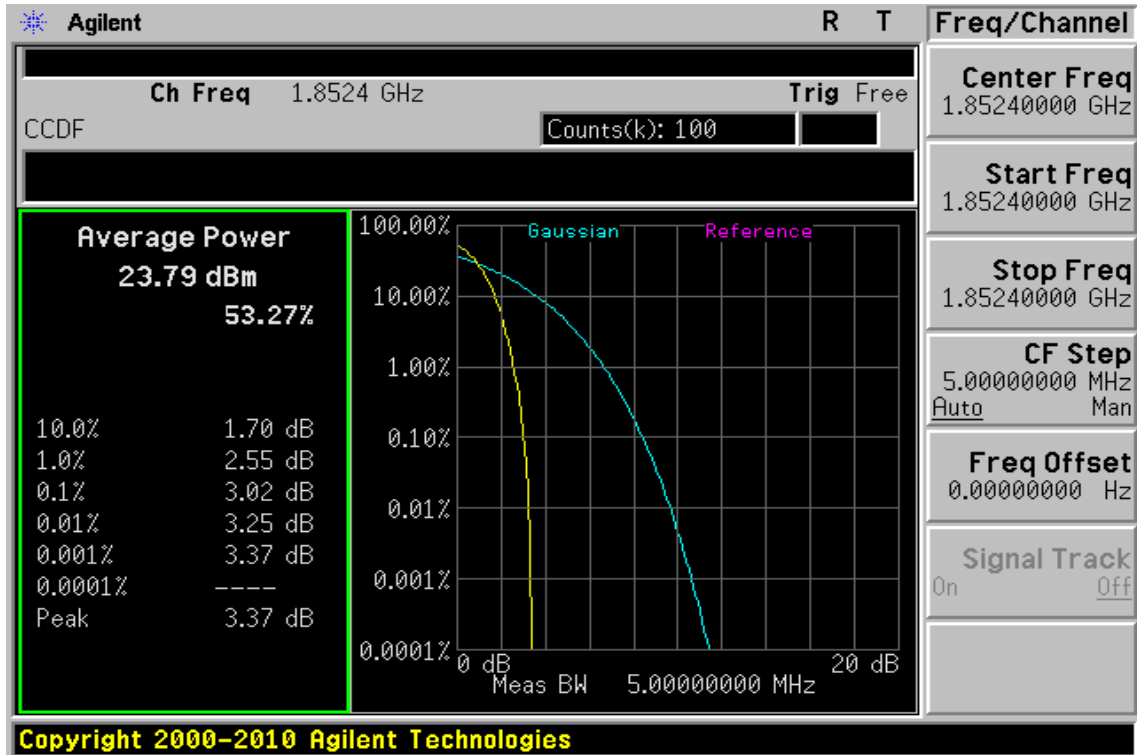

Figure 13-28: HSDPA Band II Channel Low



Unless otherwise stated the results shown in this test report refer only to the sample(s) tested and such sample(s) are retained for 90 days only.

除非另有說明，此報告結果僅對測試之樣品負責，同時此樣品僅保留90天。本報告未經本公司書面許可，不可部份複製。

This document is issued by the Company subject to its General Conditions of Service printed overleaf, available on request or accessible at www.sgs.com/terms_and_conditions.htm and, for electronic format documents, subject to Terms and Conditions for Electronic Documents at www.sgs.com/terms_e-document.htm. Attention is drawn to the limitation of liability, indemnification and jurisdiction issues defined therein. Any holder of this document is advised that information contained hereon reflects the Company's findings at the time of its intervention only and within the limits of Client's instructions, if any. The Company's sole responsibility is to its Client and this document does not exonerate parties to a transaction from exercising all their rights and obligations under the transaction documents. This document cannot be reproduced except in full, without prior written approval of the Company. Any unauthorized alteration, forgery or falsification of the content or appearance of this document is unlawful and offenders may be prosecuted to the fullest extent of the law.

Figure 13-29: HSDPA Band II Channel Mid

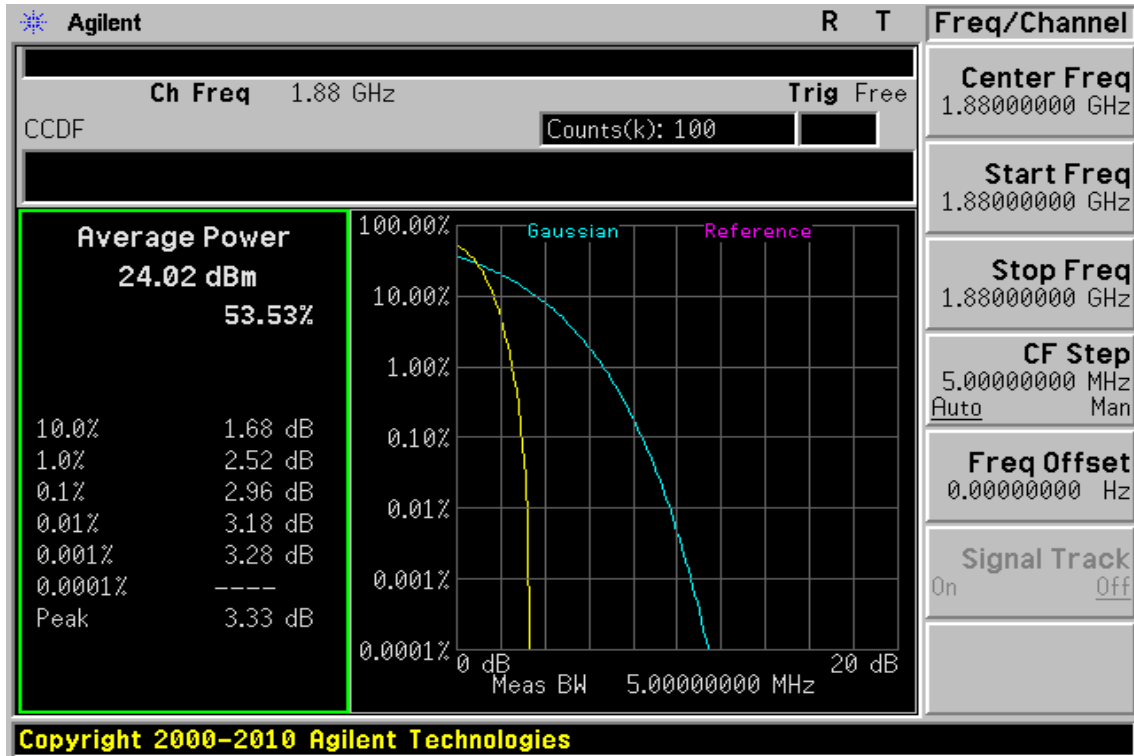
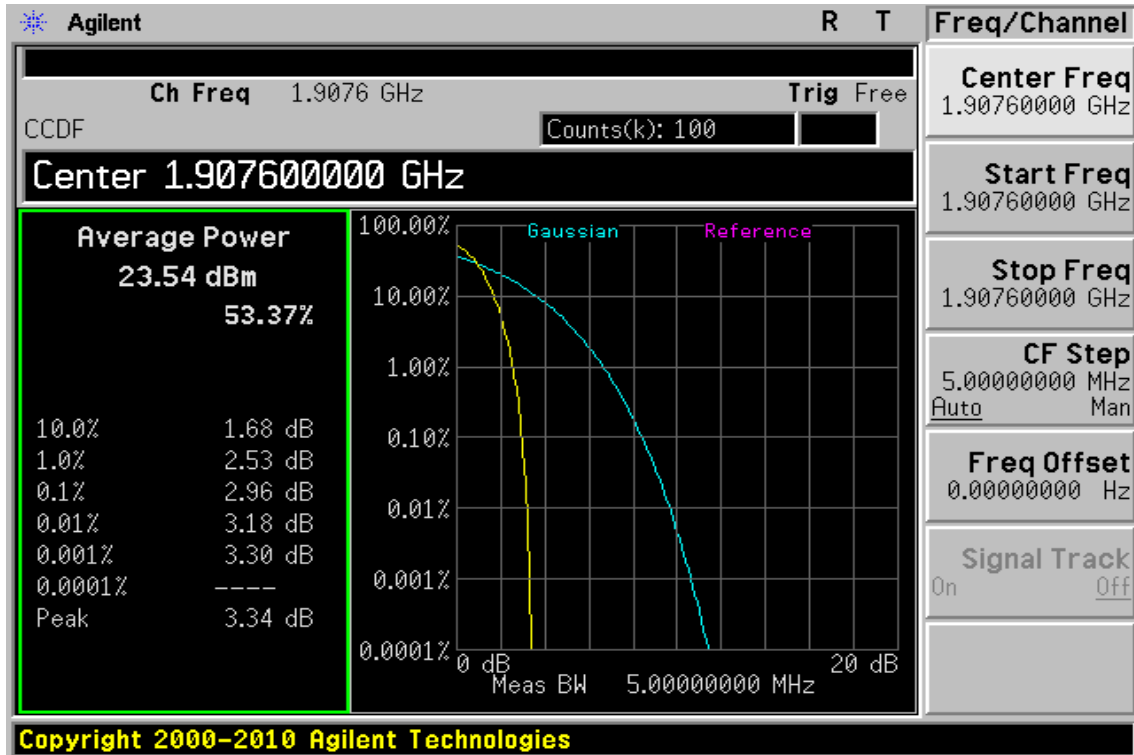

Figure 13-30: HSDPA Band II Channel High



Unless otherwise stated the results shown in this test report refer only to the sample(s) tested and such sample(s) are retained for 90 days only.

除非另有說明，此報告結果僅對測試之樣品負責，同時此樣品僅保留90天。本報告未經本公司書面許可，不可部份複製。

This document is issued by the Company subject to its General Conditions of Service printed overleaf, available on request or accessible at www.sgs.com/terms_and_conditions.htm and, for electronic format documents, subject to Terms and Conditions for Electronic Documents at www.sgs.com/terms_e-document.htm. Attention is drawn to the limitation of liability, indemnification and jurisdiction issues defined therein. Any holder of this document is advised that information contained hereon reflects the Company's findings at the time of its intervention only and within the limits of Client's instructions, if any. The Company's sole responsibility is to its Client and this document does not exonerate parties to a transaction from exercising all their rights and obligations under the transaction documents. This document cannot be reproduced except in full, without prior written approval of the Company. Any unauthorized alteration, forgery or falsification of the content or appearance of this document is unlawful and offenders may be prosecuted to the fullest extent of the law.

Figure 13-31: HSDPA Band IV Channel Low

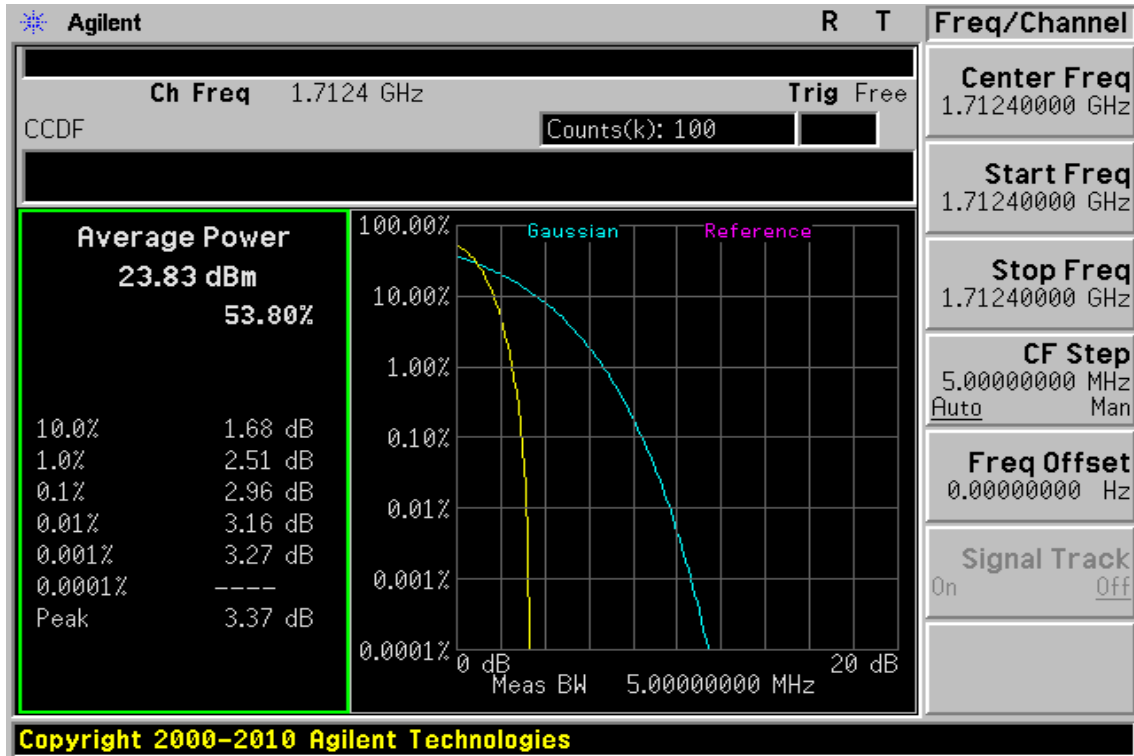
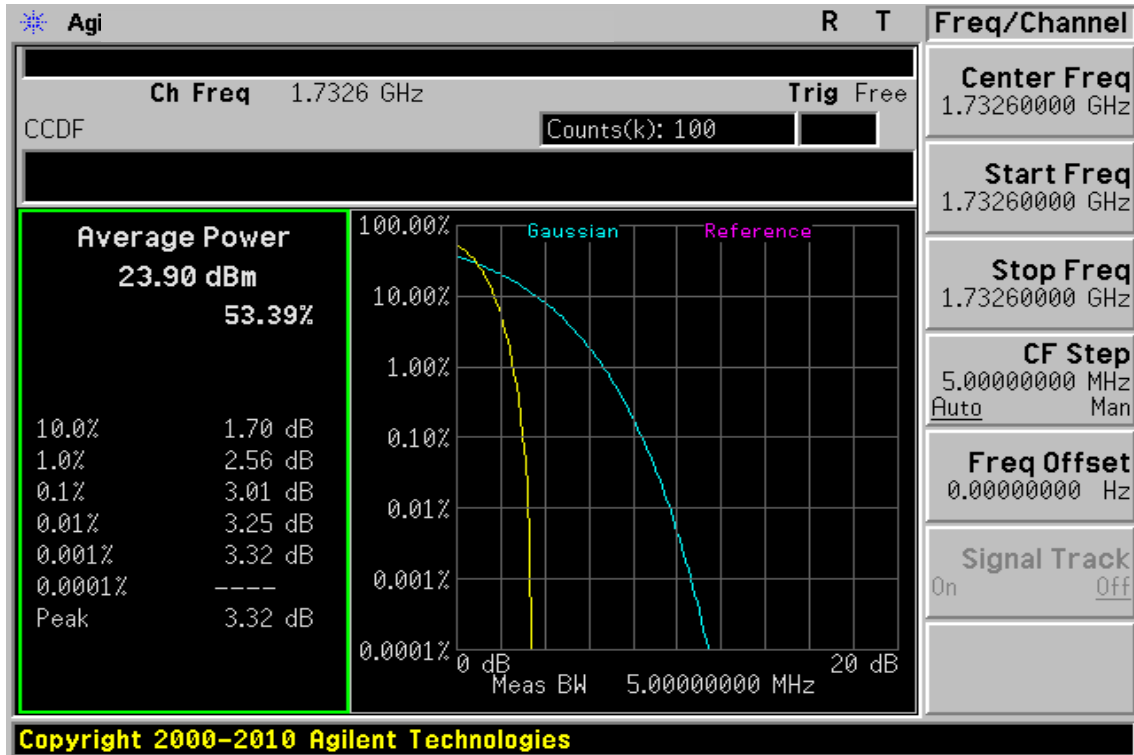

Figure 13-32: HSDPA Band IV Channel Mid



Unless otherwise stated the results shown in this test report refer only to the sample(s) tested and such sample(s) are retained for 90 days only.

除非另有說明，此報告結果僅對測試之樣品負責，同時此樣品僅保留90天。本報告未經本公司書面許可，不可部份複製。

This document is issued by the Company subject to its General Conditions of Service printed overleaf, available on request or accessible at www.sgs.com/terms_and_conditions.htm and, for electronic format documents, subject to Terms and Conditions for Electronic Documents at www.sgs.com/terms_e-document.htm. Attention is drawn to the limitation of liability, indemnification and jurisdiction issues defined therein. Any holder of this document is advised that information contained hereon reflects the Company's findings at the time of its intervention only and within the limits of Client's instructions, if any. The Company's sole responsibility is to its Client and this document does not exonerate parties to a transaction from exercising all their rights and obligations under the transaction documents. This document cannot be reproduced except in full, without prior written approval of the Company. Any unauthorized alteration, forgery or falsification of the content or appearance of this document is unlawful and offenders may be prosecuted to the fullest extent of the law.

Figure 13-33: HSDPA Band IV Channel High

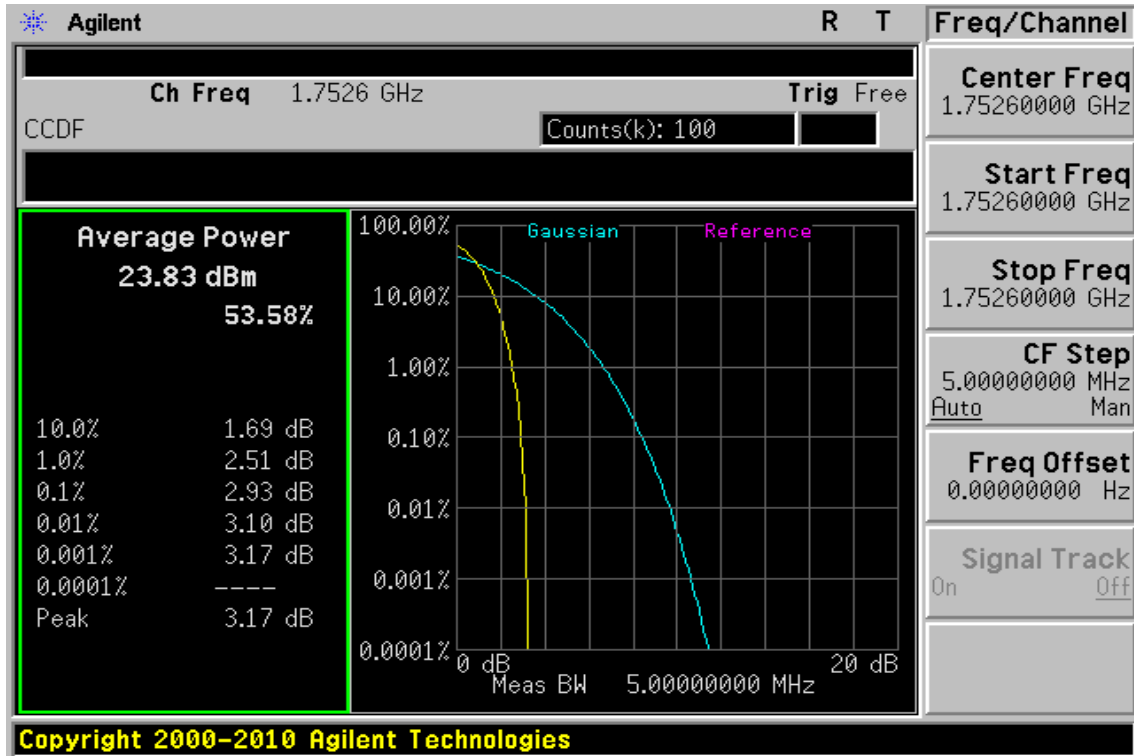
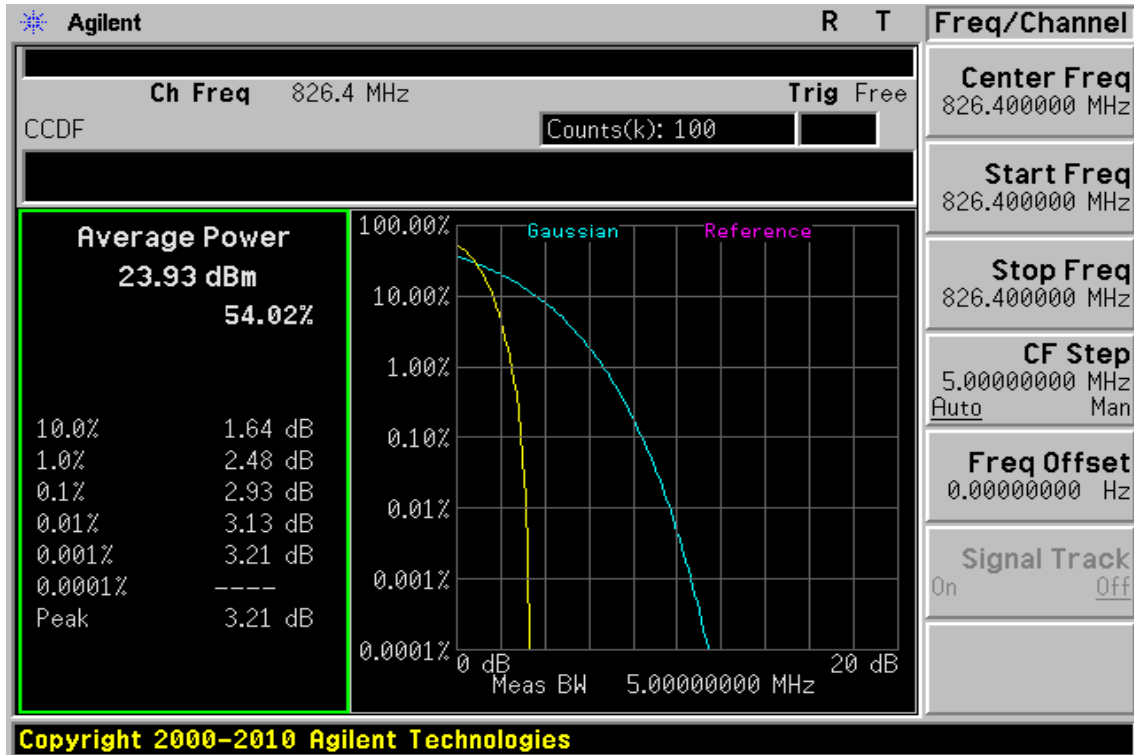

Figure 13-34: HSDPA Band V Channel Low



Unless otherwise stated the results shown in this test report refer only to the sample(s) tested and such sample(s) are retained for 90 days only.

除非另有說明，此報告結果僅對測試之樣品負責，同時此樣品僅保留90天。本報告未經本公司書面許可，不可部份複製。

This document is issued by the Company subject to its General Conditions of Service printed overleaf, available on request or accessible at www.sgs.com/terms_and_conditions.htm and, for electronic format documents, subject to Terms and Conditions for Electronic Documents at www.sgs.com/terms_e-document.htm. Attention is drawn to the limitation of liability, indemnification and jurisdiction issues defined therein. Any holder of this document is advised that information contained hereon reflects the Company's findings at the time of its intervention only and within the limits of Client's instructions, if any. The Company's sole responsibility is to its Client and this document does not exonerate parties to a transaction from exercising all their rights and obligations under the transaction documents. This document cannot be reproduced except in full, without prior written approval of the Company. Any unauthorized alteration, forgery or falsification of the content or appearance of this document is unlawful and offenders may be prosecuted to the fullest extent of the law.

Figure 13-35: HSDPA Band V Channel Mid

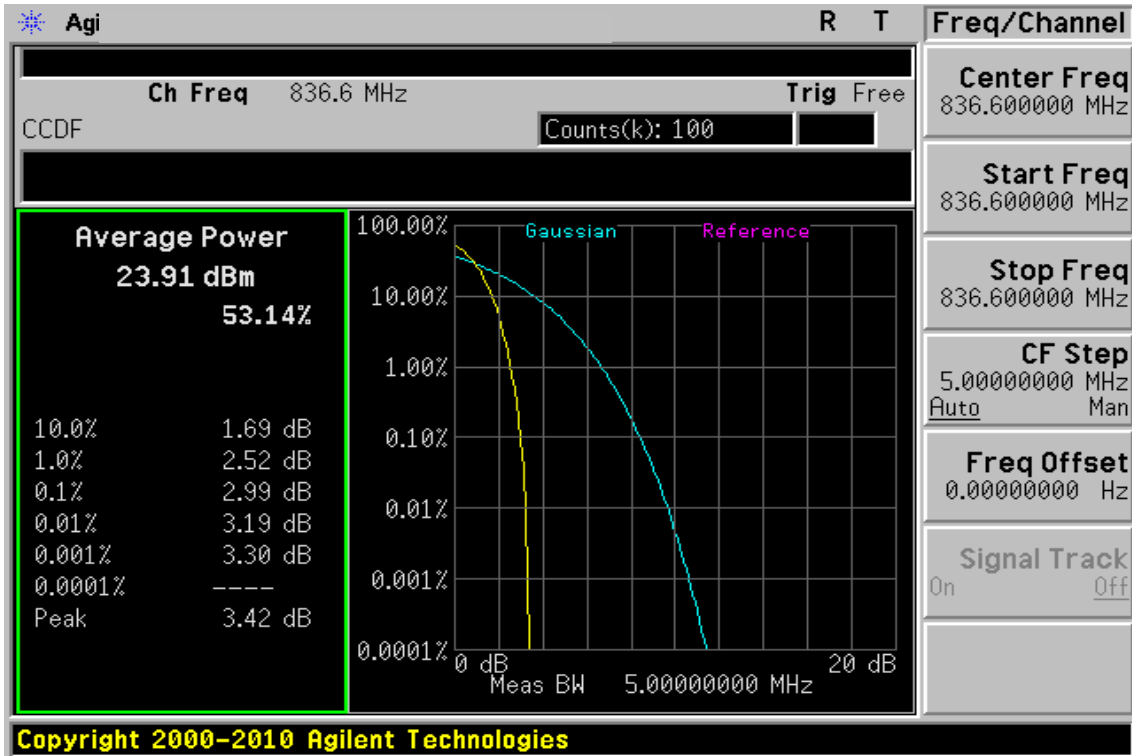
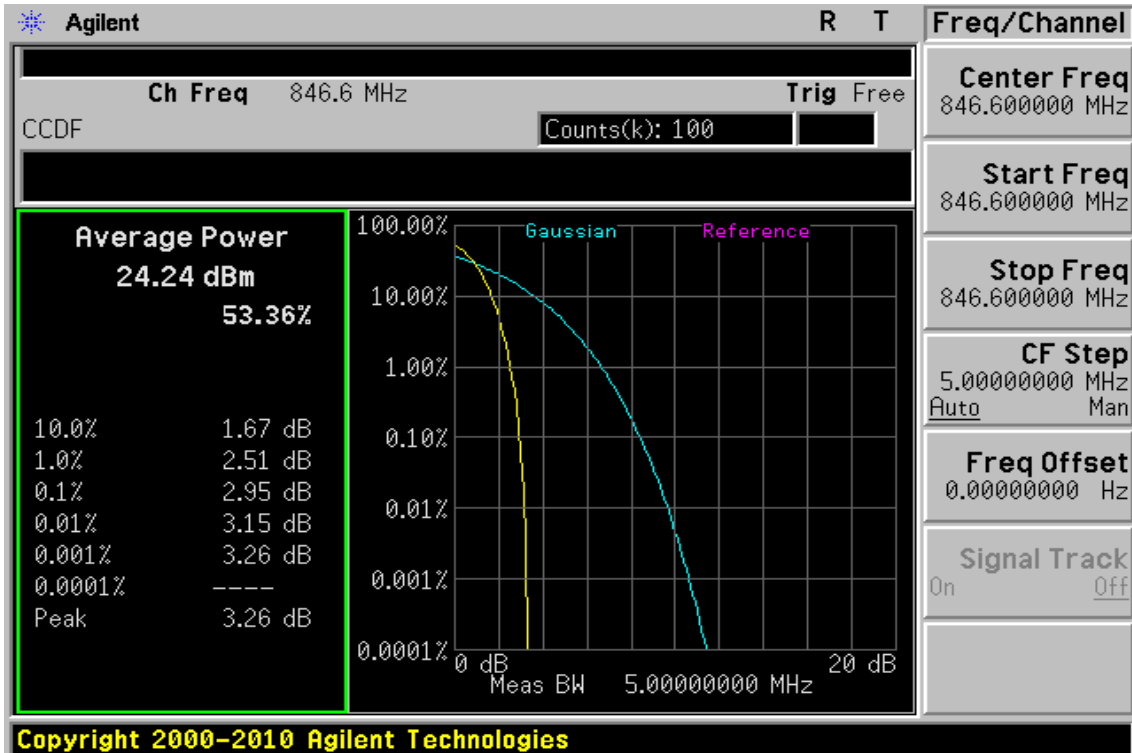

Figure 13-36: HSDPA Band V Channel High



Unless otherwise stated the results shown in this test report refer only to the sample(s) tested and such sample(s) are retained for 90 days only.

除非另有說明，此報告結果僅對測試之樣品負責，同時此樣品僅保留90天。本報告未經本公司書面許可，不可部份複製。

This document is issued by the Company subject to its General Conditions of Service printed overleaf, available on request or accessible at www.sgs.com/terms_and_conditions.htm and, for electronic format documents, subject to Terms and Conditions for Electronic Documents at www.sgs.com/terms_e-document.htm. Attention is drawn to the limitation of liability, indemnification and jurisdiction issues defined therein. Any holder of this document is advised that information contained hereon reflects the Company's findings at the time of its intervention only and within the limits of Client's instructions, if any. The Company's sole responsibility is to its Client and this document does not exonerate parties to a transaction from exercising all their rights and obligations under the transaction documents. This document cannot be reproduced except in full, without prior written approval of the Company. Any unauthorized alteration, forgery or falsification of the content or appearance of this document is unlawful and offenders may be prosecuted to the fullest extent of the law.

Figure 13-37: HSUPA Band II Channel Low

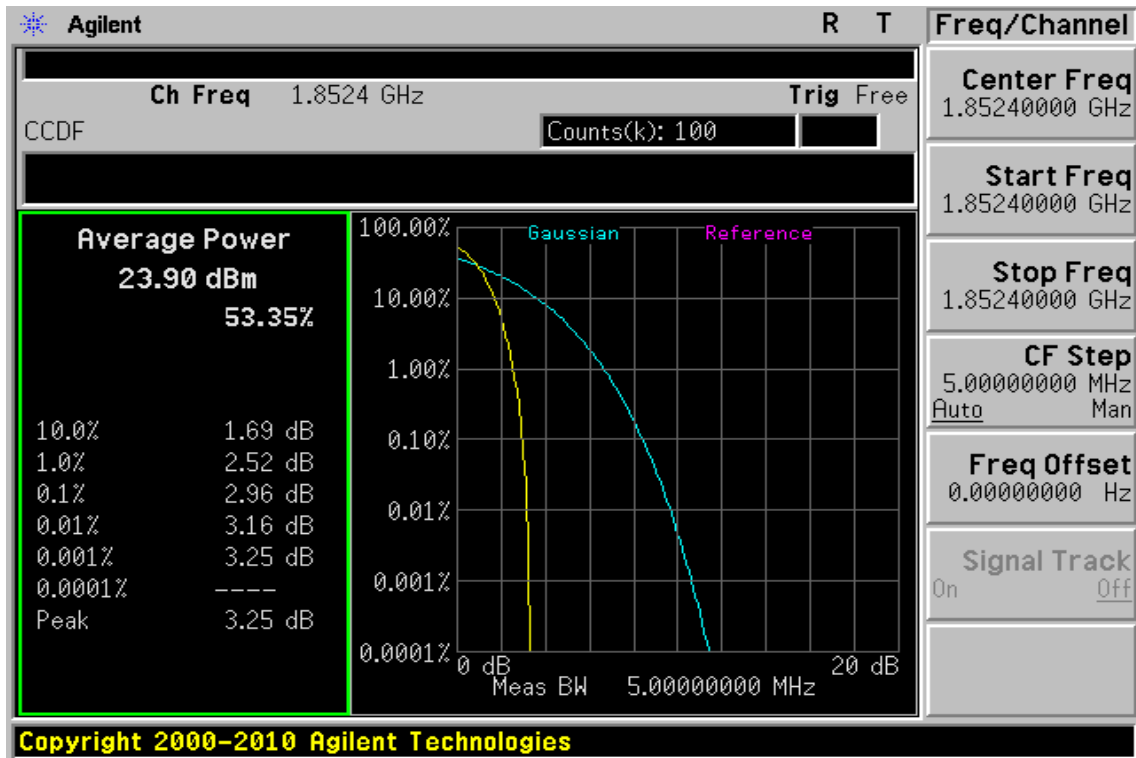
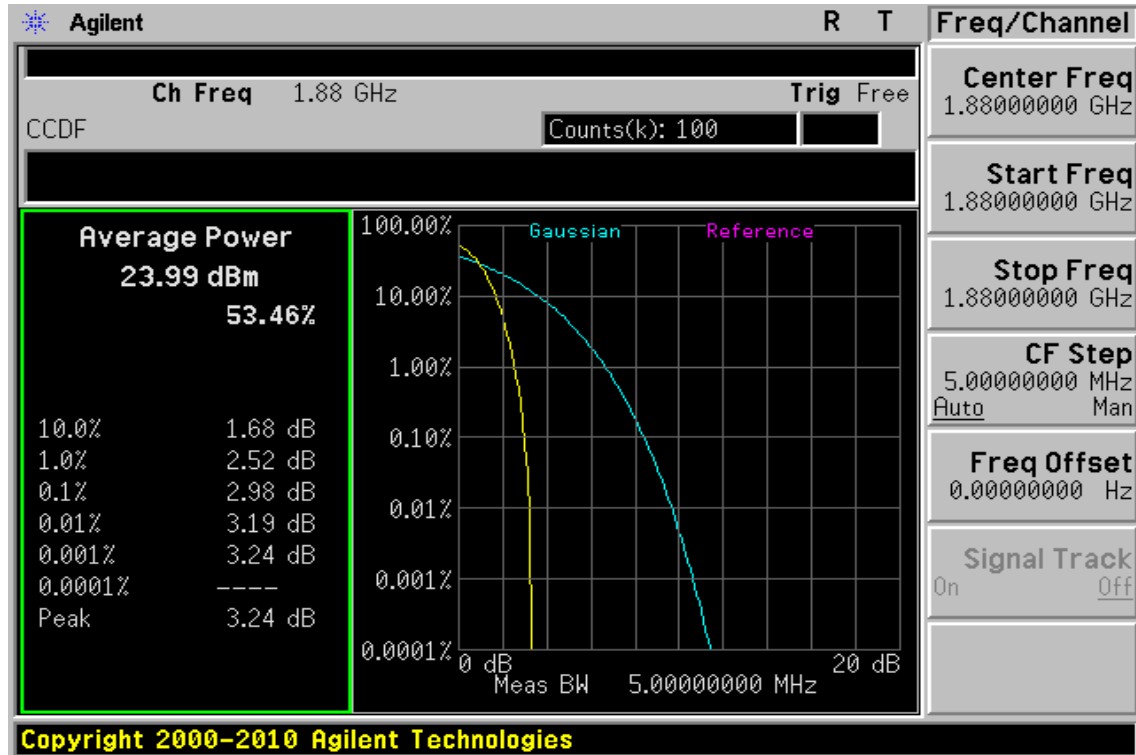

Figure 13-38: HSUPA Band II Channel Mid



Unless otherwise stated the results shown in this test report refer only to the sample(s) tested and such sample(s) are retained for 90 days only.

除非另有說明，此報告結果僅對測試之樣品負責，同時此樣品僅保留90天。本報告未經本公司書面許可，不可部份複製。

This document is issued by the Company subject to its General Conditions of Service printed overleaf, available on request or accessible at www.sgs.com/terms_and_conditions.htm and, for electronic format documents, subject to Terms and Conditions for Electronic Documents at www.sgs.com/terms_e-document.htm. Attention is drawn to the limitation of liability, indemnification and jurisdiction issues defined therein. Any holder of this document is advised that information contained hereon reflects the Company's findings at the time of its intervention only and within the limits of Client's instructions, if any. The Company's sole responsibility is to its Client and this document does not exonerate parties to a transaction from exercising all their rights and obligations under the transaction documents. This document cannot be reproduced except in full, without prior written approval of the Company. Any unauthorized alteration, forgery or falsification of the content or appearance of this document is unlawful and offenders may be prosecuted to the fullest extent of the law.

Figure 13-39: HSUPA Band II Channel High

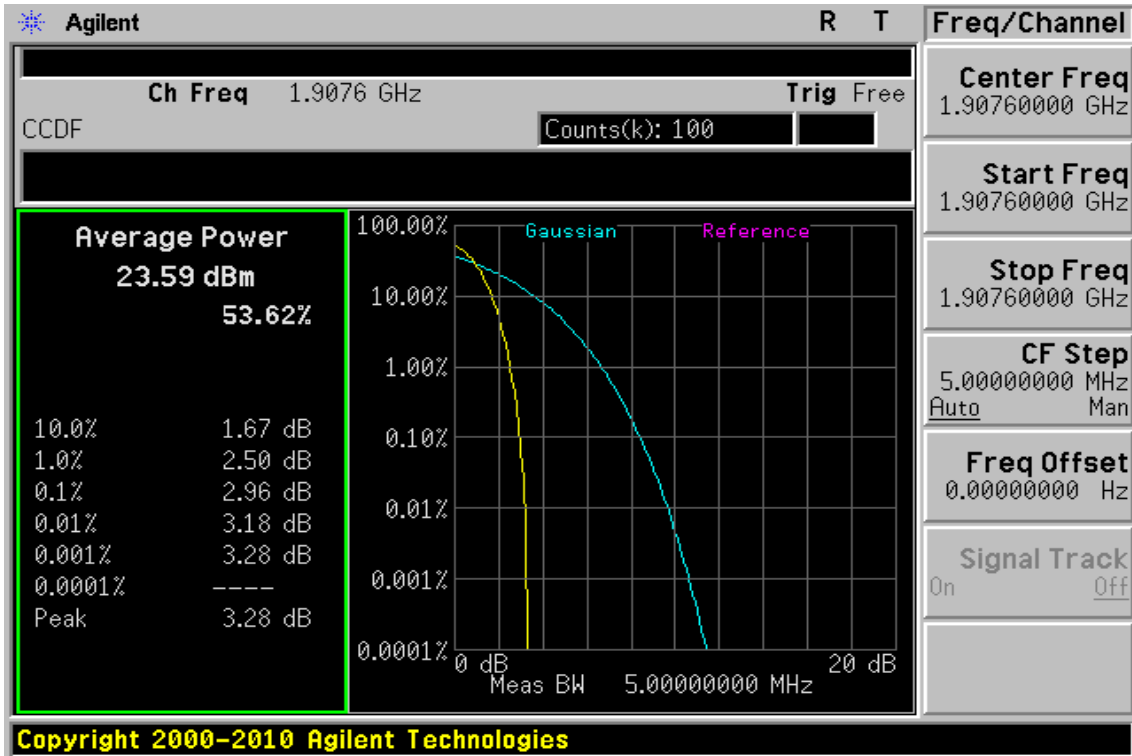
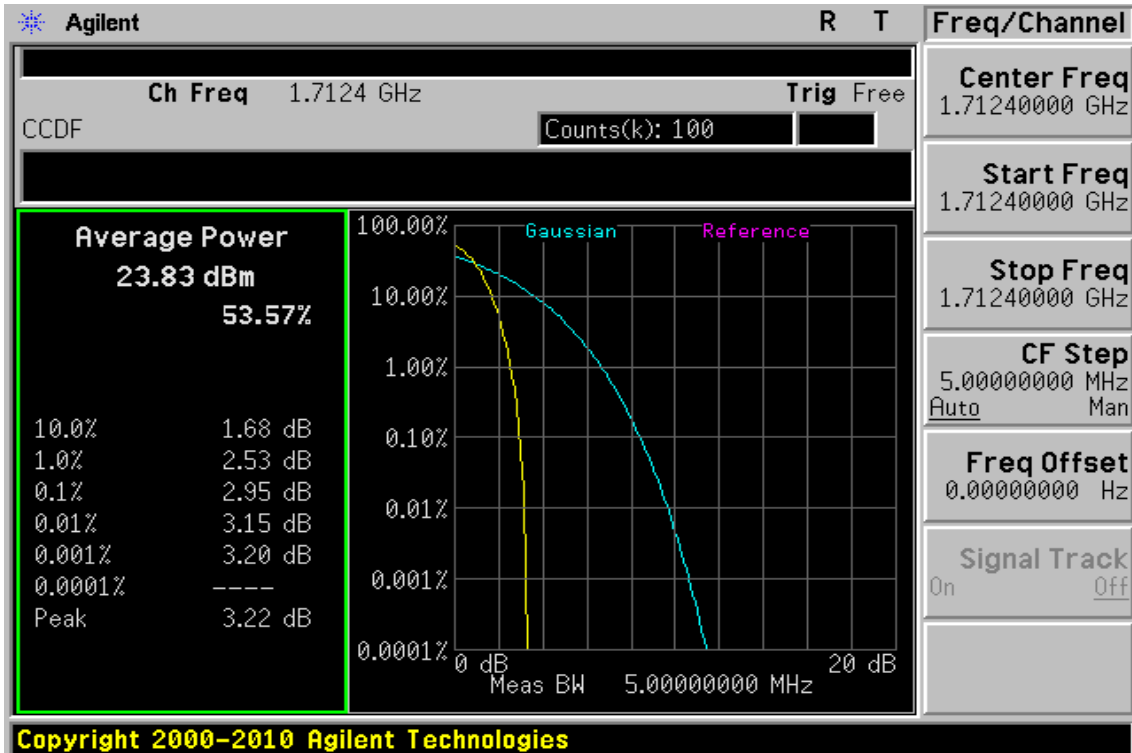

Figure 13-40: HSUPA Band IV Channel Low



Unless otherwise stated the results shown in this test report refer only to the sample(s) tested and such sample(s) are retained for 90 days only.

除非另有說明，此報告結果僅對測試之樣品負責，同時此樣品僅保留90天。本報告未經本公司書面許可，不可部份複製。

This document is issued by the Company subject to its General Conditions of Service printed overleaf, available on request or accessible at www.sgs.com/terms_and_conditions.htm and, for electronic format documents, subject to Terms and Conditions for Electronic Documents at www.sgs.com/terms_e-document.htm. Attention is drawn to the limitation of liability, indemnification and jurisdiction issues defined therein. Any holder of this document is advised that information contained hereon reflects the Company's findings at the time of its intervention only and within the limits of Client's instructions, if any. The Company's sole responsibility is to its Client and this document does not exonerate parties to a transaction from exercising all their rights and obligations under the transaction documents. This document cannot be reproduced except in full, without prior written approval of the Company. Any unauthorized alteration, forgery or falsification of the content or appearance of this document is unlawful and offenders may be prosecuted to the fullest extent of the law.

Figure 13-41: HSUPA Band IV Channel Mid

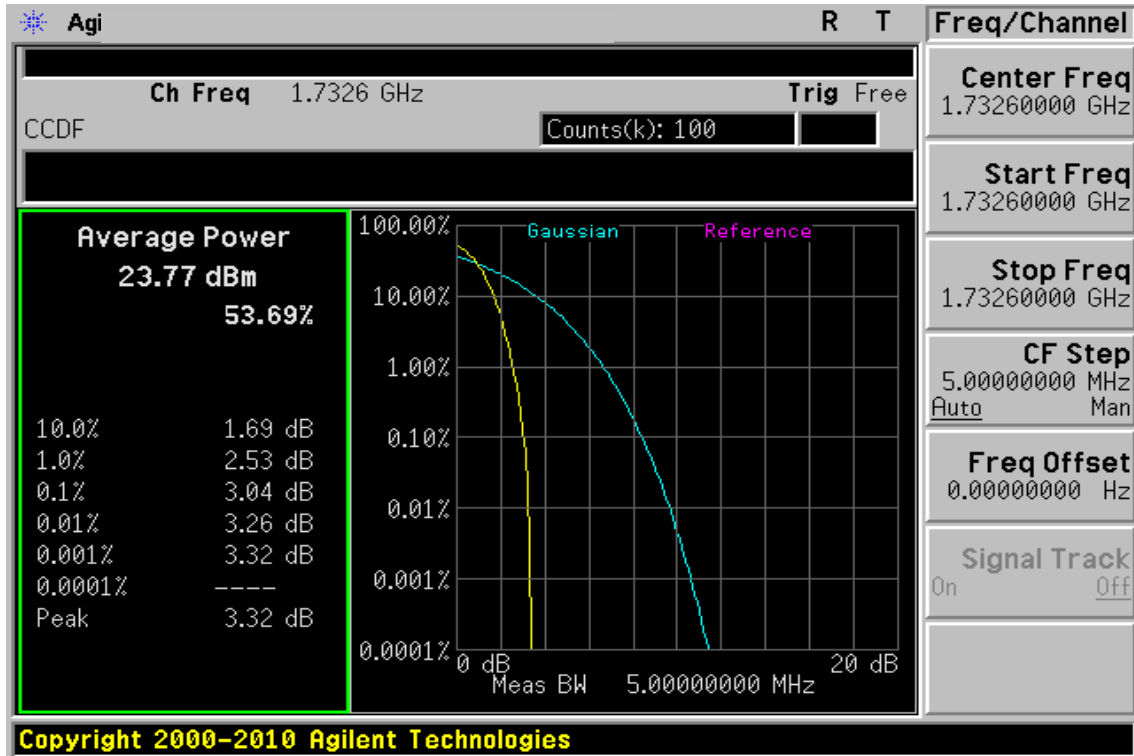
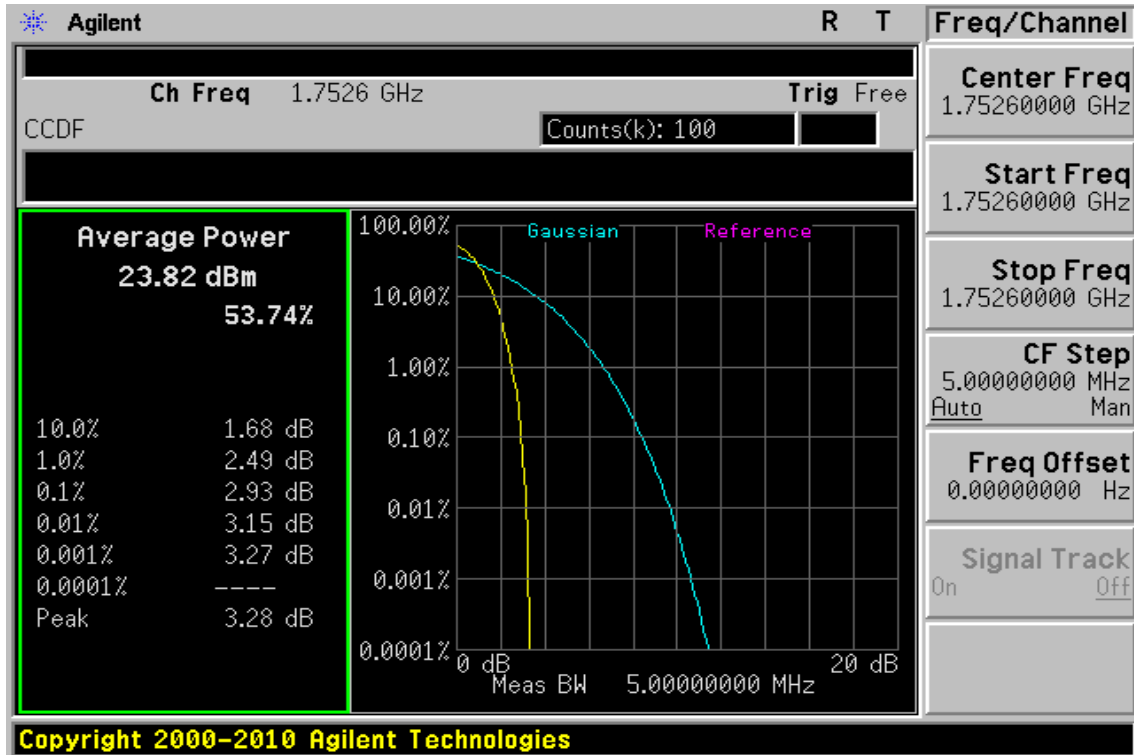

Figure 13-42: HSUPA Band IV Channel High



Unless otherwise stated the results shown in this test report refer only to the sample(s) tested and such sample(s) are retained for 90 days only.

除非另有說明，此報告結果僅對測試之樣品負責，同時此樣品僅保留90天。本報告未經本公司書面許可，不可部份複製。

This document is issued by the Company subject to its General Conditions of Service printed overleaf, available on request or accessible at www.sgs.com/terms_and_conditions.htm and, for electronic format documents, subject to Terms and Conditions for Electronic Documents at www.sgs.com/terms_e-document.htm. Attention is drawn to the limitation of liability, indemnification and jurisdiction issues defined therein. Any holder of this document is advised that information contained hereon reflects the Company's findings at the time of its intervention only and within the limits of Client's instructions, if any. The Company's sole responsibility is to its Client and this document does not exonerate parties to a transaction from exercising all their rights and obligations under the transaction documents. This document cannot be reproduced except in full, without prior written approval of the Company. Any unauthorized alteration, forgery or falsification of the content or appearance of this document is unlawful and offenders may be prosecuted to the fullest extent of the law.

Figure 13-43: HSUPA Band V Channel Low

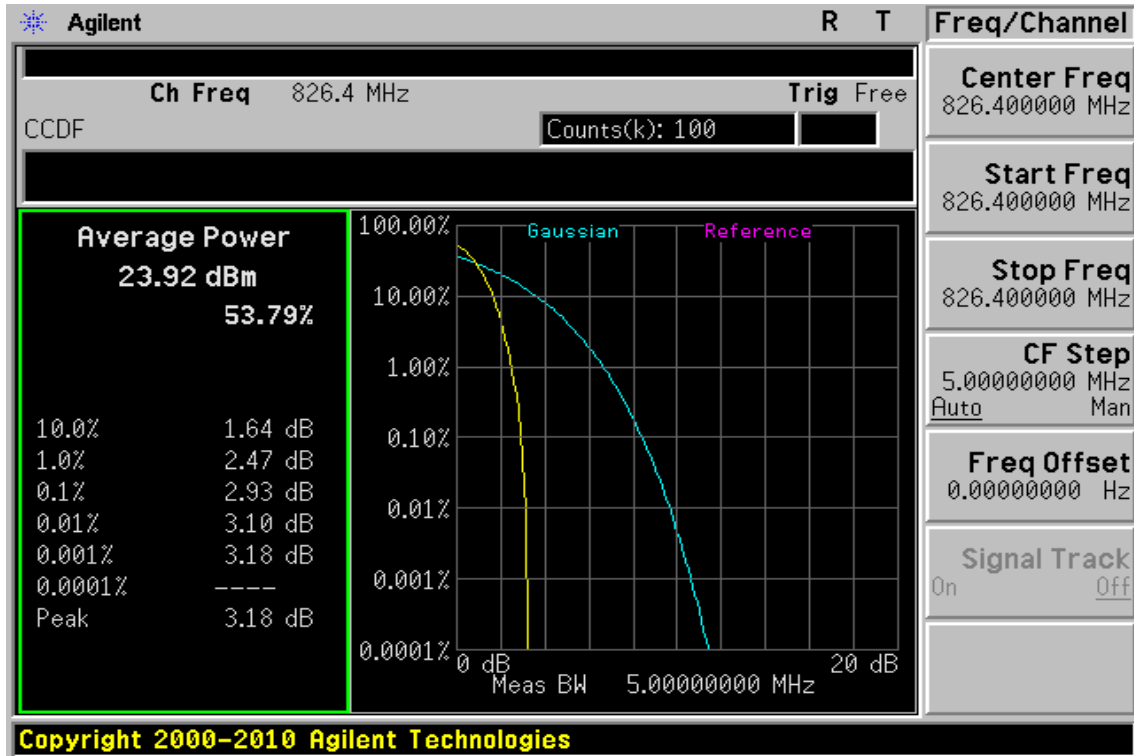
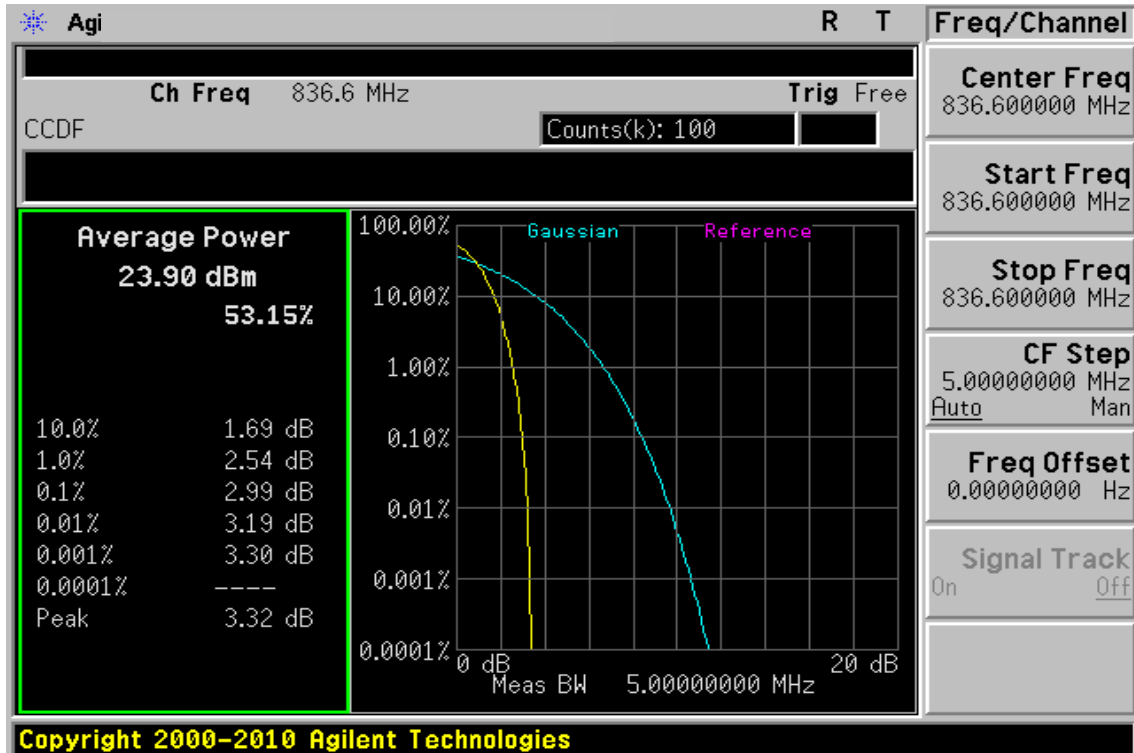

Figure 13-44: HSUPA Band V Channel Mid



Unless otherwise stated the results shown in this test report refer only to the sample(s) tested and such sample(s) are retained for 90 days only.

除非另有說明，此報告結果僅對測試之樣品負責，同時此樣品僅保留90天。本報告未經本公司書面許可，不可部份複製。

This document is issued by the Company subject to its General Conditions of Service printed overleaf, available on request or accessible at www.sgs.com/terms_and_conditions.htm and, for electronic format documents, subject to Terms and Conditions for Electronic Documents at www.sgs.com/terms_e-document.htm. Attention is drawn to the limitation of liability, indemnification and jurisdiction issues defined therein. Any holder of this document is advised that information contained hereon reflects the Company's findings at the time of its intervention only and within the limits of Client's instructions, if any. The Company's sole responsibility is to its Client and this document does not exonerate parties to a transaction from exercising all their rights and obligations under the transaction documents. This document cannot be reproduced except in full, without prior written approval of the Company. Any unauthorized alteration, forgery or falsification of the content or appearance of this document is unlawful and offenders may be prosecuted to the fullest extent of the law.

Figure 13-45: HSUPA Band V Channel High

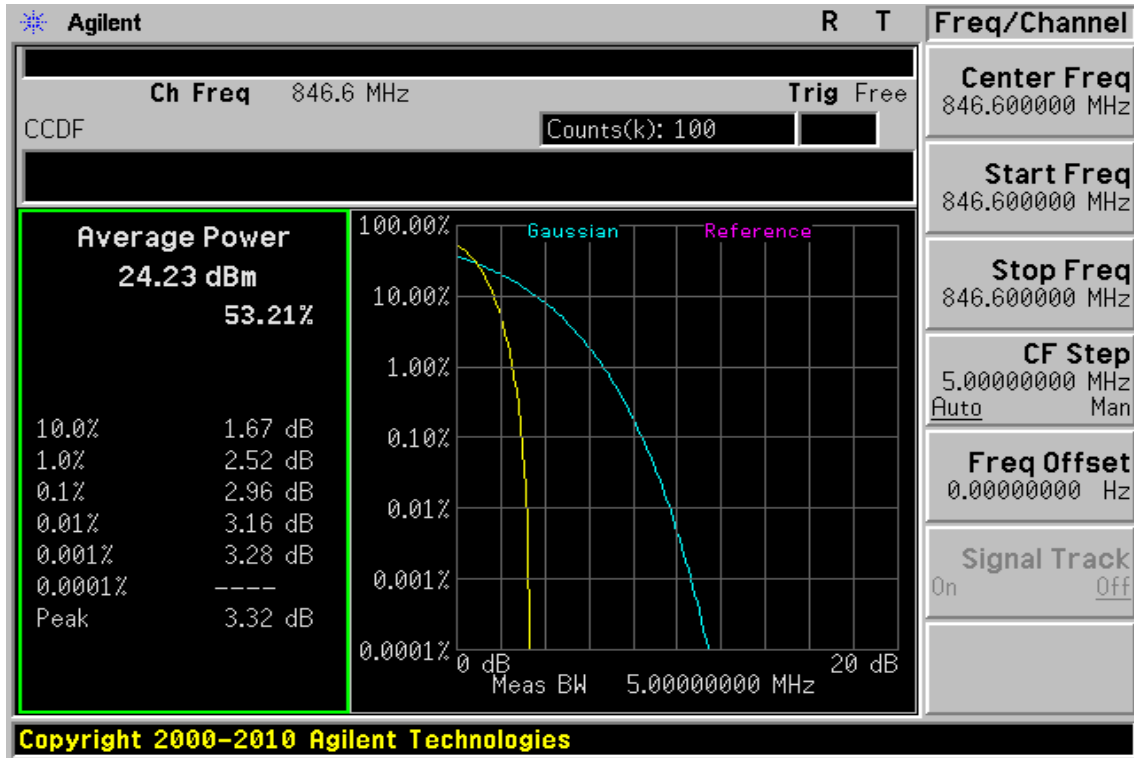

Unless otherwise stated the results shown in this test report refer only to the sample(s) tested and such sample(s) are retained for 90 days only.

除非另有說明，此報告結果僅對測試之樣品負責，同時此樣品僅保留90天。本報告未經本公司書面許可，不可部份複製。

This document is issued by the Company subject to its General Conditions of Service printed overleaf, available on request or accessible at www.sgs.com/terms_and_conditions.htm and, for electronic format documents, subject to Terms and Conditions for Electronic Documents at www.sgs.com/terms_e-document.htm. Attention is drawn to the limitation of liability, indemnification and jurisdiction issues defined therein. Any holder of this document is advised that information contained hereon reflects the Company's findings at the time of its intervention only and within the limits of Client's instructions, if any. The Company's sole responsibility is to its Client and this document does not exonerate parties to a transaction from exercising all their rights and obligations under the transaction documents. This document cannot be reproduced except in full, without prior written approval of the Company. Any unauthorized alteration, forgery or falsification of the content or appearance of this document is unlawful and offenders may be prosecuted to the fullest extent of the law.



APPENDIX 1

MEASUREMENT PLOT OF RADIATED SPURIOUS EMISSION

Unless otherwise stated the results shown in this test report refer only to the sample(s) tested and such sample(s) are retained for 90 days only.

除非另有說明，此報告結果僅對測試之樣品負責，同時此樣品僅保留90天。本報告未經本公司書面許可，不可部份複製。

This document is issued by the Company subject to its General Conditions of Service printed overleaf, available on request or accessible at www.sgs.com/terms_and_conditions.htm and, for electronic format documents, subject to Terms and Conditions for Electronic Documents at www.sgs.com/terms_e-document.htm. Attention is drawn to the limitation of liability, indemnification and jurisdiction issues defined therein. Any holder of this document is advised that information contained hereon reflects the Company's findings at the time of its intervention only and within the limits of Client's instructions, if any. The Company's sole responsibility is to its Client and this document does not exonerate parties to a transaction from exercising all their rights and obligations under the transaction documents. This document cannot be reproduced except in full, without prior written approval of the Company. Any unauthorized alteration, forgery or falsification of the content or appearance of this document is unlawful and offenders may be prosecuted to the fullest extent of the law.

Radiated Spurious Emission Measurement Result: GSM 850 Mode

Operation Band	:GSM 850	Test Date	:2013-05-27
ARFCN	:CH 128	Temp./Humi.	:24.1 deg_C / 65 RH
Fundamental Frequency	:824.2 MHz	Engineer	:Allen
Operation Mode	:TX LOW		
EUT Pol.	:E2 Plan	Measurement Antenna Pol.	:VERTICAL

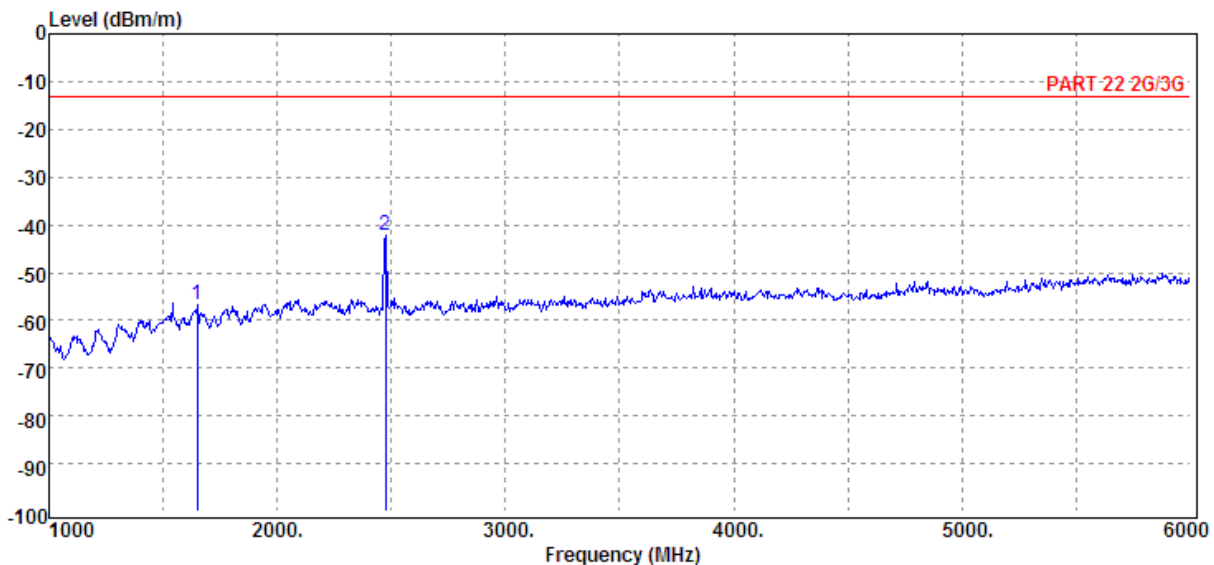
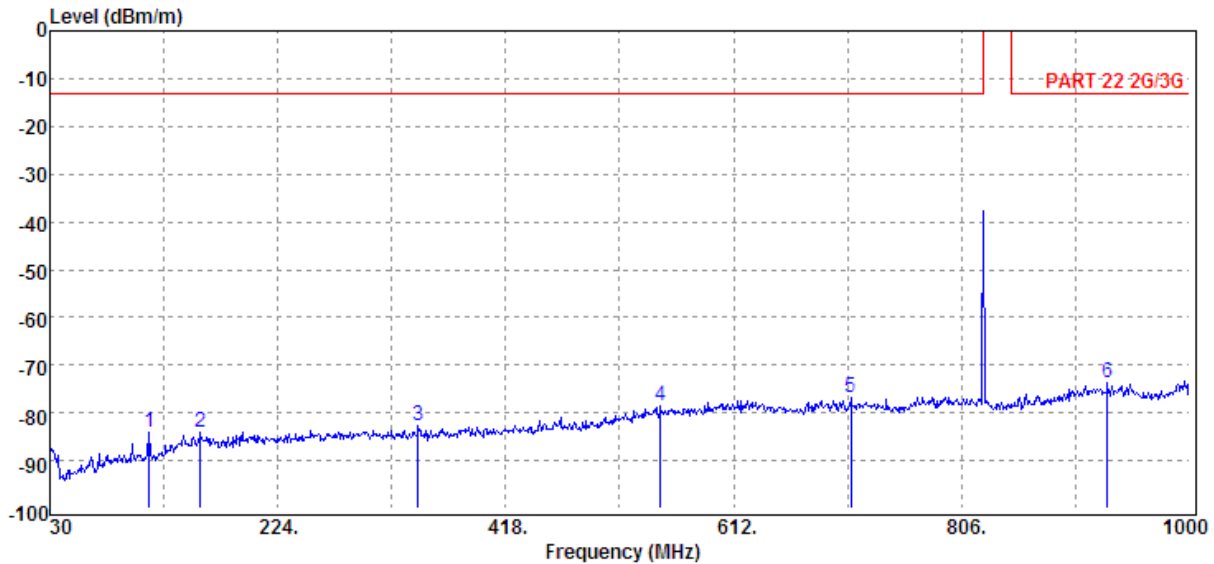

Unless otherwise stated the results shown in this test report refer only to the sample(s) tested and such sample(s) are retained for 90 days only.

除非另有說明，此報告結果僅對測試之樣品負責，同時此樣品僅保留90天。本報告未經本公司書面許可，不可部份複製。

This document is issued by the Company subject to its General Conditions of Service printed overleaf, available on request or accessible at www.sgs.com/terms_and_conditions.htm and, for electronic format documents, subject to Terms and Conditions for Electronic Documents at www.sgs.com/terms_e-document.htm. Attention is drawn to the limitation of liability, indemnification and jurisdiction issues defined therein. Any holder of this document is advised that information contained hereon reflects the Company's findings at the time of its intervention only and within the limits of Client's instructions, if any. The Company's sole responsibility is to its Client and this document does not exonerate parties to a transaction from exercising all their rights and obligations under the transaction documents. This document cannot be reproduced except in full, without prior written approval of the Company. Any unauthorized alteration, forgery or falsification of the content or appearance of this document is unlawful and offenders may be prosecuted to the fullest extent of the law.

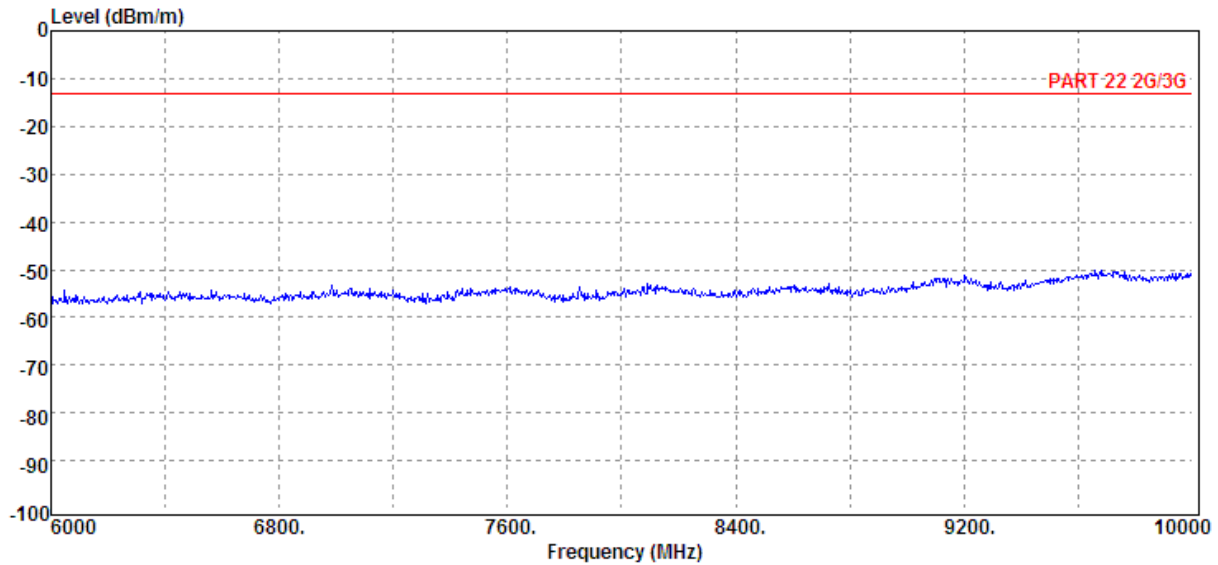

Unless otherwise stated the results shown in this test report refer only to the sample(s) tested and such sample(s) are retained for 90 days only.

除非另有說明，此報告結果僅對測試之樣品負責，同時此樣品僅保留90天。本報告未經本公司書面許可，不可部份複製。

This document is issued by the Company subject to its General Conditions of Service printed overleaf, available on request or accessible at www.sgs.com/terms_and_conditions.htm and, for electronic format documents, subject to Terms and Conditions for Electronic Documents at www.sgs.com/terms_e-document.htm. Attention is drawn to the limitation of liability, indemnification and jurisdiction issues defined therein. Any holder of this document is advised that information contained hereon reflects the Company's findings at the time of its intervention only and within the limits of Client's instructions, if any. The Company's sole responsibility is to its Client and this document does not exonerate parties to a transaction from exercising all their rights and obligations under the transaction documents. This document cannot be reproduced except in full, without prior written approval of the Company. Any unauthorized alteration, forgery or falsification of the content or appearance of this document is unlawful and offenders may be prosecuted to the fullest extent of the law.

Operation Band	: GSM 850	Test Date	: 2013-05-27
ARFCN	: CH 128	Temp./Humi.	: 24.1 deg_C / 65 RH
Fundamental Frequency	: 824.2 MHz	Engineer	: Allen
Operation Mode	: TX LOW		
EUT Pol.	: E2 Plan	Measurement Antenna Pol.	: HORIZONTAL

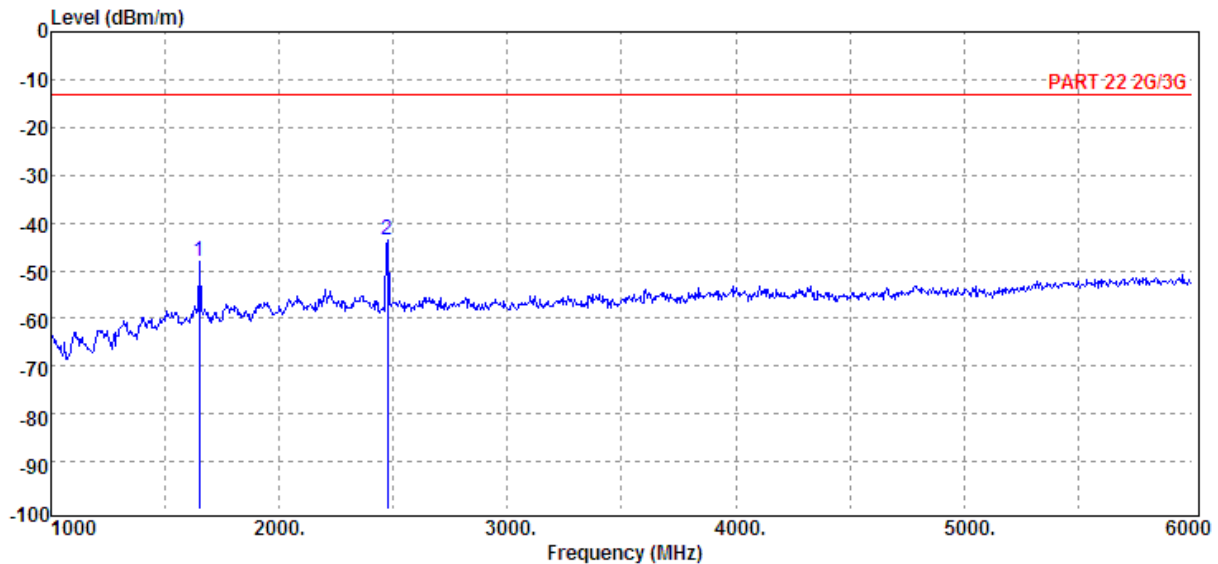
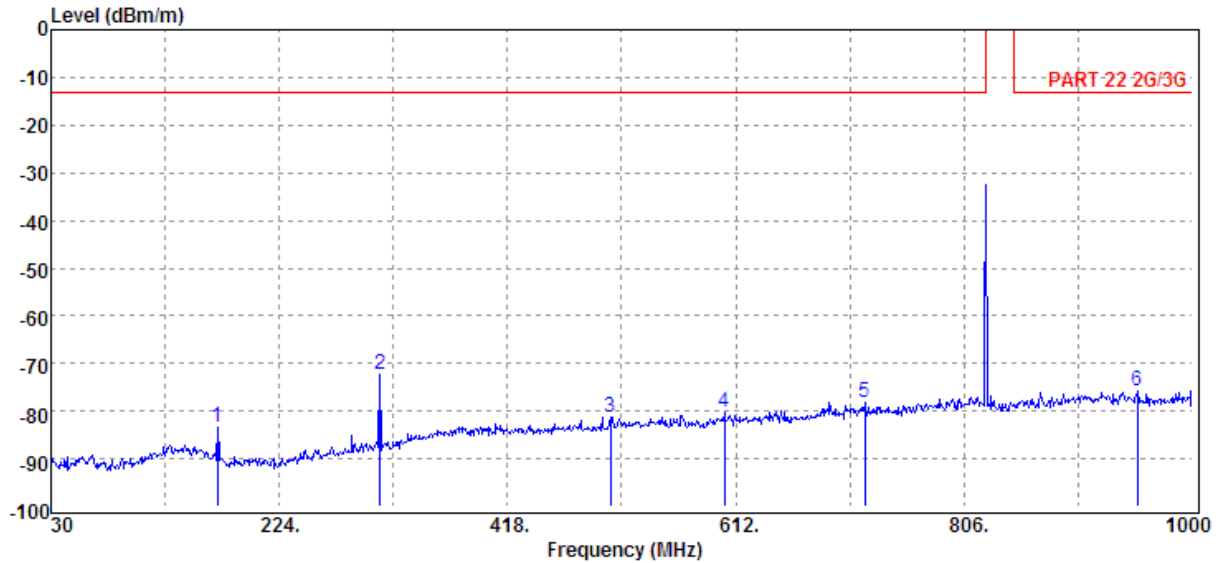

Unless otherwise stated the results shown in this test report refer only to the sample(s) tested and such sample(s) are retained for 90 days only.

除非另有說明，此報告結果僅對測試之樣品負責，同時此樣品僅保留90天。本報告未經本公司書面許可，不可部份複製。

This document is issued by the Company subject to its General Conditions of Service printed overleaf, available on request or accessible at www.sgs.com/terms_and_conditions.htm and, for electronic format documents, subject to Terms and Conditions for Electronic Documents at www.sgs.com/terms_e-document.htm. Attention is drawn to the limitation of liability, indemnification and jurisdiction issues defined therein. Any holder of this document is advised that information contained hereon reflects the Company's findings at the time of its intervention only and within the limits of Client's instructions, if any. The Company's sole responsibility is to its Client and this document does not exonerate parties to a transaction from exercising all their rights and obligations under the transaction documents. This document cannot be reproduced except in full, without prior written approval of the Company. Any unauthorized alteration, forgery or falsification of the content or appearance of this document is unlawful and offenders may be prosecuted to the fullest extent of the law.

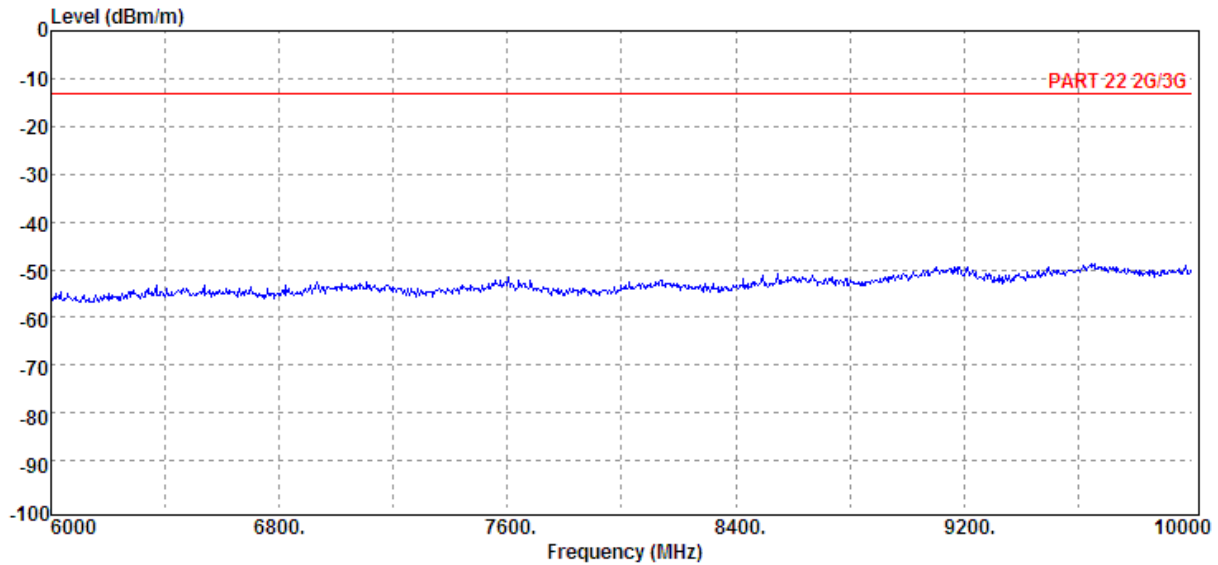

Unless otherwise stated the results shown in this test report refer only to the sample(s) tested and such sample(s) are retained for 90 days only.

除非另有說明，此報告結果僅對測試之樣品負責，同時此樣品僅保留90天。本報告未經本公司書面許可，不可部份複製。

This document is issued by the Company subject to its General Conditions of Service printed overleaf, available on request or accessible at www.sgs.com/terms_and_conditions.htm and, for electronic format documents, subject to Terms and Conditions for Electronic Documents at www.sgs.com/terms_e-document.htm. Attention is drawn to the limitation of liability, indemnification and jurisdiction issues defined therein. Any holder of this document is advised that information contained hereon reflects the Company's findings at the time of its intervention only and within the limits of Client's instructions, if any. The Company's sole responsibility is to its Client and this document does not exonerate parties to a transaction from exercising all their rights and obligations under the transaction documents. This document cannot be reproduced except in full, without prior written approval of the Company. Any unauthorized alteration, forgery or falsification of the content or appearance of this document is unlawful and offenders may be prosecuted to the fullest extent of the law.

Operation Band	:GSM 850	Test Date	:2013-05-27
ARFCN	:CH 190	Temp./Humi.	:24.1 deg_C / 65 RH
Fundamental Frequency	:836.6 MHz	Engineer	:Allen
Operation Mode	:TX MID	Measurement Antenna Pol.	:VERTICAL
EUT Pol.	:E2 Plan		

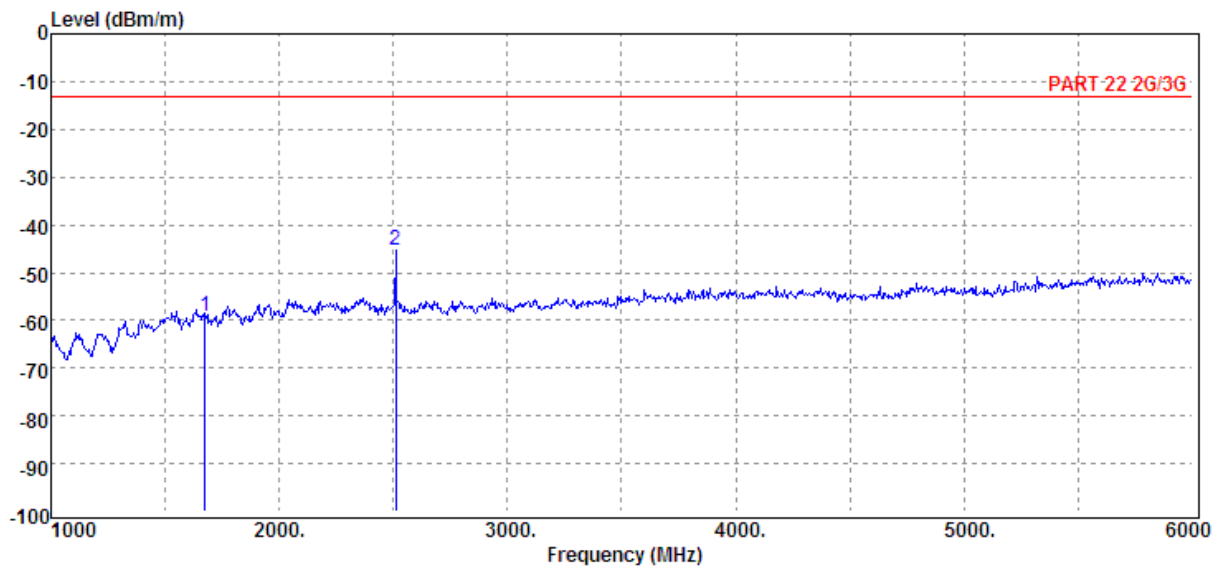
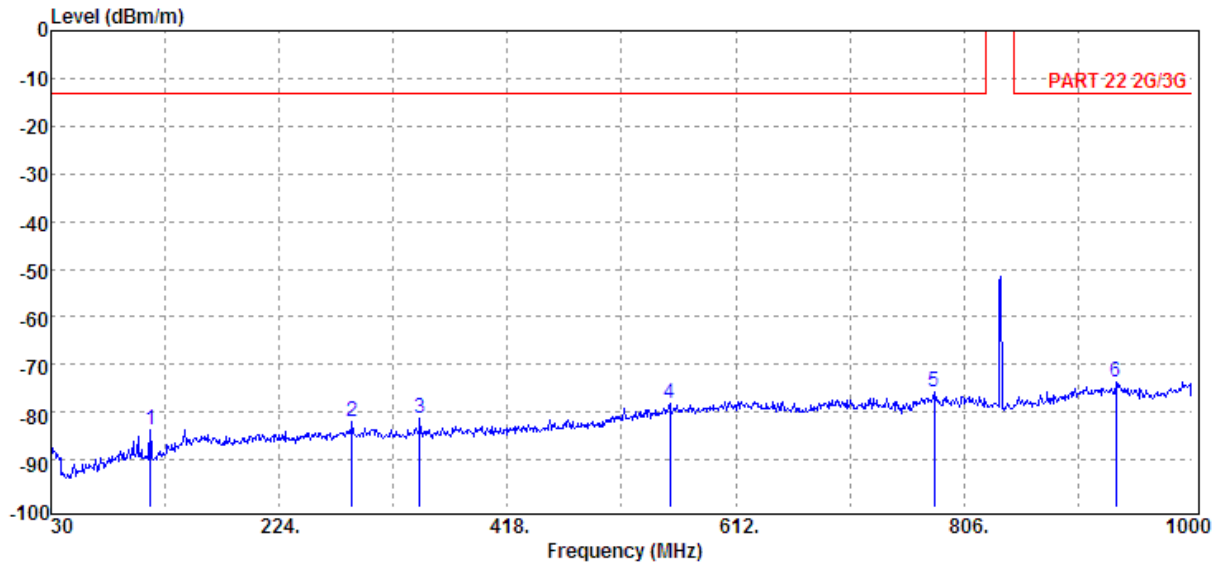

Unless otherwise stated the results shown in this test report refer only to the sample(s) tested and such sample(s) are retained for 90 days only.

除非另有說明，此報告結果僅對測試之樣品負責，同時此樣品僅保留90天。本報告未經本公司書面許可，不可部份複製。

This document is issued by the Company subject to its General Conditions of Service printed overleaf, available on request or accessible at www.sgs.com/terms_and_conditions.htm and, for electronic format documents, subject to Terms and Conditions for Electronic Documents at www.sgs.com/terms_e-document.htm. Attention is drawn to the limitation of liability, indemnification and jurisdiction issues defined therein. Any holder of this document is advised that information contained hereon reflects the Company's findings at the time of its intervention only and within the limits of Client's instructions, if any. The Company's sole responsibility is to its Client and this document does not exonerate parties to a transaction from exercising all their rights and obligations under the transaction documents. This document cannot be reproduced except in full, without prior written approval of the Company. Any unauthorized alteration, forgery or falsification of the content or appearance of this document is unlawful and offenders may be prosecuted to the fullest extent of the law.

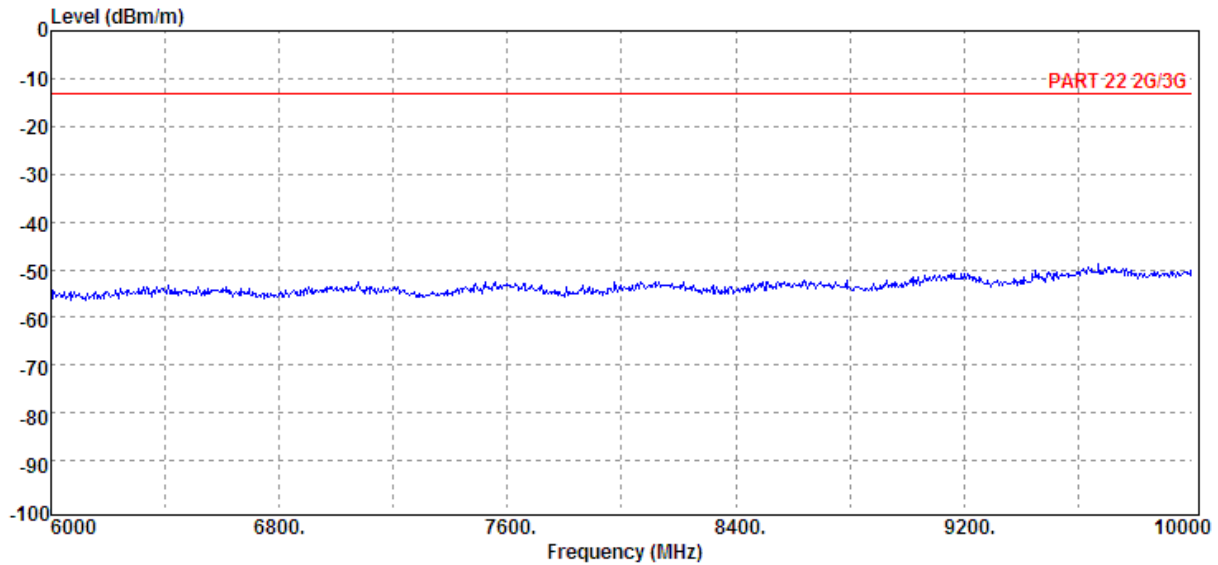

Unless otherwise stated the results shown in this test report refer only to the sample(s) tested and such sample(s) are retained for 90 days only.

除非另有說明，此報告結果僅對測試之樣品負責，同時此樣品僅保留90天。本報告未經本公司書面許可，不可部份複製。

This document is issued by the Company subject to its General Conditions of Service printed overleaf, available on request or accessible at www.sgs.com/terms_and_conditions.htm and, for electronic format documents, subject to Terms and Conditions for Electronic Documents at www.sgs.com/terms_e-document.htm. Attention is drawn to the limitation of liability, indemnification and jurisdiction issues defined therein. Any holder of this document is advised that information contained hereon reflects the Company's findings at the time of its intervention only and within the limits of Client's instructions, if any. The Company's sole responsibility is to its Client and this document does not exonerate parties to a transaction from exercising all their rights and obligations under the transaction documents. This document cannot be reproduced except in full, without prior written approval of the Company. Any unauthorized alteration, forgery or falsification of the content or appearance of this document is unlawful and offenders may be prosecuted to the fullest extent of the law.

Operation Band	:GSM 850	Test Date	:2013-05-27
ARFCN	:CH 190	Temp./Humi.	:24.1 deg_C / 65 RH
Fundamental Frequency	:836.6 MHz	Engineer	:Allen
Operation Mode	:TX MID	Measurement Antenna Pol.	:HORIZONTAL
EUT Pol.	:E2 Plan		

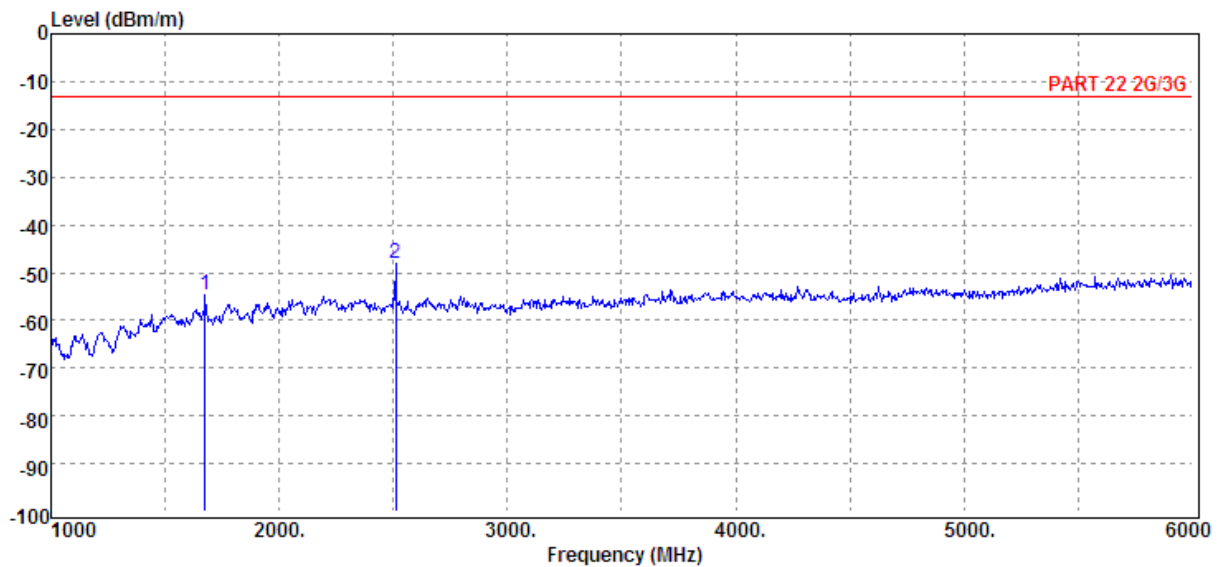
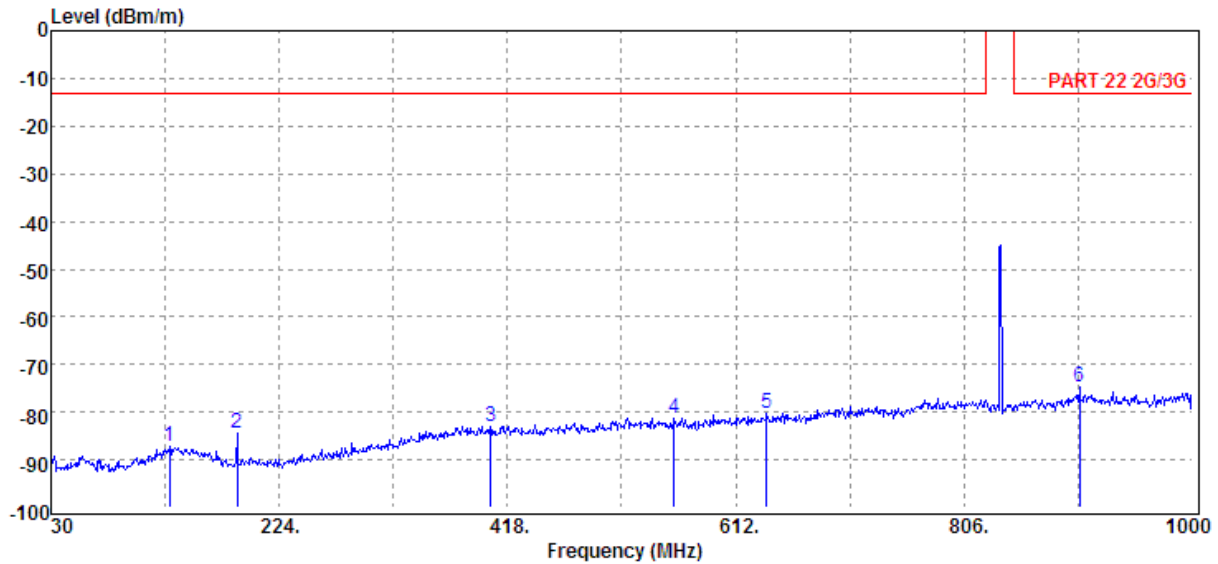

Unless otherwise stated the results shown in this test report refer only to the sample(s) tested and such sample(s) are retained for 90 days only.

除非另有說明，此報告結果僅對測試之樣品負責，同時此樣品僅保留90天。本報告未經本公司書面許可，不可部份複製。

This document is issued by the Company subject to its General Conditions of Service printed overleaf, available on request or accessible at www.sgs.com/terms_and_conditions.htm and, for electronic format documents, subject to Terms and Conditions for Electronic Documents at www.sgs.com/terms_e-document.htm. Attention is drawn to the limitation of liability, indemnification and jurisdiction issues defined therein. Any holder of this document is advised that information contained hereon reflects the Company's findings at the time of its intervention only and within the limits of Client's instructions, if any. The Company's sole responsibility is to its Client and this document does not exonerate parties to a transaction from exercising all their rights and obligations under the transaction documents. This document cannot be reproduced except in full, without prior written approval of the Company. Any unauthorized alteration, forgery or falsification of the content or appearance of this document is unlawful and offenders may be prosecuted to the fullest extent of the law.

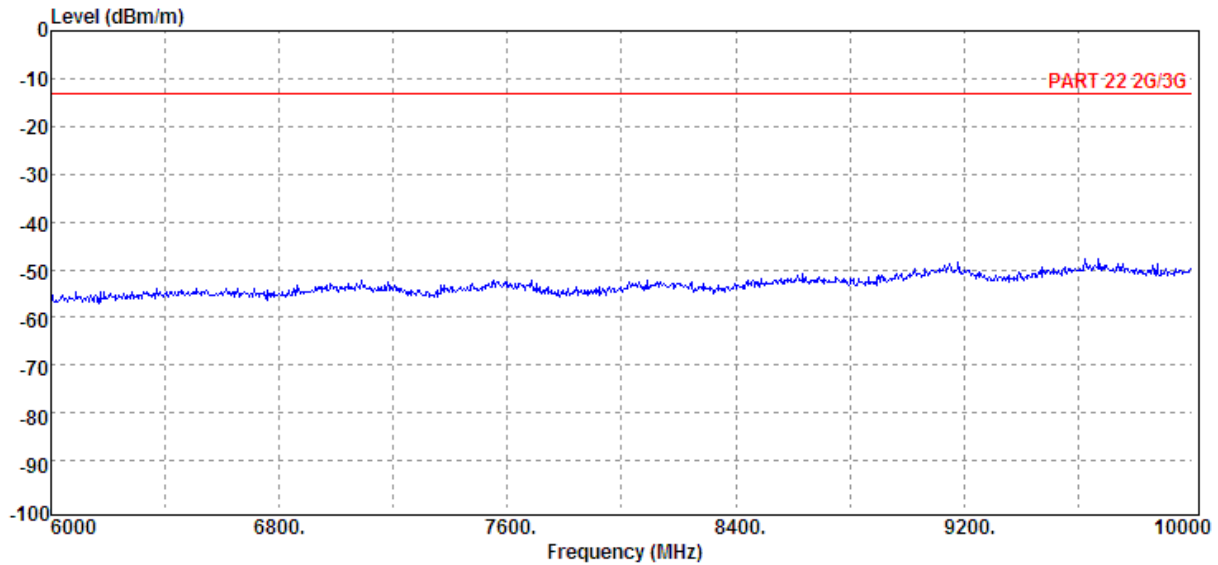

Unless otherwise stated the results shown in this test report refer only to the sample(s) tested and such sample(s) are retained for 90 days only.

除非另有說明，此報告結果僅對測試之樣品負責，同時此樣品僅保留90天。本報告未經本公司書面許可，不可部份複製。

This document is issued by the Company subject to its General Conditions of Service printed overleaf, available on request or accessible at www.sgs.com/terms_and_conditions.htm and, for electronic format documents, subject to Terms and Conditions for Electronic Documents at www.sgs.com/terms_e-document.htm. Attention is drawn to the limitation of liability, indemnification and jurisdiction issues defined therein. Any holder of this document is advised that information contained hereon reflects the Company's findings at the time of its intervention only and within the limits of Client's instructions, if any. The Company's sole responsibility is to its Client and this document does not exonerate parties to a transaction from exercising all their rights and obligations under the transaction documents. This document cannot be reproduced except in full, without prior written approval of the Company. Any unauthorized alteration, forgery or falsification of the content or appearance of this document is unlawful and offenders may be prosecuted to the fullest extent of the law.

Operation Band	:GSM 850	Test Date	:2013-05-27
ARFCN	:CH 251	Temp./Humi.	:24.1 deg_C / 65 RH
Fundamental Frequency	:848.8 MHz	Engineer	:Allen
Operation Mode	:TX HIGH	Measurement Antenna Pol.	:VERTICAL
EUT Pol.	:E2 Plan		

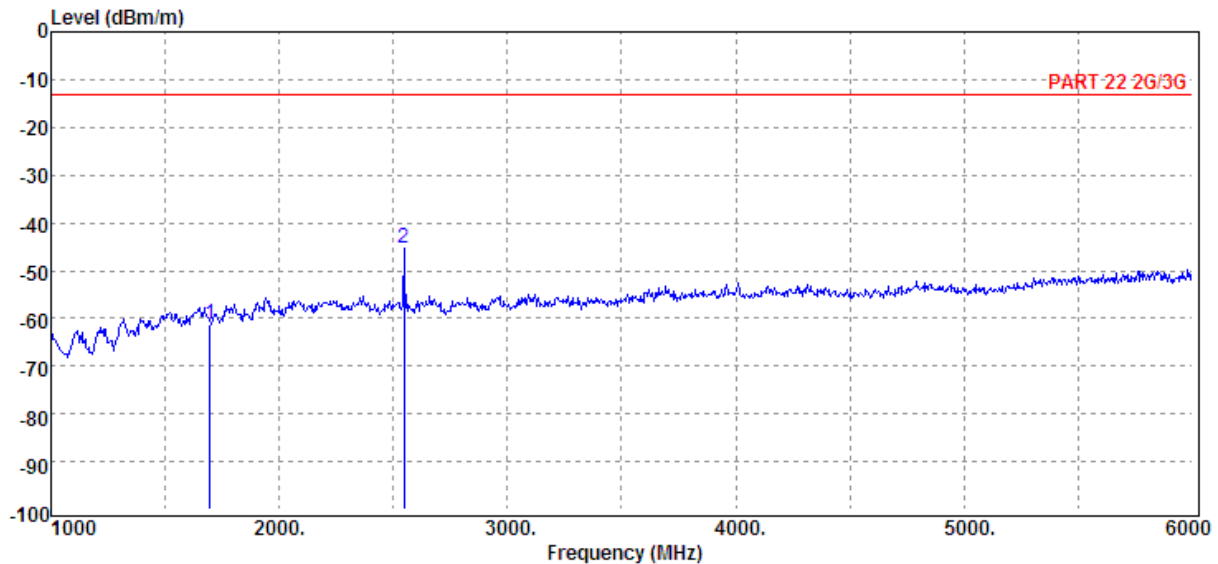
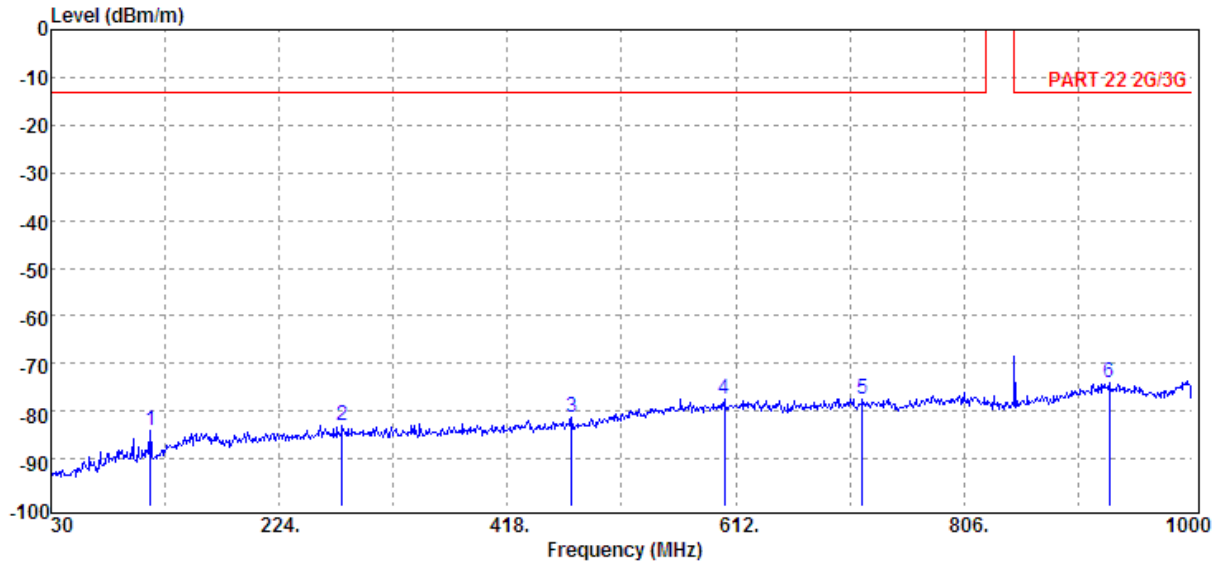

Unless otherwise stated the results shown in this test report refer only to the sample(s) tested and such sample(s) are retained for 90 days only.

除非另有說明，此報告結果僅對測試之樣品負責，同時此樣品僅保留90天。本報告未經本公司書面許可，不可部份複製。

This document is issued by the Company subject to its General Conditions of Service printed overleaf, available on request or accessible at www.sgs.com/terms_and_conditions.htm and, for electronic format documents, subject to Terms and Conditions for Electronic Documents at www.sgs.com/terms_e-document.htm. Attention is drawn to the limitation of liability, indemnification and jurisdiction issues defined therein. Any holder of this document is advised that information contained hereon reflects the Company's findings at the time of its intervention only and within the limits of Client's instructions, if any. The Company's sole responsibility is to its Client and this document does not exonerate parties to a transaction from exercising all their rights and obligations under the transaction documents. This document cannot be reproduced except in full, without prior written approval of the Company. Any unauthorized alteration, forgery or falsification of the content or appearance of this document is unlawful and offenders may be prosecuted to the fullest extent of the law.

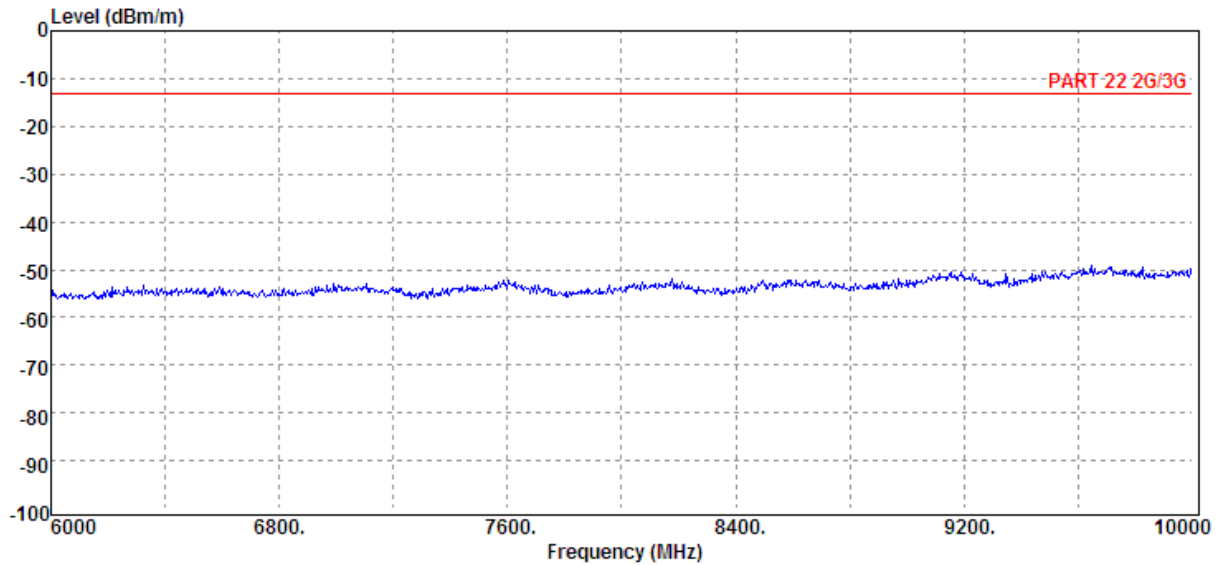

Unless otherwise stated the results shown in this test report refer only to the sample(s) tested and such sample(s) are retained for 90 days only.

除非另有說明，此報告結果僅對測試之樣品負責，同時此樣品僅保留90天。本報告未經本公司書面許可，不可部份複製。

This document is issued by the Company subject to its General Conditions of Service printed overleaf, available on request or accessible at www.sgs.com/terms_and_conditions.htm and, for electronic format documents, subject to Terms and Conditions for Electronic Documents at www.sgs.com/terms_e-document.htm. Attention is drawn to the limitation of liability, indemnification and jurisdiction issues defined therein. Any holder of this document is advised that information contained hereon reflects the Company's findings at the time of its intervention only and within the limits of Client's instructions, if any. The Company's sole responsibility is to its Client and this document does not exonerate parties to a transaction from exercising all their rights and obligations under the transaction documents. This document cannot be reproduced except in full, without prior written approval of the Company. Any unauthorized alteration, forgery or falsification of the content or appearance of this document is unlawful and offenders may be prosecuted to the fullest extent of the law.

Operation Band	:GSM 850	Test Date	:2013-05-27
ARFCN	:CH 251	Temp./Humi.	:24.1 deg_C / 65 RH
Fundamental Frequency	:848.8 MHz	Engineer	:Allen
Operation Mode	:TX HIGH	Measurement Antenna Pol.	:HORIZONTAL
EUT Pol.	:E2 Plan		

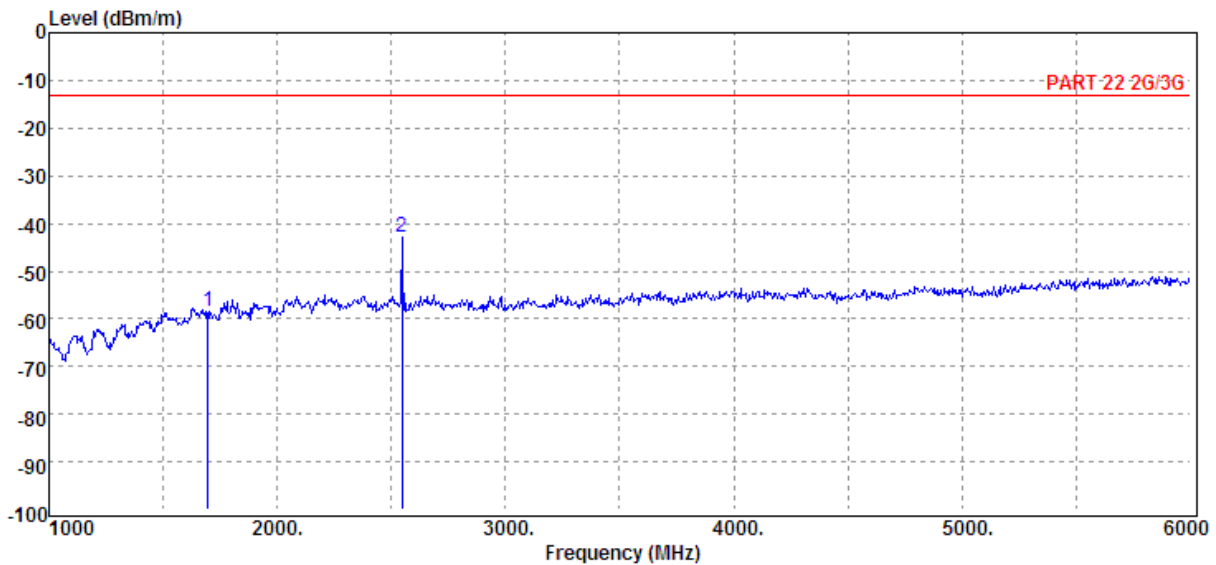
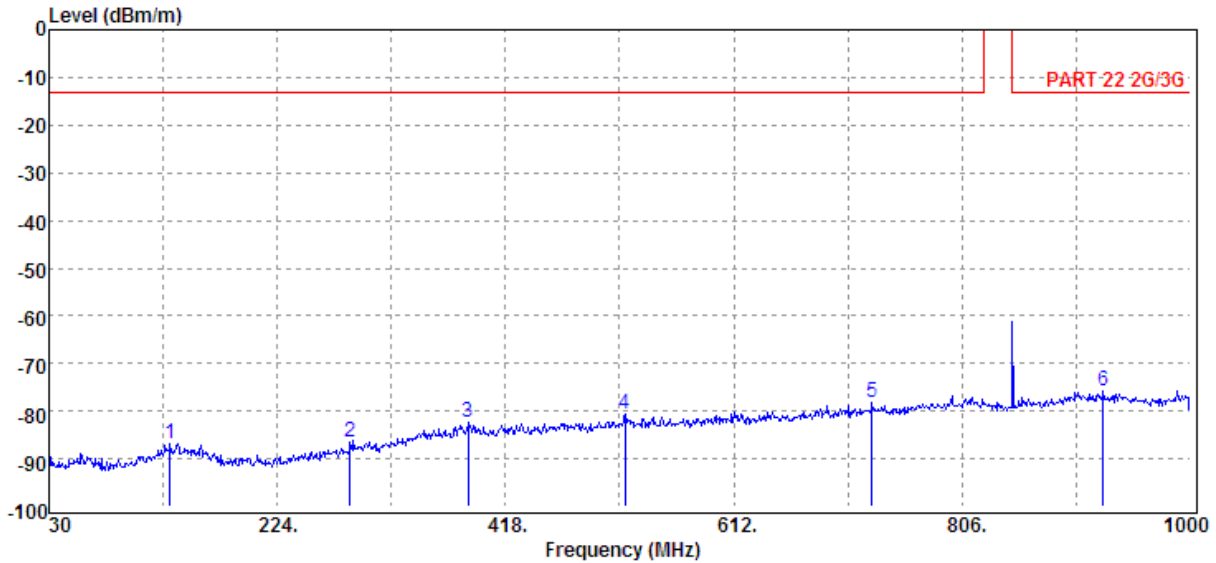

Unless otherwise stated the results shown in this test report refer only to the sample(s) tested and such sample(s) are retained for 90 days only.

除非另有說明，此報告結果僅對測試之樣品負責，同時此樣品僅保留90天。本報告未經本公司書面許可，不可部份複製。

This document is issued by the Company subject to its General Conditions of Service printed overleaf, available on request or accessible at www.sgs.com/terms_and_conditions.htm and, for electronic format documents, subject to Terms and Conditions for Electronic Documents at www.sgs.com/terms_e-document.htm. Attention is drawn to the limitation of liability, indemnification and jurisdiction issues defined therein. Any holder of this document is advised that information contained hereon reflects the Company's findings at the time of its intervention only and within the limits of Client's instructions, if any. The Company's sole responsibility is to its Client and this document does not exonerate parties to a transaction from exercising all their rights and obligations under the transaction documents. This document cannot be reproduced except in full, without prior written approval of the Company. Any unauthorized alteration, forgery or falsification of the content or appearance of this document is unlawful and offenders may be prosecuted to the fullest extent of the law.

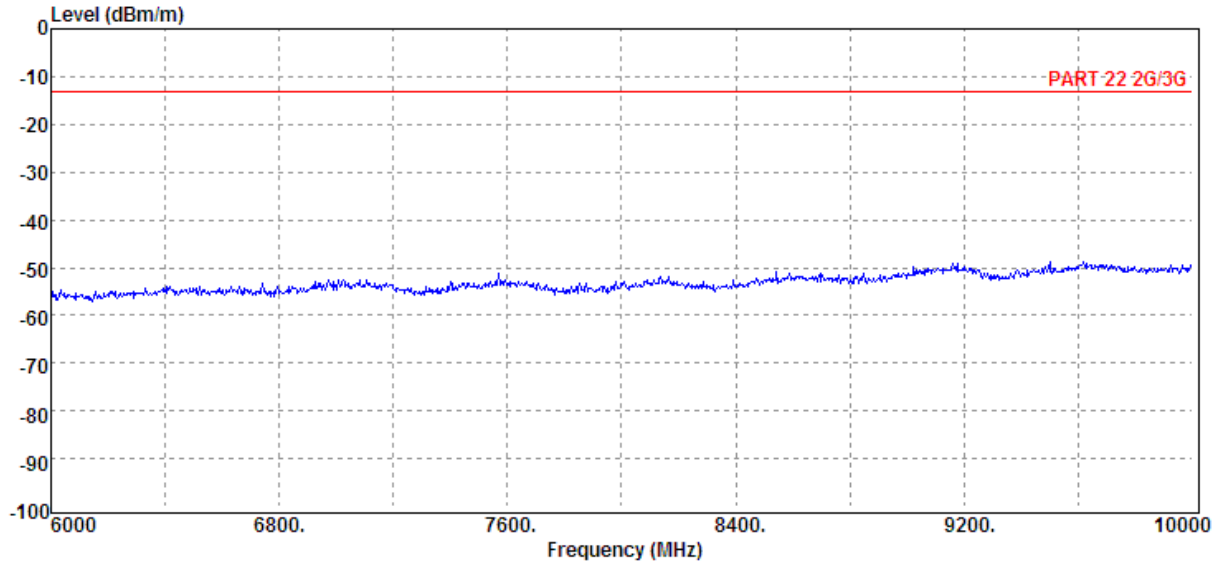

Unless otherwise stated the results shown in this test report refer only to the sample(s) tested and such sample(s) are retained for 90 days only.

除非另有說明，此報告結果僅對測試之樣品負責，同時此樣品僅保留90天。本報告未經本公司書面許可，不可部份複製。

This document is issued by the Company subject to its General Conditions of Service printed overleaf, available on request or accessible at www.sgs.com/terms_and_conditions.htm and, for electronic format documents, subject to Terms and Conditions for Electronic Documents at www.sgs.com/terms_e-document.htm. Attention is drawn to the limitation of liability, indemnification and jurisdiction issues defined therein. Any holder of this document is advised that information contained hereon reflects the Company's findings at the time of its intervention only and within the limits of Client's instructions, if any. The Company's sole responsibility is to its Client and this document does not exonerate parties to a transaction from exercising all their rights and obligations under the transaction documents. This document cannot be reproduced except in full, without prior written approval of the Company. Any unauthorized alteration, forgery or falsification of the content or appearance of this document is unlawful and offenders may be prosecuted to the fullest extent of the law.

Radiated Spurious Emission Measurement Result: GSM 1900 Mode

Operation Band	:GSM 1900	Test Date	:2013-05-03
ARFCN	:CH 512	Temp./Humi.	:24.1 deg_C / 65 RH
Fundamental Frequency	:1850.2 MHz	Engineer	:Allen
Operation Mode	:TX LOW		
EUT Pol.	:E1 Plan	Measurement Antenna Pol.	:VERTICAL

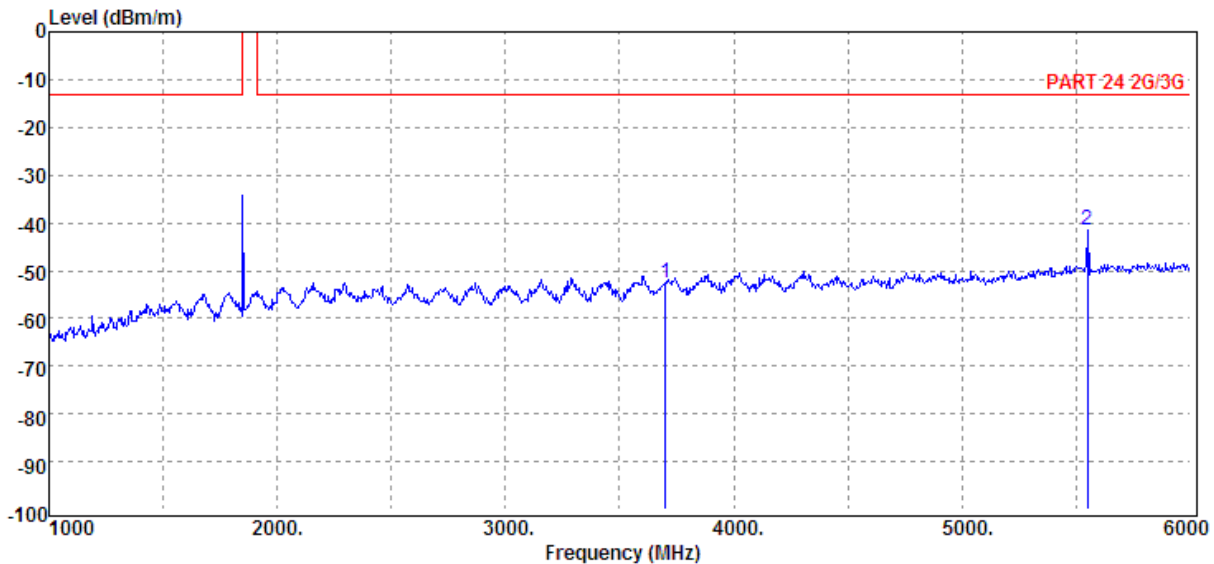
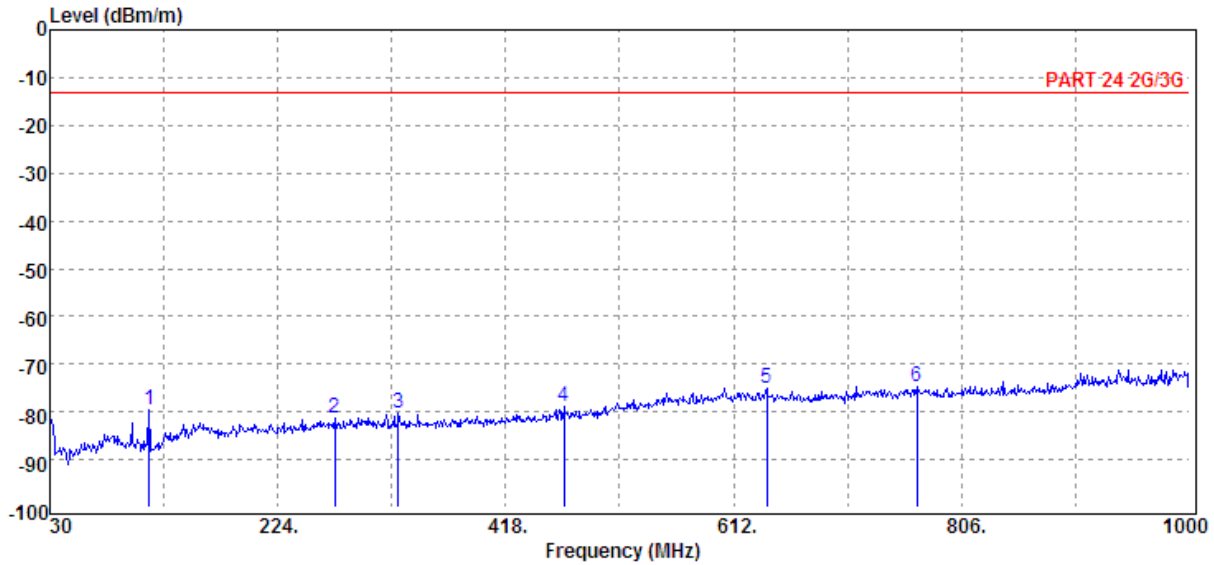

Unless otherwise stated the results shown in this test report refer only to the sample(s) tested and such sample(s) are retained for 90 days only.

除非另有說明，此報告結果僅對測試之樣品負責，同時此樣品僅保留90天。本報告未經本公司書面許可，不可部份複製。

This document is issued by the Company subject to its General Conditions of Service printed overleaf, available on request or accessible at www.sgs.com/terms_and_conditions.htm and, for electronic format documents, subject to Terms and Conditions for Electronic Documents at www.sgs.com/terms_e-document.htm. Attention is drawn to the limitation of liability, indemnification and jurisdiction issues defined therein. Any holder of this document is advised that information contained hereon reflects the Company's findings at the time of its intervention only and within the limits of Client's instructions, if any. The Company's sole responsibility is to its Client and this document does not exonerate parties to a transaction from exercising all their rights and obligations under the transaction documents. This document cannot be reproduced except in full, without prior written approval of the Company. Any unauthorized alteration, forgery or falsification of the content or appearance of this document is unlawful and offenders may be prosecuted to the fullest extent of the law.

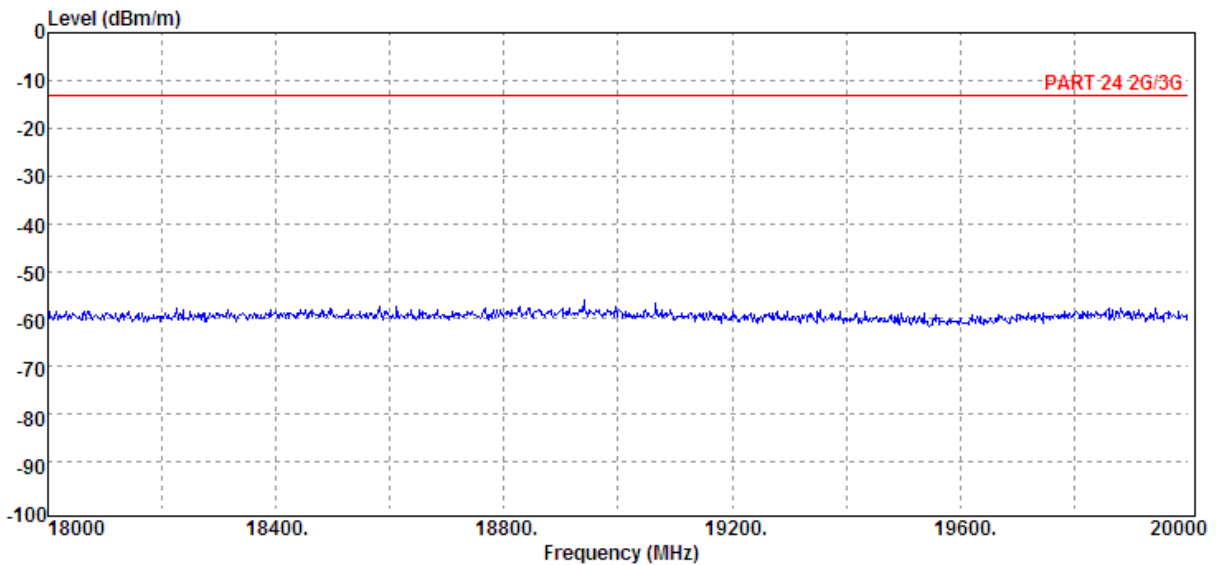
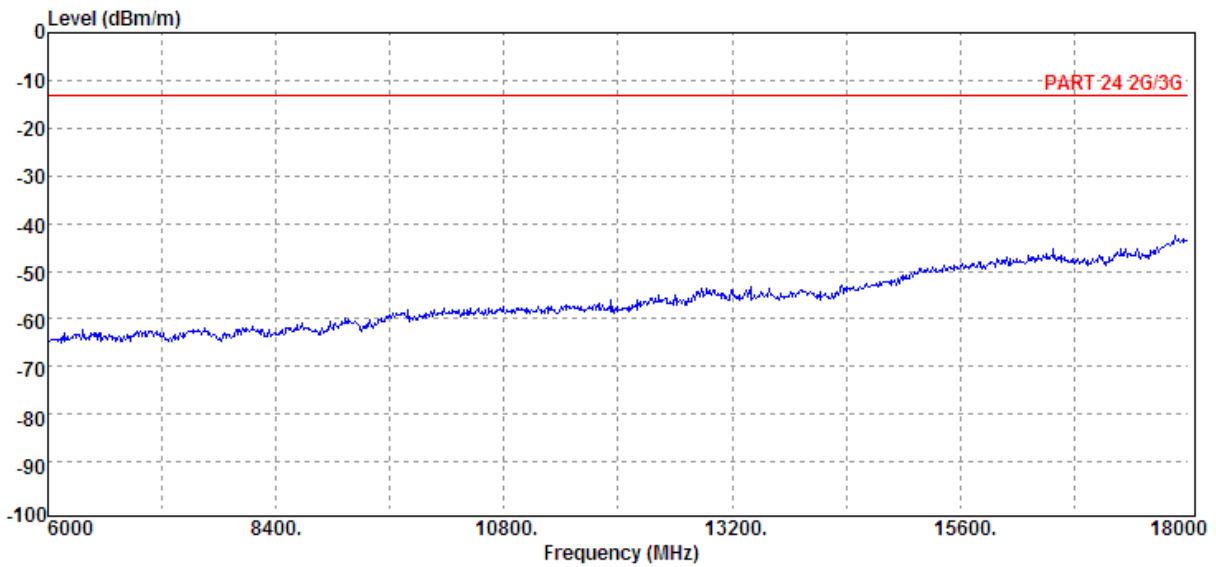

Unless otherwise stated the results shown in this test report refer only to the sample(s) tested and such sample(s) are retained for 90 days only.

除非另有說明，此報告結果僅對測試之樣品負責，同時此樣品僅保留90天。本報告未經本公司書面許可，不可部份複製。
This document is issued by the Company subject to its General Conditions of Service printed overleaf, available on request or accessible at www.sgs.com/terms_and_conditions.htm and, for electronic format documents, subject to Terms and Conditions for Electronic Documents at www.sgs.com/terms_e-document.htm. Attention is drawn to the limitation of liability, indemnification and jurisdiction issues defined therein. Any holder of this document is advised that information contained hereon reflects the Company's findings at the time of its intervention only and within the limits of Client's instructions, if any. The Company's sole responsibility is to its Client and this document does not exonerate parties to a transaction from exercising all their rights and obligations under the transaction documents. This document cannot be reproduced except in full, without prior written approval of the Company. Any unauthorized alteration, forgery or falsification of the content or appearance of this document is unlawful and offenders may be prosecuted to the fullest extent of the law.

Operation Band	:GSM 1900	Test Date	:2013-05-03
ARFCN	:CH 512	Temp./Humi.	:24.1 deg_C / 65 RH
Fundamental Frequency	:1850.2 MHz	Engineer	:Allen
Operation Mode	:TX LOW	Measurement Antenna Pol.	:HORIZONTAL
EUT Pol.	:E1 Plan		

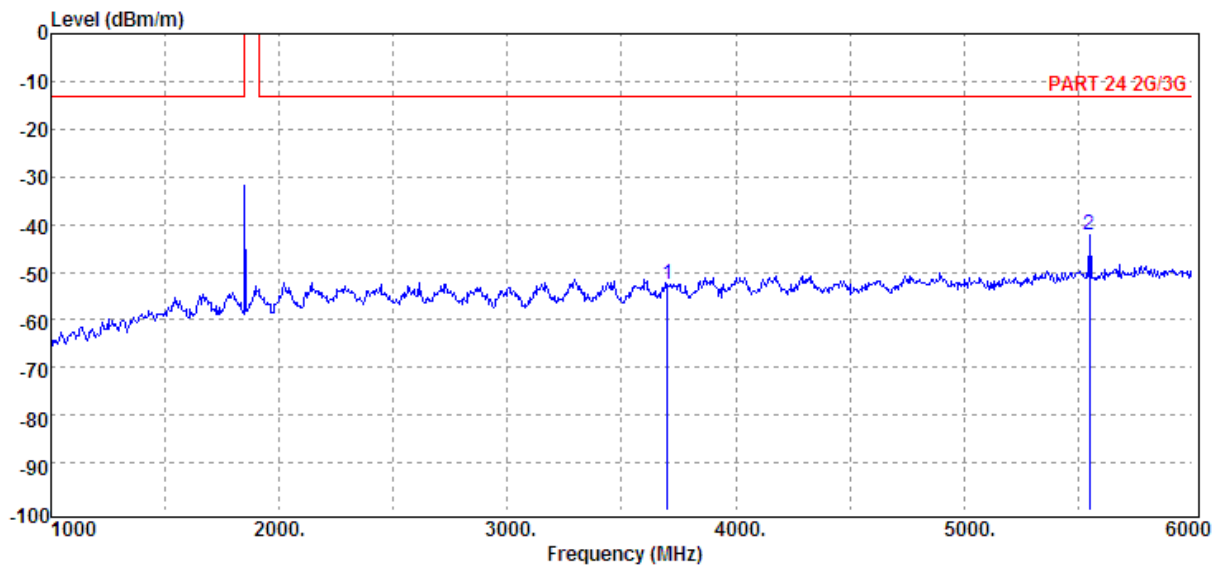
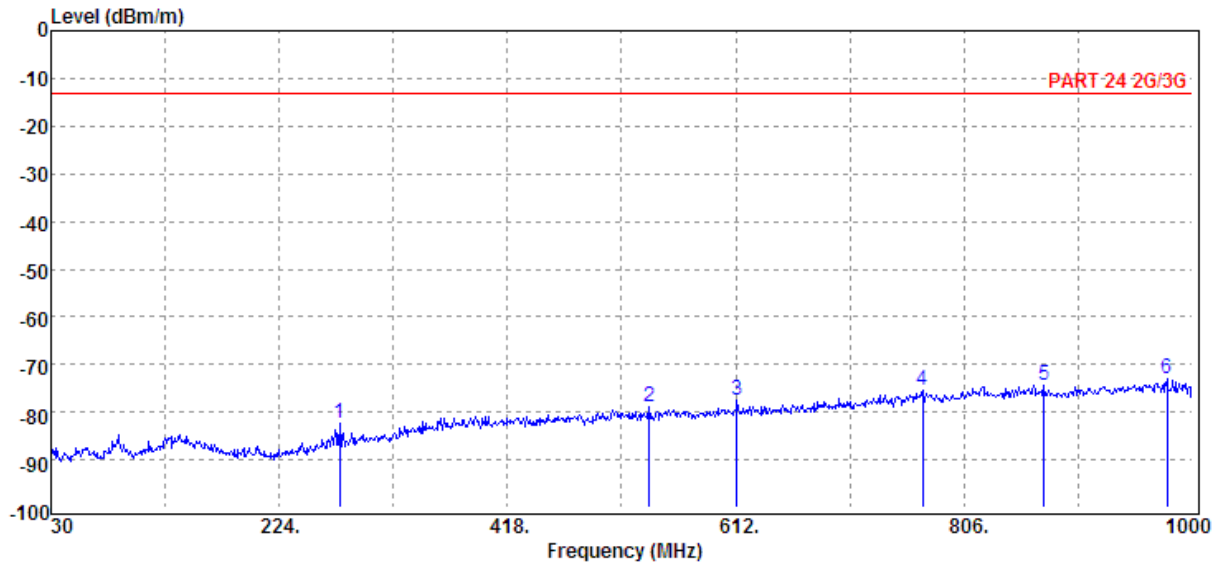

Unless otherwise stated the results shown in this test report refer only to the sample(s) tested and such sample(s) are retained for 90 days only.

除非另有說明，此報告結果僅對測試之樣品負責，同時此樣品僅保留90天。本報告未經本公司書面許可，不可部份複製。

This document is issued by the Company subject to its General Conditions of Service printed overleaf, available on request or accessible at www.sgs.com/terms_and_conditions.htm and, for electronic format documents, subject to Terms and Conditions for Electronic Documents at www.sgs.com/terms_e-document.htm. Attention is drawn to the limitation of liability, indemnification and jurisdiction issues defined therein. Any holder of this document is advised that information contained hereon reflects the Company's findings at the time of its intervention only and within the limits of Client's instructions, if any. The Company's sole responsibility is to its Client and this document does not exonerate parties to a transaction from exercising all their rights and obligations under the transaction documents. This document cannot be reproduced except in full, without prior written approval of the Company. Any unauthorized alteration, forgery or falsification of the content or appearance of this document is unlawful and offenders may be prosecuted to the fullest extent of the law.

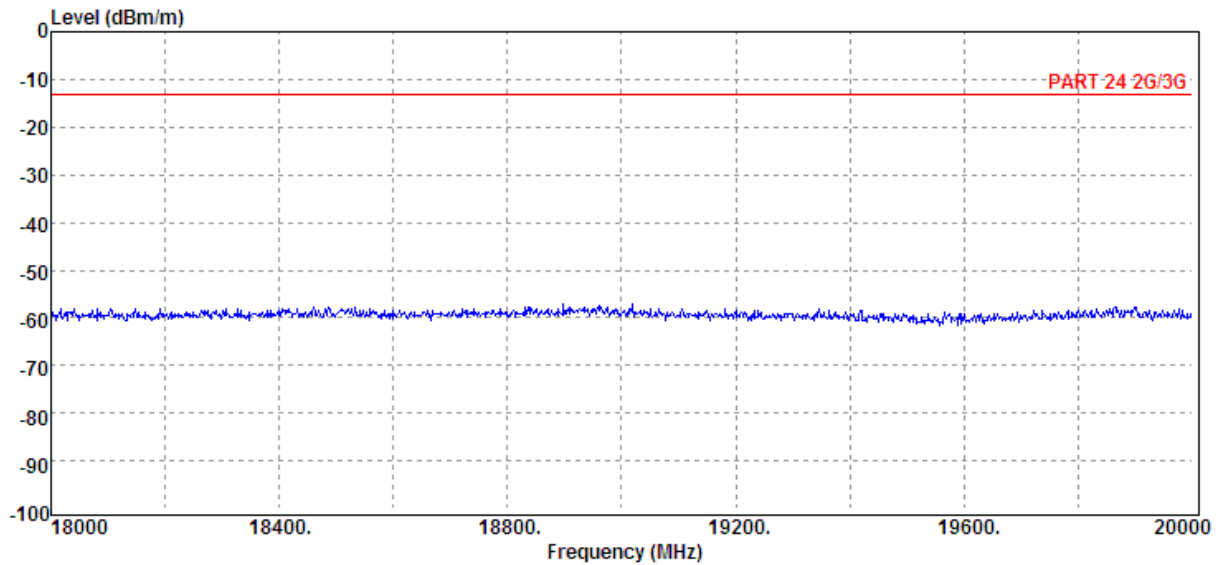
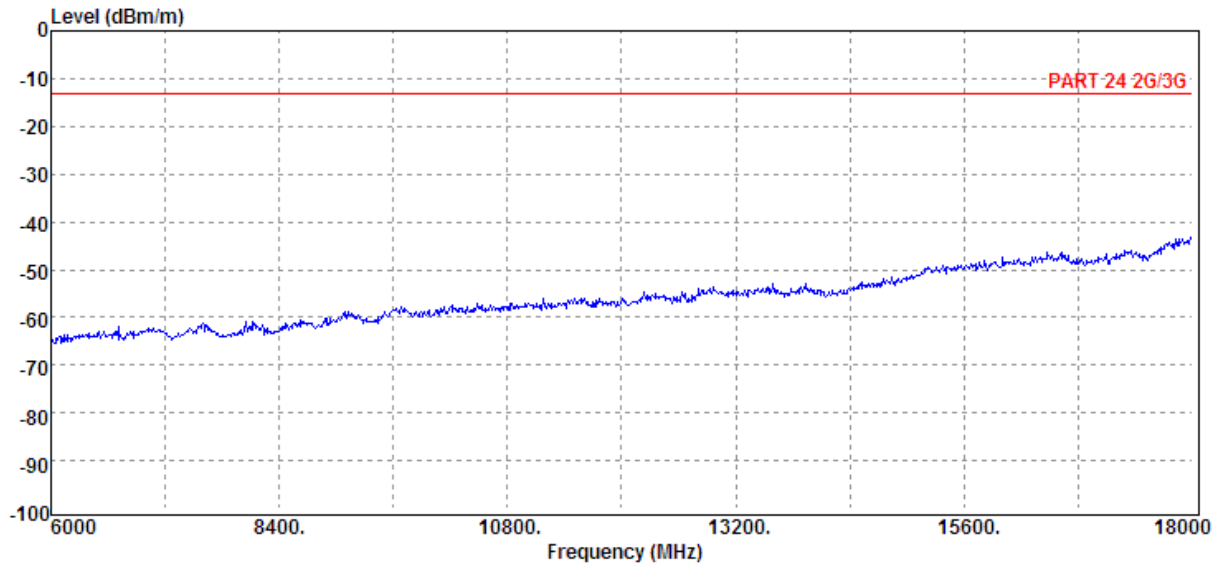

Unless otherwise stated the results shown in this test report refer only to the sample(s) tested and such sample(s) are retained for 90 days only.

除非另有說明，此報告結果僅對測試之樣品負責，同時此樣品僅保留90天。本報告未經本公司書面許可，不可部份複製。

This document is issued by the Company subject to its General Conditions of Service printed overleaf, available on request or accessible at www.sgs.com/terms_and_conditions.htm and, for electronic format documents, subject to Terms and Conditions for Electronic Documents at www.sgs.com/terms_e-document.htm. Attention is drawn to the limitation of liability, indemnification and jurisdiction issues defined therein. Any holder of this document is advised that information contained hereon reflects the Company's findings at the time of its intervention only and within the limits of Client's instructions, if any. The Company's sole responsibility is to its Client and this document does not exonerate parties to a transaction from exercising all their rights and obligations under the transaction documents. This document cannot be reproduced except in full, without prior written approval of the Company. Any unauthorized alteration, forgery or falsification of the content or appearance of this document is unlawful and offenders may be prosecuted to the fullest extent of the law.

Operation Band	:GSM 1900	Test Date	:2013-05-03
ARFCN	:CH 661	Temp./Humi.	:24.1 deg_C / 65 RH
Fundamental Frequency	:1880 MHz	Engineer	:Allen
Operation Mode	:TX MID	Measurement Antenna Pol.	:VERTICAL
EUT Pol.	:E1 Plan		

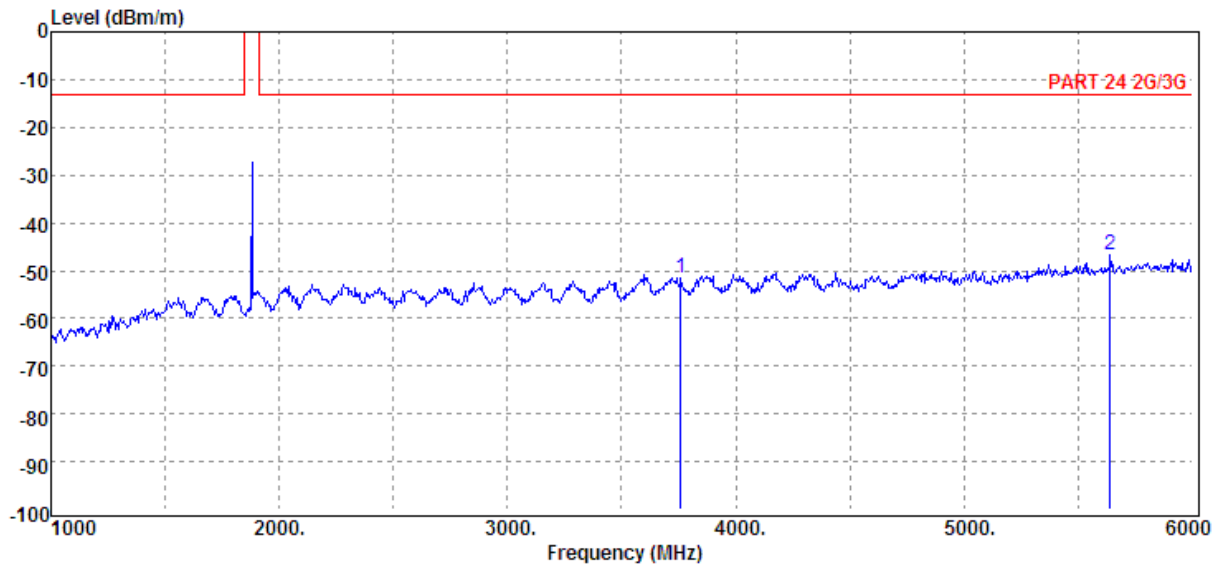
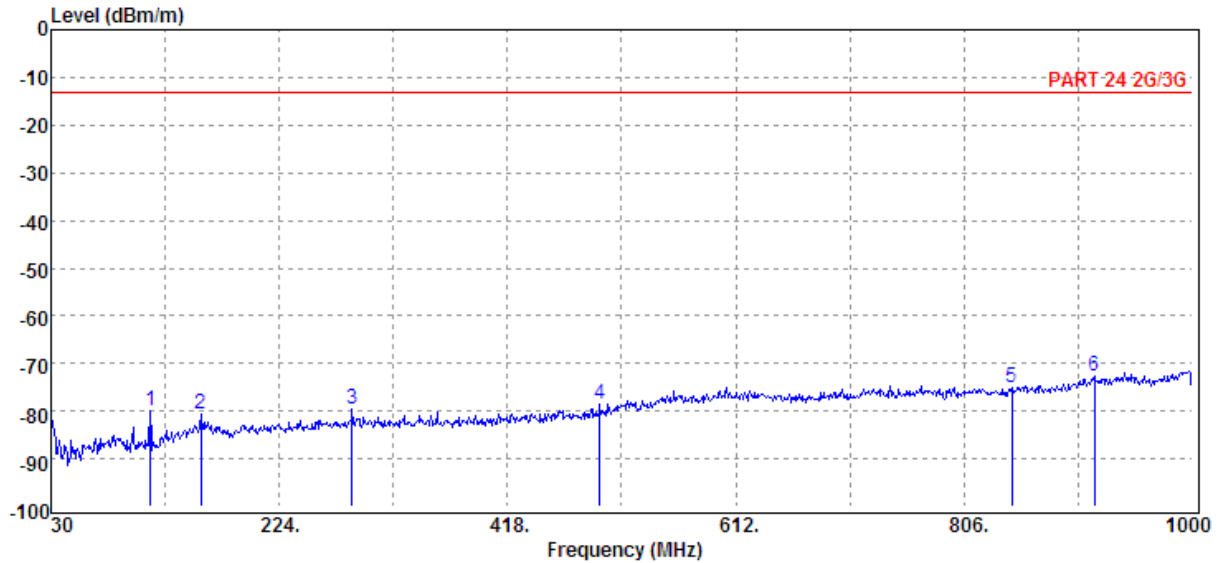

Unless otherwise stated the results shown in this test report refer only to the sample(s) tested and such sample(s) are retained for 90 days only.

除非另有說明，此報告結果僅對測試之樣品負責，同時此樣品僅保留90天。本報告未經本公司書面許可，不可部份複製。

This document is issued by the Company subject to its General Conditions of Service printed overleaf, available on request or accessible at www.sgs.com/terms_and_conditions.htm and, for electronic format documents, subject to Terms and Conditions for Electronic Documents at www.sgs.com/terms_e-document.htm. Attention is drawn to the limitation of liability, indemnification and jurisdiction issues defined therein. Any holder of this document is advised that information contained hereon reflects the Company's findings at the time of its intervention only and within the limits of Client's instructions, if any. The Company's sole responsibility is to its Client and this document does not exonerate parties to a transaction from exercising all their rights and obligations under the transaction documents. This document cannot be reproduced except in full, without prior written approval of the Company. Any unauthorized alteration, forgery or falsification of the content or appearance of this document is unlawful and offenders may be prosecuted to the fullest extent of the law.

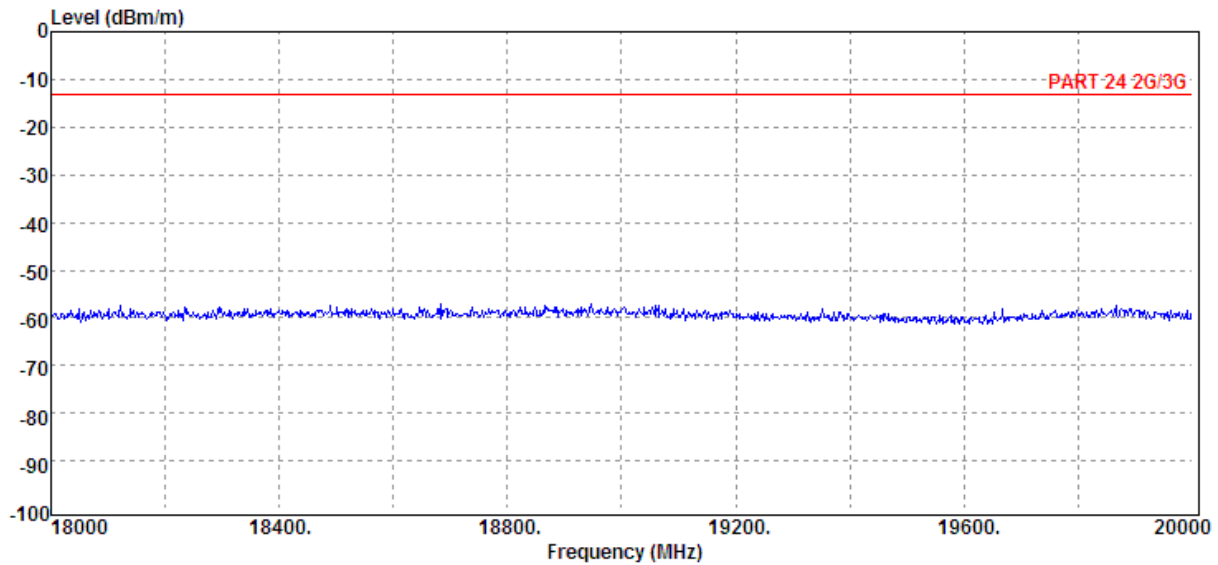
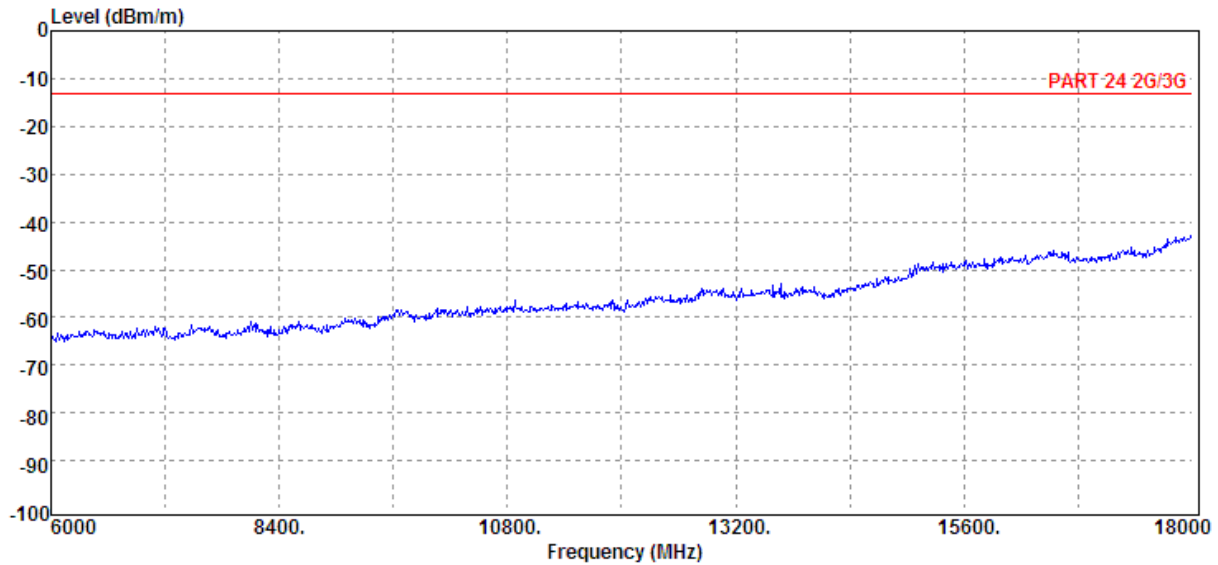

Unless otherwise stated the results shown in this test report refer only to the sample(s) tested and such sample(s) are retained for 90 days only.

除非另有說明，此報告結果僅對測試之樣品負責，同時此樣品僅保留90天。本報告未經本公司書面許可，不可部份複製。

This document is issued by the Company subject to its General Conditions of Service printed overleaf, available on request or accessible at www.sgs.com/terms_and_conditions.htm and, for electronic format documents, subject to Terms and Conditions for Electronic Documents at www.sgs.com/terms_e-document.htm. Attention is drawn to the limitation of liability, indemnification and jurisdiction issues defined therein. Any holder of this document is advised that information contained hereon reflects the Company's findings at the time of its intervention only and within the limits of Client's instructions, if any. The Company's sole responsibility is to its Client and this document does not exonerate parties to a transaction from exercising all their rights and obligations under the transaction documents. This document cannot be reproduced except in full, without prior written approval of the Company. Any unauthorized alteration, forgery or falsification of the content or appearance of this document is unlawful and offenders may be prosecuted to the fullest extent of the law.

Operation Band	:GSM 1900	Test Date	:2013-05-03
ARFCN	:CH 661	Temp./Humi.	:24.1 deg_C / 65 RH
Fundamental Frequency	:1880 MHz	Engineer	:Allen
Operation Mode	:TX MID	Measurement Antenna Pol.	:HORIZONTAL
EUT Pol.	:E1 Plan		

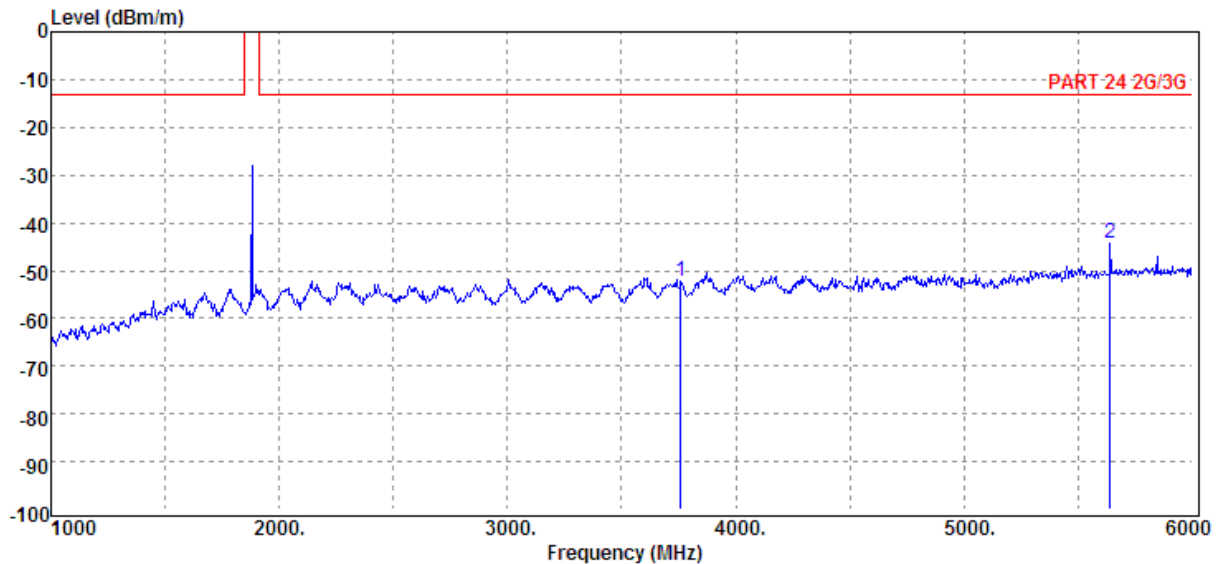
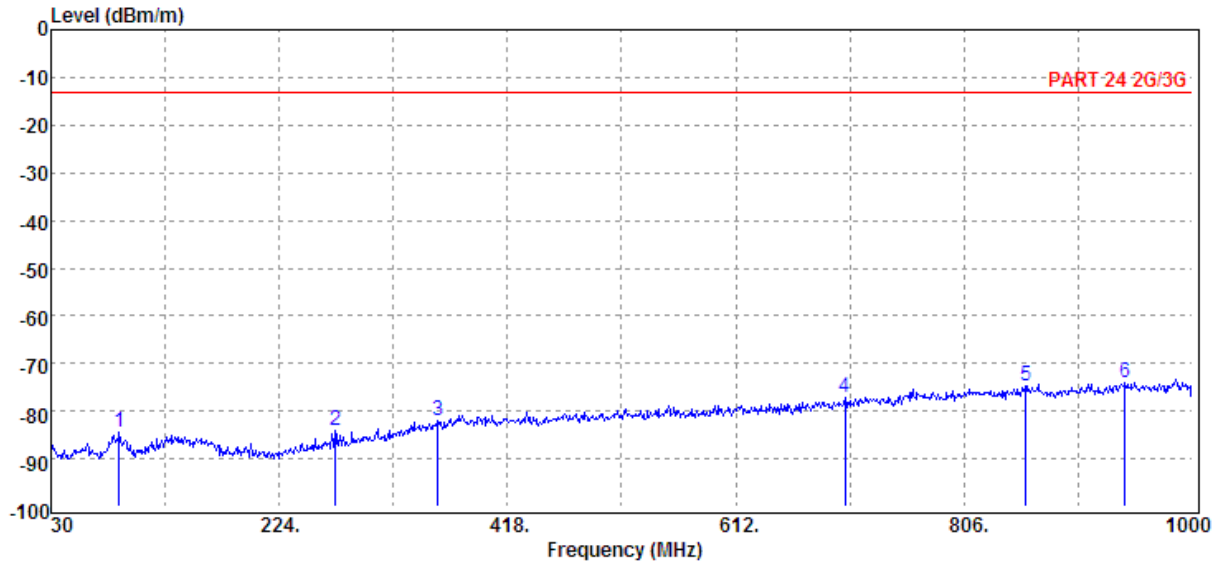

Unless otherwise stated the results shown in this test report refer only to the sample(s) tested and such sample(s) are retained for 90 days only.

除非另有說明，此報告結果僅對測試之樣品負責，同時此樣品僅保留90天。本報告未經本公司書面許可，不可部份複製。

This document is issued by the Company subject to its General Conditions of Service printed overleaf, available on request or accessible at www.sgs.com/terms_and_conditions.htm and, for electronic format documents, subject to Terms and Conditions for Electronic Documents at www.sgs.com/terms_e-document.htm. Attention is drawn to the limitation of liability, indemnification and jurisdiction issues defined therein. Any holder of this document is advised that information contained hereon reflects the Company's findings at the time of its intervention only and within the limits of Client's instructions, if any. The Company's sole responsibility is to its Client and this document does not exonerate parties to a transaction from exercising all their rights and obligations under the transaction documents. This document cannot be reproduced except in full, without prior written approval of the Company. Any unauthorized alteration, forgery or falsification of the content or appearance of this document is unlawful and offenders may be prosecuted to the fullest extent of the law.

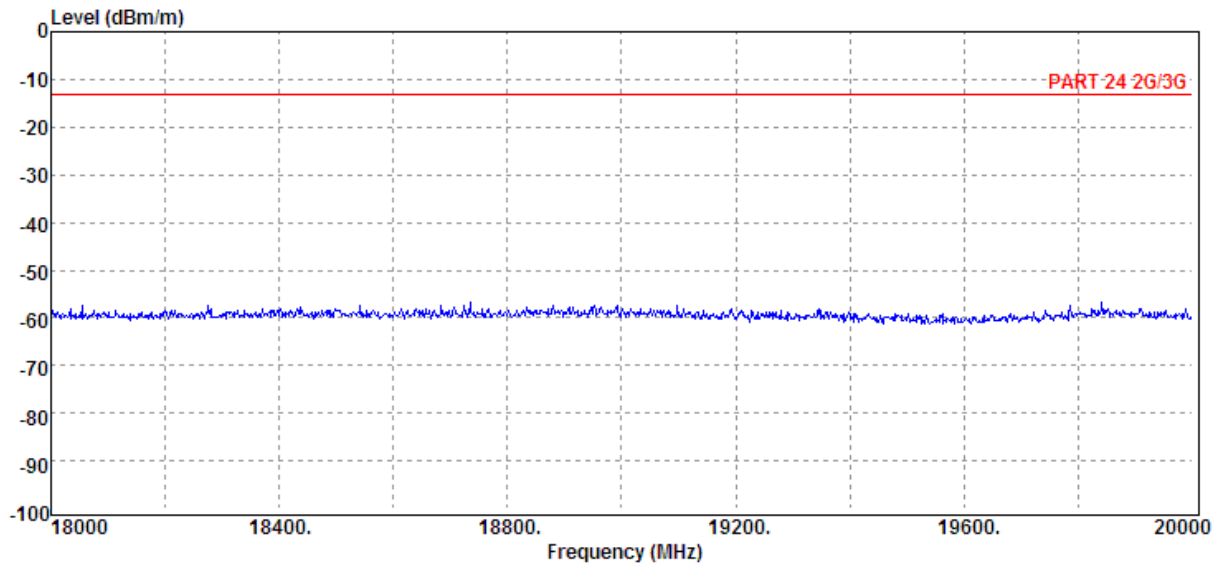
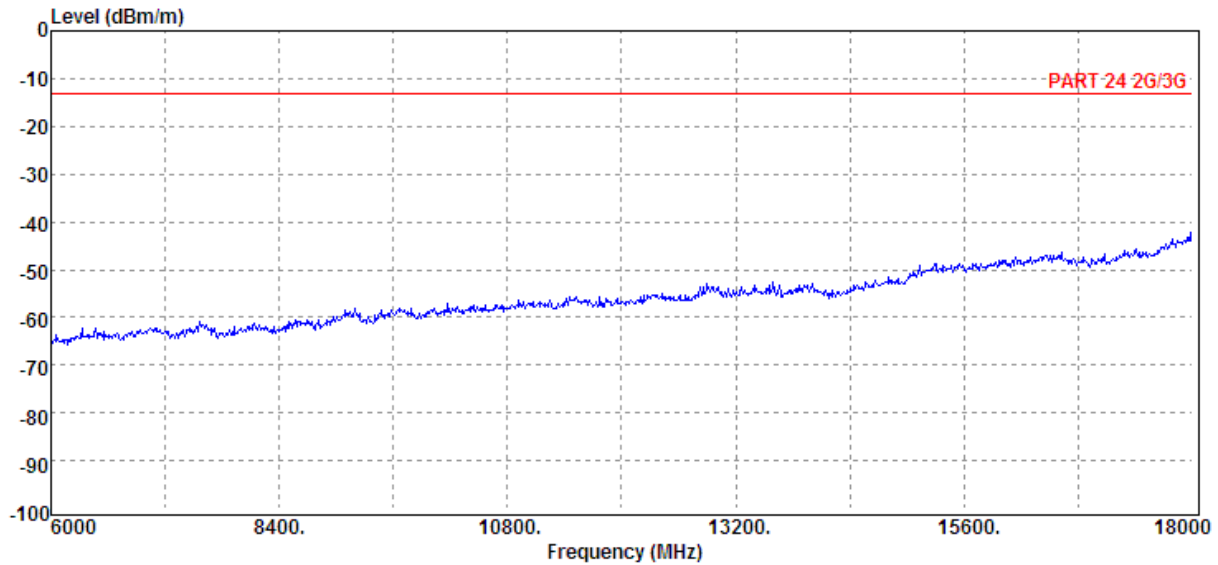

Unless otherwise stated the results shown in this test report refer only to the sample(s) tested and such sample(s) are retained for 90 days only.

除非另有說明，此報告結果僅對測試之樣品負責，同時此樣品僅保留90天。本報告未經本公司書面許可，不可部份複製。

This document is issued by the Company subject to its General Conditions of Service printed overleaf, available on request or accessible at www.sgs.com/terms_and_conditions.htm and, for electronic format documents, subject to Terms and Conditions for Electronic Documents at www.sgs.com/terms_e-document.htm. Attention is drawn to the limitation of liability, indemnification and jurisdiction issues defined therein. Any holder of this document is advised that information contained hereon reflects the Company's findings at the time of its intervention only and within the limits of Client's instructions, if any. The Company's sole responsibility is to its Client and this document does not exonerate parties to a transaction from exercising all their rights and obligations under the transaction documents. This document cannot be reproduced except in full, without prior written approval of the Company. Any unauthorized alteration, forgery or falsification of the content or appearance of this document is unlawful and offenders may be prosecuted to the fullest extent of the law.

Operation Band	:GSM 1900	Test Date	:2013-05-03
ARFCN	:CH 810	Temp./Humi.	:24.1 deg_C / 65 RH
Fundamental Frequency	:1909.8 MHz	Engineer	:Allen
Operation Mode	:TX HIGH	Measurement Antenna Pol.	:VERTICAL
EUT Pol.	:E1 Plan		

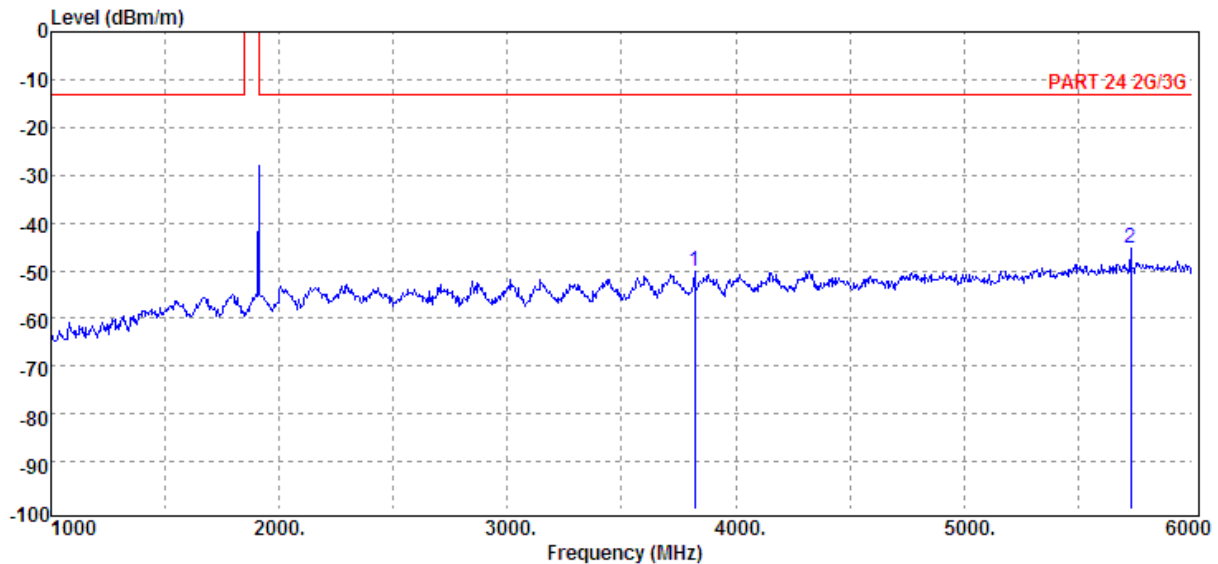
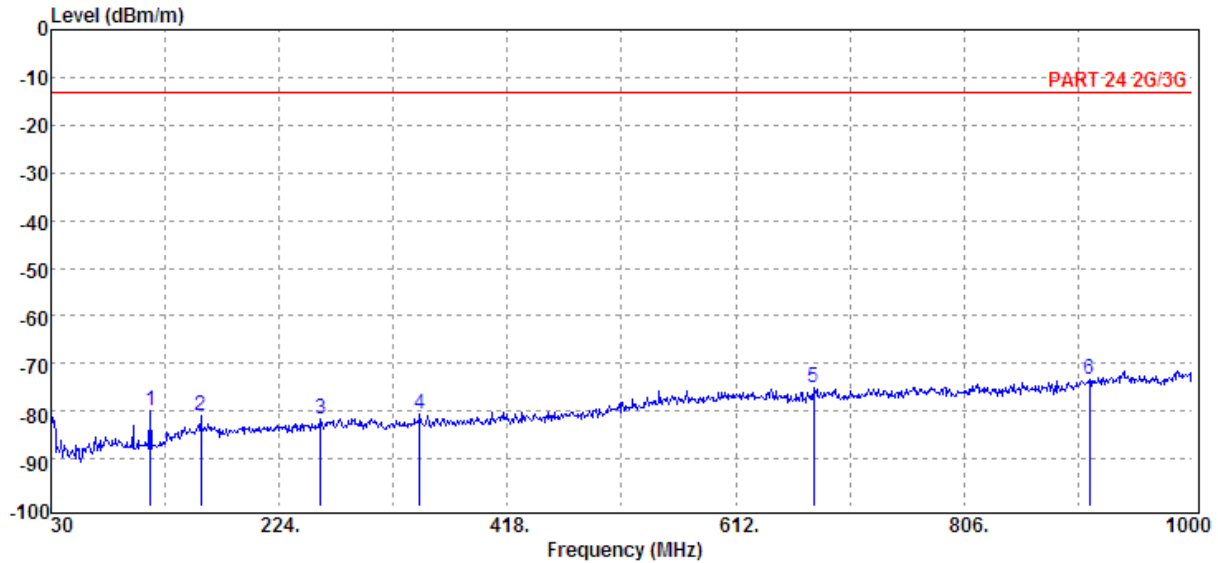

Unless otherwise stated the results shown in this test report refer only to the sample(s) tested and such sample(s) are retained for 90 days only.

除非另有說明，此報告結果僅對測試之樣品負責，同時此樣品僅保留90天。本報告未經本公司書面許可，不可部份複製。

This document is issued by the Company subject to its General Conditions of Service printed overleaf, available on request or accessible at www.sgs.com/terms_and_conditions.htm and, for electronic format documents, subject to Terms and Conditions for Electronic Documents at www.sgs.com/terms_e-document.htm. Attention is drawn to the limitation of liability, indemnification and jurisdiction issues defined therein. Any holder of this document is advised that information contained hereon reflects the Company's findings at the time of its intervention only and within the limits of Client's instructions, if any. The Company's sole responsibility is to its Client and this document does not exonerate parties to a transaction from exercising all their rights and obligations under the transaction documents. This document cannot be reproduced except in full, without prior written approval of the Company. Any unauthorized alteration, forgery or falsification of the content or appearance of this document is unlawful and offenders may be prosecuted to the fullest extent of the law.

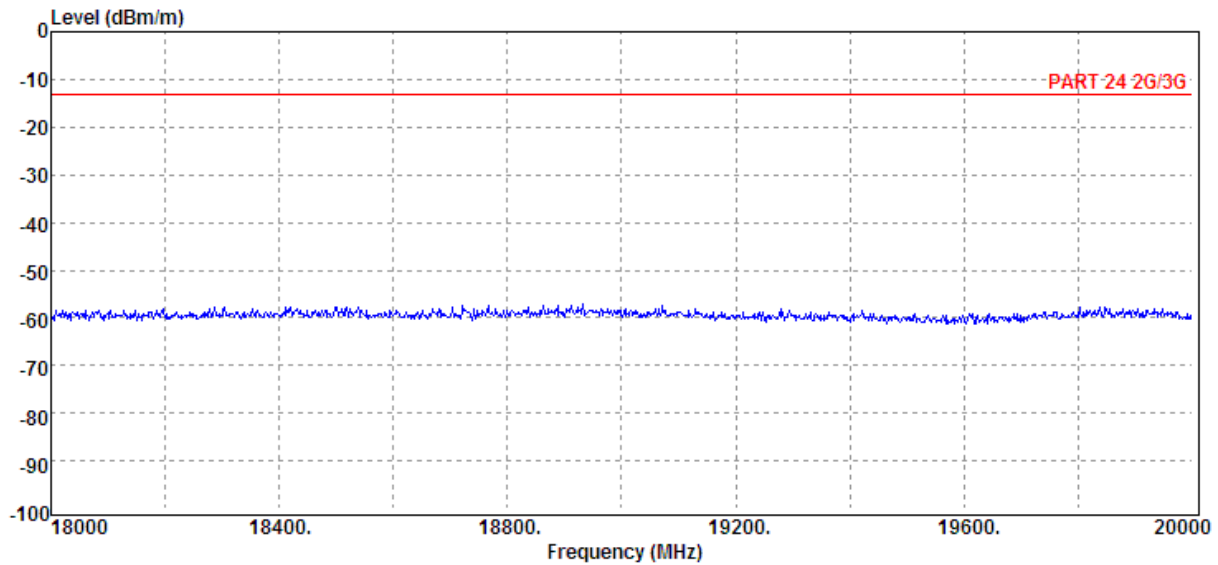
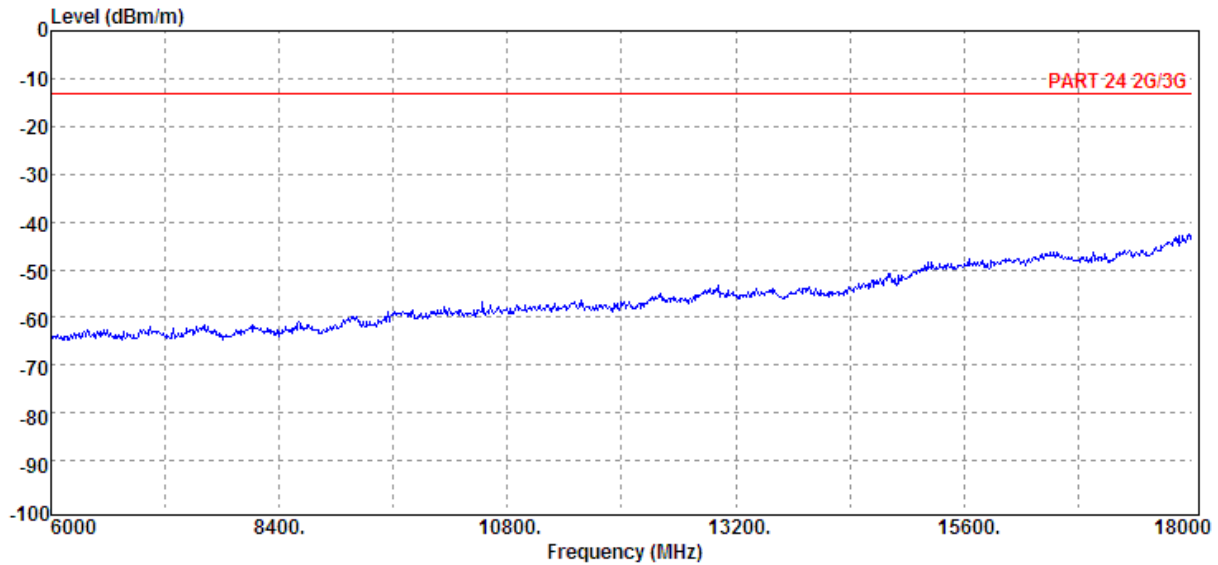

Unless otherwise stated the results shown in this test report refer only to the sample(s) tested and such sample(s) are retained for 90 days only.

除非另有說明，此報告結果僅對測試之樣品負責，同時此樣品僅保留90天。本報告未經本公司書面許可，不可部份複製。

This document is issued by the Company subject to its General Conditions of Service printed overleaf, available on request or accessible at www.sgs.com/terms_and_conditions.htm and, for electronic format documents, subject to Terms and Conditions for Electronic Documents at www.sgs.com/terms_e-document.htm. Attention is drawn to the limitation of liability, indemnification and jurisdiction issues defined therein. Any holder of this document is advised that information contained hereon reflects the Company's findings at the time of its intervention only and within the limits of Client's instructions, if any. The Company's sole responsibility is to its Client and this document does not exonerate parties to a transaction from exercising all their rights and obligations under the transaction documents. This document cannot be reproduced except in full, without prior written approval of the Company. Any unauthorized alteration, forgery or falsification of the content or appearance of this document is unlawful and offenders may be prosecuted to the fullest extent of the law.

Operation Band	:GSM 1900	Test Date	:2013-05-03
ARFCN	:CH 810	Temp./Humi.	:24.1 deg_C / 65 RH
Fundamental Frequency	:1909.8 MHz	Engineer	:Allen
Operation Mode	:TX HIGH	Measurement Antenna Pol.	:HORIZONTAL
EUT Pol.	:E1 Plan		

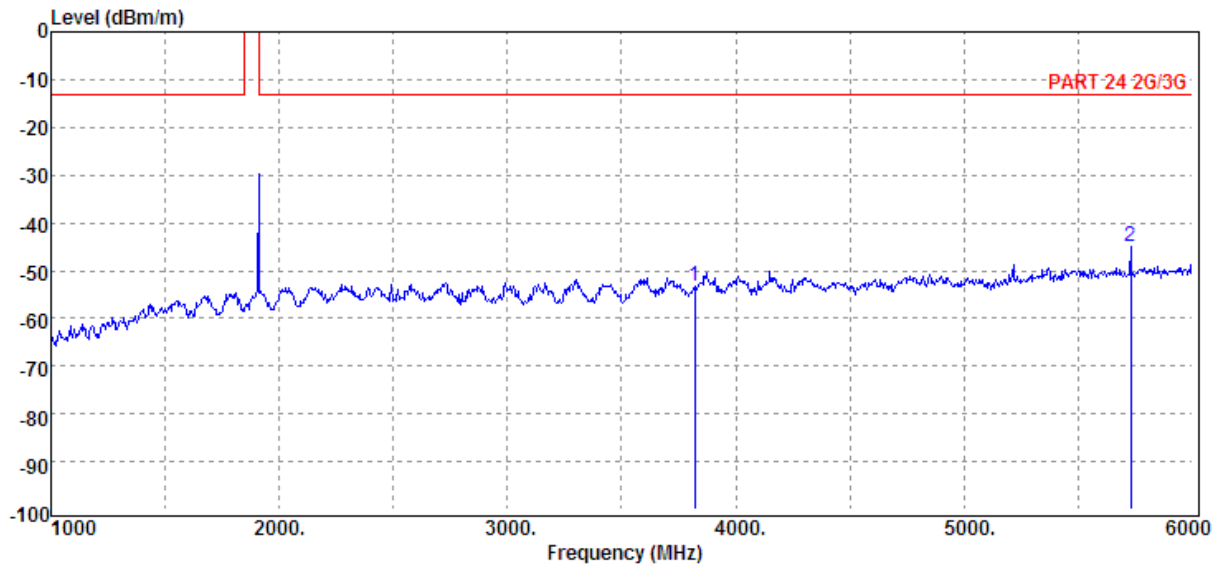
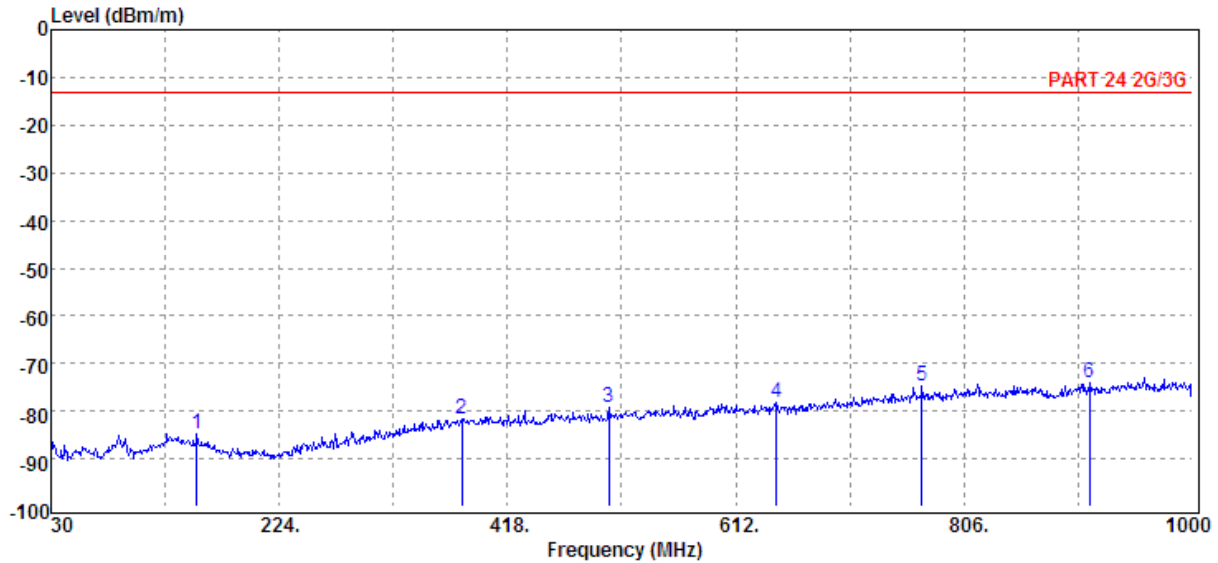

Unless otherwise stated the results shown in this test report refer only to the sample(s) tested and such sample(s) are retained for 90 days only.

除非另有說明，此報告結果僅對測試之樣品負責，同時此樣品僅保留90天。本報告未經本公司書面許可，不可部份複製。

This document is issued by the Company subject to its General Conditions of Service printed overleaf, available on request or accessible at www.sgs.com/terms_and_conditions.htm and, for electronic format documents, subject to Terms and Conditions for Electronic Documents at www.sgs.com/terms_e-document.htm. Attention is drawn to the limitation of liability, indemnification and jurisdiction issues defined therein. Any holder of this document is advised that information contained hereon reflects the Company's findings at the time of its intervention only and within the limits of Client's instructions, if any. The Company's sole responsibility is to its Client and this document does not exonerate parties to a transaction from exercising all their rights and obligations under the transaction documents. This document cannot be reproduced except in full, without prior written approval of the Company. Any unauthorized alteration, forgery or falsification of the content or appearance of this document is unlawful and offenders may be prosecuted to the fullest extent of the law.

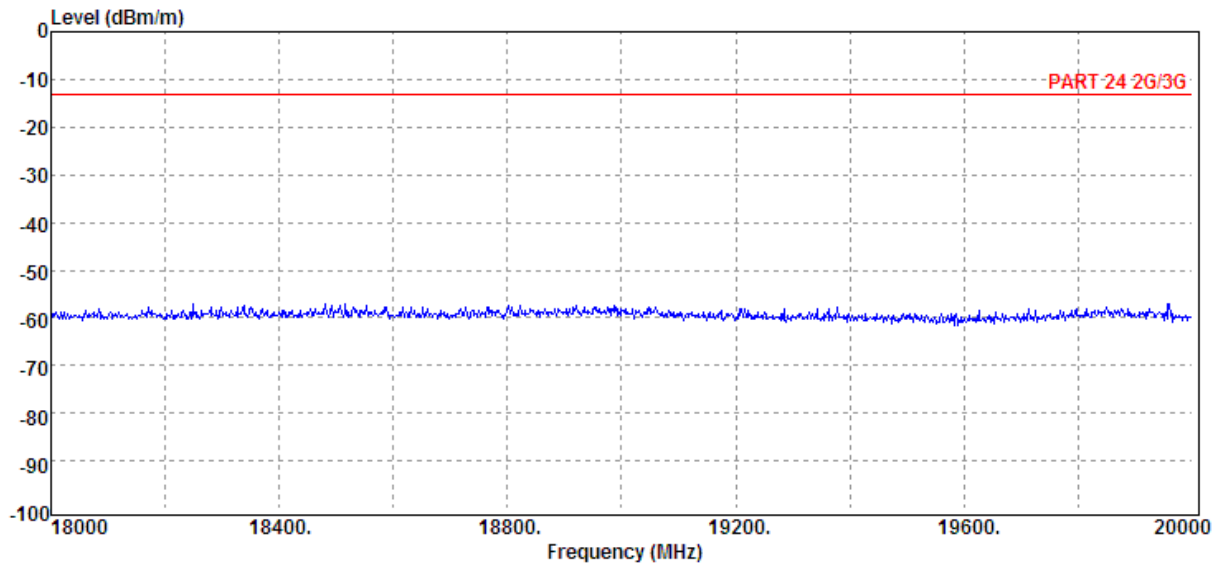
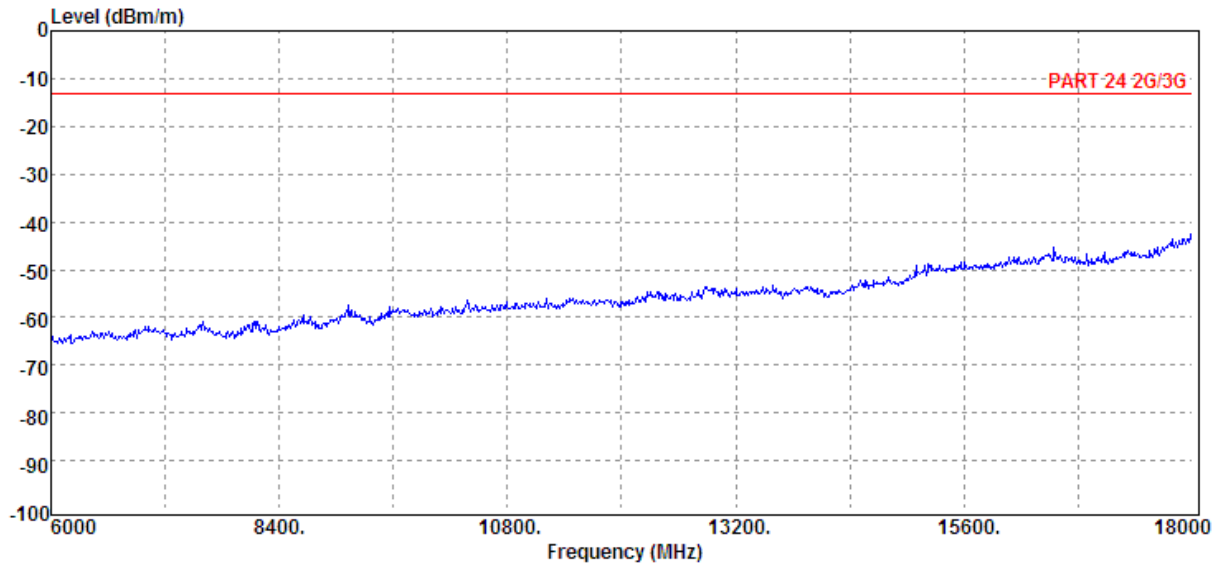

Unless otherwise stated the results shown in this test report refer only to the sample(s) tested and such sample(s) are retained for 90 days only.

除非另有說明，此報告結果僅對測試之樣品負責，同時此樣品僅保留90天。本報告未經本公司書面許可，不可部份複製。

This document is issued by the Company subject to its General Conditions of Service printed overleaf, available on request or accessible at www.sgs.com/terms_and_conditions.htm and, for electronic format documents, subject to Terms and Conditions for Electronic Documents at www.sgs.com/terms_e-document.htm. Attention is drawn to the limitation of liability, indemnification and jurisdiction issues defined therein. Any holder of this document is advised that information contained hereon reflects the Company's findings at the time of its intervention only and within the limits of Client's instructions, if any. The Company's sole responsibility is to its Client and this document does not exonerate parties to a transaction from exercising all their rights and obligations under the transaction documents. This document cannot be reproduced except in full, without prior written approval of the Company. Any unauthorized alteration, forgery or falsification of the content or appearance of this document is unlawful and offenders may be prosecuted to the fullest extent of the law.

Radiated Spurious Emission Measurement Result: WCDMA II Mode

Operation Band	:WCDMA B2	Test Date	:2013-05-03
ARFCN	:CH 9262	Temp./Humi.	:24.1 deg_C / 65 RH
Fundamental Frequency	:1852.4 MHz	Engineer	:Allen
Operation Mode	:TX LOW		
EUT Pol.	:E1 Plan	Measurement Antenna Pol.	:VERTICAL

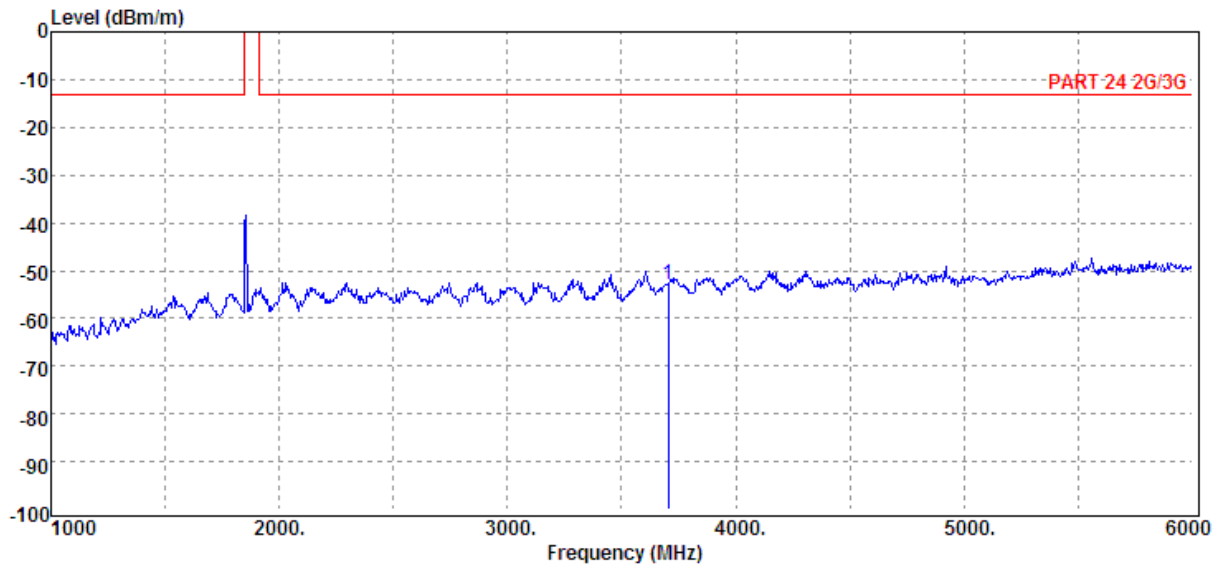
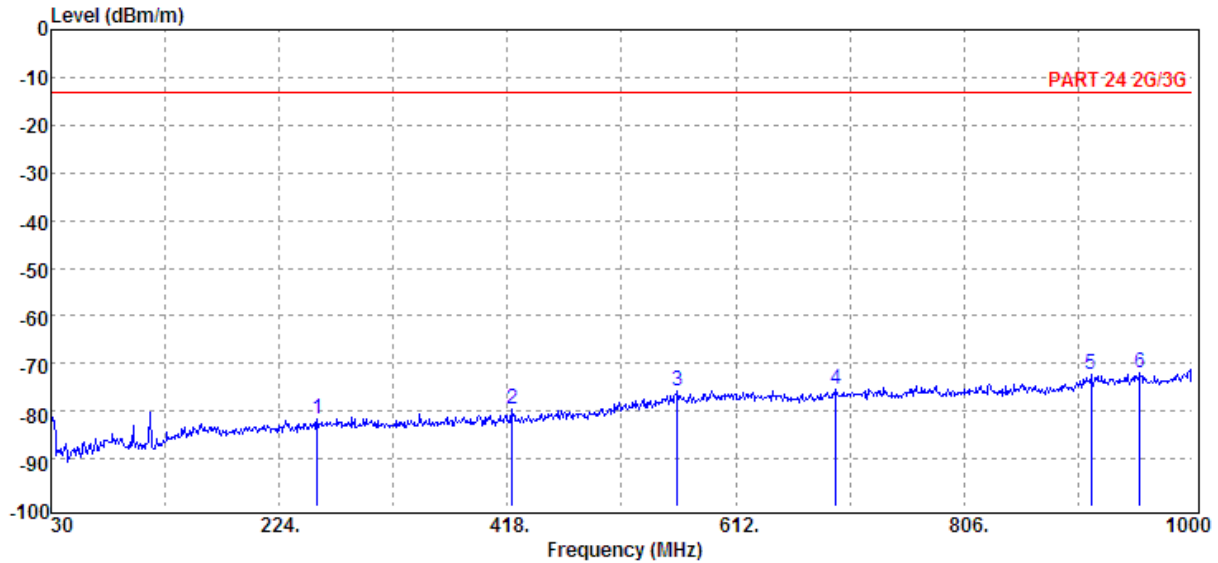

Unless otherwise stated the results shown in this test report refer only to the sample(s) tested and such sample(s) are retained for 90 days only.

除非另有說明，此報告結果僅對測試之樣品負責，同時此樣品僅保留90天。本報告未經本公司書面許可，不可部份複製。

This document is issued by the Company subject to its General Conditions of Service printed overleaf, available on request or accessible at www.sgs.com/terms_and_conditions.htm and, for electronic format documents, subject to Terms and Conditions for Electronic Documents at www.sgs.com/terms_e-document.htm. Attention is drawn to the limitation of liability, indemnification and jurisdiction issues defined therein. Any holder of this document is advised that information contained hereon reflects the Company's findings at the time of its intervention only and within the limits of Client's instructions, if any. The Company's sole responsibility is to its Client and this document does not exonerate parties to a transaction from exercising all their rights and obligations under the transaction documents. This document cannot be reproduced except in full, without prior written approval of the Company. Any unauthorized alteration, forgery or falsification of the content or appearance of this document is unlawful and offenders may be prosecuted to the fullest extent of the law.

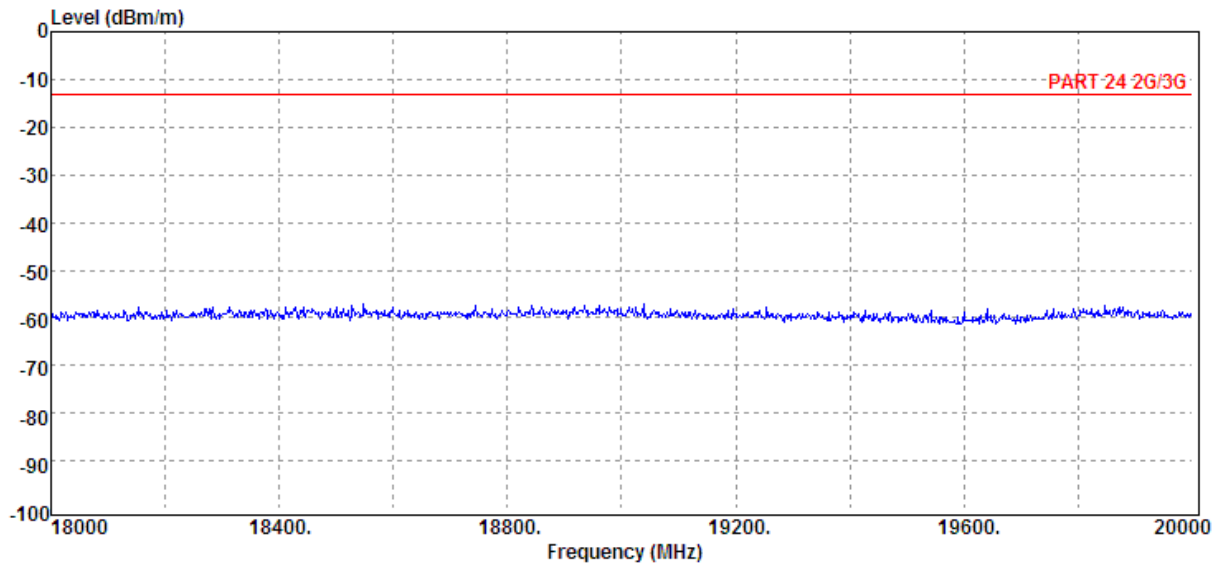
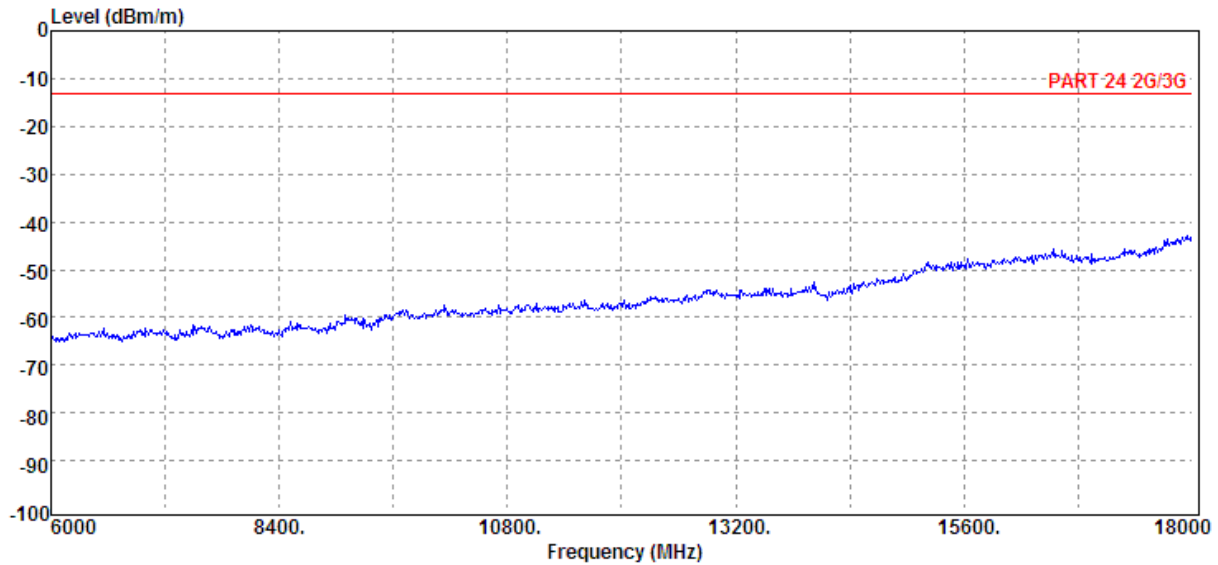

Unless otherwise stated the results shown in this test report refer only to the sample(s) tested and such sample(s) are retained for 90 days only.

除非另有說明，此報告結果僅對測試之樣品負責，同時此樣品僅保留90天。本報告未經本公司書面許可，不可部份複製。

This document is issued by the Company subject to its General Conditions of Service printed overleaf, available on request or accessible at www.sgs.com/terms_and_conditions.htm and, for electronic format documents, subject to Terms and Conditions for Electronic Documents at www.sgs.com/terms_e-document.htm. Attention is drawn to the limitation of liability, indemnification and jurisdiction issues defined therein. Any holder of this document is advised that information contained hereon reflects the Company's findings at the time of its intervention only and within the limits of Client's instructions, if any. The Company's sole responsibility is to its Client and this document does not exonerate parties to a transaction from exercising all their rights and obligations under the transaction documents. This document cannot be reproduced except in full, without prior written approval of the Company. Any unauthorized alteration, forgery or falsification of the content or appearance of this document is unlawful and offenders may be prosecuted to the fullest extent of the law.

Operation Band	:WCDMA B2	Test Date	:2013-05-03
ARFCN	:CH 9262	Temp./Humi.	:24.1 deg_C / 65 RH
Fundamental Frequency	:1852.4 MHz	Engineer	:Allen
Operation Mode	:TX LOW	Measurement Antenna Pol.	:HORIZONTAL
EUT Pol.	:E1 Plan		

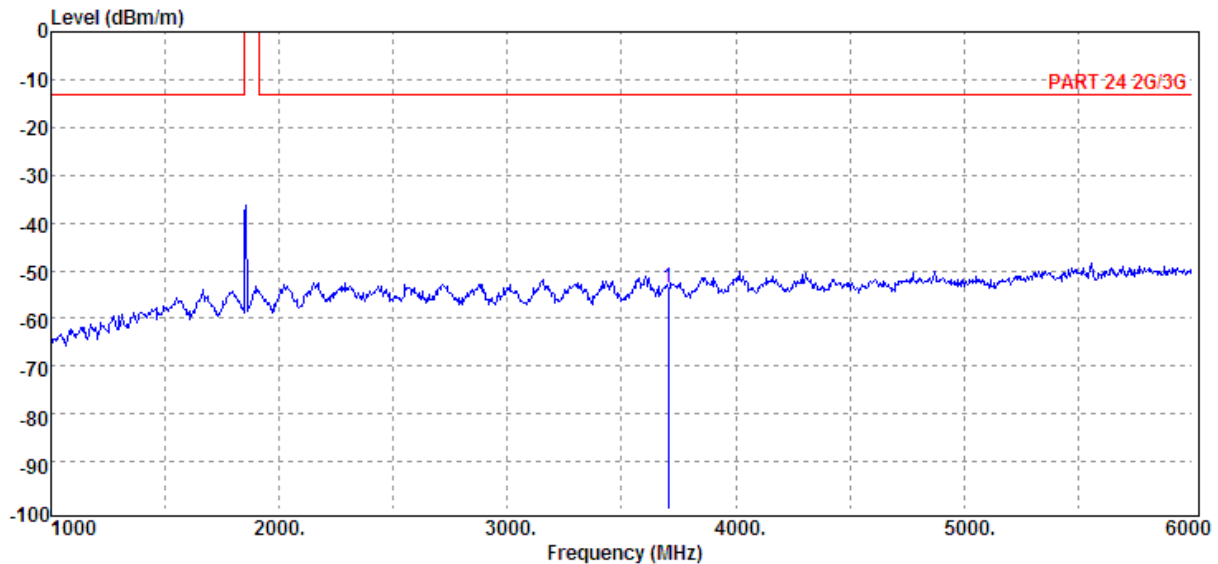
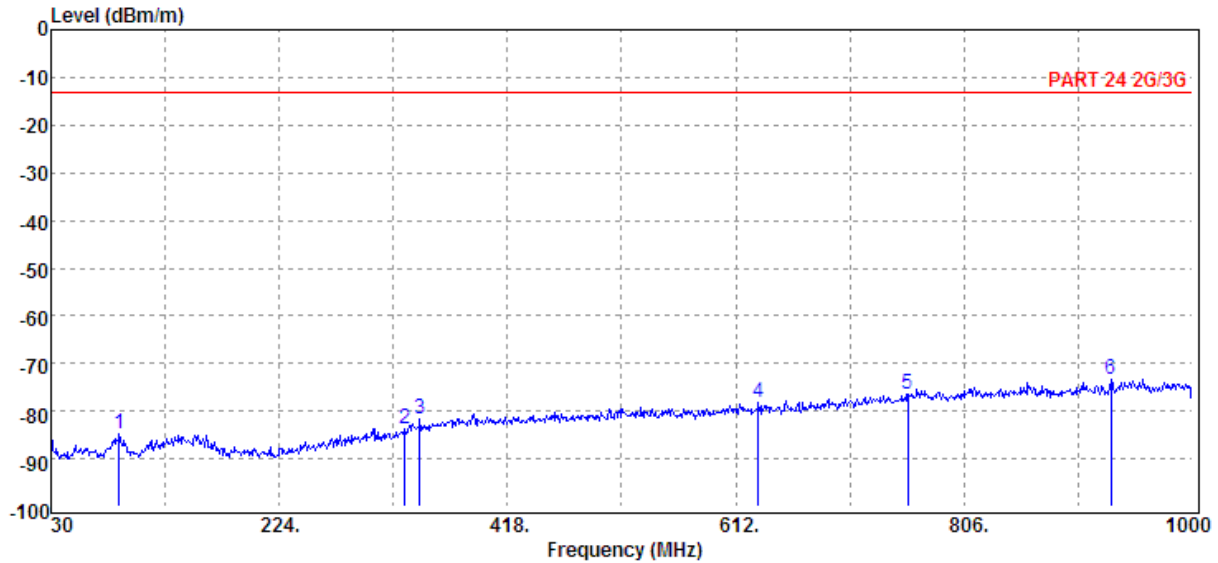

Unless otherwise stated the results shown in this test report refer only to the sample(s) tested and such sample(s) are retained for 90 days only.

除非另有說明，此報告結果僅對測試之樣品負責，同時此樣品僅保留90天。本報告未經本公司書面許可，不可部份複製。

This document is issued by the Company subject to its General Conditions of Service printed overleaf, available on request or accessible at www.sgs.com/terms_and_conditions.htm and, for electronic format documents, subject to Terms and Conditions for Electronic Documents at www.sgs.com/terms_e-document.htm. Attention is drawn to the limitation of liability, indemnification and jurisdiction issues defined therein. Any holder of this document is advised that information contained hereon reflects the Company's findings at the time of its intervention only and within the limits of Client's instructions, if any. The Company's sole responsibility is to its Client and this document does not exonerate parties to a transaction from exercising all their rights and obligations under the transaction documents. This document cannot be reproduced except in full, without prior written approval of the Company. Any unauthorized alteration, forgery or falsification of the content or appearance of this document is unlawful and offenders may be prosecuted to the fullest extent of the law.

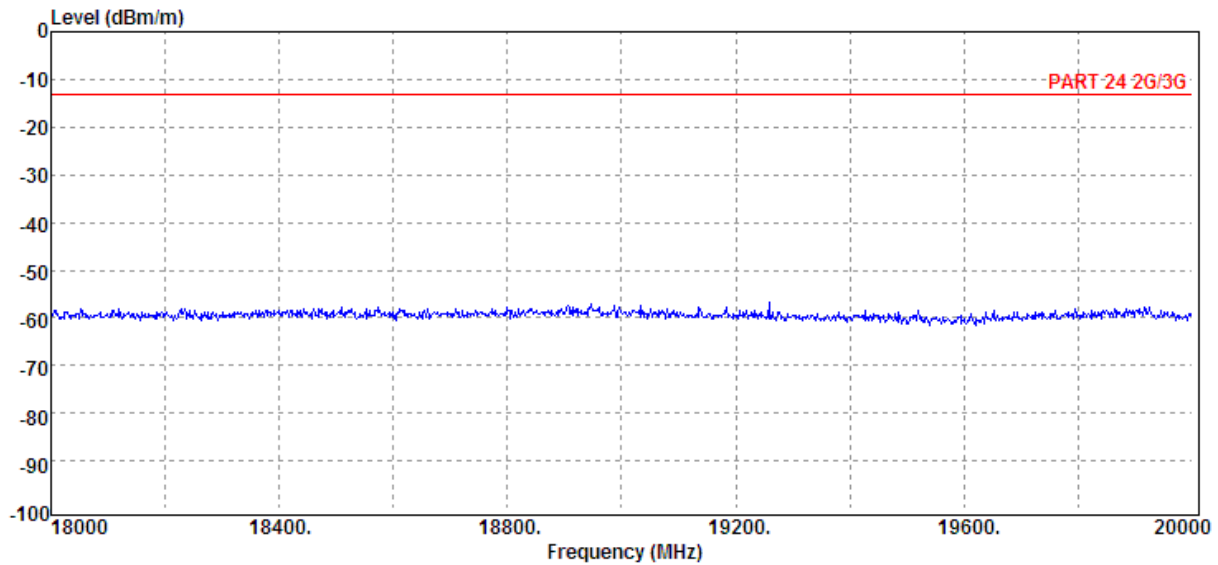
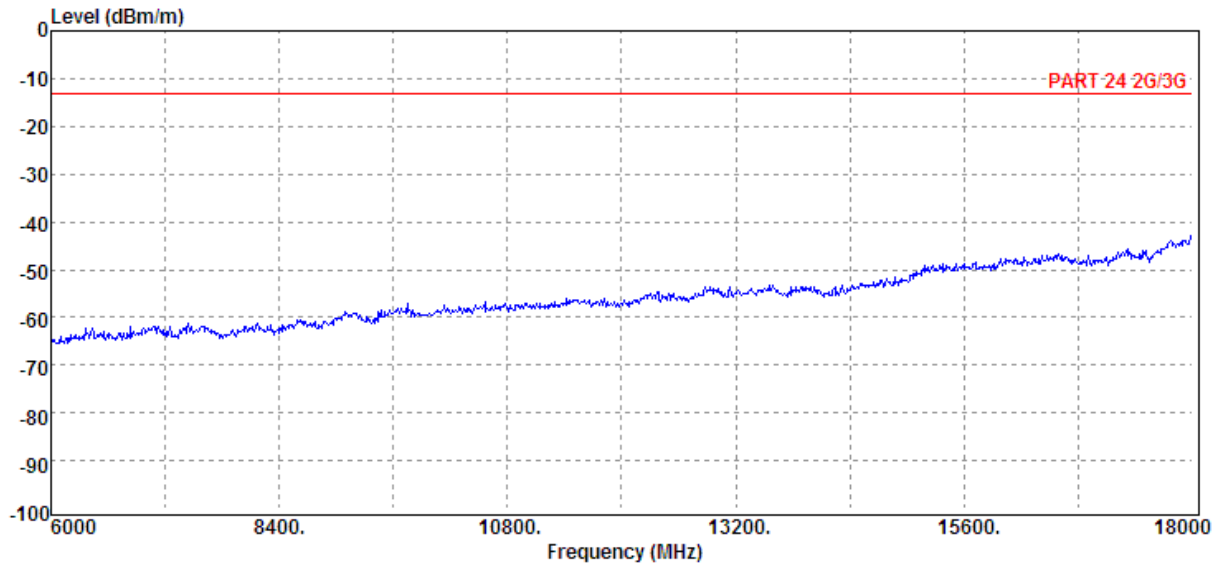

Unless otherwise stated the results shown in this test report refer only to the sample(s) tested and such sample(s) are retained for 90 days only.

除非另有說明，此報告結果僅對測試之樣品負責，同時此樣品僅保留90天。本報告未經本公司書面許可，不可部份複製。

This document is issued by the Company subject to its General Conditions of Service printed overleaf, available on request or accessible at www.sgs.com/terms_and_conditions.htm and, for electronic format documents, subject to Terms and Conditions for Electronic Documents at www.sgs.com/terms_e-document.htm. Attention is drawn to the limitation of liability, indemnification and jurisdiction issues defined therein. Any holder of this document is advised that information contained hereon reflects the Company's findings at the time of its intervention only and within the limits of Client's instructions, if any. The Company's sole responsibility is to its Client and this document does not exonerate parties to a transaction from exercising all their rights and obligations under the transaction documents. This document cannot be reproduced except in full, without prior written approval of the Company. Any unauthorized alteration, forgery or falsification of the content or appearance of this document is unlawful and offenders may be prosecuted to the fullest extent of the law.

Operation Band	:WCDMA B2	Test Date	:2013-05-03
ARFCN	:CH 9400	Temp./Humi.	:24.1 deg_C / 65 RH
Fundamental Frequency	:1880 MHz	Engineer	:Allen
Operation Mode	:TX MID	Measurement Antenna Pol.	:VERTICAL
EUT Pol.	:E1 Plan		

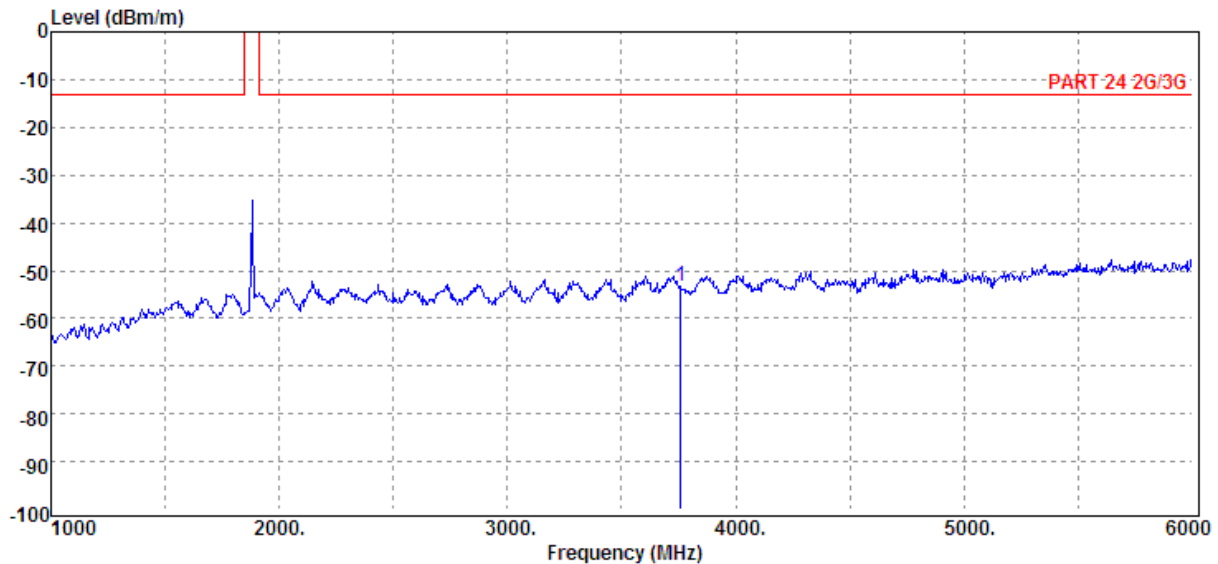
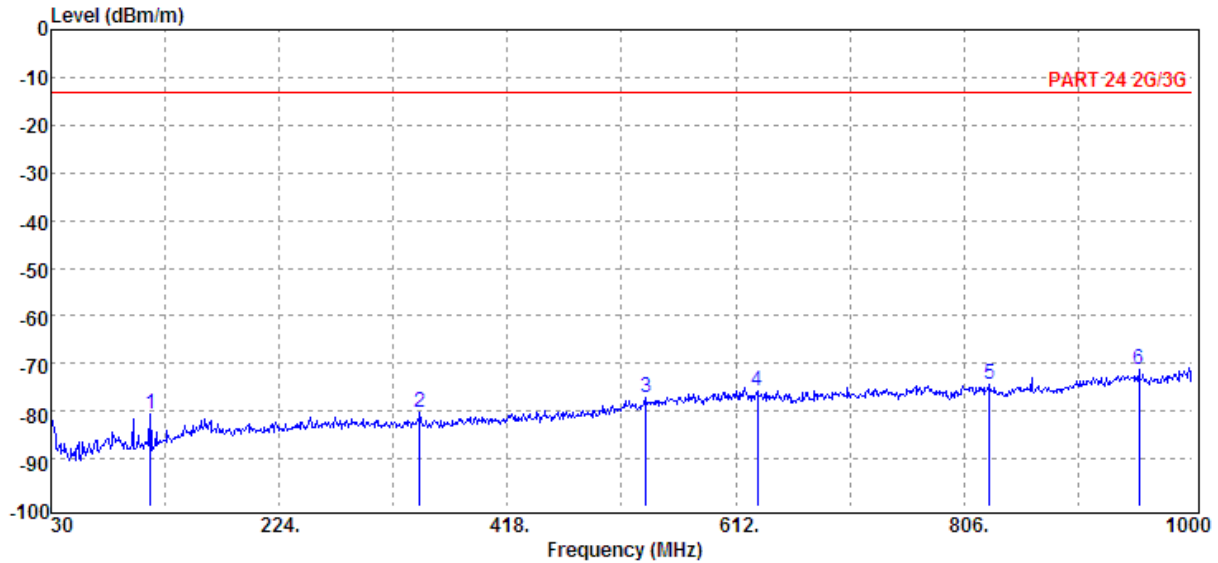

Unless otherwise stated the results shown in this test report refer only to the sample(s) tested and such sample(s) are retained for 90 days only.

除非另有說明，此報告結果僅對測試之樣品負責，同時此樣品僅保留90天。本報告未經本公司書面許可，不可部份複製。

This document is issued by the Company subject to its General Conditions of Service printed overleaf, available on request or accessible at www.sgs.com/terms_and_conditions.htm and, for electronic format documents, subject to Terms and Conditions for Electronic Documents at www.sgs.com/terms_e-document.htm. Attention is drawn to the limitation of liability, indemnification and jurisdiction issues defined therein. Any holder of this document is advised that information contained hereon reflects the Company's findings at the time of its intervention only and within the limits of Client's instructions, if any. The Company's sole responsibility is to its Client and this document does not exonerate parties to a transaction from exercising all their rights and obligations under the transaction documents. This document cannot be reproduced except in full, without prior written approval of the Company. Any unauthorized alteration, forgery or falsification of the content or appearance of this document is unlawful and offenders may be prosecuted to the fullest extent of the law.

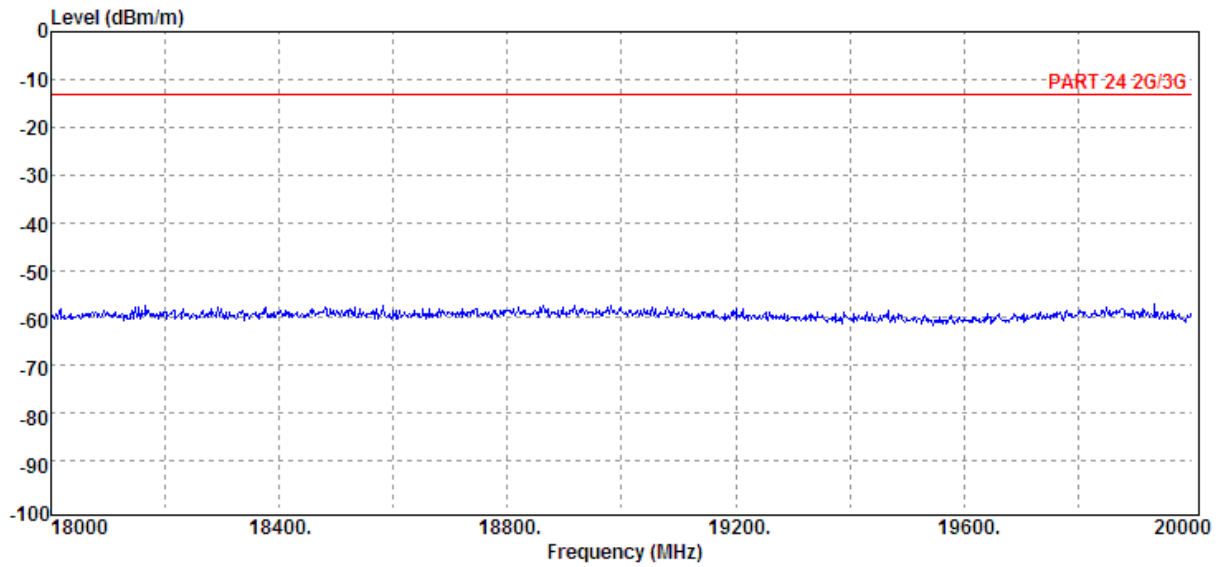
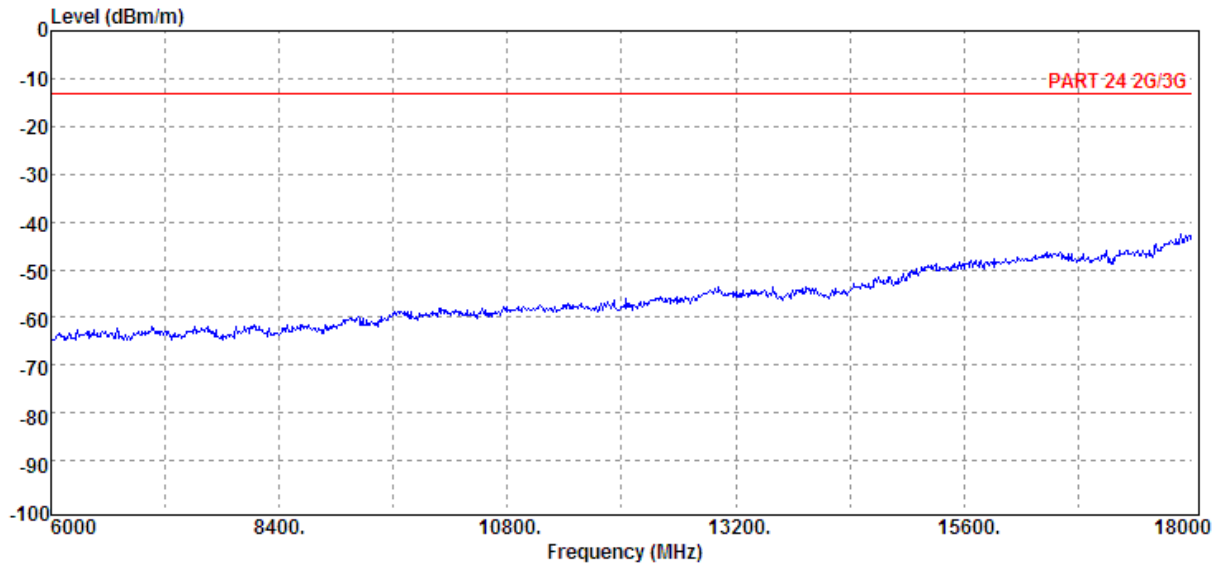

Unless otherwise stated the results shown in this test report refer only to the sample(s) tested and such sample(s) are retained for 90 days only.

除非另有說明，此報告結果僅對測試之樣品負責，同時此樣品僅保留90天。本報告未經本公司書面許可，不可部份複製。

This document is issued by the Company subject to its General Conditions of Service printed overleaf, available on request or accessible at www.sgs.com/terms_and_conditions.htm and, for electronic format documents, subject to Terms and Conditions for Electronic Documents at www.sgs.com/terms_e-document.htm. Attention is drawn to the limitation of liability, indemnification and jurisdiction issues defined therein. Any holder of this document is advised that information contained hereon reflects the Company's findings at the time of its intervention only and within the limits of Client's instructions, if any. The Company's sole responsibility is to its Client and this document does not exonerate parties to a transaction from exercising all their rights and obligations under the transaction documents. This document cannot be reproduced except in full, without prior written approval of the Company. Any unauthorized alteration, forgery or falsification of the content or appearance of this document is unlawful and offenders may be prosecuted to the fullest extent of the law.

Operation Band	:WCDMA B2	Test Date	:2013-05-03
ARFCN	:CH 9400	Temp./Humi.	:24.1 deg_C / 65 RH
Fundamental Frequency	:1880 MHz	Engineer	:Allen
Operation Mode	:TX MID	Measurement Antenna Pol.	:HORIZONTAL
EUT Pol.	:E1 Plan		

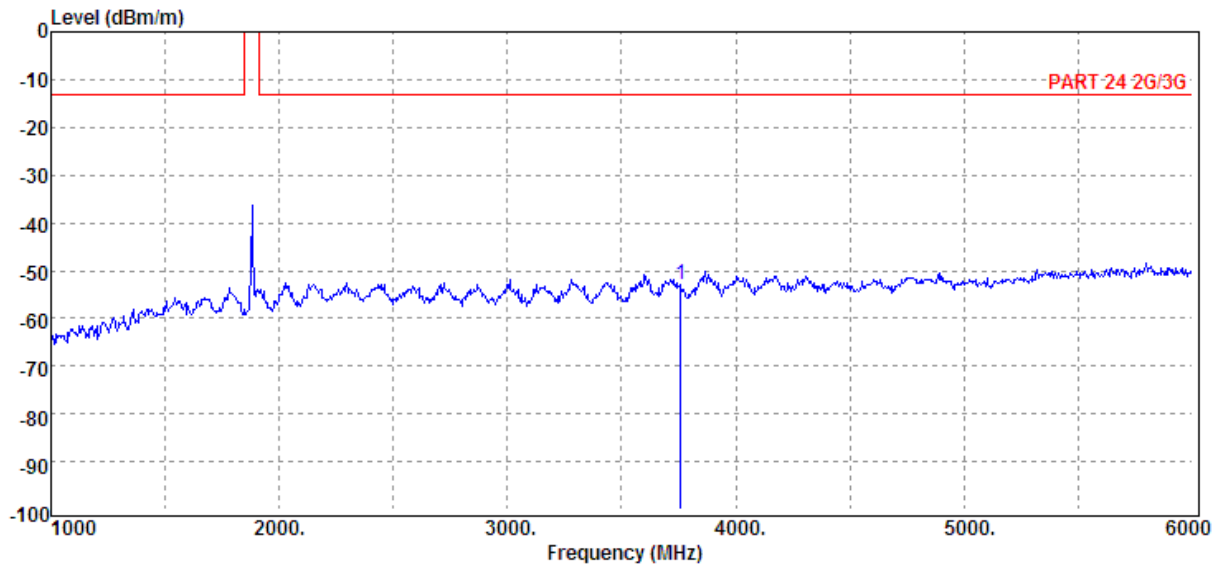
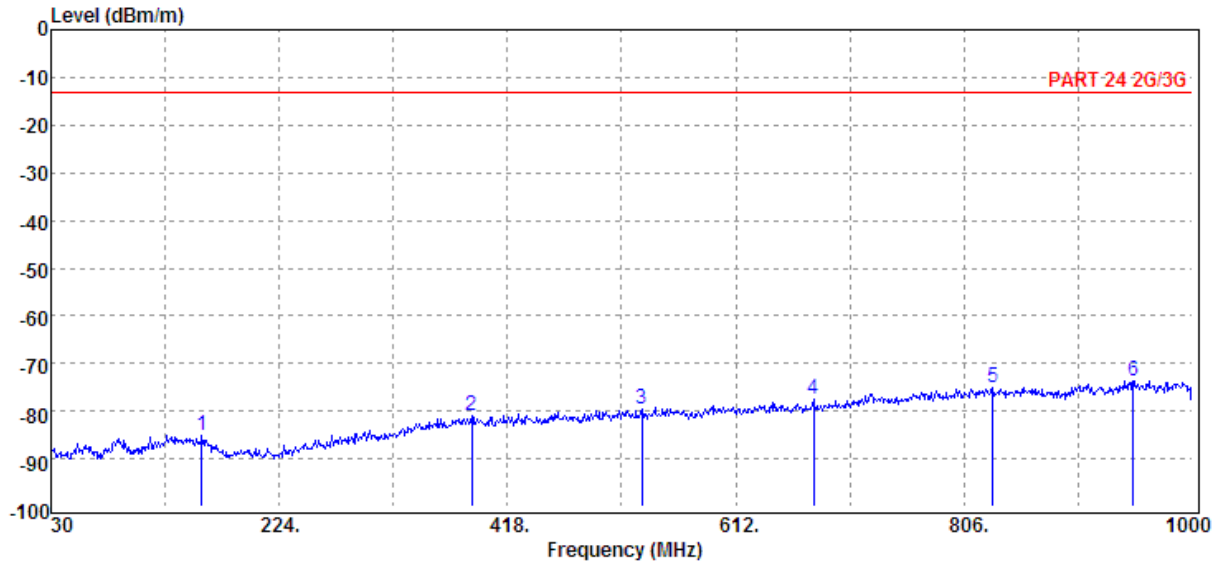

Unless otherwise stated the results shown in this test report refer only to the sample(s) tested and such sample(s) are retained for 90 days only.

除非另有說明，此報告結果僅對測試之樣品負責，同時此樣品僅保留90天。本報告未經本公司書面許可，不可部份複製。

This document is issued by the Company subject to its General Conditions of Service printed overleaf, available on request or accessible at www.sgs.com/terms_and_conditions.htm and, for electronic format documents, subject to Terms and Conditions for Electronic Documents at www.sgs.com/terms_e-document.htm. Attention is drawn to the limitation of liability, indemnification and jurisdiction issues defined therein. Any holder of this document is advised that information contained hereon reflects the Company's findings at the time of its intervention only and within the limits of Client's instructions, if any. The Company's sole responsibility is to its Client and this document does not exonerate parties to a transaction from exercising all their rights and obligations under the transaction documents. This document cannot be reproduced except in full, without prior written approval of the Company. Any unauthorized alteration, forgery or falsification of the content or appearance of this document is unlawful and offenders may be prosecuted to the fullest extent of the law.

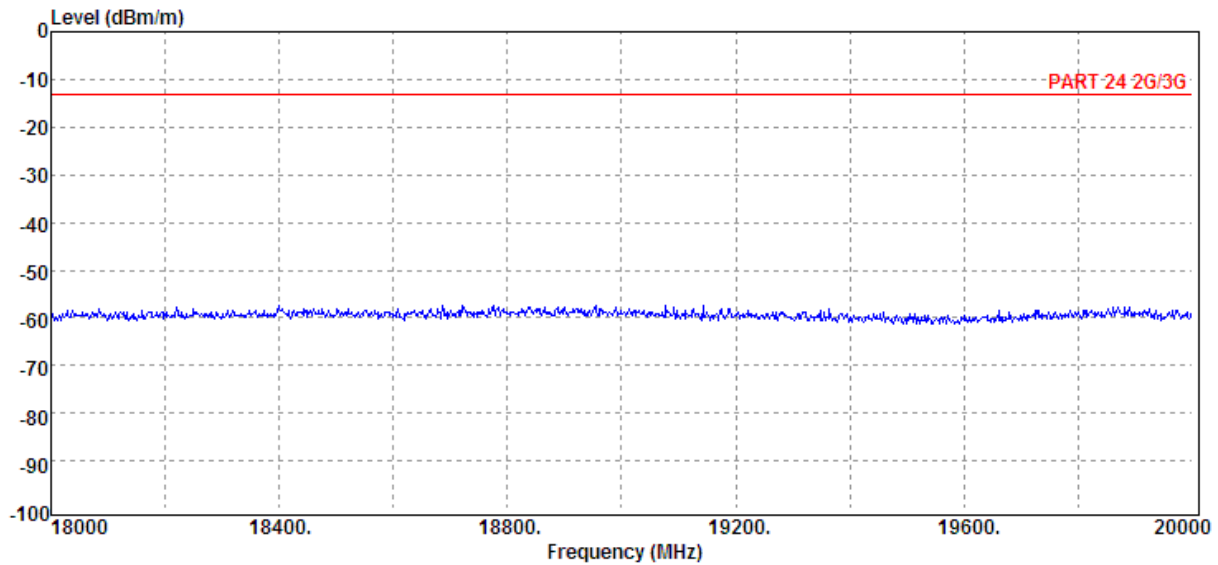
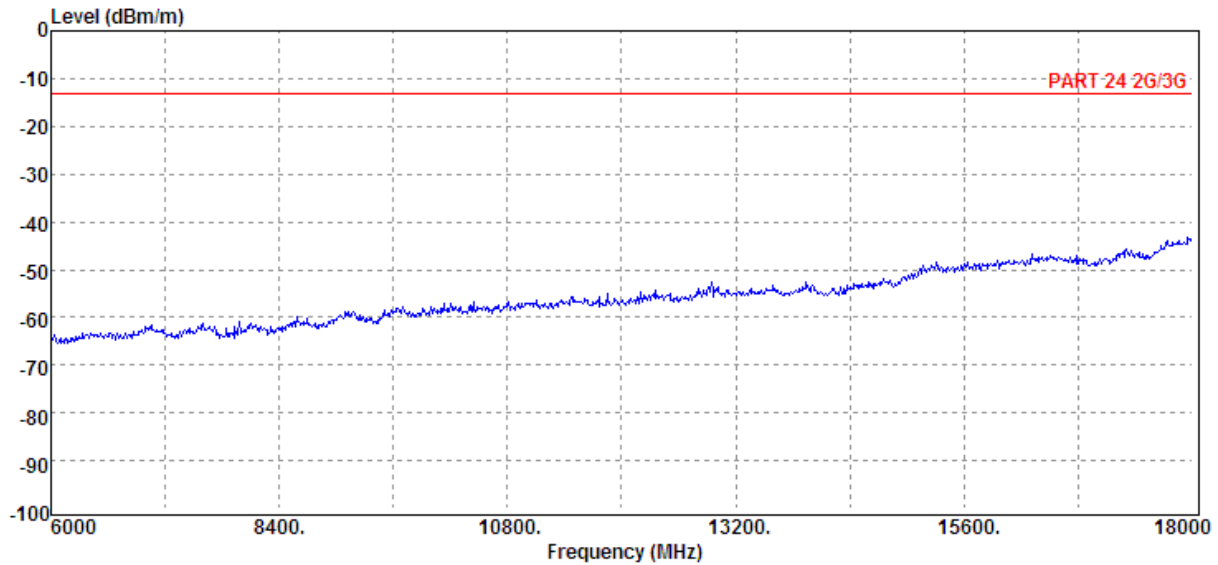

Unless otherwise stated the results shown in this test report refer only to the sample(s) tested and such sample(s) are retained for 90 days only.

除非另有說明，此報告結果僅對測試之樣品負責，同時此樣品僅保留90天。本報告未經本公司書面許可，不可部份複製。

This document is issued by the Company subject to its General Conditions of Service printed overleaf, available on request or accessible at www.sgs.com/terms_and_conditions.htm and, for electronic format documents, subject to Terms and Conditions for Electronic Documents at www.sgs.com/terms_e-document.htm. Attention is drawn to the limitation of liability, indemnification and jurisdiction issues defined therein. Any holder of this document is advised that information contained hereon reflects the Company's findings at the time of its intervention only and within the limits of Client's instructions, if any. The Company's sole responsibility is to its Client and this document does not exonerate parties to a transaction from exercising all their rights and obligations under the transaction documents. This document cannot be reproduced except in full, without prior written approval of the Company. Any unauthorized alteration, forgery or falsification of the content or appearance of this document is unlawful and offenders may be prosecuted to the fullest extent of the law.

Operation Band	:WCDMA B2	Test Date	:2013-05-03
ARFCN	:CH 9538	Temp./Humi.	:24.1 deg_C / 65 RH
Fundamental Frequency	:1907.6 MHz	Engineer	:Allen
Operation Mode	:TX HIGH	Measurement Antenna Pol.	:VERTICAL
EUT Pol.	:E1 Plan		

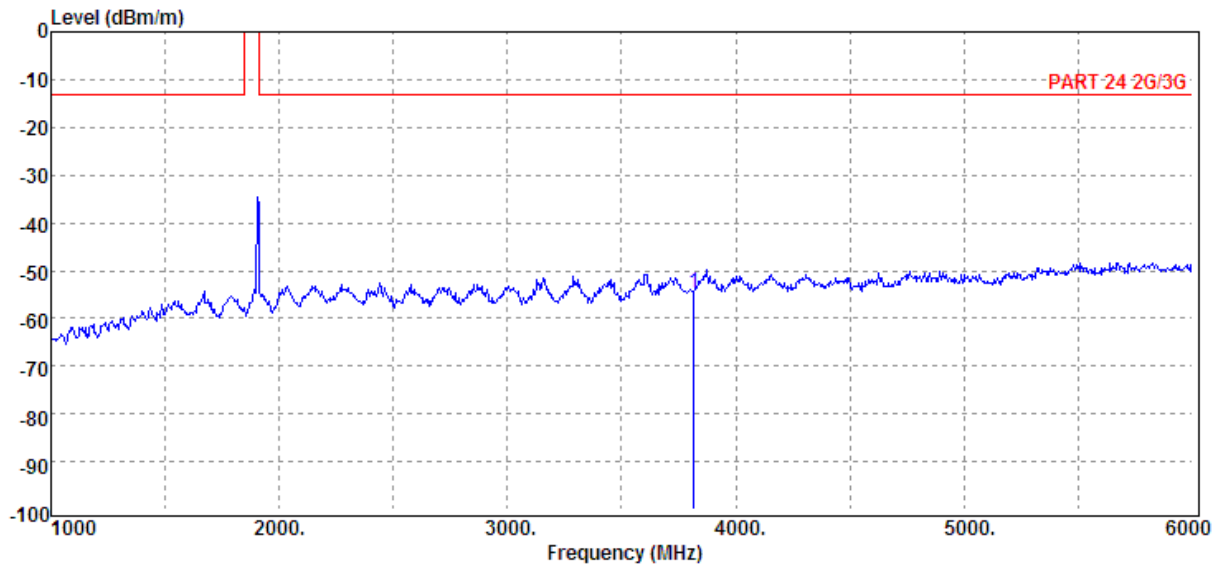
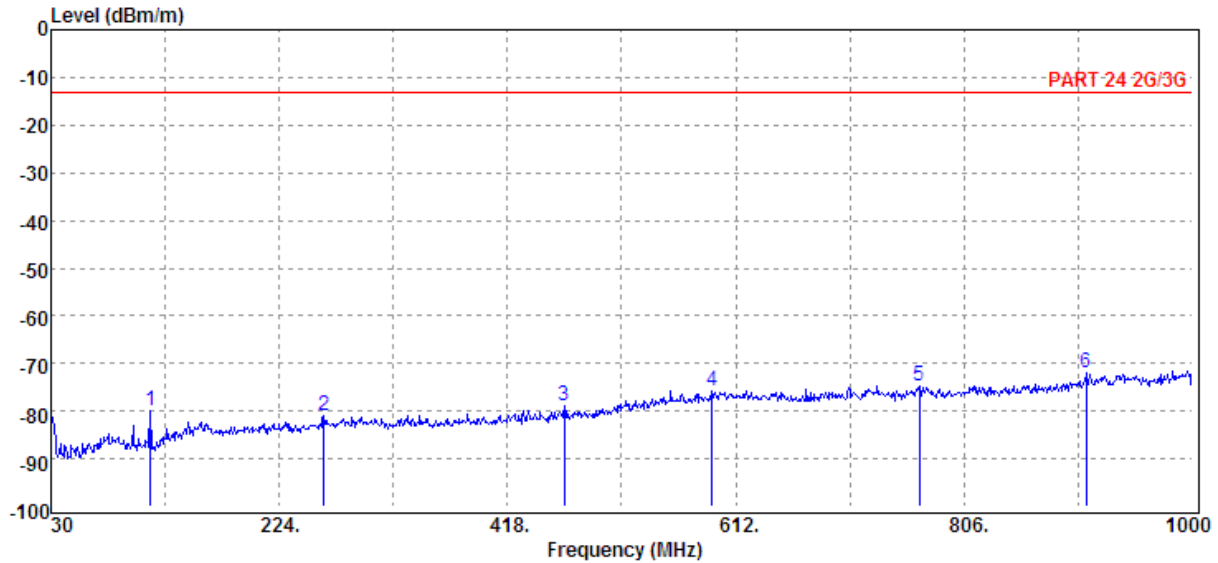

Unless otherwise stated the results shown in this test report refer only to the sample(s) tested and such sample(s) are retained for 90 days only.

除非另有說明，此報告結果僅對測試之樣品負責，同時此樣品僅保留90天。本報告未經本公司書面許可，不可部份複製。

This document is issued by the Company subject to its General Conditions of Service printed overleaf, available on request or accessible at www.sgs.com/terms_and_conditions.htm and, for electronic format documents, subject to Terms and Conditions for Electronic Documents at www.sgs.com/terms_e-document.htm. Attention is drawn to the limitation of liability, indemnification and jurisdiction issues defined therein. Any holder of this document is advised that information contained hereon reflects the Company's findings at the time of its intervention only and within the limits of Client's instructions, if any. The Company's sole responsibility is to its Client and this document does not exonerate parties to a transaction from exercising all their rights and obligations under the transaction documents. This document cannot be reproduced except in full, without prior written approval of the Company. Any unauthorized alteration, forgery or falsification of the content or appearance of this document is unlawful and offenders may be prosecuted to the fullest extent of the law.

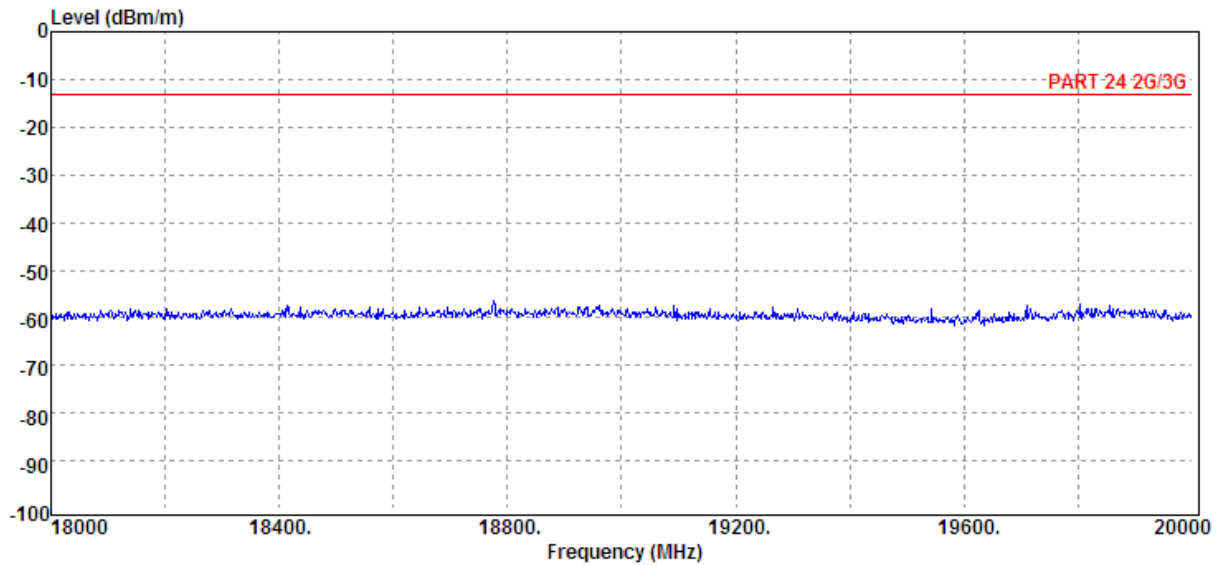
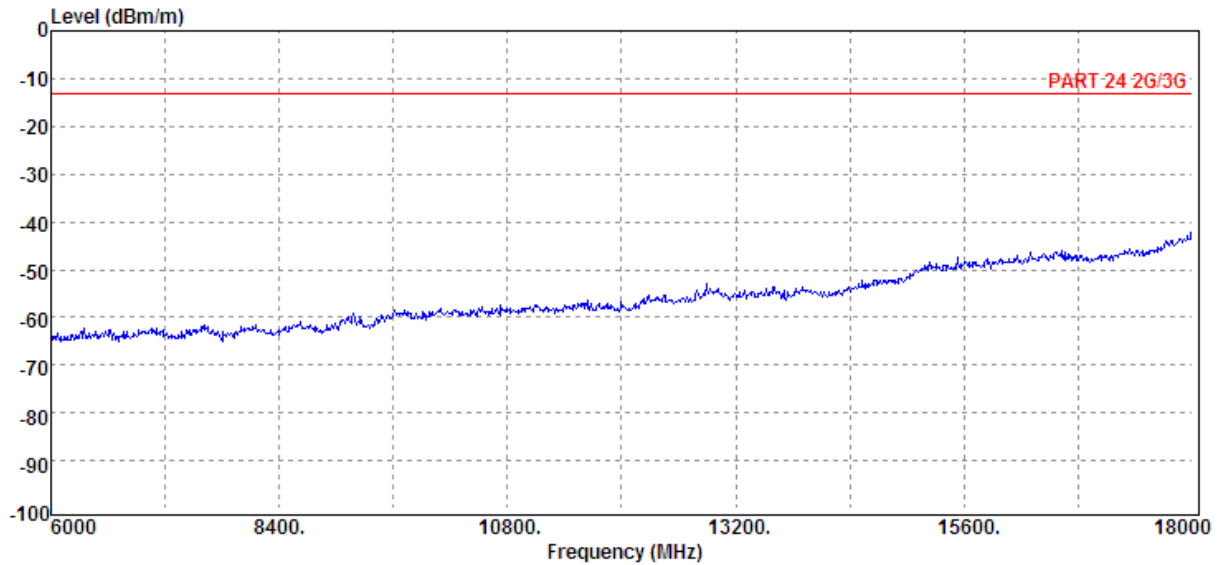

Unless otherwise stated the results shown in this test report refer only to the sample(s) tested and such sample(s) are retained for 90 days only.

除非另有說明，此報告結果僅對測試之樣品負責，同時此樣品僅保留90天。本報告未經本公司書面許可，不可部份複製。

This document is issued by the Company subject to its General Conditions of Service printed overleaf, available on request or accessible at www.sgs.com/terms_and_conditions.htm and, for electronic format documents, subject to Terms and Conditions for Electronic Documents at www.sgs.com/terms_e-document.htm. Attention is drawn to the limitation of liability, indemnification and jurisdiction issues defined therein. Any holder of this document is advised that information contained hereon reflects the Company's findings at the time of its intervention only and within the limits of Client's instructions, if any. The Company's sole responsibility is to its Client and this document does not exonerate parties to a transaction from exercising all their rights and obligations under the transaction documents. This document cannot be reproduced except in full, without prior written approval of the Company. Any unauthorized alteration, forgery or falsification of the content or appearance of this document is unlawful and offenders may be prosecuted to the fullest extent of the law.

Operation Band	:WCDMA B2	Test Date	:2013-05-03
ARFCN	:CH 9538	Temp./Humi.	:24.1 deg_C / 65 RH
Fundamental Frequency	:1907.6 MHz	Engineer	:Allen
Operation Mode	:TX HIGH	Measurement Antenna Pol.	:HORIZONTAL
EUT Pol.	:E1 Plan		

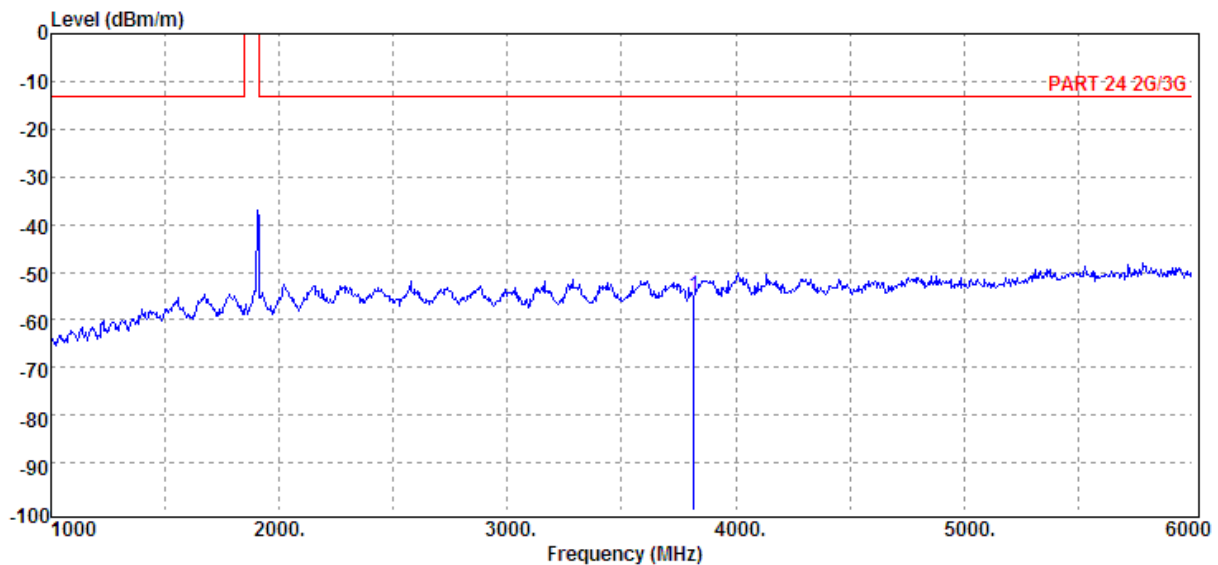
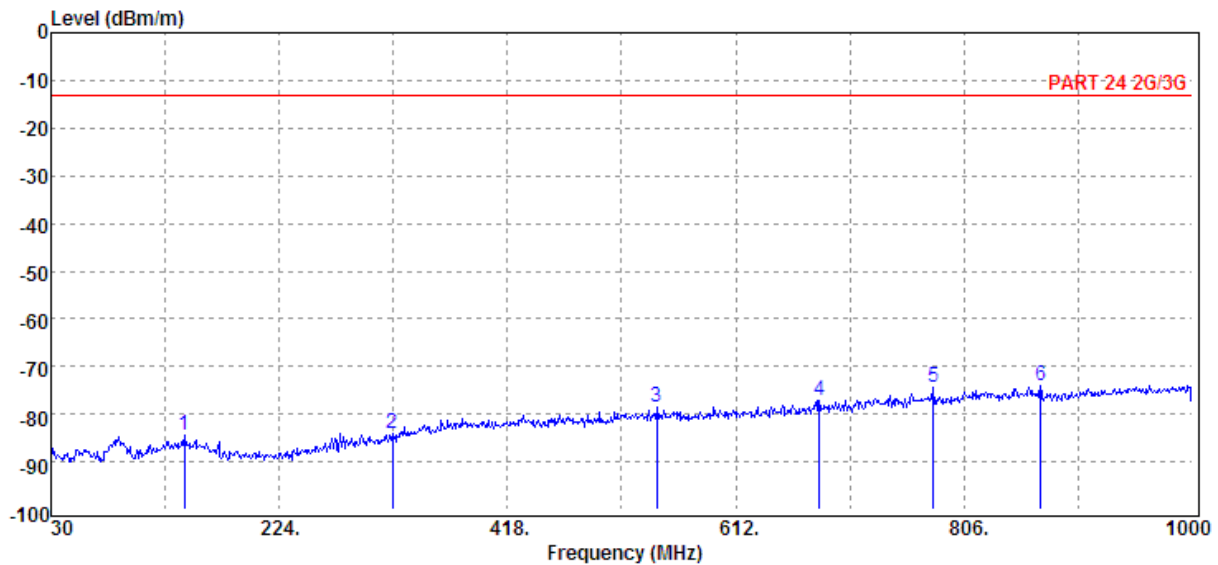

Unless otherwise stated the results shown in this test report refer only to the sample(s) tested and such sample(s) are retained for 90 days only.

除非另有說明，此報告結果僅對測試之樣品負責，同時此樣品僅保留90天。本報告未經本公司書面許可，不可部份複製。

This document is issued by the Company subject to its General Conditions of Service printed overleaf, available on request or accessible at www.sgs.com/terms_and_conditions.htm and, for electronic format documents, subject to Terms and Conditions for Electronic Documents at www.sgs.com/terms_e-document.htm. Attention is drawn to the limitation of liability, indemnification and jurisdiction issues defined therein. Any holder of this document is advised that information contained hereon reflects the Company's findings at the time of its intervention only and within the limits of Client's instructions, if any. The Company's sole responsibility is to its Client and this document does not exonerate parties to a transaction from exercising all their rights and obligations under the transaction documents. This document cannot be reproduced except in full, without prior written approval of the Company. Any unauthorized alteration, forgery or falsification of the content or appearance of this document is unlawful and offenders may be prosecuted to the fullest extent of the law.

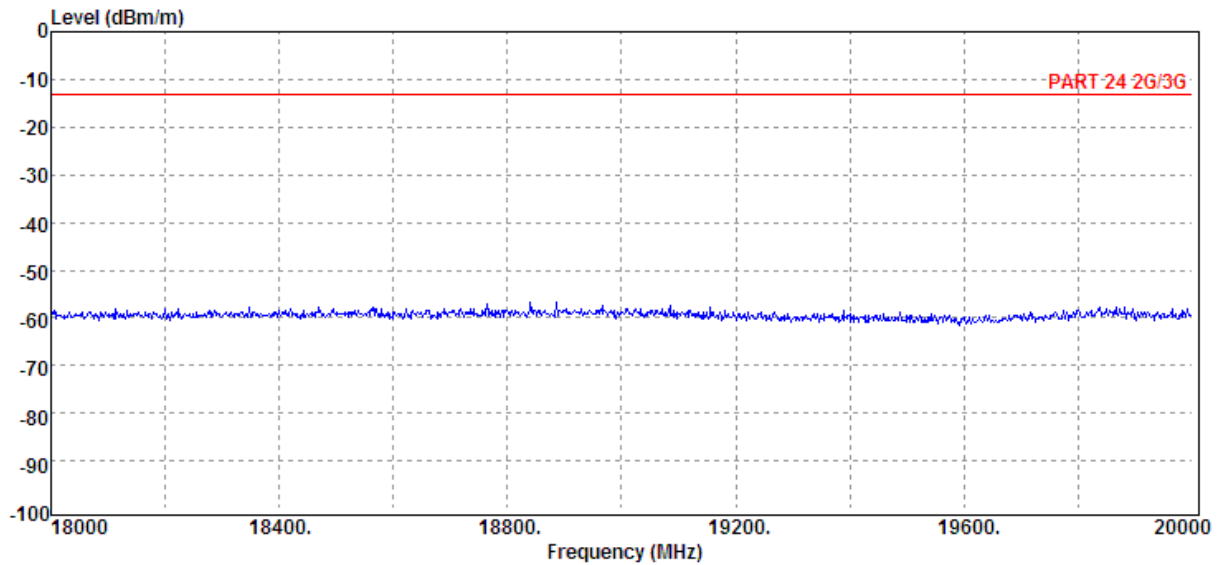
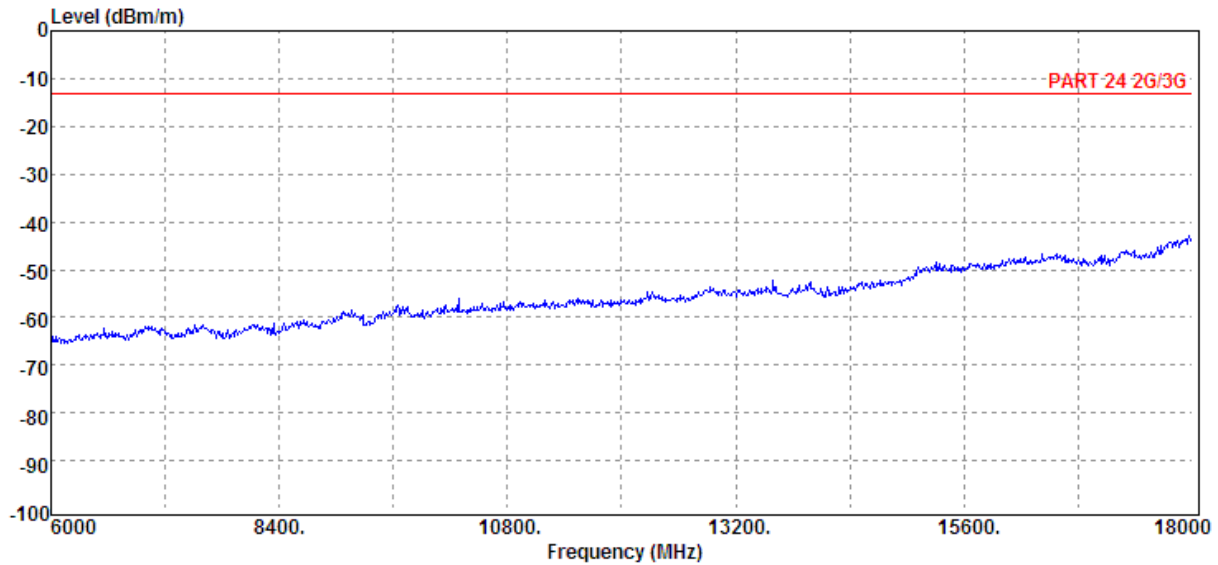

Unless otherwise stated the results shown in this test report refer only to the sample(s) tested and such sample(s) are retained for 90 days only.

除非另有說明，此報告結果僅對測試之樣品負責，同時此樣品僅保留90天。本報告未經本公司書面許可，不可部份複製。

This document is issued by the Company subject to its General Conditions of Service printed overleaf, available on request or accessible at www.sgs.com/terms_and_conditions.htm and, for electronic format documents, subject to Terms and Conditions for Electronic Documents at www.sgs.com/terms_e-document.htm. Attention is drawn to the limitation of liability, indemnification and jurisdiction issues defined therein. Any holder of this document is advised that information contained hereon reflects the Company's findings at the time of its intervention only and within the limits of Client's instructions, if any. The Company's sole responsibility is to its Client and this document does not exonerate parties to a transaction from exercising all their rights and obligations under the transaction documents. This document cannot be reproduced except in full, without prior written approval of the Company. Any unauthorized alteration, forgery or falsification of the content or appearance of this document is unlawful and offenders may be prosecuted to the fullest extent of the law.

Radiated Spurious Emission Measurement Result: WCDMA IV Mode

Operation Band	:WCDMA B4	Test Date	:2013-05-03
ARFCN	:CH 1312	Temp./Humi.	:24.1 deg_C / 65 RH
Fundamental Frequency	:1712.4 MHz	Engineer	:Allen
Operation Mode	:TX LOW		
EUT Pol.	:H Plan	Measurement Antenna Pol.	:VERTICAL

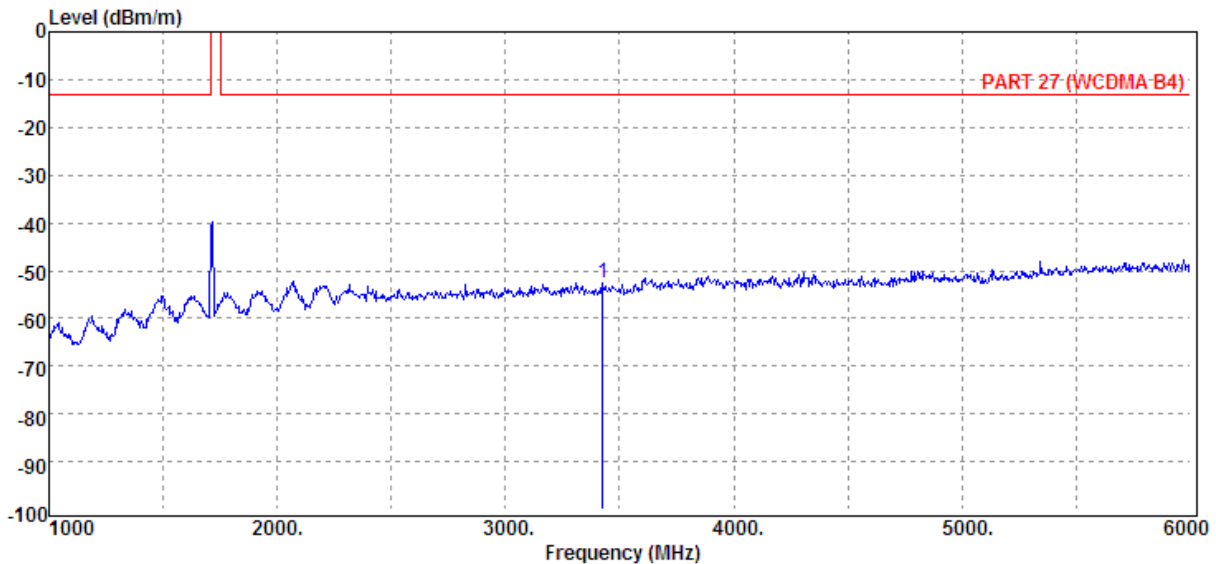
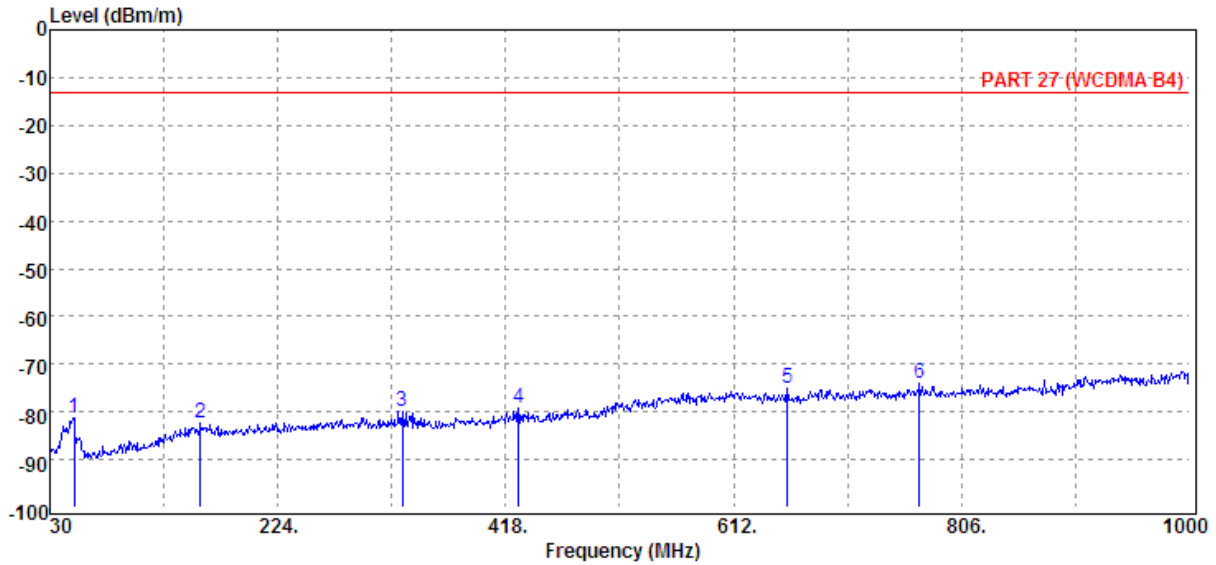

Unless otherwise stated the results shown in this test report refer only to the sample(s) tested and such sample(s) are retained for 90 days only.

除非另有說明，此報告結果僅對測試之樣品負責，同時此樣品僅保留90天。本報告未經本公司書面許可，不可部份複製。

This document is issued by the Company subject to its General Conditions of Service printed overleaf, available on request or accessible at www.sgs.com/terms_and_conditions.htm and, for electronic format documents, subject to Terms and Conditions for Electronic Documents at www.sgs.com/terms_e-document.htm. Attention is drawn to the limitation of liability, indemnification and jurisdiction issues defined therein. Any holder of this document is advised that information contained hereon reflects the Company's findings at the time of its intervention only and within the limits of Client's instructions, if any. The Company's sole responsibility is to its Client and this document does not exonerate parties to a transaction from exercising all their rights and obligations under the transaction documents. This document cannot be reproduced except in full, without prior written approval of the Company. Any unauthorized alteration, forgery or falsification of the content or appearance of this document is unlawful and offenders may be prosecuted to the fullest extent of the law.

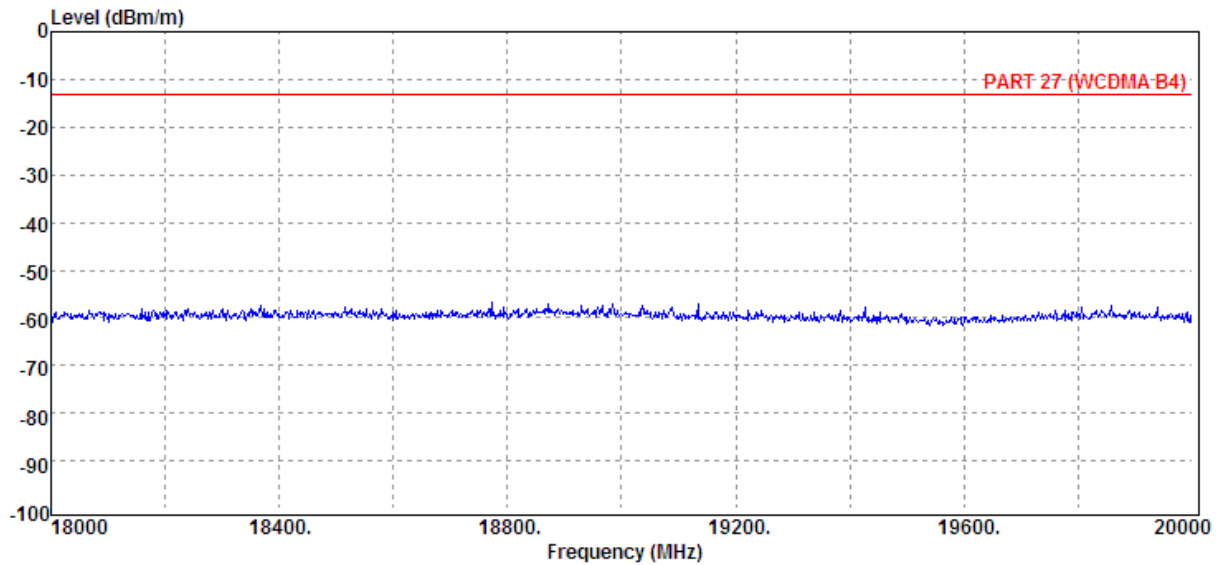
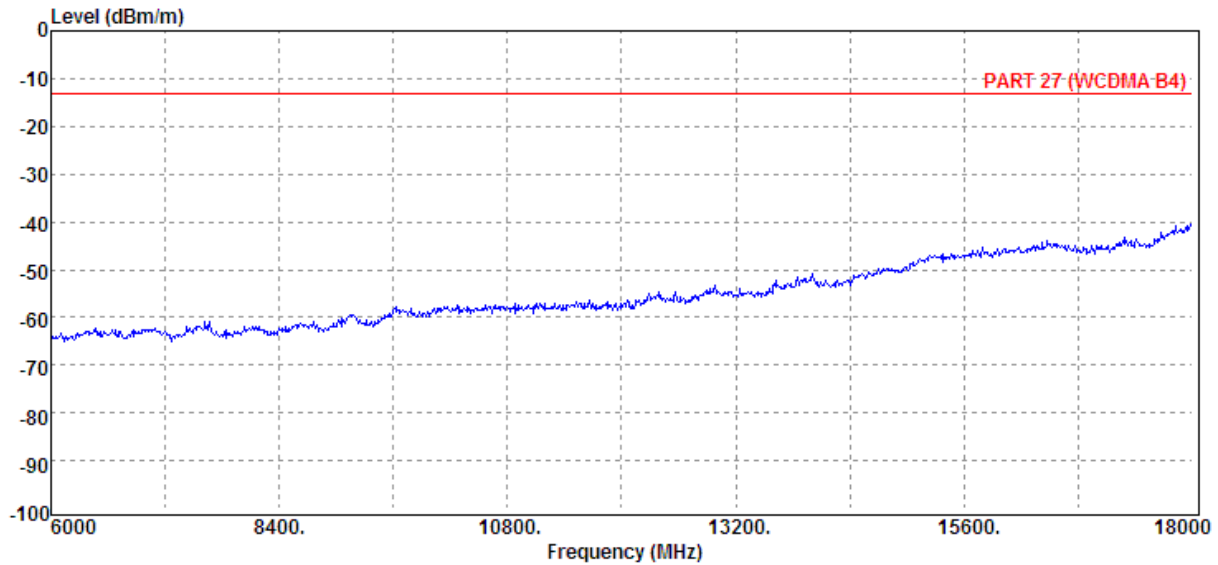

Unless otherwise stated the results shown in this test report refer only to the sample(s) tested and such sample(s) are retained for 90 days only.

除非另有說明，此報告結果僅對測試之樣品負責，同時此樣品僅保留90天。本報告未經本公司書面許可，不可部份複製。

This document is issued by the Company subject to its General Conditions of Service printed overleaf, available on request or accessible at www.sgs.com/terms_and_conditions.htm and, for electronic format documents, subject to Terms and Conditions for Electronic Documents at www.sgs.com/terms_e-document.htm. Attention is drawn to the limitation of liability, indemnification and jurisdiction issues defined therein. Any holder of this document is advised that information contained hereon reflects the Company's findings at the time of its intervention only and within the limits of Client's instructions, if any. The Company's sole responsibility is to its Client and this document does not exonerate parties to a transaction from exercising all their rights and obligations under the transaction documents. This document cannot be reproduced except in full, without prior written approval of the Company. Any unauthorized alteration, forgery or falsification of the content or appearance of this document is unlawful and offenders may be prosecuted to the fullest extent of the law.

Operation Band	:WCDMA B4	Test Date	:2013-05-03
ARFCN	:CH 1312	Temp./Humi.	:24.1 deg_C / 65 RH
Fundamental Frequency	:1712.4 MHz	Engineer	:Allen
Operation Mode	:TX LOW	Measurement Antenna Pol.	:HORIZONTAL
EUT Pol.	:H Plan		

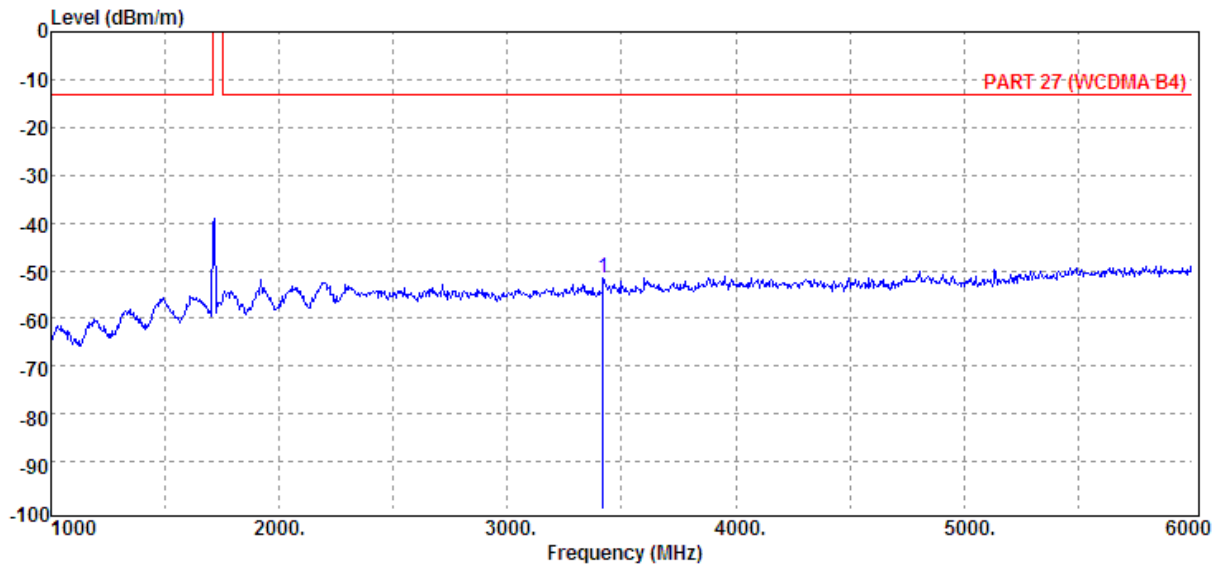
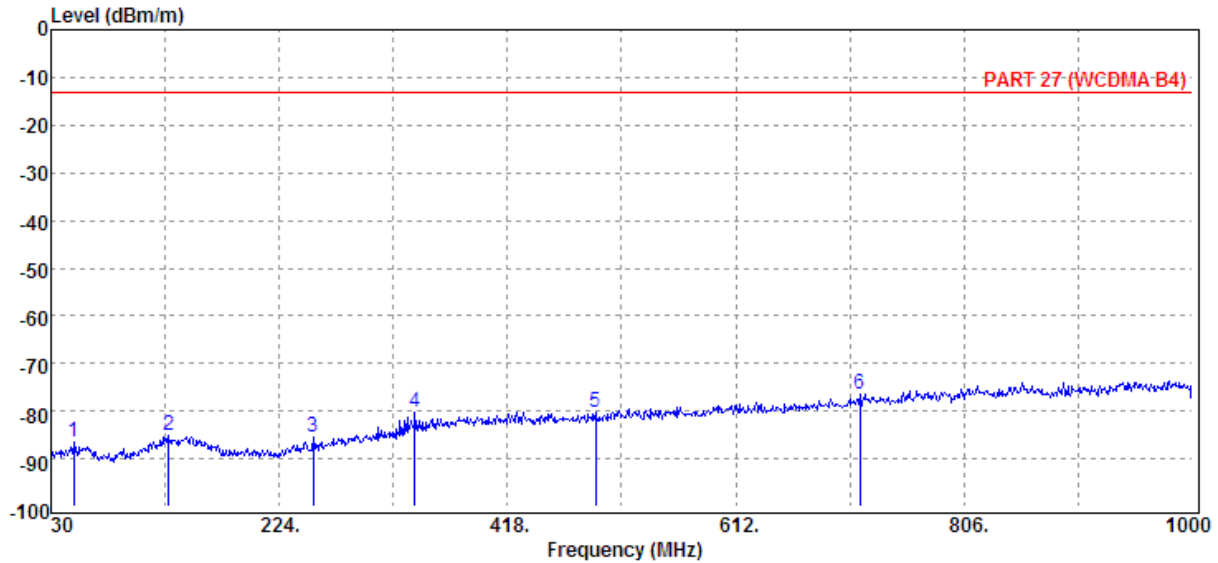

Unless otherwise stated the results shown in this test report refer only to the sample(s) tested and such sample(s) are retained for 90 days only.

除非另有說明，此報告結果僅對測試之樣品負責，同時此樣品僅保留90天。本報告未經本公司書面許可，不可部份複製。

This document is issued by the Company subject to its General Conditions of Service printed overleaf, available on request or accessible at www.sgs.com/terms_and_conditions.htm and, for electronic format documents, subject to Terms and Conditions for Electronic Documents at www.sgs.com/terms_e-document.htm. Attention is drawn to the limitation of liability, indemnification and jurisdiction issues defined therein. Any holder of this document is advised that information contained hereon reflects the Company's findings at the time of its intervention only and within the limits of Client's instructions, if any. The Company's sole responsibility is to its Client and this document does not exonerate parties to a transaction from exercising all their rights and obligations under the transaction documents. This document cannot be reproduced except in full, without prior written approval of the Company. Any unauthorized alteration, forgery or falsification of the content or appearance of this document is unlawful and offenders may be prosecuted to the fullest extent of the law.

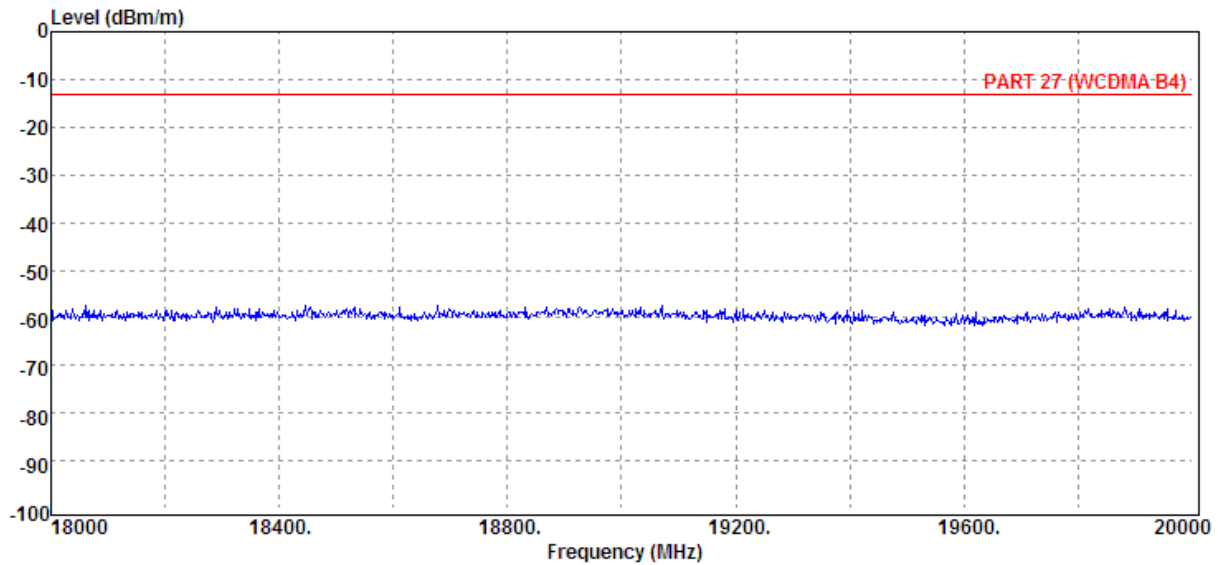
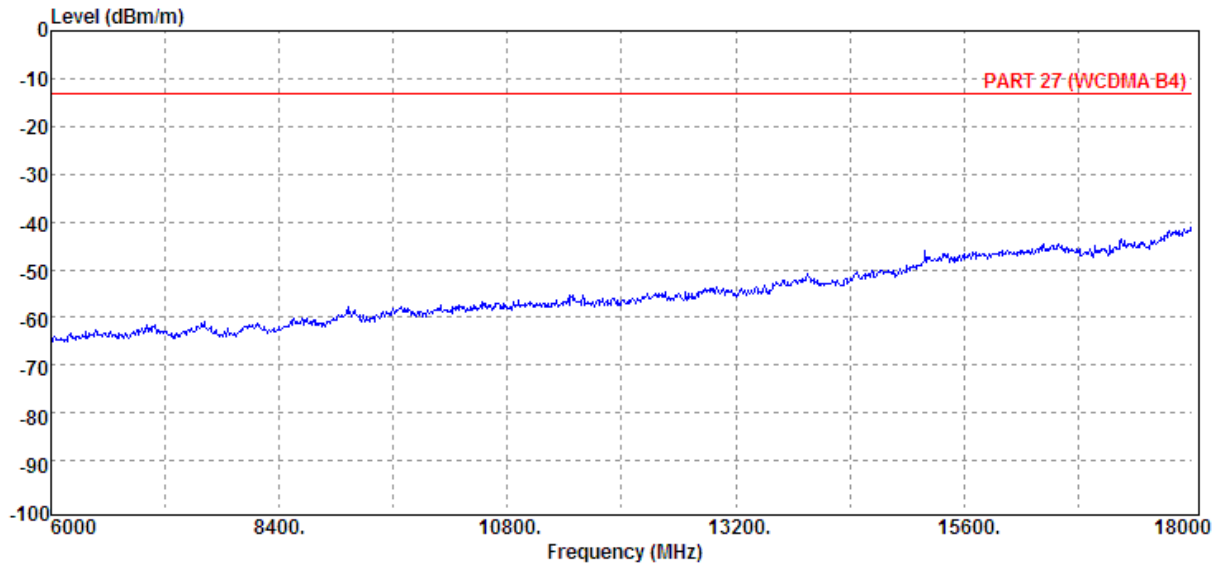

Unless otherwise stated the results shown in this test report refer only to the sample(s) tested and such sample(s) are retained for 90 days only.

除非另有說明，此報告結果僅對測試之樣品負責，同時此樣品僅保留90天。本報告未經本公司書面許可，不可部份複製。

This document is issued by the Company subject to its General Conditions of Service printed overleaf, available on request or accessible at www.sgs.com/terms_and_conditions.htm and, for electronic format documents, subject to Terms and Conditions for Electronic Documents at www.sgs.com/terms_e-document.htm. Attention is drawn to the limitation of liability, indemnification and jurisdiction issues defined therein. Any holder of this document is advised that information contained hereon reflects the Company's findings at the time of its intervention only and within the limits of Client's instructions, if any. The Company's sole responsibility is to its Client and this document does not exonerate parties to a transaction from exercising all their rights and obligations under the transaction documents. This document cannot be reproduced except in full, without prior written approval of the Company. Any unauthorized alteration, forgery or falsification of the content or appearance of this document is unlawful and offenders may be prosecuted to the fullest extent of the law.

Operation Band	:WCDMA B4	Test Date	:2013-05-03
ARFCN	:CH 1413	Temp./Humi.	:24.1 deg_C / 65 RH
Fundamental Frequency	:1732.6 MHz	Engineer	:Allen
Operation Mode	:TX MID	Measurement Antenna Pol.	:VERTICAL
EUT Pol.	:H Plan		

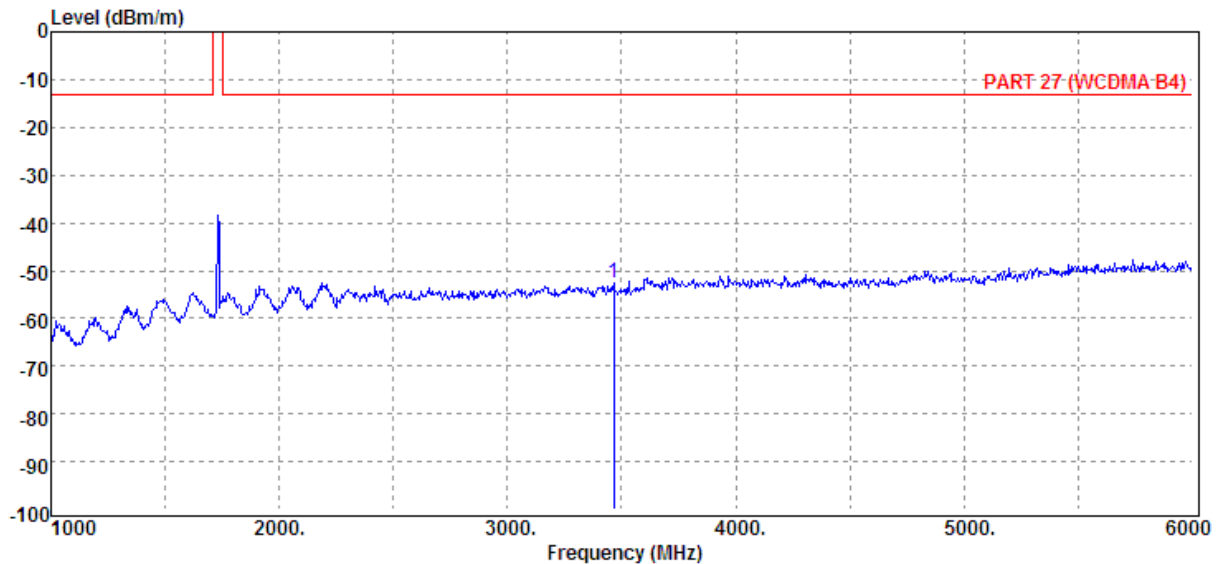
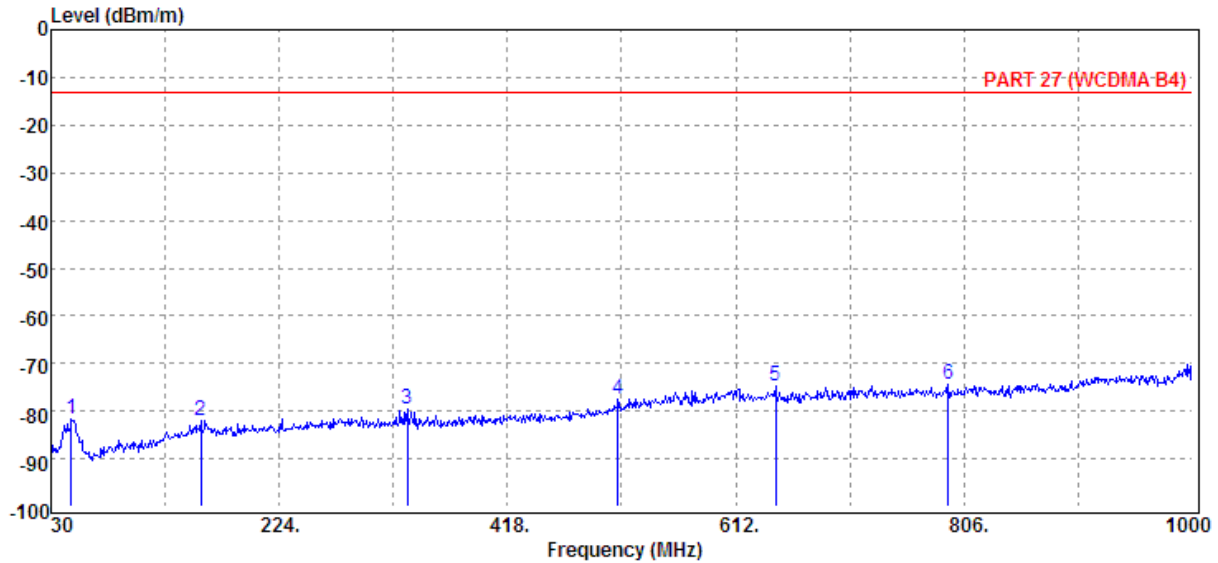

Unless otherwise stated the results shown in this test report refer only to the sample(s) tested and such sample(s) are retained for 90 days only.

除非另有說明，此報告結果僅對測試之樣品負責，同時此樣品僅保留90天。本報告未經本公司書面許可，不可部份複製。

This document is issued by the Company subject to its General Conditions of Service printed overleaf, available on request or accessible at www.sgs.com/terms_and_conditions.htm and, for electronic format documents, subject to Terms and Conditions for Electronic Documents at www.sgs.com/terms_e-document.htm. Attention is drawn to the limitation of liability, indemnification and jurisdiction issues defined therein. Any holder of this document is advised that information contained hereon reflects the Company's findings at the time of its intervention only and within the limits of Client's instructions, if any. The Company's sole responsibility is to its Client and this document does not exonerate parties to a transaction from exercising all their rights and obligations under the transaction documents. This document cannot be reproduced except in full, without prior written approval of the Company. Any unauthorized alteration, forgery or falsification of the content or appearance of this document is unlawful and offenders may be prosecuted to the fullest extent of the law.

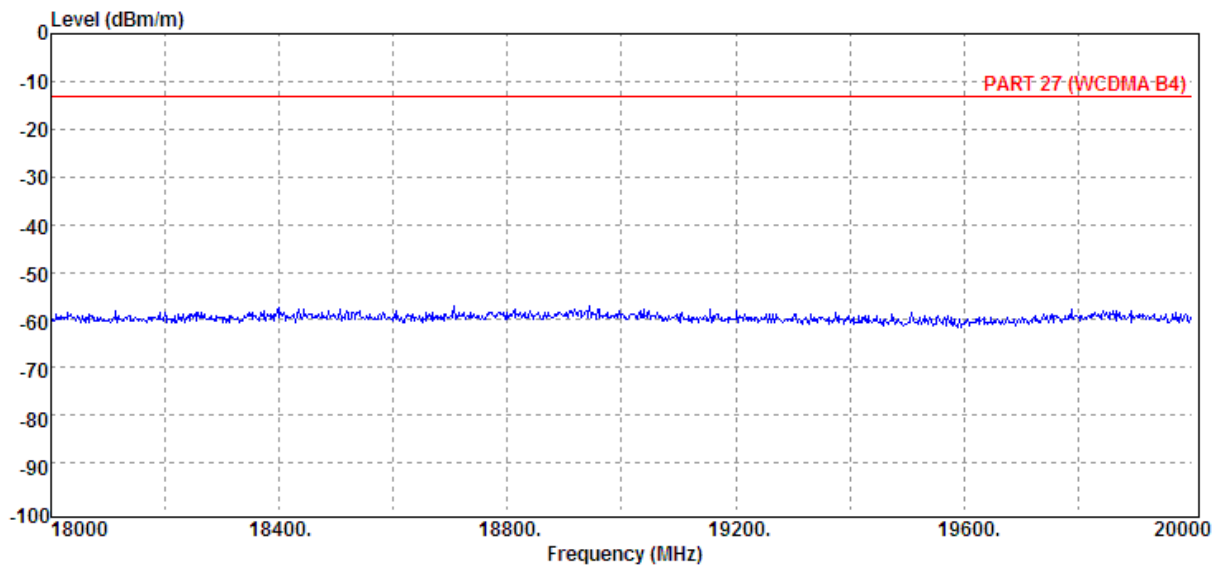
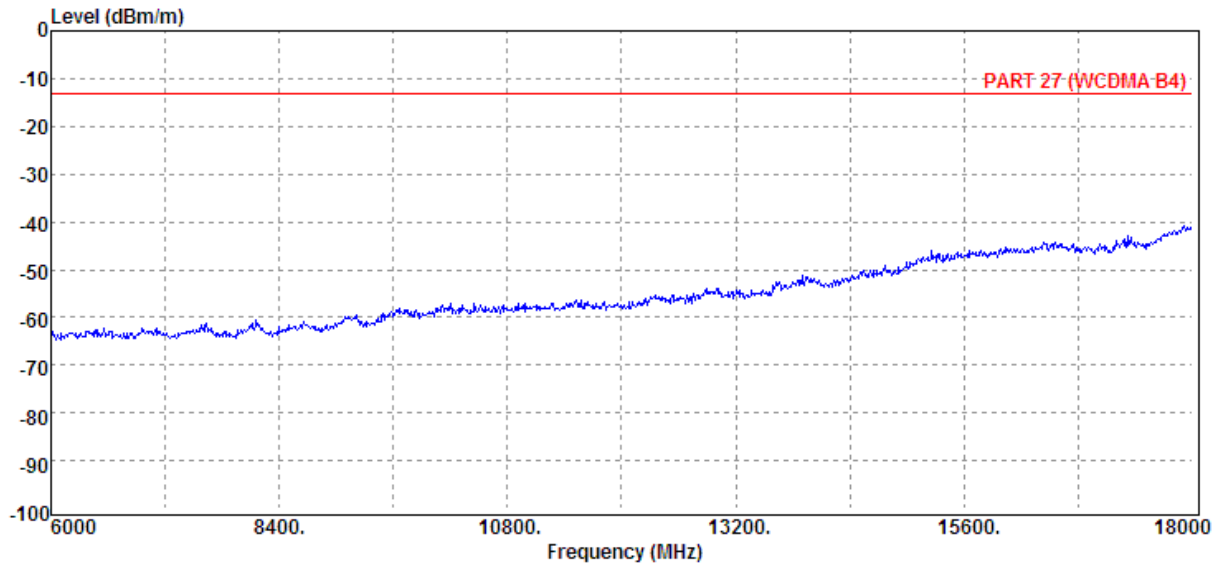

Unless otherwise stated the results shown in this test report refer only to the sample(s) tested and such sample(s) are retained for 90 days only.

除非另有說明，此報告結果僅對測試之樣品負責，同時此樣品僅保留90天。本報告未經本公司書面許可，不可部份複製。

This document is issued by the Company subject to its General Conditions of Service printed overleaf, available on request or accessible at www.sgs.com/terms_and_conditions.htm and, for electronic format documents, subject to Terms and Conditions for Electronic Documents at www.sgs.com/terms_e-document.htm. Attention is drawn to the limitation of liability, indemnification and jurisdiction issues defined therein. Any holder of this document is advised that information contained hereon reflects the Company's findings at the time of its intervention only and within the limits of Client's instructions, if any. The Company's sole responsibility is to its Client and this document does not exonerate parties to a transaction from exercising all their rights and obligations under the transaction documents. This document cannot be reproduced except in full, without prior written approval of the Company. Any unauthorized alteration, forgery or falsification of the content or appearance of this document is unlawful and offenders may be prosecuted to the fullest extent of the law.

Operation Band	:WCDMA B4	Test Date	:2013-05-03
ARFCN	:CH 1413	Temp./Humi.	:24.1 deg_C / 65 RH
Fundamental Frequency	:1732.6 MHz	Engineer	:Allen
Operation Mode	:TX MID	Measurement Antenna Pol.	:HORIZONTAL
EUT Pol.	:H Plan		

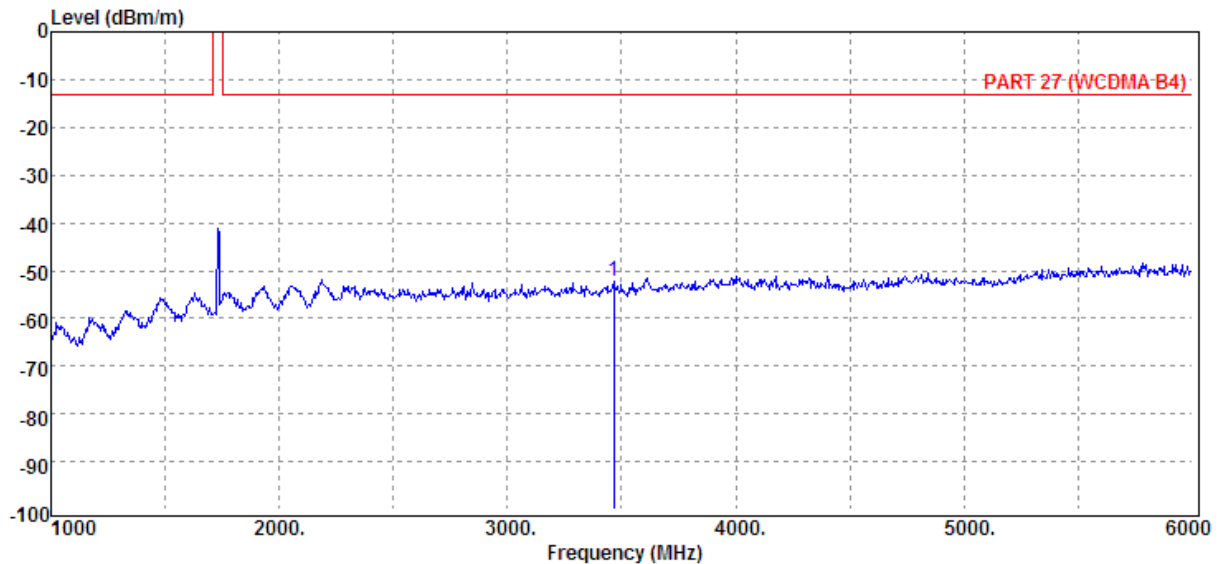
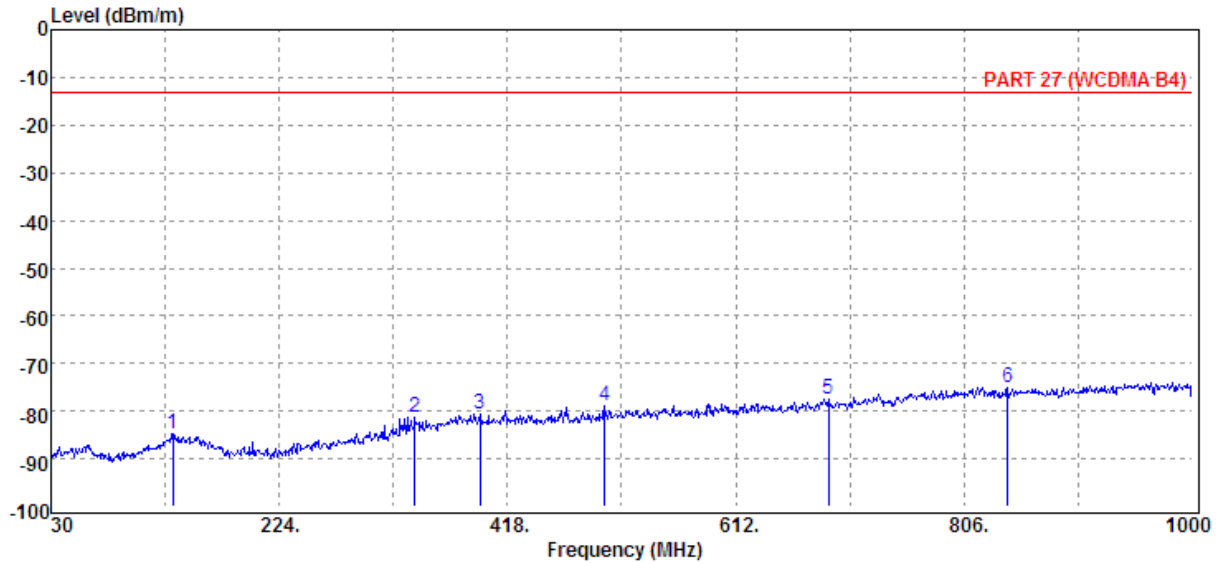

Unless otherwise stated the results shown in this test report refer only to the sample(s) tested and such sample(s) are retained for 90 days only.

除非另有說明，此報告結果僅對測試之樣品負責，同時此樣品僅保留90天。本報告未經本公司書面許可，不可部份複製。

This document is issued by the Company subject to its General Conditions of Service printed overleaf, available on request or accessible at www.sgs.com/terms_and_conditions.htm and, for electronic format documents, subject to Terms and Conditions for Electronic Documents at www.sgs.com/terms_e-document.htm. Attention is drawn to the limitation of liability, indemnification and jurisdiction issues defined therein. Any holder of this document is advised that information contained hereon reflects the Company's findings at the time of its intervention only and within the limits of Client's instructions, if any. The Company's sole responsibility is to its Client and this document does not exonerate parties to a transaction from exercising all their rights and obligations under the transaction documents. This document cannot be reproduced except in full, without prior written approval of the Company. Any unauthorized alteration, forgery or falsification of the content or appearance of this document is unlawful and offenders may be prosecuted to the fullest extent of the law.

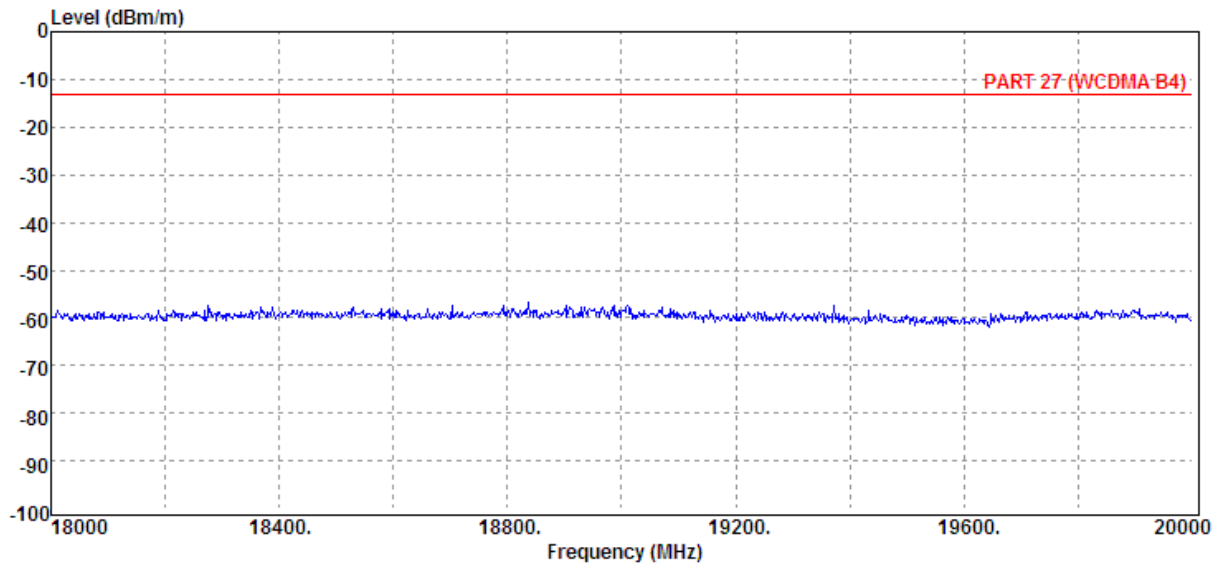
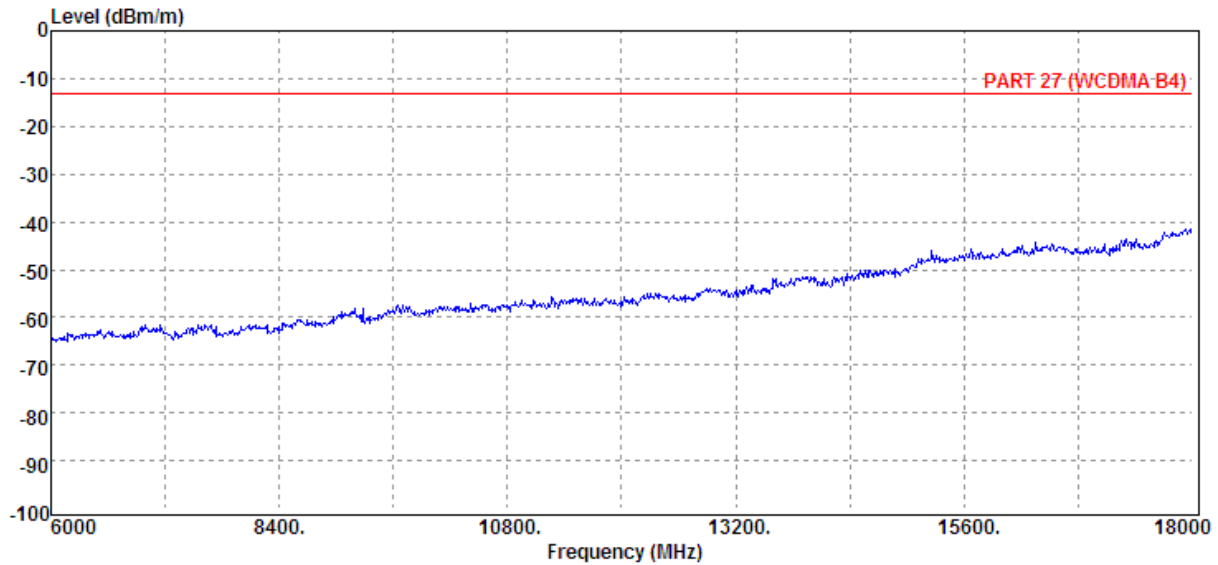

Unless otherwise stated the results shown in this test report refer only to the sample(s) tested and such sample(s) are retained for 90 days only.

除非另有說明，此報告結果僅對測試之樣品負責，同時此樣品僅保留90天。本報告未經本公司書面許可，不可部份複製。

This document is issued by the Company subject to its General Conditions of Service printed overleaf, available on request or accessible at www.sgs.com/terms_and_conditions.htm and, for electronic format documents, subject to Terms and Conditions for Electronic Documents at www.sgs.com/terms_e-document.htm. Attention is drawn to the limitation of liability, indemnification and jurisdiction issues defined therein. Any holder of this document is advised that information contained hereon reflects the Company's findings at the time of its intervention only and within the limits of Client's instructions, if any. The Company's sole responsibility is to its Client and this document does not exonerate parties to a transaction from exercising all their rights and obligations under the transaction documents. This document cannot be reproduced except in full, without prior written approval of the Company. Any unauthorized alteration, forgery or falsification of the content or appearance of this document is unlawful and offenders may be prosecuted to the fullest extent of the law.

Operation Band	:WCDMA B4	Test Date	:2013-05-03
ARFCN	:CH 1513	Temp./Humi.	:24.1 deg_C / 65 RH
Fundamental Frequency	:1752.6 MHz	Engineer	:Allen
Operation Mode	:TX HIGH	Measurement Antenna Pol.	:VERTICAL
EUT Pol.	:H Plan		

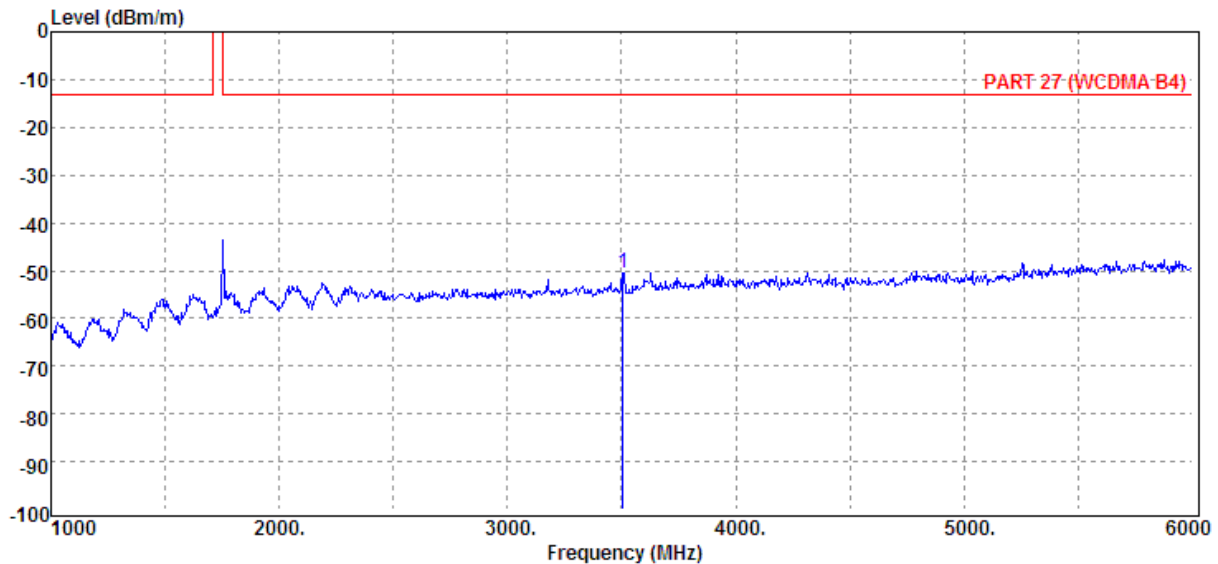
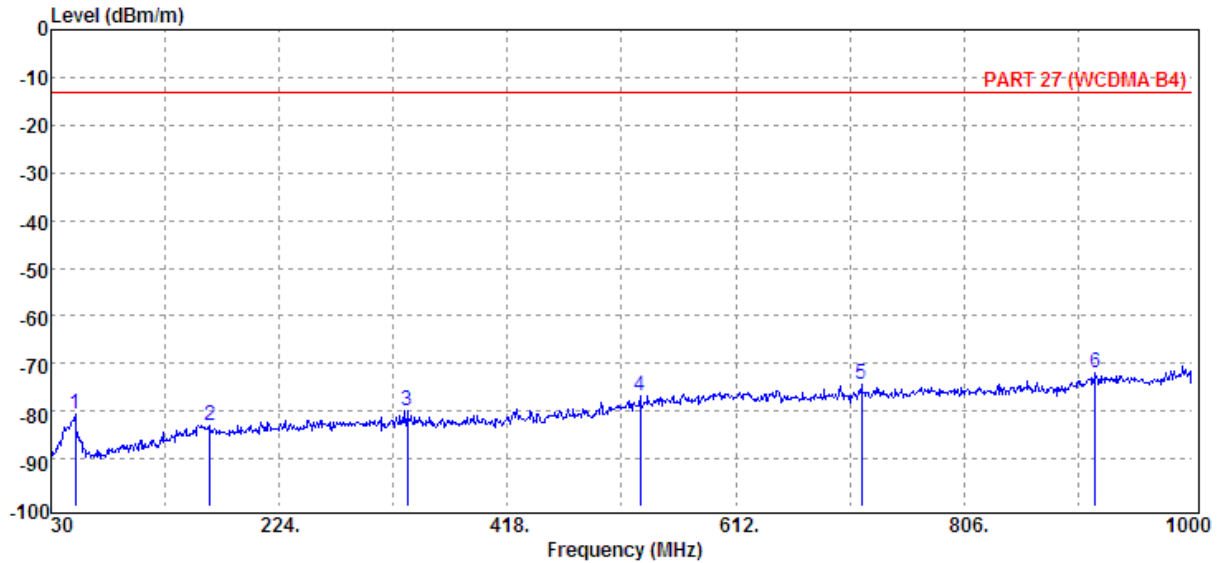

Unless otherwise stated the results shown in this test report refer only to the sample(s) tested and such sample(s) are retained for 90 days only.

除非另有說明，此報告結果僅對測試之樣品負責，同時此樣品僅保留90天。本報告未經本公司書面許可，不可部份複製。

This document is issued by the Company subject to its General Conditions of Service printed overleaf, available on request or accessible at www.sgs.com/terms_and_conditions.htm and, for electronic format documents, subject to Terms and Conditions for Electronic Documents at www.sgs.com/terms_e-document.htm. Attention is drawn to the limitation of liability, indemnification and jurisdiction issues defined therein. Any holder of this document is advised that information contained hereon reflects the Company's findings at the time of its intervention only and within the limits of Client's instructions, if any. The Company's sole responsibility is to its Client and this document does not exonerate parties to a transaction from exercising all their rights and obligations under the transaction documents. This document cannot be reproduced except in full, without prior written approval of the Company. Any unauthorized alteration, forgery or falsification of the content or appearance of this document is unlawful and offenders may be prosecuted to the fullest extent of the law.

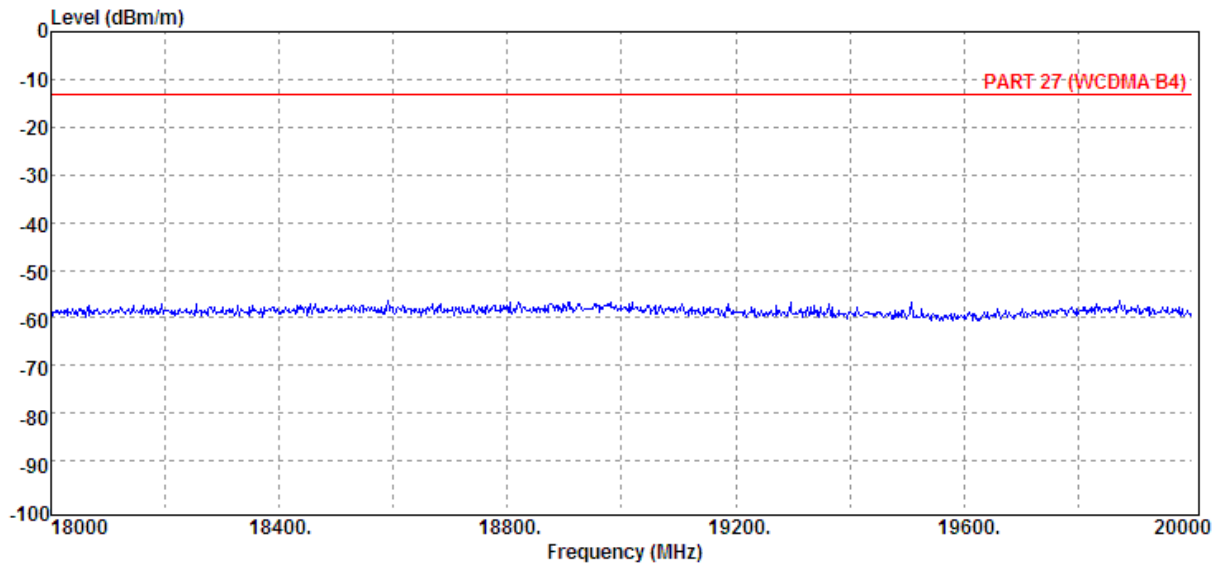
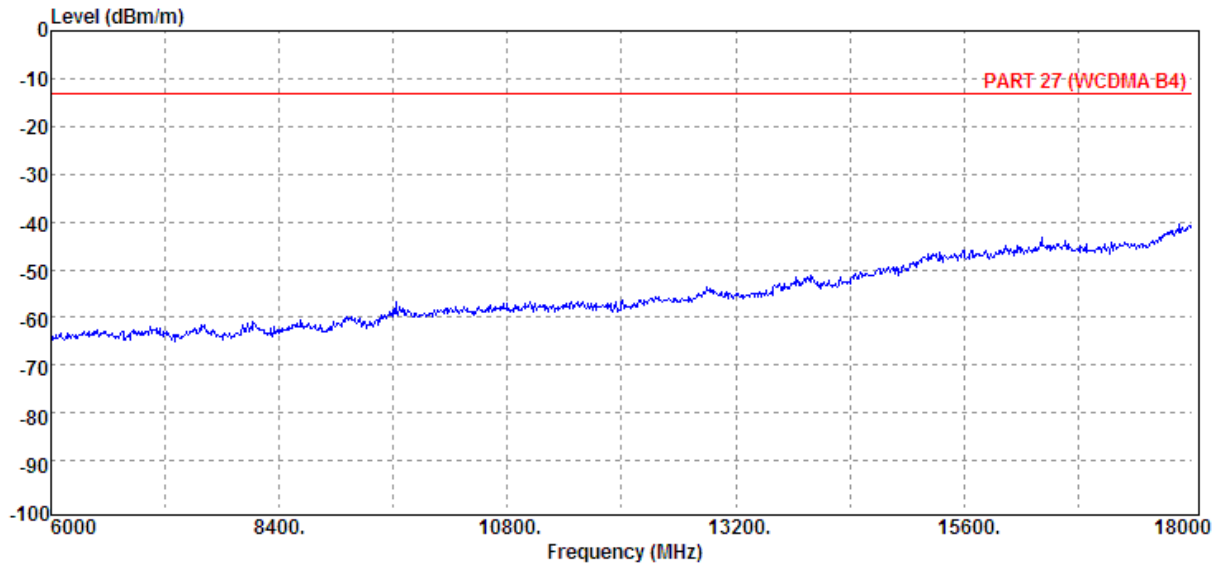

Unless otherwise stated the results shown in this test report refer only to the sample(s) tested and such sample(s) are retained for 90 days only.

除非另有說明，此報告結果僅對測試之樣品負責，同時此樣品僅保留90天。本報告未經本公司書面許可，不可部份複製。

This document is issued by the Company subject to its General Conditions of Service printed overleaf, available on request or accessible at www.sgs.com/terms_and_conditions.htm and, for electronic format documents, subject to Terms and Conditions for Electronic Documents at www.sgs.com/terms_e-document.htm. Attention is drawn to the limitation of liability, indemnification and jurisdiction issues defined therein. Any holder of this document is advised that information contained hereon reflects the Company's findings at the time of its intervention only and within the limits of Client's instructions, if any. The Company's sole responsibility is to its Client and this document does not exonerate parties to a transaction from exercising all their rights and obligations under the transaction documents. This document cannot be reproduced except in full, without prior written approval of the Company. Any unauthorized alteration, forgery or falsification of the content or appearance of this document is unlawful and offenders may be prosecuted to the fullest extent of the law.

Operation Band	:WCDMA B4	Test Date	:2013-05-03
ARFCN	:CH 1513	Temp./Humi.	:24.1 deg_C / 65 RH
Fundamental Frequency	:1752.6 MHz	Engineer	:Allen
Operation Mode	:TX HIGH	Measurement Antenna Pol.	:HORIZONTAL
EUT Pol.	:H Plan		

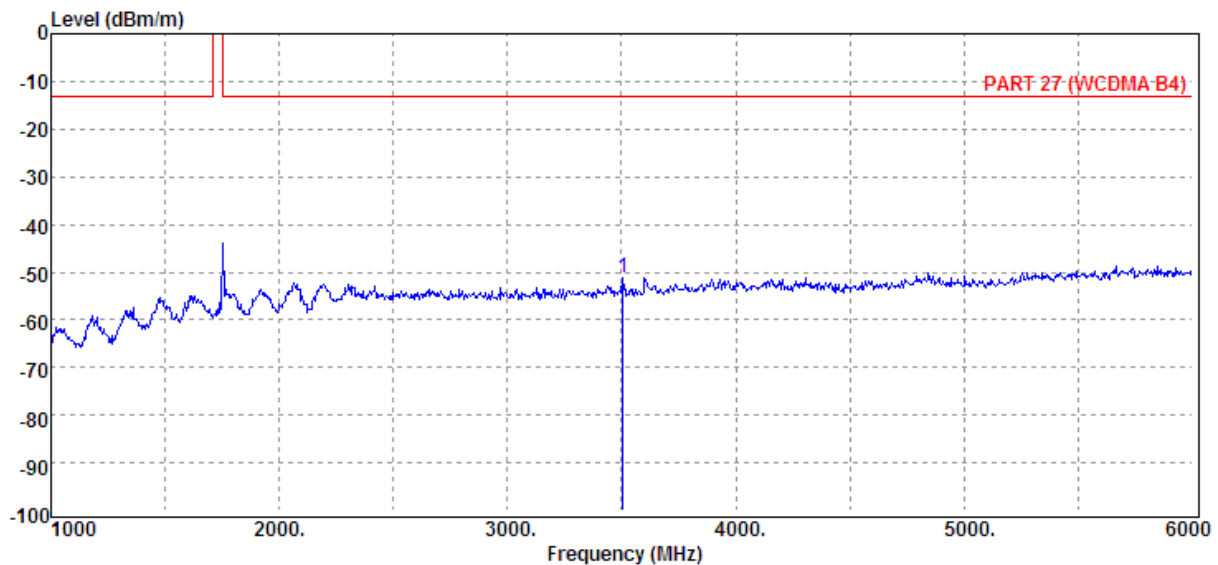
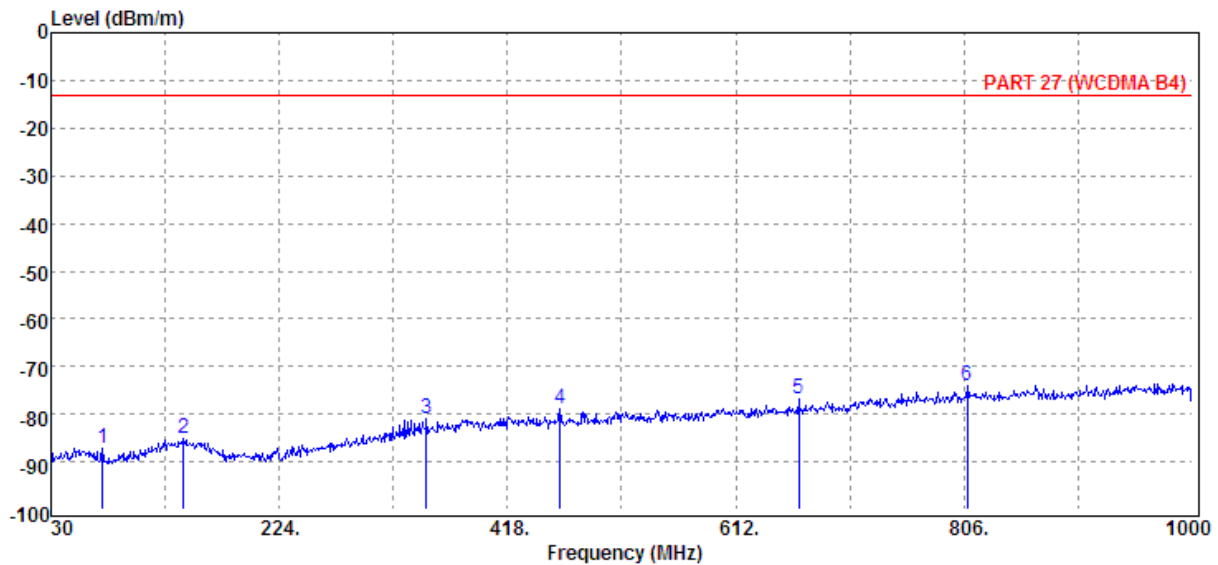

Unless otherwise stated the results shown in this test report refer only to the sample(s) tested and such sample(s) are retained for 90 days only.

除非另有說明，此報告結果僅對測試之樣品負責，同時此樣品僅保留90天。本報告未經本公司書面許可，不可部份複製。

This document is issued by the Company subject to its General Conditions of Service printed overleaf, available on request or accessible at www.sgs.com/terms_and_conditions.htm and, for electronic format documents, subject to Terms and Conditions for Electronic Documents at www.sgs.com/terms_e-document.htm. Attention is drawn to the limitation of liability, indemnification and jurisdiction issues defined therein. Any holder of this document is advised that information contained hereon reflects the Company's findings at the time of its intervention only and within the limits of Client's instructions, if any. The Company's sole responsibility is to its Client and this document does not exonerate parties to a transaction from exercising all their rights and obligations under the transaction documents. This document cannot be reproduced except in full, without prior written approval of the Company. Any unauthorized alteration, forgery or falsification of the content or appearance of this document is unlawful and offenders may be prosecuted to the fullest extent of the law.

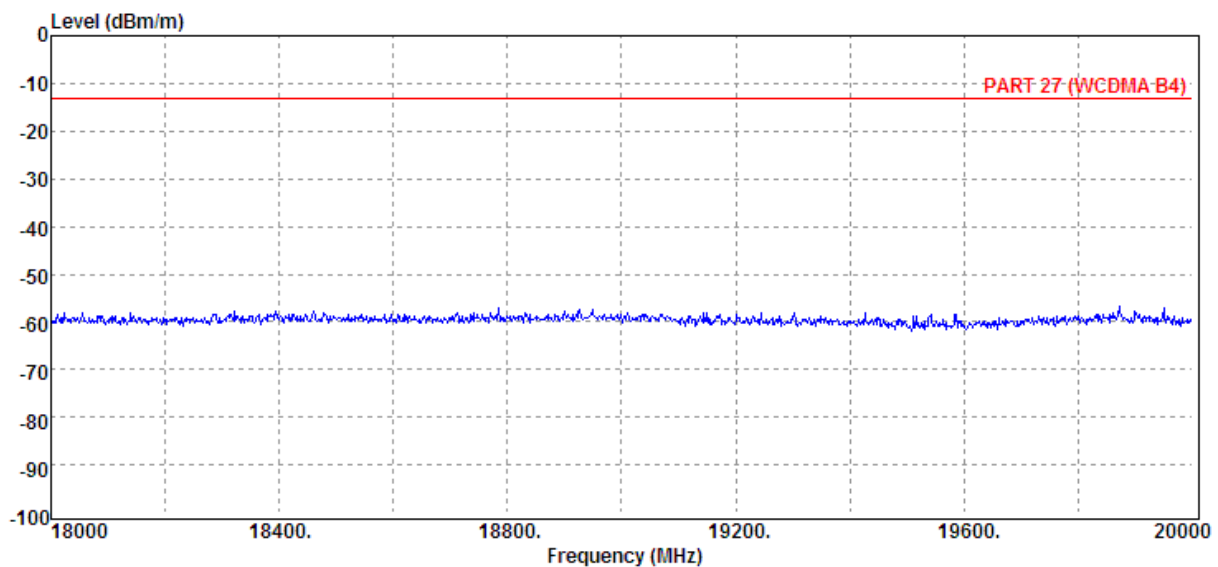
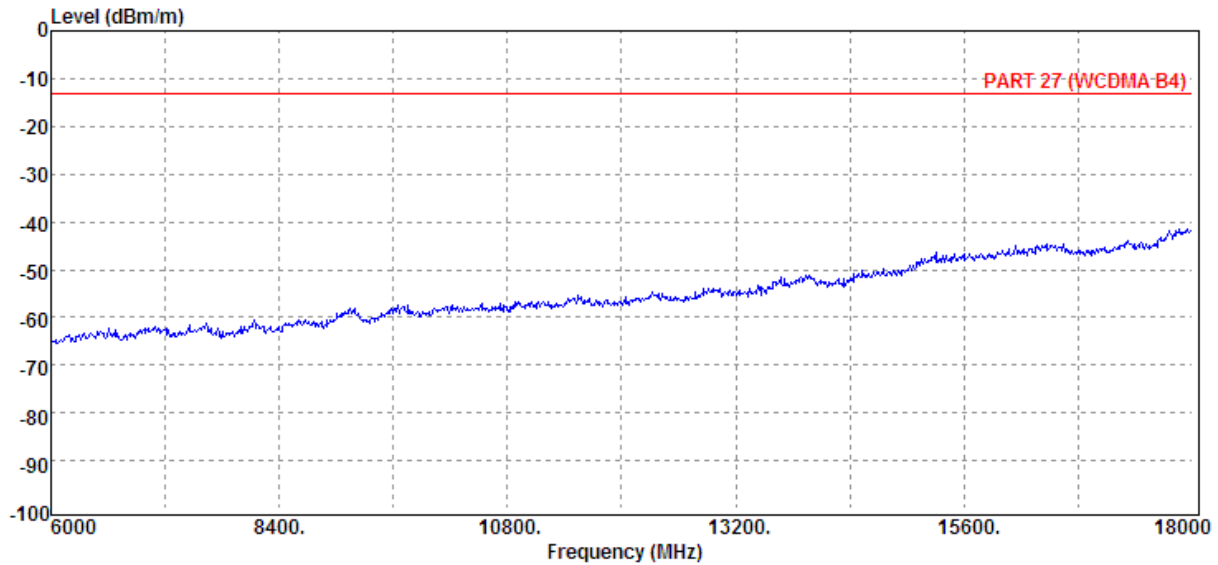

Unless otherwise stated the results shown in this test report refer only to the sample(s) tested and such sample(s) are retained for 90 days only.

除非另有說明，此報告結果僅對測試之樣品負責，同時此樣品僅保留90天。本報告未經本公司書面許可，不可部份複製。

This document is issued by the Company subject to its General Conditions of Service printed overleaf, available on request or accessible at www.sgs.com/terms_and_conditions.htm and, for electronic format documents, subject to Terms and Conditions for Electronic Documents at www.sgs.com/terms_e-document.htm. Attention is drawn to the limitation of liability, indemnification and jurisdiction issues defined therein. Any holder of this document is advised that information contained hereon reflects the Company's findings at the time of its intervention only and within the limits of Client's instructions, if any. The Company's sole responsibility is to its Client and this document does not exonerate parties to a transaction from exercising all their rights and obligations under the transaction documents. This document cannot be reproduced except in full, without prior written approval of the Company. Any unauthorized alteration, forgery or falsification of the content or appearance of this document is unlawful and offenders may be prosecuted to the fullest extent of the law.

Radiated Spurious Emission Measurement Result: WCDMA V Mode

Operation Band	:HSDPA B5	Test Date	:2013-05-03
ARFCN	:CH 4132	Temp./Humi.	:24.1 deg_C / 65 RH
Fundamental Frequency	:826.4 MHz	Engineer	:Allen
Operation Mode	:TX LOW		
EUT Pol.	:E1 Plan	Measurement Antenna Pol.	:VERTICAL

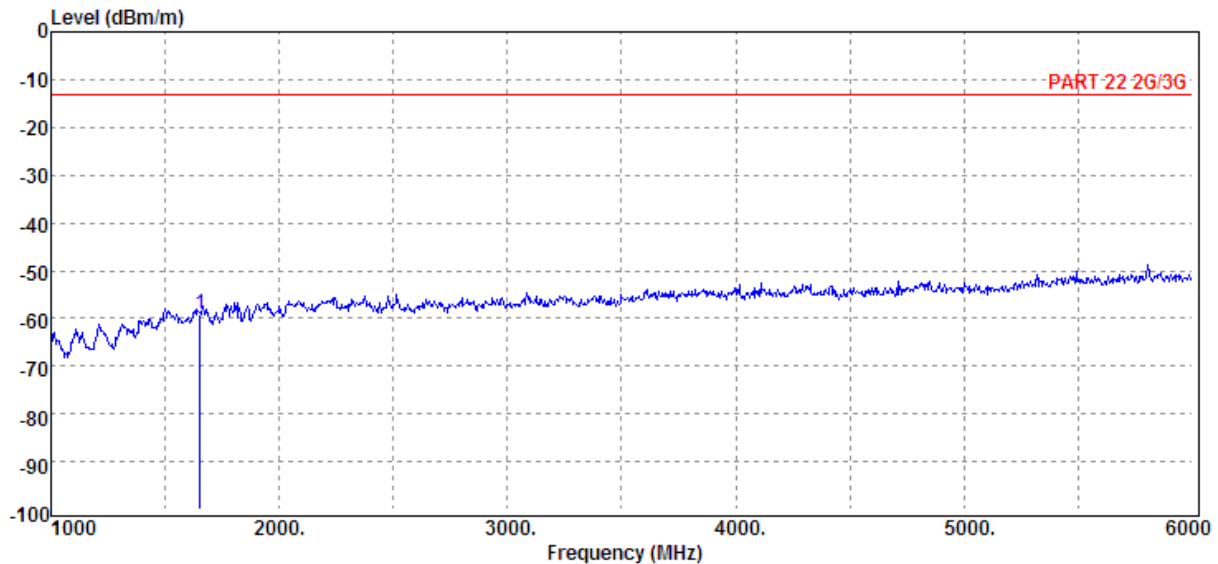
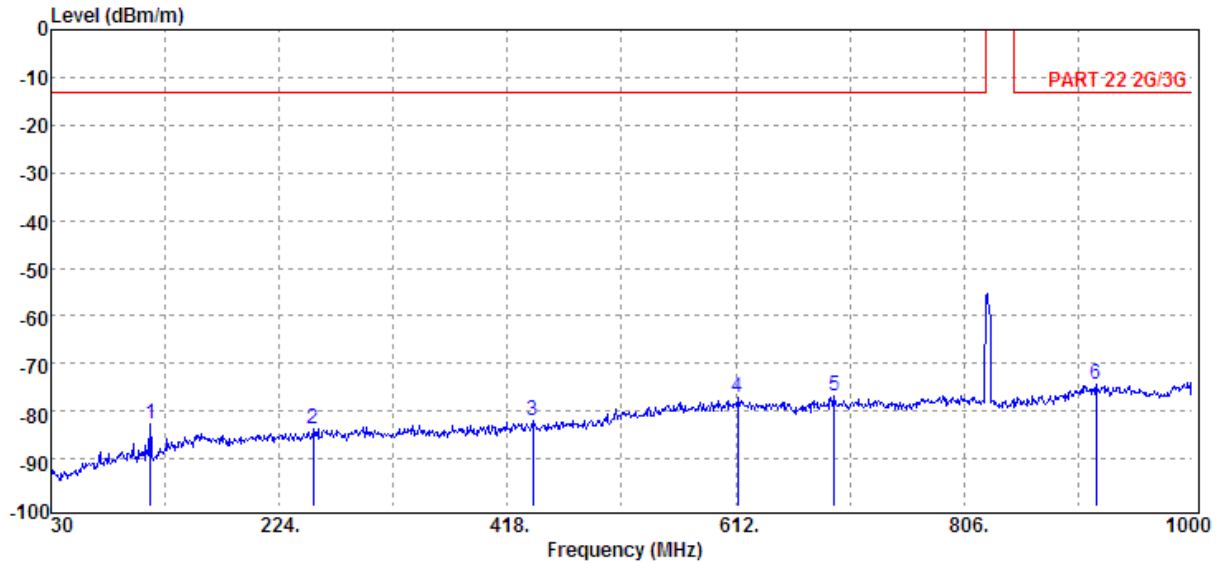

Unless otherwise stated the results shown in this test report refer only to the sample(s) tested and such sample(s) are retained for 90 days only.

除非另有說明，此報告結果僅對測試之樣品負責，同時此樣品僅保留90天。本報告未經本公司書面許可，不可部份複製。

This document is issued by the Company subject to its General Conditions of Service printed overleaf, available on request or accessible at www.sgs.com/terms_and_conditions.htm and, for electronic format documents, subject to Terms and Conditions for Electronic Documents at www.sgs.com/terms_e-document.htm. Attention is drawn to the limitation of liability, indemnification and jurisdiction issues defined therein. Any holder of this document is advised that information contained hereon reflects the Company's findings at the time of its intervention only and within the limits of Client's instructions, if any. The Company's sole responsibility is to its Client and this document does not exonerate parties to a transaction from exercising all their rights and obligations under the transaction documents. This document cannot be reproduced except in full, without prior written approval of the Company. Any unauthorized alteration, forgery or falsification of the content or appearance of this document is unlawful and offenders may be prosecuted to the fullest extent of the law.

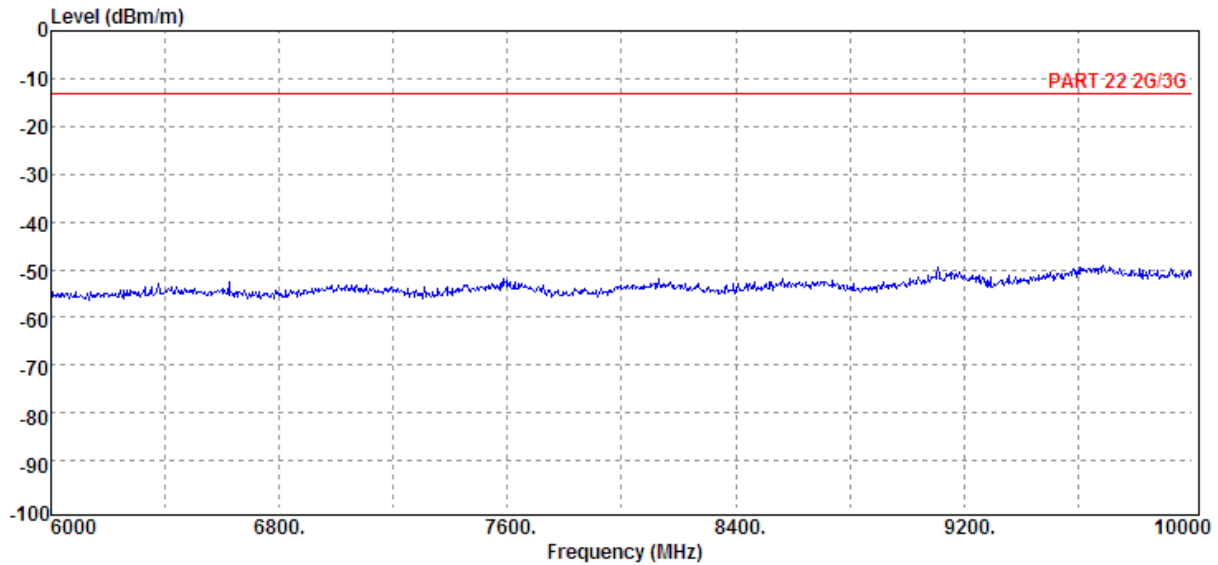

Unless otherwise stated the results shown in this test report refer only to the sample(s) tested and such sample(s) are retained for 90 days only.

除非另有說明，此報告結果僅對測試之樣品負責，同時此樣品僅保留90天。本報告未經本公司書面許可，不可部份複製。

This document is issued by the Company subject to its General Conditions of Service printed overleaf, available on request or accessible at www.sgs.com/terms_and_conditions.htm and, for electronic format documents, subject to Terms and Conditions for Electronic Documents at www.sgs.com/terms_e-document.htm. Attention is drawn to the limitation of liability, indemnification and jurisdiction issues defined therein. Any holder of this document is advised that information contained hereon reflects the Company's findings at the time of its intervention only and within the limits of Client's instructions, if any. The Company's sole responsibility is to its Client and this document does not exonerate parties to a transaction from exercising all their rights and obligations under the transaction documents. This document cannot be reproduced except in full, without prior written approval of the Company. Any unauthorized alteration, forgery or falsification of the content or appearance of this document is unlawful and offenders may be prosecuted to the fullest extent of the law.

Operation Band	:HSDPA B5	Test Date	:2013-05-03
ARFCN	:CH 4132	Temp./Humi.	:24.1 deg_C / 65 RH
Fundamental Frequency	:826.4 MHz	Engineer	:Allen
Operation Mode	:TX LOW	Measurement Antenna Pol.	:HORIZONTAL
EUT Pol.	:E1 Plan		

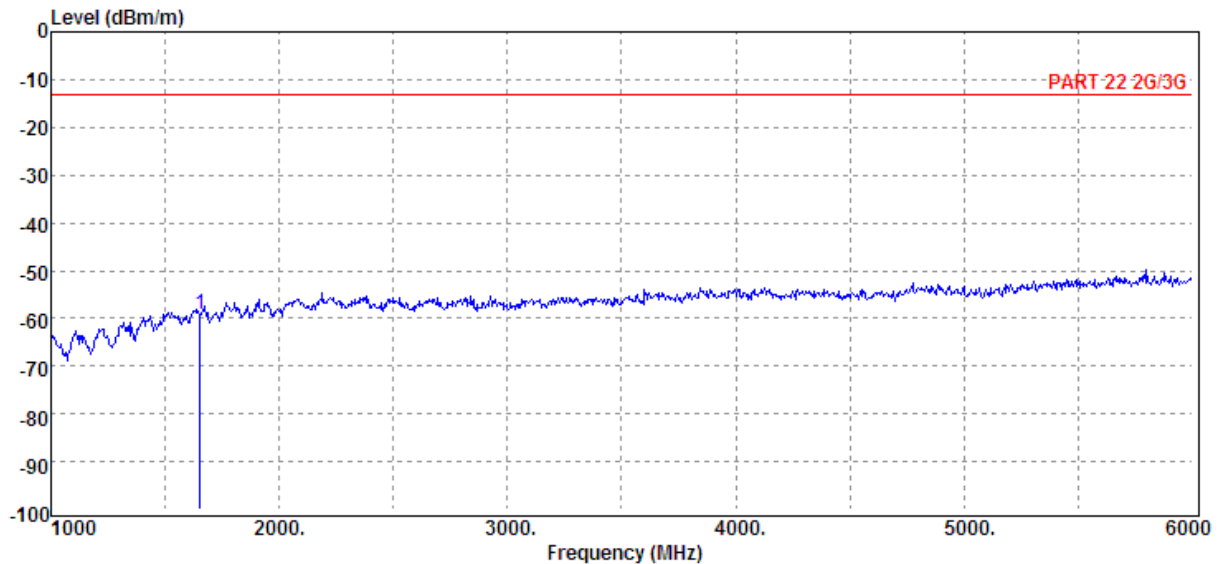
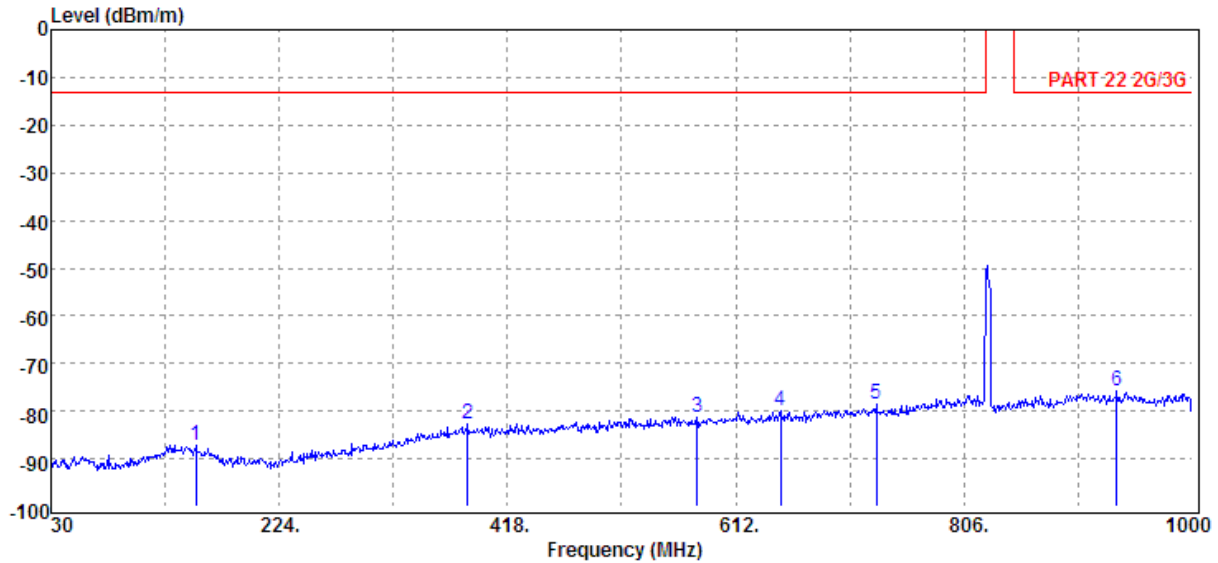

Unless otherwise stated the results shown in this test report refer only to the sample(s) tested and such sample(s) are retained for 90 days only.

除非另有說明，此報告結果僅對測試之樣品負責，同時此樣品僅保留90天。本報告未經本公司書面許可，不可部份複製。

This document is issued by the Company subject to its General Conditions of Service printed overleaf, available on request or accessible at www.sgs.com/terms_and_conditions.htm and, for electronic format documents, subject to Terms and Conditions for Electronic Documents at www.sgs.com/terms_e-document.htm. Attention is drawn to the limitation of liability, indemnification and jurisdiction issues defined therein. Any holder of this document is advised that information contained hereon reflects the Company's findings at the time of its intervention only and within the limits of Client's instructions, if any. The Company's sole responsibility is to its Client and this document does not exonerate parties to a transaction from exercising all their rights and obligations under the transaction documents. This document cannot be reproduced except in full, without prior written approval of the Company. Any unauthorized alteration, forgery or falsification of the content or appearance of this document is unlawful and offenders may be prosecuted to the fullest extent of the law.

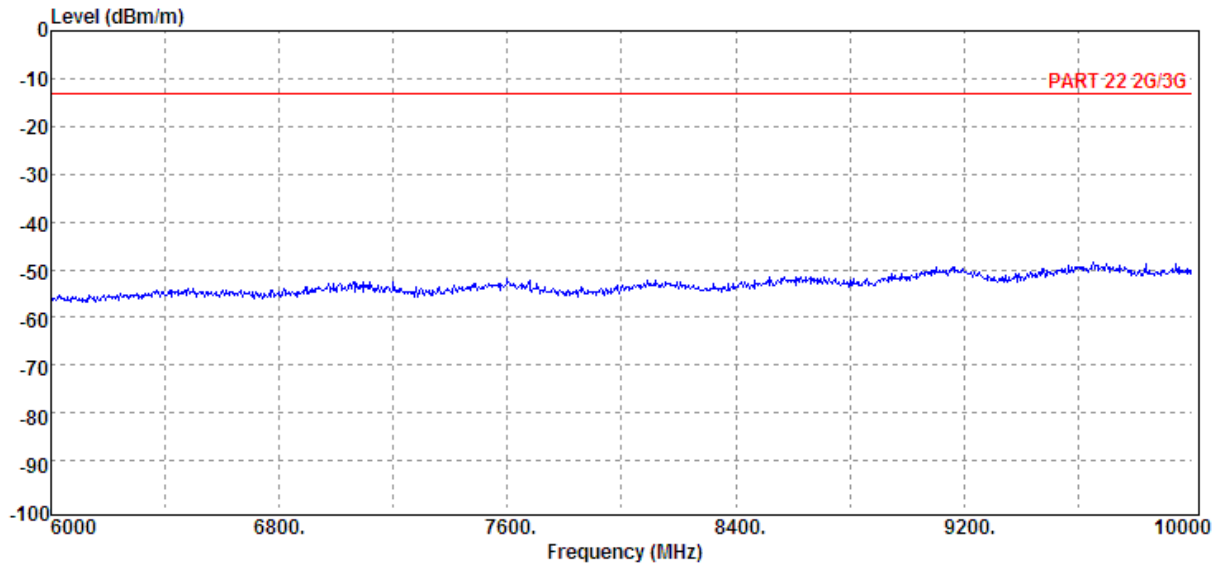

Unless otherwise stated the results shown in this test report refer only to the sample(s) tested and such sample(s) are retained for 90 days only.

除非另有說明，此報告結果僅對測試之樣品負責，同時此樣品僅保留90天。本報告未經本公司書面許可，不可部份複製。

This document is issued by the Company subject to its General Conditions of Service printed overleaf, available on request or accessible at www.sgs.com/terms_and_conditions.htm and, for electronic format documents, subject to Terms and Conditions for Electronic Documents at www.sgs.com/terms_e-document.htm. Attention is drawn to the limitation of liability, indemnification and jurisdiction issues defined therein. Any holder of this document is advised that information contained hereon reflects the Company's findings at the time of its intervention only and within the limits of Client's instructions, if any. The Company's sole responsibility is to its Client and this document does not exonerate parties to a transaction from exercising all their rights and obligations under the transaction documents. This document cannot be reproduced except in full, without prior written approval of the Company. Any unauthorized alteration, forgery or falsification of the content or appearance of this document is unlawful and offenders may be prosecuted to the fullest extent of the law.

Operation Band	:HSDPA B5	Test Date	:2013-05-03
ARFCN	:CH 4183	Temp./Humi.	:24.1 deg_C / 65 RH
Fundamental Frequency	:836.6 MHz	Engineer	:Allen
Operation Mode	:TX MID	Measurement Antenna Pol.	:VERTICAL
EUT Pol.	:E1 Plan		

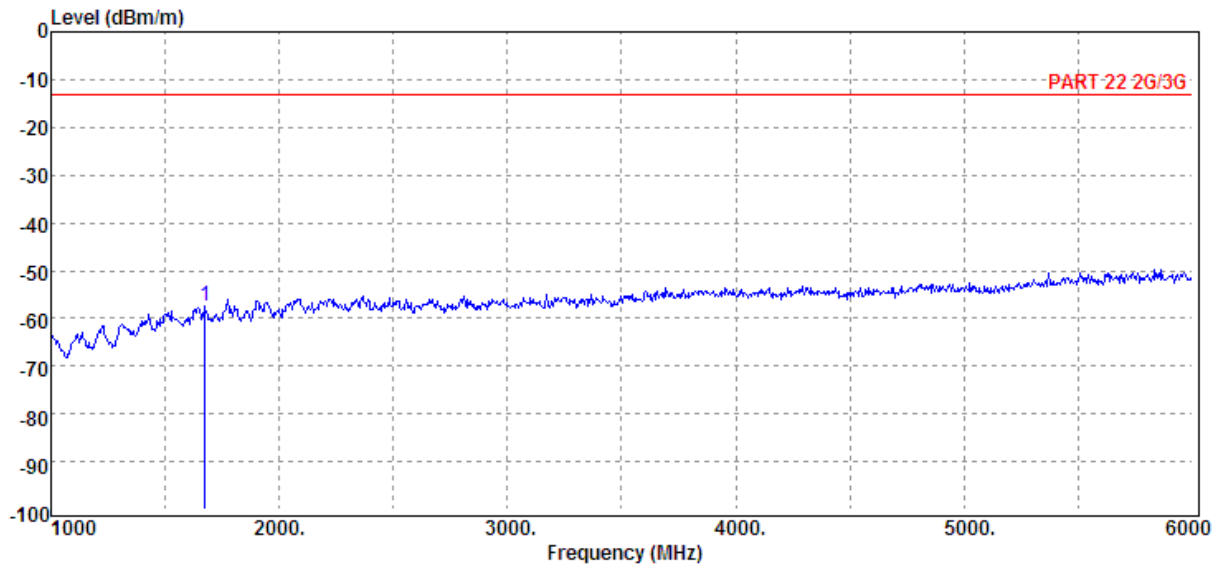
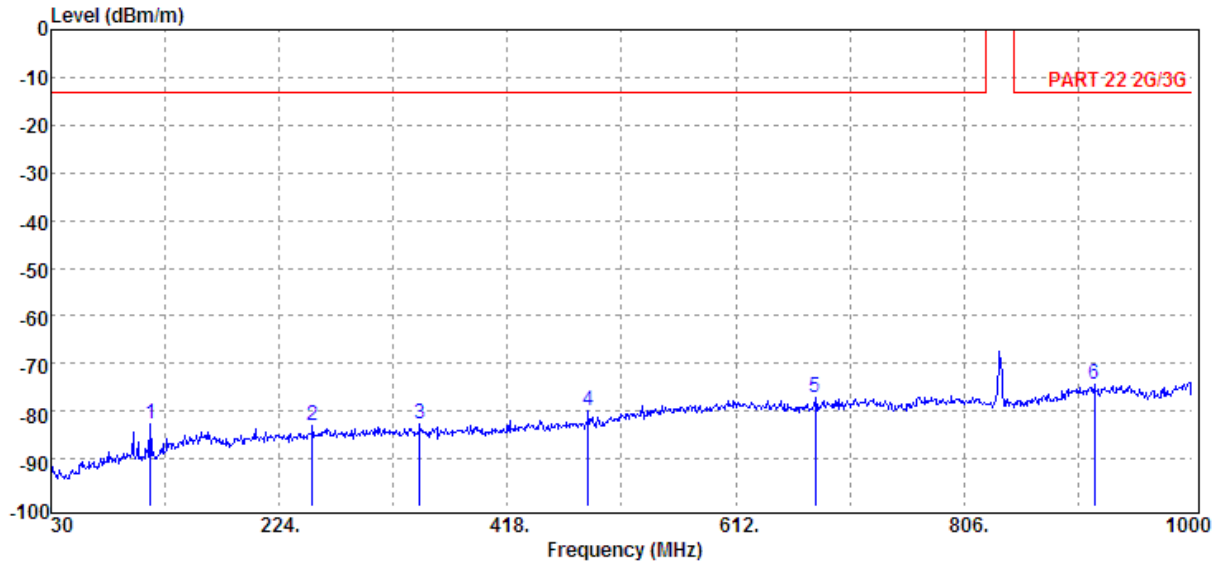

Unless otherwise stated the results shown in this test report refer only to the sample(s) tested and such sample(s) are retained for 90 days only.

除非另有說明，此報告結果僅對測試之樣品負責，同時此樣品僅保留90天。本報告未經本公司書面許可，不可部份複製。

This document is issued by the Company subject to its General Conditions of Service printed overleaf, available on request or accessible at www.sgs.com/terms_and_conditions.htm and, for electronic format documents, subject to Terms and Conditions for Electronic Documents at www.sgs.com/terms_e-document.htm. Attention is drawn to the limitation of liability, indemnification and jurisdiction issues defined therein. Any holder of this document is advised that information contained hereon reflects the Company's findings at the time of its intervention only and within the limits of Client's instructions, if any. The Company's sole responsibility is to its Client and this document does not exonerate parties to a transaction from exercising all their rights and obligations under the transaction documents. This document cannot be reproduced except in full, without prior written approval of the Company. Any unauthorized alteration, forgery or falsification of the content or appearance of this document is unlawful and offenders may be prosecuted to the fullest extent of the law.

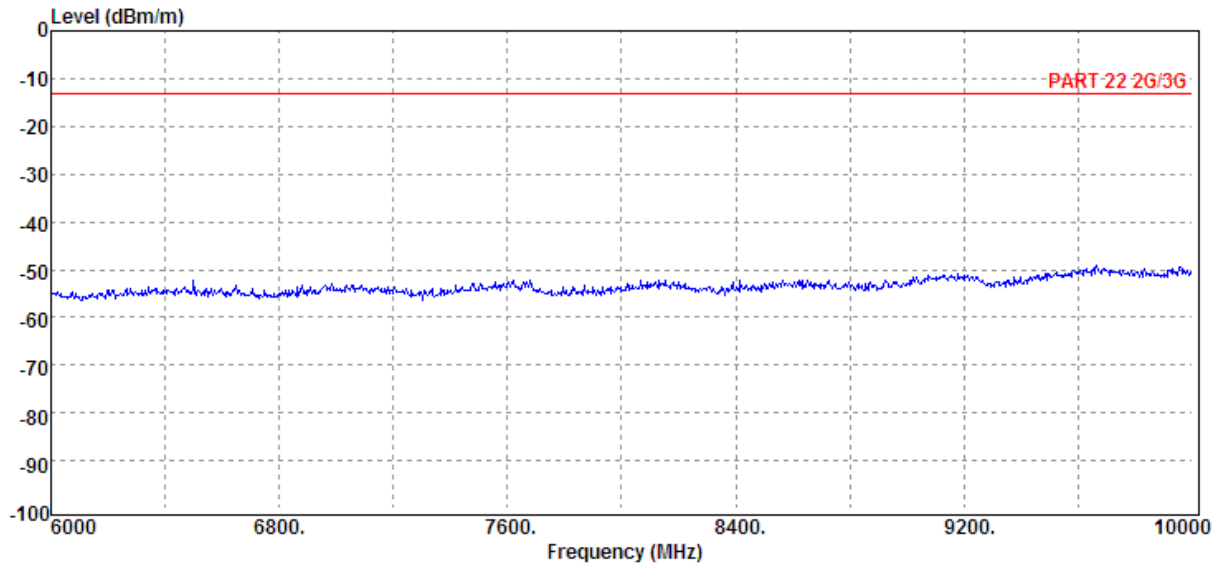

Unless otherwise stated the results shown in this test report refer only to the sample(s) tested and such sample(s) are retained for 90 days only.

除非另有說明，此報告結果僅對測試之樣品負責，同時此樣品僅保留90天。本報告未經本公司書面許可，不可部份複製。

This document is issued by the Company subject to its General Conditions of Service printed overleaf, available on request or accessible at www.sgs.com/terms_and_conditions.htm and, for electronic format documents, subject to Terms and Conditions for Electronic Documents at www.sgs.com/terms_e-document.htm. Attention is drawn to the limitation of liability, indemnification and jurisdiction issues defined therein. Any holder of this document is advised that information contained hereon reflects the Company's findings at the time of its intervention only and within the limits of Client's instructions, if any. The Company's sole responsibility is to its Client and this document does not exonerate parties to a transaction from exercising all their rights and obligations under the transaction documents. This document cannot be reproduced except in full, without prior written approval of the Company. Any unauthorized alteration, forgery or falsification of the content or appearance of this document is unlawful and offenders may be prosecuted to the fullest extent of the law.

Operation Band	:HSDPA B5	Test Date	:2013-05-03
ARFCN	:CH 4183	Temp./Humi.	:24.1 deg_C / 65 RH
Fundamental Frequency	:836.6 MHz	Engineer	:Allen
Operation Mode	:TX MID	Measurement Antenna Pol.	:HORIZONTAL
EUT Pol.	:E1 Plan		

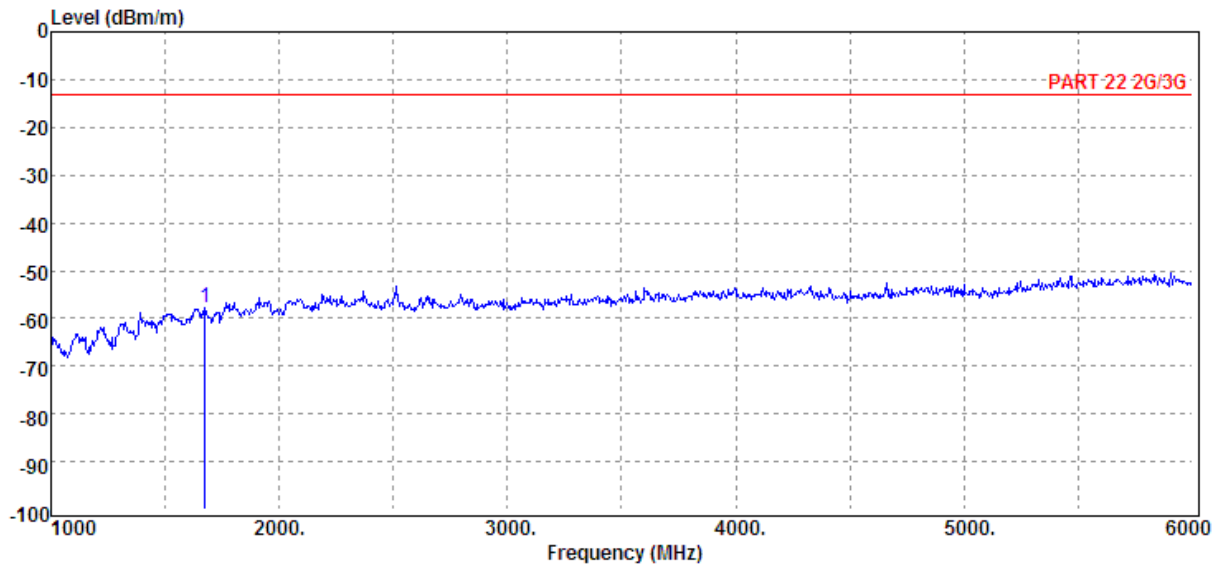
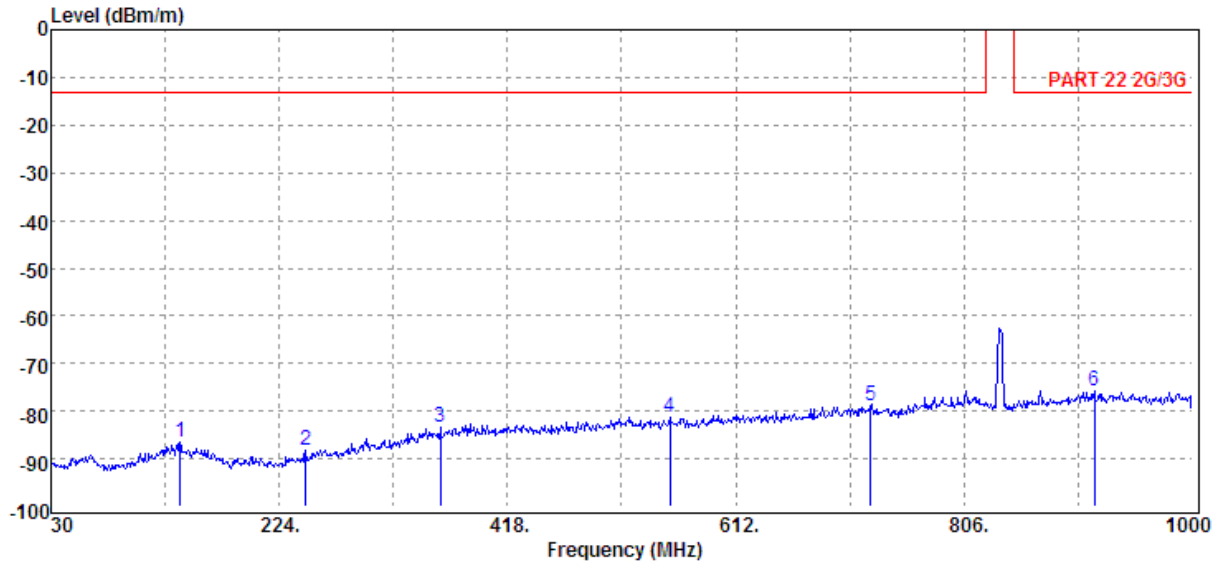

Unless otherwise stated the results shown in this test report refer only to the sample(s) tested and such sample(s) are retained for 90 days only.

除非另有說明，此報告結果僅對測試之樣品負責，同時此樣品僅保留90天。本報告未經本公司書面許可，不可部份複製。

This document is issued by the Company subject to its General Conditions of Service printed overleaf, available on request or accessible at www.sgs.com/terms_and_conditions.htm and, for electronic format documents, subject to Terms and Conditions for Electronic Documents at www.sgs.com/terms_e-document.htm. Attention is drawn to the limitation of liability, indemnification and jurisdiction issues defined therein. Any holder of this document is advised that information contained hereon reflects the Company's findings at the time of its intervention only and within the limits of Client's instructions, if any. The Company's sole responsibility is to its Client and this document does not exonerate parties to a transaction from exercising all their rights and obligations under the transaction documents. This document cannot be reproduced except in full, without prior written approval of the Company. Any unauthorized alteration, forgery or falsification of the content or appearance of this document is unlawful and offenders may be prosecuted to the fullest extent of the law.

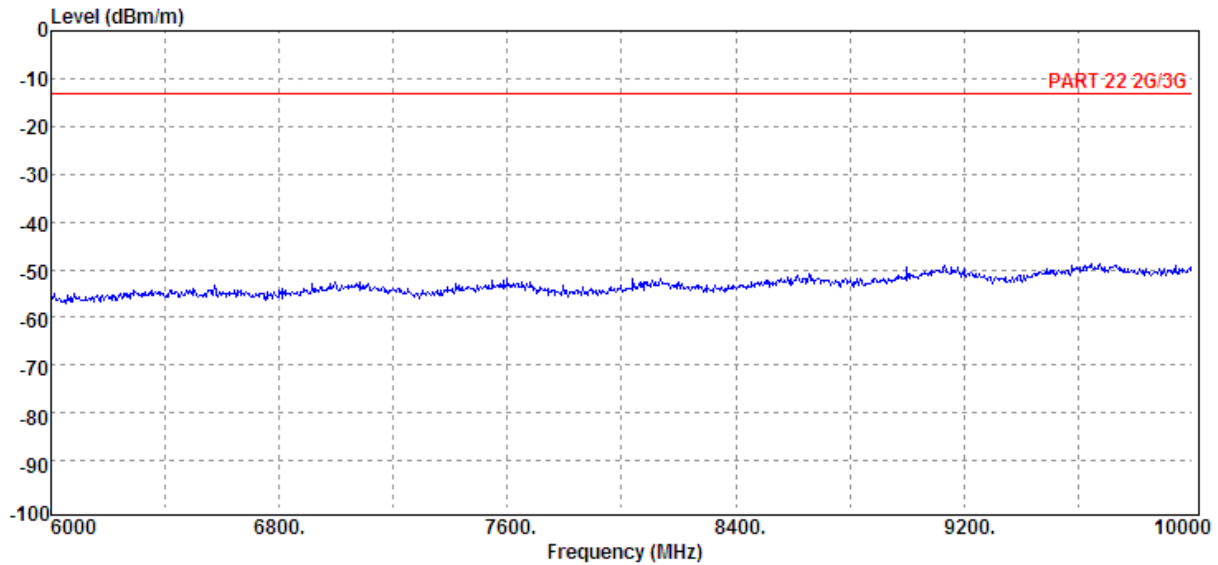

Unless otherwise stated the results shown in this test report refer only to the sample(s) tested and such sample(s) are retained for 90 days only.

除非另有說明，此報告結果僅對測試之樣品負責，同時此樣品僅保留90天。本報告未經本公司書面許可，不可部份複製。

This document is issued by the Company subject to its General Conditions of Service printed overleaf, available on request or accessible at www.sgs.com/terms_and_conditions.htm and, for electronic format documents, subject to Terms and Conditions for Electronic Documents at www.sgs.com/terms_e-document.htm. Attention is drawn to the limitation of liability, indemnification and jurisdiction issues defined therein. Any holder of this document is advised that information contained hereon reflects the Company's findings at the time of its intervention only and within the limits of Client's instructions, if any. The Company's sole responsibility is to its Client and this document does not exonerate parties to a transaction from exercising all their rights and obligations under the transaction documents. This document cannot be reproduced except in full, without prior written approval of the Company. Any unauthorized alteration, forgery or falsification of the content or appearance of this document is unlawful and offenders may be prosecuted to the fullest extent of the law.

Operation Band	:HSDPA B5	Test Date	:2013-05-03
ARFCN	:CH 4233	Temp./Humi.	:24.1 deg_C / 65 RH
Fundamental Frequency	:846.6 MHz	Engineer	:Allen
Operation Mode	:TX HIGH	Measurement Antenna Pol.	:VERTICAL
EUT Pol.	:E1 Plan		

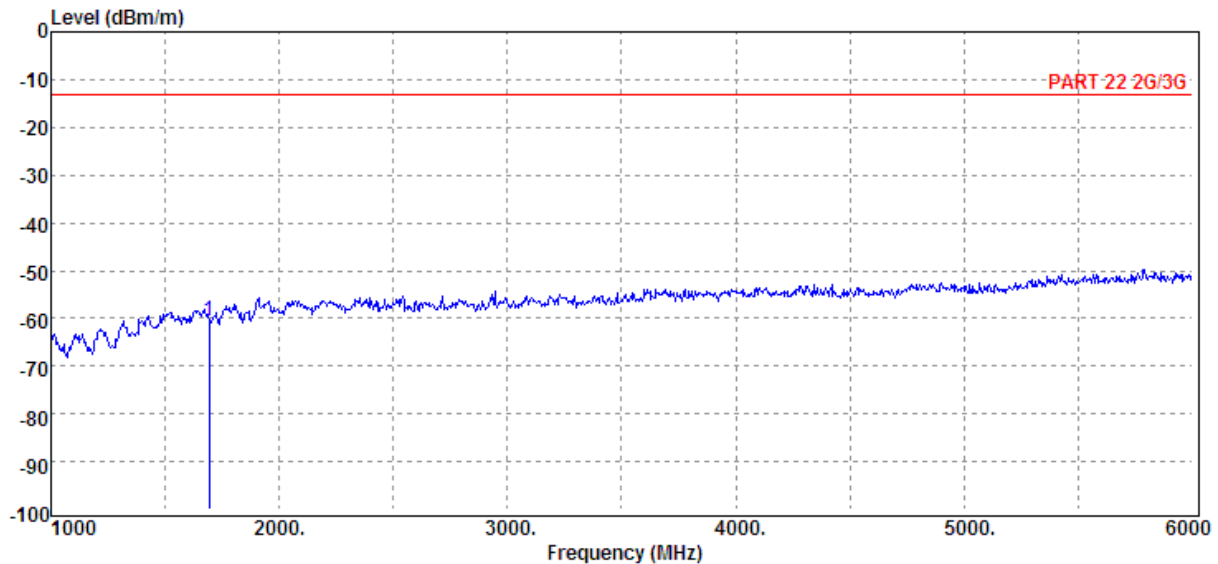
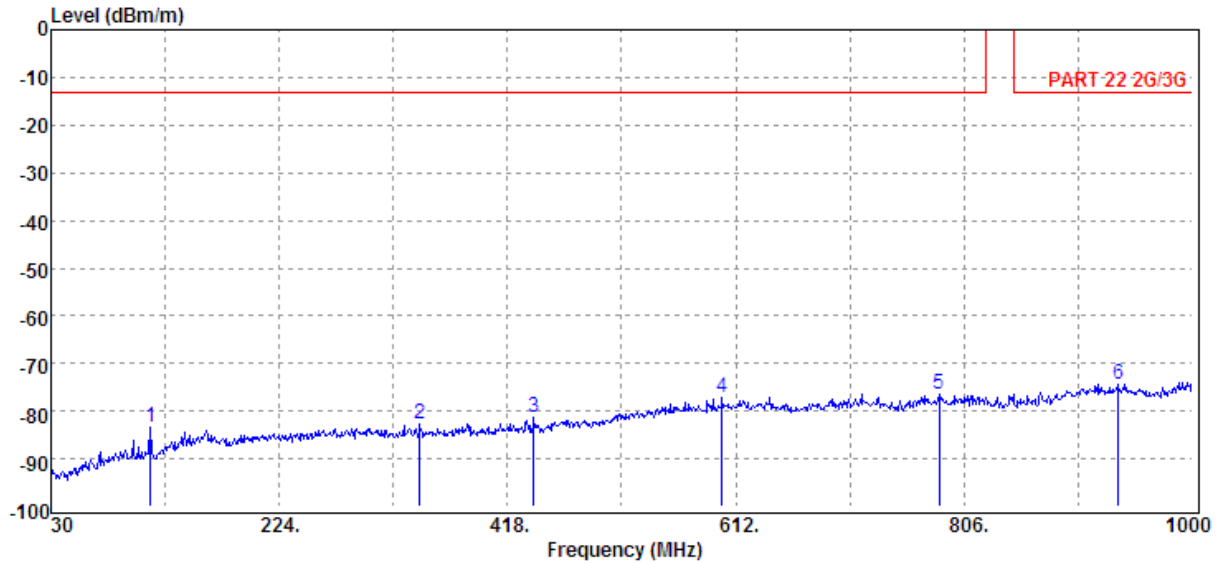

Unless otherwise stated the results shown in this test report refer only to the sample(s) tested and such sample(s) are retained for 90 days only.

除非另有說明，此報告結果僅對測試之樣品負責，同時此樣品僅保留90天。本報告未經本公司書面許可，不可部份複製。

This document is issued by the Company subject to its General Conditions of Service printed overleaf, available on request or accessible at www.sgs.com/terms_and_conditions.htm and, for electronic format documents, subject to Terms and Conditions for Electronic Documents at www.sgs.com/terms_e-document.htm. Attention is drawn to the limitation of liability, indemnification and jurisdiction issues defined therein. Any holder of this document is advised that information contained hereon reflects the Company's findings at the time of its intervention only and within the limits of Client's instructions, if any. The Company's sole responsibility is to its Client and this document does not exonerate parties to a transaction from exercising all their rights and obligations under the transaction documents. This document cannot be reproduced except in full, without prior written approval of the Company. Any unauthorized alteration, forgery or falsification of the content or appearance of this document is unlawful and offenders may be prosecuted to the fullest extent of the law.

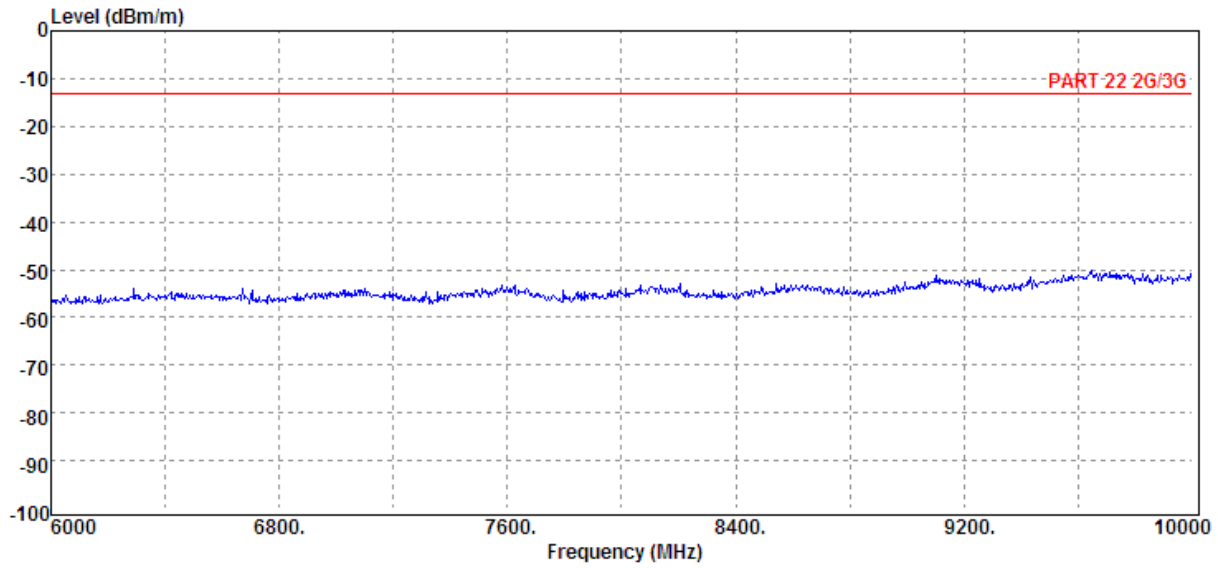

Unless otherwise stated the results shown in this test report refer only to the sample(s) tested and such sample(s) are retained for 90 days only.

除非另有說明，此報告結果僅對測試之樣品負責，同時此樣品僅保留90天。本報告未經本公司書面許可，不可部份複製。

This document is issued by the Company subject to its General Conditions of Service printed overleaf, available on request or accessible at www.sgs.com/terms_and_conditions.htm and, for electronic format documents, subject to Terms and Conditions for Electronic Documents at www.sgs.com/terms_e-document.htm. Attention is drawn to the limitation of liability, indemnification and jurisdiction issues defined therein. Any holder of this document is advised that information contained hereon reflects the Company's findings at the time of its intervention only and within the limits of Client's instructions, if any. The Company's sole responsibility is to its Client and this document does not exonerate parties to a transaction from exercising all their rights and obligations under the transaction documents. This document cannot be reproduced except in full, without prior written approval of the Company. Any unauthorized alteration, forgery or falsification of the content or appearance of this document is unlawful and offenders may be prosecuted to the fullest extent of the law.

Operation Band	:HSDPA B5	Test Date	:2013-05-03
ARFCN	:CH 4233	Temp./Humi.	:24.1 deg_C / 65 RH
Fundamental Frequency	:846.6 MHz	Engineer	:Allen
Operation Mode	:TX HIGH	Measurement Antenna Pol.	:HORIZONTAL
EUT Pol.	:E1 Plan		

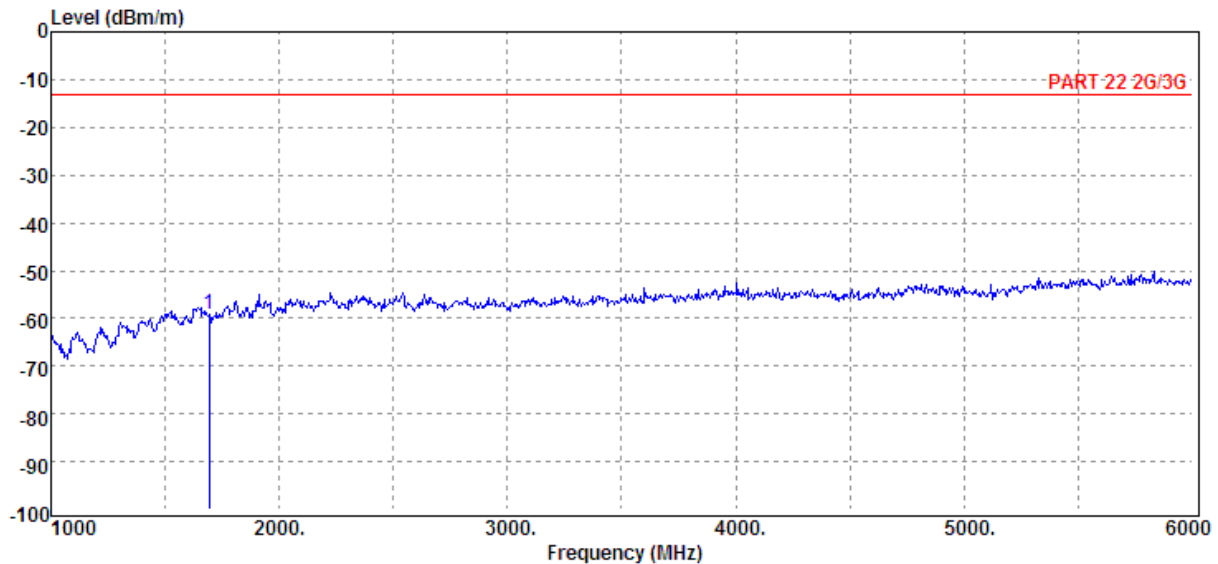
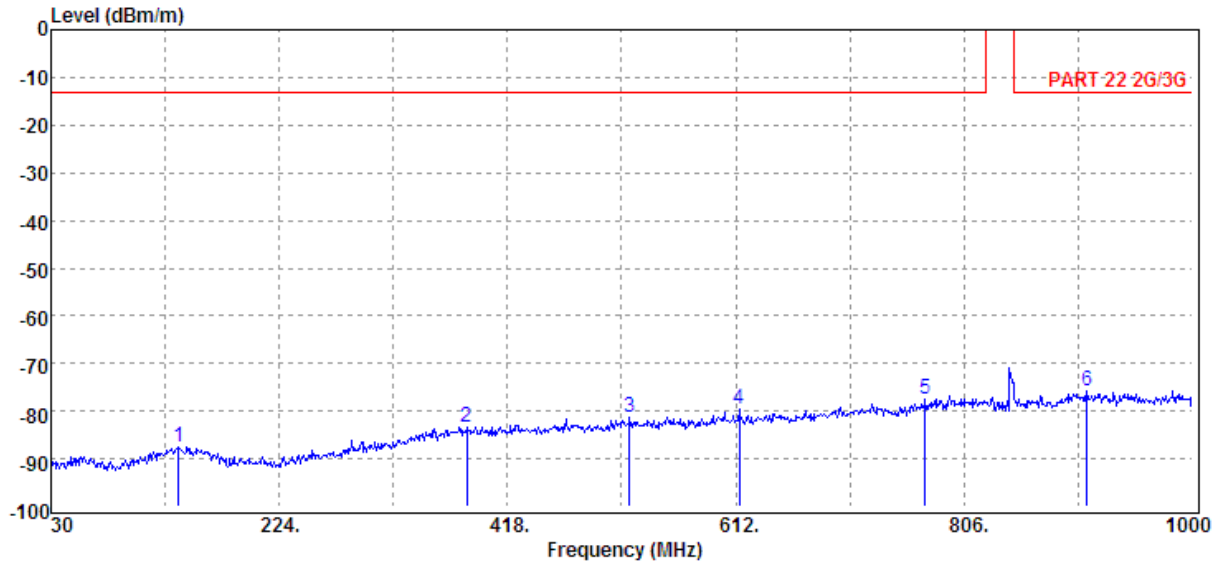

Unless otherwise stated the results shown in this test report refer only to the sample(s) tested and such sample(s) are retained for 90 days only.

除非另有說明，此報告結果僅對測試之樣品負責，同時此樣品僅保留90天。本報告未經本公司書面許可，不可部份複製。

This document is issued by the Company subject to its General Conditions of Service printed overleaf, available on request or accessible at www.sgs.com/terms_and_conditions.htm and, for electronic format documents, subject to Terms and Conditions for Electronic Documents at www.sgs.com/terms_e-document.htm. Attention is drawn to the limitation of liability, indemnification and jurisdiction issues defined therein. Any holder of this document is advised that information contained hereon reflects the Company's findings at the time of its intervention only and within the limits of Client's instructions, if any. The Company's sole responsibility is to its Client and this document does not exonerate parties to a transaction from exercising all their rights and obligations under the transaction documents. This document cannot be reproduced except in full, without prior written approval of the Company. Any unauthorized alteration, forgery or falsification of the content or appearance of this document is unlawful and offenders may be prosecuted to the fullest extent of the law.

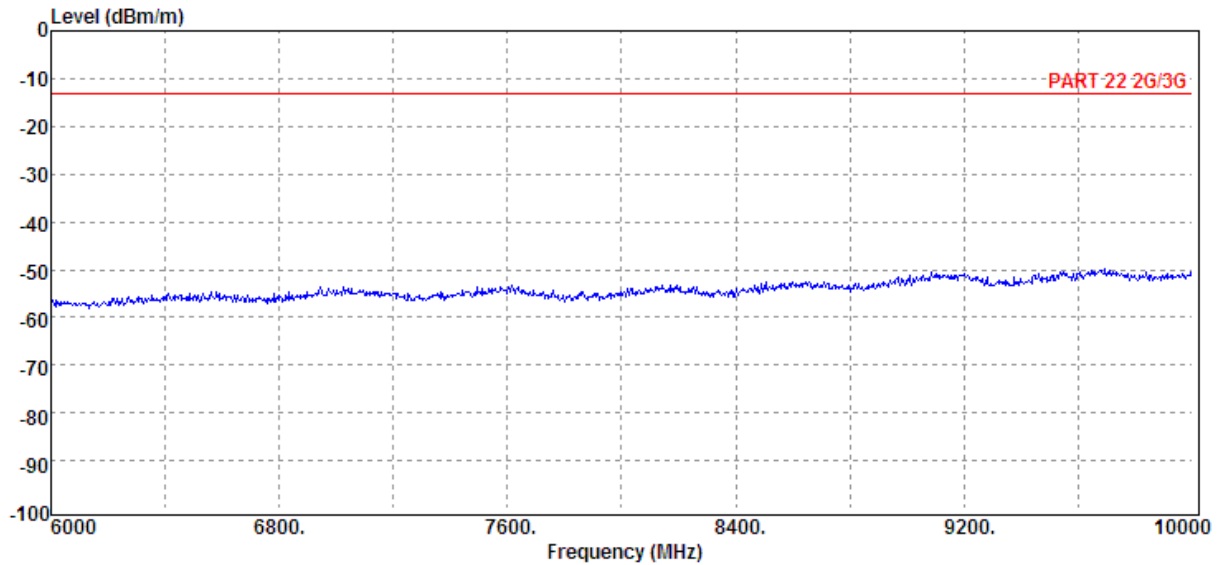

Unless otherwise stated the results shown in this test report refer only to the sample(s) tested and such sample(s) are retained for 90 days only.

除非另有說明，此報告結果僅對測試之樣品負責，同時此樣品僅保留90天。本報告未經本公司書面許可，不可部份複製。

This document is issued by the Company subject to its General Conditions of Service printed overleaf, available on request or accessible at www.sgs.com/terms_and_conditions.htm and, for electronic format documents, subject to Terms and Conditions for Electronic Documents at www.sgs.com/terms_e-document.htm. Attention is drawn to the limitation of liability, indemnification and jurisdiction issues defined therein. Any holder of this document is advised that information contained hereon reflects the Company's findings at the time of its intervention only and within the limits of Client's instructions, if any. The Company's sole responsibility is to its Client and this document does not exonerate parties to a transaction from exercising all their rights and obligations under the transaction documents. This document cannot be reproduced except in full, without prior written approval of the Company. Any unauthorized alteration, forgery or falsification of the content or appearance of this document is unlawful and offenders may be prosecuted to the fullest extent of the law.

Radiated Spurious Emission Measurement Result: GSM 850 Mode

Operation Band	:GSM 850	Test Date	:2013-05-03
Fundamental Frequency	:824.2 MHz	Temp./Humi.	:24.1 deg_C / 65 RH
Operation Mode	:RX LOW	Engineer	:Allen
EUT Pol.	:E2 Plan	Measurement Antenna Pol.	:VERTICAL

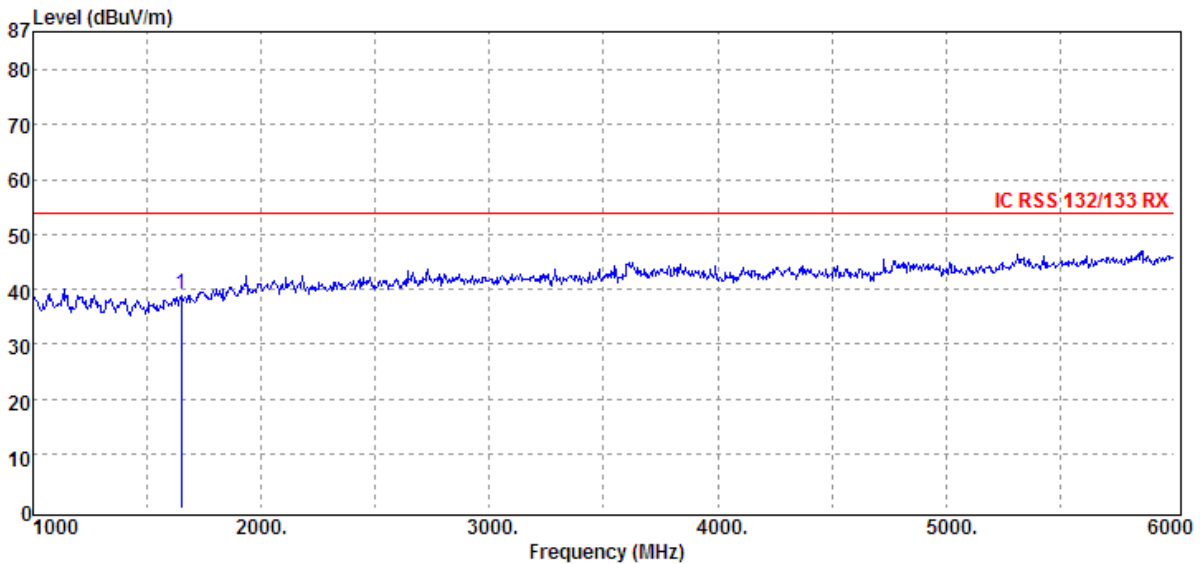
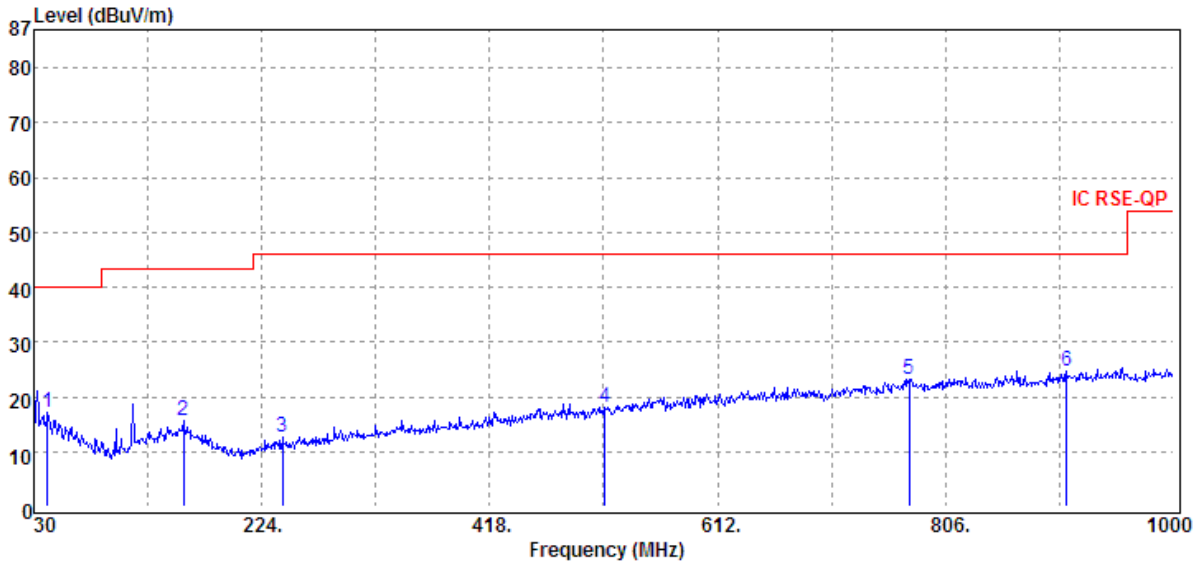

Unless otherwise stated the results shown in this test report refer only to the sample(s) tested and such sample(s) are retained for 90 days only.

除非另有說明，此報告結果僅對測試之樣品負責，同時此樣品僅保留90天。本報告未經本公司書面許可，不可部份複製。

This document is issued by the Company subject to its General Conditions of Service printed overleaf, available on request or accessible at www.sgs.com/terms_and_conditions.htm and, for electronic format documents, subject to Terms and Conditions for Electronic Documents at www.sgs.com/terms_e-document.htm. Attention is drawn to the limitation of liability, indemnification and jurisdiction issues defined therein. Any holder of this document is advised that information contained hereon reflects the Company's findings at the time of its intervention only and within the limits of Client's instructions, if any. The Company's sole responsibility is to its Client and this document does not exonerate parties to a transaction from exercising all their rights and obligations under the transaction documents. This document cannot be reproduced except in full, without prior written approval of the Company. Any unauthorized alteration, forgery or falsification of the content or appearance of this document is unlawful and offenders may be prosecuted to the fullest extent of the law.

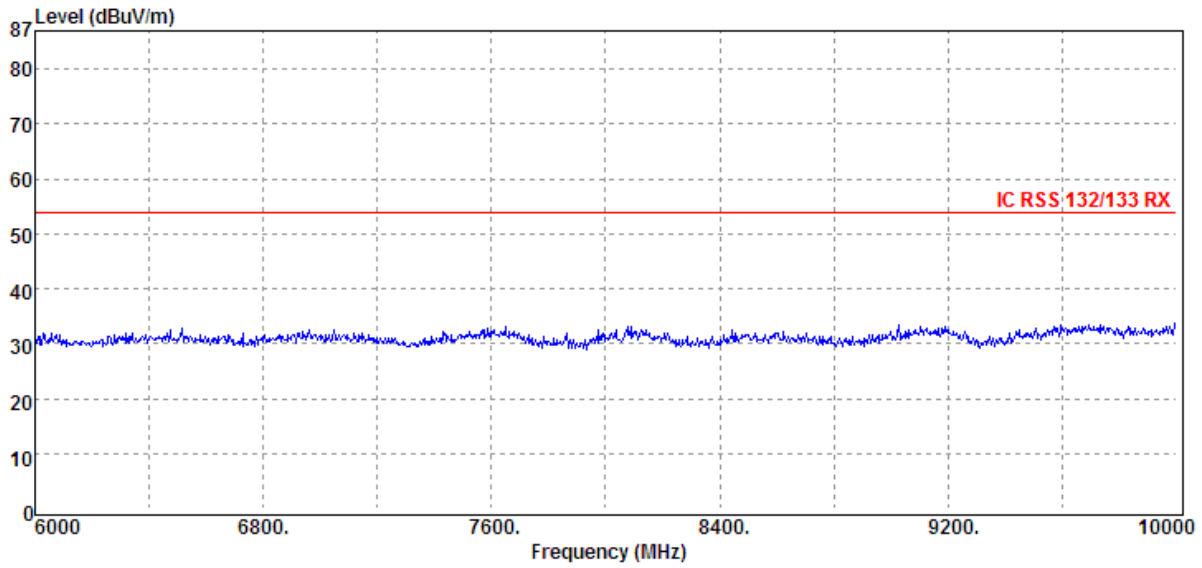

Unless otherwise stated the results shown in this test report refer only to the sample(s) tested and such sample(s) are retained for 90 days only.

除非另有說明，此報告結果僅對測試之樣品負責，同時此樣品僅保留90天。本報告未經本公司書面許可，不可部份複製。

This document is issued by the Company subject to its General Conditions of Service printed overleaf, available on request or accessible at www.sgs.com/terms_and_conditions.htm and, for electronic format documents, subject to Terms and Conditions for Electronic Documents at www.sgs.com/terms_e-document.htm. Attention is drawn to the limitation of liability, indemnification and jurisdiction issues defined therein. Any holder of this document is advised that information contained hereon reflects the Company's findings at the time of its intervention only and within the limits of Client's instructions, if any. The Company's sole responsibility is to its Client and this document does not exonerate parties to a transaction from exercising all their rights and obligations under the transaction documents. This document cannot be reproduced except in full, without prior written approval of the Company. Any unauthorized alteration, forgery or falsification of the content or appearance of this document is unlawful and offenders may be prosecuted to the fullest extent of the law.

Operation Band	:GSM 850	Test Date	:2013-05-03
Fundamental Frequency	:824.2 MHz	Temp./Humi.	:24.1 deg_C / 65 RH
Operation Mode	:RX LOW	Engineer	:Allen
EUT Pol.	:E2 Plan	Measurement Antenna Pol.	:HORIZONTAL

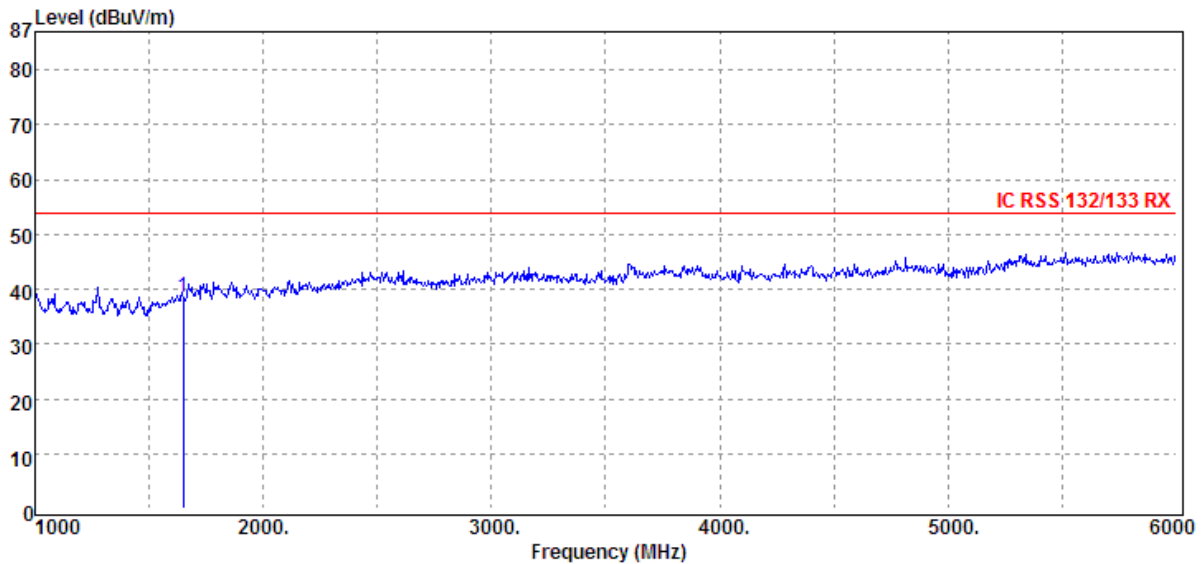
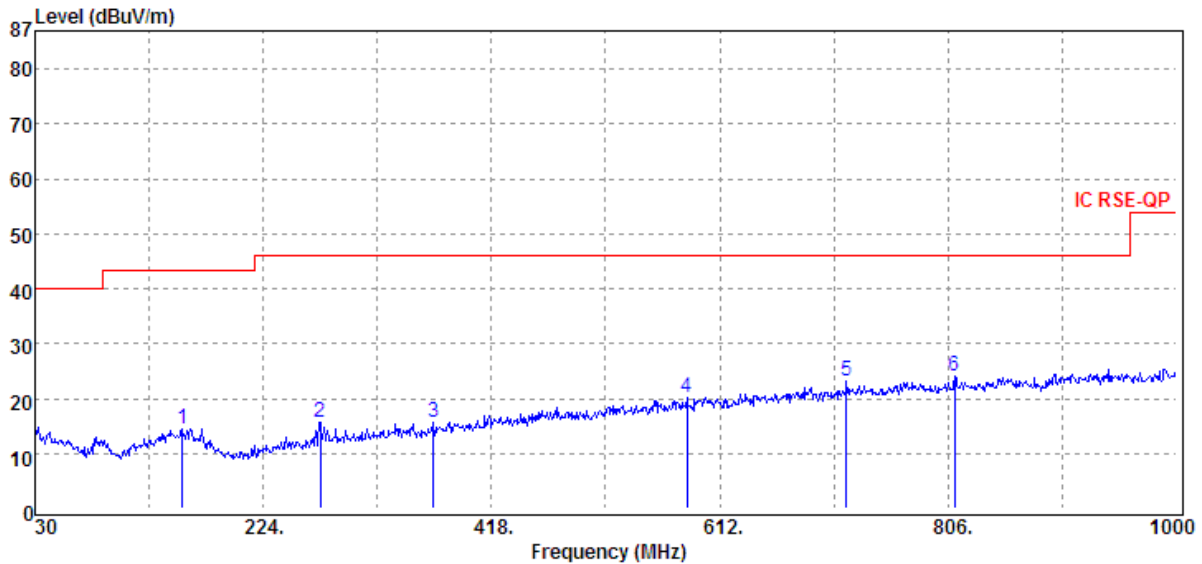

Unless otherwise stated the results shown in this test report refer only to the sample(s) tested and such sample(s) are retained for 90 days only.

除非另有說明，此報告結果僅對測試之樣品負責，同時此樣品僅保留90天。本報告未經本公司書面許可，不可部份複製。

This document is issued by the Company subject to its General Conditions of Service printed overleaf, available on request or accessible at www.sgs.com/terms_and_conditions.htm and, for electronic format documents, subject to Terms and Conditions for Electronic Documents at www.sgs.com/terms_e-document.htm. Attention is drawn to the limitation of liability, indemnification and jurisdiction issues defined therein. Any holder of this document is advised that information contained hereon reflects the Company's findings at the time of its intervention only and within the limits of Client's instructions, if any. The Company's sole responsibility is to its Client and this document does not exonerate parties to a transaction from exercising all their rights and obligations under the transaction documents. This document cannot be reproduced except in full, without prior written approval of the Company. Any unauthorized alteration, forgery or falsification of the content or appearance of this document is unlawful and offenders may be prosecuted to the fullest extent of the law.

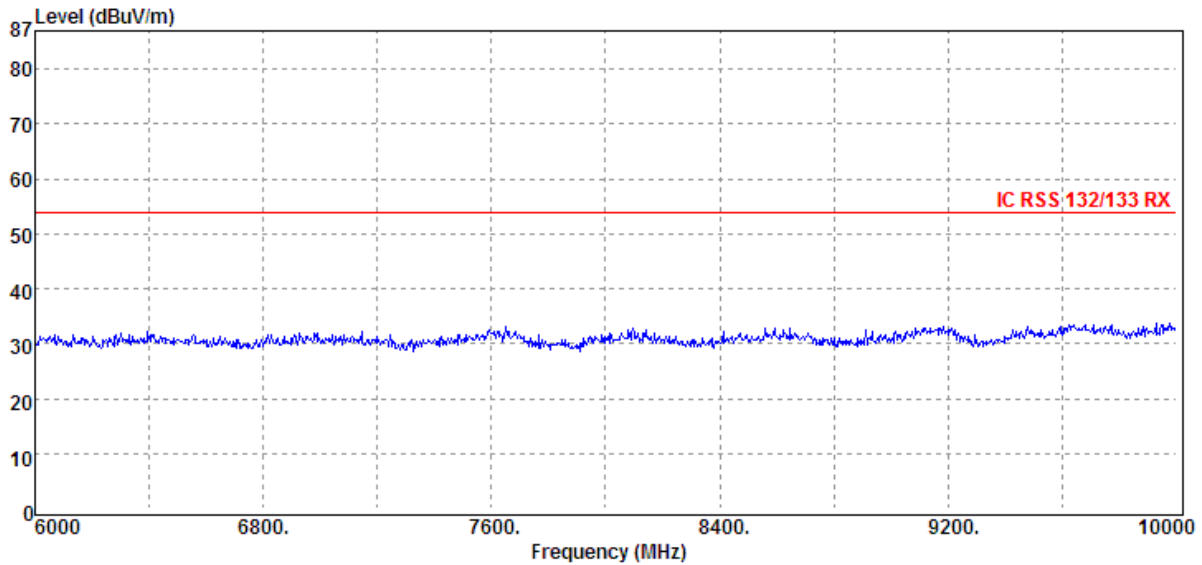

Unless otherwise stated the results shown in this test report refer only to the sample(s) tested and such sample(s) are retained for 90 days only.

除非另有說明，此報告結果僅對測試之樣品負責，同時此樣品僅保留90天。本報告未經本公司書面許可，不可部份複製。

This document is issued by the Company subject to its General Conditions of Service printed overleaf, available on request or accessible at www.sgs.com/terms_and_conditions.htm and, for electronic format documents, subject to Terms and Conditions for Electronic Documents at www.sgs.com/terms_e-document.htm. Attention is drawn to the limitation of liability, indemnification and jurisdiction issues defined therein. Any holder of this document is advised that information contained hereon reflects the Company's findings at the time of its intervention only and within the limits of Client's instructions, if any. The Company's sole responsibility is to its Client and this document does not exonerate parties to a transaction from exercising all their rights and obligations under the transaction documents. This document cannot be reproduced except in full, without prior written approval of the Company. Any unauthorized alteration, forgery or falsification of the content or appearance of this document is unlawful and offenders may be prosecuted to the fullest extent of the law.

Operation Band	:GSM 850	Test Date	:2013-05-03
Fundamental Frequency	:836.6 MHz	Temp./Humi.	:24.1 deg_C / 65 RH
Operation Mode	:RX MID	Engineer	:Allen
EUT Pol.	:E2 Plan	Measurement Antenna Pol.	:VERTICAL

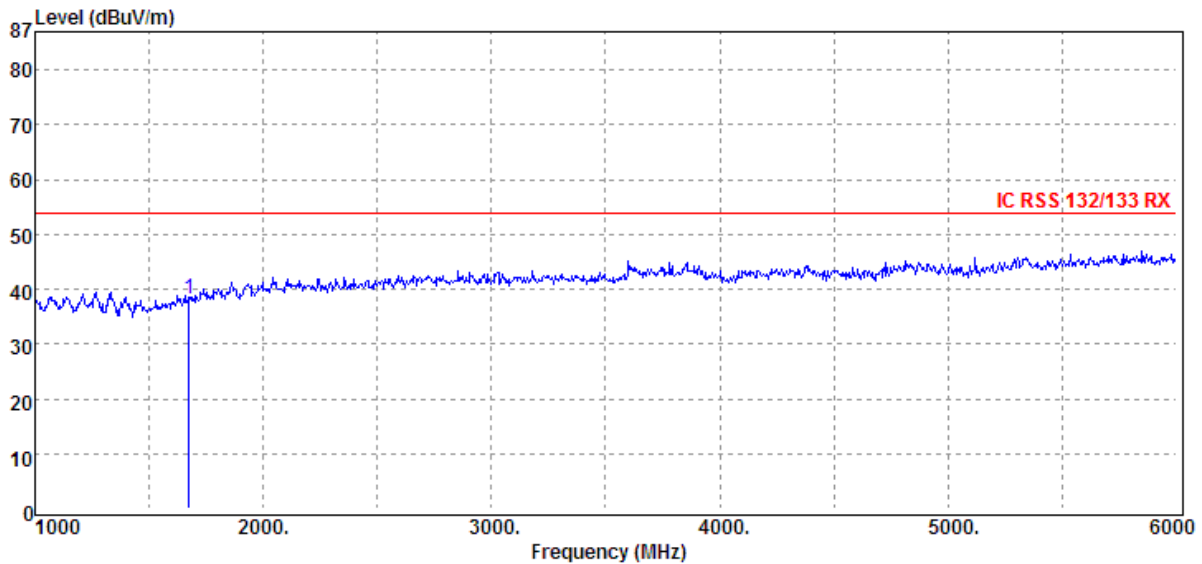
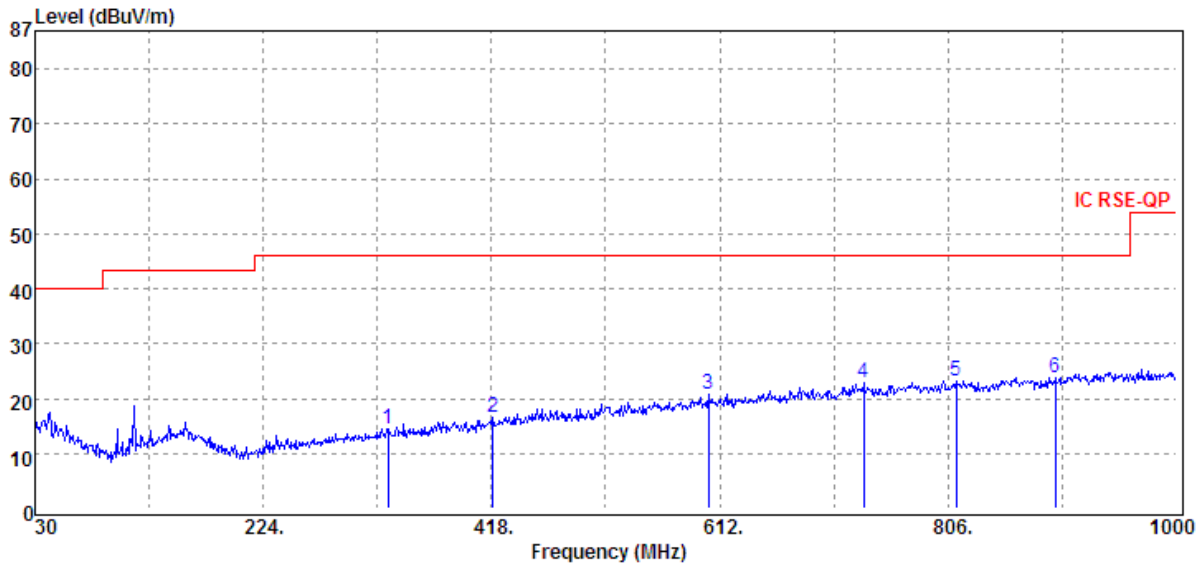

Unless otherwise stated the results shown in this test report refer only to the sample(s) tested and such sample(s) are retained for 90 days only.

除非另有說明，此報告結果僅對測試之樣品負責，同時此樣品僅保留90天。本報告未經本公司書面許可，不可部份複製。

This document is issued by the Company subject to its General Conditions of Service printed overleaf, available on request or accessible at www.sgs.com/terms_and_conditions.htm and, for electronic format documents, subject to Terms and Conditions for Electronic Documents at www.sgs.com/terms_e-document.htm. Attention is drawn to the limitation of liability, indemnification and jurisdiction issues defined therein. Any holder of this document is advised that information contained hereon reflects the Company's findings at the time of its intervention only and within the limits of Client's instructions, if any. The Company's sole responsibility is to its Client and this document does not exonerate parties to a transaction from exercising all their rights and obligations under the transaction documents. This document cannot be reproduced except in full, without prior written approval of the Company. Any unauthorized alteration, forgery or falsification of the content or appearance of this document is unlawful and offenders may be prosecuted to the fullest extent of the law.

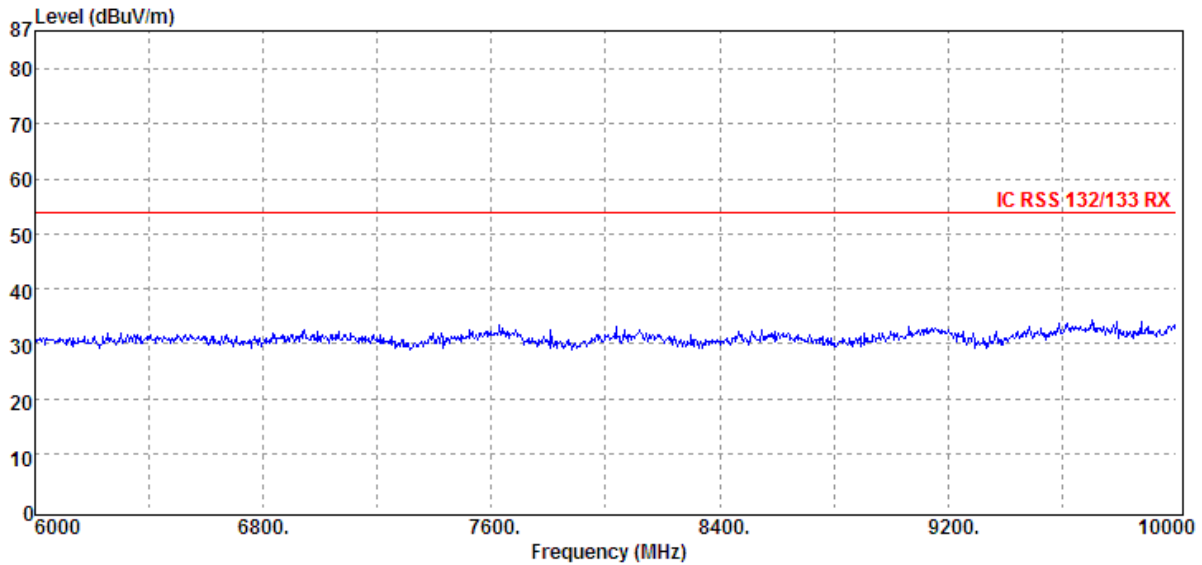

Unless otherwise stated the results shown in this test report refer only to the sample(s) tested and such sample(s) are retained for 90 days only.

除非另有說明，此報告結果僅對測試之樣品負責，同時此樣品僅保留90天。本報告未經本公司書面許可，不可部份複製。

This document is issued by the Company subject to its General Conditions of Service printed overleaf, available on request or accessible at www.sgs.com/terms_and_conditions.htm and, for electronic format documents, subject to Terms and Conditions for Electronic Documents at www.sgs.com/terms_e-document.htm. Attention is drawn to the limitation of liability, indemnification and jurisdiction issues defined therein. Any holder of this document is advised that information contained hereon reflects the Company's findings at the time of its intervention only and within the limits of Client's instructions, if any. The Company's sole responsibility is to its Client and this document does not exonerate parties to a transaction from exercising all their rights and obligations under the transaction documents. This document cannot be reproduced except in full, without prior written approval of the Company. Any unauthorized alteration, forgery or falsification of the content or appearance of this document is unlawful and offenders may be prosecuted to the fullest extent of the law.

Operation Band	:GSM 850	Test Date	:2013-05-03
Fundamental Frequency	:836.6 MHz	Temp./Humi.	:24.1 deg_C / 65 RH
Operation Mode	:RX MID	Engineer	:Allen
EUT Pol.	:E2 Plan	Measurement Antenna Pol.	:HORIZONTAL

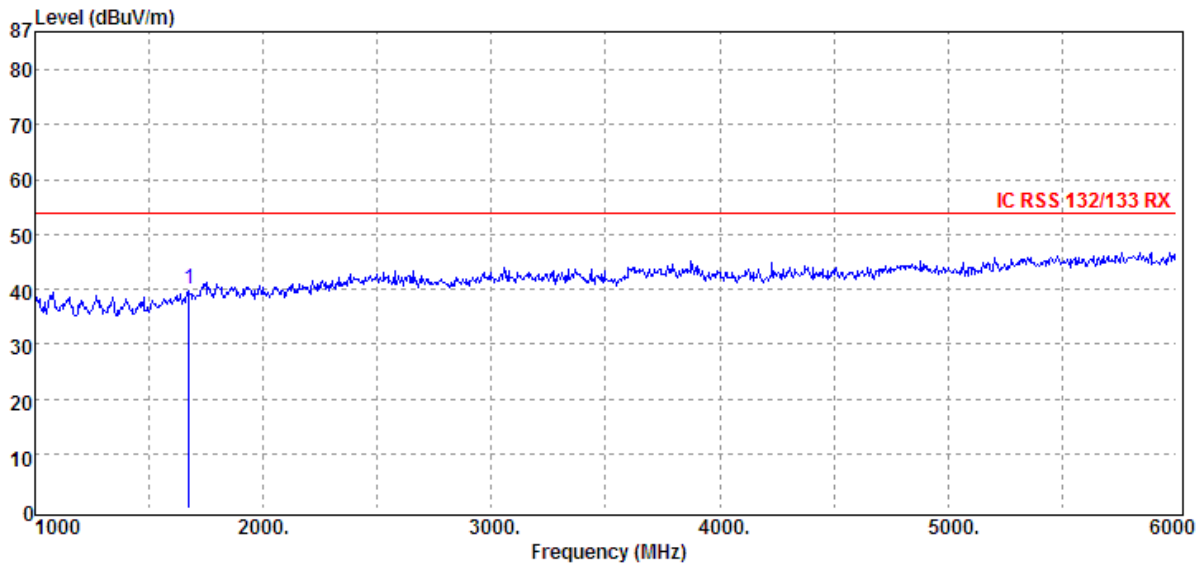
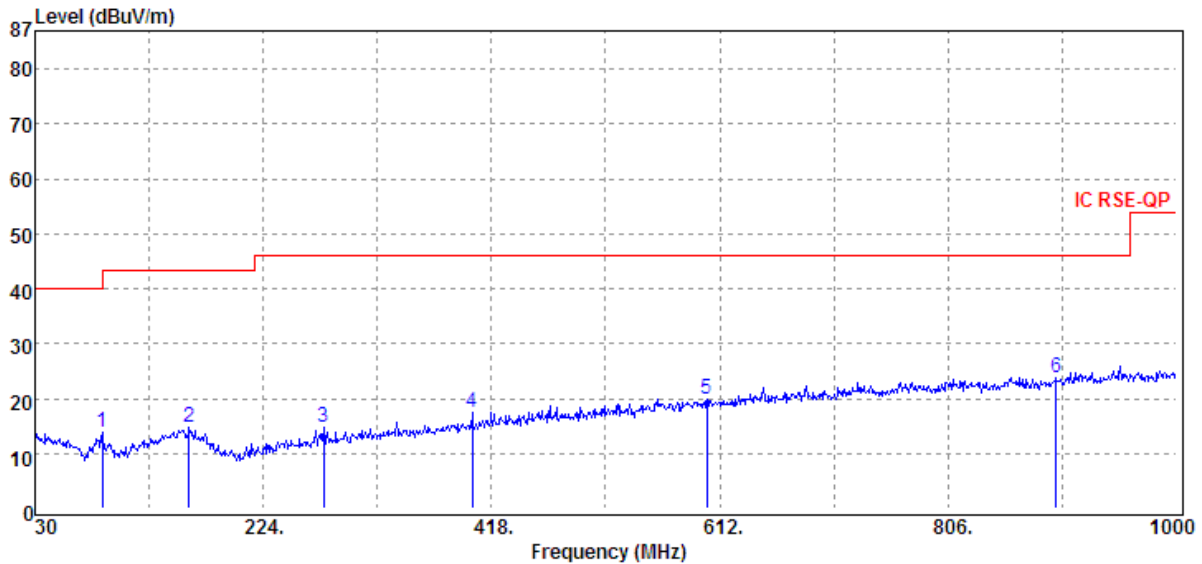

Unless otherwise stated the results shown in this test report refer only to the sample(s) tested and such sample(s) are retained for 90 days only.

除非另有說明，此報告結果僅對測試之樣品負責，同時此樣品僅保留90天。本報告未經本公司書面許可，不可部份複製。

This document is issued by the Company subject to its General Conditions of Service printed overleaf, available on request or accessible at www.sgs.com/terms_and_conditions.htm and, for electronic format documents, subject to Terms and Conditions for Electronic Documents at www.sgs.com/terms_e-document.htm. Attention is drawn to the limitation of liability, indemnification and jurisdiction issues defined therein. Any holder of this document is advised that information contained hereon reflects the Company's findings at the time of its intervention only and within the limits of Client's instructions, if any. The Company's sole responsibility is to its Client and this document does not exonerate parties to a transaction from exercising all their rights and obligations under the transaction documents. This document cannot be reproduced except in full, without prior written approval of the Company. Any unauthorized alteration, forgery or falsification of the content or appearance of this document is unlawful and offenders may be prosecuted to the fullest extent of the law.

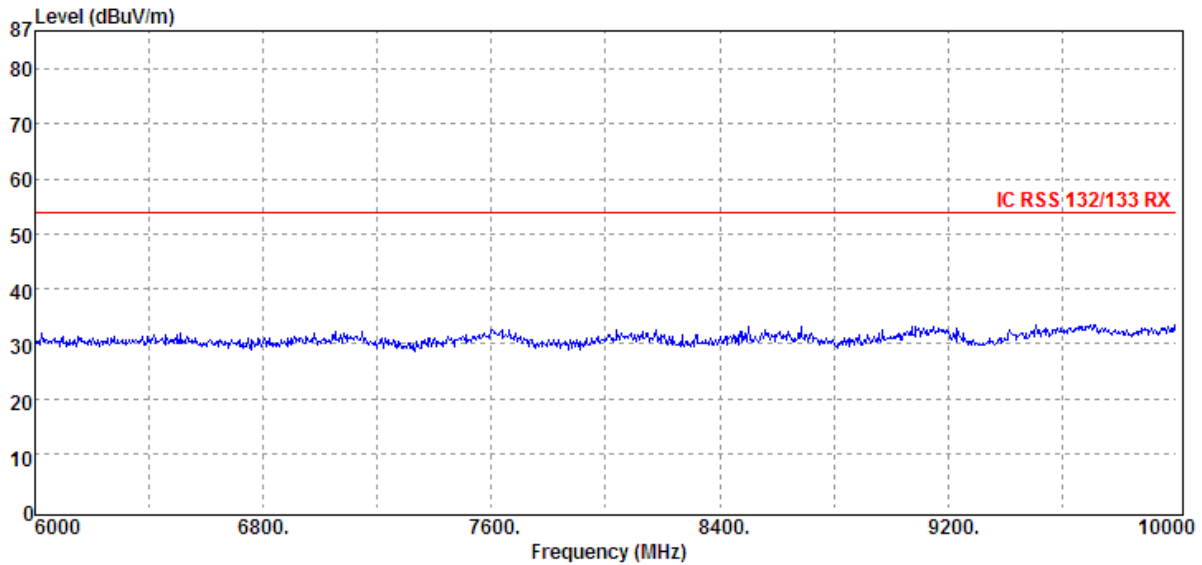

Unless otherwise stated the results shown in this test report refer only to the sample(s) tested and such sample(s) are retained for 90 days only.

除非另有說明，此報告結果僅對測試之樣品負責，同時此樣品僅保留90天。本報告未經本公司書面許可，不可部份複製。

This document is issued by the Company subject to its General Conditions of Service printed overleaf, available on request or accessible at www.sgs.com/terms_and_conditions.htm and, for electronic format documents, subject to Terms and Conditions for Electronic Documents at www.sgs.com/terms_e-document.htm. Attention is drawn to the limitation of liability, indemnification and jurisdiction issues defined therein. Any holder of this document is advised that information contained hereon reflects the Company's findings at the time of its intervention only and within the limits of Client's instructions, if any. The Company's sole responsibility is to its Client and this document does not exonerate parties to a transaction from exercising all their rights and obligations under the transaction documents. This document cannot be reproduced except in full, without prior written approval of the Company. Any unauthorized alteration, forgery or falsification of the content or appearance of this document is unlawful and offenders may be prosecuted to the fullest extent of the law.

Operation Band	:GSM 850	Test Date	:2013-05-03
Fundamental Frequency	:848.8 MHz	Temp./Humi.	:24.1 deg_C / 65 RH
Operation Mode	:RX HIGH	Engineer	:Allen
EUT Pol.	:E2 Plan	Measurement Antenna Pol.	:VERTICAL

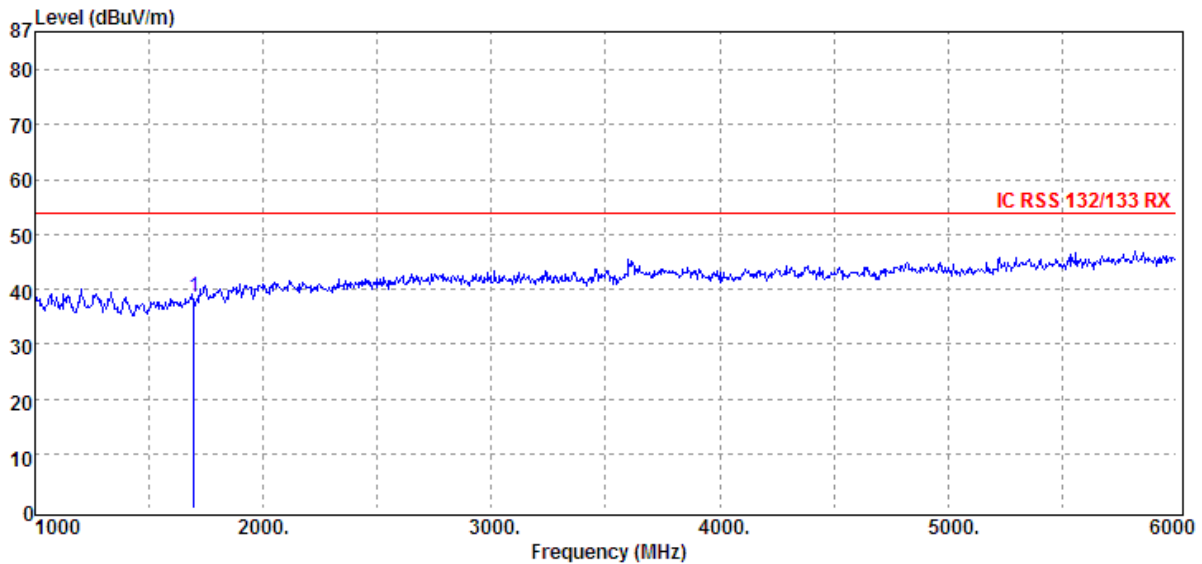
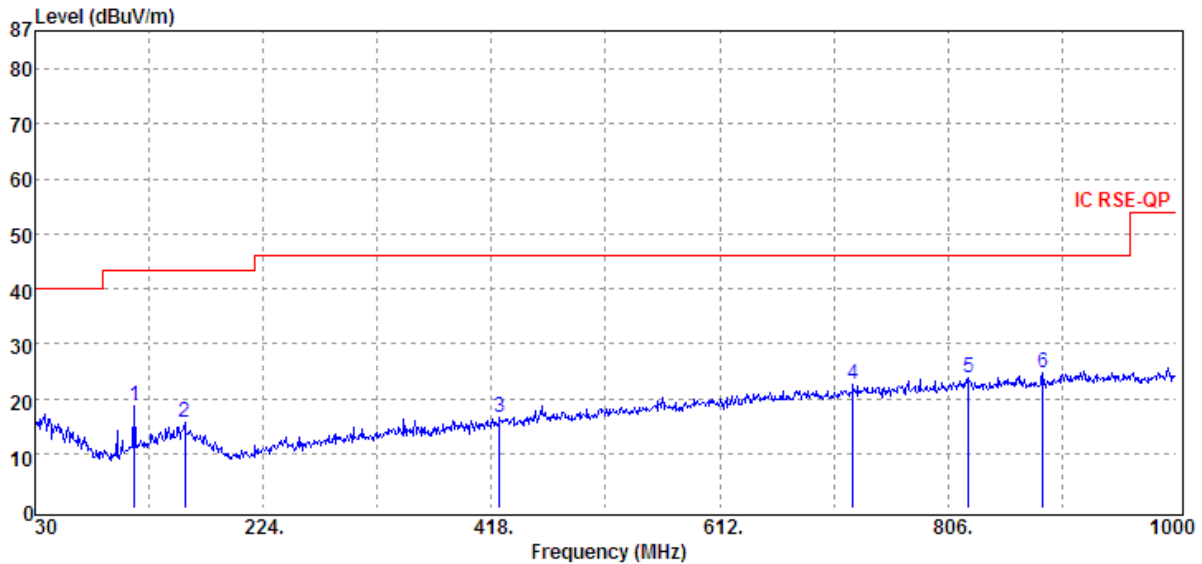

Unless otherwise stated the results shown in this test report refer only to the sample(s) tested and such sample(s) are retained for 90 days only.

除非另有說明，此報告結果僅對測試之樣品負責，同時此樣品僅保留90天。本報告未經本公司書面許可，不可部份複製。

This document is issued by the Company subject to its General Conditions of Service printed overleaf, available on request or accessible at www.sgs.com/terms_and_conditions.htm and, for electronic format documents, subject to Terms and Conditions for Electronic Documents at www.sgs.com/terms_e-document.htm. Attention is drawn to the limitation of liability, indemnification and jurisdiction issues defined therein. Any holder of this document is advised that information contained hereon reflects the Company's findings at the time of its intervention only and within the limits of Client's instructions, if any. The Company's sole responsibility is to its Client and this document does not exonerate parties to a transaction from exercising all their rights and obligations under the transaction documents. This document cannot be reproduced except in full, without prior written approval of the Company. Any unauthorized alteration, forgery or falsification of the content or appearance of this document is unlawful and offenders may be prosecuted to the fullest extent of the law.

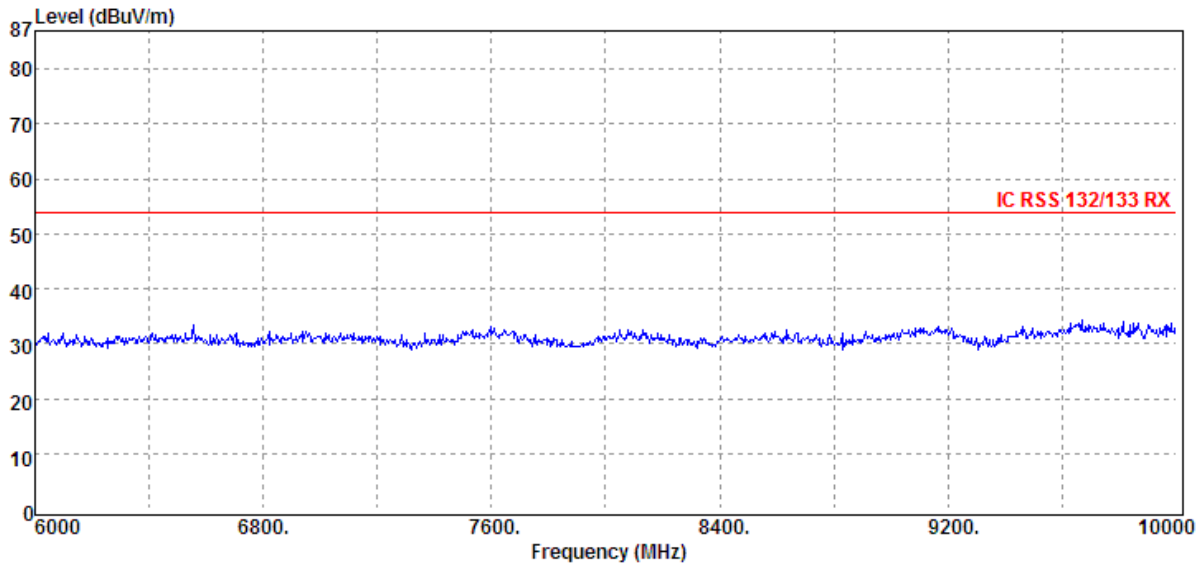

Unless otherwise stated the results shown in this test report refer only to the sample(s) tested and such sample(s) are retained for 90 days only.

除非另有說明，此報告結果僅對測試之樣品負責，同時此樣品僅保留90天。本報告未經本公司書面許可，不可部份複製。

This document is issued by the Company subject to its General Conditions of Service printed overleaf, available on request or accessible at www.sgs.com/terms_and_conditions.htm and, for electronic format documents, subject to Terms and Conditions for Electronic Documents at www.sgs.com/terms_e-document.htm. Attention is drawn to the limitation of liability, indemnification and jurisdiction issues defined therein. Any holder of this document is advised that information contained hereon reflects the Company's findings at the time of its intervention only and within the limits of Client's instructions, if any. The Company's sole responsibility is to its Client and this document does not exonerate parties to a transaction from exercising all their rights and obligations under the transaction documents. This document cannot be reproduced except in full, without prior written approval of the Company. Any unauthorized alteration, forgery or falsification of the content or appearance of this document is unlawful and offenders may be prosecuted to the fullest extent of the law.

Operation Band	:GSM 850	Test Date	:2013-05-03
Fundamental Frequency	:848.8 MHz	Temp./Humi.	:24.1 deg_C / 65 RH
Operation Mode	:RX HIGH	Engineer	:Allen
EUT Pol.	:E2 Plan	Measurement Antenna Pol.	:HORIZONTAL

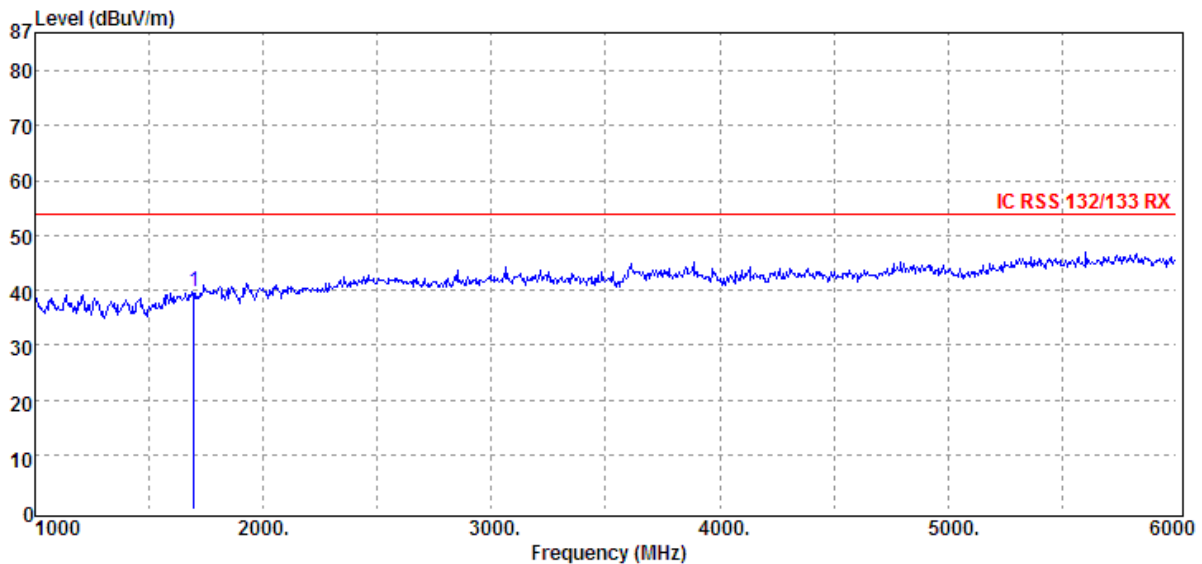
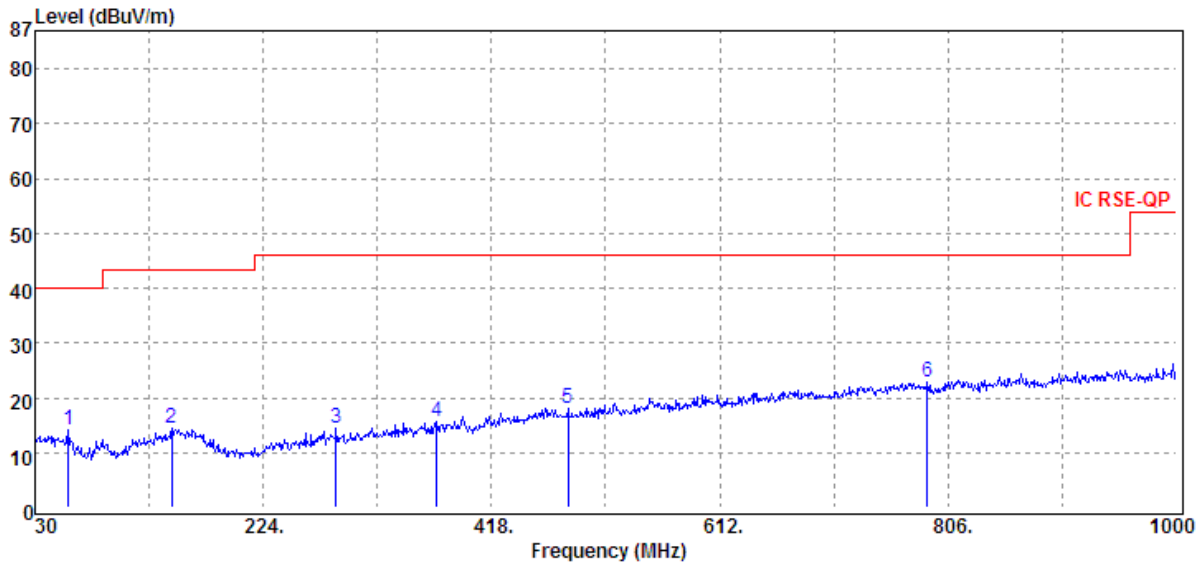

Unless otherwise stated the results shown in this test report refer only to the sample(s) tested and such sample(s) are retained for 90 days only.

除非另有說明，此報告結果僅對測試之樣品負責，同時此樣品僅保留90天。本報告未經本公司書面許可，不可部份複製。

This document is issued by the Company subject to its General Conditions of Service printed overleaf, available on request or accessible at www.sgs.com/terms_and_conditions.htm and, for electronic format documents, subject to Terms and Conditions for Electronic Documents at www.sgs.com/terms_e-document.htm. Attention is drawn to the limitation of liability, indemnification and jurisdiction issues defined therein. Any holder of this document is advised that information contained hereon reflects the Company's findings at the time of its intervention only and within the limits of Client's instructions, if any. The Company's sole responsibility is to its Client and this document does not exonerate parties to a transaction from exercising all their rights and obligations under the transaction documents. This document cannot be reproduced except in full, without prior written approval of the Company. Any unauthorized alteration, forgery or falsification of the content or appearance of this document is unlawful and offenders may be prosecuted to the fullest extent of the law.

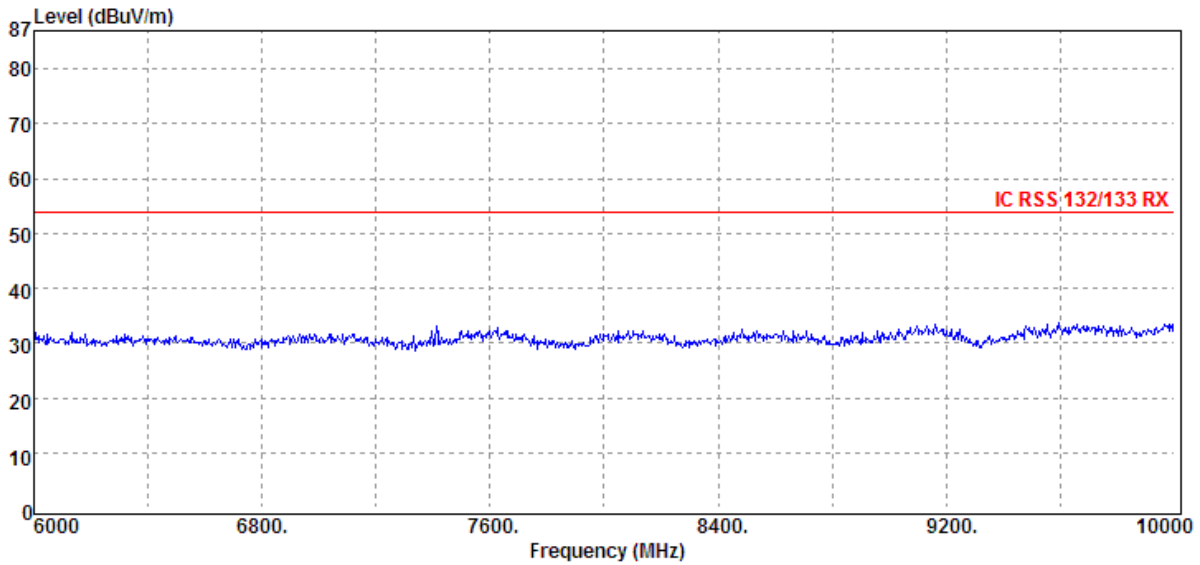

Unless otherwise stated the results shown in this test report refer only to the sample(s) tested and such sample(s) are retained for 90 days only.

除非另有說明，此報告結果僅對測試之樣品負責，同時此樣品僅保留90天。本報告未經本公司書面許可，不可部份複製。

This document is issued by the Company subject to its General Conditions of Service printed overleaf, available on request or accessible at www.sgs.com/terms_and_conditions.htm and, for electronic format documents, subject to Terms and Conditions for Electronic Documents at www.sgs.com/terms_e-document.htm. Attention is drawn to the limitation of liability, indemnification and jurisdiction issues defined therein. Any holder of this document is advised that information contained hereon reflects the Company's findings at the time of its intervention only and within the limits of Client's instructions, if any. The Company's sole responsibility is to its Client and this document does not exonerate parties to a transaction from exercising all their rights and obligations under the transaction documents. This document cannot be reproduced except in full, without prior written approval of the Company. Any unauthorized alteration, forgery or falsification of the content or appearance of this document is unlawful and offenders may be prosecuted to the fullest extent of the law.

Radiated Spurious Emission Measurement Result: GSM 1900 Mode

Operation Band	:GSM 1900	Test Date	:2013-05-03
Fundamental Frequency	:1850.2 MHz	Temp./Humi.	:24.1 deg_C / 65 RH
Operation Mode	:RX LOW	Engineer	:Allen
EUT Pol.	:E1 Plan	Measurement Antenna Pol.	:VERTICAL

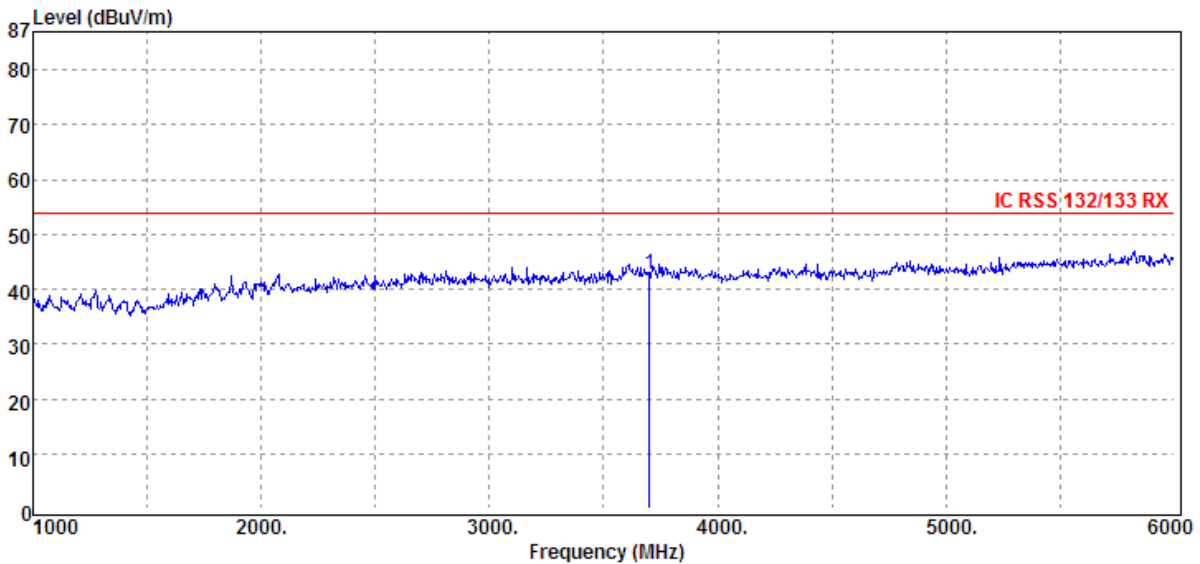
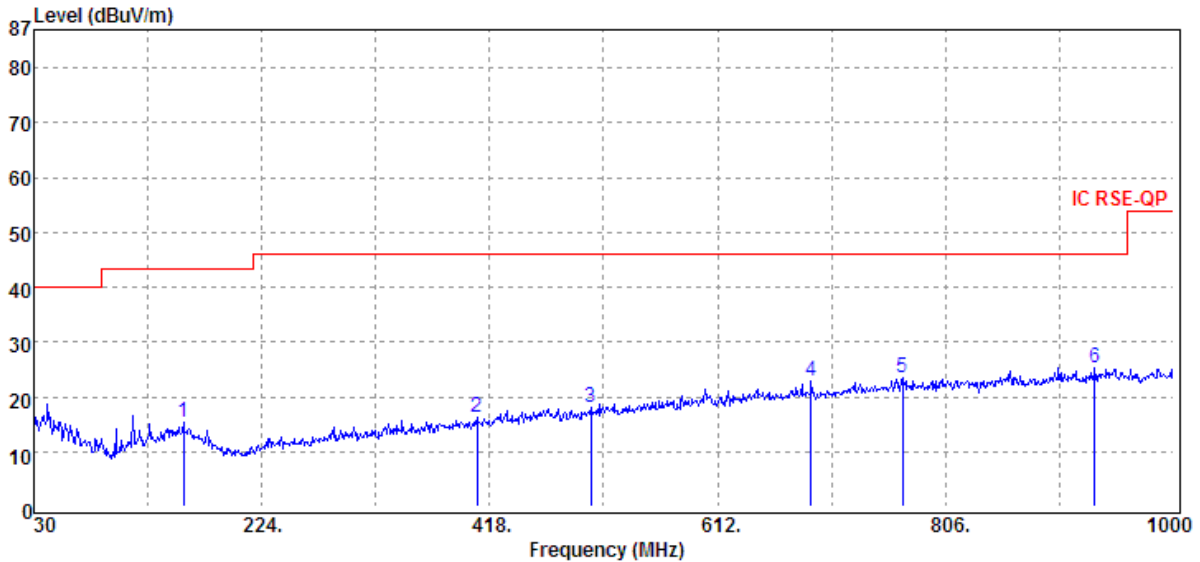

Unless otherwise stated the results shown in this test report refer only to the sample(s) tested and such sample(s) are retained for 90 days only.

除非另有說明，此報告結果僅對測試之樣品負責，同時此樣品僅保留90天。本報告未經本公司書面許可，不可部份複製。

This document is issued by the Company subject to its General Conditions of Service printed overleaf, available on request or accessible at www.sgs.com/terms_and_conditions.htm and, for electronic format documents, subject to Terms and Conditions for Electronic Documents at www.sgs.com/terms_e-document.htm. Attention is drawn to the limitation of liability, indemnification and jurisdiction issues defined therein. Any holder of this document is advised that information contained hereon reflects the Company's findings at the time of its intervention only and within the limits of Client's instructions, if any. The Company's sole responsibility is to its Client and this document does not exonerate parties to a transaction from exercising all their rights and obligations under the transaction documents. This document cannot be reproduced except in full, without prior written approval of the Company. Any unauthorized alteration, forgery or falsification of the content or appearance of this document is unlawful and offenders may be prosecuted to the fullest extent of the law.

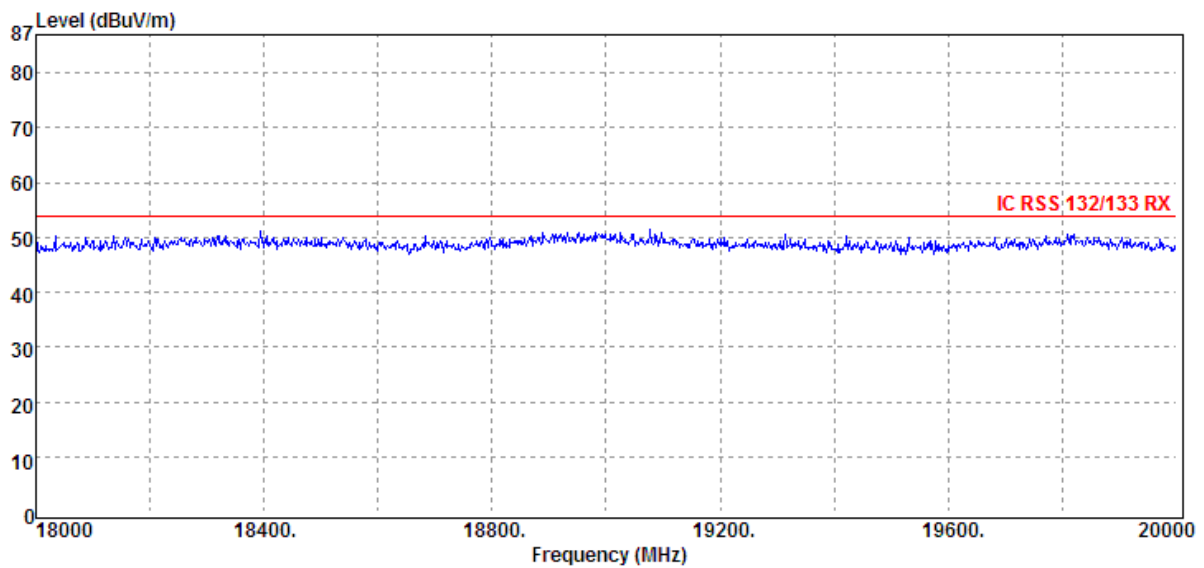
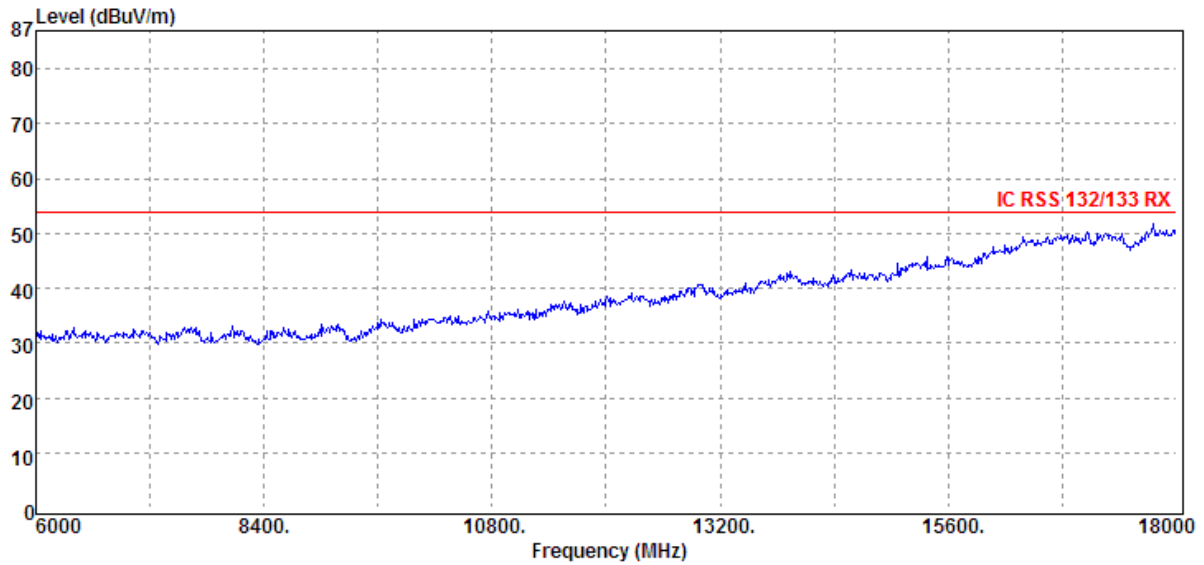

Unless otherwise stated the results shown in this test report refer only to the sample(s) tested and such sample(s) are retained for 90 days only.

除非另有說明，此報告結果僅對測試之樣品負責，同時此樣品僅保留90天。本報告未經本公司書面許可，不可部份複製。

This document is issued by the Company subject to its General Conditions of Service printed overleaf, available on request or accessible at www.sgs.com/terms_and_conditions.htm and, for electronic format documents, subject to Terms and Conditions for Electronic Documents at www.sgs.com/terms_e-document.htm. Attention is drawn to the limitation of liability, indemnification and jurisdiction issues defined therein. Any holder of this document is advised that information contained hereon reflects the Company's findings at the time of its intervention only and within the limits of Client's instructions, if any. The Company's sole responsibility is to its Client and this document does not exonerate parties to a transaction from exercising all their rights and obligations under the transaction documents. This document cannot be reproduced except in full, without prior written approval of the Company. Any unauthorized alteration, forgery or falsification of the content or appearance of this document is unlawful and offenders may be prosecuted to the fullest extent of the law.

Operation Band	:GSM 1900	Test Date	:2013-05-03
Fundamental Frequency	:1850.2 MHz	Temp./Humi.	:24.1 deg_C / 65 RH
Operation Mode	:RX LOW	Engineer	:Allen
EUT Pol.	:E1 Plan	Measurement Antenna Pol.	:HORIZONTAL

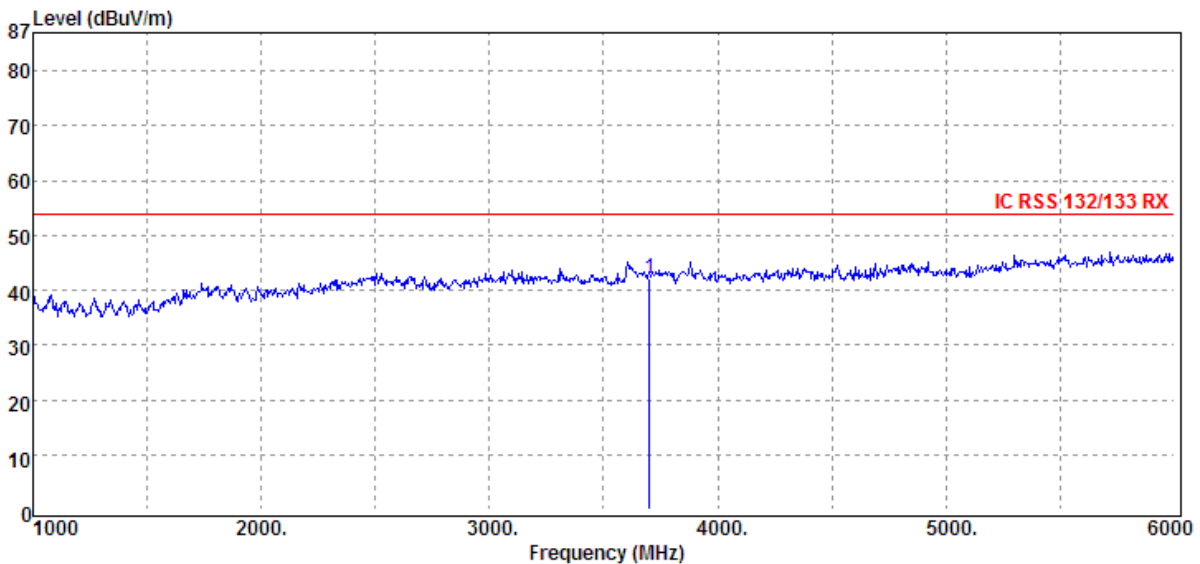
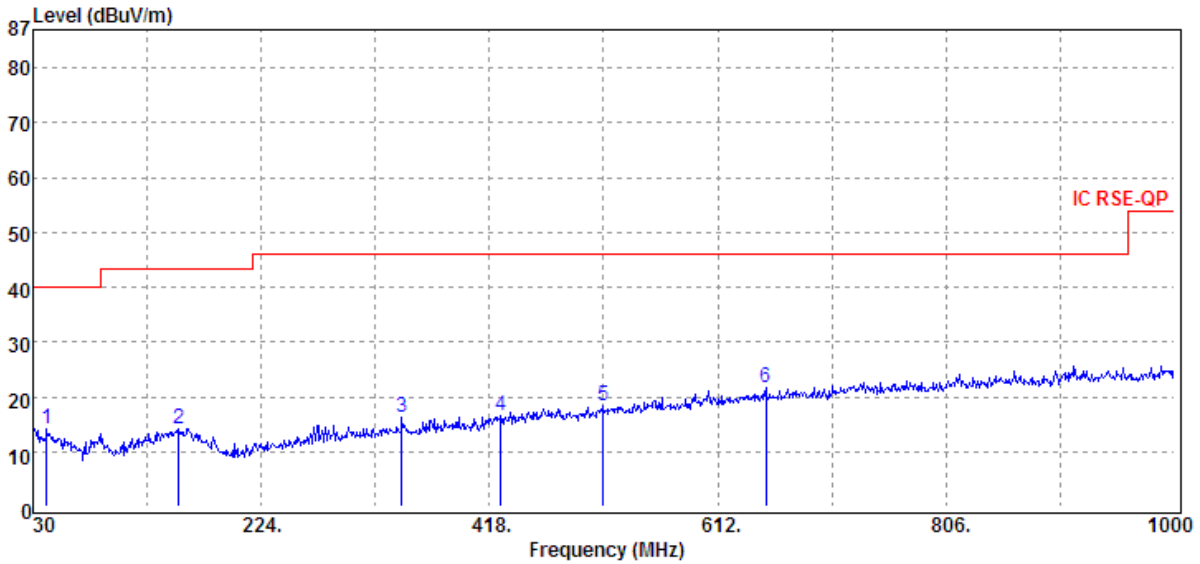

Unless otherwise stated the results shown in this test report refer only to the sample(s) tested and such sample(s) are retained for 90 days only.

除非另有說明，此報告結果僅對測試之樣品負責，同時此樣品僅保留90天。本報告未經本公司書面許可，不可部份複製。

This document is issued by the Company subject to its General Conditions of Service printed overleaf, available on request or accessible at www.sgs.com/terms_and_conditions.htm and, for electronic format documents, subject to Terms and Conditions for Electronic Documents at www.sgs.com/terms_e-document.htm. Attention is drawn to the limitation of liability, indemnification and jurisdiction issues defined therein. Any holder of this document is advised that information contained hereon reflects the Company's findings at the time of its intervention only and within the limits of Client's instructions, if any. The Company's sole responsibility is to its Client and this document does not exonerate parties to a transaction from exercising all their rights and obligations under the transaction documents. This document cannot be reproduced except in full, without prior written approval of the Company. Any unauthorized alteration, forgery or falsification of the content or appearance of this document is unlawful and offenders may be prosecuted to the fullest extent of the law.

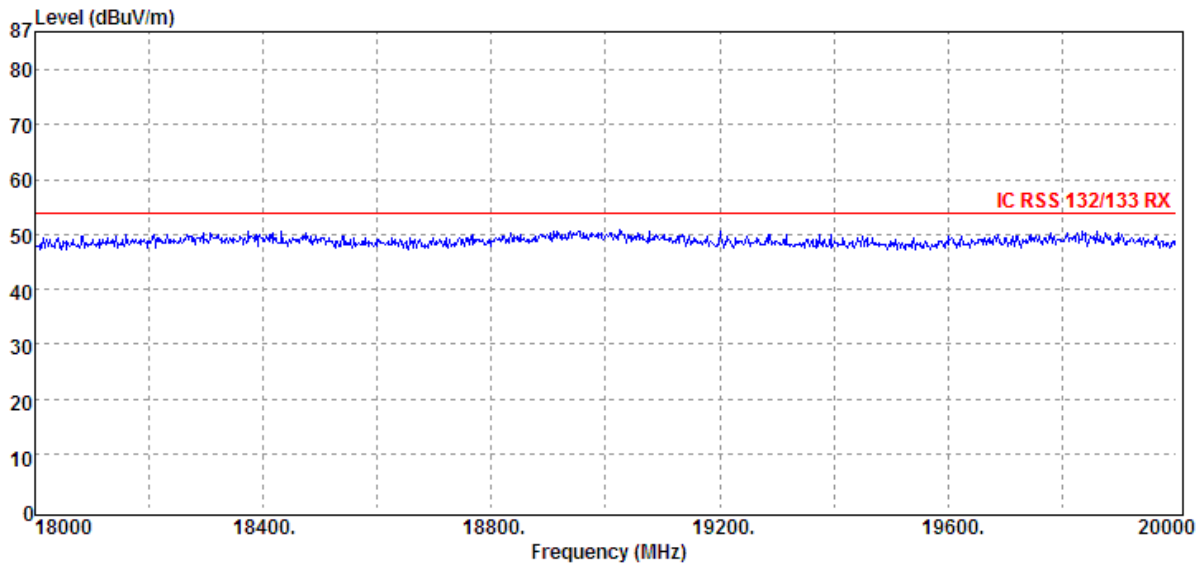
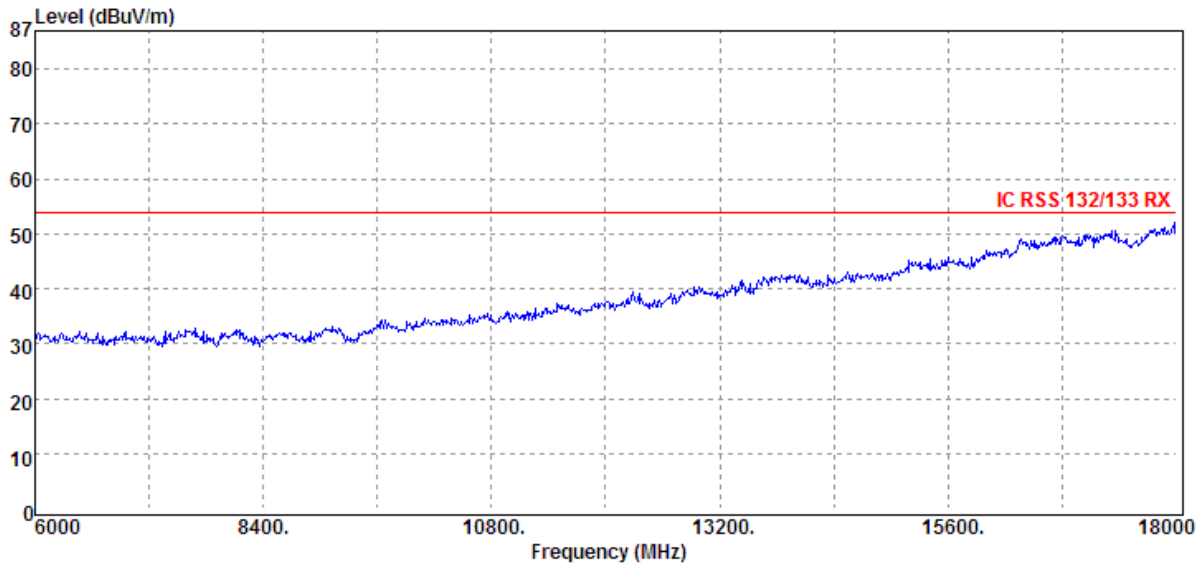

Unless otherwise stated the results shown in this test report refer only to the sample(s) tested and such sample(s) are retained for 90 days only.

除非另有說明，此報告結果僅對測試之樣品負責，同時此樣品僅保留90天。本報告未經本公司書面許可，不可部份複製。

This document is issued by the Company subject to its General Conditions of Service printed overleaf, available on request or accessible at www.sgs.com/terms_and_conditions.htm and, for electronic format documents, subject to Terms and Conditions for Electronic Documents at www.sgs.com/terms_e-document.htm. Attention is drawn to the limitation of liability, indemnification and jurisdiction issues defined therein. Any holder of this document is advised that information contained hereon reflects the Company's findings at the time of its intervention only and within the limits of Client's instructions, if any. The Company's sole responsibility is to its Client and this document does not exonerate parties to a transaction from exercising all their rights and obligations under the transaction documents. This document cannot be reproduced except in full, without prior written approval of the Company. Any unauthorized alteration, forgery or falsification of the content or appearance of this document is unlawful and offenders may be prosecuted to the fullest extent of the law.

Operation Band	:GSM 1900	Test Date	:2013-05-03
Fundamental Frequency	:1880 MHz	Temp./Humi.	:24.1 deg_C / 65 RH
Operation Mode	:RX MID	Engineer	:Allen
EUT Pol.	:E1 Plan	Measurement Antenna Pol.	:VERTICAL

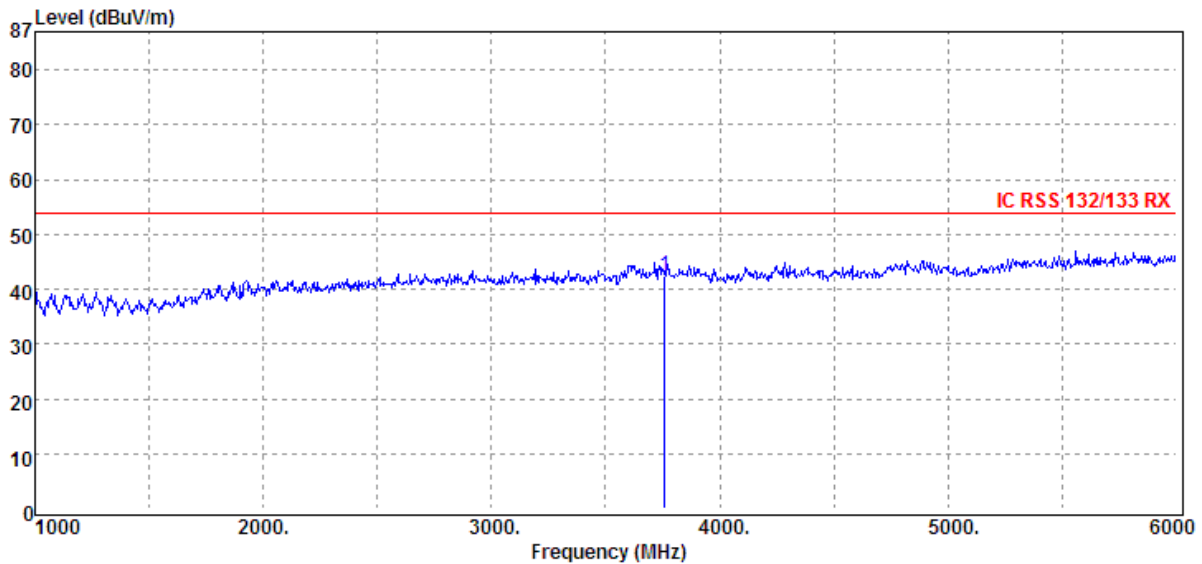
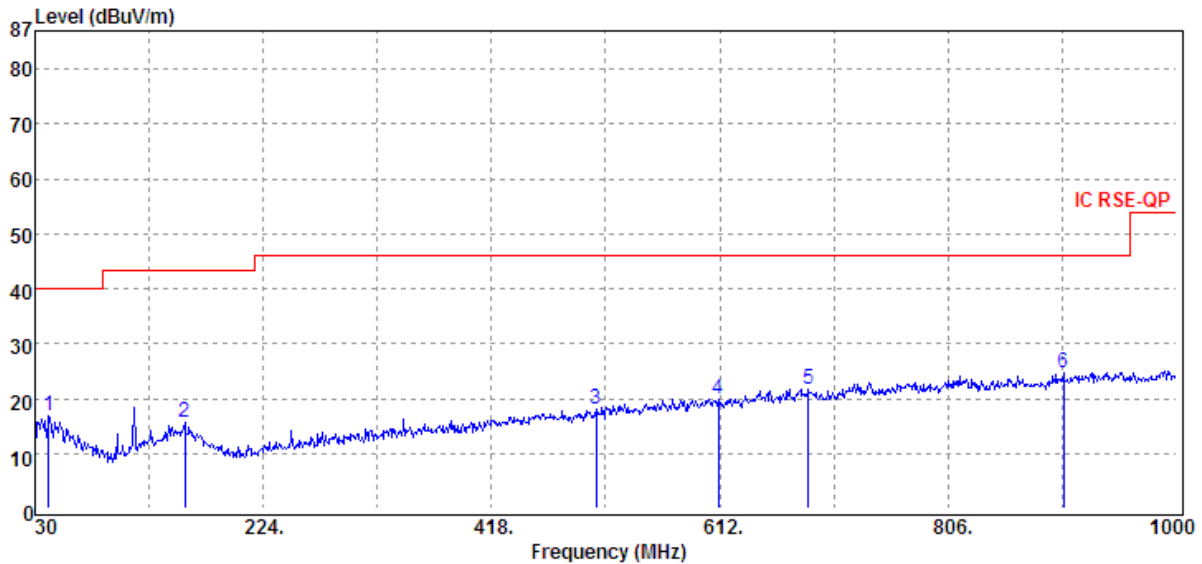

Unless otherwise stated the results shown in this test report refer only to the sample(s) tested and such sample(s) are retained for 90 days only.

除非另有說明，此報告結果僅對測試之樣品負責，同時此樣品僅保留90天。本報告未經本公司書面許可，不可部份複製。

This document is issued by the Company subject to its General Conditions of Service printed overleaf, available on request or accessible at www.sgs.com/terms_and_conditions.htm and, for electronic format documents, subject to Terms and Conditions for Electronic Documents at www.sgs.com/terms_e-document.htm. Attention is drawn to the limitation of liability, indemnification and jurisdiction issues defined therein. Any holder of this document is advised that information contained hereon reflects the Company's findings at the time of its intervention only and within the limits of Client's instructions, if any. The Company's sole responsibility is to its Client and this document does not exonerate parties to a transaction from exercising all their rights and obligations under the transaction documents. This document cannot be reproduced except in full, without prior written approval of the Company. Any unauthorized alteration, forgery or falsification of the content or appearance of this document is unlawful and offenders may be prosecuted to the fullest extent of the law.

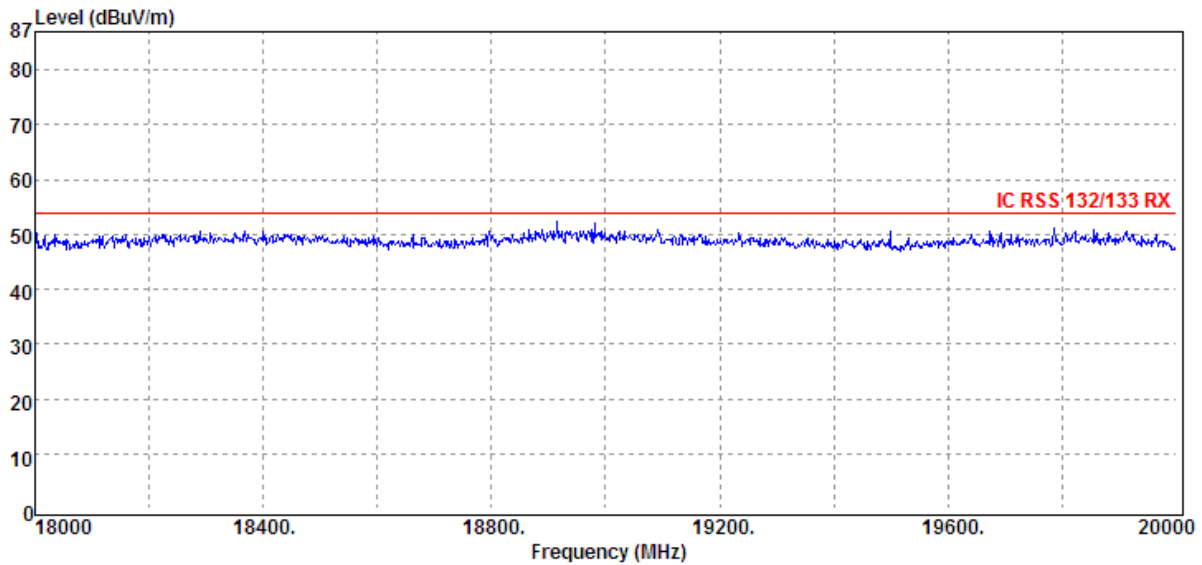
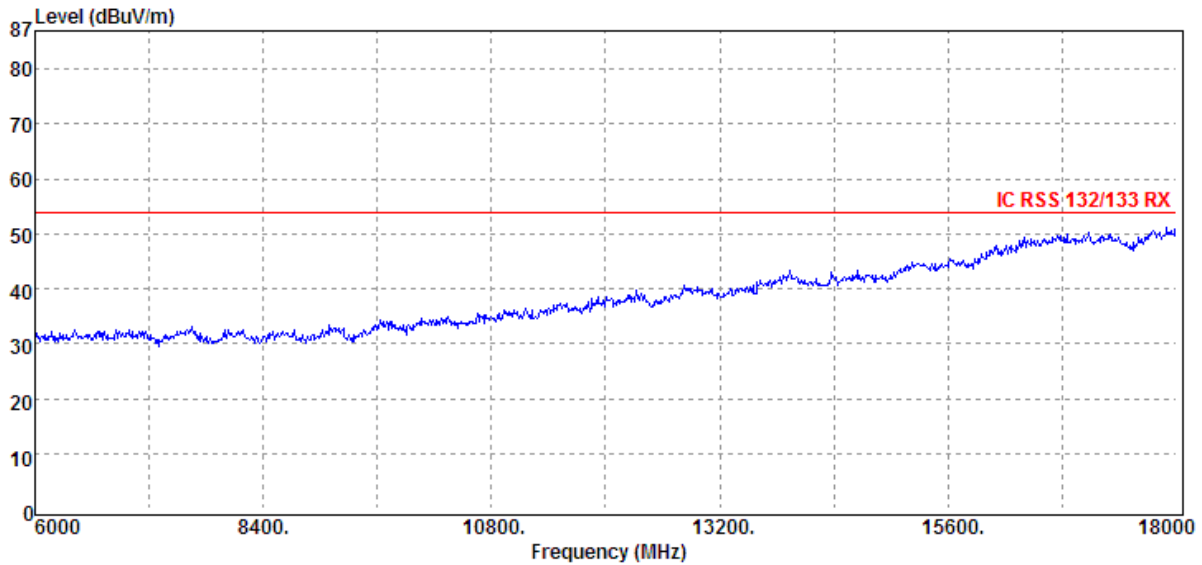

Unless otherwise stated the results shown in this test report refer only to the sample(s) tested and such sample(s) are retained for 90 days only.

除非另有說明，此報告結果僅對測試之樣品負責，同時此樣品僅保留90天。本報告未經本公司書面許可，不可部份複製。

This document is issued by the Company subject to its General Conditions of Service printed overleaf, available on request or accessible at www.sgs.com/terms_and_conditions.htm and, for electronic format documents, subject to Terms and Conditions for Electronic Documents at www.sgs.com/terms_e-document.htm. Attention is drawn to the limitation of liability, indemnification and jurisdiction issues defined therein. Any holder of this document is advised that information contained hereon reflects the Company's findings at the time of its intervention only and within the limits of Client's instructions, if any. The Company's sole responsibility is to its Client and this document does not exonerate parties to a transaction from exercising all their rights and obligations under the transaction documents. This document cannot be reproduced except in full, without prior written approval of the Company. Any unauthorized alteration, forgery or falsification of the content or appearance of this document is unlawful and offenders may be prosecuted to the fullest extent of the law.

Operation Band	:GSM 1900	Test Date	:2013-05-03
Fundamental Frequency	:1880 MHz	Temp./Humi.	:24.1 deg_C / 65 RH
Operation Mode	:RX MID	Engineer	:Allen
EUT Pol.	:E1 Plan	Measurement Antenna Pol.	:HORIZONTAL

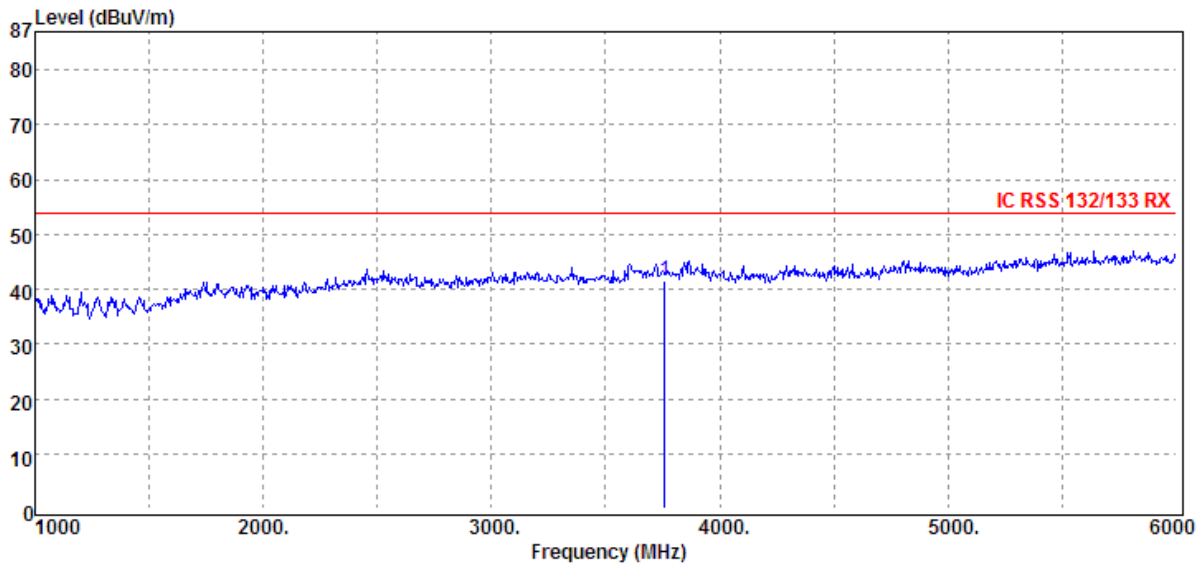
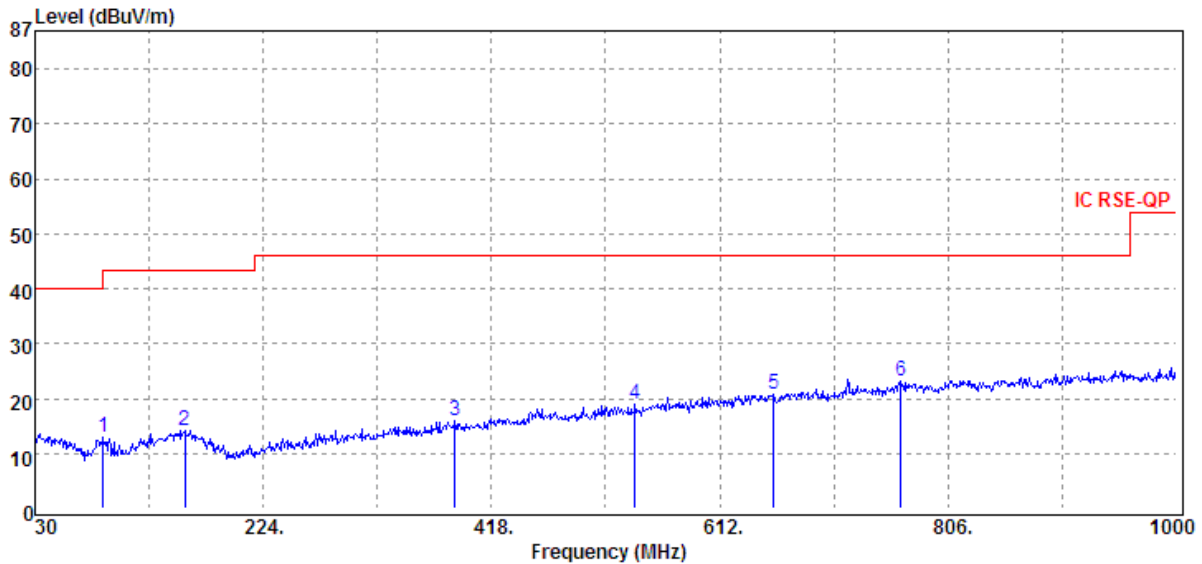

Unless otherwise stated the results shown in this test report refer only to the sample(s) tested and such sample(s) are retained for 90 days only.

除非另有說明，此報告結果僅對測試之樣品負責，同時此樣品僅保留90天。本報告未經本公司書面許可，不可部份複製。

This document is issued by the Company subject to its General Conditions of Service printed overleaf, available on request or accessible at www.sgs.com/terms_and_conditions.htm and, for electronic format documents, subject to Terms and Conditions for Electronic Documents at www.sgs.com/terms_e-document.htm. Attention is drawn to the limitation of liability, indemnification and jurisdiction issues defined therein. Any holder of this document is advised that information contained hereon reflects the Company's findings at the time of its intervention only and within the limits of Client's instructions, if any. The Company's sole responsibility is to its Client and this document does not exonerate parties to a transaction from exercising all their rights and obligations under the transaction documents. This document cannot be reproduced except in full, without prior written approval of the Company. Any unauthorized alteration, forgery or falsification of the content or appearance of this document is unlawful and offenders may be prosecuted to the fullest extent of the law.

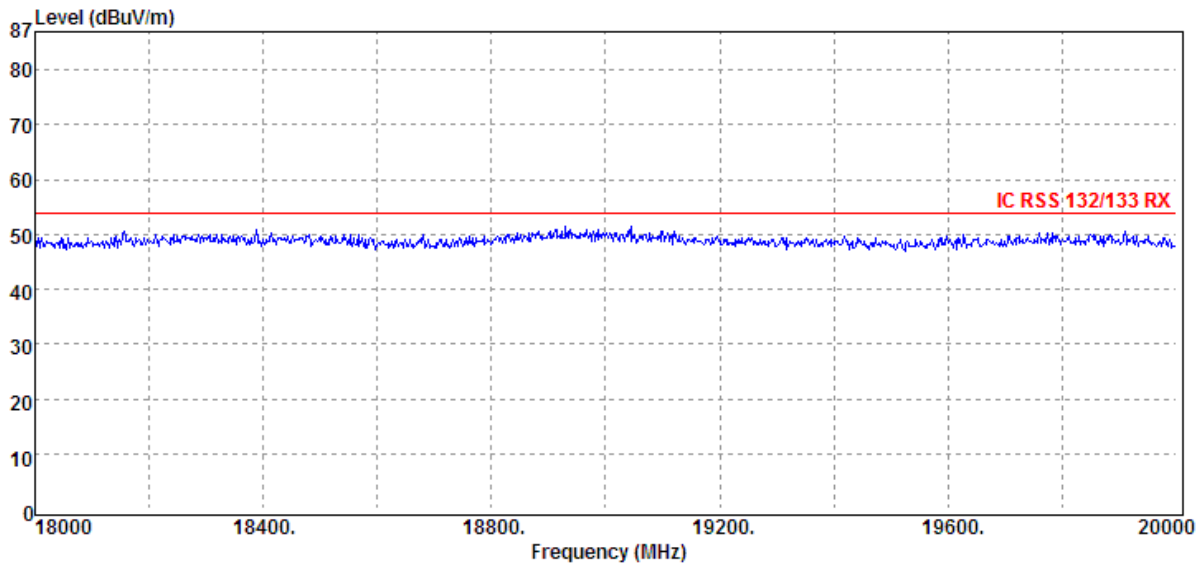
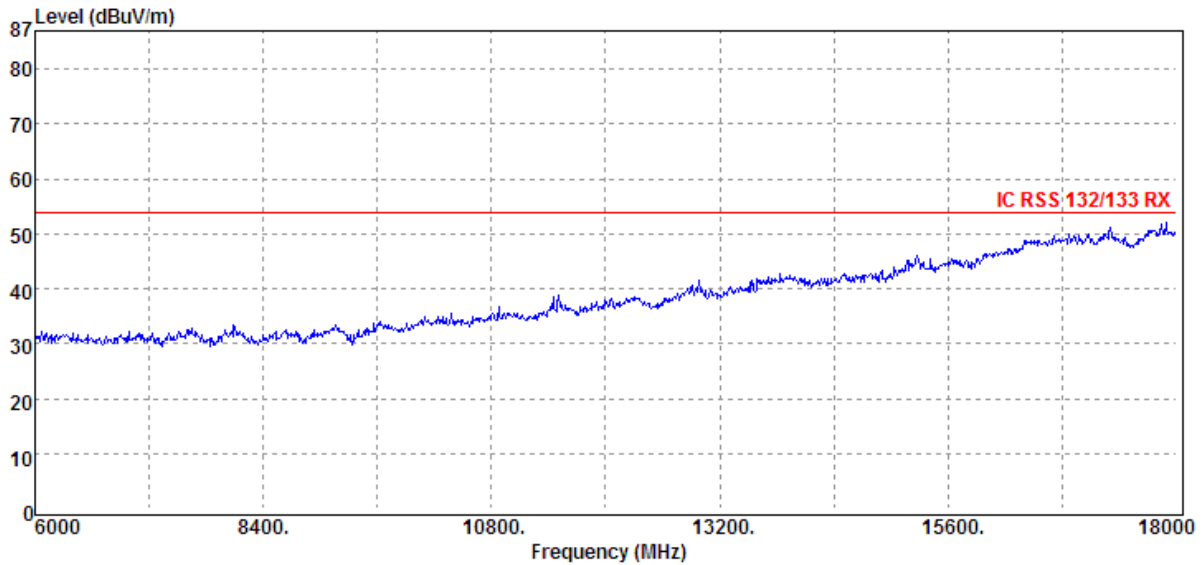

Unless otherwise stated the results shown in this test report refer only to the sample(s) tested and such sample(s) are retained for 90 days only.

除非另有說明，此報告結果僅對測試之樣品負責，同時此樣品僅保留90天。本報告未經本公司書面許可，不可部份複製。

This document is issued by the Company subject to its General Conditions of Service printed overleaf, available on request or accessible at www.sgs.com/terms_and_conditions.htm and, for electronic format documents, subject to Terms and Conditions for Electronic Documents at www.sgs.com/terms_e-document.htm. Attention is drawn to the limitation of liability, indemnification and jurisdiction issues defined therein. Any holder of this document is advised that information contained hereon reflects the Company's findings at the time of its intervention only and within the limits of Client's instructions, if any. The Company's sole responsibility is to its Client and this document does not exonerate parties to a transaction from exercising all their rights and obligations under the transaction documents. This document cannot be reproduced except in full, without prior written approval of the Company. Any unauthorized alteration, forgery or falsification of the content or appearance of this document is unlawful and offenders may be prosecuted to the fullest extent of the law.

Operation Band	:GSM 1900	Test Date	:2013-05-03
Fundamental Frequency	:1909.8 MHz	Temp./Humi.	:24.1 deg_C / 65 RH
Operation Mode	:RX HIGH	Engineer	:Allen
EUT Pol.	:E1 Plan	Measurement Antenna Pol.	:VERTICAL

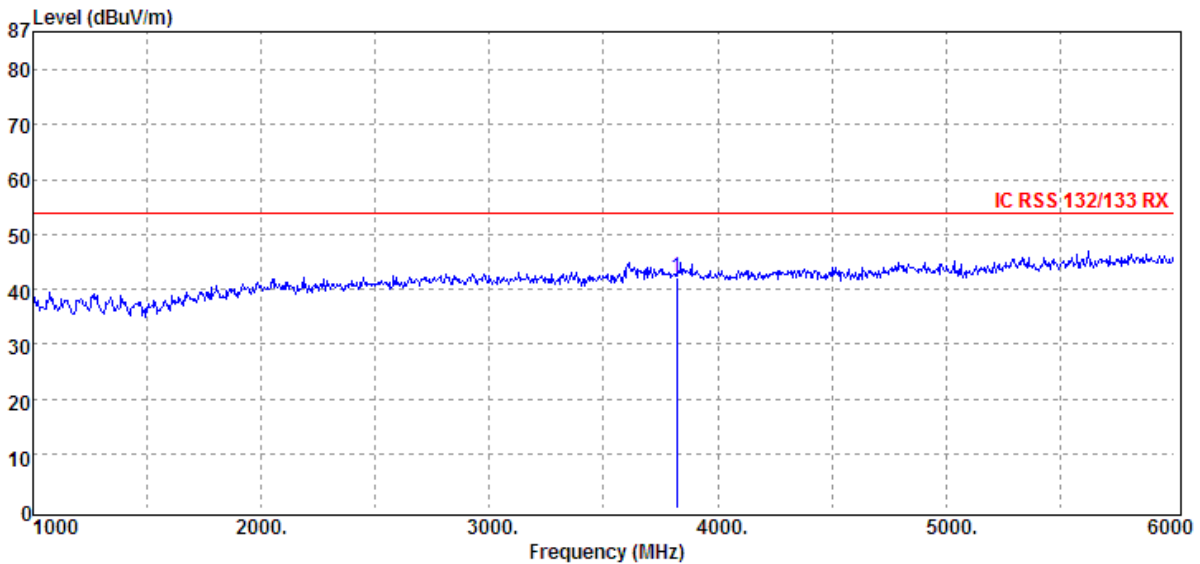
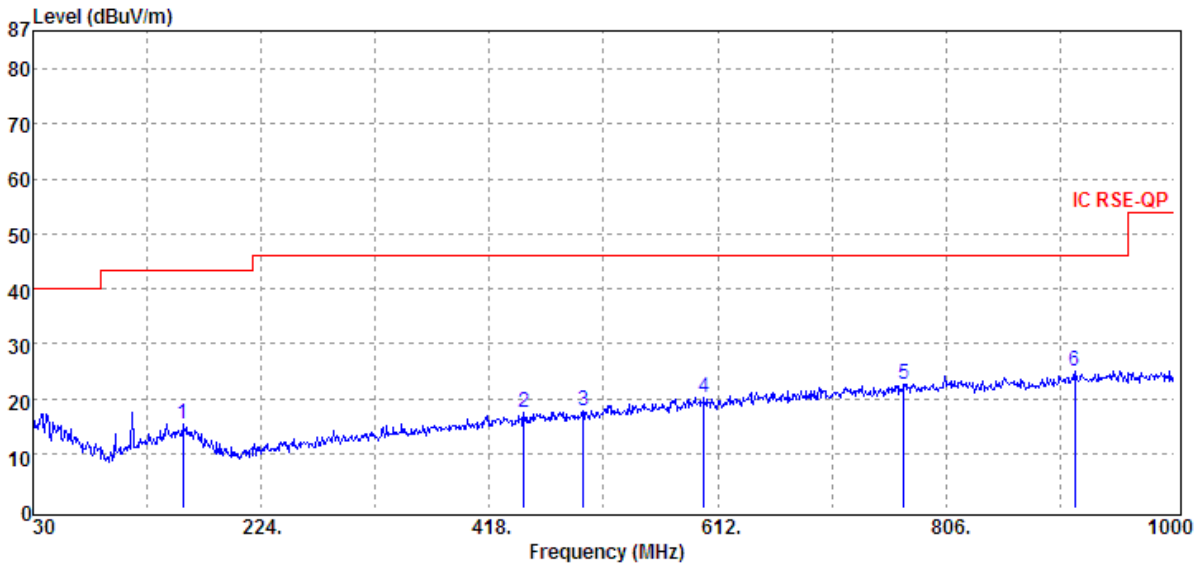

Unless otherwise stated the results shown in this test report refer only to the sample(s) tested and such sample(s) are retained for 90 days only.

除非另有說明，此報告結果僅對測試之樣品負責，同時此樣品僅保留90天。本報告未經本公司書面許可，不可部份複製。

This document is issued by the Company subject to its General Conditions of Service printed overleaf, available on request or accessible at www.sgs.com/terms_and_conditions.htm and, for electronic format documents, subject to Terms and Conditions for Electronic Documents at www.sgs.com/terms_e-document.htm. Attention is drawn to the limitation of liability, indemnification and jurisdiction issues defined therein. Any holder of this document is advised that information contained hereon reflects the Company's findings at the time of its intervention only and within the limits of Client's instructions, if any. The Company's sole responsibility is to its Client and this document does not exonerate parties to a transaction from exercising all their rights and obligations under the transaction documents. This document cannot be reproduced except in full, without prior written approval of the Company. Any unauthorized alteration, forgery or falsification of the content or appearance of this document is unlawful and offenders may be prosecuted to the fullest extent of the law.

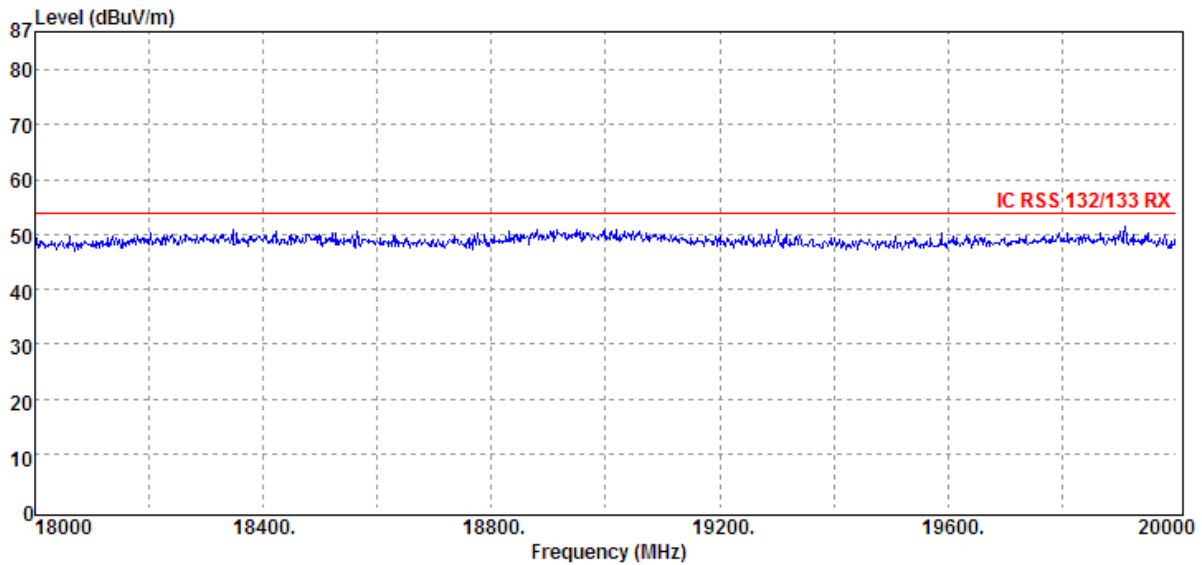
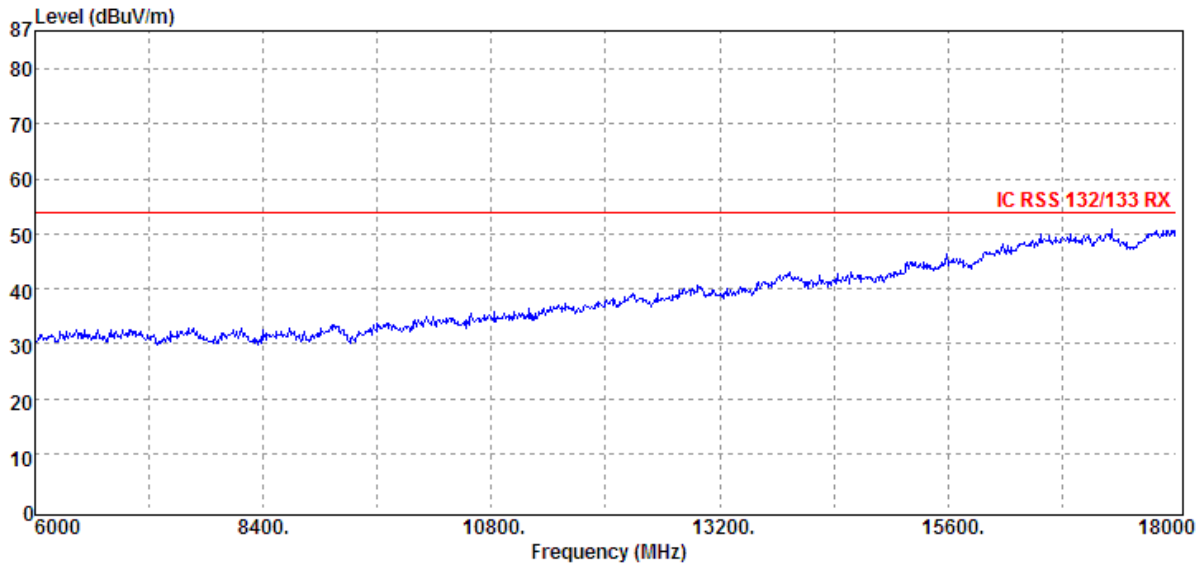

Unless otherwise stated the results shown in this test report refer only to the sample(s) tested and such sample(s) are retained for 90 days only.

除非另有說明，此報告結果僅對測試之樣品負責，同時此樣品僅保留90天。本報告未經本公司書面許可，不可部份複製。

This document is issued by the Company subject to its General Conditions of Service printed overleaf, available on request or accessible at www.sgs.com/terms_and_conditions.htm and, for electronic format documents, subject to Terms and Conditions for Electronic Documents at www.sgs.com/terms_e-document.htm. Attention is drawn to the limitation of liability, indemnification and jurisdiction issues defined therein. Any holder of this document is advised that information contained hereon reflects the Company's findings at the time of its intervention only and within the limits of Client's instructions, if any. The Company's sole responsibility is to its Client and this document does not exonerate parties to a transaction from exercising all their rights and obligations under the transaction documents. This document cannot be reproduced except in full, without prior written approval of the Company. Any unauthorized alteration, forgery or falsification of the content or appearance of this document is unlawful and offenders may be prosecuted to the fullest extent of the law.

Operation Band	:GSM 1900	Test Date	:2013-05-03
Fundamental Frequency	:1909.8 MHz	Temp./Humi.	:24.1 deg_C / 65 RH
Operation Mode	:RX HIGH	Engineer	:Allen
EUT Pol.	:E1 Plan	Measurement Antenna Pol.	:HORIZONTAL

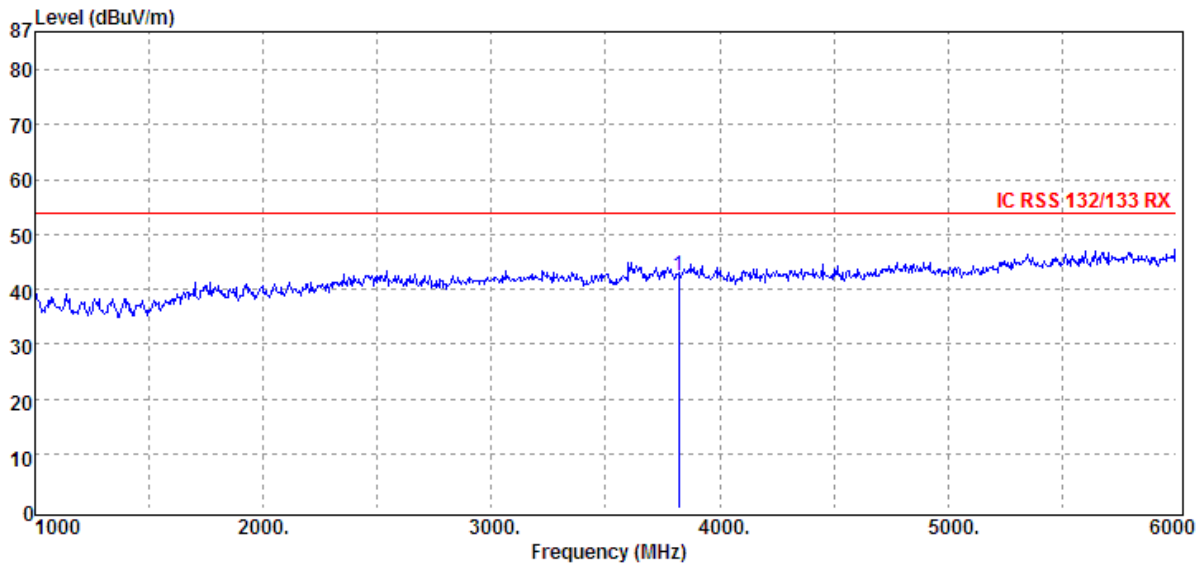
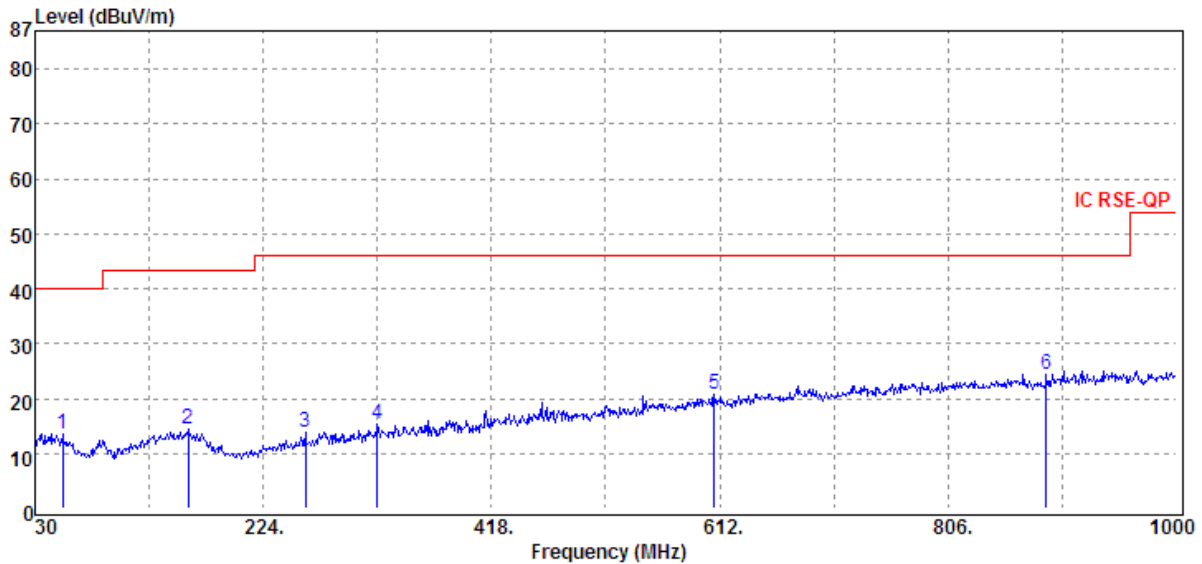

Unless otherwise stated the results shown in this test report refer only to the sample(s) tested and such sample(s) are retained for 90 days only.

除非另有說明，此報告結果僅對測試之樣品負責，同時此樣品僅保留90天。本報告未經本公司書面許可，不可部份複製。

This document is issued by the Company subject to its General Conditions of Service printed overleaf, available on request or accessible at www.sgs.com/terms_and_conditions.htm and, for electronic format documents, subject to Terms and Conditions for Electronic Documents at www.sgs.com/terms_e-document.htm. Attention is drawn to the limitation of liability, indemnification and jurisdiction issues defined therein. Any holder of this document is advised that information contained hereon reflects the Company's findings at the time of its intervention only and within the limits of Client's instructions, if any. The Company's sole responsibility is to its Client and this document does not exonerate parties to a transaction from exercising all their rights and obligations under the transaction documents. This document cannot be reproduced except in full, without prior written approval of the Company. Any unauthorized alteration, forgery or falsification of the content or appearance of this document is unlawful and offenders may be prosecuted to the fullest extent of the law.

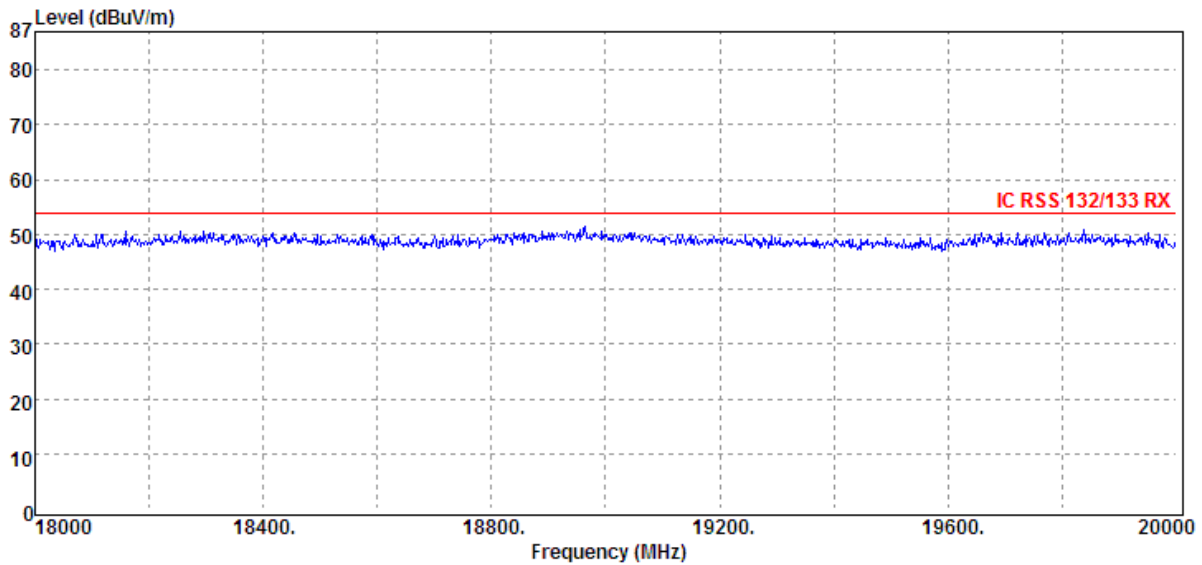
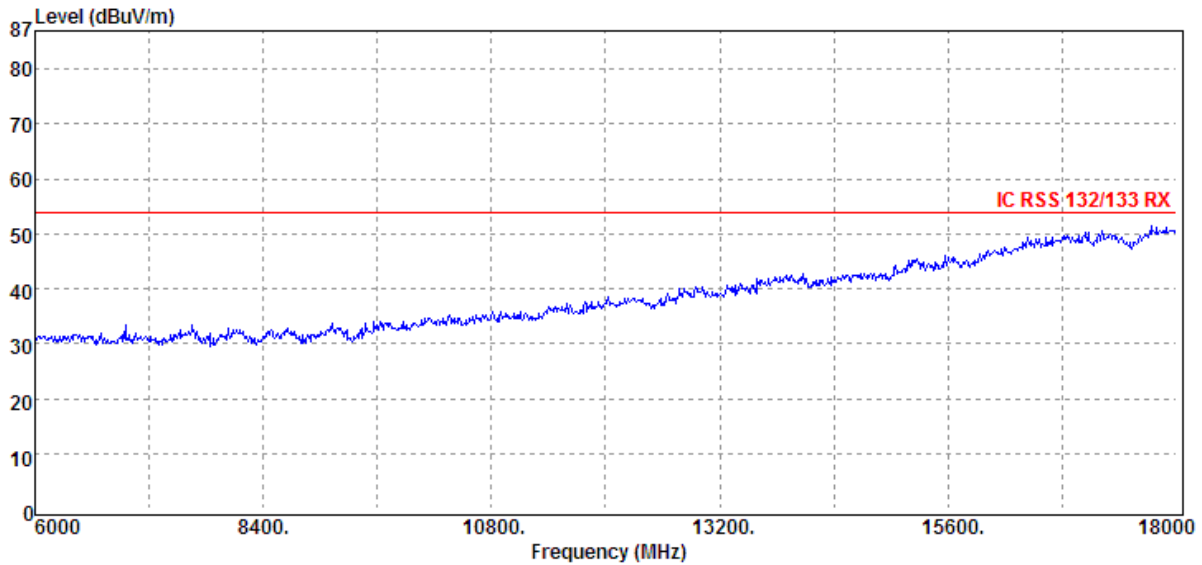

Unless otherwise stated the results shown in this test report refer only to the sample(s) tested and such sample(s) are retained for 90 days only.

除非另有說明，此報告結果僅對測試之樣品負責，同時此樣品僅保留90天。本報告未經本公司書面許可，不可部份複製。

This document is issued by the Company subject to its General Conditions of Service printed overleaf, available on request or accessible at www.sgs.com/terms_and_conditions.htm and, for electronic format documents, subject to Terms and Conditions for Electronic Documents at www.sgs.com/terms_e-document.htm. Attention is drawn to the limitation of liability, indemnification and jurisdiction issues defined therein. Any holder of this document is advised that information contained hereon reflects the Company's findings at the time of its intervention only and within the limits of Client's instructions, if any. The Company's sole responsibility is to its Client and this document does not exonerate parties to a transaction from exercising all their rights and obligations under the transaction documents. This document cannot be reproduced except in full, without prior written approval of the Company. Any unauthorized alteration, forgery or falsification of the content or appearance of this document is unlawful and offenders may be prosecuted to the fullest extent of the law.

Radiated Spurious Emission Measurement Result: WCDMA II Mode

Operation Band	:WCDMA B2	Test Date	:2013-05-03
Fundamental Frequency	:1852.4 MHz	Temp./Humi.	:24.1 deg_C / 65 RH
Operation Mode	:RX LOW	Engineer	:Allen
EUT Pol.	:E1 Plan	Measurement Antenna Pol.	:VERTICAL

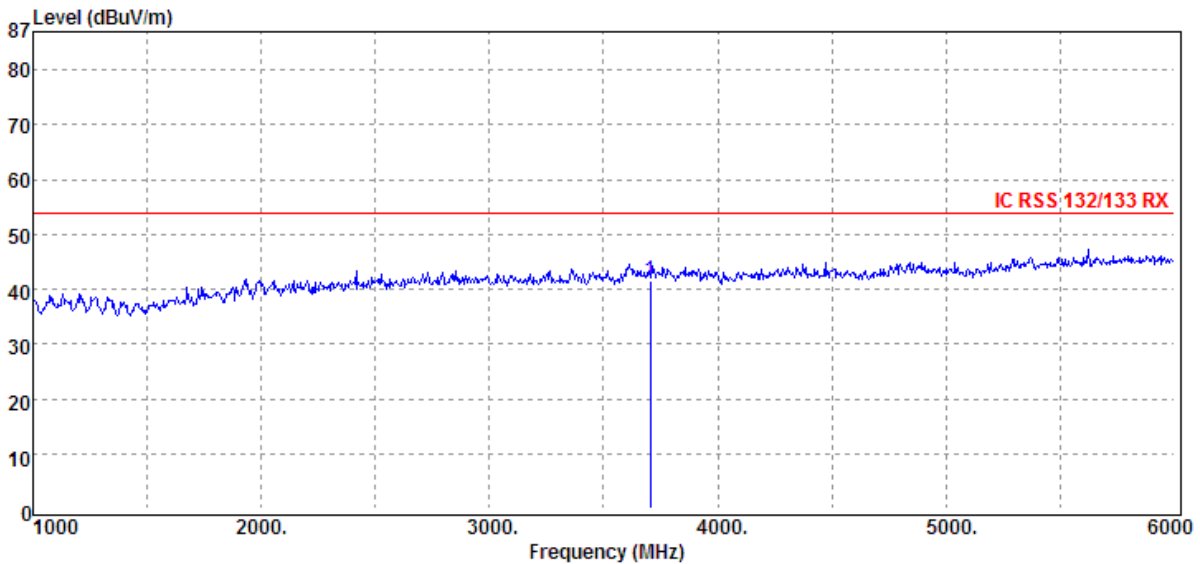
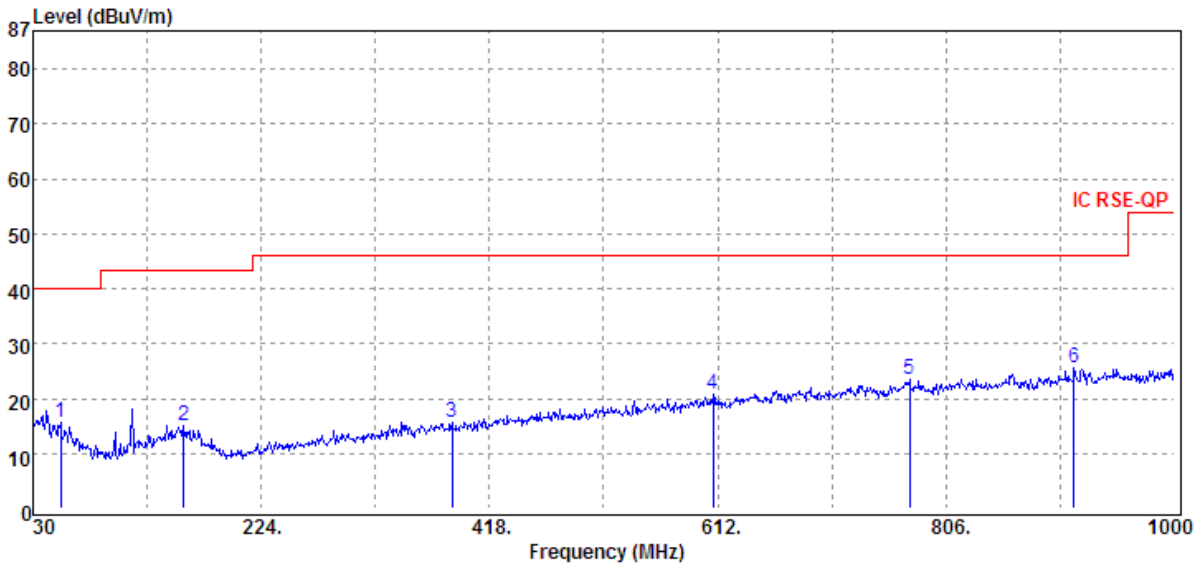

Unless otherwise stated the results shown in this test report refer only to the sample(s) tested and such sample(s) are retained for 90 days only.

除非另有說明，此報告結果僅對測試之樣品負責，同時此樣品僅保留90天。本報告未經本公司書面許可，不可部份複製。

This document is issued by the Company subject to its General Conditions of Service printed overleaf, available on request or accessible at www.sgs.com/terms_and_conditions.htm and, for electronic format documents, subject to Terms and Conditions for Electronic Documents at www.sgs.com/terms_e-document.htm. Attention is drawn to the limitation of liability, indemnification and jurisdiction issues defined therein. Any holder of this document is advised that information contained hereon reflects the Company's findings at the time of its intervention only and within the limits of Client's instructions, if any. The Company's sole responsibility is to its Client and this document does not exonerate parties to a transaction from exercising all their rights and obligations under the transaction documents. This document cannot be reproduced except in full, without prior written approval of the Company. Any unauthorized alteration, forgery or falsification of the content or appearance of this document is unlawful and offenders may be prosecuted to the fullest extent of the law.

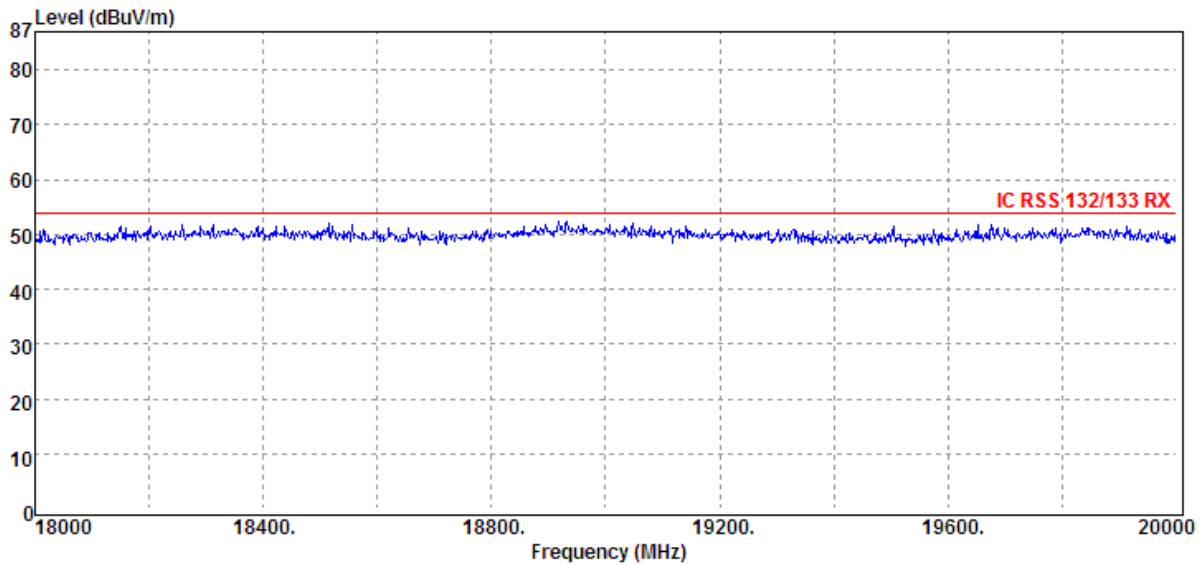
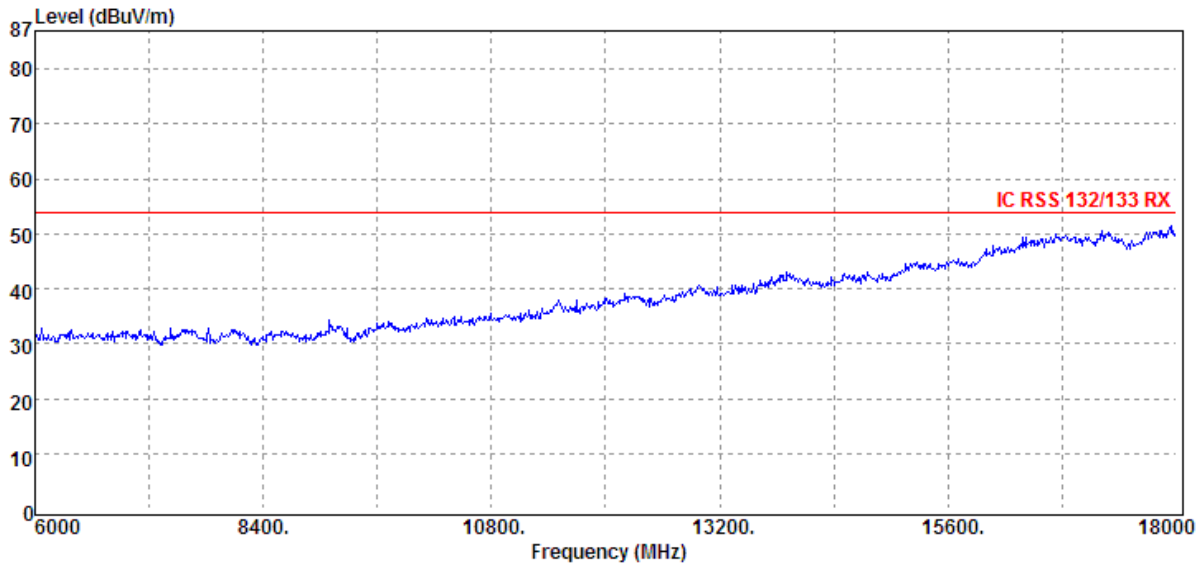

Unless otherwise stated the results shown in this test report refer only to the sample(s) tested and such sample(s) are retained for 90 days only.

除非另有說明，此報告結果僅對測試之樣品負責，同時此樣品僅保留90天。本報告未經本公司書面許可，不可部份複製。

This document is issued by the Company subject to its General Conditions of Service printed overleaf, available on request or accessible at www.sgs.com/terms_and_conditions.htm and, for electronic format documents, subject to Terms and Conditions for Electronic Documents at www.sgs.com/terms_e-document.htm. Attention is drawn to the limitation of liability, indemnification and jurisdiction issues defined therein. Any holder of this document is advised that information contained hereon reflects the Company's findings at the time of its intervention only and within the limits of Client's instructions, if any. The Company's sole responsibility is to its Client and this document does not exonerate parties to a transaction from exercising all their rights and obligations under the transaction documents. This document cannot be reproduced except in full, without prior written approval of the Company. Any unauthorized alteration, forgery or falsification of the content or appearance of this document is unlawful and offenders may be prosecuted to the fullest extent of the law.

Operation Band	:WCDMA B2	Test Date	:2013-05-03
Fundamental Frequency	:1852.4 MHz	Temp./Humi.	:24.1 deg_C / 65 RH
Operation Mode	:RX LOW	Engineer	:Allen
EUT Pol.	:E1 Plan	Measurement Antenna Pol.	:HORIZONTAL

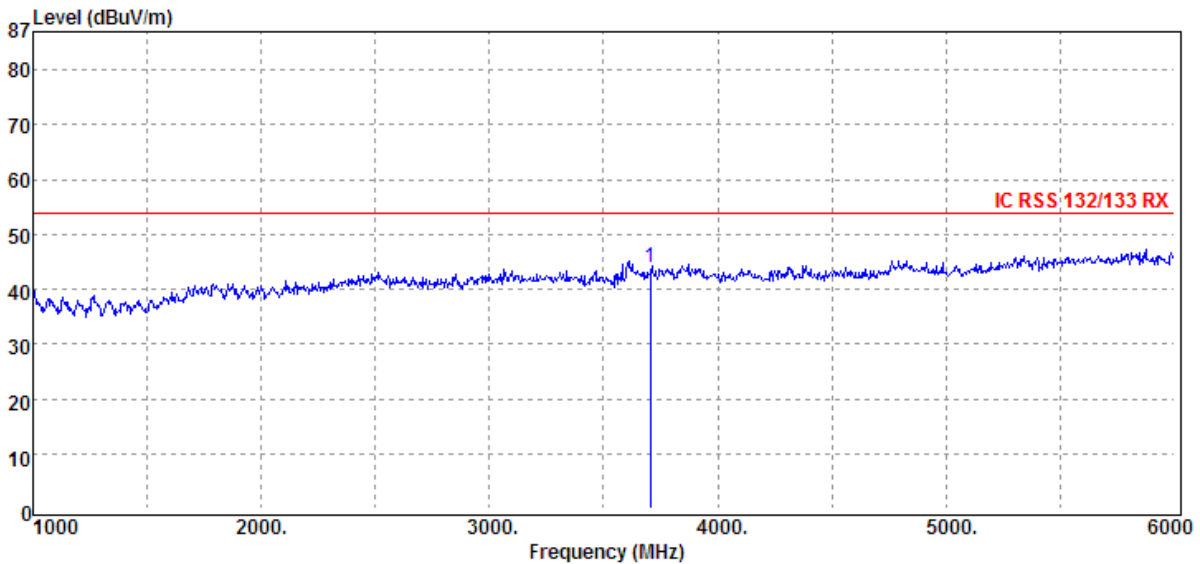
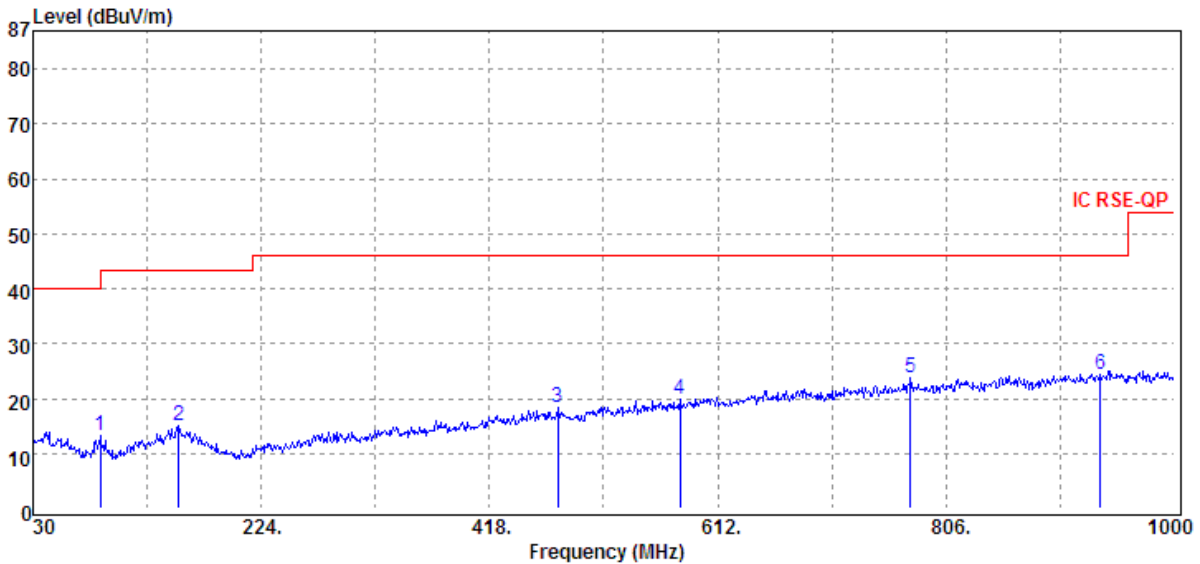

Unless otherwise stated the results shown in this test report refer only to the sample(s) tested and such sample(s) are retained for 90 days only.

除非另有說明，此報告結果僅對測試之樣品負責，同時此樣品僅保留90天。本報告未經本公司書面許可，不可部份複製。

This document is issued by the Company subject to its General Conditions of Service printed overleaf, available on request or accessible at www.sgs.com/terms_and_conditions.htm and, for electronic format documents, subject to Terms and Conditions for Electronic Documents at www.sgs.com/terms_e-document.htm. Attention is drawn to the limitation of liability, indemnification and jurisdiction issues defined therein. Any holder of this document is advised that information contained hereon reflects the Company's findings at the time of its intervention only and within the limits of Client's instructions, if any. The Company's sole responsibility is to its Client and this document does not exonerate parties to a transaction from exercising all their rights and obligations under the transaction documents. This document cannot be reproduced except in full, without prior written approval of the Company. Any unauthorized alteration, forgery or falsification of the content or appearance of this document is unlawful and offenders may be prosecuted to the fullest extent of the law.

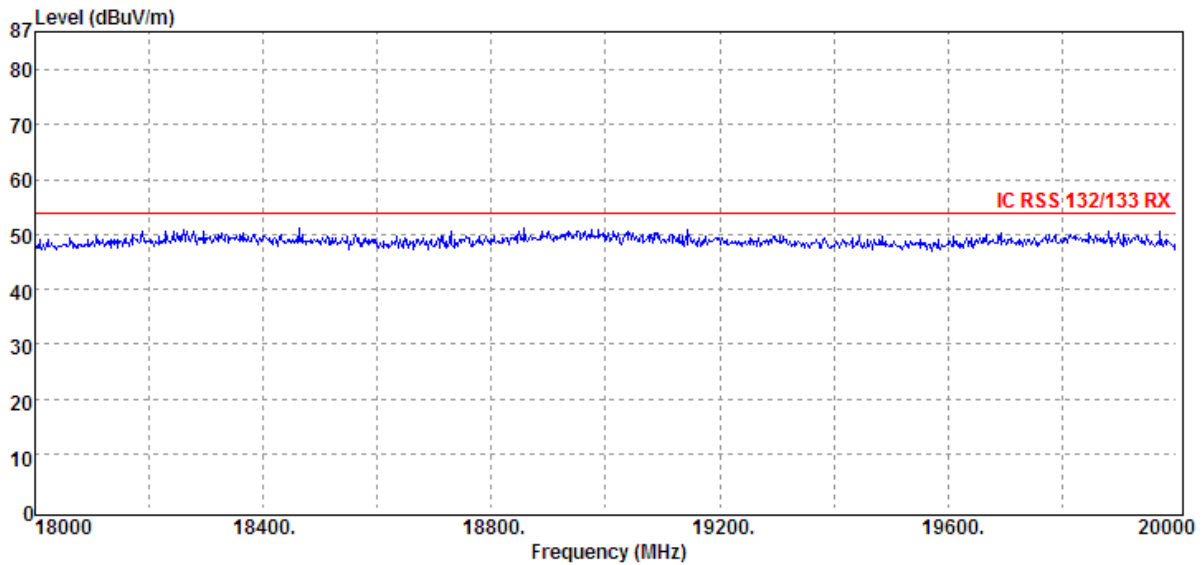
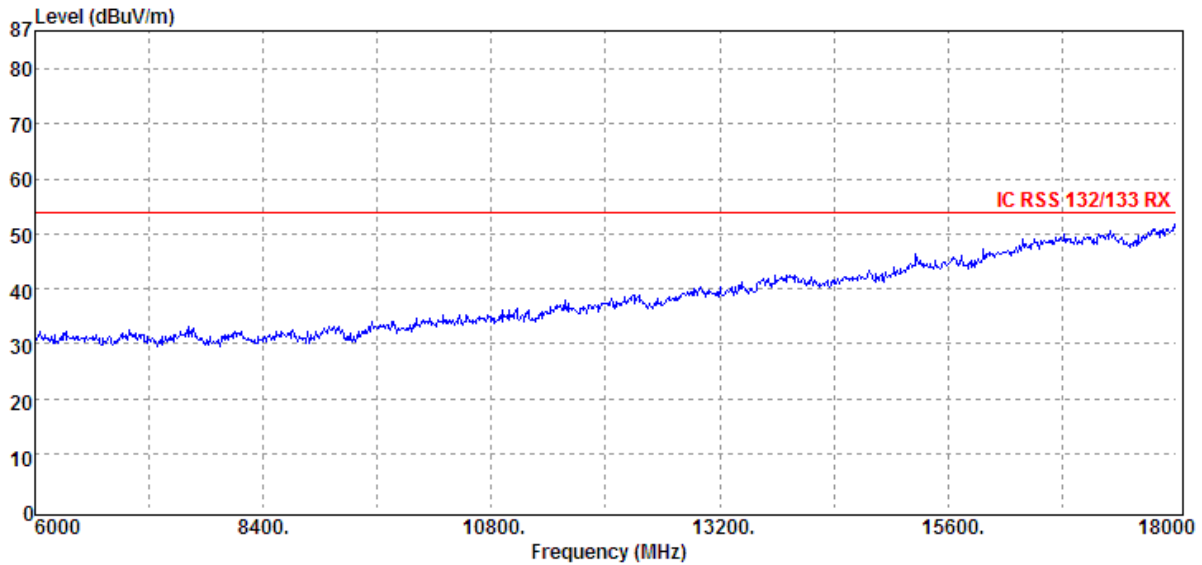

Unless otherwise stated the results shown in this test report refer only to the sample(s) tested and such sample(s) are retained for 90 days only.

除非另有說明，此報告結果僅對測試之樣品負責，同時此樣品僅保留90天。本報告未經本公司書面許可，不可部份複製。

This document is issued by the Company subject to its General Conditions of Service printed overleaf, available on request or accessible at www.sgs.com/terms_and_conditions.htm and, for electronic format documents, subject to Terms and Conditions for Electronic Documents at www.sgs.com/terms_e-document.htm. Attention is drawn to the limitation of liability, indemnification and jurisdiction issues defined therein. Any holder of this document is advised that information contained hereon reflects the Company's findings at the time of its intervention only and within the limits of Client's instructions, if any. The Company's sole responsibility is to its Client and this document does not exonerate parties to a transaction from exercising all their rights and obligations under the transaction documents. This document cannot be reproduced except in full, without prior written approval of the Company. Any unauthorized alteration, forgery or falsification of the content or appearance of this document is unlawful and offenders may be prosecuted to the fullest extent of the law.

Operation Band	:WCDMA B2	Test Date	:2013-05-03
Fundamental Frequency	:1880 MHz	Temp./Humi.	:24.1 deg_C / 65 RH
Operation Mode	:RX MID	Engineer	:Allen
EUT Pol.	:E1 Plan	Measurement Antenna Pol.	:VERTICAL

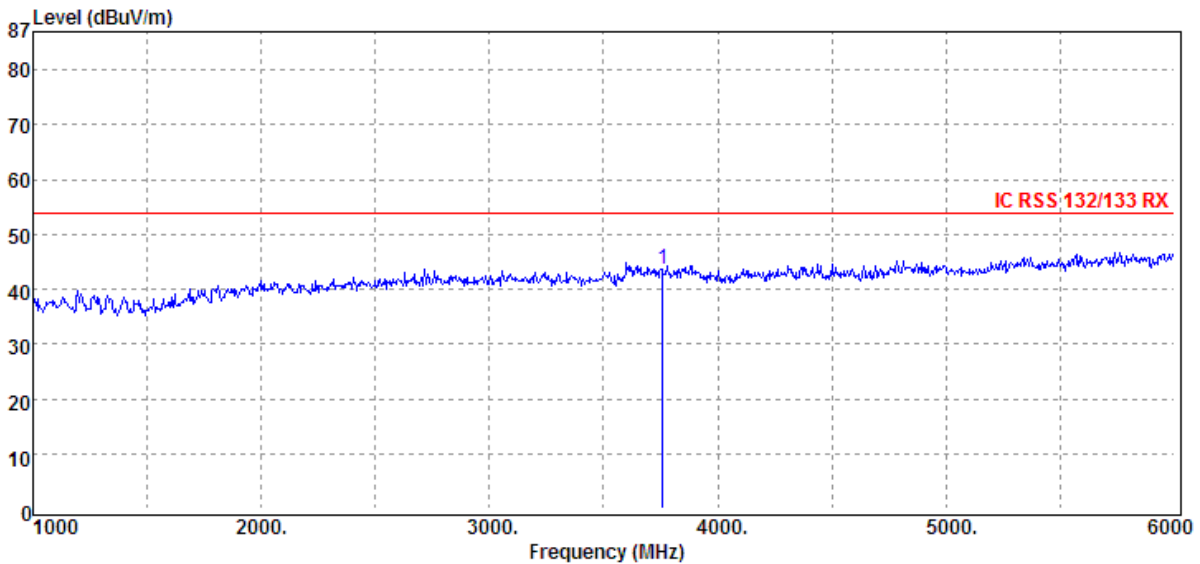
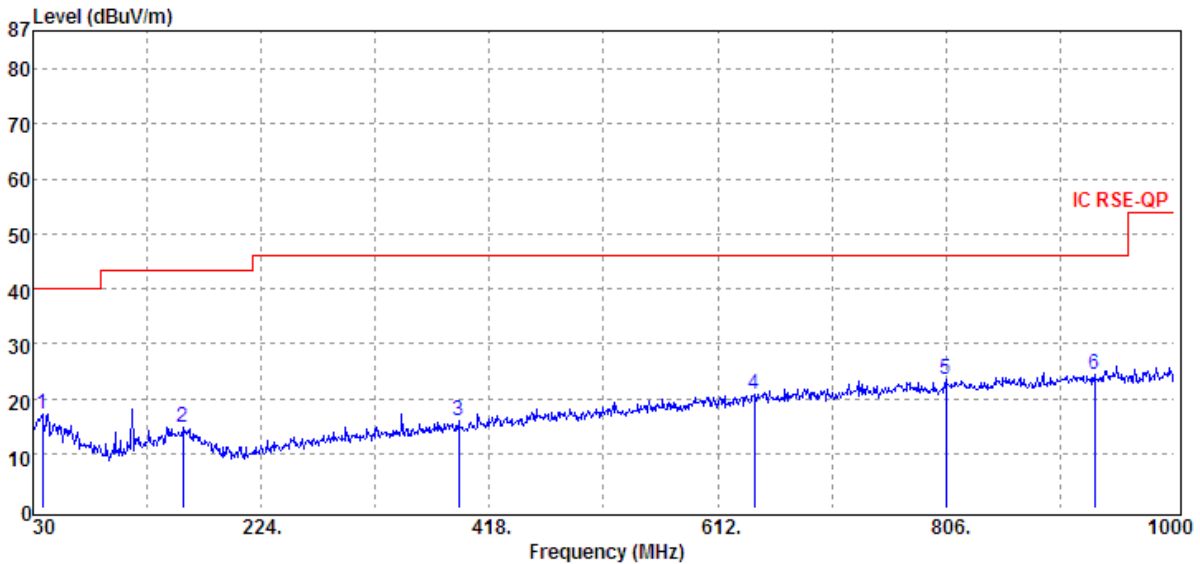

Unless otherwise stated the results shown in this test report refer only to the sample(s) tested and such sample(s) are retained for 90 days only.

除非另有說明，此報告結果僅對測試之樣品負責，同時此樣品僅保留90天。本報告未經本公司書面許可，不可部份複製。

This document is issued by the Company subject to its General Conditions of Service printed overleaf, available on request or accessible at www.sgs.com/terms_and_conditions.htm and, for electronic format documents, subject to Terms and Conditions for Electronic Documents at www.sgs.com/terms_e-document.htm. Attention is drawn to the limitation of liability, indemnification and jurisdiction issues defined therein. Any holder of this document is advised that information contained hereon reflects the Company's findings at the time of its intervention only and within the limits of Client's instructions, if any. The Company's sole responsibility is to its Client and this document does not exonerate parties to a transaction from exercising all their rights and obligations under the transaction documents. This document cannot be reproduced except in full, without prior written approval of the Company. Any unauthorized alteration, forgery or falsification of the content or appearance of this document is unlawful and offenders may be prosecuted to the fullest extent of the law.

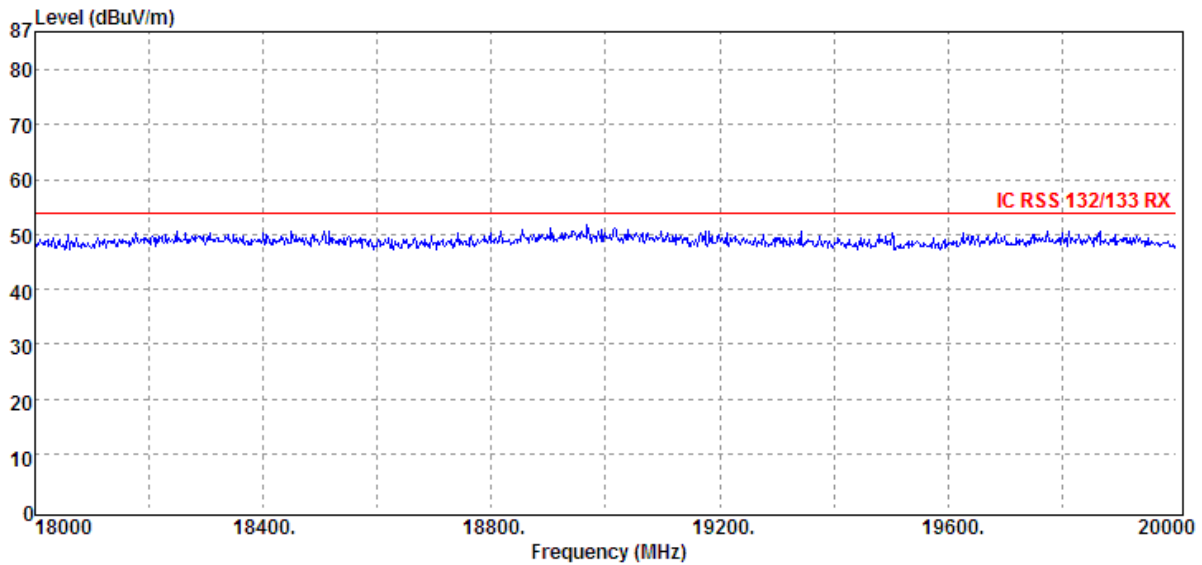
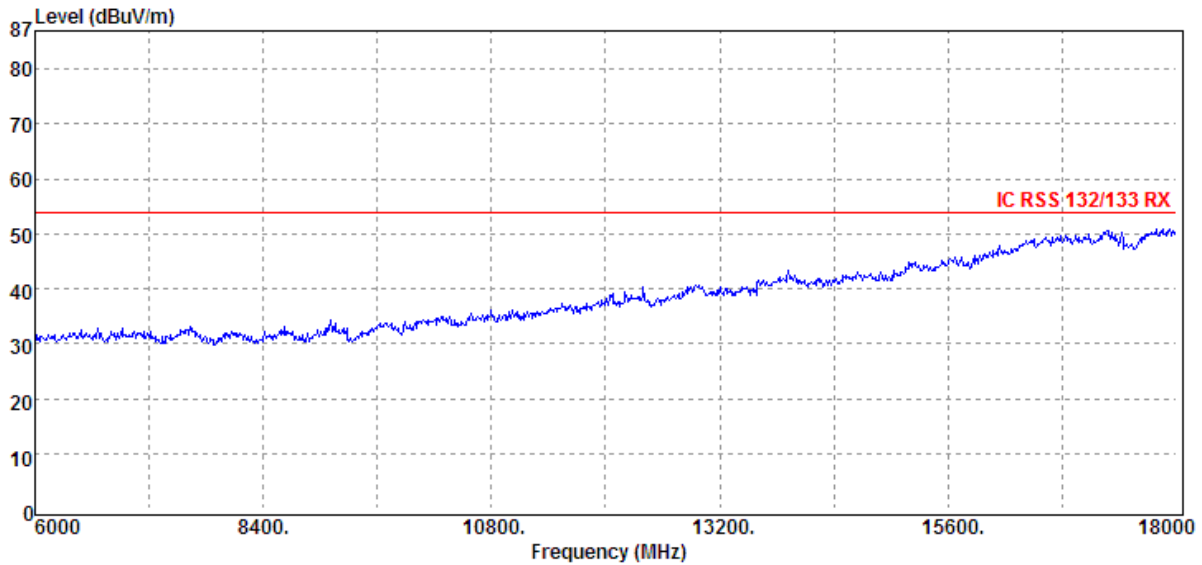

Unless otherwise stated the results shown in this test report refer only to the sample(s) tested and such sample(s) are retained for 90 days only.

除非另有說明，此報告結果僅對測試之樣品負責，同時此樣品僅保留90天。本報告未經本公司書面許可，不可部份複製。

This document is issued by the Company subject to its General Conditions of Service printed overleaf, available on request or accessible at www.sgs.com/terms_and_conditions.htm and, for electronic format documents, subject to Terms and Conditions for Electronic Documents at www.sgs.com/terms_e-document.htm. Attention is drawn to the limitation of liability, indemnification and jurisdiction issues defined therein. Any holder of this document is advised that information contained hereon reflects the Company's findings at the time of its intervention only and within the limits of Client's instructions, if any. The Company's sole responsibility is to its Client and this document does not exonerate parties to a transaction from exercising all their rights and obligations under the transaction documents. This document cannot be reproduced except in full, without prior written approval of the Company. Any unauthorized alteration, forgery or falsification of the content or appearance of this document is unlawful and offenders may be prosecuted to the fullest extent of the law.

Operation Band	:WCDMA B2	Test Date	:2013-05-03
Fundamental Frequency	:1880 MHz	Temp./Humi.	:24.1 deg_C / 65 RH
Operation Mode	:RX MID	Engineer	:Allen
EUT Pol.	:E1 Plan	Measurement Antenna Pol.	:HORIZONTAL

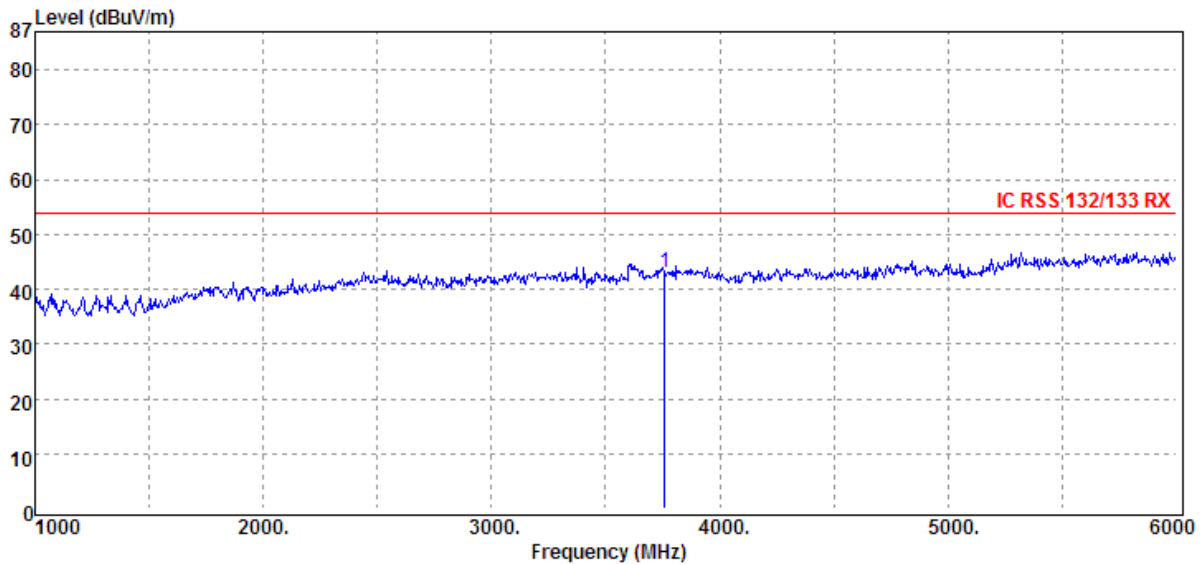
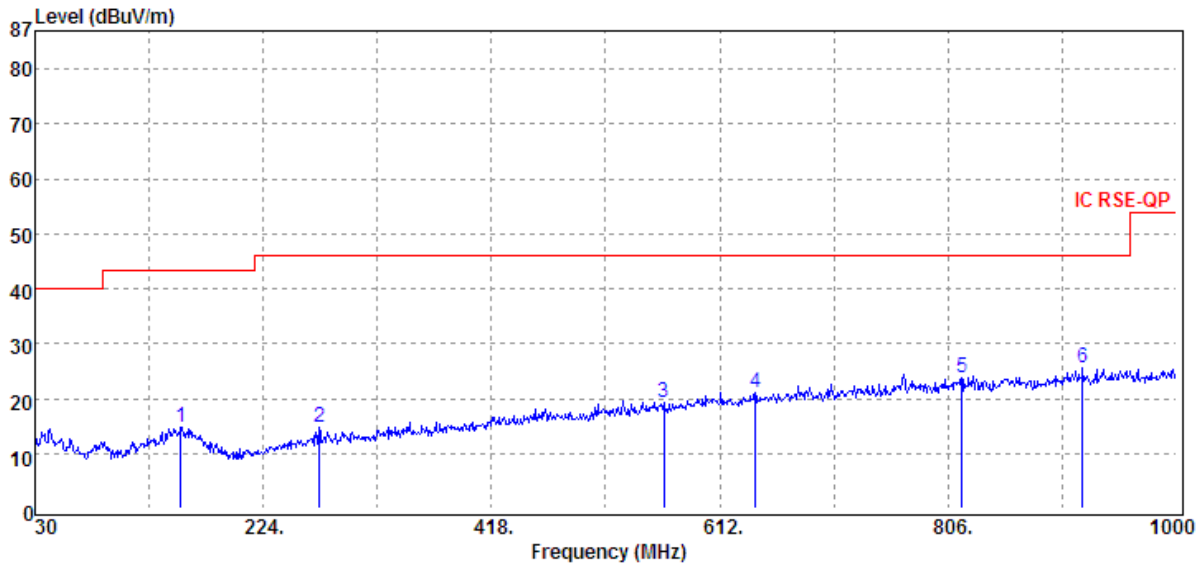

Unless otherwise stated the results shown in this test report refer only to the sample(s) tested and such sample(s) are retained for 90 days only.

除非另有說明，此報告結果僅對測試之樣品負責，同時此樣品僅保留90天。本報告未經本公司書面許可，不可部份複製。

This document is issued by the Company subject to its General Conditions of Service printed overleaf, available on request or accessible at www.sgs.com/terms_and_conditions.htm and, for electronic format documents, subject to Terms and Conditions for Electronic Documents at www.sgs.com/terms_e-document.htm. Attention is drawn to the limitation of liability, indemnification and jurisdiction issues defined therein. Any holder of this document is advised that information contained hereon reflects the Company's findings at the time of its intervention only and within the limits of Client's instructions, if any. The Company's sole responsibility is to its Client and this document does not exonerate parties to a transaction from exercising all their rights and obligations under the transaction documents. This document cannot be reproduced except in full, without prior written approval of the Company. Any unauthorized alteration, forgery or falsification of the content or appearance of this document is unlawful and offenders may be prosecuted to the fullest extent of the law.

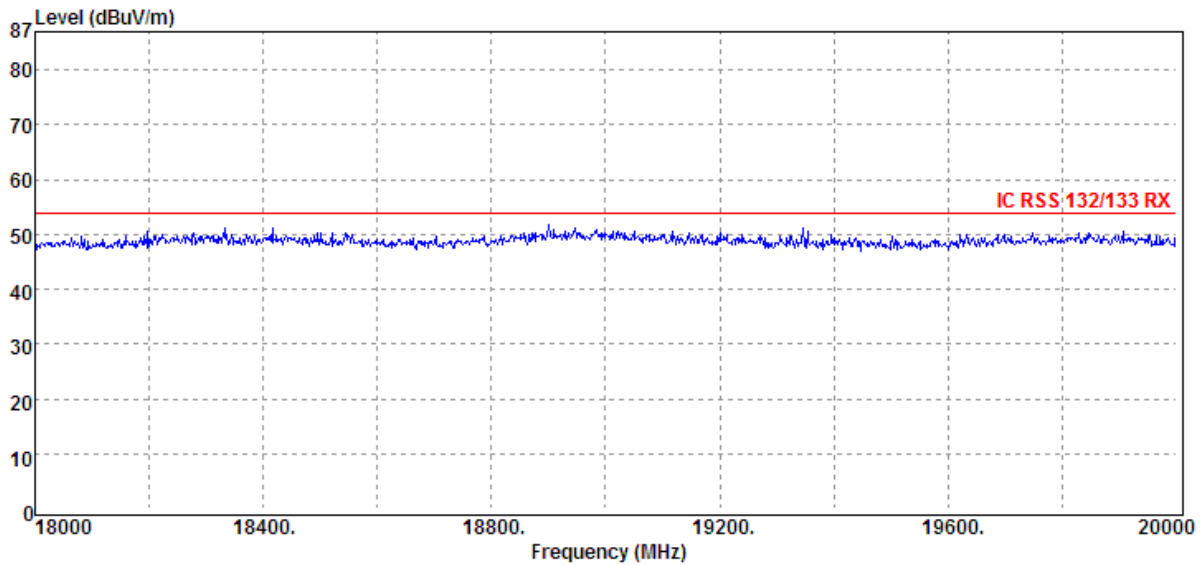
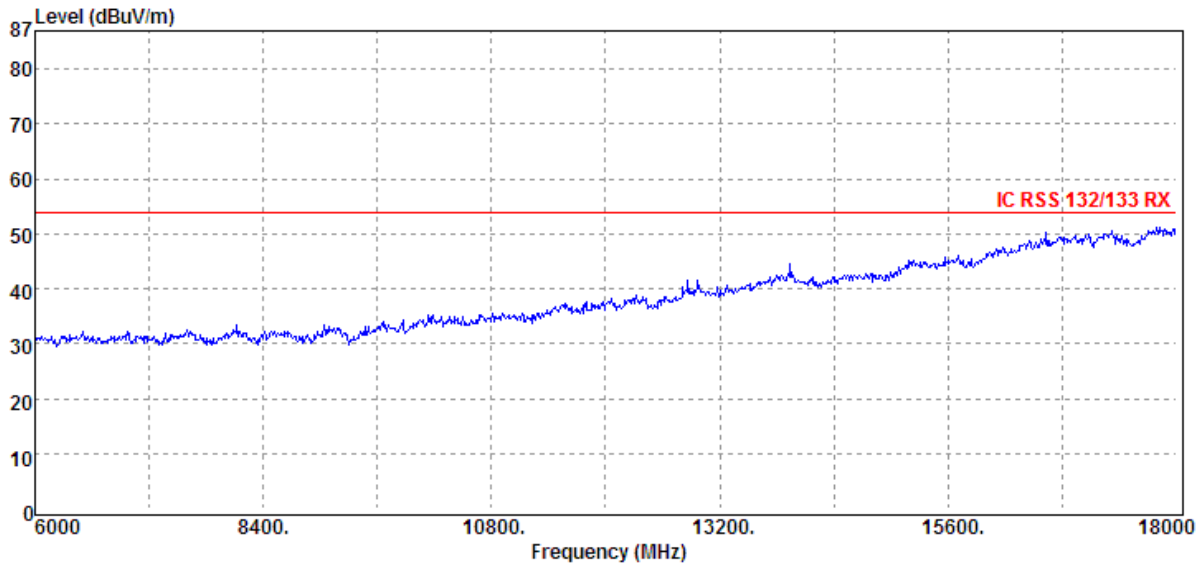

Unless otherwise stated the results shown in this test report refer only to the sample(s) tested and such sample(s) are retained for 90 days only.

除非另有說明，此報告結果僅對測試之樣品負責，同時此樣品僅保留90天。本報告未經本公司書面許可，不可部份複製。

This document is issued by the Company subject to its General Conditions of Service printed overleaf, available on request or accessible at www.sgs.com/terms_and_conditions.htm and, for electronic format documents, subject to Terms and Conditions for Electronic Documents at www.sgs.com/terms_e-document.htm. Attention is drawn to the limitation of liability, indemnification and jurisdiction issues defined therein. Any holder of this document is advised that information contained hereon reflects the Company's findings at the time of its intervention only and within the limits of Client's instructions, if any. The Company's sole responsibility is to its Client and this document does not exonerate parties to a transaction from exercising all their rights and obligations under the transaction documents. This document cannot be reproduced except in full, without prior written approval of the Company. Any unauthorized alteration, forgery or falsification of the content or appearance of this document is unlawful and offenders may be prosecuted to the fullest extent of the law.

Operation Band	:WCDMA B2	Test Date	:2013-05-03
Fundamental Frequency	:1907.6 MHz	Temp./Humi.	:24.1 deg_C / 65 RH
Operation Mode	:RX HIGH	Engineer	:Allen
EUT Pol.	:E1 Plan	Measurement Antenna Pol.	:VERTICAL

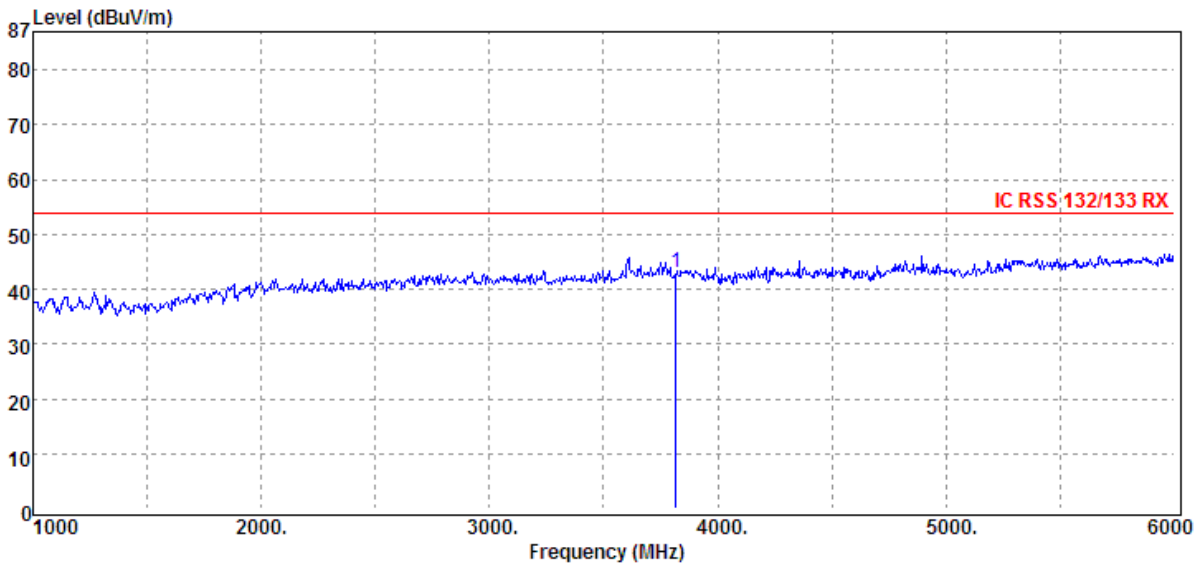
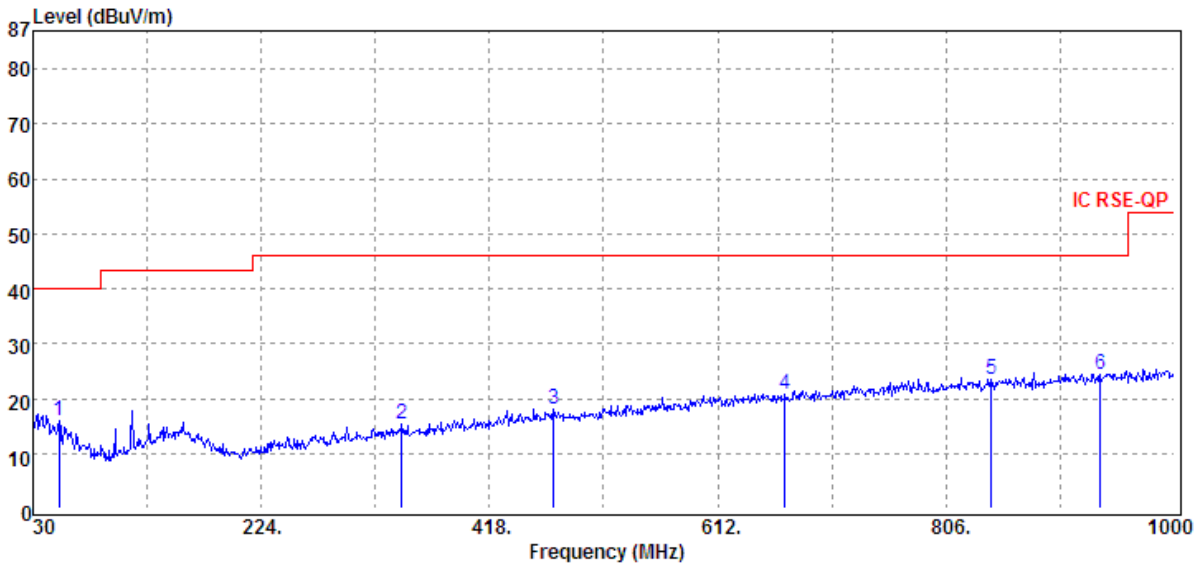

Unless otherwise stated the results shown in this test report refer only to the sample(s) tested and such sample(s) are retained for 90 days only.

除非另有說明，此報告結果僅對測試之樣品負責，同時此樣品僅保留90天。本報告未經本公司書面許可，不可部份複製。

This document is issued by the Company subject to its General Conditions of Service printed overleaf, available on request or accessible at www.sgs.com/terms_and_conditions.htm and, for electronic format documents, subject to Terms and Conditions for Electronic Documents at www.sgs.com/terms_e-document.htm. Attention is drawn to the limitation of liability, indemnification and jurisdiction issues defined therein. Any holder of this document is advised that information contained hereon reflects the Company's findings at the time of its intervention only and within the limits of Client's instructions, if any. The Company's sole responsibility is to its Client and this document does not exonerate parties to a transaction from exercising all their rights and obligations under the transaction documents. This document cannot be reproduced except in full, without prior written approval of the Company. Any unauthorized alteration, forgery or falsification of the content or appearance of this document is unlawful and offenders may be prosecuted to the fullest extent of the law.

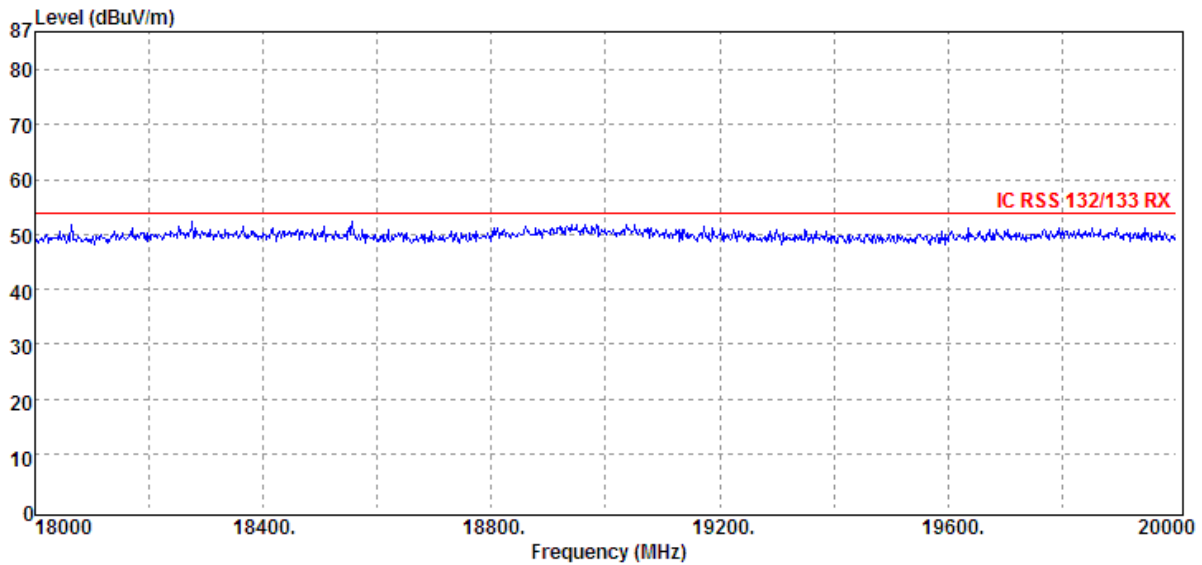
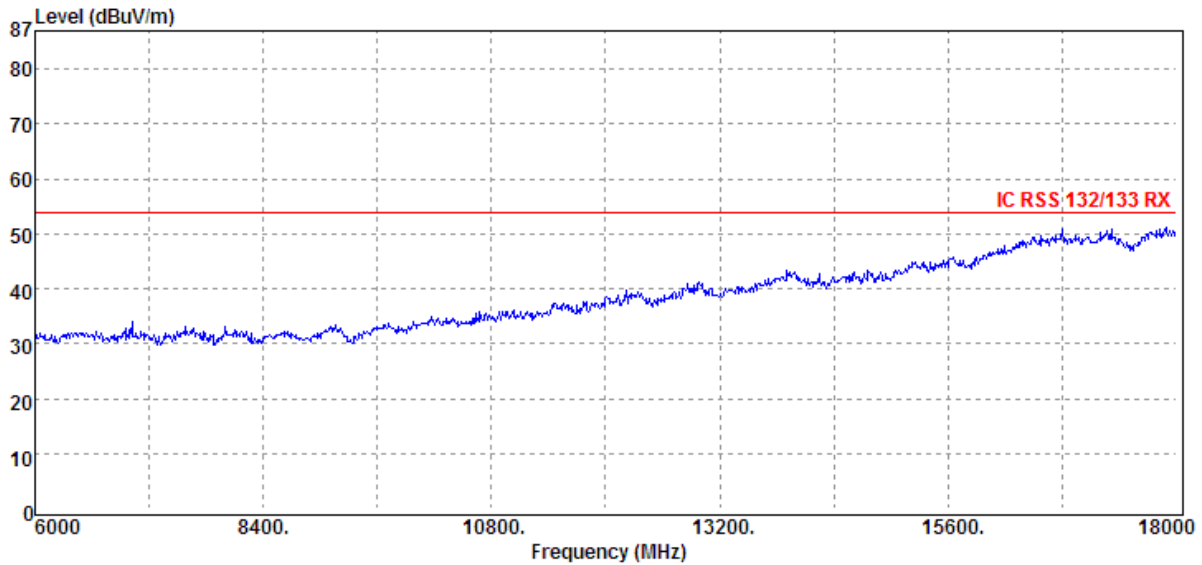

Unless otherwise stated the results shown in this test report refer only to the sample(s) tested and such sample(s) are retained for 90 days only.

除非另有說明，此報告結果僅對測試之樣品負責，同時此樣品僅保留90天。本報告未經本公司書面許可，不可部份複製。

This document is issued by the Company subject to its General Conditions of Service printed overleaf, available on request or accessible at www.sgs.com/terms_and_conditions.htm and, for electronic format documents, subject to Terms and Conditions for Electronic Documents at www.sgs.com/terms_e-document.htm. Attention is drawn to the limitation of liability, indemnification and jurisdiction issues defined therein. Any holder of this document is advised that information contained hereon reflects the Company's findings at the time of its intervention only and within the limits of Client's instructions, if any. The Company's sole responsibility is to its Client and this document does not exonerate parties to a transaction from exercising all their rights and obligations under the transaction documents. This document cannot be reproduced except in full, without prior written approval of the Company. Any unauthorized alteration, forgery or falsification of the content or appearance of this document is unlawful and offenders may be prosecuted to the fullest extent of the law.

Operation Band	:WCDMA B2	Test Date	:2013-05-03
Fundamental Frequency	:1907.6 MHz	Temp./Humi.	:24.1 deg_C / 65 RH
Operation Mode	:RX HIGH	Engineer	:Allen
EUT Pol.	:E1 Plan	Measurement Antenna Pol.	:HORIZONTAL

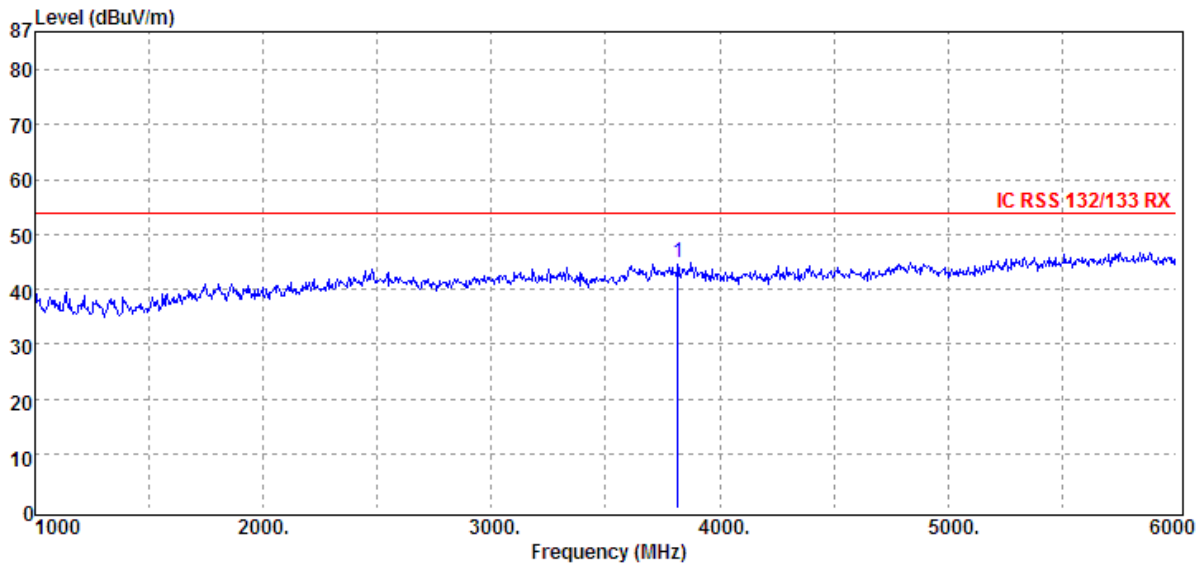
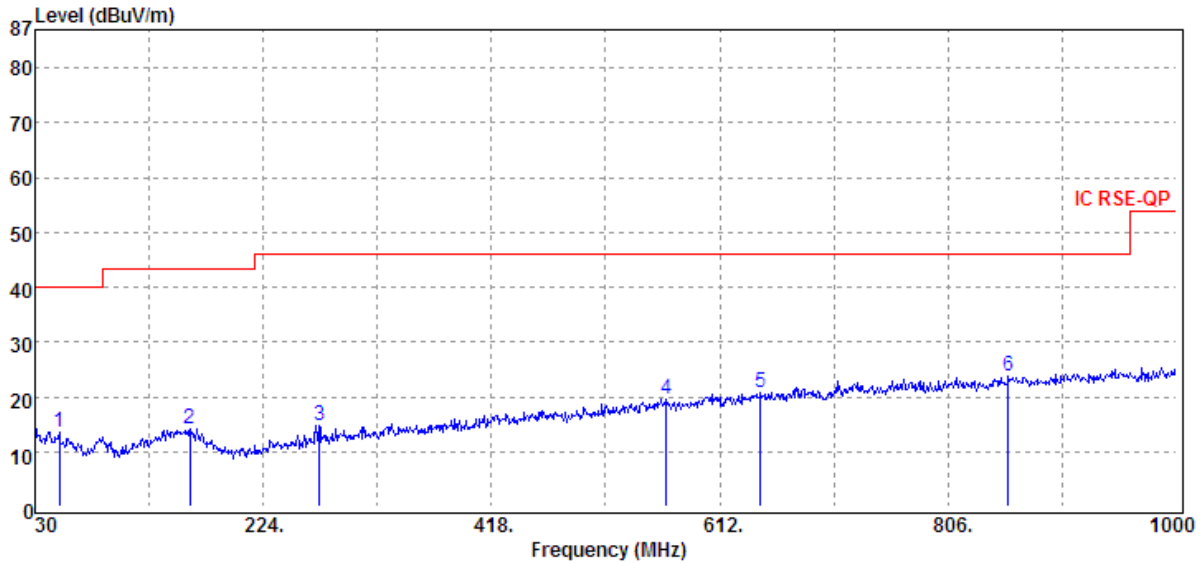

Unless otherwise stated the results shown in this test report refer only to the sample(s) tested and such sample(s) are retained for 90 days only.

除非另有說明，此報告結果僅對測試之樣品負責，同時此樣品僅保留90天。本報告未經本公司書面許可，不可部份複製。

This document is issued by the Company subject to its General Conditions of Service printed overleaf, available on request or accessible at www.sgs.com/terms_and_conditions.htm and, for electronic format documents, subject to Terms and Conditions for Electronic Documents at www.sgs.com/terms_e-document.htm. Attention is drawn to the limitation of liability, indemnification and jurisdiction issues defined therein. Any holder of this document is advised that information contained hereon reflects the Company's findings at the time of its intervention only and within the limits of Client's instructions, if any. The Company's sole responsibility is to its Client and this document does not exonerate parties to a transaction from exercising all their rights and obligations under the transaction documents. This document cannot be reproduced except in full, without prior written approval of the Company. Any unauthorized alteration, forgery or falsification of the content or appearance of this document is unlawful and offenders may be prosecuted to the fullest extent of the law.

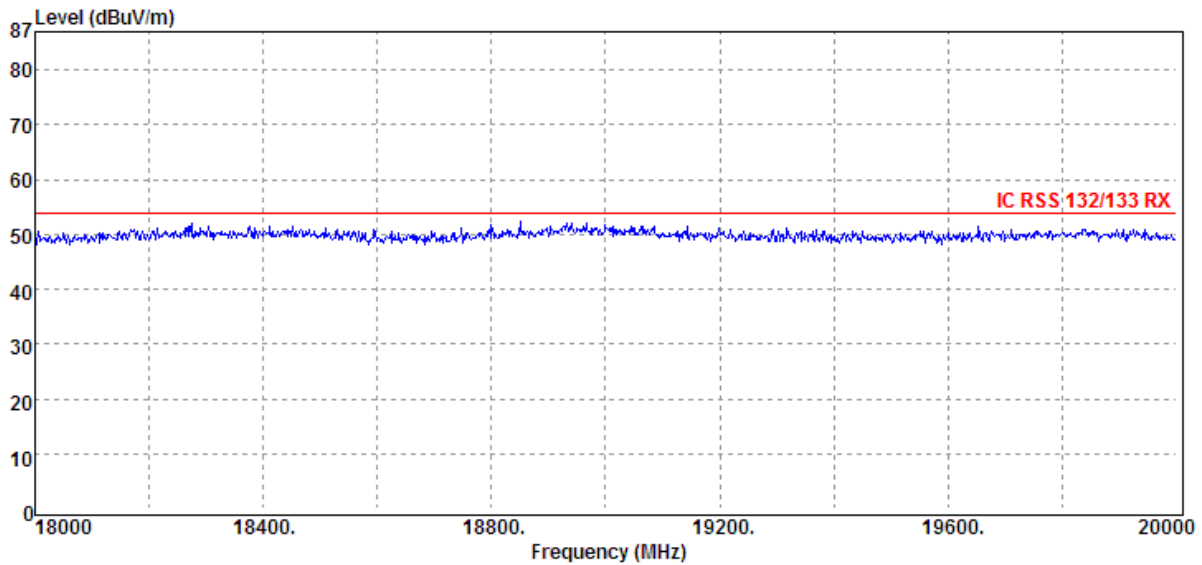
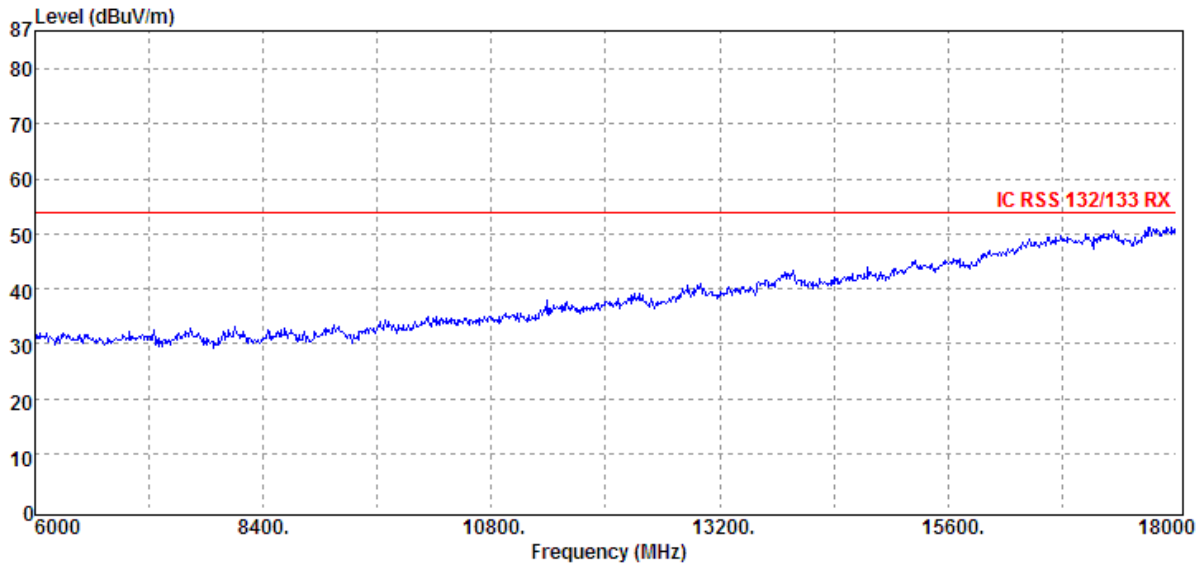

Unless otherwise stated the results shown in this test report refer only to the sample(s) tested and such sample(s) are retained for 90 days only.

除非另有說明，此報告結果僅對測試之樣品負責，同時此樣品僅保留90天。本報告未經本公司書面許可，不可部份複製。

This document is issued by the Company subject to its General Conditions of Service printed overleaf, available on request or accessible at www.sgs.com/terms_and_conditions.htm and, for electronic format documents, subject to Terms and Conditions for Electronic Documents at www.sgs.com/terms_e-document.htm. Attention is drawn to the limitation of liability, indemnification and jurisdiction issues defined therein. Any holder of this document is advised that information contained hereon reflects the Company's findings at the time of its intervention only and within the limits of Client's instructions, if any. The Company's sole responsibility is to its Client and this document does not exonerate parties to a transaction from exercising all their rights and obligations under the transaction documents. This document cannot be reproduced except in full, without prior written approval of the Company. Any unauthorized alteration, forgery or falsification of the content or appearance of this document is unlawful and offenders may be prosecuted to the fullest extent of the law.

Radiated Spurious Emission Measurement Result: WCDMA IV Mode

Operation Band	:WCDMA B4	Test Date	:2013-05-03
Fundamental Frequency	:1712.4 MHz	Temp./Humi.	:24.1 deg_C / 65 RH
Operation Mode	:RX LOW	Engineer	:Allen
EUT Pol.	:H Plan	Measurement Antenna Pol.	:VERTICAL

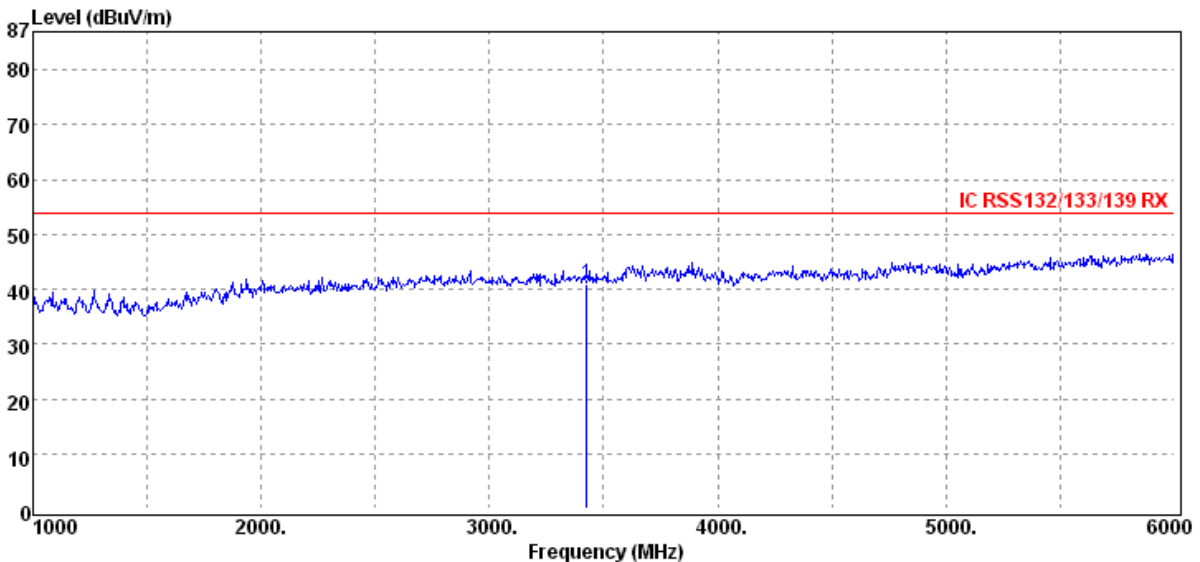
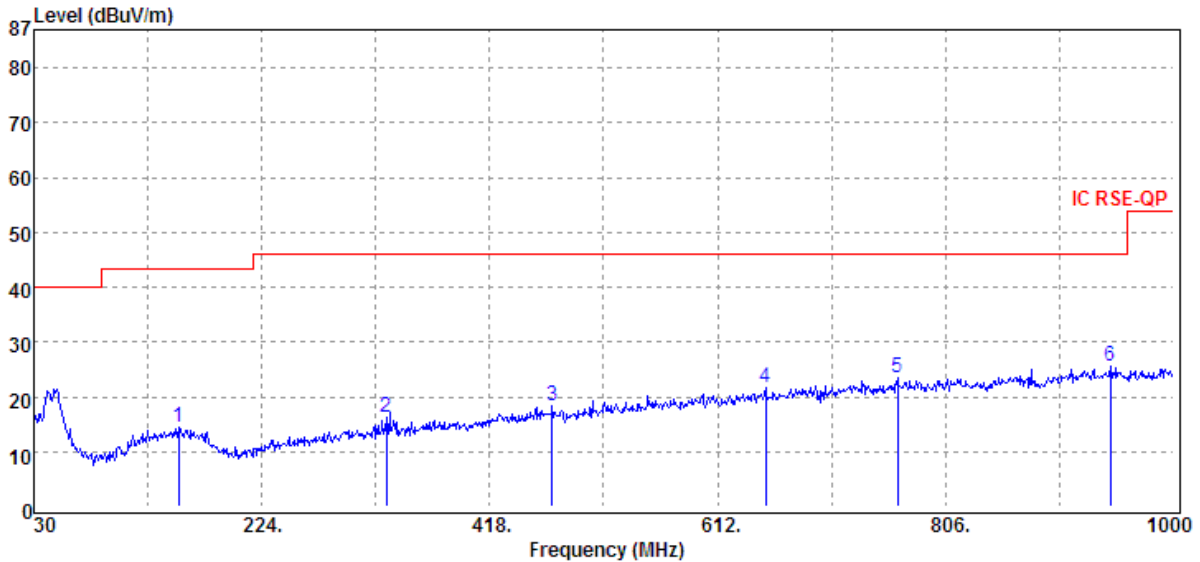

Unless otherwise stated the results shown in this test report refer only to the sample(s) tested and such sample(s) are retained for 90 days only.

除非另有說明，此報告結果僅對測試之樣品負責，同時此樣品僅保留90天。本報告未經本公司書面許可，不可部份複製。

This document is issued by the Company subject to its General Conditions of Service printed overleaf, available on request or accessible at www.sgs.com/terms_and_conditions.htm and, for electronic format documents, subject to Terms and Conditions for Electronic Documents at www.sgs.com/terms_e-document.htm. Attention is drawn to the limitation of liability, indemnification and jurisdiction issues defined therein. Any holder of this document is advised that information contained hereon reflects the Company's findings at the time of its intervention only and within the limits of Client's instructions, if any. The Company's sole responsibility is to its Client and this document does not exonerate parties to a transaction from exercising all their rights and obligations under the transaction documents. This document cannot be reproduced except in full, without prior written approval of the Company. Any unauthorized alteration, forgery or falsification of the content or appearance of this document is unlawful and offenders may be prosecuted to the fullest extent of the law.

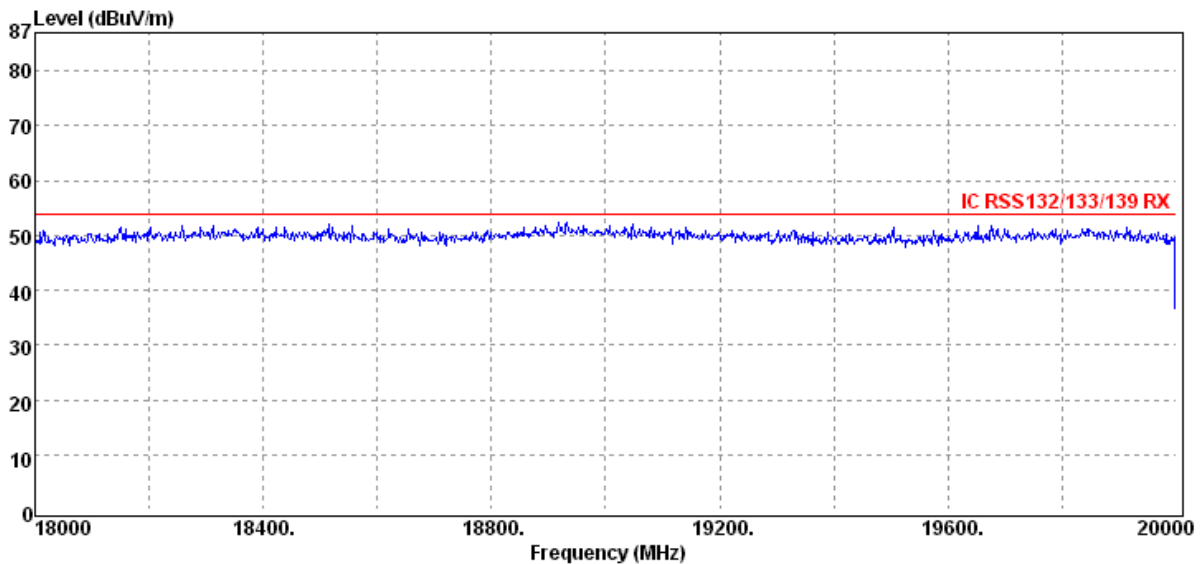
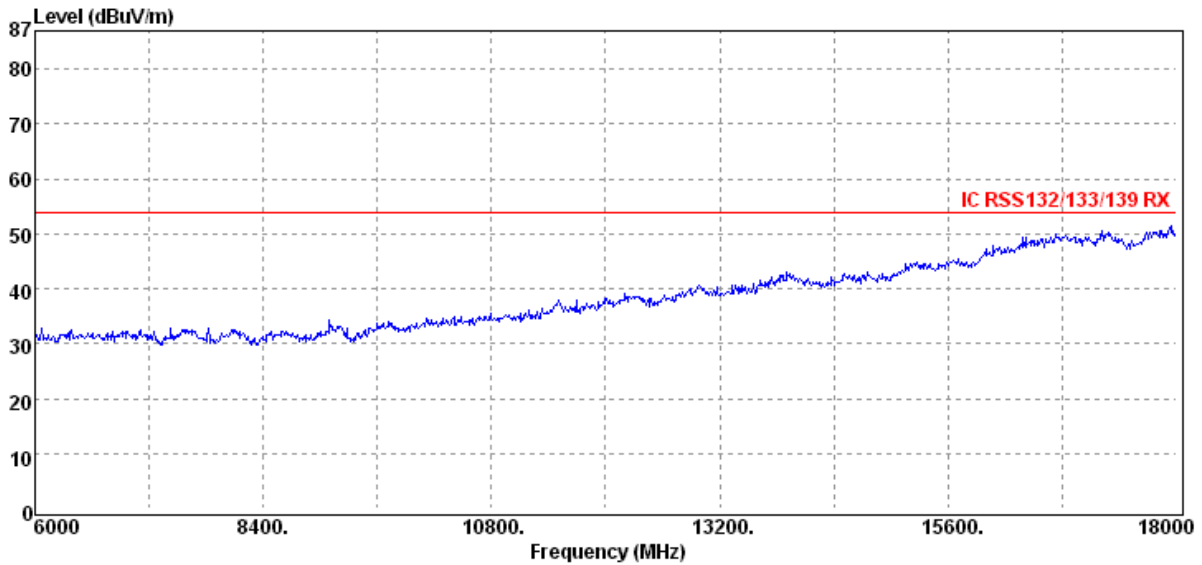

Unless otherwise stated the results shown in this test report refer only to the sample(s) tested and such sample(s) are retained for 90 days only.

除非另有說明，此報告結果僅對測試之樣品負責，同時此樣品僅保留90天。本報告未經本公司書面許可，不可部份複製。

This document is issued by the Company subject to its General Conditions of Service printed overleaf, available on request or accessible at www.sgs.com/terms_and_conditions.htm and, for electronic format documents, subject to Terms and Conditions for Electronic Documents at www.sgs.com/terms_e-document.htm. Attention is drawn to the limitation of liability, indemnification and jurisdiction issues defined therein. Any holder of this document is advised that information contained hereon reflects the Company's findings at the time of its intervention only and within the limits of Client's instructions, if any. The Company's sole responsibility is to its Client and this document does not exonerate parties to a transaction from exercising all their rights and obligations under the transaction documents. This document cannot be reproduced except in full, without prior written approval of the Company. Any unauthorized alteration, forgery or falsification of the content or appearance of this document is unlawful and offenders may be prosecuted to the fullest extent of the law.

Operation Band	:WCDMA B4	Test Date	:2013-05-03
Fundamental Frequency	:1712.4 MHz	Temp./Humi.	:24.1 deg_C / 65 RH
Operation Mode	:RX LOW	Engineer	:Allen
EUT Pol.	:H Plan	Measurement Antenna Pol.	:HORIZONTAL

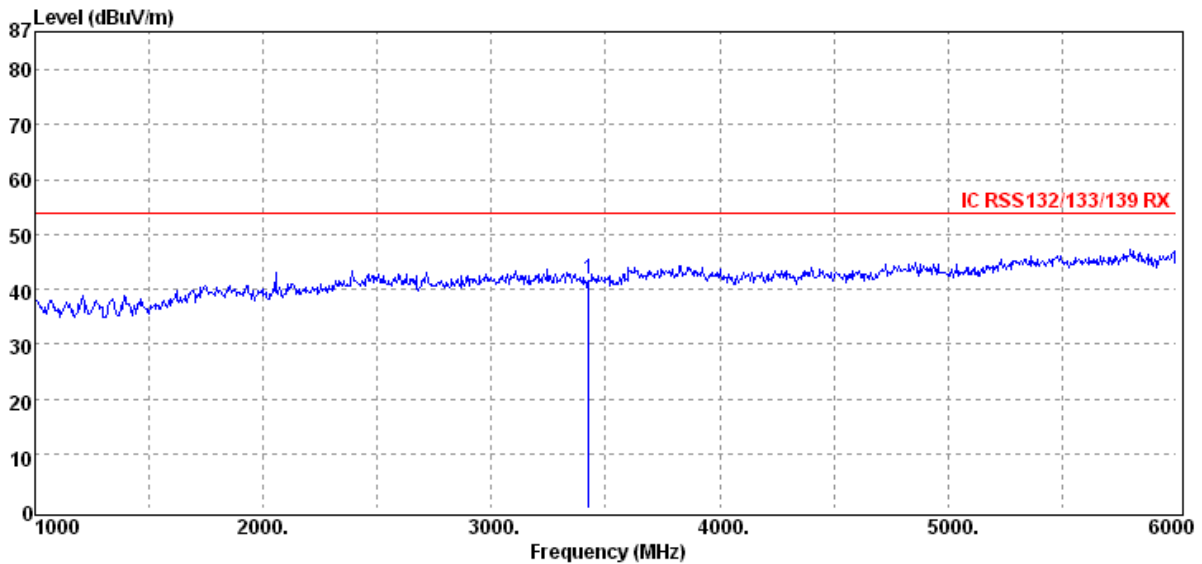
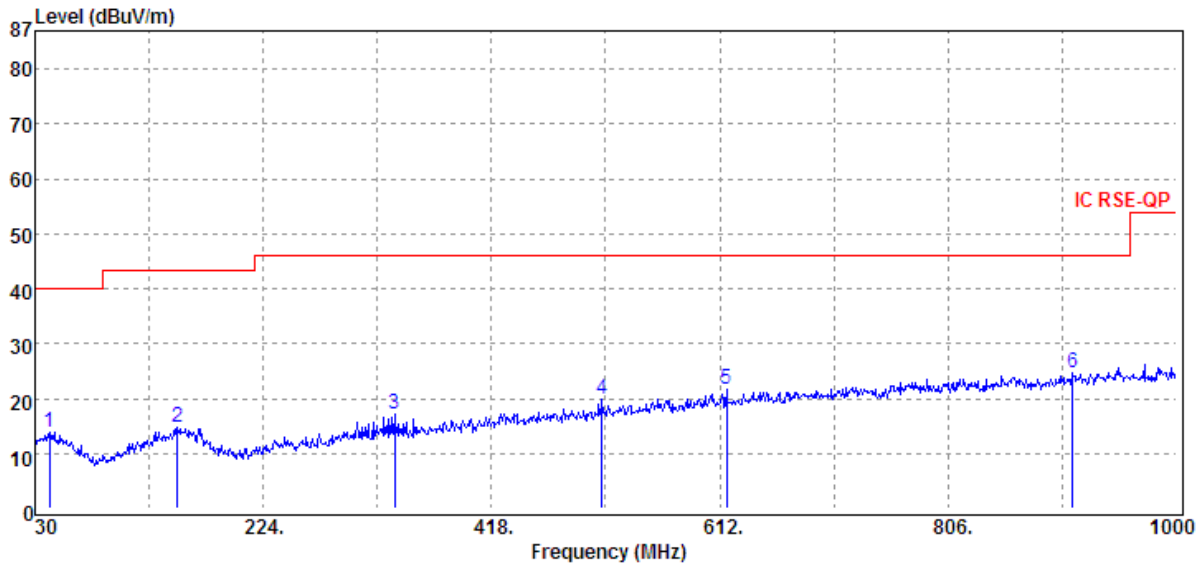

Unless otherwise stated the results shown in this test report refer only to the sample(s) tested and such sample(s) are retained for 90 days only.

除非另有說明，此報告結果僅對測試之樣品負責，同時此樣品僅保留90天。本報告未經本公司書面許可，不可部份複製。

This document is issued by the Company subject to its General Conditions of Service printed overleaf, available on request or accessible at www.sgs.com/terms_and_conditions.htm and, for electronic format documents, subject to Terms and Conditions for Electronic Documents at www.sgs.com/terms_e-document.htm. Attention is drawn to the limitation of liability, indemnification and jurisdiction issues defined therein. Any holder of this document is advised that information contained hereon reflects the Company's findings at the time of its intervention only and within the limits of Client's instructions, if any. The Company's sole responsibility is to its Client and this document does not exonerate parties to a transaction from exercising all their rights and obligations under the transaction documents. This document cannot be reproduced except in full, without prior written approval of the Company. Any unauthorized alteration, forgery or falsification of the content or appearance of this document is unlawful and offenders may be prosecuted to the fullest extent of the law.

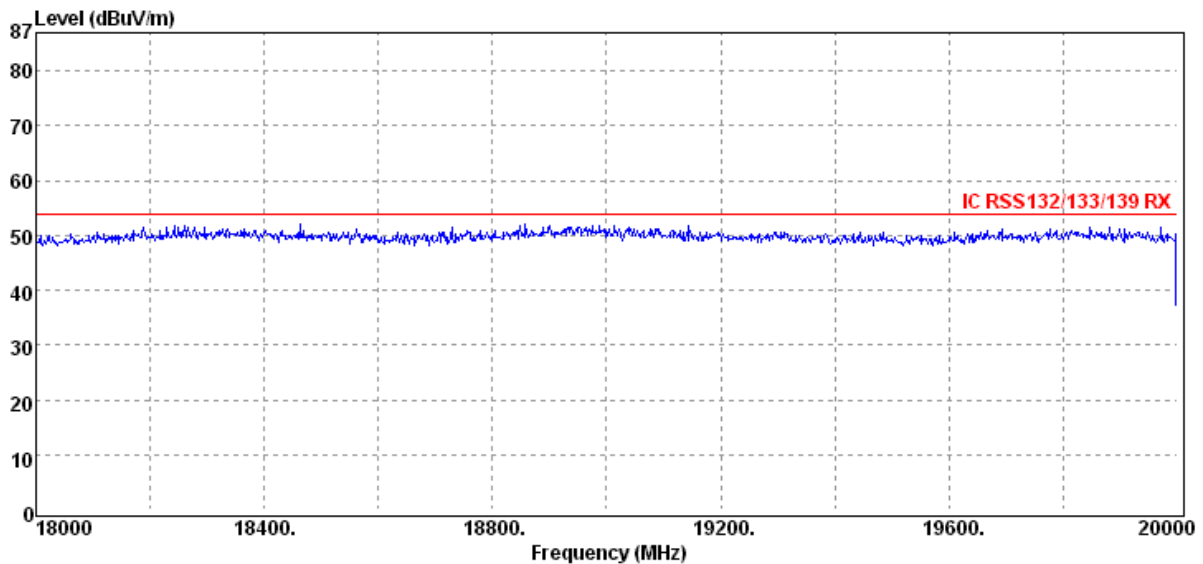
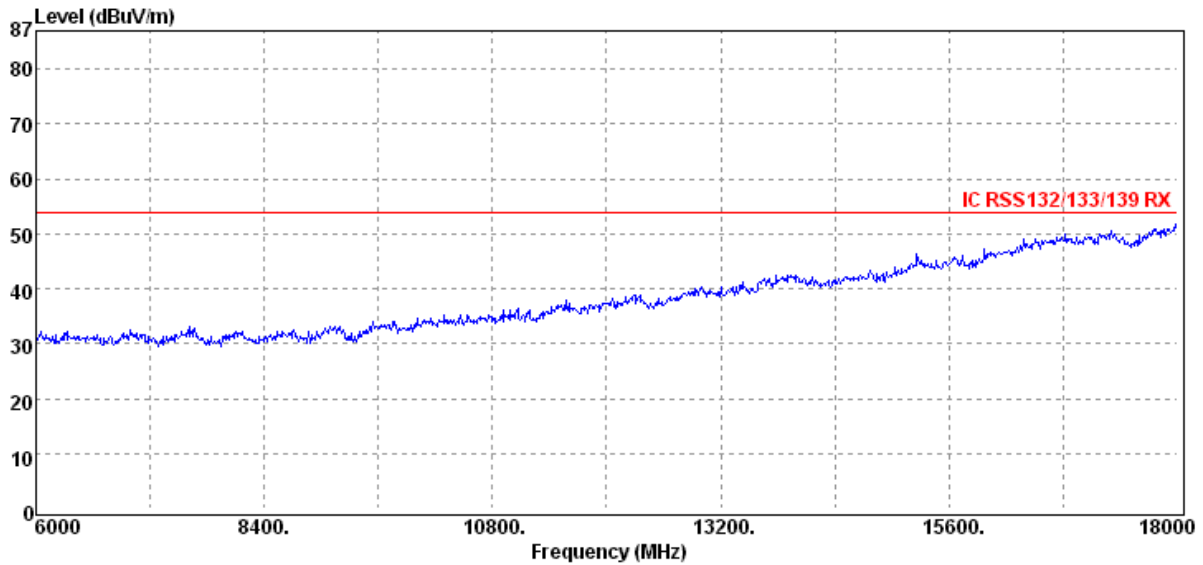

Unless otherwise stated the results shown in this test report refer only to the sample(s) tested and such sample(s) are retained for 90 days only.

除非另有說明，此報告結果僅對測試之樣品負責，同時此樣品僅保留90天。本報告未經本公司書面許可，不可部份複製。

This document is issued by the Company subject to its General Conditions of Service printed overleaf, available on request or accessible at www.sgs.com/terms_and_conditions.htm and, for electronic format documents, subject to Terms and Conditions for Electronic Documents at www.sgs.com/terms_e-document.htm. Attention is drawn to the limitation of liability, indemnification and jurisdiction issues defined therein. Any holder of this document is advised that information contained hereon reflects the Company's findings at the time of its intervention only and within the limits of Client's instructions, if any. The Company's sole responsibility is to its Client and this document does not exonerate parties to a transaction from exercising all their rights and obligations under the transaction documents. This document cannot be reproduced except in full, without prior written approval of the Company. Any unauthorized alteration, forgery or falsification of the content or appearance of this document is unlawful and offenders may be prosecuted to the fullest extent of the law.

Operation Band	:WCDMA B4	Test Date	:2013-05-03
Fundamental Frequency	:1732.6 MHz	Temp./Humi.	:24.1 deg_C / 65 RH
Operation Mode	:RX MID	Engineer	:Allen
EUT Pol.	:H Plan	Measurement Antenna Pol.	:VERTICAL

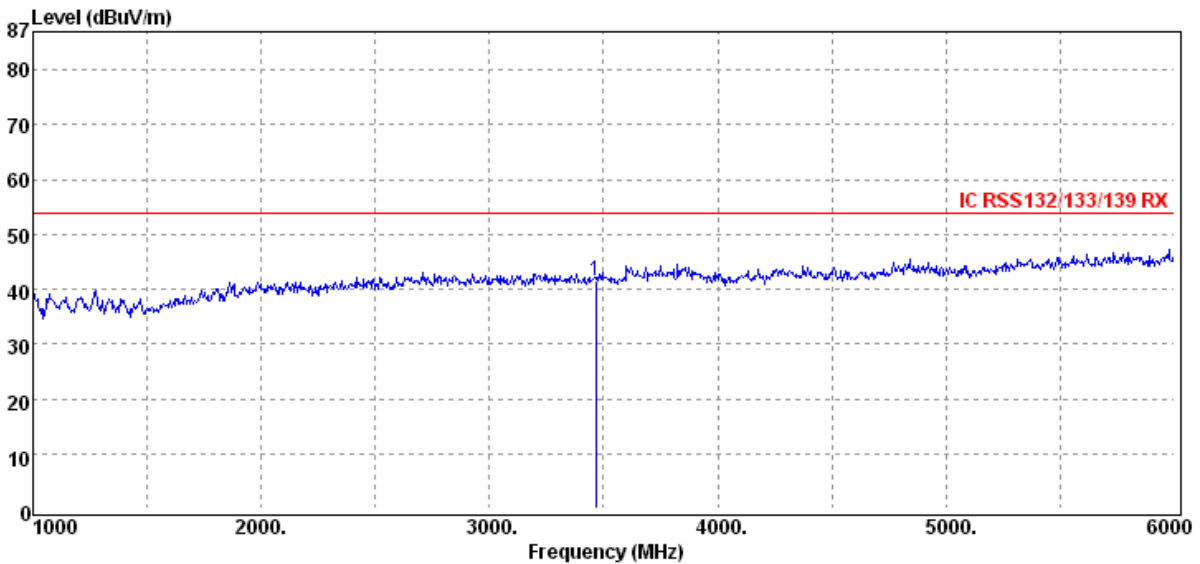
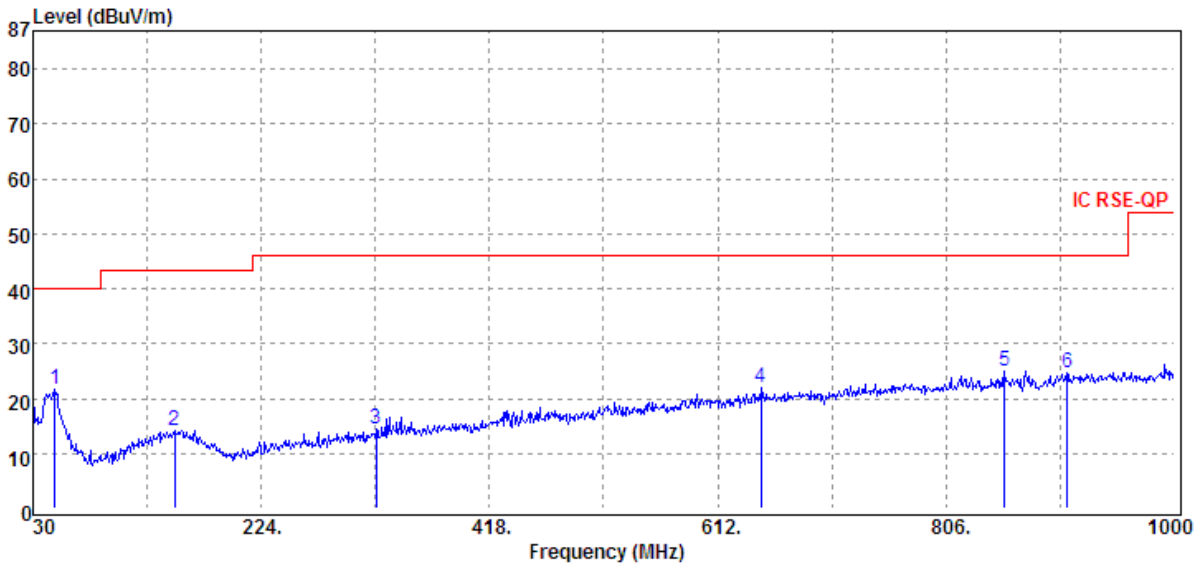

Unless otherwise stated the results shown in this test report refer only to the sample(s) tested and such sample(s) are retained for 90 days only.

除非另有說明，此報告結果僅對測試之樣品負責，同時此樣品僅保留90天。本報告未經本公司書面許可，不可部份複製。

This document is issued by the Company subject to its General Conditions of Service printed overleaf, available on request or accessible at www.sgs.com/terms_and_conditions.htm and, for electronic format documents, subject to Terms and Conditions for Electronic Documents at www.sgs.com/terms_e-document.htm. Attention is drawn to the limitation of liability, indemnification and jurisdiction issues defined therein. Any holder of this document is advised that information contained hereon reflects the Company's findings at the time of its intervention only and within the limits of Client's instructions, if any. The Company's sole responsibility is to its Client and this document does not exonerate parties to a transaction from exercising all their rights and obligations under the transaction documents. This document cannot be reproduced except in full, without prior written approval of the Company. Any unauthorized alteration, forgery or falsification of the content or appearance of this document is unlawful and offenders may be prosecuted to the fullest extent of the law.

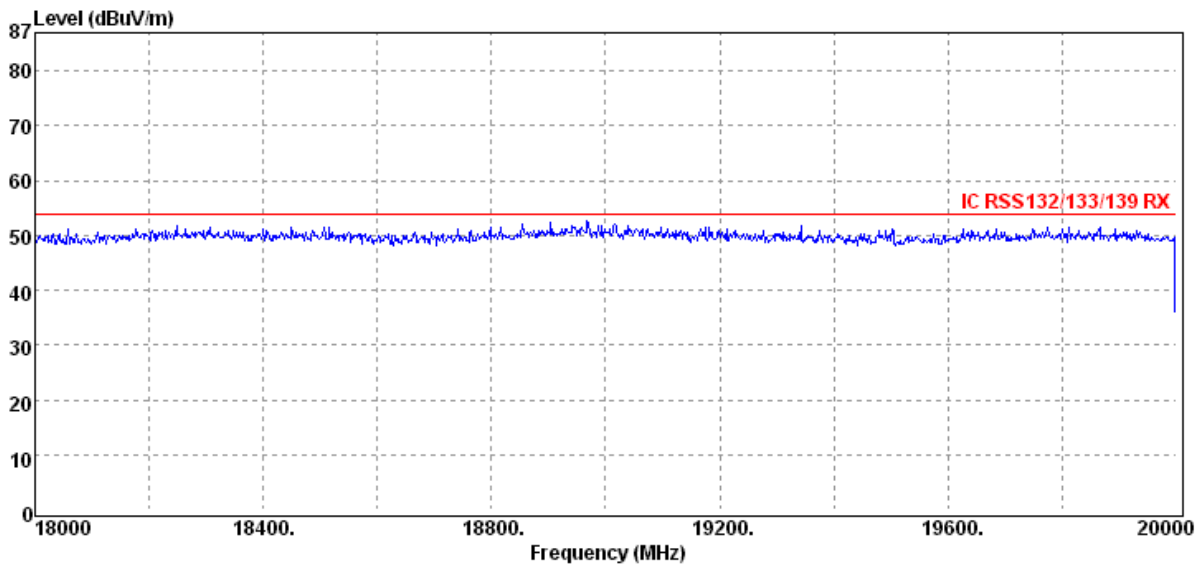
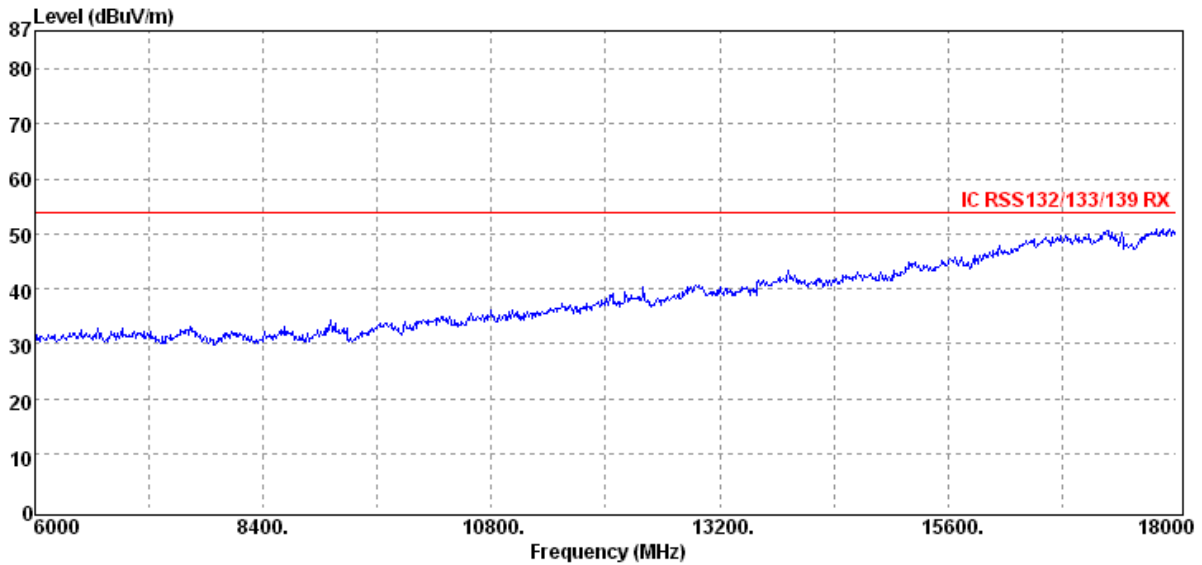

Unless otherwise stated the results shown in this test report refer only to the sample(s) tested and such sample(s) are retained for 90 days only.

除非另有說明，此報告結果僅對測試之樣品負責，同時此樣品僅保留90天。本報告未經本公司書面許可，不可部份複製。

This document is issued by the Company subject to its General Conditions of Service printed overleaf, available on request or accessible at www.sgs.com/terms_and_conditions.htm and, for electronic format documents, subject to Terms and Conditions for Electronic Documents at www.sgs.com/terms_e-document.htm. Attention is drawn to the limitation of liability, indemnification and jurisdiction issues defined therein. Any holder of this document is advised that information contained hereon reflects the Company's findings at the time of its intervention only and within the limits of Client's instructions, if any. The Company's sole responsibility is to its Client and this document does not exonerate parties to a transaction from exercising all their rights and obligations under the transaction documents. This document cannot be reproduced except in full, without prior written approval of the Company. Any unauthorized alteration, forgery or falsification of the content or appearance of this document is unlawful and offenders may be prosecuted to the fullest extent of the law.

Operation Band	:WCDMA B4	Test Date	:2013-05-03
Fundamental Frequency	:1732.6 MHz	Temp./Humi.	:24.1 deg_C / 65 RH
Operation Mode	:RX MID	Engineer	:Allen
EUT Pol.	:H Plan	Measurement Antenna Pol.	:HORIZONTAL

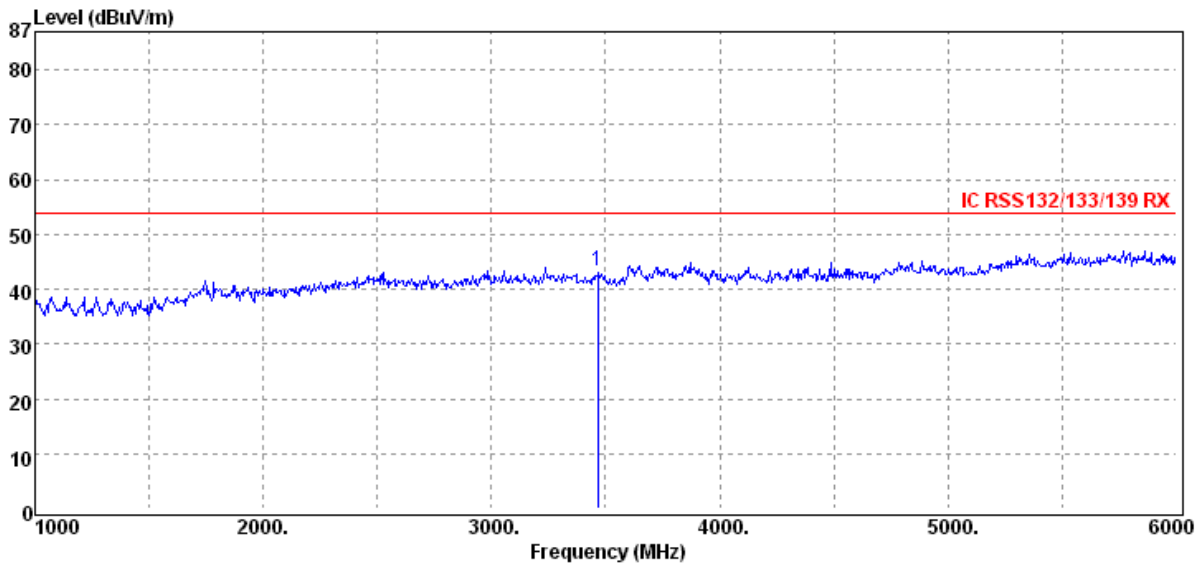
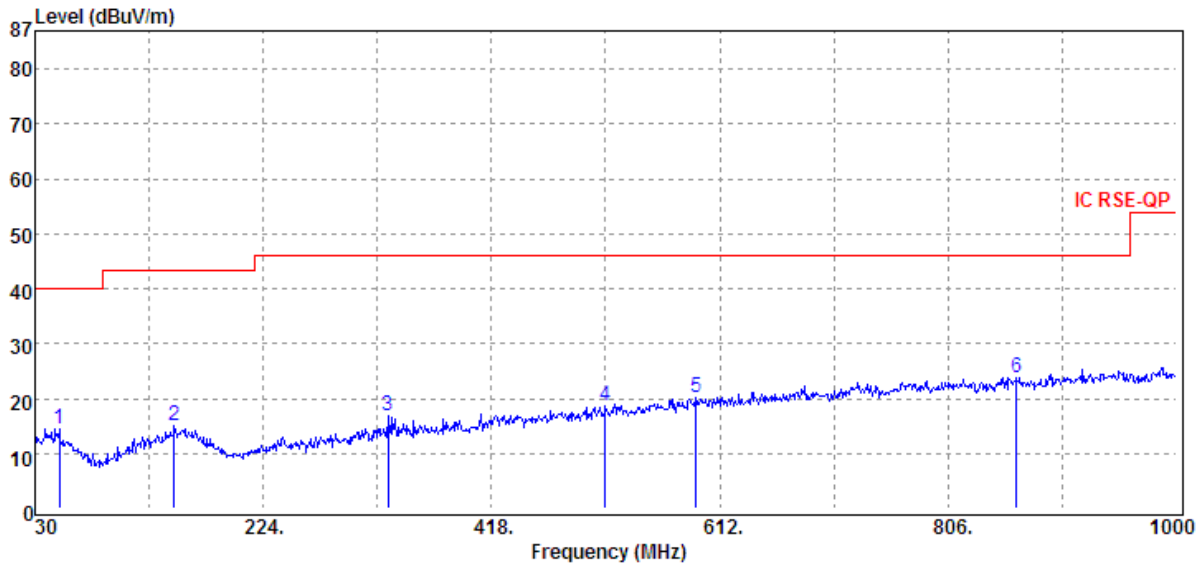

Unless otherwise stated the results shown in this test report refer only to the sample(s) tested and such sample(s) are retained for 90 days only.

除非另有說明，此報告結果僅對測試之樣品負責，同時此樣品僅保留90天。本報告未經本公司書面許可，不可部份複製。

This document is issued by the Company subject to its General Conditions of Service printed overleaf, available on request or accessible at www.sgs.com/terms_and_conditions.htm and, for electronic format documents, subject to Terms and Conditions for Electronic Documents at www.sgs.com/terms_e-document.htm. Attention is drawn to the limitation of liability, indemnification and jurisdiction issues defined therein. Any holder of this document is advised that information contained hereon reflects the Company's findings at the time of its intervention only and within the limits of Client's instructions, if any. The Company's sole responsibility is to its Client and this document does not exonerate parties to a transaction from exercising all their rights and obligations under the transaction documents. This document cannot be reproduced except in full, without prior written approval of the Company. Any unauthorized alteration, forgery or falsification of the content or appearance of this document is unlawful and offenders may be prosecuted to the fullest extent of the law.

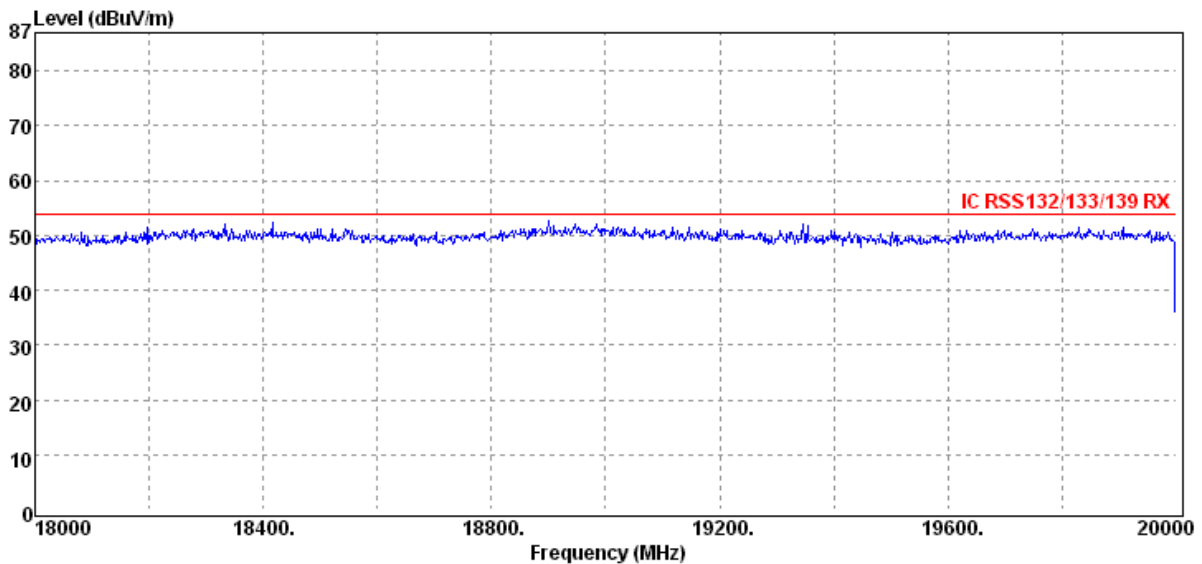
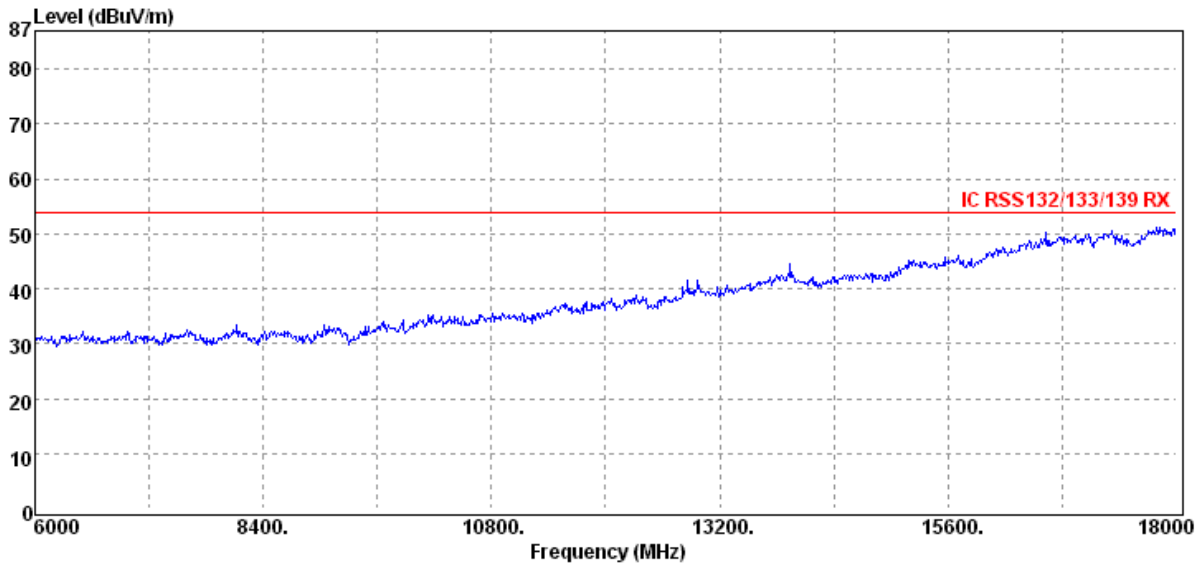

Unless otherwise stated the results shown in this test report refer only to the sample(s) tested and such sample(s) are retained for 90 days only.

除非另有說明，此報告結果僅對測試之樣品負責，同時此樣品僅保留90天。本報告未經本公司書面許可，不可部份複製。

This document is issued by the Company subject to its General Conditions of Service printed overleaf, available on request or accessible at www.sgs.com/terms_and_conditions.htm and, for electronic format documents, subject to Terms and Conditions for Electronic Documents at www.sgs.com/terms_e-document.htm. Attention is drawn to the limitation of liability, indemnification and jurisdiction issues defined therein. Any holder of this document is advised that information contained hereon reflects the Company's findings at the time of its intervention only and within the limits of Client's instructions, if any. The Company's sole responsibility is to its Client and this document does not exonerate parties to a transaction from exercising all their rights and obligations under the transaction documents. This document cannot be reproduced except in full, without prior written approval of the Company. Any unauthorized alteration, forgery or falsification of the content or appearance of this document is unlawful and offenders may be prosecuted to the fullest extent of the law.

Operation Band	:WCDMA B4	Test Date	:2013-05-03
Fundamental Frequency	:1752.6 MHz	Temp./Humi.	:24.1 deg_C / 65 RH
Operation Mode	:RX HIGH	Engineer	:Allen
EUT Pol.	:H Plan	Measurement Antenna Pol.	:VERTICAL

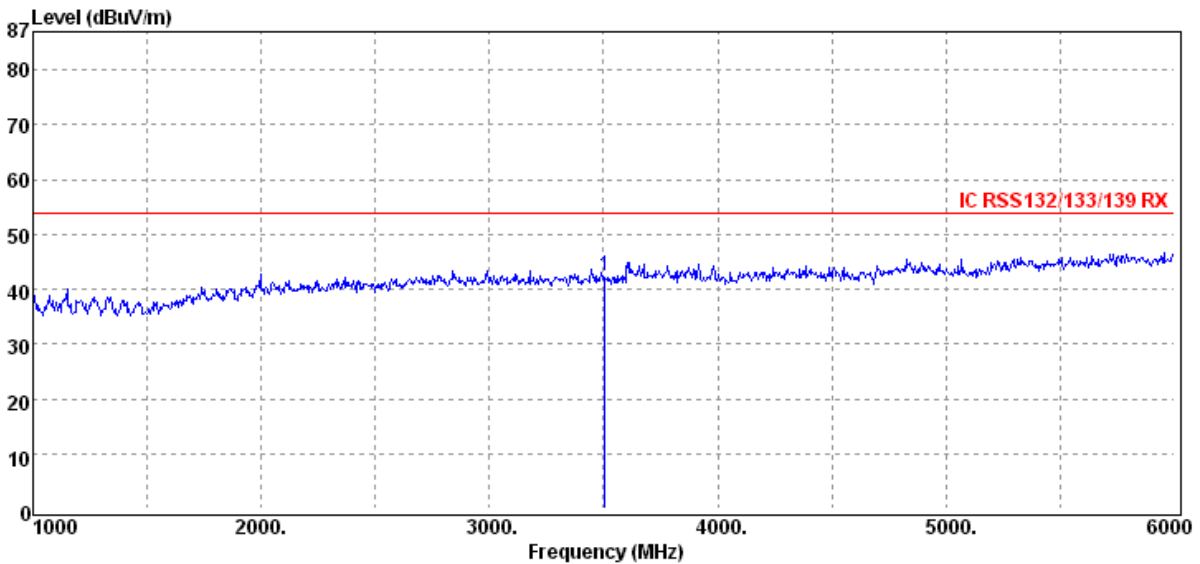
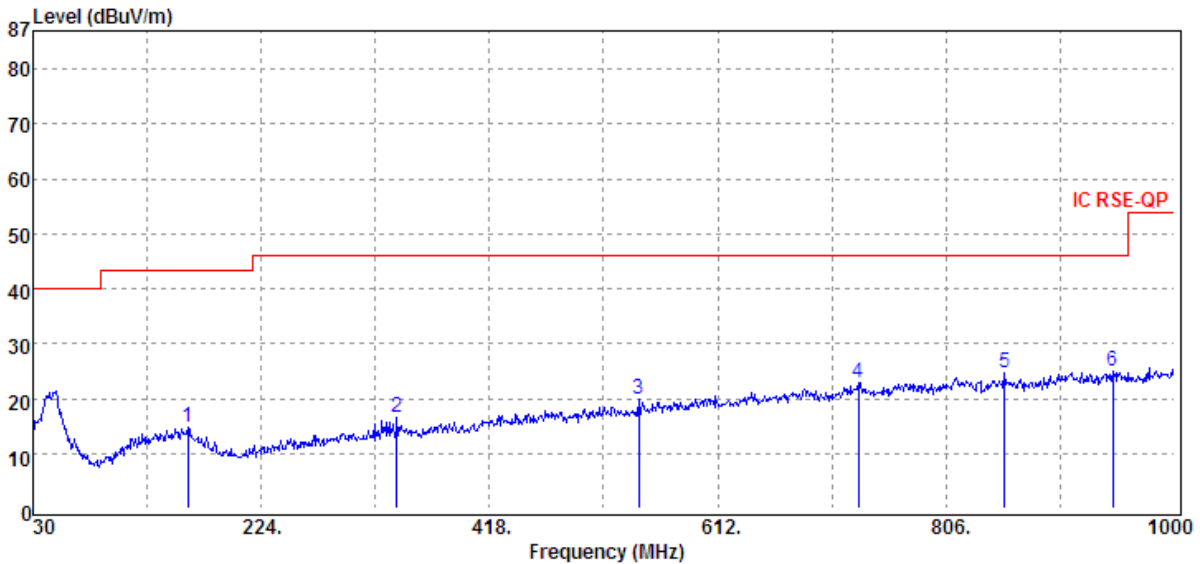

Unless otherwise stated the results shown in this test report refer only to the sample(s) tested and such sample(s) are retained for 90 days only.

除非另有說明，此報告結果僅對測試之樣品負責，同時此樣品僅保留90天。本報告未經本公司書面許可，不可部份複製。

This document is issued by the Company subject to its General Conditions of Service printed overleaf, available on request or accessible at www.sgs.com/terms_and_conditions.htm and, for electronic format documents, subject to Terms and Conditions for Electronic Documents at www.sgs.com/terms_e-document.htm. Attention is drawn to the limitation of liability, indemnification and jurisdiction issues defined therein. Any holder of this document is advised that information contained hereon reflects the Company's findings at the time of its intervention only and within the limits of Client's instructions, if any. The Company's sole responsibility is to its Client and this document does not exonerate parties to a transaction from exercising all their rights and obligations under the transaction documents. This document cannot be reproduced except in full, without prior written approval of the Company. Any unauthorized alteration, forgery or falsification of the content or appearance of this document is unlawful and offenders may be prosecuted to the fullest extent of the law.

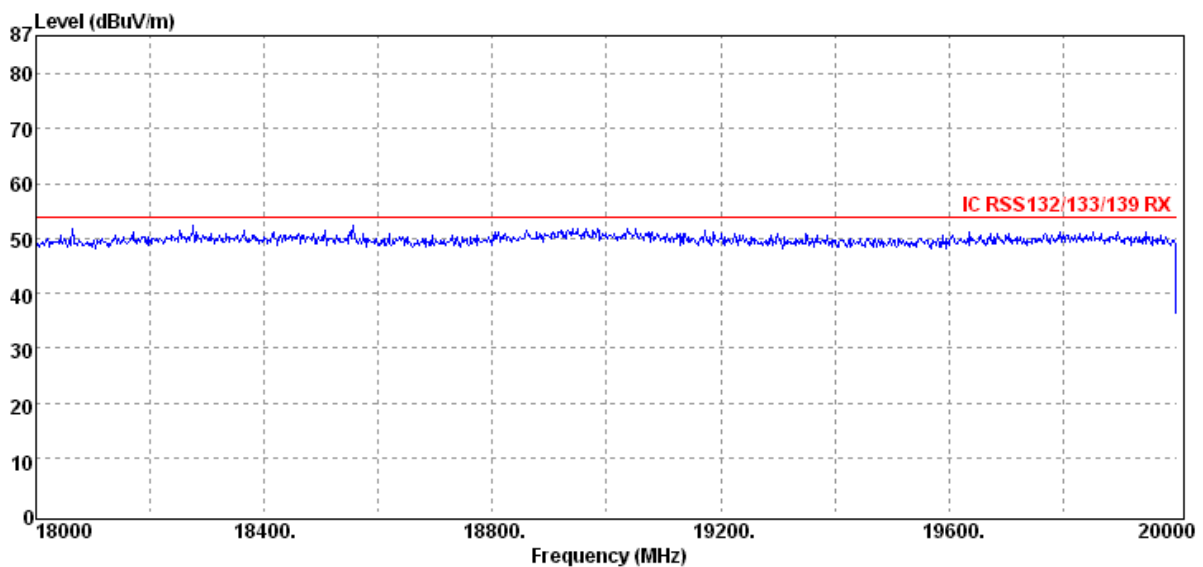
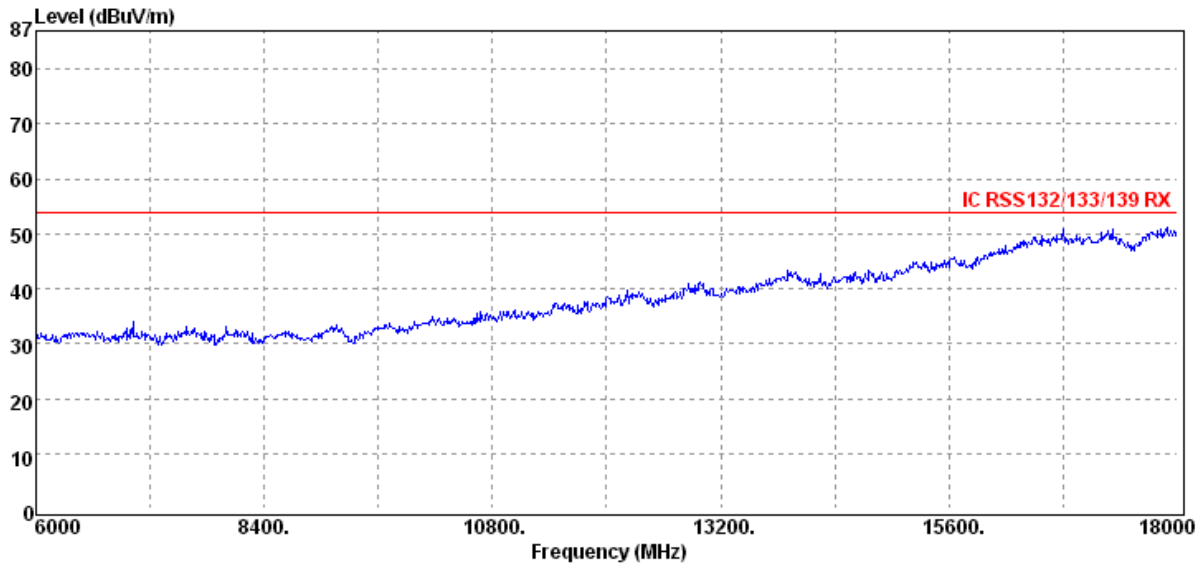

Unless otherwise stated the results shown in this test report refer only to the sample(s) tested and such sample(s) are retained for 90 days only.

除非另有說明，此報告結果僅對測試之樣品負責，同時此樣品僅保留90天。本報告未經本公司書面許可，不可部份複製。

This document is issued by the Company subject to its General Conditions of Service printed overleaf, available on request or accessible at www.sgs.com/terms_and_conditions.htm and, for electronic format documents, subject to Terms and Conditions for Electronic Documents at www.sgs.com/terms_e-document.htm. Attention is drawn to the limitation of liability, indemnification and jurisdiction issues defined therein. Any holder of this document is advised that information contained hereon reflects the Company's findings at the time of its intervention only and within the limits of Client's instructions, if any. The Company's sole responsibility is to its Client and this document does not exonerate parties to a transaction from exercising all their rights and obligations under the transaction documents. This document cannot be reproduced except in full, without prior written approval of the Company. Any unauthorized alteration, forgery or falsification of the content or appearance of this document is unlawful and offenders may be prosecuted to the fullest extent of the law.

Operation Band	:WCDMA B4	Test Date	:2013-05-03
Fundamental Frequency	:1752.6 MHz	Temp./Humi.	:24.1 deg_C / 65 RH
Operation Mode	:RX HIGH	Engineer	:Allen
EUT Pol.	:H Plan	Measurement Antenna Pol.	:HORIZONTAL

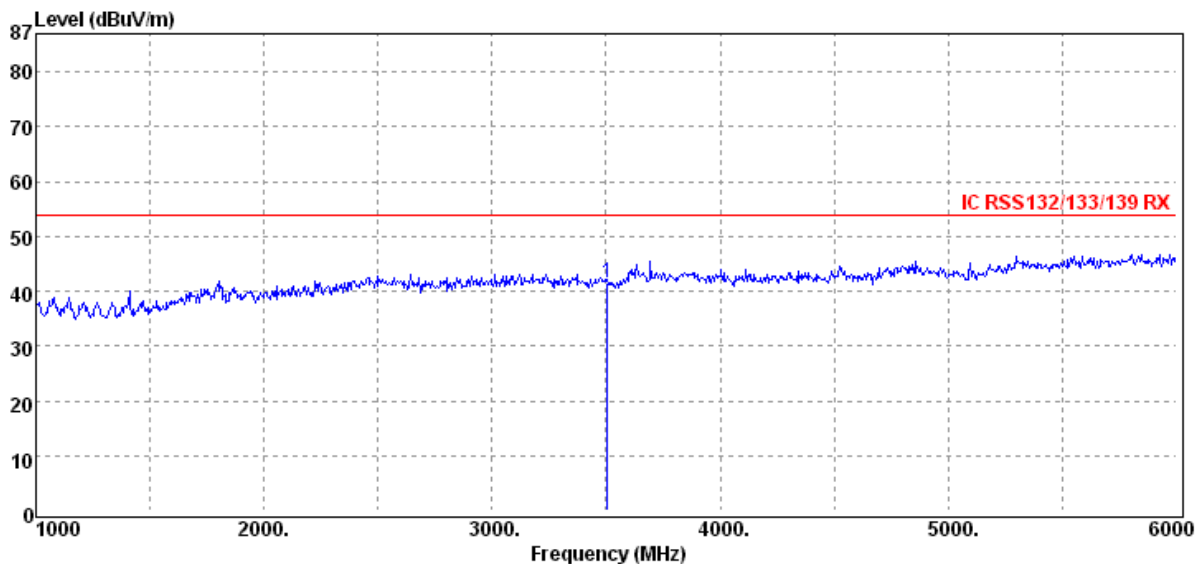
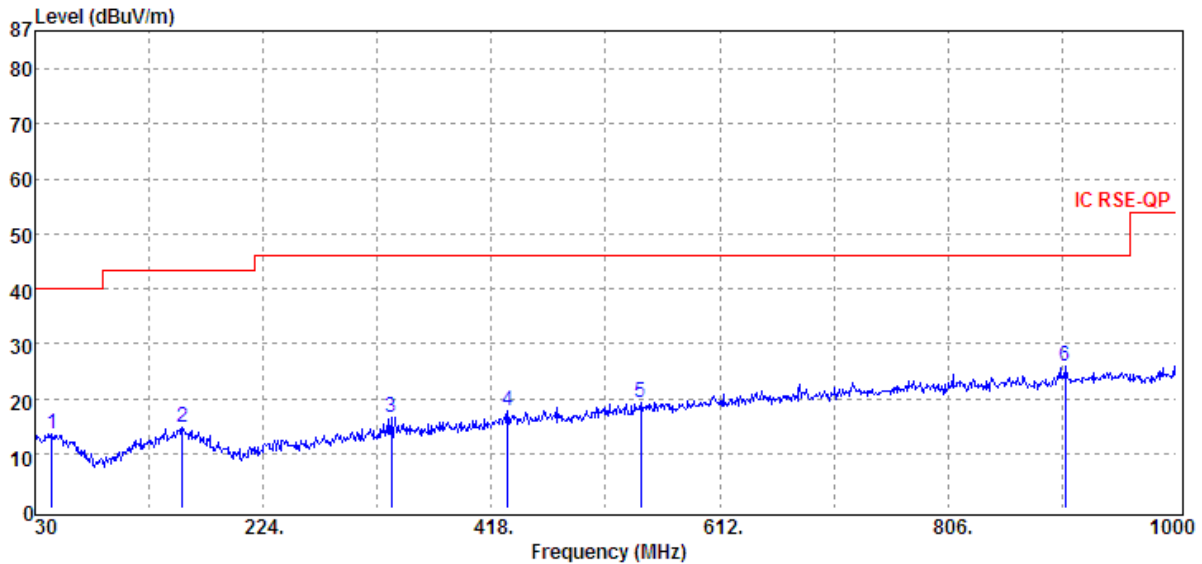

Unless otherwise stated the results shown in this test report refer only to the sample(s) tested and such sample(s) are retained for 90 days only.

除非另有說明，此報告結果僅對測試之樣品負責，同時此樣品僅保留90天。本報告未經本公司書面許可，不可部份複製。

This document is issued by the Company subject to its General Conditions of Service printed overleaf, available on request or accessible at www.sgs.com/terms_and_conditions.htm and, for electronic format documents, subject to Terms and Conditions for Electronic Documents at www.sgs.com/terms_e-document.htm. Attention is drawn to the limitation of liability, indemnification and jurisdiction issues defined therein. Any holder of this document is advised that information contained hereon reflects the Company's findings at the time of its intervention only and within the limits of Client's instructions, if any. The Company's sole responsibility is to its Client and this document does not exonerate parties to a transaction from exercising all their rights and obligations under the transaction documents. This document cannot be reproduced except in full, without prior written approval of the Company. Any unauthorized alteration, forgery or falsification of the content or appearance of this document is unlawful and offenders may be prosecuted to the fullest extent of the law.

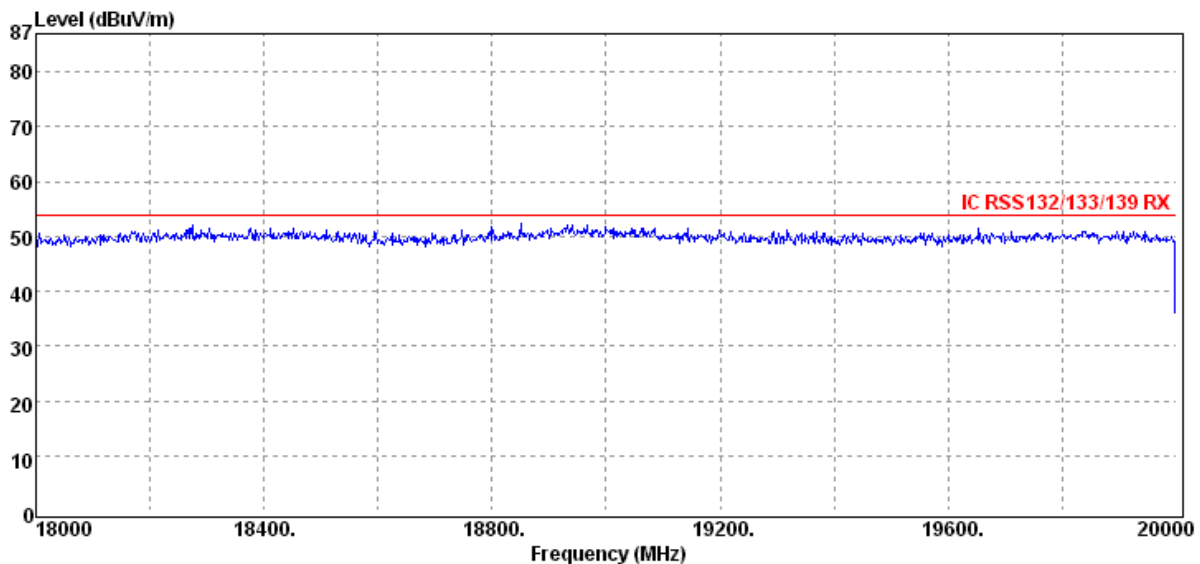
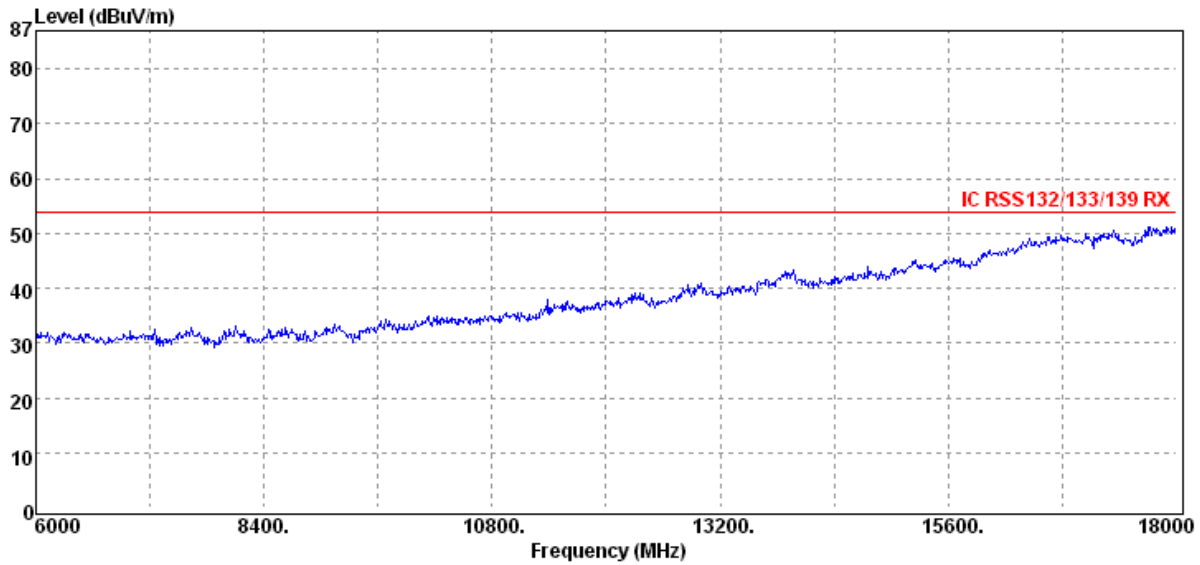

Unless otherwise stated the results shown in this test report refer only to the sample(s) tested and such sample(s) are retained for 90 days only.

除非另有說明，此報告結果僅對測試之樣品負責，同時此樣品僅保留90天。本報告未經本公司書面許可，不可部份複製。

This document is issued by the Company subject to its General Conditions of Service printed overleaf, available on request or accessible at www.sgs.com/terms_and_conditions.htm and, for electronic format documents, subject to Terms and Conditions for Electronic Documents at www.sgs.com/terms_e-document.htm. Attention is drawn to the limitation of liability, indemnification and jurisdiction issues defined therein. Any holder of this document is advised that information contained hereon reflects the Company's findings at the time of its intervention only and within the limits of Client's instructions, if any. The Company's sole responsibility is to its Client and this document does not exonerate parties to a transaction from exercising all their rights and obligations under the transaction documents. This document cannot be reproduced except in full, without prior written approval of the Company. Any unauthorized alteration, forgery or falsification of the content or appearance of this document is unlawful and offenders may be prosecuted to the fullest extent of the law.

Radiated Spurious Emission Measurement Result: HSDPA V Mode

Operation Band	:HSDPA B5	Test Date	:2013-05-03
Fundamental Frequency	:826.4 MHz	Temp./Humi.	:24.1 deg_C / 65 RH
Operation Mode	:RX LOW	Engineer	:Allen
EUT Pol.	:E1 Plan	Measurement Antenna Pol.	:VERTICAL

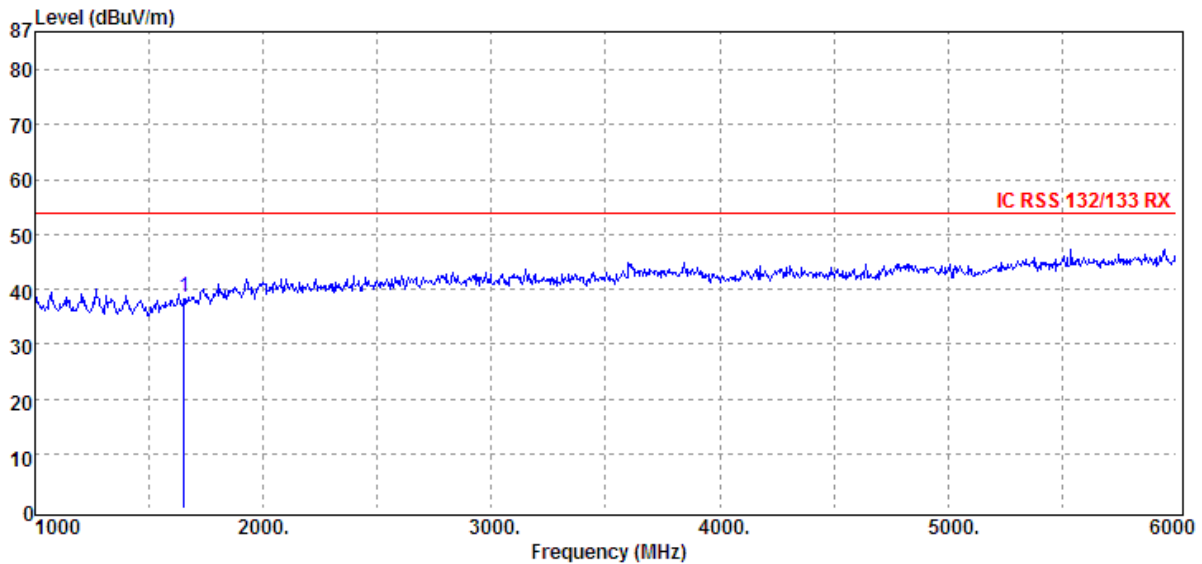
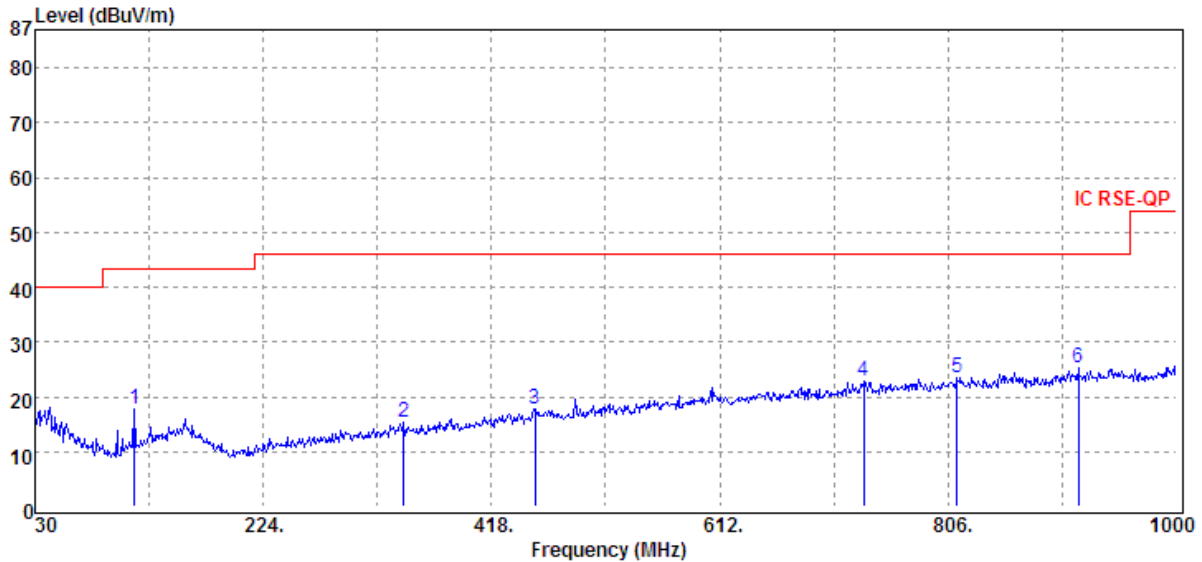

Unless otherwise stated the results shown in this test report refer only to the sample(s) tested and such sample(s) are retained for 90 days only.

除非另有說明，此報告結果僅對測試之樣品負責，同時此樣品僅保留90天。本報告未經本公司書面許可，不可部份複製。

This document is issued by the Company subject to its General Conditions of Service printed overleaf, available on request or accessible at www.sgs.com/terms_and_conditions.htm and, for electronic format documents, subject to Terms and Conditions for Electronic Documents at www.sgs.com/terms_e-document.htm. Attention is drawn to the limitation of liability, indemnification and jurisdiction issues defined therein. Any holder of this document is advised that information contained hereon reflects the Company's findings at the time of its intervention only and within the limits of Client's instructions, if any. The Company's sole responsibility is to its Client and this document does not exonerate parties to a transaction from exercising all their rights and obligations under the transaction documents. This document cannot be reproduced except in full, without prior written approval of the Company. Any unauthorized alteration, forgery or falsification of the content or appearance of this document is unlawful and offenders may be prosecuted to the fullest extent of the law.

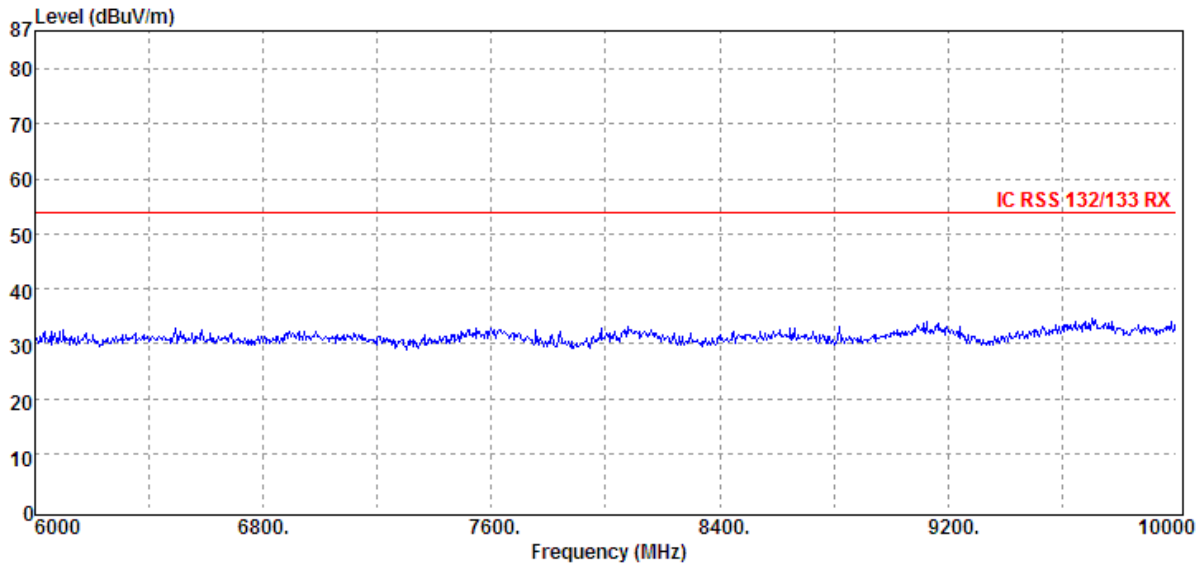

Unless otherwise stated the results shown in this test report refer only to the sample(s) tested and such sample(s) are retained for 90 days only.

除非另有說明，此報告結果僅對測試之樣品負責，同時此樣品僅保留90天。本報告未經本公司書面許可，不可部份複製。

This document is issued by the Company subject to its General Conditions of Service printed overleaf, available on request or accessible at www.sgs.com/terms_and_conditions.htm and, for electronic format documents, subject to Terms and Conditions for Electronic Documents at www.sgs.com/terms_e-document.htm. Attention is drawn to the limitation of liability, indemnification and jurisdiction issues defined therein. Any holder of this document is advised that information contained hereon reflects the Company's findings at the time of its intervention only and within the limits of Client's instructions, if any. The Company's sole responsibility is to its Client and this document does not exonerate parties to a transaction from exercising all their rights and obligations under the transaction documents. This document cannot be reproduced except in full, without prior written approval of the Company. Any unauthorized alteration, forgery or falsification of the content or appearance of this document is unlawful and offenders may be prosecuted to the fullest extent of the law.

Operation Band	:HSDPA B5	Test Date	:2013-05-03
Fundamental Frequency	:826.4 MHz	Temp./Humi.	:24.1 deg_C / 65 RH
Operation Mode	:RX LOW	Engineer	:Allen
EUT Pol.	:E1 Plan	Measurement Antenna Pol.	:HORIZONTAL

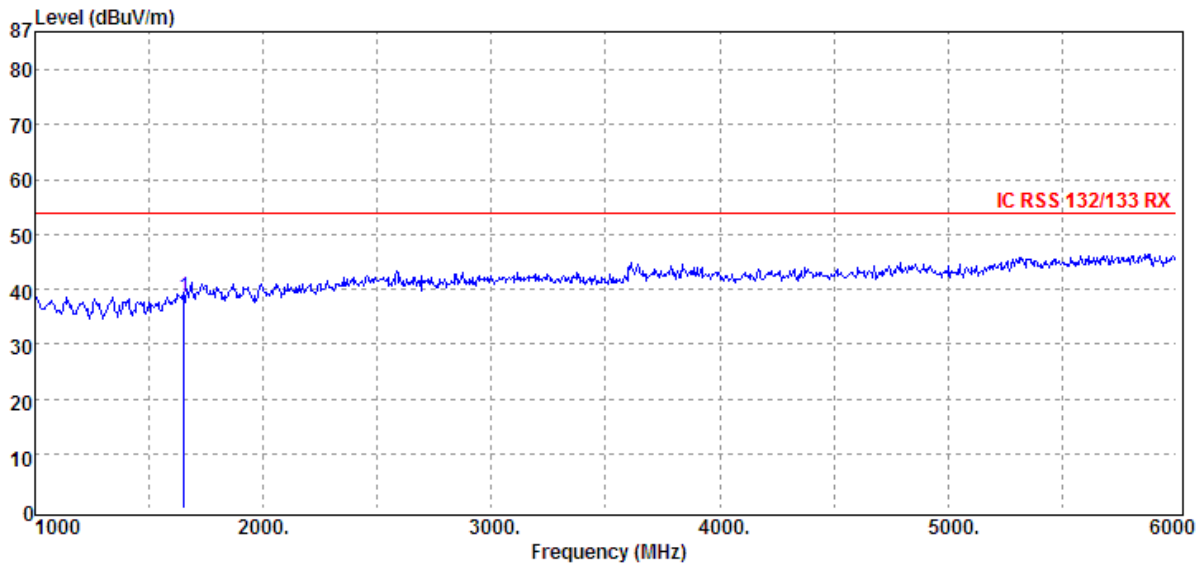
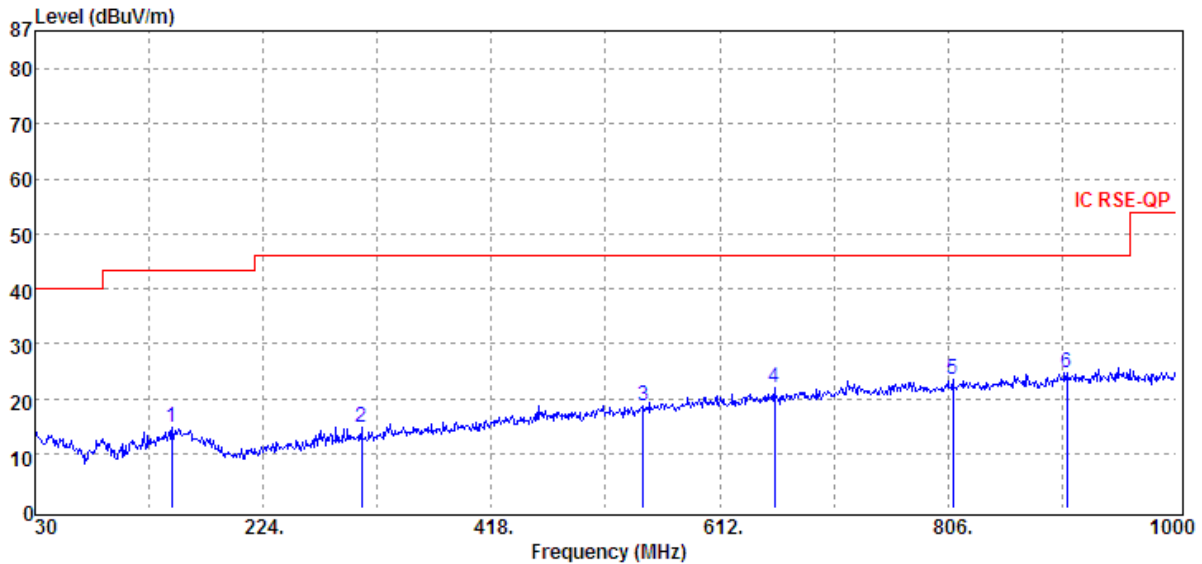

Unless otherwise stated the results shown in this test report refer only to the sample(s) tested and such sample(s) are retained for 90 days only.

除非另有說明，此報告結果僅對測試之樣品負責，同時此樣品僅保留90天。本報告未經本公司書面許可，不可部份複製。

This document is issued by the Company subject to its General Conditions of Service printed overleaf, available on request or accessible at www.sgs.com/terms_and_conditions.htm and, for electronic format documents, subject to Terms and Conditions for Electronic Documents at www.sgs.com/terms_e-document.htm. Attention is drawn to the limitation of liability, indemnification and jurisdiction issues defined therein. Any holder of this document is advised that information contained hereon reflects the Company's findings at the time of its intervention only and within the limits of Client's instructions, if any. The Company's sole responsibility is to its Client and this document does not exonerate parties to a transaction from exercising all their rights and obligations under the transaction documents. This document cannot be reproduced except in full, without prior written approval of the Company. Any unauthorized alteration, forgery or falsification of the content or appearance of this document is unlawful and offenders may be prosecuted to the fullest extent of the law.

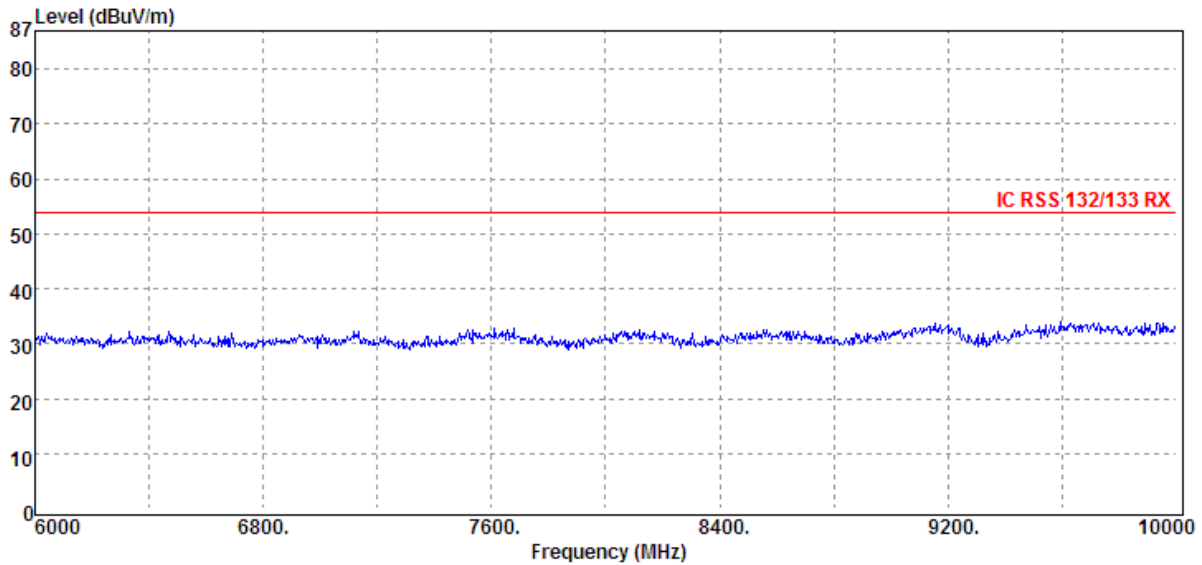

Unless otherwise stated the results shown in this test report refer only to the sample(s) tested and such sample(s) are retained for 90 days only.

除非另有說明，此報告結果僅對測試之樣品負責，同時此樣品僅保留90天。本報告未經本公司書面許可，不可部份複製。

This document is issued by the Company subject to its General Conditions of Service printed overleaf, available on request or accessible at www.sgs.com/terms_and_conditions.htm and, for electronic format documents, subject to Terms and Conditions for Electronic Documents at www.sgs.com/terms_e-document.htm. Attention is drawn to the limitation of liability, indemnification and jurisdiction issues defined therein. Any holder of this document is advised that information contained hereon reflects the Company's findings at the time of its intervention only and within the limits of Client's instructions, if any. The Company's sole responsibility is to its Client and this document does not exonerate parties to a transaction from exercising all their rights and obligations under the transaction documents. This document cannot be reproduced except in full, without prior written approval of the Company. Any unauthorized alteration, forgery or falsification of the content or appearance of this document is unlawful and offenders may be prosecuted to the fullest extent of the law.

Operation Band	:HSDPA B5	Test Date	:2013-05-03
Fundamental Frequency	:836.6 MHz	Temp./Humi.	:24.1 deg_C / 65 RH
Operation Mode	:RX MID	Engineer	:Allen
EUT Pol.	:E1 Plan	Measurement Antenna Pol.	:VERTICAL

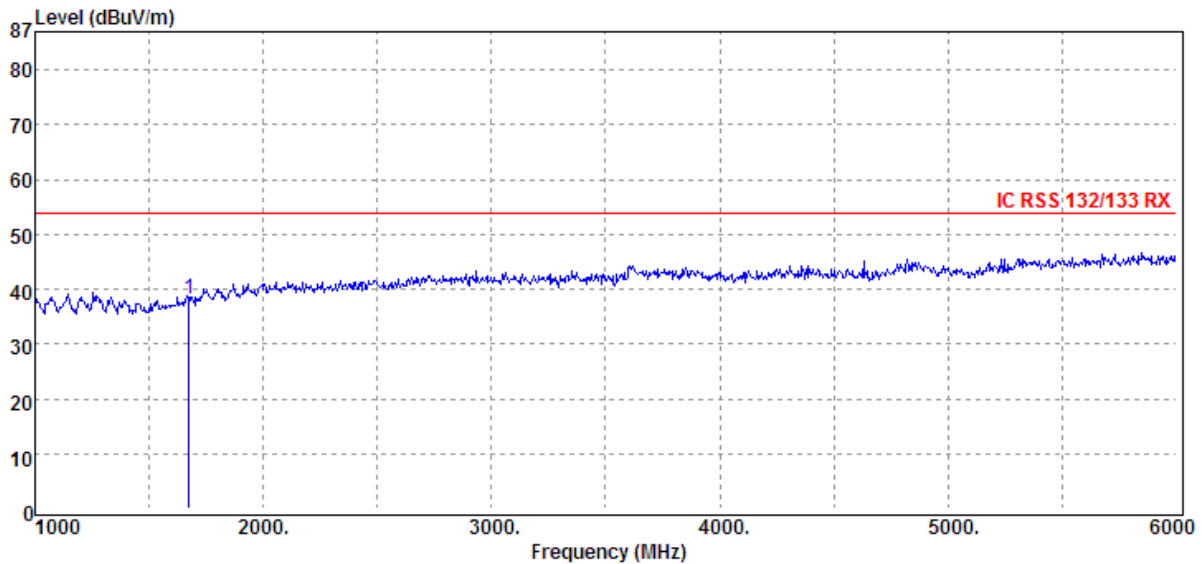
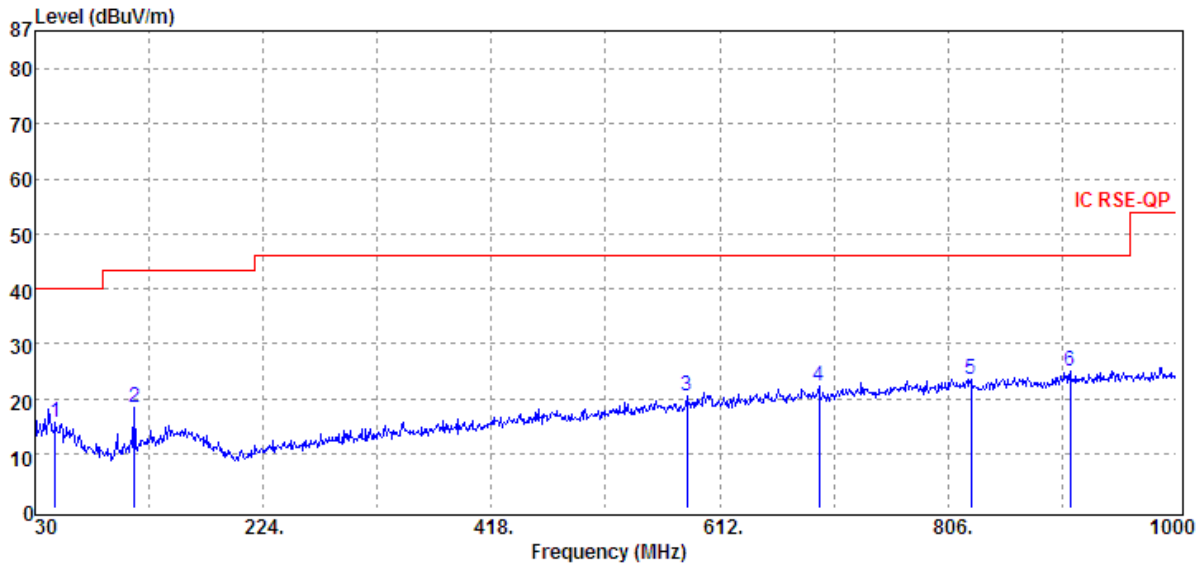

Unless otherwise stated the results shown in this test report refer only to the sample(s) tested and such sample(s) are retained for 90 days only.

除非另有說明，此報告結果僅對測試之樣品負責，同時此樣品僅保留90天。本報告未經本公司書面許可，不可部份複製。

This document is issued by the Company subject to its General Conditions of Service printed overleaf, available on request or accessible at www.sgs.com/terms_and_conditions.htm and, for electronic format documents, subject to Terms and Conditions for Electronic Documents at www.sgs.com/terms_e-document.htm. Attention is drawn to the limitation of liability, indemnification and jurisdiction issues defined therein. Any holder of this document is advised that information contained hereon reflects the Company's findings at the time of its intervention only and within the limits of Client's instructions, if any. The Company's sole responsibility is to its Client and this document does not exonerate parties to a transaction from exercising all their rights and obligations under the transaction documents. This document cannot be reproduced except in full, without prior written approval of the Company. Any unauthorized alteration, forgery or falsification of the content or appearance of this document is unlawful and offenders may be prosecuted to the fullest extent of the law.

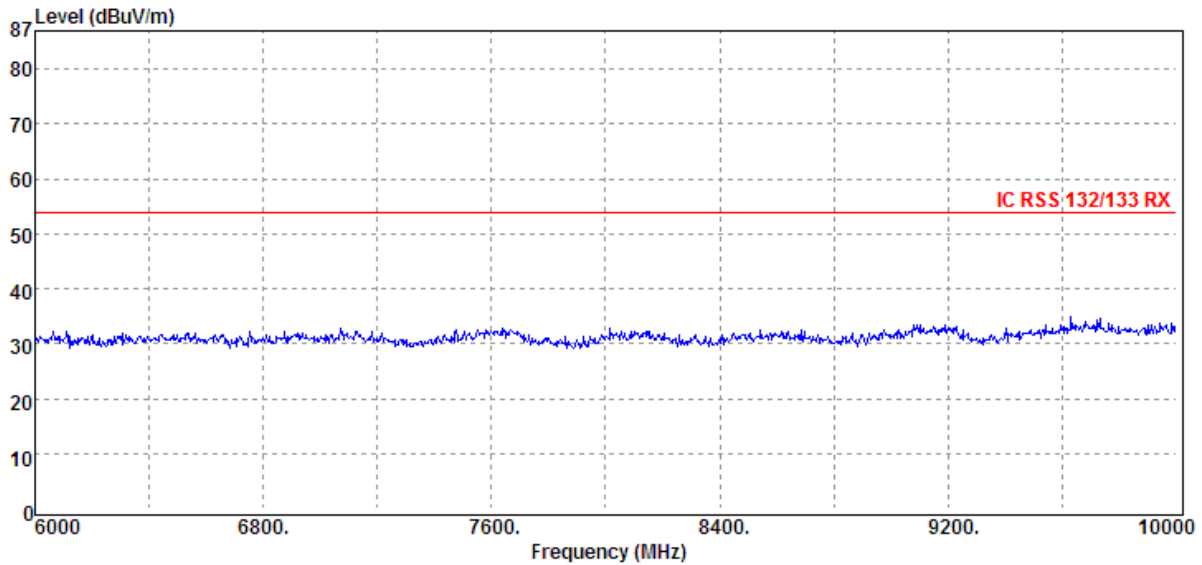

Unless otherwise stated the results shown in this test report refer only to the sample(s) tested and such sample(s) are retained for 90 days only.

除非另有說明，此報告結果僅對測試之樣品負責，同時此樣品僅保留90天。本報告未經本公司書面許可，不可部份複製。

This document is issued by the Company subject to its General Conditions of Service printed overleaf, available on request or accessible at www.sgs.com/terms_and_conditions.htm and, for electronic format documents, subject to Terms and Conditions for Electronic Documents at www.sgs.com/terms_e-document.htm. Attention is drawn to the limitation of liability, indemnification and jurisdiction issues defined therein. Any holder of this document is advised that information contained hereon reflects the Company's findings at the time of its intervention only and within the limits of Client's instructions, if any. The Company's sole responsibility is to its Client and this document does not exonerate parties to a transaction from exercising all their rights and obligations under the transaction documents. This document cannot be reproduced except in full, without prior written approval of the Company. Any unauthorized alteration, forgery or falsification of the content or appearance of this document is unlawful and offenders may be prosecuted to the fullest extent of the law.

Operation Band	:HSDPA B5	Test Date	:2013-05-03
Fundamental Frequency	:836.6 MHz	Temp./Humi.	:24.1 deg_C / 65 RH
Operation Mode	:RX MID	Engineer	:Allen
EUT Pol.	:E1 Plan	Measurement Antenna Pol.	:HORIZONTAL

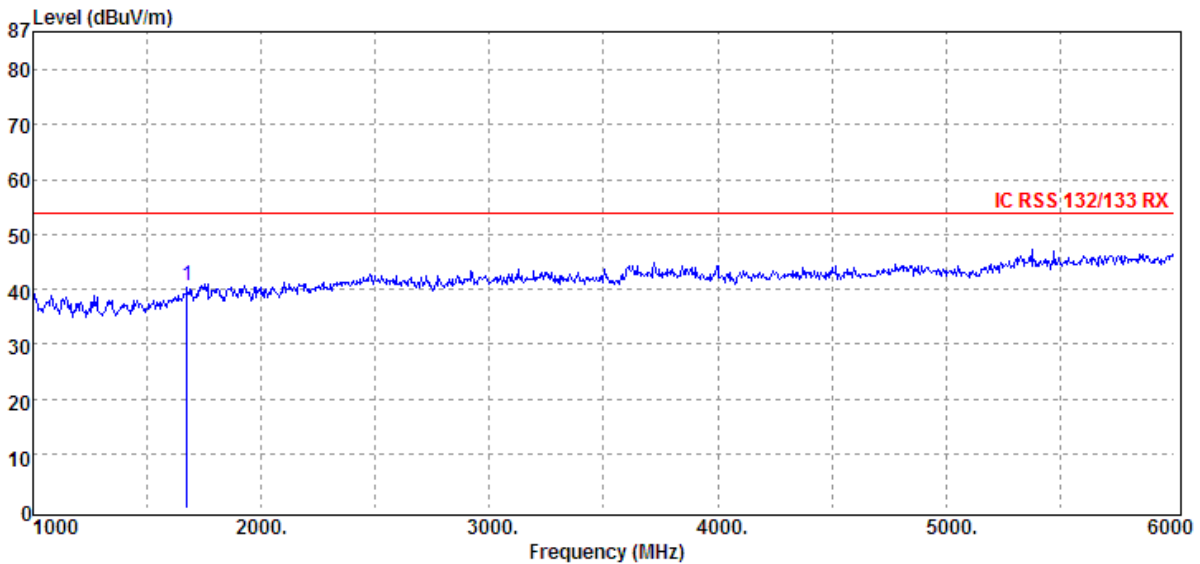
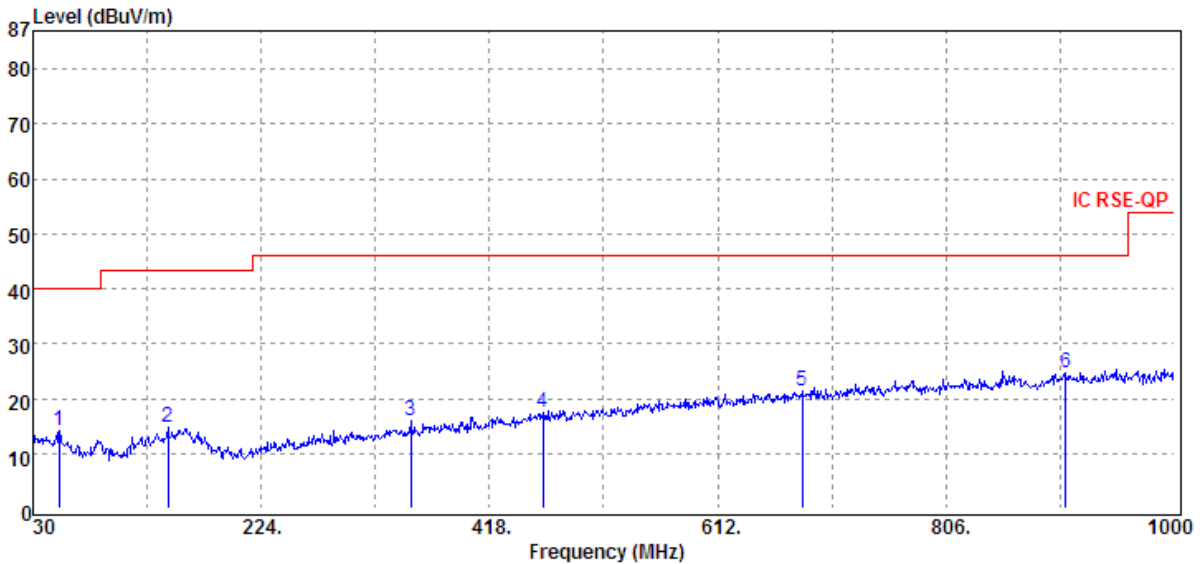

Unless otherwise stated the results shown in this test report refer only to the sample(s) tested and such sample(s) are retained for 90 days only.

除非另有說明，此報告結果僅對測試之樣品負責，同時此樣品僅保留90天。本報告未經本公司書面許可，不可部份複製。

This document is issued by the Company subject to its General Conditions of Service printed overleaf, available on request or accessible at www.sgs.com/terms_and_conditions.htm and, for electronic format documents, subject to Terms and Conditions for Electronic Documents at www.sgs.com/terms_e-document.htm. Attention is drawn to the limitation of liability, indemnification and jurisdiction issues defined therein. Any holder of this document is advised that information contained hereon reflects the Company's findings at the time of its intervention only and within the limits of Client's instructions, if any. The Company's sole responsibility is to its Client and this document does not exonerate parties to a transaction from exercising all their rights and obligations under the transaction documents. This document cannot be reproduced except in full, without prior written approval of the Company. Any unauthorized alteration, forgery or falsification of the content or appearance of this document is unlawful and offenders may be prosecuted to the fullest extent of the law.

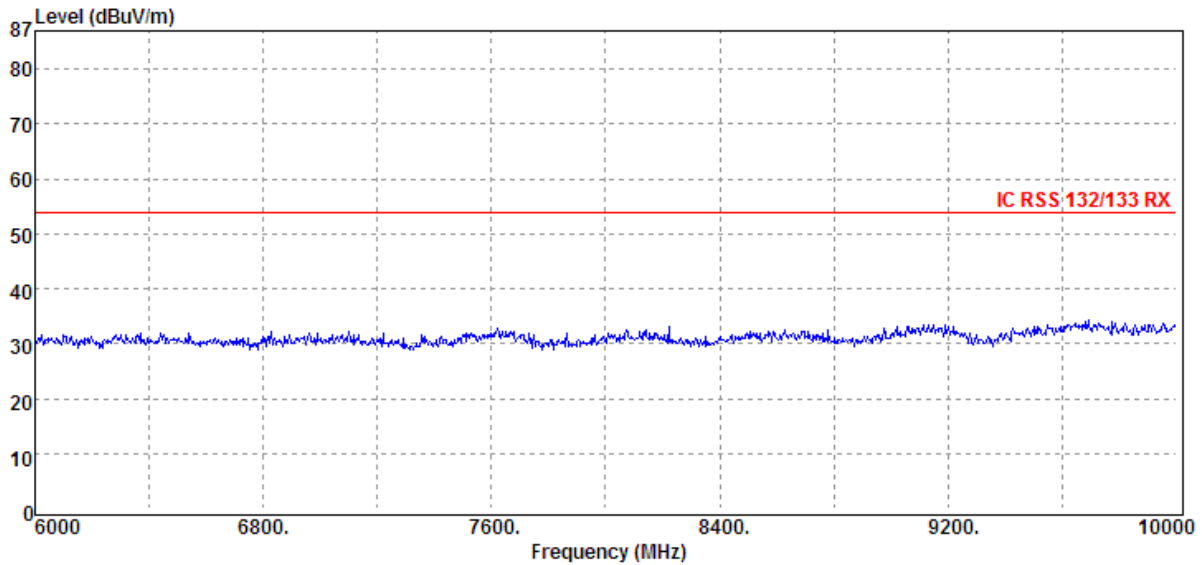

Unless otherwise stated the results shown in this test report refer only to the sample(s) tested and such sample(s) are retained for 90 days only.

除非另有說明，此報告結果僅對測試之樣品負責，同時此樣品僅保留90天。本報告未經本公司書面許可，不可部份複製。

This document is issued by the Company subject to its General Conditions of Service printed overleaf, available on request or accessible at www.sgs.com/terms_and_conditions.htm and, for electronic format documents, subject to Terms and Conditions for Electronic Documents at www.sgs.com/terms_e-document.htm. Attention is drawn to the limitation of liability, indemnification and jurisdiction issues defined therein. Any holder of this document is advised that information contained hereon reflects the Company's findings at the time of its intervention only and within the limits of Client's instructions, if any. The Company's sole responsibility is to its Client and this document does not exonerate parties to a transaction from exercising all their rights and obligations under the transaction documents. This document cannot be reproduced except in full, without prior written approval of the Company. Any unauthorized alteration, forgery or falsification of the content or appearance of this document is unlawful and offenders may be prosecuted to the fullest extent of the law.

Operation Band	:HSDPA B5	Test Date	:2013-05-03
Fundamental Frequency	:846.6 MHz	Temp./Humi.	:24.1 deg_C / 65 RH
Operation Mode	:RX HIGH	Engineer	:Allen
EUT Pol.	:E1 Plan	Measurement Antenna Pol.	:VERTICAL

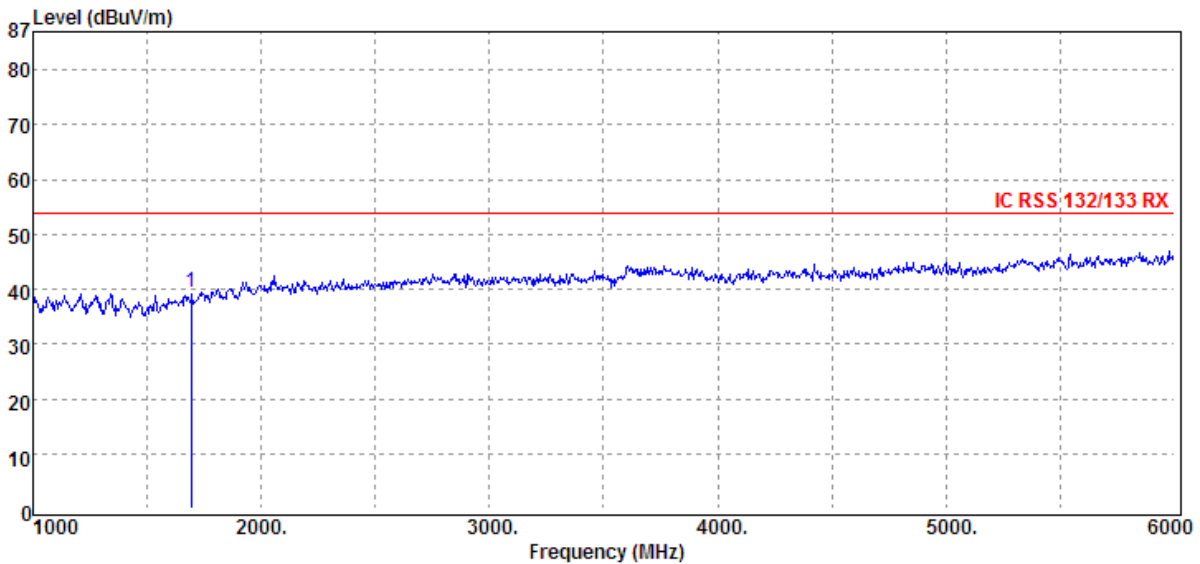
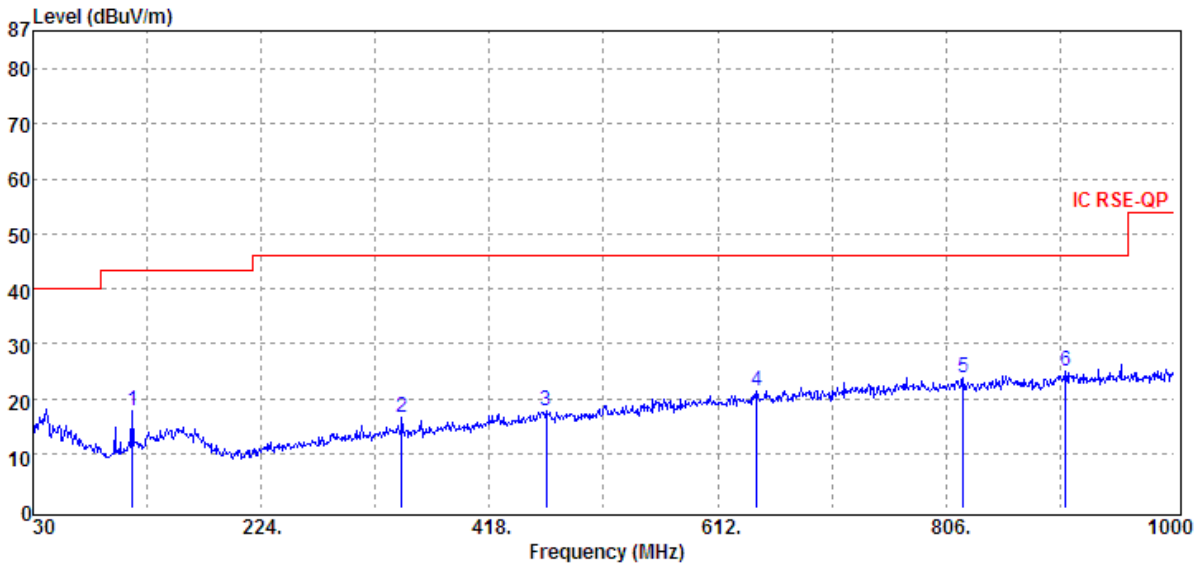

Unless otherwise stated the results shown in this test report refer only to the sample(s) tested and such sample(s) are retained for 90 days only.

除非另有說明，此報告結果僅對測試之樣品負責，同時此樣品僅保留90天。本報告未經本公司書面許可，不可部份複製。

This document is issued by the Company subject to its General Conditions of Service printed overleaf, available on request or accessible at www.sgs.com/terms_and_conditions.htm and, for electronic format documents, subject to Terms and Conditions for Electronic Documents at www.sgs.com/terms_e-document.htm. Attention is drawn to the limitation of liability, indemnification and jurisdiction issues defined therein. Any holder of this document is advised that information contained hereon reflects the Company's findings at the time of its intervention only and within the limits of Client's instructions, if any. The Company's sole responsibility is to its Client and this document does not exonerate parties to a transaction from exercising all their rights and obligations under the transaction documents. This document cannot be reproduced except in full, without prior written approval of the Company. Any unauthorized alteration, forgery or falsification of the content or appearance of this document is unlawful and offenders may be prosecuted to the fullest extent of the law.

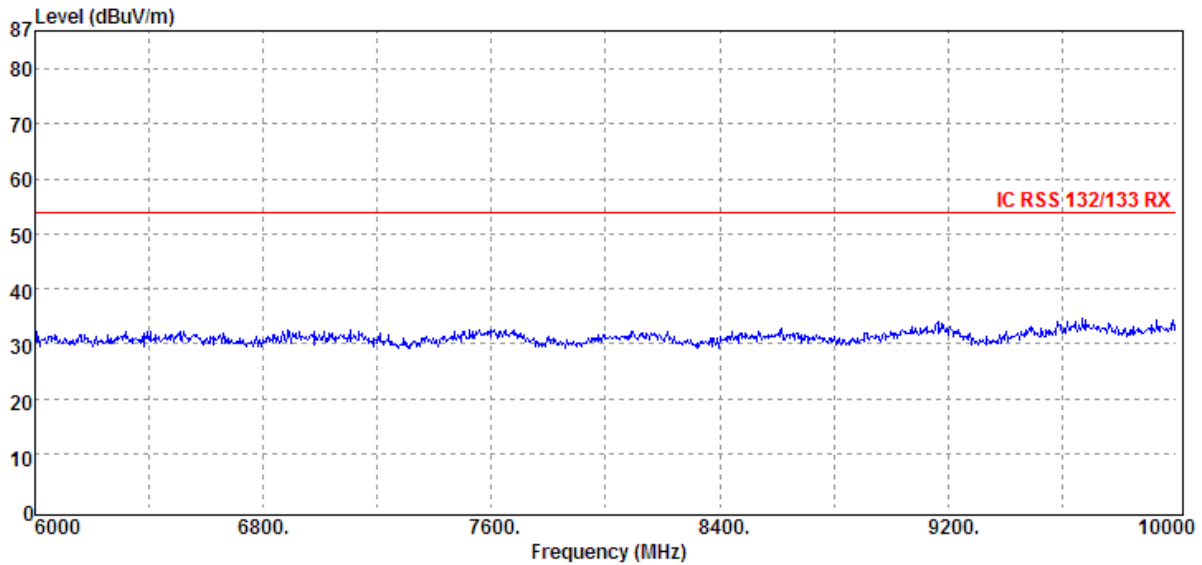

Unless otherwise stated the results shown in this test report refer only to the sample(s) tested and such sample(s) are retained for 90 days only.

除非另有說明，此報告結果僅對測試之樣品負責，同時此樣品僅保留90天。本報告未經本公司書面許可，不可部份複製。

This document is issued by the Company subject to its General Conditions of Service printed overleaf, available on request or accessible at www.sgs.com/terms_and_conditions.htm and, for electronic format documents, subject to Terms and Conditions for Electronic Documents at www.sgs.com/terms_e-document.htm. Attention is drawn to the limitation of liability, indemnification and jurisdiction issues defined therein. Any holder of this document is advised that information contained hereon reflects the Company's findings at the time of its intervention only and within the limits of Client's instructions, if any. The Company's sole responsibility is to its Client and this document does not exonerate parties to a transaction from exercising all their rights and obligations under the transaction documents. This document cannot be reproduced except in full, without prior written approval of the Company. Any unauthorized alteration, forgery or falsification of the content or appearance of this document is unlawful and offenders may be prosecuted to the fullest extent of the law.

Operation Band	:HSDPA B5	Test Date	:2013-05-03
Fundamental Frequency	:846.6 MHz	Temp./Humi.	:24.1 deg_C / 65 RH
Operation Mode	:RX HIGH	Engineer	:Allen
EUT Pol.	:E1 Plan	Measurement Antenna Pol.	:HORIZONTAL

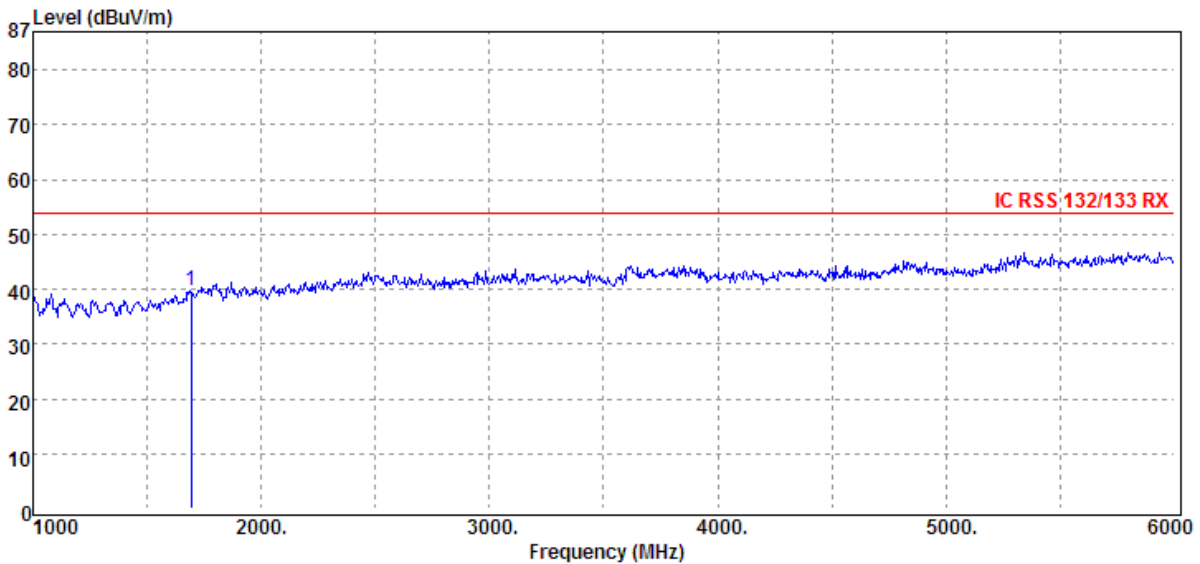
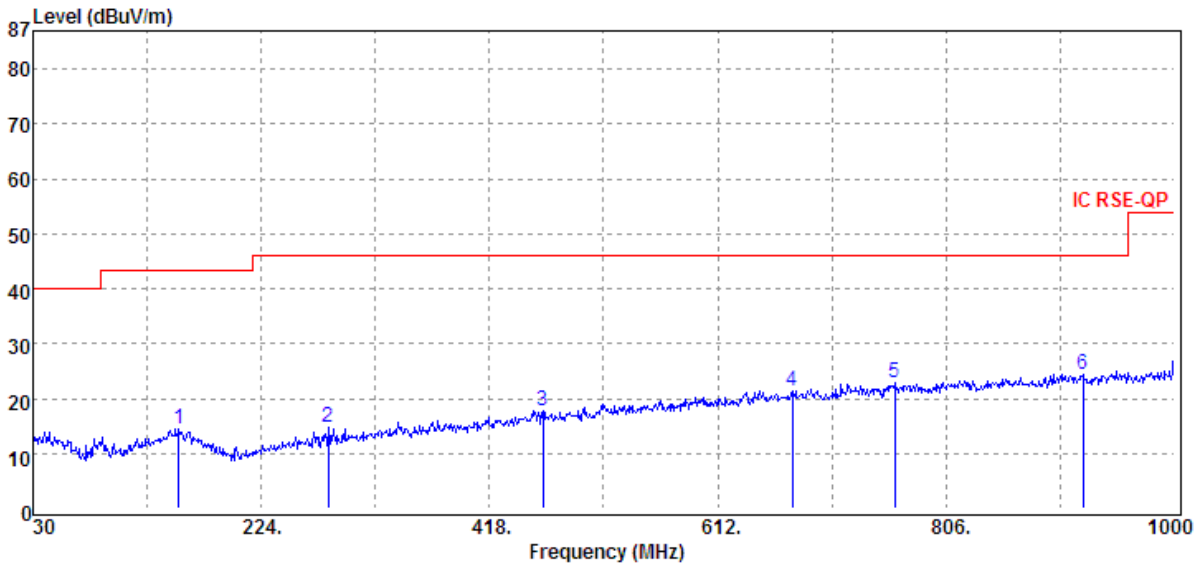

Unless otherwise stated the results shown in this test report refer only to the sample(s) tested and such sample(s) are retained for 90 days only.

除非另有說明，此報告結果僅對測試之樣品負責，同時此樣品僅保留90天。本報告未經本公司書面許可，不可部份複製。

This document is issued by the Company subject to its General Conditions of Service printed overleaf, available on request or accessible at www.sgs.com/terms_and_conditions.htm and, for electronic format documents, subject to Terms and Conditions for Electronic Documents at www.sgs.com/terms_e-document.htm. Attention is drawn to the limitation of liability, indemnification and jurisdiction issues defined therein. Any holder of this document is advised that information contained hereon reflects the Company's findings at the time of its intervention only and within the limits of Client's instructions, if any. The Company's sole responsibility is to its Client and this document does not exonerate parties to a transaction from exercising all their rights and obligations under the transaction documents. This document cannot be reproduced except in full, without prior written approval of the Company. Any unauthorized alteration, forgery or falsification of the content or appearance of this document is unlawful and offenders may be prosecuted to the fullest extent of the law.

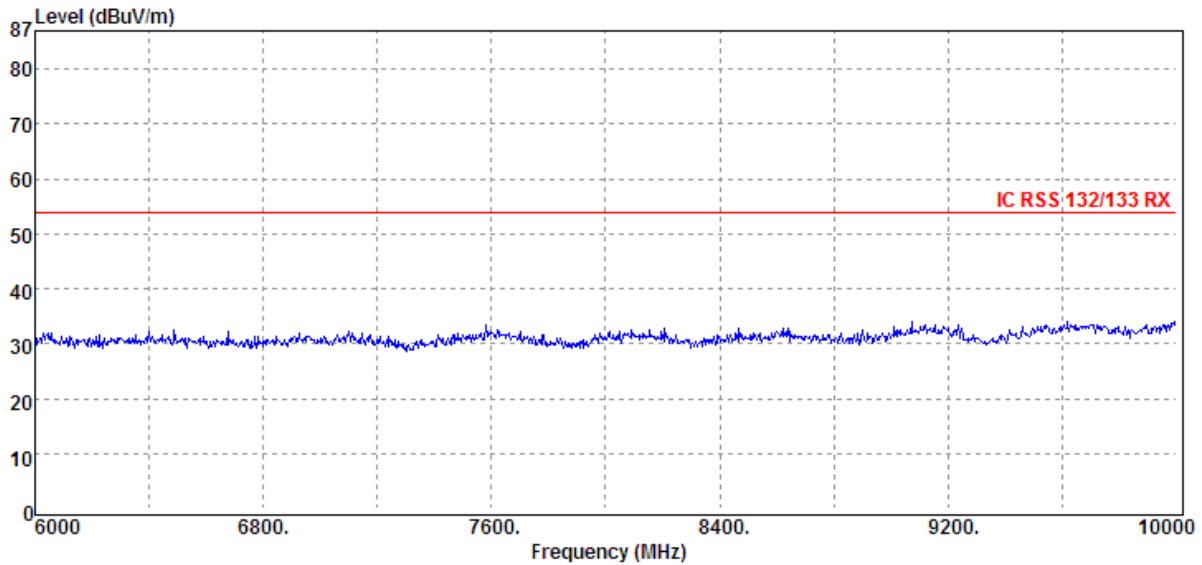

~ End of Report ~

Unless otherwise stated the results shown in this test report refer only to the sample(s) tested and such sample(s) are retained for 90 days only.

除非另有說明，此報告結果僅對測試之樣品負責，同時此樣品僅保留90天。本報告未經本公司書面許可，不可部份複製。

This document is issued by the Company subject to its General Conditions of Service printed overleaf, available on request or accessible at www.sgs.com/terms_and_conditions.htm and, for electronic format documents, subject to Terms and Conditions for Electronic Documents at www.sgs.com/terms_e-document.htm. Attention is drawn to the limitation of liability, indemnification and jurisdiction issues defined therein. Any holder of this document is advised that information contained hereon reflects the Company's findings at the time of its intervention only and within the limits of Client's instructions, if any. The Company's sole responsibility is to its Client and this document does not exonerate parties to a transaction from exercising all their rights and obligations under the transaction documents. This document cannot be reproduced except in full, without prior written approval of the Company. Any unauthorized alteration, forgery or falsification of the content or appearance of this document is unlawful and offenders may be prosecuted to the fullest extent of the law.