



SAR EVALUATION REPORT

Applicant Name:
Sony Mobile Communications AB
Nya Vattentornet
SE-221 88, Lund
Sweden

Date of Testing:
05/06/13 – 08/01/13
Test Site/Location:
PCTEST Lab, Columbia, MD, USA
Document Serial No.:
0Y1306100973.PY7

FCC ID: PY7PM-0410

APPLICANT: SONY MOBILE COMMUNICATIONS AB

DUT Type: Portable Handset
Application Type: Certification
FCC Rule Part(s): CFR §2.1093
Type Number: PM-0410-BV

Equipment Class	Band & Mode	Tx Frequency	Measured Conducted Power [dBm]	SAR			
				1 gm Head (W/kg)	1 gm Body-Worn (W/kg)	1 gm Hotspot (W/kg)	10 gm Extremity (W/kg)
PCE	GSM/GPRS/EDGE 850	824.20 - 848.80 MHz	33.37	0.41	0.47	1.01	
PCE	UMTS V	826.40 - 846.60 MHz	24.28	0.36	0.45	0.82	
PCE	UMTS IV	1712.4 - 1752.5 MHz	24.15	0.27	0.74	0.85	3.06
PCE	GSM/GPRS/EDGE 1900	1850.20 - 1909.80 MHz	30.54	< 0.1	0.40	0.73	
PCE	UMTS II	1852.4 - 1907.6 MHz	23.78	0.16	0.83	0.90	2.56
PCE	LTE Band 5 (Cell)	824.7 - 848.3 MHz	22.73	0.25	0.34	0.58	
PCE	LTE Band 4 (AWS)	1710.7 - 1754.3 MHz	23.49	0.20	0.61	0.86	2.27
PCE	LTE Band 2 (PCS)	1850.7 - 1909.3 MHz	23.47	0.14	0.93	0.92	2.87
PCE	LTE Band 7	2502.5 - 2567.5 MHz	17.56	0.19	0.43	0.85	
DTS	2.4 GHz WLAN	2412 - 2462 MHz	13.13	1.10	0.18	0.32	
DTS	5.8 GHz WLAN	5745 - 5825 MHz	13.48	1.02	0.13		0.44
NII	5.2 GHz WLAN	5180 - 5240 MHz	13.39	0.81	< 0.1		0.58
NII	5.3 GHz WLAN	5260 - 5320 MHz	12.93	0.75	0.10		0.72
NII	5.5 GHz WLAN	5500 - 5700 MHz	11.45	0.75	0.10		0.45
DSS/DTS	Bluetooth	2402 - 2480 MHz	7.72		N/A		
Simultaneous SAR per KDB 690783 D01v01r02:				1.37	1.05	1.27	3.78

Note: Powers in the above table represent output powers for the SAR test configurations and may not represent the highest output powers for all configurations for each mode.

This wireless portable device has been shown to be capable of compliance for localized specific absorption rate (SAR) for uncontrolled environment/general population exposure limits specified in ANSI/IEEE C95.1-1992 and has been tested in accordance with the measurement procedures specified in Section 1.8 of this report; for North American frequency bands only.

I attest to the accuracy of data. All measurements reported herein were performed by me or were made under my supervision and are correct to the best of my knowledge and belief. I assume full responsibility for the completeness of these measurements and vouch for the qualifications of all persons taking them. Test results reported herein relate only to the item(s) tested.



Randy Ortanez
President



FCC ID: PY7PM-0410	PCTEST ENGINEERING LABORATORY, INC.	SAR EVALUATION REPORT	SONY	Reviewed by: Quality Manager
Document S/N: 0Y1306100973.PY7	Test Dates: 05/06/13 - 08/01/13	DUT Type: Portable Handset		Page 1 of 83

T A B L E O F C O N T E N T S

1	DEVICE UNDER TEST	3
2	LTE INFORMATION	12
3	INTRODUCTION	13
4	DOSIMETRIC ASSESSMENT	14
5	DEFINITION OF REFERENCE POINTS	15
6	TEST CONFIGURATION POSITIONS FOR HANDSETS	16
7	RF EXPOSURE LIMITS	20
8	FCC MEASUREMENT PROCEDURES.....	21
9	RF CONDUCTED POWERS.....	25
10	SYSTEM VERIFICATION.....	52
11	SAR DATA SUMMARY	56
12	FCC MULTI-TX AND ANTENNA SAR CONSIDERATIONS.....	70
13	SAR MEASUREMENT VARIABILITY	76
14	EQUIPMENT LIST.....	77
15	MEASUREMENT UNCERTAINTIES	79
16	CONCLUSION.....	81
17	REFERENCES	82
APPENDIX A: SAR TEST PLOTS		
APPENDIX B: SAR DIPOLE VERIFICATION PLOTS		
APPENDIX C: PROBE AND DIPOLE CALIBRATION CERTIFICATES		
APPENDIX D: SAR TISSUE SPECIFICATIONS		
APPENDIX E: SAR SYSTEM VALIDATION		
APPENDIX F: SAR TEST SETUP PHOTOGRAPHS		

FCC ID: PY7PM-0410		SAR EVALUATION REPORT		Reviewed by: Quality Manager
Document S/N: 0Y1306100973.PY7	Test Dates: 05/06/13 - 08/01/13	DUT Type: Portable Handset		Page 2 of 83

1 DEVICE UNDER TEST

1.1 Device Overview

Band & Mode	Operating Modes	Tx Frequency
GSM/GPRS/EDGE 850	Voice/Data	824.20 - 848.80 MHz
UMTS V	Voice/Data	826.40 - 846.60 MHz
UMTS IV	Voice/Data	1712.4 - 1752.5 MHz
GSM/GPRS/EDGE 1900	Voice/Data	1850.20 - 1909.80 MHz
UMTS II	Voice/Data	1852.4 - 1907.6 MHz
LTE Band 5 (Cell)	Data	824.7 - 848.3 MHz
LTE Band 4 (AWS)	Data	1710.7 - 1754.3 MHz
LTE Band 2 (PCS)	Data	1850.7 - 1909.3 MHz
LTE Band 7	Data	2502.5 - 2567.5 MHz
2.4 GHz WLAN	Data	2412 - 2462 MHz
5.8 GHz WLAN	Data	5745 - 5825 MHz
5.2 GHz WLAN	Data	5180 - 5240 MHz
5.3 GHz WLAN	Data	5260 - 5320 MHz
5.5 GHz WLAN	Data	5500 - 5700 MHz
Bluetooth	Data	2402 - 2480 MHz
NFC	Data	13.56 MHz

1.2 Power Reduction for SAR

This device utilizes power reduction under some portable hotspot conditions (tethering) for SAR compliance. There is power reduction for GSM/GPRS/EDGE 1900, UMTS FDD 4, UMTS FDD 2, LTE Band 4, LTE Band 2, and LTE Band 7. There is no power reduction for GSM/GPRS/EDGE 850, UMTS FDD 5, LTE Band 5, and WLAN modes. The reduced powers were confirmed via conducted power measurements at the RF port (see Section 9). Detailed description of the hotspot power reduction mechanism is included in the operational description.

FCC ID: PY7PM-0410	 PCTEST ENGINEERING LABORATORY, INC.	SAR EVALUATION REPORT	SONY	Reviewed by: Quality Manager
Document S/N: 0Y1306100973.PY7	Test Dates: 05/06/13 - 08/01/13	DUT Type: Portable Handset		Page 3 of 83

1.3 Nominal and Maximum Output Power Specifications

This device operates using the following maximum and nominal output power specifications. SAR values were scaled to the maximum allowed power to determine compliance per KDB Publication 447498 D01v05.

Reduced Power with hotspot mode activated:

Mode / Band		Voice (dBm)	Burst Average GSMK (dBm)				Burst Average 8-PSK (dBm)				
			1 TX Slot	1 TX Slots	2 TX Slots	3 TX Slots	4 TX Slots	1 TX Slots	2 TX Slots	3 TX Slots	4 TX Slots
GSM/GPRS/EDGE 1900	Tethering On	Maximum	29.0	29.0	27.0	25.5	24.5	27.0	25.0	24.0	23.0
		Nominal	27.3	27.3	25.3	23.8	22.8	26.0	24.0	23.0	22.0

Mode / Band			Modulated Average (dBm)			
			3GPP RMC	3GPP HSDPA	3GPP HSUPA	3GPP DC-HSDPA
UMTS Band IV (1750 MHz)	Tethering On	Maximum	21.9	21.9	21.9	21.9
		Nominal	20.4	20.4	20.4	20.4
UMTS Band II (1900 MHz)	Tethering On	Maximum	21.0	21.0	21.0	21.0
		Nominal	19.5	19.5	19.5	19.5

Mode / Band			Modulated Average (dBm)
LTE Band 4 (AWS)	Tethering On	Maximum	21.9
		Nominal	20.3
LTE Band 2 (PCS)	Tethering On	Maximum	21.0
		Nominal	19.2
LTE Band 7	Tethering On	Maximum	18.0
		Nominal	15.2

FCC ID: PY7PM-0410	 PCTEST ENGINEERING LABORATORY, INC.	SAR EVALUATION REPORT	SONY	Reviewed by: Quality Manager
Document S/N: 0Y1306100973.PY7	Test Dates: 05/06/13 - 08/01/13	DUT Type: Portable Handset		Page 4 of 83

Maximum Power with hotspot mode inactive:

Mode / Band			Voice (dBm)	Burst Average GMSK (dBm)				Burst Average 8-PSK (dBm)			
			1 TX Slot	1 TX Slots	2 TX Slots	3 TX Slots	4 TX Slots	1 TX Slots	2 TX Slots	3 TX Slots	4 TX Slots
GSM/GPRS/EDGE 850	Tethering Off	Maximum	33.6	33.6	31.6	30.6	29.6	28.0	26.0	25.0	24.0
		Nominal	33.0	33.0	31.0	30.0	29.0	27.0	25.0	24.0	23.0
GSM/GPRS/EDGE 1900	Tethering Off	Maximum	30.6	30.6	28.5	27.5	26.5	27.0	25.0	24.0	23.0
		Nominal	30.0	30.0	28.0	27.0	26.0	26.0	24.0	23.0	22.0

Mode / Band			Modulated Average (dBm)			
			3GPP RMC	3GPP HSDPA	3GPP HSUPA	3GPP DC-HSDPA
UMTS Band V (850 MHz)	Tethering Off	Maximum	24.5	24.5	24.5	24.5
		Nominal	24.0	24.0	24.0	24.0
UMTS Band IV (1750 MHz)	Tethering Off	Maximum	24.5	24.5	24.5	24.5
		Nominal	24.0	24.0	24.0	24.0
UMTS Band II (1900 MHz)	Tethering Off	Maximum	24.0	24.0	24.0	24.0
		Nominal	23.5	23.5	23.5	23.5

Mode / Band			Modulated Average (dBm)
LTE Band 5 (Cell)	Tethering Off	Maximum	23.1
		Nominal	22.5
LTE Band 4 (AWS)	Tethering Off	Maximum	23.6
		Nominal	23.0
LTE Band 2 (PCS)	Tethering Off	Maximum	23.8
		Nominal	23.0
LTE Band 7	Tethering Off	Maximum	18.7
		Nominal	17.9

FCC ID: PY7PM-0410	 PCTEST ENGINEERING LABORATORY, INC.	SAR EVALUATION REPORT	SONY	Reviewed by: Quality Manager
Document S/N: OY1306100973.PY7	Test Dates: 05/06/13 - 08/01/13	DUT Type: Portable Handset		Page 5 of 83

Mode / Band		Modulated Average (dBm)		
IEEE 802.11b (2.4 GHz)	Channel	1	2-10	11
	Maximum	12.0	14.0	12.0
	Nominal	11.3	13.3	11.3
IEEE 802.11g (2.4 GHz)	Channel	1	2-10	11
	Maximum	11.8	13.8	11.8
	Nominal	11.1	13.1	11.1
IEEE 802.11n (2.4 GHz)	Channel	1	2-10	11
	Maximum	11.8	13.8	11.8
	Nominal	11.1	13.1	11.1
IEEE 802.11a (5 GHz 6Mbps - 18Mbps)	Channel	36-64	100-140	149-165
	Maximum	13.5	11.5	13.5
	Nominal	12.8	10.8	12.8
IEEE 802.11a (5 GHz 24Mbps - 54Mbps)	Channel	36-64	100-140	149-165
	Maximum	12.5	11.5	12.5
	Nominal	11.8	10.8	11.8
IEEE 802.11n (5GHz HT20)	Channel	36-64	100-140	149-165
	Maximum	12.0	11.0	12.0
	Nominal	11.3	10.3	11.3
IEEE 802.11n (5GHz HT40)	Channel	38-62	102-134	151-159
	Maximum	11.8	11.0	11.8
	Nominal	11.1	10.3	11.1
IEEE 802.11ac (5GHz 80MHz BW MCS0 - MCS3)	Channel	42-58	106-122	155
	Maximum	11.0	11.0	11.8
	Nominal	10.3	10.3	11.1
IEEE 802.11ac (5 GHz 80MHz BW MCS4 - MCS7)	Channel	42-58	106-122	155
	Maximum	10.5	10.5	10.5
	Nominal	9.8	9.8	9.8
Bluetooth	Maximum	9.5		
	Nominal	6.0		

FCC ID: PY7PM-0410	 PCTEST ENGINEERING LABORATORY, INC.	SAR EVALUATION REPORT	SONY	Reviewed by: Quality Manager
Document S/N: OY1306100973.PY7	Test Dates: 05/06/13 - 08/01/13	DUT Type: Portable Handset		Page 6 of 83

1.4 DUT Antenna Locations

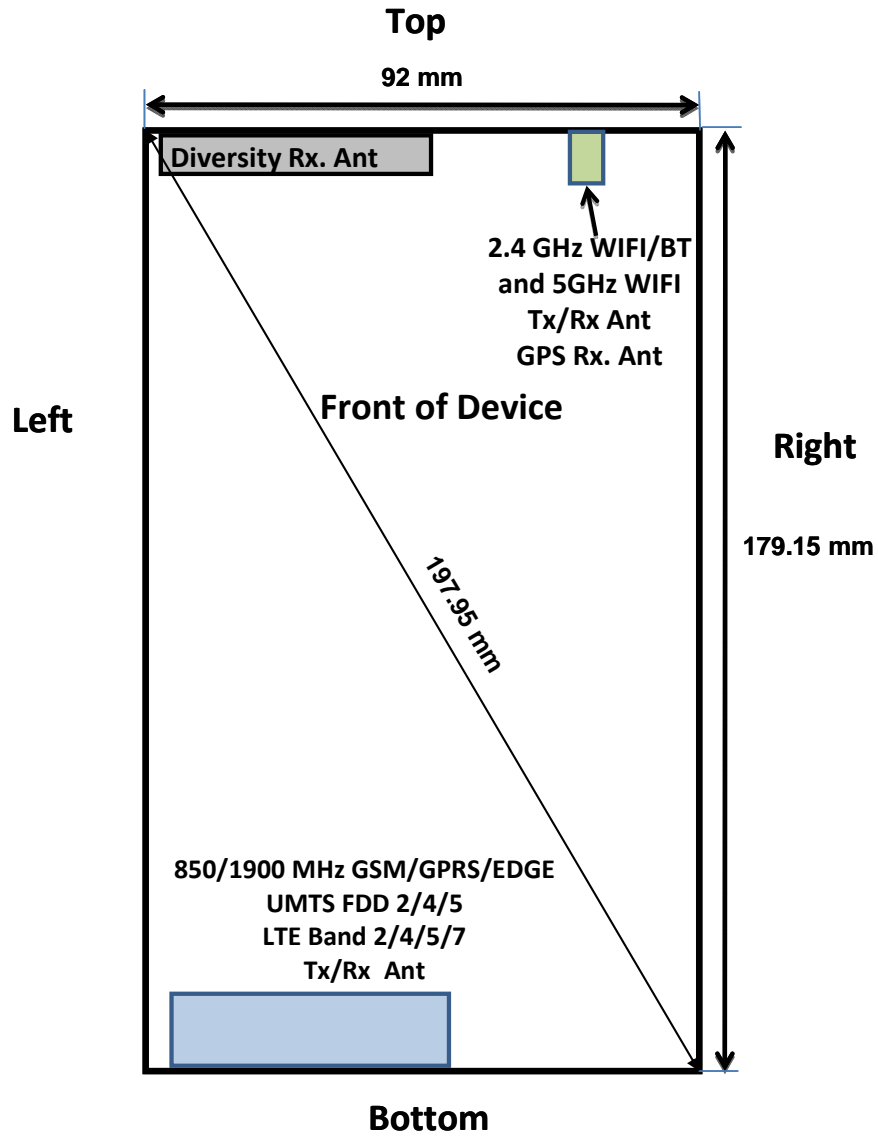

Notes:

1. Exact antenna dimensions and separation distances are shown in the Technical Descriptions in the FCC Filing.
2. Because the diagonal distance of this device is > 160 mm, it is considered a "phablet".

Figure 1-1
DUT Antenna Locations

FCC ID: PY7PM-0410	 PCTEST ENGINEERING LABORATORY, INC.	SAR EVALUATION REPORT	SONY	Reviewed by: Quality Manager
Document S/N: 0Y1306100973.PY7	Test Dates: 05/06/13 - 08/01/13	DUT Type: Portable Handset		Page 7 of 83

**Table 1-1
Sides for SAR Testing for Hotspot and Extremity Exposure Conditions**

Mode	Back	Front	Top	Bottom	Right	Left
GPRS 850	Yes	Yes	No	Yes	No	Yes
UMTS V	Yes	Yes	No	Yes	No	Yes
UMTS IV	Yes	Yes	No	Yes	No	Yes
GPRS 1900	Yes	Yes	No	Yes	No	Yes
UMTS II	Yes	Yes	No	Yes	No	Yes
LTE Band 5 (Cell)	Yes	Yes	No	Yes	No	Yes
LTE Band 4 (AWS)	Yes	Yes	No	Yes	No	Yes
LTE Band 2 (PCS)	Yes	Yes	No	Yes	No	Yes
LTE Band 7	Yes	Yes	No	Yes	No	Yes
2.4 GHz WLAN	Yes	Yes	Yes	No	Yes	No
5 GHz WLAN	Yes	Yes	Yes	No	Yes	No



Note: Particular DUT edges were not required to be evaluated for Wireless Router or Hand SAR if the edges were greater than 2.5 cm from the transmitting antenna according to FCC KDB Publication 941225 D06v01 guidance, page 2 and FCC KDB Publication 865664 D04v01r01. When the wireless router mode is enabled, all 5 GHz bands are disabled.

1.5 Near Field Communications (NFC) Antenna

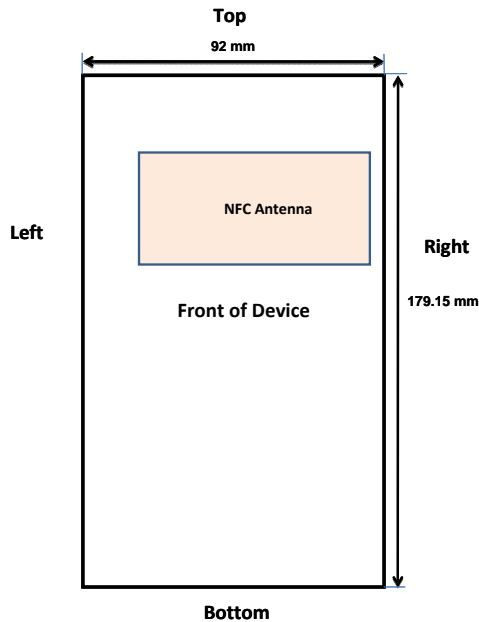
This DUT has NFC operations. The NFC antenna is integrated into the device. Therefore, all SAR tests were performed with the NFC antenna already incorporated.



**Figure 1-2
NFC Antenna Locations**

FCC ID: PY7PM-0410		SAR EVALUATION REPORT		Reviewed by: Quality Manager
Document S/N: OY1306100973.PY7	Test Dates: 05/06/13 - 08/01/13	DUT Type: Portable Handset		Page 8 of 83

1.6 Simultaneous Transmission Capabilities

According to FCC KDB Publication 447498 D05v01, transmitters are considered to be transmitting simultaneously when there is overlapping transmission, with the exception of transmissions during network hand-offs with maximum hand-off duration less than 30 seconds. This device contains multiple transmitters that may operate simultaneously, and therefore requires a simultaneous transmission analysis according to FCC KDB Publication 447498 D01v05 3) procedures.

**Table 1-2
Simultaneous Transmission Scenarios**

No.	Capable Transmit Configurations	Head	Body-Worn Accessory	Hot Spot	Extremity
		IEEE 1528, Supp C	Supp C	FCC KDB 941225 D06 edges/sides	FCC KDB 648474 D04 edges/sides
1	GSM 850/1900 MHz Voice + WiFi 2.4 GHz	Yes	15mm	N/A	Yes
2	UMTS FDD 2/4/5 Voice + WiFi 2.4 GHz	Yes	15mm	N/A	Yes
3	850/1900 MHz GPRS Data + WiFi 2.4 GHz	N/A	N/A	Yes	Yes
4	UMTS FDD 2/4/5 Data + WiFi 2.4 GHz	Yes	15mm	Yes	Yes
5	LTE B2/4/5/7 Data + WiFi 2.4 GHz	Yes*	15mm*	Yes	Yes
6	GSM 850/1900 MHz Voice + 2.4 GHz Bluetooth	N/A	15mm	N/A	Yes
7	UMTS FDD 2/4/5 Voice + 2.4 GHz Bluetooth	N/A	15mm	N/A	Yes
8	LTE B2/4/5/7 Data + 2.4 GHz Bluetooth	N/A	15mm*	N/A	Yes
9	GSM 850/1900 MHz Voice + WiFi 5 GHz	Yes	15mm	N/A	Yes
10	UMTS FDD 2/4/5 Voice + WiFi 5 GHz	Yes	15mm	N/A	Yes
11	850/1900 MHz GPRS/EDGE Data + WiFi 5GHz	N/A	N/A	N/A	Yes
12	UMTS FDD 2/4/5 Data + WIFI 5 GHz	N/A	N/A	N/A	Yes
13	LTE B2/4/5/7 Data + WiFi 5 GHz	N/A	N/A	N/A	Yes
14	All Voice + LTE	N/A	N/A	N/A	N/A
15	All Voice + WIFI + LTE	N/A	N/A	N/A	N/A

Notes:

- (*) = for VOIP 3rd party applications possibly installed and used by the end-user
- When the user utilizes multiple services in UMTS 3G mode it uses multi-Radio Access Bearer or multi-RAB. The power control is based on a physical control channel (Dedicated Physical Control Channel [DPCCH]) and power control will be adjusted to meet the needs of both services. Therefore, the UMTS+WLAN scenario also represents the UMTS Voice/DATA + WLAN Hotspot scenario.
- Per the manufacturer, WIFI Direct is not expected to be used in conjunction with a held-to-ear or body-worn accessory voice call. Therefore, the only new simultaneous transmission scenarios involving WIFI direct or WIFI display are for hand-held operations only.

FCC ID: PY7PM-0410	 PCTEST ENGINEERING LABORATORY, INC.	SAR EVALUATION REPORT	SONY	Reviewed by: Quality Manager
Document S/N: OY1306100973.PY7	Test Dates: 05/06/13 - 08/01/13	DUT Type: Portable Handset		Page 9 of 83

1.7 SAR Test Exclusions Applied

(A) WIFI/BT

Since Wireless Router operations are not allowed by the chipset firmware using 5 GHz WIFI, only 2.4 GHz WIFI Hotspot SAR tests and combinations are considered for SAR with respect to Wireless Router configurations according to FCC KDB 941225 D06v01.

Per FCC KDB 447498 D01v05, the 1g SAR exclusion threshold for distances <50mm is defined by the following equation:

$$\frac{\text{Max Power of Channel (mW)}}{\text{Test Separation Dist (mm)}} * \sqrt{\text{Frequency(GHz)}} \leq 3.0$$

Based on the maximum conducted power of Bluetooth (rounded to the nearest mW) and the antenna to user separation distance, Bluetooth SAR was not required; $[(9/15) * \sqrt{2.441}] = 0.9 < 3.0$. Per KDB Publication 447498 D01v05, the maximum power of the channel was rounded to the nearest mW before calculation.

Per FCC KDB 447498 D01v05r01, the SAR exclusion threshold for 10g Extremity SAR for distances <50mm is defined by the following equation:

$$\frac{\text{Max Power of Channel (mW)}}{\text{Separation Dist(mm)}} * \sqrt{\text{Frequency (GHz)}} \leq 7.5$$

Based on the maximum conducted power of Bluetooth (rounded to the nearest mW) and the antenna to user separation distance, Bluetooth SAR was not required; $[(9/5) * \sqrt{2.441}] = 2.8 < 7.5$. Per KDB Publication 447498 D01v05r01, the maximum power of the channel was rounded to the nearest mW before calculation.

Per FCC KDB Publication 648474 D03-D04, this device is considered a "phablet" since its diagonal distance is greater than 160 mm. Therefore hand SAR tests are required. Because wireless router operations are not supported for 5 GHz WIFI, hand SAR was evaluated for 5 GHz WIFI. However, hand SAR was not evaluated for 2.4 GHz WIFI since Hotspot SAR for 2.4 GHz WIFI when scaled up to the maximum output power tolerances is < 1.2 W/kg. A 3mm Phablet SAR test distance was used based on a FCC KDB inquiry and is established according to the specific conditions applicable to the device.

This device supports 20 MHz and 40 MHz Bandwidths for IEEE 802.11n for 5 GHz WIFI only. IEEE 802.11n was not evaluated for SAR since the average output power of 20 MHz and 40 MHz bandwidths was not more than 0.25 dB higher than the average output power of IEEE 802.11a.

This device supports IEEE 802.11ac with the following features:

- a) Up to 80 MHz Bandwidth only
- b) No aggregate channel configurations
- c) 1 Tx antenna output
- d) 256 QAM is supported
- e) No new 5 GHz channels

Full SAR evaluations for all IEEE 802.11ac configurations were not required since the average output power was not more than 0.25 dB higher than IEEE 802.11a mode. IEEE 802.11ac was evaluated for the highest IEEE 802.11a position in each 5 GHz band and exposure condition.

FCC ID: PY7PM-0410	 PCTEST ENGINEERING LABORATORY, INC.	SAR EVALUATION REPORT	SONY	Reviewed by: Quality Manager
Document S/N: OY1306100973.PY7	Test Dates: 05/06/13 - 08/01/13	DUT Type: Portable Handset		Page 10 of 83

(B) Licensed Transmitter(s)

GSM/GPRS/EDGE DTM is not supported for US bands. Therefore, the GSM Voice modes in this report do not transmit simultaneously with GPRS Data.

LTE SAR for the higher modulations and lower bandwidths were not tested since the maximum average output power of all required channels and configurations was not more than 0.5 dB higher than the highest bandwidth; and the reported LTE SAR for the highest bandwidth was less than 1.45 W/kg for all configurations according to FCC KDB 941225 D05v02.

Per FCC KDB Publication 648474 D03-D04, this device is considered a "phablet" since its diagonal distance is greater than 160 mm. Therefore hand SAR tests are required. When hotspot mode applies, 10-g SAR is required only for the surfaces and edges with hotspot mode 1-g SAR scaled up to the maximum output power tolerances > 1.2 W/kg. A 3mm Phablet SAR test distance was used based on a FCC KDB inquiry and is established according to the specific conditions applicable to the device.

1.8 Guidance Applied

- FCC OET Bulletin 65 Supplement C [June 2001]
- IEEE 1528-2003
- FCC KDB Publication 941225 D01-D06 (2G/3G/4G and Hotspot)
- FCC KDB Publication 248227 D01v01r02 (SAR Considerations for 802.11 Devices)
- FCC KDB Publication 447498 D01v05 (General SAR Guidance)
- FCC KDB Publication 865664 D01-D02 (SAR Measurements up to 6 GHz)
- FCC KDB Publication 648474 D03-D04 (Phablet Procedures)
- April 2013 TCB Workshop Notes (IEEE 802.11ac)

1.9 Device Serial Numbers

Several samples were used with identical hardware to support SAR testing. The manufacturer has confirmed that the device(s) tested have the same physical, mechanical and thermal characteristics and are within operational tolerances expected for production units.

Mode/Band	Head Serial Number	Body-Worn Serial Number	Hotspot Serial Number	Extremity Serial Number
GSM/GPRS/EDGE 850	7481	7481	7481	-
UMTS V	7320	7316	7316	-
UMTS IV	7320	7320	7320	7316
GSM/GPRS/EDGE 1900	7319	7319	7481	-
UMTS II	7316	7316	7320	7316
LTE Band 5 (Cell)	7483	7483	7483	-
LTE Band 4 (AWS)	7317	7317	7317	7483
LTE Band 2 (PCS)	7317	7317	7317	7483
LTE Band 7	8711	8711	8711	-
2.4 GHz WLAN	6717	6717	6717	-
5 GHz WLAN	3037	3039	-	3039

FCC ID: PY7PM-0410	 PCTEST ENGINEERING LABORATORY, INC.	SAR EVALUATION REPORT	SONY	Reviewed by: Quality Manager
Document S/N: 0Y1306100973.PY7	Test Dates: 05/06/13 - 08/01/13	DUT Type: Portable Handset		Page 11 of 83

2

LTE INFORMATION

LTE Information			
FCC ID	PY7PM-0410		
Form Factor	Portable Handset		
Frequency Range of each LTE transmission band	LTE Band 5 (Cell) (824.7 - 848.3 MHz)		
	LTE Band 4 (AWS) (1710.7 - 1754.3 MHz)		
	LTE Band 2 (PCS) (1850.7 - 1909.3 MHz)		
	LTE Band 7 (2502.5 - 2567.5 MHz)		
Channel Bandwidths	LTE Band 5 (Cell): 1.4 MHz, 3 MHz, 5 MHz, 10 MHz		
	LTE Band 4 (AWS): 1.4 MHz, 3 MHz, 5 MHz, 10 MHz, 15 MHz, 20 MHz		
	LTE Band 2 (PCS): 1.4 MHz, 3 MHz, 5 MHz, 10 MHz, 15 MHz, 20 MHz		
	LTE Band 7: 5 MHz, 10 MHz, 15 MHz, 20 MHz		
Channel Numbers and Frequencies (MHz)	Low	Mid	High
LTE Band 5 (Cell): 1.4 MHz	824.7 (20407)	836.5 (20525)	848.3 (20643)
LTE Band 5 (Cell): 3 MHz	825.5 (20415)	836.5 (20525)	847.5 (20635)
LTE Band 5 (Cell): 5 MHz	826.5 (20425)	836.5 (20525)	846.5 (20625)
LTE Band 5 (Cell): 10 MHz	829 (20450)	836.5 (20525)	844 (20600)
LTE Band 4 (AWS): 1.4 MHz	1710.7 (19957)	1732.5 (20175)	1754.3 (20393)
LTE Band 4 (AWS): 3 MHz	1711.5 (19965)	1732.5 (20175)	1753.5 (20385)
LTE Band 4 (AWS): 5 MHz	1712.5 (19975)	1732.5 (20175)	1752.5 (20375)
LTE Band 4 (AWS): 10 MHz	1715 (20000)	1732.5 (20175)	1750 (20350)
LTE Band 4 (AWS): 15 MHz	1717.5 (20025)	1732.5 (20175)	1747.5 (20325)
LTE Band 4 (AWS): 20 MHz	1720 (20050)	1732.5 (20175)	1745 (20300)
LTE Band 2 (PCS): 1.4 MHz	1850.7 (18607)	1880 (18900)	1909.3 (19193)
LTE Band 2 (PCS): 3 MHz	1851.5 (18615)	1880 (18900)	1908.5 (19185)
LTE Band 2 (PCS): 5 MHz	1852.5 (18625)	1880 (18900)	1907.5 (19175)
LTE Band 2 (PCS): 10 MHz	1855 (18650)	1880 (18900)	1905 (19150)
LTE Band 2 (PCS): 15 MHz	1857.5 (18675)	1880 (18900)	1902.5 (19125)
LTE Band 2 (PCS): 20 MHz	1860 (18700)	1880 (18900)	1900 (19100)
LTE Band 7: 5 MHz	2502.5 (20775)	2535 (21100)	2567.5 (21425)
LTE Band 7: 10 MHz	2505 (20800)	2535 (21100)	2565 (21400)
LTE Band 7: 15 MHz	2507.5 (20825)	2535 (21100)	2562.5 (21375)
LTE Band 7: 20 MHz	2510 (20850)	2535 (21100)	2560 (21350)
UE Category	4		
Modulations Supported in UL	QPSK, 16QAM		
LTE Voice available?	NO		
Hotspot with LTE+WIFI	YES		
Hotspot with LTE+WIFI active with Voice sessions?	NO		
LTE MPR Permanently implemented per 3GPP TS 36.101 section 6.2.3-6.2.5? (manufacturer attestation to be provided)	YES		
A-MPR (Additional MPR) disabled for SAR Testing?	YES		

FCC ID: PY7PM-0410	 PCTEST ENGINEERING LABORATORY, INC.	SAR EVALUATION REPORT	SONY	Reviewed by: Quality Manager
Document S/N: OY1306100973.PY7	Test Dates: 05/06/13 - 08/01/13	DUT Type: Portable Handset		Page 12 of 83

3 INTRODUCTION

The FCC and Industry Canada have adopted the guidelines for evaluating the environmental effects of radio frequency (RF) radiation in ET Docket 93-62 on Aug. 6, 1996 and Health Canada Safety Code 6 to protect the public and workers from the potential hazards of RF emissions due to FCC-regulated portable devices. [1]

The safety limits used for the environmental evaluation measurements are based on the criteria published by the American National Standards Institute (ANSI) for localized specific absorption rate (SAR) in IEEE/ANSI C95.1-1992 Standard for Safety Levels with Respect to Human Exposure to Radio Frequency Electromagnetic Fields, 3 kHz to 300 GHz [3] and Health Canada RF Exposure Guidelines Safety Code 6 [24]. The measurement procedure described in IEEE/ANSI C95.3-2002 Recommended Practice for the Measurement of Potentially Hazardous Electromagnetic Fields - RF and Microwave [4] is used for guidance in measuring the Specific Absorption Rate (SAR) due to the RF radiation exposure from the Equipment Under Test (EUT). These criteria for SAR evaluation are similar to those recommended by the International Committee for Non-Ionizing Radiation Protection (ICNIRP) in Biological Effects and Exposure Criteria for Radiofrequency Electromagnetic Fields," Report No. Vol 74. SAR is a measure of the rate of energy absorption due to exposure to an RF transmitting source. SAR values have been related to threshold levels for potential biological hazards.

3.1 SAR Definition

Specific Absorption Rate is defined as the time derivative (rate) of the incremental energy (dU) absorbed by (dissipated in) an incremental mass (dm) contained in a volume element (dV) of a given density (ρ). It is also defined as the rate of RF energy absorption per unit mass at a point in an absorbing body (see Equation 3-1).

Equation 3-1
SAR Mathematical Equation

$$SAR = \frac{d}{dt} \left(\frac{dU}{dm} \right) = \frac{d}{dt} \left(\frac{dU}{\rho dv} \right)$$

SAR is expressed in units of Watts per Kilogram (W/kg).

$$SAR = \frac{\sigma \cdot E^2}{\rho}$$

where:

- σ = conductivity of the tissue-simulating material (S/m)
- ρ = mass density of the tissue-simulating material (kg/m^3)
- E = Total RMS electric field strength (V/m)

NOTE: The primary factors that control rate of energy absorption were found to be the wavelength of the incident field in relation to the dimensions and geometry of the irradiated organism, the orientation of the organism in relation to the polarity of field vectors, the presence of reflecting surfaces, and whether conductive contact is made by the organism with a ground plane.[6]

FCC ID: PY7PM-0410	 PCTEST ENGINEERING LABORATORY, INC.	SAR EVALUATION REPORT	SONY	Reviewed by: Quality Manager
Document S/N: 0Y1306100973.PY7	Test Dates: 05/06/13 - 08/01/13	DUT Type: Portable Handset		Page 13 of 83

4 DOSIMETRIC ASSESSMENT

4.1 Measurement Procedure

The evaluation was performed using the following procedure:

1. The SAR distribution at the exposed side of the head or body was measured at a distance no greater than 5.0 mm from the inner surface of the shell. The area covered the entire dimension of the device-head and body interface and the horizontal grid resolution was determined per FCC KDB Publication 865664 D01v01 (See Table 4-1).
2. The point SAR measurement was taken at the maximum SAR region determined from Step 1 to enable the monitoring of SAR fluctuations/drifts during the 1g/10g cube evaluation. SAR at this fixed point was measured and used as a reference value.
3. Based on the area scan data, the peak of the region with maximum SAR was determined by spline interpolation. Around this point, a volume was assessed according to the measurement resolution and volume size requirements of FCC KDB Publication 865664 D01v01 (See Table 4-1). On the basis of this data set, the spatial peak SAR value was evaluated with the following procedure (see references or the DASy manual online for more details):
 - a. The data was extrapolated to the surface of the outer-shell of the phantom. The combined distance extrapolated was the combined distance from the center of the dipoles 2.7mm away from the tip of the probe housing plus the 1.2 mm distance between the surface and the lowest measuring point. The extrapolation was based on a least-squares algorithm. A polynomial of the fourth order was calculated through the points in the z-axis (normal to the phantom shell).
 - b. After the maximum interpolated values were calculated between the points in the cube, the SAR was averaged over the spatial volume (1g or 10g) using a 3D-Spline interpolation algorithm. The 3D-spline is composed of three one-dimensional splines with the “Not a knot” condition (in x, y, and z directions). The volume was then integrated with the trapezoidal algorithm. One thousand points (10 x 10 x 10) were obtained through interpolation, in order to calculate the averaged SAR.
 - c. All neighboring volumes were evaluated until no neighboring volume with a higher average value was found.
4. The SAR reference value, at the same location as step 2, was re-measured after the zoom scan was complete to calculate the SAR drift. If the drift deviated by more than 5%, the SAR test and drift measurements were repeated.

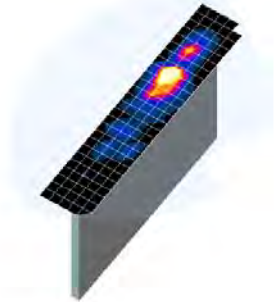



Figure 4-1
Sample SAR Area Scan

Table 4-1
Area and Zoom Scan Resolutions per FCC KDB Publication 865664 D01v01

Frequency	Maximum Area Scan Resolution (mm) ($\Delta x_{area}, \Delta y_{area}$)	Maximum Zoom Scan Resolution (mm) ($\Delta x_{zoom}, \Delta y_{zoom}$)	Maximum Zoom Scan Spatial Resolution (mm)			Minimum Zoom Scan Volume (mm) (x,y,z)
			Uniform Grid	Graded Grid		
			$\Delta z_{zoom}(n)$	$\Delta z_{zoom}(1)^*$	$\Delta z_{zoom}(n>1)^*$	
≤ 2 GHz	≤ 15	≤ 8	≤ 5	≤ 4	≤ 1.5* $\Delta z_{zoom}(n-1)$	≥ 30
2-3 GHz	≤ 12	≤ 5	≤ 5	≤ 4	≤ 1.5* $\Delta z_{zoom}(n-1)$	≥ 30
3-4 GHz	≤ 12	≤ 5	≤ 4	≤ 3	≤ 1.5* $\Delta z_{zoom}(n-1)$	≥ 28
4-5 GHz	≤ 10	≤ 4	≤ 3	≤ 2.5	≤ 1.5* $\Delta z_{zoom}(n-1)$	≥ 25
5-6 GHz	≤ 10	≤ 4	≤ 2	≤ 2	≤ 1.5* $\Delta z_{zoom}(n-1)$	≥ 22

FCC ID: PY7PM-0410	 PCTEST ENGINEERING LABORATORY, INC.	SAR EVALUATION REPORT		Reviewed by: Quality Manager
Document S/N: OY1306100973.PY7	Test Dates: 05/06/13 - 08/01/13	DUT Type: Portable Handset		Page 14 of 83

5

DEFINITION OF REFERENCE POINTS

5.1 EAR REFERENCE POINT

Figure 5-2 shows the front, back and side views of the SAM Twin Phantom. The point “M” is the reference point for the center of the mouth, “LE” is the left ear reference point (ERP), and “RE” is the right ERP. The ERP is 15mm posterior to the entrance to the ear canal (EEC) along the B-M line (Back-Mouth), as shown in Figure 5-1. The plane passing through the two ear canals and M is defined as the Reference Plane. The line N-F (Neck-Front) is perpendicular to the reference plane and passing through the RE (or LE) is called the Reference Pivoting Line (see Figure 5-1). Line B-M is perpendicular to the N-F line. Both N-F and B-M lines are marked on the external phantom shell to facilitate handset positioning [5].

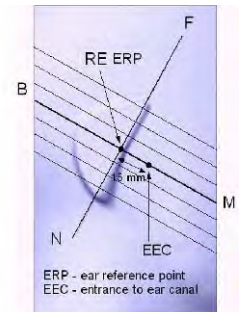

Figure 5-1
Close-Up Side view of ERP

5.2 HANDSET REFERENCE POINTS

Two imaginary lines on the handset were established: the vertical centerline and the horizontal line. The test device was placed in a normal operating position with the “test device reference point” located along the “vertical centerline” on the front of the device aligned to the “ear reference point” (See Figure 5-3). The “test device reference point” was then located at the same level as the center of the ear reference point. The test device was positioned so that the “vertical centerline” was bisecting the front surface of the handset at its top and bottom edges, positioning the “ear reference point” on the outer surface of the both the left and right head phantoms on the ear reference point.



Figure 5-2
Front, back and side view of SAM Twin Phantom

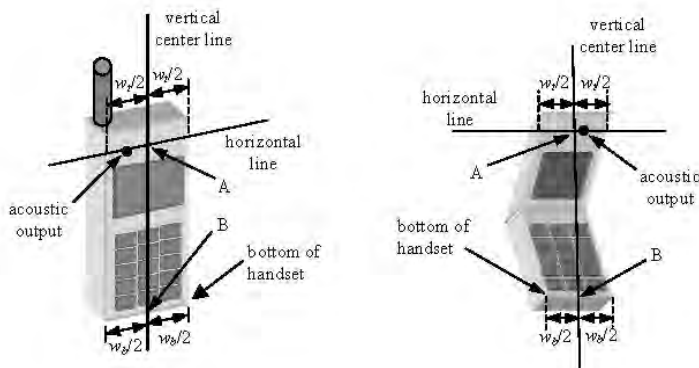



Figure 5-3
Handset Vertical Center & Horizontal Line Reference Points

FCC ID: PY7PM-0410	 PCTEST ENGINEERING LABORATORY, INC.	SAR EVALUATION REPORT	SONY	Reviewed by: Quality Manager
Document S/N: OY1306100973.PY7	Test Dates: 05/06/13 - 08/01/13	DUT Type: Portable Handset		Page 15 of 83

6 TEST CONFIGURATION POSITIONS FOR HANDSETS

6.1 Device Holder

The device holder is made out of low-loss POM material having the following dielectric parameters: relative permittivity $\epsilon = 3$ and loss tangent $\delta = 0.02$.

6.2 Positioning for Cheek

1. The test device was positioned with the device close to the surface of the phantom such that point A is on the (virtual) extension of the line passing through points RE and LE on the phantom (see Figure 6-1), such that the plane defined by the vertical center line and the horizontal line of the phone is approximately parallel to the sagittal plane of the phantom.



Figure 6-1 Front, Side and Top View of Cheek Position

2. The handset was translated towards the phantom along the line passing through RE & LE until the handset touches the ear.
3. While maintaining the handset in this plane, the handset was rotated around the LE-RE line until the vertical centerline was in the plane normal to MB-NF including the line MB (reference plane).
4. The phone was then rotated around the vertical centerline until the phone (horizontal line) was symmetrical with respect to the line NF.
5. While maintaining the vertical centerline in the reference plane, keeping point A on the line passing through RE and LE, and maintaining the device contact with the ear, the device was rotated about the NF line until any point on the handset made contact with a phantom point below the ear (cheek) (See Figure 6-2).

6.3 Positioning for Ear / 15° Tilt

With the test device aligned in the “Cheek Position”:

1. While maintaining the orientation of the phone, the phone was retracted parallel to the reference plane far enough to enable a rotation of the phone by 15 degrees.
2. The phone was then rotated around the horizontal line by 15 degrees.
3. While maintaining the orientation of the phone, the phone was moved parallel to the reference plane until any part of the handset touched the head. (In this position, point A was located on the line RE-LE). The tilted position is obtained when the contact is on the pinna. If the contact was at any location other than the pinna, the angle of the phone would then be reduced. The tilted position was obtained when any part of the phone was in contact of the ear as well as a second part of the phone was in contact with the head (see Figure 6-2).

FCC ID: PY7PM-0410	 PCTEST ENGINEERING LABORATORY, INC.	SAR EVALUATION REPORT	SONY	Reviewed by: Quality Manager
Document S/N: OY1306100973.PY7	Test Dates: 05/06/13 - 08/01/13	DUT Type: Portable Handset		Page 16 of 83

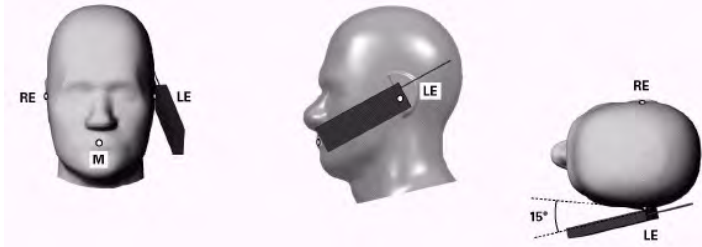

Figure 6-2 Front, Side and Top View of Ear/15° Tilt Position

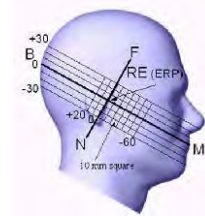

Figure 6-3 Side view w/ relevant markings

6.4 SAR Evaluations near the Mouth/Jaw Regions of the SAM Phantom

Antennas located near the bottom of a phone may require SAR measurements around the mouth and jaw regions of the SAM head phantom. This typically applies to clam-shell style phones that are generally longer in the unfolded normal use positions or to certain older style long rectangular phones.

Under these circumstances, the following procedures apply, adopted from the FCC guidance on SAR handsets document FCC KDB Publication 648474 D04_v01. The SAR required in these regions of SAM should be measured using a flat phantom. The phone should be positioned with a separation distance of 4 mm between the ear reference point (ERP) and the outer surface of the flat phantom shell. While maintaining this distance at the ERP location, the low (bottom) edge of the phone should be lowered from the phantom to establish the same separation distance between the peak SAR location identified by the truncated partial SAR distribution measured with the SAM phantom. The distance from the peak SAR location to the phone is determined by the straight line passing perpendicularly through the phantom surface. When it is not feasible to maintain 4 mm separation at the ERP while also establishing the required separation at the peak SAR location, the top edge of the phone will be allowed to touch the phantom with a separation < 4 mm at the ERP. The phone should not be tilted to the left or right while placed in this inclined position to the flat phantom.

The latest IEEE 1528 committee developments propose the usage of a tilted phantom when the antenna of the phone is mounted at the bottom or in all cases the peak absorption is in the chin region. Both SAM heads of the TwinSAM-Chin20 are rotated 20 degrees around the NF line. Each head can be removed individually from the table for emptying and cleaning.



Figure 6-4 Twin SAM Chin20

FCC ID: PY7PM-0410	 PCTEST ENGINEERING LABORATORY, INC.	SAR EVALUATION REPORT	SONY	Reviewed by: Quality Manager
Document S/N: OY1306100973.PY7	Test Dates: 05/06/13 - 08/01/13	DUT Type: Portable Handset		Page 17 of 83

6.5 Body-Worn Accessory Configurations

Body-worn operating configurations are tested with the belt-clips and holsters attached to the device and positioned against a flat phantom in a normal use configuration (see Figure 6-5). Per FCC KDB Publication 648474 D04v01, Body-worn accessory exposure is typically related to voice mode operations when handsets are carried in body-worn accessories. The body-worn accessory procedures in FCC KDB Publication 447498 D01v05 should be used to test for body-worn accessory SAR compliance, without a headset connected to it. This enables the test results for such configuration to be compatible with that required for hotspot mode when the body-worn accessory test separation distance is greater than or equal to that required for hotspot mode, when applicable. When the reported SAR for a body-worn accessory, measured without a headset connected to the handset, is $> 1.2 \text{ W/kg}$, the highest reported SAR configuration for that wireless mode and frequency band should be repeated for that body-worn accessory with a headset attached to the handset.

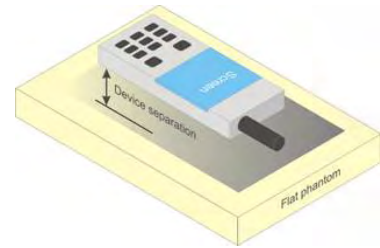



Figure 6-5
Sample Body-Worn Diagram

Accessories for Body-worn operation configurations are divided into two categories: those that do not contain metallic components and those that do contain metallic components. When multiple accessories that do not contain metallic components are supplied with the device, the device is tested with only the accessory that dictates the closest spacing to the body. Then multiple accessories that contain metallic components are tested with the device with each accessory. If multiple accessories share an identical metallic component (i.e. the same metallic belt-clip used with different holsters with no other metallic components) only the accessory that dictates the closest spacing to the body is tested.

Body-worn accessories may not always be supplied or available as options for some devices intended to be authorized for body-worn use. In this case, a test configuration with a separation distance between the back of the device and the flat phantom is used. Test position spacing was documented. Transmitters that are designed to operate in front of a person's face, as in push-to-talk configurations, are tested for SAR compliance with the front of the device positioned to face the flat phantom in head fluid. For devices that are carried next to the body such as a shoulder, waist or chest-worn transmitters, SAR compliance is tested with the accessories, including headsets and microphones, attached to the device and positioned against a flat phantom in a normal use configuration.

FCC ID: PY7PM-0410		SAR EVALUATION REPORT		Reviewed by: Quality Manager
Document S/N: 0Y1306100973.PY7	Test Dates: 05/06/13 - 08/01/13	DUT Type: Portable Handset		Page 18 of 83

6.6 Extremity Exposure Configurations

Devices that are designed or intended for use on extremities or mainly operated in extremity only exposure conditions; i.e., hands, wrists, feet and ankles, may require extremity SAR evaluation. When the device also operates in close proximity to the user's body, SAR compliance for the body is also required. The 1-g body and 10-g extremity SAR Exclusion Thresholds found in KDB Publication 44798 D01v05 should be applied to determine SAR test requirements.

For smart phones with a display diagonal dimension > 15.0 cm or an overall diagonal dimension > 16.0 cm that provide similar mobile web access and multimedia support found in mini-tablets or UMPC minitables that support voice calls next to the ear, the phablets procedures outlined in KDB Publication 648474 D04 v01r01DR04 should be applied to evaluate SAR compliance. A device marketed as phablets, regardless of form factors and operating characteristics must be tested as a phablet to determine SAR compliance. In addition to the normally required head and body-worn accessory SAR test procedures required for handsets, the UMPC mini-tablet procedures must also be applied to test the SAR of all surfaces and edges with an antenna ≤ 25 mm from that surface or edge, in direct contact with the phantom, for 10-g SAR. The UMPC mini-tablet 1-g SAR at 5 mm is not required. When hotspot mode applies, 10-g SAR is required only for the surfaces and edges with hotspot mode 1-g SAR scaled up to the maximum output power tolerances > 1.2 W/kg. A 3mm Phablet SAR test distance was used based on a FCC KDB inquiry and is established according to the specific conditions applicable to the device.

6.7 Wireless Router Configurations

Some battery-operated handsets have the capability to transmit and receive user data through simultaneous transmission of WIFI simultaneously with a separate licensed transmitter. The FCC has provided guidance in FCC KDB Publication 941225 D06 v01 where SAR test considerations for handsets ($L \times W \geq 9 \text{ cm} \times 5 \text{ cm}$) are based on a composite test separation distance of 10 mm from the front, back and edges of the device containing transmitting antennas within 2.5 cm of their edges, determined from general mixed use conditions for this type of devices. Since the hotspot SAR results may overlap with the body-worn accessory SAR requirements, the more conservative configurations can be considered, thus excluding some body-worn accessory SAR tests.

When the user enables the personal wireless router functions for the handset, actual operations include simultaneous transmission of both the WIFI transmitter and another licensed transmitter. Both transmitters often do not transmit at the same transmitting frequency and thus cannot be evaluated for SAR under actual use conditions due to the limitations of the SAR assessment probes. Therefore, SAR must be evaluated for each frequency transmission and mode separately and spatially summed with the WIFI transmitter according to FCC KDB Publication 447498 D01v05 publication procedures. The "Portable Hotspot" feature on the handset was NOT activated during SAR assessments, to ensure the SAR measurements were evaluated for a single transmission frequency RF signal at a time.

This device utilizes power reduction for some bands/modes during portable hotspot (tethering) operations for SAR compliance. A detailed description of the hotspot power reduction mechanism is included in the operational description.

FCC ID: PY7PM-0410	 PCTEST ENGINEERING LABORATORY, INC.	SAR EVALUATION REPORT	SONY	Reviewed by: Quality Manager
Document S/N: 0Y1306100973.PY7	Test Dates: 05/06/13 - 08/01/13	DUT Type: Portable Handset		Page 19 of 83

7 RF EXPOSURE LIMITS

7.1 Uncontrolled Environment

UNCONTROLLED ENVIRONMENTS are defined as locations where there is the exposure of individuals who have no knowledge or control of their exposure. The general population/uncontrolled exposure limits are applicable to situations in which the general public may be exposed or in which persons who are exposed as a consequence of their employment may not be made fully aware of the potential for exposure or cannot exercise control over their exposure. Members of the general public would come under this category when exposure is not employment-related; for example, in the case of a wireless transmitter that exposes persons in its vicinity.

7.2 Controlled Environment

CONTROLLED ENVIRONMENTS are defined as locations where there is exposure that may be incurred by persons who are aware of the potential for exposure, (i.e. as a result of employment or occupation). In general, occupational/controlled exposure limits are applicable to situations in which persons are exposed as a consequence of their employment, who have been made fully aware of the potential for exposure and can exercise control over their exposure. This exposure category is also applicable when the exposure is of a transient nature due to incidental passage through a location where the exposure levels may be higher than the general population/uncontrolled limits, but the exposed person is fully aware of the potential for exposure and can exercise control over his or her exposure by leaving the area or by some other appropriate means.

**Table 7-1
SAR Human Exposure Specified in ANSI/IEEE C95.1-1992 and Health Canada Safety Code 6**

HUMAN EXPOSURE LIMITS		
	UNCONTROLLED ENVIRONMENT <i>General Population</i> (W/kg) or (mW/g)	CONTROLLED ENVIRONMENT <i>Occupational</i> (W/kg) or (mW/g)
Peak Spatial Average SAR Head	1.6	8.0
Whole Body SAR	0.08	0.4
Peak Spatial Average SAR Hands, Feet, Ankle, Wrists, etc.	4.0	20

1. The Spatial Peak value of the SAR averaged over any 1 gram of tissue (defined as a tissue volume in the shape of a cube) and over the appropriate averaging time.
2. The Spatial Average value of the SAR averaged over the whole body.
3. The Spatial Peak value of the SAR averaged over any 10 grams of tissue (defined as a tissue volume in the shape of a cube) and over the appropriate averaging time.

FCC ID: PY7PM-0410	 PCTEST ENGINEERING LABORATORY, INC.	SAR EVALUATION REPORT	SONY	Reviewed by: Quality Manager
Document S/N: 0Y1306100973.PY7	Test Dates: 05/06/13 - 08/01/13	DUT Type: Portable Handset		Page 20 of 83

8 FCC MEASUREMENT PROCEDURES

Power measurements were performed using a base station simulator under digital average power.

8.1 Measured and Reported SAR

Per FCC KDB Publication 447498 D01v05, When SAR is not measured at the maximum power level allowed for production units, the results must be scaled to the maximum tune-up tolerance limit according to the power applied to the individual channels tested to determine compliance. For simultaneous transmission, the measured aggregate SAR must be scaled according to the sum of the differences between the maximum tune-up tolerance and actual power used to test each transmitter. When SAR is measured at or scaled to the maximum tune-up tolerance limit, the results are referred to as *reported* SAR. The highest *reported* SAR results are identified on the grant of equipment authorization according to procedures in KDB 690783 D01v01r02.

8.2 Procedures Used to Establish RF Signal for SAR

The following procedures are according to FCC KDB Publication 941225 D01 "SAR Measurement Procedures for 3G Devices" v02, October 2007.

The device was placed into a simulated call using a base station simulator in a RF shielded chamber. Establishing connections in this manner ensure a consistent means for testing SAR and are recommended for evaluating SAR [4]. Devices under test were evaluated prior to testing, with a fully charged battery and were configured to operate at maximum output power. In order to verify that the device was tested throughout the SAR test at maximum output power, the SAR measurement system measures a "point SAR" at an arbitrary reference point at the start and end of the 1 gram SAR evaluation, to assess for any power drifts during the evaluation. If the power drift deviated by more than 5%, the SAR test and drift measurements were repeated.

8.3 SAR Measurement Conditions for UMTS

8.3.1 Output Power Verification

Maximum output power is measured on the High, Middle and Low channels for each applicable transmission band according to the general descriptions in section 5.2 of 3GPP TS 34.121, using the appropriate RMC or AMR with TPC (transmit power control) set to all "1s".

Maximum output power is verified on the High, Middle and Low channels according to the general descriptions in section 5.2 of 3GPP TS 34.121 (release 5), using the appropriate RMC with TPC (transmit power control) set to all "1s" or applying the required inner loop power control procedures to maintain maximum output power while HSUPA is active. Results for all applicable physical channel configurations (DPCCH, DPDCHn and spreading codes, HS-DPCCH etc) are tabulated in this test report. All configurations that are not supported by the DUT or cannot be measured due to technical or equipment limitations are identified.

8.3.2 Head SAR Measurements for Handsets

SAR for head exposure configurations is measured using the 12.2 kbps RMC with TPC bits configured to all "1s". SAR in AMR configurations is not required when the maximum average output of each RF channel for 12.2 kbps AMR is less than 0.25 dB higher than that measured in 12.2 kbps RMC. Otherwise, SAR is measured on the maximum output channel in 12.2 AMR with a 3.4 kbps SRB (signaling radio bearer) using the exposure configuration that resulted in the highest SAR for that RF channel in the 12.2 kbps RMC mode.

FCC ID: PY7PM-0410	 PCTEST ENGINEERING LABORATORY, INC.	SAR EVALUATION REPORT	SONY	Reviewed by: Quality Manager
Document S/N: OY1306100973.PY7	Test Dates: 05/06/13 - 08/01/13	DUT Type: Portable Handset		Page 21 of 83

8.3.3 Body SAR Measurements

SAR for body exposure configurations is measured using the 12.2 kbps RMC with the TPC bits all “1s”.

8.3.4 SAR Measurements for Handsets with Rel 5 HSDPA

Body SAR for HSDPA is not required for handsets with HSDPA capabilities when the maximum average output power of each RF channel with HSDPA active is less than 0.25 dB higher than that measured without HSDPA using 12.2 kbps RMC and the maximum SAR for 12.2 kbps RMC is $\leq 75\%$ of the SAR limit. Otherwise, SAR is measured for HSDPA, using an FRC with H-Set 1 in Sub-test 1 and a 12.2 kbps RMC configured in Test Loop Mode 1, using the highest body SAR configuration measured in 12.2 kbps RMC without HSDPA, on the maximum output channel with the body exposure configuration that resulted in the highest SAR in 12.2 kbps RMC mode for that RF channel.

The H-set used in FRC for HSDPA should be configured according to the UE category of a test device. The number of HS-DSCH/HSPDSCHs, HARQ processes, minimum inter-TTI interval, transport block sizes and RV coding sequence are defined by the applicable H-set. To maintain a consistent test configuration and stable transmission conditions, QPSK is used in the FRC for SAR testing. HS-DPCCH should be configured with a CQI feedback cycle of 2 ms to maintain a constant rate of active CQI slots. DPCCH and DPDCH gain factors of $\beta_c=9$ and $\beta_d=15$, and power offset parameters of $\Delta_{ACK}=\Delta_{NACK}=5$ and $\Delta_{CQI}=2$ is used. The CQI value is determined by the UE category, transport block size, number of HS-PDSCHs and modulation used in the FRC.



8.3.5 SAR Measurements for Handsets with Rel 6 HSUPA

Body SAR for HSUPA is not required when the maximum average output of each RF channel with HSUPA/HSDPA active is less than 0.25 dB higher than as measured without HSUPA/HSDPA using 12.2 kbps RMC and maximum SAR for 12.2 kbps RMC is $\leq 75\%$ of the SAR limit. Otherwise SAR is measured on the maximum output channel for the body exposure configuration produced highest SAR in 12.2 kbps RMC for that RF channel, using the additional procedures under “Release 6 HSPA data devices”

Head SAR for VOIP operations under HSPA is not required when maximum average output of each RF channel with HSPA is less than 0.25 dB higher than as measured using 12.2 kbps RMC. Otherwise SAR is measured using same HSPA configuration as used for body SAR.

Sub-test	β_c	β_d	β_d (SF)	β_c/β_d	$\beta_{1s}^{(1)}$	β_{ec}	β_{ed}	β_{ed} (SF)	β_{ed} (codes)	CM ⁽²⁾ (dB)	MPR (dB)	AG ⁽⁴⁾ Index	E-TFCI
1	11/15 ⁽³⁾	15/15 ⁽³⁾	64	11/15 ⁽³⁾	22/15	209/225	1039/225	4	1	1.0	0.0	20	75
2	6/15	15/15	64	6/15	12/15	12/15	94/75	4	1	3.0	2.0	12	67
3	15/15	9/15	64	15/9	30/15	30/15	$\beta_{dat}: 47/15$ $\beta_{ed}: 47/15$	4	2	2.0	1.0	15	92
4	2/15	15/15	64	2/15	4/15	2/15	56/75	4	1	3.0	2.0	17	71
5	15/15 ⁽⁴⁾	15/15 ⁽⁴⁾	64	15/15 ⁽⁴⁾	30/15	24/15	134/15	4	1	1.0	0.0	21	81

Note 1: Δ_{ACK} , Δ_{NACK} and $\Delta_{CQI} = 8 \Leftrightarrow A_{1s} = \beta_{1s}/\beta_c = 30/15 \Leftrightarrow \beta_{1s} = 30/15 * \beta_c$.
 Note 2: CM = 1 for $\beta_c/\beta_d = 12/15$, $\beta_{1s}/\beta_c = 24/15$. For all other combinations of DPDCH, DPCCH, HS-DPCCH, E-DPDCH and E-DPCCH the MPR is based on the relative CM difference.
 Note 3: For subtest 1 the β_c/β_d ratio of 11/15 for the TFC during the measurement period (TF1, TF0) is achieved by setting the signaled gain factors for the reference TFC (TF1, TF1) to $\beta_c = 10/15$ and $\beta_d = 15/15$.
 Note 4: For subtest 5 the β_c/β_d ratio of 15/15 for the TFC during the measurement period (TF1, TF0) is achieved by setting the signaled gain factors for the reference TFC (TF1, TF1) to $\beta_c = 14/15$ and $\beta_d = 15/15$.
 Note 5: Testing UE using E-DPDCH Physical Layer category 1 Sub-test 3 is not required according to TS 25.306 Table 5.1g.
 Note 6: β_{ed} can not be set directly; it is set by Absolute Grant Value.

FCC ID: PY7PM-0410	 PCTEST ENGINEERING LABORATORY, INC.	SAR EVALUATION REPORT		Reviewed by: Quality Manager
Document S/N: OY1306100973.PY7	Test Dates: 05/06/13 - 08/01/13	DUT Type: Portable Handset		Page 22 of 83

8.3.6 SAR Measurement Conditions for DC-HSDPA

SAR test exclusion for DC-HSDPA devices is determined by power measurements according to the H-Set 12, Fixed Reference Channel (FRC) configuration in Table C.8.1.12 of 3GPP TS 34.121-1. A primary and a secondary serving HS-DSCH Cell are required to perform the power measurement and for the results to qualify for SAR test exclusion. DC-HSDPA uplink maximum output power measurements using the four Rel. 5 HSDPA subtests in Table C.10.1.4 of TS 234.121-1 is required.

When the maximum average output power of each RF channel with DC-HSDPA active is $\leq \frac{1}{4}$ dB higher than that measured using 12.2 kbps RMC, or the maximum reported SAR for 12.2 kbps RMC is $\leq 75\%$ of the SAR limit, SAR evaluation for DC-HSDPA is not required.

8.4 SAR Measurement Conditions for LTE

LTE modes were tested according to FCC KDB 941225 D05v02 publication. Please see notes after the tabulated SAR data for required test configurations. Establishing connections with base station simulators ensure a consistent means for testing SAR and are recommended for evaluating SAR [4]. The R&S CMW500 was used for LTE output power measurements and SAR testing. Closed loop power control was used so the UE transmits with maximum output power during SAR testing.

8.4.1 Spectrum Plots for RB Configurations

A properly configured base station simulator was used for SAR tests and power measurements. Therefore, spectrum plots for RB configurations were not required to be included in this report.

8.4.2 MPR

MPR is permanently implemented for this device by the manufacturer. The specific manufacturer target MPR is indicated alongside the SAR results. MPR is enabled for this device, according to 3GPP TS36.101 Section 6.2.3 – 6.2.5 under Table 6.2.3-1.



8.4.3 A-MPR

A-MPR (Additional MPR) has been disabled for all SAR tests by setting NS=01 on the base station simulator.

8.4.4 Required RB Size and RB Offsets for SAR Testing

According to FCC KDB 941225 D05v02r01:

- a. Per Section 5.2.1, SAR is required for QPSK 1 RB Allocation for the largest bandwidth
 - i. The required channel and offset combination with the highest maximum output power is required for SAR.
 - ii. When the reported SAR is ≤ 0.8 W/kg, testing of the remaining RB offset configurations and required test channels is not required. Otherwise, SAR is required for the remaining required test channels using the RB offset configuration with highest output power for that channel.
 - iii. When the reported SAR for a required test channel is > 1.45 W/kg, SAR is required for all RB offset configurations for that channel.
- b. Per Section 5.2.2, SAR is required for 50% RB allocation using the largest bandwidth following the same procedures outlined in Section 5.2.1.
- c. Per Section 5.2.3, QPSK SAR is not required for the 100% allocation when the highest maximum output power for the 100% allocation is less than the highest maximum output

FCC ID: PY7PM-0410	 SAR EVALUATION REPORT			Reviewed by: Quality Manager
Document S/N: OY1306100973.PY7	Test Dates: 05/06/13 - 08/01/13	DUT Type: Portable Handset		Page 23 of 83

power of the 1 RB and 50% RB allocations and the reported SAR for the 1 RB and 50% RB allocations is < 0.8 W/kg.

- d. Per Section 5.2.4 and 5.3, SAR tests for higher order modulations and lower bandwidths configurations are not required when the conducted power of the required test configurations determined by Sections 5.2.1 through 5.2.3 is less than or equal to ½ dB higher than the equivalent configuration using QPSK modulation and when the QPSK SAR for those configurations is <1.45 W/kg.

8.5 SAR Testing with 802.11 Transmitters

Normal network operating configurations are not suitable for measuring the SAR of 802.11 a/b/g/n transmitters. Unpredictable fluctuations in network traffic and antenna diversity conditions can introduce undesirable variations in SAR results. The SAR for these devices should be measured using chipset based test mode software to ensure the results are consistent and reliable. See KDB Publication 248227 D01v01r02 for more details.

8.5.1 General Device Setup

Chipset based test mode software is hardware dependent and generally varies among manufacturers. The device operating parameters established in test mode for SAR measurements must be identical to those programmed in production units, including output power levels, amplifier gain settings and other RF performance tuning parameters. The test frequencies should correspond to actual channel frequencies defined for domestic use. SAR for devices with switched diversity should be measured with only one antenna transmitting at a time during each SAR measurement, according to a fixed modulation and data rate. The same data pattern should be used for all measurements.



8.5.2 Frequency Channel Configurations [27]

For 2.4 GHz, the highest average RF output power channel between the low, mid and high channel at the lowest data rate was selected for SAR evaluation in 802.11b mode. 802.11g/n modes and higher data rates for 802.11b were additionally evaluated for SAR if the output power of the respective mode was 0.25 dB or higher than the powers of the SAR configurations tested in the 802.11b mode.

For 5 GHz, the highest average RF output power channel across the default test channels at the lowest data rate was selected for SAR evaluation in 802.11a. When the adjacent channels are higher in power than the default channels, these "required channels" were considered instead of the default channels for SAR testing. 802.11n modes and higher data rates for 802.11a/n were evaluated only if the respective mode was 0.25 dB or higher than the 802.11a mode.

If the maximum extrapolated peak SAR of the zoom scan for the highest output channel was less than 1.6 W/kg and if the 1g averaged SAR was less than 0.8 W/kg, SAR testing was not required for the other test channels in the band.

Full SAR tests for all IEEE 802.11ac configurations are not required because the average output power is not more than 0.25 dB higher than IEEE 802.11a mode. IEEE 802.11ac is evaluated for the highest IEEE 802.11a position in each 5 GHz band and exposure condition.

FCC ID: PY7PM-0410	 SAR EVALUATION REPORT 		Reviewed by: Quality Manager
Document S/N: OY1306100973.PY7	Test Dates: 05/06/13 - 08/01/13	DUT Type: Portable Handset	Page 24 of 83

9 RF CONDUCTED POWERS

9.1 GSM Conducted Powers

Table 9-1
Maximum GSM/GPRS/EDGE Average RF Conducted Powers
(Representing Hotspot Mode Inactive)

		Maximum Burst-Averaged Output Power								
		Voice	GPRS/EDGE Data (GMSK)				EDGE Data (8-PSK)			
Band	Channel	GSM [dBm] CS (1 Slot)	GPRS [dBm] 1 Tx Slot	GPRS [dBm] 2 Tx Slot	GPRS [dBm] 3 Tx Slot	GPRS [dBm] 4 Tx Slot	EDGE [dBm] 1 Tx Slot	EDGE [dBm] 2 Tx Slot	EDGE [dBm] 3 Tx Slot	EDGE [dBm] 4 Tx Slot
GSM 850	128	32.91	32.91	31.06	29.88	28.83	27.42	25.11	23.87	22.76
	190	33.22	33.24	31.08	29.94	28.95	27.49	25.20	24.00	22.88
	251	33.37	33.39	31.14	30.12	29.21	27.59	25.44	24.22	23.16
GSM 1900	512	30.09	30.11	27.92	26.93	26.01	26.53	24.11	23.00	21.85
	661	30.32	30.37	28.06	27.07	26.12	26.22	24.31	23.16	22.11
	810	30.54	30.60	28.42	27.35	26.49	26.45	24.59	23.52	22.40

		Calculated Maximum Frame-Averaged Output Power								
		Voice	GPRS/EDGE Data (GMSK)				EDGE Data (8-PSK)			
Band	Channel	GSM [dBm] CS (1 Slot)	GPRS [dBm] 1 Tx Slot	GPRS [dBm] 2 Tx Slot	GPRS [dBm] 3 Tx Slot	GPRS [dBm] 4 Tx Slot	EDGE [dBm] 1 Tx Slot	EDGE [dBm] 2 Tx Slot	EDGE [dBm] 3 Tx Slot	EDGE [dBm] 4 Tx Slot
GSM 850	128	23.88	23.88	25.04	25.62	25.82	18.39	19.09	19.61	19.75
	190	24.19	24.21	25.06	25.68	25.94	18.46	19.18	19.74	19.87
	251	24.34	24.36	25.12	25.86	26.20	18.56	19.42	19.96	20.15
GSM 1900	512	21.06	21.08	21.90	22.67	23.00	17.50	18.09	18.74	18.84
	661	21.29	21.34	22.04	22.81	23.11	17.19	18.29	18.90	19.10
	810	21.51	21.57	22.40	23.09	23.48	17.42	18.57	19.26	19.39

FCC ID: PY7PM-0410	 PCTEST ENGINEERING LABORATORY, INC.	SAR EVALUATION REPORT	SONY	Reviewed by: Quality Manager
Document S/N: OY1306100973.PY7	Test Dates: 05/06/13 - 08/01/13	DUT Type: Portable Handset		Page 25 of 83

**Table 9-2
Reduced GSM/GPRS/EDGE Average RF Conducted Powers
(Representing Hotspot Mode Active)**

		Maximum Burst-Averaged Output Power								
		Voice	GPRS/EDGE Data (GMSK)				EDGE Data (8-PSK)			
Band	Channel	GSM [dBm] CS (1 Slot)	GPRS [dBm] 1 Tx Slot	GPRS [dBm] 2 Tx Slot	GPRS [dBm] 3 Tx Slot	GPRS [dBm] 4 Tx Slot	EDGE [dBm] 1 Tx Slot	EDGE [dBm] 2 Tx Slot	EDGE [dBm] 3 Tx Slot	EDGE [dBm] 4 Tx Slot
GSM 1900	512	28.13	28.15	26.17	24.71	23.68	25.95	24.54	22.98	21.77
	661	28.20	28.23	26.27	24.80	23.81	26.12	24.26	23.15	21.99
	810	28.52	28.44	26.57	25.15	24.10	26.53	24.58	23.39	22.33

		Calculated Maximum Frame-Averaged Output Power								
		Voice	GPRS/EDGE Data (GMSK)				EDGE Data (8-PSK)			
Band	Channel	GSM [dBm] CS (1 Slot)	GPRS [dBm] 1 Tx Slot	GPRS [dBm] 2 Tx Slot	GPRS [dBm] 3 Tx Slot	GPRS [dBm] 4 Tx Slot	EDGE [dBm] 1 Tx Slot	EDGE [dBm] 2 Tx Slot	EDGE [dBm] 3 Tx Slot	EDGE [dBm] 4 Tx Slot
GSM 1900	512	19.10	19.12	20.15	20.45	20.67	16.92	18.52	18.72	18.76
	661	19.17	19.20	20.25	20.54	20.80	17.09	18.24	18.89	18.98
	810	19.49	19.41	20.55	20.89	21.09	17.50	18.56	19.13	19.32



Notes:

- Both burst-averaged and calculated frame-averaged powers are included. Frame-averaged power was calculated from the measured burst-averaged power by converting the slot powers into linear units and calculating the energy over 8 timeslots.
- The bolded GPRS modes were selected for SAR testing according to the highest frame-averaged output power table according to KDB 941225 D03v01.
- GPRS (GMSK) output powers were measured with coding scheme setting of 1 (CS1) on the base station simulator. CS1 was configured to measure GPRS output power measurements and SAR to ensure GMSK modulation in the signal. Our Investigation has shown that CS1 - CS4 settings do not have any impact on the output levels or modulation in the GPRS modes.
- EDGE (8-PSK) output powers were measured with MCS7 on the base station simulator. MCS7 coding scheme was used to measure the output powers for EDGE since investigation has shown that choosing MCS7 coding scheme will ensure 8-PSK modulation. It has been shown that MCS levels that produce 8-PSK modulation do not have an impact on output power.
- This device does not support evolved EDGE (eEDGE).
- There is no power reduction for GSM/GPRS/EDGE 850.

GSM Class: B
GPRS Multislot class: 33 (Max 4 Tx uplink slots)
EDGE Multislot class: 33 (Max 4 Tx uplink slots)
DTM Multislot Class: N/A





**Figure 9-1
Power Measurement Setup**

FCC ID: PY7PM-0410		SAR EVALUATION REPORT		Reviewed by: Quality Manager
Document S/N: OY1306100973.PY7	Test Dates: 05/06/13 - 08/01/13	DUT Type: Portable Handset		Page 26 of 83

9.2 UMTS Conducted Powers

Table 9-3
Maximum UMTS Average RF Conducted Powers
(Representing Hotspot Mode Inactive)

3GPP Release Version	Mode	3GPP 34.121 Subtest	Cellular Band [dBm]			AWS Band [dBm]			PCS Band [dBm]			3GPP MPR [dB]
			4132	4183	4233	1312	1412	1862	9262	9400	9538	
99	WCDMA	12.2 kbps RMC	24.24	24.27	24.28	24.01	24.06	24.15	23.78	23.63	23.67	-
99		12.2 kbps AMR	24.20	24.24	24.18	24.00	24.01	24.12	23.65	23.67	23.54	-
6	HSDPA	Subtest 1	24.16	24.22	24.11	24.12	23.97	24.03	23.67	23.59	23.56	0
6		Subtest 2	24.28	24.25	24.16	24.20	23.92	24.14	23.63	23.71	23.64	0
6		Subtest 3	23.84	23.74	23.72	23.60	23.52	23.55	23.22	23.16	23.09	0.5
6		Subtest 4	23.88	23.71	23.70	23.61	23.41	23.51	23.18	23.14	23.05	0.5
6	HSUPA	Subtest 1	23.59	23.43	23.98	23.15	23.42	23.37	23.17	22.61	23.03	0
6		Subtest 2	21.55	21.58	21.81	21.54	21.49	21.63	21.24	21.00	21.52	2
6		Subtest 3	23.16	22.97	23.13	22.80	22.92	22.94	22.57	22.23	22.46	1
6		Subtest 4	22.79	22.68	22.09	22.42	22.58	22.57	22.21	21.81	22.06	2
6		Subtest 5	23.73	23.53	24.09	23.30	23.49	23.45	23.07	22.69	23.00	0
8	DC-HSDPA	Subtest 1	23.97	24.14	24.02	24.36	24.21	23.70	23.80	23.70	23.29	0
8		Subtest 2	24.24	24.16	24.09	24.43	24.29	23.71	23.99	23.78	23.22	0
8		Subtest 3	23.75	23.53	23.59	23.99	23.75	23.12	23.39	23.29	22.88	0.5
8		Subtest 4	23.77	23.58	23.55	24.00	23.96	23.21	23.28	23.05	22.64	0.5

FCC ID: PY7PM-0410		SAR EVALUATION REPORT		Reviewed by: Quality Manager
Document S/N: 0Y1306100973.PY7	Test Dates: 05/06/13 - 08/01/13	DUT Type: Portable Handset		Page 27 of 83

**Table 9-4
Reduced UMTS Average RF Conducted Powers
(Representing Hotspot Mode Active)**



3GPP Release Version	Mode	3GPP 34.121 Subtest	AWS Band [dBm]			PCS Band [dBm]			3GPP MPR [dB]
			1312	1412	1862	9262	9400	9538	
99	WCDMA	12.2 kbps RMC	21.49	21.48	21.54	20.72	20.70	20.64	-
99		12.2 kbps AMR	21.37	21.23	21.35	20.62	20.61	20.59	-
6	HSDPA	Subtest 1	21.36	21.27	21.30	20.61	20.63	20.56	0
6		Subtest 2	21.36	21.33	21.28	20.60	20.64	20.54	0
6		Subtest 3	20.81	20.80	20.75	20.07	20.10	20.13	0.5
6		Subtest 4	20.90	20.82	20.89	20.13	20.16	20.12	0.5
6	HSUPA	Subtest 1	21.18	20.82	20.69	20.23	20.35	20.31	0
6		Subtest 2	18.98	18.69	18.77	18.08	18.15	18.21	2
6		Subtest 3	20.27	20.28	20.22	19.54	19.32	19.54	1
6		Subtest 4	19.95	19.50	19.46	18.94	18.97	18.88	2
6		Subtest 5	21.22	20.79	20.63	20.12	19.96	20.39	0
8	DC-HSDPA	Subtest 1	21.11	21.50	21.10	20.33	20.24	20.18	0
8		Subtest 2	21.16	21.52	21.08	20.25	20.18	20.13	0
8		Subtest 3	21.44	21.07	20.62	19.75	19.71	19.63	0.5
8		Subtest 4	21.43	21.09	20.63	19.81	19.76	19.60	0.5

Notes:

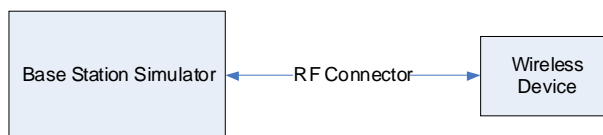
- UMTS SAR was tested under RMC 12.2 kbps with HSPA Inactive per KDB Publication 941225 D01v02. HSPA SAR was not required since the average output power of the HSPA subtests was not more than 0.25 dB higher than the RMC level and SAR was less than 1.2 W/kg. DC-HSDPA SAR was not required since SAR was less than 1.2 W/kg.
- DC-HSDPA considerations
 - 3GPP Specification 34.121-1 Release 8 Ver 8.10.0 was used for DC-HSDPA guidance
 - H-Set 12 (QPSK) was confirmed to be used during DC-HSDPA measurements
 - Per FCC KDB Publication 941225 D02, since the maximum average output power of each RF channel with DC-HSDPA active is $\leq \frac{1}{4}$ dB higher than that measured using 12.2 kbps RMC, or the maximum reported SAR for 12.2 kbps RMC is $\leq 75\%$ of the SAR limit, SAR evaluation for DC-HSDPA is not required.
 - The DUT supports UE category 24 for HSDPA
- There is no power reduction for UMTS Band 5.



**Figure 9-2
Power Measurement Setup**

FCC ID: PY7PM-0410		SAR EVALUATION REPORT		Reviewed by: Quality Manager
Document S/N: OY1306100973.PY7	Test Dates: 05/06/13 - 08/01/13	DUT Type: Portable Handset		Page 28 of 83

9.3 LTE Conducted Powers

9.3.1 LTE Band 5 (Cell)



Table 9-5
LTE Band 5 (Cell) Conducted Powers - 10 MHz Bandwidth

	Frequency [MHz]	Channel	Bandwidth [MHz]	Modulation	RB Size	RB Offset	Conducted Power [dBm]	Target MPR [dB]	MPR Allowed per 3GPP [dB]
Mid	836.5	20525	10	QPSK	1	0	22.58	0	0
	836.5	20525	10	QPSK	1	25	22.64	0	0
	836.5	20525	10	QPSK	1	49	22.73	0	0
	836.5	20525	10	QPSK	25	0	21.44	1	0-1
	836.5	20525	10	QPSK	25	12	21.52	1	0-1
	836.5	20525	10	QPSK	25	25	21.44	1	0-1
	836.5	20525	10	QPSK	50	0	21.42	1	0-1
	836.5	20525	10	16QAM	1	0	21.35	1	0-1
	836.5	20525	10	16QAM	1	25	21.48	1	0-1
	836.5	20525	10	16QAM	1	49	21.62	1	0-1
	836.5	20525	10	16QAM	25	0	20.58	2	0-2
	836.5	20525	10	16QAM	25	12	20.59	2	0-2
	836.5	20525	10	16QAM	25	25	20.57	2	0-2
836.5	20525	10	16QAM	50	0	20.45	2	0-2	

Note: LTE Band 5 (Cell) at 10 MHz bandwidth does not support three non-overlapping channels. Per KDB Publication 941225 D05v02, when a device supports overlapping channel assignment in a channel bandwidth configuration, the middle channel of the group of overlapping channels should be selected for testing.

Table 9-6
LTE Band 5 (Cell) Conducted Powers - 5 MHz Bandwidth

	Frequency [MHz]	Channel	Bandwidth [MHz]	Modulation	RB Size	RB Offset	Conducted Power [dBm]	Target MPR [dB]	MPR Allowed per 3GPP [dB]	
Low	826.5	20425	5	QPSK	1	0	22.43	0	0	
	826.5	20425	5	QPSK	1	12	22.55	0	0	
	826.5	20425	5	QPSK	1	24	22.61	0	0	
	826.5	20425	5	QPSK	12	0	21.38	1	0-1	
	826.5	20425	5	QPSK	12	6	21.40	1	0-1	
	826.5	20425	5	QPSK	12	13	21.44	1	0-1	
	826.5	20425	5	QPSK	25	0	21.26	1	0-1	
	826.5	20425	5	16-QAM	1	0	21.53	1	0-1	
	826.5	20425	5	16-QAM	1	12	21.66	1	0-1	
	826.5	20425	5	16-QAM	1	24	21.73	1	0-1	
	826.5	20425	5	16-QAM	12	0	20.41	2	0-2	
	826.5	20425	5	16-QAM	12	6	20.47	2	0-2	
	826.5	20425	5	16-QAM	12	13	20.50	2	0-2	
	826.5	20425	5	16-QAM	25	0	20.32	2	0-2	
	Mid	836.5	20525	5	QPSK	1	0	22.67	0	0
		836.5	20525	5	QPSK	1	12	22.72	0	0
		836.5	20525	5	QPSK	1	24	22.74	0	0
		836.5	20525	5	QPSK	12	0	21.59	1	0-1
		836.5	20525	5	QPSK	12	6	21.56	1	0-1
		836.5	20525	5	QPSK	12	13	21.52	1	0-1
836.5		20525	5	QPSK	25	0	21.46	1	0-1	
836.5		20525	5	16-QAM	1	0	21.43	1	0-1	
836.5		20525	5	16-QAM	1	12	21.47	1	0-1	
836.5		20525	5	16-QAM	1	24	21.44	1	0-1	
836.5		20525	5	16-QAM	12	0	20.58	2	0-2	
836.5		20525	5	16-QAM	12	6	20.56	2	0-2	
836.5		20525	5	16-QAM	12	13	20.57	2	0-2	
836.5		20525	5	16-QAM	25	0	20.44	2	0-2	
High		846.5	20625	5	QPSK	1	0	22.67	0	0
		846.5	20625	5	QPSK	1	12	22.48	0	0
		846.5	20625	5	QPSK	1	24	22.61	0	0
		846.5	20625	5	QPSK	12	0	21.70	1	0-1
		846.5	20625	5	QPSK	12	6	21.62	1	0-1
		846.5	20625	5	QPSK	12	13	21.74	1	0-1
	846.5	20625	5	QPSK	25	0	21.61	1	0-1	
	846.5	20625	5	16-QAM	1	0	21.54	1	0-1	
	846.5	20625	5	16-QAM	1	12	21.44	1	0-1	
	846.5	20625	5	16-QAM	1	24	21.56	1	0-1	
	846.5	20625	5	16-QAM	12	0	20.75	2	0-2	
	846.5	20625	5	16-QAM	12	6	20.74	2	0-2	
	846.5	20625	5	16-QAM	12	13	20.79	2	0-2	
846.5	20625	5	16-QAM	25	0	20.66	2	0-2		

FCC ID: PY7PM-0410	 PCTEST ENGINEERING LABORATORY, INC.	SAR EVALUATION REPORT		Reviewed by: Quality Manager
Document S/N: OY1306100973.PY7	Test Dates: 05/06/13 - 08/01/13	DUT Type: Portable Handset		Page 29 of 83

**Table 9-7
LTE Band 5 (Cell) Conducted Powers - 3 MHz Bandwidth**

Frequency [MHz]	Channel	Bandwidth [MHz]	Modulation	RB Size	RB Offset	Conducted Power [dBm]	Target MPR [dB]	MPR Allowed per 3GPP [dB]	
Low	825.5	20415	3	QPSK	1	0	22.26	0	0
	825.5	20415	3	QPSK	1	7	22.28	0	0
	825.5	20415	3	QPSK	1	14	22.35	0	0
	825.5	20415	3	QPSK	8	0	21.38	1	0-1
	825.5	20415	3	QPSK	8	4	21.37	1	0-1
	825.5	20415	3	QPSK	8	7	21.42	1	0-1
	825.5	20415	3	QPSK	15	0	21.41	1	0-1
	825.5	20415	3	16-QAM	1	0	21.30	1	0-1
	825.5	20415	3	16-QAM	1	7	21.14	1	0-1
	825.5	20415	3	16-QAM	1	14	21.16	1	0-1
	825.5	20415	3	16-QAM	8	0	20.44	2	0-2
	825.5	20415	3	16-QAM	8	4	20.47	2	0-2
	825.5	20415	3	16-QAM	8	7	20.51	2	0-2
	825.5	20415	3	16-QAM	15	0	20.43	2	0-2
	Mid	836.5	20525	3	QPSK	1	0	22.66	0
836.5		20525	3	QPSK	1	7	22.64	0	0
836.5		20525	3	QPSK	1	14	22.65	0	0
836.5		20525	3	QPSK	8	0	21.62	1	0-1
836.5		20525	3	QPSK	8	4	21.58	1	0-1
836.5		20525	3	QPSK	8	7	21.61	1	0-1
836.5		20525	3	QPSK	15	0	21.57	1	0-1
836.5		20525	3	16-QAM	1	0	21.46	1	0-1
836.5		20525	3	16-QAM	1	7	21.55	1	0-1
836.5		20525	3	16-QAM	1	14	21.51	1	0-1
836.5		20525	3	16-QAM	8	0	20.53	2	0-2
836.5		20525	3	16-QAM	8	4	20.53	2	0-2
836.5		20525	3	16-QAM	8	7	20.54	2	0-2
836.5		20525	3	16-QAM	15	0	20.63	2	0-2
High		847.5	20635	3	QPSK	1	0	22.59	0
	847.5	20635	3	QPSK	1	7	22.61	0	0
	847.5	20635	3	QPSK	1	14	22.61	0	0
	847.5	20635	3	QPSK	8	0	21.66	1	0-1
	847.5	20635	3	QPSK	8	4	21.83	1	0-1
	847.5	20635	3	QPSK	8	7	21.81	1	0-1
	847.5	20635	3	QPSK	15	0	21.71	1	0-1
	847.5	20635	3	16-QAM	1	0	21.56	1	0-1
	847.5	20635	3	16-QAM	1	7	21.55	1	0-1
	847.5	20635	3	16-QAM	1	14	21.56	1	0-1
	847.5	20635	3	16-QAM	8	0	20.73	2	0-2
	847.5	20635	3	16-QAM	8	4	20.79	2	0-2
	847.5	20635	3	16-QAM	8	7	20.76	2	0-2
	847.5	20635	3	16-QAM	15	0	20.76	2	0-2

**Table 9-8
LTE Band 5 (Cell) Conducted Powers -1.4 MHz Bandwidth**

Frequency [MHz]	Channel	Bandwidth [MHz]	Modulation	RB Size	RB Offset	Conducted Power [dBm]	Target MPR [dB]	MPR Allowed per 3GPP [dB]	
Low	824.7	20407	1.4	QPSK	1	0	22.43	0	0
	824.7	20407	1.4	QPSK	1	2	22.44	0	0
	824.7	20407	1.4	QPSK	1	5	22.46	0	0
	824.7	20407	1.4	QPSK	3	0	22.32	0	0
	824.7	20407	1.4	QPSK	3	2	22.33	0	0
	824.7	20407	1.4	QPSK	3	3	22.38	0	0
	824.7	20407	1.4	QPSK	6	0	21.35	1	0-1
	824.7	20407	1.4	16-QAM	1	0	21.22	1	0-1
	824.7	20407	1.4	16-QAM	1	2	21.23	1	0-1
	824.7	20407	1.4	16-QAM	1	5	21.27	1	0-1
	824.7	20407	1.4	16-QAM	3	0	21.30	1	0-1
	824.7	20407	1.4	16-QAM	3	2	21.29	1	0-1
	824.7	20407	1.4	16-QAM	3	3	21.30	1	0-1
	824.7	20407	1.4	16-QAM	6	0	20.39	2	0-2
	Mid	836.5	20525	1.4	QPSK	1	0	22.67	0
836.5		20525	1.4	QPSK	1	2	22.65	0	0
836.5		20525	1.4	QPSK	1	5	22.63	0	0
836.5		20525	1.4	QPSK	3	0	22.57	0	0
836.5		20525	1.4	QPSK	3	2	22.61	0	0
836.5		20525	1.4	QPSK	3	3	22.68	0	0
836.5		20525	1.4	QPSK	6	0	21.70	1	0-1
836.5		20525	1.4	16-QAM	1	0	21.51	1	0-1
836.5		20525	1.4	16-QAM	1	2	21.47	1	0-1
836.5		20525	1.4	16-QAM	1	5	21.52	1	0-1
836.5		20525	1.4	16-QAM	3	0	21.50	1	0-1
836.5		20525	1.4	16-QAM	3	2	21.50	1	0-1
836.5		20525	1.4	16-QAM	3	3	21.50	1	0-1
836.5		20525	1.4	16-QAM	6	0	20.67	2	0-2
High		848.3	20643	1.4	QPSK	1	0	22.64	0
	848.3	20643	1.4	QPSK	1	2	22.57	0	0
	848.3	20643	1.4	QPSK	1	5	22.58	0	0
	848.3	20643	1.4	QPSK	3	0	22.65	0	0
	848.3	20643	1.4	QPSK	3	2	22.66	0	0
	848.3	20643	1.4	QPSK	3	3	22.62	0	0
	848.3	20643	1.4	QPSK	6	0	21.73	1	0-1
	848.3	20643	1.4	16-QAM	1	0	21.59	1	0-1
	848.3	20643	1.4	16-QAM	1	2	21.51	1	0-1
	848.3	20643	1.4	16-QAM	1	5	21.55	1	0-1
	848.3	20643	1.4	16-QAM	3	0	21.69	1	0-1
	848.3	20643	1.4	16-QAM	3	2	21.69	1	0-1
	848.3	20643	1.4	16-QAM	3	3	21.65	1	0-1
	848.3	20643	1.4	16-QAM	6	0	20.67	2	0-2

9.3.2

LTE Band 4 (AWS)

Table 9-9
Maximum LTE Band 4 (AWS) Conducted Powers - 20 MHz Bandwidth
(Representing Hotspot Mode Inactive)

Frequency [MHz]	Channel	Bandwidth [MHz]	Modulation	RB Size	RB Offset	Conducted Power [dBm]	Target MPR [dB]	MPR Allowed per 3GPP [dB]
1732.5	20175	20	QPSK	1	0	23.44	0	0
1732.5	20175	20	QPSK	1	50	23.49	0	0
1732.5	20175	20	QPSK	1	99	23.38	0	0
1732.5	20175	20	QPSK	50	0	22.16	1	0-1
1732.5	20175	20	QPSK	50	25	22.16	1	0-1
1732.5	20175	20	QPSK	50	50	22.21	1	0-1
1732.5	20175	20	QPSK	100	0	22.18	1	0-1
1732.5	20175	20	16QAM	1	0	22.26	1	0-1
1732.5	20175	20	16QAM	1	50	22.29	1	0-1
1732.5	20175	20	16QAM	1	99	22.27	1	0-1
1732.5	20175	20	16QAM	50	0	21.07	2	0-2
1732.5	20175	20	16QAM	50	25	21.06	2	0-2
1732.5	20175	20	16QAM	50	50	21.07	2	0-2
1732.5	20175	20	16QAM	100	0	21.11	2	0-2

Note: LTE Band 4 (AWS) at 20 MHz bandwidth does not support three non-overlapping channels. Per KDB Publication 941225 D05v02, when a device supports overlapping channel assignment in a channel bandwidth configuration, the middle channel of the group of overlapping channels should be selected for testing.

Table 9-10
Maximum LTE Band 4 (AWS) Conducted Powers - 15 MHz Bandwidth
(Representing Hotspot Mode Inactive)

Frequency [MHz]	Channel	Bandwidth [MHz]	Modulation	RB Size	RB Offset	Conducted Power [dBm]	Target MPR [dB]	MPR Allowed per 3GPP [dB]
1717.5	20025	15	QPSK	1	0	23.51	0	0
1717.5	20025	15	QPSK	1	36	23.33	0	0
1717.5	20025	15	QPSK	1	74	23.40	0	0
1717.5	20025	15	QPSK	36	0	22.04	1	0-1
1717.5	20025	15	QPSK	36	18	22.05	1	0-1
1717.5	20025	15	QPSK	36	37	22.07	1	0-1
1717.5	20025	15	QPSK	75	0	21.99	1	0-1
1717.5	20025	15	16QAM	1	0	22.30	1	0-1
1717.5	20025	15	16QAM	1	36	22.13	1	0-1
1717.5	20025	15	16QAM	1	74	22.27	1	0-1
1717.5	20025	15	16QAM	36	0	21.00	2	0-2
1717.5	20025	15	16QAM	36	18	21.00	2	0-2
1717.5	20025	15	16QAM	36	37	21.01	2	0-2
1717.5	20025	15	16QAM	75	0	21.04	2	0-2
1732.5	20175	15	QPSK	1	0	23.53	0	0
1732.5	20175	15	QPSK	1	36	23.47	0	0
1732.5	20175	15	QPSK	1	74	23.39	0	0
1732.5	20175	15	QPSK	36	0	22.12	1	0-1
1732.5	20175	15	QPSK	36	18	22.14	1	0-1
1732.5	20175	15	QPSK	36	37	22.11	1	0-1
1732.5	20175	15	QPSK	75	0	22.13	1	0-1
1732.5	20175	15	16QAM	1	0	22.35	1	0-1
1732.5	20175	15	16QAM	1	36	22.32	1	0-1
1732.5	20175	15	16QAM	1	74	22.28	1	0-1
1732.5	20175	15	16QAM	36	0	21.03	2	0-2
1732.5	20175	15	16QAM	36	18	21.04	2	0-2
1732.5	20175	15	16QAM	36	37	21.06	2	0-2
1732.5	20175	15	16QAM	75	0	21.07	2	0-2
1747.5	20325	15	QPSK	1	0	23.26	0	0
1747.5	20325	15	QPSK	1	36	23.20	0	0
1747.5	20325	15	QPSK	1	74	23.29	0	0
1747.5	20325	15	QPSK	36	0	22.13	1	0-1
1747.5	20325	15	QPSK	36	18	22.02	1	0-1
1747.5	20325	15	QPSK	36	37	22.03	1	0-1
1747.5	20325	15	QPSK	75	0	22.01	1	0-1
1747.5	20325	15	16QAM	1	0	22.15	1	0-1
1747.5	20325	15	16QAM	1	36	22.19	1	0-1
1747.5	20325	15	16QAM	1	74	22.11	1	0-1
1747.5	20325	15	16QAM	36	0	21.05	2	0-2
1747.5	20325	15	16QAM	36	18	21.01	2	0-2
1747.5	20325	15	16QAM	36	37	21.02	2	0-2
1747.5	20325	15	16QAM	75	0	20.97	2	0-2



FCC ID: PY7PM-0410	 PCTEST ENGINEERING LABORATORY, INC.	SAR EVALUATION REPORT		Reviewed by: Quality Manager
Document S/N: OY1306100973.PY7	Test Dates: 05/06/13 - 08/01/13	DUT Type: Portable Handset		Page 31 of 83

Table 9-11
Maximum LTE Band 4 (AWS) Conducted Powers - 10 MHz Bandwidth
(Representing Hotspot Mode Inactive)

Frequency [MHz]	Channel	Bandwidth [MHz]	Modulation	RB Size	RB Offset	Conducted Power [dBm]	Target MPR [dB]	MPR Allowed per 3GPP [dB]
Low	1715	2000	10	QPSK	1	0	23.46	0
	1715	2000	10	QPSK	1	25	23.39	0
	1715	2000	10	QPSK	1	49	23.39	0
	1715	2000	10	QPSK	25	0	22.16	0
	1715	2000	10	QPSK	25	12	22.19	1
	1715	2000	10	QPSK	25	25	22.10	1
	1715	2000	10	QPSK	50	0	22.09	1
	1715	2000	10	16QAM	1	0	22.29	1
	1715	2000	10	16QAM	1	25	22.22	1
	1715	2000	10	16QAM	1	49	22.24	1
	1715	2000	10	16QAM	25	0	21.23	2
	1715	2000	10	16QAM	25	12	21.18	2
	1715	2000	10	16QAM	25	25	21.19	2
	1715	2000	10	16QAM	50	0	21.03	2
	1715	2000	10	16QAM	50	0	21.03	2
Mid	1732.5	20175	10	QPSK	1	0	23.46	0
	1732.5	20175	10	QPSK	1	25	23.49	0
	1732.5	20175	10	QPSK	1	49	23.43	0
	1732.5	20175	10	QPSK	25	0	22.21	1
	1732.5	20175	10	QPSK	25	12	22.18	1
	1732.5	20175	10	QPSK	25	25	22.21	1
	1732.5	20175	10	QPSK	50	0	22.13	1
	1732.5	20175	10	16QAM	1	0	22.33	1
	1732.5	20175	10	16QAM	1	25	22.32	1
	1732.5	20175	10	16QAM	1	49	22.29	1
	1732.5	20175	10	16QAM	25	0	21.21	2
	1732.5	20175	10	16QAM	25	12	21.23	2
	1732.5	20175	10	16QAM	25	25	21.22	2
	1732.5	20175	10	16QAM	50	0	21.06	2
	1732.5	20175	10	16QAM	50	0	21.06	2
High	1750	20350	10	QPSK	1	0	23.09	0
	1750	20350	10	QPSK	1	25	23.14	0
	1750	20350	10	QPSK	1	49	23.00	0
	1750	20350	10	QPSK	25	0	22.10	1
	1750	20350	10	QPSK	25	12	22.03	1
	1750	20350	10	QPSK	25	25	22.17	1
	1750	20350	10	QPSK	50	0	21.94	1
	1750	20350	10	16QAM	1	0	22.01	1
	1750	20350	10	16QAM	1	25	22.02	1
	1750	20350	10	16QAM	1	49	21.89	1
	1750	20350	10	16QAM	25	0	21.15	2
	1750	20350	10	16QAM	25	12	21.16	2
	1750	20350	10	16QAM	25	25	21.32	2
	1750	20350	10	16QAM	50	0	20.97	2
	1750	20350	10	16QAM	50	0	20.97	2

Table 9-12
Maximum LTE Band 4 (AWS) Conducted Powers - 5 MHz Bandwidth
(Representing Hotspot Mode Inactive)

Frequency [MHz]	Channel	Bandwidth [MHz]	Modulation	RB Size	RB Offset	Conducted Power [dBm]	Target MPR [dB]	MPR Allowed per 3GPP [dB]
Low	1712.5	19975	5	QPSK	1	0	23.26	0
	1712.5	19975	5	QPSK	1	12	23.24	0
	1712.5	19975	5	QPSK	1	24	23.22	0
	1712.5	19975	5	QPSK	12	0	22.32	1
	1712.5	19975	5	QPSK	12	6	22.31	1
	1712.5	19975	5	QPSK	12	13	22.32	1
	1712.5	19975	5	QPSK	25	0	22.24	1
	1712.5	19975	5	16-QAM	1	0	22.58	1
	1712.5	19975	5	16-QAM	1	12	22.55	1
	1712.5	19975	5	16-QAM	1	24	22.49	1
	1712.5	19975	5	16-QAM	12	0	21.32	2
	1712.5	19975	5	16-QAM	12	6	21.31	2
	1712.5	19975	5	16-QAM	12	13	21.30	2
	1712.5	19975	5	16-QAM	25	0	21.15	2
	1712.5	19975	5	16-QAM	25	0	21.15	2
Mid	1732.5	20175	5	QPSK	1	0	23.23	0
	1732.5	20175	5	QPSK	1	12	23.23	0
	1732.5	20175	5	QPSK	1	24	23.27	0
	1732.5	20175	5	QPSK	12	0	22.33	1
	1732.5	20175	5	QPSK	12	6	22.35	1
	1732.5	20175	5	QPSK	12	13	22.33	1
	1732.5	20175	5	QPSK	25	0	22.23	1
	1732.5	20175	5	16-QAM	1	0	22.52	1
	1732.5	20175	5	16-QAM	1	12	22.51	1
	1732.5	20175	5	16-QAM	1	24	22.53	1
	1732.5	20175	5	16-QAM	12	0	21.30	2
	1732.5	20175	5	16-QAM	12	6	21.30	2
	1732.5	20175	5	16-QAM	12	13	21.33	2
	1732.5	20175	5	16-QAM	25	0	21.17	2
	1732.5	20175	5	16-QAM	25	0	21.17	2
High	1752.5	20375	5	QPSK	1	0	23.22	0
	1752.5	20375	5	QPSK	1	12	23.23	0
	1752.5	20375	5	QPSK	1	24	23.11	0
	1752.5	20375	5	QPSK	12	0	22.20	1
	1752.5	20375	5	QPSK	12	6	22.20	1
	1752.5	20375	5	QPSK	12	13	22.14	1
	1752.5	20375	5	QPSK	25	0	22.16	1
	1752.5	20375	5	16-QAM	1	0	22.21	1
	1752.5	20375	5	16-QAM	1	12	22.19	1
	1752.5	20375	5	16-QAM	1	24	22.12	1
	1752.5	20375	5	16-QAM	12	0	21.25	2
	1752.5	20375	5	16-QAM	12	6	21.30	2
	1752.5	20375	5	16-QAM	12	13	21.27	2
	1752.5	20375	5	16-QAM	25	0	21.12	2
	1752.5	20375	5	16-QAM	25	0	21.12	2



FCC ID: PY7PM-0410		SAR EVALUATION REPORT		Reviewed by: Quality Manager
Document S/N: OY1306100973.PY7	Test Dates: 05/06/13 - 08/01/13	DUT Type: Portable Handset		Page 32 of 83

Table 9-13
Maximum LTE Band 4 (AWS) Conducted Powers - 3 MHz Bandwidth
(Representing Hotspot Mode Inactive)

	Frequency [MHz]	Channel	Bandwidth [MHz]	Modulation	RB Size	RB Offset	Conducted Power [dBm]	Target MPR [dB]	MPR Allowed per 3GPP [dB]
Low	1711.5	19965	3	QPSK	1	0	23.22	0	0
	1711.5	19965	3	QPSK	1	7	23.27	0	0
	1711.5	19965	3	QPSK	1	14	23.20	0	0
	1711.5	19965	3	QPSK	8	0	22.35	1	0-1
	1711.5	19965	3	QPSK	8	4	22.32	1	0-1
	1711.5	19965	3	QPSK	8	7	22.33	1	0-1
	1711.5	19965	3	QPSK	15	0	22.25	1	0-1
	1711.5	19965	3	16-QAM	1	0	22.58	1	0-1
	1711.5	19965	3	16-QAM	1	7	22.52	1	0-1
	1711.5	19965	3	16-QAM	1	14	22.49	1	0-1
	1711.5	19965	3	16-QAM	8	0	21.46	2	0-2
	1711.5	19965	3	16-QAM	8	4	21.46	2	0-2
	1711.5	19965	3	16-QAM	8	7	21.44	2	0-2
	1711.5	19965	3	16-QAM	15	0	21.32	2	0-2
	Mid	1732.5	20175	3	QPSK	1	0	23.47	0
1732.5		20175	3	QPSK	1	7	23.52	0	0
1732.5		20175	3	QPSK	1	14	23.49	0	0
1732.5		20175	3	QPSK	8	0	22.32	1	0-1
1732.5		20175	3	QPSK	8	4	22.30	1	0-1
1732.5		20175	3	QPSK	8	7	22.36	1	0-1
1732.5		20175	3	QPSK	15	0	22.31	1	0-1
1732.5		20175	3	16-QAM	1	0	22.31	1	0-1
1732.5		20175	3	16-QAM	1	7	22.33	1	0-1
1732.5		20175	3	16-QAM	1	14	22.28	1	0-1
1732.5		20175	3	16-QAM	8	0	21.18	2	0-2
1732.5		20175	3	16-QAM	8	4	21.24	2	0-2
1732.5		20175	3	16-QAM	8	7	21.20	2	0-2
1732.5		20175	3	16-QAM	15	0	21.19	2	0-2
High		1753.5	20385	3	QPSK	1	0	23.14	0
	1753.5	20385	3	QPSK	1	7	23.07	0	0
	1753.5	20385	3	QPSK	1	14	23.07	0	0
	1753.5	20385	3	QPSK	8	0	22.13	1	0-1
	1753.5	20385	3	QPSK	8	4	22.16	1	0-1
	1753.5	20385	3	QPSK	8	7	22.16	1	0-1
	1753.5	20385	3	QPSK	15	0	22.11	1	0-1
	1753.5	20385	3	16-QAM	1	0	22.03	1	0-1
	1753.5	20385	3	16-QAM	1	7	21.99	1	0-1
	1753.5	20385	3	16-QAM	1	14	21.91	1	0-1
	1753.5	20385	3	16-QAM	8	0	21.16	2	0-2
	1753.5	20385	3	16-QAM	8	4	21.21	2	0-2
	1753.5	20385	3	16-QAM	8	7	21.19	2	0-2
	1753.5	20385	3	16-QAM	15	0	21.15	2	0-2

Table 9-14
Maximum LTE Band 4 (AWS) Conducted Powers -1.4 MHz Bandwidth
(Representing Hotspot Mode Inactive)

	Frequency [MHz]	Channel	Bandwidth [MHz]	Modulation	RB Size	RB Offset	Conducted Power [dBm]	Target MPR [dB]	MPR Allowed per 3GPP [dB]
Low	1710.7	19957	1.4	QPSK	1	0	23.49	0	0
	1710.7	19957	1.4	QPSK	1	2	23.44	0	0
	1710.7	19957	1.4	QPSK	1	5	23.50	0	0
	1710.7	19957	1.4	QPSK	3	0	23.32	0	0
	1710.7	19957	1.4	QPSK	3	2	23.33	0	0
	1710.7	19957	1.4	QPSK	3	3	23.29	0	0
	1710.7	19957	1.4	QPSK	6	0	22.30	1	0-1
	1710.7	19957	1.4	16-QAM	1	0	22.31	1	0-1
	1710.7	19957	1.4	16-QAM	1	2	22.28	1	0-1
	1710.7	19957	1.4	16-QAM	1	5	22.33	1	0-1
	1710.7	19957	1.4	16-QAM	3	0	22.33	1	0-1
	1710.7	19957	1.4	16-QAM	3	2	22.31	1	0-1
	1710.7	19957	1.4	16-QAM	3	3	22.28	1	0-1
	1710.7	19957	1.4	16-QAM	6	0	21.16	2	0-2
	Mid	1732.5	20175	1.4	QPSK	1	0	23.25	0
1732.5		20175	1.4	QPSK	1	2	23.23	0	0
1732.5		20175	1.4	QPSK	1	5	23.30	0	0
1732.5		20175	1.4	QPSK	3	0	23.22	0	0
1732.5		20175	1.4	QPSK	3	2	23.29	0	0
1732.5		20175	1.4	QPSK	3	3	23.26	0	0
1732.5		20175	1.4	QPSK	6	0	22.32	1	0-1
1732.5		20175	1.4	16-QAM	1	0	22.12	1	0-1
1732.5		20175	1.4	16-QAM	1	2	22.11	1	0-1
1732.5		20175	1.4	16-QAM	1	5	22.17	1	0-1
1732.5		20175	1.4	16-QAM	3	0	22.28	1	0-1
1732.5		20175	1.4	16-QAM	3	2	22.26	1	0-1
1732.5		20175	1.4	16-QAM	3	3	22.29	1	0-1
1732.5		20175	1.4	16-QAM	6	0	21.16	2	0-2
High		1754.3	20393	1.4	QPSK	1	0	23.10	0
	1754.3	20393	1.4	QPSK	1	2	23.00	0	0
	1754.3	20393	1.4	QPSK	1	5	23.03	0	0
	1754.3	20393	1.4	QPSK	3	0	23.16	0	0
	1754.3	20393	1.4	QPSK	3	2	23.09	0	0
	1754.3	20393	1.4	QPSK	3	3	23.12	0	0
	1754.3	20393	1.4	QPSK	6	0	22.10	1	0-1
	1754.3	20393	1.4	16-QAM	1	0	22.04	1	0-1
	1754.3	20393	1.4	16-QAM	1	2	21.96	1	0-1
	1754.3	20393	1.4	16-QAM	1	5	22.06	1	0-1
	1754.3	20393	1.4	16-QAM	3	0	22.25	1	0-1
	1754.3	20393	1.4	16-QAM	3	2	22.19	1	0-1
	1754.3	20393	1.4	16-QAM	3	3	22.24	1	0-1
	1754.3	20393	1.4	16-QAM	6	0	21.06	2	0-2

Table 9-15
Reduced LTE Band 4 (AWS) Conducted Powers - 20 MHz Bandwidth
(Representing Hotspot Mode Active)

Frequency [MHz]	Channel	Bandwidth [MHz]	Modulation	RB Size	RB Offset	Conducted Power [dBm]	Target MPR [dB]	MPR Allowed per 3GPP [dB]
1732.5	20175	20	QPSK	1	0	21.39	0	0
1732.5	20175	20	QPSK	1	50	21.45	0	0
1732.5	20175	20	QPSK	1	99	21.40	0	0
1732.5	20175	20	QPSK	50	0	21.24	0	0-1
1732.5	20175	20	QPSK	50	25	21.25	0	0-1
1732.5	20175	20	QPSK	50	50	21.29	0	0-1
1732.5	20175	20	QPSK	100	0	21.21	0	0-1
1732.5	20175	20	16QAM	1	0	21.32	0	0-1
1732.5	20175	20	16QAM	1	50	21.43	0	0-1
1732.5	20175	20	16QAM	1	99	21.42	0	0-1
1732.5	20175	20	16QAM	50	0	21.23	0	0-2
1732.5	20175	20	16QAM	50	25	21.14	0	0-2
1732.5	20175	20	16QAM	50	50	21.13	0	0-2
1732.5	20175	20	16QAM	100	0	21.15	0	0-2

Note: LTE Band 4 (AWS) at 20 MHz bandwidth does not support three non-overlapping channels. Per KDB Publication 941225 D05v02, when a device supports overlapping channel assignment in a channel bandwidth configuration, the middle channel of the group of overlapping channels should be selected for testing.

Table 9-16
Reduced LTE Band 4 (AWS) Conducted Powers - 15 MHz Bandwidth
(Representing Hotspot Mode Active)

Frequency [MHz]	Channel	Bandwidth [MHz]	Modulation	RB Size	RB Offset	Conducted Power [dBm]	Target MPR [dB]	MPR Allowed per 3GPP [dB]
1717.5	20025	15	QPSK	1	0	21.43	0	0
1717.5	20025	15	QPSK	1	36	21.41	0	0
1717.5	20025	15	QPSK	1	74	21.34	0	0
1717.5	20025	15	QPSK	36	0	21.17	0	0-1
1717.5	20025	15	QPSK	36	18	21.11	0	0-1
1717.5	20025	15	QPSK	36	37	21.16	0	0-1
1717.5	20025	15	QPSK	75	0	21.15	0	0-1
1717.5	20025	15	16QAM	1	0	21.22	0	0-1
1717.5	20025	15	16QAM	1	36	21.20	0	0-1
1717.5	20025	15	16QAM	1	74	21.24	0	0-1
1717.5	20025	15	16QAM	36	0	21.18	0	0-2
1717.5	20025	15	16QAM	36	18	21.18	0	0-2
1717.5	20025	15	16QAM	36	37	21.16	0	0-2
1717.5	20025	15	16QAM	75	0	21.20	0	0-2
1732.5	20175	15	QPSK	1	0	21.26	0	0
1732.5	20175	15	QPSK	1	36	21.34	0	0
1732.5	20175	15	QPSK	1	74	21.33	0	0
1732.5	20175	15	QPSK	36	0	21.31	0	0-1
1732.5	20175	15	QPSK	36	18	21.25	0	0-1
1732.5	20175	15	QPSK	36	37	21.21	0	0-1
1732.5	20175	15	QPSK	75	0	21.23	0	0-1
1732.5	20175	15	16QAM	1	0	21.26	0	0-1
1732.5	20175	15	16QAM	1	36	21.33	0	0-1
1732.5	20175	15	16QAM	1	74	21.29	0	0-1
1732.5	20175	15	16QAM	36	0	21.17	0	0-2
1732.5	20175	15	16QAM	36	18	21.15	0	0-2
1732.5	20175	15	16QAM	36	37	21.19	0	0-2
1732.5	20175	15	16QAM	75	0	21.25	0	0-2
1747.5	20325	15	QPSK	1	0	21.32	0	0
1747.5	20325	15	QPSK	1	36	21.35	0	0
1747.5	20325	15	QPSK	1	74	21.37	0	0
1747.5	20325	15	QPSK	36	0	21.21	0	0-1
1747.5	20325	15	QPSK	36	18	21.20	0	0-1
1747.5	20325	15	QPSK	36	37	21.25	0	0-1
1747.5	20325	15	QPSK	75	0	21.19	0	0-1
1747.5	20325	15	16QAM	1	0	21.26	0	0-1
1747.5	20325	15	16QAM	1	36	21.28	0	0-1
1747.5	20325	15	16QAM	1	74	21.27	0	0-1
1747.5	20325	15	16QAM	36	0	21.09	0	0-2
1747.5	20325	15	16QAM	36	18	21.15	0	0-2
1747.5	20325	15	16QAM	36	37	21.19	0	0-2
1747.5	20325	15	16QAM	75	0	21.14	0	0-2



FCC ID: PY7PM-0410	 SAR EVALUATION REPORT		Reviewed by: Quality Manager
Document S/N: OY1306100973.PY7	Test Dates: 05/06/13 - 08/01/13	DUT Type: Portable Handset	Page 34 of 83

Table 9-17
Reduced LTE Band 4 (AWS) Conducted Powers - 10 MHz Bandwidth
(Representing Hotspot Mode Active)

	Frequency [MHz]	Channel	Bandwidth [MHz]	Modulation	RB Size	RB Offset	Conducted Power [dBm]	Target MPR [dB]	MPR Allowed per 3GPP [dB]	
Low	1715	20000	10	QPSK	1	0	21.21	0	0	
	1715	20000	10	QPSK	1	25	21.25	0	0	
	1715	20000	10	QPSK	1	49	21.25	0	0	
	1715	20000	10	QPSK	25	0	21.22	0	0-1	
	1715	20000	10	QPSK	25	12	21.18	0	0-1	
	1715	20000	10	QPSK	25	25	21.23	0	0-1	
	1715	20000	10	QPSK	50	0	21.20	0	0-1	
	1715	20000	10	16QAM	1	0	21.08	0	0-1	
	1715	20000	10	16QAM	1	25	21.14	0	0-1	
	1715	20000	10	16QAM	1	49	21.11	0	0-1	
	1715	20000	10	16QAM	25	0	21.13	0	0-2	
	1715	20000	10	16QAM	25	12	21.21	0	0-2	
	1715	20000	10	16QAM	25	25	21.15	0	0-2	
	1715	20000	10	16QAM	50	0	21.16	0	0-2	
	Mid	1732.5	20175	10	QPSK	1	0	21.29	0	0
		1732.5	20175	10	QPSK	1	25	21.30	0	0
		1732.5	20175	10	QPSK	1	49	21.31	0	0
		1732.5	20175	10	QPSK	25	0	21.22	0	0-1
1732.5		20175	10	QPSK	25	12	21.23	0	0-1	
1732.5		20175	10	QPSK	25	25	21.25	0	0-1	
1732.5		20175	10	QPSK	50	0	21.20	0	0-1	
1732.5		20175	10	16QAM	1	0	21.39	0	0-1	
1732.5		20175	10	16QAM	1	25	21.35	0	0-1	
1732.5		20175	10	16QAM	1	49	21.37	0	0-1	
1732.5		20175	10	16QAM	25	0	21.34	0	0-2	
1732.5		20175	10	16QAM	25	12	21.33	0	0-2	
1732.5		20175	10	16QAM	25	25	21.19	0	0-2	
1732.5		20175	10	16QAM	50	0	21.20	0	0-2	
High		1750	20350	10	QPSK	1	0	21.31	0	0
		1750	20350	10	QPSK	1	25	21.36	0	0
		1750	20350	10	QPSK	1	49	21.37	0	0
		1750	20350	10	QPSK	25	0	21.19	0	0-1
	1750	20350	10	QPSK	25	12	21.23	0	0-1	
	1750	20350	10	QPSK	25	25	21.22	0	0-1	
	1750	20350	10	QPSK	50	0	21.17	0	0-1	
	1750	20350	10	16QAM	1	0	21.17	0	0-1	
	1750	20350	10	16QAM	1	25	21.15	0	0-1	
	1750	20350	10	16QAM	1	49	21.24	0	0-1	
	1750	20350	10	16QAM	25	0	21.21	0	0-2	
	1750	20350	10	16QAM	25	12	21.25	0	0-2	
	1750	20350	10	16QAM	25	25	21.23	0	0-2	
	1750	20350	10	16QAM	50	0	21.20	0	0-2	

Table 9-18
Reduced LTE Band 4 (AWS) Conducted Powers - 5 MHz Bandwidth
(Representing Hotspot Mode Active)



	Frequency [MHz]	Channel	Bandwidth [MHz]	Modulation	RB Size	RB Offset	Conducted Power [dBm]	Target MPR [dB]	MPR Allowed per 3GPP [dB]	
Low	1712.5	19975	5	QPSK	1	0	21.35	0	0	
	1712.5	19975	5	QPSK	1	12	21.36	0	0	
	1712.5	19975	5	QPSK	1	24	21.30	0	0	
	1712.5	19975	5	QPSK	12	0	21.29	0	0-1	
	1712.5	19975	5	QPSK	12	6	21.34	0	0-1	
	1712.5	19975	5	QPSK	12	13	21.28	0	0-1	
	1712.5	19975	5	QPSK	25	0	21.24	0	0-1	
	1712.5	19975	5	16-QAM	1	0	21.33	0	0-1	
	1712.5	19975	5	16-QAM	1	12	21.33	0	0-1	
	1712.5	19975	5	16-QAM	1	24	21.29	0	0-1	
	1712.5	19975	5	16-QAM	12	0	21.30	0	0-2	
	1712.5	19975	5	16-QAM	12	6	21.25	0	0-2	
	1712.5	19975	5	16-QAM	12	13	21.19	0	0-2	
	1712.5	19975	5	16-QAM	25	0	21.23	0	0-2	
	Mid	1732.5	20175	5	QPSK	1	0	21.30	0	0
		1732.5	20175	5	QPSK	1	12	21.31	0	0
		1732.5	20175	5	QPSK	1	24	21.33	0	0
		1732.5	20175	5	QPSK	12	0	21.34	0	0-1
1732.5		20175	5	QPSK	12	6	21.35	0	0-1	
1732.5		20175	5	QPSK	12	13	21.34	0	0-1	
1732.5		20175	5	QPSK	25	0	21.26	0	0-1	
1732.5		20175	5	16-QAM	1	0	21.19	0	0-1	
1732.5		20175	5	16-QAM	1	12	21.22	0	0-1	
1732.5		20175	5	16-QAM	1	24	21.23	0	0-1	
1732.5		20175	5	16-QAM	12	0	21.18	0	0-2	
1732.5		20175	5	16-QAM	12	6	21.20	0	0-2	
1732.5		20175	5	16-QAM	12	13	21.24	0	0-2	
1732.5		20175	5	16-QAM	25	0	21.24	0	0-2	
High		1752.5	20375	5	QPSK	1	0	21.33	0	0
		1752.5	20375	5	QPSK	1	12	21.30	0	0
		1752.5	20375	5	QPSK	1	24	21.29	0	0
		1752.5	20375	5	QPSK	12	0	21.28	0	0-1
	1752.5	20375	5	QPSK	12	6	21.29	0	0-1	
	1752.5	20375	5	QPSK	12	13	21.26	0	0-1	
	1752.5	20375	5	QPSK	25	0	21.26	0	0-1	
	1752.5	20375	5	16-QAM	1	0	21.30	0	0-1	
	1752.5	20375	5	16-QAM	1	12	21.28	0	0-1	
	1752.5	20375	5	16-QAM	1	24	21.15	0	0-1	
	1752.5	20375	5	16-QAM	12	0	21.18	0	0-2	
	1752.5	20375	5	16-QAM	12	6	21.21	0	0-2	
	1752.5	20375	5	16-QAM	12	13	21.20	0	0-2	
	1752.5	20375	5	16-QAM	25	0	21.23	0	0-2	

Table 9-19
Reduced LTE Band 4 (AWS) Conducted Powers - 3 MHz Bandwidth
(Representing Hotspot Mode Active)

Frequency [MHz]	Channel	Bandwidth [MHz]	Modulation	RB Size	RB Offset	Conducted Power [dBm]	Target MPR [dB]	MPR Allowed per 3GPP [dB]
Low	1711.5	19965	3	QPSK	1	0	21.33	0
	1711.5	19965	3	QPSK	1	7	21.31	0
	1711.5	19965	3	QPSK	1	14	21.28	0
	1711.5	19965	3	QPSK	8	0	21.28	0
	1711.5	19965	3	QPSK	8	4	21.30	0
	1711.5	19965	3	QPSK	8	7	21.28	0
	1711.5	19965	3	QPSK	15	0	21.25	0
	1711.5	19965	3	16-QAM	1	0	21.26	0
	1711.5	19965	3	16-QAM	1	7	21.27	0
	1711.5	19965	3	16-QAM	1	14	21.27	0
	1711.5	19965	3	16-QAM	8	0	21.19	0
	1711.5	19965	3	16-QAM	8	4	21.15	0
	1711.5	19965	3	16-QAM	8	7	21.20	0
	1711.5	19965	3	16-QAM	15	0	21.18	0
	1711.5	19965	3	16-QAM	15	0	21.18	0
Mid	1732.5	20175	3	QPSK	1	0	21.27	0
	1732.5	20175	3	QPSK	1	7	21.33	0
	1732.5	20175	3	QPSK	1	14	21.30	0
	1732.5	20175	3	QPSK	8	0	21.32	0
	1732.5	20175	3	QPSK	8	4	21.25	0
	1732.5	20175	3	QPSK	8	7	21.25	0
	1732.5	20175	3	QPSK	15	0	21.20	0
	1732.5	20175	3	16-QAM	1	0	21.22	0
	1732.5	20175	3	16-QAM	1	7	21.27	0
	1732.5	20175	3	16-QAM	1	14	21.28	0
	1732.5	20175	3	16-QAM	8	0	21.27	0
	1732.5	20175	3	16-QAM	8	4	21.24	0
	1732.5	20175	3	16-QAM	8	7	21.27	0
	1732.5	20175	3	16-QAM	15	0	21.23	0
	1732.5	20175	3	16-QAM	15	0	21.23	0
High	1753.5	20385	3	QPSK	1	0	21.31	0
	1753.5	20385	3	QPSK	1	7	21.37	0
	1753.5	20385	3	QPSK	1	14	21.36	0
	1753.5	20385	3	QPSK	8	0	21.30	0
	1753.5	20385	3	QPSK	8	4	21.34	0
	1753.5	20385	3	QPSK	8	7	21.27	0
	1753.5	20385	3	QPSK	15	0	21.25	0
	1753.5	20385	3	16-QAM	1	0	21.28	0
	1753.5	20385	3	16-QAM	1	7	21.29	0
	1753.5	20385	3	16-QAM	1	14	21.25	0
	1753.5	20385	3	16-QAM	8	0	21.24	0
	1753.5	20385	3	16-QAM	8	4	21.18	0
	1753.5	20385	3	16-QAM	8	7	21.21	0
	1753.5	20385	3	16-QAM	15	0	21.20	0
	1753.5	20385	3	16-QAM	15	0	21.20	0

Table 9-20
Reduced LTE Band 4 (AWS) Conducted Powers -1.4 MHz Bandwidth
(Representing Hotspot Mode Active)

Frequency [MHz]	Channel	Bandwidth [MHz]	Modulation	RB Size	RB Offset	Conducted Power [dBm]	Target MPR [dB]	MPR Allowed per 3GPP [dB]
Low	1710.7	19957	1.4	QPSK	1	0	21.32	0
	1710.7	19957	1.4	QPSK	1	2	21.30	0
	1710.7	19957	1.4	QPSK	1	5	21.30	0
	1710.7	19957	1.4	QPSK	3	0	21.28	0
	1710.7	19957	1.4	QPSK	3	2	21.31	0
	1710.7	19957	1.4	QPSK	3	3	21.27	0
	1710.7	19957	1.4	QPSK	6	0	21.28	0
	1710.7	19957	1.4	16-QAM	1	0	21.16	0
	1710.7	19957	1.4	16-QAM	1	2	21.19	0
	1710.7	19957	1.4	16-QAM	1	5	21.21	0
	1710.7	19957	1.4	16-QAM	3	0	21.20	0
	1710.7	19957	1.4	16-QAM	3	2	21.25	0
	1710.7	19957	1.4	16-QAM	3	3	21.24	0
	1710.7	19957	1.4	16-QAM	6	0	21.20	0
	1710.7	19957	1.4	16-QAM	6	0	21.20	0
Mid	1732.5	20175	1.4	QPSK	1	0	21.34	0
	1732.5	20175	1.4	QPSK	1	2	21.31	0
	1732.5	20175	1.4	QPSK	1	5	21.30	0
	1732.5	20175	1.4	QPSK	3	0	21.27	0
	1732.5	20175	1.4	QPSK	3	2	21.33	0
	1732.5	20175	1.4	QPSK	3	3	21.26	0
	1732.5	20175	1.4	QPSK	6	0	21.25	0
	1732.5	20175	1.4	16-QAM	1	0	21.28	0
	1732.5	20175	1.4	16-QAM	1	2	21.25	0
	1732.5	20175	1.4	16-QAM	1	5	21.28	0
	1732.5	20175	1.4	16-QAM	3	0	21.27	0
	1732.5	20175	1.4	16-QAM	3	2	21.23	0
	1732.5	20175	1.4	16-QAM	3	3	21.19	0
	1732.5	20175	1.4	16-QAM	6	0	21.26	0
	1732.5	20175	1.4	16-QAM	6	0	21.26	0
High	1754.3	20393	1.4	QPSK	1	0	21.29	0
	1754.3	20393	1.4	QPSK	1	2	21.28	0
	1754.3	20393	1.4	QPSK	1	5	21.31	0
	1754.3	20393	1.4	QPSK	3	0	21.27	0
	1754.3	20393	1.4	QPSK	3	2	21.29	0
	1754.3	20393	1.4	QPSK	3	3	21.30	0
	1754.3	20393	1.4	QPSK	6	0	21.18	0
	1754.3	20393	1.4	16-QAM	1	0	21.25	0
	1754.3	20393	1.4	16-QAM	1	2	21.24	0
	1754.3	20393	1.4	16-QAM	1	5	21.27	0
	1754.3	20393	1.4	16-QAM	3	0	21.22	0
	1754.3	20393	1.4	16-QAM	3	2	21.24	0
	1754.3	20393	1.4	16-QAM	3	3	21.20	0
	1754.3	20393	1.4	16-QAM	6	0	21.21	0
	1754.3	20393	1.4	16-QAM	6	0	21.21	0

FCC ID: PY7PM-0410		SAR EVALUATION REPORT		Reviewed by: Quality Manager
Document S/N: OY1306100973.PY7	Test Dates: 05/06/13 - 08/01/13	DUT Type: Portable Handset		Page 36 of 83

9.3.3

LTE Band 2 (PCS)

LTE Band 2 bandedge conducted power has been reduced in accordance with 3GPP TS36.521-1. The power back-off at bandedge is applied if the entire allocated UL RB bandwidth is within 4 MHz of the bandedge.

Table 9-21
Maximum LTE Band 2 (PCS) Conducted Powers - 20 MHz Bandwidth
(Representing Hotspot Mode Inactive)

Frequency [MHz]	Channel	Bandwidth [MHz]	Modulation	RB Size	RB Offset	Conducted Power [dBm]	Target MPR [dB]	MPR Allowed per 3GPP [dB]
1860	18700	20	QPSK	1	0	23.47	0	0
1860	18700	20	QPSK	1	50	23.44	0	0
1860	18700	20	QPSK	1	99	23.35	0	0
1860	18700	20	QPSK	50	0	22.23	1	0-1
1860	18700	20	QPSK	50	25	22.24	1	0-1
1860	18700	20	QPSK	50	50	22.15	1	0-1
1860	18700	20	QPSK	100	0	22.22	1	0-1
1860	18700	20	16QAM	1	0	22.35	1	0-1
1860	18700	20	16QAM	1	50	22.30	1	0-1
1860	18700	20	16QAM	1	99	22.22	1	0-1
1860	18700	20	16QAM	50	0	21.21	2	0-2
1860	18700	20	16QAM	50	25	21.17	2	0-2
1860	18700	20	16QAM	50	50	21.12	2	0-2
1860	18700	20	16QAM	100	0	21.21	2	0-2
1880.0	18900	20	QPSK	1	0	23.20	0	0
1880.0	18900	20	QPSK	1	50	23.19	0	0
1880.0	18900	20	QPSK	1	99	23.23	0	0
1880.0	18900	20	QPSK	50	0	21.95	1	0-1
1880.0	18900	20	QPSK	50	25	22.17	1	0-1
1880.0	18900	20	QPSK	50	50	22.29	1	0-1
1880.0	18900	20	QPSK	100	0	22.19	1	0-1
1880.0	18900	20	16QAM	1	0	22.03	1	0-1
1880.0	18900	20	16QAM	1	50	22.11	1	0-1
1880.0	18900	20	16QAM	1	99	22.03	1	0-1
1880.0	18900	20	16QAM	50	0	21.04	2	0-2
1880.0	18900	20	16QAM	50	25	21.12	2	0-2
1880.0	18900	20	16QAM	50	50	21.28	2	0-2
1880.0	18900	20	16QAM	100	0	21.22	2	0-2
1900	19100	20	QPSK	1	0	23.01	0	0
1900	19100	20	QPSK	1	50	23.20	0	0
1900	19100	20	QPSK	1	99	21.74	0	0
1900	19100	20	QPSK	50	0	22.12	1	0-1
1900	19100	20	QPSK	50	25	22.18	1	0-1
1900	19100	20	QPSK	50	50	22.28	1	0-1
1900	19100	20	QPSK	100	0	22.18	1	0-1
1900	19100	20	16QAM	1	0	21.99	1	0-1
1900	19100	20	16QAM	1	50	22.06	1	0-1
1900	19100	20	16QAM	1	99	20.66	1	0-1
1900	19100	20	16QAM	50	0	21.14	2	0-2
1900	19100	20	16QAM	50	25	21.24	2	0-2
1900	19100	20	16QAM	50	50	21.25	2	0-2
1900	19100	20	16QAM	100	0	21.28	2	0-2

Table 9-22
Maximum LTE Band 2 (PCS) Conducted Powers - 15 MHz Bandwidth
(Representing Hotspot Mode Inactive)

Frequency [MHz]	Channel	Bandwidth [MHz]	Modulation	RB Size	RB Offset	Conducted Power [dBm]	Target MPR [dB]	MPR Allowed per 3GPP [dB]
1857.5	18675	15	QPSK	1	0	23.10	0	0
1857.5	18675	15	QPSK	1	36	23.05	0	0
1857.5	18675	15	QPSK	1	74	23.14	0	0
1857.5	18675	15	QPSK	36	0	21.91	1	0-1
1857.5	18675	15	QPSK	36	18	21.89	1	0-1
1857.5	18675	15	QPSK	36	37	21.96	1	0-1
1857.5	18675	15	QPSK	75	0	21.91	1	0-1
1857.5	18675	15	16QAM	1	0	22.11	1	0-1
1857.5	18675	15	16QAM	1	36	22.05	1	0-1
1857.5	18675	15	16QAM	1	74	22.19	1	0-1
1857.5	18675	15	16QAM	36	0	20.95	2	0-2
1857.5	18675	15	16QAM	36	18	21.00	2	0-2
1857.5	18675	15	16QAM	36	37	20.92	2	0-2
1857.5	18675	15	16QAM	75	0	20.93	2	0-2
1880.0	18900	15	QPSK	1	0	23.05	0	0
1880.0	18900	15	QPSK	1	36	23.04	0	0
1880.0	18900	15	QPSK	1	74	23.04	0	0
1880.0	18900	15	QPSK	36	0	22.00	1	0-1
1880.0	18900	15	QPSK	36	18	21.93	1	0-1
1880.0	18900	15	QPSK	36	37	21.90	1	0-1
1880.0	18900	15	QPSK	75	0	21.91	1	0-1
1880.0	18900	15	16QAM	1	0	22.24	1	0-1
1880.0	18900	15	16QAM	1	36	22.34	1	0-1
1880.0	18900	15	16QAM	1	74	22.11	1	0-1
1880.0	18900	15	16QAM	36	0	21.06	2	0-2
1880.0	18900	15	16QAM	36	18	21.06	2	0-2
1880.0	18900	15	16QAM	36	37	21.05	2	0-2
1880.0	18900	15	16QAM	75	0	21.02	2	0-2
1902.5	19125	15	QPSK	1	0	23.36	0	0
1902.5	19125	15	QPSK	1	36	23.45	0	0
1902.5	19125	15	QPSK	1	74	21.83	0	0
1902.5	19125	15	QPSK	36	0	22.28	1	0-1
1902.5	19125	15	QPSK	36	18	22.39	1	0-1
1902.5	19125	15	QPSK	36	37	22.25	1	0-1
1902.5	19125	15	QPSK	75	0	22.18	1	0-1
1902.5	19125	15	16QAM	1	0	22.29	1	0-1
1902.5	19125	15	16QAM	1	36	22.44	1	0-1
1902.5	19125	15	16QAM	1	74	20.82	1	0-1
1902.5	19125	15	16QAM	36	0	21.34	2	0-2
1902.5	19125	15	16QAM	36	18	21.41	2	0-2
1902.5	19125	15	16QAM	36	37	21.29	2	0-2
1902.5	19125	15	16QAM	75	0	21.31	2	0-2



FCC ID: PY7PM-0410	 PCTEST ENGINEERING LABORATORY, INC.	SAR EVALUATION REPORT		Reviewed by: Quality Manager
Document S/N: OY1306100973.PY7	Test Dates: 05/06/13 - 08/01/13	DUT Type: Portable Handset		Page 37 of 83

Table 9-23
Maximum LTE Band 2 (PCS) Conducted Powers - 10 MHz Bandwidth
(Representing Hotspot Mode Inactive)

	Frequency [MHz]	Channel	Bandwidth [MHz]	Modulation	RB Size	RB Offset	Conducted Power [dBm]	Target MPR [dB]	MPR Allowed per 3GPP [dB]
Low	1855	18650	10	QPSK	1	0	23.00	0	0
	1855	18650	10	QPSK	1	25	23.01	0	0
	1855	18650	10	QPSK	1	49	22.97	0	0
	1855	18650	10	QPSK	25	0	22.06	1	0-1
	1855	18650	10	QPSK	25	12	22.01	1	0-1
	1855	18650	10	QPSK	25	25	21.92	1	0-1
	1855	18650	10	QPSK	50	0	21.85	1	0-1
	1855	18650	10	16QAM	1	0	22.16	1	0-1
	1855	18650	10	16QAM	1	25	22.35	1	0-1
	1855	18650	10	16QAM	1	49	22.17	1	0-1
	1855	18650	10	16QAM	25	0	21.05	2	0-2
	1855	18650	10	16QAM	25	12	21.17	2	0-2
	1855	18650	10	16QAM	25	25	21.07	2	0-2
	1855	18650	10	16QAM	50	0	20.95	2	0-2
	1880.0	18900	10	QPSK	1	0	23.08	0	0
	1880.0	18900	10	QPSK	1	25	23.06	0	0
	1880.0	18900	10	QPSK	1	49	23.10	0	0
	1880.0	18900	10	QPSK	25	0	22.06	1	0-1
1880.0	18900	10	QPSK	25	12	22.14	1	0-1	
1880.0	18900	10	QPSK	25	25	21.92	1	0-1	
1880.0	18900	10	QPSK	50	0	21.81	1	0-1	
1880.0	18900	10	16QAM	1	0	21.83	1	0-1	
1880.0	18900	10	16QAM	1	25	22.02	1	0-1	
1880.0	18900	10	16QAM	1	49	22.13	1	0-1	
1880.0	18900	10	16QAM	25	0	21.10	2	0-2	
1880.0	18900	10	16QAM	25	12	21.14	2	0-2	
1880.0	18900	10	16QAM	25	25	21.16	2	0-2	
1880.0	18900	10	16QAM	50	0	21.01	2	0-2	
High	1905	19150	10	QPSK	1	0	23.46	0	0
	1905	19150	10	QPSK	1	25	23.34	0	0
	1905	19150	10	QPSK	1	49	21.80	0	0
	1905	19150	10	QPSK	25	0	22.26	1	0-1
	1905	19150	10	QPSK	25	12	22.25	1	0-1
	1905	19150	10	QPSK	25	25	22.15	1	0-1
	1905	19150	10	QPSK	50	0	22.13	1	0-1
	1905	19150	10	16QAM	1	0	22.41	1	0-1
	1905	19150	10	16QAM	1	25	22.30	1	0-1
	1905	19150	10	16QAM	1	49	20.78	1	0-1
	1905	19150	10	16QAM	25	0	21.31	2	0-2
	1905	19150	10	16QAM	25	12	21.19	2	0-2
	1905	19150	10	16QAM	25	25	21.27	2	0-2
	1905	19150	10	16QAM	50	0	21.14	2	0-2

Table 9-24
Maximum LTE Band 2 (PCS) Conducted Powers - 5 MHz Bandwidth
(Representing Hotspot Mode Inactive)

	Frequency [MHz]	Channel	Bandwidth [MHz]	Modulation	RB Size	RB Offset	Conducted Power [dBm]	Target MPR [dB]	MPR Allowed per 3GPP [dB]
Low	1852.5	18625	5	QPSK	1	0	23.11	0	0
	1852.5	18625	5	QPSK	1	12	23.19	0	0
	1852.5	18625	5	QPSK	1	24	23.07	0	0
	1852.5	18625	5	QPSK	12	0	22.10	1	0-1
	1852.5	18625	5	QPSK	12	6	22.13	1	0-1
	1852.5	18625	5	QPSK	12	13	22.08	1	0-1
	1852.5	18625	5	QPSK	25	0	22.05	1	0-1
	1852.5	18625	5	16-QAM	1	0	22.04	1	0-1
	1852.5	18625	5	16-QAM	1	12	22.07	1	0-1
	1852.5	18625	5	16-QAM	1	24	22.02	1	0-1
	1852.5	18625	5	16-QAM	12	0	21.17	2	0-2
	1852.5	18625	5	16-QAM	12	6	21.16	2	0-2
	1852.5	18625	5	16-QAM	12	13	21.09	2	0-2
	1852.5	18625	5	16-QAM	25	0	21.03	2	0-2
	1880.0	18900	5	QPSK	1	0	23.07	0	0
	1880.0	18900	5	QPSK	1	12	23.11	0	0
	1880.0	18900	5	QPSK	1	24	22.95	0	0
	1880.0	18900	5	QPSK	12	0	22.11	1	0-1
1880.0	18900	5	QPSK	12	6	22.18	1	0-1	
1880.0	18900	5	QPSK	12	13	22.10	1	0-1	
1880.0	18900	5	QPSK	25	0	22.05	1	0-1	
1880.0	18900	5	16-QAM	1	0	21.95	1	0-1	
1880.0	18900	5	16-QAM	1	12	21.93	1	0-1	
1880.0	18900	5	16-QAM	1	24	21.88	1	0-1	
1880.0	18900	5	16-QAM	12	0	21.23	2	0-2	
1880.0	18900	5	16-QAM	12	6	21.24	2	0-2	
1880.0	18900	5	16-QAM	12	13	21.18	2	0-2	
1880.0	18900	5	16-QAM	25	0	21.08	2	0-2	
High	1907.5	19175	5	QPSK	1	0	23.36	0	0
	1907.5	19175	5	QPSK	1	12	21.89	0	0
	1907.5	19175	5	QPSK	1	24	21.89	0	0
	1907.5	19175	5	QPSK	12	0	22.31	1	0-1
	1907.5	19175	5	QPSK	12	6	20.81	1	0-1
	1907.5	19175	5	QPSK	12	13	20.84	1	0-1
	1907.5	19175	5	QPSK	25	0	22.17	1	0-1
	1907.5	19175	5	16-QAM	1	0	22.43	1	0-1
	1907.5	19175	5	16-QAM	1	12	20.89	1	0-1
	1907.5	19175	5	16-QAM	1	24	20.86	1	0-1
	1907.5	19175	5	16-QAM	12	0	21.33	2	0-2
	1907.5	19175	5	16-QAM	12	6	19.77	2	0-2
	1907.5	19175	5	16-QAM	12	13	19.81	2	0-2
	1907.5	19175	5	16-QAM	25	0	21.22	2	0-2

Table 9-25
Maximum LTE Band 2 (PCS) Conducted Powers - 3 MHz Bandwidth
(Representing Hotspot Mode Inactive)

Frequency [MHz]	Channel	Bandwidth [MHz]	Modulation	RB Size	RB Offset	Conducted Power [dBm]	Target MPR [dB]	MPR Allowed per 3GPP [dB]	
Low	1851.5	18615	3	QPSK	1	0	23.14	0	0
	1851.5	18615	3	QPSK	1	7	23.09	0	0
	1851.5	18615	3	QPSK	1	14	23.08	0	0
	1851.5	18615	3	QPSK	8	0	22.15	1	0-1
	1851.5	18615	3	QPSK	8	4	22.12	1	0-1
	1851.5	18615	3	QPSK	8	7	22.15	1	0-1
	1851.5	18615	3	QPSK	15	0	22.07	1	0-1
	1851.5	18615	3	16-QAM	1	0	22.16	1	0-1
	1851.5	18615	3	16-QAM	1	7	22.18	1	0-1
	1851.5	18615	3	16-QAM	1	14	22.10	1	0-1
	1851.5	18615	3	16-QAM	8	0	21.07	2	0-2
	1851.5	18615	3	16-QAM	8	4	21.11	2	0-2
	1851.5	18615	3	16-QAM	8	7	21.08	2	0-2
	1851.5	18615	3	16-QAM	15	0	21.08	2	0-2
	Mid	1880.0	18900	3	QPSK	1	0	23.11	0
1880.0		18900	3	QPSK	1	7	23.09	0	0
1880.0		18900	3	QPSK	1	14	23.12	0	0
1880.0		18900	3	QPSK	8	0	22.21	1	0-1
1880.0		18900	3	QPSK	8	4	22.14	1	0-1
1880.0		18900	3	QPSK	8	7	22.23	1	0-1
1880.0		18900	3	QPSK	15	0	22.18	1	0-1
1880.0		18900	3	16-QAM	1	0	22.31	1	0-1
1880.0		18900	3	16-QAM	1	7	22.28	1	0-1
1880.0		18900	3	16-QAM	1	14	22.29	1	0-1
1880.0		18900	3	16-QAM	8	0	21.32	2	0-2
1880.0		18900	3	16-QAM	8	4	21.33	2	0-2
1880.0		18900	3	16-QAM	8	7	21.34	2	0-2
1880.0		18900	3	16-QAM	15	0	21.25	2	0-2
High		1908.5	19185	3	QPSK	1	0	21.76	0
	1908.5	19185	3	QPSK	1	7	21.75	0	0
	1908.5	19185	3	QPSK	1	14	21.79	0	0
	1908.5	19185	3	QPSK	8	0	20.86	1	0-1
	1908.5	19185	3	QPSK	8	4	20.94	1	0-1
	1908.5	19185	3	QPSK	8	7	20.89	1	0-1
	1908.5	19185	3	QPSK	15	0	20.80	1	0-1
	1908.5	19185	3	16-QAM	1	0	20.72	1	0-1
	1908.5	19185	3	16-QAM	1	7	20.81	1	0-1
	1908.5	19185	3	16-QAM	1	14	20.84	1	0-1
	1908.5	19185	3	16-QAM	8	0	19.91	2	0-2
	1908.5	19185	3	16-QAM	8	4	19.93	2	0-2
	1908.5	19185	3	16-QAM	8	7	19.91	2	0-2
	1908.5	19185	3	16-QAM	15	0	19.88	2	0-2

Table 9-26
Maximum LTE Band 2 (PCS) Conducted Powers -1.4 MHz Bandwidth
(Representing Hotspot Mode Inactive)

Frequency [MHz]	Channel	Bandwidth [MHz]	Modulation	RB Size	RB Offset	Conducted Power [dBm]	Target MPR [dB]	MPR Allowed per 3GPP [dB]	
Low	1850.7	18607	1.4	QPSK	1	0	23.17	0	0
	1850.7	18607	1.4	QPSK	1	2	23.16	0	0
	1850.7	18607	1.4	QPSK	1	5	23.11	0	0
	1850.7	18607	1.4	QPSK	3	0	23.07	0	0
	1850.7	18607	1.4	QPSK	3	2	23.15	0	0
	1850.7	18607	1.4	QPSK	3	3	23.04	0	0
	1850.7	18607	1.4	QPSK	6	0	22.23	1	0-1
	1850.7	18607	1.4	16-QAM	1	0	22.10	1	0-1
	1850.7	18607	1.4	16-QAM	1	2	22.27	1	0-1
	1850.7	18607	1.4	16-QAM	1	5	22.12	1	0-1
	1850.7	18607	1.4	16-QAM	3	0	22.23	1	0-1
	1850.7	18607	1.4	16-QAM	3	2	22.21	1	0-1
	1850.7	18607	1.4	16-QAM	3	3	22.20	1	0-1
	1850.7	18607	1.4	16-QAM	6	0	21.25	2	0-2
	Mid	1880.0	18900	1.4	QPSK	1	0	23.25	0
1880.0		18900	1.4	QPSK	1	2	23.23	0	0
1880.0		18900	1.4	QPSK	1	5	23.27	0	0
1880.0		18900	1.4	QPSK	3	0	23.23	0	0
1880.0		18900	1.4	QPSK	3	2	23.18	0	0
1880.0		18900	1.4	QPSK	3	3	23.20	0	0
1880.0		18900	1.4	QPSK	6	0	22.23	1	0-1
1880.0		18900	1.4	16-QAM	1	0	22.28	1	0-1
1880.0		18900	1.4	16-QAM	1	2	22.25	1	0-1
1880.0		18900	1.4	16-QAM	1	5	22.36	1	0-1
1880.0		18900	1.4	16-QAM	3	0	22.35	1	0-1
1880.0		18900	1.4	16-QAM	3	2	22.36	1	0-1
1880.0		18900	1.4	16-QAM	3	3	22.35	1	0-1
1880.0		18900	1.4	16-QAM	6	0	21.29	2	0-2
High		1909.3	19193	1.4	QPSK	1	0	21.86	0
	1909.3	19193	1.4	QPSK	1	2	21.86	0	0
	1909.3	19193	1.4	QPSK	1	5	21.87	0	0
	1909.3	19193	1.4	QPSK	3	0	21.85	0	0
	1909.3	19193	1.4	QPSK	3	2	21.83	0	0
	1909.3	19193	1.4	QPSK	3	3	21.91	0	0
	1909.3	19193	1.4	QPSK	6	0	20.91	1	0-1
	1909.3	19193	1.4	16-QAM	1	0	20.80	1	0-1
	1909.3	19193	1.4	16-QAM	1	2	20.78	1	0-1
	1909.3	19193	1.4	16-QAM	1	5	20.75	1	0-1
	1909.3	19193	1.4	16-QAM	3	0	20.76	1	0-1
	1909.3	19193	1.4	16-QAM	3	2	20.77	1	0-1
	1909.3	19193	1.4	16-QAM	3	3	20.81	1	0-1
	1909.3	19193	1.4	16-QAM	6	0	19.66	2	0-2

Table 9-27
Reduced LTE Band 2 (PCS) Conducted Powers - 20 MHz Bandwidth
(Representing Hotspot Mode Active)

Frequency [MHz]	Channel	Bandwidth [MHz]	Modulation	RB Size	RB Offset	Conducted Power [dBm]	Target MPR [dB]	MPR Allowed per 3GPP [dB]		
Low	1860	18700	20	QPSK	1	0	20.56	0	0	
	1860	18700	20	QPSK	1	50	20.53	0	0	
	1860	18700	20	QPSK	1	99	20.36	0	0	
	1860	18700	20	QPSK	50	0	20.46	0	0-1	
	1860	18700	20	QPSK	50	25	20.49	0	0-1	
	1860	18700	20	QPSK	50	50	20.39	0	0-1	
	1860	18700	20	QPSK	100	0	20.35	0	0-1	
	1860	18700	20	16QAM	1	0	20.46	0	0-1	
	1860	18700	20	16QAM	1	50	20.38	0	0-1	
	1860	18700	20	16QAM	1	99	20.31	0	0-1	
	1860	18700	20	16QAM	50	0	20.34	0	0-2	
	1860	18700	20	16QAM	50	25	20.34	0	0-2	
	1860	18700	20	16QAM	50	50	20.32	0	0-2	
	1860	18700	20	16QAM	100	0	20.30	0	0-2	
	Mid	1880.0	18900	20	QPSK	1	0	20.44	0	0
		1880.0	18900	20	QPSK	1	50	20.41	0	0
		1880.0	18900	20	QPSK	1	99	20.45	0	0
		1880.0	18900	20	QPSK	50	0	20.31	0	0-1
1880.0		18900	20	QPSK	50	25	20.21	0	0-1	
1880.0		18900	20	QPSK	50	50	20.36	0	0-1	
1880.0		18900	20	QPSK	100	0	20.31	0	0-1	
1880.0		18900	20	16QAM	1	0	20.45	0	0-1	
1880.0		18900	20	16QAM	1	50	20.48	0	0-1	
1880.0		18900	20	16QAM	1	99	20.35	0	0-1	
1880.0		18900	20	16QAM	50	0	20.36	0	0-2	
1880.0		18900	20	16QAM	50	25	20.29	0	0-2	
1880.0		18900	20	16QAM	50	50	20.33	0	0-2	
1880.0		18900	20	16QAM	100	0	20.34	0	0-2	
High		1900	19100	20	QPSK	1	0	20.46	0	0
		1900	19100	20	QPSK	1	50	20.55	0	0
		1900	19100	20	QPSK	1	99	20.51	0	0
		1900	19100	20	QPSK	50	0	20.49	0	0-1
	1900	19100	20	QPSK	50	25	20.41	0	0-1	
	1900	19100	20	QPSK	50	50	20.53	0	0-1	
	1900	19100	20	QPSK	100	0	20.32	0	0-1	
	1900	19100	20	16QAM	1	0	20.49	0	0-1	
	1900	19100	20	16QAM	1	50	20.49	0	0-1	
	1900	19100	20	16QAM	1	99	20.48	0	0-1	
	1900	19100	20	16QAM	50	0	20.43	0	0-2	
	1900	19100	20	16QAM	50	25	20.37	0	0-2	
	1900	19100	20	16QAM	50	50	20.39	0	0-2	
	1900	19100	20	16QAM	100	0	20.40	0	0-2	

Table 9-28
Reduced LTE Band 2 (PCS) Conducted Powers - 15 MHz Bandwidth
(Representing Hotspot Mode Active)

Frequency [MHz]	Channel	Bandwidth [MHz]	Modulation	RB Size	RB Offset	Conducted Power [dBm]	Target MPR [dB]	MPR Allowed per 3GPP [dB]		
Low	1857.5	18675	15	QPSK	1	0	20.54	0	0	
	1857.5	18675	15	QPSK	1	36	20.51	0	0	
	1857.5	18675	15	QPSK	1	74	20.50	0	0	
	1857.5	18675	15	QPSK	36	0	20.43	0	0-1	
	1857.5	18675	15	QPSK	36	18	20.49	0	0-1	
	1857.5	18675	15	QPSK	36	37	20.40	0	0-1	
	1857.5	18675	15	QPSK	75	0	20.39	0	0-1	
	1857.5	18675	15	16QAM	1	0	20.44	0	0-1	
	1857.5	18675	15	16QAM	1	36	20.37	0	0-1	
	1857.5	18675	15	16QAM	1	74	20.29	0	0-1	
	1857.5	18675	15	16QAM	36	0	20.39	0	0-2	
	1857.5	18675	15	16QAM	36	18	20.35	0	0-2	
	1857.5	18675	15	16QAM	36	37	20.36	0	0-2	
	1857.5	18675	15	16QAM	75	0	20.33	0	0-2	
	Mid	1880.0	18900	15	QPSK	1	0	20.23	0	0
		1880.0	18900	15	QPSK	1	36	20.41	0	0
		1880.0	18900	15	QPSK	1	74	20.36	0	0
		1880.0	18900	15	QPSK	36	0	20.33	0	0-1
1880.0		18900	15	QPSK	36	18	20.23	0	0-1	
1880.0		18900	15	QPSK	36	37	20.25	0	0-1	
1880.0		18900	15	QPSK	75	0	20.19	0	0-1	
1880.0		18900	15	16QAM	1	0	20.41	0	0-1	
1880.0		18900	15	16QAM	1	36	20.45	0	0-1	
1880.0		18900	15	16QAM	1	74	20.45	0	0-1	
1880.0		18900	15	16QAM	36	0	20.30	0	0-2	
1880.0		18900	15	16QAM	36	18	20.27	0	0-2	
1880.0		18900	15	16QAM	36	37	20.31	0	0-2	
1880.0		18900	15	16QAM	75	0	20.22	0	0-2	
High		1902.5	19125	15	QPSK	1	0	20.47	0	0
		1902.5	19125	15	QPSK	1	36	20.55	0	0
		1902.5	19125	15	QPSK	1	74	20.49	0	0
		1902.5	19125	15	QPSK	36	0	20.38	0	0-1
	1902.5	19125	15	QPSK	36	18	20.33	0	0-1	
	1902.5	19125	15	QPSK	36	37	20.41	0	0-1	
	1902.5	19125	15	QPSK	75	0	20.35	0	0-1	
	1902.5	19125	15	16QAM	1	0	20.35	0	0-1	
	1902.5	19125	15	16QAM	1	36	20.35	0	0-1	
	1902.5	19125	15	16QAM	1	74	20.25	0	0-1	
	1902.5	19125	15	16QAM	36	0	20.24	0	0-2	
	1902.5	19125	15	16QAM	36	18	20.35	0	0-2	
	1902.5	19125	15	16QAM	36	37	20.30	0	0-2	
	1902.5	19125	15	16QAM	75	0	20.36	0	0-2	



FCC ID: PY7PM-0410		SAR EVALUATION REPORT		Reviewed by: Quality Manager
Document S/N: OY1306100973.PY7	Test Dates: 05/06/13 - 08/01/13	DUT Type: Portable Handset		Page 40 of 83

Table 9-29
Reduced LTE Band 2 (PCS) Conducted Powers - 10 MHz Bandwidth
(Representing Hotspot Mode Active)

	Frequency [MHz]	Channel	Bandwidth [MHz]	Modulation	RB Size	RB Offset	Conducted Power [dBm]	Target MPR [dB]	MPR Allowed per 3GPP [dB]
Low	1855	18650	10	QPSK	1	0	20.40	0	0
	1855	18650	10	QPSK	1	25	20.22	0	0
	1855	18650	10	QPSK	1	49	20.34	0	0
	1855	18650	10	QPSK	25	0	20.35	0	0-1
	1855	18650	10	QPSK	25	12	20.40	0	0-1
	1855	18650	10	QPSK	25	25	20.25	0	0-1
	1855	18650	10	QPSK	50	0	20.31	0	0-1
	1855	18650	10	16QAM	1	0	20.33	0	0-1
	1855	18650	10	16QAM	1	25	20.35	0	0-1
	1855	18650	10	16QAM	1	49	20.33	0	0-1
	1855	18650	10	16QAM	25	0	20.33	0	0-2
	1855	18650	10	16QAM	25	12	20.34	0	0-2
	1855	18650	10	16QAM	25	25	20.42	0	0-2
	1855	18650	10	16QAM	50	0	20.36	0	0-2
	Mid	1880.0	18900	10	QPSK	1	0	20.31	0
1880.0		18900	10	QPSK	1	25	20.32	0	0
1880.0		18900	10	QPSK	1	49	20.36	0	0
1880.0		18900	10	QPSK	25	0	20.33	0	0-1
1880.0		18900	10	QPSK	25	12	20.35	0	0-1
1880.0		18900	10	QPSK	25	25	20.36	0	0-1
1880.0		18900	10	QPSK	50	0	20.36	0	0-1
1880.0		18900	10	16QAM	1	0	20.31	0	0-1
1880.0		18900	10	16QAM	1	25	20.30	0	0-1
1880.0		18900	10	16QAM	1	49	20.40	0	0-1
1880.0		18900	10	16QAM	25	0	20.36	0	0-2
1880.0		18900	10	16QAM	25	12	20.35	0	0-2
1880.0		18900	10	16QAM	25	25	20.33	0	0-2
1880.0		18900	10	16QAM	50	0	20.36	0	0-2
High		1905	19150	10	QPSK	1	0	20.43	0
	1905	19150	10	QPSK	1	25	20.40	0	0
	1905	19150	10	QPSK	1	49	20.31	0	0
	1905	19150	10	QPSK	25	0	20.33	0	0-1
	1905	19150	10	QPSK	25	12	20.35	0	0-1
	1905	19150	10	QPSK	25	25	20.38	0	0-1
	1905	19150	10	QPSK	50	0	20.30	0	0-1
	1905	19150	10	16QAM	1	0	20.40	0	0-1
	1905	19150	10	16QAM	1	25	20.41	0	0-1
	1905	19150	10	16QAM	1	49	20.36	0	0-1
	1905	19150	10	16QAM	25	0	20.38	0	0-2
	1905	19150	10	16QAM	25	12	20.29	0	0-2
	1905	19150	10	16QAM	25	25	20.38	0	0-2
	1905	19150	10	16QAM	50	0	20.29	0	0-2

Table 9-30
Reduced LTE Band 2 (PCS) Conducted Powers - 5 MHz Bandwidth
(Representing Hotspot Mode Active)

	Frequency [MHz]	Channel	Bandwidth [MHz]	Modulation	RB Size	RB Offset	Conducted Power [dBm]	Target MPR [dB]	MPR Allowed per 3GPP [dB]
Low	1852.5	18625	5	QPSK	1	0	20.34	0	0
	1852.5	18625	5	QPSK	1	12	20.40	0	0
	1852.5	18625	5	QPSK	1	24	20.41	0	0
	1852.5	18625	5	QPSK	12	0	20.39	0	0-1
	1852.5	18625	5	QPSK	12	6	20.35	0	0-1
	1852.5	18625	5	QPSK	12	13	20.34	0	0-1
	1852.5	18625	5	QPSK	25	0	20.21	0	0-1
	1852.5	18625	5	16-QAM	1	0	20.43	0	0-1
	1852.5	18625	5	16-QAM	1	12	20.34	0	0-1
	1852.5	18625	5	16-QAM	1	24	20.35	0	0-1
	1852.5	18625	5	16-QAM	12	0	20.36	0	0-2
	1852.5	18625	5	16-QAM	12	6	20.36	0	0-2
	1852.5	18625	5	16-QAM	12	13	20.36	0	0-2
	1852.5	18625	5	16-QAM	25	0	20.39	0	0-2
	Mid	1880.0	18900	5	QPSK	1	0	20.23	0
1880.0		18900	5	QPSK	1	12	20.21	0	0
1880.0		18900	5	QPSK	1	24	20.26	0	0
1880.0		18900	5	QPSK	12	0	20.33	0	0-1
1880.0		18900	5	QPSK	12	6	20.29	0	0-1
1880.0		18900	5	QPSK	12	13	20.31	0	0-1
1880.0		18900	5	QPSK	25	0	20.24	0	0-1
1880.0		18900	5	16-QAM	1	0	20.33	0	0-1
1880.0		18900	5	16-QAM	1	12	20.31	0	0-1
1880.0		18900	5	16-QAM	1	24	20.37	0	0-1
1880.0		18900	5	16-QAM	12	0	20.29	0	0-2
1880.0		18900	5	16-QAM	12	6	20.30	0	0-2
1880.0		18900	5	16-QAM	12	13	20.25	0	0-2
1880.0		18900	5	16-QAM	25	0	20.26	0	0-2
High		1907.5	19175	5	QPSK	1	0	20.29	0
	1907.5	19175	5	QPSK	1	12	20.33	0	0
	1907.5	19175	5	QPSK	1	24	20.40	0	0
	1907.5	19175	5	QPSK	12	0	20.39	0	0-1
	1907.5	19175	5	QPSK	12	6	20.33	0	0-1
	1907.5	19175	5	QPSK	12	13	20.32	0	0-1
	1907.5	19175	5	QPSK	25	0	20.34	0	0-1
	1907.5	19175	5	16-QAM	1	0	20.44	0	0-1
	1907.5	19175	5	16-QAM	1	12	20.41	0	0-1
	1907.5	19175	5	16-QAM	1	24	20.40	0	0-1
	1907.5	19175	5	16-QAM	12	0	20.34	0	0-2
	1907.5	19175	5	16-QAM	12	6	20.36	0	0-2
	1907.5	19175	5	16-QAM	12	13	20.34	0	0-2
	1907.5	19175	5	16-QAM	25	0	20.35	0	0-2

FCC ID: PY7PM-0410	 PCTEST ENGINEERING LABORATORY, INC.	SAR EVALUATION REPORT	SONY	Reviewed by: Quality Manager
Document S/N: OY1306100973.PY7	Test Dates: 05/06/13 - 08/01/13	DUT Type: Portable Handset		Page 41 of 83

Table 9-31
Reduced LTE Band 2 (PCS) Conducted Powers - 3 MHz Bandwidth
(Representing Hotspot Mode Active)

Frequency [MHz]	Channel	Bandwidth [MHz]	Modulation	RB Size	RB Offset	Conducted Power [dBm]	Target MPR [dB]	MPR Allowed per 3GPP [dB]
Low	1851.5	18615	3	QPSK	1	0	20.45	0
	1851.5	18615	3	QPSK	1	7	20.39	0
	1851.5	18615	3	QPSK	1	14	20.31	0
	1851.5	18615	3	QPSK	8	0	20.34	0
	1851.5	18615	3	QPSK	8	4	20.34	0
	1851.5	18615	3	QPSK	8	7	20.39	0
	1851.5	18615	3	QPSK	15	0	20.25	0
	1851.5	18615	3	16-QAM	1	0	20.40	0
	1851.5	18615	3	16-QAM	1	7	20.33	0
	1851.5	18615	3	16-QAM	1	14	20.37	0
	1851.5	18615	3	16-QAM	8	0	20.41	0
	1851.5	18615	3	16-QAM	8	4	20.33	0
	1851.5	18615	3	16-QAM	8	7	20.31	0
	1851.5	18615	3	16-QAM	15	0	20.30	0
	1851.5	18615	3	16-QAM	15	0	20.30	0
Mid	1880.0	18900	3	QPSK	1	0	20.37	0
	1880.0	18900	3	QPSK	1	7	20.26	0
	1880.0	18900	3	QPSK	1	14	20.24	0
	1880.0	18900	3	QPSK	8	0	20.30	0
	1880.0	18900	3	QPSK	8	4	20.33	0
	1880.0	18900	3	QPSK	8	7	20.34	0
	1880.0	18900	3	QPSK	15	0	20.30	0
	1880.0	18900	3	16-QAM	1	0	20.41	0
	1880.0	18900	3	16-QAM	1	7	20.48	0
	1880.0	18900	3	16-QAM	1	14	20.49	0
	1880.0	18900	3	16-QAM	8	0	20.23	0
	1880.0	18900	3	16-QAM	8	4	20.26	0
	1880.0	18900	3	16-QAM	8	7	20.28	0
	1880.0	18900	3	16-QAM	15	0	20.34	0
	1880.0	18900	3	16-QAM	15	0	20.34	0
High	1908.5	19185	3	QPSK	1	0	20.41	0
	1908.5	19185	3	QPSK	1	7	20.39	0
	1908.5	19185	3	QPSK	1	14	20.30	0
	1908.5	19185	3	QPSK	8	0	20.38	0
	1908.5	19185	3	QPSK	8	4	20.37	0
	1908.5	19185	3	QPSK	8	7	20.37	0
	1908.5	19185	3	QPSK	15	0	20.33	0
	1908.5	19185	3	16-QAM	1	0	20.29	0
	1908.5	19185	3	16-QAM	1	7	20.35	0
	1908.5	19185	3	16-QAM	1	14	20.40	0
	1908.5	19185	3	16-QAM	8	0	20.33	0
	1908.5	19185	3	16-QAM	8	4	20.37	0
	1908.5	19185	3	16-QAM	8	7	20.34	0
	1908.5	19185	3	16-QAM	15	0	20.38	0
	1908.5	19185	3	16-QAM	15	0	20.38	0

Table 9-32
Reduced LTE Band 2 (PCS) Conducted Powers -1.4 MHz Bandwidth
(Representing Hotspot Mode Active)

Frequency [MHz]	Channel	Bandwidth [MHz]	Modulation	RB Size	RB Offset	Conducted Power [dBm]	Target MPR [dB]	MPR Allowed per 3GPP [dB]
Low	1850.7	18607	1.4	QPSK	1	0	20.26	0
	1850.7	18607	1.4	QPSK	1	2	20.42	0
	1850.7	18607	1.4	QPSK	1	5	20.35	0
	1850.7	18607	1.4	QPSK	3	0	20.37	0
	1850.7	18607	1.4	QPSK	3	2	20.41	0
	1850.7	18607	1.4	QPSK	3	3	20.38	0
	1850.7	18607	1.4	QPSK	6	0	20.31	0
	1850.7	18607	1.4	16-QAM	1	0	20.40	0
	1850.7	18607	1.4	16-QAM	1	2	20.35	0
	1850.7	18607	1.4	16-QAM	1	5	20.37	0
	1850.7	18607	1.4	16-QAM	3	0	20.36	0
	1850.7	18607	1.4	16-QAM	3	2	20.28	0
	1850.7	18607	1.4	16-QAM	3	3	20.30	0
	1850.7	18607	1.4	16-QAM	6	0	20.30	0
	1850.7	18607	1.4	16-QAM	6	0	20.30	0
Mid	1880.0	18900	1.4	QPSK	1	0	20.40	0
	1880.0	18900	1.4	QPSK	1	2	20.36	0
	1880.0	18900	1.4	QPSK	1	5	20.38	0
	1880.0	18900	1.4	QPSK	3	0	20.30	0
	1880.0	18900	1.4	QPSK	3	2	20.31	0
	1880.0	18900	1.4	QPSK	3	3	20.25	0
	1880.0	18900	1.4	QPSK	6	0	20.36	0
	1880.0	18900	1.4	16-QAM	1	0	20.38	0
	1880.0	18900	1.4	16-QAM	1	2	20.39	0
	1880.0	18900	1.4	16-QAM	1	5	20.33	0
	1880.0	18900	1.4	16-QAM	3	0	20.29	0
	1880.0	18900	1.4	16-QAM	3	2	20.36	0
	1880.0	18900	1.4	16-QAM	3	3	20.33	0
	1880.0	18900	1.4	16-QAM	6	0	20.31	0
	1880.0	18900	1.4	16-QAM	6	0	20.31	0
High	1909.3	19193	1.4	QPSK	1	0	20.38	0
	1909.3	19193	1.4	QPSK	1	2	20.42	0
	1909.3	19193	1.4	QPSK	1	5	20.41	0
	1909.3	19193	1.4	QPSK	3	0	20.38	0
	1909.3	19193	1.4	QPSK	3	2	20.39	0
	1909.3	19193	1.4	QPSK	3	3	20.33	0
	1909.3	19193	1.4	QPSK	6	0	20.29	0
	1909.3	19193	1.4	16-QAM	1	0	20.39	0
	1909.3	19193	1.4	16-QAM	1	2	20.37	0
	1909.3	19193	1.4	16-QAM	1	5	20.30	0
	1909.3	19193	1.4	16-QAM	3	0	20.34	0
	1909.3	19193	1.4	16-QAM	3	2	20.28	0
	1909.3	19193	1.4	16-QAM	3	3	20.35	0
	1909.3	19193	1.4	16-QAM	6	0	20.32	0
	1909.3	19193	1.4	16-QAM	6	0	20.32	0

9.3.4

LTE Band 7

Table 9-33
Maximum LTE Band 7 Conducted Powers - 20 MHz Bandwidth
(Representing Hotspot Mode Inactive)

Frequency [MHz]	Channel	Bandwidth [MHz]	Modulation	RB Size	RB Offset	Conducted Power [dBm]	Target MPR [dB]	MPR Allowed per 3GPP [dB]	
Low	2510	20850	20	QPSK	1	0	17.36	0	0
	2510	20850	20	QPSK	1	50	17.35	0	0
	2510	20850	20	QPSK	1	99	17.40	0	0
	2510	20850	20	QPSK	50	0	17.43	0	0-1
	2510	20850	20	QPSK	50	25	17.36	0	0-1
	2510	20850	20	QPSK	50	50	17.38	0	0-1
	2510	20850	20	QPSK	100	0	17.31	0	0-1
	2510	20850	20	16QAM	1	0	17.37	0	0-1
	2510	20850	20	16QAM	1	50	17.30	0	0-1
	2510	20850	20	16QAM	1	99	17.40	0	0-1
	2510	20850	20	16QAM	50	0	17.37	0	0-2
	2510	20850	20	16QAM	50	25	17.34	0	0-2
	2510	20850	20	16QAM	50	50	17.33	0	0-2
	2510	20850	20	16QAM	100	0	17.28	0	0-2
	Mid	2535.0	21100	20	QPSK	1	0	17.47	0
2535.0		21100	20	QPSK	1	50	17.56	0	0
2535.0		21100	20	QPSK	1	99	17.34	0	0
2535.0		21100	20	QPSK	50	0	17.52	0	0-1
2535.0		21100	20	QPSK	50	25	17.48	0	0-1
2535.0		21100	20	QPSK	50	50	17.53	0	0-1
2535.0		21100	20	QPSK	100	0	17.52	0	0-1
2535.0		21100	20	16QAM	1	0	17.20	0	0-1
2535.0		21100	20	16QAM	1	50	17.31	0	0-1
2535.0		21100	20	16QAM	1	99	17.24	0	0-1
2535.0		21100	20	16QAM	50	0	17.33	0	0-2
2535.0		21100	20	16QAM	50	25	17.32	0	0-2
2535.0		21100	20	16QAM	50	50	17.22	0	0-2
2535.0		21100	20	16QAM	100	0	17.23	0	0-2
High		2560	21350	20	QPSK	1	0	17.51	0
	2560	21350	20	QPSK	1	50	17.52	0	0
	2560	21350	20	QPSK	1	99	17.53	0	0
	2560	21350	20	QPSK	50	0	17.39	0	0-1
	2560	21350	20	QPSK	50	25	17.26	0	0-1
	2560	21350	20	QPSK	50	50	17.40	0	0-1
	2560	21350	20	QPSK	100	0	17.34	0	0-1
	2560	21350	20	16QAM	1	0	17.25	0	0-1
	2560	21350	20	16QAM	1	50	17.31	0	0-1
	2560	21350	20	16QAM	1	99	17.46	0	0-1
	2560	21350	20	16QAM	50	0	17.27	0	0-2
	2560	21350	20	16QAM	50	25	17.40	0	0-2
	2560	21350	20	16QAM	50	50	17.36	0	0-2
	2560	21350	20	16QAM	100	0	17.33	0	0-2

Table 9-34
Maximum LTE Band 7 Conducted Powers - 15 MHz Bandwidth
(Representing Hotspot Mode Inactive)

Frequency [MHz]	Channel	Bandwidth [MHz]	Modulation	RB Size	RB Offset	Conducted Power [dBm]	Target MPR [dB]	MPR Allowed per 3GPP [dB]	
Low	2507.5	20825	15	QPSK	1	0	17.30	0	0
	2507.5	20825	15	QPSK	1	36	17.40	0	0
	2507.5	20825	15	QPSK	1	74	17.35	0	0
	2507.5	20825	15	QPSK	36	0	17.38	0	0-1
	2507.5	20825	15	QPSK	36	18	17.32	0	0-1
	2507.5	20825	15	QPSK	36	37	17.40	0	0-1
	2507.5	20825	15	QPSK	75	0	17.34	0	0-1
	2507.5	20825	15	16QAM	1	0	17.35	0	0-1
	2507.5	20825	15	16QAM	1	36	17.29	0	0-1
	2507.5	20825	15	16QAM	1	74	17.40	0	0-1
	2507.5	20825	15	16QAM	36	0	17.20	0	0-2
	2507.5	20825	15	16QAM	36	18	16.99	0	0-2
	2507.5	20825	15	16QAM	36	37	17.09	0	0-2
	2507.5	20825	15	16QAM	75	0	16.72	0	0-2
	Mid	2535.0	21100	15	QPSK	1	0	17.36	0
2535.0		21100	15	QPSK	1	36	17.44	0	0
2535.0		21100	15	QPSK	1	74	17.52	0	0
2535.0		21100	15	QPSK	36	0	17.24	0	0-1
2535.0		21100	15	QPSK	36	18	17.26	0	0-1
2535.0		21100	15	QPSK	36	37	17.21	0	0-1
2535.0		21100	15	QPSK	75	0	17.38	0	0-1
2535.0		21100	15	16QAM	1	0	17.40	0	0-1
2535.0		21100	15	16QAM	1	36	17.10	0	0-1
2535.0		21100	15	16QAM	1	74	16.98	0	0-1
2535.0		21100	15	16QAM	36	0	17.06	0	0-2
2535.0		21100	15	16QAM	36	18	17.09	0	0-2
2535.0		21100	15	16QAM	36	37	17.18	0	0-2
2535.0		21100	15	16QAM	75	0	17.22	0	0-2
High		2562.5	21375	15	QPSK	1	0	17.39	0
	2562.5	21375	15	QPSK	1	36	17.42	0	0
	2562.5	21375	15	QPSK	1	74	17.07	0	0
	2562.5	21375	15	QPSK	36	0	17.22	0	0-1
	2562.5	21375	15	QPSK	36	18	17.23	0	0-1
	2562.5	21375	15	QPSK	36	37	17.64	0	0-1
	2562.5	21375	15	QPSK	75	0	17.31	0	0-1
	2562.5	21375	15	16QAM	1	0	17.34	0	0-1
	2562.5	21375	15	16QAM	1	36	17.40	0	0-1
	2562.5	21375	15	16QAM	1	74	17.22	0	0-1
	2562.5	21375	15	16QAM	36	0	17.26	0	0-2
	2562.5	21375	15	16QAM	36	18	17.20	0	0-2
	2562.5	21375	15	16QAM	36	37	16.87	0	0-2
	2562.5	21375	15	16QAM	75	0	16.99	0	0-2

Table 9-35
Maximum LTE Band 7 Conducted Powers - 10 MHz Bandwidth
(Representing Hotspot Mode Inactive)

	Frequency [MHz]	Channel	Bandwidth [MHz]	Modulation	RB Size	RB Offset	Conducted Power [dBm]	Target MPR [dB]	MPR Allowed per 3GPP [dB]
Low	2505	20800	10	QPSK	1	0	17.31	0	0
	2505	20800	10	QPSK	1	25	17.38	0	0
	2505	20800	10	QPSK	1	49	17.33	0	0
	2505	20800	10	QPSK	25	0	17.36	0	0-1
	2505	20800	10	QPSK	25	12	17.30	0	0-1
	2505	20800	10	QPSK	25	25	17.36	0	0-1
	2505	20800	10	QPSK	50	0	17.32	0	0-1
	2505	20800	10	16QAM	1	0	17.33	0	0-1
	2505	20800	10	16QAM	1	25	17.10	0	0-1
	2505	20800	10	16QAM	1	49	17.38	0	0-1
	2505	20800	10	16QAM	25	0	16.98	0	0-2
	2505	20800	10	16QAM	25	12	16.97	0	0-2
	2505	20800	10	16QAM	25	25	17.07	0	0-2
	2505	20800	10	16QAM	50	0	16.70	0	0-2
	2535.0	21100	10	QPSK	1	0	17.34	0	0
2535.0	21100	10	QPSK	1	25	17.42	0	0	
2535.0	21100	10	QPSK	1	49	17.50	0	0	
2535.0	21100	10	QPSK	25	0	17.22	0	0-1	
2535.0	21100	10	QPSK	25	12	17.28	0	0-1	
2535.0	21100	10	QPSK	25	25	17.19	0	0-1	
2535.0	21100	10	QPSK	50	0	17.36	0	0-1	
2535.0	21100	10	16QAM	1	0	17.38	0	0-1	
2535.0	21100	10	16QAM	1	25	17.08	0	0-1	
2535.0	21100	10	16QAM	1	49	16.96	0	0-1	
2535.0	21100	10	16QAM	25	0	17.09	0	0-2	
2535.0	21100	10	16QAM	25	12	17.07	0	0-2	
2535.0	21100	10	16QAM	25	25	17.16	0	0-2	
2535.0	21100	10	16QAM	50	0	17.20	0	0-2	
High	2565	21400	10	QPSK	1	0	17.37	0	0
	2565	21400	10	QPSK	1	25	17.40	0	0
	2565	21400	10	QPSK	1	49	17.05	0	0
	2565	21400	10	QPSK	25	0	17.20	0	0-1
	2565	21400	10	QPSK	25	12	17.21	0	0-1
	2565	21400	10	QPSK	25	25	17.50	0	0-1
	2565	21400	10	QPSK	50	0	17.29	0	0-1
	2565	21400	10	16QAM	1	0	17.32	0	0-1
	2565	21400	10	16QAM	1	25	17.36	0	0-1
	2565	21400	10	16QAM	1	49	17.20	0	0-1
	2565	21400	10	16QAM	25	0	17.24	0	0-2
	2565	21400	10	16QAM	25	12	17.18	0	0-2
	2565	21400	10	16QAM	25	25	16.99	0	0-2
	2565	21400	10	16QAM	50	0	16.97	0	0-2

Table 9-36
Maximum LTE Band 7 Conducted Powers - 5 MHz Bandwidth
(Representing Hotspot Mode Inactive)

	Frequency [MHz]	Channel	Bandwidth [MHz]	Modulation	RB Size	RB Offset	Conducted Power [dBm]	Target MPR [dB]	MPR Allowed per 3GPP [dB]
Low	2502.5	20775	5	QPSK	1	0	17.28	0	0
	2502.5	20775	5	QPSK	1	12	17.38	0	0
	2502.5	20775	5	QPSK	1	24	17.33	0	0
	2502.5	20775	5	QPSK	12	0	17.36	0	0-1
	2502.5	20775	5	QPSK	12	6	17.30	0	0-1
	2502.5	20775	5	QPSK	12	13	17.38	0	0-1
	2502.5	20775	5	QPSK	25	0	17.32	0	0-1
	2502.5	20775	5	16-QAM	1	0	17.33	0	0-1
	2502.5	20775	5	16-QAM	1	12	17.27	0	0-1
	2502.5	20775	5	16-QAM	1	24	17.38	0	0-1
	2502.5	20775	5	16-QAM	12	0	17.18	0	0-2
	2502.5	20775	5	16-QAM	12	6	16.97	0	0-2
	2502.5	20775	5	16-QAM	12	13	17.07	0	0-2
	2502.5	20775	5	16-QAM	25	0	16.98	0	0-2
	2535.0	21100	5	QPSK	1	0	17.34	0	0
2535.0	21100	5	QPSK	1	12	17.42	0	0	
2535.0	21100	5	QPSK	1	24	17.52	0	0	
2535.0	21100	5	QPSK	12	0	17.22	0	0-1	
2535.0	21100	5	QPSK	12	6	17.24	0	0-1	
2535.0	21100	5	QPSK	12	13	17.19	0	0-1	
2535.0	21100	5	QPSK	25	0	17.36	0	0-1	
2535.0	21100	5	16-QAM	1	0	17.38	0	0-1	
2535.0	21100	5	16-QAM	1	12	17.08	0	0-1	
2535.0	21100	5	16-QAM	1	24	16.96	0	0-1	
2535.0	21100	5	16-QAM	12	0	17.04	0	0-2	
2535.0	21100	5	16-QAM	12	6	17.12	0	0-2	
2535.0	21100	5	16-QAM	12	13	17.16	0	0-2	
2535.0	21100	5	16-QAM	25	0	17.2	0	0-2	
High	2567.5	21425	5	QPSK	1	0	17.34	0	0
	2567.5	21425	5	QPSK	1	12	17.37	0	0
	2567.5	21425	5	QPSK	1	24	17.05	0	0
	2567.5	21425	5	QPSK	12	0	17.20	0	0-1
	2567.5	21425	5	QPSK	12	6	17.21	0	0-1
	2567.5	21425	5	QPSK	12	13	17.62	0	0-1
	2567.5	21425	5	QPSK	25	0	17.29	0	0-1
	2567.5	21425	5	16-QAM	1	0	17.32	0	0-1
	2567.5	21425	5	16-QAM	1	12	17.38	0	0-1
	2567.5	21425	5	16-QAM	1	24	17.20	0	0-1
	2567.5	21425	5	16-QAM	12	0	17.24	0	0-2
	2567.5	21425	5	16-QAM	12	6	17.16	0	0-2
	2567.5	21425	5	16-QAM	12	13	16.87	0	0-2
	2567.5	21425	5	16-QAM	25	0	16.97	0	0-2

Table 9-37
Reduced LTE Band 7 Conducted Powers - 20 MHz Bandwidth
(Representing Hotspot Mode Active)

Frequency [MHz]	Channel	Bandwidth [MHz]	Modulation	RB Size	RB Offset	Conducted Power [dBm]	Target MPR [dB]	MPR Allowed per 3GPP [dB]
Low	2510	20850	20	QPSK	1	0	17.34	0
	2510	20850	20	QPSK	1	50	17.41	0
	2510	20850	20	QPSK	1	99	17.36	0
	2510	20850	20	QPSK	50	0	17.39	0
	2510	20850	20	QPSK	50	25	17.33	0
	2510	20850	20	QPSK	50	50	17.39	0
	2510	20850	20	QPSK	100	0	17.35	0
	2510	20850	20	16QAM	1	0	17.36	0
	2510	20850	20	16QAM	1	50	17.13	0
	2510	20850	20	16QAM	1	99	17.41	0
	2510	20850	20	16QAM	50	0	17.01	0
	2510	20850	20	16QAM	50	25	17.00	0
	2510	20850	20	16QAM	50	50	17.10	0
	2510	20850	20	16QAM	100	0	16.73	0
	2535.0	21100	20	QPSK	1	0	17.37	0
	2535.0	21100	20	QPSK	1	50	17.45	0
	2535.0	21100	20	QPSK	1	99	17.53	0
	2535.0	21100	20	QPSK	50	0	17.25	0
2535.0	21100	20	QPSK	50	25	17.31	0	
2535.0	21100	20	QPSK	50	50	17.22	0	
2535.0	21100	20	QPSK	100	0	17.39	0	
2535.0	21100	20	16QAM	1	0	17.41	0	
2535.0	21100	20	16QAM	1	50	17.11	0	
2535.0	21100	20	16QAM	1	99	16.99	0	
2535.0	21100	20	16QAM	50	0	17.12	0	
2535.0	21100	20	16QAM	50	25	17.10	0	
2535.0	21100	20	16QAM	50	50	17.19	0	
2535.0	21100	20	16QAM	100	0	17.23	0	
High	2560	21350	20	QPSK	1	0	17.40	0
	2560	21350	20	QPSK	1	50	17.43	0
	2560	21350	20	QPSK	1	99	17.08	0
	2560	21350	20	QPSK	50	0	17.23	0
	2560	21350	20	QPSK	50	25	17.24	0
	2560	21350	20	QPSK	50	50	17.53	0
	2560	21350	20	QPSK	100	0	17.32	0
	2560	21350	20	16QAM	1	0	17.35	0
	2560	21350	20	16QAM	1	50	17.39	0
	2560	21350	20	16QAM	1	99	17.23	0
	2560	21350	20	16QAM	50	0	17.27	0
	2560	21350	20	16QAM	50	25	17.21	0
	2560	21350	20	16QAM	50	50	17.02	0
	2560	21350	20	16QAM	100	0	17.00	0

Table 9-38
Reduced LTE Band 7 Conducted Powers - 15 MHz Bandwidth
(Representing Hotspot Mode Active)



Frequency [MHz]	Channel	Bandwidth [MHz]	Modulation	RB Size	RB Offset	Conducted Power [dBm]	Target MPR [dB]	MPR Allowed per 3GPP [dB]
Low	2507.5	20825	15	QPSK	1	0	17.26	0
	2507.5	20825	15	QPSK	1	36	17.33	0
	2507.5	20825	15	QPSK	1	74	17.28	0
	2507.5	20825	15	QPSK	36	0	17.31	0
	2507.5	20825	15	QPSK	36	18	17.25	0
	2507.5	20825	15	QPSK	36	37	17.31	0
	2507.5	20825	15	QPSK	75	0	17.27	0
	2507.5	20825	15	16QAM	1	0	17.28	0
	2507.5	20825	15	16QAM	1	36	17.05	0
	2507.5	20825	15	16QAM	1	74	17.33	0
	2507.5	20825	15	16QAM	36	0	16.93	0
	2507.5	20825	15	16QAM	36	18	16.92	0
	2507.5	20825	15	16QAM	36	37	17.02	0
	2507.5	20825	15	16QAM	75	0	16.65	0
	2535.0	21100	15	QPSK	1	0	17.29	0
	2535.0	21100	15	QPSK	1	36	17.37	0
	2535.0	21100	15	QPSK	1	74	17.45	0
	2535.0	21100	15	QPSK	36	0	17.17	0
2535.0	21100	15	QPSK	36	18	17.23	0	
2535.0	21100	15	QPSK	36	37	17.14	0	
2535.0	21100	15	QPSK	75	0	17.31	0	
2535.0	21100	15	16QAM	1	0	17.33	0	
2535.0	21100	15	16QAM	1	36	17.03	0	
2535.0	21100	15	16QAM	1	74	16.91	0	
2535.0	21100	15	16QAM	36	0	17.04	0	
2535.0	21100	15	16QAM	36	18	17.02	0	
2535.0	21100	15	16QAM	36	37	17.11	0	
2535.0	21100	15	16QAM	75	0	17.15	0	
High	2562.5	21375	15	QPSK	1	0	17.32	0
	2562.5	21375	15	QPSK	1	36	17.35	0
	2562.5	21375	15	QPSK	1	74	17.00	0
	2562.5	21375	15	QPSK	36	0	17.15	0
	2562.5	21375	15	QPSK	36	18	17.16	0
	2562.5	21375	15	QPSK	36	37	17.45	0
	2562.5	21375	15	QPSK	75	0	17.24	0
	2562.5	21375	15	16QAM	1	0	17.27	0
	2562.5	21375	15	16QAM	1	36	17.31	0
	2562.5	21375	15	16QAM	1	74	17.15	0
	2562.5	21375	15	16QAM	36	0	17.19	0
	2562.5	21375	15	16QAM	36	18	17.13	0
	2562.5	21375	15	16QAM	36	37	16.94	0
	2562.5	21375	15	16QAM	75	0	16.92	0

Table 9-39
Reduced LTE Band 7 Conducted Powers - 10 MHz Bandwidth
(Representing Hotspot Mode Active)

	Frequency [MHz]	Channel	Bandwidth [MHz]	Modulation	RB Size	RB Offset	Conducted Power [dBm]	Target MPR [dB]	MPR Allowed per 3GPP [dB]
Low	2505	20800	10	QPSK	1	0	17.31	0	0
	2505	20800	10	QPSK	1	25	17.30	0	0
	2505	20800	10	QPSK	1	49	17.35	0	0
	2505	20800	10	QPSK	25	0	17.38	0	-0.1
	2505	20800	10	QPSK	25	12	17.31	0	-0.1
	2505	20800	10	QPSK	25	25	17.33	0	-0.1
	2505	20800	10	QPSK	50	0	17.26	0	-0.1
	2505	20800	10	16QAM	1	0	17.32	0	-0.1
	2505	20800	10	16QAM	1	25	17.25	0	-0.1
	2505	20800	10	16QAM	1	49	17.35	0	-0.1
	2505	20800	10	16QAM	25	0	17.32	0	-0.2
	2505	20800	10	16QAM	25	12	17.29	0	-0.2
	2505	20800	10	16QAM	25	25	17.28	0	-0.2
	2505	20800	10	16QAM	50	0	17.23	0	-0.2
	2535.0	21100	10	QPSK	1	0	17.42	0	0
2535.0	21100	10	QPSK	1	25	17.51	0	0	
2535.0	21100	10	QPSK	1	49	17.29	0	0	
2535.0	21100	10	QPSK	25	0	17.47	0	-0.1	
2535.0	21100	10	QPSK	25	12	17.43	0	-0.1	
2535.0	21100	10	QPSK	25	25	17.48	0	-0.1	
2535.0	21100	10	QPSK	50	0	17.47	0	-0.1	
2535.0	21100	10	16QAM	1	0	17.15	0	-0.1	
2535.0	21100	10	16QAM	1	25	17.26	0	-0.1	
2535.0	21100	10	16QAM	1	49	17.19	0	-0.1	
2535.0	21100	10	16QAM	25	0	17.28	0	-0.2	
2535.0	21100	10	16QAM	25	12	17.27	0	-0.2	
2535.0	21100	10	16QAM	25	25	17.17	0	-0.2	
2535.0	21100	10	16QAM	50	0	17.18	0	-0.2	
Mid	2565	21400	10	QPSK	1	0	17.46	0	0
	2565	21400	10	QPSK	1	25	17.47	0	0
	2565	21400	10	QPSK	1	49	17.48	0	0
	2565	21400	10	QPSK	25	0	17.34	0	-0.1
	2565	21400	10	QPSK	25	12	17.21	0	-0.1
	2565	21400	10	QPSK	25	25	17.35	0	-0.1
	2565	21400	10	QPSK	50	0	17.29	0	-0.1
	2565	21400	10	16QAM	1	0	17.20	0	-0.1
	2565	21400	10	16QAM	1	25	17.26	0	-0.1
	2565	21400	10	16QAM	1	49	17.41	0	-0.1
	2565	21400	10	16QAM	25	0	17.22	0	-0.2
	2565	21400	10	16QAM	25	12	17.35	0	-0.2
	2565	21400	10	16QAM	25	25	17.31	0	-0.2
	2565	21400	10	16QAM	50	0	17.28	0	-0.2
	High	2565	21400	10	16QAM	50	0	17.28	0

Table 9-40
Reduced LTE Band 7 Conducted Powers - 5 MHz Bandwidth
(Representing Hotspot Mode Active)

	Frequency [MHz]	Channel	Bandwidth [MHz]	Modulation	RB Size	RB Offset	Conducted Power [dBm]	Target MPR [dB]	MPR Allowed per 3GPP [dB]
Low	2502.5	20775	5	QPSK	1	0	17.29	0	0
	2502.5	20775	5	QPSK	1	12	17.28	0	0
	2502.5	20775	5	QPSK	1	24	17.33	0	0
	2502.5	20775	5	QPSK	12	0	17.36	0	-0.1
	2502.5	20775	5	QPSK	12	6	17.29	0	-0.1
	2502.5	20775	5	QPSK	12	13	17.31	0	-0.1
	2502.5	20775	5	QPSK	25	0	17.24	0	-0.1
	2502.5	20775	5	16-QAM	1	0	17.30	0	-0.1
	2502.5	20775	5	16-QAM	1	12	17.23	0	-0.1
	2502.5	20775	5	16-QAM	1	24	17.33	0	-0.1
	2502.5	20775	5	16-QAM	12	0	17.30	0	-0.2
	2502.5	20775	5	16-QAM	12	6	17.27	0	-0.2
	2502.5	20775	5	16-QAM	12	13	17.26	0	-0.2
	2502.5	20775	5	16-QAM	25	0	17.21	0	-0.2
	2535.0	21100	5	QPSK	1	0	17.4	0	0
2535.0	21100	5	QPSK	1	12	17.49	0	0	
2535.0	21100	5	QPSK	1	24	17.27	0	0	
2535.0	21100	5	QPSK	12	0	17.45	0	-0.1	
2535.0	21100	5	QPSK	12	6	17.41	0	-0.1	
2535.0	21100	5	QPSK	12	13	17.46	0	-0.1	
2535.0	21100	5	QPSK	25	0	17.45	0	-0.1	
2535.0	21100	5	16-QAM	1	0	17.13	0	-0.1	
2535.0	21100	5	16-QAM	1	12	17.24	0	-0.1	
2535.0	21100	5	16-QAM	1	24	17.17	0	-0.1	
2535.0	21100	5	16-QAM	12	0	17.26	0	-0.2	
2535.0	21100	5	16-QAM	12	6	17.25	0	-0.2	
2535.0	21100	5	16-QAM	12	13	17.15	0	-0.2	
2535.0	21100	5	16-QAM	25	0	17.16	0	-0.2	
Mid	2567.5	21425	5	QPSK	1	0	17.44	0	0
	2567.5	21425	5	QPSK	1	12	17.45	0	0
	2567.5	21425	5	QPSK	1	24	17.46	0	0
	2567.5	21425	5	QPSK	12	0	17.32	0	-0.1
	2567.5	21425	5	QPSK	12	6	17.19	0	-0.1
	2567.5	21425	5	QPSK	12	13	17.33	0	-0.1
	2567.5	21425	5	QPSK	25	0	17.27	0	-0.1
	2567.5	21425	5	16-QAM	1	0	17.18	0	-0.1
	2567.5	21425	5	16-QAM	1	12	17.24	0	-0.1
	2567.5	21425	5	16-QAM	1	24	17.39	0	-0.1
	2567.5	21425	5	16-QAM	12	0	17.20	0	-0.2
	2567.5	21425	5	16-QAM	12	6	17.33	0	-0.2
	2567.5	21425	5	16-QAM	12	13	17.29	0	-0.2
	2567.5	21425	5	16-QAM	25	0	17.26	0	-0.2
	High	2567.5	21425	5	16-QAM	25	0	17.26	0

FCC ID: PY7PM-0410		SAR EVALUATION REPORT		Reviewed by: Quality Manager
Document S/N: OY1306100973.PY7	Test Dates: 05/06/13 - 08/01/13	DUT Type: Portable Handset		Page 46 of 83

9.4 WLAN Conducted Powers

Table 9-41
IEEE 802.11b Average RF Power

Mode	Freq	Channel	802.11b (2.4 GHz) Conducted Power [dBm]			
			Data Rate [Mbps]			
	[MHz]		1	2	5.5	11
802.11b	2412	1*	11.18	11.26	10.84	11.29
802.11b	2417	2*	12.25	12.32	12.31	12.30
802.11b	2437	6*	13.13	13.26	13.07	13.03
802.11b	2457	10*	11.77	11.76	11.75	11.71
802.11b	2462	11*	11.66	11.64	11.21	11.19

Table 9-42
IEEE 802.11g Average RF Power

Mode	Freq	Channel	802.11g (2.4 GHz) Conducted Power [dBm]							
			Data Rate [Mbps]							
	[MHz]		6	9	12	18	24	36	48	54
802.11g	2412	1	11.14	11.13	11.12	11.13	11.09	11.08	10.66	10.66
802.11g	2417	2	12.05	12.06	12.07	12.07	12.01	12.03	11.99	12.00
802.11g	2437	6	13.02	12.98	12.96	12.98	12.96	12.93	12.91	12.89
802.11g	2457	10	11.67	11.65	11.59	11.64	11.62	11.55	11.59	11.62
802.11g	2462	11	10.97	10.96	10.96	10.95	10.94	10.91	10.93	10.94

Table 9-43
IEEE 802.11n Average RF Power

Mode	Freq	Channel	802.11n (2.4 GHz) Conducted Power [dBm]							
			Data Rate [Mbps]							
	[MHz]		6.5	13	20	26	39	52	58	65
802.11n	2412	1	10.71	10.71	10.71	11.15	10.67	10.64	10.66	11.11
802.11n	2417	2	12.16	12.08	12.06	12.03	12.05	12.07	12.06	11.99
802.11n	2437	6	13.01	13.01	13.04	12.98	12.96	12.98	12.96	12.95
802.11n	2457	10	11.64	11.66	11.65	11.59	11.62	11.57	11.64	11.65
802.11n	2462	11	11.08	11.06	11.07	11.01	11.00	10.99	10.97	11.01

FCC ID: PY7PM-0410	 PCTEST ENGINEERING LABORATORY, INC.	SAR EVALUATION REPORT	SONY	Reviewed by: Quality Manager
Document S/N: OY1306100973.PY7	Test Dates: 05/06/13 - 08/01/13	DUT Type: Portable Handset		Page 47 of 83

**Table 9-44
IEEE 802.11a Average RF Power**

Mode	Freq [MHz]	Channel	802.11a (5GHz) Conducted Power [dBm]							
			Data Rate [Mbps]							
	6	9	12	18	24	36	48	54		
802.11a	5180	36*	12.99	13.45	13.41	13.43	12.48	12.11	11.61	11.59
802.11a	5200	40	13.39	13.41	13.33	13.35	12.41	12.42	11.97	11.95
802.11a	5220	44	13.38	13.41	13.45	13.45	12.50	11.63	11.65	11.64
802.11a	5240	48*	13.39	13.36	13.37	13.40	12.46	12.47	12.02	12.49
802.11a	5260	52*	12.93	12.87	12.90	12.90	11.93	11.97	11.94	11.95
802.11a	5280	56	12.83	12.85	12.89	12.87	11.94	11.98	11.95	11.98
802.11a	5300	60	12.41	12.38	12.32	12.29	11.92	11.46	11.87	11.48
802.11a	5320	64*	12.73	12.76	12.74	12.74	11.85	12.28	12.28	12.33
802.11a	5500	100	11.09	11.10	11.11	11.16	11.05	11.09	11.05	11.06
802.11a	5520	104*	11.23	11.24	11.14	11.18	11.18	11.12	11.11	11.07
802.11a	5540	108	10.71	11.30	11.27	11.25	11.13	10.18	10.16	10.14
802.11a	5560	112	11.31	11.35	11.31	11.34	11.23	10.20	10.74	10.74
802.11a	5580	116*	11.12	11.17	11.12	11.14	11.12	11.10	11.09	11.12
802.11a	5600	120	N/A	N/A	N/A	N/A	N/A	N/A	N/A	N/A
802.11a	5620	124*	N/A	N/A	N/A	N/A	N/A	N/A	N/A	N/A
802.11a	5640	128	N/A	N/A	N/A	N/A	N/A	N/A	N/A	N/A
802.11a	5660	132	11.45	11.45	11.47	11.50	11.41	10.90	10.87	10.89
802.11a	5680	136*	10.44	11.02	11.01	11.02	10.47	10.45	10.43	10.41
802.11a	5700	140	10.76	10.72	10.76	10.78	10.77	10.69	10.70	10.72
802.11a	5745	149*	12.87	13.35	12.84	12.85	11.87	11.89	11.86	11.89
802.11a	5765	153	13.48	13.41	13.45	12.95	11.52	11.45	11.46	11.50
802.11a	5785	157*	12.61	13.12	13.09	13.12	11.63	11.63	11.71	11.62
802.11a	5805	161*	12.67	12.69	12.73	12.75	11.27	11.25	11.27	11.32
802.11a	5825	165	13.25	13.25	13.49	12.82	11.81	11.89	11.74	11.82

Per FCC KDB Publication 443999 and RSS-210 A9.2(3), transmission on channels which overlap the 5600-5650 MHz is prohibited as a client. This device does not transmit any beacons or initiate any transmissions in 5.3 and 5.5 GHz Band.

(*) – indicates default channels per KDB Publication 248227 D01v01r02. When the adjacent channels are higher in power than the default channels, these “required channels” are considered for SAR testing instead of the default channels.



FCC ID: PY7PM-0410		SAR EVALUATION REPORT		Reviewed by: Quality Manager
Document S/N: 0Y1306100973.PY7	Test Dates: 05/06/13 - 08/01/13	DUT Type: Portable Handset		Page 48 of 83

Table 9-45
IEEE 802.11n Average RF Power – 20 MHz Bandwidth

Mode	Freq	Channel	20MHz BW 802.11n (5GHz) Conducted Power [dBm]							
			Data Rate [Mbps]							
	[MHz]	6.5	13	20	26	39	52	58	65	
802.11n	5180	36	11.31	11.76	11.78	11.77	11.74	11.73	11.71	11.75
802.11n	5200	40	11.69	11.71	11.69	11.64	11.63	11.66	11.65	11.65
802.11n	5220	44	11.58	11.56	11.62	11.63	11.62	11.54	11.59	11.60
802.11n	5240	48	11.57	11.60	11.56	11.51	11.54	11.52	11.52	11.54
802.11n	5260	52	11.91	11.96	11.93	11.89	11.93	11.92	11.87	11.92
802.11n	5280	56	11.86	11.32	11.35	11.94	11.93	11.86	11.85	11.83
802.11n	5300	60	11.44	11.53	11.49	11.43	11.91	11.45	11.89	11.41
802.11n	5320	64	10.93	10.94	10.91	10.91	10.89	11.35	11.37	11.35
802.11n	5500	100	10.03	9.96	9.97	9.95	10.03	9.97	10.01	10.00
802.11n	5520	104	10.05	10.06	10.02	9.96	10.06	10.02	10.07	10.04
802.11n	5540	108	10.17	10.15	10.11	10.08	10.11	10.07	10.14	10.11
802.11n	5560	112	10.18	10.20	10.17	10.18	10.13	10.16	10.17	10.13
802.11n	5580	116	10.08	10.07	10.12	10.10	10.07	10.09	10.08	10.06
802.11n	5600	120	N/A	N/A	N/A	N/A	N/A	N/A	N/A	N/A
802.11n	5620	124	N/A	N/A	N/A	N/A	N/A	N/A	N/A	N/A
802.11n	5640	128	N/A	N/A	N/A	N/A	N/A	N/A	N/A	N/A
802.11n	5660	132	10.32	10.39	10.34	10.34	10.36	10.36	10.28	10.31
802.11n	5680	136	10.31	10.40	10.41	10.42	10.37	10.39	10.34	10.35
802.11n	5700	140	10.31	10.34	10.29	10.24	10.30	10.32	10.29	10.36
802.11n	5745	149	11.90	11.92	11.94	11.89	11.91	11.94	11.91	11.93
802.11n	5765	153	11.57	11.57	11.99	11.96	11.54	11.54	11.52	11.51
802.11n	5785	157	11.61	11.68	11.64	11.67	11.61	11.57	11.66	11.65
802.11n	5805	161	11.78	11.78	11.80	11.78	11.74	11.74	11.71	11.74
802.11n	5825	165	11.39	11.34	11.83	11.78	11.81	11.80	11.34	11.33





FCC ID: PY7PM-0410		SAR EVALUATION REPORT		Reviewed by: Quality Manager
Document S/N: 0Y1306100973.PY7	Test Dates: 05/06/13 - 08/01/13	DUT Type: Portable Handset		Page 49 of 83

Table 9-46
IEEE 802.11n Average RF Power – 40 MHz Bandwidth

Mode	Freq	Channel	40MHz BW 802.11n (5GHz) Conducted Power [dBm]							
			Data Rate [Mbps]							
	[MHz]	13.5	27	40.5	54	81	108	121.5	135	
802.11n	5190	38	10.79	10.82	10.86	10.78	10.79	11.69	10.73	10.82
802.11n	5230	46	11.07	11.10	11.12	11.10	11.05	11.03	11.06	11.07
802.11n	5270	54	10.98	11.01	11.07	10.99	10.97	10.97	11.03	10.99
802.11n	5310	62	10.98	10.89	10.89	10.89	10.90	10.89	10.88	10.89
802.11n	5510	102	10.88	10.91	10.90	10.85	10.83	10.88	10.85	10.86
802.11n	5550	110	10.47	10.50	10.56	10.50	10.47	10.46	10.47	10.45
802.11n	5590	118	N/A	N/A	N/A	N/A	N/A	N/A	N/A	N/A
802.11n	5630	126	N/A	N/A	N/A	N/A	N/A	N/A	N/A	N/A
802.11n	5670	134	9.98	10.01	10.04	9.96	9.95	9.99	9.94	9.95
802.11n	5755	151	11.01	11.03	11.02	11.01	11.01	11.02	11.05	11.04
802.11n	5795	159	11.18	11.19	11.17	11.18	11.19	11.15	11.14	11.16

Table 9-47
IEEE 802.11ac Average RF Power – 80 MHz Bandwidth

Mode	Freq	Channel	80MHz BW 802.11ac (5GHz) Conducted Power [dBm]							
			Data Rate [Mbps]							
	[MHz]	29.3	58.5	87.8	117	175.5	234	263.3	292.5	
802.11ac	5210	42	10.62	10.63	10.52	10.59	9.49	9.51	9.50	9.48
802.11ac	5290	58	10.35	10.34	10.36	10.32	9.57	9.60	9.59	9.63
802.11ac	5530	106	10.84	10.95	10.96	10.90	10.49	10.46	10.47	10.48
802.11ac	5775	155	11.04	11.05	11.11	11.13	10.02	10.13	10.12	10.09

FCC ID: PY7PM-0410		SAR EVALUATION REPORT		Reviewed by: Quality Manager
Document S/N: 0Y1306100973.PY7	Test Dates: 05/06/13 - 08/01/13	DUT Type: Portable Handset		Page 50 of 83

Justification for reduced test configurations for WIFI channels per KDB Publication 248227 D01v01r02 and October 2012/April 2013 FCC/TCB Meeting Notes:

- For 2.4 GHz, highest average RF output power channel for the lowest data rate for IEEE 802.11b were selected for SAR evaluation. Other IEEE 802.11 modes (including 802.11g/n) were not investigated since the average output powers over all channels and data rates were not more than 0.25 dB higher than the tested channel in the lowest data rate of IEEE 802.11b mode.
- According to KDB 248227 D01 Page 4, "802.11b/g modes are tested on channels 1,6,11; however, if output power reduction is necessary for channels 1 and/or 11 to meet restricted band requirements the highest output channels closest to each of these channels must be tested instead." Therefore, channels 2 and 10 were additionally considered.
- For 5 GHz, highest average RF output power channel for the lowest data rate for IEEE 802.11a were selected for SAR evaluation. Other IEEE 802.11 modes (including 802.11n) were not investigated since the average output powers over all channels and data rates were not more than 0.25 dB higher than the tested channel in the lowest data rate of IEEE 802.11a mode.
- Full SAR tests for all IEEE 802.11ac configurations were not required because the average output power was not more than 0.25 dB higher than IEEE 802.11a mode. IEEE 802.11ac was evaluated for the highest IEEE 802.11a position in each 5 GHz band and exposure condition.
- When the maximum extrapolated peak SAR of the zoom scan for the maximum output channel is <1.6 W/kg and the reported 1g averaged SAR is <0.8 W/kg, SAR testing on other channels is not required. Otherwise, the other default (or corresponding required) test channels were additionally tested using the lowest data rate.
- The bolded data rate and channel above were tested for SAR.
- The average output powers for 802.11ac -20MHz (VHT20) and 802.11ac - 40 MHz (VHT40) modes are equivalent to the 802.11n - 20 MHz (HT20) and 802.11n -40MHz (HT40). Therefore, no additional measurements were required for the lower bandwidths for 802.11ac.
- There is no power reduction for WiFi antenna.

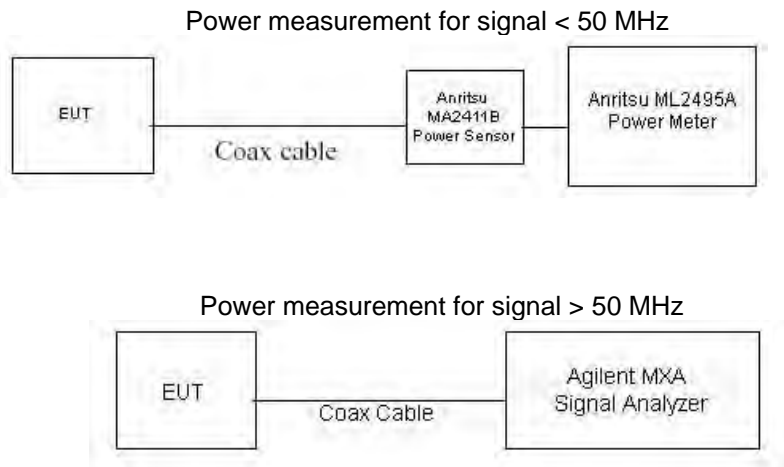



Figure 9-3
Power Measurement Setup

FCC ID: PY7PM-0410	 PCTEST ENGINEERING LABORATORY, INC.	SAR EVALUATION REPORT	SONY	Reviewed by: Quality Manager
Document S/N: OY1306100973.PY7	Test Dates: 05/06/13 - 08/01/13	DUT Type: Portable Handset		Page 51 of 83

10 SYSTEM VERIFICATION

10.1 Tissue Verification

The SAR measurement systems have implemented the SAR error compensation algorithms documented in the draft standard IEEE P1528-2011 to automatically compensate the measured SAR results for deviations between the measured and required tissue dielectric parameters for all frequencies. The test lab has verified that the required SAR error compensation algorithm has been correctly applied to only scale up the measured SAR and not downward.

**Table 10-1
Measured Tissue Properties - Head**



Calibrated for Tests Performed on:	Tissue Type	Tissue Temp During Calibration (C°)	Measured Frequency (MHz)	Measured Conductivity, σ (S/m)	Measured Dielectric Constant, ϵ	TARGET Conductivity, σ (S/m)	TARGET Dielectric Constant, ϵ	% dev σ	% dev ϵ
6/18/2013	835H	23.1	820	0.905	41.717	0.898	41.571	0.78%	0.35%
			835	0.919	41.532	0.900	41.500	2.11%	0.08%
			850	0.933	41.357	0.916	41.500	1.86%	-0.34%
6/24/2013	1750H	23.5	1710	1.336	39.921	1.348	40.136	-0.89%	-0.54%
			1750	1.378	39.734	1.370	40.100	0.58%	-0.91%
			1790	1.423	39.569	1.394	40.020	2.08%	-1.13%
6/20/2013	1900H	23.2	1850	1.394	38.878	1.400	40.000	-0.43%	-2.81%
			1880	1.422	38.735	1.400	40.000	1.57%	-3.16%
			1910	1.460	38.614	1.400	40.000	4.29%	-3.47%
6/28/2013	1900H	22.4	1850	1.349	40.602	1.400	40.000	-3.64%	1.50%
			1880	1.378	40.453	1.400	40.000	-1.57%	1.13%
			1910	1.411	40.337	1.400	40.000	0.79%	0.84%
6/18/2013	2450H	22.9	2401	1.818	40.156	1.758	39.298	3.41%	2.18%
			2450	1.878	39.996	1.800	39.200	4.33%	2.03%
			2499	1.940	39.724	1.852	39.135	4.75%	1.51%
7/26/2013	2450H-2600H	22.9	2401	1.831	38.382	1.758	39.298	4.15%	-2.33%
			2450	1.871	37.996	1.800	39.200	3.94%	-3.07%
			2499	1.909	37.908	1.852	39.135	3.08%	-3.14%
			2500	1.909	37.907	1.853	39.133	3.02%	-3.13%
			2550	1.956	37.518	1.907	39.067	2.57%	-3.96%
			2600	2.007	37.311	1.960	39.000	2.40%	-4.33%
05/09/2013	5200H - 5800H	23.5	5200	4.489	37.242	4.660	36.000	-3.67%	3.45%
			5220	4.499	37.194	4.680	35.980	-3.87%	3.37%
			5240	4.516	37.189	4.700	35.960	-3.91%	3.42%
			5260	4.538	37.198	4.720	35.940	-3.86%	3.50%
			5280	4.557	37.166	4.740	35.920	-3.86%	3.47%
			5300	4.565	37.130	4.760	35.900	-4.10%	3.43%
			5320	4.598	37.104	4.780	35.880	-3.81%	3.41%
			5500	4.768	36.807	4.965	35.650	-3.97%	3.25%
			5520	4.811	36.807	4.986	35.620	-3.51%	3.33%
			5540	4.802	36.796	5.007	35.590	-4.09%	3.39%
			5560	4.838	36.723	5.028	35.560	-3.78%	3.27%
			5600	4.884	36.704	5.070	35.500	-3.67%	3.39%
			5660	4.955	36.672	5.130	35.440	-3.41%	3.48%
			5765	5.077	36.481	5.235	35.335	-3.02%	3.24%
			5785	5.081	36.438	5.255	35.315	-3.31%	3.18%
			5800	5.092	36.381	5.270	35.300	-3.38%	3.06%
			5805	5.092	36.409	5.275	35.295	-3.47%	3.16%
5825	5.117	36.432	5.296	35.275	-3.38%	3.28%			
05/13/2013	5800H	21.8	5800	5.034	35.217	5.270	35.300	-4.48%	-0.24%
			5825	5.084	35.262	5.296	35.275	-4.00%	-0.04%

FCC ID: PY7PM-0410	 PCTEST ENGINEERING LABORATORY, INC.	SAR EVALUATION REPORT	SONY	Reviewed by: Quality Manager
Document S/N: OY1306100973.PY7	Test Dates: 05/06/13 - 08/01/13	DUT Type: Portable Handset		Page 52 of 83

**Table 10-2
Measured Tissue Properties – Body**

Calibrated for Tests Performed on:	Tissue Type	Tissue Temp During Calibration (C°)	Measured Frequency (MHz)	Measured Conductivity, σ (S/m)	Measured Dielectric Constant, ϵ	TARGET Conductivity, σ (S/m)	TARGET Dielectric Constant, ϵ	% dev σ	% dev ϵ
6/18/2013	835B	22.9	820	0.993	56.088	0.969	55.258	2.48%	1.50%
			835	1.005	55.891	0.970	55.200	3.61%	1.25%
			850	1.023	55.734	0.988	55.154	3.54%	1.05%
6/21/2013	835B	22.4	820	0.992	55.926	0.969	55.258	2.37%	1.21%
			835	1.006	55.760	0.970	55.200	3.71%	1.01%
			850	1.021	55.595	0.988	55.154	3.34%	0.80%
6/17/2013	1750B	23.2	1710	1.412	52.090	1.460	53.540	-3.29%	-2.71%
			1750	1.454	51.954	1.490	53.430	-2.42%	-2.76%
			1790	1.494	51.797	1.510	53.330	-1.06%	-2.87%
6/20/2013	1750B	22.1	1710	1.486	51.735	1.460	53.540	1.78%	-3.37%
			1750	1.527	51.582	1.490	53.430	2.48%	-3.46%
			1790	1.570	51.439	1.510	53.330	3.97%	-3.55%
8/1/2013	1750B	23.0	1710	1.472	51.192	1.460	53.540	0.82%	-4.39%
			1750	1.513	51.058	1.490	53.430	1.54%	-4.44%
			1790	1.557	50.923	1.510	53.330	3.11%	-4.51%
6/17/2013	1900B	23.1	1850	1.465	52.389	1.520	53.300	-3.62%	-1.71%
			1880	1.501	52.212	1.520	53.300	-1.25%	-2.04%
			1910	1.546	52.086	1.520	53.300	1.71%	-2.28%
6/25/2013	1900B	23.6	1850	1.447	53.178	1.520	53.300	-4.80%	-0.23%
			1880	1.480	53.071	1.520	53.300	-2.63%	-0.43%
			1910	1.512	52.964	1.520	53.300	-0.53%	-0.63%
7/11/2013	1900B	23.3	1850	1.496	53.312	1.520	53.300	-1.58%	0.02%
			1880	1.517	53.240	1.520	53.300	-0.20%	-0.11%
			1910	1.588	52.947	1.520	53.300	4.47%	-0.66%
8/1/2013	1900B	23.9	1850	1.468	53.386	1.520	53.300	-3.42%	0.16%
			1880	1.502	53.261	1.520	53.300	-1.18%	-0.07%
			1910	1.539	53.147	1.520	53.300	1.25%	-0.29%
6/18/2013	2450B	22.7	2401	1.976	50.372	1.903	52.765	3.84%	-4.54%
			2450	2.045	50.224	1.950	52.700	4.87%	-4.70%
			2499	2.111	50.031	2.019	52.638	4.56%	-4.95%
7/22/2013	2450B-2600B	22.6	2401	1.966	52.854	1.903	52.765	3.31%	0.17%
			2450	2.031	52.669	1.950	52.700	4.15%	-0.06%
			2499	2.099	52.471	2.019	52.638	3.96%	-0.32%
			2500	2.101	52.454	2.021	52.636	3.96%	-0.35%
			2550	2.171	52.260	2.092	52.573	3.78%	-0.60%
			2600	2.239	52.077	2.163	52.509	3.51%	-0.82%
05/06/2013	5200B - 5800B	22.4	5200	5.437	47.182	5.299	49.014	2.60%	-3.74%
			5220	5.463	47.153	5.323	48.987	2.63%	-3.74%
			5240	5.465	47.113	5.346	48.933	2.23%	-3.72%
			5260	5.485	47.060	5.369	48.906	2.16%	-3.77%
			5280	5.512	46.987	5.393	48.879	2.21%	-3.87%
			5300	5.546	46.946	5.416	48.851	2.40%	-3.90%
			5320	5.570	46.975	5.439	48.607	2.41%	-3.36%
			5500	5.801	46.707	5.650	48.580	2.67%	-3.86%
			5520	5.815	46.646	5.673	48.553	2.50%	-3.93%
			5540	5.844	46.565	5.696	48.526	2.60%	-4.04%
			5560	5.882	46.564	5.720	48.499	2.83%	-3.99%
			5600	5.946	46.517	5.766	48.444	3.12%	-3.98%
			5660	6.007	46.397	5.837	48.363	2.91%	-4.07%
			5765	6.177	46.255	5.959	48.220	3.66%	-4.08%
			5785	6.183	46.200	5.982	48.242	3.36%	-4.23%
			5800	6.198	46.110	6.000	48.200	3.30%	-4.34%
			5805	6.202	46.123	6.005	48.166	3.28%	-4.24%
5825	6.240	46.038	6.029	48.132	3.50%	-4.35%			

The above measured tissue parameters were used in the DASY software. The DASY software was used to perform interpolation to determine the dielectric parameters at the SAR test device frequencies (per IEEE 1528 6.6.1.2). The tissue parameters listed in the SAR test plots may slightly differ from the table above due to significant digit rounding in the software.

FCC ID: PY7PM-0410		SAR EVALUATION REPORT		Reviewed by: Quality Manager
Document S/N: OY1306100973.PY7	Test Dates: 05/06/13 - 08/01/13	DUT Type: Portable Handset		Page 53 of 83

10.2 Test System Verification

Prior to SAR assessment, the system is verified to $\pm 10\%$ of the SAR measurement on the reference dipole at the time of calibration by the calibration facility. Full system validation status and result summary can be found in Appendix E.

Table 10-3
System Verification Results

System Verification TARGET & MEASURED												
SAR System #	Tissue Frequency (MHz)	Tissue Type	Date:	Amb. Temp (°C)	Liquid Temp (°C)	Input Power (W)	Dipole SN	Probe SN	Measured SAR _{1g} (W/kg)	1 W Target SAR _{1g} (W/kg)	1 W Normalized SAR _{1g} (W/kg)	Deviation _{1g} (%)
D	835	HEAD	06/18/2013	23.1	23.1	0.100	4d132	3288	0.957	9.660	9.570	-0.93%
E	1750	HEAD	06/24/2013	24.2	23.6	0.100	1051	3920	3.720	36.500	37.200	1.92%
A	1900	HEAD	06/20/2013	24.0	23.3	0.100	5d080	3589	4.250	39.400	42.500	7.87%
E	1900	HEAD	06/28/2013	23.8	23.3	0.100	5d148	3920	3.950	39.700	39.500	-0.50%
B	2450	HEAD	06/18/2013	23.4	22.9	0.100	719	3287	5.340	52.700	53.400	1.33%
C	2450	HEAD	07/26/2013	23.6	22.7	0.100	719	3022	5.570	52.700	55.700	5.69%
C	2600	HEAD	07/26/2013	23.1	23.0	0.040	1004	3022	2.360	58.200	59.000	1.37%
E	5200	HEAD	05/09/2013	24.4	23.3	0.100	1120	3920	6.880	76.000	68.800	-9.47%
E	5300	HEAD	05/09/2013	24.5	23.3	0.100	1120	3920	8.370	78.700	83.700	6.35%
E	5500	HEAD	05/09/2013	24.3	23.2	0.100	1120	3920	8.260	80.100	82.600	3.12%
E	5600	HEAD	05/09/2013	24.3	23.3	0.100	1120	3920	7.500	79.900	75.000	-6.13%
E	5800	HEAD	05/09/2013	24.3	23.3	0.100	1120	3920	7.200	74.900	72.000	-3.87%
E	5800	HEAD	05/13/2013	22.1	21.5	0.100	1120	3920	7.540	74.900	75.400	0.67%
G	835	BODY	06/18/2013	24.6	22.9	0.100	4d132	3209	0.994	9.360	9.940	6.20%
G	835	BODY	06/21/2013	24.3	22.4	0.100	4d132	3209	0.916	9.360	9.160	-2.14%
B	1750	BODY	06/17/2013	23.8	23.0	0.100	1008	3287	3.790	38.200	37.900	-0.79%
B	1750	BODY	06/20/2013	23.0	22.1	0.100	1008	3287	3.980	38.200	39.800	4.19%
E	1900	BODY	06/17/2013	23.6	23.3	0.100	5d148	3920	4.170	40.800	41.700	2.21%
C	1900	BODY	06/25/2013	23.2	23.6	0.040	5d080	3022	1.650	40.300	41.250	2.36%
B	1900	BODY	07/11/2013	23.1	22.9	0.100	5d080	3287	4.220	40.300	42.200	4.71%
C	2450	BODY	06/18/2013	22.9	22.7	0.040	719	3022	2.080	51.600	52.000	0.78%
C	2450	BODY	07/22/2013	23.0	22.6	0.100	719	3022	5.480	51.600	54.800	6.20%
C	2600	BODY	07/22/2013	23.0	22.6	0.100	1004	3022	5.670	57.500	56.700	-1.39%
A	5200	BODY	05/06/2013	23.6	21.8	0.100	1057	3589	7.570	75.500	75.700	0.26%
A	5300	BODY	05/06/2013	23.6	21.8	0.100	1057	3589	8.090	75.300	80.900	7.44%
A	5500	BODY	05/06/2013	23.6	21.8	0.100	1057	3589	8.110	80.800	81.100	0.37%
A	5600	BODY	05/06/2013	23.7	21.9	0.100	1057	3589	8.480	80.300	84.800	5.60%
A	5800	BODY	05/06/2013	23.7	21.8	0.100	1057	3589	7.420	75.100	74.200	-1.20%

FCC ID: PY7PM-0410	 PCTEST ENGINEERING LABORATORY, INC.	SAR EVALUATION REPORT	SONY	Reviewed by: Quality Manager
Document S/N: 0Y1306100973.PY7	Test Dates: 05/06/13 - 08/01/13	DUT Type: Portable Handset		Page 54 of 83

**Table 10-4
System Verification Results – Extremity SAR**

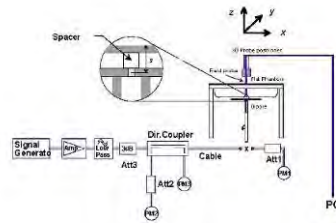

System Verification TARGET & MEASURED												
SAR System #	Tissue Frequency (MHz)	Tissue Type	Date:	Amb. Temp (°C)	Liquid Temp (°C)	Input Power (W)	Dipole SN	Probe SN	Measured SAR _{10g} (W/kg)	1 W Target SAR _{10g} (W/kg)	1 W Normalized SAR _{10g} (W/kg)	Deviation _{10g} (%)
B	1750	BODY	08/01/2013	23.2	23.0	0.100	1008	3287	2.080	20.400	20.800	1.96%
E	1900	BODY	08/01/2013	23.6	23.7	0.100	5d148	3920	2.210	21.700	22.100	1.84%
A	5200	BODY	05/06/2013	23.6	21.8	0.100	1057	3589	2.080	21.100	20.800	-1.42%
A	5300	BODY	05/06/2013	23.6	21.8	0.100	1057	3589	2.230	21.100	22.300	5.69%
A	5500	BODY	05/06/2013	23.6	21.8	0.100	1057	3589	2.220	22.400	22.200	-0.89%
A	5600	BODY	05/06/2013	23.7	21.9	0.100	1057	3589	2.310	22.300	23.100	3.59%
A	5800	BODY	05/06/2013	23.7	21.8	0.100	1057	3589	2.020	20.700	20.200	-2.42%



**Figure 10-1
System Verification Setup Diagram**



**Figure 10-2
System Verification Setup Photo**

FCC ID: PY7PM-0410		SAR EVALUATION REPORT		Reviewed by: Quality Manager
Document S/N: OY1306100973.PY7	Test Dates: 05/06/13 - 08/01/13	DUT Type: Portable Handset		Page 55 of 83

11 SAR DATA SUMMARY

11.1 Standalone Head SAR Data

**Table 11-1
GSM 850 Head SAR**

MEASUREMENT RESULTS														
FREQUENCY		Mode/Band	Service	Maximum Allowed Power [dBm]	Conducted Power [dBm]	Power Drift [dB]	Side	Test Position	Device Serial Number	Duty Cycle	SAR (1g)	Scaling Factor	Scaled SAR (1g)	Plot #
MHz	Ch.										(W/kg)		(W/kg)	
824.20	128	GSM 850	GSM	33.6	32.91	-0.05	Right	Cheek	7481	1:8.3	0.299	1.172	0.350	
836.60	190	GSM 850	GSM	33.6	33.22	0.02	Right	Cheek	7481	1:8.3	0.241	1.091	0.263	
848.80	251	GSM 850	GSM	33.6	33.37	-0.20	Right	Cheek	7481	1:8.3	0.387	1.054	0.408	A1
836.60	190	GSM 850	GSM	33.6	33.22	0.03	Right	Tilt	7481	1:8.3	0.201	1.091	0.219	
836.60	190	GSM 850	GSM	33.6	33.22	-0.07	Left	Cheek	7481	1:8.3	0.195	1.091	0.213	
836.60	190	GSM 850	GSM	33.6	33.22	0.01	Left	Tilt	7481	1:8.3	0.160	1.091	0.175	
ANSI / IEEE C95.1 1992 - SAFETY LIMIT Spatial Peak Uncontrolled Exposure/General Population								Head 1.6 W/kg (mW/g) averaged over 1 gram						

**Table 11-2
UMTS V Head SAR**

MEASUREMENT RESULTS														
FREQUENCY		Mode/Band	Service	Maximum Allowed Power [dBm]	Conducted Power [dBm]	Power Drift [dB]	Side	Test Position	Device Serial Number	Duty Cycle	SAR (1g)	Scaling Factor	Scaled SAR (1g)	Plot #
MHz	Ch.										(W/kg)		(W/kg)	
826.40	4132	UMTS V	RMC	24.5	24.24	-0.04	Right	Cheek	7320	1:1	0.331	1.062	0.352	
836.60	4183	UMTS V	RMC	24.5	24.27	0.07	Right	Cheek	7320	1:1	0.332	1.054	0.350	
846.60	4233	UMTS V	RMC	24.5	24.28	-0.13	Right	Cheek	7320	1:1	0.343	1.052	0.361	A2
836.60	4183	UMTS V	RMC	24.5	24.27	0.00	Right	Tilt	7320	1:1	0.196	1.054	0.207	
836.60	4183	UMTS V	RMC	24.5	24.27	-0.05	Left	Cheek	7320	1:1	0.238	1.054	0.251	
836.60	4183	UMTS V	RMC	24.5	24.27	0.03	Left	Tilt	7320	1:1	0.188	1.054	0.198	
ANSI / IEEE C95.1 1992 - SAFETY LIMIT Spatial Peak Uncontrolled Exposure/General Population								Head 1.6 W/kg (mW/g) averaged over 1 gram						

**Table 11-3
UMTS IV Head SAR**

MEASUREMENT RESULTS														
FREQUENCY		Mode/Band	Service	Maximum Allowed Power [dBm]	Conducted Power [dBm]	Power Drift [dB]	Side	Test Position	Device Serial Number	Duty Cycle	SAR (1g)	Scaling Factor	Scaled SAR (1g)	Plot #
MHz	Ch.										(W/kg)		(W/kg)	
1730.40	1412	UMTS IV	RMC	24.5	24.06	0.03	Right	Cheek	7320	1:1	0.161	1.107	0.178	
1730.40	1412	UMTS IV	RMC	24.5	24.06	0.16	Right	Tilt	7320	1:1	0.058	1.107	0.064	
1712.40	1312	UMTS IV	RMC	24.5	24.01	0.05	Left	Cheek	7320	1:1	0.242	1.119	0.271	A3
1730.40	1412	UMTS IV	RMC	24.5	24.06	-0.01	Left	Cheek	7320	1:1	0.187	1.107	0.207	
1752.50	1862	UMTS IV	RMC	24.5	24.15	0.06	Left	Cheek	7320	1:1	0.191	1.084	0.207	
1730.40	1412	UMTS IV	RMC	24.5	24.06	0.03	Left	Tilt	7320	1:1	0.056	1.107	0.062	
ANSI / IEEE C95.1 1992 - SAFETY LIMIT Spatial Peak Uncontrolled Exposure/General Population								Head 1.6 W/kg (mW/g) averaged over 1 gram						

FCC ID: PY7PM-0410	 PCTEST ENGINEERING LABORATORY, INC.	SAR EVALUATION REPORT	SONY	Reviewed by: Quality Manager
Document S/N: OY1306100973.PY7	Test Dates: 05/06/13 - 08/01/13	DUT Type: Portable Handset		Page 56 of 83

**Table 11-4
GSM 1900 Head SAR**



MEASUREMENT RESULTS														
FREQUENCY		Mode/Band	Service	Maximum Allowed Power [dBm]	Conducted Power [dBm]	Power Drift [dB]	Side	Test Position	Device Serial Number	Duty Cycle	SAR (1g)	Scaling Factor	Scaled SAR (1g)	Plot #
MHz	Ch.										(W/kg)		(W/kg)	
1850.20	512	GSM 1900	GSM	30.6	30.09	0.11	Right	Cheek	7319	1:8.3	0.052	1.125	0.059	A4
1880.00	661	GSM 1900	GSM	30.6	30.32	0.13	Right	Cheek	7319	1:8.3	0.072	1.067	0.077	
1909.80	810	GSM 1900	GSM	30.6	30.54	-0.09	Right	Cheek	7319	1:8.3	0.058	1.014	0.059	
1880.00	661	GSM 1900	GSM	30.6	30.32	0.19	Right	Tilt	7319	1:8.3	0.022	1.067	0.023	
1880.00	661	GSM 1900	GSM	30.6	30.32	0.05	Left	Cheek	7319	1:8.3	0.066	1.067	0.070	
1880.00	661	GSM 1900	GSM	30.6	30.32	0.03	Left	Tilt	7319	1:8.3	0.015	1.067	0.016	
ANSI / IEEE C95.1 1992 - SAFETY LIMIT Spatial Peak Uncontrolled Exposure/General Population							Head 1.6 W/kg (mW/g) averaged over 1 gram							

**Table 11-5
UMTS II Head SAR**

MEASUREMENT RESULTS														
FREQUENCY		Mode/Band	Service	Maximum Allowed Power [dBm]	Conducted Power [dBm]	Power Drift [dB]	Side	Test Position	Device Serial Number	Duty Cycle	SAR (1g)	Scaling Factor	Scaled SAR (1g)	Plot #
MHz	Ch.										(W/kg)		(W/kg)	
1880.00	9400	UMTS II	RMC	24.0	23.63	-0.04	Right	Cheek	7316	1:1	0.085	1.089	0.093	A5
1880.00	9400	UMTS II	RMC	24.0	23.63	0.02	Right	Tilt	7316	1:1	0.030	1.089	0.033	
1852.40	9262	UMTS II	RMC	24.0	23.78	0.08	Left	Cheek	7316	1:1	0.117	1.052	0.123	
1880.00	9400	UMTS II	RMC	24.0	23.63	0.07	Left	Cheek	7316	1:1	0.144	1.089	0.157	
1907.60	9538	UMTS II	RMC	24.0	23.67	0.05	Left	Cheek	7316	1:1	0.107	1.079	0.115	
1880.00	9400	UMTS II	RMC	24.0	23.63	-0.18	Left	Tilt	7316	1:1	0.018	1.089	0.020	
ANSI / IEEE C95.1 1992 - SAFETY LIMIT Spatial Peak Uncontrolled Exposure/General Population							Head 1.6 W/kg (mW/g) averaged over 1 gram							

**Table 11-6
LTE Band 5 (Cell) Head SAR**

MEASUREMENT RESULTS																			
FREQUENCY		Mode	Bandwidth [MHz]	Maximum Allowed Power [dBm]	Conducted Power [dBm]	Power Drift [dB]	MPR [dB]	Side	Test Position	Modulation	RB Size	RB Offset	Device Serial Number	Duty Cycle	SAR (1g)	Scaling Factor	Scaled SAR (1g)	Plot #	
MHz	Ch.														(W/kg)		(W/kg)		
836.50	20525	Mid	LTE Band 5 (Cell)	10	23.1	22.73	-0.06	0	Right	Cheek	QPSK	1	49	7483	1:1	0.233	1.089	0.254	A6
836.50	20525	Mid	LTE Band 5 (Cell)	10	22.1	21.52	0.11	1	Right	Cheek	QPSK	25	12	7483	1:1	0.160	1.143	0.183	
836.50	20525	Mid	LTE Band 5 (Cell)	10	23.1	22.73	0.04	0	Right	Tilt	QPSK	1	49	7483	1:1	0.145	1.089	0.158	
836.50	20525	Mid	LTE Band 5 (Cell)	10	22.1	21.52	-0.05	1	Right	Tilt	QPSK	25	12	7483	1:1	0.101	1.143	0.115	
836.50	20525	Mid	LTE Band 5 (Cell)	10	23.1	22.73	0.01	0	Left	Cheek	QPSK	1	49	7483	1:1	0.193	1.089	0.210	
836.50	20525	Mid	LTE Band 5 (Cell)	10	22.1	21.52	0.04	1	Left	Cheek	QPSK	25	12	7483	1:1	0.137	1.143	0.157	
836.50	20525	Mid	LTE Band 5 (Cell)	10	23.1	22.73	0.09	0	Left	Tilt	QPSK	1	49	7483	1:1	0.154	1.089	0.168	
836.50	20525	Mid	LTE Band 5 (Cell)	10	22.1	21.52	0.00	1	Left	Tilt	QPSK	25	12	7483	1:1	0.109	1.143	0.125	
ANSI / IEEE C95.1 1992 - SAFETY LIMIT Spatial Peak Uncontrolled Exposure/General Population							Head 1.6 W/kg (mW/g) averaged over 1 gram												

FCC ID: PY7PM-0410		SAR EVALUATION REPORT		Reviewed by: Quality Manager
Document S/N: OY1306100973.PY7	Test Dates: 05/06/13 - 08/01/13	DUT Type: Portable Handset		Page 57 of 83

**Table 11-7
LTE Band 4 (AWS) Head SAR**



MEASUREMENT RESULTS																			
FREQUENCY		Mode	Bandwidth [MHz]	Maximum Allowed Power [dBm]	Conducted Power [dBm]	Power Drift [dB]	MPR [dB]	Side	Test Position	Modulation	RB Size	RB Offset	Device Serial Number	Duty Cycle	SAR (1g)	Scaling Factor	Scaled SAR (1g)	Plot #	
MHz	Ch.														(W/kg)		(W/kg)		
1732.50	20175	Mid	LTE Band 4 (AWS)	20	23.6	23.49	0.03	0	Right	Cheek	QPSK	1	50	7317	1:1	0.153	1.026	0.157	
1732.50	20175	Mid	LTE Band 4 (AWS)	20	22.6	22.21	0.02	1	Right	Cheek	QPSK	50	50	7317	1:1	0.137	1.094	0.150	
1732.50	20175	Mid	LTE Band 4 (AWS)	20	23.6	23.49	0.02	0	Right	Tilt	QPSK	1	50	7317	1:1	0.099	1.026	0.102	
1732.50	20175	Mid	LTE Band 4 (AWS)	20	22.6	22.21	-0.03	1	Right	Tilt	QPSK	50	50	7317	1:1	0.081	1.094	0.089	
1732.50	20175	Mid	LTE Band 4 (AWS)	20	23.6	23.49	-0.05	0	Left	Cheek	QPSK	1	50	7317	1:1	0.194	1.026	0.199	A7
1732.50	20175	Mid	LTE Band 4 (AWS)	20	22.6	22.21	0.02	1	Left	Cheek	QPSK	50	50	7317	1:1	0.131	1.094	0.143	
1732.50	20175	Mid	LTE Band 4 (AWS)	20	23.6	23.49	0.06	0	Left	Tilt	QPSK	1	50	7317	1:1	0.099	1.026	0.102	
1732.50	20175	Mid	LTE Band 4 (AWS)	20	22.6	22.21	0.19	1	Left	Tilt	QPSK	50	50	7317	1:1	0.075	1.094	0.082	
ANSI / IEEE C95.1 1992 - SAFETY LIMIT Spatial Peak Uncontrolled Exposure/General Population										Head 1.6 W/kg (mW/g) averaged over 1 gram									

**Table 11-8
LTE Band 2 (PCS) Head SAR**

MEASUREMENT RESULTS																			
FREQUENCY		Mode	Bandwidth [MHz]	Maximum Allowed Power [dBm]	Conducted Power [dBm]	Power Drift [dB]	MPR [dB]	Side	Test Position	Modulation	RB Size	RB Offset	Device Serial Number	Duty Cycle	SAR (1g)	Scaling Factor	Scaled SAR (1g)	Plot #	
MHz	Ch.														(W/kg)		(W/kg)		
1860.00	18700	Low	LTE Band 2 (PCS)	20	23.8	23.47	0.00	0	Right	Cheek	QPSK	1	0	7317	1:1	0.064	1.079	0.069	
1880.00	18900	Mid	LTE Band 2 (PCS)	20	22.8	22.29	0.11	1	Right	Cheek	QPSK	50	50	7317	1:1	0.049	1.125	0.055	
1860.00	18700	Low	LTE Band 2 (PCS)	20	23.8	23.47	0.05	0	Right	Tilt	QPSK	1	0	7317	1:1	0.033	1.079	0.036	
1880.00	18900	Mid	LTE Band 2 (PCS)	20	22.8	22.29	0.06	1	Right	Tilt	QPSK	50	50	7317	1:1	0.020	1.125	0.023	
1860.00	18700	Low	LTE Band 2 (PCS)	20	23.8	23.47	0.01	0	Left	Cheek	QPSK	1	0	7317	1:1	0.118	1.079	0.127	
1880.00	18900	Mid	LTE Band 2 (PCS)	20	23.8	23.23	0.09	0	Left	Cheek	QPSK	1	99	7317	1:1	0.123	1.140	0.140	A8
1900.00	19100	High	LTE Band 2 (PCS)	20	23.8	23.20	0.15	0	Left	Cheek	QPSK	1	50	7317	1:1	0.110	1.148	0.126	
1880.00	18900	Mid	LTE Band 2 (PCS)	20	22.8	22.29	0.14	1	Left	Cheek	QPSK	50	50	7317	1:1	0.102	1.125	0.115	
1860.00	18700	Low	LTE Band 2 (PCS)	20	23.8	23.47	0.14	0	Left	Tilt	QPSK	1	0	7317	1:1	0.029	1.079	0.031	
1880.00	18900	Mid	LTE Band 2 (PCS)	20	22.8	22.29	0.20	1	Left	Tilt	QPSK	50	50	7317	1:1	0.020	1.125	0.023	
ANSI / IEEE C95.1 1992 - SAFETY LIMIT Spatial Peak Uncontrolled Exposure/General Population										Head 1.6 W/kg (mW/g) averaged over 1 gram									

**Table 11-9
LTE Band 7 Head SAR**



MEASUREMENT RESULTS																			
FREQUENCY		Mode	Bandwidth [MHz]	Maximum Allowed Power [dBm]	Conducted Power [dBm]	Power Drift [dB]	MPR [dB]	Side	Test Position	Modulation	RB Size	RB Offset	Device Serial Number	Duty Cycle	SAR (1g)	Scaling Factor	Scaled SAR (1g)	Plot #	
MHz	Ch.														(W/kg)		(W/kg)		
2535.00	21100	Mid	LTE Band 7	20	18.7	17.56	-0.04	0	Right	Cheek	QPSK	1	50	8711	1:1	0.071	1.300	0.092	
2535.00	21100	Mid	LTE Band 7	20	18.7	17.53	0.06	0	Right	Cheek	QPSK	50	50	8711	1:1	0.070	1.309	0.092	
2535.00	21100	Mid	LTE Band 7	20	18.7	17.56	0.13	0	Right	Tilt	QPSK	1	50	8711	1:1	0.070	1.300	0.091	
2535.00	21100	Mid	LTE Band 7	20	18.7	17.53	0.12	0	Right	Tilt	QPSK	50	50	8711	1:1	0.071	1.309	0.093	
2510.00	20850	Low	LTE Band 7	20	18.7	17.40	0.20	0	Left	Cheek	QPSK	1	99	8711	1:1	0.138	1.349	0.186	
2535.00	21100	Mid	LTE Band 7	20	18.7	17.56	0.12	0	Left	Cheek	QPSK	1	50	8711	1:1	0.144	1.300	0.187	A9
2560.00	21350	High	LTE Band 7	20	18.7	17.53	0.12	0	Left	Cheek	QPSK	1	99	8711	1:1	0.137	1.309	0.179	
2535.00	21100	Mid	LTE Band 7	20	18.7	17.53	-0.01	0	Left	Cheek	QPSK	50	50	8711	1:1	0.143	1.309	0.187	
2535.00	21100	Mid	LTE Band 7	20	18.7	17.56	-0.11	0	Left	Tilt	QPSK	1	50	8711	1:1	0.024	1.300	0.031	
2535.00	21100	Mid	LTE Band 7	20	18.7	17.53	0.14	0	Left	Tilt	QPSK	50	50	8711	1:1	0.045	1.309	0.059	
ANSI / IEEE C95.1 1992 - SAFETY LIMIT Spatial Peak Uncontrolled Exposure/General Population										Head 1.6 W/kg (mW/g) averaged over 1 gram									

FCC ID: PY7PM-0410		SAR EVALUATION REPORT		Reviewed by: Quality Manager
Document S/N: OY1306100973.PY7	Test Dates: 05/06/13 - 08/01/13	DUT Type: Portable Handset		Page 58 of 83

**Table 11-10
DTS Head SAR**



MEASUREMENT RESULTS															
FREQUENCY		Mode	Service	Maximum Allowed Power [dBm]	Conducted Power [dBm]	Power Drift [dB]	Side	Test Position	Device Serial Number	Data Rate (Mbps)	Duty Cycle	SAR (1g)	Scaling Factor	Scaled SAR (1g)	Plot #
MHz	Ch.											(W/kg)		(W/kg)	
2437	6	IEEE 802.11b	DSSS	14.0	13.13	0.04	Right	Cheek	6717	1	1:1	0.499	1.222	0.610	
2437	6	IEEE 802.11b	DSSS	14.0	13.13	0.05	Right	Tilt	6717	1	1:1	0.336	1.222	0.411	
2417	2	IEEE 802.11b	DSSS	14.0	12.25	0.13	Left	Cheek	6717	1	1:1	0.633	1.496	0.947	
2437	6	IEEE 802.11b	DSSS	14.0	13.13	-0.10	Left	Cheek	6717	1	1:1	0.902	1.222	1.102	A10
2457	10	IEEE 802.11b	DSSS	14.0	11.77	0.16	Left	Cheek	6717	1	1:1	0.389	1.671	0.650	
2417	2	IEEE 802.11b	DSSS	14.0	12.25	-0.02	Left	Tilt	6717	1	1:1	0.353	1.496	0.528	
2437	6	IEEE 802.11b	DSSS	14.0	13.13	-0.09	Left	Tilt	6717	1	1:1	0.753	1.222	0.920	
2457	10	IEEE 802.11b	DSSS	14.0	11.77	0.04	Left	Tilt	6717	1	1:1	0.223	1.671	0.373	
2437	6	IEEE 802.11b	DSSS	14.0	13.13	-0.06	Left	Cheek	6717	1	1:1	0.879	1.222	1.074	
5765	153	IEEE 802.11a	OFDM	13.5	13.48	0.03	Right	Cheek	3037	6	1:1	0.345	1.005	0.347	
5765	153	IEEE 802.11a	OFDM	13.5	13.48	0.02	Right	Tilt	3037	6	1:1	0.234	1.005	0.235	
5765	153	IEEE 802.11a	OFDM	13.5	13.48	0.14	Left	Cheek	3037	6	1:1	0.751	1.005	0.755	
5805	161	IEEE 802.11a	OFDM	13.5	12.67	0.08	Left	Cheek	3037	6	1:1	0.813	1.211	0.985	
5825	165	IEEE 802.11a	OFDM	13.5	13.25	0.05	Left	Cheek	3037	6	1:1	0.848	1.059	0.898	
5775	155	IEEE 802.11ac	OFDM	11.8	11.04	0.21	Left	Cheek	3037	29.3	1:1	0.375	1.191	0.447	
5765	153	IEEE 802.11a	OFDM	13.5	13.48	0.06	Left	Tilt	3037	6	1:1	0.515	1.005	0.518	
5805	161	IEEE 802.11a	OFDM	13.5	12.67	0.12	Left	Tilt	3037	6	1:1	0.537	1.211	0.650	
5825	165	IEEE 802.11a	OFDM	13.5	13.25	0.13	Left	Tilt	3037	6	1:1	0.484	1.059	0.513	
5825	165	IEEE 802.11a	OFDM	13.5	13.25	-0.09	Left	Cheek	3037	6	1:1	0.958	1.059	1.015	A11
ANSI / IEEE C95.1 1992 - SAFETY LIMIT Spatial Peak Uncontrolled Exposure/General Population								Head 1.6 W/kg (mW/g) averaged over 1 gram							

Note: Blue entry represents variability measurement.

FCC ID: PY7PM-0410		SAR EVALUATION REPORT		Reviewed by: Quality Manager
Document S/N: OY1306100973.PY7	Test Dates: 05/06/13 - 08/01/13	DUT Type: Portable Handset		Page 59 of 83

**Table 11-11
NII Head SAR**

MEASUREMENT RESULTS															
FREQUENCY		Mode	Service	Maximum Allowed Power [dBm]	Conducted Power [dBm]	Power Drift [dB]	Side	Test Position	Device Serial Number	Data Rate (Mbps)	Duty Cycle	SAR (1g)	Scaling Factor	Scaled SAR (1g)	Plot #
MHz	Ch.											(W/kg)		(W/kg)	
5240	48	IEEE 802.11a	OFDM	13.5	13.39	0.13	Right	Cheek	3037	6	1:1	0.264	1.026	0.271	
5240	48	IEEE 802.11a	OFDM	13.5	13.39	0.09	Right	Tilt	3037	6	1:1	0.180	1.026	0.185	
5200	40	IEEE 802.11a	OFDM	13.5	13.39	0.05	Left	Cheek	3037	6	1:1	0.698	1.026	0.716	
5240	48	IEEE 802.11a	OFDM	13.5	13.39	0.04	Left	Cheek	3037	6	1:1	0.789	1.026	0.810	A12
5210	42	IEEE 802.11ac	OFDM	11.0	10.62	0.03	Left	Cheek	3037	29.3	1:1	0.419	1.091	0.457	
5200	40	IEEE 802.11a	OFDM	13.5	13.39	0.16	Left	Tilt	3037	6	1:1	0.406	1.026	0.417	
5240	48	IEEE 802.11a	OFDM	13.5	13.39	0.00	Left	Tilt	3037	6	1:1	0.507	1.026	0.520	
5260	52	IEEE 802.11a	OFDM	13.5	12.93	0.18	Right	Cheek	3037	6	1:1	0.237	1.140	0.270	
5260	52	IEEE 802.11a	OFDM	13.5	12.93	0.05	Right	Tilt	3037	6	1:1	0.176	1.140	0.201	
5260	52	IEEE 802.11a	OFDM	13.5	12.93	0.01	Left	Cheek	3037	6	1:1	0.655	1.140	0.747	
5320	64	IEEE 802.11a	OFDM	13.5	12.73	0.08	Left	Cheek	3037	6	1:1	0.566	1.194	0.676	
5290	58	IEEE 802.11ac	OFDM	11.0	10.35	0.09	Left	Cheek	3037	29.3	1:1	0.490	1.161	0.569	
5260	52	IEEE 802.11a	OFDM	13.5	12.93	0.12	Left	Tilt	3037	6	1:1	0.458	1.140	0.522	
5320	64	IEEE 802.11a	OFDM	13.5	12.73	0.09	Left	Tilt	3037	6	1:1	0.444	1.194	0.530	
5660	132	IEEE 802.11a	OFDM	11.5	11.45	0.01	Right	Cheek	3037	6	1:1	0.205	1.012	0.207	
5660	132	IEEE 802.11a	OFDM	11.5	11.45	0.02	Right	Tilt	3037	6	1:1	0.150	1.012	0.152	
5520	104	IEEE 802.11a	OFDM	11.5	11.23	0.10	Left	Cheek	3037	6	1:1	0.425	1.064	0.452	
5560	112	IEEE 802.11a	OFDM	11.5	11.31	0.03	Left	Cheek	3037	6	1:1	0.491	1.045	0.513	
5660	132	IEEE 802.11a	OFDM	11.5	11.45	0.15	Left	Cheek	3037	6	1:1	0.742	1.012	0.751	
5530	106	IEEE 802.11ac	OFDM	11.0	10.84	0.03	Left	Cheek	3037	29.3	1:1	0.420	1.038	0.436	
5520	104	IEEE 802.11a	OFDM	11.5	11.23	0.03	Left	Tilt	3037	6	1:1	0.345	1.064	0.367	
5560	112	IEEE 802.11a	OFDM	11.5	11.31	-0.08	Left	Tilt	3037	6	1:1	0.410	1.045	0.428	
5660	132	IEEE 802.11a	OFDM	11.5	11.45	0.14	Left	Tilt	3037	6	1:1	0.603	1.012	0.610	
ANSI / IEEE C95.1 1992 - SAFETY LIMIT Spatial Peak Uncontrolled Exposure/General Population								Head 1.6 W/kg (mW/g) averaged over 1 gram							

FCC ID: PY7PM-0410		SAR EVALUATION REPORT		Reviewed by: Quality Manager
Document S/N: OY1306100973.PY7	Test Dates: 05/06/13 - 08/01/13	DUT Type: Portable Handset		Page 60 of 83



11.2 Standalone Body-Worn SAR Data

Table 11-12
GSM/UMTS Body-Worn SAR Data

MEASUREMENT RESULTS															
FREQUENCY		Mode	Service	Maximum Allowed Power [dBm]	Conducted Power [dBm]	Power Drift [dB]	Spacing	Device Serial Number	# of Time Slots	Duty Cycle	Side	SAR (1g) [W/kg]	Scaling Factor	Scaled SAR (1g) [W/kg]	Plot #
MHz	Ch.														
824.20	128	GSM 850	GSM	33.6	32.91	-0.02	15 mm	7481	1	1:8.3	back	0.282	1.172	0.331	
836.60	190	GSM 850	GSM	33.6	33.22	-0.02	15 mm	7481	1	1:8.3	back	0.359	1.091	0.392	
848.80	251	GSM 850	GSM	33.6	33.37	-0.09	15 mm	7481	1	1:8.3	back	0.446	1.054	0.470	A13
836.60	190	GSM 850	GSM	33.6	33.22	0.00	15 mm	7481	1	1:8.3	front	0.310	1.091	0.338	
826.40	4132	UMTS V	RMC	24.5	24.24	-0.01	15 mm	7316	N/A	1:1	back	0.381	1.062	0.405	
836.60	4183	UMTS V	RMC	24.5	24.27	-0.03	15 mm	7316	N/A	1:1	back	0.426	1.054	0.449	A15
846.60	4233	UMTS V	RMC	24.5	24.28	0.03	15 mm	7316	N/A	1:1	back	0.416	1.052	0.438	
836.60	4183	UMTS V	RMC	24.5	24.27	-0.05	15 mm	7316	N/A	1:1	front	0.364	1.054	0.384	
1712.40	1312	UMTS IV	RMC	24.5	24.01	-0.16	15 mm	7320	N/A	1:1	back	0.662	1.119	0.741	
1730.40	1412	UMTS IV	RMC	24.5	24.06	-0.08	15 mm	7320	N/A	1:1	back	0.642	1.107	0.711	
1752.50	1862	UMTS IV	RMC	24.5	24.15	-0.16	15 mm	7320	N/A	1:1	back	0.671	1.084	0.727	A17
1730.40	1412	UMTS IV	RMC	24.5	24.06	-0.02	15 mm	7320	N/A	1:1	front	0.595	1.107	0.659	
1850.20	512	GSM 1900	GSM	30.6	30.09	-0.01	15 mm	7319	1	1:8.3	back	0.333	1.125	0.375	
1880.00	661	GSM 1900	GSM	30.6	30.32	0.10	15 mm	7319	1	1:8.3	back	0.363	1.067	0.387	
1909.80	810	GSM 1900	GSM	30.6	30.54	0.03	15 mm	7319	1	1:8.3	back	0.397	1.014	0.403	A19
1880.00	661	GSM 1900	GSM	30.6	30.32	-0.12	15 mm	7319	1	1:8.3	front	0.262	1.067	0.280	
1852.40	9262	UMTS II	RMC	24.0	23.78	0.00	15 mm	7316	N/A	1:1	back	0.788	1.052	0.829	A21
1880.00	9400	UMTS II	RMC	24.0	23.63	0.06	15 mm	7316	N/A	1:1	back	0.750	1.089	0.817	
1907.60	9538	UMTS II	RMC	24.0	23.67	0.00	15 mm	7316	N/A	1:1	back	0.740	1.079	0.798	
1880.00	9400	UMTS II	RMC	24.0	23.63	-0.02	15 mm	7316	N/A	1:1	front	0.608	1.089	0.662	
ANSI / IEEE C95.1 1992 - SAFETY LIMIT Spatial Peak Uncontrolled Exposure/General Population							Body 1.6 W/kg (mW/g) averaged over 1 gram								

Table 11-13
LTE Body-Worn SAR

MEASUREMENT RESULTS																			
FREQUENCY		Mode	Bandwidth [MHz]	Maximum Allowed Power [dBm]	Conducted Power [dBm]	Power Drift [dB]	MPR [dB]	Device Serial Number	Modulation	RB Size	RB Offset	Spacing	Side	Duty Cycle	SAR (1g) [W/kg]	Scaling Factor	Scaled SAR (1g) [W/kg]	Plot #	
MHz	Ch.																		
836.50	20525	Mid	LTE Band 5 (Cell)	10	23.1	22.73	0.01	0	7483	QPSK	1	49	15 mm	back	1:1	0.308	1.089	0.335	A23
836.50	20525	Mid	LTE Band 5 (Cell)	10	22.1	21.52	0.00	1	7483	QPSK	25	12	15 mm	back	1:1	0.222	1.143	0.254	
836.50	20525	Mid	LTE Band 5 (Cell)	10	23.1	22.73	0.00	0	7483	QPSK	1	49	15 mm	front	1:1	0.222	1.089	0.242	
836.50	20525	Mid	LTE Band 5 (Cell)	10	22.1	21.52	-0.10	1	7483	QPSK	25	12	15 mm	front	1:1	0.199	1.143	0.227	
1732.50	20175	Mid	LTE Band 4 (AWS)	20	23.6	23.49	0.05	0	7317	QPSK	1	50	15 mm	back	1:1	0.592	1.026	0.607	A25
1732.50	20175	Mid	LTE Band 4 (AWS)	20	22.6	22.21	0.07	1	7317	QPSK	50	50	15 mm	back	1:1	0.455	1.094	0.498	
1732.50	20175	Mid	LTE Band 4 (AWS)	20	23.6	23.49	-0.02	0	7317	QPSK	1	50	15 mm	front	1:1	0.496	1.026	0.509	
1732.50	20175	Mid	LTE Band 4 (AWS)	20	22.6	22.21	-0.02	1	7317	QPSK	50	50	15 mm	front	1:1	0.398	1.094	0.435	
1860.00	18700	Low	LTE Band 2 (PCS)	20	23.8	23.47	0.02	0	7317	QPSK	1	0	15 mm	back	1:1	0.832	1.079	0.888	A27
1880.00	18900	Mid	LTE Band 2 (PCS)	20	23.8	23.23	0.03	0	7317	QPSK	1	99	15 mm	back	1:1	0.799	1.140	0.911	
1900.00	19100	High	LTE Band 2 (PCS)	20	23.8	23.20	0.01	0	7317	QPSK	1	50	15 mm	back	1:1	0.806	1.148	0.925	
1880.00	18900	Mid	LTE Band 2 (PCS)	20	22.8	22.29	-0.07	1	7317	QPSK	50	50	15 mm	back	1:1	0.640	1.125	0.720	
1860.00	18700	Low	LTE Band 2 (PCS)	20	22.8	22.22	-0.02	1	7317	QPSK	100	0	15 mm	back	1:1	0.509	1.143	0.582	
1860.00	18700	Low	LTE Band 2 (PCS)	20	23.8	23.47	0.00	0	7317	QPSK	1	0	15 mm	front	1:1	0.581	1.079	0.627	
1880.00	18900	Mid	LTE Band 2 (PCS)	20	22.8	22.29	0.03	1	7317	QPSK	50	50	15 mm	front	1:1	0.451	1.125	0.507	
1860.00	18700	Low	LTE Band 2 (PCS)	20	23.8	23.47	-0.01	0	7317	QPSK	1	0	15 mm	back	1:1	0.800	1.079	0.863	
2510.00	20850	Low	LTE Band 7	20	18.7	17.40	-0.04	0	8711	QPSK	1	99	15 mm	back	1:1	0.288	1.349	0.389	
2535.00	21100	Mid	LTE Band 7	20	18.7	17.56	0.09	0	8711	QPSK	1	50	15 mm	back	1:1	0.327	1.300	0.425	A29
2560.00	21350	High	LTE Band 7	20	18.7	17.53	-0.06	0	8711	QPSK	1	99	15 mm	back	1:1	0.306	1.309	0.401	
2535.00	21100	Mid	LTE Band 7	20	18.7	17.53	-0.10	0	8711	QPSK	50	50	15 mm	back	1:1	0.296	1.309	0.387	
2535.00	21100	Mid	LTE Band 7	20	18.7	17.56	-0.02	0	8711	QPSK	1	50	15 mm	front	1:1	0.179	1.300	0.233	
2535.00	21100	Mid	LTE Band 7	20	18.7	17.53	0.05	0	8711	QPSK	50	50	15 mm	front	1:1	0.170	1.309	0.223	
ANSI / IEEE C95.1 1992 - SAFETY LIMIT Spatial Peak Uncontrolled Exposure/General Population							Body 1.6 W/kg (mW/g) averaged over 1 gram												



FCC ID: PY7PM-0410		SAR EVALUATION REPORT		Reviewed by: Quality Manager
Document S/N: OY1306100973.PY7	Test Dates: 05/06/13 - 08/01/13	DUT Type: Portable Handset		Page 61 of 83

**Table 11-14
DTS Body-Worn SAR**

MEASUREMENT RESULTS															
FREQUENCY		Mode	Service	Maximum Allowed Power [dBm]	Conducted Power [dBm]	Power Drift [dB]	Spacing	Device Serial Number	Data Rate (Mbps)	Side	Duty Cycle	SAR (1g)	Scaling Factor	Scaled SAR (1g)	Plot #
MHz	Ch.											(W/kg)		(W/kg)	
2437	6	IEEE 802.11b	DSSS	14.0	13.13	-0.01	15 mm	6717	1	back	1:1	0.104	1.222	0.127	
2417	2	IEEE 802.11b	DSSS	14.0	12.25	0.02	15 mm	6717	1	front	1:1	0.117	1.496	0.175	
2437	6	IEEE 802.11b	DSSS	14.0	13.13	0.03	15 mm	6717	1	front	1:1	0.125	1.222	0.153	A31
2457	10	IEEE 802.11b	DSSS	14.0	11.77	-0.04	15 mm	6717	1	front	1:1	0.059	1.671	0.099	
5765	153	IEEE 802.11a	OFDM	13.5	13.48	0.06	15 mm	3039	6	back	1:1	0.125	1.005	0.126	A33
5805	161	IEEE 802.11a	OFDM	13.5	12.67	-0.12	15 mm	3039	6	back	1:1	0.080	1.211	0.097	
5825	165	IEEE 802.11a	OFDM	13.5	13.25	-0.20	15 mm	3039	6	back	1:1	0.109	1.059	0.115	
5775	155	IEEE 802.11a	OFDM	11.8	11.04	-0.18	15 mm	3039	29.3	back	1:1	0.083	1.191	0.099	
5765	153	IEEE 802.11a	OFDM	13.5	13.48	-0.02	15 mm	3039	6	front	1:1	0.023	1.005	0.023	
ANSI / IEEE C95.1 1992 - SAFETY LIMIT Spatial Peak Uncontrolled Exposure/General Population							Body 1.6 W/kg (mW/g) averaged over 1 gram								

**Table 11-15
NII Body-Worn SAR**

MEASUREMENT RESULTS															
FREQUENCY		Mode	Service	Maximum Allowed Power [dBm]	Conducted Power [dBm]	Power Drift [dB]	Spacing	Device Serial Number	Data Rate (Mbps)	Side	Duty Cycle	SAR (1g)	Scaling Factor	Scaled SAR (1g)	Plot #
MHz	Ch.											(W/kg)		(W/kg)	
5200	40	IEEE 802.11a	OFDM	13.5	13.39	-0.17	15 mm	3039	6	back	1:1	0.067	1.026	0.069	
5240	48	IEEE 802.11a	OFDM	13.5	13.39	-0.03	15 mm	3039	6	back	1:1	0.088	1.026	0.090	
5210	42	IEEE 802.11a	OFDM	11.0	10.62	-0.10	15 mm	3039	29.3	back	1:1	0.046	1.091	0.050	
5240	48	IEEE 802.11a	OFDM	13.5	13.39	-0.06	15 mm	3039	6	front	1:1	0.038	1.026	0.039	
5260	52	IEEE 802.11a	OFDM	13.5	12.93	-0.11	15 mm	3039	6	back	1:1	0.073	1.140	0.083	
5320	64	IEEE 802.11a	OFDM	13.5	12.73	-0.02	15 mm	3039	6	back	1:1	0.082	1.194	0.098	
5290	58	IEEE 802.11a	OFDM	11.0	10.35	-0.10	15 mm	3039	29.3	back	1:1	0.061	1.161	0.071	
5260	52	IEEE 802.11a	OFDM	13.5	12.93	-0.04	15 mm	3039	6	front	1:1	0.045	1.140	0.051	
5520	104	IEEE 802.11a	OFDM	11.5	11.23	-0.16	15 mm	3039	6	back	1:1	0.060	1.064	0.064	
5560	112	IEEE 802.11a	OFDM	11.5	11.31	-0.15	15 mm	3039	6	back	1:1	0.052	1.045	0.054	
5660	132	IEEE 802.11a	OFDM	11.5	11.45	-0.14	15 mm	3039	6	back	1:1	0.094	1.012	0.095	A34
5530	106	IEEE 802.11a	OFDM	11.0	10.84	-0.17	15 mm	3039	29.3	back	1:1	0.066	1.038	0.069	
5660	132	IEEE 802.11a	OFDM	11.5	11.45	0.12	15 mm	3039	6	front	1:1	0.021	1.012	0.021	
ANSI / IEEE C95.1 1992 - SAFETY LIMIT Spatial Peak Uncontrolled Exposure/General Population							Body 1.6 W/kg (mW/g) averaged over 1 gram								

FCC ID: PY7PM-0410		SAR EVALUATION REPORT		Reviewed by: Quality Manager
Document S/N: OY1306100973.PY7	Test Dates: 05/06/13 - 08/01/13	DUT Type: Portable Handset		Page 62 of 83

11.3 Standalone Wireless Router SAR Data

Table 11-16
GPRS/UMTS Hotspot SAR Data

MEASUREMENT RESULTS															
FREQUENCY		Mode	Service	Maximum Allowed Power [dBm]	Conducted Power [dBm]	Power Drift [dB]	Spacing	Device Serial Number	# of GPRS Slots	Duty Cycle	Side	SAR (1g)	Scaling Factor	Scaled SAR (1g)	Plot #
MHz	Ch.											(W/kg)		(W/kg)	
824.20	128	GSM 850	GPRS	29.6	28.83	-0.09	10 mm	7481	4	1:2.076	back	0.845	1.194	1.009	
836.60	190	GSM 850	GPRS	29.6	28.95	0.04	10 mm	7481	4	1:2.076	back	0.868	1.161	1.008	A14
848.80	251	GSM 850	GPRS	29.6	29.21	-0.03	10 mm	7481	4	1:2.076	back	0.793	1.094	0.868	
824.20	128	GSM 850	GPRS	29.6	28.83	0.00	10 mm	7481	4	1:2.076	front	0.797	1.194	0.952	
836.60	190	GSM 850	GPRS	29.6	28.95	-0.03	10 mm	7481	4	1:2.076	front	0.762	1.161	0.885	
848.80	251	GSM 850	GPRS	29.6	29.21	-0.17	10 mm	7481	4	1:2.076	front	0.751	1.094	0.822	
836.60	190	GSM 850	GPRS	29.6	28.95	0.01	10 mm	7481	4	1:2.076	bottom	0.398	1.161	0.462	
836.60	190	GSM 850	GPRS	29.6	28.95	0.01	10 mm	7481	4	1:2.076	left	0.193	1.161	0.224	
836.60	190	GSM 850	GPRS	29.6	28.95	-0.15	10 mm	7481	4	1:2.076	back	0.812	1.161	0.943	
826.40	4132	UMTS V	RMC	24.5	24.24	-0.06	10 mm	7316	N/A	1:1	back	0.759	1.062	0.806	
836.60	4183	UMTS V	RMC	24.5	24.27	-0.04	10 mm	7316	N/A	1:1	back	0.773	1.054	0.815	
846.60	4233	UMTS V	RMC	24.5	24.28	-0.04	10 mm	7316	N/A	1:1	back	0.779	1.052	0.820	A16
836.60	4183	UMTS V	RMC	24.5	24.27	0.00	10 mm	7316	N/A	1:1	front	0.663	1.054	0.699	
836.60	4183	UMTS V	RMC	24.5	24.27	0.03	10 mm	7316	N/A	1:1	bottom	0.374	1.054	0.394	
836.60	4183	UMTS V	RMC	24.5	24.27	-0.01	10 mm	7316	N/A	1:1	left	0.259	1.054	0.273	
1712.40	1312	UMTS IV	RMC	21.9	21.49	-0.21	10 mm	7320	N/A	1:1	back	0.749	1.099	0.823	
1730.40	1412	UMTS IV	RMC	21.9	21.48	-0.14	10 mm	7320	N/A	1:1	back	0.753	1.102	0.830	
1752.50	1862	UMTS IV	RMC	21.9	21.54	-0.02	10 mm	7320	N/A	1:1	back	0.784	1.086	0.851	A18
1730.40	1412	UMTS IV	RMC	21.9	21.48	-0.03	10 mm	7320	N/A	1:1	front	0.715	1.102	0.788	
1730.40	1412	UMTS IV	RMC	21.9	21.48	-0.10	10 mm	7320	N/A	1:1	bottom	0.715	1.102	0.788	
1730.40	1412	UMTS IV	RMC	21.9	21.48	0.01	10 mm	7320	N/A	1:1	left	0.283	1.102	0.312	
1850.20	512	GSM 1900	GPRS	24.5	23.68	0.14	10 mm	7481	4	1:2.076	back	0.586	1.208	0.708	
1880.00	661	GSM 1900	GPRS	24.5	23.81	0.03	10 mm	7481	4	1:2.076	back	0.566	1.172	0.663	
1909.80	810	GSM 1900	GPRS	24.5	24.10	-0.07	10 mm	7481	4	1:2.076	back	0.669	1.096	0.733	A20
1880.00	661	GSM 1900	GPRS	24.5	23.81	-0.02	10 mm	7481	4	1:2.076	front	0.384	1.172	0.450	
1880.00	661	GSM 1900	GPRS	24.5	23.81	-0.17	10 mm	7481	4	1:2.076	bottom	0.509	1.172	0.597	
1880.00	661	GSM 1900	GPRS	24.5	23.81	0.00	10 mm	7481	4	1:2.076	left	0.151	1.172	0.177	
1852.40	9262	UMTS II	RMC	21.0	20.72	-0.02	10 mm	7320	N/A	1:1	back	0.733	1.067	0.782	
1880.00	9400	UMTS II	RMC	21.0	20.70	0.03	10 mm	7320	N/A	1:1	back	0.773	1.072	0.829	
1907.60	9538	UMTS II	RMC	21.0	20.64	-0.02	10 mm	7320	N/A	1:1	back	0.826	1.086	0.897	A22
1880.00	9400	UMTS II	RMC	21.0	20.70	0.08	10 mm	7320	N/A	1:1	front	0.681	1.072	0.730	
1880.00	9400	UMTS II	RMC	21.0	20.70	0.08	10 mm	7320	N/A	1:1	bottom	0.725	1.072	0.777	
1880.00	9400	UMTS II	RMC	21.0	20.70	-0.05	10 mm	7320	N/A	1:1	left	0.140	1.072	0.150	
ANSI / IEEE C95.1 1992 - SAFETY LIMIT Spatial Peak Uncontrolled Exposure/General Population							Body 1.6 W/kg (mW/g) averaged over 1 gram								

Note: Blue entry represents variability measurement.



FCC ID: PY7PM-0410		SAR EVALUATION REPORT	SONY	Reviewed by: Quality Manager
Document S/N: OY1306100973.PY7	Test Dates: 05/06/13 - 08/01/13	DUT Type: Portable Handset		Page 63 of 83

Table 11-17
LTE Band 5 (Cell) Hotspot SAR

MEASUREMENT RESULTS																			
FREQUENCY		Mode	Bandwidth [MHz]	Maximum Allowed Power [dBm]	Conducted Power [dBm]	Power Drift [dB]	MPR [dB]	Device Serial Number	Modulation	RB Size	RB Offset	Spacing	Side	Duty Cycle	SAR (1g)	Scaling Factor	Scaled SAR (1g)	Plot #	
MHz	Ch.														(W/kg)		(W/kg)		
836.50	20525	Mid	LTE Band 5 (Cell)	10	23.1	22.73	-0.01	0	7483	QPSK	1	49	10 mm	back	1:1	0.534	1.089	0.582	A24
836.50	20525	Mid	LTE Band 5 (Cell)	10	22.1	21.52	-0.03	1	7483	QPSK	25	12	10 mm	back	1:1	0.397	1.143	0.454	
836.50	20525	Mid	LTE Band 5 (Cell)	10	23.1	22.73	-0.01	0	7483	QPSK	1	49	10 mm	front	1:1	0.478	1.089	0.521	
836.50	20525	Mid	LTE Band 5 (Cell)	10	22.1	21.52	-0.02	1	7483	QPSK	25	12	10 mm	front	1:1	0.363	1.143	0.415	
836.50	20525	Mid	LTE Band 5 (Cell)	10	23.1	22.73	0.08	0	7483	QPSK	1	49	10 mm	bottom	1:1	0.243	1.089	0.265	
836.50	20525	Mid	LTE Band 5 (Cell)	10	22.1	21.52	0.05	1	7483	QPSK	25	12	10 mm	bottom	1:1	0.194	1.143	0.222	
836.50	20525	Mid	LTE Band 5 (Cell)	10	23.1	22.73	0.01	0	7483	QPSK	1	49	10 mm	left	1:1	0.104	1.089	0.113	
836.50	20525	Mid	LTE Band 5 (Cell)	10	22.1	21.52	0.02	1	7483	QPSK	25	12	10 mm	left	1:1	0.072	1.143	0.082	
ANSI / IEEE C95.1 1992 - SAFETY LIMIT Spatial Peak Uncontrolled Exposure/General Population								Body 1.6 W/kg (mW/g) averaged over 1 gram											

Table 11-18
LTE Band 4 (AWS) Hotspot SAR

MEASUREMENT RESULTS																			
FREQUENCY		Mode	Bandwidth [MHz]	Maximum Allowed Power [dBm]	Conducted Power [dBm]	Power Drift [dB]	MPR [dB]	Device Serial Number	Modulation	RB Size	RB Offset	Spacing	Side	Duty Cycle	SAR (1g)	Scaling Factor	Scaled SAR (1g)	Plot #	
MHz	Ch.														(W/kg)		(W/kg)		
1732.50	20175	Mid	LTE Band 4 (AWS)	20	21.9	21.45	-0.04	0	7317	QPSK	1	50	10 mm	back	1:1	0.752	1.109	0.834	A26
1732.50	20175	Mid	LTE Band 4 (AWS)	20	21.9	21.29	-0.08	0	7317	QPSK	50	50	10 mm	back	1:1	0.745	1.151	0.857	
1732.50	20175	Mid	LTE Band 4 (AWS)	20	21.9	21.21	-0.02	0	7317	QPSK	100	0	10 mm	back	1:1	0.723	1.172	0.847	
1732.50	20175	Mid	LTE Band 4 (AWS)	20	21.9	21.45	-0.02	0	7317	QPSK	1	50	10 mm	front	1:1	0.595	1.109	0.660	
1732.50	20175	Mid	LTE Band 4 (AWS)	20	21.9	21.29	-0.14	0	7317	QPSK	50	50	10 mm	front	1:1	0.589	1.151	0.678	
1732.50	20175	Mid	LTE Band 4 (AWS)	20	21.9	21.45	0.03	0	7317	QPSK	1	50	10 mm	bottom	1:1	0.691	1.109	0.766	
1732.50	20175	Mid	LTE Band 4 (AWS)	20	21.9	21.29	0.05	0	7317	QPSK	50	50	10 mm	bottom	1:1	0.682	1.151	0.785	
1732.50	20175	Mid	LTE Band 4 (AWS)	20	21.9	21.45	-0.15	0	7317	QPSK	1	50	10 mm	left	1:1	0.366	1.109	0.406	
1732.50	20175	Mid	LTE Band 4 (AWS)	20	21.9	21.29	0.08	0	7317	QPSK	50	50	10 mm	left	1:1	0.337	1.151	0.388	
ANSI / IEEE C95.1 1992 - SAFETY LIMIT Spatial Peak Uncontrolled Exposure/General Population								Body 1.6 W/kg (mW/g) averaged over 1 gram											

FCC ID: PY7PM-0410		SAR EVALUATION REPORT		Reviewed by: Quality Manager
Document S/N: OY1306100973.PY7	Test Dates: 05/06/13 - 08/01/13	DUT Type: Portable Handset		Page 64 of 83

**Table 11-19
LTE Band 2 (PCS) Hotspot SAR**



MEASUREMENT RESULTS																			
FREQUENCY		Mode	Bandwidth [MHz]	Maximum Allowed Power [dBm]	Conducted Power [dBm]	Power Drift [dB]	MPR [dB]	Device Serial Number	Modulation	RB Size	RB Offset	Spacing	Side	Duty Cycle	SAR (1g)	Scaling Factor	Scaled SAR (1g)	Plot #	
MHz	Ch.														(W/kg)		(W/kg)		
1860.00	18700	Low	LTE Band 2 (PCS)	20	21.0	20.56	0.01	0	7317	QPSK	1	0	10 mm	back	1:1	0.831	1.107	0.920	A28
1880.00	18900	Mid	LTE Band 2 (PCS)	20	21.0	20.45	0.04	0	7317	QPSK	1	99	10 mm	back	1:1	0.806	1.135	0.915	
1900.00	19100	High	LTE Band 2 (PCS)	20	21.0	20.55	0.01	0	7317	QPSK	1	50	10 mm	back	1:1	0.823	1.109	0.913	
1860.00	18700	Low	LTE Band 2 (PCS)	20	21.0	20.49	-0.02	0	7317	QPSK	50	25	10 mm	back	1:1	0.795	1.125	0.894	
1880.00	18900	Mid	LTE Band 2 (PCS)	20	21.0	20.36	0.01	0	7317	QPSK	50	50	10 mm	back	1:1	0.793	1.159	0.919	
1900.00	19100	High	LTE Band 2 (PCS)	20	21.0	20.53	0.04	0	7317	QPSK	50	50	10 mm	back	1:1	0.767	1.114	0.854	
1860.00	18700	Low	LTE Band 2 (PCS)	20	21.0	20.35	0.01	0	7317	QPSK	100	0	10 mm	back	1:1	0.709	1.161	0.823	
1860.00	18700	Low	LTE Band 2 (PCS)	20	21.0	20.56	-0.01	0	7317	QPSK	1	0	10 mm	front	1:1	0.664	1.107	0.735	
1900.00	19100	High	LTE Band 2 (PCS)	20	21.0	20.53	-0.03	0	7317	QPSK	50	50	10 mm	front	1:1	0.652	1.114	0.726	
1860.00	18700	Low	LTE Band 2 (PCS)	20	21.0	20.56	-0.03	0	7317	QPSK	1	0	10 mm	bottom	1:1	0.639	1.107	0.707	
1900.00	19100	High	LTE Band 2 (PCS)	20	21.0	20.53	0.01	0	7317	QPSK	50	50	10 mm	bottom	1:1	0.702	1.114	0.782	
1860.00	18700	Low	LTE Band 2 (PCS)	20	21.0	20.56	-0.01	0	7317	QPSK	1	0	10 mm	left	1:1	0.100	1.107	0.111	
1900.00	19100	High	LTE Band 2 (PCS)	20	21.0	20.53	-0.03	0	7317	QPSK	50	50	10 mm	left	1:1	0.074	1.114	0.082	
ANSI / IEEE C95.1 1992 - SAFETY LIMIT Spatial Peak Uncontrolled Exposure/General Population										Body 1.6 W/kg (mW/g) averaged over 1 gram									

**Table 11-20
LTE Band 7 Hotspot SAR**

MEASUREMENT RESULTS																			
FREQUENCY		Mode	Bandwidth [MHz]	Maximum Allowed Power [dBm]	Conducted Power [dBm]	Power Drift [dB]	MPR [dB]	Device Serial Number	Modulation	RB Size	RB Offset	Spacing	Side	Duty Cycle	SAR (1g)	Scaling Factor	Scaled SAR (1g)	Plot #	
MHz	Ch.														(W/kg)		(W/kg)		
2510.00	20850	Low	LTE Band 7	20	18.0	17.41	-0.12	0	8711	QPSK	1	50	10 mm	back	1:1	0.687	1.146	0.787	
2535.00	21100	Mid	LTE Band 7	20	18.0	17.53	0.10	0	8711	QPSK	1	99	10 mm	back	1:1	0.761	1.114	0.848	A30
2560.00	21350	High	LTE Band 7	20	18.0	17.43	0.04	0	8711	QPSK	1	50	10 mm	back	1:1	0.740	1.140	0.844	
2560.00	21350	High	LTE Band 7	20	18.0	17.53	-0.20	0	8711	QPSK	50	50	10 mm	back	1:1	0.679	1.114	0.756	
2535.00	21100	Mid	LTE Band 7	20	18.0	17.39	-0.04	0	8711	QPSK	100	0	10 mm	back	1:1	0.669	1.151	0.770	
2535.00	21100	Mid	LTE Band 7	20	18.0	17.53	0.04	0	8711	QPSK	1	99	10 mm	front	1:1	0.450	1.114	0.501	
2560.00	21350	High	LTE Band 7	20	18.0	17.53	-0.02	0	8711	QPSK	50	50	10 mm	front	1:1	0.346	1.114	0.385	
2535.00	21100	Mid	LTE Band 7	20	18.0	17.53	0.15	0	8711	QPSK	1	99	10 mm	bottom	1:1	0.542	1.114	0.604	
2560.00	21350	High	LTE Band 7	20	18.0	17.53	-0.01	0	8711	QPSK	50	50	10 mm	bottom	1:1	0.404	1.114	0.450	
2535.00	21100	Mid	LTE Band 7	20	18.0	17.53	-0.02	0	8711	QPSK	1	99	10 mm	left	1:1	0.257	1.114	0.286	
2560.00	21350	High	LTE Band 7	20	18.0	17.53	0.04	0	8711	QPSK	50	50	10 mm	left	1:1	0.203	1.114	0.226	
ANSI / IEEE C95.1 1992 - SAFETY LIMIT Spatial Peak Uncontrolled Exposure/General Population										Body 1.6 W/kg (mW/g) averaged over 1 gram									

**Table 11-21
WLAN Hotspot SAR**

MEASUREMENT RESULTS															
FREQUENCY		Mode	Service	Maximum Allowed Power [dBm]	Conducted Power [dBm]	Power Drift [dB]	Spacing	Device Serial Number	Data Rate (Mbps)	Side	Duty Cycle	SAR (1g)	Scaling Factor	Scaled SAR (1g)	Plot #
MHz	Ch.											(W/kg)		(W/kg)	
2437	6	IEEE 802.11b	DSSS	14.0	13.13	-0.01	10 mm	6717	1	back	1:1	0.210	1.222	0.257	
2417	2	IEEE 802.11b	DSSS	14.0	12.25	0.03	10 mm	6717	1	front	1:1	0.100	1.496	0.150	
2437	6	IEEE 802.11b	DSSS	14.0	13.13	-0.01	10 mm	6717	1	front	1:1	0.260	1.222	0.318	A32
2457	10	IEEE 802.11b	DSSS	14.0	11.77	0.15	10 mm	6717	1	front	1:1	0.021	1.671	0.035	
2437	6	IEEE 802.11b	DSSS	14.0	13.13	-0.06	10 mm	6717	1	top	1:1	0.123	1.222	0.150	
2437	6	IEEE 802.11b	DSSS	14.0	13.13	-0.02	10 mm	6717	1	right	1:1	0.038	1.222	0.046	
ANSI / IEEE C95.1 1992 - SAFETY LIMIT Spatial Peak Uncontrolled Exposure/General Population										Body 1.6 W/kg (mW/g) averaged over 1 gram					

FCC ID: PY7PM-0410		SAR EVALUATION REPORT		Reviewed by: Quality Manager
Document S/N: OY1306100973.PY7	Test Dates: 05/06/13 - 08/01/13	DUT Type: Portable Handset		Page 65 of 83

11.4 Standalone Hand SAR Data

Please note that the following 3mm 10g SAR data was measured for configurations where 1g hotspot SAR scaled up to the maximum output power tolerances exceeded a 1g SAR level of 1.2 W/kg. The 3mm Phablet SAR test distance is based on a FCC KDB inquiry and is established according to the specific conditions applicable to the device.

**Table 11-22
UMTS Hand SAR**



MEASUREMENT RESULTS														
FREQUENCY		Mode	Service	Maximum Allowed Power [dBm]	Conducted Power [dBm]	Power Drift [dB]	Spacing	Device Serial Number	Duty Cycle	Side	SAR (10g)	Scaling Factor	Scaled SAR (10g)	Plot #
MHz	Ch.										(W/kg)		(W/kg)	
1712.40	1312	UMTS IV	RMC	24.5	24.01	-0.03	3 mm	7316	1:1	back	2.450	1.119	2.742	
1730.40	1412	UMTS IV	RMC	24.5	24.06	-0.03	3 mm	7316	1:1	back	2.560	1.107	2.834	
1752.50	1862	UMTS IV	RMC	24.5	24.15	-0.03	3 mm	7316	1:1	back	2.820	1.084	3.057	A35
1712.40	1312	UMTS IV	RMC	24.5	24.01	0.00	3 mm	7316	1:1	front	2.350	1.119	2.630	
1730.40	1412	UMTS IV	RMC	24.5	24.06	0.09	3 mm	7316	1:1	front	2.400	1.107	2.657	
1752.50	1862	UMTS IV	RMC	24.5	24.15	0.00	3 mm	7316	1:1	front	2.660	1.084	2.883	
1730.40	1412	UMTS IV	RMC	24.5	24.06	-0.03	3 mm	7316	1:1	bottom	1.750	1.107	1.937	
1752.50	1862	UMTS IV	RMC	24.5	24.15	-0.03	3 mm	7316	1:1	back	2.620	1.084	2.840	
1852.40	9262	UMTS II	RMC	24.0	23.78	-0.07	3 mm	7316	1:1	back	2.290	1.052	2.409	
1880.00	9400	UMTS II	RMC	24.0	23.63	0.00	3 mm	7316	1:1	back	2.270	1.089	2.472	
1907.60	9538	UMTS II	RMC	24.0	23.67	-0.04	3 mm	7316	1:1	back	2.370	1.079	2.557	A36
1852.40	9262	UMTS II	RMC	24.0	23.78	0.01	3 mm	7316	1:1	front	2.270	1.052	2.388	
1880.00	9400	UMTS II	RMC	24.0	23.63	0.04	3 mm	7316	1:1	front	2.250	1.089	2.450	
1907.60	9538	UMTS II	RMC	24.0	23.67	0.05	3 mm	7316	1:1	front	2.330	1.079	2.514	
1880.00	9400	UMTS II	RMC	24.0	23.63	0.02	3 mm	7316	1:1	bottom	1.670	1.089	1.819	
ANSI / IEEE C95.1 1992 - SAFETY LIMIT Spatial Peak Uncontrolled Exposure/General Population							Hand 4.0 W/kg (mW/g) averaged over 10 grams							

Note: Blue entry represents variability measurement.

**Table 11-23
LTE Hand SAR**



MEASUREMENT RESULTS																			
FREQUENCY		Mode	Bandwidth [MHz]	Maximum Allowed Power [dBm]	Conducted Power [dBm]	Power Drift [dB]	MPR [dB]	Device Serial Number	Modulation	RB Size	RB Offset	Spacing	Side	Duty Cycle	SAR (10g)	Scaling Factor	Scaled SAR (10g)	Plot #	
MHz	Ch.														(W/kg)		(W/kg)		
1732.50	20175	Mid	LTE Band 4 (AWS)	20	23.6	23.49	-0.15	0	7483	QPSK	1	50	3 mm	back	1:1	2.170	1.026	2.226	A37
1732.50	20175	Mid	LTE Band 4 (AWS)	20	22.6	22.21	-0.15	1	7483	QPSK	50	50	3 mm	back	1:1	1.650	1.094	1.805	
1732.50	20175	Mid	LTE Band 4 (AWS)	20	22.6	22.18	-0.15	1	7483	QPSK	100	0	3 mm	back	1:1	2.060	1.102	2.270	
1860.00	18700	Low	LTE Band 2 (PCS)	20	23.8	23.47	0.02	0	7483	QPSK	1	0	3 mm	back	1:1	2.160	1.079	2.331	
1860.00	18900	Mid	LTE Band 2 (PCS)	20	23.8	23.23	-0.02	0	7483	QPSK	1	99	3 mm	back	1:1	2.290	1.140	2.611	
1900.00	19100	High	LTE Band 2 (PCS)	20	23.8	23.20	0.00	0	7483	QPSK	1	50	3 mm	back	1:1	2.500	1.148	2.870	A38
1880.00	18900	Mid	LTE Band 2 (PCS)	20	22.8	22.29	0.05	1	7483	QPSK	50	50	3 mm	back	1:1	1.660	1.125	1.868	
1860.00	18700	Low	LTE Band 2 (PCS)	20	22.8	22.22	0.07	1	7483	QPSK	100	0	3 mm	back	1:1	1.690	1.143	1.932	
1860.00	18700	Low	LTE Band 2 (PCS)	20	23.8	23.47	-0.02	0	7483	QPSK	1	0	3 mm	front	1:1	2.160	1.079	2.331	
1880.00	18900	Mid	LTE Band 2 (PCS)	20	23.8	23.23	0.00	0	7483	QPSK	1	99	3 mm	front	1:1	2.180	1.140	2.485	
1900.00	19100	High	LTE Band 2 (PCS)	20	23.8	23.20	-0.05	0	7483	QPSK	1	50	3 mm	front	1:1	2.350	1.148	2.698	
1880.00	18900	Mid	LTE Band 2 (PCS)	20	22.8	22.29	0.00	1	7483	QPSK	50	50	3 mm	front	1:1	1.670	1.125	1.879	
1860.00	18700	Low	LTE Band 2 (PCS)	20	22.8	22.22	-0.08	1	7483	QPSK	100	0	3 mm	front	1:1	1.680	1.143	1.920	
1860.00	18700	Low	LTE Band 2 (PCS)	20	23.8	23.47	-0.01	0	7483	QPSK	1	0	3 mm	bottom	1:1	1.560	1.079	1.683	
1880.00	18900	Mid	LTE Band 2 (PCS)	20	22.8	22.29	-0.05	1	7483	QPSK	50	50	3 mm	bottom	1:1	1.230	1.125	1.384	
1900.00	19100	High	LTE Band 2 (PCS)	20	23.8	23.20	-0.03	0	7483	QPSK	1	50	3 mm	back	1:1	2.500	1.148	2.870	
ANSI / IEEE C95.1 1992 - SAFETY LIMIT Spatial Peak Uncontrolled Exposure/General Population							Hand 4.0 W/kg (mW/g) averaged over 10 grams												

Note: Blue entry represents variability measurement.

FCC ID: PY7PM-0410		SAR EVALUATION REPORT		Reviewed by: Quality Manager
Document S/N: OY1306100973.PY7	Test Dates: 05/06/13 - 08/01/13	DUT Type: Portable Handset		Page 66 of 83

**Table 11-24
WLAN Hand SAR**

MEASUREMENT RESULTS															
FREQUENCY		Mode	Service	Maximum Allowed Power [dBm]	Conducted Power [dBm]	Power Drift [dB]	Spacing	Device Serial Number	Data Rate (Mbps)	Side	Duty Cycle	SAR (10g)	Scaling Factor	Scaled SAR (10g)	Plot #
MHz	Ch.											(W/kg)		(W/kg)	
5765	153	IEEE 802.11a	OFDM	13.5	13.48	0.00	3 mm	3039	6	back	1:1	0.356	1.005	0.358	
5805	161	IEEE 802.11a	OFDM	13.5	12.67	-0.03	3 mm	3039	6	back	1:1	0.363	1.211	0.440	A39
5825	165	IEEE 802.11a	OFDM	13.5	13.25	-0.15	3 mm	3039	6	back	1:1	0.295	1.059	0.312	
5775	155	IEEE 802.11ac	OFDM	11.8	11.04	-0.03	3 mm	3039	29.3	back	1:1	0.264	1.191	0.314	
5765	153	IEEE 802.11a	OFDM	13.5	13.48	-0.04	3 mm	3039	6	front	1:1	0.353	1.005	0.355	
5765	153	IEEE 802.11a	OFDM	13.5	13.48	-0.15	3 mm	3039	6	top	1:1	0.156	1.005	0.157	
5765	153	IEEE 802.11a	OFDM	13.5	13.48	0.10	3 mm	3039	6	right	1:1	0.032	1.005	0.032	
5200	40	IEEE 802.11a	OFDM	13.5	13.39	-0.05	3 mm	3039	6	back	1:1	0.564	1.026	0.579	
5240	48	IEEE 802.11a	OFDM	13.5	13.39	-0.04	3 mm	3039	6	back	1:1	0.555	1.026	0.569	
5210	42	IEEE 802.11ac	OFDM	11.0	10.62	-0.12	3 mm	3039	29.3	back	1:1	0.417	1.091	0.455	
5240	48	IEEE 802.11a	OFDM	13.5	13.39	0.00	3 mm	3039	6	front	1:1	0.408	1.026	0.419	
5240	48	IEEE 802.11a	OFDM	13.5	13.39	-0.13	3 mm	3039	6	top	1:1	0.112	1.026	0.115	
5240	48	IEEE 802.11a	OFDM	13.5	13.39	0.03	3 mm	3039	6	right	1:1	0.064	1.026	0.065	
5260	52	IEEE 802.11a	OFDM	13.5	12.93	-0.20	3 mm	3039	6	back	1:1	0.504	1.140	0.575	
5320	64	IEEE 802.11a	OFDM	13.5	12.73	-0.10	3 mm	3039	6	back	1:1	0.604	1.194	0.721	A40
5290	58	IEEE 802.11ac	OFDM	11.0	10.35	-0.12	3 mm	3039	29.3	back	1:1	0.471	1.161	0.547	
5260	52	IEEE 802.11a	OFDM	13.5	12.93	0.03	3 mm	3039	6	front	1:1	0.374	1.140	0.426	
5260	52	IEEE 802.11a	OFDM	13.5	12.93	-0.09	3 mm	3039	6	top	1:1	0.115	1.140	0.131	
5260	52	IEEE 802.11a	OFDM	13.5	12.93	-0.12	3 mm	3039	6	right	1:1	0.101	1.140	0.115	
5520	104	IEEE 802.11a	OFDM	11.5	11.23	-0.10	3 mm	3039	6	back	1:1	0.276	1.064	0.294	
5560	112	IEEE 802.11a	OFDM	11.5	11.31	-0.09	3 mm	3039	6	back	1:1	0.345	1.045	0.361	
5660	132	IEEE 802.11a	OFDM	11.5	11.45	-0.10	3 mm	3039	6	back	1:1	0.442	1.012	0.447	
5530	106	IEEE 802.11ac	OFDM	11.0	10.84	-0.07	3 mm	3039	29.3	back	1:1	0.283	1.038	0.294	
5660	132	IEEE 802.11a	OFDM	11.5	11.45	-0.01	3 mm	3039	6	front	1:1	0.314	1.012	0.318	
5660	132	IEEE 802.11a	OFDM	11.5	11.45	-0.14	3 mm	3039	6	top	1:1	0.171	1.012	0.173	
5660	132	IEEE 802.11a	OFDM	11.5	11.45	0.18	3 mm	3039	6	right	1:1	0.064	1.012	0.064	
ANSI / IEEE C95.1 1992 - SAFETY LIMIT Spatial Peak Uncontrolled Exposure/General Population							Hand 4.0 W/kg (mW/g) averaged over 10 grams								

FCC ID: PY7PM-0410		SAR EVALUATION REPORT		Reviewed by: Quality Manager
Document S/N: OY1306100973.PY7	Test Dates: 05/06/13 - 08/01/13	DUT Type: Portable Handset		Page 67 of 83

11.5 SAR Test Notes

General Notes:

1. The test data reported are the worst-case SAR values according to test procedures specified in IEEE 1528-2003, FCC/OET Bulletin 65, Supplement C [June 2001] and FCC KDB Publication 447498 D01v05.
2. Batteries are fully charged at the beginning of the SAR measurements. A standard battery was used for all SAR measurements.
3. Liquid tissue depth was at least 15.0 cm for all frequencies.
4. The manufacturer has confirmed that the device(s) tested have the same physical, mechanical and thermal characteristics and are within operational tolerances expected for production units.
5. SAR results were scaled to the maximum allowed power to demonstrate compliance per FCC KDB Publication 447498 D01v05.
6. Device was tested for both back and front sides using a fixed spacing for body-worn accessory testing. A separation distance of 15 mm was considered because the manufacturer has determined that there will be body-worn accessories available in the marketplace for users to support this separation distance.
7. Per FCC KDB Publication 648474 D04v01, SAR was evaluated without a headset connected to the device. Since the standalone reported SAR was ≤ 1.2 W/kg, no additional SAR evaluations using a headset cable were required.
8. Per FCC KDB 865664 D01 v01, variability SAR tests were performed when the measured 1 gram SAR results for a frequency band were greater than 0.8 W/kg or when the measured 10 gram SAR results for a frequency band were greater than 2.0 W/kg. Repeated SAR measurements are highlighted in the tables above for clarity. Please see Section 13 for variability analysis.
9. During SAR Testing for the Wireless Router conditions per FCC KDB Publication 941225 D06v01, the actual Portable Hotspot operation (with actual simultaneous transmission of a transmitter with WIFI) was not activated (See Section 6.7 for more details).
10. This DUT has NFC operations. The NFC antenna is integrated into the device. Therefore, all SAR tests were performed with the NFC antenna already incorporated.
11. This device utilizes power reduction under some portable hotspot conditions (tethering) for SAR compliance. Therefore, hotspot was tested for some bands at reduced output power levels.

GSM Test Notes:

1. Body-Worn accessory testing is typically associated with voice operations. Therefore, GSM voice was evaluated for body-worn SAR.
2. Justification for reduced test configurations per KDB Publication 941225 D03v01: The source-based time-averaged output power was evaluated for all multi-slot operations. The multi-slot configuration with the highest frame averaged output power was evaluated for SAR for hotspot SAR.
3. Per FCC KDB Publication 447498 D01v05, if the reported (scaled) SAR measured at the middle channel or highest output power channel for each test configuration is ≤ 0.8 W/kg then testing at the other channels is not required for such test configuration(s). When the maximum output power variation across the required test channels is $> \frac{1}{2}$ dB, instead of the middle channel, the highest output power channel was used.

FCC ID: PY7PM-0410	 PCTEST ENGINEERING LABORATORY, INC.	SAR EVALUATION REPORT	SONY	Reviewed by: Quality Manager
Document S/N: 0Y1306100973.PY7	Test Dates: 05/06/13 - 08/01/13	DUT Type: Portable Handset		Page 68 of 83

UMTS Notes:



1. UMTS mode in Body SAR was tested under RMC 12.2 kbps with HSPA Inactive per KDB Publication 941225 D01v02. HSPA SAR was not required since the average output power of the HSPA subtests was not more than 0.25 dB higher than the RMC level and SAR was less than 1.2 W/kg. DC-HSDPA SAR was not required since SAR was less than 1.2 W/kg.
2. Per FCC KDB Publication 447498 D01v05, if the reported (scaled) SAR measured at the middle channel or highest output power channel for each test configuration is ≤ 0.8 W/kg then testing at the other channels is not required for such test configuration(s). When the maximum output power variation across the required test channels is $> \frac{1}{2}$ dB, instead of the middle channel, the highest output power channel was used.

LTE Notes:

1. LTE Considerations: LTE test configurations are determined according to SAR Evaluation Considerations for LTE Devices in FCC KDB Publication 941225 D05v02r01. The general test procedures used for testing can be found in Section 8.4.4.
2. MPR is permanently implemented for this device by the manufacturer. The specific manufacturer target MPR is indicated alongside the SAR results. MPR is enabled for this device, according to 3GPP TS36.101 Section 6.2.3 – 6.2.5 under Table 6.2.3-1.
3. A-MPR was disabled for all SAR tests by setting NS=01 on the base station simulator.

WLAN Notes:

1. Justification for reduced test configurations for WIFI channels per KDB Publication 248227 D01v01r02 and October 2012 FCC/TCB Meeting Notes for 2.4 GHz WIFI: Highest average RF output power channel for the lowest data rate was selected for SAR evaluation in 802.11b. Other IEEE 802.11 modes (including 802.11g/n) were not investigated since the average output powers over all channels and data rates were not more than 0.25 dB higher than the tested channel in the lowest data rate of IEEE 802.11b mode.
2. Justification for reduced test configurations for WIFI channels per KDB Publication 248227 D01v01r02 and October 2012 FCC/TCB Meeting Notes for 5 GHz WIFI: Highest average RF output power channel for the lowest data rate was selected for SAR evaluation in 802.11a. Other IEEE 802.11 modes (including 802.11n) were not investigated since the average output powers over all channels and data rates were not more than 0.25 dB higher than the tested channel in the lowest data rate of IEEE 802.11a mode.
3. When Hotspot is enabled, all 5 GHz bands are disabled. Therefore no 5 GHz WIFI Wireless Router SAR Data was required.
4. WIFI transmission was verified using an uncalibrated spectrum analyzer.
5. When maximum extrapolated peak SAR of the zoom scan for the maximum output channel is >1.6 W/kg or the reported 1g averaged SAR is >0.8 W/kg, SAR testing on other default channels is required.
6. There is no power reduction for WIFI antenna.
7. Per April 2013 TCB workshop notes, full SAR testing for 802.11ac was not required since the average output power was not more than 0.25 dB higher than the output power of IEEE 802.11a mode. IEEE 802.11ac was evaluated for the highest IEEE 802.11a position in each 5 GHz band and exposure condition.

FCC ID: PY7PM-0410	 SAR EVALUATION REPORT 		Reviewed by: Quality Manager
Document S/N: OY1306100973.PY7	Test Dates: 05/06/13 - 08/01/13	DUT Type: Portable Handset	Page 69 of 83

12 FCC MULTI-TX AND ANTENNA SAR CONSIDERATIONS

12.1 Introduction

The following procedures adopted from FCC KDB Publication 447498 D01v05 are applicable to handsets with built-in unlicensed transmitters such as 802.11a/b/g/n and Bluetooth devices which may simultaneously transmit with the licensed transmitter.

12.2 Simultaneous Transmission Procedures

This device contains transmitters that may operate simultaneously. Therefore simultaneous transmission analysis is required. Per FCC KDB 447498 D01v05r01 IV.C.1.iii, simultaneous transmission SAR test exclusion may be applied when the sum of the 1g SAR for all the simultaneous transmitting antennas in a specific physical test configuration is ≤ 1.6 W/kg and when the sum of the 10g SAR for all simultaneous transmitting antennas in a specific physical test configuration is ≤ 4.0 W/kg. When standalone SAR is not required to be measured, per FCC KDB 447498 D01v05r01 4.3.2 2), the following equations must be used to estimate the standalone 1g and 10g SAR for simultaneous transmission assessment involving that transmitter.

$$\text{Estimated 1g SAR} = \frac{\sqrt{f(\text{GHz})}}{7.5} * \frac{(\text{Max Power of channel, mW})}{\text{Min. Separation Distance, mm}}$$

$$\text{Estimated 10g SAR} = \frac{\sqrt{f(\text{GHz})}}{18.75} * \frac{(\text{Max Power of channel, mW})}{\text{Min. Separation Distance, mm}}$$

**Table 12-1
Estimated SAR**

Mode	Frequency	Maximum Allowed Power	Separation Distance (Body)	Estimated 1g SAR (Body)
	[MHz]	[dBm]	[mm]	[W/kg]
Bluetooth	2441	9.50	15	0.125

Mode	Frequency	Maximum Allowed Power	Separation Distance (Body)	Estimated 10g SAR (Hand)
	[MHz]	[dBm]	[mm]	[W/kg]
IEEE 802.11b	2437	14.00	5	0.416
Bluetooth	2441	9.50	5	0.150

Notes:

1. Held-to ear configurations are not applicable to Bluetooth operations and therefore were not considered for simultaneous transmission. Per KDB Publication 447498 D01v05, the maximum power of the channel was rounded to the nearest mW before calculation.
2. Per FCC KDB Publication 447498 D01v05r01, when the test separation distance is < 5 mm (touching), a distance of 5 mm is applied to determine estimated SAR.

FCC ID: PY7PM-0410	 PCTEST ENGINEERING LABORATORY, INC.	SAR EVALUATION REPORT	SONY	Reviewed by: Quality Manager
Document S/N: 0Y1306100973.PY7	Test Dates: 05/06/13 - 08/01/13	DUT Type: Portable Handset		Page 70 of 83

12.3 Head SAR Simultaneous Transmission Analysis

Table 12-2
Simultaneous Transmission Scenario with 2.4 GHz WLAN (Held to Ear)

Simult Tx	Configuration	GSM 850 SAR (W/kg)	2.4 GHz WLAN SAR (W/kg)	Σ SAR (W/kg)	Simult Tx	Configuration	UMTS V SAR (W/kg)	2.4 GHz WLAN SAR (W/kg)	Σ SAR (W/kg)
Head SAR	Right Cheek	0.408	0.610	1.018	Head SAR	Right Cheek	0.361	0.610	0.971
	Right Tilt	0.219	0.411	0.630		Right Tilt	0.207	0.411	0.618
	Left Cheek	0.213	1.102	1.315		Left Cheek	0.251	1.102	1.353
	Left Tilt	0.175	0.920	1.095		Left Tilt	0.198	0.920	1.118
Simult Tx	Configuration	UMTS IV SAR (W/kg)	2.4 GHz WLAN SAR (W/kg)	Σ SAR (W/kg)	Simult Tx	Configuration	GSM 1900 SAR (W/kg)	2.4 GHz WLAN SAR (W/kg)	Σ SAR (W/kg)
Head SAR	Right Cheek	0.178	0.610	0.788	Head SAR	Right Cheek	0.077	0.610	0.687
	Right Tilt	0.064	0.411	0.475		Right Tilt	0.023	0.411	0.434
	Left Cheek	0.271	1.102	1.373		Left Cheek	0.070	1.102	1.172
	Left Tilt	0.062	0.920	0.982		Left Tilt	0.016	0.920	0.936
Simult Tx	Configuration	UMTS II SAR (W/kg)	2.4 GHz WLAN SAR (W/kg)	Σ SAR (W/kg)	Simult Tx	Configuration	LTE Band 5 (Cell) SAR (W/kg)	2.4 GHz WLAN SAR (W/kg)	Σ SAR (W/kg)
Head SAR	Right Cheek	0.093	0.610	0.703	Head SAR	Right Cheek	0.254	0.610	0.864
	Right Tilt	0.033	0.411	0.444		Right Tilt	0.158	0.411	0.569
	Left Cheek	0.157	1.102	1.259		Left Cheek	0.210	1.102	1.312
	Left Tilt	0.020	0.920	0.940		Left Tilt	0.168	0.920	1.088
Simult Tx	Configuration	LTE Band 4 (AWS) SAR (W/kg)	2.4 GHz WLAN SAR (W/kg)	Σ SAR (W/kg)	Simult Tx	Configuration	LTE Band 2 (PCS) SAR (W/kg)	2.4 GHz WLAN SAR (W/kg)	Σ SAR (W/kg)
Head SAR	Right Cheek	0.157	0.610	0.767	Head SAR	Right Cheek	0.069	0.610	0.679
	Right Tilt	0.102	0.411	0.513		Right Tilt	0.036	0.411	0.447
	Left Cheek	0.199	1.102	1.301		Left Cheek	0.140	1.102	1.242
	Left Tilt	0.102	0.920	1.022		Left Tilt	0.031	0.920	0.951
Simult Tx	Configuration	LTE Band 7 SAR (W/kg)	2.4 GHz WLAN SAR (W/kg)	Σ SAR (W/kg)					
Head SAR	Right Cheek	0.092	0.610	0.702					
	Right Tilt	0.093	0.411	0.504					
	Left Cheek	0.187	1.102	1.289					
	Left Tilt	0.059	0.920	0.979					

FCC ID: PY7PM-0410	 PCTEST ENGINEERING LABORATORY, INC.	SAR EVALUATION REPORT	SONY	Reviewed by: Quality Manager
Document S/N: OY1306100973.PY7	Test Dates: 05/06/13 - 08/01/13	DUT Type: Portable Handset		Page 71 of 83

Table 12-3
Simultaneous Transmission Scenario with 5 GHz WLAN (Held to Ear)

Simult Tx	Configuration	GSM 850 SAR (W/kg)	5 GHz WLAN SAR (W/kg)	Σ SAR (W/kg)	Simult Tx	Configuration	UMTS V SAR (W/kg)	5 GHz WLAN SAR (W/kg)	Σ SAR (W/kg)
Head SAR	Right Cheek	0.408	0.347	0.755	Head SAR	Right Cheek	0.361	0.347	0.708
	Right Tilt	0.219	0.235	0.454		Right Tilt	0.207	0.235	0.442
	Left Cheek	0.213	1.015	1.228		Left Cheek	0.251	1.015	1.266
	Left Tilt	0.175	0.650	0.825		Left Tilt	0.198	0.650	0.848
Simult Tx	Configuration	UMTS IV SAR (W/kg)	5 GHz WLAN SAR (W/kg)	Σ SAR (W/kg)	Simult Tx	Configuration	GSM 1900 SAR (W/kg)	5 GHz WLAN SAR (W/kg)	Σ SAR (W/kg)
Head SAR	Right Cheek	0.178	0.347	0.525	Head SAR	Right Cheek	0.077	0.347	0.424
	Right Tilt	0.064	0.235	0.299		Right Tilt	0.023	0.235	0.258
	Left Cheek	0.271	1.015	1.286		Left Cheek	0.070	1.015	1.085
	Left Tilt	0.062	0.650	0.712		Left Tilt	0.016	0.650	0.666
Simult Tx	Configuration	UMTS II SAR (W/kg)	5 GHz WLAN SAR (W/kg)	Σ SAR (W/kg)					
Head SAR	Right Cheek	0.093	0.347	0.440					
	Right Tilt	0.033	0.235	0.268					
	Left Cheek	0.157	1.015	1.172					
	Left Tilt	0.020	0.650	0.670					

12.4 Body-Worn Simultaneous Transmission Analysis

Table 12-4
Simultaneous Transmission Scenario with 2.4 GHz WLAN (Body-Worn at 15 mm)

Configuration	Mode	2G/3G/4G SAR (W/kg)	2.4 GHz WLAN SAR (W/kg)	Σ SAR (W/kg)
Back Side	GSM 850	0.470	0.127	0.597
Front Side	GSM 850	0.338	0.175	0.513
Back Side	UMTS V	0.449	0.127	0.576
Front Side	UMTS V	0.384	0.175	0.559
Back Side	UMTS IV	0.741	0.127	0.868
Front Side	UMTS IV	0.659	0.175	0.834
Back Side	GSM 1900	0.403	0.127	0.530
Front Side	GSM 1900	0.280	0.175	0.455
Back Side	UMTS II	0.829	0.127	0.956
Front Side	UMTS II	0.662	0.175	0.837
Back Side	LTE Band 5 (Cell)	0.335	0.127	0.462
Front Side	LTE Band 5 (Cell)	0.242	0.175	0.417
Back Side	LTE Band 4 (AWS)	0.607	0.127	0.734
Front Side	LTE Band 4 (AWS)	0.509	0.175	0.684
Back Side	LTE Band 2 (PCS)	0.925	0.127	1.052
Front Side	LTE Band 2 (PCS)	0.627	0.175	0.802
Back Side	LTE Band 7	0.425	0.127	0.552
Front Side	LTE Band 7	0.233	0.175	0.408



FCC ID: PY7PM-0410		SAR EVALUATION REPORT		Reviewed by: Quality Manager
Document S/N: OY1306100973.PY7	Test Dates: 05/06/13 - 08/01/13	DUT Type: Portable Handset		Page 72 of 83



Table 12-5
Simultaneous Transmission Scenario with 5 GHz WLAN (Body-Worn at 15 mm)

Configuration	Mode	2G/3G SAR (W/kg)	5 GHz WLAN SAR (W/kg)	Σ SAR (W/kg)
Back Side	GSM 850	0.470	0.126	0.596
Front Side	GSM 850	0.338	0.051	0.389
Back Side	UMTS V	0.449	0.126	0.575
Front Side	UMTS V	0.384	0.051	0.435
Back Side	UMTS IV	0.741	0.126	0.867
Front Side	UMTS IV	0.659	0.051	0.710
Back Side	GSM 1900	0.403	0.126	0.529
Front Side	GSM 1900	0.280	0.051	0.331
Back Side	UMTS II	0.829	0.126	0.955
Front Side	UMTS II	0.662	0.051	0.713

Table 12-6
Simultaneous Transmission Scenario with Bluetooth (Body-Worn at 15 mm)

Configuration	Mode	2G/3G/4G SAR (W/kg)	Bluetooth SAR (W/kg)	Σ SAR (W/kg)
Back Side	GSM 850	0.470	0.125	0.595
Front Side	GSM 850	0.338	0.125	0.463
Back Side	UMTS V	0.449	0.125	0.574
Front Side	UMTS V	0.384	0.125	0.509
Back Side	UMTS IV	0.741	0.125	0.866
Front Side	UMTS IV	0.659	0.125	0.784
Back Side	GSM 1900	0.403	0.125	0.528
Front Side	GSM 1900	0.280	0.125	0.405
Back Side	UMTS II	0.829	0.125	0.954
Front Side	UMTS II	0.662	0.125	0.787
Back Side	LTE Band 5 (Cell)	0.335	0.125	0.460
Front Side	LTE Band 5 (Cell)	0.242	0.125	0.367
Back Side	LTE Band 4 (AWS)	0.607	0.125	0.732
Front Side	LTE Band 4 (AWS)	0.509	0.125	0.634
Back Side	LTE Band 2 (PCS)	0.925	0.125	1.050
Front Side	LTE Band 2 (PCS)	0.627	0.125	0.752
Back Side	LTE Band 7	0.425	0.125	0.550
Front Side	LTE Band 7	0.233	0.125	0.358

Note: Bluetooth SAR was not required to be measured per FCC KDB 447498. Estimated Bluetooth SAR results were used in the above table to determine simultaneous transmission SAR test exclusion.

FCC ID: PY7PM-0410		SAR EVALUATION REPORT		Reviewed by: Quality Manager
Document S/N: 0Y1306100973.PY7	Test Dates: 05/06/13 - 08/01/13	DUT Type: Portable Handset		Page 73 of 83

12.5 Hotspot SAR Simultaneous Transmission Analysis

Per FCC KDB Publication 941225 D06v01, the devices edges with antennas more than 2.5 cm from edge are not required to be evaluated for SAR (“-”).

Table 12-7
Simultaneous Transmission Scenario (2.4 GHz Hotspot at 1.0 cm)

Simult Tx	Configuration	GPRS 850 SAR (W/kg)	2.4 GHz WLAN SAR (W/kg)	Σ SAR (W/kg)	Simult Tx	Configuration	UMTS V SAR (W/kg)	2.4 GHz WLAN SAR (W/kg)	Σ SAR (W/kg)
Body SAR	Back	1.009	0.257	1.266	Body SAR	Back	0.820	0.257	1.077
	Front	0.952	0.318	1.270		Front	0.699	0.318	1.017
	Top	-	0.150	0.150		Top	-	0.150	0.150
	Bottom	0.462	-	0.462		Bottom	0.394	-	0.394
	Right	-	0.046	0.046		Right	-	0.046	0.046
	Left	0.224	-	0.224		Left	0.273	-	0.273
Simult Tx	Configuration	UMTS IV SAR (W/kg)	2.4 GHz WLAN SAR (W/kg)	Σ SAR (W/kg)	Simult Tx	Configuration	GPRS 1900 SAR (W/kg)	2.4 GHz WLAN SAR (W/kg)	Σ SAR (W/kg)
Body SAR	Back	0.851	0.257	1.108	Body SAR	Back	0.733	0.257	0.990
	Front	0.788	0.318	1.106		Front	0.450	0.318	0.768
	Top	-	0.150	0.150		Top	-	0.150	0.150
	Bottom	0.788	-	0.788		Bottom	0.597	-	0.597
	Right	-	0.046	0.046		Right	-	0.046	0.046
	Left	0.312	-	0.312		Left	0.177	-	0.177
Simult Tx	Configuration	UMTS II SAR (W/kg)	2.4 GHz WLAN SAR (W/kg)	Σ SAR (W/kg)	Simult Tx	Configuration	LTE Band 5 (Cell) SAR (W/kg)	2.4 GHz WLAN SAR (W/kg)	Σ SAR (W/kg)
Body SAR	Back	0.897	0.257	1.154	Body SAR	Back	0.582	0.257	0.839
	Front	0.730	0.318	1.048		Front	0.521	0.318	0.839
	Top	-	0.150	0.150		Top	-	0.150	0.150
	Bottom	0.777	-	0.777		Bottom	0.265	-	0.265
	Right	-	0.046	0.046		Right	-	0.046	0.046
	Left	0.150	-	0.150		Left	0.113	-	0.113
Simult Tx	Configuration	LTE Band 4 (AWS) SAR (W/kg)	2.4 GHz WLAN SAR (W/kg)	Σ SAR (W/kg)	Simult Tx	Configuration	LTE Band 2 (PCS) SAR (W/kg)	2.4 GHz WLAN SAR (W/kg)	Σ SAR (W/kg)
Body SAR	Back	0.857	0.257	1.114	Body SAR	Back	0.920	0.257	1.177
	Front	0.678	0.318	0.996		Front	0.735	0.318	1.053
	Top	-	0.150	0.150		Top	-	0.150	0.150
	Bottom	0.785	-	0.785		Bottom	0.782	-	0.782
	Right	-	0.046	0.046		Right	-	0.046	0.046
	Left	0.406	-	0.406		Left	0.111	-	0.111
Simult Tx	Configuration	LTE Band 7 SAR (W/kg)	2.4 GHz WLAN SAR (W/kg)	Σ SAR (W/kg)					
Body SAR	Back	0.848	0.257	1.105					
	Front	0.501	0.318	0.819					
	Top	-	0.150	0.150					
	Bottom	0.604	-	0.604					
	Right	-	0.046	0.046					
	Left	0.286	-	0.286					

FCC ID: PY7PM-0410	 PCTEST ENGINEERING LABORATORY, INC.	SAR EVALUATION REPORT	SONY	Reviewed by: Quality Manager
Document S/N: OY1306100973.PY7	Test Dates: 05/06/13 - 08/01/13	DUT Type: Portable Handset		Page 74 of 83

12.6 Hand SAR Simultaneous Transmission Analysis

Per FCC KDB Publication 648474 D04 Handset SAR v01r01, the devices edges with antennas more than 2.5 cm from edge are not required to be evaluated for SAR (“-“).

Table 12-8
Simultaneous Transmission Scenario (5 GHz Hand SAR at 0.3 cm)

Simult Tx	Configuration	UMTS IV SAR (W/kg)	5 GHz WLAN SAR (W/kg)	Σ SAR (W/kg)	Simult Tx	Configuration	UMTS II SAR (W/kg)	5 GHz WLAN SAR (W/kg)	Σ SAR (W/kg)
Hand SAR	Back	3.057	0.721	3.778	Hand SAR	Back	2.557	0.721	3.278
	Front	2.883	0.426	3.309		Front	2.514	0.426	2.940
	Top	-	0.173	0.173		Top	-	0.173	0.173
	Bottom	1.937	-	1.937		Bottom	1.819	-	1.819
	Right	-	0.115	0.115		Right	-	0.115	0.115
	Left	-	-	0.000		Left	-	-	0.000
Simult Tx	Configuration	LTE Band 4 (AWS) SAR (W/kg)	5 GHz WLAN SAR (W/kg)	Σ SAR (W/kg)	Simult Tx	Configuration	LTE Band 2 (PCS) SAR (W/kg)	5 GHz WLAN SAR (W/kg)	Σ SAR (W/kg)
Hand SAR	Back	2.270	0.721	2.991	Hand SAR	Back	2.870	0.721	3.591
	Front	-	0.426	0.426		Front	2.698	0.426	3.124
	Top	-	0.173	0.173		Top	-	0.173	0.173
	Bottom	-	-	0.000		Bottom	1.683	-	1.683
	Right	-	0.115	0.115		Right	-	0.115	0.115
	Left	-	-	0.000		Left	-	-	0.000

Table 12-9
Simultaneous Transmission Scenario (Bluetooth Hand SAR at 0.3 cm)

Simult Tx	Configuration	UMTS IV SAR (W/kg)	Bluetooth SAR (W/kg)	Σ SAR (W/kg)	Simult Tx	Configuration	UMTS II SAR (W/kg)	Bluetooth SAR (W/kg)	Σ SAR (W/kg)
Hand SAR	Back	3.057	0.150	3.207	Hand SAR	Back	2.557	0.150	2.707
	Front	2.883	0.150	3.033		Front	2.514	0.150	2.664
	Top	-	0.150	0.150		Top	-	0.150	0.150
	Bottom	1.937	-	1.937		Bottom	1.819	-	1.819
	Right	-	0.150	0.150		Right	-	0.150	0.150
	Left	-	-	0.000		Left	-	-	0.000
Simult Tx	Configuration	LTE Band 4 (AWS) SAR (W/kg)	Bluetooth SAR (W/kg)	Σ SAR (W/kg)	Simult Tx	Configuration	LTE Band 2 (PCS) SAR (W/kg)	Bluetooth SAR (W/kg)	Σ SAR (W/kg)
Hand SAR	Back	2.270	0.150	2.420	Hand SAR	Back	2.870	0.150	3.020
	Front	-	0.150	0.150		Front	2.698	0.150	2.848
	Top	-	0.150	0.150		Top	-	0.150	0.150
	Bottom	-	-	0.000		Bottom	1.683	-	1.683
	Right	-	0.150	0.150		Right	-	0.150	0.150
	Left	-	-	0.000		Left	-	-	0.000

Note: Bluetooth Hand SAR was not required to be measured per FCC KDB 447498. Estimated Bluetooth SAR results were used in the above table to determine simultaneous transmission SAR test exclusion.

12.7 Simultaneous Transmission Conclusion

The above numerical summed SAR results for all the worst-case simultaneous transmission conditions were below the SAR limit. Therefore, the above analysis is sufficient to determine that simultaneous transmission cases will not exceed the SAR limit and therefore no measured volumetric simultaneous SAR summation is required per FCC KDB Publication 447498 D01v05.

FCC ID: PY7PM-0410	 PCTEST ENGINEERING LABORATORY, INC.	SAR EVALUATION REPORT	SONY	Reviewed by: Quality Manager
Document S/N: OY1306100973.PY7	Test Dates: 05/06/13 - 08/01/13	DUT Type: Portable Handset		Page 75 of 83

13 SAR MEASUREMENT VARIABILITY

13.1 Measurement Variability

Per FCC KDB Publication 865664 D01v01, SAR measurement variability was assessed for each frequency band, which was determined by the SAR probe calibration point and tissue-equivalent medium used for the device measurements. When both head and body tissue-equivalent media were required for SAR measurements in a frequency band, the variability measurement procedures were applied to the tissue medium with the highest measured SAR, using the highest measured SAR configuration for that tissue-equivalent medium. These additional measurements were repeated after the completion of all measurements requiring the same head or body tissue-equivalent medium in a frequency band. The test device was returned to ambient conditions (normal room temperature) with the battery fully charged before it was re-mounted on the device holder for the repeated measurement(s) to minimize any unexpected variations in the repeated results.

SAR Measurement Variability was assessed using the following procedures for each frequency band:

- 1) When the original highest measured SAR is ≥ 0.80 W/kg, the measurement was repeated once.
- 2) A second repeated measurement was performed only if the ratio of largest to smallest SAR for the original and first repeated measurements was > 1.20 or when the original or repeated measurement was ≥ 1.45 W/kg (~ 10% from the 1-g SAR limit).
- 3) A third repeated measurement was performed only if the original, first or second repeated measurement was ≥ 1.5 W/kg and the ratio of largest to smallest SAR for the original, first and second repeated measurements is > 1.20 .
- 4) Repeated measurements are not required when the original highest measured SAR is < 0.80 W/kg
- 5) 10g Hand SAR measurement variability analysis applies a factor of 2.5 to the procedures outlines above.

**Table 13-1
Head SAR Measurement Variability Results**

HEAD VARIABILITY RESULTS														
Band	FREQUENCY		Mode/Band	Service	Side	Test Position	Data Rate (Mbps)	Measured SAR (1g)	1st Repeated SAR (1g)	Ratio	2nd Repeated SAR (1g)	Ratio	3rd Repeated SAR (1g)	Ratio
	MHz	Ch.						(W/kg)	(W/kg)		(W/kg)		(W/kg)	
2450	2437.00	6	IEEE 802.11b	DSSS	Left	Cheek	1	0.902	0.879	1.03	N/A	N/A	N/A	N/A
5800	5825.00	165	IEEE 802.11a	OFDM	Left	Cheek	6	0.848	0.958	1.13	N/A	N/A	N/A	N/A
ANSI / IEEE C95.1 1992 - SAFETY LIMIT Spatial Peak Uncontrolled Exposure/General Population							Head 1.6 W/kg (mW/g) averaged over 1 gram							

**Table 13-2
Body SAR Measurement Variability Results**



BODY VARIABILITY RESULTS														
Band	FREQUENCY		Mode	Service	# of Time Slots	Side	Spacing	Measured SAR (1g)	1st Repeated SAR (1g)	Ratio	2nd Repeated SAR (1g)	Ratio	3rd Repeated SAR (1g)	Ratio
	MHz	Ch.						(W/kg)	(W/kg)		(W/kg)		(W/kg)	
835	836.60	190	GSM 850	GPRS	4	back	10 mm	0.868	0.812	1.07	N/A	N/A	N/A	N/A
1900	1860.00	18700	LTE Band 2 (PCS)	QPSK, 1 RB, 0 RB Offset	N/A	back	15 mm	0.832	0.800	1.04	N/A	N/A	N/A	N/A
ANSI / IEEE C95.1 1992 - SAFETY LIMIT Spatial Peak Uncontrolled Exposure/General Population							Body 1.6 W/kg (mW/g) averaged over 1 gram							

**Table 13-3
Hand SAR Measurement Variability Results**

BODY VARIABILITY RESULTS													
Band	FREQUENCY		Mode	Service	Side	Spacing	Measured SAR (10g)	1st Repeated SAR (10g)	Ratio	2nd Repeated SAR (10g)	Ratio	3rd Repeated SAR (10g)	Ratio
	MHz	Ch.					(W/kg)	(W/kg)		(W/kg)		(W/kg)	
1750	1752.50	1862	UMTS IV	RMC	back	3 mm	2.820	2.620	1.08	N/A	N/A	N/A	N/A
1900	1900.00	19100	LTE Band 2 (PCS)	QPSK, 1 RB, 50 RB Offset	back	3 mm	2.500	2.500	1.00	N/A	N/A	N/A	N/A
ANSI / IEEE C95.1 1992 - SAFETY LIMIT Spatial Peak Uncontrolled Exposure/General Population							Hand 4.0 W/kg (mW/g) averaged over 10 grams						

13.2 Measurement Uncertainty

The measured SAR was < 1.5 W/kg for all frequency bands. Therefore, per KDB Publication 865664 D01v01, the extended measurement uncertainty analysis per IEEE 1528-2003 was not required.

FCC ID: PY7PM-0410	 PCTEST ENGINEERING LABORATORY, INC.	SAR EVALUATION REPORT		Reviewed by: Quality Manager
Document S/N: OY1306100973.PY7	Test Dates: 05/06/13 - 08/01/13	DUT Type: Portable Handset	Page 76 of 83	

14 EQUIPMENT LIST



Manufacturer	Model	Description	Cal Date	Cal Interval	Cal Due	Serial Number
SPEAG	D1750V2	1750 MHz SAR Dipole	4/30/2013	Annual	4/30/2014	1051
SPEAG	D1765V2	1765 MHz SAR Dipole	5/14/2013	Annual	5/14/2014	1008
SPEAG	D1900V2	1900 MHz SAR Dipole	7/20/2012	Annual	7/20/2013	5d080
SPEAG	D1900V2	1900 MHz SAR Dipole	2/6/2013	Annual	2/6/2014	5d148
SPEAG	D2450V2	2450 MHz SAR Dipole	8/23/2012	Annual	8/23/2013	719
SPEAG	D2600V2	2600 MHz SAR Dipole	5/2/2013	Annual	5/2/2014	1004
SPEAG	D5GHzV2	5 GHz SAR Dipole	1/11/2013	Annual	1/11/2014	1057
SPEAG	D5GHzV2	5 GHz SAR Dipole	2/14/2013	Annual	2/14/2014	1120
SPEAG	D835V2	835 MHz SAR Dipole	1/7/2013	Annual	1/7/2014	4d132
SPEAG	DAE4	Dasy Data Acquisition Electronics	2/6/2013	Annual	2/6/2014	649
SPEAG	DAE4	Dasy Data Acquisition Electronics	1/17/2013	Annual	1/17/2014	1272
SPEAG	DAE4	Dasy Data Acquisition Electronics	9/19/2012	Annual	9/19/2013	1323
SPEAG	DAE4	Dasy Data Acquisition Electronics	11/13/2012	Annual	11/13/2013	1333
SPEAG	DAE4	Dasy Data Acquisition Electronics	8/24/2012	Annual	8/24/2013	1322
SPEAG	DAE4	Dasy Data Acquisition Electronics	3/8/2013	Annual	3/8/2014	1334
SPEAG	ES3DV2	SAR Probe	8/28/2012	Annual	8/28/2013	3022
SPEAG	EX3DV4	SAR Probe	1/17/2013	Annual	1/17/2014	3589
SPEAG	ES3DV3	SAR Probe	3/15/2013	Annual	3/15/2014	3209
SPEAG	ES3DV3	SAR Probe	9/20/2012	Annual	9/20/2013	3288
SPEAG	ES3DV3	SAR Probe	11/15/2012	Annual	11/15/2013	3287
SPEAG	EX3DV4	SAR Probe	2/27/2013	Annual	2/27/2014	3920

FCC ID: PY7PM-0410	 PCTEST ENGINEERING LABORATORY, INC.	SAR EVALUATION REPORT	SONY	Reviewed by: Quality Manager
Document S/N: 0Y1306100973.PY7	Test Dates: 05/06/13 - 08/01/13	DUT Type: Portable Handset		Page 77 of 83

Manufacturer	Model	Description	Cal Date	Cal Interval	Cal Due	Serial Number
Agilent	8594A	(9kHz-2.9GHz) Spectrum Analyzer	N/A	N/A	N/A	3051A00187
Agilent	8753E	(30kHz-6GHz) Network Analyzer	4/16/2013	Annual	4/16/2014	JP38020182
Agilent	E8257D	(250kHz-20GHz) Signal Generator	4/16/2013	Annual	4/16/2014	MY45470194
Agilent	8648D	(9kHz-4GHz) Signal Generator	4/17/2013	Annual	4/17/2014	3629J00687
Agilent	85070C	Dielectric Probe Kit	2/14/2013	Annual	2/14/2014	MY44300633
Agilent	85047A	S-Parameter Test Set	N/A	N/A	N/A	2904A00579
Amplifier Research	5S1G4	5W, 800MHz-4.2GHz	CBT	N/A	CBT	21910
Anritsu	MA2481A	Power Sensor	2/14/2013	Annual	2/14/2014	5318
Anritsu	ML2438A	Power Meter	2/14/2013	Annual	2/14/2014	1190013
Anritsu	ML2438A	Power Meter	2/14/2013	Annual	2/14/2014	98150041
Anritsu	ML2438A	Power Meter	12/4/2012	Annual	12/4/2013	1070030
Anritsu	MA2481A	Power Sensor	2/14/2013	Annual	2/14/2014	5821
Anritsu	MA2481A	Power Sensor	2/14/2013	Annual	2/14/2014	2400
Anritsu	MA2411B	Pulse Sensor	9/19/2012	Annual	9/19/2013	1027293
Anritsu	ML2495A	Power Meter	10/11/2012	Annual	10/11/2013	1039008
Anritsu	MT8820C	Radio Communication Tester	11/6/2012	Annual	11/6/2013	6200901190
Anritsu	MA24106A	USB Power Sensor	8/22/2012	Annual	8/22/2013	1231538
Anritsu	MA24106A	USB Power Sensor	8/22/2012	Annual	8/22/2013	1231535
Anritsu	MA2481D	Universal Sensor	12/17/2012	Annual	12/17/2013	1204419
Anritsu	MA2481D	Universal Sensor	12/17/2012	Annual	12/17/2013	1204343
Anritsu	ML2496A	Power Meter	11/28/2012	Annual	11/28/2013	1138001
Anritsu	MA2411B	Pulse Power Sensor	12/4/2012	Annual	12/4/2013	1207364
Anritsu	MA2411B	Pulse Power Sensor	12/5/2012	Annual	12/5/2013	1126066
COMTECH	AR85729-5/5759B	Solid State Amplifier	CBT	N/A	CBT	M3W1A00-1002
COMTECH	AR85729-5	Solid State Amplifier	CBT	N/A	CBT	M1S5A00-009
Control Company	36934-158	Wall-Mounted Thermometer	1/4/2012	Biennial	1/4/2014	122014497
Control Company	4353	Long Stem Thermometer	9/25/2012	Biennial	9/25/2014	122539615
Fisher Scientific	15-077-960	Thermometer	11/6/2012	Biennial	11/6/2014	122640025
Fisher Scientific	15-078J	Long Stem Thermometer	10/30/2012	Biennial	10/30/2014	122626059
Gigatronics	80701A	(0.05-18GHz) Power Sensor	10/10/2012	Annual	10/10/2013	1833460
Gigatronics	8651A	Universal Power Meter	10/10/2012	Annual	10/10/2013	8650319
MCL	BW-N6W5+	6dB Attenuator	CBT	N/A	CBT	1139
MiniCircuits	SLP-2400+	Low Pass Filter	CBT	N/A	CBT	R8979500903
MiniCircuits	VLF-6000+	Low Pass Filter	CBT	N/A	CBT	N/A
MiniCircuits	VLF-6000+	Low Pass Filter	CBT	N/A	CBT	N/A
Mini-Circuits	BW-N20W5+	DC to 18 GHz Precision Fixed 20 dB Attenuator	CBT	N/A	CBT	N/A
Mini-Circuits	NLP-2950+	Low Pass Filter DC to 2700 MHz	CBT	N/A	CBT	N/A
Mini-Circuits	NLP-1200+	Low Pass Filter DC to 1000 MHz	CBT	N/A	CBT	N/A
Mini-Circuits	BW-N20W5	Power Attenuator	CBT	N/A	CBT	1226
Narda	4772-3	Attenuator (3dB)	CBT	N/A	CBT	9406
Narda	BW-S3W2	Attenuator (3dB)	CBT	N/A	CBT	120
Narda	4014C-6	4 - 8 GHz SMA 6 dB Directional Coupler	CBT	N/A	CBT	N/A
Pasternack	PE2208-6	Bidirectional Coupler	CBT	N/A	CBT	N/A
Pasternack	PE2209-10	Bidirectional Coupler	CBT	N/A	CBT	N/A
Rohde & Schwarz	CMU200	Base Station Simulator	5/3/2013	Annual	5/3/2014	836371/0079
Rohde & Schwarz	NRVD	Dual Channel Power Meter	10/12/2012	Biennial	10/12/2014	101695
Rohde & Schwarz	NRV-Z32	Peak Power Sensor	10/12/2012	Biennial	10/12/2014	836019/013
Rohde & Schwarz	SMIQ03B	Signal Generator	4/17/2013	Annual	4/17/2014	DE27259
Rohde & Schwarz	CMW500	LTE Radio Communication Tester	10/7/2011	Biennial	10/7/2013	103962
Rohde & Schwarz	CMW500	LTE Radio Communication Tester	2/8/2013	Annual	2/8/2014	101699
Rohde & Schwarz	SME06	Signal Generator	10/11/2012	Annual	10/11/2013	832026
Rohde & Schwarz	CMW500	LTE Radio Communication Tester	9/26/2012	Annual	9/26/2013	108798
Seekonk	NC-100	Torque Wrench (8" lb)	11/29/2011	Triennial	11/29/2014	21053
Seekonk	NC-100	Torque Wrench (8" lb)	3/5/2012	Triennial	3/5/2015	N/A
SPEAG	DAK-3.5	Dielectric Assessment Kit	12/11/2012	Annual	12/11/2013	1091
Tektronix	RSA6114A	Real Time Spectrum Analyzer	4/17/2013	Annual	4/17/2014	B010177
VWR	36934-158	Wall-Mounted Thermometer	9/30/2011	Biennial	9/30/2013	111859323
VWR	36934-158	Wall-Mounted Thermometer	9/30/2011	Biennial	9/30/2013	111859332
VWR	62344-925	Mini-Thermometer	10/24/2011	Biennial	10/24/2013	111886430
VWR	62344-925	Mini-Thermometer	10/24/2011	Biennial	10/24/2013	111886441
VWR	23226-658	Long Stem Thermometer	3/30/2012	Biennial	3/30/2014	122179874
VWR	23226-658	Long Stem Thermometer	5/16/2012	Biennial	5/16/2014	122295544

Notes:

- CBT (Calibrated Before Testing). Prior to testing, the measurement paths containing a cable, amplifier, attenuator, coupler or filter were connected to a calibrated source (i.e. a signal generator) to determine the losses of the measurement path. The power meter offset was then adjusted to compensate for the measurement system losses. This level offset is stored within the power meter before measurements are made. This calibration verification procedure applies to the system verification and output power measurements. The calibrated reading is then taken directly from the power meter after compensation of the losses for all final power measurements.
- All equipment was calibrated at the time it was used for testing purposes.

FCC ID: PY7PM-0410	 PCTEST PRECISION TEST EQUIPMENT, INC.	SAR EVALUATION REPORT		Reviewed by: Quality Manager
Document S/N: OY1306100973.PY7	Test Dates: 05/06/13 - 08/01/13	DUT Type: Portable Handset		Page 78 of 83

15 MEASUREMENT UNCERTAINTIES

Applicable for frequencies less than 3000 MHz.

a	b	c	d	e= f(d,k)	f	g	h = c x f/e	i = c x g/e	k
Uncertainty Component	IEEE 1528 Sec.	Tol. (± %)	Prob. Dist.	Div.	c _i 1gm	c _i 10 gms	1gm u _i (± %)	10gms u _i (± %)	v _i
Measurement System									
Probe Calibration	E.2.1	6.00	N	1	1.0	1.0	6.0	6.0	∞
Axial Isotropy	E.2.2	0.25	N	1	0.7	0.7	0.2	0.2	∞
Hemishperical Isotropy	E.2.2	1.3	N	1	1.0	1.0	1.3	1.3	∞
Boundary Effect	E.2.3	0.4	N	1	1.0	1.0	0.4	0.4	∞
Linearity	E.2.4	0.3	N	1	1.0	1.0	0.3	0.3	∞
System Detection Limits	E.2.5	5.1	N	1	1.0	1.0	5.1	5.1	∞
Readout Electronics	E.2.6	1.0	N	1	1.0	1.0	1.0	1.0	∞
Response Time	E.2.7	0.8	R	1.73	1.0	1.0	0.5	0.5	∞
Integration Time	E.2.8	2.6	R	1.73	1.0	1.0	1.5	1.5	∞
RF Ambient Conditions	E.6.1	3.0	R	1.73	1.0	1.0	1.7	1.7	∞
Probe Positioner Mechanical Tolerance	E.6.2	0.4	R	1.73	1.0	1.0	0.2	0.2	∞
Probe Positioning w/ respect to Phantom	E.6.3	2.9	R	1.73	1.0	1.0	1.7	1.7	∞
Extrapolation, Interpolation & Integration algorithms for Max. SAR Evaluation	E.5	1.0	R	1.73	1.0	1.0	0.6	0.6	∞
Test Sample Related									
Test Sample Positioning	E.4.2	6.0	N	1	1.0	1.0	6.0	6.0	287
Device Holder Uncertainty	E.4.1	3.32	R	1.73	1.0	1.0	1.9	1.9	∞
Output Power Variation - SAR drift measurement	6.6.2	5.0	R	1.73	1.0	1.0	2.9	2.9	∞
Phantom & Tissue Parameters									
Phantom Uncertainty (Shape & Thickness tolerances)	E.3.1	4.0	R	1.73	1.0	1.0	2.3	2.3	∞
Algorithm for correcting SAR for deviations in conductivity and permittivity	E.3.2	1.2	N	1	1.0	0.84	1.2	1.0	∞
Liquid Conductivity - deviation from target values	E.3.2	0.0	R	1.73	0.64	0.43	0.0	0.0	∞
Liquid Conductivity - measurement uncertainty	E.3.3	3.8	N	1	0.64	0.43	2.4	1.6	6
Liquid Permittivity - deviation from target values	E.3.2	0.0	R	1.73	0.60	0.49	0.0	0.0	∞
Liquid Permittivity - measurement uncertainty	E.3.3	4.5	N	1	0.60	0.49	2.7	2.2	6
Combined Standard Uncertainty (k=1)				RSS			11.9	11.6	299
Expanded Uncertainty (95% CONFIDENCE LEVEL)				k=2			23.7	23.2	

The above measurement uncertainties are according to IEEE Std. 1528-2003

FCC ID: PY7PM-0410	 PCTEST ENGINEERING LABORATORY, INC.	SAR EVALUATION REPORT	SONY	Reviewed by: Quality Manager
Document S/N: OY1306100973.PY7	Test Dates: 05/06/13 - 08/01/13	DUT Type: Portable Handset		Page 79 of 83

Applicable for frequencies up to 6 GHz.

a	b	c	d	e= f(d,k)	f	g	h = c x f/e	i = c x g/e	k	
Uncertainty Component	IEEE 1528 Sec.	Tol. (± %)	Prob. Dist.	Div.	c _i 1gm	c _i 10 gms	1gm u _i (± %)	10gms u _i (± %)	v _i	
Measurement System										
Probe Calibration	E.2.1	6.55	N	1	1.0	1.0	6.6	6.6	∞	
Axial Isotropy	E.2.2	0.25	N	1	0.7	0.7	0.2	0.2	∞	
Hemishperical Isotropy	E.2.2	1.3	N	1	1.0	1.0	1.3	1.3	∞	
Boundary Effect	E.2.3	0.4	N	1	1.0	1.0	0.4	0.4	∞	
Linearity	E.2.4	0.3	N	1	1.0	1.0	0.3	0.3	∞	
System Detection Limits	E.2.5	5.1	N	1	1.0	1.0	5.1	5.1	∞	
Readout Electronics	E.2.6	1.0	N	1	1.0	1.0	1.0	1.0	∞	
Response Time	E.2.7	0.8	R	1.73	1.0	1.0	0.5	0.5	∞	
Integration Time	E.2.8	2.6	R	1.73	1.0	1.0	1.5	1.5	∞	
RF Ambient Conditions	E.6.1	3.0	R	1.73	1.0	1.0	1.7	1.7	∞	
Probe Positioner Mechanical Tolerance	E.6.2	0.4	R	1.73	1.0	1.0	0.2	0.2	∞	
Probe Positioning w/ respect to Phantom	E.6.3	2.9	R	1.73	1.0	1.0	1.7	1.7	∞	
Extrapolation, Interpolation & Integration algorithms for Max. SAR Evaluation	E.5	1.0	R	1.73	1.0	1.0	0.6	0.6	∞	
Test Sample Related										
Test Sample Positioning	E.4.2	6.0	N	1	1.0	1.0	6.0	6.0	287	
Device Holder Uncertainty	E.4.1	3.32	R	1.73	1.0	1.0	1.9	1.9	∞	
Output Power Variation - SAR drift measurement	6.6.2	5.0	R	1.73	1.0	1.0	2.9	2.9	∞	
Phantom & Tissue Parameters										
Phantom Uncertainty (Shape & Thickness tolerances)	E.3.1	4.0	R	1.73	1.0	1.0	2.3	2.3	∞	
Algorithm for correcting SAR for deviations in conductivity and permittivity	E.3.2	1.2	N	1	1.0	0.84	1.2	1.0	∞	
Liquid Conductivity - deviation from target values	E.3.2	0.0	R	1.73	0.64	0.43	0.0	0.0	∞	
Liquid Conductivity - measurement uncertainty	E.3.3	3.8	N	1	0.64	0.43	2.4	1.6	6	
Liquid Permittivity - deviation from target values	E.3.2	0.0	R	1.73	0.60	0.49	0.0	0.0	∞	
Liquid Permittivity - measurement uncertainty	E.3.3	4.5	N	1	0.60	0.49	2.7	2.2	6	
Combined Standard Uncertainty (k=1)							RSS	12.2	11.9	299
Expanded Uncertainty (95% CONFIDENCE LEVEL)							k=2	24.3	23.8	

The above measurement uncertainties are according to IEEE Std. 1528-2003

FCC ID: PY7PM-0410	 PCTEST ENGINEERING LABORATORY, INC.	SAR EVALUATION REPORT	SONY	Reviewed by: Quality Manager
Document S/N: OY1306100973.PY7	Test Dates: 05/06/13 - 08/01/13	DUT Type: Portable Handset		Page 80 of 83

16 CONCLUSION

16.1 Measurement Conclusion

The SAR evaluation indicates that the EUT complies with the RF radiation exposure limits of the FCC and Industry Canada, with respect to all parameters subject to this test. These measurements were taken to simulate the RF effects of RF exposure under worst-case conditions. Precise laboratory measures were taken to assure repeatability of the tests. The results and statements relate only to the item(s) tested.

Please note that the absorption and distribution of electromagnetic energy in the body are very complex phenomena that depend on the mass, shape, and size of the body, the orientation of the body with respect to the field vectors, and the electrical properties of both the body and the environment. Other variables that may play a substantial role in possible biological effects are those that characterize the environment (e.g. ambient temperature, air velocity, relative humidity, and body insulation) and those that characterize the individual (e.g. age, gender, activity level, debilitation, or disease). Because various factors may interact with one another to vary the specific biological outcome of an exposure to electromagnetic fields, any protection guide should consider maximal amplification of biological effects as a result of field-body interactions, environmental conditions, and physiological variables. [3]

FCC ID: PY7PM-0410	 PCTEST ENGINEERING LABORATORY, INC.	SAR EVALUATION REPORT	SONY	Reviewed by: Quality Manager
Document S/N: 0Y1306100973.PY7	Test Dates: 05/06/13 - 08/01/13	DUT Type: Portable Handset		Page 81 of 83

17 REFERENCES

- [1] Federal Communications Commission, ET Docket 93-62, Guidelines for Evaluating the Environmental Effects of Radiofrequency Radiation, Aug. 1996.
- [2] ANSI/IEEE C95.1-2005, American National Standard safety levels with respect to human exposure to radio frequency electromagnetic fields, 3kHz to 300GHz, New York: IEEE, 2006.
- [3] ANSI/IEEE C95.1-1992, American National Standard safety levels with respect to human exposure to radio frequency electromagnetic fields, 3kHz to 300GHz, New York: IEEE, Sept. 1992.
- [4] ANSI/IEEE C95.3-2002, IEEE Recommended Practice for the Measurement of Potentially Hazardous Electromagnetic Fields - RF and Microwave, New York: IEEE, December 2002.
- [5] Federal Communications Commission, OET Bulletin 65 (Edition 97-01), Supplement C (Edition 01-01), Evaluating Compliance with FCC Guidelines for Human Exposure to Radiofrequency Electromagnetic Fields, June 2001.
- [6] IEEE Standards Coordinating Committee 34 – IEEE Std. 1528-2003, Recommended Practice for Determining the Peak Spatial-Average Specific Absorption Rate (SAR) in the Human Body Due to Wireless Communications Devices.
- [7] NCRP, National Council on Radiation Protection and Measurements, Biological Effects and Exposure Criteria for RadioFrequency Electromagnetic Fields, NCRP Report No. 86, 1986. Reprinted Feb. 1995.
- [8] T. Schmid, O. Egger, N. Kuster, Automated E-field scanning system for dosimetric assessments, IEEE Transaction on Microwave Theory and Techniques, vol. 44, Jan. 1996, pp. 105-113.
- [9] K. Pokovic, T. Schmid, N. Kuster, Robust setup for precise calibration of E-field probes in tissue simulating liquids at mobile communications frequencies, ICECOM97, Oct. 1997, pp. -124.
- [10] K. Pokovic, T. Schmid, and N. Kuster, E-field Probe with improved isotropy in brain simulating liquids, Proceedings of the ELMAR, Zadar, Croatia, June 23-25, 1996, pp. 172-175.
- [11] Schmid & Partner Engineering AG, Application Note: Data Storage and Evaluation, June 1998, p2.
- [12] V. Hombach, K. Meier, M. Burkhardt, E. Kuhn, N. Kuster, The Dependence of EM Energy Absorption upon Human Modeling at 900 MHz, IEEE Transaction on Microwave Theory and Techniques, vol. 44 no. 10, Oct. 1996, pp. 1865-1873.
- [13] N. Kuster and Q. Balzano, Energy absorption mechanism by biological bodies in the near field of dipole antennas above 300MHz, IEEE Transaction on Vehicular Technology, vol. 41, no. 1, Feb. 1992, pp. 17-23.
- [14] G. Hartsgrrove, A. Kraszewski, A. Surowiec, Simulated Biological Materials for Electromagnetic Radiation Absorption Studies, University of Ottawa, Bioelectromagnetics, Canada: 1987, pp. 29-36.
- [15] Q. Balzano, O. Garay, T. Manning Jr., Electromagnetic Energy Exposure of Simulated Users of Portable Cellular Telephones, IEEE Transactions on Vehicular Technology, vol. 44, no.3, Aug. 1995.
- [16] W. Gander, Computermathematik, Birkhaeuser, Basel, 1992.
- [17] W.H. Press, S.A. Teukolsky, W.T. Vetterling, and B.P. Flannery, Numerical Recipes in C, The Art of Scientific Computing, Second edition, Cambridge University Press, 1992.

FCC ID: PY7PM-0410	 PCTEST ENGINEERING LABORATORY, INC.	SAR EVALUATION REPORT	SONY	Reviewed by: Quality Manager
Document S/N: OY1306100973.PY7	Test Dates: 05/06/13 - 08/01/13	DUT Type: Portable Handset		Page 82 of 83

- [18] Federal Communications Commission, OET Bulletin 65, Evaluating Compliance with FCC Guidelines for Human Exposure to Radiofrequency Electromagnetic Fields. Supplement C, Dec. 1997.
- [19] N. Kuster, R. Kastle, T. Schmid, Dosimetric evaluation of mobile communications equipment with known precision, IEEE Transaction on Communications, vol. E80-B, no. 5, May 1997, pp. 645-652.
- [20] CENELEC CLC/SC111B, European Prestandard (prENV 50166-2), Human Exposure to Electromagnetic Fields High-frequency: 10kHz-300GHz, Jan. 1995.
- [21] Prof. Dr. Niels Kuster, ETH, Eidgenössische Technische Hochschule Zürich, Dosimetric Evaluation of the Cellular Phone.
- [22] IEC 62209-1, Human exposure to radio frequency fields from hand-held and body-mounted wireless communication devices - Human models, instrumentation, and procedures - Part 1: Procedure to determine the specific absorption rate (SAR) for hand-held devices used in close proximity to the ear (frequency range of 300 MHz to 3 GHz), Feb. 2005.
- [23] Industry Canada RSS-102 Radio Frequency Exposure Compliance of Radiocommunication Apparatus (All Frequency Bands) Issue 4, March 2010.
- [24] Health Canada Safety Code 6 Limits of Human Exposure to Radio Frequency Electromagnetic Fields in the Frequency Range from 3 kHz – 300 GHz, 2009
- [25] FCC Public Notice DA-02-1438. Office of Engineering and Technology Announces a Transition Period for the Phantom Requirements of Supplement C to OET Bulletin 65, June 19, 2002
- [26] FCC SAR Test Procedures for 2G-3G Devices, Mobile Hotspot and UMPC Devices KDB Publications 941225, D01-D07
- [27] SAR Measurement procedures for IEEE 802.11a/b/g KDB Publication 248227 D01v01r02
- [28] FCC SAR Considerations for Handsets with Multiple Transmitters and Antennas, KDB Publications 648474 D02-D04
- [29] FCC SAR Evaluation Considerations for Laptop, Notebook, Netbook and Tablet Computers, FCC KDB Publication 616217 D04
- [30] FCC SAR Measurement and Reporting Requirements for 100MHz – 6 GHz, KDB Publications 865664 D01-D02
- [31] FCC General RF Exposure Guidance and SAR Procedures for Dongles, KDB Publication 447498, D01-D02
- [32] Anexo à Resolução No. 533, de 10 de Setembro de 2009.
- [33] IEC 62209-2, Human exposure to radio frequency fields from hand-held and body-mounted wireless communication devices - Human models, instrumentation, and procedures - Part 2: Procedure to determine the specific absorption rate (SAR) for wireless communication devices used in close proximity to the human body (frequency range of 30 MHz to 6 GHz), Mar. 2010.

FCC ID: PY7PM-0410	 PCTEST ENGINEERING LABORATORY, INC.	SAR EVALUATION REPORT	SONY	Reviewed by: Quality Manager
Document S/N: OY1306100973.PY7	Test Dates: 05/06/13 - 08/01/13	DUT Type: Portable Handset		Page 83 of 83

APPENDIX A: SAR TEST DATA

PCTEST ENGINEERING LABORATORY, INC.

DUT: PY7PM-0410; Type: Portable Handset; Serial: 7481

Communication System: GSM, Frequency: 848.8 MHz; Duty Cycle: 1:8.3

Medium: 835 Head Medium parameters used (interpolated):

$f = 848.8 \text{ MHz}$; $\sigma = 0.932 \text{ S/m}$; $\epsilon_r = 41.371$; $\rho = 1000 \text{ kg/m}^3$

Phantom section: Right Section

Test Date: 06-18-2013; Ambient Temp: 23.1°C; Tissue Temp: 23.1°C

Probe: ES3DV3 - SN3288; ConvF(6.41, 6.41, 6.41); Calibrated: 9/20/2012;

Sensor-Surface: 4mm (Mechanical Surface Detection)

Electronics: DAE4 Sn1323; Calibrated: 9/19/2012

Phantom: SAM v5.0 front; Type: QD000P40CD; Serial: TP-1646

Measurement SW: DASY52, Version 52.8 (7); SEMCAD X Version 14.6.10 (7164)

Mode: GSM 850, Right Head, Cheek, High.ch

Area Scan (7x14x1): Measurement grid: dx=15mm, dy=15mm

Zoom Scan (6x6x7)/Cube 0: Measurement grid: dx=8mm, dy=8mm, dz=5mm

Reference Value = 20.524 V/m; Power Drift = -0.20 dB

Peak SAR (extrapolated) = 0.487 W/kg

SAR(1 g) = 0.387 W/kg; SAR(10 g) = 0.296 W/kg (SAR corrected for target medium)

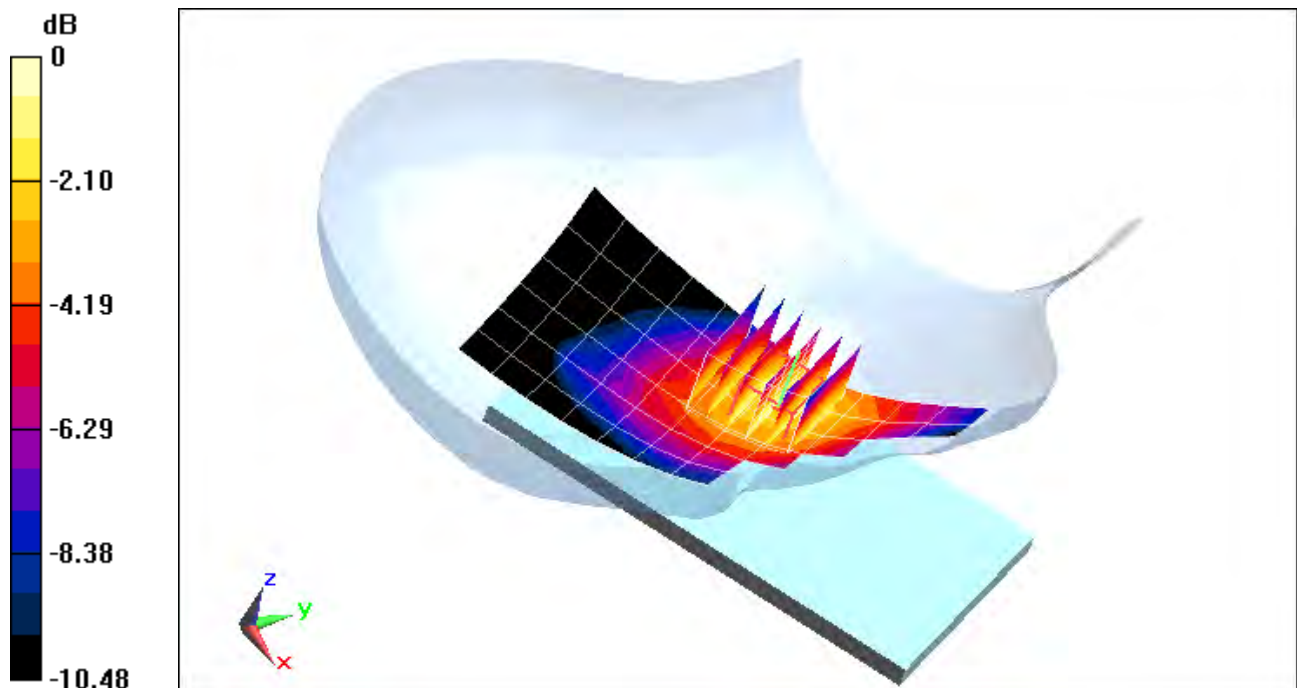

0 dB = 0.404 W/kg = -3.94 dBW/kg

PCTEST ENGINEERING LABORATORY, INC.

DUT: PY7PM-0410; Type: Portable Handset; Serial: 7320

Communication System: UMTS, Frequency: 846.6 MHz; Duty Cycle: 1:1

Medium: 835 Head Medium parameters used (interpolated):

$f = 846.6 \text{ MHz}$; $\sigma = 0.93 \text{ S/m}$; $\epsilon_r = 41.397$; $\rho = 1000 \text{ kg/m}^3$

Phantom section: Right Section

Test Date: 06-18-2013; Ambient Temp: 23.1°C; Tissue Temp: 23.1°C

Probe: ES3DV3 - SN3288; ConvF(6.41, 6.41, 6.41); Calibrated: 9/20/2012;

Sensor-Surface: 4mm (Mechanical Surface Detection)

Electronics: DAE4 Sn1323; Calibrated: 9/19/2012

Phantom: SAM v5.0 front; Type: QD000P40CD; Serial: TP-1646

Measurement SW: DASY52, Version 52.8 (7); SEMCAD X Version 14.6.10 (7164)

Mode: UMTS 850, Right Head, Cheek, High.ch

Area Scan (9x14x1): Measurement grid: dx=15mm, dy=15mm

Zoom Scan (5x5x7)/Cube 0: Measurement grid: dx=8mm, dy=8mm, dz=5mm

Reference Value = 20.384 V/m; Power Drift = -0.13 dB

Peak SAR (extrapolated) = 0.432 W/kg

SAR(1 g) = 0.343 W/kg; SAR(10 g) = 0.265 (SAR corrected for target medium)

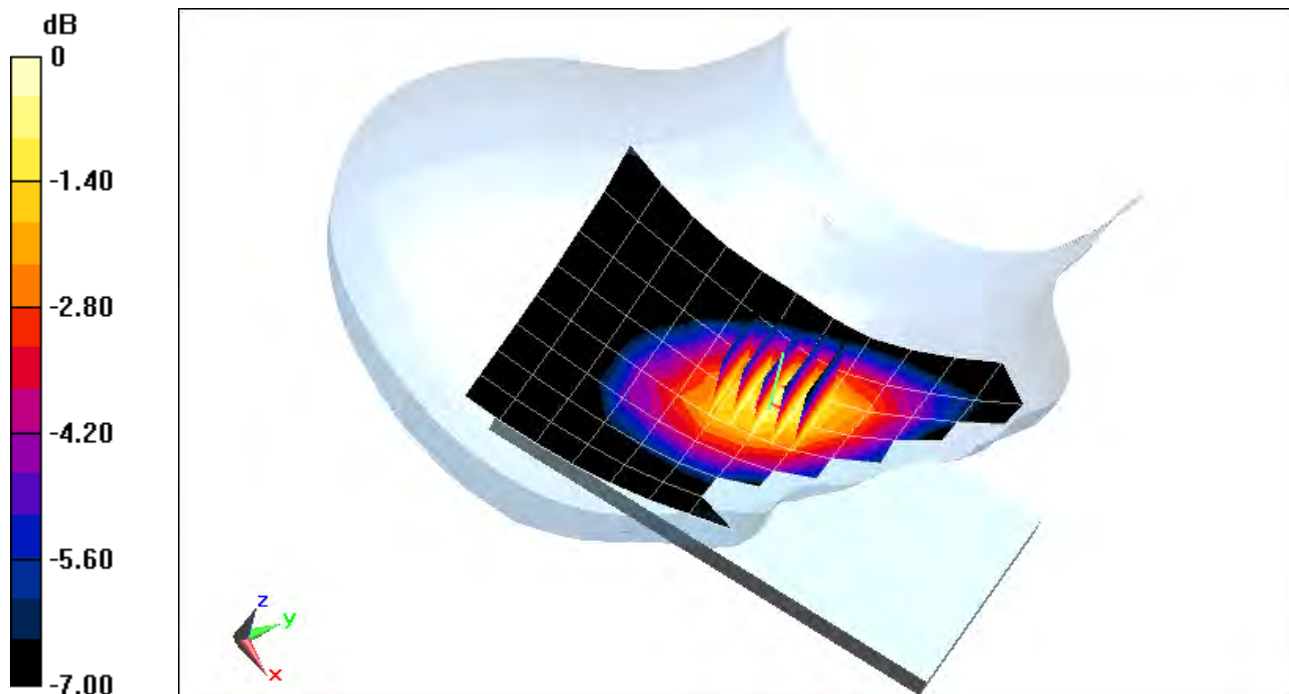

0 dB = 0.359 W/kg = -4.45 dBW/kg

PCTEST ENGINEERING LABORATORY, INC.

DUT: PY7PM-0410; Type: Portable Handset; Serial: 7320

Communication System: UMTS; Frequency: 1712.4 MHz; Duty Cycle: 1:1

Medium: 1750 Head Medium parameters used (interpolated):

$f = 1712.4 \text{ MHz}$; $\sigma = 1.339 \text{ S/m}$; $\epsilon_r = 39.91$; $\rho = 1000 \text{ kg/m}^3$

Phantom section: Left Section

Test Date: 06-24-2013; Ambient Temp: 24.2°C; Tissue Temp: 23.6°C

Probe: EX3DV4 - SN3920; ConvF(7.97, 7.97, 7.97); Calibrated: 2/27/2013;

Sensor-Surface: 4mm (Mechanical Surface Detection)

Electronics: DAE4 Sn649; Calibrated: 2/6/2013

Phantom: SAM V5.0 Right; Type: QD000P40CD; Serial: 1647

Measurement SW: DASY52, Version 52.8 (7); SEMCAD X Version 14.6.10 (7164)

Mode: AWS UMTS, Left Head, Cheek, Low.ch

Area Scan (9x13x1): Measurement grid: dx=15mm, dy=15mm

Zoom Scan (5x5x7)/Cube 0: Measurement grid: dx=8mm, dy=8mm, dz=5mm

Reference Value = 14.390 V/m; Power Drift = 0.05 dB

Peak SAR (extrapolated) = 0.408 W/kg

SAR(1 g) = 0.242 W/kg; SAR(10 g) = 0.137 W/kg (SAR corrected for target medium)

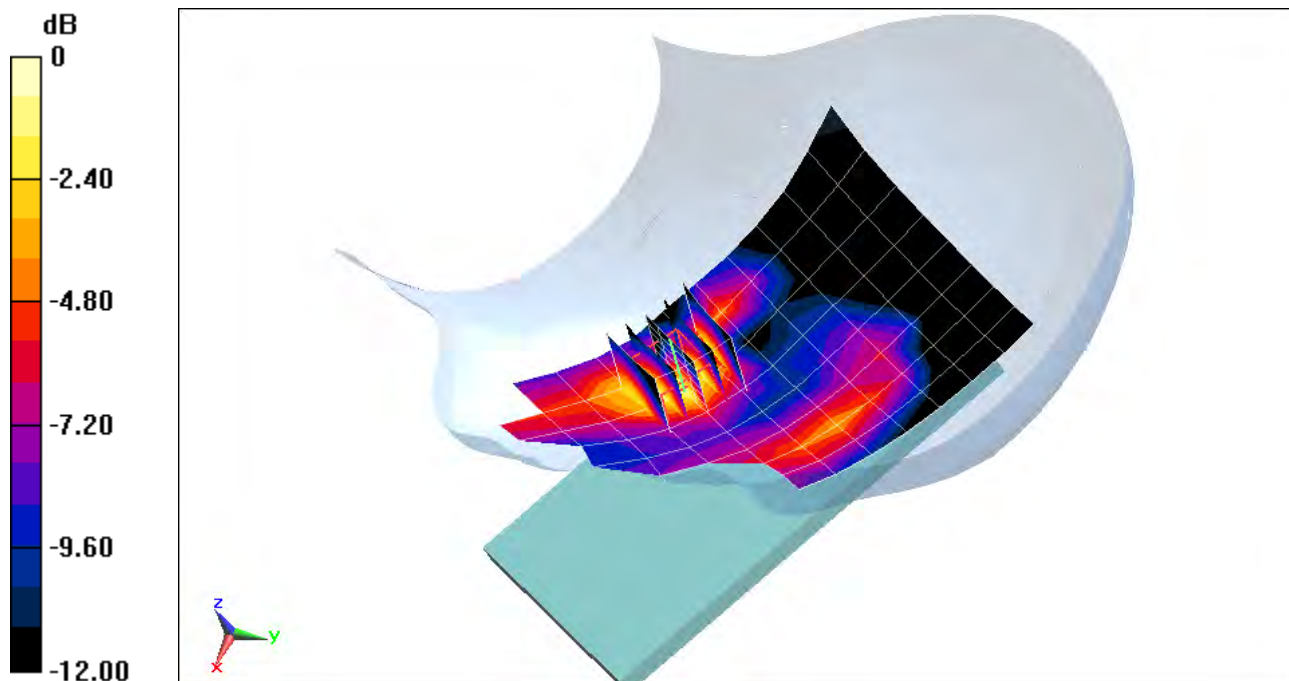

PCTEST ENGINEERING LABORATORY, INC.

DUT: PY7PM-0410; Type: Portable Handset; Serial: 7319

Communication System: GSM1900; Frequency: 1880 MHz; Duty Cycle: 1:8.3

Medium: 1900 Head Medium parameters used:

$f = 1880 \text{ MHz}$; $\sigma = 1.422 \text{ S/m}$; $\epsilon_r = 38.735$; $\rho = 1000 \text{ kg/m}^3$

Phantom section: Right Section

Test Date: 06-20-2013; Ambient Temp: 24.0°C; Tissue Temp: 23.3°C

Probe: EX3DV4 - SN3589; ConvF(7.09, 7.09, 7.09); Calibrated: 1/17/2013;

Sensor-Surface: 4mm (Mechanical Surface Detection)

Electronics: DAE4 Sn1272; Calibrated: 1/17/2013

Phantom: SAM Main; Type: SAM 4.0; Serial: TP-1114

Measurement SW: DASY4, Version 4.7 (80); SEMCAD X Version 14.6.10 (7164)

Mode: GSM 1900, Right Head, Cheek, Mid.ch

Area Scan (7x14x1): Measurement grid: dx=15mm, dy=15mm

Zoom Scan (5x5x7)/Cube 0: Measurement grid: dx=8mm, dy=8mm, dz=5mm

Reference Value = 7.560 V/m; Power Drift = 0.13 dB

Peak SAR (extrapolated) = 0.141 W/kg

SAR(1 g) = 0.072 W/kg; SAR(10 g) = 0.032 W/kg (SAR corrected for target medium)

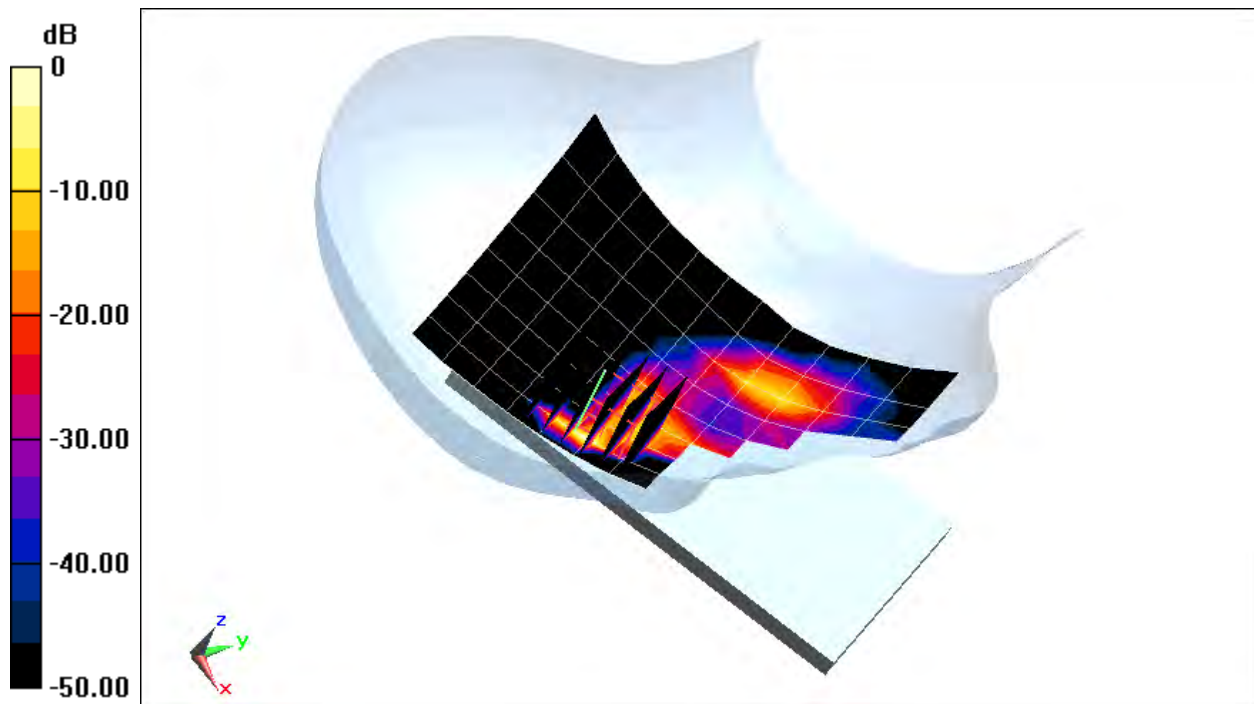

0 dB = 0.0782 W/kg = -11.07 dBW/kg

PCTEST ENGINEERING LABORATORY, INC.

DUT: PY7PM-0410; Type: Portable Handset; Serial: 7316

Communication System: WCDMA1900; Frequency: 1880 MHz; Duty Cycle: 1:1

Medium: 1900 Head Medium parameters used:

$f = 1880 \text{ MHz}$; $\sigma = 1.422 \text{ S/m}$; $\epsilon_r = 38.735$; $\rho = 1000 \text{ kg/m}^3$

Phantom section: Left Section

Test Date: 06-20-2013; Ambient Temp: 24.0°C; Tissue Temp: 23.3°C

Probe: EX3DV4 - SN3589; ConvF(7.09, 7.09, 7.09); Calibrated: 1/17/2013;

Sensor-Surface: 4mm (Mechanical Surface Detection)

Electronics: DAE4 Sn1272; Calibrated: 1/17/2013

Phantom: SAM Main; Type: SAM 4.0; Serial: TP-1114

Measurement SW: DASY4, Version 4.7 (80); SEMCAD X Version 14.6.10 (7164)

Mode: UMTS 1900, Left Head, Cheek, Mid.ch

Area Scan (7x10x1): Measurement grid: dx=15mm, dy=15mm

Zoom Scan (5x5x7)/Cube 0: Measurement grid: dx=8mm, dy=8mm, dz=5mm

Reference Value = 9.756 V/m; Power Drift = 0.07 dB

Peak SAR (extrapolated) = 0.264 W/kg

SAR(1 g) = 0.144 W/kg; SAR(10 g) = 0.077 W/kg (SAR corrected for target medium)

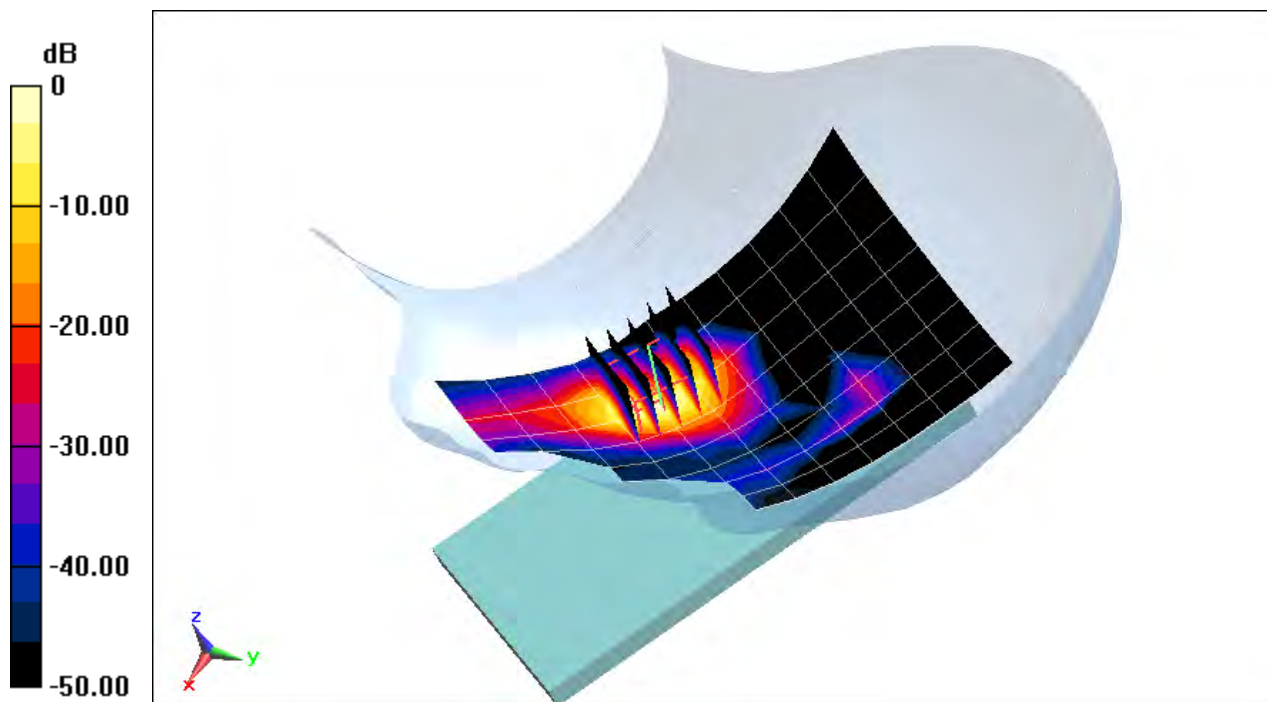

PCTEST ENGINEERING LABORATORY, INC.

DUT: PY7PM-0410; Type: Portable Handset; Serial: 7483

Communication System: LTE Band 5 (Cell.); Frequency: 836.5 MHz; Duty Cycle: 1:1

Medium: 835 Head Medium parameters used (interpolated):

$f = 836.5 \text{ MHz}$; $\sigma = 0.92 \text{ S/m}$; $\epsilon_r = 41.514$; $\rho = 1000 \text{ kg/m}^3$

Phantom section: Right Section

Test Date: 06-18-2013; Ambient Temp: 23.1°C; Tissue Temp: 23.1°C

Probe: ES3DV3 - SN3288; ConvF(6.41, 6.41, 6.41); Calibrated: 9/20/2012;

Sensor-Surface: 4mm (Mechanical Surface Detection)

Electronics: DAE4 Sn1323; Calibrated: 9/19/2012

Phantom: SAM v5.0 front; Type: QD000P40CD; Serial: TP-1646

Measurement SW: DASYS52, Version 52.8 (7); SEMCAD X Version 14.6.10 (7164)

Mode: LTE Band 5 (Cell.), Right Head, Cheek, Mid.ch

10 MHz Bandwidth, QPSK, 1 RB, RB Offset 49

Area Scan (9x13x1): Measurement grid: dx=15mm, dy=15mm

Zoom Scan (5x5x7)/Cube 0: Measurement grid: dx=8mm, dy=8mm, dz=5mm

Reference Value = 17.258 V/m; Power Drift = -0.06 dB

Peak SAR (extrapolated) = 0.293 W/kg

SAR(1 g) = 0.233 W/kg; SAR(10 g) = 0.177 W/kg (SAR corrected for target medium)

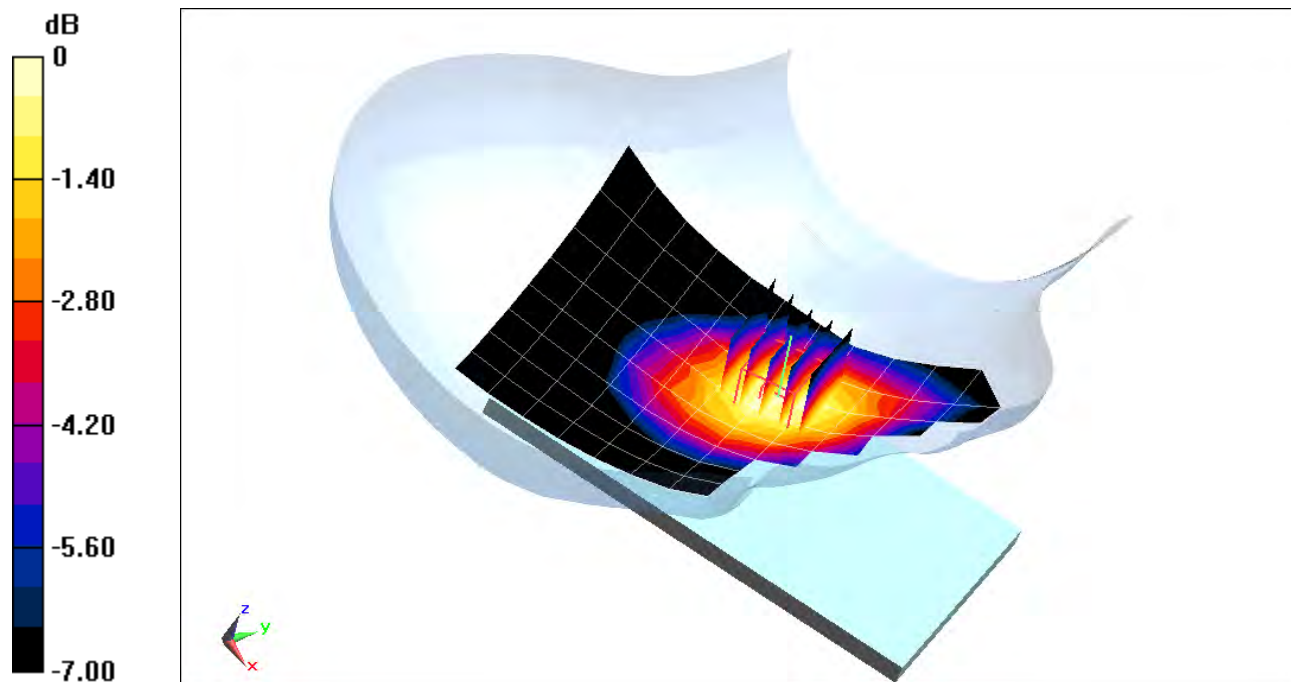

0 dB = 0.245 W/kg = -6.11 dBW/kg

PCTEST ENGINEERING LABORATORY, INC.

DUT: PY7PM-0410; Type: Portable Handset; Serial: 7317

Communication System: LTE Band 4 (AWS); Frequency: 1732.5 MHz; Duty Cycle: 1:1

Medium: 1750 Head Medium parameters used (interpolated):

$f = 1732.5 \text{ MHz}$; $\sigma = 1.36 \text{ S/m}$; $\epsilon_r = 39.816$; $\rho = 1000 \text{ kg/m}^3$

Phantom section: Left Section

Test Date: 06-24-2013; Ambient Temp: 24.2°C; Tissue Temp: 23.6°C

Probe: EX3DV4 - SN3920; ConvF(7.97, 7.97, 7.97); Calibrated: 2/27/2013;

Sensor-Surface: 4mm (Mechanical Surface Detection)

Electronics: DAE4 Sn649; Calibrated: 2/6/2013

Phantom: SAM V5.0 Right; Type: QD000P40CD; Serial: 1647

Measurement SW: DASY52, Version 52.8 (7); SEMCAD X Version 14.6.10 (7164)

Mode: LTE Band 4 (AWS), Left Head, Cheek, Mid.ch

QPSK, 20 MHz Bandwidth, 1 RB, RB Offset 50

Area Scan (11x17x1): Measurement grid: dx=12mm, dy=12mm

Zoom Scan (6x5x7)/Cube 0: Measurement grid: dx=8mm, dy=8mm, dz=5mm

Reference Value = 12.474 V/m; Power Drift = -0.05 dB

Peak SAR (extrapolated) = 0.295 W/kg

SAR(1 g) = 0.194 W/kg; SAR(10 g) = 0.126 W/kg (SAR corrected for target medium)

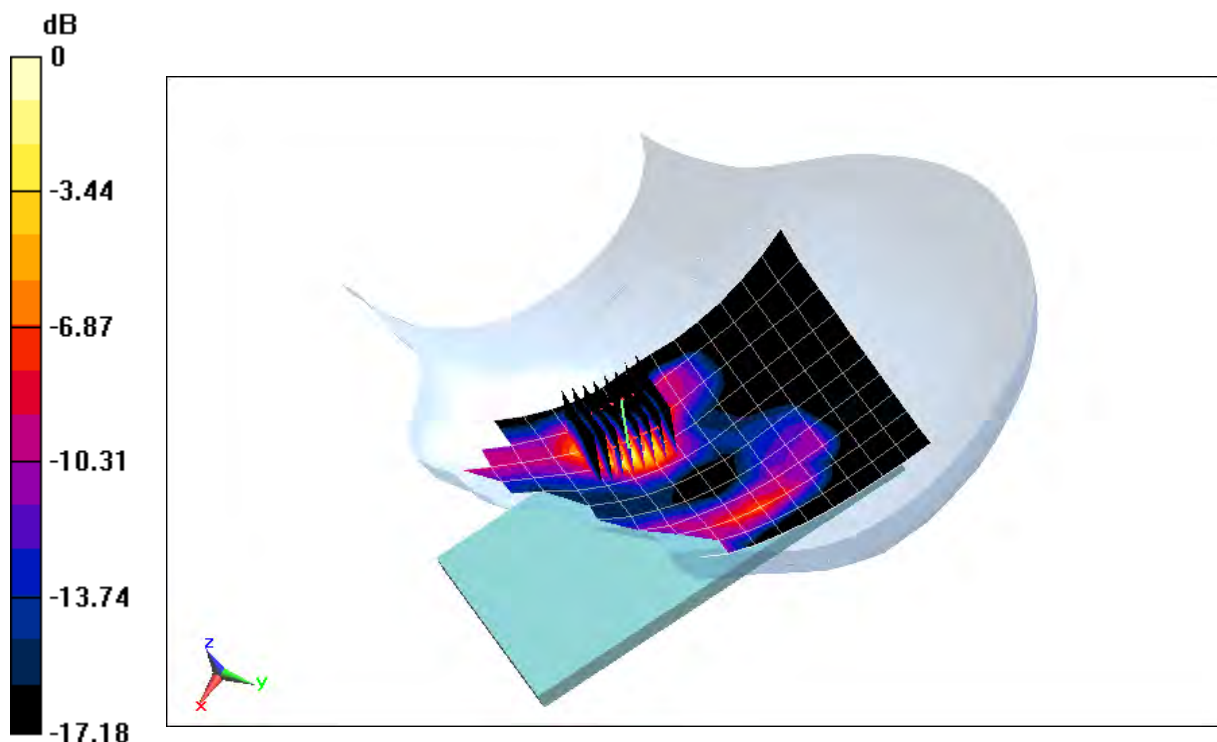

0 dB = 0.208 W/kg = -6.83 dBW/kg

PCTEST ENGINEERING LABORATORY, INC.

DUT: PY7PM-0410; Type: Portable Handset; Serial: 7317

Communication System: LTE Band 2 (PCS); Frequency: 1880 MHz; Duty Cycle: 1:1

Medium: 1900 Head Medium parameters used:

$f = 1880 \text{ MHz}$; $\sigma = 1.378 \text{ S/m}$; $\epsilon_r = 40.453$; $\rho = 1000 \text{ kg/m}^3$

Phantom section: Left Section

Test Date: 06-28-2013; Ambient Temp: 23.8°C; Tissue Temp: 23.3°C

Probe: EX3DV4 - SN3920; ConvF(7.73, 7.73, 7.73); Calibrated: 2/27/2013;

Sensor-Surface: 4mm (Mechanical Surface Detection)

Electronics: DAE4 Sn649; Calibrated: 2/6/2013

Phantom: SAM V5.0 Right; Type: QD000P40CD; Serial: 1647

Measurement SW: DASY52, Version 52.8 (7); SEMCAD X Version 14.6.10 (7164)

Mode: LTE Band 2 (PCS), Left Head, Cheek, Mid.ch
QPSK, 20 MHz Bandwidth, 1 RB, RB Offset 99

Area Scan (9x15x1): Measurement grid: dx=15mm, dy=15mm

Zoom Scan (5x5x7)/Cube 0: Measurement grid: dx=8mm, dy=8mm, dz=5mm

Reference Value = 10.314 V/m; Power Drift = 0.09 dB

Peak SAR (extrapolated) = 0.185 W/kg

SAR(1 g) = 0.123 W/kg; SAR(10 g) = 0.075 W/kg (SAR corrected for target medium)

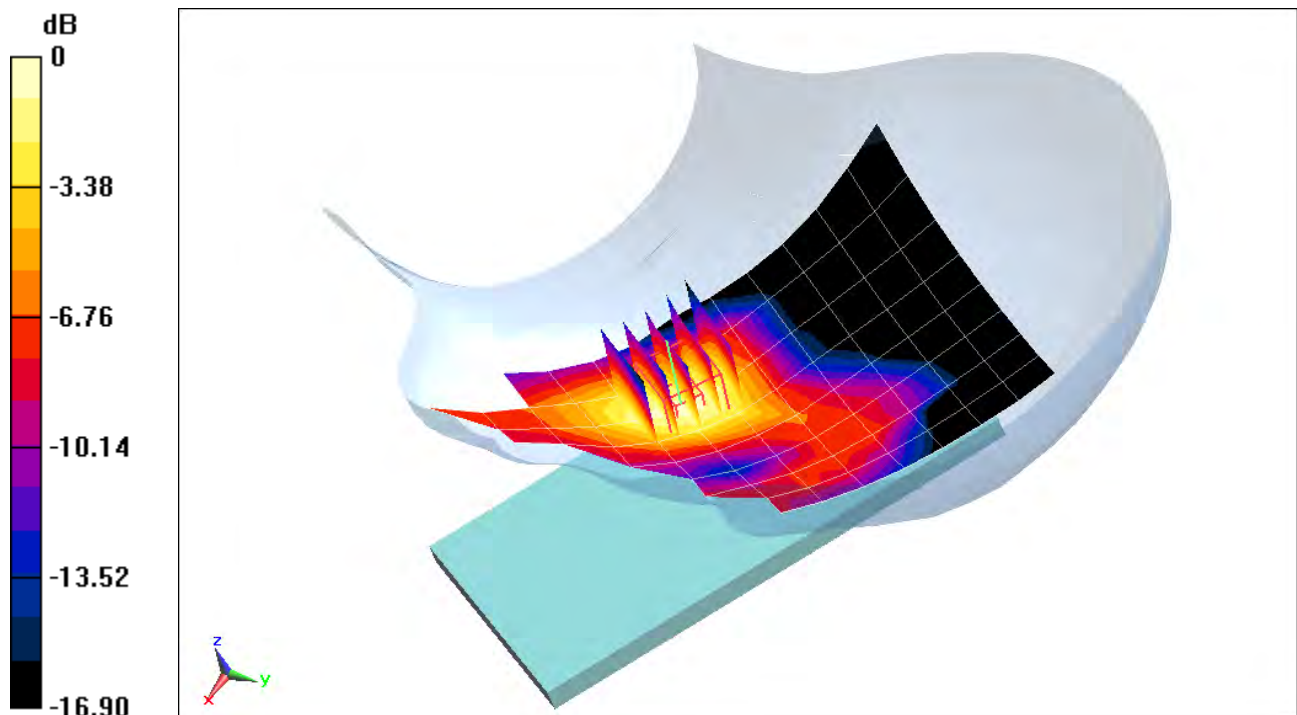

0 dB = 0.136 W/kg = -8.66 dBW/kg

PCTEST ENGINEERING LABORATORY, INC.

DUT: PY7PM-0410; Type: Portable Handset; Serial: 8711

Communication System: LTE BAND 7; Frequency: 2535 MHz; Duty Cycle: 1:1

Medium: 2500 Head Medium parameters used (interpolated):

$f = 2535 \text{ MHz}$; $\sigma = 1.942 \text{ S/m}$; $\epsilon_r = 37.635$; $\rho = 1000 \text{ kg/m}^3$

Phantom section: Left Section

Test Date: 07-26-2013; Ambient Temp: 23.1°C; Tissue Temp: 23.0°C

Probe: ES3DV2 - SN3022; ConvF(4.1, 4.1, 4.1); Calibrated: 8/28/2012;

Sensor-Surface: 3mm (Mechanical Surface Detection)

Electronics: DAE4 Sn1322; Calibrated: 8/24/2012

Phantom: SAM Main; Type: SAM 4.0; Serial: TP-1406

Measurement SW: DASY4, Version 4.7 (80); SEMCAD X Version 14.6.10 (7164)

Mode: LTE Band 7, Left Head, Cheek, Mid.ch
20 MHz Bandwidth, QPSK, 1 RB, RB Offset 50

Area Scan (11x17x1): Measurement grid: dx=12mm, dy=12mm

Zoom Scan (7x7x7)/Cube 0: Measurement grid: dx=5mm, dy=5mm, dz=5mm

Reference Value = 9.977 V/m; Power Drift = 0.12 dB

Peak SAR (extrapolated) = 0.276 W/kg

SAR(1 g) = 0.144 W/kg; SAR(10 g) = 0.070 W/kg (SAR corrected for target medium)

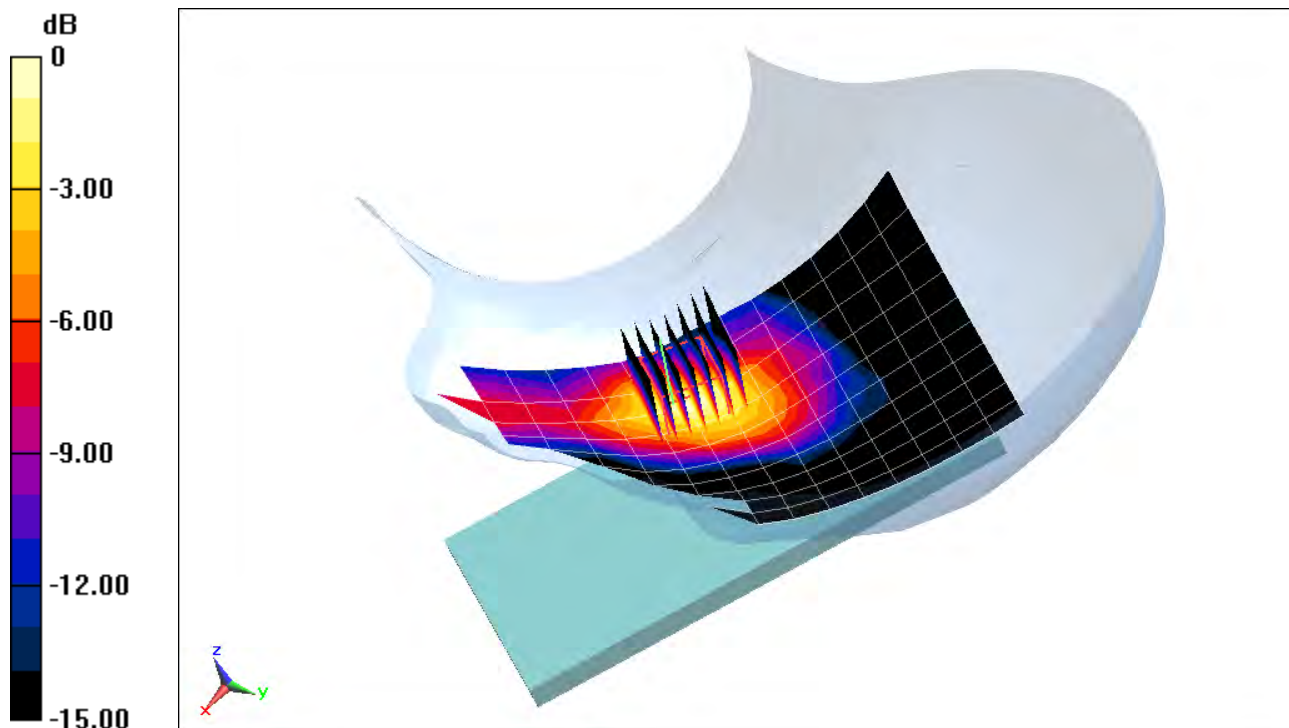

0 dB = 0.184 W/kg = -7.35 dBW/kg

PCTEST ENGINEERING LABORATORY, INC.

DUT: PY7PM-0410; Type: Portable Handset; Serial: 6717

Communication System: IEEE 802.11b; Frequency: 2437 MHz; Duty Cycle: 1:1

Medium: 2450 Head Medium parameters used (interpolated):

$f = 2437 \text{ MHz}$; $\sigma = 1.862 \text{ S/m}$; $\epsilon_r = 40.038$; $\rho = 1000 \text{ kg/m}^3$

Phantom section: Left Section

Test Date: 06-18-2013; Ambient Temp: 23.4°C; Tissue Temp: 22.9°C

Probe: ES3DV3 - SN3287; ConvF(4.3, 4.3, 4.3); Calibrated: 11/15/2012;

Sensor-Surface: 3mm (Mechanical Surface Detection)

Electronics: DAE4 Sn1333; Calibrated: 11/13/2012

Phantom: SAM Sub Dasy B; Type: SAM 5.0; Serial: TP-1626

Measurement SW: DASY4, Version 4.7 (80); SEMCAD X Version 14.6.10 (7164)

Mode: IEEE 802.11b, Left Head, Cheek, Ch 06, 1 Mbps

Area Scan (10x15x1): Measurement grid: dx=12mm, dy=12mm

Zoom Scan (7x7x7)/Cube 0: Measurement grid: dx=5mm, dy=5mm, dz=5mm

Reference Value = 20.154 V/m; Power Drift = -0.10 dB

Peak SAR (extrapolated) = 2.40 W/kg

SAR(1 g) = 0.902 W/kg; SAR(10 g) = 0.342 W/kg (SAR corrected for target medium)

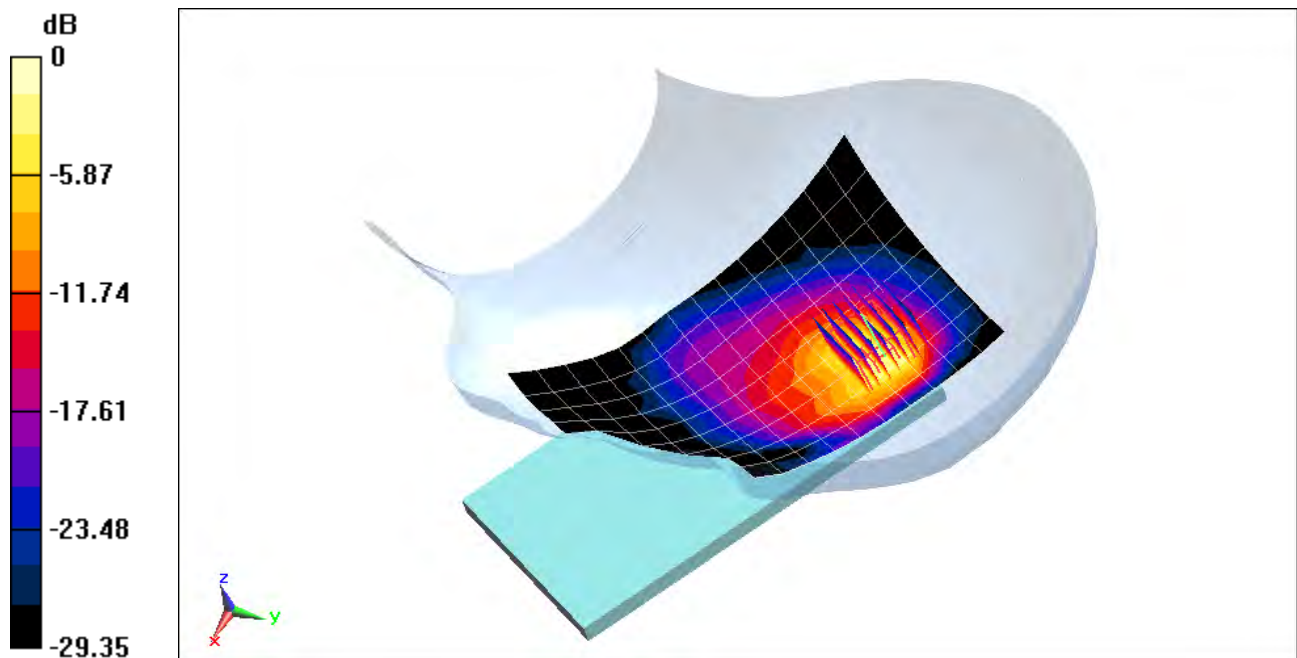

0 dB = 1.27 W/kg = 1.04 dBW/kg

PCTEST ENGINEERING LABORATORY, INC.

DUT: PY7PM-0410; Type: Portable Handset; Serial: 3037

Communication System: IEEE 802.11a; Frequency: 5825 MHz; Duty Cycle: 1:1
Medium: 5 GHz Head; Medium parameters used:

$$f = 5825 \text{ MHz}; \sigma = 5.084 \text{ S/m}; \epsilon_r = 35.262; \rho = 1000 \text{ kg/m}^3$$

Phantom section: Left Section

Test Date: 05-13-2013; Ambient Temp: 22.1°C; Tissue Temp: 21.5°C

Probe: EX3DV4 - SN3920; ConvF(4.02, 4.02, 4.02); Calibrated: 2/27/2013;

Sensor-Surface: 1.4mm (Mechanical Surface Detection)

Electronics: DAE4 Sn649; Calibrated: 2/6/2013

Phantom: SAM V5.0 Right; Type: QD000P40CD; Serial: 1647

Measurement SW: DASY52, Version 52.8 (6);SEMCAD X Version 14.6.9 (7117)

Mode: IEEE 802.11a, 5.8 GHz, Left Head, Cheek, Ch 165, 6 Mbps

Area Scan (13x21x1): Measurement grid: dx=10mm, dy=10mm

Zoom Scan (8x8x7)/Cube 0: Measurement grid: dx=4mm, dy=4mm, dz=1.4mm; Graded Ratio: 1.4

Reference Value = 11.393 V/m; Power Drift = -0.09 dB

Peak SAR (extrapolated) = 5.06 W/kg

SAR(1 g) = 0.958 W/kg; SAR(10 g) = 0.296 W/kg (SAR corrected for target medium)

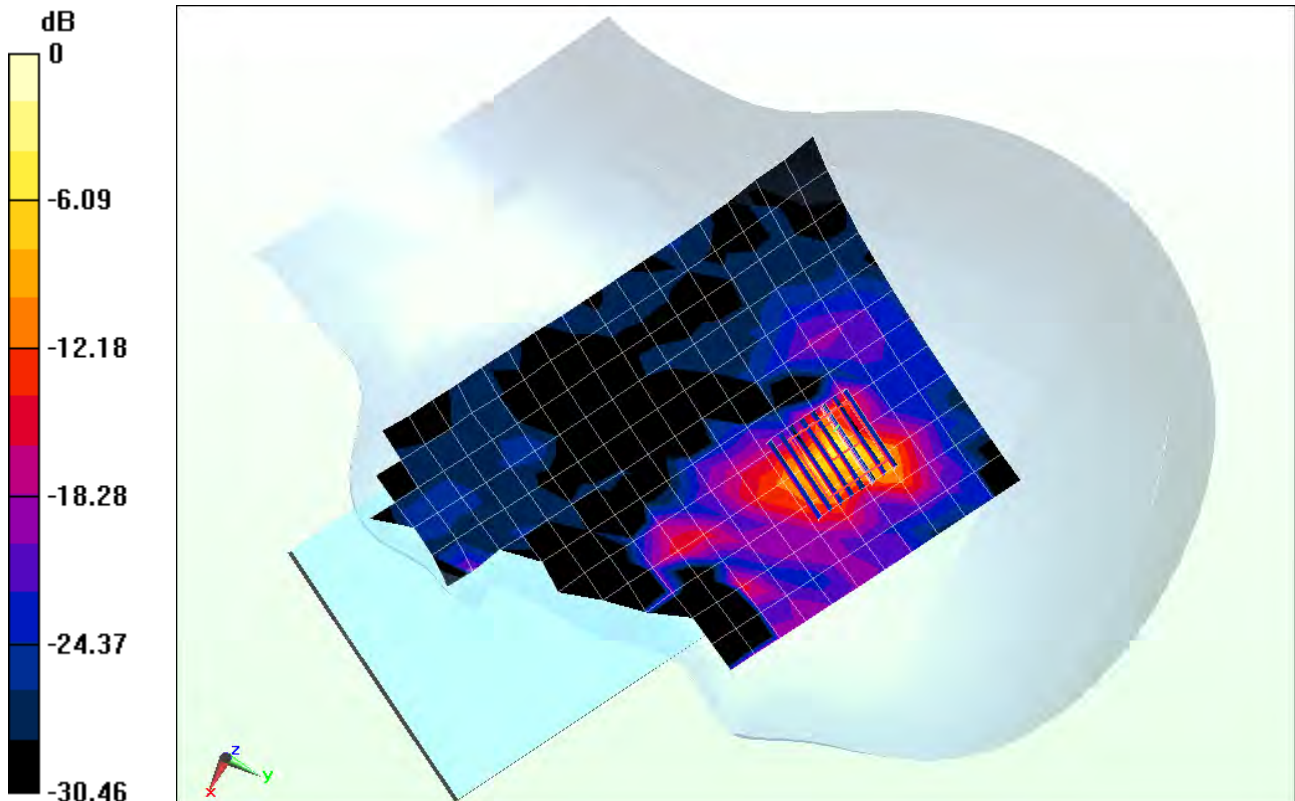

0 dB = 2.84 W/kg = 4.53 dBW/kg

PCTEST ENGINEERING LABORATORY, INC.

DUT: PY7PM-0410; Type: Portable Handset; Serial: 3037

Communication System: IEEE 802.11a; Frequency: 5240 MHz; Duty Cycle: 1:1

Medium: 5GHz Head; Medium parameters used:

$$f = 5240 \text{ MHz}; \sigma = 4.516 \text{ S/m}; \epsilon_r = 37.189; \rho = 1000 \text{ kg/m}^3$$

Phantom section: Left Section

Test Date: 05-09-2013; Ambient Temp: 24.4°C; Tissue Temp: 23.3°C

Probe: EX3DV4 - SN3920; ConvF(4.87, 4.87, 4.87); Calibrated: 2/27/2013;

Sensor-Surface: 1.4mm (Mechanical Surface Detection)

Electronics: DAE4 Sn649; Calibrated: 2/6/2013

Phantom: SAM V5.0 Right; Type: QD000P40CD; Serial: 1647

Measurement SW: DASY52, Version 52.8 (6);SEMCAD X Version 14.6.9 (7117)

Mode: IEEE 802.11a, 5.2 GHz, Left Head, Cheek, Ch 48, 6 Mbps

Area Scan (13x21x1): Measurement grid: dx=10mm, dy=10mm

Zoom Scan (9x9x7)/Cube 0: Measurement grid: dx=4mm, dy=4mm, dz=1.4mm; Graded Ratio: 1.4

Reference Value = 12.812 V/m; Power Drift = 0.04 dB

Peak SAR (extrapolated) = 3.88 W/kg

SAR(1 g) = 0.789 W/kg; SAR(10 g) = 0.233 W/kg (SAR corrected for target medium)

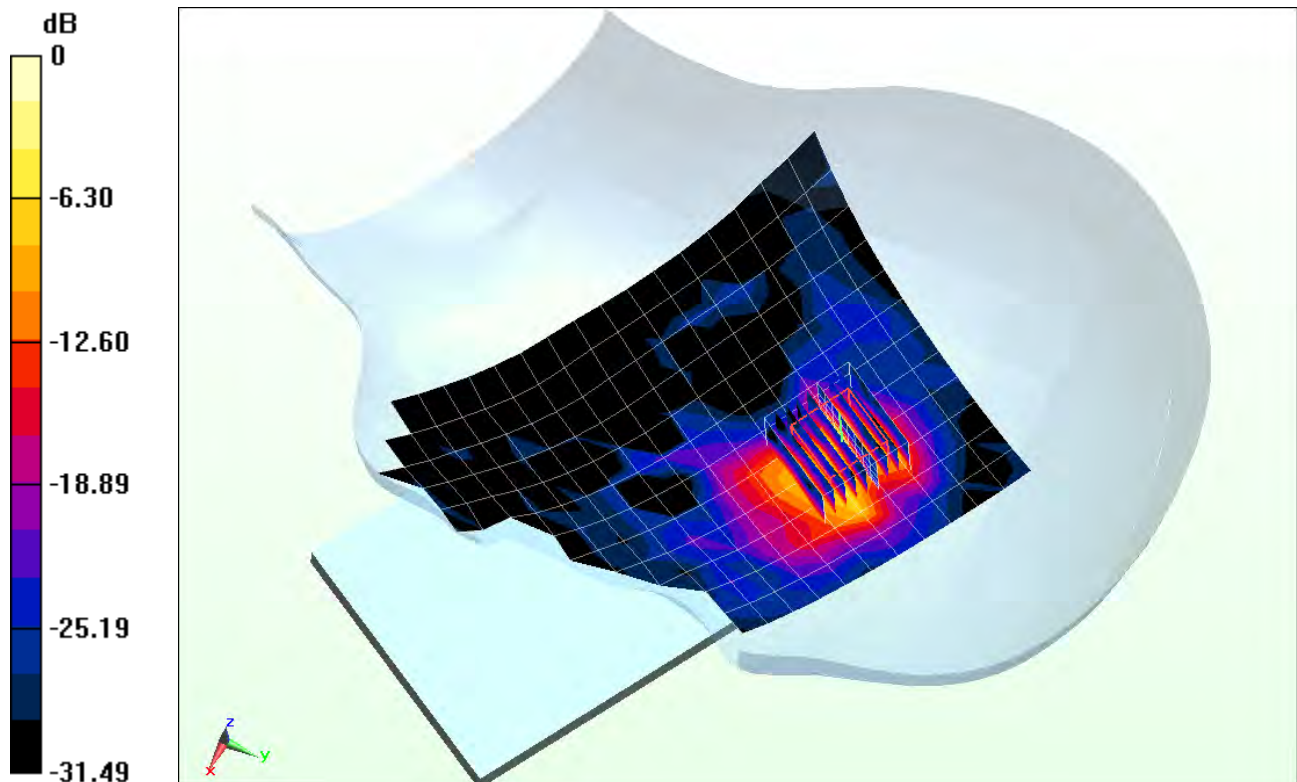

0 dB = 2.27 W/kg = 3.56 dBW/kg

PCTEST ENGINEERING LABORATORY, INC.

DUT: PY7PM-0410; Type: Portable Handset; Serial: 7481

Communication System: GSM; Frequency: 848.8 MHz; Duty Cycle: 1:8.3

Medium: 835 Body Medium parameters used (interpolated):

$f = 848.8 \text{ MHz}$; $\sigma = 1.022 \text{ S/m}$; $\epsilon_r = 55.747$; $\rho = 1000 \text{ kg/m}^3$

Phantom section: Flat Section; Space: 1.5 cm

Test Date: 06-18-2013; Ambient Temp: 24.6°C; Tissue Temp: 22.9°C

Probe: ES3DV3 - SN3209; ConvF(6.28, 6.28, 6.28); Calibrated: 3/15/2013;

Sensor-Surface: 4mm (Mechanical Surface Detection)

Electronics: DAE4 Sn1334; Calibrated: 3/8/2013

Phantom: ELI v5.0; Type: QDOVA002AA; Serial: TP-1158

Measurement SW: DASY52, Version 52.8 (7); SEMCAD X Version 14.6.10 (7164)

Mode: GSM 850, Body SAR, Back side, High.ch

Area Scan (9x15x1): Measurement grid: dx=15mm, dy=15mm

Zoom Scan (6x6x7)/Cube 0: Measurement grid: dx=8mm, dy=8mm, dz=5mm

Reference Value = 21.985 V/m; Power Drift = -0.09 dB

Peak SAR (extrapolated) = 0.664 W/kg

SAR(1 g) = 0.446 W/kg; SAR(10 g) = 0.298 W/kg (SAR corrected for target medium)

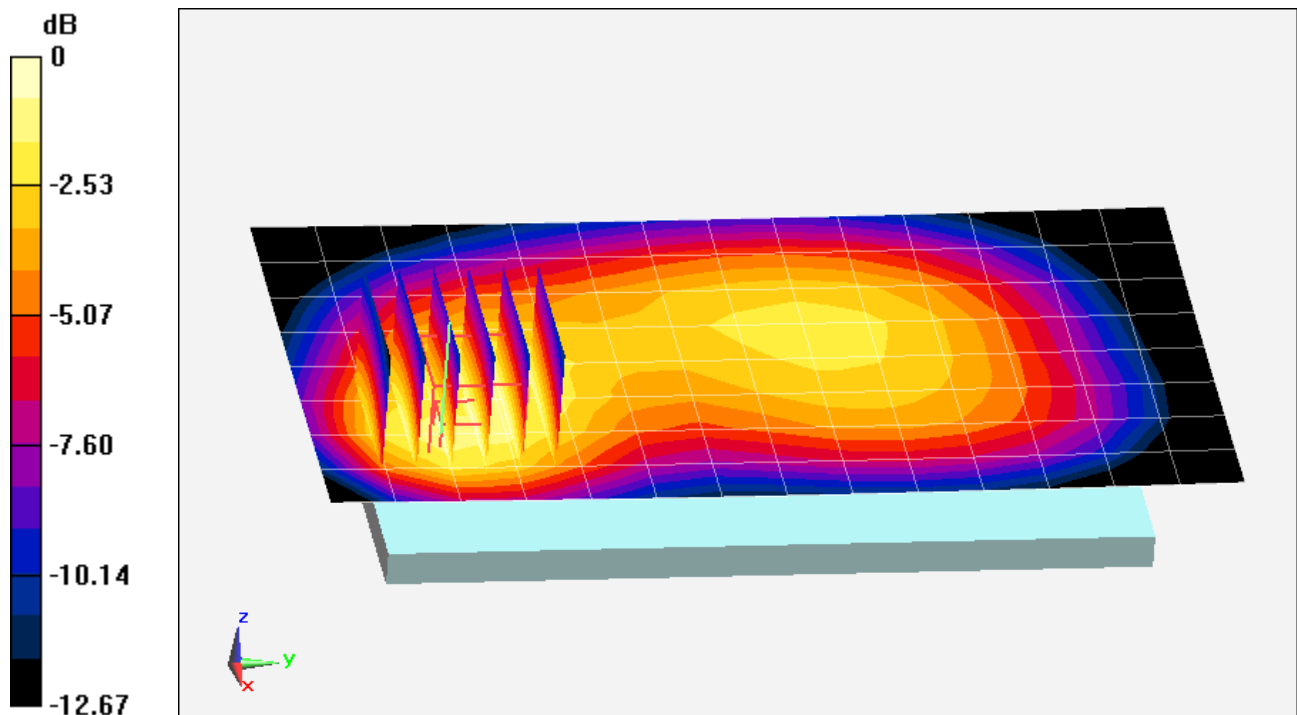

0 dB = 0.473 W/kg = -3.25 dBW/kg

PCTEST ENGINEERING LABORATORY, INC.

DUT: PY7PM-0410; Type: Portable Handset; Serial: 7481

Communication System: GSM GPRS; 4 Tx slots; Frequency: 836.6 MHz; Duty Cycle: 1:2.076

Medium: 835 Body Medium parameters used (interpolated):

$f = 836.6 \text{ MHz}$; $\sigma = 1.007 \text{ S/m}$; $\epsilon_r = 55.874$; $\rho = 1000 \text{ kg/m}^3$

Phantom section: Flat Section; Space: 1.0 cm

Test Date: 06-18-2013; Ambient Temp: 24.6°C; Tissue Temp: 22.9°C

Probe: ES3DV3 - SN3209; ConvF(6.28, 6.28, 6.28); Calibrated: 3/15/2013;

Sensor-Surface: 4mm (Mechanical Surface Detection)

Electronics: DAE4 Sn1334; Calibrated: 3/8/2013

Phantom: ELI v5.0; Type: QDOVA002AA; Serial: TP-1158

Measurement SW: DASY52, Version 52.8 (7); SEMCAD X Version 14.6.10 (7164)

Mode: GPRS 850, Body SAR, Back side, Mid.ch, 4 Tx Slots

Area Scan (9x15x1): Measurement grid: dx=15mm, dy=15mm

Zoom Scan (6x5x7)/Cube 0: Measurement grid: dx=8mm, dy=8mm, dz=5mm

Reference Value = 29.624 V/m; Power Drift = 0.04 dB

Peak SAR (extrapolated) = 1.32 W/kg

SAR(1 g) = 0.868 W/kg; SAR(10 g) = 0.568 W/kg (SAR corrected for target medium)

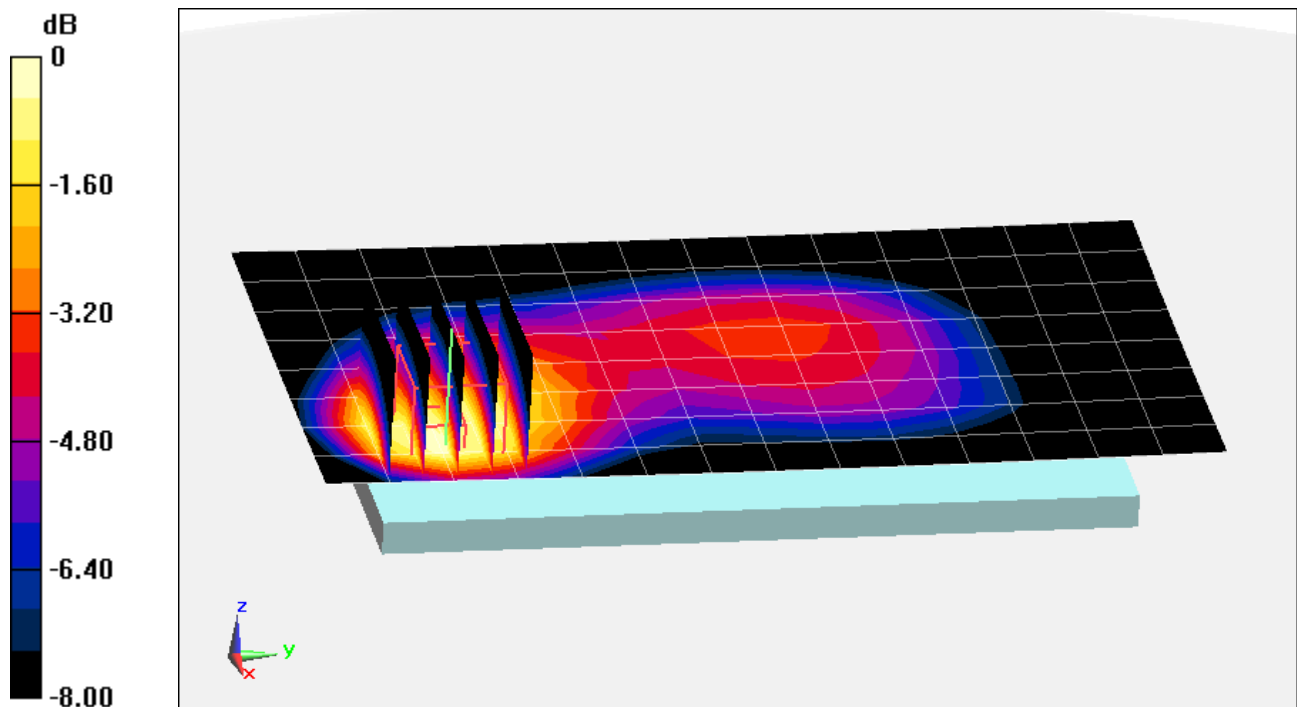

PCTEST ENGINEERING LABORATORY, INC.

DUT: PY7PM-0410; Type: Portable Handset; Serial: 7316

Communication System: UMTS; Frequency: 836.6 MHz; Duty Cycle: 1:1

Medium: 835 Body Medium parameters used (interpolated):

$f = 836.6 \text{ MHz}$; $\sigma = 1.007 \text{ S/m}$; $\epsilon_r = 55.874$; $\rho = 1000 \text{ kg/m}^3$

Phantom section: Flat Section; Space: 1.5 cm

Test Date: 06-18-2013; Ambient Temp: 24.6°C; Tissue Temp: 22.9°C

Probe: ES3DV3 - SN3209; ConvF(6.28, 6.28, 6.28); Calibrated: 3/15/2013;

Sensor-Surface: 4mm (Mechanical Surface Detection)

Electronics: DAE4 Sn1334; Calibrated: 3/8/2013

Phantom: ELI v5.0; Type: QDOVA002AA; Serial: TP-1158

Measurement SW: DASYS2, Version 52.8 (7); SEMCAD X Version 14.6.10 (7164)

Mode: UMTS 850, Body SAR, Back side, Mid.ch

Area Scan (9x15x1): Measurement grid: dx=15mm, dy=15mm

Zoom Scan (6x6x7)/Cube 0: Measurement grid: dx=8mm, dy=8mm, dz=5mm

Reference Value = 21.237 V/m; Power Drift = -0.03 dB

Peak SAR (extrapolated) = 0.629 W/kg

SAR(1 g) = 0.426 W/kg; SAR(10 g) = 0.286 W/kg (SAR corrected for target medium)

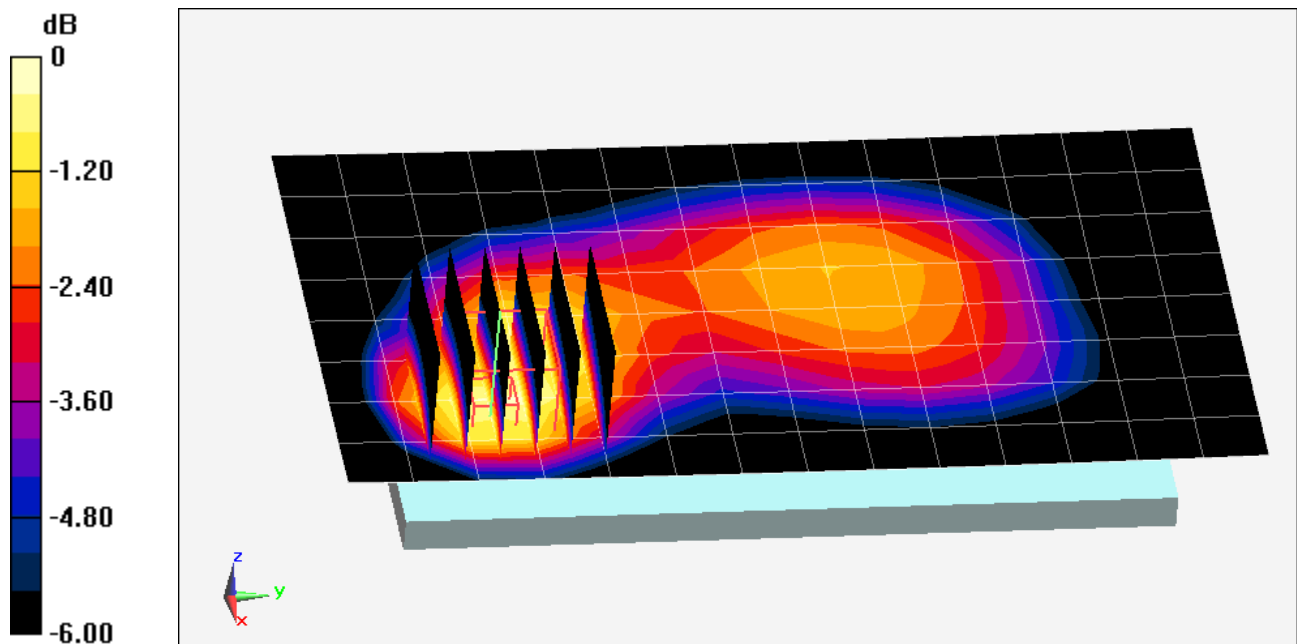

0 dB = 0.458 W/kg = -3.39 dBW/kg

PCTEST ENGINEERING LABORATORY, INC.

DUT: PY7PM-0410; Type: Portable Handset; Serial: 7316

Communication System: UMTS; Frequency: 846.6 MHz; Duty Cycle: 1:1

Medium: 835 Body Medium parameters used (interpolated):

$f = 846.6 \text{ MHz}$; $\sigma = 1.019 \text{ S/m}$; $\epsilon_r = 55.77$; $\rho = 1000 \text{ kg/m}^3$

Phantom section: Flat Section; Space: 1.0 cm

Test Date: 06-18-2013; Ambient Temp: 24.6°C; Tissue Temp: 22.9°C

Probe: ES3DV3 - SN3209; ConvF(6.28, 6.28, 6.28); Calibrated: 3/15/2013;

Sensor-Surface: 4mm (Mechanical Surface Detection)

Electronics: DAE4 Sn1334; Calibrated: 3/8/2013

Phantom: ELI v5.0; Type: QDOVA002AA; Serial: TP-1158

Measurement SW: DASYS2, Version 52.8 (7); SEMCAD X Version 14.6.10 (7164)

Mode: UMTS 850, Body SAR, Back side, High.ch

Area Scan (9x15x1): Measurement grid: dx=15mm, dy=15mm

Zoom Scan (5x6x7)/Cube 0: Measurement grid: dx=8mm, dy=8mm, dz=5mm

Reference Value = 28.308 V/m; Power Drift = -0.04 dB

Peak SAR (extrapolated) = 1.22 W/kg

SAR(1 g) = 0.779 W/kg; SAR(10 g) = 0.501 W/kg (SAR corrected for target medium)

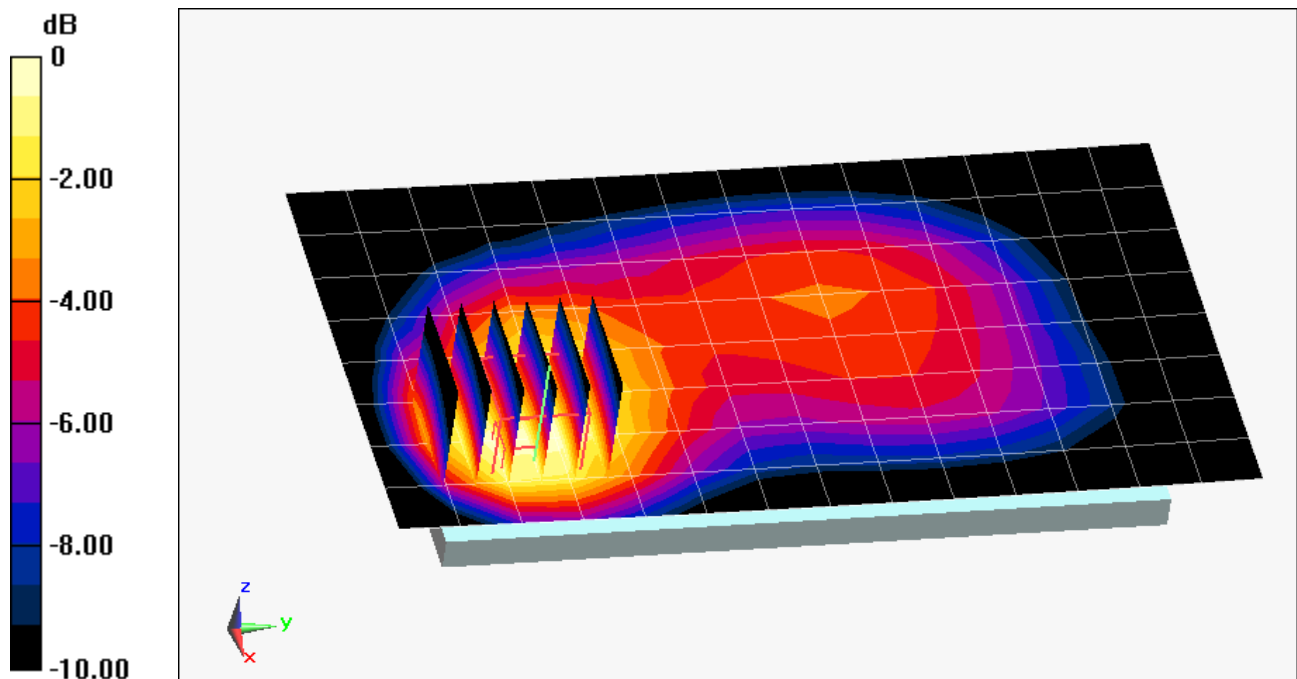

0 dB = 0.818 W/kg = -0.87 dBW/kg

PCTEST ENGINEERING LABORATORY, INC.

DUT: PY7PM-0410; Type: Portable Handset; Serial: 7320

Communication System: AWS WCDMA; Frequency: 1752.5 MHz; Duty Cycle: 1:1

Medium: 1750 Body Medium parameters used (interpolated):

$f = 1752.5 \text{ MHz}$; $\sigma = 1.456 \text{ S/m}$; $\epsilon_r = 51.944$; $\rho = 1000 \text{ kg/m}^3$

Phantom section: Flat Section; Space: 1.5 cm

Test Date: 06-17-2013; Ambient Temp: 23.8°C; Tissue Temp: 23.0°C

Probe: ES3DV3 - SN3287; ConvF(4.86, 4.86, 4.86); Calibrated: 11/15/2012;

Sensor-Surface: 4mm (Mechanical Surface Detection)

Electronics: DAE4 Sn1333; Calibrated: 11/13/2012

Phantom: SAM with CRP; Type: SAM 4.0; Serial: TP1375

Measurement SW: DASY4, Version 4.7 (80); SEMCAD X Version 14.6.10 (7164)

Mode: AWS UMTS, Body SAR, Back side, High.ch

Area Scan (9x16x1): Measurement grid: dx=15mm, dy=15mm

Zoom Scan (6x5x7)/Cube 0: Measurement grid: dx=8mm, dy=8mm, dz=5mm

Reference Value = 22.785 V/m; Power Drift = -0.16 dB

Peak SAR (extrapolated) = 1.10 W/kg

SAR(1 g) = 0.671 W/kg; SAR(10 g) = 0.379 W/kg (SAR corrected for target medium)

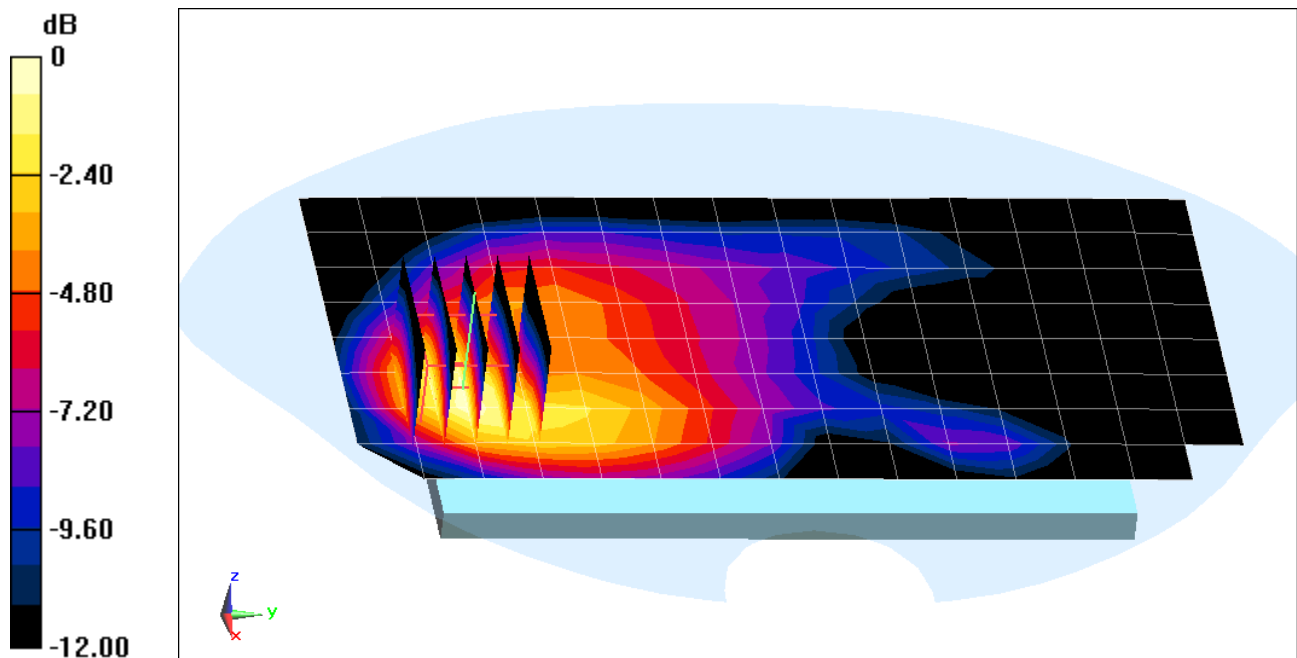

0 dB = 0.712 W/kg = -1.48 dBW/kg

PCTEST ENGINEERING LABORATORY, INC.

DUT: PY7PM-0410; Type: Portable Handset; Serial: 7320

Communication System: AWS WCDMA; Frequency: 1752.5 MHz; Duty Cycle: 1:1

Medium: 1750 Body Medium parameters used (interpolated):

$f = 1752.5$ MHz; $\sigma = 1.456$ S/m; $\epsilon_r = 51.944$; $\rho = 1000$ kg/m³

Phantom section: Flat Section; Space: 1.0 cm

Test Date: 06-17-2013; Ambient Temp: 23.8°C; Tissue Temp: 23.0°C

Probe: ES3DV3 - SN3287; ConvF(4.86, 4.86, 4.86); Calibrated: 11/15/2012;

Sensor-Surface: 4mm (Mechanical Surface Detection)

Electronics: DAE4 Sn1333; Calibrated: 11/13/2012

Phantom: SAM with CRP; Type: SAM 4.0; Serial: TP1375

Measurement SW: DASY4, Version 4.7 (80); SEMCAD X Version 14.6.10 (7164)

Mode: AWS UMTS, Body SAR, Back side, High.ch

Area Scan (9x16x1): Measurement grid: dx=15mm, dy=15mm

Zoom Scan (6x5x7)/Cube 0: Measurement grid: dx=8mm, dy=8mm, dz=5mm

Reference Value = 23.453 V/m; Power Drift = -0.02 dB

Peak SAR (extrapolated) = 1.39 W/kg

SAR(1 g) = 0.784 W/kg; SAR(10 g) = 0.405 W/kg (SAR corrected for target medium)

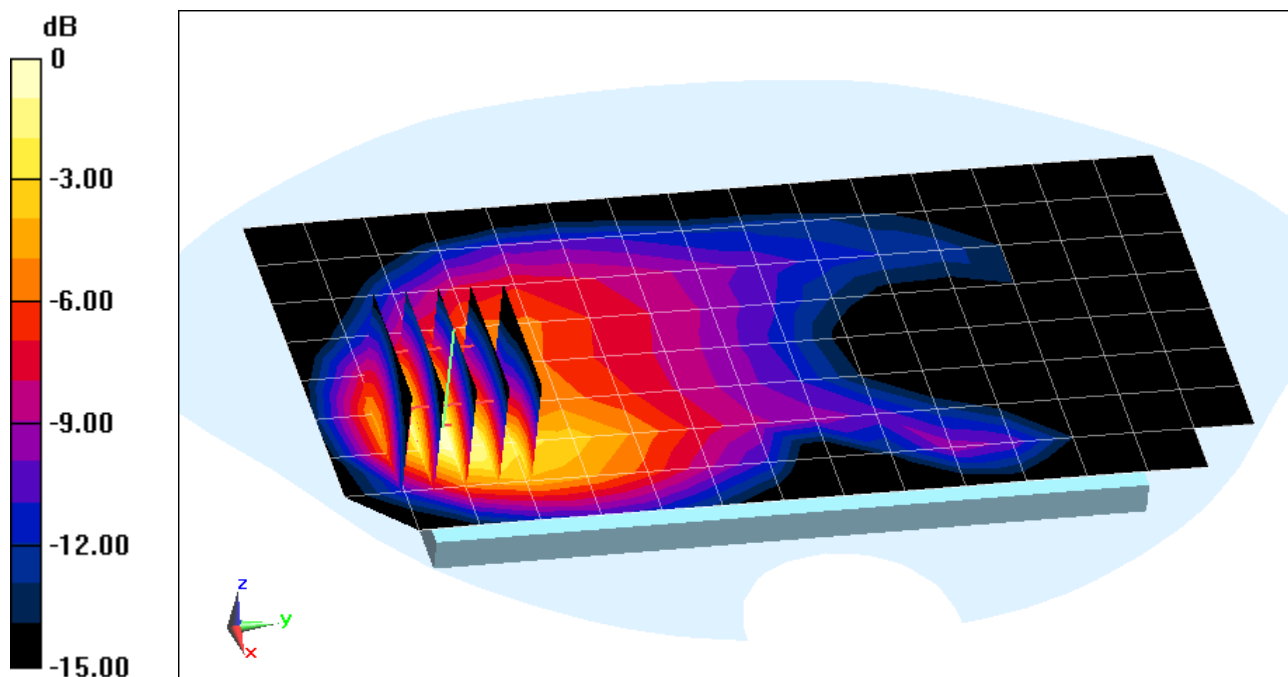

0 dB = 0.844 W/kg = -0.74 dBW/kg

PCTEST ENGINEERING LABORATORY, INC.

DUT: PY7PM-0410; Type: Portable Handset; Serial: 7319

Communication System: GSM; Frequency: 1909.8 MHz; Duty Cycle: 1:8.3

Medium: 1900 Body Medium parameters used:

$f = 1910 \text{ MHz}$; $\sigma = 1.546 \text{ S/m}$; $\epsilon_r = 52.086$; $\rho = 1000 \text{ kg/m}^3$

Phantom section: Flat Section; Space: 1.5 cm

Test Date: 06-17-2013; Ambient Temp: 23.6°C; Tissue Temp: 23.3°C

Probe: EX3DV4 - SN3920; ConvF(7.38, 7.38, 7.38); Calibrated: 2/27/2013;

Sensor-Surface: 4mm (Mechanical Surface Detection)

Electronics: DAE4 Sn649; Calibrated: 2/6/2013

Phantom: SAM 5.0 front; Type: QD000P40CD; Serial: TP:-1648

Measurement SW: DASY52, Version 52.8 (7); SEMCAD X Version 14.6.10 (7164)

Mode: GSM 1900, Body SAR, Back side, High.ch

Area Scan (9x15x1): Measurement grid: dx=15mm, dy=15mm

Zoom Scan (5x5x7)/Cube 0: Measurement grid: dx=8mm, dy=8mm, dz=5mm

Reference Value = 16.506 V/m; Power Drift = 0.03 dB

Peak SAR (extrapolated) = 0.656 W/kg

SAR(1 g) = 0.397 W/kg; SAR(10 g) = 0.218 W/kg (SAR corrected for target medium)

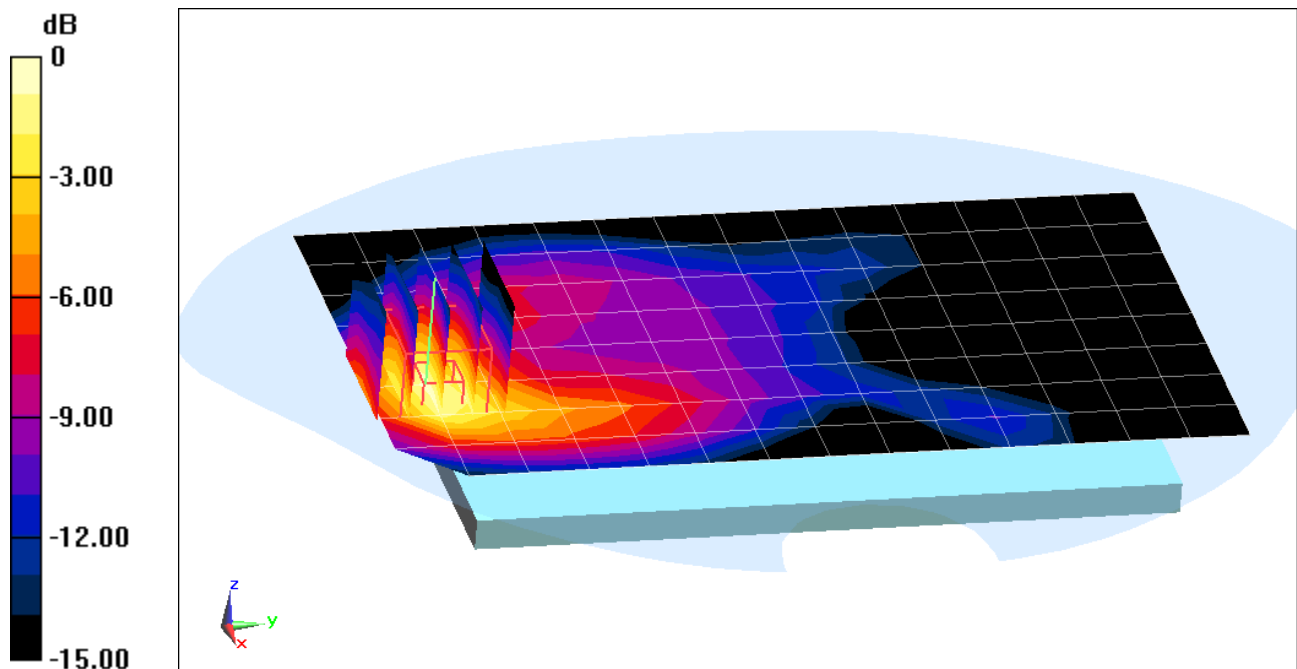

0 dB = 0.421 W/kg = -3.76 dBW/kg

PCTEST ENGINEERING LABORATORY, INC.

DUT: PY7PM-0410; Type: Portable Handset; Serial: 7481

Communication System: GSM GPRS; 4 Tx slots; Frequency: 1909.8 MHz; Duty Cycle: 1:2.076

Medium: 1900 Body Medium parameters used:

$f = 1910 \text{ MHz}$; $\sigma = 1.546 \text{ S/m}$; $\epsilon_r = 52.086$; $\rho = 1000 \text{ kg/m}^3$

Phantom section: Flat Section; Space: 1.0 cm

Test Date: 06-17-2013; Ambient Temp: 23.6°C; Tissue Temp: 23.3°C

Probe: EX3DV4 - SN3920; ConvF(7.38, 7.38, 7.38); Calibrated: 2/27/2013;

Sensor-Surface: 4mm (Mechanical Surface Detection)

Electronics: DAE4 Sn649; Calibrated: 2/6/2013

Phantom: SAM 5.0 front; Type: QD000P40CD; Serial: TP:-1648

Measurement SW: DASYS2, Version 52.8 (7); SEMCAD X Version 14.6.10 (7164)

Mode: GPRS 1900, Body SAR, Back side, High.ch, 4 Tx Slots

Area Scan (9x15x1): Measurement grid: dx=15mm, dy=15mm

Zoom Scan (5x5x7)/Cube 0: Measurement grid: dx=8mm, dy=8mm, dz=5mm

Reference Value = 21.308 V/m; Power Drift = -0.07 dB

Peak SAR (extrapolated) = 1.19 W/kg

SAR(1 g) = 0.669 W/kg; SAR(10 g) = 0.334 W/kg (SAR corrected for target medium)

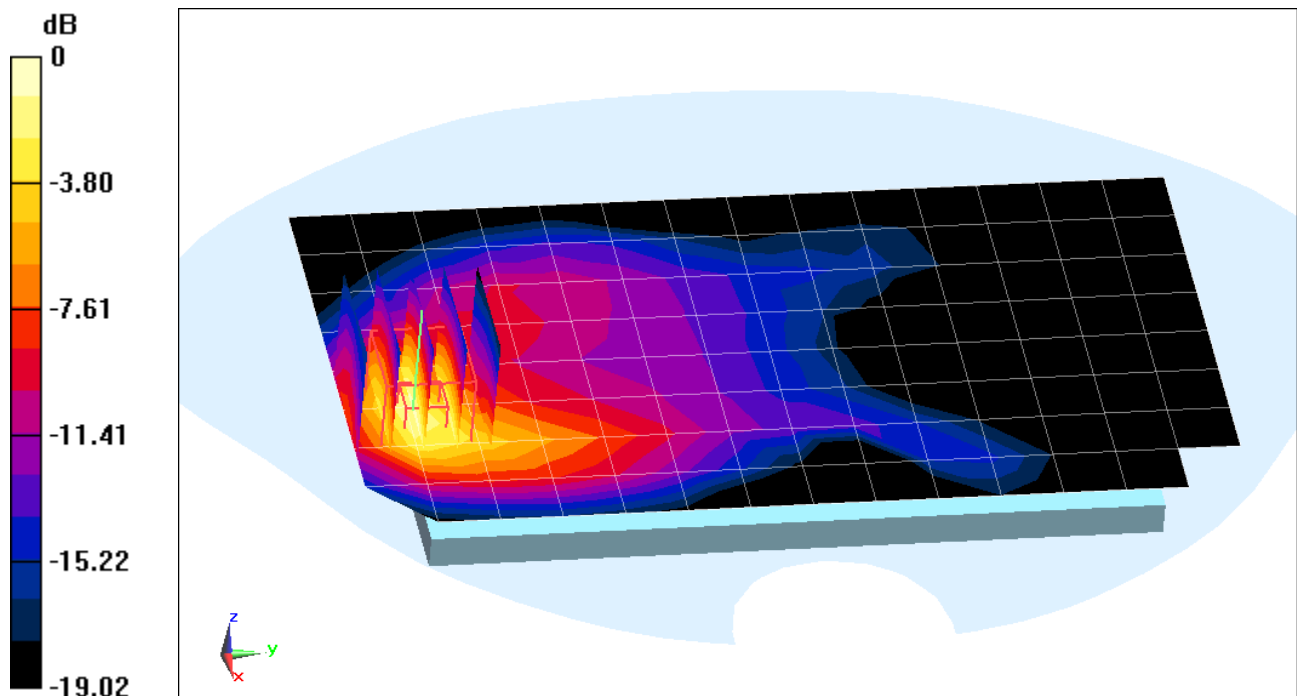

0 dB = 0.750 W/kg = -1.25 dBW/kg

PCTEST ENGINEERING LABORATORY, INC.

DUT: PY7PM-0410; Type: Portable Handset; Serial: 7316

Communication System: UMTS; Frequency: 1852.4 MHz; Duty Cycle: 1:1

Medium: 1900 Body Medium parameters used: (interpolated):

$f = 1852.4 \text{ MHz}$; $\sigma = 1.468 \text{ S/m}$; $\epsilon_r = 52.375$; $\rho = 1000 \text{ kg/m}^3$

Phantom section: Flat Section; Space: 1.5 cm

Test Date: 06-17-2013; Ambient Temp: 23.6°C; Tissue Temp: 23.3°C

Probe: EX3DV4 - SN3920; ConvF(7.38, 7.38, 7.38); Calibrated: 2/27/2013;

Sensor-Surface: 4mm (Mechanical Surface Detection)

Electronics: DAE4 Sn649; Calibrated: 2/6/2013

Phantom: SAM 5.0 front; Type: QD000P40CD; Serial: TP:-1648

Measurement SW: DASY52, Version 52.8 (7); SEMCAD X Version 14.6.10 (7164)

Mode: UMTS 1900, Body SAR, Back side, Low.ch

Area Scan (9x15x1): Measurement grid: dx=15mm, dy=15mm

Zoom Scan (5x5x7)/Cube 0: Measurement grid: dx=8mm, dy=8mm, dz=5mm

Reference Value = 23.629 V/m; Power Drift = 0.00 dB

Peak SAR (extrapolated) = 1.27 W/kg

SAR(1 g) = 0.788 W/kg; SAR(10 g) = 0.437 W/kg (SAR corrected for target medium)

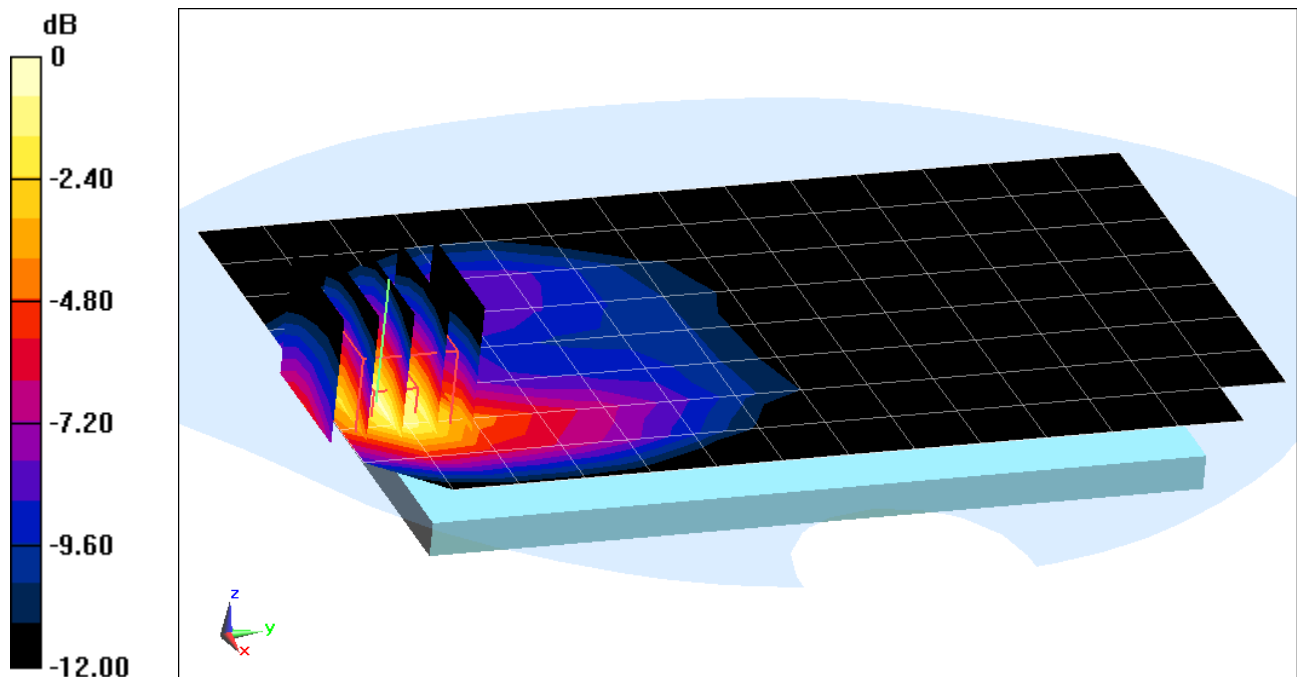

0 dB = 0.844 W/kg = -0.74 dBW/kg

PCTEST ENGINEERING LABORATORY, INC.

DUT: PY7PM-0410; Type: Portable Handset; Serial: 7320

Communication System: UMTS1900; Frequency: 1907.6 MHz; Duty Cycle: 1:1

Medium: 1900 Body Medium parameters used (interpolated):

$f = 1907.6 \text{ MHz}$; $\sigma = 1.582 \text{ S/m}$; $\epsilon_r = 52.97$; $\rho = 1000 \text{ kg/m}^3$

Phantom section: Flat Section; Space: 1.0 cm

Test Date: 07-11-2013; Ambient Temp: 23.1°C; Tissue Temp: 22.9°C

Probe: ES3DV3 - SN3287; ConvF(4.69, 4.69, 4.69); Calibrated: 11/15/2012;

Sensor-Surface: 4mm (Mechanical Surface Detection)

Electronics: DAE4 Sn1333; Calibrated: 11/13/2012

Phantom: SAM Sub Dasy B; Type: SAM 5.0; Serial: TP-1626

Measurement SW: DASY4, Version 4.7 (80); SEMCAD X Version 14.6.10 (7164)

Mode: UMTS 1900, Body SAR, Back side, High.ch

Area Scan (9x15x1): Measurement grid: dx=15mm, dy=15mm

Zoom Scan (5x5x7)/Cube 0: Measurement grid: dx=8mm, dy=8mm, dz=5mm

Reference Value = 23.575 V/m; Power Drift = -0.02 dB

Peak SAR (extrapolated) = 1.48 W/kg

SAR(1 g) = 0.826 W/kg; SAR(10 g) = 0.422 W/kg (SAR corrected for target medium)

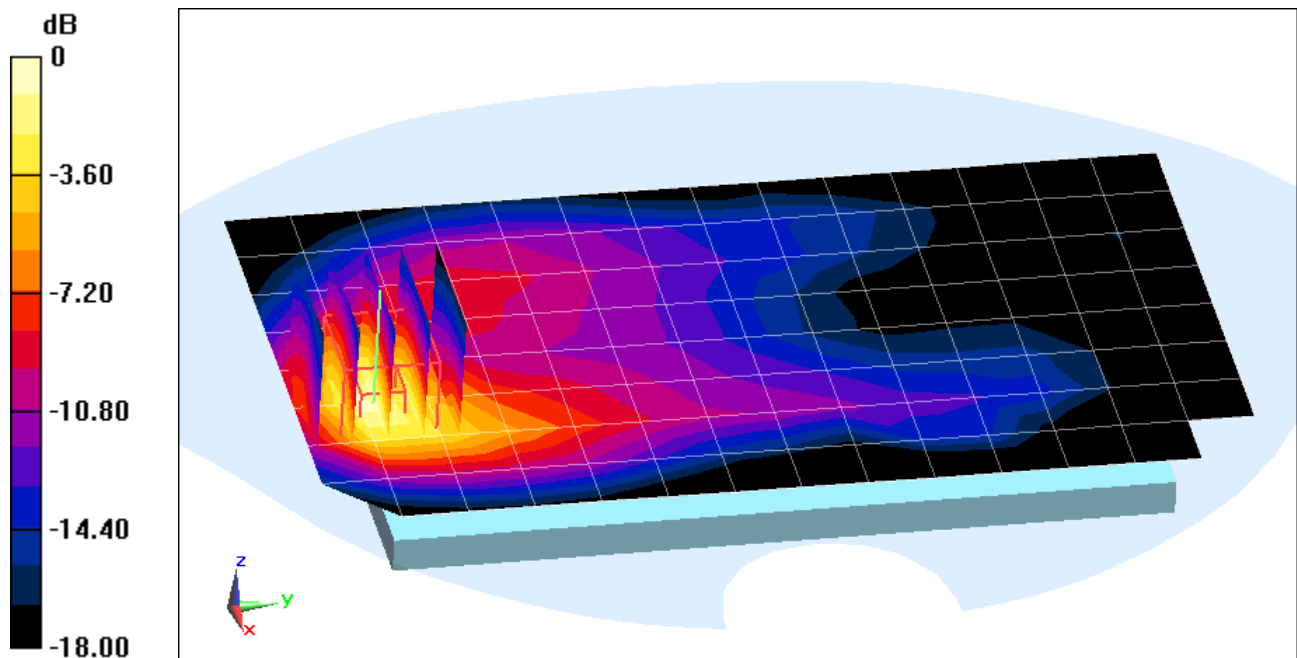

0 dB = 0.944 W/kg = -0.25 dBW/kg

PCTEST ENGINEERING LABORATORY, INC.

DUT: PY7PM-0410; Type: Portable Handset; Serial: 7483

Communication System: LTE Band 5 (Cell.); Frequency: 836.5 MHz; Duty Cycle: 1:1

Medium: 835 Body Medium parameters used (interpolated):

$f = 836.5 \text{ MHz}$; $\sigma = 1.007 \text{ S/m}$; $\epsilon_r = 55.744$; $\rho = 1000 \text{ kg/m}^3$

Phantom section: Flat Section; Space: 1.5 cm

Test Date: 06-21-2013; Ambient Temp: 24.3°C; Tissue Temp: 22.4°C

Probe: ES3DV3 - SN3209; ConvF(6.28, 6.28, 6.28); Calibrated: 3/15/2013;

Sensor-Surface: 4mm (Mechanical Surface Detection)

Electronics: DAE4 Sn1334; Calibrated: 3/8/2013

Phantom: ELI v5.0; Type: QDOVA002AA; Serial: TP-1158

Measurement SW: DASY52, Version 52.8 (7); SEMCAD X Version 14.6.10 (7164)

Mode: LTE Band 5 (Cell.), Body SAR, Back side, Mid.ch
10 MHz Bandwidth, QPSK, 1 RB, RB Offset 49

Area Scan (9x15x1): Measurement grid: dx=15mm, dy=15mm

Zoom Scan (6x6x7)/Cube 0: Measurement grid: dx=8mm, dy=8mm, dz=5mm

Reference Value = 18.332 V/m; Power Drift = 0.01 dB

Peak SAR (extrapolated) = 0.452 W/kg

SAR(1 g) = 0.308 W/kg; SAR(10 g) = 0.208 W/kg (SAR corrected for target medium)

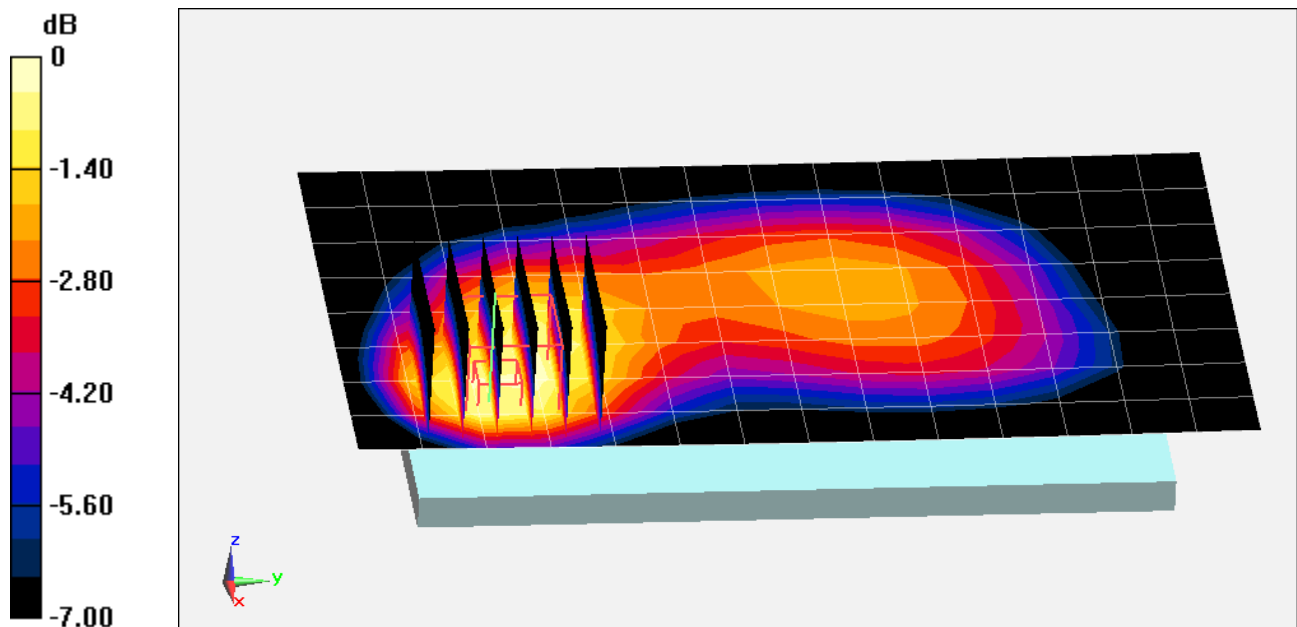

PCTEST ENGINEERING LABORATORY, INC.

DUT: PY7PM-0410; Type: Portable Handset; Serial: 7483

Communication System: LTE Band 5 (Cell.); Frequency: 836.5 MHz; Duty Cycle: 1:1

Medium: 835 Body Medium parameters used (interpolated):

$f = 836.5 \text{ MHz}$; $\sigma = 1.007 \text{ S/m}$; $\epsilon_r = 55.744$; $\rho = 1000 \text{ kg/m}^3$

Phantom section: Flat Section; Space: 1.0 cm

Test Date: 06-21-2013; Ambient Temp: 24.3°C; Tissue Temp: 22.4°C

Probe: ES3DV3 - SN3209; ConvF(6.28, 6.28, 6.28); Calibrated: 3/15/2013;

Sensor-Surface: 4mm (Mechanical Surface Detection)

Electronics: DAE4 Sn1334; Calibrated: 3/8/2013

Phantom: ELI v5.0; Type: QDOVA002AA; Serial: TP-1158

Measurement SW: DASY52, Version 52.8 (7); SEMCAD X Version 14.6.10 (7164)

Mode: LTE Band 5 (Cell.), Body SAR, Back side, Mid.ch

10 MHz Bandwidth, QPSK, 1 RB, RB Offset 49

Area Scan (9x15x1): Measurement grid: dx=15mm, dy=15mm

Zoom Scan (5x5x7)/Cube 0: Measurement grid: dx=8mm, dy=8mm, dz=5mm

Reference Value = 24.252 V/m; Power Drift = -0.01 dB

Peak SAR (extrapolated) = 0.831 W/kg

SAR(1 g) = 0.534 W/kg; SAR(10 g) = 0.347 W/kg (SAR corrected for target medium)

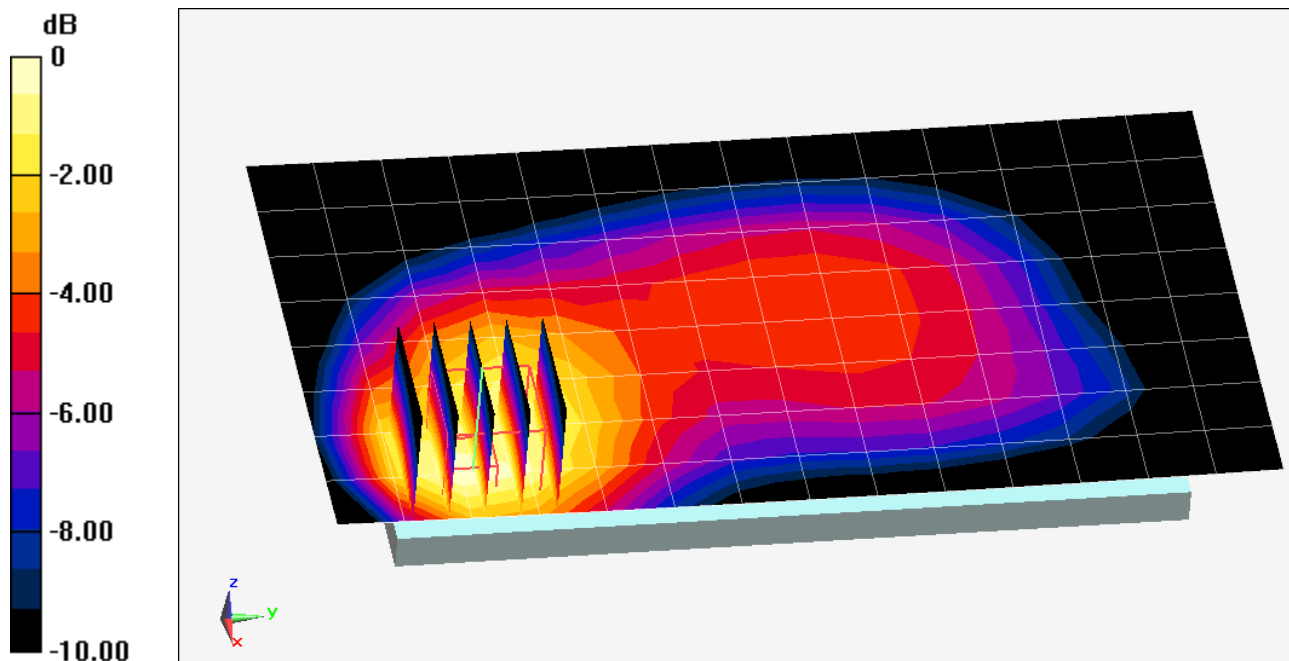

0 dB = 0.572 W/kg = -2.43 dBW/kg

PCTEST ENGINEERING LABORATORY, INC.

DUT: PY7PM-0410; Type: Portable Handset; Serial: 7317

Communication System: LTE RF; Frequency: 1732.5 MHz; Duty Cycle: 1:1

Medium: 1750 Body Medium parameters used (interpolated):

$f = 1732.5 \text{ MHz}$; $\sigma = 1.509 \text{ S/m}$; $\epsilon_r = 51.649$; $\rho = 1000 \text{ kg/m}^3$

Phantom section: Flat Section; Space: 1.5 cm

Test Date: 06-20-2013; Ambient Temp: 23.0°C; Tissue Temp: 22.1°C

Probe: ES3DV3 - SN3287; ConvF(4.86, 4.86, 4.86); Calibrated: 11/15/2012;

Sensor-Surface: 4mm (Mechanical Surface Detection)

Electronics: DAE4 Sn1333; Calibrated: 11/13/2012

Phantom: SAM with CRP; Type: SAM 4.0; Serial: TP1375

Measurement SW: DASY4, Version 4.7 (80); SEMCAD X Version 14.6.10 (7164)

Mode: LTE Band 4 (AWS), Body SAR, Back side, Mid.ch
20 MHz Bandwidth, QPSK, 1 RB, RB Offset 50

Area Scan (9x15x1): Measurement grid: dx=15mm, dy=15mm

Zoom Scan (5x5x7)/Cube 0: Measurement grid: dx=8mm, dy=8mm, dz=5mm

Reference Value = 20.979 V/m; Power Drift = 0.05 dB

Peak SAR (extrapolated) = 0.960 W/kg

SAR(1 g) = 0.592 W/kg; SAR(10 g) = 0.337 W/kg (SAR corrected for target medium)

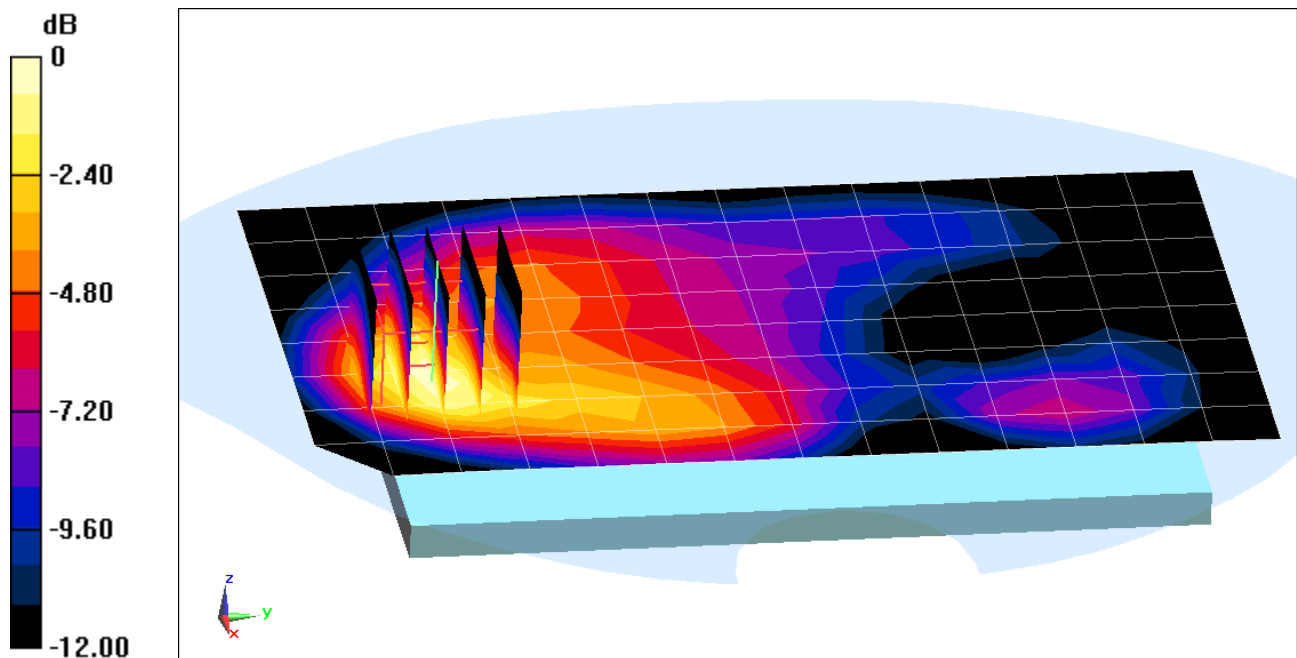

0 dB = 0.644 W/kg = -1.91 dBW/kg

PCTEST ENGINEERING LABORATORY, INC.

DUT: PY7PM-0410; Type: Portable Handset; Serial: 7317

Communication System: LTE RF; Frequency: 1732.5 MHz; Duty Cycle: 1:1

Medium: 1750 Body Medium parameters used (interpolated):

$f = 1732.5$ MHz; $\sigma = 1.509$ S/m; $\epsilon_r = 51.649$; $\rho = 1000$ kg/m³

Phantom section: Flat Section; Space: 1.0 cm

Test Date: 06-20-2013; Ambient Temp: 23.0°C; Tissue Temp: 22.1°C

Probe: ES3DV3 - SN3287; ConvF(4.86, 4.86, 4.86); Calibrated: 11/15/2012;

Sensor-Surface: 4mm (Mechanical Surface Detection)

Electronics: DAE4 Sn1333; Calibrated: 11/13/2012

Phantom: SAM with CRP; Type: SAM 4.0; Serial: TP1375

Measurement SW: DASY4, Version 4.7 (80); SEMCAD X Version 14.6.10 (7164)

Mode: LTE Band 4 (AWS), Body SAR, Back side, Mid.ch
20 MHz Bandwidth, QPSK, 1 RB, RB Offset 50

Area Scan (9x15x1): Measurement grid: dx=15mm, dy=15mm

Zoom Scan (5x5x7)/Cube 0: Measurement grid: dx=8mm, dy=8mm, dz=5mm

Reference Value = 23.596 V/m; Power Drift = -0.04 dB

Peak SAR (extrapolated) = 1.32 W/kg

SAR(1 g) = 0.752 W/kg; SAR(10 g) = 0.396 W/kg (SAR corrected for target medium)

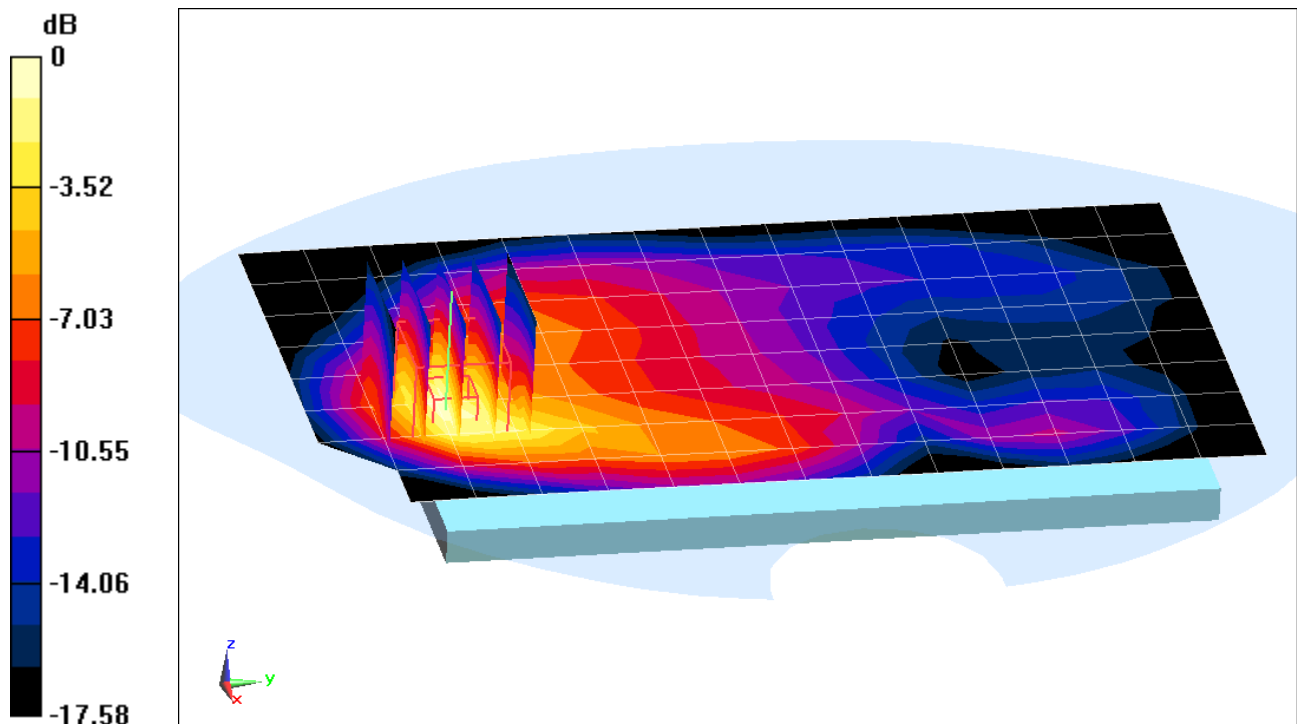

0 dB = 0.857 W/kg = -0.67 dBW/kg

PCTEST ENGINEERING LABORATORY, INC.

DUT: PY7PM-0410; Type: Portable Handset; Serial: 7317

Communication System: LTE PCS 20 Mhz; Frequency: 1860 MHz; Duty Cycle: 1:1

Medium: 1900 Body Medium parameters used (interpolated):

$f = 1860 \text{ MHz}$; $\sigma = 1.458 \text{ S/m}$; $\epsilon_r = 53.142$; $\rho = 1000 \text{ kg/m}^3$

Phantom section: Flat Section; Space: 1.5 cm

Test Date: 06-25-2013; Ambient Temp: 23.2°C; Tissue Temp: 23.6°C

Probe: ES3DV2 - SN3022; ConvF(4.43, 4.43, 4.43); Calibrated: 8/28/2012;

Sensor-Surface: 4mm (Mechanical Surface Detection)

Electronics: DAE4 Sn1322; Calibrated: 8/24/2012

Phantom: SAM Sub; Type: SAM 4.0; Serial: TP-1357

Measurement SW: DASY4, Version 4.7 (80); SEMCAD X Version 14.6.10 (7164)

Mode: LTE Band 2 (PCS), Body SAR, Back side, Low.ch
20 MHz Bandwidth, QPSK, 1 RB, RB Offset 0

Area Scan (9x15x1): Measurement grid: dx=15mm, dy=15mm

Zoom Scan (5x5x7)/Cube 0: Measurement grid: dx=8mm, dy=8mm, dz=5mm

Reference Value = 23.927 V/m; Power Drift = 0.02 dB

Peak SAR (extrapolated) = 1.36 W/kg

SAR(1 g) = 0.832 W/kg; SAR(10 g) = 0.444 W/kg (SAR corrected for target medium)

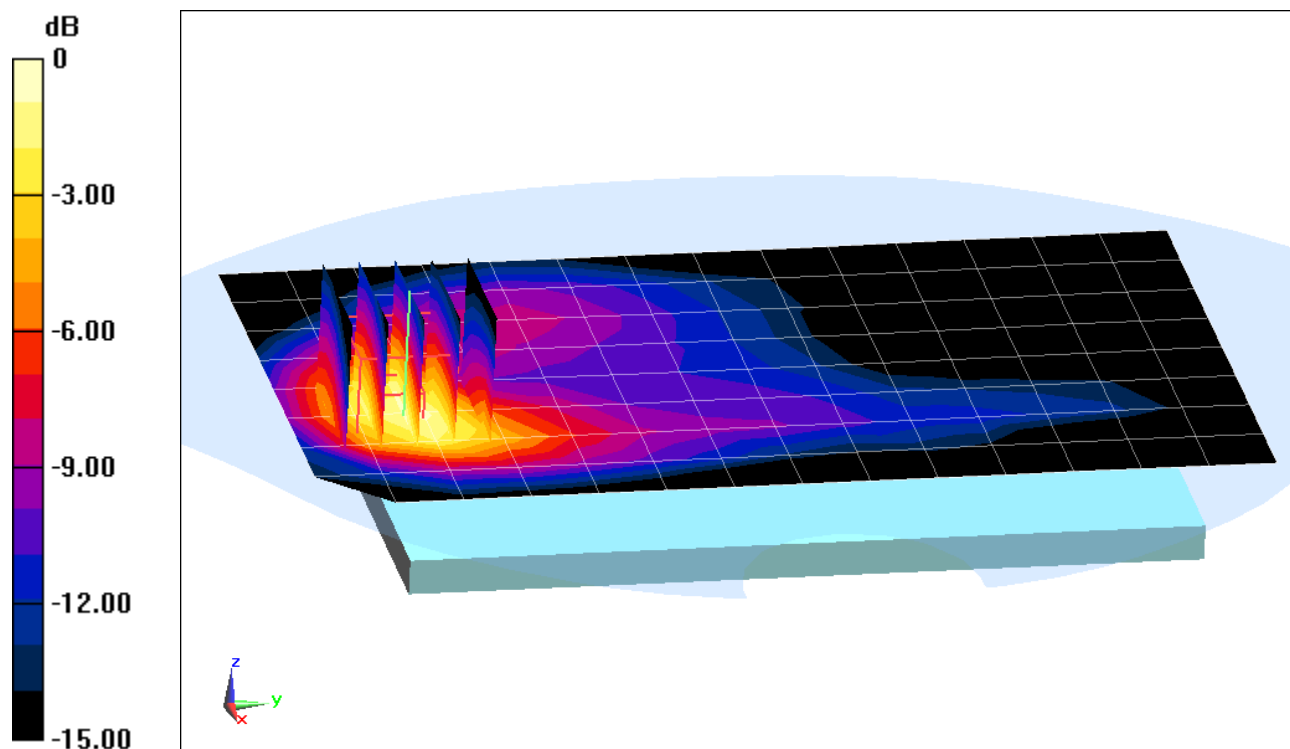

0 dB = 0.889 W/kg = -0.51 dBW/kg

PCTEST ENGINEERING LABORATORY, INC.

DUT: PY7PM-0410; Type: Portable Handset; Serial: 7317

Communication System: LTE PCS20 Mhz; Frequency: 1860 MHz; Duty Cycle: 1:1

Medium: 1900 Body Medium parameters used (interpolated):

$f = 1860 \text{ MHz}$; $\sigma = 1.458 \text{ S/m}$; $\epsilon_r = 53.142$; $\rho = 1000 \text{ kg/m}^3$

Phantom section: Flat Section; Space: 1.0 cm

Test Date: 06-25-2013; Ambient Temp: 23.2°C; Tissue Temp: 23.6°C

Probe: ES3DV2 - SN3022; ConvF(4.43, 4.43, 4.43); Calibrated: 8/28/2012;

Sensor-Surface: 4mm (Mechanical Surface Detection)

Electronics: DAE4 Sn1322; Calibrated: 8/24/2012

Phantom: SAM Sub; Type: SAM 4.0; Serial: TP-1357

Measurement SW: DASY4, Version 4.7 (80); SEMCAD X Version 14.6.10 (7164)

Mode: LTE Band 2 (PCS), Body SAR, Back side, Low.ch
20 MHz Bandwidth, QPSK, 1 RB, RB Offset 0

Area Scan (9x15x1): Measurement grid: dx=15mm, dy=15mm

Zoom Scan (5x5x7)/Cube 0: Measurement grid: dx=8mm, dy=8mm, dz=5mm

Reference Value = 21.337 V/m; Power Drift = 0.01 dB

Peak SAR (extrapolated) = 1.43 W/kg

SAR(1 g) = 0.831 W/kg; SAR(10 g) = 0.418 W/kg (SAR corrected for target medium)

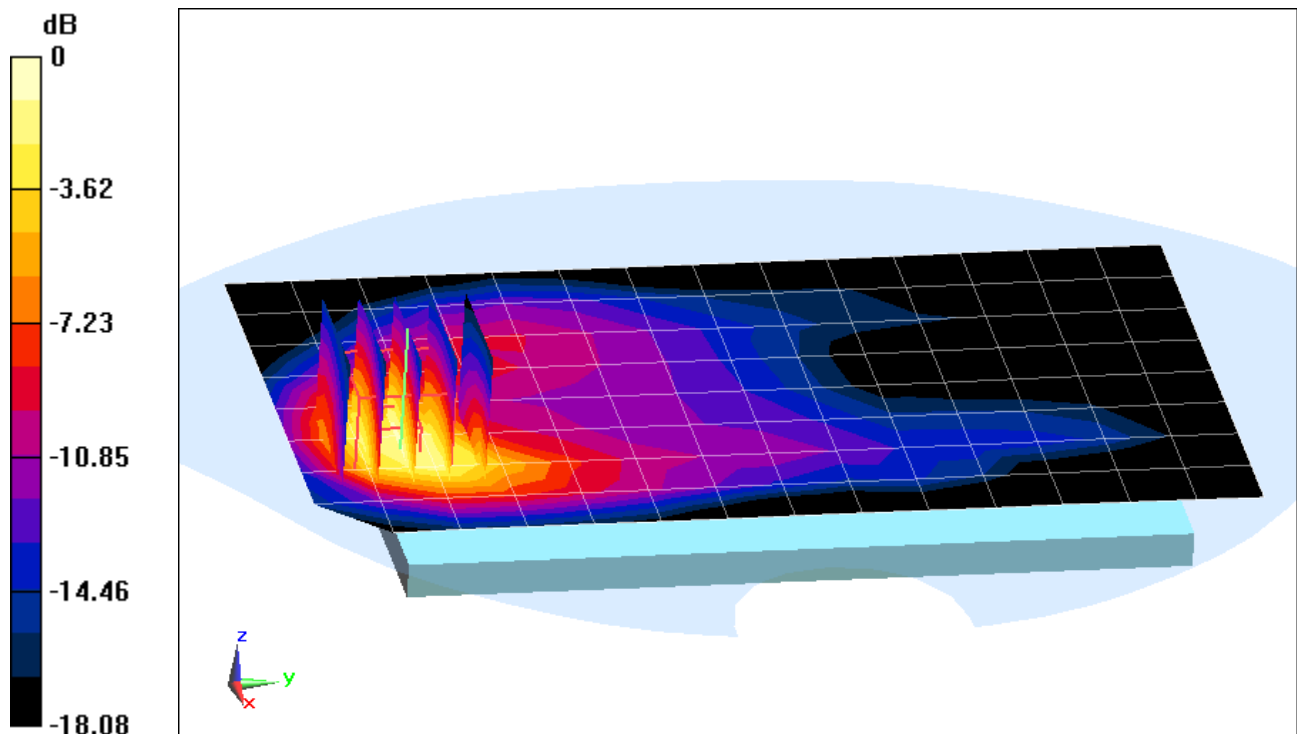

0 dB = 0.915 W/kg = -0.39 dBW/kg

PCTEST ENGINEERING LABORATORY, INC.

DUT: PY7PM-0410; Type: Portable Handset; Serial: 8711

Communication System: LTE BAND 7; Frequency: 2535 MHz; Duty Cycle: 1:1

Medium: 2600 Body Medium parameters used (interpolated):

$$f = 2535 \text{ MHz}; \sigma = 2.15 \text{ S/m}; \epsilon_r = 52.318; \rho = 1000 \text{ kg/m}^3$$

Phantom section: Flat Section; Space: 1.5 cm

Test Date: 07-22-2013; Ambient Temp: 23.0°C; Tissue Temp: 22.6°C

Probe: ES3DV2 - SN3022; ConvF(3.8, 3.8, 3.8); Calibrated: 8/28/2012;

Sensor-Surface: 3mm (Mechanical Surface Detection)

Electronics: DAE4 Sn1322; Calibrated: 8/24/2012

Phantom: SAM Sub; Type: SAM 4.0; Serial: TP-1357

Measurement SW: DASY4, Version 4.7 (80); SEMCAD X Version 14.6.10 (7164)

Mode: LTE Band 7, Body SAR, Back side, Mid.ch

20 MHz Bandwidth, QPSK, 1 RB, RB Offset 50

Area Scan (11x17x1): Measurement grid: dx=12mm, dy=12mm

Zoom Scan (9x9x7)/Cube 0: Measurement grid: dx=5mm, dy=5mm, dz=5mm

Reference Value = 12.766 V/m; Power Drift = 0.09 dB

Peak SAR (extrapolated) = 0.704 W/kg

SAR(1 g) = 0.327 W/kg; SAR(10 g) = 0.155 W/kg (SAR corrected for target medium)

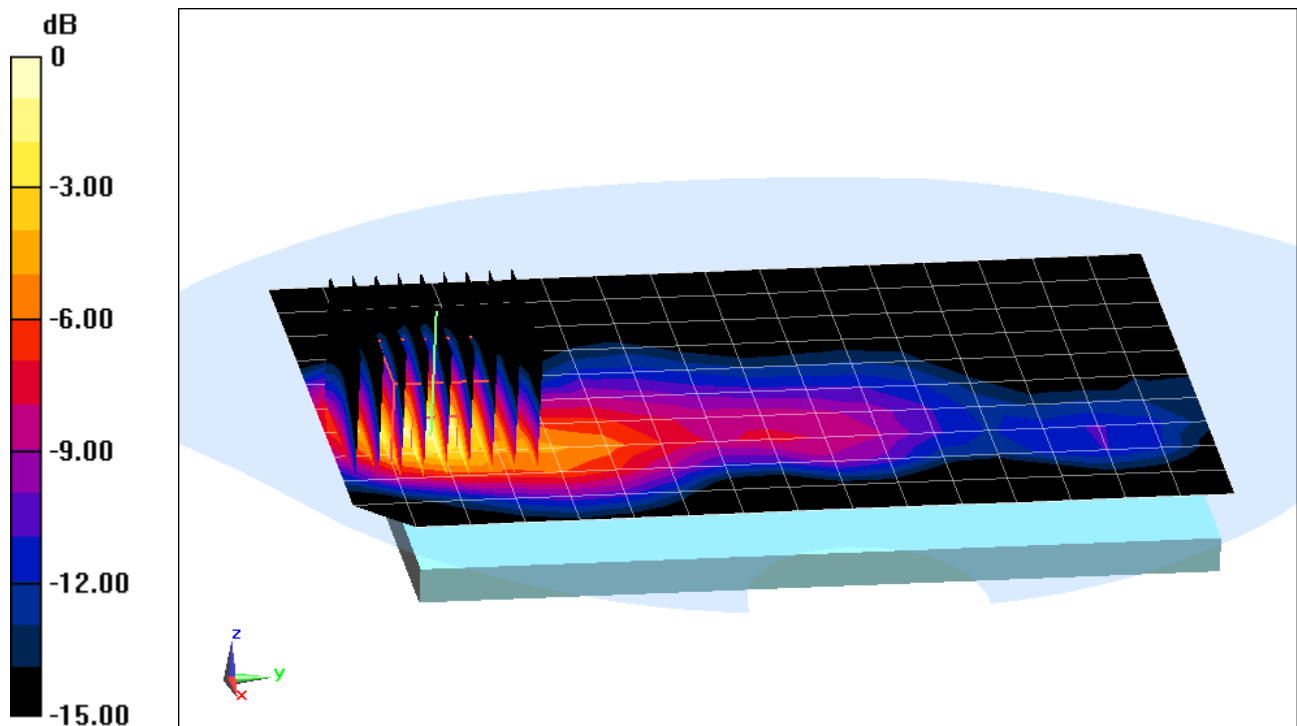

0 dB = 0.417 W/kg = -3.80 dBW/kg

PCTEST ENGINEERING LABORATORY, INC.

DUT: PY7PM-0410; Type: Portable Handset; Serial: 8711

Communication System: LTE BAND 7; Frequency: 2535 MHz; Duty Cycle: 1:1

Medium: 2600 Body Medium parameters used (interpolated):

$$f = 2535 \text{ MHz}; \sigma = 2.15 \text{ S/m}; \epsilon_r = 52.318; \rho = 1000 \text{ kg/m}^3$$

Phantom section: Flat Section; Space: 1.0 cm

Test Date: 07-22-2013; Ambient Temp: 23.0°C; Tissue Temp: 22.6°C

Probe: ES3DV2 - SN3022; ConvF(3.8, 3.8, 3.8); Calibrated: 8/28/2012;

Sensor-Surface: 3mm (Mechanical Surface Detection)

Electronics: DAE4 Sn1322; Calibrated: 8/24/2012

Phantom: SAM Sub; Type: SAM 4.0; Serial: TP-1357

Measurement SW: DASY4, Version 4.7 (80); SEMCAD X Version 14.6.10 (7164)

Mode: LTE Band 7, Body SAR, Back side, Mid.ch

20 MHz Bandwidth, QPSK, 1 RB, RB Offset 99

Area Scan (11x18x1): Measurement grid: dx=12mm, dy=12mm

Zoom Scan (9x9x7)/Cube 0: Measurement grid: dx=5mm, dy=5mm, dz=5mm

Reference Value = 17.421 V/m; Power Drift = 0.10 dB

Peak SAR (extrapolated) = 1.85 W/kg

SAR(1 g) = 0.761 W/kg; SAR(10 g) = 0.326 W/kg (SAR corrected for target medium)

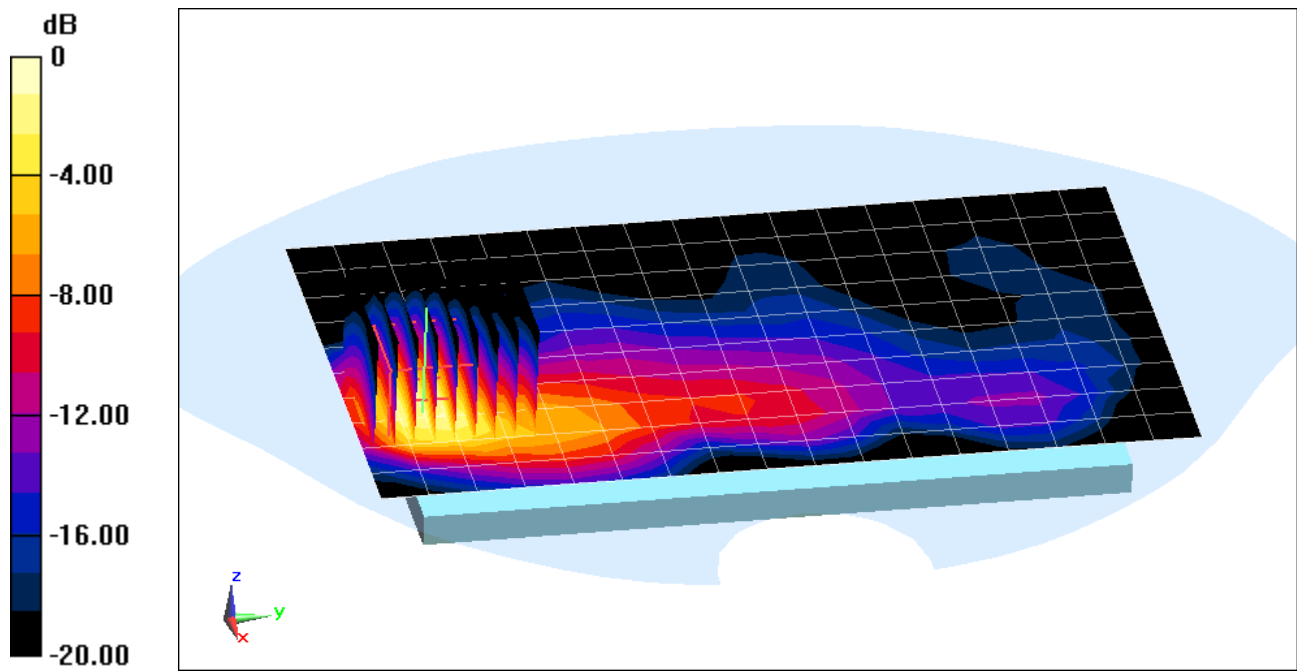

0 dB = 1.02 W/kg = 0.09 dBW/kg

PCTEST ENGINEERING LABORATORY, INC.

DUT: PY7PM-0410; Type: Portable Handset; Serial: 6717

Communication System: IEEE 802.11b; Frequency: 2437 MHz; Duty Cycle: 1:1

Medium: 2450 Body Medium parameters used (interpolated):

$f = 2437 \text{ MHz}$; $\sigma = 2.027 \text{ S/m}$; $\epsilon_r = 50.263$; $\rho = 1000 \text{ kg/m}^3$

Phantom section: Flat Section; Space: 1.5 cm

Test Date: 06-18-2013; Ambient Temp: 22.9°C; Tissue Temp: 22.7°C

Probe: ES3DV2 - SN3022; ConvF(3.97, 3.97, 3.97); Calibrated: 8/28/2012;

Sensor-Surface: 3mm (Mechanical Surface Detection)

Electronics: DAE4 Sn1322; Calibrated: 8/24/2012

Phantom: SAM Sub; Type: SAM 4.0; Serial: TP-1357

Measurement SW: DASY4, Version 4.7 (80); SEMCAD X Version 14.6.10 (7164)

Mode: IEEE 802.11b, Body SAR, Ch 06, 1 Mbps, Front Side

Area Scan (11x19x1): Measurement grid: dx=12mm, dy=12mm

Zoom Scan (7x7x7)/Cube 0: Measurement grid: dx=5mm, dy=5mm, dz=5mm

Reference Value = 7.724 V/m; Power Drift = 0.03 dB

Peak SAR (extrapolated) = 0.254 W/kg

SAR(1 g) = 0.125 W/kg; SAR(10 g) = 0.062 W/kg (SAR corrected for target medium)

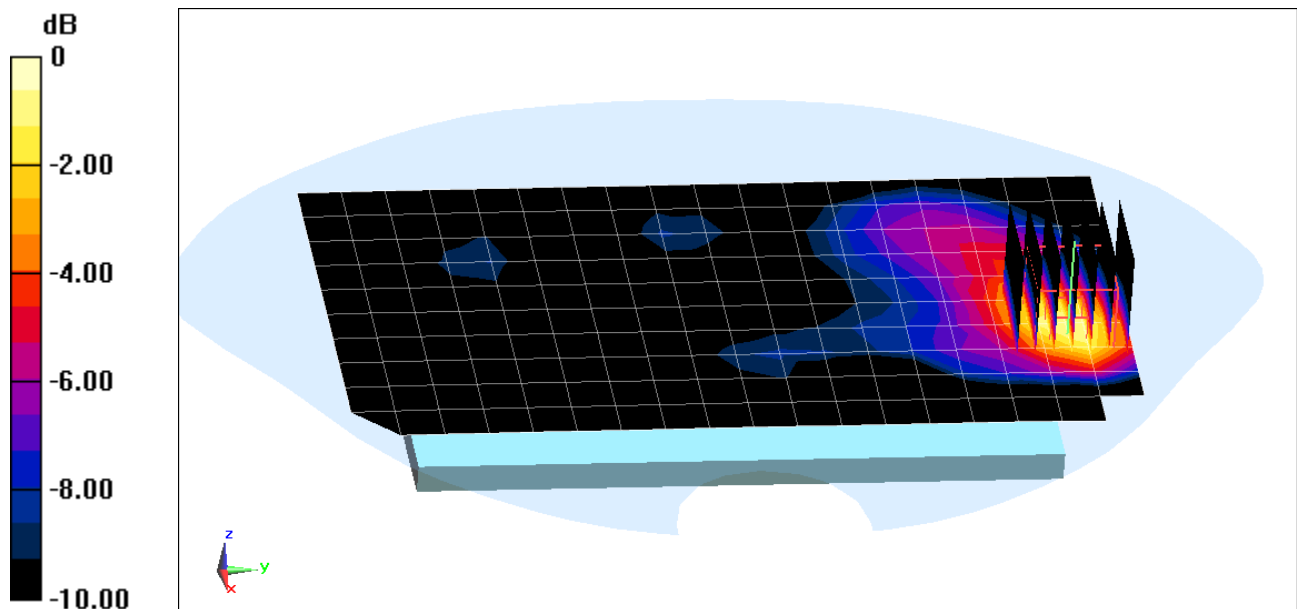

PCTEST ENGINEERING LABORATORY, INC.

DUT: PY7PM-0410; Type: Portable Handset; Serial: 6717

Communication System: IEEE 802.11b; Frequency: 2437 MHz; Duty Cycle: 1:1

Medium: 2450 Body Medium parameters used (interpolated):

$f = 2437 \text{ MHz}$; $\sigma = 2.027 \text{ S/m}$; $\epsilon_r = 50.263$; $\rho = 1000 \text{ kg/m}^3$

Phantom section: Flat Section; Space: 1.0 cm

Test Date: 06-18-2013; Ambient Temp: 22.9°C; Tissue Temp: 22.7°C

Probe: ES3DV2 - SN3022; ConvF(3.97, 3.97, 3.97); Calibrated: 8/28/2012;

Sensor-Surface: 3mm (Mechanical Surface Detection)

Electronics: DAE4 Sn1322; Calibrated: 8/24/2012

Phantom: SAM Sub; Type: SAM 4.0; Serial: TP-1357

Measurement SW: DASY4, Version 4.7 (80); SEMCAD X Version 14.6.10 (7164)

Mode: IEEE 802.11b, Body SAR, Ch 06, 1 Mbps, Front Side

Area Scan (12x19x1): Measurement grid: dx=12mm, dy=12mm

Zoom Scan (8x8x7)/Cube 0: Measurement grid: dx=5mm, dy=5mm, dz=5mm

Reference Value = 11.218 V/m; Power Drift = -0.01 dB

Peak SAR (extrapolated) = 0.570 W/kg

SAR(1 g) = 0.260 W/kg; SAR(10 g) = 0.119 W/kg (SAR corrected for target medium)

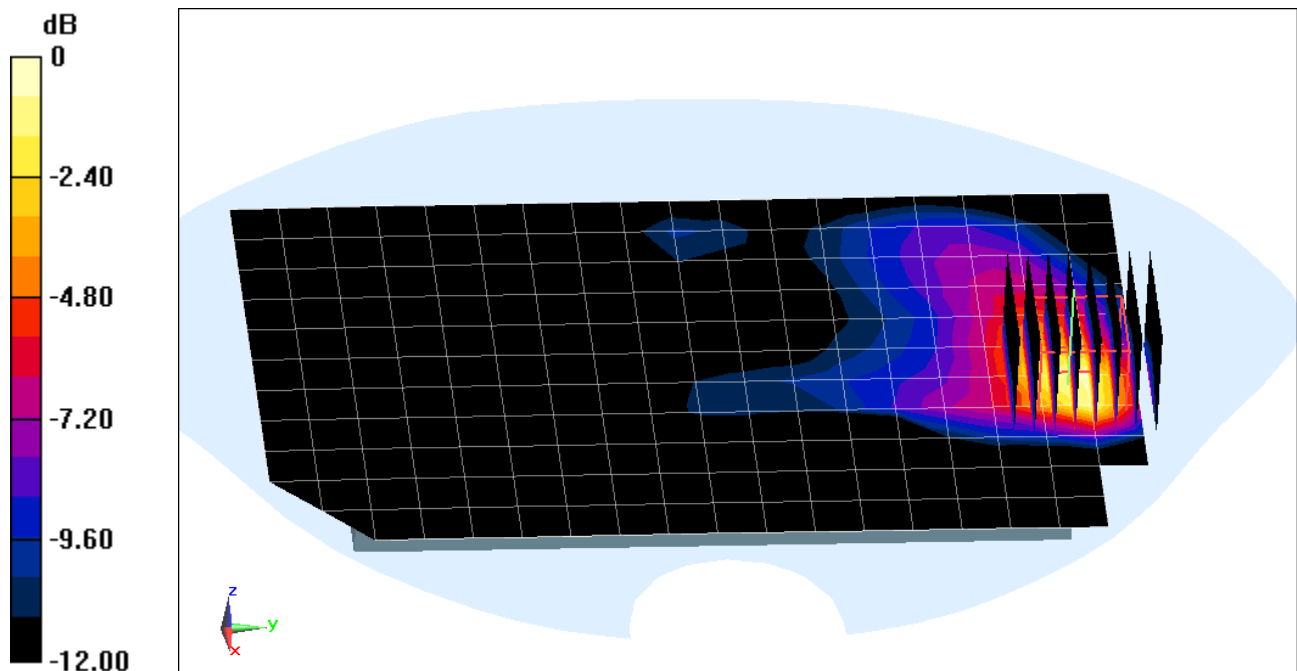

0 dB = 0.338 W/kg = -4.71 dBW/kg

PCTEST ENGINEERING LABORATORY, INC.

DUT: PY7PM-0410; Type: Portable Handset; Serial: 3039

Communication System: IEEE 802.11a 5.2-5.8 GHz Band; Frequency: 5765 MHz; Duty Cycle: 1:1
Medium: 5 GHz Body; Medium parameters used:

$$f = 5765 \text{ MHz}; \sigma = 6.177 \text{ S/m}; \epsilon_r = 46.255; \rho = 1000 \text{ kg/m}^3$$

Phantom section: Flat Section; Space: 1.5 cm

Test Date: 05-06-2013; Ambient Temp: 23.7°C; Tissue Temp: 21.8°C

Probe: EX3DV4 - SN3589; ConvF(3.66, 3.66, 3.66); Calibrated: 1/17/2013;

Sensor-Surface: 1.4mm (Mechanical Surface Detection)

Electronics: DAE4 Sn1272; Calibrated: 1/17/2013

Phantom: SAM Sub; Type: SAM 4.0; Serial: TP-1357

Measurement SW: DASY4, Version 4.7 (80);SEMCAD X Version 14.6.9 (7117)

Mode: IEEE 802.11a, 5.8 GHz, Body SAR, Ch 153, 6 Mbps, Back Side

Area Scan (13x22x1): Measurement grid: dx=10mm, dy=10mm

Zoom Scan (9x9x7)/Cube 0: Measurement grid: dx=4mm, dy=4mm, dz=1.4mm; Graded Ratio: 1.4

Reference Value = 4.627 V/m; Power Drift = 0.06 dB

Peak SAR (extrapolated) = 0.583 W/kg

SAR(1 g) = 0.125 W/kg; SAR(10 g) = 0.039 W/kg (SAR corrected for target medium)

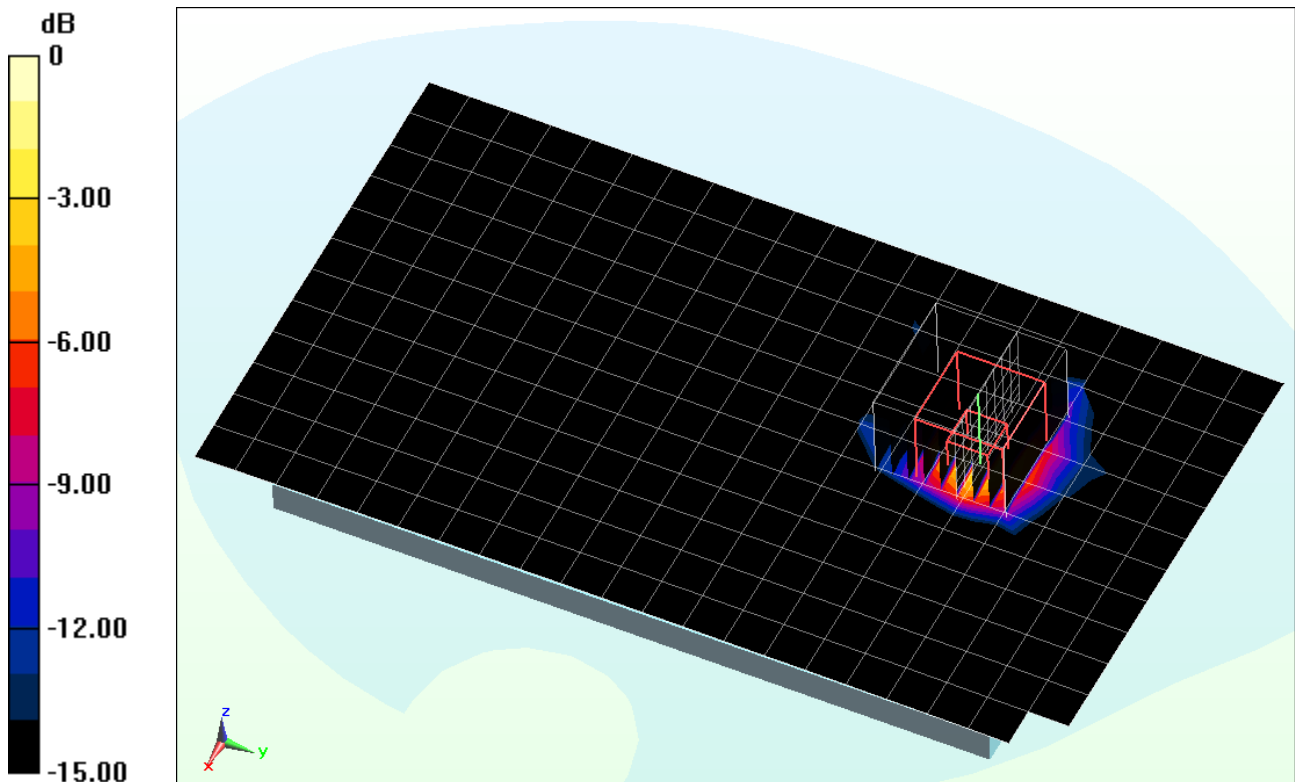

0 dB = 0.351 W/kg = -4.55 dBW/kg

PCTEST ENGINEERING LABORATORY, INC.

DUT: PY7PM-0410; Type: Portable Handset; Serial: 3039

Communication System: IEEE 802.11a 5.2-5.8 GHz Band; Frequency: 5660 MHz; Duty Cycle: 1:1

Medium: 5 GHz Body; Medium parameters used:

$$f = 5660 \text{ MHz}; \sigma = 6.007 \text{ S/m}; \epsilon_r = 46.397; \rho = 1000 \text{ kg/m}^3$$

Phantom section: Flat Section; Space: 1.5 cm

Test Date: 05-06-2013; Ambient Temp: 23.7°C; Tissue Temp: 21.9°C

Probe: EX3DV4 - SN3589; ConvF(3.32, 3.32, 3.32); Calibrated: 1/17/2013;

Sensor-Surface: 1.4mm (Mechanical Surface Detection)

Electronics: DAE4 Sn1272; Calibrated: 1/17/2013

Phantom: SAM Sub; Type: SAM 4.0; Serial: TP-1357

Measurement SW: DASY4, Version 4.7 (80);SEMCAD X Version 14.6.9 (7117)

Mode: IEEE 802.11a, 5.5 - 5.7 GHz, Body SAR, Ch 132, 6 Mbps, Back Side

Area Scan (13x22x1): Measurement grid: dx=10mm, dy=10mm

Zoom Scan (10x10x7)/Cube 0: Measurement grid: dx=4mm, dy=4mm, dz=1.4mm; Graded Ratio: 1.4

Reference Value = 4.056 V/m; Power Drift = -0.14 dB

Peak SAR (extrapolated) = 0.458 W/kg

SAR(1 g) = 0.094 W/kg; SAR(10 g) = 0.028 W/kg (SAR corrected for target medium)

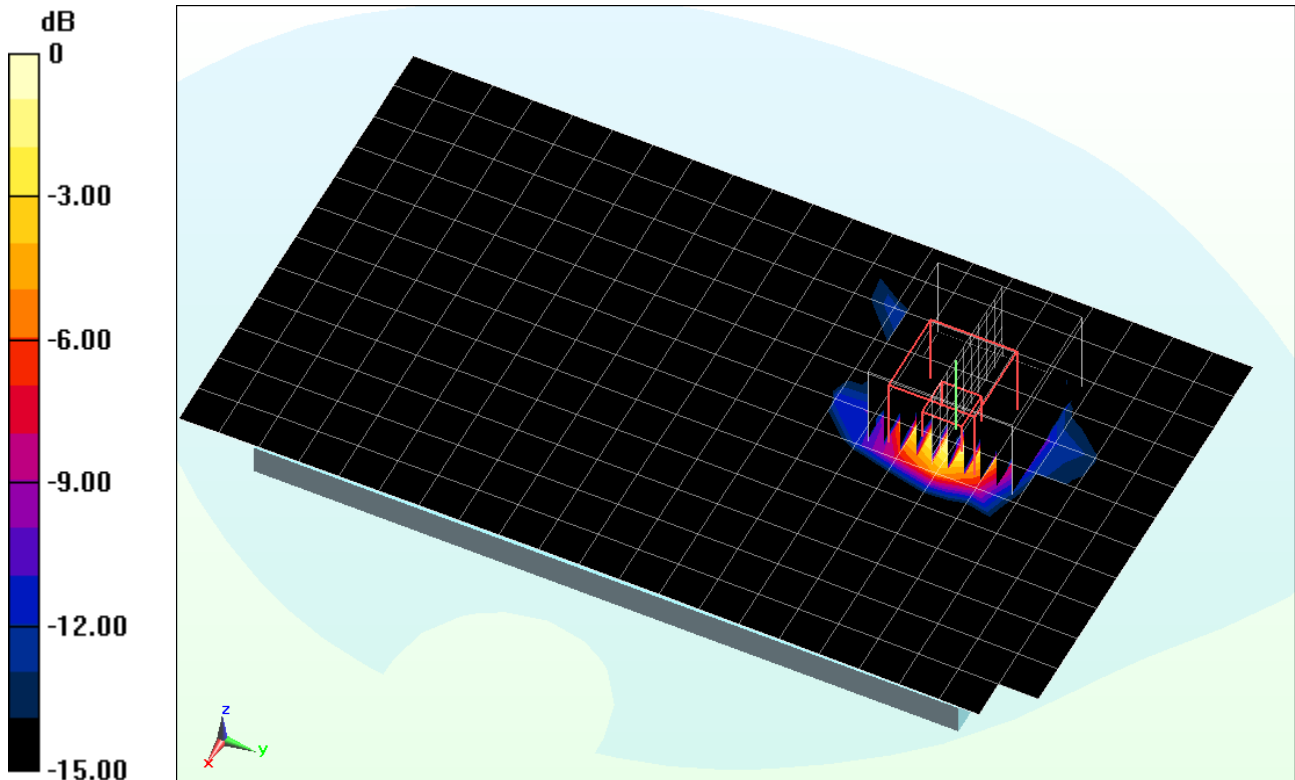

0 dB = 0.262 W/kg = -5.82 dBW/kg

PCTEST ENGINEERING LABORATORY, INC.

DUT: PY7PM-0410; Type: Portable Handset; Serial: 7316

Communication System: AWS WCDMA; Frequency: 1752.5 MHz; Duty Cycle: 1:1

Medium: 1750 Body Medium parameters used (interpolated):

$f = 1752.5 \text{ MHz}$; $\sigma = 1.516 \text{ S/m}$; $\epsilon_r = 51.05$; $\rho = 1000 \text{ kg/m}^3$

Phantom section: Flat Section; Space: 0.3 cm

Test Date: 08-01-2013; Ambient Temp: 23.2°C; Tissue Temp: 23.0°C

Probe: ES3DV3 - SN3287; ConvF(4.86, 4.86, 4.86); Calibrated: 11/15/2012;

Sensor-Surface: 4mm (Mechanical Surface Detection)

Electronics: DAE4 Sn1333; Calibrated: 11/13/2012

Phantom: SAM Sub Dasy B; Type: SAM 5.0; Serial: TP-1626

Measurement SW: DASY4, Version 4.7 (80); SEMCAD X Version 14.6.10 (7164)

Mode: AWS UMTS, Hand SAR, Back side, High.ch

Area Scan (9x15x1): Measurement grid: dx=15mm, dy=15mm

Zoom Scan (5x5x7)/Cube 0: Measurement grid: dx=8mm, dy=8mm, dz=5mm

Reference Value = 69.967 V/m; Power Drift = -0.03 dB

Peak SAR (extrapolated) = 12.8 W/kg

SAR(1 g) = 6.16 W/kg; SAR(10 g) = 2.82 W/kg (SAR corrected for target medium)

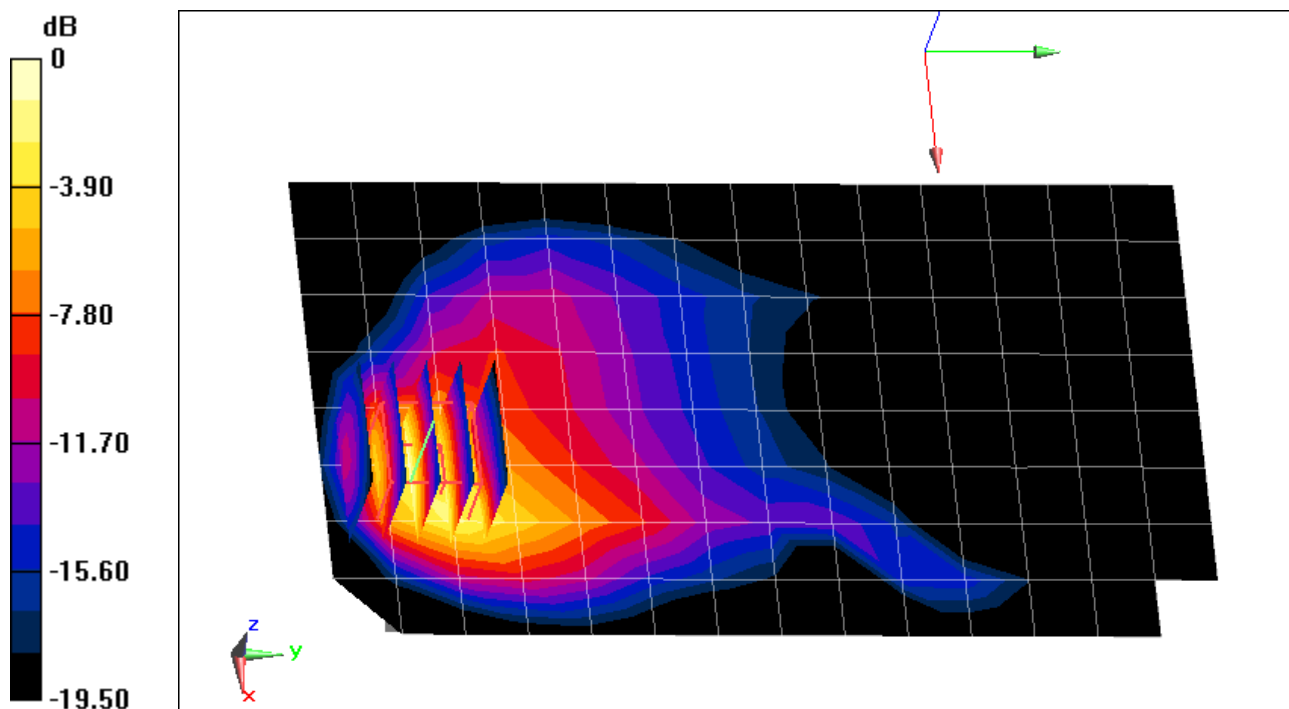

0 dB = 7.06 W/kg = 8.49 dBW/kg

PCTEST ENGINEERING LABORATORY, INC.

DUT: PY7PM-0410; Type: Portable Handset; Serial: 7316

Communication System: UMTS, Frequency: 1907.6 MHz; Duty Cycle: 1:1

Medium: 1900 Body Medium parameters used: (interpolated):

$f = 1907.6 \text{ MHz}$; $\sigma = 1.536 \text{ S/m}$; $\epsilon_r = 53.156$; $\rho = 1000 \text{ kg/m}^3$

Phantom section: Flat Section; Space: 0.3 cm

Test Date: 08-01-2013; Ambient Temp: 23.6°C; Tissue Temp: 23.7°C

Probe: EX3DV4 - SN3920; ConvF(7.38, 7.38, 7.38); Calibrated: 2/27/2013;

Sensor-Surface: 4mm (Mechanical Surface Detection)

Electronics: DAE4 Sn649; Calibrated: 2/6/2013

Phantom: SAM 5.0 front; Type: QD000P40CD; Serial: TP:-1648

Measurement SW: DASY52, Version 52.8 (7); SEMCAD X Version 14.6.10 (7164)

Mode: UMTS 1900, Hand SAR, Back side, High.ch

Area Scan (9x15x1): Measurement grid: dx=15mm, dy=15mm

Zoom Scan (5x5x7)/Cube 0: Measurement grid: dx=8mm, dy=8mm, dz=5mm

Reference Value = 63.010 V/m; Power Drift = -0.04 dB

Peak SAR (extrapolated) = 11.6 W/kg

SAR(1 g) = 5.46 W/kg; SAR(10 g) = 2.37 W/kg (SAR corrected for target medium)

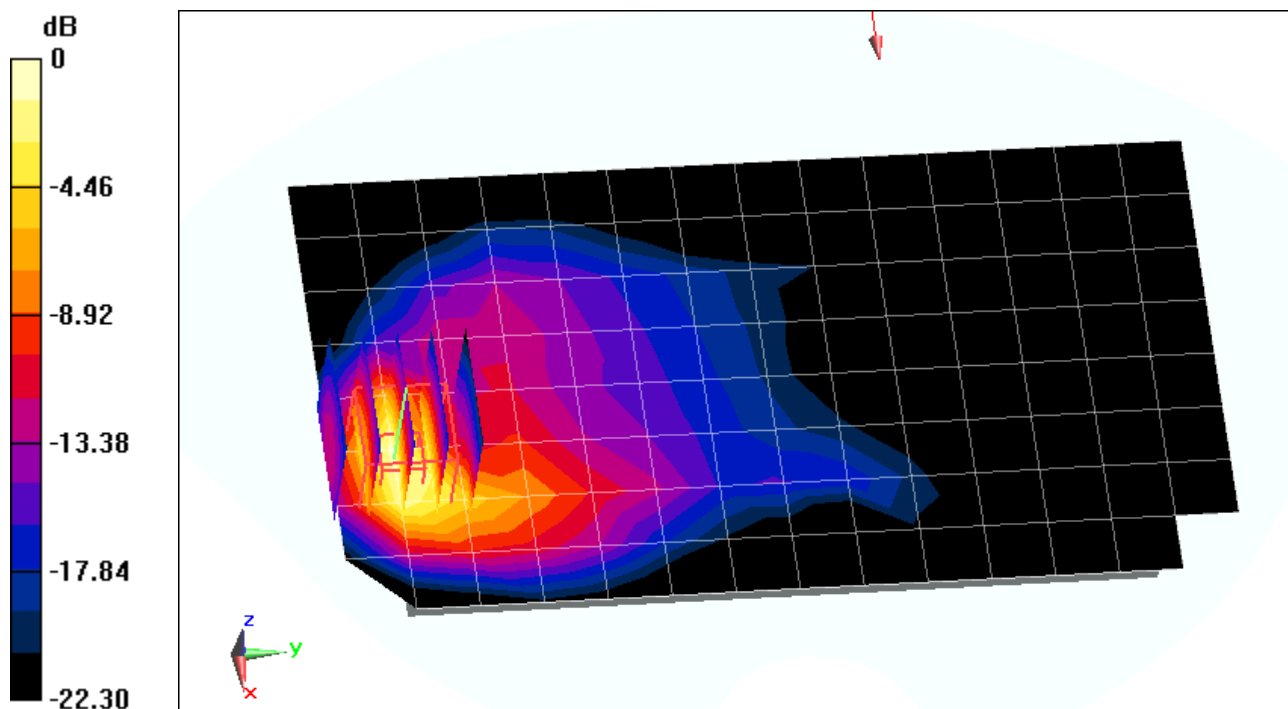

0 dB = 6.42 W/kg = 8.08 dBW/kg

PCTEST ENGINEERING LABORATORY, INC.

DUT: PY7PM-0410; Type: Portable Handset; Serial: 7483

Communication System: LTE RF; Frequency: 1732.5 MHz; Duty Cycle: 1:1

Medium: 1750 Body Medium parameters used (interpolated):

$f = 1732.5 \text{ MHz}$; $\sigma = 1.495 \text{ S/m}$; $\epsilon_r = 51.117$; $\rho = 1000 \text{ kg/m}^3$

Phantom section: Flat Section; Space: 0.3 cm

Test Date: 08-01-2013; Ambient Temp: 23.2°C; Tissue Temp: 23.0°C

Probe: ES3DV3 - SN3287; ConvF(4.86, 4.86, 4.86); Calibrated: 11/15/2012;

Sensor-Surface: 4mm (Mechanical Surface Detection)

Electronics: DAE4 Sn1333; Calibrated: 11/13/2012

Phantom: SAM Sub Dasy B; Type: SAM 5.0; Serial: TP-1626

Measurement SW: DASY4, Version 4.7 (80); SEMCAD X Version 14.6.10 (7164)

Mode: LTE Band 4 (AWS), Hand SAR, Back side, Olf .ch
20 MHz Bandwidth, QPSK, 1 RB, RB Offset 50

Area Scan (9x15x1): Measurement grid: dx=15mm, dy=15mm

Zoom Scan (5x5x7)/Cube 0: Measurement grid: dx=8mm, dy=8mm, dz=5mm

Reference Value = 59.875 V/m; Power Drift = -0.15 dB

Peak SAR (extrapolated) = 9.32 W/kg

SAR(1 g) = 4.61 W/kg; SAR(10 g) = 2.17 W/kg (SAR corrected for target medium)

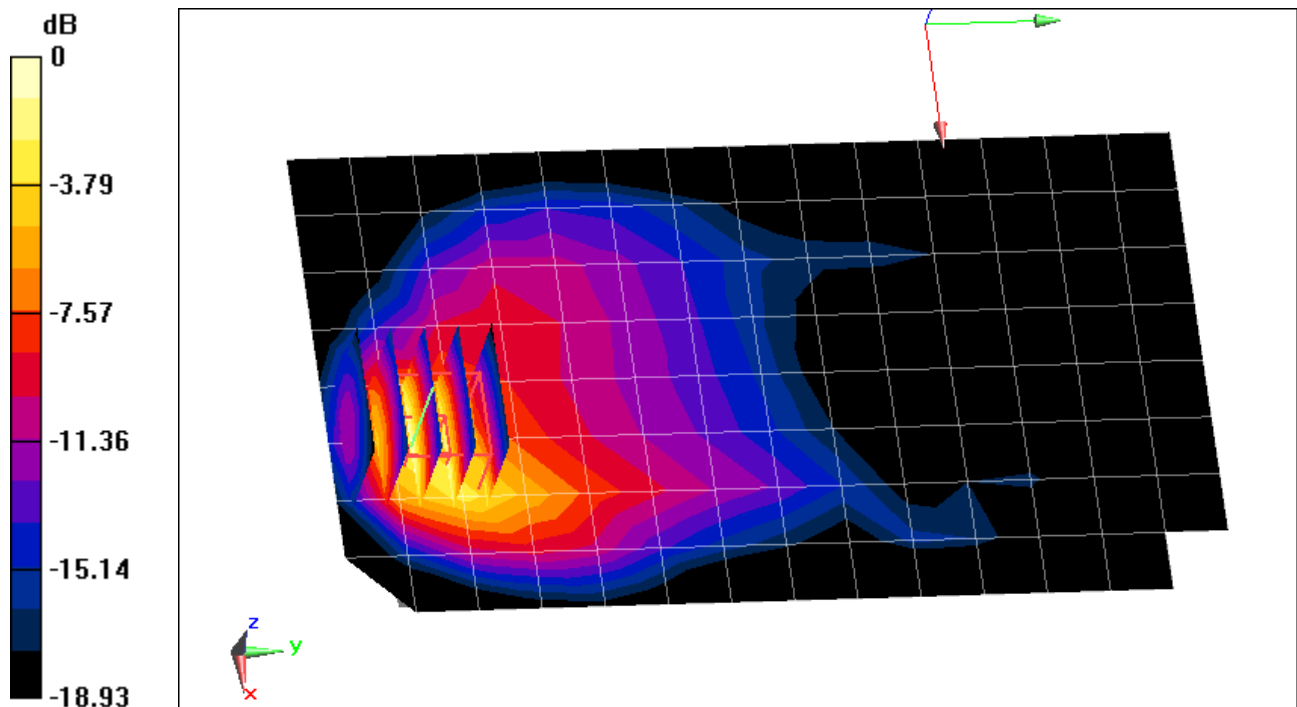

0 dB = 5.17 W/kg = 7.13 dBW/kg

PCTEST ENGINEERING LABORATORY, INC.

DUT: PY7PM-0410; Type: Portable Handset; Serial: 7483

Communication System: LTE Band 2 (PCS); Frequency: 1900 MHz; Duty Cycle: 1:1

Medium: 1900 Body Medium parameters used (interpolated):

$f = 1900 \text{ MHz}; \sigma = 1.527 \text{ S/m}; \epsilon_r = 53.185; \rho = 1000 \text{ kg/m}^3$

Phantom section: Flat Section; Space: 0.3 cm

Test Date: 08-01-2013; Ambient Temp: 23.6°C; Tissue Temp: 23.7°C

Probe: EX3DV4 - SN3920; ConvF(7.38, 7.38, 7.38); Calibrated: 2/27/2013;

Sensor-Surface: 4mm (Mechanical Surface Detection)

Electronics: DAE4 Sn649; Calibrated: 2/6/2013

Phantom: SAM 5.0 front; Type: QD000P40CD; Serial: TP:-1648

Measurement SW: DASY52, Version 52.8 (7); SEMCAD X Version 14.6.10 (7164)

Mode: LTE Band 2 (PCS), Hand SAR, Back side, High.ch
20 MHz Bandwidth, QPSK, 1 RB, RB Offset 50

Area Scan (9x15x1): Measurement grid: dx=15mm, dy=15mm

Zoom Scan (5x5x7)/Cube 0: Measurement grid: dx=8mm, dy=8mm, dz=5mm

Reference Value = 61.100 V/m; Power Drift = 0.00 dB

Peak SAR (extrapolated) = 12.6 W/kg

SAR(1 g) = 5.85 W/kg; SAR(10 g) = 2.5 W/kg (SAR corrected for target medium)

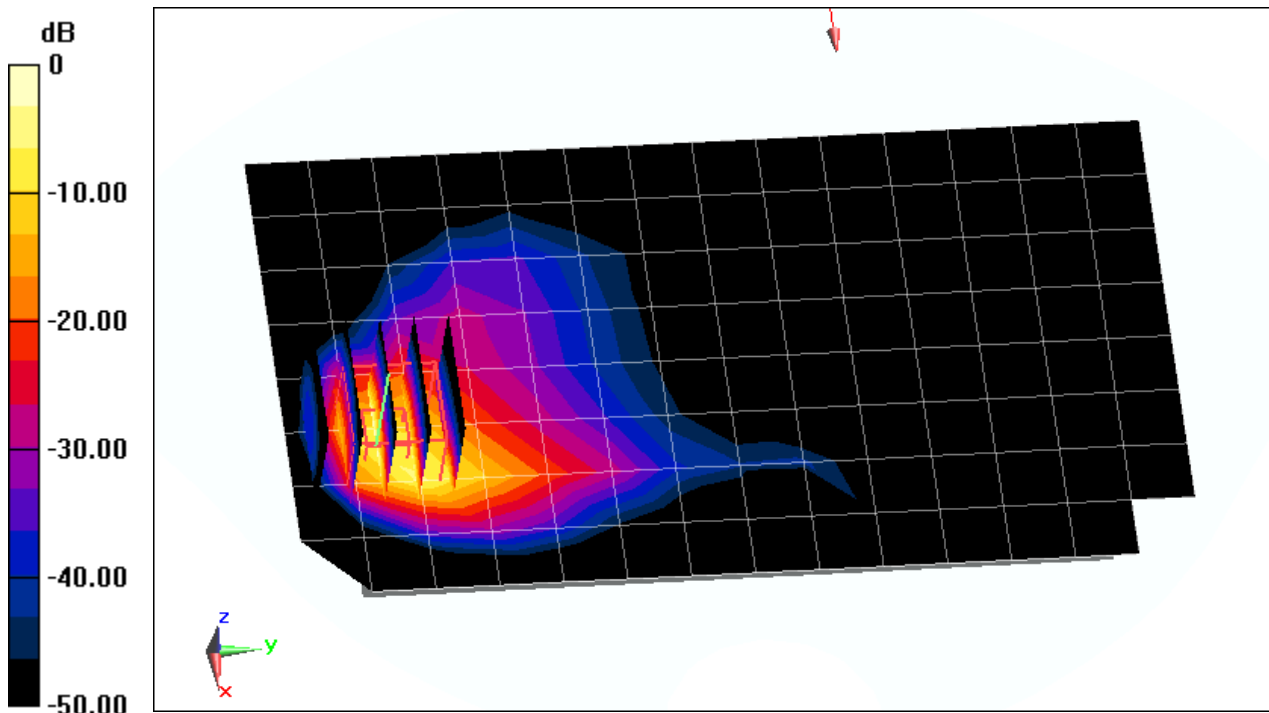

0 dB = 5.67 W/kg = 7.54 dBW/kg

PCTEST ENGINEERING LABORATORY, INC.

DUT: PY7PM-0410; Type: Portable Handset; Serial: 3039

Communication System: IEEE 802.11a 5.2-5.8 GHz Band; Frequency: 5805 MHz; Duty Cycle: 1:1

Medium: 5 GHz Body Medium parameters used:

$$f = 5805 \text{ MHz}; \sigma = 6.202 \text{ S/m}; \epsilon_r = 46.123; \rho = 1000 \text{ kg/m}^3$$

Phantom section: Flat Section; Space: 0.3 cm

Test Date: 05-06-2013; Ambient Temp: 23.7°C; Tissue Temp: 21.8°C

Probe: EX3DV4 - SN3589; ConvF(3.66, 3.66, 3.66); Calibrated: 1/17/2013;

Sensor-Surface: 1.4mm (Mechanical Surface Detection)

Electronics: DAE4 Sn1272; Calibrated: 1/17/2013

Phantom: SAM Sub; Type: SAM 4.0; Serial: TP-1357

Measurement SW: DASY4, Version 4.7 (80); SEMCAD X Version 14.6.9 (7117)

Mode: IEEE 802.11a, 5.8 GHz, J cpf SAR, Ch 161, 6 Mbps, Back Side

Area Scan (14x23x1): Measurement grid: dx=10mm, dy=10mm

Zoom Scan (9x9x7)/Cube 0: Measurement grid: dx=4mm, dy=4mm, dz=1.4mm; Graded Ratio=1.4

Reference Value = 21.377 V/m; Power Drift = -0.03 dB

Peak SAR (extrapolated) = 15.4 W/kg

SAR(1 g) = 1.65 W/kg; SAR(10 g) = 0.363 W/kg

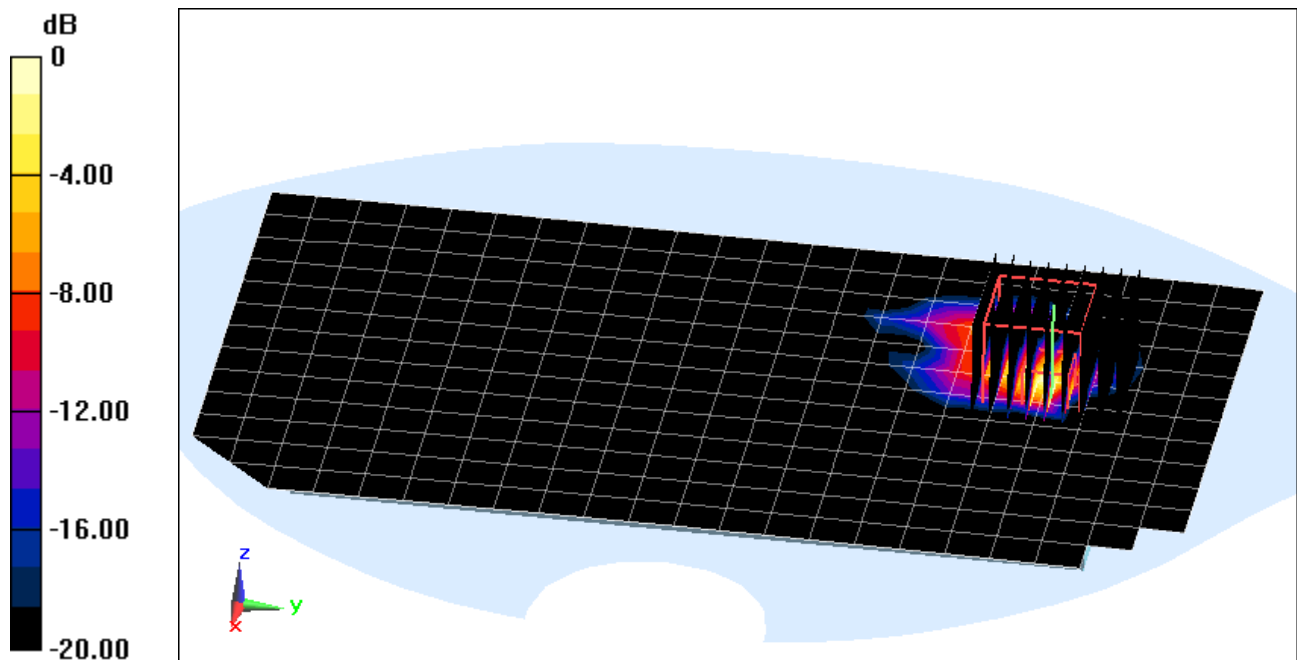

0 dB = 3.84 W/kg = 5.84 dBW/kg

PCTEST ENGINEERING LABORATORY, INC.

DUT: PY7PM-0410; Type: Portable Handset; Serial: 3039

Communication System: IEEE 802.11a 5.2-5.8 GHz Band; Frequency: 5320 MHz; Duty Cycle: 1:1

Medium: 5 GHz Body Medium parameters used:

$$f = 5320 \text{ MHz}; \sigma = 5.57 \text{ S/m}; \epsilon_r = 46.975; \rho = 1000 \text{ kg/m}^3$$

Phantom section: Flat Section; Space: 0.3 cm

Test Date: 05-06-2013; Ambient Temp: 23.6°C; Tissue Temp: 21.8°C

Probe: EX3DV4 - SN3589; ConvF(3.81, 3.81, 3.81); Calibrated: 1/17/2013;

Sensor-Surface: 1.4mm (Mechanical Surface Detection)

Electronics: DAE4 Sn1272; Calibrated: 1/17/2013

Phantom: SAM Sub; Type: SAM 4.0; Serial: TP-1357

Measurement SW: DASY4, Version 4.7 (80); SEMCAD X Version 14.6.9 (7117)

Mode: IEEE 802.11a, 5.3 GHz, Hand SAR, Ch 64, 6 Mbps, Back Side

Area Scan (14x23x1): Measurement grid: dx=10mm, dy=10mm

Zoom Scan (9x9x7)/Cube 0: Measurement grid: dx=4mm, dy=4mm, dz=1.4mm; Graded Ratio=1.4

Reference Value = 21.659 V/m; Power Drift = -0.10 dB

Peak SAR (extrapolated) = 11.4 W/kg

SAR(1 g) = 2.21 W/kg; SAR(10 g) = 0.604 W/kg

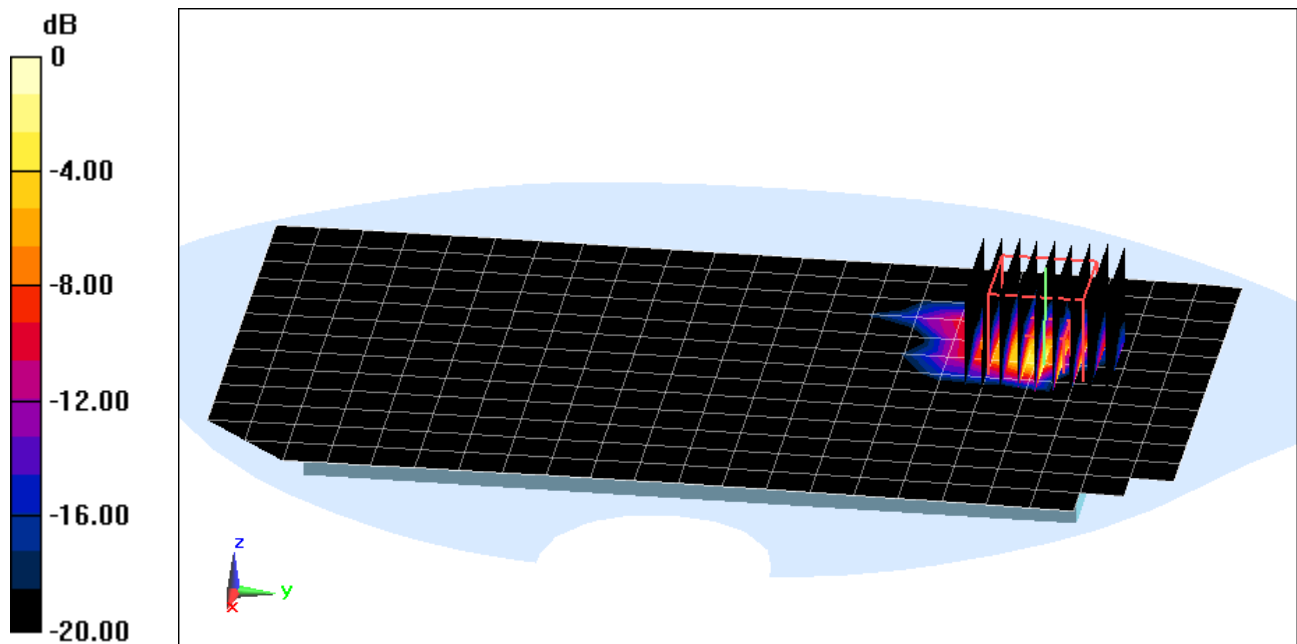

0 dB = 6.13 W/kg = 7.87 dBW/kg

APPENDIX B: SYSTEM VERIFICATION

PCTEST ENGINEERING LABORATORY, INC.

DUT: Dipole 835 MHz; Type: D835V2; Serial: 4d132

Communication System: CW; Frequency: 835 MHz; Duty Cycle: 1:1

Medium: 835 Head Medium parameters used:

$f = 835 \text{ MHz}$; $\sigma = 0.919 \text{ S/m}$; $\epsilon_r = 41.532$; $\rho = 1000 \text{ kg/m}^3$

Phantom section: Flat Section; Space: 1.5 cm

Test Date: 06-18-2013; Ambient Temp: 23.1°C; Tissue Temp: 23.1°C

Probe: ES3DV3 - SN3288; ConvF(6.41, 6.41, 6.41); Calibrated: 9/20/2012;

Sensor-Surface: 4mm (Mechanical Surface Detection)

Electronics: DAE4 Sn1323; Calibrated: 9/19/2012

Phantom: SAM v5.0 front; Type: QD000P40CD; Serial: TP-1646

Measurement SW: DASY52, Version 52.8 (7); SEMCAD X Version 14.6.10 (7164)

835 MHz System Verification

Area Scan (7x14x1): Measurement grid: dx=15mm, dy=15mm

Zoom Scan (5x5x7)/Cube 0: Measurement grid: dx=8mm, dy=8mm, dz=5mm

Input Power = 20 dBm (100 mW)

Peak SAR (extrapolated) = 1.42 W/kg

SAR(1 g) = 0.957 W/kg; SAR(10 g) = 0.623 W/kg (SAR corrected for target medium)

Deviation (1 g) = -0.93 %

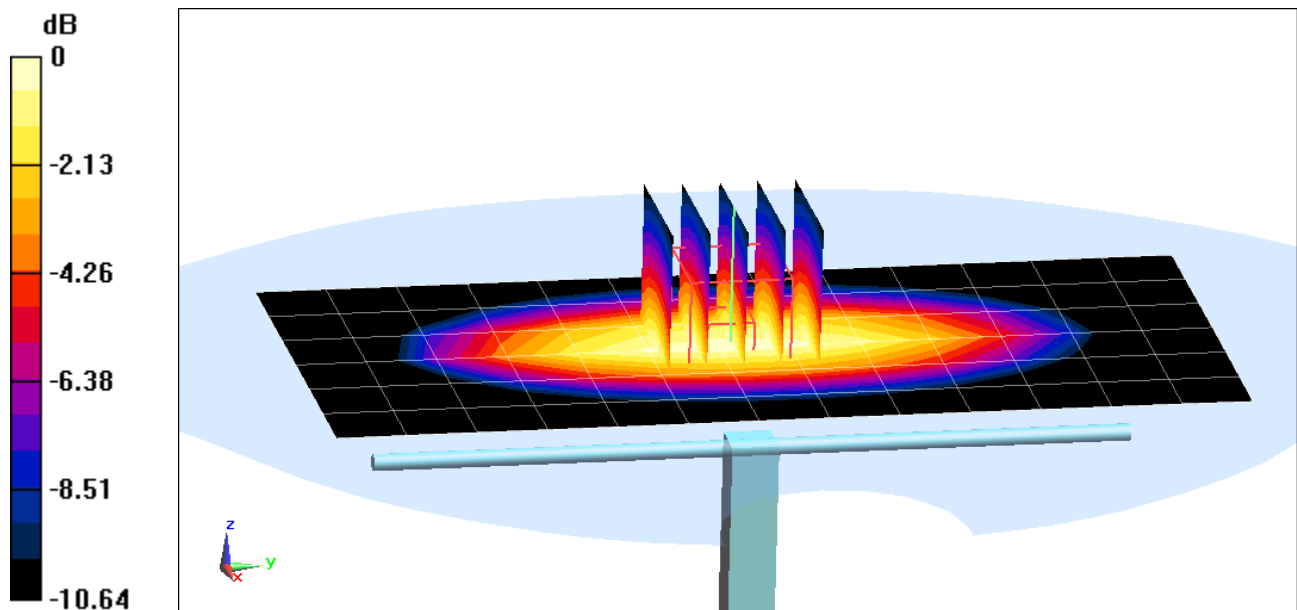

0 dB = 1.04 W/kg = 0.17 dBW/kg

PCTEST ENGINEERING LABORATORY, INC.

DUT: Dipole 1750 MHz; Type: D1750V2; Serial: 1051

Communication System: CW; Frequency: 1750 MHz; Duty Cycle: 1:1

Medium: 1750 Head Medium parameters used:

$f = 1750 \text{ MHz}$; $\sigma = 1.378 \text{ S/m}$; $\epsilon_r = 39.734$; $\rho = 1000 \text{ kg/m}^3$

Phantom section: Flat Section; Space: 1.0 cm

Test Date: 06-24-2013; Ambient Temp: 24.2°C; Tissue Temp: 23.6°C

Probe: EX3DV4 - SN3920; ConvF(7.97, 7.97, 7.97); Calibrated: 2/27/2013;

Sensor-Surface: 4mm (Mechanical Surface Detection)

Electronics: DAE4 Sn649; Calibrated: 2/6/2013

Phantom: SAM V5.0 Right; Type: QD000P40CD; Serial: 1647

Measurement SW: DASYS2, Version 52.8 (7); SEMCAD X Version 14.6.10 (7164)

1750 MHz System Verification

Area Scan (7x9x1): Measurement grid: dx=15mm, dy=15mm

Zoom Scan (5x5x7)/Cube 0: Measurement grid: dx=8mm, dy=8mm, dz=5mm

Input Power = 20 dBm (100 mW)

Peak SAR (extrapolated) = 6.74 W/kg

SAR(1 g) = 3.72 W/kg; SAR(10 g) = 1.98 W/kg (SAR corrected for target medium)

Deviation (1 g) = 1.92 %

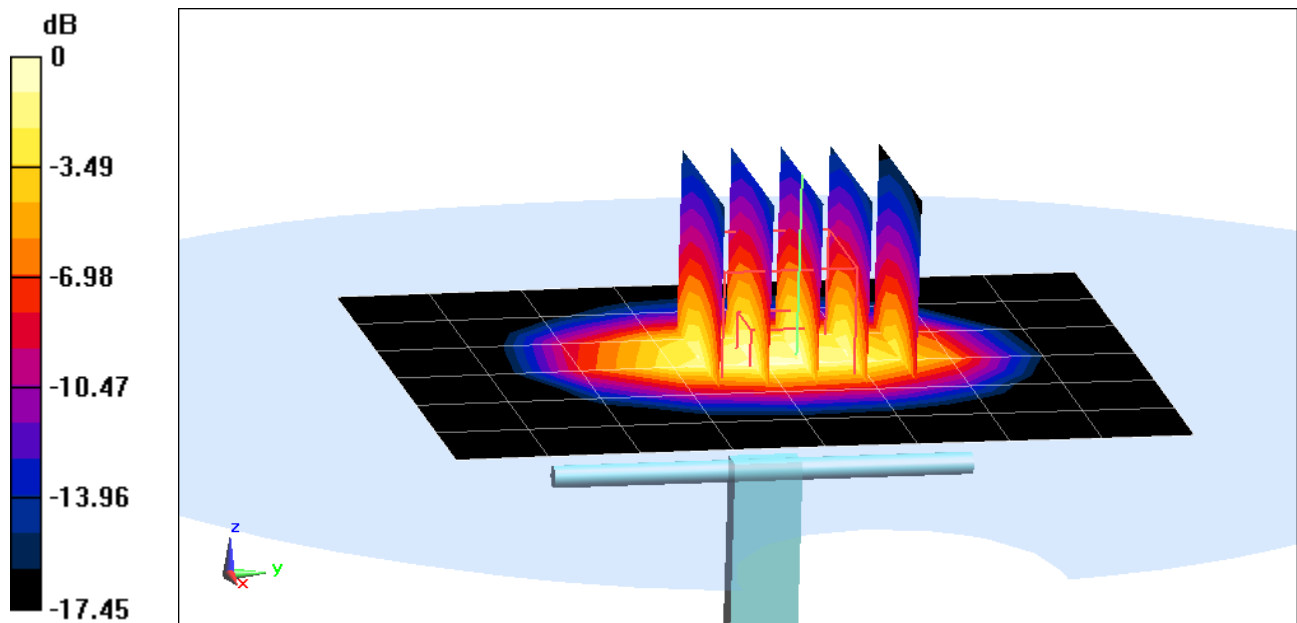

0 dB = 4.09 W/kg = 6.12 dBW/kg

PCTEST ENGINEERING LABORATORY, INC.

DUT: Dipole 1900 MHz; Type: D1900V2; Serial: 5d080

Communication System: CW; Frequency: 1900 MHz; Duty Cycle: 1:1

Medium: 1900 Head Medium parameters used (interpolated):

$f = 1900 \text{ MHz}$; $\sigma = 1.447 \text{ S/m}$; $\epsilon_r = 38.654$; $\rho = 1000 \text{ kg/m}^3$

Phantom section: Flat Section; Space: 1.0 cm

Test Date: 06-20-2013; Ambient Temp: 24.0°C; Tissue Temp: 23.3°C

Probe: EX3DV4 - SN3589; ConvF(7.09, 7.09, 7.09); Calibrated: 1/17/2013;

Sensor-Surface: 4mm (Mechanical Surface Detection)

Electronics: DAE4 Sn1272; Calibrated: 1/17/2013

Phantom: SAM Main; Type: SAM 4.0; Serial: TP-1114

Measurement SW: DASY4, Version 4.7 (80); SEMCAD X Version 14.6.10 (7164)

1900 MHz System Verification

Area Scan (5x7x1): Measurement grid: dx=15mm, dy=15mm

Zoom Scan (5x5x7)/Cube 0: Measurement grid: dx=8mm, dy=8mm, dz=5mm

Input Power = 20 dBm (100 mW)

Peak SAR (extrapolated) = 8.06 W/kg

SAR(1 g) = 4.25 W/kg; SAR(10 g) = 2.17 W/kg (SAR corrected for target medium)

Deviation (1 g) = 7.87 %

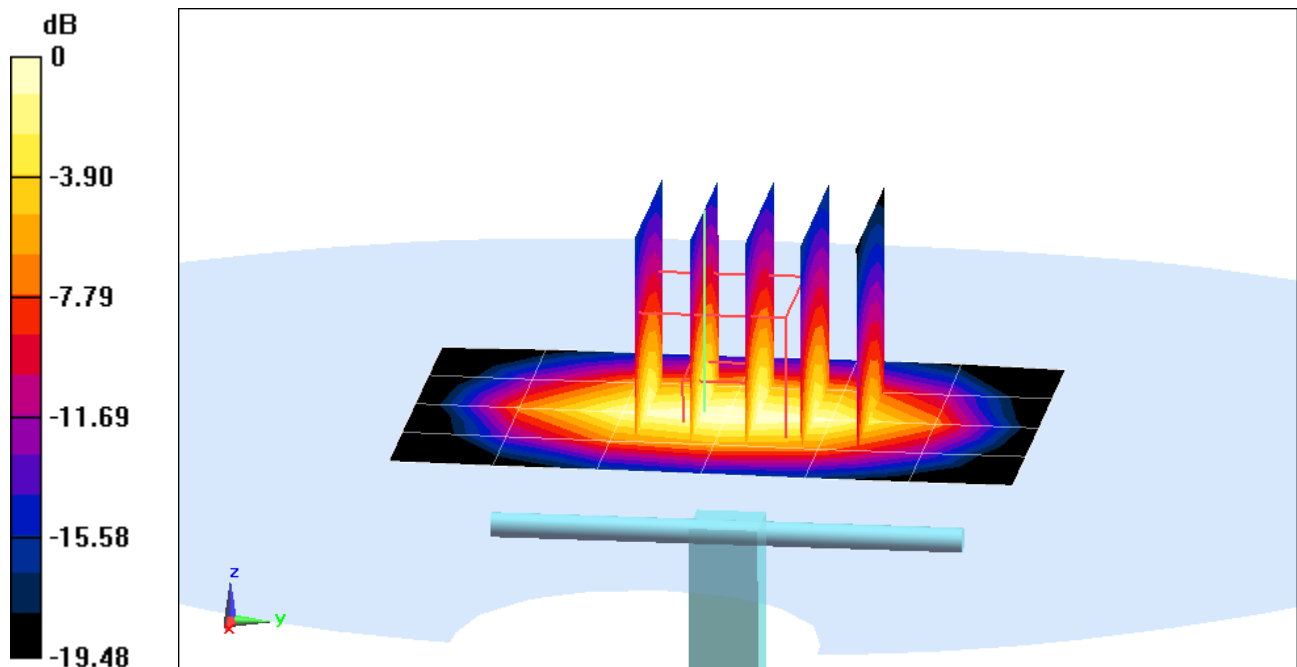

0 dB = 4.76 W/kg = 6.78 dBW/kg

PCTEST ENGINEERING LABORATORY, INC.

DUT: Dipole 1900 MHz; Type: D1900V2; Serial: 5d148

Communication System: CW; Frequency: 1900 MHz; Duty Cycle: 1:1

Medium: 1900 Head; Medium parameters used (interpolated):

$f = 1900 \text{ MHz}$; $\sigma = 1.4 \text{ S/m}$; $\epsilon_r = 40.376$; $\rho = 1000 \text{ kg/m}^3$

Phantom section: Flat Section; Space: 1.0 cm

Test Date: 06-28-2013; Ambient Temp: 23.8°C; Tissue Temp: 23.3°C

Probe: EX3DV4 - SN3920; ConvF(7.73, 7.73, 7.73); Calibrated: 2/27/2013;

Sensor-Surface: 4mm (Mechanical Surface Detection)

Electronics: DAE4 Sn649; Calibrated: 2/6/2013

Phantom: SAM V5.0 Right; Type: QD000P40CD; Serial: 1647

Measurement SW: DASY52, Version 52.8 (7); SEMCAD X Version 14.6.10 (7164)

1900 MHz System Verification

Area Scan (7x10x1): Measurement grid: dx=15mm, dy=15mm

Zoom Scan (5x5x7)/Cube 0: Measurement grid: dx=8mm, dy=8mm, dz=5mm

Input Power = 20.0 dBm (100 mW)

Peak SAR (extrapolated) = 7.16 W/kg

SAR(1 g) = 3.95 W/kg; SAR(10 g) = 2.07 W/kg (SAR corrected for target medium)

Deviation (1 g) = -0.50%

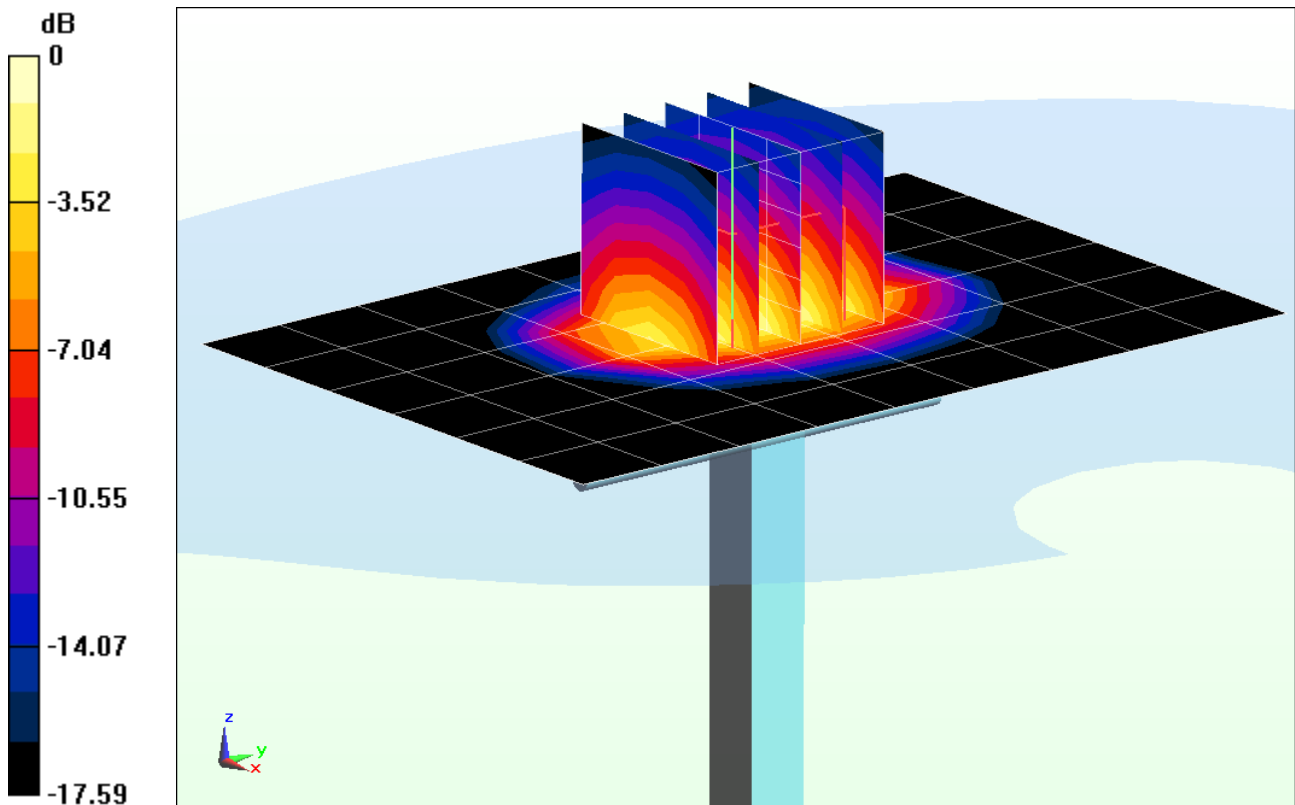

0 dB = 4.41 W/kg = 6.44 dBW/kg

PCTEST ENGINEERING LABORATORY, INC.

DUT: Dipole 2450 MHz; Type: D2450V2; Serial: 719

Communication System: CW; Frequency: 2450 MHz; Duty Cycle: 1:1

Medium: 2450 Head Medium parameters used:

$f = 2450 \text{ MHz}$; $\sigma = 1.878 \text{ S/m}$; $\epsilon_r = 39.996$; $\rho = 1000 \text{ kg/m}^3$

Phantom section: Flat Section; Space: 1.0 cm

Test Date: 06-18-2013; Ambient Temp: 23.4°C; Tissue Temp: 22.9°C

Probe: ES3DV3 - SN3287; ConvF(4.3, 4.3, 4.3); Calibrated: 11/15/2012;

Sensor-Surface: 3mm (Mechanical Surface Detection)

Electronics: DAE4 Sn1333; Calibrated: 11/13/2012

Phantom: SAM Sub Dasy B; Type: SAM 5.0; Serial: TP-1626

Measurement SW: DASY4, Version 4.7 (80); SEMCAD X Version 14.6.10 (7164)

2450 MHz System Verification

Area Scan (6x9x1): Measurement grid: dx=12mm, dy=12mm

Zoom Scan (7x7x7)/Cube 0: Measurement grid: dx=5mm, dy=5mm, dz=5mm

Input Power = 20 dBm (100 mW)

Peak SAR (extrapolated) = 11.3 W/kg

SAR(1 g) = 5.34 W/kg; SAR(10 g) = 2.44 W/kg (SAR corrected for target medium)

Deviation (1 g) = 1.33 %

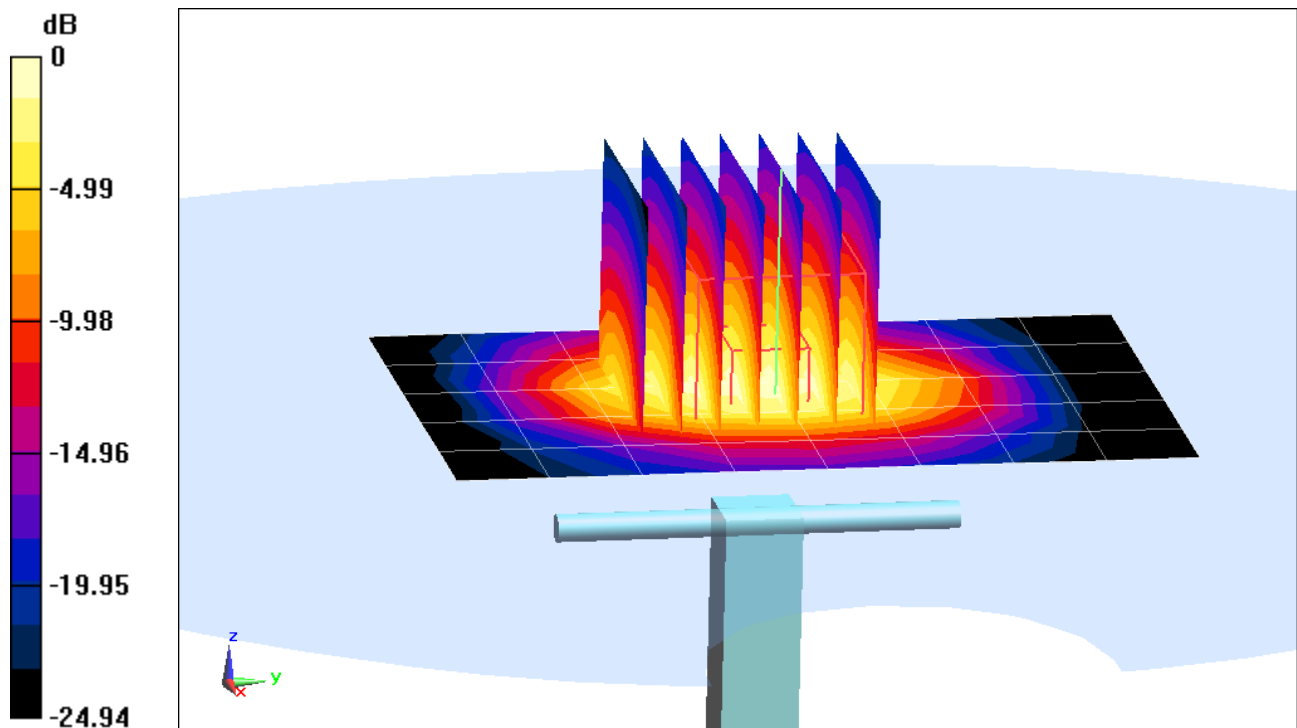

0 dB = 6.80 W/kg = 8.33 dBW/kg

PCTEST ENGINEERING LABORATORY, INC.

DUT: Dipole 2450 MHz; Type: D2450V2; Serial: 719

Communication System: CW; Frequency: 2450 MHz; Duty Cycle: 1:1

Medium: 2450 Head Medium parameters used:

$f = 2450 \text{ MHz}$; $\sigma = 1.871 \text{ S/m}$; $\epsilon_r = 37.996$; $\rho = 1000 \text{ kg/m}^3$

Phantom section: Flat Section; Space: 1.0 cm

Test Date: 07-26-2013; Ambient Temp: 23.6°C; Tissue Temp: 22.7°C

Probe: ES3DV2 - SN3022; ConvF(4.23, 4.23, 4.23); Calibrated: 8/28/2012;

Sensor-Surface: 3mm (Mechanical Surface Detection)

Electronics: DAE4 Sn1322; Calibrated: 8/24/2012

Phantom: SAM Main; Type: SAM 4.0; Serial: TP-1406

Measurement SW: DASY4, Version 4.7 (80); SEMCAD X Version 14.6.10 (7164)

2450 MHz System Verification

Area Scan (6x9x1): Measurement grid: dx=12mm, dy=12mm

Zoom Scan (7x7x7)/Cube 0: Measurement grid: dx=5mm, dy=5mm, dz=5mm

Input Power = 20 dBm (100 mW)

Peak SAR (extrapolated) = 11.4 W/kg

SAR(1 g) = 5.57 W/kg; SAR(10 g) = 2.62 W/kg (SAR corrected for target medium)

Deviation (1 g) = 5.69 %

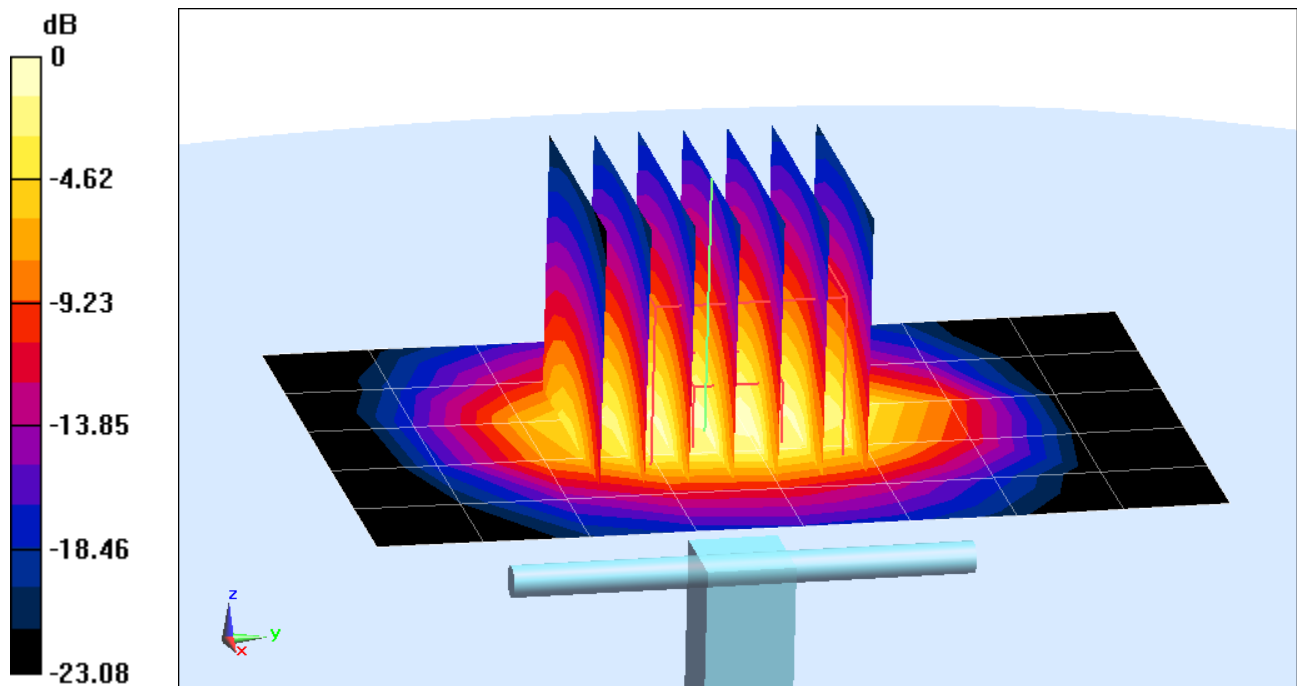

0 dB = 7.09 W/kg = 8.51 dBW/kg

PCTEST ENGINEERING LABORATORY, INC.

DUT: Dipole 2600 MHz; Type: D2600V2; Serial: 1004

Communication System: CW; Frequency: 2600 MHz; Duty Cycle: 1:1

Medium: 2500 Head Medium parameters used:

$f = 2600 \text{ MHz}$; $\sigma = 2.007 \text{ S/m}$; $\epsilon_r = 37.311$; $\rho = 1000 \text{ kg/m}^3$

Phantom section: Flat Section; Space: 1.0 cm

Test Date: 07-26-2013; Ambient Temp: 23.1°C; Tissue Temp: 23.0°C

Probe: ES3DV2 - SN3022; ConvF(4.1, 4.1, 4.1); Calibrated: 8/28/2012;

Sensor-Surface: 3mm (Mechanical Surface Detection)

Electronics: DAE4 Sn1322; Calibrated: 8/24/2012

Phantom: SAM Main; Type: SAM 4.0; Serial: TP-1406

Measurement SW: DASY4, Version 4.7 (80); SEMCAD X Version 14.6.10 (7164)

2600 MHz System Verification

Area Scan (6x8x1): Measurement grid: dx=12mm, dy=12mm

Zoom Scan (7x7x7)/Cube 0: Measurement grid: dx=5mm, dy=5mm, dz=5mm

Input Power = 16 dBm (40 mW)

Peak SAR (extrapolated) = 5.31 W/kg

SAR(1 g) = 2.36 W/kg; SAR(10 g) = 1.02 W/kg (SAR corrected for target medium)

Deviation (1 g) = 1.37 %

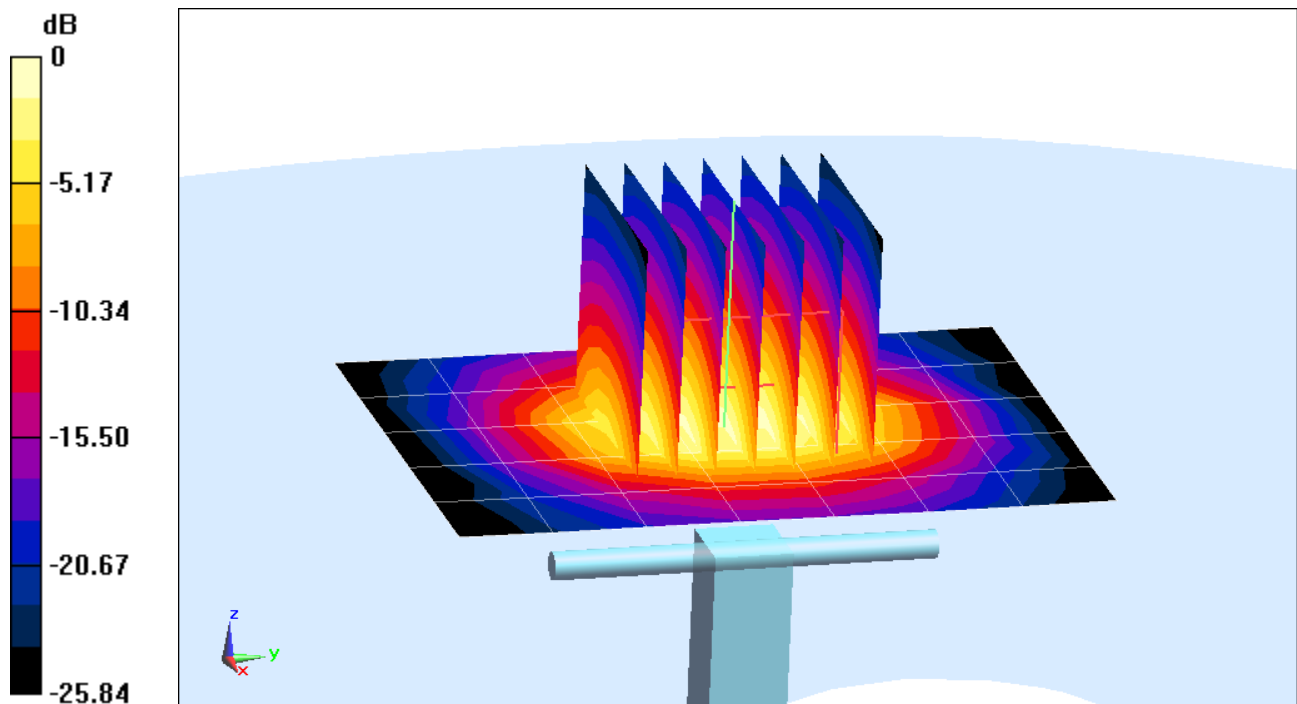

0 dB = 3.15 W/kg = 4.98 dBW/kg

PCTEST ENGINEERING LABORATORY, INC.

DUT: Dipole 5200 MHz; Type: D5GHzV2; Serial: 1120

Communication System: CW; Frequency: 5200 MHz; Duty Cycle: 1:1

Medium: 5GHz Head; Medium parameters used:

$f = 5200 \text{ MHz}$; $\sigma = 4.489 \text{ S/m}$; $\epsilon_r = 37.242$; $\rho = 1000 \text{ kg/m}^3$

Phantom section: Flat Section; Space: 1.0 cm

Test Date: 05-09-2013; Ambient Temp: 24.4°C; Tissue Temp: 23.3°C

Probe: EX3DV4 - SN3920; ConvF(4.87, 4.87, 4.87); Calibrated: 2/27/2013;

Sensor-Surface: 1.4mm (Mechanical Surface Detection)

Electronics: DAE4 Sn649; Calibrated: 2/6/2013

Phantom: SAM V5.0 Right; Type: QD000P40CD; Serial: 1647

Measurement SW: DASY52, Version 52.8 (6);SEMCAD X Version 14.6.9 (7117)

5200 MHz System Verification

Area Scan (7x8x1): Measurement grid: dx=10mm, dy=10mm

Zoom Scan (9x9x7)/Cube 0: Measurement grid: dx=4mm, dy=4mm, dz=1.4mm; Graded Ratio: 1.4

Input Power = 20.0 dBm (100 mW)

Peak SAR (extrapolated) = 26.9 W/kg

SAR(1 g) = 6.88 W/kg; SAR(10 g) = 2.02 W/kg (SAR corrected for target medium)

Deviation (1 g) = -9.47%

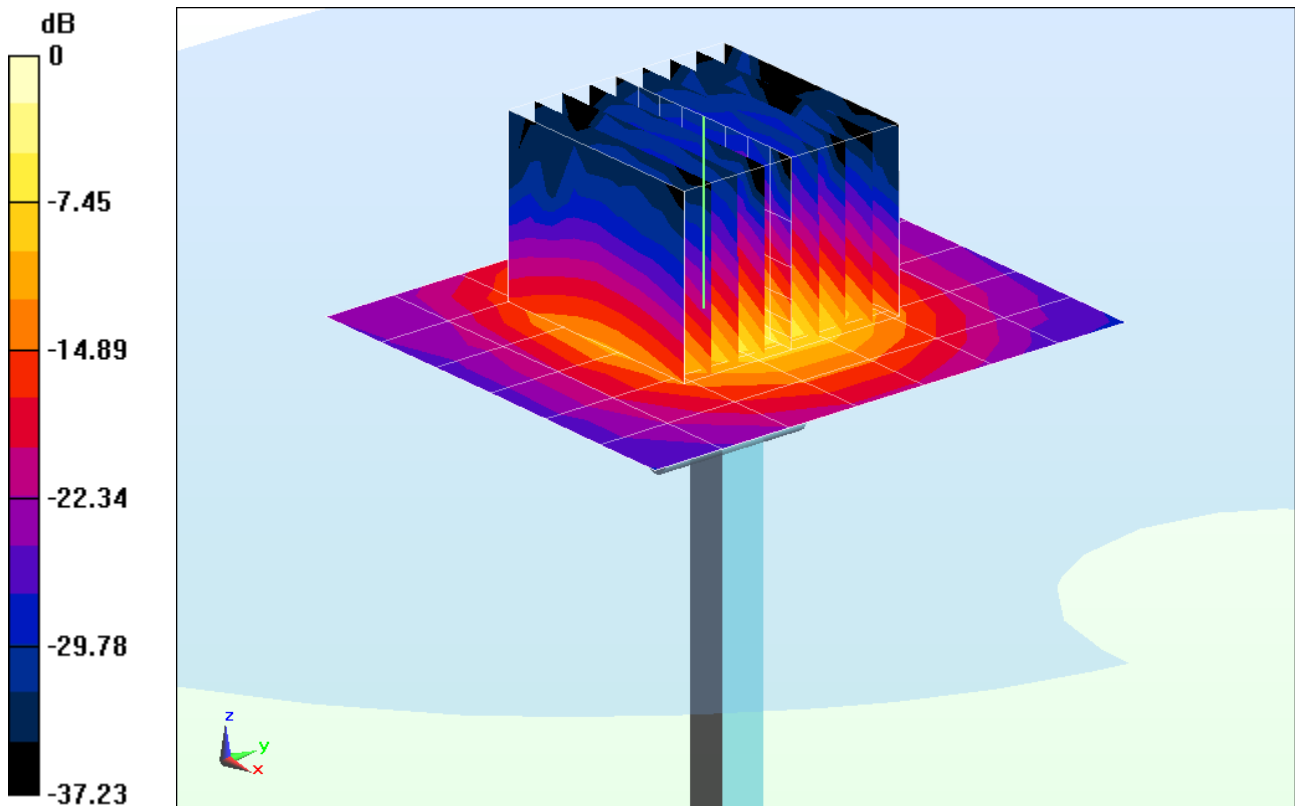

0 dB = 16.9 W/kg = 12.28 dBW/kg

PCTEST ENGINEERING LABORATORY, INC.

DUT: Dipole 5300 MHz; Type: D5GHzV2; Serial: 1120

Communication System: CW; Frequency: 5300 MHz; Duty Cycle: 1:1
Medium: 5GHz Head; Medium parameters used:

$$f = 5300 \text{ MHz}; \sigma = 4.565 \text{ S/m}; \epsilon_r = 37.13; \rho = 1000 \text{ kg/m}^3$$

Phantom section: Flat Section; Space: 1.0 cm

Test Date: 05-09-2013; Ambient Temp: 24.5°C; Tissue Temp: 23.3°C

Probe: EX3DV4 - SN3920; ConvF(4.73, 4.73, 4.73); Calibrated: 2/27/2013;

Sensor-Surface: 1.4mm (Mechanical Surface Detection)

Electronics: DAE4 Sn649; Calibrated: 2/6/2013

Phantom: SAM V5.0 Right; Type: QD000P40CD; Serial: 1647

Measurement SW: DASY52, Version 52.8 (6); SEMCAD X Version 14.6.9 (7117)

5300 MHz System Verification

Area Scan (7x8x1): Measurement grid: dx=10mm, dy=10mm

Zoom Scan (8x8x7)/Cube 0: Measurement grid: dx=4mm, dy=4mm, dz=1.4mm; Graded Ratio: 1.4

Input Power = 20.0 dBm (100 mW)

Peak SAR (extrapolated) = 33.3 W/kg

SAR(1 g) = 8.37 W/kg; SAR(10 g) = 2.4 W/kg (SAR corrected for target medium)

Deviation (1 g) = 6.35%

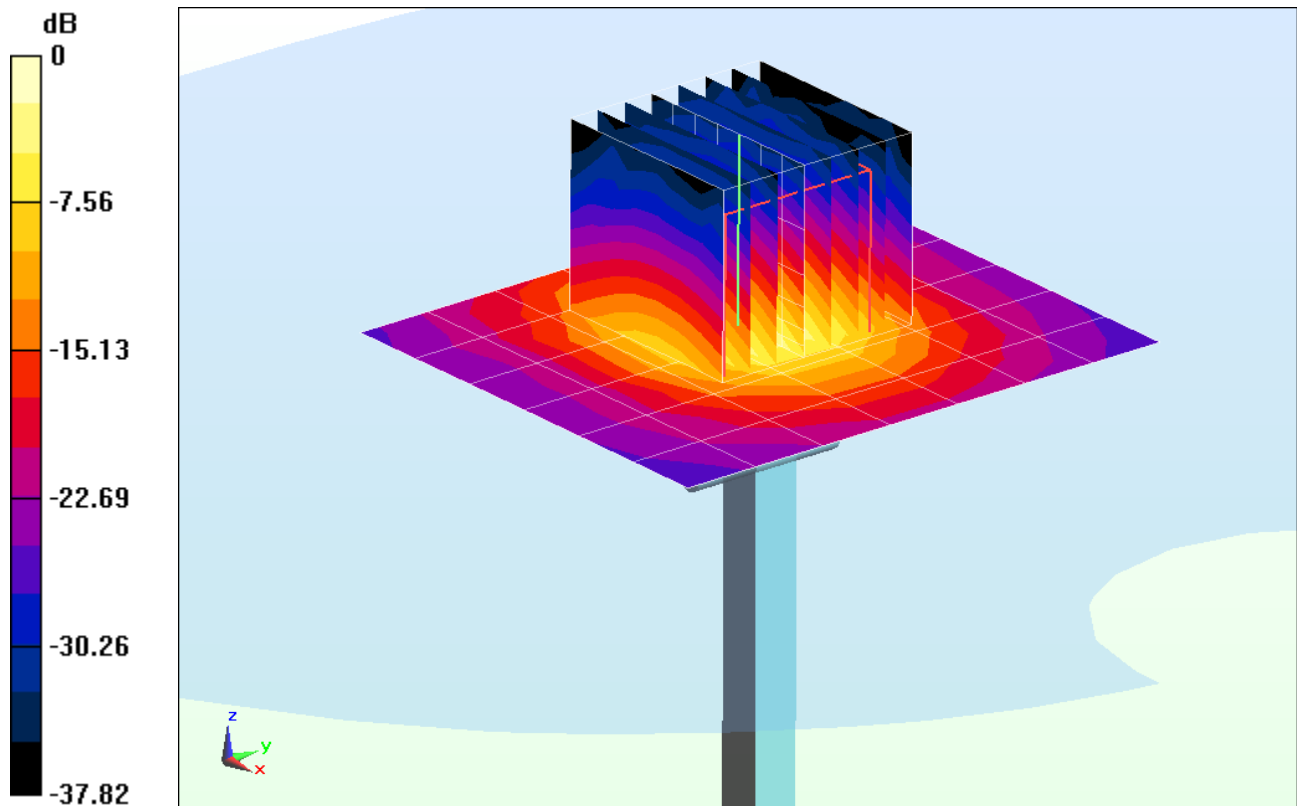

0 dB = 20.8 W/kg = 13.18 dBW/kg

PCTEST ENGINEERING LABORATORY, INC.

DUT: Dipole 5500 MHz; Type: D5GHzV2; Serial: 1120

Communication System: CW; Frequency: 5500 MHz; Duty Cycle: 1:1

Medium: 5GHz Head; Medium parameters used:

$f = 5500 \text{ MHz}$; $\sigma = 4.768 \text{ S/m}$; $\epsilon_r = 36.807$; $\rho = 1000 \text{ kg/m}^3$

Phantom section: Flat Section; Space: 1.0 cm

Test Date: 05-09-2013; Ambient Temp: 24.3°C; Tissue Temp: 23.2°C

Probe: EX3DV4 - SN3920; ConvF(4.52, 4.52, 4.52); Calibrated: 2/27/2013;

Sensor-Surface: 1.4mm (Mechanical Surface Detection)

Electronics: DAE4 Sn649; Calibrated: 2/6/2013

Phantom: SAM V5.0 Right; Type: QD000P40CD; Serial: 1647

Measurement SW: DASY52, Version 52.8 (6); SEMCAD X Version 14.6.9 (7117)

5500 MHz System Verification

Area Scan (7x8x1): Measurement grid: dx=10mm, dy=10mm

Zoom Scan (8x8x7)/Cube 0: Measurement grid: dx=4mm, dy=4mm, dz=1.4mm; Graded Ratio: 1.4

Input Power = 20.0 dBm (100 mW)

Peak SAR (extrapolated) = 34.1 W/kg

SAR(1 g) = 8.26 W/kg; SAR(10 g) = 2.36 W/kg (SAR corrected for target medium)

Deviation (1 g) = 3.12%

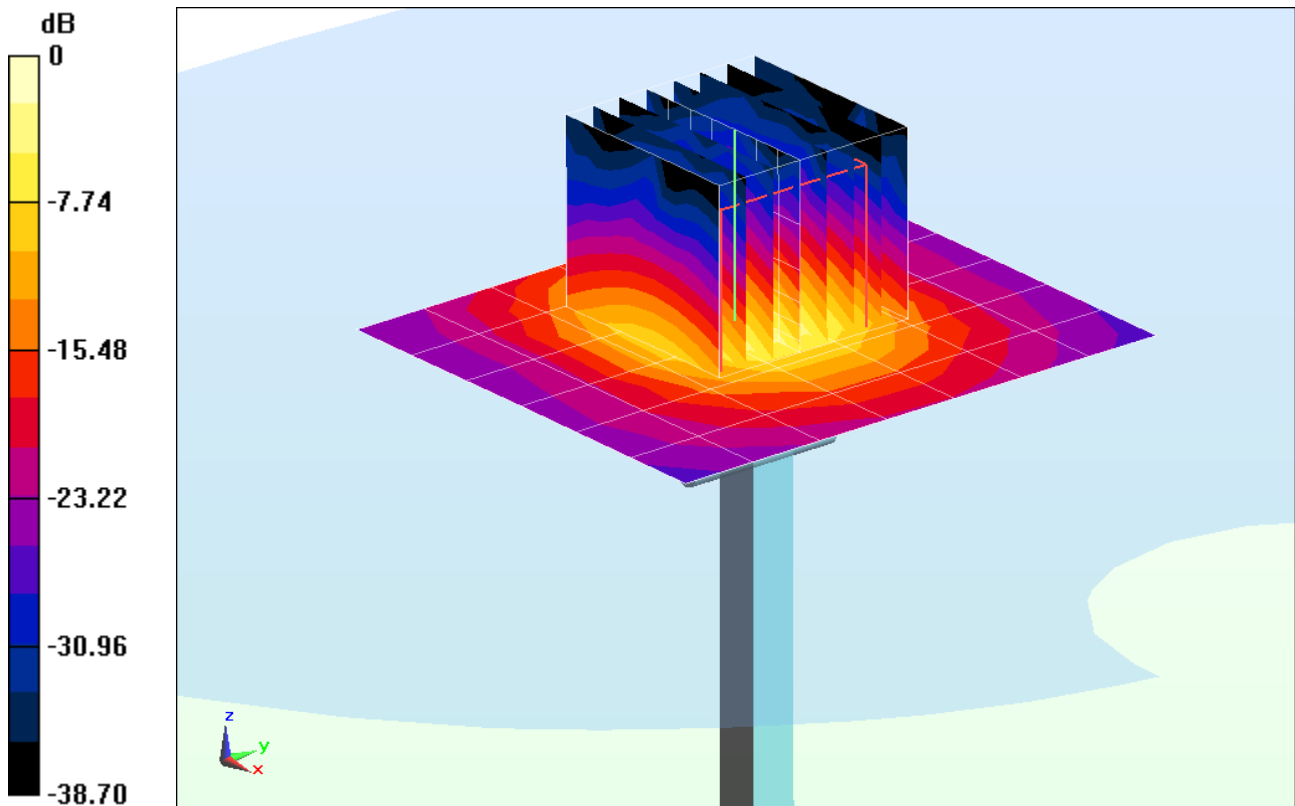

0 dB = 20.9 W/kg = 13.20 dBW/kg

PCTEST ENGINEERING LABORATORY, INC.

DUT: Dipole 5600 MHz; Type: D5GHzV2; Serial: 1120

Communication System: CW; Frequency: 5600 MHz; Duty Cycle: 1:1
Medium: 5GHz Head; Medium parameters used:

$f = 5600 \text{ MHz}$; $\sigma = 4.884 \text{ S/m}$; $\epsilon_r = 36.704$; $\rho = 1000 \text{ kg/m}^3$

Phantom section: Flat Section; Space: 1.0 cm

Test Date: 05-09-2013; Ambient Temp: 24.3°C; Tissue Temp: 23.3°C

Probe: EX3DV4 - SN3920; ConvF(4.17, 4.17, 4.17); Calibrated: 2/27/2013;

Sensor-Surface: 1.4mm (Mechanical Surface Detection)

Electronics: DAE4 Sn649; Calibrated: 2/6/2013

Phantom: SAM V5.0 Right; Type: QD000P40CD; Serial: 1647

Measurement SW: DASY52, Version 52.8 (6);SEMCAD X Version 14.6.9 (7117)

5600 MHz System Verification

Area Scan (7x8x1): Measurement grid: dx=10mm, dy=10mm

Zoom Scan (8x8x7)/Cube 0: Measurement grid: dx=4mm, dy=4mm, dz=1.4mm; Graded Ratio: 1.4

Input Power = 20.0 dBm (100 mW)

Peak SAR (extrapolated) = 30.3 W/kg

SAR(1 g) = 7.5 W/kg; SAR(10 g) = 2.17 W/kg (SAR corrected for target medium)

Deviation (1 g) = -6.13%

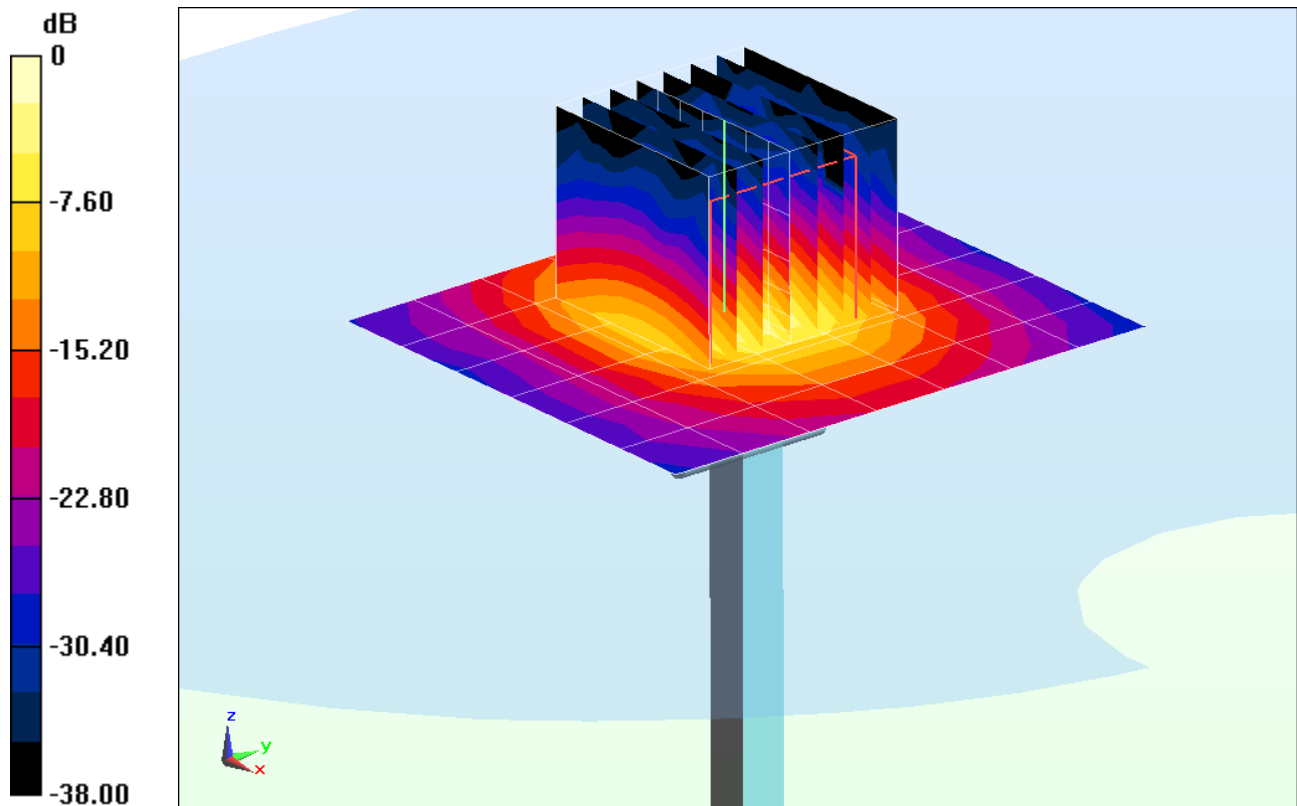

0 dB = 18.9 W/kg = 12.76 dBW/kg

PCTEST ENGINEERING LABORATORY, INC.

DUT: Dipole 5800 MHz; Type: D5GHzV2; Serial: 1120

Communication System: CW; Frequency: 5800 MHz; Duty Cycle: 1:1

Medium: 5GHz Head; Medium parameters used:

$f = 5800 \text{ MHz}$; $\sigma = 5.092 \text{ S/m}$; $\epsilon_r = 36.381$; $\rho = 1000 \text{ kg/m}^3$

Phantom section: Flat Section; Space: 1.0 cm

Test Date: 05-09-2013; Ambient Temp: 24.3°C; Tissue Temp: 23.3°C

Probe: EX3DV4 - SN3920; ConvF(4.02, 4.02, 4.02); Calibrated: 2/27/2013;

Sensor-Surface: 1.4mm (Mechanical Surface Detection)

Electronics: DAE4 Sn649; Calibrated: 2/6/2013

Phantom: SAM V5.0 Right; Type: QD000P40CD; Serial: 1647

Measurement SW: DASY52, Version 52.8 (6); SEMCAD X Version 14.6.9 (7117)

5800 MHz System Verification

Area Scan (7x8x1): Measurement grid: dx=10mm, dy=10mm

Zoom Scan (8x8x7)/Cube 0: Measurement grid: dx=4mm, dy=4mm, dz=1.4mm; Graded Ratio: 1.4

Input Power = 20.0 dBm (100 mW)

Peak SAR (extrapolated) = 31.1 W/kg

SAR(1 g) = 7.2 W/kg; SAR(10 g) = 2.08 W/kg (SAR corrected for target medium)

Deviation (1 g) = -3.87%

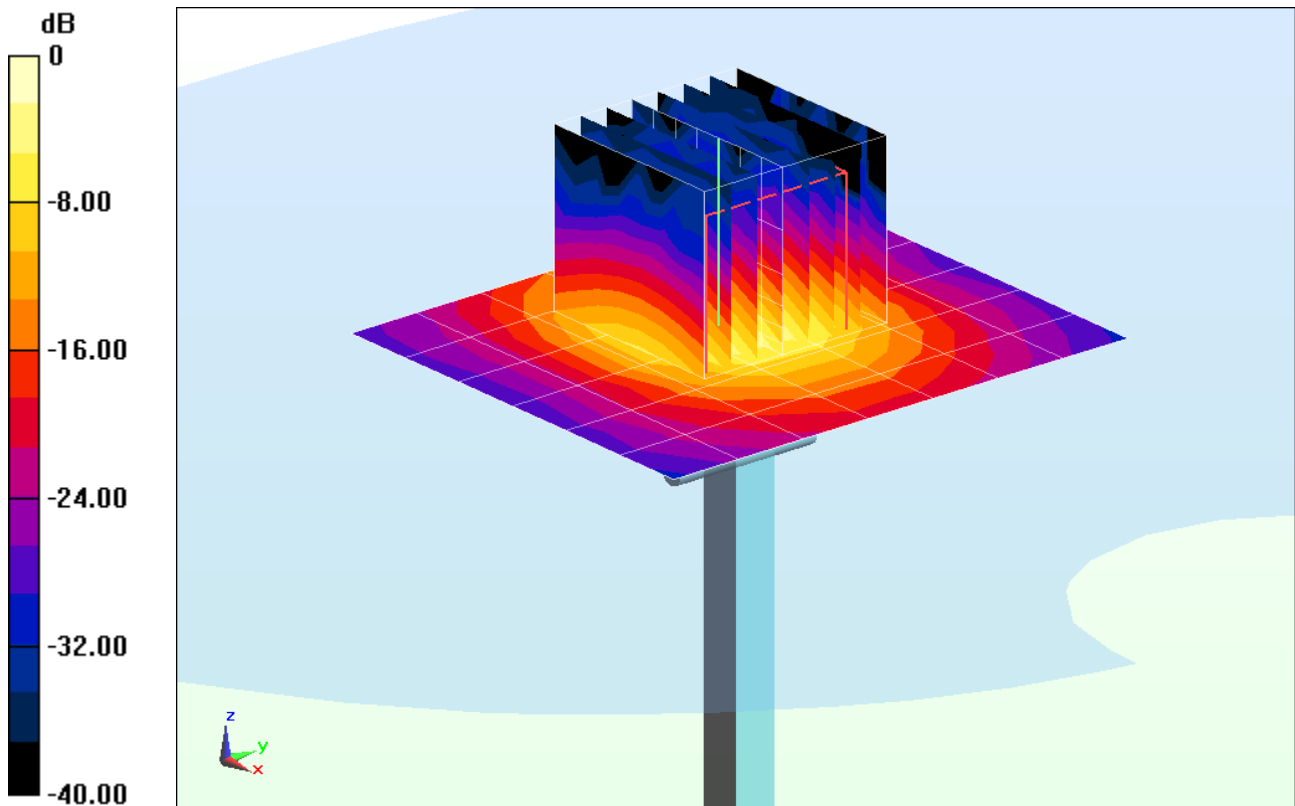

0 dB = 18.6 W/kg = 12.70 dBW/kg

PCTEST ENGINEERING LABORATORY, INC.

DUT: Dipole 835 MHz; Type: D835V2; Serial: 4d132

Communication System: CW; Frequency: 835 MHz; Duty Cycle: 1:1

Medium: 835 Body Medium parameters used:

$f = 835 \text{ MHz}$; $\sigma = 1.005 \text{ S/m}$; $\epsilon_r = 55.891$; $\rho = 1000 \text{ kg/m}^3$

Phantom section: Flat Section; Space: 1.5 cm

Test Date: 06-18-2013; Ambient Temp: 24.6°C; Tissue Temp: 22.9°C

Probe: ES3DV3 - SN3209; ConvF(6.28, 6.28, 6.28); Calibrated: 3/15/2013;

Sensor-Surface: 4mm (Mechanical Surface Detection)

Electronics: DAE4 Sn1334; Calibrated: 3/8/2013

Phantom: ELI v5.0; Type: QDOVA002AA; Serial: TP-1158

Measurement SW: DASY52, Version 52.8 (7); SEMCAD X Version 14.6.10 (7164)

835 MHz System Verification

Area Scan (7x14x1): Measurement grid: dx=15mm, dy=15mm

Zoom Scan (5x5x7)/Cube 0: Measurement grid: dx=8mm, dy=8mm, dz=5mm

Input Power = 20 dBm (100 mW)

Peak SAR (extrapolated) = 1.44 W/kg

SAR(1 g) = 0.994 W/kg; SAR(10 g) = 0.656 W/kg (SAR corrected for target medium)

Deviation (1 g) = 6.20 %

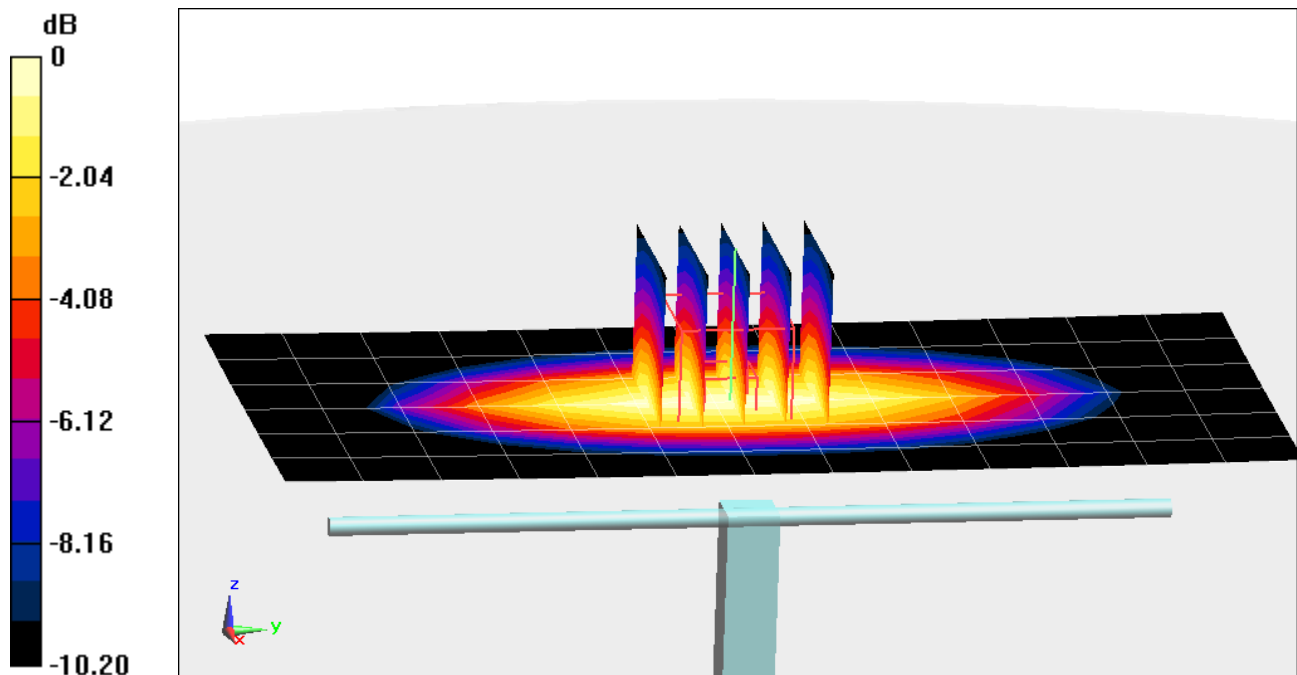

0 dB = 1.08 W/kg = 0.33 dBW/kg

PCTEST ENGINEERING LABORATORY, INC.

DUT: Dipole 1750 MHz; Type: D1765V2; Serial: 1008

Communication System: CW; Frequency: 1750 MHz; Duty Cycle: 1:1

Medium: 1750 Body Medium parameters used:

$f = 1750 \text{ MHz}$; $\sigma = 1.527 \text{ S/m}$; $\epsilon_r = 51.582$; $\rho = 1000 \text{ kg/m}^3$

Phantom section: Flat Section; Space: 1.0 cm

Test Date: 06-20-2013; Ambient Temp: 23.0°C; Tissue Temp: 22.1°C

Probe: ES3DV3 - SN3287; ConvF(4.86, 4.86, 4.86); Calibrated: 11/15/2012;

Sensor-Surface: 4mm (Mechanical Surface Detection)

Electronics: DAE4 Sn1333; Calibrated: 11/13/2012

Phantom: SAM with CRP; Type: SAM 4.0; Serial: TP1375

Measurement SW: DASY4, Version 4.7 (80); SEMCAD X Version 14.6.10 (7164)

1750 MHz System Verification

Area Scan (6x8x1): Measurement grid: dx=15mm, dy=15mm

Zoom Scan (5x5x7)/Cube 0: Measurement grid: dx=8mm, dy=8mm, dz=5mm

Input Power = 20 dBm (100 mW)

Peak SAR (extrapolated) = 7.11 W/kg

SAR(1 g) = 3.98 W/kg; SAR(10 g) = 2.09 W/kg (SAR corrected for target medium)

Deviation (1 g) = 4.19 %

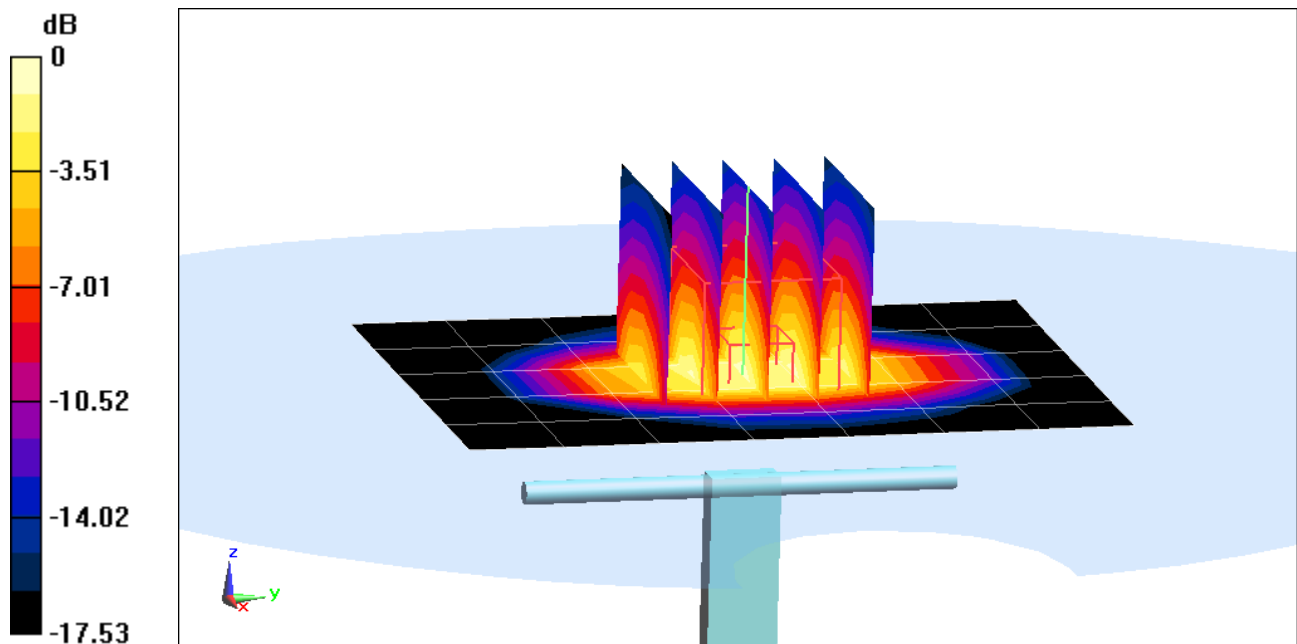

0 dB = 4.46 W/kg = 6.49 dBW/kg

PCTEST ENGINEERING LABORATORY, INC.

DUT: Dipole 1750 MHz; Type: D1765V2; Serial: 1008

Communication System: CW; Frequency: 1750 MHz; Duty Cycle: 1:1

Medium: 1750 Body Medium parameters used:

$f = 1750 \text{ MHz}$; $\sigma = 1.513 \text{ S/m}$; $\epsilon_r = 51.058$; $\rho = 1000 \text{ kg/m}^3$

Phantom section: Flat Section; Space: 1.0 cm

Test Date: 08-01-2013; Ambient Temp: 23.2°C; Tissue Temp: 23.0°C

Probe: ES3DV3 - SN3287; ConvF(4.86, 4.86, 4.86); Calibrated: 11/15/2012;

Sensor-Surface: 4mm (Mechanical Surface Detection)

Electronics: DAE4 Sn1333; Calibrated: 11/13/2012

Phantom: SAM Sub Dasy B; Type: SAM 5.0; Serial: TP-1626

Measurement SW: DASY4, Version 4.7 (80); SEMCAD X Version 14.6.10 (7164)

1750 MHz System Verification

Area Scan (6x8x1): Measurement grid: dx=15mm, dy=15mm

Zoom Scan (5x5x7)/Cube 0: Measurement grid: dx=8mm, dy=8mm, dz=5mm

Input Power = 20 dBm (100 mW)

Peak SAR (extrapolated) = 7.03 W/kg

SAR(1 g) = 3.92 W/kg; SAR(10 g) = 2.08 W/kg (SAR corrected for target medium)

Deviation (10 g) = 1.96 %

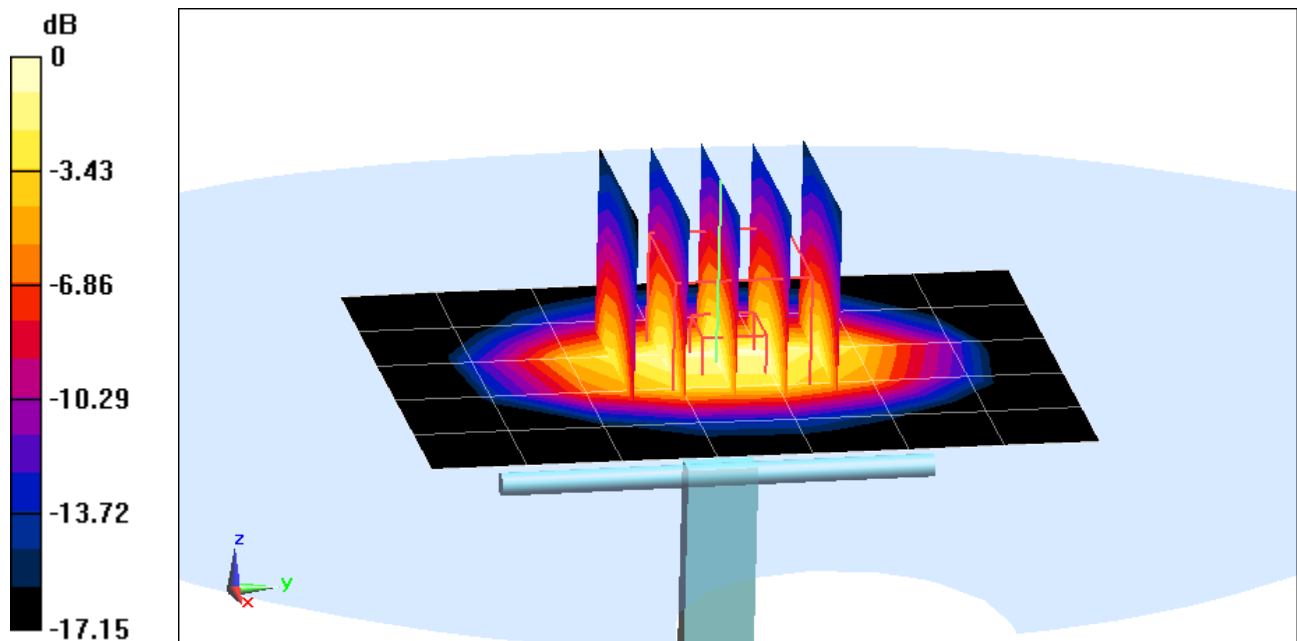

0 dB = 4.39 W/kg = 6.42 dBW/kg

PCTEST ENGINEERING LABORATORY, INC.

DUT: Dipole 1900 MHz; Type: D1900V2; Serial: 5d148

Communication System: CW; Frequency: 1900 MHz; Duty Cycle: 1:1

Medium: 1900 Body Medium parameters used (interpolated):

$f = 1900 \text{ MHz}$; $\sigma = 1.531 \text{ S/m}$; $\epsilon_r = 52.128$; $\rho = 1000 \text{ kg/m}^3$

Phantom section: Flat Section; Space: 1.0 cm

Test Date: 06-17-2013; Ambient Temp: 23.6°C; Tissue Temp: 23.3°C

Probe: EX3DV4 - SN3920; ConvF(7.38, 7.38, 7.38); Calibrated: 2/27/2013;

Sensor-Surface: 4mm (Mechanical Surface Detection)

Electronics: DAE4 Sn649; Calibrated: 2/6/2013

Phantom: SAM 5.0 front; Type: QD000P40CD; Serial: TP:-1648

Measurement SW: DASY52, Version 52.8 (7); SEMCAD X Version 14.6.10 (7164)

1900 MHz System Verification

Area Scan (7x10x1): Measurement grid: dx=15mm, dy=15mm

Zoom Scan (5x5x7)/Cube 0: Measurement grid: dx=8mm, dy=8mm, dz=5mm

Input Power = 20 dBm (100 mW)

Peak SAR (extrapolated) = 7.52 W/kg

SAR(1 g) = 4.17 W/kg; SAR(10 g) = 2.19 W/kg (SAR corrected for target medium)

Deviation (1 g) = 2.21 %

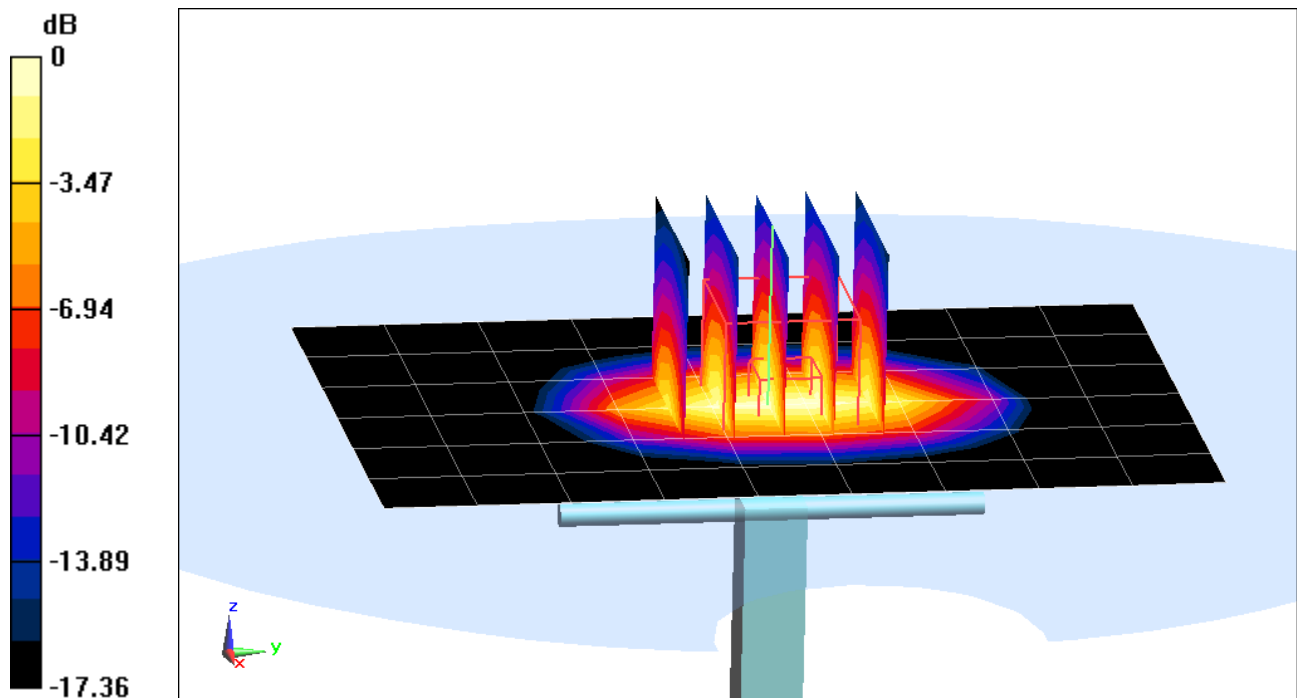

0 dB = 4.65 W/kg = 6.67 dBW/kg

PCTEST ENGINEERING LABORATORY, INC.

DUT: Dipole 1900 MHz; Type: D1900V2; Serial: 5d080

Communication System: CW; Frequency: 1900 MHz; Duty Cycle: 1:1

Medium: 1900 Body Medium parameters used (interpolated):

$f = 1900 \text{ MHz}$; $\sigma = 1.501 \text{ S/m}$; $\epsilon_r = 53$; $\rho = 1000 \text{ kg/m}^3$

Phantom section: Flat Section; Space: 1.0 cm

Test Date: 06-25-2013; Ambient Temp: 23.2°C; Tissue Temp: 23.6°C

Probe: ES3DV2 - SN3022; ConvF(4.43, 4.43, 4.43); Calibrated: 8/28/2012;

Sensor-Surface: 4mm (Mechanical Surface Detection)

Electronics: DAE4 Sn1322; Calibrated: 8/24/2012

Phantom: SAM Sub; Type: SAM 4.0; Serial: TP-1357

Measurement SW: DASY4, Version 4.7 (80); SEMCAD X Version 14.6.10 (7164)

1900 MHz System Verification

Area Scan (5x8x1): Measurement grid: dx=15mm, dy=15mm

Zoom Scan (5x5x7)/Cube 0: Measurement grid: dx=8mm, dy=8mm, dz=5mm

Input Power = 16 dBm (40 mW)

Peak SAR (extrapolated) = 2.78 W/kg

SAR(1 g) = 1.65 W/kg; SAR(10 g) = 0.894 W/kg (SAR corrected for target medium)

Deviation (1 g) = 2.36 %

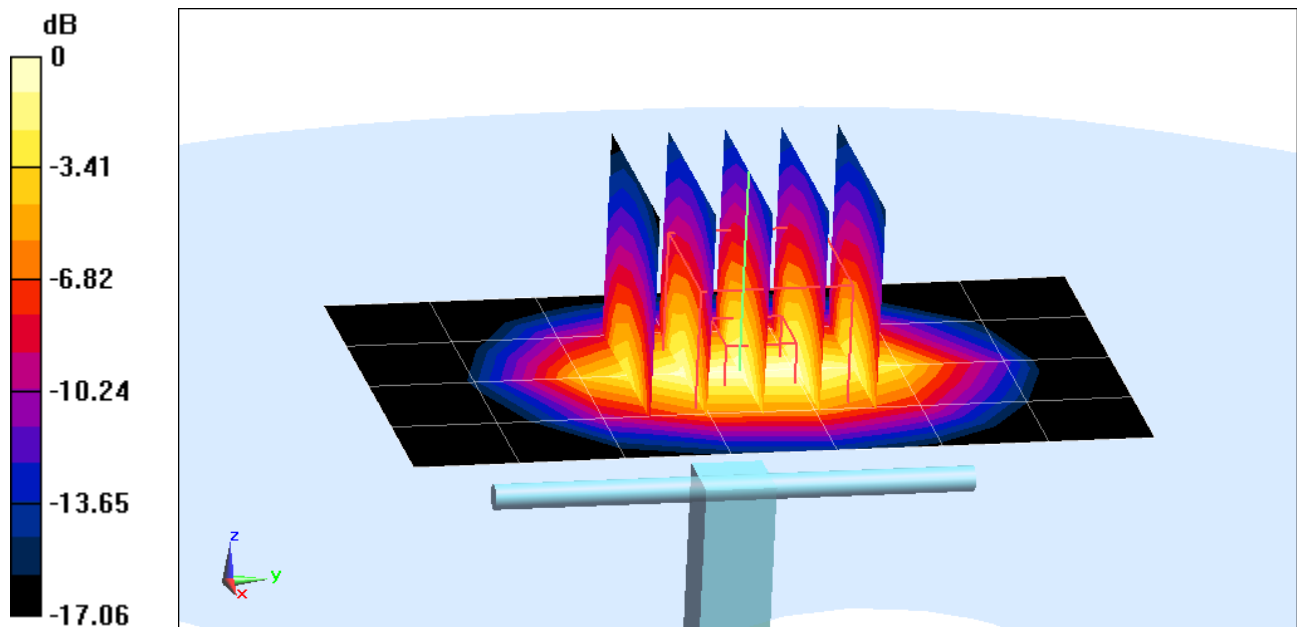

0 dB = 1.83 W/kg = 2.62 dBW/kg

PCTEST ENGINEERING LABORATORY, INC.

DUT: Dipole 1900 MHz; Type: D1900V2; Serial: 5d080

Communication System: CW; Frequency: 1900 MHz; Duty Cycle: 1:1

Medium: 1900 Body Medium parameters used (interpolated):

$f = 1900 \text{ MHz}$; $\sigma = 1.564 \text{ S/m}$; $\epsilon_r = 53.045$; $\rho = 1000 \text{ kg/m}^3$

Phantom section: Flat Section; Space: 1.0 cm

Test Date: 07-11-2013; Ambient Temp: 23.1°C; Tissue Temp: 22.9°C

Probe: ES3DV3 - SN3287; ConvF(4.69, 4.69, 4.69); Calibrated: 11/15/2012;

Sensor-Surface: 4mm (Mechanical Surface Detection)

Electronics: DAE4 Sn1333; Calibrated: 11/13/2012

Phantom: SAM Sub Dasy B; Type: SAM 5.0; Serial: TP-1626

Measurement SW: DASY4, Version 4.7 (80); SEMCAD X Version 14.6.10 (7164)

1900 MHz System Verification

Area Scan (5x7x1): Measurement grid: dx=15mm, dy=15mm

Zoom Scan (5x5x7)/Cube 0: Measurement grid: dx=8mm, dy=8mm, dz=5mm

Input Power = 20 dBm (100 mW)

Peak SAR (extrapolated) = 7.59 W/kg

SAR(1 g) = 4.22 W/kg; SAR(10 g) = 2.23 W/kg (SAR corrected for target medium)

Deviation (1 g) = 4.71 %

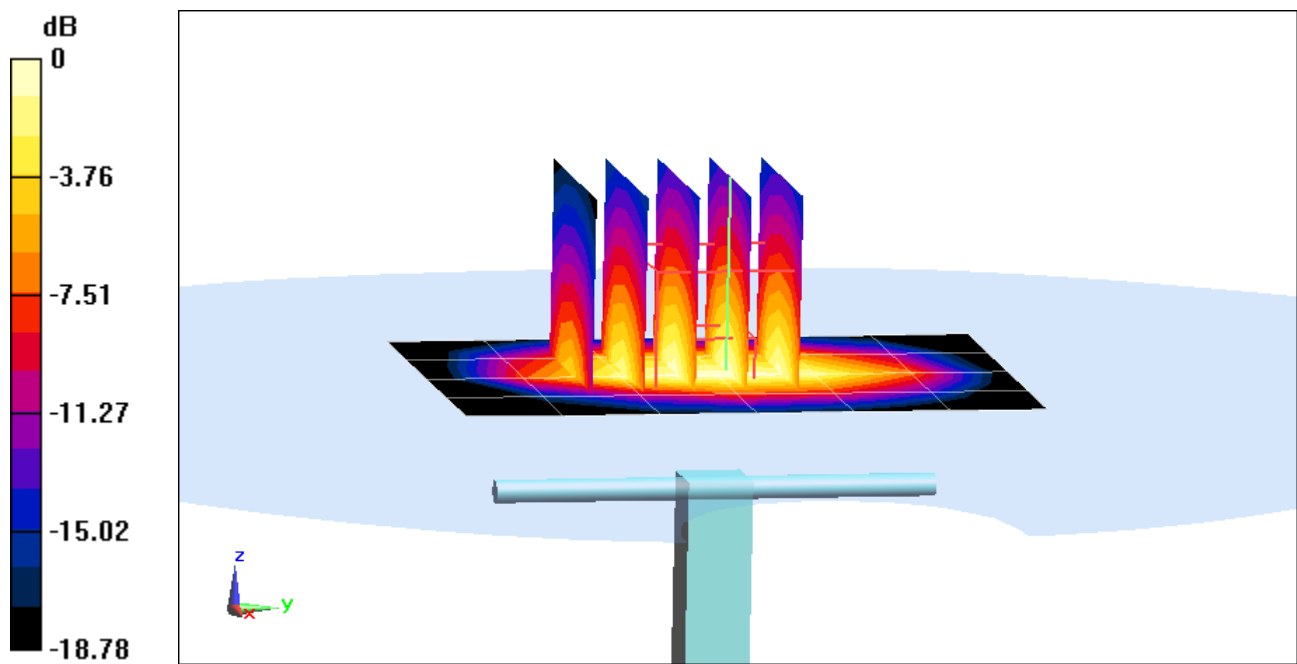

0 dB = 4.72 W/kg = 6.74 dBW/kg

PCTEST ENGINEERING LABORATORY, INC.

DUT: Dipole 1900 MHz; Type: D1900V2; Serial: 5d148

Communication System: CW; Frequency: 1900 MHz; Duty Cycle: 1:1

Medium: 1900 Body Medium parameters used (interpolated):

$f = 1900 \text{ MHz}$; $\sigma = 1.527 \text{ S/m}$; $\epsilon_r = 53.185$; $\rho = 1000 \text{ kg/m}^3$

Phantom section: Flat Section; Space: 1.0 cm

Test Date: 08-01-2013; Ambient Temp: 23.6°C; Tissue Temp: 23.7°C

Probe: EX3DV4 - SN3920; ConvF(7.38, 7.38, 7.38); Calibrated: 2/27/2013;

Sensor-Surface: 4mm (Mechanical Surface Detection)

Electronics: DAE4 Sn649; Calibrated: 2/6/2013

Phantom: SAM 5.0 front; Type: QD000P40CD; Serial: TP:-1648

Measurement SW: DASY52, Version 52.8 (7); SEMCAD X Version 14.6.10 (7164)

1900 MHz System Verification

Area Scan (7x10x1): Measurement grid: dx=15mm, dy=15mm

Zoom Scan (5x5x7)/Cube 0: Measurement grid: dx=8mm, dy=8mm, dz=5mm

Input Power = 20 dBm (100 mW)

Peak SAR (extrapolated) = 7.54 W/kg

SAR(1 g) = 4.21 W/kg; SAR(10 g) = 2.21 W/kg (SAR corrected for target medium)

Deviation (10 g) = 1.84 %

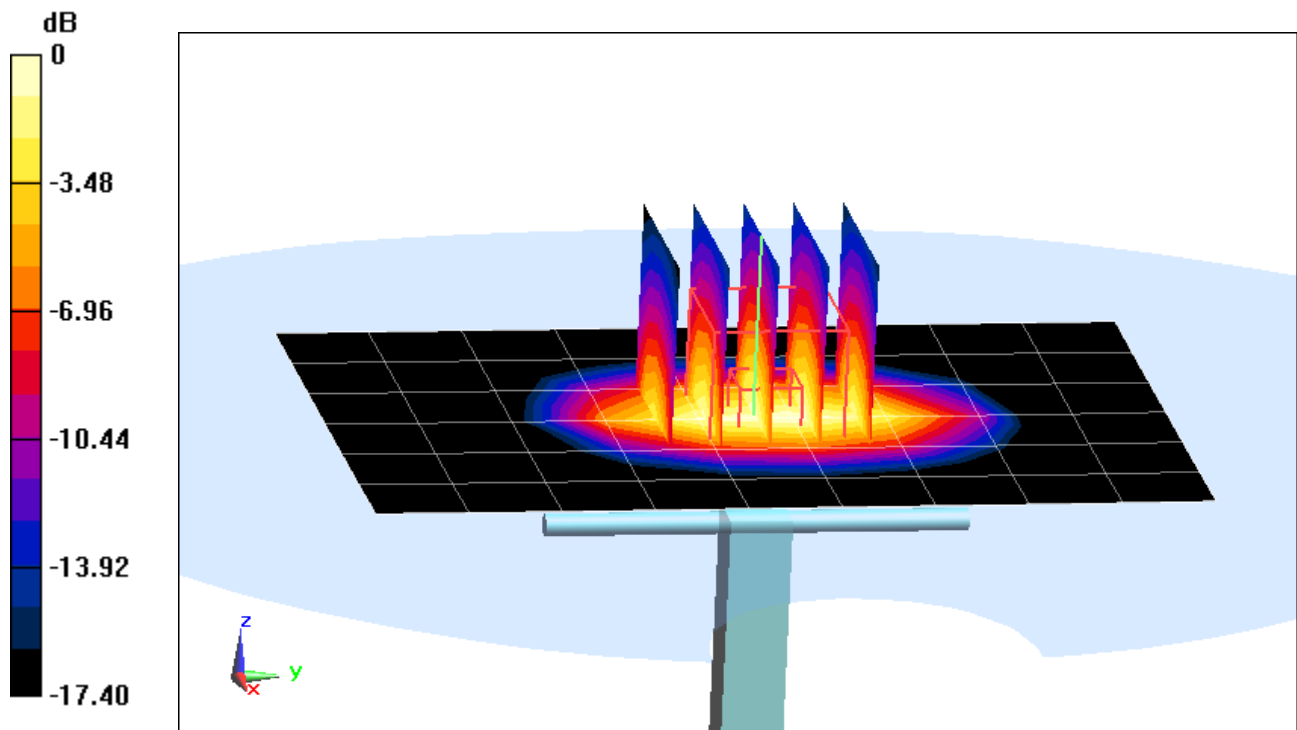

0 dB = 4.71 W/kg = 6.73 dBW/kg

PCTEST ENGINEERING LABORATORY, INC.

DUT: Dipole 2450 MHz; Type: D2450V2; Serial: 719

Communication System: CW; Frequency: 2450 MHz; Duty Cycle: 1:1

Medium: 2450 Body Medium parameters used:

$f = 2450 \text{ MHz}$; $\sigma = 2.031 \text{ S/m}$; $\epsilon_r = 52.669$; $\rho = 1000 \text{ kg/m}^3$

Phantom section: Flat Section; Space: 1.0 cm

Test Date: 07-22-2013; Ambient Temp: 23.0°C; Tissue Temp: 22.6°C

Probe: ES3DV2 - SN3022; ConvF(3.97, 3.97, 3.97); Calibrated: 8/28/2012;

Sensor-Surface: 3mm (Mechanical Surface Detection)

Electronics: DAE4 Sn1322; Calibrated: 8/24/2012

Phantom: SAM Sub; Type: SAM 4.0; Serial: TP-1357

Measurement SW: DASY4, Version 4.7 (80); SEMCAD X Version 14.6.10 (7164)

2450 MHz System Verification

Area Scan (6x9x1): Measurement grid: dx=12mm, dy=12mm

Zoom Scan (7x7x7)/Cube 0: Measurement grid: dx=5mm, dy=5mm, dz=5mm

Input Power = 20 dBm (100 mW)

Peak SAR (extrapolated) = 12.0 W/kg

SAR(1 g) = 5.48 W/kg; SAR(10 g) = 2.53 W/kg (SAR corrected for target medium)

Deviation (1 g) = 6.20 %

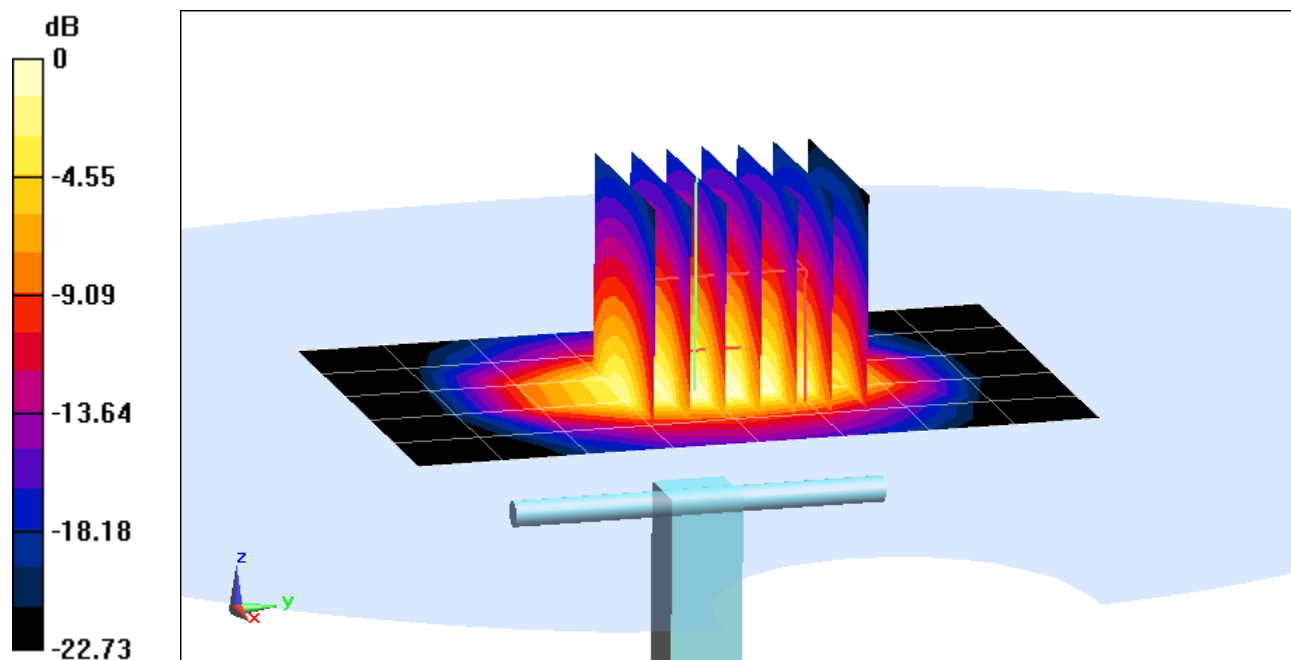

0 dB = 7.03 W/kg = 8.47 dBW/kg

PCTEST ENGINEERING LABORATORY, INC.

DUT: Dipole 2600 MHz; Type: D2600V2; Serial: 1004

Communication System: CW; Frequency: 2600 MHz; Duty Cycle: 1:1

Medium: 2600 Body Medium parameters used:

$f = 2600 \text{ MHz}$; $\sigma = 2.239 \text{ S/m}$; $\epsilon_r = 52.077$; $\rho = 1000 \text{ kg/m}^3$

Phantom section: Flat Section; Space: 1.0 cm

Test Date: 07-22-2013; Ambient Temp: 23.0°C; Tissue Temp: 22.6°C

Probe: ES3DV2 - SN3022; ConvF(3.8, 3.8, 3.8); Calibrated: 8/28/2012;

Sensor-Surface: 3mm (Mechanical Surface Detection)

Electronics: DAE4 Sn1322; Calibrated: 8/24/2012

Phantom: SAM Sub; Type: SAM 4.0; Serial: TP-1357

Measurement SW: DASY4, Version 4.7 (80); SEMCAD X Version 14.6.10 (7164)

2600 MHz System Verification

Area Scan (6x8x1): Measurement grid: dx=12mm, dy=12mm

Zoom Scan (7x7x7)/Cube 0: Measurement grid: dx=5mm, dy=5mm, dz=5mm

Input Power = 20 dBm (100 mW)

Peak SAR (extrapolated) = 13.8 W/kg

SAR(1 g) = 5.67 W/kg; SAR(10 g) = 2.5 W/kg (SAR corrected for target medium)

Deviation (1 g) = -1.39 %

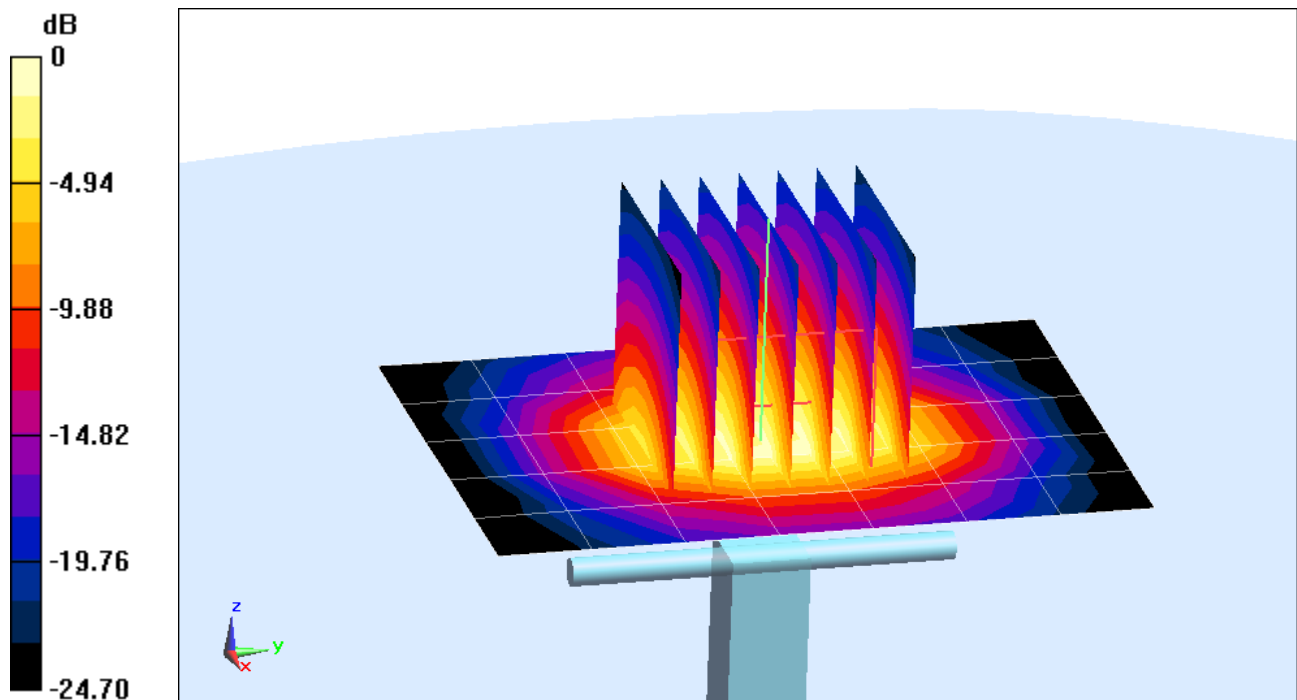

0 dB = 7.44 W/kg = 8.72 dBW/kg

PCTEST ENGINEERING LABORATORY, INC.

DUT: Dipole 5200 MHz; Type: D5GHzV2; Serial: 1057

Communication System: CW; Frequency: 5200 MHz; Duty Cycle: 1:1

Medium: 5 GHz Body; Medium parameters used:

$f = 5200 \text{ MHz}$; $\sigma = 5.437 \text{ S/m}$; $\epsilon_r = 47.182$; $\rho = 1000 \text{ kg/m}^3$

Phantom section: Flat Section; Space: 1.0 cm

Test Date: 05-06-2013; Ambient Temp: 23.6°C; Tissue Temp: 21.8°C

Probe: EX3DV4 - SN3589; ConvF(3.99, 3.99, 3.99); Calibrated: 1/17/2013;

Sensor-Surface: 1.4mm (Mechanical Surface Detection)

Electronics: DAE4 Sn1272; Calibrated: 1/17/2013

Phantom: SAM Sub; Type: SAM 4.0; Serial: TP-1357

Measurement SW: DASY4, Version 4.7 (80);SEMCAD X Version 14.6.9 (7117)

5200MHz System Verification

Area Scan (7x9x1): Measurement grid: dx=10mm, dy=10mm

Zoom Scan (9x9x7)/Cube 0: Measurement grid: dx=4mm, dy=4mm, dz=1.4mm; Graded Ratio: 1.4

Input Power = 20.0 dBm (100 mW)

Peak SAR (extrapolated) = 31.4 W/kg

SAR(1 g) = 7.57 W/kg; SAR(10 g) = 2.08 W/kg (SAR corrected for target medium)

Deviation (1 g) = 0.26%

Deviation (10 g) = -1.42 %

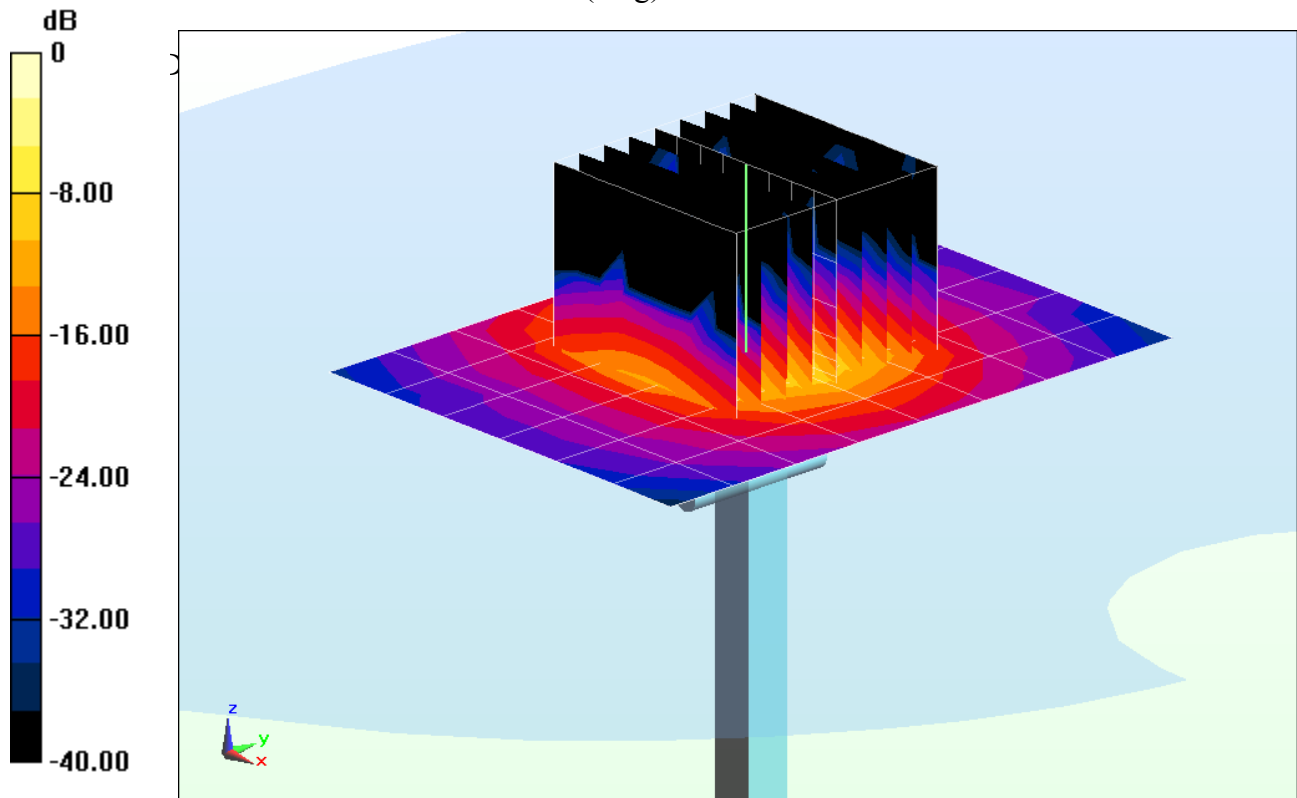

0 dB = 19.3 W/kg = 12.86 dBW/kg

PCTEST ENGINEERING LABORATORY, INC.

DUT: Dipole 5300 MHz; Type: D5GHzV2; Serial: 1057

Communication System: CW; Frequency: 5300 MHz; Duty Cycle: 1:1

Medium: 5 GHz Body; Medium parameters used:

$f = 5300 \text{ MHz}$; $\sigma = 5.546 \text{ S/m}$; $\epsilon_r = 46.946$; $\rho = 1000 \text{ kg/m}^3$

Phantom section: Flat Section; Space: 1.0 cm

Test Date: 05-06-2013; Ambient Temp: 23.6°C; Tissue Temp: 21.8°C

Probe: EX3DV4 - SN3589; ConvF(3.81, 3.81, 3.81); Calibrated: 1/17/2013;

Sensor-Surface: 1.4mm (Mechanical Surface Detection)

Electronics: DAE4 Sn1272; Calibrated: 1/17/2013

Phantom: SAM Sub; Type: SAM 4.0; Serial: TP-1357

Measurement SW: DASY4, Version 4.7 (80);SEMCAD X Version 14.6.9 (7117)

5300MHz System Verification

Area Scan (7x9x1): Measurement grid: dx=10mm, dy=10mm

Zoom Scan (9x9x7)/Cube 0: Measurement grid: dx=4mm, dy=4mm, dz=1.4mm; Graded Ratio: 1.4

Input Power = 20.0 dBm (100 mW)

Peak SAR (extrapolated) = 33.5 W/kg

SAR(1 g) = 8.09 W/kg; SAR(10 g) = 2.23 W/kg (SAR corrected for target medium)

Deviation (1 g) = 7.44%

Deviation (10 g) = 5.69 %

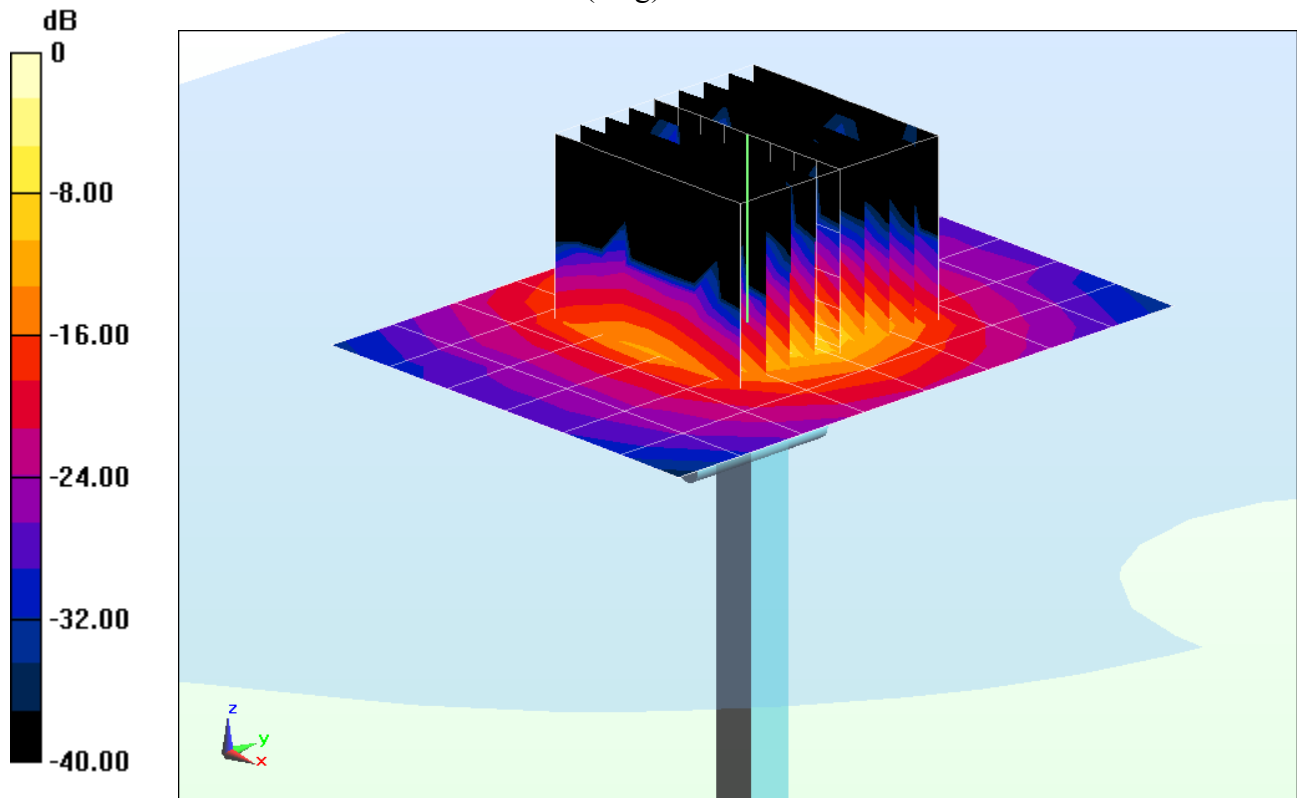

0 dB = 20.6 W/kg = 13.14 dBW/kg

PCTEST ENGINEERING LABORATORY, INC.

DUT: Dipole 5500 MHz; Type: D5GHzV2; Serial: 1057

Communication System: CW; Frequency: 5500 MHz; Duty Cycle: 1:1

Medium: 5 GHz Body; Medium parameters used:

$f = 5500 \text{ MHz}$; $\sigma = 5.801 \text{ S/m}$; $\epsilon_r = 46.707$; $\rho = 1000 \text{ kg/m}^3$

Phantom section: Flat Section; Space: 1.0 cm

Test Date: 05-06-2013; Ambient Temp: 23.6°C; Tissue Temp: 21.8°C

Probe: EX3DV4 - SN3589; ConvF(3.52, 3.52, 3.52); Calibrated: 1/17/2013;

Sensor-Surface: 1.4mm (Mechanical Surface Detection)

Electronics: DAE4 Sn1272; Calibrated: 1/17/2013

Phantom: SAM Sub; Type: SAM 4.0; Serial: TP-1357

Measurement SW: DASY4, Version 4.7 (80);SEMCAD X Version 14.6.9 (7117)

5500MHz System Verification

Area Scan (7x9x1): Measurement grid: dx=10mm, dy=10mm

Zoom Scan (9x9x7)/Cube 0: Measurement grid: dx=4mm, dy=4mm, dz=1.4mm; Graded Ratio: 1.4

Input Power = 20.0 dBm (100 mW)

Peak SAR (extrapolated) = 39.8 W/kg

SAR(1 g) = 8.11 W/kg; SAR(10 g) = 2.22 W/kg (SAR corrected for target medium)

Deviation (1 g) = 0.37%

Deviation (10 g) = -0.89 %

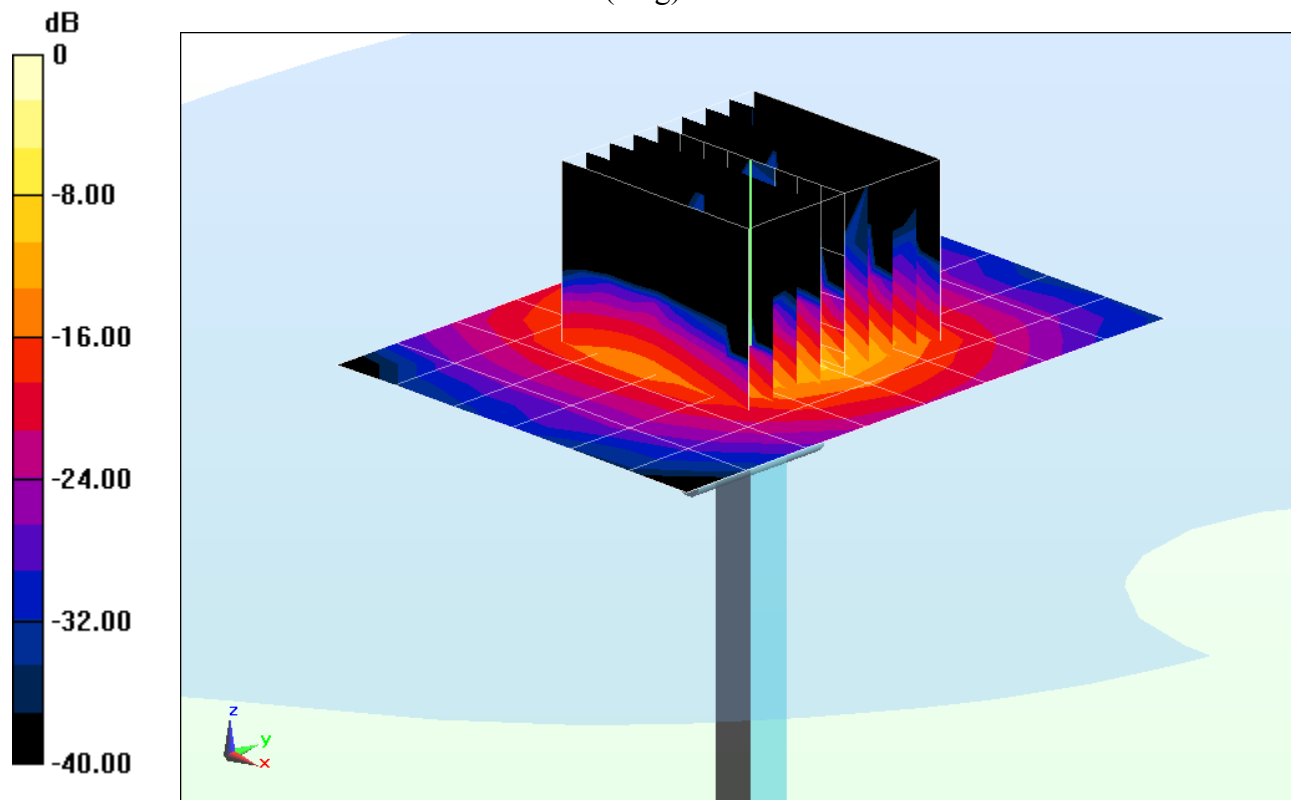

0 dB = 21.3 W/kg = 13.28 dBW/kg

PCTEST ENGINEERING LABORATORY, INC.

DUT: Dipole 5600 MHz; Type: D5GHzV2; Serial: 1057

Communication System: CW; Frequency: 5600 MHz; Duty Cycle: 1:1

Medium: 5 GHz Body; Medium parameters used:

$f = 5600 \text{ MHz}$; $\sigma = 5.946 \text{ S/m}$; $\epsilon_r = 46.517$; $\rho = 1000 \text{ kg/m}^3$

Phantom section: Flat Section; Space: 1.0 cm

Test Date: 05-06-2013; Ambient Temp: 23.7°C; Tissue Temp: 21.9°C

Probe: EX3DV4 - SN3589; ConvF(3.32, 3.32, 3.32); Calibrated: 1/17/2013;

Sensor-Surface: 1.4mm (Mechanical Surface Detection)

Electronics: DAE4 Sn1272; Calibrated: 1/17/2013

Phantom: SAM Sub; Type: SAM 4.0; Serial: TP-1357

Measurement SW: DASY4, Version 4.7 (80);SEMCAD X Version 14.6.9 (7117)

5600MHz System Verification

Area Scan (7x9x1): Measurement grid: dx=10mm, dy=10mm

Zoom Scan (9x9x7)/Cube 0: Measurement grid: dx=4mm, dy=4mm, dz=1.4mm; Graded Ratio: 1.4

Input Power = 20.0 dBm (100 mW)

Peak SAR (extrapolated) = 37.4 W/kg

SAR(1 g) = 8.48 W/kg; SAR(10 g) = 2.31 W/kg (SAR corrected for target medium)

Deviation (1 g) = 5.60%

Deviation (10 g) = 3.59 %

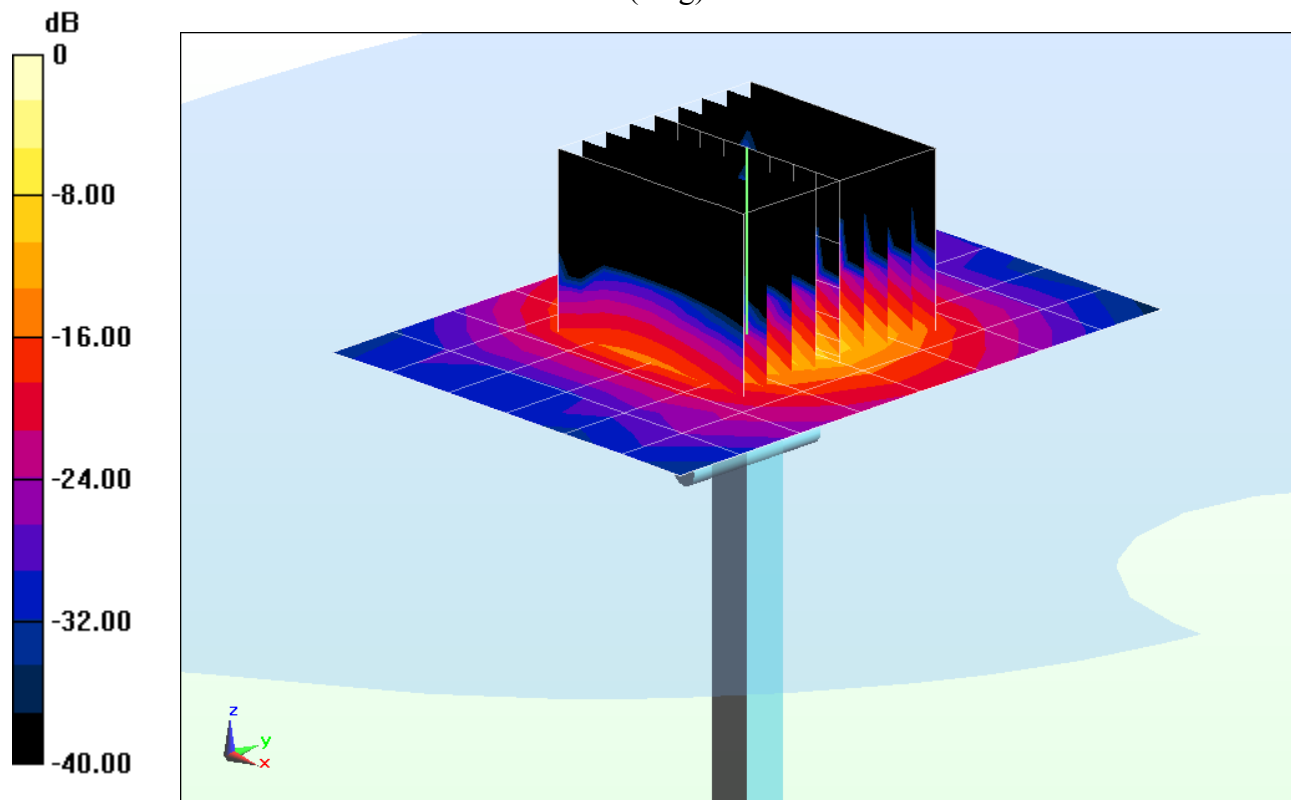

0 dB = 21.4 W/kg = 13.30 dBW/kg

PCTEST ENGINEERING LABORATORY, INC.

DUT: Dipole 5800 MHz; Type: D5GHzV2; Serial: 1057

Communication System: CW; Frequency: 5800 MHz; Duty Cycle: 1:1

Medium: 5 GHz Body; Medium parameters used:

$f = 5800 \text{ MHz}$; $\sigma = 6.198 \text{ S/m}$; $\epsilon_r = 46.11$; $\rho = 1000 \text{ kg/m}^3$

Phantom section: Flat Section; Space: 1.0 cm

Test Date: 05-06-2013; Ambient Temp: 23.7°C; Tissue Temp: 21.8°C

Probe: EX3DV4 - SN3589; ConvF(3.66, 3.66, 3.66); Calibrated: 1/17/2013;

Sensor-Surface: 1.4mm (Mechanical Surface Detection)

Electronics: DAE4 Sn1272; Calibrated: 1/17/2013

Phantom: SAM Sub; Type: SAM 4.0; Serial: TP-1357

Measurement SW: DASY4, Version 4.7 (80);SEMCAD X Version 14.6.9 (7117)

5800MHz System Verification

Area Scan (7x9x1): Measurement grid: dx=10mm, dy=10mm

Zoom Scan (9x9x7)/Cube 0: Measurement grid: dx=4mm, dy=4mm, dz=1.4mm; Graded Ratio: 1.4

Input Power = 20.0 dBm (100 mW)

Peak SAR (extrapolated) = 39.6 W/kg

SAR(1 g) = 7.42 W/kg; SAR(10 g) = 2.02 W/kg (SAR corrected for target medium)

Deviation (1 g) = -1.20%

Deviation (10 g) = -2.42 %

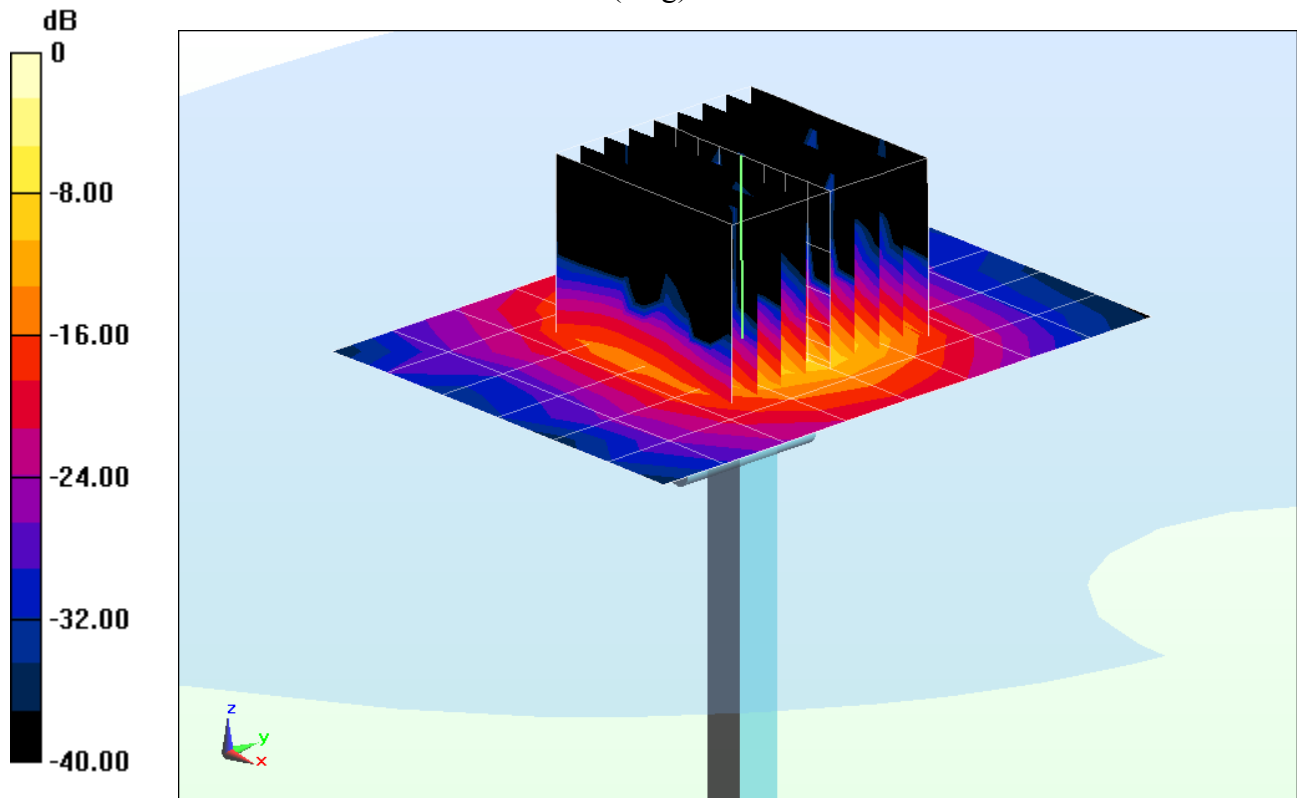

0 dB = 19.2 W/kg = 12.83 dBW/kg

APPENDIX C: PROBE CALIBRATION



Accredited by the Swiss Accreditation Service (SAS)
The Swiss Accreditation Service is one of the signatories to the EA
Multilateral Agreement for the recognition of calibration certificates

Accreditation No.: **SCS 108**

Client **PC Test**

Certificate No: **D2600V2-1004_May13**

CALIBRATION CERTIFICATE

Object **D2600V2 - SN: 1004**

Calibration procedure(s) **QA CAL-05.v9
Calibration procedure for dipole validation kits above 700 MHz**

Calibration date: **May 02, 2013**

✓
1004
5/8/13

This calibration certificate documents the traceability to national standards, which realize the physical units of measurements (SI).
The measurements and the uncertainties with confidence probability are given on the following pages and are part of the certificate.

All calibrations have been conducted in the closed laboratory facility: environment temperature (22 ± 3)°C and humidity < 70%.

Calibration Equipment used (M&TE critical for calibration)

Primary Standards	ID #	Cal Date (Certificate No.)	Scheduled Calibration
Power meter EPM-442A	GB37480704	01-Nov-12 (No. 217-01640)	Oct-13
Power sensor HP 8481A	US37292783	01-Nov-12 (No. 217-01640)	Oct-13
Reference 20 dB Attenuator	SN: 5058 (20k)	04-Apr-13 (No. 217-01736)	Apr-14
Type-N mismatch combination	SN: 5047.3 / 06327	04-Apr-13 (No. 217-01739)	Apr-14
Reference Probe ES3DV3	SN: 3205	28-Dec-12 (No. ES3-3205_Dec12)	Dec-13
DAE4	SN: 601	25-Apr-13 (No. DAE4-601_Apr13)	Apr-14
DAE4	SN: 909	11-Sep-12 (No. DAE4-909_Sep12)	Sep-13
Secondary Standards	ID #	Check Date (in house)	Scheduled Check
Power sensor HP 8481A	MY41092317	18-Oct-02 (in house check Oct-11)	In house check: Oct-13
RF generator R&S SMT-06	100005	04-Aug-99 (in house check Oct-11)	In house check: Oct-13
Network Analyzer HP 8753E	US37390585 S4206	18-Oct-01 (in house check Oct-12)	In house check: Oct-13

Calibrated by: **Claudio Leubler** Laboratory Technician

Signature

Approved by: **Katja Pokovic** Technical Manager

Issued: May 2, 2013

This calibration certificate shall not be reproduced except in full without written approval of the laboratory.



Accredited by the Swiss Accreditation Service (SAS)

The Swiss Accreditation Service is one of the signatories to the EA
Multilateral Agreement for the recognition of calibration certificates

Accreditation No.: **SCS 108**

Glossary:

TSL	tissue simulating liquid
ConvF	sensitivity in TSL / NORM x,y,z
N/A	not applicable or not measured

Calibration is Performed According to the Following Standards:

- IEEE Std 1528-2003, "IEEE Recommended Practice for Determining the Peak Spatial-Averaged Specific Absorption Rate (SAR) in the Human Head from Wireless Communications Devices: Measurement Techniques", December 2003
- IEC 62209-1, "Procedure to measure the Specific Absorption Rate (SAR) for hand-held devices used in close proximity to the ear (frequency range of 300 MHz to 3 GHz)", February 2005
- Federal Communications Commission Office of Engineering & Technology (FCC OET), "Evaluating Compliance with FCC Guidelines for Human Exposure to Radiofrequency Electromagnetic Fields; Additional Information for Evaluating Compliance of Mobile and Portable Devices with FCC Limits for Human Exposure to Radiofrequency Emissions", Supplement C (Edition 01-01) to Bulletin 65

Additional Documentation:

- DASY4/5 System Handbook

Methods Applied and Interpretation of Parameters:

- Measurement Conditions:* Further details are available from the Validation Report at the end of the certificate. All figures stated in the certificate are valid at the frequency indicated.
- Antenna Parameters with TSL:* The dipole is mounted with the spacer to position its feed point exactly below the center marking of the flat phantom section, with the arms oriented parallel to the body axis.
- Feed Point Impedance and Return Loss:* These parameters are measured with the dipole positioned under the liquid filled phantom. The impedance stated is transformed from the measurement at the SMA connector to the feed point. The Return Loss ensures low reflected power. No uncertainty required.
- Electrical Delay:* One-way delay between the SMA connector and the antenna feed point. No uncertainty required.
- SAR measured:* SAR measured at the stated antenna input power.
- SAR normalized:* SAR as measured, normalized to an input power of 1 W at the antenna connector.
- SAR for nominal TSL parameters:* The measured TSL parameters are used to calculate the nominal SAR result.

The reported uncertainty of measurement is stated as the standard uncertainty of measurement multiplied by the coverage factor $k=2$, which for a normal distribution corresponds to a coverage probability of approximately 95%.

Measurement Conditions

DASY system configuration, as far as not given on page 1.

DASY Version	DASY5	V52.8.6
Extrapolation	Advanced Extrapolation	
Phantom	Modular Flat Phantom	
Distance Dipole Center - TSL	10 mm	with Spacer
Zoom Scan Resolution	dx, dy, dz = 5 mm	
Frequency	2600 MHz \pm 1 MHz	

Head TSL parameters

The following parameters and calculations were applied.

	Temperature	Permittivity	Conductivity
Nominal Head TSL parameters	22.0 °C	39.0	1.96 mho/m
Measured Head TSL parameters	(22.0 \pm 0.2) °C	37.2 \pm 6 %	1.99 mho/m \pm 6 %
Head TSL temperature change during test	< 0.5 °C	----	----

SAR result with Head TSL

SAR averaged over 1 cm ³ (1 g) of Head TSL	Condition	
SAR measured	250 mW input power	14.8 W/kg
SAR for nominal Head TSL parameters	normalized to 1W	58.2 W/kg \pm 17.0 % (k=2)

SAR averaged over 10 cm ³ (10 g) of Head TSL	condition	
SAR measured	250 mW input power	6.57 W/kg
SAR for nominal Head TSL parameters	normalized to 1W	26.0 W/kg \pm 16.5 % (k=2)

Body TSL parameters

The following parameters and calculations were applied.

	Temperature	Permittivity	Conductivity
Nominal Body TSL parameters	22.0 °C	52.5	2.16 mho/m
Measured Body TSL parameters	(22.0 \pm 0.2) °C	50.8 \pm 6 %	2.20 mho/m \pm 6 %
Body TSL temperature change during test	< 0.5 °C	----	----

SAR result with Body TSL

SAR averaged over 1 cm ³ (1 g) of Body TSL	Condition	
SAR measured	250 mW input power	14.6 W/kg
SAR for nominal Body TSL parameters	normalized to 1W	57.5 W/kg \pm 17.0 % (k=2)

SAR averaged over 10 cm ³ (10 g) of Body TSL	condition	
SAR measured	250 mW input power	6.43 W/kg
SAR for nominal Body TSL parameters	normalized to 1W	25.5 W/kg \pm 16.5 % (k=2)

Appendix

Antenna Parameters with Head TSL

Impedance, transformed to feed point	50.0 Ω - 4.3 j Ω
Return Loss	- 27.3 dB

Antenna Parameters with Body TSL

Impedance, transformed to feed point	46.7 Ω - 2.9 j Ω
Return Loss	- 26.8 dB

General Antenna Parameters and Design

Electrical Delay (one direction)	1.149 ns
----------------------------------	----------

After long term use with 100W radiated power, only a slight warming of the dipole near the feedpoint can be measured.

The dipole is made of standard semirigid coaxial cable. The center conductor of the feeding line is directly connected to the second arm of the dipole. The antenna is therefore short-circuited for DC-signals. On some of the dipoles, small end caps are added to the dipole arms in order to improve matching when loaded according to the position as explained in the "Measurement Conditions" paragraph. The SAR data are not affected by this change. The overall dipole length is still according to the Standard.

No excessive force must be applied to the dipole arms, because they might bend or the soldered connections near the feedpoint may be damaged.

Additional EUT Data

Manufactured by	SPEAG
Manufactured on	December 23, 2006

DASY5 Validation Report for Head TSL

Date: 02.05.2013

Test Laboratory: SPEAG, Zurich, Switzerland

DUT: Dipole 2600 MHz; Type: D2600V2; Serial: D2600V2 - SN: 1004

Communication System: UID 0 - CW; Frequency: 2600 MHz

Medium parameters used: $f = 2600$ MHz; $\sigma = 1.99$ S/m; $\epsilon_r = 37.2$; $\rho = 1000$ kg/m³

Phantom section: Flat Section

Measurement Standard: DASY5 (IEEE/IEC/ANSI C63.19-2007)

DASY52 Configuration:

- Probe: ES3DV3 - SN3205; ConvF(4.45, 4.45, 4.45); Calibrated: 28.12.2012;
- Sensor-Surface: 3mm (Mechanical Surface Detection)
- Electronics: DAE4 Sn601; Calibrated: 25.04.2013
- Phantom: Flat Phantom 5.0 (front); Type: QD000P50AA; Serial: 1001
- DASY52 52.8.6(1115); SEMCAD X 14.6.9(7117)

Dipole Calibration for Head Tissue/Pin=250 mW, d=10mm/Zoom Scan (7x7x7)/Cube 0:

Measurement grid: dx=5mm, dy=5mm, dz=5mm

Reference Value = 101.3 V/m; Power Drift = 0.07 dB

Peak SAR (extrapolated) = 31.9 W/kg

SAR(1 g) = 14.8 W/kg; SAR(10 g) = 6.57 W/kg

Maximum value of SAR (measured) = 19.0 W/kg

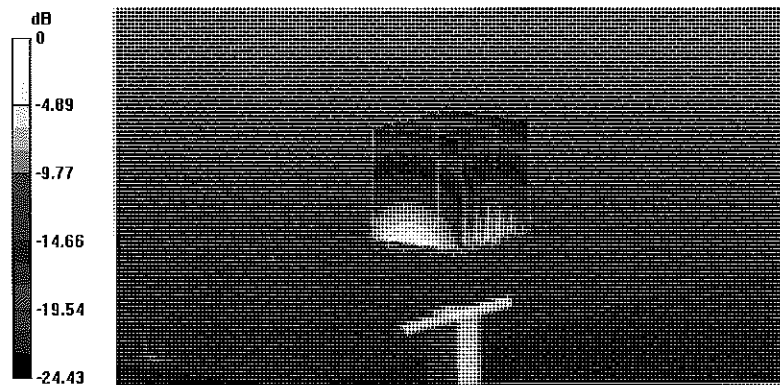

0 dB = 19.0 W/kg = 12.79 dBW/kg

Impedance Measurement Plot for Head TSL

2 May 2013 10:13:16

[CH1] S11 1 U FS 1: 49.990 Ω -4.3359 Ω 14.118 μ F 2 600.000 000 MHz

De1

CΔ

Avg
16

H1 d

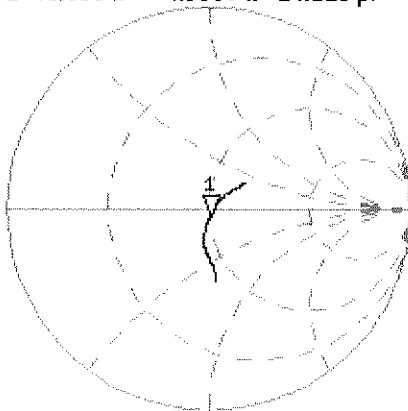

CH2 S11 LOG 5 dB/REF -20 dB 1:-27.259 dB 2 600.000 000 MHz

CΔ

Avg
16

H1 d

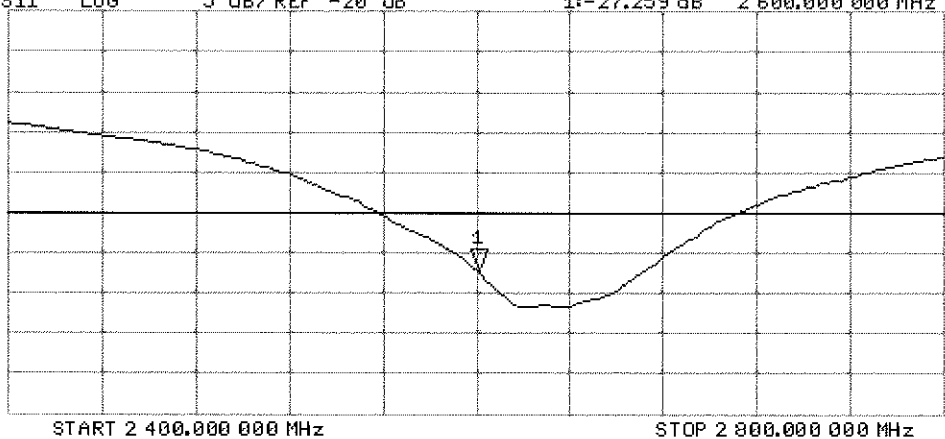

DASY5 Validation Report for Body TSL

Date: 25.04.2013

Test Laboratory: SPEAG, Zurich, Switzerland

DUT: Dipole 2600 MHz; Type: D2600V2; Serial: D2600V2 - SN: 1004

Communication System: UID 0 - CW; Frequency: 2600 MHz

Medium parameters used: $f = 2600$ MHz; $\sigma = 2.2$ S/m; $\epsilon_r = 50.8$; $\rho = 1000$ kg/m³

Phantom section: Flat Section

Measurement Standard: DASY5 (IEEE/IEC/ANSI C63.19-2007)

DASY52 Configuration:

- Probe: ES3DV3 - SN3205; ConvF(4.32, 4.32, 4.32); Calibrated: 28.12.2012;
- Sensor-Surface: 3mm (Mechanical Surface Detection)
- Electronics: DAE4 Sn909; Calibrated: 11.09.2012
- Phantom: Flat Phantom 5.0 (back); Type: QD000P50AA; Serial: 1002
- DASY52 52.8.6(1115); SEMCAD X 14.6.9(7117)

Dipole Calibration for Body Tissue/Pin=250 mW, d=10mm/Zoom Scan (7x7x7)/Cube 0:

Measurement grid: dx=5mm, dy=5mm, dz=5mm

Reference Value = 96.605 V/m; Power Drift = 0.02 dB

Peak SAR (extrapolated) = 32.0 W/kg

SAR(1 g) = 14.6 W/kg; SAR(10 g) = 6.43 W/kg

Maximum value of SAR (measured) = 19.4 W/kg

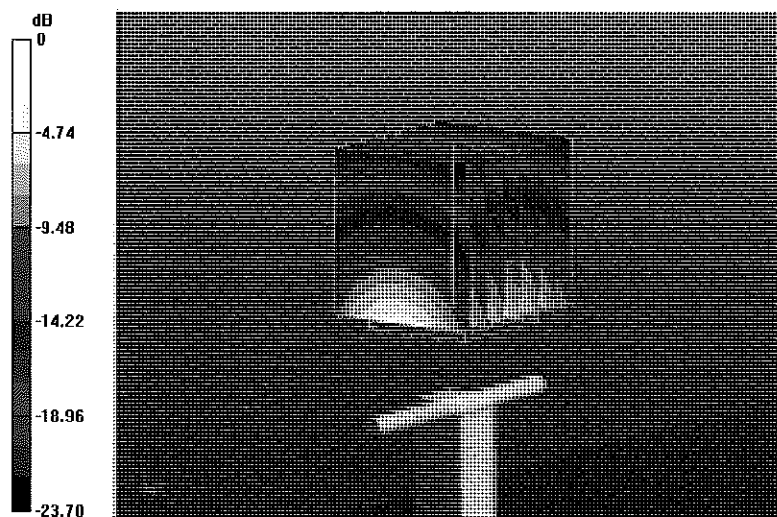

0 dB = 19.4 W/kg = 12.88 dBW/kg

Impedance Measurement Plot for Body TSL

25 Apr 2013 17:47:33

CH1 S11 1 U FS 1: 46.711 Ω -2.9453 Ω 20.783 pF 2 500.000 000 MHz

*

DeI

Cor

Avg
16

H1d

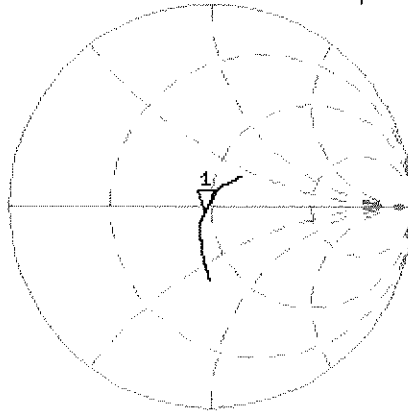

CH2 S11 LOG 5 dB/REF -20 dB 1: -26.810 dB 2 500.000 000 MHz

Cor

Avg
16

H1d

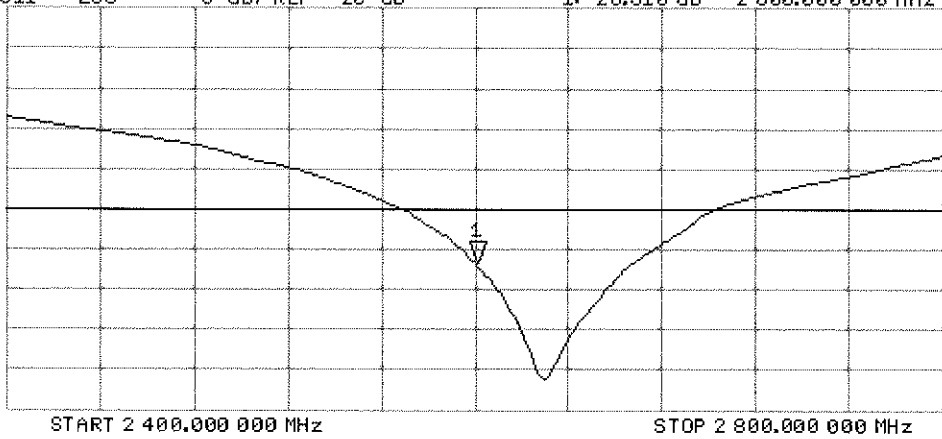



Accredited by the Swiss Accreditation Service (SAS)
The Swiss Accreditation Service is one of the signatories to the EA
Multilateral Agreement for the recognition of calibration certificates

Accreditation No.: **SCS 108**

Client **PC Test**

Certificate No: **D1750V2-1051_Apr13**

CALIBRATION CERTIFICATE

Object **D1750V2 - SN: 1051**

Calibration procedure(s) **QA CAL-05.v9
Calibration procedure for dipole validation kits above 700 MHz**

Calibration date: **April 30, 2013**

✓
LOK
5/8/13

This calibration certificate documents the traceability to national standards, which realize the physical units of measurements (SI).
The measurements and the uncertainties with confidence probability are given on the following pages and are part of the certificate.

All calibrations have been conducted in the closed laboratory facility: environment temperature (22 ± 3)°C and humidity < 70%.

Calibration Equipment used (M&TE critical for calibration)

Primary Standards	ID #	Cal Date (Certificate No.)	Scheduled Calibration
Power meter EPM-442A	GB37480704	01-Nov-12 (No. 217-01640)	Oct-13
Power sensor HP 8481A	US37292783	01-Nov-12 (No. 217-01640)	Oct-13
Reference 20 dB Attenuator	SN: 5058 (20k)	04-Apr-13 (No. 217-01736)	Apr-14
Type-N mismatch combination	SN: 5047.3 / 06327	04-Apr-13 (No. 217-01739)	Apr-14
Reference Probe ES3DV3	SN: 3205	28-Dec-12 (No. ES3-3205_Dec12)	Dec-13
DAE4	SN: 601	25-Apr-13 (No. DAE4-601_Apr13)	Apr-14
Secondary Standards	ID #	Check Date (in house)	Scheduled Check
Power sensor HP 8481A	MY41092317	18-Oct-02 (in house check Oct-11)	In house check: Oct-13
RF generator R&S SMT-06	100005	04-Aug-99 (in house check Oct-11)	In house check: Oct-13
Network Analyzer HP 8753E	US37390585 S4206	18-Oct-01 (in house check Oct-12)	In house check: Oct-13

Calibrated by: **Claudio Leubler** Name: Claudio Leubler Function: Laboratory Technician

Signature

Approved by: **Katja Pokovic** Name: Katja Pokovic Technical Manager

Issued: April 30, 2013

This calibration certificate shall not be reproduced except in full without written approval of the laboratory.



Accredited by the Swiss Accreditation Service (SAS)

The Swiss Accreditation Service is one of the signatories to the EA Multilateral Agreement for the recognition of calibration certificates

Accreditation No.: **SCS 108**

Glossary:

TSL	tissue simulating liquid
ConvF	sensitivity in TSL / NORM x,y,z
N/A	not applicable or not measured

Calibration is Performed According to the Following Standards:

- IEEE Std 1528-2003, "IEEE Recommended Practice for Determining the Peak Spatial-Averaged Specific Absorption Rate (SAR) in the Human Head from Wireless Communications Devices: Measurement Techniques", December 2003
- IEC 62209-1, "Procedure to measure the Specific Absorption Rate (SAR) for hand-held devices used in close proximity to the ear (frequency range of 300 MHz to 3 GHz)", February 2005
- Federal Communications Commission Office of Engineering & Technology (FCC OET), "Evaluating Compliance with FCC Guidelines for Human Exposure to Radiofrequency Electromagnetic Fields; Additional Information for Evaluating Compliance of Mobile and Portable Devices with FCC Limits for Human Exposure to Radiofrequency Emissions", Supplement C (Edition 01-01) to Bulletin 65

Additional Documentation:

- DASY4/5 System Handbook

Methods Applied and Interpretation of Parameters:

- Measurement Conditions:* Further details are available from the Validation Report at the end of the certificate. All figures stated in the certificate are valid at the frequency indicated.
- Antenna Parameters with TSL:* The dipole is mounted with the spacer to position its feed point exactly below the center marking of the flat phantom section, with the arms oriented parallel to the body axis.
- Feed Point Impedance and Return Loss:* These parameters are measured with the dipole positioned under the liquid filled phantom. The impedance stated is transformed from the measurement at the SMA connector to the feed point. The Return Loss ensures low reflected power. No uncertainty required.
- Electrical Delay:* One-way delay between the SMA connector and the antenna feed point. No uncertainty required.
- SAR measured:* SAR measured at the stated antenna input power.
- SAR normalized:* SAR as measured, normalized to an input power of 1 W at the antenna connector.
- SAR for nominal TSL parameters:* The measured TSL parameters are used to calculate the nominal SAR result.

The reported uncertainty of measurement is stated as the standard uncertainty of measurement multiplied by the coverage factor $k=2$, which for a normal distribution corresponds to a coverage probability of approximately 95%.

Measurement Conditions

DASY system configuration, as far as not given on page 1.

DASY Version	DASY5	V52.8.6
Extrapolation	Advanced Extrapolation	
Phantom	Modular Flat Phantom	
Distance Dipole Center - TSL	10 mm	with Spacer
Zoom Scan Resolution	dx, dy, dz = 5 mm	
Frequency	1750 MHz \pm 1 MHz	

Head TSL parameters

The following parameters and calculations were applied.

	Temperature	Permittivity	Conductivity
Nominal Head TSL parameters	22.0 °C	40.1	1.37 mho/m
Measured Head TSL parameters	(22.0 \pm 0.2) °C	39.1 \pm 6 %	1.33 mho/m \pm 6 %
Head TSL temperature change during test	< 0.5 °C	----	----

SAR result with Head TSL

SAR averaged over 1 cm³ (1 g) of Head TSL	Condition	
SAR measured	250 mW input power	9.01 W/kg
SAR for nominal Head TSL parameters	normalized to 1W	36.5 W/kg \pm 17.0 % (k=2)

SAR averaged over 10 cm³ (10 g) of Head TSL	condition	
SAR measured	250 mW input power	4.83 W/kg
SAR for nominal Head TSL parameters	normalized to 1W	19.5 W/kg \pm 16.5 % (k=2)

Body TSL parameters

The following parameters and calculations were applied.

	Temperature	Permittivity	Conductivity
Nominal Body TSL parameters	22.0 °C	53.4	1.49 mho/m
Measured Body TSL parameters	(22.0 \pm 0.2) °C	51.8 \pm 6 %	1.50 mho/m \pm 6 %
Body TSL temperature change during test	< 0.5 °C	----	----

SAR result with Body TSL

SAR averaged over 1 cm³ (1 g) of Body TSL	Condition	
SAR measured	250 mW input power	9.55 W/kg
SAR for nominal Body TSL parameters	normalized to 1W	37.8 W/kg \pm 17.0 % (k=2)

SAR averaged over 10 cm³ (10 g) of Body TSL	condition	
SAR measured	250 mW input power	5.13 W/kg
SAR for nominal Body TSL parameters	normalized to 1W	20.4 W/kg \pm 16.5 % (k=2)

Appendix

Antenna Parameters with Head TSL

Impedance, transformed to feed point	50.9 Ω + 0.3 j Ω
Return Loss	- 40.7 dB

Antenna Parameters with Body TSL

Impedance, transformed to feed point	47.0 Ω + 0.4 j Ω
Return Loss	- 30.1 dB

General Antenna Parameters and Design

Electrical Delay (one direction)	1.222 ns
----------------------------------	----------

After long term use with 100W radiated power, only a slight warming of the dipole near the feedpoint can be measured.

The dipole is made of standard semirigid coaxial cable. The center conductor of the feeding line is directly connected to the second arm of the dipole. The antenna is therefore short-circuited for DC-signals. On some of the dipoles, small end caps are added to the dipole arms in order to improve matching when loaded according to the position as explained in the "Measurement Conditions" paragraph. The SAR data are not affected by this change. The overall dipole length is still according to the Standard.

No excessive force must be applied to the dipole arms, because they might bend or the soldered connections near the feedpoint may be damaged.

Additional EUT Data

Manufactured by	SPEAG
Manufactured on	February 19, 2010

DASY5 Validation Report for Head TSL

Date: 30.04.2013

Test Laboratory: SPEAG, Zurich, Switzerland

DUT: Dipole 1750 MHz; Type: D1750V2; Serial: D1750V2 - SN: 1051

Communication System: UID 0 - CW; Frequency: 1750 MHz

Medium parameters used: $f = 1750$ MHz; $\sigma = 1.33$ S/m; $\epsilon_r = 39.1$; $\rho = 1000$ kg/m³

Phantom section: Flat Section

Measurement Standard: DASY5 (IEEE/IEC/ANSI C63.19-2007)

DASY52 Configuration:

- Probe: ES3DV3 - SN3205; ConvF(5.18, 5.18, 5.18); Calibrated: 28.12.2012;
- Sensor-Surface: 3mm (Mechanical Surface Detection)
- Electronics: DAE4 Sn601; Calibrated: 25.04.2013
- Phantom: Flat Phantom 5.0 (front); Type: QD000P50AA; Serial: 1001
- DASY52 52.8.6(1115); SEMCAD X 14.6.9(7117)

Dipole Calibration for Head Tissue/Pin=250 mW, d=10mm/Zoom Scan (8x7x7)/Cube 0:

Measurement grid: dx=5mm, dy=5mm, dz=5mm

Reference Value = 90.104 V/m; Power Drift = 0.09 dB

Peak SAR (extrapolated) = 16.0 W/kg

SAR(1 g) = 9.01 W/kg; SAR(10 g) = 4.83 W/kg

Maximum value of SAR (measured) = 11.3 W/kg

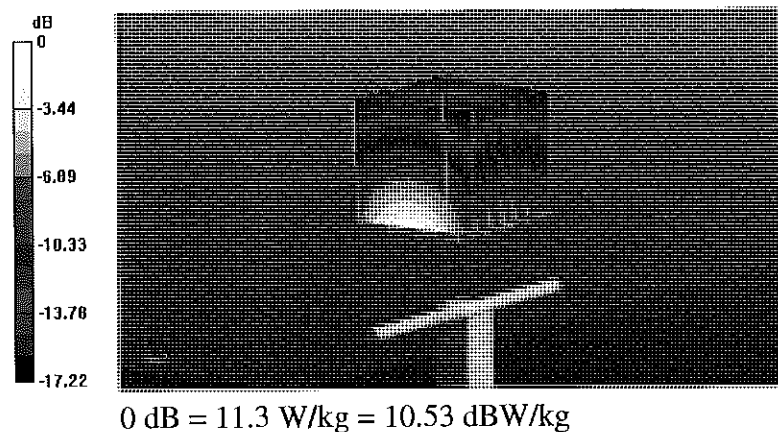

Impedance Measurement Plot for Head TSL

30 Apr 2013 12:59:57

CH1 S11 1 U FS 1: 50.889 Ω 0.2813 Ω 25.578 pF 1 750.000 000 MHz

*
Del
CA
Avg
4
Hid

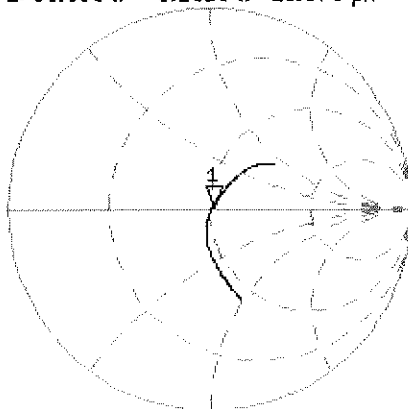

CH2 S11 LOG 5 dB/REF -20 dB 1:-40.692 dB 1 750.000 000 MHz

CA
Avg
4
Hid

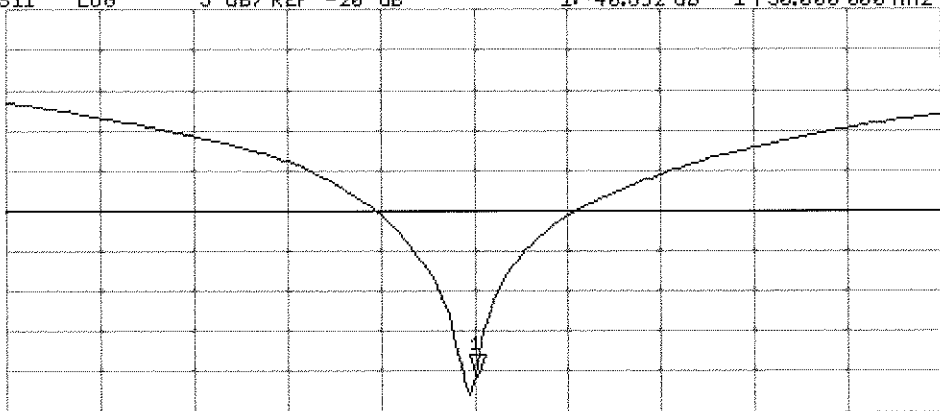

START 1 550.000 000 MHz

STOP 1 950.000 000 MHz

DASY5 Validation Report for Body TSL

Date: 30.04.2013

Test Laboratory: SPEAG, Zurich, Switzerland

DUT: Dipole 1750 MHz; Type: D1750V2; Serial: D1750V2 - SN: 1051

Communication System: UID 0 - CW; Frequency: 1750 MHz

Medium parameters used: $f = 1750$ MHz; $\sigma = 1.5$ S/m; $\epsilon_r = 51.8$; $\rho = 1000$ kg/m³

Phantom section: Flat Section

Measurement Standard: DASY5 (IEEE/IEC/ANSI C63.19-2007)

DASY52 Configuration:

- Probe: ES3DV3 - SN3205; ConvF(4.83, 4.83, 4.83); Calibrated: 28.12.2012;
- Sensor-Surface: 3mm (Mechanical Surface Detection)
- Electronics: DAE4 Sn601; Calibrated: 25.04.2013
- Phantom: Flat Phantom 5.0 (back); Type: QD000P50AA; Serial: 1002
- DASY52 52.8.6(1115); SEMCAD X 14.6.9(7117)

Dipole Calibration for Body Tissue/Pin=250 mW, d=10mm/Zoom Scan (7x7x7)/Cube 0:

Measurement grid: dx=5mm, dy=5mm, dz=5mm

Reference Value = 93.473 V/m; Power Drift = 0.01 dB

Peak SAR (extrapolated) = 16.4 W/kg

SAR(1 g) = 9.55 W/kg; SAR(10 g) = 5.13 W/kg

Maximum value of SAR (measured) = 12.0 W/kg

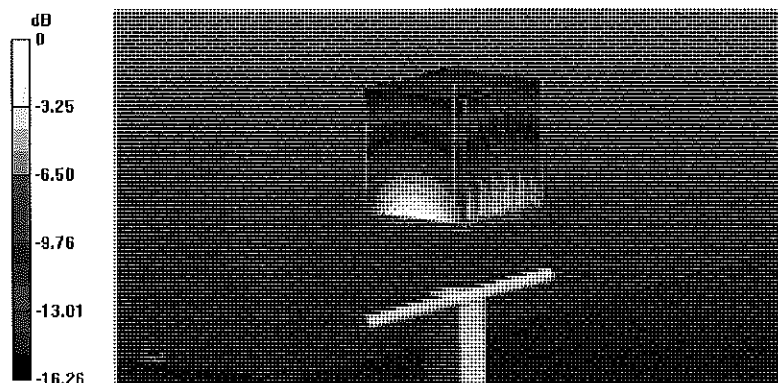

0 dB = 12.0 W/kg = 10.79 dBW/kg

Impedance Measurement Plot for Body TSL

30 Apr 2013 12:59:14

CH1 S11 1 U FS 1: 46.998 Ω 0.4160 Ω 37.835 pF 1 750.000 000 MHz

*
De1
CA
Avg
16
H1d

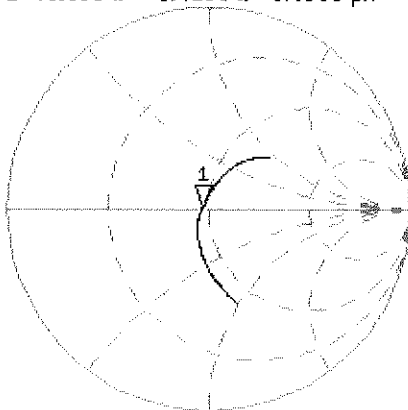

CH2 S11 LOG 5 dB/REF -20 dB 1:-30.102 dB 1 750.000 000 MHz

CA
Avg
16
H1d

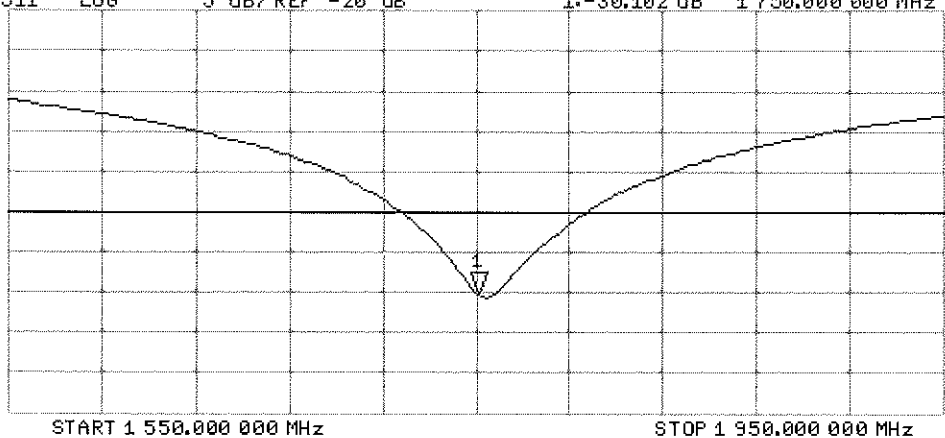



Accredited by the Swiss Accreditation Service (SAS)
The Swiss Accreditation Service is one of the signatories to the EA
Multilateral Agreement for the recognition of calibration certificates

Accreditation No.: **SCS 108**

Client **PC Test**

Certificate No: **D1765V2-1008_May13**

CALIBRATION CERTIFICATE

Object **D1765V2 - SN: 1008**

Calibration procedure(s) **QA CAL-05.v9
Calibration procedure for dipole validation kits above 700 MHz**

Calibration date: **May 14, 2013**

*✓ 100K
5/23/13*

This calibration certificate documents the traceability to national standards, which realize the physical units of measurements (SI).
The measurements and the uncertainties with confidence probability are given on the following pages and are part of the certificate.

All calibrations have been conducted in the closed laboratory facility: environment temperature (22 ± 3)°C and humidity < 70%.

Calibration Equipment used (M&TE critical for calibration)

Primary Standards	ID #	Cal Date (Certificate No.)	Scheduled Calibration
Power meter EPM-442A	GB37480704	01-Nov-12 (No. 217-01640)	Oct-13
Power sensor HP 8481A	US37292783	01-Nov-12 (No. 217-01640)	Oct-13
Reference 20 dB Attenuator	SN: 5058 (20k)	04-Apr-13 (No. 217-01736)	Apr-14
Type-N mismatch combination	SN: 5047.3 / 06327	04-Apr-13 (No. 217-01739)	Apr-14
Reference Probe ES3DV3	SN: 3205	28-Dec-12 (No. ES3-3205_Dec12)	Dec-13
DAE4	SN: 601	25-Apr-13 (No. DAE4-601_Apr13)	Apr-14
Secondary Standards	ID #	Check Date (in house)	Scheduled Check
Power sensor HP 8481A	MY41092317	18-Oct-02 (in house check Oct-11)	In house check: Oct-13
RF generator R&S SMT-06	100005	04-Aug-99 (in house check Oct-11)	In house check: Oct-13
Network Analyzer HP 8753E	US37390585 S4206	18-Oct-01 (in house check Oct-12)	In house check: Oct-13

Calibrated by: **Jeton Kastat** Name: **Jeton Kastat** Function: **Laboratory Technician** Signature: *[Signature]*

Approved by: **Katja Pokovic** Name: **Katja Pokovic** Function: **Technical Manager** Signature: *[Signature]*

Issued: May 15, 2013

This calibration certificate shall not be reproduced except in full without written approval of the laboratory.



Accredited by the Swiss Accreditation Service (SAS)

Accreditation No.: **SCS 108**

The Swiss Accreditation Service is one of the signatories to the EA Multilateral Agreement for the recognition of calibration certificates

Glossary:

TSL	tissue simulating liquid
ConvF	sensitivity in TSL / NORM x,y,z
N/A	not applicable or not measured

Calibration is Performed According to the Following Standards:

- IEEE Std 1528-2003, "IEEE Recommended Practice for Determining the Peak Spatial-Averaged Specific Absorption Rate (SAR) in the Human Head from Wireless Communications Devices: Measurement Techniques", December 2003
- IEC 62209-1, "Procedure to measure the Specific Absorption Rate (SAR) for hand-held devices used in close proximity to the ear (frequency range of 300 MHz to 3 GHz)", February 2005
- Federal Communications Commission Office of Engineering & Technology (FCC OET), "Evaluating Compliance with FCC Guidelines for Human Exposure to Radiofrequency Electromagnetic Fields; Additional Information for Evaluating Compliance of Mobile and Portable Devices with FCC Limits for Human Exposure to Radiofrequency Emissions", Supplement C (Edition 01-01) to Bulletin 65

Additional Documentation:

- DASY4/5 System Handbook

Methods Applied and Interpretation of Parameters:

- Measurement Conditions:* Further details are available from the Validation Report at the end of the certificate. All figures stated in the certificate are valid at the frequency indicated.
- Antenna Parameters with TSL:* The dipole is mounted with the spacer to position its feed point exactly below the center marking of the flat phantom section, with the arms oriented parallel to the body axis.
- Feed Point Impedance and Return Loss:* These parameters are measured with the dipole positioned under the liquid filled phantom. The impedance stated is transformed from the measurement at the SMA connector to the feed point. The Return Loss ensures low reflected power. No uncertainty required.
- Electrical Delay:* One-way delay between the SMA connector and the antenna feed point. No uncertainty required.
- SAR measured:* SAR measured at the stated antenna input power.
- SAR normalized:* SAR as measured, normalized to an input power of 1 W at the antenna connector.
- SAR for nominal TSL parameters:* The measured TSL parameters are used to calculate the nominal SAR result.

The reported uncertainty of measurement is stated as the standard uncertainty of measurement multiplied by the coverage factor $k=2$, which for a normal distribution corresponds to a coverage probability of approximately 95%.

Measurement Conditions

DASY system configuration, as far as not given on page 1.

DASY Version	DASY5	V52.8.6
Extrapolation	Advanced Extrapolation	
Phantom	Modular Flat Phantom	
Distance Dipole Center - TSL	10 mm	with Spacer
Zoom Scan Resolution	dx, dy, dz = 5 mm	
Frequency	1750 MHz \pm 1 MHz	

Head TSL parameters

The following parameters and calculations were applied.

	Temperature	Permittivity	Conductivity
Nominal Head TSL parameters	22.0 °C	40.1	1.37 mho/m
Measured Head TSL parameters	(22.0 \pm 0.2) °C	39.1 \pm 6 %	1.33 mho/m \pm 6 %
Head TSL temperature change during test	< 0.5 °C	----	----

SAR result with Head TSL

SAR averaged over 1 cm³ (1 g) of Head TSL	Condition	
SAR measured	250 mW input power	9.09 W/kg
SAR for nominal Head TSL parameters	normalized to 1W	36.8 W/kg \pm 17.0 % (k=2)

SAR averaged over 10 cm³ (10 g) of Head TSL	condition	
SAR measured	250 mW input power	4.85 W/kg
SAR for nominal Head TSL parameters	normalized to 1W	19.6 W/kg \pm 16.5 % (k=2)

Body TSL parameters

The following parameters and calculations were applied.

	Temperature	Permittivity	Conductivity
Nominal Body TSL parameters	22.0 °C	53.4	1.49 mho/m
Measured Body TSL parameters	(22.0 \pm 0.2) °C	51.7 \pm 6 %	1.47 mho/m \pm 6 %
Body TSL temperature change during test	< 0.5 °C	----	----

SAR result with Body TSL

SAR averaged over 1 cm³ (1 g) of Body TSL	Condition	
SAR measured	250 mW input power	9.53 W/kg
SAR for nominal Body TSL parameters	normalized to 1W	38.2 W/kg \pm 17.0 % (k=2)

SAR averaged over 10 cm³ (10 g) of Body TSL	condition	
SAR measured	250 mW input power	5.10 W/kg
SAR for nominal Body TSL parameters	normalized to 1W	20.4 W/kg \pm 16.5 % (k=2)

Appendix

Antenna Parameters with Head TSL

Impedance, transformed to feed point	48.3 Ω - 6.4 j Ω
Return Loss	- 23.5 dB

Antenna Parameters with Body TSL

Impedance, transformed to feed point	43.8 Ω - 6.1 j Ω
Return Loss	- 20.6 dB

General Antenna Parameters and Design

Electrical Delay (one direction)	1.211 ns
----------------------------------	----------

After long term use with 100W radiated power, only a slight warming of the dipole near the feedpoint can be measured.

The dipole is made of standard semirigid coaxial cable. The center conductor of the feeding line is directly connected to the second arm of the dipole. The antenna is therefore short-circuited for DC-signals. On some of the dipoles, small end caps are added to the dipole arms in order to improve matching when loaded according to the position as explained in the "Measurement Conditions" paragraph. The SAR data are not affected by this change. The overall dipole length is still according to the Standard.

No excessive force must be applied to the dipole arms, because they might bend or the soldered connections near the feedpoint may be damaged.

Additional EUT Data

Manufactured by	SPEAG
Manufactured on	October 06, 2005

DASY5 Validation Report for Head TSL

Date: 14.05.2013

Test Laboratory: SPEAG, Zurich, Switzerland

DUT: Dipole 1765 MHz; Type: D1765V2; Serial: D1765V2 - SN: 1008

Communication System: UID 0 - CW ; Frequency: 1750 MHz

Medium parameters used: $f = 1750$ MHz; $\sigma = 1.33$ S/m; $\epsilon_r = 39.1$; $\rho = 1000$ kg/m³

Phantom section: Flat Section

Measurement Standard: DASY5 (IEEE/IEC/ANSI C63.19-2007)

DASY52 Configuration:

- Probe: ES3DV3 - SN3205; ConvF(5.18, 5.18, 5.18); Calibrated: 28.12.2012;
- Sensor-Surface: 3mm (Mechanical Surface Detection)
- Electronics: DAE4 Sn601; Calibrated: 25.04.2013
- Phantom: Flat Phantom 5.0 (front); Type: QD000P50AA; Serial: 1001
- DASY52 52.8.6(1115); SEMCAD X 14.6.9(7117)

Dipole Calibration for Head Tissue/Pin=250 mW, d=10mm/Zoom Scan (7x7x7)/Cube 0:

Measurement grid: dx=5mm, dy=5mm, dz=5mm

Reference Value = 94.430 V/m; Power Drift = 0.01 dB

Peak SAR (extrapolated) = 16.3 W/kg

SAR(1 g) = 9.09 W/kg; SAR(10 g) = 4.85 W/kg

Maximum value of SAR (measured) = 11.3 W/kg

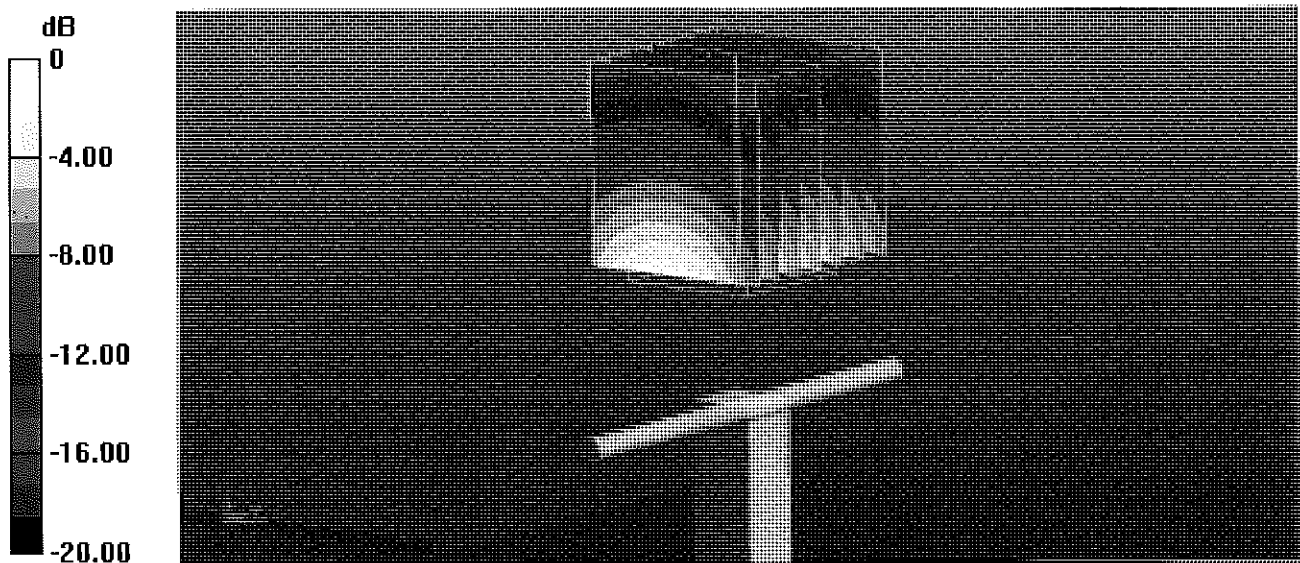

0 dB = 11.3 W/kg = 10.53 dBW/kg

Impedance Measurement Plot for Head TSL

14 May 2013 15:57:39

CH1 S11 1 U FS 1: 48.322 Ω -6.3848 Ω 14.244 pF 1 750.000 000 MHz

*
De1
C Δ
Avg
16
H1 d

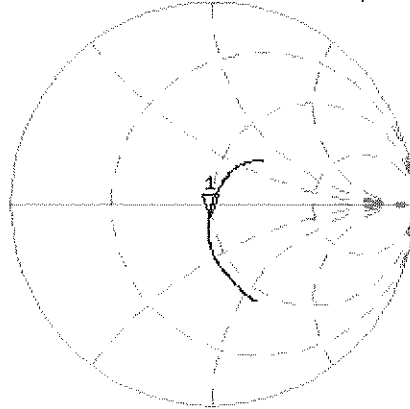

CH2 S11 LOG 5 dB/REF -20 dB 1:-23.476 dB 1 750.000 000 MHz

C Δ
Avg
16
H1 d

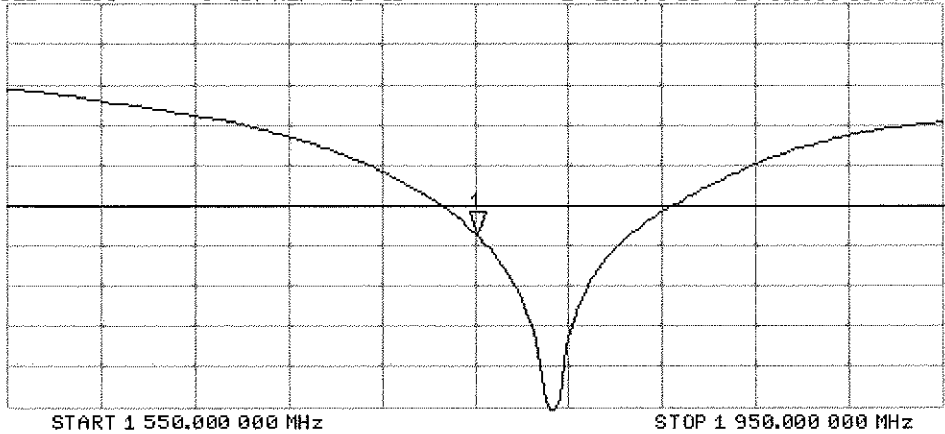

DASY5 Validation Report for Body TSL

Date: 13.05.2013

Test Laboratory: SPEAG, Zurich, Switzerland

DUT: Dipole 1765 MHz; Type: D1765V2; Serial: D1765V2 - SN: 1008

Communication System: UID 0 - CW ; Frequency: 1750 MHz

Medium parameters used: $f = 1750$ MHz; $\sigma = 1.47$ S/m; $\epsilon_r = 51.7$; $\rho = 1000$ kg/m³

Phantom section: Flat Section

Measurement Standard: DASY5 (IEEE/IEC/ANSI C63.19-2007)

DASY52 Configuration:

- Probe: ES3DV3 - SN3205; ConvF(4.83, 4.83, 4.83); Calibrated: 28.12.2012;
- Sensor-Surface: 3mm (Mechanical Surface Detection)
- Electronics: DAE4 Sn601; Calibrated: 25.04.2013
- Phantom: Flat Phantom 5.0 (back); Type: QD000P50AA; Serial: 1002
- DASY52 52.8.6(1115); SEMCAD X 14.6.9(7117)

Dipole Calibration for Body Tissue/Pin=250 mW, d=10mm/Zoom Scan (7x7x7)/Cube 0:

Measurement grid: dx=5mm, dy=5mm, dz=5mm

Reference Value = 94.430 V/m; Power Drift = 0.01 dB

Peak SAR (extrapolated) = 16.4 W/kg

SAR(1 g) = 9.53 W/kg; SAR(10 g) = 5.1 W/kg

Maximum value of SAR (measured) = 12.0 W/kg

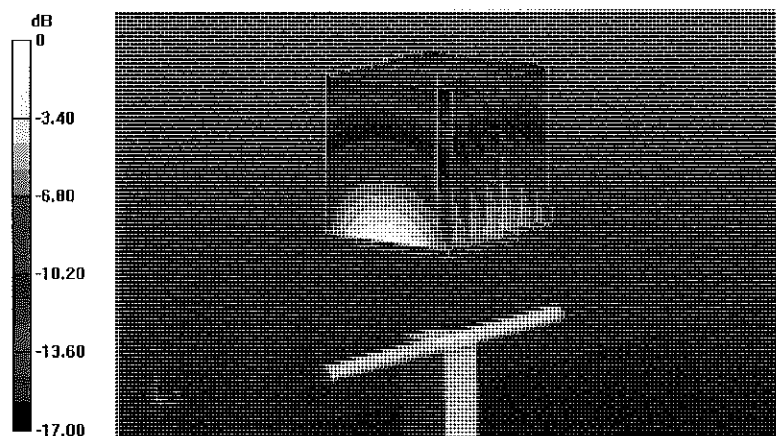

Impedance Measurement Plot for Body TSL

13 May 2013 15:25:53

CH1 S11 1 U FS

1: 43.775 Ω -6.1426 Ω 14.806 pF

1 750.000 000 MHz

*

De1

Cor

Avg

16

H1d

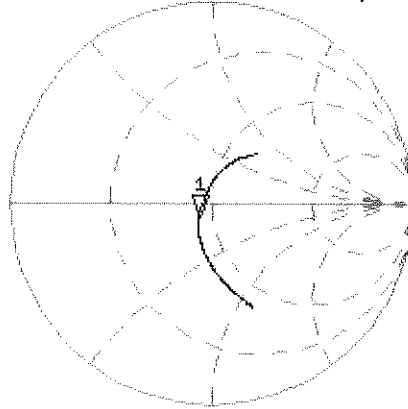

CH2 S11 LOG

5 dB/REF -20 dB

1:-20.627 dB

1 750.000 000 MHz

Cor

Avg

16

H1d

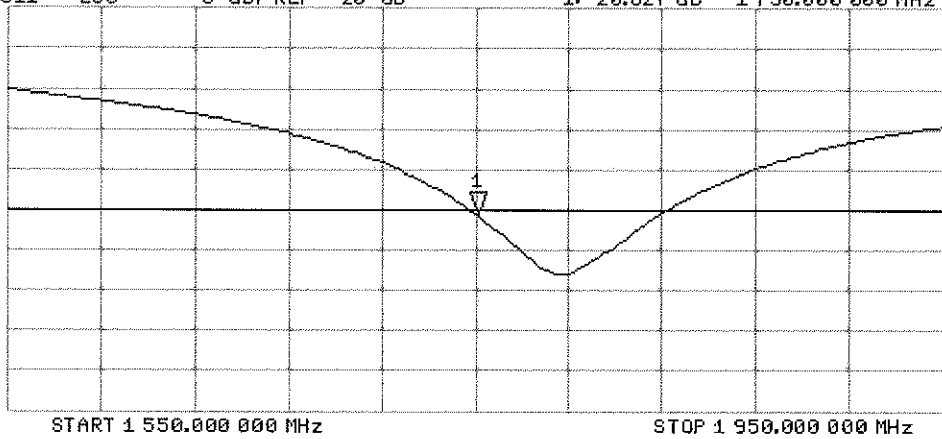



Accredited by the Swiss Accreditation Service (SAS)
The Swiss Accreditation Service is one of the signatories to the EA
Multilateral Agreement for the recognition of calibration certificates

Accreditation No.: **SCS 108**

Client **PC Test**

Certificate No: **D1900V2-5d148_Feb13**

CALIBRATION CERTIFICATE

Object **D1900V2 - SN: 5d148**

Calibration procedure(s) **QA CAL-05.v9
Calibration procedure for dipole validation kits above 700 MHz**

Calibration date: **February 06, 2013**

*KOK
2/21/13*

This calibration certificate documents the traceability to national standards, which realize the physical units of measurements (SI).
The measurements and the uncertainties with confidence probability are given on the following pages and are part of the certificate.

All calibrations have been conducted in the closed laboratory facility: environment temperature (22 ± 3)°C and humidity < 70%.

Calibration Equipment used (M&TE critical for calibration)

Primary Standards	ID #	Cal Date (Certificate No.)	Scheduled Calibration
Power meter EPM-442A	GB37480704	01-Nov-12 (No. 217-01640)	Oct-13
Power sensor HP 8481A	US37292783	01-Nov-12 (No. 217-01640)	Oct-13
Reference 20 dB Attenuator	SN: 5058 (20k)	27-Mar-12 (No. 217-01530)	Apr-13
Type-N mismatch combination	SN: 5047.3 / 06327	27-Mar-12 (No. 217-01533)	Apr-13
Reference Probe ES3DV3	SN: 3205	28-Dec-12 (No. ES3-3205_Dec12)	Dec-13
DAE4	SN: 601	27-Jun-12 (No. DAE4-601_Jun12)	Jun-13
Secondary Standards	ID #	Check Date (in house)	Scheduled Check
Power sensor HP 8481A	MY41092317	18-Oct-02 (in house check Oct-11)	In house check: Oct-13
RF generator R&S SMT-06	100005	04-Aug-99 (in house check Oct-11)	In house check: Oct-13
Network Analyzer HP 8753E	US37390585 S4206	18-Oct-01 (in house check Oct-12)	In house check: Oct-13

Calibrated by: **Leif Klysner** Name: **Leif Klysner** Function: **Laboratory Technician**

Signature: *Leif Klysner*

Approved by: **Katja Pokovic** Name: **Katja Pokovic** Technical Manager

Signature: *Katja Pokovic*

Issued: February 6, 2013

This calibration certificate shall not be reproduced except in full without written approval of the laboratory.



Accredited by the Swiss Accreditation Service (SAS)

The Swiss Accreditation Service is one of the signatories to the EA Multilateral Agreement for the recognition of calibration certificates

Accreditation No.: **SCS 108**

Glossary:

TSL	tissue simulating liquid
ConvF	sensitivity in TSL / NORM x,y,z
N/A	not applicable or not measured

Calibration is Performed According to the Following Standards:

- IEEE Std 1528-2003, "IEEE Recommended Practice for Determining the Peak Spatial-Averaged Specific Absorption Rate (SAR) in the Human Head from Wireless Communications Devices: Measurement Techniques", December 2003
- IEC 62209-1, "Procedure to measure the Specific Absorption Rate (SAR) for hand-held devices used in close proximity to the ear (frequency range of 300 MHz to 3 GHz)", February 2005
- Federal Communications Commission Office of Engineering & Technology (FCC OET), "Evaluating Compliance with FCC Guidelines for Human Exposure to Radiofrequency Electromagnetic Fields; Additional Information for Evaluating Compliance of Mobile and Portable Devices with FCC Limits for Human Exposure to Radiofrequency Emissions", Supplement C (Edition 01-01) to Bulletin 65

Additional Documentation:

- DASY4/5 System Handbook

Methods Applied and Interpretation of Parameters:

- Measurement Conditions:* Further details are available from the Validation Report at the end of the certificate. All figures stated in the certificate are valid at the frequency indicated.
- Antenna Parameters with TSL:* The dipole is mounted with the spacer to position its feed point exactly below the center marking of the flat phantom section, with the arms oriented parallel to the body axis.
- Feed Point Impedance and Return Loss:* These parameters are measured with the dipole positioned under the liquid filled phantom. The impedance stated is transformed from the measurement at the SMA connector to the feed point. The Return Loss ensures low reflected power. No uncertainty required.
- Electrical Delay:* One-way delay between the SMA connector and the antenna feed point. No uncertainty required.
- SAR measured:* SAR measured at the stated antenna input power.
- SAR normalized:* SAR as measured, normalized to an input power of 1 W at the antenna connector.
- SAR for nominal TSL parameters:* The measured TSL parameters are used to calculate the nominal SAR result.

The reported uncertainty of measurement is stated as the standard uncertainty of measurement multiplied by the coverage factor $k=2$, which for a normal distribution corresponds to a coverage probability of approximately 95%.

Measurement Conditions

DASY system configuration, as far as not given on page 1.

DASY Version	DASY5	V52.8.5
Extrapolation	Advanced Extrapolation	
Phantom	Modular Flat Phantom	
Distance Dipole Center - TSL	10 mm	with Spacer
Zoom Scan Resolution	dx, dy, dz = 5 mm	
Frequency	1900 MHz \pm 1 MHz	

Head TSL parameters

The following parameters and calculations were applied.

	Temperature	Permittivity	Conductivity
Nominal Head TSL parameters	22.0 °C	40.0	1.40 mho/m
Measured Head TSL parameters	(22.0 \pm 0.2) °C	39.4 \pm 6 %	1.38 mho/m \pm 6 %
Head TSL temperature change during test	< 0.5 °C	----	----

SAR result with Head TSL

SAR averaged over 1 cm³ (1 g) of Head TSL	Condition	
SAR measured	250 mW input power	9.87 W/kg
SAR for nominal Head TSL parameters	normalized to 1W	39.7 W/kg \pm 17.0 % (k=2)

SAR averaged over 10 cm³ (10 g) of Head TSL	condition	
SAR measured	250 mW input power	5.18 W/kg
SAR for nominal Head TSL parameters	normalized to 1W	20.8 W/kg \pm 16.5 % (k=2)

Body TSL parameters

The following parameters and calculations were applied.

	Temperature	Permittivity	Conductivity
Nominal Body TSL parameters	22.0 °C	53.3	1.52 mho/m
Measured Body TSL parameters	(22.0 \pm 0.2) °C	51.9 \pm 6 %	1.53 mho/m \pm 6 %
Body TSL temperature change during test	< 0.5 °C	----	----

SAR result with Body TSL

SAR averaged over 1 cm³ (1 g) of Body TSL	Condition	
SAR measured	250 mW input power	10.3 W/kg
SAR for nominal Body TSL parameters	normalized to 1W	40.8 W/kg \pm 17.0 % (k=2)

SAR averaged over 10 cm³ (10 g) of Body TSL	condition	
SAR measured	250 mW input power	5.45 W/kg
SAR for nominal Body TSL parameters	normalized to 1W	21.7 W/kg \pm 16.5 % (k=2)

Appendix

Antenna Parameters with Head TSL

Impedance, transformed to feed point	52.1 Ω + 5.9 j Ω
Return Loss	- 24.3 dB

Antenna Parameters with Body TSL

Impedance, transformed to feed point	48.3 Ω + 6.3 j Ω
Return Loss	- 23.6 dB

General Antenna Parameters and Design

Electrical Delay (one direction)	1.199 ns
----------------------------------	----------

After long term use with 100W radiated power, only a slight warming of the dipole near the feedpoint can be measured.

The dipole is made of standard semirigid coaxial cable. The center conductor of the feeding line is directly connected to the second arm of the dipole. The antenna is therefore short-circuited for DC-signals. On some of the dipoles, small end caps are added to the dipole arms in order to improve matching when loaded according to the position as explained in the "Measurement Conditions" paragraph. The SAR data are not affected by this change. The overall dipole length is still according to the Standard.

No excessive force must be applied to the dipole arms, because they might bend or the soldered connections near the feedpoint may be damaged.

Additional EUT Data

Manufactured by	SPEAG
Manufactured on	March 11, 2011

DASY5 Validation Report for Head TSL

Date: 06.02.2013

Test Laboratory: SPEAG, Zurich, Switzerland

DUT: Dipole 1900 MHz; Type: D1900V2; Serial: D1900V2 - SN: 5d148

Communication System: CW; Frequency: 1900 MHz

Medium parameters used: $f = 1900$ MHz; $\sigma = 1.38$ S/m; $\epsilon_r = 39.4$; $\rho = 1000$ kg/m³

Phantom section: Flat Section

Measurement Standard: DASY5 (IEEE/IEC/ANSI C63.19-2007)

DASY52 Configuration:

- Probe: ES3DV3 - SN3205; ConvF(4.98, 4.98, 4.98); Calibrated: 28.12.2012;
- Sensor-Surface: 3mm (Mechanical Surface Detection)
- Electronics: DAE4 Sn601; Calibrated: 27.06.2012
- Phantom: Flat Phantom 5.0 (front); Type: QD000P50AA; Serial: 1001
- DASY52 52.8.5(1059); SEMCAD X 14.6.8(7028)

Dipole Calibration for Head Tissue/Pin=250 mW, d=10mm/Zoom Scan (7x7x7)/Cube 0:

Measurement grid: dx=5mm, dy=5mm, dz=5mm

Reference Value = 96.534 V/m; Power Drift = 0.05 dB

Peak SAR (extrapolated) = 17.8 W/kg

SAR(1 g) = 9.87 W/kg; SAR(10 g) = 5.18 W/kg

Maximum value of SAR (measured) = 12.1 W/kg

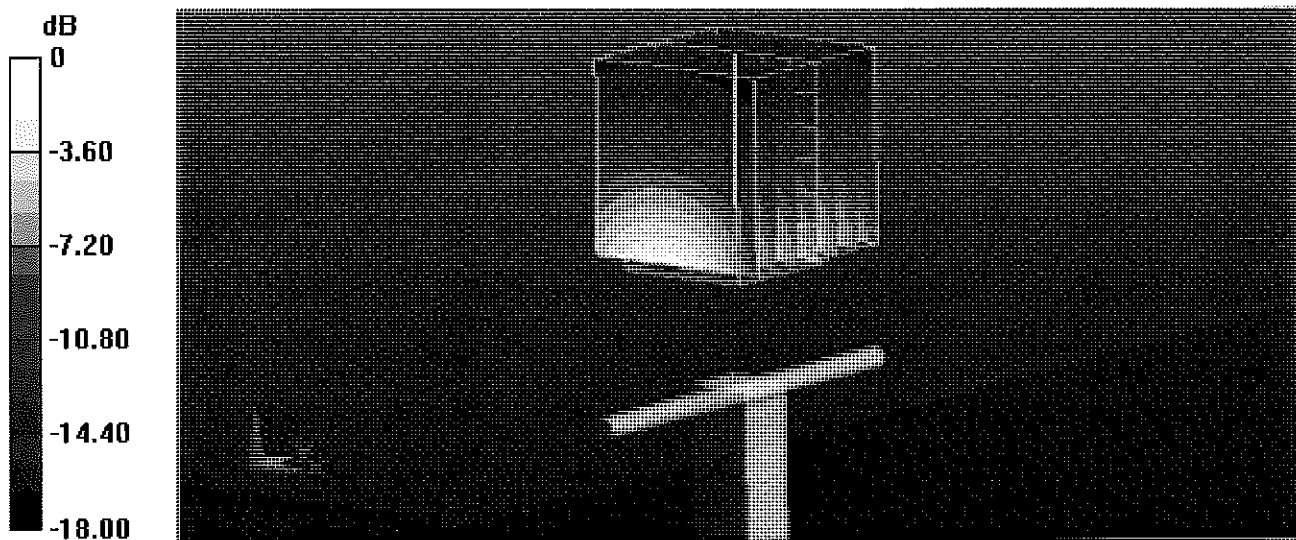

0 dB = 12.1 W/kg = 10.83 dBW/kg

Impedance Measurement Plot for Head TSL

6 Feb 2013 09:25:10

CH1 S11 1 U FS

1: 52.125 Ω 5.8711 Ω 491.80 μ H

1 900.000 000 MHz

*
Del
CA
Avg
16
H1d

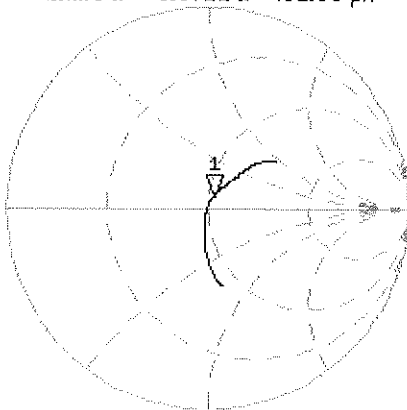

CH2 S11 LOG

5 dB/REF -20 dB

1: -24.287 dB 1 900.000 000 MHz

CA
Avg
16
H1d

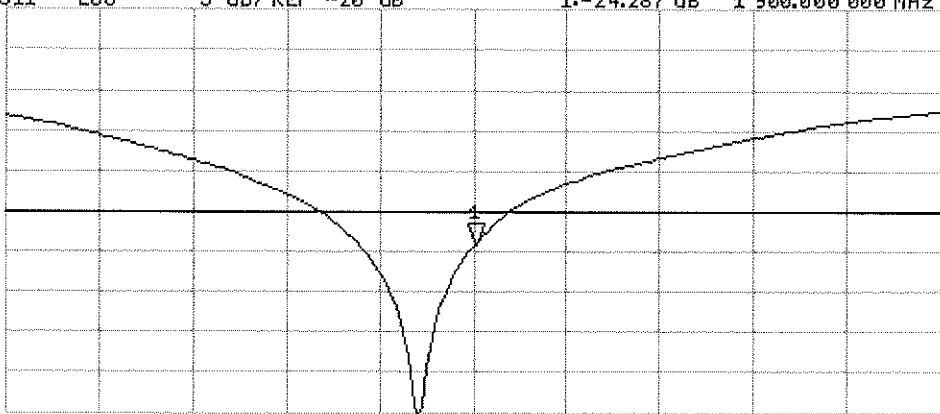

START 1 700.000 000 MHz

STOP 2 1 000.000 000 MHz

DASY5 Validation Report for Body TSL

Date: 06.02.2013

Test Laboratory: SPEAG, Zurich, Switzerland

DUT: Dipole 1900 MHz; Type: D1900V2; Serial: D1900V2 - SN: 5d148

Communication System: CW; Frequency: 1900 MHz

Medium parameters used: $f = 1900$ MHz; $\sigma = 1.53$ S/m; $\epsilon_r = 51.9$; $\rho = 1000$ kg/m³

Phantom section: Flat Section

Measurement Standard: DASY5 (IEEE/IEC/ANSI C63.19-2007)

DASY52 Configuration:

- Probe: ES3DV3 - SN3205; ConvF(4.6, 4.6, 4.6); Calibrated: 28.12.2012;
- Sensor-Surface: 3mm (Mechanical Surface Detection)
- Electronics: DAE4 Sn601; Calibrated: 27.06.2012
- Phantom: Flat Phantom 5.0 (back); Type: QD000P50AA; Serial: 1002
- DASY52 52.8.5(1059); SEMCAD X 14.6.8(7028)

Dipole Calibration for Body Tissue/Pin=250 mW, d=10mm/Zoom Scan (7x7x7)/Cube 0:

Measurement grid: dx=5mm, dy=5mm, dz=5mm

Reference Value = 96.534 V/m; Power Drift = -0.02 dB

Peak SAR (extrapolated) = 17.9 W/kg

SAR(1 g) = 10.3 W/kg; SAR(10 g) = 5.45 W/kg

Maximum value of SAR (measured) = 13.1 W/kg

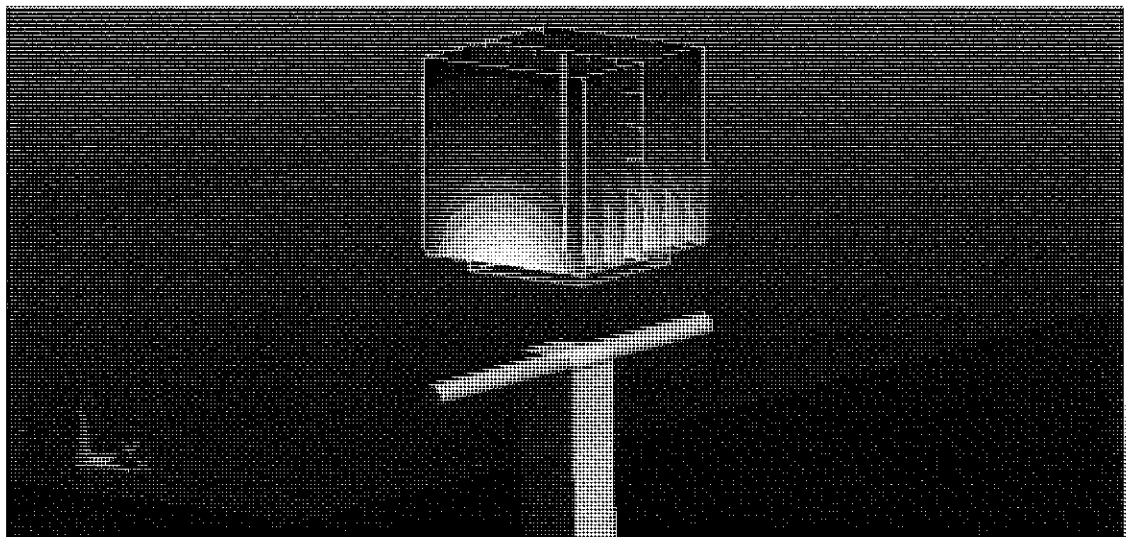
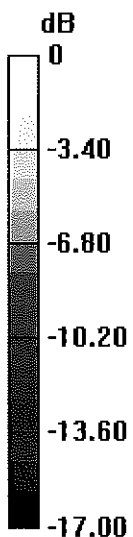

0 dB = 13.1 W/kg = 11.17 dBW/kg

Impedance Measurement Plot for Body TSL

6 Feb 2013 09:24:17

CH1 S11 1 U FS 1: 48.344 Ω 6.2715 Ω 525.34 μ H 1 900.000 000 MHz

*
De1

CA

Avg
16

H1d

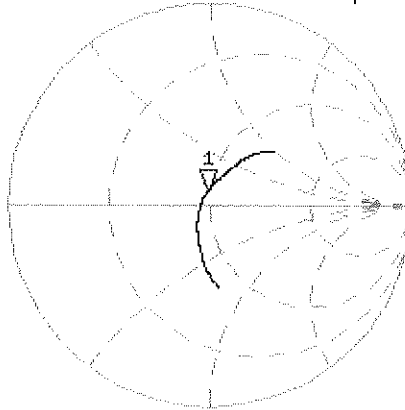

CH2 S11 LOG 5 dB/REF -20 dB 1:-23.628 dB 1 900.000 000 MHz

CA

Avg
16

H1d

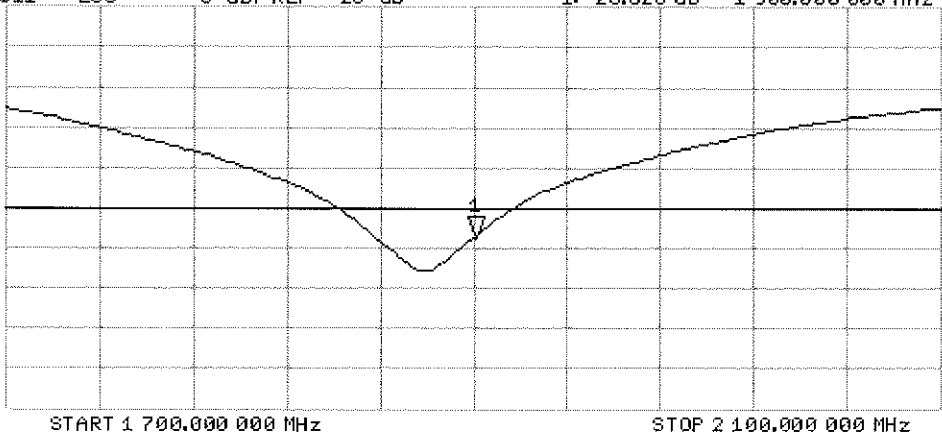



Accredited by the Swiss Accreditation Service (SAS)
The Swiss Accreditation Service is one of the signatories to the EA
Multilateral Agreement for the recognition of calibration certificates

Accreditation No.: **SCS 108**

Client **PC Test**

Certificate No: **D1900V2-5d080_Jul12**

CALIBRATION CERTIFICATE

Object **D1900V2 - SN: 5d080**

Calibration procedure(s) **QA CAL-05.v8
Calibration procedure for dipole validation kits above 700 MHz**

Calibration date: **July 20, 2012**

*KOK
8/13/12*

This calibration certificate documents the traceability to national standards, which realize the physical units of measurements (SI).
The measurements and the uncertainties with confidence probability are given on the following pages and are part of the certificate.

All calibrations have been conducted in the closed laboratory facility: environment temperature (22 ± 3)°C and humidity < 70%.

Calibration Equipment used (M&TE critical for calibration)

Primary Standards	ID #	Cal Date (Certificate No.)	Scheduled Calibration
Power meter EPM-442A	GB37480704	05-Oct-11 (No. 217-01451)	Oct-12
Power sensor HP 8481A	US37292783	05-Oct-11 (No. 217-01451)	Oct-12
Reference 20 dB Attenuator	SN: 5058 (20k)	27-Mar-12 (No. 217-01530)	Apr-13
Type-N mismatch combination	SN: 5047.2 / 06327	27-Mar-12 (No. 217-01533)	Apr-13
Reference Probe ES3DV3	SN: 3205	30-Dec-11 (No. ES3-3205_Dec11)	Dec-12
DAE4	SN: 601	27-Jun-12 (No. DAE4-601_Jun12)	Jun-13

Secondary Standards	ID #	Check Date (in house)	Scheduled Check
Power sensor HP 8481A	MY41092317	18-Oct-02 (in house check Oct-11)	In house check: Oct-13
RF generator R&S SMT-06	100005	04-Aug-99 (in house check Oct-11)	In house check: Oct-13
Network Analyzer HP 8753E	US37390585 S4206	18-Oct-01 (in house check Oct-11)	In house check: Oct-12

Calibrated by: **Dimce Iliev** Name: **Dimce Iliev** Function: **Laboratory Technician**

Signature: *Dimce Iliev*

Approved by: **Katja Pokovic** Name: **Katja Pokovic** Technical Manager

Signature: *Katja Pokovic*

Issued: July 20, 2012

This calibration certificate shall not be reproduced except in full without written approval of the laboratory.

Calibration Laboratory of
Schmid & Partner
Engineering AG
Zeughausstrasse 43, 8004 Zurich, Switzerland



S Schweizerischer Kalibrierdienst
C Service suisse d'étalonnage
S Servizio svizzero di taratura
S Swiss Calibration Service

Accreditation No.: **SCS 108**

Accredited by the Swiss Accreditation Service (SAS)
The Swiss Accreditation Service is one of the signatories to the EA
Multilateral Agreement for the recognition of calibration certificates

Glossary:

TSL	tissue simulating liquid
ConvF	sensitivity in TSL / NORM x,y,z
N/A	not applicable or not measured

Calibration is Performed According to the Following Standards:

- IEEE Std 1528-2003, "IEEE Recommended Practice for Determining the Peak Spatial-Averaged Specific Absorption Rate (SAR) in the Human Head from Wireless Communications Devices: Measurement Techniques", December 2003
- IEC 62209-1, "Procedure to measure the Specific Absorption Rate (SAR) for hand-held devices used in close proximity to the ear (frequency range of 300 MHz to 3 GHz)", February 2005
- Federal Communications Commission Office of Engineering & Technology (FCC OET), "Evaluating Compliance with FCC Guidelines for Human Exposure to Radiofrequency Electromagnetic Fields; Additional Information for Evaluating Compliance of Mobile and Portable Devices with FCC Limits for Human Exposure to Radiofrequency Emissions", Supplement C (Edition 01-01) to Bulletin 65

Additional Documentation:

- DASY4/5 System Handbook

Methods Applied and Interpretation of Parameters:

- Measurement Conditions:** Further details are available from the Validation Report at the end of the certificate. All figures stated in the certificate are valid at the frequency indicated.
- Antenna Parameters with TSL:** The dipole is mounted with the spacer to position its feed point exactly below the center marking of the flat phantom section, with the arms oriented parallel to the body axis.
- Feed Point Impedance and Return Loss:** These parameters are measured with the dipole positioned under the liquid filled phantom. The impedance stated is transformed from the measurement at the SMA connector to the feed point. The Return Loss ensures low reflected power. No uncertainty required.
- Electrical Delay:** One-way delay between the SMA connector and the antenna feed point. No uncertainty required.
- SAR measured:** SAR measured at the stated antenna input power.
- SAR normalized:** SAR as measured, normalized to an input power of 1 W at the antenna connector.
- SAR for nominal TSL parameters:** The measured TSL parameters are used to calculate the nominal SAR result.

The reported uncertainty of measurement is stated as the standard uncertainty of measurement multiplied by the coverage factor $k=2$, which for a normal distribution corresponds to a coverage probability of approximately 95%.

Measurement Conditions

DASY system configuration, as far as not given on page 1.

DASY Version	DASY5	V52.8.1
Extrapolation	Advanced Extrapolation	
Phantom	Modular Flat Phantom	
Distance Dipole Center - TSL	10 mm	with Spacer
Zoom Scan Resolution	dx, dy, dz = 5 mm	
Frequency	1900 MHz \pm 1 MHz	

Head TSL parameters

The following parameters and calculations were applied.

	Temperature	Permittivity	Conductivity
Nominal Head TSL parameters	22.0 °C	40.0	1.40 mho/m
Measured Head TSL parameters	(22.0 \pm 0.2) °C	39.9 \pm 6 %	1.38 mho/m \pm 6 %
Head TSL temperature change during test	< 0.5 °C	----	----

SAR result with Head TSL

SAR averaged over 1 cm ³ (1 g) of Head TSL	Condition	
SAR measured	250 mW input power	9.78 mW / g
SAR for nominal Head TSL parameters	normalized to 1W	39.4 mW / g \pm 17.0 % (k=2)

SAR averaged over 10 cm ³ (10 g) of Head TSL	condition	
SAR measured	250 mW input power	5.17 mW / g
SAR for nominal Head TSL parameters	normalized to 1W	20.8 mW / g \pm 16.5 % (k=2)

Body TSL parameters

The following parameters and calculations were applied.

	Temperature	Permittivity	Conductivity
Nominal Body TSL parameters	22.0 °C	53.3	1.52 mho/m
Measured Body TSL parameters	(22.0 \pm 0.2) °C	52.6 \pm 6 %	1.52 mho/m \pm 6 %
Body TSL temperature change during test	< 0.5 °C	----	----

SAR result with Body TSL

SAR averaged over 1 cm ³ (1 g) of Body TSL	Condition	
SAR measured	250 mW input power	10.1 mW / g
SAR for nominal Body TSL parameters	normalized to 1W	40.3 mW / g \pm 17.0 % (k=2)

SAR averaged over 10 cm ³ (10 g) of Body TSL	condition	
SAR measured	250 mW input power	5.35 mW / g
SAR for nominal Body TSL parameters	normalized to 1W	21.4 mW / g \pm 16.5 % (k=2)

Appendix

Antenna Parameters with Head TSL

Impedance, transformed to feed point	$50.9 \Omega + 5.7 j\Omega$
Return Loss	- 24.9 dB

Antenna Parameters with Body TSL

Impedance, transformed to feed point	$46.9 \Omega + 6.0 j\Omega$
Return Loss	- 23.1 dB

General Antenna Parameters and Design

Electrical Delay (one direction)	1.191 ns
----------------------------------	----------

After long term use with 100W radiated power, only a slight warming of the dipole near the feedpoint can be measured.

The dipole is made of standard semirigid coaxial cable. The center conductor of the feeding line is directly connected to the second arm of the dipole. The antenna is therefore short-circuited for DC-signals. On some of the dipoles, small end caps are added to the dipole arms in order to improve matching when loaded according to the position as explained in the "Measurement Conditions" paragraph. The SAR data are not affected by this change. The overall dipole length is still according to the Standard.

No excessive force must be applied to the dipole arms, because they might bend or the soldered connections near the feedpoint may be damaged.

Additional EUT Data

Manufactured by	SPEAG
Manufactured on	June 28, 2006

DASY5 Validation Report for Head TSL

Date: 20.07.2012

Test Laboratory: SPEAG, Zurich, Switzerland

DUT: Dipole 1900 MHz; Type: D1900V2; Serial: D1900V2 - SN: 5d080

Communication System: CW; Frequency: 1900 MHz

Medium parameters used: $f = 1900$ MHz; $\sigma = 1.38$ mho/m; $\epsilon_r = 39.9$; $\rho = 1000$ kg/m³

Phantom section: Flat Section

Measurement Standard: DASY5 (IEEE/IEC/ANSI C63.19-2007)

DASY52 Configuration:

- Probe: ES3DV3 - SN3205; ConvF(5.01, 5.01, 5.01); Calibrated: 30.12.2011;
- Sensor-Surface: 3mm (Mechanical Surface Detection)
- Electronics: DAE4 Sn601; Calibrated: 27.06.2012
- Phantom: Flat Phantom 5.0 (front); Type: QD000P50AA; Serial: 1001
- DASY52 52.8.1(838); SEMCAD X 14.6.5(6469)

Dipole Calibration for Head Tissue/Pin=250 mW, d=10mm/Zoom Scan (7x7x7)/Cube 0:

Measurement grid: dx=5mm, dy=5mm, dz=5mm

Reference Value = 97.586 V/m; Power Drift = 0.02 dB

Peak SAR (extrapolated) = 17.454 mW/g

SAR(1 g) = 9.78 mW/g; SAR(10 g) = 5.17 mW/g

Maximum value of SAR (measured) = 12.2 mW/g

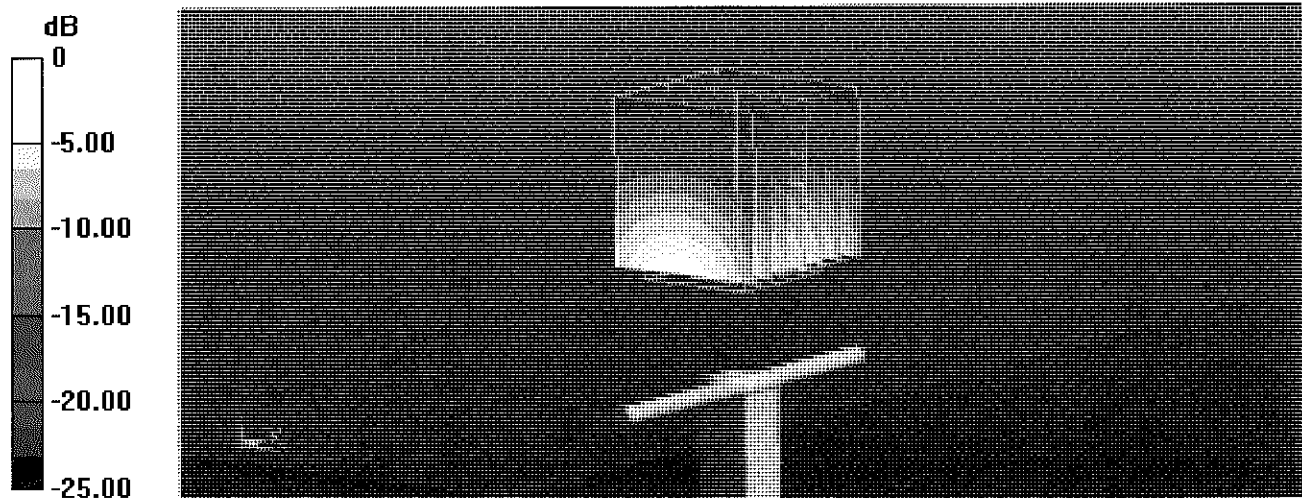

0 dB = 12.2 mW/g = 21.73 dB mW/g

Impedance Measurement Plot for Head TSL

18 Jul 2012 16:15:02

CH1 S11 1 U FS 1: 50.879 Ω 5.7270 Ω 478.05 pF 1 900.000 000 MHz

*
Del
Cor
Avg
15
H1d

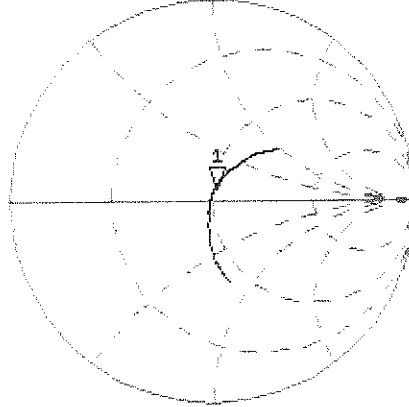

CH2 S11 LOG 5 dB/REF -20 dB 1: -24.851 dB 1 900.000 000 MHz

Del
Cor
Avg
15
H1d

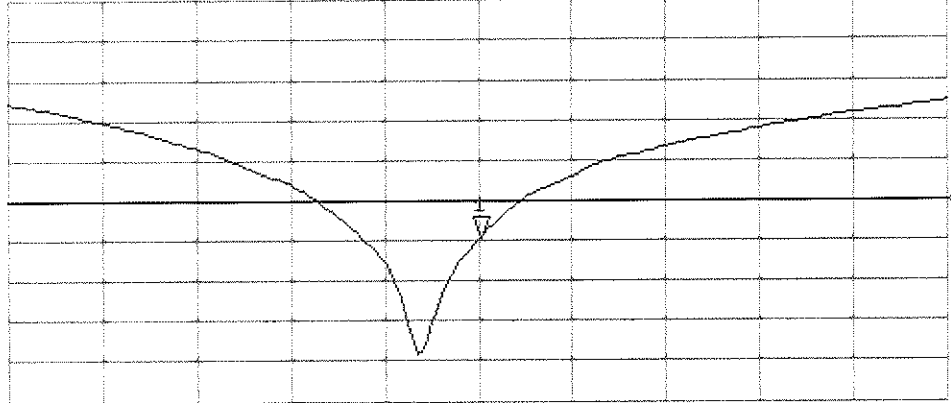

START 1 700.000 000 MHz

STOP 2 100.000 000 MHz

DASY5 Validation Report for Body TSL

Date: 20.07.2012

Test Laboratory: SPEAG, Zurich, Switzerland

DUT: Dipole 1900 MHz; Type: D1900V2; Serial: D1900V2 - SN: 5d080

Communication System: CW; Frequency: 1900 MHz

Medium parameters used: $f = 1900$ MHz; $\sigma = 1.52$ mho/m; $\epsilon_r = 52.6$; $\rho = 1000$ kg/m³

Phantom section: Flat Section

Measurement Standard: DASY5 (IEEE/IEC/ANSI C63.19-2007)

DASY52 Configuration:

- Probe: ES3DV3 - SN3205; ConvF(4.62, 4.62, 4.62); Calibrated: 30.12.2011;
- Sensor-Surface: 3mm (Mechanical Surface Detection)
- Electronics: DAE4 Sn601; Calibrated: 27.06.2012
- Phantom: Flat Phantom 5.0 (back); Type: QD000P50AA; Serial: 1002
- DASY52 52.8.1(838); SEMCAD X 14.6.5(6469)

Dipole Calibration for Body Tissue/Pin=250 mW, d=10mm/Zoom Scan (7x7x7)/Cube 0:

Measurement grid: dx=5mm, dy=5mm, dz=5mm

Reference Value = 95.688 V/m; Power Drift = -0.00 dB

Peak SAR (extrapolated) = 17.552 mW/g

SAR(1 g) = 10.1 mW/g; SAR(10 g) = 5.35 mW/g

Maximum value of SAR (measured) = 12.8 mW/g

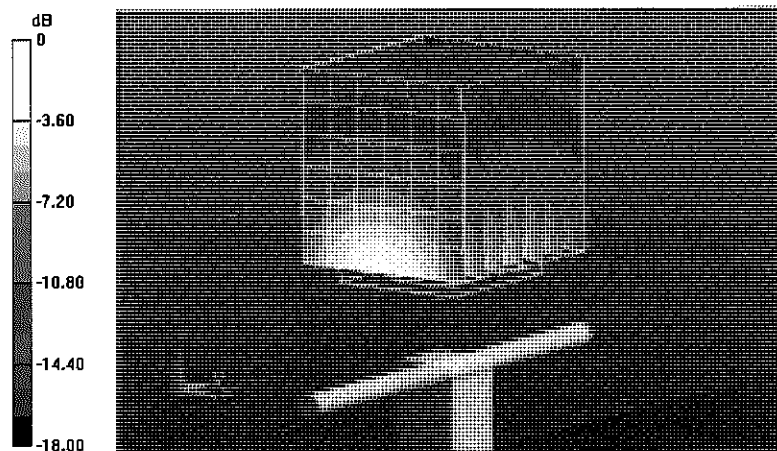

0 dB = 12.8 mW/g = 22.14 dB mW/g

Impedance Measurement Plot for Body TSL

18 Jul 2012 16:16:11

CH1 S11 1 U FS 1: 46.941 \angle 6.0313 \angle 505.21 pH 1 900.000 000 MHz

*
De1
Cor
Avg
16
H1d

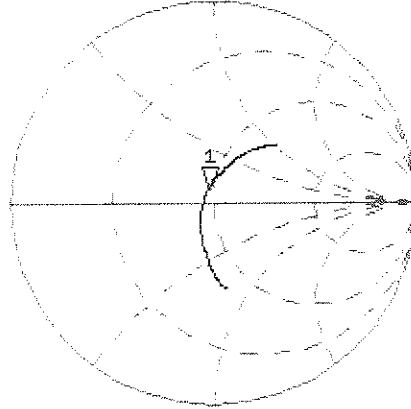

CH2 S11 LOG 5 dB/REF -20 dB 1:-23.145 dB 1 900.000 000 MHz

De1
Cor
Avg
16
H1d

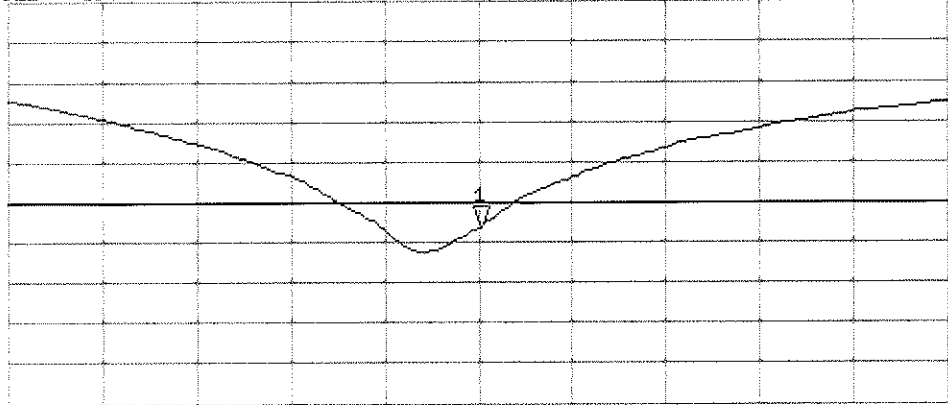

START 1 700.000 000 MHz

STOP 2 100.000 000 MHz

**Calibration Laboratory of
Schmid & Partner
Engineering AG**
Zeughausstrasse 43, 8004 Zurich, Switzerland



S Schweizerischer Kalibrierdienst
C Service suisse d'étalonnage
S Servizio svizzero di taratura
S Swiss Calibration Service

Accredited by the Swiss Accreditation Service (SAS)
The Swiss Accreditation Service is one of the signatories to the EA
Multilateral Agreement for the recognition of calibration certificates

Accreditation No.: **SCS 108**

Client **PC Test**

Certificate No: **D2450V2-719_Aug12**

CALIBRATION CERTIFICATE

Object **D2450V2 - SN: 719**

Calibration procedure(s) **QA CAL-05.v8
Calibration procedure for dipole validation kits above 700 MHz**

Calibration date: **August 23, 2012**

*✓ KOK
9/17/12*

This calibration certificate documents the traceability to national standards, which realize the physical units of measurements (SI).
The measurements and the uncertainties with confidence probability are given on the following pages and are part of the certificate.

All calibrations have been conducted in the closed laboratory facility: environment temperature (22 ± 3)°C and humidity < 70%.

Calibration Equipment used (M&TE critical for calibration)

Primary Standards	ID #	Cal Date (Certificate No.)	Scheduled Calibration
Power meter EPM-442A	GB37480704	05-Oct-11 (No. 217-01451)	Oct-12
Power sensor HP 8481A	US37292783	05-Oct-11 (No. 217-01451)	Oct-12
Reference 20 dB Attenuator	SN: 5058 (20k)	27-Mar-12 (No. 217-01530)	Apr-13
Type-N mismatch combination	SN: 5047.2 / 06327	27-Mar-12 (No. 217-01533)	Apr-13
Reference Probe ES3DV3	SN: 3205	30-Dec-11 (No. ES3-3205_Dec11)	Dec-12
DAE4	SN: 601	27-Jun-12 (No. DAE4-601_Jun12)	Jun-13

Secondary Standards	ID #	Check Date (in house)	Scheduled Check
Power sensor HP 8481A	MY41092317	18-Oct-02 (in house check Oct-11)	In house check: Oct-13
RF generator R&S SMT-06	100005	04-Aug-99 (in house check Oct-11)	In house check: Oct-13
Network Analyzer HP 8753E	US37390585 S4206	18-Oct-01 (in house check Oct-11)	In house check: Oct-12

Calibrated by: **Israe El-Naouq** Name: **Israe El-Naouq** Function: **Laboratory Technician**

Approved by: **Katja Pokovic** Name: **Katja Pokovic** Function: **Technical Manager**

Signature: *Israe El-Naouq*
Katja Pokovic

Issued: August 23, 2012

This calibration certificate shall not be reproduced except in full without written approval of the laboratory.



Accredited by the Swiss Accreditation Service (SAS)
The Swiss Accreditation Service is one of the signatories to the EA
Multilateral Agreement for the recognition of calibration certificates

Accreditation No.: **SCS 108**

Glossary:

TSL	tissue simulating liquid
ConvF	sensitivity in TSL / NORM x,y,z
N/A	not applicable or not measured

Calibration is Performed According to the Following Standards:

- a) IEEE Std 1528-2003, "IEEE Recommended Practice for Determining the Peak Spatial-Averaged Specific Absorption Rate (SAR) in the Human Head from Wireless Communications Devices: Measurement Techniques", December 2003
- b) IEC 62209-1, "Procedure to measure the Specific Absorption Rate (SAR) for hand-held devices used in close proximity to the ear (frequency range of 300 MHz to 3 GHz)", February 2005
- c) Federal Communications Commission Office of Engineering & Technology (FCC OET), "Evaluating Compliance with FCC Guidelines for Human Exposure to Radiofrequency Electromagnetic Fields; Additional Information for Evaluating Compliance of Mobile and Portable Devices with FCC Limits for Human Exposure to Radiofrequency Emissions", Supplement C (Edition 01-01) to Bulletin 65

Additional Documentation:

- d) DASY4/5 System Handbook

Methods Applied and Interpretation of Parameters:

- *Measurement Conditions:* Further details are available from the Validation Report at the end of the certificate. All figures stated in the certificate are valid at the frequency indicated.
- *Antenna Parameters with TSL:* The dipole is mounted with the spacer to position its feed point exactly below the center marking of the flat phantom section, with the arms oriented parallel to the body axis.
- *Feed Point Impedance and Return Loss:* These parameters are measured with the dipole positioned under the liquid filled phantom. The impedance stated is transformed from the measurement at the SMA connector to the feed point. The Return Loss ensures low reflected power. No uncertainty required.
- *Electrical Delay:* One-way delay between the SMA connector and the antenna feed point. No uncertainty required.
- *SAR measured:* SAR measured at the stated antenna input power.
- *SAR normalized:* SAR as measured, normalized to an input power of 1 W at the antenna connector.
- *SAR for nominal TSL parameters:* The measured TSL parameters are used to calculate the nominal SAR result.

The reported uncertainty of measurement is stated as the standard uncertainty of measurement multiplied by the coverage factor $k=2$, which for a normal distribution corresponds to a coverage probability of approximately 95%.

Measurement Conditions

DASY system configuration, as far as not given on page 1.

DASY Version	DASY5	V52.8.2
Extrapolation	Advanced Extrapolation	
Phantom	Modular Flat Phantom	
Distance Dipole Center - TSL	10 mm	with Spacer
Zoom Scan Resolution	dx, dy, dz = 5 mm	
Frequency	2450 MHz ± 1 MHz	

Head TSL parameters

The following parameters and calculations were applied.

	Temperature	Permittivity	Conductivity
Nominal Head TSL parameters	22.0 °C	39.2	1.80 mho/m
Measured Head TSL parameters	(22.0 ± 0.2) °C	39.2 ± 6 %	1.81 mho/m ± 6 %
Head TSL temperature change during test	< 0.5 °C	----	----

SAR result with Head TSL

SAR averaged over 1 cm ³ (1 g) of Head TSL	Condition	
SAR measured	250 mW input power	13.2 mW / g
SAR for nominal Head TSL parameters	normalized to 1W	52.7 mW / g ± 17.0 % (k=2)

SAR averaged over 10 cm ³ (10 g) of Head TSL	condition	
SAR measured	250 mW input power	6.19 mW / g
SAR for nominal Head TSL parameters	normalized to 1W	24.7 mW / g ± 16.5 % (k=2)

Body TSL parameters

The following parameters and calculations were applied.

	Temperature	Permittivity	Conductivity
Nominal Body TSL parameters	22.0 °C	52.7	1.95 mho/m
Measured Body TSL parameters	(22.0 ± 0.2) °C	51.3 ± 6 %	1.99 mho/m ± 6 %
Body TSL temperature change during test	< 0.5 °C	----	----

SAR result with Body TSL

SAR averaged over 1 cm ³ (1 g) of Body TSL	Condition	
SAR measured	250 mW input power	13.1 mW / g
SAR for nominal Body TSL parameters	normalized to 1W	51.6 mW / g ± 17.0 % (k=2)

SAR averaged over 10 cm ³ (10 g) of Body TSL	condition	
SAR measured	250 mW input power	6.16 mW / g
SAR for nominal Body TSL parameters	normalized to 1W	24.4 mW / g ± 16.5 % (k=2)

Appendix

Antenna Parameters with Head TSL

Impedance, transformed to feed point	54.4 Ω + 3.8 j Ω
Return Loss	- 25.1 dB

Antenna Parameters with Body TSL

Impedance, transformed to feed point	50.7 Ω + 5.9 j Ω
Return Loss	- 24.6 dB

General Antenna Parameters and Design

Electrical Delay (one direction)	1.150 ns
----------------------------------	----------

After long term use with 100W radiated power, only a slight warming of the dipole near the feedpoint can be measured.

The dipole is made of standard semirigid coaxial cable. The center conductor of the feeding line is directly connected to the second arm of the dipole. The antenna is therefore short-circuited for DC-signals. On some of the dipoles, small end caps are added to the dipole arms in order to improve matching when loaded according to the position as explained in the "Measurement Conditions" paragraph. The SAR data are not affected by this change. The overall dipole length is still according to the Standard.

No excessive force must be applied to the dipole arms, because they might bend or the soldered connections near the feedpoint may be damaged.

Additional EUT Data

Manufactured by	SPEAG
Manufactured on	September 10, 2002

DASY5 Validation Report for Head TSL

Date: 23.08.2012

Test Laboratory: SPEAG, Zurich, Switzerland

DUT: Dipole 2450 MHz; Type: D2450V2; Serial: D2450V2 - SN: 719

Communication System: CW; Frequency: 2450 MHz

Medium parameters used: $f = 2450$ MHz; $\sigma = 1.81$ mho/m; $\epsilon_r = 39.2$; $\rho = 1000$ kg/m³

Phantom section: Flat Section

Measurement Standard: DASY5 (IEEE/IEC/ANSI C63.19-2007)

DASY52 Configuration:

- Probe: ES3DV3 - SN3205; ConvF(4.45, 4.45, 4.45); Calibrated: 30.12.2011;
- Sensor-Surface: 3mm (Mechanical Surface Detection)
- Electronics: DAE4 Sn601; Calibrated: 27.06.2012
- Phantom: Flat Phantom 5.0 (front); Type: QD000P50AA; Serial: 1001
- DASY52 52.8.2(969); SEMCAD X 14.6.6(6824)

Dipole Calibration for Head Tissue/Pin=250 mW, d=10mm/Zoom Scan (7x7x7)/Cube 0:

Measurement grid: dx=5mm, dy=5mm, dz=5mm

Reference Value = 99.219 V/m; Power Drift = 0.03 dB

Peak SAR (extrapolated) = 26.633 mW/g

SAR(1 g) = 13.2 mW/g; SAR(10 g) = 6.19 mW/g

Maximum value of SAR (measured) = 16.5 W/kg

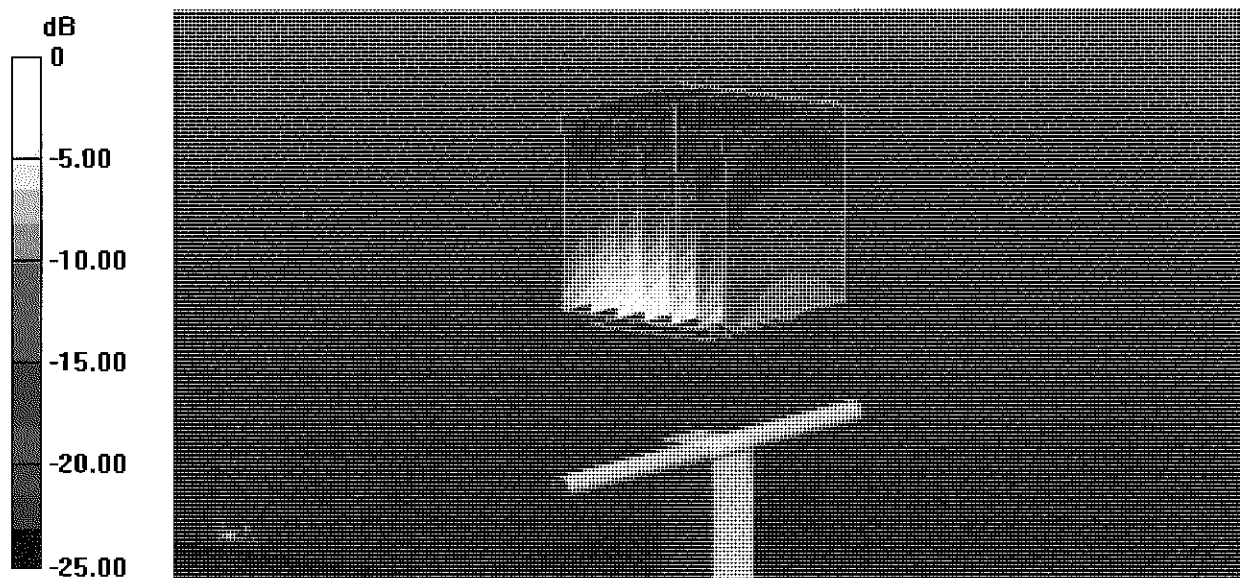

0 dB = 16.5 W/kg = 24.35 dB W/kg

Impedance Measurement Plot for Head TSL

22 Aug 2012 15:39:08

CH1 S11 1 U FS

3: 54.416 Ω 3.7656 Ω 244.62 pF

2 450.000 000 MHz

*
DeI
CA

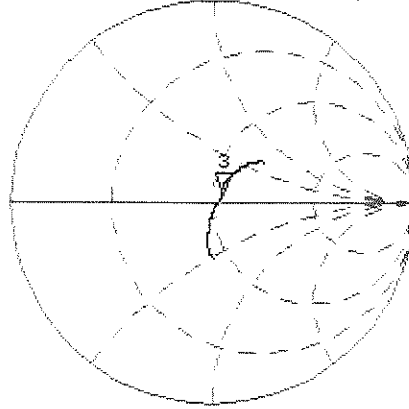

Avg
16
H1d

CH2 S11 LOG 5 dB/REF -20 dB 3: -25.109 dB 2 450.000 000 MHz

CA
Avg
16
H1d

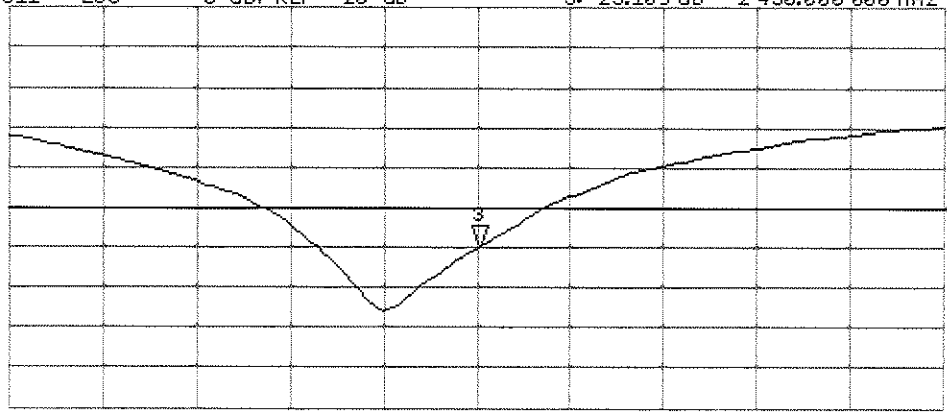

START 2 250.000 000 MHz

STOP 2 650.000 000 MHz

DASY5 Validation Report for Body TSL

Date: 22.08.2012

Test Laboratory: SPEAG, Zurich, Switzerland

DUT: Dipole 2450 MHz; Type: D2450V2; Serial: D2450V2 - SN: 719

Communication System: CW; Frequency: 2450 MHz

Medium parameters used: $f = 2450$ MHz; $\sigma = 1.99$ mho/m; $\epsilon_r = 51.3$; $\rho = 1000$ kg/m³

Phantom section: Flat Section

Measurement Standard: DASY5 (IEEE/IEC/ANSI C63.19-2007)

DASY52 Configuration:

- Probe: ES3DV3 - SN3205; ConvF(4.26, 4.26, 4.26); Calibrated: 30.12.2011;
- Sensor-Surface: 3mm (Mechanical Surface Detection)
- Electronics: DAE4 Sn601; Calibrated: 27.06.2012
- Phantom: Flat Phantom 5.0 (back); Type: QD000P50AA; Serial: 1002
- DASY52 52.8.2(969); SEMCAD X 14.6.6(6824)

Dipole Calibration for Body Tissue/Pin=250 mW, d=10mm/Zoom Scan (7x7x7)/Cube 0:

Measurement grid: dx=5mm, dy=5mm, dz=5mm

Reference Value = 95.970 V/m; Power Drift = 0.03 dB

Peak SAR (extrapolated) = 26.692 mW/g

SAR(1 g) = 13.1 mW/g; SAR(10 g) = 6.16 mW/g

Maximum value of SAR (measured) = 17.1 W/kg

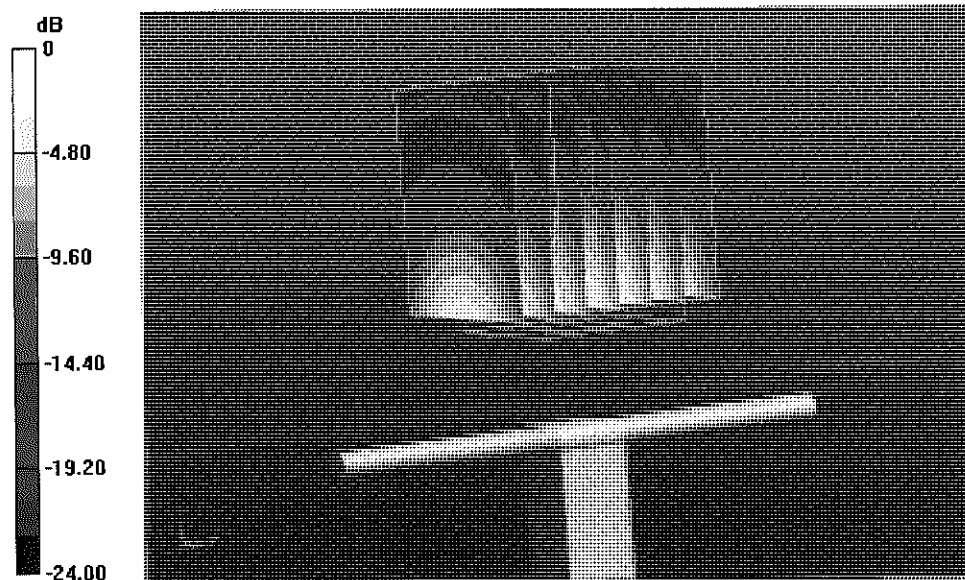

0 dB = 17.1 W/kg = 24.66 dB W/kg

Impedance Measurement Plot for Body TSL

22 Aug 2012 15:38:22

[CH1] S11 1 U FS

3: 50.709 Ω 5.8906 Ω 382.66 pF

2 450.000 000 MHz

*
Del
CA
Avg
16
H1d

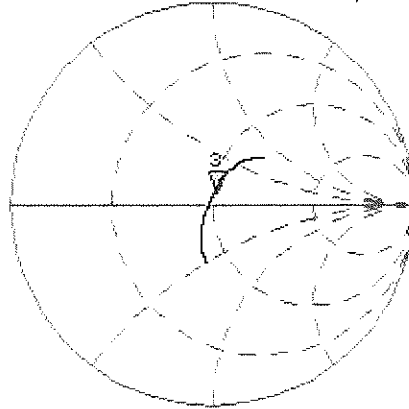

CH2 S11 LOG 5 dB/REF -20 dB 3: -24.605 dB 2 450.000 000 MHz

CA
Avg
16
H1d

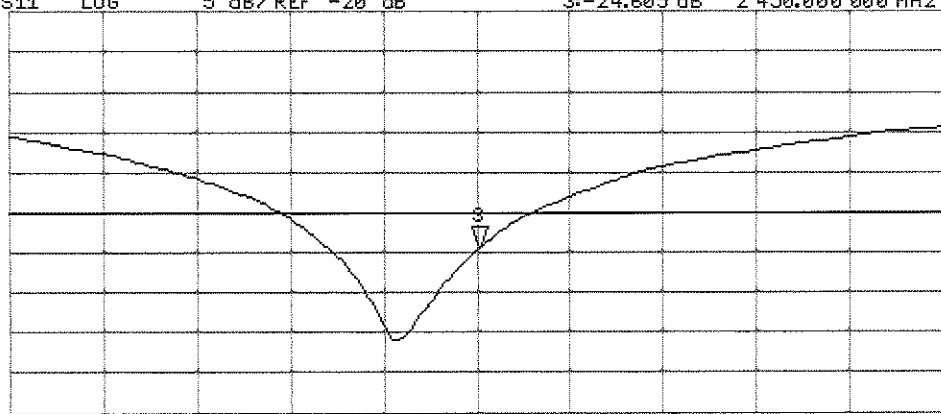

START 2 250.000 000 MHz

STOP 2 650.000 000 MHz



Accredited by the Swiss Accreditation Service (SAS)
The Swiss Accreditation Service is one of the signatories to the EA
Multilateral Agreement for the recognition of calibration certificates

Accreditation No.: **SCS 108**

Client **PC Test**

Certificate No: **D5GHzV2-1120_Feb13**

CALIBRATION CERTIFICATE

Object **D5GHzV2 - SN: 1120**

Calibration procedure(s) **QA CAL-22.v2
Calibration procedure for dipole validation kits between 3-6 GHz**

Calibration date: **February 14, 2013**

*✓
Kok
2/2/13*

This calibration certificate documents the traceability to national standards, which realize the physical units of measurements (SI).
The measurements and the uncertainties with confidence probability are given on the following pages and are part of the certificate.

All calibrations have been conducted in the closed laboratory facility: environment temperature (22 ± 3)°C and humidity < 70%.

Calibration Equipment used (M&TE critical for calibration)

Primary Standards	ID #	Cal Date (Certificate No.)	Scheduled Calibration
Power meter EPM-442A	GB37480704	01-Nov-12 (No. 217-01640)	Oct-13
Power sensor HP 8481A	US37292783	01-Nov-12 (No. 217-01640)	Oct-13
Reference 20 dB Attenuator	SN: 5058 (20k)	27-Mar-12 (No. 217-01530)	Apr-13
Type-N mismatch combination	SN: 5047.3 / 06327	27-Mar-12 (No. 217-01533)	Apr-13
Reference Probe EX3DV4	SN: 3503	28-Dec-12 (No. EX3-3503_Dec12)	Dec-13
DAE4	SN: 601	27-Jun-12 (No. DAE4-601_Jun12)	Jun-13
Secondary Standards	ID #	Check Date (in house)	Scheduled Check
Power sensor HP 8481A	MY41092317	18-Oct-02 (in house check Oct-11)	In house check: Oct-13
RF generator R&S SMT-06	100005	04-Aug-99 (in house check Oct-11)	In house check: Oct-13
Network Analyzer HP 8753E	US37390585 S4206	18-Oct-01 (in house check Oct-12)	In house check: Oct-13

Calibrated by: **Israe El-Naouq** Function: **Laboratory Technician**

Approved by: **Katja Pokovic** Technical Manager

Signature

Israe El-Naouq
Katja Pokovic

Issued: February 14, 2013

This calibration certificate shall not be reproduced except in full without written approval of the laboratory.



Accredited by the Swiss Accreditation Service (SAS)

The Swiss Accreditation Service is one of the signatories to the EA Multilateral Agreement for the recognition of calibration certificates

Accreditation No.: **SCS 108**

Glossary:

TSL	tissue simulating liquid
ConvF	sensitivity in TSL / NORM x,y,z
N/A	not applicable or not measured

Calibration is Performed According to the Following Standards:

- a) IEC 62209-2, "Evaluation of Human Exposure to Radio Frequency Fields from Handheld and Body-Mounted Wireless Communication Devices in the Frequency Range of 30 MHz to 6 GHz: Human models, Instrumentation, and Procedures"; Part 2: "Procedure to determine the Specific Absorption Rate (SAR) for including accessories and multiple transmitters", March 2010
- b) Federal Communications Commission Office of Engineering & Technology (FCC OET), "Evaluating Compliance with FCC Guidelines for Human Exposure to Radiofrequency Electromagnetic Fields; Additional Information for Evaluating Compliance of Mobile and Portable Devices with FCC Limits for Human Exposure to Radiofrequency Emissions", Supplement C (Edition 01-01) to Bulletin 65

Additional Documentation:

- c) DASY4/5 System Handbook

Methods Applied and Interpretation of Parameters:

- *Measurement Conditions:* Further details are available from the Validation Report at the end of the certificate. All figures stated in the certificate are valid at the frequency indicated.
- *Antenna Parameters with TSL:* The dipole is mounted with the spacer to position its feed point exactly below the center marking of the flat phantom section, with the arms oriented parallel to the body axis.
- *Feed Point Impedance and Return Loss:* These parameters are measured with the dipole positioned under the liquid filled phantom. The impedance stated is transformed from the measurement at the SMA connector to the feed point. The Return Loss ensures low reflected power. No uncertainty required.
- *Electrical Delay:* One-way delay between the SMA connector and the antenna feed point. No uncertainty required.
- *SAR measured:* SAR measured at the stated antenna input power.
- *SAR normalized:* SAR as measured, normalized to an input power of 1 W at the antenna connector.
- *SAR for nominal TSL parameters:* The measured TSL parameters are used to calculate the nominal SAR result.

The reported uncertainty of measurement is stated as the standard uncertainty of measurement multiplied by the coverage factor $k=2$, which for a normal distribution corresponds to a coverage probability of approximately 95%.

Measurement Conditions

DASY system configuration, as far as not given on page 1.

DASY Version	DASY5	V52.8.5
Extrapolation	Advanced Extrapolation	
Phantom	Modular Flat Phantom V5.0	
Distance Dipole Center - TSL	10 mm	with Spacer
Zoom Scan Resolution	dx, dy = 4.0 mm, dz = 1.4 mm	Graded Ratio = 1.4 (Z direction)
Frequency	5200 MHz ± 1 MHz 5300 MHz ± 1 MHz 5500 MHz ± 1 MHz 5600 MHz ± 1 MHz 5800 MHz ± 1 MHz	

Head TSL parameters at 5200 MHz

The following parameters and calculations were applied.

	Temperature	Permittivity	Conductivity
Nominal Head TSL parameters	22.0 °C	36.0	4.66 mho/m
Measured Head TSL parameters	(22.0 ± 0.2) °C	34.7 ± 6 %	4.47 mho/m ± 6 %
Head TSL temperature change during test	< 0.5 °C	----	----

SAR result with Head TSL at 5200 MHz

SAR averaged over 1 cm³ (1 g) of Head TSL	Condition	
SAR measured	100 mW input power	7.67 W/kg
SAR for nominal Head TSL parameters	normalized to 1W	76.0 W/kg ± 19.9 % (k=2)

SAR averaged over 10 cm³ (10 g) of Head TSL	condition	
SAR measured	100 mW input power	2.18 W/kg
SAR for nominal Head TSL parameters	normalized to 1W	21.5 W/kg ± 19.5 % (k=2)

Head TSL parameters at 5300 MHz

The following parameters and calculations were applied.

	Temperature	Permittivity	Conductivity
Nominal Head TSL parameters	22.0 °C	35.9	4.76 mho/m
Measured Head TSL parameters	(22.0 ± 0.2) °C	34.5 ± 6 %	4.57 mho/m ± 6 %
Head TSL temperature change during test	< 0.5 °C	----	----

SAR result with Head TSL at 5300 MHz

SAR averaged over 1 cm ³ (1 g) of Head TSL	Condition	
SAR measured	100 mW input power	7.94 W/kg
SAR for nominal Head TSL parameters	normalized to 1W	78.7 W / kg ± 19.9 % (k=2)

SAR averaged over 10 cm ³ (10 g) of Head TSL	condition	
SAR measured	100 mW input power	2.27 W/kg
SAR for nominal Head TSL parameters	normalized to 1W	22.4 W/kg ± 19.5 % (k=2)

Head TSL parameters at 5500 MHz

The following parameters and calculations were applied.

	Temperature	Permittivity	Conductivity
Nominal Head TSL parameters	22.0 °C	35.6	4.96 mho/m
Measured Head TSL parameters	(22.0 ± 0.2) °C	34.2 ± 6 %	4.74 mho/m ± 6 %
Head TSL temperature change during test	< 0.5 °C	----	----

SAR result with Head TSL at 5500 MHz

SAR averaged over 1 cm ³ (1 g) of Head TSL	Condition	
SAR measured	100 mW input power	8.09 W/kg
SAR for nominal Head TSL parameters	normalized to 1W	80.1 W/kg ± 19.9 % (k=2)

SAR averaged over 10 cm ³ (10 g) of Head TSL	condition	
SAR measured	100 mW input power	2.29 W/kg
SAR for nominal Head TSL parameters	normalized to 1W	22.6 W/kg ± 19.5 % (k=2)

Head TSL parameters at 5600 MHz

The following parameters and calculations were applied.

	Temperature	Permittivity	Conductivity
Nominal Head TSL parameters	22.0 °C	35.5	5.07 mho/m
Measured Head TSL parameters	(22.0 ± 0.2) °C	34.1 ± 6 %	4.83 mho/m ± 6 %
Head TSL temperature change during test	< 0.5 °C	----	----

SAR result with Head TSL at 5600 MHz

SAR averaged over 1 cm ³ (1 g) of Head TSL	Condition	
SAR measured	100 mW input power	8.08 W/kg
SAR for nominal Head TSL parameters	normalized to 1W	79.9 W/kg ± 19.9 % (k=2)

SAR averaged over 10 cm ³ (10 g) of Head TSL	condition	
SAR measured	100 mW input power	2.28 W/kg
SAR for nominal Head TSL parameters	normalized to 1W	22.5 W/kg ± 19.5 % (k=2)

Head TSL parameters at 5800 MHz

The following parameters and calculations were applied.

	Temperature	Permittivity	Conductivity
Nominal Head TSL parameters	22.0 °C	35.3	5.27 mho/m
Measured Head TSL parameters	(22.0 ± 0.2) °C	33.9 ± 6 %	5.05 mho/m ± 6 %
Head TSL temperature change during test	< 0.5 °C	----	----

SAR result with Head TSL at 5800 MHz

SAR averaged over 1 cm ³ (1 g) of Head TSL	Condition	
SAR measured	100 mW input power	7.57 W/kg
SAR for nominal Head TSL parameters	normalized to 1W	74.9 W/kg ± 19.9 % (k=2)

SAR averaged over 10 cm ³ (10 g) of Head TSL	condition	
SAR measured	100 mW input power	2.13 W/kg
SAR for nominal Head TSL parameters	normalized to 1W	21.0 W/kg ± 19.5 % (k=2)

Body TSL parameters at 5200 MHz

The following parameters and calculations were applied.

	Temperature	Permittivity	Conductivity
Nominal Body TSL parameters	22.0 °C	49.0	5.30 mho/m
Measured Body TSL parameters	(22.0 ± 0.2) °C	46.9 ± 6 %	5.36 mho/m ± 6 %
Body TSL temperature change during test	< 0.5 °C	----	----

SAR result with Body TSL at 5200 MHz

SAR averaged over 1 cm ³ (1 g) of Body TSL	Condition	
SAR measured	100 mW input power	7.73 W/kg
SAR for nominal Body TSL parameters	normalized to 1W	76.6 W/kg ± 19.9 % (k=2)

SAR averaged over 10 cm ³ (10 g) of Body TSL	condition	
SAR measured	100 mW input power	2.17 W/kg
SAR for nominal Body TSL parameters	normalized to 1W	21.5 W/kg ± 19.5 % (k=2)

Body TSL parameters at 5300 MHz

The following parameters and calculations were applied.

	Temperature	Permittivity	Conductivity
Nominal Body TSL parameters	22.0 °C	48.9	5.42 mho/m
Measured Body TSL parameters	(22.0 ± 0.2) °C	46.7 ± 6 %	5.48 mho/m ± 6 %
Body TSL temperature change during test	< 0.5 °C	----	----

SAR result with Body TSL at 5300 MHz

SAR averaged over 1 cm ³ (1 g) of Body TSL	Condition	
SAR measured	100 mW input power	7.75 W/kg
SAR for nominal Body TSL parameters	normalized to 1W	76.8 W/kg ± 19.9 % (k=2)

SAR averaged over 10 cm ³ (10 g) of Body TSL	condition	
SAR measured	100 mW input power	2.18 W/kg
SAR for nominal Body TSL parameters	normalized to 1W	21.5 W/kg ± 19.5 % (k=2)

Body TSL parameters at 5500 MHz

The following parameters and calculations were applied.

	Temperature	Permittivity	Conductivity
Nominal Body TSL parameters	22.0 °C	48.6	5.65 mho/m
Measured Body TSL parameters	(22.0 ± 0.2) °C	46.3 ± 6 %	5.71 mho/m ± 6 %
Body TSL temperature change during test	< 0.5 °C	----	----

SAR result with Body TSL at 5500 MHz

SAR averaged over 1 cm ³ (1 g) of Body TSL	Condition	
SAR measured	100 mW input power	8.06 W/kg
SAR for nominal Body TSL parameters	normalized to 1W	79.8 W/kg ± 19.9 % (k=2)

SAR averaged over 10 cm ³ (10 g) of Body TSL	condition	
SAR measured	100 mW input power	2.24 W/kg
SAR for nominal Body TSL parameters	normalized to 1W	22.1 W/kg ± 19.5 % (k=2)

Body TSL parameters at 5600 MHz

The following parameters and calculations were applied.

	Temperature	Permittivity	Conductivity
Nominal Body TSL parameters	22.0 °C	48.5	5.77 mho/m
Measured Body TSL parameters	(22.0 ± 0.2) °C	46.2 ± 6 %	5.83 mho/m ± 6 %
Body TSL temperature change during test	< 0.5 °C	----	----

SAR result with Body TSL at 5600 MHz

SAR averaged over 1 cm ³ (1 g) of Body TSL	Condition	
SAR measured	100 mW input power	8.15 W/kg
SAR for nominal Body TSL parameters	normalized to 1W	80.7 W/kg ± 19.9 % (k=2)

SAR averaged over 10 cm ³ (10 g) of Body TSL	condition	
SAR measured	100 mW input power	2.26 W/kg
SAR for nominal Body TSL parameters	normalized to 1W	22.3 W/kg ± 19.5 % (k=2)

Body TSL parameters at 5800 MHz

The following parameters and calculations were applied.

	Temperature	Permittivity	Conductivity
Nominal Body TSL parameters	22.0 °C	48.2	6.00 mho/m
Measured Body TSL parameters	(22.0 ± 0.2) °C	45.9 ± 6 %	6.12 mho/m ± 6 %
Body TSL temperature change during test	< 0.5 °C	----	----

SAR result with Body TSL at 5800 MHz

SAR averaged over 1 cm ³ (1 g) of Body TSL	Condition	
SAR measured	100 mW input power	7.62 W/kg
SAR for nominal Body TSL parameters	normalized to 1W	75.5 W/kg ± 19.9 % (k=2)

SAR averaged over 10 cm ³ (10 g) of Body TSL	condition	
SAR measured	100 mW input power	2.12 W/kg
SAR for nominal Body TSL parameters	normalized to 1W	20.9 W/kg ± 19.5 % (k=2)

Appendix

Antenna Parameters with Head TSL at 5200 MHz

Impedance, transformed to feed point	53.8 Ω - 6.3 j Ω
Return Loss	- 23.0 dB

Antenna Parameters with Head TSL at 5300 MHz

Impedance, transformed to feed point	50.1 Ω + 0.5 j Ω
Return Loss	- 45.3 dB

Antenna Parameters with Head TSL at 5500 MHz

Impedance, transformed to feed point	51.0 Ω - 0.9 j Ω
Return Loss	- 37.9 dB

Antenna Parameters with Head TSL at 5600 MHz

Impedance, transformed to feed point	55.3 Ω - 0.9 j Ω
Return Loss	- 25.8 dB

Antenna Parameters with Head TSL at 5800 MHz

Impedance, transformed to feed point	53.5 Ω + 3.3 j Ω
Return Loss	- 26.7 dB

Antenna Parameters with Body TSL at 5200 MHz

Impedance, transformed to feed point	53.7 Ω - 4.8 j Ω
Return Loss	- 24.8 dB

Antenna Parameters with Body TSL at 5300 MHz

Impedance, transformed to feed point	50.2 Ω + 2.4 j Ω
Return Loss	- 32.5 dB

Antenna Parameters with Body TSL at 5500 MHz

Impedance, transformed to feed point	51.6 Ω - 1.5 j Ω
Return Loss	- 33.3 dB

Antenna Parameters with Body TSL at 5600 MHz

Impedance, transformed to feed point	57.4 Ω + 0.9 j Ω
Return Loss	- 23.2 dB

Antenna Parameters with Body TSL at 5800 MHz

Impedance, transformed to feed point	53.5 Ω + 3.2 j Ω
Return Loss	- 26.7 dB

General Antenna Parameters and Design

Electrical Delay (one direction)	1.206 ns
----------------------------------	----------

After long term use with 100W radiated power, only a slight warming of the dipole near the feedpoint can be measured.

The dipole is made of standard semirigid coaxial cable. The center conductor of the feeding line is directly connected to the second arm of the dipole. The antenna is therefore short-circuited for DC-signals. On some of the dipoles, small end caps are added to the dipole arms in order to improve matching when loaded according to the position as explained in the "Measurement Conditions" paragraph. The SAR data are not affected by this change. The overall dipole length is still according to the Standard.

No excessive force must be applied to the dipole arms, because they might bend or the soldered connections near the feedpoint may be damaged.

Additional EUT Data

Manufactured by	SPEAG
Manufactured on	September 08, 2011

DASY5 Validation Report for Head TSL

Date: 08.02.2013

Test Laboratory: SPEAG, Zurich, Switzerland

DUT: Dipole 5GHz; Type: D5GHzV2; Serial: D5GHzV2 - SN: 1120

Communication System: CW; Frequency: 5200 MHz, Frequency: 5300 MHz, Frequency: 5500 MHz, Frequency: 5600 MHz, Frequency: 5800 MHz

Medium parameters used: $f = 5200$ MHz; $\sigma = 4.47$ S/m; $\epsilon_r = 34.7$; $\rho = 1000$ kg/m³, Medium parameters used: $f = 5300$ MHz; $\sigma = 4.57$ S/m; $\epsilon_r = 34.5$; $\rho = 1000$ kg/m³, Medium parameters used: $f = 5500$ MHz; $\sigma = 4.74$ S/m; $\epsilon_r = 34.2$; $\rho = 1000$ kg/m³, Medium parameters used: $f = 5600$ MHz; $\sigma = 4.83$ S/m; $\epsilon_r = 34.1$; $\rho = 1000$ kg/m³, Medium parameters used: $f = 5800$ MHz; $\sigma = 5.05$ S/m; $\epsilon_r = 33.9$; $\rho = 1000$ kg/m³

Phantom section: Flat Section

Measurement Standard: DASY5 (IEEE/IEC/ANSI C63.19-2007)

DASY52 Configuration:

- Probe: EX3DV4 - SN3503; ConvF(5.41, 5.41, 5.41); Calibrated: 28.12.2012, ConvF(5.1, 5.1, 5.1); Calibrated: 28.12.2012, ConvF(4.91, 4.91, 4.91); Calibrated: 28.12.2012, ConvF(4.76, 4.76, 4.76); Calibrated: 28.12.2012, ConvF(4.81, 4.81, 4.81); Calibrated: 28.12.2012;
- Sensor-Surface: 1.4mm (Mechanical Surface Detection)
- Electronics: DAE4 Sn601; Calibrated: 27.06.2012
- Phantom: Flat Phantom 5.0 (front); Type: QD000P50AA; Serial: 1001
- DASY52 52.8.5(1059); SEMCAD X 14.6.8(7028)

Dipole Calibration for Head Tissue/Pin=100mW, dist=10mm, f=5200 MHz/Zoom Scan, dist=1.4mm (8x8x7)/Cube 0: Measurement grid: dx=4mm, dy=4mm, dz=1.4mm

Reference Value = 61.561 V/m; Power Drift = 0.05 dB

Peak SAR (extrapolated) = 28.8 W/kg

SAR(1 g) = 7.67 W/kg; SAR(10 g) = 2.18 W/kg

Maximum value of SAR (measured) = 17.7 W/kg

Dipole Calibration for Head Tissue/Pin=100mW, dist=10mm, f=5300 MHz/Zoom Scan, dist=1.4mm (8x8x7)/Cube 0: Measurement grid: dx=4mm, dy=4mm, dz=1.4mm

Reference Value = 62.429 V/m; Power Drift = 0.03 dB

Peak SAR (extrapolated) = 30.3 W/kg

SAR(1 g) = 7.94 W/kg; SAR(10 g) = 2.27 W/kg

Maximum value of SAR (measured) = 18.5 W/kg

Dipole Calibration for Head Tissue/Pin=100mW, dist=10mm, f=5500 MHz/Zoom Scan, dist=1.4mm (8x8x7)/Cube 0: Measurement grid: dx=4mm, dy=4mm, dz=1.4mm

Reference Value = 61.998 V/m; Power Drift = 0.08 dB

Peak SAR (extrapolated) = 32.7 W/kg

SAR(1 g) = 8.09 W/kg; SAR(10 g) = 2.29 W/kg

Maximum value of SAR (measured) = 19.3 W/kg

Dipole Calibration for Head Tissue/Pin=100mW, dist=10mm, f=5600 MHz/Zoom Scan, dist=1.4mm (8x8x7)/Cube 0: Measurement grid: dx=4mm, dy=4mm, dz=1.4mm

Reference Value = 62.540 V/m; Power Drift = 0.02 dB

Peak SAR (extrapolated) = 33.3 W/kg

SAR(1 g) = 8.08 W/kg; SAR(10 g) = 2.28 W/kg

Maximum value of SAR (measured) = 19.5 W/kg

Dipole Calibration for Head Tissue/Pin=100mW, dist=10mm, f=5800 MHz/Zoom Scan, dist=1.4mm (8x8x7)/Cube 0: Measurement grid: dx=4mm, dy=4mm, dz=1.4mm

Reference Value = 58.600 V/m; Power Drift = 0.09 dB

Peak SAR (extrapolated) = 32.9 W/kg

SAR(1 g) = 7.57 W/kg; SAR(10 g) = 2.13 W/kg

Maximum value of SAR (measured) = 18.8 W/kg

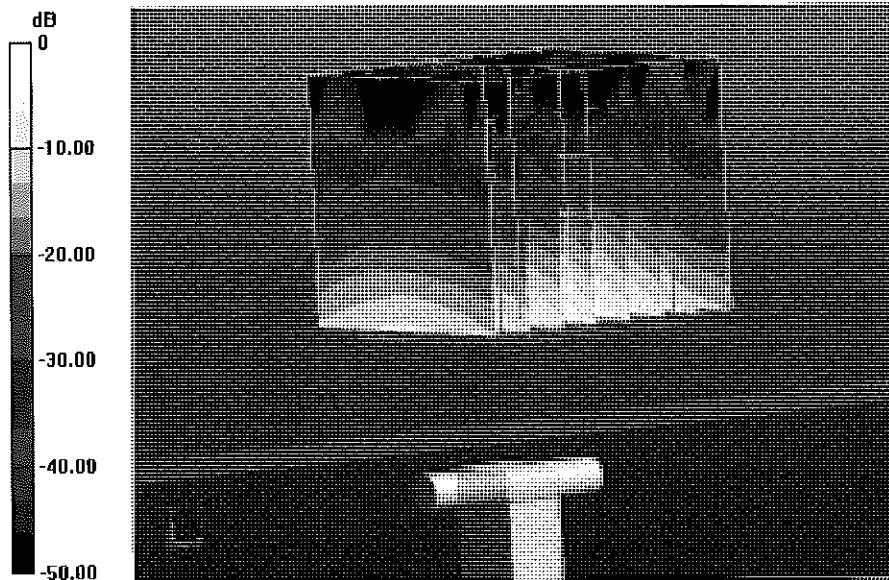

0 dB = 18.8 W/kg = 12.74 dBW/kg

Impedance Measurement Plot for Head TSL

8 Feb 2013 10:10:29

CH1 S11 1 U FS 1: 53.764 Ω -6.3086 Ω 4.8516 pF 5 200.000 000 MHz

*
De1
Cor
Avg
0
H1d

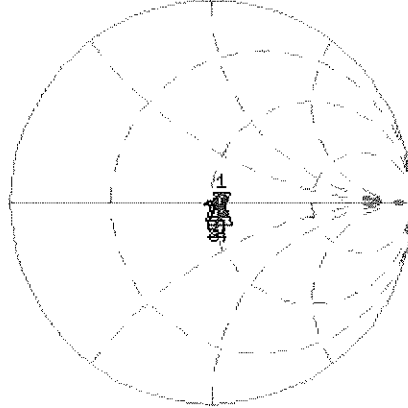

CH1 Markers
2: 50.104 Ω
0.5313 Ω
5.30000 GHz
3: 50.959 Ω
-853.52 m Ω
5.50000 GHz
4: 55.305 Ω
-902.34 m Ω
5.60000 GHz
5: 53.500 Ω
3.3027 Ω
5.80000 GHz

CH2 S11 LOG 5 dB/REF -20 dB 1: -23.013 dB 5 200.000 000 MHz

Cor
Avg
0
H1d

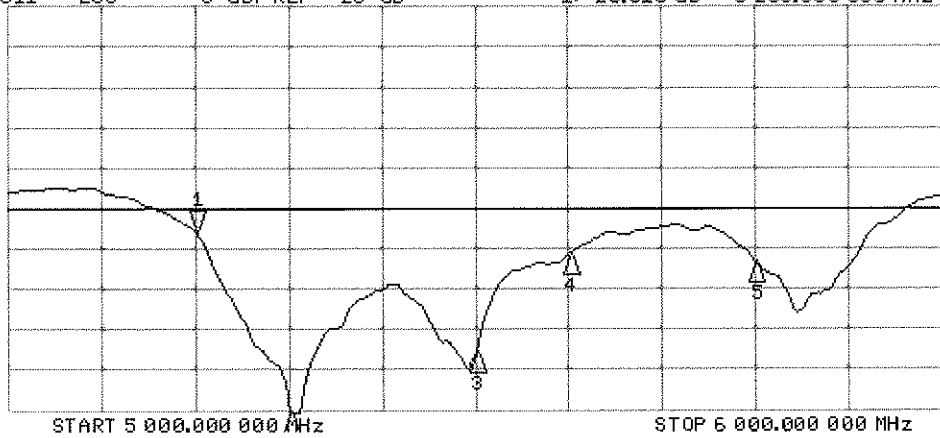

CH2 Markers
2: -45.321 dB
5.30000 GHz
3: -37.887 dB
5.50000 GHz
4: -25.835 dB
5.60000 GHz
5: -26.651 dB
5.80000 GHz

DASY5 Validation Report for Body TSL

Date: 14.02.2013

Test Laboratory: SPEAG, Zurich, Switzerland

DUT: Dipole 5GHz; Type: D5GHzV2; Serial: D5GHzV2 - SN: 1120

Communication System: CW; Frequency: 5200 MHz, Frequency: 5300 MHz, Frequency: 5500 MHz, Frequency: 5600 MHz, Frequency: 5800 MHz

Medium parameters used: $f = 5200$ MHz; $\sigma = 5.36$ S/m; $\epsilon_r = 46.9$; $\rho = 1000$ kg/m³, Medium parameters used: $f = 5300$ MHz; $\sigma = 5.48$ S/m; $\epsilon_r = 46.7$; $\rho = 1000$ kg/m³, Medium parameters used: $f = 5500$ MHz; $\sigma = 5.71$ S/m; $\epsilon_r = 46.3$; $\rho = 1000$ kg/m³, Medium parameters used: $f = 5600$ MHz; $\sigma = 5.83$ S/m; $\epsilon_r = 46.2$; $\rho = 1000$ kg/m³, Medium parameters used: $f = 5800$ MHz; $\sigma = 6.12$ S/m; $\epsilon_r = 45.9$; $\rho = 1000$ kg/m³

Phantom section: Flat Section

Measurement Standard: DASY5 (IEEE/IEC/ANSI C63.19-2007)

DASY52 Configuration:

- Probe: EX3DV4 - SN3503; ConvF(4.91, 4.91, 4.91); Calibrated: 28.12.2012, ConvF(4.67, 4.67, 4.67); Calibrated: 28.12.2012, ConvF(4.43, 4.43, 4.43); Calibrated: 28.12.2012, ConvF(4.22, 4.22, 4.22); Calibrated: 28.12.2012, ConvF(4.38, 4.38, 4.38); Calibrated: 28.12.2012;
- Sensor-Surface: 1.4mm (Mechanical Surface Detection)
- Electronics: DAE4 Sn601; Calibrated: 27.06.2012
- Phantom: Flat Phantom 5.0 (back); Type: QD000P50AA; Serial: 1002
- DASY52 52.8.5(1059); SEMCAD X 14.6.8(7028)

Dipole Calibration for Body Tissue/Pin=100mW, dist=10mm, f=5200 MHz/Zoom Scan,

dist=1.4mm (8x8x7)/Cube 0: Measurement grid: dx=4mm, dy=4mm, dz=1.4mm

Reference Value = 61.053 V/m; Power Drift = -0.08 dB

Peak SAR (extrapolated) = 31.1 W/kg

SAR(1 g) = 7.73 W/kg; SAR(10 g) = 2.17 W/kg

Maximum value of SAR (measured) = 18.2 W/kg

Dipole Calibration for Body Tissue/Pin=100mW, dist=10mm, f=5300 MHz/Zoom Scan,

dist=1.4mm (8x8x7)/Cube 0: Measurement grid: dx=4mm, dy=4mm, dz=1.4mm

Reference Value = 60.021 V/m; Power Drift = -0.02 dB

Peak SAR (extrapolated) = 32.1 W/kg

SAR(1 g) = 7.75 W/kg; SAR(10 g) = 2.18 W/kg

Maximum value of SAR (measured) = 18.5 W/kg

Dipole Calibration for Body Tissue/Pin=100mW, dist=10mm, f=5500 MHz/Zoom Scan,

dist=1.4mm (8x8x7)/Cube 0: Measurement grid: dx=4mm, dy=4mm, dz=1.4mm

Reference Value = 59.894 V/m; Power Drift = -0.02 dB

Peak SAR (extrapolated) = 35.3 W/kg

SAR(1 g) = 8.06 W/kg; SAR(10 g) = 2.24 W/kg

Maximum value of SAR (measured) = 19.4 W/kg

Dipole Calibration for Body Tissue/Pin=100mW, dist=10mm, f=5600 MHz/Zoom Scan,

dist=1.4mm (8x8x7)/Cube 0: Measurement grid: dx=4mm, dy=4mm, dz=1.4mm

Reference Value = 59.730 V/m; Power Drift = -0.02 dB

Peak SAR (extrapolated) = 36.8 W/kg

SAR(1 g) = 8.15 W/kg; SAR(10 g) = 2.26 W/kg

Maximum value of SAR (measured) = 19.9 W/kg

Dipole Calibration for Body Tissue/Pin=100mW, dist=10mm, f=5800 MHz/Zoom Scan,

dist=1.4mm (8x8x7)/Cube 0: Measurement grid: dx=4mm, dy=4mm, dz=1.4mm

Reference Value = 56.663 V/m; Power Drift = -0.02 dB

Peak SAR (extrapolated) = 36.4 W/kg

SAR(1 g) = 7.62 W/kg; SAR(10 g) = 2.12 W/kg

Maximum value of SAR (measured) = 19.0 W/kg

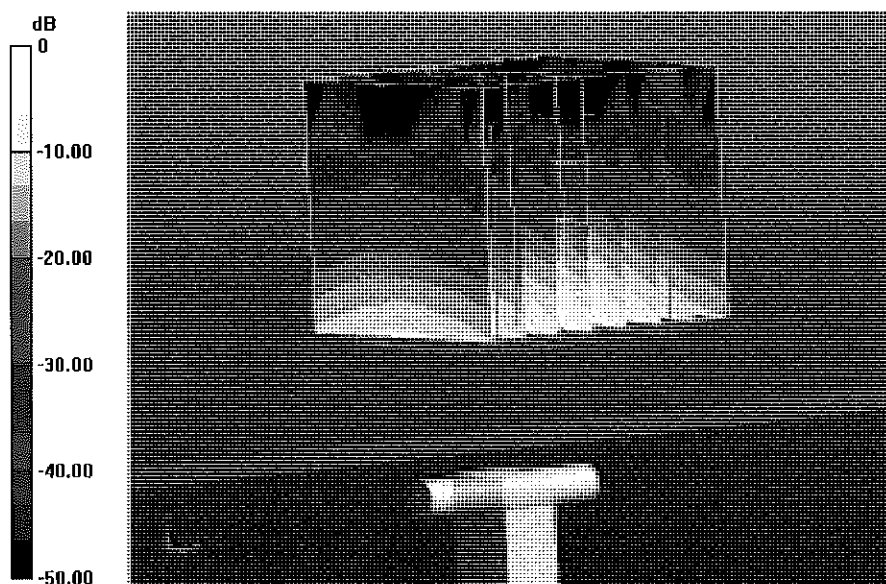

0 dB = 19.0 W/kg = 12.79 dBW/kg

Impedance Measurement Plot for Body TSL

14 Feb 2013 15:47:05

CH1 S11 1 U FS 1: 53.672 Ω -4.7539 Ω 6.4382 pF 5 200.000 000 MHz

*
De1
Cor
Avg
16
H1d

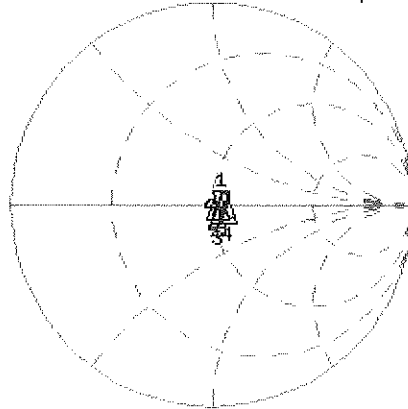

CH1 Markers
2: 50.250 Ω
2.3555 Ω
5.30000 GHz
3: 51.629 Ω
-1.4824 Ω
5.50000 GHz
4: 57.389 Ω
0.9180 Ω
5.60000 GHz
5: 53.543 Ω
3.2441 Ω
5.80000 GHz

CH2 S11 LOG 5 dB/REF -20 dB 1: -24.750 dB 5 200.000 000 MHz

Cor
Avg
16
H1d

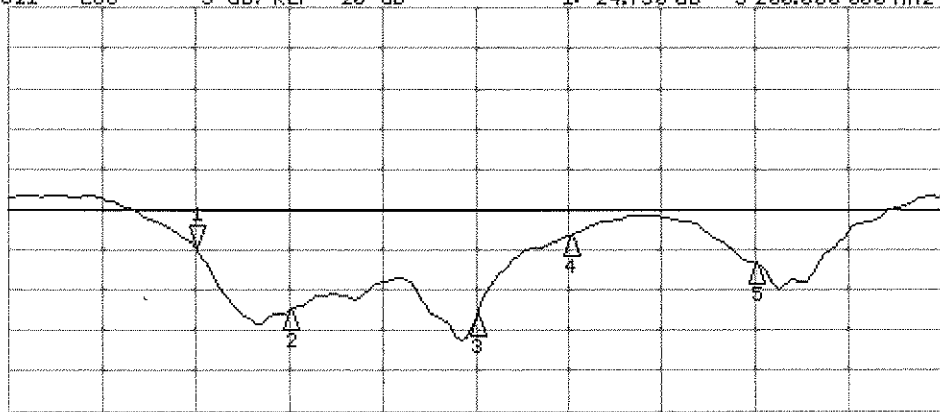

CH2 Markers
2: -32.508 dB
5.30000 GHz
3: -33.267 dB
5.50000 GHz
4: -23.183 dB
5.60000 GHz
5: -26.672 dB
5.80000 GHz

START 5 000.000 000 MHz

STOP 6 000.000 000 MHz



Accredited by the Swiss Accreditation Service (SAS)
The Swiss Accreditation Service is one of the signatories to the EA
Multilateral Agreement for the recognition of calibration certificates

Accreditation No.: **SCS 108**

Client **PC Test**

Certificate No: **D5GHzV2-1057_Jan13**

CALIBRATION CERTIFICATE

Object **D5GHzV2 - SN: 1057**

Calibration procedure(s) **QA CAL-22.v2
Calibration procedure for dipole validation kits between 3-6 GHz**

Calibration date: **January 11, 2013**

✓
KOK
1/29/13

This calibration certificate documents the traceability to national standards, which realize the physical units of measurements (SI).
The measurements and the uncertainties with confidence probability are given on the following pages and are part of the certificate.

All calibrations have been conducted in the closed laboratory facility: environment temperature (22 ± 3)°C and humidity < 70%.

Calibration Equipment used (M&TE critical for calibration)

Primary Standards	ID #	Cal Date (Certificate No.)	Scheduled Calibration
Power meter EPM-442A	GB37480704	01-Nov-12 (No. 217-01640)	Oct-13
Power sensor HP 8481A	US37292783	01-Nov-12 (No. 217-01640)	Oct-13
Reference 20 dB Attenuator	SN: 5058 (20k)	27-Mar-12 (No. 217-01530)	Apr-13
Type-N mismatch combination	SN: 5047.3 / 06327	27-Mar-12 (No. 217-01533)	Apr-13
Reference Probe EX3DV4	SN: 3503	28-Dec-12 (No. EX3-3503_Dec12)	Dec-13
DAE4	SN: 601	27-Jun-12 (No. DAE4-601_Jun12)	Jun-13
Secondary Standards	ID #	Check Date (in house)	Scheduled Check
Power sensor HP 8481A	MY41092317	18-Oct-02 (in house check Oct-11)	In house check: Oct-13
RF generator R&S SMT-06	100005	04-Aug-99 (in house check Oct-11)	In house check: Oct-13
Network Analyzer HP 8753E	US37390585 S4206	18-Oct-01 (in house check Oct-12)	In house check: Oct-13

Calibrated by: **Israe El-Naouq** Name: **Israe El-Naouq** Function: **Laboratory Technician** Signature: *Israe El-Naouq*

Approved by: **Katja Pokovic** Name: **Katja Pokovic** Function: **Technical Manager** Signature: *Katja Pokovic*

Issued: January 11, 2013

This calibration certificate shall not be reproduced except in full without written approval of the laboratory.



Accredited by the Swiss Accreditation Service (SAS)

The Swiss Accreditation Service is one of the signatories to the EA
Multilateral Agreement for the recognition of calibration certificates

Accreditation No.: **SCS 108**

Glossary:

TSL	tissue simulating liquid
ConvF	sensitivity in TSL / NORM x,y,z
N/A	not applicable or not measured

Calibration is Performed According to the Following Standards:

- a) IEC 62209-2, "Evaluation of Human Exposure to Radio Frequency Fields from Handheld and Body-Mounted Wireless Communication Devices in the Frequency Range of 30 MHz to 6 GHz: Human models, Instrumentation, and Procedures"; Part 2: "Procedure to determine the Specific Absorption Rate (SAR) for including accessories and multiple transmitters", March 2010
- b) Federal Communications Commission Office of Engineering & Technology (FCC OET), "Evaluating Compliance with FCC Guidelines for Human Exposure to Radiofrequency Electromagnetic Fields; Additional Information for Evaluating Compliance of Mobile and Portable Devices with FCC Limits for Human Exposure to Radiofrequency Emissions", Supplement C (Edition 01-01) to Bulletin 65

Additional Documentation:

- c) DASY4/5 System Handbook

Methods Applied and Interpretation of Parameters:

- *Measurement Conditions:* Further details are available from the Validation Report at the end of the certificate. All figures stated in the certificate are valid at the frequency indicated.
- *Antenna Parameters with TSL:* The dipole is mounted with the spacer to position its feed point exactly below the center marking of the flat phantom section, with the arms oriented parallel to the body axis.
- *Feed Point Impedance and Return Loss:* These parameters are measured with the dipole positioned under the liquid filled phantom. The impedance stated is transformed from the measurement at the SMA connector to the feed point. The Return Loss ensures low reflected power. No uncertainty required.
- *Electrical Delay:* One-way delay between the SMA connector and the antenna feed point. No uncertainty required.
- *SAR measured:* SAR measured at the stated antenna input power.
- *SAR normalized:* SAR as measured, normalized to an input power of 1 W at the antenna connector.
- *SAR for nominal TSL parameters:* The measured TSL parameters are used to calculate the nominal SAR result.

The reported uncertainty of measurement is stated as the standard uncertainty of measurement multiplied by the coverage factor $k=2$, which for a normal distribution corresponds to a coverage probability of approximately 95%.

Measurement Conditions

DASY system configuration, as far as not given on page 1.

DASY Version	DASY5	V52.8.5
Extrapolation	Advanced Extrapolation	
Phantom	Modular Flat Phantom V5.0	
Distance Dipole Center - TSL	10 mm	with Spacer
Zoom Scan Resolution	dx, dy = 4.0 mm, dz = 1.4 mm	Graded Ratio = 1.4 (Z direction)
Frequency	5200 MHz ± 1 MHz 5300 MHz ± 1 MHz 5500 MHz ± 1 MHz 5600 MHz ± 1 MHz 5800 MHz ± 1 MHz	

Head TSL parameters at 5200 MHz

The following parameters and calculations were applied.

	Temperature	Permittivity	Conductivity
Nominal Head TSL parameters	22.0 °C	36.0	4.66 mho/m
Measured Head TSL parameters	(22.0 ± 0.2) °C	34.6 ± 6 %	4.50 mho/m ± 6 %
Head TSL temperature change during test	< 0.5 °C	----	----

SAR result with Head TSL at 5200 MHz

SAR averaged over 1 cm³ (1 g) of Head TSL	Condition	
SAR measured	100 mW input power	7.66 W/kg
SAR for nominal Head TSL parameters	normalized to 1W	75.9 W/kg ± 19.9 % (k=2)

SAR averaged over 10 cm³ (10 g) of Head TSL	condition	
SAR measured	100 mW input power	2.17 W/kg
SAR for nominal Head TSL parameters	normalized to 1W	21.4 W/kg ± 19.5 % (k=2)

Head TSL parameters at 5300 MHz

The following parameters and calculations were applied.

	Temperature	Permittivity	Conductivity
Nominal Head TSL parameters	22.0 °C	35.9	4.76 mho/m
Measured Head TSL parameters	(22.0 ± 0.2) °C	34.5 ± 6 %	4.60 mho/m ± 6 %
Head TSL temperature change during test	< 0.5 °C	----	----

SAR result with Head TSL at 5300 MHz

SAR averaged over 1 cm ³ (1 g) of Head TSL	Condition	
SAR measured	100 mW input power	7.76 W/kg
SAR for nominal Head TSL parameters	normalized to 1W	76.9 W / kg ± 19.9 % (k=2)

SAR averaged over 10 cm ³ (10 g) of Head TSL	condition	
SAR measured	100 mW input power	2.22 W/kg
SAR for nominal Head TSL parameters	normalized to 1W	21.9 W/kg ± 19.5 % (k=2)

Head TSL parameters at 5500 MHz

The following parameters and calculations were applied.

	Temperature	Permittivity	Conductivity
Nominal Head TSL parameters	22.0 °C	35.6	4.96 mho/m
Measured Head TSL parameters	(22.0 ± 0.2) °C	34.2 ± 6 %	4.79 mho/m ± 6 %
Head TSL temperature change during test	< 0.5 °C	----	----

SAR result with Head TSL at 5500 MHz

SAR averaged over 1 cm ³ (1 g) of Head TSL	Condition	
SAR measured	100 mW input power	8.09 W/kg
SAR for nominal Head TSL parameters	normalized to 1W	80.1 W/kg ± 19.9 % (k=2)

SAR averaged over 10 cm ³ (10 g) of Head TSL	condition	
SAR measured	100 mW input power	2.28 W/kg
SAR for nominal Head TSL parameters	normalized to 1W	22.5 W/kg ± 19.5 % (k=2)

Head TSL parameters at 5600 MHz

The following parameters and calculations were applied.

	Temperature	Permittivity	Conductivity
Nominal Head TSL parameters	22.0 °C	35.5	5.07 mho/m
Measured Head TSL parameters	(22.0 ± 0.2) °C	34.1 ± 6 %	4.88 mho/m ± 6 %
Head TSL temperature change during test	< 0.5 °C	----	----

SAR result with Head TSL at 5600 MHz

SAR averaged over 1 cm ³ (1 g) of Head TSL	Condition	
SAR measured	100 mW input power	8.12 W/kg
SAR for nominal Head TSL parameters	normalized to 1W	80.4 W/kg ± 19.9 % (k=2)

SAR averaged over 10 cm ³ (10 g) of Head TSL	condition	
SAR measured	100 mW input power	2.30 W/kg
SAR for nominal Head TSL parameters	normalized to 1W	22.7 W/kg ± 19.5 % (k=2)

Head TSL parameters at 5800 MHz

The following parameters and calculations were applied.

	Temperature	Permittivity	Conductivity
Nominal Head TSL parameters	22.0 °C	35.3	5.27 mho/m
Measured Head TSL parameters	(22.0 ± 0.2) °C	33.8 ± 6 %	5.09 mho/m ± 6 %
Head TSL temperature change during test	< 0.5 °C	----	----

SAR result with Head TSL at 5800 MHz

SAR averaged over 1 cm ³ (1 g) of Head TSL	Condition	
SAR measured	100 mW input power	7.69 W/kg
SAR for nominal Head TSL parameters	normalized to 1W	76.1 W/kg ± 19.9 % (k=2)

SAR averaged over 10 cm ³ (10 g) of Head TSL	condition	
SAR measured	100 mW input power	2.17 W/kg
SAR for nominal Head TSL parameters	normalized to 1W	21.4 W/kg ± 19.5 % (k=2)

Body TSL parameters at 5200 MHz

The following parameters and calculations were applied.

	Temperature	Permittivity	Conductivity
Nominal Body TSL parameters	22.0 °C	49.0	5.30 mho/m
Measured Body TSL parameters	(22.0 ± 0.2) °C	47.0 ± 6 %	5.42 mho/m ± 6 %
Body TSL temperature change during test	< 0.5 °C	----	----

SAR result with Body TSL at 5200 MHz

SAR averaged over 1 cm ³ (1 g) of Body TSL	Condition	
SAR measured	100 mW input power	7.61 W/kg
SAR for nominal Body TSL parameters	normalized to 1W	75.5 W/kg ± 19.9 % (k=2)

SAR averaged over 10 cm ³ (10 g) of Body TSL	condition	
SAR measured	100 mW input power	2.13 W/kg
SAR for nominal Body TSL parameters	normalized to 1W	21.1 W/kg ± 19.5 % (k=2)

Body TSL parameters at 5300 MHz

The following parameters and calculations were applied.

	Temperature	Permittivity	Conductivity
Nominal Body TSL parameters	22.0 °C	48.9	5.42 mho/m
Measured Body TSL parameters	(22.0 ± 0.2) °C	46.8 ± 6 %	5.55 mho/m ± 6 %
Body TSL temperature change during test	< 0.5 °C	----	----

SAR result with Body TSL at 5300 MHz

SAR averaged over 1 cm ³ (1 g) of Body TSL	Condition	
SAR measured	100 mW input power	7.59 W/kg
SAR for nominal Body TSL parameters	normalized to 1W	75.3 W/kg ± 19.9 % (k=2)

SAR averaged over 10 cm ³ (10 g) of Body TSL	condition	
SAR measured	100 mW input power	2.13 W/kg
SAR for nominal Body TSL parameters	normalized to 1W	21.1 W/kg ± 19.5 % (k=2)

Body TSL parameters at 5500 MHz

The following parameters and calculations were applied.

	Temperature	Permittivity	Conductivity
Nominal Body TSL parameters	22.0 °C	48.6	5.65 mho/m
Measured Body TSL parameters	(22.0 ± 0.2) °C	46.5 ± 6 %	5.81 mho/m ± 6 %
Body TSL temperature change during test	< 0.5 °C	----	----

SAR result with Body TSL at 5500 MHz

SAR averaged over 1 cm ³ (1 g) of Body TSL	Condition	
SAR measured	100 mW input power	8.14 W/kg
SAR for nominal Body TSL parameters	normalized to 1W	80.8 W/kg ± 19.9 % (k=2)

SAR averaged over 10 cm ³ (10 g) of Body TSL	condition	
SAR measured	100 mW input power	2.26 W/kg
SAR for nominal Body TSL parameters	normalized to 1W	22.4 W/kg ± 19.5 % (k=2)

Body TSL parameters at 5600 MHz

The following parameters and calculations were applied.

	Temperature	Permittivity	Conductivity
Nominal Body TSL parameters	22.0 °C	48.5	5.77 mho/m
Measured Body TSL parameters	(22.0 ± 0.2) °C	46.3 ± 6 %	5.94 mho/m ± 6 %
Body TSL temperature change during test	< 0.5 °C	----	----

SAR result with Body TSL at 5600 MHz

SAR averaged over 1 cm ³ (1 g) of Body TSL	Condition	
SAR measured	100 mW input power	8.10 W/kg
SAR for nominal Body TSL parameters	normalized to 1W	80.3 W/kg ± 19.9 % (k=2)

SAR averaged over 10 cm ³ (10 g) of Body TSL	condition	
SAR measured	100 mW input power	2.25 W/kg
SAR for nominal Body TSL parameters	normalized to 1W	22.3 W/kg ± 19.5 % (k=2)

Body TSL parameters at 5800 MHz

The following parameters and calculations were applied.

	Temperature	Permittivity	Conductivity
Nominal Body TSL parameters	22.0 °C	48.2	6.00 mho/m
Measured Body TSL parameters	(22.0 ± 0.2) °C	46.0 ± 6 %	6.21 mho/m ± 6 %
Body TSL temperature change during test	< 0.5 °C	----	----

SAR result with Body TSL at 5800 MHz

SAR averaged over 1 cm ³ (1 g) of Body TSL	Condition	
SAR measured	100 mW input power	7.57 W/kg
SAR for nominal Body TSL parameters	normalized to 1W	75.1 W/kg ± 19.9 % (k=2)

SAR averaged over 10 cm ³ (10 g) of Body TSL	condition	
SAR measured	100 mW input power	2.09 W/kg
SAR for nominal Body TSL parameters	normalized to 1W	20.7 W/kg ± 19.5 % (k=2)

Appendix

Antenna Parameters with Head TSL at 5200 MHz

Impedance, transformed to feed point	50.5 Ω - 9.8 j Ω
Return Loss	- 20.3 dB

Antenna Parameters with Head TSL at 5300 MHz

Impedance, transformed to feed point	48.5 Ω - 4.5 j Ω
Return Loss	- 26.4 dB

Antenna Parameters with Head TSL at 5500 MHz

Impedance, transformed to feed point	50.6 Ω - 5.8 j Ω
Return Loss	- 24.8 dB

Antenna Parameters with Head TSL at 5600 MHz

Impedance, transformed to feed point	53.9 Ω - 3.8 j Ω
Return Loss	- 25.6 dB

Antenna Parameters with Head TSL at 5800 MHz

Impedance, transformed to feed point	52.5 Ω - 4.4 j Ω
Return Loss	- 26.1 dB

Antenna Parameters with Body TSL at 5200 MHz

Impedance, transformed to feed point	49.3 Ω - 7.9 j Ω
Return Loss	- 22.0 dB

Antenna Parameters with Body TSL at 5300 MHz

Impedance, transformed to feed point	48.7 Ω - 3.2 j Ω
Return Loss	- 29.2 dB

Antenna Parameters with Body TSL at 5500 MHz

Impedance, transformed to feed point	51.2 Ω - 4.8 j Ω
Return Loss	- 26.2 dB

Antenna Parameters with Body TSL at 5600 MHz

Impedance, transformed to feed point	53.6 Ω - 2.1 j Ω
Return Loss	- 27.9 dB

Antenna Parameters with Body TSL at 5800 MHz

Impedance, transformed to feed point	53.3 Ω - 2.9 j Ω
Return Loss	- 27.4 dB

General Antenna Parameters and Design

Electrical Delay (one direction)	1.202 ns
----------------------------------	----------

After long term use with 100W radiated power, only a slight warming of the dipole near the feedpoint can be measured.

The dipole is made of standard semirigid coaxial cable. The center conductor of the feeding line is directly connected to the second arm of the dipole. The antenna is therefore short-circuited for DC-signals. On some of the dipoles, small end caps are added to the dipole arms in order to improve matching when loaded according to the position as explained in the "Measurement Conditions" paragraph. The SAR data are not affected by this change. The overall dipole length is still according to the Standard.

No excessive force must be applied to the dipole arms, because they might bend or the soldered connections near the feedpoint may be damaged.

Additional EUT Data

Manufactured by	SPEAG
Manufactured on	November 27, 2006

DASY5 Validation Report for Head TSL

Date: 11.01.2013

Test Laboratory: SPEAG, Zurich, Switzerland

DUT: Dipole 5GHz; Type: D5GHzV2; Serial: D5GHzV2 - SN: 1057

Communication System: CW; Frequency: 5200 MHz, Frequency: 5300 MHz, Frequency: 5500 MHz, Frequency: 5600 MHz, Frequency: 5800 MHz

Medium parameters used: $f = 5200$ MHz; $\sigma = 4.5$ S/m; $\epsilon_r = 34.6$; $\rho = 1000$ kg/m³, Medium parameters used: $f = 5300$ MHz; $\sigma = 4.6$ S/m; $\epsilon_r = 34.5$; $\rho = 1000$ kg/m³, Medium parameters used: $f = 5500$ MHz; $\sigma = 4.79$ S/m; $\epsilon_r = 34.2$; $\rho = 1000$ kg/m³, Medium parameters used: $f = 5600$ MHz; $\sigma = 4.88$ S/m; $\epsilon_r = 34.1$; $\rho = 1000$ kg/m³, Medium parameters used: $f = 5800$ MHz; $\sigma = 5.09$ S/m; $\epsilon_r = 33.8$; $\rho = 1000$ kg/m³

Phantom section: Flat Section

Measurement Standard: DASY5 (IEEE/IEC/ANSI C63.19-2007)

DASY52 Configuration:

- Probe: EX3DV4 - SN3503; ConvF(5.41, 5.41, 5.41); Calibrated: 28.12.2012, ConvF(5.1, 5.1, 5.1); Calibrated: 28.12.2012, ConvF(4.91, 4.91, 4.91); Calibrated: 28.12.2012, ConvF(4.76, 4.76, 4.76); Calibrated: 28.12.2012, ConvF(4.81, 4.81, 4.81); Calibrated: 28.12.2012;
- Sensor-Surface: 1.4mm (Mechanical Surface Detection)
- Electronics: DAE4 Sn601; Calibrated: 27.06.2012
- Phantom: Flat Phantom 5.0 (front); Type: QD000P50AA; Serial: 1001
- DASY52 52.8.5(1059); SEMCAD X 14.6.8(7028)

Dipole Calibration for Head Tissue/Pin=100mW, dist=10mm, f=5200 MHz/Zoom Scan,

dist=1.4mm (8x8x7)/Cube 0: Measurement grid: dx=4mm, dy=4mm, dz=1.4mm

Reference Value = 63.671 V/m; Power Drift = 0.09 dB

Peak SAR (extrapolated) = 29.4 W/kg

SAR(1 g) = 7.66 W/kg; SAR(10 g) = 2.17 W/kg

Maximum value of SAR (measured) = 18.5 W/kg

Dipole Calibration for Head Tissue/Pin=100mW, dist=10mm, f=5300 MHz/Zoom Scan,

dist=1.4mm (8x8x7)/Cube 0: Measurement grid: dx=4mm, dy=4mm, dz=1.4mm

Reference Value = 63.473 V/m; Power Drift = 0.09 dB

Peak SAR (extrapolated) = 30.3 W/kg

SAR(1 g) = 7.76 W/kg; SAR(10 g) = 2.22 W/kg

Maximum value of SAR (measured) = 18.8 W/kg

Dipole Calibration for Head Tissue/Pin=100mW, dist=10mm, f=5500 MHz/Zoom Scan,

dist=1.4mm (8x8x7)/Cube 0: Measurement grid: dx=4mm, dy=4mm, dz=1.4mm

Reference Value = 63.735 V/m; Power Drift = 0.08 dB

Peak SAR (extrapolated) = 33.2 W/kg

SAR(1 g) = 8.09 W/kg; SAR(10 g) = 2.28 W/kg

Maximum value of SAR (measured) = 20.1 W/kg

Dipole Calibration for Head Tissue/Pin=100mW, dist=10mm, f=5600 MHz/Zoom Scan, dist=1.4mm (8x8x7)/Cube 0: Measurement grid: dx=4mm, dy=4mm, dz=1.4mm
Reference Value = 63.848 V/m; Power Drift = 0.09 dB
Peak SAR (extrapolated) = 33.5 W/kg
SAR(1 g) = 8.12 W/kg; SAR(10 g) = 2.3 W/kg
Maximum value of SAR (measured) = 20.2 W/kg

Dipole Calibration for Head Tissue/Pin=100mW, dist=10mm, f=5800 MHz/Zoom Scan, dist=1.4mm (8x8x7)/Cube 0: Measurement grid: dx=4mm, dy=4mm, dz=1.4mm
Reference Value = 60.467 V/m; Power Drift = 0.08 dB
Peak SAR (extrapolated) = 33.3 W/kg
SAR(1 g) = 7.69 W/kg; SAR(10 g) = 2.17 W/kg
Maximum value of SAR (measured) = 19.4 W/kg

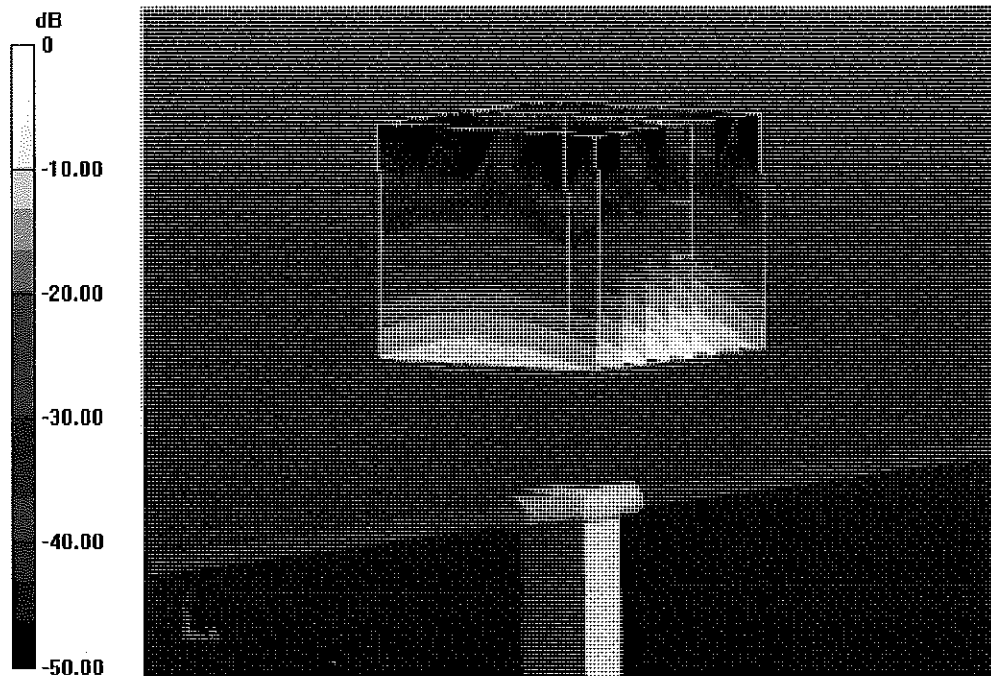

0 dB = 19.4 W/kg = 12.88 dBW/kg

Impedance Measurement Plot for Head TSL

11 Jan 2013 09:26:56

CH1 S11 1 U FS 1: 50.543 Ω -9.7754 Ω 3.1310 pF 5 200.000 000 MHz

*
De1
CA
Avg
16
H1d

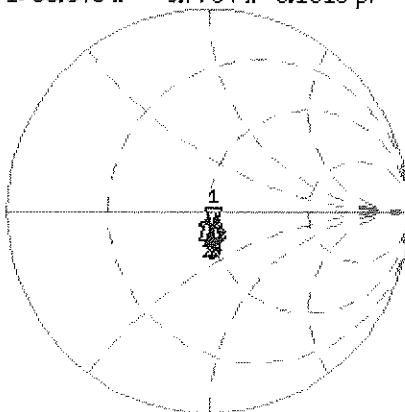

CH1 Markers

- 2: 48.508 Ω
-4.4805 Ω
5.30000 GHz
- 3: 50.617 Ω
-5.7559 Ω
5.50000 GHz
- 4: 53.891 Ω
-3.8418 Ω
5.60000 GHz
- 5: 52.500 Ω
-4.4160 Ω
5.80000 GHz

CH2 S11 LOG 5 dB/REF -20 dB 1: -20.273 dB 5 200.000 000 MHz

CA
Avg
16
H1d

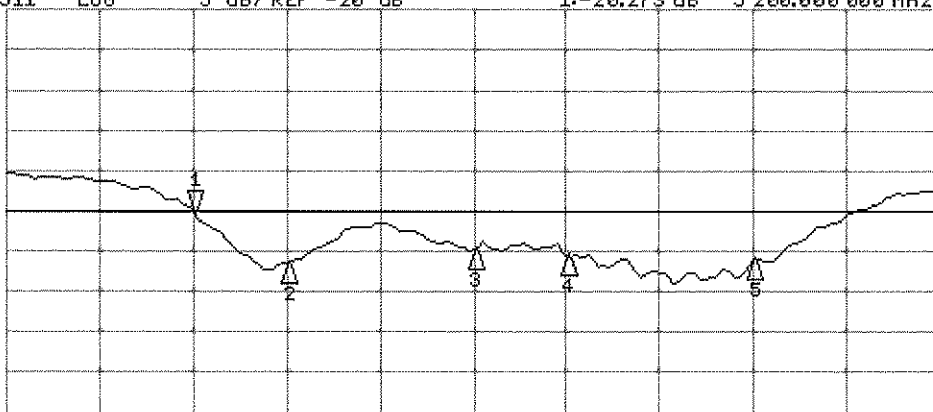

CH2 Markers

- 2: -25.396 dB
5.30000 GHz
- 3: -24.818 dB
5.50000 GHz
- 4: -25.573 dB
5.60000 GHz
- 5: -26.115 dB
5.80000 GHz

START 5 000.000 000 MHz

STOP 6 000.000 000 MHz

DASY5 Validation Report for Body TSL

Date: 10.01.2013

Test Laboratory: SPEAG, Zurich, Switzerland

DUT: Dipole 5GHz; Type: D5GHzV2; Serial: D5GHzV2 - SN: 1057

Communication System: CW; Frequency: 5200 MHz, Frequency: 5300 MHz, Frequency: 5500 MHz, Frequency: 5600 MHz, Frequency: 5800 MHz

Medium parameters used: $f = 5200$ MHz; $\sigma = 5.42$ S/m; $\epsilon_r = 47$; $\rho = 1000$ kg/m³, Medium parameters used: $f = 5300$ MHz; $\sigma = 5.55$ S/m; $\epsilon_r = 46.8$; $\rho = 1000$ kg/m³, Medium parameters used: $f = 5500$ MHz; $\sigma = 5.81$ S/m; $\epsilon_r = 46.5$; $\rho = 1000$ kg/m³, Medium parameters used: $f = 5600$ MHz; $\sigma = 5.94$ S/m; $\epsilon_r = 46.3$; $\rho = 1000$ kg/m³, Medium parameters used: $f = 5800$ MHz; $\sigma = 6.21$ S/m; $\epsilon_r = 46$; $\rho = 1000$ kg/m³

Phantom section: Flat Section

Measurement Standard: DASY5 (IEEE/IEC/ANSI C63.19-2007)

DASY52 Configuration:

- Probe: EX3DV4 - SN3503; ConvF(4.91, 4.91, 4.91); Calibrated: 28.12.2012, ConvF(4.67, 4.67, 4.67); Calibrated: 28.12.2012, ConvF(4.43, 4.43, 4.43); Calibrated: 28.12.2012, ConvF(4.22, 4.22, 4.22); Calibrated: 28.12.2012, ConvF(4.38, 4.38, 4.38); Calibrated: 28.12.2012;
- Sensor-Surface: 1.4mm (Mechanical Surface Detection)
- Electronics: DAE4 Sn601; Calibrated: 27.06.2012
- Phantom: Flat Phantom 5.0 (back); Type: QD000P50AA; Serial: 1002
- DASY52 52.8.5(1059); SEMCAD X 14.6.8(7028)

Dipole Calibration for Body Tissue/Pin=100mW, dist=10mm, f=5200 MHz/Zoom Scan, dist=1.4mm (8x8x7)/Cube 0: Measurement grid: dx=4mm, dy=4mm, dz=1.4mm

Reference Value = 59.074 V/m; Power Drift = -0.01 dB

Peak SAR (extrapolated) = 30.4 W/kg

SAR(1 g) = 7.61 W/kg; SAR(10 g) = 2.13 W/kg

Maximum value of SAR (measured) = 18.0 W/kg

Dipole Calibration for Body Tissue/Pin=100mW, dist=10mm, f=5300 MHz/Zoom Scan, dist=1.4mm (8x8x7)/Cube 0: Measurement grid: dx=4mm, dy=4mm, dz=1.4mm

Reference Value = 58.924 V/m; Power Drift = -0.00 dB

Peak SAR (extrapolated) = 30.9 W/kg

SAR(1 g) = 7.59 W/kg; SAR(10 g) = 2.13 W/kg

Maximum value of SAR (measured) = 17.9 W/kg

Dipole Calibration for Body Tissue/Pin=100mW, dist=10mm, f=5500 MHz/Zoom Scan, dist=1.4mm (8x8x7)/Cube 0: Measurement grid: dx=4mm, dy=4mm, dz=1.4mm

Reference Value = 59.561 V/m; Power Drift = -0.01 dB

Peak SAR (extrapolated) = 35.3 W/kg

SAR(1 g) = 8.14 W/kg; SAR(10 g) = 2.26 W/kg

Maximum value of SAR (measured) = 19.7 W/kg

Dipole Calibration for Body Tissue/Pin=100mW, dist=10mm, f=5600 MHz/Zoom Scan,

dist=1.4mm (8x8x7)/Cube 0: Measurement grid: dx=4mm, dy=4mm, dz=1.4mm

Reference Value = 58.884 V/m; Power Drift = -0.02 dB

Peak SAR (extrapolated) = 36.3 W/kg

SAR(1 g) = 8.1 W/kg; SAR(10 g) = 2.25 W/kg

Maximum value of SAR (measured) = 20.0 W/kg

Dipole Calibration for Body Tissue/Pin=100mW, dist=10mm, f=5800 MHz/Zoom Scan,

dist=1.4mm (8x8x7)/Cube 0: Measurement grid: dx=4mm, dy=4mm, dz=1.4mm

Reference Value = 55.753 V/m; Power Drift = -0.00 dB

Peak SAR (extrapolated) = 35.6 W/kg

SAR(1 g) = 7.57 W/kg; SAR(10 g) = 2.09 W/kg

Maximum value of SAR (measured) = 18.9 W/kg

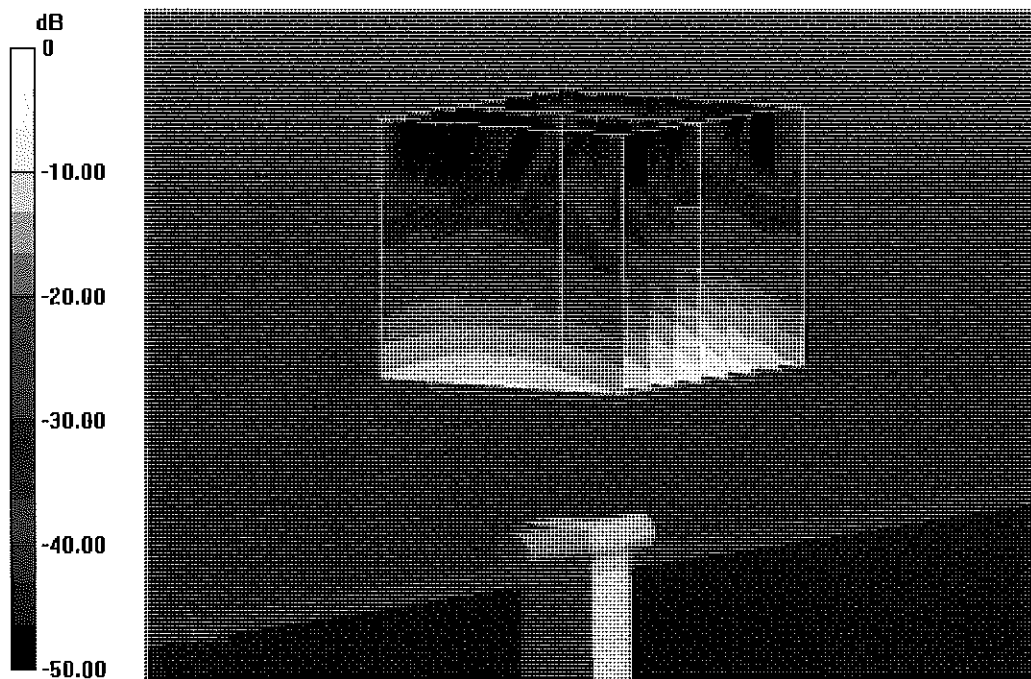

0 dB = 18.9 W/kg = 12.76 dBW/kg

Impedance Measurement Plot for Body TSL

10 Jan 2013 13:20:10

CH1 S11 1 U FS 1: 49.311 Ω -7.8789 Ω 3.8846 pF 5 200.000 000 MHz

*
Del
CA
Avg
16
H1d

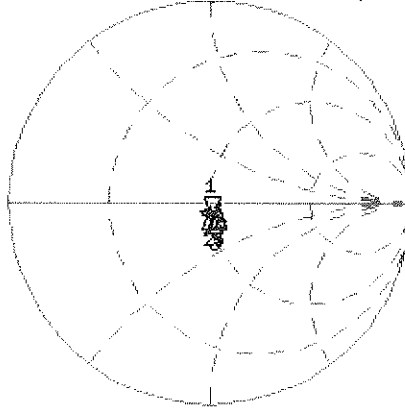

CH1 Markers
2: 48.729 Ω
-3.1895 Ω
5.30000 GHz
3: 51.209 Ω
-4.8184 Ω
5.50000 GHz
4: 53.596 Ω
-2.1113 Ω
5.60000 GHz
5: 53.314 Ω
-2.9355 Ω
5.90000 GHz

CH2 S11 LOG 5 dB/REF -20 dB 1: -22.005 dB 5 200.000 000 MHz

CA
Avg
16
H1d

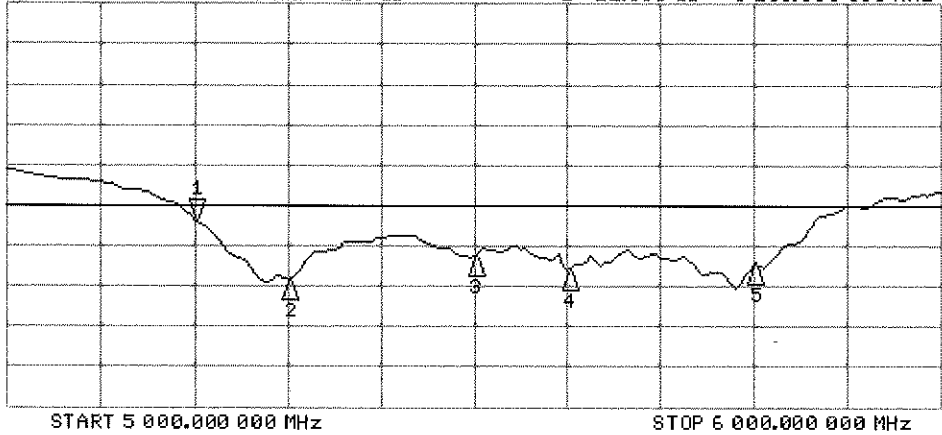

CH2 Markers
2: -29.181 dB
5.30000 GHz
3: -26.190 dB
5.50000 GHz
4: -27.903 dB
5.60000 GHz
5: -27.367 dB
5.80000 GHz



Accredited by the Swiss Accreditation Service (SAS)
The Swiss Accreditation Service is one of the signatories to the EA
Multilateral Agreement for the recognition of calibration certificates

Accreditation No.: **SCS 108**

Client **PC Test**

Certificate No: **D835V2-4d132_Jan13**

CALIBRATION CERTIFICATE

Object **D835V2 - SN: 4d132**

Calibration procedure(s) **QA CAL-05.v9
Calibration procedure for dipole validation kits above 700 MHz**

Calibration date: **January 07, 2013**

*✓ KOK
1/28/13*

This calibration certificate documents the traceability to national standards, which realize the physical units of measurements (SI).
The measurements and the uncertainties with confidence probability are given on the following pages and are part of the certificate.

All calibrations have been conducted in the closed laboratory facility: environment temperature (22 ± 3)°C and humidity < 70%.

Calibration Equipment used (M&TE critical for calibration)

Primary Standards	ID #	Cal Date (Certificate No.)	Scheduled Calibration
Power meter EPM-442A	GB37480704	01-Nov-12 (No. 217-01640)	Oct-13
Power sensor HP 8481A	US37292783	01-Nov-12 (No. 217-01640)	Oct-13
Reference 20 dB Attenuator	SN: 5058 (20k)	27-Mar-12 (No. 217-01530)	Apr-13
Type-N mismatch combination	SN: 5047.3 / 06327	27-Mar-12 (No. 217-01533)	Apr-13
Reference Probe ES3DV3	SN: 3205	28-Dec-12 (No. ES3-3205_Dec12)	Dec-13
DAE4	SN: 601	27-Jun-12 (No. DAE4-601_Jun12)	Jun-13
Secondary Standards	ID #	Check Date (in house)	Scheduled Check
Power sensor HP 8481A	MY41092317	18-Oct-02 (in house check Oct-11)	In house check: Oct-13
RF generator R&S SMT-06	100005	04-Aug-99 (in house check Oct-11)	In house check: Oct-13
Network Analyzer HP 8753E	US37390585 S4206	18-Oct-01 (in house check Oct-12)	In house check: Oct-13

	Name	Function	Signature
Calibrated by:	Leif Klysner	Laboratory Technician	
Approved by:	Katja Pokovic	Technical Manager	

Issued: January 8, 2013

This calibration certificate shall not be reproduced except in full without written approval of the laboratory.



Accredited by the Swiss Accreditation Service (SAS)
The Swiss Accreditation Service is one of the signatories to the EA
Multilateral Agreement for the recognition of calibration certificates

Glossary:

TSL	tissue simulating liquid
ConvF	sensitivity in TSL / NORM x,y,z
N/A	not applicable or not measured

Calibration is Performed According to the Following Standards:

- IEEE Std 1528-2003, "IEEE Recommended Practice for Determining the Peak Spatial-Averaged Specific Absorption Rate (SAR) in the Human Head from Wireless Communications Devices: Measurement Techniques", December 2003
- IEC 62209-1, "Procedure to measure the Specific Absorption Rate (SAR) for hand-held devices used in close proximity to the ear (frequency range of 300 MHz to 3 GHz)", February 2005
- Federal Communications Commission Office of Engineering & Technology (FCC OET), "Evaluating Compliance with FCC Guidelines for Human Exposure to Radiofrequency Electromagnetic Fields; Additional Information for Evaluating Compliance of Mobile and Portable Devices with FCC Limits for Human Exposure to Radiofrequency Emissions", Supplement C (Edition 01-01) to Bulletin 65

Additional Documentation:

- DASY4/5 System Handbook

Methods Applied and Interpretation of Parameters:

- Measurement Conditions:** Further details are available from the Validation Report at the end of the certificate. All figures stated in the certificate are valid at the frequency indicated.
- Antenna Parameters with TSL:** The dipole is mounted with the spacer to position its feed point exactly below the center marking of the flat phantom section, with the arms oriented parallel to the body axis.
- Feed Point Impedance and Return Loss:** These parameters are measured with the dipole positioned under the liquid filled phantom. The impedance stated is transformed from the measurement at the SMA connector to the feed point. The Return Loss ensures low reflected power. No uncertainty required.
- Electrical Delay:** One-way delay between the SMA connector and the antenna feed point. No uncertainty required.
- SAR measured:** SAR measured at the stated antenna input power.
- SAR normalized:** SAR as measured, normalized to an input power of 1 W at the antenna connector.
- SAR for nominal TSL parameters:** The measured TSL parameters are used to calculate the nominal SAR result.

The reported uncertainty of measurement is stated as the standard uncertainty of measurement multiplied by the coverage factor $k=2$, which for a normal distribution corresponds to a coverage probability of approximately 95%.

Measurement Conditions

DASY system configuration, as far as not given on page 1.

DASY Version	DASY5	V52.8.4
Extrapolation	Advanced Extrapolation	
Phantom	Modular Flat Phantom	
Distance Dipole Center - TSL	15 mm	with Spacer
Zoom Scan Resolution	dx, dy, dz = 5 mm	
Frequency	835 MHz ± 1 MHz	

Head TSL parameters

The following parameters and calculations were applied.

	Temperature	Permittivity	Conductivity
Nominal Head TSL parameters	22.0 °C	41.5	0.90 mho/m
Measured Head TSL parameters	(22.0 ± 0.2) °C	42.0 ± 6 %	0.92 mho/m ± 6 %
Head TSL temperature change during test	< 0.5 °C	----	----

SAR result with Head TSL

SAR averaged over 1 cm³ (1 g) of Head TSL	Condition	
SAR measured	250 mW input power	2.45 W/kg
SAR for nominal Head TSL parameters	normalized to 1W	9.66 W/kg ± 17.0 % (k=2)

SAR averaged over 10 cm³ (10 g) of Head TSL	condition	
SAR measured	250 mW input power	1.59 W/kg
SAR for nominal Head TSL parameters	normalized to 1W	6.29 W/kg ± 16.5 % (k=2)

Body TSL parameters

The following parameters and calculations were applied.

	Temperature	Permittivity	Conductivity
Nominal Body TSL parameters	22.0 °C	55.2	0.97 mho/m
Measured Body TSL parameters	(22.0 ± 0.2) °C	54.7 ± 6 %	0.99 mho/m ± 6 %
Body TSL temperature change during test	< 0.5 °C	----	----

SAR result with Body TSL

SAR averaged over 1 cm³ (1 g) of Body TSL	Condition	
SAR measured	250 mW input power	2.38 W/kg
SAR for nominal Body TSL parameters	normalized to 1W	9.36 W/kg ± 17.0 % (k=2)

SAR averaged over 10 cm³ (10 g) of Body TSL	condition	
SAR measured	250 mW input power	1.57 W/kg
SAR for nominal Body TSL parameters	normalized to 1W	6.20 W/kg ± 16.5 % (k=2)

Appendix

Antenna Parameters with Head TSL

Impedance, transformed to feed point	$54.2 \Omega + 1.3 j\Omega$
Return Loss	- 27.5 dB

Antenna Parameters with Body TSL

Impedance, transformed to feed point	$48.8 \Omega - 1.3 j\Omega$
Return Loss	- 34.9 dB

General Antenna Parameters and Design

Electrical Delay (one direction)	1.391 ns
----------------------------------	----------

After long term use with 100W radiated power, only a slight warming of the dipole near the feedpoint can be measured.

The dipole is made of standard semirigid coaxial cable. The center conductor of the feeding line is directly connected to the second arm of the dipole. The antenna is therefore short-circuited for DC-signals. On some of the dipoles, small end caps are added to the dipole arms in order to improve matching when loaded according to the position as explained in the "Measurement Conditions" paragraph. The SAR data are not affected by this change. The overall dipole length is still according to the Standard.

No excessive force must be applied to the dipole arms, because they might bend or the soldered connections near the feedpoint may be damaged.

Additional EUT Data

Manufactured by	SPEAG
Manufactured on	July 22, 2011

DASY5 Validation Report for Head TSL

Date: 07.01.2013

Test Laboratory: SPEAG, Zurich, Switzerland

DUT: Dipole 835 MHz; Type: D835V2; Serial: D835V2 - SN: 4d132

Communication System: CW; Frequency: 835 MHz

Medium parameters used: $f = 835$ MHz; $\sigma = 0.92$ S/m; $\epsilon_r = 42$; $\rho = 1000$ kg/m³

Phantom section: Flat Section

Measurement Standard: DASY5 (IEEE/IEC/ANSI C63.19-2007)

DASY52 Configuration:

- Probe: ES3DV3 - SN3205; ConvF(6.05, 6.05, 6.05); Calibrated: 28.12.2012;
- Sensor-Surface: 3mm (Mechanical Surface Detection)
- Electronics: DAE4 Sn601; Calibrated: 27.06.2012
- Phantom: Flat Phantom 4.9L; Type: QD000P49AA; Serial: 1001
- DASY52 52.8.4(1052); SEMCAD X 14.6.8(7028)

Dipole Calibration for Head Tissue/Pin=250 mW, d=15mm/Zoom Scan (7x7x7)/Cube 0:

Measurement grid: dx=5mm, dy=5mm, dz=5mm

Reference Value = 57.542 V/m; Power Drift = 0.07 dB

Peak SAR (extrapolated) = 3.71 W/kg

SAR(1 g) = 2.45 W/kg; SAR(10 g) = 1.59 W/kg

Maximum value of SAR (measured) = 2.88 W/kg

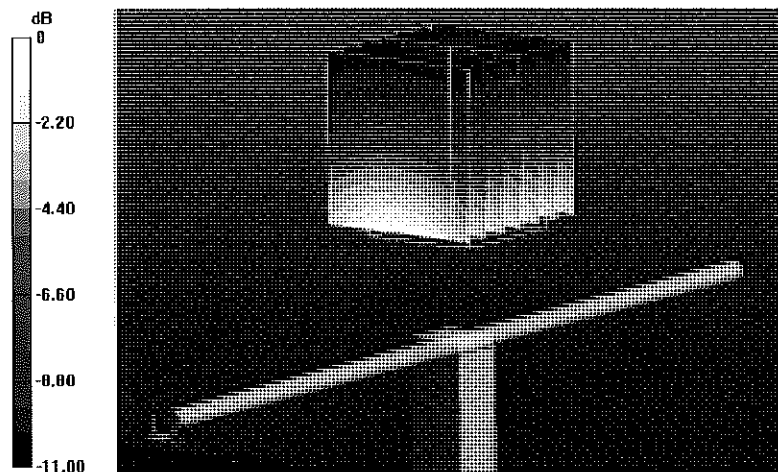

0 dB = 2.88 W/kg = 4.59 dBW/kg

Impedance Measurement Plot for Head TSL

7 Jan 2013 13:03:50

CH1 S11 1 U FS 2: 54.162 Ω 1.3398 Ω 255.38 μH 835.000 000 MHz

*
Del
CA
Avg
16
Hid

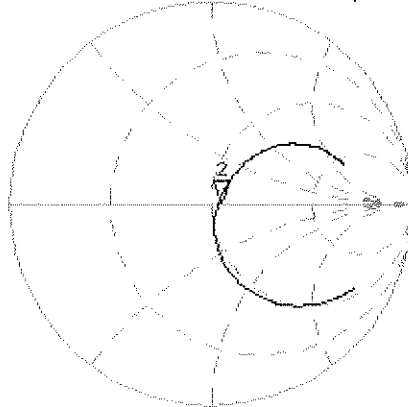

CH2 S11 LOG 5 dB/REF -20 dB 2:-27.537 dB 835.000 000 MHz

CA
Avg
16
Hid

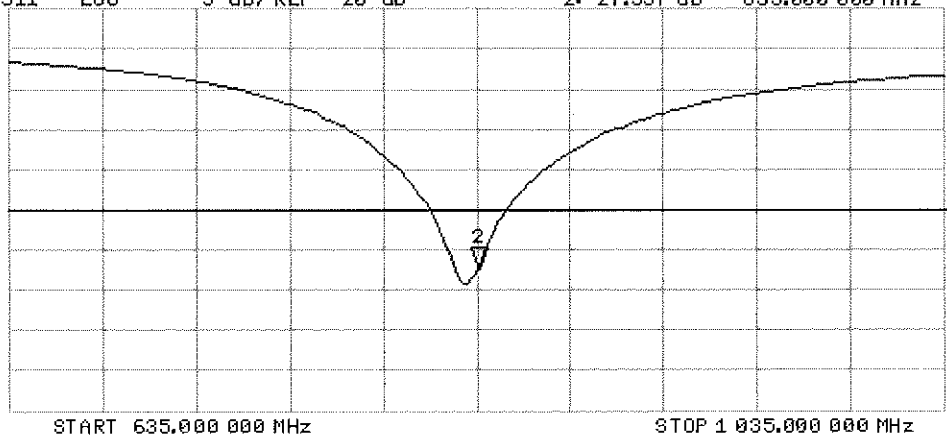

DASY5 Validation Report for Body TSL

Date: 07.01.2013

Test Laboratory: SPEAG, Zurich, Switzerland

DUT: Dipole 835 MHz; Type: D835V2; Serial: D835V2 - SN: 4d132

Communication System: CW; Frequency: 835 MHz

Medium parameters used: $f = 835$ MHz; $\sigma = 0.99$ S/m; $\epsilon_r = 54.7$; $\rho = 1000$ kg/m³

Phantom section: Flat Section

Measurement Standard: DASY5 (IEEE/IEC/ANSI C63.19-2007)

DASY52 Configuration:

- Probe: ES3DV3 - SN3205; ConvF(6.04, 6.04, 6.04); Calibrated: 28.12.2012;
- Sensor-Surface: 3mm (Mechanical Surface Detection)
- Electronics: DAE4 Sn601; Calibrated: 27.06.2012
- Phantom: Flat Phantom 4.9L; Type: QD000P49AA; Serial: 1001
- DASY52 52.8.4(1052); SEMCAD X 14.6.8(7028)

Dipole Calibration for Body Tissue/Pin=250 mW, d=15mm/Zoom Scan (7x7x7)/Cube 0:

Measurement grid: dx=5mm, dy=5mm, dz=5mm

Reference Value = 54.512 V/m; Power Drift = 0.07 dB

Peak SAR (extrapolated) = 3.47 W/kg

SAR(1 g) = 2.38 W/kg; SAR(10 g) = 1.57 W/kg

Maximum value of SAR (measured) = 2.77 W/kg

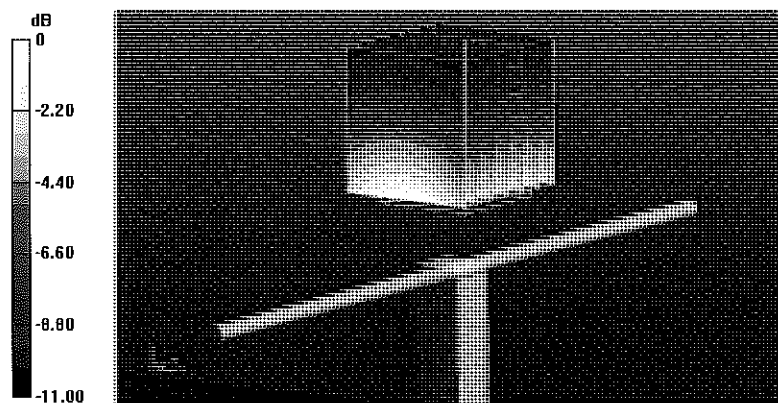

0 dB = 2.77 W/kg = 4.42 dBW/kg

Impedance Measurement Plot for Body TSL

7 Jan 2013 10:07:01

CH1 S11 1 U FS

2: 48.762 Ω -1.2773 Ω 149.22 pF

835.000 000 MHz

*
De1
CΔ
Avg
16
H1d

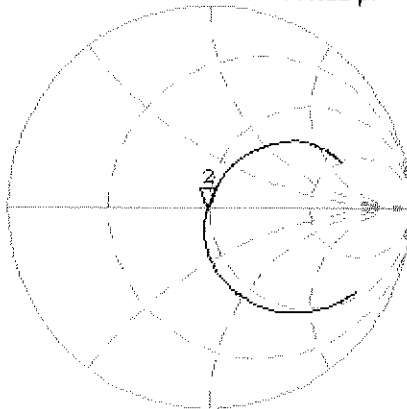

CH2 S11 LOG

5 dB/REF -20 dB

2:-34.896 dB

835.000 000 MHz

CΔ
Avg
16
H1d

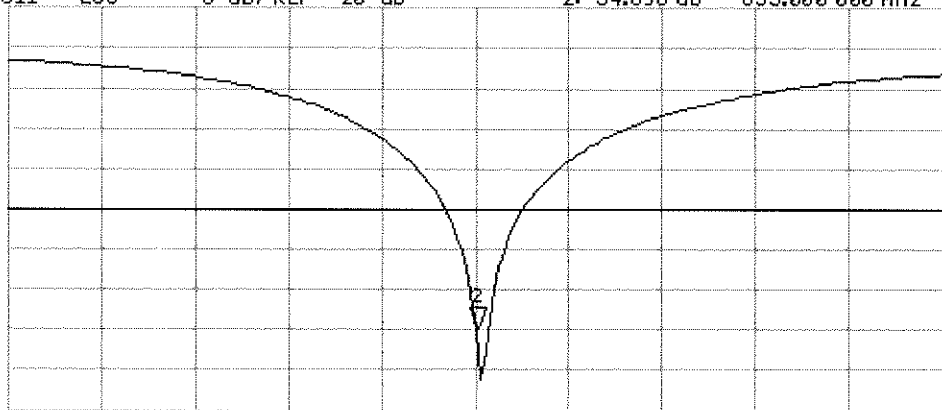

START 635.000 000 MHz

STOP 1 035.000 000 MHz



Accredited by the Swiss Accreditation Service (SAS)
The Swiss Accreditation Service is one of the signatories to the EA
Multilateral Agreement for the recognition of calibration certificates

Accreditation No.: **SCS 108**

Client **PC Test**

Certificate No: **ES3-3022_Aug12**

CALIBRATION CERTIFICATE

Object **ES3DV2 - SN:3022**

Calibration procedure(s) **QA CAL-01.v8, QA CAL-23.v4, QA CAL-25.v4
Calibration procedure for dosimetric E-field probes**

Calibration date: **August 28, 2012**

This calibration certificate documents the traceability to national standards, which realize the physical units of measurements (SI).
The measurements and the uncertainties with confidence probability are given on the following pages and are part of the certificate.

All calibrations have been conducted in the closed laboratory facility: environment temperature (22 ± 3)°C and humidity < 70%.

Calibration Equipment used (M&TE critical for calibration)

*✓
Kok
7/10*

Primary Standards	ID	Cal Date (Certificate No.)	Scheduled Calibration
Power meter E4419B	GB41293874	29-Mar-12 (No. 217-01508)	Apr-13
Power sensor E4412A	MY41498087	29-Mar-12 (No. 217-01508)	Apr-13
Reference 3 dB Attenuator	SN: S5054 (3c)	27-Mar-12 (No. 217-01531)	Apr-13
Reference 20 dB Attenuator	SN: S5086 (20b)	27-Mar-12 (No. 217-01529)	Apr-13
Reference 30 dB Attenuator	SN: S5129 (30b)	27-Mar-12 (No. 217-01532)	Apr-13
Reference Probe ES3DV2	SN: 3013	29-Dec-11 (No. ES3-3013_Dec11)	Dec-12
DAE4	SN: 660	20-Jun-12 (No. DAE4-660_Jun12)	Jun-13
Secondary Standards	ID	Check Date (in house)	Scheduled Check
RF generator HP 8648C	US3642U01700	4-Aug-99 (in house check Apr-11)	In house check: Apr-13
Network Analyzer HP 8753E	US37390585	18-Oct-01 (in house check Oct-11)	In house check: Oct-12

	Name	Function	Signature
Calibrated by:	Jeton Kastrati	Laboratory Technician	
Approved by:	Katja Pokovic	Technical Manager	

Issued: August 28, 2012

This calibration certificate shall not be reproduced except in full without written approval of the laboratory.



Accredited by the Swiss Accreditation Service (SAS)

Accreditation No.: **SCS 108**

The Swiss Accreditation Service is one of the signatories to the EA
Multilateral Agreement for the recognition of calibration certificates

Glossary:

TSL	tissue simulating liquid
NORM _{x,y,z}	sensitivity in free space
ConvF	sensitivity in TSL / NORM _{x,y,z}
DCP	diode compression point
CF	crest factor (1/duty_cycle) of the RF signal
A, B, C	modulation dependent linearization parameters
Polarization ϕ	ϕ rotation around probe axis
Polarization ϑ	ϑ rotation around an axis that is in the plane normal to probe axis (at measurement center), i.e., $\vartheta = 0$ is normal to probe axis

Calibration is Performed According to the Following Standards:

- IEEE Std 1528-2003, "IEEE Recommended Practice for Determining the Peak Spatial-Averaged Specific Absorption Rate (SAR) in the Human Head from Wireless Communications Devices: Measurement Techniques", December 2003
- IEC 62209-1, "Procedure to measure the Specific Absorption Rate (SAR) for hand-held devices used in close proximity to the ear (frequency range of 300 MHz to 3 GHz)", February 2005

Methods Applied and Interpretation of Parameters:

- NORM_{x,y,z}**: Assessed for E-field polarization $\vartheta = 0$ ($f \leq 900$ MHz in TEM-cell; $f > 1800$ MHz: R22 waveguide). NORM_{x,y,z} are only intermediate values, i.e., the uncertainties of NORM_{x,y,z} does not affect the E²-field uncertainty inside TSL (see below ConvF).
- NORM(f)_{x,y,z}** = NORM_{x,y,z} * frequency_response (see Frequency Response Chart). This linearization is implemented in DASY4 software versions later than 4.2. The uncertainty of the frequency response is included in the stated uncertainty of ConvF.
- DCP_{x,y,z}**: DCP are numerical linearization parameters assessed based on the data of power sweep with CW signal (no uncertainty required). DCP does not depend on frequency nor media.
- PAR**: PAR is the Peak to Average Ratio that is not calibrated but determined based on the signal characteristics
- A_{x,y,z}; B_{x,y,z}; C_{x,y,z}; VR_{x,y,z}**: A, B, C are numerical linearization parameters assessed based on the data of power sweep for specific modulation signal. The parameters do not depend on frequency nor media. VR is the maximum calibration range expressed in RMS voltage across the diode.
- ConvF and Boundary Effect Parameters**: Assessed in flat phantom using E-field (or Temperature Transfer Standard for $f \leq 800$ MHz) and inside waveguide using analytical field distributions based on power measurements for $f > 800$ MHz. The same setups are used for assessment of the parameters applied for boundary compensation (alpha, depth) of which typical uncertainty values are given. These parameters are used in DASY4 software to improve probe accuracy close to the boundary. The sensitivity in TSL corresponds to NORM_{x,y,z} * ConvF whereby the uncertainty corresponds to that given for ConvF. A frequency dependent ConvF is used in DASY version 4.4 and higher which allows extending the validity from ± 50 MHz to ± 100 MHz.
- Spherical isotropy (3D deviation from isotropy)**: in a field of low gradients realized using a flat phantom exposed by a patch antenna.
- Sensor Offset**: The sensor offset corresponds to the offset of virtual measurement center from the probe tip (on probe axis). No tolerance required.

Probe ES3DV2

SN:3022

Manufactured: April 15, 2003
Calibrated: August 28, 2012

Calibrated for DASY/EASY Systems
(Note: non-compatible with DASY2 system!)

DASY/EASY - Parameters of Probe: ES3DV2 - SN:3022

Basic Calibration Parameters

	Sensor X	Sensor Y	Sensor Z	Unc (k=2)
Norm ($\mu\text{V}/(\text{V}/\text{m})^2$) ^A	1.00	1.04	0.99	$\pm 10.1 \%$
DCP (mV) ^B	98.3	99.5	101.3	

Modulation Calibration Parameters

UID	Communication System Name	PAR		A dB	B dB	C dB	VR mV	Unc ^E (k=2)
0	CW	0.00	X	0.00	0.00	1.00	133.3	$\pm 2.7 \%$
			Y	0.00	0.00	1.00	140.3	
			Z	0.00	0.00	1.00	178.9	

The reported uncertainty of measurement is stated as the standard uncertainty of measurement multiplied by the coverage factor k=2, which for a normal distribution corresponds to a coverage probability of approximately 95%.

^A The uncertainties of NormX,Y,Z do not affect the E²-field uncertainty inside TSL (see Pages 5 and 6).

^B Numerical linearization parameter: uncertainty not required.

^E Uncertainty is determined using the max. deviation from linear response applying rectangular distribution and is expressed for the square of the field value.

DASY/EASY - Parameters of Probe: ES3DV2 - SN:3022

Calibration Parameter Determined in Head Tissue Simulating Media

f (MHz) ^C	Relative Permittivity ^F	Conductivity (S/m) ^F	ConvF X	ConvF Y	ConvF Z	Alpha	Depth (mm)	Unct. (k=2)
750	41.9	0.89	6.30	6.30	6.30	0.30	1.72	± 12.0 %
835	41.5	0.90	6.03	6.03	6.03	0.35	1.63	± 12.0 %
1750	40.1	1.37	5.07	5.07	5.07	0.32	1.89	± 12.0 %
1900	40.0	1.40	4.86	4.86	4.86	0.40	1.57	± 12.0 %
2450	39.2	1.80	4.23	4.23	4.23	0.59	1.44	± 12.0 %
2600	39.0	1.96	4.10	4.10	4.10	0.67	1.37	± 12.0 %

^C Frequency validity of ± 100 MHz only applies for DASY v4.4 and higher (see Page 2), else it is restricted to ± 50 MHz. The uncertainty is the RSS of the ConvF uncertainty at calibration frequency and the uncertainty for the indicated frequency band.

^F At frequencies below 3 GHz, the validity of tissue parameters (ϵ and σ) can be relaxed to ± 10% if liquid compensation formula is applied to measured SAR values. At frequencies above 3 GHz, the validity of tissue parameters (ϵ and σ) is restricted to ± 5%. The uncertainty is the RSS of the ConvF uncertainty for indicated target tissue parameters.

DASY/EASY - Parameters of Probe: ES3DV2 - SN:3022

Calibration Parameter Determined in Body Tissue Simulating Media

f (MHz) ^C	Relative Permittivity ^F	Conductivity (S/m) ^F	ConvF X	ConvF Y	ConvF Z	Alpha	Depth (mm)	Unct. (k=2)
750	55.5	0.96	6.07	6.07	6.07	0.23	2.09	± 12.0 %
835	55.2	0.97	6.02	6.02	6.02	0.47	1.44	± 12.0 %
1750	53.4	1.49	4.70	4.70	4.70	0.46	1.55	± 12.0 %
1900	53.3	1.52	4.43	4.43	4.43	0.36	1.87	± 12.0 %
2450	52.7	1.95	3.97	3.97	3.97	0.65	1.06	± 12.0 %
2600	52.5	2.16	3.80	3.80	3.80	0.54	0.75	± 12.0 %

^C Frequency validity of ± 100 MHz only applies for DASY v4.4 and higher (see Page 2), else it is restricted to ± 50 MHz. The uncertainty is the RSS of the ConvF uncertainty at calibration frequency and the uncertainty for the indicated frequency band.

^F At frequencies below 3 GHz, the validity of tissue parameters (ϵ and σ) can be relaxed to ± 10% if liquid compensation formula is applied to measured SAR values. At frequencies above 3 GHz, the validity of tissue parameters (ϵ and σ) is restricted to ± 5%. The uncertainty is the RSS of the ConvF uncertainty for indicated target tissue parameters.

Frequency Response of E-Field

(TEM-Cell:ifi110 EXX, Waveguide: R22)

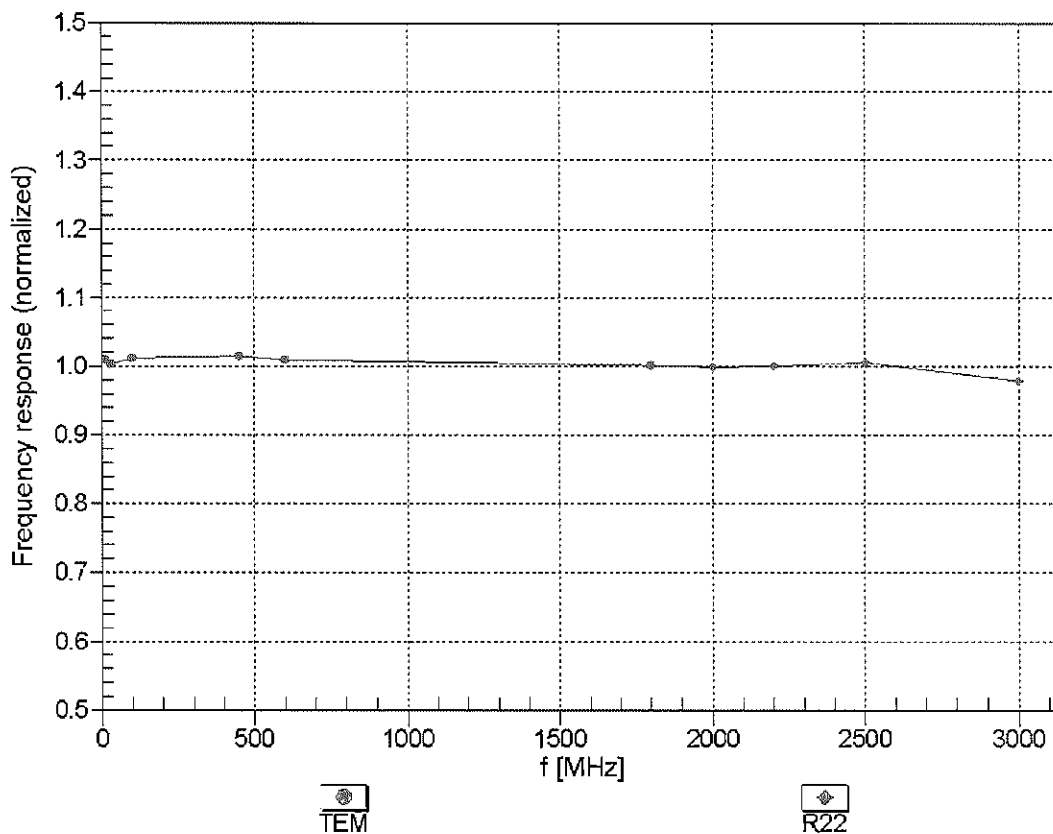

Uncertainty of Frequency Response of E-field: $\pm 6.3\%$ (k=2)

Receiving Pattern (ϕ), $\theta = 0^\circ$

f=600 MHz, TEM

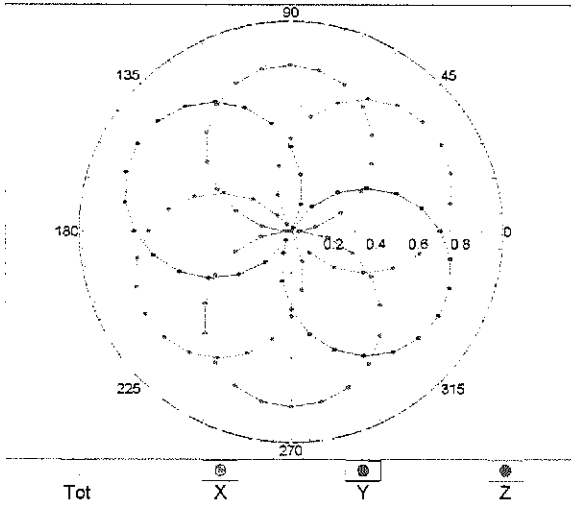

f=1800 MHz, R22

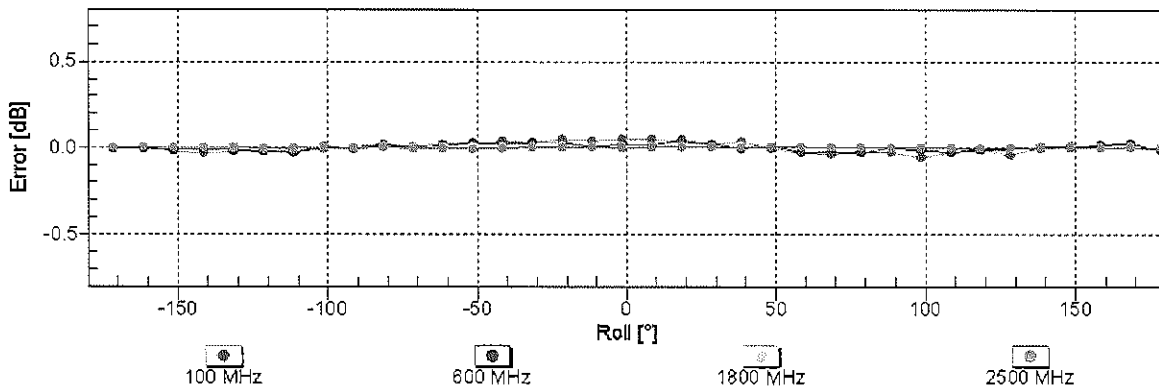
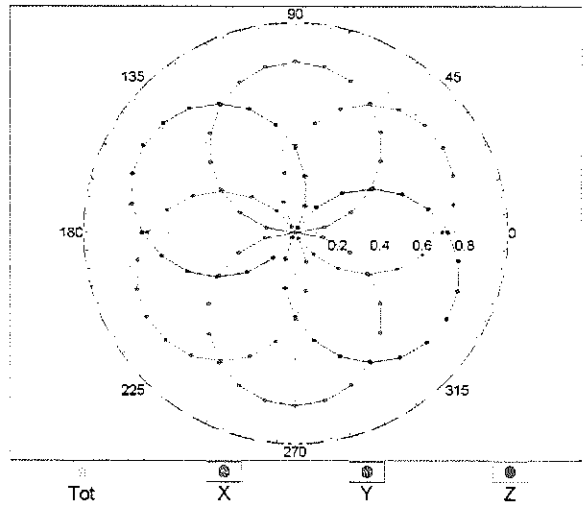

Uncertainty of Axial Isotropy Assessment: $\pm 0.5\%$ (k=2)

Dynamic Range $f(\text{SAR}_{\text{head}})$ (TEM cell , $f = 900 \text{ MHz}$)

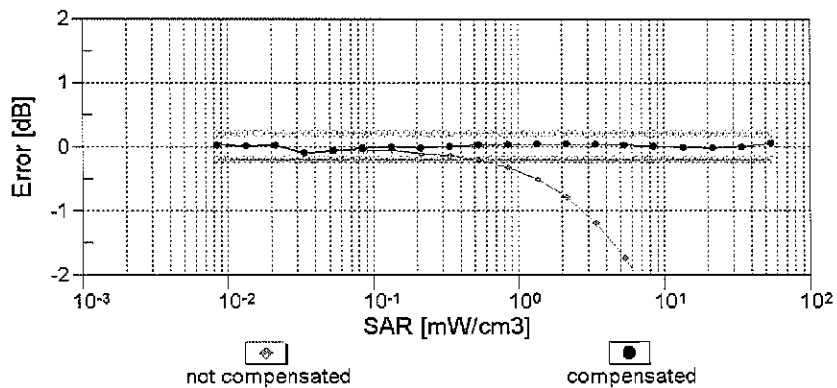
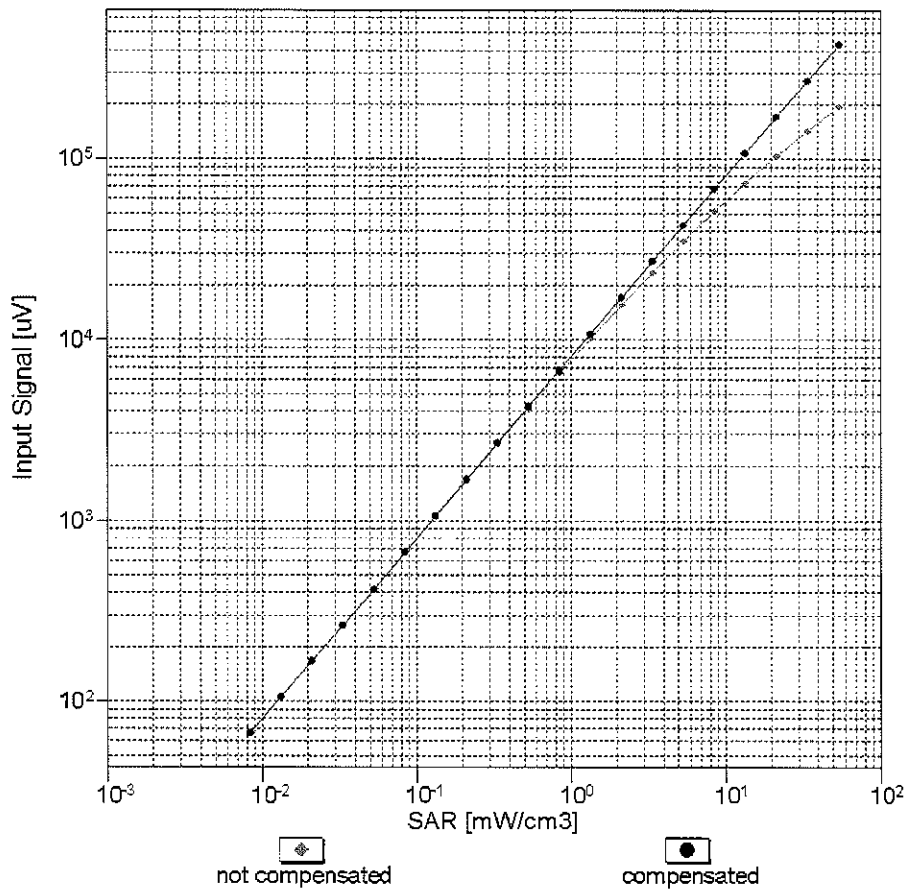

Uncertainty of Linearity Assessment: $\pm 0.6\%$ ($k=2$)

Conversion Factor Assessment

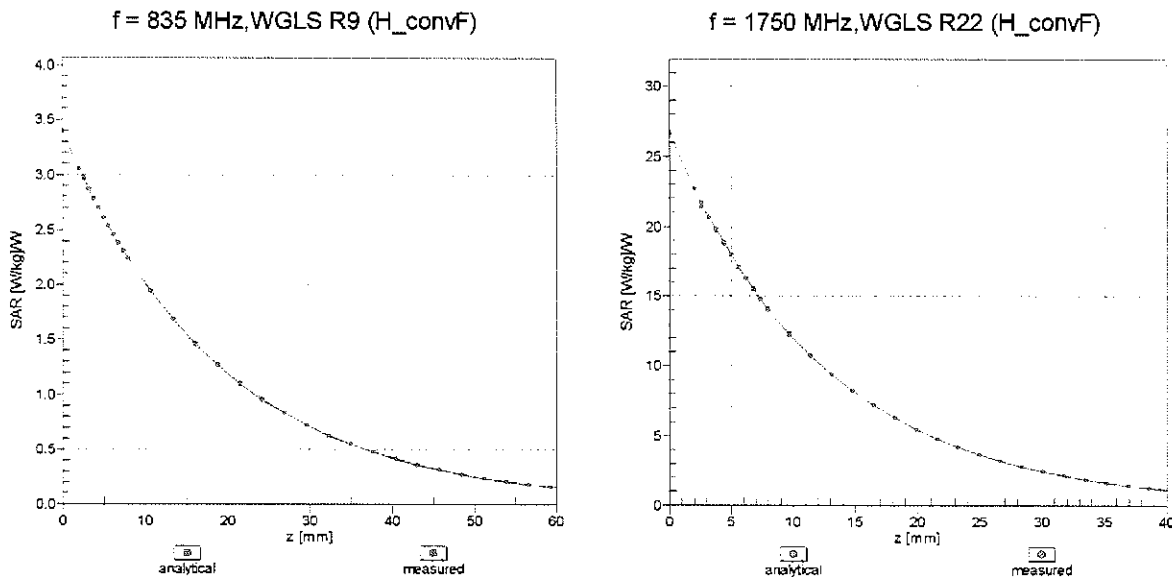

Deviation from Isotropy in Liquid Error (ϕ, θ), f = 900 MHz

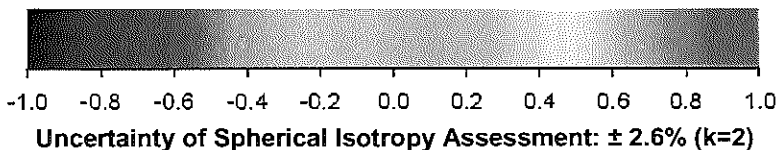
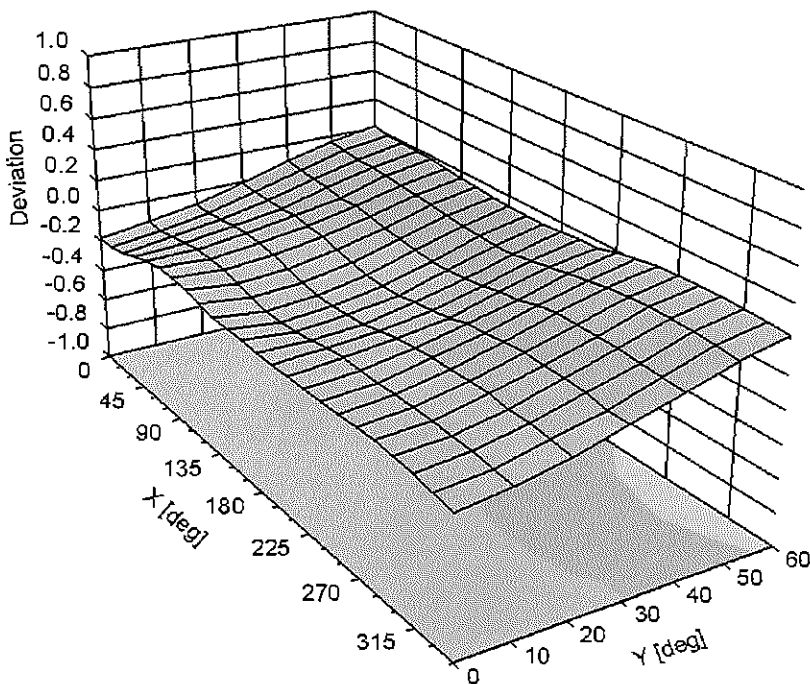

DASY/EASY - Parameters of Probe: ES3DV2 - SN:3022

Other Probe Parameters

Sensor Arrangement	Triangular
Connector Angle (°)	98.5
Mechanical Surface Detection Mode	enabled
Optical Surface Detection Mode	disabled
Probe Overall Length	337 mm
Probe Body Diameter	10 mm
Tip Length	10 mm
Tip Diameter	4 mm
Probe Tip to Sensor X Calibration Point	2 mm
Probe Tip to Sensor Y Calibration Point	2 mm
Probe Tip to Sensor Z Calibration Point	2 mm
Recommended Measurement Distance from Surface	3 mm



Accredited by the Swiss Accreditation Service (SAS)
The Swiss Accreditation Service is one of the signatories to the EA
Multilateral Agreement for the recognition of calibration certificates

Accreditation No.: **SCS 108**

Client **PC Test**

Certificate No: **ES3-3209_Mar13**

CALIBRATION CERTIFICATE

Object **ES3DV3 - SN:3209**

Calibration procedure(s) **QA CAL-01.v8, QA CAL-23.v4, QA CAL-25.v4
Calibration procedure for dosimetric E-field probes**

Calibration date: **March 15, 2013**

This calibration certificate documents the traceability to national standards, which realize the physical units of measurements (SI).
The measurements and the uncertainties with confidence probability are given on the following pages and are part of the certificate.

All calibrations have been conducted in the closed laboratory facility: environment temperature (22 ± 3)°C and humidity < 70%.

✓ KOK 3/22/13

Calibration Equipment used (M&TE critical for calibration)

Primary Standards	ID	Cal Date (Certificate No.)	Scheduled Calibration
Power meter E4419B	GB41293874	29-Mar-12 (No. 217-01508)	Apr-13
Power sensor E4412A	MY41498087	29-Mar-12 (No. 217-01508)	Apr-13
Reference 3 dB Attenuator	SN: S5054 (3c)	27-Mar-12 (No. 217-01531)	Apr-13
Reference 20 dB Attenuator	SN: S5086 (20b)	27-Mar-12 (No. 217-01529)	Apr-13
Reference 30 dB Attenuator	SN: S5129 (30b)	27-Mar-12 (No. 217-01532)	Apr-13
Reference Probe ES3DV2	SN: 3013	28-Dec-12 (No. ES3-3013_Dec12)	Dec-13
DAE4	SN: 660	31-Jan-13 (No. DAE4-660_Jan13)	Jan-14
Secondary Standards	ID	Check Date (in house)	Scheduled Check
RF generator HP 8648C	US3642U01700	4-Aug-99 (in house check Apr-11)	In house check: Apr-13
Network Analyzer HP 8753E	US37390585	18-Oct-01 (in house check Oct-12)	In house check: Oct-13

	Name	Function	Signature
Calibrated by:	Israe El-Naouq	Laboratory Technician	<i>Israe El-Naouq</i>
Approved by:	Katja Pokovic	Technical Manager	<i>Katja Pokovic</i>

Issued: March 15, 2013

This calibration certificate shall not be reproduced except in full without written approval of the laboratory.

80242



Accredited by the Swiss Accreditation Service (SAS)

Accreditation No.: **SCS 108**

The Swiss Accreditation Service is one of the signatories to the EA
Multilateral Agreement for the recognition of calibration certificates

Glossary:

TSL	tissue simulating liquid
NORM _{x,y,z}	sensitivity in free space
ConvF	sensitivity in TSL / NORM _{x,y,z}
DCP	diode compression point
CF	crest factor (1/duty_cycle) of the RF signal
A, B, C, D	modulation dependent linearization parameters
Polarization φ	φ rotation around probe axis
Polarization ϑ	ϑ rotation around an axis that is in the plane normal to probe axis (at measurement center), i.e., $\vartheta = 0$ is normal to probe axis

Calibration is Performed According to the Following Standards:

- IEEE Std 1528-2003, "IEEE Recommended Practice for Determining the Peak Spatial-Averaged Specific Absorption Rate (SAR) in the Human Head from Wireless Communications Devices: Measurement Techniques", December 2003
- IEC 62209-1, "Procedure to measure the Specific Absorption Rate (SAR) for hand-held devices used in close proximity to the ear (frequency range of 300 MHz to 3 GHz)", February 2005

Methods Applied and Interpretation of Parameters:

- NORM_{x,y,z}**: Assessed for E-field polarization $\vartheta = 0$ ($f \leq 900$ MHz in TEM-cell; $f > 1800$ MHz: R22 waveguide). NORM_{x,y,z} are only intermediate values, i.e., the uncertainties of NORM_{x,y,z} does not affect the E²-field uncertainty inside TSL (see below ConvF).
- NORM(f)_{x,y,z}** = NORM_{x,y,z} * frequency_response (see Frequency Response Chart). This linearization is implemented in DASY4 software versions later than 4.2. The uncertainty of the frequency response is included in the stated uncertainty of ConvF.
- DCP_{x,y,z}**: DCP are numerical linearization parameters assessed based on the data of power sweep with CW signal (no uncertainty required). DCP does not depend on frequency nor media.
- PAR**: PAR is the Peak to Average Ratio that is not calibrated but determined based on the signal characteristics
- A_{x,y,z}; B_{x,y,z}; C_{x,y,z}; D_{x,y,z}; VR_{x,y,z}; A, B, C, D** are numerical linearization parameters assessed based on the data of power sweep for specific modulation signal. The parameters do not depend on frequency nor media. VR is the maximum calibration range expressed in RMS voltage across the diode.
- ConvF and Boundary Effect Parameters**: Assessed in flat phantom using E-field (or Temperature Transfer Standard for $f \leq 800$ MHz) and inside waveguide using analytical field distributions based on power measurements for $f > 800$ MHz. The same setups are used for assessment of the parameters applied for boundary compensation (alpha, depth) of which typical uncertainty values are given. These parameters are used in DASY4 software to improve probe accuracy close to the boundary. The sensitivity in TSL corresponds to NORM_{x,y,z} * ConvF whereby the uncertainty corresponds to that given for ConvF. A frequency dependent ConvF is used in DASY version 4.4 and higher which allows extending the validity from ± 50 MHz to ± 100 MHz.
- Spherical isotropy (3D deviation from isotropy)**: in a field of low gradients realized using a flat phantom exposed by a patch antenna.
- Sensor Offset**: The sensor offset corresponds to the offset of virtual measurement center from the probe tip (on probe axis). No tolerance required.

Probe ES3DV3

SN:3209

Manufactured: October 14, 2008
Calibrated: March 15, 2013

Calibrated for DASY/EASY Systems
(Note: non-compatible with DASY2 system!)

DASY/EASY - Parameters of Probe: ES3DV3 - SN:3209

Basic Calibration Parameters

	Sensor X	Sensor Y	Sensor Z	Unc (k=2)
Norm ($\mu\text{V}/(\text{V}/\text{m})^2$) ^A	1.35	1.33	1.14	$\pm 10.1 \%$
DCP (mV) ^B	99.2	97.8	98.3	

Modulation Calibration Parameters

UID	Communication System Name		A dB	B dB $\sqrt{\mu\text{V}}$	C	D dB	VR mV	Unc ^E (k=2)
0	CW	X	0.0	0.0	1.0	0.00	163.6	$\pm 3.5 \%$
		Y	0.0	0.0	1.0		170.3	
		Z	0.0	0.0	1.0		158.7	

The reported uncertainty of measurement is stated as the standard uncertainty of measurement multiplied by the coverage factor k=2, which for a normal distribution corresponds to a coverage probability of approximately 95%.

^A The uncertainties of NormX,Y,Z do not affect the E²-field uncertainty inside TSL (see Pages 5 and 6).

^B Numerical linearization parameter: uncertainty not required.

^E Uncertainty is determined using the max. deviation from linear response applying rectangular distribution and is expressed for the square of the field value.

DASY/EASY - Parameters of Probe: ES3DV3 - SN:3209

Calibration Parameter Determined in Head Tissue Simulating Media

f (MHz) ^C	Relative Permittivity ^F	Conductivity (S/m) ^F	ConvF X	ConvF Y	ConvF Z	Alpha	Depth (mm)	Unct. (k=2)
750	41.9	0.89	6.74	6.74	6.74	0.76	1.18	± 12.0 %
835	41.5	0.90	6.46	6.46	6.46	0.31	1.81	± 12.0 %
1750	40.1	1.37	5.39	5.39	5.39	0.80	1.21	± 12.0 %
1900	40.0	1.40	5.21	5.21	5.21	0.78	1.26	± 12.0 %
2450	39.2	1.80	4.57	4.57	4.57	0.65	1.43	± 12.0 %
2600	39.0	1.96	4.43	4.43	4.43	0.75	1.36	± 12.0 %

^C Frequency validity of ± 100 MHz only applies for DASY v4.4 and higher (see Page 2), else it is restricted to ± 50 MHz. The uncertainty is the RSS of the ConvF uncertainty at calibration frequency and the uncertainty for the indicated frequency band.

^F At frequencies below 3 GHz, the validity of tissue parameters (ϵ and σ) can be relaxed to ± 10% if liquid compensation formula is applied to measured SAR values. At frequencies above 3 GHz, the validity of tissue parameters (ϵ and σ) is restricted to ± 5%. The uncertainty is the RSS of the ConvF uncertainty for indicated target tissue parameters.

DASY/EASY - Parameters of Probe: ES3DV3 - SN:3209

Calibration Parameter Determined in Body Tissue Simulating Media

f (MHz) ^C	Relative Permittivity ^F	Conductivity (S/m) ^F	ConvF X	ConvF Y	ConvF Z	Alpha	Depth (mm)	Unct. (k=2)
750	55.5	0.96	6.38	6.38	6.38	0.80	1.16	± 12.0 %
835	55.2	0.97	6.28	6.28	6.28	0.52	1.45	± 12.0 %
1750	53.4	1.49	5.03	5.03	5.03	0.58	1.45	± 12.0 %
1900	53.3	1.52	4.77	4.77	4.77	0.70	1.36	± 12.0 %
2450	52.7	1.95	4.34	4.34	4.34	0.80	1.15	± 12.0 %
2600	52.5	2.16	4.11	4.11	4.11	0.80	1.00	± 12.0 %

^C Frequency validity of ± 100 MHz only applies for DASY v4.4 and higher (see Page 2), else it is restricted to ± 50 MHz. The uncertainty is the RSS of the ConvF uncertainty at calibration frequency and the uncertainty for the indicated frequency band.

^F At frequencies below 3 GHz, the validity of tissue parameters (ϵ and σ) can be relaxed to ± 10% if liquid compensation formula is applied to measured SAR values. At frequencies above 3 GHz, the validity of tissue parameters (ϵ and σ) is restricted to ± 5%. The uncertainty is the RSS of the ConvF uncertainty for indicated target tissue parameters.

Frequency Response of E-Field (TEM-Cell:ifi110 EXX, Waveguide: R22)

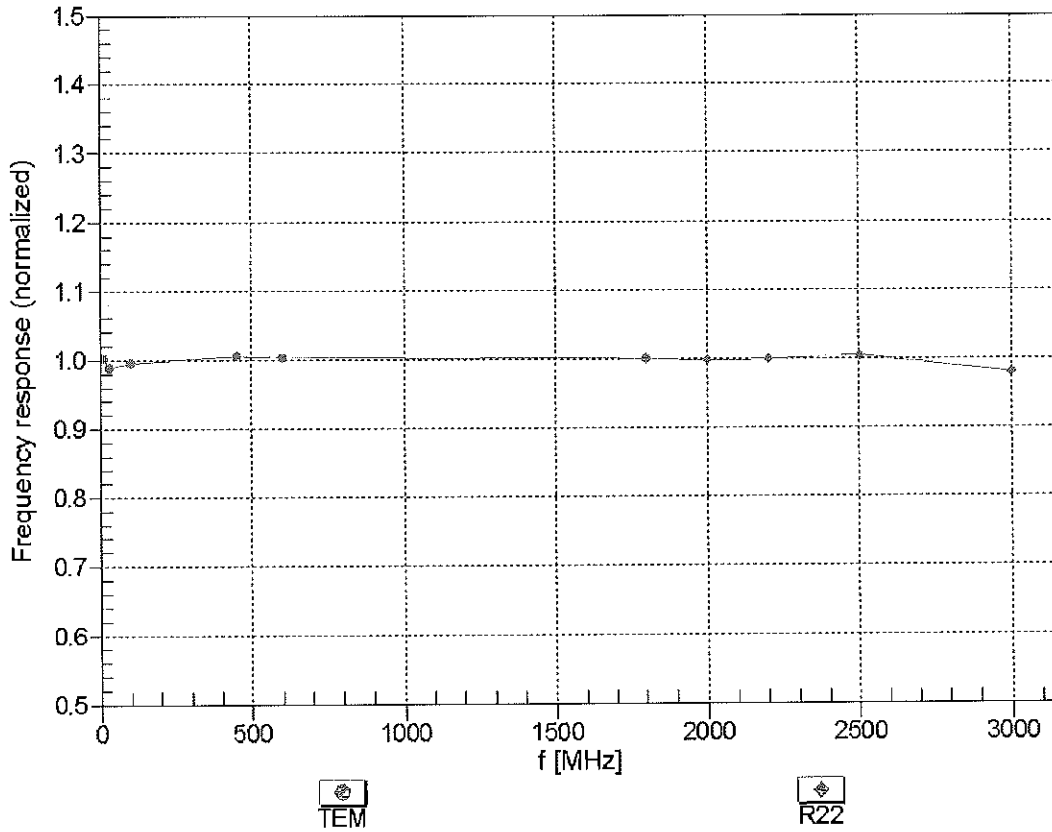

Uncertainty of Frequency Response of E-field: $\pm 6.3\%$ (k=2)

Receiving Pattern (ϕ), $\theta = 0^\circ$

f=600 MHz,TEM

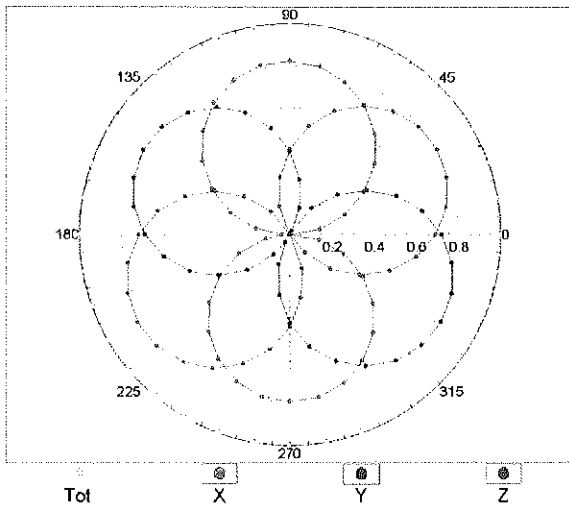

f=1800 MHz,R22

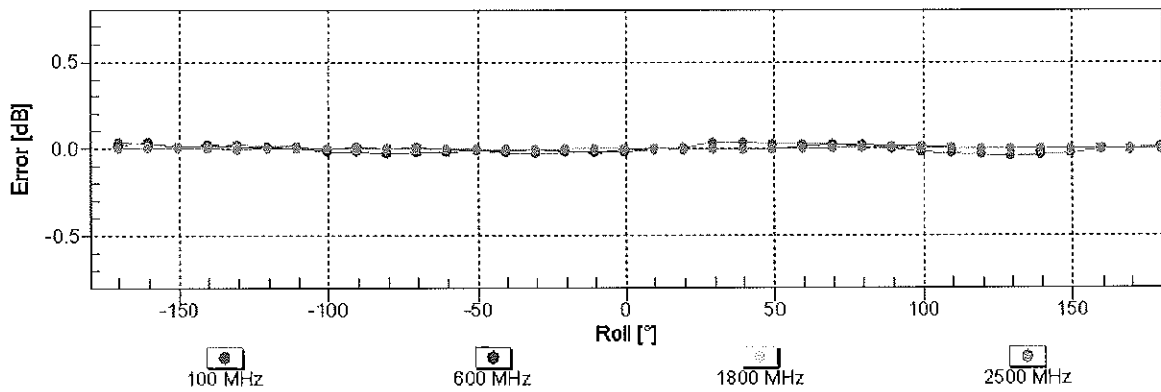
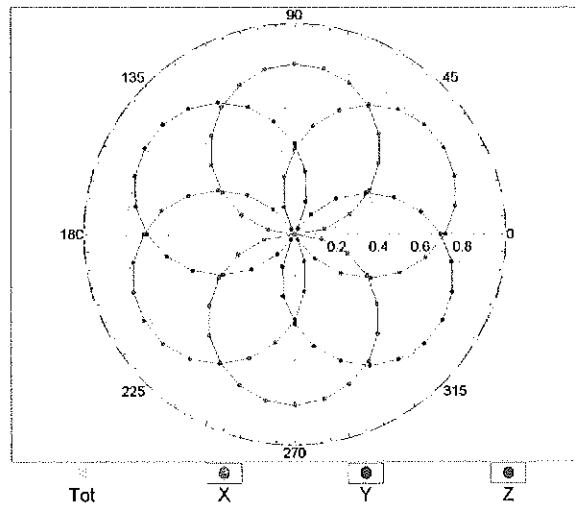

Uncertainty of Axial Isotropy Assessment: $\pm 0.5\%$ (k=2)

Dynamic Range f(SAR_{head}) (TEM cell , f = 900 MHz)

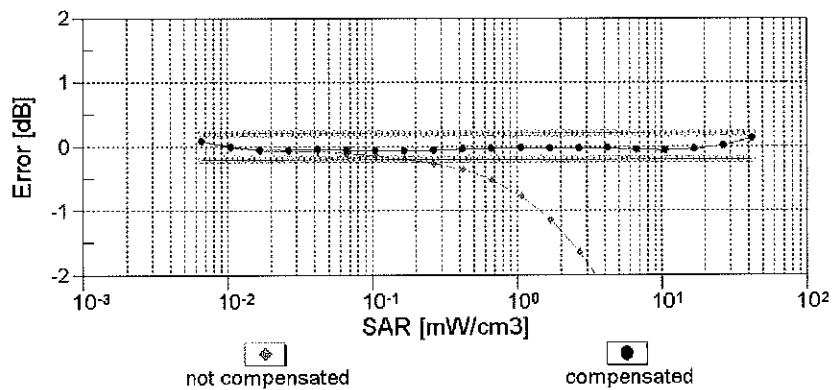
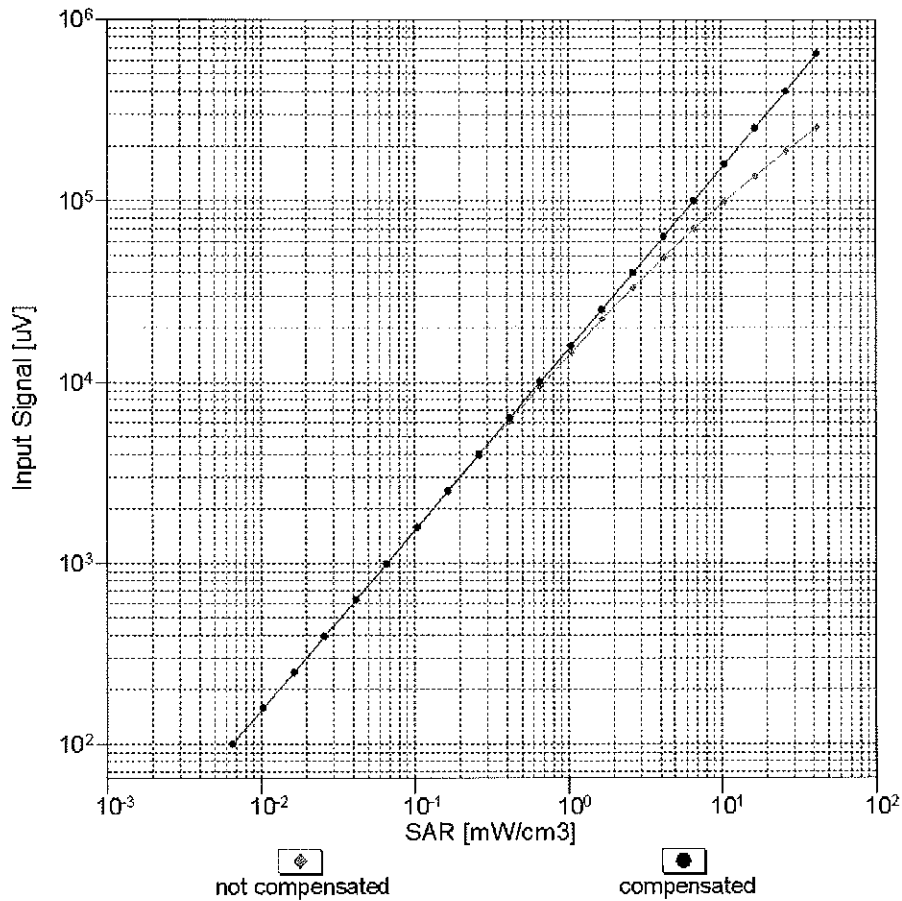

Uncertainty of Linearity Assessment: ± 0.6% (k=2)

Conversion Factor Assessment

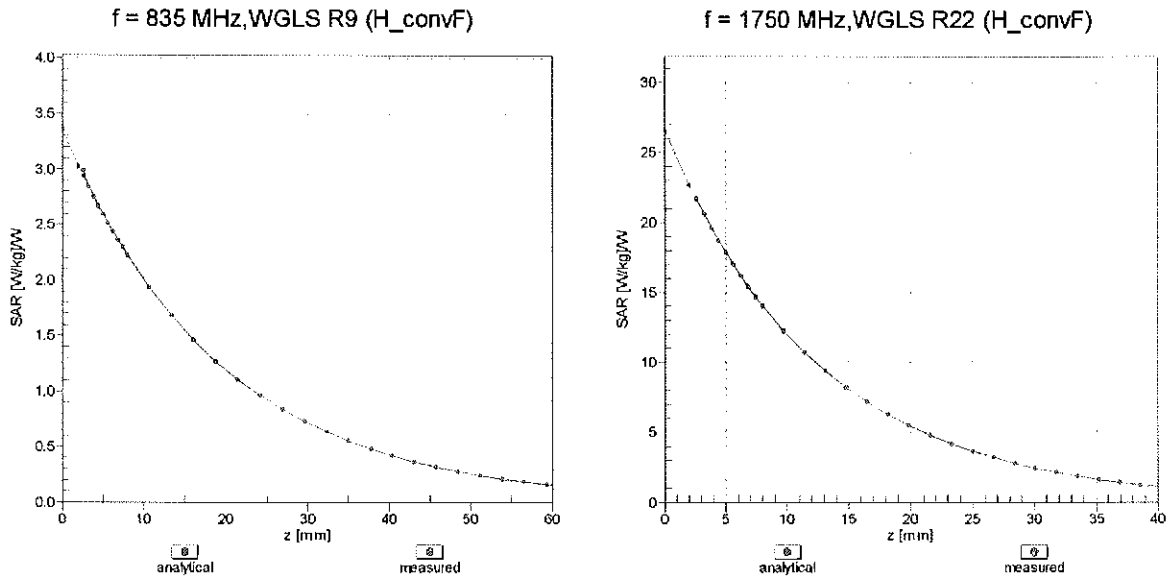

Deviation from Isotropy in Liquid Error (ϕ, θ), f = 900 MHz

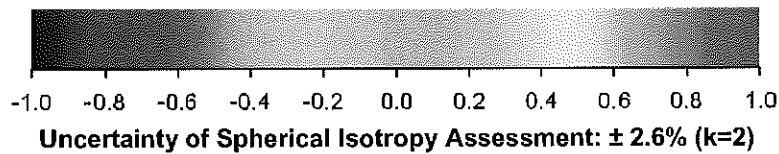
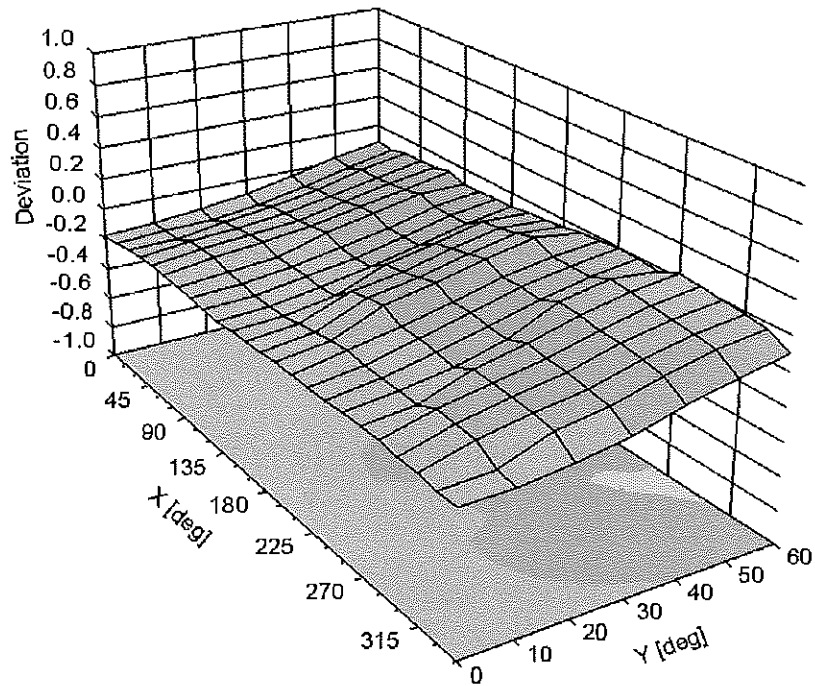

DASY/EASY - Parameters of Probe: ES3DV3 - SN:3209

Other Probe Parameters

Sensor Arrangement	Triangular
Connector Angle (°)	-40.6
Mechanical Surface Detection Mode	enabled
Optical Surface Detection Mode	disabled
Probe Overall Length	337 mm
Probe Body Diameter	10 mm
Tip Length	10 mm
Tip Diameter	4 mm
Probe Tip to Sensor X Calibration Point	2 mm
Probe Tip to Sensor Y Calibration Point	2 mm
Probe Tip to Sensor Z Calibration Point	2 mm
Recommended Measurement Distance from Surface	3 mm

**Calibration Laboratory of
Schmid & Partner
Engineering AG**
Zeughausstrasse 43, 8004 Zurich, Switzerland



S Schweizerischer Kalibrierdienst
C Service suisse d'étalonnage
S Servizio svizzero di taratura
Swiss Calibration Service

Accredited by the Swiss Accreditation Service (SAS)
The Swiss Accreditation Service is one of the signatories to the EA
Multilateral Agreement for the recognition of calibration certificates

Accreditation No.: **SCS 108**

Client **PC Test**

Certificate No: **ES3-3287_Nov12**

CALIBRATION CERTIFICATE

Object **ES3DV3 - SN:3287**

Calibration procedure(s) **QA CAL-01.v8, QA CAL-23.v4, QA CAL-25.v4
Calibration procedure for dosimetric E-field probes**

Calibration date: **November 15, 2012**

*✓ KOK
11/2012*

This calibration certificate documents the traceability to national standards, which realize the physical units of measurements (SI).
The measurements and the uncertainties with confidence probability are given on the following pages and are part of the certificate.

All calibrations have been conducted in the closed laboratory facility: environment temperature (22 ± 3)°C and humidity < 70%.

Calibration Equipment used (M&TE critical for calibration)

Primary Standards	ID	Cal Date (Certificate No.)	Scheduled Calibration
Power meter E4419B	GB41293874	29-Mar-12 (No. 217-01508)	Apr-13
Power sensor E4412A	MY41498087	29-Mar-12 (No. 217-01508)	Apr-13
Reference 3 dB Attenuator	SN: S5054 (3c)	27-Mar-12 (No. 217-01531)	Apr-13
Reference 20 dB Attenuator	SN: S5086 (20b)	27-Mar-12 (No. 217-01529)	Apr-13
Reference 30 dB Attenuator	SN: S5129 (30b)	27-Mar-12 (No. 217-01532)	Apr-13
Reference Probe ES3DV2	SN: 3013	29-Dec-11 (No. ES3-3013_Dec11)	Dec-12
DAE4	SN: 660	20-Jun-12 (No. DAE4-660_Jun12)	Jun-13
Secondary Standards	ID	Check Date (in house)	Scheduled Check
RF generator HP 8648C	US3642U01700	4-Aug-99 (in house check Apr-11)	In house check: Apr-13
Network Analyzer HP 8753E	US37390585	18-Oct-01 (in house check Oct-12)	In house check: Oct-13

Calibrated by:	Name Claudio Leubler	Function Laboratory Technician	Signature
Approved by:	Name Katja Pokovic	Function Technical Manager	Signature

Issued: November 16, 2012

This calibration certificate shall not be reproduced except in full without written approval of the laboratory.



Accredited by the Swiss Accreditation Service (SAS)

Accreditation No.: **SCS 108**

The Swiss Accreditation Service is one of the signatories to the EA
Multilateral Agreement for the recognition of calibration certificates

Glossary:

TSL	tissue simulating liquid
NORM _{x,y,z}	sensitivity in free space
ConvF	sensitivity in TSL / NORM _{x,y,z}
DCP	diode compression point
CF	crest factor (1/duty_cycle) of the RF signal
A, B, C	modulation dependent linearization parameters
Polarization φ	φ rotation around probe axis
Polarization ϑ	ϑ rotation around an axis that is in the plane normal to probe axis (at measurement center), i.e., $\vartheta = 0$ is normal to probe axis

Calibration is Performed According to the Following Standards:

- IEEE Std 1528-2003, "IEEE Recommended Practice for Determining the Peak Spatial-Averaged Specific Absorption Rate (SAR) in the Human Head from Wireless Communications Devices: Measurement Techniques", December 2003
- IEC 62209-1, "Procedure to measure the Specific Absorption Rate (SAR) for hand-held devices used in close proximity to the ear (frequency range of 300 MHz to 3 GHz)", February 2005

Methods Applied and Interpretation of Parameters:

- NORM_{x,y,z}**: Assessed for E-field polarization $\vartheta = 0$ ($f \leq 900$ MHz in TEM-cell; $f > 1800$ MHz: R22 waveguide). NORM_{x,y,z} are only intermediate values, i.e., the uncertainties of NORM_{x,y,z} does not affect the E²-field uncertainty inside TSL (see below ConvF).
- NORM(f)_{x,y,z}** = NORM_{x,y,z} * frequency_response (see Frequency Response Chart). This linearization is implemented in DASY4 software versions later than 4.2. The uncertainty of the frequency response is included in the stated uncertainty of ConvF.
- DCP_{x,y,z}**: DCP are numerical linearization parameters assessed based on the data of power sweep with CW signal (no uncertainty required). DCP does not depend on frequency nor media.
- PAR**: PAR is the Peak to Average Ratio that is not calibrated but determined based on the signal characteristics
- A_{x,y,z}; B_{x,y,z}; C_{x,y,z}; VR_{x,y,z}**: A, B, C are numerical linearization parameters assessed based on the data of power sweep for specific modulation signal. The parameters do not depend on frequency nor media. VR is the maximum calibration range expressed in RMS voltage across the diode.
- ConvF and Boundary Effect Parameters**: Assessed in flat phantom using E-field (or Temperature Transfer Standard for $f \leq 800$ MHz) and inside waveguide using analytical field distributions based on power measurements for $f > 800$ MHz. The same setups are used for assessment of the parameters applied for boundary compensation (alpha, depth) of which typical uncertainty values are given. These parameters are used in DASY4 software to improve probe accuracy close to the boundary. The sensitivity in TSL corresponds to NORM_{x,y,z} * ConvF whereby the uncertainty corresponds to that given for ConvF. A frequency dependent ConvF is used in DASY version 4.4 and higher which allows extending the validity from ± 50 MHz to ± 100 MHz.
- Spherical isotropy (3D deviation from isotropy)**: in a field of low gradients realized using a flat phantom exposed by a patch antenna.
- Sensor Offset**: The sensor offset corresponds to the offset of virtual measurement center from the probe tip (on probe axis). No tolerance required.

Probe ES3DV3

SN:3287

Manufactured: June 7, 2010
Calibrated: November 15, 2012

Calibrated for DASY/EASY Systems
(Note: non-compatible with DASY2 system!)

DASY/EASY - Parameters of Probe: ES3DV3 - SN:3287

Basic Calibration Parameters

	Sensor X	Sensor Y	Sensor Z	Unc (k=2)
Norm ($\mu\text{V}/(\text{V}/\text{m})^2$) ^A	1.31	1.25	1.25	± 10.1 %
DCP (mV) ^B	102.9	103.6	101.6	

Modulation Calibration Parameters

UID	Communication System Name	PAR		A dB	B dB	C dB	VR mV	Unc ^E (k=2)
0	CW	0.00	X	0.0	0.0	1.0	116.8	±3.5 %
			Y	0.0	0.0	1.0	118.5	
			Z	0.0	0.0	1.0	154.1	

The reported uncertainty of measurement is stated as the standard uncertainty of measurement multiplied by the coverage factor $k=2$, which for a normal distribution corresponds to a coverage probability of approximately 95%.

^A The uncertainties of NormX,Y,Z do not affect the E^2 -field uncertainty inside TSL (see Pages 5 and 6).

^B Numerical linearization parameter: uncertainty not required.

^E Uncertainty is determined using the max. deviation from linear response applying rectangular distribution and is expressed for the square of the field value.

DASY/EASY - Parameters of Probe: ES3DV3 - SN:3287

Calibration Parameter Determined in Head Tissue Simulating Media

f (MHz) ^C	Relative Permittivity ^F	Conductivity (S/m) ^F	ConvF X	ConvF Y	ConvF Z	Alpha	Depth (mm)	Unct. (k=2)
750	41.9	0.89	6.40	6.40	6.40	0.20	2.54	± 12.0 %
835	41.5	0.90	6.17	6.17	6.17	0.34	1.68	± 12.0 %
1750	40.1	1.37	5.16	5.16	5.16	0.63	1.30	± 12.0 %
1900	40.0	1.40	4.96	4.96	4.96	0.48	1.55	± 12.0 %
2450	39.2	1.80	4.30	4.30	4.30	0.79	1.31	± 12.0 %
2600	39.0	1.96	4.19	4.19	4.19	0.80	1.31	± 12.0 %

^C Frequency validity of ± 100 MHz only applies for DASY v4.4 and higher (see Page 2), else it is restricted to ± 50 MHz. The uncertainty is the RSS of the ConvF uncertainty at calibration frequency and the uncertainty for the indicated frequency band.

^F At frequencies below 3 GHz, the validity of tissue parameters (ϵ and σ) can be relaxed to ± 10% if liquid compensation formula is applied to measured SAR values. At frequencies above 3 GHz, the validity of tissue parameters (ϵ and σ) is restricted to ± 5%. The uncertainty is the RSS of the ConvF uncertainty for indicated target tissue parameters.

DASY/EASY - Parameters of Probe: ES3DV3 - SN:3287

Calibration Parameter Determined in Body Tissue Simulating Media

f (MHz) ^C	Relative Permittivity ^F	Conductivity (S/m) ^F	ConvF X	ConvF Y	ConvF Z	Alpha	Depth (mm)	Unct. (k=2)
750	55.5	0.96	6.14	6.14	6.14	0.28	2.06	± 12.0 %
835	55.2	0.97	6.06	6.06	6.06	0.42	1.63	± 12.0 %
1750	53.4	1.49	4.86	4.86	4.86	0.43	1.64	± 12.0 %
1900	53.3	1.52	4.69	4.69	4.69	0.56	1.54	± 12.0 %
2450	52.7	1.95	4.29	4.29	4.29	0.80	1.02	± 12.0 %
2600	52.5	2.16	4.12	4.12	4.12	0.64	0.92	± 12.0 %

^C Frequency validity of ± 100 MHz only applies for DASY v4.4 and higher (see Page 2), else it is restricted to ± 50 MHz. The uncertainty is the RSS of the ConvF uncertainty at calibration frequency and the uncertainty for the indicated frequency band.

^F At frequencies below 3 GHz, the validity of tissue parameters (ϵ and σ) can be relaxed to ± 10% if liquid compensation formula is applied to measured SAR values. At frequencies above 3 GHz, the validity of tissue parameters (ϵ and σ) is restricted to ± 5%. The uncertainty is the RSS of the ConvF uncertainty for indicated target tissue parameters.

Frequency Response of E-Field

(TEM-Cell:ifi110 EXX, Waveguide: R22)

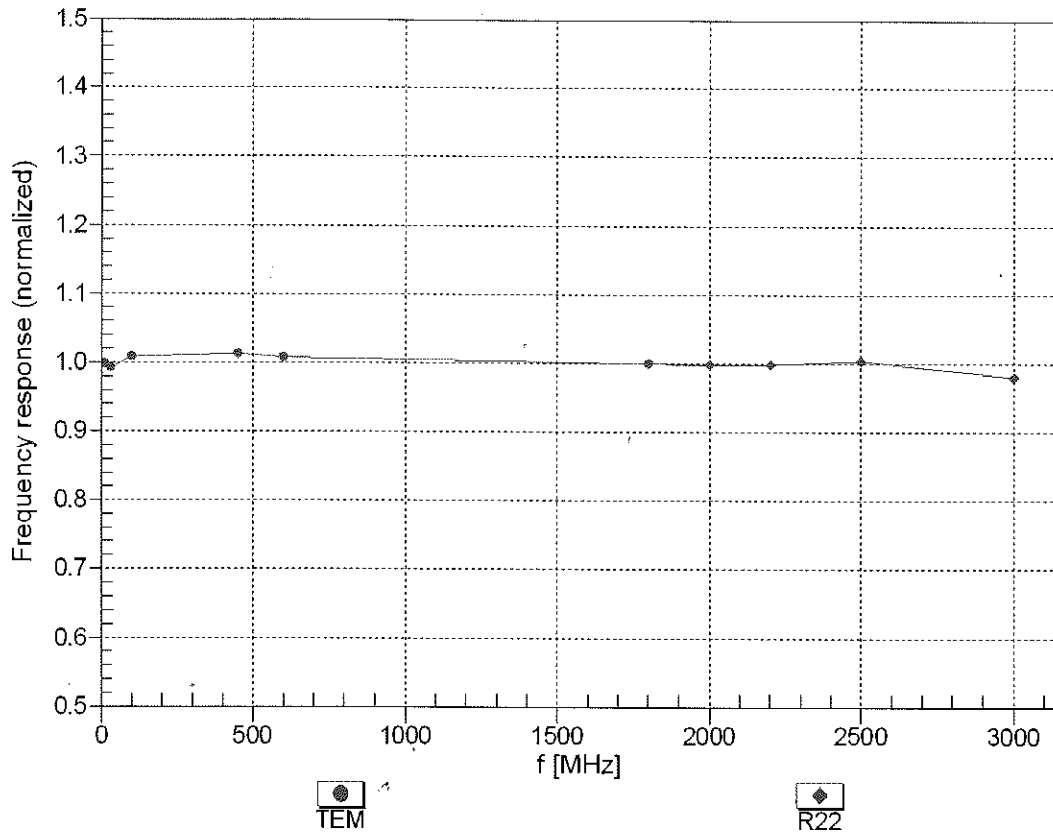

Uncertainty of Frequency Response of E-field: $\pm 6.3\%$ (k=2)

Receiving Pattern (ϕ), $\theta = 0^\circ$

f=600 MHz,TEM

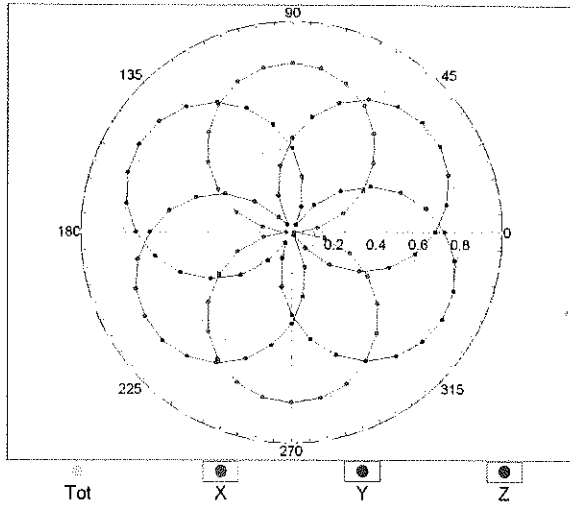

f=1800 MHz,R22

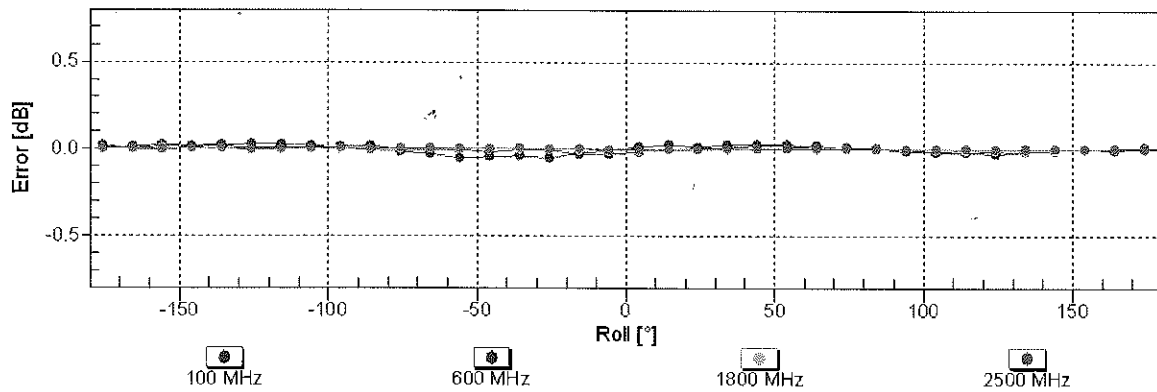
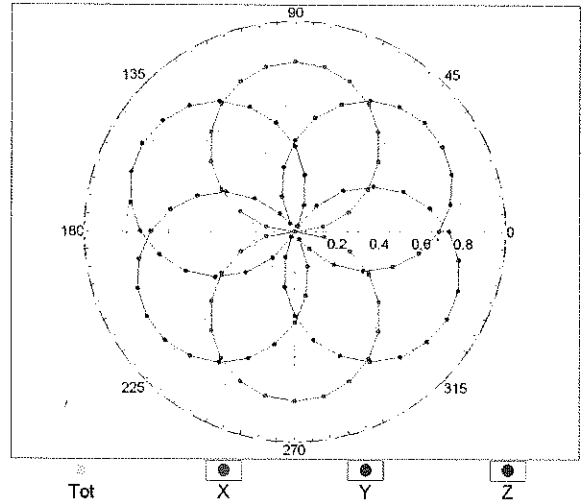

Uncertainty of Axial Isotropy Assessment: $\pm 0.5\%$ (k=2)

Dynamic Range f(SAR_{head}) (TEM cell , f = 900 MHz)

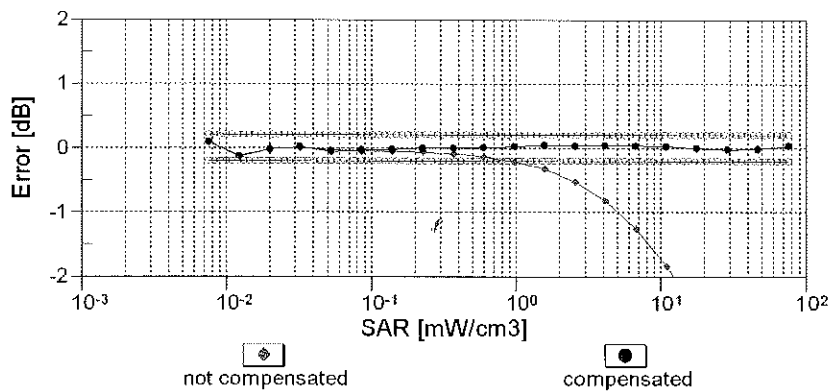
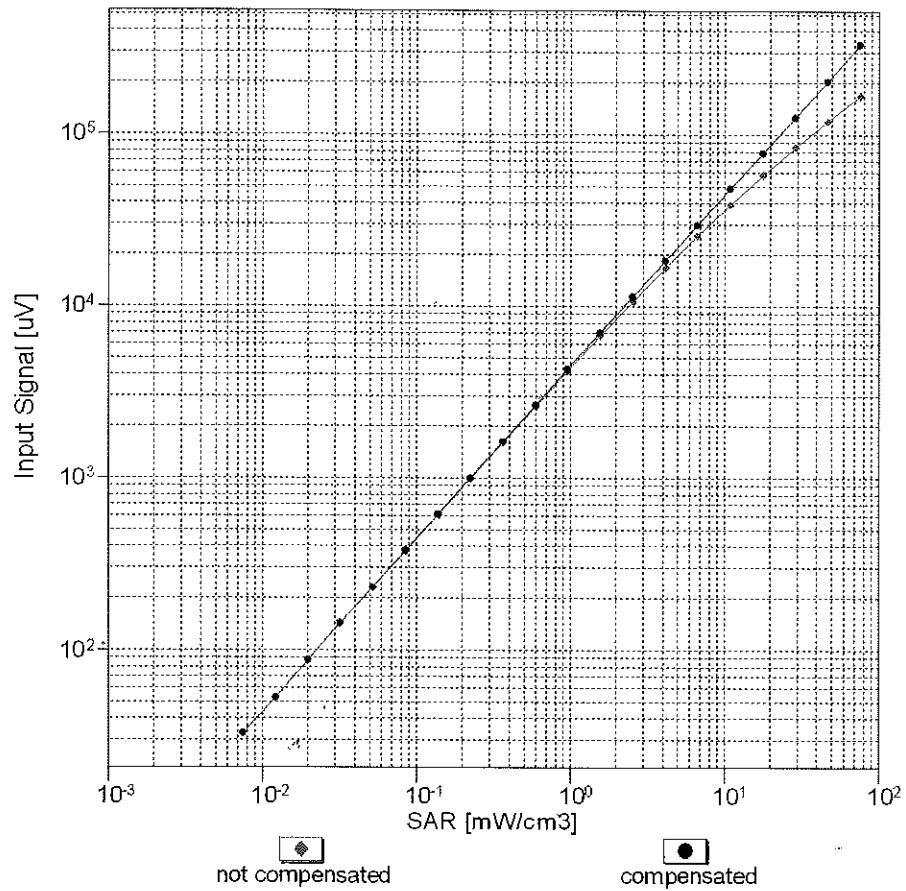

Uncertainty of Linearity Assessment: ± 0.6% (k=2)

Conversion Factor Assessment

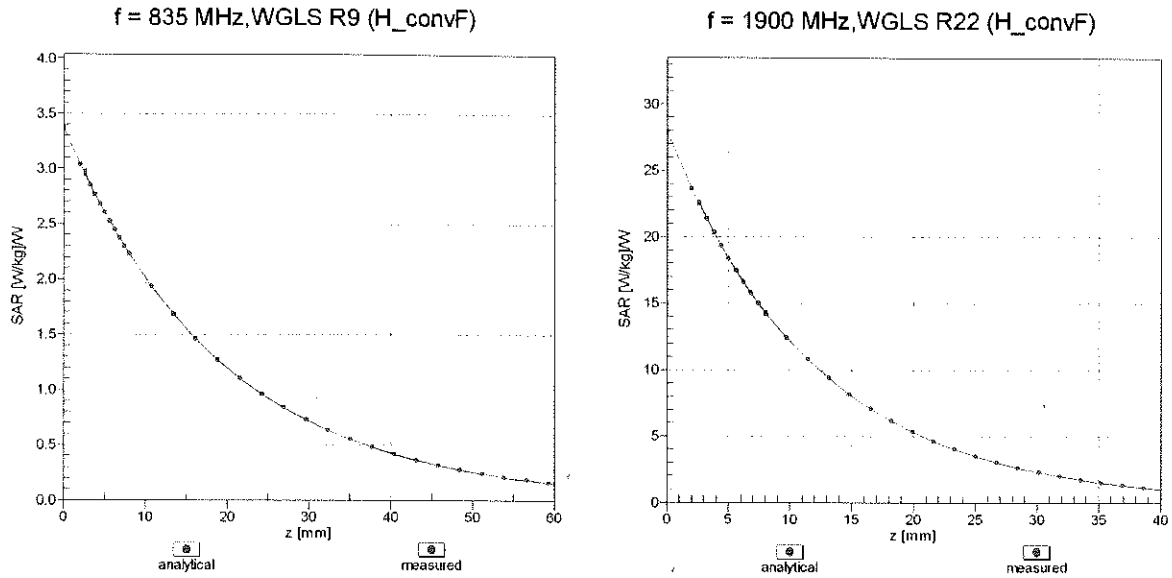

Deviation from Isotropy in Liquid Error (ϕ, θ), f = 900 MHz

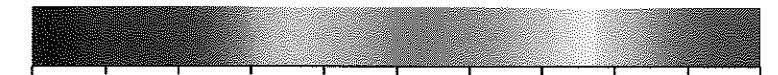
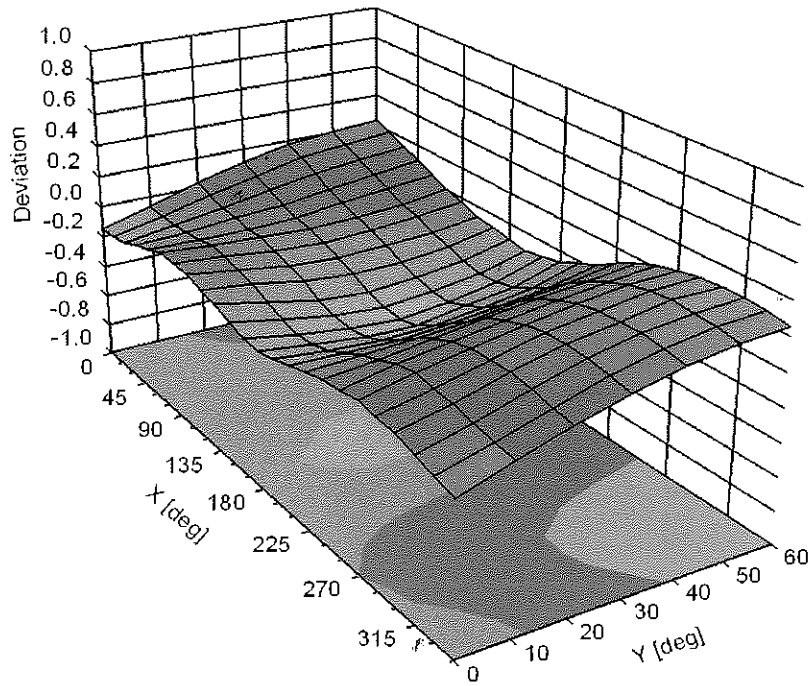

Uncertainty of Spherical Isotropy Assessment: $\pm 2.6\%$ (k=2)

DASY/EASY - Parameters of Probe: ES3DV3 - SN:3287

Other Probe Parameters

Sensor Arrangement	Triangular
Connector Angle (°)	-15.9
Mechanical Surface Detection Mode	enabled
Optical Surface Detection Mode	disabled
Probe Overall Length	337 mm
Probe Body Diameter	10 mm
Tip Length	10 mm
Tip Diameter	4 mm
Probe Tip to Sensor X Calibration Point	2 mm
Probe Tip to Sensor Y Calibration Point	2 mm
Probe Tip to Sensor Z Calibration Point	2 mm
Recommended Measurement Distance from Surface	3 mm

**Calibration Laboratory of
Schmid & Partner
Engineering AG**
Zeughausstrasse 43, 8004 Zurich, Switzerland



S Schweizerischer Kalibrierdienst
S Service suisse d'étalonnage
S Servizio svizzero di taratura
S Swiss Calibration Service

Accredited by the Swiss Accreditation Service (SAS)
The Swiss Accreditation Service is one of the signatories to the EA
Multilateral Agreement for the recognition of calibration certificates

Accreditation No.: **SCS 108**

Client **PC Test**

Certificate No: **ES3-3288_Sep12**

CALIBRATION CERTIFICATE

Object **ES3DV3 - SN:3288**

Calibration procedure(s) **QA CAL-01.v8, QA CAL-23.v4, QA CAL-25.v4
Calibration procedure for dosimetric E-field probes**

Calibration date: **September 20, 2012**

This calibration certificate documents the traceability to national standards, which realize the physical units of measurements (SI).
The measurements and the uncertainties with confidence probability are given on the following pages and are part of the certificate.

All calibrations have been conducted in the closed laboratory facility: environment temperature (22 ± 3)°C and humidity < 70%.

Calibration Equipment used (M&TE critical for calibration)

*KOK
10/2/12*

Primary Standards	ID	Cal Date (Certificate No.)	Scheduled Calibration
Power meter E4419B	GB41293874	29-Mar-12 (No. 217-01508)	Apr-13
Power sensor E4412A	MY41498087	29-Mar-12 (No. 217-01508)	Apr-13
Reference 3 dB Attenuator	SN: S5054 (3c)	27-Mar-12 (No. 217-01531)	Apr-13
Reference 20 dB Attenuator	SN: S5086 (20b)	27-Mar-12 (No. 217-01529)	Apr-13
Reference 30 dB Attenuator	SN: S5129 (30b)	27-Mar-12 (No. 217-01532)	Apr-13
Reference Probe ES3DV2	SN: 3013	29-Dec-11 (No. ES3-3013_Dec11)	Dec-12
DAE4	SN: 660	20-Jun-12 (No. DAE4-660_Jun12)	Jun-13
Secondary Standards	ID	Check Date (in house)	Scheduled Check
RF generator HP 8648C	US3642U01700	4-Aug-99 (in house check Apr-11)	In house check: Apr-13
Network Analyzer HP 8753E	US37390585	18-Oct-01 (in house check Oct-11)	In house check: Oct-12

Calibrated by: **Jeton Kastrati** Name: **Jeton Kastrati** Function: **Laboratory Technician** Signature:

Approved by: **Katja Pokovic** Name: **Katja Pokovic** Function: **Technical Manager** Signature:

Issued: September 20, 2012

This calibration certificate shall not be reproduced except in full without written approval of the laboratory.



Accredited by the Swiss Accreditation Service (SAS)

Accreditation No.: **SCS 108**

The Swiss Accreditation Service is one of the signatories to the EA
Multilateral Agreement for the recognition of calibration certificates

Glossary:

TSL	tissue simulating liquid
NORM _{x,y,z}	sensitivity in free space
ConvF	sensitivity in TSL / NORM _{x,y,z}
DCP	diode compression point
CF	crest factor (1/duty_cycle) of the RF signal
A, B, C	modulation dependent linearization parameters
Polarization ϕ	ϕ rotation around probe axis
Polarization ϑ	ϑ rotation around an axis that is in the plane normal to probe axis (at measurement center), i.e., $\vartheta = 0$ is normal to probe axis

Calibration is Performed According to the Following Standards:

- IEEE Std 1528-2003, "IEEE Recommended Practice for Determining the Peak Spatial-Averaged Specific Absorption Rate (SAR) in the Human Head from Wireless Communications Devices: Measurement Techniques", December 2003
- IEC 62209-1, "Procedure to measure the Specific Absorption Rate (SAR) for hand-held devices used in close proximity to the ear (frequency range of 300 MHz to 3 GHz)", February 2005

Methods Applied and Interpretation of Parameters:

- NORM_{x,y,z}**: Assessed for E-field polarization $\vartheta = 0$ ($f \leq 900$ MHz in TEM-cell; $f > 1800$ MHz: R22 waveguide). NORM_{x,y,z} are only intermediate values, i.e., the uncertainties of NORM_{x,y,z} does not affect the E²-field uncertainty inside TSL (see below ConvF).
- NORM(f)_{x,y,z}** = NORM_{x,y,z} * frequency_response (see Frequency Response Chart). This linearization is implemented in DASY4 software versions later than 4.2. The uncertainty of the frequency response is included in the stated uncertainty of ConvF.
- DCP_{x,y,z}**: DCP are numerical linearization parameters assessed based on the data of power sweep with CW signal (no uncertainty required). DCP does not depend on frequency nor media.
- PAR**: PAR is the Peak to Average Ratio that is not calibrated but determined based on the signal characteristics
- A_{x,y,z}; B_{x,y,z}; C_{x,y,z}; VR_{x,y,z}; A, B, C** are numerical linearization parameters assessed based on the data of power sweep for specific modulation signal. The parameters do not depend on frequency nor media. VR is the maximum calibration range expressed in RMS voltage across the diode.
- ConvF and Boundary Effect Parameters**: Assessed in flat phantom using E-field (or Temperature Transfer Standard for $f \leq 800$ MHz) and inside waveguide using analytical field distributions based on power measurements for $f > 800$ MHz. The same setups are used for assessment of the parameters applied for boundary compensation (alpha, depth) of which typical uncertainty values are given. These parameters are used in DASY4 software to improve probe accuracy close to the boundary. The sensitivity in TSL corresponds to NORM_{x,y,z} * ConvF whereby the uncertainty corresponds to that given for ConvF. A frequency dependent ConvF is used in DASY version 4.4 and higher which allows extending the validity from ± 50 MHz to ± 100 MHz.
- Spherical isotropy (3D deviation from isotropy)**: in a field of low gradients realized using a flat phantom exposed by a patch antenna.
- Sensor Offset**: The sensor offset corresponds to the offset of virtual measurement center from the probe tip (on probe axis). No tolerance required.

Probe ES3DV3

SN:3288

Manufactured: July 6, 2010
Calibrated: September 20, 2012

Calibrated for DASY/EASY Systems
(Note: non-compatible with DASY2 system!)

DASY/EASY - Parameters of Probe: ES3DV3 - SN:3288

Basic Calibration Parameters

	Sensor X	Sensor Y	Sensor Z	Unc (k=2)
Norm ($\mu\text{V}/(\text{V}/\text{m})^2$) ^A	0.87	0.97	0.75	$\pm 10.1 \%$
DCP (mV) ^B	101.3	102.4	103.9	

Modulation Calibration Parameters

UID	Communication System Name	PAR		A dB	B dB	C dB	VR mV	Unc ^E (k=2)
0	CW	0.00	X	0.00	0.00	1.00	168.6	$\pm 3.3 \%$
			Y	0.00	0.00	1.00	132.2	
			Z	0.00	0.00	1.00	156.8	

The reported uncertainty of measurement is stated as the standard uncertainty of measurement multiplied by the coverage factor $k=2$, which for a normal distribution corresponds to a coverage probability of approximately 95%.

^A The uncertainties of NormX,Y,Z do not affect the E^2 -field uncertainty inside TSL (see Pages 5 and 6).

^B Numerical linearization parameter: uncertainty not required.

^E Uncertainty is determined using the max. deviation from linear response applying rectangular distribution and is expressed for the square of the field value.

DASY/EASY - Parameters of Probe: ES3DV3 - SN:3288

Calibration Parameter Determined in Head Tissue Simulating Media

f (MHz) ^c	Relative Permittivity ^F	Conductivity (S/m) ^F	ConvF X	ConvF Y	ConvF Z	Alpha	Depth (mm)	Unct. (k=2)
750	41.9	0.89	6.67	6.67	6.67	0.80	1.14	± 12.0 %
835	41.5	0.90	6.41	6.41	6.41	0.76	1.18	± 12.0 %
1750	40.1	1.37	5.51	5.51	5.51	0.70	1.28	± 12.0 %
1900	40.0	1.40	5.28	5.28	5.28	0.80	1.22	± 12.0 %
2450	39.2	1.80	4.61	4.61	4.61	0.80	1.26	± 12.0 %
2600	39.0	1.96	4.45	4.45	4.45	0.80	1.31	± 12.0 %

^c Frequency validity of ± 100 MHz only applies for DASY v4.4 and higher (see Page 2), else it is restricted to ± 50 MHz. The uncertainty is the RSS of the ConvF uncertainty at calibration frequency and the uncertainty for the indicated frequency band.

^F At frequencies below 3 GHz, the validity of tissue parameters (ϵ and σ) can be relaxed to ± 10% if liquid compensation formula is applied to measured SAR values. At frequencies above 3 GHz, the validity of tissue parameters (ϵ and σ) is restricted to ± 5%. The uncertainty is the RSS of the ConvF uncertainty for indicated target tissue parameters.

DASY/EASY - Parameters of Probe: ES3DV3 - SN:3288

Calibration Parameter Determined in Body Tissue Simulating Media

f (MHz) ^C	Relative Permittivity ^F	Conductivity (S/m) ^F	ConvF X	ConvF Y	ConvF Z	Alpha	Depth (mm)	Unct. (k=2)
750	55.5	0.96	6.44	6.44	6.44	0.62	1.31	± 12.0 %
835	55.2	0.97	6.31	6.31	6.31	0.38	1.78	± 12.0 %
1750	53.4	1.49	5.18	5.18	5.18	0.64	1.43	± 12.0 %
1900	53.3	1.52	4.89	4.89	4.89	0.50	1.64	± 12.0 %
2450	52.7	1.95	4.35	4.35	4.35	0.74	1.23	± 12.0 %
2600	52.5	2.16	4.09	4.09	4.09	0.80	1.07	± 12.0 %

^C Frequency validity of ± 100 MHz only applies for DASY v4.4 and higher (see Page 2), else it is restricted to ± 50 MHz. The uncertainty is the RSS of the ConvF uncertainty at calibration frequency and the uncertainty for the indicated frequency band.

^F At frequencies below 3 GHz, the validity of tissue parameters (ϵ and σ) can be relaxed to ± 10% if liquid compensation formula is applied to measured SAR values. At frequencies above 3 GHz, the validity of tissue parameters (ϵ and σ) is restricted to ± 5%. The uncertainty is the RSS of the ConvF uncertainty for indicated target tissue parameters.

Frequency Response of E-Field (TEM-Cell:ifi110 EXX, Waveguide: R22)

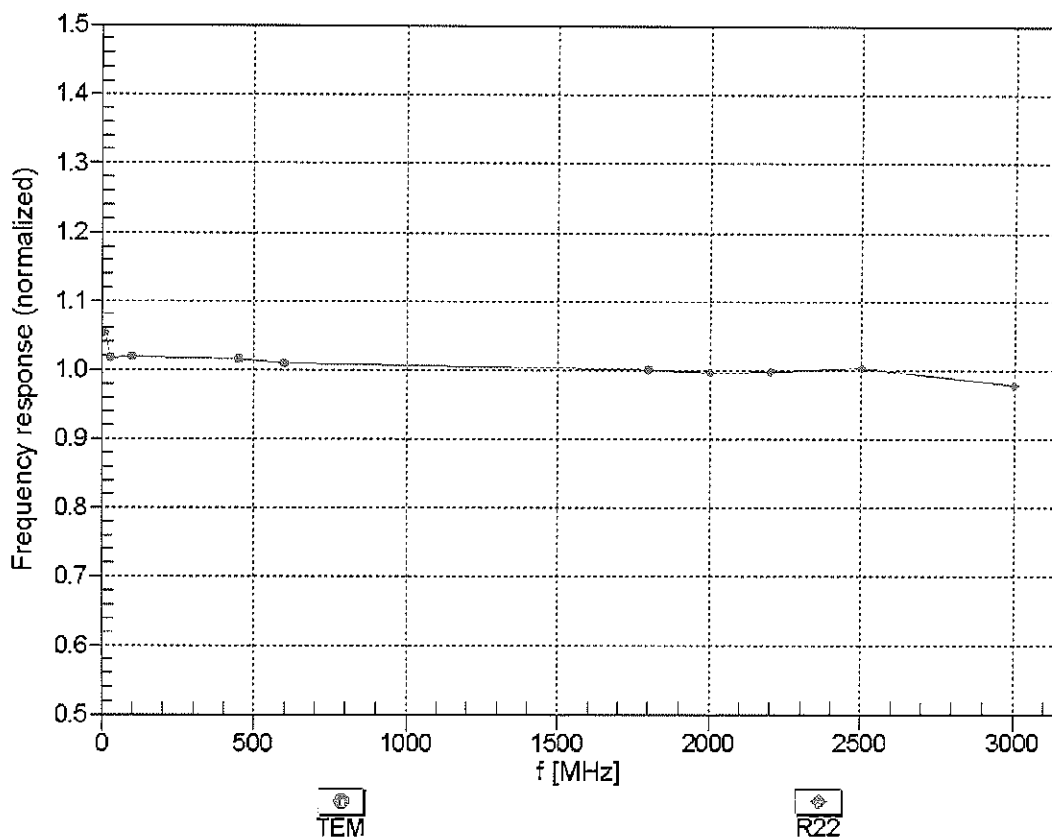

Uncertainty of Frequency Response of E-field: $\pm 6.3\%$ (k=2)

Receiving Pattern (ϕ), $\vartheta = 0^\circ$

f=600 MHz, TEM

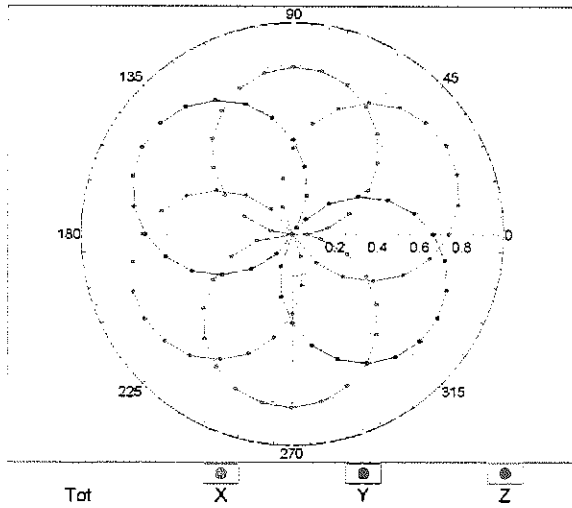

f=1800 MHz, R22

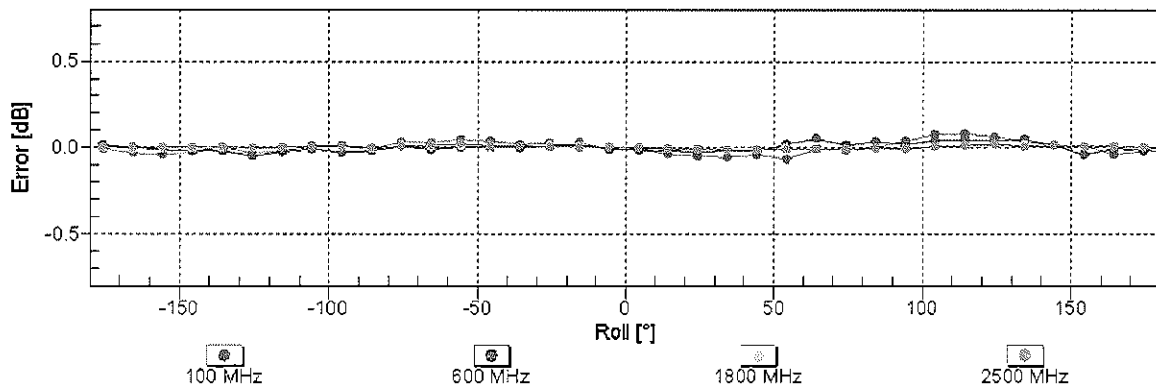
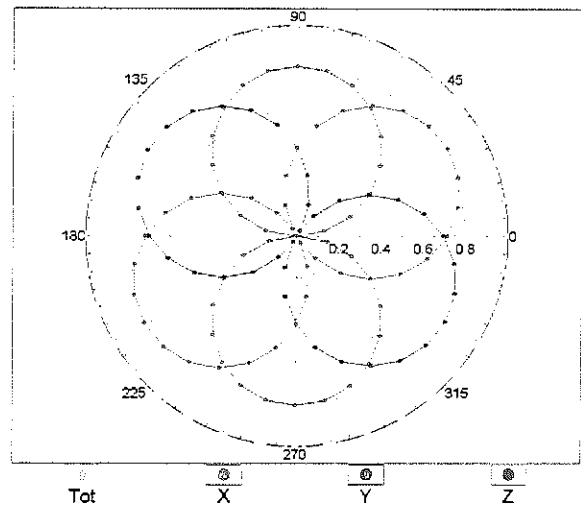

Uncertainty of Axial Isotropy Assessment: $\pm 0.5\%$ (k=2)

Dynamic Range $f(SAR_{head})$ (TEM cell , $f = 900$ MHz)

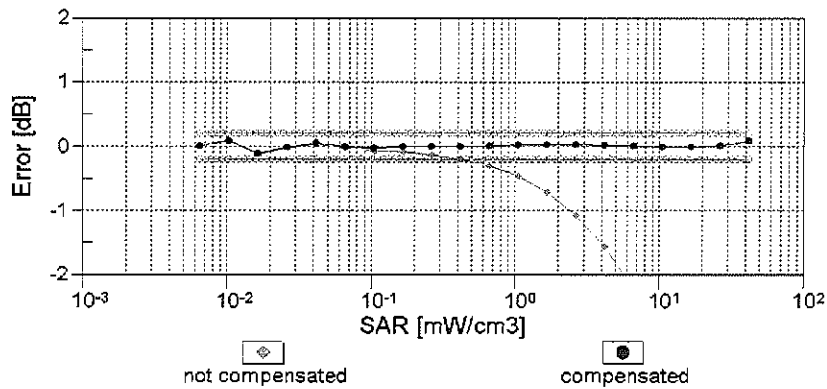
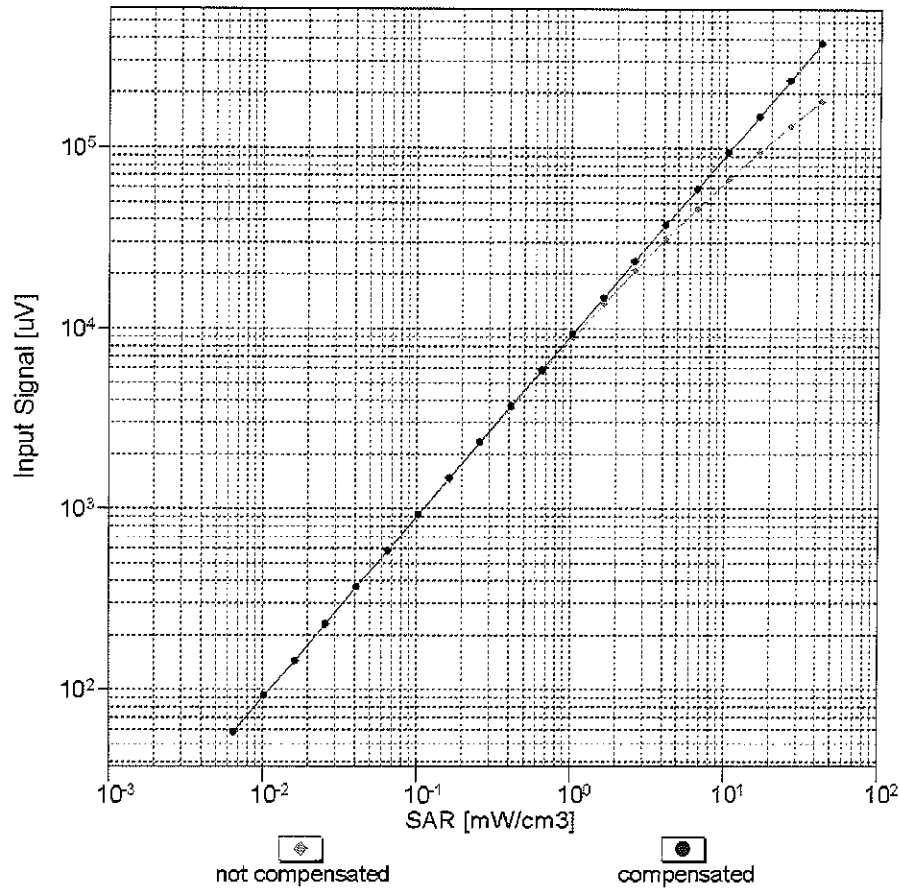

Uncertainty of Linearity Assessment: $\pm 0.6\%$ ($k=2$)

Conversion Factor Assessment

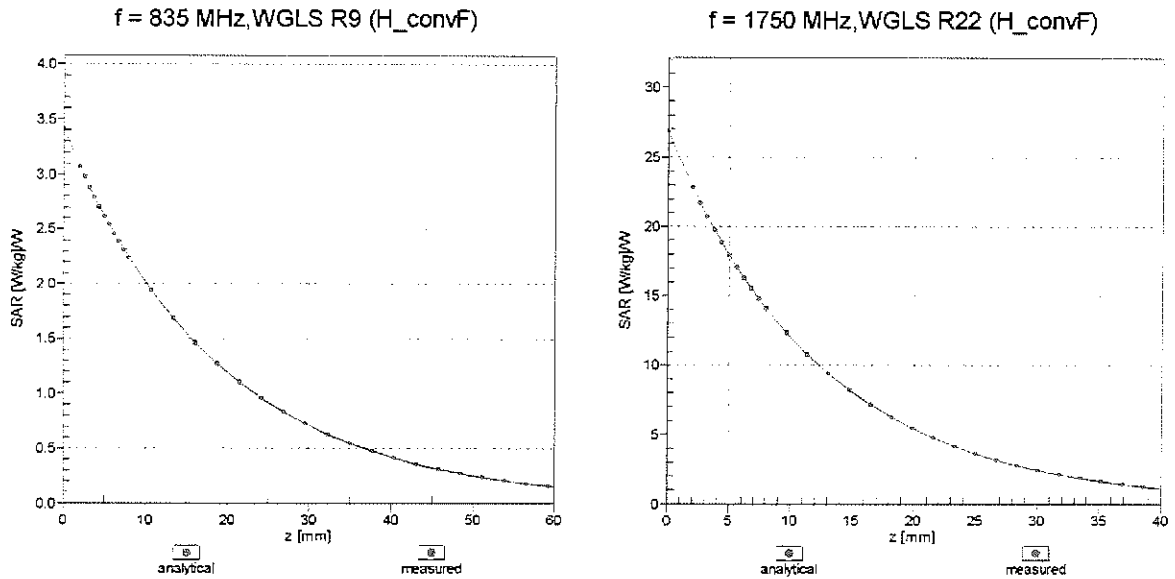

Deviation from Isotropy in Liquid

Error (ϕ, θ), f = 900 MHz

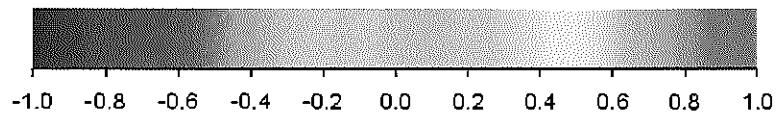
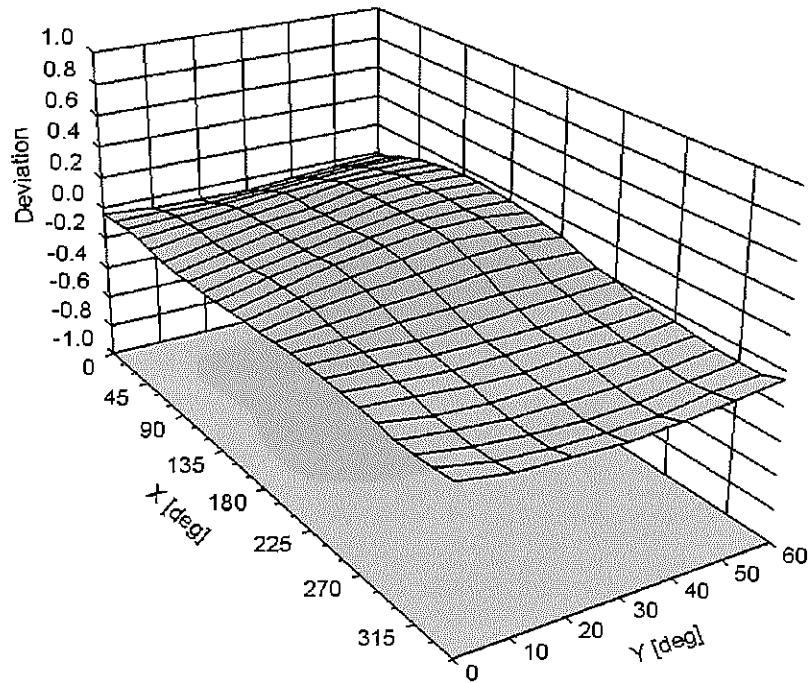

Uncertainty of Spherical Isotropy Assessment: $\pm 2.6\%$ (k=2)

DASY/EASY - Parameters of Probe: ES3DV3 - SN:3288**Other Probe Parameters**

Sensor Arrangement	Triangular
Connector Angle (°)	54.3
Mechanical Surface Detection Mode	enabled
Optical Surface Detection Mode	disabled
Probe Overall Length	337 mm
Probe Body Diameter	10 mm
Tip Length	10 mm
Tip Diameter	4 mm
Probe Tip to Sensor X Calibration Point	2 mm
Probe Tip to Sensor Y Calibration Point	2 mm
Probe Tip to Sensor Z Calibration Point	2 mm
Recommended Measurement Distance from Surface	3 mm



Accredited by the Swiss Accreditation Service (SAS)
The Swiss Accreditation Service is one of the signatories to the EA
Multilateral Agreement for the recognition of calibration certificates

Accreditation No.: **SCS 108**

Client **PC Test**

Certificate No: **EX3-3920_Feb13/2**

CALIBRATION CERTIFICATE (Replacement of No: EX3-3920_Feb13)

Object: **EX3DV4 - SN:3920**

Calibration procedure(s): **QA CAL-01.v8, QA CAL-14.v3, QA CAL-23.v4, QA CAL-25.v4
Calibration procedure for dosimetric E-field probes**

Calibration date: **February 27, 2013**

This calibration certificate documents the traceability to national standards, which realize the physical units of measurements (SI).
The measurements and the uncertainties with confidence probability are given on the following pages and are part of the certificate.

All calibrations have been conducted in the closed laboratory facility: environment temperature (22 ± 3)°C and humidity < 70%.

✓ KOK 3/27/13

Calibration Equipment used (M&TE critical for calibration)

Primary Standards	ID	Cal Date (Certificate No.)	Scheduled Calibration
Power meter E4419B	GB41293874	29-Mar-12 (No. 217-01508)	Apr-13
Power sensor E4412A	MY41498087	29-Mar-12 (No. 217-01508)	Apr-13
Reference 3 dB Attenuator	SN: S5054 (3c)	27-Mar-12 (No. 217-01531)	Apr-13
Reference 20 dB Attenuator	SN: S5086 (20b)	27-Mar-12 (No. 217-01529)	Apr-13
Reference 30 dB Attenuator	SN: S5129 (30b)	27-Mar-12 (No. 217-01532)	Apr-13
Reference Probe ES3DV2	SN: 3013	28-Dec-12 (No. ES3-3013_Dec12)	Dec-13
DAE4	SN: 660	31-Jan-13 (No. DAE4-660_Jan13)	Jan-14
Secondary Standards	ID	Check Date (in house)	Scheduled Check
RF generator HP 8648C	US3642U01700	4-Aug-99 (in house check Apr-11)	In house check: Apr-13
Network Analyzer HP 8753E	US37390585	18-Oct-01 (in house check Oct-12)	In house check: Oct-13

Calibrated by:	Name Claudio Leubler	Function Laboratory Technician	Signature
Approved by:	Name Katja Pokovic	Function Technical Manager	Signature

Issued: March 5, 2013

This calibration certificate shall not be reproduced except in full without written approval of the laboratory.



Accredited by the Swiss Accreditation Service (SAS)

The Swiss Accreditation Service is one of the signatories to the EA
Multilateral Agreement for the recognition of calibration certificates

Accreditation No.: **SCS 108**

Glossary:

TSL	tissue simulating liquid
NORM _{x,y,z}	sensitivity in free space
ConvF	sensitivity in TSL / NORM _{x,y,z}
DCP	diode compression point
CF	crest factor (1/duty_cycle) of the RF signal
A, B, C, D	modulation dependent linearization parameters
Polarization φ	φ rotation around probe axis
Polarization ϑ	ϑ rotation around an axis that is in the plane normal to probe axis (at measurement center), i.e., $\vartheta = 0$ is normal to probe axis

Calibration is Performed According to the Following Standards:

- IEEE Std 1528-2003, "IEEE Recommended Practice for Determining the Peak Spatial-Averaged Specific Absorption Rate (SAR) in the Human Head from Wireless Communications Devices: Measurement Techniques", December 2003
- IEC 62209-1, "Procedure to measure the Specific Absorption Rate (SAR) for hand-held devices used in close proximity to the ear (frequency range of 300 MHz to 3 GHz)", February 2005

Methods Applied and Interpretation of Parameters:

- NORM_{x,y,z}**: Assessed for E-field polarization $\vartheta = 0$ ($f \leq 900$ MHz in TEM-cell; $f > 1800$ MHz: R22 waveguide). NORM_{x,y,z} are only intermediate values, i.e., the uncertainties of NORM_{x,y,z} does not affect the E²-field uncertainty inside TSL (see below ConvF).
- NORM(f)_{x,y,z}** = NORM_{x,y,z} * frequency_response (see Frequency Response Chart). This linearization is implemented in DASY4 software versions later than 4.2. The uncertainty of the frequency response is included in the stated uncertainty of ConvF.
- DCP_{x,y,z}**: DCP are numerical linearization parameters assessed based on the data of power sweep with CW signal (no uncertainty required). DCP does not depend on frequency nor media.
- PAR**: PAR is the Peak to Average Ratio that is not calibrated but determined based on the signal characteristics
- A_{x,y,z}; B_{x,y,z}; C_{x,y,z}; D_{x,y,z}; VR_{x,y,z}**: A, B, C, D are numerical linearization parameters assessed based on the data of power sweep for specific modulation signal. The parameters do not depend on frequency nor media. VR is the maximum calibration range expressed in RMS voltage across the diode.
- ConvF and Boundary Effect Parameters**: Assessed in flat phantom using E-field (or Temperature Transfer Standard for $f \leq 800$ MHz) and inside waveguide using analytical field distributions based on power measurements for $f > 800$ MHz. The same setups are used for assessment of the parameters applied for boundary compensation (alpha, depth) of which typical uncertainty values are given. These parameters are used in DASY4 software to improve probe accuracy close to the boundary. The sensitivity in TSL corresponds to NORM_{x,y,z} * ConvF whereby the uncertainty corresponds to that given for ConvF. A frequency dependent ConvF is used in DASY version 4.4 and higher which allows extending the validity from ± 50 MHz to ± 100 MHz.
- Spherical isotropy (3D deviation from isotropy)**: in a field of low gradients realized using a flat phantom exposed by a patch antenna.
- Sensor Offset**: The sensor offset corresponds to the offset of virtual measurement center from the probe tip (on probe axis). No tolerance required.

Probe EX3DV4

SN:3920

Manufactured: December 18, 2012
Calibrated: February 27, 2013

Calibrated for DASY/EASY Systems
(Note: non-compatible with DASY2 system!)

DASY/EASY - Parameters of Probe: EX3DV4 - SN:3920

Basic Calibration Parameters

	Sensor X	Sensor Y	Sensor Z	Unc (k=2)
Norm ($\mu\text{V}/(\text{V}/\text{m})^2$) ^A	0.34	0.50	0.50	$\pm 10.1\%$
DCP (mV) ^B	101.2	101.0	99.1	

Modulation Calibration Parameters

UID	Communication System Name		A dB	B dB $\sqrt{\mu\text{V}}$	C	D dB	VR mV	Unc ^E (k=2)
0	CW	X	0.0	0.0	1.0	0.00	134.3	$\pm 3.3\%$
		Y	0.0	0.0	1.0		164.7	
		Z	0.0	0.0	1.0		161.4	

The reported uncertainty of measurement is stated as the standard uncertainty of measurement multiplied by the coverage factor $k=2$, which for a normal distribution corresponds to a coverage probability of approximately 95%.

^A The uncertainties of NormX,Y,Z do not affect the E^2 -field uncertainty inside TSL (see Pages 5 and 6).

^B Numerical linearization parameter: uncertainty not required.

^E Uncertainty is determined using the max. deviation from linear response applying rectangular distribution and is expressed for the square of the field value.

DASY/EASY - Parameters of Probe: EX3DV4 - SN:3920

Calibration Parameter Determined in Head Tissue Simulating Media

f (MHz) ^C	Relative Permittivity ^F	Conductivity (S/m) ^F	ConvF X	ConvF Y	ConvF Z	Alpha	Depth (mm)	Unct. (k=2)
750	41.9	0.89	9.86	9.86	9.86	0.19	1.39	± 12.0 %
835	41.5	0.90	9.58	9.58	9.58	0.77	0.54	± 12.0 %
1750	40.1	1.37	7.97	7.97	7.97	0.57	0.69	± 12.0 %
1900	40.0	1.40	7.73	7.73	7.73	0.54	0.73	± 12.0 %
2450	39.2	1.80	7.04	7.04	7.04	0.40	0.82	± 12.0 %
2600	39.0	1.96	6.80	6.80	6.80	0.49	0.76	± 12.0 %
5200	36.0	4.66	4.87	4.87	4.87	0.35	1.80	± 13.1 %
5300	35.9	4.76	4.73	4.73	4.73	0.37	1.80	± 13.1 %
5500	35.6	4.96	4.52	4.52	4.52	0.39	1.80	± 13.1 %
5600	35.5	5.07	4.17	4.17	4.17	0.50	1.80	± 13.1 %
5800	35.3	5.27	4.02	4.02	4.02	0.45	1.80	± 13.1 %

^C Frequency validity of ± 100 MHz only applies for DASY v4.4 and higher (see Page 2), else it is restricted to ± 50 MHz. The uncertainty is the RSS of the ConvF uncertainty at calibration frequency and the uncertainty for the indicated frequency band.

^F At frequencies below 3 GHz, the validity of tissue parameters (ϵ and σ) can be relaxed to ± 10% if liquid compensation formula is applied to measured SAR values. At frequencies above 3 GHz, the validity of tissue parameters (ϵ and σ) is restricted to ± 5%. The uncertainty is the RSS of the ConvF uncertainty for indicated target tissue parameters.

DASY/EASY - Parameters of Probe: EX3DV4 - SN:3920

Calibration Parameter Determined in Body Tissue Simulating Media

f (MHz) ^C	Relative Permittivity ^F	Conductivity (S/m) ^F	ConvF X	ConvF Y	ConvF Z	Alpha	Depth (mm)	Unct. (k=2)
750	55.5	0.96	9.57	9.57	9.57	0.43	0.83	± 12.0 %
835	55.2	0.97	9.42	9.42	9.42	0.36	0.98	± 12.0 %
1750	53.4	1.49	7.59	7.59	7.59	0.43	0.78	± 12.0 %
1900	53.3	1.52	7.38	7.38	7.38	0.33	0.91	± 12.0 %
2450	52.7	1.95	7.07	7.07	7.07	0.80	0.55	± 12.0 %
2600	52.5	2.16	6.73	6.73	6.73	0.80	0.56	± 12.0 %
5200	49.0	5.30	4.23	4.23	4.23	0.51	1.90	± 13.1 %
5300	48.9	5.42	4.13	4.13	4.13	0.49	1.90	± 13.1 %
5500	48.6	5.65	3.63	3.63	3.63	0.52	1.90	± 13.1 %
5600	48.5	5.77	3.62	3.62	3.62	0.49	1.90	± 13.1 %
5800	48.2	6.00	3.91	3.91	3.91	0.54	1.90	± 13.1 %

^C Frequency validity of ± 100 MHz only applies for DASY v4.4 and higher (see Page 2), else it is restricted to ± 50 MHz. The uncertainty is the RSS of the ConvF uncertainty at calibration frequency and the uncertainty for the indicated frequency band.

^F At frequencies below 3 GHz, the validity of tissue parameters (ϵ and σ) can be relaxed to ± 10% if liquid compensation formula is applied to measured SAR values. At frequencies above 3 GHz, the validity of tissue parameters (ϵ and σ) is restricted to ± 5%. The uncertainty is the RSS of the ConvF uncertainty for indicated target tissue parameters.

Frequency Response of E-Field (TEM-Cell:ifi110 EXX, Waveguide: R22)

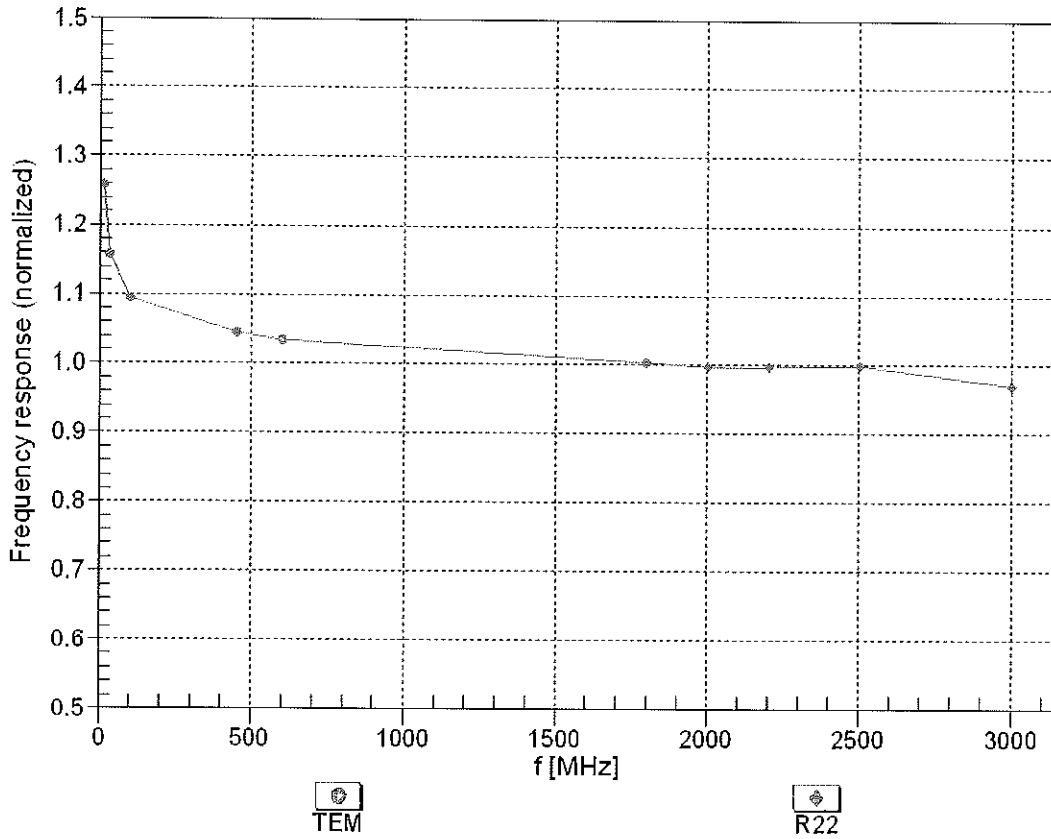

Uncertainty of Frequency Response of E-field: $\pm 6.3\%$ (k=2)

Receiving Pattern (ϕ), $\theta = 0^\circ$

f=600 MHz,TEM

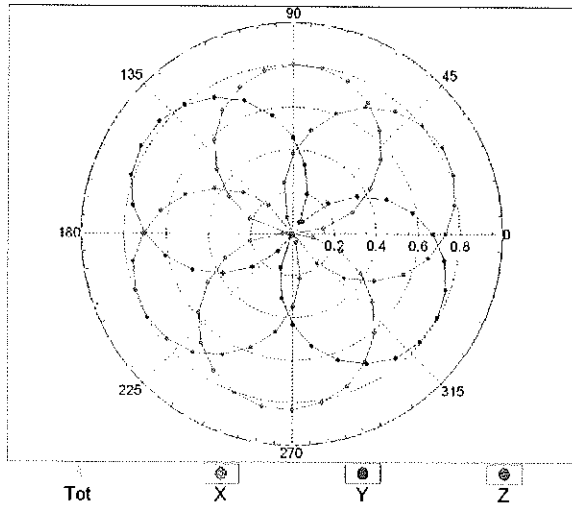

f=1800 MHz,R22

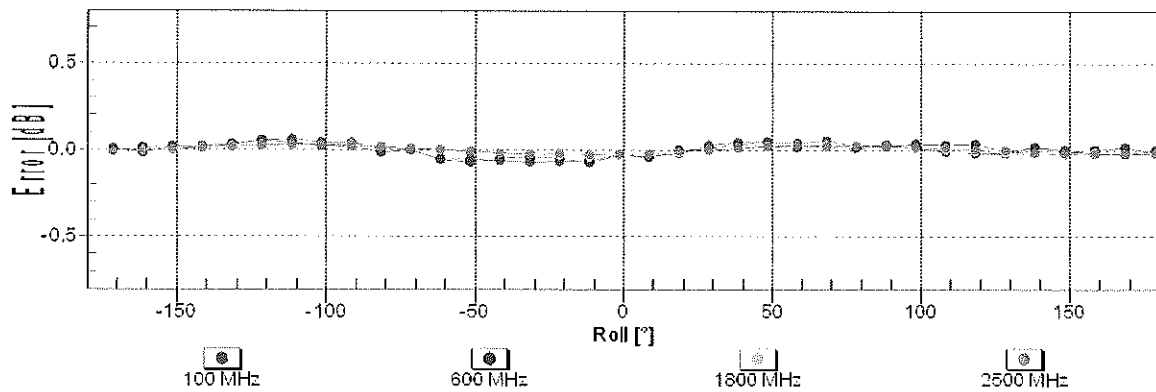
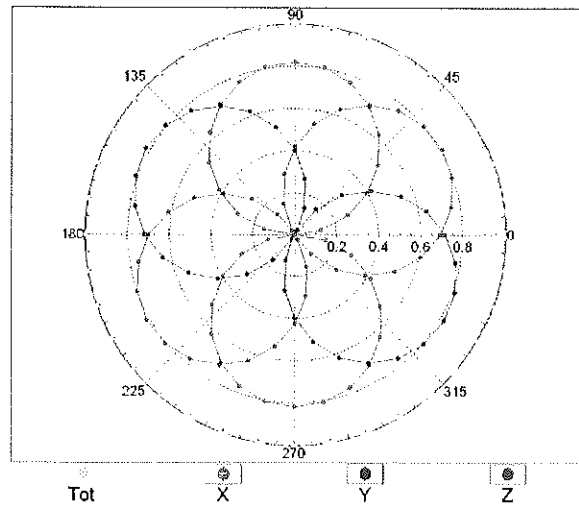

Uncertainty of Axial Isotropy Assessment: $\pm 0.5\%$ (k=2)

Dynamic Range f(SAR_{head}) (TEM cell , f = 900 MHz)

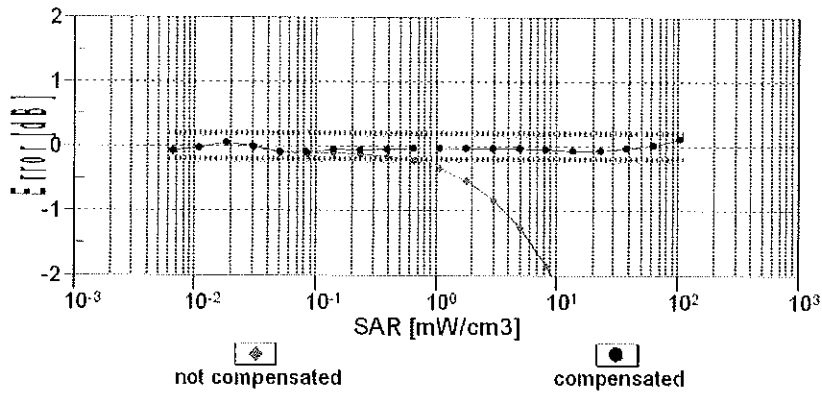
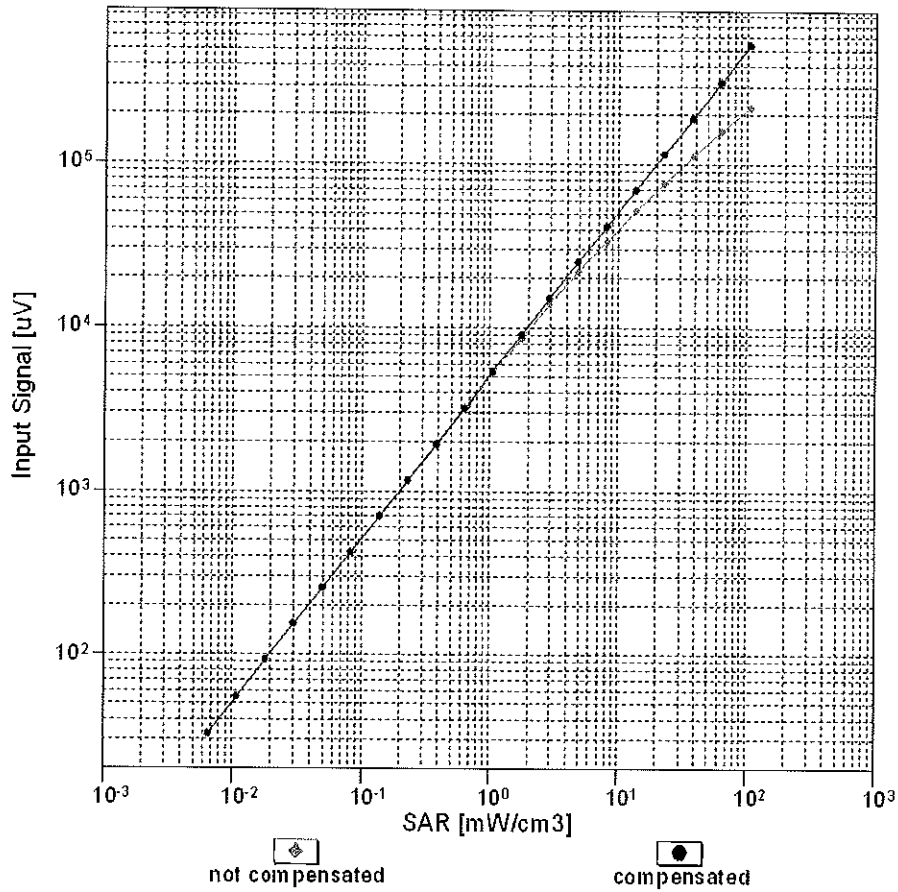

Uncertainty of Linearity Assessment: ± 0.6% (k=2)

Conversion Factor Assessment

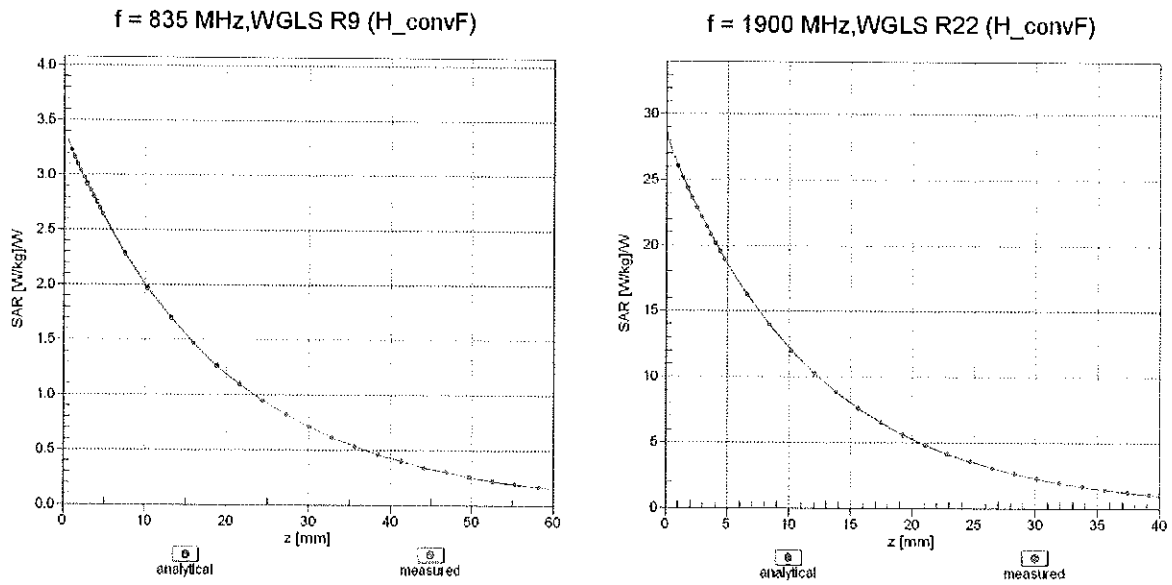

Deviation from Isotropy in Liquid Error (ϕ, θ), f = 900 MHz

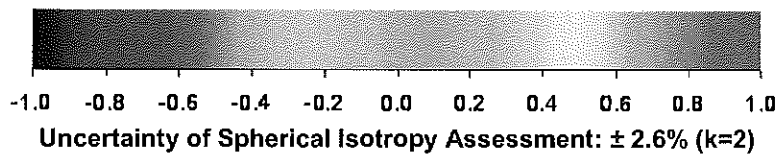
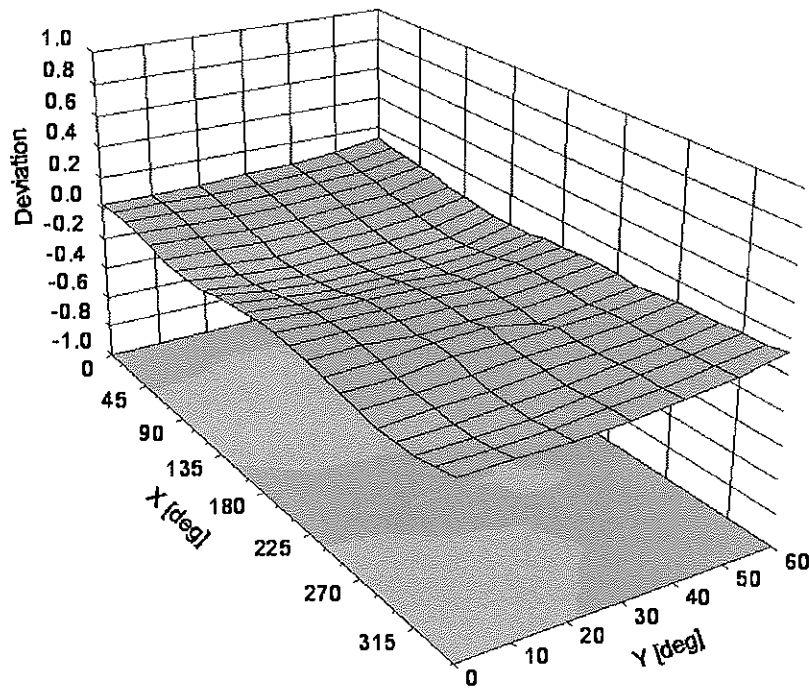

DASY/EASY - Parameters of Probe: EX3DV4 - SN:3920

Other Probe Parameters

Sensor Arrangement	Triangular
Connector Angle (°)	-21.6
Mechanical Surface Detection Mode	enabled
Optical Surface Detection Mode	disabled
Probe Overall Length	337 mm
Probe Body Diameter	10 mm
Tip Length	9 mm
Tip Diameter	2.5 mm
Probe Tip to Sensor X Calibration Point	1 mm
Probe Tip to Sensor Y Calibration Point	1 mm
Probe Tip to Sensor Z Calibration Point	1 mm
Recommended Measurement Distance from Surface	2 mm



Accredited by the Swiss Accreditation Service (SAS)
The Swiss Accreditation Service is one of the signatories to the EA
Multilateral Agreement for the recognition of calibration certificates

Accreditation No.: **SCS 108**

Client **PC Test**

Certificate No: **EX3-3589_Jan13**

CALIBRATION CERTIFICATE

Object **EX3DV4 - SN:3589**

Calibration procedure(s) **QA CAL-01 v3, QA CAL-14 v3, QA CAL-23 v4, QA CAL-25 v4
Calibration procedure for dosimetric E-field probes**

Calibration date: **January 17, 2013**

✓
Kok
1/28/13

This calibration certificate documents the traceability to national standards, which realize the physical units of measurements (SI).
The measurements and the uncertainties with confidence probability are given on the following pages and are part of the certificate.

All calibrations have been conducted in the closed laboratory facility: environment temperature (22 ± 3)°C and humidity < 70%.

Calibration Equipment used (M&TE critical for calibration)

Primary Standards	ID	Cal Date (Certificate No.)	Scheduled Calibration
Power meter E4419B	GB41293874	29-Mar-12 (No. 217-01508)	Apr-13
Power sensor E4412A	MY41498087	29-Mar-12 (No. 217-01508)	Apr-13
Reference 3 dB Attenuator	SN: S5054 (3c)	27-Mar-12 (No. 217-01531)	Apr-13
Reference 20 dB Attenuator	SN: S5086 (20b)	27-Mar-12 (No. 217-01529)	Apr-13
Reference 30 dB Attenuator	SN: S5129 (30b)	27-Mar-12 (No. 217-01532)	Apr-13
Reference Probe ES3DV2	SN: 3013	28-Dec-12 (No. ES3-3013_Dec12)	Dec-13
DAE4	SN: 660	20-Jun-12 (No. DAE4-660_Jun12)	Jun-13
Secondary Standards	ID	Check Date (in house)	Scheduled Check
RF generator HP 8648C	US3642U01700	4-Aug-99 (in house check Apr-11)	In house check: Apr-13
Network Analyzer HP 8753E	US37390585	18-Oct-01 (in house check Oct-12)	In house check: Oct-13

	Name	Function	Signature
Calibrated by:	Jeton Kastrati	Laboratory Technician	
Approved by:	Katja Pokovic	Technical Manager	

Issued: January 17, 2013

This calibration certificate shall not be reproduced except in full without written approval of the laboratory.



Accredited by the Swiss Accreditation Service (SAS)

Accreditation No.: **SCS 108**

The Swiss Accreditation Service is one of the signatories to the EA
Multilateral Agreement for the recognition of calibration certificates

Glossary:

TSL	tissue simulating liquid
NORM _{x,y,z}	sensitivity in free space
ConvF	sensitivity in TSL / NORM _{x,y,z}
DCP	diode compression point
CF	crest factor (1/duty_cycle) of the RF signal
A, B, C, D	modulation dependent linearization parameters
Polarization φ	φ rotation around probe axis
Polarization ϑ	ϑ rotation around an axis that is in the plane normal to probe axis (at measurement center), i.e., $\vartheta = 0$ is normal to probe axis

Calibration is Performed According to the Following Standards:

- IEEE Std 1528-2003, "IEEE Recommended Practice for Determining the Peak Spatial-Averaged Specific Absorption Rate (SAR) in the Human Head from Wireless Communications Devices: Measurement Techniques", December 2003
- IEC 62209-1, "Procedure to measure the Specific Absorption Rate (SAR) for hand-held devices used in close proximity to the ear (frequency range of 300 MHz to 3 GHz)", February 2005

Methods Applied and Interpretation of Parameters:

- NORM_{x,y,z}**: Assessed for E-field polarization $\vartheta = 0$ ($f \leq 900$ MHz in TEM-cell; $f > 1800$ MHz: R22 waveguide). NORM_{x,y,z} are only intermediate values, i.e., the uncertainties of NORM_{x,y,z} does not affect the E²-field uncertainty inside TSL (see below ConvF).
- NORM(f)_{x,y,z}** = NORM_{x,y,z} * frequency_response (see Frequency Response Chart). This linearization is implemented in DASY4 software versions later than 4.2. The uncertainty of the frequency response is included in the stated uncertainty of ConvF.
- DCP_{x,y,z}**: DCP are numerical linearization parameters assessed based on the data of power sweep with CW signal (no uncertainty required). DCP does not depend on frequency nor media.
- PAR**: PAR is the Peak to Average Ratio that is not calibrated but determined based on the signal characteristics
- A_{x,y,z}; B_{x,y,z}; C_{x,y,z}; D_{x,y,z}; VR_{x,y,z}**: A, B, C, D are numerical linearization parameters assessed based on the data of power sweep for specific modulation signal. The parameters do not depend on frequency nor media. VR is the maximum calibration range expressed in RMS voltage across the diode.
- ConvF and Boundary Effect Parameters**: Assessed in flat phantom using E-field (or Temperature Transfer Standard for $f \leq 800$ MHz) and inside waveguide using analytical field distributions based on power measurements for $f > 800$ MHz. The same setups are used for assessment of the parameters applied for boundary compensation (alpha, depth) of which typical uncertainty values are given. These parameters are used in DASY4 software to improve probe accuracy close to the boundary. The sensitivity in TSL corresponds to NORM_{x,y,z} * ConvF whereby the uncertainty corresponds to that given for ConvF. A frequency dependent ConvF is used in DASY version 4.4 and higher which allows extending the validity from ± 50 MHz to ± 100 MHz.
- Spherical isotropy (3D deviation from isotropy)**: in a field of low gradients realized using a flat phantom exposed by a patch antenna.
- Sensor Offset**: The sensor offset corresponds to the offset of virtual measurement center from the probe tip (on probe axis). No tolerance required.

Probe EX3DV4

SN:3589

Manufactured: March 30, 2006
Calibrated: January 17, 2013

Calibrated for DASY/EASY Systems
(Note: non-compatible with DASY2 system!)

DASY/EASY - Parameters of Probe: EX3DV4 - SN:3589

Basic Calibration Parameters

	Sensor X	Sensor Y	Sensor Z	Unc (k=2)
Norm ($\mu\text{V}/(\text{V}/\text{m})^2$) ^A	0.46	0.40	0.40	$\pm 10.1 \%$
DCP (mV) ^B	100.5	103.8	99.6	

Modulation Calibration Parameters

UID	Communication System Name		A dB	B dB $\sqrt{\mu\text{V}}$	C	D dB	VR mV	Unc ^E (k=2)
0	CW	X	0.0	0.0	1.0	0.00	165.8	$\pm 3.3 \%$
		Y	0.0	0.0	1.0		134.3	
		Z	0.0	0.0	1.0		140.5	

The reported uncertainty of measurement is stated as the standard uncertainty of measurement multiplied by the coverage factor k=2, which for a normal distribution corresponds to a coverage probability of approximately 95%.

^A The uncertainties of NormX,Y,Z do not affect the E²-field uncertainty inside TSL (see Pages 5 and 6).

^B Numerical linearization parameter: uncertainty not required.

^E Uncertainty is determined using the max. deviation from linear response applying rectangular distribution and is expressed for the square of the field value.

DASY/EASY - Parameters of Probe: EX3DV4 - SN:3589

Calibration Parameter Determined in Head Tissue Simulating Media

f (MHz) ^C	Relative Permittivity ^F	Conductivity (S/m) ^F	ConvF X	ConvF Y	ConvF Z	Alpha	Depth (mm)	Unct. (k=2)
750	41.9	0.89	8.70	8.70	8.70	0.39	0.96	± 12.0 %
835	41.5	0.90	8.40	8.40	8.40	0.52	0.74	± 12.0 %
1750	40.1	1.37	7.34	7.34	7.34	0.45	0.93	± 12.0 %
1900	40.0	1.40	7.09	7.09	7.09	0.80	0.65	± 12.0 %
2450	39.2	1.80	6.37	6.37	6.37	0.39	0.97	± 12.0 %
2600	39.0	1.96	6.19	6.19	6.19	0.30	1.12	± 12.0 %
5200	36.0	4.66	4.48	4.48	4.48	0.45	1.80	± 13.1 %
5300	35.9	4.76	4.27	4.27	4.27	0.45	1.80	± 13.1 %
5500	35.6	4.96	4.14	4.14	4.14	0.50	1.80	± 13.1 %
5600	35.5	5.07	3.81	3.81	3.81	0.55	1.80	± 13.1 %
5800	35.3	5.27	3.85	3.85	3.85	0.55	1.80	± 13.1 %

^C Frequency validity of ± 100 MHz only applies for DASY v4.4 and higher (see Page 2), else it is restricted to ± 50 MHz. The uncertainty is the RSS of the ConvF uncertainty at calibration frequency and the uncertainty for the indicated frequency band.

^F At frequencies below 3 GHz, the validity of tissue parameters (ϵ and σ) can be relaxed to ± 10% if liquid compensation formula is applied to measured SAR values. At frequencies above 3 GHz, the validity of tissue parameters (ϵ and σ) is restricted to ± 5%. The uncertainty is the RSS of the ConvF uncertainty for indicated target tissue parameters.

DASY/EASY - Parameters of Probe: EX3DV4 - SN:3589

Calibration Parameter Determined in Body Tissue Simulating Media

f (MHz) ^C	Relative Permittivity ^F	Conductivity (S/m) ^F	ConvF X	ConvF Y	ConvF Z	Alpha	Depth (mm)	Unct. (k=2)
750	55.5	0.96	8.59	8.59	8.59	0.49	0.86	± 12.0 %
835	55.2	0.97	8.43	8.43	8.43	0.38	1.05	± 12.0 %
1750	53.4	1.49	7.87	7.87	7.87	0.44	0.89	± 12.0 %
1900	53.3	1.52	7.46	7.46	7.46	0.58	0.75	± 12.0 %
2450	52.7	1.95	7.07	7.07	7.07	0.80	0.50	± 12.0 %
2600	52.5	2.16	6.68	6.68	6.68	0.80	0.50	± 12.0 %
5200	49.0	5.30	3.99	3.99	3.99	0.50	1.90	± 13.1 %
5300	48.9	5.42	3.81	3.81	3.81	0.50	1.90	± 13.1 %
5500	48.6	5.65	3.52	3.52	3.52	0.55	1.90	± 13.1 %
5600	48.5	5.77	3.32	3.32	3.32	0.60	1.90	± 13.1 %
5800	48.2	6.00	3.66	3.66	3.66	0.60	1.90	± 13.1 %

^C Frequency validity of ± 100 MHz only applies for DASY v4.4 and higher (see Page 2), else it is restricted to ± 50 MHz. The uncertainty is the RSS of the ConvF uncertainty at calibration frequency and the uncertainty for the indicated frequency band.

^F At frequencies below 3 GHz, the validity of tissue parameters (ϵ and σ) can be relaxed to ± 10% if liquid compensation formula is applied to measured SAR values. At frequencies above 3 GHz, the validity of tissue parameters (ϵ and σ) is restricted to ± 5%. The uncertainty is the RSS of the ConvF uncertainty for indicated target tissue parameters.

Frequency Response of E-Field (TEM-Cell:ifi110 EXX, Waveguide: R22)

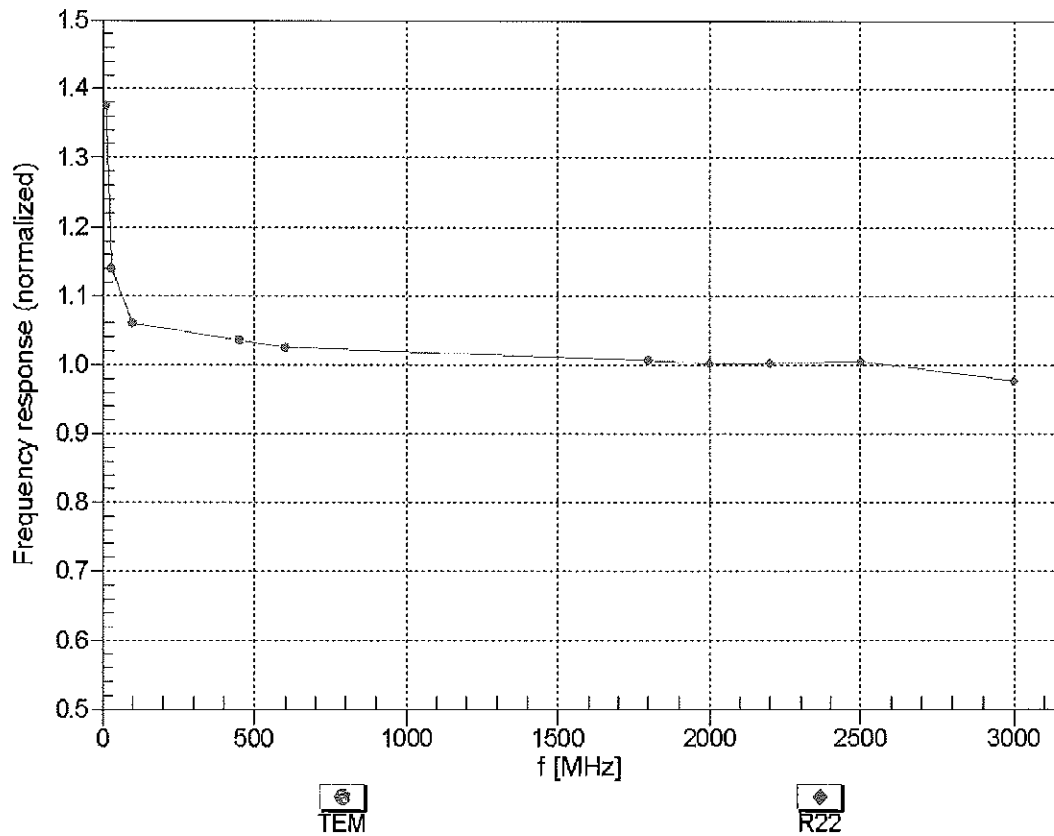

Uncertainty of Frequency Response of E-field: $\pm 6.3\%$ (k=2)

Receiving Pattern (ϕ), $\vartheta = 0^\circ$

f=600 MHz, TEM

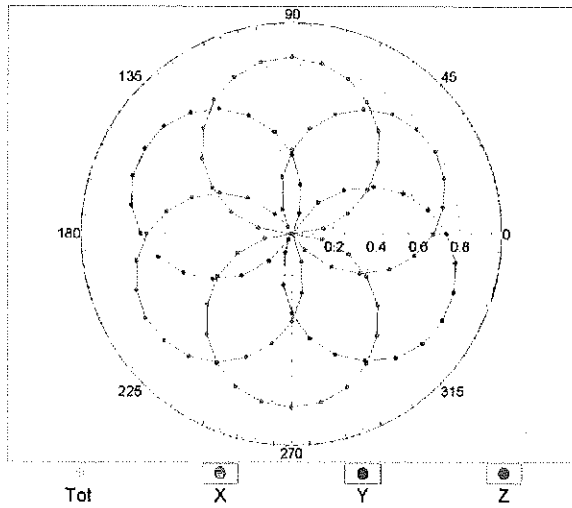

f=1800 MHz, R22

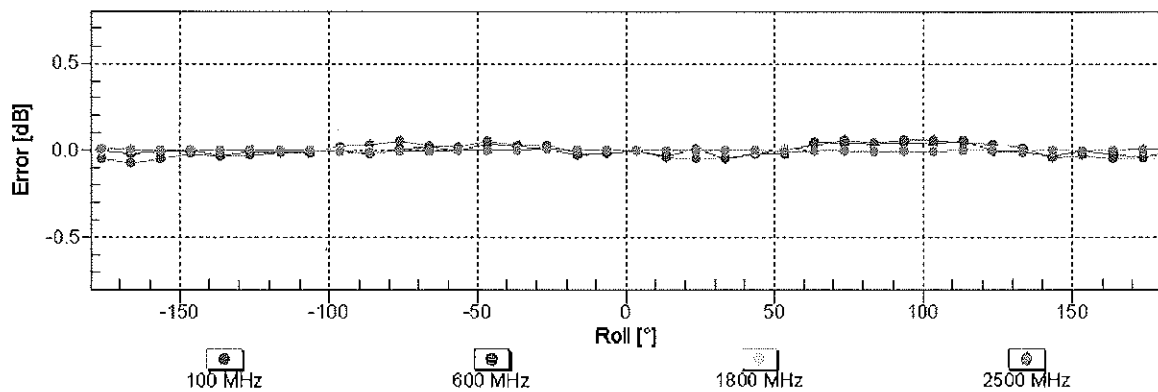
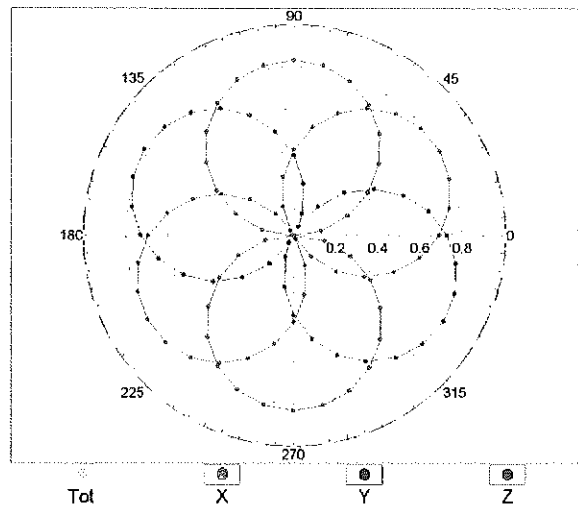

Uncertainty of Axial Isotropy Assessment: $\pm 0.5\%$ (k=2)

Dynamic Range $f(\text{SAR}_{\text{head}})$ (TEM cell , $f = 900 \text{ MHz}$)

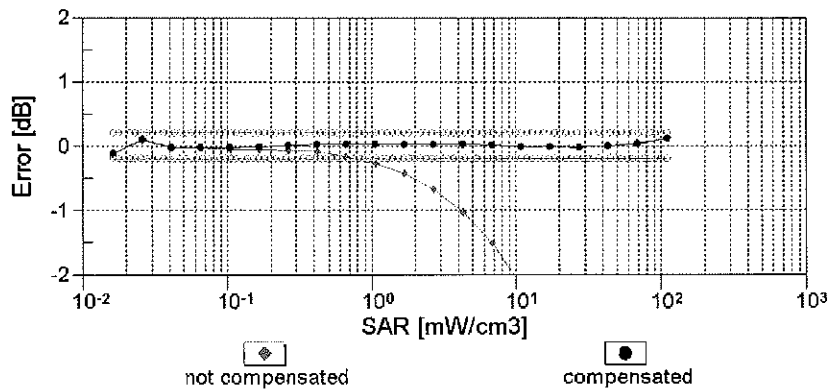
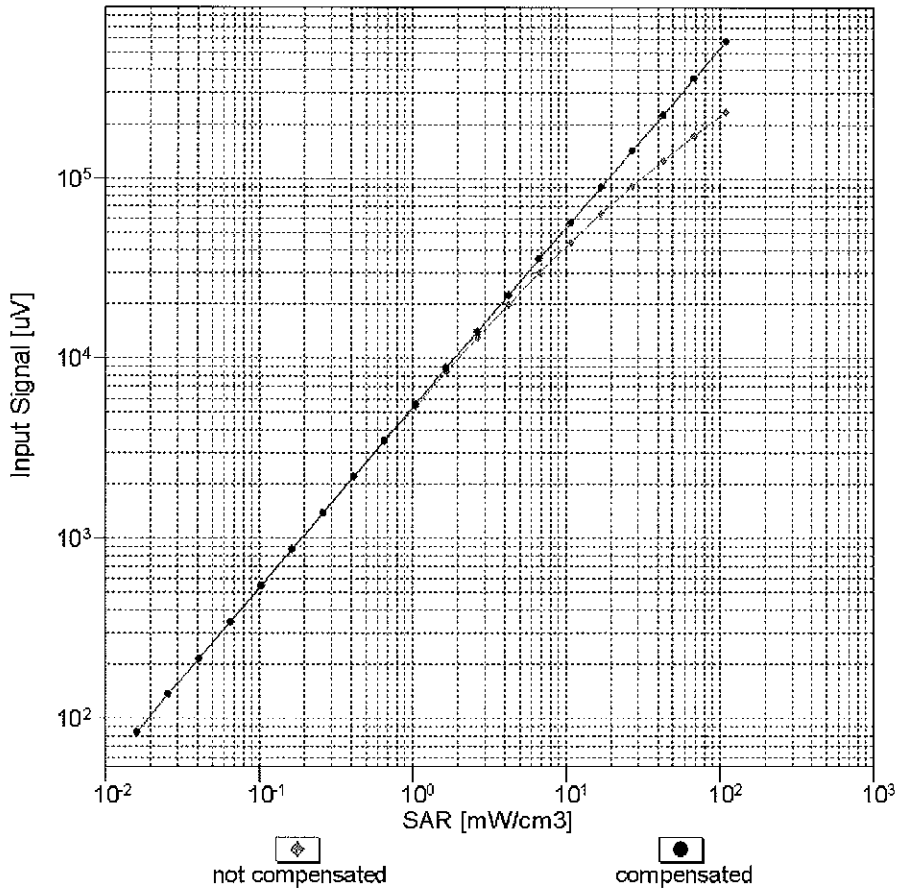

Uncertainty of Linearity Assessment: $\pm 0.6\%$ ($k=2$)

Conversion Factor Assessment

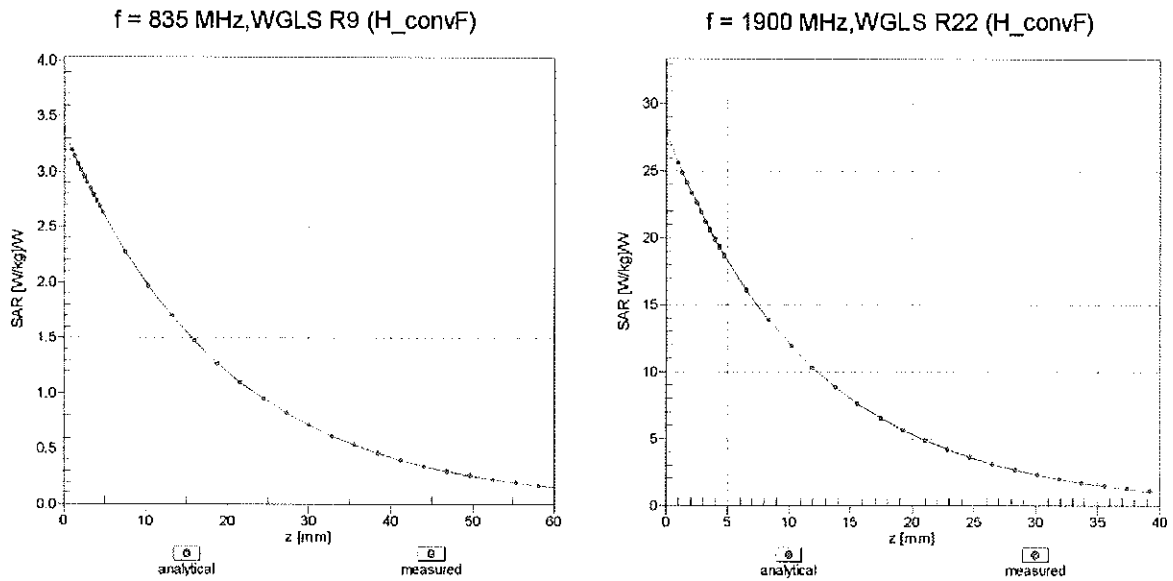

Deviation from Isotropy in Liquid Error (ϕ, ϑ), $f = 900$ MHz

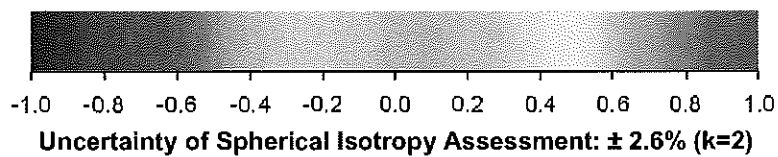
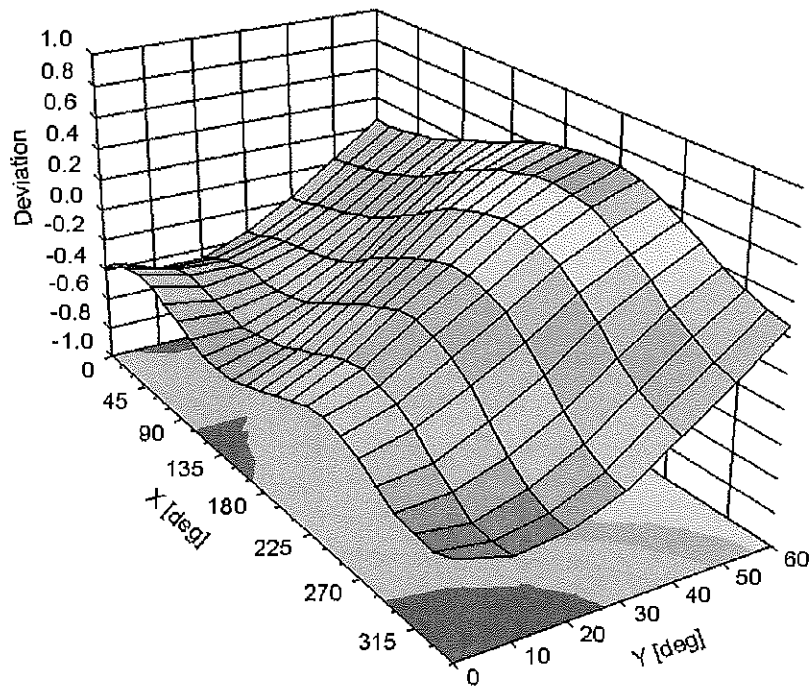

DASY/EASY - Parameters of Probe: EX3DV4 - SN:3589

Other Probe Parameters

Sensor Arrangement	Triangular
Connector Angle (°)	-26.4
Mechanical Surface Detection Mode	enabled
Optical Surface Detection Mode	disabled
Probe Overall Length	337 mm
Probe Body Diameter	10 mm
Tip Length	9 mm
Tip Diameter	2.5 mm
Probe Tip to Sensor X Calibration Point	1 mm
Probe Tip to Sensor Y Calibration Point	1 mm
Probe Tip to Sensor Z Calibration Point	1 mm
Recommended Measurement Distance from Surface	2 mm

APPENDIX 8 : SAR T=GGI 9 GD97 = =7 5 H=CBG

APPENDIX D: SAR TISSUE SPECIFICATIONS

Measurement Procedure for Tissue verification:

- 1) The network analyzer and probe system was configured and calibrated.
- 2) The probe was immersed in the tissue. The tissue was placed in a nonmetallic container. Trapped air bubbles beneath the flange were minimized by placing the probe at a slight angle.
- 3) The complex admittance with respect to the probe aperture was measured
- 4) The complex relative permittivity ϵ can be calculated from the below equation (Pournaropoulos and Misra):

$$Y = \frac{j2\omega\epsilon_r\epsilon_0}{[\ln(b/a)]^2} \int_a^b \int_a^b \int_0^\pi \cos\phi' \frac{\exp[-j\omega r(\mu_0\epsilon_r'\epsilon_0)^{1/2}]}{r} d\phi' d\rho' d\rho$$

where Y is the admittance of the probe in contact with the sample, the primed and unprimed coordinates refer to source and observation points, respectively, $r^2 = \rho^2 + \rho'^2 - 2\rho\rho' \cos\phi'$, ω is the angular frequency, and $j = \sqrt{-1}$.

Table D-I
Composition of the Tissue Equivalent Matter

Frequency (MHz)	835	835	1750	1750	1900	1900	2450	2450	5200-5800	5200-5800
Tissue	Head	Body	Head	Body	Head	Body	Head	Body	Head	Body
Ingredients (% by weight)										
Bactericide	0.1	0.1					See Page 2		See Page 3	
DGBE			47	31	44.92	29.44		26.7		
HEC	1	1								
NaCl	1.45	0.94	0.4	0.2	0.18	0.39		0.1		
Sucrose	57	44.9								
Polysorbate (Tween) 80										20
Water	40.45	53.06	52.6	68.8	54.9	70.17	73.2		80	

FCC ID: PY7PM-0410		SAR EVALUATION REPORT	SONY	Reviewed by: Quality Manager
Test Dates: 05/06/13 - 08/01/13	DUT Type: Portable Handset			APPENDIX D: Page 1 of 3

2 Composition / Information on ingredients

The Item is composed of the following ingredients:

H2O	Water, 52 – 75%
C8H18O3	Diethylene glycol monobutyl ether (DGBE), 25 – 48% (CAS-No. 112-34-5, EC-No. 203-961-6, EC-index-No. 603-096-00-8) Relevant for safety; Refer to the respective Safety Data Sheet*.
NaCl	Sodium Chloride, <1.0%

Figure D-1
Composition of 2.4 GHz Head Tissue Equivalent Matter

Note: 2.4 GHz head liquid recipes are proprietary SPEAG. Since the composition is approximate to the actual liquids utilized, the manufacturer tissue-equivalent liquid data sheets are provided below.

Measurement Certificate / Material Test

Item Name	Head Tissue Simulating Liquid (HSL 2450)
Product No.	SL AAH 245 BA (Charge: 120112-4)
Manufacturer	SPEAG

Measurement Method

TSL dielectric parameters measured using calibrated OCP probe (type DAK).

Target Parameters

Target parameters as defined in the IEEE 1528 and IEC 62209 compliance standards.

Test Condition

Ambient Condition 22°C; 30% humidity
TSL Temperature 23°C
Test Date 18-Jan-12

Additional Information

TSL Density 0.988 g/cm³
TSL Heat-capacity 3.680 kJ/(kg*K)

Results

f [MHz]	Measured			Target		Diff.to Target [%]	
	HP-e'	HP-e''	sigma	eps	sigma	Δ-eps	Δ-sigma
1900	40.5	11.99	1.27	40.0	1.40	1.1	-9.5
1925	40.3	12.08	1.29	40.0	1.40	0.9	-7.6
1950	40.2	12.17	1.32	40.0	1.40	0.6	-5.7
1975	40.1	12.26	1.35	40.0	1.40	0.3	-3.8
2000	40.0	12.35	1.37	40.0	1.40	0.0	-1.9
2025	39.9	12.44	1.40	40.0	1.42	-0.1	-1.5
2050	39.9	12.53	1.43	39.9	1.44	-0.3	-1.1
2075	39.7	12.60	1.46	39.9	1.47	-0.4	-0.8
2100	39.6	12.68	1.48	39.8	1.49	-0.6	-0.5
2125	39.5	12.76	1.51	39.8	1.51	-0.7	-0.2
2150	39.4	12.84	1.54	39.7	1.53	-0.8	0.2
2175	39.3	12.93	1.56	39.7	1.56	-1.0	0.6
2200	39.2	13.02	1.59	39.6	1.58	-1.1	1.0
2225	39.1	13.09	1.62	39.6	1.60	-1.3	1.3
2250	39.0	13.17	1.65	39.6	1.62	-1.4	1.6
2275	38.9	13.25	1.68	39.5	1.64	-1.5	2.0
2300	38.8	13.33	1.71	39.5	1.67	-1.7	2.3
2325	38.7	13.40	1.73	39.4	1.69	-1.8	2.7
2350	38.6	13.48	1.76	39.4	1.71	-2.0	3.0
2375	38.5	13.56	1.79	39.3	1.73	-2.1	3.3
2400	38.4	13.63	1.82	39.3	1.76	-2.3	3.7
2425	38.3	13.71	1.85	39.2	1.78	-2.4	4.0
2450	38.2	13.78	1.88	39.2	1.80	-2.6	4.4
2475	38.1	13.85	1.91	39.2	1.83	-2.7	4.4
2500	38.0	13.93	1.94	39.1	1.85	-2.9	4.4
2525	37.9	13.99	1.97	39.1	1.88	-3.1	4.4
2550	37.8	14.06	1.99	39.1	1.91	-3.3	4.4
2575	37.7	14.13	2.02	39.0	1.94	-3.5	4.5
2600	37.6	14.20	2.05	39.0	1.96	-3.7	4.6
2625	37.5	14.28	2.08	39.0	1.99	-3.8	4.6
2650	37.4	14.32	2.11	38.9	2.02	-4.0	4.6
2675	37.3	14.39	2.14	38.9	2.05	-4.3	4.7
2700	37.1	14.46	2.17	38.9	2.07	-4.5	4.8

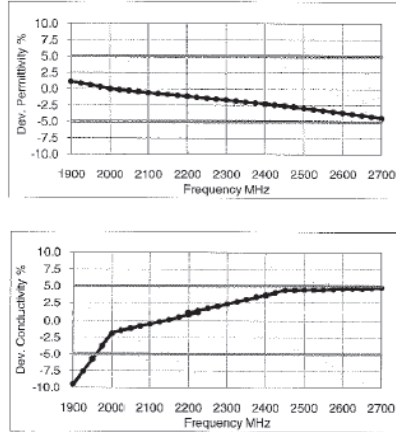



Figure D-2
2.4 GHz Head Tissue Equivalent Matter

FCC ID: PY7PM-0410	 PCTEST <small>ENGINEERING LABORATORY, INC.</small>	SAR EVALUATION REPORT	 SONY	Reviewed by: Quality Manager
Test Dates: 05/06/13 - 08/01/13	DUT Type: Portable Handset			APPENDIX D: Page 2 of 3

2 Composition / Information on ingredients

The Item is composed of the following ingredients:

Water	50 – 65%
Mineral oil	10 – 30%
Emulsifiers	8 – 25%
Sodium salt	0 – 1.5%

Figure D-3

Composition of 5 GHz Head Tissue Equivalent Matter

Note: 5GHz head liquid recipes are proprietary SPEAG. Since the composition is approximate to the actual liquids utilized, the manufacturer tissue-equivalent liquid data sheets are provided below.

Measurement Certificate / Material Test

Item Name	Head Tissue Simulating Liquid (HBBL3500-5800V5)
Product No.	SL AAH 502 AB (Charge: 120402-2)
Manufacturer	SPEAG

Measurement Method

TSL dielectric parameters measured using calibrated OCP probe (type DAK).

Target Parameters

Target parameters as defined in the IEEE 1528 and IEC 62209 compliance standards.

Test Condition

Ambient Condition 22°C ; 30% humidity
TSL Temperature 22°C
Test Date 4-Apr-12

Additional Information

TSL Density 0.985 g/cm³
TSL Heat-capacity 3.383 kJ/(kg*K)

Results

f [MHz]	Measured			Target		Diff. to Target [%]	
	HP-e'	HP-e''	sigma	eps	sigma	Δ-eps	Δ-sigma
3400	38.7	14.96	2.83	38.0	2.81	1.8	0.7
3500	38.6	14.91	2.90	37.9	2.91	1.7	-0.3
3600	38.5	14.92	2.99	37.8	3.02	1.7	-0.9
3700	38.3	14.92	3.07	37.7	3.12	1.7	-1.5
3800	38.2	14.94	3.16	37.6	3.22	1.7	-1.9
3900	38.1	14.95	3.24	37.5	3.32	1.7	-2.4
4000	38.0	15.00	3.34	37.4	3.43	1.8	-2.5
4100	37.9	15.04	3.43	37.2	3.53	1.8	-2.6
4200	37.8	15.08	3.52	37.1	3.63	1.8	-2.9
4300	37.7	15.14	3.62	37.0	3.73	1.8	-3.0
4400	37.5	15.18	3.71	36.9	3.84	1.7	-3.1
4500	37.4	15.20	3.81	36.8	3.94	1.6	-3.3
4600	37.3	15.29	3.91	36.7	4.04	1.6	-3.2
4700	37.1	15.34	4.01	36.6	4.14	1.5	-3.2
4800	37.0	15.39	4.11	36.4	4.25	1.4	-3.2
4850	36.9	15.43	4.16	36.4	4.30	1.3	-3.1
4900	36.8	15.45	4.21	36.3	4.35	1.3	-3.1
4950	36.7	15.47	4.26	36.3	4.40	1.2	-3.1
5000	36.7	15.50	4.31	36.2	4.45	1.2	-3.1
5050	36.6	15.55	4.37	36.2	4.50	1.1	-3.0
5100	36.5	15.60	4.43	36.1	4.55	1.1	-2.8
5150	36.4	15.62	4.48	36.0	4.60	1.0	-2.8
5200	36.4	15.65	4.53	36.0	4.66	1.0	-2.8
5250	36.3	15.67	4.58	35.9	4.71	1.0	-2.8
5300	36.2	15.70	4.63	35.9	4.76	1.0	-2.7
5350	36.1	15.70	4.67	35.8	4.81	0.9	-2.9
5400	36.1	15.74	4.73	35.8	4.86	0.8	-2.7
5450	36.0	15.75	4.77	35.7	4.91	0.9	-2.8
5500	35.9	15.75	4.82	35.6	4.96	0.8	-2.9
5550	35.9	15.80	4.88	35.6	5.01	0.8	-2.7
5600	35.8	15.82	4.93	35.5	5.07	0.7	-2.7
5650	35.7	15.86	4.98	35.5	5.12	0.7	-2.6
5700	35.7	15.88	5.03	35.4	5.17	0.7	-2.6
5750	35.6	15.90	5.08	35.4	5.22	0.6	-2.6
5800	35.5	15.94	5.14	35.3	5.27	0.6	-2.4
5850	35.4	15.98	5.20	35.3	5.34	0.4	-2.5
5900	35.4	16.02	5.26	35.3	5.40	0.2	-2.6

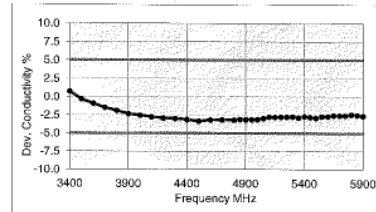
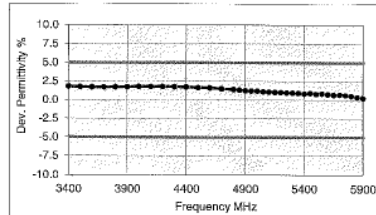



Figure D-4
5GHz Head Tissue Equivalent Matter

FCC ID: PY7PM-0410		SAR EVALUATION REPORT		Reviewed by: Quality Manager
Test Dates: 05/06/13 - 08/01/13	DUT Type: Portable Handset			APPENDIX D: Page 3 of 3

APPENDIX 9: G5 F SYSTEM V5 @-8 5 H=C B

APPENDIX E: SAR SYSTEM VALIDATION

Per FCC KDB 865664 D02v01, SAR system validation status should be documented to confirm measurement accuracy. The SAR systems (including SAR probes, system components and software versions) used for this device were validated against its performance specifications prior to the SAR measurements. Reference dipoles were used with the required tissue- equivalent media for system validation, according to the procedures outlined in IEEE 1528-2003 and FCC KDB 865664 D01 v01. Since SAR probe calibrations are frequency dependent, each probe calibration point was validated at a frequency within the valid frequency range of the probe calibration point, using the system that normally operates with the probe for routine SAR measurements and according to the required tissue-equivalent media.

A tabulated summary of the system validation status including the validation date(s), measurement frequencies, SAR probes and tissue dielectric parameters has been included.

Table E-I
SAR System Validation Summary

SAR SYSTEM #	FREQ. [MHz]	DATE	PROBE SN	PROBE TYPE	PROBE CAL. POINT		COND.	PERM.	CW VALIDATION			MOD. VALIDATION		
							(σ)	(ε)	SENSI-TIVITY	PROBE LINEARITY	PROBE ISOTROPY	MOD. TYPE	DUTY FACTOR	PAR
D	835	10/17/2012	3288	ES3DV3	835	Head	0.899	42.07	PASS	PASS	PASS	GMSK	PASS	N/A
E	1750	3/13/2013	3920	EX3DV4	1750	Head	1.386	38.47	PASS	PASS	PASS	N/A	N/A	N/A
A	1900	1/29/2013	3589	EX3DV4	1900	Head	1.437	38.10	PASS	PASS	PASS	GMSK	PASS	N/A
E	1900	3/5/2013	3920	EX3DV4	1900	Head	1.410	38.62	PASS	PASS	PASS	GMSK	PASS	N/A
B	2450	1/30/2013	3287	ES3DV3	2450	Head	1.857	37.79	PASS	PASS	PASS	OFDM	N/A	PASS
C	2450	11/9/2012	3022	ES3DV2	2450	Head	1.874	38.23	PASS	PASS	PASS	OFDM	N/A	PASS
C	2600	5/10/2013	3022	ES3DV2	2600	Head	2.007	39.36	PASS	PASS	PASS	TDD	PASS	N/A
E	5200	3/21/2013	3920	EX3DV4	5200	Head	4.529	35.64	PASS	PASS	PASS	OFDM	N/A	PASS
E	5300	3/21/2013	3920	EX3DV4	5300	Head	4.638	35.52	PASS	PASS	PASS	OFDM	N/A	PASS
E	5500	3/28/2013	3920	EX3DV4	5500	Head	4.813	34.07	PASS	PASS	PASS	OFDM	N/A	PASS
E	5600	3/22/2013	3920	EX3DV4	5600	Head	4.916	35.05	PASS	PASS	PASS	OFDM	N/A	PASS
E	5800	3/22/2013	3920	EX3DV4	5800	Head	5.108	34.76	PASS	PASS	PASS	OFDM	N/A	PASS
G	835	3/26/2013	3209	ES3DV3	835	Body	1.006	54.42	PASS	PASS	PASS	GMSK	PASS	N/A
B	1750	1/28/2013	3287	ES3DV3	1750	Body	1.524	52.77	PASS	PASS	PASS	N/A	N/A	N/A
E	1900	3/5/2013	3920	EX3DV4	1900	Body	1.574	52.42	PASS	PASS	PASS	GMSK	PASS	N/A
C	1900	10/22/2012	3022	ES3DV2	1900	Body	1.532	52.48	PASS	PASS	PASS	GMSK	PASS	N/A
B	1900	1/29/2013	3287	ES3DV3	1900	Body	1.570	51.00	PASS	PASS	PASS	GMSK	PASS	N/A
C	2450	11/8/2012	3022	ES3DV2	2450	Body	2.038	51.10	PASS	PASS	PASS	OFDM	N/A	PASS
C	2600	5/9/2013	3022	ES3DV2	2600	Body	2.252	52.36	PASS	PASS	PASS	TDD	PASS	N/A
A	5200	1/23/2013	3589	EX3DV4	5200	Body	5.292	47.85	PASS	PASS	PASS	OFDM	N/A	PASS
A	5300	1/23/2013	3589	EX3DV4	5300	Body	5.477	47.47	PASS	PASS	PASS	OFDM	N/A	PASS
A	5500	1/23/2013	3589	EX3DV4	5500	Body	5.729	47.03	PASS	PASS	PASS	OFDM	N/A	PASS
A	5600	1/23/2013	3589	EX3DV4	5600	Body	6.233	46.20	PASS	PASS	PASS	OFDM	N/A	PASS
A	5800	1/23/2013	3589	EX3DV4	5800	Body	6.233	46.20	PASS	PASS	PASS	OFDM	N/A	PASS

Table E-II
SAR System Validation Summary: Extremity SAR Considerations

SAR SYSTEM #	FREQ. [MHz]	DATE	PROBE SN	PROBE TYPE	PROBE CAL. POINT		COND.	PERM.	CW VALIDATION			MOD. VALIDATION		
							(σ)	(ε)	SENSI-TIVITY	PROBE LINEARITY	PROBE ISOTROPY	MOD. TYPE	DUTY FACTOR	PAR
B	1750	6/24/2013	3287	ES3DV3	1750	Body	1.451	50.97	PASS	PASS	PASS	N/A	N/A	N/A
E	1900	4/30/2013	3920	EX3DV4	1900	Body	1.565	52.51	PASS	PASS	PASS	GMSK	PASS	N/A
A	5200	3/11/2013	3589	EX3DV4	5200	Body	5.268	48.58	PASS	PASS	PASS	OFDM	N/A	PASS
A	5300	3/11/2013	3589	EX3DV4	5300	Body	5.405	48.31	PASS	PASS	PASS	OFDM	N/A	PASS
A	5500	3/11/2013	3589	EX3DV4	5500	Body	5.703	47.90	PASS	PASS	PASS	OFDM	N/A	PASS
A	5600	3/11/2013	3589	EX3DV4	5600	Body	5.875	47.66	PASS	PASS	PASS	OFDM	N/A	PASS
A	5800	3/11/2013	3589	EX3DV4	5800	Body	6.160	47.11	PASS	PASS	PASS	OFDM	N/A	PASS

NOTE: All measurements were performed using probes calibrated for CW signals only. Modulations in the table above represent test configurations for which the measurement system has been validated per FCC KDB Publication 865664 D01v01. SAR systems were validated for modulated signals with a periodic duty cycle, such as GMSK, or with a high peak to average ratio (>5 dB), such as OFDM according to KDB 865664.

FCC ID: PY7PM-0410	 PCTEST <small>PROBATION CONSULTANTS, INC.</small>	SAR EVALUATION REPORT	SONY	Reviewed by: Quality Manager
Test Dates: 05/06/13 - 08/01/13	DUT Type: Portable Handset			APPENDIX E: Page 1 of 1