



**FCC PART 15
TEST REPORT
No. 2013WLN0649**

for

Sony Mobile Communications (China) Co. Ltd

GSM/UMTS/LTE mobile phone

Type: PM-0350-BV

With

FCC ID: PY7PM-0350

Hardware Version: A

Software Version: 12.0.A.1.18

Issued Date: 2013-04-27



Note:

The test results in this test report relate only to the devices specified in this report. This report shall not be reproduced except in full without the written approval of TMC Beijing.

Test Laboratory:

TMC Beijing, Telecommunication Metrology Center of Ministry of Industry and Information Technology

Shouxiang Science Building, No 51, Xueyuan Road, Haidian District, Beijing, P.R.China 100191

Tel: +86(0)10-62304633-2561, Fax: +86(0)10-62304633-2504 Email:welcome@emcite.com. www.emcite.com

CONTENTS

CONTENTS	2
1. TEST LATORATORY	3
1.1. TESTING LOCATION.....	3
1.2. TESTING ENVIRONMENT.....	3
1.3. PROJECT DATA	3
1.4. SIGNATURE	3
2. CLIENT INFORMATION	4
2.1. APPLICANT INFORMATION.....	4
2.2. MANUFACTURER INFORMATION.....	4
3. EQUIPMENT UNDER TEST (EUT) AND ANCILLARY EQUIPMENT(AE)	5
3.1. ABOUT EUT	5
3.2. INTERNAL IDENTIFICATION OF EUT USED DURING THE TEST.....	5
3.3. GENERAL DESCRIPTION	5
4. REFERENCE DOCUMENTS	6
4.1. DOCUMENTS SUPPLIED BY APPLICANT.....	6
4.2. REFERENCE DOCUMENTS FOR TESTING	6
5. LABORATORY ENVIRONMENT	6
6. SUMMARY OF TEST RESULTS	6
6.1. SUMMARY OF TEST RESULTS	6
6.2. STATEMENTS.....	7
7. TEST EQUIPMENTS UTILIZED	7
ANNEX A: MEASUREMENT RESULTS	8
A.1. MEASUREMENT METHOD	8
A.2. CHANNEL MOVE TIME AND CHANNEL CLOSING TRANSMISSION TIME	9
A.3. NON-OCCUPANCY PERIOD.....	11
A3.1 NON-ASSOCIATED TEST	11
A3.2 ASSOCIATED TEST	12
ANNEX B: PHOTOGRAPHS OF THE TEST SET-UP	13
ANNEX C: PHOTOGRAPHS OF THE EUT	14

1. TEST LATORATORY

1.1. Testing Location

Company Name: TMC Beijing, Telecommunication Metrology Center of MIIT
Address: No 52 Hua Yuanbei Road, Haidian District, Beijing, P.R.China
Postal Code: 100191
Telephone: 008610623046332561
Fax: 008610623046332504

1.2. Testing Environment

Normal Temperature: 15-30℃
Extreme Temperature: -20/+55℃
Relative Humidity: 30-60%
Air Pressure 990hPa-1040hPa

Note:The climatic requirements above are general exclude the special requirements for dedicated test environments listed in section 5 and some specific test cases in other parts of this report.

1.3. Project data

Project Leader: SunZhenyu
Testing Start Date: 2013-01-28
Testing End Date: 2013-03-13

1.4. Signature

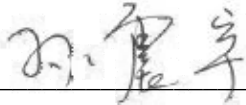

Sun Zhenyu

(Prepared this test report)



Gao Hong

(Reviewed this test report)

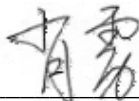

Xiao Li

Deputy Director of the laboratory

(Approved this test report)

2. CLIENT INFORMATION

2.1. Applicant Information

Company Name: Sony Mobile Communications (China) Co. Ltd
Address /Post: Sony Mobile R&D Center, No. 16, Guangshun South Street,
Chaoyang District
City: Beijing
Postal Code: 100102
Country: China
Contact: Ma, Gang
Telephone: +86-10-58656312
Fax: +86-10-58659049

2.2. Manufacturer Information

Company Name: Sony Mobile Communications (China) Co. Ltd
Address /Post: Sony Mobile R&D Center, No. 16, Guangshun South Street,
Chaoyang District
City: Beijing
Postal Code: 100102
Country: China
Contact: Ma, Gang
Telephone: +86-10-58656312
Fax: +86-10-58659049

3. EQUIPMENT UNDER TEST (EUT) AND ANCILLARY EQUIPMENT(AE)

3.1. About EUT

Description	GSM 850/900/1800/1900, GPRS, EDGE, WCDMA FDD Band 1/5/8, HSDPA, HSUPA, LTE FDD Band 1/3/5/7/8/20, Bluetooth EDR & BLE, WLAN (802.11 a/b/g/n), FM, NFC, GPS receiver mobile phone
Type	PM-0350-BV
FCC ID	PY7PM-0350
WLAN Frequency Range	ISM Band: -5250MHz~5350MHz -5470MHz~5725MHz
Type of modulation	OFDM
Number of Channels	15
GSM Frequency Band	GSM 850/900/1800/1900
UMTS Frequency Band	FDD Band 1 / FDD Band 5 / FDD Band 8
LTE Frequency Band	FDD Band 1 / FDD Band 3 / FDD Band 5 / FDD Band 7 / FDD Band 8 / FDD Band 20
Antenna	Integral Antenna
MAX E.I.R.P.	8.01dBm(OFDM)
MIN E.I.R.P.	0.56dBm(OFDM)
Extreme Temperature	-20/+55°C
Normal Voltage	3.7V
Extreme Low Voltage	3.5V
Extreme High Voltage	4.1V

Note1: Photographs of EUT are shown in ANNEX C of this test report. Components list, please refer to documents of the manufacturer; it is also included in the original test record of Telecommunication Metrology Center of MIIT of People's Republic of China.

Note2:The E.I.R.P. measurement is performed with 15.407, which report number is 2013WLN0647 and applied with this report together

3.2. Internal Identification of EUT used during the test

EUT ID*	S/N	IMEI	HW Version	SW Version
EUT1	CB5123BN1N	004402450616077	A	12.0.A.1.18

*EUT ID: is used to identify the test sample in the lab internally.

3.3. General Description

The Equipment Under Test (EUT) is a model of GSM/UMTS/LTE mobile phone with

integrated antenna and inbuilt Li-Polymer battery.

The EUT supports GSM 850/900/1800/1900MHz bands, WCDMA FDD bands 1/5/8 and LTE FDD bands 1/3/5/7/8/20. It also supports GPRS service with multi-slots class 33 and EGPRS service with multi-slots class 33 too. The HSDPA and HSUPA features are also supported.

It has MP3, camera, FM radio, USB memory, GPS receiver, NFC, Mobile High-Definition Link (MHL), Bluetooth (EDR and Bluetooth 4.0), WLAN (802.11 a/b/g/n) and Wi-Fi hotspot functions.

It consists of normal options: Inbuilt li-Polymer battery and USB cable.

Manual and specifications of the EUT were provided to fulfil the test.

Samples undergoing test were selected by the client.

4. REFERENCE DOCUMENTS

4.1. Documents supplied by applicant

EUT feature information is supplied by the applicant or manufacturer, which is the basis of testing.

4.2. Reference Documents for testing

The following documents listed in this section are referred for testing.

FCC Part15	Title 47 of the Code of Federal Regulations; Chapter I Part 15 - Radio frequency devices Subpart E – UNII Devices	Oct, 2012
------------	-------------------------------------------------------------------------------------------------------------------------	--------------

5. LABORATORY ENVIRONMENT

Shielding Room1 (6.0 metersx3.0 metersx2.7 meters) did not exceed following limits along the conducted RF performance testing:

Temperature	Min. = 15 °C, Max. = 30 °C
Relative humidity	Min. = 30 %, Max. = 60 %
Shielding effectiveness	> 110 dB
Ground system resistance	< 0.5 Ω
Uniformity of field strength	Between 0 and 6 dB, from 80MHz to 3000 MHz

6. SUMMARY OF TEST RESULTS

6.1. Summary of Test Results

SUMMARY OF MEASUREMENT RESULTS	Sub-clause of Part15E	Verdict
Channel move time and channel closing transmission time	15.407 (h)(2)(iii)	P
Non-Occupancy Period	15.407 (h)(2) (iv)	P

Please refer to **ANNEX A** for detail.

Terms used in Verdict column

P	Pass, The EUT complies with the essential requirements in the standard.
NM	Not measured, The test was not measured by TMC
NA	Not Applicable, The test was not applicable
F	Fail, The EUT does not comply with the essential requirements in the standard

6.2. Statements

TMC has evaluated the test cases requested by the client/manufacturer as listed in section 6.1 of this report for the EUT specified in section 3 according to the standards or reference documents listed in section 4.1.

This report only deal with the UNII DFS functions among the features described in section 3, and The EUT met all requirements of the reference documents.

End user has no way to get the parameters of the detected Radar Waveforms in this product.

Test Conditions

T nom	Normal Temperature
T min	Low Temperature
T max	High Temperature
V nom	Normal Voltage
V min	Low Voltage
V max	High Voltage
H nom	Norm Humidity
A nom	Norm Air Pressure

For this report, all the test case listed above is tested under Normal Temperature and Normal Voltage, and also under norm humidity, the specific conditions as following:

Temperature	T nom	26°C
Voltage	V nom	3.7V(By battery)
Humidity	H nom	44%
Air Pressure	A nom	1010hPa

7. TEST EQUIPMENTS UTILIZED

Conducted test system

No.	Equipment	Model	Serial Number	Manufacturer	Calibration Due date
1	Vector Signal Analyzer	FSQ40	200089	Rohde & Schwarz	2013-07-19
2	Vector Signal General	SMU200A	103752	Rohde & Schwarz	2013-07-19

Anechoic chamber

Fully anechoic chamber by Frankonia German.

ANNEX A: MEASUREMENT RESULTS

A.1. Measurement Method

A.1.1. Conducted Measurements

The below figure shows the DFS setup, where the EUT is a RLAN device operating in slave mode, without Radar Interference Detection function. This setup also contains a device operating in master mode. The radar test signals are injected into the master device. The EUT (slave device) is associated with the master device.

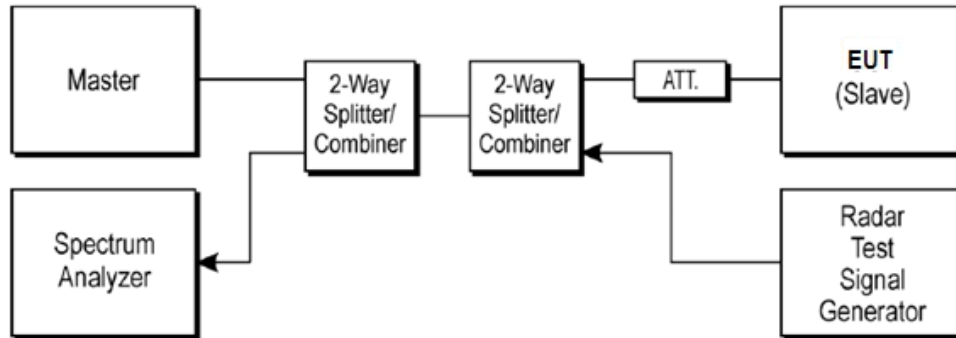

Note:

- 1) All Measurements are performed with the EUT's narrowest channel bandwidth.
- 2) The master device information is as follows

Vendor: Cisco

Model: AIR-AP1252AG-A-K9

FCC ID: LDK102061, 1DK102062

A.1.2. Parameters of DFS test signal

1. Interference threshold values, master or client incorporation in service monitoring

Maximum Transmit Power	Value
> 200 mW	-64 dBm
< 200 mW	-62 dBm

2. DFS requirement values

Parameter	Value
Non-occupancy	> 1800 s
Channel Availability Check Time	60 s
Channel Move Time	10 s
Channel Closing Transmission Time	200 ms + 60 ms
U-NII Detection Bandwidth	Minimum 80% of the 99% transmission power bandwidth

A.1.3. Measurement Uncertainty

Item	Measurement Uncertainty
Time	0.70 ms
Power	0.75 dBm

A.2. Channel move time and channel closing transmission time

Measurement Limit:

Test Items	Limit
channel closing transmission time	< 200 ms + 60 ms
Channel move time	< 10 s

Measurement Results:

Channel 64:

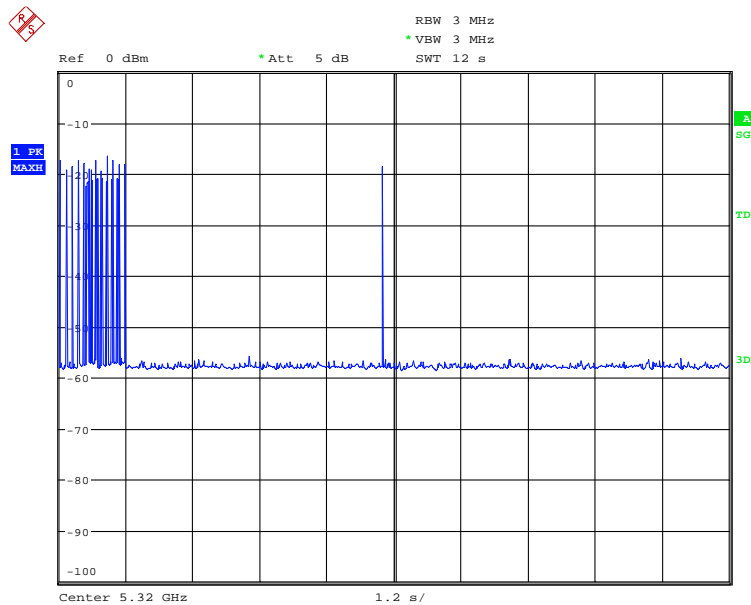

Date: 11.MAR.2013 20:53:14

The figure shows the time of the radar and the client pulses. On the figure, no transmissions occur from the master device after sending the radar burst. And the channel closing transmission time after 200ms of the slave device is less than 60ms.

Conclusion: PASS

Channel 116:

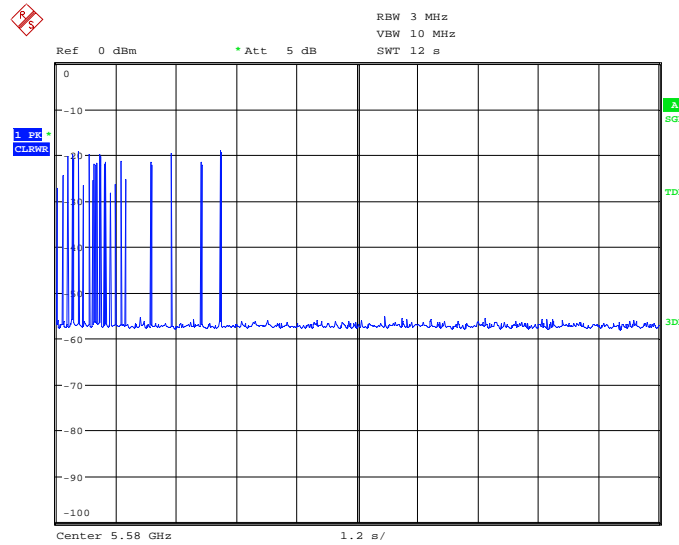

Date: 13.MAR.2013 19:47:30

The figure shows the time of the radar and the client pulses. On the figure, no transmissions occur from the master device after sending the radar burst. And the channel closing transmission time after 200ms of the slave device is less than 60ms.

Conclusion: PASS

A.3. Non-Occupancy Period

Measurement Limit:

Test Items	Limit
Non-Occupancy Period	> 1800 s

A3.1 Non-associated test

Turn off the master, monitor the analyzer on operating frequency which has been selected to be test. Power up the client for 1800 seconds to make sure no beacons transmitted.

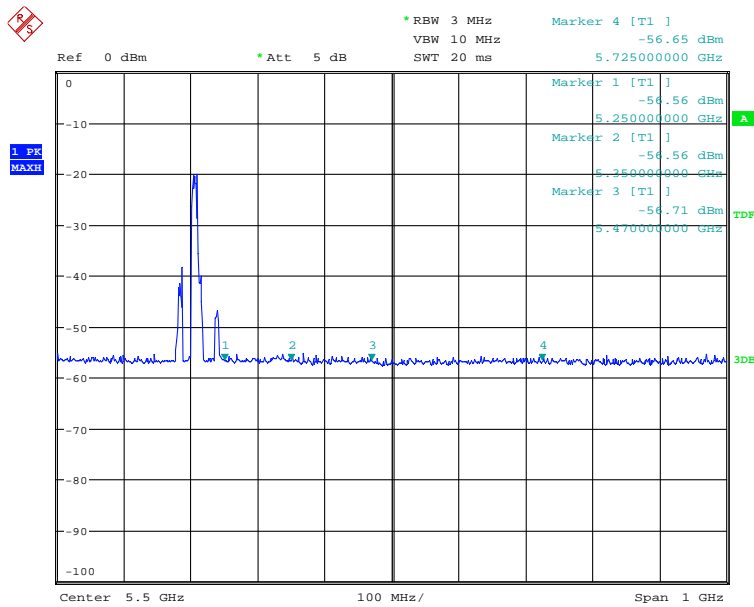

Date: 12.MAR.2013 11:30:27

The figure above shows that no transmissions over a period of 1800 seconds occur within the DFS-Bands.

A3.2 Associated test

Associate the master and client, transmit specified stream between the master and client; monitor the analyzer on the operating frequency to make sure no beacons have been transmitted for 1800 seconds.

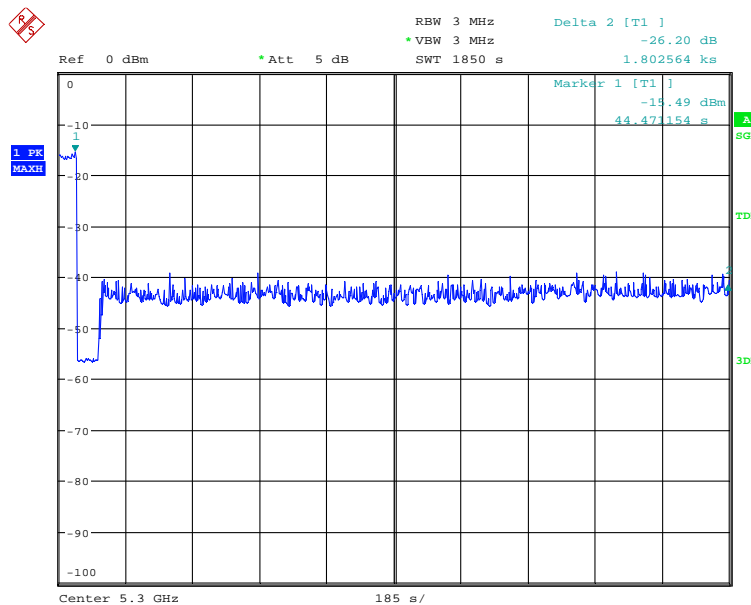

Date: 11.MAR.2013 18:45:42

The figure above shows that the client does not transmit any emission within 1800 seconds after getting the order of “stop transmits” from the DFS master (access point).

Conclusion: PASS

ANNEX B: PHOTOGRAPHS OF THE TEST SET-UP**Layout of Conducted Test**

ANNEX C: PHOTOGRAPHS OF THE EUT

External Photo



EUT Photo



EUT Photo



Label of Mobile Phone

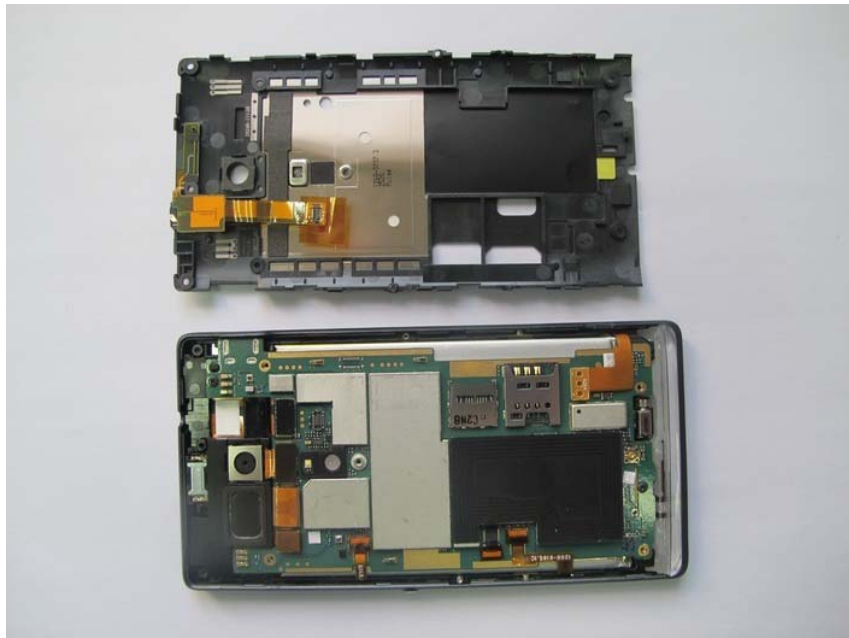

Mobile Phone Disassembly



Mobile Phone Disassembly



Mobile Phone Disassembly



Mobile Phone Disassembly

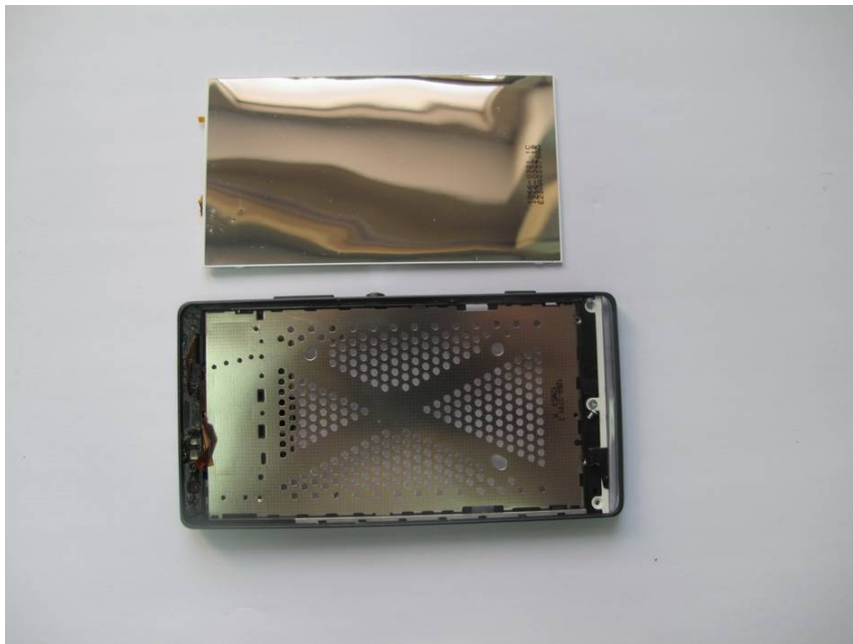

Mobile Phone Disassembly



Inbuilt Li-Polymer Battery

***** END OF REPORT BODY *****