



FCC/IC RF TEST REPORT

47 CFR FCC Part 15 Subpart C § 15.249

IC RSS-210 A2.9

Equipment : Smart phone
BRAND NAME : SONY
Type NAME : PM-0385-BV
FCC ID : PY7PM-0385

We, SPORTON INTERNATIONAL INC., would like to declare that the tested sample has been evaluated in accordance with the test procedures and has been in compliance with the applicable technical standards.

The test results in this report apply exclusively to the tested model / sample. Without written approval of SPORTON INTERNATIONAL INC., the test report shall not be reproduced except in full.

Reviewed by: Joseph Lin / Supervisor

Approved by: Jones Tsai / Manager



SPORTON INTERNATIONAL INC.

No. 52, Hwa Ya 1st Rd., Hwa Ya Technology Park, Kwei-Shan Hsiang, Tao Yuan Hsien, Taiwan, R.O.C.



Table of Contents

1. SUMMARY OF THE TEST RESULT 3
2. GENERAL INFORMATION..... 4
2.1 Applicant 4
2.2 Manufacturer..... 4
2.3 Product Details..... 4
2.4 Table for Test Modes 5
2.5 Table for Testing Locations..... 6
2.6 Table for Supporting Units 6
2.7 Test Configurations 7
3. TEST RESULT 8
3.1 AC Power Line Conducted Emissions Measurement 8
3.2 20dB and & 99% Occupied Bandwidth 14
3.3 Field Strength of Fundamental Emissions and Radiated Spurious Emissions 17
3.4 Antenna Requirements 28
4. LIST OF MEASURING EQUIPMENT 29
5. UNCERTAINTY OF EVALUATION 31



REVISION HISTORY

REPORT NO.	VERSION	DESCRIPTION	ISSUED DATE
FR450249E	Rev. 01	Initial issue of report	Jul. 14, 2014
FR450249E	Rev. 02	Update EUT Information List for SW version change as 18.4.C.1.10	Aug. 01, 2014



1. SUMMARY OF THE TEST RESULT

Applied Standard:					
Part	FCC Rule	IC Rule	Description of Test	Result	Under Limit
3.1	15.207	RSS-GEN 7.2.4	AC Power Line Conducted Emissions	Complies	11.90 dB at 2.630MHz
3.2	2.1049	RSS-GEN 4.6.1	20dB & 99% Occupied Bandwidth	Complies	-
3.3	15.249(a)	RSS-210 A2.9	Field Strength of Fundamental Emissions	Complies	16.31 dB at 2402.000MHz
3.4	15.249(a)(d)	RSS-210 A2.9	Radiated Spurious Emissions	Complies	9.93 dB at 30.540MHz
3.5	15.203	-	Antenna Requirements	Complies	-



2. GENERAL INFORMATION

2.1 Applicant

Sony Mobile Communications Inc.
Nya Vattentornet, 22188 Lund, Sweden

2.2 Manufacturer

Arima Communication Corp.
6F, No. 866, Jhongjheng Rd., Jhonghe Dist., New Taipei City 23586, Taiwan

2.3 Product Details

For more detailed features description, please refer to the manufacturer's specifications or user's manual.

Items	Description
Modulation	GFSK
Channel Bandwidth (99%)	1.011MHz
Max. Field Strength (Peak)	97.69dBµV/m
Max. Field Strength (Average)	61.21dBµV/m
ANT+ Channel Number	79
ANT+ Frequency Range	2402-2480MHz

EUT Information List				
IMEI	HW Version	SW Version	S/N	Performed Test Item
IMEI : 004402452636586	A	18.4.C.1.10	ZL4416D28274	RF conducted measurement
IMEI : 004402452638509			WUJ01AYKJ8	Radiated Spurious Emission
IMEI : 004402452636123			ZL4416D28653	Conducted Emission



Accessory List	
AC Adapter	Model No. : EP800
	Type No. : CAA-0002016-US B
	S/N : 3113W45408465 (for Radiated Spurious Emission) 3113W45408551 (for AC Conducted Emission)
Battery	Model No. : LIS1551ERPC
Earphone	Model No. : MH410c
	Type No. : AG-1100
	S/N : 13511E5B0076390 (for Radiated Spurious Emission) 13511E5B00763EC (for AC Conducted Emission)
USB Cable	Model No. : EC450
	Type No. : AI-0700
	S/N : 134912DC0004380 (for Radiated Spurious Emission) 134912D80008076 (for AC Conducted Emission)

Note:

1. Above EUT list and accessory list used are electrically identical per declared by manufacturer.
2. Above the accessories list are used to exercise the EUT during test.
3. For other wireless features of this EUT, test report will be issued separately.

2.4 Table for Test Modes

Investigation has been done on all the possible configurations for searching the worst cases. The following table is a list of the test modes shown in this test report.

Test Items	Mode
AC Power Line Conducted Emissions	CTX
Field Strength of Fundamental Emissions	CTX
Bandwidth	CTX
Radiated Emissions	CTX

Note:

1. CTX=continuously transmitting.
2. The programmed RF utility, "QRCT Tool" installed in the notebook to make the EUT get into the engineering modes to continuously transmit.



2.5 Table for Testing Locations

Sporton Lab is accredited to ISO 17025 by Taiwan Accreditation Foundation (TAF code : 1190) and the FCC designation No. TW1022 under the FCC 2.948(e) by Mutual Recognition Agreement (MRA) in FCC Test.

Test Site	SPORTON INTERNATIONAL INC.			
Test Site Location	No. 52, Hwa Ya 1 st Rd., Hwa Ya Technology Park, Kwei-Shan Hsiang, Tao Yuan Hsien, Taiwan, R.O.C. TEL: +886-3-3273456 / FAX: +886-3-3284978			
Test Site No.	Sporton Site No.			IC Registration No.
	TH02-HY	CO05-HY	03CH07-HY	4086B-1

2.6 Table for Supporting Units

Item	Equipment	Trade Name	Model Name	FCC ID	Data Cable	Power Cord
1.	System Simulator	R&S	CMU 200	N/A	N/A	Unshielded, 1.8 m
2.	WLAN AP	D-Link	DIR-628	KA2DIR628A2	N/A	Unshielded, 1.8 m
3.	Bluetooth Earphone	Sony	SBH20	PY7-RD0010	Unshielded, 0.75m	N/A
4.	Notebook	DELL	Latitude E6320	FCC DoC/ Contains FCC ID: QDS-BRCM1054	N/A	AC I/P: Unshielded, 1.2 m DC O/P: Shielded, 1.8 m
5.	SD Card	SanDisk	MicroSD HC	FCC DoC	N/A	N/A

2.7 Test Configurations

<AC Conducted Emissions>

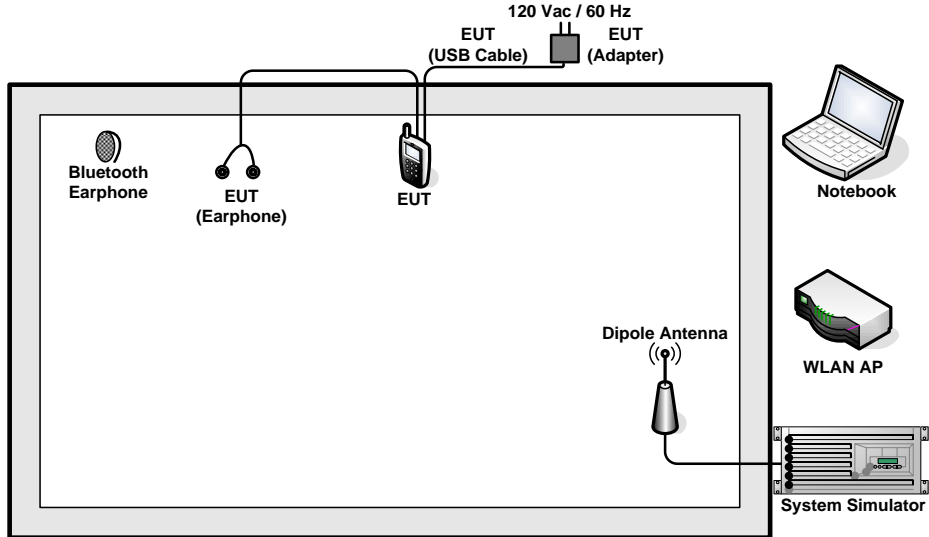

<Radiated Spurious Emissions>

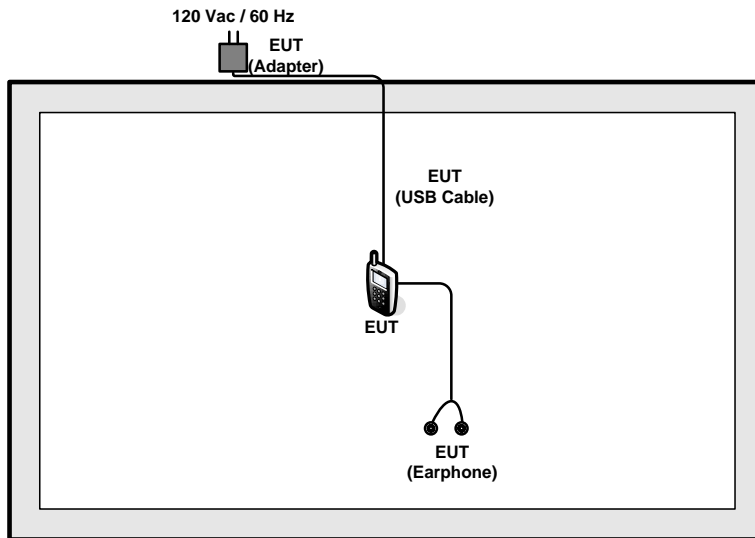



3. TEST RESULT

3.1 AC Power Line Conducted Emissions Measurement

3.1.1 Limit

For a Low-power Radio-frequency device which is designed to be connected to the AC power line, the radio frequency voltage that is conducted back onto the AC power line on any frequency or frequencies within the band 150 kHz to 30 MHz shall not exceed below limits table.

Frequency (MHz)	QP Limit (dBµV)	AV Limit (dBµV)
0.15~0.5	66~56	56~46
0.5~5	56	46
5~30	60	50

3.1.2 Measuring Instruments

The measuring equipment is listed in the section 4 of this test report.

3.1.3 Test Procedures

1. Configure the EUT according to ANSI C63.4. The EUT or host of EUT has to be placed 0.4 meter far from the conducting wall of the shielding room and at least 80 centimeters from any other grounded conducting surface.
2. Connect EUT or host of EUT to the power mains through a line impedance stabilization network (LISN).
3. All the support units are connected to the other LISNs. The LISN should provide 50uH/50ohms coupling impedance.
4. The frequency range from 150 kHz to 30 MHz was searched.
5. Set the test-receiver system to Peak Detect Function and Specified Bandwidth with Maximum Hold Mode.
6. The measurement has to be done between each power line and ground at the power terminal.

3.1.4 Test Setup Layout

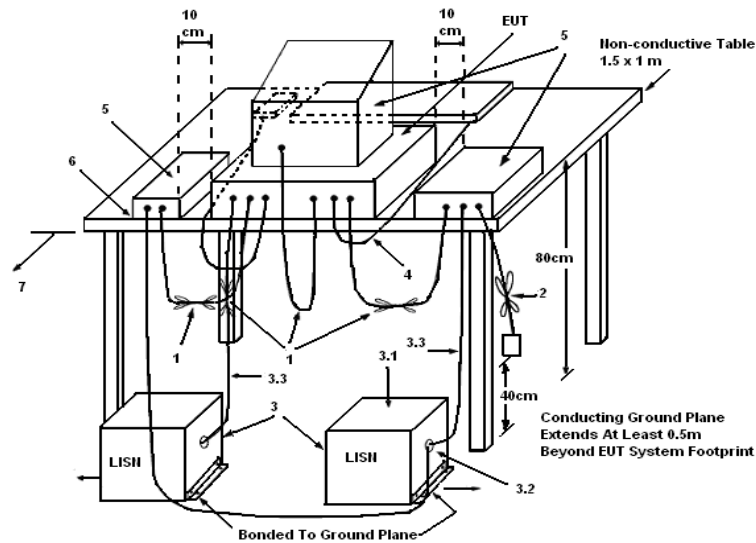

LEGEND:

- (1) Interconnecting cables that hang closer than 40 cm to the ground plane shall be folded back and forth in the center forming a bundle 30 to 40 cm long.
- (2) I/O cables that are not connected to a peripheral shall be bundled in the center. The end of the cable may be terminated, if required, using the correct terminating impedance. The overall length shall not exceed 1 m.
- (3) EUT connected to one LISN. Unused LISN measuring port connectors shall be terminated in 50 Ω. LISN can be placed on top of, or immediately beneath, reference ground plane.
- (3.1) All other equipment powered from additional LISN(s).
- (3.2) Multiple outlet strip can be used for multiple power cords of non-EUT equipment.
- (3.3) LISN at least 80 cm from nearest part of EUT chassis.
- (4) Cables of hand-operated devices, such as keyboards, mice, etc., shall be placed as for normal use.
- (5) Non-EUT components of EUT system being tested.
- (6) Rear of EUT, including peripherals, shall all be aligned and flush with rear of tabletop.
- (7) Rear of tabletop shall be 40 cm removed from a vertical conducting plane that is bonded to the ground plane.

3.1.5 Test Deviation

There is no deviation with the original standard.

3.1.6 EUT Operation during Test

The EUT was placed on the test table and programmed in transmitting function.

3.1.7 Results of AC Power Line Conducted Emissions Measurement

Test Date	May 20, 2014	Test Site No.	CO05-HY
Temperature	20~22°C	Humidity	46~48%
Test Engineer	Kai-Chun Chu	Configuration	ANT+ Transmitting Mode
Mode	GSM850 Idle + Bluetooth Link + WLAN Link + ANT+ Tx + Earphone + USB Cable (Charging from Adapter) + Battery		

Line

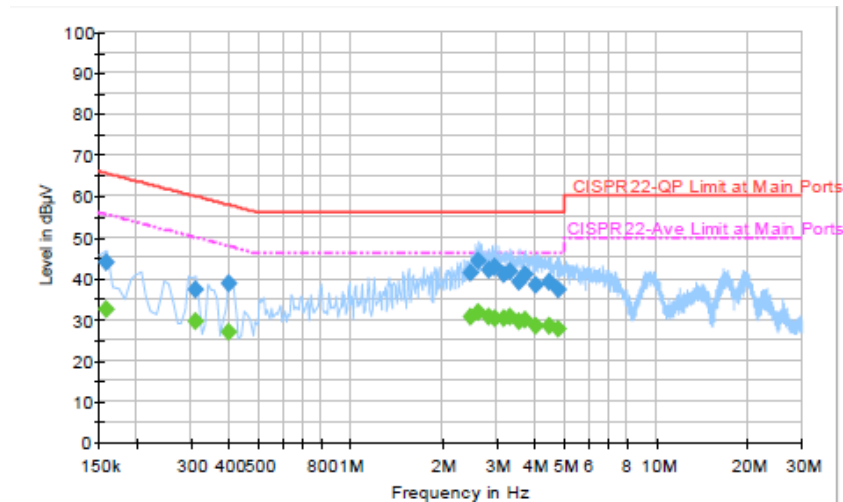

Final Result: Quasi-Peak

Frequency (MHz)	Quasi-Peak (dBµV)	Filter	Line	Corr. (dB)	Margin (dB)	Limit (dBµV)
0.158000	43.8	Off	L1	19.3	21.8	65.6
0.310000	37.3	Off	L1	19.3	22.7	60.0
0.398000	38.6	Off	L1	19.3	19.3	57.9
2.478000	41.4	Off	L1	19.5	14.6	56.0
2.630000	44.1	Off	L1	19.5	11.9	56.0
2.822000	42.0	Off	L1	19.6	14.0	56.0
2.974000	42.8	Off	L1	19.6	13.2	56.0
3.166000	41.1	Off	L1	19.6	14.9	56.0
3.318000	41.6	Off	L1	19.6	14.4	56.0
3.574000	39.0	Off	L1	19.6	17.0	56.0
3.718000	41.1	Off	L1	19.6	14.9	56.0
4.046000	38.3	Off	L1	19.6	17.7	56.0
4.462000	38.9	Off	L1	19.6	17.1	56.0
4.814000	37.3	Off	L1	19.6	18.7	56.0



Test Date	May 20, 2014	Test Site No.	CO05-HY
Temperature	20~22°C	Humidity	46~48%
Test Engineer	Kai-Chun Chu	Configuration	ANT+ Transmitting Mode
Mode	GSM850 Idle + Bluetooth Link + WLAN Link + ANT+ Tx + Earphone + USB Cable (Charging from Adapter) + Battery		

Line

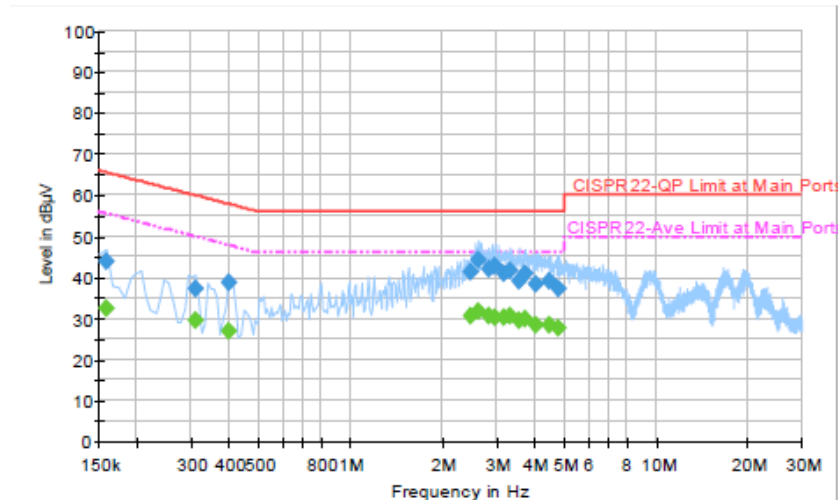

Final Result: Average

Frequency (MHz)	Average (dBµV)	Filter	Line	Corr. (dB)	Margin (dB)	Limit (dBµV)
0.158000	32.6	Off	L1	19.3	23.0	55.6
0.310000	29.7	Off	L1	19.3	20.3	50.0
0.398000	26.9	Off	L1	19.3	21.0	47.9
2.478000	30.7	Off	L1	19.5	15.3	46.0
2.630000	31.8	Off	L1	19.5	14.2	46.0
2.822000	30.5	Off	L1	19.6	15.5	46.0
2.974000	30.3	Off	L1	19.6	15.7	46.0
3.166000	30.1	Off	L1	19.6	15.9	46.0
3.318000	30.7	Off	L1	19.6	15.3	46.0
3.574000	29.4	Off	L1	19.6	16.6	46.0
3.718000	29.9	Off	L1	19.6	16.1	46.0
4.046000	28.3	Off	L1	19.6	17.7	46.0
4.462000	28.4	Off	L1	19.6	17.6	46.0
4.814000	27.7	Off	L1	19.6	18.3	46.0



Test Date	May 20, 2014	Test Site No.	CO05-HY
Temperature	20~22°C	Humidity	46~48%
Test Engineer	Kai-Chun Chu	Configuration	ANT+ Transmitting Mode
Mode	GSM850 Idle + Bluetooth Link + WLAN Link + ANT+ Tx + Earphone + USB Cable (Charging from Adapter) + Battery		

Neutral

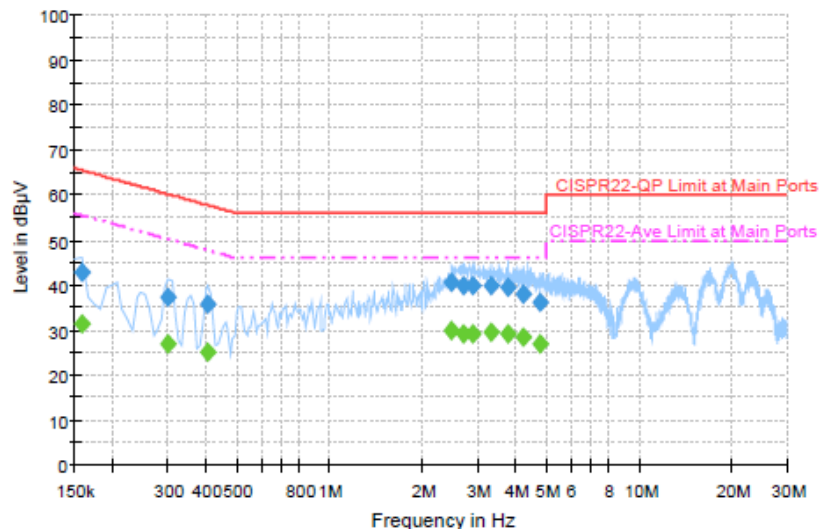

Final Result: Quasi-Peak

Frequency (MHz)	Quasi-Peak (dBµV)	Filter	Line	Corr. (dB)	Margin (dB)	Limit (dBµV)
0.158000	42.8	Off	N	19.3	22.8	65.6
0.302000	37.3	Off	N	19.4	22.9	60.2
0.406000	35.6	Off	N	19.4	22.1	57.7
2.486000	40.5	Off	N	19.6	15.5	56.0
2.702000	40.0	Off	N	19.6	16.0	56.0
2.910000	39.8	Off	N	19.6	16.2	56.0
3.318000	39.9	Off	N	19.6	16.1	56.0
3.782000	39.4	Off	N	19.6	16.6	56.0
4.246000	37.9	Off	N	19.6	18.1	56.0
4.814000	36.3	Off	N	19.6	19.7	56.0



Test Date	May 20, 2014	Test Site No.	CO05-HY
Temperature	20~22°C	Humidity	46~48%
Test Engineer	Kai-Chun Chu	Configuration	ANT+ Transmitting Mode
Mode	GSM850 Idle + Bluetooth Link + WLAN Link + ANT+ Tx + Earphone + USB Cable (Charging from Adapter) + Battery		

Neutral

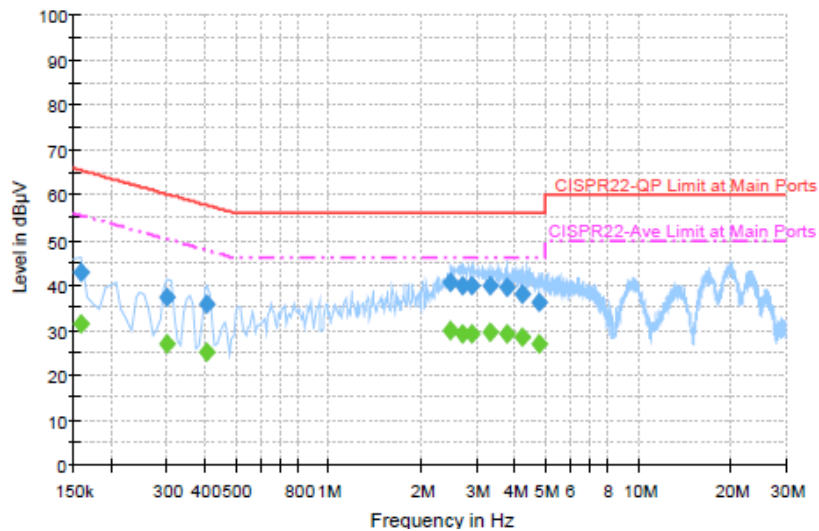

Final Result: Average

Frequency (MHz)	Average (dBµV)	Filter	Line	Corr. (dB)	Margin (dB)	Limit (dBµV)
0.158000	31.3	Off	N	19.3	24.3	55.6
0.302000	27.0	Off	N	19.4	23.2	50.2
0.406000	25.1	Off	N	19.4	22.6	47.7
2.486000	29.8	Off	N	19.6	16.2	46.0
2.702000	29.0	Off	N	19.6	17.0	46.0
2.910000	29.1	Off	N	19.6	16.9	46.0
3.318000	29.6	Off	N	19.6	16.4	46.0
3.782000	29.0	Off	N	19.6	17.0	46.0
4.246000	28.5	Off	N	19.6	17.5	46.0
4.814000	26.8	Off	N	19.6	19.2	46.0

3.2 20dB and & 99% Occupied Bandwidth

3.2.1 Limit

Intentional radiators must be designed to ensure that the 20 dB bandwidth of the emissions in the specific band.

3.2.2 Measuring Instruments

The measuring equipment is listed in the section 4 of this test report.

3.2.3 Test Procedures

1. The transmitter output port was connected to the spectrum analyzer.
2. Measured the spectrum width with highest power setting.

3.2.4 Test Setup Layout

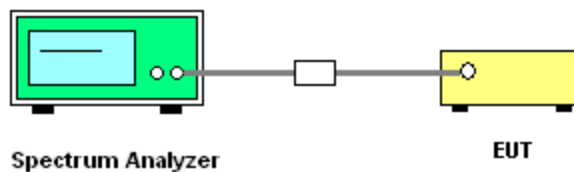

3.2.5 Test Deviation

There is no deviation with the original standard.

3.2.6 EUT Operation during Test

The EUT was programmed to be in continuously transmitting mode.



3.2.7 Test Result of 20dB Spectrum Bandwidth

Final Test Date	May 07, 2014	Test Site No.	TH02-HY
Temperature	24~26°C	Humidity	48~51%
Test Engineer	Osolemio Chang		

Frequency	20dB BW (MHz)	99% OBW (MHz)
2402MHz	1.038	1.011
2441MHz	1.032	1.008
2480MHz	1.038	1.008

20 dB Bandwidth Plot on 2402MHz

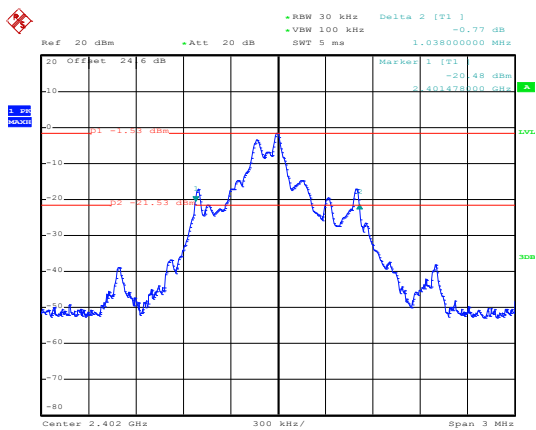

Date: 7.MAY.2014 02:13:41

99% Bandwidth Plot on 2402MHz

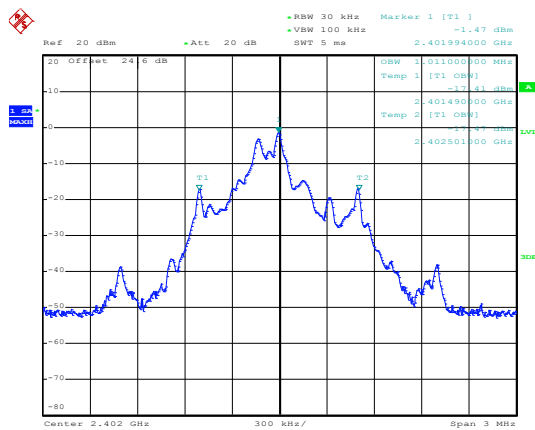

Date: 7.MAY.2014 02:43:37

20 dB Bandwidth Plot on 2441MHz

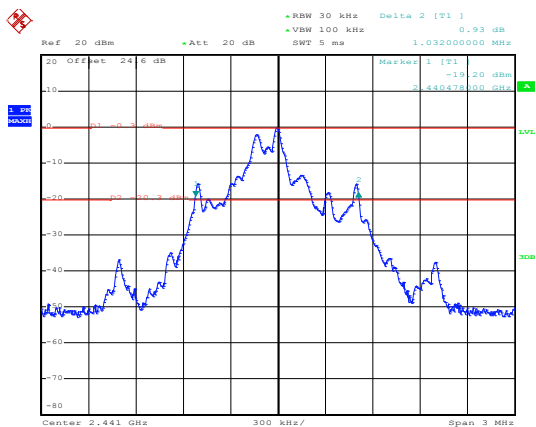

Date: 7.MAY.2014 02:20:44

99% Bandwidth Plot on 2441MHz

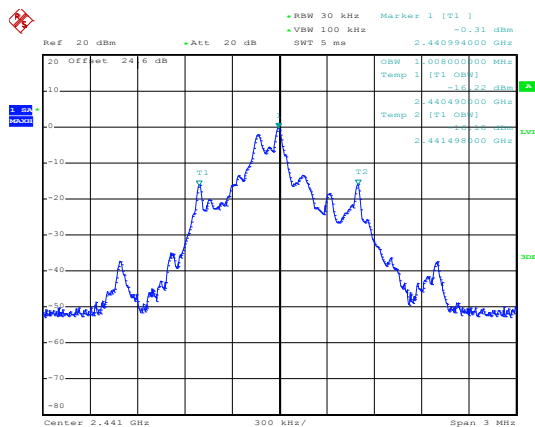

Date: 7.MAY.2014 02:47:20



20 dB Bandwidth Plot on 2480MHz

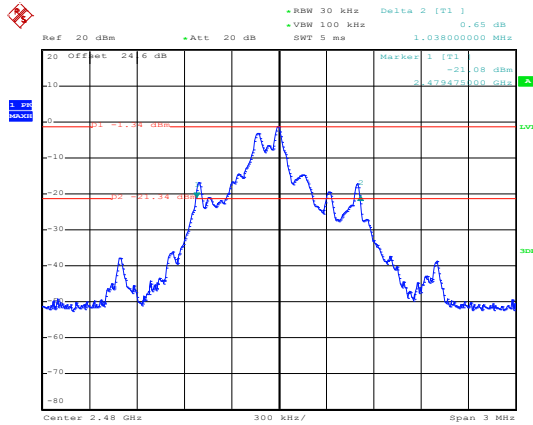

Date: 7.MAY.2014 02:27:17

99% Bandwidth Plot on 2480MHz

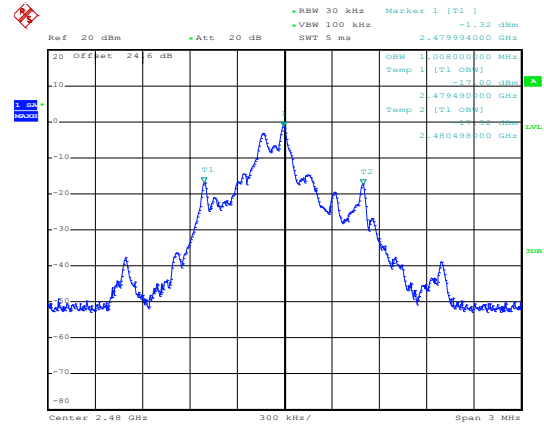

Date: 7.MAY.2014 03:04:16



3.3 Field Strength of Fundamental Emissions and Radiated Spurious Emissions

3.3.1 Limit

The field strength measured at 3 meters shall not exceed the limits in the following table:

Fundamental Frequencies(MHz)	Field Strength(millivolts/m)	
	Fundamental	Harmonics
902~928	50	0.5
2400~2483.5	50	0.5
5725~5875	50	0.5

Note: The limits shown in the above table are based on measurements using an average detector, except for the fundamental emission in the frequency band 902-928 MHz, which is based on measurements using a CISPR quasi-peak detector.

Emissions radiated outside of the specified frequency bands, except for harmonics, shall be attenuated by at least 50 dB below the level of the fundamental or to the general field strength limits listed in 15.209 as below, whichever is less stringent.

Frequency (MHz)	Field Strength (microvolts/meter)	Measurement Distance (meters)
0.009 – 0.490	2400/F(kHz)	300
0.490 – 1.705	24000/F(kHz)	30
1.705 – 30.0	30	30
30 – 88	100	3
88 – 216	150	3
216 - 960	200	3
Above 960	500	3



3.3.2 Measuring Instruments

The measuring equipment is listed in the section 4 of this test report.

3.3.3 Test Procedures

1. The EUT was placed on a turntable with 0.8 meter above ground.
2. The EUT was set 3 meters from the interference receiving antenna, which was mounted on the top of a variable height antenna tower.
3. For each suspected emission, the EUT was arranged to its worst case and then tune the Antenna tower (from 1 m to 4 m) and turntable (from 0 degree to 360 degrees) to find the maximum reading. A pre-amp and a high pass filter are used for the test in order to get better signal level to comply with the guidelines.
4. Set to the maximum power setting and enable the EUT transmit continuously.

Remark:

1. Corrected Reading: Antenna Factor + Cable Loss + Read Level - Preamp Factor = Level
2. For average measurement: use duty cycle correction factor method per 15.35(c).

Duty cycle = On time/100 milliseconds

On time = $N1*L1+N2*L2+...+Nn-1*LNn-1+Nn*Ln$

Where N1 is number of type 1 pulses, L1 is length of type 1 pulses, etc.

Average Emission Level = Peak Emission Level + $20*\log(\text{Duty cycle})$

3.3.4 Test Setup Layout

For radiated emissions below 30MHz

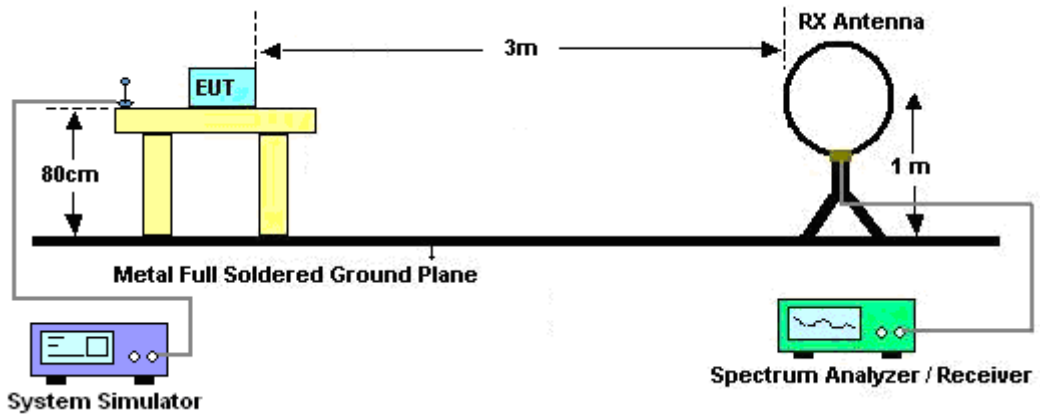

For radiated emissions from 30MHz to 1GHz

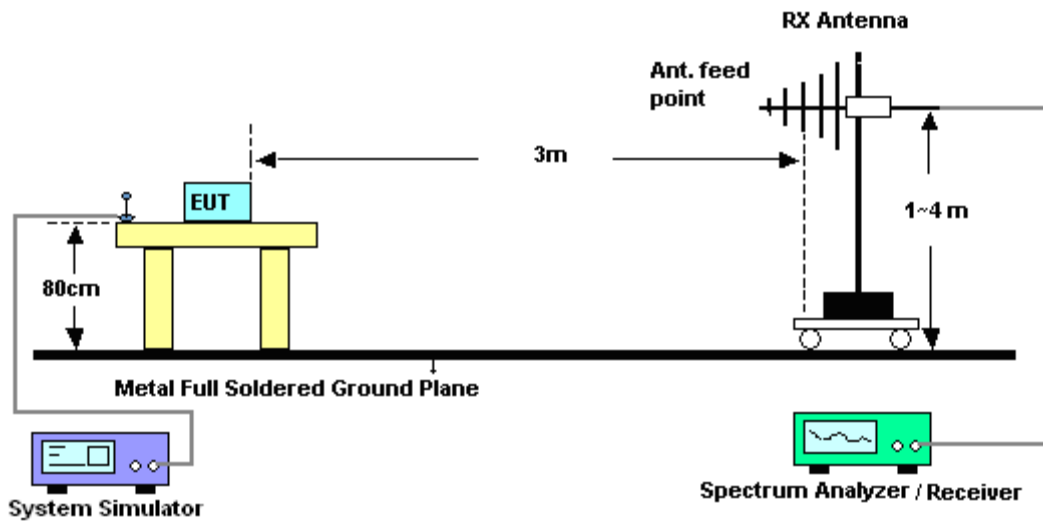

For radiated emissions above 1GHz

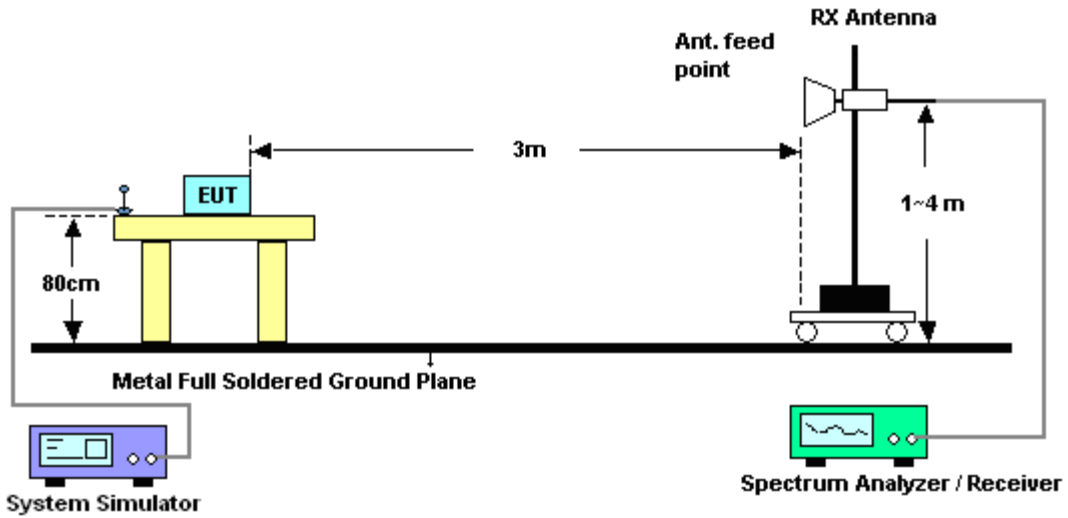

3.3.5 Test Deviation

There is no deviation with the original standard.

3.3.6 EUT Operation during Test

The EUT was programmed to be in continuously transmitting mode.

3.3.7 Test Results of Radiated Spurious Emissions (9 kHz ~ 30 MHz)

The low frequency, which started from 9 kHz to 30MHz, was pre-scanned and the result which was 20dB lower than the limit line per 15.31(o) was not reported.



3.3.8 Duty cycle correction factor for average measurement

On time (One Pulse) Plot on 2441MHz

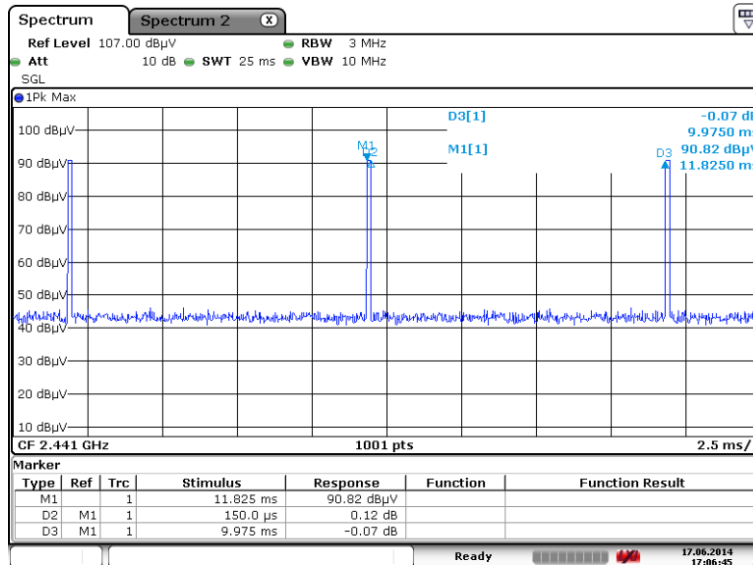

Date: 17.JUN.2014 17:06:45

On time (Count Pulses) Plot on 2441MHz

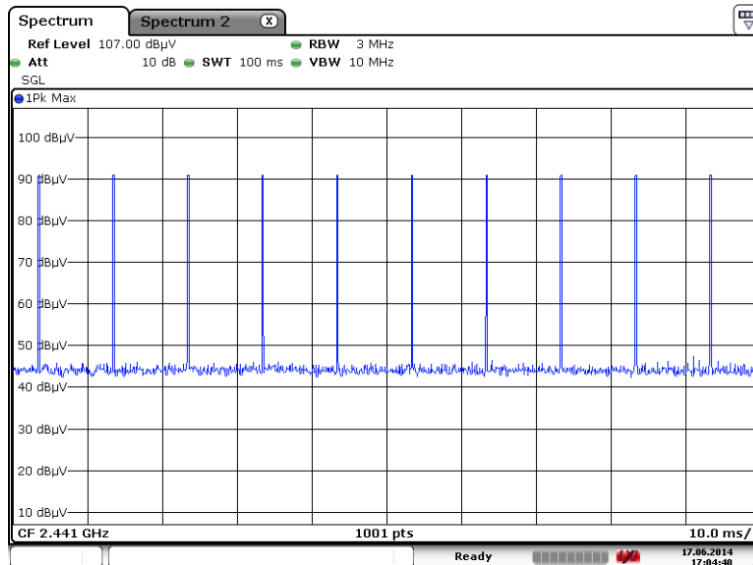

Date: 17.JUN.2014 17:04:40

Note:

1. Worst case Duty cycle = on time/100 milliseconds = $10 * 0.15 / 100 = 1.50 \%$
2. Worst case Duty cycle correction factor = $20 * \log(\text{Duty cycle}) = -36.48 \text{ dB}$



3.3.9 Test Result of Field Strength of Fundamental Emissions and Spurious Emissions

Test Date	Jun. 17, 2014	Test Engineer	Kai Wang
Temperature	21~23°C	Humidity	45~47%

2402MHz

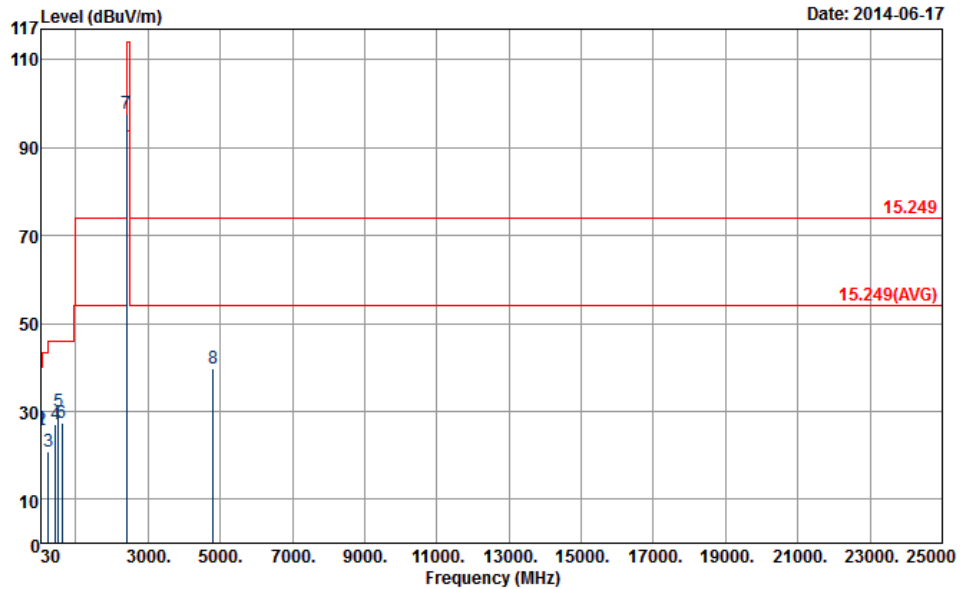

Site : 03CH07-HY
 Condition : 15.249 3m SHF-EHF_131029 HORIZONTAL

	Freq	Level	Over Limit	Limit Line	ReadAntenna Level	Antenna Factor	Cable Loss	Preamp Factor	A/Pos	T/Pos	Remark
	MHz	dBuV/m	dB	dBuV/m	dBuV	dB/m	dB	dB	cm	deg	
1	31.89	26.08	-13.92	40.00	39.19	17.76	0.55	31.42	100	345	Peak
2	48.36	25.87	-14.13	40.00	47.29	9.10	0.68	31.20	---	---	Peak
3	236.82	20.71	-25.29	46.00	39.26	10.94	1.51	31.00	---	---	Peak
4	428.80	26.94	-19.06	46.00	38.58	16.88	2.24	30.76	---	---	Peak
5	521.20	30.06	-15.94	46.00	40.14	18.12	2.49	30.69	---	---	Peak
6	617.80	27.21	-18.79	46.00	34.89	20.14	2.74	30.56	---	---	Peak
7	2402.00	97.69	-16.31	114.00	92.90	32.18	6.91	34.30	120	335	Peak
8	4803.00	39.91	-34.09	74.00	55.87	34.25	8.75	58.96	100	0	Peak

Frequency (MHz)	Level (dBuV/m)	Over Limit (dB)	Limit Line (dBuV/m)	Read Level (dBuV)	Antenna Factor (dB)	Cable Loss (dB)	Preamp Factor (dB)	Ant Pos (cm)	Table Pos (deg)	Remark
2402	97.69	-16.31	114	92.9	32.18	6.91	34.3	120	335	Peak
2402	61.21	-32.79	94	-	-	-	-	-	-	Average

Note: For average measurement: use duty cycle correction factor method per 15.35(c).

Average measurement was not performed if peak level went lower than the average limit.

Test result of emissions which are 20 dB lower than the limit is not reported per 15.31.

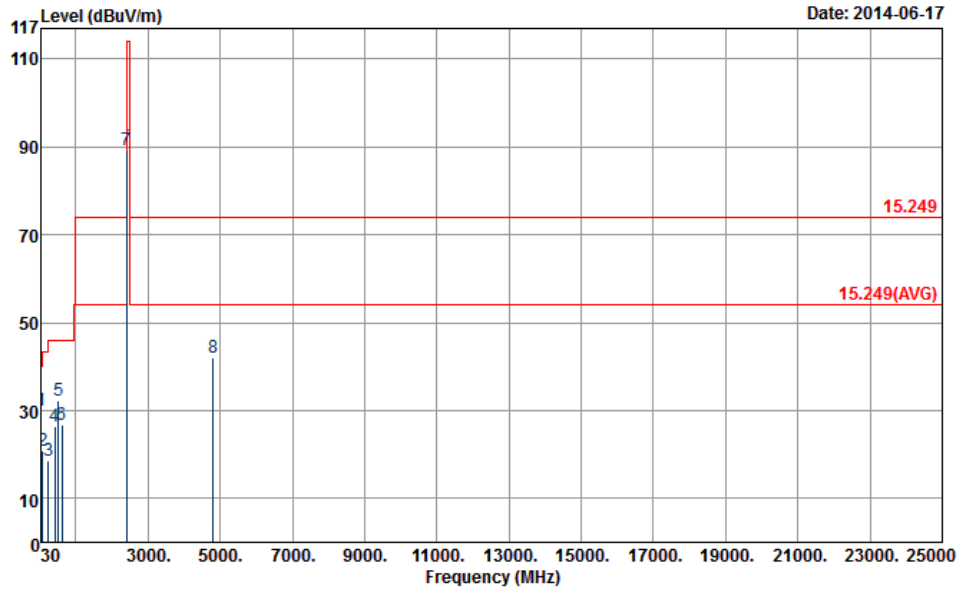

Site : 03CH07-HY
 Condition : 15.249 3m SHF-EHF_131029 VERTICAL

	Freq	Level	Over Limit	Limit Line	ReadAntenna Level	Antenna Factor	Cable Loss	Preamp Loss	A/Pos	T/Pos	Remark
	MHz	dBuV/m	dB	dBuV/m	dBuV	dB/m	dB	dB	cm	deg	
1	30.54	30.07	-9.93	40.00	42.71	18.28	0.54	31.46	117	55	Peak
2	76.17	20.85	-19.15	40.00	44.32	6.87	0.86	31.20	---	---	Peak
3	236.82	18.60	-27.40	46.00	37.15	10.94	1.51	31.00	---	---	Peak
4	425.30	26.52	-19.48	46.00	38.24	16.82	2.23	30.77	---	---	Peak
5	521.20	32.18	-13.82	46.00	42.26	18.12	2.49	30.69	---	---	Peak
6	617.80	26.75	-19.25	46.00	34.43	20.14	2.74	30.56	---	---	Peak
7	2402.00	89.33	-24.67	114.00	84.54	32.18	6.91	34.30	100	268	Peak
8	4803.00	42.17	-31.83	74.00	58.13	34.25	8.75	58.96	100	0	Peak

Frequency (MHz)	Level (dBuV/m)	Over Limit (dB)	Limit Line (dBuV/m)	Read Level (dBuV)	Antenna Factor (dB)	Cable Loss (dB)	Preamp Factor (dB)	Ant Pos (cm)	Table Pos (deg)	Remark
2402	89.33	-24.67	114	84.54	32.18	6.91	34.3	100	268	Peak
2402	52.85	-41.15	94	-	-	-	-	-	-	Average

Note: For average measurement: use duty cycle correction factor method per 15.35(c).

Average measurement was not performed if peak level went lower than the average limit.

Test result of emissions which are 20 dB lower than the limit is not reported per 15.31.



2441MHz

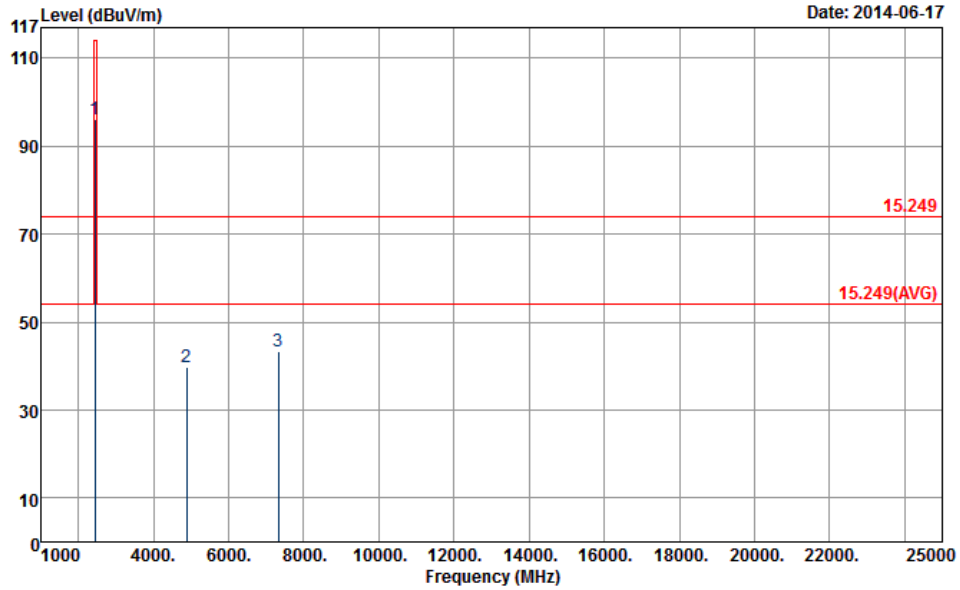

Site : 03CH07-HY
 Condition : 15.249 3m SHF-EHF_131029 HORIZONTAL

	Freq	Level	Over Limit	Limit Line	Read Level	Antenna Factor	Cable Loss	Preamp Factor	A/Pos	T/Pos	Remark
	MHz	dBuV/m	dB	dBuV/m	dBuV	dB/m	dB	dB	cm	deg	
1	2442.00	96.05	-17.95	114.00	91.21	32.24	6.99	34.39	117	317	Peak
2	4881.00	39.60	-34.40	74.00	55.28	34.30	8.85	58.83	100	0	Peak
3	7323.00	43.48	-30.52	74.00	54.71	35.60	10.91	57.74	100	0	Peak

Frequency (MHz)	Level (dBuV/m)	Over Limit (dB)	Limit Line (dBuV/m)	Read Level (dBuV)	Antenna Factor (dB)	Cable Loss (dB)	Preamp Factor (dB)	Ant Pos (cm)	Table Pos (deg)	Remark
2442	96.05	-17.95	114	91.21	32.24	6.99	34.39	117	317	Peak
2442	59.57	-34.43	94	-	-	-	-	-	-	Average

Note: For average measurement: use duty cycle correction factor method per 15.35(c).

Average measurement was not performed if peak level went lower than the average limit.

Test result of emissions which are 20 dB lower than the limit is not reported per 15.31.

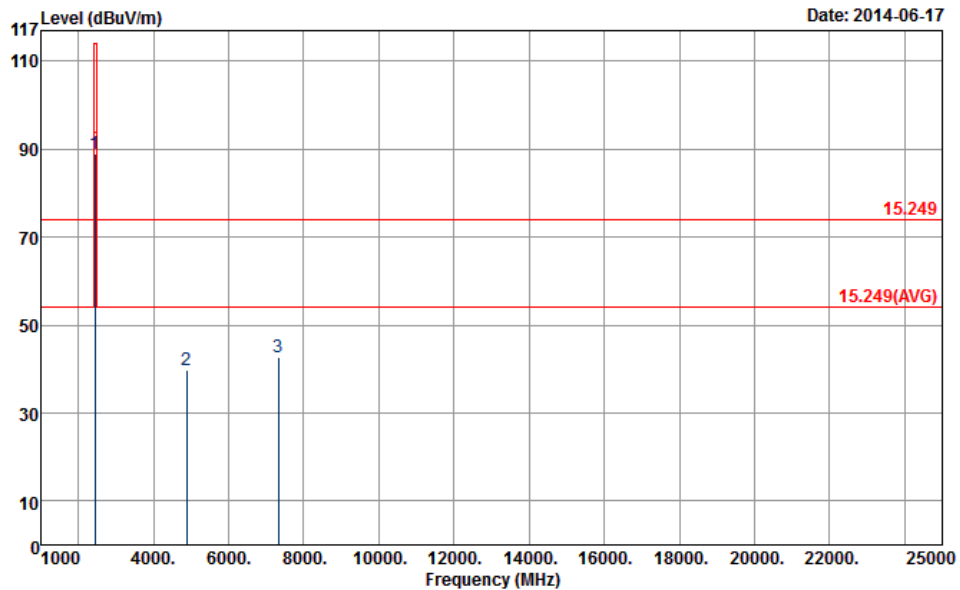

Site : 03CH07-HY
 Condition : 15.249 3m SHF-EHF_131029 VERTICAL

	Freq	Level	Over Limit	Limit Line	Read Level	Antenna Factor	Cable Loss	Preamp Factor	A/Pos	T/Pos	Remark
	MHz	dBuV/m	dB	dBuV/m	dBuV	dB/m	dB	dB	cm	deg	
1	2442.00	89.10	-24.90	114.00	84.26	32.24	6.99	34.39	100	268	Peak
2	4881.00	39.77	-34.23	74.00	55.45	34.30	8.85	58.83	100	0	Peak
3	7323.00	42.82	-31.18	74.00	54.05	35.60	10.91	57.74	100	0	Peak

Frequency (MHz)	Level (dBμV/m)	Over Limit (dB)	Limit Line (dBμV/m)	Read Level (dBμV)	Antenna Factor (dB)	Cable Loss (dB)	Preamp Factor (dB)	Ant Pos (cm)	Table Pos (deg)	Remark
2442	89.1	-24.9	114	84.26	32.24	6.99	34.39	100	268	Peak
2442	52.62	-41.38	94	-	-	-	-	-	-	Average

Note: For average measurement: use duty cycle correction factor method per 15.35(c).

Average measurement was not performed if peak level went lower than the average limit.

Test result of emissions which are 20 dB lower than the limit is not reported per 15.31.



2480MHz

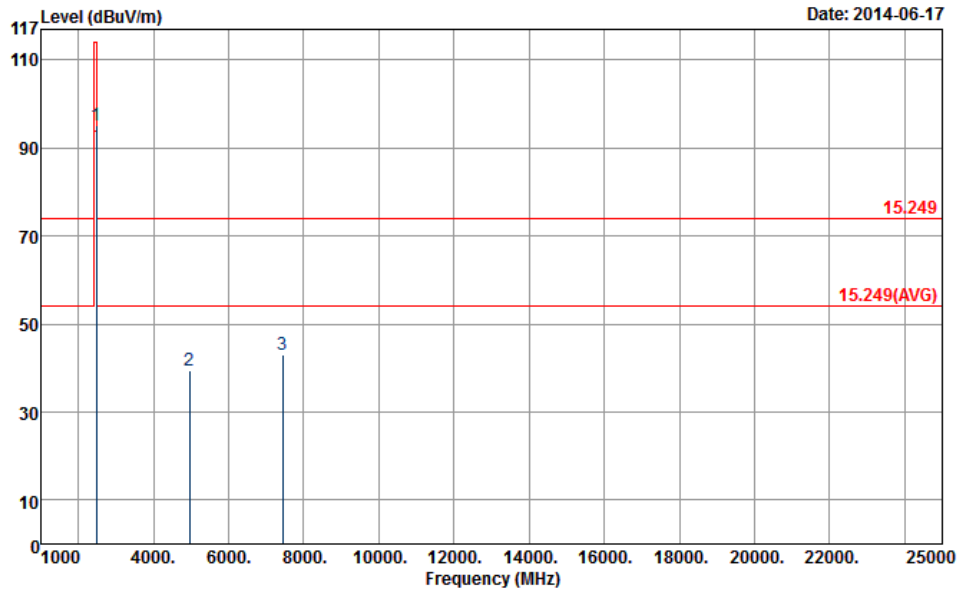

Site : 03CH07-HY
 Condition : 15.249 3m SHF-EHF_131029 HORIZONTAL

	Freq	Level	Over Limit	Limit Line	ReadAntenna Level	Antenna Factor	Cable Loss	Preamp Factor	A/Pos	T/Pos	Remark
	MHz	dBuV/m	dB	dBuV/m	dBuV	dB/m	dB	dB	cm	deg	
1	2482.00	95.23	-18.77	114.00	90.32	32.28	7.06	34.43	112	339	Peak
2	4959.00	39.34	-34.66	74.00	54.71	34.37	8.92	58.66	100	0	Peak
3	7440.00	42.90	-31.10	74.00	54.11	35.60	11.04	57.85	100	0	Peak

Frequency (MHz)	Level (dBμV/m)	Over Limit (dB)	Limit Line (dBμV/m)	Read Level (dBμV)	Antenna Factor (dB)	Cable Loss (dB)	Preamp Factor (dB)	Ant Pos (cm)	Table Pos (deg)	Remark
2482	95.23	-18.77	114	90.32	32.28	7.06	34.43	112	339	Peak
2482	58.75	-35.25	94	-	-	-	-	-	-	Average

Note: For average measurement: use duty cycle correction factor method per 15.35(c).

Average measurement was not performed if peak level went lower than the average limit.

Test result of emissions which are 20 dB lower than the limit is not reported per 15.31.

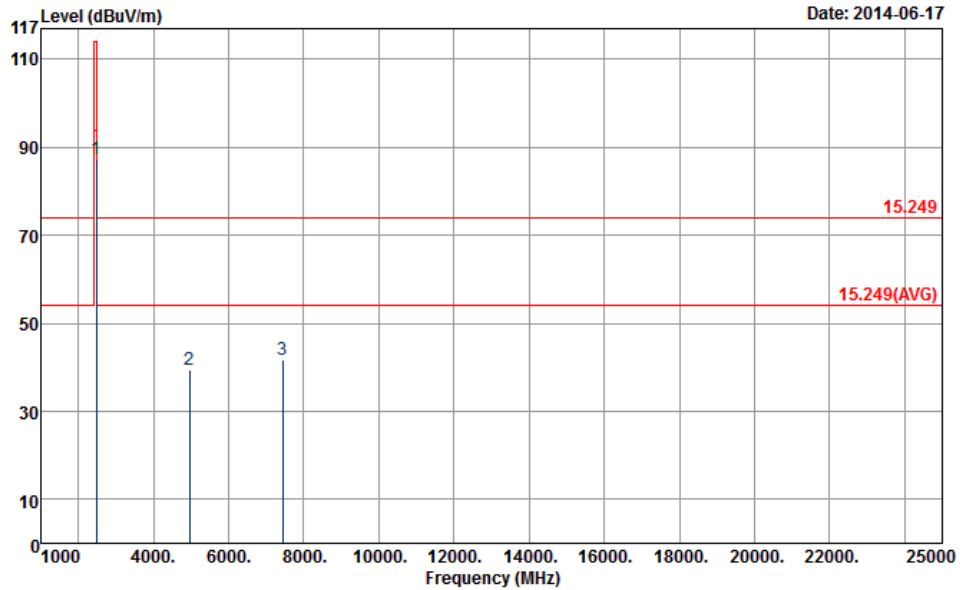

Site : 03CH07-HY
 Condition : 15.249 3m SHF-EHF_131029 VERTICAL

	Freq	Level	Over Limit	Limit Line	ReadAntenna Level	Antenna Factor	Cable Loss	Preamp Loss	A/Pos	T/Pos	Remark
	MHz	dBuV/m	dB	dBuV/m	dBuV	dB/m	dB	dB	cm	deg	
1	2482.00	87.31	-26.69	114.00	82.40	32.28	7.06	34.43	100	270	Peak
2	4959.00	39.37	-34.63	74.00	54.74	34.37	8.92	58.66	100	0	Peak
3	7440.00	41.82	-32.18	74.00	53.03	35.60	11.04	57.85	100	0	Peak

Frequency (MHz)	Level (dBμV/m)	Over Limit (dB)	Limit Line (dBμV/m)	Read Level (dBμV)	Antenna Factor (dB)	Cable Loss (dB)	Preamp Factor (dB)	Ant Pos (cm)	Table Pos (deg)	Remark
2482	87.31	-26.69	114	82.4	32.28	7.06	34.43	100	270	Peak
2482	50.83	-43.17	94	-	-	-	-	-	-	Average

Note: For average measurement: use duty cycle correction factor method per 15.35(c).

Average measurement was not performed if peak level went lower than the average limit.

Test result of emissions which are 20 dB lower than the limit is not reported per 15.31.



3.4 Antenna Requirements

3.4.1 Limit

Except for special regulations, the Low-power Radio-frequency Devices must not be equipped with any jacket for installing an antenna with extension cable. An intentional radiator shall be designed to ensure that no antenna other than that furnished by the responsible party shall be used with the device. The use of a permanently attached antenna or of an antenna that uses a unique coupling to the intentional radiator shall be considered sufficient to comply with the provisions of this Section. The manufacturer may design the unit so that the user can replace a broken antenna, but the use of a standard antenna jack or electrical connector is prohibited.

3.4.2 Antenna Connector Construction

Embedded in Antenna.



4. LIST OF MEASURING EQUIPMENT

Instrument	Manufacturer	Model No.	Serial No.	Characteristics	Calibration Date	Test Date	Due Date	Remark
Spectrum Analyzer	Rohde & Schwarz	FSP40	100055	9kHz~40GHz	Jun. 07, 2013	May 07, 2014	Jun. 06, 2014	Conducted (TH02-HY)
Power Meter	Agilent	E4416A	GB41292344	300MHz~40GHz	Jan. 28, 2014	May 07, 2014	Jan. 27, 2015	Conducted (TH02-HY)
Power Sensor	Agilent	E9327A	US40441548	300MHz~40GHz	Jan. 28, 2014	May 07, 2014	Jan. 27, 2015	Conducted (TH02-HY)
Hygrometer	Testo	608-H1	34897199	N/A	May 06, 2014	May 07, 2014	May 05, 2015	Conducted (TH02-HY)
RF cable	WOKEN	S05	S05-130708-038	N/A	Jan. 22, 2014	May 07, 2014	Jan. 21, 2015	Conducted (TH02-HY)
EMI Test Receiver	Rohde & Schwarz	ESCI 7	100724	9 kHz~7 GHz	Sep. 06, 2013	Jun. 17, 2014	Sep. 05, 2014	Radiation (03CH07-HY)
Spectrum Analyzer	Rohde & Schwarz	FSV30	101749	10Hz ~ 30GHz	Feb. 10, 2014	Jun. 17, 2014	Feb. 09, 2015	Radiation (03CH07-HY)
Loop Antenna	Rohde & Schwarz	HFH2-Z2	860004/0001	9 kHz~30 MHz	Jul. 03, 2012	Jun. 17, 2014	Jul. 02, 2014	Radiation (03CH07-HY)
Bilog Antenna	Schaffner	CBL6111C	2726	30 MHz ~ 1 GHz	Oct. 10, 2013	Jun. 17, 2014	Oct. 09, 2014	Radiation (03CH07-HY)
Double Ridge Horn Antenna	ESCO	3117	75962	1 GHz~18 GHz	Aug. 22, 2013	Jun. 17, 2014	Aug. 21, 2014	Radiation (03CH07-HY)
SHF-EHF Horn Antenna	SCHWARZBECK	BBHA 9170	BBHA9170251	15 GHz- 40 GHz	Oct. 03, 2013	Jun. 17, 2014	Oct. 02, 2014	Radiation (03CH07-HY)
Preamplifier	COM-POWER	PA-103A	161241	10 MHz ~ 1000MHz	Mar. 17, 2014	Jun. 17, 2014	Mar. 16, 2015	Radiation (03CH07-HY)
Preamplifier	Agilent	8449B	3008A02362	1 GHz~26.5 GHz	Nov. 29, 2013	Jun. 17, 2014	Nov. 28, 2014	Radiation (03CH07-HY)
Preamplifier	MITEQ	AMF-7D-001 01800-30-10 P	1590074	DC~18 G	Jul. 09, 2013	Jun. 17, 2014	Jul. 08, 2014	Radiation (03CH07-HY)
Turn Table	ChainTek	ChainTek 3000	N/A	0 ~ 360 degree	N/A	Jun. 17, 2014	N/A	Radiation (03CH07-HY)
Antenna Mast	ChainTek	ChainTek 3000	N/A	N/A	N/A	Jun. 17, 2014	N/A	Radiation (03CH07-HY)
LF RF Cable	Warison+HUBER SUHNER	WCBA-WC0 4NM.NM2	N/A	30MHz~1GHz	Nov. 28, 2013	Jun. 17, 2014	Nov. 27, 2014	Radiation (03CH07-HY)
HF RF Cable	HUBER SUHNER	SUCOFLEX 104	38411/6	1GHz~26.5GHz	Nov. 28, 2013	Jun. 17, 2014	Nov. 27, 2014	Radiation (03CH07-HY)
High Pass Filter	Microwave Circuits	H3G018G1	SN477220	3G HPF	Nov. 28, 2013	Jun. 17, 2014	Nov. 27, 2014	Radiation (03CH07-HY)
Low Pass Filter	Wainwright Instruments GmbH	WLKS1200- 8SS	SN3	1.5G LPF	Nov. 28, 2013	Jun. 17, 2014	Nov. 27, 2014	Radiation (03CH07-HY)
Hygrometer	Testo	608-H1	34897197	N/A	May 06, 2014	Jun. 17, 2014	May 05, 2015	Radiation (03CH07-HY)
Test Software	Audix	E3 V6.0	N/A	N/A	N/A	Jun. 17, 2014	N/A	Radiation (03CH07-HY)



Instrument	Manufacturer	Model No.	Serial No.	Characteristics	Calibration Date	Test Date	Due Date	Remark
EMI Test Receiver	Rohde & Schwarz	ESCS 30	100356	9kHz ~ 2.75GHz	Nov. 15, 2013	May 20, 2014	Nov. 14, 2014	Conduction (CO05-HY)
LISN	Rohde & Schwarz	ENV216	100081	9kHz ~ 30MHz	Dec. 12, 2013	May 20, 2014	Dec. 11, 2014	Conduction (CO05-HY)
LISN (for auxiliary equipment)	Rohde & Schwarz	ENV216	100080	9kHz ~ 30MHz	Dec. 04, 2013	May 20, 2014	Dec. 03, 2014	Conduction (CO05-HY)
AC Power Source	APC	APC-1000W	N/A	N/A	N/A	May 20, 2014	N/A	Conduction (CO05-HY)
Test Software	N/A	EMC32	8.40.0	N/A	N/A	May 20, 2014	N/A	Conduction (CO05-HY)
Hygrometer	Testo	608-H1	34913912	N/A	Apr. 23, 2014	May 20, 2014	Apr. 22, 2015	Conduction (CO05-HY)
LF Cable	Shuner	RG-402	N/A	N/A	Oct. 17, 2013	May 20, 2014	Oct. 16, 2014	Conduction (CO05-HY)

Note: Test equipment calibration is traceable to the procedure of ISO17025.



5. UNCERTAINTY OF EVALUATION

Uncertainty of Conducted Emission Measurement (150kHz ~ 30MHz)

Measuring Uncertainty for a Level of Confidence of 95% (U = 2Uc(y))	2.26
---	------

Uncertainty of Radiated Emission Measurement (30 MHz ~ 1000 MHz)

Measuring Uncertainty for a Level of Confidence of 95% (U = 2Uc(y))	4.50
---	------