



FCC RF Test Report

APPLICANT : Sony Mobile Communications Inc.
EQUIPMENT : Smart phone
BRAND NAME : SONY
TYPE NAME : PM-0380-BV
FCC ID : PY7PM-0380
STANDARD : FCC 47 CFR Part 2, 22(H), 24(E)
CLASSIFICATION : PCS Licensed Transmitter Held to Ear (PCE)

The product was received on May 02, 2014 and testing was completed on Jun. 20, 2014. We, SPORTON INTERNATIONAL INC., would like to declare that the tested sample has been evaluated in accordance with the test procedures given in ANSI / TIA / EIA-603-C-2004 and has been in compliance with the applicable technical standards.

The test results in this report apply exclusively to the tested model / sample. Without written approval of SPORTON INTERNATIONAL INC., the test report shall not be reproduced except in full.

Reviewed by: Joseph Lin / Supervisor

Approved by: Jones Tsai / Manager



SPORTON INTERNATIONAL INC.

No. 52, Hwa Ya 1st Rd., Hwa Ya Technology Park, Kwei-Shan Hsiang, Tao Yuan Hsien, Taiwan, R.O.C.

SPORTON INTERNATIONAL INC.

TEL : 886-3-327-3456

FAX : 886-3-328-4978

FCC ID : PY7PM-0380

Page Number : 1 of 115

Report Issued Date : Aug. 01, 2014

Report Version : Rev. 02

Report Template No.: BU5-FG22/24 Version 1.1



TABLE OF CONTENTS

REVISION HISTORY..... 3

SUMMARY OF TEST RESULT 4

1 GENERAL DESCRIPTION 5

 1.1 Applicant..... 5

 1.2 Manufacturer 5

 1.3 Product Feature of Equipment Under Test 5

 1.4 Product Specification subjective to this standard 6

 1.5 Modification of EUT 7

 1.6 Maximum ERP/EIRP Power, Frequency Tolerance, and Emission Designator 7

 1.7 Testing Location 8

 1.8 Applicable Standards 8

2 TEST CONFIGURATION OF EQUIPMENT UNDER TEST 9

 2.1 Test Mode..... 9

 2.2 Connection Diagram of Test System 11

 2.3 Support Unit used in test configuration 11

 2.4 Measurement Results Explanation Example 12

3 TEST RESULT 13

 3.1 Conducted Output Power Measurement..... 13

 3.2 Peak-to-Average Ratio 15

 3.3 Effective Radiated Power and Effective Isotropic Radiated Power Measurement 27

 3.4 99% Occupied Bandwidth and 26dB Bandwidth Measurement..... 32

 3.5 Band Edge Measurement..... 49

 3.6 Conducted Spurious Emission Measurement 55

 3.7 Field Strength of Spurious Radiation Measurement 92

 3.8 Frequency Stability Measurement..... 109

4 LIST OF MEASURING EQUIPMENT 113

5 UNCERTAINTY OF EVALUATION 115



REVISION HISTORY

REPORT NO.	VERSION	DESCRIPTION	ISSUED DATE
FG450251A	Rev. 01	Initial issue of report	Jul. 16, 2014
FG450251A	Rev. 02	Update EUT Information List for SW version change as 18.4.C.1.10	Aug. 01, 2014



SUMMARY OF TEST RESULT

Report Section	FCC Rule	Description	Limit	Result	Remark
3.1	§2.1046	Conducted Output Power	N/A	PASS	-
3.2	§24.232(d)	Peak-to-Average Ratio	<13 dB	PASS	-
3.3	§22.913(a)(2)	Effective Radiated Power	< 7 Watts	PASS	-
	§24.232(c)	Equivalent Isotropic Radiated Power	< 2 Watts	PASS	-
3.4	§2.1049 §22.917(b) §24.238(b)	Occupied Bandwidth	N/A	PASS	-
3.5	§2.1051 §22.917(a) §24.238(a)	Band Edge Measurement	< 43+10log ₁₀ (P[Watts])	PASS	-
3.6	§2.1051 §22.917(a) §24.238(a)	Conducted Spurious Emission	< 43+10log ₁₀ (P[Watts])	PASS	-
3.7	§2.1053 §22.917(a) §24.238(a)	Field Strength of Spurious Radiation	< 43+10log ₁₀ (P[Watts])	PASS	Under limit 21.21 dB at 2512.000 MHz
3.8	§2.1055 §22.355 §24.235	Frequency Stability for Temperature & Voltage	< 2.5 ppm	PASS	-



1 General Description

1.1 Applicant

Sony Mobile Communications Inc.
Nya Vattentorget, 22188 Lund, Sweden

1.2 Manufacturer

Arima Communication Corp.
6F, No. 866, Jhongjheng Rd., Jhonghe Dist., New Taipei City 23586, Taiwan

1.3 Product Feature of Equipment Under Test

The Equipment Under Test (hereafter called: EUT) is Smart phone supporting, GSM / WCDMA / LTE, Wi-Fi 2.4GHz 802.11b/g/n, Bluetooth with FM Receiver, ANT+, GPS, and NFC features, and below is details of information.

Product Feature	
Equipment	Smart phone
Brand Name	SONY
Type Name	PM-0380-BV
FCC ID	PY7PM-0380
GSM Operating Band(s)	GSM 850/900/1800/1900MHz
GPRS / EGPRS Multi Slot Class	GPRS Class 33 , EGPRS Class 33
WCDMA Operating Band(s)	FDD Band I / V / VIII
WCDMA Rel. Version	Rel. 9
LTE Operating Band(s)	FDD Band I / III / V / VII / VIII / XX
LTE Rel. Version	Rel. 8
Wi-Fi Specification	802.11b/g/n (HT20)
Bluetooth Version	v3.0 + EDR / v4.0 - LE
NFC Specification	ISO14443A / ISO14443B / Felica / ISO15693
ANT+	ANT+
Power Supply	Battery / AC Adapter / Car Charger

Remark: The above EUT's information was declared by manufacturer. Please refer to the specifications or user's manual for more detailed description.



1.4 Product Specification subjective to this standard

Product Specification subjective to this standard	
Tx Frequency	GSM850: 824.2 MHz ~ 848.8 MHz GSM1900: 1850.2 MHz ~ 1909.8MHz WCDMA Band V: 826.4 MHz ~ 846.6 MHz
Rx Frequency	GSM850: 869.2 MHz ~ 893.8 MHz GSM1900: 1930.2 MHz ~ 1989.8 MHz WCDMA Band V: 871.4 MHz ~ 891.6 MHz
Maximum Output Power to Antenna	GSM850 : 32.52 dBm GSM1900 : 29.68 dBm WCDMA Band V : 23.48 dBm
Antenna Type / Gain	I-FA Antenna / 0.22 dBi
Type of Modulation	GSM: GMSK GPRS: GMSK EDGE: GMSK / 8PSK WCDMA: QPSK (Uplink) HSDPA: 64QAM(Downlink) HSUPA: QPSK (Uplink)

EUT Information List				
IMEI	HW Version	SW Version	S/N	Performed Test Item
IMEI : 004402452587839	A	18.4.C.1.10	WUJ01B01FF	RF Conducted Measurement
IMEI : 004402452587839			WUJ01B01FF	Radiated Spurious Emission ERP Test

Accessory List	
AC Adapter	Model No. : EP800
	Type No. : CAA-0002016-US B
	S/N : 3113W45408465
Battery	Model No. : LIS1551ERPC
Earphone	Model No. : MH410c
	Type No. : AG-1100
	S/N : 13511E5B0076390
USB Cable	Model No. : EC450
	Type No. : AI-0700
	S/N : 134912DC0004380

Note:

1. Above EUT list and accessory list used are electrically identical per declared by manufacturer.
2. Above the accessories list are used to exercise the EUT during test.
3. For other wireless features of this EUT, test report will be issued separately.



1.5 Modification of EUT

No modifications are made to the EUT during all test items.

1.6 Maximum ERP/EIRP Power, Frequency Tolerance, and Emission Designator

FCC Rule	System	Type of Modulation	Maximum ERP/EIRP (W)	Frequency Tolerance (ppm)	Emission Designator
Part 22	GSM850 GPRS class 8	GMSK	0.62	0.07 ppm	246KGXW
Part 22	GSM850 EDGE class 8	8PSK	0.28	0.08 ppm	248KG7W
Part 22	WCDMA Band V RMC 12.2Kbps	QPSK	0.10	0.02 ppm	4M18F9W
Part 24	GSM1900 GPRS class 8	GMSK	0.97	0.01 ppm	246KGXW
Part 24	GSM1900 EDGE class 8	8PSK	0.42	0.08 ppm	244KG7W



1.7 Testing Location

Sporton Lab is accredited to ISO 17025 by Taiwan Accreditation Foundation (TAF code : 1190) and the FCC designation No. TW1022 under the FCC 2.948(e) by Mutual Recognition Agreement (MRA) in FCC Test.

Test Site	SPORTON INTERNATIONAL INC.	
Test Site Location	No. 52, Hwa Ya 1 st Rd., Hwa Ya Technology Park, Kwei-Shan Hsiang, Tao Yuan Hsien, Taiwan, R.O.C. TEL: +886-3-327-3456 FAX: +886-3-328-4978	
Test Site No.	Sporton Site No.	
	TH02-HY	03CH07-HY

1.8 Applicable Standards

According to the specifications of the manufacturer, the EUT must comply with the requirements of the following standards:

- FCC 47 CFR Part 2, 22(H), 24(E)
- ANSI / TIA / EIA-603-C-2004
- FCC KDB 971168 D01 Power Meas. License Digital Systems v02r01

Remark:

1. All test items were verified and recorded according to the standards and without any deviation during the test.
2. This EUT has also been tested and complied with the requirements of FCC Part 15, Subpart B, recorded in a separate test report.



2 Test Configuration of Equipment Under Test

2.1 Test Mode

Antenna port conducted and radiated test items were performed according to KDB 971168 D01 Power Meas. License Digital Systems v02r01 with maximum output power.

Radiated measurements were performed with rotating EUT in different three orthogonal test planes to find the maximum emission.

Radiated emissions were investigated as following frequency range:

1. 30 MHz to 9000 MHz for GSM850 and WCDMA Band V.
2. 30 MHz to 19000 MHz for GSM1900.

Test Modes		
Band	Radiated TCs	Conducted TCs
GSM 850	<ul style="list-style-type: none">■ GPRS class 8 Link■ EDGE class 8 Link	<ul style="list-style-type: none">■ GPRS class 8 Link■ EDGE class 8 Link
GSM 1900	<ul style="list-style-type: none">■ GPRS class 8 Link■ EDGE class 8 Link	<ul style="list-style-type: none">■ GPRS class 8 Link■ EDGE class 8 Link
WCDMA Band V	<ul style="list-style-type: none">■ RMC 12.2Kbps Link	<ul style="list-style-type: none">■ RMC 12.2Kbps Link

Note: The maximum power levels are chosen to test as the worst case configuration as follows:

GSM or GPRS multi-slot class 8 mode for GMSK modulation,
EDGE multi-slot class 8 mode for 8PSK modulation,
RMC 12.2Kbps mode for WCDMA band V,
only these modes were used for all tests.



Conducted Power Measurement Results:

Conducted Power		Burst Average Power (dBm)					
Band		GSM850			GSM1900		
Channel		128	189	251	512	661	810
Frequency (MHz)		824.2	836.4	848.8	1850.2	1880.0	1909.8
GSM		32.43	32.50	32.41	29.67	29.34	29.32
GPRS Class 8		32.45	32.52	32.44	29.68	29.56	29.31
GPRS Class 10		29.57	29.61	29.41	26.92	26.72	26.59
GPRS Class 11		27.80	27.84	27.60	25.17	24.85	24.72
GPRS Class 33		26.51	26.58	26.35	23.76	23.49	23.29
EGPRS Class 8		27.73	27.80	27.70	26.01	25.78	25.61
EGPRS Class 10		25.22	25.37	25.23	23.47	23.20	23.11
EGPRS Class 11		23.62	23.68	23.55	22.61	22.27	22.24
EGPRS Class 33		23.48	23.43	23.38	21.40	21.20	20.92
DTM 5	GSM (GMSK, 1 Tx slot)	29.52	29.53	29.37	26.89	26.70	26.55
	GPRS (GMSK, 1 Tx slot)	29.48	29.46	29.33	26.84	26.66	26.51
DTM 9	GSM (GMSK, 1 Tx slot)	29.49	29.50	29.33	26.85	26.66	26.51
	GPRS (GMSK, 1 Tx slot)	29.44	29.45	29.30	26.82	26.64	26.47
DTM 11	GSM (GMSK, 1 Tx slot)	27.78	27.82	27.55	25.15	24.83	24.69
	GPRS (GMSK, 2 Tx slots)	27.72	27.69	27.48	25.11	24.81	24.65
DTM 5	GSM (GMSK, 1 Tx slot)	29.45	29.47	29.30	26.81	26.62	26.49
	EDGE (8PSK, 1 Tx slot)	25.19	25.32	25.20	23.42	23.16	23.08
DTM 9	GSM (GMSK, 1 Tx slot)	29.41	29.42	29.28	26.79	26.58	26.45
	EDGE (8PSK, 1 Tx slot)	25.17	25.30	25.18	23.39	23.11	23.02
DTM 11	GSM (GMSK, 1 Tx slot)	27.77	27.79	27.49	25.11	24.79	24.61
	EDGE (8PSK, 2 Tx slots)	23.58	23.61	23.49	22.55	22.19	22.17

Conducted Power (*Unit: dBm)			
Band	WCDMA Band V		
Channel	4132	4182	4233
Frequency	826.4	836.4	846.6
RMC 12.2K	23.36	23.48	23.14
HSDPA Subtest-1	23.29	23.40	23.06
HSDPA Subtest-2	22.80	23.22	23.14
HSDPA Subtest-3	23.18	23.28	23.07
HSDPA Subtest-4	22.52	22.71	22.66
HSUPA Subtest-1	22.56	22.77	22.61
HSUPA Subtest-2	22.55	22.24	22.56
HSUPA Subtest-3	21.92	21.66	21.55
HSUPA Subtest-4	21.85	21.72	21.84
HSUPA Subtest-5	22.76	22.78	22.80

2.2 Connection Diagram of Test System

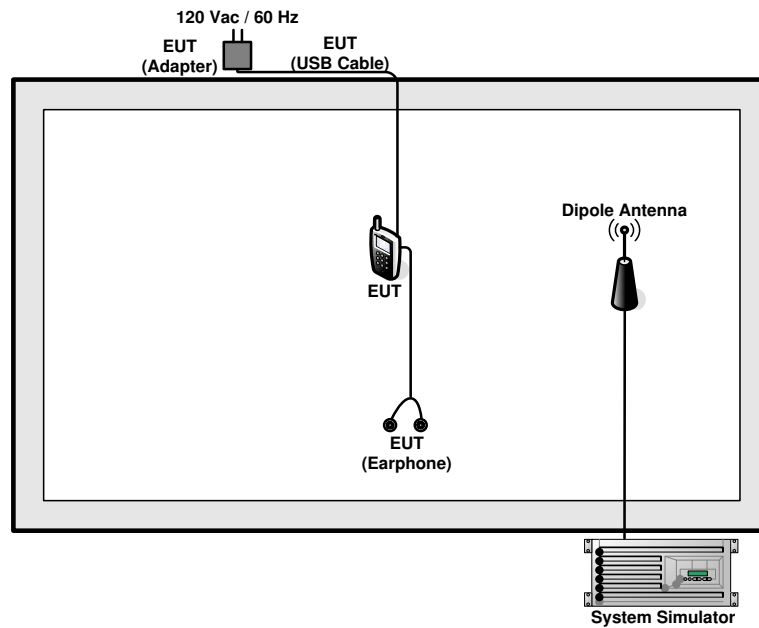

2.3 Support Unit used in test configuration

Item	Equipment	Trade Name	Model No.	FCC ID	Data Cable	Power Cord
1.	System Simulator	R&S	CMU 200	N/A	N/A	Unshielded, 1.8 m



2.4 Measurement Results Explanation Example

For all conducted test items:

The offset level is set in the spectrum analyzer to compensate the RF cable loss and attenuator factor between RF conducted output port and spectrum analyzer. With the offset compensation, the spectrum analyzer reading level will be exactly the RF output level.

The spectrum analyzer offset is derived from RF cable loss and attenuator factor.

Offset = RF cable loss + attenuator factor.

The following shows an offset computation example with RF cable loss 4.2 dB and a 10dB attenuator.

Example :

$$\begin{aligned} \text{Offset(dB)} &= \text{RF cable loss(dB)} + \text{attenuator factor(dB)}. \\ &= 4.2 + 10 = 14.2 \text{ (dB)} \end{aligned}$$

3 Test Result

3.1 Conducted Output Power Measurement

3.1.1 Description of the Conducted Output Power Measurement

A system simulator was used to establish communication with the EUT. Its parameters were set to enforce EUT transmitting at the maximum power. The measured power in the radio frequency on the transmitter output terminals shall be reported.

3.1.2 Measuring Instruments

The measuring equipment is listed in the section 4 of this test report.

3.1.3 Test Procedures

1. The transmitter output port was connected to the system simulator.
2. Set EUT at maximum power through system simulator.
3. Select lowest, middle, and highest channels for each band and different modulation.
4. Measure the maximum burst average power for GSM and maximum average power for other modulation signal.

3.1.4 Test Setup

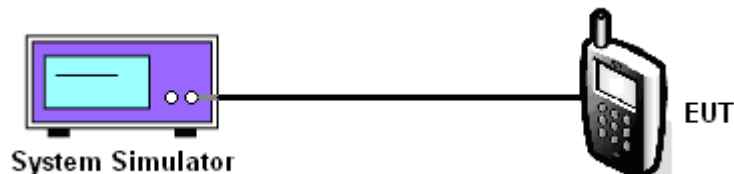



3.1.5 Test Result of Conducted Output Power

Cellular Band									
Modes	GSM850 (GPRS class 8)			GSM850 (EDGE class 8)			WCDMA Band V (RMC 12.2Kbps)		
Channel	128 (Low)	189 (Mid)	251 (High)	128 (Low)	189 (Mid)	251 (High)	4132 (Low)	4182 (Mid)	4233 (High)
Frequency (MHz)	824.2	836.4	848.8	824.2	836.4	848.8	826.4	836.4	846.6
Conducted Power (dBm)	32.45	32.52	32.44	27.73	27.80	27.70	23.36	23.48	23.14

PCS Band						
Modes	GSM1900 (GPRS class 8)			GSM1900 (EDGE class 8)		
Channel	512 (Low)	661 (Mid)	810 (High)	512 (Low)	661 (Mid)	810 (High)
Frequency (MHz)	1850.2	1880	1909.8	1850.2	1880	1909.8
Conducted Power (dBm)	29.68	29.56	29.31	26.01	25.78	25.61

Note: maximum burst average power for GSM, and maximum average power for WCDMA.

3.2 Peak-to-Average Ratio

3.2.1 Description of the PAR Measurement

The peak-to-average ratio (PAR) of the transmission may not exceed 13 dB.

3.2.2 Measuring Instruments

The measuring equipment is listed in the section 4 of this test report.

3.2.3 Test Procedures

1. The EUT was connected to spectrum analyzer and system simulator via a power divider.
2. Set EUT to transmit at maximum output power.
3. When the duty cycle is less than 98%, then signal gating will be implemented on the spectrum analyzer by triggering from the system simulator.
4. Set the CCDF (Complementary Cumulative Distribution Function) option of the spectrum analyzer.
Record the maximum PAPR level associated with a probability of 0.1%.

3.2.4 Test Setup

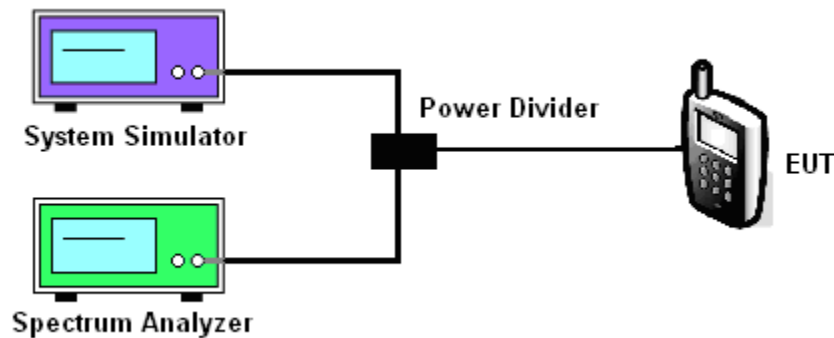



3.2.5 Test Result of Peak-to-Average Ratio

Cellular Band									
Modes	GSM850 (GPRS class 8)			GSM850 (EDGE class 8)			WCDMA Band V (RMC 12.2Kbps)		
Channel	128 (Low)	189 (Mid)	251 (High)	128 (Low)	189 (Mid)	251 (High)	4132 (Low)	4182 (Mid)	4233 (High)
Frequency (MHz)	824.2	836.4	848.8	824.2	836.4	848.8	826.4	836.4	846.6
Peak-to-Average Ratio (dB)	0.28	0.28	0.32	2.96	3.16	3.12	2.84	2.92	2.96

PCS Band						
Modes	GSM1900 (GPRS class 8)			GSM1900 (EDGE class 8)		
Channel	512 (Low)	661 (Mid)	810 (High)	512 (Low)	661 (Mid)	810 (High)
Frequency (MHz)	1850.2	1880	1909.8	1850.2	1880	1909.8
Peak-to-Average Ratio (dB)	0.32	0.28	0.28	3.08	2.96	3.04



3.2.6 Test Result (Plots) of Peak-to-Average Ratio

Band :	GSM 850	Test Mode :	GPRS class 8 Link (GMSK)
--------	---------	-------------	--------------------------

Peak-to-Average Ratio on Channel 128 (824.2 MHz)

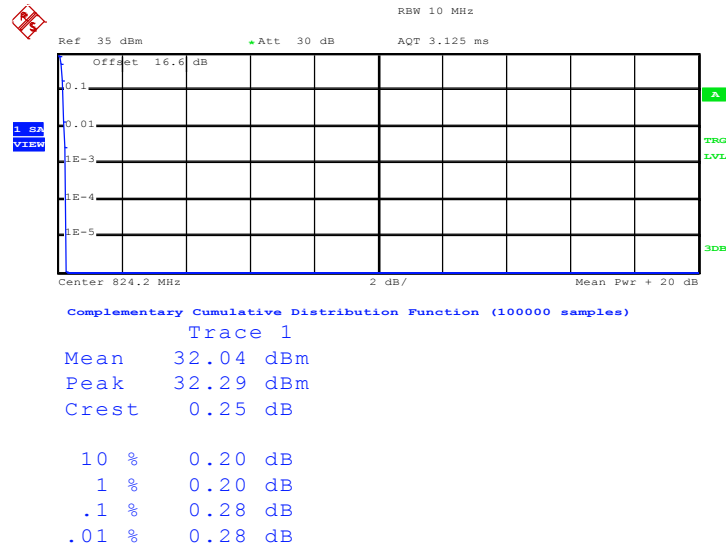

Date: 19.JUN.2014 15:31:40

Peak-to-Average Ratio on Channel 189 (836.4 MHz)

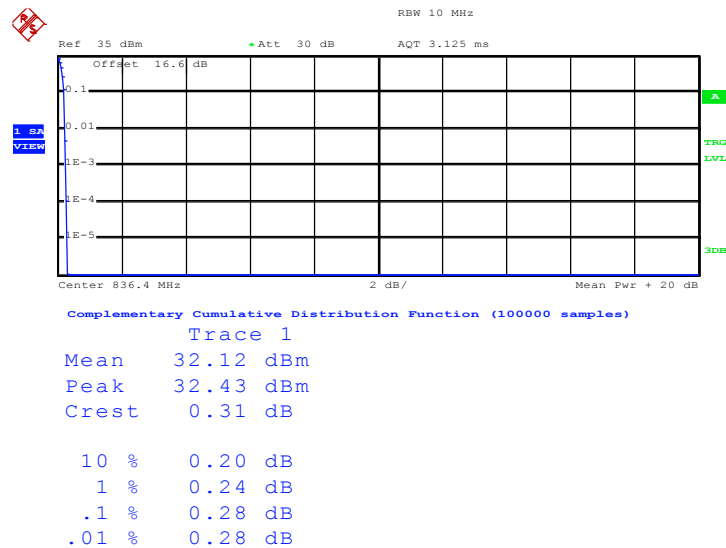

Date: 19.JUN.2014 15:32:10



Peak-to-Average Ratio on Channel 251 (848.8 MHz)

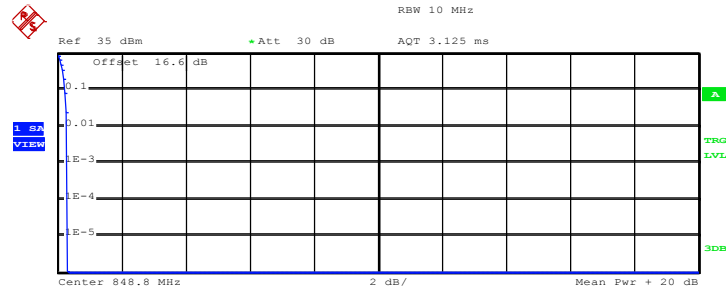

Complementary Cumulative Distribution Function (100000 samples)

Trace 1

Mean	31.57 dBm
Peak	31.87 dBm
Crest	0.30 dB
10 %	0.24 dB
1 %	0.32 dB
.1 %	0.32 dB
.01 %	0.32 dB

Date: 19.JUN.2014 15:32:42



Band :	GSM 850	Test Mode :	EDGE class 8 Link (8PSK)
---------------	---------	--------------------	--------------------------

Peak-to-Average Ratio on Channel 128 (824.2 MHz)

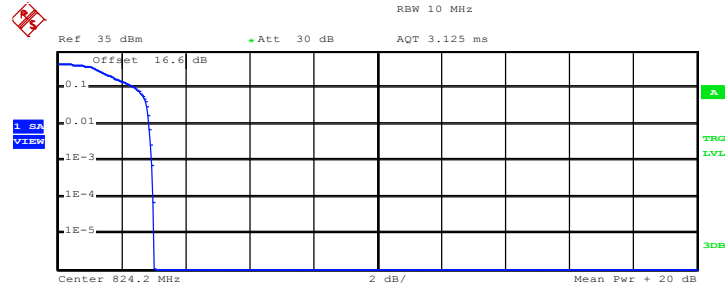

Complementary Cumulative Distribution Function (100000 samples)

Trace 1
 Mean 27.81 dBm
 Peak 30.81 dBm
 Crest 3.00 dB

10 %	2.44 dB
1 %	2.88 dB
.1 %	2.96 dB
.01 %	3.00 dB

Date: 19.JUN.2014 16:22:50

Peak-to-Average Ratio on Channel 189 (836.4 MHz)

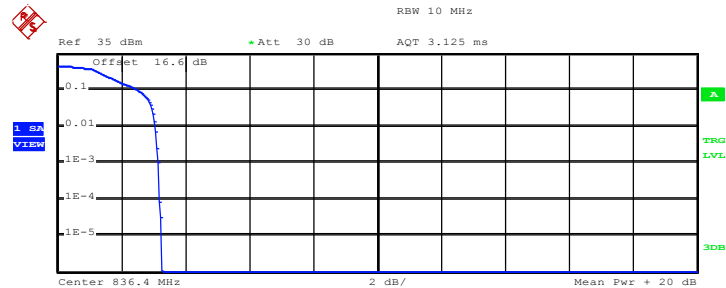

Complementary Cumulative Distribution Function (100000 samples)

Trace 1
 Mean 27.34 dBm
 Peak 30.60 dBm
 Crest 3.26 dB

10 %	2.56 dB
1 %	3.08 dB
.1 %	3.16 dB
.01 %	3.20 dB

Date: 19.JUN.2014 16:25:38



Peak-to-Average Ratio on Channel 251 (848.8 MHz)

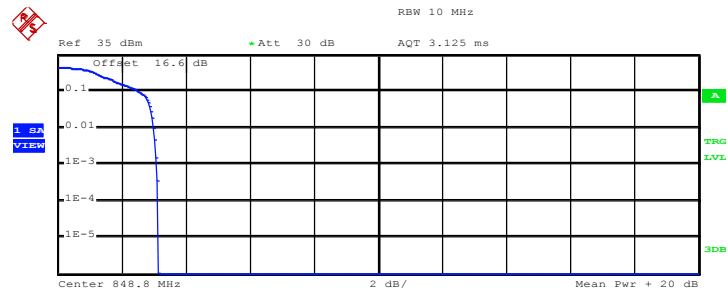

Complementary Cumulative Distribution Function (100000 samples)

Trace 1

Mean 27.12 dBm
 Peak 30.24 dBm
 Crest 3.13 dB

10 % 2.56 dB
 1 % 3.00 dB
 .1 % 3.12 dB
 .01 % 3.16 dB

Date: 19.JUN.2014 16:26:45



Band :	GSM 1900	Test Mode :	GPRS class 8 Link (GMSK)
---------------	----------	--------------------	--------------------------

Peak-to-Average Ratio on Channel 512 (1850.2 MHz)

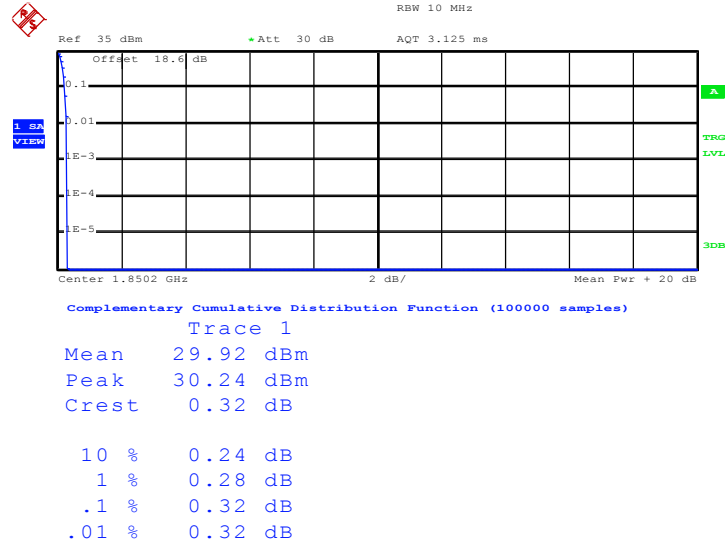

Date: 19.JUN.2014 17:54:55

Peak-to-Average Ratio on Channel 661 (1880.0 MHz)

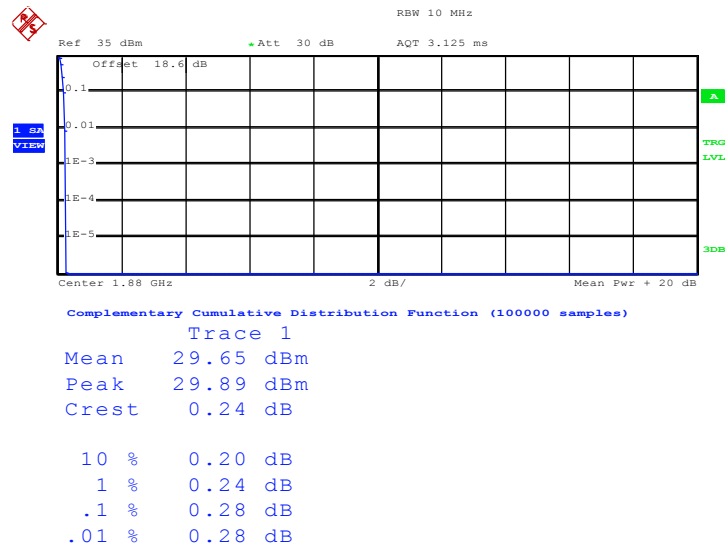

Date: 19.JUN.2014 17:56:28



Peak-to-Average Ratio on Channel 810 (1909.8 MHz)

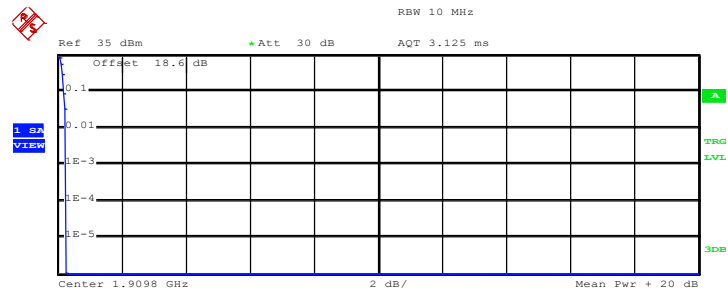

Complementary Cumulative Distribution Function (100000 samples)

Trace 1

Mean	29.84 dBm
Peak	30.10 dBm
Crest	0.26 dB
10 %	0.20 dB
1 %	0.28 dB
.1 %	0.28 dB
.01 %	0.28 dB

Date: 19.JUN.2014 17:56:56



Band :	GSM 1900	Test Mode :	EDGE class 8 Link (8PSK)
---------------	----------	--------------------	--------------------------

Peak-to-Average Ratio on Channel 512 (1850.2 MHz)

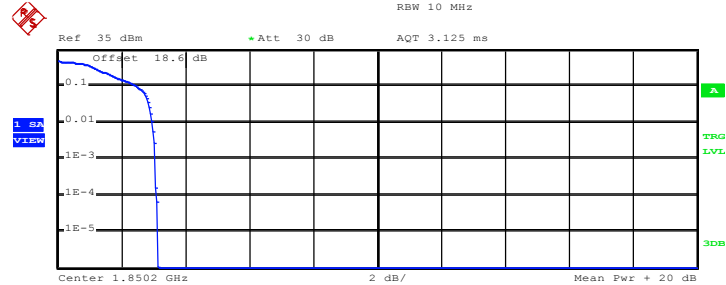

Complementary Cumulative Distribution Function (100000 samples)
 Trace 1
 Mean 26.18 dBm
 Peak 29.33 dBm
 Crest 3.14 dB

10 %	2.48 dB
1 %	2.96 dB
.1 %	3.08 dB
.01 %	3.12 dB

Date: 20.JUN.2014 09:38:00

Peak-to-Average Ratio on Channel 661 (1880.0 MHz)

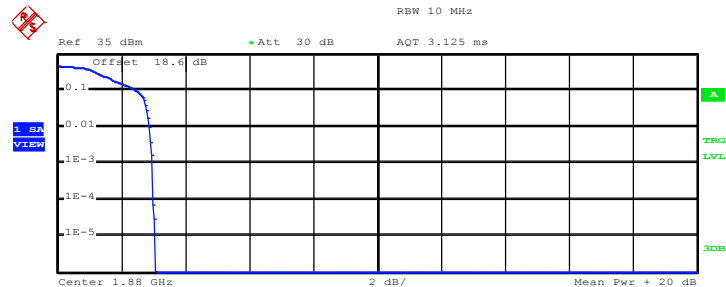

Complementary Cumulative Distribution Function (100000 samples)
 Trace 1
 Mean 26.20 dBm
 Peak 29.26 dBm
 Crest 3.06 dB

10 %	2.48 dB
1 %	2.88 dB
.1 %	2.96 dB
.01 %	3.00 dB

Date: 20.JUN.2014 09:38:54



Peak-to-Average Ratio on Channel 810 (1909.8 MHz)

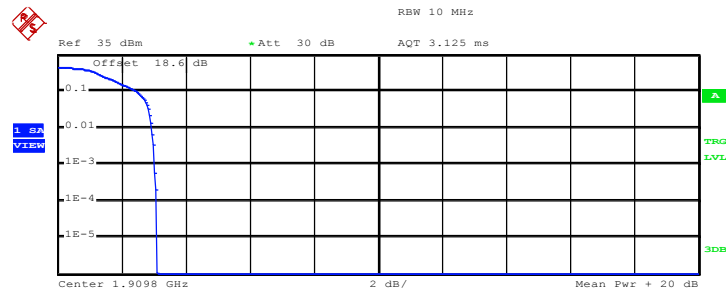

Complementary Cumulative Distribution Function (100000 samples)

Trace 1

Mean 26.16 dBm
 Peak 29.26 dBm
 Crest 3.10 dB

10 % 2.48 dB
 1 % 2.96 dB
 .1 % 3.04 dB
 .01 % 3.12 dB

Date: 20.JUN.2014 09:39:43



Band :	WCDMA Band V	Test Mode :	RMC 12.2Kbps Link (QPSK)
---------------	--------------	--------------------	--------------------------

Peak-to-Average Ratio on Channel 4132 (826.4 MHz)

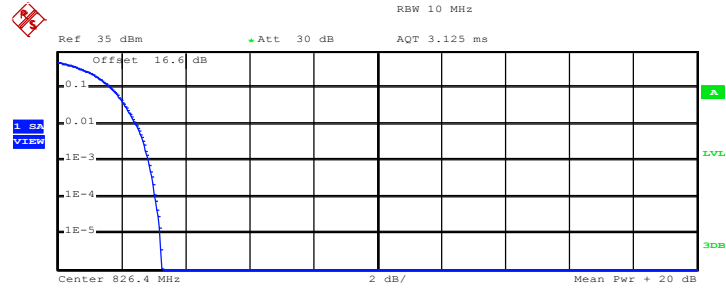

Complementary Cumulative Distribution Function (100000 samples)

Trace 1
Mean 23.26 dBm
Peak 26.50 dBm
Crest 3.25 dB

10 %	1.68 dB
1 %	2.48 dB
.1 %	2.84 dB
.01 %	3.08 dB

Date: 20.JUN.2014 10:21:47

Peak-to-Average Ratio on Channel 4182 (836.4 MHz)

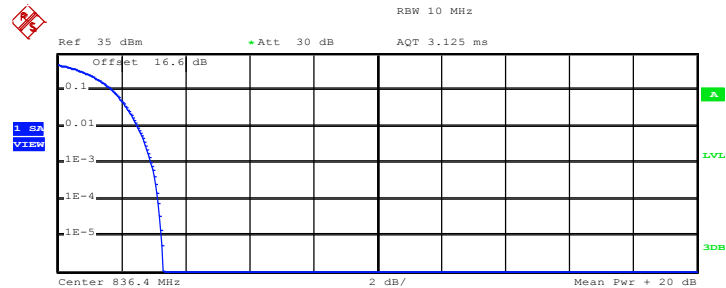

Complementary Cumulative Distribution Function (100000 samples)

Trace 1
Mean 23.12 dBm
Peak 26.43 dBm
Crest 3.31 dB

10 %	1.72 dB
1 %	2.52 dB
.1 %	2.92 dB
.01 %	3.16 dB

Date: 20.JUN.2014 10:22:31



Peak-to-Average Ratio on Channel 4233 (846.6 MHz)

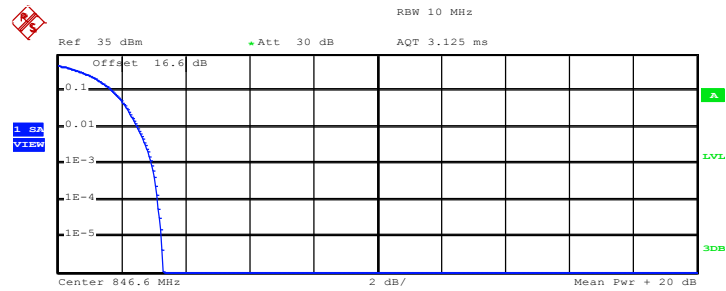

Complementary Cumulative Distribution Function (100000 samples)

Trace 1

Mean 23.00 dBm
 Peak 26.29 dBm
 Crest 3.29 dB

10 % 1.72 dB
 1 % 2.52 dB
 .1 % 2.96 dB
 .01 % 3.16 dB

Date: 20.JUN.2014 10:23:07



3.3 Effective Radiated Power and Effective Isotropic Radiated Power Measurement

3.3.1 Description of the ERP/EIRP Measurement

The substitution method, in ANSI / TIA / EIA-603-C-2004, was used for ERP/EIRP measurement, and the spectrum analyzer configuration follows KDB 971168 D01 Power Meas. License Digital Systems v02r01. The ERP of mobile transmitters must not exceed 7 Watts and the EIRP of mobile transmitters are limited to 2 Watts.

3.3.2 Measuring Instruments

The measuring equipment is listed in the section 4 of this test report.

3.3.3 Test Procedures

1. The EUT was placed on a non-conductive rotating platform 0.8 meters high in a semi-anechoic chamber. The radiated emission at the fundamental frequency was measured at 3 m with a test antenna and a spectrum analyzer with RMS detector per section 5. of KDB 971168 D01.
2. During the measurement, the system simulator parameters were set to force the EUT transmitting at maximum output power. The maximum emission was recorded from analyzer power level (LVL) from the 360 degrees rotation of the turntable and the test antenna raised and lowered over a range from 1 to 4 meters in both horizontally and vertically polarized orientations.
3. Effective Isotropic Radiated Power (EIRP) was measured by substitution method according to TIA/EIA-603-C. The EUT was replaced by dipole antenna (substitution antenna) at the same location, and then a known power from S.G. was applied into the dipole antenna through a Tx cable, and then recorded the maximum Analyzer reading through raised and lowered the test antenna. The correction factor (in dB) = S.G. - Tx Cable loss + Substitution antenna gain - Analyzer reading. Then the EUT's EIRP was calculated with the correction factor, $EIRP = LVL + \text{Correction factor}$ and $ERP = EIRP - 2.15$.

3.3.4 Test Setup

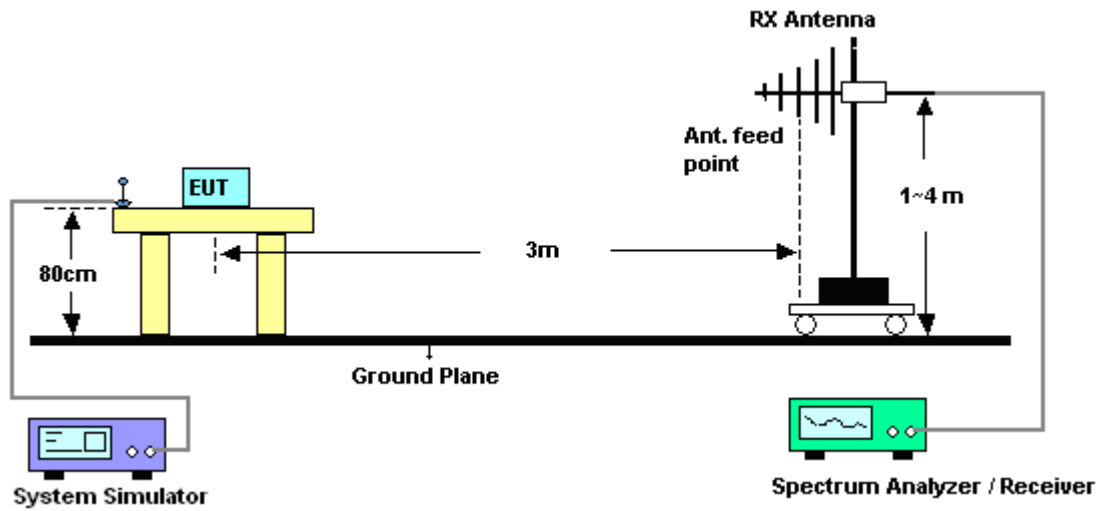



3.3.5 Test Result of ERP

GSM850 (GPRS class 8) Radiated Power ERP				
Horizontal Polarization				
Frequency (MHz)	LVL (dBm)	Correction Factor (dB)	ERP (dBm)	ERP (W)
824.2	-1.49	31.54	27.90	0.62
836.4	-2.48	32.04	27.41	0.55
848.8	-5.05	32.59	25.39	0.35
Vertical Polarization				
Frequency (MHz)	LVL (dBm)	Correction Factor (dB)	ERP (dBm)	ERP (W)
824.2	-15.43	32.93	15.35	0.03
836.4	-15.85	32.82	14.82	0.03
848.8	-16.79	33.62	14.68	0.03

* ERP = LVL (dBm) + Correction Factor (dB) – 2.15

GSM850 (EDGE class 8) Radiated Power ERP				
Horizontal Polarization				
Frequency (MHz)	LVL (dBm)	Correction Factor (dB)	ERP (dBm)	ERP (W)
824.2	-4.99	31.54	24.40	0.28
836.4	-6.40	32.04	23.49	0.22
848.8	-9.55	32.59	20.89	0.12
Vertical Polarization				
Frequency (MHz)	LVL (dBm)	Correction Factor (dB)	ERP (dBm)	ERP (W)
824.2	-18.85	32.93	11.93	0.02
836.4	-19.82	32.82	10.85	0.01
848.8	-21.67	33.62	9.80	0.01

* ERP = LVL (dBm) + Correction Factor (dB) – 2.15



WCDMA Band V (RMC 12.2Kbps) Radiated Power ERP				
Horizontal Polarization				
Frequency (MHz)	LVL (dBm)	Correction Factor (dB)	ERP (dBm)	ERP (W)
826.40	-9.46	31.44	19.83	0.10
836.40	-10.98	32.04	18.91	0.08
846.60	-13.04	32.63	17.44	0.06
Vertical Polarization				
Frequency (MHz)	LVL (dBm)	Correction Factor (dB)	ERP (dBm)	ERP (W)
826.40	-23.37	32.78	7.26	0.01
836.40	-24.31	32.82	6.36	0.00
846.60	-24.66	33.4	6.59	0.00

* ERP = LVL (dBm) + Correction Factor (dB) – 2.15



3.3.6 Test Result of EIRP

GSM1900 (GPRS class 8) Radiated Power EIRP				
Horizontal Polarization				
Frequency (MHz)	LVL (dBm)	Correction Factor (dB)	EIRP (dBm)	EIRP (W)
1850.2	-15.47	45.34	29.87	0.97
1880.0	-16.66	46.01	29.35	0.86
1909.8	-17.18	45.81	28.63	0.73
Vertical Polarization				
Frequency (MHz)	LVL (dBm)	Correction Factor (dB)	EIRP (dBm)	EIRP (W)
1850.2	-20.41	49.22	28.81	0.76
1880.0	-21.48	50.42	28.94	0.78
1909.8	-21.02	49.00	27.98	0.63

* EIRP = LVL (dBm) + Correction Factor (dB)

GSM1900 (EDGE class 8) Radiated Power EIRP				
Horizontal Polarization				
Frequency (MHz)	LVL (dBm)	Correction Factor (dB)	EIRP (dBm)	EIRP (W)
1850.2	-19.11	45.34	26.23	0.42
1880.0	-20.23	46.01	25.78	0.38
1909.8	-20.99	45.81	24.82	0.30
Vertical Polarization				
Frequency (MHz)	LVL (dBm)	Correction Factor (dB)	EIRP (dBm)	EIRP (W)
1850.2	-23.93	49.22	25.29	0.34
1880.0	-25.30	50.42	25.12	0.33
1909.8	-24.72	49.00	24.28	0.27

* EIRP = LVL (dBm) + Correction Factor (dB)

3.4 99% Occupied Bandwidth and 26dB Bandwidth Measurement

3.4.1 Description of 99% Occupied Bandwidth and 26dB Bandwidth Measurement

The 99% occupied bandwidth is the width of a frequency band such that, below the lower and above the upper frequency limits, the mean powers emitted are each equal to a specified percentage 0.5% of the total mean transmitted power.

The emission bandwidth is defined as the width of the signal between two points, located at the 2 sides of the carrier frequency, outside of which all emissions are attenuated at least 26 dB below the transmitter power.

3.4.2 Measuring Instruments

The measuring equipment is listed in the section 4 of this test report.

3.4.3 Test Procedures

1. The EUT was connected to the spectrum analyzer and system simulator via a power divider.
2. The RF output of the EUT was connected to the spectrum analyzer by RF cable and attenuator. The path loss was compensated to the results for each measurement.
3. The 99% occupied bandwidth were measured, set RBW= 1% of span, VBW= 3*RBW, sample detector, trace maximum hold.
4. The 26dB bandwidth were measured, set RBW= 1% of EBW, VBW= 3*RBW, peak detector, trace maximum hold.

3.4.4 Test Setup

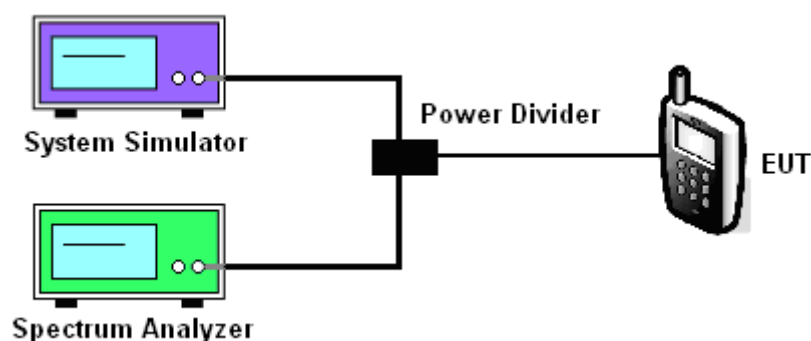



3.4.5 Test Result of Occupied Bandwidth and 26dB Bandwidth

Cellular Band						
Modes	GSM850 (GPRS class 8)			GSM850 (EDGE class 8)		
Channel	128 (Low)	189 (Mid)	251 (High)	128 (Low)	189 (Mid)	251 (High)
Frequency (MHz)	824.2	836.4	848.8	824.2	836.4	848.8
99% OBW (kHz)	242.00	246.00	244.00	248.00	242.00	242.00
26dB BW (kHz)	304.00	314.00	314.00	302.00	300.00	302.00

PCS Band						
Modes	GSM1900 (GPRS class 8)			GSM1900 (EDGE class 8)		
Channel	512 (Low)	661 (Mid)	810 (High)	512 (Low)	661 (Mid)	810 (High)
Frequency (MHz)	1850.2	1880	1909.8	1850.2	1880	1909.8
99% OBW (kHz)	244.00	246.00	246.00	244.00	244.00	242.00
26dB BW (kHz)	318.00	312.00	314.00	292.00	302.00	310.00

Cellular Band			
Modes	WCDMA Band V (RMC 12.2Kbps)		
Channel	4132 (Low)	4182 (Mid)	4233 (High)
Frequency (MHz)	826.4	836.4	846.6
99% OBW (MHz)	4.18	4.16	4.18
26dB BW (MHz)	4.68	4.68	4.70



3.4.6 Test Result (Plots) of Occupied Bandwidth and 26dB Bandwidth

Band :	GSM 850	Test Mode :	GPRS class 8 Link (GMSK)
---------------	---------	--------------------	--------------------------

99% Occupied Bandwidth Plot on Channel 128 (824.2 MHz)

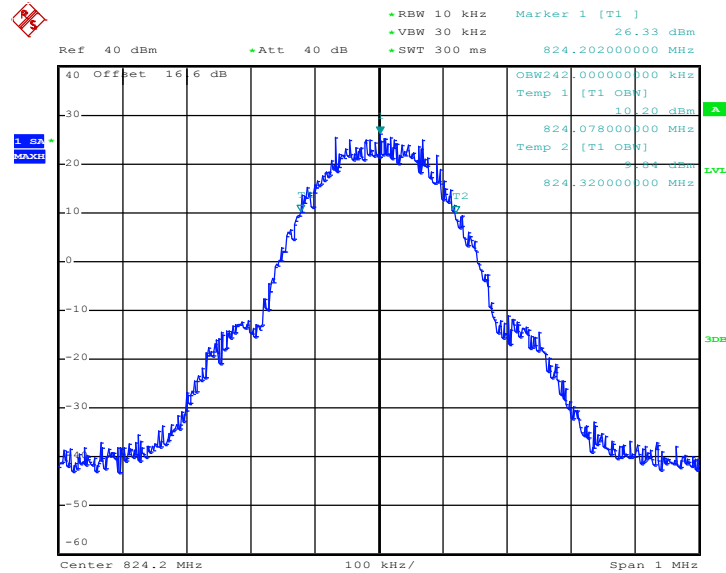

Date: 19.JUN.2014 15:53:45

26dB Bandwidth Plot on Channel 128 (824.2 MHz)

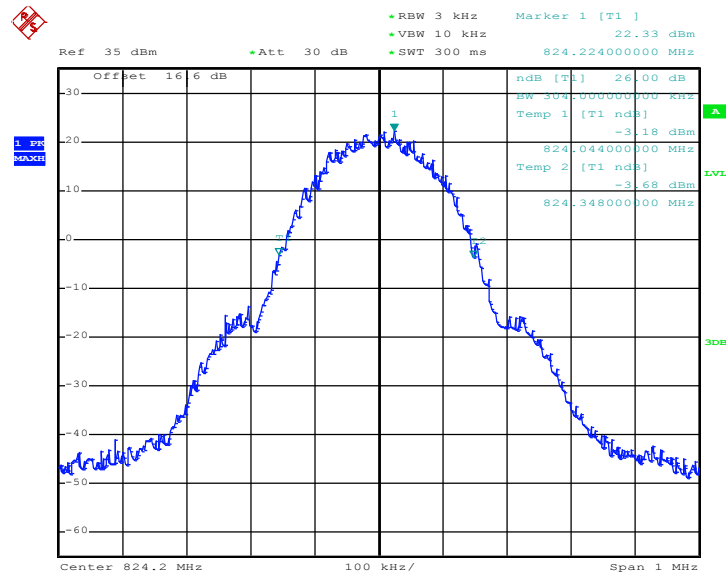

Date: 19.JUN.2014 15:49:44



99% Occupied Bandwidth Plot on Channel 189 (836.4 MHz)

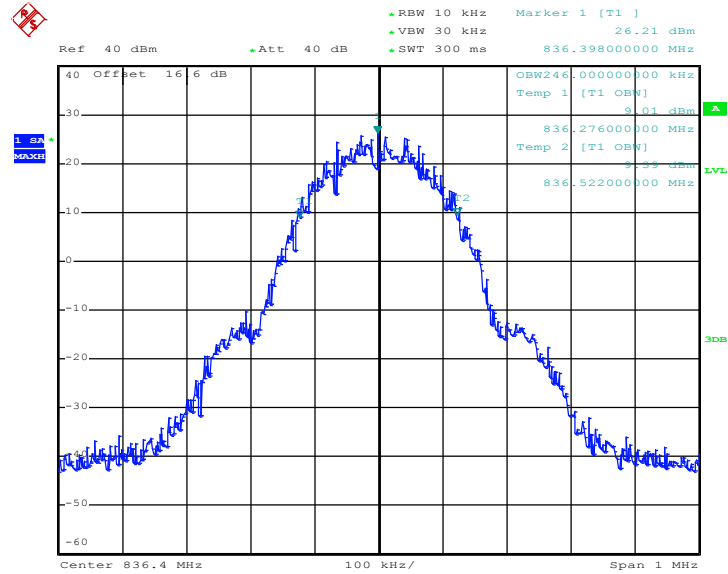

Date: 19.JUN.2014 15:54:14

26dB Bandwidth Plot on Channel 189 (836.4 MHz)

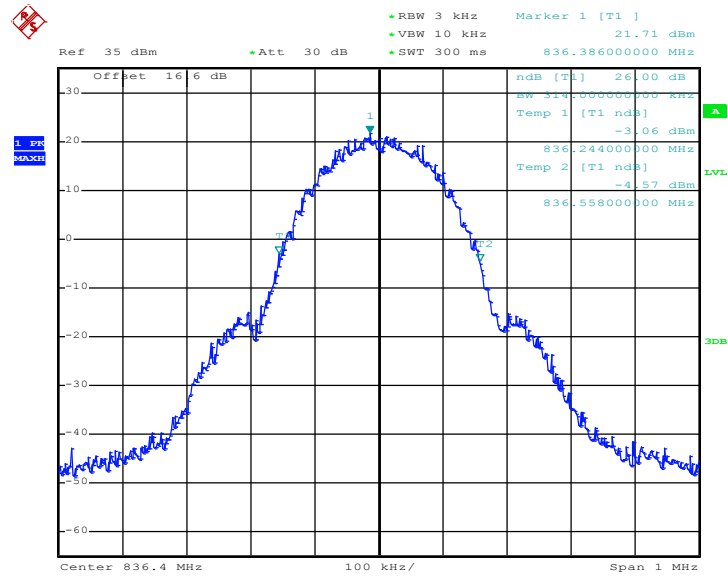

Date: 19.JUN.2014 15:50:13



99% Occupied Bandwidth Plot on Channel 251 (848.8 MHz)

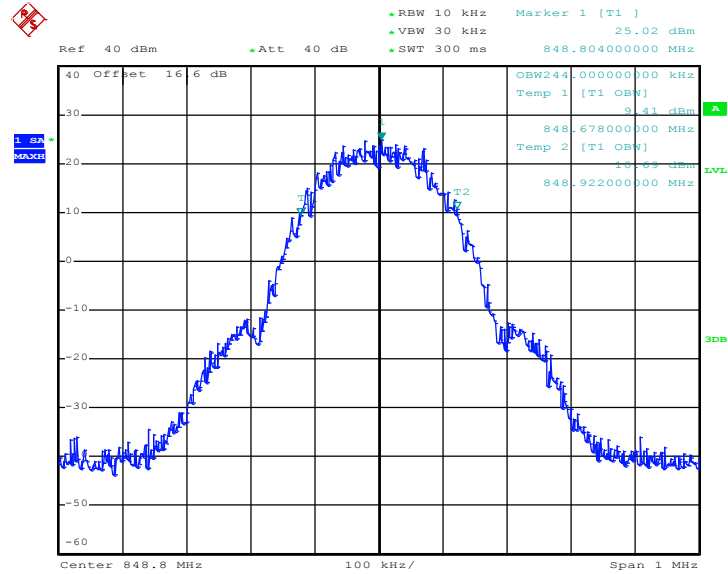

Date: 19.JUN.2014 15:54:43

26dB Bandwidth Plot on Channel 251 (848.8 MHz)

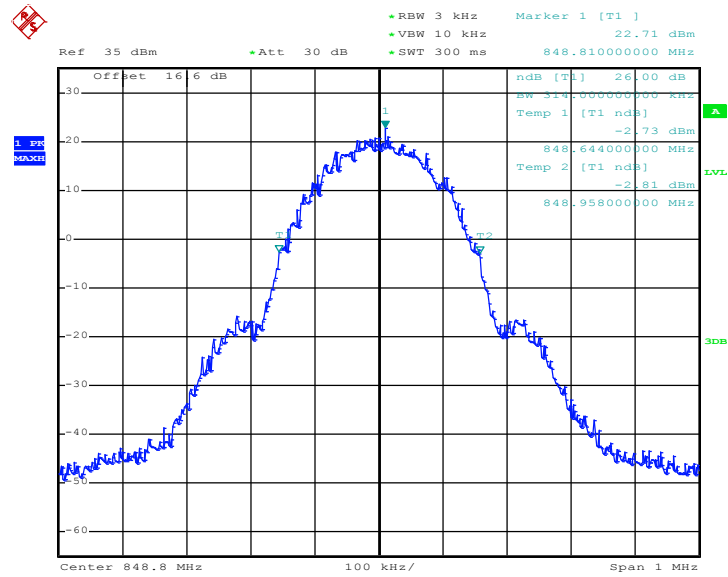

Date: 19.JUN.2014 15:50:41



Band :	GSM 850	Test Mode :	EDGE class 8 Link (8PSK)
---------------	---------	--------------------	--------------------------

99% Occupied Bandwidth Plot on Channel 128 (824.2 MHz)

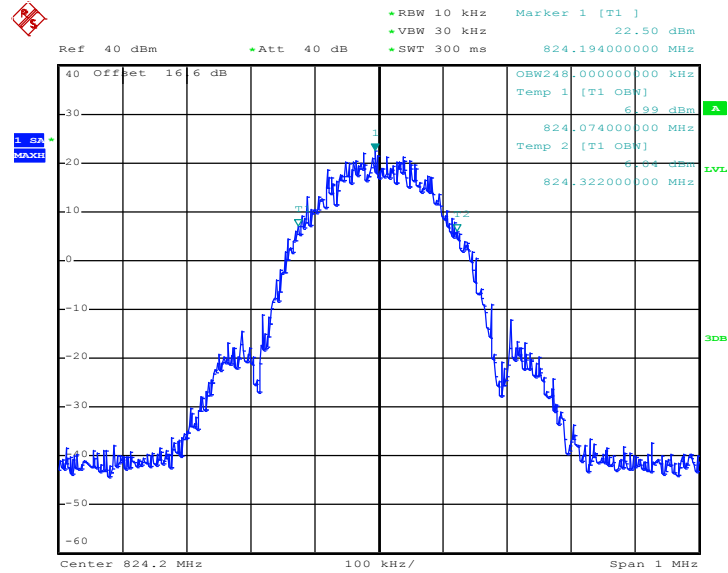

Date: 19.JUN.2014 16:53:59

26dB Bandwidth Plot on Channel 128 (824.2 MHz)

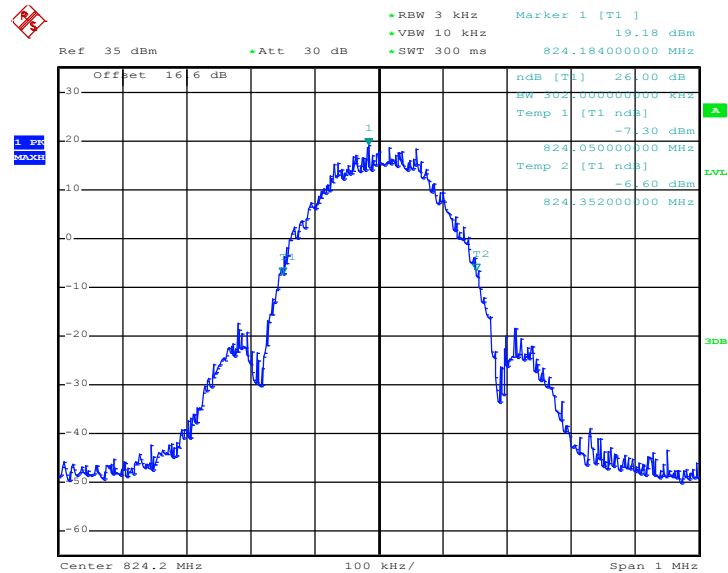

Date: 19.JUN.2014 16:50:00



99% Occupied Bandwidth Plot on Channel 189 (836.4 MHz)

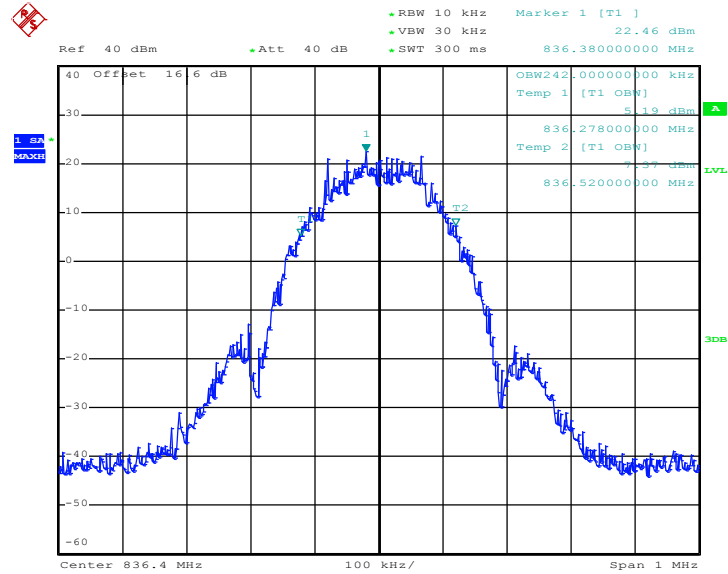

Date: 19.JUN.2014 16:54:28

26dB Bandwidth Plot on Channel 189 (836.4 MHz)

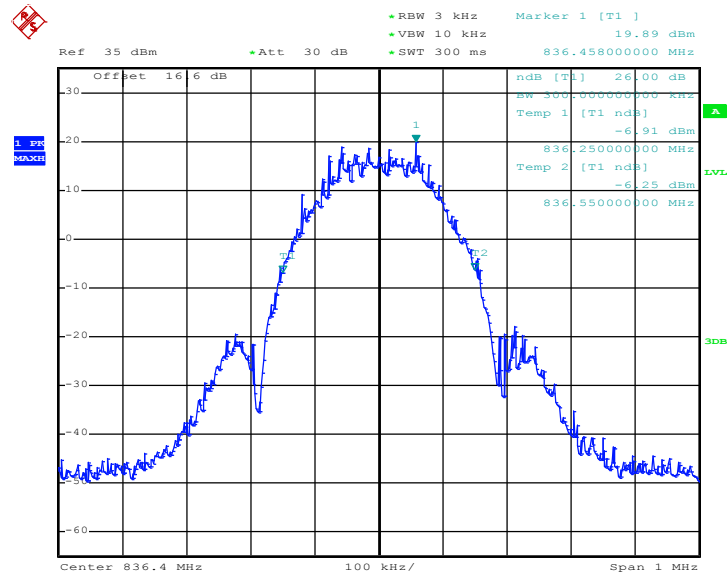

Date: 19.JUN.2014 16:50:29



99% Occupied Bandwidth Plot on Channel 251 (848.8 MHz)

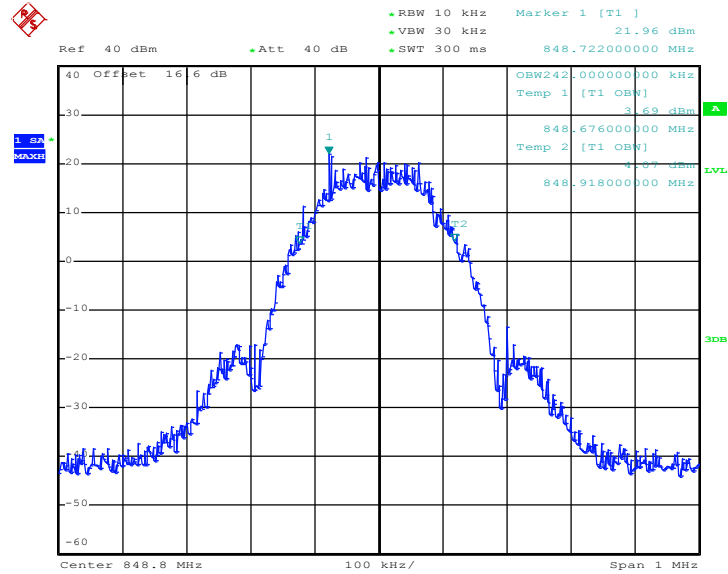

Date: 19.JUN.2014 16:54:56

26dB Bandwidth Plot on Channel 251 (848.8 MHz)

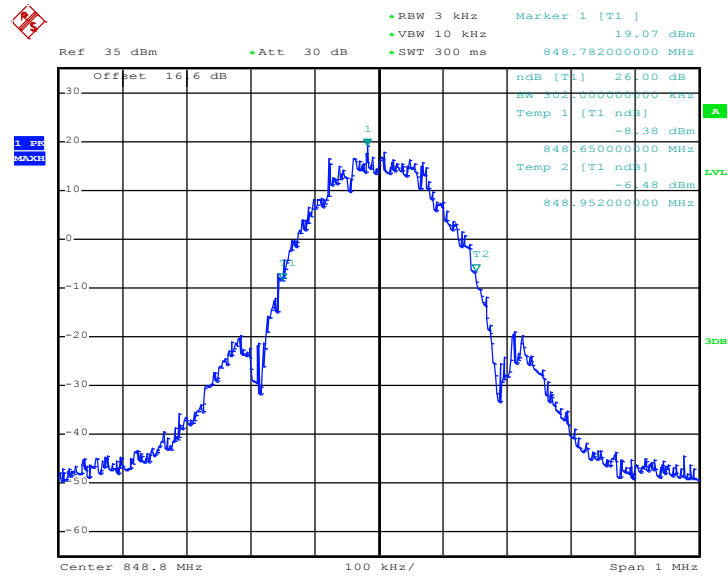

Date: 19.JUN.2014 16:48:18



Band :	GSM 1900	Test Mode :	GPRS class 8 Link (GMSK)
---------------	----------	--------------------	--------------------------

99% Occupied Bandwidth Plot on Channel 512 (1850.2 MHz)

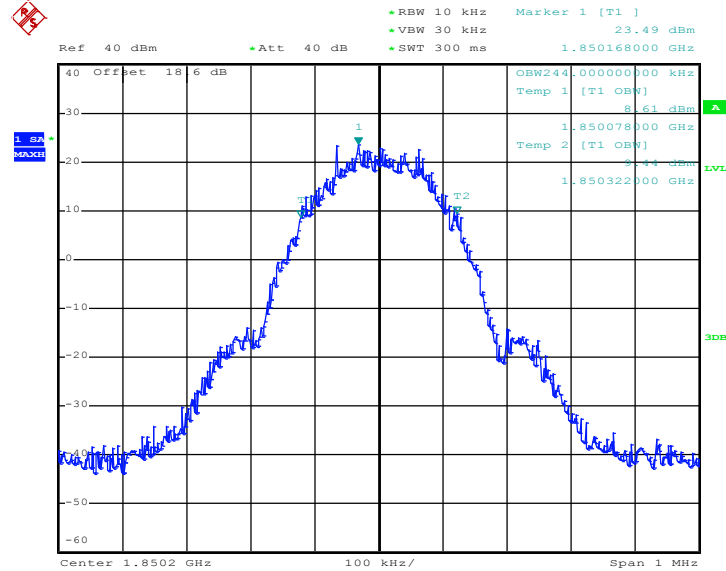

Date: 20.JUN.2014 09:18:35

26dB Bandwidth Plot on Channel 512 (1850.2 MHz)

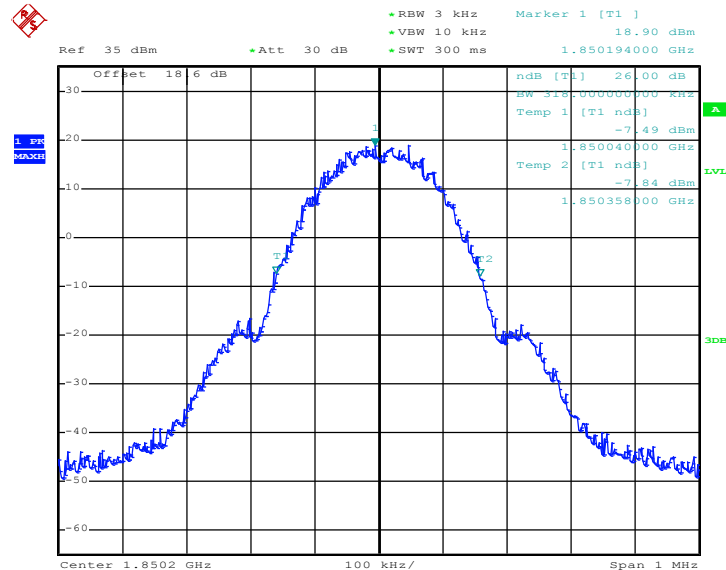

Date: 20.JUN.2014 09:16:55



99% Occupied Bandwidth Plot on Channel 661 (1880.0 MHz)

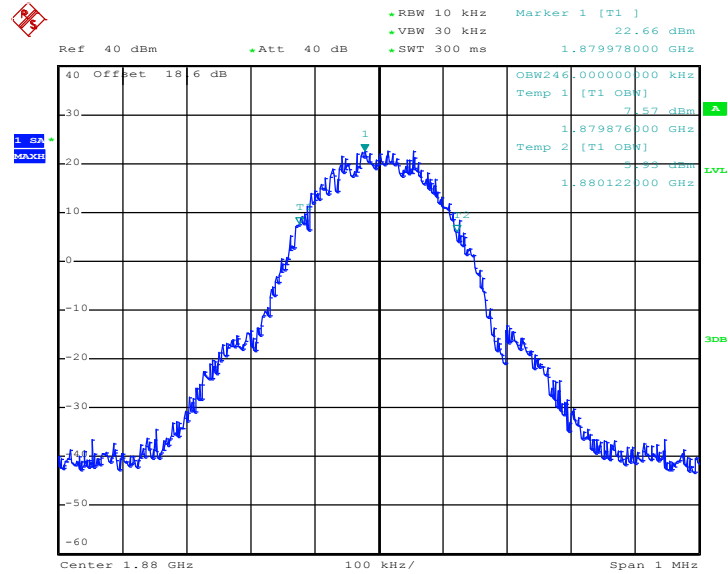

Date: 20.JUN.2014 09:19:03

26dB Bandwidth Plot on Channel 661 (1880.0 MHz)

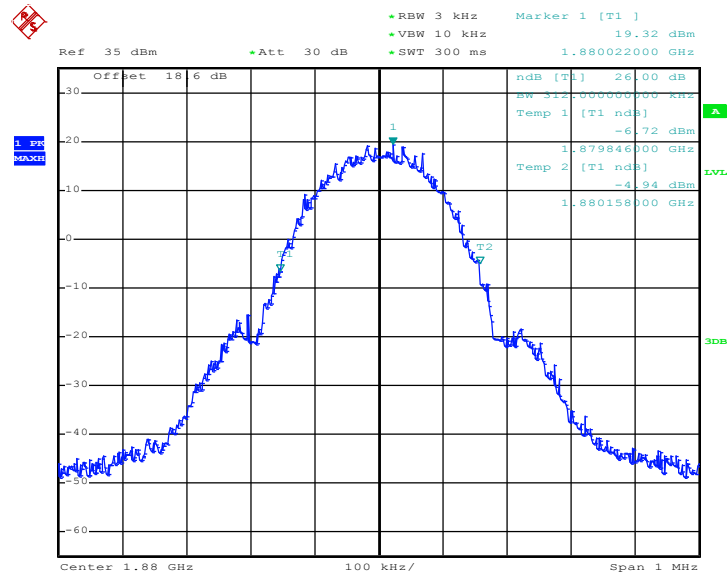

Date: 20.JUN.2014 09:17:24



99% Occupied Bandwidth Plot on Channel 810 (1909.8 MHz)

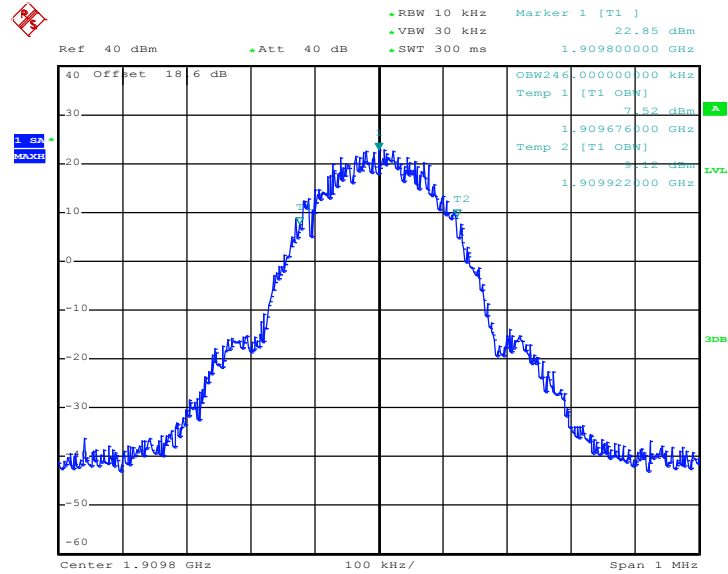

Date: 20.JUN.2014 09:19:32

26dB Bandwidth Plot on Channel 810 (1909.8 MHz)

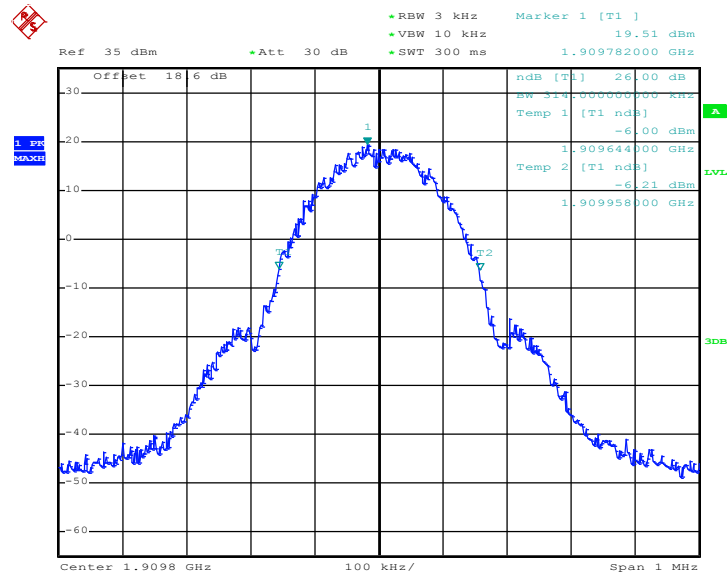

Date: 20.JUN.2014 09:17:52



Band :	GSM 1900	Test Mode :	EDGE class 8 Link (8PSK)
---------------	----------	--------------------	--------------------------

99% Occupied Bandwidth Plot on Channel 512 (1850.2 MHz)

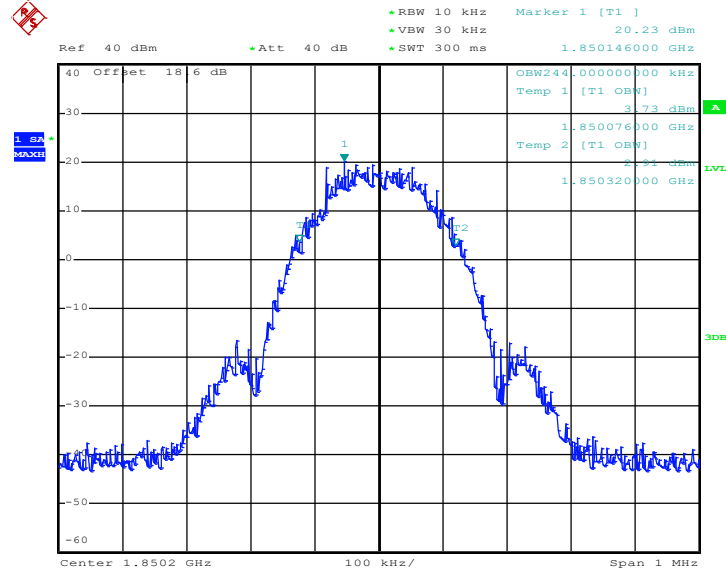

Date: 20.JUN.2014 10:04:51

26dB Bandwidth Plot on Channel 512 (1850.2 MHz)

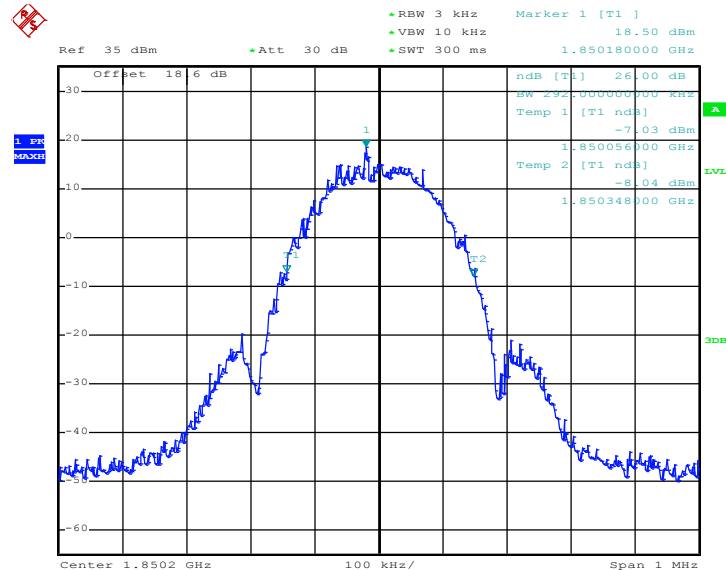

Date: 20.JUN.2014 10:02:41



99% Occupied Bandwidth Plot on Channel 661 (1880.0 MHz)

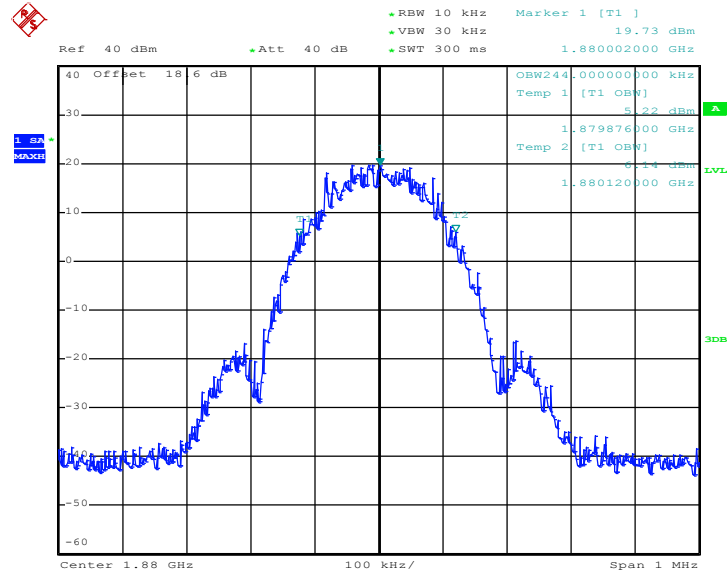

Date: 20.JUN.2014 10:05:19

26dB Bandwidth Plot on Channel 661 (1880.0 MHz)

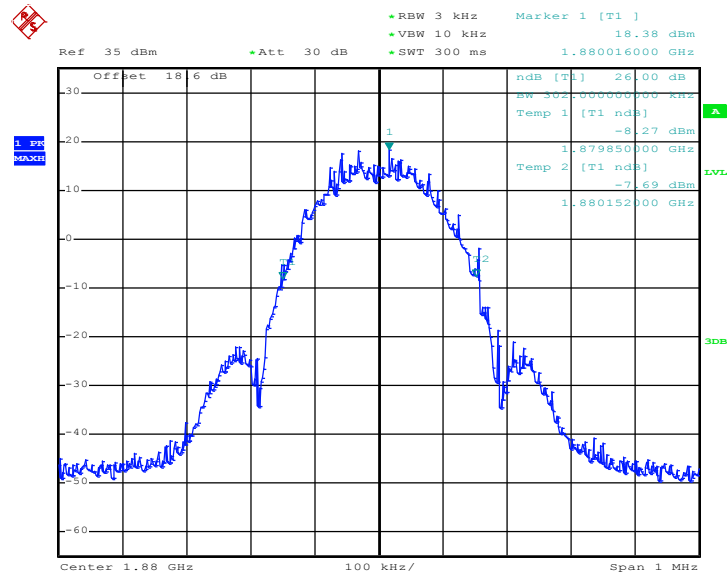

Date: 20.JUN.2014 10:03:10



99% Occupied Bandwidth Plot on Channel 810 (1909.8 MHz)

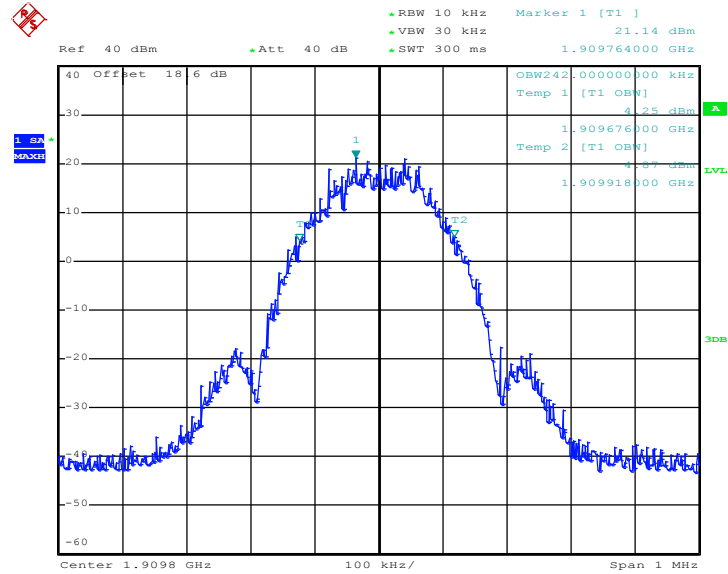

Date: 20.JUN.2014 10:05:48

26dB Bandwidth Plot on Channel 810 (1909.8 MHz)

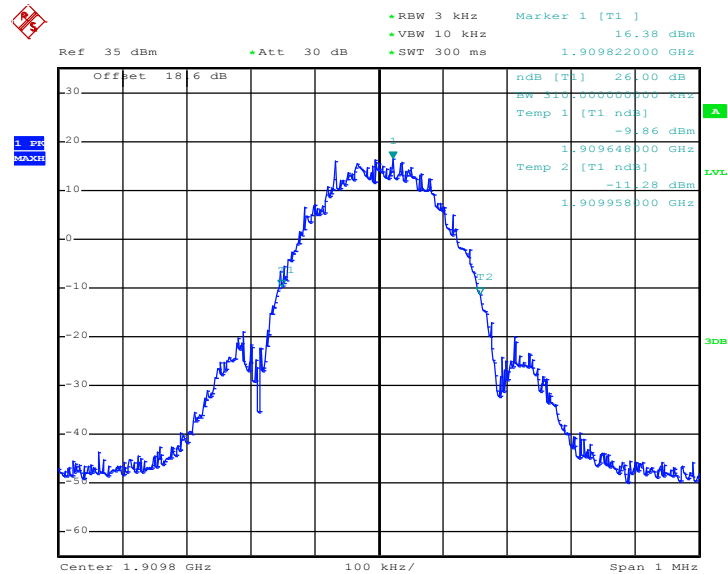

Date: 20.JUN.2014 10:03:39



Band :	WCDMA Band V	Test Mode :	RMC 12.2Kbps Link (QPSK)
---------------	--------------	--------------------	--------------------------

99% Occupied Bandwidth Plot on Channel 4132 (826.4 MHz)

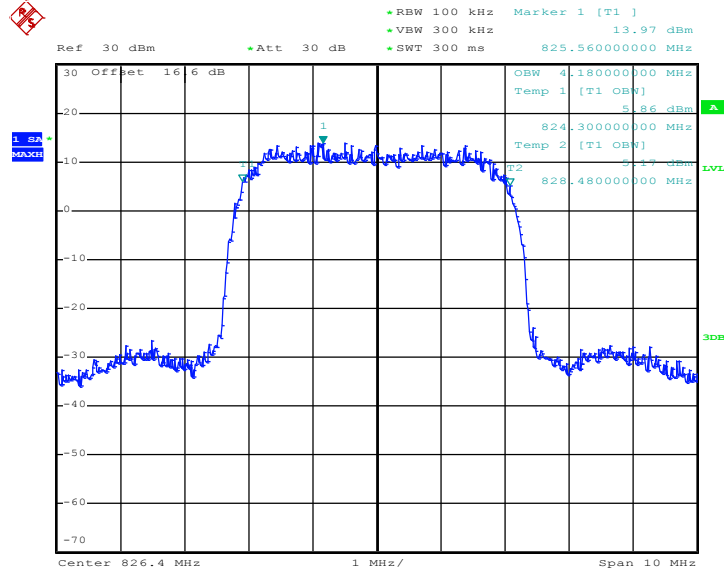

Date: 20.JUN.2014 10:43:27

26dB Bandwidth Plot on Channel 4132 (826.4 MHz)

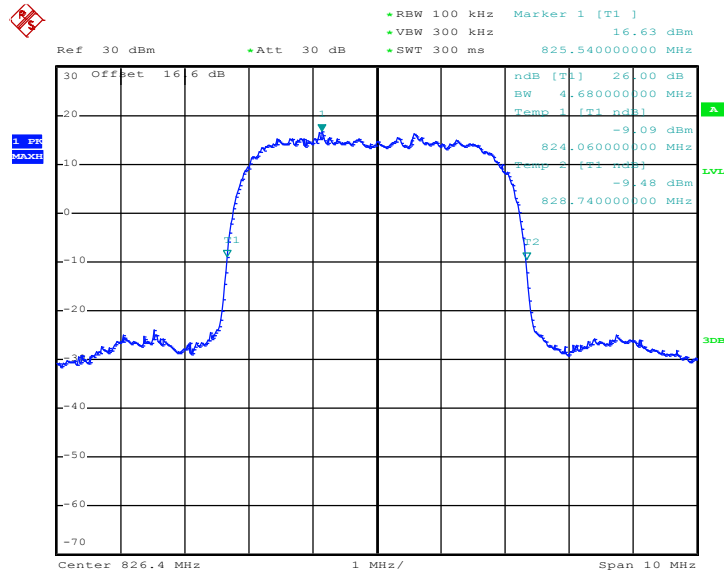

Date: 20.JUN.2014 10:39:56



99% Occupied Bandwidth Plot on Channel 4182 (836.4 MHz)

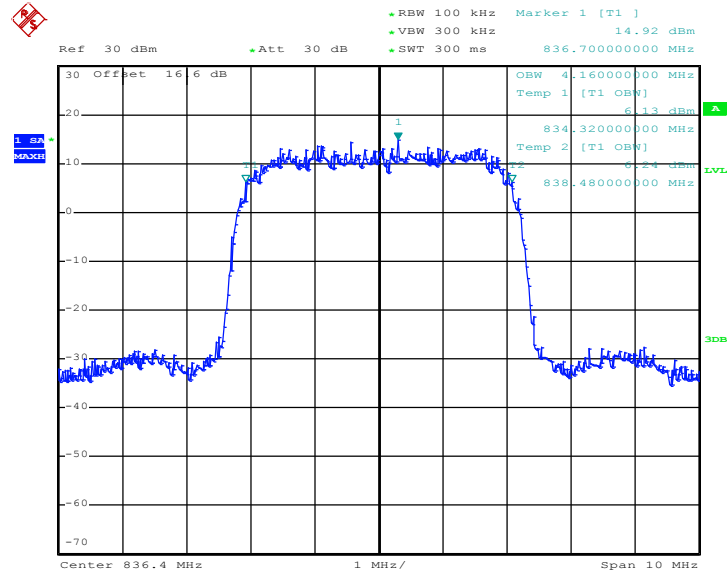

Date: 20.JUN.2014 10:43:56

26dB Bandwidth Plot on Channel 4182 (836.4 MHz)

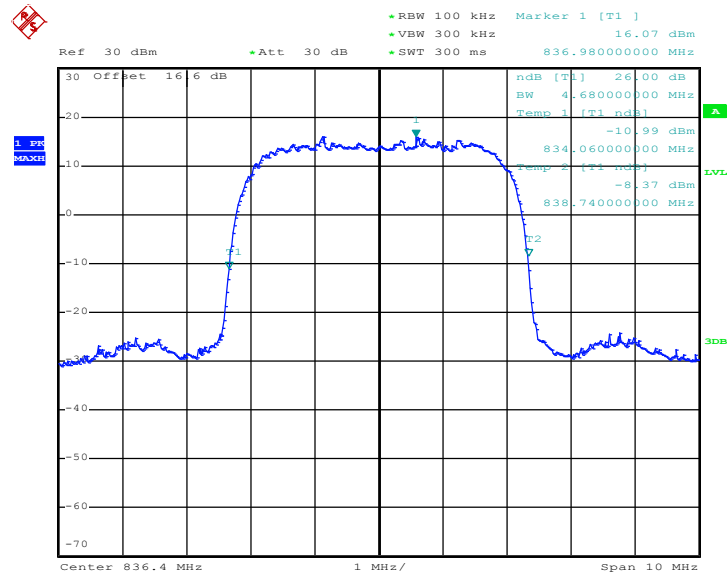

Date: 20.JUN.2014 10:40:25



99% Occupied Bandwidth Plot on Channel 4233 (846.6 MHz)

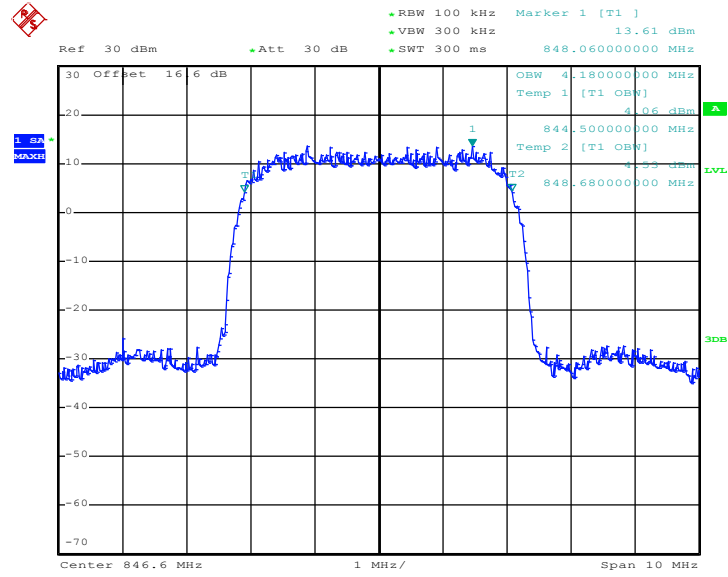

Date: 20.JUN.2014 10:44:25

26dB Bandwidth Plot on Channel 4233 (846.6 MHz)

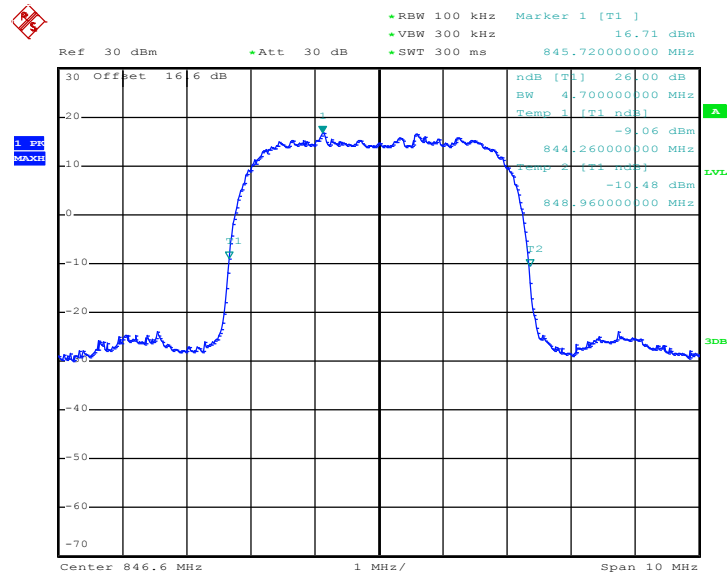

Date: 20.JUN.2014 10:40:53

3.5 Band Edge Measurement

3.5.1 Description of Band Edge Measurement

The power of any emission outside of the authorized operating frequency ranges must be lower than the transmitter power (P) by a factor of at least $43 + 10 \log (P)$ dB.

3.5.2 Measuring Instruments

The measuring equipment is listed in the section 4 of this test report.

3.5.3 Test Procedures

1. The EUT was connected to the spectrum analyzer and system simulator via a power divider.
2. The RF output of EUT was connected to the spectrum analyzer by an RF cable and attenuator. The path loss was compensated to the results for each measurement.
3. The band edges of low and high channels for the highest RF powers were measured.
4. The RF fundamental frequency should be excluded against the limit line in the operating frequency band.
5. The limit line is derived from $43 + 10\log(P)$ dB below the transmitter power P(Watts)
 $= P(W) - [43 + 10\log(P)]$ (dB)
 $= [30 + 10\log(P)]$ (dBm) - $[43 + 10\log(P)]$ (dB)
 $= -13\text{dBm}$.

3.5.4 Test Setup

<Conducted Band Edge >

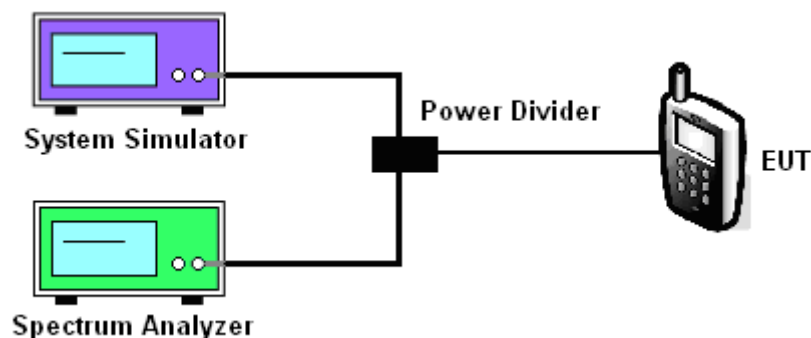



3.5.5 Test Result (Plots) of Conducted Band Edge

Band :	GSM850	Test Mode :	GPRS class 8 Link (GMSK)
--------	--------	-------------	--------------------------

Lower Band Edge Plot on Channel 128 (824.2 MHz)

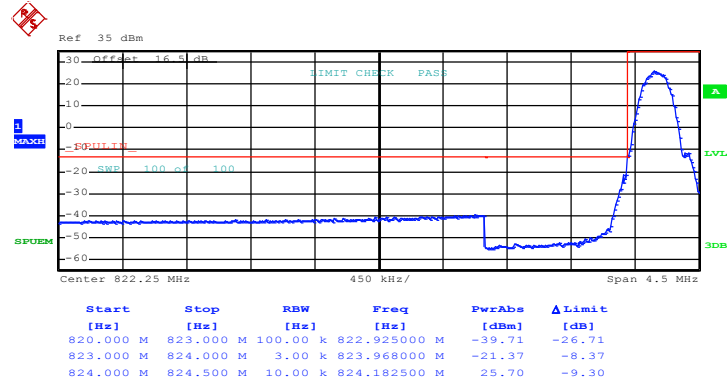

Date: 19.JUN.2014 15:43:11

Higher Band Edge Plot on Channel 251 (848.8 MHz)

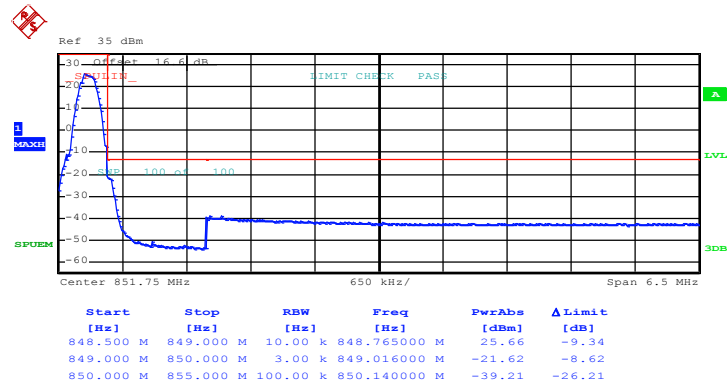

Date: 19.JUN.2014 15:39:20



Band :	GSM850	Test Mode :	EDGE class 8 Link (8PSK)
--------	--------	-------------	--------------------------

Lower Band Edge Plot on Channel 128 (824.2 MHz)

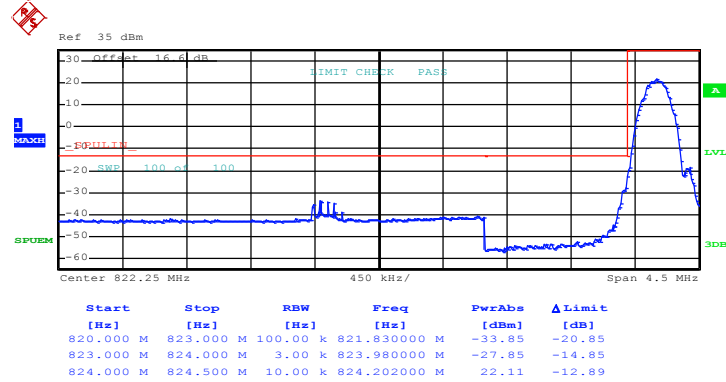

Date: 19.JUN.2014 16:36:32

Higher Band Edge Plot on Channel 251 (848.8 MHz)

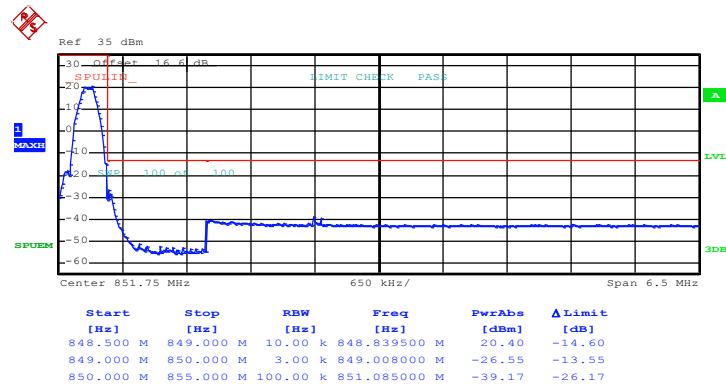

Date: 19.JUN.2014 16:29:37



Band :	GSM1900	Test Mode :	GPRS class 8 Link (GMSK)
--------	---------	-------------	--------------------------

Lower Band Edge Plot on Channel 512 (1850.2 MHz)

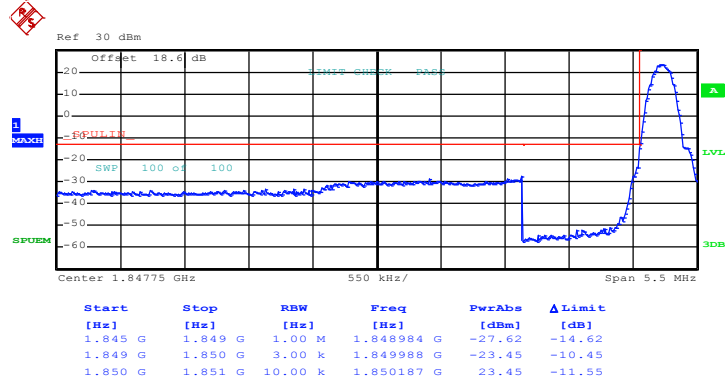

Date: 20.JUN.2014 09:14:05

Higher Band Edge Plot on Channel 810 (1909.8 MHz)

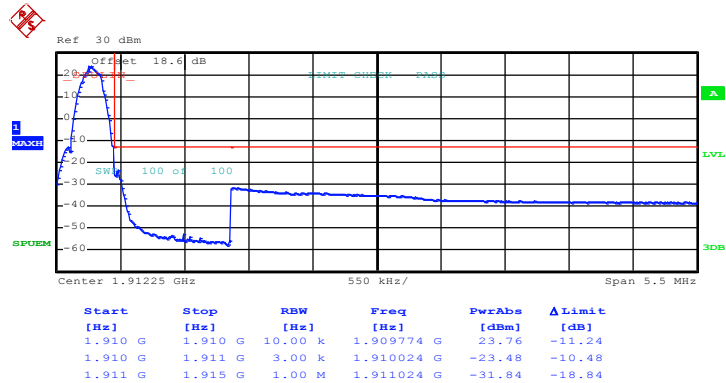

Date: 20.JUN.2014 09:11:40



Band :	GSM1900	Test Mode :	EDGE class 8 Link (8PSK)
--------	---------	-------------	--------------------------

Lower Band Edge Plot on Channel 512 (1850.2 MHz)

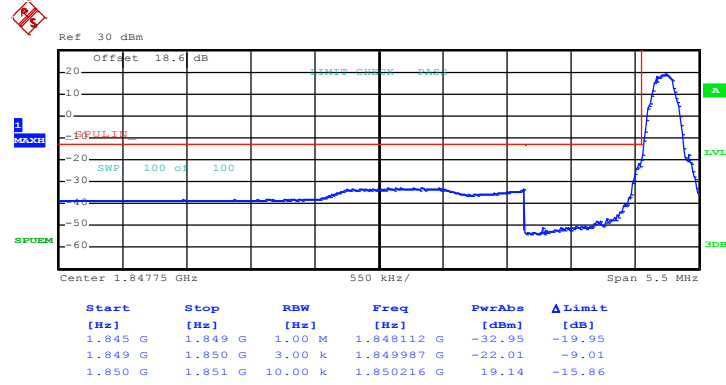

Date: 20.JUN.2014 09:56:27

Higher Band Edge Plot on Channel 810 (1909.8 MHz)

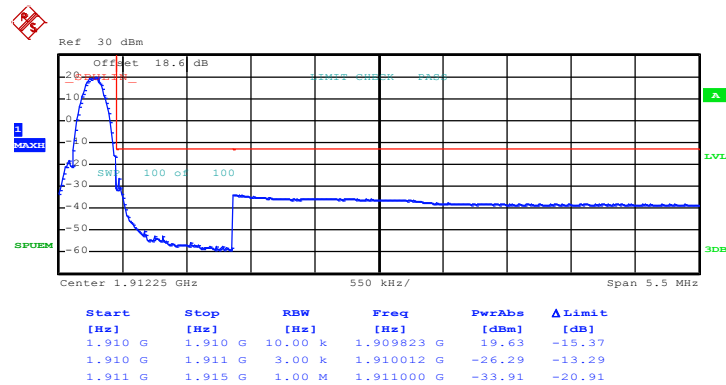

Date: 20.JUN.2014 09:44:20



Band :	WCDMA Band V	Test Mode :	RMC 12.2Kbps Link (QPSK)
--------	--------------	-------------	--------------------------

Lower Band Edge Plot on Channel 4132 (826.4 MHz)

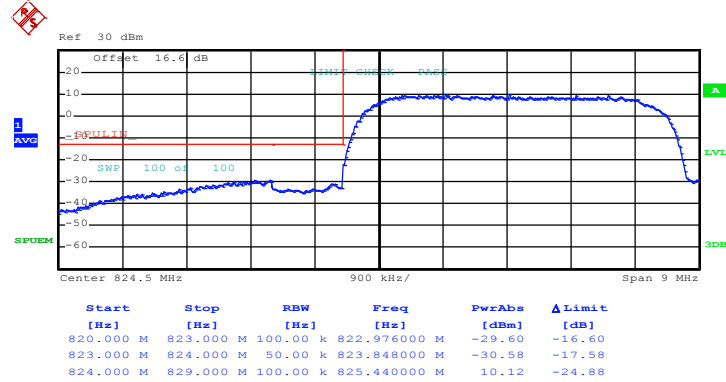

Date: 20.JUN.2014 10:34:27

Higher Band Edge Plot on Channel 4233 (846.6 MHz)

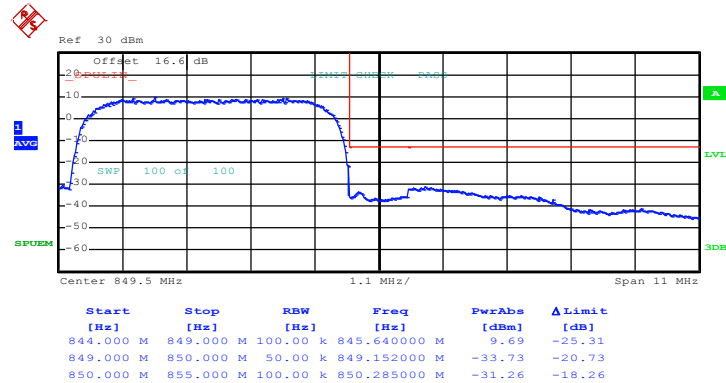

Date: 20.JUN.2014 10:30:35

3.6 Conducted Spurious Emission Measurement

3.6.1 Description of Conducted Spurious Emission Measurement

The power of any emission outside of the authorized operating frequency ranges must be lower than the transmitter power (P) by a factor of at least $43 + 10 \log (P)$ dB.

It is measured by means of a calibrated spectrum analyzer and scanned from 30 MHz up to a frequency including its 10th harmonic.

3.6.2 Measuring Instruments

The measuring equipment is listed in the section 4 of this test report.

3.6.3 Test Procedures

1. The EUT was connected to the spectrum analyzer and system simulator via a power divider.
2. The RF output of EUT was connected to the spectrum analyzer by an RF cable and attenuator. The path loss was compensated to the results for each measurement.
3. The middle channel for the highest RF power within the transmitting frequency was measured.
4. The conducted spurious emission for the whole frequency range was taken.
5. The RF fundamental frequency should be excluded against the limit line in the operating frequency band.
6. The limit line is derived from $43 + 10\log(P)$ dB below the transmitter power P(Watts)
 $= P(W) - [43 + 10\log(P)]$ (dB)
 $= [30 + 10\log(P)]$ (dBm) - $[43 + 10\log(P)]$ (dB)
 $= -13\text{dBm}$.

3.6.4 Test Setup

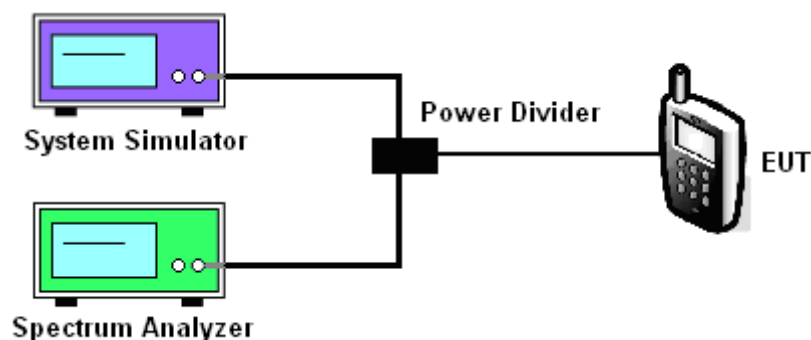



3.6.5 Test Result (Plots) of Conducted Spurious Emission

Band :	GSM850	Channel :	CH128
Test Mode :	GPRS class 8 Link (GMSK)	Frequency :	824.2 MHz

Conducted Spurious Emission Plot between 30MHz ~ 1GHz

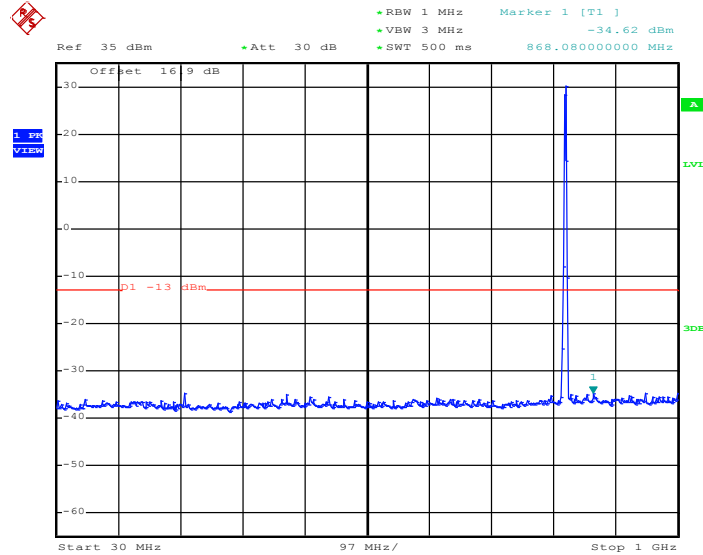

Date: 19.JUN.2014 16:04:44

Conducted Spurious Emission Plot between 1GHz ~ 3GHz

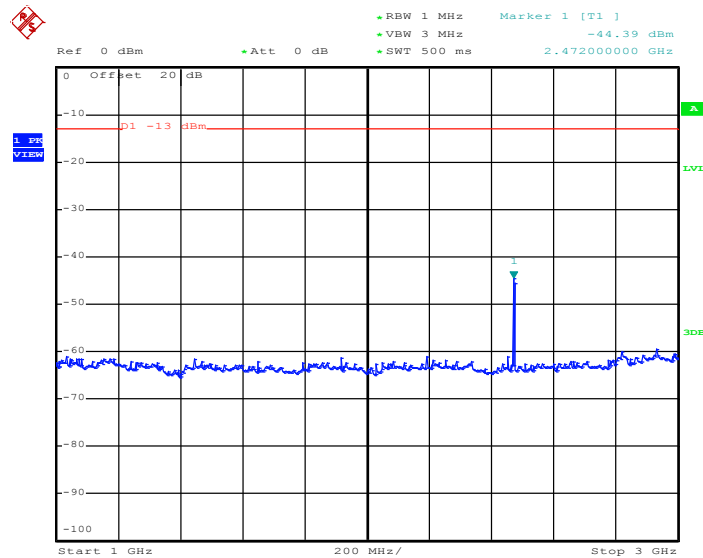

Date: 19.JUN.2014 16:04:59



Conducted Spurious Emission Plot between 3GHz ~ 7GHz

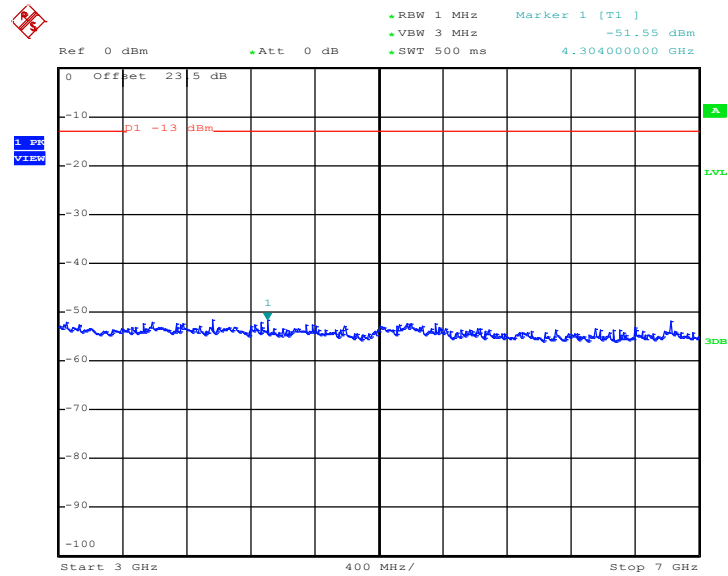

Date: 19.JUN.2014 16:05:07

Conducted Spurious Emission Plot between 7GHz ~ 9GHz

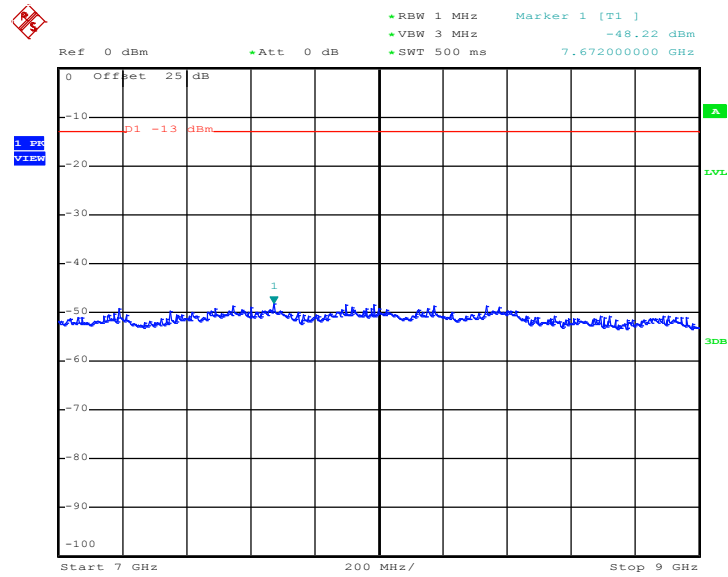

Date: 19.JUN.2014 16:05:16



Band :	GSM850	Channel :	CH189
Test Mode :	GPRS class 8 Link (GMSK)	Frequency :	836.4 MHz

Conducted Spurious Emission Plot between 30MHz ~ 1GHz

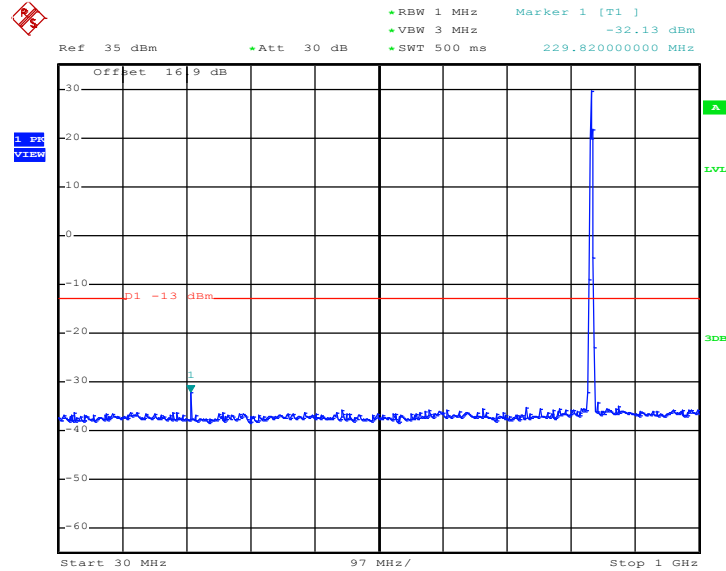

Date: 19.JUN.2014 16:06:19

Conducted Spurious Emission Plot between 1GHz ~ 3GHz

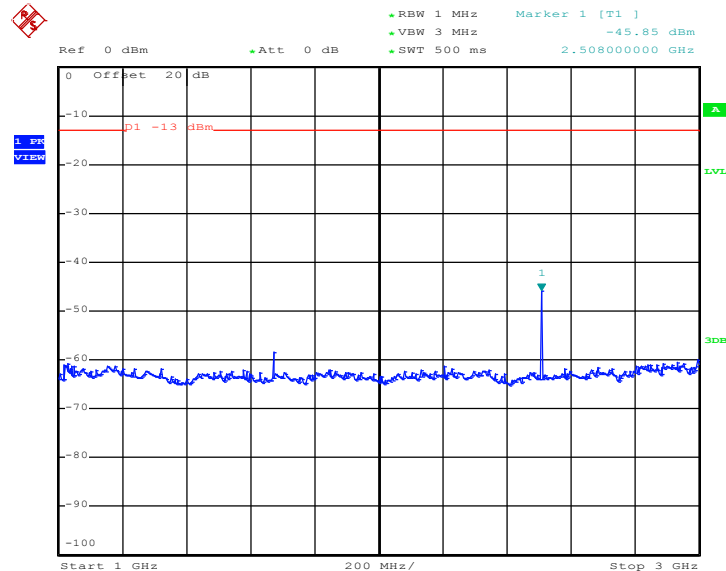

Date: 19.JUN.2014 16:06:30



Conducted Spurious Emission Plot between 3GHz ~ 7GHz

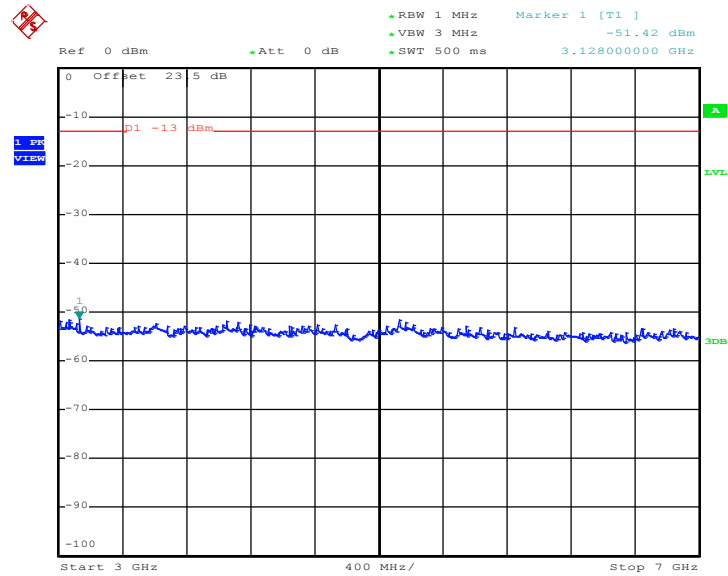

Date: 19.JUN.2014 16:06:39

Conducted Spurious Emission Plot between 7GHz ~ 9GHz

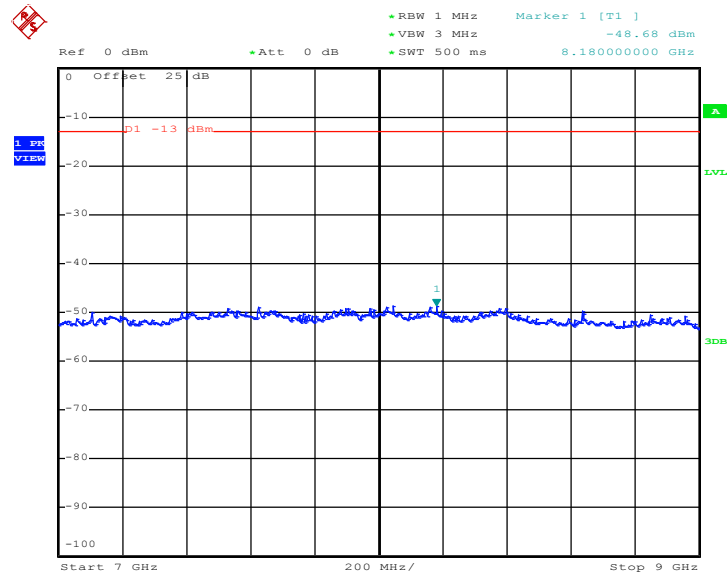

Date: 19.JUN.2014 16:06:47



Band :	GSM850	Channel :	CH251
Test Mode :	GPRS class 8 Link (GMSK)	Frequency :	848.8 MHz

Conducted Spurious Emission Plot between 30MHz ~ 1GHz

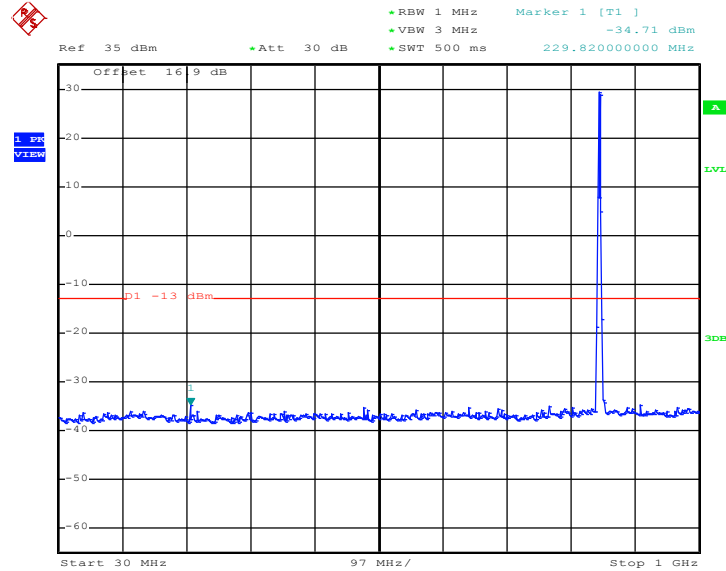

Date: 19.JUN.2014 16:07:48

Conducted Spurious Emission Plot between 1GHz ~ 3GHz

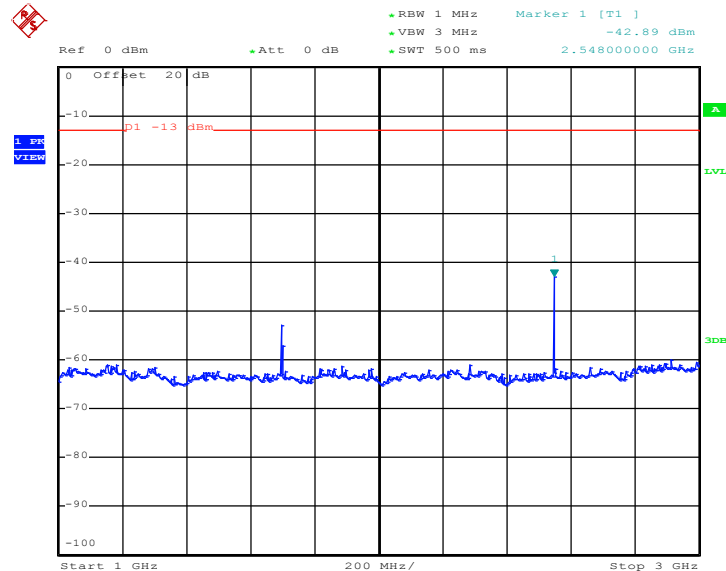

Date: 19.JUN.2014 16:07:59



Conducted Spurious Emission Plot between 3GHz ~ 7GHz

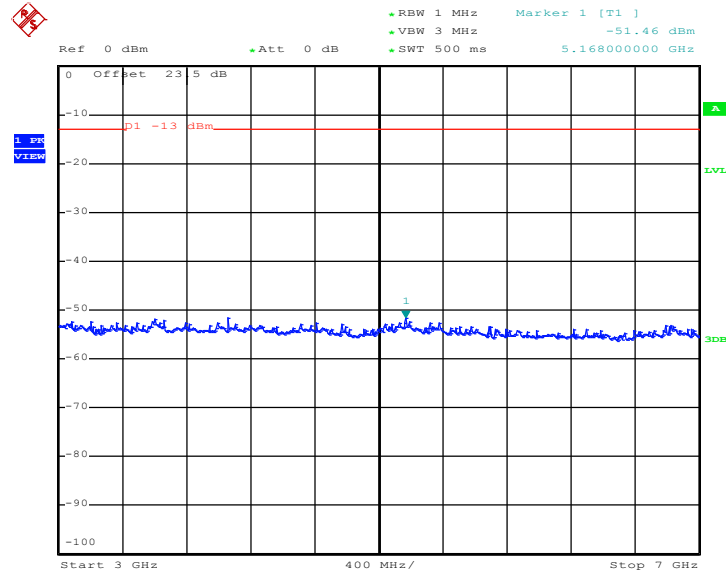

Date: 19.JUN.2014 16:08:08

Conducted Spurious Emission Plot between 7GHz ~ 9GHz

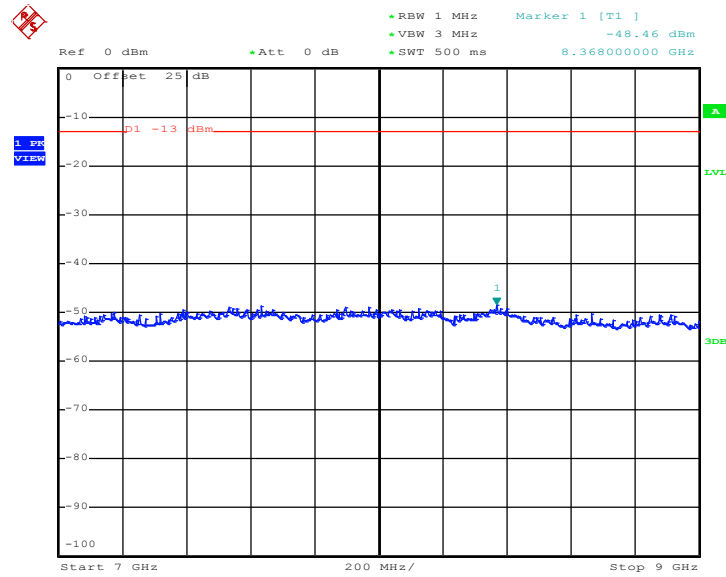

Date: 19.JUN.2014 16:08:16



Band :	GSM850	Channel :	CH128
Test Mode :	EDGE class 8 Link (8PSK)	Frequency :	824.2 MHz

Conducted Spurious Emission Plot between 30MHz ~ 1GHz

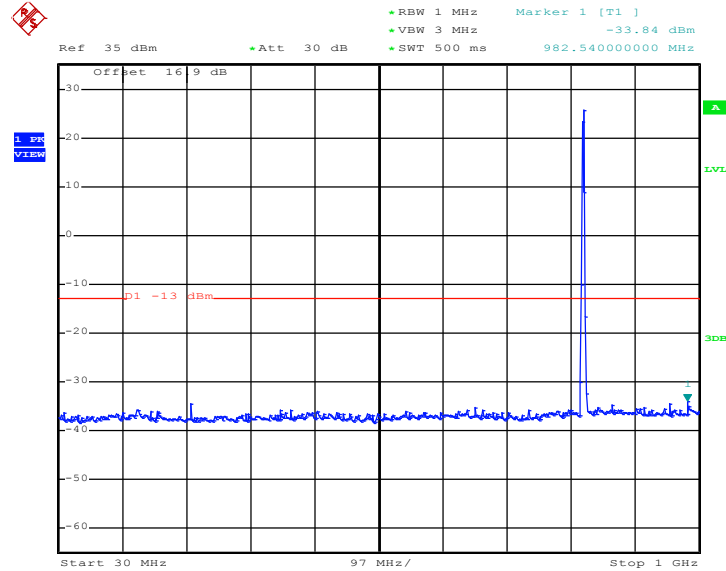

Date: 19.JUN.2014 17:00:39

Conducted Spurious Emission Plot between 1GHz ~ 3GHz

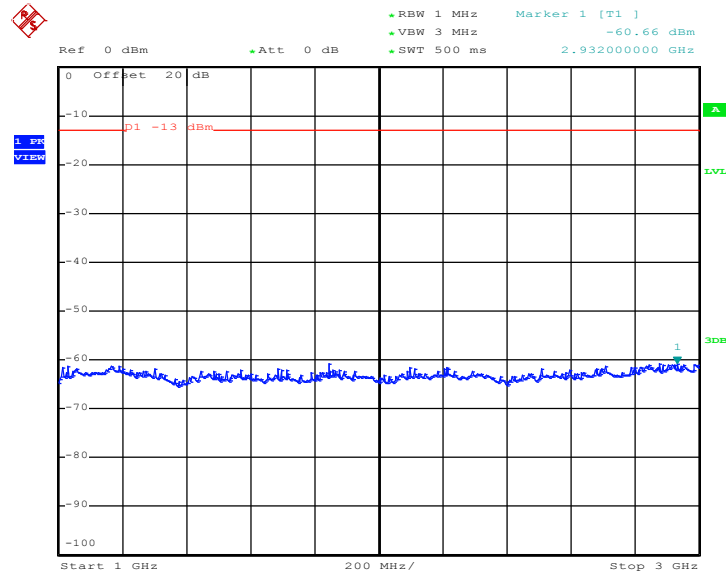

Date: 19.JUN.2014 17:00:49



Conducted Spurious Emission Plot between 3GHz ~ 7GHz

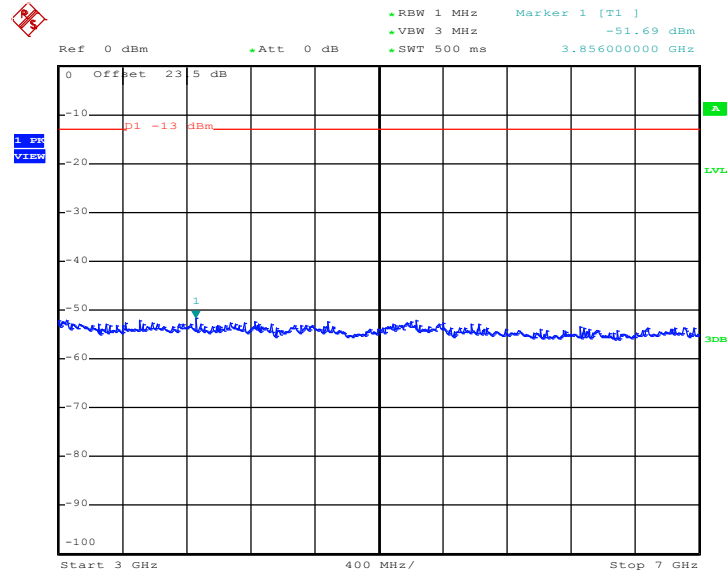

Date: 19.JUN.2014 17:00:58

Conducted Spurious Emission Plot between 7GHz ~ 9GHz

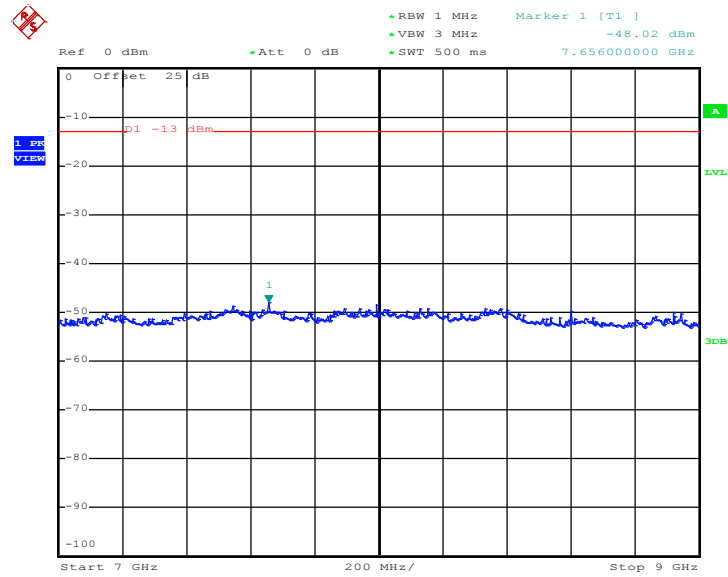

Date: 19.JUN.2014 17:01:06



Band :	GSM850	Channel :	CH189
Test Mode :	EDGE class 8 Link (8PSK)	Frequency :	836.4 MHz

Conducted Spurious Emission Plot between 30MHz ~ 1GHz

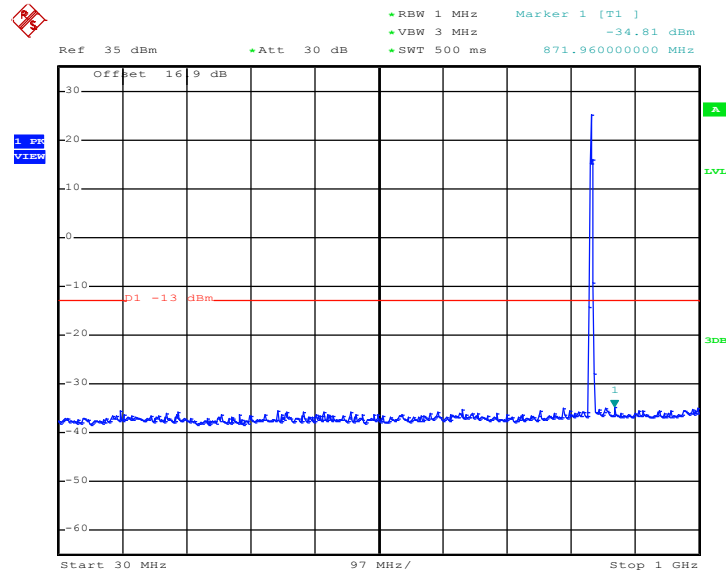

Date: 19.JUN.2014 16:59:31

Conducted Spurious Emission Plot between 1GHz ~ 3GHz

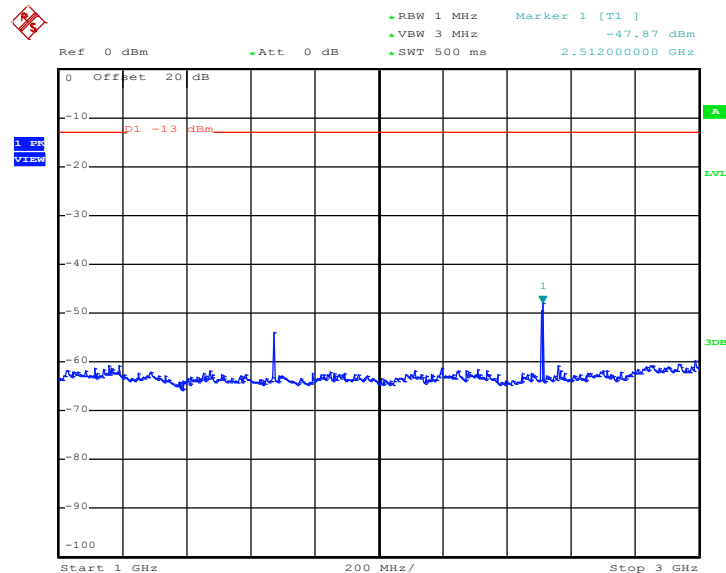

Date: 19.JUN.2014 16:59:41



Conducted Spurious Emission Plot between 3GHz ~ 7GHz

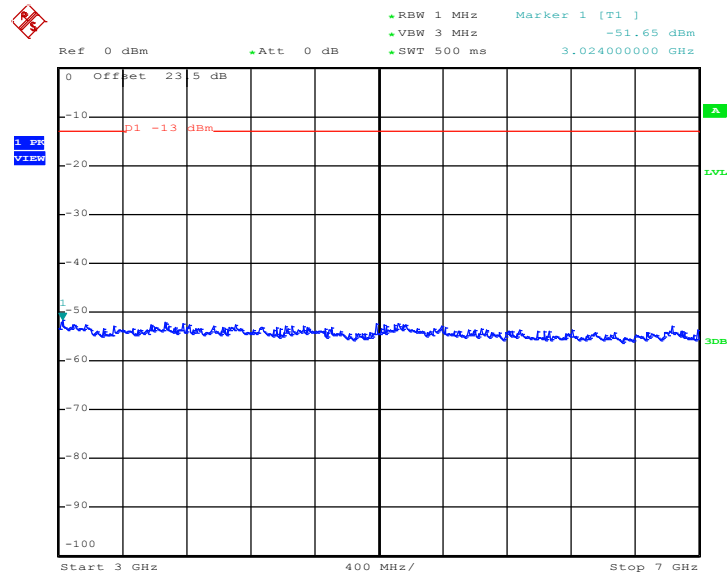

Date: 19.JUN.2014 16:59:50

Conducted Spurious Emission Plot between 7GHz ~ 9GHz

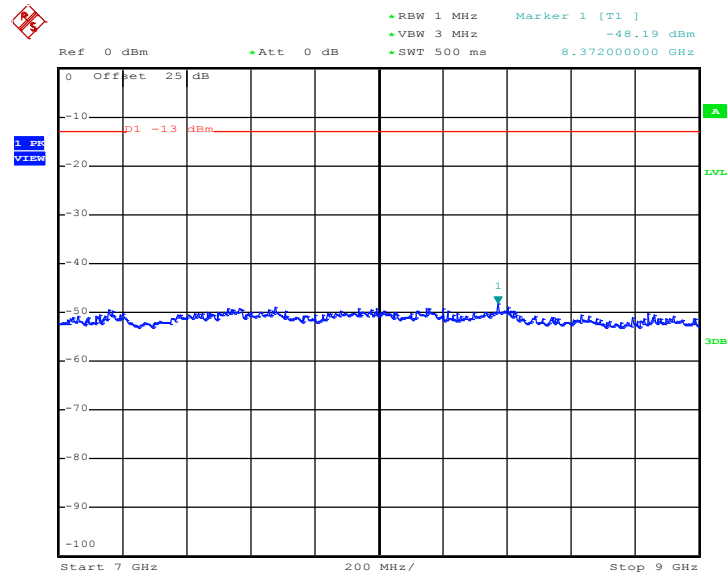

Date: 19.JUN.2014 16:59:58



Band :	GSM850	Channel :	CH251
Test Mode :	EDGE class 8 Link (8PSK)	Frequency :	848.8 MHz

Conducted Spurious Emission Plot between 30MHz ~ 1GHz

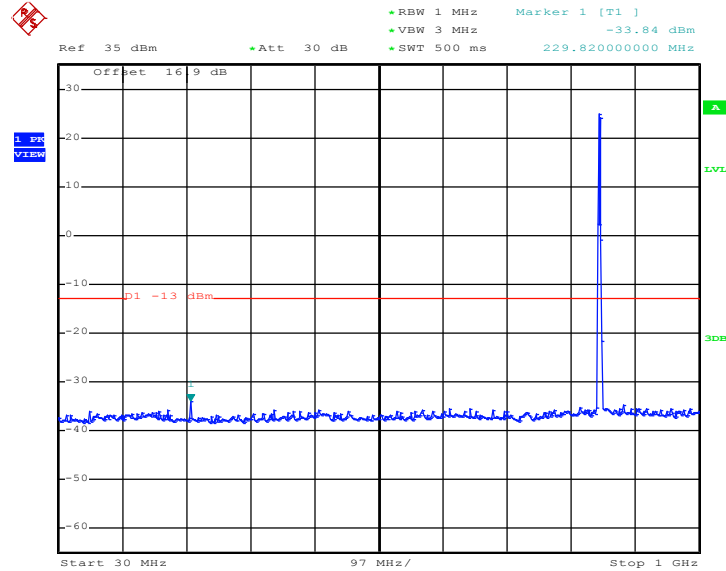

Date: 19.JUN.2014 17:37:45

Conducted Spurious Emission Plot between 1GHz ~ 3GHz

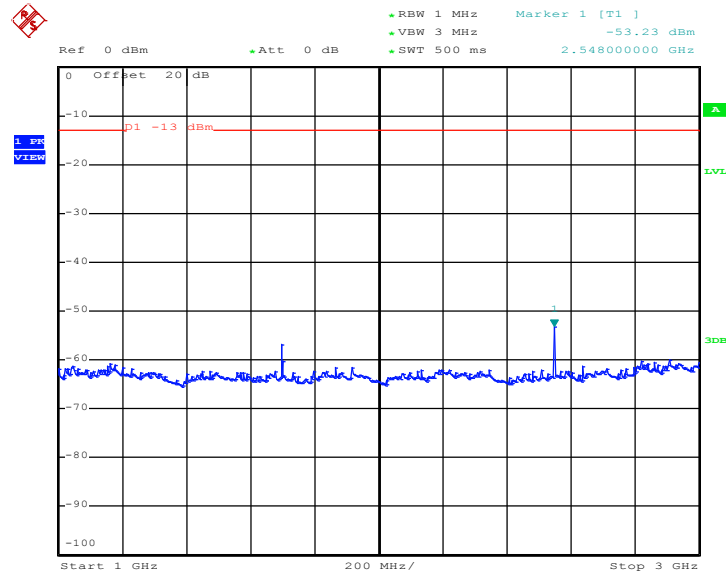

Date: 19.JUN.2014 17:37:56



Conducted Spurious Emission Plot between 3GHz ~ 7GHz

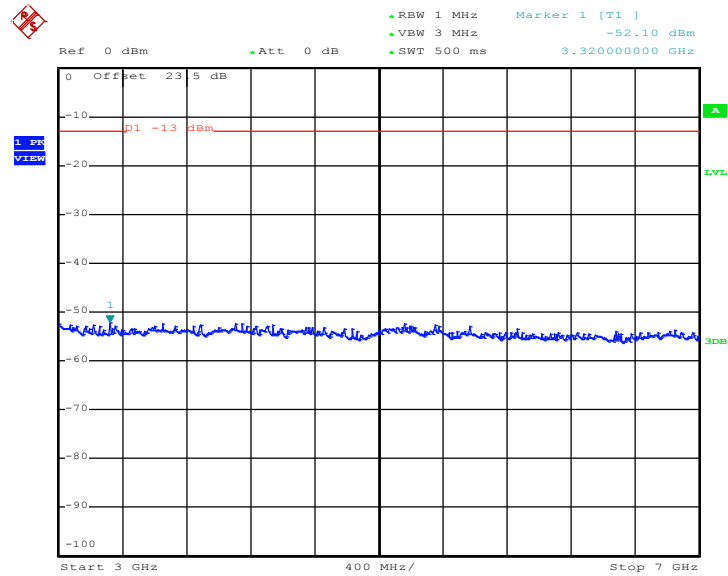

Date: 19.JUN.2014 17:38:05

Conducted Spurious Emission Plot between 7GHz ~ 9GHz

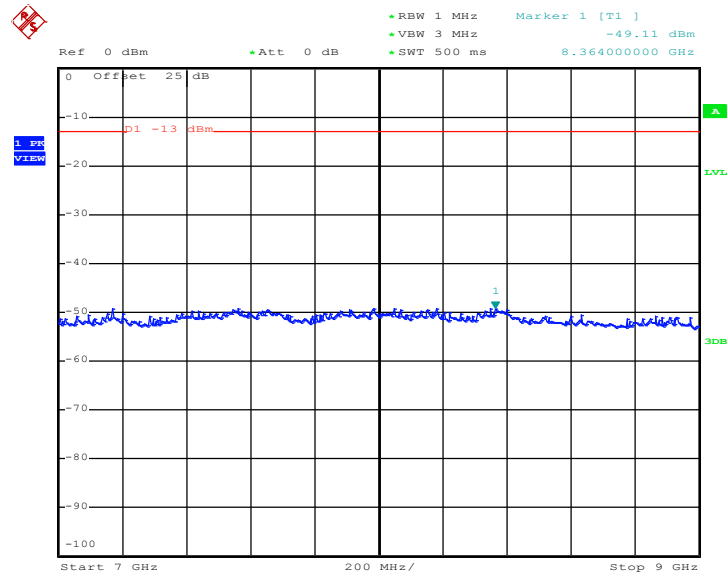

Date: 19.JUN.2014 17:38:13



Band :	GSM1900	Channel :	CH512
Test Mode :	GPRS class 8 Link (GMSK)	Frequency :	1850.2 MHz

Conducted Spurious Emission Plot between 30MHz ~ 1GHz

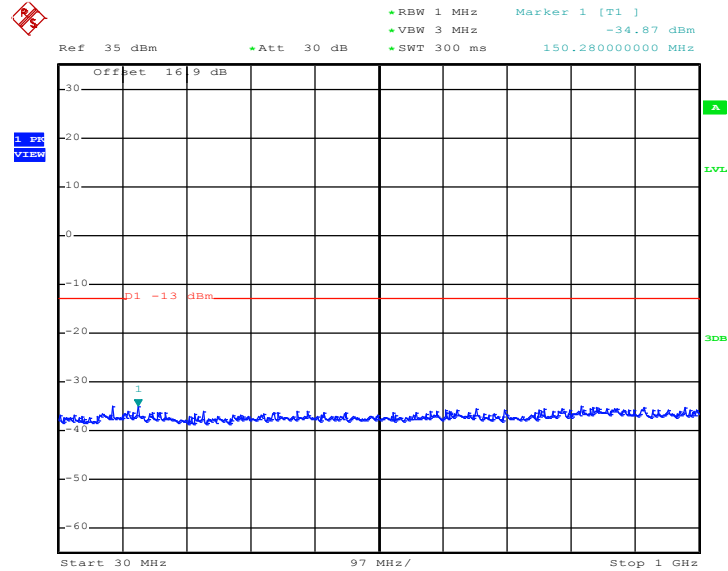

Date: 20.JUN.2014 09:24:00

Conducted Spurious Emission Plot between 1GHz ~ 3GHz

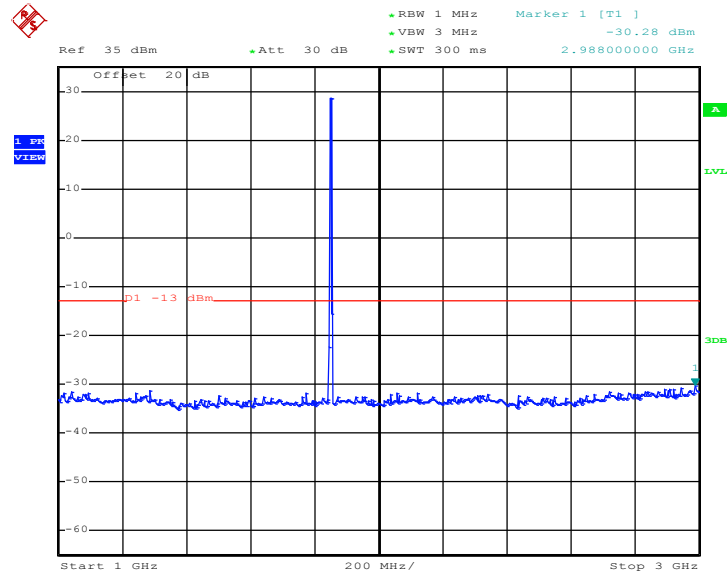

Date: 20.JUN.2014 09:24:08



Conducted Spurious Emission Plot between 3GHz ~ 7GHz

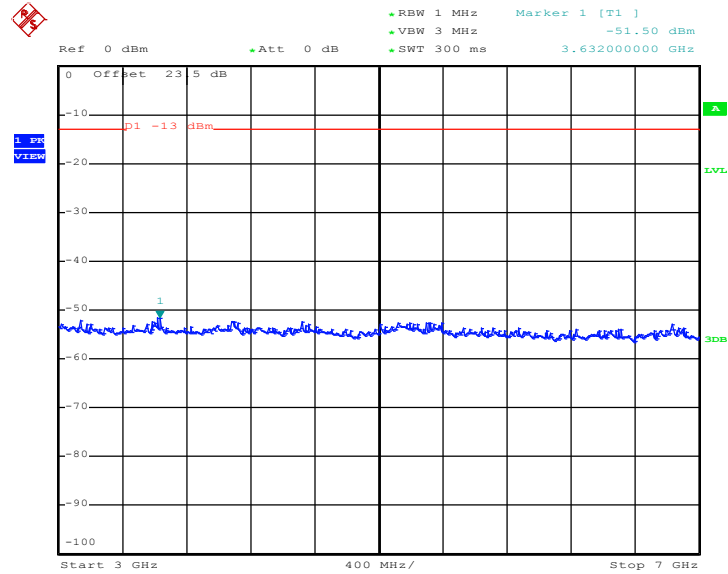

Date: 20.JUN.2014 09:24:20

Conducted Spurious Emission Plot between 7GHz ~ 13.6GHz

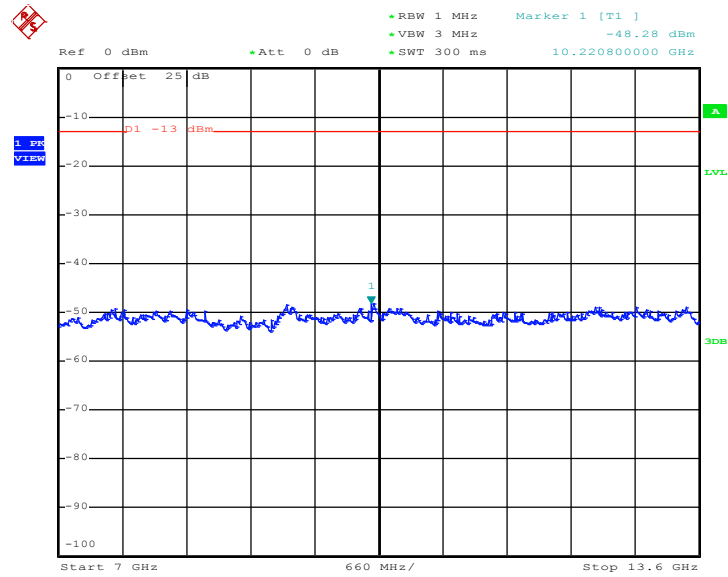

Date: 20.JUN.2014 09:24:28



Conducted Spurious Emission Plot between 13.6GHz ~ 19.1GHz

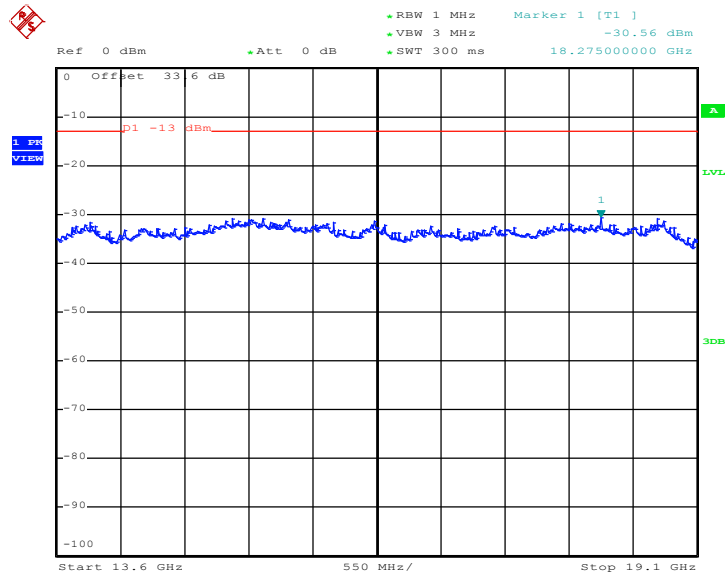

Date: 20.JUN.2014 09:24:37



Band :	GSM1900	Channel :	CH661
Test Mode :	GPRS class 8 Link (GMSK)	Frequency :	1880.0 MHz

Conducted Spurious Emission Plot between 30MHz ~ 1GHz

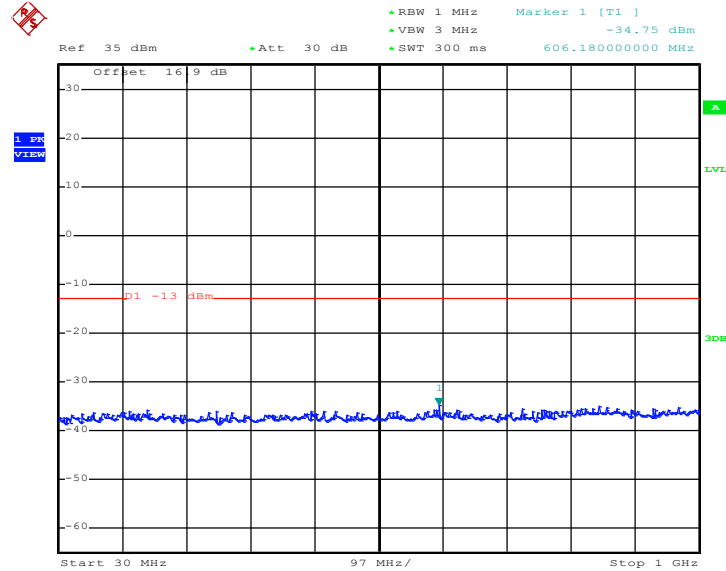

Date: 20.JUN.2014 09:22:26

Conducted Spurious Emission Plot between 1GHz ~ 3GHz

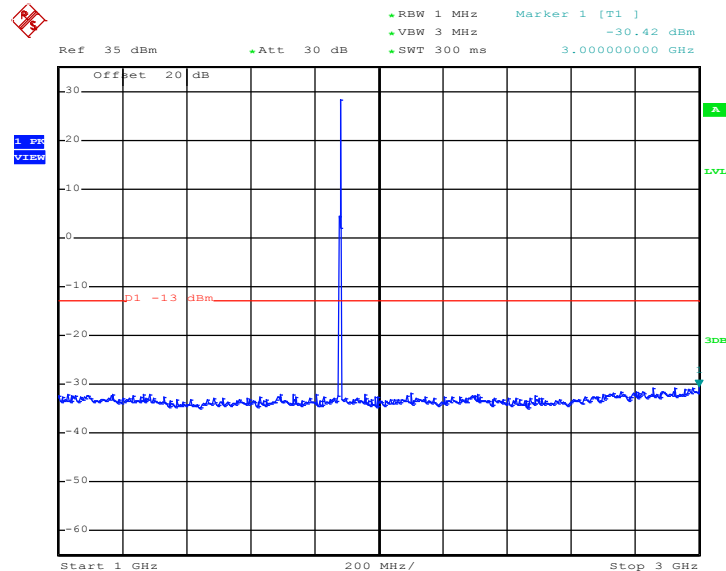

Date: 20.JUN.2014 09:22:34



Conducted Spurious Emission Plot between 3GHz ~ 7GHz

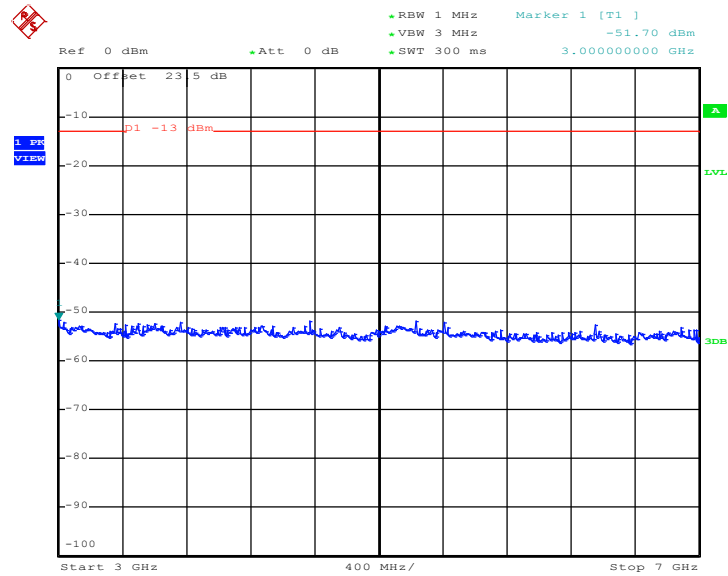

Date: 20.JUN.2014 09:22:46

Conducted Spurious Emission Plot between 7GHz ~ 13.6GHz

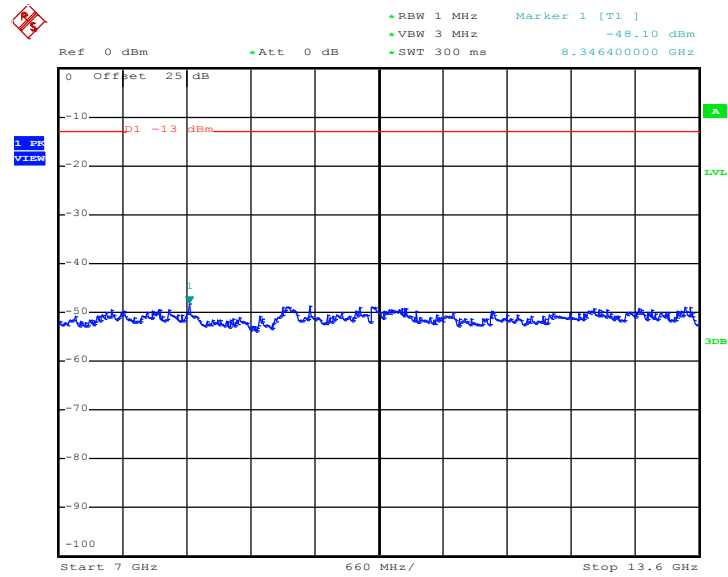

Date: 20.JUN.2014 09:22:54



Conducted Spurious Emission Plot between 13.6GHz ~ 19.1GHz

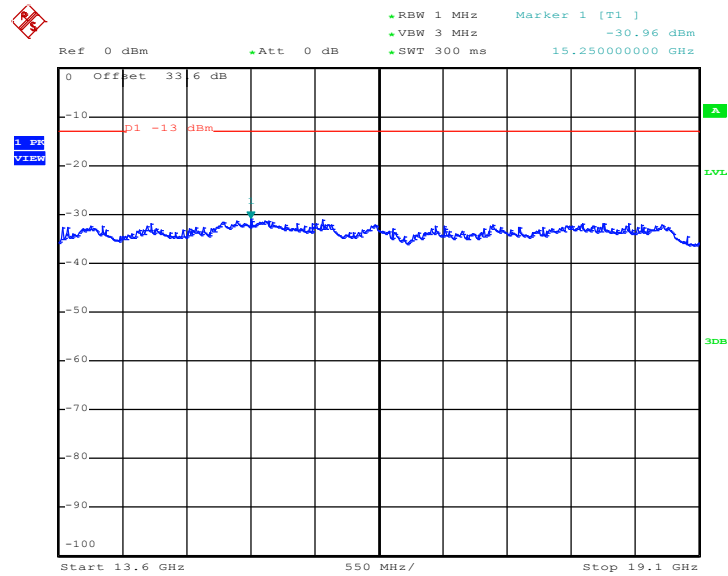

Date: 20.JUN.2014 09:23:03



Band :	GSM1900	Channel :	CH810
Test Mode :	GPRS class 8 Link (GMSK)	Frequency :	1909.8 MHz

Conducted Spurious Emission Plot between 30MHz ~ 1GHz

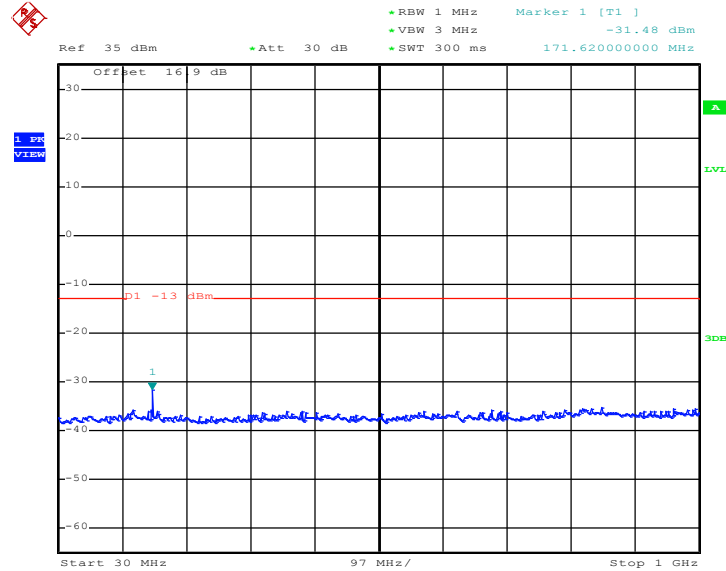

Date: 20.JUN.2014 09:25:54

Conducted Spurious Emission Plot between 1GHz ~ 3GHz

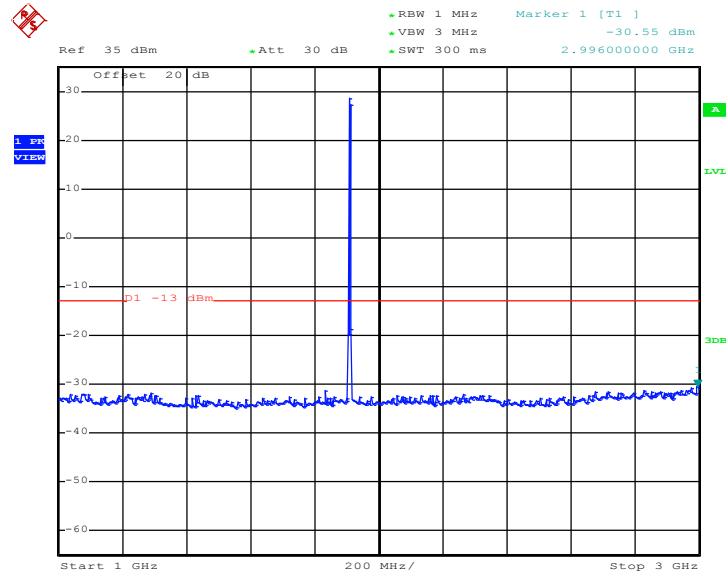

Date: 20.JUN.2014 09:26:02



Conducted Spurious Emission Plot between 3GHz ~ 7GHz

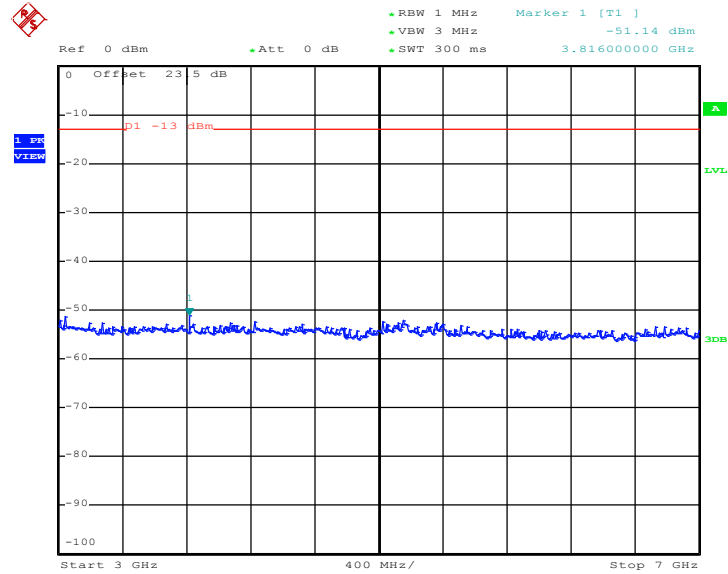

Date: 20.JUN.2014 09:26:13

Conducted Spurious Emission Plot between 7GHz ~ 13.6GHz

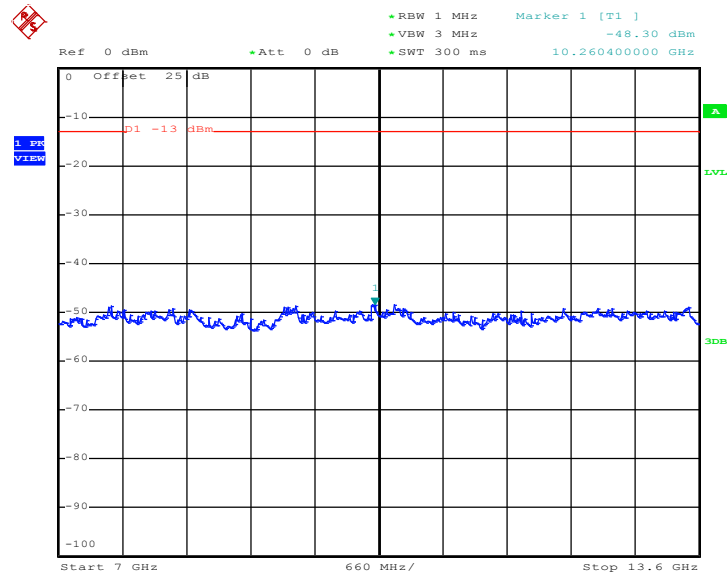

Date: 20.JUN.2014 09:26:22



Conducted Spurious Emission Plot between 13.6GHz ~ 19.1GHz

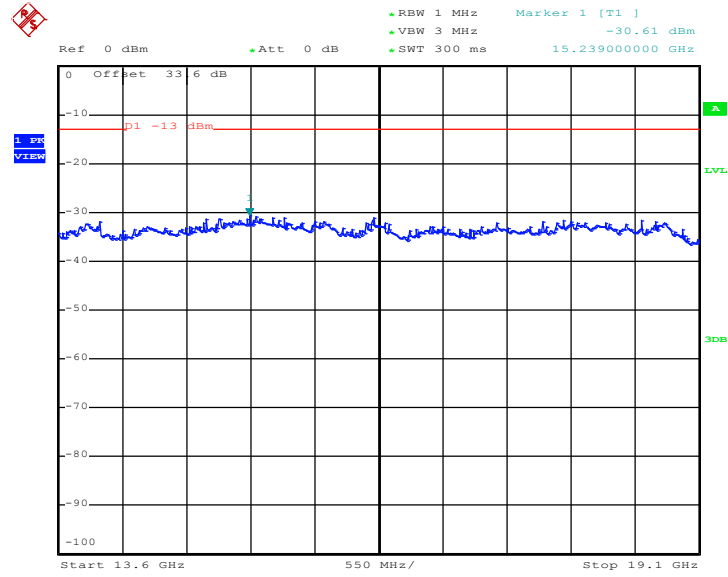

Date: 20.JUN.2014 09:26:30



Band :	GSM1900	Channel :	CH512
Test Mode :	EDGE class 8 Link (8PSK)	Frequency :	1850.2 MHz

Conducted Spurious Emission Plot between 30MHz ~ 1GHz

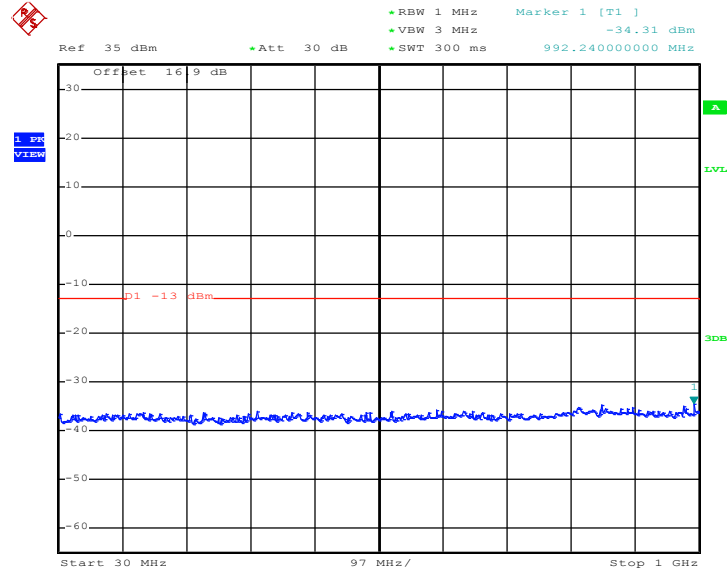

Date: 20.JUN.2014 10:11:12

Conducted Spurious Emission Plot between 1GHz ~ 3GHz

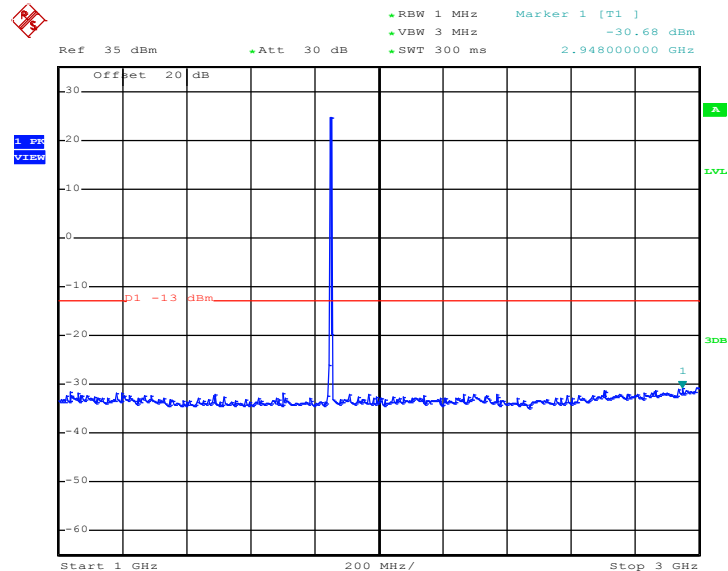

Date: 20.JUN.2014 10:11:20



Conducted Spurious Emission Plot between 3GHz ~ 7GHz

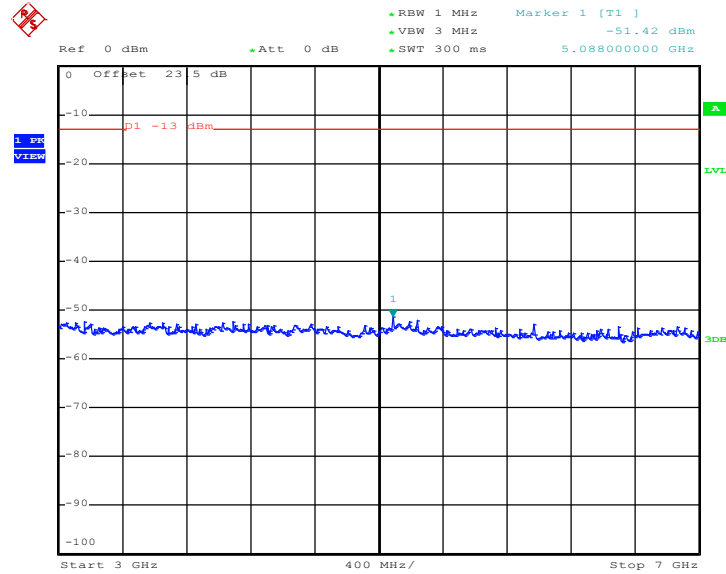

Date: 20.JUN.2014 10:11:34

Conducted Spurious Emission Plot between 7GHz ~ 13.6GHz

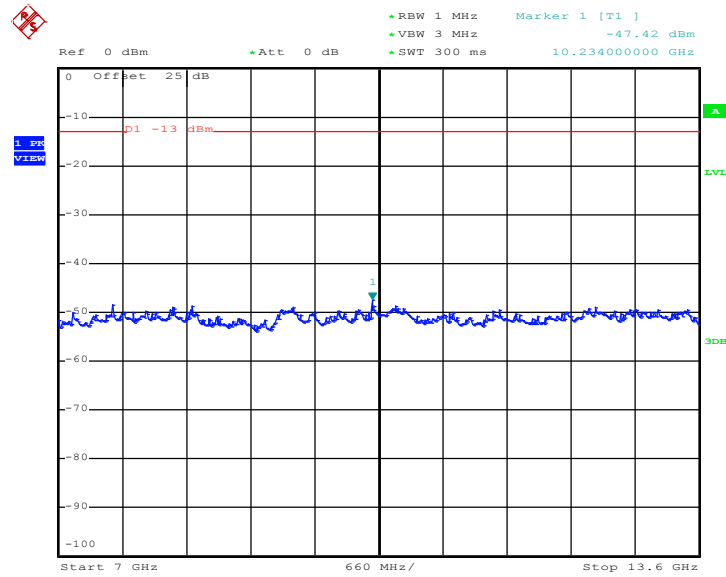

Date: 20.JUN.2014 10:11:43



Conducted Spurious Emission Plot between 13.6GHz ~ 19.1GHz

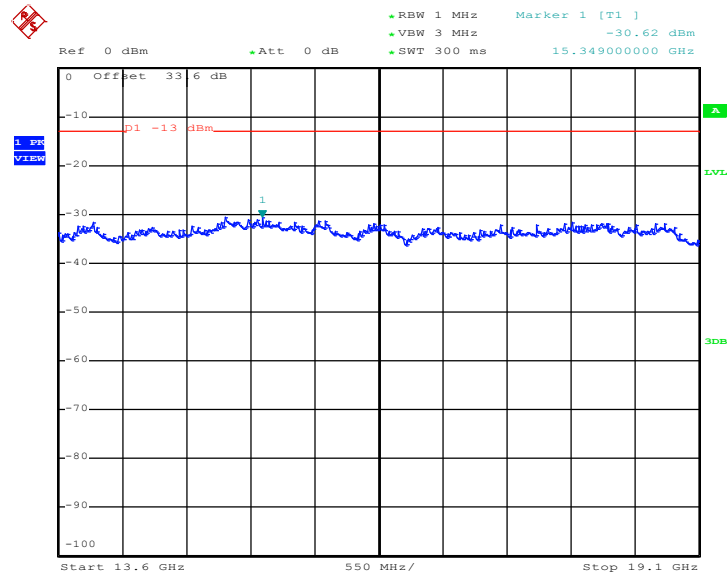

Date: 20.JUN.2014 10:11:51



Band :	GSM1900	Channel :	CH661
Test Mode :	EDGE class 8 Link (8PSK)	Frequency :	1880.0 MHz

Conducted Spurious Emission Plot between 30MHz ~ 1GHz

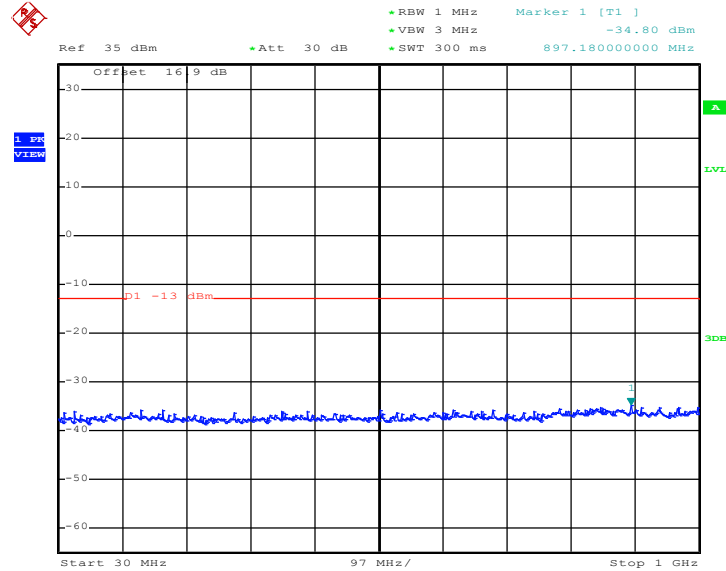

Date: 20.JUN.2014 10:08:20

Conducted Spurious Emission Plot between 1GHz ~ 3GHz

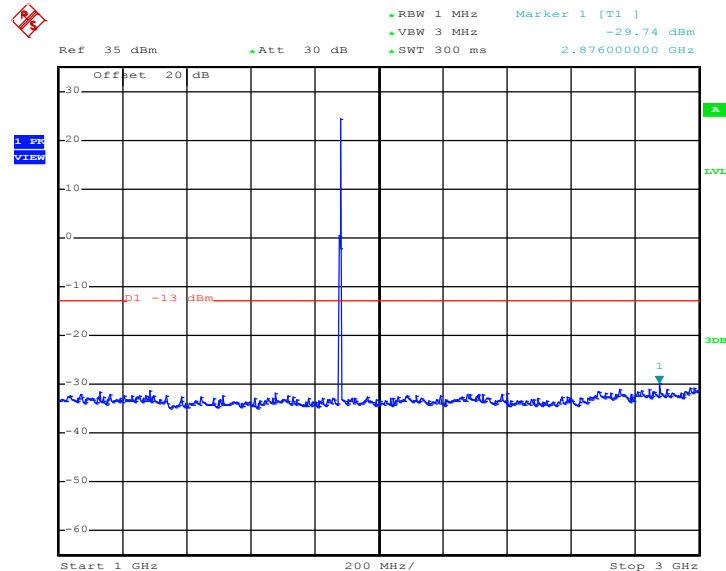

Date: 20.JUN.2014 10:08:28



Conducted Spurious Emission Plot between 3GHz ~ 7GHz

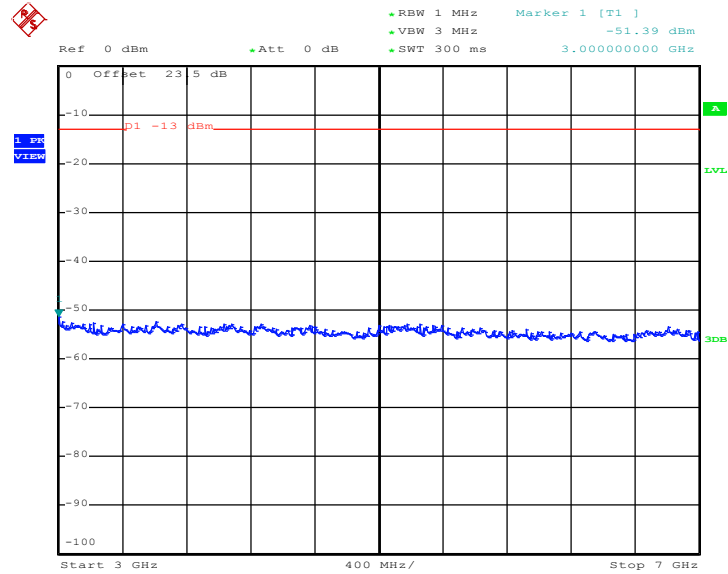

Date: 20.JUN.2014 10:08:39

Conducted Spurious Emission Plot between 7GHz ~ 13.6GHz

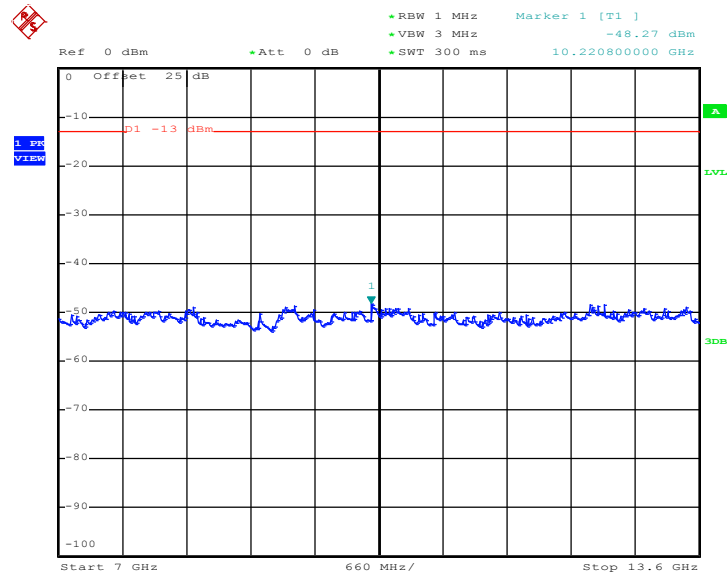

Date: 20.JUN.2014 10:08:48



Conducted Spurious Emission Plot between 13.6GHz ~ 19.1GHz

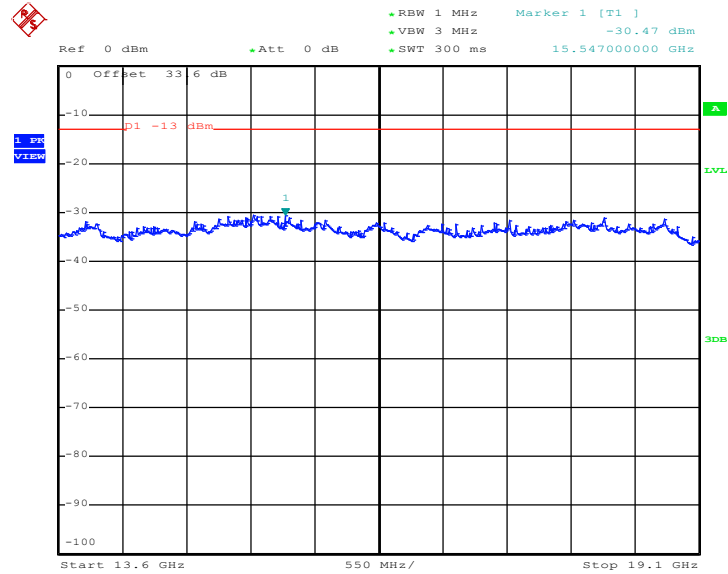

Date: 20.JUN.2014 10:08:56



Band :	GSM1900	Channel :	CH810
Test Mode :	EDGE class 8 Link (8PSK)	Frequency :	1909.8 MHz

Conducted Spurious Emission Plot between 30MHz ~ 1GHz

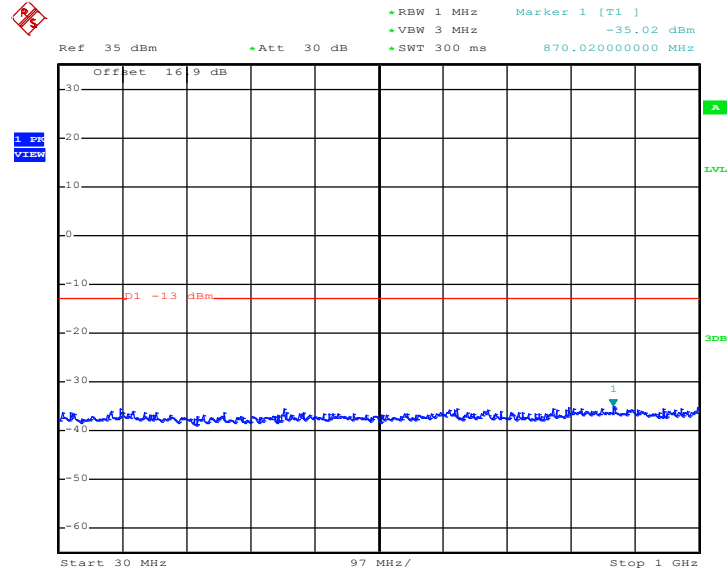

Date: 20.JUN.2014 10:13:06

Conducted Spurious Emission Plot between 1GHz ~ 3GHz

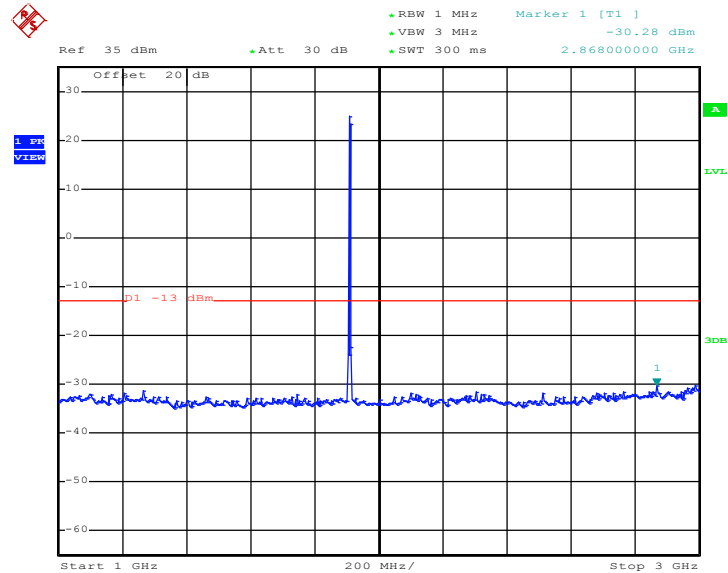

Date: 20.JUN.2014 10:13:14



Conducted Spurious Emission Plot between 3GHz ~ 7GHz

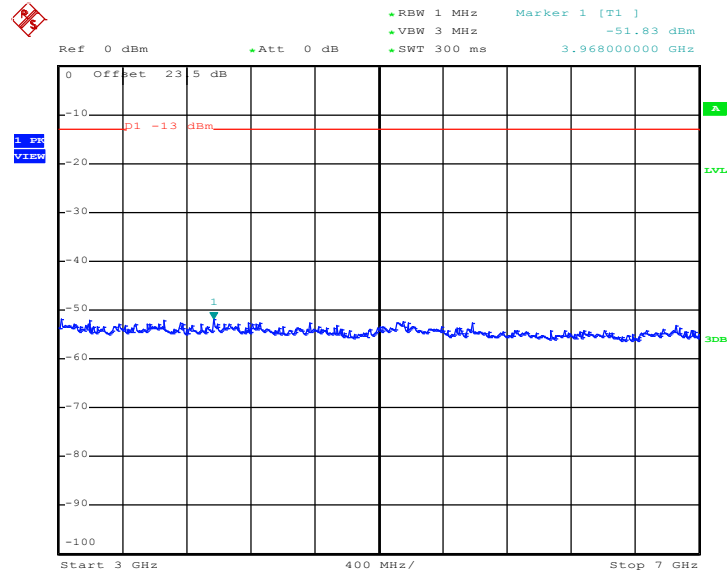

Date: 20.JUN.2014 10:13:26

Conducted Spurious Emission Plot between 7GHz ~ 13.6GHz

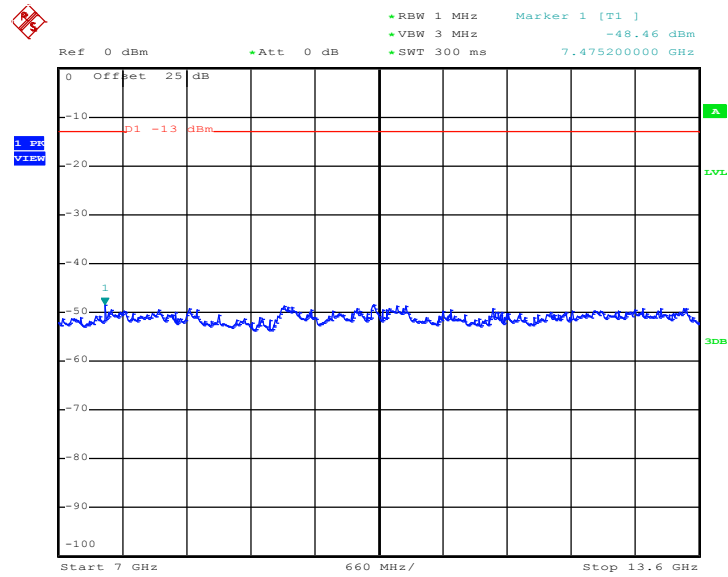

Date: 20.JUN.2014 10:13:34



Conducted Spurious Emission Plot between 13.6GHz ~ 19.1GHz

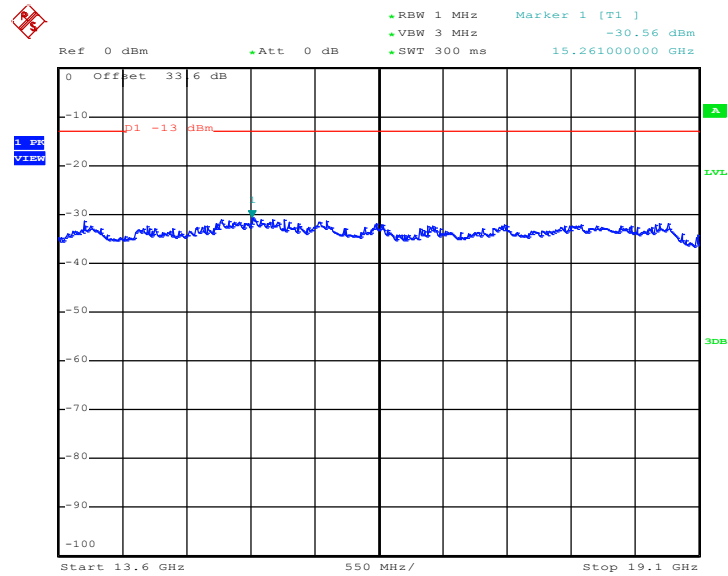

Date: 20.JUN.2014 10:13:43



Band :	WCDMA Band V	Channel :	CH4132
Test Mode :	RMC 12.2Kbps Link (QPSK)	Frequency :	826.4 MHz

Conducted Spurious Emission Plot between 30MHz ~ 1GHz

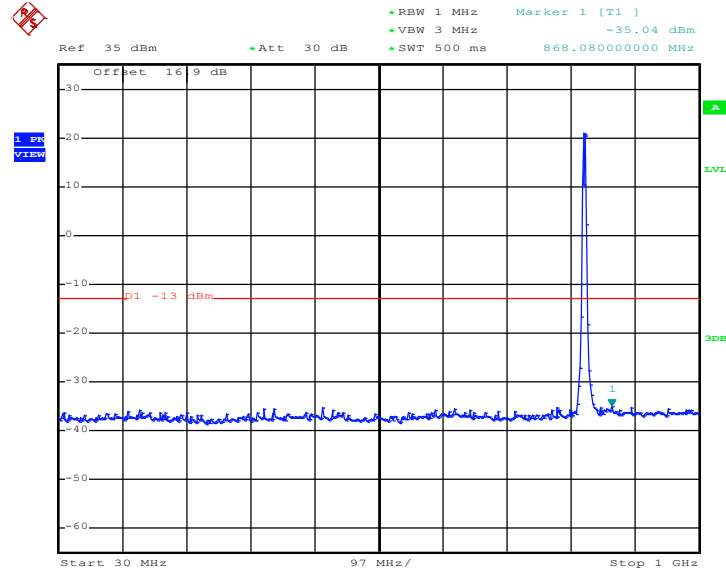

Date: 20.JUN.2014 10:47:18

Conducted Spurious Emission Plot between 1GHz ~ 3GHz

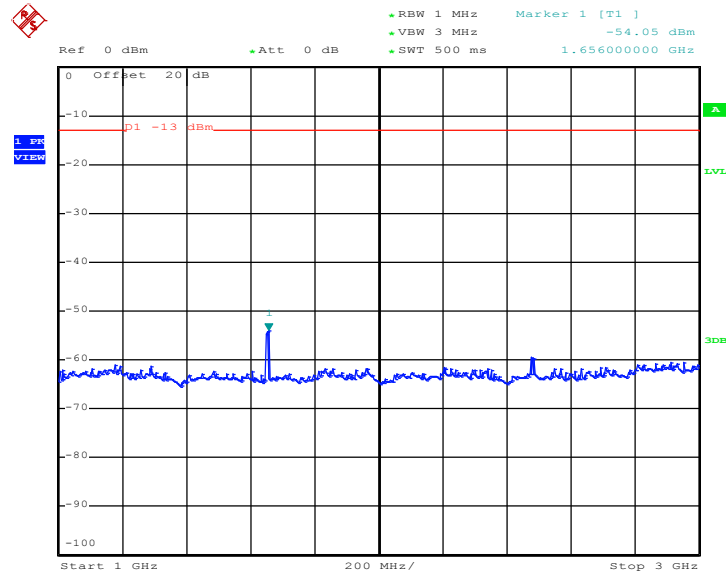

Date: 20.JUN.2014 10:47:28



Conducted Spurious Emission Plot between 3GHz ~ 7GHz

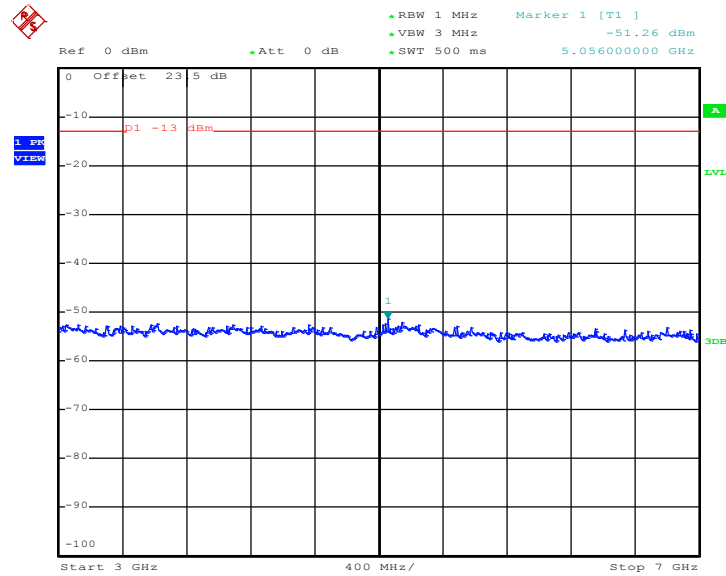

Date: 20.JUN.2014 10:47:37

Conducted Spurious Emission Plot between 7GHz ~ 9GHz

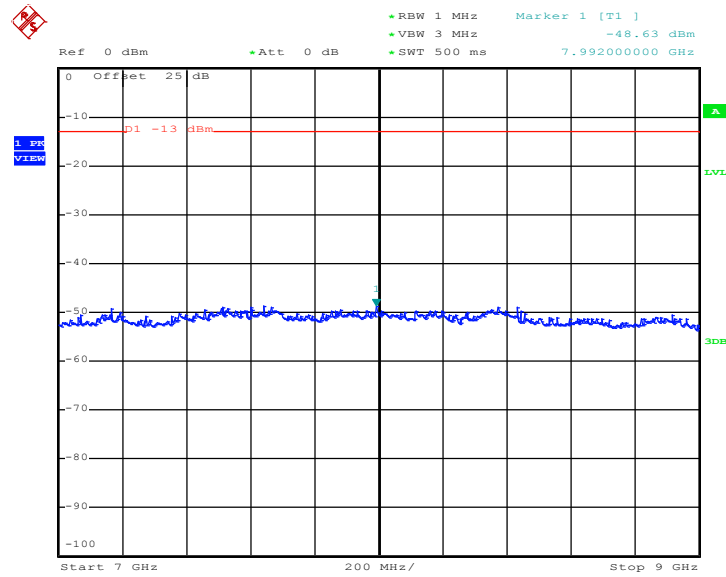

Date: 20.JUN.2014 10:47:45



Band :	WCDMA Band V	Channel :	CH4182
Test Mode :	RMC 12.2Kbps Link (QPSK)	Frequency :	836.4 MHz

Conducted Spurious Emission Plot between 30MHz ~ 1GHz

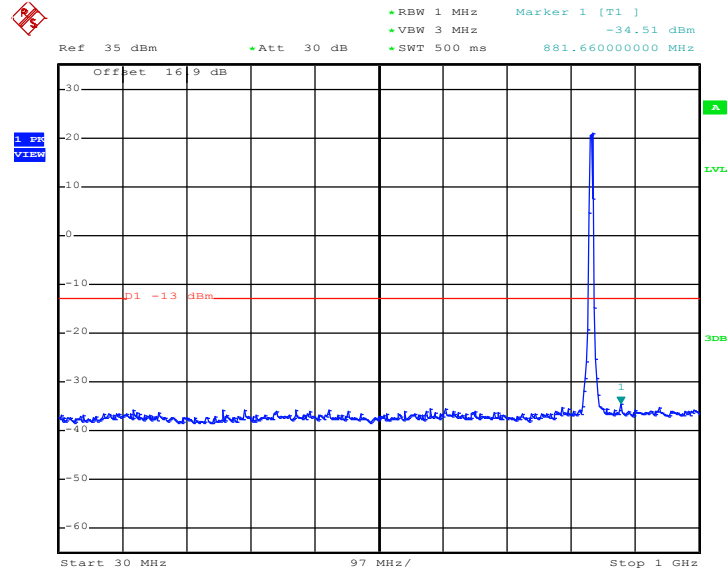

Date: 20.JUN.2014 10:45:02

Conducted Spurious Emission Plot between 1GHz ~ 3GHz

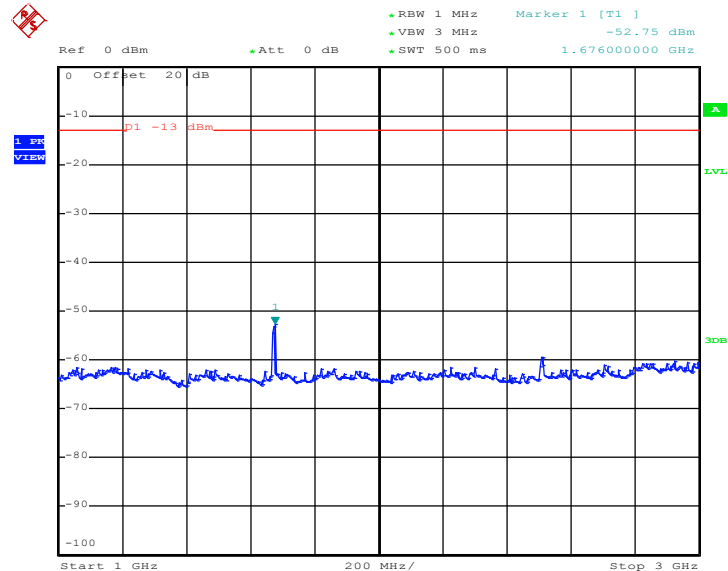

Date: 20.JUN.2014 10:45:12



Conducted Spurious Emission Plot between 3GHz ~ 7GHz

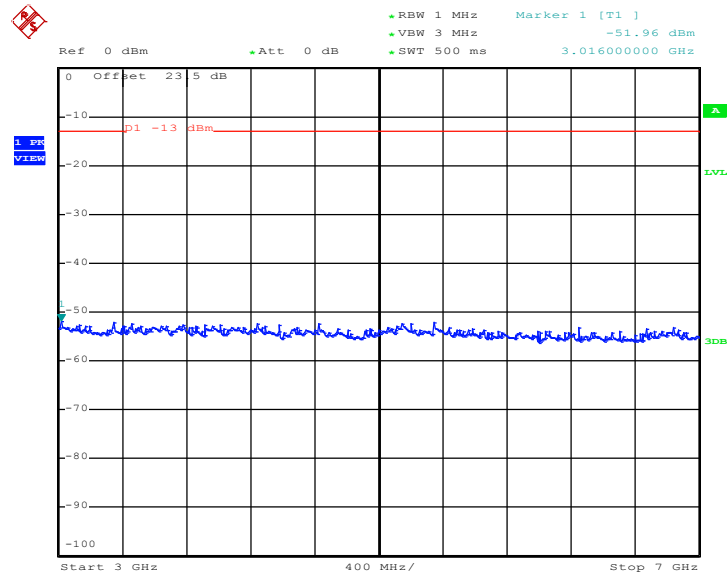

Date: 20.JUN.2014 10:45:21

Conducted Spurious Emission Plot between 7GHz ~ 9GHz

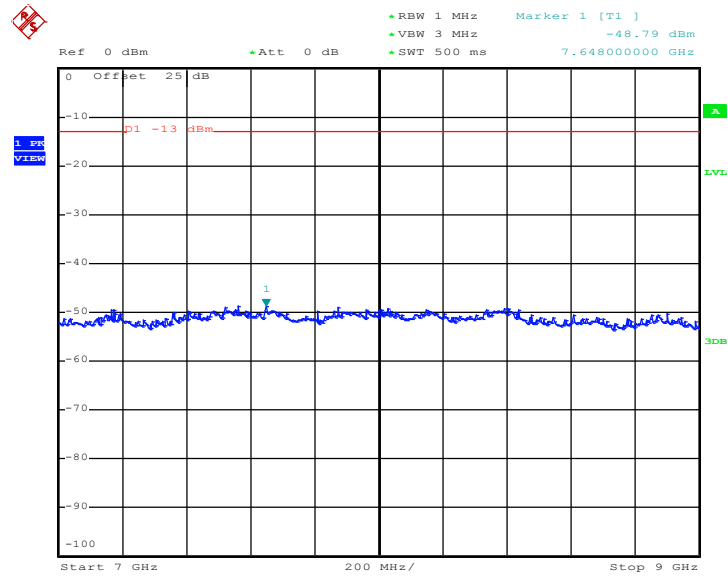

Date: 20.JUN.2014 10:45:29



Band :	WCDMA Band V	Channel :	CH4233
Test Mode :	RMC 12.2Kbps Link (QPSK)	Frequency :	846.6 MHz

Conducted Spurious Emission Plot between 30MHz ~ 1GHz

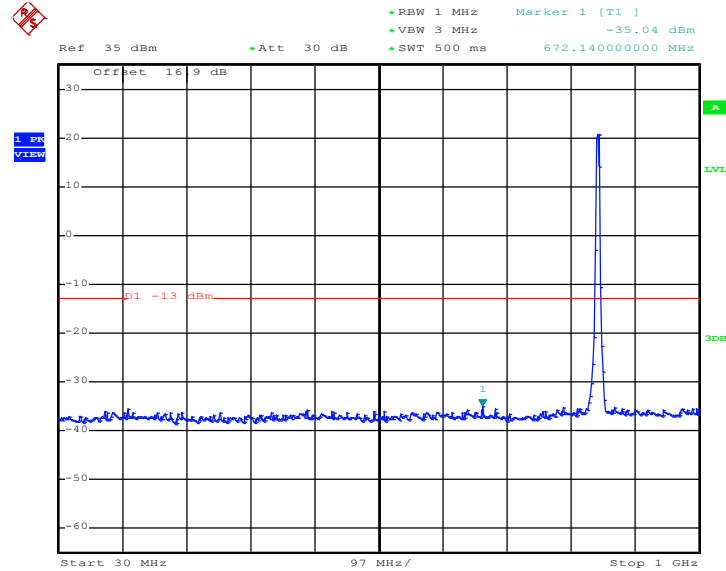

Date: 20.JUN.2014 10:55:07

Conducted Spurious Emission Plot between 1GHz ~ 3GHz

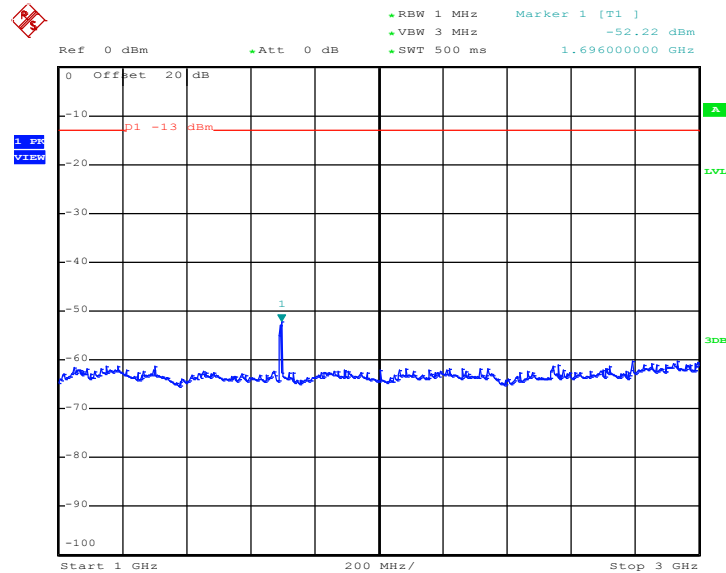

Date: 20.JUN.2014 10:55:20



Conducted Spurious Emission Plot between 3GHz ~ 7GHz

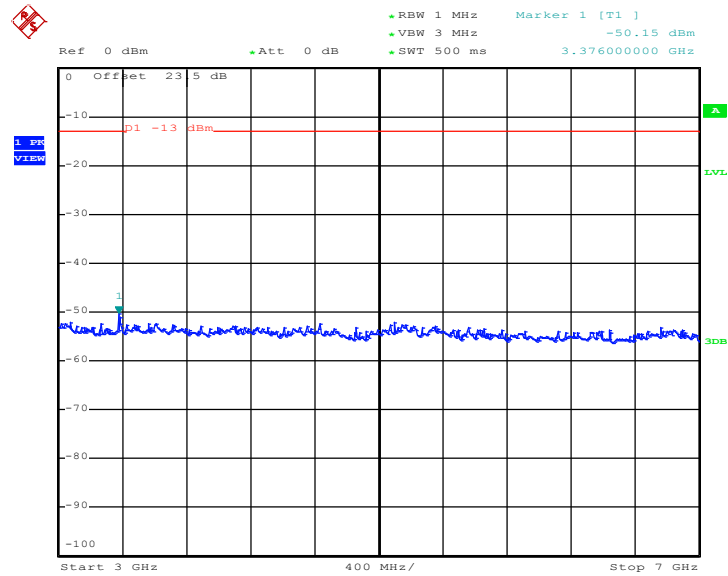

Date: 20.JUN.2014 10:55:29

Conducted Spurious Emission Plot between 7GHz ~ 9GHz

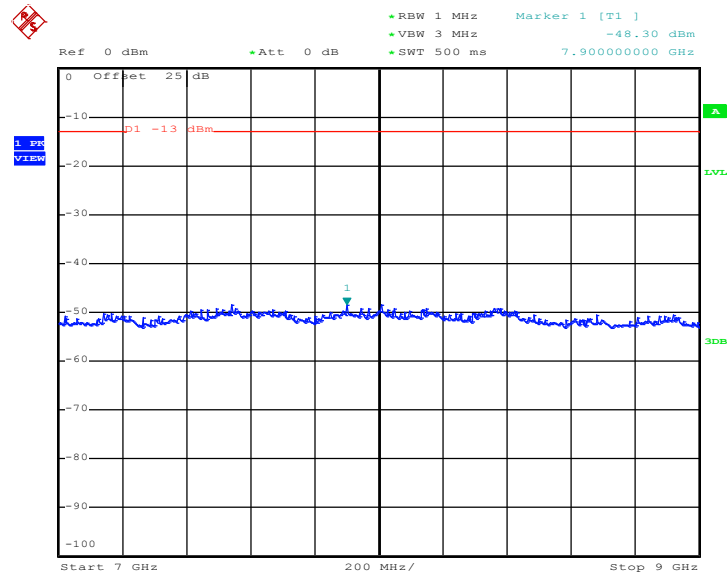

Date: 20.JUN.2014 10:55:37



3.7 Field Strength of Spurious Radiation Measurement

3.7.1 Description of Field Strength of Spurious Radiated Measurement

The power of any emission outside of the authorized operating frequency ranges must be attenuated below the transmitter power (P) by a factor of at least $43 + 10 \log (P)$ dB. The spectrum is scanned from 30 MHz up to a frequency including its 10th harmonic.

3.7.2 Measuring Instruments

The measuring equipment is listed in the section 4 of this test report.

3.7.3 Test Procedures

1. The EUT was placed on a rotatable wooden table 0.8 meters above the ground.
2. The EUT was set 3 meters from the receiving antenna, which was mounted on the antenna tower.
3. The table was rotated 360 degrees to determine the position of the highest spurious emission.
4. The height of the receiving antenna is varied between one meter and four meters to search for the maximum spurious emission for both horizontal and vertical polarizations.
5. Make the measurement with the spectrum analyzer's RBW = 1MHz, VBW = 3MHz, taking record of maximum spurious emission.
6. A horn antenna was substituted in place of the EUT and was driven by a signal generator.
7. Tune the output power of signal generator to the same emission level with EUT maximum spurious emission.
8. Taking the record of output power at antenna port.
9. Repeat step 7 to step 8 for another polarization.
10. $EIRP \text{ (dBm)} = S.G. \text{ Power} - Tx \text{ Cable Loss} + Tx \text{ Antenna Gain}$
11. $ERP \text{ (dBm)} = EIRP - 2.15$
12. The RF fundamental frequency should be excluded against the limit line in the operating frequency band.
13. The limit line is derived from $43 + 10\log(P)$ dB below the transmitter power P(Watts)
 $= P(W) - [43 + 10\log(P)] \text{ (dB)}$
 $= [30 + 10\log(P)] \text{ (dBm)} - [43 + 10\log(P)] \text{ (dB)}$
 $= -13\text{dBm}.$

3.7.4 Test Setup

For radiated emissions from 30MHz to 1GHz

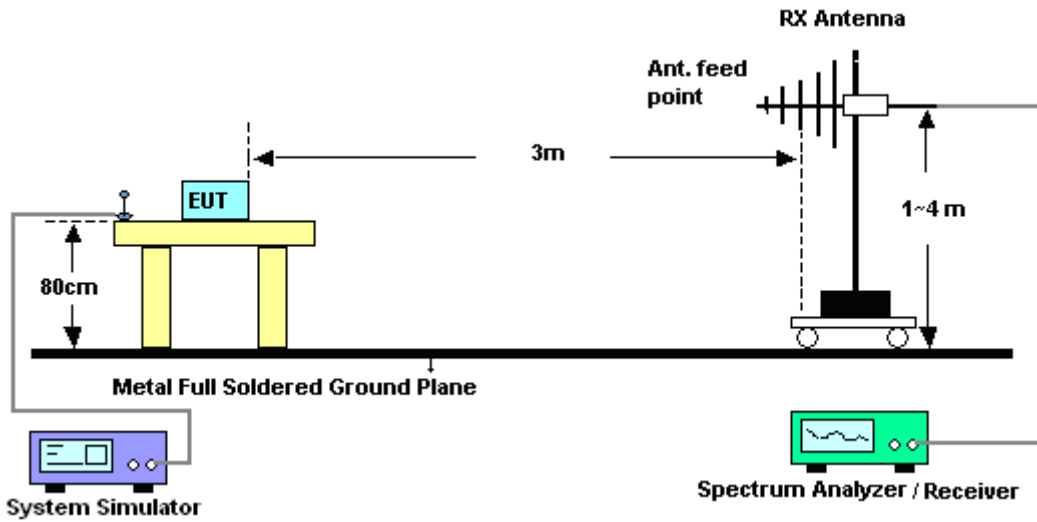

For radiated emissions above 1GHz

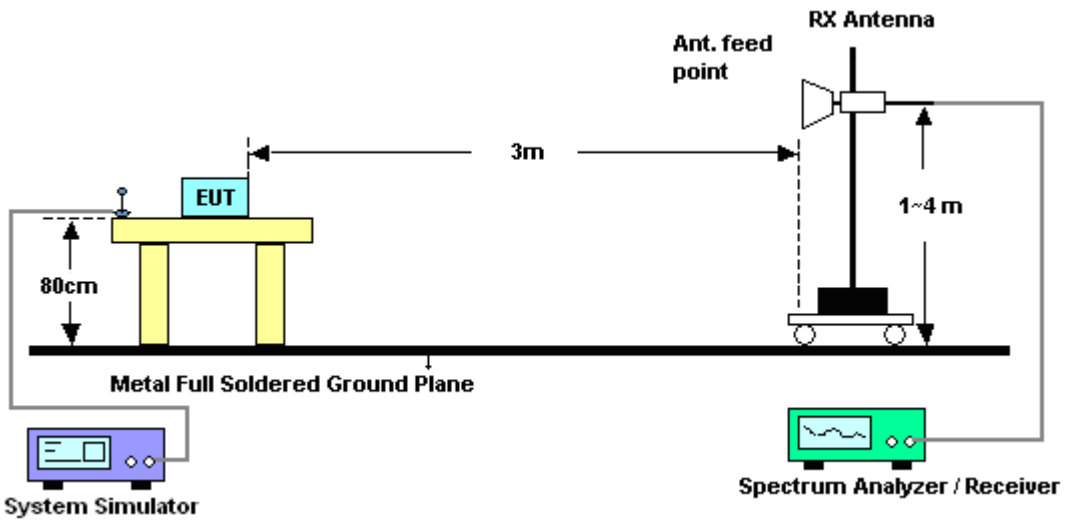



3.7.5 Test Result of Field Strength of Spurious Radiated

<Low Channel>

Band :	GSM850		Temperature :	21~24°C					
Test Mode :	GPRS class 8 Link (GMSK)		Relative Humidity :	44~48%					
Test Engineer :	Stan Hsieh, Kai Wang, and Ken Wu		Polarization :	Horizontal					
Remark :	Spurious emissions within 30-1000MHz were found more than 20dB below limit line.								
Frequency (MHz)	ERP (dBm)	Limit (dBm)	Over Limit (dB)	SPA Reading (dBm)	S.G. Power (dBm)	TX Cable loss (dB)	TX Antenna Gain (dBi)	Polarization (H/V)	Result
1648	-53.10	-13	-40.10	-61.86	-57.1	1.53	5.53	H	Pass
2472	-35.21	-13	-22.21	-48.4	-39.3	2.06	6.15	H	Pass
3296	-53.85	-13	-40.85	-67.9	-59.3	2.48	7.93	H	Pass

Band :	GSM850		Temperature :	21~24°C					
Test Mode :	GPRS class 8 Link (GMSK)		Relative Humidity :	44~48%					
Test Engineer :	Stan Hsieh, Kai Wang, and Ken Wu		Polarization :	Vertical					
Remark :	Spurious emissions within 30-1000MHz were found more than 20dB below limit line.								
Frequency (MHz)	ERP (dBm)	Limit (dBm)	Over Limit (dB)	SPA Reading (dBm)	S.G. Power (dBm)	TX Cable loss (dB)	TX Antenna Gain (dBi)	Polarization (H/V)	Result
1648	-50.02	-13	-37.02	-61.06	-54.02	1.53	5.53	V	Pass
2472	-41.71	-13	-28.71	-55.4	-45.8	2.06	6.15	V	Pass
3296	-51.61	-13	-38.61	-67.25	-57.06	2.48	7.93	V	Pass



<Middle Channel>

Band :	GSM850	Temperature :	21~24°C						
Test Mode :	GPRS class 8 Link (GMSK)	Relative Humidity :	44~48%						
Test Engineer :	Stan Hsieh, Kai Wang, and Ken Wu	Polarization :	Horizontal						
Remark :	Spurious emissions within 30-1000MHz were found more than 20dB below limit line.								
Frequency (MHz)	ERP (dBm)	Limit (dBm)	Over Limit (dB)	SPA Reading (dBm)	S.G. Power (dBm)	TX Cable loss (dB)	TX Antenna Gain (dBi)	Polarization (H/V)	Result
1672	-51.74	-13	-38.74	-60.69	-55.61	1.62	5.49	H	Pass
2512	-34.21	-13	-21.21	-47.56	-38.33	2.1	6.22	H	Pass
3345	-53.83	-13	-40.83	-68.01	-58.87	3.03	8.07	H	Pass

Band :	GSM850	Temperature :	21~24°C						
Test Mode :	GPRS class 8 Link (GMSK)	Relative Humidity :	44~48%						
Test Engineer :	Stan Hsieh, Kai Wang, and Ken Wu	Polarization :	Vertical						
Remark :	Spurious emissions within 30-1000MHz were found more than 20dB below limit line.								
Frequency (MHz)	ERP (dBm)	Limit (dBm)	Over Limit (dB)	SPA Reading (dBm)	S.G. Power (dBm)	TX Cable loss (dB)	TX Antenna Gain (dBi)	Polarization (H/V)	Result
1672	-49.27	-13	-36.27	-60.45	-53.14	1.62	5.49	V	Pass
2512	-42.31	-13	-29.31	-56.07	-46.43	2.1	6.22	V	Pass
3345	-51.71	-13	-38.71	-67.35	-56.75	3.03	8.07	V	Pass



<High Channel>

Band :	GSM850		Temperature :	21~24°C					
Test Mode :	GPRS class 8 Link (GMSK)		Relative Humidity :	44~48%					
Test Engineer :	Stan Hsieh, Kai Wang, and Ken Wu		Polarization :	Horizontal					
Remark :	Spurious emissions within 30-1000MHz were found more than 20dB below limit line.								
Frequency (MHz)	ERP (dBm)	Limit (dBm)	Over Limit (dB)	SPA Reading (dBm)	S.G. Power (dBm)	TX Cable loss (dB)	TX Antenna Gain (dBi)	Polarization (H/V)	Result
1696	-52.72	-13	-39.72	-61.74	-56.6	1.57	5.45	H	Pass
2544	-36.79	-13	-23.79	-50.13	-41.05	2.02	6.28	H	Pass
3392	-53.53	-13	-40.53	-67.81	-59.43	2.3	8.20	H	Pass

Band :	GSM850		Temperature :	21~24°C					
Test Mode :	GPRS class 8 Link (GMSK)		Relative Humidity :	44~48%					
Test Engineer :	Stan Hsieh, Kai Wang, and Ken Wu		Polarization :	Vertical					
Remark :	Spurious emissions within 30-1000MHz were found more than 20dB below limit line.								
Frequency (MHz)	ERP (dBm)	Limit (dBm)	Over Limit (dB)	SPA Reading (dBm)	S.G. Power (dBm)	TX Cable loss (dB)	TX Antenna Gain (dBi)	Polarization (H/V)	Result
1696	-49.48	-13	-36.48	-60.76	-53.36	1.57	5.45	V	Pass
2544	-46.30	-13	-33.30	-60.22	-50.56	2.02	6.28	V	Pass
3392	-52.03	-13	-39.03	-67.64	-57.93	2.3	8.20	V	Pass



<Low Channel>

Band :	GSM850					Temperature :	21~24°C		
Test Mode :	EDGE class 8 Link (8PSK)					Relative Humidity :	44~48%		
Test Engineer :	Stan Hsieh, Kai Wang, and Ken Wu					Polarization :	Horizontal		
Remark :	Spurious emissions within 30-1000MHz were found more than 20dB below limit line.								
Frequency (MHz)	ERP (dBm)	Limit (dBm)	Over Limit (dB)	SPA Reading (dBm)	S.G. Power (dBm)	TX Cable loss (dB)	TX Antenna Gain (dBi)	Polarization (H/V)	Result
1648	-55.05	-13	-42.05	-63.84	-59.05	1.53	5.53	H	Pass
2472	-38.44	-13	-25.44	-50.65	-42.53	2.06	6.15	H	Pass
3296	-53.96	-13	-40.96	-67.98	-59.41	2.48	7.93	H	Pass

Band :	GSM850					Temperature :	21~24°C		
Test Mode :	EDGE class 8 Link (8PSK)					Relative Humidity :	44~48%		
Test Engineer :	Stan Hsieh, Kai Wang, and Ken Wu					Polarization :	Vertical		
Remark :	Spurious emissions within 30-1000MHz were found more than 20dB below limit line.								
Frequency (MHz)	ERP (dBm)	Limit (dBm)	Over Limit (dB)	SPA Reading (dBm)	S.G. Power (dBm)	TX Cable loss (dB)	TX Antenna Gain (dBi)	Polarization (H/V)	Result
1648	-53.22	-13	-40.22	-64.26	-57.22	1.53	5.53	V	Pass
2472	-43.99	-13	-30.99	-57.65	-48.08	2.06	6.15	V	Pass
3296	-52.28	-13	-39.28	-67.94	-57.73	2.48	7.93	V	Pass



<Middle Channel>

Band :	GSM850	Temperature :	21~24°C						
Test Mode :	EDGE class 8 Link (8PSK)	Relative Humidity :	44~48%						
Test Engineer :	Stan Hsieh, Kai Wang, and Ken Wu	Polarization :	Horizontal						
Remark :	Spurious emissions within 30-1000MHz were found more than 20dB below limit line.								
Frequency (MHz)	ERP (dBm)	Limit (dBm)	Over Limit (dB)	SPA Reading (dBm)	S.G. Power (dBm)	TX Cable loss (dB)	TX Antenna Gain (dBi)	Polarization (H/V)	Result
1672	-53.81	-13	-40.81	-62.74	-57.68	1.62	5.49	H	Pass
2512	-39.30	-13	-26.30	-52.61	-43.42	2.1	6.22	H	Pass
3345	-53.26	-13	-40.26	-67.37	-58.3	3.03	8.07	H	Pass

Band :	GSM850	Temperature :	21~24°C						
Test Mode :	EDGE class 8 Link (8PSK)	Relative Humidity :	44~48%						
Test Engineer :	Stan Hsieh, Kai Wang, and Ken Wu	Polarization :	Vertical						
Remark :	Spurious emissions within 30-1000MHz were found more than 20dB below limit line.								
Frequency (MHz)	ERP (dBm)	Limit (dBm)	Over Limit (dB)	SPA Reading (dBm)	S.G. Power (dBm)	TX Cable loss (dB)	TX Antenna Gain (dBi)	Polarization (H/V)	Result
1672	-52.62	-13	-39.62	-63.81	-56.49	1.62	5.49	V	Pass
2512	-44.57	-13	-31.57	-58.34	-48.69	2.1	6.22	V	Pass
3345	-51.69	-13	-38.69	-67.36	-56.73	3.03	8.07	V	Pass



<High Channel>

Band :	GSM850		Temperature :	21~24°C					
Test Mode :	EDGE class 8 Link (8PSK)		Relative Humidity :	44~48%					
Test Engineer :	Stan Hsieh, Kai Wang, and Ken Wu		Polarization :	Horizontal					
Remark :	Spurious emissions within 30-1000MHz were found more than 20dB below limit line.								
Frequency (MHz)	ERP (dBm)	Limit (dBm)	Over Limit (dB)	SPA Reading (dBm)	S.G. Power (dBm)	TX Cable loss (dB)	TX Antenna Gain (dBi)	Polarization (H/V)	Result
1696	-53.12	-13	-40.12	-62.16	-57	1.57	5.45	H	Pass
2544	-40.97	-13	-27.97	-54.3	-45.23	2.02	6.28	H	Pass
3395	-53.40	-13	-40.40	-67.64	-59.3	2.3	8.20	H	Pass

Band :	GSM850		Temperature :	21~24°C					
Test Mode :	EDGE class 8 Link (8PSK)		Relative Humidity :	44~48%					
Test Engineer :	Stan Hsieh, Kai Wang, and Ken Wu		Polarization :	Vertical					
Remark :	Spurious emissions within 30-1000MHz were found more than 20dB below limit line.								
Frequency (MHz)	ERP (dBm)	Limit (dBm)	Over Limit (dB)	SPA Reading (dBm)	S.G. Power (dBm)	TX Cable loss (dB)	TX Antenna Gain (dBi)	Polarization (H/V)	Result
1696	-54.62	-13	-41.62	-65.88	-58.5	1.57	5.45	V	Pass
2544	-48.51	-13	-35.51	-62.41	-52.77	2.02	6.28	V	Pass
3395	-51.80	-13	-38.80	-67.38	-57.7	2.3	8.20	V	Pass



<Low Channel>

Band :	GSM1900		Temperature :	21~24°C					
Test Mode :	GPRS class 8 Link (GMSK)		Relative Humidity :	44~48%					
Test Engineer :	Stan Hsieh, Kai Wang, and Ken Wu		Polarization :	Horizontal					
Remark :	Spurious emissions within 30-1000MHz were found more than 20dB below limit line.								
Frequency (MHz)	EIRP (dBm)	Limit (dBm)	Over Limit (dB)	SPA Reading (dBm)	S.G. Power (dBm)	TX Cable loss (dB)	TX Antenna Gain (dBi)	Polarization (H/V)	Result
3700	-53.65	-13	-40.65	-68.61	-59.8	2.59	8.74	H	Pass
5550	-48.44	-13	-35.44	-69.13	-56.1	3.04	10.70	H	Pass
7401	-41.26	-13	-28.26	-68.67	-50	3.28	12.02	H	Pass

Band :	GSM1900		Temperature :	21~24°C					
Test Mode :	GPRS class 8 Link (GMSK)		Relative Humidity :	44~48%					
Test Engineer :	Stan Hsieh, Kai Wang, and Ken Wu		Polarization :	Vertical					
Remark :	Spurious emissions within 30-1000MHz were found more than 20dB below limit line.								
Frequency (MHz)	EIRP (dBm)	Limit (dBm)	Over Limit (dB)	SPA Reading (dBm)	S.G. Power (dBm)	TX Cable loss (dB)	TX Antenna Gain (dBi)	Polarization (H/V)	Result
3700	-52.25	-13	-39.25	-68.57	-58.4	2.59	8.74	V	Pass
5550	-48.74	-13	-35.74	-68.61	-56.4	3.04	10.70	V	Pass
7401	-42.26	-13	-29.26	-69.29	-51	3.28	12.02	V	Pass



<Middle Channel>

Band :	GSM1900	Temperature :	21~24°C						
Test Mode :	GPRS class 8 Link (GMSK)	Relative Humidity :	44~48%						
Test Engineer :	Stan Hsieh, Kai Wang, and Ken Wu	Polarization :	Horizontal						
Remark :	Spurious emissions within 30-1000MHz were found more than 20dB below limit line.								
Frequency (MHz)	EIRP (dBm)	Limit (dBm)	Over Limit (dB)	SPA Reading (dBm)	S.G. Power (dBm)	TX Cable loss (dB)	TX Antenna Gain (dBi)	Polarization (H/V)	Result
3760	-51.20	-13	-38.20	-66.67	-57.5	2.51	8.81	H	Pass
5640	-48.19	-13	-35.19	-69.1	-55.9	2.99	10.70	H	Pass
7520	-41.87	-13	-28.87	-69.11	-50.4	3.59	12.12	H	Pass

Band :	GSM1900	Temperature :	21~24°C						
Test Mode :	GPRS class 8 Link (GMSK)	Relative Humidity :	44~48%						
Test Engineer :	Stan Hsieh, Kai Wang, and Ken Wu	Polarization :	Vertical						
Remark :	Spurious emissions within 30-1000MHz were found more than 20dB below limit line.								
Frequency (MHz)	EIRP (dBm)	Limit (dBm)	Over Limit (dB)	SPA Reading (dBm)	S.G. Power (dBm)	TX Cable loss (dB)	TX Antenna Gain (dBi)	Polarization (H/V)	Result
3760	-51.60	-13	-38.60	-68.28	-57.9	2.51	8.81	V	Pass
5640	-48.59	-13	-35.59	-69.14	-56.3	2.99	10.70	V	Pass
7520	-42.57	-13	-29.57	-69.21	-51.1	3.59	12.12	V	Pass



<High Channel>

Band :	GSM1900		Temperature :	21~24°C					
Test Mode :	GPRS class 8 Link (GMSK)		Relative Humidity :	44~48%					
Test Engineer :	Stan Hsieh, Kai Wang, and Ken Wu		Polarization :	Horizontal					
Remark :	Spurious emissions within 30-1000MHz were found more than 20dB below limit line.								
Frequency (MHz)	EIRP (dBm)	Limit (dBm)	Over Limit (dB)	SPA Reading (dBm)	S.G. Power (dBm)	TX Cable loss (dB)	TX Antenna Gain (dBi)	Polarization (H/V)	Result
3820	-50.29	-13	-37.29	-65.94	-56.7	2.47	8.88	H	Pass
5729	-48.10	-13	-35.10	-69.18	-55.8	3	10.70	H	Pass
7639	-42.52	-13	-29.52	-68.68	-51.3	3.43	12.21	H	Pass

Band :	GSM1900		Temperature :	21~24°C					
Test Mode :	GPRS class 8 Link (GMSK)		Relative Humidity :	44~48%					
Test Engineer :	Stan Hsieh, Kai Wang, and Ken Wu		Polarization :	Vertical					
Remark :	Spurious emissions within 30-1000MHz were found more than 20dB below limit line.								
Frequency (MHz)	EIRP (dBm)	Limit (dBm)	Over Limit (dB)	SPA Reading (dBm)	S.G. Power (dBm)	TX Cable loss (dB)	TX Antenna Gain (dBi)	Polarization (H/V)	Result
3820	-50.59	-13	-37.59	-66.98	-57	2.47	8.88	V	Pass
5729	-48.40	-13	-35.40	-68.98	-56.1	3	10.70	V	Pass
7639	-42.92	-13	-29.92	-69.12	-51.7	3.43	12.21	V	Pass



<Low Channel>

Band :	GSM1900					Temperature :	21~24°C		
Test Mode :	EDGE class 8 Link (8PSK)					Relative Humidity :	44~48%		
Test Engineer :	Stan Hsieh, Kai Wang, and Ken Wu					Polarization :	Horizontal		
Remark :	Spurious emissions within 30-1000MHz were found more than 20dB below limit line.								
Frequency (MHz)	EIRP (dBm)	Limit (dBm)	Over Limit (dB)	SPA Reading (dBm)	S.G. Power (dBm)	TX Cable loss (dB)	TX Antenna Gain (dBi)	Polarization (H/V)	Result
3700	-53.45	-13	-40.45	-68.8	-59.6	2.59	8.74	H	Pass
5550	-49.44	-13	-36.44	-69.46	-57.1	3.04	10.70	H	Pass
7401	-42.06	-13	-29.06	-69.27	-50.8	3.28	12.02	H	Pass

Band :	GSM1900					Temperature :	21~24°C		
Test Mode :	EDGE class 8 Link (8PSK)					Relative Humidity :	44~48%		
Test Engineer :	Stan Hsieh, Kai Wang, and Ken Wu					Polarization :	Vertical		
Remark :	Spurious emissions within 30-1000MHz were found more than 20dB below limit line.								
Frequency (MHz)	EIRP (dBm)	Limit (dBm)	Over Limit (dB)	SPA Reading (dBm)	S.G. Power (dBm)	TX Cable loss (dB)	TX Antenna Gain (dBi)	Polarization (H/V)	Result
3700	-53.05	-13	-40.05	-69.22	-59.2	2.59	8.74	V	Pass
5550	-49.14	-13	-36.14	-69.3	-56.8	3.04	10.70	V	Pass
7401	-42.66	-13	-29.66	-69.3	-51.4	3.28	12.02	V	Pass



<Middle Channel>

Band :	GSM1900	Temperature :	21~24°C						
Test Mode :	EDGE class 8 Link (8PSK)	Relative Humidity :	44~48%						
Test Engineer :	Stan Hsieh, Kai Wang, and Ken Wu	Polarization :	Horizontal						
Remark :	Spurious emissions within 30-1000MHz were found more than 20dB below limit line.								
Frequency (MHz)	EIRP (dBm)	Limit (dBm)	Over Limit (dB)	SPA Reading (dBm)	S.G. Power (dBm)	TX Cable loss (dB)	TX Antenna Gain (dBi)	Polarization (H/V)	Result
3760	-53.20	-13	-40.20	-68.56	-59.5	2.51	8.81	H	Pass
5640	-48.39	-13	-35.39	-69.01	-56.1	2.99	10.70	H	Pass
7520	-41.67	-13	-28.67	-68.75	-50.2	3.59	12.12	H	Pass

Band :	GSM1900	Temperature :	21~24°C						
Test Mode :	EDGE class 8 Link (8PSK)	Relative Humidity :	44~48%						
Test Engineer :	Stan Hsieh, Kai Wang, and Ken Wu	Polarization :	Vertical						
Remark :	Spurious emissions within 30-1000MHz were found more than 20dB below limit line.								
Frequency (MHz)	EIRP (dBm)	Limit (dBm)	Over Limit (dB)	SPA Reading (dBm)	S.G. Power (dBm)	TX Cable loss (dB)	TX Antenna Gain (dBi)	Polarization (H/V)	Result
3760	-51.50	-13	-38.50	-67.89	-57.8	2.51	8.81	V	Pass
5640	-48.09	-13	-35.09	-69.09	-55.8	2.99	10.70	V	Pass
7520	-42.77	-13	-29.77	-69.77	-51.3	3.59	12.12	V	Pass



<High Channel>

Band :	GSM1900	Temperature :	21~24°C						
Test Mode :	EDGE class 8 Link (8PSK)	Relative Humidity :	44~48%						
Test Engineer :	Stan Hsieh, Kai Wang, and Ken Wu	Polarization :	Horizontal						
Remark :	Spurious emissions within 30-1000MHz were found more than 20dB below limit line.								
Frequency (MHz)	EIRP (dBm)	Limit (dBm)	Over Limit (dB)	SPA Reading (dBm)	S.G. Power (dBm)	TX Cable loss (dB)	TX Antenna Gain (dBi)	Polarization (H/V)	Result
3820	-50.69	-13	-37.69	-66.51	-57.1	2.47	8.88	H	Pass
5729	-47.90	-13	-34.90	-68.9	-55.6	3	10.70	H	Pass
7639	-42.02	-13	-29.02	-68.35	-50.8	3.43	12.21	H	Pass

Band :	GSM1900	Temperature :	21~24°C						
Test Mode :	EDGE class 8 Link (8PSK)	Relative Humidity :	44~48%						
Test Engineer :	Stan Hsieh, Kai Wang, and Ken Wu	Polarization :	Vertical						
Remark :	Spurious emissions within 30-1000MHz were found more than 20dB below limit line.								
Frequency (MHz)	EIRP (dBm)	Limit (dBm)	Over Limit (dB)	SPA Reading (dBm)	S.G. Power (dBm)	TX Cable loss (dB)	TX Antenna Gain (dBi)	Polarization (H/V)	Result
3820	-50.99	-13	-37.99	-67.28	-57.4	2.47	8.88	V	Pass
5729	-47.40	-13	-34.40	-68.7	-55.1	3	10.70	V	Pass
7639	-42.82	-13	-29.82	-68.98	-51.6	3.43	12.21	V	Pass



<Low Channel>

Band :	WCDMA Band V					Temperature :	21~24°C		
Test Mode :	RMC 12.2Kbps Link (QPSK)					Relative Humidity :	44~48%		
Test Engineer :	Stan Hsieh, Kai Wang, and Ken Wu					Polarization :	Horizontal		
Remark :	Spurious emissions within 30-1000MHz were found more than 20dB below limit line.								
Frequency (MHz)	ERP (dBm)	Limit (dBm)	Over Limit (dB)	SPA Reading (dBm)	S.G. Power (dBm)	TX Cable loss (dB)	TX Antenna Gain (dBi)	Polarization (H/V)	Result
1656	-49.17	-13	-36.17	-58.04	-53.17	1.53	5.53	H	Pass
2479	-53.01	-13	-40.01	-66.24	-57.1	2.06	6.15	H	Pass
3305	-51.05	-13	-38.05	-65.1	-56.5	2.48	7.93	H	Pass

Band :	WCDMA Band V					Temperature :	21~24°C		
Test Mode :	RMC 12.2Kbps Link (QPSK)					Relative Humidity :	44~48%		
Test Engineer :	Stan Hsieh, Kai Wang, and Ken Wu					Polarization :	Vertical		
Remark :	Spurious emissions within 30-1000MHz were found more than 20dB below limit line.								
Frequency (MHz)	ERP (dBm)	Limit (dBm)	Over Limit (dB)	SPA Reading (dBm)	S.G. Power (dBm)	TX Cable loss (dB)	TX Antenna Gain (dBi)	Polarization (H/V)	Result
1656	-50.21	-13	-37.21	-61.31	-54.21	1.53	5.53	V	Pass
2479	-53.05	-13	-40.05	-66.73	-57.14	2.06	6.15	V	Pass
3305	-50.82	-13	-37.82	-66.46	-56.27	2.48	7.93	V	Pass



<Middle Channel>

Band :	WCDMA Band V					Temperature :	21~24°C		
Test Mode :	RMC 12.2Kbps Link (QPSK)					Relative Humidity :	44~48%		
Test Engineer :	Stan Hsieh, Kai Wang, and Ken Wu					Polarization :	Horizontal		
Remark :	Spurious emissions within 30-1000MHz were found more than 20dB below limit line.								
Frequency (MHz)	ERP (dBm)	Limit (dBm)	Over Limit (dB)	SPA Reading (dBm)	S.G. Power (dBm)	TX Cable loss (dB)	TX Antenna Gain (dBi)	Polarization (H/V)	Result
1672	-49.13	-13	-36.13	-58.11	-53	1.62	5.49	H	Pass
2509	-53.59	-13	-40.59	-66.94	-57.71	2.1	6.22	H	Pass
3345	-51.32	-13	-38.32	-65.43	-56.36	3.03	8.07	H	Pass

Band :	WCDMA Band V					Temperature :	21~24°C		
Test Mode :	RMC 12.2Kbps Link (QPSK)					Relative Humidity :	44~48%		
Test Engineer :	Stan Hsieh, Kai Wang, and Ken Wu					Polarization :	Vertical		
Remark :	Spurious emissions within 30-1000MHz were found more than 20dB below limit line.								
Frequency (MHz)	ERP (dBm)	Limit (dBm)	Over Limit (dB)	SPA Reading (dBm)	S.G. Power (dBm)	TX Cable loss (dB)	TX Antenna Gain (dBi)	Polarization (H/V)	Result
1672	-50.56	-13	-37.56	-61.67	-54.43	1.62	5.49	V	Pass
2509	-53.49	-13	-40.49	-67.25	-57.61	2.1	6.22	V	Pass
3345	-52.05	-13	-39.05	-67.7	-57.09	3.03	8.07	V	Pass



<High Channel>

Band :	WCDMA Band V					Temperature :	21~24°C		
Test Mode :	RMC 12.2Kbps Link (QPSK)					Relative Humidity :	44~48%		
Test Engineer :	Stan Hsieh, Kai Wang, and Ken Wu					Polarization :	Horizontal		
Remark :	Spurious emissions within 30-1000MHz were found more than 20dB below limit line.								
Frequency (MHz)	ERP (dBm)	Limit (dBm)	Over Limit (dB)	SPA Reading (dBm)	S.G. Power (dBm)	TX Cable loss (dB)	TX Antenna Gain (dBi)	Polarization (H/V)	Result
1696	-46.05	-13	-33.05	-55.12	-49.93	1.57	5.45	H	Pass
2544	-54.31	-13	-41.31	-67.64	-58.57	2.02	6.28	H	Pass
3393	-51.61	-13	-38.61	-65.87	-57.51	2.3	8.20	H	Pass

Band :	WCDMA Band V					Temperature :	21~24°C		
Test Mode :	RMC 12.2Kbps Link (QPSK)					Relative Humidity :	44~48%		
Test Engineer :	Stan Hsieh, Kai Wang, and Ken Wu					Polarization :	Vertical		
Remark :	Spurious emissions within 30-1000MHz were found more than 20dB below limit line.								
Frequency (MHz)	ERP (dBm)	Limit (dBm)	Over Limit (dB)	SPA Reading (dBm)	S.G. Power (dBm)	TX Cable loss (dB)	TX Antenna Gain (dBi)	Polarization (H/V)	Result
1696	-46.12	-13	-33.12	-57.38	-50	1.57	5.45	V	Pass
2544	-53.01	-13	-40.01	-66.91	-57.27	2.02	6.28	V	Pass
3393	-52.10	-13	-39.10	-67.68	-58	2.3	8.20	V	Pass



3.8 Frequency Stability Measurement

3.8.1 Description of Frequency Stability Measurement

The frequency stability shall be measured by variation of ambient temperature and variation of primary supply voltage to ensure that the fundamental emission stays within the authorized frequency block. The frequency stability of the transmitter shall be maintained within $\pm 0.00025\%$ ($\pm 2.5\text{ppm}$) of the center frequency.

3.8.2 Measuring Instruments

The measuring equipment is listed in the section 4 of this test report.

3.8.3 Test Procedures for Temperature Variation

1. The EUT was set up in the thermal chamber and connected with the system simulator.
2. With power OFF, the temperature was decreased to -30°C and the EUT was stabilized before testing. Power was applied and the maximum change in frequency was recorded within one minute.
3. With power OFF, the temperature was raised in 10°C steps up to 50°C . The EUT was stabilized at each step for at least half an hour. Power was applied and the maximum frequency change was recorded within one minute.

3.8.4 Test Procedures for Voltage Variation

1. The EUT was placed in a temperature chamber at $25\pm 5^{\circ}\text{C}$ and connected with the system simulator.
2. The power supply voltage to the EUT was varied from BEP to 115% of the nominal value measured at the input to the EUT.
3. The variation in frequency was measured for the worst case.

3.8.5 Test Setup

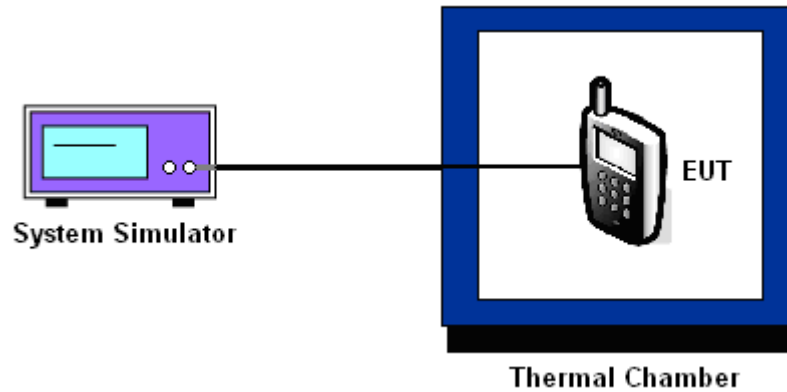

3.8.6 Test Result of Temperature Variation

Band :	GSM 850	Channel :	189
Limit (ppm) :	2.5	Frequency :	836.4 MHz

Temperature (°C)	GPRS class 8	EDGE class 8	Limit (ppm)	Result
	Deviation (ppm)	Deviation (ppm)		
50	0.0215	0.0167	2.5	PASS
40	0.0167	0.0096		
30	0.0096	0.0024		
20 (Ref.)	0.0000	0.0000		
10	0.0012	0.0012		
0	0.0060	0.0012		
-10	0.0036	0.0036		
-20	0.0132	0.0753		
-30	0.0741	0.0801		



Band :	GSM 1900	Channel :	661
Limit (ppm) :	2.5	Frequency :	1880.0 MHz

Temperature (°C)	GPRS class 8	EDGE class 8	Limit (ppm)	Result
	Deviation (ppm)	Deviation (ppm)		
50	0.0101	0.0074	2.5	PASS
40	0.0059	0.0080		
30	0.0011	0.0048		
20 (Ref.)	0.0000	0.0000		
10	0.0027	0.0043		
0	0.0011	0.0053		
-10	0.0016	0.0787		
-20	0.0037	0.0059		
-30	0.0032	0.0069		

Band :	WCDMA Band V	Channel :	4182
Limit (ppm) :	2.5	Frequency :	836.4 MHz

Temperature (°C)	RMC 12.2Kbps	Limit (ppm)	Result
	Deviation (ppm)		
50	0.0036	2.5	PASS
40	0.0012		
30	0.0143		
20 (Ref.)	0.0000		
10	0.0108		
0	0.0167		
-10	0.0132		
-20	0.0191		
-30	0.0155		



3.8.7 Test Result of Voltage Variation

Band & Channel	Mode	Voltage (Volt)	Deviation (ppm)	Limit (ppm)	Result
GSM 850 CH189	GPRS class 8	4.10	0.0048	2.5	PASS
		3.7	0.0084		
		BEP	0.0705		
	EDGE class 8	4.10	0.0000		
		3.7	0.0036		
		BEP	0.0012		
GSM 1900 CH661	GPRS class 8	4.10	0.0053		
		3.7	0.0016		
		BEP	0.0005		
	EDGE class 8	4.10	0.0011		
		3.7	0.0027		
		BEP	0.0064		
WCDMA Band V CH4182	RMC 12.2Kbps	4.10	0.0143		
		3.7	0.0108		
		BEP	0.0120		

Note:

1. Normal Voltage = 3.7V.
2. Battery End Point (BEP) = 3.5 V.



4 List of Measuring Equipment

Instrument	Manufacturer	Model No.	Serial No.	Characteristics	Calibration Date	Test Date	Due Date	Remark
System Simulator	Rohde & Schwarz	CMU200	117995	N/A	Aug. 01, 2013	Jun. 19, 2014 ~ Jun. 20, 2014	Jul. 31, 2014	Conducted (TH02-HY)
Spectrum Analyzer	Rohde & Schwarz	FSP40	100057	9kHz~40GHz	Oct. 23, 2013	Jun. 19, 2014 ~ Jun. 20, 2014	Oct. 22, 2014	Conducted (TH02-HY)
Thermal Chamber	Ten Billion	TTH-D3SP	TBN-930701	N/A	Jul. 19, 2013	Jun. 19, 2014 ~ Jun. 20, 2014	Jul. 18, 2014	Conducted (TH02-HY)
Hygrometer	Testo	608-H2	41410069	N/A	Jul. 18, 2013	Jun. 19, 2014 ~ Jun. 20, 2014	Jul. 17, 2014	Conducted (TH02-HY)
Filter	WAINWRIGHT	whkx2..0/18g	N/A	2GHighPass Filter	Nov. 28, 2013	Jun. 19, 2014 ~ Jun. 20, 2014	Nov. 27, 2014	Conducted (TH02-HY)
RF cable	WOKEN	SMA(M)-SMA(M) for	S05-130703-32	N/A	Jul. 09, 2013	Jun. 19, 2014 ~ Jun. 20, 2014	Jul. 08, 2014	Conducted (TH02-HY)
Spectrum Analyzer	Rohde & Schwarz	FSV30	101749	10Hz ~ 30GHz	Feb. 10, 2014	Jun. 01, 2014 ~ Jun. 03, 2014	Feb. 09, 2015	Radiation (03CH07-HY)
Bilog Antenna	Schaffner	CBL6111C	2726	30MHz ~ 1GHz	Oct. 10, 2013	Jun. 01, 2014 ~ Jun. 03, 2014	Oct. 09, 2014	Radiation (03CH07-HY)
Double Ridge Horn Antenna	ESCO	3117	75962	1GHz~18GHz	Aug. 22, 2013	Jun. 01, 2014 ~ Jun. 03, 2014	Aug. 21, 2014	Radiation (03CH07-HY)
Preamplifier	COM-POWER	PA-103A	161241	10 MHz ~ 1000MHz	Mar. 17, 2014	Jun. 01, 2014 ~ Jun. 03, 2014	Mar. 16, 2015	Radiation (03CH07-HY)
Preamplifier	Agilent	8449B	3008A02362	1 GHz~26.5 GHz	Nov. 29, 2013	Jun. 01, 2014 ~ Jun. 03, 2014	Nov. 28, 2014	Radiation (03CH07-HY)
Turn Table	ChainTek	ChainTek 3000	N/A	0 ~ 360 degree	N/A	Jun. 01, 2014 ~ Jun. 03, 2014	N/A	Radiation (03CH07-HY)
Antenna Mast	ChainTek	M-400-0	114/8000604/L	N/A	N/A	Jun. 01, 2014 ~ Jun. 03, 2014	N/A	Radiation (03CH07-HY)
SHF-EHF Horn Antenna	SCHWARZBECK	BBHA 9170	BBHA9170251	15GHz- 40GHz	Oct. 03, 2013	Jun. 01, 2014 ~ Jun. 03, 2014	Oct. 02, 2014	Radiation (03CH07-HY)



Instrument	Manufacturer	Model No.	Serial No.	Characteristics	Calibration Date	Test Date	Due Date	Remark
Filter	Microwave Circuits	H1G013G1	SN477215	1GHz HPF	Nov. 28, 2013	Jun. 01, 2014~ Jun. 03 2014	Nov. 27, 2014	Radiation (03CH07-HY)
Filter	Wainwright Instruments	WHKX1.5G/1 5G-10SS	SN32	1.5GHz HPF	Nov. 28, 2013	Jun. 01, 2014~ Jun. 03 2014	Nov. 27, 2014	Radiation (03CH07-HY)
Filter	Wainwright Instruments	WLKS1200-8 SS	SN3	1.2GHz LPF	Nov. 28, 2013	Jun. 01, 2014~ Jun. 03 2014	Nov. 27, 2014	Radiation (03CH07-HY)
Filter	Wainwright Instruments	WHKX2.0/18 G-10SS	SN12	2GHz HPF	Nov. 28, 2013	Jun. 01, 2014~ Jun. 03 2014	Nov. 27, 2014	Radiation (03CH07-HY)
Filter	Microwave Circuits	H3G018G1	SN477220	3GHz HPF	Nov. 28, 2013	Jun. 01, 2014~ Jun. 03 2014	Nov. 27, 2014	Radiation (03CH07-HY)
Notch Filter	Wainwright	WRCT 1800/2000-2	SN1	GSM 1900	Nov. 28, 2013	Jun. 01, 2014~ Jun. 03 2014	Nov. 27, 2014	Radiation (03CH07-HY)
Notch Filter	Wainwright	WRCG 824/849/814/	SN35	GSM850 / WCDMA 850	Nov. 28, 2013	Jun. 01, 2014~ Jun. 03 2014	Nov. 27, 2014	Radiation (03CH07-HY)
HF RF Cable	HUBER SUHNER	SUCOFLEX 104	38411/6	1GHz ~ 18GHz	Nov. 28, 2013	Jun. 01, 2014~ Jun. 03 2014	Nov. 27, 2014	Radiation (03CH07-HY)
LF RF Cable	Warison+HUBER SUHNER	WCBA-WC04 NM.NM2	N/A	30MHz ~ 1GHz	Nov. 28, 2013	Jun. 01, 2014~ Jun. 03 2014	Nov. 27, 2014	Radiation (03CH07-HY)
Test Software	Audix	E3	Version 6.2009-08-24	N/A	N/A	Jun. 01, 2014~ Jun. 03 2014	N/A	Radiation (03CH07-HY)
Hygrometer	Testo	608-H1	34897197	N/A	May 06, 2013	Jun. 01, 2014~ Jun. 03 2014	May 07, 2015	Radiation (03CH07-HY)

Note: Test equipment calibration is traceable to the procedure of ISO17025.



5 Uncertainty of Evaluation

Uncertainty of Radiated Emission Measurement (30 MHz ~ 1000 MHz)

Measuring Uncertainty for a Level of Confidence of 95% ($U = 2Uc(y)$)	4.50
---	------